

CHAMELEON 32 MONITORING REFERENCE MANUAL

Volume II

Part No. 910-3272

This document, Manual Version 4.1, corresponds to
Software Release 3.1, and subsequent releases.

TEKELEC

Copyright © 1988, Tekelec. All rights reserved. Version 4.1

July, 1988

This document in whole or in part, may not be copied, photocopied, reproduced, translated or reduced to any electronic medium or machine-readable form without prior written consent from TEKELEC.

**CHAMELEON 32 MONITORING REFERENCE, VOLUME II
SOFTWARE RELEASE 3.1
MANUAL CHANGES**

Part Number 910-3327
Revision A

This page lists the pages to replace or add to the Chameleon 32 Reference Guide, Version 4.0 to update it for Software Release 3.1.

Volume II: Chameleon 32 Reference Guide

<u>Replace pages:</u>	<u>Topic</u>
Title Page	Title Page
TOC -1 to TOC-16	Table of Contents
6-23 to 6-24	SNA Statistics
10-3 to 10-4	ISDN Monitoring
11-1 to 11-30	Primary Rate Interface
12-1 to 12-40	Basic Rate Interface
13-1 to 13-34	SS#7 Monitoring

TABLE OF CONTENTS

Chapter	Title	Page
One	Overview	
	Monitoring	1-1
	Applications	1-2
	Analysis	1-2
	Statistics	1-3
	Triggering	1-3
	Direct-to-Disk	1-3
	Event	1-4
	User Applications in C	1-4
	Manual Organization	1-5
	Related Documents	1-6
Two	X.25 Monitoring	
	Introduction	2-1
	Monitor Setup Menu	2-1
	Link Layer	2-2
	Modulo	2-2
	Extended Addressing	2-2
	Analysis	2-3
	DCE/DTE	2-4
	Baud Rate Changes	2-4
	Colors	2-4
	Interface Lead Transitions	2-4
	Function Keys	2-5
	F1: Code	2-5
	F2: Acquisition Information	2-5
	F3: Event Types	2-6
	F4: Frame Level	2-6
	F5: Packet Level	2-7
	F10: User Data	2-7
	X.25 Analysis Interpretation	2-8
	HDLC Interpretation	2-9
	Frame Errors	2-9
	Link Address	2-9
	Frame Mnemonic	2-9
	N(s)	2-10

TABLE OF CONTENTS - CONTINUED

Chapter	Title	Page
	N(r)	2-10
	Poll/Final Bit	2-10
	Size of I-Field.	2-10
X.25	Data Packet	2-11
	Packet Type Mnemonic	2-11
	P(r)	2-12
	P(s)	2-12
	M Bit	2-12
	Modulo, D bit, Q bit	2-12
	LCN, LCGN.	2-12
	User data, Packet Type, or Message	2-12
	Unnumbered and Supervisory Packets	2-13
X.25	Statistics	2-14
	Time Display	2-15
	Start Time	2-15
	Last Time	2-15
	LCN	2-15
	State	2-15
	Calls Placed	2-16
	CALLS Active	2-16
	DCE/DTE Packets	2-16
	DCE/DTE Data Packets	2-16
	DCE/DTE Overhead	2-16
	Packet Retries	2-17
	RESET	2-17
	RESTART	2-17
	PRNR	2-17
	PREJ	2-17
	PRR	2-17
	DIAG	2-17
	ACCESS	2-18
	CLEAR	2-18
	SESSION	2-18
	DCE Length	2-18
	DTE Length	2-18
	DCE/DTE Utilization	2-19
	DCE/DTE Data	2-19
	DCE/DTE Overhead	2-19

TABLE OF CONTENTS - CONTINUED

Chapter	Title	Page
	Function Keys for X.25 Statistics	2-20
	F1: LCNS/FUNCT	2-20
	F2: HDLC +/-	2-22
	F3: Print	2-23
	F4: Reset	2-24
	F5: Time/Date	2-24
	HDLC Line Statistics Page	2-25
	START TIME	2-25
	LAST TIME	2-25
	DCE/DTE Frames	2-26
	DCE/DTE I-Frames	2-26
	DCE/DTE Overhead	2-26
	RR	2-26
	RNR	2-26
	REJ	2-26
	RETRIES	2-26
	SABM	2-26
	DISC	2-26
	UA	2-26
	FRMR	2-27
	SABM	2-27
	Aborts	2-27
	CRC Errors	2-27
	DCE N(r)	2-27
	DTE N(r)	2-27
	DCE RESP	2-27
	DTE RESP	2-27
	DCE Delta	2-27
	DTE Delta	2-27
	DCE Length	2-28
	DTE Length	2-28
	I-Frames/Sec	2-28
	DCE/DTE Utilization	2-28
	DCE/DTE Data	2-28
	DCE/DTE Overhead	2-29

TABLE OF CONTENTS - CONTINUED

Chapter	Title	Page
Three	X.75 Monitoring	
	Introduction	3-1
	Monitor Setup Menu	3-1
	Link Layer	3-2
	Encoding	3-2
	Modulo	3-2
	Analysis	3-3
	DCE/DTE	3-4
	Baud Rate Changes	3-4
	Colors	3-4
	Interface Lead Transitions	3-4
	Function Keys	3-5
	F1: Code	3-5
	F2: Acquisition Information	3-5
	F3: Event Types	3-6
	F4: Frame Level	3-6
	F5: Packet Level	3-7
	F10: User Data	3-7
	X.75 Analysis Interpretation	3-8
	HDLC	3-9
	Frame Errors	3-9
	Link Address	3-9
	Frame Mnemonic	3-9
	N(s)	3-10
	N(r)	3-10
	Poll/Final Bit	3-10
	Size of I-Field	3-10
	X.75 Data Packet	3-11
	Packet Type Mnemonic	3-11
	P(r)	3-12
	P(s)	3-12
	More Bit	3-12
	Modulo	3-12
	Delivery Bit	3-12
	Qualifier Bit	3-12
	LCN/LCGN	3-12
	User Data	3-12
	Unnumbered and Supervisory Packets	3-13

TABLE OF CONTENTS - CONTINUED

Chapter	Title	Page
Four	QLLC Monitoring	
	Introduction	4-1
	Monitor Setup Menu	4-1
	Link Layer	4-2
	Encoding	4-2
	Modulo	4-2
	Extended Addressing	4-2
	Analysis	4-3
	DCE/DTE	4-4
	Baud Rate	4-4
	Colors	4-4
	Interface Lead Transitions	4-4
	Function Keys	4-5
	F1: Code	4-5
	F2: Acquisition Information	4-6
	F3: Event Types	4-6
	F4: Frame Level	4-7
	F5: X.25 Data	4-7
	F6: SNA Data	4-7
	F7: TH Data	4-8
	F8: RH Data	4-8
	F9: RU Data	4-8
	F10: User Data	4-9
	QLLC Analysis Interpretation	4-10
	HDLC	4-11
	Frame Errors	4-11
	Link Address	4-11
	Frame Mnemonic	4-11
	N(s)	4-12
	N(r)	4-12
	Poll/Final Bit	4-12
	Size of I-Field	4-12
	QLLC Data Packet	4-13
	Packet Type Mnemonic	4-13
	P(r)	4-14
	P(s)	4-14
	More Bit	4-14

TABLE OF CONTENTS - CONTINUED

Chapter	Title	Page
	Modulo	4-14
	Delivery Bit	4-14
	Qualifier Bit	4-14
	LCN/LCGN	4-14
	QLLC Address Field	4-14
	QLLC Control Field Value	4-14
	QLLC Mnemonic	4-15
	User Data	4-15
Five	PSH Monitoring	
	Introduction	5-1
	Monitor Setup Menu	5-1
	Link Layer	5-2
	Encoding	5-2
	Modulo	5-2
	Extended Addressing	5-2
	Analysis	5-3
	DCE/DTE	5-4
	Baud Rate Changes	5-4
	Colors	5-4
	Interface Lead Transitions	5-4
	Function Keys	5-5
	F1: Code	5-5
	F2: Acquisition Information	5-5
	F3: Event Types	5-6
	F4: Frame Level	5-6
	F10: User Data	5-6
	PSH Analysis Interpretation	5-7
	HDLC	5-8
	Frame Errors	5-8
	Link Address	5-8
	Frame Mnemonic	5-8
	N(s)	5-9
	N(r)	5-9
	Poll/Final Bit	5-9
	Size of I-Field	5-9
	PSH Data Packet	5-10
	Packet Type Mnemonic	5-10

TABLE OF CONTENTS - CONTINUED

Chapter	Title	Page
	P(r)	5-11
	P(s)	5-11
	More Bit	5-11
	Modulo	5-11
	Delivery Bit	5-11
	Qualifier Bit	5-11
	LCN/LCGN	5-11
	Segmenting Indicator	5-11
	Sequence Number	5-12
	PSC Value	5-12
	PSC	5-12
	User Data	5-12
Six	SNA Monitoring	
	Introduction	6-1
	Monitor Setup Menu	6-1
	Encoding	6-2
	Address Selection	6-2
	Modulo	6-2
	Extended Addressing	6-2
	Analysis	6-3
	DCE/DTE	6-4
	Baud Rate Changes	6-4
	Colors	6-4
	Interface Lead Transitions	6-4
	Function Keys	6-5
	F1: Code	6-5
	F2: Acquisition Information	6-5
	F3: Frame Types	6-6
	F4: SDLC	6-6
	F6: SNA	6-6
	F7: TH	6-7
	F8: RH	6-7
	F9: RU	6-7
	F10 User Data	6-8
	SNA Display	6-9
	SDLC Display	6-9

TABLE OF CONTENTS - CONTINUED

Chapter	Title	Page
	TH Display	6-11
	RH Display	6-12
	RU Display	6-14
	SNA Statistics	6-15
	Introduction	6-15
	SDLC Line Statistics	6-15
	Start Time	6-16
	Last Time	6-16
	PU	6-16
	State	6-16
	Number of Polls	6-16
	Productive Polls	6-16
	Non-Productive Polls	6-16
	I-Frames	6-16
	REJs	6-16
	Retries	6-16
	RNRs	6-16
	FRMRs	6-16
	Frame Aborts	6-16
	CRC Errors	6-16
	DCE/DTE Utilization	6-17
	DCE/DTE Data	6-17
	DCE/DTE Overhead	6-17
	DCE Length	6-17
	DTE Length	6-17
	Frame Response Time	6-17
	Mean Poll Time	6-17
	Poll to Data Time	6-17
	Poll to Poll Time	6-17
	I-Frames/Sec	6-17
	Statistics Function Keys	6-18
	F1: FUNCT/PUs	6-18
	F2: Sess +/-	6-19
	F3: Print	6-22
	F4: Reset	6-22
	F5: Time/Date	6-22

TABLE OF CONTENTS - CONTINUED

Chapter	Title	Page
Seven	ASYNCR Monitoring	
	Introduction	7-1
	Monitor Setup Menus	7-1
	Baud Rate	7-2
	Parity	7-2
	Data Bits	7-2
	Analysis	7-3
	Function Keys	7-4
	F1: Code	7-4
	F2: Acquisition Information	7-4
	F10: User Data	7-5
Eight	BISYNCR Monitoring	
	Introduction	8-1
	Monitor Setup Menu	8-1
	Coding	8-2
	Sync 1 and 2	8-2
	Block Check	8-2
	Analysis	8-3
	Function Keys	8-4
	F1: Code	8-4
	F2: Acquisition Information	8-4
	F10: User Data	8-5
	BSC Analysis Interpretation	8-6
	BCC Errors	8-7
	Controller Address	8-7
	Terminal Address	8-7
	Message Type	8-7
	Message Size	8-7
	3270 Command	8-8
	Status Mnemonic	8-8
	User Data	8-8
	BSC Statistics	8-9
	Introduction	8-9
	Time Display	8-10
	Start Time	8-10
	Last Time	8-10

TABLE OF CONTENTS - CONTINUED

Chapter	Title	Page
	Active CUs	8-10
	CU	8-10
	State	8-10
	Transaction Statistics	8-11
	Transactions	8-11
	Transactions/Sec	8-11
	Poll Statistics	8-12
	Number of Polls	8-12
	Productive Polls	8-12
	Non-Productive Polls	8-12
	Transmit/Receive Statistics	8-12
	Xmit Messages	8-12
	Rcv Messages	8-12
	Xmit Chars	8-13
	Rcv Chars	8-13
	Error and Status Statistics	8-13
	BCC Errors	8-13
	NAKS	8-13
	Status Messages	8-13
	Line Utilization Statistics	8-14
	Line Utilization	8-14
	Data	8-14
	Control	8-14
	Time and Length Statistics	8-14
	Msg Len	8-14
	Resp Time	8-14
	Mean Poll Tm	8-15
	Poll to Data	8-15
	Trans Time	8-15
	Longest Message from CU	8-15
	Longest Message from Device	8-15
	Data Bytes /Sec	8-15
	Function Keys for BSC Statistics	8-16
	F1: CUS /FUNCT	8-16
	F2: Print	8-18
	F3: Reset	8-19
	F4: Time/Date	8-19

TABLE OF CONTENTS - CONTINUED

Chapter	Title	Page
Nine	DPNSS Monitoring	
	Introduction	9-1
	Monitor Setup Menu	9-1
	Encoding	9-2
	Analysis	9-3
	DCE/DTE	9-4
	Baud Rate Changes	9-4
	Colors	9-4
	Function Keys	9-5
	F1: Code	9-5
	F2: Acquisition Information	9-5
	F4: Layer 2	9-6
	F5: Layer 3	9-6
	F10: User Data	9-6
	Layer 2 Interpretation	9-7
	Address	9-7
	Control	9-8
	Layer 3 Interpretation	9-9
	Message Type	9-9
	Service Indicator Code	9-11
	Rejection and Clear Cause	9-12
	Indication Block	9-12
	Selection Block	9-12
	Supplementary Information String	9-12
	Supplementary Information Parameters	9-14
Ten	ISDN (Q.921 and Q.931) Monitoring	
	Introduction	10-1
	Monitor Setup Menu	10-2
	Default Network Layer	10-2
	Alternative Network Layer	10-2
	Q.931 Standard	10-3
	Link Layer	10-3
	Modulo	10-4
	Extended Addressing	10-4
	Analysis	10-5
	DCE/DTE	10-6

TABLE OF CONTENTS - CONTINUED

Chapter	Title	Page
	Baud Rate	10-6
	Colors	10-6
	Interface Lead Transitions	10-6
	Function Keys	10-7
	F1: Code	10-7
	F2: Acquisition Information	10-7
	F3: Event Types	10-8
	F4: Layer 2	10-8
	F5: Layer 3	10-8
	F8: Detail	10-9
	F10: User Data	10-9
	ISDN Layer 2 Interpretation	10-10
	Command/Response Bit	10-10
	SAPI Value	10-10
	SAPI Mnemonic	10-10
	TEI	10-11
	Control Field Mnemonic	10-11
	N(s)	10-11
	N(r)	10-11
	Size of I-Field	10-11
	LTID Byte Interpretation	10-12
	ISDN Layer 3 Interpretation	10-13
	Protocol Discriminator	10-14
	Call Reference	10-14
	Message Type	10-15
	Information Elements	10-16
	Single Octet Information Elements	10-17
	Shift	10-17
	Congestion Level	10-18
	Diagnostic Information Elements	10-18
	Information Element Parameters	10-19
	Error Messages	10-20
	ISDN Statistics	10-21
	ISDN Statistics Pages	10-21
	Q.921 Line Statistics Page	10-22
	Start Time	10-22
	Last Time	10-22
	Frames on SAPI	10-22

TABLE OF CONTENTS - CONTINUED

Chapter	Title	Page
<hr/>		
	TEI Assignments	10-23
	ID Requests	10-23
	ID Assigned	10-23
	ID Denied	10-23
	I-Frames	10-23
	UIs	10-23
	SI0s	10-23
	XIDs	10-23
	RRs	10-23
	RNRs	10-23
	FRMRs	10-23
	Retries	10-23
	CRC Errors	10-23
	Aborts	10-23
	Line Utilization	10-23
	Data	10-24
	Control	10-24
	I-Frames per Second	10-24
	Frame Response	10-24
	Frame Length	10-24
	Q.921 Statistics Function Keys	10-25
	F1 - F4: SAPI Pages	10-25
	F5: Print	10-26
	F6: Reset	10-26
	F7: Time/Date	10-26
Eleven	ISDN Primary Rate Interface	
	Introduction	11-1
	ANSI Primary Rate Interface	11-3
	CEPT Primary Rate Interface	11-4
	Primary Rate Interface Hardware	11-6
	Interface Modules	11-6
	LED Overlays	11-9
	Port Configuration	11-13
	Setup Menu	11-17
	Mode	11-18
	Framing	11-18
	Line 2	11-18

TABLE OF CONTENTS - CONTINUED

Chapter	Title	Page
	Signal Coding	11-18
	Signaling	11-19
	Transmit Mode	11-19
	Data Rate	11-20
	CRC	11-20
	DS0	11-21
	Receive Data X	11-21
	Receive CODEC	11-21
	Receive Data Y	11-21
	Transmit Data Y	11-21
	Transmit CODEC	11-21
	Transmit Milliwatt	11-21
	Milliwatt Tone	11-21
	DS0 Inversion	11-21
	Primary Runtime Page	11-22
	Application Notes	11-23
	Monitoring Channels from Both Lines	11-25
	Monitoring One Line Only	11-28
	Drop and Insert	11-29
Twelve	ISDN Basic Rate Interface	
	Introduction	12-1
	Basic Rate Interface Hardware	12-3
	Basic Rate Interface Module	12-3
	LED Overlay	12-6
	Configuration	12-8
	Setup Menus	12-11
	Mode	12-12
	Channel Selection	12-12
	Device	12-12
	Channel B1/B2	12-13
	Layer 1	12-13
	Bit Inversion	12-13
	NT Power	12-14
	DTMF Number	12-14
	Basic I/F Runtime Page	12-15
	Simulate Runtime Page	12-16
	Transmit Signal	12-17

TABLE OF CONTENTS - CONTINUED

Chapter	Title	Page
	Status Messages	12-18
	Signal Diagrams	12-20
	Monitor Runtime Page	12-22
	Chameleon 32 Basic Rate Applications	12-23
	Testing Configurations	12-24
	Basic Rate Access Information	12-26
	Line Code	12-30
	2B + D Frame Structure	12-30
	Framing Signals	12-34
	Frame Alignment Procedure (NT to TE)	12-35
	Frame Alignment Procedure (TE to NT)	12-35
	D Channel Access Control	12-35
	Interframe Time Fill	12-36
	D-Echo Channel	12-36
	D-Channel Monitoring	12-36
	Priority Mechanism	12-36
	Collision Detection	12-37
	Signals	12-37
	Activation Procedure	12-37
	EXT B and EXT D Connector Pinouts	12-40
Thirteen	SS#7 Monitoring	
	Introduction	13-1
	Signalling System 7	13-1
	Message Transfer Parts	13-2
	Signal Units	13-4
	FISU	13-4
	LSSU	13-4
	MSU	13-4
	Monitor Setup Menu	13-6
	SS-7 Standard	13-6
	Condensed Mode Acquisition	13-7
	Encoding	13-7
	SS#7 Analysis	13-8
	Function Keys	13-8
	F1 Code	13-8
	F2 Acquisition Information	13-9
	F3 Event Type	13-9

TABLE OF CONTENTS - CONTINUED

Chapter	Title	Page
	F4 Message Transfer Part	13-10
	F5 User Part	13-10
	F6 TCAP	13-11
	F8 Detail Level	13-11
	F9 Data Item Display	13-11
	F10 User Data	13-12
SS#7	Interpretation	13-13
	Common Display Fields	13-13
	FISU Interpretation	13-13
	LSSU Interpretation	13-13
	MSU Interpretation	13-14
	User Part Editor	13-16
	User Part Editor Editing Keys	13-19
	Heading Code Mnemonic	13-20
	Routing Table Configuration	13-21
	Routing Label Correlations	13-23
	TCAP Interpretation	13-25
	Introduction	13-25
	Routing Label	13-26
	800 Query Message Types	13-28
	Called Party Address	13-29
	Calling Party Address	13-29
	Data Parameter	13-31
	Data Parameter Field Format	13-33
	Originating Station Type	13-34
	TCAP Sample Interpretation	13-35

CHAPTER ONE:

OVERVIEW

CHAPTER ONE: OVERVIEW

Monitoring

In Monitoring Mode, the Chameleon 32 passively monitors the traffic between entities on a data line, without affecting any aspect of the network.

In Monitoring Mode, you can:

- Monitor and troubleshoot a data communications line
- Interpret captured traffic
- Capture 10 Mbytes of data to disk
- Analyze traffic between:
 - ▶ Network Access (modem)
 - ▶ Cluster Controller
 - ▶ Front End Processor
 - ▶ Intelligent Terminal
 - ▶ Process Controller
 - ▶ ISDN devices
 - ▶ Other intelligent digital communications devices

Figure 1.1 illustrates the flow of data during Monitoring.

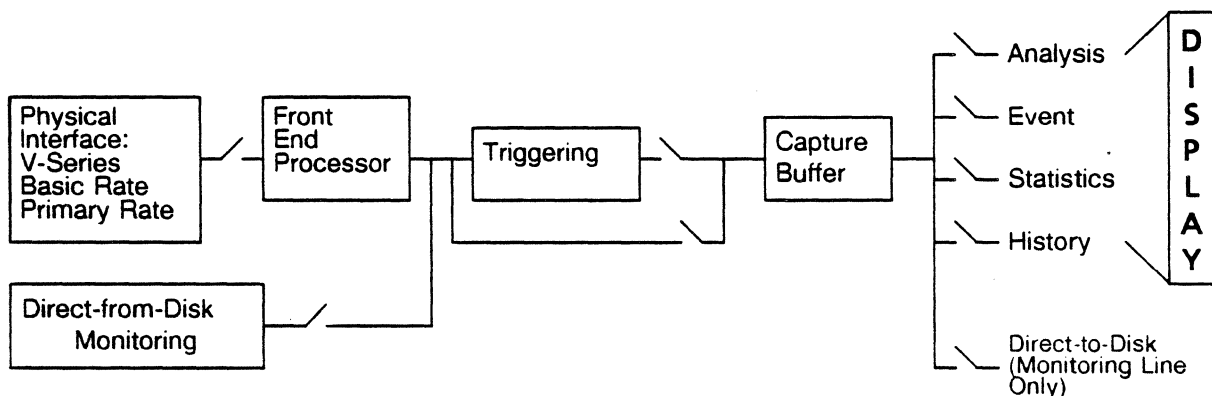


Figure 1.1: Monitoring Data Flow

Applications

When using Monitoring, you have access to several different monitoring applications. These applications include:

- Analysis (Real Time and History)
- Statistics
- Triggering
- Direct-to-Disk
- Event
- User applications in C (optional C package only)

Analysis

Analysis provides two pages: Real Time and History. The Analysis pages display the traffic from both sides of the line in a split screen mode, for either one or two ports.

The Real Time page displays traffic as it is acquired from the line or from disk (previously saved traffic).

The History page displays traffic that has been acquired and put in a history buffer. You can move back and forth through the traffic in the buffer to display specific parts of it.

The Analysis application is available for the following protocols:

- X.25
- X.75
- QLLC
- PSH
- SNA
- ISDN
- ASYNC
- BSC
- DPNSS
- SS7

Analysis also provides a print feature which enables you to output a specified range of events to a printer or print file. Refer to the *Chameleon 32 User's Guide, Chapter 4: Analysis*, for more information.

Statistics

The Statistics application displays statistical data about acquired traffic for the following protocols:

- X.25
- ISDN
- SNA
- BSC

The Statistics application provides you with multiple pages for each protocol, summarizing information about the entire line, or specific devices on the line. You can also display statistics for layer 2 or layer 3 traffic (except for BSC). Using the Print function, you can print a report for any of the Statistics pages.

Refer to the *Chameleon 32 User's Guide, Chapter 7: Statistics*, for more information.

Triggering

The Triggering application filters traffic according to user-defined conditions, enabling you to perform *if/then* and *while* actions. Triggering can be used when analyzing data from the line or from disk. For example, you could write a trigger that marked events with CRC errors.

For HDLC, Q.921, and Q.931, there are pre-defined key words that are specific to the protocol, and enable you to develop triggers for these protocols with less effort.

Triggering is not available for Async.

Refer to the *Chameleon 32 User's Guide, Chapter 8: Triggering*, for more information.

Direct-to-Disk

The Direct-to-Disk application saves acquired traffic to the hard disk. This enables you to capture traffic, but perform your analysis at a later date. It also enables you to analyze the same traffic multiple times.

Refer to the *Chameleon 32 User's Guide, Chapter 6: Direct-To-Disk*, for more information.

Event

The Event application displays traffic as a series of events. The format enables you to quickly determine the sequence of events on the line. The Event application is available for the following protocols:

- X.25
- X.75
- QLLC
- PSH
- SNA
- ISDN
- ASYNC
- BSC
- DPNSS
- SS7

The Event page displays the data in a dual line format (DTE over DCE) using five characters:

- I Information frame transmitted
- S Supervisory frame transmitted
- U Unnumbered frame transmitted
- L Lead transition
- B Baud rate change

Refer to the *Chameleon 32 User's Guide, Chapter 5: Event*, for more information.

User Applications in C

With the optional C Development System, you can program you own applications to analyze data. Refer to the *Chameleon 32 C Manual, Volume IV*, for more information.

Manual Organization

This manual contains protocol-specific information for the Chameleon 32 Monitoring software. It is divided into separate chapters for each protocol as follows:

<u>Chapter</u>	<u>Protocol</u>
2	X.25
3	X.75
4	QLLC
5	PSH
6	SNA
7	Async
8	Bisync
9	DPNSS
10	ISDN (Q.921 and Q.931)
11	ISDN ANSI/CEPT Primary Rate Interface
12	ISDN Basic Rate Interface
13	SS#7

Related Documents

- *Volume I, Chameleon 32 User's Guide*

Refer to this manual for a general description of the Chameleon 32, how to use it, a description of the displays and softkey functions, and hardware-specific information.

- *Volume III, Chameleon 32 Simulation Manual*

Refer to this manual for Chameleon 32 information specific to the Simulation software.

- *Volume IV, Chameleon 32 C Manual*

Refer to this manual for Chameleon 32 information specific to the C Software Package.

CHAPTER TWO:

X.25 MONITORING

CHAPTER TWO: X.25 MONITORING

Introduction

Monitoring allows you to passively monitor the traffic on a data line without affecting the traffic. By doing this, you can interpret captured traffic and troubleshoot the line. This section describes X.25 Analysis and Statistics, by focusing on the protocol-specific details of these applications. For a general description of these applications, refer to Chapter One.

This section assumes that you know how to select Monitoring for a port and select X.25 as the protocol. If you do not know how to do this, refer to the *Chameleon 32 User's Guide, Volume 1, Chapter 3: Using the Chameleon 32*.

Monitor Setup Menu

When you select X.25 as your Monitoring protocol, you are prompted for several configurable parameters as shown in Figure 2.1. These parameters are described on the following page.

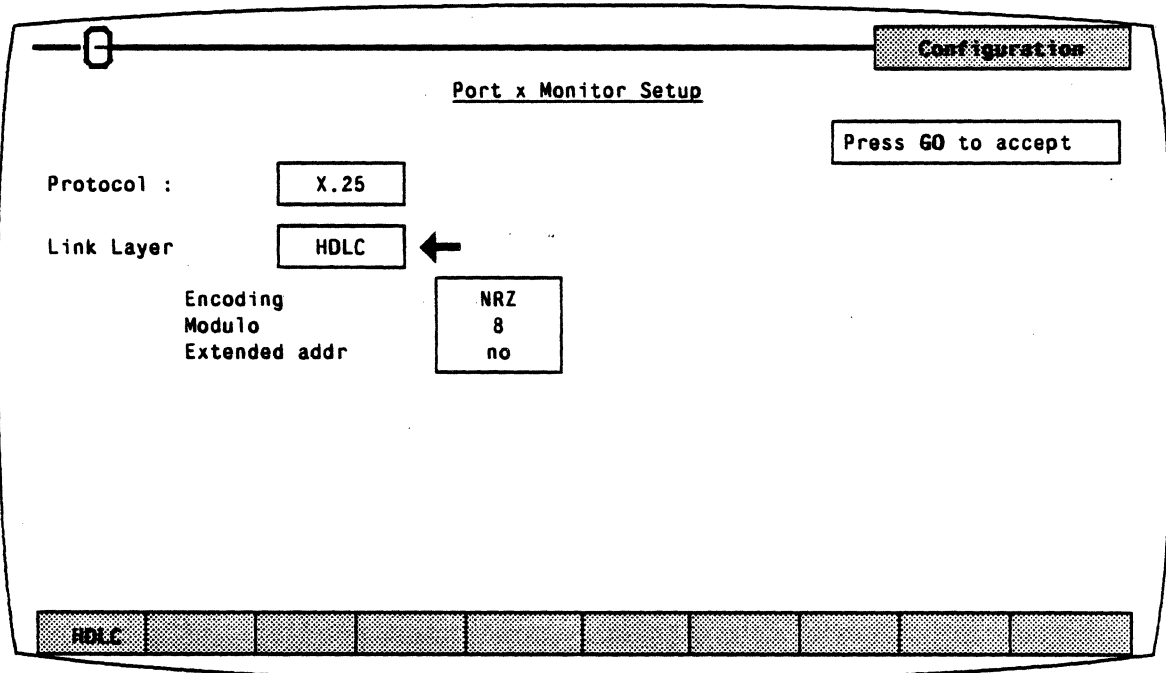


Figure 2.1: X.25 Monitor Setup Menu

Link Layer

Link Layer specifies the link layer protocol to use. There is only one option at this time, HDLC.

Encoding

Encoding is a level 1 (physical) parameter that determines how the Chameleon 32 interprets the electrical signal to distinguish between binary 1 and 0. The options are:

NRZ Non Return to Zero. In NRZ encoding, a 1 is represented by a high level, and a 0 is represented by a low level.

NRZI Non Return to Zero Inverted. In NRZI encoding, a 1 is represented by no change in level, and a 0 is represented by a change in level.

Modulo

Modulo determines the packet numbering sequence range that will be used to keep track of the packets that are transmitted and received by the two sides. The options are:

Modulo 8 Packets are numbered from 0 - 7

Modulo 128 Packets are numbered from 0 - 127

Extended Addressing

Extended Addressing determines whether 8-bit addressing or 16-bit (extended) addressing is being used for transmission. The options are:

Yes Extended (16-bit) addressing

No 8-bit addressing

Analysis

Analysis provides two pages: Real Time and History. Both pages display traffic in a split screen format (DCE/DTE).

The Real Time page displays traffic from both sides of the line as it is acquired. The data scrolls as the traffic is acquired.

History displays traffic that has been acquired and put in a buffer. You can move back and forth through the traffic in the buffer to display specific parts of it.

The display format and function keys are the same for both pages, as shown in Figure 2.2. The page components are described on the following pages.

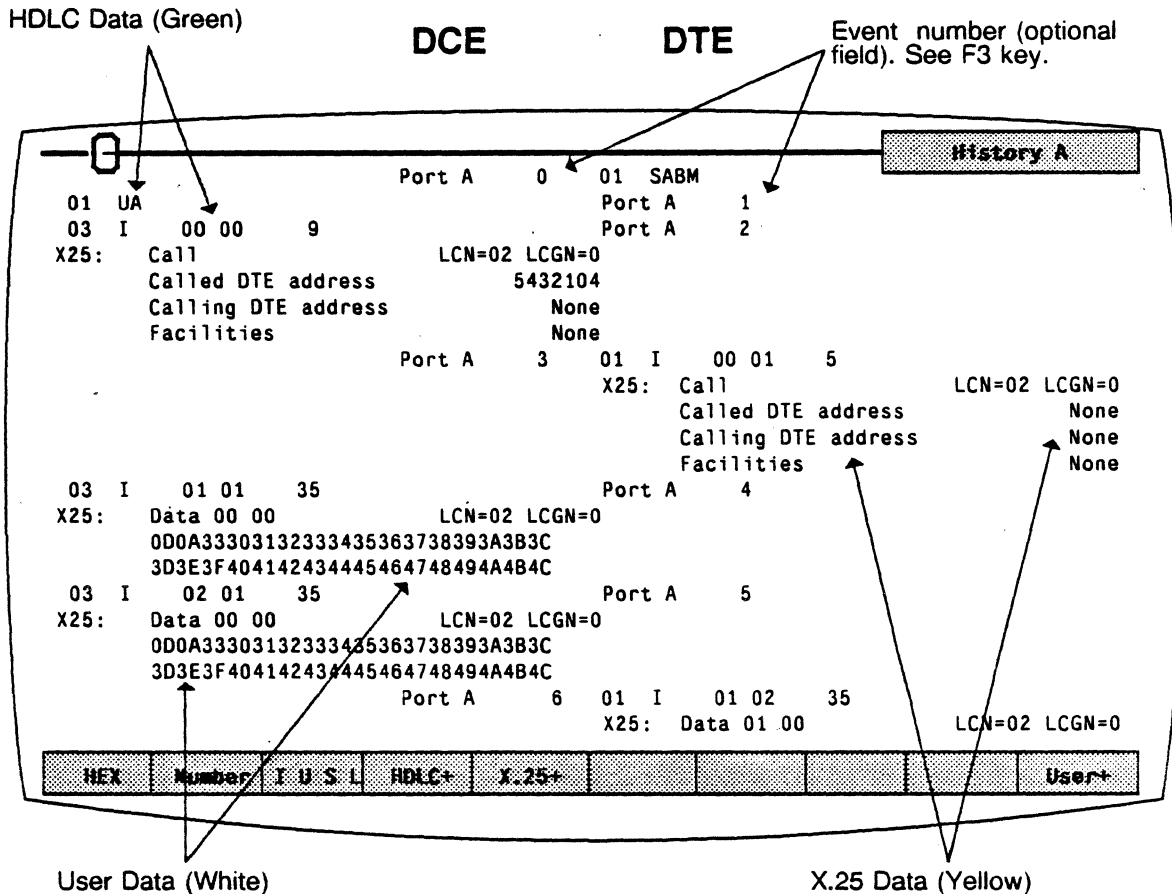


Figure 2.2: Analysis History Page with Sample X.25 Traffic

Function Keys

The function keys control how the traffic is interpreted and displayed. These functions are available for both the History and Real Time pages. The X.25 Analysis function keys are described below.

F1: Code

F1 determines the format of the user data display. This is the data which does not belong to a protocol specific format. Each time you press **F1**, the user data (in white) changes to the code indicated in the softkey strip. The options are:

- ASCII** Each byte is displayed as an ASCII character. Characters in the range 0 - 1F hex are shown as single character mnemonics. Characters above 80 hex are shown as '.'.(default)
- EBCDIC** Each byte is displayed as an EBCDIC character.
- HEX** Each byte is displayed as a pair of hexadecimal digits
- HEXS** Each byte is displayed as a pair of hexadecimal digits, with a space between each pair.

F2: Acquisition Information

F2 determines the acquisition information display format, which is displayed in green or white in the center of the screen, between the DCE and DTE sides (See Figure 2.1). The options are:

- Number** Event number in decimal (default)
- Flags** Number of flags preceding the frame, in decimal
- Time** Event time stamp as hh:mm:ss
- dTime** Displays the elapsed time between events
- CRC** CRC value in hex (**OK** is good CRC, **BAD** is bad CRC)
- None** No acquisition information is displayed

The port receiving the traffic is also displayed (**Port A** or **Port B**) unless the **None** option is selected.

F3: Event Types

F3 determines what types of events will be displayed on the Analysis page. The options are:

- I** Information frames only
- IU** Information and Unnumbered frames only
- IUS** Information, Unnumbered, and Supervisory frames (default)
- IUSL** All frames, plus lead transitions

Note

F3 affects the page *display* only. All events are captured, regardless of the **F3** selection (unless you are running a Triggering application which captures specific traffic or events).

F4: Frame Level

F4 determines how the frame level (HDLC) is interpreted and displayed. The options are:

- HDLC +** HDLC is displayed interpreted (default)
- HDLC"** HDLC is displayed uninterpreted in the code selected in **F1** (ASCII, HEX, HEXS, EBCDIC)
- HDLC*** HDLC is displayed interpreted and uninterpreted in the code selected in **F1**
- HDLC-** HDLC is acquired but not displayed

The frame level components include the information listed below. See page 2-9 for an example of HDLC interpretation.

F5: Packet Level

F5 determines how the packet level (X.25) is interpreted and displayed. The options are:

- X.25 + X.25 is displayed interpreted (default)
- X.25“ X.25 is displayed uninterpreted in the code selected in **F1** (ASCII, HEX, HEXS, EBCDIC)
- X.25* X.25 is displayed interpreted and uninterpreted in the code selected in **F1**
- X.25- X.25 is acquired but not displayed

F10: User Data

F10 determines if user data is displayed. It also controls the display of traffic in an uninterpreted (raw) mode. The options are:

- User + User data is displayed (default)
- User- User data is not displayed
- Raw All traffic (data, HDLC, X25) is displayed uninterpreted (raw) in the code selected in **F1**

X.25 Analysis Interpretation

This section identifies the components of the X.25 Analysis page display. Figure 2.3 shows a sample X.25 History page. The area of the screen in the box is described in detail in this section.

The first line of data in the box is HDLC data, which is displayed in green. The second line of data in the box is the X.25 data, which is displayed in yellow. The first line of interpreted X.25 data is preceded by the message **X25:**.

The remaining lines are the user data, which is displayed in white. The user data is shown in HEX, since it is the code displayed in the softkey strip for the **F1** key.

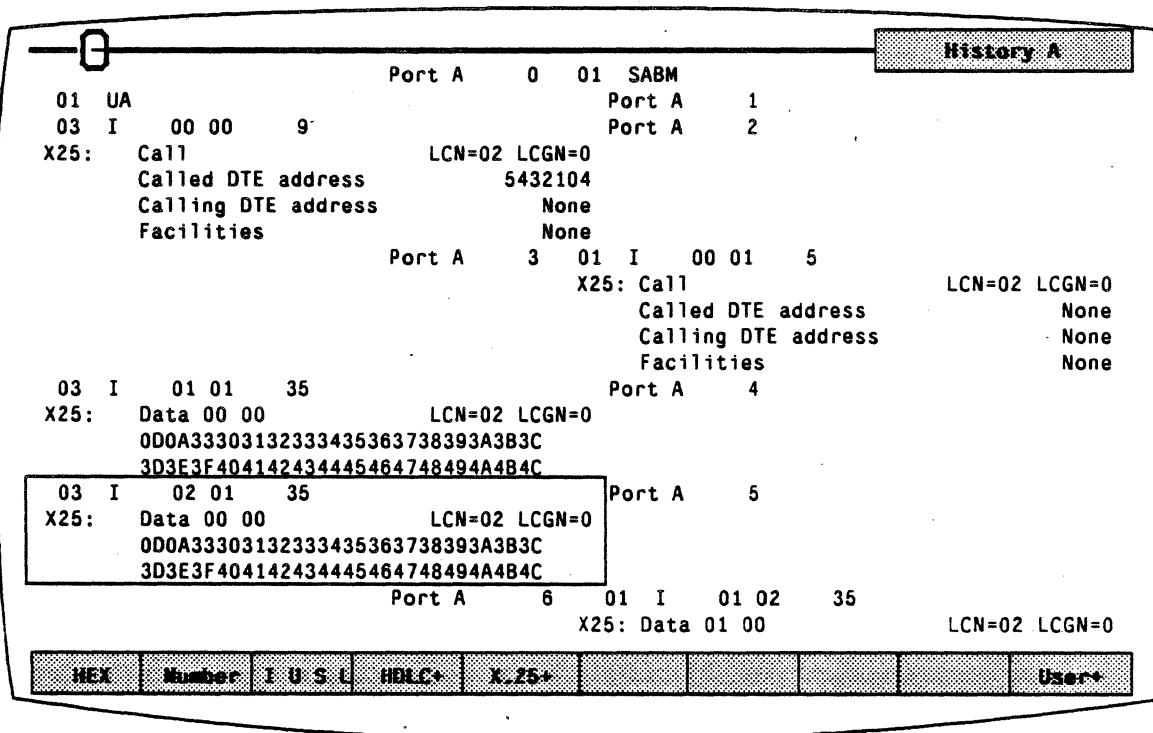


Figure 2.3: Analysis History Page with Sample X.25 Traffic

HDLC Interpretation

Figure 2.4 is a detail of the HDLC component from Figure 2.3. Each HDLC field in this sample display is described below.

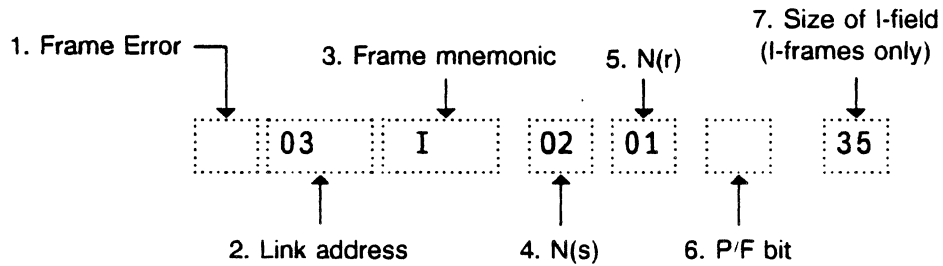


Figure 2.4: Sample HDLC Interpretation

1. Frame Errors

A single letter indicates if a frame error has occurred.

A	Aborted frame received
B	Frame with bad FCS received
(blank)	No frame error

2. Link Address

This field displays the link address.

3. Frame Mnemonic

Field 3 indicates the type of frame received, using the following mnemonics:

Information frame:

I I-Frame

Supervisory frames:

RR Receiver Ready
RNR Receiver Not Ready
REJ Reject

Unnumbered frames:

BCN	Beacon
CFGR	Configure
DISC	Disconnect
DM	Disconnect Mode
FRMR	Frame Reject
RD	Request Disconnect
RIM	Request Initialization Mode
SABM	Set Asynchronous Balanced Mode
SARM	Set Asynchronous Response Mode
SIM	Set Initialization Mode
SNRM	Set Normal Response Mode
TEST	Test Frame
UA	Unnumbered Acknowledge
UI	Unnumbered Information
UP	Unnumbered Poll
XID	Exchange ID
(hex value)	Unknown unnumbered frame type

4. N(s)

This field displays the N(s) count.

5. N(r)

This field displays the N(r) count.

6. Poll/Final Bit

This field displays the Poll/Final bit setting.

P	Poll/final bit is set
(blank)	Poll/final bit not set

7. Size of I-Field.

This field displays the size of I-field.

(decimal value)	Size in octets
(blank)	0

X.25 Data Packet

Figure 2.5 is a detail of the X.25 component from Figure 2.3, which is a data packet. Each X.25 field in this sample display is described below.

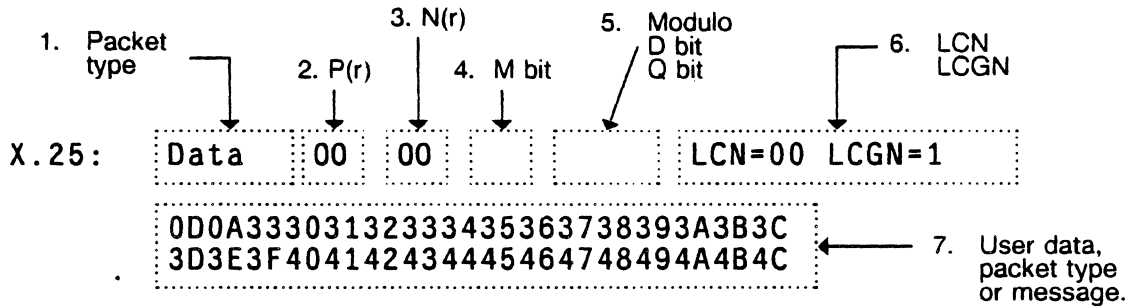


Figure 2.5: Sample X.25 Data Packet Interpretation

1. Packet Type Mnemonic

Data Packet:
Data

Unnumbered Packets:
Call
Call Connected
Clear
Clear Confirm
Diagnostic
Interrupt
Interrupt Confirm
Reset
Reset Confirm
Restart
Restart Confirm

Supervisory Packets:
REJ
RNR
RR

2. P(r)

This field displays the P(r) count.

3. P(s)

This field displays the P(s) count.

4. M Bit

This field displays the More bit (M bit) setting.

M	M bit is set
(blank)	M bit is not set

5. Modulo, D bit, Q bit

This field indicates the modulo, and the setting of the Delivery bit (D bit), and the Qualifier (Q) bit.

(blank)	Modulo 8
E	Modulo 128
D	Delivery bit (D bit) set
Q	Qualifier bit (Q bit) set

6. LCN, LCGN

This field displays the Logical Channel Number (LCN) and the Logical Channel Group Number (LCGN).

7. User data, Packet Type, or Message

This field displays uninterpreted user data, packet type, or message. Each line displays a maximum of 32 bytes.

X.25 STATISTICS

Introduction

X.25 Statistics displays and prints statistical information about the traffic on an X.25 application line. You have the ability to activate several pages that show the following statistical information:

- X.25 Line Displays packet level statistics for all LCNs.
- X.25 LCN Displays X.25 statistics for individual LCNs.
- HDLC Line Displays frame level statistics for all LCNs.

When you start X.25 Statistics, the X.25 Line statistics page is displayed as shown in Figure 2.7. This page shows X.25 Statistics for all active LCNs on an X.25 line. The format of this page is described on the following page.

If you do not know how to start the Statistics application, refer to the *Chameleon 32 User's Guide, Chapter 3: Using the Chameleon 32.*

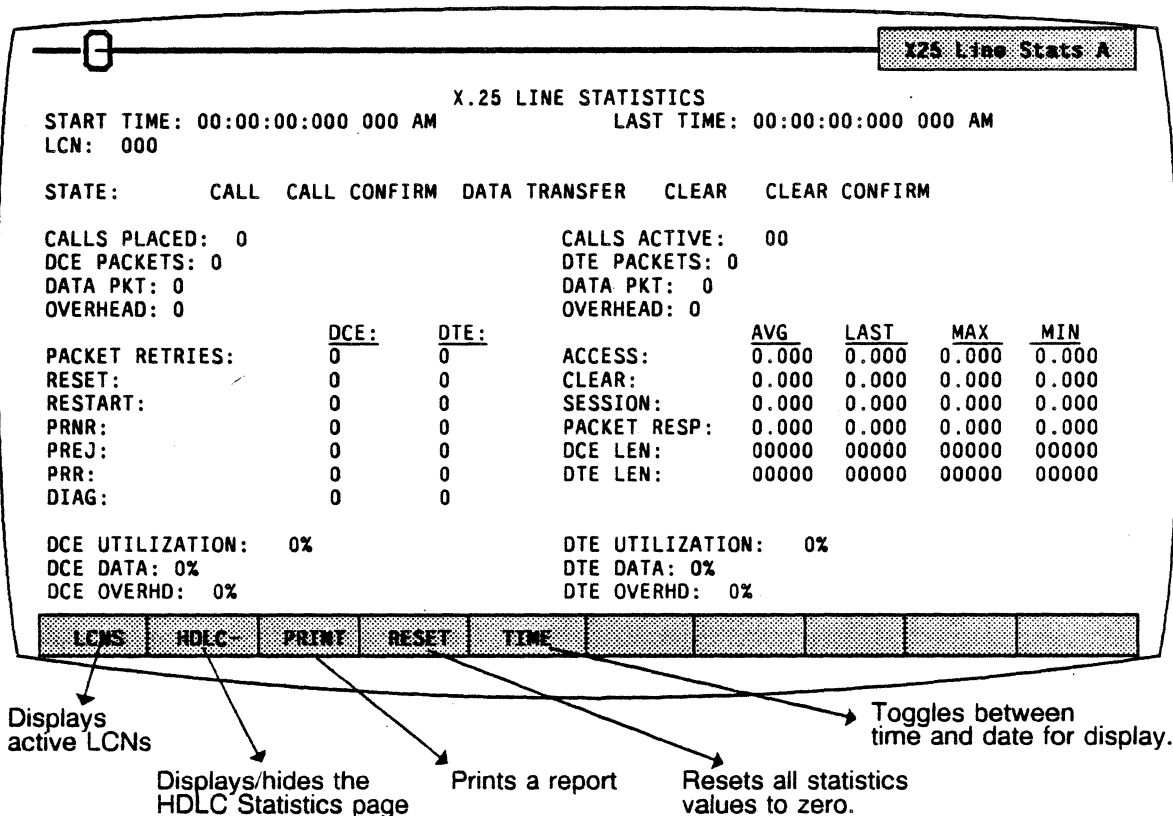


Figure 2.7: The X.25 Line Statistics Page

Time Display

The top of the Statistics page displays two times in the format *hh:mm:ss:ddd ddd*, as described below.

START TIME

Displays the time of the *end* of the first event (frame) in a statistics session.

LAST TIME

Displays the time of the *end* of the last event (frame) in a statistics session.

F5 Time/Date switches this display between time and date. To switch between time and date, you must first press **F5 Time/Date** and then press **F4 Reset**, to reset the time or data and all statistics values.

Active LCNs

Following the time/date display is the information about the active Logical Channel Number (LCNs), as described below.

LCN

This field displays the Logical Channel Group Number (LCGN) and the Logical Channel Numbers (LCN) of all active LCNs/LCGNs.

The highlighted LCN indicates the LCN from which the last packet was received.

STATE

This field displays the possible states of an LCN. The highlighted state is the state of the LCN from which the last packet was received.

CALL	A Call Request was last received.
CALL CONFIRM	A Call Confirm was last received.
DATA TRANSFER	A Data packet was last received.
CLEAR	A Clear packet was last received.
CLEAR CONFIRM	A Clear Confirm was last received.

Call Statistics

The next area of the X.25 Statistics page displays information about the calls that have been made. This information is displayed for the DCE and the DTE sides. The call statistics fields are described below.

CALLS PLACED

This field displays the total number of calls placed on all LCNs.

CALLS ACTIVE

This field displays the number of LCNs that are in the Data Transfer state.

DCE/DTE PACKETS

These fields display the total number of packets (of all types) on all LCNs received from the DCE and the DTE.

DCE/DTE DATA PACKETS

These fields display the number of data packets received from all LCNs. This information is also shown as a bar graph to the right of the percentage. This enables you to quickly compare the amount of time used for data transfer and call overhead.

DCE/DTE Overhead

These fields display the number of control (non-data) packets received on all LCNs. This information is also shown as a bar graph to the right of the percentage. This enables you to quickly compare the amount of time used for data transfer and call overhead.

Packet Types

The next area of the X.25 Statistics page shows the number of control packets for all LCNs for the DCE and the DTE, as described below.

Packet Retries

This indicates the number of packet retries, which are the packets retransmitted as a result of a RESTART packet.

RESET

The number of DCE/DTE resets received.

RESTART

The number of DCE/DTE restarts received.

PRNR

The number of RNRs (Receiver Not Ready) packets received the DCE/DTE.

PREJ

The number of REJECT packets received from the DCE/DTE.

PRR

The number of RRs (Receiver Ready) packets received from the DCE/DTE.

DIAG

The number of diagnostic packets received from the DCE/DTE.

Timing Statistics

For the fields below, the average, last, maximum, and minimum times in seconds are displayed.

ACCESS

The time from the transmission/reception of a CALL REQUEST packet to the transmission/reception of a CALL CONFIRMATION packet on the same LCN.

CLEAR

The time between the transmission/reception of a CLEAR packet and the transmission/reception of a CLEAR CONFIRMATION packet on the same LCN.

SESSION

The time between the reception of a CALL packet and a CLEAR CONFIRM packet for the same LCN.

PACKET RESPONSE

The time between the *end* of an X.25 DATA packet and the *end* of the packet with the P(R) confirmation for that DATA packet.

Packet Length

The following fields display the average, last, maximum and minimum lengths for the DCE and DTE packets.

DCE LENGTH

This line displays the average, last maximum, and minimum length of DCE packets.

DTE LENGTH

This line displays the average, last maximum, and minimum length of DTE packets.

Utilization

The last area of the X.25 Statistics page displays information about line utilization for both the DTE and DCE, in the fields described below.

DCE/DTE Utilization

This field displays a percentage which indicates the total line utilization by DCE/DTE on all LCNs.

Line utilization is determined by calculating the number of bytes that could have been received at the measured baud rate, divided by the actual number of bytes that were received.

For example, if the baud rate was set at 9600, and the elapsed time was one second, the total number of bytes that could have been received is 1200. If only 600 bytes were received, the line utilization was 50%.

DCE/DTE DATA

This field displays a percentage which indicates the amount of time the line is utilized for data transfer by the DCE or DTE. This information is also shown as a bar graph so that you can quickly compare it to the graph of overhead usage.

DCE/DTE OVERHEAD

The percentage of time the line is utilized for the transfer of all non-data traffic. This information is also shown as a bar graph so that you can quickly compare it to the graph of data transfer usage.

Function Keys for X.25 Statistics

There are five function keys available for X.25 Statistics. These are shown and briefly described in Figure 2.7. These keys are available for for all X.25 Statistics pages. A complete description of each key is provided below.

F1: LCNS/FUNCT

You can activate a page which displays statistical information for a specific LCN that is active on the line. **F1 LCNS** displays the active LCNs in the softkey strip at the bottom of the screen.

In the softkey key strip, if the LCN has + next to it, a page has been activated for that LCN. If the LCN has - next to it, a separate page has not been activated for that LCN.

When the LCNs are displayed in the softkey strip at the bottom of the screen, the **F1** key displays **FUNCT**. If you press **F1 FUNCT**, the softkey strip with the statistics functions is displayed. In other words, **F1** switches you between the Statistics functions and the active LCNs.

To activate a statistics page for an LCN, perform these steps:

1. Make one of the X.25 Statistics pages active. (You can activate and deactivate LCN pages from any X.25 Statistics page.)
2. If the active LCNS are not displayed in the softkey strip, press **F1 LCNS** to display them.
3. Press the function key that corresponds to the desired LCN. This causes a page banner for that LCN to be displayed at the bottom of the screen. The LCN softkey strip should also show a + next to the LCN.
4. You can then make the new page active and use its function keys. (If the statistics page is in Blow mode when you activate an LCN page, the LCN page banner is hidden behind the other X.25 statistics banner. Use **Hide Page/Show Page** to display the pages as needed.)

To deactivate a page for an LCN, perform these steps:

1. Make one of the X.25 statistics pages active.
2. If the active LCNS are not displayed in the softkey strip, press **F1 LCNS** to display them.
3. Press the function key that corresponds to the desired LCN. The LCN softkey strip should show - next to the LCN in the softkey strip and the LCN page should disappear.

F2: HDLC +/-

F2 HDLC activates and deactivates a statistics page with HDLC (frame level) statistics for the line. This enables you to focus on level 2 statistical information.

In the softkey strip, if **HDLC** has + next to it, a page has been activated for frame level statistics. If **HDLC** has - next to it, a separate page has not been activated for HDLC.

To activate a statistics page for HDLC, perform these steps:

1. Make one of the X.25 Statistics pages active. (You can activate and deactivate the HDLC statistics page from any X.25 Statistics page.)
2. If HDLC is not displayed as **F2** in the softkey strip, press **F1 FUNCT** to display the X.25 Statistics function keys.
3. Press **F2 HDLC**. This causes an HDLC Line Stats page banner to be displayed at the bottom of the screen. The softkey strip should also show + next to **HDLC**.
4. You can then make the new page active and use its function keys. (If the statistics page is in Blow mode when you activate an **HDLC** statistics page, the HDLC banner is hidden behind the existing X.25 statistics banner. Use **Hide Page/Show Page** to display the pages as needed.)

A sample HDLC Line Statistics page is shown and described on page 2-28.

The HDLC Statistics function keys are identical to the X.25 Statistics function keys.

To deactivate a page for an LCN, perform these steps:

1. Make one of the X.25 Statistics pages active.
2. If **HDLC +** is not displayed in the softkey strip, press **F1 FUNCT** to display the X.25 Statistics function keys.
3. Press **F2 HDLC**. The softkey strip should show - next to **HDLC** and the HDLC Line Stats banner should disappear.

F3: Print

F3 Print prints a statistical report that is similar to the screen display format. If you have a printer connected to the Chameleon 32, you can print a report. If you do not know how to connect a printer to the *Chameleon 32*, refer to the *Chameleon 32 User's Guide, Chapter 9: Utilities*.

If you do not have a printer connected to the Chameleon 32, pressing **F3 Print** has no effect. The report will not be shown on the Chameleon 32 screen.

A sample X.25 Line statistics report is shown in Figure 2.8.

TEKELEC X25 LINE STATISTICS REPORT				
START TIME:	00:00:00:000	000		
LAST TIME:	00:00:00:000	000		
LCNs ACTIVE :	000	000	000	
CALLS ACTIVE :	0			
		DCE	DTE	
CALLS PLACED :	00000000	00000000	00000000	
PACKET COUNT :	00000000	00000000	00000000	
DATA PACKETS	00000000	00000000	00000000	
OVERHEAD PACKETS :	00000000	00000000	00000000	
FRAME ABORTS :	00000000	00000000	00000000	
CRC ERRORS :	00000000	00000000	00000000	
FRAME RETRIES :	00000000	00000000	00000000	
PACKET RETRIES :	00000000	00000000	00000000	
FRAME RRs :	00000000	00000000	00000000	
FRAME RNRs :	00000000	00000000	00000000	
FRAME REJs :	00000000	00000000	00000000	
FRAME FRMRs :	00000000	00000000	00000000	
PACKET RRs :	00000000	00000000	00000000	
PACKET RNRs :	00000000	00000000	00000000	
PACKET REJs :	00000000	00000000	00000000	
RACKET RESETs :	00000000	00000000	00000000	
PACKET RESTARTs :	00000000	00000000	00000000	
PACKET DIAGs :	00000000	00000000	00000000	
		AVG	LAST	MAX
ACCESS TIME :	0.000	0.000	0.000	0.000
CLEAR TIME :	0.000	0.000	0.000	0.000
SESSION TIME :	0.000	0.000	0.000	0.000
DTE PACKET RESPONSE :	0.000	0.000	0.000	0.000
DCE PACKET RESPONSE :	0.000	0.000	0.000	0.000
DCE PACKET LENGTH :	00000	00000	00000	00000
DTE PACKET LENGTH :	00000	00000	00000	00000
DCE LINE UTILIZATION :	00 %			
DCE DATA UTILIZATION :	00 %			
DTE LINE UTILIZATION :	00 %			
DTE DATA UTILIZATION :	00 %			

Figure 2.8: X.25 Line Statistics Report

F4: Reset

F4 Reset resets the statistics values to zero and resets the times (or dates) displayed at the top of the page. This resets the values on all X.25 statistics pages that are currently activated.

F5: Time/Date

F5 Time/Date switches the display at the top of the statistics pages between the time and the date. This changes the timer display on all X.25 statistics pages that are currently activated. The timer display changes when the next event is received.

HDLC Line Statistics Page

An HDLC Line Statistics page is shown in Figure 2-9. Each field of the HDLC Line Statistics page is described on the following pages.

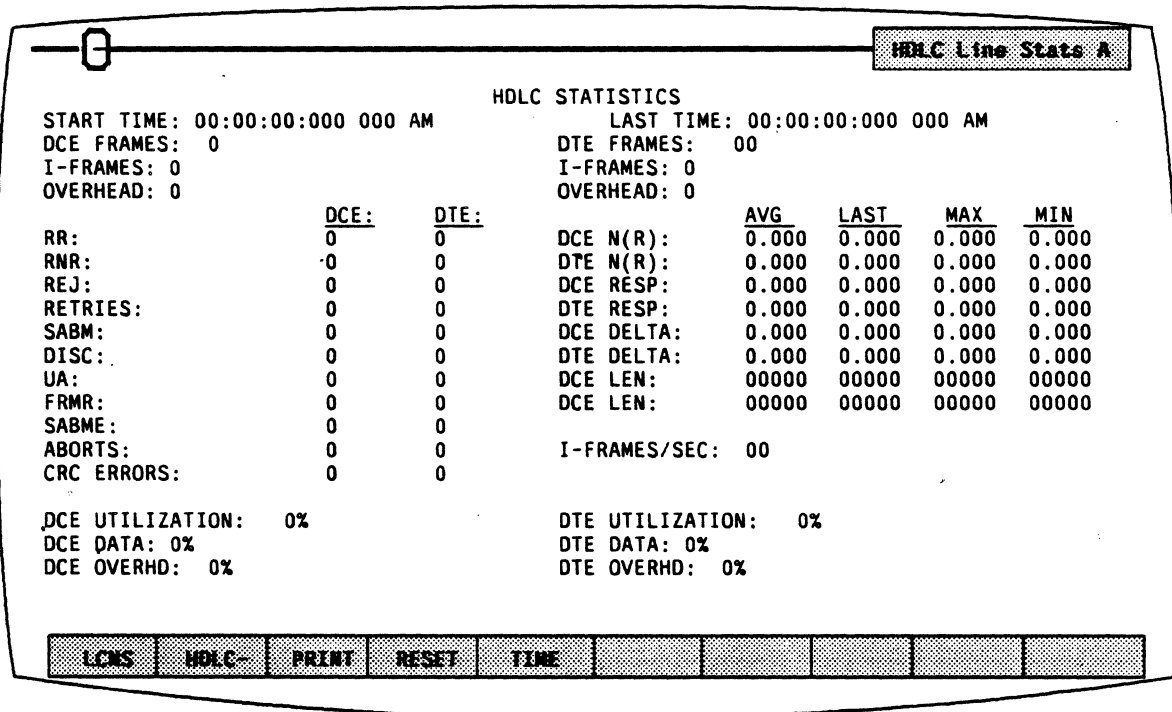


Figure 2.9: The HDLC Line Statistics Page

Start and Last Time

The top of the statistics page displays two times in the format hh:mm:ss, as described below.

F5 Time/Date switches this display between time and date. These keys affect all X.25 Statistics pages that are currently active.

- | | |
|-------------------|---|
| START TIME | Displays the time of the <i>end</i> of the first event (frame) in a statistics session. |
| LAST TIME | Displays the time of the <i>end</i> of the last event (frame) |

Frame Statistics

The next area of the HDLC Line Statistics page displays information about the frames that have received from the DCE and the DTE.

DCE/DTE FRAMES	This field displays the total number of frames received from the DCE and the DTE.
DCE/DTE I-FRAMES	This field displays the number of information frames received from the DCE and the DTE.
DCE/DTE OVERHEAD	This field displays the number of control frames (non I-frames) received from the DCE and the DTE.

Frame Types and Errors Received

The next area of the HDLC Line Statistics page shows the number of each frame type received from the DCE and the DTE.

RR	The number of Receiver Ready frames received.
RNR	The number of Receiver Not Ready frames received.
REJ	The number of Reject frames received.
RETRIES	The number of retries received.
SABM	The number of Set Asynchronous Balanced Mode frames received.
DISC	The number of Disconnect frames received.
UA	The number of Unnumbered Acknowledge frames received.

FRMR	The number of frame rejects frames received.
SABM	The number of Set Asynchronous Balanced Mode Extended frames received.
ABORTS	The number of frame aborts that have occurred.
CRC ERRORS	The number of Cyclic Redundancy Check errors that have occurred.

Timing Statistics

For the fields below, the average, last, maximum, and minimum times in seconds are displayed.

DCE N(r)	The time between the receipt of an I-frame from the DTE and the receipt of the response to that I-frame from the DCE.
DTE N(r)	The time between the receipt of an I-frame from the DCE and the receipt of the response to that I-frame from the DTE.
DCE RESP	The time between the receipt of a frame from the DTE and the receipt of the response to that frame from the DCE.
DTE RESP	The time between the receipt of a frame from the DCE and the receipt of the response to that frame from the DTE.
DCE DELTA	The time between the receipt of one frame from the DCE and the receipt of the next frame from the DCE.
DTE DELTA	The time between the receipt of one frame from the DTE and the receipt of the next frame from the DTE.

Frame Length

The following fields display the average, last, maximum and minimum lengths for the DCE and DTE frames.

DCE LENGTH	This line displays the average, last maximum, and minimum length of the DCE frames received.
DTE LENGTH	This line displays the average, last maximum, and minimum length of the DTE frames received.
I-FRAMES/SEC	The total number of I-frames received per second from both DTE and DCE.

Utilization

The last area of the HDLC Line Statistics page displays information about line utilization for both the DTE and DCE, in the fields described below.

DCE/DTE UTILIZATION	This field displays a percentage which indicates the total line utilization by DCE/DTE on all LCNs.
----------------------------	---

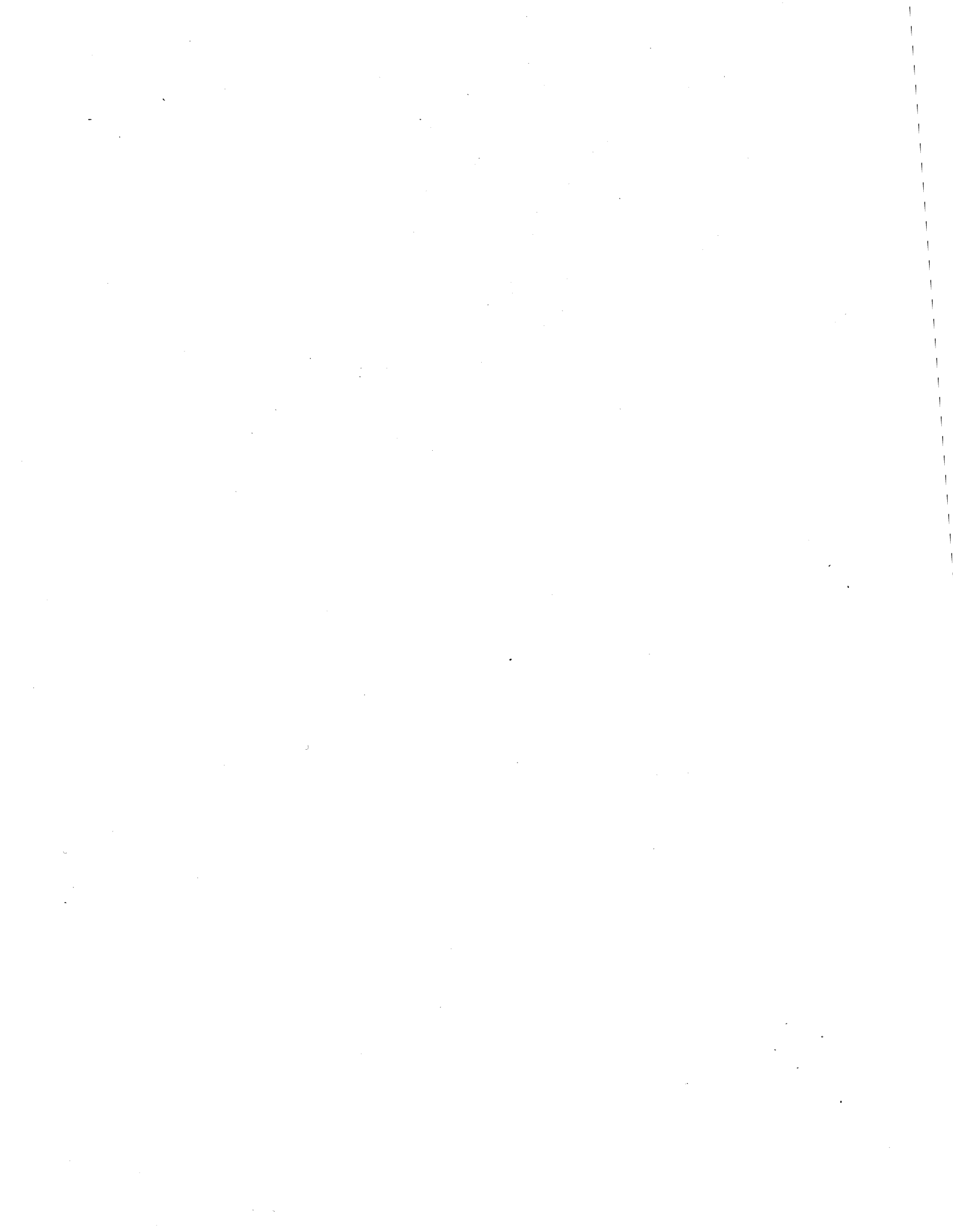
Line utilization is determined by calculating the number of bytes that could have been received at the measured baud rate, divided by the actual number of bytes that were received.

For example, if the baud rate was set at 9600, and the elapsed time was one second, the total number of bytes that could have been received is 1200. If 600 bytes were received, the line utilization was 50%.

DCE/DTE DATA	This field displays a percentage which indicates the amount of time the line is utilized for data transfer by the DCE or DTE. This information is also shown as a bar graph so that you can quickly compare it to the graph of overhead usage.
---------------------	--

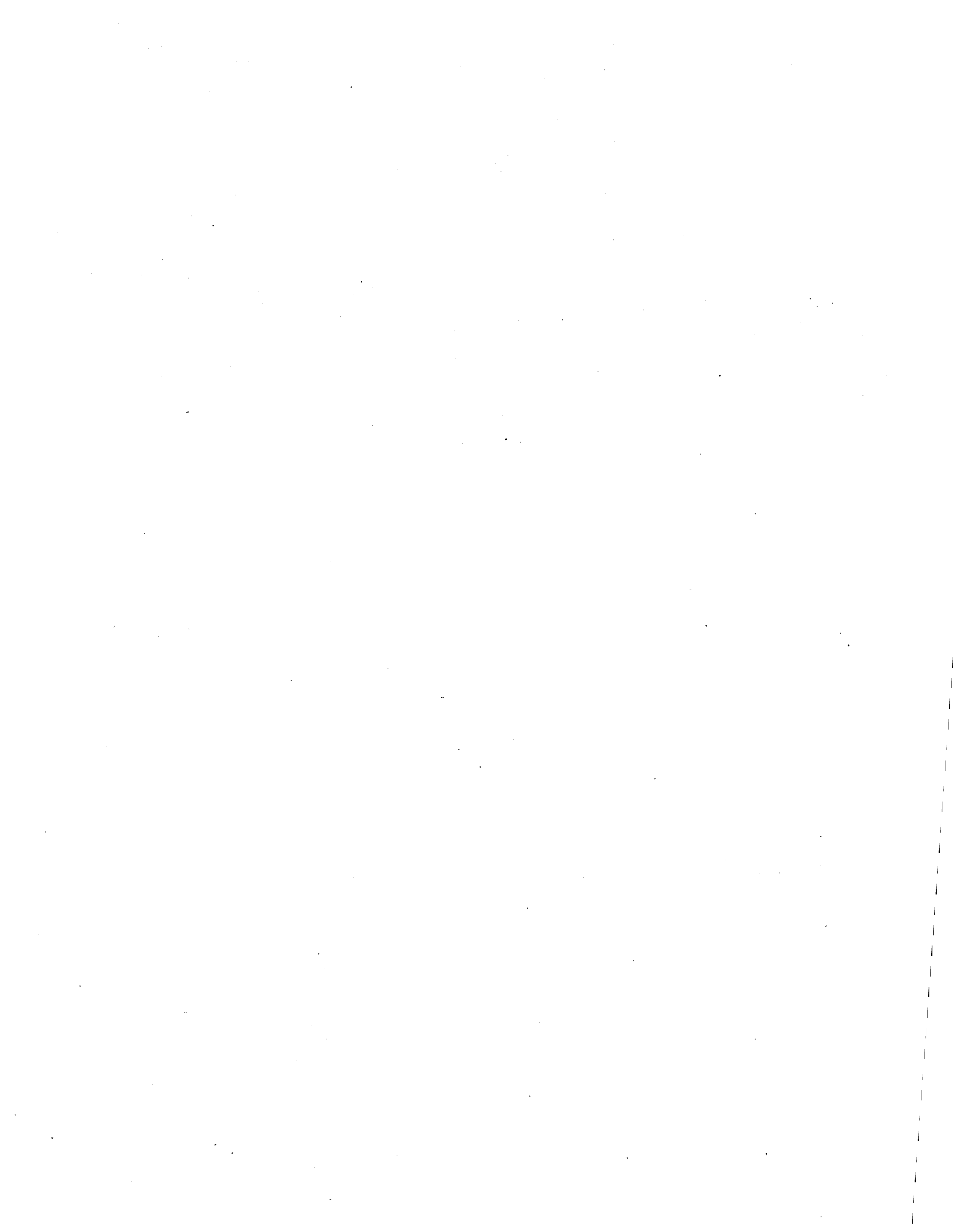
**DCE/DTE
OVERHEAD**

The percentage of time the line is utilized for the reception of all non-data traffic. This information is also shown as a bar graph so that you can quickly compare it to the graph of data transfer usage.



CHAPTER THREE:

X.75 MONITORING



CHAPTER THREE: X.75 MONITORING

Introduction

Monitoring allows you to passively monitor the traffic on a data line without affecting the traffic. By doing this, you can interpret captured traffic and troubleshoot the line. This section focuses on the protocol-specific details of X.75 Analysis. For a general description of Analysis, refer to Chapter 1.

This section assumes that you know how to select Monitoring for a port with X.75 as the protocol. If you do not know how to do this, refer to the Chameleon 32 User's Guide, Chapter 3: Using the Chameleon 32.

Monitor Setup Menu

When you select X.75 as your Monitoring protocol, you are prompted for several configurable parameters as shown in Figure 3.1. Each of these parameters is described on the next page.

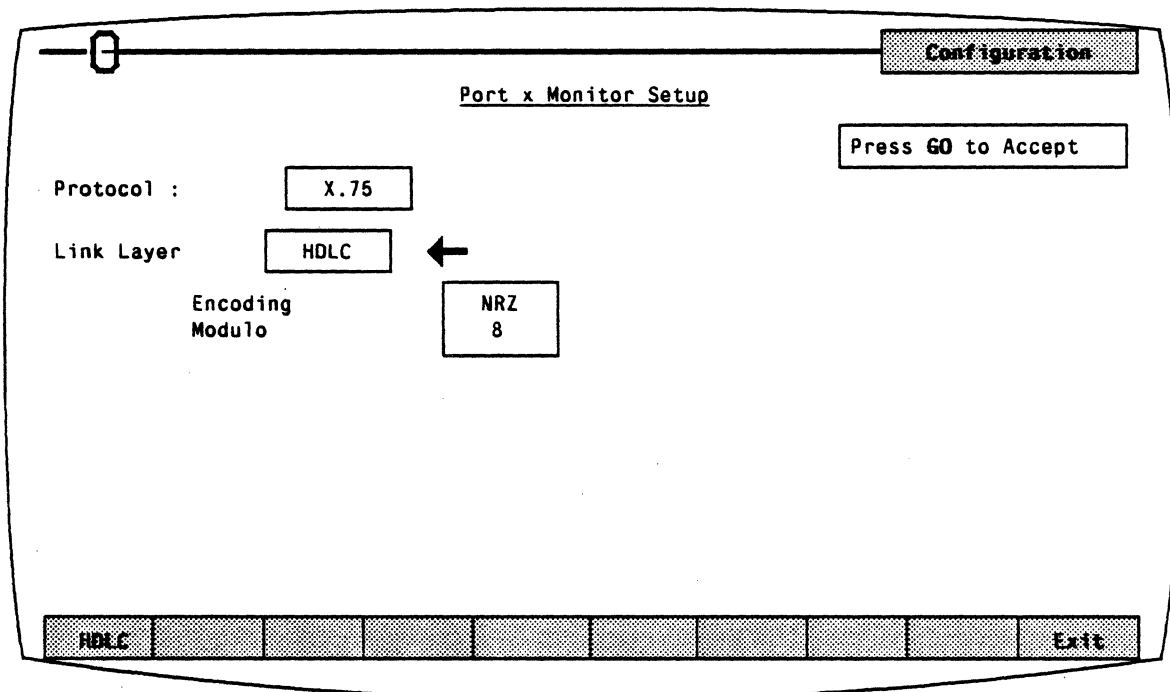


Figure 3.1: X.75 Protocol Parameters

Link Layer

Link Layer specifies the link layer protocol to use. There is only one option, HDLC.

Encoding

Encoding is a level 1 (physical) parameter that determines how the Chameleon 32 interprets the electrical signal to distinguish between binary 1 and 0. The options are:

NRZ Non Return to Zero. In NRZ encoding, a 1 is represented by a high level, and a 0 is represented by a low level.

NRZI Non Return to Zero Inverted. In NRZI encoding, a 1 is represented by no change in level, and a 0 is represented by a change in level.

Modulo

Modulo determines the frames numbering sequence that will be used to keep track of the frames that are transmitted and received. The options are:

Modulo 8 Frames numbered from 0 - 7

Modulo 128 Frames numbered from 0 - 127

ANALYSIS

Analysis provides two pages: Real Time and History. Both pages display traffic in a split screen format (DCT/DTE)

The Real Time page displays traffic from both sides of the line as it is acquired. The data scrolls as the traffic is acquired.

History displays traffic that has been acquired and put in a buffer. You can move back and forth through the traffic in the buffer to display specific parts of it.

The display format and function keys are the same for both pages, as shown in Figure 3.2. The page components are described on the following pages.

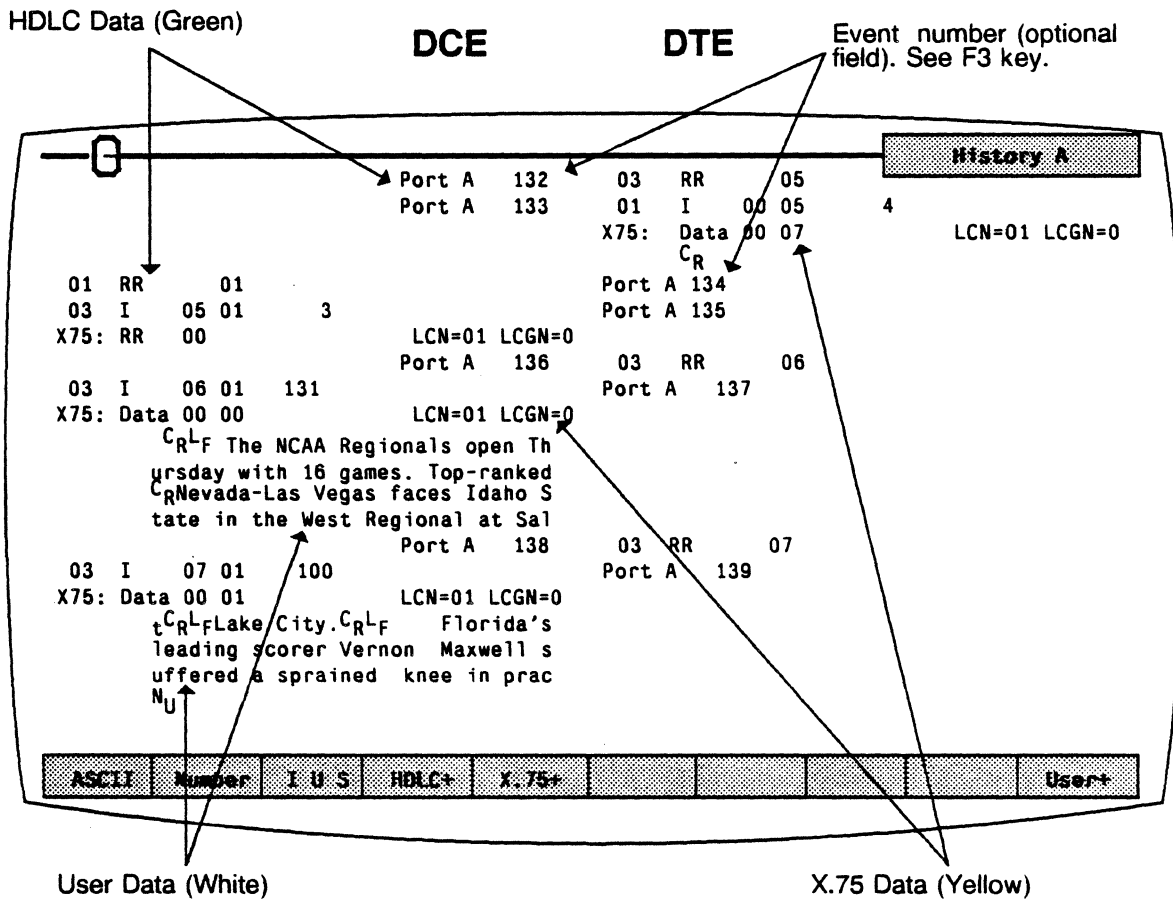


Figure 3.2: Analysis History Page with Sample X.75 Traffic

DCE/DTE

Frames received from the DCE are displayed on the left half of the screen. Frames transmitted from the DTE are displayed on the right half of the screen.

Baud Rate Changes

The interpretation of a baud rate change event is as shown below (example: the new baud rate is 9600)

New Baud Rate 9600

Colors

Colors distinguish the different levels of the display:

- Green = Frame level (HDLC)
- Yellow = Packet level (X.75)
- White = User data
- Red = Errors

In addition, the optional field selected using **F2** is displayed in green or white, depending on the event type.

Interface Lead Transitions

Interface lead transitions are shown as an up arrow character (↑) if the specified lead made a transition from low to high, or a down arrow character (↓) if the lead made a transition from high to low. Note that all transitions for a given event are shown on one line. The leads are:

DCE Leads

CTS
DSR
DCD
SDCD
RI

DTE Leads

RTS
DTR

Function Keys

The function keys control how the traffic is interpreted and displayed. These functions are available for both the History and Real Time pages. The X.75 Analysis function keys are described below.

F1: Code

F1 determines the format of the user data display. This is the data which does not belong to a protocol specific format. Each time you press **F1**, the user data (in white) changes to the code indicated in the softkey strip. The options are:

- | | |
|---------------|--|
| ASCII | Each byte is displayed as an ASCII character. Characters in the range 0 - 1F hex are shown as single character mnemonics. Characters above 80 hex are shown as '.'.(default) |
| EBCDIC | Each byte is displayed as an EBCDIC character. |
| HEX | Each byte is displayed as a pair of hex digits |
| HEXS | Each byte is displayed as a pair of hexadecimal digits, with a space between each pair. |

F2: Acquisition Information

F2 determines the acquisition information display format, which is displayed in green or white in the center of the screen, between the DCE and DTE sides (See Figure 3.1). The options are:

- | | |
|---------------|--|
| Number | Event number in decimal (default) |
| Flags | Number of flags preceding the frame, in decimal |
| Time | Event time stamp as hh:mm:ss |
| dTime | Displays the elapsed time between events |
| CRC | CRC value in hex, and OK if CRC is good or BAD if CRC is bad |
| None | No acquisition information is displayed |

The port receiving the packet (**Port A** or **Port B**) is displayed as part of the acquisition information unless the **None** option is selected.

F3: Event Types

F3 determines what types of events will be displayed on the Analysis page. The options are:

I	Information frames only
IU	Information and Unnumbered frames only
IUS	Information, Unnumbered, and Supervisory frames (default)
IUSL	All frames, plus lead transitions

Note

F3 affects the page *display* only. All events are captured, regardless of the **F3** selection (unless you are running a Triggering application which captures specific traffic or events).

F4: Frame Level

F4 determines how the frame level (HDLC) is interpreted and displayed. The options are:

HDLC +	HDLC is displayed interpreted (default)
HDLC"	HDLC is displayed uninterpreted in the code selected in F1 (ASCII, HEX, HEXS, EBCDIC)
HDLC*	HDLC is displayed interpreted and uninterpreted in the code selected in F1
HDLC-	HDLC is acquired but not displayed

The frame level components include the information listed below. See page 3-8 for an example of HDLC interpretation.

- Frame address in hex
- Frame mnemonic
- N(r) and N(s) in hex
- Poll/Final bit
- Indication of bad CRC and aborted frames
- Size of I-field in decimal

F5: Packet Level

F5 determines how the packet level (X.75) is interpreted and displayed. The options are:

- | | |
|--------|--|
| X.75 + | X.75 is displayed interpreted (default) |
| X.75" | X.75 is displayed uninterpreted in the code selected in F1 (ASCII, HEX, HEXS, EBCDIC) |
| X.75* | X.75 is displayed interpreted and uninterpreted in the code selected in F1 |
| X.75- | X.75 is acquired but not displayed |

The packet level components include the information listed below. See page 3-10 for example of X.75 interpretations.

- Packet Identification mnemonic, eg., CALL
- Call packet address
- P(r) and P(s)
- Q, D and M bits
- Logical Channel Number (LCN)
- Logical Channel Group Number (LCGN)
- Facilities information
- Clear/restart causes and diagnostics

F10: User Data

F10 determines if user data is displayed. It also controls the display of traffic in an uninterpreted (raw) mode. The options are:

- | | |
|--------|---|
| User + | User data is displayed (default) |
| User- | User data is not displayed |
| Raw | All traffic (data, HDLC, X.75) is displayed uninterpreted (raw) in the code selected in F1 |

X.75 ANALYSIS INTERPRETATION

This section identifies the components of the X.75 Analysis page display. Figure 3.3 shows a sample X.75 History page. The area in the box is described in detail in this section.

The first line data in the box is HDLC data, which is displayed in green. The second line in the box is the X.75 data, which is displayed in yellow. The first line of interpreted X.75 data is preceded by the message **X.75:**.

The remaining lines are the user data, which is displayed in white. The user data is shown in ASCII, since it is the code displayed in the softkey strip for the **F1** key.

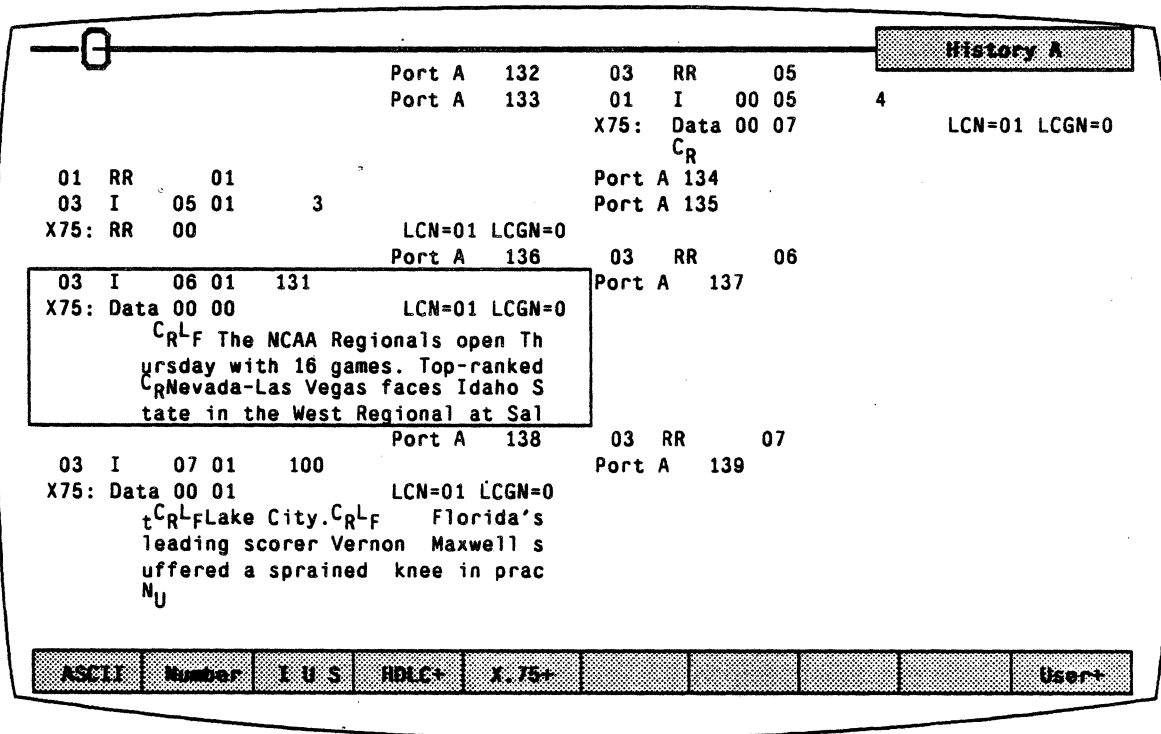


Figure 3.3: Analysis History Page with Sample X.75 Traffic

HDLC

Figure 3.4 is a detail of the HDLC component from Figure 3.3. Each HDLC field in this sample display is described below.

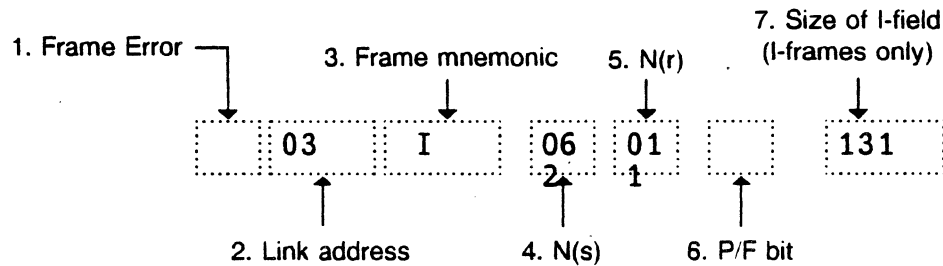


Figure 3.4: Sample HDLC Interpretation

1. Frame Errors

A single letter indicates if a frame error has occurred.

A	Aborted frame received
B	Frame with bad FCS received
(blank)	No frame error

2. Link Address

This field displays the link address.

3. Frame Mnemonic

Field 3 indicates the type of frame received, using the following mnemonics:

Information frame:

I I-Frame

Supervisory frames:

RR Receiver Ready
RNR Receiver Not Ready
REJ Reject

Unnumbered frames:

BCN	Beacon
CFGR	Configure
DISC	Disconnect
DM	Disconnect Mode
FRMR	Frame Reject
RD	Request Disconnect
RIM	Request Initialization Mode
SABM	Set Asynchronous Balanced Mode
SARM	Set Asynchronous Response Mode
SIM	Set Initialization Mode
SNRM	Set Normal Response Mode
TEST	Test Frame
UA	Unnumbered Acknowledge
UI	Unnumbered Information
UP	Unnumbered Poll
XID	Exchange ID
(hex value)	Unknown unnumbered frame type

4. N(s)

This field displays the N(s) count.

5. N(r)

This field displays the N(r) count.

6. Poll/Final Bit

This field displays the Poll/Final bit setting.

P	Poll/final bit is set
(blank)	Poll/final bit not set

7. Size of I-Field.

This field displays the size of I-field.

(decimal value)	Size in octets
(blank)	0

X.75 Data Packet

Figure 3.5 is a detail of the X.75 component from Figure 3.3, which is a data packet. Each X.75 field in this sample display is described below.

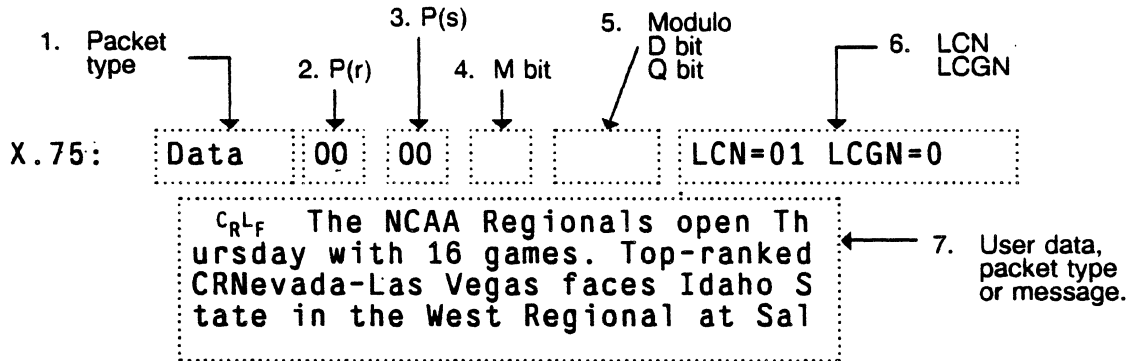


Figure 3.5: Sample X.75 Data Packet Interpretation

1. Packet Type Mnemonic

Data Packet:
Data

Unnumbered Packets:
Call
Call Connected
Clear
Clear Confirm
Diagnostic
Interrupt
Interrupt Confirm
Reset
Reset Confirm
Restart
Restart Confirm

Supervisory Packets:
REJ
RNR
RR

2. P(r)

This field displays the P(r) count.

3. P(s)

This field displays the P(s) count.

4. M Bit

This field displays the More bit (M bit) setting.

M	M bit is set
(blank)	M bit is not set

5. Modulo, D bit, Q bit

This field indicates the modulo, and the setting of the Delivery bit (D bit), and the Qualifier (Q) bit.

(blank)	Modulo 8
E	Modulo 128
D	Delivery bit (D bit) set
Q	Qualifier bit (Q bit) set

6. LCN, LCGN

This field displays the Logical Channel Number (LCN) and the Logical Channel Group Number (LCGN).

7. User data, packet type, or message

This field displays uninterpreted user data, packet type, or message. Each line displays a maximum of 32 bytes. See page 2-14 for a list of the messages and packet types.

Unnumbered and Supervisory Packets

The components of the various Unnumbered and Supervisory packets vary by packet type. For example, Figure 3.6 shows the format of an X.75 Call packet.

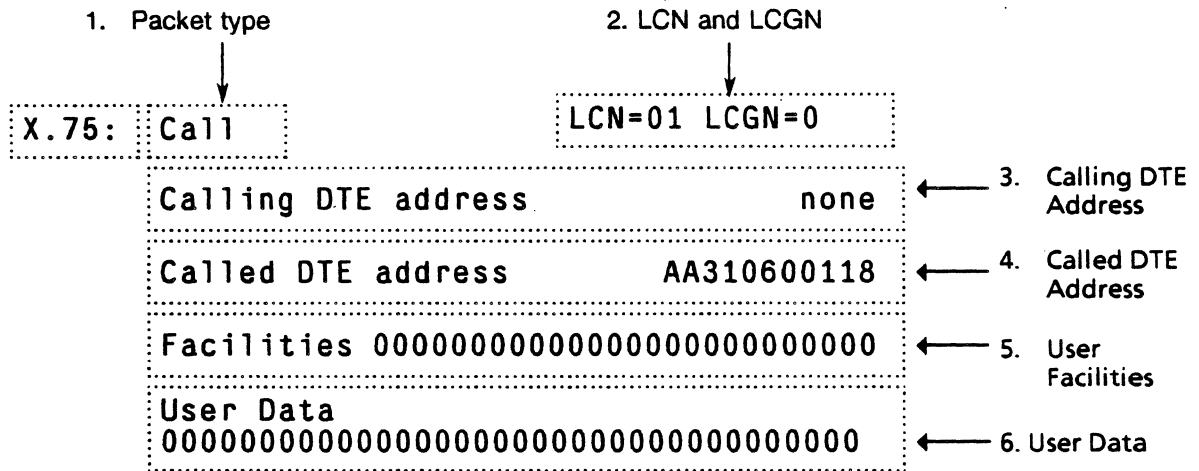
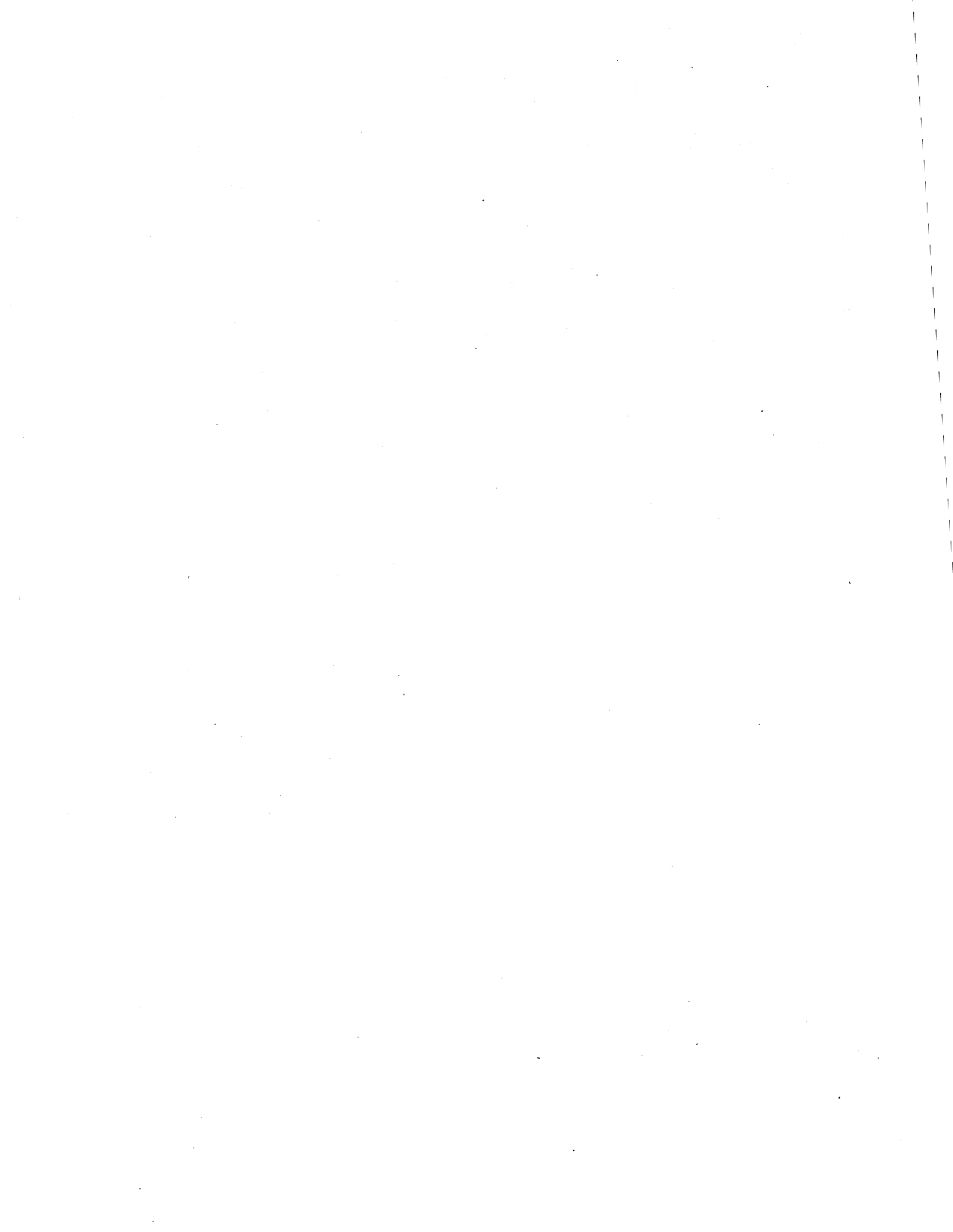


Figure 3.6: Sample X.75 Call Packet Interpretation



CHAPTER FOUR:
QLLC MONITORING

CHAPTER FOUR: QLLC MONITORING

Introduction

Monitoring allows you to passively monitor the traffic on a data line without affecting the traffic. By doing this, you can interpret captured traffic and troubleshoot the line. This section focuses on the protocol-specific details of QLLC Analysis. For a general description of Analysis, refer to Chapter 1.

This section assumes that you know how to select Monitoring for a port with QLLC as the protocol. If you do not know how to do this, refer to the *Chameleon 32 User's Guide, Chapter 3: Using the Chameleon 32*.

Monitor Setup Menu

When you select QLLC as your Monitoring protocol, you are prompted for several configurable parameters as shown in Figure 4.1. Each of these parameters is described on the next page.

The screenshot shows a terminal window titled "Port x Monitor Setup" with a "Configuration" label in the top right corner. A box in the top right says "Press GO to accept". The menu lists several parameters:

- Protocol : QLLC
- Link Layer : HDLC (with a left-pointing arrow)
- Encoding : NRZ
- Modulo : 8
- Extended Addr : No

At the bottom, there is a navigation bar with buttons for "HELC" and "Exit", and several unlabeled buttons.

Figure 4.1: QLLC Monitor Setup Parameters

Link Layer

Link Layer specifies the link layer protocol to use. There is only one option, HDLC.

Encoding

Encoding is a level 1 (physical) parameter that determines how the Chameleon 32 interprets the electrical signal to distinguish between binary 1 and 0. The options are:

NRZ Non Return to Zero. In NRZ encoding, a 1 is represented by a high level, and a 0 is represented by a low level.

NRZI Non Return to Zero Inverted. In NRZI encoding, a 1 is represented by no change in level, and a 0 is represented by a change in level.

Modulo

Modulo determines the frame numbering sequence that will be used to keep track of the frames that are transmitted and received. The options are:

Modulo 8 Frames numbered from 0 - 7

Modulo 128 Frames numbered from 0 - 127

Extended Addressing

Extended Addressing determines whether 8-bit addressing or 16-bit (extended) addressing is being used for transmission. The options are:

Yes Extended (16-bit) addressing

No 8-bit addressing

ANALYSIS

Analysis provides two pages: Real Time and History. Both pages display traffic in a split screen format (DCE/DTE).

The Real Time page displays traffic from both sides of the line as it is acquired. The data scrolls as traffic is acquired.

History displays traffic that has been acquired and put in a buffer. You can move back and forth through the traffic in the buffer to display specific parts of it.

The display format and function keys are the same for both pages, as shown in Figure 4.2. The page components are described on the following pages.

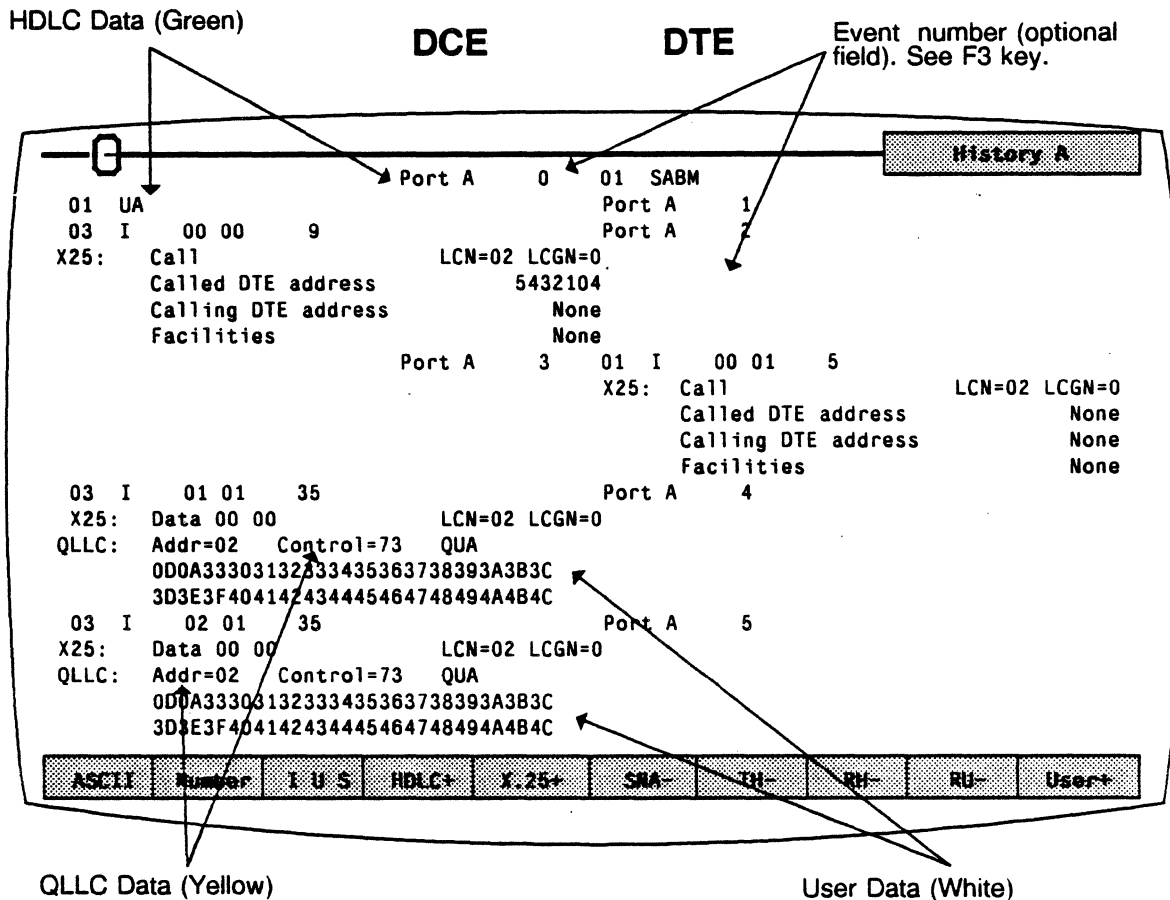


Figure 4.2: Analysis History Page with Sample QLLC Traffic

DCE/DTE

Frames received from the DCE are displayed on the left half of the screen. Frames received from the DTE are displayed on the right half of the screen.

Baud Rate Changes

The interpretation of a baud rate change event is as shown below (example: the new baud rate is 9600)

New Baud Rate	9600
----------------------	-------------

Colors

Colors distinguish the different levels of the display:

- Green = Frame level (HDLC)
- Yellow = X.25 and QLLC
- Blue = SNA
- White = User data
- Red = Errors

In addition, the optional field selected using **F2** is displayed in green or white, depending on the event type.

Interface Lead Transitions

Interface lead transitions are shown as an up arrow character (↑) if the specified lead made a transition from low to high, or a down arrow character (↓) if the lead made a transition from high to low. Note that all transitions for a given event are shown on one line. The leads are:

DCE Leads

CTS
DSR
DCD
SDCD
RI

DTE Leads

RTS
DTR

Function Keys

The function keys control how the traffic is interpreted and displayed. These functions are available for both the History and Real Time pages.

Note

When the Qualifier bit is set, the user data portion of a data packet is interpreted as QLLC (see Figure 4.5 on page 4-13). If the Qualifier bit is not set, the user data portion of a data packet is interpreted as SNA (see Chapter 6).

The QLLC Analysis function keys are described on the following pages.

F1: Code

F1 determines the format of the user data display. This is the data which does not belong to a protocol specific format. Each time you press **F1**, the user data (in white) changes to the code indicated in the softkey strip. The options are:

- | | |
|---------------|--|
| ASCII | Each byte is displayed as an ASCII character. Characters in the range 0 - 1F hex are shown as single character mnemonics. Characters above 80 hex are shown as '.'.(default) |
| EBCDIC | Each byte is displayed as an EBCDIC character. |
| HEX | Each byte is displayed as a pair of hex digits |
| HEXS | Each byte is displayed as a pair of hexadecimal digits, with a space between each pair. |

F2: Acquisition Information

F2 determines the acquisition information display format, which is displayed in green or white in the center of the screen, between the DCE and DTE sides (See Figure 4.2). The options are:

Number	Event number in decimal (default)
Flags	Number of flags preceding the frame, in decimal
Time	Event time stamp as hh:mm:ss ddd ddd
dTime	Displays the elapsed time between events
CRC	CRC value in hex, and OK if good CRC, BAD if bad CRC
None	No acquisition information is displayed

The port which received the frame (**Port A** or **Port B**) is also displayed as part of the acquisition information, unless the **None** option is selected.

F3: Event Types

F3 determines what types of events will be displayed on the Analysis page. The options are:

I	Information frames only
IU	Information and Unnumbered frames only
IUS	Information, Unnumbered, and Supervisory frames (default)
IUSL	All frames, plus lead transitions

Note

F3 affects the page *display* only. All events are captured, regardless of the **F3** selection (unless you are running a Triggering application which captures specific traffic or events).

F4: Frame Level

F4 determines how the frame level (HDLC) is interpreted and displayed. This information is displayed in green. The options are:

HDLC +	HDLC is displayed interpreted (default)
HDLC"	HDLC is displayed uninterpreted in the code selected in F1 (ASCII, HEX, HEXS, EBCDIC)
HDLC*	HDLC is displayed interpreted and uninterpreted in the code selected in F1
HDLC-	HDLC is acquired but not displayed

F5: X.25 Data

F5 determines how the X.25 data is interpreted and displayed. This information is displayed in yellow. The options are:

X.25 +	X.25 is displayed interpreted (default)
X.25"	X.25 is displayed uninterpreted in the code selected in F1 (ASCII, HEX, HEXS, EBCDIC)
X.25*	X.25 is displayed interpreted and uninterpreted in the code selected in F1
X.25-	X.25 is acquired but not displayed

F6: SNA Data

F6 determines how the SNA data is interpreted and displayed. The TH and RH components the SNA data information are displayed in blue. The RU component is displayed in white. The options are:

SNA +	SNA is displayed interpreted (default)
SNA"	SNA is displayed uninterpreted in the code selected in F1 (ASCII, HEX, HEXS, EBCDIC)
SNA*	SNA is displayed interpreted and uninterpreted in the code selected in F1
SNA-	SNA is acquired but not displayed

If the SNA data is not displayed (SNA-), the TH, RH and RU displays are also inhibited. When the SNA component is displayed (SNA +, SNA", SNA*), the TH, RH, and RU displays are controlled with **F7**, **F8** and **F9** respectively.

F7: TH Data

F7 determines how the Transmission Header (TH) data is interpreted and displayed. This information is displayed in bright blue. The options are:

- TH +** TH is displayed interpreted (default)
- TH"** TH is displayed uninterpreted in the code selected in **F1** (ASCII, HEX, HEXS, EBCDIC)
- TH*** TH is displayed interpreted and uninterpreted in the code selected in **F1**
- TH-** TH is acquired but not displayed

F8: RH Data

F8 determines how the Request/Response Header (RH) data is interpreted and displayed. This information is displayed in dim blue. The options are:

- RH +** RH is displayed interpreted (default)
- RH"** RH is displayed uninterpreted in the code selected in **F1** (ASCII, HEX, HEXS, EBCDIC)
- RH*** RH is displayed interpreted and uninterpreted in the code selected in **F1**
- RH-** RH is acquired but not displayed

F9: RU Data

F9 determines how the Request/Response Unit (RU) data is interpreted and displayed. This information is displayed in dim blue. The options are:

- RU +** RU is displayed interpreted (default)
- RU"** RU is displayed uninterpreted in the code selected in **F1** (ASCII, HEX, HEXS, EBCDIC)
- RU*** RU is displayed interpreted and uninterpreted in the code selected in **F1**
- RU-** RU is acquired but not displayed

F10: User Data

F10 determines if user data is displayed. It also controls the display of traffic in an uninterpreted (raw) mode. The options are:

- User +** User data is displayed (default)
- User-** User data is not displayed
- Raw** All traffic is displayed uninterpreted (raw) in the code selected in **F1**

QLLC ANALYSIS INTERPRETATION

This section identifies the components of the QLLC Analysis page display. Figure 4.3 shows a sample QLLC History page. The area in the box is described in detail in this section.

The first line data in the box is HDLC data, which is displayed in green. The second line in the box is the X.25 data with the QLLC component directly below it. The X.25 and QLLC components are displayed in yellow. The first line of interpreted QLLC data is preceded by the message **QLLC:**.

The remaining lines are the user data, which is displayed in white. The user data is shown in hex, since it is the code displayed in the softkey strip for the **F1** key.

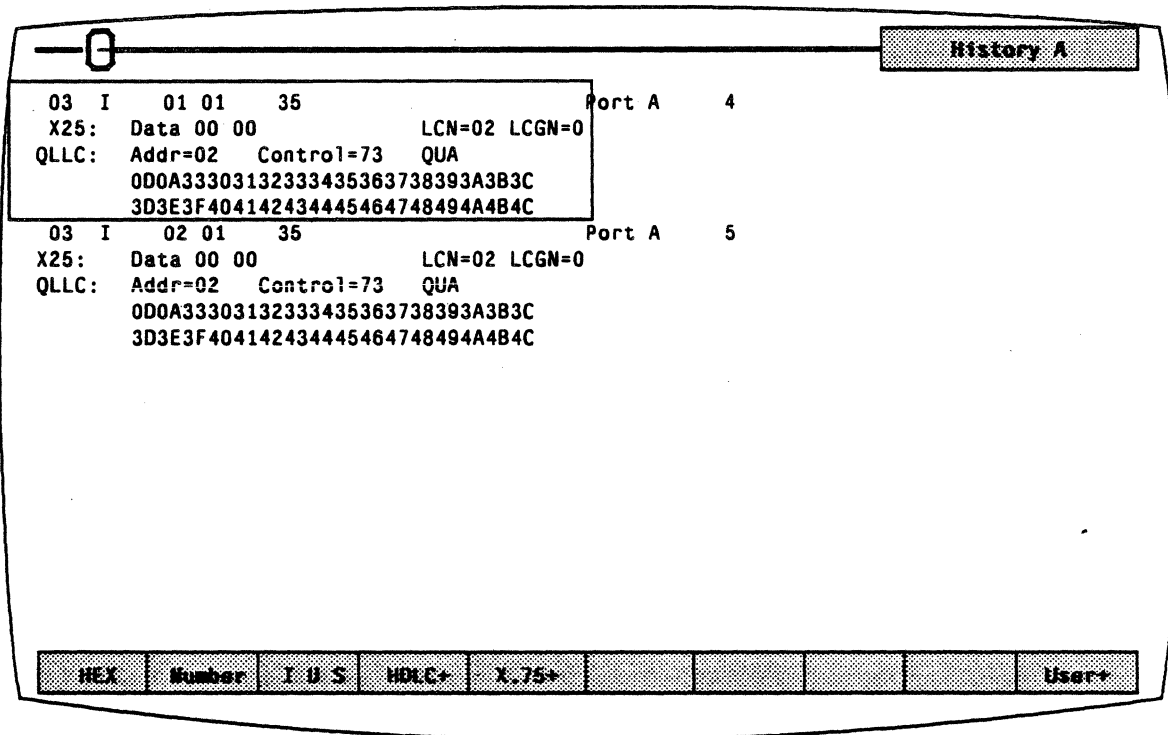


Figure 4.3: Analysis History Page with Sample QLLC Traffic

HDLC

Figure 4.4 is a detail of the HDLC component from Figure 4.3. Each HDLC field in this sample display is described below.

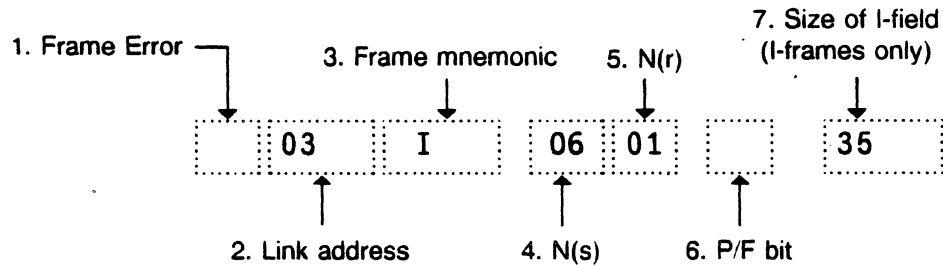


Figure 4.4: Sample HDLC Interpretation

1. Frame Errors

A single letter indicates if a frame error has occurred.

A	Aborted frame received
B	Frame with bad FCS received
(blank)	No frame error

2. Link Address

This field displays the link address.

3. Frame Mnemonic

Field 3 indicates the type of frame received, using the following mnemonics:

Information frame:

I I-Frame

Supervisory frames:

RR	Receiver Ready
RNR	Receiver Not Ready
REJ	Reject

Unnumbered frames:

BCN	Beacon
CFGR	Configure
DISC	Disconnect
DM	Disconnect Mode
FRMR	Frame Reject
RD	Request Disconnect
RIM	Request Initialization Mode
SABM	Set Asynchronous Balanced Mode
SARM	Set Asynchronous Response Mode
SIM	Set Initialization Mode
SNRM	Set Normal Response Mode
TEST	Test Frame
UA	Unnumbered Acknowledge
UI	Unnumbered Information
UP	Unnumbered Poll
XID	Exchange ID
(hex value)	Unknown unnumbered frame type

4. N(s)

This field displays the N(s) count.

5. N(r)

This field displays the N(r) count.

6. Poll/Final Bit

This field displays the Poll/Final bit setting.

P	Poll/final bit is set
(blank)	Poll/final bit not set

7. Size of I-Field.

This field displays the size of I-field.

(decimal value)	Size in octets
(blank)	0

QLLC Packet

Figure 4.5 is a detail of the QLLC component from Figure 4.3, which is a data packet. Each QLLC field in this sample display is described below.

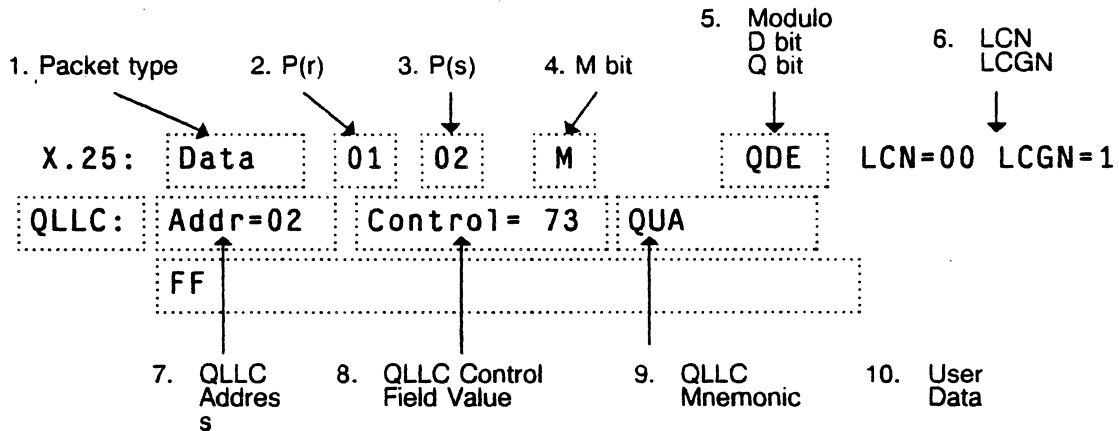


Figure 4.5: QLLC Data Packet Analysis Display

1. Packet Type Mnemonic

Data Packet:
Data

Unnumbered Packets:
Call
Call Connected
Clear
Clear Confirm
Diagnostic
Interrupt
Interrupt Confirm
Reset
Reset Confirm
Restart
Restart Confirm

Supervisory Packets:
REJ
RNR
RR

2. P(r)

This field displays the P(r) count.

3. P(s)

This field displays the P(s) count.

4. M Bit

This field displays the More bit (M bit) setting.

M	M bit is set
(blank)	M bit is not set

5. Modulo, D bit, Q bit

This field indicates the modulo, and the setting of the Delivery bit (D bit), and the Qualifier (Q) bit.

(blank)	Modulo 8
E	Modulo 128
D	Delivery bit (D bit) set
Q	Qualifier bit (Q bit) set

6. LCN, LCGN

This field displays the Logical Channel Number (LCN) and the Logical Channel Group Number (LCGN).

7. QLLC Address Field

This field displays the QLLC address.

8. QLLC Control Field value

This field displays the value of the QLLC control field. These values and their mnemonics are listed in Figure 4.6.

9. QLLC Mnemonic

This field displays the QLLC control field mnemonic. Valid mnemonics and control field values are shown in Figure 4.6 below.

Control Field Value	Control Field Mnemonic
1F	QDM
53	QDISC/QRD
73	QUA
93	QSM
97	QFRMR
BF	QXID
F1	QRR
F3	QTEST
Any other	Unknown

Figure 4.6: QLLC Control Field Mnemonics

10. User Data

This displays uninterpreted user data, packet type, or message. A line of user data, or the Facilities, wrap around to the next line if it is longer than 32 bytes.

CHAPTER FIVE:
PSH MONITORING

CHAPTER FIVE: PSH MONITORING

Introduction

Monitoring allows you to passively monitor the traffic on a data line without affecting the traffic. By doing this, you can interpret captured traffic and troubleshoot the line. This section focuses on the protocol-specific details of PSH Analysis. For a general description of Analysis, refer to Chapter 1.

This section assumes that you know how to select Monitoring for a port with PSH as the protocol. If you do not know how to do this, refer to the *Chameleon 32 User's Guide, Chapter 3: Using the Chameleon 32*.

Monitor Setup Menu

When you select PSH as your Monitoring protocol, you are prompted for several configurable parameters as shown in Figure 5.1. Each of these parameters is described on the next page.

The screenshot shows a terminal window titled "Port x Monitor Setup" with a "Configuration" label in the top right corner. A box in the top right says "Press 60 to Accept". The main area contains the following settings:

- Protocol : PSH
- Link Layer : HDLC (with a left-pointing arrow)
- Encoding : NRZ
- Modulo : 8
- Extended Addr : No

At the bottom, there is a horizontal menu bar with several buttons. The first button is labeled "HDLC" and is highlighted. The last button is labeled "Exit".

Figure 5.1: PSH Monitor Setup Parameters

Link Layer

Link Layer specifies the link layer protocol to use. There is only one option, HDLC.

Encoding

Encoding is a level 1 (physical) parameter that determines how the Chameleon 32 interprets the electrical signal to distinguish between binary 1 and 0. The options are:

NRZ Non Return to Zero. In NRZ encoding, a 1 is represented by a high level, and a 0 is represented by a low level.

NRZI Non Return to Zero Inverted. In NRZI encoding, a 1 is represented by no change in level, and a 0 is represented by a change in level.

Modulo

Modulo determines the frame numbering sequence that will be used to keep track of the frames that are transmitted and received. The options are:

Modulo 8 Frames numbered from 0 - 7

Modulo 128 Frames numbered from 0 - 127

Extended Addressing

Extended Addressing determines whether 8-bit addressing or 16-bit (extended) addressing is being used for transmission. The options are:

Yes Extended (16-bit) addressing

No 8-bit addressing

ANALYSIS

Analysis provides two pages: Real Time and History. Both pages display traffic in a split screen format (DCE/DTE).

The Real Time page displays traffic from both sides of the line as it is acquired. The data scrolls as traffic is acquired.

History displays traffic that has been acquired and put in a buffer. You can move back and forth through the traffic in the buffer to display specific parts of it.

The display format and function keys are the same for both pages, as shown in Figure 5.2. The page components are described on the following pages.

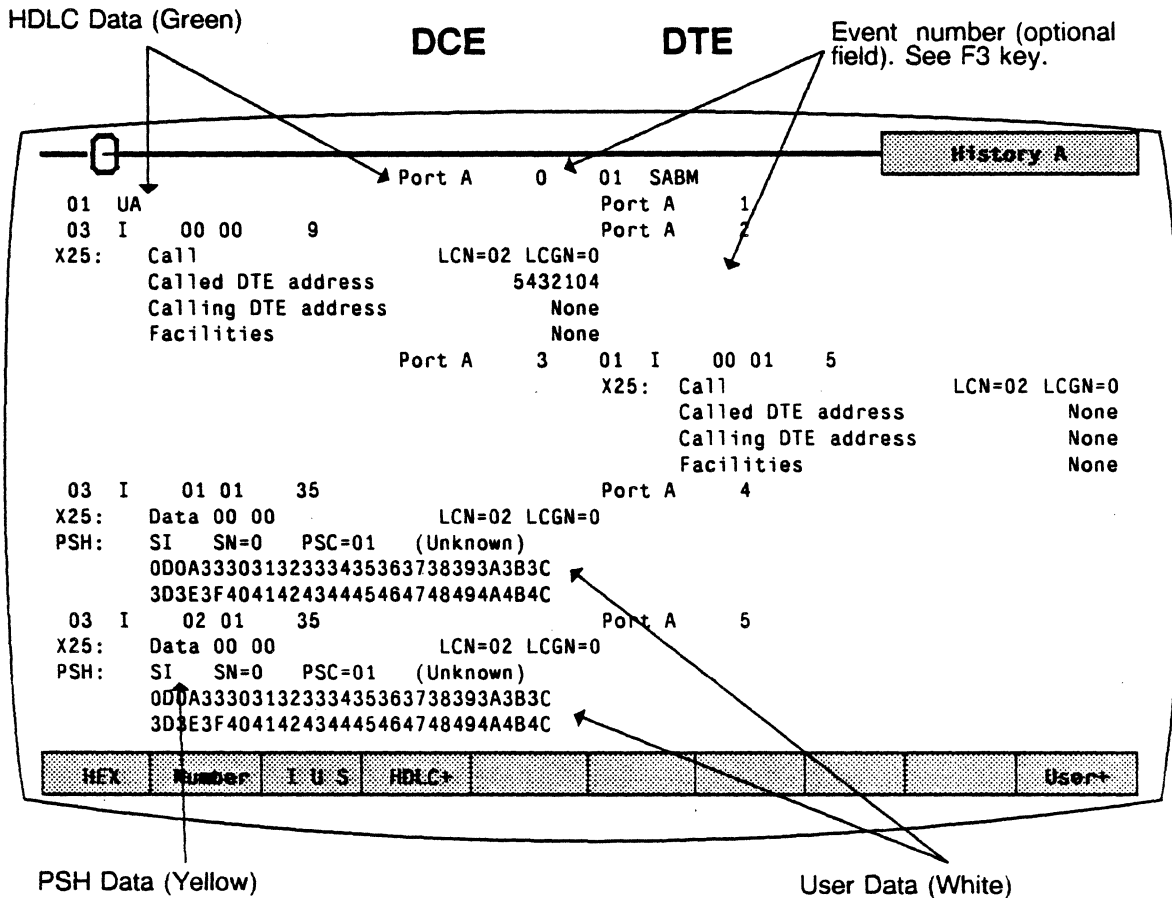


Figure 5.2: Analysis History Page with Sample PSH Traffic

Function Keys

The function keys control how the traffic is interpreted and displayed. These functions are available for both the History and Real Time pages. The PSH Analysis function keys are described below.

F1: Code

F1 determines the format of the user data display. This is the data which does not belong to a protocol specific format. Each time you press **F1**, the user data (in white) changes to the code indicated in the softkey strip. The options are:

- | | |
|---------------|--|
| ASCII | Each byte is displayed as an ASCII character. Characters in the range 0 - 1F hex are shown as single character mnemonics. Characters above 80 hex are shown as '.'.(default) |
| EBCDIC | Each byte is displayed as an EBCDIC character. |
| HEX | Each byte is displayed as a pair of hex digits |
| HEXS | Each byte is displayed as a pair of hexadecimal digits, with a space between each pair. |

F2: Acquisition Information

F2 determines the acquisition information display format, which is displayed in green or white in the center of the screen, between the DCE and DTE sides (See Figure 5.2). The options are:

- | | |
|---------------|--|
| Number | Event number in decimal (default) |
| Flags | Number of flags preceding the frame, in decimal |
| Time | Event time stamp as hh:mm:ss ddd ddd |
| dTime | Displays the elapsed time between events |
| CRC | CRC value in hex, and OK if good CRC, BAD if bad CRC |
| None | No acquisition information is displayed |

The port which received the frame (**Port A** or **Port B**) is also displayed as part of the acquisition information, unless the **None** option is selected.

F3: Event Types

F3 determines what types of events will be displayed on the Analysis page. The options are:

I	Information frames only
IU	Information and Unnumbered frames only
IUS	Information, Unnumbered, and Supervisory frames (default)
IUSL	All frames, plus lead transitions

Note

F3 affects the page *display* only. All events are captured, regardless of the **F3** selection (unless you are running a Triggering application which captures specific traffic or events).

F4: Frame Level

F4 determines how the frame level (HDLC) is interpreted and displayed. The options are:

HDLC+	HDLC is displayed interpreted (default)
HDLC"	HDLC is displayed uninterpreted in the code selected in F1 (ASCII, HEX, HEXS, EBCDIC)
HDLC*	HDLC is displayed interpreted and uninterpreted in the code selected in F1
HDLC-	HDLC is acquired but not displayed

The frame level components include the information listed below. See page 5-8 for an example of HDLC interpretation.

- Frame address in hex
- Frame mnemonic
- N(r) and N(s) in hex
- Poll/Final bit
- Indication of bad CRC and aborted frames
- Size of I-field in decimal

F10: User Data

F10 determines if user data is displayed. It also controls the display of traffic in an uninterpreted (raw) mode. The options are:

User+	User data is displayed (default)
User-	User data is not displayed
Raw	All traffic (data, HDLC, PSH) is displayed uninterpreted (raw) in the code selected in F1

PSH ANALYSIS INTERPRETATION

This section identifies the components of the PSH Analysis page display. Figure 5.3 shows a sample PSH History page. The area in the box is described in detail in this section.

The first line data in the box is HDLC data, which is displayed in green. The second display line in the box is the X.25 data with the PSH component directly under it. The X.25/PSH data is displayed in yellow. The first line of interpreted PSH data is preceded by the message **PSH:**.

The remaining lines are the user data, which is displayed in white. The user data is shown in hex, since it is the code displayed in the softkey strip for the **F1** key.

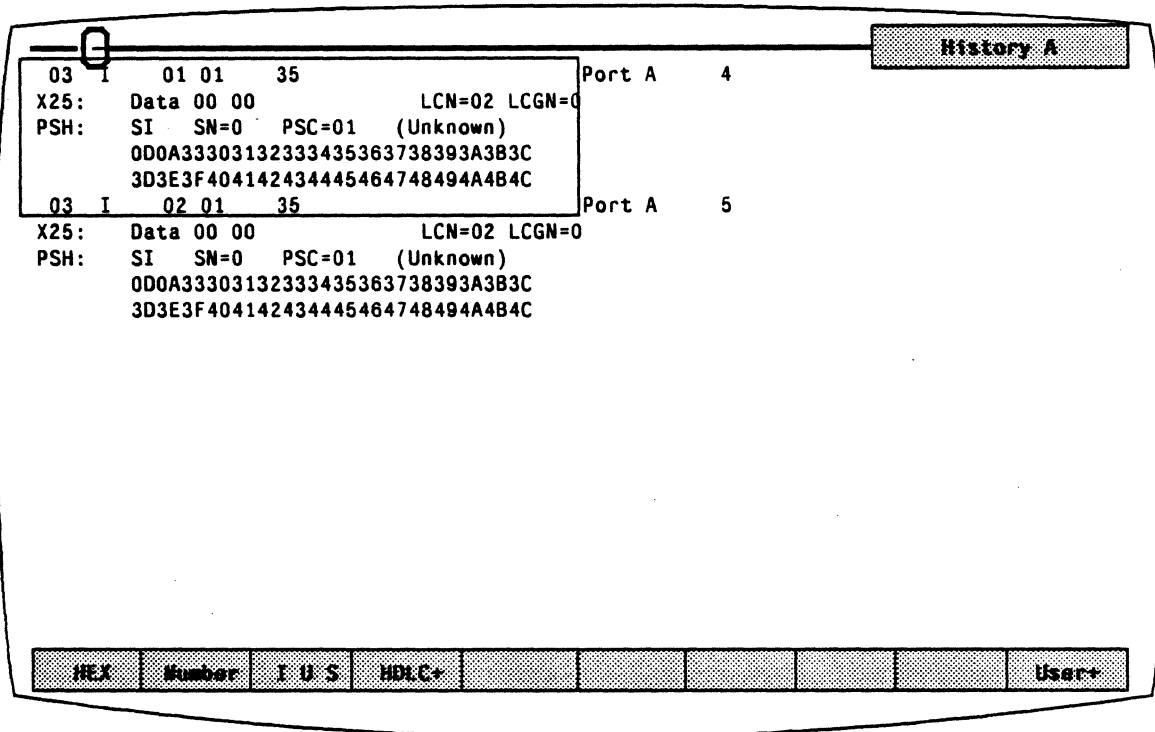


Figure 5.3: Analysis History Page with Sample PSH Traffic

HDLC

Figure 5.4 is a detail of the HDLC component from Figure 5.3. Each HDLC field in this sample display is described below.

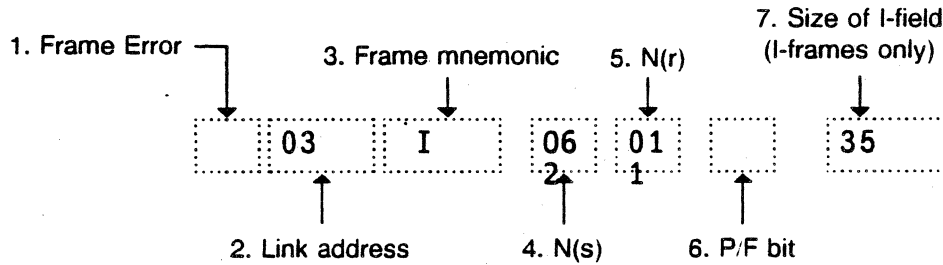


Figure 5.4: Sample HDLC Interpretation

1. Frame Errors

A single letter indicates if a frame error has occurred.

A	Aborted frame received
B	Frame with bad FCS received
(blank)	No frame error

2. Link Address

This field displays the link address.

3. Frame Mnemonic

Field 3 indicates the type of frame received, using the following mnemonics:

Information frame:

I I-Frame

Supervisory frames:

RR Receiver Ready
RNR Receiver Not Ready
REJ Reject

Unnumbered frames:

BCN	Beacon
CFGR	Configure
DISC	Disconnect
DM	Disconnect Mode
FRMR	Frame Reject
RD	Request Disconnect
RIM	Request Initialization Mode
SABM	Set Asynchronous Balanced Mode
SARM	Set Asynchronous Response Mode
SIM	Set Initialization Mode
SNRM	Set Normal Response Mode
TEST	Test Frame
UA	Unnumbered Acknowledge
UI	Unnumbered Information
UP	Unnumbered Poll
XID	Exchange ID
(hex value)	Unknown unnumbered frame type

4. N(s)

This field displays the N(s) count.

5. N(r)

This field displays the N(r) count.

6. Poll/Final Bit

This field displays the Poll/Final bit setting.

P	Poll/final bit is set
(blank)	Poll/final bit not set

7. Size of I-Field.

This field displays the size of I-field.

(decimal value)	Size in octets
(blank)	0

PSH Packet

Figure 5.5 is a detail of the PSH component from Figure 5.3, which is a data packet. Each PSH field in this sample display is described below.

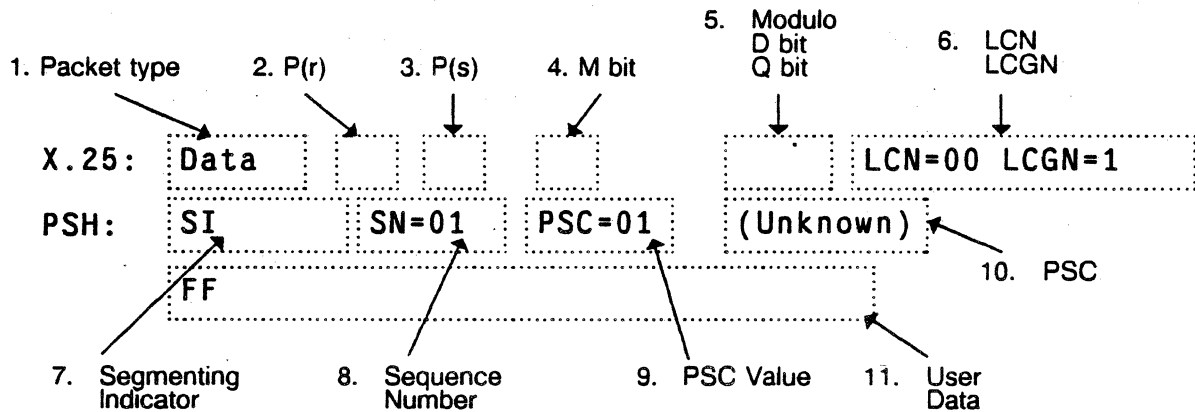


Figure 5.5: PSH Data Packet Analysis Display

1. Packet Type Mnemonic

Data Packet:
Data

Unnumbered Packets:
Call
Call Connected
Clear
Clear Confirm
Diagnostic
Interrupt
Interrupt Confirm
Reset
Reset Confirm
Restart
Restart Confirm

Supervisory Packets:
REJ
RNR
RR

2. P(r)

This field displays the P(r) count.

3. P(s)

This field displays the P(s) count.

4. M Bit

This field displays the More bit (M bit) setting.

M	M bit is set
(blank)	M bit is not set

5. Modulo, D bit, Q bit

This field indicates the modulo, and the setting of the Delivery bit (D bit), and the Qualifier (Q) bit.

(blank)	Modulo 8
E	Modulo 128
D	Delivery bit (D bit) set
Q	Qualifier bit (Q bit) set

6. LCN, LCGN

This field displays the Logical Channel Number (LCN) and the Logical Channel Group Number (LCGN).

7. Segmenting Indicator

8. Sequence Number (SN)

This field displays the data packet Sequence Number (SN) in hex. If the Packet Sequence Indicator (PSI) bit is not set, *None* is displayed.

9. PSC Value

This field displays the Physical Services Command (PSC) value in hex. If the Control Present Indicator (CPI) is not set, *None* is displayed. The PSC Values and commands are listed in Figure 5.6.

10. PSC

The field displays the Physical Services Command, if present. Commands and PSC values are listed in Figure 5.6.

PSC Value	PSC Command
01	Unknown
02	PSDISC
04	PSXID
06	PSTEST
08	PSCONTACT
Any other	Unknown

Figure 5.6: PSC Commands

11. User Data

This field displays uninterpreted user data, packet type, or message. A line of user data, or the Facilities, will wrap around to the next line if it is longer than 32 bytes.

CHAPTER SIX:
SNA MONITORING

CHAPTER SIX: SNA MONITORING

Introduction

Monitoring allows you to passively monitor the traffic on a data line without affecting the traffic. By doing this, you can interpret captured traffic and troubleshoot the line. This section describes SNA Analysis and Statistics, by focusing on the protocol-specific details of these applications. For a general description of the applications, refer to Chapter 1.

This section assumes that you know how to select Monitoring for a port with SNA as the protocol. If you do not know how to do this, refer to the *Chameleon 32 User's Guide, Volume 1*.

Monitor Setup Menu

When you select SNA as your Monitoring protocol, you are prompted for several configurable parameters, as shown in Figure 6.1 below. Each of these parameters is explained on the following page.

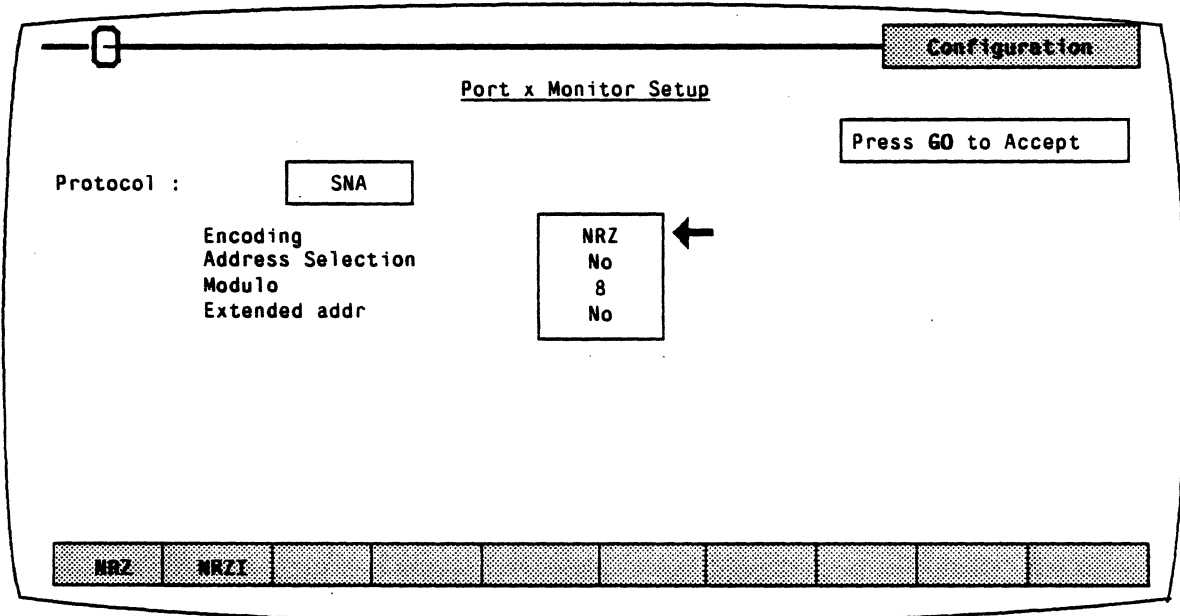


Figure 6.1: SNA Monitor Setup Menu

Encoding

Encoding is a level 1 (physical) parameter that determines how the Chameleon 32 interprets the electrical signal to distinguish between binary 1 and 0. The options are:

- NRZ** Non Return to Zero. In NRZ encoding, a 1 is represented by a high level, and a 0 is represented by a low level.
- NRZI** Non Return to Zero Inverted. In NRZI encoding, a 1 is represented by no change in level, and a 0 is represented by a change in level.

Address Selection

Address Selection determines whether the Chameleon 32 monitors all traffic on the line, or monitors only traffic to and from a specific address. The options are:

- No** Analyzes all traffic on the line, regardless of address.
- Yes** Analyzes traffic with the specified address. If you select this option, you are prompted for a hex address (00-FF). After entering an address, press **RETURN** to continue.

Modulo

Modulo determines the frames numbering sequence that will be used to keep track of the frames that are transmitted and received. The options are:

- Modulo 8** Frames numbered from 0 - 7
- Modulo 128** Frames numbered from 0 - 127

Extended Addressing

Extended Addressing determines whether 8-bit addressing or 16-bit (extended) addressing is being used for transmission. The options are:

- Yes** Extended (16-bit) addressing
- No** 8-bit addressing

Analysis

Analysis provides two pages: Real Time and History. Both pages display traffic in a split screen format (DCE/DTE).

The Real Time page displays traffic from both sides of the line as it is acquired. The data scrolls as traffic is acquired.

History displays traffic that has been acquired and put in a buffer. You can move back and forth through the traffic in the buffer to display specific parts of it.

The display format and function keys are the same for both pages, as shown in Figure 6.2 below.

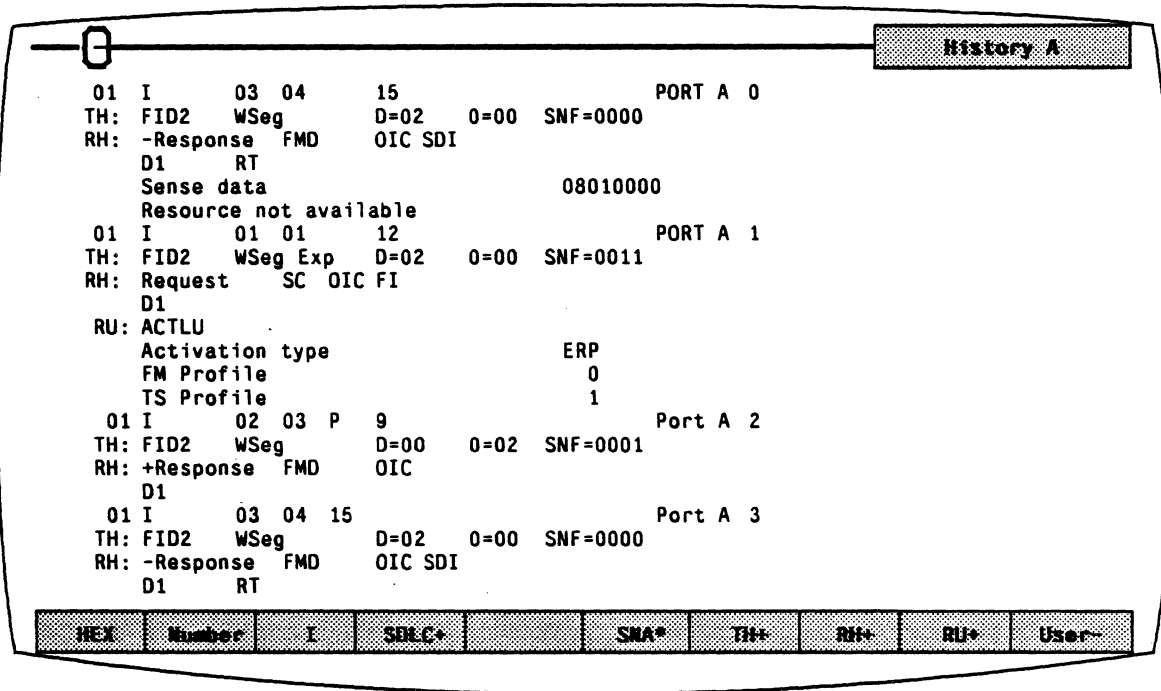


Figure 6.2: Sample SNA Analysis Page

DCE/DTE

Frames transmitted by the DCE are displayed on the left half of the screen. Frames transmitted by the DTE are displayed on the right half of the screen.

Baud Rate Changes

A baud rate change is as shown in the displays, as follows:

New Baud Rate	9600
---------------	------

Colors

Colors distinguish the different levels of the display:

- Green = Frame level (SDLC)
- Blue = SNA
- White = User data
- Red = Errors

Interface Lead Transitions

Interface lead transitions are shown as an up arrow character (↑) if the specified lead made a transition from low to high, or a down arrow character (↓) if the lead made a transition from high to low. All transitions for a given event are shown on one line. The leads are:

<u>DCE Leads</u>	<u>DTE Leads</u>
CTS	RTS
DSR	DTR
DCD	
SDCD	
RI	

Function Keys

The function keys control how the traffic is interpreted and displayed. These functions are available for both the History and Real Time pages. The SNA Analysis function keys are described below.

F1: Code

F1 determines the format of the user data display. This is the data which does not belong to a protocol specific format. Each time you press **F1**, the user data (in white) changes to the code indicated in the softkey strip. The options are:

- | | |
|---------------|--|
| ASCII | Each byte is displayed as an ASCII character. Characters in the range 0 - 1F hex are shown as single character mnemonics. Characters above 80 hex are shown as '.'.(default) |
| EBCDIC | Each byte is displayed as an EBCDIC character. |
| HEX | Each byte is displayed as a pair of hex digits |
| HEXS | Each byte is displayed as a pair of hexadecimal digits, with a space between each pair. |

F2: Acquisition Information

F2 determines the acquisition information display format, which is displayed in green or white in the center of the screen, between the DCE and DTE sides (See Figure 3.1). The options are:

- | | |
|---------------|--|
| Number | Event number in decimal (default) |
| Flags | Number of flags preceding the frame, in decimal |
| Time | Event time stamp as hh:mm:ss |
| dTime | Displays the elapsed time between events |
| CRC | CRC value in hex, and OK if CRC is good or BAD if CRC is bad |
| None | No acquisition information is displayed |

The port receiving the packet (**Port A** or **Port B**) is displayed as part of the acquisition information unless the **None** option is selected.

F3: Event Types

F3 determines what types of events will be displayed on the Analysis page. The options are:

- I** Information frames only
- IU** Information and Unnumbered frames only
- IUS** Information, Unnumbered, and Supervisory frames (default)
- IUSL** All frames, plus lead transitions

Note

F3 affects the page *display* only. All events are captured, regardless of the **F3** selection (unless you are running a Triggering application which captures specific traffic or events).

F4: SDLC

F4 determines how the frame level (SDLC) is interpreted and displayed. The options are:

- SDLC-** SDLC is acquired, but not displayed
- SDLC +** SDLC is displayed interpreted
- SDLC"** SDLC is displayed raw
- SDLC*** SDLC is displayed interpreted and raw

F6: SNA

F6 determines how the session level (SNA) is interpreted and displayed. The options are:

- SNA-** SNA is acquired, but not displayed
- SNA +** SNA is displayed interpreted
- SNA"** SNA is displayed raw
- SNA*** SNA is displayed interpreted and raw

F7: TH

F7 determines how the Transmission Header (TH) is interpreted and displayed. The options are:

- TH- TH is acquired, but not displayed
- TH+ TH is displayed interpreted
- TH" TH is displayed raw
- TH* TH is displayed interpreted and raw

F8: RH

F8 determines how the Request/Response Header (RH) is interpreted and displayed. The RH follows the TH in the information field, and is 3 bytes in length. It functions as the header for the Request/Response Unit (RU). The options are:

- RH- RH is acquired but not displayed
- RH+ RH is displayed interpreted
- RH" RH is displayed raw
- RH* RH is displayed interpreted and raw

F9: RU

F9 determines how the Request/Response Unit (RU) is interpreted and displayed. The RU contains the user data or network control information that is being transmitted between LUs. The sofkey options are:

- RU- RU is acquired, but not displayed
- RU+ RU is displayed interpreted
- RU" RU is displayed raw
- RU* RU is displayed interpreted and raw

F10: User Data

F10 determines if user data is displayed. It also displays the traffic in a raw mode (uninterpreted). The options are:

User + User data is displayed

User- User data is not displayed

Raw All traffic (data, SDLC, SNA) is displayed uninterpreted (raw) in the code selected in **F1**

SNA Display

Figure 6.3 below shows the SNA Analysis display.

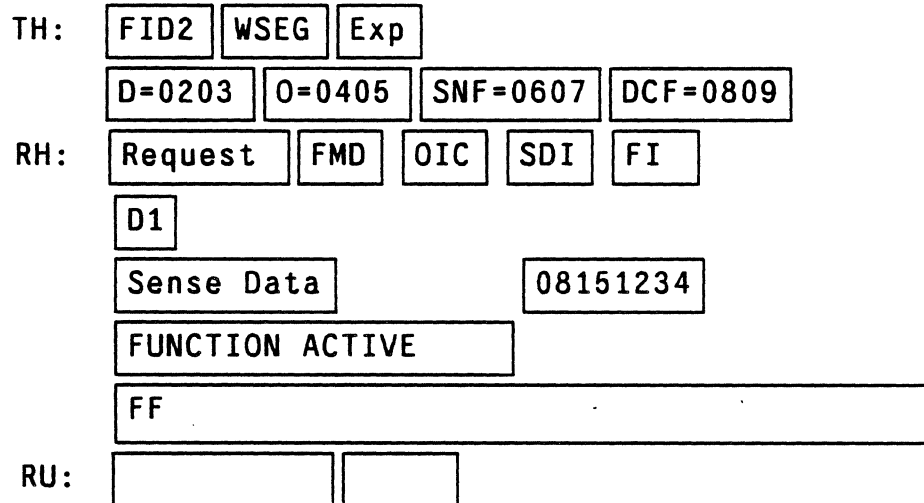


Figure 6.3: Sample SNA Traffic

SDLC Display

Figure 6.4 below shows the fields of the SDLC Analysis display.

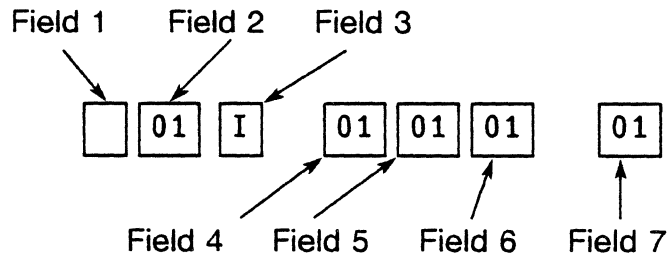


Figure 6.4: SDLC Components Analysis Display

- Field 1: Frame Abort/CRC Errors
 - A Frame abort
 - B Bad FCS (Frame Sequence Check)
 - blank Frame is OK
- Field 2: Address in hexadecimal

Field 3: Frame type, as follows:

I Information Frame
U Unnumbered frame and mnemonic:
 UI Unnumbered Information
 RIM Request Initialization Mode
 SIM Set Initialization Mode
 TEST Test frame
 SNRM Set Normal Response Mode
 DM Disconnect Mode
 DISC Disconnect
 UP Unnumbered Poll
 UA Unnumbered Acknowledge
 FRMR Frame Reject
 CFGR Configure
 RD Request Disconnect
 XID Exchange Identification
S Supervisory frame and frame mnemonic:
 RR Receiver Ready
 RNR Receiver Non Ready
 REJ Reject

Field 4: N(S) count (I-Frames only)

Field 5: N(R) count (I and S frames only)

Field 6: Poll/ Final Bit
F Final bit set (DTE)
P Poll bit set (DCE)
blank P/F bit not set

Field 7: Length of the I-Field in decimal if > 0 (all frame types)

TH Display

The fields of the TH display depend on the type of Transmission Header that was transmitted. The type of TH is referred to by Format Identifier (FID). There are six FID types, as shown in Figure 6.5 below:

Bit				FID Type	Length (Bytes)
0	1	2	3		
0	0	0	0	FID 0	10
0	0	0	1	FID 1	10
0	0	1	0	FID 2	6
0	0	1	1	FID 3	2
0	1	0	0	FID 4	26
1	1	1	1	FID F	26

Figure 6.5: TH Types

The TH Option Mnemonics are shown in Figure 6.6 below.

Mnemonic	Description	Mnemonic	Description
IERN	Initial Explicit Route Number	WR-	(Decrement) Window Reply
ERN	Explicit Route Number	WR +	(Increment) Window Reply
VRN	Virtual Route Number	VRSSN	VR Send Sequence Number
Pri	Priority (Lo, Med, Hi)	RWI	Reset Window Indicator
TG	TG Sweep Indicator	PRQ	VR Pacing Response
ERVR	ER and VR Support Indicator	PRS	VR Pacing Request
NSNS	NonSequenced NonSupervisory VR Sequencing	TGSNF	Transmission Group Sequence Number Field
VRPC	VR Pacing Count Indicator	OSAF	Origin Subarea Field
W-	Decrement Window Size	DSAF	Destination Subarea Field
W +	Increment Window Size	Fmt	Command Format
FIFO	TG FIFO Not Required	Type	Command Type
NPri	Network Priority		

Figure 6.6: TH Option Mnemonics

RH Display

Figure 6.7 below shows the fields of the Request/Response Header (RH) component of the SNA display. The RH contains information about the Request/Response Unit (RU).

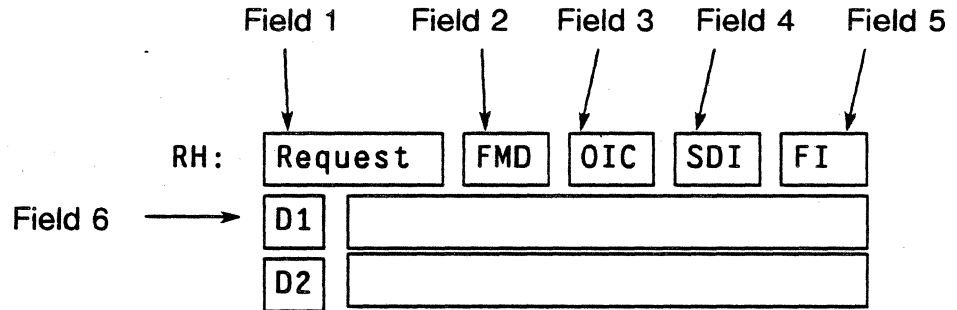


Figure 6.7: RH Component of the SNA Analysis Display

The following information may be contained in the fields shown in Figure 6.7:

- Field 1: Message type:**
 Request RU contains a request
 + Response RU contains a positive response
 -Response RU contains a negative response
- Field 2: RU Category:**
 FMD Function Management Data
 NC Network Control
 DFC Data Flow Control
 SC Session Control
- Field 3: Begin/End Chain Indicator (shows which section of the chain has been captured):**
 FIC First In Chain
 MIC Middle In Chain
 LIC Last In Chain
 OIC Only In Chain
- Field 4: Sense Data Indicator (SDI)**
 SDI Sense Data is included
 blank Sense Data not included

Field 5: Format Indicator (FI) bit setting
 FI Format Indicator bit is set
 blank Format Indicator bit is not set

Field 6 Other RH Fields:

If mnemonic appears, the relevant bit is set. If mnemonic does not appear, the bit is not set. (See Figure 6.8 below for possible mnemonics.)

RH Field	Description
D1	Definite Response 1
D2	Definite Response 2
RT	Exception Response Indicator
QR	Queued Response
PI	Pacing Indicator
BB	Begin Bracket
EB	End Bracket
CD	Change Direction
CS	Code Selector
ED	Enciphered Data
PD	Padded Data
CB	Conditioned End Bracket Indicator

Figure 6.8: RH Field Mnemonics

RU Display

Figure 6.9 below shows the RU component of the SNA display.

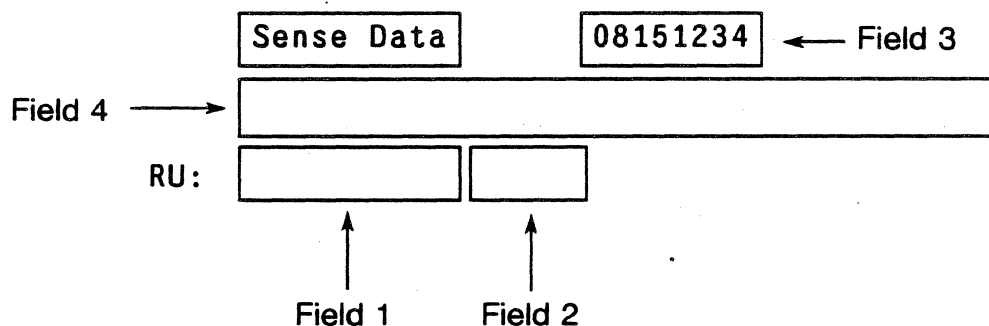


Figure 6.9: RU Component of the SNA Analysis Display

The following information may be contained in the fields shown in Figure 6.9:

Field 1: RU name (for example BIND)

Field 2: Value (for example 31)

If there is Sense Data, the following fields will be displayed:

Field 3: Major Code, as follows:

First two bytes are the major code:

08	Request Reject
10	Request Error
20	State Error
40	RH Error
80	Path Error

The next two bytes are the Modifier.

The last four bytes are user sense data.

Field 4: Meaning of the Major Code + Modifier.

SNA Statistics

SNA Statistics displays and prints statistical information about the traffic on the line. You have the ability to activate six pages that show the following statistical information:

- SDLC Line SDLC statistics for all PUs
- SNA Session SNA statistics for all PUs
- SDLC PU SDLC statistics for one PU
- Session PU SNA statistics for one PU
- SNA LU SNA statistics for one LU
- SNA LU Line SNA Statistics for all LUs

Activating SNA Statistics Pages

When you start the SNA Statistics, only the SDLC Line statistics page is activated. (If you do not know how to start the statistics application, refer to the *Chameleon 32 User's Guide, Volume 1*, for information.)

From the SDLC Line Statistics page, you can activate the other SNA Statistics pages as shown in Figure 6.10. The function keys that you use to activate and deactivate each page are also shown.

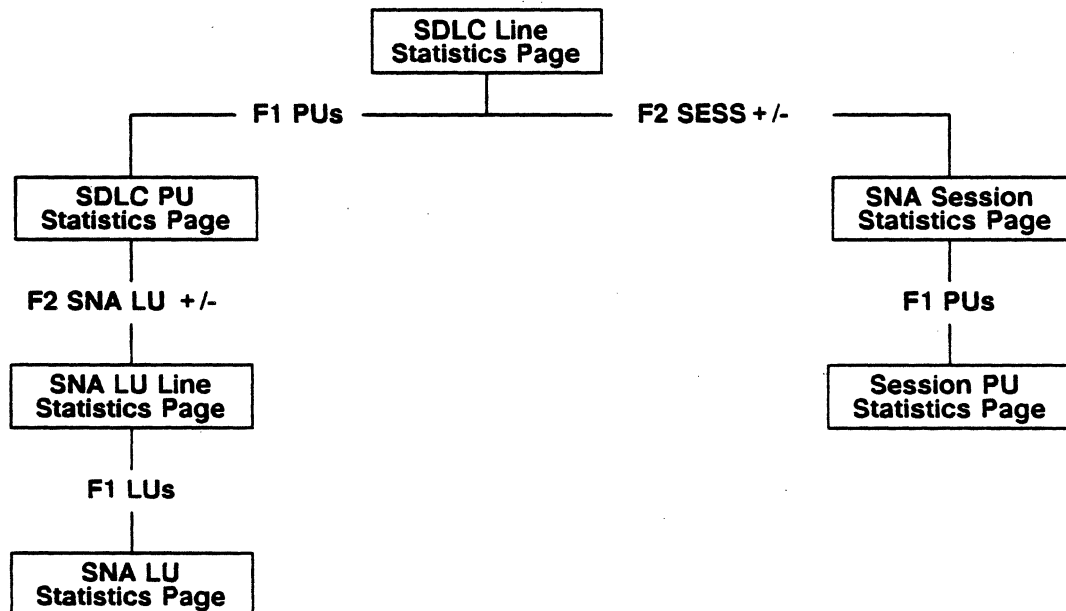


Figure 6.10: Activating SNA Statistics Pages

Each SNA Statistics page can only be activated and deactivated from other specific statistics pages. For example, a Session PU Statistics page can be activated only from an SNA Session page.

Function Keys

Each SNA Statistics page has its own set of function keys. Many of the function keys are the same for all pages. For example, the RESET function key resets all statistical values to zero in that page.

The function keys for all SNA Statistics pages are described on page 6-17.

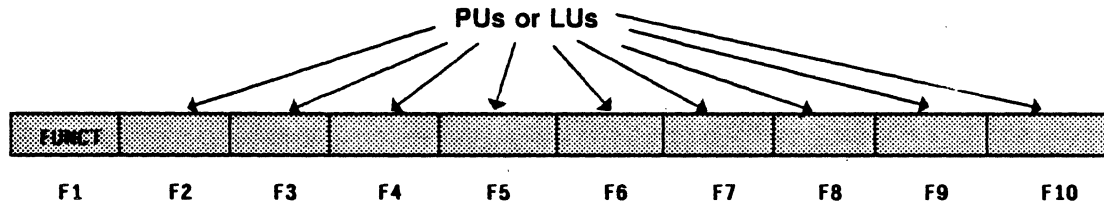
Page Display

The page displays for the SNA Statistics pages are described on the following pages:

SDLC Line	6-21
SDLC PU	6-21
SNA Session	6-24
Session PU	6-24
SNA LU	6-27
SNA LU Line	6-27

Function Keys for SNA Statistics

Each SNA Statistics page has two softkey strips. When an SNA Statistics page is activated, the first softkey strip that appears, will be similar to the figure shown below.



F1 FUNCT

F1 FUNCT appears in the first softkey strip for all SNA Statistics pages. When you press **F1 FUNCT**, it displays the second softkey strip for the active statistics page.

F2 - F10: PUs or LUs

In this first softkey strip, **F2-F10** display the Physical Units (PUs) or Logical Units (LUs) that are active. LUs are displayed for the SNA LU and SNA LU Line Statistics pages. PUs are displayed for the other four SNA Statistics pages.

The number of PUs or LUs that are shown in the softkey strip depends on the traffic you are monitoring. If there are more than eight PUs or LUs active, you can display the additional PUs or CUs by pressing **F9 More**.

This softkey strip enables you to activate a page which displays statistical information for a specific PU or LU. If the PU/LU has + next to it, a page has been activated for that PU or LU. If the PU/LU has a - next to it, a page is not currently activated for that PU or LU.

To activate or deactivate a PU or LU page, press the function key that corresponds to that PU or LU. This causes the softkey strip to change to + or - for that PU or LU, and a PU or LU page to appear or disappear from the screen.

The second softkey strip for the SNA pages, will be one of the following:

PU _s	SESS+	PRINT	RESET	DATE					
F1	F2	F3	F4	F5	F6	F7	F8	F9	F10

Second softkey strip for: SDLC Line Statistics
SNA Session Statistics
Session PU Statistics

LU _s	SNA LU-	PRINT	RESET	DATE					
F1	F2	F3	F4	F5	F6	F7	F8	F9	F10

Second softkey strip for: SNA LU Statistics
SNA LU Line Statistics
SDLC PU Statistics

F1 PUs/LUs

The **F1** key displays the softkey strip of active PUs or LUs, as described on the previous page.

F2: SNA LU +/-

F2 SNA LU activates and deactivates a page for SNA Logical Unit (LU) statistics. If **F2 SNA LU** has + next to it, a page has been activated. If **F2 SNA LU** has a - next to it, a page is not currently activated.

To activate or deactivate an SNA LU page, press **F2**. The softkey strip should then change to **SNA LU+** or **SNA LU-** and the page should appear or disappear from the screen.

F2: SESS +/-

F2 SESS activates and deactivates a page for SNA Session statistics. If **F2 SESS** has + next to it, a page has been activated. If **F2 SESS** has a - next to it, a page is not currently activated for SNA Session Statistics.

To activate or deactivate an SNA Session page, press **F2**. The softkey strip should then change to **SESS+** or **SESS-** and a page banner should appear or disappear from the screen.

F3: Print

F3 Print prints a statistical report that is very similar to the screen display format. If you have a printer connected to the Chameleon 32, you can print a report.

If you do not have a printer, pressing F3 has no effect. The report is not displayed on the Chameleon 32 screen. Refer to the *Chameleon 32 User's Guide, Chapter 6: Utilities*, for information about configuring the Chameleon to use your printer.

A sample SDLC Line statistics report is shown in Figure 6.11 on page 6-20.

F4: Reset

F4 Reset resets the statistics values on the active page to zero.

F5: Time/Date

F5 Time/Date enables you to display the time or the date at the top of the Statistics page. The timer display changes when the next event is received.

TEKELEC SNA LINE STATISTICS REPORT				
START TIME:	00:00:00:000 000			
LAST TIME:	00:00:00:000 000			
PUs ACTIVE :	XX	XX	XX	
NUMBER OF POLLS (RR):	0			
PRODUCTIVE POLLS (RR)	0			
NON-PRODUCTIVE POLLS (RR)	0			
DCE		DCE		DTE
I-FRAMES :	00000000		00000000	
FRAME RETRANSMISSIONS :	00000000		00000000	
RNRs	00000000		00000000	
CRC ERRORS :	00000000		00000000	
FRAME ABORTS :	00000000		00000000	
FRMR :	00000000		00000000	
SNRM :	00000000		00000000	
UI :	00000000		00000000	
BCN :	00000000		00000000	
CFGR :	00000000		00000000	
UP :	00000000		00000000	
TEST :	00000000		00000000	
	AVG	LAST	MAX	MIN
DCE PUI LEN :	00000	00000	00000	00000
DTE PIU LEN :	00000	00000	00000	00000
FRAME RESPONSE TIME :	0.000	0.000	0.000	0.000
MEAN POLL TIME :	0.000	0.000	0.000	0.000
POLL TO DATA TIME :	0.000	0.000	0.000	0.000
POLL FREQUENCY :	0.000	0.000	0.000	0.000
LINE UTILIZATION :	00 %			
DATA LINE UTILIZATION :	00 %			
CONTROL LINE UTILIZATION :	00 %			

Figure 6.11: SNA Line Statistics Report

SDLC Line Statistics Page
SDLC PU Statistics Page

The SDLC Line Statistics page is shown in Figure 6.12. The SDLC PU Statistics page has the same format, except that it does not include several of the SDLC Line fields, as described below.

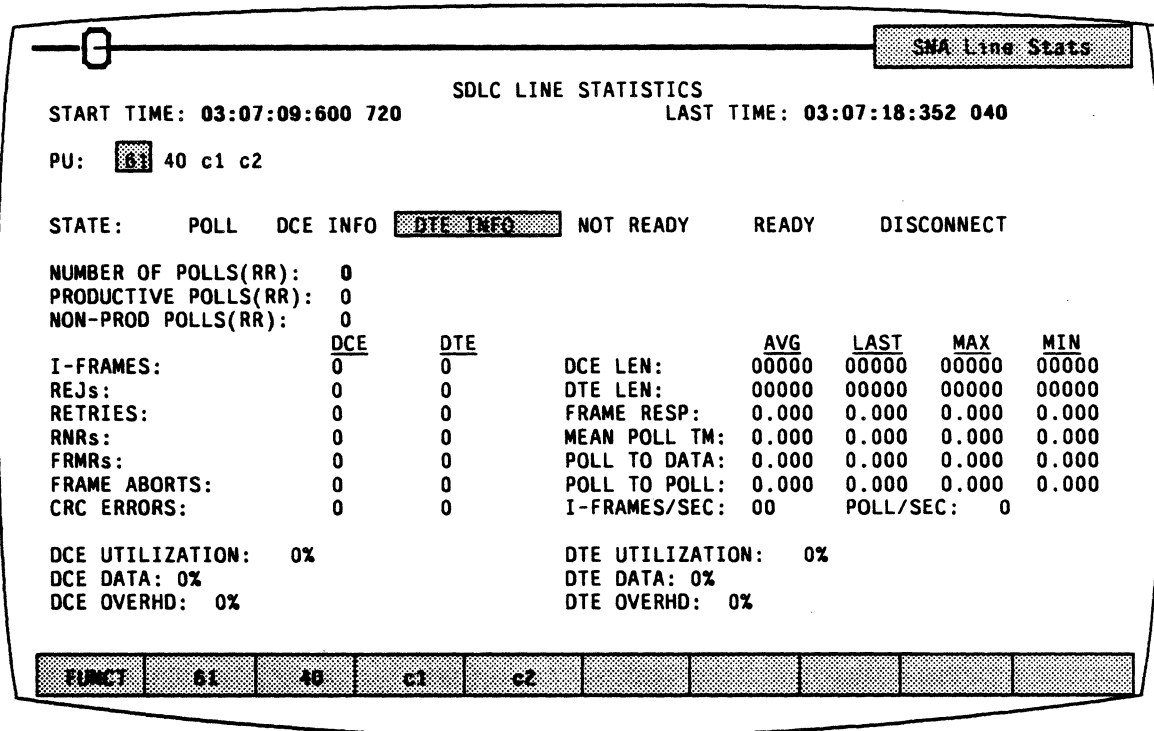


Figure 6.12: SDLC Line Statistics Page

Start Time Time of the end of the first event (frame).

Last Time Time of the end of the last event (frame).

PU In SDLC Line statistics, this field displays the addresses of the first 16 active PUs. In SDLC PU Statistics, it displays the address in hex of the PU selected for that page.

State	Last activity or current state of each PU. Possible states are: <ul style="list-style-type: none">• Poll• DCE Info• DTE Info• Not Ready• Ready• Disconnect
Number of Polls	Total number of polls (RRs) during session.
Productive Polls	Polls (RRs) that are responded to with an I-frame.
Non-productive Polls	Polls (RRs) that are not responded to with an I-frame.

For the following fields, the statistical information for the DCE and DTE is calculated and displayed separately.

I-Frames	Number of Information frames received.
REJs	Number of Reject frames received.
Retries	Number of re-transmitted frames received.
RNRs	Number of Receive Not Ready frames received.
FRMRs	Number of Frame Reject frames received.
Frame Aborts	SDLC Line Statistics only. Number of frame aborts received.
CRC Errors	SDLC Line Statistics only. Number of DCE/DTE Cyclic Redundancy Check errors received.

DCE/DTE Utilization	<p>Displays line utilization on all PUs. Determined by calculating the number of bytes that could have been transmitted at the measured baud rate, divided by the actual number of bytes that were transmitted.</p> <p>The bar graph shows the relative proportion of the time the line is utilized for the transfer of data and overhead (control) packets.</p>
DCE/DTE Data	<p>Percentage of time there is user data on the line. User data is the information field of an I-frame or Request/Response Unit (RU).</p>
DCE/DTE Overhead	<p>Percentage of time there is non-user data on the line.</p>

For the following parameters, the average, last, maximum, and minimum times in seconds are displayed.

DCE Length	<p>The average, last, maximum, and minimum length of a DCE I-frame.</p>
DTE Length	<p>The average, last, maximum, and minimum length of a DTE I-frame.</p>
Frame Response Time	<p>The time between the end of an I-frame and the end of the frame carrying the N(R) confirmation for that I-frame.</p>
Mean Poll Time	<p>One-half the time between polls to the same PU.</p>
Poll to Data Time	<p>The time from a poll to the completion of the I-frame responding to that poll.</p>
Poll to Poll Time	<p>SDLC Line Statistics only. The time from a poll to the next poll on any address.</p>

I-Frames/Sec	The total number of I-frames, divided by the total number of seconds, rounded down.
Polls/Sec	The total number of polls, divided by the total number of seconds, rounded down.

SNA Session Statistics Page
SNA Session PU Statistics Page

The format of the SNA Session and SNA Session PU Statistics pages is shown in Figure 6.13. Each field of the display is described below.

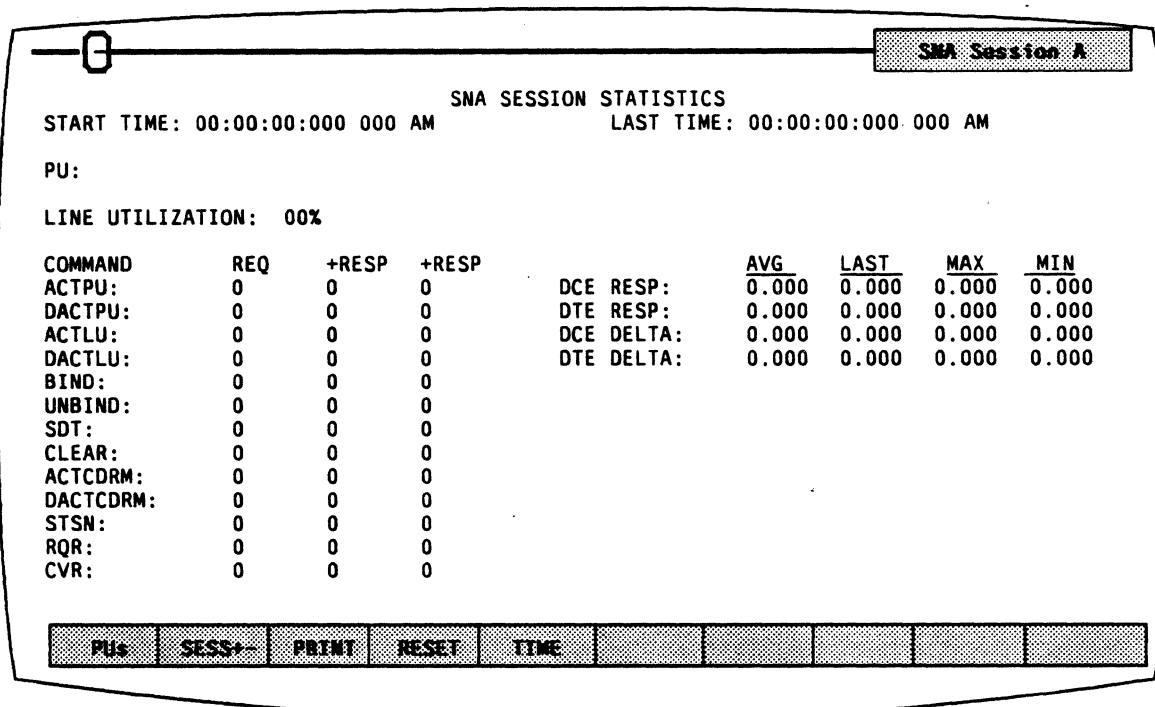


Figure 6.13: SNA Session/SNA Session PU Statistics

The SNA Session statistics page contains the following session information:

Start Time Time of the end of the first event

Last Time Time of the end of the last event

PU The Physical Units (PUs) active during the session, shown in hex.

Line Utilization The percentage of time the line is being used for all traffic.

SNA Commands

The SNA Session page indicates the number of Requests (REQ), positive responses (+RESP), and negative responses (-RESP) for the following commands:

ACTPU	Activate Physical Unit. Establishes the SSCP-PU session, permitting data to flow between the host and a devices. After the PU is activated, session may be established with the LUs.
DACTPU	Deactivate Physical Unit. Sent by the operator to conclude the SSCP-PU session.
ACTLU	Activate Logical Unit. Sets the states and parameters for SSCP-LU sessions.
DACTLU	Deactivate Logical Unit. Sent by an operator to terminate an SSCP-LU session.
BIND	The BIND commands determines the session parameters and protocol options for establishing LU-LU sessions.
UNBIND	The UNBIND command terminates a LU-LU session. It is sent when a terminal logs off, at the conclusion of an application program, or when certain types of errors occur.
SDT	Start Data Traffic. SDT is sent by primary session control to secondary session control to enable the sending and receiving of FMD and DFC requests and responses by both half-sessions.
CLEAR	Clear is sent by primary session control to reset the data traffic FSMs and subtrees (for example, brackets, pacing, sequence numbers) in the primary and secondary half-sessions (and boundary function, if any).
ACTCDRM	Activate Cross-Domain Resource Manager. ACTCDRM is sent from one SSCP to another SSCP to activate a session between them and to exchange information about the SSCPs.
DACTCDRM	Deactivate Cross Domain Resource Manager. DACTCDRM deactivates an SSCP-SSCP session.

STSN	Set and Test Sequence Numbers. STSN is sent by the primary half-session sync point manager to resynchronize the values of the half-session sequence numbers, for one or both of the normal flows at both ends of the session.
RQR	Request Recovery. RQR is sent by the secondary to request the primary to initiate recovery for the session, by sending CLEAR or to deactivate the session.
CRV	Cryptography Verification. CRV is a valid request only when session-level cryptography was selected in BIND. It is sent by the primary LU session control to verify cryptography security, so that both half-sessions can send and receive FMD requests.

Timing Statistics

The remaining fields display the average, last, maximum, and minimum times, as described.

DCE RESP	The time between a frame sent from the DCE side and the acknowledging frame from the DTE side.
DTE RESP	The time between a frame sent from the DTE side and the acknowledging frame from the DCE side.
DCE DELTA	The time between the last two DCE frames received.
DTE DELTA	The time between the last two DTE frames received.

SNA LU Statistics Page

SNA LU Line Statistics Page

The format of the LU Statistics and the LU Line Statistics pages are the same, as shown in Figure 6.14. Each field of the display is described below.

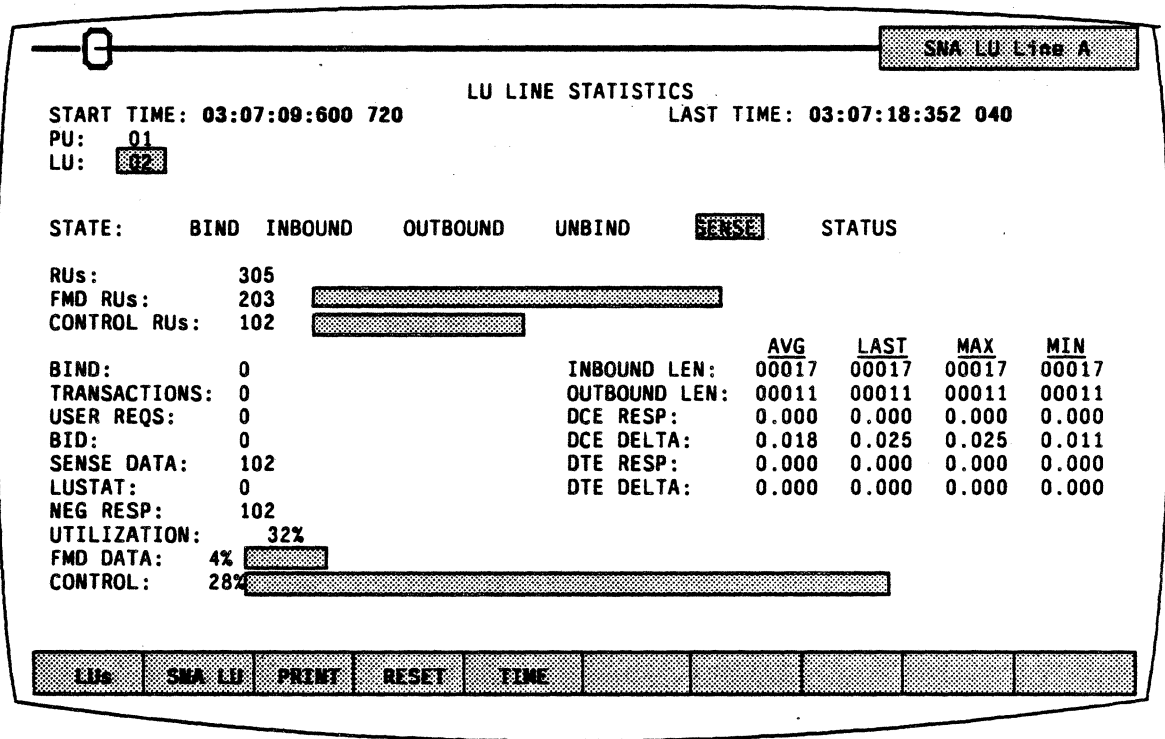


Figure 6.14: SNA LU Line/SNA LU Statistics Page

- Start Time** Time of the end of the first event.
- Last Time** Time of the end of the last event.
- PU** Address of the PU in hex.
- LU** Logical Units currently active in hex.

State The state of the LU from which the last event was received. Possible states are:

**BIND
INBOUND
OUTBOUND
UNBIND
SENSE
STATUS**

Response Unit Statistics

RUs The number of SNA frames with an RU field. The RUs can be Requests or Responses.

FMD RUs All function Management Data (FMD) RUs, including:

**Configuration Services
Maintenance Services
Measurement Services
Management Services
Network Operator Services
Session Services**

Control RUs Data, Session, and network control Response Units.

BIND The number of BIND sessions on the line. A BIND is sent from a primary LU to a secondary LU to activate a session between the LUs. The secondary LU uses the BIND parameters to determine whether it will respond positively or negatively to BIND.

TRANSACTIONS The number of all transactions on the line.

USER REQS The number of all requests on the line.

BID The number of all BIDs. BID is used by the bidder to request permission to initiate a bracket.

SENSE DATA The number of response frames containing Sense data (frames with the SDI bit set).

LUSTAT	The number of Logical Unit Status (LUSTAT) on the line. LUSTAT is used by one half-session to send four bytes of status information to its paired half-session.
NEG RESP	The number of negative responses on the line.

Line Utilization

Utilization	Percentage of total line utilization. The number of bytes that have been sent divided by the number of bytes that could have been sent.
FMD Data	Percentage of FMD data frames received. The number of FMD data frames received divided by the total number of frames received.
Control	Percentage of control frames received. The number of control frames received divided by the total number of frames received.

Length and Timing Statistics

These fields display the maximum, minimum, average, and last values as described below.

Inbound Len	The length of all inbound frames.
Outbound Len	The length of all outbound frames.
DCE Resp	The time between a frame sent from the DCE side and the acknowledging frame from the DTE side.
DTE Resp	The time between a frame sent from the DTE side and the acknowledging frame from the DCE side.
DCE Delta	The time between the last two DCE frames received.
DTE Delta	The time between the last two DTE frames received.

CHAPTER SEVEN:
ASYNC MONITORING



CHAPTER SEVEN: ASYNC MONITORING

Introduction

Monitoring allows you to passively monitor the traffic on a data line without affecting the traffic. By doing this, you can interpret captured traffic and troubleshoot the line. This section describes protocol-specific information about Async Monitoring. Since the Statistics application is not available for Async, this section describes the Analysis application only. For a general description of Analysis, refer to Chapter 1.

This section assumes that you know how to select Monitoring for a port and select Async as the protocol. If you do not know how to do this, refer to the *Chameleon 32 User's Guide, Chapter 3: Using the Chameleon 32*.

Monitor Setup Menu

When you select Async as your Monitoring protocol, you are prompted for several configurable parameters as shown in Figure 7.1. Each parameter is described on the next page.

The screenshot shows a terminal window titled "Port x Monitor Setup" with a "Configuration" label in the top right corner. A box in the top right says "Press 60 to accept". The "Protocol" is set to "ASYNC". The "Baud rate" is set to "9600" with a left-pointing arrow next to it. The "Parity" is set to "None" and the "Data Bits" is set to "8". At the bottom, there is a menu bar with the following options: 75, 110, 300, 600, 1200, 2400, 4800, 9600, More, and Exit.

Figure 7.1: Async Monitor Setup Parameters

Baud Rate

The baud rate specifies the speed of the data transmission (bits per seconds) on the line being monitored. When the red screen arrow is at baud rate, the options are displayed in the softkey strip. **F9 More** displays additional baud rate options. The available baud rates are:

75	2400
110	4800
300	9600
600	19200
1200	

Parity

Parity is the error checking technique used for the Async protocol. A parity bit may follow the data bits. The parity bit is sent by the transmitter and indicates whether an odd number or an even number of 1s were transmitted in the data bits. The receiver determines the number of 1s received, and compares the result to the parity bit. If the parity bit indicates that an odd number of 1s were transmitted, but an even number of 1s were received, the receiver recognizes that an error has occurred. The options are:

- Even
- Odd
- None

Data Bits

Data bits determines how many bits are used to identify a single character. This is determined by the code set being used. For example, ASCII code generally uses 7 data bits to transmit one character. The options are:

- 5
- 6
- 7
- 8

ANALYSIS

Analysis provides two pages: Real Time and History.

The Real Time page displays traffic as it is acquired.

History displays traffic that has been acquired and put in a buffer. You can move back and forth through the traffic in the buffer to display specific parts of it.

The display format and function keys are the same for both pages, as shown in Figure 7.2. The page components are described on the following pages.

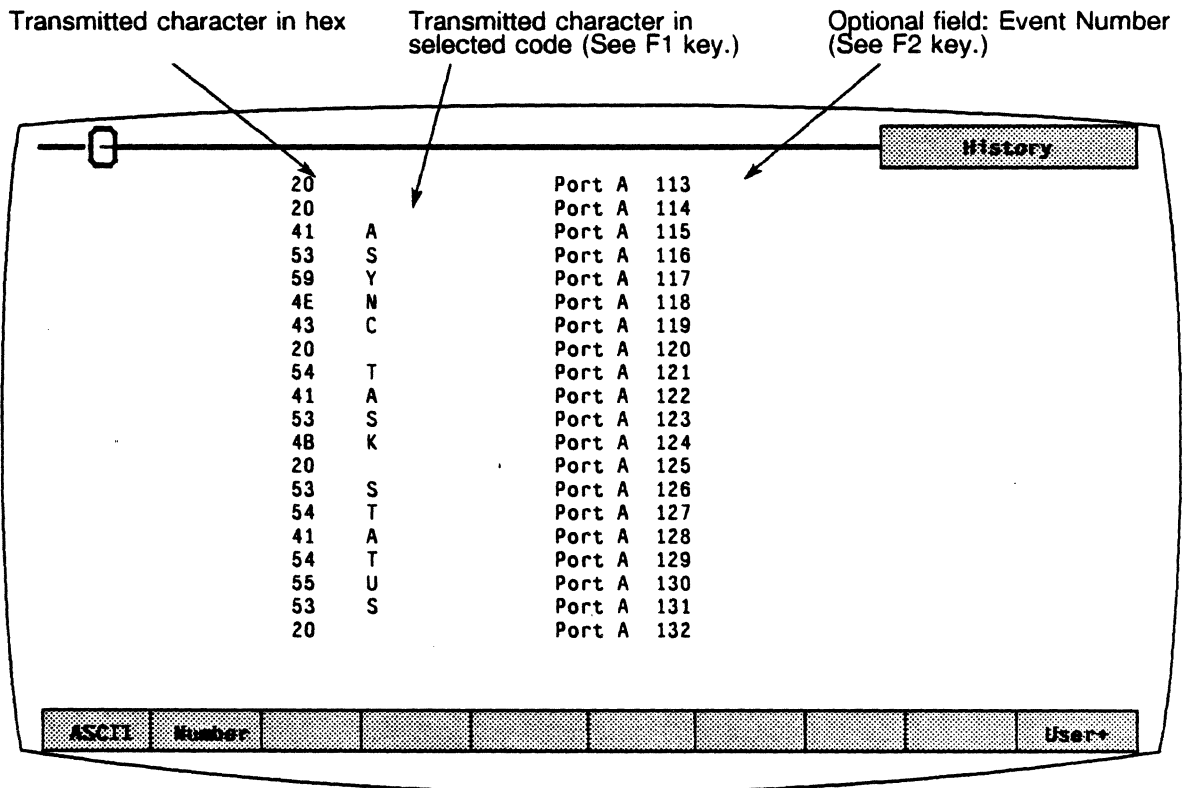


Figure 7.2: Analysis Page with Sample Async Traffic

Function Keys

The function keys control how the traffic is interpreted and displayed. These functions are available for both the History and Real Time pages. The Async Analysis function keys are described below.

F1: Code

F1 determines the format of the user data display. This is the data which does not belong to a protocol specific format. Each time you press **F1**, the user data (in white) changes to the code indicated in the softkey strip. The options are:

- | | |
|---------------|--|
| ASCII | Each byte is displayed as an ASCII character. Characters in the range 0 - 1F hex are shown as single character mnemonics. Characters above 80 hex are shown as '.'.(default) |
| EBCDIC | Each byte is displayed as an EBCDIC character. |
| HEX | Each byte is displayed as a pair of hexadecimal digits |
| HEXS | Each byte is displayed as a pair of hexadecimal digits, with a space between each pair. |

F2: Acquisition Information

F2 determines the acquisition information display format, which is displayed at the end of each display line (See Figure 7.1). The options are:

- | | |
|---------------|--|
| Number | Event number in decimal (default) |
| Time | Event time stamp as hh:mm:ss ddd ddd |
| dTime | Displays the elapsed time between events |
| None | No acquisition information is displayed |

The port which received the event is displayed (**Port A** or **Port B**) as part of the acquisition information, unless the **None** option is selected.

F10: User Data

F10 determines if user data is displayed. It also controls the display of traffic in an uninterpreted (raw) mode. The options are:

- User + User data is displayed (default)
- User- User data is not displayed
- Raw All traffic is displayed uninterpreted (raw) in the code selected in **F1**

CHAPTER EIGHT:
BISYNC MONITORING

CHAPTER EIGHT: BSC MONITORING

Introduction

Monitoring allows you to passively monitor the traffic on a data line without affecting the traffic. By doing this, you can interpret captured traffic and troubleshoot the line. This section describes BSC Analysis and Statistics, by focusing on the protocol-specific details of these applications. For a general description of the applications, refer to Chapter 1.

This section assumes that you know how to select Monitoring for a port and select BSC as the protocol. If you do not know how to do this, refer to the *Chameleon 32 User's Guide, Volume 1, Chapter 3: Using the Chameleon 32*.

Monitor Setup Menu

When you select BSC as your Monitoring protocol, you are prompted for several configurable parameters as shown in Figure 8.1. Each of these parameters is described on the following page.

The screenshot shows a terminal window titled "Port x Monitor Setup" with a "Configuration" label in the top right corner. A box in the top right says "Press GO to Accept". The main content area contains the following configuration options:

- Protocol : BISYNC
- Coding EBCDIC (with a left-pointing arrow next to it)
- Enter Sync Char 1 32
- Enter Sync Char 2 32
- Block Check CRC16

At the bottom of the screen is a menu bar with several options: ASCL1, EBCDIC, and several shaded boxes.

Figure 8.1: BSC Monitor Setup Page

Coding

Coding enables you to select the code set being monitored. The options are:

ASCII If you select ASCII coding, you can select a parity setting. Parity is used for error checking when ASCII code is used. The Parity options are None, Odd and Even.

EBCDIC If you select EBCDIC coding there is no Parity option.

Sync 1 and 2

For EBCDIC coding the default value is 32 hex for both synchronizing characters 1 and 2. For ASCII coding, Sync char 1 and Sync char 2 default value is 16 hex. You can change the Sync 1 and Sync 2 character values by entering a two-digit hex string.

Block Check

Block check enables you to specify what type of calculation should be used to determine the Block Check Characters (BCC) for error checking blocks of data. The options are:

LRC Longitudinal Redundancy Check which uses the polynomial $x^8 + 1$.

CRC16 Cyclic Redundancy Check which calculates a two-byte CRC using the polynomial: $x^{16} + x^{15} + x^2 + 1$.

CCITT The CCITT CRC uses the polynomial $x^{16} + x^{12} + x^5 + 1$.

BSC ANALYSIS INTERPRETATION

Analysis provides two pages: Real Time and History. Both pages display traffic in a split screen format (DCE/DTE).

The Real Time page displays traffic from both sides of the line as it is acquired. The data scrolls as traffic is acquired.

History displays traffic that has been acquired and put in a buffer. You can move back and forth through the traffic in the buffer to display specific parts of it.

The display format and function keys are the same for both pages, as shown in Figure 8.2. The page components are described on the following pages.

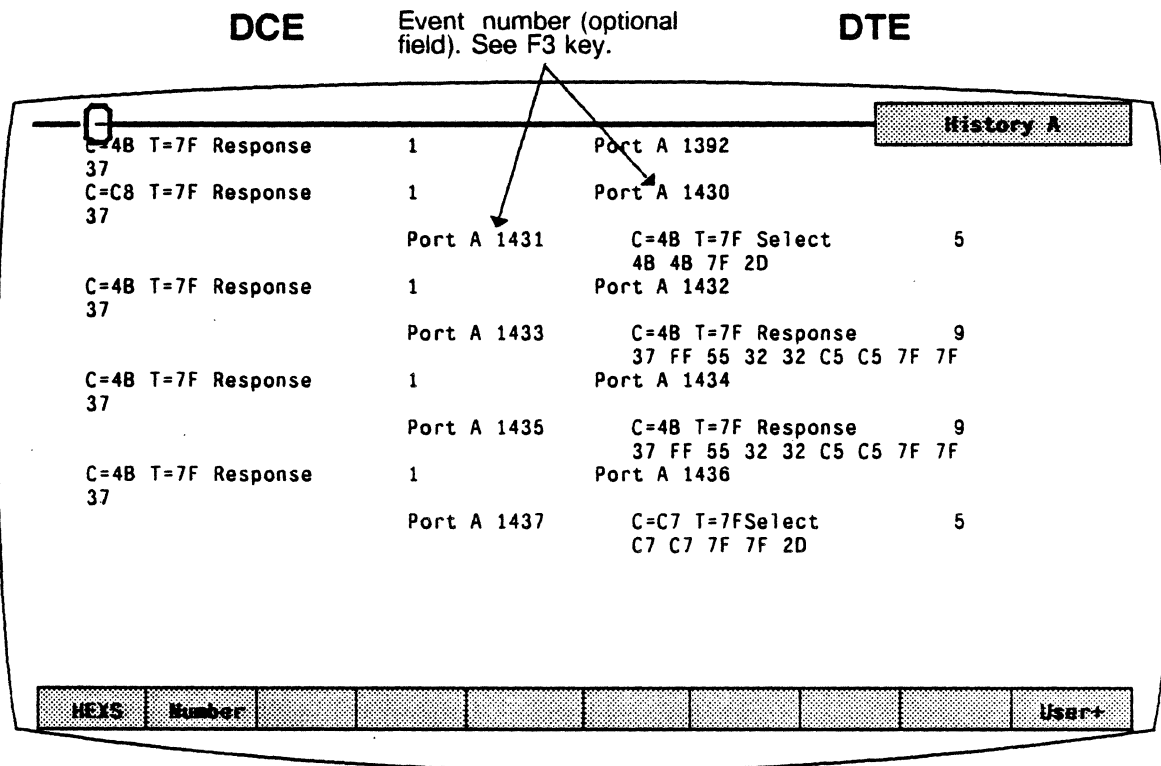


Figure 8.2: Analysis Page with Sample BSC Traffic

Function Keys

The function keys control how the traffic is interpreted and displayed. These functions are available for both the History and Real Time pages. The Async Analysis function keys are described below.

F1: Code

F1 determines the format of the user data display. This is the data which does not belong to a protocol specific format. Each time you press **F1**, the user data (in white) changes to the code indicated in the softkey strip. The options are:

- | | |
|---------------|--|
| ASCII | Each byte is displayed as an ASCII character. Characters in the range 0 - 1F hex are shown as single character mnemonics. Characters above 80 hex are shown as '.'.(default) |
| EBCDIC | Each byte is displayed as an EBCDIC character. |
| HEX | Each byte is displayed as a pair of hexadecimal digits |
| HEXS | Each byte is displayed as a pair of hexadecimal digits, with a space between each pair. |

F2: Acquisition Information

F2 determines the acquisition information display format, which is displayed at the end of each display line (See Figure 7.1). The options are:

- | | |
|---------------|--|
| Number | Event number in decimal (default) |
| Time | Event time stamp as hh:mm:ss ddd ddd |
| dTime | Displays the elapsed time between events |
| None | No acquisition information is displayed |

The port receiving the event (**Port A** or **Port B**) is displayed as part of the acquisition information, unless the **None** option is selected.

F10: User Data

F10 determines if user data is displayed. It also controls the display of traffic in an uninterpreted (raw) mode. The options are:

- User +** User data is displayed (default)
- User-** User data is not displayed
- Raw** All traffic is displayed uninterpreted (raw) in the code selected in **F1**

BSC ANALYSIS INTERPRETATION

This section identifies the components of the BSC Analysis page display. Figure 8.3 shows a sample BSC History page. The area in the box is described in detail in this section.

In this example, the user data is shown in hex pairs separated by spaces, since HEXS is the code displayed in the softkey strip for the **F1** key.

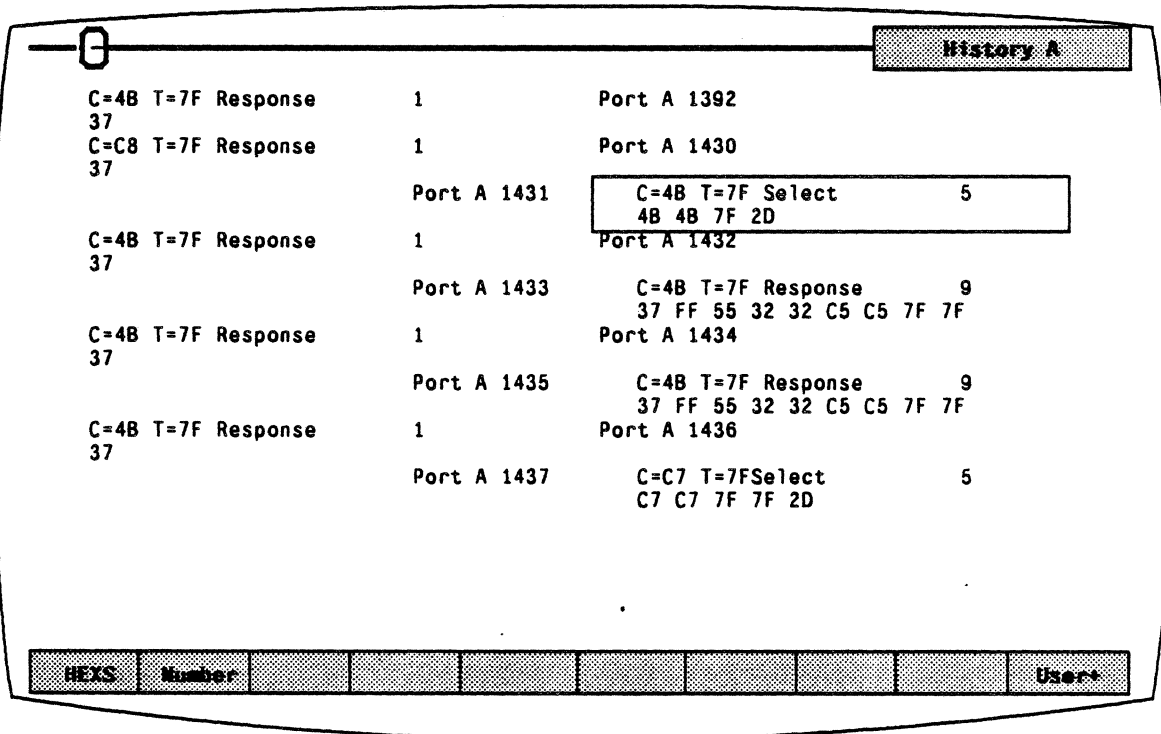


Figure 8.3: Analysis History Page with Sample BSC Traffic

Figure 8.4 is a detail of the BSC display from Figure 8.3. Each field in this sample display is described below.

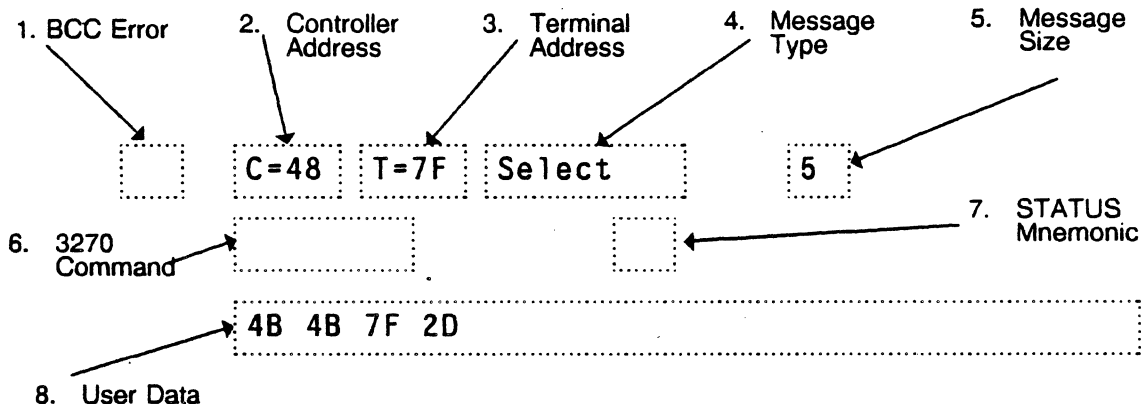


Figure 8.4: BSC Display Components

1. BCC Errors

B BCC error
(blank) No BCC error

2. Controller Address

This field displays the controller address, as derived from the P1 board.

3. Terminal Address

This field displays the terminal address, as derived from the P1 board.

4. Message Type

This field displays the message type, as derived from the P1 board, and will be one of the following:

- Poll** (general poll identified)
- Select**
- Response**
- Status**
- Test**
- Text**

5. Message Size

This field displays the message size in decimal.

6. 3270 Command

This field displays the 3270 command, if applicable, as derived from the analysis of message type 021Bxx.

7. Status Mnemonic

If the message type (field 4) is **Status**, this field displays one or more of the status mnemonics shown in Figure 8-5.

Status Mnemonic	Description
DB	Device Busy
US	Unit Specify
DE	Device End
TC	Transmission Check Bit Set
EC	Equipment Check
DC	Data Check
CC	Control Check
OC	Operation Check

Figure 8.5: BSC Status Mnemonics

A second line may appear, depending on the message, containing:

Status Sense data explanation
Test Interpretation of 3270 command code

8. User Data

This field displays uninterpreted user data and messages.

BSC STATISTICS

Introduction

BSC Statistics displays and prints statistical information about the traffic on the line. You have the ability to activate pages that show the following statistical information:

- BSC Line Displays statistics for all Control Units (CUs)
- BSC CU Displays statistics for specified CUs

When you start BSC Statistics, the BSC Line statistics page is displayed as shown in Figure 8.6. This page displays statistics for all Control Units (CUs) on a BSC line. The format of this page is described on the following page.

If you do not know how to start the statistics application, refer to the *Chameleon 32 User's Guide, Chapter 3: Using the Chameleon 32*.

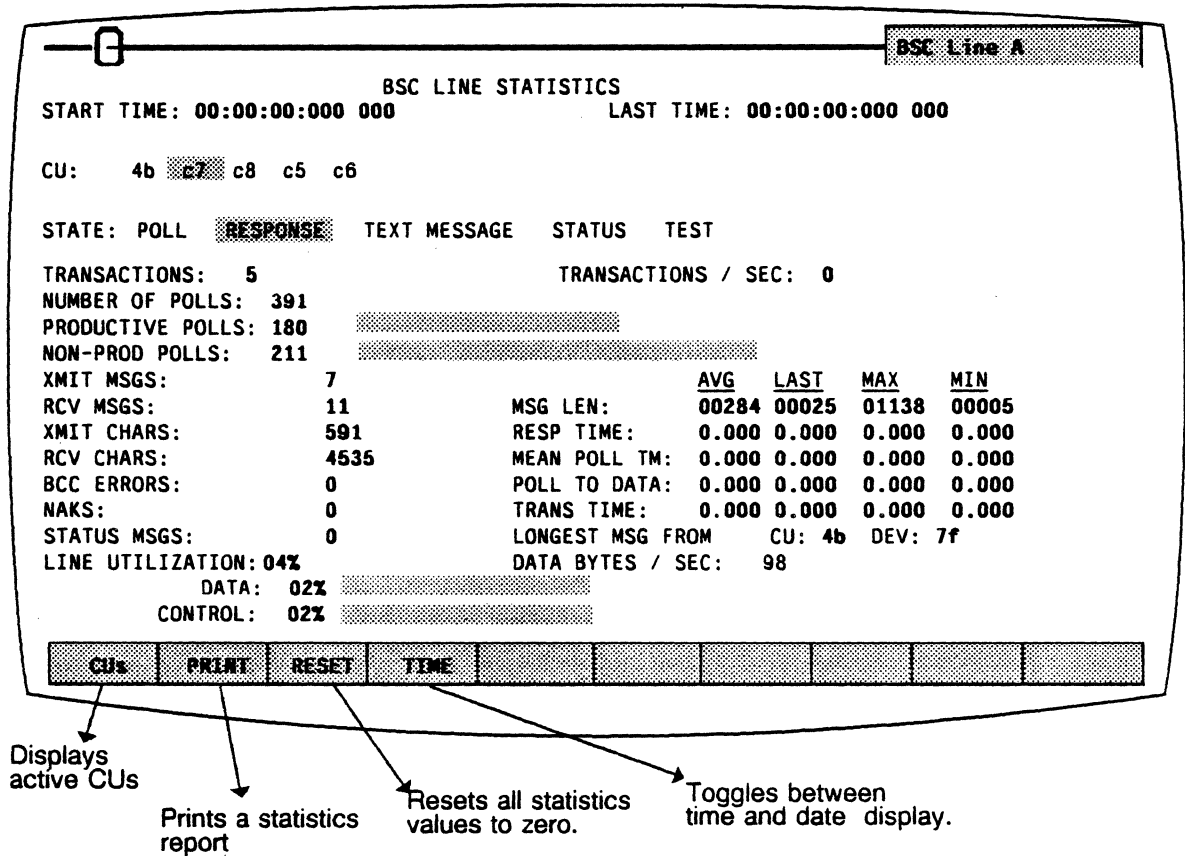


Figure 8.6: BSC Line Statistics Page

Time Display

The top of the statistics page displays two times in the format hh:mm:ss:ddd ddd, as described below. **F4 Time/Date** switches this display between time and date in these two fields.

START TIME

Displays the time of the *end* of the first event (message) in a statistics session.

LAST TIME

Displays the time of the *end* of the last event (message).

Active CUs

Following the time/date display is the information about the active Control Units (CUs), as described below.

CU

This field displays the active Control Unit (CU) addresses. The highlighted CU is the CU from which the last message was received.

STATE

The highlighted field shows the state of the CU from which the last message was received. The possible states are:

POLL	Communication initiated by the host to solicit communication from a device. A specific poll is to a specific device on a CU. A general poll can be to any device on a CU.
RESPONSE	The CU's or host's acknowledgment of a text message or Poll.

TEXT MESSAGE	The information received from individual CUs or by the host. Text messages are defined as starting with STX or SOH, and ending with ETX, ETB, or ITB.
STATUS	The message containing the sense/status information about the active device.
TEST	A TEST Request message was sent.

Transaction Statistics

Below the CU STATE display are two fields with statistical information about the transactions.

TRANSACTIONS

This field displays the number of transactions completed by all devices. A transaction is the completion of a full cycle of communication started by a device's text message and ended by that device's acknowledgement of the host's message to the same device. The sequence begins with a Start of Text (STX) and ends with an Acknowledgment (ACK) of an End of Text (ETX).

TRANSACTIONS / SEC

This field displays the number of transactions divided by the number of seconds. If the number of Transactions per Second is less than one, zero is displayed.

Poll Statistics

Below the Transaction display are three fields with statistical information about the polls that have occurred.

NUMBER OF POLLS

This field displays the number of Polls (general or specific) received from the host.

PRODUCTIVE POLLS

The number of productive polls, which are the polls responded to by a Text Message or an Acknowledgement (ACK). This statistic is also shown as a bar graph that represents the proportion of all polls that were productive.

NON-PRODUCTIVE POLLS

The number of non-productive polls, which are polls responded to with an End of Transmission (EOT). This statistic is also shown as a bar graph that represents the proportion of all polls that were non-productive.

Transmit/Receive Statistics

XMIT MESSAGES

This field displays the number of text messages received from the DCE side. This may be the host or the CU, depending on the configuration.

RCV MESSAGES

This field displays the number of text messages received from the DTE side. This may be the host or the CU, depending on the configuration.

XMIT CHARS

This field displays the number of characters in text messages received from the DCE side. This may be the host or the CU, depending on the configuration.

RCV CHARS

This field displays the number of characters in text messages received from the DTE side. This may be the host or the CU, depending on the configuration.

Error and Status StatisticsBCC ERRORS

This field displays the number of received messages that contained Block Check Character (BCC) errors.

NAKS

This field displays the number of Negative Acknowledgments (NAKS) received.

STATUS MSGS

This field displays the number of Status Messages received.

Line Utilization Statistics

The bottom of the BSC Line Statistics page displays three fields with information about line utilization.

LINE UTILIZATION

This field displays the line utilization for all CUs and all message types. The utilization is shown as a percentage.

DATA

This field displays the percentage of time the line is used for text messages. Text messages are defined as the number of bytes in a text message, including STX and ETX, but not including BCC characters. This statistic is also shown as a bar graph so that you can quickly compare the proportion of the line being used for data and control.

CONTROL

This field displays the percentage of the time the line is utilized for control messages. Control is defined as Poll and Response messages, including two PAD characters for each message. This statistic is also shown as a bar graph so that you can quickly compare the proportion of the line being used for data and control.

Time and Length Statistics

The remaining fields display statistical information for message lengths and various transmission times. For these fields, the average, last, maximum, and minimum values are displayed.

MSG LEN

This field displays the average, last, maximum, and minimum length of text messages received.

RESP TIME

This field displays the total response time, which is defined as the sum of the Mean Poll Time, the Poll to Data Time, and the Transaction Time.

MEAN POLL TM

This field displays the mean poll time, which is defined as the mean time to the next Poll (half the time between Polls to a given device).

POLL TO DATA

This field displays the time from the poll of a given device to the end of the text message from the device.

TRANS TIME

This field display the time duration of a transaction. A transaction is the completion of a full cycle of communication started by a device's text message and ended by that device's acknowledgement of the host's message to the same device.

The sequence begins with a Start of Text (STX) and ends with an Acknowledgment (ACK) of an End of Text (ETX). Transaction time measurement begins with the end of the text message from the device and ends with the end of the device Acknowledgement of the last message

LONGEST MESSAGE FROM CU

This field displays the address of the CU from which the longest message was received.

LONGEST MESSAGE FROM DEV

This field displays the address of the device from which the longest message was received.

DATA BYTES / SEC

This field displays the number of text message data bytes received per second.

Function Keys for BSC Statistics

There are four function keys available for BSC Statistics. These are shown and briefly described in Figure 8.6. These keys are available for for all BSC Statistics pages. A complete description of each key is provided below.

F1 CUs / FUNCT

You can activate a page which displays statistical information for a specific Control Unit (CU) that is active on the line. **F1 CUs** displays the active CUs in the softkey strip at the bottom of the screen.

In the softkey strip, if the CU has + next to it, a page has been activated for that CU. If the CU has - next to it, a separate page has not been activated for that CU.

When the CUs are displayed in the softkey strip at the bottom of the screen, the **F1** key displays **FUNCT**. If you press **F1 FUNCT**, the softkey strip with the statistics functions is displayed. In other words, **F1** switches you between the Statistics functions and the active CUs.

To activate a statistics page for an CU, perform these steps:

1. Make one of the BSC Statistics pages active. (You can activate and deactivate CU pages from any BSC Statistics page.)
2. If the active CUs are not displayed in the softkey strip, press **F1 CUs** to display them.
3. Press the function key that corresponds to the desired CU. This causes a page banner for that CU to be displayed at the bottom of the screen. The CU softkey strip should also show a + next to the CU.
4. You can then make the new page active and use its function keys. (If the statistics page is in Blow mode when you activate an CU page, the CU page banner is hidden behind the other BSC statistics banner. Use **Hide Page/Show Page** to display the pages as needed.)

To deactivate a page for an CU, perform these steps:

1. Make one of the BSC statistics pages active.
2. If the active CUs are not displayed in the softkey strip, press **F1 CUs** to display them.
3. Press the function key that corresponds to the desired CU. The CU softkey strip should show - next to the CU in the softkey strip and the CU page should disappear.

F2 PRINT

F2 PRINT prints a statistical report that is similar to the screen display format. If you have a printer connected to the Chameleon 32, you can print a report. If you do not know how to connect a printer to the Chameleon 32, refer to the *Chameleon 32 User's Guide, Chapter 9: Utilities*.

If you do not have a printer connected to the Chameleon 32, pressing **F2 Print** has no effect. The report will not be shown on the Chameleon 32 screen.

A sample BSC Line statistics report is shown in Figure 8.7.

TEKELEC BSC LINE STATISTICS REPORT				
START TIME:	00:00:00:000	000		
LAST TIME:	00:00:00:000	000		
CUs ACTIVE:				
NUMBER OF TRANSACTIONS :	0			
TRANSACTIONS PER SECOND :	0			
NUMBER OF POLLS :	0			
PRODUCTIVE POLLS :	0			
NON-PRODUCTIVE POLLS	0			
BCC ERRORS :	00000000			
STATUS MESSAGES :	00000000			
TEST REQUESTS :	00000000			
	DCE		DTE	
TEXT MESSAGES :	00000000		00000000	
CHARACTER COUNT :	00000000		00000000	
TEXT CHARACTERS :	00000000		00000000	
EOTs :	00000000		00000000	
ACKs :	00000000		00000000	
NAKs :	00000000		00000000	
WACKs :	00000000		00000000	
RVis :	00000000		00000000	
LONGEST MESSAGE FROM CU :	00		DEV : 00	
	AVG	LAST	MAX	MIN
MESSAGE LENGTH :	00000	00000	00000	00000
MEAN POLL TIME :	0.000	0.000	0.000	0.000
POLL TO DATA TIME :	0.000	0.000	0.000	0.000
TRANSACTION TIME :	0.000	0.000	0.000	0.000
OVERALL RESPONSE TIME :	0.000	0.000	0.000	0.000
LINE UTILIZATION :	00%			
DATA LINE UTILIZATION :	00%			
CONTROL LINE UTILIZATION:	00%			

Figure 8.7: BSC Statistical Report

F3 Reset

F3 Reset resets the statistics values to zero and resets the times (or dates) displayed at the top of the page. This resets the values on all BSC statistics pages that are currently activated.

F4 Time/Date

F4 Time/Date switches the display at the top of the statistics pages between the time and the date. This changes the timer display on all BSC statistics pages when the next event is received.



CHAPTER NINE:
DPNSS MONITORING



CHAPTER NINE: DPNSS MONITORING

Introduction

Monitoring allows you to passively monitor the traffic on a data line without affecting the traffic. By doing this, you can interpret captured traffic and troubleshoot the line. This section describes Digital Private Network Signaling System (DPNSS) Analysis, by focusing on the protocol-specific details of the application. For a general description of Analysis, refer to Chapter 1.

This section assumes that you know how to select Monitoring for a port and select DPNSS as the protocol. If you do not know how to do this, refer to the *Chameleon 32 User's Guide, Volume 1, Chapter 3: Using the Chameleon 32*.

Monitor Setup Menu

When you select DPNSS as your Monitoring protocol, you are prompted for configurable parameters as shown in Figure 9.1 and described below.

The screenshot shows a terminal window titled "Port x Monitor Setup". In the top right corner, there is a "Configuration" button. Below it is a prompt "Press GO to Accept". The main area shows "Protocol : DPNSS" and "Encoding NRZ" with a left-pointing arrow next to the "NRZ" box. At the bottom, there is a horizontal bar with "NRZ" and "NRZI" options, and several other empty slots.

Figure 9.1: DPNSS Monitor Setup Menu

Encoding

Encoding is a level 1 (physical) parameter that determines how the Chameleon 32 interprets the electrical signal to distinguish between binary 1 and 0. The options are:

NRZ Non Return to Zero. In NRZ encoding, a 1 is represented by a high level, and a 0 is represented by a low level.

NRZI Non Return to Zero Inverted. In NRZI encoding, a 1 is represented by no change in level, and a 0 is represented by a change in level.

ANALYSIS

Analysis provides two pages: Real Time and History. Both pages display traffic in a split screen format (DCT/DTE).

The Real Time page displays traffic from both sides of the line as it is acquired. The data scrolls as the traffic is acquired.

History displays traffic that has been acquired and put in a buffer. You can move back and forth through the traffic in the buffer to display specific parts of it. The components of the display are described on the following pages.

Function Keys

The function keys control how the traffic is interpreted and displayed. These functions are available for both the History and Real Time pages. The DPNSS Analysis function keys are described below.

F1: Code

F1 determines the format of the user data display. This is the data which does not belong to a protocol specific format. Each time you press **F1**, the user data (in white) changes to the code indicated in the softkey strip. The options are:

- ASCII** Each byte is displayed as an ASCII character. Characters in the range 0 - 1F hex are shown as single character mnemonics. Characters above 80 hex are shown as '.'.(default)
- EBCDIC** Each byte is displayed as an EBCDIC character.
- HEX** Each byte is displayed as a pair of hex digits
- HEXS** Each byte is displayed as a pair of hexadecimal digits, with a space between each pair.

F2: Acquisition Information

F2 determines the acquisition information display format, which is displayed in green or white in the center of the screen, between the DCE and DTE sides (See Figure 3.1). The options are:

- Number** Event number in decimal (default)
- Flags** Number of flags preceding the frame, in decimal
- Time** Event time stamp as hh:mm:ss
- dTime** Displays the elapsed time between events
- CRC** CRC value in hex, and **OK** if CRC is good or **BAD** if CRC is bad
- None** No acquisition information is displayed

The port receiving the packet (**Port A** or **Port B**) is displayed as part of the acquisition information unless the **None** option is selected.

F4: Layer 2

F4 determines how the Layer 2 is interpreted and displayed. The options are:

- Layer 2-** Layer 2 is acquired but not displayed
- Layer 2 +** Layer 2 is displayed interpreted
- Layer 2''** Layer 2 is displayed raw
- Layer 2*** Layer 2 is displayed interpreted and raw

F5: Layer 3

F5 determines how the Layer 3 is interpreted and displayed. The options are:

- Layer 3-** Layer 3 is acquired but not displayed
- Layer 3 +** Layer 3 is displayed interpreted
- Layer 3''** Layer 3 is displayed uninterpreted (raw)
- Layer 3*** Layer 3 is displayed interpreted and uninterpreted (raw)

F10: User Data

F10 determines if user data is displayed. It also controls the display of traffic in an uninterpreted (raw) mode. The options are:

- User +** User data is displayed (default)
- User-** User data is not displayed
- Raw** All traffic is displayed uninterpreted (raw) in the code selected in **F1**

LAYER 2 INTERPRETATION

Layer 2 interpretation consists of Address and Control information.

Address

Address is interpreted on up to two lines; one line for each byte. If the extension bit is not set on the first byte, then only one line is given. Figure 9.3 shows the first line of Address interpretation.

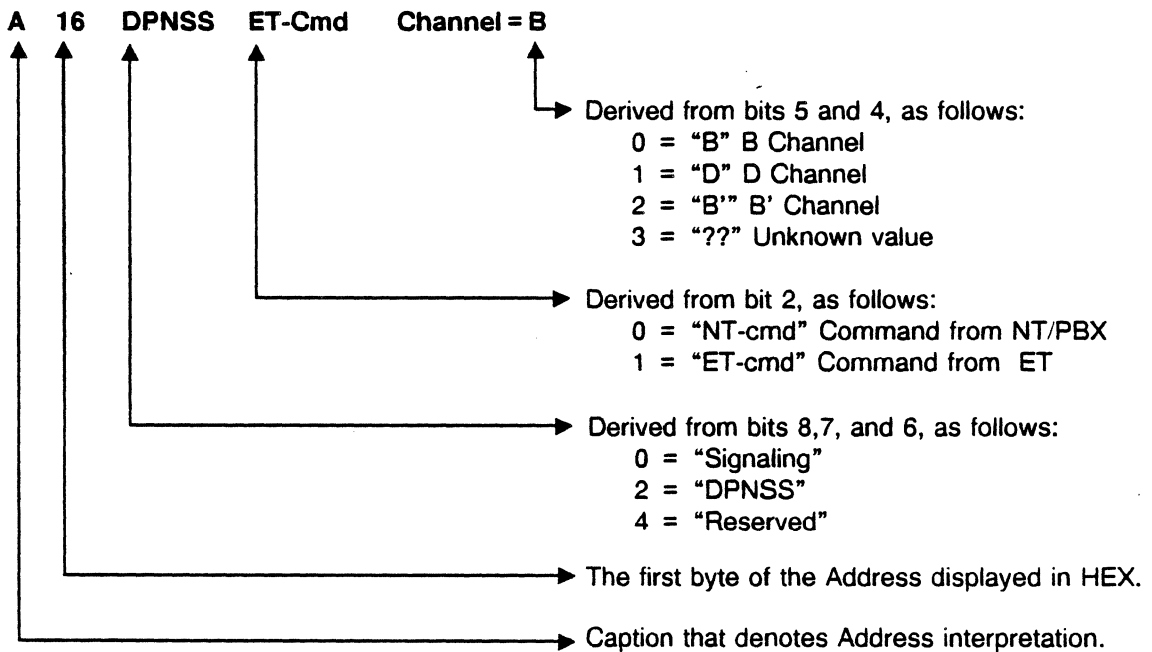


Figure 9.3: The First Line of Address Interpretation

Figure 9.4 is an example of the second line of Address interpretation.

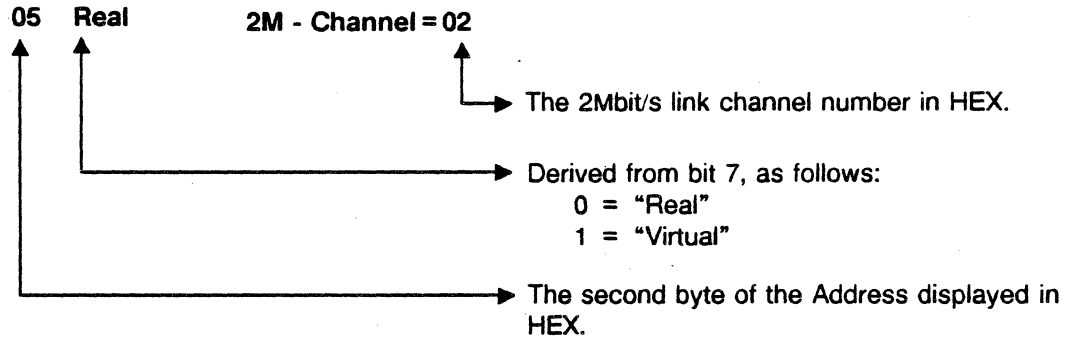


Figure 9.4: The second Line of Address Interpretation

Control

Figure 9.5 shows an example of Control interpretation.

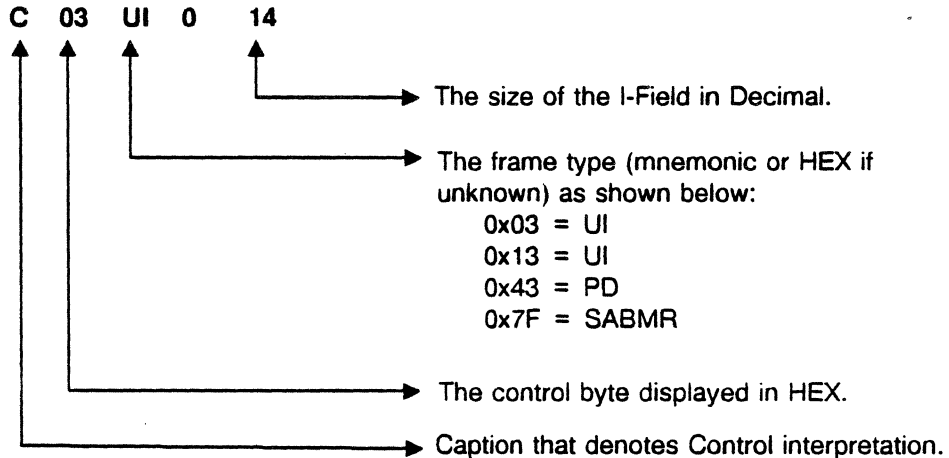


Figure 9.5: Control Interpretation

LAYER 3 INTERPRETATION

The unit of Layer 3 information is called a *message*. Messages can consist of the following sub-components:

- Message Type
- Service Indicator Code (SIC)
- Clear Cause
- Restart Cause
- Indication Block
- Selection Block

Note

Decimal coded data is terminated by the first non-numeric character, and the remainder is ignored. For example, the strings *123# and 123M# will both decode to the same value (123).

IA5 coded binary data is not validated. For example, A decodes to HEX 1, however, so does a (and any character with the low 4 bits equal to 1).

Message Type

The Message Type is present in all messages. From the Message Type, the system can predict the sub-components that complete the message, and interpret them accordingly. Table 9.7 shows the messages recognized by the system. Below is an example of Message Type interpretation.

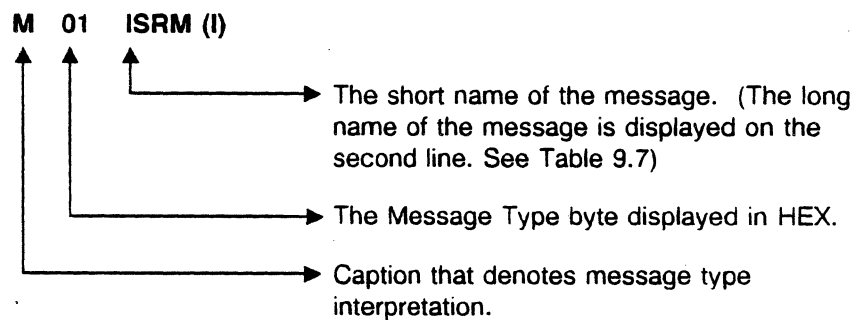


Figure 9.6: Message Type Interpretation

SHORT NAME	LONG NAME
ISRM (C)	INDICATION SERVICE REQUEST (COMPLETE)
ISRM (I)	INDICATION SERVICE REQUEST (INCOMPLETE)
SSRM (C)	SUBSEQUENT SERVICE REQUEST (COMPLETE)
SSRM (I)	SUBSEQUENT SERVICE REQUEST (INCOMPLETE)
NAM	NUMBER ACKNOWLEDGE
NIM	NETWORK INDICATION
CCM	CALL CONNECTED
CRM	CLEAR REQUEST
CIM	CLEAR INDICATION
RM (C)	RECALL (COMPLETE)
RM (I)	RECALL (INCOMPLETE)
RRM	RECALL REJECT
SM	SWAP
EEM (C)	END-TO-END (COMPLETE)
EEM (I)	END-TO-END (INCOMPLETE)
LLM (C)	LINK-BY-LINK (COMPLETE)
LLM (I)	LINK-BY-LINK (INCOMPLETE)
LLRM	LINK-BY-LINK REJECT
SCRM	SINGLE CHANNEL CLEAR REQUEST
SCIM	SINGLE CHANNEL CLEAR INDICATION

Table 9.7: Message Types

Note

Any unknown messages are displayed in red as **Unknown**.

Service Indicator Code (SIC)

The SIC consists of one or two bytes, depending upon an extension bit in the first byte. The interpretation of the first byte of the SIC is illustrated in Figure 9.8.

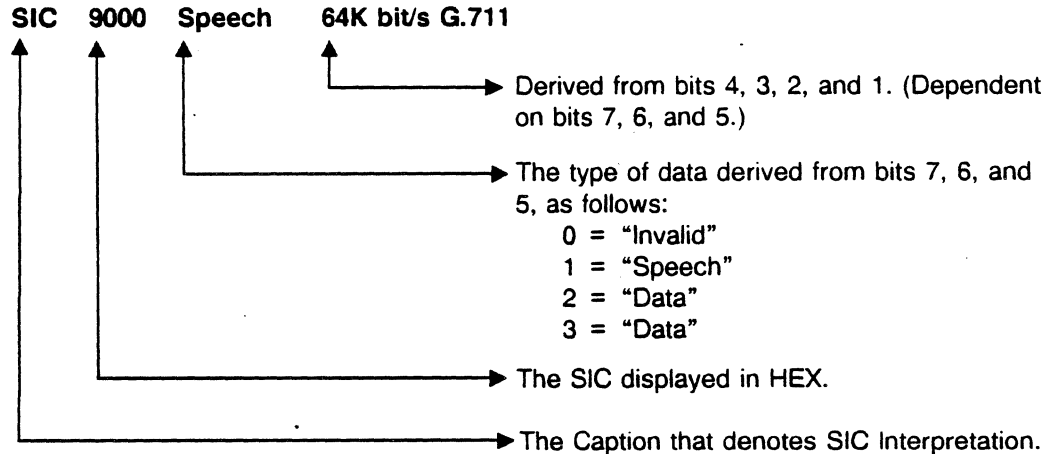


Figure 9.8: Interpretation of the First Byte of the SIC

The interpretation of the second byte of the SIC is only given when the extension bit is set in the first byte. Table 9.9 shows each caption with its possible values.

SERVICE INDICATOR CODES	
CAPTION	POSSIBLE VALUES
Data Type	3 "Sync V.110" 4 "Sync X.30" 5 "Async 1 stop" 6 "Async 1.5 stop" 7 "Async 2 stop"
Data Mode	FDX/HDX
Byte timing provided	Yes/No
Network independent clock	Yes/No
Data format	Anonymous/DPNSS packet mode
TA has flow control capability	Yes/No

Table 9.9: Service Indicator Codes

Rejection and Clear Cause

Rejection Cause is displayed on two lines, for example:

```
Rejection cause      07  
CON Congestion
```

The first line is a standard caption plus value line, with the value displayed in HEX. The second line has the mnemonic and meaning of the Rejection Cause value.

Clear Cause is displayed in the same way as the Rejection Cause, with the appropriate caption.

Indication Block

An Indication Block is a list of Supplementary Information Strings. Any data following the last valid Supplementary Information String is displayed in raw form.

Selection Block

A Selection Block is an Indication Block followed by a Destination Address. Any data following the last valid Supplementary Information String is displayed as a Destination Address.

Supplementary Information String

A Supplementary Information String (SI) consists of a Supplementary Information String Identifier (SID) and zero or more Supplementary Information String Parameters (SIP).

When no SI's are present, the following message is displayed:

No Supplementary Information

The SI is delimited with an asterisk (*) at the start, and a hash sign (#) at the end. Any string not starting with an * terminates the block. If the SI is not well formed, the following message is displayed in red:

Bad SIS format

Note

When the above message is displayed, the rest of the interpretation should be used with care.

The interpretation of the SI starts with a line consisting of the complete name. The SI is displayed in ASCII. The next line consists of the short name of the SID. If the SID is unknown, the display is in red.

The SID values recognized are as follows:

CLC.ORD	DVT.R	A13
CLC.DEC	BSS.M	A14
CLC.DASS2	BSS.P	A12
CLC.PSTN	BSS.N	A7
CLC.MF5	SU	CBWF.CLB
CLC.OP	RR.SNU	DVT
CLC.NET	IG.SNU	SOD.REQ
CBWF.R	IG.SU	CBWF.CB
CBWF.FN	TEXT	OLICLI
CBWF.CSUI	SIM.A	RTI
CBWF.C	ROP.R	REJ
RO	ROP.CSU	ACK
CBC	ROP.CON	NSI
CBWF.CSUD	EST	HOLD.REQ
EI.PVR	CDIV	RECON
EI.R	RDG	HDG
IPL.R	RCF	SOD.B
IPL	TOV.R	SOD.F
EI.I	TOV.V	SI
CW	SER.R	SPL
CO	SER.C	TWP
DIV.V	SER.E	ENQ
DIV.FM	NS.N	SCE
DIV.BY	NS.DVT	TRFD
DIV.CI	NS.DVG	SHTL
DIV.CR	NS.DVD	COC
DIV.CB	NS.RDVT	AD.RQ
DIV.CA	NS.RDVG	AD.V
DVG.I	NS.RDVD	AD.O
DVG.B	NS.DA	ENH
DVG.R	SW.V	BAS
DVT.I	SW.R	SNU
DVT.B	A2	
DVD.I	A5	
DVD.B	A8	
DVD.R	A10	

Supplementary Information Parameters

For each possible SI, the system knows which parameters may be present. Any unexpected (undocumented) parameters are printed with the generic caption: **parameter**. Missing parameters are not flagged as errors.

Each parameter has an *internal* parameter type that describes the interpretation performed on that parameter. Recognized parameters are listed below by types. The names given are used as captions.

Type **S** is a literal output of uncoded input, for example:

***ABCD* ⇒ ABCD**

- Parameter (generic)
- A party address
- B party address
- C party address
- HC-CLC
- Call reference number
- Reconnect address
- Signal ID

Type **I** is HEX output of IA5 encoded binary input, for example:

***@ABC* ⇒ 0123**

- SIC
- Clearing Cause

Type **D** is a decimal encoded output of decimal decoded input, for example:

***012A* ⇒ 12**

- Intrusion capability level
- Intrusion protection level

Type **W** is a table lookup output of decimal decoded input, for example:

***01* ⇒ PSTN BARRED**

- Service Markings:
 - 1 - PSTN BARRED
 - 2 - EMERGENCY TELEPHONE
 - 3 - HUNT GROUP
 - 4 - HOLDING PSTN
 - 5 - EXTRAORDINARY EXTENSION
- Routing Information:
 - 1 - Alternative route
 - 2 - DASS1 encountering
 - 3 - DASS2 encountering
 - 4 - PSTN
 - 5 - 10pps
 - 6 - MF5
- Status:
 - 0 - DDI
 - 1 - Non DDI
 - 2 - No release signal

Type **C** is a table lookup output of undecoded input, for example:

***M* ⇒ Missing Information**

- String ID:
 - S - Service Indicator Code
 - E - Syntax Error
 - M - Missing Information
 - R - Recall Not Supported
 - F - Selection Block Capacity Exceeded
- Location:
 - T - Other Terminal
 - P - Call Path
 - E - Equipment needed
 - I - Incompatible due to clash

- **CALL-DIR:**
 - O - Originating PBX**
 - T - Terminating PBX**

- **State of Operator:**
 - N - Night Mode activated**
 - T - Night Mode deactivated**

- **Reason for Re-directing:**
 - A - Awaiting answer**
 - H - Held**
 - W- Waiting on busy**
 - E - Transferred by extension**
 - N - Not transferred**
 - O - Transferred by operator**
 - R - Transferred by re-directed party**

CHAPTER TEN:
ISDN (Q.921 AND Q.931) MONITORING

CHAPTER TEN: ISDN MONITORING

Introduction

Monitoring allows you to passively monitor the traffic on a data line without affecting the network. By doing this, you can interpret captured traffic and troubleshoot the line. This section describes ISDN Analysis and Statistics, by focusing on the protocol-specific details of these applications. For a general description of the applications, refer to Chapter 1.

This section assumes that you know how to select Monitoring for a port, and select ISDN as the protocol. If you do not know how to do this, refer to the *Chameleon 32 User's Guide, Volume 1*.

The Physical Interface used for ISDN Monitoring is selected at the Physical Interface parameter on the Main Configuration Menu. When the Physical Interface used for ISDN Monitoring is Basic Rate or Primary Rate, there are two ways of configuring the Physical Layer:

- Active
- Passive

When in Simulation Mode, the Physical Layer signals are active, but no data will be transmitted. The received data is decoded and displayed on the Analysis pages. However, when in Monitor Mode, the Physical Layer, as well as the layers above, are passive. The system is then configured completely for Monitoring.

Monitor Setup Menu

When you select ISDN as your Monitoring protocol, you are prompted for several configurable parameters, as shown in Figure 10.1 below.

Configuration

Port x Monitor Setup

Press 60 to Accept

Protocol : ISDN

Default Network Layer Q.931 ←

Alternative Network Layer X.25
on SAPI number (0-63)

Alternative Network Layer None

Q.931 standard AT&T

Link Layer Q.921

Modulo Extended addr 128 yes

Q.931 X.25 User Data

Figure 10.1: The ISDN Monitor Setup Menu

Default Network Layer

This parameter determines which Network layer protocol you are monitoring. The options are:

- Q.931
- X.25
- User Data

Alternative Network Layer

You also have the option of specifying two Alternative Network Layers. The options for the alternative network layers include:

- Q.931
- X.25
- User Data
- None

However, whichever option you select as the Default Network Layer will not be available as a softkey option for the Alternative Network Layers. For example, in Figure 10.1, Q.931 is the Default Network Layer. Therefore, the softkey options for the Alternative Network Layers will not include Q.931.

When you configure an Alternative Network Layer, you are prompted for a SAPI number to search on:

On SAPI number (0 - 63)

Specifying a SAPI gives you the option of specifying the same network layer with two different SAPIs as your two Alternative Network Layers. For example, you could configure one Alternative Network Layer as X.25 on **SAPI 16**, and configure the second Alternative Network Layer as X.25 on **SAPI 0**.

Q.931 Standard

There are several different Q.931 standards available on the Chameleon 32. Currently these standards are:

- NTT
- CCITT Basic Rate
- Siemens Basic Rate Interface
- Northern Telecom Basic Rate Interface
- Australian PTT Primary Rate Interface
- AT&T
 - Primary Rate Interface (Compatible with AT & T Publication 41459, Addendum 1)
 - Basic Rate Interface (Compatible with 5E4.2 software)
- German PTT
 - 1TR6 Interface
 - 1R6-86 Interface

Link Layer

The only Link layer option is Q.921 layer 2, which follows the CCITT Q.921 standard.

Modulo

Modulo determines the frame numbering sequence that will be used to keep track of the frames that are transmitted and received. The options are:

- **Modulo 8** Frames numbered from 0 - 7
- **Modulo 128** Frames numbered from 0 - 127

Extended Addressing

Extended Addressing determines whether 8-bit addressing or 16-bit (extended) addressing is being used for transmission. The options are:

- **Yes** Extended (16-bit) addressing
- **No** 8-bit addressing

Analysis

Analysis provides two pages: Real Time and History. Both pages display the traffic in a split screen format (DCE/DTE).

The Real Time page displays traffic from both sides of the line as it is acquired. The data scrolls as traffic is acquired.

History displays traffic that has been acquired and put in a buffer. You can move back and forth through the traffic in the buffer to display specific parts of it.

The display format and function keys are the same for both pages, as shown in Figure 10.2.

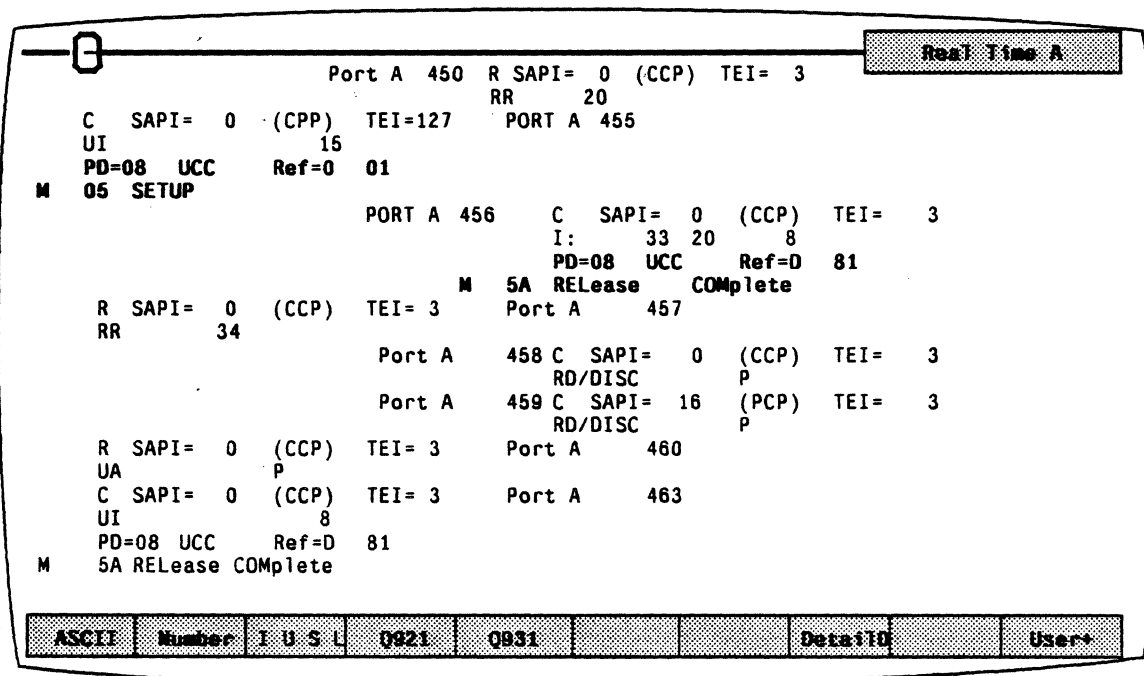


Figure 10.2: Real Time Page with Sample ISDN Traffic

Function Keys

The function keys control how the traffic is interpreted and displayed. These functions are available for both the History and Real Time pages. The ISDN Analysis function keys are described below.

F1: Code

F1 determines the format of the user data display. This is the data which does not belong to a protocol specific format. Each time you press **F1**, the user data (in white) changes to the code indicated in the softkey strip. The options are:

- ASCII** Each byte is displayed as an ASCII character. Characters in the range 0 - 1F hex are shown as single character mnemonics. Characters above 80 hex are shown as '.'.(default)
- EBCDIC** Each byte is displayed as an EBCDIC character.
- HEX** Each byte is displayed as a pair of hex digits
- HEXS** Each byte is displayed as a pair of hexadecimal digits, with a space between each pair.

F2: Acquisition Information

F2 determines the acquisition information display format, which is displayed in green or white in the center of the screen, between the DCE and DTE sides (See Figure 3.1). The options are:

- Number** Event number in decimal (default)
- Flags** Number of flags preceding the frame, in decimal
- Time** Event time stamp as hh:mm:ss
- dTime** Displays the elapsed time between events
- CRC** CRC value in hex, and **OK** if CRC is good or **BAD** if CRC is bad
- None** No acquisition information is displayed

The port receiving the packet (**Port A** or **Port B**) is displayed as part of the acquisition information unless the **None** option is selected.

F3: Event Types

F3 determines what types of events will be displayed on the Analysis page. The options are:

- I** Information frames only
- IU** Information and Unnumbered frames only
- IUS** Information, Unnumbered, and Supervisory frames (default)
- IUSL** All frames, plus lead transitions

Note

F3 affects the page *display* only. All events are captured, regardless of the **F3** selection (unless you are running a Triggering application which captures specific traffic or events).

F4: Level 2

F4 determines how the Level 2 is interpreted and displayed. The options are:

- Q.921-** Q.921 is acquired but not displayed
- Q.921 +** Q.921 is displayed interpreted
- Q.921"** Q.921 is displayed raw
- Q.921*** Q.921 is displayed interpreted and raw

F5: Level 3

F5 determines how the packet level (Q.931) is interpreted and displayed. The options are:

- Q.931-** Q.931 is acquired but not displayed
- Q.931 +** Q.931 is displayed interpreted
- Q.931"** Q.931 is displayed raw
- Q.931*** Q.931 is displayed interpreted and raw

F8: Detail

F8 determines the level of detail displayed on the screen.

Detail1 More detail

Detail0 Less detail

F10: User Data

F10 determines if user data is displayed. It also displays the traffic in a raw mode (uninterpreted). The options are:

User + User data is displayed

User- User data is not displayed

Raw All traffic is displayed raw (uninterpreted) in the code selected in **F1**

ISDN Layer 2 Interpretation

Figure 10.3 below shows a sample Layer 2 interpretation.

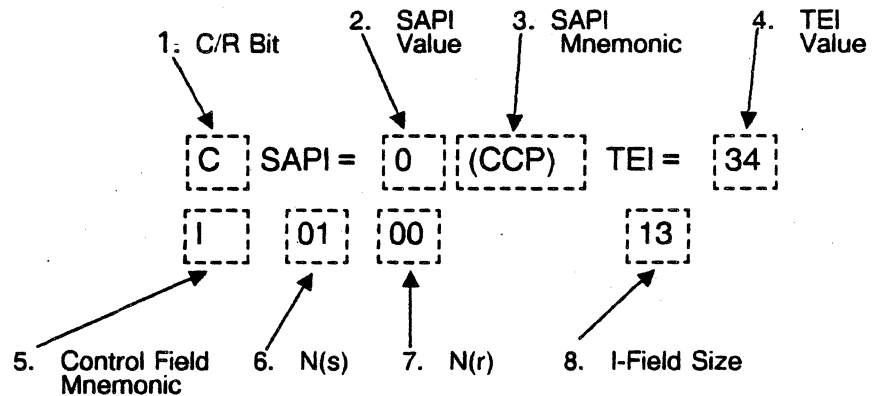


Figure 10.3: ISDN Layer 2 Interpretation

1. C/R Bit

This field displays the setting of the Command/Response (C/R) bit, as follows:

C	Command bit set
R	Response bit set
(blank)	C/R bit not set

2. SAPI Value

This field displays the value of the Service Access Point Identifier (SAPI) in decimal.

00	Call Control Procedures
16	Packet Communications Procedures
63	Management Procedures

3. SAPI Mnemonic

This field displays the Service Access Point Identifier (SAPI) mnemonic, as follows:

CCP	Call Control Procedures
PCP	Packet Communications Procedures
MP	Management Procedures

4. TEI

This field displays the Terminal Endpoint Identifier in decimal.

5. Control Field Mnemonic

This field displays the control field mnemonic, for example: I-Frame.

6. N(s)

This field displays N(s) in hex.

7. N(r)

This field displays N(r) in hex.

8. Size of I-Field

This field displays the size of the I-Field (if applicable) in decimal.

LTID Byte Interpretation

For the Northern Telecom version of ISDN, there are two additional layer 2 bytes that form a 14-bit word:

- LTID high byte
- LTID low byte

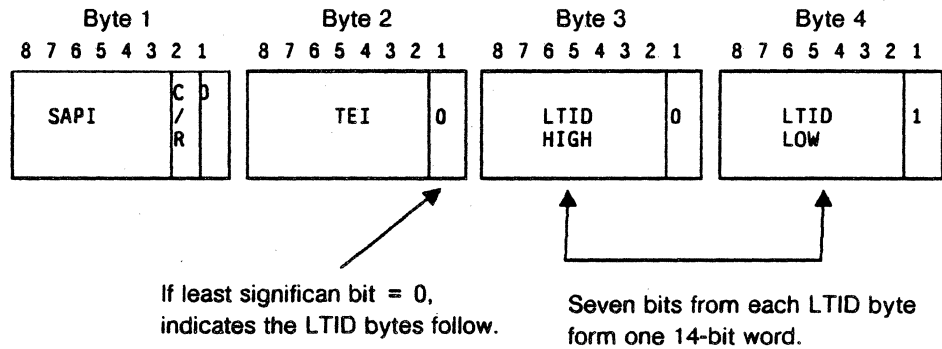


Figure 10.4: Northern Telecom LTID High and Low Order Bytes

The LTID bytes are interpreted only after **CTRL N** is pressed. The least significant bits from each LTID byte are stripped. The remaining bits are combined into a single 14-bit word that is represented in decimal and hex on the Chameleon 32 display. A sample display is shown in Figure 10.5 below.

```

C SAPI = 0(CCP) TEI = 8
-----
LTID: Hex=040F | Decimal = 263
-----
I 00 20 P 35
Q.921:0210040F0041
    
```

Figure 10.5: Chameleon 32 LTID Byte Interpretation

To disable LTID byte interpretation, press **CTRL N** again. (This assumes that the frame does not contain LTID bytes.)

ISDN Layer 3 Interpretation

ISDN layer 3 follows either the CCITT Q.931 protocol, or a manufacturer specific variant of Q.931.

The Q.931 message structure consists of the following parts:

- Protocol Discriminator
- Call Reference
- Message Type
- Information Elements

The first three components are present in all messages. Information elements can be either optional or mandatory, according to the message type. This is shown in Figure 10.6 below.

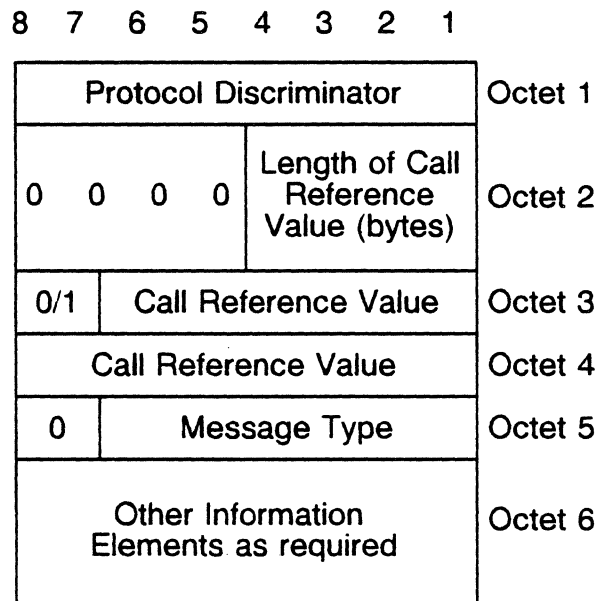


Figure 10.6: Message Structure

ISDN Layer 3 Interpretation

In Q.931, values which have no interpretation in any of the implemented protocols are shown as *Unknown*. Values which are not valid for the selected manufacturer specific protocol (including *Unknown* values) are displayed in red.

Figure 10.7 below shows an example of the first line of the Q.931 display.

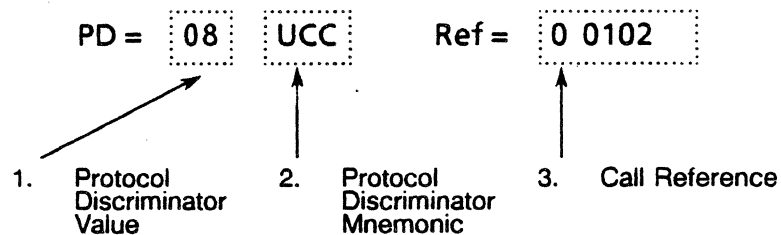


Figure 10.7: First Line of Q.931 Interpretation

1. Protocol Discriminator Value

This field displays the Protocol Discriminator value in hex.

2. Protocol Discriminator Mnemonic3. Call Reference Value

This field displays the Call Reference value, shown as a series of hex digits. The example above is interpreted as follows:

Ref	Caption
O	Origin (or D - Destination)
0102	Hex value of call reference (variable length)

Message Type

The next line of Q.931 interpretation is the message type. This is illustrated in Figure 10.8 below.

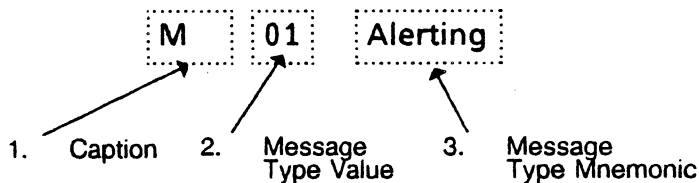


Figure 10.8: Second Line of Q.931 Interpretation

1. Caption

This field displays the caption, in this case, *M* indicates message type follows.

2. Message Type

This field displays the Message type value in hex.

Certain Q.931 implementations sometimes require two message type bytes. These are displayed on two consecutive lines.

3. Message Type Mnemonic

This field displays the Message Type mnemonic, or *Unknown*.

Information Elements

The rest of the Q.931 message consists of a number (possibly zero) of structures called information *elements*. These can be either single octet (byte) or multiple octet information elements.

Each of the information elements is interpreted in a manner outlined below. Interpretation of information elements is repeated until the end of the message is reached.

The first line of the information element interpretation is as shown in Figure 10.9.

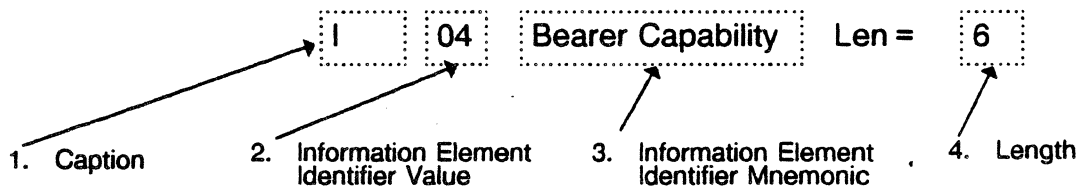


Figure 10.9: First Line of Information Element

1. Caption

This field displays the caption.

- I Indicates the start of information element interpretation.
- I+ Indicates that the information element was not expected (according to protocol rules) in the message.

2. Information Element Identifier Value

This displays the Information Element Identifier value in hex.

3. Information Element Mnemonic

This field displays the Information Element Identifier mnemonic, or *Unknown*.

4. Length

This field displays the length of the information element.

Single Octet Information Elements

Single octet information elements do not have Field 4, and may have alternate information.

Shift

Figure 10.10 below shows a sample Shift information element.

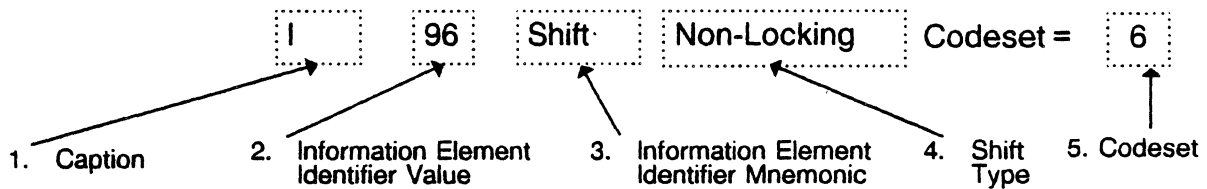


Figure 10.10: Shift Information Element

1. Caption

This field shows the Caption, which in this example, is / (Information element).

2. Information Element Identifier Value

This field shows the Information Element Identifier value in hex, which in this example, is 96.

3. Information Element Mnemonic

This field shows the Information Element Identifier mnemonic, which in this example, is Shift.

4. Shift Type

Locking
Non-Locking

5. Codeset

This field displays the new codeset in decimal.

Congestion Level

Figure 10.11 shows a sample of a Congestion Level information element.

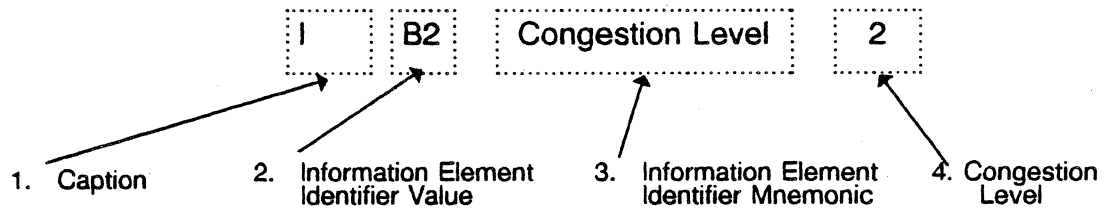


Figure 10.11: Congestion Level Information Element

1. Caption

This field shows the Caption, which in this example, is 1 (Information element).

2. Information Element identifier Value

This field shows the Information Element Identifier value in hex, which in this example, is B2.

3. Information element Mnemonic

This field shows the Information Element Identifier mnemonic, which in this example, is Congestion Level.

4. Congestion Level

This field displays the new congestion level in decimal, which in this case, is 2.

Diagnostic Information Elements

The Cause Information Element is of variable length, and can have special diagnostic information elements embedded within them. This is indicated in Field 1 of the Information Element display.

If the Field 1 displays a D (instead of I), it indicates a diagnostic information element. The remaining fields are identical to the non-diagnostic information elements.

Information Element Parameters

Figure 10.12 below provides an example of the complete interpretation of a Bearer Capability information element.

1	04	Bearer Capability	Len = 6	← Line	1
		Coding Standard	CCITT		2
1 →	11	Transfer capability	7kHz Audio		3
		Transfer mode	Circuit		4
	10	Transfer rate	64 Kbits/s		5
	50	Structure	(05)		6
		Configuration	Point-to-Point		7
		Establishment	Demand		8
	10	Symmetry	Bi/Sym		9
	.	Dest. Transfer rate	64 kbits/s		10

Figure 10-10: Bearer Capability Information

Field 1 shows the value (in hex) of the next byte to be interpreted.

In all lines, except line 1, the structure of the line is caption, followed by value. On these lines, when text is shown, it is the text description, or mnemonic, derived from the value. When digits are shown, it is the value itself.

When a line appears in red, it indicates that the value is not legal for this protocol implementation. The value may correspond to a textual description in another implementation, in which case the textual description is shown.

Error Messages

Error messages are displayed when the Monitoring applications detects a problem with the structure of the Q.931 message. The error messages are described below.

Information element out of sequence

This message is displayed at the end of the message, when it is determined that one or more of the information elements were found in the incorrect sequence.

Missing

This message is displayed at the end of the message interpretation when mandatory information elements are missing.

Information element too short

This message is displayed when the value of the length octet in a variable length information element is less than the required minimum.

ISDN Statistics

The Chameleon 32 ISDN Statistics is based on the CCITT Redbook Q.921 Recommendations of October 1984, and includes information on the following:

- **SAPI** **Service Access Point Identifier**, as defined in the CCITT Recommendation Q.921. SAPIs identify a point at which data link layer services are available.
- **TEI** **Terminal End Point Identifier**, as defined in the CCITT Recommendation Q.921. TEIs are used for point to point data link connections. Each TEI is associated with a single terminal.
- **SI** **Sequenced Information frames** as defined in the CCITT Recommendation Q.921. SI frames transfer information between data link entities using sequentially acknowledged frames. SI commands may or may not contain user data.
- **N_(R)/N_(S)** **Sequence numbers** used for flow control and error recovery in HDLC.

ISDN Statistics Pages

There are two types of ISDN Statistics pages available. These are:

- Q.921 Line Statistics
- Q.921 SAPI Statistics

The Q.921 Line Statistics page displays information for all SAPIs. There are also four Statistics pages that provide information specific to these SAPIs:

- **SAPI 0** **Call control procedures**
- **SAPI 16** **Packet communications procedures**
- **SAPI 63** **Management procedures**
- **All others** **SAPIs 32-47 are reserved for national use. All others are undefined at this time.**

Q.921 Line Statistics Page

Figure 10.11 below shows the Q.921 Line Statistics display. The fields are described below.

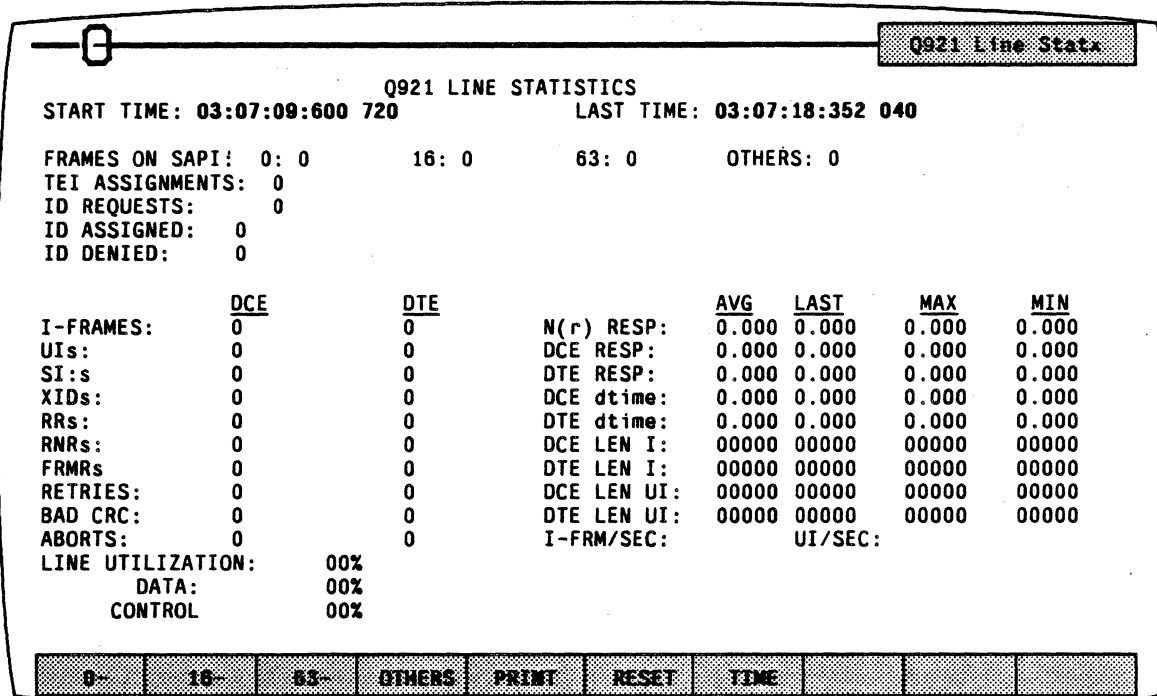


Figure 10.11: Q921 Line Statistics Page

- Start time** Displays the time of the end of the first event (frame).
- Last Time** Displays the time of the end of the last event (frame).
- Frames on SAPI** The number of frames received in each category of SAPIs:
 - SAPI 0 Call control procedures
 - SAPI 16 Packet communication procedures
 - SAPI 63 Management procedures
 - All others SAPIs 32-47 are reserved for national use. All others are undefined.

TEI Assignments	The total number of UI frames with a SAPI value of 63, a TEI value of 127, and a message type concerning TEI assignments. These include: ID request, ID assigned, ID denied, ID check request, ID check response, and ID remove.
ID Requests	The number of TEI assignment frames with MEIs = 0FH and Message Type = 1 (Identity request - user to network).
ID Assigned	The number of TEI assignment frames with MEIs = 0FH and Message Type = 2 (Identity assigned - network to user).
ID Denied	The number of TEI assignment frames with MEIs = 0FH and Message Type = 3 (Identity denied - network to user).
I-Frames	The number of information frames (the low order bit of the control field is set to 0).
UIs	The number of Unnumbered Information frames received.
SI0s	The number of Sequenced Information 0 frames received.
XIDs	The number of Exchange ID frames received.
RRs	The number of Receiver Ready frames received.
RNRs	The number of Receiver Not Ready frames received.
FRMRs	The number of Reject frames received.
Retries	The number of frames that have been retransmitted.
CRC Errors	The number of frames received with an incorrect Frame Check Sequence.
Aborts	The number of frame aborts on the line.
Line Utilization	The percentage of time there is any traffic on the line.

Data	The percentage of time that there is user data on the line.
Control	The percentage of time that there is non-user data on the line.
I-Frames Per second	The total number of I-frames divided by the total number of seconds expired. This number is truncated to the nearest whole number.
Frame Response	The time from the end of an I-frame to the end of N(R) confirmation for that I-Frame.
Frame Length	Displays the last, average, maximum, and minimum lengths of I-frames.

Q.921 Statistics Function Keys

F1 - F4: SAPI Pages

The F1 to F4 function keys enable you to activate a page that displays statistical information for SAPI 0, 16, 63, or all other SAPIs. The softkey strip at the bottom of the screen displays the SAPI page options.

If the SAPI has + next to the number, a page has been activated. If the SAPI has - next to it, a page is not currently activated for that SAPI.

To activate a SAPI Statistics page, perform these steps:

1. Make one of the ISDN Statistics pages active. (You can activate and deactivate SAPI pages from any ISDN Statistics page.)
2. Press the function key that corresponds to the desired SAPI. This causes a page banner for that SAPI to be displayed at the bottom of the screen. The softkey strip should also show a + next to the SAPI.
3. You can then make the new page active and use its function keys. (If the statistics page is in Blow mode when you activate a SAPI page, the SAPI page banner is hidden behind the other ISDN statistics banner. Use **Hide page/Show Page** to display the pages as needed.)

The SAPI function keys are the same as the Q.921 Line Statistics function keys page. The differences between the Q.921 Line Statistics and SAPI Statistics pages are:

- The SAPI 0, 16, and others pages do not display TEI Assignment, ID Request, ID Assigned and ID Denied.
- Only the number of SAPIs for that specific SAPI number are displayed. For example, the SAPI 16 page displays the number of SAPI 16 frames that have been received. The number of frames received with SAPIs other than 16 are not shown.

To deactivate a page for an SAPI, perform these steps:

1. Make one of the ISDN Statistics pages active.
2. Press the function key that corresponds to the SAPI page you want to deactivate. The softkey strip should show - next to the SAPI number and the SAPI banner disappears from the screen.

F5: Print

F5 Print prints a statistical report that is very similar to the screen display format. If you have a printer connected to the Chameleon 32, you can print a report. If you do not know how to connect a printer to the Chameleon 32, refer to the Chameleon 32 User's Guide, Chapter Nine: Utilities.

If you do not have a printer, the Print function key has no effect. The report will not be displayed on the Chameleon 32 screen.

A sample Q.921 Line statistics report is shown in Figure 10.12 on Page 10-28.

F6: Reset

F6 Reset resets the statistics values to zero, and resets the times (or dates) displayed at the top of the Statistics page.

F7: Time/Date

F7 Time/Date enables you to display the time or the date at the top of the Statistics page. The timer display changes when the next event is received.

TEKELEC Q921 LINE STATISTICS REPORT				
START TIME:	00:00:00:000	000		
LAST TIME:	00:00:00:000	000		
	DCE		DTE	
FRAMES ON SAPI 0 :	00000000		00000000	
FRAMES ON SAPI 16 :	00000000		00000000	
FRAMES ON SAPI 63 :	00000000		00000000	
FRAMES ON OTHER SAPIs:	00000000		00000000	
TEI ASSIGNMENTS :	00000000		00000000	
ID REQUESTS :	00000000		00000000	
ID ASSIGNED :	00000000		00000000	
ID DENIED:	00000000		00000000	
ID CHECK REQUESTS:	00000000		00000000	
ID CHECK RESPONSES:	00000000		00000000	
FRAME ABORTS :	00000000		00000000	
CRC ERRORS :	00000000		00000000	
RETRANSMISSIONS :	00000000		00000000	
I-FRAMES :	00000000		00000000	
RRs :	00000000		00000000	
RNRs :	00000000		00000000	
REJs :	00000000		00000000	
FRMRs :	00000000		00000000	
SABMs :	00000000		00000000	
UAs :	00000000		00000000	
DISCs :	00000000		00000000	
Dms :	00000000		00000000	
SI0s :	00000000		00000000	
SI1s :	00000000		00000000	
UIs :	00000000		00000000	
SABMEs :	00000000		00000000	
XIDs :	00000000		00000000	
	AVG	LAST	MAX	MIN
N(s)-N(r) RESPONSE:	0.000	0.000	0.000	0.000
DCE RESPONSE TIME :	0.000	0.000	0.000	0.000
DTE RESPONSE TIME :	0.000	0.000	0.000	0.000
DCE DELTA TIME :	0.000	0.000	0.000	0.000
DTE DELTA TIME :	0.000	0.000	0.000	0.000
DCE I-FRAME LENGTH :	00000000000000000000			
DTE I-FRAME LENGTH :	00000000000000000000			
DCE UI LENGTH :	00000000000000000000			
DTE UI LENGTH :	00000000000000000000			
LINE UTILIZATION :	00 %			
DATA UTILIZATION :	00 %			

Figure 10.12: Sample Q.921 Print Display



CHAPTER ELEVEN:

ISDN PRIMARY RATE INTERFACE

CHAPTER ELEVEN:

ISDN PRIMARY RATE INTERFACE

Introduction

The Primary Rate Interface enables the Chameleon 32 to monitor a DS1 service (two DS1 signals), or to simulate a DS1 TE/NT or CO/ET. The Primary Rate Interface can also be used to drop and insert a selected channel of a DS1 signal.

Voice frequency signals can also be inserted into or extracted from a selected DS0 channel. Using Codec, a handset is provided to allow a conversation through the channel. The Chameleon 32 Primary Rate Interface also generates a digital milliwatt tone which can be inserted into a selected channel.

Note

The monitoring of two selected DS1 channels is handled by any one of the Chameleon 32 Monitoring applications, and is displayed in separate pages.

Details on the physical level performance of the received DS1 signals are derived, and then presented, on the Chameleon 32 LED front panel display.

The CCITT has defined two ways of accessing ISDN Primary Rate:

- ANSI 1.544Mbs version, popular in the United States,
- CEPT 2.048Mbs version, popular in Europe

Although the Chameleon 32 software user-interface is the same for both options, the signaling and framing techniques used in ANSI and CEPT are quite different, and require different hardware. CCITT Recommendations G.703, G.704, G.732 (CEPT), and G.733 (ANSI) specify the physical layer characteristics for Primary Rate.

The LAPD package has been developed specifically for ISDN testing, but other Chameleon 32 packages are available (X.25 analysis and SNA/SDLC analysis). Likewise, LAPD, X.25, and SNA/SDLC Simulation packages are available.

To use the Chameleon 32 with a Primary Rate Interface you must do the following:

1. Install the hardware for either ANSI 1.544Mbps or CEPT 2.048Mbps Primary Rate Interface. If your Primary Rate Interface option is not already installed, refer to the installation instructions which accompanied the Primary Rate Interface package for details.
2. Configure the port with the Primary Rate Interface for Monitoring or Simulation. This procedure is described on page 11-13.
3. Configure the Primary Rate Interface parameters using the Setup menu. This procedure is described on page 11-17.
4. Run the PRIMARY application (to monitor the physical interface) and additional Monitoring or Simulation applications for upper layer testing. This procedure is described on page 11-22.

ANSI Primary Rate Interface

The ANSI version of Primary Rate, developed and installed in the United States, is specified in CCITT Recommendation G.733. There is no pre-assigned channel for sending signaling information.

Level 1 information is presented on the Chameleon 32 front panel LED display (see Figure 11.3) for both DS1 signals includes:

- No Frame Synchronization
- Yellow Alarm
- Signaling (A bit) - when applicable

DS1 Interface:

- Signal Format: SF and ESF
- Zero Suppression: B8ZS ON/OFF
- WECO 310 type jacks

DS1 Receiver:

- Dual Receiver
- Input Impedance:
 - ▶ Terminate: 100 ohms balanced nominal
 - ▶ Bridge: Greater than 1K ohms balanced (use Bridge input at Monitor Jack)
- Received Signal Level--DSX-1 in accordance with CB No. 119 or bridged at Monitor Jack
- Received Signal Frequency-1.544 MBPS \pm 130 PPM

DS1 Transmitter:

- Dual Transmitter
- Signal Level: 3 ± 0.3 volt peak pulse in accordance with CB No. 119 and T1X1 specifications
- Output Impedance: 100 ohms balanced nominal
- Signal Frequency: 1.544 MBPS \pm 50 PPM
- Digital Milliwatt Tone Generator (μ dBm, 1004Hz)

CEPT Primary Rate Interface

The Conference of European Postal and Telecommunication (CEPT) Administration is an important organization that plays a key role in the development of European Telecommunications standards.

The CCITT Recommendation G.732 contains the specifications for the CEPT Primary Rate Interface at 2.048 Mbps or CEPT PCM-30. The CEPT Primary Rate Interface can handle 30 data or voice channels. CEPT PCM-30 has 32 time slots (8-bit positions in a frame). Two time slots are used for signaling and framing. The remaining 30 time slots are available for user data.

The two frequencies available in the Digital Milliwatt Tone Generator are 820Hz and 1020Hz.

Details on the physical level performance of the received DS1 signals are derived, and then presented, on the Chameleon 32 LED front panel display.

Level 1 information presented on the Chameleon 32 LED front panel display for both DS1 signals includes:

- No Frame Synchronization
- Remote Alarm
- Signaling (A bit) - when applicable

DS1 Interface:

- Signal Format: With or without signaling
- Zero Suppression: HDB3 ON/OFF
- BNC Connector (75 Ω , 120 Ω)

DS1 Receiver:

- Dual Receiver
- Input Impedance:
 - ▶ Terminate: 100 ohms balanced nominal
 - ▶ Bridge: Greater than 1K ohms balanced (use Bridge input at Monitor Jack)
- Received Signal Level--DSX-1 in accordance with CB No. 119 or bridged at Monitor Jack
- Received Signal Frequency--2.048 MBPS \pm 130 PPM

DS1 Transmitter:

- Dual Transmitter
- Signal Level: 3 ± 0.3 volt peak pulse in accordance with CB No. 119 and T1X1 specifications.
- Output Impedance: 100 ohms balanced nominal
- Signal Frequency: 2.048 MBPS ± 50 PPM
- Digital Milliwatt Tone (820Hz and 1020Hz)

Primary Rate Interface Hardware

The ANSI and CEPT versions of the Primary Rate Interface hardware includes:

- The Primary Rate Interface module (installed in one of the I/O module slots on the rear of the Chameleon 32)
- The Primary Rate Interface Boards (installed in the card cage of the Chameleon 32) with handset
- A DS1 LED overlay for the Chameleon 32 front panel LED display.

Note

For information on how to install the Primary Rate Interface hardware, refer to the installation instructions which accompanied the Primary Rate Interface package.

Interface Modules

The Chameleon 32 ANSI and CEPT Primary Rate Interface modules provide four jacks:

- Two for transmitting (T1,T2)
- Two for receiving (R1,R2)

Each of these interface jacks carry half-duplex signals. T1 and R1 constitute a full-duplex line (Line 1). Similarly, T2 and R2 make up Line 2.

The ANSI and CEPT Primary Rate Interface modules are shown on the following page.

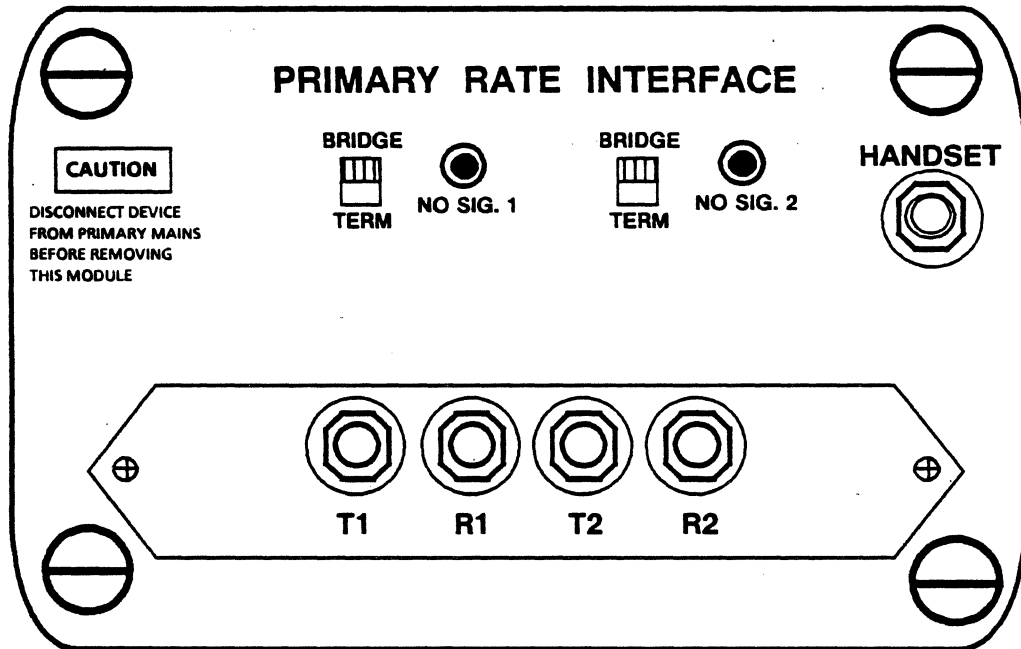


Figure 11.1: The ANSI Primary Rate Interface Module

The CEPT Interface module is the same, except the jacks are different, as shown in Figure 11.2 below.

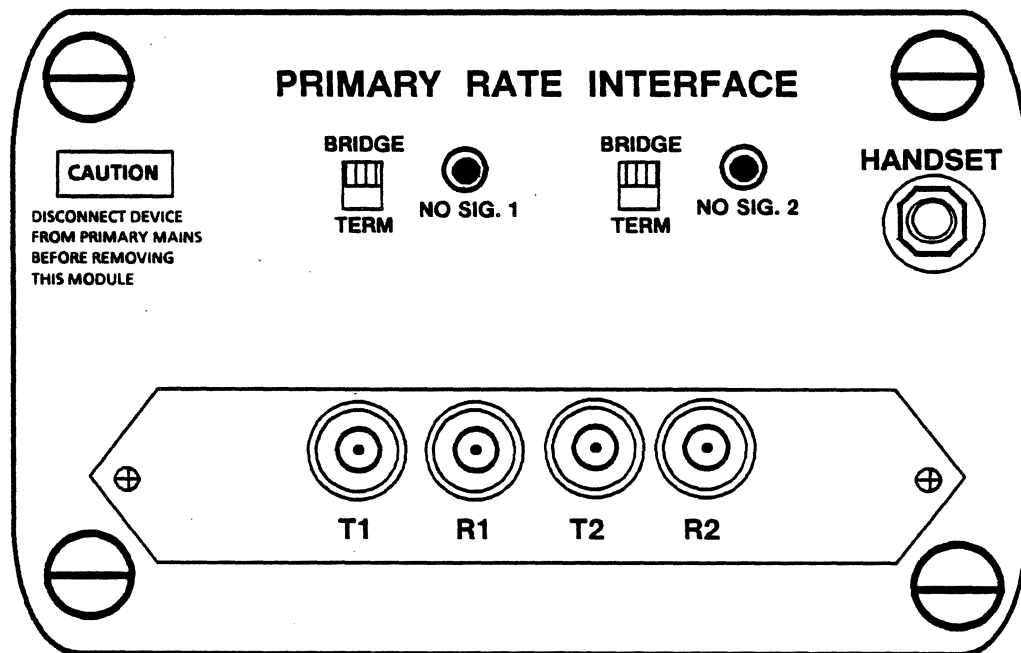


Figure 11.2: The CEPT Primary Rate Interface Module

The selectors and indicators on the Primary Interface module include:

- The **BRIDGE/TERM** switch that allows you to either bridge the Receivers at greater than 1K ohms, or terminate the Receivers at 100 ohms.
- The **NO SIG** (no signals) LEDs that are lit when no signal is present on the Receive lines.

Note

Line 1 receive signal (**R1**) must always be present in Simulation.

LED Overlays

The ANSI Primary Rate Interface DS1 LED overlay for the Chameleon 32 front panel LED display is shown in Figure 11.3 below.

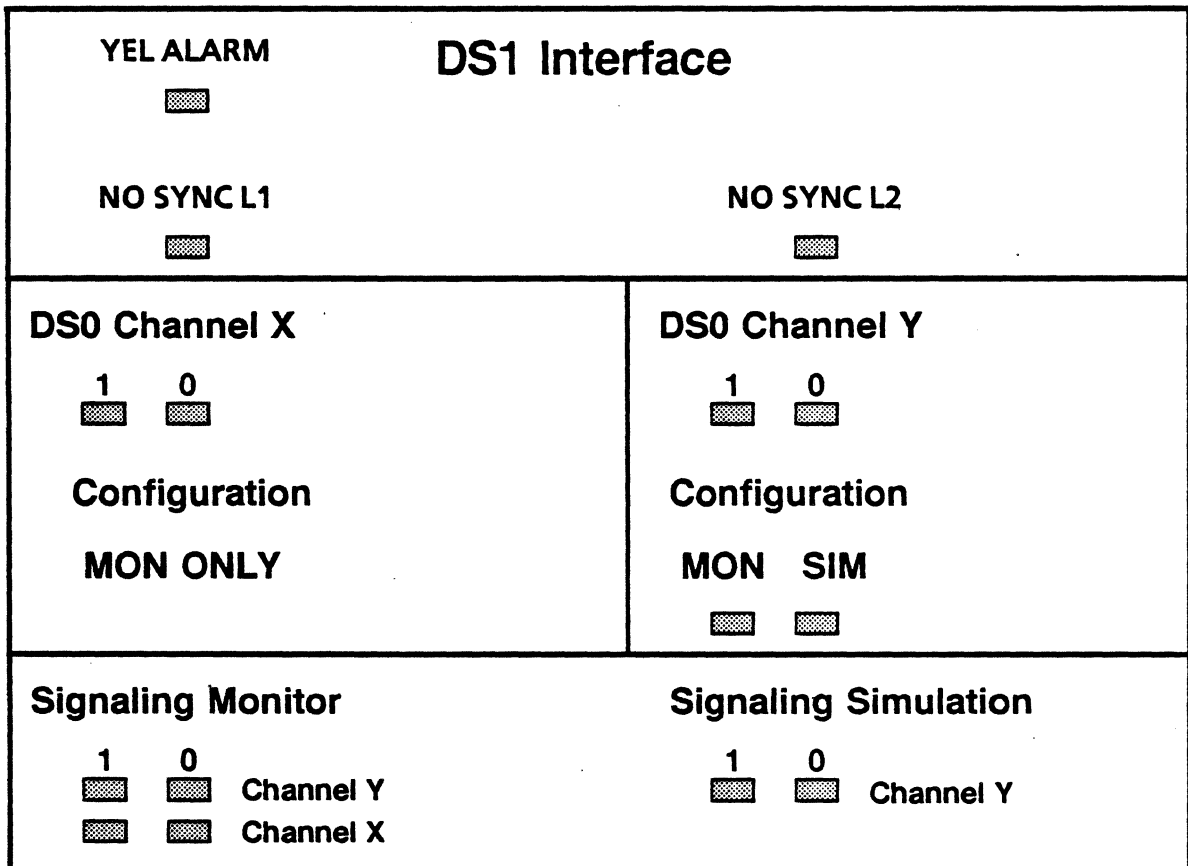


Figure 11.3: The ANSI Primary Rate Interface LED Display

Level 1 information on the LED display for both lines includes:

- **YEL ALARM**
 Yellow Alarm

This LED is lit when remote end problems exist, indicating one of the following conditions has been met:

- ▶ In **ESF** framing (Extended Superframe, with or without signaling), the Receiver has detected 16 Yellow Alarm patterns of 0000000111111111 or 1111111100000000 on the 4K bps Data Link.
- ▶ In **SF** framing (Superframe, with or without signaling), a Yellow Alarm is detected when BIT 2 equals 0 for 255 consecutive channels. A switch on the Multibus Board allows selection of an alternate Yellow Alarm which activates when the S-bit of Frame 12 is *high*.

- **NO SYNC L1/2**

No Frame Synchronization

The LED for the corresponding line is lit when an out-of-frame condition exists on that line.

- **DS0 Channel X/Y**

The two LEDs for channels X and Y show what constitutes the **DS0** data of the corresponding channel. If the data is all ones, only the LED labeled 1 is lit. The same is true for all zero data. If the data is ones and zeros, then both the LED labeled 0 and 1 are lit.

- ▶ **Configuration**

The **MON** LED, when lit, indicates that the DS0 channel Y is in Receiving Mode. (DS0 channel X is always in Receiving Mode.)

The **SIM** LED indicates that the channel Y is in Simulation Mode.

- **Signaling Monitor**

The two LEDs for channels X and Y show the current state of the "A" signaling bit for the corresponding channel.

- **Signaling Simulation**

The two LEDs show the current state of the "A" signaling bit for channel Y, when the channel is in Transmitting Mode.

The CEPT Primary Rate Interface DS1 LED overlay for the Chameleon 32 front panel LED display is shown in Figure 11.4 below.

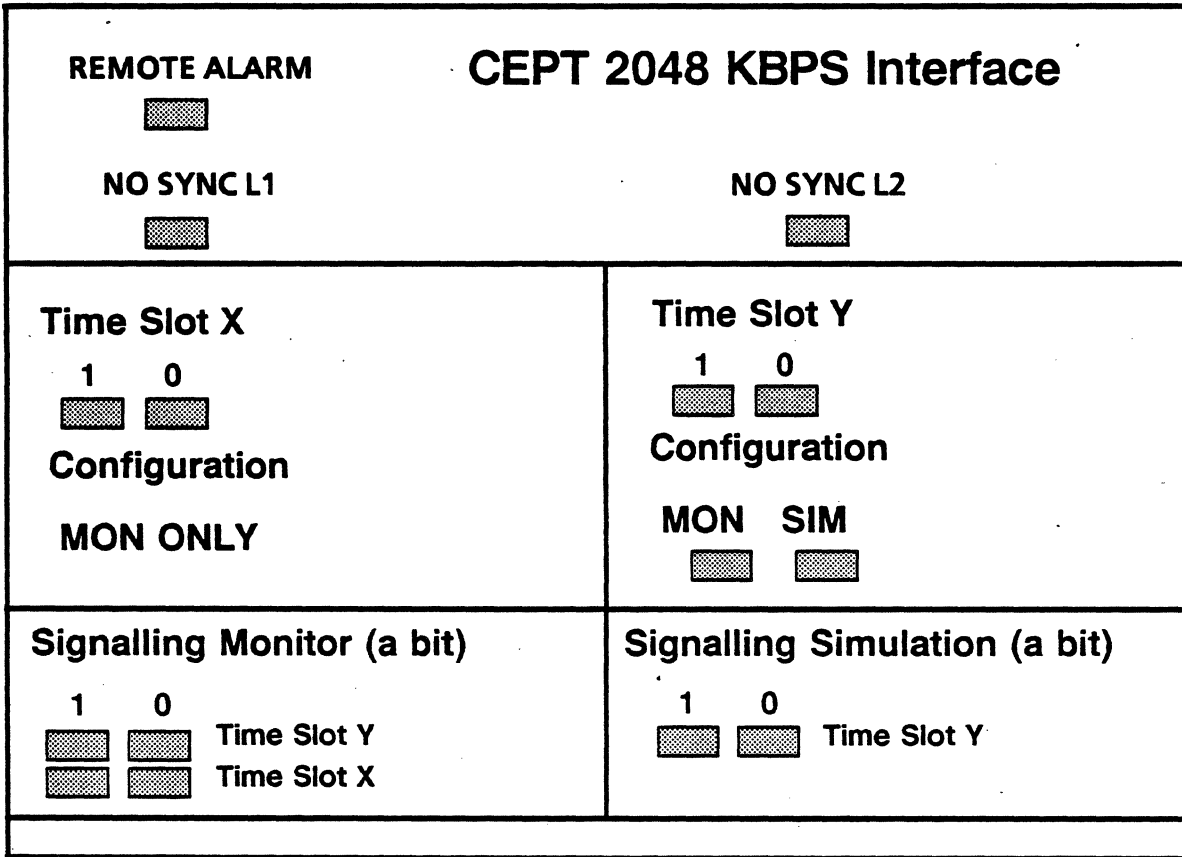


Figure 11.4: CEPT Primary Rate Interface LED Display

Level 1 information on the CEPT Primary Rate LED display for both signals includes:

- **REMOTE ALARM**

This LED is lit when a Remote Alarm signal is received (for example, when the Remote receiver loses synchronization).

- **NO SYNC L1/2**

No Frame Synchronization

The LED for the corresponding line is lit when an out-of-frame condition exists on that line.

- **Time Slot X/Y**

The two LEDs for time slots X and Y show what constitutes the data of the corresponding time slot. If the data is all ones, only the LED labeled 1 is lit. The same is true for all zero data. If the data contains changing ones and zeros, then both the LED labeled 0 and 1 are lit.

- ▶ **Configuration**

The **MON** LED, when lit, indicates that time slot Y is in Monitoring Mode.

The **SIM** LED indicates that the time slot Y is in Simulation Mode.

time slot X is always in Receive (Monitor) Mode.

- **Signalling Monitor (a bit)**

The two LEDs for time slots X and Y show the current state of the "A" signaling bit for the corresponding time slot.

- **Signalling Simulation (a bit)**

The two LEDs show the current state of the "A" signaling bit for time slot Y, when the time slot is in Simulation Mode.

Port Configuration

When the Primary Rate Interface option is installed, the Chameleon 32 detects its presence, and includes Primary Rate options in the configuration menus. The Primary Rate Interface is currently available on Port A only.

To configure the Primary Rate Interface for Monitoring, perform the steps below.

Note

The term *channel* refers to the use of the ANSI Primary Rate Interface. The term *time slot* refers to the use of the CEPT Primary Rate Interface.

1. Connect the devices you are monitoring to the Chameleon 32 Primary Rate Interface.

If a receive channel or a time slot is selected when a cable is not connected to the receive lines (R1 or R2), the receive selection may not work. You must connect the line before setting up from a default file or making selections from a runtime screen.

2. Power up your Chameleon 32 and display the main Configuration Menu (Figure 11.5).
3. Select **Monitor** or **Simulate** as the Mode of Operation for Port A. The option you select depends on your testing application.

If you are monitoring the traffic between two devices, select **Monitor**. If you are using the Chameleon 32 to emulate a device so that you can test a second device, select **Simulate**.

4. Select **Primary** as the Physical Interface. If you have only one type of physical interface installed, the correct physical interface option will already be displayed.
5. Press **F6 Protocol** to display the next menu.

If you selected **Monitor** for Mode of Operation, a menu is displayed which enables you to select a protocol. There are several parameters displayed for each protocol. These are described in the appropriate protocol chapter of this volume.

If you selected **Simulate** for Mode of Operation, a menu is displayed which enables you to select a simulator.

There are several parameters displayed for each simulator. These are described in the simulator chapters of the *Chameleon 32 Simulation Manual*.

6. Use the function keys to select the desired protocol or simulator and related parameters.
7. Press **Go** to accept the displayed values and return to the main configuration menu.
8. Press **F7 Physicl** to display the Primary Rate Interface setup menu. This menu enables you to configure the Primary Rate interface and is described on page 11-17.
9. When you have the desired setup values displayed in the Setup menu, press **Go** to accept the values and return to the main configuration menu.
10. From the main configuration menu, press **Go**.
11. If you selected **Simulate** for Mode of Operation, skip this step and continue with step 12.

If you selected **Monitor** for Mode of Operation, the Applications Selection menu is displayed. Load the Primary Rate Interface software, as follows:

- a. Move the red arrow cursor to the **PRIMARY** application.
 - b. Press **F1 Load A** to load the Primary Rate Interface software.
 - c. Load the Monitoring applications (Analysis, Statistics, Direct-to-Disk, etc) that you want to use to analyze the traffic you will be monitoring.
 - d. Press **Go** to start the selected applications.
12. A **Primary** page banner should appear at the bottom of the screen. This page enables you to view and modify your Primary Rate Interface setup without stopping the other applications. It is described on page 11-22.

If you selected **Monitor** for Mode of Operation, there should also be a page banner for each of the selected Monitoring applications (except Direct-to-Disk, which does not have a page display). Refer to the *Chameleon 32 User's Guide* for information about using Monitoring application pages.

If you selected **Simulate** for Mode of Operation, there should be a page banner for the Simulator you selected. Refer to the *Chameleon 32 Simulation Manual* for information about using Simulation pages.

Configuration Files

You can save your Primary Rate Interface configuration in a file so that the Chameleon 32 is automatically configured on power up, or when the configuration file is loaded. Refer to the *Chameleon 32 User's Guide* for more information about configuration files.

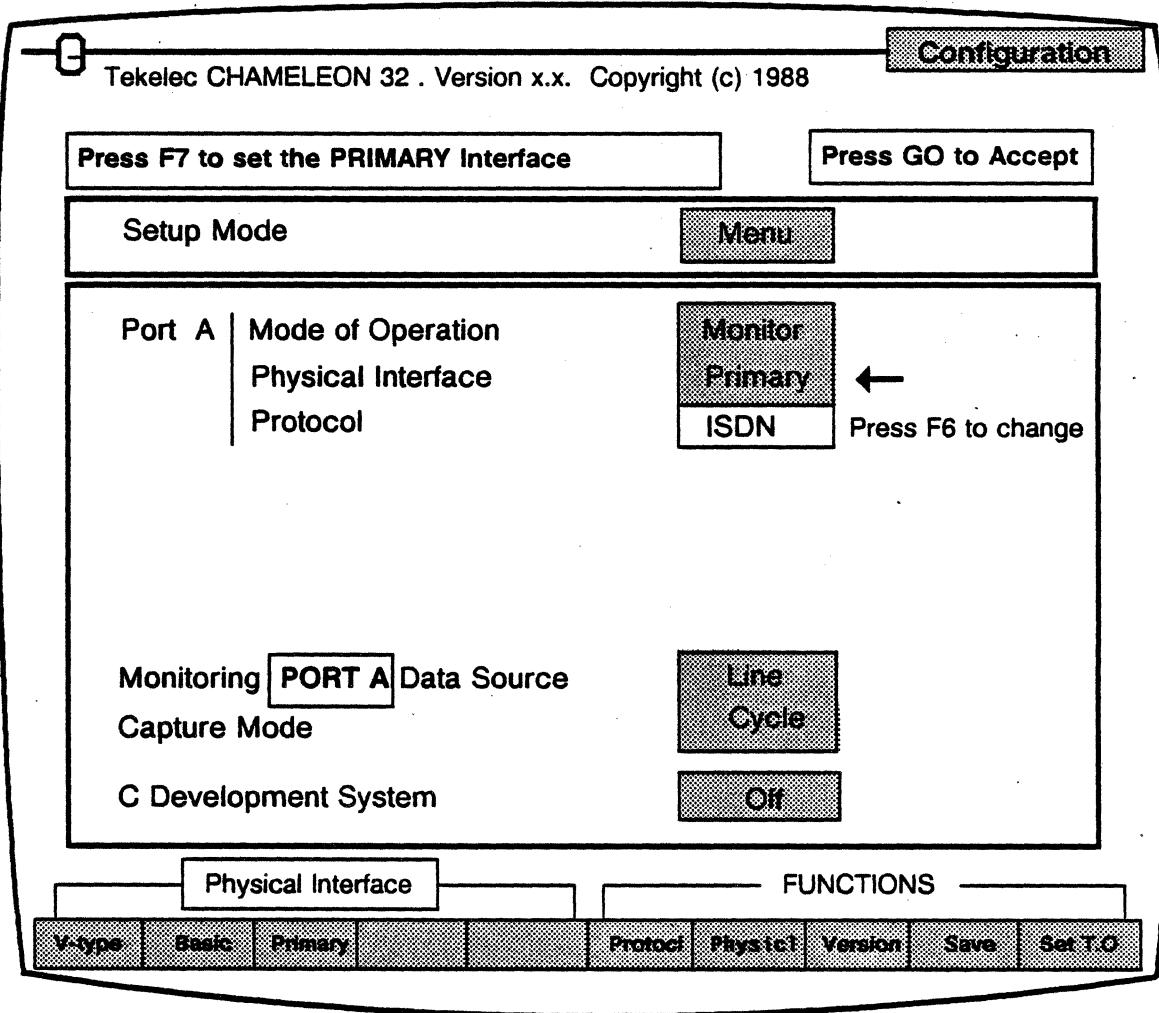


Figure 11.5: Main Configuration Menu (Dual Port Machine)

SETUP MENU

When you press **F7 Physicl** from the main configuration page, the setup menu is displayed. The parameters displayed in the menu vary depending on whether you are in Monitor or Simulate Mode, and whether you are using ANSI or CEPT framing. These variations are noted in the description of the menu, which begins on the next page.

Note To display the CEPT menu, move the red arrow cursor to the Framing parameter and select CEPT.

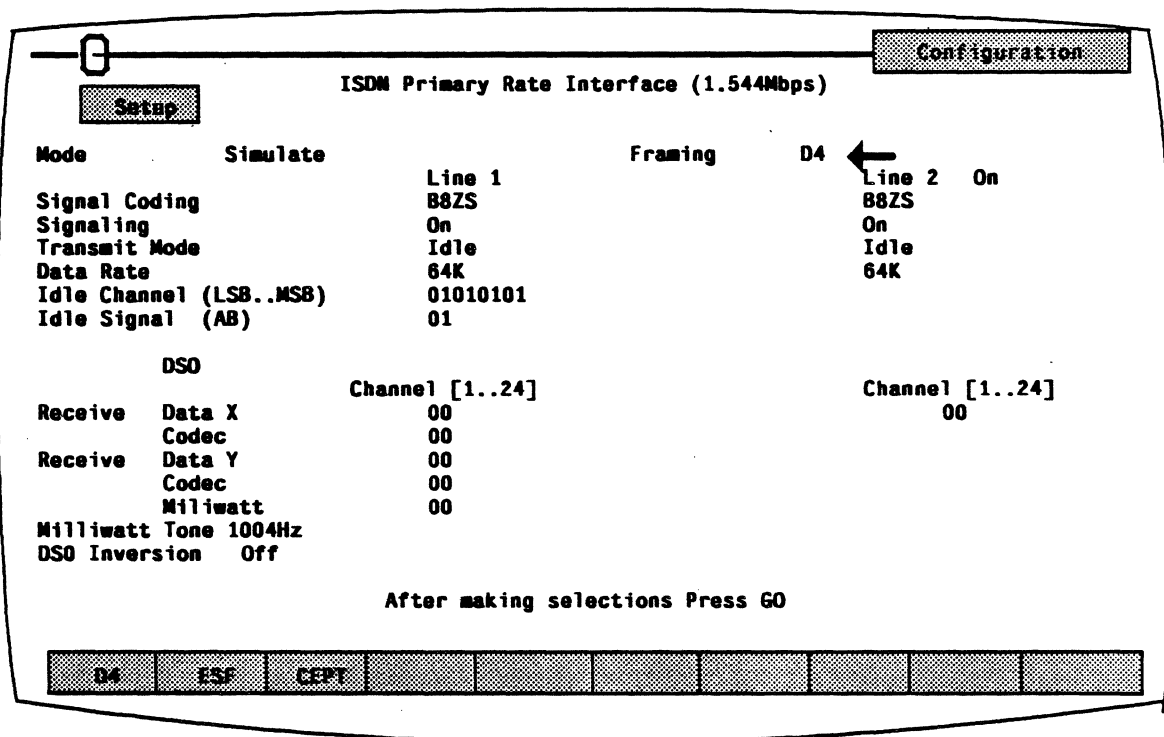


Figure 11.6: ANSI Primary Rate Interface Monitoring Setup Menu

Default settings are automatically displayed when the setup menu first appears. The red arrow cursor indicates the selected parameter. The values for the selected parameter are shown in the softkey strip at the bottom of the page.

To change a parameter, use the arrow keys to move the red arrow cursor to the parameter you want to change, and then press the function key that corresponds to the desired value. Several parameters require you to type in a value rather than select a value using the function keys.

Mode Selects the mode to use. If you selected Simulate for the Mode of Operation when configuring the port, Simulate is the only valid option for this parameter.

If you selected Monitor for the Mode of Operation when configuring the port, you may select either Simulate or Monitor for this parameter.

Simulate This option enables you to generate data from the Chameleon 32, and send it on the line.

If you selected Monitor for Mode of Operation, the Chameleon 32 simulates the physical layer, while monitoring layers 2 and above.

Monitor The Chameleon 32 can monitor the line only.

Framing Selects the type of framing to be used. All three options are displayed regardless of whether you have the ANSI or CEPT option installed. However, the selections are valid only for the interface options as noted below.

D4 D4 Framing. This is valid only for ANSI.

ESF Extended Super-Frame. This is valid only for ANSI.

CEPT CEPT recommended framing. This is valid only for CEPT.

Line 2 Enables/disables Line 2 by selecting On or Off.

Signal Coding Selects the Zero Suppression scheme to be used. The ANSI options are:

B8ZS Bipolar 8 Zero Suppression

AMI Alternate Mark Inversion, without zero suppression.

The CEPT options are:

HDB3 High Density Bipolar 3 (HDB3) is a coding scheme that provides sufficient 1s density when there is a stream of continuous zeros. This is done by substituting the zero sequence with a signal sequence containing bipolar violations.

ON = Zero Suppression

OFF = No Zero Suppression

Signaling For ANSI, enables/disables signaling information for Lines 1 and 2, by selecting On or Off. In D4 framing, this is done using robbed-bit signaling (8-bit, least significant bit, on every sixth frame). With ESF framing, the signaling bits are transmitted using F-bits from the frames in the ESF (24 frames).

For CEPT, enables signaling information in time slot 16. When ON, time slot 16 contains the current signaling information. When OFF, time slot 16 is available for other uses. (When OFF, the time slot parameter changes to [1-31]).

Transmit Mode

This parameter has five selections:

Resync Re-synchronizes the line.

Idle Transmits an Idle Sequence on the line. The Idle Sequence default pattern can be changed in the Idle Channel parameter.

When *Idle* is selected, two additional parameters are displayed. This parameter allows the idle data to be sent on all data and signal channels. The parameters are:

Idle Channel (LSB..MSB) 01010101

Idle Signal (AB) 01

Idle Channel is the idle sequence to be sent on the channels for which no other functions have been selected, for example DS0 and Codec.

Idle Signal is the sequence of bits sent on the signaling channel using the selected signaling technique. For D4 and ESF framing, a single hex pair is required. For CEPT framing, two hex pairs are required.

Repeater Loops the Receiver line back to the Transmit line without re-framing.

Transparency Available for Line 1 only.

All channels/time slots, except those for which selections are made, are looped from the Receive line to the Transmit line. The data provided by the Transmit Mode options (Codec, Data Y, and Milliwatt) replace the incoming traffic on those channels/time slots.

Yellow Alarm Transmits the Yellow Alarm signal.

**Data
Rate**

Available only when ANSI (D4 or ESF) framing is selected. This parameter allows you to set Data X and Data Y for either 56K or 64K.

CRC

Available only when CEPT framing is selected. Enables/disables a Cyclic Redundancy Check in the signals by selecting On or Off.

DS0 The remaining parameters allow you to make selections for a specific channel/time slots. A value of 00 de-selects the current selection.

For ANSI, these parameters accept a value for the channel number (1-24).

For CEPT, these parameters accept a value for the time slot (1 - 31). If Signaling is On, time slot 16 is reserved for signaling information and is not available for these parameters.

Receive Data X Selects the receive channel/time slot for Simulation or Monitoring packages. Data can be received on either Line 1 or Line 2, but not on both simultaneously.

Receive Codec Selects the channel/time slot to enable the Codec Receiver (available on Line 1 only).

Receive Data Y Selects the channel/time slot to enable the Data Y Receiver (Monitor Mode only, Line 1 only).

Transmit Data Y Simulate mode only. Selects the channel/time slot to be used with the DS0 Y Receiver in Monitor Mode. In Simulation Mode, this parameter takes the channel/time slot for the Line 1 Transmitter.

Transmit Codec Simulate mode only. Selects the channel/time slot for the Codec Transmitter.

Transmit Milliwatt Simulate mode only. Selects the channel/time slot to enable the Digital Milliwatt Tone Generator. The tone generated in ANSI (D4/ESF) is 1004Hz at 0 dBm. In CEPT, the tone can be either 820Hz or 1020Hz.

Milliwatt Tone Simulate mode only. Selects the Milliwatt Tone for CEPT.

DS0 Inversion Inverts the data on the specified channels (ANSI), or time slots (CEPT) in Data X and Data Y.

PRIMARY RUNTIME PAGE

When you load and run the PRIMARY application from the Applications Selection menu, a page is displayed with the following banner:

xxx Primary

where *xxx* is the name of the selected protocol. This page displays the current Primary Rate Interface setup and enables you to modify certain parameters while the Monitoring applications are running.

The format of the runtime page is the same as the setup menu, except it displays the following message in the upper left corner of the page:

running

While Primary Rate is running, you cannot change the **Mode** and **Framing** parameters. However, other parameters can be modified. The changes are displayed as soon as you press the function key for softkey selections, or press **Return** for a value entered from the keyboard. (The arrow keys can also be used to move to another parameter field with the same result.)

Application Notes

Figure 11.7 below illustrates several Primary Rate Interface testing configurations using the Chameleon 32.

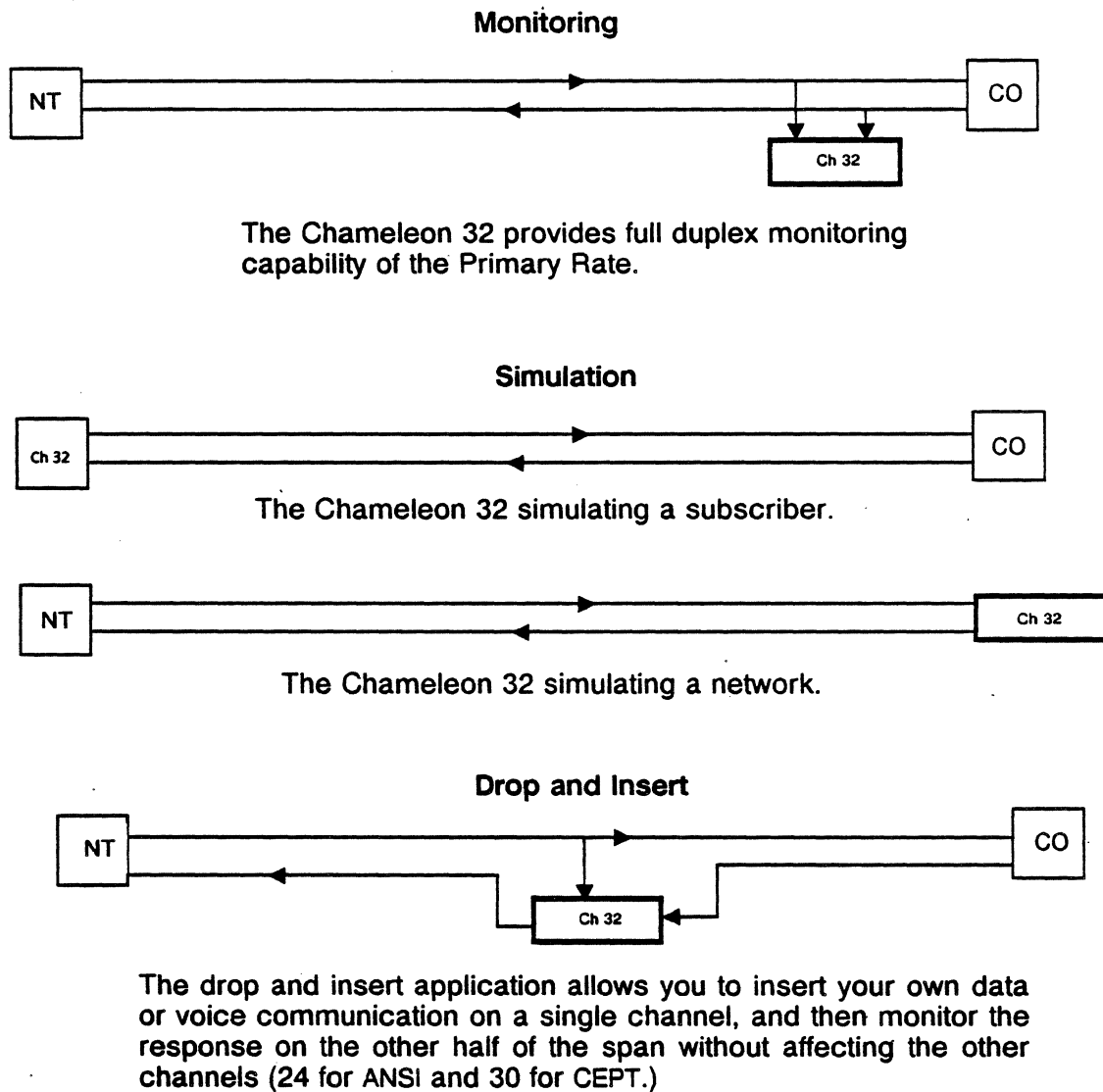
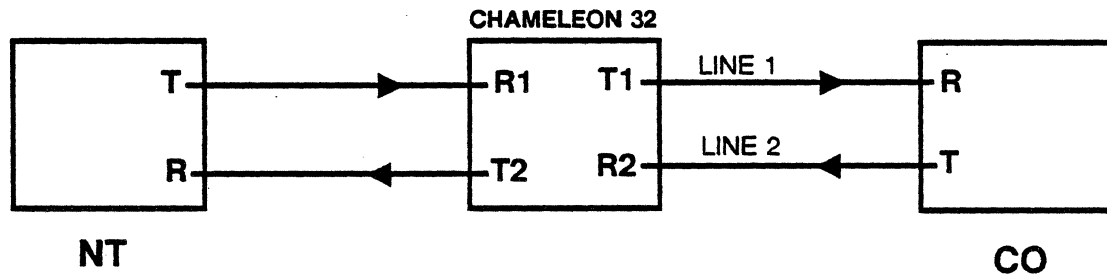


Figure 11.7: Primary Rate Interface Applications

You can perform two types of Monitoring:

- In-line Monitoring (with or without Drop and Insert)
- Bridge Monitoring (at Monitor Jack or equivalent)

Figure 11.8 below shows the In-line Monitoring cable connections.



Note: BRIDGE/TERM switch is in the TERM position.

Figure 11.8: Chameleon 32 with the Primary Rate Interface

Notes

You must stop acquisition before making changes to the DS0 Channel selections. To stop acquisition, press *RUN/STOP*. To start acquisition again, press *RUN/STOP*.

You cannot simultaneously listen to both sides of a conversation on the Codec Receiver.

Monitoring Channels From Both Lines

Figure 11.9 below shows the following setup:

- D4 Framing
- B8ZS Zero Suppression
- Signaling ON
- Channel 8 enabled on the DS0 x Receiver, Line 2
- Codec Receiver enabled on Channel 2, Line 1
- DS0 y Receiver enabled on Channel 5, Line 1

The data Rate for DS0 x and DS0 y Channels is 64kbps. The data received on DS0 x and DS0 y (displayed by the Monitoring package) is inverted.

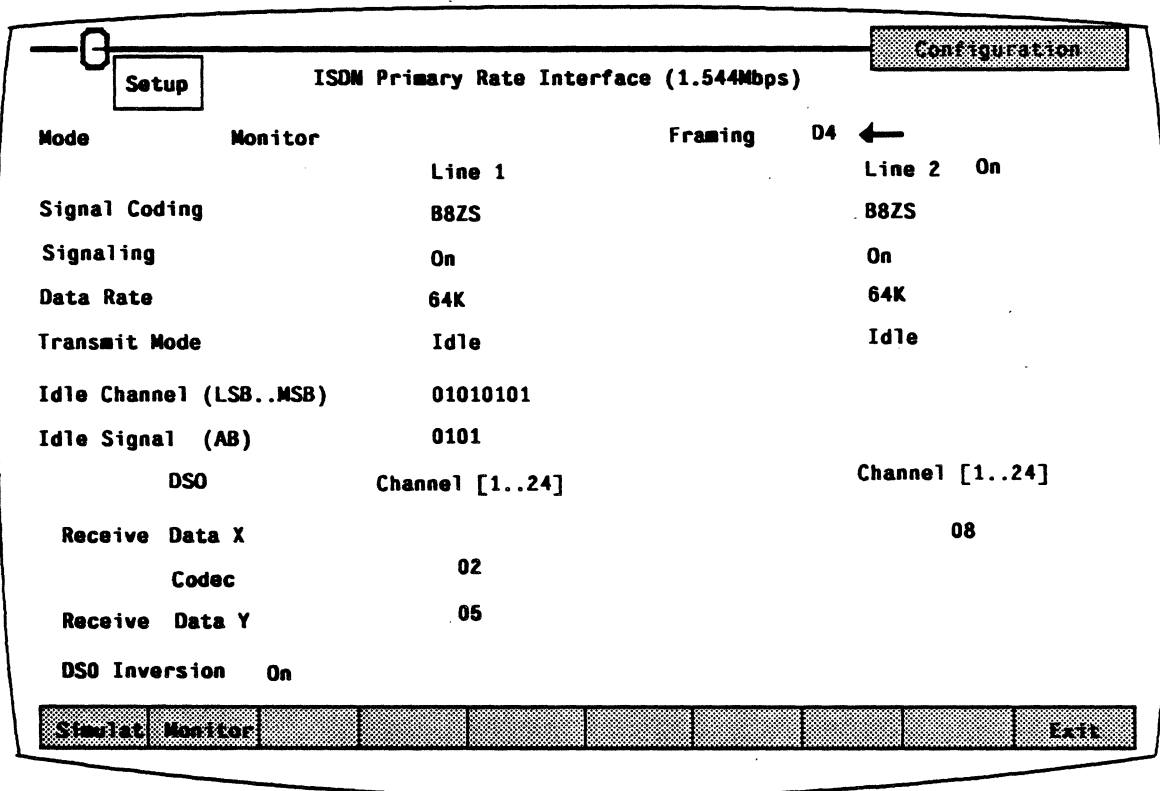


Figure 11.9: Primary Rate Interface Monitoring Setup

Figure 11.10 below illustrates one of the possible cabling configurations used for this setup.

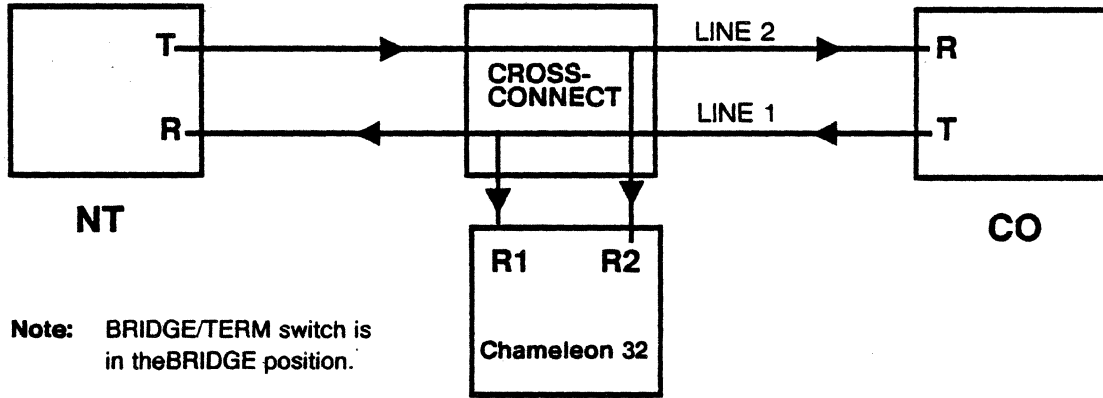


Figure 11.10: Chameleon 32 with the Primary Rate Interface

Figure 11.11 shows the following setup:

- Extended Superframe Format
- Signaling OFF
- Line 2 OFF
- Codec selected on Channel 2, Line 1
- DS0 y selected for Channel 5, Line 1

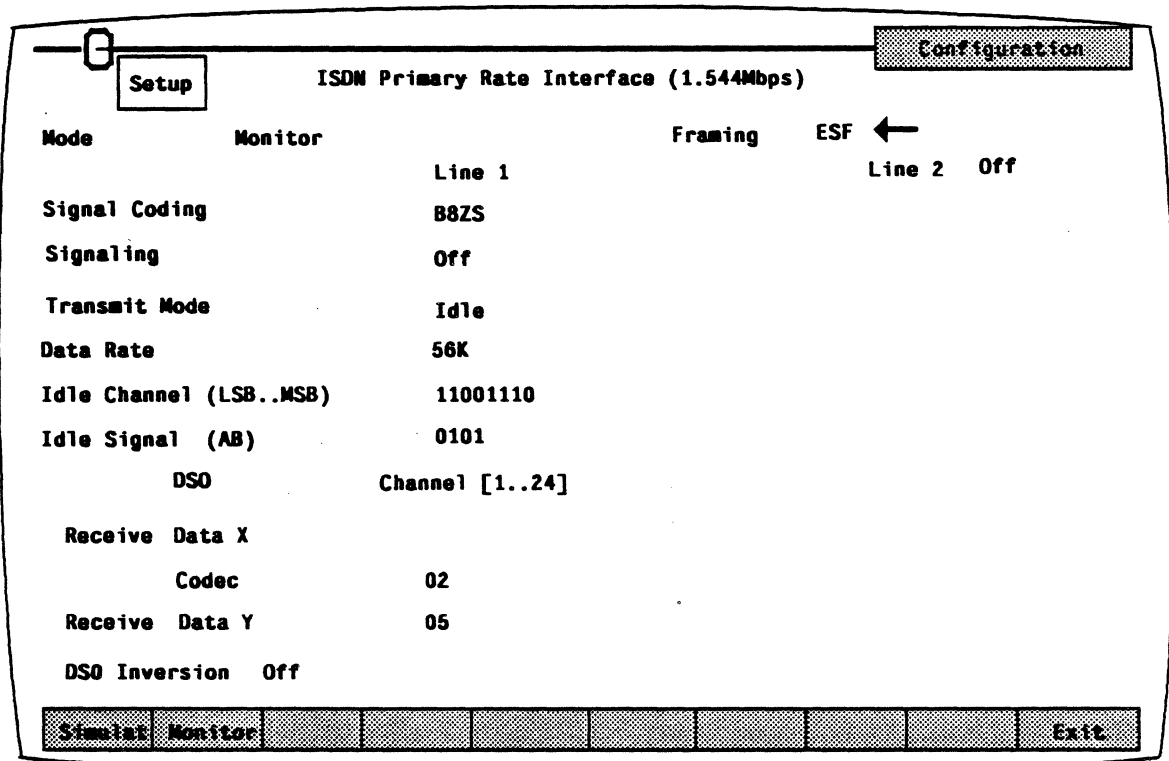


Figure 11.13: Primary Rate Interface Monitoring Setup

Monitoring One Line Only

To Monitor one line only, the Primary Rate Interface should be connected as follows:

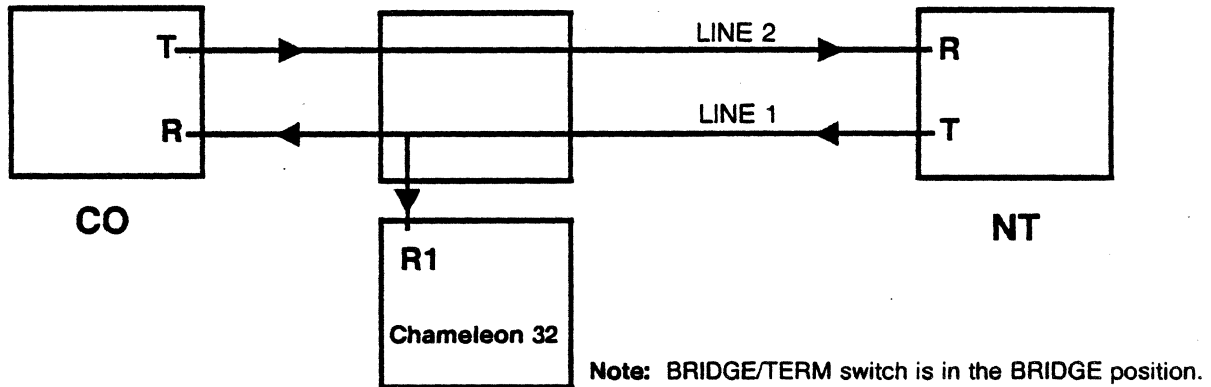


Figure 11.12: Chameleon 32 with the Primary Rate Interface

Drop and Insert

The drop and insert application allows you to insert your own data or voice communication on a single channel, and then monitor the response on the other half of the span without affecting the other channels (24 for ANSI and 30 for CEPT).

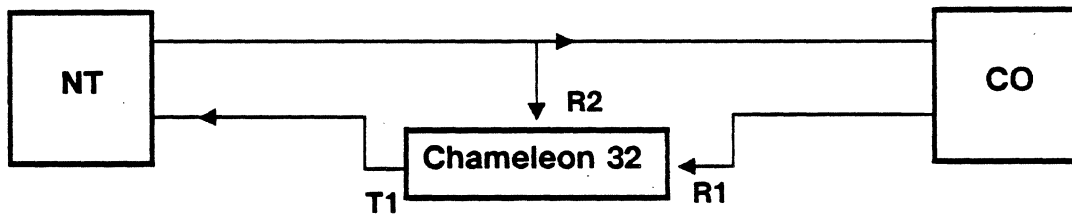


Figure 11.13: Primary Rate Interface Application (Drop and Insert)

Figure 11.14 shows the following Drop and Insert setup:

- Codec Receiver ON (Line 1), Channel 2
- DS0 x Receiver ON (Line 2), Channel 5
- DS0 y Transmitter inserted (Line 1), Channel 5
- Codec Transmitter inserted signal (Line 1), Channel 3
- Digital Milliwatt Tone inserted (Line 1), Channel 7

All Channels, except 3, 5, and 7, pass through without modification.

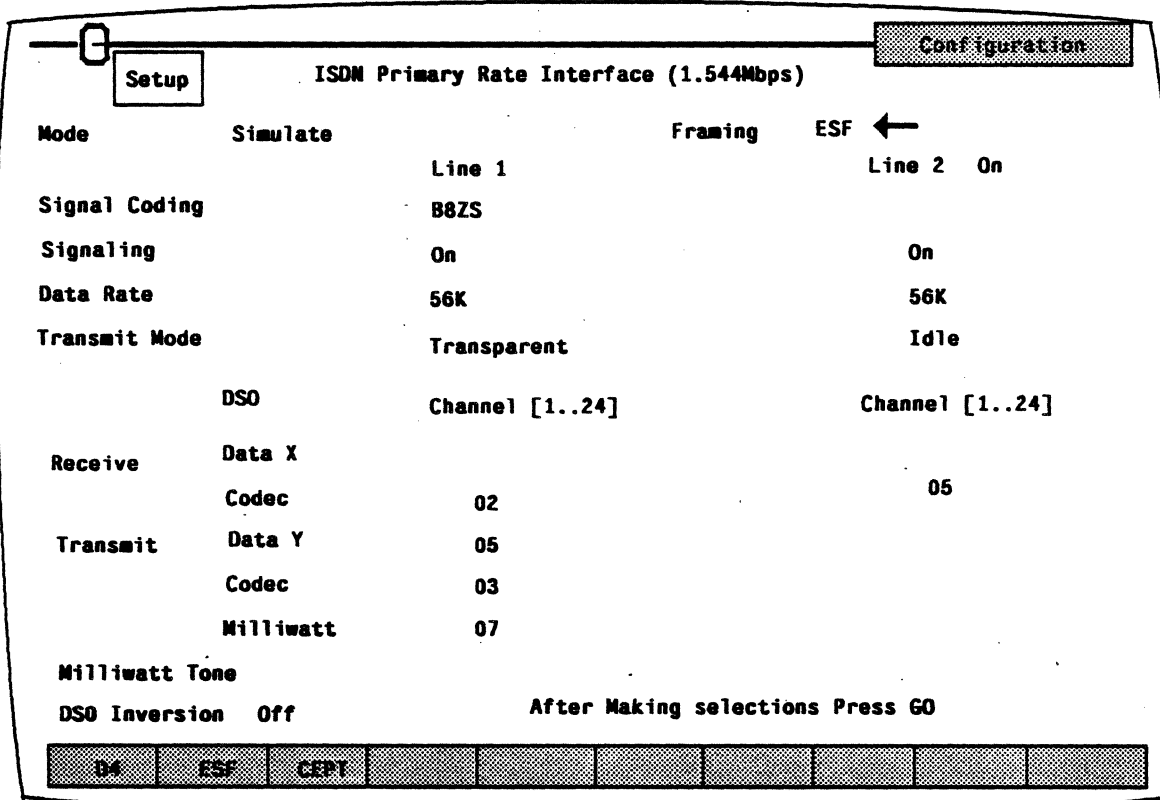


Figure 11.14: Primary Rate Interface Simulation Setup (Drop and Insert)

Monitoring One Line Only

To Monitor one line only, the Primary Rate Interface should be connected as follows:

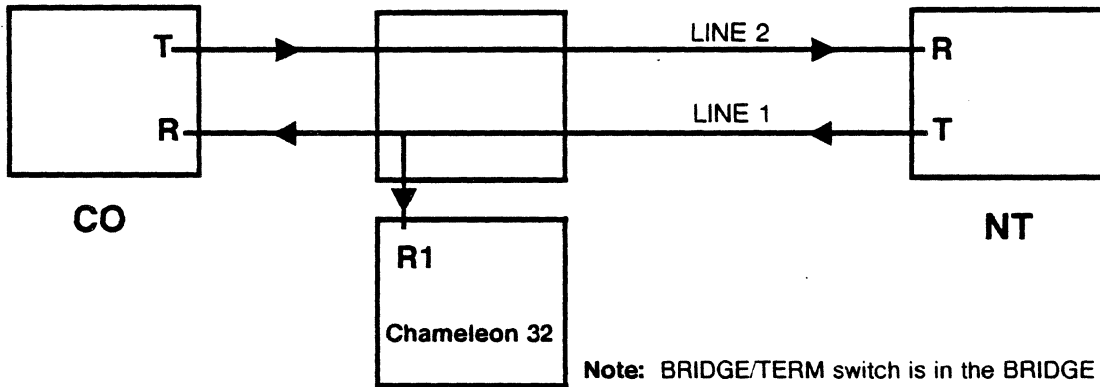


Figure 11.14: Chameleon 32 with the Primary Rate Interface

Drop and Insert

The drop and insert application allows you to insert your own data or voice communication on a single channel, and then monitor the response on the other half of the span without affecting the other channels (24 for ANSI and 30 for CEPT.)

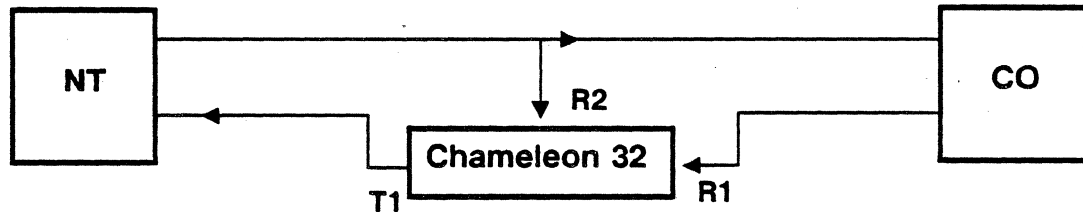


Figure 11.15: Primary Rate Interface Application (Drop and Insert)

Figure 11.16 on Page 11-33 shows the following Drop and Insert setup:

- Codec Receiver ON (Line 1), Channel 2
- DS0 x Receiver ON (Line 2), Channel 5
- DS0 y Transmitter inserted (Line 2), Channel 5
- Codec Transmitter inserted signal (Line 1), Channel 3
- Digital Milliwatt Tone inserted (Line 1), Channel 7

All Channels, except 3, 5, and 7, pass through without modification.

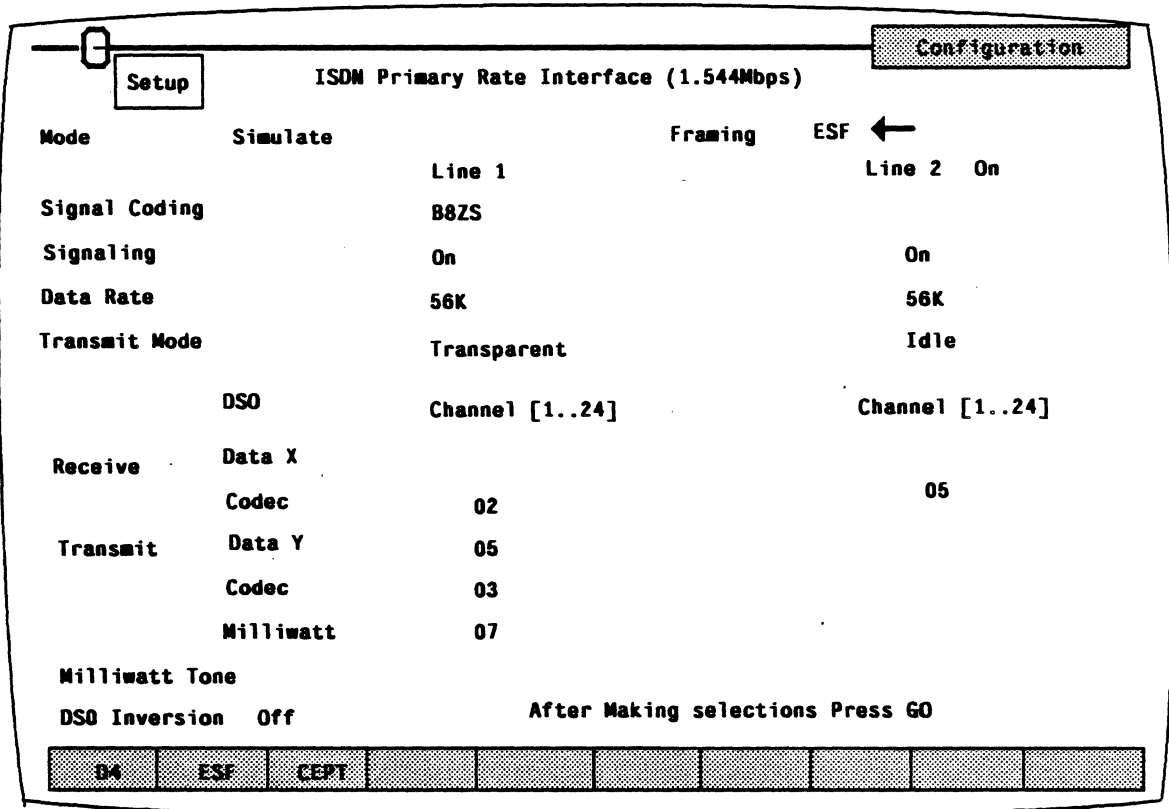


Figure 11.16: Primary Rate Interface Simulation Setup (Drop and Insert)

CHAPTER TWELVE:

ISDN BASIC RATE INTERFACE



CHAPTER TWELVE:

ISDN BASIC RATE INTERFACE

Introduction

The Basic Rate Interface allows the Chameleon 32 to monitor a Basic Rate Interface (S/T), or to simulate a Basic access as a TE or NT.

Voice frequency signals can also be inserted into or extracted from a selected Basic Rate Interface channel. A handset is provided to allow a voice conversation through the channel. The Chameleon 32 Basic Rate Interface also generates a digital Milliwatt (0dBm, 1004 Hz μ -law or 1020 Hz A-law) which can be inserted into a selected channel.

S/T Transmitter and Receivers are compatible with the I.430 CCITT Red Book 1984 recommendation. The S/T Interface includes:

- Line Code: Pseudo-ternary inverted per I.430 CCITT Red Book 1984
- Frame Structure: 48 bit NT to TE and TE to NT formats
- Connectors: 8 pin RJ45 Type
- Switchable Terminating Resistor: 100 ohms \pm 1%
- Surge Protection Provided on Transmit and Receive Pairs

The B1, B2, or D channel can be selected to run any of the available synchronous Monitoring or Simulation packages.

The LAPD package has been developed specifically for ISDN testing, but other Chameleon 32 packages are available for specific applications (for example, X.25 Analysis, SNA/SDLC Analysis, and BISYNC Monitoring). Likewise, LAPD, X.25, SNA/SDLC, and BISYNC Simulation packages are available.

For one B Channel, features include:

1. Availability at the external RS422 compatible interface, and the RS449 Adapter Cable (the 15-pin connector on the back panel of the Chameleon 32).
2. Connection to a handset using CODEC
3. Generation of a 1004 Hz μ -law tone or 1020 Hz A-law tone (Milliwatt Tone Generator).
4. Idle capability (the selected channel has no signal and is sending continuous 1s).

For the D Channel, features include:

1. Availability at the external RS422 compatible interface, and the RS449 Adapter Cable (at the 15-pin connector on the back panel of the Chameleon 32.
2. Idle capability (the selected channel has no signal, and is sending continuous 1s.

There is also an Interactive Mode for sending synchronizing information signals interactively.

To use the Chameleon 32 with a Basic Rate Interface you must do the following:

1. Install the hardware for the Basic Rate Interface. If your Basic Rate Interface option is not already installed, refer to the installation instructions which accompanied the Basic Rate Interface package for details.
2. Configure the port with the Basic Rate Interface for Monitoring or Simulation. This procedure is described on page 12-8.
3. Configure the Basic Rate Interface parameters using the Setup menu. This procedure is described on page 12-11.
4. Run the BASIC application (to monitor the physical interface) and additional Monitoring or Simulation applications for upper layer testing. This procedure is described on page 12-14.

Basic Rate Interface Hardware

This section describes the hardware for the Chameleon 32 Basic Rate Interface.

Basic Rate Interface Module

The Basic Rate Interface Module is shown in Figure 12.1. The features are described on the following page.

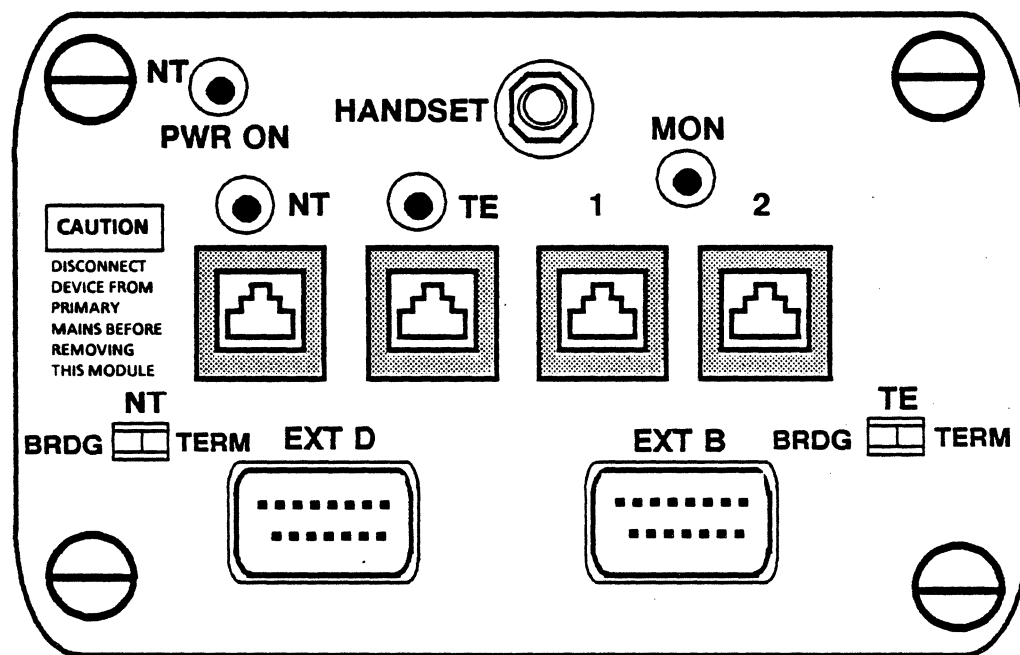


Figure 12.1: The Basic Rate Interface Module

<u>FEATURE</u>	<u>DESCRIPTION</u>
BRDG/TERM	This switch allows you to either bridge the received signal, or terminate the signal.
NT,TE, and MON	These LEDs are lit to indicate the operating state of the Chameleon 32. It can be either NT Simulation, TE Simulation, or Monitor.
NT /PWR ON	This LED is lit to indicate that the Chameleon 32 is providing the power feed (40 volts) in the NT Simulation State. (Not used in the current release.)
RJ45 JACKS	The RJ45 (ISO8877/) jack labeled NT is used for NT Simulation. The RJ45 jack labeled TE is used for TE Simulation. The RJ45 jack labeled 1 or 2 is used for monitoring the Basic Rate Interface. The RJ45 jack labeled 2 is wired in parallel with jack 1 to allow the Basic Rate Interface to be connected to another device (NT or TE). (See Figure 12.2.)
EXT D	This 15-pin connector is used to connect the Basic Rate Interface D Channel (16K bps) to another test set or device. The interface signals are RS422 compatible. (An adapter cable is provided to allow connection to an RS449 device.)
EXT B	This 15-pin connector is used to connect one of the Basic Rate Interface B Channels (64K bps) to another test set or device. The interface signals are RS422 compatible. (An adapter cable is provided to allow connection to an RS449 device.)
HANDSET	This jack is used to attach the handset (provided by Tekelec), thus allowing conversations through a selected B Channel.

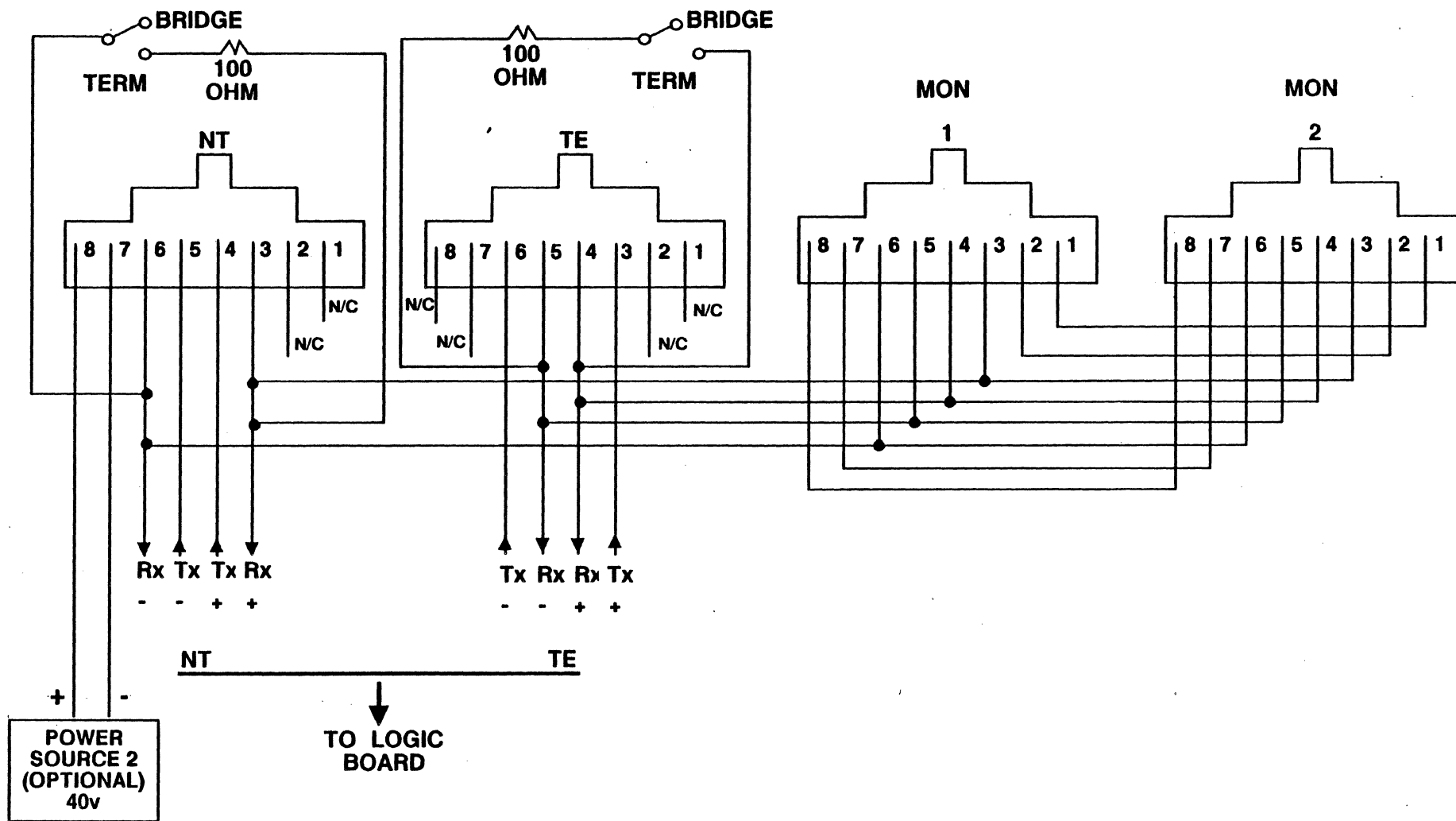


Figure 12.2: RJ45 Jacks Wiring for ISDN

LED Overlay

The Basic Rate Interface LED overlay for the Chameleon 32 front panel is shown in Figure 12.3 below.

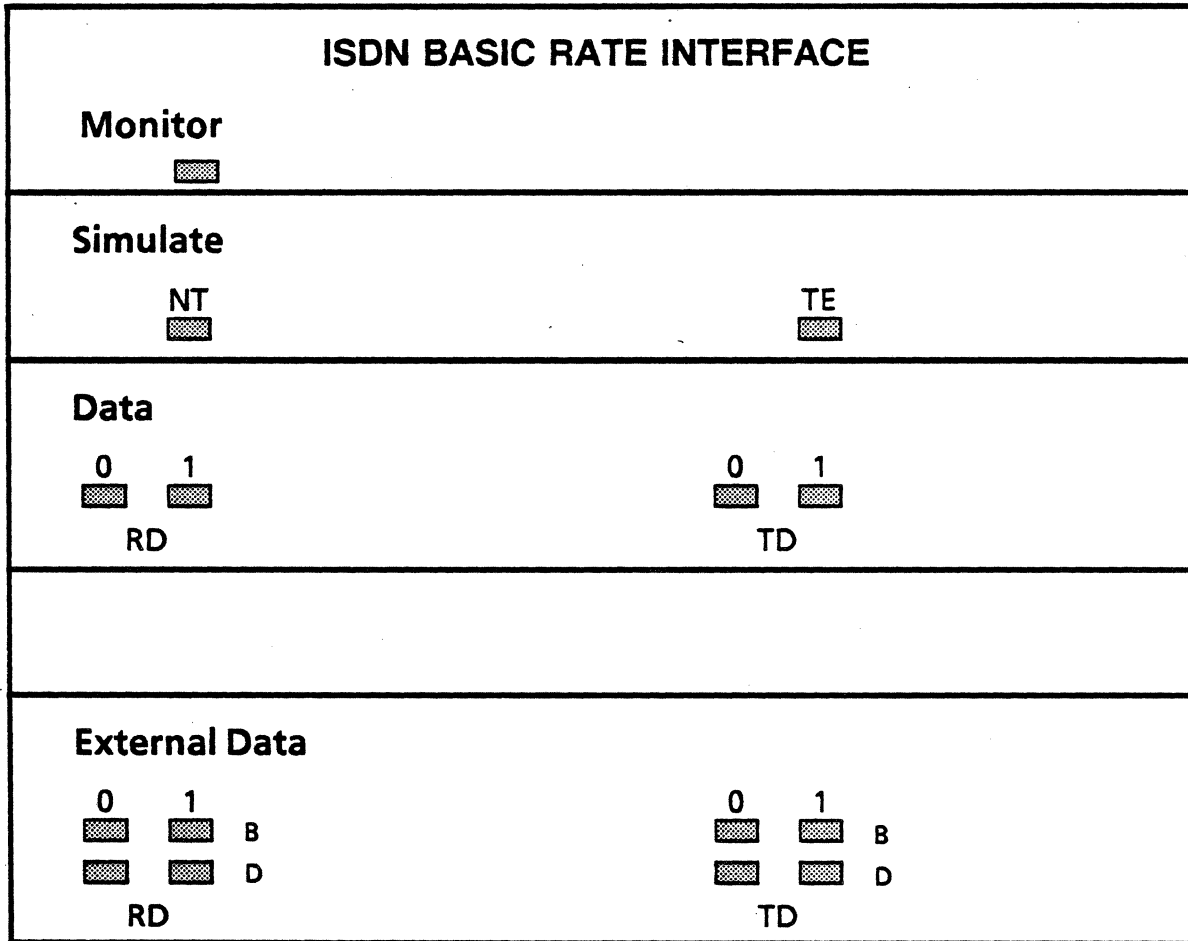


Figure 12.3: Basic Rate Interface LED Display (Front Panel)

The Level 1 information on the LED display includes:

Monitor and Simulate

These LEDs indicate the operating state of the Chameleon 32. It can be NT Simulation, TE Simulation, or Monitor (Analysis).

RD/TD Data

These LEDs show the state of the signals (Receive and Transmit) on the B or D Channel running the Chameleon 32 protocol software. If the data is all 1s, then only the LED labeled 1 is lit. (The same is true for all zero data.) If the data is 1s and 0s, then both the LEDs labeled 0 and 1 are lit.

Note: In the current release of the Basic Rate Interface, the RD/TD Data LEDs show the data on the S/T Interface.

**RD/TD
External
Data**

These LEDs show the state of the signals on the External B and D connectors on the Chameleon 32 Interface Module.

Configuration

When the Basic Rate Interface option is installed, the Chameleon 32 detects its presence, and includes Basic Rate options in the configuration menus.

To configure the Basic Rate Interface for Monitoring or Simulation, perform the steps below.

1. Connect the devices you are testing to the Chameleon 32 Basic Rate Interface.
2. Power up your Chameleon 32 and display the main Configuration Menu (Figure 12.4).
3. Select either **Monitor** or **Simulate** as the Mode of Operation for the Port with the Basic Rate Interface.

If you are monitoring the traffic between two devices, select **Monitor**. If you are using the Chameleon 32 to emulate a device so that you can test a second device, select **Simulate**.

4. Select **Basic** as the Physical Interface. If you have only one type of physical interface installed, the correct physical interface option will already be displayed.
5. Press **F6 Protocol** to display the next menu.

If you selected **Monitor** for Mode of Operation, a menu is displayed which enables you to select a protocol. There are several parameters displayed for each protocol. These are described in the appropriate protocol chapter of this volume.

If you selected **Simulate** for Mode of Operation, a menu is displayed which enables you to select a simulator. There are several parameters displayed for each simulator. These are described in the appropriate simulator chapter of the *Chameleon 32 Simulation Manual*.

6. Use the function keys to select the desired protocol or simulator and the related parameters.
7. Press **Go** to accept the displayed values and return to the main configuration menu.

8. Press **F7 Physical** to display the Basic Rate Interface Setup menu, which enables you to configure the Basic Rate interface and is described on page 12-11.
9. When you have the desired setup values displayed in the Setup menu, press **Go** to accept the values and return to the main configuration menu.
10. From the main configuration menu, press **Go**.
11. If you selected **Simulate** for Mode of Operation, skip this step and continue with step 12.

If you selected **Monitor** for Mode of Operation, the Applications Selection menu is displayed. Load the Basic Rate Interface software, as follows:

- a. Move the red arrow cursor to the **BASIC** application.
 - b. Press the **Load A** or Load B function key to load the software on the port with the Basic Rate Interface.
 - c. Load the Monitoring applications (Analysis, Statistics, Direct-to-Disk, etc) that you want to use to analyze the traffic you will be monitoring.
 - d. Press **Go** to start the selected applications.
12. A **Basic I/F** page banner should appear at the bottom of the screen. This page enables you to view and modify your Basic Rate Interface setup without stopping the other applications. It is described on page 12-14.

If you selected **Monitor** for Mode of Operation, there should also be a page banner for each of the selected Monitoring applications (except Direct-to-Disk, which does not have a page display). Refer to the *Chameleon 32 User's Guide* for information about using Monitoring application pages.

If you selected **Simulate** for Mode of Operation, there should be a page banner for the Simulator you selected. Refer to the *Chameleon 32 Simulation Manual* for information about using Simulation pages.

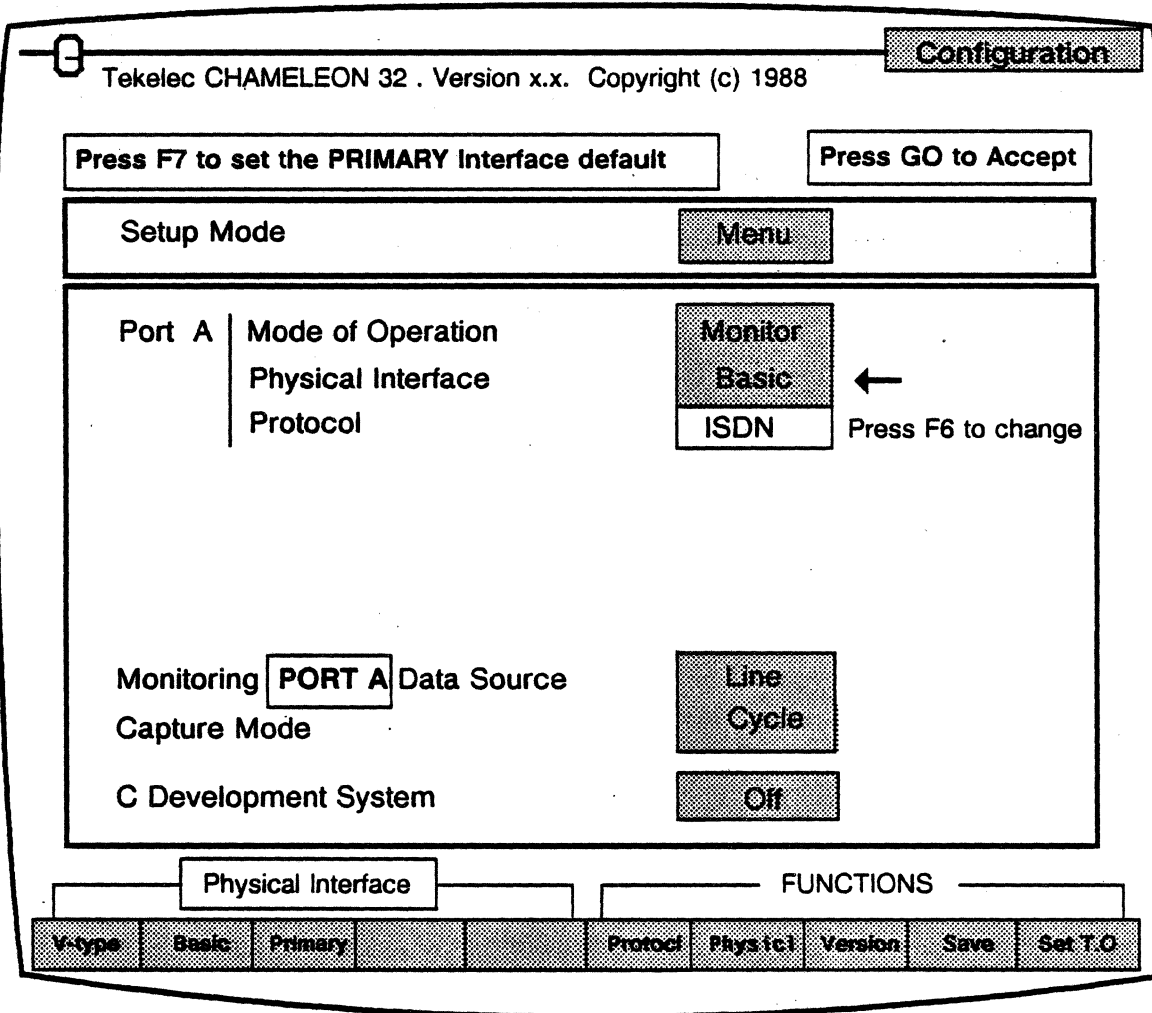


Figure 12.4: Configuration Menu

SETUP MENUS

When you press **F7 Physicl** from the main configuration page, the setup menu (Figure 12.5) is displayed. The parameters displayed in the setup menu vary depending on the selections you choose in the menu.

For example, if **D** is selected for Channel Selection, the parameter displayed under it will be **Channel B1**. But, if **B1** is selected for Channel Selection, the parameter displayed under it will be **Channel B2**. This way, each channel need be specified only once.

When the Channel Selection is **B1** or **B2**, the **D** channel is automatically available at the External D Interface. However, this is not the case with the External Channel B Interface, where only one of the B Channels is available for selection.

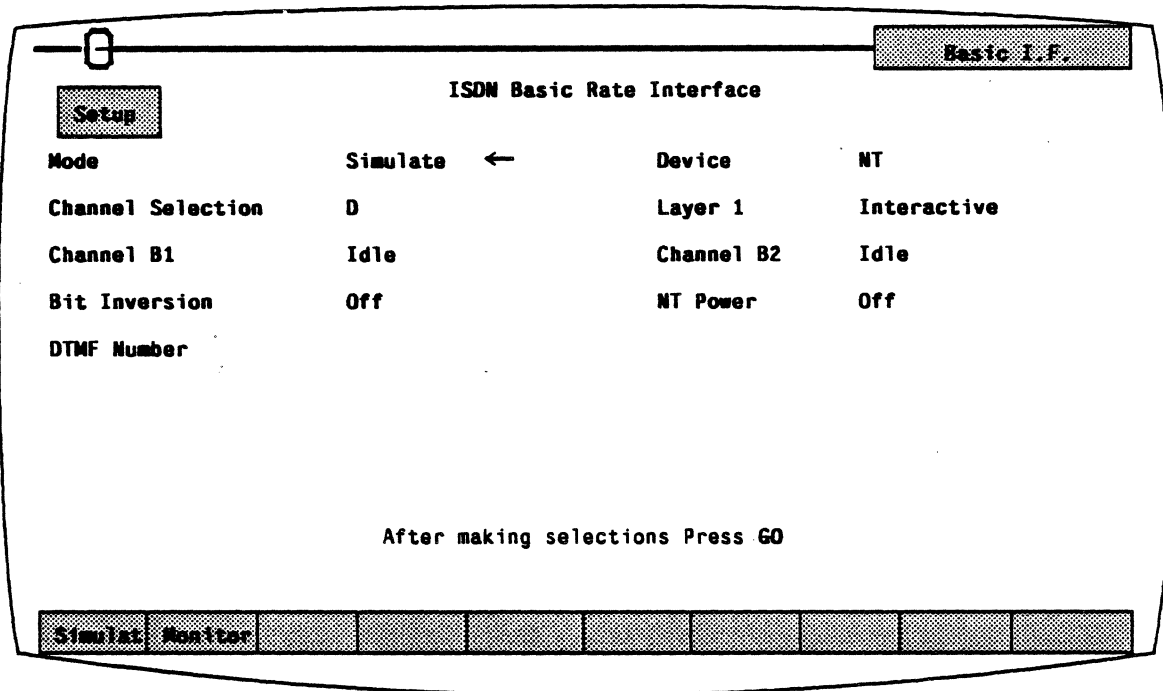


Figure 12.5: Basic Rate Setup Menu (Simulate)

Default settings are automatically displayed when the setup menu first appears. The red arrow cursor indicates the selected parameter. The available settings for the selected parameter are shown in the softkey strip at the bottom of the page.

To change a parameter, use the arrow keys to move the red arrow cursor to the parameter you want to change, and then press the function key that corresponds to the desired value. Several parameters require you to type in a value rather than select a value using the function keys.

The Basic Rate Interface menu setup menu parameters are described below.

Mode Selects the mode to use.

Simulate Selects the layer 1 operation mode. Simulates layer 1 as an NT or as a TE. (default)

Monitor Monitors layer 1.

Channel Selection Selects the channel to be used for running the upper level (above layer 1) protocol software, which can be any of the standard simulation or analysis packages available for the Chameleon 32. the options are:

B1
B2
D (default)

Device This parameter appears only when in Simulation mode. Selects the type of device to be simulated.

NT Network Termination (default)
TE Terminal Endpoint

Channel B2

Channel B1 Selects an option for the B1 or B2 channel.

<i>Milliwatt</i>	Allows a digital milliwatt (0dBm, 1004 Hz μ -law or 1020 Hz A-law) to be inserted in the selected channel (B2 or B1). (Available only in Simulation.)
<i>Codec</i>	Allows a handset using Codec to be connected to the Chameleon 32 rear panel at the Basic Interface.
<i>Idle</i>	Idles the channel with all ones data. (default)
<i>Ext B</i>	Selected B channel available at the Chameleon 32 rear panel Basic Rate Interface (RS422 compatible).

Layer 1 Selects an option for layer 1 activation.

<i>Interactive</i>	At runtime, interactive transmission of signals is possible. (No automatic activation is done.) (default)
<i>Automatic</i>	Whenever Layer 1 is deactivated, or goes to error state, the system automatically activates.

Note

The Basic Rate Interface setup menu displays the NT Power, Bit Inversion, and Dual Tone Multi-Frequency (DTMF) Number parameters, although they are supported only on machines with Basic Rate Interface Board (805-0259) Revision F.

Bit

Inversion This parameter allows you to invert the data bits when a B channel is selected for the Channel Selection parameter. The selections are:

- OFF* Data transmitted is *not* inverted.
- ON* Data transmitted *is* inverted.

NT Power This parameter enables you to specify the type of power provided from the TE to the NT. This selection affects the voltage, amount of power available, and the lines that are used to carry the power to the NT.

The Chameleon 32 supports power source 1 and power source 2 in two modes: Normal Mode and Emergency Mode.

F1SCR1Nor Power source 1 under normal conditions.

F2 SCR1Rev Power source 1 under emergency conditions (reverses polarity).

F3 SCR2Nor Power source 2 under normal conditions.

F4 SCR2Rev Power source 2 under emergency conditions (reverses polarity).

Off The NT power lines are turned off.

When NT Power is enabled, the NT Power LED is illuminated. This LED is located in the Basic Rate Interface module in the rear of the machine.

**DTMF
Number**

This parameter is relevant when the Codec unit is selected for a B-channel. It causes the Chameleon 32 to generate the Dual Tone Multi-Frequency (DTMF) tones corresponding to the numbers entered in this field.

You can enter a maximum of 20 digits in the DTMF Number field. Only digits are allowed.

The Chameleon 32 generates the DTMF tones when the red arrow cursor is moved from the DTMF field. For this reason, the following is recommended:

- Enter the DTMF number after all other parameters have been set up
- If the DTMF feature is not being used, leave the DTMF field blank

BASIC I/F RUNTIME PAGE

When you load and run the BASIC application from the Applications Selection menu, a page is displayed with the following banner:

xxx Basic IF

where **xxx** is the name of the selected protocol. This page displays the current Basic Rate Interface setup and enables you to modify certain parameters while the Monitoring applications are running.

The format of the runtime page is the similar to the setup menu. One difference is that it displays the following message in the upper left corner of the page:

running

Parameter values which cannot be changed are displayed in red. The remaining parameters can be changed by moving the red arrow cursor to the parameter and pressing the appropriate softkey or entering a value.

The runtime page also displays additional information and provides options depending on whether you are in Simulate mode or Monitor mode. The runtime pages for both modes are described beginning on the next page.

Simulate Runtime Page

A sample runtime screen for simulate mode is shown in Figure 12.6 below.

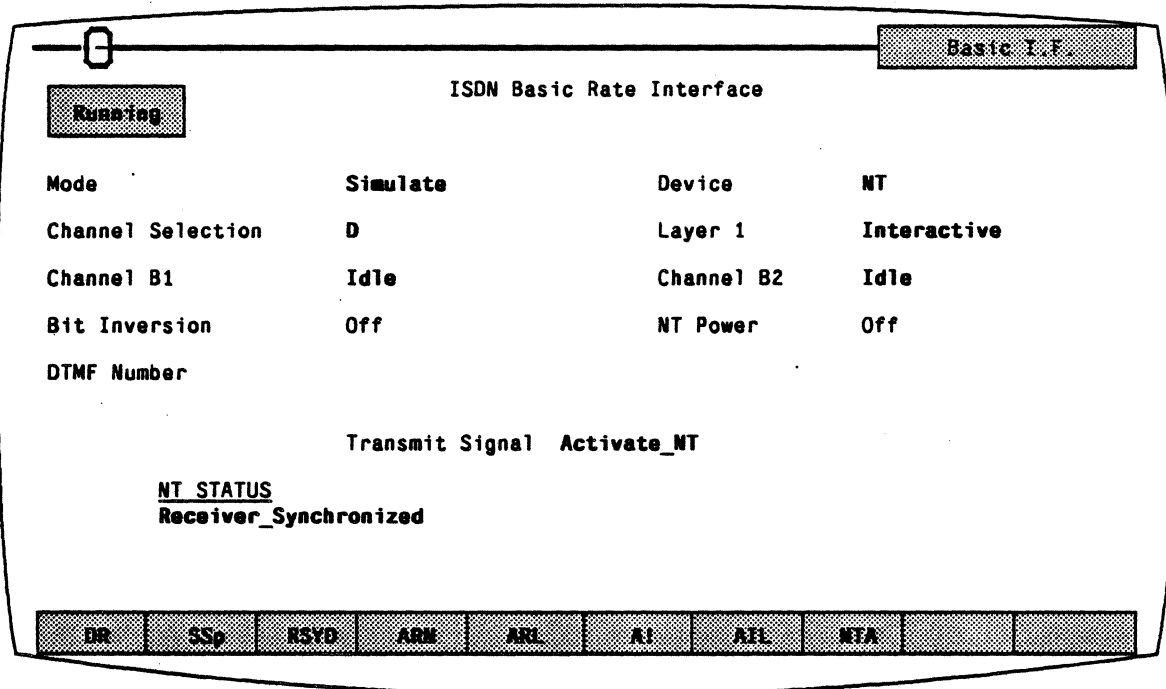


Figure 12.6: Running Simulation Mode (NT)

In Simulate mode, the runtime page enables you to control the action of the physical layer by selecting a Transmit Signal command which performs one or more actions. The status of the Chameleon 32 (as NT or TE) is displayed in the lower left (NT) or lower right (TE) corner of the screen.

The Transmit Signal commands and Status messages depend on whether the Chameleon 32 is simulating an NT or a TE as described on the following page.

The Transmit Signal commands and Status messages are based on the capabilities of the Siemen's PEB 2080 S-Bus Transceiver.

Transmit Signal

When the red arrow cursor is at Transmit Signal, you have the softkey options listed below. The command sequence needed to make the action is issued to the ISDN Transceiver. However, the action will only be effected if the Transceiver is in the proper state. (For more information, refer to the *Siemens Catalog*.)

If the Chameleon 32 is simulating an NT, the Transmit Signal commands are:

Softkey	Message	Action
DR	Deact_Request	Deactivates the link (Layer 1).
ARN	Send_Info_2	Sends an Info 2 signal.
AI	Send_Info_4	Sends Info 4 signal.
NTA	Activate_NT	Executes activation sequence.
DIAG	Diagnostics	Toggle that displays or undisplay additional, less common commands.
SSp	Send_Single_pulses	Sends a test signal (4 KHZ).
RSYD	Resynchronization	Tries to re-synchronize the line.
ARL	Send_I2_Test_loop2	Sends a test sequence, plus a loop back (96 KHZ).
AIL	Send_I4_Test_loop2	Sends a test sequence, plus a loop back (96 KHZ).

If the Chameleon 32 is simulating a TE, the Transmit Signal commands are:

Softkey	Message	Action
DIU	Deactivate	Module interface is shut down.
AR8	Activate __Priority 8	Activation instruction, D Channel priority equals 8.
AR10	Activate __Priority10	Activation instruction, D Channel priority equals 10.
TEA	Activate __TE	Executes activation sequence.
DIAG	Diagnostics	Toggle that displays or undisplays additional, less common commands.
TIM	Timing	Clocks Module Interface.
RS	Reset	Resets.
SSP	Send __Single __Pulses	Transmits single pulses.
TM	Test __Mode	Transmits continuous pulses.
ARL	Activate __Test __Loop3	Activates Test Loop 3.

Status Messages

If the Chameleon 32 is simulating an NT, the Status messages are displayed in the lower left corner of the Basic I/F runtime page. The possible messages are:

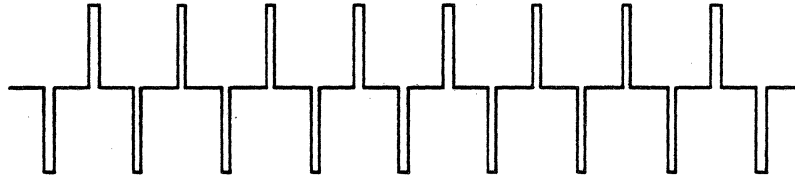
Siemen's Reference	Message	Note
RIM	No __Clock __Signal	
LSL	Lost __Signal __Level	
RSYUN	Resynchronization	
EI	Error	
ARU	Receiving Info __1	
AIU	Receiver __Synchronized	(Status when Layer 1 activation is completed.)
UNDF	Undefined	

If the Chameleon 32 is simulating a TE, the Status messages are displayed in the lower right corner of the Basic I/F runtime page. The possible messages are:

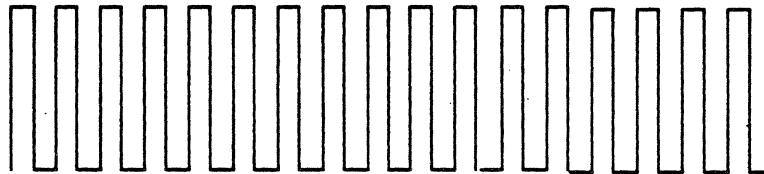
Siemen's Reference	Message	Note
PU	Power_up	
DR	Deactivate_Request	
SD	Slip_Detected	
DIS	Disconnected	
EI	Error	
RSYD	Resynchronizing	
ARD	Receiving_Info_2	
TI	Test_Mode	
ATI	Level_Received_Test_Loop	
AI 8	Info-4_Priority 8/9	(This is the status when Layer 1 activation is completed.)
AI 10	Info-4_Priority 10/11	(This is the status when Layer 1 activation is completed.)
DID	Quiescent_State	
UNDF	Undefined	

Signal Diagrams

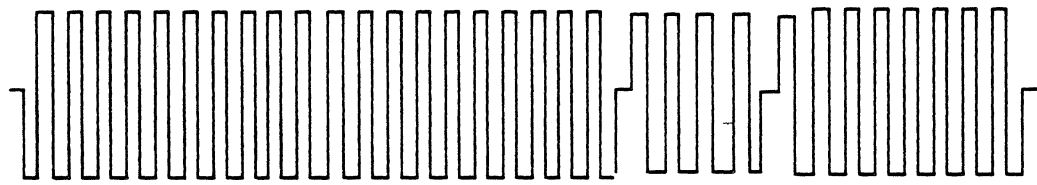
The following diagrams illustrate signals on the line when selections are chosen as Transmit Signal parameters.



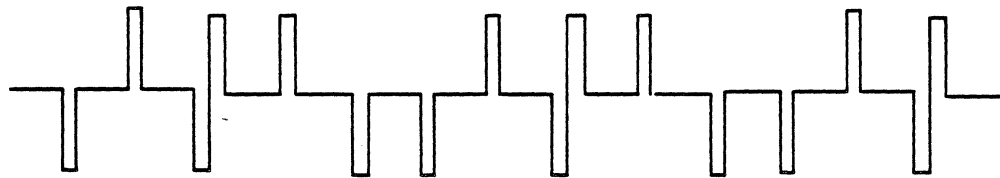
Single Pulse -- NT and TE (SSp)



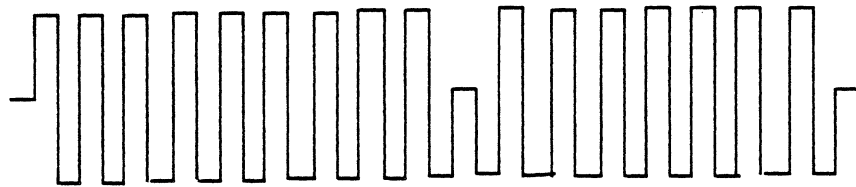
Resynchronization -- NT and TE (RSYD)



Info 2 --NT (ARN)



Info 4 -- NT (AI)



Info 4 -- TE (AI)

Monitor Runtime Page

In Monitor mode, the runtime page (Figure 12.7) enables you to change certain setup parameters. The red arrow cursor can be moved only to those parameters that can be modified during runtime.

The status of the NT and the TE are shown at the bottom of the page. The possible status messages for NT and TE are shown on the previous page.

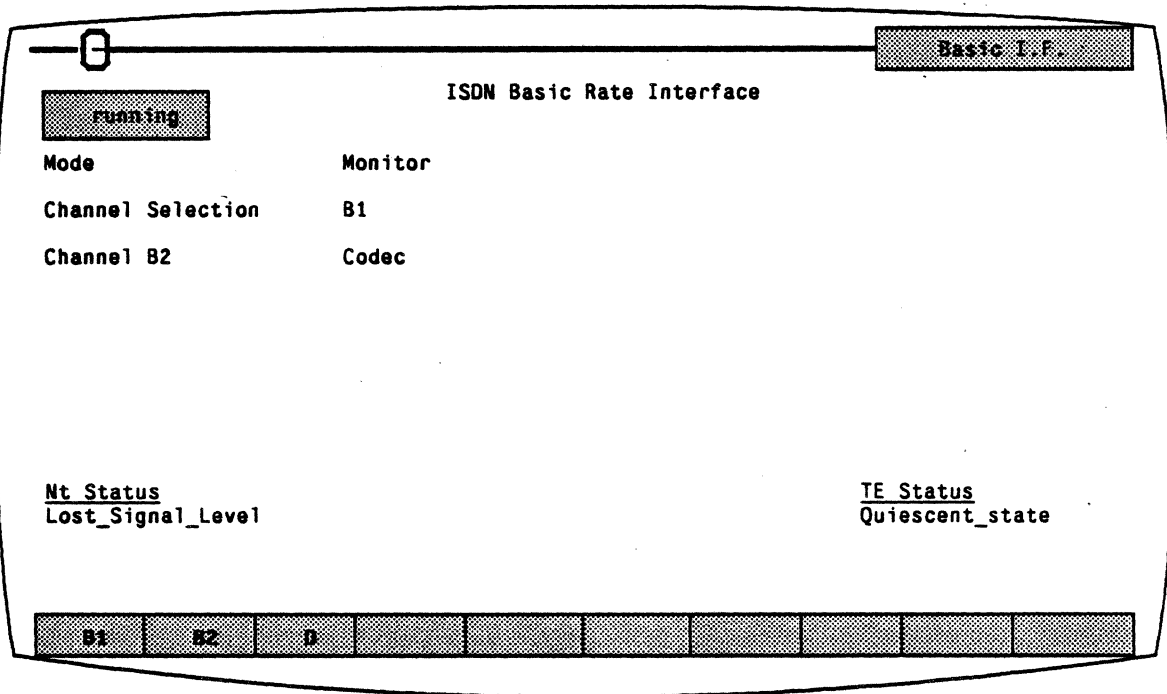
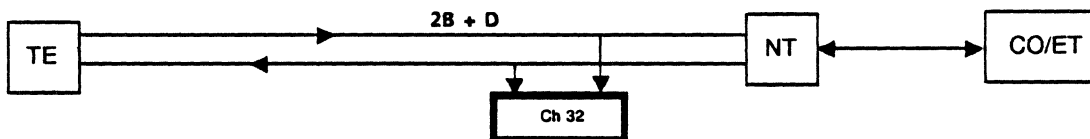


Figure 12.7: ISDN Basic Rate Monitor Mode Runtime Page

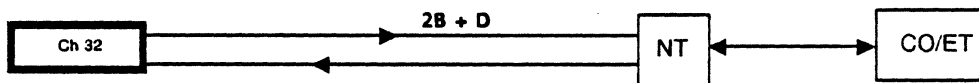
**Chameleon 32
Basic Rate Interface
Applications**

Monitoring (Analysis Packages)

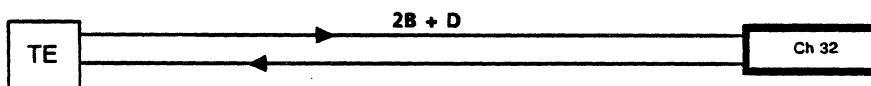


Chameleon 32 Monitoring the 2B + D Line by Extracting the Two 64K and the One 16K Channels

Simulation (Analysis & Simulation Packages)



Chameleon 32 Simulating a Subscriber (TE)



Chameleon 32 Simulating a Network (NT)

Figure 12.8: Chameleon 32 Basic Rate Interface Applications

Testing Configurations

This section shows testing configuration examples.

In Configuration A, LAPD software is running on **Channel D** of the Basic Rate Interface on the Chameleon 32. The handset is connected to the jack located on the back panel of the machine for monitoring voice communication on **Channel B1**. The Milliwatt Tone Generator (at 1004 Hz) is sent on **Channel B2**.

In Configuration B, LAPD software is running on **Channel D** of the Basic Rate Interface on the Chameleon 32. The handset is connected to the jack located on the back panel of the machine for monitoring voice communication on **Channel B1**. **Channel B2** is available on the External B Interface (RS422-compatible) located on the back panel of the machine.

In Configuration C, X.25 Simulation or Analysis is running on **Channel B2**. **Channel B1** is available on the External B Interface (RS422-compatible) located on the back panel of the machine. **Channel D** is available on the External D Interface (RS422-compatible) located on the back panel of the machine.

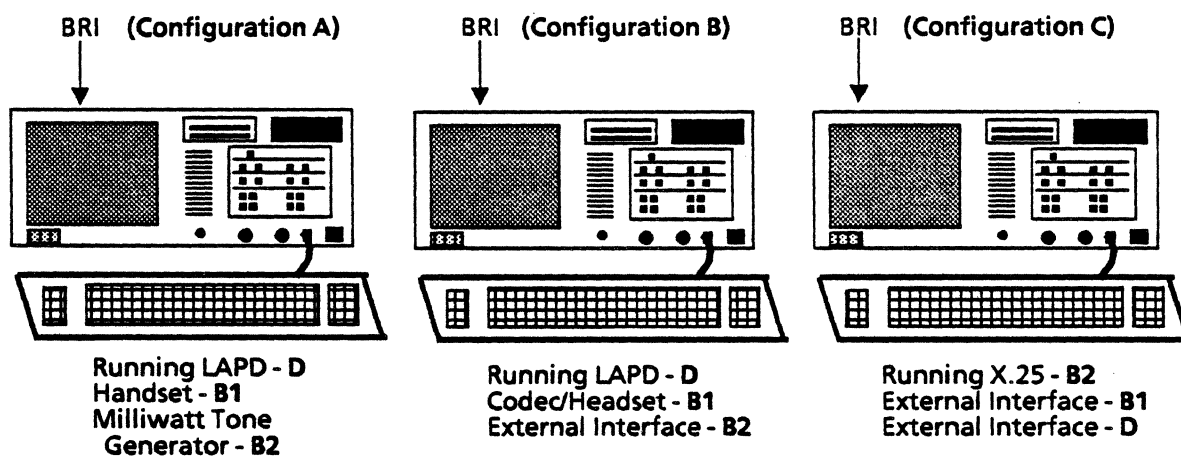


Figure 12.9: Single Chameleon Configurations

In Figure 12.10 below, three Chameleon 32s are used to run extensive Simulation on **Channels B1, B2, and D**. The Basic Rate Interface is installed on Machine 1. **Channel B1** is running X.25 Simulation. **Channel B2** is selected for the External B Interface (RS422-compatible). **Channel D** is selected for the External D Interface (RS422-compatible).

Channel B2 is connected to Machine 2 using the RS449 Interface and is running X.25 Simulation or Analysis. **Channel D** is connected to Machine 3 using the RS449 Interface. It is running LAPD Simulation.

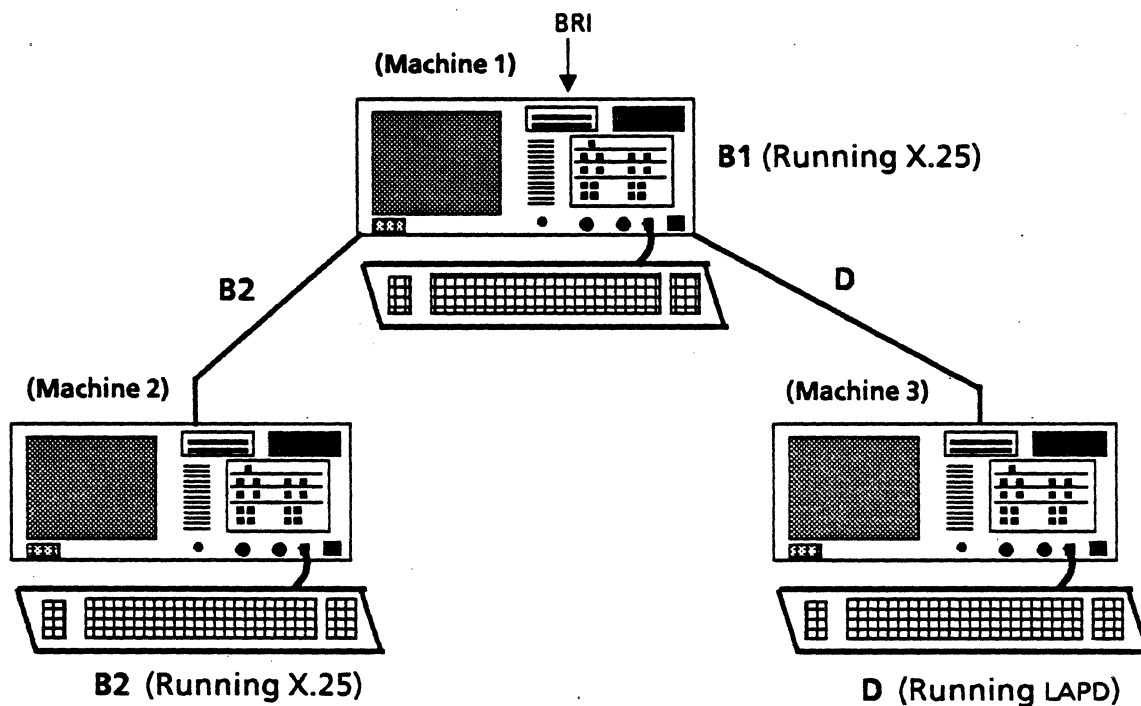
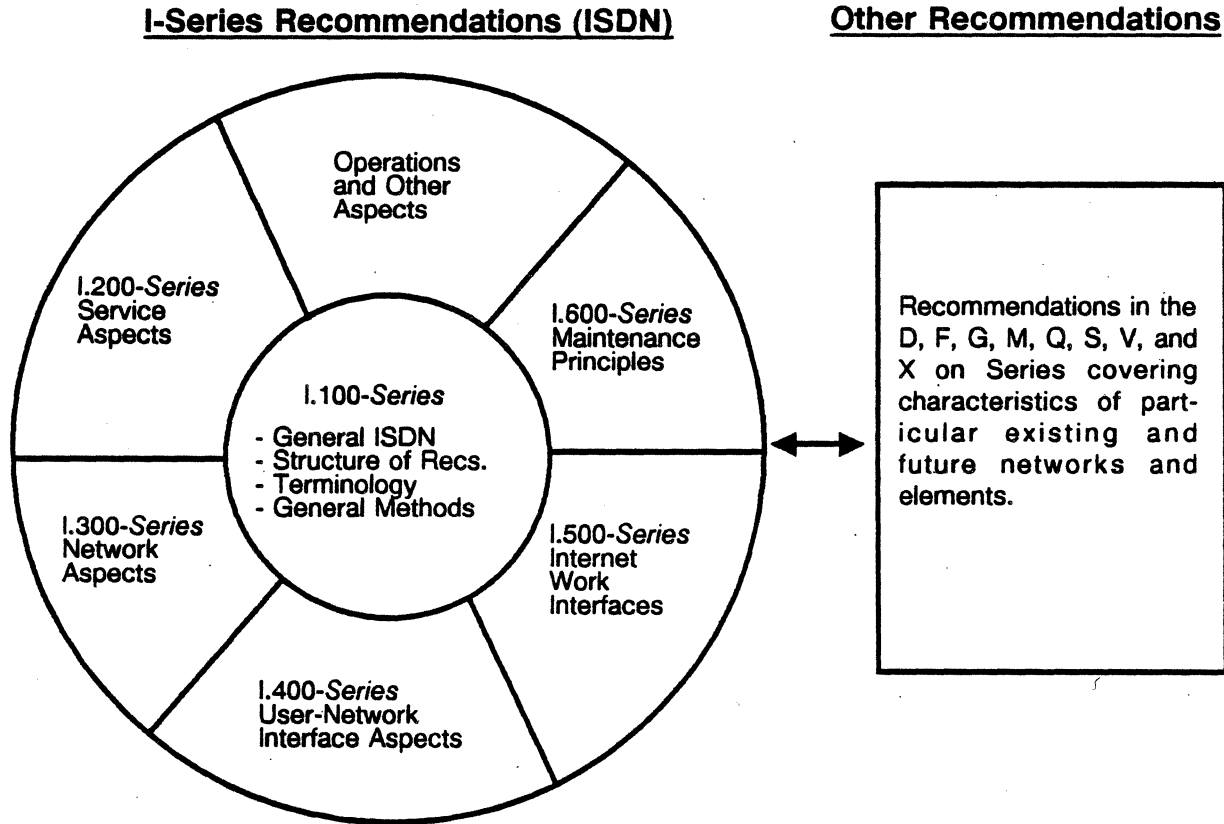


Figure 12.10: Three Chameleon Configuration

Basic Rate Access Information

There are currently two ways to access ISDN -- Basic Rate Access and Primary Rate Access. Basic Rate Access is part of the CCITT I-Series Recommendations. The relationship between various I-Series Recommendations are shown in Figure 12.11 below.



Note: Models, Reference Configurations, Tools, and Methods are contained in the appropriate I-Series Recommendations.

Figure 12.11: Structure of I-Series Recommendations (ISDN)

The 1984 CCITT ISDN Recommendations are shown in Figure 12.12 below.

<u>Part I: General</u>	
<u>NO.</u>	<u>TITLE</u>
I.110	General structure of the I-Series Recommendations
I.111	Relationship with other Recommendations relevant to ISDNs
I.1112	Vocabulary of terms for ISDNs
I.130	Integrated Services Digital (ISDNs) (was G.705)
I.130	Attributes for characterization of telecommunications services supported by an ISDN and network capabilities of an ISDN
<u>Part II: Service Capabilities</u>	
I.210	Principles of Telecommunication Services supported by an ISDN
I.211	Bearer Services supported by an ISDN
I.212	Tele-Services supported by an ISDN
<u>Part III: Overall Network Aspects and Functions</u>	
I.310	ISDN--Network functional principles
I.320	ISDN protocol reference model
I.330	ISDN numbering and addressing principles
I.331	(E.164) The numbering plan for the ISDN
I.340	ISDN connection types
<u>Part IV: User-Network Interfaces</u>	
I.410	General aspects and principles relating to recommendations on ISDN user-network interfaces
I.411	ISDN user-network interfaces -- reference configurations
I.412	ISDN user-network interfaces -- channel structures and access capabilities
I.420	Basic user-network interface
I.421	Primary rate user-network interface
I.430	Basic user-network interface -- Layer 1 specification
I.431	Primary rate user-network interface -- Layer 1 specification
I.440	(Q.920) ISDN user-network interface data link layer -- general aspects
I.441	(Q.921) ISDN user-network interface data link layer specification
I.450	(Q.930) ISDN user-network interface Layer 3 general aspects
I.451	(Q.931) ISDN user-network interface Layer 3 specifications
I.460	Multiplexing, rate adaption, and support of existing interfaces
I.461	(X.30) Support of X.21 and X.21bis based DTEs by an ISDN
I.462	(X.31) Support of Packet Mode Terminal equipment by an ISDN
I.463	V.110) Support of DTEs with V-series type interfaces by an ISDN
I.464	Rate adaption, multiplexing, and support of existing interfaces for restricted 64 kb/s transfer capability

Figure 12.12: 1984 CCITT ISDN Recommendations

The Basic Rate Access, as defined by the CCITT, has the following reference points, as shown in Figure 12.13 :

- S
- T
- R

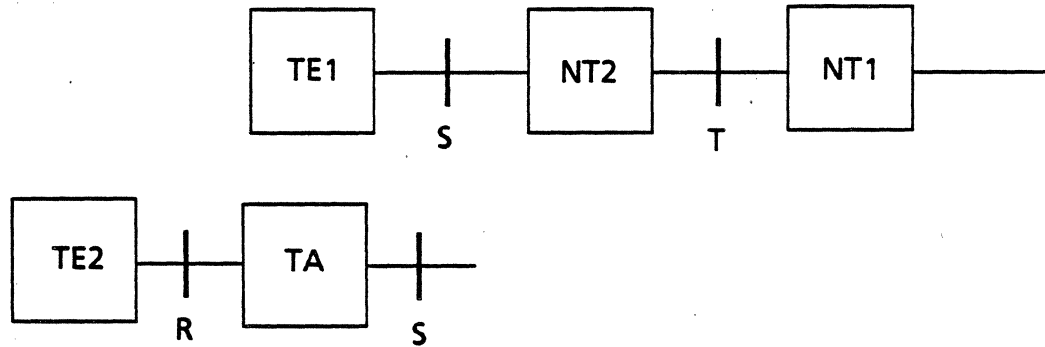


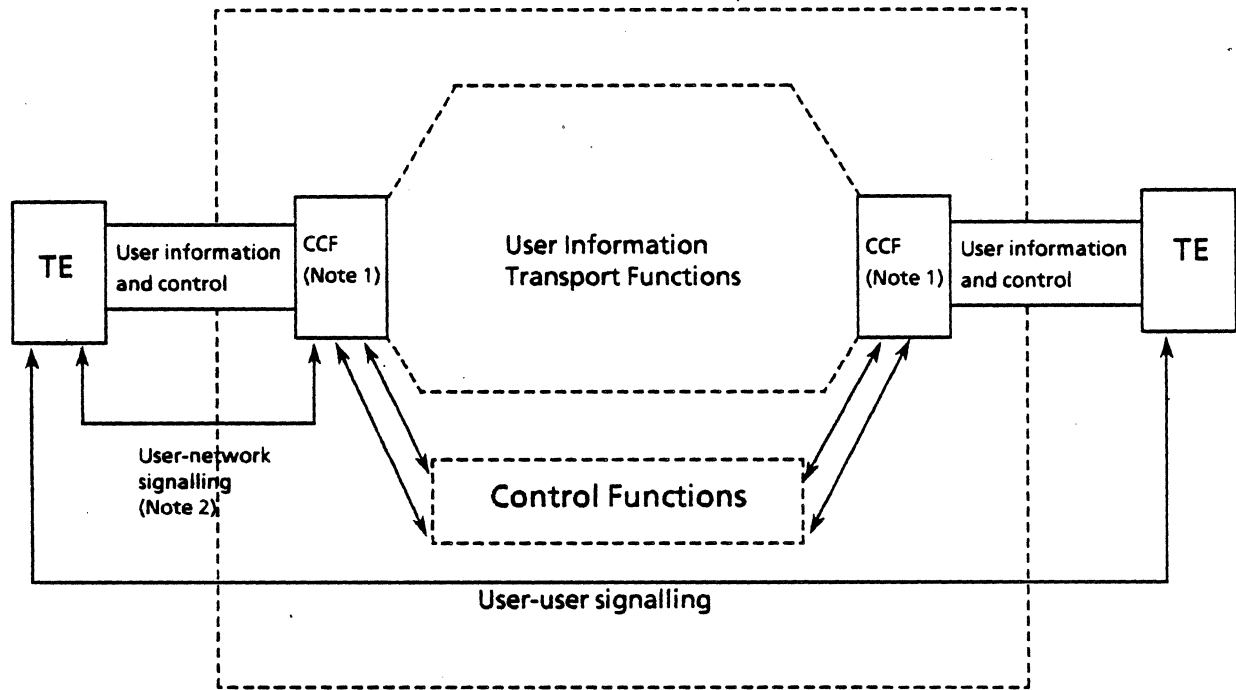
Figure 12.13: Customer Access to Services Supported by an ISDN

Note

In many applications, NT2 is absent. TA is used when using a non-ISDN device.

Basic Rate Access is a Layer 1 interface for ISDN. It makes available digital communication for integrated data, voice, and video interfaces at a customer site. Those customers who have larger traffic can use the Primary Rate Access for ISDN applications.

The rest of this section gives a brief technical introduction to Basic Rate Access.



Note 1: CCF - Connection Control Function

Note 2: Includes connection control and communication with operations centers

Figure 12.14: Information Flows

With the Basic Rate Interface, three channels are available:

- Two B channels at 64 Kbps
- One D channel at 16 Kbps

Basic Rate runs at 144K *bps* data rate and at 192K *bps* line rate.

Line Code

For both directions of transmission, pseudoternary coding is used with 100-percent pulsewidth as shown in Figure 12.15 below. Coding is performed in such a way that a binary 1 is represented by no line signal, whereas a binary 0 is represented by a positive or negative pulse.

The first binary 0 following the framing signal balance bit is of the same polarity as the framing signal balance bit. Subsequent binary 0s must alternate in polarity, for example Alternate Space Inversion (ASI).

A balance bit is a binary 0 if the number of binary 0s following the previous balance bit is odd. A balance bit is a binary 1 if the number of binary 0s following the previous balance bit is even.

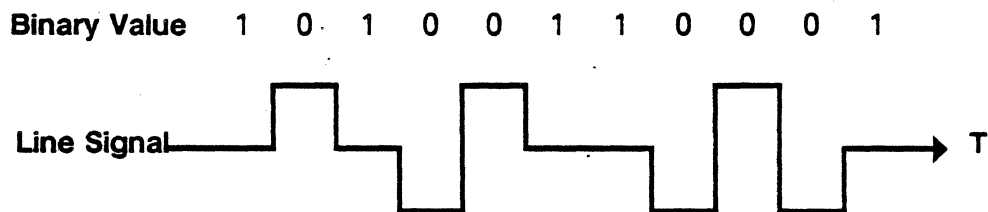
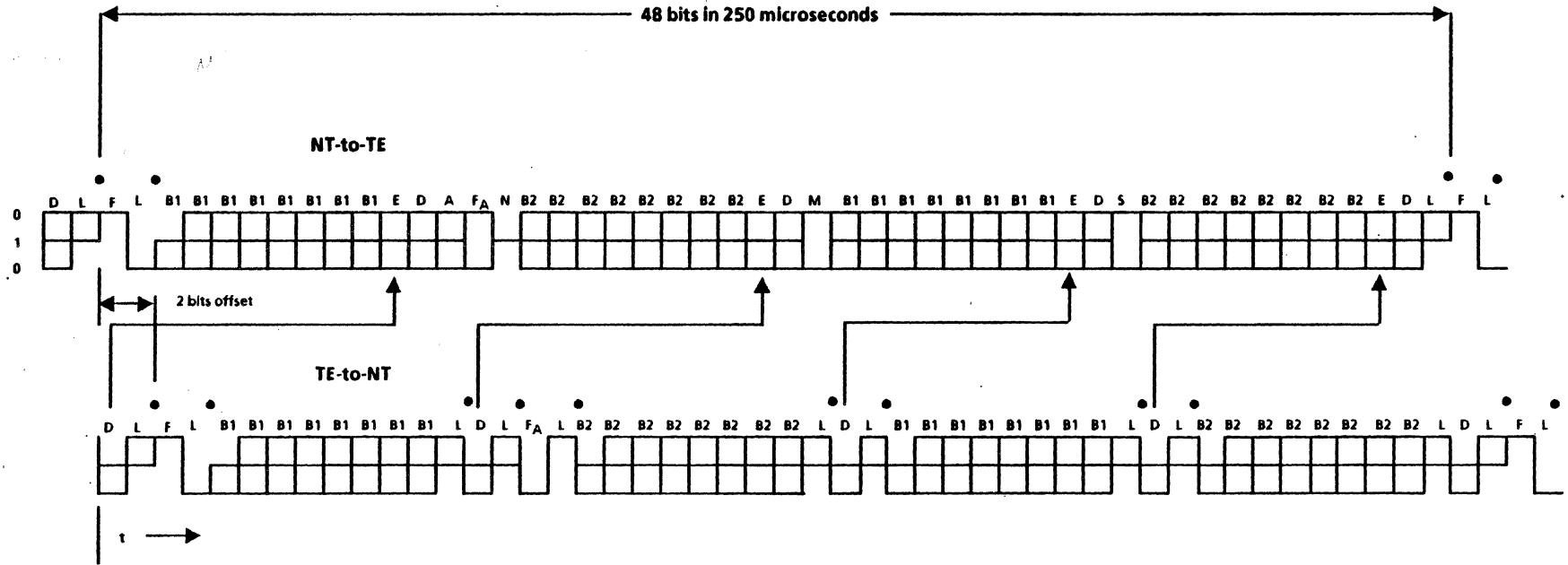


Figure 12.15: Pseudoternary Line Signal

2B + D Frame Structure

There are two frame structures -- one for NT-to-TE transmission, and another for TE-to-NT transmission. Figure 12.17 on the next page shows the frame structures.

Figure 12.16: 2B + D Frame Structure



- F = framing bit
- L = DC balancing bit
- D = D-channel bit
- E = D-echo channel bit
- F_A = Auxiliary framing or Q-bit (= 0)
- M = Multiframing bit
- N = bit set to a binary value N = F_A
- B1 = bit within B channel 1
- B2 = bit within B channel 2
- A = bit used for activation
- S = Reserved for future standardization

Note: Dots demarcate those parts of the frame that are independently DC-balanced.

Each frame consists of the following groups of bits. Each individual group is DC-balanced by its last bit (L-bit). The bits are grouped as follows:

**Network to
Terminal**

<u>Bit Position</u>	<u>Bit Symbol</u>	<u>Group</u>
1 and 2	F, L	Framing signal with balance bit.
3-10	B1	B1-channel (first octet).
11	E	E, D-echo-channel bit.
12	D	D-channel bit.
13	A	Bit A used for activation.
14	FA	FA auxiliary framing bit.
15	N	N bit.
16-23	B2	B2 channel (first octet).
24	E	E, D-echo-channel bit.
25	D	D-channel bit.
26	M	Multiframe bit.
27-34	B1	B1 channel (second octet).
35	E	E, D-echo channel bit.
36	D	D-channel bit
37	S	S, reserved for future standardization (set to 0).
38-45	B2	B2 channel (second octet).
46	E	E, D-echo channel bit.
47	D	D-channel bit.
48	L	Frame balance bit.

Terminal to Network	Bit Position	Bit Symbol	Group
	1 and 2	F, L	Framing signal with balance bit.
	3-11	B1, L	B1 channel with balance bit (first octet).
	12 and 13	D, L	D channel bit with balance bit.
	14 and 15	FA, L	Auxiliary framing or Q-bit with balance bit.
	16-24	B2	B2 channel with balance bit (first octet).
	25 and 26	D, L	D channel bit with balance bit.
	27-35	B1,L	B1 channel with balance bit (second octet).
	36 and 37	D, L	D channel bit with balance bit.
	38-46	B2,L	B2 channel with balance bit (second octet).
	47 and 48	D, L	D channel bit with balance bit.

Frames transmitted by the network (NT) contain an echo channel (E-bits) used to re-transmit the D-bits received from the terminals. The D-echo Channel is used for D Channel access control. The last bit of the frame (L-bit) is used for balancing each complete frame.

At the terminals, timing in the direction TE-to-NT is derived from the frames received from the NT.

The first bit of each frame transmitted from a TE towards the NT is delayed by two bit periods with respect to the first bit of the frame received from the NT.

Framing Signals

The first bit of each frame is the framing bit--F. The framing bit is binary 0. The frame alignment procedure makes use of the fact that the framing bit is represented by a pulse having the same polarity as the preceding binary 0 pulse (an Alternate Space Inversion (ASI) violation). This allows rapid re-framing.

According to the coding rule, both the framing signal and the first binary 0 bit following the framing signal balance bit (in the same frame) produce an ASI violation.

To guarantee secure framing, the auxiliary framing bit pair F_A and N in the direction NT to TE, or in the auxiliary framing bit F_A with the associated balancing bit L in the direction TE to NT, are introduced (with the F_A bit in the 14th bit position in both cases).

This ensures that there is always an ASI violation at 14 bits, or less, from the framing bit F, due to F_A or N being a binary 0 bit (NT to TE), or to F_A always being a binary 0 bit (TE to NT). The framing procedures do not depend on the polarity of the framing bit F, and thus are not sensitive to wiring polarity.

The coding rule for the auxiliary framing bit pair F_A and N, in the direction NT to TE is such that N is binary opposite of F_A ($N = F_A$ (inverted)). The F_A and L bits in the direction TE to NT are always coded such that the binary values of F_A and L are equal.

Frame Alignment Procedure (NT to TE)

Loss of frame alignment may be assumed when a time period equivalent to two 48-bit frames has elapsed without detection of valid pairs of code (ASI) violations obeying the ≤ 14 -bit criterion. The TE ceases transmission immediately (for example, transmit Info 0).

Frame re-alignment can be assumed to occur when three consecutive pairs of line ASI violations obeying the ≤ 14 -bit criterion have been detected.

Frame Alignment Procedure (TE to NT)

The criterion of an ASI violation at 13 bits or less from the framing bit (F) applies.

The NT assumes loss of frame alignment if a time period equivalent to two 48-bit frames have elapsed since detecting consecutive violations according to the 13-bit criterion. On detection of loss of frame alignment, the NT continues transmitting towards the TE.

D Channel Access Control

The following procedures allow a number of terminals connected in a multipoint configuration to gain access to the D-channel in an orderly fashion. The procedure ensures that even in cases where two or more TEs attempt to access the D-channel simultaneously, one TE will always be successful in completing transmission of its information.

This procedure relies on the use of Layer 2 frames delimited by flags consisting of the binary pattern 01111110 and the use of 0 bit insertion to prevent flag imitation. The procedure also permits terminals to operate in a point-to-point manner.

**Interframe Time
Fill (Layer 2)**

When a TE has no Layer 2 frames to transmit, it sends binary 1s on the D-channel. For example, interframe time fill is at all binary 1s. When an NT has no Layer 2 frames to transmit, it sends either binary 1s or continuous HDLC flags 01111110 on the D-channel. Interframe time fill is all binary 1s or flags.

Note

The permission for interframe time fill being continuous flag in the NT to TE direction is not presently covered in the I.430 CCITT Red Book 1984.

**D-Echo
Channel**

The NT, on receipt of a D-channel bit from TE, reflects the binary value in the next available D-echo channel bit position towards the TE.

**D-channel
Monitoring**

A TE, while in active condition, monitors the D-echo channel, counting the number of consecutive binary 1 bits. If the TE detects a binary 0 bit, the TE restarts counting the number of consecutive binary 1 bits. The current value of the count is called C. C need not be incremented after TE reached the value 11 (decimal).

**Priority
Mechanism**

Layer 2 frames are transmitted in such a way that signaling information receives priority (priority Class 1) over all other types of information (priority Class 2).

Furthermore, to ensure that within each priority calls all competing TEs are given a fair access to the D-channel, once a TE has successfully completed the transmission of a frame, it is given a lower level of priority within that class. The TE is given back its normal level within a priority class when all TEs have had an opportunity to transmit information at the normal level within that priority class.

The priority class of a particular Layer 2 frame can be a characteristic of the TE that is preset or set at installation time. It can be passed down from Layer 2 as a parameter for each data transmit request.

The priority mechanism is based on the requirement that a TE can only start Layer 2 frame transmission when C is equal to, or exceeds the value of X_1 for priority Class 1, or is equal to or exceeds the value of X_2 for priority Class 2. The value of X_1 is 8 for the normal level and 9 for the lower level of priority. For Class 1, the value of X_2 is 10 for the normal level and 11 for the lower level of priority for Class 2.

Each TE starts with the normal priority level (8 or 10). When a terminal (TE) has successfully transmitted a complete frame, the X_1 is incremented by one, for example, to 9 or 11.

In a priority Class, the value of the priority (X_1) is changed into the value of the normal level of priority when C equals the value of the lower level (higher value) of priority.

Collision Detection

While transmitting information in the D-channel, a TE monitors the received D-echo channel and compares the last transmitted bit to the next available D-echo bit. If the transmitted bit is the same as the received echo, the TE continues its transmission. However, if the received echo is different from the transmitted bit, the TE ceases transmission immediately and returns to the D-channel monitoring state.

Signals

Figure 12.18 on page 12-38 gives the identification of specific signals that are passed across the S/T interface, and includes the coding for these signals. The signals are important for the specification (I.430 CCITT Red Book 1984) of procedures for activation/de-activation.

Activation Procedure

Activation of the link can be initiated by either the Terminal (TE) or by the exchange. By sending *Info 1*, the activation procedure is initiated by the Terminal (TE). The opposite end of the connection responds by sending *Info 2*.

All Terminals (TEs) (for example, TE2 through TE8) connected to this bus receive *Info 2*, and respond by sending back *Info 3*. After the confirmed reception of *Info 3*, Channels B1, B2, and D are switched into Transparent State in the direction of the exchange.

After the reception of *Info 4* by the terminals (TEs), Channels B1, B2, and D are switched into a Transparent Mode in the direction towards the Terminal (TE). Furthermore, the echoing E-Bit is active. Activating the Interface from the switch initiates the procedure by sending *Info 2* from the Network Terminations (NT) to the Terminal (TE).

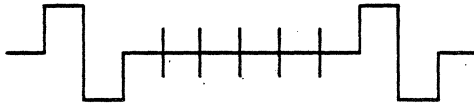
Signals from NT to TE	Signals from TE to NT
Info 0: No signal	Info 0: No signal
	Info 1: A continuous signal with the following pattern: - Positive binary 0 - Negative binary 0 - Six binary 1s Nominal bit rate = 192 Kbps 
Info 2: Frame with all bits of B, D, and D-echo channels set to binary 0. Bit A is set to binary 0. N and L bits are set according to the normal coding rules.	
Info 4: Frames with operational data on B, D, and D-echo channels. Bit A is set to binary 1.	Info 3: Synchronized frames with operational data on the B and D Channels.

Figure 12.17: Definition of Info Signals

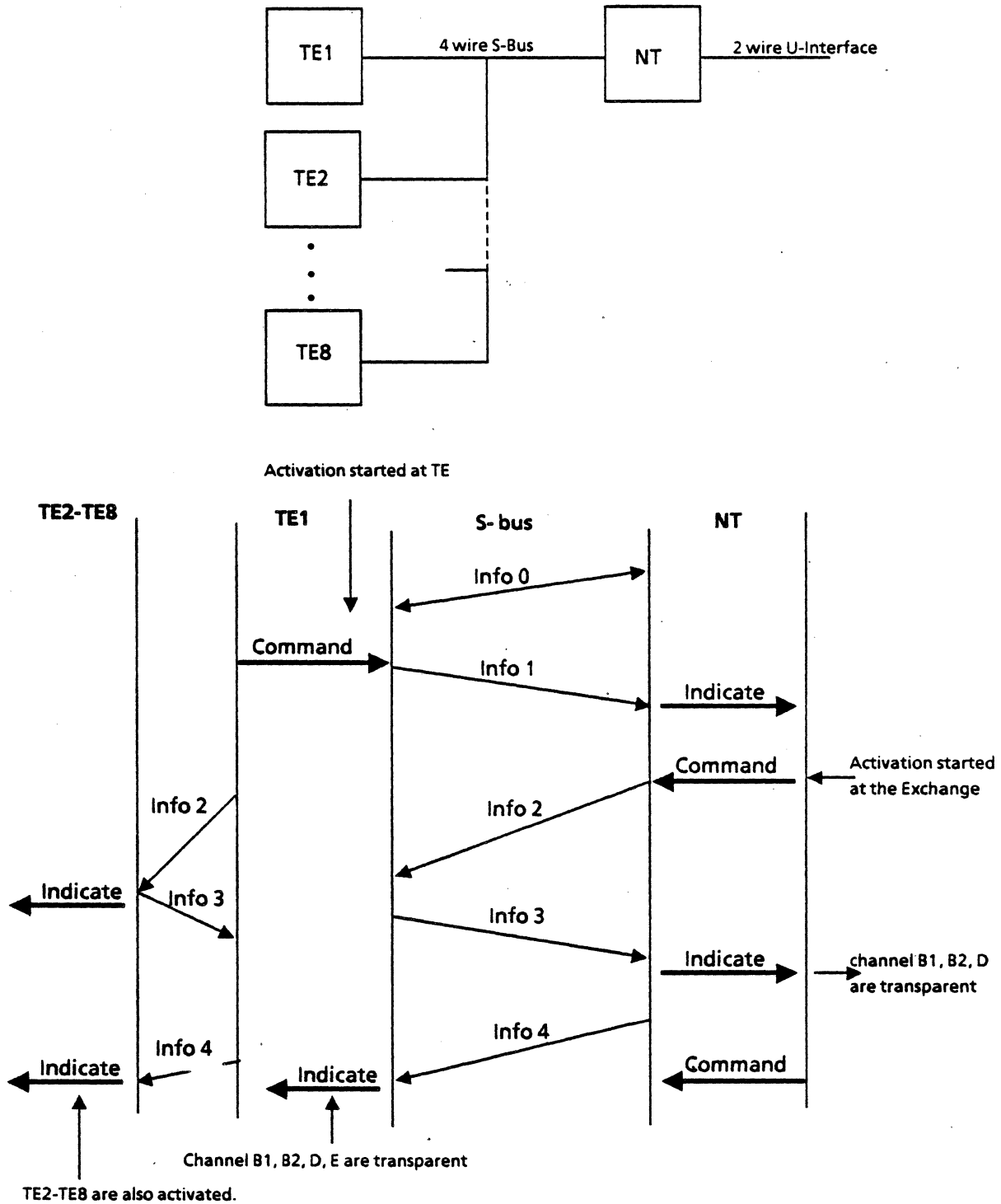
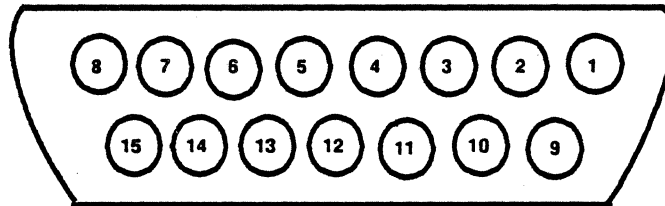


Figure 12.18: Activation Procedure

**EXT B and EXT D
Connector Pinout**

The Chameleon 32 Basic Rate Interface **EXT B** and **EXT D** connectors are 15-pin, D-subminiature socket (female, DA15S) connectors. The pinout is shown below:



All signals are standard RS422 voltage levels.

DA15 Pin Number	DC37 Pin Number	Signal Name
1	1	Chassis Ground
9	4	+ (SDCA) Send Data A
11	6	+ (RDCA) Receive Data A
13	5	(STCA) Signal or Send Timing A
2	22	- (SDCB) Send Data B
4	24	- (RDCB) Receive Data B
6	23	(STCB) Signal or Send Timing B
15	8	(RTCA) Receive Timing A
7	26	(RTCB) Receive Timing B
8	19	Signal Ground

A cable is provided with the Basic Rate Interface that attaches to the DA15S connector. This provides an RS449 interface. The cable connector is a 37-pin D-subminiature pin (male, DC37P) connector.

CHAPTER THIRTEEN: SS#7 MONITORING

Introduction

This chapter focuses on the protocol-specific details of Signalling System 7 (SS#7) Monitoring. For a general description of Chameleon 32 Monitoring, refer to Chapter 1.

This section assumes that you know how to select Monitoring for a port with SS#7 as the protocol. If you do not know how to do this, refer to the *Chameleon 32 User's Guide, Chapter 3: Using the Chameleon 32*.

Signalling System 7

The objective of Signalling System 7 (SS#7) is to provide an *internationally* standardized general purpose common channel signalling system.

Common channel signalling is a method in which a single channel conveys signalling information relating to a multiplicity of circuits or other information used for network management. It can be regarded as a specialized form of data communications for signalling and information transfer between processors in telecommunications networks.

The signalling system uses signalling links for transfer of signalling messages between exchanges or other nodes in the telecommunications network. The protocol includes the ability to detect and correct errors on each signalling link. The system is normally applied with redundancy of signalling links and includes functions for automatic rerouting of signalling traffic to alternate paths in case of link failures.

A major characteristic of the signalling system is that it is specified with a functional structure to ensure flexibility and modularity for diverse applications within one system concept. This allows the system to be realized as a number of functional modules. However, as a consequence of its modularity and its intended use as a standard base for national applications, the protocol may be implemented in many forms.

SS#7 is one common channel signalling system. The signalling system is optimized for operation over 64 kbps digital channels. It is also suitable for operation over analog channels and at lower speeds. The system is suitable for use on point-to-point terrestrial and satellite links.

Message Transfer Parts

The fundamental principle of the SS#7 structure is the division of functions into a common Message Transfer Part (MTP) and separate User Parts for different users on the other. This is illustrated in Figure 13-1 below.

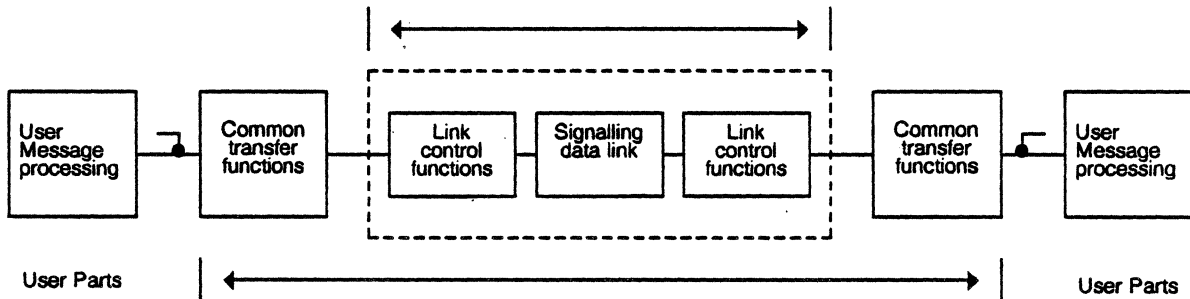


Figure 13-1: Relation of MTP and User Parts in SS#7

The overall function of the MTP is to serve as a transport system providing reliable transfer of signalling messages between the locations of communicating user functions. The term *user* refers to any functional entity that utilizes the transport capability provided by the MTP. A User Part comprises those functions of, or related to, a particular type of user that are part of the common channel signalling system, typically because those functions needed to be specified in a signalling context.

The functions of the MTP are separated into three functional levels. The User Parts constitute parallel elements at the fourth functional level. This is illustrated on the next page.

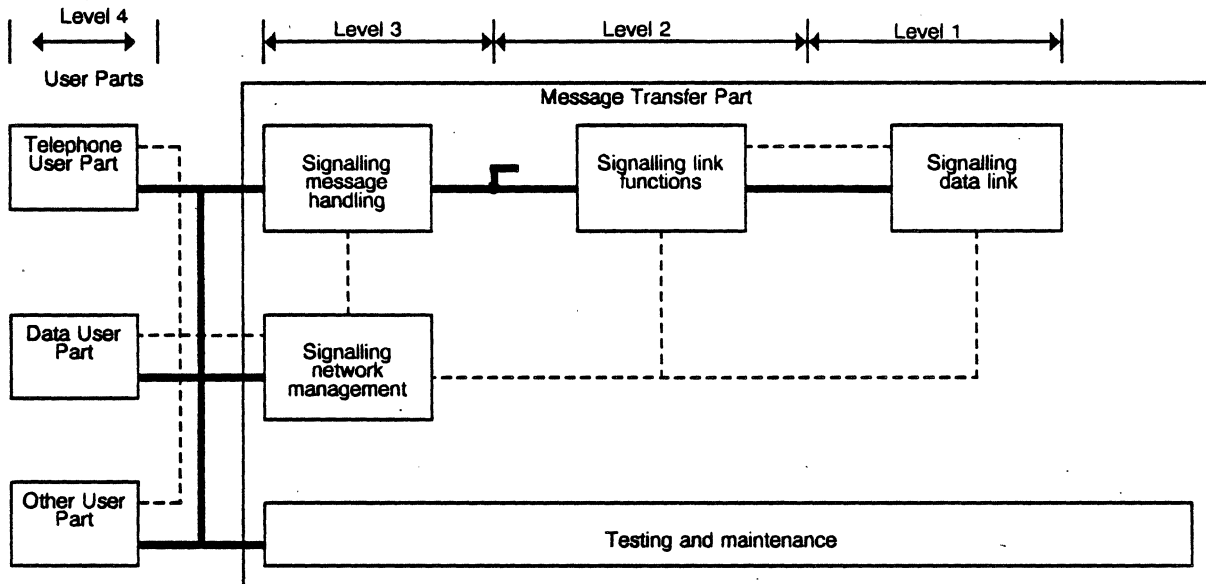


Figure 13-2: MTP Functional Levels

Briefly the functions of the MTP are:

- Level 1 The Signalling Data Link Functions define the physical, electrical and functional characteristics of a signalling data link, and the means to access it.
- Level 2 The Signalling Link Functions defines the functions and procedures for the transfer of signalling messages over one individual signalling data link.
- Level 3 The Signalling Network Functions defines those transport functions and procedures that are common to and independent of the operation of individual signalling links. The two major categories of functions at this level are signalling message handling functions and signalling network management functions.
- Level 4 Level 4 consists of the different User Parts. Each User Part defines the functions and procedures of the signalling system that are particular to a certain type of user of the system.

Signal Units

Signalling and other information originating from a User Part is transferred over the signalling link by means of signal units. There are three different types of Signal Units as shown in Figure 13-3 below:

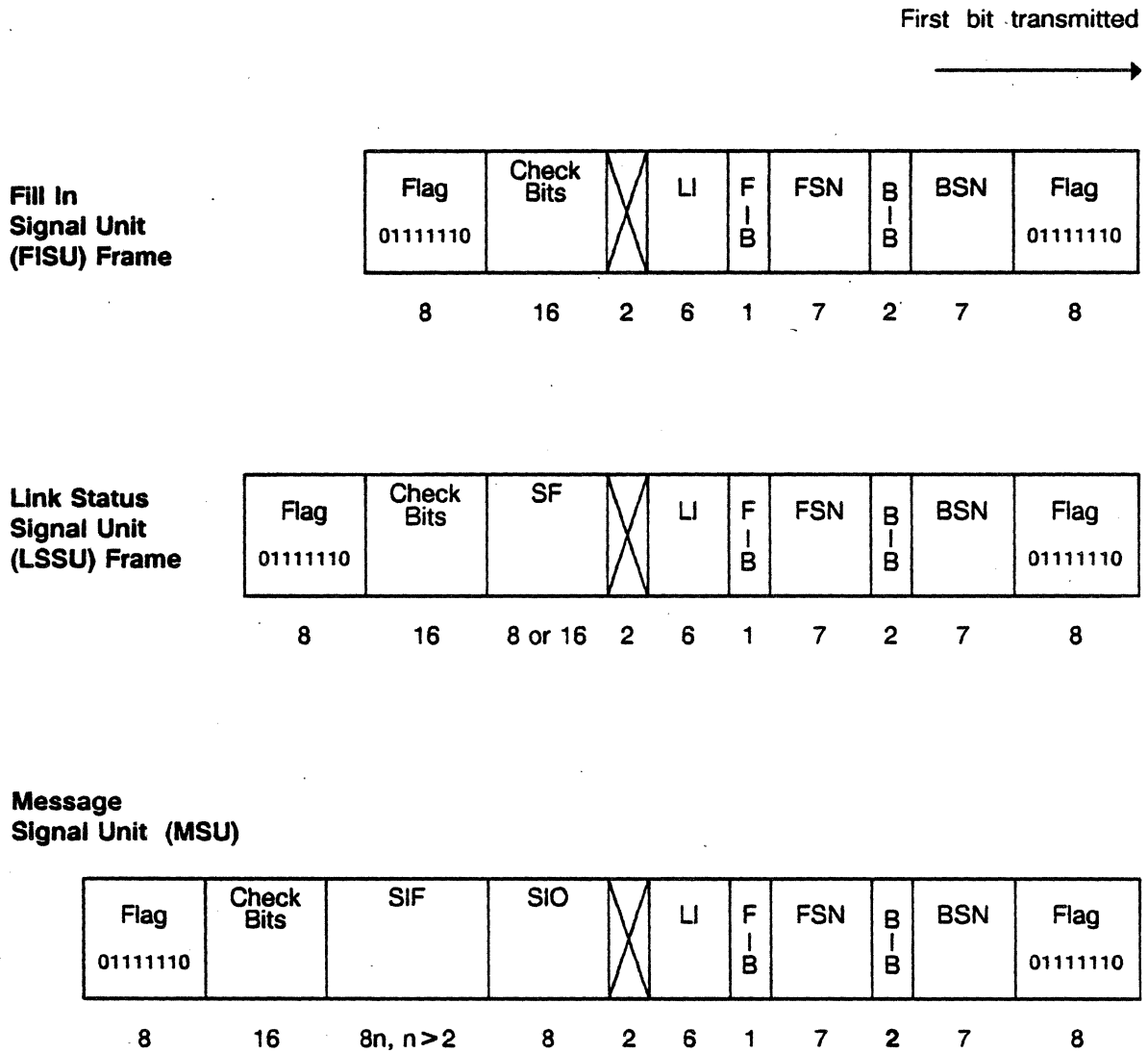


Figure 13-3: SS#7 Signal Unit Formats

The following elements are in all Signal Units.

The Backward Sequence Number (**BSN**) is the sequence number of a signal unit being acknowledged.

The Forward Sequence Number (**FSN**) is the sequence number of the signal unit in which it is carried.

The Backward Indicator Bit (**BIB**) and Forward Indicator Bit (**FIB**) are used with the BSN and FSN in the basic error control method to perform the signal unit sequence control and acknowledgement functions.

The Length Indicator (**LI**) indicates the number of octets following the LI octet and is a number in binary code in the range 0 - 63. The LI differentiates between the three types of signal units, as follows:

- LI = 0 Fill In Signal Unit (FISU)
- LI = 1 or 2 Link Status Signal Unit (LSSU)
- LI > 2 Message Signal Unit (MSU)

Link Status Signal Units (**LSSU**) contain the Status Field (**SF**).

Message Signal Units (**MSU**) contain the Service Information Octet (**SIO**) which is divided into the Service Indicator and the Subservice Field. The Service Indicator associates signalling information with a particular User Part.

MSUs also contain the Signalling Information Field (SIF) which consists of an integral number of octets, greater than or equal to 2 and less than or equal to 62. The format and codes of the SIF are defined for each User Part.

Monitor Setup Menu

When you select SS#7 as your Monitoring protocol, you are prompted for two configurable parameters as shown in Figure 13-4. These parameters are described below.

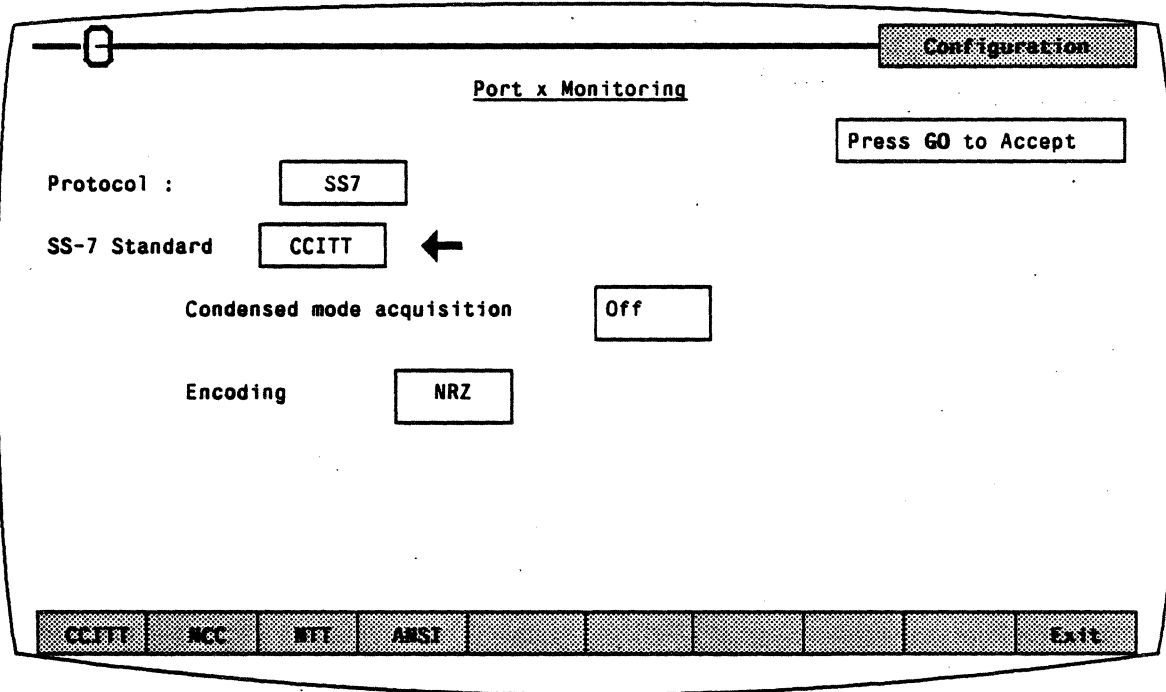


Figure 13-4: SS#7 Protocol Parameters

SS-7 Standard

The SS-7 standard you select affects how MSUs will be interpreted. The four available SS#7 standards are:

- CCITT**
- NCC**
- NTT**
- ANSI**

If you select ANSI, you are prompted for the TCAP version that you want to support. You have the following options:

- None**
- AT & T**
- Bellcore**
- 800DBAS**

Information about TCAP interpretation begins on page 13-26 of this chapter.

Condensed Mode Acquisition

This option enables you to view FISU events in two ways:

OFF Each FISU is shown on the screen as an individual event.

ON FISUs are shown in a condensed mode. When multiple FISUs occur in sequence, a single FISU display is shown. This condensed display includes the normal FISU fields, and the number of events (FISUs) that occurred in the sequence. This enables you to view more non-FISU events on a single page. Refer to page 13-13 for a description of the FISU display.

The number of events is displayed only when the acquisition information function key **F2** is set for the **Flags** option. Refer to page 13-9 for more information about **F2**.

Encoding

Encoding is a level 1 (physical) parameter that determines how the Chameleon 32 interprets the electrical signal to distinguish between binary 1 and 0. The options are:

NRZ Non Return to Zero. In NRZ encoding, a 1 is represented by a high level, and a 0 is represented by a low level.

NRZI Non Return to Zero Inverted. In NRZI encoding, a 1 is represented by no change in level, and a 0 is represented by a change in level.

SS#7 Analysis

The only Chameleon 32 application currently available for the SS#7 protocol is Analysis. SS#7 Analysis provides two pages: Real Time and History. Both pages display traffic in a split screen format (DCE/DTE).

The Real Time page displays traffic from both sides of the line as it is acquired. The data scrolls as the traffic is acquired.

History displays traffic that has been acquired and put in a buffer. You can move back and forth through the traffic in the buffer independent of activity on the line.

The display format and function keys are the same for both pages, as described below.

Function Keys

The function keys control how the traffic is interpreted and displayed. These functions are available for both the History and Real Time pages. The SS#7 Analysis function keys are described below.

F1: Code

F1 determines the format of the user data display. This is the data which does not belong to a protocol specific format. Each time you press **F1**, the user data (in white) changes to the code indicated in the softkey strip. The options are:

- | | |
|---------------|--|
| ASCII | Each byte is displayed as an ASCII character (default). Data item values cannot be shown in ASCII. |
| EBCDIC | Each byte is displayed as an EBCDIC character. Data item values cannot be shown in EBCDIC. |
| HEXS | Each byte is displayed as a pair of hexadecimal digits, with a space between each pair. |
| HEX | Each byte is displayed as a pair of hex digits. |

F2: Acquisition Information:

F2 determines the acquisition information display format, which is displayed in green or white in the center of the screen, between the DCE and DTE sides. The options are:

Number	Event number in decimal (default)
Flags	Number of flags between events
Time	Event time stamp as hh:mm:ss:ddd (ddd is 20 millisecond units)
dTime	Displays the elapsed time between events
CRC	CRC value and OK if the CRC is good, or Bad if the CRC is not good
None	No acquisition information is displayed

The port receiving the packet (**Port A** or **Port B**) is displayed as part of the acquisition information unless the **None** option is selected.

F3: Event Type

F3 determines what types of events will be displayed on the Analysis page. The options are:

M	MSUs are shown
MS	MSUs and LSSUs are shown
MSF	MSUs, LSSUs and FISUs are shown
MSFL	MSUs, LSSUs, FISUs, and lead changes are shown

Note: **F3** affects the page *display* only. All events are captured, regardless of the **F3** selection.

F4: Message Transfer Part (MTP)

F4 determines how the Message Transfer Part (MTP) is interpreted.

For MSUs, the MTP includes the following fields: BSN, BIB, FSN, FIB, LI, SIO (Sub-Service Field and Service Indicator).

For LSSUs, the MTP includes the following fields: BSN, BIB, FSN, FIB, LI and SF.

For FISUs, the MTP includes the Length Indicator field.

- MTP +** Message Transfer Part is displayed interpreted (default).
- MTP"** Message Transfer Part is displayed uninterpreted in the code selected in **F1**.
- MTP*** Message Transfer Part is displayed interpreted and uninterpreted.
- MTP-** Message Transfer Part is acquired but not displayed.

F5: User Part (UP)

F5 determines how the User Part is interpreted. The UP is relevant for MSUs only.

- UP +** User Part is displayed interpreted (default).
- UP"** User Part is displayed uninterpreted in the code selected in **F1**.
- UP*** User Part is displayed interpreted and uninterpreted.
- UP-** User Part is displayed is acquired but not displayed.

F6: TCAP (Transaction Capabilities Application Protocol)

F6 determines how the TCAP is interpreted. The TCAP is relevant for MSUs only. See page 13-26 for more information.

TCAP + TCAP is displayed interpreted (default).

TCAP- TCAP is displayed uninterpreted in the code selected in **F1**.

TCAP* TCAP is displayed interpreted and uninterpreted.

TCAP TCAP is displayed is acquired but not displayed.

F8: Detail Level

F8 determines the detail level for each interpreted data item. The options are:

Detail0 Signaling unit type (MSU, LSSU, FISU)

Detail1 Heading code

Detail 2 Routing Label

Detail 3 Major message parameter units

F9: Data Item Display

Each data item is composed of a number of consecutively acquired bits, which are built into bytes and stored in acquisition memory. These bits can be interpreted as *values* or *patterns*.

A *value* is up to 32 bits, can start at any offset in a byte, and can span byte boundaries. The first acquired bit is the least significant bit. For example, if the bytes 01,02,03 are acquired, the value of the first 16 bits is hex 0201 (decimal 513). Values cannot be shown in ASCII or EBCDIC.

A *pattern* has any length and alignment. However, a pattern is always displayed aligned on a byte boundary, and is always an integral number of bytes long. No numerical significance is placed on any bit in a pattern. For example, the bytes 41,42,43 form the string **ABC**.

F9 determines the display format of data item values. Each data item is normally displayed with a caption which identifies the data item, and a value which represents the acquired data. The format of the value part is determined by this option, as follows:

Meaning Documented interpretation of the data item value

Offset Offset of the item from the start of the acquired data is shown in the format *n.m*, where *n* is the number of bytes and *m* is the number of bits. Items derived from a combination of other data items cannot be shown in this format.

Length Length is the size of the data item, in the format *n.m*, where *n* is the number of bytes and *m* is the number of bits. Items derived from a combination of other data items cannot be shown in this format.

Hex Data is shown in hexadecimal.

Hex displays for values and patterns appear similar, but there are two differences. First, values are shown with the first acquired (least significant) bytes on the right, whereas patterns are shown in order of acquisition, i.e. the first acquired bytes on the left. Second, patterns are shown as an integral number of byte aligned bytes, however Offset and Length still show the actual length and alignment

Decimal Data is shown in decimal. Patterns cannot be displayed in decimal.

Binary Data is shown in binary. Patterns cannot be displayed in binary.

Where a value cannot be shown in a specific mode, a dash (-) is displayed.

F10: User Data

F10 determines if user data is displayed. It also controls the display of traffic in an uninterpreted (raw) mode. The options are:

User + User data is displayed (default)

User- User data is not displayed

Raw All traffic is displayed uninterpreted (raw) in the code selected in **F1**

MSU Interpretation

Message Signal Unit interpretation includes the *BSN*, *BIB*, *FSN*, *FIB*, and *LI* display as described above. The level four interpretation is determined by the implementation that you selected as the SS#7 Standard in the SS#7 menu (CCITT, NTT, NCC, or ANSI) and the User Part that the MSU corresponds to.

The MSU interpretation includes the following:

- Service Information Octet (SIO)
- Service Information Field (SIF)

The location of these items within an MSU are shown in Figure 13-5. Although they are always present, the format depends on the User Part the MSU corresponds to.

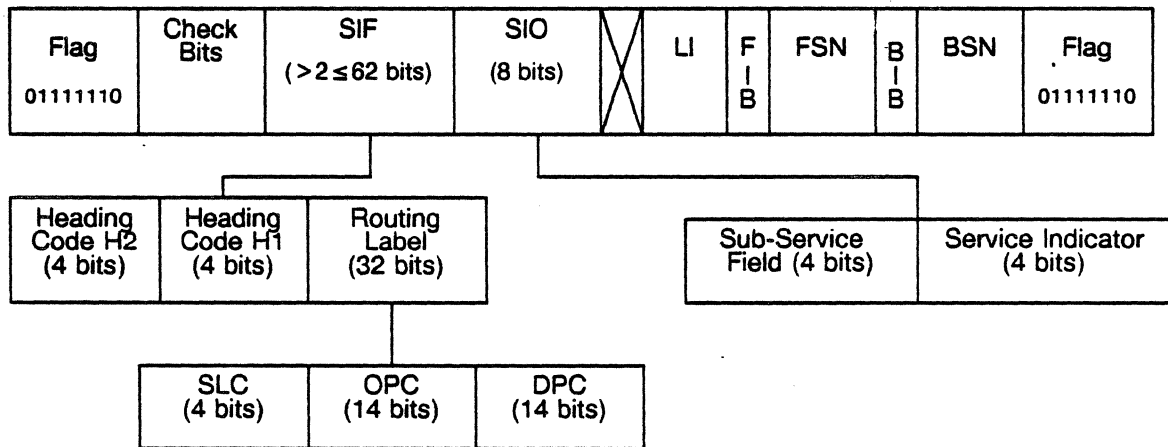


Figure 13-5: MSU Components

The Service Information Octet (SIO) is interpreted as follows:

$$SIC = cccc \quad SSF = x$$

where: *SIC* is the Service Indicator Code, *cccc* is the name of the corresponding User Part, and *SSF* is the Sub-Service Field.

Note

See page 13-25 for information relating to TCAP interpretation.

The Service Information Field (SIF) has two major components:

- Routing Label
- Heading Code

The Routing Label specifies the following:

- Destination Point Code (DPC)
- Origination Point Code (OPC)
- Signal Link Code (SLC)

These three items can be configured for your particular SS#7 implementation using the Chameleon 32 User Parts Editor, as described on the next page.

The Heading Code has two 4-bit fields: H1 and H2. The Heading Code can also be configured for your particular SS#7 implementation using the Chameleon 32 User Parts Editor. The Heading Code is interpreted and displayed in the following format:

Heading code	xx
User mnemonic	ccc
Internal mnemonic	ccc

The User mnemonic field is not shown if no User mnemonics have been created with the User Parts Editor. The internal and user defined mnemonic may not be the same, but the internal one is always shown, as are any internally defined contents for that message.

User Part Editor

Since User Parts are specific to a user, the Chameleon 32 Analysis application gives you the ability to configure two aspects of the User Parts. Using the User Part Editor, you can configure the User Parts:

- Heading Code Mnemonic
- Routing Label Structure

When the SS#7 Analysis application is first started, the built-in User Parts configuration is loaded. This information is hard-coded into the Chameleon 32 system. Once these built-in values are loaded, you can invoke a User Parts Editor, configure the User Parts for your application, and save the information in a file. This file can then be loaded, as needed.

To invoke the User Parts Editor, do the following:

1. Start the SS#7 Analysis application.
2. Select and display the History page.
3. Press **Ctrl Z**. This displays the User Part selection Menu which enables you to select a specific User Part for configuration (Figure 13-6).

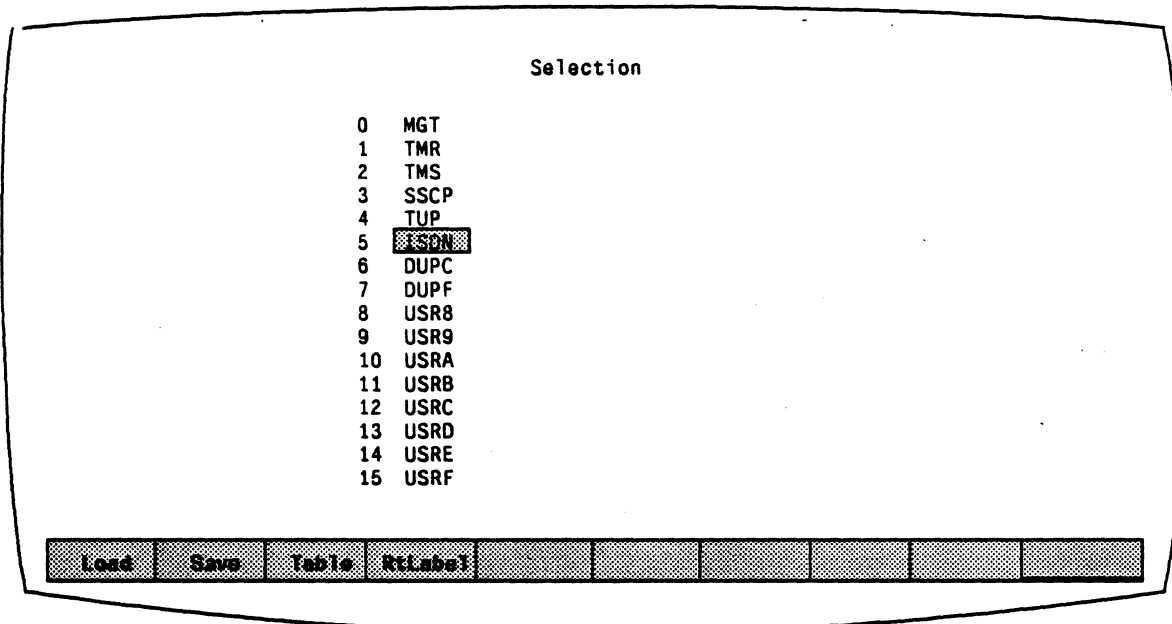


Figure 13-6: User Parts Selection Menu

There are 16 User Parts numbered 0 - 15. The defined User Parts are as follows:

0	MGT	Signalling network management
1	TMR	Signalling network testing and maintenance
2	TMS	Signalling network testing and maintenance
3	SSCP	Signalling Connection Control Part
4	TUP	Telephone User Part
5	ISDN	Integrated Services Digital Network
6	DUPC	Data User Part (call and circuit related)
7	DUPF	Data User Part (facility registration and cancellation)

The unused User Parts are listed in the format **USRn**, where **n** is the Service Indicator Code associated with that User Part.

To configure a specific User Part, use the arrows keys to highlight the desired User Part, and then select the appropriate menu option, as described below. The User Part Selection Menu has four softkey options for each User part:

- F1 Load** This option enables you to specify a file that contains the configuration for the selected User Part. When you press **F1 Load**, the User Part name is displayed in blue, indicating that it is now an editable field. Enter the file name and press **Go** to load the file. Refer to the next page for a list of editing keys that you can use when editing the field.
- F2 Save** This option saves the displayed configuration of the selected User Part to a named file. When you press **F2 Save**, the User Part name is displayed in blue, indicating that it is now an editable field. Enter a file name and then press **Go** to create the file. Refer to the next page for a list of editing keys that you can use when editing the field.
- F3 Table** This option displays the Mnemonic Table screen (Figure 13-7) for the selected User Part. The use of this screen is described on the following page. To exit from this screen and return to the User Parts Selection Menu, press **Go** or **Cancel**. Refer to the next page for a list of editing keys that you can use when editing the field.
- F4 RtLabel** This option displays the Routing Label Structure screen (Figure 13-8) for the selected User Part. To exit from this screen and return to the User Parts Selection Menu, press **Go** or **Cancel**. Refer to the next page for a list of editing keys that you can use when editing the field.

This message contents parameters are always interpreted according to built-in definitions, but you can use the **F8 Detail** function key to set the detail level to suppress the display of these interpretations if they do not apply.

Editing the Menu Fields

Figure 13-7 lists the keys that are available for editing user input in the User Parts Editor. These keys function in each of the screens when the field is editable.

When a field is read, it is validated according to the required data type. If validation fails, the user will hear a beep. The field is reselected for input until valid data is read.

EDITING KEY	FUNCTION
Cancel	Exits the field, generally without being read. Usually CANCEL will exit the entire function, and return to the previous activity without carrying out the function.
Go	Reads the field, and usually the entire function is activated. If successful, the function is exited, returning to the previous activity.
↑ ↓ Return	These keys read and exit the field. The next field to be selected is whatever is appropriate to the particular key, and the result of the read.
→	Non-destructive space, moves the cursor one column to the right. On certain fields, if pressed when the cursor is at the right boundary, the field is read and exited.
←	Non-destructive backspace, moves the cursor one column to the left. On certain fields, if pressed when the cursor is at the left boundary, the field is read and exited.
Delete	Destructive backspace, moves the cursor one column to the left (if possible), and deleting a single character at the new cursor position. DELETE does not exit the field.
Ctrl C	The field is erased.
Ctrl O	Inserts a single space at the cursor position, moving the remainder of the field to the right of the cursor one column to the right.
Ctrl V	The next key is taken as a data key, regardless of its possible meaning as a control key. For example, to enter the DELETE key into a data entry field.
F1 - F10	These keys may be interpreted as data or control keys depending upon the application. No fixed meaning is attached to these keys

Figure 13-7: User Parts Editor Editing Keys

Heading Code Mnemonic

To configure the Heading Code Mnemonic, highlight the desired User Part from the Selection menu and press **F3 Table**. This displays the Mnemonic Table for the Selected User Part. For example, Figure 13-8 shows a sample mnemonic table for the MGT User Part.

The Mnemonic Table Menu allows the user to enter the desired mnemonics in the fields formed at the intersections of the rows and columns. If the user presses **F1 Init**, the built-in mnemonics are displayed. To change a field, highlight the desired field, press **F2 Clear** to clear the field, and then enter the new mnemonic using the editing keys.

Mnemonic Table for MGT																
	0	1	2	3	4	5	6	7	8	9	A	B	C	D	E	F
0																
1		COO	COA				CBD	CBA								
2		ECO	ECA													
3		RCT	TFC													
4		TFP		TFR		TFA										
5		RSP	RSR													
6		LIN	LUN	LIA	LUA	LID	LFU									
7																
8		DLC	CSS	CNS	CNP											
9																
A																
B																
C																
D																
E																
F																

Init	Clear															
------	-------	--	--	--	--	--	--	--	--	--	--	--	--	--	--	--

Figure 13-8: Heading Code Mnemonics

Routing Table Configuration

To configure the Routing Label, highlight the desired User Part from the Selection menu and press **F4 RtLabel**. This displays the Routing Label screen for the Selected User Part. For example, Figure 13-9 shows a sample mnemonic table for the DUPF User Part.

Routing label structure edit for DUPF

Length	Display
14	DPC
14	OPC
4	SLC
0	

Black	Red	Green	Yellow	Blue	Purple	LtBlue	White	
-------	-----	-------	--------	------	--------	--------	-------	--

Figure 13-9.: Heading Code Mnemonics

Use the arrow keys to move the highlight to the desired field. The information in the field can then be edited using the keys listed in Figure 13-6.

You can then edit the following Routing label information:

DPC Destination Point Code
OPC Origination Point Code
SLC Signalling Link Code

You can configure two aspects of the Routing label, which affect how it is displayed in the History and Real time pages. You can configure:

- Length** This affects the length of the field display. To configure the length, highlight the desired field and then enter the new length using the editing keys.
- Display** This determines the caption that is displayed and the color of the display. To configure the Display, highlight the desired field and then enter the new caption using the editing keys. When a Display field is highlighted, the functions keys enable you to select a color for the display of that field.

For example, if the Routing Label screen displays the following for a User Part

```

14   DPC
14   OPC
4    SLC

```

the first 14 bits following the SIC will be displayed with the caption **DPC**, the next 14 bits will be displayed with the caption **OPC**, and the next 4 will be displayed with the caption **SLC**. The fourth field is unused in this example, but is available if required. The display looks like this:

```

DPC  0001
OPC  0203
SLC  4

```

The actual values displayed will be dependent upon acquired data. If you were to change the length of the fields to the following:

```

16   DPC
8    OPC
8    SLC

```

the display would be more like:

```

DPC  0001
OPC  02
SLC  03

```

Remember that the User Parts Editor also allows you to select the color of the display for each item.

**Routing Label
Correlations**

The name of the STP that correlates to the routing label (DPC, OPC and SLC) is displayed in the History and Real Time pages according to the contents of a file named RTLABL.DAT.

The RTLABL.DAT file is located in the following hard disk directory:

A:\tekelec\analysis\ss7

The contents of the file is shown below. If you have the optional C package, you can use the vi Editor to edit the file to add or change the STP entries.

The format of an entry in the file is as follows:

OPC-DPC-SLC; name

where: OPC, DPC and SLC are decimal numbers and name is the name that will be correlated with those numbers. If you make an invalid entry, it will be discarded. The RTLABL.DAT file contains the entries shown below.

248-11-0;	DENVER STP
248-112-0;	ST PAUL MINN STP
248-111-0;	MINN BEARD STP
284-113-0;	OMAHA DOUGLAS STP
248-114-0;	OMAHA 84TH ST STP
248-211-0	SEATTLE STP
248-212-0;	PORTLAND STP
248-2-1;	TEMPE AZ STP
248-3-1;	TEMPE STP
248-5-1;	THORNTON CO STP
248-6-1;	THORNTON CO STP
248-34-1;	PHOENIX 1 STP
248-34-2;	PHOENIX 2 STP
248-34-3;	PRESCOTT STP
248-35-1;	TUCSON STP
248-32-1;	COLD SPRINGS STP
248-31-1;	DENVER 1 STP
248-31-2;	DENVER 2 STP
248-31-3;	DENVER 3 STP
248-28-1;	BOISE STP
248-27-1;	BILLINGS WEST STP
248-26-1;	HELENA STP
248-33-1;	ALBUQUERQUE 1 STP
248-33-2;	ALBUQUERQUE 2 STP
248-30-1;	SALT LAKE CITY STP
248-20-2;	PROVO STP

248-29-1;	CHEYENNE STP
248-226-1;	SEATTLE #1 STP
248-226-2;	SEATTLE #2 STP
248-226-3;	SEATTLE #3 STP
248-227-1;	SPOKANE STP
248-227-2;	YAKIMA STP
248-228-1;	PORTLAND A STP
248-228-2;	PORTLAND B STP
248-228-3;	PORTLAND C STP
248-229-1;	EUGENE STP
248-229-2;	ASHLAND STP
248-130-1;	MINN STP
248-129-1;	ST CLOUD STP
248-131-1;	OWATONNA STP
248-131-2;	WINDOM STP
248-131-3;	ROCHESTER STP
248-128-1;	DULUTH STP
248-127-1;	FARGO STP
248-127-2;	GRAND FORKS STP
248-127-3;	WADENA STP
248-126-1;	BISMARCK STP
248-132-1;	SIOUX FALLS STP
248-132-1;	RAPID CITY STP
248-136-1;	DES MOINES STP
248-136-2;	MASON CITY STP
248-133-1;	SIOUX CITY STP
248-133-2;	SPENCER STP
248-134-1;	CEDAR RAPIDS STP
248-135-1;	DAVENPORT STP
248-137-1;	OMAHA STP
248-137-2;	NORFOLK STP
248-138-1;	GRAND ISLAND STP
248-138-2;	SIDNEY STP

TCAP INTERPRETATION

Introduction

When you select ANSI as the SS#7 standard, you can select a Transaction Capabilities Application Protocol (TCAP) standard. There are four TCAP options:

- F1 None TCAP is not interpreted
- F2 AT & T
- F3 Bellcore
- F4 800DBAS

From an end-user point of view, Transaction Capabilities lie above the Network layer of the OSI model. Within SS#7 it is located between the SCCP and an application specific entity, as shown in Figure 13-10.

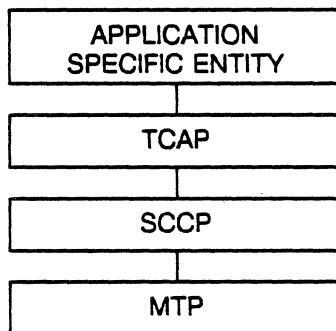


Figure 13-10: Location of TCAP in SS#7

The objective of TCAP is to provide for the transfer of information between nodes and to provide facilities common to a number of supported applications, while being independent of any of these. In an SS#7 network, TCAP is considered for use between exchanges, an exchange and a network service center, or between network service centers.

The Chameleon 32 supports the 800 Query Message portion within TCAP, which is based on a connectionless network service. In this case, TCAP interfaces directly with the Signalling Connection Control Part (SCCP), and since SS#7 is used as the network service, the addressing options supported by the SCCP are used.

All 800 Services Messages are encoded in SCCP UDT messages in MSUs. Since SCCP procedures depend on the application data transported, the SCCP message parameters may vary between 800 MSUs.

Routing Label

The Routing Label for an 800 Query Message has the format shown in Figure 13-11 below. (The other MSU components shown in the figure are described on page 13-4.) The first octet is the first transmitted. Bits in an octet are labeled, as shown, with bit 0 the least significant and the first transmitted.

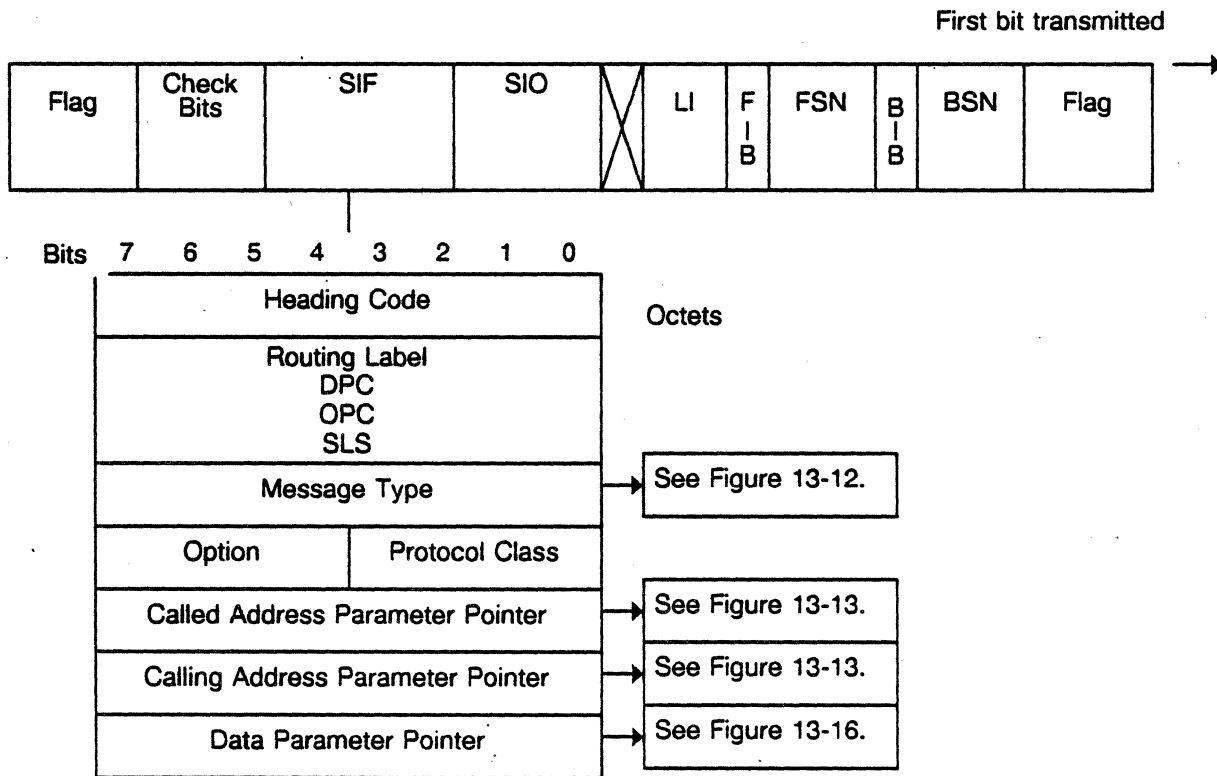


Figure 13-11: 800 Query Message Routing Label Format

The Routing Label has the following fields:

- The Destination Point Code (DPC) is the SS#7 address of the node receiving the MSU.
- The Origination Point Code (OPC) is the SS#7 address of the node sending the MSU.
- The Signalling Link Selection (SLS) is the code that directs the MSU to a particular signalling link for transmission.

- The Message Types are listed in Figure 13-12.
- The Protocol Class must be Class 0 (connectionless service, no message sequencing required) for all 800 service messages.
- The Option field indicates any options that should be used with the Protocol Class.
- Pointers identify the location of the beginning of variable length SCCP parameters. The pointer indicates how many octets from the octet containing the pointer, the variable length parameter begins.

For example, if the Called Address Parameter Pointer is 0000 0011, it indicates that the Called Party Address field begins in the third octet following its pointer.

Figure 13-12 on the following page lists the SCCP Message types and the Protocol classes associated with each. The TCAP message is carried within a Unitdata (UDT) message of the SCCP.

SCCP Message Type		Protocol Classes	7	6	5	4	3	2	1	0
CR	Connection Request	2 3 4	0	0	0	0	0	0	0	1
CC	Connection Confirm	2 3 4	0	0	0	0	0	0	1	0
CREF	Connection Refused	2 3 4	0	0	0	0	0	0	1	1
RLSD	Released	2 3 4	0	0	0	0	0	1	0	0
RLC	Release Complete	2 3 4	0	0	0	0	0	1	0	1
DT1	Data Form 1	2	0	0	0	0	0	1	1	0
DT2	Data Form 2	3 4	0	0	0	0	0	1	1	1
AK	Data Acknowledgement	3 4	0	0	0	0	1	0	0	0
UDT	Unitdata	0 1	0	0	0	0	1	0	0	1
UDTS	Unitdata Service	0 1	0	0	0	0	1	0	1	0
ED	Expedited Data	3 4	0	0	0	0	1	0	1	1
EA	Expedited Data Ack.	3 4	0	0	0	0	1	1	0	0
RSR	Reset Request	3 4	0	0	0	0	1	1	0	1
RSC	Reset Confirmation	3 4	0	0	0	0	1	1	1	1
ERR	Error	2 3 4	0	0	0	0	1	1	1	1
IT	Inactivity Test	2 3 4	0	0	0	1	0	0	0	1

Figure 13-12: 800 Query Message Types

Called Party Address

The Called Party address indicates the functional component of the SS#7 protocol that is the basis for decoding information in the data field. The format is shown in Figure 13-13 below. The location of the Called Party Addresses is indicated by the Called Address Parameter Pointer in the Routing Label (Figure 13-11). The pointer indicates how many octets from the pointer octet, the Called Party Address begins.

Calling Party Address

The Calling Party Address has the same format as the Called Party Address and provides information about the user that originated the message. The location of the Calling Party Address is determined by the Calling Address Parameter Pointer in the Routing Label (Figure 13-11). The pointer indicates how many octets from the pointer octet, the Calling Party Address begins.

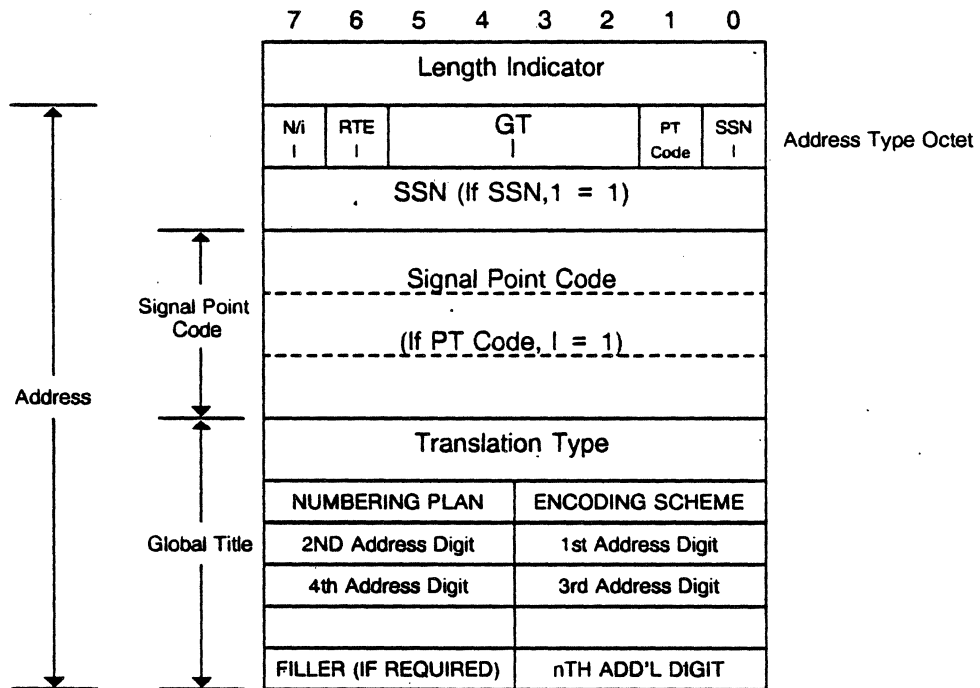


Figure 13-13: Called/Calling Party Address Field Format

The Called/Calling Address has the following fields:

- The Length Indicator, which identifies the number of octets in the Called/Calling Address, not including the Length Indicator octet, or the parameter name octet, if used.
- Address-Type octet, as follows:
 - N/I Indicator Indicates if the Called/Calling party address is coded according to National (1) or International (0) specifications.
 - RTE Indicator Identifies Routing based on Global Title (0) or on Point Code (1)
 - GT Indicator Indicates whether a Global Title is present, and how the Global Title is coded, if present. A Global title is a non-signalling network address that identifies an SCCP user.
 - PT Code Indicator Indicates whether a Point Code is present.
 - SSN Indicator Indicates presence of a subsystem number. If present, the subsystem number identifies the SCCP user that will receive the message.
- The Translation Type octet identifies which translation table to use for SCCP routing information, based on the Global Title.
- The Global Title value is in a multi-octet field in binary-coded form of the 800-NXX digits dialed by the caller.

Data Parameter

A TCAP message is structured as a single constructor information element, which consists of a number of information elements. The types of elements are:

- A Transaction Portion which contains information elements used by the Transaction sub-layer
- A Component Portion which contains information elements used by the Component sub-layer.

One of the Transaction Portion elements is the Component Sequence, which contains the Component sub-layer information elements.

Each information element (Figure 13-14) consists of three fields, appearing in the following order:

- Tag Identifies the type of information element and the interpretation of the contents
- Length Specifies the length (number of octets) of the contents (does not include the Tag or the Length).
- Contents Contains the information the element is intended to convey. Its length is variable, but is always an integral number of octets.

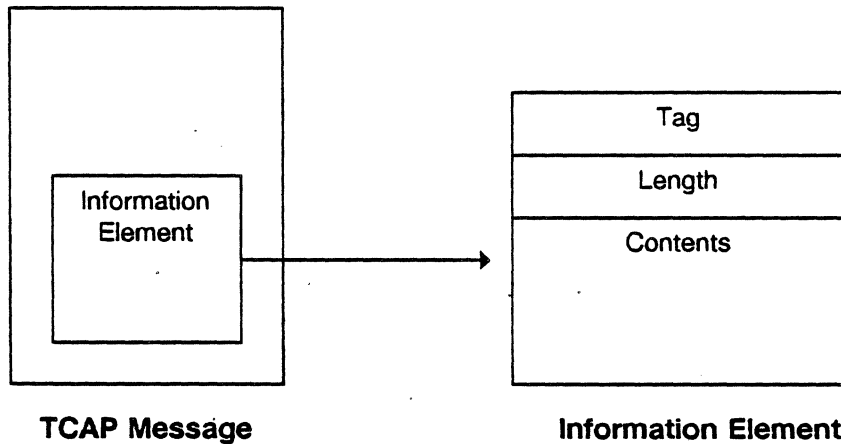


Figure 13-14: TCAP Information Element

These information elements are nested as shown in Figure 13-15.

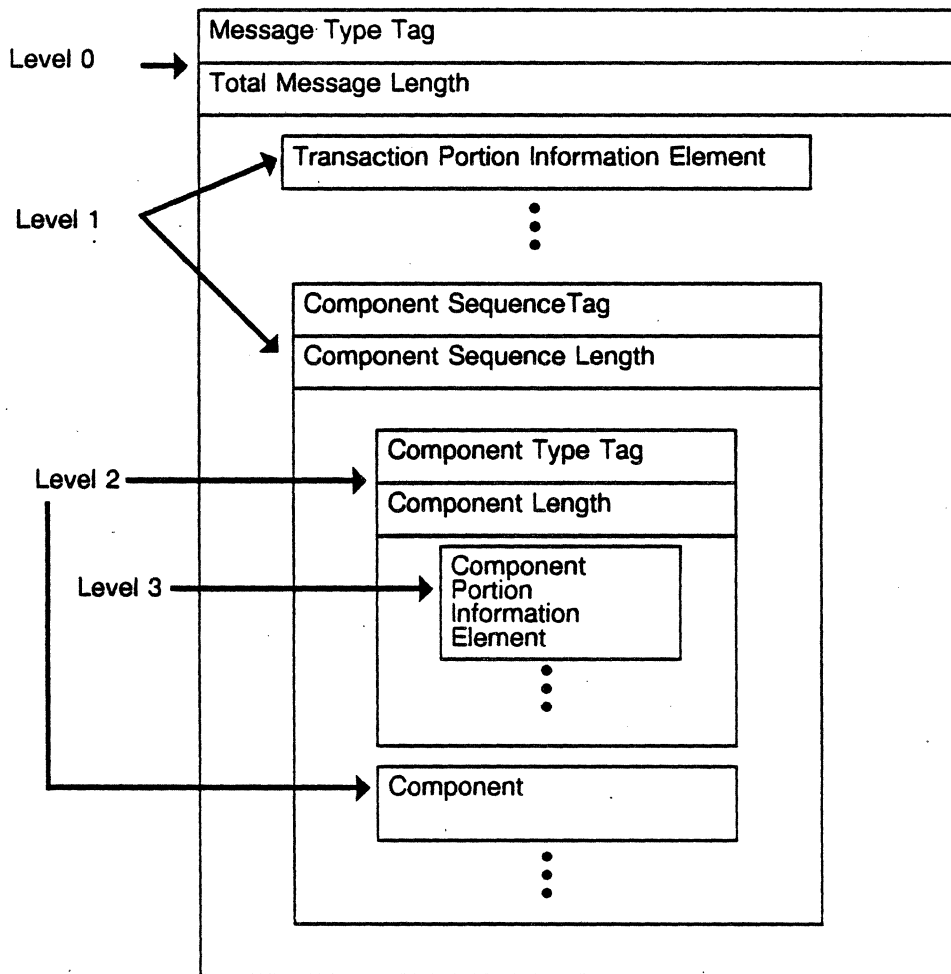


Figure 13-15: Information Element Nesting

Figure 13-16 illustrates a typical data field for an 800 Query message from an SSP to the STP. The location of the Data Parameter is determined by the Data Parameter Pointer in the Routing Label (Figure 13-11). The pointer indicates how many octets from the pointer, the Data Parameter begins.

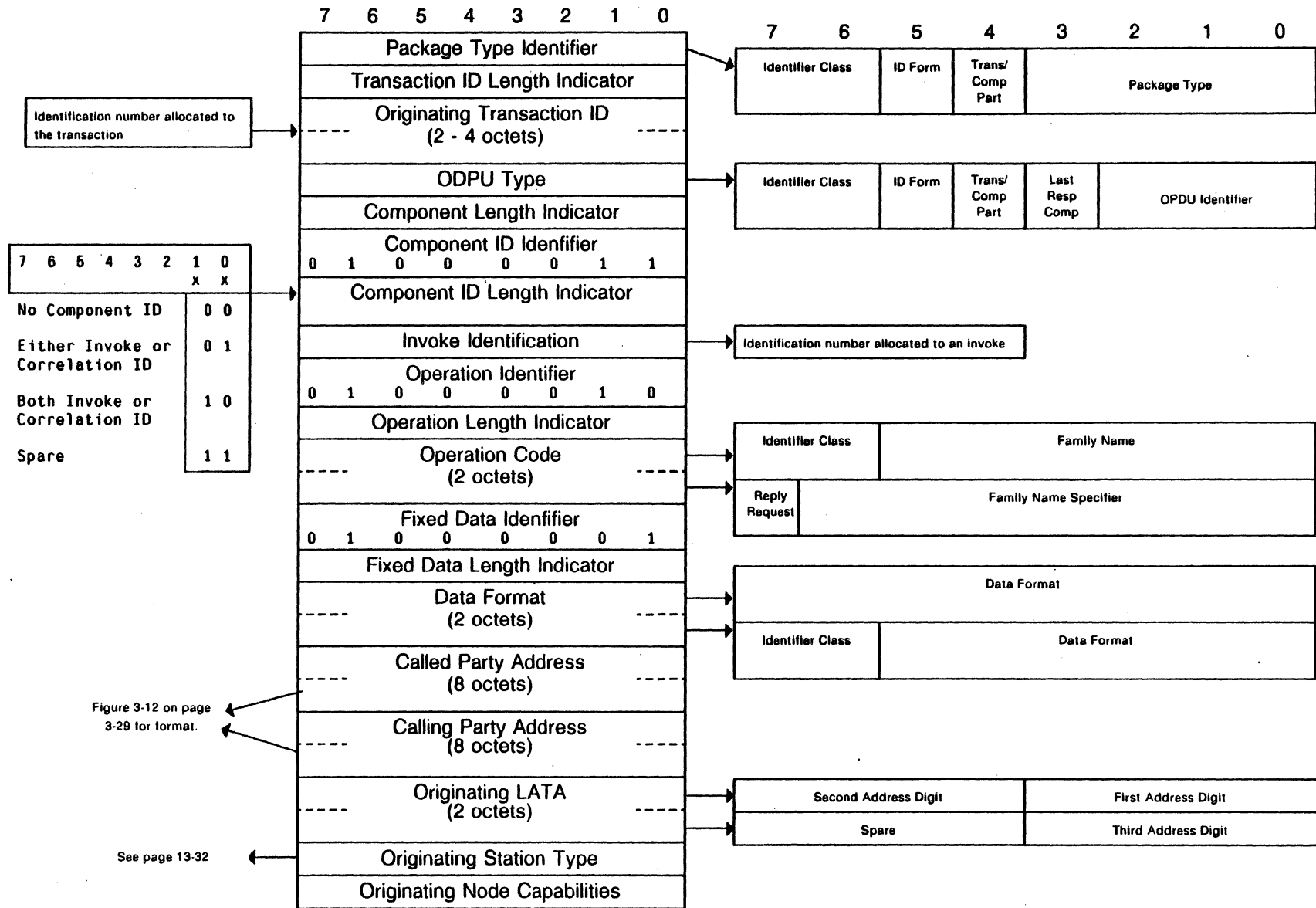


Figure 13-16: Data Parameter Field Format

Originating Station Type

The Originating Station Type octet in Figure 13-16 on the previous page is interpreted as shown in Figure 13-17.

7 6 5 4 3 2 1 0	INTERPRETATION
0 0 0 0 0 0 0 0	Identified Line (No SPL Treatment)
0 0 0 0 0 0 0 1	ONI (Multi-Party)
0 0 0 0 0 0 1 0	ANI Fail
0 0 0 0 0 0 1 1	Spare
↓	
0 0 0 0 0 1 0 0	Hotel without Room Identification
0 0 0 0 0 1 1 0	Hotel without Room Identification
0 0 0 0 0 1 1 1	Coinless, Hospital Inmate, etc.
0 0 0 0 1 0 0 0	Inter Data Restricted
0 0 0 0 1 0 0 1	Spare
0 0 0 0 1 1 0 0	Reserved
↓	
0 0 0 1 0 0 1 1	Reserved
0 0 0 1 0 1 0 0	AIOD-Listed DN Set
0 0 0 1 0 1 0 1	Reserved
0 0 0 1 0 1 1 0	Reserved
0 0 0 1 0 1 1 1	Identified Line (Coin or Non-Coin)
0 0 0 1 1 0 0 0	Spare
0 0 0 1 1 0 0 1	Spare
0 0 0 1 1 0 1 0	Spare
0 0 0 1 1 0 1 1	Coin Call
0 0 0 1 1 1 0 0	Spare
0 1 0 0 0 0 1 1	Spare
0 1 0 0 0 1 0 0	Interlata Restricted (Hotel Line)
0 1 0 0 0 1 0 1	Spare
↓	
0 0 0 0 1 1 0 1	Interlata Restricted (Coinless Line, etc)
0 0 0 0 1 1 1 0	Spare
↓	
0 1 0 1 1 1 1 0	Interlata Restricted (Coinless Line, etc)
0 1 0 1 1 1 1 1	Test Call
0 1 1 0 0 0 0 0	Spare
1 1 1 1 1 1 1 1	

Figure 13-17: Originating Station Type Interpretation

TCAP Interpretation Figure 13-18 illustrates a sample History page interpretation of an SS#7 message containing TCAP data. This is using the 800DBAS option as the TCAP Application layer. The area enclosed in the dotted box is described on the following page.

BSN=31	BIB=1	FSN=88	FIB=1
LI=MSU	SIC=SCCP	SSF=9	
DPC			F00000
OPC			F06308
SLS			13
Heading code			09
Internal mnemonic			UDT
Unitdata			
F 05 01 Protocol class			80
Pointers			030B10
V 03 08 Called party address			
		8900FE0840884100	
V 04 05 Calling party address			C3FE0B63F0
V 0F 39 Data			
		E237C7046003D18CE82FE92DCF0100D0	
		028301F224AA0B84090100210A084088	
		410084090200210A1233619114840607	
		0001033700DF450100	

0 E2	55 Query with permission	
1 C7	4 Transaction ID	
value		6003D18C
1 E8	47 Component Sequence	
2 E9	45 Invoke (Last)	
3 CF	1 Component ID	
value		00

3 D0	2 Operation Code (National)	
Family		Provide Instructions
Reply required		Yes
Specifier		Start
3 F2	36 Parameter Set	
4 AA	11 Service Key	
5 84	9 Digits (National)	
Type of digits		Dialed (Called)
Nature of number		Not Applicable
Encoding scheme		BCD
Numbering plan		Telephony
Number of digits		10
Digits		8004881400
4 84	9 Digits (National)	
Type of digits		ANI (Calling)
Nature of number		Not Applicable
Encoding scheme		BCD
Numbering plan		Telephony
Number of digits		10
Digits		2135550778
4 84	6 Digits (National)	
Type of digits		LATA
Nature of number		Not Applicable
Encoding scheme		BCD
Numbering plan		Unknown
Number of digits		3
Digits		730
4 45DF	1 Orig. Station type	
value		00

Message Transfer Part
 Interpretation controlled by F4 key.
 See page 13-10.

User Part
 Interpretation controlled by F5 key.
 See page 13-10.

Data portion of User Part
 corresponds to TCAP interpretation
 which follows.

TCAP
 Interpretation controlled by F6 key.
 See page 13-11.
 The area enclosed in the dotted box
 is described on the following page.

Figure 13-18: TCAP Analysis Interpretation

Figure 13-19 below shows a sample interpretation of a portion of a TCAP History page display. Refer to the previous page for the complete display.

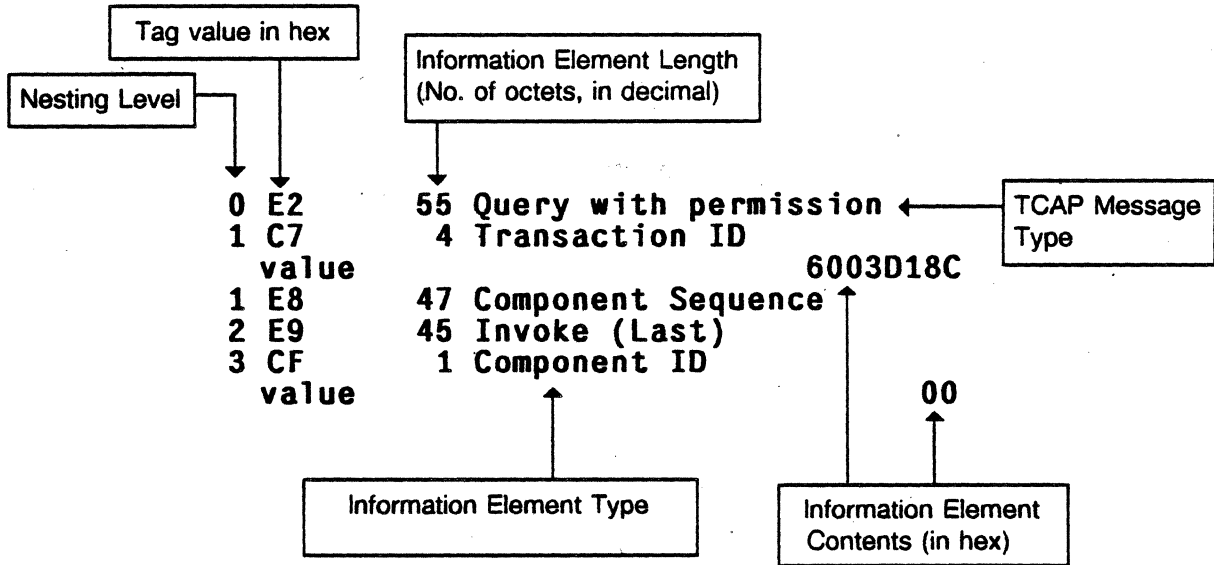


Figure 13-19: Sample TCAP Interpretation

Mnemonic table for ISDN

	0	1	2	3	4	5	6	7	8	9	A	B	C	D	E	F
0																
1	IAM	RLC	FRJ													
2	SAM	RSC	FAD													
3	INR	BLO	FAI													
4	INF	UBL														
5	COT	BLA	CSV													
6	ACM	UBA	CSV													
7		GRS	DRS													
8	FOT	CGB	PAM													
9	ANM	CGU	GRA													
0	UBM	CGBA														
A	REL	CGUA														
B		CMR														
C	PAU	CMC														
D	RES	RCM														
E	RLS	FAR														
F																

Figure 13-9: Mnemonics

ISDN message contents

Message Type 5 Ref: Table 5

- F Backward call indicators
- O Called party address
- O Call reference
- O Connection request
- O User-to user information indicators
- O Redirection indicators
- O End of optional parameters

Message Type 5 Ref: Table 5

- F Backward call indicators
- O Called party address
- O Call reference
- O Connection request
- O User-to user information indicators
- O Redirection indicators
- O End of optional parameters

Message Type 6 Ref: Table 6

- F Backward call indicators
- O Call reference
- O User-to user information indicators
- O End of optional parameters

Message Type 7 Ref: Table 7

- V Called party address
- V Calling party address
- O Index
- O Call reference
- O End of optional parameters

Message Type 8 Ref: Table 8

- F Closed user group check response indicator
- V Called party address
- V Calling party address
- O Closed user group interlock code
- O Index
- O Call reference
- O End of optional parameters

Message Type 9 Ref: Table 9

- F Continuity indicators
- O End of optional parameters

Message Type 10 Ref: Table 10

- F Facility indicator indicator
- F Facility information indicators
- O Called party address
- O Calling party address
- O Call reference
- O End of optional parameters

Message Type 11 Ref: Table 11

- F Facility indicator indicator
- F Cause indicator
- O Called party address
- O Calling party address

- Compatibility information
- Call reference
- End of optional parameters

Message Type 12 Ref: Table 12

- F Information indicators
- Calling party category
- Called party address
- Calling party address
- Charge information
- Call reference
- Connection request
- User-to user information indicators
- Address presentation restriction indicators
- End of optional parameters

Message Type 13 Ref: Table 13

- F Information indicatorsReq
- Call reference
- Connection request
- End of optional parameters

Message Type 14 Ref: Table 14

- F Nature of connection indicators
- F Forward call indicators
- F Calling party category
- F Transmission medium requirements indicators
- V Called party address
- Call reference
- Calling party address
- Optional forward call indicators
- Original address
- Closed user group interlock code
- Connection request
- Compatibility information
- User-to user information indicators
- Address presentation restriction indicators
- User service information indicators
- End of optional parameters

Message Type 15 Ref: Table 15

- V Subsequent address
- User-to user information indicators

- O End of optional parameters

Message Type 16 Ref: Table 16

- F Cause indicator
- O Redirection indicators
- O Redirection address
- O Called party address
- O Call reference
- O Address presentation restriction indicators
- O Signalling point code
- O Closed user group interlock code
- O End of optional parameters

Message Type 17 Ref: Table 17

- O Call reference
- O End of optional parameters

Message Type 18 Ref: Table 18

- O End of optional parameters

Message Type 19 Ref: Table 19

- F Call modification indicators
- O Call reference
- O End of optional parameters

Message Type 20 Ref: Table 20

- F Circuit group supervision message type ind
- V Range and status
- O End of optional parameters

Message Type 21 Ref: Table 21

- V Range and status
- O End of optional parameters

Message Type 22 Ref: Table 22

- F Facility indicator indicator
- O Called party address

- O Calling party address
- O Compatibility information
- O Call reference
- O End of optional parameters

Message Type 23 Ref: Table 23

- O End of optional parameters

Ref	Size	Name
3.2	1	Address presentation restriction indicators
3.3	2	Backward call indicators
3.4	1	Call modification indicators
3.5	V	Call reference
3.6	V	Called party address
3.7	V	Calling party address
3.8	1	Calling party category
3.9	1	Cause indicator
3.10	V	Charge information
3.11	1	Circuit group supervision message type ind
3.12	1	Closed user group check response indicator
3.13	4	Closed user group interlock code
3.14	V	Compatibility information
3.15	7	Connection request
3.16	1	Continuity indicators
3.17	V	End of optional parameters
3.18	1	Facility indicator indicator indicator
3.19	1	Facility indicator indicator information indicators
3.20	2	Forward call indicators
3.21	1	Index
3.22	2	Information indicators
3.23	2	Information request indicators
3.24	2	Nature of connection indicators
3.25	1	Optional forward call indicators
3.26	V	Original address
3.27	V	Range and status and status
3.28	V	Redirection address
3.29	1	Redirection indicators
3.30	2	Signalling point code
3.31	V	Subsequent address
3.32	1	Transmission medium requirements indicators
3.33	1	User service information
3.34	V	User-to user information

Output: Address presentation restriction indicators
Ref: 3.2

:	Address presentation restrict	x(V)
:	Calling party	x(1)
:	Called party	x(1)
:	Original	x(1)
:	Redirection	x(1)

Output: Backward call indicators

Ref: 3.3

:	Backward call indicators	x(V)
:	Charge indicator	x(2)
:	Called line status indicator	x(2)
:	Called line category	x(2)
:	End-to end method indicator	x(2)
:	Interworking indicator	x(1)
:	End-to end info indicator	x(1)
:	ISDN user part indicator	x(1)
:	Reverse holding indicator	x(1)

Output: Call modification indicators

Ref: 3.4

:	Call modification indicators	x(V)
:	Voice/data indicator	x(2)

Output: Call reference

Ref: 3.5

:	Call reference	x(V)
:	Call identity	x(8)
:	Point code	x(15)

Output: Called party address

Ref: 3.6

:	Called party address	x(V)
:	Nature of address	x(7)
:	Address	x(V)

Output: Calling party address

Ref: 3.7

:	Calling party address	x(V)
:	Nature of address	x(7)
:	Address	x(V)

Output: Calling party category
Ref: 3.8

: Calling party category x(n)

Output: Cause indicator
Ref: 3.9

: Cause indicator x(n)

Output: Charge information
Ref: 3.10

: Charge information x(V)

Output: Circuit group supervision message type ind
Ref: 3.11

: Circuit grp supervision type x(V)
: Type indicator x(2)

Output: Closed user group check response indicator
Ref: 3.12

: CUG check response indicator x(V)
: Access indicator x(1)
: Divergence x(1)
: Check successful x(1)
: Normal call x(1)
: CUG call indicator x(2)

Output: Closed user group interlock code
Ref: 3.13

: CUG interlock code x(V)
: Binary code x(16)
: ISDN code x(16)

Output: Compatibility information
Ref: 3.14

: Compatibility information x(V)

Output: Connection request

Ref: 3.15

	:	Connection request	x(V)
	:	Local reference	x(24)
	:	Point code	x(15)
_M(1) ;	:	Protocol class	x(8)
	:	Credit	x(8)

Output: Continuity indicators

Ref: 3.16

:	Continuity indicator	x(1)
---	----------------------	------

Output: End of optional parameters

Ref: 3.17

:	End of optional parameters	x(V)
---	----------------------------	------

Output: Facility indicator

Ref: 3.18

:	Facility indicator	x(1)
---	--------------------	------

Output: Facility information indicators

Ref: 3.19

:	Facility information ind	x(V)
:	Called party free ind	x(1)
:	Called party answer ind	x(1)
:	Facility req enquiry ind	x(1)
:	Facility req active ind	x(1)

Output: Forward call indicators

Ref: 3.20

:	Forward call indicators	x(V)
:	National/international	x(1)
:	End-to-end method	x(2)
:	Interworking	x(1)
:	End-to-end information	x(1)
:	ISDN user part	x(1)

Output: Index

Ref: 3.21

: Index x(V)

Output: Information indicators

Ref: 3.22

: Information indicators x(V)
 : Calling party address resp x(3)
 : Called party address resp x(2)
 : Calling party category resp x(1)
 : Charge information resp x(1)
 : Original address resp x(2)
 : Index response indicator x(1)

Output: Information request indicators

Ref: 3.23

: Information request indicators x(V)
 : Calling party address req x(2)
 : Called party address req x(1)
 : Calling party category req x(1)
 : Charge information req x(1)
 : Original address resp x(1)
 : Index response indicator x(1)
 : Malicious call id req x(1)
 : Reverse holding indicator x(1)

Output: Nature of connection indicators

Ref: 3.24

: Nature of connection x(V)
 : Satellite indicator x(1)
 : Continuity check indicator x(1)
 : Echo suppressor indicator x(1)

Output: Optional forward call indicators

Ref: 3.25

: Optional forward call x(V)
 : CUG call indicator x(2)
 : Call rerouting x(1)
 : Call forwarding x(1)
 : CCBS call indicator x(1)
 : Calling address presentation x(1)
 : Calling address incomplete x(1)
 : Calling address request x(1)

Output: Original address

Ref: 3.26

:	Original address	x(V)
:	Nature of address	x(7)
:	Address	x(V)

Output: Range and status

Ref: 3.27

:	Range and status	x(V)
:	Range	x(8)
:	Status	x(V)

Output: Redirection address

Ref: 3.28

:	Redirection address	x(V)
:	Nature of address	x(7)
:	Address	x(V)

Output: Redirection indicators

Ref: 3.29

:	Redirection indicator	x(V)
---	-----------------------	------

Output: Signalling point code

Ref: 3.30

:	Signalling point code	x(V)
:	Point code	x(15)

Output: Subsequent address

Ref: 3.31

:	Subsequent address	x(V)
:	Nature of address	x(7)
:	Address	x(V)

Output: Transmission medium requirements indicatorsRef: 3.32

: Trans medium requirement x(V)
: Transmission medium x(6)
: In call modification x(2)

Output: User service information
Ref: 3.33

: User service information x(V)
: User class x(4)
: High layer service indicator x(3)

Output: User-to user information
Ref: 3.34

: User-to user information x(V)

User Part DUPC Reference document is X.61

Routing Label for DUPC part has the following structure:

```

14  DPC
14  OPC
12  BIC
8   TSC
    
```

Heading code for DUPC contains 4 bits.

DUPC Message set

Ref	Code	Mnemonic	Full description
3.3.2	0x01	AM	Address
3.3.3	0x04	CAM	Call accepted
3.3.4	0x05	CRM	Call rejected
3.3.5	0x06	CM	Clear
3.3.6	0x07	CSM	Circuit state
3.3.7	0x02	CLI	Calling line ID

Mnemonic table for DUPC

- 1 .
- 2
- 3 ...
- 4
- 5
- 6 .
- 7

DUPC message contents

Output: Address Message (AM)

Ref: 3.3.2

```

:Message indicator                x(4)
:FIOI DCC NICI ARTI
x  x  x  x
    
```

```

FIOI x(1)    First indicator octer indicator
DCC x(1)    DCC/DNIC indicator
NICI x(1)    National/international call indicator
ARTI x(1)    Alternative routing indicator
    
```

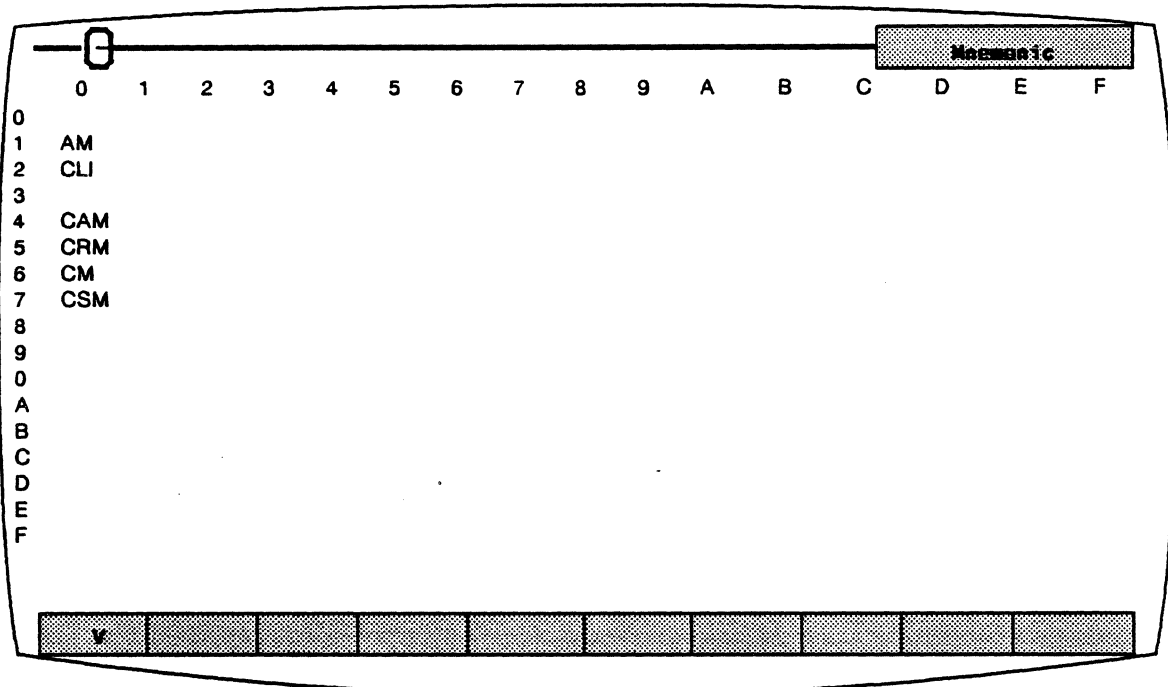



Figure 13-10: Mnemonics

:User class indicator x(6)

: Address x(V)
: Extension x(V)

Destination address

: Address x(V)
: Extension x(V)

: First indicator octet x(8)
: CgLI CUGI BCUG F->H
: x x x x

CgLI	x(2)	Calling line identity indicator
CUGI	x(2)	Closed user group call indicator
BCUG	x(1)	BCUG call indicator
F->H	x(3)	Spare bits F to H

: Second indicator octet x(8)
: RCII RPOA RCRI CLIR E->H
: x x x x x

: CUG interlock code x(6)

Redirection address

: Address x(V)
: Extension x(V)

: Transit network identities x(V)

Output: CRM

Ref: 3.3.4

: Indicators x(4)
: NIOI DTEI
: x x

NIOI x(1) network identity of origin indicator
DTEI x(1) DTE provided information indicator

: Cause x(8)
: Network identity of origin x(16)

Output: Signal (CM)

Ref: 3.3.5

: Signal x(4)

Output: Signal (CSM)

Ref: 3.3.6

: Signal x(4)

Output: Calling line identity (CLI)

Ref: 3.3.7

: Indicators x(4)
: CgLI C->D
: x x

CgLI x(2) calling line identity indicator
C->D x(2) Spare bits C to D

: Calling line identity x(V)
: Extension x(V)

User Part DUPF Reference document is X.61

Routing Label for DUPF part has the following structure:

14 DPC
 14 OPC
 4 (spare)

Heading code for DUPF contains 4 bits.

DUPF Message set

Ref	Code	Mnemonic	Full description
3.4.2	0x01	FQM	Facility request
3.4.3	0x02	FAM	Facility accepted
3.4.4	0x03	FJM	Facility rejected

Mnemonic table for DUPF

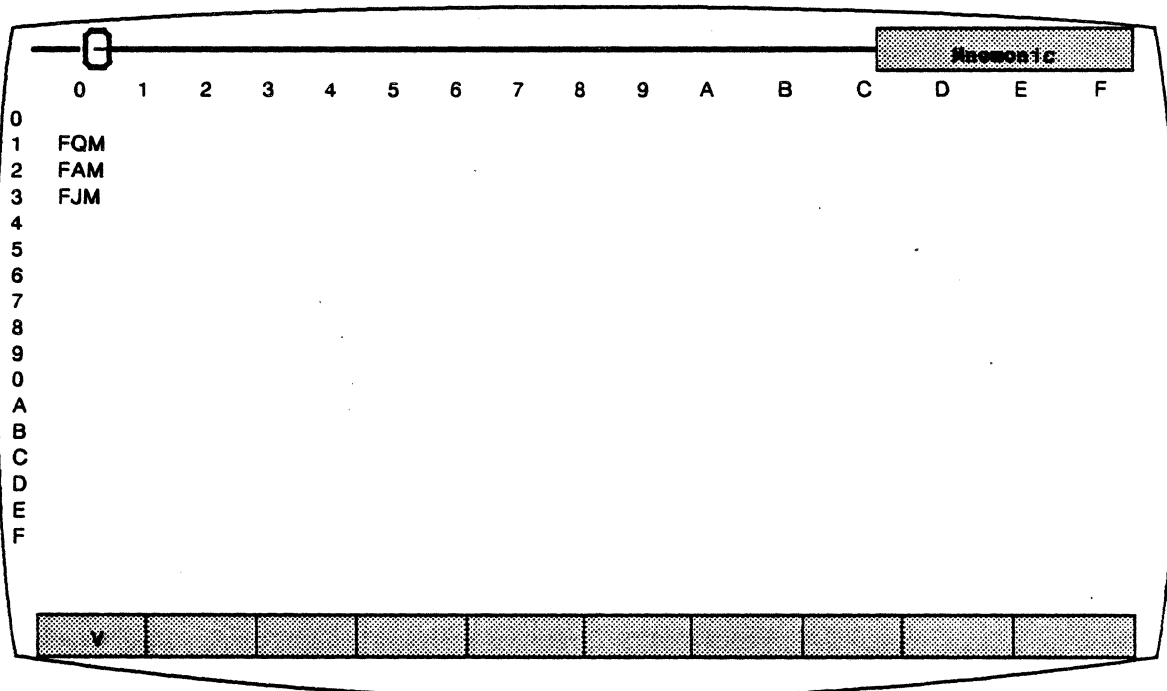


Figure 13-11: Mnemonics

DUPF message contents

Output: FQM
Ref: 3.4.2

```

:
: Signal x(4)
: Address x(V)
: Extension x(V)
:
: First indicator octet x(8)
: CgLI BCUG LIXI E-> H
: x x x x
:
CgLI x(2) calling identity indicator
BCUG x(1) BCUG registration/cancellation indicator
LIXI x(1) Local index indicator
E-> H x(4) Spare bits E to H
:
: Local index x(8)
:
: Calling line identity x(V)
: Extension x(V)

```

Output: FAM /
Ref: 3.4.3

```

:
: Signal x(4)
: Address x(V)
: Extension x(V)
:
: First indicator octet x(8)
: CgLI BCUG LIXI E-> H
: x x x x
:
CgLI x(2) calling identity indicator
BCUG x(1) BCUG registration/cancellation
indicator
LIXI x(1) Local index indicator
E-> H x(4) Spare bits E to H
:
: Local index x(8)

```

Output: FJM
Ref: 3.4.4

```

:
: Cause x(8)
: Address x(V)
: Extension x(V)

```

User Part USRn There are no reference documents for USRn parts.
Routing Label for all USRn parts has a null structure
Heading code for USRn contains 8 bits.
USRn Message set

Ref	Code	Mnemonic	Full description
-----	------	----------	------------------

Message set for all USRn parts are empty.

USRn message contents

NTT User Parts

	0	1	2	3	4	5	6	7	8	9	A	B	C	D	E	F
0	MGT_NTT															
1	TMR_NTT															
2	USR2															
3	USR3															
4	TUP_NTT															
5	IUP_NTT															
6	USR6															
7	USR7															
8	USR8															
9	USR9															
A	USRA															
B	USRB															
C	USRC															
D	USRD															
E	USRE															
F	USRF															

Figure 13-12: Mnemonics

The USRn parts are identical to the USRn parts described in the CCITT User Part USRn section

**User Part
MGT__NTT**

Reference document is unknown

Routing Label for all NTT user parts have the following structure:

16 DPC
16 OPC
4 BIC
12 (spare)

Heading code for MGT__NTT contains 8 bits.

MGT__NTT Message set

Ref	Code	Mnemonic	Full description
	0x11	COO	
	0x21	COA	
	0x51	CBD	
	0x61	CBA	
	0x23	TFC	
	0x14	TFP	
	0x24	TPA	
	0x34	TFR	
	0x54	TFA	
	0x64	TAA	
	0x15	RST	
	0x25	RST	

Mnemonic table for MGT__NTT

	0	1	2	3	4	5	6	7	8	9	A	B	C	D	E	F
0																
1		COO	COA				CBD	CBA								
2																
3			TFC													
4		TFP	TPA	TFR			TFA	TAA								
5		RST	RST													
6																
7																
8																
9																
0																
A																
B																
C																
D																
E																
F																

Figure 13-13: Mnemonics

MGT__NTT message contents

User Part
TMR_NTT

Reference document is unknown

Routing Label has standard NTT structure (see MGT_NTT).

Heading code for TMR_NTT contains 8 bits.

TMR_NTT Message set

Ref	Code	Mnemonic	Full description
	0x13	SRT	
	0x14	USM	
	0x24	USS	
	0x34	USN	
	0x84	SRA	

Mnemonic table for TMR_NTT

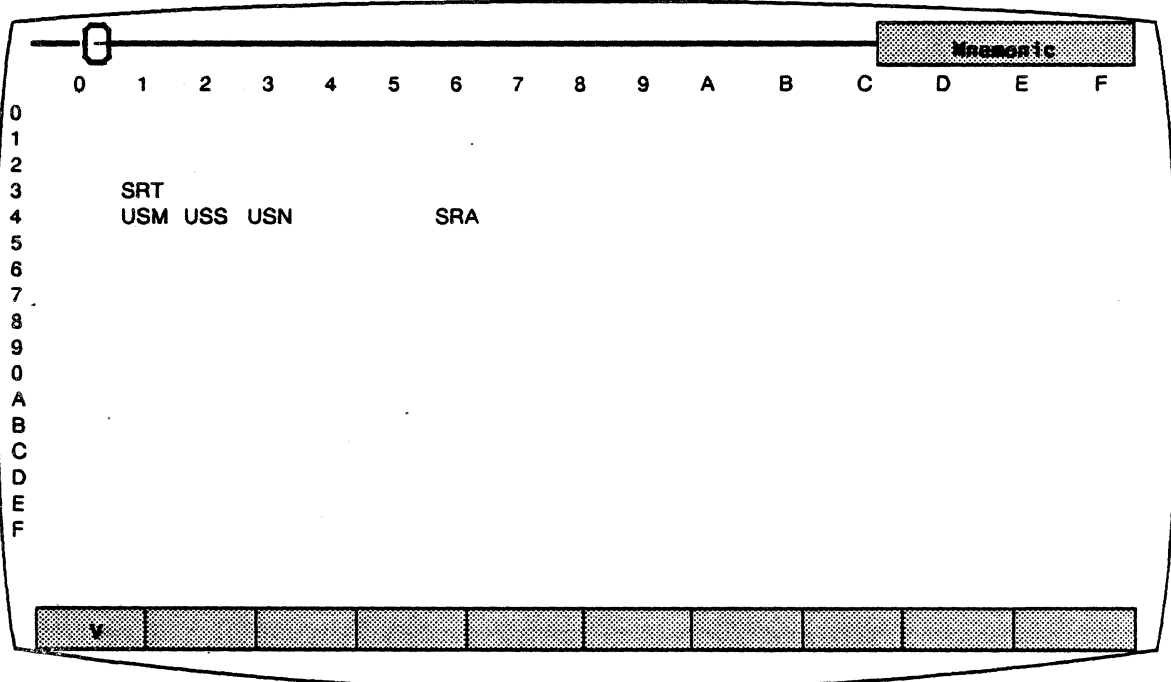


Figure 13-14: Mnemonics

TMR_NTT message contents

Output: TSTPTN

Ref: None

: TSTPTN x(16)

Output: VSP

Ref: None

: VSP x(16)

User Part TUP__NTT

Reference document is unknown

Routing Label has standard NTT structure (see MGT__NTT).

Heading code for TUP__NTT contains 8 bits.

TUP__NTT Message set

Ref	Code	Mnemonic	Full description
	0x11	IAM	
	0x32	COT	
	0x42	COF	
	0x15	SEC	
	0x25	CGC	
	0x16	ANC	
	0x26	ANN	
	0x36	CBK	
	0x46	CLF	
	0x56	RAN	
	0x17	RLG	
	0x27	BLO	
	0x37	BLA	
	0x47	UBL	
	0x57	UBA	
	0x67	COR	
	0x77	COR	
	0x87	TQU	
	0x97	TQO	
	0xA7	TQF	
	0x68	GRS	
	0x78	GRA	

Mnemonic table for TUP__NTT

TUP__NTT message contents

Output: IAM
 Ref: None

: CPC x(6)
 : MI d(12)
 : ADS x(V)

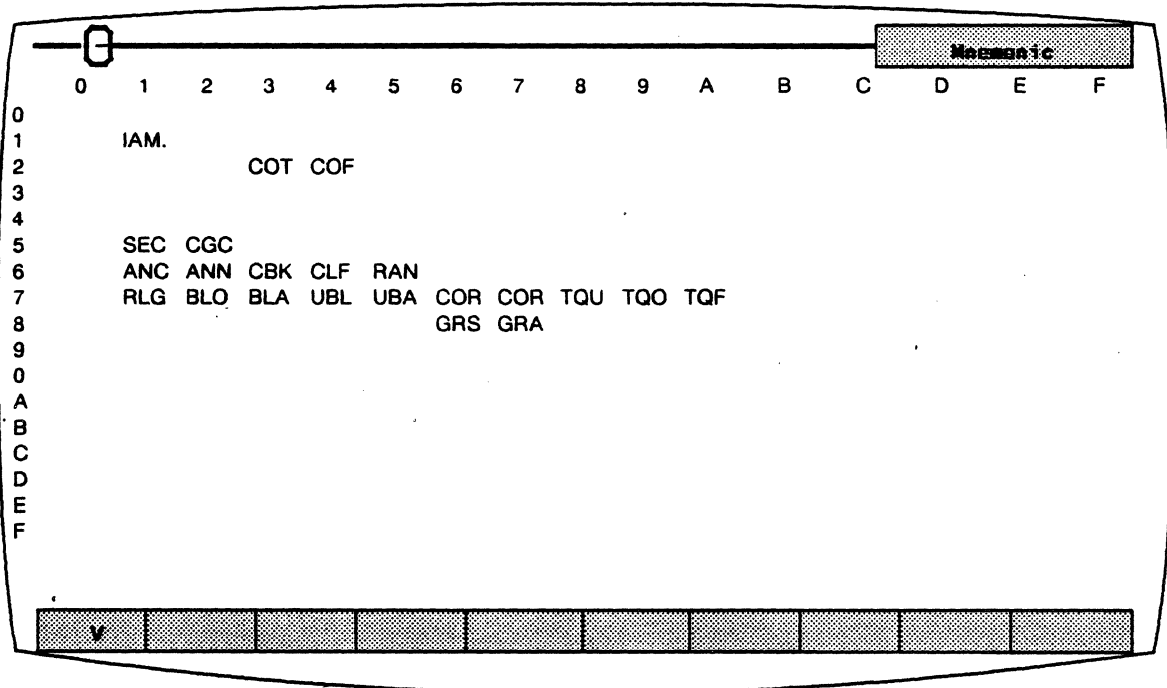


Figure 13-15: Mnemonics

User Part
IUP_NTT

Reference document is unknown

Routing Label has standard NTT structure (see MGT_NTT).

Heading code for IUP_NTT contains 8 bits.

IUP_NTT Message set

Ref	Code	Mnemonic	Full description
	0x14	ACM	
	0x16	ANC	
	0x17	RLG	
	0x26	ANN	
	0x27	BLO	
	0x32	COT	
	0x36	CBK	
	0x37	BLA	
	0x46	CLF	
	0x47	UBL	
	0x56	RAN	
	0x57	UBA	
	0x61	IAA	

0x68	GRS
0x77	RSC
0x78	GRA
0x87	TQU
0xA5	UBM
0xA7	TQF

Mnemonic table for IUP_NTT

	0	1	2	3	4	5	6	7	8	9	A	B	C	D	E	F
0																
1							IAA									
2			COT													
3																
4		ACM														
5												UBM				
6		ANC	ANN	CBK	CLF	RAN										
7		RLG	BLO	BLA	UBL	UBA		RSC	TQU		TQF					
8							GRS	GRA								
9																
A																
B																
C																
D																
E																
F																

Figure 13-16: Mnemonics

IUP_NTT message contents

NCC User Parts

0	MGT NCC
1	TMR NCC
2	USR2
3	USR3
4	USR4
5	IUP NCC
6	USR6
7	USR7
8	USR8
9	USR9
A	USRA
B	USRB
C	USRC
D	USRD
E	USRE
F	USRF

The USRn parts are identical to the USRn parts described in the CCITT User Part USRn section

User Part
MGT__NCC

Reference document is unknown

Routing Label for all NCC user parts have the following structure:

- 16 DPC
- 16 OPC
- 4 BIC
- 12 (spare)

Heading code for MGT__NCC contains 8 bits.

MGT__NCC Message set

Ref	Code	Mnemonic	Full description
	0x11	COO	
	0x21	COA	
	0x51	CBD	
	0x61	CBA	
	0x33	TFR	
	0x14	TFP	
	0x24	TPA	
	0x54	TFA	
	0x64	TAA	
	0x15	RST	
	0x25	RTR	

Mnemonic table for MGT__NCC

MGT__NCC message contents

Output: Various message contents

Ref: None

- : CBDN x(3)
- : CTMGN d(8)
- : DPC x(16)
- : DMCON x(4)

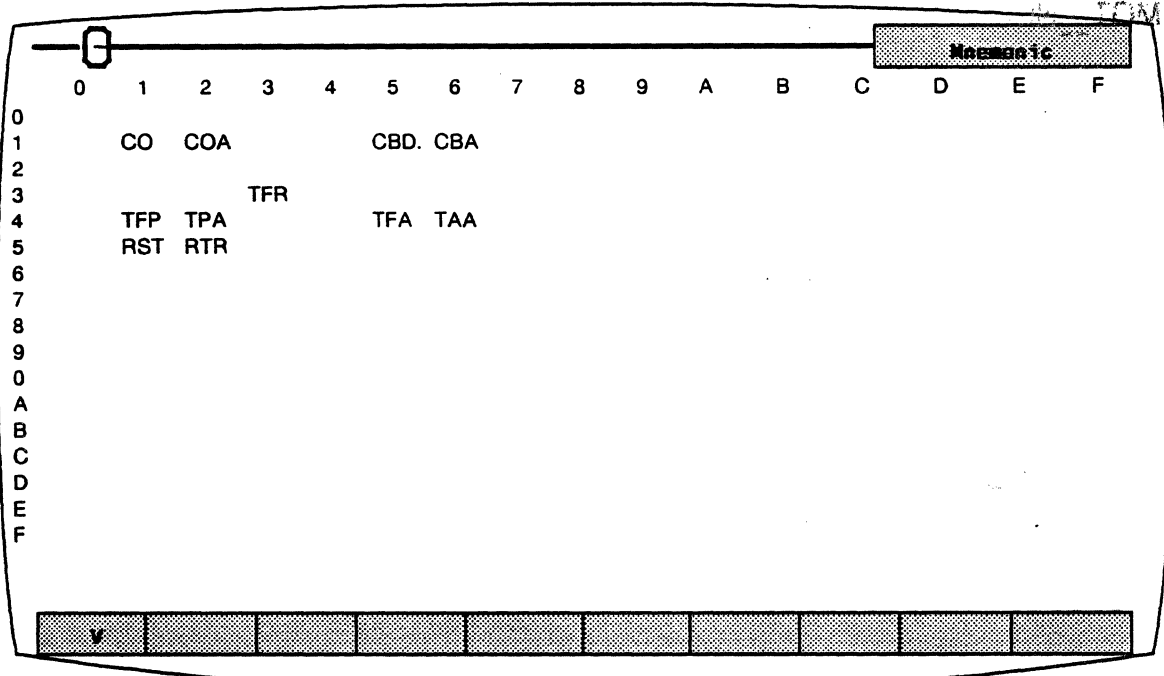


Figure 13-17: Mnemonics

User Part
TMR_NCC

Reference document is unknown

Routing Label has standard NCC structure (see MGT_NCC).

Heading code for TMR_NCC contains 8 bits.

TMR_NCC Message set

Ref	Code	Mnemonic	Full description
	0x13	SRT	
	0x14	USM	
	0x24	USS	
	0x34	USN	
	0x84	SRA	

Mnemonic table for TMR_NCC

TMR_NCC message contents

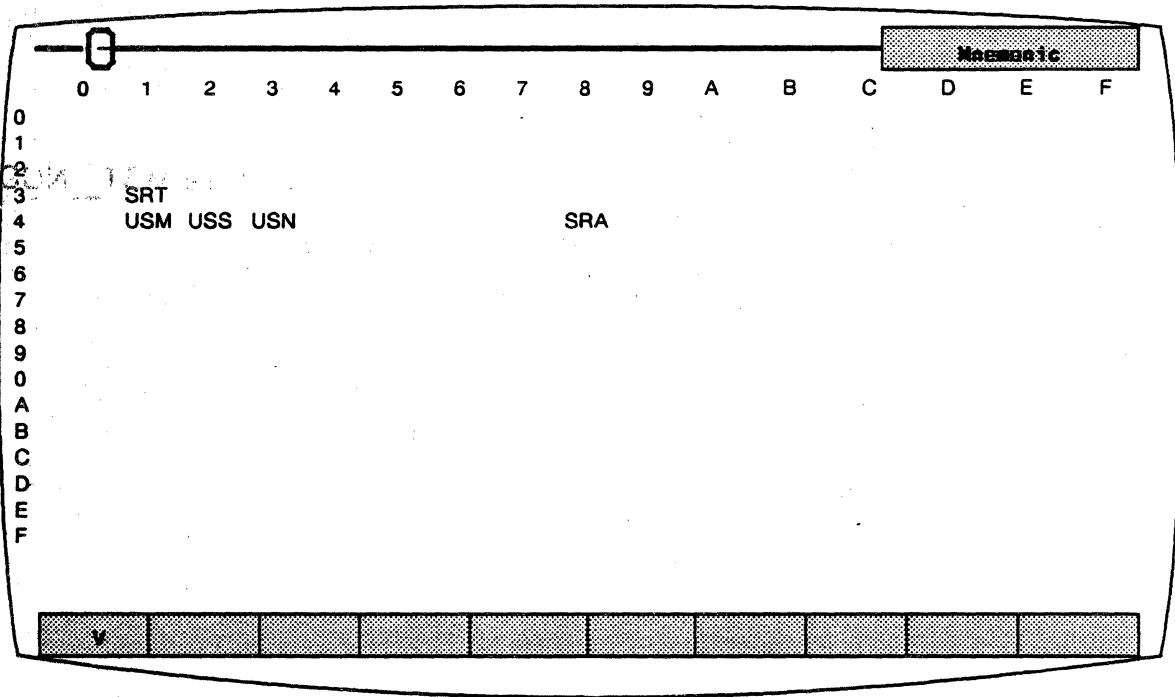


Figure 13-18: Mnemonics

Output: TSTPTN
 Ref: None

: TSTPTN x(16)

Output: VSP
 Ref: None

: VSP x(16)

User Part
IUP_NCC

Reference document is unknown.

Routing Label has standard NCC structure (see MGT_NCC).

Heading code for IUP_NCC contains 8 bits.

IUP_NCC Message set

Ref	Code	Mnemonic	Full description
	0x16	ANC	
	0x17	RLG	
	0x26	ANN	
	0x27	BLO	
	0x32	COT	
	0x36	CBK	
	0x37	BLA	
	0x46	CLF	
	0x47	UBL	
	0x56	RAN	
	0x57	UBA	
	0x61	IAA	
	0x68	GRS	
	0x77	RSC	
	0x78	GRA	
	0x87	TQU	
	0xA5	UBM	
	0xA7	TQF	

Mnemonic table for IUP_NCC

IUP_NCC message contents

	0	1	2	3	4	5	6	7	8	9	A	B	C	D	E	F
0																
1							IAA									
2			COT													
3																
4																
5												UBM				
6		ANC	ANN	CBK	CLF	RAN										
7		RLG	BLO	BLA	UBL	UBA		RSC	TQU		TQF					
8							GRS	GRA								
9																
0																
A																
B																
C																
D																
E																
F																

Figure 13-19: Mnemonics