405GP
PPC405GP Embedded Processor

Preliminary User's Manual

**PPC405GP Embedded Processor
User's Manual**

PowerPC™



***Applied Micro Circuits Corporation
6290 Sequence Dr., San Diego, CA 92121***

Phone: (858) 450-9333 — (800) 755-2622 — Fax: (858) 450-9885

<http://www.amcc.com>

AMCC reserves the right to make changes to its products, its datasheets, or related documentation, without notice and warrants its products solely pursuant to its terms and conditions of sale, only to substantially comply with the latest available datasheet. Please consult AMCC's Term and Conditions of Sale for its warranties and other terms, conditions and limitations. AMCC may discontinue any semiconductor product or service without notice, and advises its customers to obtain the latest version of relevant information to verify, before placing orders, that the information is current. AMCC does not assume any liability arising out of the application or use of any product or circuit described herein, neither does it convey any license under its patent rights nor the rights of others. AMCC reserves the right to ship devices of higher grade in place of those of lower grade.

AMCC SEMICONDUCTOR PRODUCTS ARE NOT DESIGNED, INTENDED, AUTHORIZED, OR WARRANTED TO BE SUITABLE FOR USE IN LIFE-SUPPORT APPLICATIONS, DEVICES OR SYSTEMS OR OTHER CRITICAL APPLICATIONS.

AMCC is a registered Trademark of Applied Micro Circuits Corporation. Copyright © 2006 Applied Micro Circuits Corporation.

Preliminary User's Manual**Contents**

Figures	27
Tables	39
About This Book	45
Part I. Introducing the PPC405GP Embedded Processor	49
Chapter 1. Overview	51
PPC405GP Features	52
Bus and Peripheral Features	52
PowerPC Processor Core Features	53
PowerPC Architecture	54
The PPC405GP as a PowerPC Implementation	55
RISC Processor Core Organization	55
Instruction and Data Cache Controllers	55
Instruction Cache Unit	56
Data Cache Unit	56
Memory Management Unit	56
Timer Facilities	57
Debug	58
Development Tool Support	58
Debug Modes	58
Processor Core Interfaces	58
Processor Local Bus	59
Device Control Register Bus	59
Clock and Power Management	59
JTAG	59
Interrupts	59
On-Chip Memory	59
Processor Core Programming Model	59
Data Types	59
Processor Core Register Set Summary	60
General Purpose Registers	60
Special Purpose Registers	60
Machine State Register	60
Condition Register	60
Device Control Registers	60
Memory-Mapped I/O Registers	61
Addressing Modes	61
Chapter 2. On-Chip Buses	63
Processor Local Bus	63
PLB Features	63
PLB Masters and Slaves	64
PLB Master Assignments	64
PLB Transfer Protocol	65
Overlapped PLB Transfers	66
PLB Arbiter Registers	67
PLB Arbiter Control Register (PLB0_ACR)	67
PLB Error Address Register (PLB0_BEAR)	69
PLB Error Status Register (PLB0_BESR)	69
PLB to OPB Bridge Registers	71
Bridge Error Address Register (POB0_BEAR)	71
Bridge Error Status Registers (POB0_BESR0–POB0_BESR1)	72

On-Chip Peripheral Bus	74
OPB Features	74
OPB Master Assignments	74
OPB Arbiter Registers	75
OPB Arbiter Control Register (OPBA0_CR)	75
OPB Arbiter Priority Register (OPBA0_PR)	76
Part II. The PPC405GP RISC Processor	77
Chapter 3. Programming Model	79
User and Privileged Programming Models	79
Memory Organization and Addressing	79
Physical Address Map	80
Storage Attributes	80
Registers	81
General Purpose Registers (R0-R31)	83
Special Purpose Registers	83
Count Register (CTR)	85
Link Register (LR)	86
Fixed Point Exception Register (XER)	87
Special Purpose Register General (SPRG0–SPRG7)	90
Processor Version Register (PVR)	91
Condition Register (CR)	91
CR Fields after Compare Instructions	93
The CR0 Field	94
The Time Base	95
Machine State Register (MSR)	95
Device Control Registers	96
Directly Accessed DCRs	97
Indirectly Accessed DCRs	99
Memory-Mapped Input/Output Registers	101
Directly Accessed MMIO Registers	101
Indirectly Accessed MMIO Registers	105
Data Types and Alignment	106
Alignment for Storage Reference and Cache Control Instructions	107
Alignment and Endian Operation	107
Summary of Instructions Causing Alignment Exceptions	107
Byte Ordering	108
Structure Mapping Examples	109
Big Endian Mapping	109
Little Endian Mapping	110
Support for Little Endian Byte Ordering	110
Endian (E) Storage Attribute	110
Fetching Instructions from Little Endian Storage Regions	111
Accessing Data in Little Endian Storage Regions	112
PowerPC Byte-Reverse Instructions	113
Instruction Processing	114
Branch Processing	115
Unconditional Branch Target Addressing Options	115
Conditional Branch Target Addressing Options	116
Conditional Branch Condition Register Testing	116
BO Field on Conditional Branches	116
Branch Prediction	117
Speculative Accesses	118
Speculative Accesses in the PPC405GP	119
Prefetch Distance Down an Unresolved Branch Path	119
Prefetch of Branches to the CTR and Branches to the LR	119
Preventing Inappropriate Speculative Accesses	120

Preliminary User's Manual

Fetching Past an Interrupt-Causing or Interrupt-Returning Instruction	120
Fetching Past tw or twi Instructions	121
Fetching Past an Unconditional Branch	121
Suggested Locations of Memory-Mapped Hardware	121
Summary	122
Privileged Mode Operation	122
MSR Bits and Exception Handling	122
Privileged Instructions	123
Privileged SPRs	123
Privileged DCRs	124
Synchronization	124
Context Synchronization	124
Execution Synchronization	126
Storage Synchronization	127
Instruction Set	127
Instructions Specific to the IBM PowerPC Embedded Environment	128
Storage Reference Instructions	129
Arithmetic Instructions	129
Logical Instructions	130
Compare Instructions	130
Branch Instructions	131
CR Logical Instructions	131
Rotate Instructions	131
Shift Instructions	132
Cache Management Instructions	132
Interrupt Control Instructions	132
TLB Management Instructions	133
Processor Management Instructions	133
Extended Mnemonics	133
Chapter 4. Cache Operations	135
ICU Organization	136
ICU Operations	137
Instruction Cachability Control	138
Instruction Cache Synonyms	138
ICU Coherency	139
DCU Organization	139
DCU Operations	140
DCU Write Strategies	140
DCU Load and Store Strategies	141
Data Cachability Control	141
DCU Coherency	142
Cache Instructions	142
ICU Instructions	142
DCU Instructions	143
Cache Control and Debugging Features	144
CCR0 Programming Guidelines	146
ICU Debugging	147
DCU Debugging	148
DCU Performance	149
Pipeline Stalls	149
Cache Operation Priorities	150
Simultaneous Cache Operations	150
Sequential Cache Operations	151
Chapter 5. On-Chip Memory	153
OCM Addressing	154

OCM Programming Guidelines	155
Store Data Bypass Behavior and Memory Coherency	156
Registers	157
OCM Instruction-Side Address Range Compare Register (OCM0_ISARC)	157
OCM Instruction-Side Control Register (OCM0_ISCNTL)	158
OCM Data-Side Address Range Compare Register (OCM0_DSARC)	159
OCM Data-Side Control Register (OCM0_DSCNTL)	159
Chapter 6. Memory Management	161
MMU Overview	161
Address Translation	161
Translation Lookaside Buffer (TLB)	162
Unified TLB	163
TLB Fields	163
Page Identification Fields	163
Translation Field	164
Access Control Fields	165
Storage Attribute Fields	165
Shadow Instruction TLB	166
ITLB Accesses	166
Shadow Data TLB	167
DTLB Accesses	167
Shadow TLB Consistency	167
TLB-Related Interrupts	168
Data Storage Interrupt	169
Instruction Storage Interrupt	170
Data TLB Miss Interrupt	170
Instruction TLB Miss Interrupt	170
TLB Management	170
TLB Search Instructions (tlbsx/tlbsx.)	171
TLB Read/Write Instructions (tlbre/tlbwe)	171
TLB Invalidate Instruction (tlbia)	171
TLB Sync Instruction (tlbsync)	171
Recording Page References and Changes	171
Access Protection	172
Access Protection Mechanisms in the TLB	172
General Access Protection	172
Execute Permissions	173
Write Permissions	173
Zone Protection	173
Access Protection for Cache Control Instructions	175
Access Protection for String Instructions	176
Real-Mode Storage Attribute Control	177
Storage Attribute Control Registers	177
Data Cache Write-through Register (DCWR)	178
Data Cache Cachability Register (DCCR)	178
Instruction Cache Cachability Register (ICCR)	178
Storage Guarded Register (SGR)	178
Storage User-defined 0 Register (SU0R)	179
Storage Little-Endian Register (SLER)	179
Part III. PPC405GP System Operations	181
Chapter 7. Clocking	183
PLL Overview	184
Input Reference Clock (SysClk)	184
External Clock Strapping Setup	185
Sample Clock Ratios	186

Preliminary User's Manual

PCI Clocking	189
PCI Clocks	190
PCI Adapter Applications	191
Serial Port Clocking	192
Clocking Registers	192
PLL Mode Register (CPC0_PLLMR)	192
Chip Control Register 0 (CPC0_CR0)	194
Chip Control Register 1 (CPC0_CR1)	196
Chapter 8. Reset and Initialization	197
Reset Signals	197
Reset Types	197
Core Reset	197
Chip Reset	198
System Reset	198
PCI Power Management Initiated Resets	198
Processor Initiated Resets	198
Processor State After Reset	199
Machine State Register Contents after Reset	199
Contents of Special Purpose Registers after Reset	200
DCR Contents after Reset	201
MMIO Register Contents After Reset	204
PPC405GP Chip Initialization	209
OCM Initialization	209
Initializing Instruction-Side OCM	209
Initializing Data-Side OCM	210
UIC Initialization	210
UART Initialization	210
PPC405GP Initial Processor Sequencing	211
Initialization Requirements	211
Initialization Code Example	212
Chapter 9. Pin Strapping and Sharing	215
Pin Strapping	215
Chip Pin Strapping Register (CPC0_PSR)	215
Pin Sharing	217
Chapter 10. Interrupt Controller Operations	219
UIC Overview	219
UIC Features	219
UIC Interrupt Assignments	220
Interrupt Programmability	221
UIC Registers	221
UIC Status Register (UIC0_SR)	222
UIC Enable Register (UIC0_ER)	224
UIC Critical Register (UIC0_CR)	229
UIC Polarity Register (UIC0_PR)	231
UIC Trigger Register (UIC0_TR)	233
UIC Masked Status Register (UIC0_MSR)	237
UIC Vector Configuration Register (UIC0_VCR)	242
UIC Vector Register (UIC0_VR)	243
Using the Value in UIC0_VR as a Vector Address or Entry Table Lookup	243
Vector Generation Scenarios	244
Interrupt Handling in the Processor Core	245
Architectural Definitions and Behavior	245
Behavior of the PPC405GP Implementation	246
Interrupt Handling Priorities	247
Critical and Noncritical Interrupts	249

General Interrupt Handling Registers	251
Machine State Register (MSR)	251
Save/Restore Registers 0 and 1 (SRR0–SRR1)	252
Save/Restore Registers 2 and 3 (SRR2–SRR3)	253
Exception Vector Prefix Register (EVPR)	254
Exception Syndrome Register (ESR)	255
Data Exception Address Register (DEAR)	257
Critical Input Interrupts	257
Machine Check Interrupts	258
Instruction Machine Check Handling	258
Data Machine Check Handling	259
Data Storage Interrupt	259
Instruction Storage Interrupt	261
External Interrupt	262
External Interrupt Handling	262
Alignment Interrupt	263
Program Interrupt	264
System Call Interrupt	265
Programmable Interval Timer (PIT) Interrupt	265
Fixed Interval Timer (FIT) Interrupt	266
Watchdog Timer Interrupt	266
Data TLB Miss Interrupt	267
Instruction TLB Miss Interrupt	268
Debug Interrupt	268
Chapter 11. Timer Facilities	271
Time Base	272
Reading the Time Base	273
Writing the Time Base	273
Programmable Interval Timer (PIT)	274
Fixed Interval Timer (FIT)	275
Watchdog Timer	276
Timer Status Register (TSR)	278
Timer Control Register (TCR)	279
Chapter 12. Debugging	281
Development Tool Support	281
Debug Interfaces	281
IEEE 1149.1 Test Access Port (JTAG Debug Port)	281
JTAG Connector	282
JTAG Instructions	282
JTAG Boundary Scan	282
JTAG Implementation	283
JTAG ID Register (CPC0_JTAGID)	283
Trace Port	284
Debug Modes	284
Internal Debug Mode	284
External Debug Mode	285
Debug Wait Mode	285
Real-time Trace Debug Mode	286
Processor Control	286
Processor Status	287
Debug Registers	287
Debug Control Registers	287
Debug Control Register 0 (DBCR0)	287
Debug Control Register1 (DBCR1)	289
Debug Status Register (DBSR)	291

Preliminary User's Manual

Instruction Address Compare Registers (IAC1–IAC4)	292
Data Address Compare Registers (DAC1–DAC2)	293
Data Value Compare Registers (DVC1–DVC2)	293
Debug Events	294
Instruction Complete Debug Event	295
Branch Taken Debug Event	295
Exception Taken Debug Event	295
Trap Taken Debug Event	295
Unconditional Debug Event	295
IAC Debug Event	295
IAC Exact Address Compare	295
IAC Range Address Compare	295
DAC Debug Event	297
DAC Exact Address Compare	297
DAC Range Address Compare	298
DAC Applied to Cache Instructions	299
DAC Applied to String Instructions	300
Data Value Compare Debug Event	300
Imprecise Debug Event	302
Chapter 13. Clock and Power Management	303
CPM Registers	303
CPM Enable Register (CPC0_ER)	305
CPM Force Register (CPC0_FR)	305
CPM Status Register (CPC0_SR)	305
Chapter 14. Decompression Controller Operation	307
Code Compression and Decompression	307
Code Compression	307
Code Decompression	308
Instruction Fetches to Compressed Pages	308
Instruction Fetches to Uncompressed Pages	309
Performance	309
Decompression Controller Registers	309
Index Table Origin Registers (DCP0_ITOR0–DCP0_ITOR3)	310
Decompression Address Decode Definition Registers (DCP0_ADDR0–DCP0_ADDR1)	311
Decompression Configuration Register (DCP0_CFG)	311
Decompression Controller ID Register (DCP0_ID)	312
Decompression Controller Version Register (DCP0_VER)	312
Decompression Controller PLB Error Address Register (DCP0_PLBBEAR)	313
Decompression Controller Bus Error Address Register (DCP0_MEMBEAR)	313
Decompression Controller Error Status Register 0 (DCP0_ESR)	314
Decompression Decode Table Entries	316
Decompression Controller Initialization	316
Decompression Operations	317
Indexed Addressing	317
Index Table Format	318
Decoding Compressed Instructions	319
Instruction Decode	320
Compressed Instruction Format	321
Decompressed Buffer Access	321
Transparent Access to Uncompressed Memory	322
Error Handling	322
Returning Error Information	323

Part IV. PPC405GP External Interfaces	325
Chapter 15. SDRAM Controller	327
Interface Signals	327
Accessing SDRAM Registers	328
SDRAM Controller Configuration and Status	330
Memory Controller Configuration Register (SDRAM0_CFG)	330
Memory Controller Status (SDRAM0_STATUS)	332
Memory Bank 0–3 Configuration (SDRAM0_B0CR–SDRAM0_B3CR)	332
Page Management	334
Logical Address to Memory Address Mapping	334
SDRAM Timing Register (SDRAM0_TR)	335
Selected Timing Diagrams	337
Auto (CAS Before RAS) Refresh	340
Refresh Timer Register (SDRAM0_RTR)	341
Error Checking and Correction (ECC)	341
ECC Configuration Register (SDRAM0_ECCCFG)	342
Correctable ECC Errors	342
Uncorrectable ECC Errors	344
Error Locking	344
ECC Error Status Register (SDRAM0_ECCEsr)	344
Bus Error Address Register (SDRAM0_BEAR)	345
Bus Error Syndrome Register 0 (SDRAM0_BESR0)	345
Bus Error Syndrome Register 1 (SDRAM0_BESR1)	347
Self-Refresh	348
Power Management	348
Sleep Mode Entry	348
Power Management Idle Timer (SDRAM0_PMIT)	349
Sleep Mode Exit	349
Chapter 16. External Bus Controller	351
Interface Signals	352
Interfacing to Byte, Halfword and Word Devices	353
Multiplexed I/Os	354
Driver Enables	354
Non-Burst Peripheral Bus Transactions	355
Single Read Transfer	356
Single Write Transfer	358
Burst Transactions	359
Burst Read Transfer	360
Burst Write Transfer	361
Device-Paced Transfers	362
Device-Paced Single Read Transfer	363
Device-Paced Single Write Transfer	364
Device-Paced Burst Read Transfer	365
Device-Paced Burst Write Transfer	366
External Bus Master Interface	368
Arbitration	369
Transaction Overview	370
Single Read and Single Write Transfers	370
Burst Read Transfer	372
Burst Write Transfer	373
External Master Error Interrupts	373
EBC Registers	374
EBC Configuration Register (EBC0_CFG)	375
Peripheral Bank Configuration Registers (EBC0_BnCR)	376
Peripheral Bank Access Parameters (EBC0_BnAP)	377

Preliminary User's Manual

Error Reporting	379
Error Locking	380
Peripheral Bus Error Address Register (EBC0_BEAR)	380
Peripheral Bus Error Status Register 0 (EBC0_BESR0)	381
Peripheral Bus Error Status Register 1 (EBC0_BESR1)	383
Chapter 17. PCI Interface	385
PCI Overview	385
PCI Bridge Features	385
PCI Bridge Block Diagram	386
Byte Ordering	386
Reference Information	387
PCI Bridge Functional Blocks	388
PLB-to-PCI Half-Bridge	388
PCI-to-PLB Half-Bridge	389
PCI Arbiter	389
PCI Bridge Address Mapping	390
PLB-to-PCI Address Mapping	390
PCI-to-PLB Address Mapping	392
PCI Target Map Configuration	393
PCI Bridge Transaction Handling	394
PLB-to-PCI Transaction Handling	394
PCI Master Commands	395
PLB Slave Read Handling	396
Prefetching	396
PLB Slave Write Handling	396
Aborted PLB Requests	397
Retried PCI Reads	397
PCI-to-PLB Transaction Handling	398
PLB Master Commands	399
Handling of Reads from PCI Masters	400
Handling Writes from PCI Masters	401
Miscellaneous	402
Completion Ordering	402
PCI Producer-Consumer Model	402
Collision Resolution	403
PCI Bridge Configuration Registers	403
PCI Bridge Register Summary	403
PCI Bridge Local Configuration Registers	405
PMM 0 Local Address Register (PCIL0_PMM0LA)	406
PMM 0 Mask/Attribute Register (PCIL0_PMM0MA)	406
PMM 0 PCI Low Address Register (PCIL0_PMM0PCILA)	407
PMM 0 PCI High Address Register (PCIL0_PMM0PCIHA)	407
PMM 1 Local Address Register (PCIL0_PMM1LA)	408
PMM 1 Mask/Attribute Register (PCIL0_PMM1MA)	408
PMM 1 PCI Low Address Register (PCIL0_PMM1PCILA)	409
PMM 1 PCI High Address Register (PCIL0_PMM1PCIHA)	409
PMM 2 Local Address Register (PCIL0_PMM2LA)	409
PMM 2 Mask/Attribute Register (PCIL0_PMM2MA)	410
PMM 2 PCI Low Address Register (PCIL0_PMM2PCILA)	410
PMM 2 PCI High Address Register (PCIL0_PMM2PCIHA)	411
PTM 1 Memory Size/Attribute Register (PCIL0_PTM1MS)	411
PTM 1 Local Address Register (PCIL0_PTM1LA)	412
PTM 2 Memory Size/Attribute Register (PCIL0_PTM2MS)	412
PTM 2 Local Address Register (PCIL0_PTM2LA)	413
PCI Configuration Registers	413
PCI Configuration Address Register (PCIC0_CFGADDR)	414

PCI Configuration Data Register (PCIC0_CFGDATA)	414
PCI Vendor ID Register (PCIC0_VENDID)	415
PCI Device ID Register (PCIC0_DEVID)	415
PCI Command Register (PCIC0_CMD)	416
PCI Status Register (PCIC0_STATUS)	417
PCI Revision ID Register (PCIC0_REVID)	419
PCI Class Register (PCIC0_CLS)	419
PCI Cache Line Size Register (PCIC0_CACHELS)	420
PCI Latency Timer Register (PCIC0_LATTIM)	420
PCI Header Type Register (PCIC0_HDTYPE)	421
PCI Built-In Self Test (BIST) Control Register (PCIC0_BIST)	421
Unused PCI Base Address Register Space	422
PCI PTM 1 BAR (PCIC0_PTM1BAR)	422
PCI PTM 2 BAR (PCIC0_PTM2BAR)	423
PCI Subsystem Vendor ID Register (PCIC0_SBSYSVID)	423
PCI Subsystem ID Register (PCIC0_SBSYSID)	424
PCI Capabilities Pointer (PCIC0_CAP)	424
PCI Interrupt Line Register (PCIC0_INTLN)	424
PCI Interrupt Pin Register (PCIC0_INTPN)	425
PCI Minimum Grant Register (PCIC0_MINGNT)	425
PCI Maximum Latency Register (PCIC0_MAXLTNCY)	425
PCI Interrupt Control/Status Register (PCIC0_ICS)	426
Error Enable Register (PCIC0_ERREN)	426
Error Status Register (PCIC0_ERRSTS)	427
Bridge Options 1 Register (PCIC0_BRDGOPT1)	428
PLB Slave Error Syndrome Register 0 (PCIC0_PLBBESR0)	429
PLB Slave Error Syndrome Register 1 (PCIC0_PLBBESR1)	431
PLB Slave Error Address Register (PCIC0_PLBBEAR)	432
Capability Identifier (PCIC0_CAPID)	433
Next Item Pointer (PCIC0_NEXTIPTR)	433
Power Management Capabilities (PCIC0_PMC)	434
Power Management Control/Status Register (PCIC0_PMCSR)	435
PMCSR PCI-to-PCI Bridge Support Extensions (PCIC0_PMCSRSE)	436
PCI Data Register (PCIC0_DATA)	436
Bridge Options 2 Register (PCIC0_BRDGOPT2)	437
Power Management State Change Request Register (PCIC0_PMSCRR)	438
Error Handling	439
PLB Unsupported Transfer Type	439
PCI Master Abort	440
Bridge PCI Master Receives Target Abort While PCI Bus Master	440
PCI Target Data Bus Parity Error Detection	441
PCI Master Data Bus Parity Error Detection	441
PCI Address Bus Parity Error While PCI Target	442
PLB Master Bus Error Detection	442
PCI Bridge Clocking Configuration	443
PCI Power Management Interface	443
Capabilities and Power Management Status and Control Registers	443
Power State Control	443
Changing Power States	443
PCI Bridge Reset and Initialization	444
Address Map Initialization	444
Other Configuration Register Initialization	446
Target Bridge Initialization	447
Local Processor Boot from PCI Memory	447
Type 0 Configuration Cycles for Other Devices	447
Timing Diagrams	448
PCI Timing Diagram Descriptions	448

Preliminary User's Manual

PCI Master Burst Read From SDRAM	448
PCI Master Burst Write To SDRAM	448
CPU Read From PCI Memory Slave, Nonprefetching	448
CPU Read From PCI Memory Slave, Prefetching	448
CPU Write To PCI Memory Slave	449
PCI Memory To SDRAM DMA Transfer	449
SDRAM To PCI Memory DMA Transfer	449
Asynchronous	450
Synchronous	472
Chapter 18. Direct Memory Access Controller	501
External Interface Signals	501
Functional Overview	502
Peripheral Mode Transfers	503
Memory-to-Memory Transfers	503
Scatter/Gather Transfers	504
Configuration and Status Registers	504
DMA Polarity Configuration Register (DMA0_POL)	505
DMA Sleep Mode Register (DMA0_SLP)	506
DMA Status Register (DMA0_SR)	507
DMA Channel Control Registers (DMA0_CR0–DMA0_CR3)	508
DMA Source Address Registers (DMA0_SA0–DMA0_SA3)	510
DMA Destination Address Registers (DMA0_DA0–DMA0_DA3)	511
DMA Count Registers (DMA0_CT0–DMA0_CT3)	511
DMA Scatter/Gather Descriptor Address Registers (DMA0_SG0–DMA0_SG3)	512
DMA Scatter/Gather Command Register (DMA0_SGC)	512
Channel Priorities	513
Data Parity During DMA Peripheral Transfers	513
Errors	513
Address Alignment Error	514
PLB Timeout	514
Slave Errors	514
DMA Interrupts	514
Scatter/Gather Transfers	515
Programming the DMA Controller	516
Peripheral Mode Transfers	517
Memory-to-Memory Transfers	520
Software-Initiated Memory-to-Memory Transfers (Non-Deviced Paced)	521
Chapter 19. Ethernet Media Access Controller	523
EMAC Features	525
EMAC Operation	526
MAL Slave Logic	526
OPB Slave Logic	526
Ethernet Address Match Logic	527
Configuration and Status Registers	527
Wake On LAN Logic	527
Ethernet MAC	527
EMAC Loopback Modes	527
EMAC Transmit Operation	529
Arbitration Between TX Channels	529
Independent Mode	529
Dependent Mode	529
MAL TX Descriptor Control/Status Field	530
Early Packet Termination during Transmit	532
Empty Packets	532
Automatic Retransmission of Colliding Packets	532

Inter-Packet Gap (IPG) Tuning	533
Full-Duplex Operation	533
Packet Content Configuration Options	533
EMAC Receive Operation	535
EMAC – MAL RX Packet Transfer Flow	535
MAL RX Descriptor Status	535
Early Packet Termination during Receive	537
Discarding Packets During Receive	537
WOL Support	537
EMAC WOL Support	538
Flow Control	539
MAC Control Packet	539
Control Packet Transmission	539
Integrated Flow Control	540
Control Packet Reception	540
VLAN Support	542
VLAN Tagged Packet Transmission	543
VLAN Tagged Packet Reception	543
Address Match Mechanism	543
Non-WOL Mode	544
WOL Mode	545
EMAC Registers	546
Mode Register 0 (EMAC0_MR0)	547
Mode Register 1 (EMAC0_MR1)	548
Transmit Mode Register 0 (EMAC0_TMR0)	550
Transmit Mode Register 1 (EMAC0_TMR1)	551
Low-Priority Requests	551
Urgent-Priority Requests	551
Receive Mode Register (EMAC0_RMR)	552
Interrupt Status Register (EMAC0_ISR)	553
Interrupt Status Enable Register (EMAC0_ISER)	556
Individual Address High (EMAC0_IAHR)	558
Individual Address Low (EMAC0_IALR)	559
VLAN TPID Register (EMAC0_VTPID)	559
VLAN TCI Register (EMAC0_VTCI)	560
Pause Timer Register (EMAC0_PTR)	560
Individual Address Hash Tables 1–4 (EMAC0_IAHT1–EMAC0_IAHT4)	561
Group Address Hash Tables 1–4 (EMAC0_GAHT1–EMAC0_GAHT4)	561
Last Source Address High (EMAC0_LSAH)	562
Last Source Address Low (EMAC0_LSAH)	562
Inter-Packet Gap Value Register (EMAC0_IPGVR)	563
STA Control Register (EMAC0_STACR)	563
Transmit Request Threshold Register (EMAC0_TRTR)	564
Receive Low/High Water Mark Register (EMAC0_RWMR)	565
Number of Octets Transmitted (EMAC0_OCTX)	566
Number of Octets Received (EMAC0_OCRX)	567
MII	567
MII Station Management Interface	567
EMAC – MII	568
MAL – EMAC Packet Transfer Flow	568
Programming Notes	569
Reset and Initialization	569
Scenario 1	570
Scenario 2	570
Scenario 3	571

Preliminary User's Manual

Chapter 20. Memory Access Layer	573
MAL Features	573
MAL Internal Structure	575
PLB Master	575
OPB Master	575
Transmit Channel Handler	575
Receive Channel Handler	575
Transmit Channel Arbiter	575
Receive Channel Arbiter	576
Transmit Common Channel Logic	576
Receive Common Channel Logic	576
Register Map File	576
Transmit and Receive Operations	576
Buffer Descriptor Overview	579
Transmit Software Interface	581
Wrapping the BD Table for Transmit	582
Continuous Mode for Transmit	582
Back Up a Packet for Transmit	582
Descriptor Not Valid for Transmit	583
Scroll Descriptors for Transmit	583
Receive Software Interface	584
Wrapping the BD Table for Receive	584
Continuous Mode for Receive	585
Descriptor Not Valid for Receive	585
Buffer Length for Receive	585
Descriptor Buffer Status/Control Fields	585
Information from a Software Device Driver Directed To MAL and COMMAC	586
Information from MAL and COMMAC Directed to Software	586
Status/Control Field Handling	586
Status/Control Field Format	586
Transmit Status/Control Field Format	587
Bit 0 – R – Ready	587
Bit 1 – W – Wrap	587
Bit 2 – CM – Continuous Mode	587
Bit 3 – L – Last	587
Bit 4 – Reserved	587
Bit 5 – I – Interrupt	588
Bits 6 to 15	588
Receive Status/Control Field Format	588
Bit 0 – E – Empty	588
Bit 1 – W – Wrap	588
Bit 2 – CM – Continuous Mode	589
Bit 3 – L – Last	589
Bit 4 – F – First	589
Bit 5 – I – Interrupt	589
Bits 6 to 15	589
MAL Programming Notes	589
MAL Initialization	590
Interrupts	590
Error Handling	591
Error Detection	591
Indicated Errors	591
Error Handling Registers	592
Operational Error Modes	593
Resolution of an Error Situation	593
Interrupts To Software	595

MAL Registers	596
MAL Configuration Register (MAL0_CFG)	597
Channel Active Set and Reset Registers	598
End of Buffer Interrupt Status Registers	600
MAL Error Status Register (MAL0_ESR)	601
MAL Interrupt Enable Register (MAL0_IER)	603
Descriptor Error Interrupt Registers (MAL0_TXDEIR, MAL0_RXDEIR)	604
Channel Table Pointer Registers (MAL0_TXCTPxR, MAL0_RXCTPxR)	605
Receive Channel Buffer Size Register (MAL0_RCBS0)	606
Chapter 21. Serial Port Operations	607
Functional Description	607
Serial Input Clocking	608
UART Registers	611
Receiver Buffer Registers (UARTx_RBR)	612
Transmitter Holding Registers (UARTx_THR)	612
Interrupt Enable Registers (UARTx_IER)	613
Interrupt Identification Registers (UARTx_IIR)	614
FIFO Control Registers (UARTx_FCR)	615
Line Control Registers (UARTx_LCR)	617
Modem Control Registers (UARTx_MCR)	618
Line Status Registers (UARTx_LSR)	619
Modem Status Registers (UARTx_MSR)	621
Scratchpad Registers (UARTx_SCR)	622
Divisor Latch LSB and MSB Registers (UARTx_DLL, UARTx_DLM)	622
FIFO Operation	623
Interrupt Mode	623
Receiver Interrupts	623
Transmitter Interrupts	624
Polled Mode	624
UART and Sleep Mode	625
DMA Operation	625
Chip Control Register 0 (CPC0_CR0)	625
Transmitter DMA Mode	628
Receiver DMA Mode	629
Chapter 22. IIC Bus Interface	631
Addressing	631
Addressing Modes	631
Seven-Bit Addresses	632
Ten-Bit Addresses	632
IIC Registers	633
IIC Register Descriptions	634
IIC0 Master Data Buffer (IIC0_MDBUF)	634
IIC0 Slave Data Buffer (IIC0_SDBUF)	635
IIC0 Low Master Address Register (IIC0_LMADR)	636
IIC0 High Master Address Register (IIC0_HMADR)	637
IIC0 Control Register (IIC0_CNTL)	638
IIC0 Mode Control Register (IIC0_MDCNTL)	639
IIC0 Status Register (IIC0_STS)	641
IIC0 Extended Status Register (IIC0_EXTSTS)	643
IIC0 Low Slave Address Register (IIC0_LSADR)	645
IIC0 High Slave Address Register (IIC0_HSADR)	646
IIC0 Clock Divide Register (IIC0_CLKDIV)	647
IIC0 Interrupt Mask Register (IIC0_INTRMSK)	648
IIC0 Transfer Count Register (IIC0_XFRCNT)	649
IIC0 Extended Control and Slave Status Register (IIC0_XTCNTLSS)	650

Preliminary User's Manual

IIC0 Direct Control Register (IIC0_DIRECTCNTL)	652
Interrupt Handling	653
General Considerations	654
Chapter 23. GPIO Operations	655
GPIO Controller Overview	655
Features	655
GPIO Interface Signals	656
External Macro Signals	657
External Module Signals	657
Clock and Power Management	659
GPIO Register Overview	659
GPIO Register Reset Values	659
Detailed Register Description	659
GPIO Output Register (GPIO0_OR)	660
GPIO Three-State Control Register (GPIO0_TCR)	660
GPIO Open Drain Register (GPIO0_ODR)	660
GPIO Input Register (GPIO0_IR)	660
Part V. Reference	661
Chapter 24. Instruction Set	663
Instruction Set Portability	663
Instruction Formats	664
Pseudocode	664
Operator Precedence	666
Register Usage	667
Alphabetical Instruction Listing	667
add	668
addc	669
adde	670
addi	671
addic	672
addic.	673
addis	674
addme	675
addze	676
and	677
andc	678
andi.	679
andis.	680
b	681
bc	682
bcctr	688
bclr	692
cmp	696
cmpi	697
cmpl	698
cmpli	699
cntlzw	700
crand	701
crandc	702
creqv	703
crnand	704
crnor	705
cror	706
croc	707

crxor	708
dcba	709
dcbf	711
dcbi	712
dcbst	713
dcbt	714
dcbtst	715
dcbz	716
dccci	718
dcread	719
divw	721
divwu	722
eieio	723
eqv	724
extsb	725
extsh	726
icbi	727
icbt	728
iccci	729
icread	730
isync	732
lbz	733
lbzu	734
lbzux	735
lbzx	736
lha	737
lhau	738
lhaux	739
lhax	740
lhbrx	741
lhz	742
lhzu	743
lhzux	744
lhzx	745
lmw	746
lswi	747
lswx	749
lwarx	751
lwbrx	752
lwz	753
lwzu	754
lwzux	755
lwzx	756
macchw	757
macchws	758
macchwsu	759
macchwu	760
machhw	761
machhws	762
machhwsu	763
machhwu	764
maclhw	765
maclhws	766
maclhwsu	767

Preliminary User's Manual

machwu	768
mcrf	769
mcrxr	770
mfcrr	771
mfocr	772
mfmsr	773
mfmspr	774
mftb	776
mtcrf	778
mtocr	779
mtmsr	780
mtmspr	781
mulchw	783
mulchwu	784
mulhww	785
mulhwwu	786
mulhw	787
mulhwu	788
mullhw	789
mullhwu	790
mulli	791
mullw	792
nand	793
neg	794
nmacchw	795
nmacchws	796
nmachhw	797
nmachhws	798
nmaclhw	799
nmaclhws	800
nor	801
or	802
orc	803
ori	804
oris	805
rfci	806
rfi	807
rlwimi	808
rlwinm	809
rlwnm	812
sc	813
slw	814
sraw	815
srawi	816
srw	817
stb	818
stbu	819
stbux	820
stbx	821
sth	822
sthbrx	823
sthu	824
sthux	825
sthx	826

stmw	827
stswi	828
stswx	829
stw	831
stwbrx	832
stwcx.	833
stwu	835
stwux	836
stwx	837
subf	838
subfc	839
subfe	840
subfic	841
subfme	842
subfze	843
sync	844
tlbia	845
tlbre	846
tlbsx	848
tlbsync	849
tlbwe	850
tw	852
twi	855
wrtee	858
wrteei	859
xor	860
xori	861
xoris	862
Chapter 25. Register Summary	863
Reserved Registers	863
Reserved Fields	863
General Purpose Registers	863
Machine State Register and Condition Register	863
Special Purpose Registers	863
Time Base Registers	865
Device Control Registers	866
Directly Addressed DCRs	866
Indirectly Accessed DCRs	868
Indirect Access of SDRAM Controller DCRs	869
Indirect Access of EBC DCRs	870
Indirect Access of Decompression Controller DCRs	871
Memory-Mapped Input/Output Registers	872
Directly Accessed MMIO Registers	872
Indirectly Accessed MMIO Registers	875
Alphabetical Listing of Processor Core Registers	877
CCR0	878
CR	880
CTR	881
DAC1–DAC2	882
DBCRO	883
DBCR1	885
DBSR	887
DCCR	889
DCWR	891

Preliminary User's Manual

DEAR	893
DVCR1–DVCR2	894
ESR	895
EVPR	896
GPR0–GPR31	897
IAC1–IAC4	898
ICCR	899
ICDBDR	901
LR	902
MSR	903
PID	904
PIT	905
PVR	906
SGR	907
SLER	909
SPRG0–SPRG7	911
SRR0	912
SRR1	913
SRR2	914
SRR3	915
SU0R	916
TBL	918
TBU	919
TCR	920
TSR	921
USPRG0	922
XER	923
ZPR	924
Alphabetical Listing of Chip Control and Peripheral Registers	925
Chip Control Registers	925
CPC0_CR0	925
CPC0_CR1	928
CPC0_ER	929
CPC0_FR	930
CPC0_JTAGID	931
CPC0_PLLMR	932
CPC0_PSR	934
CPC0_SR	936
Decompression Controller Registers.....	937
DCP0_ADDR0–DCP0_ADDR1	937
DCP0_CFG	938
DCP0_CFGADDR	939
DCP0_CFGDATA	940
DCP0_ESR	941
DCP0_ID	943
DCP0_ITOR0–DCP0_ITOR3	944
DCP0_MEMBEAR	945
DCP0_PLBBEAR	946
DCP0_RAM0–DCP0_RAM3FF	947
DCP0_VER	948
DMA Registers	949
DMA0_CR0–DMA0_CR3	949
DMA0_CT0–DMA0_CT3	951
DMA0_DA0–DMA0_DA3	952

DMA0_POL	953
DMA0_SA0–DMA0_SA3	954
DMA0_SG0–DMA0_SG3	955
DMA0_SGC	956
DMA0_SLP	957
DMA0_SR	958
EBC Registers	959
EBC0_BEAR	959
EBC0_BESR0	960
EBC0_BESR1	962
EBC0_BnAP	963
EBC0_BnCR	964
EBC0_CFG	965
EBC0_CFGADDR	967
EBC0_CFGDATA	968
Ethernet Registers	969
EMAC00_GAHT1–EMAC00_GAHT4	969
EMAC00_IAHR	970
EMAC00_IAHT1–EMAC00_IAHT4	971
EMAC00_IALR	972
EMAC00_IPGVR	973
EMAC00_ISER	974
EMAC00_ISR	976
EMAC00_LSAH	979
EMAC00_LSAH	980
EMAC00_MR0	981
EMAC00_MR1	982
EMAC00_OCRX	984
EMAC00_OCTX	985
EMAC00_PTR	986
EMAC00_RMR	987
EMAC00_RWMMR	989
EMAC00_STACR	990
EMAC00_TMR0	991
EMAC00_TMR1	992
EMAC00_TRTR	993
EMAC00_VTCI	994
EMAC00_VTPID	995
GPIO Registers	996
GPIO0_IR	996
GPIO0_ODR	997
GPIO0_OR	998
GPIO0_TCR	999
IIC Registers	1000
IIC0_CLKDIV	1000
IIC0_CNTL	1001
IIC0_DIRECTCNTL	1002
IIC0_EXTSTS	1003
IIC0_HMADR	1005
IIC0_HSADR	1006
IIC0_INTRMSK	1007
IIC0_LMADR	1008
IIC0_LSADR	1009
IIC0_MDBUF	1010

Preliminary User's Manual

IIC0_MDCNTL	1011
IIC0_SDBUF	1012
IIC0_STS	1013
IIC0_XFRCNT	1014
IIC0_XTCNTLSS	1015
MAL Registers	1017
MAL0_CFG	1017
MAL0_ESR	1019
MAL0_IER	1021
MAL0_RCBS0	1022
MAL0_RXCARR	1023
MAL0_RXCASR	1024
MAL0_RXCTPxR	1025
MAL0_RXDEIR	1026
MAL0_RXEOBISR	1027
MAL0_TXCARR	1028
MAL0_TXCASR	1029
MAL0_TXCTPxR	1030
MAL0_TXDEIR	1031
MAL0_TXEOBISR	1032
On-Chip Memory Controller Registers	1033
OCM0_DSARC	1033
OCM0_DSCNTL	1034
OCM0_ISARC	1035
OCM0_ISCNTL	1036
OPB Arbiter Registers	1037
OPBA0_CR	1037
OPBA0_PR	1038
PCI Registers	1039
PCIC0_BAR0	1039
PCIC0_BIST	1040
PCIC0_BRDGOPT1	1041
PCIC0_BRDGOPT2	1042
PCIC0_CACHELS	1043
PCIC0_CAP	1044
PCIC0_CAPID	1045
PCIC0_CFGADDR	1046
PCIC0_CFGATA	1047
PCIC0_CLS	1048
PCIC0_CMD	1049
PCIC0_DATA	1051
PCIC0_DEVID	1052
PCIC0_ERREN	1053
PCIC0_ERRSTS	1054
PCIC0_HDTYPE	1055
PCIC0_ICS	1056
PCIC0_INTLN	1057
PCIC0_INTPN	1058
PCIC0_LATTIM	1059
PCIC0_MAXLTNCY	1060
PCIC0_MINGNT	1061
PCIC0_NEXTIPTR	1062
PCIC0_PLBBEAR	1063
PCIC0_PLBBESR0	1064

PCIC0_PLBBESR1	1066
PCIC0_PMC	1067
PCIC0_PMCSR	1068
PCIC0_PMCSRBE	1069
PCIC0_PMSCRR	1070
PCIC0_PTM1BAR	1071
PCIC0_PTM2BAR	1072
PCIC0_REVID	1073
PCIC0_SBSYSID	1074
PCIC0_SBSYSVID	1075
PCIC0_STATUS	1076
PCIC0_VENDID	1078
PCIL0_PMM0LA	1079
PCIL0_PMM0MA	1080
PCIL0_PMM0PCIHA	1081
PCIL0_PMM0PCILA	1082
PCIL0_PMM1LA	1083
PCIL0_PMM1MA	1084
PCIL0_PMM1PCIHA	1085
PCIL0_PMM1PCILA	1086
PCIL0_PMM2LA	1087
PCIL0_PMM2MA	1088
PCIL0_PMM2PCIHA	1089
PCIL0_PMM2PCILA	1090
PCIL0_PTM1LA	1091
PCIL0_PTM1MS	1092
PCIL0_PTM2LA	1093
PCIL0_PTM2MS	1094
PLB Registers	1095
PLB0_ACR	1095
PLB0_BEAR	1096
PLB0_BESR	1097
PLB-OPB Bridge Registers	1099
POB0_BEAR	1099
POB0_BESR0	1100
POB0_BESR1	1102
SDRAM Registers	1103
SDRAM0_B0CR–SDRAM0_B3CR	1103
SDRAM0_BEAR	1104
SDRAM0_BESR0	1105
SDRAM0_BESR1	1107
SDRAM0_CFG	1108
SDRAM0_CFGADDR	1109
SDRAM0_CFGDATA	1110
SDRAM0_ECCCFG	1111
SDRAM0_ECCESR	1112
SDRAM0_PMIT	1113
SDRAM0_RTR	1114
SDRAM0_STATUS	1115
SDRAM0_TR	1116
UART Registers.....	1118
UARTx_DLL	1118
UARTx_DLM	1119
UARTx_FCR	1120

Preliminary User's Manual

UARTx_IER	1121
UARTx_IIR	1122
UARTx_LCR	1123
UARTx_LSR	1124
UARTx_MCR	1126
UARTx_MSR	1127
UARTx_RBR	1128
UARTx_SCR	1129
UARTx_THR	1130
UIC Registers	1131
UIC0_CR	1131
UIC0_ER	1133
UIC0_MSR	1135
UIC0_PR	1138
UIC0_SR	1140
UIC0_TR	1143
UUIC0_VCR	1146
UIC0_VR	1147
Chapter 26. Signal Summary	1149
Signals Listed Alphabetically	1149
Signal Descriptions	1153
A. Instruction Summary	1159
Instruction Set and Extended Mnemonics – Alphabetical	1159
Instructions Sorted by Opcode	1192
Instruction Formats	1199
Instruction Fields	1200
Instruction Format Diagrams	1201
I-Form	1201
B-Form	1201
SC-Form	1202
D-Form	1202
X-Form	1203
XL-Form	1203
XFX-Form	1204
X0-Form	1204
M-Form	1204
B. Instructions by Category	1205
Implementation-Specific Instructions	1205
Instructions in the IBM PowerPC Embedded Environment	1209
Privileged Instructions	1211
Assembler Extended Mnemonics	1213
Storage Reference Instructions	1232
Arithmetic and Logical Instructions	1236
Condition Register Logical Instructions	1240
Branch Instructions	1241
Comparison Instructions	1242
Rotate and Shift Instructions	1243
Cache Control Instructions	1244
Interrupt Control Instructions	1245
TLB Management Instructions	1245
Processor Management Instructions	1247
C. Code Optimization and Instruction Timings	1249
Code Optimization Guidelines	1249

Condition Register Bits for Boolean Variables	1249
CR Logical Instruction for Compound Branches	1249
Floating-Point Emulation	1249
Cache Usage	1250
CR Dependencies	1250
Branch Prediction	1250
Alignment	1250
Instruction Timings	1251
General Rules	1251
Branches	1251
Multiplies	1252
Scalar Load Instructions	1253
Scalar Store Instructions	1253
Alignment in Scalar Load and Store Instructions	1254
String and Multiple Instructions	1254
Loads and Store Misses	1254
Instruction Cache Misses	1255
Revision Log	1257

Preliminary User's Manual**Figures**

Figure 1-1. PPC405GP Block Diagram	52
Figure 2-1. Overlapped PLB Transfers	66
Figure 2-2. PLB Arbiter Control Register (PLB0_ACR)	67
Figure 2-3. PLB Error Address Register (PLB0_BEAR)	69
Figure 2-4. PLB Error Status Register (PLB0_BESR)	69
Figure 2-5. Bridge Error Address Register (POB0_BEAR)	71
Figure 2-6. Bridge Error Status Register 0 (POB0_BESR0)	72
Figure 2-7. Bridge Error Status Register 1 (POB0_BESR1)	73
Figure 2-8. OPB Arbiter Control Register (OPBA0_CR)	75
Figure 2-9. OPB Arbiter Priority Register (OPBA0_PR)	76
Figure 3-1. PPC405GP Programming Model—Registers	82
Figure 3-2. General Purpose Registers (R0-R31)	83
Figure 3-3. Count Register (CTR)	85
Figure 3-4. Link Register (LR)	86
Figure 3-5. Fixed Point Exception Register (XER)	88
Figure 3-6. Special Purpose Register General (SPRG0–SPRG7)	90
Figure 3-7. Processor Version Register (PVR)	91
Figure 3-8. Condition Register (CR)	92
Figure 3-9. Machine State Register (MSR)	95
Figure 3-10. PPC405GP Data Types	106
Figure 3-11. Normal Word Load or Store (Big Endian Storage Region)	113
Figure 3-12. Byte-Reverse Word Load or Store (Little Endian Storage Region)	113
Figure 3-13. Byte-Reverse Word Load or Store (Big Endian Storage Region)	113
Figure 3-14. Normal Word Load or Store (Little Endian Storage Region)	114
Figure 3-15. PPC405GP Instruction Pipeline	115
Figure 4-1. Instruction Flow	137
Figure 4-2. Core Configuration Register 0 (CCR0)	144
Figure 4-3. Instruction Cache Debug Data Register (ICDBDR)	147
Figure 5-1. OCM Address Usage	154
Figure 5-2. OCM Instruction-Side Address Range Compare Register (OCM0_ISARC)	157
Figure 5-3. OCM Instruction-Side Control Register (OCM0_ISCNTL)	158
Figure 5-4. OCM Data-Side Address Range Compare Register (OCM0_DSARC)	159
Figure 5-5. OCM Data-Side Control Register (OCM0_DSCNTL)	159
Figure 6-1. Effective to Real Address Translation Flow	162
Figure 6-2. TLB Entries	163
Figure 6-3. ITLB/DTLB/UTLB Address Resolution	168
Figure 6-4. Process ID (PID)	173
Figure 6-5. Zone Protection Register (ZPR)	174
Figure 6-6. Generic Storage Attribute Control Register	177
Figure 7-1. PPC405GP Clocking	183
Figure 7-2. PLL Mode Register (CPC0_PLLMR)	192
Figure 7-3. Chip Control Register 0 (CPC0_CR0)	194
Figure 7-4. Chip Control Register 1 (CPC0_CR1)	196

Figure 9-1. Chip Pin Strapping Register (CPC0_PSR)	215
Figure 10-1. UIC Status Register (UIC0_SR)	222
Figure 10-2. UIC Enable Register (UIC0_ER)	224
Figure 10-3. UIC Enable Register (UIC0_ER)	226
Figure 10-4. UIC Critical Register (UIC0_CR)	229
Figure 10-5. UIC Polarity Register (UIC0_PR)	231
Figure 10-6. UIC Trigger Register (UIC0_TR)	234
Figure 10-7. UIC Masked Status Register (UIC0_MSR)	237
Figure 10-8. UIC Masked Status Register (UIC0_MSR)	239
Figure 10-9. UIC Vector Configuration Register (UIC0_VCR)	242
Figure 10-10. UIC Vector Register (UIC0_VR)	243
Figure 10-11. Machine State Register (MSR)	251
Figure 10-12. Save/Restore Register 0 (SRR0)	252
Figure 10-13. Save/Restore Register 1 (SRR1)	253
Figure 10-14. Save/Restore Register 2 (SRR2)	253
Figure 10-15. Save/Restore Register 3 (SRR3)	254
Figure 10-16. Exception Vector Prefix Register (EVPR)	254
Figure 10-17. Exception Syndrome Register (ESR)	255
Figure 10-18. Data Exception Address Register (DEAR)	257
Figure 11-1. Relationship of Timer Facilities to the Time Base	271
Figure 11-2. Time Base Lower (TBL)	272
Figure 11-3. Time Base Upper (TBU)	272
Figure 11-4. Programmable Interval Timer (PIT)	275
Figure 11-5. Watchdog Timer State Machine	277
Figure 11-6. Timer Status Register (TSR)	278
Figure 11-7. Timer Control Register (TCR)	279
Figure 12-1. JTAG ID Register (CPC0_JTAGID)	283
Figure 12-2. Debug Control Register 0 (DBCR0)	287
Figure 12-3. Debug Control Register 1 (DBCR1)	289
Figure 12-4. Debug Status Register (DBSR)	291
Figure 12-5. Instruction Address Compare Registers (IAC1–IAC4)	292
Figure 12-6. Data Address Compare Registers (DAC1–DAC2)	293
Figure 12-7. Data Value Compare Registers (DVC1–DVC2)	293
Figure 12-8. Inclusive IAC Range Address Compares	296
Figure 12-9. Exclusive IAC Range Address Compares	296
Figure 12-10. Inclusive DAC Range Address Compares	298
Figure 12-11. Exclusive DAC Range Address Compares	298
Figure 13-1. CPM Registers (CPC0_ER, CPC0_FR, CPC0_SR)	304
Figure 14-1. Decompression Index Table Origin Registers (DCP0_ITOR0–DCP0_ITOR3)	310
Figure 14-2. Decompression Controller Configuration Register (DCP0_CFG)	311
Figure 14-3. Decompression Controller ID Register (DCP0_ID)	312
Figure 14-4. Decompression Controller Version Register (DCP0_VER)	312
Figure 14-5. Decompression Controller PLB Error Address Register (DCP0_PLBBEAR)	313
Figure 14-6. Decompression Controller Bus Error Address Register (DCP0_MEMBEAR)	313
Figure 14-7. Decompression Controller Error Status Register 0 (DCP0_ESR)	314
Figure 14-8. Decompression Decode Table Entries (DCP0_RAM0–DCP0_RAM3FF)	316
Figure 14-9. Memory Mapping	317

Preliminary User's Manual

Figure 14-10. Index Table Entry (ITE) Format	318
Figure 14-11. Compressed Instruction Format	321
Figure 15-1. SDRAM Controller Signals	327
Figure 15-2. Memory Controller Configuration (SDRAM0_CFG)	331
Figure 15-3. Memory Controller Status (SDRAM0_STATUS)	332
Figure 15-4. Memory Bank 0–3 Configuration Registers (SDRAM0_B0CR–SDRAM0_B3CR)	332
Figure 15-5. SDRAM Timing Register (SDRAM0_TR)	336
Figure 15-6. Activate, Four Word Read, Precharge, Activate	338
Figure 15-7. Activate, Four Word Write, Precharge, Activate	338
Figure 15-8. Precharge All, Activate	339
Figure 15-9. CAS Before RAS Refresh	339
Figure 15-10. Self-Refresh Entry and Exit	340
Figure 15-11. Refresh Timing Register (SDRAM0_RTR)	341
Figure 15-12. ECC Configuration Register (SDRAM0_ECCCFG)	342
Figure 15-13. ECC Error Status Register (SDRAM0_ECCESR)	343
Figure 15-14. Bus Error Address Register (SDRAM0_BEAR)	345
Figure 15-15. Bus Error Syndrome Register 0 (SDRAM0_BESR0)	345
Figure 15-16. Bus Error Status Register 1 (SDRAM0_BESR1)	347
Figure 15-17. Power Management Idle Timer (SDRAM0_PMIT)	349
Figure 16-1. EBC Signals	352
Figure 16-2. Attachment of Devices of Various Widths to the Peripheral Data Bus	354
Figure 16-3. Single Read Transfer	357
Figure 16-4. Single Write Transfer	358
Figure 16-5. Burst Read Transfer	360
Figure 16-6. Burst Write Transfer	361
Figure 16-7. Device-Paced Single Read Transfer	363
Figure 16-8. Device-Paced Single Write Transfer	364
Figure 16-9. Device-Paced Burst Read Transfer	365
Figure 16-10. Device-Paced Burst Write Transfer	367
Figure 16-11. Sample External Bus Master System	368
Figure 16-12. External Master Arbitration, Single Read and Single Write	371
Figure 16-13. External Master Burst Read	372
Figure 16-14. External Master Burst Write	373
Figure 16-15. EBC Configuration Register (EBC0_CFG)	375
Figure 16-16. Peripheral Bank Configuration Registers (EBC0_B0CR–EBC0_B7CR)	376
Figure 16-17. Peripheral Bank Access Parameters (EBC0_B0AP–EBC0_B7AP)	377
Figure 16-18. Peripheral Bus Error Address Register (EBC0_BEAR)	380
Figure 16-19. Peripheral Bus Error Status Register 0 (EBC0_BESR0)	381
Figure 16-20. Peripheral Bus Error Status Register 1 (EBC0_BESR1)	383
Figure 17-1. PCI Bridge Block Diagram	386
Figure 17-2. PLB-to-PCI Half-Bridge Block Diagram	388
Figure 17-3. PCI-to-PLB Half-Bridge Block Diagram	389
Figure 17-4. Arbitration Structure	389
Figure 17-5. PMM Register Sets Map PLB Address Space to PCI Address Space	392
Figure 17-6. PTM Register Sets Map PCI Address Space to PLB Address Space	393
Figure 17-7. PMM 0 Local Address Register (PCILO_PMM0LA)	406
Figure 17-8. PMM 0 Mask/Attribute Register (PCILO_PMM0MA)	406

Figure 17-9. PMM 0 PCI Low Address Register (PCIL0_PMM0PCILA)	407
Figure 17-10. PMM 0 High Address Register (PCIL0_PMM0PCIHA)	407
Figure 17-11. PMM 1 Local Address Register (PCIL0_PMM1LA)	408
Figure 17-12. PMM 1 Mask/Attribute Register (PCIL0_PMM1MA)	408
Figure 17-13. PMM 1 PCI Low Address Register (PCIL0_PMM1PCILA)	409
Figure 17-14. PMM 0 High Address Register (PCIL0_PMM0PCIHA)	409
Figure 17-15. PMM 2 Local Address Register (PCIL0_PMM2LA)	409
Figure 17-16. PMM 2 Mask/Attribute Register (PCIL0_PMM2MA)	410
Figure 17-17. PMM 2 PCI Low Address Register (PCIL0_PMM2PCILA)	410
Figure 17-18. PMM 2 PCI High Address Register (PCIL0_PMM2PCIHA)	411
Figure 17-19. PTM 1 Memory Size/Attribute Register (PCIL0_PTM1MS)	411
Figure 17-20. PTM 2 Local Address Register (PCIL0_PTM1LA)	412
Figure 17-21. PTM 2 Memory Size/Attribute Register (PCIL0_PTM2MS)	412
Figure 17-22. PTM 2 Local Address Register (PCIL0_PTM2LA)	413
Figure 17-23. PCI Configuration Address Register (PCIC0_CFGADDR)	414
Figure 17-24. PCI Configuration Data Register (PCIC0_CFGDATA)	415
Figure 17-25. PCI Vendor ID Register (PCIC0_VENDID)	415
Figure 17-26. PCI Device ID Register (PCIC0_DEVID)	415
Figure 17-27. PCI Command Register (PCIC0_CMD)	416
Figure 17-28. PCI Status Register (PCIC0_STATUS)	417
Figure 17-29. PCI Revision ID Register (PCIC0_REVID)	419
Figure 17-30. PCI Class Register (PCIC0_CLS)	419
Figure 17-31. PCI Cache Line Size Register (PCIC0_CACHELS)	420
Figure 17-32. PCI Latency Timer Register (PCIC0_LATTIM)	420
Figure 17-33. PCI Header Type Register (PCIC0_HDTYPE)	421
Figure 17-34. PCI Built-in Self Test Control Register (PCIC0_BIST)	421
Figure 17-35. PCI PTM 1 BAR Register (PCIC0_PTM1BAR)	422
Figure 17-36. PCI PTM 2 BAR Register (PCIC0_PTM2BAR)	423
Figure 17-37. PCI Subsystem Vendor ID Register (PCIC0_SBSYSVID)	423
Figure 17-38. PCI Subsystem ID Register (PCIC0_SBSYSID)	424
Figure 17-39. PCI Capabilities Pointer (PCIC0_CAP)	424
Figure 17-40. PCI Interrupt Line Register (PCIC0_INTLN)	424
Figure 17-41. PCI Interrupt Pin Register (PCIC0_INTPN)	425
Figure 17-42. PCI Minimum Grant Register (PCIC0_MINGNT)	425
Figure 17-43. PCI Maximum Latency Register (PCIC0_MAXLTNCY)	425
Figure 17-44. PCI Interrupt Control/Status Register	426
Figure 17-45. Error Enable Register (PCIC0_ERREN)	426
Figure 17-46. Error Status Register (PCIC0_ERRSTS)	427
Figure 17-47. Bridge Options 1 Register (PCIC0_BRDGOPT1)	428
Figure 17-48. PLB Slave Error Syndrome Register 0 (PCIC0_PLBBESR0)	430
Figure 17-49. PLB Slave Error Syndrome 1 (PCIC0_PLBBESR1)	431
Figure 17-50. PLB Slave Error Address Register (PCIC0_PLBBEAR)	432
Figure 17-51. Capability Identifier (PCIC0_CAPID)	433
Figure 17-52. Next Item Pointer (PCIC0_NEXTIPTR)	433
Figure 17-53. Power Management Capabilities Register (PCIC0_PMC)	434
Figure 17-54. Power Management Control/Status Register (PCIC0_PMCSR)	435
Figure 17-55. PMCSR PCI to PCI Bridge Support Extensions (PCIC0_PMCSRBSE)	436

Preliminary User's Manual

Figure 17-56. PCI Data (PCIC0_DATA)	436
Figure 17-57. Bridge Options 2 Register (PCIC0_BRDGOPT2)	437
Figure 17-58. Power Management State Change Request Register (PCIC0_PMSCRR)	438
Figure 17-60. PCI Master Burst Read From SDRAM	450
Figure 17-61. PCI Master Burst Write To SDRAM	454
Figure 17-62. CPU Read From PCI Memory Slave, Nonprefetching	458
Figure 17-63. CPU Read From PCI Memory Slave, Prefetching	460
Figure 17-64. CPU Write To PCI Memory Slave	464
Figure 17-65. PCI Memory To SDRAM DMA Transfer	467
Figure 17-66. SDRAM To PCI Memory DMA Transfer	469
Figure 17-67. PCI Master Burst Read From SDRAM	472
Figure 17-68. PCI Master Burst Write To SDRAM	479
Figure 17-69. CPU Read From PCI Memory Slave, Nonprefetching	485
Figure 17-70. CPU Read From PCI Memory Slave, Prefetching	487
Figure 17-71. CPU Write To PCI Memory Slave	491
Figure 17-72. PCI Memory To SDRAM DMA Transfer	495
Figure 17-73. SDRAM To PCI Memory DMA Transfer	498
Figure 18-1. DMA Controller External Bus Control Signals	502
Figure 18-2. DMA Polarity Configuration Register (DMA0_POL)	505
Figure 18-3. DMA Sleep Mode Register (DMA0_SLP)	506
Figure 18-4. DMA Status Register (DMA0_SR)	507
Figure 18-5. DMA Channel Control Registers (DMA0_CR0–DMA0_CR3)	508
Figure 18-6. DMA Source Address Registers (DMA0_SAO–DMA0_SA3)	510
Figure 18-7. DMA Destination Address Registers (DMA0_DAO–DMA0_DA3)	511
Figure 18-8. DMA Count Registers (DMA0_CT0–DMA0_CT3)	511
Figure 18-9. DMA Scatter/Gather Descriptor Address Registers (DMA0_SG0–DMA0_SG3)	512
Figure 18-10. DMA Scatter/Gather Command Register (DMA0_SGC)	512
Figure 18-11. Peripheral-to-Memory DMA Transfer	517
Figure 18-12. Memory-to-Peripheral DMA Transfer	518
Figure 19-1. EMAC in a Typical Ethernet Application	524
Figure 19-2. Internal EMAC Structure	526
Figure 19-3. EMAC Loopback Modes	527
Figure 19-4. MAL TX Descriptor Control/Status Field	530
Figure 19-5. Transmit Packet Structure (Excluding VLAN Tagged and Control Packets)	533
Figure 19-6. MAL RX Descriptor Control/Status Field	535
Figure 19-7. Wake-Up Packet Format	538
Figure 19-8. Control Packet Format	539
Figure 19-9. Integrated Flow Control Mechanism	540
Figure 19-10. Pause Operation State Machine	541
Figure 19-11. Tagged MAC Packet Format	542
Figure 19-12. Tag Control Information Field Structure	542
Figure 19-13. Receive Address Recognition Flowchart	545
Figure 19-14. Ethernet Address Filter Operation	546
Figure 19-15. Mode Register 0 (EMAC0_MR0)	548
Figure 19-16. Mode Register 1 (EMAC0_MR1)	549
Figure 19-17. Transmit Mode Register 0 (EMAC0_TMR0)	550
Figure 19-18. Transmit Mode Register 1 (EMAC0_TMR1)	551

Figure 19-19. Receive Mode Register (EMAC0_RMR)	552
Figure 19-20. Interrupt Status Register (EMAC0_ISR)	554
Figure 19-21. Interrupt Status Enable Register (EMAC0_ISER)	556
Figure 19-22. Individual Address High Register (EMAC0_IAHR)	559
Figure 19-23. Individual Address Low Register (EMAC0_IALR)	559
Figure 19-24. VLAN TPID Register (EMAC0_VTPID)	560
Figure 19-25. VLAN TCI Register (EMAC0_VTCI)	560
Figure 19-26. Pause Timer Register (EMAC0_PTR)	560
Figure 19-27. Individual Address Hash Tables 1–4 (EMAC0_IAHT1–EMAC0_IAHT4)	561
Figure 19-28. Group Address Hash Tables 1–4 (EMAC0_GAHT1–EMAC0_GAHT4)	561
Figure 19-29. Last Source Address High Register (EMAC0_LSAH)	562
Figure 19-30. Last Source Address Low Register (EMAC0_LSA)	562
Figure 19-31. Inter-Packet Gap Value Register (EMAC0_IPGVR)	563
Figure 19-32. STA Control Register (EMAC0_STACR)	564
Figure 19-33. Transmit Request Threshold Register (EMAC0_TRTR)	565
Figure 19-34. Receive Low/High Water Mark Register (EMAC0_RWWMR)	566
Figure 19-35. Number of Octets Transmitted (EMAC0_OCTX)	566
Figure 19-36. Number of Octets Received (EMAC0_OCRX)	567
Figure 19-37. Management Interface with PHY	567
Figure 19-38. EMAC-MAL Communication Phases	568
Figure 20-1. General MAL Structure	574
Figure 20-2. MAL Internal Structure	575
Figure 20-3. Transmit Operation	577
Figure 20-4. Receive Operation	578
Figure 20-5. Buffer Descriptor Structure	580
Figure 20-6. Packet Structure in Memory	581
Figure 20-7. Transmit Status/Control Field	587
Figure 20-8. Receive Status/Control Field	588
Figure 20-9. Error Status Register Field	593
Figure 20-10. MAL Error Processing	595
Figure 20-11. MAL Configuration Register (MAL0_CFG)	597
Figure 20-12. TX Channel_Active Set Register (MAL0_TXCASR)	599
Figure 20-13. TX Channel Active Reset Register (MAL0_TXCARR)	599
Figure 20-14. RX Channel_Active Set Register (MAL0_RXCASR)	599
Figure 20-15. RX Channel_Active Reset Register (MAL0_RXCARR)	600
Figure 20-16. TX End of Buffer Interrupt Status Register (MAL0_TXEOBISR)	600
Figure 20-17. RX End of Buffer Interrupt Status Register (MAL0_RXEOBISR)	601
Figure 20-18. MAL Error Status Register (MAL0_ESR)	602
Figure 20-19. MAL Interrupt Enable Register (MAL0_IER)	603
Figure 20-20. TX Descriptor Error Interrupt Register (MAL0_TXDEIR)	604
Figure 20-21. RX Descriptor Error Interrupt Register (MAL0_RXDEIR)	604
Figure 20-22. TX Channel Table Pointer Registers (MAL0_TXCTPXR)	605
Figure 20-23. RX Channel Table Pointer Register (MAL0_RXCTPXR)	605
Figure 20-24. RX Channel Buffer Size Register (MAL0_RCBS0)	606
Figure 21-1. UART Receiver Buffer Registers (UARTx_RBR)	612
Figure 21-2. UART Transmitter Holding Registers (UARTx_THR)	612
Figure 21-3. UART Interrupt Enable Registers (UARTx_IER)	613

Preliminary User's Manual

Figure 21-5. UART FIFO Control Registers (UARTx_FCR)	615
Figure 21-4. UART Interrupt Identification Registers (UARTx_IIR)	615
Figure 21-6. UART Line Control Registers (UARTx_LCR)	617
Figure 21-7. UART Modem Control Registers (UARTx_MCR)	618
Figure 21-8. UART Line Status Registers (UARTx_LSR)	619
Figure 21-9. UART Modem Status Registers (UARTx_MSR)	621
Figure 21-10. Scratchpad Registers (UARTx_SCR)	622
Figure 21-11. UART Baud-Rate Divisor Latch (MSB) Registers (UARTx_DLM)	622
Figure 21-12. UART Baud-Rate Divisor Latch (LSB) Registers (UARTx_DLL)	622
Figure 21-13. Chip Control Register 0 (CPC0_CR0)	625
Figure 22-1. 7-Bit Addressing	632
Figure 22-2. 10-Bit Addressing	632
Figure 22-3. IIC0 Master Data Buffer (IIC0_MDBUF)	634
Figure 22-4. FIFO Stages	634
Figure 22-5. IIC0 Slave Data Buffer (IIC0_SDBUF)	635
Figure 22-6. IIC0 Low Master Address Register (IIC0_LMADR)	636
Figure 22-7. IIC0 High Master Address Register (IIC0_HMADR)	637
Figure 22-8. IIC0 Control Register (IIC0_CNTL)	638
Figure 22-9. IIC0 Mode Control Register (IIC0_MDCNTL)	640
Figure 22-10. IIC0 Status Register (IIC0_STS)	641
Figure 22-11. IIC0 Extended Status Register (IIC0_EXTSTS)	643
Figure 22-12. IIC0 Low Slave Address Register (IIC0_LSADR)	645
Figure 22-13. IIC0 High Slave Address Register (IIC0_HSADR)	646
Figure 22-14. IIC0 Clock Divide Register (IIC0_CLKDIV)	647
Figure 22-15. IIC0 Interrupt Mask Register (IIC0_INTRMSK)	648
Figure 22-16. IIC0 Transfer Count Register (IIC0_XFRCNT)	649
Figure 22-17. IIC0 Extended Control and Slave Status Register (IIC0_XTCNTLSS)	650
Figure 22-18. IIC0 Direct Control Register (IIC0_DIRECTCNTL)	652
Figure 23-1. GPIO Functional Block Diagram	656
Figure 23-2. CPC0_CR0 Bits Controlling GPIO	657
Figure 23-3. GPIO Registers	659
Figure 25-1. Core Configuration Register 0 (CCR0)	878
Figure 25-2. Condition Register (CR)	880
Figure 25-3. Count Register (CTR)	881
Figure 25-4. Data Address Compare Registers (DAC1–DAC2)	882
Figure 25-5. Debug Control Register 0 (DBCR0)	883
Figure 25-6. Debug Control Register 1 (DBCR1)	885
Figure 25-7. Debug Status Register (DBSR)	887
Figure 25-8. Data Cache Cachability Register (DCCR)	889
Figure 25-9. Data Cache Write-through Register (DCWR)	891
Figure 25-10. Data Exception Address Register (DEAR)	893
Figure 25-11. Data Value Compare Registers (DVC1–DVC2)	894
Figure 25-12. Exception Syndrome Register (ESR)	895
Figure 25-13. Exception Vector Prefix Register (EVPR)	896
Figure 25-14. General Purpose Registers (R0-R31)	897
Figure 25-15. Instruction Address Compare Registers (IAC1–IAC4)	898
Figure 25-16. Instruction Cache Cachability Register (ICCR)	899

Figure 25-17. Instruction Cache Debug Data Register (ICDBDR)	901
Figure 25-18. Link Register (LR)	902
Figure 25-19. Machine State Register (MSR)	903
Figure 25-20. Process ID (PID)	904
Figure 25-21. Programmable Interval Timer (PIT)	905
Figure 25-22. Processor Version Register (PVR)	906
Figure 25-23. Storage Guarded Register (SGR)	907
Figure 25-24. Storage Little-Endian Register (SLER)	909
Figure 25-25. Special Purpose Registers General (SPRG0–SPRG7)	911
Figure 25-26. Save/Restore Register 0 (SRR0)	912
Figure 25-27. Save/Restore Register 1 (SRR1)	913
Figure 25-28. Save/Restore Register 2 (SRR2)	914
Figure 25-29. Save/Restore Register 3 (SRR3)	915
Figure 25-30. Storage User-defined 0 Register (SUOR)	916
Figure 25-31. Time Base Lower (TBL)	918
Figure 25-32. Time Base Upper (TBU)	919
Figure 25-33. Timer Control Register (TCR)	920
Figure 25-34. Timer Status Register (TSR)	921
Figure 25-35. User SPR General 0 (USPRG0)	922
Figure 25-36. Fixed Point Exception Register (XER)	923
Figure 25-37. Zone Protection Register (ZPR)	924
Figure 25-38. Chip Control Register 0 (CPC0_CR0)	925
Figure 25-39. Chip Control Register 1 (CPC0_CR1)	928
Figure 25-40. CPM Enable Register (CPC0_ER)	929
Figure 25-41. CPM Force Register (CPC0_FR)	930
Figure 25-42. JTAG ID Register (CPC0_JTAGID)	931
Figure 25-43. PLL Mode Register (CPC0_PLLMR)	932
Figure 25-44. Chip Pin Strapping Register (CPC0_PSR)	934
Figure 25-45. CPM Status Register (CPC0_SR)	936
Figure 25-46. Decompression Controller Configuration Register (DCP0_CFG)	938
Figure 25-47. Decompression Controller Address Register (DCP0_CFGADDR)	939
Figure 25-48. Decompression Controller Configuration Data Register (DCP0_CFGDATA)	940
Figure 25-49. Decompression Controller Error Status Register 0 (DCP0_ESR)	941
Figure 25-50. Decompression Controller ID Register (DCP0_ID)	943
Figure 25-51. Decompression Index Table Origin Registers (DCP0_ITOR0–DCP0_ITOR3)	944
Figure 25-52. Decompression Controller Bus Error Address Register (DCP0_MEMBEAR)	945
Figure 25-53. Decompression Controller PLB Error Address Register (DCP0_PLBBEAR)	946
Figure 25-54. Decompression Decode Table Entries (DCP0_RAM0–DCP0_RAM3FF)	947
Figure 25-55. Decompression Controller Version Register (DCP0_VER)	948
Figure 25-56. DMA Channel Control Registers (DMA0_CR0–DMA0_CR3)	949
Figure 25-57. DMA Count Registers (DMA0_CT0–DMA0_CT3)	951
Figure 25-58. DMA Destination Address Registers (DMA0_DA0–DMA0_DA3)	952
Figure 25-59. DMA Polarity Configuration Register (DMA0_POL)	953
Figure 25-60. DMA Source Address Registers (DMA0_SA0–DMA0_SA3)	954
Figure 25-61. DMA Scatter/Gather Descriptor Address Registers (DMA0_SG0–DMA0_SG3)	955
Figure 25-62. DMA Scatter/Gather Command Register (DMA0_SGC)	956
Figure 25-63. DMA Sleep Mode Register (DMA0_SLP)	957

Preliminary User's Manual

Figure 25-64. DMA Status Register (DMA0_SR)	958
Figure 25-65. Peripheral Bus Error Address Register (EBC0_BEAR)	959
Figure 25-66. Peripheral Bus Error Status Register 0 (EBC0_BESR0)	960
Figure 25-67. Peripheral Bus Error Status Register 1 (EBC0_BESR1)	962
Figure 25-68. Peripheral Bank Access Parameters (EBC0_B0AP–EBC0_B7AP)	963
Figure 25-69. Peripheral Bank Configuration Registers (EBC0_B0CR–EBC0_B7CR)	964
Figure 25-70. EBC Configuration Register (EBC0_CFG)	965
Figure 25-71. EBC Configuration Address Register (EBC0_CFGADDR)	967
Figure 25-72. EBC Configuration Data Register (EBC0_CFGDATA)	968
Figure 25-73. Group Address Hash Tables 1–4 (EMAC0_GAHT1–EMAC0_GAHT4)	969
Figure 25-74. Individual Address High Register (EMAC0_IAHR)	970
Figure 25-75. Individual Address Hash Tables 1–4 (EMAC0_IAHT1–EMAC0_IAHT4)	971
Figure 25-76. Individual Address Low Register (EMAC0_IALR)	972
Figure 25-77. Inter-Packet Gap Value Register (EMAC0_IPGVR)	973
Figure 25-78. Interrupt Status Enable Register (EMAC0_ISER)	974
Figure 25-79. Interrupt Status Register (EMAC0_ISR)	976
Figure 25-80. Last Source Address High Register (EMAC0_LSAH)	979
Figure 25-81. Last Source Address Low Register (EMAC0_LSAL)	980
Figure 25-82. Mode Register 0 (EMAC0_MR0)	981
Figure 25-83. Mode Register 1 (EMAC0_MR1)	982
Figure 25-84. Number of Octets Received (EMAC0_OCRX)	984
Figure 25-85. Number of Octets Transmitted (EMAC0_OCTX)	985
Figure 25-86. Pause Timer Register (EMAC0_PTR)	986
Figure 25-87. Receive Mode Register (EMAC0_RMR)	987
Figure 25-88. Receive Low/High Water Mark Register (EMAC0_RWMR)	989
Figure 25-89. STA Control Register (EMAC0_STACR)	990
Figure 25-90. Transmit Mode Register 0 (EMAC0_TMR0)	991
Figure 25-91. Transmit Mode Register 1 (EMAC0_TMR1)	992
Figure 25-92. Transmit Request Threshold Register (EMAC0_TRTR)	993
Figure 25-93. VLAN TCI Register (EMAC0_VTCI)	994
Figure 25-94. VLAN TPID Register (EMAC0_VTPID)	995
Figure 25-95. GPIO Input Register (GPIO0_IR)	996
Figure 25-96. GPIO Open Drain Register (GPIO0_ODR)	997
Figure 25-97. GPIO Output Register (GPIO0_OR)	998
Figure 25-98. GPIO Three-State Control Register (GPIO0_TCR)	999
Figure 25-99. IIC0 Clock Divide Register (IIC0_CLKDIV)	1000
Figure 25-100. IIC0 Control Register (IIC0_CNTL)	1001
Figure 25-101. IIC0 Direct Control Register (IIC0_DIRECTCNTL)	1002
Figure 25-102. IIC0 Extended Status Register (IIC0_EXTSTS)	1003
Figure 25-103. IIC0 High Master Address Register (IIC0_HMADR)	1005
Figure 25-104. IIC0 High Slave Address Register (IIC0_HSADR)	1006
Figure 25-105. IIC0 Interrupt Mask Register (IIC0_INTRMSK)	1007
Figure 25-106. IIC0 Low Master Address Register (IIC0_LMADR)	1008
Figure 25-107. IIC0 Low Slave Address Register (IIC0_LSADR)	1009
Figure 25-108. IIC0 Master Data Buffer (IIC0_MDBUF)	1010
Figure 25-109. IIC0 Mode Control Register (IIC0_MDCNTL)	1011
Figure 25-110. IIC0 Slave Data Buffer (IIC0_SDBUF)	1012

Figure 25-111.	IIC0 Status Register (IIC0_STS)	1013
Figure 25-112.	IIC0 Transfer Count Register (IIC0_XFRCNT)	1014
Figure 25-113.	IIC0 Extended Control and Slave Status Register (IIC0_XTCNTLSS)	1015
Figure 25-114.	MAL Configuration Register (MAL0_CFG)	1017
Figure 25-115.	MAL Error Status Register (MAL0_ESR)	1019
Figure 25-116.	MAL Interrupt Enable Register (MAL0_IER)	1021
Figure 25-117.	RX Channel Buffer Size Register (MAL0_RCBS0)	1022
Figure 25-118.	RX Channel_Active Reset Register (MAL0_RXCARR)	1023
Figure 25-119.	RX Channel_Active Set Register (MAL0_RXCASR)	1024
Figure 25-120.	RX Channel Table Pointer Register (MAL0_RXCTPxR)	1025
Figure 25-121.	RX Descriptor Error Interrupt Register (MAL0_RXDEIR)	1026
Figure 25-122.	RX End of Buffer Interrupt Status Register (MAL0_RXEOBISR)	1027
Figure 25-123.	TX Channel Active Reset Register (MAL0_TXCARR)	1028
Figure 25-124.	TX Channel_Active Set Register (MAL0_TXCASR)	1029
Figure 25-125.	TX Channel Table Pointer Registers (MAL0_TXCTPxR)	1030
Figure 25-126.	TX Descriptor Error Interrupt Register (MAL0_TXDEIR)	1031
Figure 25-127.	TX End of Buffer Interrupt Status Register (MAL0_TXEOBISR)	1032
Figure 25-128.	OCM Data-Side Address Range Compare Register (OCM0_DSARC)	1033
Figure 25-129.	OCM Data-Side Control Register (OCM0_DSCNTL)	1034
Figure 25-130.	OCM Instruction-Side Address Range Compare Register (OCM0_ISARC)	1035
Figure 25-131.	OCM Instruction-Side Control Register (OCM0_ISCNTL)	1036
Figure 25-132.	OPB Arbiter Control Register (OPBA0_CR)	1037
Figure 25-133.	OPB Arbiter Priority Register (OPBA0_PR)	1038
Figure 25-134.	PCI Base Address Register (PCIC0_BAR0)	1039
Figure 25-135.	PCI Built-in Self Test Control Register (PCIC0_BIST)	1040
Figure 25-136.	Bridge Options 1 Register (PCIC0_BRDGOPT1)	1041
Figure 25-137.	Bridge Options 2 Register (PCIC0_BRDGOPT2)	1042
Figure 25-138.	PCI Cache Line Size Register (PCIC0_CACHELS)	1043
Figure 25-139.	PCI Capabilities Pointer (PCIC0_CAP)	1044
Figure 25-140.	Capability Identifier (PCIC0_CAPID)	1045
Figure 25-141.	PCI Configuration Address Register (PCIC0_CFGADDR)	1046
Figure 25-142.	PCI Configuration Data Register (PCIC0_CFGDATA)	1047
Figure 25-143.	PCI Class Register (PCIC0_CLS)	1048
Figure 25-144.	PCI Command Register (PCIC0_CMD)	1049
Figure 25-145.	PCI Data (PCIC0_DATA)	1051
Figure 25-146.	PCI Device ID Register (PCIC0_DEVID)	1052
Figure 25-147.	Error Enable Register (PCIC0_ERREN)	1053
Figure 25-148.	Error Status Register (PCIC0_ERRSTS)	1054
Figure 25-149.	PCI Header Type Register (PCIC0_HDTYPE)	1055
Figure 25-150.	PCI Interrupt Control/Status Register	1056
Figure 25-151.	PCI Interrupt Line Register (PCIC0_INTLN)	1057
Figure 25-152.	PCI Interrupt Pin Register (PCIC0_INTPN)	1058
Figure 25-153.	PCI Latency Timer Register (PCIC0_LATTIM)	1059
Figure 25-154.	PCI Maximum Latency Register (PCIC0_MAXLTNCY)	1060
Figure 25-155.	PCI Minimum Grant Register (PCIC0_MINGNT)	1061
Figure 25-156.	Next Item Pointer (PCIC0_NEXTIPTR)	1062
Figure 25-157.	PLB Slave Error Address Register (PCIC0_PLBBEAR)	1063

Preliminary User's Manual

Figure 25-158. PLB Slave Error Syndrome Register 0 (PCIC0_PLBBESR0)	1064
Figure 25-159. PLB Slave Error Syndrome 1 (PCIC0_PLBBESR1)	1066
Figure 25-160. Power Management Capabilities Register (PCIC0_PMC)	1067
Figure 25-161. Power Management Control/Status Register (PCIC0_PMCSR)	1068
Figure 25-162. PMCSR PCI to PCI Bridge Support Extensions (PCIC0_PMCSRBSE)	1069
Figure 25-163. Power Management State Change Request Register (PCIC0_PMSCRR)	1070
Figure 25-164. PCI PTM 1 BAR Register (PCIC0_PTM1BAR)	1071
Figure 25-165. PCI PTM 2 BAR Register (PCIC0_PTM2BAR)	1072
Figure 25-166. PCI Revision ID Register (PCIC0_REVID)	1073
Figure 25-167. PCI Subsystem ID Register (PCIC0_SBSYSID)	1074
Figure 25-168. PCI Subsystem Vendor ID Register (PCIC0_SBSYSVID)	1075
Figure 25-169. PCI Status Register (PCIC0_STATUS)	1076
Figure 25-170. PCI Vendor ID Register (PCIC0_VENDID)	1078
Figure 25-171. PMM 0 Local Address Register (PCIL0_PMM0LA)	1079
Figure 25-172. PMM 0 Mask/Attribute Register (PCIL0_PMM0MA)	1080
Figure 25-173. PMM 1 PCI High Address Register (PCIL0_PMM1PCIHA)	1081
Figure 25-174. PMM 0 PCI Low Address Register (PCIL0_PMM0PCILA)	1082
Figure 25-175. PMM 1 Local Address Register (PCIL0_PMM1LA)	1083
Figure 25-176. PMM 1 Mask/Attribute Register (PCIL0_PMM1MA)	1084
Figure 25-177. PMM 1 PCI High Address Register (PCIL0_PMM1PCIHA)	1085
Figure 25-178. PMM 1 PCI Low Address Register (PCIL0_PMM1PCILA)	1086
Figure 25-179. PMM 2 Local Address Register (PCIL0_PMM2LA)	1087
Figure 25-180. PMM 2 Mask/Attribute Register (PCIL0_PMM2MA)	1088
Figure 25-181. PMM 2 PCI High Address Register (PCIL0_PMM2PCIHA)	1089
Figure 25-182. PMM 2 PCI Low Address Register (PCIL0_PMM2PCILA)	1090
Figure 25-183. PTM 2 Local Address Register (PCIL0_PTM1LA)	1091
Figure 25-184. PTM 1 Memory Size/Attribute Register (PCIL0_PTM1MS)	1092
Figure 25-185. PTM 2 Local Address Register (PCIL0_PTM2LA)	1093
Figure 25-186. PTM 2 Memory Size/Attribute Register (PCIL0_PTM2MS)	1094
Figure 25-187. PLB Arbiter Control Register (PLB0_ACR)	1095
Figure 25-188. PLB Error Address Register (PLB0_BEAR)	1096
Figure 25-189. PLB Error Status Register (PLB0_BESR)	1097
Figure 25-190. Bridge Error Address Register (POB0_BEAR)	1099
Figure 25-191. Bridge Error Status Register 0 (POB0_BESR0)	1100
Figure 25-192. Bridge Error Status Register 1 (POB0_BESR1)	1102
Figure 25-193. Memory Bank 0–3 Configuration Registers (SDRAM0_B0CR–SDRAM0_B3CR)	1103
Figure 25-194. Bus Error Address Register (SDRAM0_BEAR)	1104
Figure 25-195. Bus Error Syndrome Register 0 (SDRAM0_BESR0)	1105
Figure 25-196. Bus Error Status Register 1 (SDRAM0_BESR1)	1107
Figure 25-197. Memory Controller Configuration (SDRAM0_CFG)	1108
Figure 25-198. SDRAM Configuration Address Register (SDRAM0_CFGADDR)	1109
Figure 25-199. SDRAM Configuration Data Register (SDRAM0_CFGDATA)	1110
Figure 25-200. ECC Configuration Register (SDRAM0_ECCCFG)	1111
Figure 25-201. ECC Error Status Register (SDRAM0_ECCEsr)	1112
Figure 25-202. Power Management Idle Timer (SDRAM0_PMIT)	1113
Figure 25-203. Refresh Timing Register (SDRAM0_RTR)	1114
Figure 25-204. Memory Controller Status (SDRAM0_STATUS)	1115

Figure 25-205. SDRAM Timing Register (SDRAM0_TR)	1116
Figure 25-206. UART Baud-Rate Divisor Latch (LSB) Registers (UARTx_DLL)	1118
Figure 25-207. UART Baud-Rate Divisor Latch (MSB) Registers (UARTx_DLM)	1119
Figure 25-208. UART FIFO Control Registers (UARTx_FCR)	1120
Figure 25-209. UART Interrupt Enable Registers (UARTx_IER)	1121
Figure 25-210. UART Interrupt Identification Registers (UARTx_IIR)	1122
Figure 25-211. UART Line Control Registers (UARTx_LCR)	1123
Figure 25-212. UART Line Status Registers (UARTx_LSR)	1124
Figure 25-213. UART Modem Control Registers (UARTx_MCR)	1126
Figure 25-214. UART Modem Status Registers (UARTx_MSR)	1127
Figure 25-215. UART Receiver Buffer Registers (UARTx_RBR)	1128
Figure 25-216. Scratchpad Registers (UARTx_SCR)	1129
Figure 25-217. UART Transmitter Holding Registers (UARTx_THR)	1130
Figure 25-218. UIC Critical Register (UIC0_CR)	1131
Figure 25-219. UIC Enable Register (UIC0_ER)	1133
Figure 25-220. UIC Masked Status Register (UIC0_MSR)	1135
Figure 25-221. UIC Polarity Register (UIC0_PR)	1138
Figure 25-222. UIC Status Register (UIC0_SR)	1140
Figure 25-223. UIC Trigger Register (UIC0_TR)	1143
Figure 25-224. UIC Vector Configuration Register (UIC0_VCR)	1146
Figure 25-225. UIC Vector Register (UIC0_VR)	1147
Figure A-1. I Instruction Format	1201
Figure A-2. B Instruction Format	1201
Figure A-3. SC Instruction Format	1202
Figure A-4. D Instruction Format	1202
Figure A-5. X Instruction Format	1203
Figure A-6. XL Instruction Format	1203
Figure A-7. XFX Instruction Format	1204
Figure A-8. XO Instruction Format	1204
Figure A-9. M Instruction Format	1204

Preliminary User's Manual**Tables**

Table 2-1. PPC405GP PLB Agents as Masters and Slaves.....	64
Table 2-2. Registers Controlling PLB Master Priority Assignments.....	65
Table 2-3. PLB Arbiter Registers.....	67
Table 2-4. PLB-OPB Bridge Registers.....	71
Table 2-5. PPC405GP OPB Master Assignments.....	74
Table 2-6. OPB Arbiter Registers.....	75
Table 3-1. PPC405GP Address Space.....	80
Table 3-2. PPC405GP SPRs.....	84
Table 3-3. XER[CA] Updating Instructions.....	88
Table 3-4. XER[SO,OV] Updating Instructions.....	89
Table 3-5. Time Base Registers.....	95
Table 3-6. Directly Accessed DCRs.....	97
Table 3-7. SDRAM Controller DCR Usage.....	99
Table 3-8. Offsets for SDRAM Controller Registers.....	99
Table 3-9. EBC DCR Usage.....	100
Table 3-10. Offsets for EBC Registers.....	100
Table 3-11. Decompression Controller DCR Usage.....	101
Table 3-12. Offsets for Decompression Controller Registers.....	101
Table 3-13. Directly Accessed MMIO Registers.....	102
Table 3-14. PCI Configuration Address and Data Registers.....	105
Table 3-15. PCI Configuration Registers.....	105
Table 3-16. Alignment Exception Summary.....	107
Table 3-17. Bits of the BO Field.....	116
Table 3-18. Conditional Branch BO Field.....	117
Table 3-19. Example Memory Mapping.....	121
Table 3-20. Privileged Instructions.....	123
Table 3-21. PPC405GP Instruction Set Summary.....	128
Table 3-22. Implementation-specific Instructions.....	128
Table 3-23. Storage Reference Instructions.....	129
Table 3-24. Arithmetic Instructions.....	129
Table 3-25. Multiply-Accumulate and Multiply Halfword Instructions.....	130
Table 3-26. Logical Instructions.....	130
Table 3-27. Compare Instructions.....	130
Table 3-28. Branch Instructions.....	131
Table 3-29. CR Logical Instructions.....	131
Table 3-30. Rotate Instructions.....	131
Table 3-31. Shift Instructions.....	132
Table 3-32. Cache Management Instructions.....	132
Table 3-33. Interrupt Control Instructions.....	132
Table 3-34. TLB Management Instructions.....	133
Table 3-35. Processor Management Instructions.....	133
Table 4-1. Instruction Cache Organization.....	136
Table 4-2. Data Cache Organization.....	139

Table 4-3. Priority Changes With Different Data Cache Operations	150
Table 5-1. Examples of Store Data Bypass	156
Table 5-2. OCM DCRs	157
Table 6-1. TLB Fields Related to Page Size	164
Table 6-2. Protection Applied to Cache Control Instructions	175
Table 7-1. Clock Strapping Values	185
Table 7-2. PLL Tuning Settings	186
Table 7-3. Possible Clocking Ratios for Reference Clock of 33.3MHz	187
Table 7-4. Possible Clocking Ratios for Reference Clock of 25MHz	188
Table 7-5. Possible Clocking Ratios for Reference Clock of 41.6MHz	189
Table 7-6. Acceptable PCI Asynchronous Clock Frequency Range	190
Table 7-7. Example Synchronous PCI Clock Frequencies in Asynchronous Mode	191
Table 7-8. Clocking Control Registers	192
Table 8-1. MSR Contents after Reset	199
Table 8-2. SPR Contents After Reset	200
Table 8-3. DCR Contents After Reset	201
Table 8-4. MMIO Register Contents After Reset	205
Table 9-1. Multiplexed Pins	217
Table 10-1. UIC Interrupt Assignments	220
Table 10-2. UIC DCRs	221
Table 10-3. Interrupt Handling Priorities	247
Table 10-4. Interrupt Vector Offsets	250
Table 10-5. ESR Alteration by Various Interrupts	256
Table 10-6. Register Settings during Critical Input Interrupts	258
Table 10-7. Register Settings during Machine Check—Instruction Interrupts	259
Table 10-8. Register Settings during Machine Check—Data Interrupts	259
Table 10-9. Register Settings during Data Storage Interrupts	260
Table 10-10. Register Settings during Instruction Storage Interrupts	261
Table 10-11. Register Settings during External Interrupts	262
Table 10-12. Alignment Interrupt Summary	263
Table 10-13. Register Settings during Alignment Interrupts	263
Table 10-14. ESR Usage for Program Interrupts	264
Table 10-15. Register Settings during Program Interrupts	264
Table 10-16. Register Settings during System Call Interrupts	265
Table 10-17. Register Settings during Programmable Interval Timer Interrupts	265
Table 10-18. Register Settings during Fixed Interval Timer Interrupts	266
Table 10-19. Register Settings during Watchdog Timer Interrupts	267
Table 10-20. Register Settings during Data TLB Miss Interrupts	267
Table 10-21. Register Settings during Instruction TLB Miss Interrupts	268
Table 10-22. SRR2 during Debug Interrupts	268
Table 10-23. Register Settings during Debug Interrupts	269
Table 11-1. Time Base Access	273
Table 11-2. FIT Controls	275
Table 11-3. Watchdog Timer Controls	276
Table 12-1. JTAG Instructions	282
Table 12-2. Debug Events	294
Table 12-3. DAC Applied to Cache Instructions	299

Preliminary User's Manual

Table 12-4. Setting of DBSR Bits for DAC and DVC Events	300
Table 12-5. Comparisons Based on DBCR1[DVnM]	301
Table 12-6. Comparisons for Aligned DVC Accesses	302
Table 12-7. Comparisons for Misaligned DVC Accesses	302
Table 13-1. CPM Registers.....	303
Table 14-2. Offsets for Decompression Controller Registers	310
Table 14-1. DCRs Used to Access the Decompression Controller Registers	310
Table 14-3. Index Offset Format.....	319
Table 14-4. 512 Entry Index Table Bucketing/Address Generation.....	320
Table 14-5. Decode Lookup Table Topologies	321
Table 15-1. SDRAM Signal Usage and State During/Following Reset.....	328
Table 15-2. SDRAM Controller DCR Addresses	329
Table 15-3. SDRAM Controller Configuration and Status Registers	329
Table 15-4. SDRAM Addressing Modes	333
Table 15-5. SDRAM Page Size	334
Table 15-6. Logical Address Bit on BA1:0 and MemAddr12:0 Versus Addressing Mode.	334
Table 15-7. SDRAM Memory Timing Parameters	337
Table 15-8. Additional Latency when using ECC.....	341
Table 16-1. EBC Signal Usage and State During and After Chip and System Resets.....	352
Table 16-2. Effect of Driver Enable Programming on EBC Signal States.....	355
Table 16-3. External Master Arbitration.	369
Table 16-4. Signal States During Hold Acknowledge (HoldAck=1)	369
Table 16-5. EBC DCR Addresses.....	374
Table 16-6. EBC Configuration and Status Registers.....	374
Table 17-1. PowerPC, CoreConnect PLB, and PCI Address Bit-Naming Conventions.....	386
Table 17-2. PowerPC, CoreConnect PLB, and PCI Data Bus Bit-Naming Conventions	387
Table 17-3. PLB Address Map.....	390
Table 17-4. PCI Memory Address Map.....	392
Table 17-5. Transaction Mapping: PLB → PCI.....	394
Table 17-6. Transaction Mapping: PCI → PLB.....	398
Table 17-7. Collision Resolution	403
Table 17-8. Directly Accessed MMIO Registers	403
Table 17-9. PCI Configuration Address and Data Registers	404
Table 17-10. PCI Configuration Register Offsets.....	404
Table 17-11. PLB Unsupported Transfer Types	439
Table 17-12. Address Map Register Values	445
Table 18-1. DMA Controller External I/Os	501
Table 18-2. DMA Controller Configuration and Status Registers	504
Table 18-3. DMA Transfer Priorities	513
Table 18-4. Address Alignment Requirements	514
Table 18-5. Scatter/Gather Descriptor Table	515
Table 18-6. Bit Fields in the Scatter/Gather Descriptor Table	515
Table 18-7. DMA Registers Loaded from Scatter/Gather Descriptor Table.....	516
Table 19-1. FCS/SA Enable - Possible Configurations.....	534
Table 19-2. FCS/Pad Enable - Possible Configurations	535
Table 19-3. FCS/VLAN Tag Enable - Possible Configurations.....	535
Table 19-4. In Range Length Error Behavior for Various Packet Lengths.....	536

Table 19-5. EMAC0 Register Summary.....	546
Table 20-1. MAL Register Summary.....	596
Table 21-1. Baud Rate Settings.....	609
Table 21-2. UART Configuration Registers	611
Table 21-3. Interrupt Priority Level.....	614
Table 21-4. Divisor Latch Settings for Certain Baud Rates	623
Table 21-5. UART0 Transmitter DMA Mode Register Field Settings.....	628
Table 21-6. UART0 Receiver DMA Mode Register Field Settings.....	629
Table 22-1. IIC Registers	633
Table 22-2. IIC Response to IIC0_CNTL Field Settings	639
Table 22-3. IIC0_STS[ERR, PT] Decoding.....	642
Table 22-4. IIC0 Clock Divide Programming.....	647
Table 23-1. Macro I/O Interface Signals	657
Table 23-2. GPIO Register Summary	659
Table 23-3. GPIO0_ODR Control Logic.....	660
Table 24-1. Implementation-Specific Instructions	663
Table 24-2. Operator Precedence	666
Table 24-3. Extended Mnemonics for addi	671
Table 24-4. Extended Mnemonics for addic	672
Table 24-5. Extended Mnemonics for addic.	673
Table 24-6. Extended Mnemonics for addis	674
Table 24-7. Extended Mnemonics for bc, bca, bcl, bcla	683
Table 24-8. Extended Mnemonics for bcctr, bcctrl.....	689
Table 24-9. Extended Mnemonics for bclr, bclrl.....	692
Table 24-10. Extended Mnemonics for cmp	696
Table 24-11. Extended Mnemonics for cmpi	697
Table 24-12. Extended Mnemonics for cmpl	698
Table 24-13. Extended Mnemonics for cmpli.....	699
Table 24-14. Extended Mnemonics for creqv	703
Table 24-15. Extended Mnemonics for crnor	705
Table 24-16. Extended Mnemonics for cror.....	706
Table 24-17. Extended Mnemonics for crxor	708
Table 24-18. Transfer Bit Mnemonic Assignment.....	770
Table 24-19. Extended Mnemonics for mfspr	775
Table 24-20. Extended Mnemonics for mftb	776
Table 24-21. Extended Mnemonics for mftb	777
Table 24-22. Extended Mnemonics for mtrcf	778
Table 24-23. Extended Mnemonics for mtspr	782
Table 24-24. Extended Mnemonics for nor, nor.....	801
Table 24-25. Extended Mnemonics for or, or.....	802
Table 24-26. Extended Mnemonics for ori	804
Table 24-27. Extended Mnemonics for rlwimi, rlwimi.	808
Table 24-28. Extended Mnemonics for rlwinm, rlwinm.	809
Table 24-29. Extended Mnemonics for rlwnm, rlwnm.	812
Table 24-30. Extended Mnemonics for subf, subf., subfo, subfo.....	838
Table 24-31. Extended Mnemonics for subfc, subfc., subfco, subfco.....	839
Table 24-32. Extended Mnemonics for tlbre	847

Preliminary User's Manual

Table 24-33. Extended Mnemonics for tlwbe.....	851
Table 24-34. Extended Mnemonics for tw	853
Table 24-35. Extended Mnemonics for twi.....	856
Table 25-1. PPC405GP General Purpose Registers.....	863
Table 25-2. Special Purpose Registers	864
Table 25-3. Time Base Registers	866
Table 25-4. Directly Accessed DCRs.....	866
Table 25-5. SDRAM Controller DCR Usage	869
Table 25-6. Offsets for SDRAM Controller Registers	869
Table 25-7. EBC DCR Usage	870
Table 25-8. Offsets for EBC Registers.....	870
Table 25-9. Decompression Controller DCR Usage	871
Table 25-10. Offsets for Decompression Controller Registers	871
Table 25-11. Directly Accessed MMIO Registers	872
Table 25-12. PCI Configuration Address and Data Registers	875
Table 25-13. PCI Configuration Registers	875
Table 26-1. Alphabetical Signal List.....	1149
Table 26-2. Signal Descriptions	1153
Table A-1. PPC405GP Instruction Syntax Summary.....	1159
Table A-2. PPC405GP Instructions by Opcode	1192
Table B-1. PPC405GPr Instruction Set Categories	1205
Table B-2. Implementation-specific Instructions	1205
Table B-3. Instructions in the IBM PowerPC Embedded Environment	1209
Table B-4. Privileged Instructions	1211
Table B-5. Extended Mnemonics for PPC405GPr.....	1213
Table B-6. Storage Reference Instructions.....	1232
Table B-7. Arithmetic and Logical Instructions.....	1236
Table B-8. Condition Register Logical Instructions	1240
Table B-9. Branch Instructions.....	1241
Table B-10. Comparison Instructions.....	1242
Table B-11. Rotate and Shift Instructions	1243
Table B-12. Cache Control Instructions	1244
Table B-13. Interrupt Control Instructions	1245
Table B-14. TLB Management Instructions	1245
Table B-15. Processor Management Instructions.....	1247
Table C-1. Cache Sizes, Tag Fields, and Lines.....	1250
Table C-2. Multiply and MAC Instruction Timing.....	1253
Table C-3. Instruction Cache Miss Penalties	1255

Preliminary User's Manual

About This Book

This user's manual provides the architectural overview, programming model, and detailed information about the registers, the instruction set, and operations of the PowerPC™ 405GP (PPC405GP) 32-bit RISC embedded processor.

The PPC405GP RISC embedded processor features:

- PowerPC Architecture™
- Single-cycle execution for most instructions
- Instruction cache unit and data cache unit
- Support for little endian operation
- Interrupt interface for one critical and one non-critical interrupt signal
- JTAG interface
- Extensive development tool support

Who Should Use This Book

This book is for system hardware and software developers, and for application developers who need to understand the PPC405GP. The audience should understand embedded processor design, embedded system design, operating systems, RISC processing, and design for testability.

How to Use This Book

This book describes the PPC405GP device architecture, programming model, external interfaces, internal registers, and instruction set. This book contains the following chapters, arranged in parts:

Part I Introducing the PPC405GP Embedded Processor

- Chapter 1 Overview
- Chapter 2 On-Chip Buses

Part II The PPC405GP RISC Processor

- Chapter 3 Programming Model
- Chapter 4 Cache Operations
- Chapter 5 On-Chip Memory
- Chapter 6 Memory Management

Part III PPC405GP System Operations

- Chapter 7 Clocking
- Chapter 8 Reset and Initialization
- Chapter 9 Pin Strapping and Sharing
- Chapter 10 Interrupt Controller Operations
- Chapter 11 Timer Facilities
- Chapter 12 Debugging
- Chapter 13 Clock and Power Management
- Chapter 14 Decompression Controller Operation

Part IV PPC405GP External Interfaces

- Chapter 15 SDRAM Controller
- Chapter 16 External Bus Controller
- Chapter 17 PCI Interface
- Chapter 18 Direct Memory Access Controller
- Chapter 19 Ethernet Media Access Controller
- Chapter 20 Memory Access Layer
- Chapter 21 Serial Port Operations
- Chapter 22 IIC Bus Interface
- Chapter 23 GPIO Operations

Part V Reference

- Chapter 24 Instruction Set
- Chapter 25 Register Summary
- Chapter 26 Signal Summary

This book contains the following appendixes:

- Appendix A Instruction Summary
- Appendix B Instructions by Category
- Appendix C Code Optimization and Instruction Timings

To help readers find material in these chapters, the book contains:

- Contents, on page 3.
- Figures, on page 27.
- Tables, on page 39.

Preliminary User's Manual

Index, on page X-1259.

Conventions

The following is a list of notational conventions frequently used in this manual.

$\overline{\text{ActiveLow}}$	An overbar indicates an active-low signal.
n	A decimal number
$0xn$	A hexadecimal number
$0bn$	A binary number
$=$	Assignment
\wedge	AND logical operator
\neg	NOT logical operator
\vee	OR logical operator
\oplus	Exclusive-OR (XOR) logical operator
$+$	Twos complement addition
$-$	Twos complement subtraction, unary minus
\times	Multiplication
\div	Division yielding a quotient
$\%$	Remainder of an integer division; $(33 \% 32) = 1$.
$\ $	Concatenation
$=, \neq$	Equal, not equal relations
$<, >$	Signed comparison relations
\lessgtr, \gtrless	Unsigned comparison relations
if...then...else...	Conditional execution; if <i>condition</i> then <i>a</i> else <i>b</i> , where <i>a</i> and <i>b</i> represent one or more pseudocode statements. Indenting indicates the ranges of <i>a</i> and <i>b</i> . If <i>b</i> is null, the else does not appear.
do	Do loop. “to” and “by” clauses specify incrementing an iteration variable; “while” and “until” clauses specify terminating conditions. Indenting indicates the scope of a loop.
leave	Leave innermost do loop or do loop specified in a leave statement.
FLD	An instruction or register field
FLD_b	A bit in a named instruction or register field
$\text{FLD}_{b:b}$	A range of bits in a named instruction or register field
$\text{FLD}_{b,b, \dots}$	A list of bits, by number or name, in a named instruction or register field
REG_b	A bit in a named register
$\text{REG}_{b:b}$	A range of bits in a named register
$\text{REG}_{b,b, \dots}$	A list of bits, by number or name, in a named register

REG[FLD]	A field in a named register
REG[FLD, FLD . . .]	A list of fields in a named register
REG[FLD:FLD]	A range of fields in a named register
GPR(<i>r</i>)	General Purpose Register (GPR) <i>r</i> , where $0 \leq r \leq 31$.
(GPR(<i>r</i>))	The contents of GPR <i>r</i> , where $0 \leq r \leq 31$.
DCR(DCRN)	A Device Control Register (DCR) specified by the DCRF field in an mfocr or mtocr instruction
SPR(SPRN)	An SPR specified by the SPRF field in an mfspir or mtspir instruction
TBR(TBRN)	A Time Base Register (TBR) specified by the TBRF field in an mftrb instruction
GPRs	RA, RB, . . .
(Rx)	The contents of a GPR, where <i>x</i> is A, B, S, or T
(RA 0)	The contents of the register RA or 0, if the RA field is 0.
CR _{FLD}	The field in the condition register pointed to by a field of an instruction.
c _{0:3}	A 4-bit object used to store condition results in compare instructions.
ⁿ b	The bit or bit value <i>b</i> is replicated <i>n</i> times.
xx	Bit positions which are don't-cares.
CEIL(<i>x</i>)	Least integer $\geq x$.
EXTS(<i>x</i>)	The result of extending <i>x</i> on the left with sign bits.
PC	Program counter.
RESERVE	Reserve bit; indicates whether a process has reserved a block of storage.
CIA	Current instruction address; the 32-bit address of the instruction being described by a sequence of pseudocode. This address is used to set the next instruction address (NIA). Does not correspond to any architected register.
NIA	Next instruction address; the 32-bit address of the next instruction to be executed. In pseudocode, a successful branch is indicated by assigning a value to NIA. For instructions that do not branch, the NIA is CIA +4.
MS(addr, <i>n</i>)	The number of bytes represented by <i>n</i> at the location in main storage represented by <i>addr</i> .
EA	Effective address; the 32-bit address, derived by applying indexing or indirect addressing rules to the specified operand, that specifies a location in main storage.
EA _b	A bit in an effective address.
EA _{b:b}	A range of bits in an effective address.
ROTL((RS), <i>n</i>)	Rotate left; the contents of RS are shifted left the number of bits specified by <i>n</i> .
MASK(MB,ME)	Mask having 1s in positions MB through ME (wrapping if MB > ME) and 0s elsewhere.
instruction(EA)	An instruction operating on a data or instruction cache block associated with an EA.

Part I. Introducing the PPC405GP Embedded Processor

Chapter 1. Overview

The AMCC PowerPC 405GP 32-bit reduced instruction set computer (RISC) embedded processor, referred to as the PPC405GP, is a system-on-a-chip (SOC) that integrates a PowerPC embedded processor core with a rich set of on-chip peripherals:

- SDRAM controller
- External bus controller (EBC)
- PCI bus interface
- Direct memory access (DMA) with scatter/gather support
- Ethernet and media access layer (MAL) interfaces
- Two serial ports
- Inter-integrated circuit (IIC) interface
- General-purpose input/output (GPIO)

In addition, the PPC405GP supports CodePack™, a code compression scheme that can significantly reduce application code memory requirements, and a variety of debug tools.

This chapter describes:

- PPC405GP features
- The PowerPC Architecture™
- The PPC405GP implementation of the AMCC PowerPC Embedded Environment, an extension of the PowerPC Architecture for embedded applications
- PPC405GP organization, including a block diagram and descriptions of the functional units
- PPC405GP registers
- PPC405GP addressing modes

Figure 1-1 illustrates the logical organization of the PPC405GP:

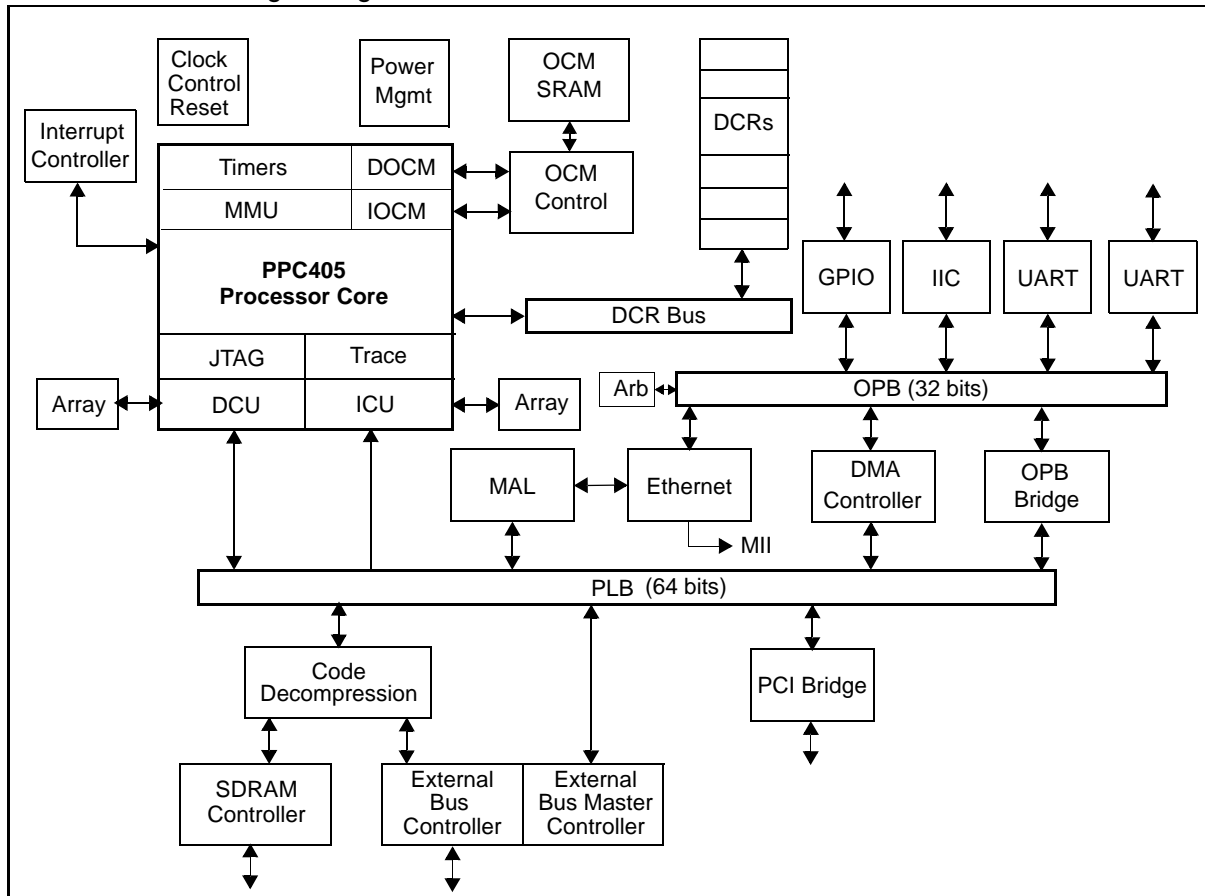

Figure 1-1. PPC405GP Block Diagram

1.1 PPC405GP Features

The PPC405GP provides high performance and low power consumption. The PPC405GP RISC CPU executes at sustained speeds approaching one cycle per instruction. On-chip instruction and data caches reduce chip count and design complexity in systems and improve system throughput.

1.1.1 Bus and Peripheral Features

The PPC405GP multilevel bus architecture and peripherals feature:

- Processor local bus (PLB)
- On-chip peripheral bus (OPB)
- Synchronous DRAM (SDRAM) controller
 - 32-bit interface for non-ECC applications
 - 40-bit interface (32 data bits and 8 check bits) for ECC applications
- External bus controller (EBC)
 - Flash ROM/Boot ROM interface
 - Direct support for 8-, 16-, or 32-bit SRAM or external peripherals

Preliminary User's Manual

- One external master supported
- PCI bus, Revision 2.2 compliant (32-bit, up to 66 MHz)
 - PCI bus interface can be configured to operate synchronously or asynchronously to the PLB
 - Internal PCI bus arbiter that can be disabled for use with an external arbiter
- DMA support for OPB and external peripherals
- Ethernet 10/100 Mbps (full-duplex) controller with media access layer (MAL) support
- Interrupt controller supporting programmable interrupt handling from a variety of sources
- Two 8-bit serial ports (16550 compatible UARTs)
- Inter-integrated circuit (IIC) controller
- General purpose I/O (GPIO) controller

1.1.2 PowerPC Processor Core Features

The PowerPC RISC fixed-point CPU features:

- PowerPC User Instruction Set Architecture (UIA) and extensions for embedded applications
- Thirty-two 32-bit general purpose registers (GPRs)
- Static branch prediction
- Five-stage pipeline with single-cycle execution of most instructions, including loads/stores
- Unaligned load/store support to cache arrays, main memory, and on-chip memory (OCM)
- Hardware multiply/divide for faster integer arithmetic (4-cycle multiply, 35-cycle divide)
- Multiply-accumulate instructions
- Enhanced string and multiple-word handling
- True little endian operation
- Programmable Interval Timer (PIT), Fixed Interval Timer (FIT), and watchdog timer
- Forward and reverse trace from a trigger event
- Storage control
 - Separate, configurable, two-way set-associative instruction and data cache units
 - Eight words (32 bytes) per cache line
 - 16KB instruction and 8KB data cache arrays
 - Instruction cache unit (ICU) non-blocking during line fills, data cache unit (DCU) non-blocking during line fills and flushes
 - Read and write line buffers
 - Instruction fetch hits are supplied from line buffer
 - Data load/store hits can be made from and to a line fill buffer
 - Programmable ICU prefetching of next sequential line into a line fill buffer
 - Programmable ICU prefetching of non-cacheable instructions, full line (eight words) or half line (four words)
 - Write-back or write-through DCU write strategies

- Programmable allocation on loads and stores
- Operand forwarding during cache line fills
- Memory Management
 - Translation of the 4GB logical address space into physical addresses
 - Independent enabling of instruction and data translation/protection
 - Page level access control using the translation mechanism
 - Software control of page replacement strategy
 - Additional control over protection using zones
 - WIU0GE (write-through, cachability, compresseduser-defined 0, guarded, endian) storage attribute control for each virtual memory region
- WIU0GE storage attribute control for thirty-two real 128MB regions
- PowerPC timer facilities
 - 64-bit time base
 - PIT, FIT, and watchdog timers
 - Synchronous external time base clock input
- Debug Support
 - Enhanced debug support with logical operators
 - Four instruction address compares (IACs)
 - Two data address compares (DACs)
 - Two data value compares (DVCs)
 - JTAG instruction to write to ICU
 - Forward or backward instruction tracing
- Minimized interrupt latency
- Advanced power management support

1.2 PowerPC Architecture

The PowerPC Architecture comprises three levels of standards:

- PowerPC User Instruction Set Architecture (UIISA), including the base user-level instruction set, user-level registers, programming model, data types, and addressing modes. This is referred to as Book I of the PowerPC Architecture.
- PowerPC Virtual Environment Architecture, describing the memory model, cache model, cache-control instructions, address aliasing, and related issues. While accessible from the user level, these features are intended to be accessed from within library routines provided by the system software. This is referred to as Book II of the PowerPC Architecture.
- PowerPC Operating Environment Architecture, including the memory management model, supervisor-level registers, and the exception model. These features are not accessible from the user level. This is referred to as Book III of the PowerPC Architecture.

Preliminary User's Manual

Book I and Book II define the instruction set and facilities available to the application programmer. Book III defines features, such as system-level instructions, that are not directly accessible by user applications. The PowerPC Architecture is described in *The PowerPC Architecture: A Specification for a New Family of RISC Processors*.

The PowerPC Architecture provides compatibility of PowerPC Book I application code across all PowerPC implementations to help maximize the portability of applications developed for PowerPC processors. This is accomplished through compliance with the first level of the architectural definition, the PowerPC UISA, which is common to all PowerPC implementations.

1.3 The PPC405GP as a PowerPC Implementation

The PPC405GP implements the PowerPC UISA, user-level registers, programming model, data types, addressing modes, and 32-bit fixed-point operations. The PPC405GP fully complies with the PowerPC UISA. The UISA 64-bit and floating-point operations are not implemented. The floating point operations, which cause exceptions, can then be emulated by software.

Most of the features of the PPC405GP processor core are compatible with the PowerPC Virtual Environment and Operating Environment Architectures, as implemented in PowerPC processors such as the 6xx/7xx family. The PPC405GP processor core also provides a number of optimizations and extensions to these layers of the PowerPC Architecture. The full architecture of the PPC405GP is defined by the PowerPC Embedded Environment and the PowerPC User Instruction Set Architecture.

The primary extensions of the PowerPC Architecture defined in the Embedded Environment are:

- A simplified memory management mechanism with enhancements for embedded applications
- An enhanced, dual-level interrupt structure
- An architected DCR address space for integrated peripheral control
- The addition of several instructions to support these modified and extended resources

Finally, some of the specific implementation features of the PPC405GP are beyond the scope of the PowerPC Architecture. These features are included to enhance performance, integrate functionality, and reduce system complexity in embedded control applications.

1.4 RISC Processor Core Organization

The processor core consists of a 5-stage pipeline, separate instruction and data cache units, virtual memory management unit (MMU), three timers, debug, and interfaces to other functions.

1.4.1 Instruction and Data Cache Controllers

The PPC405GP processor core provides a 16KB instruction cache unit (ICU) and an 8KB data cache unit (DCU) to enable concurrent accesses and minimize pipeline stalls. Both cache units are two-way set-associative and use a 32-byte line size. The instruction set provides a rich assortment of cache control instructions, including instructions to read tag information and data arrays. See Chapter 4, "Cache Operations," for detailed information about the ICU and DCU.

1.4.1.1 Instruction Cache Unit

The ICU provides one or two instructions per cycle to the execution unit (EXU) over a 64-bit bus. A line buffer enables the ICU to be accessed only once for every four instructions, to reduce power consumption by the array.

The ICU can forward any or all of the words of a line fill to the EXU to minimize pipeline stalls caused by cache misses. The ICU aborts speculative fetches abandoned by the EXU, eliminating unnecessary line fills and enabling the ICU to handle the next EXU fetch. Aborting abandoned requests also eliminates unnecessary PLB activity to increase PLB availability for other on-chip cores, such as the EBC and Ethernet controllers.

1.4.1.2 Data Cache Unit

The DCU transfers 1, 2, 3, 4, or 8 bytes per cycle, depending on the number of byte enables presented by the CPU. The DCU contains a single-element command and store data queue to reduce pipeline stalls; this queue enables the DCU to independently process load/store and cache control instructions. Dynamic PLB request prioritization reduces pipeline stalls even further. When the DCU is busy with a low-priority request while a subsequent storage operation requested by the CPU is stalled, the DCU automatically increases the priority of the current request to the PLB.

The DCU uses a two-line flush queue to minimize pipeline stalls caused by cache misses. Line flushes are postponed until after a line fill is completed. Pipeline stalls are further reduced by forwarding the requested word to the CPU during the line fill. Single-queued flushes are non-blocking. When a flush operation is pending, the DCU can continue to access the array to determine subsequent load or store hits. Under these conditions, load hits can occur concurrently with store hits to write-back memory without stalling the pipeline. Requests abandoned by the CPU can also be aborted by the cache controller.

Additional DCU features enable the programmer to tailor performance for a given application. The DCU can function in write-back or write-through mode, as controlled by the Data Cache Write-through Register (DCWR) or the translation look-aside buffer (TLB). DCU performance can be tuned to balance performance and memory coherency. Store-without-allocate, controlled by the SWOA field of the Core Configuration Register 0 (CCR0), can inhibit line fills caused by store misses to further reduce potential pipeline stalls and unwanted external bus traffic. Similarly, load-without-allocate, controlled by CCR0[LWOA], can inhibit line fills caused by load misses.

1.4.2 Memory Management Unit

The 4GB address space of the PPC405GP is presented as a flat address space.

The MMU provides address translation, protection functions, and storage attribute control for embedded applications. The MMU supports demand paged virtual memory and other management schemes that require precise control of logical to physical address mapping and flexible memory protection. Working with appropriate system level software, the MMU provides the following functions:

- Translation of the 4GB logical address space into physical addresses
- Independent enabling of instruction and data translation/protection
- Page level access control using the translation mechanism
- Software control of page replacement strategy
- Additional control over protection using zones
- Storage attributes for cache policy and speculative memory access control

Preliminary User's Manual

The MMU can be disabled under software control. If the MMU is not used, the PPC405GP provides other storage control mechanisms.

The translation lookaside buffer (TLB) is the hardware resource that controls translation and protection. It consists of 64 entries, each specifying a page to be translated. The TLB is fully associative; a page entry can be placed anywhere in the TLB. The translation function of the MMU occurs pre-cache for data accesses. Cache tags and indexing use physical addresses for data accesses; instruction fetches are virtually indexed and physically tagged.

Software manages the establishment and replacement of TLB entries. This gives system software significant flexibility in implementing a custom page replacement strategy. For example, to reduce TLB thrashing or translation delays, software can reserve several TLB entries for globally accessible static mappings. The instruction set provides several instructions to manage TLB entries. These instructions are privileged and require the software to be executing in supervisor state. Additional TLB instructions are provided to move TLB entry fields to and from GPRs.

The MMU divides logical storage into pages. Eight page sizes (1KB, 4KB, 16KB, 64KB, 256KB, 1MB, 4MB, 16MB) are simultaneously supported, so that, at any given time, the TLB can contain entries for any combination of page sizes. For a logical to physical translation to occur, a valid entry for the page containing the logical address must be in the TLB. Addresses for which no TLB entry exists cause TLB-Miss exceptions.

To improve performance, 4 instruction-side and 8 data-side TLB entries are kept in shadow arrays. The shadow arrays prevent TLB contention. Hardware manages the replacement and invalidation of shadow-TLB entries; no system software action is required. The shadow arrays can be thought of as level 1 TLBs, with the main TLB serving as a level 2 TLB.

When address translation is enabled, the translation mechanism provides a basic level of protection. Physical addresses not mapped by a page entry are inaccessible when translation is enabled. Read access is implied by the existence of the valid entry in the TLB. The EX and WR bits in the TLB entry further define levels of access for the page, by permitting execute and write access, respectively.

The Zone Protection Register (ZPR) enables the system software to override the TLB access controls. For example, the ZPR provides a way to deny read access to application programs. The ZPR can be used to classify storage by type; access by type can be changed without manipulating individual TLB entries.

The PowerPC Architecture provides WIU0GE (write-back/write through, cachability, user-defined 0, guarded, endian) storage attributes that control memory accesses, using bits in the TLB or, when address translation is disabled, storage attribute control registers.

When address translation is enabled ($MSR[IR, DR] = 1$), storage attribute control bits in the TLB control the storage attributes associated with the current page. When address translation is disabled ($MSR[IR, DR] = 0$), bits in each storage attribute control register control the storage attributes associated with storage regions. Each storage attribute control register contains 32 fields. Each field sets the associated storage attribute for a 128MB memory region. See “Real-Mode Storage Attribute Control” on page 6-177 for more information about the storage attribute control registers.

1.4.3 Timer Facilities

The processor core contains a time base and three timers:

- Programmable Interval Timer (PIT)
- Fixed Interval Timer (FIT)
- Watchdog timer

The time base is a 64-bit counter incremented either by an internal signal equal to the CPU clock rate or by a separate external timer clock signal. No interrupts are generated when the time base rolls over.

The PIT is a 32-bit register that is decremented at the same rate as the time base is incremented. The user loads the PIT register with a value to create the desired delay. When a decrement occurs on a PIT count of 1, the timer stops decrementing, a bit is set in the Timer Status Register (TSR), and a PIT interrupt is generated. Optionally, the PIT can be programmed to reload automatically the last value written to the PIT register, after which the PIT begins decrementing again. The Timer Control Register (TCR) contains the interrupt enable for the PIT interrupt.

The FIT generates periodic interrupts based on selected bits in the time base. Users can select one of four intervals for the timer period by setting the appropriate bits in the TCR. When the selected bit in the time base changes from 0 to 1, a bit is set in the TSR and a FIT interrupt is generated. The FIT interrupt enable is contained in the TCR.

The watchdog timer generates a periodic interrupt based on selected bits in the time base. Users can select one of four time periods for the interval and the type of reset generated if the watchdog timer expires twice without an intervening clear from software.

1.4.4 Debug

The processor core debug facilities include debug modes for the various types of debugging used during hardware and software development. Also included are debug events that allow developers to control the debug process. Debug modes and debug events are controlled using debug registers in the chip. The debug registers are accessed either through software running on the processor, or through the JTAG port. The JTAG port can also be used for board test.

The debug modes, events, controls, and interfaces provide a powerful combination of debug facilities for hardware and software development tools.

1.4.4.1 Development Tool Support

The PPC405GP supports a wide range of hardware and software development tools.

An operating system debugger is an example of an operating system-aware debugger, implemented using software traps.

RISCWatch is an example of a development tool that uses the external debug mode, debug events, and the JTAG port to support hardware and software development and debugging.

The RISCTrace™ feature of RISCWatch is an example of a development tool that uses the real-time trace capability of the processor core.

1.4.4.2 Debug Modes

The internal, external, real-time-trace, and debug wait modes support a variety of debug tool used in embedded systems development. These debug modes are described in detail in “Debug Modes” on page 12-284.

1.4.5 Processor Core Interfaces

The processor core provides a range of I/O interfaces.

Preliminary User's Manual

1.4.5.1 Processor Local Bus

The PLB-compliant interface provides separate 32-bit address and 64-bit data buses for the instruction and data sides.

1.4.5.2 Device Control Register Bus

The Device Control Register (DCR) bus interface provides access to on-chip registers for configuration and status of the peripherals such as SDRAM, DMA and so on.

These registers are accessed using the **mfdcr** and **mtdcr** instructions.

1.4.5.3 Clock and Power Management

This interface supports several methods of clock distribution and power management.

1.4.5.4 JTAG

The JTAG port is enhanced to support the attachment of a debug tool such as the RISCWatch product from IBM Microelectronics. Through the JTAG test access port, a debug tool can single-step the processor and interrogate internal processor state to facilitate software debugging. The enhancements comply with the IEEE 1149.1 specification for vendor-specific extensions, and are therefore compatible with standard JTAG hardware for boundary-scan system testing.

1.4.5.5 Interrupts

The processor core provides an interface to the UIC, an on-chip interrupt controller that is logically outside the processor core. The UIC combines asynchronous interrupt inputs from on-chip and off-chip sources and presents them to the processor core using a pair of interrupt signals: critical and non-critical.

1.4.5.6 On-Chip Memory

The on-chip memory (OCM) interface supports the implementation of instruction- and data-side memory that can be accessed at performance levels matching the cache arrays.

The PPC405GP provides 4KB of OCM.

1.5 Processor Core Programming Model

The programming model is described in detail in Chapter 3, "Programming Model."

The PowerPC instruction set and Special Purpose Registers (SPRs) provide a high degree of user control over configuration and operation of the processor core functional units.

1.5.1 Data Types

Processor core operands are bytes, halfwords, and words. Multiple words or strings of bytes can be transferred using the load/store multiple and load/store string instructions. Data is represented in twos complement notation or in unsigned fixed-point format.

The address of a multibyte operand is always the lowest memory address occupied by that operand. Byte ordering can be selected as big endian (the lowest memory address of an operand contains its most significant byte) or as little endian (the lowest memory address of an operand contains its least significant byte). See "Byte Ordering" on page 3-108 for more information about big and little endian operation.

1.5.2 Processor Core Register Set Summary

The processor core registers can be grouped into basic categories based on function and access mode: general purpose registers (GPRs), special purpose registers (SPRs), the machine state register (MSR), the condition register (CR), and device control registers (DCRs).

Chapter 25, “Register Summary,” provides a register diagram and a register field description table for each register.

1.5.2.1 General Purpose Registers

The processor core contains 32 GPRs; each register contains 32 bits. The contents of the GPRs can be transferred from memory using load instructions and stored to memory using store instructions. GPRs, which are specified as operands in many instructions, can also receive instruction results and the contents of other registers.

1.5.2.2 Special Purpose Registers

Special Purpose Registers (SPRs), which are part of the PowerPC Architecture, are accessed using the **mtspr** and **mfspir** instructions. SPRs control the use of the debug facilities, timers, interrupts, storage control attributes, and other architected processor resources.

All SPRs are privileged (unavailable to user-mode programs), except the Count Register (CTR), the Link Register (LR), SPR General Purpose Registers (SPRG4–SPRG7, read-only), and the Fixed-point Exception Register (XER). Note that access to the Time Base Lower (TBL) and Time Base Upper (TBU) registers, when addressed as SPRs, is write-only and privileged. However, when addressed as Time Base Registers (TBRs), read access to these registers is not privileged. See “Time Base Registers” on page 25-865 for more information.

1.5.2.3 Machine State Register

The processor core contains a 32-bit Machine State Register (MSR). The contents of a GPR can be written to the MSR using the **mtmsr** instruction, and the MSR contents can be read into a GPR using the **mfmsr** instruction. The MSR contains fields that control the operation of the processor core.

1.5.2.4 Condition Register

The processor core contains a 32-bit Condition Register (CR). These bits are grouped into eight 4-bit fields, CR[CR0]–CR[CR7]. Instructions are provided to perform logical operations on CR fields and bits within fields and to test CR bits within fields. The CR fields, which are set by compare instructions, can be used to control branches. CR[CR0] can be set implicitly by arithmetic instructions.

1.5.2.5 Device Control Registers

DCRs, which are architecturally outside of the processor core, are accessed using the **mtdcr** and **mf dcr** instructions. DCRs are used to control, configure, and hold status for various functional units that are not part of the processor core.

The **mtdcr** and **mf dcr** instructions are privileged, for all DCRs. Therefore, all accesses to DCRs are privileged. See “Privileged Mode Operation” on page 3-122.

Preliminary User's Manual

1.5.3 Memory-Mapped I/O Registers

The memory-mapped I/O (MMIO) registers are accessed using load and store instructions. MMIO registers, which are outside processor core and which are not architected, are used to control, configure, and hold status for various functional units that are not part of the processor core.

1.5.4 Addressing Modes

The processor core supports the following addressing modes, which enable efficient retrieval and storage of data in memory:

- Base plus displacement addressing
- Indexed addressing
- Base plus displacement addressing and indexed addressing, with update

In the base plus displacement addressing mode, an effective address (EA) is formed by adding a displacement to a base address contained in a GPR (or to an implied base of 0). The displacement is an immediate field in an instruction.

In the indexed addressing mode, the EA is formed by adding an index contained in a GPR to a base address contained in a GPR (or to an implied base of 0).

The base plus displacement and the indexed addressing modes also have a “with update” mode. In “with update” mode, the effective address calculated for the current operation is saved in the base GPR, and can be used as the base in the next operation. The “with update” mode relieves the processor from repeatedly loading a GPR with an address for each piece of data, regardless of the proximity of the data in memory.

Preliminary User's Manual

Chapter 2. On-Chip Buses

The on-chip bus architecture, which consists of the processor local bus (PLB), on-chip peripheral bus (OPB), and device control register (DCR) bus, provides a link between the cache units in the processor core and other PLB and OPB master and slave devices used in the PPC405GP. These devices include the SDRAM controller, PCI bridge, MAL, DMA controller, and external bus controller (EBC).

The PLB is a high performance bus used to access memory through bus interface units. The PLB master and slave assignments for the PPC405GP are listed in “PLB Masters and Slaves” on page 2-64.

Lower performance peripherals, such as serial ports, are attached to the OPB. A bridge between the PLB and OPB enables data transfers between PLB masters and OPB slaves. DMA peripherals can also be OPB peripherals.

The DCR bus is used primarily to access status and control registers of the various PLB and OPB masters and slaves. The DCR bus offloads status and control read and write transfers from the PLB. The DCR bus is not described further in this chapter.

The following publications, which are available from your AMCC representative and in the AMCC technical library (www.amcc.com), describe the on-chip bus architecture:

- *The CoreConnect™ Bus Architecture*
- *Processor Local Bus Architecture Specifications*
- *On-Chip Peripheral Bus Architecture Specifications*
- *Device Control Register Bus Architecture Specifications*

The PPC405GP block diagram (Figure 1-1 on page 1-52) illustrates the on-chip bus structure of the PPC405GP.

2.1 Processor Local Bus

The PLB is a high-performance on-chip bus. The PLB supports read and write data transfers between master and slave devices equipped with a PLB interface and connected through PLB signals.

Each PLB master is attached to the PLB through separate address, read data and write data buses, and transfer qualifier signals. PLB slaves are attached to the PLB through shared, but decoupled, address, read data and write data buses, and transfer control and status signals for each data bus.

Access to the PLB is granted through a central arbitration mechanism that enables masters to compete for bus ownership. This arbitration mechanism provides for fixed and fair priority schemes.

Timing for all PLB signals is provided by a clock source that is shared by all PLB masters and slaves.

2.1.1 PLB Features

The PLB features:

- Overlapping read and write transfers to enable two data transfers per clock cycle for maximum bus utilization
- Decoupled address and data buses to support split-bus transaction capability for improved bandwidth
- Address pipelining to reduce overall bus latency, enabling the latency associated with a new request to be overlapped with an ongoing data transfer in the same direction
- Late master request abort capability to reduce latency associated with aborted requests
- Four levels of request priority and selectable arbitration modes to provide flexible arbitration policies
- Support for 16-, 32-, and 64-byte line data transfers
- Sequential burst protocol to enable byte, halfword, and word burst data transfers.
- DMA buffered peripheral-to-memory, memory-to-peripheral, and memory-to-memory operations

2.1.2 PLB Masters and Slaves

Table 2-1 lists the PLB masters and slaves provided in the PPC405GP.

Table 2-1. PPC405GP PLB Agents as Masters and Slaves

PLB Agent	PLB Master/Slave
Processor core ICU	Master
Processor core DCU	Master
External bus master interface	Master
EBC	Slave
PCI bridge (PCI to PLB)	Master
PCI bridge (PLB to PCI)	Slave
MAL	Master
DMA controller	Master
PLB to OPB bridge	Slave
SDRAM controller	Slave

The SDRAM and EBC slaves are connected in line with the decompression controller. When the decompression controller is disabled, a bypass mode that directly accesses SDRAM and the EBC is used. When the decompression controller is enabled, it intercepts reads from compressed regions before they reach SDRAM and the EBC.

2.1.3 PLB Master Assignments

Each PLB master can be programmed to use one of four priority levels during PLB transfers, enabling the system designer to tune PLB transfer priorities to the requirements of a particular application. For example, if an application always requires PCI to SDRAM transfers to have the lowest latency, the PCI master can be programmed to the highest PLB master priority. This causes the PLB arbiter to grant PCI access requests before granting the access requests of any other master.

Programming Note: PLB master priority assignments, which are application-dependent, must be considered carefully to prevent potential lockouts of lower priority masters. For most applications, assigning a priority of 0b10 to each master is a useful starting point.

Preliminary User's Manual

A register associated with each master controls the priority of that master. Table 2-2 lists the PLB masters and the register fields controlling the priority of the masters. Priorities range from 0b00 (lowest) to 0b11 (highest).

Table 2-2. Registers Controlling PLB Master Priority Assignments

Master ID	Description	Register Field	Comments
0	Processor core ICU	CCR0[IPP]	
1	Processor core data cache unit DCU	CCR0[DPP1]	The high-order bit of CCR0[DPP1] is controlled by the DCU logic, so only the low-order priority bit can be programmed.
2	External bus master	EBC0_CFG[EMPL] EBC0_CFG[EMPH]	Which field sets external master priority depends upon the setting of the HoldPri signal.
3	PCI bridge	PCIC0_BRDGOPT1[PRP]	Reset value is 0b11
4	MAL	MAL0_CFG[PLBP]	
5	DMA controller	DMA0_CR0[CP] DMA0_CR1[CP] DMA0_CR2[CP] DMA0_CR3[CP]	Unique priorities can be assigned to each DMA channel.

See “PLB Arbiter Control Register (PLB0_ACR)” on page 2-67 for information about programming the PLB0_ACR to control PLB priority mode and priority order, which determine how the PLB arbitrates simultaneous PLB bus access requests having equal priorities.

2.1.4 PLB Transfer Protocol

A PLB transaction is composed of an address cycle and a data cycle.

The address cycle has three phases: request, transfer, and address acknowledge. A PLB transaction begins when a master drives its address and transfer qualifier signals and requests ownership of the bus during the request phase of the address cycle. Once bus ownership has been granted by the PLB arbiter, the master's address and transfer qualifiers are presented to the slave devices during the transfer phase.

During normal operation, the address cycle is terminated by a slave latching the master's address and transfer qualifiers during the address acknowledge phase.

Each data beat in the data cycle has two phases: transfer and data acknowledge. During the transfer phase, the master drives the write data bus for a write transfer or samples the read data bus for a read transfer. Data acknowledge signals are required during the data acknowledge phase for each data beat in a data cycle.

Note: For single-beat transfers, data acknowledge signals also indicate the end of the data transfer. For line or burst transfers, the data acknowledge signals apply to each beat and indicate the end of the data cycle only after the final beat.

2.1.5 Overlapped PLB Transfers

Figure 2-1 shows an example of overlapped PLB transactions on the read/write data buses with pipelining. PLB address, read data, and write data buses are decoupled from one another, allowing for address cycles to be overlapped with read or write data cycles, and for read data cycles to be overlapped with write data cycles. The PLB split-bus transaction capability allows the address and data buses to have different masters at the same time.

PLB address pipelining capability enables a new bus transfer to begin before an ongoing transfer finishes. Address pipelining reduces overall bus latency on the PLB by enabling the latency associated with a new transfer request to be overlapped with an ongoing data transfer in the same direction.

PLB masters A and B each present a read request followed by a write request. Master B gets the bus first, so its read is the primary read transaction. The master A address cycle begins as soon as the master B address cycle ends. The master A read is taken as a secondary transfer. After each master's read address cycle completes, write transfer address and data cycles follow.

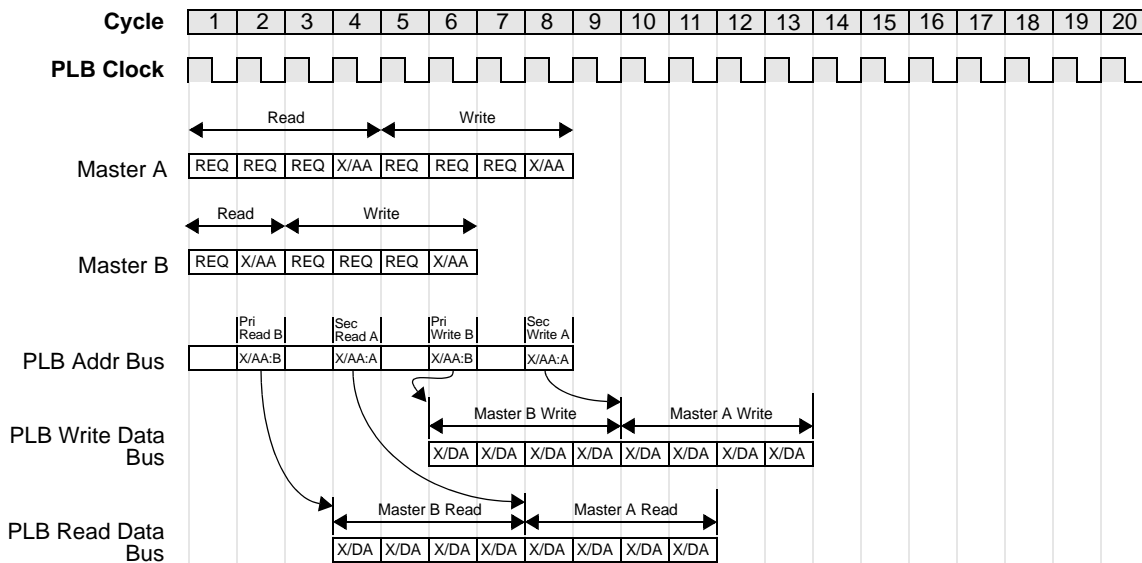

Note: X/AA = Xfer/AddrAck
 X/DA = Xfer/DataAck
 X/AA:A = X/AA Master A
 X/AA:B = X/AA Master B

Figure 2-1. Overlapped PLB Transfers

Note: A master can begin to request ownership of the PLB in parallel with the address cycle or data cycle of another master bus transfer. Overlapped read and write data transfers and split-bus transactions enable the PLB to operate at a very high bandwidth.

Preliminary User's Manual**2.1.6 PLB Arbiter Registers**

PLB arbiter registers are DCRs accessed using the **mfdcr** and **mtdcr** instructions.

Table 2-3 summarizes the PLB arbiter DCRs.

Table 2-3. PLB Arbiter Registers

Mnemonic	Register Name	Address	Access
PLB0_ACR	PLB Arbiter Control Register	0x087	R/W
PLB0_BEAR	PLB Error Address Register	0x086	R
PLB0_BESR	PLB Error Status Register	0x084	R/Clear

2.1.6.1 PLB Arbiter Control Register (PLB0_ACR)

The PLB0_ACR controls PLB arbitration priority, which is determined by PLB priority mode and PLB priority order.

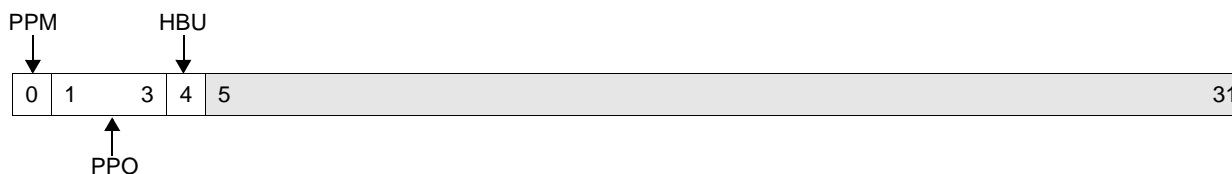
**Figure 2-2. PLB Arbiter Control Register (PLB0_ACR)**

0	PPM	PLB Priority Mode 0 Fixed 1 Fair
1:3	PPO	PLB Priority Order 000 Masters 0, 1, 2, 3, 4, 5 001 Masters 1, 2, 3, 4, 5, 0 010 Masters 2, 3, 4, 5, 0, 1 011 Masters 3, 4, 5, 0, 1, 2 100 Masters 4, 5, 0, 1, 2, 3 101 Masters 5, 0, 1, 2, 3, 4 110 Reserved 111 Reserved
4	HBU	High Bus Utilization 0 Disabled 1 Enabled
5:31		Reserved

The PLB arbiter supports fixed and fair priority schemes to handle situations when two or more PLB masters simultaneously present requests of the same priority. In both fixed and fair modes, the arbiter services pending requests in the order specified by PLB0_ACR[PPO]. Fair mode differs in that the arbiter automatically updates PLB0_ACR[PPO] after arbitration cycles where multiple masters requested at the same priority. The value written into PLB0_ACR[PPO] gives the next to highest priority-requesting master the highest priority for the next arbitration cycle. For example, if the arbiter is operating in fair mode, PLB0_ACR[PPO]=0b011, and masters 0, 3, and 4 request service at the same priority level, master 3 is

granted the PLB. Subsequently, PLB0_ACR[PPO] is set to 0b100, giving master 4 the highest priority for the next arbitration cycle.

Enabling PLB0_ACR[HBU] maximizes the total PLB data bus throughput when there are active master requests for the PLB read and write data buses pending with one data bus busy and the other idle. If a primary transfer is busy using one of the data buses, a secondary request for that bus has been acknowledged, and a third request destined for the same bus is the next highest priority request a lower priority master requesting use of the other bus would be “blocked” from gaining use of the address and transfer qualifiers bus. When PLB0_ACR[HBU]=1 the PLB arbiter internally promotes the lower priority master to the level of the currently active master thus allowing the lower priority master to utilize the idle bus.

Preliminary User’s Manual

2.1.6.2 PLB Error Address Register (PLB0_BEAR)

The read-only PLB0_BEAR contains the address of the access on which a bus timeout error occurred.

The PCI bridge and memory access layer (MAL) masters can qualify their PLB transactions so that a bus timeout error causes PLB0_BEAR to become locked. Once locked, the PLB0_BEAR cannot be updated, if a subsequent error occurs, until all PLB0_BESR[FLCKn] fields are cleared (n is the master ID).

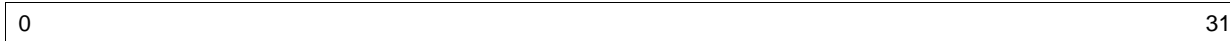
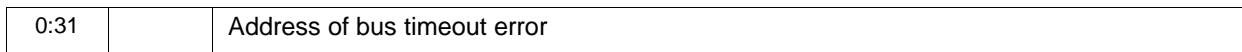

Figure 2-3. PLB Error Address Register (PLB0_BEAR)



2.1.6.3 PLB Error Status Register (PLB0_BESR)

The read/clear PLB0_BESR identifies timeout errors on PLB bus transfers, the master initiating the transfer, and the type of transfer.

The PCI Bridge and Memory Access Layer (MAL) masters may qualify their PLB transactions such that the information describing any timeout errors that occur during these transfers becomes locked. Once locked, a master's PLB0_BESR[PTE_n] and PLB0_BESR[R/W_n] fields cannot be updated until the corresponding PLB0_BESR[FLK_n] field is cleared. To clear a PLB0_BESR field, write 1 to the field. Writing 0 to a PLB0_BESR field does not affect the field.

For PLB0_BESR[FLK3, AL3] to become locked, an error must occur while the PCI bridge has error locking enabled (PCIC0_BRDGOPT1[PLESE] = 1).

For PLB0_BESR[FLK4, AL4] to become locked, an error must occur while the MAL has error locking enabled (MAL0_CFG[PLBLE]=1).

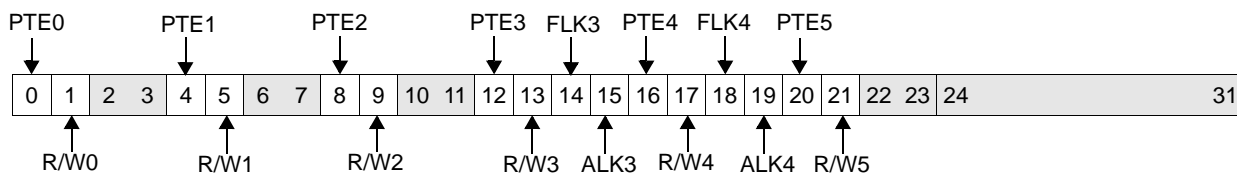

Figure 2-4. PLB Error Status Register (PLB0_BESR)

0	PTE0	Master 0 PLB Timeout Error Status	Master 0 is the processor core ICU.
		0 No master 0 timeout error	
		1 Master 0 timeout error	
1	R/W0	Master 0 Read/Write Status	
		0 Master 0 error operation was a write	
		1 Master 0 ICU error operation was a read	
2:3		Reserved	

4	PTE1	Master 1 PLB Timeout Error Status 0 No master 1 timeout error 1 Master 1 timeout error	Master 1 is the processor core DCU.
5	R/W1	Master 1 Read/Write Status 0 Master 1 error operation was a write 1 Master 1 error operation was a read	
6:7		Reserved	
8	PTE2	Master 2 PLB Timeout Error Status 0 No master 2 timeout error 1 Master 2 timeout error	Master 2 is the external master.
9	R/W2	Master 2 Read/Write Status 0 Master 2 error operation was a write 1 Master 2 error operation was a read	
10:11		Reserved	
12	PTE3	Master 3 PLB Timeout Error Status 0 No Master 3 timeout error 1 Master 3 timeout error	Master 3 is PCI.
13	R/W3	Master 3 Read/Write Status 0 Master 3 error operation was a write 1 Master 3 error operation was a read	
14	FLK3	Master 3 PLB0_BESR Field Lock 0 Master 3 PLB0_BESR field is unlocked 1 Master 3 PLB0_BESR field is locked	
15	ALK3	Master 3 PLB0_BEAR Address Lock 0 Master 3 PLB0_BEAR is unlocked 1 Master 3 PLB0_BEAR is locked	
16	PTE4	Master 4 PLB Timeout Error Status 0 No master 4 timeout error 1 Master 4 timeout error	Master 4 is MAL.
17	R/W4	Master 4 Read/Write Status 0 Master 4 error operation was a write 1 Master 4 error operation was a read	
18	FLK4	Master 4 PLB0_BESR Field Lock 0 Master 4 PLB0_BESR field is unlocked 1 Master 4 field is locked	
19	ALK4	Master 4 PLB0_BEAR Address Lock 0 Master 4 PLB0_BEAR is unlocked 1 Master 4 PLB0_BEAR is locked	
20	PTE5	Master 5 PLB Timeout Error Status 0 No master 5 timeout error 1 Master 5 timeout error	Master 5 is DMA.
21	R/W5	Master 5 Read/Write Status 0 Master 5 error operation was a write 1 Master 5 error operation was a read	
22:31		Reserved	

Preliminary User's Manual**2.1.7 PLB to OPB Bridge Registers**

The PLB to OPB bridge registers are DCRs accessed using the **mfdcr** and **mtdcr** instructions.

Table 2-4 lists the PLB to OPB bridge registers.

Table 2-4. PLB-OPB Bridge Registers

Mnemonic	Register Name	Address	Access
POB0_BEAR	Bridge Error Address Register	0x0A2	R/O
POB0_BESR0	Bridge Error Status Register 0 (Master IDs 0, 1, 2, 3)	0x0A0	R/Clear
POB0_BESR1	Bridge Error Status Register 1 (Master IDs 4, 5)	0x0A4	R/Clear

POB0_BEAR and the POB0_BESR n registers record information on errors that occur during PLB master transactions that target OPB address space. When an error is detected, the address is saved in the POB0_BEAR, and details on the type of error are logged in one of the POB0_BESR n registers.

Unlike the other PLB masters, the PCI bridge and the MAL can qualify PLB transactions with a lock request, so that slave error status information becomes locked. The PCI Bridge requests error locking for its PLB transfers when PCIC0_BRDGOPT1[PLESE] = 1, and the MAL issue PLB transfers with error locking requested when MAL0_CFG[PLBLE] = 1.

When an error occurs during a PLB transaction with error locking enabled and POB0_BEAR is not already locked, the address of the error is stored in POB0_BEAR and the address lock bit (POB0_BESR m [ALK n]) is set for the master whose transaction caused the error. (m is either 0 or 1, depending on the master ID specified by n) At the same time, if the field lock bit is not set (POB0_BESR m [FLK n]=0), the type of error is saved in POB0_BESR m [PTE n , R/W n], and these fields can then be locked by setting POB0_BESR m [FLK n] = 1. When software processes the error, it should clear the error status and both lock bits at the same time.

2.1.7.1 Bridge Error Address Register (POB0_BEAR)

The read-only POB0_BEAR reports the address of a PLB to OPB transfer that results in an error. Errors detected by the PLB to OPB bridge are recorded in the POB0_BEAR, unless the associated POB0_BESR m [ALK n] field was previously set. (m is either 0 or 1, depending on the master ID specified by n . For master IDs 0, 1, 2, and 3, $m = 0$; for master IDs 4, and 5, $m = 1$.) An address lock field is set when a PLB master requests error locking, and the PLB to OPB Bridge detects an error during transaction. The only masters that can request error locking are the PCI Bridge and the MAL. Once locked, the PLB to OPB bridge cannot write POB0_BEAR until all POB0_BESR m [ALK n] fields that are set are cleared.

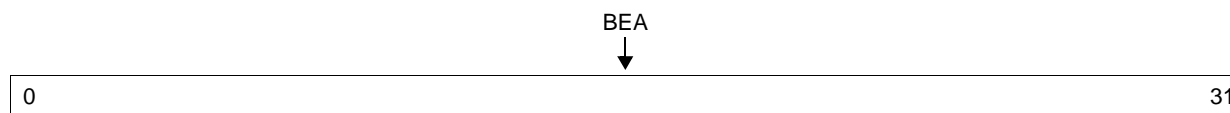
**Figure 2-5. Bridge Error Address Register (POB0_BEAR)**

0:31	BEA	Address of bus error
------	-----	----------------------

2.1.7.2 Bridge Error Status Registers (POB0_BESR0–POB0_BESR1)

Errors detected by the PLB to OPB bridge are recorded in the appropriate POB0_BESR m register. (For master IDs 0, 1, 2, and 3, $m = 0$; for master IDs 4, and 5, $m = 1$.)

The PCI bridge and MAL can qualify PLB transactions so that information describing errors that occur during the transactions becomes locked. When POB0_BESR m [FLK n] is set, subsequent errors cannot update POB0_BESR m [PTE n , R/W n]. Similarly, if any POB0_BESR m [ALK n] = 1, POB0_BEAR is locked. Once locked, the POB0_BESR m fields associated with a master cannot be overwritten if a subsequent error occurs until the locking fields are cleared. To clear a lock, write 1 to the POB0_BESR m [FLK n] and POB0_BESR m [ALK n] fields that are set. Writing 0 to a lock field does not affect the field.

For PLB0_BESR[FLK3, AL3] to become locked, an error must occur while the PCI bridge has error locking enabled (PCIC0_BRDGOPT1[PLESE] = 1).

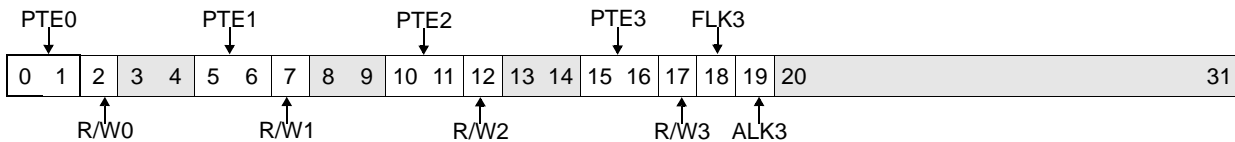

Figure 2-6. Bridge Error Status Register 0 (POB0_BESR0)

0:1	PTE0	PLB Timeout Error Status Master 0 00 No master 0 error occurred 01 Master 0 timeout error occurred 10 Master 0 slave error occurred 11 Reserved	Master 0 is the processor core ICU.
2	R/W0	Read Write Status Master 0 0 Master 0 error operation is a write 1 Master 0 error operation is a read	
3:4		Reserved	
5:6	PTE1	PLB Timeout Error Status Master 1 00 No master 1 error occurred 01 Master 1 timeout error occurred 10 Master 1 slave error occurred 11 Reserved	Master 1 is the processor core DCU.
7	R/W1	Read/Write Status Master 1 0 Master 1 error operation is a write 1 Master 1 error operation is a read	
8:9		Reserved	
10:11	PTE2	PLB Timeout Error Status Master 2 00 No master 2 error occurred 01 Master 2 timeout error occurred 10 Master 2 slave error occurred 11 Reserved	Master 2 is the external master.
12	R/W2	Read/Write Status Master 2 0 Master 2 error operation is a write 1 Master 2 error operation is a read	
13:14		Reserved	

Preliminary User’s Manual

15:16	PTE3	PLB Timeout Error Status Master 3 00 No master 3 error occurred 01 Master 3 timeout error occurred 10 Master 3 slave error occurred 11 Reserved	Master 3 is PCI.
17	R/W3	Read/Write Status Master 3 0 Master 3 error operation is a write 1 Master 3 error operation is a read	
18	FLK3	POB0_BESR0 Field Lock Master 3 0 Master 3 POB0_BESR0 field is unlocked 1 Master 3 POB0_BESR0 field is locked	
19	ALK3	POB0_BEAR Address Lock Master 3 0 Master 3 POB0_BEAR address is unlocked 1 Master 3 POB0_BEAR address is locked	
20:31		Reserved	

Figure 2-7 illustrates POB0_BESR1.

For PLB0_BESR[FLK4, AL4] to become locked, an error must occur while the MAL has error locking enabled (MAL0_CFG[PLBLE]=1).

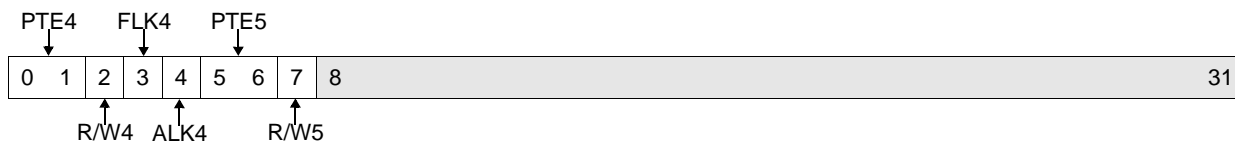

Figure 2-7. Bridge Error Status Register 1 (POB0_BESR1)

0:1	PTE4	PLB Timeout Error Status Master 4 00 No Master 4 error occurred 01 Master 4 timeout error occurred 10 Master 4 slave error occurred 11 Reserved	Master 4 is MAL.
2	R/W4	Read/Write Status Master 4 0 Master 4 error operation is a write 1 Master 4 error operation is a read	
3	FLK4	POB0_BESR1 Field Lock Master 4 0 Master 4 POB0_BESR1 field is unlocked 1 Master 4 POB0_BESR1 field is locked	

4	ALK4	POB0_BEAR Address Lock Master 4 0 Master 4 POB0_BEAR address is unlocked 1 Master 4 POB0_BEAR address is locked
5:6	PTE5	PLB Timeout Error Status Master 5 00 No Master 5 error occurred 01 Master 5 timeout error occurred 10 Master 5 slave error occurred 11 Reserved
7	R/W5	Read/Write Status Master 5 0 Master 5 error operation is a write 1 Master 5 error operation is a read
8:31		Reserved

2.2 On-Chip Peripheral Bus

The OPB is used to attach peripherals that do not require the bandwidth of the PLB. The OPB does not connect directly to the PPC405GP processor core, which accesses peripherals attached to the OPB through a PLB-to-OPB bridge.

2.2.1 OPB Features

The on-chip peripheral bus features:

- A 32-bit address bus and a 32-bit data bus
- Dynamic bus sizing; byte, halfword, and word transfers
- Byte and halfword duplication for byte and halfword transfers
- Single-cycle transfer of data between OPB bus master and OPB slaves
- Sequential address (burst) protocol support
- Devices on the OPB may be memory mapped, act as DMA peripherals, or support both transfer methods
- A 16-cycle fixed bus timeout provided by the OPB arbiter
- Bus parking for reduced latency
- Bus arbitration overlapped with last cycle of bus transfers

2.2.2 OPB Master Assignments

Table 2-5 lists the OPB masters.

Table 2-5. PPC405GP OPB Master Assignments

Master ID	OPB Agent
0	DMA
1	Unused
2	OPB to PLB bridge
3	Unused

Preliminary User's Manual**2.2.3 OPB Arbiter Registers**

The OPB arbiter contains the MMIO registers (accessed using byte instructions) summarized in Table 2-6.

Table 2-6. OPB Arbiter Registers

Mnemonic	Address	Access	Description	Page
OPBA0_PR	0xEF600600	R/W	OPB Arbiter Priority Register	2-76
OPBA0_CR	0xEF600601	R/W	OPB Arbiter Control Register	2-75

2.2.3.1 OPB Arbiter Control Register (OPBA0_CR)

The OPBA0_CR fields controls updating of the OPBA0_PR (described in “OPB Arbiter Priority Register (OPBA0_PR)” on page 2-76). Because the PPC405GP provides only two masters, master IDs 1 and 3 are ignored.

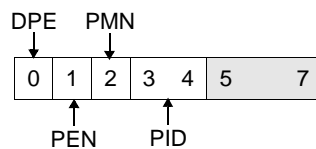
**Figure 2-8. OPB Arbiter Control Register (OPBA0_CR)**

0	DPE	Dynamic Priority Enable 0 Dynamic priority disabled 1 Dynamic priority enabled	When DPE = 1, the OPB arbiter uses an approximately fair arbitration algorithm.
1	PEN	Park Enable 0 Park disabled 1 Park enabled	
2	PMN	Park on Master Not Last 0 Park on last master last 1 Park on master specified by PID	
3:4	PID	Parked Master ID 00 DMA 01 Unused 10 OPB to PLB bridge 11 Unused	
5:7		Reserved	

2.2.3.2 OPB Arbiter Priority Register (OPBA0_PR)

The OPBA0_PR assigns priorities to the OPB master IDs. The relative priority of each master is determined by OPBA0_PR field associated with the master ID. For example, the OPBA0_PR reset value is 0x00011011: master ID 0 (0b00) has the highest priority, master ID 1 (0b01) has the next to highest priority, master ID 2 (0b10) has the next to lowest priority, and master ID 3 (0b11) has the lowest priority. Because the PPC405GP provides only two masters, master IDs 1 and 3 are ignored. At reset, master ID 0 (DMA) has a higher priority than master 2 (OPB to PLB bridge).

Because each OPB master must have a unique priority, the values of each OPBA0_PR field must be unique.

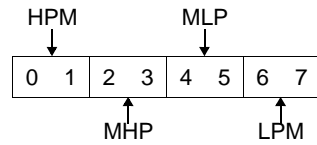

Figure 2-9. OPB Arbiter Priority Register (OPBA0_PR)

0:1	HPM	High Priority Master ID 00 Master ID 0 01 Master ID 1 10 Master ID 2 11 Master ID 3
2:3	MHP	Medium High Priority Master ID 00 Master ID 0 01 Master ID 1 10 Master ID 2 11 Master ID 3
4:5	MLP	Medium Low Priority Master ID 00 Master ID 0 01 Master ID 1 10 Master ID 2 11 Master ID 3
6:7	LPM	Low Priority Master ID 00 Master ID 0 01 Master ID 1 10 Master ID 2 11 Master ID 3

Part II. The PPC405GP RISC Processor

Chapter 3. Programming Model

The programming model of the PPC405GP embedded processor describes the following features and operations:

- **Memory organization and addressing, starting on page 3-79**
- **Registers, starting on page 3-81**
- **Data types and alignment, starting on page 3-106**
- **Byte ordering, starting on page 3-108**
- **Instruction processing, starting on page 3-114**
- **Branching control, starting on page 3-115**
- **Speculative accesses, starting on page 3-118**
- **Privileged mode operation, starting on page 3-122**
- **Synchronization, starting on page 3-124**
- **Instruction set, starting on page 3-127**

3.1 User and Privileged Programming Models

The PPC405GP executes programs in two modes, also referred to as states. Programs running in *privileged mode* (also referred to as the supervisor state) can access any register and execute any instruction. These instructions and registers comprise the privileged programming model. In *user mode*, certain registers and instructions are unavailable to programs. This is also called the problem state. Those registers and instructions that are available comprise the user programming model.

Privileged mode provides operating system software access to all processor resources. Because access to certain processor resources is denied in user mode, application software runs in user mode. Operating system software and other application software is protected from the effects of an errant application program.

Throughout this book, the terms user program and privileged programs are used to associate programs with one of the programming models. Registers and instructions are described as user or privileged. Privileged mode operation is described in detail in “Privileged Mode Operation” on page 3-122.

3.2 Memory Organization and Addressing

The PowerPC Architecture defines a 32-bit, 4-gigabyte (GB) address space for memory and peripherals, as shown in Figure 3-1 on page 3-82.

3.2.1 Physical Address Map

Table 3-1 illustrates the physical address map. Addresses that are not shown are reserved.

Table 3-1. PPC405GP Address Space

Function	Start Address	End Address	Size
Local Memory/Peripherals¹	0x00000000	0x7FFFFFFF	2GB
PCI Bridge (Total)	0x80000000	0xEF5FFFFFFF	1.744GB
PCI Memory	0x80000000	0xE7FFFFFFF	1.625GB
PCI I/O	0xE8000000	0xE800FFFF	64KB
PCI I/O	0xE8800000	0xEBFFFFFFF	56MB
PCI Configuration Registers	0xEEC00000	0xEEC00007	8B
PCI Interrupt Acknowledge (read)	0xEED00000	0xEED00003	4B
PCI Special Cycle (write)	0xEED00000	0xEED00003	4B
PCI Local Configuration Registers	0xEF400000	0xEF40003F	64B
Internal Peripherals (Total)	0xEF600000	0xEFFFFFFF	10MB
UART0 Registers	0xEF600300	0xEF600307	8B
UART1 Registers	0xEF600400	0xEF600407	8B
IIC Registers	0xEF600500	0xEF600510	17B
OPB Arbiter Registers	0xEF600600	0xEF600601	2B
GPIO Controller Registers	0xEF600700	0xEF60077F	128B
EMAC Registers	0xEF600800	0xEF600867	104B
Expansion ROM²	0xF0000000	0xFFDFFFFFFF	254MB
Boot ROM^{2, 3}	0xFFE00000	0xFFFFFFFF	2MB

1. The local memory/peripheral area of the memory map can be configured for SDRAM, ROM, or peripherals.
2. The boot ROM and expansion ROM areas of the memory map are intended for ROM or flash devices. The controller supports volatile memory devices such as SDRAM and SRAM in these areas.
3. When booting from PCI memory, the boot ROM address space begins at 0xFFFE 0000 (size is 128KB).

3.2.2 Storage Attributes

The PowerPC Architecture defines storage attributes that control data and instruction accesses. Storage attributes are provided to control cache write-through policy (the W storage attribute), cachability (the I storage attribute), memory coherency in multiprocessor environments (the M storage attribute), and guarding against speculative memory accesses (the G storage attribute). The AMCC PowerPC Embedded Environment defines additional storage attributes for storage compression (the U0 storage attribute) and byte ordering (the E storage attribute).

The PPC405GP provides two control mechanisms for the W, I, U0, G, and E attributes. Because the PPC405GP does not provide hardware support for multiprocessor environments, the M storage attribute, when present, has no effect.

Preliminary User's Manual

When the PPC405GP operates in virtual mode (address translation is enabled), each storage attribute is controlled by the W, I, U0, G, and E fields in the translation lookaside buffer (TLB) entry for each memory page. The size of memory pages, and hence the size of storage attribute control regions, is variable. Multiple sizes can be in effect simultaneously on different pages.

When the PPC405GP operates in real mode (address translation is disabled), storage attribute control registers control the corresponding storage attributes. These registers are:

- **Data Cache Write-through Register (DCWR)**
- **Data Cache Cachability Register (DCCR)**
- **Instruction Cache Cachability Register (ICCR)**
- **Storage Guarded Register (SGR)**
- **Storage Little-Endian Register (SLER)**
- **Storage User-defined 0 Register (SU0R)**

Each storage attribute control register contains 32 bits; each bit controls one of thirty-two 128MB storage attribute control regions. Bit 0 of each register controls the lowest-order region, with ascending bits controlling ascending regions in memory. The storage attributes in each storage attribute region are set independently of each other and of the storage attributes for other regions.

3.3 Registers

All PPC405GP registers are listed in this section. Some of the frequently-used registers are described in detail. Other registers are covered in their respective topic chapters (for example, the cache registers are described in Chapter 4, “Cache Operations”). All registers are summarized in Chapter 25, “Register Summary.”

The registers are grouped into categories: General Purpose Registers (GPRs), Special Purpose Registers (SPRs), Time Base Registers (TBRs), the Machine State Register (MSR), the Condition Register (CR), Device Control Registers (DCRs), and memory-mapped I/O registers (MMIO). Different instructions are used to access each category of registers.

For all registers with fields marked as *reserved*, the reserved fields should be written as 0 and read as *undefined*. That is, when writing to a register with a reserved field, write a 0 to the reserved field. When reading from a register with a reserved field, ignore that field.

Programming Note: A good coding practice is to perform the initial write to a register with reserved fields as described, and to perform all subsequent writes to the register using a read-modify-write strategy: read the register, use logical instructions to alter defined fields, leaving reserved fields unmodified, and write the register.

Figure 3-1 on page 3-82 illustrates the registers in the user and supervisor programming models.

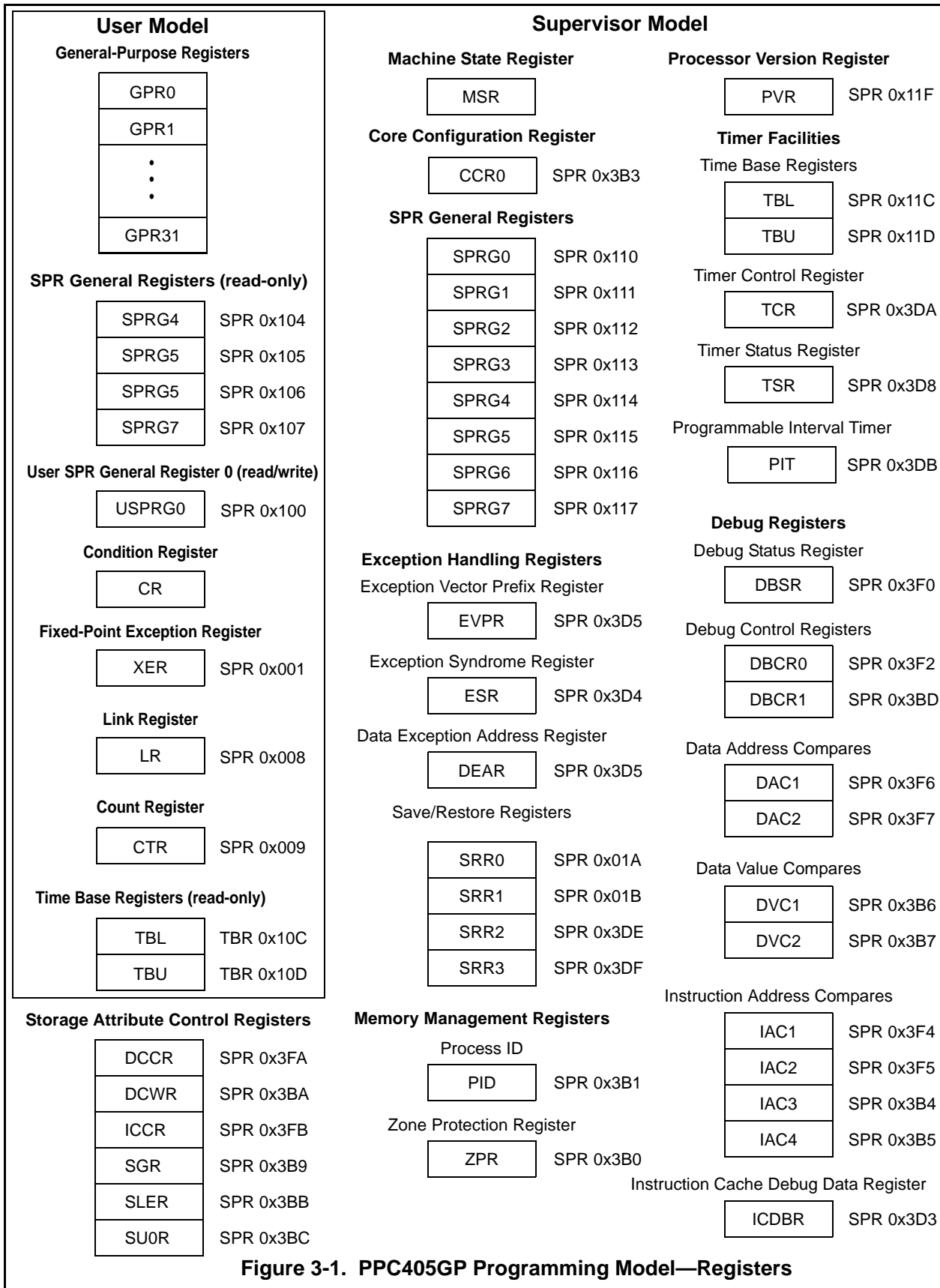
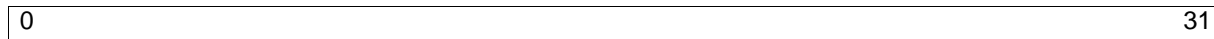
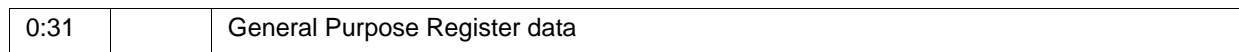

Figure 3-1. PPC405GP Programming Model—Registers

Preliminary User's Manual**3.3.1 General Purpose Registers (R0-R31)**

The PPC405GP contains thirty-two 32-bit general purpose registers (GPRs). Data from memory can be read into GPRs using load instructions and the contents of GPRs can be written to memory using store instructions. Most integer instructions use GPRs for source and destination operands. See Table 25, “Register Summary,” on page 25-863 for the numbering of the GPRs.

**Figure 3-2. General Purpose Registers (R0-R31)****3.3.2 Special Purpose Registers**

Special purpose registers (SPRs), which are part of the PowerPC Architecture and the AMCC PowerPC Embedded Environment, are accessed using the **mtspr** and **mfspr** instructions.

SPRs control the operation of debug facilities, timers, interrupts, storage control attributes, and other architected processor resources. Table 25, “Register Summary,” on page 25-863 shows the mnemonic, name, and number for each SPR. Table 3-2, “PPC405GP SPRs,” on page 3-84 lists the PPC405GP SPRs by function and indicates the pages where the SPRs are described more fully.

Except for the Link Register (LR), the Count Register (CTR), the Fixed-point Exception Register (XER), User SPR General 0 (USPRG0, and read access to SPR General 4–7 (SPRG4–SPRG7), all SPRs are privileged. As SPRs, the registers TBL and TBU are privileged write-only; as TBRs, these registers can be read in user mode. Unless used to access non-privileged SPRs, attempts to execute **mfspr** and **mtspr** instructions while in user mode cause privileged violation program interrupts. See “Privileged SPRs” on page 3-123.

Table 3-2. PPC405GP SPRs

Function	Register				Access	Page
Configuration	CCR0				Privileged	4-144
Branch Control	CTR				User	3-91
	LR				User	3-86
Debug	DAC1	DAC2			Privileged	12-293
	DBCR0	DBCR1			Privileged	12-287
	DBSR				Privileged	12-291
	DVC1	DVC2			Privileged	12-293
	IAC1	IAC2	IAC3	IAC4	Privileged	12-292
	ICDBDR				Privileged	4-147
Fixed-point Exception	XER				User	3-87
General-Purpose SPR	SPRG0	SPRG1	SPRG2	SPRG3	Privileged	3-90
	SPRG4	SPRG5	SPRG6	SPRG7	User read, privileged write	3-90
	USPRG0				User	3-90
Interrupts and Exceptions	DEAR				Privileged	0-246
	ESR				Privileged	0-244
	EVPR				Privileged	0-243
	SRR0	SRR1			Privileged	0-242
	SRR2	SRR3			Privileged	0-243
Processor Version	PVR				Privileged, read-only	3-91
Storage Attribute Control	DCCR				Privileged	6-177
	DCWR				Privileged	6-177
	ICCR				Privileged	6-177
	SGR				Privileged	6-177
	SLER				Privileged	6-177
	SU0R				Privileged	6-177
Timer Facilities	TBL	TBU			Privileged, write-only	11-27 2
	PIT				Privileged	11-27 4
	TCR				Privileged	11-27 9
	TSR				Privileged	11-27 8
Zone Protection	ZPR				Privileged	6-173

Preliminary User's Manual**3.3.2.1 Count Register (CTR)**

The CTR is written from a GPR using **mtspr**. The CTR contents can be used as a loop count that is decremented and tested by some branch instructions. Alternatively, the CTR contents can specify a target address for the **bcctr** instruction, enabling branching to any address.

The CTR is in the user programming model.

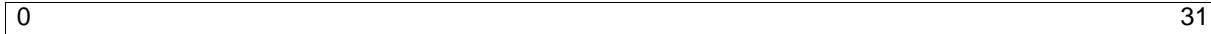

Figure 3-3. Count Register (CTR)

0:31		Count	Used as count for branch conditional with decrement instructions, or as address for branch-to-counter instructions.
------	--	-------	---

3.3.2.2 Link Register (LR)

The LR is written from a GPR using **mtspr**, and by branch instructions that have the LK bit set to 1. Such branch instructions load the LR with the address of the instruction following the branch instruction. Thus, the LR contents can be used as the return address for a subroutine that was called using the branch.

The LR contents can be used as a target address for the **bclr** instruction. This allows branching to any address.

When the LR contents represent an instruction address, LR_{30:31} are assumed to be 0, because all instructions must be word-aligned. However, when LR is read using **mfspr**, all 32 bits are returned as written.

The LR is in the user programming model.

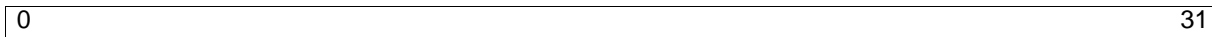

Figure 3-4. Link Register (LR)

0:31		Link Register contents	If (LR) represents an instruction address, LR _{30:31} should be 0.
------	--	------------------------	---

Preliminary User's Manual

3.3.2.3 Fixed Point Exception Register (XER)

The XER records overflow and carry conditions generated by integer arithmetic instructions.

The Summary Overflow (SO) field is set to 1 when instructions cause the Overflow (OV) field to be set to 1. The SO field does not necessarily indicate that an overflow occurred on the most recent arithmetic operation, but that an overflow occurred since the last clearing of XER[SO]. **mtspr**(XER) sets XER[SO, OV] to the value of bit positions 0 and 1 in the source register, respectively.

Once set, XER[SO] is not reset until an **mtspr**(XER) is executed with data that explicitly puts a 0 in the SO bit, or until an **mcrxr** instruction is executed.

XER[OV] is set to indicate whether an instruction that updates XER[OV] produces a result that “overflows” the 32-bit target register. XER[OV] = 1 indicates overflow. For arithmetic operations, this occurs when an operation has a carry-in to the most-significant bit of the result that does not equal the carry-out of the most-significant bit (that is, the exclusive-or of the carry-in and the carry-out is 1).

The following instructions set XER[OV] differently. The specific behavior is indicated in the instruction descriptions in Chapter 24, “Instruction Set.”

- **Move instructions:**

- mcrxr, mtspr**(XER)

- **Multiply and divide instructions:**

- mullwo, mullwo., divwo, divwo., divwuo, divwuo**

The Carry (CA) field is set to indicate whether an instruction that updates XER[CA] produces a result that has a carry-out of the most-significant bit. XER[CA] = 1 indicates a carry.

The following instructions set XER[CA] differently. The specific behavior is indicated in the instruction descriptions in Chapter 24, “Instruction Set.”

- **Move instructions**

- mcrxr, mtspr**(XER)

- **Shift-algebraic operations**

- sraw, srawi**

The Transfer Byte Count (TBC) field is the byte count for load/store string instructions.

The XER is part of the user programming model.

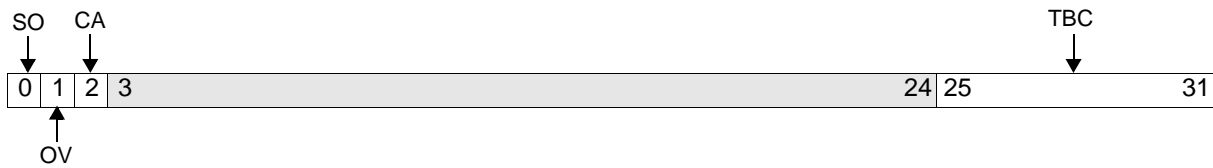

Figure 3-5. Fixed Point Exception Register (XER)

0	SO	Summary Overflow 0 No overflow has occurred. 1 Overflow has occurred.	Can be set by mtspr or by using “o” form instructions; can be reset by mtspr or by mcrxr .
1	OV	Overflow 0 No overflow has occurred. 0 Overflow has occurred.	Can be set by mtspr or by using “o” form instructions; can be reset by mtspr , by mcrxr , or “o” form instructions.
2	CA	Carry 0 Carry has not occurred. 1 Carry has occurred.	Can be set by mtspr or arithmetic instructions that update the CA field; can be reset by mtspr , by mcrxr , or by arithmetic instructions that update the CA field.
3:24		Reserved	
25:31	TBC	Transfer Byte Count	Used by lswx and stswx ; written by mtspr .

Table 3-3 and Table 3-4 list the PPC405GP instructions that update the XER. In the tables, the syntax “[o]” indicates that the instruction has an “o” form that updates XER[SO,OV], and a “non-o” form. The syntax “[.]” indicates that the instruction has a “record” form that updates CR[CR0] (see “Condition Register (CR)” on page 3-91), and a “non-record” form.

Table 3-3. XER[CA] Updating Instructions

Integer Arithmetic		Integer Shift	Processor Control
Add	Subtract	Shift Right Algebraic	Register Management
addc[o][.] adde[o][.] addic[.] addme[o][.] addze[o][.]	subfc[o][.] subfe[o][.] subfc subfme[o][.] subfze[o][.]	sraw[.] srawi[.]	mtspr mcrxr

Preliminary User's Manual

Table 3-4. XER[SO,OV] Updating Instructions

Integer Arithmetic					Auxiliary Processor		Processor Control
Add	Subtract	Multiply	Divide	Negate	Multiply-Accumulate	Negative Multiply-Accumulate	Register Management
addo[.] addco[.] addeo[.] addmeo[.] addzeo[.]	subfo[.] subfco[.] subfeo[.] subfmeo[.] subfzeo[.]	mullwo[.]	divwo[.] divwuo[.]	nego[.]	macchwo[.] macchwso[.] macchwsuo[.] macchwuo[.] machhwo[.] machhwsuo[.] machhwuo[.] maclhwo[.] maclhwsuo[.] maclhwuo[.]	nmacchwo[.] nmacchwso[.] nmachhwo[.] nmachhwso[.] nmaclhwo[.] nmaclhwsuo[.]	mtspr mcrxr

3.3.2.4 Special Purpose Register General (SPRG0–SPRG7)

USPRG0 and SPRG0–SPRG7 are provided for general purpose software use. For example, these registers are used as temporary storage locations. For example, an interrupt handler might save the contents of a GPR to an SPRG, and later restore the GPR from it. This is faster than a save/restore to a memory location. These registers are written using **mtspr** and read using **mf spr**.

Access to USPRG0 is non-privileged for both read and write.

SPRG0–SPRG7 provide temporary storage locations. For example, an interrupt handler might save the contents of a GPR to an SPRG, and later restore the GPR from it. This is faster than performing a save/restore to memory. These registers are written by **mtspr** and read by **mf spr**.

Access to SPRG0–SPRG7 is privileged, except for read access to SPRG4–SPRG7. See “Privileged SPRs” on page 3-123 for more information.

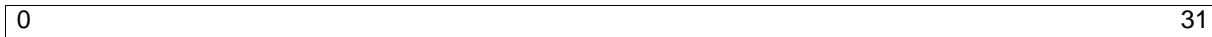

Figure 3-6. Special Purpose Register General (SPRG0–SPRG7)

0:31	General data	Software value; no hardware usage.
------	--------------	------------------------------------

Preliminary User's Manual**3.3.2.5 Processor Version Register (PVR)**

The PVR is a read-only register that uniquely identifies a standard product or Core+ASIC implementation. Software can examine the PVR to recognize implementation-dependent features and determine available hardware resources.

Access to the PVR is privileged. See “Privileged SPRs” on page 3-123 for more information.

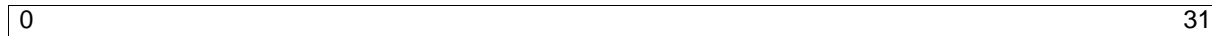
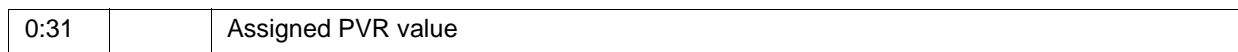

Figure 3-7. Processor Version Register (PVR)

**3.3.3 Condition Register (CR)**

The CR contains eight 4-bit fields (CR0–CR7), as shown in Figure 3-8. The fields contain conditions detected during the execution of integer or logical compare instructions, as indicated in the instruction descriptions in Chapter 24, “Instruction Set.” The CR contents can be used in conditional branch instructions.

The CR can be modified in any of the following ways:

- **mtcrf sets specified CR fields by writing to the CR from a GPR, under control of a mask specified as an instruction field.**
- **mcrf sets a specified CR field by copying another CR field to it.**
- **mcrxr copies certain bits of the XER into a designated CR field, and then clears the corresponding XER bits.**
- **The “with update” forms of integer instructions implicitly update CR[CR0].**
- **Integer compare instructions update a specified CR field.**
- **The CR-logical instructions update a specified CR bit with the result of a logical operation on a specified pair of CR bit fields.**
- **Conditional branch instructions can test a CR bit as one of the branch conditions.**

If a CR field is set by a compare instruction, the bits are set as described in “CR Fields after Compare Instructions.”

The CR is part of the user programming model.

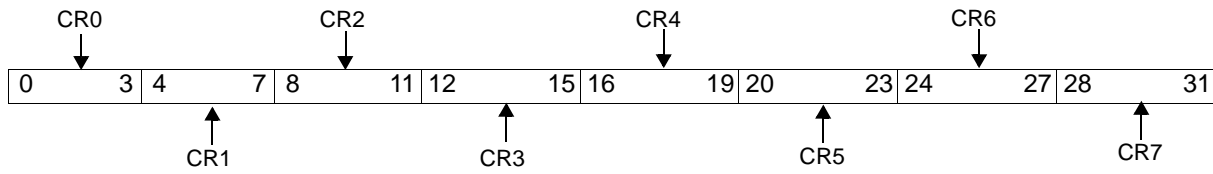

Figure 3-8. Condition Register (CR)

0:3	CR0	Condition Register Field 0
4:7	CR1	Condition Register Field 1
8:11	CR2	Condition Register Field 2
12:15	CR3	Condition Register Field 3
16:19	CR4	Condition Register Field 4
20:23	CR5	Condition Register Field 5
24:27	CR6	Condition Register Field 6
28:31	CR7	Condition Register Field 7

Preliminary User's Manual

3.3.3.1 CR Fields after Compare Instructions

Compare instructions compare the values of two 32-bit registers. The two types of compare instructions, *arithmetic* and *logical*, are distinguished by the interpretation given to the 32-bit values. For *arithmetic* compares, the values are considered to be signed, where 31 bits represent the magnitude and the most-significant bit is a sign bit. For *logical* compares, the values are considered to be unsigned, so all 32 bits represent magnitude. There is no sign bit. As an example, consider the comparison of 0 with 0xFFFFFFFF. In an *arithmetic* compare, 0 is larger, because 0xFFFF FFFF represents –1; in a *logical* compare, 0xFFFFFFFF is larger.

A compare instruction can direct its CR update to any CR field. The first data operand of a compare instruction specifies a GPR. The second data operand specifies another GPR, or immediate data derived from the IM field of the immediate instruction form. The contents of the GPR specified by the first data operand are compared with the contents of the GPR specified by the second data operand (or with the immediate data). See descriptions of the compare instructions (page 0-674 through page 0-677) for precise details.

After a compare, the specified CR field is interpreted as follows:

LT (bit 0)	The first operand is less than the second operand.
GT (bit 1)	The first operand is greater than the second operand.
EQ (bit 2)	The first operand is equal to the second operand.
SO (bit 3)	Summary overflow; a copy of XER[SO].

3.3.3.2 The CR0 Field

After the execution of compare instructions that update CR[CR0], CR[CR0] is interpreted as described in “CR Fields after Compare Instructions” on page 3-93. The “dot” forms of arithmetic and logical instructions also alter CR[CR0]. After most instructions that update CR[CR0], the bits of CR0 are interpreted as follows:

LT (bit 0)	Less than 0; set if the most-significant bit of the 32-bit result is 1.
GT (bit 1)	Greater than 0; set if the 32-bit result is non-zero and the most-significant bit of the result is 0.
EQ (bit 2)	Equal to 0; set if the 32-bit result is 0.
SO (bit 3)	Summary overflow; a copy of XER[SO] at instruction completion.

The CR[CR0]_{LT,GT,EQ} subfields are set as the result of an algebraic comparison of the instruction result to 0, regardless of the type of instruction that sets CR[CR0]. If the instruction result is 0, the EQ subfield is set to 1. If the result is not 0, either LT or GT is set, depending on the value of the most-significant bit of the result.

When updating CR[CR0], the most significant bit of an instruction result is considered a sign bit, even for instructions that produce results that are not usually thought of as signed. For example, logical instructions such as **and.**, **or.**, and **nor.** update CR[CR0]_{LT,GT,EQ} using such an arithmetic comparison to 0, although the result of such a logical operation is not actually an arithmetic result.

If an arithmetic overflow occurs, the “sign” of an instruction result indicated in CR[CR0]_{LT,GT,EQ} might not represent the “true” (infinitely precise) algebraic result of the instruction that set CR0. For example, if an **add.** instruction adds two large positive numbers and the magnitude of the result cannot be represented as a twos-complement number in a 32-bit register, an overflow occurs and CR[CR0]_{LT,SO} are set, although the infinitely precise result of the add is positive.

Adding the largest 32-bit twos-complement negative number, 0x8000 0000, to itself results in an arithmetic overflow and 0x0000 0000 is recorded in the target register. CR[CR0]_{EQ,SO} is set, indicating a result of 0, but the infinitely precise result is negative.

The CR[CR0]_{SO} subfield is a copy of XER[SO]. Instructions that do not alter the XER[SO] bit cannot cause an overflow, but even for these instructions CR[CR0]_{SO} is a copy of XER[SO].

Some instructions set CR[CR0] differently or do not specifically set any of the subfields. These instructions include:

- **Compare instructions**
cmp, cmpi, cmpl, cmpli
- **CR logical instructions**
crand, crandc, creqv, crnand, crnor, cror, crorc, crxor, mcrf
- **Move CR instructions**
mtrcf, mcrxr
- **stwcx.**

The instruction descriptions provide detailed information about how the listed instructions alter CR[CR0].

Preliminary User's Manual

3.3.4 The Time Base

The PowerPC Architecture provides a 64-bit time base. “Time Base” on page 11-272 describes the architected time base. Access to the time base is through two 32-bit time base registers (TBRs). The least-significant 32 bits of the time base are read from the Time Base Lower (TBL) register and the most-significant 32 bits are read from the Time Base Upper (TBU) register.

User-mode access to the time base is read-only, and there is no explicitly privileged read access to the time base.

The **mtfb** instruction reads from TBL and TBU. Writing the time base is accomplished by moving the contents of a GPR to a pair of SPRs, which are also called TBL and TBU, using **mtspr**.

Table 3-5 shows the mnemonics and names of the TBRs.

Table 3-5. Time Base Registers

Mnemonic	Register Name	Access
TBL	Time Base Lower (Read-only)	Read-only
TBU	Time Base Upper (Read-only)	Read-only

3.3.5 Machine State Register (MSR)

The Machine State Register (MSR) controls processor core functions, such as the enabling or disabling of interrupts and address translation.

The MSR is written from a GPR using the **mtmsr** instruction. The contents of the MSR can be read into a GPR using the **mfmsr** instruction. MSR[EE] is set or cleared using the **wrtee** or **wrteei** instructions.

The MSR contents are automatically saved, altered, and restored by the interrupt-handling mechanism. See “Machine State Register (MSR)” on page 0-240.

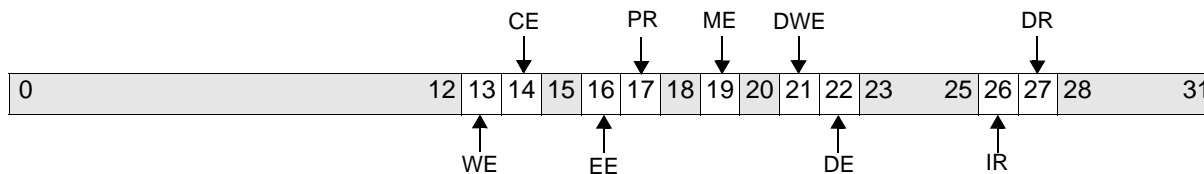

Figure 3-9. Machine State Register (MSR)

0:12		Reserved	
13	WE	Wait State Enable 0 The processor is not in the wait state. 1 The processor is in the wait state.	If MSR[WE] = 1, the processor remains in the wait state until an interrupt is taken, a reset occurs, or an external debug tool clears WE.
14	CE	Critical Interrupt Enable 0 Critical interrupts are disabled. 1 Critical interrupts are enabled.	Controls the critical interrupt input and watchdog timer first time-out interrupts.
15		Reserved	

16	EE	External Interrupt Enable 0 Asynchronous interrupts (external to the processor core) are disabled. 1 Asynchronous interrupts are enabled.	Controls the non-critical external interrupt input, PIT, and FIT interrupts.
17	PR	Problem State 0 Supervisor state (all instructions allowed). 1 Problem state (some instructions not allowed).	
18		Reserved	
19	ME	Machine Check Enable 0 Machine check interrupts are disabled. 1 Machine check interrupts are enabled.	
20		Reserved	
21	DWE	Debug Wait Enable 0 Debug wait mode is disabled. 1 Debug wait mode is enabled.	
22	DE	Debug Interrupts Enable 0 Debug interrupts are disabled. 1 Debug interrupts are enabled.	
23:25		Reserved	
26	IR	Instruction Relocate 0 Instruction address translation is disabled. 1 Instruction address translation is enabled.	
27	DR	Data Relocate 0 Data address translation is disabled. 1 Data address translation is enabled.	
28:31		Reserved	

3.3.6 Device Control Registers

Device Control Registers (DCRs), on-chip registers that exist architecturally outside the processor core, are not part of the AMCC PowerPC Embedded Environment. The Embedded Environment simply defines the existence of a DCR address space and the instructions that access the DCRs, but does not define any DCRs. The instructions that access the DCRs are **mtdcr** (move to device control register) and **mf dcr** (move from device control register).

DCRs are used to control the operations of on-chip buses, peripherals, and some processor behavior.

Preliminary User's Manual**3.3.6.1 Directly Accessed DCRs**

The DCRs listed in Table 3-6 are directly accessed; that is, they are accessed using their DCR numbers.

Table 3-6. Directly Accessed DCRs

Register	DCR Number	Access	Description
DCRs Used for Indirect Access			
SDRAM0_CFGADDR	0x010	R/W	Memory Controller Address Register
SDRAM0_CFGDATA	0x011	R/W	Memory Controller Data Register
EBC0_CFGADDR	0x012	R/W	Peripheral Controller Address Register
EBC0_CFGDATA	0x013	R/W	Peripheral Controller Data Register
DCP0_CFGADDR	0x014	R/W	Decompression Controller Address Register
DCP0_CFGDATA	0x015	R/W	Decompression Controller Data Register
On-Chip Memory			
OCM0_ISARC	0x018	R/W	OCM Instruction-Side Address Range Compare Register
OCM0_ISCNTL	0x019	R/W	OCM Instruction-Side Control Register
OCM0_DSARC	0x01A	R/W	OCM Data-Side Address Range Compare Register
OCM0_DSCNTL	0x01B	R/W	OCM Data-Side Control Register
On-Chip Buses			
PLB0_BESR	0x084	R/Clear	PLB Bus Error Status Register
PLB0_BEAR	0x086	R	PLB Bus Error Address Register
PLB0_ACR	0x087	R/W	PLB Arbiter Control Register
POB0_BESR0	0x0A0	R/Clear	PLB to OPB Bus Error Status Register 0
POB0_BEAR	0x0A2	R	PLB to OPB Bus Error Address Register
POB0_BESR1	0x0A4	R/Clear	PLB to OPB Bus Error Status Register 1
Clocking, Power Management, and Chip Control			
CPC0_PLLMR	0x0B0	R	PLL Mode Register
CPC0_CR0	0x0B1	R/W	Chip Control Register 0
CPC0_CR1	0x0B2	R/W	Chip Control Register 1
CPC0_PSR	0x0B4	R	Chip Pin Strapping Register
CPC0_JTAGID	0x0B5	R	JTAG ID Register
CPC0_SR	0x0B8	R	CPM Status Register
CPC0_ER	0x0B9	R/W	CPM Enable Register
CPC0_FR	0x0BA	R/W	CPM Force Register
Universal Interrupt Controllers			
UIC0_SR	0x0C0	R/Clear	UIC0 Status Register
UIC0_ER	0x0C2	R/W	UIC0 Enable Register
UIC0_CR	0x0C3	R/W	UIC0 Critical Register
UIC0_PR	0x0C4	R/W	UIC0 Polarity Register
UIC0_TR	0x0C5	R/W	UIC0 Triggering Register
UIC0_MSR	0x0C6	R	UIC0 Masked Status Register
UIC0_VR	0x0C7	R	UIC0 Vector Register
UIC0_VCR	0x0C8	W	UIC0 Vector Configuration Register

Table 3-6. Directly Accessed DCRs (continued)

Register	DCR Number	Access	Description
Direct Memory Access			
DMA0_CR0	0x100	R/W	DMA Channel Control Register 0
DMA0_CT0	0x101	R/W	DMA Count Register 0
DMA0_DA0	0x102	R/W	DMA Destination Address Register 0
DMA0_SA0	0x103	R/W	DMA Source Address Register 0
DMA0_SG0	0x104	R/W	DMA Scatter/Gather Descriptor Address Register 0
DMA0_CR1	0x108	R/W	DMA Channel Control Register 1
DMA0_CT1	0x109	R/W	DMA Count Register 1
DMA0_DA1	0x10A	R/W	DMA Destination Address Register 1
DMA0_SA1	0x10B	R/W	DMA Source Address Register 1
DMA0_SG1	0x10C	R/W	DMA Scatter/Gather Descriptor Address Register 1
DMA0_CR2	0x110	R/W	DMA Channel Control Register 2
DMA0_CT2	0x111	R/W	DMA Count Register 2
DMA0_DA2	0x112	R/W	DMA Destination Address Register 2
DMA0_SA2	0x113	R/W	DMA Source Address Register 2
DMA0_SG2	0x114	R/W	DMA Scatter/Gather Descriptor Address Register 2
DMA0_CR3	0x118	R/W	DMA Channel Control Register 3
DMA0_CT3	0x119	R/W	DMA Count Register 3
DMA0_DA3	0x11A	R/W	DMA Destination Address Register 3
DMA0_SA3	0x11B	R/W	DMA Source Address Register 3
DMA0_SG3	0x11C	R/W	DMA Scatter/Gather Descriptor Address
DMA0_SR	0x120	R/Clear	DMA Status Register
DMA0_SGC	0x123	R/W	DMA Scatter/Gather Command Register
DMA0_SLP	0x125	R/W	DMA Sleep Mode Register
DMA0_POL	0x126	R/W	DMA Polarity Configuration Register
Memory Access Layer			
MAL0_CFG	0x180	R/W	MAL Configuration Register
MAL0_ESR	0x181	R/Clear	Error Status Register
MAL0_IER	0x182	R/W	Interrupt Enable Register
MAL0_TXCASR	0x184	R/W	Tx Channel Active Register (Set)
MAL0_TXCARR	0x185	R/W	Tx Channel Active Register (Reset)
MAL0_TXEOBISR	0x186	R/Clear	Tx End of Buffer Interrupt Status Register
MAL0_TXDEIR	0x187	R/Clear	Tx Descriptor Error Interrupt Register
MAL0_RXCASR	0x190	R/W	Rx Channel Active Register (Set)
MAL0_RXCARR	0x191	R/W	Rx Channel Active Register (Reset)
MAL0_RXEOBISR	0x192	R/Clear	Rx End of Buffer Interrupt Status Register
MAL0_RXDEIR	0x193	R/Clear	Rx Descriptor Error Interrupt Register
MAL0_TXCTP0R	0x1A0	R/W	Channel Tx 0 Channel Table Pointer Register
MAL0_TXCTP1R	0x1A1	R/W	Channel Tx 1 Channel Table Pointer Register
MAL0_RCBS0	0x1E0	R/W	Channel RX 0 Channel Buffer Size Register

Preliminary User's Manual**3.3.6.2 Indirectly Accessed DCRs**

The DCRs for the SDRAM controller, external bus controller (EBC), and decompression controller are indirectly accessed.

The following general procedure can be used to access the indirectly accessed DCRs:

1. Write an offset to an address DCR.
2. Read data from or write data to a data DCR.

Detailed procedures for indirectly accessing the DCRs for the specific peripherals follow.

Indirect Access of SDRAM Controller DCRs

The following procedure accesses the SDRAM controller DCRs.

1. Write the offset to the Memory Controller Address Register (SDRAM0_CFGADDR).
2. Read data from or write data to the Memory Controller Data Register (SDRAM0_CFGDATA).

Table 3-7. SDRAM Controller DCR Usage

Register	DCR Number	Access	Description
SDRAM0_CFGADDR	0x010	R/W	Memory Controller Address Register
SDRAM0_CFGDATA	0x011	R/W	Memory Controller Data Register

Table 3-8. Offsets for SDRAM Controller Registers

Register	Offset	R/W	Description
SDRAM0_BESR0	0x00	R/Clear	Bus Error Syndrome Register 0
SDRAM0_BESR1	0x08	R/Clear	Bus Error Syndrome Register 1
SDRAM0_BEAR	0x10	R/W	Bus Error Address Register
SDRAM0_CFG	0x20	R/W	Memory Controller Options 1
SDRAM0_RTR	0x30	R/W	Refresh Timer Register
SDRAM0_PMIT	0x34	R/W	Power Management Idle Timer
SDRAM0_B0CR	0x40	R/W	Memory Bank 0 Configuration Register
SDRAM0_B1CR	0x44	R/W	Memory Bank 1 Configuration Register
SDRAM0_B2CR	0x48	R/W	Memory Bank 2 Configuration Register
SDRAM0_B3CR	0x4C	R/W	Memory Bank 3 Configuration Register
SDRAM0_B4CR	0x50	R/W	Memory Bank 4 Configuration Register
SDRAM0_B5CR	0x54	R/W	Memory Bank 5 Configuration Register
SDRAM0_B6CR	0x58	R/W	Memory Bank 6 Configuration Register
SDRAM0_B7CR	0x5C	R/W	Memory Bank 7 Configuration Register
SDRAM0_TR	0x80	R/W	SDRAM Timing Register 1
SDRAM0_ECCCFG	0x94	R/W	ECC Configuration
SDRAM0_ECCESR	0x98	R/Clear	ECC Error Status Register

Indirect Access of EBC DCRs

The following procedure accesses the EBC DCRs.

1. Write the offset to the Peripheral Controller Address Register (EBC0_CFGADDR).
2. Read data from or write data to the Peripheral Controller Data Register (EBC0_CFGDATA).

Table 3-9. EBC DCR Usage

Register	DCR Number	Access	Description
EBC0_CFGADDR	0x012	R/W	Peripheral Controller Address Register
EBC0_CFGDATA	0x013	R/W	Peripheral Controller Data Register

Table 3-10. Offsets for EBC Registers

Register	Offset	Access	Description
EBC0_B0CR	0x00	R/W	Peripheral Bank 0 Configuration Register
EBC0_B1CR	0x01	R/W	Peripheral Bank 1 Configuration Register
EBC0_B2CR	0x02	R/W	Peripheral Bank 2 Configuration Register
EBC0_B3CR	0x03	R/W	Peripheral Bank 3 Configuration Register
EBC0_B4CR	0x04	R/W	Peripheral Bank 4 Configuration Register
EBC0_B5CR	0x05	R/W	Peripheral Bank 5 Configuration Register
EBC0_B6CR	0x06	R/W	Peripheral Bank 6 Configuration Register
EBC0_B7CR	0x07	R/W	Peripheral Bank 7 Configuration Register
EBC0_B0AP	0x10	R/W	Peripheral Bank 0 Access Parameters
EBC0_B1AP	0x11	R/W	Peripheral Bank 1 Access Parameters
EBC0_B2AP	0x12	R/W	Peripheral Bank 2 Access Parameters
EBC0_B3AP	0x13	R/W	Peripheral Bank 3 Access Parameters
EBC0_B4AP	0x14	R/W	Peripheral Bank 4 Access Parameters
EBC0_B5AP	0x15	R/W	Peripheral Bank 5 Access Parameters
EBC0_B6AP	0x16	R/W	Peripheral Bank 6 Access Parameters
EBC0_B7AP	0x17	R/W	Peripheral Bank 7 Access Parameters
EBC0_BEAR	0x20	R/W	Peripheral Bus Error Address Register
EBC0_BESR0	0x21	R/W	Peripheral Bus Error Status Register 0
EBC0_BESR1	0x22	R/W	Peripheral Bus Error Status Register 1
EBC0_CFG	0x23	R/W	External Peripheral Control Register

Preliminary User's Manual**Indirect Access of Decompression Controller DCRs**

The following procedure accesses the decompression controller DCRs.

1. Write the offset to the Decompression Controller Address Register (DCP0_CFGADDR).
2. Read data from or write data to the Decompression Controller Data Register (DCP0_CFGDATA).

Table 3-11. Decompression Controller DCR Usage

Register	DCR Number	Access	Description
DCP0_CFGADDR	0x014	R/W	Decompression Controller Address Register
DCP0_CFGDATA	0x015	R/W	Decompression Controller Data Register

Table 3-12. Offsets for Decompression Controller Registers

Register	Offset	R/W	Description
DCP0_ITOR0	0x00	R/W	Index Table Origin Register 0
DCP0_ITOR1	0x01	R/W	Index Table Origin Register 1
DCP0_ITOR2	0x02	R/W	Index Table Origin Register 2
DCP0_ITOR3	0x03	R/W	Index Table Origin Register 3
DCP0_ADDR0	0x04	R/W	Address Decode Definition Register 0
DCP0_ADDR1	0x05	R/W	Address Decode Definition Register 1
DCP0_CFG	0x40	R/W	Decompression Controller Configuration Register
DCP0_ID	0x41	R	Decompression Controller ID Register
DCP0_VER	0x42	R	Decompression Controller Version Number Register
DCP0_PLBBEAR	0x50	R	Bus Error Address Register (PLB address)
DCP0_MEMBEAR	0x51	R	Bus Error Address Register (DCP to EBC address)
DCP0_ESR	0x52	R/Clear	Bus Error Status Register 0 (masters 0-3)
DCP0_RAM0– DCP0_RAM3FF	0x400–0x7FF	R/W	Decode Tables

3.3.7 Memory-Mapped Input/Output Registers

Some registers associated with on-chip peripherals are memory-mapped input/output (MMIO) registers. Such registers are mapped into the system memory space and are accessed using load/store instructions.

3.3.8 Directly Accessed MMIO Registers

Directly-accessed MMIO registers are accessed using load/store instructions that contain the register addresses. Table 3-13 lists the directly-accessed MMIO registers.

Table 3-13. Directly Accessed MMIO Registers

Register	Address	Access	Description
MMIO Registers Used for Indirect Access			
PCIC0_CFGADDR	0xEEC00000	R/W	PCI Configuration Address Register
PCIC0_CFGDATA	0xEEC00004	R/W	PCI Configuration Data Register
PCI-to-PLB Bridge			
PCIL0_PMM0LA	0xEF400000	R/W	PMM 0 Local Address
PCIL0_PMM0MA	0xEF400004	R/W	PMM 0 Mask/Attribute
PCIL0_PMM0PCILA	0xEF400008	R/W	PMM 0 PCI Low Address
PCIL0_PMM0PCIHA	0xEF40000C	R/W	PMM 0 PCI High Address
PCIL0_PMM1LA	0xEF400010	R/W	PMM 1 Local Address
PCIL0_PMM1MA	0xEF400014	R/W	PMM 1 Mask/Attribute
PCIL0_PMM1PCILA	0xEF400018	R/W	PMM 1 PCI Low Address
PCIL0_PMM1PCIHA	0xEF40001C	R/W	PMM 1 PCI High Address
PCIL0_PMM2LA	0xEF400020	R/W	PMM 2 Local Address
PCIL0_PMM2MA	0xEF400024	R/W	PMM 2 Mask/Attribute
PCIL0_PMM2PCILA	0xEF400028	R/W	PMM 2 PCI Low Address
PCIL0_PMM2PCIHA	0xEF40002C	R/W	PMM 2 PCI High Address
PCIL0_PTM1MS	0xEF400030	R/W	PTM 1 Memory Size
PCIL0_PTM1LA	0xEF400034	R/W	PTM 1 Local Address
PCIL0_PTM2MS	0xEF400038	R/W	PTM 2 Memory Size
PCIL0_PTM2LA	0xEF40003C	R/W	PTM 2 Local Address
Serial Ports			
UART0_RBR	0xEF600300	R	UART 0 Receiver Buffer Register Note: Set UART0_LCR[DLAB] = 0 to access.
UART0_THR		W	UART 0 Transmitter Holding Register Note: Set UART0_LCR[DLAB] = 0 to access.
UART0_DLL		R/W	UART 0 Baud-rate Divisor Latch LSB Note: Set UART0_LCR[DLAB] = 1 to access.
UART0_IER	0xEF600301	R/W	UART 0 Interrupt Enable Register Note: Set UART0_LCR[DLAB] = 0 to access.
UART0_DLM		R/W	UART 0 Baud-rate Divisor Latch MSB Note: Set UART0_LCR[DLAB] = 1 to access.
UART0_IIR	0xEF600302	R	UART 0 Interrupt Identification Register
UART0_FCR	0xEF600302	W	UART 0 FIFO Control Register
UART0_LCR	0xEF600303	R/W	UART 0 Line Control Register
UART0_MCR	0xEF600304	R/W	UART 0 Modem Control Register
UART0_LSR	0xEF600305	R/W	UART 0 Line Status Register
UART0_MSR	0xEF600306	R/W	UART 0 Modem Status Register
UART0_SCR	0xEF600307	R/W	UART 0 Scratch Register

Preliminary User's Manual**Table 3-13. Directly Accessed MMIO Registers (continued)**

Register	Address	Access	Description
UART1_RBR	0xEF600400	R	UART 1 Receiver Buffer Register Note: Set UART1_LCR[DLAB] = 0 to access.
UART1_THR		W	UART 1 Transmitter Holding Register Note: Set UART1_LCR[DLAB] = 0 to access.
UART1_DLL		R/W	UART 1 Baud-rate Divisor Latch LSB Note: Set UART1_LCR[DLAB] = 1 to access.
UART1_IER	0xEF600401	R/W	UART 1 Interrupt Enable Register Note: Set UART1_LCR[DLAB] = 0 to access.
UART1_DLM		R/W	UART 1 Baud-rate Divisor Latch MSB Note: Set UART1_LCR[DLAB] = 1 to access.
UART1_IIR	0xEF600402	R	UART 1 Interrupt Identification Register
UART1_FCR	0xEF600402	W	UART 1 FIFO Control Register
UART1_LCR	0xEF600403	R/W	UART 1 Line Control Register
UART1_MCR	0xEF600404	R/W	UART 1 Modem Control Register
UART1_LSR	0xEF600405	R/W	UART 1 Line Status Register
UART1_MSR	0xEF600406	R/W	UART 1 Modem Status Register
UART1_SCR	0xEF600407	R/W	UART 1 Scratch Register
Inter-Integrated Circuit			
IIC0_MDBUF	0xEF600500	R/W	IIC0 Master Data Buffer
IIC0_SDBUF	0xEF600502	R/W	IIC0 Slave Data Buffer
IIC0_LMADR	0xEF600504	R/W	IIC0 Low Master Address
IIC0_HMADR	0xEF600505	R/W	IIC0 High Master Address
IIC0_CNTL	0xEF600506	R/W	IIC0 Control
IIC0_MDCNTL	0xEF600507	R/W	IIC0 Mode Control
IIC0_STS	0xEF600508	R/W	IIC0 Status
IIC0_EXTSTS	0xEF600509	R/W	IIC0 Extended Status
IIC0_LSADR	0xEF60050A	R/W	IIC0 Low Slave Address
IIC0_HSADR	0xEF60050B	R/W	IIC0 High Slave Address
IIC0_CLKDIV	0xEF60050C	R/W	IIC0 Clock Divide
IIC0_INTRMSK	0xEF60050D	R/W	IIC0 Interrupt Mask
IIC0_XFRCNT	0xEF60050E	R/W	IIC0 Transfer Count
IIC0_XTCNTLSS	0xEF60050F	R/W	IIC0 Extended Control and Slave Status
IIC0_DIRECTCNTL	0xEF600510	R/W	IIC0 Direct Control
OPB Arbiter			
OPBA0_PR	0xEF600600	R/W	OPB Arbiter Priority Register
OPBA0_CR	0xEF600601	R/W	OPB Arbiter Control Register

Table 3-13. Directly Accessed MMIO Registers (continued)

Register	Address	Access	Description
General-Purpose I/O			
GPIO0_OR	0xEF600700	R/W	GPIO0 Output Register
GPIO0_TCR	0xEF600704	R/W	GPIO0 Three-State Control Register
GPIO0_ODR	0xEF600718	R/W	GPIO0 Open Drain Register
GPIO0_IR	0xEF60071C	R	GPIO0 Input Register
Ethernet			
EMAC0_MR0	0xEF600800	R/W	Mode Register 0
EMAC0_MR1	0xEF600804	R/W	Mode Register 1
EMAC0_TMR0	0xEF600808	R/W	Transmit Mode Register 0
EMAC0_TMR1	0xEF60080C	R/W	Transmit Mode Register 1
EMAC0_RMR	0xEF600810	R/W	Receive Mode Register
EMAC0_ISR	0xEF600814	R/W	Interrupt Status Register
EMAC0_ISER	0xEF600818	R/W	Interrupt Status Enable Register
EMAC0_IAHR	0xEF60081C	R/W	Individual Address High
EMAC0_IALR	0xEF600820	R/W	Individual Address Low
EMAC0_VTPID	0xEF600824	R/W	VLAN TPID Register
EMAC0_VTCI	0xEF600828	R/W	VLAN TCI Register
EMAC0_PTR	0xEF60082C	R/W	Pause Timer Register
EMAC0_IAHT1	0xEF600830	R/W	Individual Address Hash Table 1
EMAC0_IAHT2	0xEF600834	R/W	Individual Address Hash Table 2
EMAC0_IAHT3	0xEF600838	R/W	Individual Address Hash Table 3
EMAC0_IAHT4	0xEF60083C	R/W	Individual Address Hash Table 4
EMAC0_GAHT1	0xEF600840	R/W	Group Address Hash Table 1
EMAC0_GAHT2	0xEF600844	R/W	Group Address Hash Table 2
EMAC0_GAHT3	0xEF600848	R/W	Group Address Hash Table 3
EMAC0_GAHT4	0xEF60084C	R/W	Group Address Hash Table 4
EMAC0_LSAH	0xEF600850	R	Last Source Address High
EMAC0_LSAL	0xEF600854	R	Last Source Address Low
EMAC0_IPGVR	0xEF600858	R/W	Inter-Packet Gap Value Register
EMAC0_STACR	0xEF60085C	R/W	STA Control Register
EMAC0_TRTR	0xEF600860	R/W	Transmit Request Threshold Register
EMAC0_RWMR	0xEF600864	R/W	Receive Low/High Water Mark Register
EMAC0_OCTX	0xEF600868	R/W	Number of Octets Transmitted Register
EMAC0_OCRX	0xEF60086C	R/W	Number of Octets Received Register

Preliminary User's Manual**3.3.8.1 Indirectly Accessed MMIO Registers**

The PCI configuration registers, listed in Table 3-15, are indirectly accessed.

The following procedure accesses the PCI configuration registers, using the address and data registers listed in Table 3-14:

1. OR the Enable, Bus, Device, and Function fields of the PCI Configuration Address Register (PCIC0_CFGADDR) with the high-order 6 bits of the offset from Table 3-15 and write the result to the PCIC0_CFGADDR.
2. OR the low-order 2 bits of the offset from Table 3-15 with the address of the PCI Configuration Data Register (PCIC0_CFGDATA) to form an address.

Read data from or write data to the address.

Table 3-14. PCI Configuration Address and Data Registers

Register	Address	Access	Description
PCIC0_CFGADDR	0xEEC00000	R/W	PCI Configuration Address Register
PCIC0_CFGDATA	0xEEC00004	R/W	PCI Configuration Data Register

Table 3-15. PCI Configuration Registers

Register	Offset	Access		Description
		PLB	PCI	
PCIC0_VENDID	0x01–0x00	R/W	R	PCI Vendor ID
PCIC0_DEVID	0x03–0x02	R/W	R	PCI Device ID
PCIC0_CMD	0x05–0x04	R/W	R/W	PCI Command Register
PCIC0_STATUS	0x07–0x06	R/W	R/W	PCI Status Register
PCIC0_REVID	0x08	R/W	R/W	PCI Revision ID
PCIC0_CLS	0x0B–0x09	R/W	R	PCI Class Register
PCIC0_CACHELS	0x0C	R	R	PCI Cache Line Size
PCIC0_LATTIM	0x0D	R/W	R/W	PCI Latency Timer
PCIC0_HDTYPE	0x0E	R	R	PCI Header Type
PCIC0_BIST	0x0F	R	R	PCI Built In Self Test Control
PCIC0_BAR0	0x13–0x10	R	R	PCI Reserved BAR 0
PCIC0_PTM1BAR	0x17–0x14	R/W	R/W	PCI PTM 1 BAR
PCIC0_PTM2BAR	0x1B–0x18	R/W	R/W	PCI PTM 2 BAR
PCIC0_BAR3	0x1F–0x1C	—	—	PCI Reserved BAR 3
PCIC0_BAR4	0x23–0x20	—	—	PCI Reserved BAR 4
PCIC0_BAR5	0x27–0x24	—	—	PCI Reserved BAR 5
PCIC0_CISPTR	0x2B–0x28	—	—	Unused Cardbus CIS Pointer
PCIC0_SBSYSVID	0x2D–0x2C	R/W	R	PCI Subsystem Vendor ID
PCIC0_SBSYSID	0x2F–0x2E	R/W	R	PCI Subsystem ID
PCIC0_EROMBA	0x33–0x30	—	—	Unused Expansion ROM Base Address
PCIC0_CAP	0x34	R	R	PCI Capabilities Pointer
PCIC0_INTLN	0x3C	R/W	R/W	PCI Interrupt Line
PCIC0_INTPN	0x3D	R	R	PCI Interrupt Pin
PCIC0_MINGNT	0x3E	R	R	PCI Minimum Grant

Table 3-15. PCI Configuration Registers (continued)

Register	Offset	Access		Description
		PLB	PCI	
PCIC0_MAXLTNCY	0x3F	R	R	PCI Maximum Latency
PCIC0_ICS	0x44	R/W	R/W	PCI Interrupt Control/Status
PCIC0_ERREN	0x48	R/W	R/W	Error Enable
PCIC0_ERRSTS	0x49	R/W	R/W	Error Status
PCIC0_BRDGOPT1	0x4B–0x4A	R/W	R/W	PCI Bridge Options 1
PCIC0_PLBBESR0	0x4F–0x4C	R/W	R/W	PLB Slave Error Syndrome 0
PCIC0_PLBBESR1	0x53–0x50	R/W	R/W	PLB Slave Error Syndrome 1
PCIC0_PLBBEAR	0x57–0x54	R/W	R/W	PLB Slave Error Address Register
PCIC0_CAPID	0x58	R	R	Capability Identifier
PCIC0_NEXTIPTR	0x59	R	R	Next Item Pointer
PCIC0_PMC	0x5B–0x5A	R	R	Power Management Capabilities
PCIC0_PMCSR	0x5D–0x5C	R/W	R/W	Power Management Control Status
PCIC0_PMCSRBSE	0x5E	R	R	PMCSR PCI to PCI Bridge Support Extensions
PCIC0_DATA	0x5F	—	—	Unused Data
PCIC0_BRDGOPT2	0x63–0x60	R/W	R/W	PCI Bridge Options 2
PCIC0_PMSCRR	0x64	R/W	R/W	Power Management State Change Request Register

3.4 Data Types and Alignment

The data types consist of bytes (eight bits), halfwords (two bytes), words (four bytes), and strings (1 to 128 bytes). Figure 3-10 shows the byte, halfword, and word data types and their bit and byte definitions for big endian representations of values. Note that PowerPC bit numbering is reversed from industry conventions; bit 0 represents the most significant bit of a value.

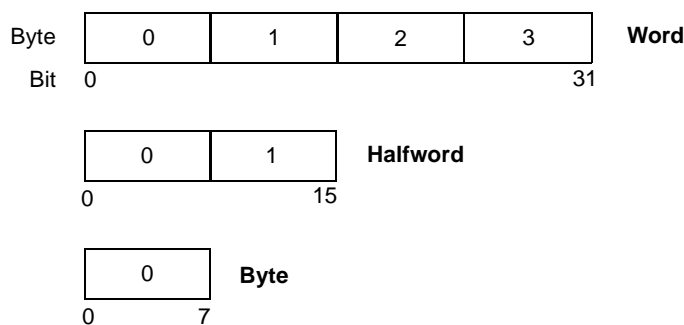

Figure 3-10. PPC405GP Data Types

Data is represented in either two's-complement notation or in an unsigned integer format; data representation is independent of alignment issues.

The address of a data object is always the lowest address of any byte comprising the object.

All instructions are words, and are word-aligned (the lowest byte address is divisible by 4).

Preliminary User's Manual

3.4.1 Alignment for Storage Reference and Cache Control Instructions

The storage reference instructions (loads and stores; see Table 3-23, “Storage Reference Instructions,” on page 3-129) move data to and from storage. The data cache control instructions listed in Table 3-32, “Cache Management Instructions,” on page 3-132, control the contents and operation of the data cache unit (DCU). Both types of instructions form an effective address (EA). The method of calculating the EA for the storage reference and cache control instructions is detailed in the description of those instructions. See Chapter 24, “Instruction Set,” for more information.

Cache control instructions ignore the five least significant bits of the EA; no alignment restrictions exist in the DCU because of EAs. However, storage control attributes can cause alignment exceptions. When data address translation is disabled and a **dcbz** instruction references a storage region that is non-cachable, or for which write-through caching is the write strategy, an alignment exception is taken. Such exceptions result from the storage control attributes, not from EA alignment. The alignment exception enables system software to emulate the write-through function.

Alignment requirements for the storage reference instructions and the **dcread** instruction depend on the particular instruction. Table 3-16, “Alignment Exception Summary,” on page 3-107, summarizes the instructions that cause alignment exceptions.

The data targets of instructions are of types that depend upon the instruction. The load/store instructions have the following “natural” alignments:

- Load/store word instructions have word targets, word-aligned.
- Load/ store halfword instructions have halfword targets, halfword-aligned.
- Load/store byte instructions have byte targets, byte-aligned (that is, any alignment).

Misalignments are addresses that are not naturally aligned on data type boundaries. An address not divisible by four is misaligned with respect to word instructions. An address not divisible by two is misaligned with respect to halfword instructions. The PPC405GP implementation handles misalignments within and across word boundaries, but there is a performance penalty because additional cycles are required.

3.4.2 Alignment and Endian Operation

The endian storage control attribute does not affect alignment behavior. In little endian storage regions, the alignment of data is treated as it is in big endian storage regions; no special alignment exceptions occur when accessing data in little endian storage regions. Note that the alignment exceptions that apply to big endian region accesses also apply to little endian storage region accesses.

3.4.3 Summary of Instructions Causing Alignment Exceptions

Table 3-16 summarizes the instructions that cause alignment exceptions and the conditions under which the alignment exceptions occur.

Table 3-16. Alignment Exception Summary

Instructions Causing Alignment Exceptions	Conditions
dcbz	EA in non-cachable or write-through storage
dcread, lwarx, stwcx.	EA not word-aligned

3.5 Byte Ordering

The following discussion describes the “endianness” of the PPC405GP core, which, by default and in normal use is “big endian.” The PPC405GP also contains “little endian” peripherals and supports the attachment of external little endian peripherals.

If scalars (individual data items and instructions) were indivisible, “byte ordering” would not be a concern. It is meaningless to consider the order of bits or groups of bits within a byte, the smallest addressable unit of storage; nothing can be observed about such order. Only when scalars, which the programmer and processor regard as indivisible quantities, can comprise more than one addressable unit of storage does the question of byte order arise.

For a machine in which the smallest addressable unit of storage is the 32-bit word, there is no question of the ordering of bytes within words. All transfers of individual scalars between registers and storage are of words, and the address of the byte containing the high-order eight bits of a scalar is the same as the address of any other byte of the scalar.

For the PowerPC Architecture, as for most computer architectures currently implemented, the smallest addressable unit of storage is the 8-bit byte. Other scalars are halfwords, words, or doublewords, which consist of groups of bytes. When a word-length scalar is moved from a register to storage, the scalar is stored in four consecutive byte addresses. It thus becomes meaningful to discuss the order of the byte addresses with respect to the value of the scalar: that is, which byte contains the highest-order eight bits of the scalar, which byte contains the next-highest-order eight bits, and so on.

Given a scalar that contains multiple bytes, the choice of byte ordering is essentially arbitrary. There are $4! = 24$ ways to specify the ordering of four bytes within a word, but only two of these orderings are commonly used:

- **The ordering that assigns the lowest address to the highest-order (“leftmost”) eight bits of the scalar, the next sequential address to the next-highest-order eight bits, and so on.**

This ordering is called *big endian* because the “big end” of the scalar, considered as a binary number, comes first in storage.

- **The ordering that assigns the lowest address to the lowest-order (“rightmost”) eight bits of the scalar, the next sequential address to the next-lowest-order eight bits, and so on.**

This ordering is called *little endian* because the “little end” of the scalar, considered as a binary number, comes first in storage.

Preliminary User's Manual

3.5.1 Structure Mapping Examples

The following C language structure, *s*, contains an assortment of scalars and a character string. The comments show the value assumed to be in each structure element; these values show how the bytes comprising each structure element are mapped into storage.

```
struct {
    int a;          /* 0x1112_1314 word */
    long long b;   /* 0x2122_2324_2526_2728 doubleword */
    char *c;       /* 0x3132_3334 word */
    char d[7];     /* 'A','B','C','D','E','F','G' array of bytes */
    short e;       /* 0x5152 halfword */
    int f;         /* 0x6162_6364 word */
} s;
```

C structure mapping rules permit the use of padding (skipped bytes) to align scalars on desirable boundaries. The structure mapping examples show each scalar aligned at its natural boundary. This alignment introduces padding of four bytes between *a* and *b*, one byte between *d* and *e*, and two bytes between *e* and *f*. The same amount of padding is present in both big endian and little endian mappings.

3.5.1.1 Big Endian Mapping

The big endian mapping of structure *s* follows. (The data is highlighted in the structure mappings. Addresses, in hexadecimal, are below the data stored at the address. The contents of each byte, as defined in structure *s*, is shown as a (hexadecimal) number or character (for the string elements).

11	12	13	14				
0x00	0x01	0x02	0x03	0x04	0x05	0x06	0x07
21	22	23	24	25	26	27	28
0x08	0x09	0x0A	0x0B	0x0C	0x0D	0x0E	0x0F
31	32	33	34	'A'	'B'	'C'	'D'
0x10	0x11	0x12	0x13	0x14	0x15	0x16	0x17
'E'	'F'	'G'		51	52		
0x18	0x19	0x1A	0x1B	0x1C	0x1D	0x1E	0x1F
61	62	63	64				
0x20	0x21	0x22	0x23	0x24	0x25	0x26	0x27

3.5.1.2 Little Endian Mapping

Structure s is shown mapped little endian.

14 0x00	13 0x01	12 0x02	11 0x03	0x04	0x05	0x06	0x07
28 0x08	27 0x09	26 0x0A	25 0x0B	24 0x0C	23 0x0D	22 0x0E	21 0x0F
34 0x10	33 0x11	32 0x12	31 0x13	'A' 0x14	'B' 0x15	'C' 0x16	'D' 0x17
'E' 0x18	'F' 0x19	'G' 0x1A	0x1B	52 0x1C	51 0x1D	0x1E	0x1F
64 0x20	63 0x21	62 0x22	61 0x23	0x24	0x25	0x26	0x27

3.5.2 Support for Little Endian Byte Ordering

Except as noted, this book describes the processor as if it operated only in a big endian fashion. In fact, the AMCC PowerPC Embedded Environment also supports little endian operation.

The PowerPC little endian mode, defined in the PowerPC Architecture, is not implemented.

3.5.3 Endian (E) Storage Attribute

The endian (E) storage attribute supports direct connection of the PPC405GP to little endian peripherals and to memory containing little endian instructions and data. For every storage reference (instruction fetch or load/store access), an E storage attribute is associated with the storage region of the reference. The E attribute specifies whether that region is organized as big endian (E = 0) or little endian (E = 1).

When address translation is enabled (MSR[IR] = 1 or MSR[DR] = 1), the E field in the corresponding TLB entry controls the endianness of a memory region. When address translation is disabled (MSR[IR] = 0 or MSR[DR] = 0), the SLER controls the endianness of a memory region.

Bytes in storage that are accessed as little endian are arranged in true little endian format. The PPC405GP does not support the little endian mode defined in the PowerPC architecture and used in PPC401xx and PPC403xx processors. Furthermore, no address modification is performed when accessing storage regions programmed as little endian. Instead, the PPC405GP reorders the bytes as they are transferred between the processor and memory.

The on-the-fly reversal of bytes in little endian storage regions is handled in one of two ways, depending on whether the storage access is an instruction fetch or a data access (load/store). The following sections describe byte reordering for the two kinds of storage accesses.

Preliminary User's Manual**3.5.3.1 Fetching Instructions from Little Endian Storage Regions**

Instructions are words (four bytes) that are aligned on word boundaries in memory. As such, instructions in a big endian memory region are arranged with the most significant byte (MSB) of the instruction word at the lowest address.

Consider the big endian mapping of instruction p at address 00, where, for example, $p = \text{add r7, r7, r4}$:

MSB			LSB
0x00	0x01	0x02	0x03

On the other hand, in the little endian mapping instruction p is arranged with the least significant byte (LSB) of the instruction word at the lowest numbered address:

LSB			MSB
0x00	0x01	0x02	0x03

When an instruction is fetched from memory, the instruction must be placed in the instruction queue in the proper order. The execution unit assumes that the MSB of an instruction word is at the lowest address. Therefore, when instructions are fetched from little endian storage regions, the four bytes of an instruction word are reversed before the instruction is decoded. In the PPC405GP, the byte reversal occurs between memory and the instruction cache unit (ICU). The ICU always stores instructions in big endian format, regardless of whether the memory region containing the instruction is programmed as big endian or little endian. Thus, the bytes are already in the proper order when an instruction is transferred from the ICU to the decode stage of the pipeline.

If a storage region is reprogrammed from one endian format to the other, the storage region must be reloaded with program and data structures in the appropriate endian format. If the endian format of instruction memory changes, the ICU must be made coherent with the updates. The ICU must be invalidated and the updated instruction memory using the new endian format must be fetched so that the proper byte ordering occurs before the new instructions are placed in the ICU.

3.5.3.2 Accessing Data in Little Endian Storage Regions

Unlike instruction fetches from little endian storage regions, data accesses from little endian storage regions are *not* byte-reversed between memory and the DCU. Data byte ordering, in memory, depends on the data type (byte, halfword, or word) of a specific data item. It is only when moving a data item *of a specific type* from or to a GPR that it becomes known what type of byte reversal is required. Therefore, byte reversal during load/store accesses is performed between the DCU and the GPR.

When accessing data in a little endian storage region:

- **For byte loads/stores, no reordering occurs.**
- **For halfword loads/stores, bytes are reversed within the halfword.**
- **For word loads/stores, bytes are reversed within the word.**

Note that this applies, regardless of data alignment.

The big endian and little endian mappings of the structure *s*, shown in “Structure Mapping Examples” on page 3-109, demonstrate how the size of an item determines its byte ordering. For example:

- **The word *a* has its four bytes reversed within the word spanning addresses 0x00–0x03.**
- **The halfword *e* has its two bytes reversed within the halfword spanning addresses 0x1C–0x1D.**

Note that the array of bytes *d*, where each data item is a byte, is not reversed when the big endian and little endian mappings are compared. For example, the character 'A' is located at address 0x14 in both the big endian and little endian mappings.

In little endian storage regions, the alignment of data is treated as it is in big endian storage regions. Unlike PowerPC little endian mode, no special alignment exceptions occur when accessing data in little endian storage regions.

Preliminary User's Manual**3.5.3.3 PowerPC Byte-Reverse Instructions**

For big endian storage regions, normal load/store instructions move the more significant bytes of a register to and from the lower-numbered memory addresses. The load/store with byte-reverse instructions move the more significant bytes of the register to and from the higher numbered memory addresses.

As Figure 3-11 through Figure 3-14 illustrate, a normal store to a big endian storage region is the same as a byte-reverse store to a little endian storage region. Conversely, a normal store to a little endian storage region is the same as a byte-reverse store to a big endian storage region.

Figure 3-11 illustrates the contents of a GPR and memory (starting at address 00) after a normal load/store in a big endian storage region.

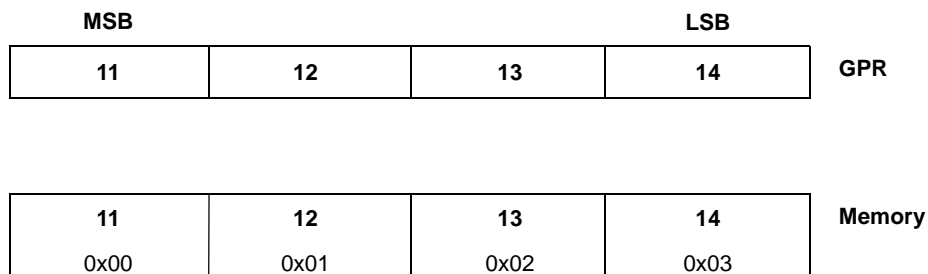

Figure 3-11. Normal Word Load or Store (Big Endian Storage Region)

Note that the results are identical to the results of a load/store with byte-reverse in a little endian storage region, as illustrated in Figure 3-12.

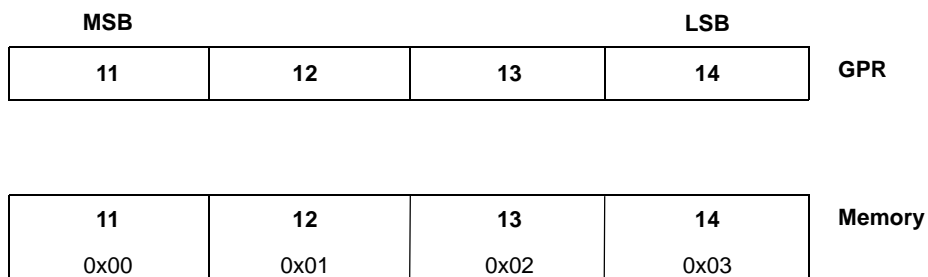

Figure 3-12. Byte-Reverse Word Load or Store (Little Endian Storage Region)

Figure 3-13 illustrates the contents of a GPR and memory (starting at address 00) after a load/store with byte-reverse in a big endian storage region.

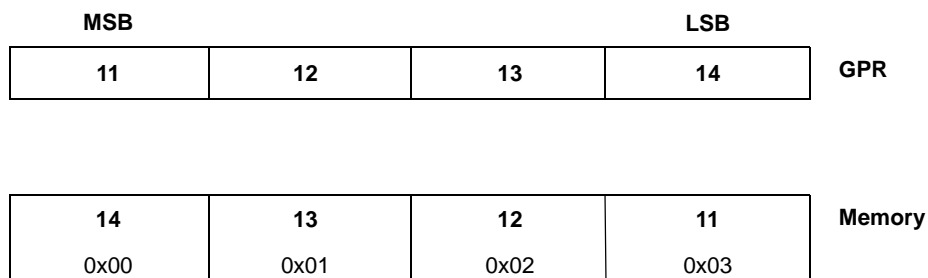

Figure 3-13. Byte-Reverse Word Load or Store (Big Endian Storage Region)

Note that the results are identical to the results of a normal load/store in a little endian storage region, as illustrated in Figure 3-14.

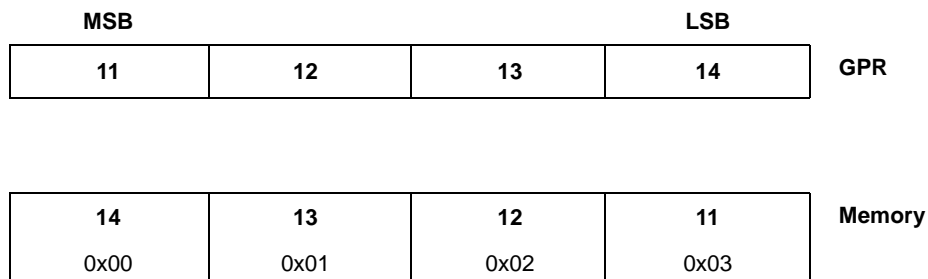

Figure 3-14. Normal Word Load or Store (Little Endian Storage Region)

The E storage attribute augments the byte-reverse load/store instructions in two important ways:

- **The load/store with byte-reverse instructions do not solve the problem of fetching instructions from a storage region in little endian format.**

Only the endian storage attribute mechanism supports the fetching of little endian program images.

- **Typical compilers cannot make general use of the byte-reverse load/store instructions, so these instructions are ordinarily used only in device drivers written in hand-coded assembler.**

Compilers can, however, take full advantage of the endian storage attribute mechanism, enabling application programmers working in a high-level language, such as C, to compile programs and data structures into little endian format.

3.6 Instruction Processing

The instruction pipeline, illustrated in Figure 3-15, contains three queue locations: prefetch buffer 1 (PFB1), prefetch buffer 0 (PFB0), and decode (DCD). This queue implements a pipeline with the following functional stages: fetch, decode, execute, write-back and load write-back. Instructions are fetched from the instruction cache unit (ICU), placed in the instruction queue, and eventually dispatched to the execution unit (EXU).

Instructions are fetched from the ICU at the request of the EXU. Cachable instructions are forwarded directly to the instruction queue and stored in the ICU cache array. Non-cachable instructions are also forwarded directly to the instruction queue, but are not stored in the ICU cache array. Fetched instructions drop to the empty queue location closest to the EXU. When there is room in the queue, instructions can be returned from the ICU two at a time. If the queue is empty and the ICU is returning two instructions, one instruction drops into DCD while the other drops into PFB0. PFB1 buffers instructions when the pipeline stalls.

Preliminary User's Manual

Branch instructions are examined in DCD and PFB0 while all other instructions are decoded in DCD. All instructions must pass through DCD before entering the EXU. The EXU contains the execute, write-back and load write-back stages of the pipe. The results of most instructions are calculated during the execute stage and written to the GPR file during the write back stage. Load instructions write the GPR file during the load write-back stage.

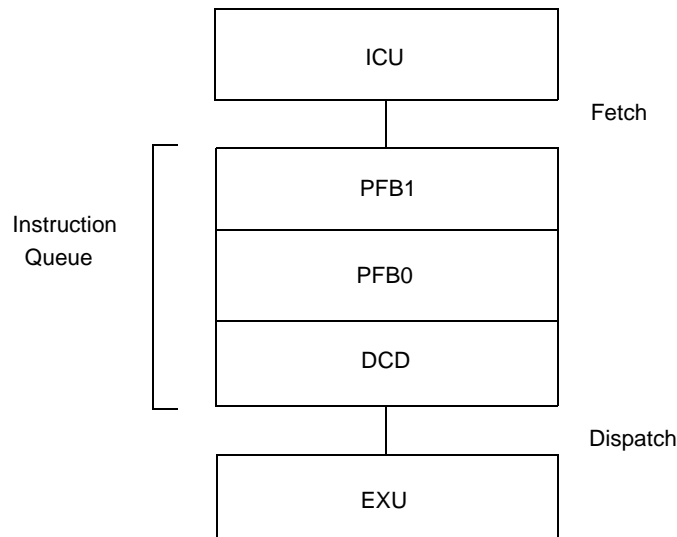

Figure 3-15. PPC405GP Instruction Pipeline

3.7 Branch Processing

The PPC405GP, which provides a variety of conditional and unconditional branching instructions, uses the branch prediction techniques described in “Branch Prediction” on page 3-35.

3.7.1 Unconditional Branch Target Addressing Options

The unconditional branches (**b**, **ba**, **bl**, **bla**) carry the displacement to the branch target address as a signed 26-bit value (the 24-bit LI field right-extended with 0b00). The displacement enables unconditional branches to cover an address range of $\pm 32\text{MB}$.

For the relative (AA = 0) forms (**b**, **bl**), the target address is the current instruction address (CIA, the address of the branch instruction) plus the signed displacement.

For the absolute (AA = 1) forms (**ba**, **bla**), the target address is 0 plus the signed displacement. If the sign bit (LI[0]) is 0, the displacement is the target address. If the sign bit is 1, the displacement is a negative value and wraps to the highest memory addresses. For example, if the displacement is 0x3FF FFFC (the 26-bit representation of -4), the target address is 0xFFFF FFFC (0 – 4B, or 4 bytes below the top of memory).

3.7.2 Conditional Branch Target Addressing Options

The conditional branches (**bc**, **bca**, **bcl**, **bcla**) carry the displacement to the branch target address as a signed 16-bit value (the 14-bit BD field right-extended with 0b00). The displacement enables conditional branches to cover an address range of $\pm 32\text{KB}$.

For the relative (AA = 0) forms (**bc**, **bcl**), the target address is the CIA plus the signed displacement.

For the absolute (AA = 1) forms (**bca**, **bcla**), the target address is 0 plus the signed displacement. If the sign bit (BD[0]) is 0, the displacement is the target address. If the sign bit is 1, the displacement is negative and wraps to the highest memory addresses. For example, if the displacement is 0xFFFFC (the 16-bit representation of -4), the target address is 0xFFFF FFFC (0 – 4B, or 4 bytes from the top of memory).

3.7.3 Conditional Branch Condition Register Testing

Conditional branch instructions can test a CR bit. The value of the BI field specifies the bit to be tested (bit 0–31). The BO field controls whether the CR bit is tested, as described in the following section.

3.7.4 BO Field on Conditional Branches

The BO field of the conditional branch instruction specifies the conditions used to control branching, and specifies how the branch affects the CTR.

Conditional branch instructions can test one bit in the CR. This option is selected when BO[0] = 0; if BO[0] = 1, the CR does not participate in the branch condition test. If this option is selected, the condition is satisfied (branch can occur) if CR[BI] = BO[1].

Conditional branch instructions can decrement the CTR by one, and after the decrement, test the CTR value. This option is selected when BO[2] = 0. If this option is selected, BO[3] specifies the condition that must be satisfied to allow a branch to be taken. If BO[3] = 0, CTR \neq 0 is required for a branch to occur. If BO[3] = 1, CTR = 0 is required for a branch to occur.

If BO[2] = 1, the contents of the CTR are left unchanged, and the CTR does not participate in the branch condition test.

Table 3-17 summarizes the usage of the bits of the BO field. BO[4] is further discussed in “Branch Prediction.”

Table 3-17. Bits of the BO Field

BO Bit	Description
BO[0]	CR Test Control 0 Test CR bit specified by BI field for value specified by BO[1] 1 Do not test CR
BO[1]	CR Test Value 0 Test for CR[BI] = 0. 1 Test for CR[BI] = 1.
BO[2]	CTR Test Control 0 Decrement CTR by one and test whether CTR satisfies the condition specified by BO[3]. 1 Do not change CTR, do not test CTR.

Preliminary User's Manual**Table 3-17. Bits of the BO Field (continued)**

BO Bit	Description
BO[3]	CTR Test Value 0 Test for CTR \neq 0. 1 Test for CTR = 0.
BO[4]	Branch Prediction Reversal 0 Apply standard branch prediction. 1 Reverse the standard branch prediction.

Table 3-18 lists specific BO field contents, and the resulting actions; z represents a mandatory value of 0, and y is a branch prediction option discussed in “Branch Prediction.”

Table 3-18. Conditional Branch BO Field

BO Value	Description
0000y	Decrement the CTR, then branch if the decremented CTR \neq 0 and CR[BI]=0.
0001y	Decrement the CTR, then branch if the decremented CTR = 0 and CR[BI] = 0.
001zy	Branch if CR[BI] = 0.
0100y	Decrement the CTR, then branch if the decremented CTR \neq 0 and CR[BI] = 1.
0101y	Decrement the CTR, then branch if the decremented CTR=0 and CR[BI] = 1.
011zy	Branch if CR[BI] = 1.
1z00y	Decrement the CTR, then branch if the decremented CTR \neq 0.
1z01y	Decrement the CTR, then branch if the decremented CTR = 0.
1z1zz	Branch always.

3.7.5 Branch Prediction

Conditional branches present a problem to the instruction fetcher. A branch might be taken. The branch EXU attempts to predict whether or not a branch is taken before all information necessary to determine the branch direction is available. This decision is called a *branch prediction*. The fetcher can then prefetch instructions starting at the predicted branch target address. If the prediction is correct, time is saved because the branched-to instruction is available in the instruction queue. Otherwise, the instruction pipeline stalls while the correct instruction is fetched into the instruction queue. To be effective, branch prediction must be correct most of the time.

The PowerPC Architecture enables software to reverse the default branch prediction, which is defined as follows:

Predict that the branch is to be taken if $((BO[0] \wedge BO[2]) \vee s) = 1$

where s is the sign bit of the displacement for conditional branch (**bc**) instructions, and 0 for **bclr** and **bcctr** instructions.

$(BO[0] \wedge BO[2]) = 1$ only when the conditional branch tests nothing (the “branch always” condition). Obviously, the branch should be predicted taken for this case.

If the branch tests anything, $(BO[0] \wedge BO[2]) = 0$, and s entirely controls the prediction. The default prediction for this case was decided by considering the relative form of **bc**, which is commonly used at the end of loops to control the number of times that a loop is executed. The branch is taken every time the loop is executed except the last, so it is best if the branch is predicted taken. The branch target is the beginning of the loop, so the branch displacement is negative and $s = 1$.

If branch displacements are positive ($s = 0$), the branch is predicted not taken. If the branch instruction is any form of **bclr** or **bcctr** except the “branch always” forms, then $s = 0$, and the branch is predicted not taken.

There is a peculiar consequence of this prediction algorithm for the absolute forms of **bc** (**bca** and **bcla**). As described in “Unconditional Branch Target Addressing Options” on page 3-115, if the algebraic sign of the displacement is negative ($s = 1$), the branch target address is in high memory. If the algebraic sign of the displacement is positive ($s = 0$), the branch target address is in low memory. Because these are absolute-addressing forms, there is no reason to treat high and low memory differently. Nevertheless, for the high memory case the default prediction is taken, and for the low memory case the default prediction is not taken.

$BO[4]$ is the *prediction reversal bit*. If $BO[4] = 0$, the default prediction is applied. If $BO[4] = 1$, the reverse of the standard prediction is applied. For the cases in Table 3-17 where $BO[4] = y$, software can reverse the default prediction. This should only be done when the default prediction is likely to be wrong. Note that for the “branch always” condition, reversal of the default prediction is not allowed.

The PowerPC Architecture requires assemblers to provide a way to conveniently control branch prediction. For any conditional branch mnemonic, a suffix may be added to the mnemonic to control prediction, as follows:

- + Predict branch to be taken
- Predict branch to be not taken

For example, **bcctr+** causes $BO[4]$ to be set appropriately to force the branch to be predicted taken.

3.8 Speculative Accesses

The PowerPC Architecture permits implementations to perform speculative accesses to memory, either for instruction fetching, or for data loads. A speculative access is defined as any access which is not required by a sequential execution model.

For example, prefetching instructions beyond an undetermined conditional branch is a speculative fetch; if the branch is not in the predicted direction, the program, as executed, never needs the instructions from the predicted path.

Sometimes speculative accesses are inappropriate. For example, attempting to fetch instructions from addresses that cannot contain instructions can cause problems. To protect against errant accesses to “sensitive” memory or I/O devices, the PowerPC Architecture provides the G (guarded) storage attribute, which can be used to specify memory pages from which speculative accesses are prohibited. (Actually, speculative accesses to guarded storage are allowed in certain limited circumstances; if an instruction in a cache block will be executed, the rest of the cache block can be speculatively accessed.)

Preliminary User's Manual

3.8.1 Speculative Accesses in the PPC405GP

The PPC405GP does not perform speculative loads.

Two methods control speculative instruction fetching. If instruction address translation is enabled (MSR[IR] = 1), the G (guarded) field in the translation lookaside buffer (TLB) entries controls speculative accesses.

If instruction address translation is disabled (MSR[IR] = 0), the Storage Guarded Register (SGR) controls speculative accesses for regions of memory. When a region is guarded (speculative fetching is disallowed), instruction prefetching is disabled for that region. A fetch request must be completely resolved (no longer speculative) before it is issued. There is a considerable performance penalty for fetching from guarded storage, so guarding should be used only when required.

Note that, following any reset, the PPC405GP operates with all of storage guarded.

Note that when address translation is enabled, attempts to fetch from guarded storage result in instruction storage exceptions. Guarded memory is in most often needed with peripheral status registers that are cleared automatically after being read, because an unintended access resulting from a speculative fetch would cause the loss of status information. Because the MMU provides 64 pages with a wide range of page sizes as small as 1KB, fetching instructions from guarded storage should be unnecessary.

3.8.1.1 Prefetch Distance Down an Unresolved Branch Path

The fetcher will speculatively access up to 19 instructions down a predicted branch path, whether taken or sequential, regardless of cachability.

3.8.1.2 Prefetch of Branches to the CTR and Branches to the LR

When the instruction fetcher predicts that a **bctr** or **blr** instruction will be taken, the fetcher does not attempt to fetch an instruction from the target address in the CTR or LR if an executing instruction updates the register ahead of the branch. (See "Instruction Processing" on page 3-114 for a description of the instruction pipeline). The fetcher recognizes that the CTR or LR contains data left from an earlier use and that such data is probably not valid.

In such cases, the fetcher does not fetch the instruction at the target address until the instruction that is updating the CTR or LR completes. Only then are the "correct" CTR or LR contents known. This prevents the fetcher from speculatively accessing a completely "random" address. After the CTR or LR contents are known to be correct, the fetcher accesses no more than five instructions down the sequential or taken path of an unresolved branch, or at the address contained in the CTR or LR.

3.8.2 Preventing Inappropriate Speculative Accesses

A memory-mapped I/O peripheral, such as a serial port having a status register that is automatically reset when read provides a simple example of storage that should not be speculatively accessed. If code is in memory at an address adjacent to the peripheral (for example, code goes from 0x0000 0000 to 0x0000 0FFF, and the peripheral is at 0x0000 1000), prefetching past the end of the code will read the peripheral.

Guarding storage also prevents prefetching past the end of memory. If the highest memory address is left unguarded, the fetcher could attempt to fetch past the last valid address, potentially causing machine checks on the fetches from invalid addresses. While the machine checks do not actually cause an exception until the processor attempts to execute an instruction at an invalid address, some systems could suffer from the attempt to access such an invalid address. For example, an external memory controller might log an error.

System designers can avoid problems from speculative fetching without using the guarded storage attributes. The rest of this section describes ways to prevent speculative instruction fetches to sensitive addresses in unguarded memory regions.

3.8.2.1 Fetching Past an Interrupt-Causing or Interrupt-Returning Instruction

Suppose a **bctr** or **blr** instruction closely follows an interrupt-causing or interrupt-returning instruction (**sc**, **rfi**, or **rfti**). The fetcher does not prevent speculatively fetching past one of these instructions. In other words, the fetcher does not treat the interrupt-causing and interrupt-returning instructions specially when deciding whether to predict down a branch path. Instructions after an **rfti**, for example, are considered to be on the determined branch path.

To understand the implications of this situation, consider the code sequence:

```

handler:  aaa
          bbb
          rfi
subroutine: bctr

```

When executing the interrupt handler, the fetcher does not recognize the **rfti** as a break in the program flow, and speculatively fetches the target of the **bctr**, which is really the first instruction of a subroutine that has not been called. Therefore, the CTR might contain an invalid pointer.

To protect against such a prefetch, the software must insert an unconditional branch hang (**b \$**) just after the **rfti**. This prevents the hardware from prefetching the invalid target address used by **bctr**.

Consider also the above code sequence, with the **rfti** instruction replaced by an **sc** instruction used to initialize the CTR with the appropriate value for the **bctr** to branch to, upon return from the system call. The **sc** handler returns to the instruction following the **sc**, which can't be a branch hang. Instead, software could put a **mtctr** just before the **sc** to load a non-sensitive address into the CTR. This address will be used as the prediction address before the **sc** executes. An alternative would be to put a **mfctr** or **mtctr** between the **sc** and the **bctr**; the **mtctr** prevents the fetcher from speculatively accessing the address contained in the CTR before initialization.

Preliminary User's Manual

3.8.2.2 Fetching Past `tw` or `twi` Instructions

The interrupt-causing instructions, `tw` and `twi`, do not require the special handling described in “Fetching Past an Interrupt-Causing or Interrupt-Returning Instruction” on page 3-120. These instructions are typically used by debuggers, which implement software breakpoints by substituting a trap instruction for the instruction originally at the breakpoint address. In a code sequence `mtlr` followed by `blr` (or `mtctr` followed by `bctr`), replacement of `mtlr/mtctr` by `tw` or `twi` leaves the LR/CTR uninitialized. It would be inappropriate to fetch from the `blr/bctr` target address. This situation is common, and the fetcher is designed to prevent the problem.

3.8.2.3 Fetching Past an Unconditional Branch

When an unconditional branch is in DCD in the instruction queue, the fetcher recognizes that the sequential instructions following the branch are unnecessary. These sequential addresses are not accessed. Addresses at the branch target are accessed instead.

Therefore, placing an unconditional branch just before the start of a sensitive address space (for example, at the “end” of a memory area that borders an I/O device) guarantees that addresses in the sensitive area will not be speculatively fetched.

3.8.2.4 Suggested Locations of Memory-Mapped Hardware

The preferred method of protecting memory-mapped hardware from inadvertent access is to use address translation, with hardware isolated to guarded pages (the G storage attribute in the associated TLB entry is set to 1.) The pages can be as small as 1KB. Code should never be stored in such pages.

If address translation is disabled, the preferred protection method is to isolate memory-mapped hardware into regions guarded using the SGR. Code should never be stored in such regions. The disadvantage of this method, compared to the preferred method, is that each region guarded by the SGR consumes 128MB of the address space.

Table 3-19 shows two address regions of the PPC405GP. Suppose a system designer can map all I/O devices and all ROM and SRAM devices into any location in either region. The choices made by the designer can prevent speculative accesses to the memory-mapped I/O devices.

Table 3-19. Example Memory Mapping

0x7800 0000 – 0x7FFF FFFF (SGR bit 15)	128MB Region 2
0x7000 0000 – 0x77FF FFFF (SGR bit 14)	128MB Region 1

A simple way to avoid the problem of speculative reads to peripherals is to map all storage containing code into Region 2, and all I/O devices into Region 1. Thus, accesses to Region 2 would only be for code and program data. Speculative fetches occurring in Region 2 would never access addresses in Region 1. Note that this hardware organization eliminates the need to use of the G storage attribute to protect Region 1. However, Region 1 could be set as guarded with no performance penalty, because there is no code to execute or variable data to access in Region 1.

The use of these regions could be reversed (code in Region 1 and I/O devices in Region 2), if Region 2 is set as guarded. Prefetching from the highest addresses of Region 1 could cause an attempt to speculatively access the bottom of Region 2, but guarding prevents this from occurring. The performance penalty is slight, under the assumption that code infrequently executes the instructions in the highest addresses of Region 1.

3.8.3 Summary

Software should take the following actions to prevent speculative accesses to sensitive data areas, if the sensitive data areas are not in guarded storage:

- **Protect against accesses to “random” values in the LR or CTR on blr or bctr branches following rfi, rfci, or sc instructions by putting appropriate instructions before or after the rfi, rfci, or sc instruction. See “Fetching Past an Interrupt-Causing or Interrupt-Returning Instruction” on page 3-120.**
- **Protect against “running past” the end of memory into a bordering I/O device by putting an unconditional branch at the end of the memory area. See “Fetching Past an Unconditional Branch” on page 3-121.**
- **Recognize that a maximum of 19 words can be prefetched past an unresolved conditional branch, either down the target path or the sequential path. See “Prefetch Distance Down an Unresolved Branch Path” on page 3-119.**

Of course, software should not code branches with known unsafe targets (either relative to the instruction counter, or to addresses contained in the LR or CTR), on the assumption that the targets are “protected” by code guaranteeing that the unsafe direction is not taken. The fetcher assumes that if a branch is predicted to be taken, it is safe to fetch down the target path.

3.9 Privileged Mode Operation

In the PowerPC Architecture, several terms describe two operating modes that have different instruction execution privileges. When a processor is in “privileged mode,” it can execute all instructions in the instruction set. This mode is also called the “supervisor state.” The other mode, in which certain instructions cannot be executed, is called the “user mode,” or “problem state.” These terms are used in pairs:

Privileged	Non-privileged
Privileged Mode	User Mode
Supervisor State	Problem State

The architecture uses MSR[PR] to control the execution mode. When MSR[PR] = 1, the processor is in user mode (problem state); when MSR[PR] = 0, the processor is in privileged mode (supervisor state).

After a reset, MSR[PR] = 0.

3.9.1 MSR Bits and Exception Handling

The current value of MSR[PR] is saved, along with all other MSR bits, in the SRR1 (for non-critical interrupts) or SRR3 (for critical interrupts) upon any interrupt, and MSR[PR] is set to 0. Therefore, all exception handlers operate in privileged mode.

Attempting to execute a privileged instruction while in user mode causes a privileged violation program exception (see “Program Interrupt” on page 0-253). The PPC405GP does not execute the instruction, and the program counter is loaded with EVPR[0:15] || 0x0700, the address of an exception processing routine.

The PRR field of the Exception Syndrome Register (ESR) is set when an interrupt was caused by a privileged instruction program exception. Software is not required to clear ESR[PPR].

Preliminary User's Manual**3.9.2 Privileged Instructions**

The instructions listed in Table 3-20 are privileged and cannot be executed while in user mode (MSR[PR] = 1).

Table 3-20. Privileged Instructions

dcbi	
dccci	
dcread	
iccci	
icread	
mfocr	
mfmsr	
mfspr	For all SPRs except CTR, LR, SPRG4–SPRG7, and XER. See “Privileged SPRs” on page 3-123
mtocr	
mtmsr	
mtspr	For all SPRs except CTR, LR, XER. See “Privileged SPRs” on page 3-123
rftci	
rftci	
tlbia	
tlbre	
tlbsx	
tlbsync	
tlbwe	
wrttee	
wrtteei	

3.9.3 Privileged SPRs

All SPRs are privileged, except for the LR, the CTR, the XER, USPRG0, and read access to SPRG4–SPRG7. Reading from the time base registers Time Base Lower (TBL) and Time Base Upper (TBU) is not privileged. These registers are read using the **mftb** instruction, rather than the **mfmsr** instruction. TBL and TBU are written (with different addresses) using **mtspr**, which is privileged for these registers. Except for moves to and from non-privileged SPRs, attempts to execute **mfmsr** and **mtspr** instructions while in user mode result in privileged violation program exceptions.

In a **mfmsr** or **mtspr** instruction, the 10-bit SPRN field specifies the SPR number of the source or destination SPR. The SPRN field contains two five-bit subfields, SPRN_{0,4} and SPRN_{5,9}. The assembler handles the unusual register number encoding to generate the SPRF field. In the *machine code* for the **mfmsr** and **mtspr** instructions, the SPRN subfields are *reversed* (ending up as SPRF_{5,9} and SPRF_{0,4}) for compatibility with the POWER Architecture.

In the PowerPC Architecture, SPR numbers having a 1 in the most-significant bit of the SPRF field are privileged.

The following example illustrates how SPR numbers appear in assembler language coding and in machine coding of the **mf spr** and **mt spr** instructions.

In assembler language coding, SRR0 is SPR 26. Note that the assembler handles the unusual register number encoding to generate the SPRF field.

```
mf spr r5,26
```

When the SPR number is considered as a binary number (0b0000011010), the most-significant bit is 0. However, the machine code for the instruction reverses the subfields, resulting in the following SPRF field: 0b1101000000. The most-significant bit is 1; SRR0 is privileged.

When an SPR number is considered as a hexadecimal number, the second digit of the three-digit hexadecimal number indicates whether an SPR is privileged. If the second digit is odd (1, 3, 5, 7, 9, B, D, F), the SPR is privileged.

For example, the SPR number of SRR0 is 26 (0x01A). The second hexadecimal digit is odd; SRR0 is privileged. In contrast, the LR is SPR 8 (0x008); the second hexadecimal digit is not odd; the LR is non-privileged.

3.9.4 Privileged DCRs

The **mt dcr** and **mf dcr** instructions themselves are privileged, in all cases. All DCRs are privileged.

3.10 Synchronization

The PPC405GP supports the synchronization operations of the PowerPC Architecture. The following book, chapter, and section numbers refer to related information in *The PowerPC Architecture: A Specification for a New Family of RISC Processors*:

- Book II, Section 1.8.1, “Storage Access Ordering” and “Enforce In-order Execution of I/O”
- Book III, Section 1.7, “Synchronization”
- Book III, Chapter 7, “Synchronization Requirements for Special Registers and Lookaside Buffers”

3.10.1 Context Synchronization

The context of a program is the environment (for example, privilege and address translation) in which the program executes. Context is controlled by the content of certain registers, such as the Machine State Register (MSR), and includes the content of all GPRs and SPRs.

An instruction or event is context synchronizing if it satisfies the following requirements:

1. All instructions that *precede* a context synchronizing operation must complete in the context that existed *before* the context synchronizing operation.
2. All instructions that *follow* a context synchronizing operation must complete in the context that exists *after* the context synchronizing operation.

Such instructions and events are called “context synchronizing operations.” In the PPC405GP, these include any interrupt, except a non-recoverable instruction machine check, and the **isync**, **r fci**, **r fi**, and **sc** instructions.

Preliminary User's Manual

However, context specifically excludes the contents of memory. A context synchronizing operation does not guarantee that subsequent instructions observe the memory context established by previous instructions. To guarantee memory access ordering in the PPC405GP, one must use either an **eieio** instruction or a **sync** instruction. Note that for the PPC405GP, the **eieio** and **sync** instructions are implemented identically. See “Storage Synchronization” on page 3-127.

The contents of DCRs are not considered as part of the processor “context” managed by a context synchronizing operation. DCRs are not part of the processor core, and are analogous to memory-mapped registers. Their context is managed in a manner similar to that of memory contents.

Finally, implementations of the PowerPC Architecture can exempt the machine check exception from context synchronization control. If the machine check exception is exempted, an instruction that *precedes* a context synchronizing operation can cause a machine check exception *after* the context synchronizing operation occurs and additional instructions have completed.

The following scenarios use pseudocode examples to illustrate these limitations of context synchronization. Subsequent text explains how software can further guarantee “storage ordering.”

1. Consider the following instruction sequence:

```
STORE non-cachable to address XYZ
isync
XYZ instruction
```

In this sequence, the **isync** instruction does not guarantee that the XYZ instruction is fetched after the STORE has occurred to memory. There is no guarantee which XYZ instruction will execute; either the old version or the new (stored) version might.

2. Consider the following instruction sequence, which assumes that the PPC405GP uses DCRs to provide bus region control:

```
STORE non-cachable to address XYZ
isync
MTDCR to change a bus region containing XYZ
```

In this sequence, there is no guarantee that the STORE will occur before the **mtdcr** changing the bus region control DCR. The STORE could fail because of a configuration error.

Consider an interrupt that changes privileged mode. An interrupt is a context synchronizing operation, because interrupts cause the MSR to be updated. The MSR is part of the processor context; the context synchronizing operation guarantees that all instructions that precede the interrupt complete using the preinterrupt value of MSR[PR], and that all instructions that follow the interrupt complete using the postinterrupt value.

Consider, on the other hand, some code that uses **mtmsr** to change the value of MSR[PR], which changes the privileged mode. In this case, the MSR is changed, changing the context. It is possible, for example, that prefetched privileged instructions expect to execute after the **mtmsr** has changed the operating mode from privileged mode to user mode. To prevent privileged instruction program exceptions, the code must execute a context synchronization operation, such as **isync**, immediately after the **mtmsr** instruction to prevent further instruction execution until the **mtmsr** completes.

eieio or **sync** can ensure that the contents of memory and DCRs are synchronized in the instruction stream. These instructions guarantee storage ordering because all memory accesses that precede **eieio** or **sync** are completed before subsequent memory accesses. Neither **eieio** nor **sync** guarantee that instruction prefetching is delayed until the **eieio** or **sync** completes. The instructions do not cause the prefetch queues to be purged and instructions to be refetched. See “Storage Synchronization” on page 3-127 for more information.

Instruction cache state is part of context. A context synchronization operation is required to guarantee instruction cache access ordering.

3. Consider the following instruction sequence, which is required for creating self-modifying code:

STORE	Change data cache contents
dcbst	Flush the new data cache contents to memory
sync	Guarantee that dcbst completes before subsequent instructions begin
icbi	Context changing operation; invalidates instruction cache contents.
isync	Context synchronizing operation; causes refetch using new instruction cache context text and new memory context, due to the previous sync .

If software wishes to ensure that all storage accesses are complete before executing a **mtdcr** to change a bus region (Example 2), the software must issue a **sync** after all storage accesses and before the **mtdcr**. Likewise, if the software is to ensure that all instruction fetches after the **mtdcr** use the new bank register contents, the software must issue an **isync**, after the **mtdcr** and before the first instruction that should be fetched in the new context.

isync guarantees that all subsequent instructions are fetched and executed using the context established by all previous instructions. **isync** is a context synchronizing operation; **isync** causes all subsequently prefetched instructions to be discarded and refetched.

The following example illustrates the use of **isync** with debug exceptions:

mtdbcr0	Enable an instruction address compare (IAC) event
isync	Wait for the new Debug Control Register 0 (DBCR0) context to be established
XYZ	This instruction is at the IAC address; an isync was necessary to guarantee that the IAC event occurs at the execution of this instruction

3.10.2 Execution Synchronization

For completeness, consider the definition of execution synchronizing as it relates to context synchronization. Execution synchronization is architecturally a subset of context synchronization.

Execution synchronization guarantees that the following requirement is met:

All instructions that *precede* an execution synchronizing operation must complete in the context that existed *before* the execution synchronizing operation.

The following requirement need not be met:

All instructions that *follow* an execution synchronizing operation must complete in the context that exists *after* the execution synchronizing operation.

Execution synchronization ensures that preceding instructions execute in the old context; subsequent instructions might execute in either the new or old context (indeterminate). The PPC405GP provides three execution synchronizing operations: the **eieio**, **mtmsr**, and **sync** instructions.

Preliminary User's Manual

Because **mtmsr** is execution synchronizing, it guarantees that previous instructions complete using the old MSR value. (For example, using **mtmsr** to change the endian mode.) However, to guarantee that subsequent instructions use the new MSR value, we have to insert a context synchronization operation, such as **isync**.

Note that the PowerPC Architecture requires MSR[EE] (the external interrupt bit) to be, in effect, execution synchronizing: if a **mtmsr** sets MSR[EE] = 1, and an external interrupt is pending, the exception must be taken before the instruction that follows **mtmsr** is executed. However, the **mtmsr** instruction is not a context synchronizing operation, so the PPC405GP does not, for example, discard prefetched instructions and refetch. Note that the **wrtee** and **wrteei** instructions can change the value of MSR[EE], but are not execution synchronizing.

Finally, while **sync** and **eieio** are execution synchronizing, they are also more restrictive in their requirement of memory ordering. Stating that an operation is execution synchronizing does not imply storage ordering. This is an additional specific requirement of **sync** and **eieio**.

3.10.3 Storage Synchronization

The **sync** instruction guarantees that all previous storage references complete with respect to the PPC405GP before the **sync** instruction completes (therefore, before any subsequent instructions begin to execute). The **sync** instruction is execution synchronizing.

Consider the following use of **sync**:

stw	Store to peripheral
sync	Wait for store to actually complete
mtdcr	Reconfigure device

The **eieio** instruction guarantees the order of storage accesses. All storage accesses that precede **eieio** complete before any storage accesses that follow the instruction, as in the following example:

stb X	Store to peripheral, address X; this resets a status bit in the device
eieio	Guarantee stb X completes before next instruction
lbz Y	Load from peripheral, address Y; this is the status register updated by stb X . eieio was necessary, because the read and write addresses are different, but affect each other

The PPC405GP implements both **sync** and **eieio** identically, in the manner described above for **sync**. In the PowerPC Architecture, **sync** can function across all processors in a multiprocessor environment; **eieio** functions only within its executing processor. The PPC405GP does not provide hardware support for multiprocessor memory coherency, so **sync** does not guarantee memory ordering across multiple processors.

3.11 Instruction Set

The PPC405GP instruction set contains instructions defined in the PowerPC Architecture and instructions specific to the AMCC PowerPC 400 family of embedded processors.

Chapter 24, "Instruction Set," contains detailed descriptions of each instruction.

Appendix A, “Instruction Summary,” alphabetically lists each instruction and extended mnemonic and provides a short-form description. Appendix A, “Instructions by Category,” provides short-form descriptions of instructions, grouped by the instruction categories listed in Table 3-21, “PPC405GP Instruction Set Summary,” on page 3-128.

Table 3-21 summarizes the PPC405GP instruction set functions by categories. Instructions within each category are described in subsequent sections.

Table 3-21. PPC405GP Instruction Set Summary

Storage Reference	load, store
Arithmetic	add, subtract, negate, multiply, multiply-accumulate, multiply halfword, divide
Logical	and, andc, or, orc, xor, nand, nor, xnor, sign extension, count leading zeros
Comparison	compare, compare logical, compare immediate
Branch	branch, branch conditional, branch to LR, branch to CTR
CR Logical	crand, crandc, cror, crorc, crnand, crnor, crxor, crxnor, move CR field
Rotate	rotate and insert, rotate and mask, shift left, shift right
Shift	shift left, shift right, shift right algebraic
Cache Management	invalidate, touch, zero, flush, store, read
Interrupt Control	write to external interrupt enable bit, move to/from MSR, return from interrupt, return from critical interrupt
Processor Management	system call, synchronize, trap, move to/from DCRs, move to/from SPRs, move to/from CR

3.11.1 Instructions Specific to the AMCC PowerPC Embedded Environment

To support functions required in embedded real-time applications, the AMCC PowerPC 400 family of embedded processors defines instructions that are not defined in the PowerPC Architecture.

Table 3-22 lists the instructions specific to AMCC PowerPC embedded processors. Programs using these instructions are not portable to PowerPC implementations that are not part of the AMCC PowerPC 400 family of embedded processors.

In the table, the syntax [s] indicates that the instruction has a signed form. The syntax [u] indicates that the instruction has an unsigned form. The syntax “[.]” indicates that the instruction has a “record” form that updates CR[CR0], and a “non-record” form.

Table 3-22. Implementation-specific Instructions

dccci dcread iccci icread	macchw[s][u] machhw[s][u] maclhw[s][u] nmacchw[s] nmachhw[s] nmaclhw[s]	mulchw[u] mulhhw[u] mullhw[u]	mfdcr mtdcr rfci tlbre tlbsx[.] tlbwe wrtee wrteei
------------------------------------	--	-------------------------------------	---

Preliminary User's Manual**3.11.2 Storage Reference Instructions**

Table 3-23 lists the PPC405GP storage reference instructions. Load/store instructions transfer data between memory and the GPRs. These instructions operate on bytes, halfwords, and words. Storage reference instructions also support loading or storing multiple registers, character strings, and byte-reversed data.

In the table, the syntax “[u]” indicates that an instruction has an “update” form that updates the RA addressing register with the calculated address, and a “non-update” form. The syntax “[x]” indicates that an instruction has an “indexed” form, which forms the address by adding the contents of the RA and RB GPRs and a “base + displacement” form, in which the address is formed by adding a 16-bit signed immediate value (included as part of the instruction word) to the contents of RA GPR.

Table 3-23. Storage Reference Instructions

Loads				Stores			
Byte	Halfword	Word	Multiple/String	Byte	Halfword	Word	Multiple/String
lbz[u][x]	lha[u][x] lhbrx lhz[u][x]	lwarx lwbrx lwz[u][x]	lmw lswi lswx	stb[u][x]	sth[u][x] sthbrx	stw[u][x] stwbrx stwcx.	stmw stswi stswx

3.11.3 Arithmetic Instructions

Arithmetic operations are performed on integer operands stored in GPRs. Instructions that perform operations on two operands are defined in a three-operand format; an operation is performed on the operands, which are stored in two GPRs. The result is placed in a third, operand, which is stored in a GPR. Instructions that perform operations on one operand are defined using a two-operand format; the operation is performed on the operand in a GPR and the result is placed in another GPR. Several instructions also have immediate formats in which an operand is contained in a field in the instruction word.

Most arithmetic instructions have versions that can update CR[CR0] and XER[SO, OV], based on the result of the instruction. Some arithmetic instructions also update XER[CA] implicitly. See “Condition Register (CR)” on page 3-91 and “Fixed Point Exception Register (XER)” on page 3-87 for more information.

Table 3-24 lists the PPC405GP arithmetic instructions. In the table, the syntax “[o]” indicates that an instruction has an “o” form that updates XER[SO,OV], and a “non-o” form. The syntax “[.]” indicates that the instruction has a “record” form that updates CR[CR0], and a “non-record” form.

Table 3-24. Arithmetic Instructions

Add	Subtract	Multiply	Divide	Negate
add[o][.] addc[o][.] adde[o][.] addi addic[.] addis addme[o][.] addze[o][.]	subf[o][.] subfc[o][.] subfe[o][.] subfic subfme[o][.] subfze[o][.]	mulhw[.] mulhwu[.] mulli mullw[o][.]	divw[o][.] divwu[o][.]	neg[o][.]

Table 3-25 lists additional arithmetic instructions for multiply-accumulate and multiply halfword operations. In the table, the syntax “[o]” indicates that an instruction has an “o” form that updates XER[SO,OV], and a “non-o” form. The syntax “[.]” indicates that the instruction has a “record” form that updates CR[CR0], and a “non-record” form.

Table 3-25. Multiply-Accumulate and Multiply Halfword Instructions

Multiply-Accumulate	Negative-Multiply-Accumulate	Multiply Halfword
macchw[o][.] macchws[o][.] macchwsu[o][.] macchwu[o][.] machhw[o][.] machhws[o][.] machhwsu[o][.] machhwu[o][.] maclhw[o][.] maclhws[o][.] maclhwsu[o][.] maclhwu[o][.]	nmacchw[o][.] nmacchws[o][.] nmachhw[o][.] nmachhws[o][.] nmaclhw[o][.] nmaclhws[o][.]	mulchw[.] mulchwu[.] mulhhw[.] mulhhwu[.] mullhw[.] mullhwu[.]

3.11.4 Logical Instructions

Table 3-26 lists the PPC405GP logical instructions. In the table, the syntax “[.]” indicates that the instruction has a “record” form that updates CR[CR0], and a “non-record” form.

Table 3-26. Logical Instructions

And	And with complement	Nand	Or	Or with complement	Nor	Xor	Equivalence	Extend sign	Count leading zeros
and[.] andi. andis.	andc[.]	nand[.]	or[.] ori oris	orc[.]	nor[.]	xor[.] xori xoris	eqv[.]	extsb[.] extsh[.]	cntlzw[.]

3.11.5 Compare Instructions

These instructions perform arithmetic or logical comparisons between two operands and update the CR with the result of the comparison.

Table 3-27 lists the PPC405GP compare instructions.

Table 3-27. Compare Instructions

Arithmetic	Logical
cmp cmpi	cmpl cmpli

Preliminary User's Manual**3.11.6 Branch Instructions**

These instructions unconditionally or conditionally branch to an address. Conditional branch instructions can test condition codes set by a previous instruction and branch accordingly. Conditional branch instructions can also decrement and test the CTR as part of branch determination, and can save the return address in the LR. The target address for a branch can be a displacement from the current instruction address (a relative address), an absolute address, or contained in the CTR or LR.

See “Branch Processing” on page 3-115 for more information on branch operations.

Table 3-28 lists the PPC405GP branch instructions. In the table, the syntax “[I]” indicates that the instruction has a “link update” form that updates LR with the address of the instruction after the branch, and a “non-link update” form. The syntax “[a]” indicates that the instruction has an “absolute address” form, in which the target address is formed directly using the immediate field specified as part of the instruction, and a “relative” form, in which the target address is formed by adding the immediate field to the address of the branch instruction).

Table 3-28. Branch Instructions

Branch
b[I][a]
bc[I][a]
bcctr[I]
bclr[I]

3.11.6.1 CR Logical Instructions

These instructions perform logical operations on a specified pair of bits in the CR, placing the result in another specified bit. These instructions can logically combine the results of several comparisons without incurring the overhead of conditional branch instructions. Software performance can significantly improve if multiple conditions are tested at once as part of a branch decision.

Table 3-29 lists the PPC405GP condition register logical instructions.

Table 3-29. CR Logical Instructions

crand	crnor
crandc	cror
creqv	crorc
crnand	crxor
	mcrf

3.11.6.2 Rotate Instructions

These instructions rotate operands stored in the GPRs. Rotate instructions can also mask rotated operands.

Table 3-30 lists the PPC405GP rotate instructions. In the table, the syntax “[.]” indicates that the instruction has a “record” form that updates CR[CR0], and a “non-record” form.

Table 3-30. Rotate Instructions

Rotate and Insert	Rotate and Mask
rlwimi[.]	rlwinm[.]
	rlwnm[.]

3.11.6.3 Shift Instructions

These instructions rotate operands stored in the GPRs.

Table 3-31 lists the PPC405GP shift instructions. Shift right algebraic instructions implicitly update XER[CA]. In the table, the syntax “[.]” indicates that the instruction has a “record” form that updates CR[CR0], and a “non-record” form.

Table 3-31. Shift Instructions

Shift Left	Shift Right	Shift Right Algebraic
slw[.]	srw[.]	sraw[.] srawi[.]

3.11.6.4 Cache Management Instructions

These instructions control the operation of the ICU and DCU. Instructions are provided to fill or invalidate instruction cache blocks. Instructions are also provided to fill, flush, invalidate, or zero data cache blocks, where a block is defined as a 32-byte cache line.

Table 3-32 lists the PPC405GP cache management instructions.

Table 3-32. Cache Management Instructions

DCU	ICU
dcba dcbf dcbi dcbst dcbt dcbtst dcbz dccc dcread	icbi icbt iccci icread

3.11.7 Interrupt Control Instructions

mfmsr and **mtmsr** read and write data between the MSR and a GPR to enable and disable interrupts. **wrtee** and **wrteei** enable and disable external interrupts. **rfi** and **rfci** return from interrupt handlers. Table 3-33 lists the PPC405GP interrupt control instructions.

Table 3-33. Interrupt Control Instructions

mfmsr mtmsr rfi rfci wrtee wrteei
--

Preliminary User's Manual**3.11.8 TLB Management Instructions**

The TLB management instructions read and write entries of the TLB array in the MMU, search the TLB array for an entry which will translate a given address, and invalidate all TLB entries. There is also an instruction for synchronizing TLB updates with other processors, but because the PPC405GP is for use in uniprocessor environments, this instruction performs no operation.

Table 3-34 lists the TLB management instructions. In the table, the syntax “[.]” indicates that the instruction has a “record” form that updates CR[CR0], and a “non-record” form.

Table 3-34. TLB Management Instructions

tlbia
tlbre
tlbsx[.]
tlbsync
tlbwe

3.11.9 Processor Management Instructions

These instructions move data between the GPRs and SPRs, the CR, and DCRs in the PPC405GP, and provide traps, system calls, and synchronization controls.

Table 3-35 lists the processor management instructions in the PPC405GP.

Table 3-35. Processor Management Instructions

eieio	mcrxr	mtrcf
isync	mfcrr	mtdcr
sync	mfcdcr	mtspr
	mfspr	sc
		tw
		twi

3.11.10 Extended Mnemonics

In addition to mnemonics for instructions supported directly by hardware, the PowerPC Architecture defines numerous *extended mnemonics*.

An extended mnemonic translates directly into the mnemonic of a hardware instruction, typically with carefully specified operands. For example, the PowerPC Architecture does not define a “shift right word immediate” instruction, because the “rotate left word immediate then AND with mask,” (**rlwinm**) instruction can accomplish the same result:

rlwinm RA,RS,32–n,n,31

However, because the required operands are not obvious, the PowerPC Architecture defines an extended mnemonic:

srwi RA,RS,n

Extended mnemonics transfer the problem of remembering complex or frequently used operand combinations to the assembler, and can more clearly reflect a programmer's intentions. Thus, programs can be more readable.

Refer to the following chapter and appendixes for lists of the extended mnemonics:

- **Chapter 24, "Instruction Set," lists extended mnemonics under the associated hardware instruction mnemonics.**
- **Appendix A, "Instruction Summary," lists extended mnemonics alphabetically, along with the hardware instruction mnemonics.**
- **Table A-5 in Appendix A, "Instructions by Category," lists all extended mnemonics.**

Preliminary User's Manual

Chapter 4. Cache Operations

The PPC405GP incorporates two internal caches, a 16KB instruction cache and an 8KB data cache. Instructions and data can be accessed in the caches much faster than in main memory.

The instruction cache unit (ICU) controls instruction accesses to main memory and stores frequently used instructions to reduce the overhead of instruction transfers between the instruction pipeline and external memory. Using the instruction cache minimizes access latency for frequently executed instructions.

The data cache unit (DCU) controls data accesses to main memory and stores frequently used data to reduce the overhead of data transfers between the GPRs and external memory. Using the data cache minimizes access latency for frequently used data.

The ICU features:

- Programmable address pipelining and prefetching for cache misses and non-cachable lines
- Support for non-cachable hits from lines contained in the line fill buffer
- Programmable non-cachable requests to memory as 4 or 8 words (or half line or line)
- Bypass path for critical words
- Non-blocking cache for hits during fills
- Flash invalidate (one instruction invalidates entire cache)
- Programmable allocation for fetch fills, enabling program control of cache contents using the **icbt** instruction
- Virtually indexed, physically tagged cache arrays
- Support for 64-bit and 32-bit PLB slaves
- A rich set of cache control instructions

The DCU features:

- Address pipelining for line fills
- Support for load hits from non-cachable and non-allocated lines contained in the line fill buffer
- Bypass path for critical words
- Non-blocking cache for hits during fills
- Write-back and write-through write strategies controlled by storage attributes
- Programmable non-cachable load requests to memory as lines or words.
- Handling of up to two pending line flushes.
- Holding of up to three stores before stalling the core pipeline
- Physically indexed, physically tagged cache arrays
- Support for 64-bit and 32-bit PLB slaves
- A rich set of cache control instructions

“ICU Organization” on page 4-136 and “DCU Organization” on page 4-139 describe the organization and provide overviews of the ICU and the DCU.

4.1 ICU Organization

The ICU manages instruction transfers between external cachable memory and the instruction queue in the execution unit.

The ICU contains a two-way set-associative 16KB cache memory. Each way is organized in 256 lines of eight words (eight instructions) each.

As shown in Table 4-1, tag ways A and B store instruction address bits $A_{0:21}$ for each line in cache ways A and B. Instruction address bits $A_{19:26}$ serve as the index to the cache array. The two cache lines that correspond to the same line index (one in each way) are called a congruence class.

Table 4-1. Instruction Cache Organization

Tags (Two-way Set)		Instructions (Two-way Set)	
Way A	Way B	Way A	Way B
$A_{0:21}$ Line 0 A	$A_{0:21}$ Line 0 B	Line 0 A	Line 0 B
$A_{0:21}$ Line 1 A	$A_{0:21}$ Line 1 B	Line 1 A	Line 1 B
• • •	• • •	• • •	• • •
$A_{0:21}$ Line 254 A	$A_{0:21}$ Line 254 B	Line 254 A	Line 254 B
$A_{0:21}$ Line 255 A	$A_{0:21}$ Line 255 B	Line 255 A	Line 255 B

When a cache line is to be loaded, the cache way to receive the line is determined by using an least-recently-used (LRU) policy. The index, determined by the instruction address, selects a congruence class. Within a congruence class, the line which was accessed most recently is retained, and the other line is marked as LRU, using an LRU bit in the tag array. The line to receive the incoming data is the LRU line. After the cache line fill, the LRU bit is then set to identify as least-recently-used the line opposite the line just filled.

Preliminary User's Manual

Figure 4-1 shows the relationships between the ICU and the instruction pipeline.

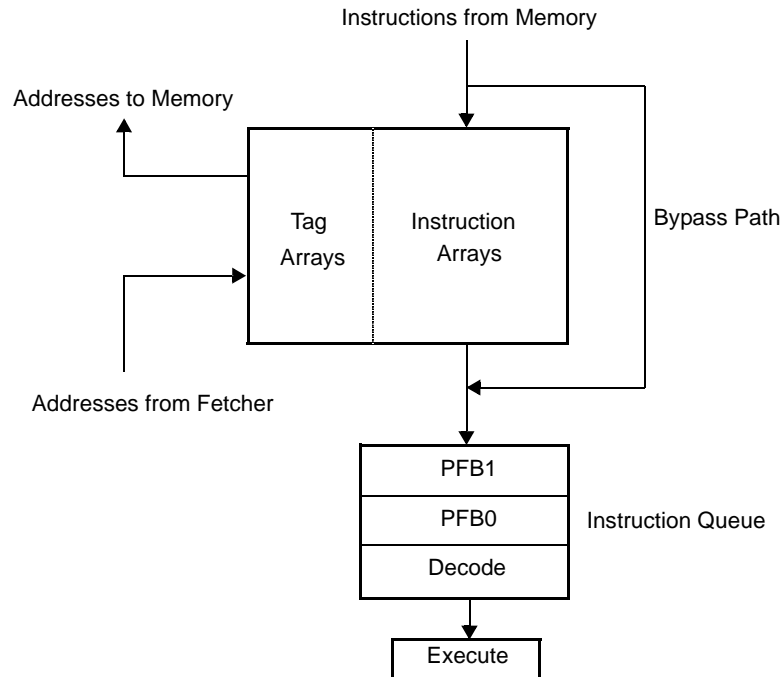

Figure 4-1. Instruction Flow

4.1.1 ICU Operations

Instructions from cachable memory regions are copied into the instruction cache array. The fetcher can access instructions much more quickly from a cache array than from memory. Cache lines are loaded either target-word-first or sequentially. Target-word-first fills start at the requested word, continue to the end of the line, and then wrap to fill the remaining words at the beginning of the line. Sequential fills start at the first word of the cache line and proceed sequentially to the last word of the line.

The bypass path handles instructions in cache-inhibited memory and improves performance during line fill operations. If a request from the fetcher obtains an entire line from memory, the queue does not have to wait for the entire line to reach the cache. The target word (the word requested by the fetcher) is sent on the bypass path to the queue while the line fill proceeds, even if the selected line fill order is not target-word-first.

Cache line fills always run to completion, even if the instruction stream branches away from the rest of the line. As requested instructions are received, they go to the fetcher from the fill register before the line fills in the cache. The filled line is always placed in the ICU; if an external memory subsystem error occurs during the fill, the line is not written to the cache. During a clock cycle, the ICU can send two instructions to the fetcher.

4.1.2 Instruction Cachability Control

When instruction address translation is enabled ($MSR[IR] = 1$), instruction cachability is controlled by the I storage attribute in the translation lookaside buffer (TLB) entry for the memory page. If $TLB_entry[I] = 1$, caching is inhibited; otherwise caching is enabled. Cachability is controlled separately for each page, which can range in size from 1KB to 16MB. "Translation Lookaside Buffer (TLB)" on page 6-162 describes the TLB.

When instruction address translation is disabled ($MSR[IR] = 0$), instruction cachability is controlled by the Instruction Cache Cachability Register (ICCR). Each field in the ICCR ($ICCR[S0:S31]$) controls the cachability of a 128MB region (see "Real-Mode Storage Attribute Control" on page 6-177). If $ICCR[S_n] = 1$, caching is enabled for the specified region; otherwise, caching is inhibited.

The performance of the PPC405GP is significantly lower while fetching instructions from cache-inhibited regions.

Following system reset, address translation is disabled and all ICCR bits are reset to 0 so that no memory regions are cachable. Before regions can be designated as cachable, the ICU cache array must be invalidated. The **iccci** instruction must execute before the cache is enabled. Address translation can then be enabled, if required, and the TLB or the ICCR can then be configured for the required cachability.

4.1.3 Instruction Cache Synonyms

The following information applies only if instruction address translation is enabled ($MSR[IR] = 1$) and 1KB or 4KB page sizes are used. See Chapter 6, "Memory Management," for information about address translation and page sizes.

An instruction cache synonym occurs when the instruction cache array contains multiple cache lines from the same real address. Such synonyms result from combinations of:

- Cache array size
- Cache associativity
- Page size
- The use of effective addresses (EAs) to index the cache array

For example, the instruction cache array has a "way size" of 8KB (16KB array/2 ways). Thus, 11 bits ($EA_{19:29}$) are needed to select a word (instruction) in each way. For the minimum page size of 1KB, the low order 8 bits ($EA_{22:29}$) address a word in a page. The high order address bits ($EA_{0:21}$) are translated to form a real address (RA), which the ICU uses to perform the cache tag match. Cache synonyms could occur because the index bits ($EA_{19:29}$) overlap the translated RA bits. For 1KB pages, overlap in $EA_{19:21}$ and $RA_{19:21}$ could result in as many as 8 synonyms. In other words, data from the same RA could occur as many as 8 locations in the cache array. Similarly, for 4KB pages, $EA_{0:19}$ are translated. Differences in EA_{19} and RA_{19} could result in as many as 2 synonyms. For the next largest page size (16KB), only $EA_{0:17}$ are translated. Because there is no overlap with index bits $EA_{19:21}$, synonyms do not occur.

In practice, cache synonyms occur when a real instruction page having multiple virtual mappings exists in multiple cache lines. For 1KB pages, all EAs differing in $EA_{19:21}$ must be cast out of cache, using an **icbi** instruction for each such EA (up to 8 per cache line in the page). For 4KB pages, all EAs differing in EA_{19} must be cast out in the same manner (up to 2 per cache line in the page). For larger pages, cache synonyms do not occur, and casting out any of the multiple EAs removes the physical information from the cache.

Programming Note: To prevent the occurrence of cache synonyms, use only page sizes greater than the cache way size (8KB), if possible. For the PPC405GP, the minimum such page size is 16KB.

Preliminary User's Manual

4.1.4 ICU Coherency

The ICU does not “snoop” external memory or the DCU. Programmers must follow special procedures for ICU synchronization when self-modifying code is used or if a peripheral device updates memory containing instructions.

The following code example illustrates the necessary steps for self-modifying code. This example assumes that *addr1* is both data and instruction cachable.

```

stw      regN, addr1  # the data in regN is to become an instruction at addr1
dcbst   addr1        # forces data from the data cache to memory
sync    # wait until the data actually reaches the memory
icbi    addr1        # the previous value at addr1 might already be in
                    # the instruction cache; invalidate it in the cache
isync   # the previous value at addr1 may already have been
                    # pre-fetched into the queue; invalidate the queue
                    # so that the instruction must be re-fetched

```

4.2 DCU Organization

The DCU manages data transfers between external cachable memory and the general-purpose registers in the execution unit.

The DCU contains a two-way set-associative 8KB cache memory. Each way is organized in 128 lines of eight words (32 bytes) each.

As shown in Table 4-2, tag ways A and B store data address bits $A_{0:19}$ for each line in cache ways A and B. Data address bits $A_{18:26}$ serve as the index to the cache array. The two cache lines that correspond to the same line index (one in each way) are called a congruence class.

Table 4-2. Data Cache Organization

Tags (Two-way Set)		Data (Two-way Set)	
Way A	Way B	Way A	Way B
$A_{0:19}$ Line 0 A	$A_{0:19}$ Line 0 B	Line 0 A	Line 0 B
$A_{0:19}$ Line 1 A	$A_{0:19}$ Line 1 B	Line 1 A	Line 1 B
⋮	⋮	⋮	⋮
$A_{0:19}$ Line 126 A	$A_{0:19}$ Line 126 B	Line 126 A	Line 126 B
$A_{0:19}$ Line 127 A	$A_{0:19}$ Line 127 B	Line 127 A	Line 127 B

A bypass path handles data operations in cache-inhibited memory and improves performance during line fill operations.

4.2.1 DCU Operations

Data from cachable memory regions are copied from external memory into lines in the data cache array so that subsequent cache operations result in cache hits. Loads and stores that hit in the DCU are completed in one cycle. For loads, GPRs receive the requested byte, halfword, or word of data from the data cache array. The DCU supports byte-writeability to improve the performance of byte and halfword store operations.

Cache operations require a line fill when they require data from cachable memory regions that are not currently in the DCU. A line fill is the movement of a cache line (eight words) from external memory to the data cache array. Eight words are copied from external memory into the fill buffer, either target-word-first or sequentially. Loading order is controlled by the PLB slave. Target-word-first fills start at the requested word, continue to the end of the line, and then wrap to fill the remaining words at the beginning of the line. Sequential fills start at the first word of the cache line and proceed sequentially to the last word of the line. In both types of fills, the fill buffer, when full, is transferred to the data cache array. The cache line is marked valid when it is filled.

Loads that result in a line fill, and loads from non-cachable memory, are sent to a GPR. The requested byte, halfword, or word is sent from the DCU to the GPR from the fill buffer, using a cache bypass mechanism. Additional loads for data in the fill buffer can be bypassed to the GPR until the data is moved into the data array.

Stores that result in a line fill have their data held in the fill buffer until the line fill completes. Additional stores to the line being filled will also have their data placed in the fill buffer before being transferred into the data cache array.

To complete a line fill, the DCU must access the tag and data arrays. The tag array is read to determine the tag addresses, the LRU line, and whether the LRU line is dirty. A dirty cache line is one that was accessed by a store instruction after the line was established, and can be inconsistent with external memory. If the line being replaced is dirty, the address and the cache line must be saved so that external memory can be updated. During the cache line fill, the LRU bit is set to identify the line opposite the line just filled as LRU.

When a line fill completes and replaces a dirty line, a line flush begins. A flush copies updated data in the data cache array to main storage. Cache flushes are always sequential, starting at the first word of the cache line and proceeding sequentially to the end of the line.

Cache lines are always completely flushed or filled, even if the program does not request the rest of the bytes in the line, or if a bus error occurs after a bus interface unit accepts the request for the line fill. If a bus error occurs during a line fill, the line is filled and the data is marked valid. However, the line can contain invalid data, and a machine check exception occurs.

4.2.2 DCU Write Strategies

DCU operations can use write-back or write-through strategies to maintain coherency with external cachable memory.

The write-back strategy updates only the data cache, not external memory, during store operations. Only modified data lines are flushed to external memory, and then only when necessary to free up locations for incoming lines, or when lines are explicitly flushed using **dcbf** or **dcbst** instructions. The write-back strategy minimizes the amount of external bus activity and avoids unnecessary contention for the external bus between the ICU and the DCU.

The write-back strategy is contrasted with the write-through strategy, in which stores are written simultaneously to the cache and to external memory. A write-through strategy can simplify maintaining coherency between cache and memory.

Preliminary User's Manual

When data address translation is enabled ($MSR[DR] = 1$), the W storage attribute in the TLB entry for the memory page controls the write strategy for the page. If $TLB_entry[W] = 0$, write-back is selected; otherwise, write-through is selected. The write strategy is controlled separately for each page. “Translation Lookaside Buffer (TLB)” on page 6-162 describes the TLB.

When data address translation is disabled ($MSR[DR] = 0$), the Data Cache Write-through Register (DCWR) sets the storage attribute. Each bit in the DCWR ($DCWR[W0:W31]$) controls the write strategy of a 128MB storage region (see “Real-Mode Storage Attribute Control” on page 6-177). If $DCWR[Wn] = 0$, write-back is enabled for the specified region; otherwise, write-through is enabled.

Programming Note: The PowerPC Architecture does not support memory models in which write-through is enabled and caching is inhibited.

4.2.3 DCU Load and Store Strategies

The DCU can control whether a load receives one word or one line of data from main memory.

For cachable memory, the load without allocate (LWOA) field of the CCR0 controls the type of load resulting from a load miss. If $CCR0[LWOA] = 0$, a load miss causes a line fill. If $CCR0[LWOA] = 1$, load misses do not result in a line fill, but in a word load from external memory. For infrequent reads of non-contiguous memory, setting $CCR0[LWOA] = 1$ may provide a small performance improvement.

For non-cachable memory and for loads misses when $CCR0[LWOA] = 1$, the load word as line (LWL) field in the CCR0 affects whether load misses are satisfied with a word, or with eight words (the equivalent of a cache line) of data. If $CCR0[LWL] = 0$, only the target word is bypassed to the core. If $CCR0[LWL] = 1$, the DCU saves eight words (one of which is the target word) in the fill buffer and bypasses the target data to the core to satisfy the load word request. The fill buffer is not written to the data cache array.

Setting $CCR0[LWL] = 1$ provides the fastest accesses to sequential non-cachable memory. Subsequent loads from the same line are bypassed to the core from the fill buffer and do not result in additional external memory accesses. The load data remains valid in the fill buffer until one of the following occurs: the beginning of a subsequent load that requires the fill buffer, a store to the target address, a **dcbi** or **dccci** instruction issued to the target address, or the execution of a **sync** instruction. Non-cachable loads to guarded storage never cause a line transfer on the PLB even if $CCR0[LWL] = 1$. Subsequent loads to the same non-cachable storage are always requested again from the PLB.

For cachable memory, the store without allocate (SWOA) field of the CCR0 controls the type of store resulting from a store miss. If $CCR0[SWOA] = 0$, a store miss causes a line fill. If $CCR0[SWOA] = 1$, store misses do not result in a line fill, but in a single word store to external memory.

4.2.4 Data Cachability Control

When data address translation is disabled ($MSR[DR] = 0$), data cachability is controlled by the Data Cache Cachability Register (DCCR). Each bit in the DCCR ($DCCR[S0:S31]$) controls the cachability of a 128MB region (see “Real-Mode Storage Attribute Control” on page 6-177). If $DCCR[Sn] = 1$, caching is enabled for the specified region; otherwise, caching is inhibited.

When data address translation is enabled ($MSR[DR] = 1$), data cachability is controlled by the I bit in the TLB entry for the memory page. If $TLB_entry[I] = 1$, caching is inhibited; otherwise caching is enabled. Cachability is controlled separately for each page, which can range in size from 1KB to 16MB. “Translation Lookaside Buffer (TLB)” on page 6-162 describes the TLB.

Programming Note: The PowerPC Architecture does not support memory models in which write-through is enabled and caching is inhibited.

The performance of the PPC405GP is significantly lower while accessing memory in cache-inhibited regions.

Following system reset, address translation is disabled and all DCCR bits are reset to 0 so that no memory regions are cachable. The **dccci** instruction must execute 128 times before regions can be designated as cachable. This invalidates all congruence classes before enabling the cache. Address translation can then be enabled, if required, and the TLB or the DCCR can then be configured for the desired cachability.

Programming Note: If a data block corresponding to the effective address (EA) exists in the cache, but the EA is non-cachable, loads and stores (including **dcbz**) to that address are considered programming errors (the cache block should previously have been flushed). The only instructions that can legitimately access such an EA in the data cache are the cache management instructions **dcbf**, **dcbi**, **dcbst**, **dcbt**, **dcbtst**, **dccci**, and **dcread**.

4.2.5 DCU Coherency

The DCU does not provide snooping. Application programs must carefully use cache-inhibited regions and cache control instructions to ensure proper operation of the cache in systems where external devices can update memory.

4.3 Cache Instructions

For detailed descriptions of the instructions described in the following sections, see Chapter 24, "Instruction Set."

In the instruction descriptions, the term "block" is synonymous with cache line. A block is the unit of storage operated on by all cache block instructions.

4.3.1 ICU Instructions

The following instructions control instruction cache operations:

icbi	Instruction Cache Block Invalidate
	Invalidate a cache block.
icbt	Instruction Cache Block Touch
	Initiates a block fill, enabling a program to begin a cache block fetch before the program needs an instruction in the block.
	The program can subsequently branch to the instruction address and fetch the instruction without incurring a cache miss.
	This is a privileged instruction.
iccci	Instruction Cache Congruence Class Invalidate
	Invalidate the instruction cache array.
	This is a privileged instruction.

Preliminary User's Manual

icread Instruction Cache Read

Reads either an instruction cache tag entry or an instruction word from an instruction cache line, typically for debugging. Fields in CCR0 control instruction behavior (see “Cache Control and Debugging Features” on page 4-144).

This is a privileged instruction.

4.3.2 DCU Instructions

Data cache flushes and fills are triggered by load, store and cache control instructions. Cache control instructions are provided to fill, flush, or invalidate cache blocks.

The following instructions control data cache operations.

dcba Data Cache Block Allocate

Speculatively establishes a line in the cache and marks the line as modified.

If the line is not currently in the cache, the line is established and marked as modified without actually filling the line from external memory.

If **dcba** references a non-cachable address, **dcba** is treated as a no-op.

If **dcba** references a cachable address, write-through required (which would otherwise cause an alignment exception), **dcba** is treated as a no-op.

dcbf Data Cache Block Flush

Flushes a line, if found in the cache and marked as modified, to external memory; the line is then marked invalid.

If the line is found in the cache and is not marked modified, the line is marked invalid but is not flushed.

This operation is performed regardless of whether the address is marked cachable.

dcbi Data Cache Block Invalidate

Invalidates a block, if found in the cache, regardless of whether the address is marked cachable. Any modified data is not flushed to memory.

This is a privileged instruction.

dcbst Data Cache Block Store

Stores a block, if found in the cache and marked as modified, into external memory; the block is not invalidated but is no longer marked as modified.

If the block is marked as not modified in the cache, no operation is performed.

This operation is performed regardless of whether the address is marked cachable.

dcbt Data Cache Block Touch

Fills a block with data, if the address is cachable and the data is not already in the cache. If the address is non-cachable, this instruction is a no-op.

- dcbtst** Data Cache Block Touch for Store
 Implemented identically to the **dcbt** instruction for compatibility with compilers and other tools.

- dcbz** Data Cache Block Set to Zero
 Fills a line in the cache with zeros and marks the line as modified.
 If the line is not currently in the cache (and the address is marked as cachable and non-write-through), the line is established, filled with zeros, and marked as modified without actually filling the line from external memory. If the line is marked as either non-cachable or write-through, an alignment exception results.

- dccci** Data Cache Congruence Class Invalidate
 Invalidates a congruence class (both cache ways).
 This is a privileged instruction.

- dcread** Data Cache Read
 Reads either a data cache tag entry or a data word from a data cache line, typically for debugging. Bits in CCR0 control instruction behavior (see “Cache Control and Debugging Features” on page 4-144).
 This is a privileged instruction.

4.4 Cache Control and Debugging Features

Registers and instructions are provided to control cache operation and help debug cache problems. For ICU debug, the **icread** instruction and the Instruction Cache Debug Data Register (ICDBDR) are provided. See “ICU Debugging” on page 4-147 for more information. For DCU debug, the **dcread** instruction is provided. See “DCU Debugging” on page 4-148 for more information.

CCR0 controls the behavior of the **icread** and the **dcread** instructions.

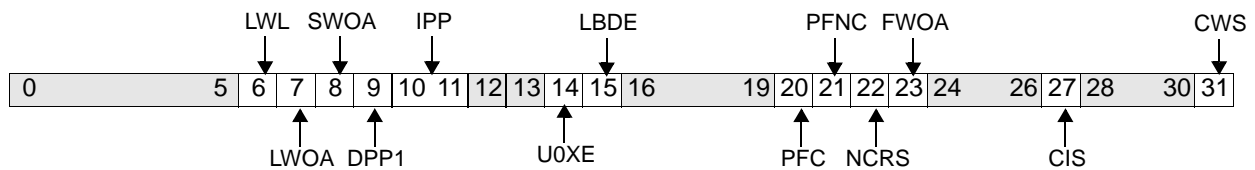

Figure 4-2. Core Configuration Register 0 (CCR0)

0:5		Reserved
6	LWL	Load Word as Line 0 The DCU performs load misses or non-cachable loads as words, halfwords, or bytes, as requested 1 For load misses or non-cachable loads, the DCU moves eight words (including the target word) into the line fill buffer

Preliminary User's Manual

7	LWOA	Load Without Allocate 0 Load misses result in line fills 1 Load misses do not result in a line fill, but in non-cachable loads	
8	SWOA	Store Without Allocate 0 Store misses result in line fills 1 Store misses do not result in line fills, but in non-cachable stores	
9	DPP1	DCU PLB Priority Bit 1 0 DCU PLB priority 0 on bit 1 1 DCU PLB priority 1 on bit 1	Note: DCU logic dynamically controls DCU priority bit 0.
10:11	IPP	ICU PLB Priority Bits 0:1 00 Lowest ICU PLB priority 01 Next to lowest ICU PLB priority 10 Next to highest ICU PLB priority 11 Highest ICU PLB priority	
12:13		Reserved	
14	U0XE	Enable U0 Exception 0 Disables the U0 exception 1 Enables the U0 exception	
15	LDBE	Load Debug Enable 0 Load data is invisible on data-side (on-chip memory (OCM)) 1 Load data is visible on data-side OCM	
16:19		Reserved	
20	PFC	ICU Prefetching for Cachable Regions 0 Disables prefetching for cachable regions 1 Enables prefetching for cachable regions	
21	PFNC	ICU Prefetching for Non-Cachable Regions 0 Disables prefetching for non-cachable regions 1 Enables prefetching for non-cachable regions	
22	NCRS	Non-cachable ICU request size 0 Requests are for four-word lines 1 Requests are for eight-word lines	
23	FWOA	Fetch Without Allocate 0 An ICU miss results in a line fill. 1 An ICU miss does not cause a line fill, but results in a non-cachable fetch.	
24:26		Reserved	
27	CIS	Cache Information Select 0 Information is cache data. 1 Information is cache tag.	
28:30		Reserved	

31	CWS	Cache Way Select 0 Cache way is A. 1 Cache way is B.
----	-----	--

4.4.1 CCR0 Programming Guidelines

Several fields in CCR0 affect ICU and DCU operation. Altering these fields while the cache units are involved in PLB transfers can cause errant operation, including a processor hang.

To guarantee correct ICU and DCU operation, specific code sequences must be followed when altering CCR0 fields.

CCR0[IPP, FWOA] affect ICU operation. When these fields are altered, execution of the following code sequence (Sequence 1) is required.

```
! SEQUENCE 1 Altering CCR0[IPP, FWOA]
! Turn off interrupts
mfmsr    RM
addis    RZ,r0,0x0002 ! CE bit
ori      RZ,RZ,0x8000 ! EE bit
andc     RZ,RM,RZ    ! Turn off MSR[CE,EE]
mtmsr    RZ
! sync
sync
! Touch code sequence into i-cache
addis    RX,r0,seq1@h
ori      RX,RX,seq1@l
icbt     r0,RX
```

```
! Call function to alter CCR0 bits
b seq1
```

```
back:
```

```
! Restore MSR to original value
```

```
mtmsr    RM
•
•
•
```

```
! The following function must be in cacheable memory
```

```
.align 5    ! Align CCR0 altering code on a cache line boundary.
seq1:
icbt     r0,RX          ! Repeat ICBT and execute an ISYNC to guarantee CCR0
isync                    ! altering code has been completely fetched across the PLB.
mfspr    RN,CCR0       ! Read CCR0.
andi/ori RN,RN,0xFFFF ! Execute and/or function to change any CCR0 bits.
                        ! Can use two instructions before having to touch
                        ! in two cache lines.

mtspr    CCR0, RN ! Update CCR0.
isync                    ! Refetch instructions under new processor context.
```

Preliminary User's Manual

b back ! Branch back to initialization code.

CCR0[DPP1, U0XE] affect DCU operation. When these fields are altered, execution of the following code sequence (Sequence 2) is required. Note that Sequence 1 includes Sequence 2, so Sequence 1 can be used to alter any CCR0 fields.

In the following sample code, registers RN, RM, RX, and RZ are any available GPRs.

! SEQUENCE 2 Alter CCR0[DPP1, U0XE)

! Turn off interrupts

```
mfmsr    RM
addis    RZ,r0,0x0002 ! CE bit
ori      RZ,RZ,0x8000 ! EE bit
andc     RZ,RM,RZ    ! Turn off MSR[CE,EE]
mtmsr    RZ
```

! sync

```
sync
```

! Alter CCR0 bits

```
mfspr    RN,CCR0    ! Read CCR0.
andi/ori RN,RN,0xXXXX ! Execute and/or function to change any CCR0 bits.
mtspr    CCR0, RN   ! Update CCR0.
isync    ! Refetch instructions under new processor context.
```

! Restore MSR to original value

```
mtmsr    RM
```

CCR0[CIS, CWS] do not require special programming.

4.4.2 ICU Debugging

The **icread** instruction enables the reading of the instruction cache entries for the congruence class specified by EA_{18:26}. The cache information is read into the ICDBDR; from there it can subsequently be moved, using a **mf spr** instruction, into a GPR.

0		31
---	--	----

Figure 4-3. Instruction Cache Debug Data Register (ICDBDR)

0:31	Instruction cache information	See icread , page -708.
------	-------------------------------	--------------------------------

ICU tag information is placed into the ICDBDR as shown:

0:21	TAG	Cache Tag
22:26		Reserved
27	V	Cache Line Valid 0 Not valid 1 Valid
28:30		Reserved
31	LRU	Least Recently Used (LRU) 0 A-way LRU 1 B-way LRU

If CCR0[CIS] = 0, the data is a word of ICU data from the addressed line, specified by EA_{27:29}. If CCR0[CWS] = 0, the data is from the A-way; otherwise; the data from the B-way.

If CCR0[CIS] = 1, the cache information is the cache tag. If CCR0[CWS] = 0, the tag is from the A-way; otherwise, the tag is from the B-way.

Programming Note: The instruction pipeline does not wait for data from an **icread** instruction to arrive before attempting to use the contents the ICDBDR. The following code sequence ensures proper results:

```
icread r5,r6# read cache information
isync      # ensure completion of icread
mficbdr r7# move information to GPR
```

4.4.3 DCU Debugging

The **dcread** instruction provides a debugging tool for reading the data cache entries for the congruence class specified by EA_{18:26}. The cache information is read into a GPR.

If CCR0[CIS] = 0, the data is a word of DCU data from the addressed line, specified by EA_{27:29}. If EA_{30:31} are not 00, an alignment exception occurs. If CCR0[CWS] = 0, the data is from the A-way; otherwise; the data is from the B-way.

If CCR0[CIS] = 1, the cache information is the cache tag. If CCR0[CWS] = 0, the tag is from the A-way; otherwise the tag is from the B-way.

Preliminary User's Manual

DCU tag information is placed into the GPR as shown:

0:19	TA G	Cache Tag
20:25		Reserved
26	D	Cache Line Dirty 0 Not dirty 1 Dirty
27	V	Cache Line Valid 0 Not valid 1 Valid
28:30		Reserved
31	LR U	Least Recently Used (LRU) 0 A-way LRU 1 B-way LRU

Note: A “dirty” cache line is one which has been accessed by a store instruction after it was established, and can be inconsistent with external memory.

4.5 DCU Performance

DCU performance depends upon the application, but, in general, cache hits complete in one cycle without stalling the CPU pipeline. Under certain conditions and limitations of the DCU, the pipeline stalls (stops executing instructions) until the DCU completes current operations.

Several factors affect DCU performance, including:

- Pipeline stalls
- DCU priority
- Simultaneous cache operations
- Sequential cache operations

4.5.1 Pipeline Stalls

The CPU issues commands for cache operations to the DCU. If the DCU can immediately perform the requested cache operation, no pipeline stall occurs. In some cases, however, the DCU cannot immediately perform the requested cache operation, and the pipeline stalls until the DCU can perform the pending cache operation.

In general, the DCU, when hitting in the cache array, can execute a load/store every cycle. If a cache miss occurs, the DCU must retrieve the line from main memory. For cache misses, the DCU stores the cache line in a line fill buffer until the entire cache line is received. The DCU can accept new DCU commands while the fill progresses. If the instruction causing the line fill is a load, the target word is bypassed to the GPR during the cycle after it becomes available in the fill buffer. When the fill buffer is full, it must be moved into the tag and data arrays. During this time, the DCU cannot begin a new cache operation and stalls the pipeline if new DCU commands are presented. Storing a line in the line fill buffer takes 3 cycles, unless the line being replaced has been modified. In that case, the operation takes 4 cycles.

The DCU can accept up to two load commands. If the data for the first load command is not immediately available, the DCU can still accept the second load command. If the load data is not required by subsequent instructions, those instructions will continue to execute. If data is required from either load command, the CPU pipeline will stall until the load data has been delivered. The pipeline will also stall until the second load has read the data array if a subsequent data cache command is issued.

In general, if the fill buffer is being used and the next load or store command requires the fill buffer, only one additional command can be accepted before causing additional DCU commands to stall the pipeline.

The DCU can accept up to three outstanding store commands before stalling the CPU pipeline for additional data cache commands.

The DCU can have two flushes pending before stalling the CPU pipeline.

DCU cache operations other than loads and stores stall the CPU pipeline until all prior data cache operations complete. Any subsequent data cache command will stall the pipeline until the prior operation is complete.

4.5.2 Cache Operation Priorities

The DCU uses a priority signal to improve performance when pipeline stalls occur. When the pipeline is stalled because of a data cache operation, the DCU asserts the priority signal to the PLB. The priority signal tells the external bus that the DCU requires immediate service, and is valid only when the data cache is requesting access to the PLB. The priority signal is asserted for all loads that require external data, or when the data cache is requesting the PLB and stalling an operation that is being presented to the data cache.

Table 4-3 provides examples of when the priority is asserted and deasserted.

Table 4-3. Priority Changes With Different Data Cache Operations

Instruction Requesting PLB	Priority	Next Instruction	Priority
Any load from external memory	1	N/A	N/A
Any store	0	Any other cache operation not being accepted by the DCU.	1
dcbf	0	Any cache hit.	0
dcbf/dcbst	0	Load non-cache.	1
dcbf/dcbst	0	Another command that requires a line flush.	1
dcbt	0	Any cache hit.	0
dcbi/dccci/dcbz	0	N/A	N/A

4.5.3 Simultaneous Cache Operations

Some cache operations can occur simultaneously to improve DCU performance. For example, combinations of line fills, line flushes, word load/stores, and operations that hit in the cache can occur simultaneously. Cache operations other than loads/stores cannot begin until the PLB completes all previous operations.

Preliminary User's Manual

4.5.4 Sequential Cache Operations

Some common cache operations, when performed sequentially, can limit DCU performance: sequential loads/stores to non-cachable storage regions, sequential line fills, and sequential line flushes.

In the case of sequential cache hits, the most commonly occurring operations, the DCU loads or stores data every cycle. In such cases, the DCU does not limit performance.

However, when a load from a non-cachable storage region is followed by multiple loads from non-cachable regions, the loads can complete no faster than every four cycles, assuming that the addresses are accepted during the same cycle in which it is requested, and that the data is returned during the cycle after the load is accepted.

Similarly, when a store to a non-cachable storage region is followed by multiple stores to non-cachable regions the fastest that the stores can complete is every other cycle. The DCU can have accepted up to three stores before additional DCU commands will stall waiting for the prior stores to complete.

Sequential line fills can limit DCU performance. Line fills occur when a load/store or **dcbt** instruction misses in the cache, and can be pipelined on the PLB interface such that up to two requests can be accepted before stalling subsequent requests. The subsequent operations will wait in the DCU until the first line fill completes. The line fills must complete in the order that they are accepted.

Sequential line flushes from the DCU to main memory also limit DCU performance. Flushes occur when a line fill replaces a valid line that is marked dirty (modified), or when a **dcbf** instruction flushes a specific line. If two flushes are pending, the DCU stalls any new data cache operations until the first flush finishes and the second flush begins.

Chapter 5. On-Chip Memory

The on-chip memory (OCM) subsystem consists of a memory controller that connects the PPC405GP processor core to a one-port, 4KB on-chip SRAM array. OCM is ideal for applications requiring low-latency access to critical instructions and data. OCM can provide performance that is identical to cache hits, yet, unlike a cache, the OCM never misses. Instructions and data stored in the OCM are always available because OCM contents only change under program control. Therefore, if the programmer avoids instruction-side and data-side OCM access contention, OCM can provide information availability that is superior to a cache line locking scheme. OCM is superior because it can provide single cycle performance identical to cache hits without locking down portions of the cache. This results in more effective cache utilization for the processor.

Instructions and data returned from OCM interface do not flow through the PPC405GP core caches. The caches remain available for caching from other memory sources accessed across the PLB interface. The system designer must ensure that each address has a single access path into the PPC405GP core for a given software process. Each address that is requested should be found in either the OCM address space or the PLB address space, *but not in both*.

Code to initialize OCM should execute in non-OCM address space in a region marked as non-cachable. The initialization code should invalidate the cache arrays (in the instruction cache unit (ICU) and data cache unit (DCU), as appropriate) to ensure that no addresses to be programmed as OCM space are in the cache. After programming the OCM address and control registers, the OCM address space should remain marked as non-cachable. Chip initialization for OCM usage is described in “OCM Initialization” on page 8-209.

Read and write accesses to the OCM array share a single access port. OCM accesses have the following priorities:

1. Data-side OCM reads (loads)
2. Data-side OCM writes (stores)
3. Instruction-side OCM read (fetches)

Data-side OCM reads occur in one cycle. Data-side writes also complete in one cycle, though they can be pre-empted by higher priority data-side reads. Instruction-side OCM reads occur by default (that is, after a reset) in two cycles. However, when the Instruction-Side Two-Cycle Mode field of the OCM Instruction-Side Control Register is set to 0 (OCM0_ISCNTL[ISTCM] = 0), instruction-side OCM reads occur in one cycle, unless pre-empted by higher priority data-side transfers. Two-cycle mode is provided for chips that cannot make instruction-side timing to the processor core. The PPC405GP, however, meets the timing requirement. Therefore, programmers should set OCM0_ISCNTL[ISTCM] = 0 during chip initialization, as described in “OCM Initialization” on page 8-209.

5.1 OCM Addressing

The address space for the instruction-side OCM and the data side OCM are defined by the OCM Instruction-Side Address Range Compare Register (OCM0_ISARC) and OCM Data-Side Address Range Compare Register (OCM0_DSARC), respectively. These registers are implemented as 6-bit registers that define the most significant address bits of the respective OCM address space. Using 6 bits defines a 64MB address space. The instruction side and data side can share a 64MB address space, or each can have its own 64MB address space. The address spaces are fully relocatable on 64MB boundaries within the 4GB address space of the PPC405GP, but the programmer must assign OCM address space to avoid conflicts with other assigned addresses. See “Programming Model” on page 3-79 for information about the PPC405GP memory map.



Figure 5-1. OCM Address Usage

Figure 5-1 illustrates OCM address usage. The OCM SRAM array size is 4KB. Address bits 20:31 select byte addresses for data-side accesses. Address bits 30:31 are ignored for instruction-side accesses, because instruction-side accesses return either one or two words per transfer.

Note that the instruction-side and data-side OCM address spaces overlap physically, even if defined as distinct logical address spaces, because the 4KB SRAM is shared. There is no distinction between data space or instruction space, except as defined by the programmer.

Addresses in the OCM array are aliased throughout the larger OCM address spaces. The larger OCM address spaces are filled with multiple images of the 4KB SRAM. Aliased addresses refer to the same physical memory locations.

Programming Note: To avoid possible memory coherency problems when using aliased addresses, align aliased addresses on 16KB boundaries rather than on 4KB boundaries. See “Store Data Bypass Behavior and Memory Coherency” on page 5-156 for details.

If address translation is enabled ($MSR[IR, DR] = 1$), one or more TLB entries for the OCM address space must exist to validate accesses. However, the virtual addresses are *not* translated, and 32-bit effective addresses (virtual addresses) are presented to OCM.

Data-side OCM contents can use big endian or little endian byte ordering. Instruction-side OCM contents *must* use big endian byte ordering. See “Byte Ordering” on page 3-108 for detailed information about byte ordering.

Preliminary User's Manual

5.2 OCM Programming Guidelines

The following guidelines prevent potential problems associated with using OCM:

- Code that uses **mtdcr** to disable instruction-side OCM access should not run out of the instruction-side OCM.

Instructions following an **mtdcr** are not guaranteed to be fetched before the instruction-side OCM is disabled.

- Do not change the value in OCM0_ISARC while fetching from the instruction-side OCM.
- To change the value in OCM0_ISARC or OCM0_DSARC:
 1. Set OCM0_ISCNTL[ISEN] = 0 to disable instruction-side OCM accesses, or set OCM0_DSCNTL[DSEN] = 0 to disable data-side OCM accesses.
 2. Clear MSR[EE] and MSR[CE] to mask interrupts, to ensure that interrupts do not interfere with the cache invalidation described in Step 4. This avoids a potential problem with “dirty” cache addresses that would not be fetched from the cache because they have been marked as non-cachable.
 3. Mark the address region to be programmed as OCM address space as noncachable.
 4. Invalidate the cache array that corresponds to the OCM (instruction-side or data-side) whose address range compare register is to be modified to ensure that no addresses to be programmed as OCM addresses exist in the cache. A single **iccci** instruction invalidates the ICU cache array. To invalidate the DCU cache array, use a sequence of **dcbf** instructions (one per cache line).
 5. Modify the value in OCM0_ISARC or OCM0_DSARC.
 6. Set OCM0_ISCNTL[ISEN] = 1 to enable instruction-side OCM accesses, or set OCM0_DSCNTL[DSEN] = 1 to enable data-side OCM accesses.
- Self-modifying code that accesses OCM to update instructions should not fetch instructions from the area being modified until a **sync** instruction executes, followed by an **isync** instruction.

The **sync** instruction ensures that instructions are updated. The **isync** instruction ensures that only updated instructions are fetched into the pipeline.

Instructions in OCM can be updated while instructions from non-OCM addresses execute. A **sync-isync** pair should still be used whenever such self-modifying code is updated.

- The CPU can become less efficient when instructions and data in OCM are accessed at the same time, because the SRAM has only one access port and instruction fetches have the lowest priority.

For example, instructions fetched from OCM that contain several sequential data-side loads accessing OCM can result in bubbles in the instruction pipeline. The sequential data-side loads dominate OCM accesses, resulting in the inability to fetch instructions from OCM.

- If aliased addresses are used, the aliased 4KB address spaces should be aligned on 16KB boundaries to eliminate potential store data bypass problems, as described in “Store Data Bypass Behavior and Memory Coherency.”

5.3 Store Data Bypass Behavior and Memory Coherency

The OCM subsystem provides only one mechanism, data-side store operations, for writing both instructions and data into the OCM array. However, two independent mechanisms request read access of OCM contents; one for instruction-side fetches and the other for data-side loads.

The following description applies only to applications that alias the OCM address space and perform a mix of data-side loads and stores. It does not apply to applications that use data-side stores only to initialize OCM with instructions.

If a data-side OCM store is followed in the next cycle by a data-side load, the load actually accesses the OCM array before the store. This is due to the nature of the processor pipeline, the cycle availability of the store data, and the fact that data-side loads have a higher priority than data-side stores. In this scenario, store data is queued in a register while the load accesses the array. Further, if the store is immediately followed by a sequence of consecutive loads, it remains in the queue until the last of the consecutive loads has accessed the OCM array. The queued store data is written into the OCM array in the first cycle that does not have a data-side load operation accessing the array.

Consider a scenario where such a situation causes store data to be held in the store data queue. If any of the loads access the same address as the address of the store operation whose data is being held in the store data queue, there is a need to bypass the store data from the store data queue to provide the correct data to the load operation.

A bypass is determined to be required by comparing the pending store address with the load address. However, the comparison is done with a 16KB address representation for the load and store operations, not the 4KB address (the physical size of the PPC405GP OCM array). If the 16KB address compares, the store data is bypassed to the load operation. This implies that a bypass results for address aliasing only when the OCM addresses match at a 16KB multiple, which corresponds to a match of address bits 18:29 (a word address that is further specified by byte enables). Although the physical address space is aliased at 4KB multiples, the bypass determination is made at 16KB multiples. Therefore, if bits 18:19 of an aliased load address do not match bits 18:19 of the 16KB store address of the data being held in the store data queue, the load data will not be coherent. Instead of returning the most recently stored data, which is being held in the store data queue, the load returns “old” data previously stored in and accessed from the OCM array.

Table 5-1 provides examples that describe bypass behavior when address aliasing is used.

Table 5-1. Examples of Store Data Bypass

Example	Store Address	Load Address	4KB Aliased Address	16KB Aliased Address	Bypass
1	0x00000100	0x00000100	Same	Same	Yes
2	0x00000100	0x00000400	No	No	No
3	0x00000100	0x00001100	Yes	No, loads old data	No
4	0x00000100	0x00005100	Yes	No, loads old data	No
5	0x00000100	0x00004100	Yes	Yes	Yes
6	0x00000100	0x00008100	Yes	Yes	Yes

Example 1 provides the most basic example, in which the load and store addresses are the same. This results in the load accessing the queued store data, bypassing the OCM array to satisfy the load.

Example 2 shows two different addresses that are *not* aliased (both addresses are in the 4KB SRAM address space). No bypass occurs, and the load returns the correct data from the OCM array.

Preliminary User's Manual

Examples 3 and 4 show aliased addresses that do not bypass data because the addresses do not compare within a 16KB address space. In both examples, address bits 18:19 do not match. In both examples, the load does not return the most recently stored data from the store data queue; the load returns the “old” data from the array. To avoid such problems, alias on 16KB boundaries. If addresses are aliased on 4KB boundaries, place at least one instruction that does not access the data-side OCM between a load and a store to the same aliased address so the store data has a cycle to be written into the array.

Examples 5 and 6 bypass data out of the store data queue because the aliased addresses compare within a 16KB address space. In both examples, address bits 18:29 match, and load data is returned from the store data queue.

5.4 Registers

The OCM controller uses the Device Control Registers (DCRs) listed in Table 5-2.

Table 5-2. OCM DCRs

Register	Mnemonic	DCR Number	Access	Page
OCM Instruction-Side Address Range Compare Register	OCM0_ISARC	0x018	R/W	5-157
OCM Instruction-Side Control Register	OCM0_ISCNTL	0x019	R/W	5-158
OCM Data-Side Address Range Compare Register	OCM0_DSARC	0x01A	R/W	5-159
OCM Data-Side Control Register	OCM0_DSCNTL	0x01B	R/W	5-159

5.4.1 OCM Instruction-Side Address Range Compare Register (OCM0_ISARC)

OCM0_ISARC defines the address range of the OCM controller when it is presented with instruction fetch requests. OCM0_ISARC[ISAR] is compared to the high-order 6 bits of the requested instruction address, providing a 64MB address space. The address space can be shared with, or distinct from, the data-side OCM address space.

The OCM controller returns requested instructions if instruction-side OCM access is enabled (OCM0_ISCNTL[ISEN] = 1) and OCM0_ISARC[ISAR] matches the high-order 6 bits of the requested instruction address.

OCM0_ISARC must be initialized before OCM0_ISCNTL[ISEN] is set to 1 to enable instruction-side OCM accesses. See “OCM Initialization” on page 8-209 for details



Figure 5-2. OCM Instruction-Side Address Range Compare Register (OCM0_ISARC)

0:5	ISAR	Instruction-side OCM address range
6:31		Reserved

5.4.2 OCM Instruction-Side Control Register (OCM0_ISCNTL)

OCM0_ISCNTL enables and disables instruction-side OCM access and controls whether instruction requests are satisfied in one or two cycles.

OCM0_ISCNTL[ISEN] enables the OCM controller to respond to requests for instruction fetches to addresses in the instruction-side OCM address range defined by OCM0_ISARC[ISAR]. At reset, OCM0_ISCNTL[ISEN] = 0; instruction-side OCM is not enabled. If instruction-side OCM is to be accessed, this field must be set to 1 during chip initialization, as described in “OCM Initialization” on page 8-209.

Setting OCM0_ISCNTL[ISTCM] = 1 places the instruction-side OCM in a mode in which accesses complete in no fewer than two cycles. Two-cycle mode is provided for chips that cannot make instruction-side timing to the processor core. The PPC405GP, however, meets the timing requirement. At reset, OCM0_ISCNTL[ISTCM] = 1. This field should be set to 0 during chip initialization so that instruction-side accesses can complete in one cycle. OCM0_ISCNTL[ISTCM] does not affect data-side OCM operation.

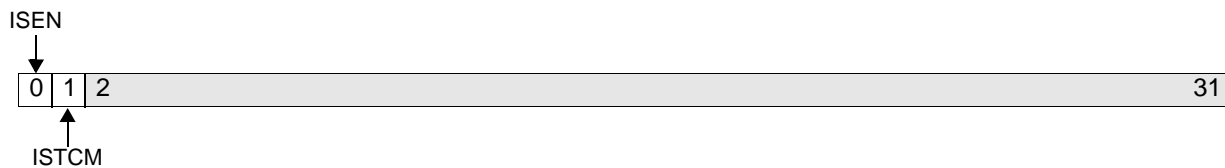

Figure 5-3. OCM Instruction-Side Control Register (OCM0_ISCNTL)

0	ISEN	Instruction-Side OCM Enable 0 Instruction-side OCM accesses are disabled. 1 Instruction-side OCM accesses are enabled.	
1	ISTCM	Instruction-Side Two Cycle Mode 0 Instruction-side OCM accesses are returned in one cycle. 1 Instruction-side OCM accesses are returned in two cycles.	OCM0_ISCNTL[ISTCM], which has a reset value of 1, should be set to OCM0_ISCNTL[ISTCM] = 0 during chip initialization.
2:31		Reserved	

Preliminary User's Manual**5.4.3 OCM Data-Side Address Range Compare Register (OCM0_DSARC)**

OCM0_DSARC defines the address range of the OCM controller when it is presented with load and store requests. OCM0_DSARC[DSAR] is compared to the high-order 6 bits of the requested data address, providing a 64MB address space. The address space can be shared with, or distinct from, the instruction-side OCM address space.

The OCM controller transfers the requested load/store data if data-side OCM access is enabled (OCM0_DSCNTL[DSEN] = 1) and OCM0_DSARC[DSAR] matches the high-order 6 bits of the requested data address.

OCM0_DSARC must be initialized before OCM0_DSCNTL[DSEN] is set to 1 to enable data-side OCM accesses. See “OCM Initialization” on page 8-209 for details.

**Figure 5-4. OCM Data-Side Address Range Compare Register (OCM0_DSARC)**

0:5	DSAR	Data-side OCM address range
6:31		Reserved

5.4.4 OCM Data-Side Control Register (OCM0_DSCNTL)

OCM0_DSCNTL enables and disables data-side OCM access.

OCM0_DSCNTL[DSEN] enables the OCM controller to respond to requests for data loads and stores within the data-side OCM address range defined by OCM0_DSARC[DSAR]. At reset, OCM0_DSCNTL[DSEN] = 0; data-side OCM is not enabled. If data-side OCM is to be accessed, this field must be set to 1 during chip initialization, as described in “OCM Initialization” on page 8-209.

The reset value of the DOF field is 1. This field should always remain set to 1 when writing OCM0_DSCNTL.

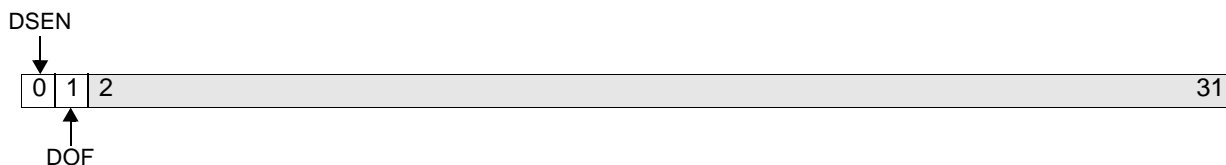
**Figure 5-5. OCM Data-Side Control Register (OCM0_DSCNTL)**

0	DSEN	Data-Side OCM Enable 0 Data-side OCM accesses are disabled. 1 Data-side OCM accesses are enabled.
1	DOF	This field should remain set to 1.
2:31		Reserved

Chapter 6. Memory Management

The PPC405GP memory management unit (MMU) performs address translation and protection functions. With appropriate system software, the MMU supports:

- Translation of effective addresses to real addresses
- Independent enabling of instruction and data address translation and protection
- Page-level access control using the translation mechanism
- Software control of page replacement strategy
- Additional virtual-mode control of protection using zones
- Real-mode write protection

6.1 MMU Overview

The instruction and integer units generate 32-bit effective addresses (EAs) for instruction fetches and data accesses, respectively. Instruction EAs are generated for sequential instruction fetches, and for instruction fetches causing changes in program flow (branches and interrupts). Data EAs are generated for load/store and cache control instructions. The MMU translates EAs into real addresses; the instruction cache unit (ICU) and data cache unit (DCU) use real addresses to access memory.

The PPC405GP MMU supports demand-paged virtual memory and other memory management schemes that depend on precise control of effective to real address mapping and flexible memory protection. Translation misses and protection faults cause precise interrupts. Sufficient information is available to correct the fault and restart the faulting instruction.

The MMU divides storage into pages. A page represents the granularity of EA translation and protection controls. Eight page sizes (1KB, 4KB, 16KB, 64KB, 256KB, 1MB, 4MB, 16MB) are simultaneously supported. A valid entry for a page containing the EA to be translated must be in the translation lookaside buffer (TLB) for address translation to be performed. EAs for which no valid TLB entry exists cause TLB-miss interrupts.

6.2 Address Translation

Fields in the Machine State Register (MSR) control the use of the MMU for address translation. The instruction relocate (IR) field of the MSR controls translation for instruction accesses. The data relocate (DR) field of the MSR controls the translation mechanism for data accesses. These fields, specified independently, can be changed at any time by a program in supervisor state. Note that all interrupts clear MSR[IR, DR] and place the processor in the supervisor state. Subsequent discussion about translation and protection assumes that MSR[IR, DR] are set, enabling address translation.

The processor references memory when it fetches an instruction, and when it executes load/store, branch, and cache control instructions. Processor accesses to memory use EAs to reference a memory location. When translation is enabled, the EA is translated into a real address, as illustrated in Figure 6-1 on page 6-162. The ICU or DCU uses the real address for the access. (When translation is not enabled, the EA is already a real address.)

In address translation, the EA is combined with an 8-bit process ID (PID) to create a 40-bit virtual address. The virtual address is compared to all of the TLB entries. A matching entry supplies the real address for the storage reference. Figure 6-1 illustrates the process.

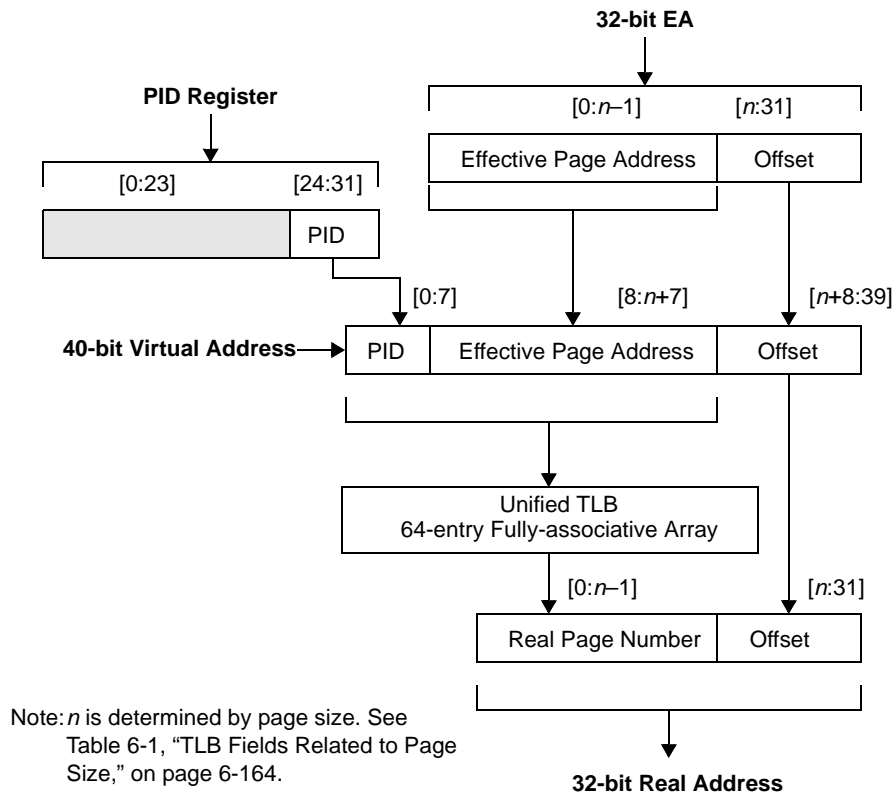

Figure 6-1. Effective to Real Address Translation Flow

6.3 Translation Lookaside Buffer (TLB)

The TLB is hardware that controls translation, protection, and storage attributes. The instruction and data units share a unified fully-associative TLB, in which any page entry (TLB entry) can be placed anywhere in the TLB. TLB entries are maintained under program control. System software determines the TLB entry replacement strategy and the format and use of page state information. A TLB entry contains the information required to identify the page, to specify translation and protection controls, and to specify the storage attributes.

Preliminary User's Manual

6.3.1 Unified TLB

The unified TLB (UTLB) contains 64 entries; each has a TLBHI (tag) portion and a TLBLO (data) portion, as described in Figure 6-2 on page 6-163. TLBHI contains 36 bits; TLBLO contains 32 bits. When translation is enabled, the UTLB tag portion compares some or all of $EA_{0:21}$ with some or all of the effective page number $EPN_{0:21}$, based on the size bits $SIZE_{0:2}$. All 64 entries are simultaneously checked for a match. If an entry matches, the corresponding data portion of the UTLB provides the real page number (RPN), access control bits (ZSEL, EX, WR), and storage attributes (W, I, M, G, E, U0)

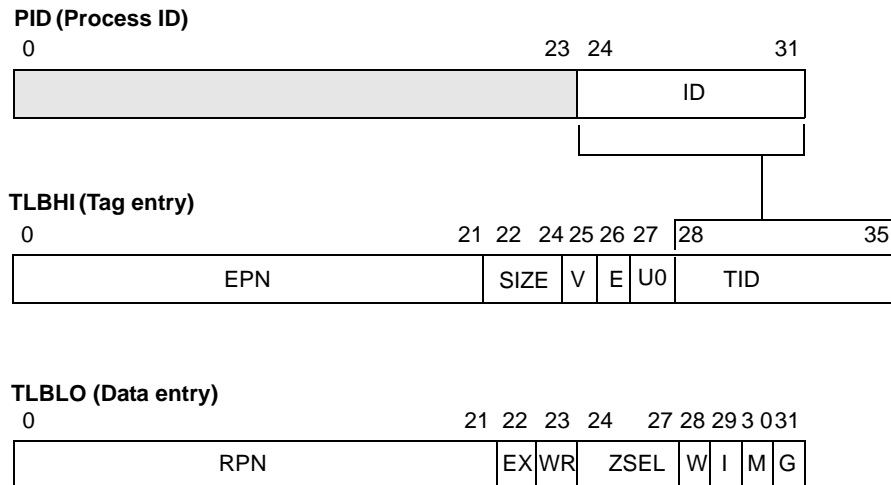

Figure 6-2. TLB Entries

The virtual address space is extended by adding an 8-bit translation ID (TID) loaded from the Process ID (PID) register during a TLB access. The PID identifies one of 255 unique software entities, usually used as a process or thread ID. $TLBHI[TID]$ is compared to the PID during a TLB look-up.

Tag and data entries are written by copying data from GPRs and the PID, using the **tlbwe** instruction. Tag and data entries are read by copying data to GPRs and the PID, using the **tlbre** instruction. Software can search for specific entries using the **tlbsx** instruction.

6.3.2 TLB Fields

Each TLB entry describes a page that is enabled for translation and access controls. Fields in the TLB entry fall into four categories:

- Information required to identify the page to the hardware translation mechanism
- Control information specifying the translation
- Access control information
- Storage attribute control information

6.3.2.1 Page Identification Fields

When an EA is presented to the MMU for processing, the MMU applies several selection criteria to each TLB entry to select the appropriate entry. Although it is possible to place multiple entries into the TLB to match a specific EA and PID, this is considered a programming error, and the result of a TLB lookup for such an EA is undefined. The following fields in the TLB entry identify the page. Except as noted, all comparisons must succeed to validate an entry for subsequent use.

EPN (effective page number, 22 bits)

Compared to some number of the EA_{0:21} bits presented to the MMU. The number of bits corresponds to the page size.

The exact comparison depends on the page size, as shown in Table 6-1.

Table 6-1. TLB Fields Related to Page Size

Page Size	SIZE Field	n Bits Compared	EPN to EA Comparison	RPN Bits Set to 0
1KB	000	22	EPN _{0:21} ↔ EA _{0:21}	—
4KB	001	20	EPN _{0:19} ↔ EA _{0:19}	RPN _{20:21}
16KB	010	18	EPN _{0:17} ↔ EA _{0:17}	RPN _{18:21}
64KB	011	16	EPN _{0:15} ↔ EA _{0:15}	RPN _{16:21}
256KB	100	14	EPN _{0:13} ↔ EA _{0:13}	RPN _{14:21}
1MB	101	12	EPN _{0:11} ↔ EA _{0:11}	RPN _{12:21}
4MB	110	10	EPN _{0:9} ↔ EA _{0:9}	RPN _{10:21}
16MB	111	8	EPN _{0:7} ↔ EA _{0:7}	RPN _{8:21}

SIZE (page size, 3 bits)

Selects one of the eight page sizes, 1KB–16MB, listed in Table 6-1.

V (valid, 1 bit)

Indicates whether a TLB entry is valid and can be used for translation.

A valid TLB entry implies read access, unless overridden by zone protection. TLB_entry[V] can be written using a **tlbwe** instruction. The **tlbia** instruction invalidates all TLB entries.

TID (translation ID, 8 bits)

Loaded from the PID register during a **tlbwe** operation. The TID value is compared with the PID value during a TLB access. The TID provides a convenient way to associate a translation with one of 255 unique software entities, typically a process or thread ID maintained by operating system software. Setting TLBHI_entry[TID] = 0x00 disables TID-PID comparison and identifies a TLB entry as valid for all processes; the value of the PID register is then irrelevant.

6.3.2.2 Translation Field

When a TLB entry is identified as matching an EA (and possibly the PID), TLBLO_entry[RPN] defines how the EA is translated.

RPN (real page number, 22 bits)

Replaces some, or all, of EA_{0:21}, depending on page size. For example, a 16KB page uses EA_{0:17} for comparison. The translation mechanism replaces EA_{0:17} with TLBLO_entry[RPN]_{0:17} to form the physical address, and EA_{18:31} becomes the real page offset, as illustrated in Figure 6-1.

Programming Note: Software must set all unused bits of RPN (as determined by page size) to 0. See Table 6-1.

Preliminary User's Manual

6.3.2.3 Access Control Fields

Several access controls are available in the UTLB entries.

ZSEL (zone select, 4 bits)

Selects one of 16 zone fields (Z0—Z15) from the Zone Protection Register (ZPR). The ZPR field bits can modify the access protection specified by the TLB_entry[V, EX, WR] bits of a TLB entry. Zone protection is described in detail in “Zone Protection” on page 6-173.

EX (execute enable, 1 bit)

When set (TLBLO_entry[EX] = 1), enables instruction execution at addresses within a page. ZPR settings can override TLBLO_entry[EX]; see “Zone Protection” on page 6-173, for more information.

WR (write-enable 1 bit)

When set (TLBLO_entry[WR] = 1), enables store operations to addresses in a page. ZPR settings can override TLBLO_entry[WR]; see “Zone Protection” on page 6-173.

6.3.2.4 Storage Attribute Fields

TLB entries contain bits that control and provide information about the storage control attributes. Four of the attributes (W, I, M, and G) are defined in the PowerPC Architecture. The E storage attribute is defined in the AMCC PowerPC Embedded Environment. For the PPC405GP, the U0 attribute controls the CodePack instruction decompression function.

W (write-through, 1 bit)

When set (TLBLO_entry[W] = 1), stores are specified as write-through. If data in the referenced page is in the data cache, a store updates the cached copy of the data and the external memory location. Contrast this with a write-back strategy, which updates memory only when a cache line is flushed.

In real mode, the Data Cache Write-through Register (DCWR) controls the write strategy.

Note that the PowerPC Architecture does not support memory models in which write-through is enabled and caching is inhibited. It is considered a programming error to use these memory models; the results are undefined.

I (caching inhibited, 1 bit)

When set (TLBLO_entry[I] = 1), a memory access is completed by using the location in main memory, bypassing the cache arrays. During the access, the accessed location is not put into the cache arrays.

In real mode, the Instruction Cache Cachability Register (ICCR) and Data Cache Cachability Register (DCCR) control cachability. In these registers, the setting of the bit is reversed; 1 indicates that a storage control region is cachable, rather than caching inhibited.

Note that the PowerPC Architecture does not support memory models in which write-through is enabled and caching is inhibited. It is considered a programming error to use these memory models; the results are undefined.

It is considered a programming error if the target location of a load/store, **dcbz**, or fetch access to caching inhibited storage is in the cache; the results are undefined. It is *not* considered a programming error for the target locations of other cache control instructions to be in the cache when caching is inhibited.

M (memory coherent, 1 bit)

For implementations that support multiprocessing, the M storage attribute improves the performance of memory coherency management. Because the PPC405GP does not provide multi-processor support or hardware support for data coherency, the M bit is implemented, but has no effect.

G (guarded, 1 bit)

When set ($TLBLO_entry[G] = 1$), indicates that the hardware cannot speculatively access the location for pre-fetching or out-of-order load access. The G storage attribute is typically used to protect memory-mapped I/O from inadvertent access. Attempted execution of an instruction from a guarded data storage address while instruction address translation is enabled results in an instruction storage interrupt because data storage and memory mapped I/O (MMIO) addresses are not used to contain instructions.

An instruction fetch from a guarded region does not occur until the execution pipeline is empty, thus guaranteeing that the access is necessary and therefore not speculative. For this reason, performance is degraded when executing out of guarded regions, and software should avoid unnecessarily marking regions of instruction storage as guarded.

In real mode, the Storage Guarded Register (SGR) controls guarding.

U0 (user-defined attribute, 1 bit)

When set ($TLBLO[U0] = 1$), indicates the user-defined attribute applies to the data in the associated page. This storage attribute controls CodePack decompression for a page.

In real mode, the Storage User-defined 0 Register (SU0R) controls the setting of the U0 storage attribute.

E (endian, 1 bit)

When set ($TLBLO[E] = 1$), indicates that data in the associated page is stored in true little endian format.

In real mode, the Storage Little-Endian Register (SLER) controls the setting of the E storage attribute.

6.3.3 Shadow Instruction TLB

To enhance performance, four instruction-side TLB entries are kept in a four-entry fully-associative shadow array. This array, called the instruction TLB (ITLB), helps to avoid TLB contention between instruction accesses to the TLB and load/store operations. Replacement and invalidation of the ITLB entries is managed by hardware. See “Shadow TLB Consistency” on page 6-167 for details.

The ITLB can be considered a level-1 instruction-side TLB; the UTLB serves as the level-2 instruction-side TLB. The ITLB is used only during instruction fetches for storing instruction address translations. Each ITLB entry contains the translation information for a page. The processor uses the ITLB for address translation of instruction accesses when $MSR[IR] = 1$.

6.3.3.1 ITLB Accesses

The instruction unit accesses the ITLB independently of the rest of the MMU. ITLB accesses are transparent to the executing program, except that ITLB hits contribute to higher overall instruction throughput by allowing data address translations to occur in parallel. Therefore, when instruction accesses hit in the ITLB, the address translation mechanisms in the UTLB are available for use by data accesses simultaneously.

The ITLB requests a new entry from the UTLB when an ITLB miss occurs. A four-cycle latency occurs at each ITLB miss that is also a UTLB hit; the latency is longer if it is also a UTLB miss, or if there is contention for the UTLB from the data side. A round-robin replacement algorithm replaces existing entries with new entries.

Preliminary User's Manual

6.3.4 Shadow Data TLB

To enhance performance, eight data-side TLB entries are kept in a eight-entry fully-associative shadow array. This array, called the data TLB (DTLB), helps to avoid TLB contention between instruction accesses to the TLB and load/store operations. Replacement and invalidation of the DTLB entries is managed by hardware. See “Shadow TLB Consistency” on page 6-167 for details.

The DTLB can be considered a level-1 data-side TLB; the UTLB serves as the level-2 data-side TLB. The DTLB is used only during instruction execute for storing data address translations. Each DTLB entry contains the translation information for a page. The processor uses the DTLB for address translation of data accesses when MSR[DR] = 1.

6.3.4.1 DTLB Accesses

The execute unit accesses the DTLB independently of the rest of the MMU. DTLB accesses are transparent to the executing program, except that DTLB hits contribute to higher overall instruction throughput by allowing instruction address translations to occur in parallel. Therefore, when data accesses hit in the DTLB, the address translation mechanisms in the UTLB are available for use by instruction accesses simultaneously.

The DTLB requests a new entry from the UTLB when a DTLB miss occurs. A three-cycle latency occurs at each DTLB miss that is also a UTLB hit; the latency is longer if it is also a UTLB miss. If there is contention for the UTLB from the instruction side, the data side has priority. A round-robin replacement algorithm replaces existing entries with new entries.

6.3.5 Shadow TLB Consistency

To help maintain the integrity of the shadow TLBs, the processor invalidates the ITLB and DTLB contents when the following context-synchronizing events occur:

- **isync** instruction
- Processor context switch (all interrupts, **rfi**, **rfci**)
- **sc** instruction

If software updates a translation/protection mechanism (UTLB, PID, ZPR, or MSR) and must synchronize these updates with the ITLB and DTLB, the *software* must perform the necessary context synchronization.

A typical example is the manipulation of the TLB by an operating system within an interrupt handler for a TLB miss. Upon entry to the interrupt handler, the contents of the ITLB and DTLB are invalidated and translation is disabled. If the operating system simply made the TLB updates and returned from the handler (using **rfi** or **rfci**), no additional explicit software action would be required to synchronize the ITLB and DTLB.

If, instead, the operating system enables translation within the handler and then performs TLB updates within the handler, those updates would not be effective in the ITLB and DTLB until **rfi** or **rfci** is executed to return from the handler. For those TLB updates to be reflected in the ITLB and DTLB *within* the handler, an **isync** must be issued after TLB updates finish. Failure to properly synchronize the shadow TLBs can cause unexpected behavior.

Programming Note: As a rule of thumb, follow software manipulation of an translation mechanism (if performed while translation is active) with a context-synchronizing operation (usually **isync**).

Figure 6-3 illustrates the relationship of the shadow TLBs and UTLB in address translation:

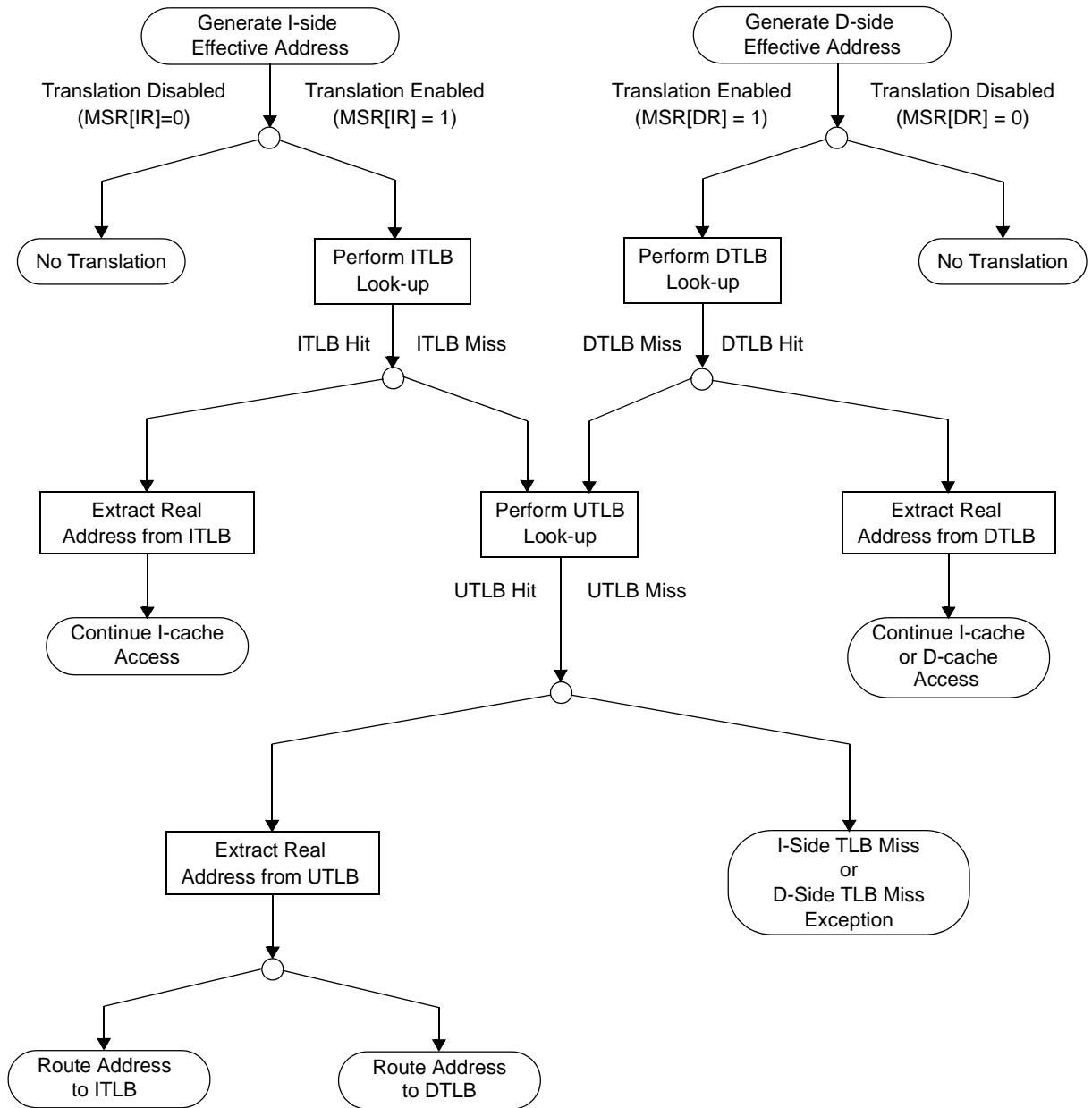

Figure 6-3. ITLB/DTLB/UTLB Address Resolution

Preliminary User's Manual

6.4 TLB-Related Interrupts

The processor relies on interrupt handling software to implement paged virtual memory, and to enforce protection of specified memory pages.

When an interrupt occurs, the processor clears MSR[IR, DR]. Therefore, at the start of all interrupt handlers, the processor operates in real mode for instruction accesses and data accesses. Note that when address translation is disabled for an instruction fetch or load/store, the EA is equal to the real address and is passed directly to the memory subsystem (including cache units). Such untranslated addresses bypass all memory protection checks that would otherwise be performed by the MMU.

When translation is enabled, MMU accesses can result in the following interrupts:

- Data storage interrupt
- Instruction storage interrupt
- Data TLB miss interrupt
- Instruction TLB miss interrupt

6.4.1 Data Storage Interrupt

A data storage interrupt is generated when data address translation is active, and the desired access to the EA is not permitted for one of the following reasons:

- In the problem state
 - **icbi**, load/store, **dcbz**, or **dcbf** with an EA whose zone field is set to no access ($ZPR[Zn] = 00$). In this case, **dcbt** and **dcbtst** no-op, rather than cause an interrupt. Privileged instructions cannot cause data storage interrupts.
 - Stores, or **dcbz**, to an EA having $TLB[WR] = 0$ (write access disabled) and $ZPR[Zn] \neq 11$. (The privileged instructions **dcbi** and **dccci** are treated as “stores”, but cause program interrupts, rather than data storage interrupts.)
- In supervisor state
 - Data store, **dcbi**, **dcbz**, or **dccci** to an EA having $TLB[WR] = 0$ and $ZPR[Zn]$ other than 11 or 10.

dcba does not cause data storage exceptions (cache line locking or protection). If conditions occur that would otherwise cause such an exception, **dcba** is treated as a no-op.

“Zone Protection” on page 6-173 describes zone protection in detail. See “Data Storage Interrupt” on page 0-249 for a detailed discussion of the data storage interrupt.

6.4.2 Instruction Storage Interrupt

An instruction storage interrupt is generated when instruction address translation is active and the processor attempts to execute an instruction at an EA for which fetch access is not permitted, for any of the following reasons:

- In the problem state
 - Instruction fetch from an EA with $ZPR[Zn] = 00$.
 - Instruction fetch from an EA having $TLB_entry[EX] = 0$ and $ZPR[Zn] \neq 11$.
 - Instruction fetch from an EA having $TLB_entry[G] = 1$.
- In the supervisor state
 - Instruction fetch from an EA having $TLB_entry[EX] = 0$ and $ZPR[Zn]$ other than 11 or 10.
 - Instruction fetch from an EA having $TLB_entry[G] = 1$.

See “Zone Protection” on page 6-173 for a detailed discussion of zone protection. See “Instruction Storage Interrupt” on page 0-250 for a detailed discussion of the instruction storage interrupt.

6.4.3 Data TLB Miss Interrupt

A data TLB miss interrupt is generated if data address translation is enabled and a valid TLB entry matching the EA and PID is not present. The interrupt applies to data access instructions and cache operations (excluding cache touch instructions).

See “Data TLB Miss Interrupt” on page 0-256 for a detailed discussion.

6.4.4 Instruction TLB Miss Interrupt

The instruction TLB miss interrupt is generated if instruction address translation is enabled and execution is attempted for an instruction for which a valid TLB entry matching the EA and PID for the instruction fetch is not present.

See “Instruction TLB Miss Interrupt” on page 0-256 for a detailed discussion.

6.5 TLB Management

The processor does not imply any format for the page tables or the page table entries because there is no hardware support for page table management. Software has complete flexibility in implementing a replacement strategy, because software does the replacing. For example, software can “lock” TLB entries that correspond to frequently used storage by electing to never replace them, so that those entries are never cast out of the TLB.

TLB management is performed by software with some hardware assist, consisting of:

- Storage of the missed EA in the Save/Restore Register 0 (SRR0) for an instruction-side miss, or in the Data Exception Address Register (DEAR) for a data-side miss.
- Instructions for reading, writing, searching, and invalidating the TLB, as described briefly in the following subsections. See Chapter 24, “Instruction Set,” for detailed instruction descriptions.

Preliminary User's Manual

6.5.1 TLB Search Instructions (**tlbsx/tlbsx.**)

tlbsx locates entries in the TLB, to find the TLB entry associated with an interrupt, or to locate candidate entries to cast out. **tlbsx** searches the UTLB array for a matching entry. The EA is the value to be matched; $EA = (RA|0)+(RB)$.

If the TLB entry is found, its index is placed in $RT_{26:31}$. RT can then serve as the source register for a **tlbre** or **tlbwe** instruction to read or write the entry, respectively. If no match is found, the contents of RT are undefined.

tlbsx. sets the Condition Register (CR) bit $CR0_{EQ}$. The value of $CR0_{EQ}$ depends on whether an entry is found: $CR0_{EQ} = 1$ if an entry is found; $CR0_{EQ} = 0$ if no entry is found.

6.5.2 TLB Read/Write Instructions (**tlbre/tlbwe**)

TLB entries can be accessed for reading and writing by **tlbre** and **tlbwe**, respectively. Separate extended mnemonics are available for the TLBHI (tag) and TLBLO (data) portions of a TLB entry.

6.5.3 TLB Invalidate Instruction (**tlbia**)

tlbia sets $TLB_entry[V] = 0$ to invalidate all TLB entries. All other TLB entry fields remain unchanged.

Using **tlbwe** to set $TLB_entry[V] = 0$ invalidates a specific TLB entry.

6.5.4 TLB Sync Instruction (**tlbsync**)

tlbsync guarantees that all TLB operations have completed for all processors in a multi-processor system. PPC405GP provides no multiprocessor support, so this instruction performs no function. The instruction is included to facilitate code portability.

6.6 Recording Page References and Changes

When system software manages virtual memory, the software views physical memory as a collection of pages. Each page is associated with at least one TLB entry. To manage memory effectively, system software often must know whether a particular page has been referenced or modified. Note that this involves more than knowing whether a particular TLB entry was used to reference or alter memory, because multiple TLB entries can translate to the same page.

When system software manages a demand-paged environment, and the software needs to replace the contents of a page with other data, previously referenced pages (accessed for any purpose) are more likely to be maintained than pages that were never referenced. If the contents of a page must be replaced, and data contained in that page was modified, system software generally must write the contents of the modified page to the backing store before replacing its contents. System software must maintain records to control the environment.

Similarly, when system software manages TLB entries, the software often must know whether a particular TLB entry was referenced. When the system software must select a TLB entry to cast out, previously referenced entries are more likely to be maintained than entries which were never referenced. System software must also maintain records for this purpose.

The PPC405GP does not provide hardware reference or change bits, but TLB miss interrupts and data storage interrupts enable system software to maintain reference information for TLB entries and their associated pages, respectively.

A possible algorithm follows. First, the TLB entries are built, with each $TLB_entry[V, WR] = 0$. System software retains the index and EPN of each entry.

The first attempt by application code to access a page causes a TLB miss interrupt, because its TLB entry is marked invalid. The TLB miss handler records the reference to the TLB entry (and to the associated page) in a data structure, then sets $TLB_entry[V] = 1$. (Note that $TLB_entry[V]$ can be considered a reference bit for the TLB entry.) Subsequent read accesses to the page associated with the TLB entry proceed normally.

In the example just given for recording TLB entry references, the first write access to the page using the TLB entry, after the entry is made valid, causes a data storage interrupt because write access was turned off. The TLB miss handler records the write to the page in a data structure, for use as a “changed” flag, then sets $TLB_entry[WR] = 1$ to enable write access. (Note that $TLB_entry[WR]$ can be considered a change bit for the page.) Subsequent write accesses to the page proceed normally.

6.7 Access Protection

The PPC405GP provides virtual-mode access protection. The TLB entry enables system software to control general access for programs in the problem state, and control write and execute permissions for all pages. The TLB entry can specify zone protection that can override the other access control mechanisms supported in the TLB entries.

TLB entry and zone protection methods also support access controls for cache operation and string loads/stores.

6.7.1 Access Protection Mechanisms in the TLB

For MMU access protection to be in effect, one or both of $MSR[IR]$ or $MSR[DR]$ must be set to one to enable address translation. $MSR[IR]$ enables protection on instruction fetches, which are inherently read-only. $MSR[DR]$ enables protection on data accesses (loads/stores).

6.7.1.1 General Access Protection

The translation ID ($TLB_entry[TID]$) provides the first level of MMU access protection. This 8-bit field, if non-zero, is compared to the contents of $TLB_entry[PID]$. These fields must match in a valid TLB entry if any access is to be allowed. In typical use, it is assumed that a program in the supervisor state, such as a real-time operating system, sets the PID before starting a problem state program that is subject to access control.

Preliminary User's Manual

If TLB_entry[TID] = 0x00, the associated memory page is accessible to all programs, regardless of their PID. This enables multiple processes to share common code and data. The common area is still subject to all other access protection mechanisms. Figure 6-4 illustrates the PID.



Figure 6-4. Process ID (PID)

0:23		Reserved
24:31		Process ID

6.7.1.2 Execute Permissions

If instruction address translation is enabled, instruction fetches are subject to MMU translation and have MMU access protection. Fetches are inherently read-only, so write protection is not needed. Instead, using TLB_entry[EX], a memory page is marked as executable (contains instructions) or not executable (contains only data or memory-mapped control hardware).

If an instruction is pre-fetched from a memory page for which TLB_entry[EX] = 0, the instruction is tagged as an error. If the processor subsequently attempts to execute this instruction, an instruction storage interrupt results. This interrupt is precise with respect to the attempted execution. If the fetcher discards the instruction without attempting to execute it, no interrupt will result.

Zone protection can alter execution protection.

6.7.1.3 Write Permissions

If MSR[DR] = 1, data loads and stores are subject to MMU translation and are afforded MMU access protection. The existence of a TLB entry describing a memory page implies read access; write access is controlled by TLB_entry[WR].

If a store (including those caused by **dcbz**, **dcbi**, or **dccci**) is made to an EA having TLB_entry[WR] = 0, a data storage interrupt results. This interrupt is precise.

Zone protection can alter write protection (see “Zone Protection” on page 6-173). In addition, only zone protection can prevent read access of a page defined by a TLB entry.

6.7.1.4 Zone Protection

Each TLB entry contains a 4-bit zone select (ZSEL) field. A zone is an arbitrary identifier for grouping TLB entries (memory pages) for purposes of protection. As many as 16 different zones may be defined. Any zone can have any number of member pages.

Each zone is associated with a 2-bit field (Z0–Z15) in the ZPR. The values of the field define how protection is applied to all pages that are member of that zone. Changing the value of the ZPR field can alter the protection attributes of all pages in the zone. Without ZPR, the change would require finding, reading, altering, and rewriting the TLB entry for each page in a zone, individually. The ZPR provides a much faster means of altering the protection for groups of memory pages.

The ZSEL values 0–15 select ZPR fields Z0–Z15, respectively.

The fields are defined within the ZPR as follows:

While it is common for TLB_entry[EX, WR] to be identical for all member pages in a group, this is not required. The ZPR field alters the protection defined by TLB_entry[EX] and TLB_entry[WR], on a page-by-page basis, as shown in the ZPR illustration. An application program (presumed to be running in the problem state) can have execute and write permissions as defined by TLB_entry[EX] and TLB_entry[WR] for the individual pages, or no access (denies loads, as well as stores and execution), or complete access.

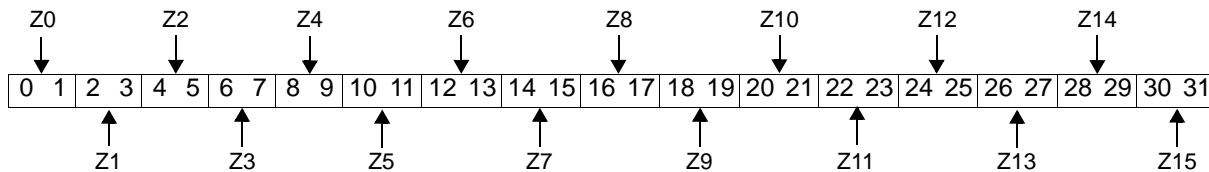

Figure 6-5. Zone Protection Register (ZPR)

0:1	Z0	TLB page access control for all pages in this zone.										
		<table border="0"> <tr> <td>In the problem state (MSR[PR] = 1):</td> <td>In the supervisor state (MSR[PR] = 0):</td> </tr> <tr> <td>00 No access</td> <td>00 Access controlled by applicable TLB_entry[EX, WR]</td> </tr> <tr> <td>01 Access controlled by applicable TLB_entry[EX, WR]</td> <td>01 Access controlled by applicable TLB_entry[EX, WR]</td> </tr> <tr> <td>10 Access controlled by applicable TLB_entry[EX, WR]</td> <td>10 Accessed as if execute and write permissions (TLB_entry[EX, WR]) are granted</td> </tr> <tr> <td>11 Accessed as if execute and write permissions (TLB_entry[EX, WR]) are granted</td> <td>11 Accessed as if execute and write permissions (TLB_entry[EX, WR]) are granted</td> </tr> </table>	In the problem state (MSR[PR] = 1):	In the supervisor state (MSR[PR] = 0):	00 No access	00 Access controlled by applicable TLB_entry[EX, WR]	01 Access controlled by applicable TLB_entry[EX, WR]	01 Access controlled by applicable TLB_entry[EX, WR]	10 Access controlled by applicable TLB_entry[EX, WR]	10 Accessed as if execute and write permissions (TLB_entry[EX, WR]) are granted	11 Accessed as if execute and write permissions (TLB_entry[EX, WR]) are granted	11 Accessed as if execute and write permissions (TLB_entry[EX, WR]) are granted
In the problem state (MSR[PR] = 1):	In the supervisor state (MSR[PR] = 0):											
00 No access	00 Access controlled by applicable TLB_entry[EX, WR]											
01 Access controlled by applicable TLB_entry[EX, WR]	01 Access controlled by applicable TLB_entry[EX, WR]											
10 Access controlled by applicable TLB_entry[EX, WR]	10 Accessed as if execute and write permissions (TLB_entry[EX, WR]) are granted											
11 Accessed as if execute and write permissions (TLB_entry[EX, WR]) are granted	11 Accessed as if execute and write permissions (TLB_entry[EX, WR]) are granted											
2:3	Z1	See the description of Z0.										
4:5	Z2	See the description of Z0.										
6:7	Z3	See the description of Z0.										
8:9	Z4	See the description of Z0.										
10:11	Z5	See the description of Z0.										
12:13	Z6	See the description of Z0.										
14:15	Z7	See the description of Z0.										
16:17	Z8	See the description of Z0.										
18:19	Z9	See the description of Z0.										
20:21	Z10	See the description of Z0.										
22:23	Z11	See the description of Z0.										
24:25	Z12	See the description of Z0.										
26:27	Z13	See the description of Z0.										
28:29	Z14	See the description of Z0.										
30:31	Z15	See the description of Z0.										

Preliminary User's Manual

Setting $ZPR[Zn] = 00$ for a ZPR field is the only way to deny read access to a page defined by an otherwise valid TLB entry. $TLB_entry[EX]$ and $TLB_entry[WR]$ do not support read protection. Note that the **icbi** instruction is considered a load with respect to access protection; executed in user mode, it causes a data storage interrupt if $MSR[DR] = 1$ and $ZPR[Zn] = 00$ is associated with the EA.

For a given ZPR field value, a program in supervisor state always has equal or greater access than a program in the problem state. System software can never be denied read (load) access for a valid TLB entry.

6.7.2 Access Protection for Cache Control Instructions

Architecturally the instructions **dcba**, **dcbi**, and **dcbz** are treated as “stores” because they can change data, or cause loss of data by invalidating a dirty line (a modified cache block).

Table 6-2 summarizes the conditions under which the cache control instructions can cause data storage interrupts.

Table 6-2. Protection Applied to Cache Control Instructions

Instruction	Possible Data Storage interrupt	
	When $ZPR[Zn] = 00$	When $TLB_entry[WR] = 0$
dcba	No (instruction no-ops)	No (instruction no-ops)
dcbf	Yes	No
dcbi	No	Yes
dcbst	Yes	No
dcbt	No (instruction no-ops)	No
dcbstst	No (instruction no-ops)	No
dcbz	Yes	Yes
dccci	No	Yes
dcread	No	No
icbi	Yes	No
icbt	No (instruction no-ops)	No
iccci	No	No
icread	No	No

If data address translation is enabled, and write permission is denied ($TLB_entry[WR] = 0$), **dcbi** and **dcbz** can cause data storage interrupts. **dcbz** can cause a data storage interrupt when executed in the problem state and all access is denied ($ZPR[Zn] = 00$); **dcbi** cannot cause a data storage interrupt because it is a privileged instruction.

The **dcba** instruction enables “speculative” line establishment in the cache arrays; the established lines do not cause a line fill. Because the effects of **dcba** are speculative, interrupts that would otherwise result when $ZPR[Zn] = 00$ or $TLB_entry[WR] = 0$ do not occur. In such cases, **dcba** is treated as a no-op.

The **dccci** instruction can also be considered a “store” because it can change data by invalidating a dirty line; however, **dccci** is not address-specific (it affects an entire congruence class regardless of the operand address of the instruction). To restrict possible damage from an instruction which can change data and yet avoids the protection mechanism, the **dccci** instruction is privileged.

If data address translation is enabled, **dccci** can cause data storage interrupts when $TLB_entry[WR] = 0$; the operand is treated as if it were address-specific. **dccci** cannot cause a data storage interrupt when $ZPR[Zn] = 00$, because it is a privileged instruction.

Because **dccci** can cause data storage and TLB -miss interrupts, use of **dccci** is not recommended when $MSR[DR] = 1$; if **dccci** is used. Note that the specific operand address can cause an interrupt.

Architecturally, **dcbt** and **dcbtst** are treated as “loads” because they do not change data; they cannot cause data storage interrupts when $TLB_entry[WR] = 0$.

The cache block touch instructions **dcbt** and **dcbtst** are considered “speculative” loads; therefore, if a data storage interrupt would otherwise result from the execution of **dcbt** or **dcbtst** when $ZPR[Zn] = 00$, the instruction is treated as a no-op and the interrupt does not occur. Similarly, TLB miss interrupts do not occur for these instructions.

Architecturally, **dcbf** and **dcbst** are treated as “loads”. Flushing or storing a line from the cache is not architecturally considered a “store” because a store was performed to update the cache, and **dcbf** or **dcbst** only update main memory. Therefore, neither **dcbf** nor **dcbst** can cause data storage interrupts when $TLB_entry[WR] = 0$. Because neither instruction is privileged, they can cause data storage interrupts when $ZPR[Zn] = 00$ and data address translation is enabled.

dcread is a “load” from a non-specific address, and is privileged. Therefore, it cannot cause data storage interrupts when $ZPR[Zn] = 00$ or $TLB_entry[WR] = 0$.

icbi and **icbt** are considered “loads” and cannot cause data storage interrupts when $TLB_entry[WR] = 0$. **icbi** can cause data storage interrupts when $ZPR[Zn] = 00$.

The **iccci** instruction cannot change data; an instruction cache line cannot be dirty. The **iccci** instruction is privileged and is considered a load. It does not cause data storage interrupts when $ZPR[Zn] = 00$ or $TLB_entry[WR] = 0$.

Because **iccci** can cause a TLB miss interrupt, using **iccci** is not recommended when data address translation is enabled; if it is used, note that the specific operand address can cause an interrupt.

icread is considered a “load” from a non-specific address, and is privileged. Therefore, it cannot cause data storage interrupts when $ZPR[Zn] = 00$ or $TLB_entry[WR] = 0$.

6.7.3 Access Protection for String Instructions

The **stswx** instruction with string length equal to 0 ($XER[TBC] = 0$) is a no-op.

When data address translation is enabled and the Transfer Byte Count (TBC) field of the Fixed Point Exception Register (XER) is 0, neither **lswx** nor **stswx** can cause TLB miss interrupts, or data storage interrupts when $ZPR[Zn] = 0$ or $TLB_entry[WR] = 0$.

Preliminary User's Manual**6.8 Real-Mode Storage Attribute Control**

The PowerPC Architecture and the PowerPC Embedded Environment define several SPRs to control the following storage attributes in real mode: W, I, G,U0, and E. Note that the U0 and E attributes are not defined in the PowerPC Architecture. The E attribute is defined in the AMCC PowerPC Embedded Environment, and the U0 attribute is implementation-specific. No storage attribute control register is implemented for the M storage attribute because the PPC405GP does not provide multi-processor support or hardware support for data coherency.

These SPRs, called storage attribute control registers, control the various storage attributes when address translation is disabled. When address translation is enabled, these registers are ignored, and the storage attributes supplied by the TLB entry are used (see “TLB Fields” on page 6-163).

The storage attribute control registers divide the 4GB real address space into thirty-two 128MB regions. In a storage attribute control register, bit 0 controls the lowest addressed 128MB region, bit 1 the next higher-addressed 128MB region, and so on. EA_{0:4} specify a storage control region.

For detailed information on the function of the storage attributes, see “Storage Attribute Fields” on page 6-165.

6.8.1 Storage Attribute Control Registers

Figure 6-6 shows a generic storage attribute control register. The storage attribute control registers have the same bit numbering and address ranges.

0	1	2	3	4	5	6	7	8	9	10	11	12	13	14	15	16	17	18	19	20	21	22	23	24	25	26	27	28	29	30	31
---	---	---	---	---	---	---	---	---	---	----	----	----	----	----	----	----	----	----	----	----	----	----	----	----	----	----	----	----	----	----	----

Figure 6-6. Generic Storage Attribute Control Register

Bit	Address Range	Bit	Address Range
0	0x0000 0000–0x07FF FFFF	16	0x8000 0000–0x87FF FFFF
1	0x0800 0000–0x0FFF FFFF	17	0x8800 0000–0x8FFF FFFF
2	0x1000 0000–0x17FF FFFF	18	0x9000 0000–0x97FF FFFF
3	0x1800 0000–0x1FFF FFFF	19	0x9800 0000–0x9FFF FFFF
4	0x2000 0000–0x27FF FFFF	20	0xA000 0000–0xA7FF FFFF
5	0x2800 0000–0x2FFF FFFF	21	0xA800 0000–0xAFFF FFFF
6	0x3000 0000–0x37FF FFFF	22	0xB000 0000–0xB7FF FFFF
7	0x3800 0000–0x3FFF FFFF	23	0xB800 0000–0xBFFF FFFF
8	0x4000 0000–0x47FF FFFF	24	0xC000 0000–0xC7FF FFFF
9	0x4800 0000–0x4FFF FFFF	25	0xC800 0000–0xCFFF FFFF
10	0x5000 0000–0x57FF FFFF	26	0xD000 0000–0xD7FF FFFF
11	0x5800 0000–0x5FFF FFFF	27	0xD800 0000–0xDFFF FFFF
12	0x6000 0000–0x67FF FFFF	28	0xE000 0000–0xE7FF FFFF

Figure 6-6. Generic Storage Attribute Control Register (continued)

13	0x6800 0000–0x6FFF FFFF	29	0xE800 0000–0xEFFF FFFF
14	0x7000 0000–0x77FF FFFF	30	0xF000 0000–0xF7FF FFFF
15	0x7800 0000–0x7FFF FFFF	31	0xF800 0000–0xFFFF FFFF

6.8.1.1 Data Cache Write-through Register (DCWR)

The DCWR controls write-through policy (the W storage attribute) for the data cache unit (DCU). Write-through is not applicable to the instruction cache unit (ICU).

After any reset, all DCWR bits are set to 0, which establishes a write-back write strategy for all regions.

The PowerPC Architecture does not support memory models in which write-through is enabled and caching is inhibited.

6.8.1.2 Data Cache Cachability Register (DCCR)

The DCCR controls the I storage attribute for data accesses and cache management instructions. Note that the polarity of the bits in this register is opposite to that of the I attribute in the TLB; $DCCR[S_n] = 1$ enables caching, while $TLB_entry[I] = 1$ inhibits caching.

After any reset, all DCCR bits are set to 0. No memory regions are cachable. Before memory regions can be designated as cachable in the DCCR, it is necessary to execute the **dccci** instruction once for each congruence class in the DCU cache array. This procedure invalidates all congruence classes. The DCCR can then be reconfigured, and the DCU can begin normal operation.

The PowerPC Architecture does not support memory models in which write-through is enabled and caching is inhibited.

6.8.1.3 Instruction Cache Cachability Register (ICCR)

The ICCR controls the I storage attribute for instruction fetches. Note that the polarity of the bits in this register is opposite of that of the I attribute ($ICCR[S_n] = 1$ enables caching, while $TLB_entry[I] = 1$ inhibits caching).

After any reset, all ICCR bits are set to 0. No memory regions are cachable. Before memory regions can be designated as cachable in the ICCR, it is necessary to execute the **iccci** instruction. This procedure invalidates all congruence classes. The ICCR can then be reconfigured, and the ICU can begin normal operation.

6.8.1.4 Storage Guarded Register (SGR)

The SGR controls the G storage attribute for instruction and data accesses.

This attribute does not affect data accesses; the PPC405GP does not perform speculative loads or stores.

After any reset, all SGR bits are set to 1, marking all storage as guarded. For best performance, system software should clear the guarded attribute of appropriate regions as soon as possible. If $MSR[IR] = 1$, the G attribute comes from the TLB entry. Attempting to execute from a guarded region in translate mode causes an instruction storage interrupt. See "Instruction Storage Interrupt" on page 0-250 for more information.

Preliminary User's Manual

6.8.1.5 Storage User-defined 0 Register (SU0R)

The Storage User-defined 0 Register (SU0R) controls the user-defined (U0) storage attribute for instruction and data accesses.

After any reset, all SU0R bits are set to 0.

6.8.1.6 Storage Little-Endian Register (SLER)

The SLER controls the E storage attribute for instruction and data accesses.

This attribute determines the byte ordering of storage. “Byte Ordering” on page 3-108 provides a detailed description of byte ordering in the AMCC PowerPC Embedded Environment.

After any reset, all SLER bits are set to 0 (big endian).

Part III. PPC405GP System Operations

Preliminary User's Manual

Chapter 7. Clocking

Clocking in the PPC405GP is highly configurable and supports a wide range of clock ratios on the internal and external buses.

Figure 7-1 illustrates the clocking options for the PPC405GP. A phase-locked loop (PLL) is the source for the CPU clock. Generated clock frequencies are integer ratios of this reference clock. Optional external clock inputs are shown where appropriate. The clocking inputs, which are highlighted in the figure (IIC SCL is I/O), are described in more detail in Chapter 26, "Signal Summary."

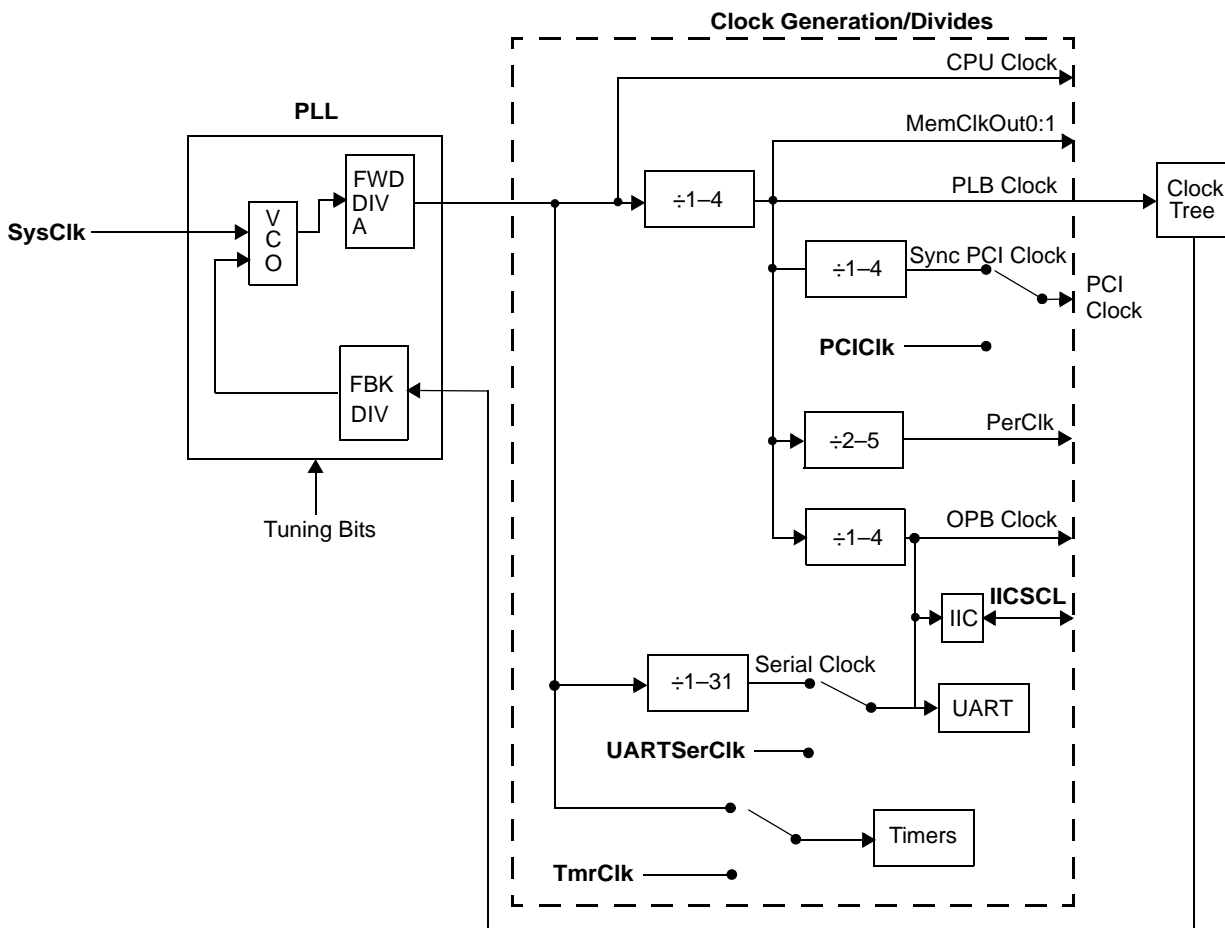

Figure 7-1. PPC405GP Clocking

7.1 PLL Overview

The PLL AV_{DD} input to the PPC405GP requires $2.5\text{ V} \pm 0.2\text{ V}$, which should be supplied from a 2.5 V filtered board voltage.

The PLL operating range is controlled by forward divide and feedback divide ratios, tuning bits, and SysClk. The voltage controlled oscillator (VCO) in the PLL must operate at a range of 400–800 MHz. The value of the forward divide and feedback divide ratios affects the CPU frequency and the VCO operating frequency.

Several strapping values are required to correctly configure the PPC405GP. When setting the values, pay close attention to the following information to avoid accidentally configuring the controller in an unusable state.

For any acceptable SysClk input, the VCO frequency is set by the feedback and forward dividers, and the CPU to PLB divider, as shown in the following equation:

$$\text{VCO} = \text{Reference Clock} \times M$$

where $M = \text{Feedback Divide} \times \text{Forward Divide} \times \text{CPU to PLB Divide}$

For example, with an input reference frequency of 33.33 MHz, feedback divider of 3, CPU to PLB divider of 2, and forward divider of 3, the VCO frequency at which the PLL stabilizes is 600 MHz.

Strap selection for PLL tuning depends upon the value of M , which can range from 6 to 32. The upper limit is based on a minimum input reference clock frequency of 25 MHz and a maximum VCO frequency of 800 MHz. The lower limit is based on a maximum input reference clock of 66 MHz and a minimum VCO frequency of 400MHz. M decreases as the reference clock frequency increases.

7.2 Input Reference Clock (SysClk)

The input reference clock, SysClk, must be between 25 MHz and 66 MHz for the PLL to achieve a stable lock. *Input clocks outside this range are not supported.* When synchronous PCI mode is selected, clock generation logic ensures that the internally generated PCI clock and SysClk are phase-aligned. This means that rising edges will coincide as long as the frequencies are the same. In most cases, the input reference clock is expected to be the same as the PCI clock provided to other PCI devices outside of the 405GP. Therefore, the phase alignment that automatically occurs ensures that the internally generated PCI clock matches the clock used by other PCI devices.

Clock generation logic also ensures that the internally generated peripheral clock (PerClk) is phase-aligned with SysClk, as long as both run at the same clock frequency. This is useful when an external device, such as an external master, cannot be synchronized with the PPC405GP PerClk.

Preliminary User's Manual**7.3 External Clock Strapping Setup**

The PPC405GP configures its clocking based on strapping resistors connected to module I/O pins. The state of the strapping pins is stored in the Chip Pin Strapping Register (CPC0_PSR) upon power-on or system reset. Software can use this read-only register to determine clock strapping values. Table 7-1 indicates which CPC0_PSR fields are assigned to clocking functions and how they are encoded. See Chapter 9, “Pin Strapping and Sharing” for a more information and a complete list of strapping values.

Table 7-1. Clock Strapping Values

Strap Option	Description
PLL Forward Divide Ratio CPC0_PSR[PFWD] 00 Bypass mode 01 Divide by 3 10 Divide by 4 11 Divide by 6	These bits indicate bypass mode or one of three valid PLL forward divide ratios. Bypass mode is useful when the PPC405GP is run with a low-frequency reference clock input that is too low for the PLL to lock. For example, if the PPC405GP is clocked at 1 MHz in an emulation system, the PLL cannot be used and should be placed in bypass mode. The other three strapping combinations select one of three valid PLL forward divide ratios: 3, 4, or 6. These ratios are the only acceptable ratios.
PLL Feedback Divide Ratio CPC0_PSR[PFBD] 00 Divide by 1 01 Divide by 2 10 Divide by 3 11 Divide by 4	These bits indicate one of four valid PLL feedback divide ratios: 1, 2, 3, or 4.
PLL Tuning CPC0_PSR[PT] 000 Choice 1; TUNE[5:0] = 010001 001 Choice 2; TUNE[5:0] = 010010 010 Choice 3; TUNE[5:0] = 010011 011 Choice 4; TUNE[5:0] = 010100 100 Choice 5; TUNE[5:0] = 010101 101 Choice 6; TUNE[5:0] = 010110 110 Choice 7; TUNE[5:0] = 010111 111 Choice 8; TUNE[5:0] = 100100	Note: The tune bits adjust parameters that control PLL jitter. The recommended values minimize jitter for the PLL implemented in the PPC405GP. These bits are shown for information only, and do not require modification except in special clocking circumstances, such as spread spectrum clocking. For details on the use of spread spectrum clock generators (SSCGs) with the PPC405GP, visit the technical documents area of the AMCC PowerPC web site.
PLB Divide Ratio from CPU CPC0_PSR[PDC] 00 Divide by 1 01 Divide by 2 10 Divide by 3 11 Divide by 4	These bits indicate one of four PLB divide ratios from the CPU: 1, 2, 3, or 4.
OPB Divide Ratio from PLB CPC0_PSR[ODP] 00 Divide by 1 01 Divide by 2 10 Divide by 3 11 Divide by 4	These bits indicate one of four OPB divide ratios from the PLB: 1, 2, 3, or 4.

Table 7-1. Clock Strapping Values (continued)

Strap Option	Description
PCI Divide Ratio from PLB CPC0_PSR[PDP] 00 Divide by 1 01 Divide by 2 10 Divide by 3 11 Divide by 4	These bits indicate one of four PCI divide ratios from the PLB: 1, 2, 3 or 4.
Peripheral Bus Divide Ratio from PLB CPC0_PSR[EBDP] 00 Divide by 2 01 Divide by 3 10 Divide by 4 11 Divide by 5	These bits indicate one of four peripheral bus divide ratios from the PLB: 2, 3, 4, or 5.

Table 7-2 lists PLL tuning settings, which are controlled by the pin strappings reported by CPC0_PSR[PT]. The tune bits adjust parameters that control PLL jitter. The recommended values minimize jitter for the PLL implemented in the PPC405GP. These bits are shown for information only, and do not require modification except in special clocking circumstances, such as spread spectrum clocking. For details on the use of spread spectrum clock generators (SSCGs) with the PPC405GP, visit the technical documents area of the AMCC PowerPC web site.

Table 7-2. PLL Tuning Settings

M Range	Recommended Choice	CPC0_PSR[PT] Value	Equivalent TUNE[5:0]
$6 \leq M \leq 7$	3	010	010011
$7 \leq M \leq 12$	5	100	010101
$12 \leq M \leq 32$	6	101	010110

7.4 Sample Clock Ratios

Table 7-3, Table 7-4, and Table 7-5 list all usable clocking ratio combinations that can be achieved using the strapping inputs for three different reference clock frequencies. VCO frequencies and M multipliers are calculated for each valid combination of forward divide (FWD), CPU to PLB divide (CPU/PLB), and feedback divide (FBK). The resulting clock frequencies for CPU and PLB are also shown. To simplify the table, PCI, OPB, external bus, and serial clock frequencies are not shown.

Ratios that result in unusable configurations are not listed. In some cases, the table indicates identical CPU and PLB frequencies. However, in such cases, the VCO frequency varies. When the table indicates a choice of VCO frequencies, select the highest frequency in the range of 400–800 MHz for best PLL performance.

Preliminary User's Manual**Table 7-3. Possible Clocking Ratios for Reference Clock of 33.3MHz**

Strapping Options			M	Calculated Values (MHz)		
FWD	CPU/PLB	FBK		VCO	CPU	PLB
By-pass ²	1	x	—	—	refclk	refclk
	2	x	—	—	refclk	refclk/2
	3	x	—	—	refclk	refclk/3
	4	x	—	—	refclk	refclk/4
3	1	4	12	400	133	133
3	2	2	12	400	133	66
3	2	3	18	600	200	100
3	2	4	24	800	266	133
3	3	2	18	600	200	66
3	4	1	12	400	133	33
3	4	2	24	800	266	66
4	1	3	12	400	100	100
4	1	4	16	533	133	133
4	2	2	16	533	133	66
4	2	3	24	800	200	100
4	3	1	12	400	100	33
4	3	2	24	800	200	66
4	4	1	16	533	133	33
6	1	2	12	400	66	66
6	1	3	18	600	100	100
6	1	4	24	800	133	133
6	2	1	12	400	66	33
6	2	2	24	800	133	66
6	3	1	18	600	100	33
6	4	1	24	800	133	33

Note 1: x = don't care.

Note 2: By-pass mode is for hardware emulator use only. Contact your AMCC representative for more information.

Note 3: Not all PPC405GP parts support the frequencies shown. Check *PPC405GP Datasheet* for supported CPU and PLB frequencies for a specific part number.

Table 7-4. Possible Clocking Ratios for Reference Clock of 25MHz

Strapping Options			M	Calculated Values (MHz)		
FWD	CPU/PLB	FBK		VCO	CPU	PLB
By-pass ²	1	x	—	—	refclk	refclk
	2	x	—	—	refclk	refclk/2
	3	x	—	—	refclk	refclk/3
	4	x	—	—	refclk	refclk/4
3	2	3	18	450	150	75
3	2	4	24	600	200	100
3	3	2	18	450	150	50
3	3	3	27	675	225	75
3	4	2	24	600	200	50
4	1	4	16	400	100	100
4	2	2	16	400	100	50
4	2	3	24	600	150	75
4	2	4	32	800	200	100
4	3	2	24	600	150	50
4	4	1	16	400	100	25
4	4	2	32	800	200	50
6	1	3	18	450	75	75
6	1	4	24	600	100	100
6	2	2	24	600	100	50
6	3	1	18	450	75	25
6	4	1	24	600	100	25

Note 1: x = don't care.

Note 2: By-pass mode is designed for hardware emulator use only. Contact your AMCC representative for more information.

Note 3: Not all PPC405GP parts support the frequencies shown. Check *PPC405GP Datasheet* for supported CPU and PLB frequencies for a specific part number.

Preliminary User's Manual**Table 7-5. Possible Clocking Ratios for Reference Clock of 41.6MHz**

Strapping Options			M	Calculated Values (MHz)		
FWD	CPU/PLB	FBK		VCO	CPU	PLB
By-pass ²	1	x	—	—	refclk	refclk
	2	x	—	—	refclk	refclk/2
	3	x	—	—	refclk	refclk/3
	4	x	—	—	refclk	refclk/4
3	2	2	12	500	166	83
3	2	3	18	750	250	125
3	3	2	18	750	250	83
3	4	1	12	500	166	41
4	1	3	12	500	125	125
4	2	2	16	666	166	83
4	3	1	12	500	125	41
4	4	1	16	666	166	41
6	1	2	12	500	83	83
6	1	3	18	750	125	125
6	2	1	12	500	83	41
6	3	1	18	750	125	41

Note 1: x = don't care.

Note 2: By-pass mode is designed for hardware emulator use only. Contact your AMCC representative for more information.

Note 3: Not all PPC405GP parts support the frequencies shown. Check *PPC405GP Datasheet* for supported CPU and PLB frequencies for a specific part number.

7.5 PCI Clocking

The PPC405GP PCI interface can run synchronously or asynchronously relative to the on-chip PLB. The state at reset of the PCI Asynchronous Mode Enable (PAME) strapping pin selects synchronous PCI mode or asynchronous PCI mode. The state of the PAME pin is reported in the PAME field of the CPC0_PSR. For information about the strapping pins, refer to *PowerPC 405GP Embedded Processor Data Sheet*, which is available from your AMCC representative and in the AMCC web site (www.amcc.com).

Lower PCI latency through the PCI logic occurs in synchronous PCI mode, which should be used for host-bridge applications in which the PCI bus frequency is less than or equal to 33 Mhz, and the PLB frequency is an integer multiple of the PCI frequency. PPC405GP applications for higher PCI frequencies, or for PCI adapters, should use asynchronous PCI mode.

7.5.1 PCI Clocks

The following clocks are related to the PCI logic:

- The on-chip PLB clock
- The on-chip synchronous PCI clock
- An external asynchronous PCI clock, PCIClk

In synchronous PCI mode, the asynchronous PCI clock input is ignored and the on-chip PCI logic runs synchronously at the selected PLB:PCI divide ratio. In this mode, the on-chip synchronous PCI clock must be programmed such that it is the same frequency as SysClk.

In asynchronous PCI mode, the synchronous clock must still be provided to the PCI logic, even though the asynchronous PCI clock is used. The synchronous PCI clock must also meet certain frequency requirements relative to the chosen asynchronous clock frequency.

Table 7-6 describes a set of rules for determining the acceptable asynchronous PCI frequency range based on the selected PLB:PCI Mode and PLB clock frequency. Note that the synchronous PCI clock frequency is the selected PLB clock frequency divided by the selected PLB:PCI Mode.

Table 7-6. Acceptable PCI Asynchronous Clock Frequency Range

PLB:PCI Mode	Asynchronous PCI Lower Bound	Asynchronous PCI Upper Bound
1:1	$0.5 \times \text{PLB_freq} + 1 \text{ MHz}$	$\text{PLB_freq} + 1 \text{ MHz}$
	Example: If the PLB clock frequency is 66 MHz, the PCI asynchronous frequency can range from 34.3 MHz to 66.7 MHz	
2:1	$0.25 \times \text{PLB_freq} + 1 \text{ MHz}$	$0.5 \times \text{PLB_freq} + 1 \text{ MHz}$
	Example: If the PLB clock frequency is 66 MHz, the PCI asynchronous frequency can range from 17.7 MHz to 34.3 MHz	
3:1	$0.167 \times \text{PLB_freq} + 1 \text{ MHz}$	$0.33 \times \text{PLB_freq} + 2 \text{ MHz}$
	Example: If the PLB clock frequency is 100MHz, the PCI asynchronous frequency can range from 17.7 MHz to 35.3 MHz	
4:1	$0.125 \times \text{PLB_freq} + 1 \text{ MHz}$	$0.25 \times \text{PLB_freq} + 2 \text{ MHz}$
	Example: If the PLB clock frequency is 133MHz, the PCI asynchronous frequency can range from 17.6 MHz to 35.3 MHz	
Note: Asynchronous PCI frequencies cannot exceed 66.7 MHz.		

In general, the allowable range of asynchronous PCI frequencies in any given PLB:PCI Mode can be determined as follows:

Calculate a frequency value by dividing the PLB frequency by the selected clock mode. The allowable asynchronous PCI frequency range is from half of this calculated frequency to the value itself.

For example, if the PLB runs at 100MHz and the clock mode is 3:1, the allowable PCI frequency range is from 16MHz (half of 33) to 33 MHz.

Preliminary User's Manual

Table 7-7 describes the relationships between the synchronous PCI clock, the asynchronous PCI clock, and the PLB clock, when in asynchronous PCI mode. It lists supported and commonly used combinations of synchronous and asynchronous PCI clocks. In general, higher synchronous PCI clock frequencies provide better performance, while lower synchronous PCI clock frequencies minimize power consumption.

Table 7-7. Example Synchronous PCI Clock Frequencies in Asynchronous Mode

Asynchronous PCI Frequency	Synchronous PCI Frequency	PLB Frequency	Sync PCI:PLB Ratio
20 MHz	33.3 MHz	133.3 MHz	1:4
	33.3 MHz	100 MHz	1:3
	27.6 MHz	83.3 MHz	1:3
33.3 MHz	44.4 MHz	133.3 MHz	1:3
	33.3 MHz	133.3 MHz	1:4
	50 MHz	100 MHz	1:2
	41.6 MHz	83.3 MHz	1:2
40 MHz	44.4 MHz	133.3 MHz	1:3
	50 MHz	100 MHz	1:2
	41.6 MHz	83.3 MHz	1:2
66.6 MHz	66.6 MHz	133.3 MHz	1:2
	100 MHz	100 MHz	1:1
	83.3 MHz	83.3 MHz	1:1

7.5.2 PCI Adapter Applications

Because various systems run PCI expansion buses at different PCI frequencies, several PCI clock frequencies may need to be supported when the PPC405GP is used in PCI adapters. Using the PCI clock as a PPC405GP system clock input, as required for synchronous PCI mode, can adversely affect PPC405GP CPU performance. In some cases, the PPC405GP might not function.

For example, if the PPC405GP is used on a PCI adapter and the PCI expansion bus frequency is 33MHz, the PPC405GP strapping pins can be configured to run the chip at 200 MHz. However, if the same strapping configuration is used and the PPC405GP is used in a system in which the PCI expansion bus frequency is 25 MHz (an application supported by the PCI specification), the PPC405GP would run suboptimally at 150 MHz. Worse problems would be encountered if the PCI frequency were less than 25 Mhz (the PPC405GP PLL locking frequency). In this application, the PPC405GP might not function. For these reasons, asynchronous PCI mode is recommended when the PPC405GP is used in PCI adapter applications.

Asynchronous PCI mode uses an externally provided PCI clock that does not interact with an on-chip PLL, so there is no lower frequency limit imposed by loss of PLL lock. However, the requirements resulting from the relationship between the synchronous and asynchronous PCI clocks must still be satisfied.

Note: Satisfying the equation in “PCI Clocks” on page 7-190 presents a potential problem. The strapping pin selection needed to set an acceptable synchronous PCI clock for a 33 MHz asynchronous PCI clock differs from the strapping pin selection for a 66 MHz asynchronous PCI clock. External logic is required to detect the state of the M66 pin on the PCI adapter interface and select appropriate PPC405GP strapping pins during system reset.

7.6 Serial Port Clocking

The two PPC405GP UARTs (serial ports) can be clocked individually, either from an external serial clock or from an internally generated serial clock. The internally generated clock is derived from the CPU clock, and is CPU/n, where n ranges from 1 to 32.). Subsequently, the serial clock input to the UART is further divided in the UART to generate the desired serial data rate (baud rate).

Refer to Chapter 21, “Serial Port Operations,” for more information about choosing CPU clock and serial input clock divisors.

7.7 Clocking Registers

Table 7-8 summarizes the Device Control Registers (DCRs) that control clocking in the PPC405GP.

Table 7-8. Clocking Control Registers

Register	Address	R/W	Description
CPC0_PLLMR	0x0B0	R/O	PLL Mode Register
CPC0_CR0	0x0B1	R/W	Chip Control Register 0

CPC0_CR0 selects the internal serial clock source. The clocking registers are read and written using the **mtdcr** and **mf dcr** instructions.

7.7.1 PLL Mode Register (CPC0_PLLMR)

The read-only CPC0_PLLMR contains a number of PLL and clock divisor values.

CPC0_PLLMR fields are based on the external strapping options.

The CPC0_PLLMR is big endian. However, values returned for the CPC0_PLLMR[FWDV, FBDV, TUN] fields are little endian to enable easier comparison of these bits with the PLL documentation in *ASIC SA-12E Databook* (available from your AMCC representative), which uses little endian formats.

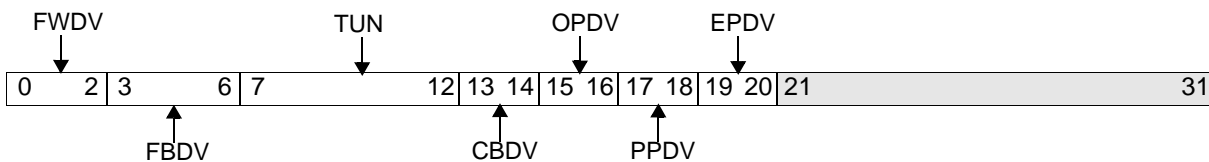

Figure 7-2. PLL Mode Register (CPC0_PLLMR)

0:2	FWDV	Forward Divisor 000 Forward divisor is 8. 001 Forward divisor is 7. 010 Forward divisor is 6. 011 Forward divisor is 5. 100 Forward divisor is 4. 101 Forward divisor is 3. 110 Forward divisor is 2. 111 Forward divisor is 1.	PLLOUTA Value: 50 MHz–100 MHz 58 MHz–114 MHz 66 MHz–134 MHz 80 MHz–160 MHz 100 MHz–200 MHz 133 MHz–267 MHz 200 MHz–400 MHz 400 MHz–800 MHz Note: PLLOUTA is the CPU clock.
-----	------	---	--

Preliminary User's Manual

3:6	FBDV	Feedback Divisor 0000 Feedback divisor is 16. 0001 Feedback divisor is 1. 0010 Feedback divisor is 2. 0011 Feedback divisor is 3. 0100 Feedback divisor is 4. 0101 Feedback divisor is 5. 0110 Feedback divisor is 6. 0111 Feedback divisor is 7. 1000 Feedback divisor is 8. 1001 Feedback divisor is 9. 1010 Feedback divisor is 10. 1011 Feedback divisor is 11. 1100 Feedback divisor is 12. 1101 Feedback divisor is 13. 1110 Feedback divisor is 14. 1111 Feedback divisor is 15.	
7:12	TUN	TUNE[5:0] Field	Note: The tune bits adjust parameters that control PLL jitter. The recommended values minimize jitter for the PLL. These bits are shown for information only, and do not require modification except in special clocking circumstances, such as spread spectrum clocking. For details on the use of spread spectrum clock generators (SSCGs), visit the technical documents area of the AMCC PowerPC web site.
13:14	CBDV	CPU:PLB Frequency Divisor 00 CPU:PLB divisor is 1 01 CPU:PLB divisor is 2 10 CPU:PLB divisor is 3 11 CPU:PLB divisor is 4	
15:16	OPDV	OPB–PLB Frequency Divisor 00 OPB–PLB divisor is 1 01 OPB–PLB divisor is 2 10 OPB–PLB divisor is 3 11 OPB–PLB divisor is 4	
17:18	PPDV	PCI–PLB Frequency Divisor 00 PCI–PLB divisor is 1 01 PCI–PLB divisor is 2 10 PCI–PLB divisor is 3 11 PCI–PLB divisor is 4	See “PCI Clocks” on page 7-190 for details regarding asynchronous PCI clocking and how it relates to synchronous clocking.
19:20	EPDV	External Bus–PLB Frequency Divisor 00 External bus–PLB divisor ratio is 2:1 01 External bus–PLB divisor ratio is 3:1 10 External bus–PLB divisor ratio is 4:1 11 External bus–PLB divisor ratio is 5:1	
21:31		Reserved	

7.7.2 Chip Control Register 0 (CPC0_CR0)

Only CPC0_CR0 fields related to clocking are shown in Figure 7-3. CPC0_CR0_{10:23}, which control GPIO and UART functions, are summarized in “CPC0_CR0” on page 0-903.

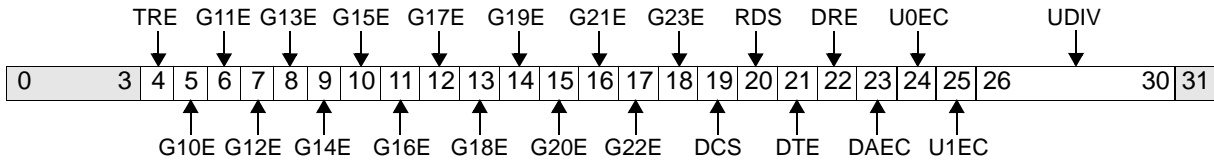

Figure 7-3. Chip Control Register 0 (CPC0_CR0)

0:3		Reserved
4	TRE	CPU Trace Enable 0 GPIO1-9 are enabled 1 GPIO1-9 are disabled Trace interface cannot be used when GPIO is enabled.
5	G10E	GPIO 10 Enable 0 Enable PerCS1 as a chip select 1 Enable PerCS1 as GPIO10
6	G11E	GPIO 11 Enable 0 Enable PerCS2 as a chip select 1 Enable PerCS2 as GPIO11
7	G12E	GPIO 12 Enable 0 Enable PerCS3 as a chip select 1 Enable PerCS3 as GPIO12
8	G13E	GPIO 13 Enable 0 Enable PerCS4 as a chip select 1 Enable PerCS4 as GPIO13
9	G14E	GPIO 14 Enable 0 Enable PerCS5 as a chip select 1 Enable PerCS5 as GPIO14
10	G15E	GPIO 15 Enable 0 Enable PerCS6 as a chip select 1 Enable PerCS6 as GPIO15
11	G16E	GPIO 16 Enable 0 Enable PerCS7 as a chip select 1 Enable PerCS7 as GPIO16

Preliminary User's Manual

12	G17E	GPIO 17 Enable 0 Enable interrupt IRQ0 as an interrupt 1 Enable interrupt IRQ0 as GPIO17	The purpose of G17E through G23E is to isolate the interrupt controller from activity on a shared pin when that pin is being used as a GPIO. For instance, when G17E is set to a 1, IRQ0 at the UIC will always be forced to a zero. Note: Setting G17E to a 0 will not prevent GPIO channel 17 (if configured as an output) from creating contention with the off-chip source of the IRQ input. Therefore, be sure to leave the shared GPIO channel disabled when using the pin as an interrupt input.
13	G18E	GPIO 18 Enable 0 Enable interrupt IRQ1 as an interrupt 1 Enable interrupt IRQ1 as GPIO18	
14	G19E	GPIO 19 Enable 0 Enable interrupt IRQ2 as an interrupt 1 Enable interrupt IRQ2 as GPIO19	
15	G20E	GPIO 20 Enable 0 Enable interrupt IRQ3 as an interrupt 1 Enable interrupt IRQ3 as GPIO20	
16	G21E	GPIO 21 Enable 0 Enable interrupt IRQ4 as an interrupt 1 Enable interrupt IRQ4 as GPIO21	
17	G22E	GPIO 22 Enable 0 Enable interrupt IRQ5 as an interrupt 1 Enable interrupt IRQ5 as GPIO22	
18	G23E	GPIO 23 Enable 0 Enable interrupt IRQ6 as an interrupt 1 Enable interrupt IRQ6 as GPIO23	
19	DCS	DSR/CTS select for UART1 0 DSR is selected. 1 CTS is selected.	
20	RDS	RTS/DTR select for UART1 0 RTS is selected. 1 DTR is selected.	
21	DTE	DMA Transmit Enable for UART0 0 DMA transmit channel is disabled. 1 DMA transmit channel is enabled.	
22	DRE	DMA Receive Enable for UART0 0 DMA receive channel is disabled. 1 DMA receive channel is enabled.	
23	DAEC	DMA Allow Enable Clear for UART0 0 DTE and DRE for UART0 are not cleared when the UART receives a corresponding terminal count. 1 DTE and DRE for UART0 are cleared when the UART receives a corresponding terminal count.	

24	U0EC	Select External Clock for UART0 0 UART0 uses the internally derived serial clock 1 UART0 uses the external UARTSerClk input
25	U1EC	Select External Clock for UART1 0 UART1 uses the internally derived serial clock 1 UART1 uses the external UARTSerClk input
26:30	UDIV	UART Internal Clock Divisor 00000 Divide by 1 00001 Divide by 2 00010 Divide by 3 . . . 11110 Divide by 31 11111 Divide by 32 UDIV specifies the divisor of the CPU clock frequency used to derive a UART serial clock frequency. For example, if the CPU is running at 200MHz, a divider value of 20 sets the serial clock frequency to 10MHz. Note: The serial clock frequency must be less than 1/2 the OPB frequency
31		Reserved

7.7.3 Chip Control Register 1 (CPC0_CR1)

CPC0_CR1 determines whether CPU timers increment at the CPU clock frequency or at the frequency of the TmrClk input. See Chapter 11, "Timer Facilities," for more information about the CPU timers.

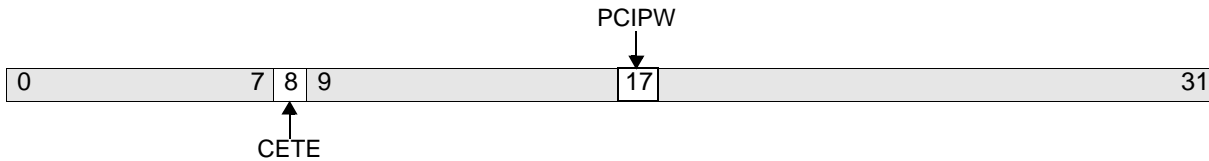

Figure 7-4. Chip Control Register 1 (CPC0_CR1)

0:7		Reserved
8	CETE	CPU External Timer Enable 0 CPU timers increment at CPU clock frequency. 1 CPU timers increment at frequency of TmrClk input.
9:16		Reserved
17	PCIPW	PCI Interrupt/Peripheral Write Enable Select 0 Enable $\overline{\text{PCIINT}}[\overline{\text{PerWE}}]$ as $\overline{\text{PCIINT}}$. 1 Enable $\overline{\text{PCIINT}}[\overline{\text{PerWE}}]$ as $\overline{\text{PerWE}}$.
18:31		Reserved

Chapter 8. Reset and Initialization

This chapter describes reset operations, the initial state of the PPC405GP processor core after a reset, and an example of the initialization code required to begin executing application code. Initialization of external system components or system-specific chip facilities must also be performed, in addition to the basic initialization described in this chapter.

Reset operations affect the PPC405GP at power on time as well as during normal operation, if programmed to do so. To understand how these operations work it is necessary to first understand the signal pins involved as well as the terminology of core, chip and system resets.

8.1 Reset Signals

The PPC405GP has three reset signals: $\overline{\text{TRST}}$, $\overline{\text{SysReset}}$, and $\overline{\text{ExtReset}}$. $\overline{\text{TRST}}$ is an input, $\overline{\text{SysReset}}$ is bidirectional, and $\overline{\text{ExtReset}}$ is an output.

$\overline{\text{TRST}}$ is used to asynchronously initialize the internal JTAG test access port controller. Note that $\overline{\text{TRST}}$ must be asserted during power-on reset (POR) to initialize the JTAG controller, and for normal operation of the PPC405GP. This is necessary because the IEEE 1149.1 Standard Test Access Port and Boundary-Scan Architecture prohibits the device reset ($\overline{\text{SysReset}}$) from resetting the JTAG logic.

When the $\overline{\text{SysReset}}$ signal is an input (asserted by an off-chip device), such as during POR, the chip responds by performing a system reset as described in “System Reset” on page 8-198. An external assertion of $\overline{\text{SysReset}}$ is not extended by an assertion of the open drain bidirectional $\overline{\text{SysReset}}$ driver.

As an output, the PPC405GP asserts the $\overline{\text{SysReset}}$ signal when a system reset request is detected. The $\overline{\text{SysReset}}$ open drain driver is activated and the signal is driven low for 8192 SysClk periods. This enables the PPC405GP to reset itself and other devices attached to the same reset network.

The $\overline{\text{ExtReset}}$ signal is used by synchronous peripheral devices served by the $\overline{\text{PerClk}}$ external bus clock, such as ROM and external bus masters. During chip and system resets, $\overline{\text{ExtReset}}$ is asserted until the $\overline{\text{PerClk}}$ signal is stable and all internal resets are released.

8.2 Reset Types

Three types of reset, each with different scope, are possible in the PPC405GP. A core reset affects only the processor core. Chip resets affect the processor core, all on-chip peripherals, and any device attached to $\overline{\text{ExtReset}}$. System resets affect the processor core, all on-chip peripherals, and any off-chip devices connected to either $\overline{\text{SysReset}}$ or $\overline{\text{ExtReset}}$. See “Processor Initiated Resets” on page 8-198 for information about the reset behavior of the processor core. See chapters describing the on-chip peripherals for detailed information about their reset behavior.

8.2.1 Core Reset

A core reset results in a reset of the processor core. No other on-chip logic is affected. Clocking logic, outside the processor core, detects the core reset request and asserts the reset input to the processor core for a period of 8 processor core clock cycles.

8.2.2 Chip Reset

During a chip reset, most registers are reset to their default power-on values. Strapping values are not reread, however, and the CPC0_PLLMR register maintains its programmed value. When clocking logic detects a request for a chip reset, it begins the process by resetting the system PLL for 16 SysClk cycles. Following that, PLL locking is performed as described for a system reset.

During chip reset, the $\overline{\text{ExtReset}}$ signal is driven low to ensure the reset of synchronous devices that use the external bus clock signal, PerClk.

8.2.3 System Reset

A system reset results in a reset of all PPC405GP logic, including the processor core, internal phase-locked loop (PLL), and on-chip peripherals. A system reset can be initiated externally or internally. External system resets are initiated by the assertion of the $\overline{\text{SysReset}}$ signal for at least 16 SysClk cycles. Note that this is the minimum number of SysClk cycles that $\overline{\text{SysReset}}$ must remain low whenever it is asserted, not time for the PPC405GP to detect and accept a valid system reset request. Internal system resets are initiated by either the processor core or PCI power management logic.

When a system reset is requested internally, the bidirectional open drain $\overline{\text{SysReset}}$ signal is asserted to enable other chips to be reset at the same time. In this case, the $\overline{\text{SysReset}}$ signal is driven low for 8192 SysClk periods, resulting in a System reset of the PPC405GP chip and all other devices attached to the reset network connected to $\overline{\text{SysReset}}$.

After the $\overline{\text{SysReset}}$ signal is deasserted, the PLL begins its locking process, which also requires 8192 SysClk periods. When 64 SysClk cycles remain, the internal PPC405GP clocks (OPB, PCI, EXT, and Serial) begin toggling. The PLB and CPU clocks toggle while $\overline{\text{SysReset}}$ is asserted, and during the PLL locking process. When the PLL lock timer expires, internal resets are released, and the processor core begins its initial instruction fetch.

During system reset, the $\overline{\text{ExtReset}}$ signal is driven low to ensure the reset of synchronous devices that use the external bus clock signal, PerClk.

8.3 PCI Power Management Initiated Resets

An external PCI master can write the Power Management Control/Status Register (PCIC0_PMCSR) to request a change from the D3hot PCI power management state to the D0 state. The on-chip PCI logic always accepts such a write and assumes that requested state changes from D3hot are always to D0. After receiving such a write, the PCI logic asserts a signal that immediately results in an internally requested system reset.

8.4 Processor Initiated Resets

The processor core in the PPC405GP can request three types of processor resets: core, chip, and system. Each type of reset can be generated by a JTAG debug tool, by the second expiration of the watchdog timer, or by writing a non-zero value to the Reset (RST) field of Debug Control Register 0 (DBCR0).

The effects of core and chip resets on the processor core are identical. To determine which reset type occurred, the most-recent reset (MRR) field of the Debug Status Register (DBSR) can be examined.

Preliminary User's Manual**8.5 Processor State After Reset**

After a reset, the contents of the Machine State Register (MSR) and the Special Purpose Registers (SPRs) control the initial processor state. The contents of Device Control Registers (DCRs) control the initial states of on-chip devices. Chapter 25, "Register Summary," contains descriptions of the registers.

In general, the contents of SPRs are undefined after a reset. Reset initializes the minimum number of SPR fields required for allow successful instruction fetching. "Contents of Special Purpose Registers after Reset" on page 8-200 describes these initial values. System software fully configures the processor.

"Machine State Register Contents after Reset" on page 8-199 describes the MSR contents.

The MCI field of the Exception Syndrome Register (ESR) is cleared so that it can be determined if there has been a machine check during initialization, before machine check exceptions are enabled.

Two SPRs contain status on the type of reset that has occurred. The Debug Status Register (DBSR) contains the most recent reset type. The Timer Status Register (TSR) contains the most recent watchdog reset.

8.5.1 Machine State Register Contents after Reset

After all resets, all fields of the Machine State Register (MSR) contain zeros. Table 8-1 shows how this affects chip operation.

Table 8-1. MSR Contents after Reset

Register	Field	Core Reset	Chip Reset	System Reset	Comment
MSR	WE	0	0	0	Wait state disabled
	CE	0	0	0	Critical interrupts disabled
	EE	0	0	0	External interrupts disabled
	PR	0	0	0	Supervisor mode
	ME	0	0	0	Machine check exceptions disabled
	DWE	0	0	0	Debug wait mode disabled
	DE	0	0	0	Debug interrupts disabled
	DR	0	0	0	Instruction translation disabled
	IR	0	0	0	Data translation disabled

8.5.2 Contents of Special Purpose Registers after Reset

In general, the contents of Special Purpose Registers (SPRs) are undefined after a core, chip, or system reset. Some SPRs retain the contents they had before a reset occurred.

Table 8-2 shows the contents of SPRs that are defined or unchanged after core, chip, and system resets.

Table 8-2. SPR Contents After Reset

Register	Bits/Fields	Core Reset	Chip Reset	System Reset	Comment
CCR0	0:31	0x00700000	0x00700000	0x00700000	Sets ICU and DCU PLB priorities
DBCR0	EDM	0	0	0	External debug mode disabled
	RST	00	00	00	No reset action.
DBCR1	0:31	0x00000000	0x00000000	0x00000000	Data compares disabled
DBSR	MRR	01	10	11	Most recent reset
DCCR	S0:S31	0x00000000	0x00000000	0x00000000	Data cache disabled
DCWR	W0:W31	0x00000000	0x00000000	0x00000000	Data cache write-through disabled
ESR	0:31	0x00000000	0x00000000	0x00000000	No exception syndromes
ICCR	S0:S31	0x00000000	0x00000000	0x00000000	Instruction cache disabled
PVR	0:31				Processor version; refer to <i>PPC405GP Embedded Processor Data Sheet</i> for the value of this read-only register.
SGR	G0:G31	0xFFFFFFFF	0xFFFFFFFF	0xFFFFFFFF	Storage is guarded
SLER	S0:S31	0x00000000	0x00000000	0x00000000	Storage is big endian
SU0R	K0:K31	0x00000000	0x00000000	0x00000000	Storage is uncompressed
TCR	WRC	00	00	00	Watchdog timer reset disabled
TSR	WRS	Copy of TCR[WRC]	Copy of TCR[WRC]	Copy of TCR[WRC]	Watchdog reset status
	PIS	Undefined	Undefined	Undefined	After POR
	FIS	Unchanged	Unchanged	Unchanged	If reset not caused by watchdog timer

Preliminary User's Manual**8.6 DCR Contents after Reset**

DCR reset values are unaffected by core resets and are generally identical for chip and system resets.

Table 8-3. DCR Contents After Reset

Register	Bits	Reset Value	Comment
Chip Control			
CPC0_CR0	0:31	0x0000003C	
CPC0_CR1	0:31	0x2B0DB800	
CPC0_JTAGID	0:31		Refer to <i>PPC405GP Network Processor Data Sheet</i> for the value of this read-only register.
CPC0_PLLMR	0:31		At POR, CPC0_PLLMR fields are set to the strapping values of the corresponding pins. CPC0_PLLMR is read-only.
CP0_PSR	0:31		
Clock and Power Management (CPM)			
CPC0_ER	0:31	0x0000xxxx	
CPC0_FR	0:31	0x0000xxxx	
CPC0_SR	0:31	0xFFFFxxxx	
Decompression Controller			
DCP0_ADDR0	0:31	0x00000000	
DCP0_ADDR1	0:31	0x00000000	
DCP0_MEMBEAR	0:31	0x00000000	
DCP0_CFG	0:31	0x00000001	
DCP0_ESR	0:31	0x00000000	
DCP0_ID	0:31	0x0000504D	
DCP0_ITOR0	0:31	0x00000000	
DCP0_ITOR1	0:31	0x00000000	
DCP0_ITOR2	0:31	0x00000000	
DCP0_ITOR3	0:31	0x00000000	
DCP0_PLBBEAR	0:31	0x00000000	
DCP0_RAM0– DCP0_RAM3FF	1KB	Undefined	
DCP0_VER	0:31	0x00000200	
Direct Memory Access (DMA)			
DMA0_CR0	0:31	0x00000000	
DMA0_CR1	0:31	0x00000000	
DMA0_CR2	0:31	0x00000000	
DMA0_CR3	0:31	0x00000000	

Table 8-3. DCR Contents After Reset (continued)

Register	Bits	Reset Value	Comment
DMA0_CT0	0:31	0x00000000	
DMA0_CT1	0:31	0x00000000	
DMA0_CT2	0:31	0x00000000	
DMA0_CT3	0:31	0x00000000	
DMA0_DA0	0:31	0x00000000	
DMA0_DA1	0:31	0x00000000	
DMA0_DA2	0:31	0x00000000	
DMA0_DA3	0:31	0x00000000	
DMA0_POL	0:31	0x00000000	
DMA0_SA0	0:31	0x00000000	
DMA0_SA1	0:31	0x00000000	
DMA0_SA2	0:31	0x00000000	
DMA0_SA3	0:31	0x00000000	
DMA0_SG0	0:31	0x00000000	
DMA0_SG1	0:31	0x00000000	
DMA0_SG2	0:31	0x00000000	
DMA0_SG3	0:31	0x00000000	
DMA0_SGC	0:31	0x00000000	
DMA0_SLP	0:31	0x7C000000	
DMA0_SR	0:31	0x00000000	
External Bus Controller (EBC)			
EBC0_B0AP	0:31	0x7F8FFE80	Slowest possible bus timings.
EBC0_B0CR	0:31	0xFFE28000	2MB read-only bank.
EBC0_B1AP	0:31	0x00000000	
EBC0_B1CR	0:31	0x00000000	
EBC0_B2AP	0:31	0x00000000	
EBC0_B2CR	0:31	0x00000000	
EBC0_B3AP	0:31	0x00000000	
EBC0_B3CR	0:31	0x00000000	
EBC0_B4AP	0:31	0x00000000	
EBC0_B4CR	0:31	0x00000000	
EBC0_B5AP	0:31	0x00000000	
EBC0_B5CR	0:31	0x00000000	
EBC0_B6AP	0:31	0x00000000	

Preliminary User's Manual**Table 8-3. DCR Contents After Reset (continued)**

Register	Bits	Reset Value	Comment
EBC0_B6CR	0:31	0x00000000	
EBC0_B7AP	0:31	0x00000000	
EBC0_B7CR	0:31	0x00000000	
EBC0_BEAR	0:31	0x00000000	
EBC0_BESR0	0:31	0x00000000	
EBC0_BESR1	0:31	0x00000000	
EBC0_CFG	0:31	0x80400000	
Indirect Addressing Registers			
DCP0_CFGADDR		0x00000000	
DCP0_CFGDATA		0x00000000	
EBC0_CFGADDR		0x00000000	
EBC0_CFGDATA		0x00000000	
SDRAM0_CFGADDR		0x00000000	
SDRAM0_CFGDATA		0x00000000	
Media Access Layer (MAL)			
MAL0_CFG	0:31	0x0007C000	
MAL0_ESR	0:31	0x00000000	
MAL0_IER	0:31	0x00000000	
MAL0_RCBS0	0:31	Undefined	
MAL0_RXCASR	0:31	0x00000000	
MAL0_RXCTP0R	0:31	Undefined	
MAL0_RXDEIR	0:31	0x00000000	
MAL0_RXEOBISR	0:31	0x00000000	
MAL0_TXCASR	0:31	0x00000000	
MAL0_TXCTP0R	0:31	Undefined	
MAL0_TXCTP1R	0:31	Undefined	
MAL0_TXDEIR	0:31	0x00000000	
MAL0_TXEOBISR	0:31	0x00000000	
On-Chip Buses			
PLB0_ACR	0:31	0x00000000	
PLB0_BEAR	0:31	Undefined	
POB0_BEAR	0:31	Undefined	
POB0_BESR0	0:31	0x00000000	
POB0_BESR1	0:31	0x00000000	

Table 8-3. DCR Contents After Reset (continued)

Register	Bits	Reset Value	Comment
On-Chip Memory			
OCM0_DSARC	0:31	Undefined	
OCM0_DSCNTL	0:31	0x40000000	
OCM0_ISARC	0:31	Undefined	
OCM0_ISCNTL	0:31	0x40000000	
SDRAM Controller			
SDRAM0_B0CR	0:31	0x00000000	
SDRAM0_B1CR	0:31	0x00000000	
SDRAM0_B2CR	0:31	0x00000000	
SDRAM0_B3CR	0:31	0x00000000	
SDRAM0_BEAR	0:31	0x00000000	
SDRAM0_BESR0	0:31	0x00000000	
SDRAM0_BESR1	0:31	0x00000000	
SDRAM0_CFG	0:31	0x00000000	
SDRAM0_ECCCFG	0:31	0x00000000	
SDRAM0_ECCESR	0:31	0x00000000	
SDRAM0_PMIT	0:31	0x07C00000	
SDRAM0_RTR	0:31	0x05F00000	
SDRAM0_TR	0:31	0x00854009	
Universal Interrupt Controller (UIC)			
UIC0_CR		Undefined	
UIC0_ER		0x00000000	
UIC0_MSR		Undefined	
UIC0_PR		Undefined	
UIC0_SR		Undefined	
UIC0_TR		Undefined	
UIC0_VCR		Undefined	
UIC0_VR		Undefined	

8.7 MMIO Register Contents After Reset

MMIO registers are unaffected by core resets, and are generally identical for chip and system resets.

Preliminary User's Manual**Table 8-4. MMIO Register Contents After Reset**

Register	Bits	Reset Value	Comment
Ethernet (EMAC0)			
EMAC0_GAHT1	0:31	0x00000000	
EMAC0_GAHT2	0:31	0x00000000	
EMAC0_GAHT3	0:31	0x00000000	
EMAC0_GAHT4	0:31	0x00000000	
EMAC0_IAHR	0:31	0x00000000	
EMAC0_IAHT1	0:31	0x00000000	
EMAC0_IAHT2	0:31	0x00000000	
EMAC0_IAHT3	0:31	0x00000000	
EMAC0_IAHT4	0:31	0x00000000	
EMAC0_IALR	0:31	0x00000000	
EMAC0_IPGVR	0:31	0x00000004	
EMAC0_ISER	0:31	0x00000000	
EMAC0_ISR	0:31	0x00000000	
EMAC0_LSAH	0:31	0x00000000	
EMAC0_LSAL	0:31	0x00000000	
EMAC0_MR0	0:31	0xC0000000	
EMAC0_MR1	0:31	0x00000000	
EMAC0_PTR	0:31	0x0000FFFF	
EMAC0_RMR	0:31	0x00000000	
EMAC0_RWMR	0:31	0x04001000	
EMAC0_STACR	0:31	0x00008000	
EMAC0_TMR0	0:31	0x00000000	
EMAC0_TMR1	0:31	0x380F0000	
EMAC0_TRTR	0:31	0x00000000	
EMAC0_VTCI	0:31	0x00000000	
EMAC0_VTPID	0:31	0x00008808	

Table 8-4. MMIO Register Contents After Reset (continued)

Register	Bits	Reset Value	Comment
General Purpose I/O (GPIO)			
GPIO0_IR	0:31	Undefined	Read-only; follows the GPIO inputs.
GPIO0_ODR	0:31	0x00000000	
GPIO0_OR	0:31	0x00000000	
GPIO0_TCR	0:31	0x00000000	
Inter-Integrated Circuit (IIC)			
IIC0_CLKDIV	0:7	0x00	
IIC0_CNTL	0:7	0x00	
IIC0_DIRECTCNTL	0:7	0x0F	
IIC0_EXTSTS	0:7	0x00	
IIC0_HMADR	0:7	Undefined	
IIC0_HSADR	0:7	Undefined	
IIC0_INTRMSK	0:7	0x00	
IIC0_LMADR	0:7	Undefined	
IIC0_LSADR	0:7	Undefined	
IIC0_MDBUF	0:7	0x00	
IIC0_MDCNTL	0:7	0x00	
IIC0_SDBUF	0:7	0x00	
IIC0_STS	0:7	0x00	
IIC0_XFRCNT	0:7	0x00	
IIC0_XTCNTLSS	0:7	0x00	
OPB Arbiter			
OPBA0_CR	0:31	0x00000000	
OPBA0_PR	0:31	0x00011011	
PCI Bridge			
PCIC0_BASECC	0:7	0x06	
PCIC0_BIST	0:7	0x00	
PCIC0_BRDGOPT1	0:15	0xFF60	
PCIC0_BRDGOPT2	0:15	0x0100	
PCIC0_CACHELS	0:7	0x00	
PCIC0_CAP	0:7	0x00	
PCIC0_CAPID	0:7	0x00	
PCIC0_CFGADDR	0:31	0x00000000	
PCIC0_CFGDATA	0:31	0x00000000	

Preliminary User's Manual**Table 8-4. MMIO Register Contents After Reset (continued)**

Register	Bits	Reset Value	Comment
PCIC0_CLS	0:23	0x060000	
PCIC0_CMD	0:15	0x0000	
PCIC0_DEVID	0:15	0x0156	
PCIC0_ERREN	0:7	0x00	
PCIC0_ERRSTS	0:7	0x00	
PCIC0_HDTYPE	0:7	0x00	
PCIC0_ICS	0:7	0x00	
PCIC0_INTCLS	0:7	0x00	
PCIC0_INTLN	0:7	0x00	
PCIC0_INTPN	0:7	0x01	
PCIC0_LATTIM	0:7	0x07	
PCIC0_MAXLTNCY	0:7	0x00	
PCIC0_MINGNT	0:7	0x00	
PCIC0_NEXTIPTR	0:7	0x00	
PCIC0_PLBBEAR	0:31	0x00000000	
PCIC0_PLBBESR0	0:31	0x00000000	
PCIC0_PLBBESR1	0:31	0x00000000	
PCIC0_PMC	0:15	0x0202	
PCIC0_PMCSR	0:15	0x0000	
PCIC0_PMCSRBSE	0:7	0x00	
PCIC0_PMSCRR	0:7	0x10	
PCIC0_PTM1BAR	0:31	0x00000008	
PCIC0_PTM2BAR	0:31	0x00000000	
PCIC0_REVID	0:7	0x00	Value corresponds to revision level.
PCIC0_SBSYSID	0:15	0x0000	
PCIC0_SBSYSVID	0:15	0x0000	
PCIC0_STATUS	0:15	0x0210	
PCIC0_SUBCLS	0:7	0x00	
PCIC0_VENDID	0:15	0x1014	
PCIL0_PMM0LA	0:31	0xFFFE0000	Value if strapped for PCI boot at reset.
PCIL0_PMM0MA	0:31	0xFFFE0001	Value if strapped for PCI boot at reset.
PCIL0_PMM0PCIHA	0:31	0x00000000	Value if strapped for PCI boot at reset.
PCIL0_PMM0PCILA	0:31	0xFFFE0000	Value if strapped for PCI boot at reset.
PCIL0_PMM1LA	0:31	Undefined	

Table 8-4. MMIO Register Contents After Reset (continued)

Register	Bits	Reset Value	Comment
PCIL0_PMM1MA	0:31	0x00000000	
PCIL0_PMM1PCIHA	0:31	Undefined	
PCIL0_PMM1PCILA	0:31	Undefined	
PCIL0_PMM2LA	0:31	Undefined	
PCIL0_PMM2MA	0:31	0x00000000	
PCIL0_PMM2PCIHA	0:31	Undefined	
PCIL0_PMM2PCILA	0:31	Undefined	
PCIL0_PTM1LA	0:31	Undefined	
PCIL0_PTM1MS	0:31	Undefined	
PCIL0_PTM2LA	0:31	Undefined	
PCIL0_PTM2MS	0:31	Undefined	
PCIC0_PLBBEAR2	0:31	0x00000000	
PCIC0_PLBBEAR3	0:31	0x00000000	
Serial Port (UART0)			
UART0_DLL	0:7	0b00000000	
UART0_DLM	0:7	0b00000000	
UART0_FCR	0:7	0b00000000	
UART0_IER	0:7	0b00000000	
UART0_IIR	0:7	0b00000001	
UART0_LCR	0:7	0b00000000	
UART0_LSR	0:7	0b01100000	
UART0_MCR	0:7	0b00000000	
UART0_MSR	0:7	0bxxxx0000	UART0_MSR _{0:3} are driven by <u>UART0_DCD</u> , <u>UART0_RI</u> , <u>UART0_DSR</u> and <u>UART0_CTS</u> .
UART0_RBR	0:7	0b00000000	
UART0_SCR	0:7	Undefined	
UART0_THR	0:7	0b00000000	
Serial Port (UART1)			
UART1_DLL	0:7	0b00000000	
UART1_DLM	0:7	0b00000000	
UART1_FCR	0:7	0b00000000	
UART1_IER	0:7	0b00000000	
UART1_IIR	0:7	0b00000001	
UART1_LCR	0:7	0b00000000	

Preliminary User's Manual**Table 8-4. MMIO Register Contents After Reset (continued)**

Register	Bits	Reset Value	Comment
UART1_LSR	0:7	0b01100000	
UART1_MCR	0:7	0b00000000	
UART1_MSR	0:7	Undefined	
UART1_RBR	0:7	Undefined	
UART1_SCR	0:7	Undefined	
UART1_THR	0:7	0b00000000	

8.8 PPC405GP Chip Initialization

The on-chip memory (OCM) controller and the universal Interrupt controller (UIC) require initialization for best performance (in the case of OCM) and proper operation (in the case of the UIC). The UART controller may require initialization, depending upon the application.

Other peripheral devices can be initialized as appropriate for the system design.

8.8.1 OCM Initialization

The following information applies if OCM is to be accessed.

If instruction-side OCM is to be accessed, the OCM Instruction-Side Address Range Compare Register (OCM0_ISARC) must be initialized to locate the instruction-side OCM address space in the PPC405GP address map. If data-side OCM is to be accessed, the OCM Data-Side Address Range Compare Register (OCM0_DSARC) must be initialized to locate the data-side OCM address space into the PPC405GP address map. “OCM Addressing” on page 5-154 provides details of the instruction-side OCM and data-side OCM address spaces. See “Memory Organization and Addressing” on page 3-79 for information about the PPC405GP memory map.

8.8.1.1 Initializing Instruction-Side OCM

The following procedure describes the steps to be taken if instruction-side OCM is to be accessed.

1. Set the ISEN field of the OCM Instruction-Side Control Register to disable instruction-side OCM accesses (OCM0_ISCNTL[ISEN] = 0).
2. To ensure that interrupts do not interfere with the instruction cache array invalidation performed in step 4, set MSR[EE] = 0 and MSR[CE] = 0 to mask interrupts. This prevents a potential problem caused by dirty cache addresses that would not be fetched from the cache because they are marked as non-cachable.
3. Mark the address region to be programmed as OCM address space as non-cachable.
4. Invalidate the instruction cache array to ensure that no addresses to be programmed as OCM addresses are in the cache. The **iccci** instruction invalidates the instruction cache array.
5. Modify the value in OCM0_ISARC.
6. Set OCM0_ISCNTL[ISEN] = 1 to enable instruction-side OCM accesses. Also, set OCM0_ISCNTL[ISTCM] = 0.

OCM0_ISCNTL[ISTCM] should be initialized to 0 to take the instruction-side OCM controller out of two cycle mode, the default mode after a reset. This enables instruction-side fetches to complete in a single cycle, providing the same performance as cache hits. See “OCM Instruction-Side Control Register (OCM0_ISCNTL)” on page 5-158 for details.

8.8.1.2 Initializing Data-Side OCM

The following procedure describes the steps to be taken if data-side OCM is used to load the initial contents of instruction-side OCM, or if data-side OCM is to be accessed.

1. Set the DSEN field of the Data-Side Control Register to disable data-side OCM accesses (OCM0_DSCNTL[DSEN] = 0).
2. To ensure that interrupts do not interfere with the data cache array invalidation performed in step 4, set MSR[EE] = 0 and MSR[CE] = 0 to mask interrupts. This prevents a potential problem caused by dirty cache addresses that would not be fetched from the cache because they are marked as non-cachable.
3. Mark the address region that is to be programmed as OCM address space as non-cachable.
4. Invalidate the data cache array to ensure that no addresses to be programmed as OCM addresses are in the cache. Use a sequence of **dcbf** instructions to invalidate the data cache.
5. Modify the value in OCM0_DSARC.
6. Set OCM0_DSCNTL[DSEN] = 1 to enable data-side OCM accesses.

OCM0_DSCNTL[DOF] should remain at its reset value of 1. See “OCM Data-Side Control Register (OCM0_DSCNTL)” on page 5-159 for details.

8.8.2 UIC Initialization

The following information does not provide all initialization information for the UIC. Some initialization details are application-dependent.

The polarity and sensitivity of the on-chip interrupts must be initialized for proper chip operation. The fields controlling on-chip interrupts in the UIC Polarity Register (UIC0_PR_{0:18}) must be set to 1. See “Interrupt Controller Operations” on page 10-219 for details. The fields controlling on-chip interrupts in the UIC Trigger Register (UIC0_TR_{0:2, 4:18}) must be set to 0. The field controlling the external master interrupt trigger (UIC0_TR₃) must be set to 1. See “UIC Trigger Register (UIC0_TR)” on page 10-233 for details.

8.8.3 UART Initialization

Bits 19 and 20 of Chip Control Register 0 (CPC0_CR0) control which of two modem control signal pairs, Data Set Ready (DSR) and Data Terminal Ready (DTR) or Clear to Send (CTS) and Ready to Send (RSR), are used. The signal pairs are implemented using the multiplexed pins UART1_DSR[UART1_CTS], controlled by CPC0_CR0₁₉, and UART1_RTS[UART1_DTR], controlled by CPC0_CR0₂₀. After reset, CPC0_CR0₁₉ or CPC0_CR0₂₀ must be changed to achieve a required typical pairing.

Preliminary User's Manual

8.9 PPC405GP Initial Processor Sequencing

After any reset, the processor core fetches the word at address 0xFFFFFFF0 and attempts to execute it. Because the only memory configured immediately after reset is the upper 2MB region (0xFFE00000–0xFFFFFFF0), the instruction at 0xFFFFFFF0 must be a branch instruction.

Because the processor is initially in big endian mode, initialization code must be in big endian format until the endian storage attribute for the addressed region is changed, or until code branches to a region defined as little endian storage.

Before a reset operation begins, the system must provide non-volatile memory, or memory initialized by some mechanism external to the processor. This memory must be located at address 0xFFFFFFF0. This memory can be attached to the external bus controller (EBC) or to the system PCI bus. For memory attached to the EBC, the upper 2MB bank configuration after reset is 255 wait states, three cycles of address to chip select delay, three cycles of chip select to output enable delay, and seven cycles of hold time. The bus width (8-, 16-, or 32-bit) is controlled by the ROM width strapping signals. See “Pin Strapping and Sharing” on page 9-215 for details. See “Local Processor Boot from PCI Memory” on page 17-447 for information about memory attached to the system PCI bus.

8.10 Initialization Requirements

When any reset is performed, the processor is initialized to a minimum configuration to start executing initialization code. Initialization code is necessary to complete the processor and system configuration.

The initialization code example in this section performs the configuration tasks required to prepare the PPC405GP to boot an operating system or run an application program.

Some portions of the initialization code work with system components that are beyond the scope of this manual.

Initialization code should perform the following tasks to configure the processor resources.

To improve instruction fetching performance: initialize the SGR appropriately for guarded or unguarded storage. Since all storage is initially guarded and speculative fetching is inhibited to guarded storage, reprogramming the SGR will improve performance for unguarded regions.

1. Configure the following storage attribute control registers, if necessary:
 - Initialize the SLER to configure storage byte ordering.
 - Initialize the SU0R to configure storage compression.
2. Before executing instructions as cachable:
 - Invalidate the instruction cache.
 - Initialize the ICCR to configure instruction cachability.
3. Before using storage access instructions:
 - Invalidate the data cache.
 - Initialize CRRO to determine if a store miss results in a line fill (SWOA).
 - Initialize the DCWR to select copy-back or write-through caching.
 - Initialize the DCCR to configure data cachability.

4. Before allowing interrupts (synchronous or asynchronous):
 - Initialize the EVPR to point to vector table.
 - Provide vector table with branches to interrupt handlers.
5. Before enabling asynchronous interrupts:
 - Initialize timer facilities.
 - Initialize MSR to enable appropriate interrupts.
6. Initialize other processor features, such as the MMU, debug, and trace.
7. Initialize non-processor resources.
 - Initialize system memory as required by the operating system or application code.
 - Initialize off-chip system facilities.
8. Start the execution of operating system or application code.

8.11 Initialization Code Example

The following initialization code illustrates the steps that should be taken to initialize the processor before an operating system or user programs begin execution. The example is presented in pseudo-code; function calls are named similarly to PPC405GP mnemonics where appropriate.

```

/* _____ */
/*  PPC405GP Initialization Pseudo Code                */
/* _____ */
@0xFFFFFFFFFC:          /* initial instruction fetch from 0xFFFFFFFFFC */
  ba(init_code);        /* branch to initialization code                */

@init_code:

/* _____ */
/* Configure guarded attribute for performance.      */
/* _____ */

  mtspr(SGR, guarded_attribute);

/* _____ */
/* Configure endianness and compression.             */
/* _____ */

  mtspr(SLER, endianness);
  mtspr(SUOR, compression_attribute);

/* _____ */
/* Invalidate the instruction cache and enable cachability — */
/* _____ */

iccci;                  /* invalidate i-cache */
  mtspr(ICCR, i_cache_cachability);          /* enable I-cache*/
isync;

/* _____ */
/* Invalidate the data cache and enable cachability    */
/* _____ */

```

Preliminary User's Manual

```

address = 0;                /* start at first line                */
for (line = 0; line < m_lines; line++) /* D-cache has m_lines congruence classes */
{
    dccci(address);        /* invalidate congruence class        */
    address += 32;         /* point to the next congruence class  */
}
mtspr(CCR0, store-miss_line-fill);
mtspr(DCWR, copy-back_write-thru);
mtspr(DCCR, d_cache_cachability); /* enable D-cache */
isync;

/* ----- */
/* Prepare system for synchronous interrupts. */
/* ----- */

mtspr(EVPR, prefix_addr); /* initialize exception vector prefix */

/* Initialize vector table and interrupt handlers if not already done */

/* Initialize and configure timer facilities */

mtspr(PIT, 0);             /* clear PIT so no PIT indication after TSR cleared */
mtspr(TSR, 0xFFFFFFFF);   /* clear TSR */
mtspr(TCR, timer_enable); /* enable desired timers */
mtspr(TBL, 0);            /* reset time base low first to avoid ripple */
mtspr(TBU, time_base_u);  /* set time base, hi first to catch possible ripple */
mtspr(TBL, time_base_l);  /* set time base, low */
mtspr(PIT, pit_count);    /* set desired PIT count */

/* Initialize the MSR */

/* ----- */
/* Exceptions must be enabled immediately after timer facilities to avoid missing a */
/* timer exception. */
/* ----- */
/* The MSR also controls privileged/user mode, translation, and the wait state. */
/* These must be initialized by the operating system or application code. */
/* If enabling translation, code must initialize the TLB. */
/* ----- */

mtmsr(machine_state);

/* ----- */
/* Initialization of other processor facilities should be performed at this time. */
/* ----- */

/* ----- */
/* Initialization of non-processor facilities should be performed at this time. */
/* ----- */

/* ----- */
/* Branch to operating system or application code can occur at this time. */
/* ----- */

```

Preliminary User’s Manual

Chapter 9. Pin Strapping and Sharing

9.1 Pin Strapping

When power is applied to the PPC405GP, a start-up process is initiated in which internal functions are initialized. Some of these functions have optional choices. The options used for initialization are determined by the way a specific set of I/O pins (balls) are conditioned. The conditioning is achieved using external pull-up (indicated as 1) or pull-down (indicated as 0) resistors connected to the pins.

While the SysReset input signal is low (system reset), the state of the I/O pins is read to enable default initial conditions before PPC405GP start-up. The actual capture instant is the nearest SysClk clock edge before the deassertion of SysReset. The state of the pins as read is stored in the Chip Pin Strapping Register (CPC0_PSR) shown in Figure 9-1. Refer to PowerPC PPC405GP datasheet, which describes the strapping pins.

9.1.1 Chip Pin Strapping Register (CPC0_PSR)

Figure 9-1 describes CPC0_PSR register bits which contain the state of the strapping pins as read during system reset. For additional information on strapping pins associated with each bit see Table 7-1, “Clock Strapping Values,” on page 7-185.

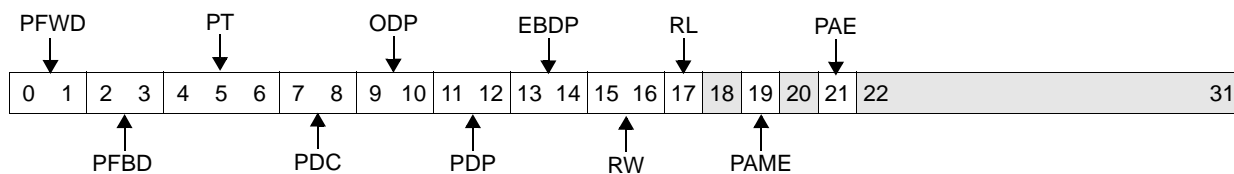

Figure 9-1. Chip Pin Strapping Register (CPC0_PSR)

0:1	PFWD	PLL Forward Divider 00 Bypass Mode 01 Divide by 3 10 Divide by 4 11 Divide by 6	
2:3	PFBD	PLL Feedback Divider 00 Divide By 1 01 Divide By 2 10 Divide By 3 11 Divide By 4	
4:6	PT	PLL Tuning 000 Choice 1; TUNE[5:0] = 010001 001 Choice 2; TUNE[5:0] = 010010 010 Choice 3; TUNE[5:0] = 010011 011 Choice 4; TUNE[5:0] = 010100 100 Choice 5; TUNE[5:0] = 010101 101 Choice 6; TUNE[5:0] = 010110 110 Choice 7; TUNE[5:0] = 010111 111 Choice 8; TUNE[5:0] = 100100	Note: The tune bits adjust parameters that control PLL jitter. The recommended values minimize jitter for the PLL. These bits are shown for information only, and do not require modification except in special clocking circumstances, such as spread spectrum clocking. For details on the use of spread spectrum clock generators (SSCGs), visit the technical documents area of the AMCC PowerPC web site.

7:8	PDC	PLB Divider from CPU 00 Divide By 1 01 Divide By 2 10 Divide By 3 11 Divide By 4
9:10	ODP	OPB Divider from PLB 00 Divide By 1 01 Divide By 2 10 Divide By 3 11 Divide By 4
11:12	PDP	PCI Divider from PLB 00 Divide By 1 01 Divide By 2 10 Divide By 3 11 Divide By 4
13:14	EBDP	External Bus Divider from PLB 00 Divide By 2 01 Divide By 3 10 Divide By 4 11 Divide By 5
15:16	RW	ROM Width 00 8-bit ROM 01 16-bit ROM 10 32-bit ROM 11 Reserved
17	RL	ROM Location 0 405GP Peripheral Attach 1 405GP PCI Attach
18		Reserved
19	PAME	PCI Asynchronous Mode Enable 0 Synchronous PCI Mode 1 Asynchronous Mode
20		Reserved
21	PAE	PCI Arbiter Enable 0 Internal Arbiter Disabled 1 Internal Arbiter Enabled
22:31		Reserved

Preliminary User's Manual**9.2 Pin Sharing**

The PPC405GP uses pin (ball) multiplexing (sharing) to reduce the total pin requirement without significantly reducing functionality. Some of the pins that are multiplexed require DCR register programming to configure the pin for the desired function. It is expected that in an application, a particular pin is programmed to serve one function. While nothing prevents changing the function of a pin during operation, most applications configure a pin once at power-on reset (POR). Table 9-1 lists the multiplexed PPC405GP signals and indicates the DCR bit that controls the pin. The default signal appears first and the alternate signal is in brackets. In addition to IRQ0[GPIO17]-IRQ6[GPIO23] any six of the other PPC405GP GPIOs may be configured for use as external interrupts. Please see the "Interrupt Controller Operations" on page 10-219 for additional details.

Table 9-1. Multiplexed Pins

Signal	DCR Bit	Description
GPIO1[TS1E]	CPC0_CR0[TRE]	Set of GPIO pins that can be reconfigured for use as the CPU Trace interface.
GPIO2[TS2E]		
GPIO3[TS1O]		
GPIO4[TS2O]		
GPIO5[TS3]		
GPIO6[TS4]		
GPIO7[TS5]		
GPIO8[TS6]		
GPIO9[TrcClk]		
PerCS1[GPIO10]	CPC0_CR0[G10E]	Peripheral Chip selects that can be reconfigured for use as GPIOs.
PerCS2[GPIO11]	CPC0_CR0[G11E]	
PerCS3[GPIO12]	CPC0_CR0[G12E]	
PerCS4[GPIO13]	CPC0_CR0[G13E]	
PerCS5[GPIO14]	CPC0_CR0[G14E]	
PerCS6[GPIO15]	CPC0_CR0[G15E]	
PerCS7[GPIO16]	CPC0_CR0[G16E]	
IRQ0[GPIO17]	CPC0_CR0[G17E]	External Interrupts that can be reconfigured for use as GPIOs.
IRQ1[GPIO18]	CPC0_CR0[G18E]	
IRQ2[GPIO19]	CPC0_CR0[G19E]	
IRQ3[GPIO20]	CPC0_CR0[G20E]	
IRQ4[GPIO21]	CPC0_CR0[G21E]	
IRQ5[GPIO22]	CPC0_CR0[G22E]	
IRQ6[GPIO23]	CPC0_CR0[G23E]	

Table 9-1. Multiplexed Pins (continued)

Signal	DCR Bit	Description
UART1_DSR[UART1_CTS] ¹	CPC0_CR0[DCS]	UART1_DSR pin that can be reconfigured for use as UART1_CTS.
UART1_RTS[UART1_DTR] ¹	CPC0_CR0[RDS]	UART1_RTS pin that can be reconfigured for use as UART1_DTR.
PCIINT[PerWE]	CPC0_CR1[PCIPW]	PCI Interrupt output that can be reconfigured for use by peripherals as a Write Byte Enable (logical AND of the four PerWBE0:3 write byte enables and PerR/W).
PCIReq0[Gnt]	CPC0_PSR[PAE]	PCIReq0 when internal arbiter is used or Gnt when external arbiter is used.
PCIGnt0[Req]	CPC0_PSR[PAE]	PCIGnt0 when internal arbiter is used or Req when external arbiter is used.
Note: Typically DSR and DTR are paired and CTS and RTS are paired. With the current multiplex defaults one of the pins must be changed during initialization to achieve the typical pairings.		

Chapter 10. Interrupt Controller Operations

The PPC405GP contains a universal interrupt controller (UIC0) that provides all necessary control, status, and communication between the various internal and external interrupt sources and the processor core.

10.1 UIC Overview

The UIC provides programmable control of interrupts from on-chip peripherals and seven external interrupts, which are listed in Table 10-1. Status reporting, using the UIC Status Register (UIC0_SR), enables system software to determine the current and interrupting state of the system and respond appropriately. Software can generate interrupts to simplify software development and for diagnostics.

The interrupts can be programmed, using the UIC Critical Register (UIC0_CR), to generate either a critical or a non-critical interrupt signal to the processor core.

The privileged **mtdcr** and **mfdcr** instructions, which are used by system software, are used to read and write the UIC registers.

An optional critical interrupt vector generator can reduce interrupt handling latency for critical interrupts. Vector calculation is described in detail in “UIC Vector Register (UIC0_VR)” on page 10-243.

10.2 UIC Features

- Support for asynchronous level- or edge-sensitive interrupt types
- Programmable polarity for all interrupt types
- Programmable critical/non-critical interrupt selection for each interrupt bit
- Prioritized critical interrupt vector generation
- A UIC Status Register (UIC0_SR) providing the following information:
 - Current state of interrupts
 - Current state of all enabled interrupts (those masked using the UIC Enable Register (UIC0_ER))

10.3 UIC Interrupt Assignments

The UIC supports various internal and external interrupt sources as shown in Table 10-1.

Table 10-1. UIC Interrupt Assignments

Interrupt	Polarity	Sensitivity	Interrupt Source
0	High	Level	UART0
1	High	Level	UART1
2	High	Level	IIC
3	High	Edge	External Master
4	High	Level	PCI ExternalCommand Write
5	High	Level	DMA Channel 0
6	High	Level	DMA Channel 1
7	High	Level	DMA Channel 2
8	High	Level	DMA Channel 3
9	High	Level	Ethernet Wake Up
10	High	Level	MAL System Error (SERR)
11	High	Level	MAL TX End of Buffer (TXEOB0)
12	High	Level	MAL RX End of Buffer (RXEOB)
13	High	Level	MAL TX Descriptor Error (TXDE)
14	High	Level	MAL RX Descriptor Error (RXDE)
15	High	Level	Ethernet
16	High	Level	External PCI SERR
17	High	Level	ECC Correctable Error
18	High	Level	PCI Power Management
19	Reserved		
20			
21			
22			
23			
24			
25	Programmable	Programmable	External IRQ 0
26	Programmable	Programmable	External IRQ 1
27	Programmable	Programmable	External IRQ 2
28	Programmable	Programmable	External IRQ 3
29	Programmable	Programmable	External IRQ 4
30	Programmable	Programmable	External IRQ 5
31	Programmable	Programmable	External IRQ 6

Preliminary User's Manual**10.4 Interrupt Programmability**

The on-chip interrupts and the external interrupts are programmable. However, the polarity and sensitivity of the on-chip interrupts must be programmed as shown in Table 10-1, "UIC Interrupt Assignments," on page 10-220, using the UIC Polarity Register (UIC0_PR) and the UIC Trigger Register (UIC0_TR), respectively.

10.5 UIC Registers

The UIC includes the Device Control Registers (DCRs) listed in Table 10-2.

The registers are accessed using the **mfdcr** and **mtdcr** instructions.

Table 10-2. UIC DCRs

Mnemonic	Register	DCR Number	Access	Page
UIC0_SR	UIC Status Register	0x0C0	Read/Clear	10-22 2
UIC0_ER	UIC Enable Register	0x0C2	R/W	10-22 4
UIC0_CR	UIC Critical Register	0x0C3	R/W	10-22 9
UIC0_PR	UIC Polarity Register	0x0C4	R/W	10-23 1
UIC0_TR	UIC Trigger Register	0x0C5	R/W	10-23 3
UIC0_MSR	UIC Masked Status Register	0x0C6	Read-only	10-23 7
UIC0_VR	UIC Vector Register	0x0C7	Read-only	10-24 3
UIC0_VCR	UIC Vector Configuration Register	0x0C8	Write-only	10-24 2

10.5.1 UIC Status Register (UIC0_SR)

To report interrupt status, the UIC0_SR fields capture and hold internal and external interrupts until the fields are intentionally cleared. To clear a field, write 1 to the field. Writing a 0 to a field has no effect.

The values of other UIC registers do not affect the UIC0_SR fields.

Figure 10-1 illustrates UIC0_SR.

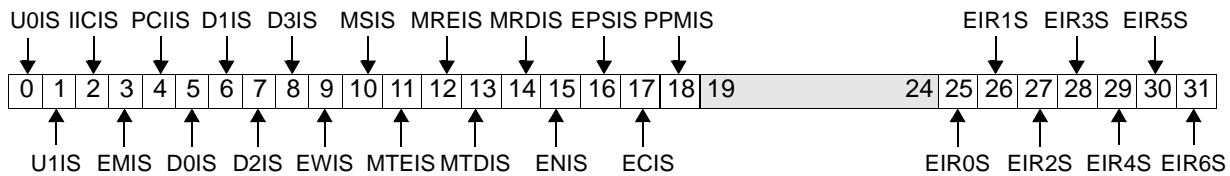

Figure 10-1. UIC Status Register (UIC0_SR)

0	U0IS	UART0 Interrupt Status 0 A UART0 interrupt has not occurred. 1 A UART0 interrupt occurred.	
1	U1IS	UART1 Interrupt Status 0 A UART1 interrupt has not occurred. 1 A UART1 interrupt occurred.	
2	IICIS	IIC Interrupt Status 0 An IIC interrupt has not occurred. 1 An IIC interrupt occurred.	
3	EMIS	External Master Interrupt Status 0 An external master interrupt has not occurred. 1 An external master interrupt occurred.	
4	PCIIS	PCI Interrupt Status 0 A PCI interrupt has not occurred. 1 A PCI interrupt occurred.	An external write to PCIC0_CMD causes UIC0_SR[PCIIS] to be set.
5	D0IS	DMA Channel 0 Interrupt Status 0 A DMA channel 0 interrupt has not occurred. 1 A DMA channel 0 interrupt occurred.	
6	D1IS	DMA Channel 1 Interrupt Status 0 A DMA channel 1 interrupt has not occurred. 1 A DMA channel 1 interrupt occurred.	
7	D2IS	DMA Channel 2 Interrupt Status 0 A DMA channel 2 interrupt has not occurred. 1 A DMA channel 2 interrupt occurred.	
8	D3IS	DMA Channel 3 Interrupt Status 0 A DMA channel 3 interrupt has not occurred. 1 A DMA channel 3 interrupt occurred.	

Preliminary User's Manual

9	EWIS	Ethernet Wake-up Interrupt Status 0 An Ethernet wake-up interrupt has not occurred. 1 An Ethernet wake-up interrupt occurred.	
10	MSIS	MAL SERR Interrupt Status 0 A MAL SERR interrupt has not occurred. 1 A MAL SERR interrupt occurred.	
11	MTEIS	MAL TX EOB Interrupt Status 0 A MAL TX EOB interrupt has not occurred. 1 A MAL TX EOB interrupt occurred.	
12	MREIS	MAL RX EOB Interrupt Status 0 A MAL RX EOB interrupt has not occurred. 1 A MAL RX EOB interrupt occurred.	
13	MTDIS	MAL TX DE Interrupt Status 0 A MAL TX DE interrupt has not occurred. 1 A MAL TX DE interrupt occurred.	
14	MRDIS	MAL RX DE Interrupt Status 0 A MAL RX DE interrupt has not occurred. 1 A MAL RX DE interrupt occurred.	
15	EIS	Ethernet Interrupt Status 0 An Ethernet interrupt has not occurred. 1 An Ethernet interrupt occurred.	
16	EPSIS	External PCI SERR Interrupt Status 0 An external PCI SERR interrupt has not occurred. 1 An external PCI SERR interrupt occurred.	If enabled, a PCI SERR interrupt occurs whenever the PCI SERR signal is asserted, either by the PCI bridge or by an external device.
17	ECIS	ECC Correctable Error Interrupt Status 0 An ECC correctable error interrupt did not occur. 1 An ECC correctable error interrupt occurred.	
18	PPMIS	PCI Power Management Interrupt Status 0 A PCI power management interrupt did not occur. 1 A PCI power management interrupt occurred.	
19:24		Reserved	
25	EIR0S	External IRQ 0 Status 0 An external IRQ 0 interrupt has not occurred. 1 An external IRQ 0 interrupt occurred.	
26	EIR1S	External IRQ 1 Status 0 An external IRQ 1 interrupt has not occurred. 1 An external IRQ 1 interrupt occurred.	

27	EIR2S	External IRQ 2 Status 0 An external IRQ 2 interrupt has not occurred. 1 An external IRQ 2 interrupt occurred.
28	EIR3S	External IRQ 3 Status 0 An external IRQ 3 interrupt has not occurred. 1 An external IRQ 3 interrupt occurred.
29	EIR4S	External IRQ 4 Status 0 An external IRQ 4 interrupt has not occurred. 1 An external IRQ 4 interrupt occurred.
30	EIR5S	External IRQ 5 Status 0 An external IRQ 5 interrupt has not occurred. 1 An external IRQ 5 interrupt occurred.
31	EIR6S	External IRQ 6 Status 0 An external IRQ 6 interrupt has not occurred. 1 An external IRQ 6 interrupt occurred.

10.5.2 UIC Enable Register (UIC0_ER)

Fields in UIC0_ER, which correspond to fields in UIC0_SR, enable or disable the reporting of the corresponding fields of UIC0_SR.

If a UIC0_ER field is set to 1, the corresponding field of UIC0_SR generates a critical or non-critical interrupt signal to the processor core, if the UIC0_SR field is set to 1. If a UIC0_ER field is set to 0, the corresponding field of the UIC0_SR field does not generate a critical or non-critical interrupt signal to the processor core, regardless of the setting of the UIC0_SR field. The critical and non-critical interrupt signals in the processor core are controlled by fields in the Machine State Register (MSR).

The class of generated signals (critical or non-critical) is controlled by UIC0_CR.

Figure 10-3 illustrates UIC0_ER.

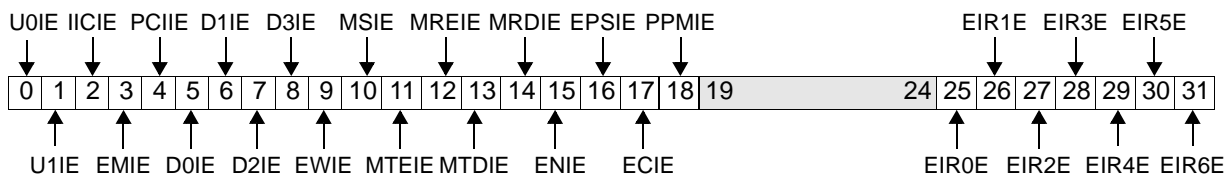

Figure 10-2. UIC Enable Register (UIC0_ER)

0	U0IE	UART0 Interrupt Enable 0 UART0 interrupt is disabled. 1 UART0 interrupt is enabled.
---	------	---

Preliminary User's Manual

1	U1IE	UART1 Interrupt Enable 0 UART1 interrupt is disabled. 1 UART1 interrupt is enabled.	
2	IICIE	IIC Interrupt Enable 0 IIC interrupt is disabled. 1 IIC interrupt is enabled.	
3	EMIE	External Master Interrupt Enable 0 External master interrupt is disabled. 1 External master interrupt is enabled.	
4	PCIIE	PCI Interrupt Enable 0 PCI interrupt is disabled. 1 PCI interrupt is enabled.	Enables a PCI interrupt when an external write to PCIC0_CMD is performed.
5	D0IE	DMA Channel 0 Interrupt Enable 0 DMA channel 0 interrupt is disabled. 1 DMA channel 0 interrupt is enabled.	
6	D1IE	DMA Channel 1 Interrupt Enable 0 DMA channel 1 interrupt is disabled. 1 DMA channel 1 interrupt is enabled.	
7	D2IE	DMA Channel 2 Interrupt Enable 0 DMA channel 2 interrupt is disabled. 1 DMA channel 2 interrupt is enabled.	
8	D3IE	DMA Channel 3 Interrupt Enable 0 DMA channel 3 interrupt is disabled. 1 DMA channel 3 interrupt is enabled.	
9	EWIE	Ethernet Wake-up Interrupt Enable 0 Ethernet wake-up interrupt is disabled. 1 Ethernet wake-up interrupt is enabled.	
10	MSIE	MAL SERR Interrupt Enable 0 MAL SERR interrupt is disabled. 1 MAL SERR interrupt is enabled.	
11	MTEIE	MAL TX EOB Interrupt Enable 0 MAL TX EOB interrupt is disabled. 1 MAL TX EOB interrupt is enabled.	
12	MREIE	MAL RX EOB Interrupt Enable 0 MAL RX EOB interrupt is disabled. 1 MAL RX EOB interrupt is enabled.	
13	MTDIE	MAL TX DE Interrupt Enable 0 MAL TX DE interrupt is disabled. 1 MAL TX DE interrupt is enabled.	
14	MRDIE	MAL RX DE Interrupt Enable 0 MAL RX DE interrupt is disabled. 1 MAL RX DE interrupt is enabled.	
15	EIE	Ethernet Interrupt Enable 0 An Ethernet interrupt is disabled. 1 An Ethernet interrupt is enabled.	

16	EPSIE	External PCI SERR Interrupt Enable 0 External PCI SERR interrupt is disabled. 1 External PCI SERR interrupt is enabled.
17	ECIE	ECC Correctable Error Interrupt Enable 0 ECC correctable error interrupt is disabled. 1 ECC correctable error interrupt is enabled.
18	PPMI	PCI Power management Interrupt Enable 0 PCI power management interrupt is disabled. 1 PCI power management interrupt is enabled.
19:24		Reserved
25	EIR0E	External IRQ 0 Interrupt Enable 0 An external IRQ 0 interrupt is disabled. 1 An external IRQ 0 interrupt is enabled.
26	EIR1E	External IRQ 1 Interrupt Enable 0 An external IRQ 1 interrupt is disabled. 1 An external IRQ 1 interrupt is enabled.
27	EIR2E	External IRQ 2 Interrupt Enable 0 An external IRQ 2 interrupt is disabled. 1 An external IRQ 2 interrupt is enabled.
28	EIR3E	External IRQ 3 Interrupt Enable 0 An external IRQ 3 interrupt is disabled. 1 An external IRQ 3 interrupt is enabled.
29	EIR4E	External IRQ 4 Interrupt Enable 0 An external IRQ 4 interrupt is disabled. 1 An external IRQ 4 interrupt is enabled.
30	EIR5E	External IRQ 5 Interrupt Enable 0 An external IRQ 5 interrupt is disabled. 1 An external IRQ 5 interrupt is enabled.
31	EIR6E	External IRQ 6 Interrupt Enable 0 An external IRQ 6 interrupt is disabled. 1 An external IRQ 6 interrupt is enabled.

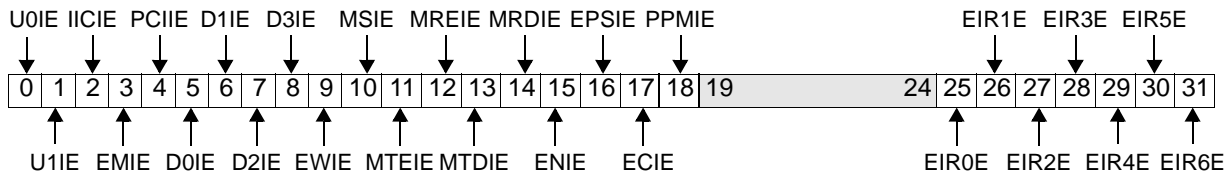

Figure 10-3. UIC Enable Register (UIC0_ER)

0	U0IE	UART0 Interrupt Enable 0 UART0 interrupt is disabled. 1 UART0 interrupt is enabled.
1	U1IE	UART1 Interrupt Enable 0 UART1 interrupt is disabled. 1 UART1 interrupt is enabled.

Preliminary User's Manual

2	IICIE	IIC Interrupt Enable 0 IIC interrupt is disabled. 1 IIC interrupt is enabled.	
3	EMIE	External Master Interrupt Enable 0 External master interrupt is disabled. 1 External master interrupt is enabled.	
4	PCIIE	PCI Interrupt Enable 0 PCI interrupt is disabled. 1 PCI interrupt is enabled.	Enables a PCI interrupt when an external write to PCIC0_CMD is performed.
5	D0IE	DMA Channel 0 Interrupt Enable 0 DMA channel 0 interrupt is disabled. 1 DMA channel 0 interrupt is enabled.	
6	D1IE	DMA Channel 1 Interrupt Enable 0 DMA channel 1 interrupt is disabled. 1 DMA channel 1 interrupt is enabled.	
7	D2IE	DMA Channel 2 Interrupt Enable 0 DMA channel 2 interrupt is disabled. 1 DMA channel 2 interrupt is enabled.	
8	D3IE	DMA Channel 3 Interrupt Enable 0 DMA channel 3 interrupt is disabled. 1 DMA channel 3 interrupt is enabled.	
9	EWIE	Ethernet Wake-up Interrupt Enable 0 Ethernet wake-up interrupt is disabled. 1 Ethernet wake-up interrupt is enabled.	
10	MSIE	MAL SERR Interrupt Enable 0 MAL SERR interrupt is disabled. 1 MAL SERR interrupt is enabled.	
11	MTEIE	MAL TX EOB Interrupt Enable 0 MAL TX EOB interrupt is disabled. 1 MAL TX EOB interrupt is enabled.	
12	MREIE	MAL RX EOB Interrupt Enable 0 MAL RX EOB interrupt is disabled. 1 MAL RX EOB interrupt is enabled.	
13	MTDIE	MAL TX DE Interrupt Enable 0 MAL TX DE interrupt is disabled. 1 MAL TX DE interrupt is enabled.	
14	MRDIE	MAL RX DE Interrupt Enable 0 MAL RX DE interrupt is disabled. 1 MAL RX DE interrupt is enabled.	
15	EIE	Ethernet Interrupt Enable 0 An Ethernet interrupt is disabled. 1 An Ethernet interrupt is enabled.	
16	EPSIE	External PCI SERR Interrupt Enable 0 External PCI SERR interrupt is disabled. 1 External PCI SERR interrupt is enabled.	

17	ECIE	ECC Correctable Error Interrupt Enable 0 ECC correctable error interrupt is disabled. 1 ECC correctable error interrupt is enabled.
18	PPMI	PCI Power management Interrupt Enable 0 PCI power management interrupt is disabled. 1 PCI power management interrupt is enabled.
19:24		Reserved
25	EIR0E	External IRQ 0 Interrupt Enable 0 An external IRQ 0 interrupt is disabled. 1 An external IRQ 0 interrupt is enabled.
26	EIR1E	External IRQ 1 Interrupt Enable 0 An external IRQ 1 interrupt is disabled. 1 An external IRQ 1 interrupt is enabled.
27	EIR2E	External IRQ 2 Interrupt Enable 0 An external IRQ 2 interrupt is disabled. 1 An external IRQ 2 interrupt is enabled.
28	EIR3E	External IRQ 3 Interrupt Enable 0 An external IRQ 3 interrupt is disabled. 1 An external IRQ 3 interrupt is enabled.
29	EIR4E	External IRQ 4 Interrupt Enable 0 An external IRQ 4 interrupt is disabled. 1 An external IRQ 4 interrupt is enabled.
30	EIR5E	External IRQ 5 Interrupt Enable 0 An external IRQ 5 interrupt is disabled. 1 An external IRQ 5 interrupt is enabled.
31	EIR6E	External IRQ 6 Interrupt Enable 0 An external IRQ 6 interrupt is disabled. 1 An external IRQ 6 interrupt is enabled.

Preliminary User's Manual**10.5.3 UIC Critical Register (UIC0_CR)**

Fields in UIC0_CR, which correspond to fields in UIC0_SR and UIC0_ER, determine whether an interrupt captured in corresponding UIC0_SR fields generates a non-critical or critical interrupt, if the interrupts are enabled in the corresponding UIC0_ER fields. The processor core handles critical interrupts when MSR[CE] = 1 and non-critical interrupts when MSR[EE]=1.

If a UIC0_CR field is set to 0, an enabled interrupt (captured in the corresponding UIC0_SR field and enabled in the corresponding UIC0_ER field) generates a non-critical interrupt signal to the processor core. If a UIC0_CR field is a 1, a critical interrupt signal is generated.

Figure 10-3 illustrates UIC0_CR.

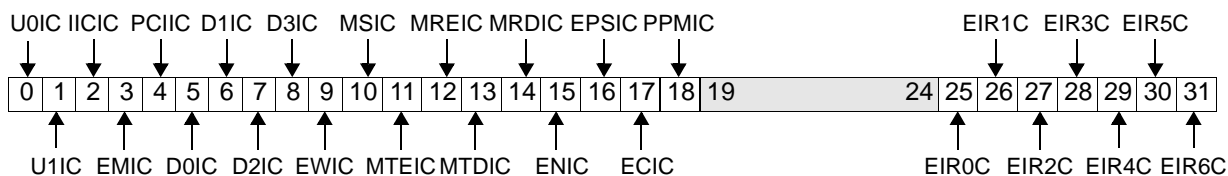

Figure 10-4. UIC Critical Register (UIC0_CR)

0	U0IC	UART0 Interrupt Class 0 UART0 interrupt is non-critical. 1 UART0 interrupt is critical.
1	U1IC	UART1 Interrupt Class 0 UART1 interrupt is non-critical. 1 UART1 interrupt is critical.
2	IICIC	IIC Interrupt Class 0 IIC interrupt is non-critical. 1 IIC interrupt is critical.
3	EMIC	External Master Interrupt Class 0 External master interrupt is non-critical. 1 External master interrupt is critical.
4	PCIIC	PCI Interrupt Class 0 PCI interrupt is non-critical. 1 PCI interrupt is critical.
5	D0IC	DMA Channel 0 Interrupt Class 0 DMA channel 0 interrupt is non-critical. 1 DMA channel 0 interrupt is critical.
6	D1IC	DMA Channel 1 Interrupt Class 0 DMA channel 1 interrupt is non-critical. 1 DMA channel 1 interrupt is critical.
7	D2IC	DMA Channel 2 Interrupt Class 0 DMA channel 2 interrupt is non-critical. 1 DMA channel 2 interrupt is critical.
8	D3IC	DMA Channel 3 Interrupt Class 0 DMA channel 3 interrupt is non-critical. 1 DMA channel 3 interrupt is critical.

9	EWIC	Ethernet Wake-up Interrupt Class 0 Ethernet wake-up interrupt is non-critical. 1 Ethernet wake-up interrupt is critical.
10	MSIC	MAL SERR Interrupt Class 0 MAL SERR interrupt is non-critical. 1 MAL SERR interrupt is critical.
11	MTEIC	MAL TX EOB Interrupt Class 0 MAL TX EOB interrupt is non-critical. 1 MAL TX EOB interrupt is critical.
12	MREIC	MAL RX EOB Interrupt Class 0 MAL RX EOB interrupt is non-critical. 1 MAL RX EOB interrupt is critical.
13	MTDIC	MAL TX DE Interrupt Class 0 MAL TX DE interrupt is non-critical. 1 MAL TX DE interrupt is critical.
14	MRDIC	MAL RX DE Interrupt Class 0 MAL RX DE interrupt is non-critical. 1 MAL RX DE interrupt is critical.
15	EIC	Ethernet Interrupt Class 0 An Ethernet interrupt is non-critical. 1 An Ethernet interrupt is critical.
16	EPSIC	External PCI SERR Interrupt Class 0 External PCI SERR interrupt is non-critical. 1 External PCI SERR interrupt is critical.
17	ECIC	ECC Correctable Error Interrupt Class 0 ECC correctable error interrupt is non-critical. 1 ECC correctable error interrupt is critical.
18	PPMIC	PCI Power management Interrupt Class 0 PCI power management interrupt is non-critical. 1 PCI power management interrupt is critical.
19:24		Reserved
25	EIR0C	External IRQ 0 Class 0 An external IRQ 0 interrupt is non-critical. 1 An external IRQ 0 interrupt is critical.
26	EIR1C	External IRQ 1 Class 0 An external IRQ 1 interrupt is non-critical. 1 An external IRQ 1 interrupt is critical.
27	EIR2C	External IRQ 2 Class 0 An external IRQ 2 interrupt is non-critical. 1 An external IRQ 2 interrupt is critical.
28	EIR3C	External IRQ 3 Class 0 An external IRQ 3 interrupt is non-critical. 1 An external IRQ 3 interrupt is critical.

Preliminary User's Manual

29	EIR4C	External IRQ 4 Class 0 An external IRQ 4 interrupt is non-critical. 1 An external IRQ 4 interrupt is critical.
30	EIR5C	External IRQ 5 Class 0 An external IRQ 5 interrupt is non-critical. 1 An external IRQ 5 interrupt is critical.
31	EIR6C	External IRQ 6 Class 0 An external IRQ 6 interrupt is non-critical. 1 An external IRQ 6 interrupt is critical.

10.5.4 UIC Polarity Register (UIC0_PR)

Fields in UIC0_PR, which correspond to the fields in UIC0_SR, determine whether the interrupts associated with the corresponding fields in the UIC0_SR are active high (have positive polarity) or active low (have negative polarity).

For level-sensitive interrupts, a 0 in a UIC0_PR field causes the corresponding interrupt to be active low. A 1 in a UIC0_PR field causes the corresponding interrupt to be active high.

For edge-sensitive interrupts, a 0 in a UIC0_PR field causes the corresponding interrupt to be detected on a falling edge (as polarity changes from 1 to 0). A 1 in a UIC0_PR field causes the corresponding interrupt to be detected on a rising edge (as polarity changes from 0 to 1).

Because the on-chip interrupts are active high, the associated fields must be set to 1, as shown in Figure 10-4.

Figure 10-4 illustrates UIC0_PR.

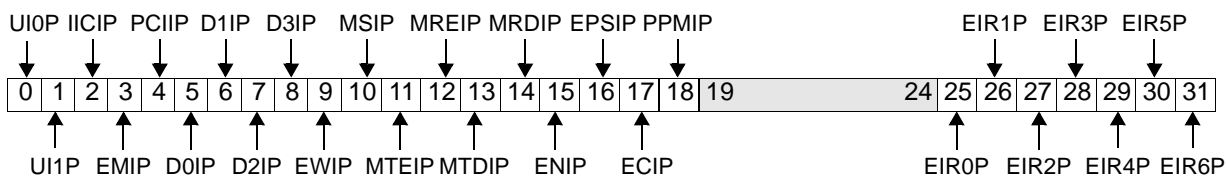

Figure 10-5. UIC Polarity Register (UIC0_PR)

0	U0IP	UART0 Interrupt Polarity 0 UART0 interrupt has negative polarity. 1 UART0 interrupt has positive polarity.	Must be set to 1.
1	U1IP	UART1 Interrupt Polarity 0 UART1 interrupt has negative polarity. 1 UART1 interrupt has positive polarity.	Must be set to 1.
2	IICIP	IIC Interrupt Polarity 0 IIC interrupt has negative polarity. 1 IIC interrupt has positive polarity.	Must be set to 1.
3	EMIP	External Master Interrupt Polarity 0 External master interrupt has negative polarity. 1 External master interrupt has positive polarity.	Must be set to 1.

4	PCIIP	PCI Interrupt Polarity 0 PCI interrupt has negative polarity. 1 PCI interrupt has positive polarity.	Must be set to 1.
5	D0IP	DMA Channel 0 Interrupt Polarity 0 DMA channel 0 interrupt has negative polarity. 1 DMA channel 0 interrupt has positive polarity.	Must be set to 1.
6	D1IP	DMA Channel 1 Interrupt Polarity 0 DMA channel 1 interrupt has negative polarity. 1 DMA channel 1 interrupt has positive polarity.	Must be set to 1.
7	D2IP	DMA Channel 2 Interrupt Polarity 0 DMA channel 2 interrupt has negative polarity. 1 DMA channel 2 interrupt has positive polarity.	Must be set to 1.
8	D3IP	DMA Channel 3 Interrupt Polarity 0 DMA channel 3 interrupt has negative polarity. 1 DMA channel 3 interrupt has positive polarity.	Must be set to 1.
9	EWIP	Ethernet Wake-up Interrupt Polarity 0 Ethernet wake-up interrupt has negative polarity. 1 Ethernet wake-up interrupt has positive polarity.	Must be set to 1.
10	MSIP	MAL SERR Interrupt Polarity 0 MAL SERR interrupt has negative polarity. 1 MAL SERR interrupt has positive polarity.	Must be set to 1.
11	MTEIP	MAL TX EOB Interrupt Polarity 0 MAL TX EOB interrupt has negative polarity. 1 MAL TX EOB interrupt has positive polarity.	Must be set to 1.
12	MREIP	MAL RX EOB Interrupt Polarity 0 MAL RX EOB interrupt has negative polarity. 1 MAL RX EOB interrupt has positive polarity.	Must be set to 1.
13	MTDIP	MAL TX DE Interrupt Polarity 0 MAL TX DE interrupt has negative polarity. 1 MAL TX DE interrupt has positive polarity.	Must be set to 1.
14	MRDIP	MAL RX DE Interrupt Polarity 0 MAL RX DE interrupt has negative polarity. 1 MAL RX DE interrupt has positive polarity.	Must be set to 1.
15	EIP	Ethernet Interrupt Polarity 0 An Ethernet interrupt has negative polarity. 1 An Ethernet interrupt has positive polarity.	Must be set to 1.
16	EPSIP	External PCI SERR Interrupt Polarity 0 External PCI SERR interrupt has negative polarity. 1 External PCI SERR interrupt has positive polarity.	Must be set to 1.
17	ECIP	ECC Correctable Error Interrupt Polarity 0 ECC correctable error interrupt has negative polarity. 1 ECC correctable error interrupt has positive polarity.	Must be set to 1.

Preliminary User's Manual

18	PPMIC	PCI Power management Interrupt Polarity 0 PCI power management interrupt has negative polarity. 1 PCI power management interrupt has positive polarity.	Must be set to 1.
19:24		Reserved	
25	EIR0P	External IRQ 0 Polarity 0 An external IRQ 0 interrupt has negative polarity. 1 An external IRQ 0 interrupt has positive polarity.	
26	EIR1P	External IRQ 1 Polarity 0 An external IRQ 1 interrupt has negative polarity. 1 An external IRQ 1 interrupt has positive polarity.	
27	EIR2P	External IRQ 2 Polarity 0 An external IRQ 2 interrupt has negative polarity. 1 An external IRQ 2 interrupt has positive polarity.	
28	EIR3P	External IRQ 3 Polarity 0 An external IRQ 3 interrupt has negative polarity. 1 An external IRQ 3 interrupt has positive polarity.	
29	EIR4P	External IRQ 4 Polarity 0 An external IRQ 4 interrupt has negative polarity. 1 An external IRQ 4 interrupt has positive polarity.	
30	EIR5P	External IRQ 5 Polarity 0 An external IRQ 5 interrupt has negative polarity. 1 An external IRQ 5 interrupt has positive polarity.	
31	EIR6P	External IRQ 6 Polarity 0 An external IRQ 6 interrupt has negative polarity. 1 An external IRQ 6 interrupt has positive polarity.	

10.5.5 UIC Trigger Register (UIC0_TR)

Fields in UIC0_TR, which correspond to fields in UIC0_SR, determine whether interrupts associated with the corresponding UIC0_SR fields are edge-sensitive or level-sensitive.

Level-sensitive interrupts are triggered depending on whether the associated interrupt signal is high (1) or low (0). Edge-sensitive interrupts are triggered depending on whether the associated interrupt signal is rising or falling (changing from 0 to 1 or 1 to 0, respectively). Whether a rising or falling edge causes the trigger is controlled by bits in UIC0_TR.

If a UIC0_TR field is 0, the associated interrupt is level-sensitive. If the UIC0_TR field is 1, the interrupt is edge-sensitive.

Except for the external master interrupt, the on-chip interrupts are level-sensitive, so the associated fields must be set to 0 as shown in Figure 10-5. The external master interrupt trigger (controlled by UIC0_TR₃) is edge-sensitive; this field must be set to 1.

Figure 10-5 illustrates UIC0_TR.

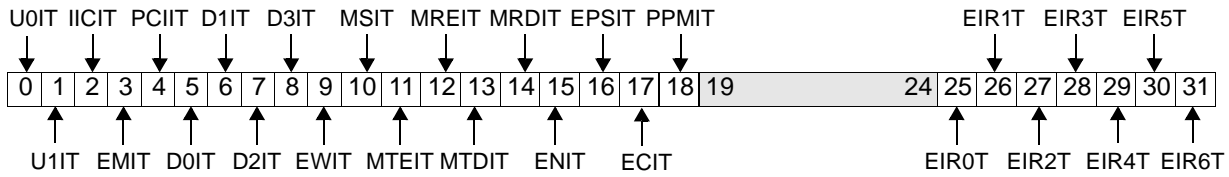

Figure 10-6. UIC Trigger Register (UIC0_TR)

0	U0IT	UART0 Interrupt Trigger 0 UART0 interrupt is level-sensitive. 1 UART0 interrupt is edge-sensitive.	Must be set to 0.
1	U1IT	UART1 Interrupt Trigger 0 UART1 interrupt is level-sensitive. 1 UART1 interrupt is edge-sensitive.	Must be set to 0.
2	IICIT	IIC Interrupt Trigger 0 IIC interrupt is level-sensitive. 1 IIC interrupt is edge-sensitive.	Must be set to 0.
3	EMIT	External Master Interrupt Trigger 0 External master interrupt is level-sensitive. 1 External master interrupt is edge-sensitive.	Must be set to 1.
4	PCIIT	PCI Interrupt Trigger 0 PCI interrupt is level-sensitive. 1 PCI interrupt is edge-sensitive.	Must be set to 0.
5	D0IT	DMA Channel 0 Interrupt Trigger 0 DMA channel 0 interrupt is level-sensitive. 1 DMA channel 0 interrupt is edge-sensitive.	Must be set to 0.
6	D1IT	DMA Channel 1 Interrupt Trigger 0 DMA channel 1 interrupt is level-sensitive. 1 DMA channel 1 interrupt is edge-sensitive.	Must be set to 0.
7	D2IT	DMA Channel 2 Interrupt Trigger 0 DMA channel 2 interrupt is level-sensitive. 1 DMA channel 2 interrupt is edge-sensitive.	Must be set to 0.
8	D3IT	DMA Channel 3 Interrupt Trigger 0 DMA channel 3 interrupt is level-sensitive. 1 DMA channel 3 interrupt is edge-sensitive.	Must be set to 0.

Preliminary User's Manual

9	EWIT	Ethernet Wake-up Interrupt Trigger 0 Ethernet wake-up interrupt is level-sensitive. 1 Ethernet wake-up interrupt is edge-sensitive.	Must be set to 0.
10	MSIT	MAL SERR Interrupt Trigger 0 MAL SERR interrupt is level-sensitive. 1 MAL SERR interrupt is edge-sensitive.	Must be set to 0.
11	MTEIT	MAL TX EOB Interrupt Trigger 0 MAL TX EOB interrupt is level-sensitive. 1 MAL TX EOB interrupt is edge-sensitive.	Must be set to 0.
12	MREIT	MAL RX EOB Interrupt Trigger 0 MAL RX EOB interrupt is level-sensitive. 1 MAL RX EOB interrupt is edge-sensitive.	Must be set to 0.
13	MTDIT	MAL TX DE Interrupt Trigger 0 MAL TX DE interrupt is level-sensitive. 1 MAL TX DE interrupt is edge-sensitive.	Must be set to 0.
14	MRDIT	MAL RX DE Interrupt Trigger 0 MAL RX DE interrupt is level-sensitive. 1 MAL RX DE interrupt is edge-sensitive.	Must be set to 0.
15	EIT	Ethernet Interrupt Trigger 0 An Ethernet interrupt is level-sensitive. 1 An Ethernet interrupt is edge-sensitive.	Must be set to 0.
16	EPSIT	External PCI SERR Interrupt Trigger 0 External PCI SERR interrupt is level-sensitive. 1 External PCI SERR interrupt is edge-sensitive.	Must be set to 0.
17	ECIT	ECC Correctable Error Interrupt Trigger 0 ECC correctable error interrupt is level-sensitive. 1 ECC correctable error interrupt is edge-sensitive.	Must be set to 0.
18	PPMIT	PCI Power management Interrupt Trigger 0 PCI power management interrupt is level-sensitive. 1 PCI power management interrupt is edge-sensitive.	Must be set to 0.
19:24		Reserved	
25	EIR0T	External IRQ 0 Trigger 0 An external IRQ 0 interrupt is level-sensitive. 1 An external IRQ 0 interrupt is edge-sensitive.	
26	EIR1T	External IRQ 1 Trigger 0 An external IRQ 1 interrupt is level-sensitive. 1 An external IRQ 1 interrupt is edge-sensitive.	

27	EIR2T	External IRQ 2 Trigger 0 An external IRQ 2 interrupt is level-sensitive. 1 An external IRQ 2 interrupt is edge-sensitive.
28	EIR3T	External IRQ 3 Trigger 0 An external IRQ 3 interrupt is level-sensitive. 1 An external IRQ 3 interrupt is edge-sensitive.
29	EIR4T	External IRQ 4 Trigger 0 An external IRQ 4 interrupt is level-sensitive. 1 An external IRQ 4 interrupt is edge-sensitive.
30	EIR5T	External IRQ 5 Trigger 0 An external IRQ 5 interrupt is level-sensitive. 1 An external IRQ 5 interrupt is edge-sensitive.
31	EIR6T	External IRQ 6 Trigger 0 An external IRQ 6 interrupt is level-sensitive. 1 An external IRQ 6 interrupt is edge-sensitive.

Preliminary User's Manual**10.5.6 UIC Masked Status Register (UIC0_MSR)**

This read-only register contains the result of masking the UIC0_SR with UIC0_ER. Reading this register, instead of the actual UIC0_SR, eliminates the need for software to read and apply the enable mask to the contents of the UIC0_SR to determine which enabled interrupt fields are active.

If an interrupt is configured as level-sensitive, and a clear is attempted on the UIC0_SR, the UIC0_SR field is not cleared if the incoming interrupt signal is at the asserted polarity. The interrupt signal must be reset before UIC0_SR can be successfully cleared.

Figure 10-8 illustrates UIC0_MSR.

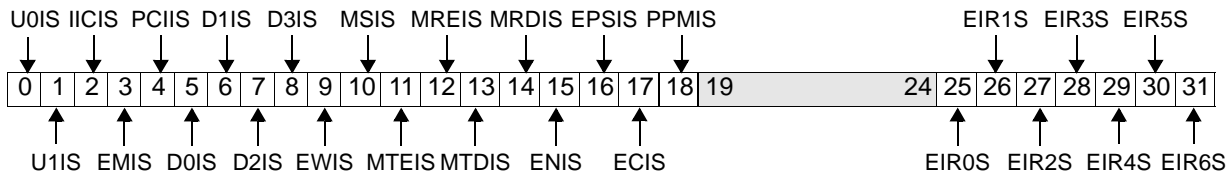

Figure 10-7. UIC Masked Status Register (UIC0_MSR)

0	U0IS	UART0 Masked Interrupt Status 0 A UART0 interrupt has not occurred. 1 A UART0 interrupt occurred.
1	U1IS	UART1 Masked Interrupt Status 0 A UART1 interrupt has not occurred. 1 A UART1 interrupt occurred.
2	IICIS	IIC Masked Interrupt Status 0 An IIC interrupt has not occurred. 1 An IIC interrupt occurred.
3	EMIS	External Master Masked Interrupt Status 0 An external master interrupt has not occurred. 1 An external master interrupt occurred.
4	PCIIS	PCI Masked Interrupt Status 0 A PCI interrupt has not occurred. 1 A PCI interrupt occurred.
5	D0IS	DMA Channel 0 Masked Interrupt Status 0 A DMA channel 0 interrupt has not occurred. 1 A DMA channel 0 interrupt occurred.
6	D1IS	DMA Channel 1 Masked Interrupt Status 0 A DMA channel 1 interrupt has not occurred. 1 A DMA channel 1 interrupt occurred.
7	D2IS	DMA Channel 2 Masked Interrupt Status 0 A DMA channel 2 interrupt has not occurred. 1 A DMA channel 2 interrupt occurred.
8	D3IS	DMA Channel 3 Masked Interrupt Status 0 A DMA channel 3 interrupt has not occurred. 1 A DMA channel 3 interrupt occurred.

9	EWIS	Ethernet Wake-up Masked Interrupt Status 0 An Ethernet wake-up interrupt has not occurred. 1 An Ethernet wake-up interrupt occurred.
10	MSIS	MAL SERR Masked Interrupt Status 0 A MAL SERR interrupt has not occurred. 1 A MAL SERR interrupt occurred.
11	MTEIS	MAL TX EOB Masked Interrupt Status 0 A MAL TX EOB interrupt has not occurred. 1 A MAL TX EOB interrupt occurred.
12	MREIS	MAL RX EOB Masked Interrupt Status 0 A MAL RX EOB interrupt has not occurred. 1 A MAL RX EOB interrupt occurred.
13	MTDIS	MAL TX DE Masked Interrupt Status 0 A MAL TX DE interrupt has not occurred. 1 A MAL TX DE interrupt occurred.
14	MRDIS	MAL RX DE Masked Interrupt Status 0 A MAL RX DE interrupt has not occurred. 1 A MAL RX DE interrupt occurred.
15	EIS	Ethernet Masked Interrupt Status 0 An Ethernet interrupt has not occurred. 1 An Ethernet interrupt occurred.
16	EPSIE	External PCI SERR Masked Interrupt Status 0 An external PCI SERR interrupt has not occurred. 1 An external PCI SERR interrupt occurred.
17	ECIS	ECC Correctable Error Masked Interrupt Status 0 An ECC correctable error interrupt did not occur. 1 An ECC correctable error interrupt occurred.
18	PPMIS	PCI Power Management Masked Interrupt Status 0 A PCI power management interrupt did not occur. 1 A PCI power management interrupt occurred.
19:24		Reserved
25	EIR0E	External IRQ 0 Masked Status 0 An external IRQ 0 interrupt has not occurred. 1 An external IRQ 0 interrupt occurred.
26	EIR1S	External IRQ 1 Masked Status 0 An external IRQ 1 interrupt has not occurred. 1 An external IRQ 1 interrupt occurred.

Preliminary User's Manual

27	EIR2S	External IRQ 2 Masked Status 0 An external IRQ 2 interrupt has not occurred. 1 An external IRQ 2 interrupt occurred.
28	EIR3S	External IRQ 3 Masked Status 0 An external IRQ 3 interrupt has not occurred. 1 An external IRQ 3 interrupt occurred.
29	EIR4S	External IRQ 4 Masked Status 0 An external IRQ 4 interrupt has not occurred. 1 An external IRQ 4 interrupt occurred.
30	EIR5S	External IRQ 5 Masked Status 0 An external IRQ 5 interrupt has not occurred. 1 An external IRQ 5 interrupt occurred.
31	EIR6S	External IRQ 6 Masked Status 0 An external IRQ 6 interrupt has not occurred. 1 An external IRQ 6 interrupt occurred.

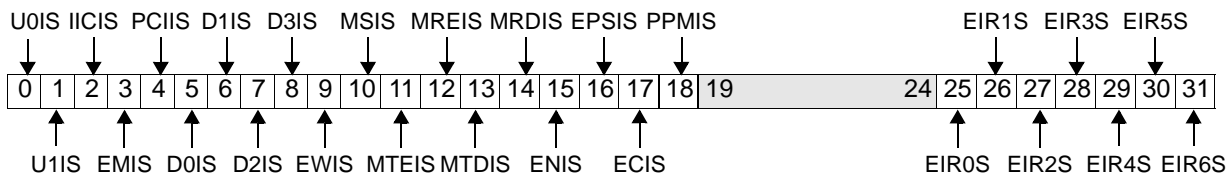

Figure 10-8. UIC Masked Status Register (UIC0_MSR)

0	U0IS	UART0 Masked Interrupt Status 0 A UART0 interrupt has not occurred. 1 A UART0 interrupt occurred.
1	U1IS	UART1 Masked Interrupt Status 0 A UART1 interrupt has not occurred. 1 A UART1 interrupt occurred.
2	IICIS	IIC Masked Interrupt Status 0 An IIC interrupt has not occurred. 1 An IIC interrupt occurred.
3	EMIS	External Master Masked Interrupt Status 0 An external master interrupt has not occurred. 1 An external master interrupt occurred.
4	PCIIS	PCI Masked Interrupt Status 0 A PCI interrupt has not occurred. 1 A PCI interrupt occurred.
5	D0IS	DMA Channel 0 Masked Interrupt Status 0 A DMA channel 0 interrupt has not occurred. 1 A DMA channel 0 interrupt occurred.

6	D1IS	DMA Channel 1 Masked Interrupt Status 0 A DMA channel 1 interrupt has not occurred. 1 A DMA channel 1 interrupt occurred.
7	D2IS	DMA Channel 2 Masked Interrupt Status 0 A DMA channel 2 interrupt has not occurred. 1 A DMA channel 2 interrupt occurred.
8	D3IS	DMA Channel 3 Masked Interrupt Status 0 A DMA channel 3 interrupt has not occurred. 1 A DMA channel 3 interrupt occurred.
9	EWIS	Ethernet Wake-up Masked Interrupt Status 0 An Ethernet wake-up interrupt has not occurred. 1 An Ethernet wake-up interrupt occurred.
10	MSIS	MAL SERR Masked Interrupt Status 0 A MAL SERR interrupt has not occurred. 1 A MAL SERR interrupt occurred.
11	MTEIS	MAL TX EOB Masked Interrupt Status 0 A MAL TX EOB interrupt has not occurred. 1 A MAL TX EOB interrupt occurred.
12	MREIS	MAL RX EOB Masked Interrupt Status 0 A MAL RX EOB interrupt has not occurred. 1 A MAL RX EOB interrupt occurred.
13	MTDIS	MAL TX DE Masked Interrupt Status 0 A MAL TX DE interrupt has not occurred. 1 A MAL TX DE interrupt occurred.
14	MRDIS	MAL RX DE Masked Interrupt Status 0 A MAL RX DE interrupt has not occurred. 1 A MAL RX DE interrupt occurred.
15	EIS	Ethernet Masked Interrupt Status 0 An Ethernet interrupt has not occurred. 1 An Ethernet interrupt occurred.
16	EPSIE	External PCI SERR Masked Interrupt Status 0 An external PCI SERR interrupt has not occurred. 1 An external PCI SERR interrupt occurred.
17	ECIS	ECC Correctable Error Masked Interrupt Status 0 An ECC correctable error interrupt did not occur. 1 An ECC correctable error interrupt occurred.

Preliminary User's Manual

18	PPMIS	PCI Power Management Masked Interrupt Status 0 A PCI power management interrupt did not occur. 1 A PCI power management interrupt occurred.
19:24		Reserved
25	EIR0E	External IRQ 0 Masked Status 0 An external IRQ 0 interrupt has not occurred. 1 An external IRQ 0 interrupt occurred.
26	EIR1S	External IRQ 1 Masked Status 0 An external IRQ 1 interrupt has not occurred. 1 An external IRQ 1 interrupt occurred.
27	EIR2S	External IRQ 2 Masked Status 0 An external IRQ 2 interrupt has not occurred. 1 An external IRQ 2 interrupt occurred.
28	EIR3S	External IRQ 3 Masked Status 0 An external IRQ 3 interrupt has not occurred. 1 An external IRQ 3 interrupt occurred.
29	EIR4S	External IRQ 4 Masked Status 0 An external IRQ 4 interrupt has not occurred. 1 An external IRQ 4 interrupt occurred.
30	EIR5S	External IRQ 5 Masked Status 0 An external IRQ 5 interrupt has not occurred. 1 An external IRQ 5 interrupt occurred.
31	EIR6S	External IRQ 6 Masked Status 0 An external IRQ 6 interrupt has not occurred. 1 An external IRQ 6 interrupt occurred.

10.5.7 UIC Vector Configuration Register (UIC0_VCR)

The write-only UIC0_VCR enables software control of interrupt vector generation for critical interrupts. The UIC0_VCR contains an address, used as an interrupt vector base address, and specifies interrupt ordering priority. Vector generation is not performed for non-critical interrupts.

UIC0_VCR[VBA] can contain either the base address for an interrupt handler vector table or the base address for the interrupt handler associated with each interrupt. The actual interrupt vector (the address of the interrupt handler that services the interrupt) is generated in the UIC0_VR, using UIC0_VCR[VBA]. Vector generation is described in “UIC Vector Register (UIC0_VR)” on page 10-243. Because the two lowest-order bits of an interrupt handler address are assumed to be 00 to ensure word alignment, 30 bits are sufficient to form the base address.

A general interrupt handler uses the vector to access a table of interrupt vectors. Each interrupt vector table entry contains the address of an interrupt handler for a specific interrupt. Alternatively, UIC0_VCR[VBA] can directly address the interrupt handlers for specific interrupts, which in memory are separated by an offset calculated in UIC0_VR.

UIC0_VCR[PRO] controls whether the interrupt associated with UIC0_SR[0] or UIC0_SR[31] has the highest priority. If UIC0_VCR[PRO] = 0, the interrupt associated with UIC0_SR[31] has the highest priority; if UIC0_VCR[PRO] = 1, the interrupt associated with UIC0_SR[0] has the highest priority. Priority decreases across the UIC0_SR to the end opposite the highest priority field.

Figure 10-7 illustrates UIC0_VCR.

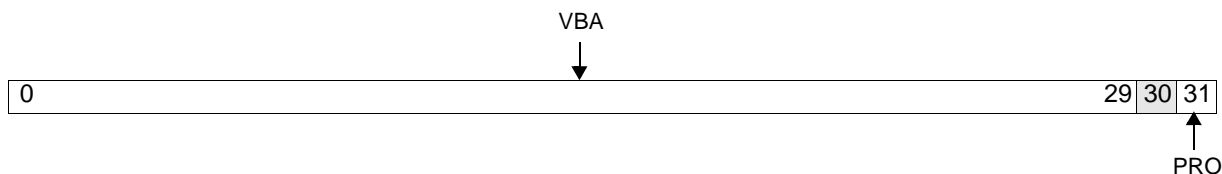

Figure 10-9. UIC Vector Configuration Register (UIC0_VCR)

0:29	VBA	Vector Base Address
30		Reserved
31	PRO	Priority Ordering 0 UIC0_SR[31] is the highest priority interrupt. 1 UIC0_SR[0] is the highest priority interrupt. Note: Vector generation is not performed for non-critical interrupts.

Preliminary User's Manual**10.5.8 UIC Vector Register (UIC0_VR)**

The read-only UIC0_VR contains an interrupt vector that can reduce interrupt handling latency for critical interrupts. Vector generation logic adds an offset to UIC0_VCR[VBA], and the sum is returned in the UIC0_VR. Vectors are not computed for non-critical interrupts.

The interrupt vector is based on the field position of the current highest priority, enabled, active, critical interrupt relative to the highest priority interrupt in UIC0_SR. The generated vectors can be programmed to point directly to the interrupt handlers.

Programming Note: Regardless of the programming of UIC0_VCR and UIC0_VR registers, the processor always vectors to EVPR[0:15] || 0x100 when a critical interrupt occurs.

The interrupt vector offset is based on the bit position of the current highest priority, enabled, active, critical interrupt relative to the highest priority interrupt in the UIC0_SR. The offset has a fixed value of 512 per bit. The main critical interrupt handler can interpret the vector returned by UIC0_VR as the address of the interrupt handler for that interrupt, assuming the routine is 512 bytes or smaller. Alternatively, the main critical interrupt handler can interpret the vector as a look-up table entry for the address of the interrupt handler for that interrupt.

Figure 10-8 illustrates UIC0_VR.



Figure 10-10. UIC Vector Register (UIC0_VR)

0:31	VBA	Interrupt Vector
------	-----	------------------

The following example illustrates the generation of a UIC0_VR vector for external interrupt request IRQ2.

For the example, assume that UIC0_VCR[PRO] = 0, so that UIC0_SR[EIR6S] (UIC0_SR₃₁) has the highest interrupt priority, and that UIC0_SR[EIR2S] (UIC0_SR₂₇) is the current highest priority, enabled, active, critical interrupt. To generate the vector for the interrupt associated with UIC0_SR[EIR2S], internal logic multiplies the difference between the highest priority interrupt bit and the active enabled priority interrupt bit by 512. The interrupt vector offset is therefore $(31 - 27) \times 512 = 4 \times 512$. This offset is added to the base address in UIC0_VCR[VBA], and the UIC0_VR returns UIC0_VCR[VBA] + (4×512) .

10.5.8.1 Using the Value in UIC0_VR as a Vector Address or Entry Table Lookup

If an interrupt handler is 512 bytes or smaller, system software can interpret the value returned in the UIC0_VR as an address. In this case, when the interrupt is received, the UIC0_VR is read and software simply jumps to the address represented by the UIC0_VR value. Alternatively, the routine can be at a different address, and system software can treat the value of the UIC0_VR as a pointer, storing the interrupt handler address in the UIC0_VR during system initialization. In this case, when the interrupt is handled, software must read the UIC0_VR, read the entry at the UIC0_VR value, and jump to the entry. Hardware has no knowledge of the method is used, which is determined by system software.

10.5.8.2 Vector Generation Scenarios

For the following sequence, assume that the interrupts are enabled and critical (vectors are not generated for disabled or non-critical interrupts). The sequence illustrates several scenarios for vector generation.

1. An intermediate priority interrupt goes active; its vector is stored in UIC0_VR.
2. A low priority interrupt goes active; UIC0_VR is unchanged.
3. Software reads the vector; UIC0_VR is unchanged.
4. Software resets the intermediate priority interrupt; UIC0_VR contains the vector for the low priority interrupt.
5. A high priority interrupt goes active; UIC0_VR contains the vector for the high priority interrupt.
6. Software resets the high priority interrupt; UIC0_VR contains the vector for the low priority interrupt.
7. Software resets the UIC0_ER field for the low priority interrupt, disabling it; UIC0_VR contains 0x00000000.
8. UIC0_CR is reprogrammed to make the low priority interrupt non-critical and UIC0_ER is reprogrammed to re-enable the low priority interrupt; UIC0_VR continues to contain 0x00000000.

Preliminary User's Manual

10.6 Interrupt Handling in the Processor Core

An *interrupt* is the action in which the processor saves its old context (MSR and instruction pointer) and begins execution at a pre-determined interrupt-handler address, with a modified MSR. *Exceptions* are events which, if enabled, cause the processor to take an interrupt. Exceptions are generated by signals from internal and external peripherals, instructions, internal timer facilities, debug events, or error conditions.

Table 10-4, “Interrupt Vector Offsets,” on page 10-250, lists the interrupts handled by the PPC405GP in the order of interrupt vector offsets. Detailed descriptions of each interrupt follow, in the same order. Table 10-4 also provides an index to the descriptions.

Several registers support interrupt handling and control. “General Interrupt Handling Registers” on page 10-251 describes the general interrupt handling registers:

- Data Exception Address Register (DEAR)
- Exception Syndrome Register (ESR)
- Exception Vector Prefix Register (EVPR)
- Machine State Register (MSR)
- Save/Restore Registers (SRR0–SRR3)

10.7 Architectural Definitions and Behavior

Precise interrupts are those for which the instruction pointer saved by the interrupt must be either the address of the excepting instruction or the address of the next sequential instruction. *Imprecise* interrupts are those for which it is possible (but not required) for the saved instruction pointer to be something else, possibly prohibiting guaranteed software recovery.

Note that “precise” and “imprecise” are defined assuming that the interrupts are unmasked (enabled to occur) when the associated exception occurs. Consider an exception that would cause a precise interrupt, if the interrupt was enabled at the time of the exception, but that occurs while the interrupt is masked. Some exceptions of this type can cause the interrupt to occur later, immediately upon its enabling. In such a case, the interrupt is not considered precise with respect to the enabling instruction, but imprecise (“delayed precise”) with respect to the cause of the exception.

Asynchronous interrupts are caused by events which are independent of instruction execution. All asynchronous interrupts are precise, and the following rules apply:

1. All instructions prior to the one whose address is reported to the interrupt handling routine (in the save/restore register) have completed execution. However, some storage accesses generated by these preceding instructions may not have completed.
2. No subsequent instruction has begun execution, including the instruction whose address is reported to the interrupt handling routine.
3. The instruction having its address reported to the interrupt handler may appear not to have begun execution, or may have partially completed.

Synchronous interrupts are caused directly by the execution (or attempted execution) of instructions. Synchronous interrupts can be either precise or imprecise.

For synchronous precise interrupts, the following rules apply:

1. The save/restore register addresses either the instruction causing the exception or the next sequential instruction. Which instruction is addressed is determined by the interrupt type and status bits.
2. All instructions preceding the instruction causing the exception have completed execution. However, some storage accesses generated by these preceding instructions may not have completed.
3. The instruction causing the exception may appear not to have begun execution (except for causing the exception), may have partially completed, or may have completed, depending on the interrupt type.
4. No subsequent instruction has begun execution.

Refer to *AMCC PowerPC Embedded Environment* for an architectural description of imprecise interrupts.

Machine check interrupts are a special case typically caused by some kind of hardware or storage subsystem failure, or by an attempt to access an invalid address. A machine check can be indirectly caused by the execution of an instruction, but not recognized or reported until long after the processor has executed past the instruction that caused the machine check. As such, machine check interrupts cannot properly be thought of as synchronous, nor as precise or imprecise. For machine checks, the following general rules apply:

1. No instruction following the one whose address is reported to the machine check handler in the save/restore register has begun execution.
2. The instruction whose address is reported to the machine check handler in the save/restore register, and all previous instructions, may or may not have completed successfully. All previous instructions that would ever complete have completed, within the context existing before the machine check interrupt. No further interrupt (other than possible additional machine checks) can occur as a result of those instructions.

10.8 Behavior of the PPC405GP Implementation

All interrupts, except for machine checks, are handled precisely. Precise handling implies that the address of the excepting instruction (for synchronous exceptions other than the system call exception), or the address of the next instruction to be executed (asynchronous exceptions and the system call exception), is passed to an interrupt handling routine. Precise handling also implies that all instructions that precede the instruction whose address is reported to the interrupt handling routine have executed and that no subsequent instruction has begun execution. The specific instruction whose address is reported may not have begun execution or may have partially completed, as specified for each precise interrupt type.

Synchronous precise interrupts include most debug event interrupts, program interrupts, instruction and data storage interrupts, TLB miss interrupts, system call interrupts, and alignment interrupts.

Asynchronous precise interrupts include the critical and noncritical external interrupts, and can be caused by on-chip peripherals, timer facility interrupts, and some debug events.

In the PPC405GP, machine checks are handled as critical interrupts (see “Critical and Noncritical Interrupts” on page 10-249). If a machine check is associated with an instruction fetch, the critical interrupt save/restore register contains the address of the instruction being fetched when the machine check occurred.

The synchronism of instruction-side machine checks (errors that occur while attempting to fetch an instruction from external memory) requires further explanation. Fetch requests to cachable memory that miss in the instruction cache unit (ICU) cause an instruction cache line fill (eight words). If any instructions (words) in the fetched line are associated with an exception, an interrupt occurs upon attempted execution and the cache line is invalidated.

Preliminary User's Manual

It is improper to declare an exception when an erroneous word is passed to the fetcher; the address could be the result of an incorrect speculative access. It is quite likely that no attempt will be made to execute an instruction from the erroneous address. An instruction-side machine check interrupt occurs only when execution is attempted. If an exception occurs, execution is suppressed, SRR2 contains the erroneous address, and the indicates that an instruction-side machine check occurred. Although such an interrupt is clearly asynchronous to the erroneous memory access, it is handled synchronously with respect to the attempted execution from the erroneous address.

Except for machine checks, all PPC405GP interrupts are handled precisely:

- The address of the excepting instruction (for synchronous exceptions, other than the system call exception) or the address of the next sequential instruction (for asynchronous exceptions and the system call exception) is passed to the interrupt handling routine.
- All instructions that precede the instruction whose address is reported to the interrupt handling routine have completed execution and that no subsequent instruction has begun execution. The specific instruction whose address is reported might not have begun execution or might have partially completed, as specified for each interrupt type.

10.9 Interrupt Handling Priorities

The PPC405GP processor core handles only one interrupt at a time. Multiple simultaneous interrupts are handled in the priority order shown in Table 10-3 (assuming, of course, that the interrupt types are enabled).

Multiple interrupts can exist simultaneously, each of which requires the generation of an interrupt. The architecture does not provide for simultaneously reporting more than one interrupt of the same class (critical or non-critical). Therefore, interrupts are ordered with respect to each other. A masking mechanism is available for certain persistent interrupt types.

When an interrupt type is masked, and an event causes an exception which would normally generate an interrupt of that type, the exception *persists* as a *status* bit in a register. However, no interrupt is generated. Later, if the interrupt type is enabled (unmasked), and the exception status has not been cleared by software, the interrupt due to the original exception event is finally generated.

All asynchronous interrupt types can be masked. In addition, certain synchronous interrupt types can be masked.

Table 10-3. Interrupt Handling Priorities

Priority	Interrupt Type	Critical or Noncritical	Causing Conditions
1	Machine check—data	Critical	External bus error during data-side access
2	Debug—IAC	Critical	IAC debug event (in internal debug mode)
3	Machine check— instruction	Critical	Attempted execution of instruction for which an external bus error occurred during fetch
4	Debug—EXC, UDE	Critical	EXC or UDE debug event (in internal debug mode)
5	Critical interrupt input	Critical	Active level on the critical interrupt input
6	Watchdog timer—first time-out	Critical	Posting of an enabled first time-out of the watchdog timer in the TSR
7	Instruction TLB Miss	Noncritical	Attempted execution of an instruction at an address and process ID for which a valid matching entry was not found in the TLB

Table 10-3. Interrupt Handling Priorities (continued)

Priority	Interrupt Type	Critical or Noncritical	Causing Conditions
8	Instruction storage — ZPR[Zn] = 00	Noncritical	Instruction translation is active, execution access to the translated address is not permitted because ZPR[Zn] = 00 in user mode, and an attempt is made to execute the instruction
9	Instruction storage — TLB_entry[EX] = 0	Noncritical	Instruction translation is active, execution access to the translated address is not permitted because TLB_entry[EX] = 0, and an attempt is made to execute the instruction
	Instruction storage — TLB_entry[G] = 1 or SGR[Gn] = 1	Noncritical	Instruction translation is active, the page is marked guarded, and an attempt is made to execute the instruction
10	Program	Noncritical	Attempted execution of illegal instructions, TRAP instruction, privileged instruction in problem state
	System call	Noncritical	Execution of the sc instruction
11	Data TLB miss	Noncritical	Valid matching entry for the effective address and process ID of an attempted data access is not found in the TLB
12	Data storage— ZPR[Zn] = 00	Noncritical	Data translation is active and data-side access to the translated address is not permitted because ZPR[Zn] = 00 in user mode
13	Data storage— TLB_entry[WR] = 0	Noncritical	Data translation is active and write access to the translated address is not permitted because TLB_entry[WR] = 0
	Data storage— TLB_entry[U0] = 1 or SU0R[U _n] = 1	Noncritical	Data translation is active and write access to the translated address is not permitted because TLB_entry[U0] = 1 or SU0R[U _n] = 1
14	Alignment	Noncritical	dcbz to non-cachable address or write-through storage; non-word aligned dcread , lwarx , and stwcx , as described in Table 10-12
15	Debug—BT, DAC, DVC, IC, TIE	Critical	BT, DAC, DVC, IC, TIE debug event (in internal debug mode)
16	External interrupt input	Noncritical	Interrupts from the external interrupt (external to the processor core) input
17	Fixed Interval Timer (FIT)	Noncritical	Posting of an enabled FIT interrupt in the TSR
18	Programmable Interval Timer (PIT)	Noncritical	Posting of an enabled PIT interrupt in the TSR

Preliminary User's Manual

10.10 Critical and Noncritical Interrupts

The PPC405GP processes interrupts as noncritical and critical. The following interrupts are defined as *noncritical*: data storage, instruction storage, an active external interrupt input, alignment, program, system call, programmable interval timer (PIT), fixed interval timer (FIT), data TLB miss, and instruction TLB miss. The following interrupts are defined as *critical*: machine check interrupts (instruction- and data-side), debug interrupts, interrupts caused by an active critical interrupt input, and the first time-out from the watchdog timer.

When a *noncritical* interrupt is taken, Save/Restore Register 0 (SRR0) is written with the address of the excepting instruction (most synchronous interrupts) or the next sequential instruction to be processed (asynchronous interrupts and system call).

If the PPC405GP was executing a multicycle instruction (multiply, divide, or cache operation), the instruction is terminated and its address is written in SRR0.

Aligned scalar loads/stores that are interrupted do not appear on the PLB. An aligned scalar load/store cannot be interrupted after it is requested on the PLB, so the Guarded (G) storage attribute does not need to prevent the interruption of an aligned scalar load/store.

To enhance performance, the DCU can respond to non-cachable load requests by retrieving a line instead of a word. This is controlled by CCR0[LWL]. Note, however, that if CCR0[LWL] = 1, and the target non-cachable region is also marked as guarded (the G storage attribute is set to 1), that the DCU will request on the PLB only those bytes requested by the CPU.

Load/store multiples, load/store string, and misaligned scalar loads/stores that cross a word boundary can be interrupted and restarted upon return from the interrupt handler.

When load instructions terminate, the addressing registers are not updated. This ensures that the instructions can be restarted; if the addressing registers were in the range of registers to be loaded, this would be an invalid form in any event. Some target registers of a load instruction may have been written by the time of the interrupt; when the instruction restarts, the registers will simply be written again. Similarly, some of the target memory of a store instruction may have been written, and is written again when the instruction restarts.

Save/Restore Register 1 (SRR1) is written with the contents of the MSR; the MSR is then updated to reflect the new machine context. The new MSR contents take effect beginning with the first instruction of the interrupt handling routine.

Interrupt handling routine instructions are fetched at an address determined by the interrupt type. The address of the interrupt handling routine is formed by concatenating the 16 high-order bits of the EVPR and the interrupt vector offset. (A user must initialize the EVPR contents at power-up using an **mtspr** instruction.)

Table 10-4 shows the interrupt vector offsets for the interrupt types. Note that there can be multiple sources of the same interrupt type; interrupts of the same type are mapped to the same interrupt vector, regardless of source. In such cases, the interrupt handling routine must examine status registers to determine the exact source of the interrupt.

At the end of the interrupt handling routine, execution of an **rfi** instruction forces the contents of SRR0 and SRR1 to be written to the program counter and the MSR, respectively. Execution then begins at the address in the program counter.

Critical interrupts are processed similarly. When a critical interrupt is taken, Save/Restore Register 2 (SRR2) and Save/Restore Register 3 (SRR3) hold the next sequential address to be processed when returning from the interrupt, and the contents of the MSR, respectively. At the end of the critical interrupt handling routine, execution of an **rftci** instruction writes the contents of SRR2 and SRR3 into the program counter and the MSR, respectively.

Table 10-4. Interrupt Vector Offsets

Offset	Interrupt Type	Interrupt Class	Category	Page
0x0100	Critical input interrupt	Asynchronous precise	Critical	10-257
0x0200	Machine check—data	—	Critical	10-258
	Machine check—instruction	—	Critical	10-258
0x0300	Data storage interrupt— MSR[DR]=1 and ZPR[Zn] = 0 or TLB_entry[WR] = 0 or TLB_entry[U0] = 1 or SUOR[Un] = 1	Synchronous precise	Noncritical	10-259
0x0400	Instruction storage interrupt	Synchronous precise	Noncritical	10-261
0x0500	External interrupt (external to the processor core)	Asynchronous precise	Noncritical	10-262
0x0600	Alignment	Synchronous precise	Noncritical	10-263
0x0700	Program	Synchronous precise	Noncritical	10-264
0x0C00	System Call	Synchronous precise	Noncritical	10-265
0x1000	PIT	Asynchronous precise	Noncritical	10-265
0x1010	FIT	Asynchronous precise	Noncritical	10-266
0x1020	Watchdog timer	Asynchronous precise	Critical	10-266
0x1100	Data TLB miss	Synchronous precise	Noncritical	10-267
0x1200	Instruction TLB miss	Synchronous precise	Noncritical	10-268
0x2000	Debug—BT, DAC, DVC, IAC, IC, TIE	Synchronous precise	Critical	10-268
	Debug—EXC, UDE	Asynchronous precise	Critical	

Preliminary User's Manual**10.11 General Interrupt Handling Registers**

The general interrupt handling registers are the Machine State Register (MSR), SRR0–SRR3, the Exception Vector Prefix Register (EVPR), the Exception Syndrome Register (ESR), and the Data Exception Address Register (DEAR).

10.11.1 Machine State Register (MSR)

The MSR is a 32-bit register that holds the current context of the PPC405GP. When a noncritical interrupt is taken, the MSR contents are written to SRR1; when a critical interrupt is taken, the MSR contents are written to SRR3. When an **rfi** or **rfdi** instruction executes, the contents of the MSR are read from SRR1 or SRR3, respectively.

Programming Note: The **rfi** and **rfdi** instructions can alter reserved MSR fields.

The MSR contents can be read into a general purpose register (GPRs) using an **mfmsr** instruction. The contents of a GPR can be written to the MSR using an **mtmsr** instruction. The MSR[EE] bit may be set/cleared atomically using the **wrtee** or **wrteei** instructions.

Figure 10-11 shows the MSR bit definitions and describes the function of each bit.

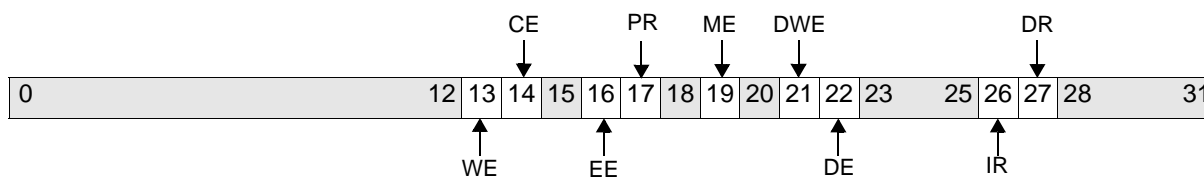

Figure 10-11. Machine State Register (MSR)

0:12		Reserved	
13	WE	Wait State Enable 0 The processor is not in the wait state. 1 The processor is in the wait state.	If MSR[WE] = 1, the processor remains in the wait state until an interrupt is taken, a reset occurs, or an external debug tool clears WE.
14	CE	Critical Interrupt Enable 0 Critical interrupts are disabled. 1 Critical interrupts are enabled.	Controls the critical interrupt input and watchdog timer first time-out interrupts.
15		Reserved	
16	EE	External Interrupt Enable 0 Asynchronous interrupts (external to the processor core) are disabled. 1 Asynchronous interrupts are enabled.	Controls the non-critical external interrupt input, PIT, and FIT interrupts.
17	PR	Problem State 0 Supervisor state (all instructions allowed). 1 Problem state (some instructions not allowed).	
18		Reserved	

19	ME	Machine Check Enable 0 Machine check interrupts are disabled. 1 Machine check interrupts are enabled.
20		Reserved
21	DWE	Debug Wait Enable 0 Debug wait mode is disabled. 1 Debug wait mode is enabled.
22	DE	Debug Interrupts Enable 0 Debug interrupts are disabled. 1 Debug interrupts are enabled.
23:25		Reserved
26	IR	Instruction Relocate 0 Instruction address translation is disabled. 1 Instruction address translation is enabled.
27	DR	Data Relocate 0 Data address translation is disabled. 1 Data address translation is enabled.
28:31		Reserved

10.11.2 Save/Restore Registers 0 and 1 (SRR0–SRR1)

SRR0 and SRR1 are 32-bit registers that hold the interrupted machine context when a noncritical interrupt is processed. On interrupt, SRR0 is set to the current or next instruction address and the contents of the MSR are written to SRR1. When an *rfi* instruction is executed at the end of the interrupt handler, the program counter and the MSR are restored from SRR0 and SRR1, respectively.

The contents of SRR0 and SRR1 can be written into GPRs using the *mf spr* instruction. The contents of GPRs can be written to SRR0 and SRR1 using the *mt spr* instruction.

Figure 10-12 shows the bit definitions for SRR0.

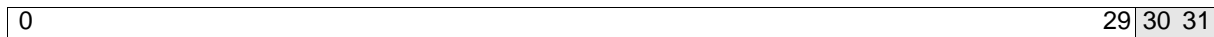

Figure 10-12. Save/Restore Register 0 (SRR0)

0:29		SRR0 receives an instruction address when a non-critical interrupt is taken; the Program Counter is restored from SRR0 when <i>rfi</i> executes.
30:31		Reserved

Preliminary User's Manual

Figure 10-13 shows the bit definitions for SRR1.

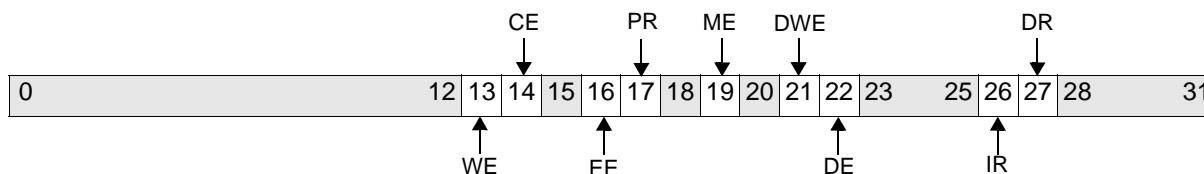

Figure 10-13. Save/Restore Register 1 (SRR1)

0:31	SRR1 receives a copy of the MSR when an interrupt is taken; the MSR is restored from SRR1 when rfi executes.
------	---

10.11.3 Save/Restore Registers 2 and 3 (SRR2–SRR3)

SRR2 and SRR3 are 32-bit registers that hold the interrupted machine context when a critical interrupt is processed. On interrupt, SRR2 is set to the current or next instruction address and the contents of the MSR are written to SRR3. When an **rfti** instruction is executed at the end of the interrupt handler, the program counter and the MSR are restored from SRR2 and SRR3, respectively.

The contents of SRR2 and SRR3 can be written to GPRs using the **mfspr** instruction. The contents of GPRs can be written to SRR2 and SRR3 using the **mtspr** instruction.

Figure 10-14 shows the bit definitions for SRR2.

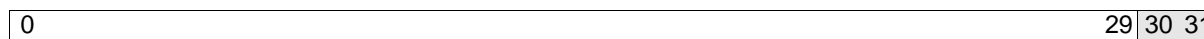

Figure 10-14. Save/Restore Register 2 (SRR2)

0:29	SRR2 receives an instruction address when a critical interrupt is taken; the Program Counter is restored from SRR2 when rfti executes.
30:31	Reserved

Figure 10-15 shows the bit definitions for SRR3.

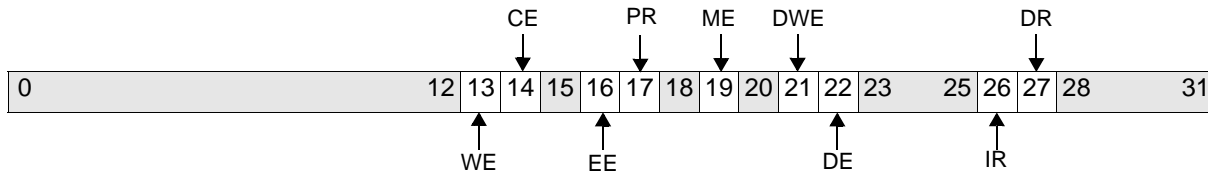

Figure 10-15. Save/Restore Register 3 (SRR3)

0:31	SRR3 receives a copy of the MSR when a critical interrupt is taken; the MSR is restored from SRR3 when <code>rfci</code> executes.
------	--

Because critical interrupts do not automatically clear MSR[ME], SRR2 and SRR3 can be corrupted by a machine check interrupt, if the machine check occurs while SRR2 and SRR3 contain valid data that has not yet been saved by the critical interrupt handler.

10.11.4 Exception Vector Prefix Register (EVPR)

The EVPR is a 32-bit register whose high-order 16 bits contain the prefix for the address of an interrupt handling routine. The 16-bit interrupt vector offsets (shown in Table 10-4, “Interrupt Vector Offsets,” on page 10-250) are concatenated to the right of the high-order 16 bits of the EVPR to form the 32-bit address of an interrupt handling routine.

The contents of the EVPR can be written to a GPR using the `mfspr` instruction. The contents of a GPR can be written to EVPR using the `mtspr` instruction.

Figure 10-16 shows the EVPR bit definitions.

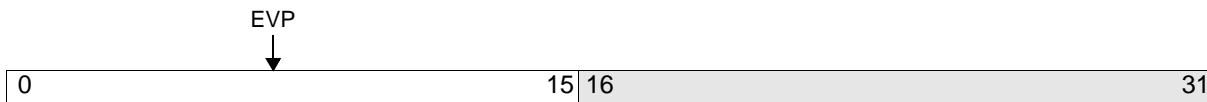

Figure 10-16. Exception Vector Prefix Register (EVPR)

0:15	EVP	Exception Vector Prefix
16:31		Reserved

Preliminary User's Manual

10.11.5 Exception Syndrome Register (ESR)

The ESR is a 32-bit register whose bits help to specify the exact cause of various synchronous interrupts. These interrupts include instruction side machine checks, data storage interrupts, and program interrupts, instruction storage interrupts, and data TLB miss interrupts.

“Instruction Machine Check Handling” on page 10-258 describes instruction machine checks. “Data Storage Interrupt” on page 10-259 describes data storage interrupts. “Program Interrupt” on page 10-264 describes program interrupts.

Although interrupt handling routines are not required to reset the ESR, it is recommended that instruction machine check handlers reset the ESR; “Instruction Machine Check Handling” on page 10-258 describes why such resets are recommended.

The contents of the ESR can be written to a GPR using the **mf spr** instruction. The contents of a GPR can be written to the ESR using the **mt spr** instruction.

Figure 10-17 shows the ESR bit definitions.

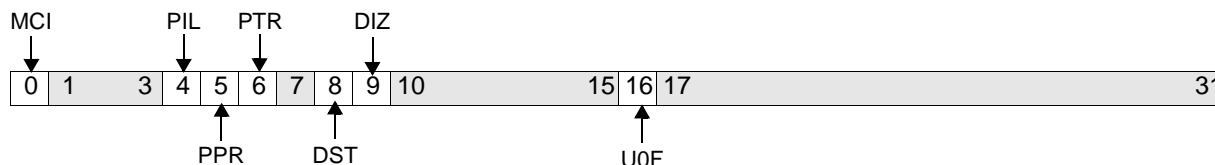

Figure 10-17. Exception Syndrome Register (ESR)

0	MCI	Machine check—instruction 0 Instruction machine check did not occur. 1 Instruction machine check occurred.
1:3		Reserved
4	PIL	Program interrupt—illegal 0 Illegal Instruction error did not occur. 1 Illegal Instruction error occurred.
5	PPR	Program interrupt—privileged 0 Privileged instruction error did not occur. 1 Privileged instruction error occurred.
6	PTR	Program interrupt—trap 0 Trap with successful compare did not occur. 1 Trap with successful compare occurred.
7		Reserved
8	DST	Data storage interrupt—store fault 0 Excepting instruction was not a store. 1 Excepting instruction was a store (includes dcbi , dcbz , and dccci).
9	DIZ	Data/instruction storage interrupt—zone fault 0 Excepting condition was not a zone fault. 1 Excepting condition was a zone fault.
10:15		Reserved

16	U0F	Data storage interrupt—U0 fault 0 Excepting instruction did not cause a U0 fault. 1 Excepting instruction did cause a U0 fault.
17:31		Reserved

In general, ESR bits are set to indicate the type of precise interrupt that occurred; other bits are cleared. However, the machine check—instruction (ESR[MCI]) bit behaves differently. Because instruction-side machine checks can occur without an interrupt being taken (if MSR[ME] = 0), ESR[MCI] can be set even while other ESR-setting interrupts (program, data storage, DTLB-miss) occurring. Thus, data storage and program interrupts leave ESR[MCI] unchanged, clear all other ESR bits, and set the bits associated with any data storage or program interrupts that occurred. Enabled instruction-side machine checks (MSR[ME] = 1) set ESR[MCI] and clear the data storage and program interrupt bits.

If a machine check—instruction interrupt occurs but is disabled (MSR[ME] = 0), it sets but leaves the data storage and program interrupt bits alone. If a machine check—instruction interrupt occurs while MSR[ME] = 0, and the instruction upon which the machine check—instruction interrupt is occurring also is some other kind of ESR-setting instruction (program, data storage, DTLB-miss, or instruction storage interrupt), ESR[MCI] is set to indicate that a machine check—instruction interrupt occurred; the other ESR bits are set or cleared to indicate the other interrupt. These scenarios are summarized in Table 10-5

Table 10-5. ESR Alteration by Various Interrupts

Scenario	ECR[MCI]	ESR _{4:}	ESR _{8:9, 16}
Program interrupt	Unchanged	Set to type	Cleared
Data storage interrupt	Unchanged	Cleared	Set to Type
Data TLB miss interrupt	Unchanged	Cleared	Cleared
Machine check—instruction	Set to 1	Cleared	Cleared
Disabled MCI, no others	Unchanged	Unchanged	Unchanged
Disabled MCI and program interrupt	Unchanged	Set to type	Cleared

Preliminary User's Manual**10.11.6 Data Exception Address Register (DEAR)**

The DEAR is a 32-bit register that contains the address of the access for which one of the following synchronous precise errors occurred: alignment error, data TLB miss, or data storage interrupt.

The contents of the DEAR can be written to a GPR using the **mf spr** instruction. The contents of a GPR can be written to the DEAR using the **mt spr** instruction.

Figure 10-18 shows the DEAR bit definitions.

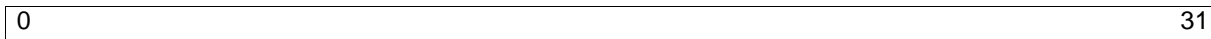

Figure 10-18. Data Exception Address Register (DEAR)

0:31	Address of Data Error (synchronous)
------	-------------------------------------

10.12 Critical Input Interrupts

The UICCR can be programmed so that any UIC interrupt can be presented as a critical interrupt input to the processor core. See “UIC Critical Register (UIC0_CR)” on page 10-229 for details. Critical interrupts are recognized only if enabled by MSR[CE].

MSR[CE] also enables the watchdog timer first-time-out interrupt. However, the watchdog interrupt has a different interrupt vector than the critical pin interrupt. See “Watchdog Timer Interrupt” on page 10-266.

After detecting a critical interrupt, if no synchronous precise interrupts are outstanding, the PPC405GP immediately takes the critical interrupt and writes the address of the next instruction to be executed in SRR2. Simultaneously, the contents of the MSR are saved in SRR3. MSR[CE] is reset to 0 to prevent another critical interrupt or the watchdog timer first time-out interrupt from interrupting the critical interrupt handler before SRR2 and SRR3 get saved. MSR[DE] is reset to 0 to disable debug interrupts during the critical interrupt handler.

The MSR is also written with the values shown in Table 10-6, “Register Settings during Critical Input Interrupts,” on page 10-258. The high-order 16 bits of the program counter are then loaded with the contents of the EVPR and the low-order 16 bits of the program counter are loaded with 0x0100. Interrupt processing begins at the address in the program counter.

Inside the interrupt handling routine, after the contents of SRR2/SRR3 are saved, critical interrupts can be enabled again by setting MSR[CE] = 1.

Executing an **rfci** instruction restores the program counter from SRR2 and the MSR from SRR3, and execution resumes at the address in the program counter.

Table 10-6. Register Settings during Critical Input Interrupts

SRR2	Written with the address of the next instruction to be executed
SRR3	Written with the contents of the MSR
MSR	WE, CE, EE, PR, DWE, DE, IR, DR←0 ME← unchanged
PC	EVPR[0:15] 0x0100

10.13 Machine Check Interrupts

When an external bus error occurs on an instruction fetch, and execution of that instruction is subsequently attempted, a machine check—instruction interrupt occurs.

When an external bus error occurs while attempting data accesses, a machine check—data interrupt occurs.

When an instruction-side machine check interrupt occurs, the PPC405GP stores the address of the excepting instruction in SRR2. When a data-side machine check occurs, the PPC405GP stores the address of the next sequential instruction in SRR2. Simultaneously, for all machine check interrupts, the contents of the MSR are loaded into SRR3.

The MSR Machine Check Enable bit (MSR[ME]) is reset to 0 to disable another machine check from interrupting the machine check interrupt handling routine. The other MSR bits are loaded with the values shown in Table 10-7, “Register Settings during Machine Check—Instruction Interrupts,” on page 10-259 and Table 10-8, “Register Settings during Machine Check—Data Interrupts,” on page 10-259. The high-order 16 bits of the program counter are then written with the contents of the EVPR and the low-order 16 bits of the program counter are written with 0x0200. Interrupt processing begins at the new address in the program counter.

Executing an **rfci** instruction restores the program counter from SRR2 and the MSR from SRR3, and execution resumes at the address in the program counter.

10.13.1 Instruction Machine Check Handling

When a machine check occurs on an instruction fetch, *and execution of that instruction is subsequently attempted*, a machine check—instruction interrupt occurs. If enabled by MSR[ME], the processor reports the machine check—instruction interrupt by vectoring to the machine check handler (EVPR[0:15] || 0x0200), setting. Note that only a bus error can cause a machine check—instruction interrupt. Taking the vector automatically clears MSR[ME] and the other MSR fields.

Note that it is improper to declare a machine check—instruction interrupt when the instruction is fetched, because the address is possibly the result of an incorrect speculation by the fetcher. It is quite likely that no attempt will be made to execute an instruction from the erroneous address. The interrupt will occur only if execution of the instruction is subsequently attempted.

When a machine check occurs on an instruction fetch, the erroneous instruction is never validated in the instruction cache unit (ICU). Fetch requests to cachable memory that miss in the ICU cause an instruction cache line fill (eight words). If any words in the fetched line are associated with an error, an interrupt occurs upon attempted execution and the cache line is invalidated. If any word in the line is in error, the cache line is invalidated after the line fill.

Preliminary User's Manual

is set, even if MSR[ME] = 0. This means that if a machine check—instruction interrupt occurs while running in code in which MSR[ME] is disabled, the machine check—instruction interrupt is recorded in the , but no interrupt occurs. Software running with MSR[ME] disabled can sample to determine whether at least one machine check—instruction interrupt occurred during the disabled execution.

If a new machine check—instruction interrupt occurs after MSR[ME] is enabled again, the new machine check—instruction interrupt is recorded in , and the machine check—instruction interrupt handler is invoked. However, enabling MSR[ME] again does *not* cause a machine Check interrupt to occur simply due to the presence of indicating that a machine check—instruction interrupt occurred while MSR[ME] was disabled. The machine check—instruction interrupt must occur while MSR[ME] is enabled for the machine check interrupt to be taken. Software should, in general, clear the bits before returning from a machine check interrupt to avoid any ambiguity when handling subsequent machine check interrupts.

Table 10-7. Register Settings during Machine Check—Instruction Interrupts

SRR2	Written with the address that caused the machine check.
SRR3	Written with the contents of the MSR
MSR	WE, CE, EE, PR, ME, DWE, DE, IR, DR ← 0
PC	EVPR[0:15] 0x0200
ESR	MCI ← 1 All other bits are cleared.

10.13.2 Data Machine Check Handling

When a machine check occurs on an data access, a machine check—data interrupt occurs. To determine the cause of a machine check, examine the various error reporting registers of the external PLB slaves.

Table 10-8. Register Settings during Machine Check—Data Interrupts

SRR2	Written with the address of the next sequential instruction.
SRR3	Written with the contents of the MSR
MSR	WE, CE, EE, PR, ME, DWE, DE, IR, DR ← 0
PC	EVPR[0:15] 0x0200

10.14 Data Storage Interrupt

The data storage interrupt occurs when the desired access to the effective address is not permitted for any of the following reasons:

- A U0 fault: any store to an EA with the U0 storage attribute set and CCR0[U0XE] = 1
- In the problem state with data translation enabled:
 - A *zone fault*, which is any user-mode storage access (data load, store, **icbi**, **dcbz**, **dcbst**, or **dcbf**) with an effective address with (ZPR field) = 00. (**dcbt** and **dcbtst** will no-op in this situation, rather than cause an interrupt. The instructions **dcbi**, **dccci**, **icbt**, and **iccci**, being privileged, cannot cause zone fault data storage interrupts.)
 - Data store or **dcbz** to an effective address with the WR bit clear and (ZPR field) ≠ 11. (The privileged instructions **dcbi** and **dccci** are treated as “stores,” but will cause privileged program interrupts, rather than data storage interrupts.)
- In the supervisor state with data translation enabled:

- Data store, **dcbi**, **dcbz**, or **dccci** to an effective address with the WR bit clear and (ZPR field) other than 11 or 10.

Programming Note: The **icbi**, **icbt**, and **iccci** instructions are treated as loads from the addressed byte with respect to address translation and protection. Instruction cache operations use MSR[DR], not MSR[IR], to determine translation of their operands. Instruction storage interrupts and Instruction-side TLB Miss Interrupts are associated with the *fetching* of instructions, not with the execution of instructions. Data storage interrupts and data TLB miss interrupts are associated with the *execution* of instruction cache operations.

When a data storage interrupt is detected, the PPC405GP suppresses the instruction causing the interrupt and writes the instruction address in SRR0. The Data Exception Address Register (DEAR) is loaded with the data address that caused the access violation. ESR bits are loaded as shown in Table 10-9, “Register Settings during Data Storage Interrupts,” on page 10-260 to provide further information about the error. The current contents of the MSR are loaded into SRR1, and MSR bits are then loaded with the values shown in Table 10-9.

The high-order 16 bits of the program counter are then loaded with the contents of the EVPR and the low-order 16 bits of the program counter are loaded with 0x0300. Interrupt processing begins at the new address in the program counter. Executing the return from interrupt instruction (**rfi**) restores the contents of the program counter and the MSR from SRR0 and SRR1, respectively, and the PPC405GP resumes execution at the new program counter address.

For instructions that can simultaneously generate program interrupts (privileged instructions executed in Problem State) and data storage interrupts, the program interrupt has priority.

Table 10-9. Register Settings during Data Storage Interrupts

SRR0	Written with the EA of the instruction causing the data storage interrupt
SRR1	Written with the value of the MSR at the time of the interrupt
MSR	WE, EE, PR, DWE, IR, DR ← 0 CE, ME, DE ← unchanged
PC	EVPR[0:15] 0x0300
DEAR	Written with the EA of the failed access
ESR	DST ← 1 if excepting operation is a store DIZ ← 1 if access failure caused by a zone protection fault (ZPR[Zn] = 00 in user mode) U0F ← 1 if access failure caused by a U0 fault (the U0 storage attribute is set and CCR0[U0XE] = 1) MCI ← unchanged All other bits are cleared.

Preliminary User's Manual**10.15 Instruction Storage Interrupt**

The instruction storage interrupt is generated when instruction translation is active and execution is attempted for an instruction whose fetch access to the effective address is not permitted for any of the following reasons:

- In Problem State:
 - Instruction fetch from an effective address with (ZPR field) = 00.
 - Instruction fetch from an effective address with the EX bit clear and (ZPR field) \neq 11.
 - Instruction fetch from an effective address contained within a Guarded region (G=1).
- In Supervisor State:
 - Instruction fetch from an effective address with the EX bit clear and (ZPR field) other than 11 or 10.
 - Instruction fetch from an effective address contained within a Guarded region (G=1).

SRR0 will save the address of the instruction causing the instruction storage interrupt.

ESR is set to indicate the following conditions:

- If ESR[DIZ] = 1, the excepting condition was a zone fault: the attempted execution of an instruction address fetched in user-mode with (ZPR field) = 00.
- If ESR[DIZ] = 0, then the excepting condition was either EX = 0 or G = 1.

The interrupt is precise with respect to the attempted execution of the instruction. Program flow vectors to EVPR[0:15] || 0x0400.

The following registers are modified to the specified values:

Table 10-10. Register Settings during Instruction Storage Interrupts

SRR0	Set to the EA of the instruction for which execute access was not permitted
SRR1	Set to the value of the MSR at the time of the interrupt
MSR	WE, EE, PR, DWE, IR, DR \leftarrow 0 CE, ME, DE \leftarrow unchanged
PC	EVPR[0:15] 0x0400
ESR	DIZ \leftarrow 1If access failure due to a zone protection fault (ZPR[Zn] = 00 in user mode) Note: If ESR[DIZ] is not set, the interrupt occurred because TBL_entry[EX] was clear in an otherwise accessible zone, or because of an instruction fetch from a storage region marked as guarded. See "Exception Syndrome Register (ESR)" on page 10-255 for details of ESR operation. MCI \leftarrow unchanged All other bits are cleared.

10.16 External Interrupt

External interrupts (external to the processor core) are triggered by active levels non-critical interrupts in the UIC. All external interrupting events are presented to the processor as a single external interrupt. External interrupts are enabled or disabled by MSR[EE].

Programming Note: MSR[EE] also enables PIT and FIT interrupts. However, after timer interrupts, control passes to different interrupt vectors than for the interrupts discussed in the preceding paragraph. Therefore, these timer interrupts are described in “Programmable Interval Timer (PIT) Interrupt” on page 10-265 and “Fixed Interval Timer (FIT) Interrupt” on page 10-266.

10.16.1 External Interrupt Handling

When MSR[EE] = 1 (external interrupts are enabled), a noncritical external interrupt occurs, and this interrupt is the highest priority interrupt condition, the processor immediately writes the address of the next sequential instruction into SRR0. Simultaneously, the contents of the MSR are saved in SRR1.

When the processor takes a noncritical external interrupt, MSR[EE] is set to 0. This disables other external interrupts from interrupting the interrupt handler before SRR0 and SRR1 are saved. The MSR is also written with the other values shown in Table 10-11, “Register Settings during External Interrupts,” on page 10-262. The high-order 16 bits of the program counter are written with the contents of the EVPR and the low-order 16 bits of the program counter are written with 0x0500. Interrupt processing begins at the address in the program counter.

Executing an **rfi** instruction restores the program counter from SRR0 and the MSR from SRR1, and execution resumes at the address in the program counter.

Table 10-11. Register Settings during External Interrupts

SRR0	Written with the address of the next sequential instruction
SRR1	Written with the contents of the MSR
MSR	WE, EE, PR, DWE, IR, DR ← 0 CE, ME, DE ← unchanged
PC	EVPR[0:15] 0x0500

Preliminary User's Manual**10.17 Alignment Interrupt**

Alignment interrupts are caused by **dcbz** instructions to non-cachable or write-through storage and misaligned **dcread**, **lwarx**, or **stwx**. instructions. Table 10-12 summarizes the instructions and conditions causing alignment interrupts.

Table 10-12. Alignment Interrupt Summary

Instructions Causing Alignment Interrupts	Conditions
dcbz	EA in non-cachable or write-through storage
dcread, lwarx, stwxc.	EA not word-aligned

Execution of an instruction causing an alignment interrupt is prohibited from completing. SRR0 is written with the address of that instruction and the current contents of the MSR are saved into SRR1. The DEAR is written with the address that caused the alignment error. The MSR bits are written with the values shown in Table 10-13, "Register Settings during Alignment Interrupts," on page 10-263. The high-order 16 bits of the program counter are written with the contents of the EVPR and the low-order 16 bits of the program counter are written with 0x0600. Interrupt processing begins at the new address in the program counter.

Executing an **rfi** instruction restores the program counter from SRR0 and the MSR from SRR1, and execution resumes at the address in the program counter

Alignment interrupts cannot be disabled. To avoid overwrites of SRR0 and SRR1 by alignment interrupts that occur within a handler, interrupt handlers should save these registers as soon as possible.

Table 10-13. Register Settings during Alignment Interrupts

SRR0	Written with the address of the instruction causing the alignment interrupt
SRR1	Written with the contents of the MSR
MSR	WE, EE, PR, DWE, IR, DR ← 0 CE, ME, DE ← unchanged
PC	EVPR[0:15] 0x0600
DEAR	Written with the address that caused the alignment violation

10.18 Program Interrupt

Program interrupts are caused by attempting to execute:

- An illegal instruction
- A privileged instruction while in the problem state
- Executing a trap instruction with conditions satisfied

The ESR bits that differentiate these situations are listed and described in Table 10-14. When a program interrupt occurs, the appropriate bit is set and the others are cleared. These interrupts are not maskable.

Table 10-14. ESR Usage for Program Interrupts

Bits	Interrupts	Cause
ESR[PIL]	Illegal instruction	Opcode not recognized
ESR[PPR]	Privileged instruction	Attempt to use a privileged instruction in the problem state
ESR[PTR]	Trap	Excepting instruction is a trap

The program interrupt handler does not need to reset the ESR.

When one of the following occurs, the PPC405GP does not execute the instruction, but writes the address of the excepting instruction into SRR0:

- Attempted execution of a privileged instruction in problem state
- Attempted execution of an illegal instruction (including memory management instructions when memory management is disabled)

Trap instructions can be used as a program interrupt or a debug event, or both (see “Debug Events” on page 12-294 for information about debug events). When a trap instruction is detected as a program interrupt, the PPC405GP writes the address of the trap instruction into SRR0. See **tw** on page -830 and **twi** on page -833 (both in Chapter 24, “Instruction Set”) for a detailed discussion of the behavior of trap instructions with various interrupts enabled.

After any program interrupt, the contents of the MSR or MSR[APA] = 0, an attempt to execute an instruction intended for an APU causes a program interrupt if MSR[APE] = 0e written into SRR1 and the MSR bits are written with the values shown in Table 10-15. The high-order 16 bits of the program counter are written with the contents of the EVPR; the low-order 16 bits of the program counter are written with 0x0700. Interrupt processing begins at the new address in the program counter.

Executing an **rfi** instruction restores the program counter from SRR0 and the MSR from SRR1, and execution resumes at the address in the program counter.

Table 10-15. Register Settings during Program Interrupts

SRR0	Written with the address of the excepting instruction
SRR1	Written with the contents of the MSR
MSR	WE, EE, PR, DWE, IR, DR ← 0 CE, ME, DE ← unchanged
PC	EVPR[0:15] 0x0700
ESR	Written with the type of program interrupt. (See Table 10-14) MCI ← unchanged All other bits are cleared.

Preliminary User's Manual**10.19 System Call Interrupt**

System call interrupts occur when a **sc** instruction is executed. The PPC405GP writes the address of the instruction following the **sc** into SRR0. The contents of the MSR are written into SRR1 and the MSR bits are written with the values shown in Table 10-16. The high-order 16 bits of the program counter are then written with the contents of the EVPR and the low-order 16 bits of the program counter are written with 0x0C00. Interrupt processing begins at the new address in the program counter.

Executing an **rfi** instruction restores the program counter from SRR0 and the MSR from SRR1, and execution resumes at the address in the program counter.

Table 10-16. Register Settings during System Call Interrupts

SRR0	Written with the address of the instruction following the sc instruction
SRR1	Written with the contents of the MSR
MSR	WE, EE, PR, DWE, IR, DR ← 0 CE, ME, DE ← unchanged
PC	EVPR[0:15] 0x0C00

10.20 Programmable Interval Timer (PIT) Interrupt

For a discussion of the PPC405GP timer facilities, see Chapter 11, “Timer Facilities.” The PIT is described in “Programmable Interval Timer (PIT)” on page 11-274.

If the PIT interrupt is enabled by TCR[PIE] and MSR[EE], the PPC405GP initiates a PIT interrupt after detecting a time-out from the PIT. Time-out is detected when, at the beginning of a clock cycle, TSR[PIS] = 1. (This occurs on the cycle after the PIT decrements on a PIT count of 1.) The PPC405GP immediately takes the interrupt. The address of the next sequential instruction is saved in SRR0; simultaneously, the contents of the MSR are written into SRR1 and the MSR is written with the values shown in Table 10-17. The high-order 16 bits of the program counter are then written with the contents of the EVPR and the low-order 16 bits of the program counter are written with 0x1000. Interrupt processing begins at the address in the program counter.

To clear a PIT interrupt, the interrupt handling routine must clear the PIT interrupt bit, TSR[PIS]. Clearing is performed by writing a word to TSR, using an **mtspr** instruction, that has 1 in bit positions to be cleared and 0 in all other bit positions. The data written to the TSR is not direct data, but a mask; a 1 clears the bit and 0 has no effect.

Executing an **rfi** instruction restores the program counter from SRR0 and the MSR from SRR1, and execution resumes at the address in the program counter.

Table 10-17. Register Settings during Programmable Interval Timer Interrupts

SRR0	Written with the address of the next instruction to be executed
SRR1	Written with the contents of the MSR
MSR	WE, EE, PR, DWE, IR, DR ← 0 CE, ME, DE ← unchanged
PC	EVPR[0:15] 0x1000
TSR	PIS ← 1

10.21 Fixed Interval Timer (FIT) Interrupt

For a discussion of the PPC405GP timer facilities, see Chapter 11, “Timer Facilities.” The FIT is described in “Fixed Interval Timer (FIT) Interrupt” on page 10-266.

If the FIT interrupt is enabled by TCR[FIE] and MSR[EE], the PPC405GP initiates a FIT interrupt after detecting a time-out from the FIT. Time-out is detected when, at the beginning of a clock cycle, TSR[FIS] = 1. (This occurs on the second cycle after the 0 → 1 transition of the appropriate time-base bit.) The PPC405GP immediately takes the interrupt. The address of the next sequential instruction is written into SRR0; simultaneously, the contents of the MSR are written into SRR1 and the MSR is written with the values shown in Table 10-18. The high-order 16 bits of the program counter are then written with the contents of the EVPR and the low-order 16 bits of the program counter are written with 0x1010. Interrupt processing begins at the address in the program counter.

To clear a FIT interrupt, the interrupt handling routine must clear the FIT interrupt bit, TSR[FIS]. Clearing is performed by writing a word to TSR, using an **mtspr** instruction, that has 1 in any bit positions to be cleared and 0 in all other bit positions. The data written to the TSR is not direct data, but a mask; a 1 clears a bit and 0 has no effect.

Executing an **rfi** instruction restores the program counter from SRR0 and the MSR from SRR1, and execution resumes at the address in the program counter.

Table 10-18. Register Settings during Fixed Interval Timer Interrupts

SRR0	Written with the address of the next sequential instruction
SRR1	Written with the contents of the MSR
MSR	WE, EE, PR, DWE, IR, DR ← 0 CE, ME, DE ← unchanged
PC	EVPR[0:15] 0x1010
TSR	FIS ← 1

10.22 Watchdog Timer Interrupt

For a general description of the PPC405GP timer facilities, see Chapter 11, “Timer Facilities.” The watchdog timer (WDT) is described in “Watchdog Timer” on page 11-276.

If the WDT interrupt is enabled by TCR[WIE] and MSR[CE], the PPC405GP initiates a WDT interrupt after detecting the first WDT time-out. First time-out is detected when, at the beginning of a clock cycle, TSR[WIS] = 1. (This occurs on the second cycle after the 0→1 transition of the appropriate time-base bit while TSR[ENW] = 1 and TSR[WIS] = 0.) The PPC405GP immediately takes the interrupt. The address of the next sequential instruction is saved in SRR2; simultaneously, the contents of the MSR are written into SRR3 and the MSR is written with the values shown in Table 10-19. The high-order 16 bits of the program counter are then written with the contents of the EVPR and the low-order 16 bits of the program counter are written with 0x1020. Interrupt processing begins at the address in the program counter.

To clear the WDT interrupt, the interrupt handling routine must clear the WDT interrupt bit TSR[WIS]. Clearing is done by writing a word to TSR (using **mtspr**), with a 1 in any bit position that is to be cleared and 0 in all other bit positions. The data written to the status register is not direct data, but a mask; a 1 causes the bit to be cleared, and a 0 has no effect.

Preliminary User's Manual

Executing the return from critical interrupt instruction (**rfci**) restores the contents of the program counter and the MSR from SRR2 and SRR3, respectively, and the PPC405GP resumes execution at the contents of the program counter.

Table 10-19. Register Settings during Watchdog Timer Interrupts

SRR2	Written with the address of the next sequential instruction
SRR3	Written with the contents of the MSR
MSR	WE, CE, EE, PR, DE, DWE, IR, DR ← 0 ME ← unchanged
PC	EVPR[0:15] 0x1020
TSR	WIS ← 1

10.23 Data TLB Miss Interrupt

The data TLB miss interrupt is generated if data translation is enabled and a valid TLB entry matching the EA and PID is not present. The address of the instruction generating the untranslatable effective data address is saved in SRR0. In addition, the hardware also saves the data address (that missed in the TLB) in the DEAR.

The ESR is set to indicate whether the excepting operation was a store (includes **dcbz**, **dcbi**, **dccci**).

The interrupt is precise. Program flow vectors to EVPR[0:15] || 0x1100.

The following registers are modified to the values specified in Table 10-20.

Table 10-20. Register Settings during Data TLB Miss Interrupts

SRR0	Set to the address of the instruction generating the effective address for which no valid translation exists.
SRR1	Set to the value of the MSR at the time of the interrupt
MSR	WE, EE, PR, DWE, R, DR ← 0 CE, ME, DE ← unchanged
PC	EVPR[0:15] 0x1100
DEAR	Set to the effective address of the failed access
ESR	DST ← 1 if excepting operation is a store operation (includes dcbi , dcbz , and dccci). MCI ← unchanged All other bits are cleared.

Programming Note: Data TLB miss interrupts can happen whenever data translation is enabled. Therefore, ensure that SRR0 and SRR1 are saved before enabling translation in an interrupt handler.

10.24 Instruction TLB Miss Interrupt

The instruction TLB miss interrupt is generated if instruction translation is enabled and execution is attempted for an instruction for which a valid TLB entry matching the EA and PID for the instruction fetch is not present. The instruction whose fetch caused the TLB miss is saved in SRR0.

The interrupt is precise with respect to the attempted execution of the instruction. Program flow vectors to EVPR[0:15 || 0x1200.

The following are modified to the values specified in Table 10-21.

Table 10-21. Register Settings during Instruction TLB Miss Interrupts

SRR0	Set to the address of the instruction for which no valid translation exists.
SRR1	Set to the value of the MSR at the time of the interrupt
MSR	WE, EE, PR, DWE, IR, DR ← 0 CE, ME, DE ← unchanged
PC	EVPR[0:15] 0x1200

Programming Note: Instruction TLB miss interrupts can happen whenever instruction translation is active. Therefore, insure that SRR0 and SRR1 are saved before enabling translation in an interrupt handler.

10.25 Debug Interrupt

Debug interrupts can be either *synchronous* or *asynchronous*. These debug events generate synchronous interrupts: branch taken (BT), data address compare (DAC), data value compare (DVC), instruction address compare (IAC), instruction completion (IC), and trap instruction (TIE). The exception (EXC) and unconditional (UDE) debug events generate asynchronous interrupts. See “Debug Events” on page 12-294 for more information about debug events.

For debug events, SRR2 is written with an address, which varies with the type of debug event, as shown in Table 10-22.

Table 10-22. SRR2 during Debug Interrupts

Debug Event	Address Saved in SRR2
BT DAC IAC TIE	Address of the instruction causing the event
DVC IC	Address of the instruction <i>following</i> the instruction that causing the event
EXC	Interrupt vector address of the initial exception that caused the exception debug event
UDE	Address of next instruction to be executed at time of UDE

SRR3 is written with the contents of the MSR and the MSR is written with the values shown in Table 10-23, “Register Settings during Debug Interrupts,” on page 10-269. The high-order 16 bits of the program counter are then written with the contents of the EVPR; the low-order 16 bits of the program counter are written with 0x2000. Interrupt processing begins at the address in the program counter.

Preliminary User's Manual

Executing an **rfci** instruction restores the program counter from SRR2 and the MSR from SRR3, and execution resumes at the address in the program counter.

Table 10-23. Register Settings during Debug Interrupts

SRR2	Written with an address as described in Table 10-22
SRR3	Written with the contents of the MSR
MSR	WE, CE, EE, PR, DE, DWE, IR, DR ← 0 ME ← unchanged
PC	EVPR[0:15] 0x2000
DBSR	Set to indicate type of debug event.

Chapter 11. Timer Facilities

The PPC405GP provides four timer facilities: a time base, a Programmable Interval Timer (PIT), a fixed interval timer (FIT), and a watchdog timer. The PIT is a Special Purpose Register (SPR). These facilities, which are driven by the same base clock, can, among other things, be used for:

- Time-of-day functions
- Data logging functions
- Peripherals requiring periodic service
- Periodic task switching

Additionally, the watchdog timer can help a system to recover from faulty hardware or software.

Figure 11-1 shows the relationship of the timers and the clock source to the time base.

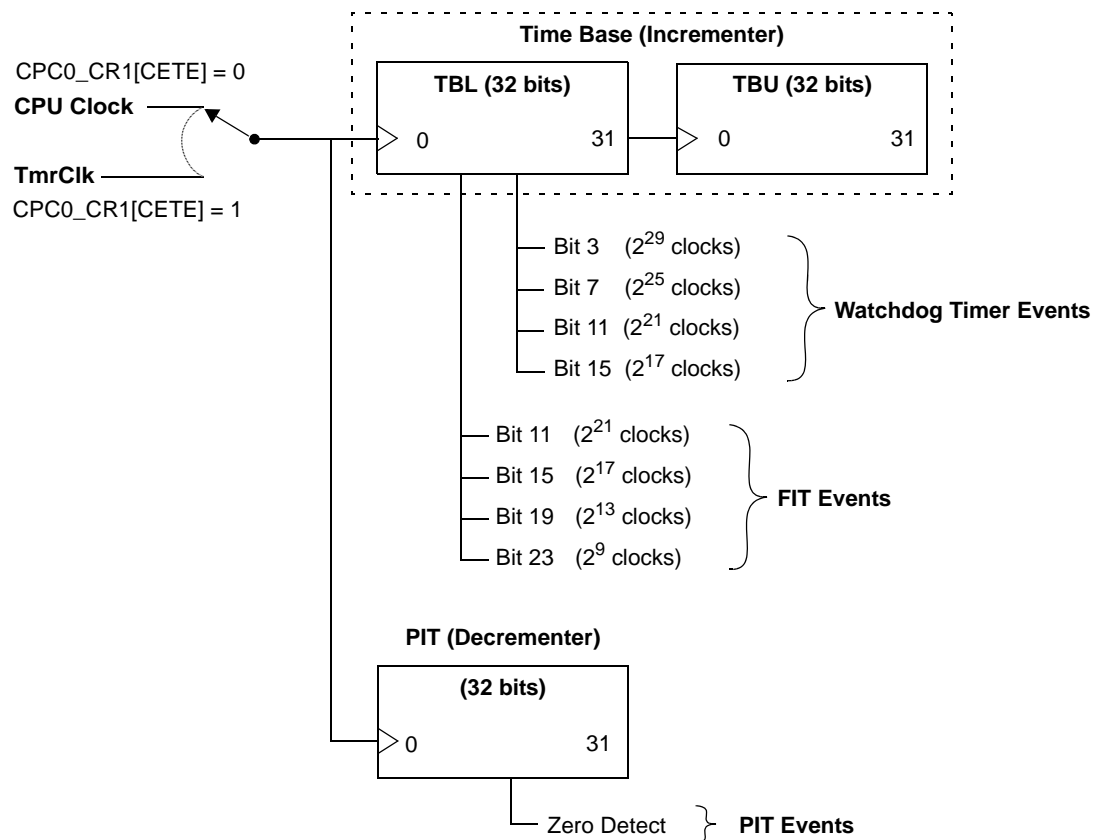

Figure 11-1. Relationship of Timer Facilities to the Time Base

11.1 Time Base

The PPC405GP implements a 64-bit time base as required in *The PowerPC Architecture*. The time base, which increments once during each period of the source clock, provides a time reference. The source clock is either the CPU clock or an external clock connected to the TmrClk input. The CETE field of Chip Control Register 1 (CPC0_CR1[CETE]) selects the clock source.

Read access to the time base is through the **mftb** instruction. **mftb** provides user-mode read-only access to the time base. The TBR numbers (0x10C and 0x10D; TBL and TBU, respectively) that specify the time base registers to **mftb** are not SPR numbers. However, the PowerPC Architecture allows an implementation to handle **mftb** as **mf spr**. Accordingly, these register numbers cannot be used for other SPRs. PowerPC compilers cannot use **mftb** with register numbers other than those specified in the PowerPC Architecture as read-access time base registers (0x10C and 0x10D).

Write access to the time base, using **mtspr**, is privileged. Different register numbers are used for read access and write access. Writing the time base is accomplished by using SPR 0x11C and SPR 0x11D (TBL and TBU, respectively) as operands for **mtspr**.

The period of the 64-bit time base is approximately 2925 years for a 200 MHz clock source. The time base does not generate interrupts, even when it wraps. For most applications, the time base is set once at system reset and only read thereafter. Note that the FIT and the watchdog timer (discussed below) are driven by 0→1 transitions of bits from the TBL. Transitions caused by software alteration of TBL have the same effect as transitions caused by normal incrementing of the time base.

Figure 11-2 illustrates the TBL.

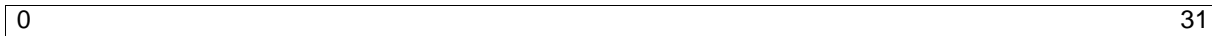

Figure 11-2. Time Base Lower (TBL)

0:31		Time Base Lower	Current count; low-order 32 bits of time base.
------	--	-----------------	--

Figure 11-3 illustrates the TBU.

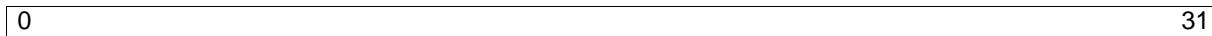

Figure 11-3. Time Base Upper (TBU)

0:31		Time Base Upper	Current count, high-order 32 bits of time base.
------	--	-----------------	---

Preliminary User's Manual

Table 11-1 summarizes the TBRs, instructions used to access the TBRs, and access restrictions.

Table 11-1. Time Base Access

Instructions		Register Number	Access Restrictions
TBU Upper 32 bits	mftbu RT <i>Extended mnemonic for mftb RT,TBU</i>	0x10D	Read-only
	mttbu RS <i>Extended mnemonic for mtspr TBU,RS</i>	0x11D	Privileged; write-only
TBL Lower 32 bits	mftb RT <i>Extended mnemonic for mftb RT,TBL</i>	0x10C	Read-only
	mttbl RS <i>Extended mnemonic for mtspr TBL,RS</i>	0x11C	Privileged; write-only

11.1.1 Reading the Time Base

The following code provides an example of reading the time base. **mftb** moves the low-order 32 bits of the time base to a GPR; **mftbu** moves the high-order 32 bits of the time base to a second GPR.

```
loop:
    mftbu Rx          # load from TBU
    mftb  Ry         # load from TBL
    mftbu Rz         # load from TBU
    cmpw Rz, Rx     # see if old = new
    bne  loop       # loop/re-read if rollover occurred
```

The comparison and loop ensure that a consistent pair of values is obtained.

11.1.2 Writing the Time Base

The following code provides an example of writing the time base. Writing the time base is privileged. **mttbl** moves the contents of a GPR to the low-order 32 bits of the time base; **mttbu** moves the contents of a second GPR to the high-order 32 bits of the time base.

```
lwz    Rx, upper    # load 64-bit time base value into Rx and Ry
lwz    Ry, lower
li     Rz, 0
mttbl  Rz          # force TBL to 0 to avoid rollover while writing TBU
mttbu  Rx          # set TBU
mttbl  Ry          # set TBL
```

11.2 Programmable Interval Timer (PIT)

The PIT is a 32-bit SPR that decrements at the same rate as the time base. The PIT is read and written using **mf spr** and **mt spr**, respectively. Writing to the PIT also simultaneously writes to a hidden reload register. Reading the PIT using **mf spr** returns the current PIT contents; the hidden reload register cannot be read. When a non-zero value is written to the PIT, it begins to decrement. A PIT event occurs when a decrement occurs on a PIT count of 1. When a PIT event occurs, the following occurs:

1. If the PIT is in auto-reload mode (the ARE field of the Timer Control Register (TCR) is 1), the PIT is loaded with the last value an **mt spr** wrote to the PIT. A decrement from a PIT count of 1 immediately causes a reload; no intermediate PIT content of 0 occurs.

If the PIT is not in auto-reload mode (TCR[ARE] = 0), a decrement from a PIT count of 1 simply causes a PIT content of 0.

2. TSR[PIS] is set to 1.
3. If enabled (TCR[PIE] = 1 and the EE field of the Machine State Register (MSR) is 1), a PIT interrupt is taken. See “Programmable Interval Timer (PIT) Interrupt” on page 0-254 for details of register behavior during a PIT interrupt.

The interrupt handler should use software to reset the PIS field of the Timer Status Register (TSR). This is done by using **mt spr** to write a word to the TSR having a 1 in TSR[PIS] and any other bits to be cleared, and a 0 in all other bits. The data written to the TSR is not direct data, but a mask. A 1 clears a bit; a 0 has no effect.

Using **mt spr** to force the PIT to 0 *does not* cause a PIT interrupt. However, decrementing that was ongoing at the instant of the **mt spr** instruction can cause the appearance of an interrupt. To eliminate the PIT as a source of interrupts, write a 0 to TCR[PIE], the PIT interrupt enable bit.

To eliminate all PIT activity:

1. Write a 0 to TCR[PIE]. This prevents PIT activity from causing interrupts.
2. Write a 0 to TCR[ARE]. This disables the PIT auto-reload feature.
3. Write zeroes to the PIT to halt PIT decrementing. Although this action does not cause a pit PIT interrupt to become pending, a near-simultaneous decrement to 0 might have done so.
4. Write a 1 to TSR[PIS] (PIT Interrupt Status bit). This clears TSR[PIS] to 0 (see “Timer Status Register (TSR)” on page 11-278). This also clears any pending PIT interrupt. Because the PIT stops decrementing, no further PIT events are possible.

If the auto-reload feature is disabled (TCR[ARE] = 0) when the PIT decrements to 0, the PIT remains 0 until software uses **mt spr** to reload it.

After a reset, TCR[ARE] = 0, which disables the auto-reload feature.

Preliminary User's Manual

Figure 11-4 illustrates the PIT.



Figure 11-4. Programmable Interval Timer (PIT)

0:31		Programmed interval remaining	Number of clocks remaining until the PIT event
------	--	-------------------------------	--

11.2.1 Fixed Interval Timer (FIT)

The FIT provides timer interrupts having a repeatable period. The FIT is functionally similar to an auto-reload PIT, except that only a smaller fixed selection of interrupt periods are available.

The FIT exception occurs on 0→1 transitions of selected bits from the time base, as shown in Table 11-2.

Table 11-2. FIT Controls

TCR[FP]	TBL Bit	Period (Time Base Clocks)	Period (200 Mhz Clock)
0, 0	23	2^9 clocks	2.56 μ sec
0, 1	19	2^{13} clocks	40.96 μ sec
1, 0	15	2^{17} clocks	0.655 msec
1, 1	11	2^{21} clocks	10.49 msec

The TSR[FIS] field logs a FIT exception as a pending interrupt. A FIT interrupt occurs if TCR[FIE] and MSR[EE] are enabled at the time of the FIT exception. “Fixed Interval Timer (FIT) Interrupt” on page 0-255 describes register settings during a FIT interrupt.

The interrupt handler should reset TSR[FIS]. This is done by using **mtspr** to write a word to the TSR having a 1 in TSR[FIS] and any other bits to be cleared, and a 0 in all other bits. The data written to the TSR is not direct data, but a mask. A 1 clears a bit and a 0 has no effect.

11.3 Watchdog Timer

The watchdog timer aids system recovery from software or hardware faults.

A watchdog timeout occurs on 0→1 transitions of a selected bit from the time base, as shown in the following table.

Table 11-3. Watchdog Timer Controls

TCR[WP]	TBL Bit	Period (Time Base Clocks)	Period (200 MHz Clock)
0,0	15	2^{17} clocks	0.655 msec
0,1	11	2^{21} clocks	10.49 msec
1,0	7	2^{25} clocks	0.168 sec
1,1	3	2^{29} clocks	2.684 sec

If a watchdog timeout occurs while TSR[WIS] = 0 and TSR[ENW] = 1, a watchdog interrupt occurs if the interrupt is enabled by TCR[WIE] and MSR[CE]. “Watchdog Timer” on page 11-276 describes register behavior during a watchdog interrupt.

The interrupt handler should reset the TSR[WIS] bit. This is done by using **mtspr** to write a word to the TSR having a 1 in TSR[WIS] and any other bits to be cleared, and a 0 in all other bits. The data written to the TSR is not direct data, but a mask. A 1 clears a bit and a 0 has no effect.

If a watchdog timeout occurs while TSR[WIS] = 1 and TSR[ENW] = 1, a hardware reset occurs if enabled by a non-zero value of TCR[WRC]. In other words, a reset can occur if a watchdog timeout occurs while a previous watchdog timeout is pending. The assumption is that TSR[WIS] was not cleared because the processor could not execute the watchdog handler, leaving reset as the only way to restart the system. Note that after TCR[WRC] is set to a non-zero value, it cannot be reset by software. This prevents errant software from disabling the watchdog timer reset capability. After a reset, the initial value of TCR[WRC] = 00.

Preliminary User's Manual

Figure 11-5 describes the watchdog state machine. In the figure, numbers in parentheses refer to descriptions of operating modes that follow the table.

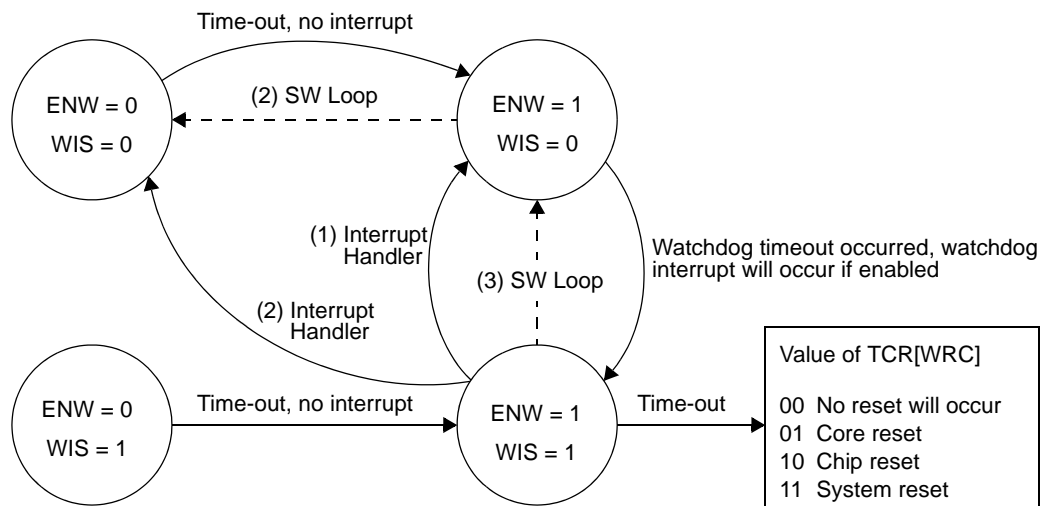

Figure 11-5. Watchdog Timer State Machine

Enable Next Watchdog TSR[ENW]	Watchdog Timer Status TSR[WIS]	Action When Timer Interval Expires
0	0	Set TSR[ENW] = 1.
0	1	Set TSR[ENW] = 1.
1	0	Set TSR[WIS] = 1. If TCR[WIE] = 1 and MSR[CE] = 1, then interrupt.
1	1	Cause the watchdog reset action specified by TCR[WRC]. On reset, copy current TCR[WRC] to TSR[WRS] and clear TCR[WRC], disabling the watchdog timer.

The controls described in Figure 11-5 imply three different ways of using the watchdog timer. The modes assume that TCR[WRC] was set to allow processor reset by the watchdog timer:

1. Always take a pending watchdog interrupt, and never attempt to prevent its occurrence. (This mode is described in the preceding text.)
 - a. Clear TSR[WIS] in the watchdog timer handler.
 - b. Never use TSR[ENW].
2. Always take a pending watchdog interrupt, but avoid it whenever possible by delaying a reset until a second watchdog timer occurs.

This assumes that a recurring code loop of known maximum duration exists outside the interrupt handlers, or that a FIT interrupt handler is operational. One of these mechanisms clears TSR[ENW] more frequently than the watchdog period.

- a. Clear TSR[ENW] to 0 in loop or in FIT interrupt handler.

To clear TSR[ENW], use **mtspr** to write a 1 to TSR[ENW] (and to any other bits that are to be cleared), with 0 in all other bit locations.

b. Clear TSR[WIS] in watchdog timer handler.

It is not expected that a watchdog interrupt will occur every time, but only if an exceptionally high execution load delays clearing of TSR[ENW] in the usual time frame.

3. Never take a watchdog interrupt.

This assumes that a recurring code loop of reliable duration exists outside the interrupt handlers, or that a FIT interrupt handler is operational. This method only guarantees one watchdog timeout period before a reset occurs.

a. Clear TSR[WIS] in the loop or in FIT handler.

b. Never use TSR[ENW] but have it set.

11.4 Timer Status Register (TSR)

The TSR can be accessed for read or write-to-clear.

Status registers are generally set by hardware and read and cleared by software. The **mf spr** instruction reads the TSR. Clearing the TSR is performed by writing a word to the TSR, using **mt spr**, having a 1 in all fields to be cleared and a 0 in all other fields. The data written to the TSR is not direct data, but a mask. A 1 clears the field and a 0 has no effect.

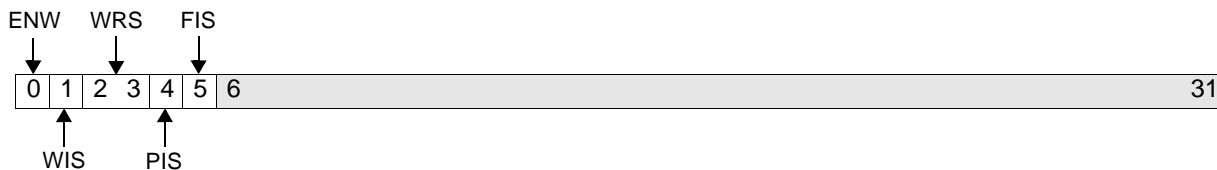

Figure 11-6. Timer Status Register (TSR)

0	ENW	Enable Next Watchdog 0 Action on next watchdog event is to set TSR[ENW] = 1. 1 Action on next watchdog event is governed by TSR[WIS].	Software must reset TSR[ENW] = 0 after each watchdog timer event.
1	WIS	Watchdog Interrupt Status 0 No Watchdog interrupt is pending. 1 Watchdog interrupt is pending.	
2:3	WRS	Watchdog Reset Status 00 No Watchdog reset has occurred. 01 Core reset was forced by the watchdog. 10 Chip reset was forced by the watchdog. 11 System reset was forced by the watchdog.	
4	PIS	PIT Interrupt Status 0 No PIT interrupt is pending. 1 PIT interrupt is pending.	
5	FIS	FIT Interrupt Status 0 No FIT interrupt is pending. 1 FIT interrupt is pending.	
6:31		Reserved	

Preliminary User's Manual**11.5 Timer Control Register (TCR)**

The TCR controls PIT, FIT, and watchdog timer operation.

The TCR[WRC] field is cleared to 0 by all processor resets. (Chapter 8, “Reset and Initialization,” describes the types of processor reset.) This field is set only by software. However, hardware does not allow software to clear the field after it is set. After software writes a 1 to a bit in the field, that bit remains a 1 until any reset occurs. This prevents errant code from disabling the watchdog timer reset function.

All processor resets clear TCR[ARE] to 0, disabling the auto-reload feature of the PIT.

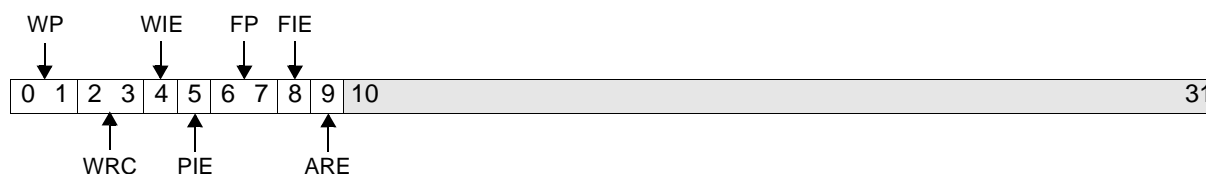

Figure 11-7. Timer Control Register (TCR)

0:1	WP	Watchdog Period 00 2^{17} clocks 01 2^{21} clocks 10 2^{25} clocks 11 2^{29} clocks	
2:3	WRC	Watchdog Reset Control 00 No Watchdog reset will occur. 01 Core reset will be forced by the Watchdog. 10 Chip reset will be forced by the Watchdog. 11 System reset will be forced by the Watchdog.	TCR[WRC] resets to 00. This field can be set by software, but cannot be cleared by software, except by a software-induced reset.
4	WIE	Watchdog Interrupt Enable 0 Disable watchdog interrupt. 1 Enable watchdog interrupt.	
5	PIE	PIT Interrupt Enable 0 Disable PIT interrupt. 1 Enable PIT interrupt.	
6:7	FP	FIT Period 00 2^9 clocks 01 2^{13} clocks 10 2^{17} clocks 11 2^{21} clocks	
8	FIE	FIT Interrupt Enable 0 Disable FIT interrupt. 1 Enable FIT interrupt.	
9	ARE	Auto Reload Enable 0 Disable auto reload. 1 Enable auto reload.	Disables on reset.
10:31		Reserved	

Chapter 12. Debugging

The debug facilities of the PPC405GP include support for debug modes for debugging during hardware and software development, and debug events that allow developers to control the debug process. Debug registers control the debug modes and debug events. The debug registers are accessed through software running on the processor or through a JTAG debug port. The debug interface is the JTAG debug port. The JTAG debug port can also be used for board test.

The debug modes, events, controls, and interface provide a powerful combination of debug facilities for a wide range of hardware and software development tools.

12.1 Development Tool Support

The RISCWatch product from IBM is an example of a development tool that uses the external debug mode, debug events, and the JTAG debug port to implement a hardware and software development tool. The RISCTrace™ feature of RISCWatch is an example of a development tool that uses the real-time instruction trace capability of the PPC405GP.

12.2 Debug Interfaces

The PPC405GP provides JTAG and trace interfaces to support hardware and software test and debug. Typically, the JTAG interface connects to a debug port external to the PPC405GP; the debug port is typically connected to a JTAG connector on a processor board.

The trace interface connects to a trace port, also external to the PPC405GP, that is typically connected to a trace connector on the processor board.

12.3 IEEE 1149.1 Test Access Port (JTAG Debug Port)

The IEEE 1149.1 Test Access Port (TAP), commonly called the JTAG (Joint Test Action Group) debug port, is an architectural standard described in IEEE Std 1149.1–1990, *IEEE Standard Test Access Port and Boundary Scan Architecture*. The standard describes a method for accessing internal chip facilities using a four- or five-signal interface.

The JTAG debug port, originally designed to support scan-based board testing, is enhanced to support the attachment of debug tools. The enhancements, which are designed to the IEEE 1149.1 specifications for vendor-specific extensions, are compatible with standard JTAG hardware for boundary-scan system testing.

JTAG Signals

The JTAG debug port implements the four required JTAG signals: TCK, TMS, TDI, and TDO, and the optional $\overline{\text{TRST}}$ signal.

JTAG Clock Requirements

The frequency of the TCK signal can range from DC to one-half of the internal chip clock frequency.

JTAG Reset Requirements

The JTAG debug port logic is reset at the same time as a system reset. Upon receiving $\overline{\text{TRST}}$, the JTAG debug port returns to the Test-Logic Reset state.

12.4 JTAG Connector

A 16-pin male 2x8 header connector is suggested as the JTAG debug port connector. This connector definition matches the requirements of the RISCWatch debugger from IBM. The connector is described in detail in *RISCWatch Debugger User's Guide*.

12.4.1 JTAG Instructions

The JTAG debug port provides the standard *extest*, *idcode*, *sample/preload*, and *bypass* instructions and the optional *highz* and *clamp* instructions. Invalid instructions behave as the *bypass* instruction.

Table 12-1. JTAG Instructions

Instruction	Code	Comments
Extest	1111000	IEEE 1149.1 standard.
	1111001	Reserved.
Sample/Preload	1111010	IEEE 1149.1 standard.
IDCode	1111011	IEEE 1149.1 standard.
Private	xxxx100	Private instructions
HighZ	1111101	IEEE 1149.1a-1993 optional
Clamp	1111110	IEEE 1149.1a-1993 optional
Bypass	1111111	IEEE 1149.1 standard.

12.4.2 JTAG Boundary Scan

Boundary Scan Description Language (BSDL), IEEE 1149.1b-1994, is a supplement to IEEE 1149.1-1990 and IEEE 1149.1a-1993 *Standard Test Access Port and Boundary-Scan Architecture*. BSDL, a subset of the IEEE 1076-1993 Standard VHSIC Hardware Description Language (VHDL), allows a rigorous description of testability features in components which comply with the standard. BSDL is used by automated test pattern generation tools for package interconnect tests and by electronic design automation (EDA) tools for synthesized test logic and verification. BSDL supports robust extensions that can be used for internal test generation and to write software for hardware debug and diagnostics.

The primary components of BSDL include the logical port description, the physical pin map, the instruction set, and the boundary register description.

The logical port description assigns symbolic names to the pins of a chip. Each pin has a logical type of in, out, inout, buffer, or linkage that defines the logical direction of signal flow.

The physical pin map correlates the logical ports of the chip to the physical pins of a specific package. A BSDL description can have several physical pin maps; each map is given a unique name.

Instruction set statements describe the bit patterns that must be shifted into the Instruction Register to place the chip in the various test modes defined by the standard. Instruction set statements also support descriptions of instructions that are unique to the chip.

Preliminary User's Manual

The boundary register description lists each cell or shift stage of the Boundary Register. Each cell has a unique number: the cell numbered 0 is the closest to the Test Data Out (TDO) pin; the cell with the highest number is closest to the Test Data In (TDI) pin. Each cell contains additional information, including: cell type, logical port associated with the cell, logical function of the cell, safe value, control cell number, disable value, and result value.

12.4.3 JTAG Implementation

PPC405GP JTAG interface I/Os (TDI, TDO, TMs, TCK, and $\overline{\text{TRST}}$) are 5V tolerant and do not contain internal pull up resistors.

The optional JTAG instructions, *idcode* and *highz*, offer additional JTAG functionality. The *idcode* instruction returns the PPC405GP JTAG ID, which is unique for each chip version. The *highz* instruction disables all chip outputs regardless of whether they are included in the JTAG boundary scan chain.

The PPC405GP provides boundary scan structures on most I/O signals. However, the following signals are excluded because of speed and functional considerations:

- Drvrlnh1
- Drvrlnh2
- PciClk
- Rcvrlnh
- TestEn

12.4.4 JTAG ID Register (CPC0_JTAGID)

CPC0_JTAGID is a Device Control Register that enables manufacturing, part number, and version information to be determined through the TAP. The *mfocr* instruction is used to read this register.

Refer to *PowerPC 405GP Embedded Processor Data Sheet* for the values of the CPC0_JTAGID fields.

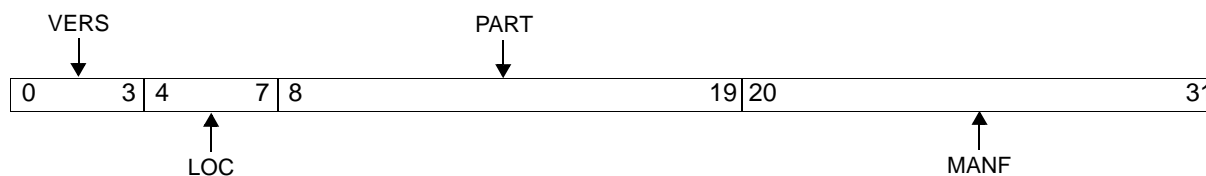

Figure 12-1. JTAG ID Register (CPC0_JTAGID)

0:3	VERS	Version
4:7	LOC	Developer Location
8:19	PART	Part Number
20:31	MANF	Manufacturer Identifier

12.5 Trace Port

The PPC405GP implements a trace status interface to support the tracing of code running in real-time. This interface enables the connection of an external trace tool, such as RISCWatch, and allows for user-extended trace functions. A software tool with trace capability, such as RISCWatch with RISCTrace, can use the data collected from this port to trace code running on the processor. The result is a trace of the code executed, including code executed out of the instruction cache if it was enabled. Information on trace capabilities, how trace works, and how to connect the external trace tool is available in *RISCWatch Debugger User's Guide*.

12.6 Debug Modes

The PPC405GP supports the following debug modes, each of which supports a type of debug tool or debug task commonly used in embedded systems development:

- Internal debug mode, which supports ROM monitors
- External debug mode, which supports JTAG debuggers
- Debug wait mode, which supports processor stopping or stepping for JTAG debuggers while servicing interrupts
- Real-time trace mode, which supports trigger events for real-time tracing

Internal and external debug modes can be enabled simultaneously. Both modes are controlled by fields in Debug Control Register 0 (DBCR0). Real-time trace mode is available only if internal, external, and debug wait modes are disabled.

12.6.1 Internal Debug Mode

Internal debug mode provides access to architected processor resources and supports setting hardware and software breakpoints and monitoring processor status. In this mode, debug events generate debug interrupts, which can interrupt normal program flow so that monitor software can collect processor status and alter processor resources.

Internal debug mode relies on exception handling software at a dedicated interrupt vector and an external communications path to debug software problems. This mode, used while the processor executes instructions, enables debugging of operating system or application programs.

In this mode, debugger software is accessed through a communications port, such as a serial port, external to the processor core.

To enable internal debug mode, the Debug Control Register 0 (DBCR0) field IDM is set to 1 (DBCR0[IDM] = 1). To enable debug interrupts, MSR[DE] = 1. A debug interrupt occurs on a debug event only if DBCR0[IDM] = 1 and MSR[DE] = 1.

Preliminary User's Manual

12.6.2 External Debug Mode

External debug mode provides access to architected processor resources and supports stopping, starting, and stepping the processor, setting hardware and software breakpoints, and monitoring processor status. In this mode, debug events cause the processor to become architecturally frozen. While the processor is frozen, normal instruction execution stops and architected processor resources can be accessed and altered. External bus activity continues in external debug mode.

The JTAG mechanism can pass instructions to the processor for execution, allowing a JTAG debugger to display and alter processor resources, including memory.

The JTAG mechanism prevents the occurrence of a privileged exception when a privileged instruction is executed while the processor is in user mode.

Storage access control by a memory management unit (MMU) remains in effect while in external debug mode; the debugger may need to modify MSR or TLB values to access protected memory.

Because external debug mode relies only on internal processor resources, it can be used to debug system hardware and software.

In this mode, access to the processor is through the JTAG debug port.

To enable external debug mode, $DBCRO[EDM] = 1$. To enable debug interrupts, $MSR[DE] = 1$. A debug interrupt occurs on a debug event only if $DBCRO[EDM] = 1$ and $MSR[DE] = 1$.

12.6.3 Debug Wait Mode

In debug wait mode, debug events cause the PPC405GP to enter a state in which interrupts can be serviced while the processor appears to be stopped.

Debug wait mode provides access to architected processor resources in a manner similar to external debug mode, except that debug wait mode allows the servicing of interrupt handlers. It supports stopping, starting, and stepping the processor, setting hardware and software breakpoints, and monitoring processor status. In this mode, if a debug event caused the processor to become architecturally frozen, an interrupt causes the processor to run an interrupt handler and return to the architecturally frozen state upon returning from the interrupt handler. While the processor is frozen, normal instruction execution stops and architected processor resources can be accessed and altered. External bus activity continues in debug wait mode.

The processor enters debug wait mode when internal and external debug modes are disabled ($DBCRO[IDM, EDM] = 0$), debug wait mode is enabled ($MSR[DWE] = 1$), debug wait is enabled by the JTAG debugger, and a debug event occurs.

For example, while the PPC405GP is in debug wait mode, an external device might generate an interrupt that requires immediate service. The PPC405GP can service the interrupt (vector to an interrupt handler and execute the interrupt handler code) and return to the previous stopped state.

Debug wait mode relies only on internal processor resources, so it can be used to debug both system hardware and software problems. This mode can also be used for software development on systems without a control program, or to debug control program problems.

In this mode, access to the processor is through the JTAG debug port.

12.6.4 Real-time Trace Debug Mode

Real-time trace debug mode supports the generation of trigger events for tracing the instruction stream being executed out of the instruction cache in real-time. In this mode, debug events can be used to control the collection of trace information through the use of trigger event generation. The broadcast of trace information is independent of the use of debug events as trigger events. This mode does not alter the processor performance.

A trace event occurs when internal and external debug modes are disabled (DBCR0[IDM, EDM] = 0) and a debug events occurs.

When a trace event occurs, a trace device can capture trace signals that provide the instruction trace information. Most trace events generated from debug events are blocked when internal debug, external debug, or debug wait modes are enabled

12.7 Processor Control

The PPC405GP provides the following debug functions for processor control. Not all facilities are available in all debug modes.

Instruction Step	The processor is stepped one instruction at a time, while stopped, using the JTAG debug port.
Instruction Stuff	While the processor is stopped, instructions can be stuffed into the processor and executed using the JTAG debug port.
Halt	The processor can be stopped by activating an external halt signal on an external event, such as a logic analyzer trigger. This signal freezes the processor architecturally. While frozen, normal instruction execution stops and architected processor resources can be accessed and altered using the JTAG debug port. Normal execution resumes when the halt signal is deactivated.
Stop	The processor can be stopped using the JTAG debug port. Activating a stop causes the processor to become architecturally frozen. While frozen, normal instruction execution stops and the architected processor resources can be accessed and altered using the JTAG debug port.
Reset	An external reset signal, the JTAG debug port, or DBCR0 can request core, chip, and system resets.
Debug Events	A debug event triggers a debug operation. The operation depends on the debug mode. For more information and a list of debug events, see “Debug Events” on page 12-294.
Freeze Timers	The JTAG debug port or DBCR0 can control timer resources. The timers can be enabled to run, freeze always, or freeze on a debug event.
Trap Instructions	The trap instructions tw and twi can be used, with debug events, to implement software breakpoints.

Preliminary User's Manual

12.8 Processor Status

The processor execution status, exception status, and most recent reset can be monitored.

Execution Status The JTAG debug port can monitor processor execution status to determine whether the processor is stopped, waiting, or running.

Exception Status The JTAG debug port can monitor the status of pending synchronous exceptions.

Most Recent Reset The JTAG debug port or an **mfsp** instruction can be used to read the Debug Status Register (DBSR) to determine the type of the most recent reset.

12.9 Debug Registers

Several debug registers, available to debug tools running on the processor, are not intended for use by application code. Debug tools control debug resources such as debug events. Application code that uses debug resources can cause the debug tools to fail, as well as other unexpected results, such as program hangs and processor resets.

Application code should not use the debug resources, including the debug registers.

12.9.1 Debug Control Registers

The debug control registers (DBCR0 and DBCR1) can enable and configure debug events, reset the processor, control timer operation during debug events, enable debug interrupts, and set the processor debug mode.

12.9.1.1 Debug Control Register 0 (DBCR0)

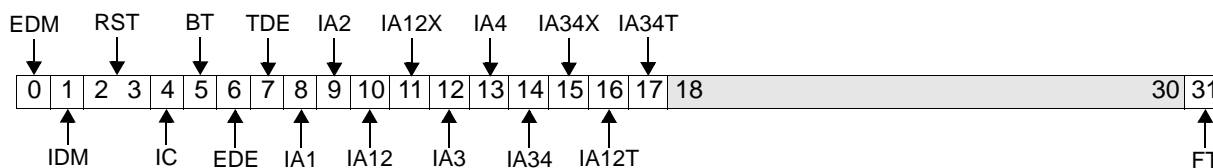

Figure 12-2. Debug Control Register 0 (DBCR0)

0	EDM	External Debug Mode 0 Disabled 1 Enabled	
1	IDM	Internal Debug Mode 0 Disabled 1 Enabled	
2:3	RST	Reset 00 No action 01 Core reset 10 Chip reset 11 System reset	Causes a processor reset request when set by software.
Attention: Writing 01, 10, or 11 to this field causes a processor reset request.			

4	IC	Instruction Completion Debug Event 0 Disabled 1 Enabled	
5	BT	Branch Taken Debug Event 0 Disabled 1 Enabled	
6	EDE	Exception Debug Event 0 Disabled 1 Enabled	
7	TDE	Trap Debug Event 0 Disabled 1 Enabled	
8	IA1	IAC 1 Debug Event 0 Disabled 1 Enabled	
9	IA2	IAC 2 Debug Event 0 Disabled 1 Enabled	
10	IA12	Instruction Address Range Compare 1–2 0 Disabled 1 Enabled	Registers IAC1 and IAC2 define an address range used for IAC address comparisons.
11	IA12X	Enable Instruction Address Exclusive Range Compare 1–2 0 Inclusive 1 Exclusive	Selects the range defined by IAC1 and IAC2 to be inclusive or exclusive.
12	IA3	IAC 3 Debug Event 0 Disabled 1 Enabled	
13	IA4	IAC 4 Debug Event 0 Disabled 1 Enabled	
14	IA34	Instruction Address Range Compare 3–4 0 Disabled 1 Enabled	Registers IAC3 and IAC4 define an address range used for IAC address comparisons.
15	IA34X	Instruction Address Exclusive Range Compare 3–4 0 Inclusive 1 Exclusive	Selects range defined by IAC3 and IAC4 to be inclusive or exclusive.
16	IA12T	Instruction Address Range Compare 1-2 Toggle 0 Disabled 1 Enable	Toggles range 12 inclusive, exclusive DBCR[IA12X] on debug event.
17	IA34T	Instruction Address Range Compare 3–4 Toggle 0 Disabled 1 Enable	Toggles range 34 inclusive, exclusive DBCR[IA34X] on debug event.
18:30		Reserved	

Preliminary User's Manual

31	FT	Freeze timers on debug event 0 Timers not frozen 1 Timers frozen
----	----	--

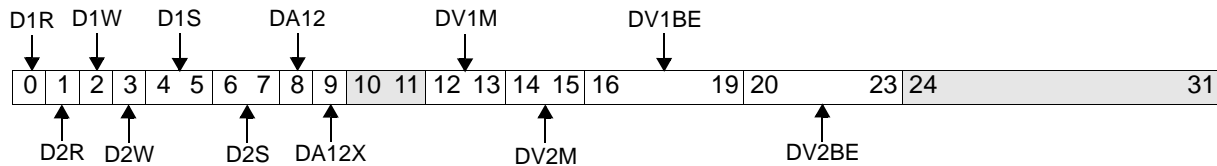
12.9.1.2 Debug Control Register1 (DBCR1)**Figure 12-3. Debug Control Register 1 (DBCR1)**

0	D1R	DAC1 Read Debug Event 0 Disabled 1 Enabled	
1	D2R	DAC 2 Read Debug Event 0 Disabled 1 Enabled	
2	D1W	DAC 1 Write Debug Event 0 Disabled 1 Enabled	
3	D2W	DAC 2 Write Debug Event 0 Disabled 1 Enabled	
4:5	D1S	DAC 1 Size 00 Compare all bits 01 Ignore lsb (least significant bit) 10 Ignore two lsbs 11 Ignore five lsbs	Address bits used in the compare: Byte address Halfword address Word address Cache line (8-word) address
6:7	D2S	DAC 2 Size 00 Compare all bits 01 Ignore lsb (least significant bit) 10 Ignore two lsbs 11 Ignore five lsbs	Address bits used in the compare: Byte address Halfword address Word address Cache line (8-word) address
8	DA12	Enable Data Address Range Compare 1:2 0 Disabled 1 Enabled	Registers DAC1 and DAC2 define an address range used for DAC address comparisons
9	DA12X	Data Address Exclusive Range Compare 1:2 0 Inclusive 1 Exclusive	Selects range defined by DAC1 and DAC2 to be inclusive or exclusive
10:11		Reserved	

12:13	DV1M	<p>Data Value Compare 1 Mode</p> <p>00 Undefined</p> <p>01 AND</p> <p>10 OR</p> <p>11 AND-OR</p>	<p>Type of data comparison used:</p> <p>All bytes selected by DBCR1[DV1BE] must compare to the appropriate bytes of DVC1.</p> <p>One of the bytes selected by DBCR1[DV1BE] must compare to the appropriate bytes of DVC1.</p> <p>The upper halfword or lower halfword must compare to the appropriate halfword in DVC1. When performing halfword compares set DBCR1[DV1BE] = 0011, 1100, or 1111.</p>
14:15	DV2M	<p>Data Value Compare 2 Mode</p> <p>00 Undefined</p> <p>01 AND</p> <p>10 OR</p> <p>11 AND-OR</p>	<p>Type of data comparison used</p> <p>All bytes selected by DBCR1[DV2BE] must compare to the appropriate bytes of DVC2.</p> <p>One of the bytes selected by DBCR1[DV2BE] must compare to the appropriate bytes of DVC2.</p> <p>The upper halfword or lower halfword must compare to the appropriate halfword in DVC2. When performing halfword compares set DBCR1[DV2BE] = 0011, 1100, or 1111.</p>
16:19	DV1B E	<p>Data Value Compare 1 Byte</p> <p>0 Disabled</p> <p>1 Enabled</p>	<p>Selects which data bytes to use in data value comparison</p>
20:23	DV2B E	<p>Data Value Compare 2 Byte</p> <p>0 Disabled</p> <p>1 Enabled</p>	<p>Selects which data bytes to use in data value comparison</p>
24:31		Reserved	

Preliminary User's Manual**12.9.2 Debug Status Register (DBSR)**

The DBSR contains status on debug events and the most recent reset; the status is obtained by reading the DBSR. The status bits are normally set by debug events or by any of the three reset types.

Clearing DBSR fields is performed by writing a word to the DBSR, using the **mtdbsr** extended mnemonic, having a 1 in all bit positions to be cleared and a 0 in the all other bit positions. The data written to the DBSR is not direct data, but a mask. A 1 clears the bit and a 0 has no effect.

Application code should not use the DBSR.

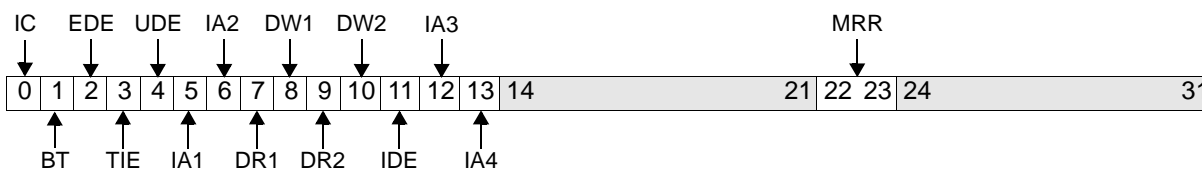

Figure 12-4. Debug Status Register (DBSR)

0	IC	Instruction Completion Debug Event 0 Event did not occur 1 Event occurred
1	BT	Branch Taken Debug Event 0 Event did not occur 1 Event occurred
2	EDE	Exception Debug Event 0 Event did not occur 1 Event occurred
3	TIE	Trap Instruction Debug Event 0 Event did not occur 1 Event occurred
4	UDE	Unconditional Debug Event 0 Event did not occur 1 Event occurred
5	IA1	IAC1 Debug Event 0 Event did not occur 1 Event occurred
6	IA2	IAC2 Debug Event 0 Event did not occur 1 Event occurred
7	DR1	DAC1 Read Debug Event 0 Event did not occur 1 Event occurred
8	DW1	DAC1 Write Debug Event 0 Event did not occur 1 Event occurred
9	DR2	DAC2 Read Debug Event 0 Event did not occur 1 Event occurred

Preliminary User's Manual**12.9.4 Data Address Compare Registers (DAC1–DAC2)**

The PPC405GP can take a debug event upon storage or cache references to addresses specified in the DAC registers. The specified addresses in the DAC registers are EAs of operands of storage references or cache instructions. The fields DBCR1[D1R], [D2R] and DBCR[D1W], [D2W] control the DAC-read and DAC-write debug events, respectively.

Addresses in the DAC registers specify exact byte EAs for DAC debug events. However, one may want to take a debug event on any byte within a halfword (ignore the least significant bit (LSb) of the DAC), on any byte within a word (ignore the two LSbs of DAC), or on any byte within eight words (ignore four LSbs of DAC). DBCR1[D1S, D2S] control the addressing options.

Errors related to execution of storage reference or cache instructions prevent DAC debug events.

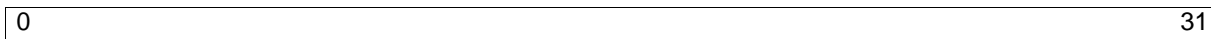
**Figure 12-6. Data Address Compare Registers (DAC1–DAC2)**

0:31		Data Address Compare (DAC) byte address	DBCR0[D1S] determines which address bits are examined.
------	--	---	--

12.9.5 Data Value Compare Registers (DVC1–DVC2)

The PPC405GP can take a debug event upon storage or cache references to addresses specified in the DAC registers, that also require the data at that address to match the value specified in the DVC registers. The data address compare for a DVC events works the same as for a DAC event. Cache operations do not cause DVC events. If the data at the address specified matches the value in the corresponding DVC register a DVC event will occur. The fields DBCR1[DV1M, DV2M] control how the data value are compared.

Errors related to execution of storage reference or cache instructions prevent DVC debug events.

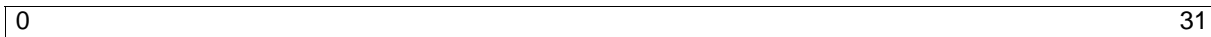
**Figure 12-7. Data Value Compare Registers (DVC1–DVC2)**

0:31		Data Value to Compare
------	--	-----------------------

12.9.6 Debug Events

Debug events, enabled and configured by DBCR0 and DBCR1 and recorded in the DBSR, cause debug operations. A debug event occurs when an event listed in Table 12-2, "Debug Events," on page 12-294 is detected. The debug operation is performed after the debug event.

In internal debug mode, the processor generates a debug interrupt when a debug event occurs. In external debug mode, the processor stops when a debug event occurs. When internal and external debug mode are both enabled, the processor stops on a debug event with the debug interrupt pending. When external and internal debug mode are both disabled, and debug wait mode is enabled the processor stops, but can be restarted by an interrupt. When all debug modes are disabled, debug events are recorded in the DBSR, but no action is taken.

Table 12-2 lists the debug events and the related fields in DBCR0, DBCR1, and DBSR. DBCR0 and DBCR1 enable the debugs events, and the DBSR fields report their occurrence.

Table 12-2. Debug Events

Event	Enabling DBCR0, DBCR1 Fields	Reporting DBSR Fields	Description
Instruction Completion	IC	IC	Occurs after completion of an instruction.
Branch Taken	BT	BT	Occurs before execution of a branch instruction determined to be taken.
Exception Taken	EDE	EXC	Occurs after an exception.
Trap Instruction	TDE	TIE	Occurs before execution of a trap instruction where the conditions are such that the trap will occur.
Unconditional	UDE	UDE	Occurs immediately upon being set by the JTAG debug port.
Instruction Address Compare	IA1, IA2, IA3, IA4, IA12, IA12X, IA12T, IA34, IA34X, IA34T	IA1, IA2, IA3, IA4	Occurs before execution of an instruction at an address that matches an address defined by the Instruction Address Compare Registers (IAC1–IAC4).
Data Address Compare	D1R, D1W, D1S, D2R, D2W, D2S, DA12, DA12X	DR2, DW2	Occurs before execution of an instruction that accesses a data address that matches the contents of the specified DAC register.
Data Value Compare	DV1M, DV2M, DV1BE, DV2BE	DR1, DW1	Occurs after execution of an instruction that accesses a data address for which a DAC occurs, and for which the value at the address matches the value in the specified DVC register.
Imprecise		IDE	Indicates that another debug event occurred while MSR[DE] = 0

Preliminary User's Manual

12.9.7 Instruction Complete Debug Event

This debug event occurs after the completion of an instruction. If DBCR0[IDM] = 1, DBCR0[EDM] = 0 and MSR[DE] = 0 this debug event is disabled.

12.9.8 Branch Taken Debug Event

This debug event occurs before execution of a branch instruction determined to be taken. If DBCR0[IDM] = 1, DBCR0[EDM] = 0 and MSR[DE] = 0 this debug event is disabled.

12.9.9 Exception Taken Debug Event

This debug event occurs after an exception. Exception debug events always include the non-critical class of exceptions. When DBCR0[IDM] = 1 and DBCR0[EDM] = 0 the critical exceptions are not included.

12.9.10 Trap Taken Debug Event

This debug event occurs before execution of a trap instruction where the conditions are such that the trap will occur. When trap is enabled for a debug event, external debug mode is enabled, internal debug mode is enabled with MSR[DE] enabled, or debug wait mode is enabled, a trap instruction will not cause a program exception.

12.9.11 Unconditional Debug Event

This debug event occurs immediately upon being set by the JTAG debug port.

12.9.12 IAC Debug Event

This debug event occurs before execution of an instruction at an address that matches an address defined by the Instruction Address Compare Registers (IAC1–IAC4). DBCR0[IA1, IA2, IA3, IA4] enable IAC debug events IAC can be defined as an exact address comparison to one of the IAC n registers or on a range of addresses to compare defined by a pair of IAC n registers.

12.9.12.1 IAC Exact Address Compare

In this mode each IAC n register specifies an exact address to compare. These are enabled by setting DBCR0[IA n] = 1 and disabling IAC range compare (DBCR0[IA12X] = 0 for IAC1 and IAC2 and DBCR0[IA23X] = 0 for IAC3 and IAC4). The corresponding DBSR[IA n] bit displays the results of the debug event.

12.9.12.2 IAC Range Address Compare

In this mode a pair of IAC n registers are used to define a range of addresses to compare:

Range 1:2 corresponds to IAC1 and IAC2

Range 3:4 corresponds to IAC3 and IAC4

To enable Range 1:2, DBCR0[IA12] = 1 and DBCR0[IA1] or DBCR0[IA2] = 1. An IAC event will be seen on the DBSR[IA n] field that corresponds to the enabled DBCR0[IA n] field. If DBCR0[IA1] and DBCR0[IA2] are enabled, the results of the event are reported on both DBSR fields. Setting DBCR0[IA12] = 1 prohibits IAC1 and IAC2 from being used for exact address compares.

To enable Range 3:4, DBCR0[IA34] = 1 and DBCR0[IA3] or DBCR0[IA4] = 1. An IAC event will be seen on the DBSR[IA n] field that corresponds to the enabled DBCR0[IA n] field. If DBCR0[IA3] and DBCR0[IA4] are enabled, the results of the event will be reported on both DBSR fields. Setting DBCR0[IA34] = 1 prohibits IAC3 and IAC4 from being used for exact address compares.

Ranges can be defined as inclusive, as shown in the preceding examples, or exclusive, using DBCR0[IA12X] (corresponding to range 1:2) and DBCR0[IA34X] (corresponding to range 3:4), as follows:

- DBCRO[IA12] = 1: Range 1:2 = IAC1 ≤ range < IAC2.
- DBCRO[IA12X] = 1: Range 1:2 = Range low < IAC1 or IAC2 ≤ Range high
- DBCRO[IA34] = 1: Range 3:4 = IAC3 ≤ range < IAC4.
- DBCRO[IA34X] = 1: Range 3:4 = Range low < IAC3 or IAC4 ≤ Range high

Figure 12-8 shows the range selected in an inclusive IAC range address compare. Note that the address in IAC1 is considered part of the range, but the address in IAC2 is not, as shown in the preceding examples. The thick lines indicate that the indicated address is included in the compare results.

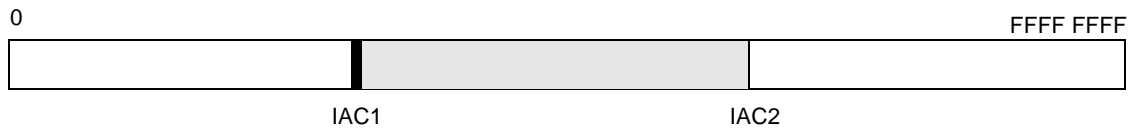

Figure 12-8. Inclusive IAC Range Address Compares

Figure 12-9 shows the range selected in an exclusive IAC range address compare. Note that the address in IAC1 is not considered part of the range, but the address in IAC2 is, along with the highest memory address, as shown in the preceding examples.

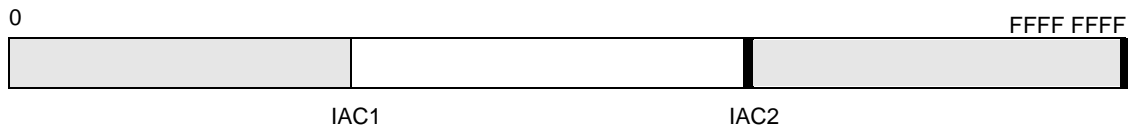

Figure 12-9. Exclusive IAC Range Address Compares

To toggle the range from inclusive to exclusive or from exclusive to inclusive on a IAC range debug event, DBCR0[IA12T] (corresponding to range 1:2) and DBCR0[IA34T] (corresponding to range 3:4) are used. If these fields are set, the DBCR0[IA12X] or DBCR0[IA34X] fields toggle on an IAC debug event, changing the defined range.

When a toggle is enabled (DBCRO[IA12T] for range 1:2 or DBCRO[IA34T] = 1 for range 3:4), and DBCRO[IDM] = 1, DBCRO[EDM] = 0, and MSR[DE] = 0, IAC range comparisons for the corresponding toggle field are disabled.

Preliminary User's Manual**12.9.13 DAC Debug Event**

This debug event occurs before execution of an instruction that accesses a data address that matches the contents of the specified DAC register. DBCR1[D1R, D2R, D1W, D2W] enable DAC debug events for address comparisons on DAC1 and DAC2 for read instructions, DAC2 for read instructions, DAC1 for write instructions, DAC2 for write instructions respectively. Loads are reads and stores are writes. DAC can be defined (DBCR1[D1R, D2R]) as an exact address comparison to one of the DAC_n registers or a range of addresses to compare defined by DAC1 and DAC2 registers.

12.9.13.1 DAC Exact Address Compare

In this mode, each DAC_n register specifies an exact address to compare. These registers are enabled by setting one or more of DBCR1[D1R, D2R, D1W, D2W] = 1, and disabling DAC range compare DBCR1[DA12X] = 0. The corresponding DBSR[DR1, DR2, DW1, DW2] field displays the results of a DAC debug event.

The address for a DAC is the effective address (EA) of a storage reference instruction. EAs are always generated within a single aligned word of memory. Unaligned load and store, strings, and multiples generate multiple EAs to be used in DAC comparisons.

Data address compare (DAC) debug events can be set to react to any byte in a larger block of memory, in addition to reacting to a byte address match. The DAC Compare Size fields (DBCR1[D1S, D2S]) allow DAC debug events to react to byte, halfword, word, or 8-word line address by ignoring a number of LSBs in the EA.

DAC 1 Size	
00 Compare all bits	Byte address
01 Ignore LSB (least significant bit)	Halfword address
10 Ignore two LSBs	Word address
11 Ignore five LSBs	Cache line (8-word) address

The user must determine how the addresses of interest are accessed, relative to byte, halfword, word, string, and unaligned storage instructions, and adjust the DAC compare size field appropriately to cover the addresses of interest.

For example, suppose that a DAC debug event should react to byte 3 of a word-aligned target. A DAC set for exact compare would not recognize a reference to that byte by load/store word or load/store halfword instructions, because the byte address is not the EA of such instructions. In such a case, the D1S field must be set for a wider capture range (for example, to ignore the two least significant bits (LSBs) if word operations to the misaligned byte are to be detected). The wider capture range may result in excess debug events (events that are within the specified capture range, but reflect byte operations in addition to the desired byte). Such excess debug events must be handled by software.

While load/store string instructions are inherently byte addressed the processor will generate EAs containing the largest portion of an aligned word address as possible. It may not be possible to DAC on a specific individual byte using load/store string instructions.

12.9.13.2 DAC Range Address Compare

In this mode, the pair of DAC1 and DAC2 registers are used to define a range of addresses to compare.

To enable DAC range, DBCR1[DA12] = 1 and one or more of DBCR1[D1R,D2R,D1W,D2W] =1. The DAC event is seen on the DBSR[DR1,DR2,DW1,DW2] field that corresponds to the DBCR1[D1R,D2R,D1W,D2W] field that is enabled. For example, if DBCR1[D1R] and DBCR1[D2R] are enabled, the results of a DAC debug event are reported on DBSR[DR1, DR2]. Setting DBCR1[DA12] =1 prohibits DAC1 and DAC2 from being used for exact address compares.

Ranges are defined to be inclusive or exclusive, using the DBCR1[DA12X], as follows:

- DBCR1[DA12] = 1: Range = DAC1 ≤ range < DAC2.
- DBCR1[DA12X] = 1: Range = Range low < DAC1 or DAC2 ≤ Range high.

Figure 12-10 shows the range selected in an inclusive DAC range address compare. Note that the address in DAC1 is considered part of the range, but the address in DAC2 is not, as shown in the preceding examples. The thick lines indicate that the indicated address is included in the compare results.

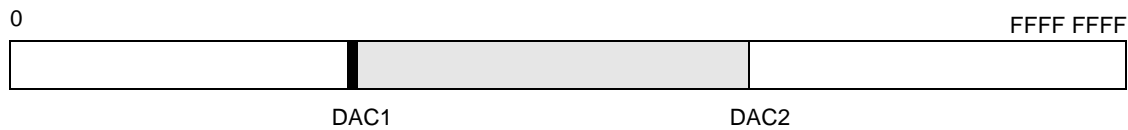

Figure 12-10. Inclusive DAC Range Address Compares

Figure 12-11 shows the range selected in an exclusive DAC range address compare. Note that the address in DAC1 is not considered part of the range, but the address in DAC2 is, along with the highest memory address, as shown in the preceding examples.

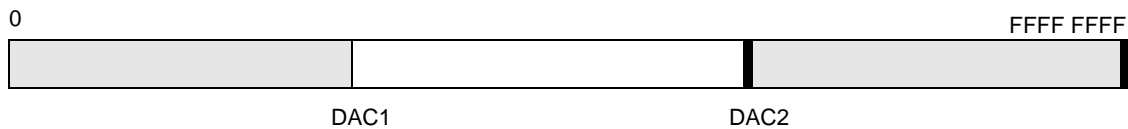

Figure 12-11. Exclusive DAC Range Address Compares

The DAC Compare Size fields (DBCR1[D1S, D2S]) are not used by DAC range comparisons.

Preliminary User's Manual**12.9.13.3 DAC Applied to Cache Instructions**

Some cache instructions can cause DAC debug events. There are several special cases.

Table 12-3 summarizes possible DAC debug events by cache instruction:

Table 12-3. DAC Applied to Cache Instructions

Instruction	Possible DAC Debug Event	
	DAC-Read	DAC-Write
dcba	No	Yes
dcbf	No	Yes
dcbi	No	Yes
dcbst	No	Yes
dcbt	Yes	No
dcbz	No	Yes
dccci	No	No
dcread	No	No
dcbtst	Yes	No
icbi	Yes	No
icbt	Yes	No
iccci	No	No
icread	No	No

Architecturally, the **dcbi** and **dcbz** instructions are “stores.” These instructions can change data, or cause the loss of data by invalidating a dirty line. Therefore, they can cause DAC-write debug events.

The **dccci** instruction can also be considered a “store” because it can change data by invalidating a dirty line. However, **dccci** is not address-specific; it affects an entire congruence class regardless of the operand address of the instruction. Because it is not address-specific, **dccci** does not cause DAC-write debug events.

Architecturally, the **dcbt**, **dcbtst**, **dcbf**, and **dcbst** instructions are “loads.” These instructions do not change data. Flushing or storing a cache line from the cache is not architecturally a “store” because a store had already updated the cache; the **dcbf** or **dcbst** instruction only updates the copy in main memory.

The **dcbt** and **dcbtst** instructions can cause DAC-read debug events regardless of cachability.

Although **dcbf** and **dcbst** are architecturally “loads,” these instructions can create DAC-write (but not DAC-read) debug events. In a debug environment, the fact that external memory is being written is the event of interest.

Even though **dcread** and **dccci** are not address-specific (they affect a congruence class regardless of the instruction operand address), and are considered “loads,” in the PPC405GP they do not cause DAC debug events.

All ICU operations (**icbi**, **icbt**, **iccci**, and **icread**) are architecturally treated as “loads.” **icbi** and **icbt** cause DAC debug events. **iccci** and **icread** do not cause DAC debug events in the PPC405GP.

12.9.13.4 DAC Applied to String Instructions

An **stswx** instruction with a string length of 0 is a no-op. The **lswx** instruction with the string length equal to 0 does not alter the RT operand with undefined data, as allowed by the PowerPC Architecture. Neither **stswx** nor **lswx** with zero length causes a DAC debug event because storage is not accessed by these instructions.

12.9.14 Data Value Compare Debug Event

A data value compare (DVC) debug event can occur only after execution of a load or store instruction to an address that compares with the address in one of the DACn registers and has a data value that matches the corresponding DVCn register. Therefore, a DVC debug event requires both the data address comparison and the data value comparison to be true. A DVCn debug event when enabled in the DBCR1 supercedes a DACn debug event since the DVCn and the DACn both use the same DACn register.

DVC1 debug events are enabled by setting the appropriate DAC enable DBCR1[D1R,D1W] to cause an address comparison and by setting anybit combination in the DBCR1[DV1BE]. DVC2 debug events are enabled by setting the appropriate DAC enable DBCR1[D2R,D2W] to cause an address comparison and by setting any bit combination in the DBCR1[DV1BE]. Each bit in DBCR1[DV1BE, DV2BE] corresponds to a byte in DVC1 and DVC2. Exact address compare and range address compare work the same for DVC as for a simple DAC.

DBSR[DR1] and DBSR[DW1] record status for DAC1 debug events. Which DBSR bit is set depends on the setting of DBCR1[D1R] and DBCR1[D1W]. If DBCR1[D1R] = 1, DBSR[DR1] = 1, assuming that a DVC event occurred. Similarly, if DBCR1[D1W] = 1, DBSR[DW1] = 1, assuming that a DVC event occurred.

Similarly, DBSR[DR2] and DBSR[DW2] record status for DAC2 debug events. Which DBSR bit is set depends on the setting of DBCR1[D2R] and DBCR1[D2W]. If DBCR1[D2R] = 1, DBSR[DR2] = 1, assuming that a DVC event occurred. Similarly, if DBCR1[D2W] = 1, DBSR[DW2] = 1, assuming that a DVC event occurred.

In the following example, a DVC1 event is enabled by setting DBCR1[D1R] = 1, DBCR1[D1W] = 1, DBCR1[DA12] = 0, and DBCR1[DV1BE] = 0000. When the data address and data value match the DAC1 and DVC1, a DVC1 event is recorded in DBSR[DR1] or DBSR[DW1], depending on whether the operation is a load (read) or a store (write). This example corresponds to the last line of Table 12-4.

In Table 12-4, n is 1 or 2, depending on whether the bits apply to DAC1, DAC2, DVC1, and DVC2 events. “Hold” indicates that the DBSR holds its value unless cleared by software. “RA” indicates that the operation is a read (load) and the data address compares (exact or range). “WA” indicates that the operation is a write (store) and the data address compares (exact or range). “RV” indicates that the operation is a read (load), the data address compares (exact or range), and the data value compares according to DBCR1[DVCn].

Table 12-4. Setting of DBSR Bits for DAC and DVC Events

DACn Event	DVCn Enabled	DVCn Event	DBCR1			DBSR	
			[DnR]	[DnW]	[DA12]	[DRn]	[DWn]
0	—	—	—	—	—	Hold	Hold
—	—	—	0	0	—	Hold	Hold
1	0	—	0	1	—	Hold	WA
1	0	—	1	0	—	RA	Hold
1	0	—	1	1	—	RA	WA

Preliminary User's Manual**Table 12-4. Setting of DBCR1 Bits for DAC and DVC Events**

DACn Event	DVCn Enabled	DVCn Event	DBC1			DBSR	
			[DnR]	[DnW]	[DA12]	[DRn]	[DWn]
1	1	0	—	—	—	Hold	Hold
1	1	1	0	1	—	Hold	WV
1	1	1	1	0	—	RV	Hold
1	1	1	1	1	—	RV	WV

The settings of DBCR1[DV1M] and DBCR1[DV2M] are more precisely defined in Table 12-6 and Table 12-7. (*n* enables the table to apply to DBCR1[DV1M, DV2M] and DBCR1[DV1BE, DV2BE]). DVnBE_m indicates bytes selected (or not selected) for comparison in DBCR1[DVnBE].

When DBCR1[DVnM] = 01, the comparison is an AND; all bytes must compare to the appropriate bytes of DVC1.

When DBCR1[DVnM] = 10, the comparison is an OR; at least one of the selected bytes must compare to the appropriate bytes of DVC1.

When DBCR1[DVnM] = 11, the comparison is an AND-OR (halfword) comparison. This is intended for use when DBCR1[DVnBE] is set to 0011, 0111, or 1111. Other values of DBCR1[DVnBE] can be compared, but the results are more easily understood using the AND and OR comparisons. In Table 12-5, “not” is ¬, AND is ∧, and OR is ∨.

Table 12-5. Comparisons Based on DBCR1[DVnM]

DBC1[DVnM] Setting	Operation	Comparison
00	—	Undefined
01	AND	(¬DVnBE ₀ ∨ (DVC1[byte 0] = data[byte 0])) ∧ (¬DVnBE ₁ ∨ (DVC1[byte 1] = data[byte 1])) ∧ (¬DVnBE ₂ ∨ (DVC1[byte 2] = data[byte 2])) ∧ (¬DVnBE ₃ ∨ (DVC1[byte 3] = data[byte 3]))
10	OR	(DVnBE ₀ ∧ (DVC1[byte 0] = data[byte 0])) ∨ (DVnBE ₁ ∧ (DVC1[byte 1] = data[byte 1])) ∨ (DVnBE ₂ ∧ (DVC1[byte 2] = data[byte 2])) ∨ (DVnBE ₃ ∧ (DVC1[byte 3] = data[byte 3]))
11	AND-OR	(DVnBE ₀ ∧ (DVC1[byte 0] = data[byte 0])) ∧ (DVnBE ₁ ∧ (DVC1[byte 1] = data[byte 1])) ∨ (DVnBE ₂ ∧ (DVC1[byte 2] = data[byte 2])) ∧ (DVnBE ₃ ∧ (DVC1[byte 3] = data[byte 1]))

Table 12-6 illustrates comparisons for aligned DVC accesses, that is, words, halfwords, or bytes on naturally aligned boundaries (all byte accesses are aligned).

Table 12-6. Comparisons for Aligned DVC Accesses

Access	DBCR1[DVnBE] Setting	Value	Operation
Word	All	Word value	AND
Halfword (Low-Order)	All	Halfword value replicated	AND-OR
Halfword (High-Order)	All	Halfword value replicated	AND-OR
Byte	All	Byte value replicated	OR

For halfword accesses, the halfword value is replicated in the “empty “ halfword in the DVC register, for example, if the low-order halfword is to be compared, its value is stored in the low-order halfword and the high-order halfword of the register. Similarly, a byte value is replicated in each byte in the register.

Table 12-7 illustrates comparisons for misaligned DVC accesses. In the “DVC1” and “DVC2” columns, “x” indicates a don't care.

Table 12-7. Comparisons for Misaligned DVC Accesses

Access	Operation	DVC1 (Hex)	DVC2 (Hex)	DBCR1[DV1BE] Setting	DBCR1[DV2BE] Setting	DBCR1[D2S] Setting
Word (Offset 1)	AND	xx112233	44xx xxxx	123	0	01
Word (Offset 2)	AND	xxxx1122	3344xxxx	23	01	10
Word (Offset 3)	AND	xxxxxx11	223344xx	3	012	10
Halfword (Offset 1)	AND	xx1122xx		12	12	10
Halfword (Offset 3)	AND	xxxxxx11	22xxxxxx	3	0	10

Note: Misaligned accesses stop the processor on the instruction causing the compare hit. The second part of an instruction is not performed if the first part of the compare hits.

12.9.15 Imprecise Debug Event

The imprecise debug event is not an independent debug event, but indicates that a debug event occurred while MSR[DE] = 0. This is useful in internal debug mode if a debug event occurs while in a critical interrupt handler. On return from interrupt, a debug interrupt occurs if MSR[DE] = 1. If DBSR[IDE] = 1, the debug event causing the interrupt occurred sometime earlier, not immediately after a debug event.

Chapter 13. Clock and Power Management

The PPC405GP provides a clock and power management (CPM) controller that reduces power dissipation by stopping clocks in unused or dormant functional units. Use of the CPM controller requires careful programming and special consideration to avoid compromising system and functional unit integrity.

The CPM controller supports three different types of sleep interfaces to the functional units:

- In a CPM class 1 interface, the CPM_Sleep_N signal is asserted by the CPM controller when a register bit is set by software. The functional unit is unconditionally put to sleep. There is no other communication with the functional unit.
- In a CPM class 2 interface, the functional unit uses a combination of its internal state and external inputs to determine whether or not it can be put to sleep. If sleeping is permitted, the functional unit asserts the Sleep_Req signal to the CPM controller that responds by asserting CPM_Sleep_N if the enable for that unit is set. The CPM_Sleep_N signal to a class 2 unit is deasserted when the CPM controller enable bit for that unit is reset, or when the unit deasserts its Sleep_Req signal.
- The CPM class 3 interface has a CPM_SleepInit signal that is asserted by the CPM controller to request that a functional unit go to sleep. If the unit can sleep, it asserts the Sleep_Req signal to the CPM controller. The CPM_Sleep_N signal is then asserted by the CPM controller to shut off the class 3 clocks in the functional unit. The functional unit or the CPM controller can end the sleep state. If the CPM controller enable bit for the unit is reset, the CPM controller immediately deasserts CPM_SleepInit and CPM_Sleep_N.

13.1 CPM Registers

Table 13-1 lists the registers used to program the CPM controller.

Table 13-1. CPM Registers

Register Name	DCR Address	Access	Reset Value (0:16) (bits 17:31 reserved)
CPC0_ER	0x0B9	Read/Write	0x0000xxxx
CPC0_FR	0x0BA	Read/Write	0x0000xxxx
CPC0_SR	0x0B8	Read Only	0xFFFFxxxx

Each functional unit has one bit in each of CPC0_ER, CPC0_FR, and CPC0_SR. The bit assignment is the same in the three registers. Figure 13-1 on page 13-304 shows the bit assignment and CPM class for each PPC405GP functional units.

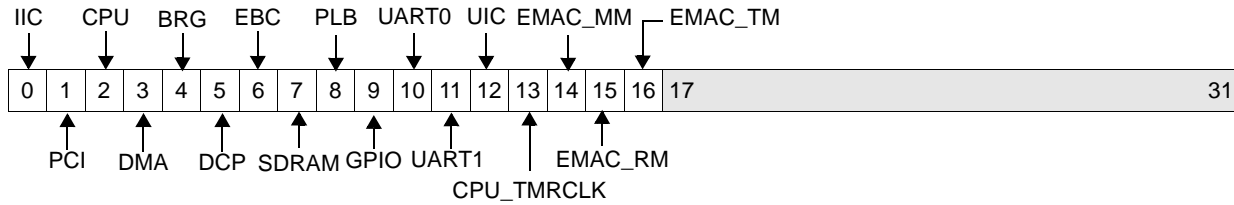

Figure 13-1. CPM Registers (CPC0_ER, CPC0_FR, CPC0_SR)

0	IIC	IIC Interface	Class 3
1	PCI	PCI Bridge	Class 1
2	CPU	Processor Core	Class 2
3	DMA	DMA Controller	Class 2
4	BRG	PLB to OPB Bridge	Class 2
5	DCP	CodePack	Class 2
6	EBC	ROM/SRAM Peripheral Controller	Class 2
7	SDRAM	SDRAM Memory Controller	Class 2
8	PLB	PLB Bus Arbiter	Class 2
9	GPIO	General Purpose Interrupt Controller	Class 1
10	UART0	Serial Port 0	Class 1
11	UART1	Serial Port 1	Class 1
12	UIC	Universal Interrupt Controller	Class 1
13	CPU_TMRCLK	CPU Timers	Class 1
14	EMAC_MM	Ethernet MM Unit	Class 1
15	EMAC_RM	Ethernet RM Unit	Class 1
16	EMAC_TM	Ethernet TM Unit	Class 1
17:31		Reserved	

Preliminary User's Manual

13.1.1 CPM Enable Register (CPC0_ER)

The CPC0_ER bits enable the process of putting a functional unit to sleep. The class of a unit determines how its interface signals are controlled when the bit associated with the unit is set to 1.

- Class 1** When an associated CPC0_ER bit is set to 1, the CPM_Sleep_N signal to the class 1 unit is asserted. When the bit is set to 0, CPM_Sleep_N is deasserted. There are some additional considerations to avoid generating extraneous interrupts when waking the UIC. Before enabling sleep mode (setting DPC0_ER[UIC] to 1), save the contents of the UIC Masked Status Register (UIC0_MSR) and UIC Enable Register (UIC0_ER), and disable all interrupts by setting UIC0_ER to 0. After exiting sleep mode, write the ones complement of the saved contents of the UIC0_MSR to the UIC Status Register (UIC0_SR), and restore the state of the UIC0_ER.
- Class 2** When an associated CPC0_ER bit is set to 1, and the Sleep_Req signal from the class 2 unit is asserted (the unit is requesting sleep state), CPM_Sleep_N to the class 2 unit is asserted. When the bit is set to 0, the CPM_Sleep_N signal is deasserted.
- Class 3** When an associated CPC0_ER bit is set to 1, the CPM_SleepNnit signal to the class 3 unit is asserted (the CPM controller is requesting permission to put the unit to sleep). When the class 3 unit activating the Sleep_Req in response, (the unit is giving permission to be put to sleep), CPM_Sleep_N signal to the class 3 unit is asserted. When the bit is set to 0, CPM_SleepNnit and CPM_Sleep_N are deasserted.

13.1.2 CPM Force Register (CPC0_FR)

Setting a CPC0_FR bit forces assertion of the CPM_Sleep_N signal to the functional unit. For a class 1 unit, this is equivalent to setting the CPC0_ER bit associated with the unit. For class 2 or class 3 units, CPM_Sleep_N is asserted regardless of the state of the Sleep_Req signal coming from the unit.

13.1.3 CPM Status Register (CPC0_SR)

The read-only CPC0_SR shows the current state of the CPM_Sleep_N signals associated with each unit. If a bit is 0, the associated unit is asleep. If a bit is 1, the associated unit is awake and operating normally.

Chapter 14. Decompression Controller Operation

The decompression controller enables PPC405GP instructions to be stored in memory in a compressed form, thus, reducing memory requirements and overall system cost. Because the processor core cannot execute compressed instructions, hardware is provided to decompress the compressed instructions. The decompression controller decompresses instructions on-the-fly, as the processor core fetches instructions from memory. The decompression unit is located in the path between memory and the processor core.

When decompressed instructions are stored in the instruction cache unit (ICU), the performance penalty is minimized. Increased latency occurs only when instruction fetches miss in the cache. Average latency is further reduced by a buffer in the decompression hardware that holds more instructions than are requested by the CPU. If a subsequent fetch occurs to a nearby memory location that is already in the buffer, data is returned from the buffer; no memory cycle is required. In such cases, initial latency is less than a normal uncompressed fetch from memory.

Code to be stored in compressed form is compressed by software after compiling and before loading. Thus, code compression can be performed once by the application developer. The compressed code is in the load image.

The decompression controller, located between the processor core and memory, is transparent to the processor core. When the processor core performs an instruction fetch, the decompression controller works with the memory controller (SDRAM or external bus controller [EBC]) to provide a decompressed instruction stream to the CPU. The memory controllers deliver the compressed stream of instructions to the decompression controller, which decompresses the instructions and delivers the resulting instruction stream to the processor core.

14.1 Code Compression and Decompression

While code decompression is performed in hardware when the processor core fetches instructions in a compressed code address space, code compression is performed only once, between the compile and load steps in the usual programming sequence.

14.1.1 Code Compression

Compression software analyzes compiled code, finds the set of most frequently used instructions, and builds decode tables from those instructions.

The compression software splits each instruction, analyzes the upper and lower halfwords of the instruction to find the most common 16-bit patterns. The most frequently used patterns are tagged for insertion in a decode table. Infrequently used instructions are tagged as not compressed. The 16-bit patterns that match those in the decode table are stored in the compressed code image, along with uncompressed instructions. The decode table is loaded into the decompression controller before attempted execution of the compressed instruction streams.

After the decode table is built, a compiled code image is compressed, using a scheme employing a tag and an index. The decompression controller generates an address into the decode table to select the original 16-bit pattern.

The compression software stores compressed and uncompressed instructions in 64-byte blocks, called compression blocks. The number of bytes used to store compressed code varies in each compression block,

depending on the encoding. Because the length resulting compressed block varies, the compression software generates an index table that translates addresses of uncompressed 64-byte blocks, called target instruction addresses (TIAs), to addresses of the compressed variable length blocks. The index table also contains information indicating, for each block, whether the compression block was compressed or left uncompressed. The index table is loaded into system memory with the compressed blocks of program code. The decompression controller accesses the index table when a fetch is made to compressed program space.

14.1.2 Code Decompression

The decompression controller is located between the processor core and the SDRAM and EBC memory controllers, isolating the memory controllers from the processor local bus (PLB). The decompression controller is transparent to the processor core and the memory controllers. The processor core side of the decompression controller is a PLB slave to the PLB bus, and the memory controller side is a PLB master to the memory controllers. Instruction-side requests for external memory go through the decompression controller, and are either intercepted for decompression or allowed to pass through unaltered.

The decompression controller must distinguish between compressed and uncompressed code space. To accomplish this, the processor core provides a signal with each instruction memory reference, indicating whether the reference is in compressed or uncompressed memory space. The CPU's U0 storage attribute is used to implement this signal. When address translation is enabled (the IR field of the Machine State Register (MSR) is 1), a corresponding U0 bit is implemented in translation lookaside buffer (TLB) entries in the memory management unit (MMU). When address translation is disabled (MSR[IR] = 0, the Storage User-defined 0 Register (SUOR) implements the U0 storage attribute for memory regions. The U0 storage attribute indicates whether a page is marked as compressed.

14.1.3 Instruction Fetches to Compressed Pages

The decompression controller intercepts instruction fetches to code in uncompressed pages, locates the compressed code in memory, and decompresses the instruction stream before forwarding it to the processor core. These steps are detailed in the following procedure:

1. Locate compressed code
 - a. Calculate offset into index table.
 - b. Retrieve index from index table.
 - c. Calculate address of compression block using the index table entry.
 - d. Retrieve compression block.
2. Decode instructions into the output buffer, if required.
3. Return instructions to the processor core.

The decompression controller contains a 64B output buffer that stores instruction words as they are decompressed. Because code is compressed and decompressed in 64B blocks and the CPU requests smaller line fills (32 bytes), some accesses to compressed instructions may already be available in the decompression controller output buffer, decompressed and ready for execution. In this case, line fill requests are serviced from the output buffer, without having to address external memory.

Step 2, above, indicates that compressed code is decoded "if required." Some compression blocks do not contain compressed code, even though they reside in compressed code space. The compression algorithm can infrequently result in blocks that are larger than the original code. In such cases, the compression software does not compress the instruction block and marks it as uncompressed. The decoder will not attempt to decompress such blocks.

Preliminary User's Manual

14.1.4 Instruction Fetches to Uncompressed Pages

The decompression controller does not intercept instruction fetches to code in uncompressed memory space. These fetches are passed, unaltered, to the appropriate memory controller. The decompression controller also provides unaltered data, from the appropriate memory controller, back to the CPU in the case of a read. This transaction does not incur any additional latency.

14.1.5 Performance

The decompression controller is designed so that read/write requests to uncompressed memory spaces incur no additional latency over a system without a decompression controller.

The decompression controller adds additional latency to some read accesses to compressed memory space. The decompression controller requires additional cycles to locate compressed code, fetch it, decode the instructions, and place them in the output buffer. However, because instructions are encoded in 64-byte compression blocks, the decompression controller continues to decompress instructions until its 64-byte output buffer is full. In such cases, the decompression controller acts as a prefetch buffer, and subsequent fetches to instructions in the same 64-byte block actually incur less latency than if the decompression controller were not present.

More significant latencies occur when the processor core executes a branch out of the current 64-byte block. If the branch is to a TIA that is not at the beginning of a 64-byte block, the decompression controller must fetch and decode the block containing the TIA, byte by byte, until it reaches the desired instruction. The worst latencies occur when the TIA is outside of the 128-byte group, since the decompression controller must then go through its entire decode process, including a refetch of the index table entry.

14.2 Decompression Controller Registers

The registers that control operation of the decompression controller, listed in Table 14-1, are indirectly accessed using the Decompression Controller Address Register (DCP0_CFGADDR) and Decompression Controller Data Register (DCP0_CFGDATA) listed in Table 14-2. The DCP0_CFGADDR and DCP0_CFGDATA are accessed using the **mfocr** and **mtocr** instructions.

Descriptions of the registers follow Table 14-2.

The DCP0_CFGADDR stores the address of the target register, while the DCP0_CFGDATA register is used to write or read the target register contents.

The following procedure accesses the decompression controller registers.

1. Write the offset from Table 14-2 to the Decompression Controller Address Register (DCP0_CFGADDR).
2. Read data from or write data to the Decompression Controller Data Register (DCP0_CFGDATA).

Table 14-1. DCRs Used to Access the Decompression Controller Registers

Register	DCR Address	Access	Description
DCP0_CFGADDR	0x014	R/W	Decompression Controller Address Register
DCP0_CFGDATA	0x015	R/W	Decompression Controller Data Register

Table 14-2. Offsets for Decompression Controller Registers

Register	Offset	R/W	Description
DCP0_ITOR0	0x00	R/W	Index Table Origin Register 0
DCP0_ITOR1	0x01	R/W	Index Table Origin Register 1
DCP0_ITOR2	0x02	R/W	Index Table Origin Register 2
DCP0_ITOR3	0x03	R/W	Index Table Origin Register 3
DCP0_ADDR0	0x04	R/W	Address Decode Definition Register 0
DCP0_ADDR1	0x05	R/W	Address Decode Definition Register 1
DCP0_CFG	0x40	R/W	Decompression Controller Configuration Register
DCP0_ID	0x41	R	Decompression Controller ID Register
DCP0_VER	0x42	R	Decompression Controller Version Register
DCP0_PLBBEAR	0x50	R	Bus Error Address Register (PLB)
DCP0_MEMBEAR	0x51	R	Bus Error Address Register (EBC/SDRAM)
DCP0_ESR	0x52	R/Clear	Bus Error Status Register 0 (Masters 0–3)
DCP0_RAM0– DCP0_RAM3FF	0x400–0x7FF	R/W	Decompression Decode Table Entries (SRAM) 0x400–0x5FF Low 16-bit decode table 0x600–0x7FF High 16-bit decode table

14.2.1 Index Table Origin Registers (DCP0_ITOR0–DCP0_ITOR3)

DCP0_ITOR0–DCP0_ITOR3 each contain the high-order address bits of the index table for a compression region.



Figure 14-1. Decompression Index Table Origin Registers (DCP0_ITOR0–DCP0_ITOR3)

0:20		Reserved
21:31	ITO	Index Table Origin High-order index table address bits

Preliminary User’s Manual

14.2.2 Decompression Address Decode Definition Registers (DCP0_ADDR0–DCP0_ADDR1)

DCP0_ADDR0–DCP0_ADDR1 each define an address space used by the decompression controller for compressed instructions, and for uncompressed accesses that are passed to a memory controller.

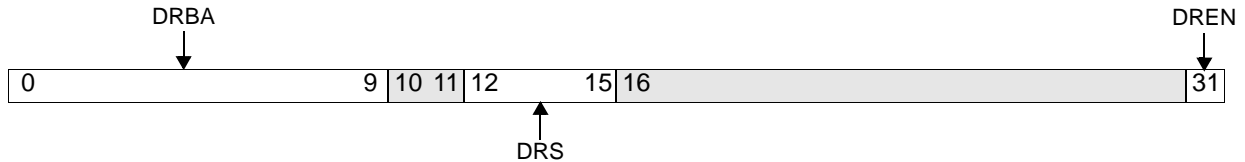

Address Decode Definition Registers (DCP0_ADDR0–DCP0_ADDR1)

0:9	DRBA	Decode Region Base Address	High-order decode region address bits
10:11		Reserved	
12:15	DRS	Decode Region Size	
		0000–0100 Reserved	
		0101 4MB	
		0110 8MB	
		0111 16MB	
		1000 32MB	
		1001 64MB	
		1010 128MB	
		1011 256MB	
		1100 512MB	
		1101 1GB	
		1110 2GB	
		1111 4GB	
16:30		Reserved	
31	DREN	Enable Decode Region	
		0 Decoding is disabled for region	
		1 Decoding is enabled for region.	

14.2.3 Decompression Configuration Register (DCP0_CFG)

DCP0_CFG is used to configure the operation of the decompression controller.

DCP0_CFG[IKB] must be set to 0 to enable decompression. The value of this field determines whether the U0 storage attribute is recognized; the storage attribute must be recognized for decompression to occur.

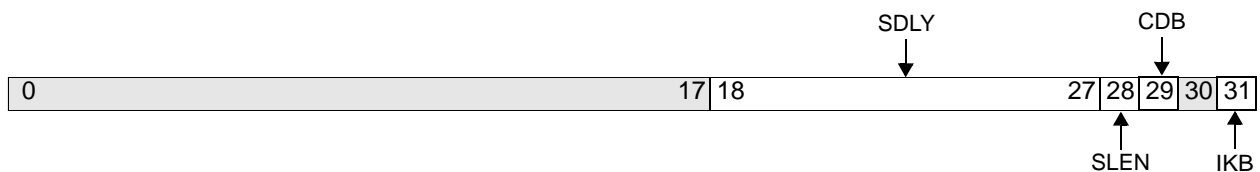

Figure 14-2. Decompression Controller Configuration Register (DCP0_CFG)

0:17		Reserved
------	--	----------

18:27	SLDY	Sleep Delay	Sleep delay
28	SLEN	Sleep Enable 0 Disable sleep 1 Enable sleep	
29	CDB	Clear Decompression Buffer 0 Normal operation 1 Clear decompression buffer	Self-clearing; always reads 0
30		Reserved	
31	IKB	Enable Decompression 0 Decompression is enabled; U0 storage attribute is recognized 1 Decompression is disabled; U0 storage attribute is ignored	

14.2.4 Decompression Controller ID Register (DCP0_ID)

DCP0_ID contains the decompression controller ID.

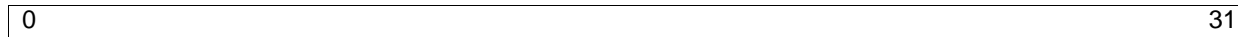

Figure 14-3. Decompression Controller ID Register (DCP0_ID)

0:31		Decompression Controller ID	Read-only, value is 0000504D
------	--	-----------------------------	------------------------------

14.2.5 Decompression Controller Version Register (DCP0_VER)

DCP0_VER contains the decompression controller version.

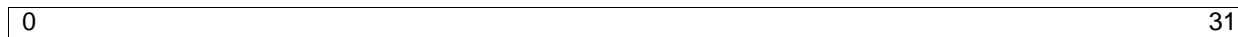

Figure 14-4. Decompression Controller Version Register (DCP0_VER)

0:31		Decompression ControllerVersion	Read-only, value is 0x00000200
------	--	---------------------------------	--------------------------------

Preliminary User's Manual**14.2.6 Decompression Controller PLB Error Address Register (DCP0_PLBBEAR)**

On an error, DCP0_PLBBEAR contains the address on the PLB that caused the decompression controller to generate cycles to the SDRAM and EBC memory controllers.

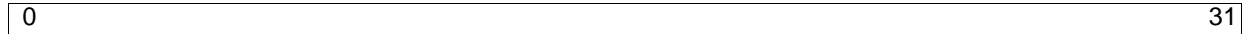
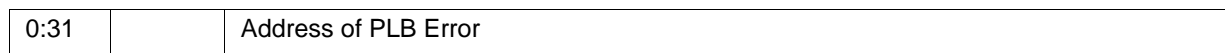

Figure 14-5. Decompression Controller PLB Error Address Register (DCP0_PLBBEAR)

**14.2.7 Decompression Controller Bus Error Address Register (DCP0_MEMBEAR)**

On an error, DCP0_MEMBEAR contains the address, presented to the memory controllers, that caused an error in the decompression controller. The address was presented to the memory controllers for either an index table entry fetch or a block burst request.

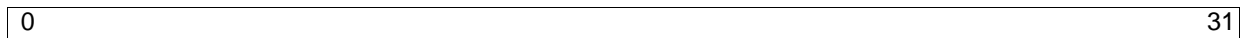
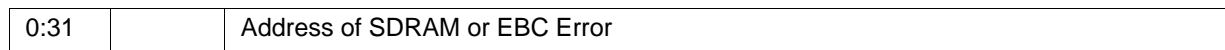

Figure 14-6. Decompression Controller Bus Error Address Register (DCP0_MEMBEAR)



14.2.8 Decompression Controller Error Status Register 0 (DCP0_ESR)

DCP0_ESR reports error status.

Status information includes error type and master read/write status. DCP0_ESR0 field and DCP0_PLBBEAR or DCP0_MEMBEAR lock status is also reported.

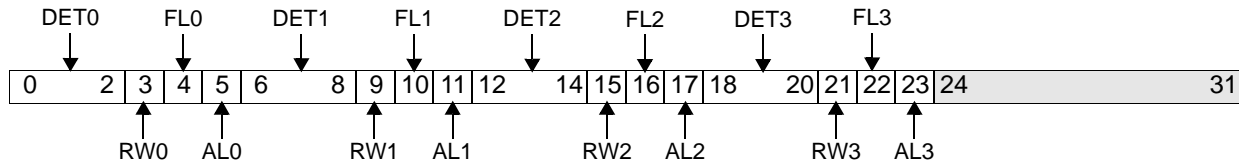

Figure 14-7. Decompression Controller Error Status Register 0 (DCP0_ESR)

0:2	DET0	Decompression Error Type for Master 0 000 Time-out during ITE fetch 001 Time-out during block fetch 010 Memory controller error during ITE fetch 011 Memory controller error during block fetch 100–111 Reserved	Master 0 is the processor core instruction cache unit (ICU).
3	RW0	Read/Write Status for Master 0 0 Error operation was a write 1 Error operation was a read	This implementation only reports errors for compressed reads.
4	FL0	DCP0_ESR Field Lock for Master 0 0 DCP0_ESR fields are unlocked 1 DCP0_ESR fields are locked	DCP0_ESR register fields are locked when the PLB_lockErr signal was active in the cycle in which the error occurred.
5	AL0	DCP0_MEMBEAR/DCP0_PLBBEAR Address Lock for Master 0 0 Master has not locked DCP0_MEMBEAR and DCP0_PLBBEAR 1 Master has locked DCP0_MEMBEAR and DCP0_PLBBEAR	DCP0_MEMBEAR and DCP0_PLBBEAR are locked to this master address when the PLB_lockErr signal was active in the cycle in which the error occurred.
6:8	DET1	Decompression Error Type for Master 1	See description for DCP0_ESR[DET0]. Master1 is the processor core data cache unit (DCU).
9	RW1	Read/Write Status for Master 1 0 Error operation was a write 1 Error operation was a read	This implementation only reports errors for compressed reads.
10	FL1	DCP0_ESR Field Lock for Master 1 0 DCP0_ESR fields are unlocked 1 DCP0_ESR fields are locked	DCP0_ESR register fields are locked when the PLB_lockErr signal was active in the cycle in which the error occurred.

Preliminary User's Manual

11	AL1	DCP0_MEMBEAR/DCP0_PLBBEAR Address Lock for Master 1 0 Master has not locked DCP0_MEMBEAR and DCP0_PLBBEAR 1 Master has locked DCP0_MEMBEAR and DCP0_PLBBEAR	DCP0_MEMBEAR and DCP0_PLBBEAR are locked to this master address when the PLB_lockErr signal was active in the cycle in which the error occurred.
12:14	DET2	Decompression Error Type for Master 2	See description for DCP0_ESR[DET0]. Master 2 is the external master.
15	RW2	Read/Write Status for Master 2 0 Error operation was a write 1 Error operation was a read	This implementation only reports errors for compressed reads.
16	FL2	DCP0_ESR Field Lock for Master 2 0 DCP0_ESR fields are unlocked 1 DCP0_ESR fields are locked	DCP0_ESR register fields are locked when the PLB_lockErr signal was active in the cycle in which the error occurred.
17	AL2	DCP0_MEMBEAR/DCP0_PLBBEAR Address Lock for Master 2 0 Master has not locked DCP0_MEMBEAR and DCP0_PLBBEAR 1 Master has locked DCP0_MEMBEAR and DCP0_PLBBEAR	DCP0_MEMBEAR and DCP0_PLBBEAR are locked to this master address when the PLB_lockErr signal was active in the cycle in which the error occurred.
18:20	DET3	Decompression Error Type for Master 3	See description for DCP0_ESR[DET0]. Master 3 is PCI.
21	RW3	Read/Write Status for Master 3 0 Error operation was a write 1 Error operation was a read	This implementation only reports errors for compressed reads.
22	FL3	DCP0_ESR Field Lock for Master 3 0 DCP0_ESR fields are unlocked 1 DCP0_ESR fields are locked	DCP0_ESR register fields are locked when the PLB_lockErr signal was active in the cycle in which the error occurred.
23	AL3	DCP0_MEMBEAR/DCP0_PLBBEAR Address Lock for Master 3 0 Master has not locked DCP0_MEMBEAR and DCP0_PLBBEAR 1 Master has locked DCP0_MEMBEAR and DCP0_PLBBEAR	DCP0_MEMBEAR and DCP0_PLBBEAR are locked to this master address when the PLB_lockErr signal was active in the cycle in which the error occurred.
24:31		Reserved	

For more information, refer to *CodePack™ PowerPC Code Compression Utility User's Manual*, Version 3.0.

14.2.9 Decompression Decode Table Entries

DCP0_RAM0–DCP0_RAM3FF contain both decompression decode tables. The first (offsets 0x400–0x5FF) is a 512-entry table of 16-bit values used by the decompression controller to decode the lower half of compressed instructions. The second (offsets 0x600–0x7FF) is a 512-entry table of 16-bit values used by the decompression controller to decode the upper half of compressed instructions.

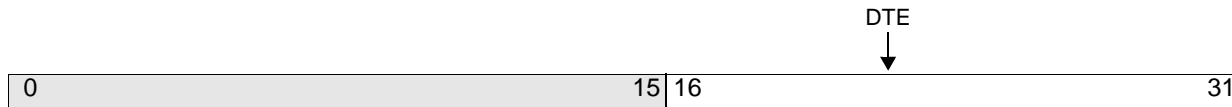

Figure 14-8. Decompression Decode Table Entries (DCP0_RAM0–DCP0_RAM3FF)

0:15		Reserved
16:31	DTE	Decode Table Entry

14.3 Decompression Controller Initialization

Following any reset, address translation is disabled and all SU0R bits are reset to 0 so that no memory regions are treated as compressed. In addition, the decompression controller is disabled after a system or chip reset. Because of this, the instruction at 0xFFFFF0FC and the code that initializes the decompression controller must be uncompressed. Below are the steps required to prepare the PPC405GP to execute compressed instructions.

1. Initialize the required DCP0_ITORx registers. To determine which DCP0_ITOR registers need to be initialized, look at bits 4:5 of all index table entries generated by the compression software utility. If bits 4:5 = 0b00, then DCP0_ITOR0 must be initialized, if bits 4:5 = 0b01, then DCP0_ITOR1 must be initialized, and so on. The value that should be written to DCP0_ITORx[ITO] is bits 0:10 of an index table entry address. For example, if the compression software utility generates index table entries starting at address 0xFFFFE000, the DCP0_ITOR3 register should be initialized to 0x7FF.
2. Initialize the SU0R register or TLB entries to specify which memory regions contain compressed instructions. The decompression controller will ignore these settings until it is enabled below.
3. Initialize the DCP0_ADDRx registers. These registers tell the decompression controller, once it is enabled, which address ranges it needs to respond to on the PLB for the SDRAM controller and External Bus Controller (EBC). These registers should be set to cover all memory that can be addressed through the EBC or SDRAM controller. Setting the DCP0_ADDR0 register to 0x000E0001 will cover all SDRAM addresses from 0x00000000 to 0x7FFFFFFF (2GB). Setting the DCP0_ADDR1 register to 0xF00B0001 will cover all external peripheral addresses including ROM from 0xF0000000 to 0xFFFFFFFF (256MB).
4. Set the CCR0[U0XE] bit so that a Data Storage Interrupt occurs when a store to an EA with the U0 storage attribute set occurs. The decompression controller does not support stores to memory regions with the U0 attribute set.
5. Initialize decode tables DCP0_RAM0–DCP0_RAM3FF with the decode table values. This information should come from the compression software utility.
6. Enable the decompression controller by clearing the DCP0_CFG[IKB] bit.

Preliminary User's Manual

7. Clear error status in the decompression controller by writing 0xFFFFFFFF to the DCP0_ESR register. This must be the last step.
8. Branch to compressed code is now possible.

14.4 Decompression Operations

This section describes in detail the operation of the decompression controller:

- Indexed addressing method to locate compressed code
- Index table format
- Compressed code format
- Decompressed buffer access

14.4.1 Indexed Addressing

Program instructions are compressed in 64-byte compression blocks and stored in memory for subsequent fetching and execution. Because the blocks are compressed, they typically occupy less than 64 bytes in the compressed memory image. Further, each 64-byte block compresses into a variable length block of compressed code. Because the PPC405GP processor cannot know that the program image is compressed and uses the uncompressed image addresses (TIA) to fetch instructions, the decompression controller must map the uncompressed address space to the compressed address space.

Figure 14-9 illustrates this mapping.

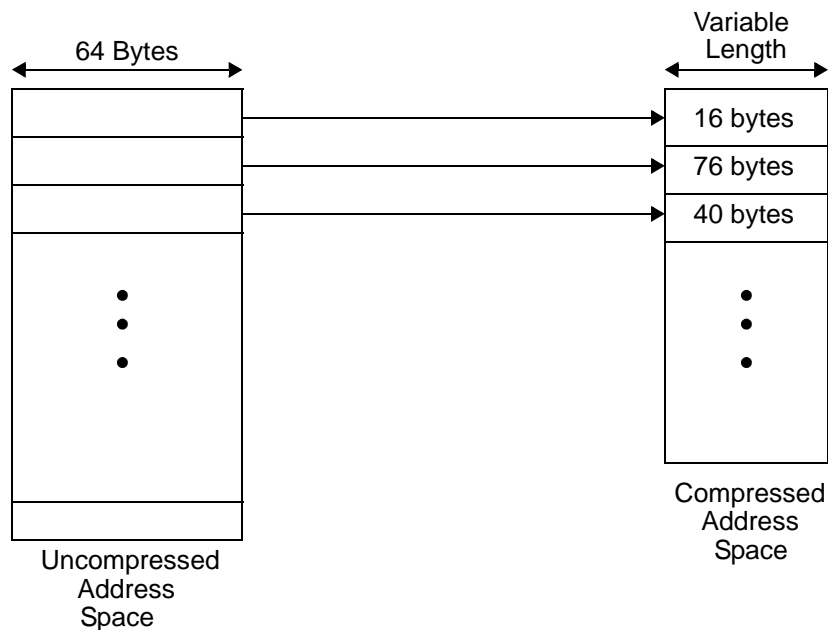

Figure 14-9. Memory Mapping

An index table, generated by the compression software, accomplishes this mapping

When the CPU fetches code from memory it generates a bit known as the “K” bit that indicates whether the instruction fetch is within a compression region or not. Compression regions are 64MB blocks of compressed code address space in main memory. If the access is to a compression region the decompression controller must locate the code in that region by using an index table. Since the index table is located in memory, the decompression controller must locate the starting address of the index table and add an offset, to address the proper entry in the table corresponding to the target instruction address. The decompression controller contains a set of registers known as the “Index Table Origin Registers” (ITOR) which locate the compression region as well as the starting address of the Index table within that compression region. There is an Index Table Origin Register programmed for each compression region (up to 4 simultaneously). The decompression controller computes the address of the index table entry from the PLB address together with the contents of the Index Table Origin Register, and executes a memory read to the memory controller to get a copy of the index table entry. After retrieving the index table entry the decompression controller calculates the starting address of the compression block within the compression region and executes a burst cycle from the memory controller to begin filling its buffers with the compressed data.

14.4.1.1 Index Table Format

The index table is a list of 32-bit wide entries with each entry indicating the address of two sequential blocks (a compression group) of variable length compressed instruction streams.

Figure 14-10 illustrates the index table format.

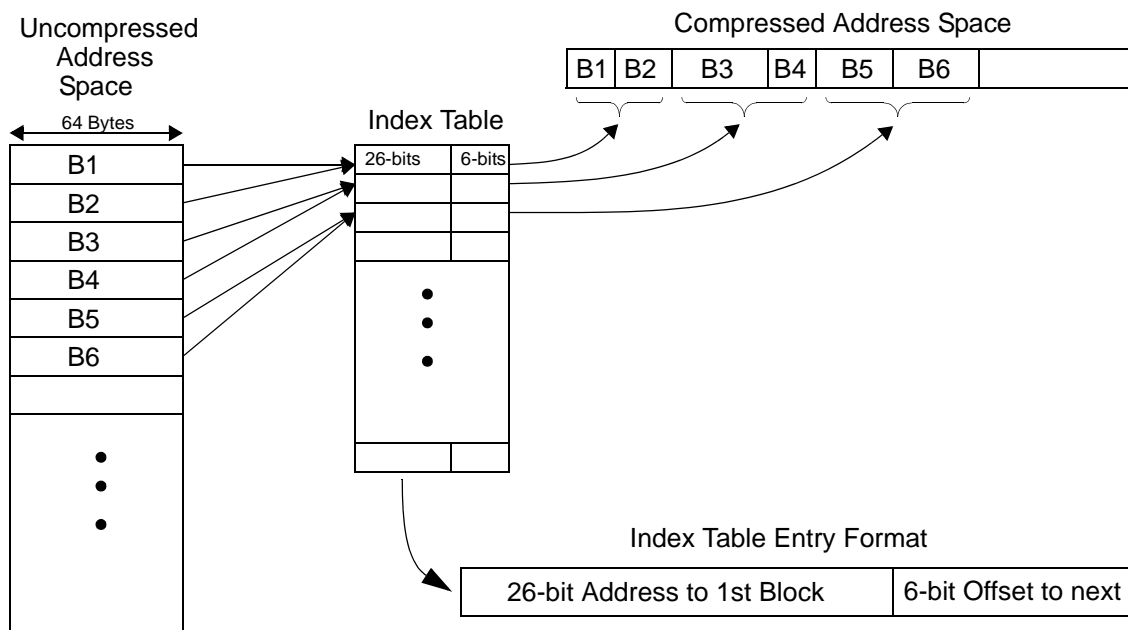

Figure 14-10. Index Table Entry (ITE) Format

Preliminary User's Manual

As shown, each entry is composed of a 26-bit field and a 6-bit field. The 26-bit field indicates where, within the current compression region, the first of the two compression blocks is located. The 6-bit field is an offset from that address to the next compression block. This format allows 128 bytes of uncompressed code to be located using only 4 bytes of space in the index table. The 6-bit field uses a format that not only locates the second block of code, but it also indicates whether those compression blocks have actually been compressed or not.

Table 14-3. Index Offset Format

First Block	Second Block	6-bit Offset Value	Description
Not Compressed	Not Compressed	0	Both are 64-byte uncompressed blocks
Not Compressed	Compressed	1	Only the 2nd Block is compressed
Compressed	Compressed	> 1	Both blocks are compressed
Compressed	Not Compressed	Illegal Case	Cannot represent address of 2nd block

There are three allowed possible scenarios for the value of the 6-bit offset as indicated in Table 14-3. A value of 0 indicates that neither of the blocks are compressed, so the address of block 2 is always 64 bytes past the address of the first block. If the index is 1 the address of block 2 is calculated the same as in the first case, but the decompression controller must treat the second block as compressed code. The third allowed case is when the offset is greater than 1, in which case both blocks are considered to be compressed and the 6-bit offset must be added to the 26-bit address field to locate the second block.

Note: The first 64-byte block must never be allowed to “compress” to a block larger than 63 bytes since the 6-bit offset cannot point past 63 bytes. If the block becomes larger than 63 bytes then it should not be compressed.

No information is stored to indicate the size of the second block. It may be compressed or not and may in fact compress to larger than 64 bytes. The decode unit has the responsibility of continuing to fetch data from memory until it has decompressed enough instructions to reassemble the original 64-byte block.

The illegal case cannot be represented because if the first block is compressed, the entire 6-bit field is required to indicate the length of the first compressed block (up to 63 bytes). Using all 6 bits for length information does not allow any way to indicate whether the second block is compressed or not. Because of this only one case may be allowed and it was chosen to require the second block to be compressed as well which should yield the best overall compression. If the compression software comes across two blocks which are shortest of represented using the “illegal” case, it must make a trade-off, and pick one of the other combinations.

14.4.2 Decoding Compressed Instructions

The decoder is responsible for accepting the data from the burst transfers from the memory controller and decompressing the instructions if required. A signal is presented to the decoder to indicate whether specific blocks need decompressing or not according to the offset encoded in the index table, as shown in Table 14-3. If the offset indicates that the block is uncompressed, the decoder passes the data directly through to the output buffer, unaltered. If the block is compressed the decoder decompresses the instructions before writing them into the output buffer.

14.4.2.1 Instruction Decode

Each PowerPC instruction is contained in a 32-bit word. The encoding scheme employed encodes the instructions in two 16-bit pieces, the upper and lower halves of the instruction code. The most frequently used 16-bit patterns are placed in a Decode Lookup Table attached to the decompression controller. The table is divided into “buckets” so that the 16-bit patterns which are encountered most frequently may be encoded with the fewest number of bits. Instructions used less frequently require more bits to represent them in memory.

The encoded instructions are actually used as an address into this decode lookup table which provides the decode for each half of the instruction. The table can be implemented in either ROM or RAM. The encoding for each 16-bit pattern is broken into two pieces, a 2 or 3-bit Tag (T_x) and a 0 to 8-bit ROM Index (R_x). In the case where the 16-bit pattern was not placed in the table, the pattern is represented by a 3-bit Tag and the original 16-bit pattern, or “Literal.” Each Tag represents a different number of 16-bit patterns which leads to a partitioning or “bucketing” of the index table. The encoding is different for the high 16 bits and the low 16 bits of the instructions, so two tables are required to decode a full PowerPC instruction.

The decode lookup table may be 256 or 512 entries long and it may be composed of one physical table with two read ports, or two physical tables, through which the upper and lower 16-bit patterns are decoded.

The coding for the upper and lower 16-bit patterns and the address ranges each group falls into in the 512 entry decode lookup table are found in Table 14-4. Note that some positions in each table are unused, so the full 512 entries are not used for this particular encoding scheme. In this table the tag and ROM index bits are the actual bits stored in compressed program memory. These bits are translated into the 9-bit decode lookup table address shown in the table. The bit positions shown in the table using the letter “n” are the actual bits that are stored in the compressed program memory (The R_x bits).

Table 14-4. 512 Entry Index Table Bucketing/Address Generation

High Tag T_{HX}	High ROM Index Bits R_{HX}	High Decode Lookup Table Address	High Decode Table Bucket Position	Low Tag T_{LX}	Low ROM Index Bits R_{LX}	Low Decode Lookup Table Addr.	Low Decode Table Bucket Position
0 0	3	0 0 0 0 0 1 n n n	8–15	0 0	0	0 0 0 0 0 0 0 0 1	1
0 1	5	0 0 0 1 n n n n n	32–63	0 1	4	0 0 0 0 1 n n n n	16–31
1 0 0	6	0 0 1 n n n n n n	64–127	1 0 0	5	0 0 0 1 n n n n n	32–63
1 0 1	7	0 1 n n n n n n n	128–255	1 0 1	7	0 1 n n n n n n n	128–255
1 1 0	8	1 n n n n n n n n	256–511	1 1 0	8	1 n n n n n n n n	256–511
1 1 1	16	Literal		1 1 1	16	Literal	

Note: If the decode lookup table is implemented using a 256 entry bucketing scheme, the table above is used with the exception of bucket number “110”. Using an optimized scheme would give the best possible compression but would increase the amount of logic required to decode the new ROM Addresses. Using this bucketing scheme does not yield optimal compression. This trade-off must be considered if considering using the 256 entry decode lookup table.

Preliminary User's Manual

The various options available for the decode lookup table size and organization are shown in Table 14-5.

Table 14-5. Decode Lookup Table Topologies

Physical Memory Arrays	Entries per Logical Table	Array Size
2	256	256 × 16 (×2)
2	512	512 × 16 (×2)

14.4.2.2 Compressed Instruction Format

Compressed instructions are stored in memory using the format shown in Figure 14-11. The combination of the two Tags and two ROM Indexes decodes into a full PowerPC instruction (32 bits). The compressed form of the 32-bit instruction may vary in size from 7 to 38 bits.

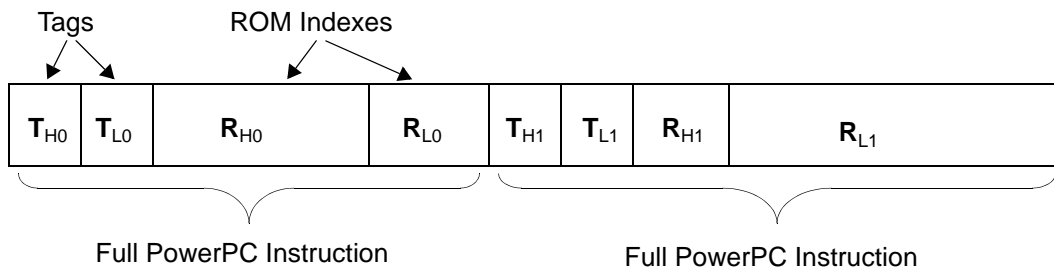

Figure 14-11. Compressed Instruction Format

14.4.3 Decompressed Buffer Access

The output of the decode lookup table or the 16-bit literal is placed in the output buffer and reunited with the other half of the 32-bit instruction. Once the word that was originally requested by the CPU has been decoded and placed in the output buffer, the CPU read request may be completed. The decompression controller continues to request compressed instructions from the memory controller until the entire 64-byte buffer has been filled or a request to fetch a compressed instruction outside of the current compression block has been received (CPU branch with K=1).

In the case where the CPU is executing code sequentially the output buffer acts as a prefetch buffer for the CPU. If the CPU executes a jump instruction to a different compressed block, the decompression controller aborts any burst transfer to the memory controller which may be in progress and begins a new transaction with the new address.

CPU accesses to uncompressed addresses (K=0) while a compression block is being decoded are held up until decompression of the current block is complete. Once the 64-byte buffer has been filled, the access to uncompressed memory space is forwarded on to the memory controller and the data returned to the CPU.

Note: The decompression controller design does not preclude compression of data. Data is generally more random in nature and does not lend itself well to the compression algorithm implemented in the decompression controller.

The decompression controller only services line fill and single word read cycles from compressed memory space. PLB burst requests from compressed memory space are not supported. (The decompression controller however, generates burst requests to the memory controller to transfer compression blocks into the decoder).

14.4.4 Transparent Access to Uncompressed Memory

If the decompression controller is idle when the CPU requests instructions or data from an uncompressed memory space, the decompression controller appears to be transparent in the system, and no additional latency cycles are added due to its existence. The decompression controller is implemented such that it provides a pass-through path for just such accesses. However, when the CPU requests data while the decompression controller is in the middle of bursting instructions from the memory controller to fill the decompression buffers, then additional latency may be added.

14.4.5 Error Handling

Accesses to compressed instructions via the decompression controller may encounter errors which must be reported to the CPU for handling. Errors detected by the decompression controller are either caused by a time-out on the memory controller due to an incorrect address being presented to it, or the memory controller may encounter an error while attempting to fulfill a request from the decompression controller. Time-out conditions may occur in the event that either the ITOR register value or the Index table entry value are programmed incorrectly causing the decompression controller to address a memory space not recognized by the memory controller. The memory controller may indicate an error to the decompression controller due to any of the error types that it is able to detect. The error types that the memory controller may encounter during a single word read or a word read burst cycle would be a parity or ECC error, a protected memory error, or an invalid bank error. The latter two could occur for the same reasons as a time-out described above (incorrectly programmed ITOR or ITE).

The errors reported to the CPU include the following:

- Time-out on the memory controller interface during an index table entry fetch.
- Time-out on the memory controller interface during a block fetch.
- Error from the memory controller during an index table entry fetch - Parity/ECC, protected memory, or non-configured bank.
- Error from the memory controller during a block fetch - Parity/ECC, protected memory, or non-configured bank.

Once an error is detected, the TIA from the PLB as well as the address presented to the memory controller are stored in error address registers (DCP0_PLBBEAR and DCP0_MEMBEAR) and the error status is stored in the error status register (DCP0_ESR).

Preliminary User's Manual

14.4.5.1 Returning Error Information

Error information is returned to the master whose request encountered an error along with the returned data. The decompression controller keeps track of which master requests data so the error may be returned correctly.

If the error occurs during the burst transfer from the memory controller, it is possible that the data requested by the PLB Master may have been returned and the cycle completed, and so may not be reported immediately. Since the decompression controller prefetches the entire 64-byte block an error may occur at the end of the block burst so the controller must keep track of which bytes in the decompressed buffer are valid and which contain errors.

This method insures that no invalid data is decoded in the instruction decoder and that all data in the buffer, after the last valid word from the DCU, is marked as having encountered an error. Accesses in progress (line fills) return good data where the word is marked valid and return bad data on words where the error bit is set. Subsequent fetches which hit on the buffer generate a compression block fetch from the EBC instead of providing erroneous data from the buffer even though there may be a partially good block decoded in the buffer.

If the error occurs during the index table entry fetch, the buffer fulfills the request to the PLB (word read or line fill) with whatever data happens to be in the buffer at the time, disregarding the valid and error bits.

Part IV. PPC405GP External Interfaces

Preliminary User's Manual**Chapter 15. SDRAM Controller**

The SDRAM controller provides a 32-bit interface to SDRAM memory with optional Error Checking and Correction (ECC). The memory controller provides flexible, fully programmable timings for interfacing to a wide variety of SDRAM devices. It supports four physical banks of dual- or quad-bank SDRAMs, where each physical bank is from 4 MB to 256 MB in size. In addition, the SDRAM controller supports the use of registered SDRAMs.

The controller supports page mode operation with bank interleaving and maintains up to four open pages. To improve performance, the controller features separate 32-byte read and 128-byte write buffers. For applications where data integrity must be guaranteed, optional ECC provides standard single error correction and double error detection. Designers also have the opportunity to reduce system power by placing the SDRAM controller in sleep and/or self-refresh mode.

15.1 Interface Signals

In many systems the memory controller can directly interface to SDRAM, relieving designers from the need to buffer signals or add circuitry to phase adjust the SDRAM clock. However, since each application is unique, a detailed timing and signal integrity analysis using the PPC405GP IBIS model must always be performed. Please note that while the SDRAM address signals (MemAddr12:0 and BA1:0) utilize industry standard bit ordering, the data bus (MemData0:31) follows the PowerPC bit numbering convention. That is, MemData0 is the most significant bit and DQM0 is the byte enable for MemData0:7.

Figure 15-1 illustrates the SDRAM signal I/Os.

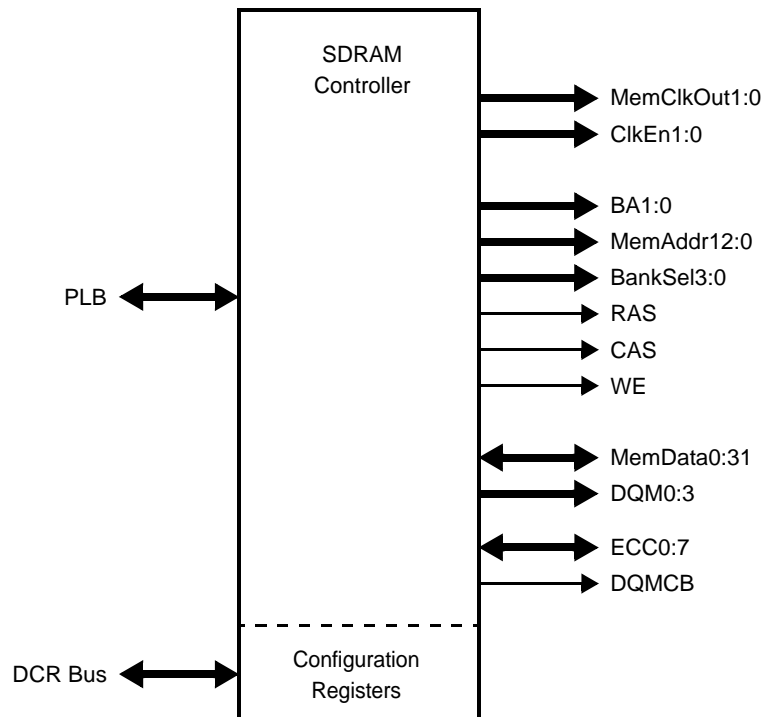

Figure 15-1. SDRAM Controller Signals

The usage and signal state after a PPC405GP reset for each of these signals is shown in Table 15-1 on page 15-328.

Table 15-1. SDRAM Signal Usage and State During/Following Reset

Signal	Reset State	Usage
MemClkOut1:0	Toggling ¹	Two copies of the SDRAM clock.
ClkEn1:0	1	SDRAM clock enable.
BA1:0	2'b0	Bank address. Used to select an internal SDRAM bank in dual- and quad-bank SDRAM devices.
MemAddr12:0	13b'0	Memory address. See Table 15-6, "Logical Address Bit on BA1:0 and MemAddr12:0 Versus Addressing Mode.," on page 15-334 for additional details.
BankSel3:0	4b'1	Bank Selects. Used to select between different physical banks of SDRAM memory.
$\overline{\text{RAS}}$	1	Row Address Strobe.
$\overline{\text{CAS}}$	1	Column Address Strobe.
$\overline{\text{WE}}$	1	Write Enable.
MemData0:31	High-Z	Data input/output. MemData0 is the most significant bit.
DQM0:3	1	Data Mask, an input mask for write accesses and an output enable during read operations. DQM0 applies to MemData0:7, DQM1 to MemData8:15, DQM2 to MemData16:23 and DQM3 to MemData24:31.
ECC0:7	High-Z	ECC check bits.
DQMCB	1	Data Mask for ECC check bits.

Note 1: MemClkOut1:0 follow the internal PLB clock. During power-up, PLBclk and MemClkOut1:0 run at SysClk/4, until PLBclk is configured for normal operation. During power-up, MemClkOut1:0 tracks SysClk until the internal PLL begins to lock. At that time MemClkOut1:0 transitions to the clock rate configured using the strapping resistors.

15.2 Accessing SDRAM Registers

After a system reset, software is required to configure and then enable the SDRAM controller. When this is complete, the SDRAM memory is ready for access by the processor, or any other master in the PPC405GP. Once the controller is operating, it is usually not necessary for software to access the SDRAM configuration registers. The status registers, however, are useful for determining the state of the memory controller or querying information regarding any corrected or uncorrectable ECC errors that may have occurred.

Preliminary User's Manual

All SDRAM configuration and status registers are accessed using the **mtdcr** and **mfddcr** PowerPC instructions. Access to these registers is performed using an indirect addressing method through the SDRAM0_CFGADDR and SDRAM0_CFGDATA registers.

Table 15-2. SDRAM Controller DCR Addresses

Register	DCR Address	Access	Description
SDRAM0_CFGADDR	0x010	R/W	SDRAM Controller Address Register
SDRAM0_CFGDATA	0x011	R/W	SDRAM Controller Data Register

Table 15-3 lists the indirectly accessed SDRAM configuration and status registers.

Table 15-3. SDRAM Controller Configuration and Status Registers

Mnemonic	Address Offset	Access	Description	Page
SDRAM0_BESR0	0x00	R/Clear	Bus Error Syndrome Register 0	15-345
SDRAM0_BESR1	0x08	R/Clear	Bus Error Syndrome Register 1	15-347
SDRAM0_BEAR	0x10	R	Bus Error Address Register	15-345
SDRAM0_CFG	0x20	R/W	SDRAM Configuration	15-330
SDRAM0_STATUS	0x24	R	SDRAM Controller Status	15-331
SDRAM0_RTR	0x30	R/W	Refresh Timer Register	15-341
SDRAM0_PMIT	0x34	R/W	Power Management Idle Timer	15-349
SDRAM0_B0CR	0x40	R/W	Memory Bank 0 Configuration Register	15-332
SDRAM0_B1CR	0x44	R/W	Memory Bank 1 Configuration Register	15-332
SDRAM0_B2CR	0x48	R/W	Memory Bank 2 Configuration Register	15-332
SDRAM0_B3CR	0x4C	R/W	Memory Bank 3 Configuration Register	15-332
SDRAM0_TR	0x80	R/W	SDRAM Timing Register	15-335
SDRAM0_ECCCFG	0x94	R/W	ECC Configuration	15-342
SDRAM0_ECCESR	0x98	R/Clear	ECC Error Status	15-344

To read or write one of these SDRAM controller registers, software must first write the register's address offset into the SDRAM0_CFGADDR register. The target register can then be read or written through the SDRAM0_CFGDATA DCR address. The following PowerPC code illustrates this procedure by reading the SDRAM0_CFG register.

```
li      r3,SDRAM0_CFG          ! address offset of SDRAM0_CFG
mtdcr  SDRAM0_CFGADDR,r3      ! set offset address
mfddcr r4,SDRAM0_CFGDATA      ! read value of SDRAM0_CFG
```

Programming Note: Reserved fields in SDRAM controller configuration registers must not change when the register is written. To modify bit fields within a register, read the register, use a mask to clear the target bits, OR in the new field value, and then write the result back.

15.3 SDRAM Controller Configuration and Status

Software must program a number of SDRAM control registers before the SDRAM controller can be started and memory accessed. At a minimum, this involves writing to the SDRAM Configuration Register (SDRAM0_CFG), SDRAM Timing Register (SDRAM0_TR) and one or more Memory Bank Configuration Registers (SDRAM0_BnCR).

15.3.1 Memory Controller Configuration Register (SDRAM0_CFG)

After a system reset the SDRAM controller is disabled and must be configured before memory transactions can occur. The Memory Controller Configuration Register (SDRAM0_CFG) serves to both enable the controller and select from various memory controller features. These features include enabling power management, ECC error checking, and registered SDRAM support. Each of these settings is global and applies to the entire SDRAM subsystem.

Prior to enabling the SDRAM controller by setting SDRAM0_CFG[DCE], the SDRAM0_TR, SDRAM0_RTR, SDRAM0_PMIT, and SDRAM0_BnCR registers must be configured. This is because once SDRAM0_CFG[DCE]=1 writing any of the listed SDRAM registers does not actually update the target register. Write access to SDRAM0_CFG is independent of SDRAM0_CFG[DCE]. However, software must ensure that the SDRAM controller is idle when updating SDRAM0_CFG[3:10]. This guarantees that the register update does not affect any in-progress SDRAM operations.

Before software enables the SDRAM controller by setting SDRAM0_CFG[DCE] it must ensure that the SDRAM power-on delay has been satisfied. For example, the 16MB SDRAM requires a 100µs pause; the 64MB SDRAM requires a 200µs pause. Once enabled, the SDRAM controller automatically performs the following initialization procedure:

1. Issues the precharge command to all banks.
2. Waits SDRAM0_TR[PTA] cycles.
3. Performs eight $\overline{\text{CAS}}$ before $\overline{\text{RAS}}$ refresh cycles, each separated by SDRAM0_TR[RFTA] clock cycles)
4. Issues the mode register write command to each bank.
5. Perform eight $\overline{\text{CAS}}$ before $\overline{\text{RAS}}$ refresh cycles (each separated by SDRAM0_TR[RFTA] clock cycles).
6. Waits SDRAM0_TR[RFTA] clock cycles.

The SDRAM is then available for read and write access.

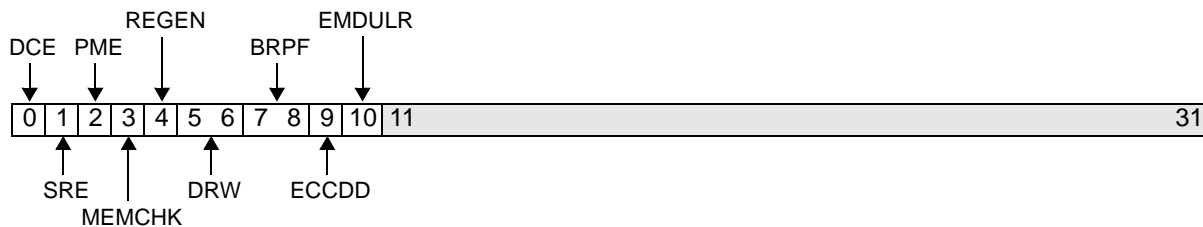

Figure 15-2. Memory Controller Configuration (SDRAM0_CFG)

0	DCE	SDRAM Controller Enable 0 Disable 1 Enable	All SDRAM controller configuration registers must be initialized and valid prior to setting DCE.
1	SRE	Self-Refresh Enable 0 Disable 1 Enable	See "Self-Refresh" on page 15-348.
2	PME	Power Management Enable 0 Disable 1 Enabled	See "Power Management" on page 15-348.
3	MEMCHK	Memory Data Error Checking 0 None 1 ECC	See "Error Checking and Correction (ECC)" on page 15-341.

Preliminary User’s Manual

4	REGEN	Registered Memory Enable 0 Disabled 1 Enabled	
5:6	DRW	SDRAM Width 00 32-bit 01 Reserved 10 Reserved 11 Reserved	Must be set to 0b00.
7:8	BRPF	Burst Read Prefetch Granularity 00 Reserved 01 16 bytes 10 32 bytes 11 Reserved	Most applications should set this field to 0b01.
9	ECCDD	ECC Driver Disable 0 Check bit data output on ECC0:7. 1 ECC0:7 are placed in high impedance.	Regardless of whether ECC checking is enabled, SDRAM writes cause the chip to write check bit data on ECC0:7. If ECC is unused, setting ECCDD = 1 disables these drivers.
10	EMDULR	Enable Memory Data Unless Read 0 MemData0:31 are placed in high impedance unless a memory write is being performed. 1 MemData0:31 are driven unless a memory read is being performed.	
11:31		Reserved	

15.3.2 Memory Controller Status (SDRAM0_STATUS)

The Memory Controller Status Register (SDRAM0_STATUS) allows software to determine the current state of the SDRAM controller. If SDRAM0_STATUS[MRSCMP]=0 the SDRAM is not accessible for either read or write operations. Similarly, the SDRAM is also inaccessible when the SDRAM is in self-refresh mode, SDRAM0_STATUS[SRSTATUS]=1.

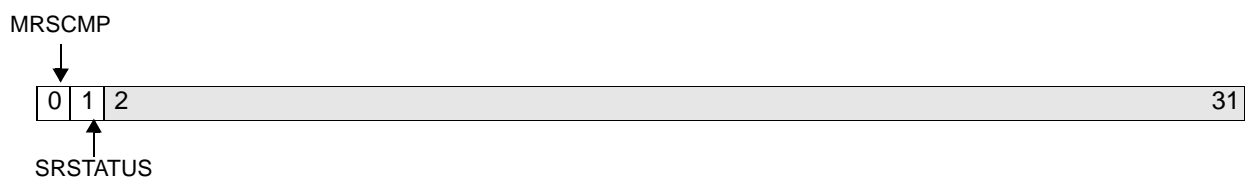

Figure 15-3. Memory Controller Status (SDRAM0_STATUS)

0	MRSCMP	Mode Register Set Complete 0 MRS not complete 1 MRS completed	Set to 1 when the SDRAM controller completes the Mode Register Set Command, which results from setting SDRAM0_CFG[DCE]. Clearing SDRAM0_CFG[DCE] causes this bit to clear in the following MemClkOut1:0 cycle.
1	SRSTATUS	Self-Refresh State 0 Not in Self-Refresh Mode 1 Self-Refresh Mode	See “Self-Refresh” on page 15-348.
2:31		Reserved	

15.3.3 Memory Bank 0–3 Configuration (SDRAM0_B0CR–SDRAM0_B3CR)

These registers are used to configure and enable memory in each respective bank. Only SDRAM banks with SDRAM0_BnCR[BE]=1 are initialized when SDRAM0_CFG[DCE] is set to 1 and subsequently available for access. Since the SDRAM0_BnCR registers cannot be modified when SDRAM0_CFG[DCE]=1, adding or removing memory banks requires that the SDRAM controller be disabled and then reinitialized.

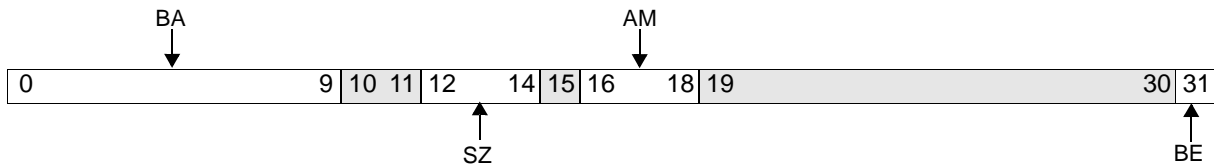

Figure 15-4. Memory Bank 0–3 Configuration Registers (SDRAM0_B0CR–SDRAM0_B3CR)

0:9	BA	Base Address	The base address must be aligned on a boundary that matches the size of the region defined in the SZ field. For example, a 4 MB region must begin on an address that is divisible by 4 MB.
10:11		Reserved	
12:14	SZ	Size 000 4M byte 001 8M byte 010 16M byte 011 32M byte 100 64M byte 101 128M byte 110 256M byte 111 Reserved	
15		Reserved	
16:18	AM	Addressing Mode 000 Mode 1 001 Mode 2 010 Mode 3 011 Mode 4 100 Mode 5 101 Mode 6 110 Mode 7 111 Reserved	See Table 15-4, “SDRAM Addressing Modes,” on page 15-333.
19:30		Reserved	
31	BE	Memory Bank Enable 0 Bank is disabled 1 Bank is enabled	

Preliminary User's Manual**Table 15-4. SDRAM Addressing Modes**

Addressing Mode	SDRAM Memory Organization
1	11 x 9 - 2 Bank 11 x 10 - 2 Bank
2	12 x 9 - 4 Bank 12 x 10 - 4 Bank
3	13 x 9 - 4 Bank 13 x 10 - 4 Bank 13 x 11 - 4 Bank
4	12 x 8 - 2 Bank 12 x 8 - 4 Bank 13 x 8 - 2 Bank
5	11 x 8 - 2 Bank 11 x 8 - 4 Bank
6	13 x 8 - 2 Bank 13 x 8 - 4 Bank
7	13 x 9 - 2 Bank 13 x 10 - 2 Bank

15.3.4 Page Management

The SDRAM controller supports page mode operation with bank interleaving and maintains up to four open pages in the memory subsystem. The SDRAM controller page management unit (PMU) tracks memory accesses (activate, read/write, precharge, and refresh) and maintains a directory of up to four open pages. All PMU entries are allocated and deallocated based on current and pending accesses. Allocated entries are checked against the address of the pending access, and a page hit occurs when a match exists. All PMU directory entries are deallocated when a $\overline{\text{CAS}}$ before $\overline{\text{RAS}}$ refresh occurs.

Open pages can be spread across the system memory array on different bank selects ($\overline{\text{BankSelIn}}$) or be contained in a single bank select, depending on the memory access sequences and the memory subsystem implementation. For a single bank memory subsystem, the number of open pages is limited to the number of internal banks associated with the SDRAM devices in that bank. For example, a single bank implementation consisting of SDRAMs with two internal banks can have two open pages. In this case, the maximum of two open pages is a limitation of the memory subsystem implementation, not the SDRAM controller.

The SDRAM page size for page hits varies, depending on the address mode programmed in SDRAM0_BnCR[AM]. Table 15-5, “SDRAM Page Size,” on page 15-334 details the relationship of the address mode to the page size.

Table 15-5. SDRAM Page Size

Address Mode	Page Size
1,2,3,7	2 KB
4,5,6	1 KB

15.3.5 Logical Address to Memory Address Mapping

SDRAM memory requires that addresses be divided into row and column portions. The relationship between a logical address and the SDRAM row and column address is determined by the address mode programmed in SDRAM0_BnCR[AM] and is shown in Table 15-6.

Table 15-6. Logical Address Bit on BA1:0 and MemAddr12:0 Versus Addressing Mode.

Mode	Bank Size	Address Phase	BA		MemAddr												
	Organization ¹		1	0	12	11	10	9	8	7	6	5	4	3	2	1	0
1	8 MB	Row	7	9	7	9	10	11	12	13	14	15	16	17	18	19	20
	11 x 9 x 2	Column	7	9	7	9	AP	8	21	22	23	24	25	26	27	28	29
	16 MB	Row	7	9	7	9	10	11	12	13	14	15	16	17	18	19	20
	11 x 10 x 2	Column	7	9	7	9	AP	8	21	22	23	24	25	26	27	28	29
2	32 MB	Row	7	8	7	9	10	11	12	13	14	15	16	17	18	19	20
	12 x 9 x 4	Column	7	8	7	4	AP	6	21	22	23	24	25	26	27	28	29
	64 MB	Row	7	8	7	9	10	11	12	13	14	15	16	17	18	19	20
	12 x 10 x 4	Column	7	8	7	4	AP	6	21	22	23	24	25	26	27	28	29

Preliminary User's Manual**Table 15-6. Logical Address Bit on BA1:0 and MemAddr12:0 Versus Addressing Mode.**

Mode	Bank Size	Address Phase	BA		MemAddr												
	Organization ¹		1	0	12	11	10	9	8	7	6	5	4	3	2	1	0
3	64 MB	Row	6	7	8	9	10	11	12	13	14	15	16	17	18	19	20
	13 x 9 x 4	Column	6	7	7	4	AP	5	21	22	23	24	25	26	27	28	29
	128 MB	Row	6	7	8	9	10	11	12	13	14	15	16	17	18	19	20
	13 x 10 x 4	Column	6	7	7	4	AP	5	21	22	23	24	25	26	27	28	29
	256 MB	Row	6	7	8	9	10	11	12	13	14	15	16	17	18	19	20
	13 x 11 x 4	Column	6	7	7	4 ²	AP	5	21	22	23	24	25	26	27	28	29
4	8/16 MB	Row	8	21	8	9	10	11	12	13	14	15	16	17	18	19	20
	12 x 8 x 2/4	Column	8	21	8	4	AP	6	21	22	23	24	25	26	27	28	29
5	4/8 MB	Row	9	21	9	21	10	11	12	13	14	15	16	17	18	19	20
	11 x 8 x 2/4	Column	9	21	9	21	AP	8	21	22	23	24	25	26	27	28	29
6	16/32 MB	Row	7	21	8	9	10	11	12	13	14	15	16	17	18	19	20
	13 x 8 x 2/4	Column	7	21	8	9	AP	8	21	22	23	24	25	26	27	28	29
7	32 MB	Row	7	7	8	9	10	11	12	13	14	15	16	17	18	19	20
	13 x 9 x 2	Column	7	7	7	4	AP	6	21	22	23	24	25	26	27	28	29
	64 MB	Row	7	7	8	9	10	11	12	13	14	15	16	17	18	19	20
	13 x 10 x 2	Column	7	7	7	4	AP	6	21	22	23	24	25	26	27	28	29

Note 1: Memory organization is the number of rows x columns x internal banks.

Note 2: Column address bit 10 sent out on MemAddr11 for 13 x 11 x 4 parts.

Note 3: All read operations transfer 64-bits from SDRAM memory to the controller. Therefore, MemAddr0 is first driven with 0 and then 1. For data items narrower than 64-bits, the requested byte(s) are fulfilled from the 64-bit doubleword.

15.3.6 SDRAM Timing Register (SDRAM0_TR)

The SDRAM Timing Register sets the timing parameters for all SDRAM memory banks. This register must be written prior to setting SDRAM0_CFG[DCE]. If SDRAM0_CFG[DCE]=1, writes to this register appear to complete, but do not affect the contents of SDRAM0_TR.

If the SDRAM interface is operated in registered mode, (SDRAM0_CFG[REGE]=1) a programmed $\overline{\text{CAS}}$ latency of 2 clocks (SDRAM0_TR[CASL] = 2'b01) corresponds to a registered $\overline{\text{CAS}}$ latency of 3 clocks, and a programmed latency of 3 clocks (SDRAM0_TR[CASL] = 2'b10) corresponds to a registered $\overline{\text{CAS}}$ latency of 4 clocks. Programming the $\overline{\text{CAS}}$ latency to 4 clocks (SDRAM0_TR[CASL] = 2'b11), corresponding to a registered $\overline{\text{CAS}}$ latency of 5 clocks, is not supported.

See "Selected Timing Diagrams" on page 15-337 for timing diagrams illustrating how the fields in SDRAM0_TR affect the signalling on the SDRAM memory interface.

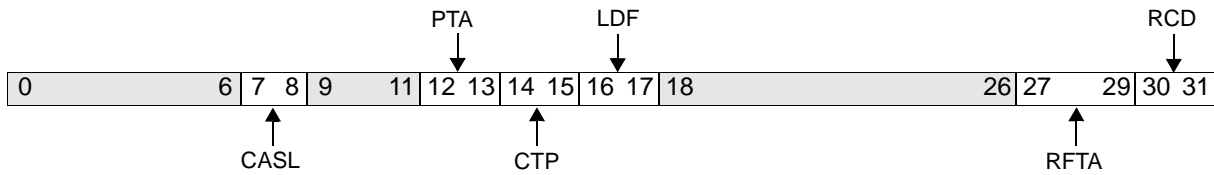

Figure 15-5. SDRAM Timing Register (SDRAM0_TR)

0:6		Reserved
7:8	CASL	SDRAM CAS latency. 00 Reserved 01 2 MemClkOut1:0 cycles 10 3 MemClkOut1:0 cycles 11 4 MemClkOut1:0 cycles
9:11		Reserved
12:13	PTA	SDRAM Precharge Command to next Activate Command minimum. 00 Reserved 01 2 MemClkOut1:0 cycles 10 3 MemClkOut1:0 cycles 11 4 MemClkOut1:0 cycles
14:15	CTP	SDRAM Read / Write Command to Precharge Command minimum. 00 Reserved 01 2 MemClkOut1:0 cycles 10 3 MemClkOut1:0 cycles 11 4 MemClkOut1:0 cycles
16:17	LDF	SDRAM Command Leadoff. 00 Reserved 01 2 MemClkOut1:0 cycles 10 3 MemClkOut1:0 cycles 11 4 MemClkOut1:0 cycles
18:26		Reserved
27:29	RFTA	SDRAM $\overline{\text{CAS}}$ before $\overline{\text{RAS}}$ Refresh Command to next Activate Command minimum. 000 4 MemClkOut1:0 cycles 001 5 MemClkOut1:0 cycles 010 6 MemClkOut1:0 cycles 011 7 MemClkOut1:0 cycles 100 8 MemClkOut1:0 cycles 101 9 MemClkOut1:0 cycles 110 10 MemClkOut1:0 cycles 111 Reserved
30:31	RCD	SDRAM RAS to CAS Delay 00 Reserved 01 2 MemClkOut1:0 cycles 10 3 MemClkOut1:0 cycles 11 4 MemClkOut1:0 cycles

Preliminary User's Manual**15.3.7 Selected Timing Diagrams**

The SDRAM controller is capable of performing many different types of read and write operations. For example, while the CPU generally issues four doubleword line fills and line writes, the EBC external master interface can issue various types of burst transactions. Since the SDRAM controller is often servicing read and write requests from several masters, the exact sequence of operations on the external SDRAM interface cannot be predicted. Therefore, the timing diagrams in this section should be considered as examples of the signalling that can be observed on the SDRAM interface, and not the only types of transactions that occur.

The timing diagrams in this section are intended to illustrate cycle-based SDRAM programmable timing parameters only. As such, AC specific timing information should not be inferred from the timing diagrams. Instead, please refer to the PPC405GP data sheet for AC specifications.

Table 15-7 summarizes the SDRAM memory timing parameters used to annotate the waveforms. These parameters are set in the SDRAM Timing Register (SDRAM0_TR).

Table 15-7. SDRAM Memory Timing Parameters

Name	Function	Description
RCD	Activate to Read/Write Command	Minimum number of clock cycles from an activate command to a read or write command. Corresponds to SDRAM RAS to CAS assertion delay.
RFTA	Refresh to Activate	Minimum number of clock cycles from a $\overline{\text{CAS}}$ before $\overline{\text{RAS}}$ refresh command to the next activate command.
CTP	Command to Precharge	Minimum number of clock cycles from a read or write command to a precharge command.
PTA	Precharge to Active	Minimum number of clock cycles required to wait following a Precharge Command to issuing the next activate command.
CASL	$\overline{\text{CAS}}$ Latency	$\overline{\text{CAS}}$ access latency.
LDF	Command Leadoff Delay	Number of clock cycles from address/command assertion to bank select ($\overline{\text{BankSeln}}$) assertion.

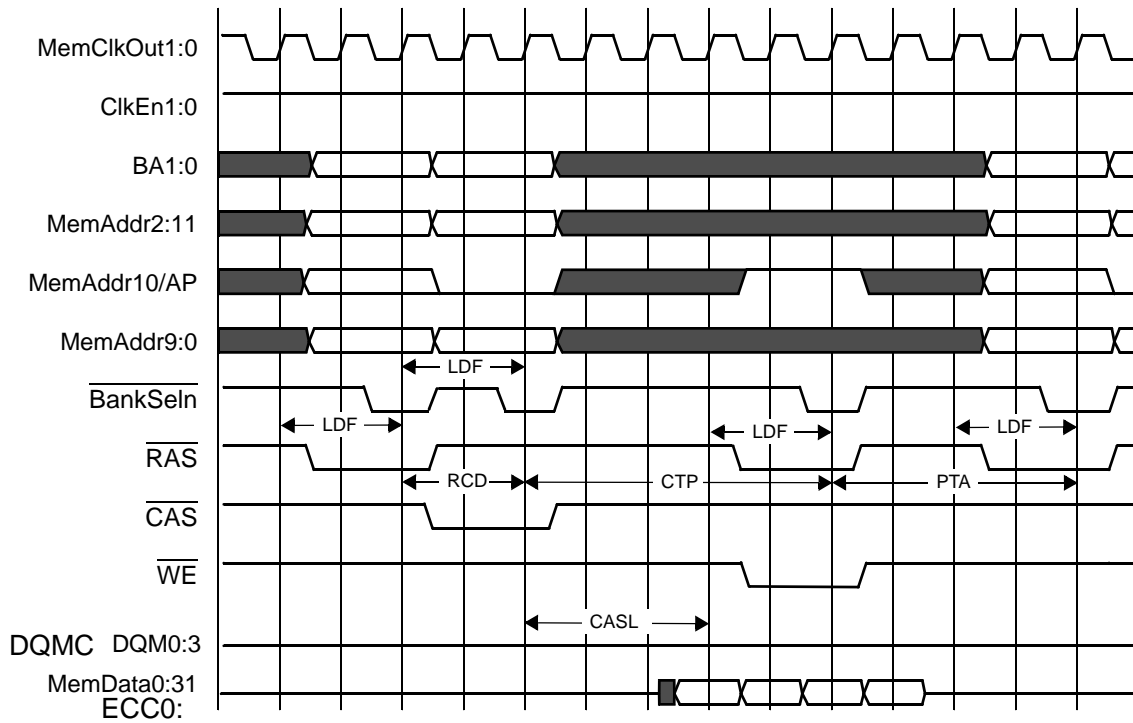

Figure 15-6. Activate, Four Word Read, Precharge, Activate

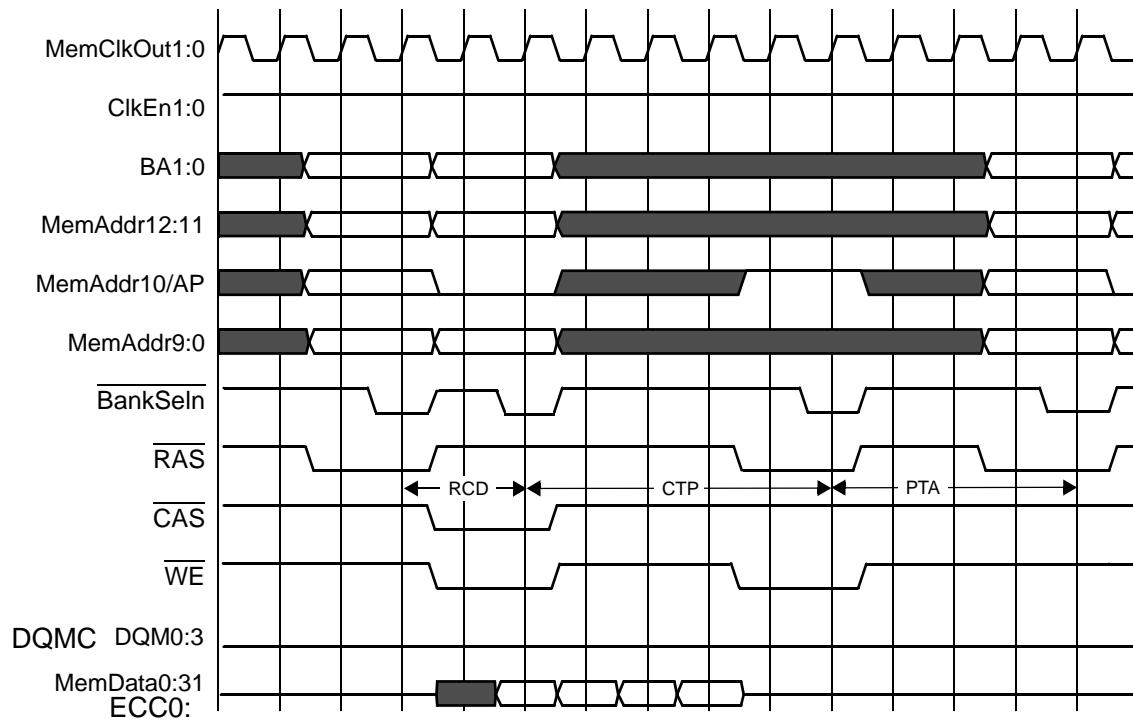

Figure 15-7. Activate, Four Word Write, Precharge, Activate

Preliminary User's Manual

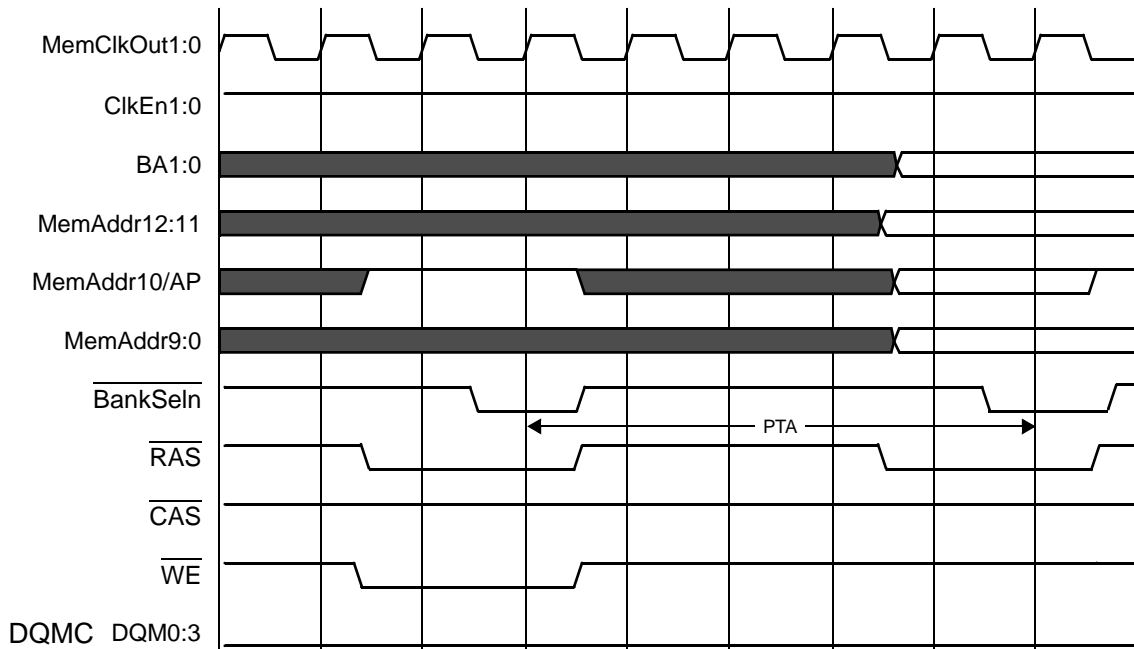

Figure 15-8. Precharge All, Activate

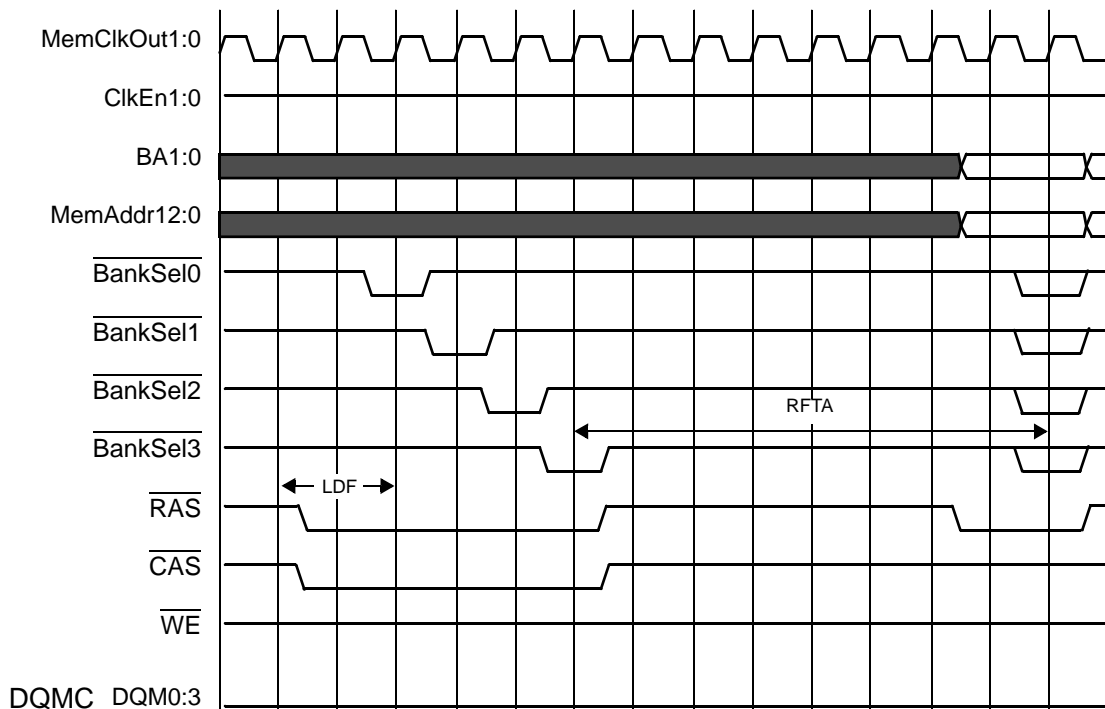

Figure 15-9. \overline{CAS} Before \overline{RAS} Refresh

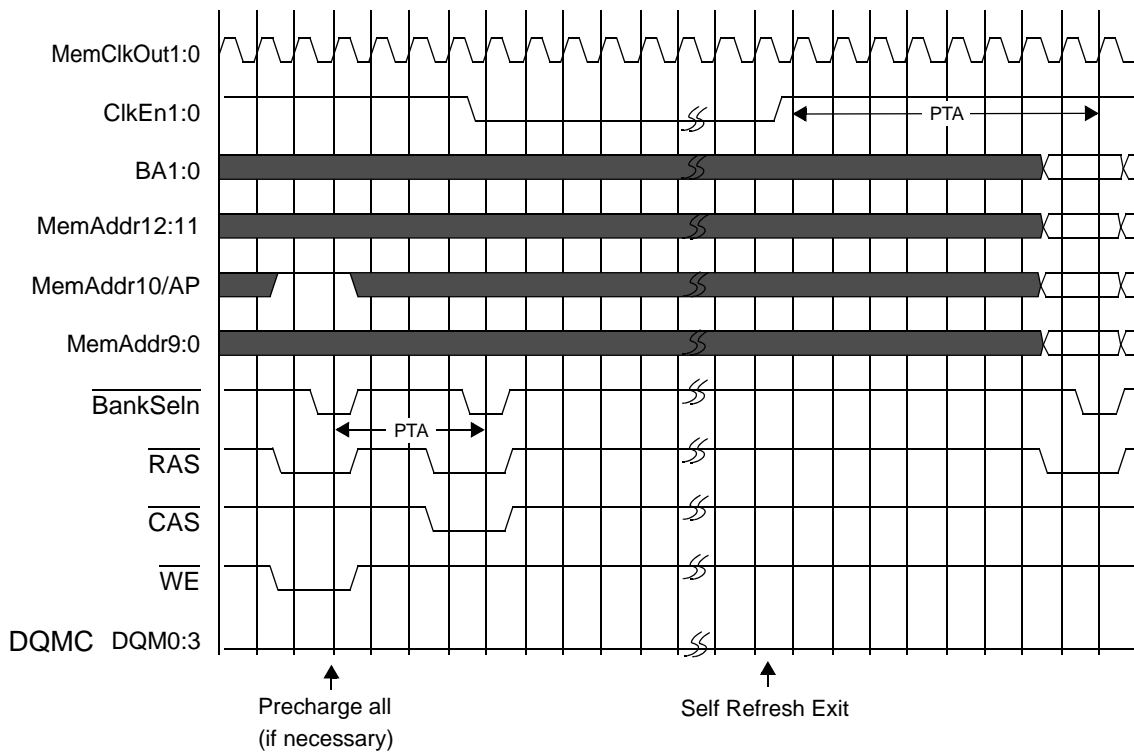

Figure 15-10. Self-Refresh Entry and Exit

15.3.8 Auto (CAS Before RAS) Refresh

Refresh of odd memory banks is staggered from the refresh of even memory banks. Only enabled SDRAM banks (SDRAM0_BnCR[BE]=1) are initialized when the controller is enabled (SDRAM0_CFG[DCE] set to 1) and refreshed during normal operation. Once the memory controller is enabled and the initialization sequence has completed, the refresh mechanism starts automatically with refreshing of the memory continuing independent of SDRAM0_CFG[DCE].

Refresh requests are generated internally when the refresh timer expires. The refresh interval is programmable via the Refresh Timer Register (SDRAM0_RTR). During refresh, all SDRAM accesses are delayed until the refresh cycle completes.

Preliminary User's Manual**15.3.9 Refresh Timer Register (SDRAM0_RTR)**

The Refresh Timer Register determines the memory refresh rate for the SDRAM. The internal counter runs at the controller clock frequency, thus if MemClkOut1:0 is 100MHz, a value of 0x05F0 produces a refresh interval of 15.20 μ s (1520 x 10 ns = 15.20 μ s). This register is programmable to accommodate other SDRAM clock frequencies.

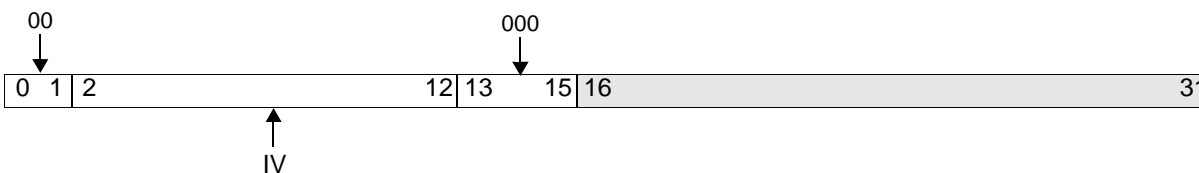
**Figure 15-11. Refresh Timing Register (SDRAM0_RTR)**

0:1		Always 0b00	
2:12	IV	Interval	Including bits 0:1 and 13:15, the value of the high-order halfword of the register can range from 0x0000–0x3BF8
13:15		Always 0b000	
16:31		Reserved	

15.4 Error Checking and Correction (ECC)

Error Checking and Correction (ECC) corrects all single bit errors and detects all double bit errors when reading from SDRAM memory. In addition, ECC detects any and all errors which may exist in an aligned 4-bit nibble. As detailed in Table 15-8, “Additional Latency when using ECC,” on page 15-341, the ECC function is transparent in terms of latency, except for partial write operations. On partial writes, a read-modify-write sequence, including bus turn-around, is required to generate the write check bits and store the resultant data.

Table 15-8. Additional Latency when using ECC

PLB Transaction	Added Latency
Read	None
Burst or full single beat write	None
Partial write	SDRAM0_TR[CASL] + 4 clocks

ECC is enabled for all SDRAM banks by setting SDRAM0_CFG[MEMCHK]=1 during the SDRAM initialization procedure. Software is then required to write each word of SDRAM to set the check bits to a valid state. When this is complete, ECC checking and correction is enabled on a per-bank basis through the SDRAM0_ECCCFG register.

15.4.1 ECC Configuration Register (SDRAM0_ECCCFG)

Write access to SDRAM0_ECCCFG is independent of SDRAM0_CFG[DCE]. Software must ensure that the SDRAM controller is idle when updating SDRAM0_ECCCFG. This guarantees that the register update does not affect any SDRAM operations in progress.

When SDRAM0_ECCCFG[CE n] is set (where $n = 0, 1, 2,$ or 3), ECC correction is enabled for bank n (BankSel n). When cleared, the ECC logic ignores the check bits and passes read data along unmodified.

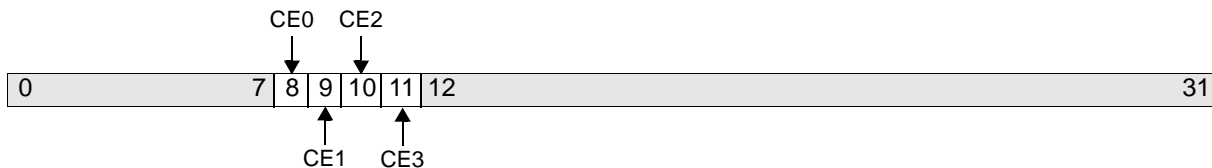

Figure 15-12. ECC Configuration Register (SDRAM0_ECCCFG)

0:7		Reserved
8	CE0	ECC Correction Enable for Bank 0. 0 Disabled 1 Enabled
9	CE1	ECC Correction Enable for Bank 1. 0 Disabled 1 Enabled
10	CE2	ECC Correction Enable for Bank 2. 0 Disabled 1 Enabled
11	CE3	ECC Correction Enable for Bank 3. 0 Disabled 1 Enabled
12:31		Reserved

15.4.2 Correctable ECC Errors

During SDRAM memory read operations the ECC logic automatically detects and corrects any single bit error that occurs within each 32-bit word of SDRAM memory. This includes errors detected during the read portion of the read-modify-sequence sequence required for partial (less than 64-bit) SDRAM writes.

If a correctable ECC error occurs during a memory read the corrected data is returned to the requesting master. When a correctable error is detected during the read portion of a partial write the corrected data is combined with the write data and written back to memory with new ECC check bits. In both cases, the memory bank (BankSel n) that caused the error is logged in SDRAM0_ECCEsr[BK n E] (where $n = 0, 1, 2,$ or 3) and the byte lane that experienced the correctable error is identified in SDRAM0_ECCEsr[EWBL n CE] or SDRAM0_ECCEsr[OWBL n CE]. Furthermore, the correctable error bit (SDRAM0_ECCEsr[CE]) is set causing an ECC Correctable Error interrupt to the Universal Interrupt Controller. The interrupt remains active until software clears SDRAM0_ECCEsr[CE].

Preliminary User's Manual

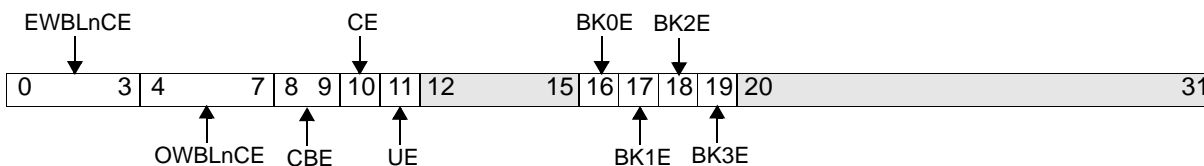

Figure 15-13. ECC Error Status Register (SDRAM0_ECCESR)

0:3	EWBLnCE	Even Word Byte Lane n Corrected Error 0000 No error 0001 Error occurred in byte lane 0 0010 Error occurred in byte lane 1 0100 Error occurred in byte lane 2 1000 Error occurred in byte lane 3	Because only one byte lane corrected error can occur at a time, field values containing more than one 1 do not occur.
4:7	OWBLnCE	Odd Word Byte Lane n Corrected Error 0000 No error 0001 Error occurred in byte lane 0 0010 Error occurred in byte lane 1 0100 Error occurred in byte lane 2 1000 Error occurred in byte lane 3	Because only one byte lane corrected error can occur at a time, field values containing more than one 1 do not occur.
8:9	CBE	Error Detected in Check bits 00 No error 01 Error in lower check bits 10 Error in upper check bits 11 Error in both sets of check bits	
10	CE	Correctable Error	
11	UE	Uncorrectable Error	
12:15		Reserved	
16	BK0E	Bank 0 Error 0 No error 1 Error occurred in bank 0	
17	BK1E	Bank 0 Error 0 No error 1 Error occurred in bank 1	
18	BK2E	Bank 0 Error 0 No error 1 Error occurred in bank 2	
19	BK3E	Bank 0 Error 0 No error 1 Error occurred in bank 3	
20:31		Reserved	

15.4.3 Uncorrectable ECC Errors

Uncorrectable ECC errors may occur during SDRAM read and SDRAM partial write operations. An uncorrectable error detected during a memory read results in the data from system memory (unchanged) being returned to the requesting master. An uncorrectable error detected on the read portion of a read-modify-write sequence for an SDRAM partial write results in the data from system memory (unchanged) being combined with the write data and written back to memory with new ECC check bits.

Whenever an uncorrectable ECC error occurs the errant memory address is captured in SDRAM0_BEAR. The error status for the master that initiated the memory operation is logged in either SDRAM0_BESR0 or SDRAM0_BESR1. The memory bank (BankSel n) that experienced the error is recorded in SDRAM0_ECCEsr[BK n E] (where $n = 0, 1, 2, \text{ or } 3$) and an uncorrectable error is flagged in SDRAM0_ECCEsr[UE].

Since an uncorrectable error also results in an error signal to the master that initiated the transfer, other side effects may occur. For example, an instruction fetch with an uncorrectable error causes a machine check. In the case of a DMA transfer, the DMA channel stops and an error is logged.

15.4.4 Error Locking

The PCI Bridge and Media Access Layer (MAL) controllers may qualify their PLB transactions to the SDRAM Controller such that the information describing any errors that occur during these transfers becomes locked. When an error is locked, subsequent errors are not permitted to overwrite the information detailing the first error.

When a master requests error locking an error locks not only the SDRAM0_BESR n field for the master, but also SDRAM0_BEAR. These remain locked until software clears them. The SDRAM Controller has a SDRAM0_BESR n field for each PLB master containing two bits associated with error locking. One is the field lock bit and the other is the address lock bit. When an error is detected with locking enabled the field lock bit is set to a value of one. Setting the field lock bit prevents subsequent errors for this master from being logged and overwriting the contents of the field. In addition, the address lock bit is set if no other master has previously locked the SDRAM0_BEAR. Once the SDRAM0_BEAR is locked, no future errors from this or any master can update the SDRAM0_BEAR until software clears the lock bits. When software processes an error it should clear the error status and both lock bits at the same time.

15.4.5 ECC Error Status Register (SDRAM0_ECCEsr)

The ECC Error Status Register (SDRAM0_ECCEsr) tracks ECC related errors encountered during SDRAM memory accesses. Bits in SDRAM0_ECCEsr are cleared by writing a 32-bit value to SDRAM0_ECCEsr with a 1 in any bit position that is to be cleared and 0 in all other bit positions.

Preliminary User's Manual

15.4.6 Bus Error Address Register (SDRAM0_BEAR)

The SDRAM Bus Error Address Register (SDRAM0_BEAR) is a 32-bit register containing the address of the access where an uncorrectable ECC error occurred. If the master that initiated the transfer requested error locking, and the SDRAM0_BEAR is not already locked, the contents of SDRAM0_BEAR are locked until the lock bit in one of the Peripheral Bus Error Status Registers (SDRAM0_BESR0 or SDRAM0_BESR1) is cleared. The contents of the SDRAM0_BEAR are accessed indirectly through the SDRAM_CFGADDR and SDRAM0_CFGDATA registers using the **mfocr** and **mtocr** instructions.

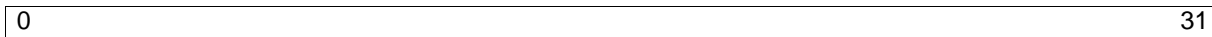

Figure 15-14. Bus Error Address Register (SDRAM0_BEAR)

0:31	Address of Bus Error.
------	-----------------------

15.4.7 Bus Error Syndrome Register 0 (SDRAM0_BESR0)

This register tracks errors encountered during CPU, external bus master and PCI accesses to SDRAM memory. Bits in SDRAM0_BESR0 are cleared by writing a 32-bit value to SDRAM0_BESR0 with a 1 in any bit position that is to be cleared and 0 in all other bit positions.

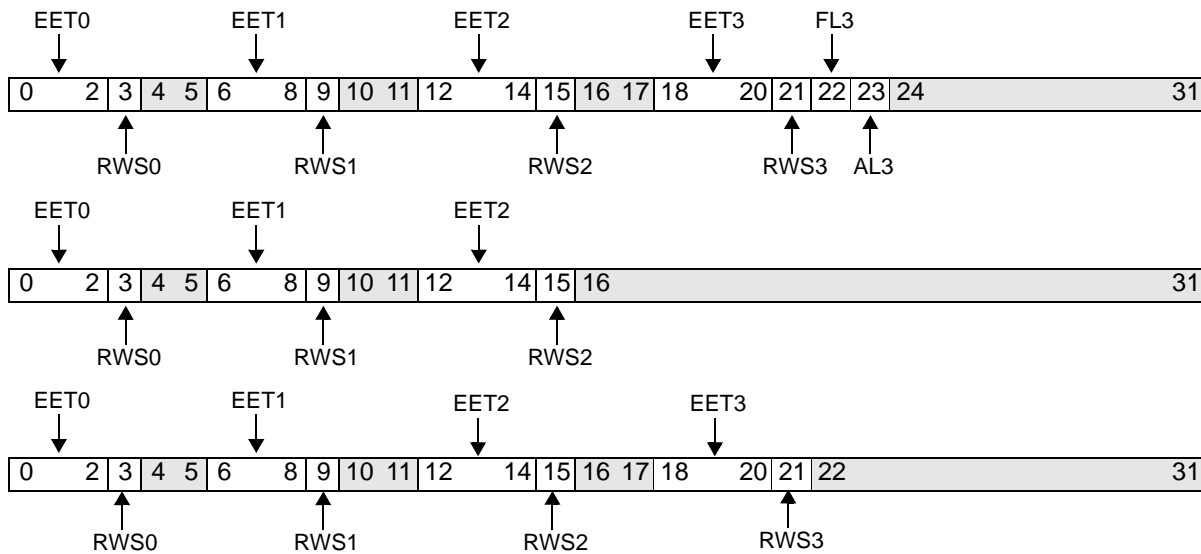

Figure 15-15. Bus Error Syndrome Register 0 (SDRAM0_BESR0)

0:2	EET0	Error type for master 0 000 No error 001 Reserved 01X ECC uncorrectable error 1XX Reserved	Master 0 is the processor instruction fetcher.
-----	------	--	--

3	RWS0	Read/write status for master 0 0 Error operation was a write operation 1 Error operation was a read operation	
4:5		Reserved	
6:8	EET1	Error type for master 1 000 No error 001 Reserved 01X ECC uncorrectable error 1XX Reserved	Master 1 is the processor data side.
9	RWS1	Read/write status for master 1 0 Error operation was a write operation 1 Error operation was a read operation	
10:11		Reserved	
12:14	EET2	Error type for master 2 000 No error 001 Reserved 01X ECC uncorrectable error 1XX Reserved	Master 2 is the external bus master.
15	RWS2	Read/write status for master 2 0 Error operation was a write operation 1 Error operation was a read operation	
16:17		Reserved	
18:20	EET3	Error type for master 3 000 No error 001 Reserved 01X ECC uncorrectable error 1XX Reserved	Master 3 is the PCI bridge.
21	RWS3	Read/write status for master 3 0 Error operation was a write operation 1 Error operation was a read operation	
22	FL3	Field lock for master 3 0 EET3 and RWS3 fields are unlocked 1 EET3 and RWS3 fields are locked	
23	AL3	SDRAM0_BEAR address lock for master 3 0 SDRAM0_BEAR address unlocked 1 SDRAM0_BEAR address locked	
24:31		Reserved	

Preliminary User's Manual**15.4.8 Bus Error Syndrome Register 1 (SDRAM0_BESR1)**

This register tracks errors encountered during MAL and DMA accesses to SDRAM memory. Bits in SDRAM0_BESR1 are cleared by writing a 32-bit value to SDRAM0_BESR1 with a 1 in any bit position that is to be cleared and 0 in all other bit positions.

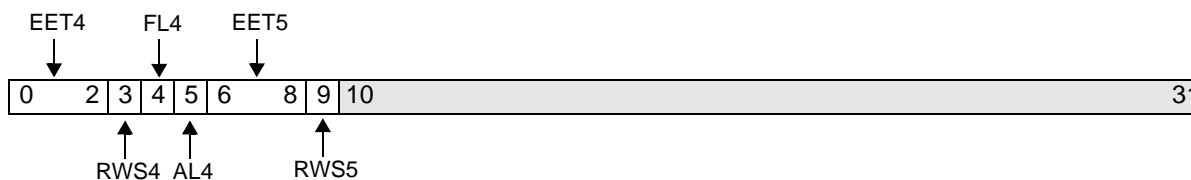
**Figure 15-16. Bus Error Status Register 1 (SDRAM0_BESR1)**

0:2	EET4	Error type for master 4 000 No error 001 Reserved 01X ECC uncorrectable error 1XX Reserved	Master 4 is the MAL.
3	RWS4	Read/write status for master 4 0 Error operation was a write operation 1 Error operation was a read operation	
4	FL4	Field lock for master 4 0 EET4 and RWS4 fields are unlocked 1 EET4 and RWS4 fields are locked	
5	AL4	SDRAM0_BEAR address lock for master 4 0 SDRAM0_BEAR address unlocked 1 SDRAM0_BEAR address locked	
6:8	EET5	Error type for master 5 000 No error 001 Reserved 01X ECC uncorrectable error 1XX Reserved	Master 5 is the DMA controller.
9	RWS5	Read/write status for master 5 0 Error operation was a write operation 1 Error operation was a read operation	
10:31		Reserved	

15.5 Self-Refresh

The SDRAM controller supports self-refresh operation for applications desiring lower power. When the SDRAM memory is placed in self-refresh mode it is no longer accessible for read or write accesses. Prior to placing the SDRAM controller in self-refresh mode all pending and previously queued requests targeting the SDRAM controller must be allowed to complete. Self-refresh entry is then initiated by setting SDRAM0_CFG[SRE]. When set, the SDRAM controller:

1. Completes the current SDRAM operation.
2. Issues precharge all commands to close all open pages.
3. Performs an auto-refresh cycle.
4. Enters self-refresh mode and sets SDRAM0_STATUS[SRSTATUS].

The SDRAM controller maintains the SDRAM in self-refresh mode, independent of any pending memory access requests, until SDRAM0_CFG[SRE] is cleared. Any attempt to read or write SDRAM memory during this time will stall the PLB.

Once SDRAM0_CFG[SRE] is cleared, the SDRAM controller performs the following:

1. Exits self-refresh mode.
2. Performs an auto-refresh cycle.
3. Clears SDRAM0_STATUS[SRSTATUS].

The SDRAM controller is then ready to service any memory request.

15.6 Power Management

The SDRAM controller provides a sleep mode where all SDRAM controller clocking is disabled with the exception of the SDRAM refresh logic and the power management wake-up logic. When the SDRAM controller is in sleep mode SDRAM refresh continues to preserve the contents of the memory and maintain the refresh interval.

15.6.1 Sleep Mode Entry

Sleep mode is enabled by setting SDRAM0_CFG[PME] and CPM0_ER[SDRAM]. Once sleep mode is enabled and the SDRAM controller has been idle for the number of cycles programmed in SDRAM0_PMIT, the SDRAM controller goes to sleep.

Preliminary User's Manual**15.6.2 Power Management Idle Timer (SDRAM0_PMIT)**

The SDRAM0_PMIT register determines the number for SDRAM clock (MemClkOut1:0) cycles that the controller must be idle before it asserts a sleep request when power management is enabled (SDRAM0_CFG[PME]=1). At system reset, SDRAM0_PMIT[CNT] is set to zero. This corresponds to a sleep request after 32 idle cycles.

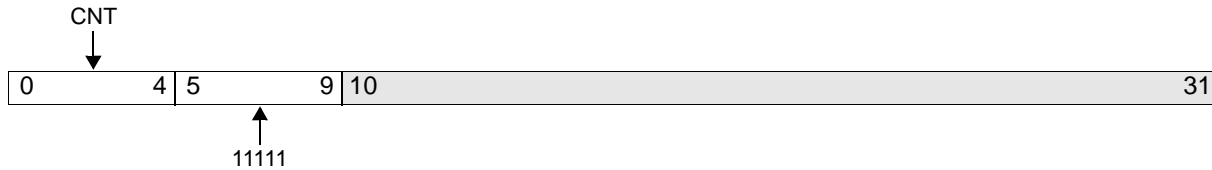
**Figure 15-17. Power Management Idle Timer (SDRAM0_PMIT)**

0:4	CNT	Cycle Count Before Sleep Request (0b00000–0b11111)	If CNT = 0b00000, the SDRAM clock must be idle for 32 cycles before the SDRAM controller asserts a sleep request.
5:9		Always 0b11111	
10:31		Reserved	

15.6.3 Sleep Mode Exit

The power management wake-up logic monitors the PLB for SDRAM reads or writes from other masters. In addition, the wakeup logic also monitor the DCR bus for accesses to SDRAM configuration and status registers. If either a PLB or DCR operation targeting the SDRAM controller is detected the SDRAM controller wakes up. The wakeup process results in a two cycle additional latency to the pending operation.

Chapter 16. External Bus Controller

The PPC405GP external bus controller (EBC) provides direct attachment for most SRAM and Flash memory and peripheral devices. The interface minimizes the amount of external glue logic needed to communicate with memory and peripheral devices, reducing embedded system device count, circuit board area, and cost.

To eliminate off-chip address decoding, the EBC provides eight programmable chip selects that enable system designers to locate memory and peripherals within the PPC405GP memory map. Chip select, data bus, and associated control signal timings are programmable for both single and burst transfers. For peripherals with variable timing requirements, the EBC supports device-paced transfers with optional bus-timeout. System design is further simplified through dynamic bus sizing that supports seamlessly attaching 8-, 16-, and 32-bit wide memories and peripherals. Whenever a size mismatch exists between a read or write operation and the externally attached device, the EBC automatically packs or unpacks data as appropriate.

In addition to the peripheral and memory interface, the EBC includes an external bus master (EBM) interface. Using the EBM, external masters arbitrate and gain access to the peripheral interface. Once an external master owns the peripheral interface it can read and write all PLB- and OPB-addressable memory, with the exception of devices controlled by the EBC. Typical destinations for EBM transactions are PCI address space and SDRAM memory. For EBC-attached peripherals and memory, the external master is required to directly control the target.

16.1 Interface Signals

Figure 16-1 illustrates the signal I/O between the EBC and the external peripheral bus. The signals are described in detail in Chapter 26, "Signal Summary."

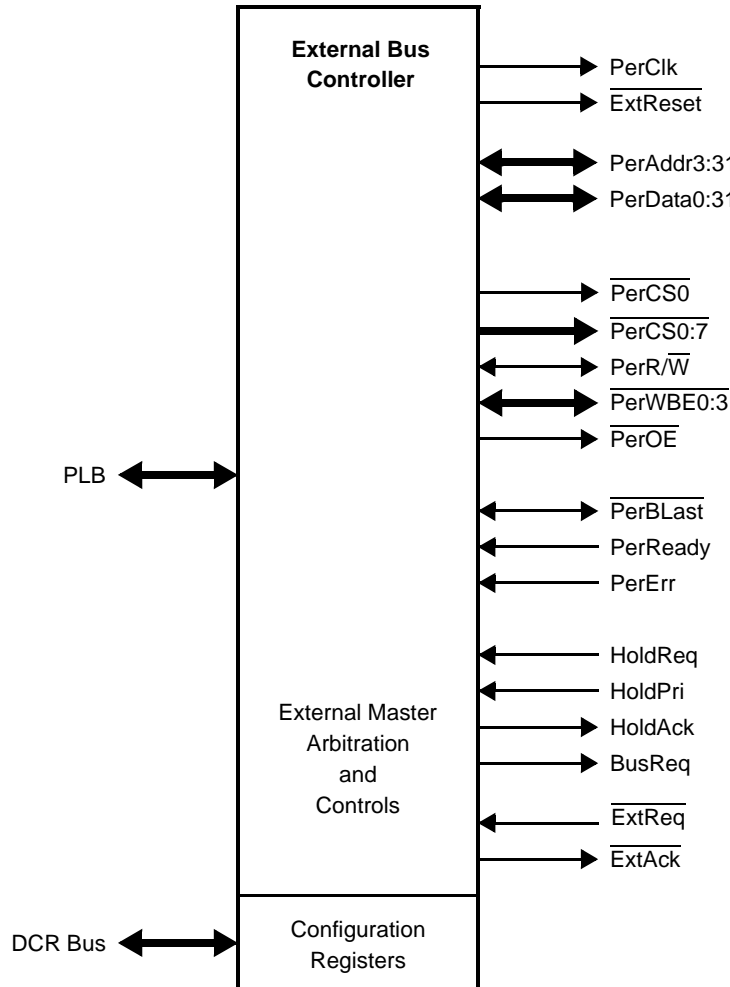

Figure 16-1. EBC Signals

Table 16-1 describes signal usage and state during and after chip and system resets.

Table 16-1. EBC Signal Usage and State During and After Chip and System Resets

Signal	$\overline{\text{ExtReset}} = 0$	$\overline{\text{ExtReset}} = 1$	Usage
PerClk	See Note 1	Toggling	Peripheral bus clock. During an EBC transfer all EBC signal transitions and data sampling occurs synchronous to PerClk.
$\overline{\text{ExtReset}}$	0	1	Peripheral reset for use by slaves and external bus masters.
PerAddr0:3 1	High-Z	Last Address	Peripheral address bus. PerAddr0 is the most significant bit.
PerData0:3 1	High-Z	High-Z	Peripheral data bus. PerData0 is the most significant bit.
PerPar0:3	High-Z	High-Z	Peripheral parity bus. The EBC implements odd parity.

Preliminary User's Manual**Table 16-1. EBC Signal Usage and State During and After Chip and System Resets (continued)**

Signal	ExtReset = 0	ExtReset = 1	Usage
PerCS0:7	High-Z	1	Chip selects. PerCS1:7 are multiplexed with GPIO10:16 and power up as actively driven chip selects. See "Pin Sharing" on page 9-217 for additional details.
PerR/W	High-Z	1	Read not write.
PerWBE0:3	High-Z	1	Write byte enables or read/write byte enables.
PerOE	High-Z	1	Output enable.
PerWE	High-Z	High-Z	Write enable. PerWE is low whenever any bit in PerWBE0:3 is low and PerR/W = 0. This signal is multiplexed with and defaults to PCIINT after a reset. PerWE is selected by setting CPC0_CR1[PCIPW].
PerBLast	High-Z	1	Burst Last. Active during non-burst operations and the last transfer of a burst access.
PerReady	Input	Input	An input to allow external peripherals to perform device-paced transfers.
PerErr	Input	Input	Peripheral data error input.
HoldReq	Input	Input	Hold request, used by an external master to request ownership of the peripheral bus.
HoldPri	Input	Input	Hold priority, used by an external master to indicate the priority in effect for an external master bus tenure.
HoldAck	High-Z	0	Hold acknowledge, informs the external master that it has been granted ownership of the peripheral bus.
BusReq	0	0	Bus request, active when the EBC needs to regain control of the peripheral interface from an external master.
ExtReq	Input	Input	External request, used by an external master to indicate that it is prepared to transfer data.
ExtAck	High-Z	1	External acknowledge, used by the PPC405GP to indicate that an external master data transfer occurred.

Note 1: During a chip or system reset PerClk begins clocking 64 SysClk cycles prior to the time when the ExtReset output switches from 0 to 1.

16.1.1 Interfacing to Byte, Halfword and Word Devices

Figure 16-2 illustrates how to interface byte, halfword, and word devices to the peripheral data bus. When devices are connected in this way, the EBC supports burst transfers and automatically converts read and write operations to the data width of the external device. As shown in Figure 16-2, halfword devices should not connect to PerAddr31. Similarly, a 32-bit device does not require either PerAddr30 or PerAddr31. Instead, the active byte lanes should be inferred from PerWBE0:3, the read/write byte enables.

When a large number of byte and halfword devices are attached to the peripheral data bus, the capacitive loading on byte lane 0 (and byte lane 1, if many halfword devices are used) is much larger than the loading on byte 3, possibly resulting in unacceptable timing performance on byte 0 or byte 1.

If a bank register is configured as word-wide, then byte-wide devices may be attached to the bus in any byte lane (and accessed using byte loads and stores). Similarly, if a bank register is configured as word-wide, then

halfword-wide devices may be attached to the bus in the byte 0/byte 1 lane, or in the byte 2/byte 3 lane, and accessed using halfword loads and stores. External logic may be required to develop additional control signals if the data bus is used in this manner.

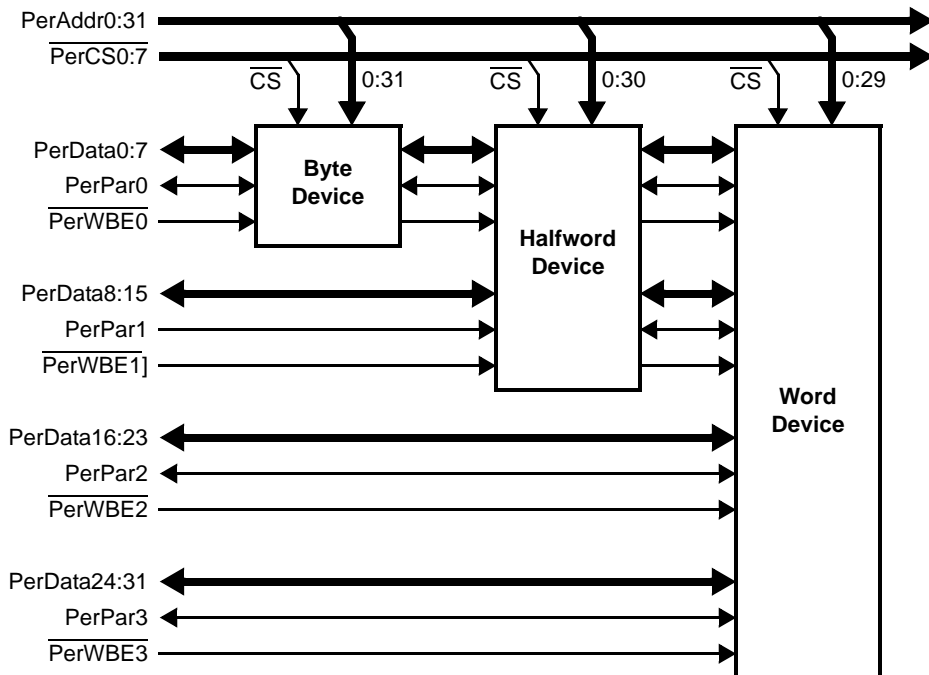

Figure 16-2. Attachment of Devices of Various Widths to the Peripheral Data Bus

16.1.2 Multiplexed I/Os

Seven of the chip select outputs, $\overline{PerCS1:7}$, are multiplexed with GPIOs, while \overline{PerWE} is multiplexed with \overline{PCIINT} . The multiplexing of these I/Os occurs outside of the EBC logic; see “Pin Sharing” on page 9-217 for additional details. As a result, software can still configure and attempt to use a peripheral memory bank whose output is set up as a GPIO. Doing so causes an EBC transaction without an active chip select and the results are therefore undefined.

In the rest of this chapter, $\overline{PerCS0:7}$ and \overline{PerWE} are assumed to be configured as EBC outputs.

16.1.3 Driver Enables

As shown in Table 16-2 the output enables for the peripheral address, data and most of the EBC control signals are configurable. For systems that do not use an external master or where the external master does not directly control devices on the peripheral bus, setting `EBC0_CFG[CSTC]=1` eliminates the need for pull-up resistors on $\overline{PerCS0:7}$. Pullups are also unnecessary on the remainder of the EBC control signals when `EBC0_CFG[EBTC]=1`.

Preliminary User's Manual

Both chip and system resets set EBC0_CFG[EBTC]=1 and EBC0_CFG[CSTC]=1. In most applications, clearing EBC0_CFG[CSTC] is not recommended. If EBC0_CFG[EBTC]=0, EBC control signals can change from the active state to high-Z without first being driven inactive. To prevent this, peripheral banks must be configured with at least one hold cycle (EBC0_BnAP[TH] > 0).

Table 16-2. Effect of Driver Enable Programming on EBC Signal States

EBC Operation	ExtReset PerClk PerWE HoldAck BusReq ExtAck	PerCS0:7	PerAddr0:31 PerR/W PerWBE0:3 PerOE PerBLast	PerData0:31 PerPar0:3
Reset	High-Z	High-Z	High-Z	High-Z
Idle	Driven	EBC0_CFG[CSTC]	EBC0_CFG[EBTC]	EBC0_CFG[EBTC]
Read	Driven	Driven	Driven	High-Z
Write	Driven	Driven	Driven	Driven
External Master	Driven	EBC0_CFG[CSTC]	High-Z	High-Z

Note: If the EBC0_CFG bit is set, the signal is driven to the appropriate state during the indicated EBC operation. Otherwise, the I/O is High-Z.

16.2 Non-Burst Peripheral Bus Transactions

The timing of the $\overline{\text{PerCSn}}$, $\overline{\text{PerOE}}$, and $\overline{\text{PerWBE0:3}}$ signals is programmable using the Peripheral Bank Access Parameter (EBC0_BnAP) registers. For non-burst transfers, the access parameter registers control the peripheral bus timing as follows:

- $\overline{\text{PerCSn}}$ becomes active 0–3 PerClk cycles (EBC0_BnAP[CSN]) after the address is driven.
- $\overline{\text{PerOE}}$ is driven low 0–3 PerClk cycles (EBC0_BnAP[OEN]) after $\overline{\text{PerCSn}}$ is active.
- PerBLast is active throughout the entire transfer and is driven high during the programmed hold time (EBC0_BnAP[TH]).
- $\overline{\text{PerWBE0:3}}$ can be either write byte enables or read and write enables.

If EBC0_BnAP[BEM]=0, $\overline{\text{PerWBE0:3}}$ are write byte enables and:

- $\overline{\text{PerWBE0:3}}$ goes active 0–3 (EBC0_BnAP[WBN]) PerClk cycles after $\overline{\text{PerCSn}}$ becomes active.
- $\overline{\text{PerWBE0:3}}$ becomes inactive 0–3 (EBC0_BnAP[WBF]) PerClk cycles before $\overline{\text{PerCSn}}$ becomes inactive.

If EBC0_BnAP[BEM]=1, $\overline{\text{PerWBE0:3}}$ are read/write byte enables and have timing identical to the peripheral address bus. In this case the EBC0_BnAP[WBN] and EBC0_BnAP[WBF] parameters are ignored.

- 1–256 PerClk cycles (EBC0_BnAP[TWT] + 1) after the address became valid:
 - If EBC0_CFG[CSTC]=1 or EBC0_BnAP[TH]>0, $\overline{\text{PerCSn}}$ is driven high.
 - If EBC0_CFG[CSTC]=0 and EBC0_BnAP[TH]=0, $\overline{\text{PerCSn}}$ transitions directly from logic 0 to the high-impedance state.

- The parameters TWT, CSN, OEN, WBN, and WBF in EBC0_BnAP are not independent. For non-burst configured banks it is required that $TWT \geq CSN + \text{MAX}(OEN, WBN) + WBF$.
- The hold time, EBC0_BnAP[TH], is programmable from 0–7 PerClk cycles. During the hold time, the peripheral address bus remains driven with the last address and all control signals are actively driven high. If the operation was a write, the peripheral data bus continues driving the last data value.
- There is no guarantee of dead cycles between transfers on the peripheral interface. If there are back-to-back transfers to the same memory bank and the number of hold cycles is programmed to zero (EBC0_BnAP[TH]=0) and EBC0_BnAP[CSN]=0, then:
 - $\overline{\text{PerCSn}}$ may not go inactive between the back-to-back transfers.
 - If EBC0_BnAP[OEN]=0, $\overline{\text{PerOE}}$ may not become inactive between the two transfers.
 - If EBC0_BnAP[WBN]=0 and EBC0_BnAP[WBF]=0, $\overline{\text{PerWBE0:3}}$ may not go inactive between the back-to-back transfers.

16.2.1 Single Read Transfer

Figure 16-3 shows the peripheral interface timing for a single read transfer from a non-burst enabled (EBC0_BnAP[BME]=0) bank. The transaction begins with the address being driven. Since this is a single transfer, $\overline{\text{PerBLast}}$ is also driven active along with the address. If byte enable mode is enabled for the bank (EBC0_BnAP[BEM]=1) the byte enables are also output concurrently on $\overline{\text{PerWBE0:3}}$. $\overline{\text{PerCSn}}$ then becomes active EBC0_BnAP[CSN] cycles after the address, while $\overline{\text{PerOE}}$ goes low EBC0_BnAP[OEN] cycles after $\overline{\text{PerCSn}}$. The EBC then waits until EBC0_BnAP[TWT]+1 cycles have elapsed since the start of the transaction and then reads the data bus and the peripheral error input, $\overline{\text{PerErr}}$. If parity checking is enabled (EBC0_BnAP[PAR]=1) the parity is also read at this time. The EBC then drives $\overline{\text{PerCSn}}$, $\overline{\text{PerOE}}$ and $\overline{\text{PerBLast}}$ high and waits EBC0_BnAP[TH] cycles.

Preliminary User's Manual

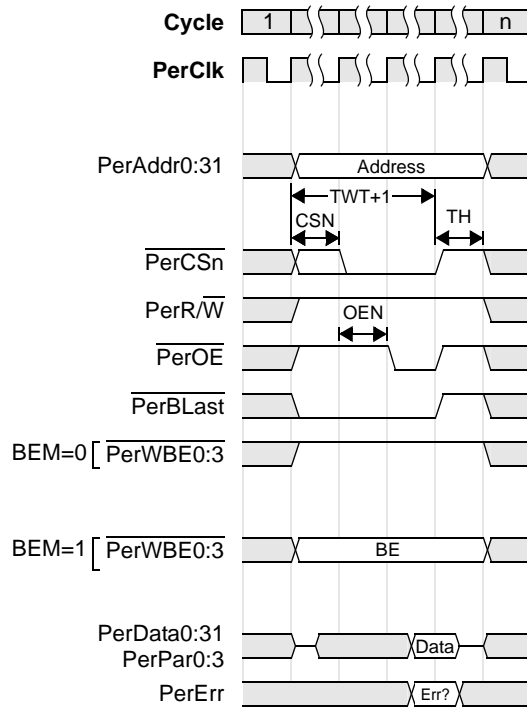

Figure 16-3. Single Read Transfer

16.2.2 Single Write Transfer

Figure 16-4 shows the peripheral interface timing for a single write transfer to a non-burst enabled ($EBC0_BnAP[BME]=0$) bank. The transaction begins with the address being driven. Since this is a single transfer, $\overline{PerBLast}$ is also driven active along with the address. \overline{PerCSn} then becomes active $EBC0_BnAP[CSN]$ cycles after the address. At this point the signalling sequence depends on whether or not byte enable mode is enabled for the bank.

- If $EBC0_BnAP[BEM]=0$, byte enable mode is disabled and the $\overline{PerWBE0:3}$ are write byte enables. The appropriate write byte enables go low $EBC0_BnAP[WBN]$ cycles after \overline{PerCSn} . The EBC then waits until $(EBC0_BnAP[TWT] - EBC0_BnAP[WBF] + 1)$ cycles have elapsed since the start of the transaction, then drives all the $\overline{PerWBE0:3}$ inactive.
- If $EBC0_BnAP[BEM]=1$, the $\overline{PerWBE0:3}$ lines are byte enables and have the same timing as the peripheral address bus.

After $EBC0_BnAP[TWT+1]$ cycles elapse from the start of transfer, \overline{PerCSn} and $\overline{PerBLast}$ are driven high. The EBC then waits $EBC0_BnAP[TH]$ cycles before allowing any pending transfers to occur.

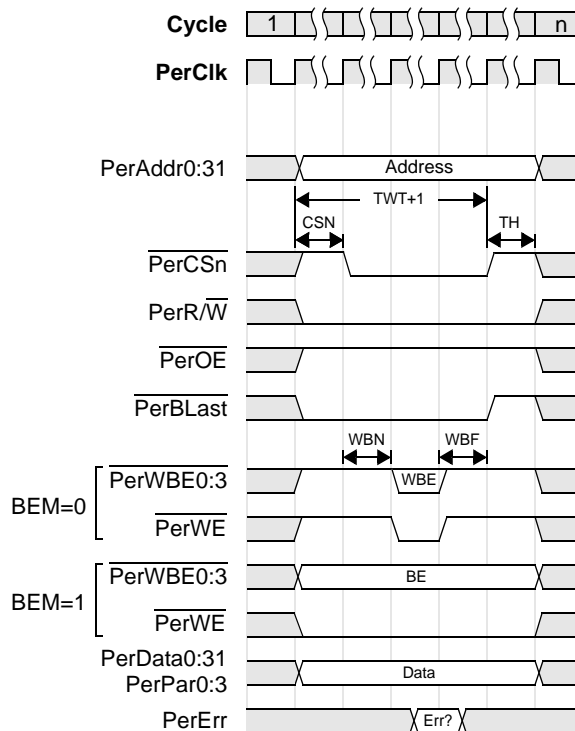

Figure 16-4. Single Write Transfer

Preliminary User's Manual

16.3 Burst Transactions

Bursting is controlled on a per-bank basis by the Burst Mode Enable bit in the EBC0_BnAP registers. When enabled (EBC0_BnAP[BME]=1) this mode activates bursting for all cache line fills and flushes, PLB burst transfers to the EBC, and all packing and unpacking operations. When bursting is enabled:

- $\overline{\text{PerCSn}}$ becomes active 0–3 (EBC0_BnAP[CSN]) PerClk cycles after the address becomes valid.
- $\overline{\text{PerCSn}}$ is no longer actively driven:
 - 1–32 (EBC0_BnAP[FWT]+1) PerClk cycles after the address becomes valid when a single transfer occurs to a burst-enabled bank.
 - 1–8 (EBC0_BnAP[BWT]+1) PerClk cycles after the last address becomes valid during a burst:
 - If EBC0_CFG[CSTC]=1 or EBC0_BnAP[TH]>0, $\overline{\text{PerCSn}}$ is driven high.
 - If EBC0_CFG[CSTC]=0 and EBC0_BnAP[TH]=0, $\overline{\text{PerCSn}}$ transitions directly from logic 0 to the high-impedance state.
- During read operations $\overline{\text{PerOE}}$ is driven low 0–3 (EBC0_BnAP[OEN]) PerClk cycles after $\overline{\text{PerCSn}}$ is active. $\overline{\text{PerOE}}$ goes inactive when $\overline{\text{PerCSn}}$ goes inactive.
- For bursts, the EBC drives a new address (EBC0_BnAP[FWT]+1) + N*(EBC0_BnAP[BWT]+1) cycles after the start of the transaction, where N = 0, 1, 2, ...
- Addresses during a burst may “wrap.” For example, cache line fills are processed critical word first.
- During write operations, the write data is driven concurrent with each address.
- $\overline{\text{PerWBE0:3}}$ can be either write byte enables or read and write enables.
 - If EBC0_BnAP[BEM]=0, $\overline{\text{PerWBE0:3}}$ are write byte enables and:
 - For the first transfer of a burst, or a single transfer to a burst enabled bank, the appropriate write byte enables go low 0–3 (EBC0_BnAP[WBN]) cycles after $\overline{\text{PerCSn}}$ becomes active. The EBC then waits until EBC0_BnAP[FWT] – EBC0_BnAP[WBF] + 1 cycles have elapsed since the start of the transaction and drives $\overline{\text{PerWBE0:3}}$ inactive.
 - The remaining transfers of the burst are similar, except that $\overline{\text{PerWBE0:3}}$ becomes active at the same time that each new address is driven on the interface. The $\overline{\text{PerWBE0:3}}$ remain low for (EBC0_BnAP[BWT] + 1) – EBC0_BnAP[WBF] cycles.
 - If EBC0_BnAP[BEM]=1, $\overline{\text{PerWBE0:3}}$ are byte enables that have timing identical to the peripheral address bus. In this case the EBC0_BnAP[WBN] and EBC0_BnAP[WBF] parameters are ignored.
- $\overline{\text{PerBLast}}$ is active throughout the entire last (or only) transfer of a burst operation and is deactivated during the programmed hold time (EBC0_BnAP[TH]).
- Access bank parameters CSN, OEN and WBN apply to the first (or only) transfer of a burst, while WBF applies to all transfers. It is required that $\text{FWT} \geq \text{CSN} + \text{MAX}(\text{OEN}, \text{WBN}) + \text{WBF}$ and $\text{BWT} \geq \text{WBF}$.
- Hold time (EBC0_BnAP[TH]) is programmable from 0 to 7 cycles. During the hold time, the peripheral address bus remains driven and all control signals are driven inactive. If the operation was a write, the peripheral data bus continues driving the write data.
- There is no guarantee of dead cycles between transfers on the peripheral interface. If there are back-to-back transfers to the same memory bank and the number of hold cycles is programmed to zero (EBC0_BnAP[TH]=0) and EBC0_BnAP[CSN]=0, then:

- $\overline{\text{PerCSn}}$ may not go inactive between the back-to-back transfers.
- If $\text{EBC0_BnAP}[\text{OEN}]=0$, $\overline{\text{PerOE}}$ may not become inactive between the two transfers.
- If $\text{EBC0_BnAP}[\text{WBN}]=0$ and $\text{EBC0_BnAP}[\text{WBF}]=0$, $\overline{\text{PerWBE0:3}}$ may not go inactive between the back-to-back transfers.

16.3.1 Burst Read Transfer

Figure 16-5 shows the peripheral interface timing for a burst read transfer from a burst enabled ($\text{EBC0_BnAP}[\text{BME}]=1$) bank. The transaction begins with the address being driven. If byte enable mode is enabled for the bank ($\text{EBC0_BnAP}[\text{BEM}]=1$) the byte enables are also output concurrently on $\overline{\text{PerWBE0:3}}$. $\overline{\text{PerCSn}}$ then becomes active $\text{EBC0_BnAP}[\text{CSN}]$ cycles after the address, while $\overline{\text{PerOE}}$ goes low $\text{EBC0_BnAP}[\text{OEN}]$ cycles after $\overline{\text{PerCSn}}$. The EBC then waits until $\text{EBC0_BnAP}[\text{FWT}]+1$ cycles have elapsed since the start of the transaction and then reads the data bus and the peripheral error input, $\overline{\text{PerErr}}$. If parity checking is enabled ($\text{EBC0_BnAP}[\text{PEN}]=1$) the parity is also read at this same time.

The next address of the burst is then driven and after $\text{EBC0_BnAP}[\text{BWT}]+1$ cycles the EBC performs the next read. The remaining items in the burst are read in the same manner, except that $\overline{\text{PerBLast}}$ is active during the last data element. The EBC then drives $\overline{\text{PerCSn}}$, $\overline{\text{PerOE}}$ and $\overline{\text{PerBLast}}$ high and waits $\text{EBC0_BnAP}[\text{TH}]$ cycles before allowing any pending transfers to occur.

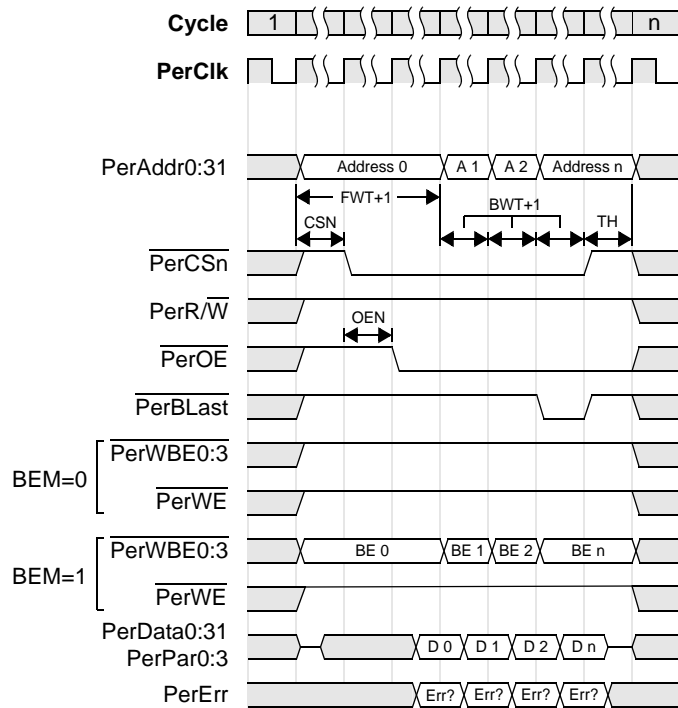

Figure 16-5. Burst Read Transfer

Preliminary User’s Manual

16.3.2 Burst Write Transfer

Figure 16-6 shows the peripheral interface timing for a burst write transfer to burst enabled (EBC0_BnAP[BME]=1) bank. The transaction begins with the address being driven. At this point the signalling sequence depends on whether byte enable mode is enabled for the bank.

- If EBC0_BnAP[BEM]=0, byte enable mode is disabled and $\overline{\text{PerWBE0:3}}$ are write byte enables. In this case, the appropriate write byte enables go low EBC0_BnAP[WBN] cycles after $\overline{\text{PerCSn}}$. The EBC then waits until $(\text{EBC0_BnAP[FWT]} + 1) - \text{EBC0_BnAP[WBF]}$ cycles have elapsed since the start of the transaction and drives $\overline{\text{PerWBE0:3}}$ inactive. EBC0_BnAP[WBF] cycles are then allowed to elapse after which the address and data are output for the second element in the burst. As shown in Figure 16-6, the EBC transfers the subsequent data items in a similar manner.
- If EBC0_BnAP[BEM]=1, the $\overline{\text{PerWBE0:3}}$ lines are byte enables and have the same timing as the peripheral address bus. In this configuration external logic may be necessary to latch write data at the appropriate times.

$\overline{\text{PerBLast}}$ goes low at the beginning of the last transfer to indicate that the burst is ending. The EBC then drives $\overline{\text{PerCSn}}$ and $\overline{\text{PerBLast}}$ high and waits EBC0_BnAP[TH] cycles before allowing any pending transfers to occur.

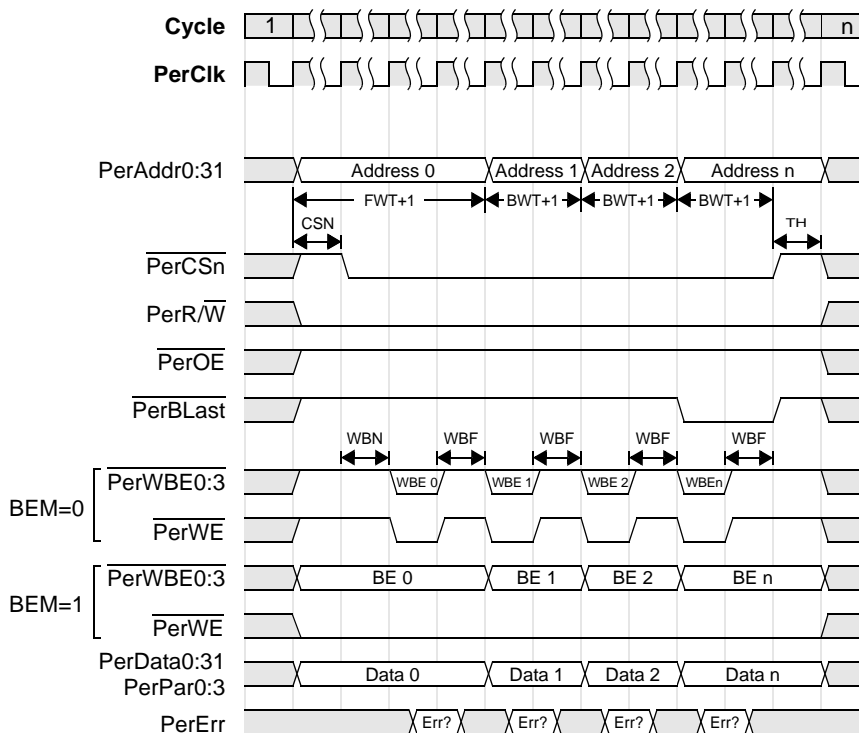

Figure 16-6. Burst Write Transfer

16.4 Device-Paced Transfers

For device-paced transfers, the EBC provides two distinct modes: Sample On Ready enabled and Sample On Ready disabled. The selection of these modes is controlled, for each bank, by EBC0_BnAP[SOR]. When Sample On Ready is enabled (EBC0_BnAP[SOR] = 1) data is transferred on the PerClk rising edge when PerReady is sampled active. When Sampling On Ready is disabled (EBC0_BnAP[SOR] = 0), PerReady sampled active causes the data transfer to occur in the next cycle, which results in an additional cycle of wait time.

The ready signal (PerReady) is an input which allows the insertion of externally generated (device-paced) wait states. PerReady is monitored only when EBC0_BnAP[RE]=1.

- For burst disabled banks (EBC0_BnAP[BME] = 0) sampling of the PerReady input starts EBC0_BnAP[TWT] cycles after the beginning of the transfer. Wait states are inserted and sampling continues once per cycle until either PerReady is high when sampled or a timeout occurs.
- For burst enabled banks (EBC0_BnAP[BME] = 1) sampling of the PerReady input starts EBC0_BnAP[FWT] PerClk cycles after the beginning of the first transfer of a burst, and EBC0_BnAP[BWT] cycles after the beginning of subsequent transfers of the burst. Sampling continues once per cycle until either PerReady is sampled high or a timeout occurs.
- When EBC0_BnAP[SOR] = 1 data transfer occurs in the same cycle where PerReady is sampled active. In contrast, if EBC0_BnAP[SOR]=0 the data transfer occurs in the next cycle.
- When EBC0_BnAP[SOR] = 1, if the hold time is set to zero, EBC0_BnAP[TH] = 0, the programmed hold time is ignored and the EBC performs the transaction with one hold cycle.
- When EBC0_BnAP[RE] = 1, the Write Byte Enable Off parameter must be programmed to 0, EBC0_BnAP[WBF] = 0. As a result, during device-paced burst write transfers PerWBEO:3 does not become inactive between data elements.

The EBC may be programmed to wait only a limited time for PerReady to become active, or it may be programmed for unlimited wait. If EBC0_CFG[PTD] = 1, timeouts are disabled and the EBC waits indefinitely for an active PerReady.

If EBC0_CFG[PTD] = 0, device-paced timeouts are enabled and the EBC only waits for the number of PerClk cycles programmed in EBC0_CFG[RTC]. The timeout counter is reset whenever the peripheral address changes. In this manner each data element within a device-paced burst transaction is treated separately for the purposes of determining whether a timeout error occurs. If PerReady does not become active before the timeout counter reaches the value programmed into EBC0_CFG[RTC], the transfer is aborted and an error is signalled. See “Error Reporting” on page 16-379 for details about how timeout errors are logged.

Preliminary User's Manual

16.4.1 Device-Paced Single Read Transfer

Figure 16-7 shows the peripheral interface timing for a device-paced single read transfer from a burst disabled ($EBC0_BnAP[BME]=0$) bank. The transaction begins with the address being driven. Since this is a single transfer, $PerBLast$ is also driven active along with the address. If byte enable mode is enabled for the bank ($EBC0_BnAP[BEM]=1$) the byte enables are also output concurrently on $PerWBE0:3$. $PerCSn$ then becomes active $EBC0_BnAP[CSN]$ cycles after the address, while $PerOE$ goes low $EBC0_BnAP[OEN]$ cycles after $PerCSn$.

The EBC then waits until $EBC0_BnAP[TWT]$ cycles have elapsed since the start of the transaction and then begins sampling $PerReady$. If device-paced timeouts are disabled ($EBC0_CFG[PTD]=1$) the EBC waits indefinitely for $PerReady$ to become active. Otherwise, the EBC waits only $EBC0_CFG[RTC]$ cycles from the start of the transaction until logging a timeout error.

Once $PerReady$ is sampled active if Sample On Ready is disabled ($EBC0_BnAP[SOR]=0$) the EBC waits one more cycle. The EBC then samples the data bus and the peripheral error input, $PerErr$. If parity checking is enabled ($EBC0_BnAP[PEN]=1$) the parity is also read at this time. The EBC then drives $PerCSn$, $PerOE$ and $PerBLast$ high and waits $EBC0_BnAP[TH]$ cycles before allowing any pending EBC transfers to occur.

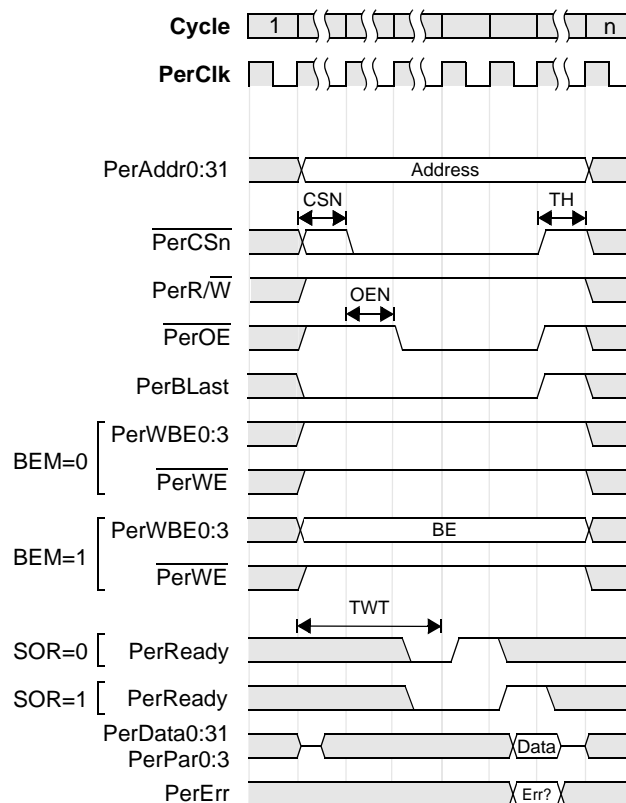

Figure 16-7. Device-Paced Single Read Transfer

16.4.2 Device-Paced Single Write Transfer

Figure 16-8 shows the peripheral interface timing for a device-paced single write transfer from a burst enabled ($EBC0_BnAP[BME]=1$) bank. The transaction begins with the address being driven. Since this is a single transfer, $PerBLast$ is also driven active along with the address. At this point the signalling sequence depends on whether byte enable mode is enabled for the particular bank.

- If $EBC0_BnAP[BEM]=0$, byte enable mode is disabled and the $\overline{PerWBE0:3}$ are write byte enables. The appropriate write byte enables go low $EBC0_BnAP[WBN]$ cycles after \overline{PerCSn} went low. $\overline{PerWBE0:3}$ return high on the same $PerClk$ edge that the write data is transferred (see below).
- If $EBC0_BnAP[BEM]=1$, the $\overline{PerWBE0:3}$ lines are byte enables and have the same timing as the peripheral address bus.

The EBC then waits until $EBC0_BnAP[TWT]$ cycles have elapsed since the start of the transaction and then begins sample $PerReady$. If device-paced timeouts are disabled ($EBC0_CFG[PTD]=1$) the EBC waits indefinitely for $PerReady$ to become active. Otherwise, the EBC waits only $EBC0_CFG[RTC]$ cycles from the start of the transaction until logging a timeout error.

If $PerReady$ is sampled active and Sample On Ready is disabled ($EBC0_BnAP[SOR]=0$) the EBC waits one more cycle. At this point, the write transfer occurs and the EBC reads the peripheral error input, $PerErr$. The EBC then drives $PerCSn$, $PerOE$ and $PerBLast$ high and waits $EBC0_BnAP[TH]$ cycles.

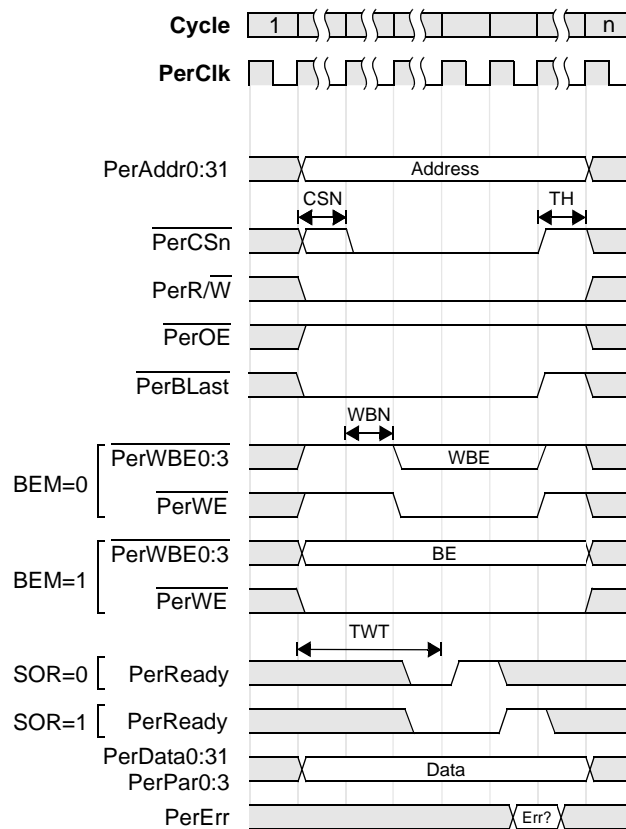

Figure 16-8. Device-Paced Single Write Transfer

Preliminary User's Manual

16.4.3 Device-Paced Burst Read Transfer

Figure 16-9 shows the peripheral interface timing for a device-paced burst read transfer from a burst enabled (EBC0_BnAP[BME]=1) bank. The transaction begins with the address being driven. If byte enable mode is enabled for the bank (EBC0_BnAP[BEM]=1) the byte enables are also output concurrently on PerWBE0:3. PerCSn then becomes active EBC0_BnAP[CSN] cycles after the address, while PerOE goes low EBC0_BnAP[OEN] cycles after PerCSn. The EBC then waits until EBC0_BnAP[FWT] cycles have elapsed since the start of the transaction and begins sampling PerReady.

If device-paced timeouts are disabled (EBC0_CFG[PTD]=1) the EBC waits indefinitely for PerReady to become active. Otherwise, the EBC waits only EBC0_CFG[RTC] cycles from the start of the transaction until logging a timeout error.

If PerReady is sampled active and Sample On Ready is disabled (EBC0_BnAP[SOR]=0) the EBC waits one more cycle before sampling read data. The EBC then reads the data bus and the peripheral error input, PerErr. If parity checking is enabled (EBC0_BnAP[PEN]=1) the parity is also read.

The next address of the burst is then driven and after EBC0_BnAP[BWT] cycles the EBC waits for PerReady as described above. The remaining items in the burst are read in this same manner, except that PerBLast is active during the last data element. The EBC then drives PerCSn, PerOE and PerBLast high and waits EBC0_BnAP[TH] cycles before allowing any pending transfers to occur.

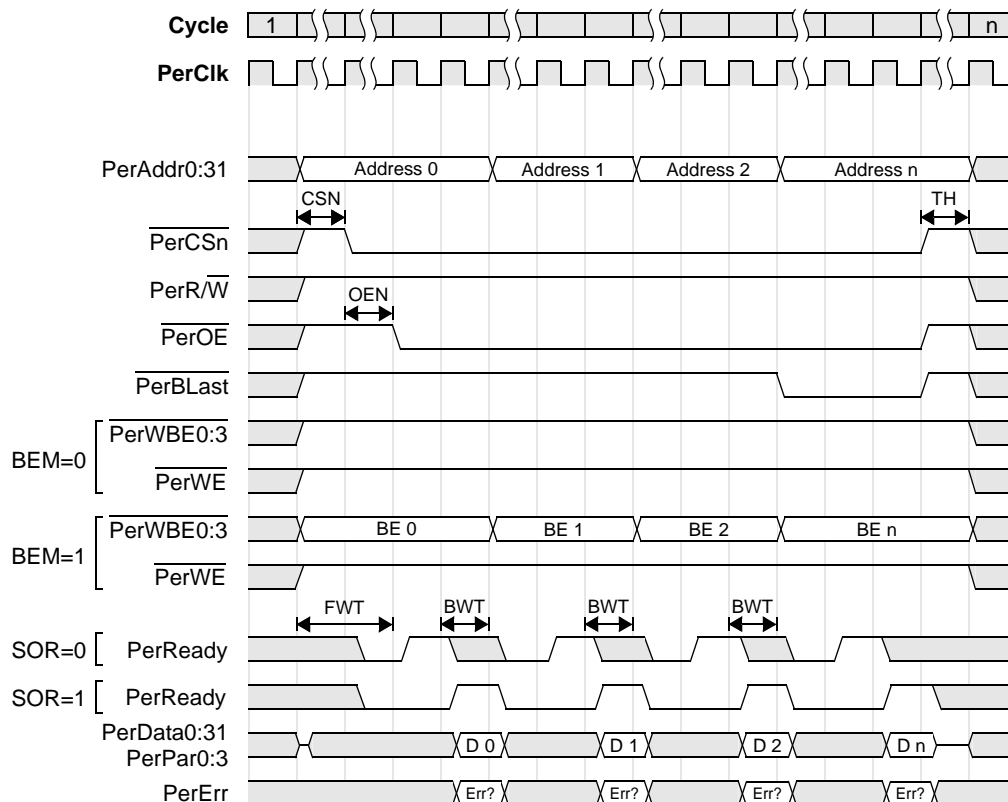

Figure 16-9. Device-Paced Burst Read Transfer

16.4.4 Device-Paced Burst Write Transfer

Figure 16-10 shows the peripheral interface timing for a device-paced burst write transfer to a burst enabled ($EBC0_BnAP[BME]=1$) bank. The transaction begins with the address being driven. \overline{PerCSn} then becomes active $EBC0_BnAP[CSN]$ cycles after the address. At this point the signalling sequence depends on whether or not byte enable mode is enabled for the bank.

- If byte enable mode is disabled ($EBC0_BnAP[BEM]=0$) $\overline{PerWBE0:3}$ are write byte enables. In this case the appropriate write byte enables go low $EBC0_BnAP[WBN]$ cycles after \overline{PerCSn} becomes active for the first element in a burst and $EBC0_BnAP[WBN]$ cycles after each new address for the remainder of the burst. If $EBC0_BnAP[WBN]<>0$, $\overline{PerWBE0:3}$ is driven inactive on the same $PerClk$ edge that write data is transferred (see below). Otherwise, $\overline{PerWBE0:3}$ remains low for all data elements in the burst.
- If $EBC0_BnAP[BEM]=1$, $\overline{PerWBE0:3}$ are byte enables and have the same timing as $PerAddr3:31$.

The EBC then waits until $EBC0_BnAP[FWT]$ cycles have elapsed since the start of the transaction and begins sampling $PerReady$. If device-paced timeouts are disabled ($EBC0_CFG[PTD]=1$) the EBC waits indefinitely for $PerReady$. Otherwise, the EBC waits only $EBC0_CFG[RTC]$ cycles from the start of the transaction until logging a timeout error.

If $PerReady$ is sampled active and Sample On Ready is disabled ($EBC0_BnAP[SOR]=0$) the EBC waits one more cycle. At this point the write transfer occurs and the EBC reads the peripheral error input, $PerErr$.

The next address of the burst is then driven and after $EBC0_BnAP[BWT]$ cycles the EBC waits for $PerReady$ as described above. The remaining items in the burst are transferred in this same manner, except that $\overline{PerBLast}$ is active for the last data element. The EBC then drives \overline{PerCSn} , \overline{PerOE} and $\overline{PerBLast}$ high and waits $EBC0_BnAP[TH]$ cycles before allowing any pending transfers to occur.

Preliminary User's Manual

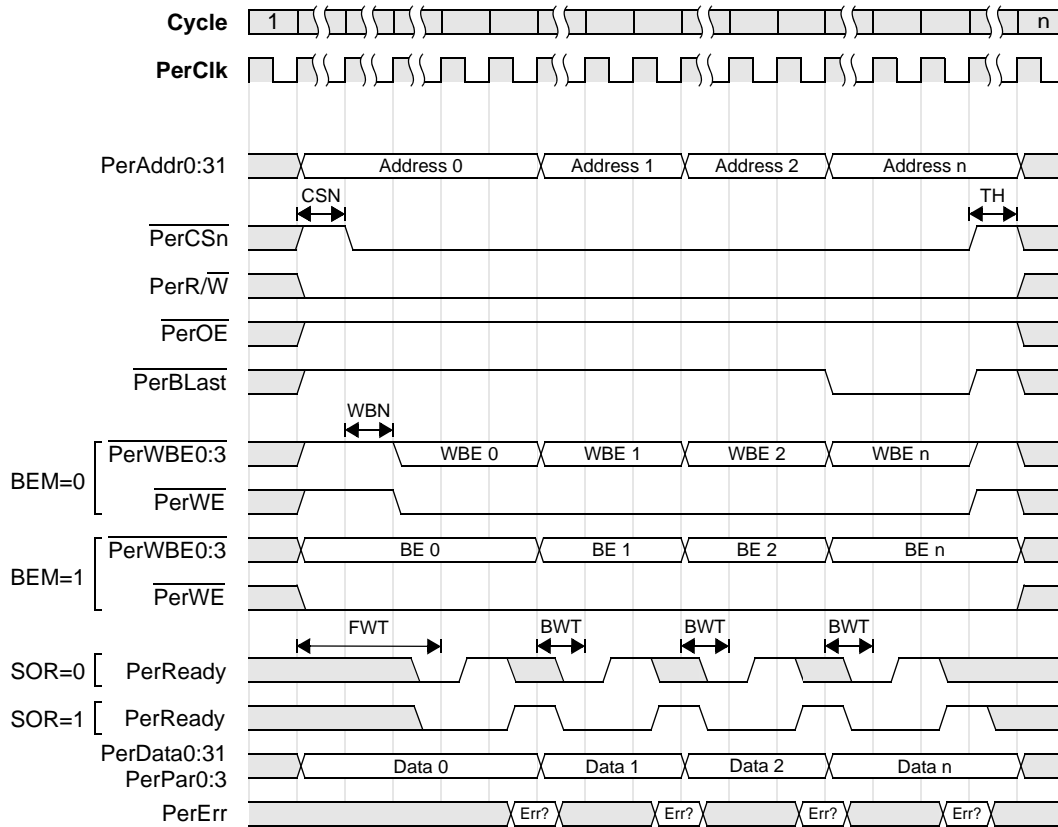

Figure 16-10. Device-Paced Burst Write Transfer

16.5 External Bus Master Interface

The EBC includes an External Bus Master (EBM) interface supporting a shared bus protocol which allows an EBM to gain control of the peripheral bus. Once an external master has been granted access to the peripheral interface it can read and write all PLB- and OPB-addressable memory, with the exception of devices controlled by the EBC. Typical destinations for EBM transactions are PCI address space and SDRAM memory. SDRAM memory is the typical destination for an EBM transaction. For EBC-attached peripherals and memory, the external master is required to directly control the target.

Figure 16-11 shows a sample interconnection of the EBC, one SRAM bank, and one external bus master. While only one SRAM bank is shown, the bus master could access all eight of the SRAM banks. Also, with the appropriate arbitration logic, multiple bus masters may be used in a system.

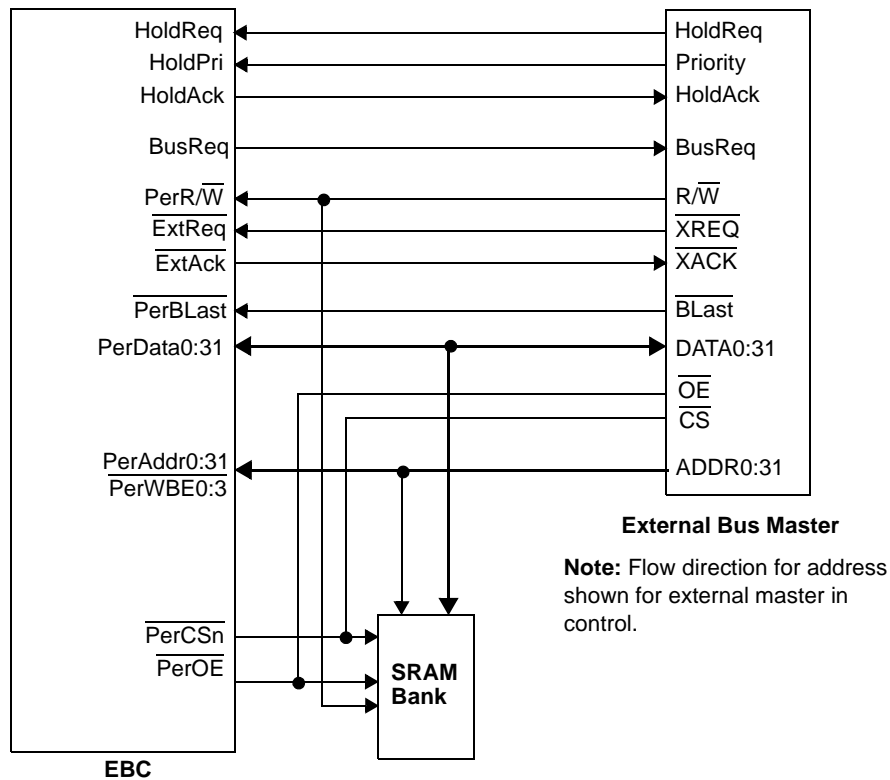

Figure 16-11. Sample External Bus Master System

The EBM interface includes both arbitration and data transfer functions. The arbiter grants the peripheral bus to either the EBC or an external master, while the datapath logic implements an external master to PLB bridge function. This bridge function translates the EBM interface protocol to that required by the on-chip PLB bus.

Preliminary User's Manual**16.5.1 Arbitration**

To gain control of the peripheral bus, the external bus master places an active level on the HoldReq input and drives the HoldPri signal to the desired value (see Figure 16-12 on page 16-371 for an illustrative waveform). The HoldPri input selects the priority of the external master's transactions relative to other EBC operations. Internal to the PPC405GP all reads and writes that target the EBC are assigned the priority 0b10.

If HoldPri=0 the external master priority is set to EBC0_CFG[EMPL], whereas HoldPri=1 sets the priority to EBC0_CFG[EMPH]. Table 16-3 details the only unique ways of programming the external master priority fields in EBC0_CFG, along with the arbiter's response.

Table 16-3. External Master Arbitration.

EMPL	EMPH	HoldPri	When HoldReq=1 HoldAck Becomes Active	When HoldAck=1 BusReq Goes Active
0b11	0b11	X	After any active EBC operation completes.	Never.
0b00	0b11	0	If no EBC transfers are active or pending.	If an EBC transfer is pending.
		1	After any active EBC operation completes.	Never.
0b00	0b00	X	If no EBC transfers are active or pending.	If an EBC transfer is pending.

When an external bus master requests the bus by driving HoldAck=1, the EBC finishes any transfer in progress (except for bursts) before arbitrating between any pending PLB request and the external master request. If the external master presents a higher priority request during a PLB burst, the burst is terminated. Note that processor cache reads and writes are PLB line operations, not PLB bursts, and are never interrupted.

As detailed in Table 16-4, the arbitration logic drives HoldAck active either when the current EBC transaction completes or when there are no EBC transfers pending. Once the external master has been granted the bus, it may either directly control devices on the peripheral bus or read and write PLB- and OPB-addressable memory. If the EBC detects a pending PLB request when the external master owns the peripheral bus (HoldAck=1), BusReq may be asserted to signal the external master that the PPC405GP wants to regain ownership of the peripheral bus. Table 16-3 lists the cases where a PLB request causes BusReq to go active. To ensure fairness and optimize bus utilization, an external master that receives an active BusReq should complete its current transaction and then relinquish ownership of the peripheral bus by driving HoldReq inactive. This is important since the EBC cannot reclaim ownership of the external bus until the external master negates HoldReq.

Table 16-4, "Signal States During Hold Acknowledge (HoldAck=1)," on page 16-369 details the usage of the EBC I/Os when an external master has been granted ownership of the peripheral bus. The usage statements in this table for signals other than HoldPri, HoldReq, HoldAck and BusReq do not apply if an external master directly controls a device on the peripheral bus.

Table 16-4. Signal States During Hold Acknowledge (HoldAck=1)

Signal Name	State	Usage
HoldPri	Input	Requested priority for external master tenure. HoldPri must not change state when HoldReq=1.
HoldReq	Input (=1)	External master must maintain its request when it owns the bus.
HoldAck	Output (=1)	External master is receiving an active bus grant.
BusReq	Output	See Table 16-3 on Page 16-369.
ExtReq	Input	Indicates the external master is ready to transfer data.

Table 16-4. Signal States During Hold Acknowledge (HoldAck=1)

Signal Name	State	Usage
ExtAck	Output	Indicates to the external master that a data transfer occurred.
PerAddr3:31	Input	Requested address from external master.
PerWBE0:3	Input	Selects the requested byte(s) for reads and writes.
PerR/W	Input	Determines if the operation is a read or write.
PerBLast	Input	Active during single transfers and the last transfer of a burst.
PerData0:31	I/O	Read and write data.
PerOE	High-Z	Unused.
PerErr	High-Z	Unused.

16.5.2 Transaction Overview

The EBM interface supports direct attachment of 8-, 16-, and 32-bit masters. By programming the width of the external master into EBC0_CFG[EMS] the interface accepts write data and provides read data at the appropriate width for the master. The EBM interface includes a 32-byte data buffer, used for both read and write operations between the EBM and PLB- and OPB-mapped memory locations. While write operations only use the buffer during bursts, all reads prefetch one doubleword and burst reads prefetch EBC0_CFG[BPF] doublewords from the source memory into the buffer. This prefetched data remains in the buffer until either a write operation is performed or a read is requested to a different 32-byte block of memory.

To provide the best possible performance, the EBM interface supports both single and burst transactions. Single read transfers result in the EBM reading and buffering a 64-bit doubleword from the requested memory address. The requested read data is then serviced from within this doubleword. If the next operation on the EBM interface is a read and targets this same doubleword, it is serviced directly from the buffer. Burst reads are similar, except that the EBM prefetches four doublewords beginning with the requested word.

Single write transfers result in a separate PLB transaction for each data item. To improve performance, burst writes are gathered in the 32-byte buffer and forwarded in a single PLB transaction to the target memory.

16.5.3 Single Read and Single Write Transfers

Figure 16-12 illustrates external master bus arbitration along with a single read and signal write transfer. An external master requests ownership of the peripheral bus by driving HoldReq active along with the desired priority on HoldPri. Observe that HoldPri must be held at constant value throughout the entire external master tenure. After two or more PerClk cycles the arbiter will grant the peripheral bus to the external master. The delay from when the external master asserts HoldReq to when HoldAck becomes active is variable and depends on any EBC transaction that may be in progress or pending, the level on HoldPri, and the programming in EBC0_CFG[EMPL] and EBC0_CFG[EMPH].

Once the external master is granted the peripheral bus (HoldAck=1), it may either directly control a device on the EBC or issue read and write transactions to the external master interface. This waveform and the ones that follow apply only to the later case. Additionally, cycles shown with breaks in the clock may not be present or may extend for multiple cycles.

To perform a single read operation the external master must:

- Place the desired address on PerAddr0:31.
- Indicate the requested data byte(s) on PerWBE0:3.

Preliminary User's Manual

- Drive $\overline{\text{PerR/W}}$ high.
- Assert $\overline{\text{PerBLast}}$ to mark this as a single transfer.
- Request the transfer by driving and holding $\overline{\text{ExtReq}}$ low.

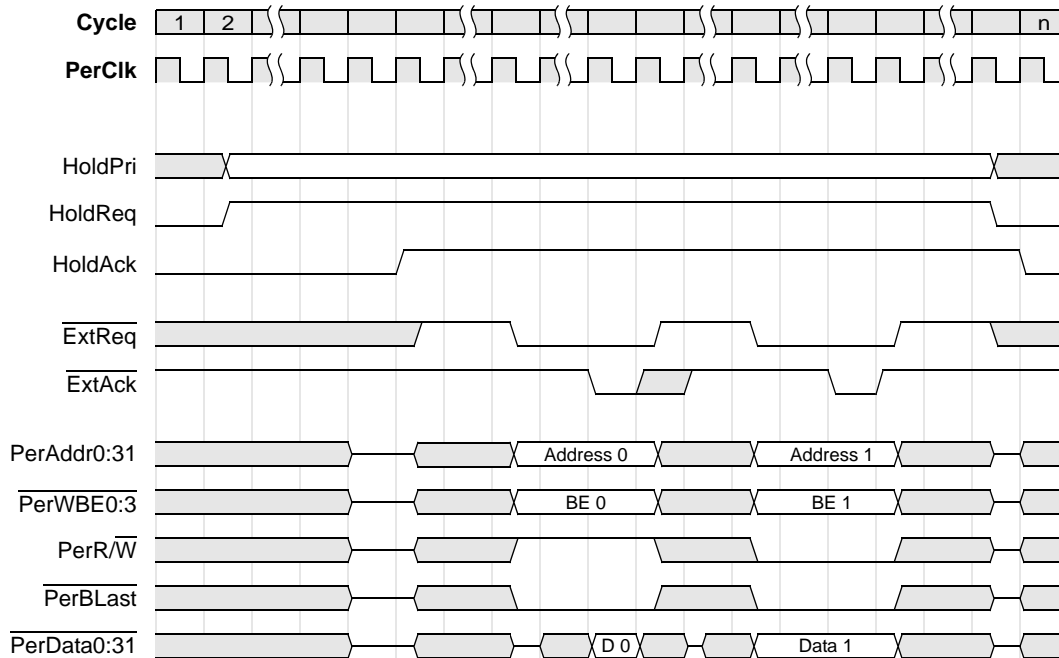

Figure 16-12. External Master Arbitration, Single Read and Single Write

The EBM interface then converts this read request into a PLB transaction and reads the target memory location. $\overline{\text{ExtAck}}$ then goes low when read data is available on $\overline{\text{PerData}}$. Note that the external master must not remove $\overline{\text{ExtReq}}$ until the cycle after $\overline{\text{ExtAck}}$ becomes active. In addition, $\overline{\text{ExtReq}}$ must be high for at least one cycle between all external master transactions.

Write transfers are similar to reads except that the write data must be provided along with the address and $\overline{\text{PerR/W}}$ is low to indicate a write. As with reads, $\overline{\text{ExtReq}}$ must be held until the cycle after $\overline{\text{ExtAck}}$ is received.

16.5.4 Burst Read Transfer

Burst reads are preferred when accessing sequential addresses as they provide much better performance. Figure 16-13 illustrates an external master burst read transaction. A burst read differs from a single read in that PerBLast is held inactive for all but the last transfer of the burst. In addition, the EBM only requires the address of the first burst element. Following each ExtAck the EBM uses the size of the master configured in EBC0_CFG[EMS] to increment its internal address counter as appropriate.

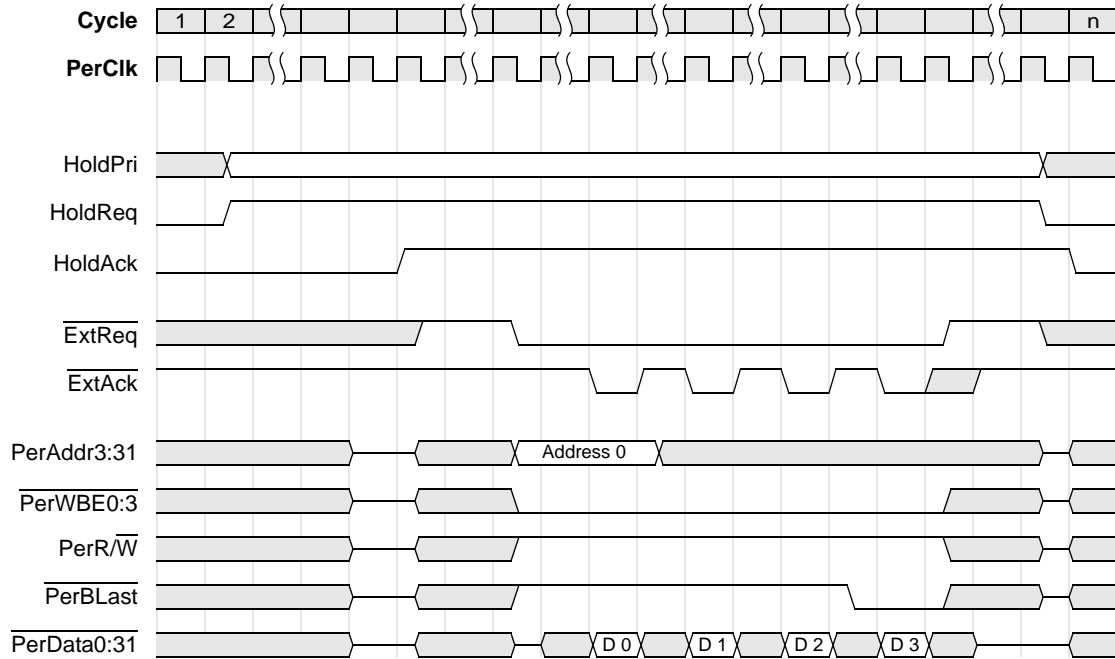

Figure 16-13. External Master Burst Read

Preliminary User's Manual**16.5.5 Burst Write Transfer**

Burst writes are preferred when accessing sequential addresses as they provide much better performance. Figure 16-14 illustrates an external master burst write transaction. A burst write differs from a single write in that $\overline{\text{PerBLast}}$ is held inactive for all but the last transfer of the burst. In addition, the EBM only requires the address of the first burst element. Following each $\overline{\text{ExtAck}}$ the EBM uses the size of the master in EBC0_CFG[EMS] to increment its internal address counter as appropriate.

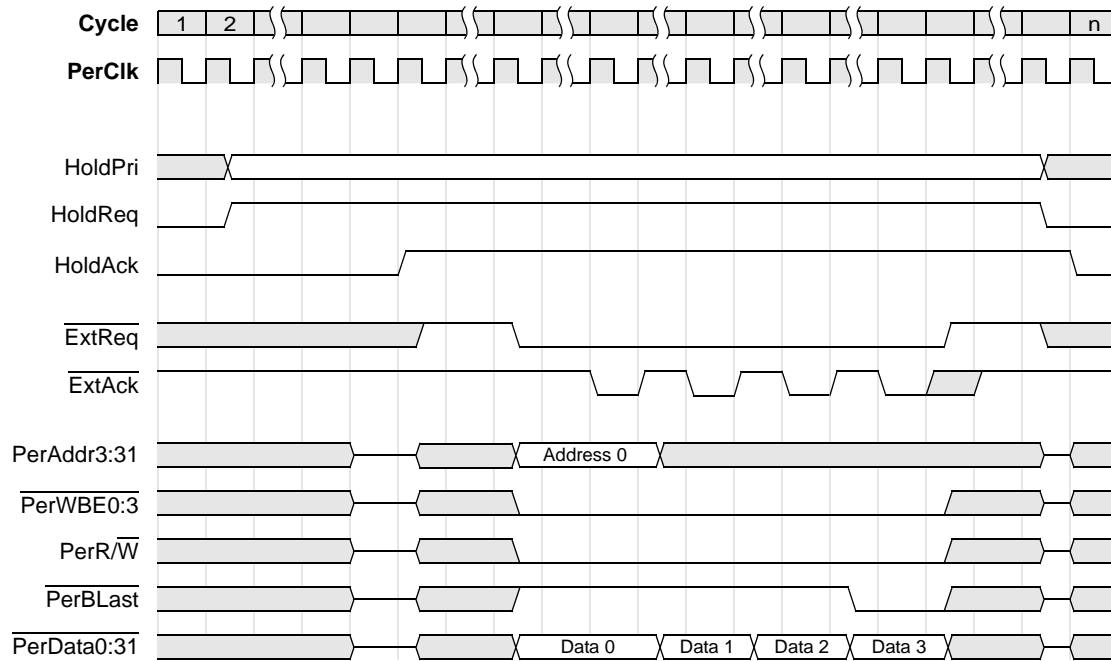

Figure 16-14. External Master Burst Write

16.5.6 External Master Error Interrupts

The EBM can generate an interrupt if a PLB error is encountered while read or writing data. As example, an SDRAM uncorrectable ECC error will cause an EBM interrupt. Please refer to the UIC Chapter for additional information regarding interrupts.

16.6 EBC Registers

All EBC configuration and status registers are accessed using the **mtdcr** and **mfocr** instructions. Access to these registers is performed using an indirect addressing method through the EBC0_CFGADDR and EBC0_CFGDATA registers.

Table 16-5. EBC DCR Addresses

Register	DCR Address	Access	Description
EBC0_CFGADDR	0x012	R/W	External Bus Controller Address Register
EBC0_CFGDATA	0x013	R/W	External Bus Controller Data Register

Table 16-6 lists the indirectly accessed EBC configuration and status registers.

Table 16-6. EBC Configuration and Status Registers

Mnemonic	Address Offset	Access	Description	Page
EBC0_B0CR–EBC0_B7CR	0x00–0x07	R/W	Peripheral Bank Configuration Registers	16-376
EBC0_B0AP–EBC0_B7AP	0x10–0x17	R/W	Peripheral Bank Access Parameters	16-377
EBC0_BEAR	0x20	R	Peripheral Bus Error Address Register	16-380
EBC0_BESR0	0x21	R/W	Peripheral Bus Error Status Register 0	16-381
EBC0_BESR1	0x22	R/W	Peripheral Bus Error Status Register 1	16-383
EBC0_CFG	0x23	R/W	EBC Configuration Register	16-377

To access an indirectly accessed register, software must first write the address offset into the EBC0_CFGADDR register. The target register can then be read or written through the EBC0_CFGDATA DCR address. The following PowerPC code illustrates this procedure by writing the EBC0_B0CR register and then reading back the written value.

```
li      r3,EBC0_B0CR          ! address offset
lis    r4,<config upper>      ! upper 16-bits of configuration data
ori    r4,r4,<config lower>   ! lower 16-bits of configuration data
mtdcr EBC0_CFGADDR,r3        ! set offset addr
mtdcr EBC0_CFGDATA,r4        ! write config data
mfocr  r5,EBC0_CFGDATA       ! read back config data
```

Preliminary User's Manual**16.6.1 EBC Configuration Register (EBC0_CFG)**

The contents of EBC0_CFG are accessed indirectly, using the EBC0_CFGADDR and EBC0_CFGDATA. .

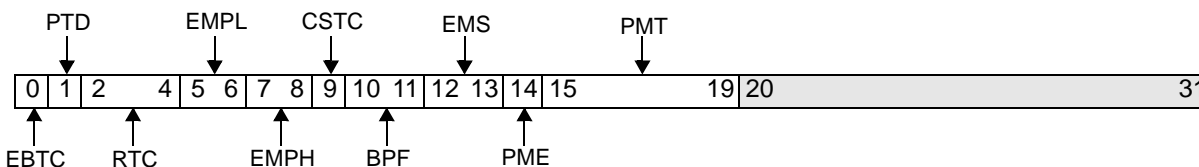

Figure 16-15. EBC Configuration Register (EBC0_CFG)

0	EBTC	External Bus Three-State Control 0 Address, data and control signals are high-Z between EBC transfers. 1 Between EBC transfers the peripheral data bus, address bus and control signals are driven.	Default after reset is EBTC=1. See “Effect of Driver Enable Programming on EBC Signal States” on page 16-355.
1	PTD	Device-Paced Time-out Disable 0 Enabled time-outs 1 Disable time-outs	If PTD=1, the EBC waits indefinitely for assertion of PerReady during device-paced accesses.
2:4	RTC	Ready Timeout Count 000 16 PerClk cycles 001 32 PerClk cycles 010 64 PerClk cycles 011 128 PerClk cycles 100 256 PerClk cycles 101 512 PerClk cycles 110 1024 PerClk cycles 111 2048 PerClk cycles	When PTD=0, the number of cycles from PerAddr0:31 changing until a timeout error occurs.
5:6	EMPL	External Master Priority Low 00 Low 01 Medium low 10 Medium high 11 High	The PLB priority for external master initiated transfers when the external master hold priority input is low (HoldPri=0).
7:8	EMPH	External Master Priority High 00 Low 01 Medium low 10 Medium high 11 High	The PLB priority for external master initiated transfers when the external master hold priority input is high (HoldPri=1).
9	CSTC	Chip Select Three-state Control 0 $\overline{\text{PerCS0:7}}$ are high-Z between EBC transfers and when an external master is active (HoldAck=1). 1 $\overline{\text{PerCS0:7}}$ are always driven.	Default after reset is CSTC=1. See “Effect of Driver Enable Programming on EBC Signal States” on page 16-355.
10:11	BPF	Burst Prefetch 00 Prefetch 1 doubleword 01 Prefetch 2 doublewords 10 Prefetch 4 doublewords 11 Reserved	Controls the amount of data prefetching when the EBC is servicing a PLB burst read. For most applications set this field to 0b00.

12:13	EMS	External Master Size 00 8-bit 01 16-bit 10 32-bit 11 No external master attached	Width of the attached external master.
14	PME	Power Management Enable 0 Disabled 1 Enabled	
15:19	PMT	Power Management Timer 0000–1111	The EBC makes a sleep request to the Clock and Power Management unit when PME=1 and the EBC has been idle for 32 × PMT PerCk cycles.
20:31		Reserved	

16.6.2 Peripheral Bank Configuration Registers (EBC0_BnCR)

These registers must be configured to enable memory in each respective bank. Boot ROM, if installed, must be attached to bank 0. If a boot ROM is installed, the bank 0 starting address register is loaded with a value of 0xFFE, and the bank 0 size register is loaded with a value of 0b001 (2MB) immediately following SysReset inactive.

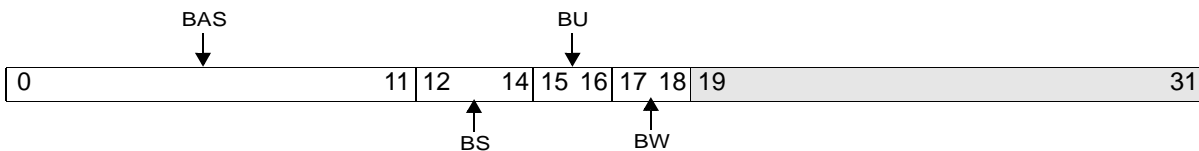

Figure 16-16. Peripheral Bank Configuration Registers (EBC0_B0CR–EBC0_B7CR)

0:11	BAS	Base Address Select	Specifies the bank starting address, which must be a multiple of the bank size.
12:14	BS	Bank Size 000 1 MB bank 001 2 MB bank 010 4 MB bank 011 8 MB bank 100 16 MB bank 101 32 MB bank 110 64 MB bank 111 128 MB bank	
15:16	BU	Bank Usage 00 Disabled 01 Read-only 10 Write-only 11 Read/Write	Specifies the type of accesses allowed for the bank. A protect error occurs if a write is attempted to a read-only bank or a read from a write-only bank.
17:18	BW	Bus Width 00 8-bit bus 01 16-bit bus 10 32-bit bus 11 Reserved	The boot ROM must be attached to bank 0. Its bus width is controlled by strapping pins.

Preliminary User’s Manual

19:31	Reserved
-------	----------

- **BAS (Base Address Select, bits 0:11)** – Sets the base address for a peripheral device. The bank starting address must be a multiple of the bank size programmed in the BS field. The BAS field is compared to bits 0:11 of the address. If the address is within the range of a BAS field, the associated bank is enabled for the transaction.

Multiple bank registers may be inadvertently programmed with the same base address or as overlapping banks. An attempt to use such overlapping banks is recorded in EBC0_BESR0 or EBC0_BESR1 as a configuration error and no external access occurs. This error may result in a machine check exception if the requesting master is the CPU. If the error occurred during a DMA access, the DMA may signal an interrupt to the PPC405GP through the UIC.

- **BS (Bank Size, bits 12:14)** – Sets the number of bytes which the bank may access, beginning with the base address set in the BAS field.
- **BU (Bank Usage, bits 15:16)** – Protects banks of physical devices from read or write accesses.

When a write access is attempted to an address within the range of the BAS field, and the bank is designated as read-only, a protection error occurs. Also, when a read access is attempted to an address within the range of the BAS field, and the bank is designated as write-only, a protection error occurs. The address of the attempted access is logged in EBC0_BEAR and type of error is logged in either EBC0_BESR0 or EBC0_BESR1.

- **BW (Bus Width, bits 17:18)** – Controls the width of region accesses. If the BW field is 0b00, the region is configured for an 8-bit data bus; 0b01 indicates a 16-bit data bus and 0b10 indicates a 32-bit data bus. If devices are attached to the data bus as shown in Figure 16-2 on page 16-354, the EBC automatically packs read data and unpacks write data when a data transfer size mismatch exists.

16.6.3 Peripheral Bank Access Parameters (EBC0_BnAP)

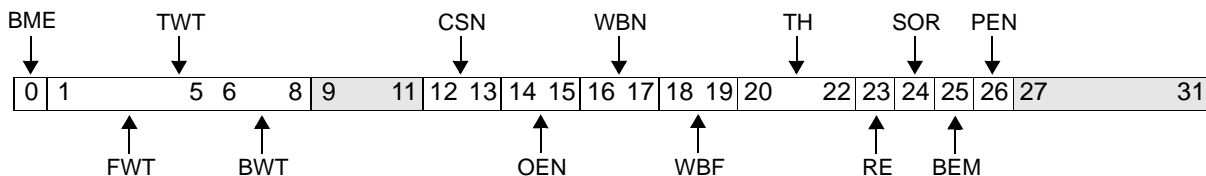

Figure 16-17. Peripheral Bank Access Parameters (EBC0_B0AP–EBC0_B7AP)

0	BME	Burst Mode Enable 0 Bursting is disabled 1 Bursting is enabled	
1:8	TWT	Transfer Wait 0–255 PerClk cycles	Wait states on all transfers when BME=0.
1:5	FWT	First Wait 0–31 PerClk cycles	If BME=1, number of wait states on the first transfer of a burst.
6:8	BWT	Burst Wait 0–7 PerClk cycles	If BME=1, number of wait states on non-first transfers of a burst.
9:11		Reserved	
12:13	CSN	Chip Select On Timing 0–3 PerClk cycles	Number of cycles from peripheral address driven to PerCSn low.

14:15	OEN	Output Enable On Timing 0–3 PerClk cycles	Number of cycles from $\overline{\text{PerCSn}}$ low to $\overline{\text{PerOE}}$ low.
16:17	WBN	Write Byte Enable On Timing 0–3 PerClk cycles	If BEM=0, number of cycles from $\overline{\text{PerCSn}}$ low to $\overline{\text{PerWBE0:3}}$ active.
18:19	WBF	Write Byte Enable Off Timing 0–3 PerClk cycles	If BEM=0 and RE=0, number of cycles $\overline{\text{PerWBEn}}$ becomes inactive prior to $\overline{\text{PerCSn}}$ inactive.
20:22	TH	Transfer Hold 0–7 PerClk cycles	Contains the number of hold cycles inserted at the end of a transfer.
23	RE	Ready Enable 0 PerReady is disabled 1 PerReady is enabled	
24	SOR	Sample on Ready 0 Data transfer occurs one PerClk cycle after PerReady is sampled active 1 Data transfer occurs in the same PerClk cycle that PerReady becomes active	
25	BEM	Byte Enable Mode 0 $\overline{\text{PerWBE0:3}}$ are only active for write cycles 1 $\overline{\text{PerWBE0:3}}$ are active for read and write cycles	If BEM=0, $\overline{\text{PerWBE0:3}}$ timing is controlled by WBN and WBF. If BEM=1, $\overline{\text{PerWBE0:3}}$ has the same timing as $\overline{\text{PerAddr0:31}}$.
26	PEN	Parity Enable 0 Disable parity checking 1 Enable parity checking	The EBC implements odd parity.
27:31		Reserved	

- **BME (Burst Mode Enable, bit 0)** – Controls bursting for cache line fills and flushes, PLB burst transfers and all packing and unpacking operations. If BME=1, bursting is enabled. When bursting is enabled the parameters Chip Select On (CSN), Output Enable On (OEN), and First Wait (FWT) apply only to the first transfer, while Burst Wait (BWT) and Write Byte Enable On (WBN) apply during all remaining transfers of the burst.
- **TWT (Transfer Wait, bits 1:8)** – Specifies the number of wait states taken by each transfer to the bank. The number of cycles from address valid to the deassertion of $\overline{\text{PerCSn}}$ is $(1 + \text{TWT})$, where $0 \leq \text{TWT} \leq 255$. This field is used for non-burst transfers (field BME = 0).
- **FWT (First Wait, bits 1:5)** – Specifies the number of wait states to be taken by the first access to the bank during a burst transfer (field BME = 1). During a burst the number of cycles from the first address valid to the second address is $(1 + \text{FWT})$, where $0 \leq \text{FWT} \leq 31$.
- **BWT (Burst Wait, bits 6:8)** – Specifies the number of wait states to be taken by accesses beyond the first during a burst transfer (field BME = 1). On burst accesses except for the last, the number of cycles from address valid to the next valid address on each burst access is $(1 + \text{BWT})$, where $0 \leq \text{BWT} \leq 7$. On the last burst access, the number of cycles from address valid to the deassertion of $\overline{\text{PerCSn}}$ is $(1 + \text{BWT})$, where $0 \leq \text{BWT} \leq 7$.
- **CSN (Chip Select On Timing, bits 12:13)** – Specifies the chip select turn on delay relative to the address. $\overline{\text{PerCSn}}$ may turn on coincident with the address or be delayed by 1, 2, or 3 PerClk cycles.

Preliminary User's Manual

- **OEN (Output Enable On Timing, bits 14:15)** – Specifies when the output enable signal, $\overline{\text{PerOE}}$, is asserted for read operations relative to the chip select signal. If 0, $\overline{\text{PerOE}}$ is asserted coincident with the chip select. If 1, 2 or 3, $\overline{\text{PerOE}}$ is delayed by 1, 2, or 3 PerClk cycles.
- **WBN (Write Byte Enable On Timing, bits 16:17)** – Specifies when the write byte enables, $\overline{\text{PerWBE0:3}}$, are asserted relative to the chip select signal. If 0, then $\overline{\text{PerWBE0:3}}$ turns on coincident with the chip select. If 1, 2, or 3, $\overline{\text{PerWBE0:3}}$ is delayed 1, 2, or 3 PerClk cycles from the chip select.
- **WBF (Write Byte Enable Off Timing, bits 18:19)** – Specifies when the write byte enables are deasserted, relative to the deassertion of the chip select signal. If $\text{WBF}=0$, $\overline{\text{PerWBE0:3}}$ goes high coincident with the chip select signal. If WBF is 1, 2, or 3, $\overline{\text{PerWBE0:3}}$ turns off 1, 2, or 3 PerClk cycles before the turn-off of the chip select signal.

Programming Note: It is an error to set $\text{WBF} > \text{BWT}$. Moreover, for device-paced transfers ($\text{EBC0_BnAP}[\text{RE}]=1$) WBF must be set to 0.

- **TH (Transfer Hold, bits 20:22)** – Specifies the number of PerClk cycles (0 through 7) that the peripheral bus is held idle after the deassertion of $\overline{\text{PerCSn}}$. During these cycles, the address bus and data bus are active and $\overline{\text{PerR/W}}$ is valid. During the hold time, chip select, output enable, and write byte enables are inactive. If Ready Mode is used ($\text{RE}=1$) along with Sample on Ready ($\text{SOR}=1$) TH must be set to at least 1.
- **RE (Ready Enable, bit 23)** – Controls the use of the PerReady input signal. If $\text{RE}=0$, the PerReady input is ignored and no additional wait states are inserted into bus transactions. If $\text{RE}=1$, the PerReady input is examined after the wait period expires; additional wait states are inserted if the PerReady input is 0. The maximum number of wait states in each transaction is determined by the settings in the Device-Paced Timeout Disable (PTD) and Ready Timeout Counter (RTC) fields in EBC0_CFG . If $\text{EBC0_CFG}[\text{PTD}] = 0$, the PPC405GP waits the number of cycles indicated by $\text{EBC0_CFG}[\text{RTC}]$ for PerReady to become active. If $\text{EBC0_CFG}[\text{PTD}] = 1$, the ready timeout function is disabled and the PPC405GP waits indefinitely until $\overline{\text{PerReady}}=1$. If PerReady does not become active in the allotted time, the address of the error is logged in EBC0_BEAR and the type of error is captured in either EBC0_BESR0 or EBC0_BESR1 .
- **SOR (Sample Ready, bit 24)** – Controls the location of the data transfer cycle with respect to the PerReady input. If $\text{SOR}=1$ the data transfer occurs on the same PerClk edge that PerReady is sampled active, whereas if $\text{SOR}=0$ the data transfer occurs one cycle later.
- **BEM (Byte Enable Mode, bit 25)** – Controls whether $\overline{\text{PerWBE0:3}}$ is active during writes or for both reads and writes.
- **PEN (Parity Enable Mode, bit 26)** – Enables parity generation and checking.

16.7 Error Reporting

The EBC monitors four kinds of the following errors when performing read and write transfers. Of these four, bank protect and external bus errors are always checked, while timeout and read parity error checking must be enabled using DCR-mapped configuration registers.

- **Protect Error** – Requested read or write operation violates the bank usage programmed in $\text{EBC0_BnCR}[\text{BU}]$. For example, write attempt to read-only bank. In all cases, no external bus activity occurs.
- **External Bus Error** – The PerErr input was sampled active during the data transfer cycle of a read or write operation. The associated data is read or written as usual.

- **Timeout Error** – This error is possible during memory operations when both PerReady sampling is enabled, EBC0_BnAP[RE]=1, and device paced timeouts are enabled, EBC0_CFG[PTD]=0. Whenever the peripheral address bus changes the EBC begins counting PerClk cycles. If the count reaches the value represented by EBC0_CFG[RTC] a timeout error occurs. Note that timeout errors are not possible during the peripheral portion of DMA transfers.
- **Parity Error** – Indicates that the parity calculated for the read data did not match the parity read. Parity generation and checking is enabled for memory operations by setting EBC0_BnAP[PEN]=1 and for DMA peripheral transfers by programming DMA0_CRn[PCE]=1.

When the EBC slave detects one of the above errors it reports the error condition to the PLB master that initiated the transfer. The EBC also logs the type of error into EBC0_BESR0 or EBC0_BESR1 and the address of the error in EBC0_BEAR.

16.7.1 Error Locking

The PCI Bridge and Memory Access Layer (MAL) controllers may qualify their PLB transactions to the EBC such that the information describing any errors that occur during these transfers becomes locked. When an error is locked, subsequent errors are not permitted to overwrite the information detailing the first error.

When a master requests error locking an error locks not only the EBC0_BESRn field for the master, but also the EBC0_BEAR. These remain locked until software clears them. For each PLB master that supports error locking the EBC has a EBC0_BESRn field containing two bits associated with error locking. One is the field lock bit and the other is the address lock bit. When an error is detected with locking enabled the field lock bit is set to a value of one. Setting the field lock bit prevents subsequent errors for this master from being logged and overwriting the contents of the field. In addition, the address lock bit is set if no other master has previously locked the EBC0_BEAR. Once the EBC0_BEAR is locked, no future errors from this or any master can update the EBC0_BEAR until software clears the lock bits. When software processes an error it should clear the error status and both lock bits at the same time.

16.7.2 Peripheral Bus Error Address Register (EBC0_BEAR)

The Peripheral Bus Error Address Register (EBC0_BEAR) is a 32-bit register containing the address of the access where a data bus error occurred. If the master that initiated the transfer requested error locking, and the EBC0_BEAR is not already locked, the contents of EBC0_BEAR are locked until the lock bit in one of the Peripheral Bus Error Status Registers (EBC0_BESR0 or EBC0_BESR1) is cleared. The contents of the EBC0_BEAR are accessed indirectly through the EBC0_CFGADDR and EBC0_CFGDATA registers using the **mfdcr** and **mtdcr** instructions.

Precise address capture in the EBC0_BEAR when a parity error occurs only applies to devices with at least one cycle of hold time: EBC0_BnAP[TH] > 0. This is because parity errors are not calculated until the cycle after the data was valid on the external bus, and the EBC0_BEAR is loaded with the address on the bus during that cycle. If the device timings do not include at least one hold cycle, the address may transition to the next address in a burst or the address of a new transaction before the EBC0_BEAR latches the value.

0

31

Preliminary User’s Manual

Figure 16-18. Peripheral Bus Error Address Register (EBC0_BEAR)

0:31		Address of Bus Error (asynchronous)
------	--	-------------------------------------

16.7.3 Peripheral Bus Error Status Register 0 (EBC0_BESR0)

The Peripheral Bus Error Status Register 0 (EBC0_BESR0) records the occurrence and type of errors for transactions attempted on behalf of the processor core, EBM and PCI bridge. The contents of EBC0_BESR0 are accessed indirectly through the EBC0_CFGADDR and EBC0_CFGDATA registers using the **mfocr** and **mtocr** instructions.

It is possible to have both a parity error and a bus error during the same data transfer. If this occurs, the bus error is detected first and EBC0_BESR0 and EBC0_BEAR are updated. In the next cycle the parity error is detected and, if error locking is not enabled, logged in EBC0_BESR0.

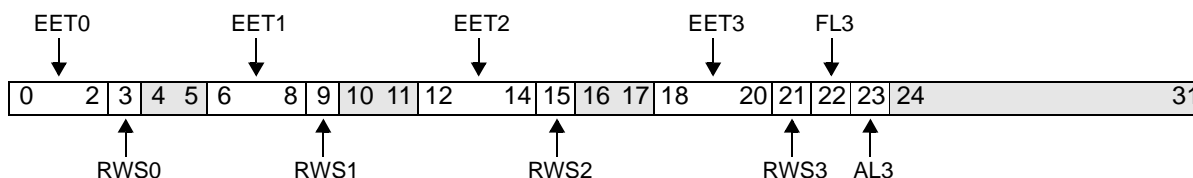

Figure 16-19. Peripheral Bus Error Status Register 0 (EBC0_BESR0)

0:2	EET0	Error type for master 0 000 No error 001 Parity error 010 Reserved 011 Reserved 100 Protection error 101 Reserved 110 External bus input error 111 External bus timeout error	Master 0 is the instruction cache unit.
3	RWS0	Read/write status for master 0 0 Error operation was a write operation 1 Error operation was a read operation	
4:5		Reserved	
6:8	EET1	Error type for master 1 000 No error 001 Parity error 010 Reserved 011 Reserved 100 Protection error 101 Reserved 110 External bus input error 111 External bus timeout error	Master 1 is the data cache unit.
9	RWS1	Read/write status for master 1 0 Error operation was a write operation 1 Error operation was a read operation	
10:11		Reserved	

12:14	EET2	Error type for master 2 000 No error 001 Parity error 010 Reserved 011 Reserved 100 Protection error 101 Reserved 110 External bus input error 111 External bus timeout error	Master 2 is the external bus master.
15	RWS2	Read/write status for master 2 0 Error operation was a write operation 1 Error operation was a read operation	
16:17		Reserved	
18:20	EET3	Error type for master 3 000 No error 001 Parity error 010 Reserved 011 Reserved 100 Protection error 101 Reserved 110 External bus input error 111 External bus timeout error	Master 3 is the PCI bridge.
21	RWS3	Read/write status for master 3 0 Error operation was a write operation 1 Error operation was a read operation	
22	FL3	Field lock for master 3 0 EET3 and RWS3 fields are unlocked 1 EET3 and RWS3 fields are locked	
23	AL3	EBC0_BEAR address lock for master 3 0 EBC0_BEAR address unlocked 1 EBC0_BEAR address locked	
24:31		Reserved	

Preliminary User's Manual**16.7.4 Peripheral Bus Error Status Register 1 (EBC0_BESR1)**

EBC0_BESR1 records the occurrence and type of errors for transactions attempted on behalf of the MAL and DMA controllers. The contents of EBC0_BESR1 are accessed indirectly through the EBC0_CFGADDR and EBC0_CFGDATA registers using the **mfocr** and **mtocr** instructions.

It is possible to have both a parity error and a bus error during the same data transfer. If this occurs the bus error is detected first and EBC0_BESR1 and EBC0_BEAR are updated. In the next cycle the parity error is detected and, if error locking is not enabled, logged in EBC0_BESR1.

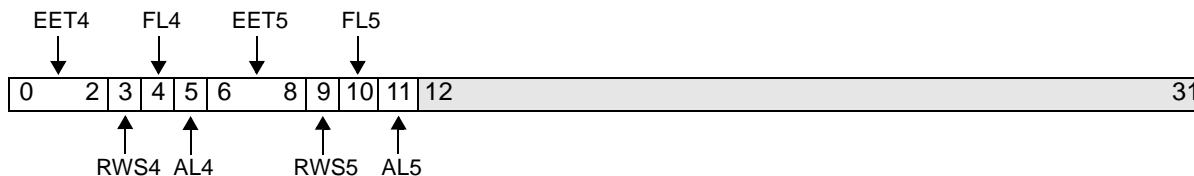

Figure 16-20. Peripheral Bus Error Status Register 1 (EBC0_BESR1)

0:2	EET4	Error type for master 4 000 No error 001 Parity error 010 Reserved 011 Reserved 100 Protection error 101 Reserved 110 External bus input error 111 External bus timeout error	Master 4 is the MAL.
3	RWS4	Read/write status for master 4 0 Error operation was a write operation 1 Error operation was a read operation	
4	FL4	Field lock for master 4 0 EET4 and RWS4 fields are unlocked 1 EET4 and RWS4 fields are locked	
5	AL4	EBC0_BEAR address lock for master 4 0 EBC0_BEAR address unlocked 1 EBC0_BEAR address locked	
6:8	EET5	Error type for master 5 000 No error 001 Parity error 010 Reserved 011 Reserved 100 Protection error 101 Reserved 110 External bus input error 111 External bus timeout error	Master 5 is the DMA controller.
9	RWS5	Read/write status for master 5 0 Error operation was a write operation 1 Error operation was a read operation	
10	FL5	Field lock for master 5 0 EET5 and RWS5 fields are unlocked 1 EET5 and RWS5 fields are locked	

11	AL5	EBC0_BEAR address lock for master 5 0 EBC0_BEAR address unlocked 1 EBC0_BEAR address locked
12:31		Reserved

Chapter 17. PCI Interface

17.1 PCI Overview

The peripheral component interconnect (PCI) interface and bridge (referred to as PCI bridge in this chapter) provides a means for connecting PCI-compatible devices to the on-chip bus architecture of the PPC405GP chip. The PCI bridge is designed to the *PCI Specification, Version 2.2*. The PCI bridge is bidirectional in that it allows PPC405GP PLB masters to access PCI targets off-chip. It also allows PCI masters to access PLB slave devices such as the SDRAM controller. The PCI bridge contains an arbiter which can optionally be used for host applications.

The PCI bridge can be used as the host bridge. The PCI bridge is also configurable by an external PCI agent, allowing it to be used in target adapter applications. The PCI bridge contains address mapping register sets to provide address mapping for both transaction directions. See Figure 17-3 on page 17-389 for a graphic overview of the PCI bridge.

Agents on the PLB are referred to as masters or slaves. Agents on the PCI are referred to as targets or masters.

17.1.1 PCI Bridge Features

- PCI bus frequency up to 66 MHz (asynchronous) or 33 MHz (synchronous)
- Asynchronous clocking between PLB and PCI buses (optional)
- Supports 1:1, 2:1, 3:1, and 4:1 clock ratios from PLB to PCI
- 32-bit PCI Address/Data Bus
- Power Management
- Buffering:
 - PCI target 64-byte write post buffer
 - PCI target 96-byte read prefetch buffer
 - PLB slave 32-byte write post buffer
 - PLB slave 64-byte read prefetch buffer
- Error tracking/status
- PCI arbitration function (optional)
- Supports PCI target-side configuration
- Supports processor access to all PCI address spaces:
 - Single-beat PCI I/O reads and writes
 - PCI memory single-beat and prefetch-burst reads and single-beat writes
 - Single-beat PCI configuration reads and writes (type 0 and type 1)
 - PCI interrupt acknowledge

17.1.2 PCI Bridge Block Diagram

Figure 17-1 shows the PCI bridge block diagram.

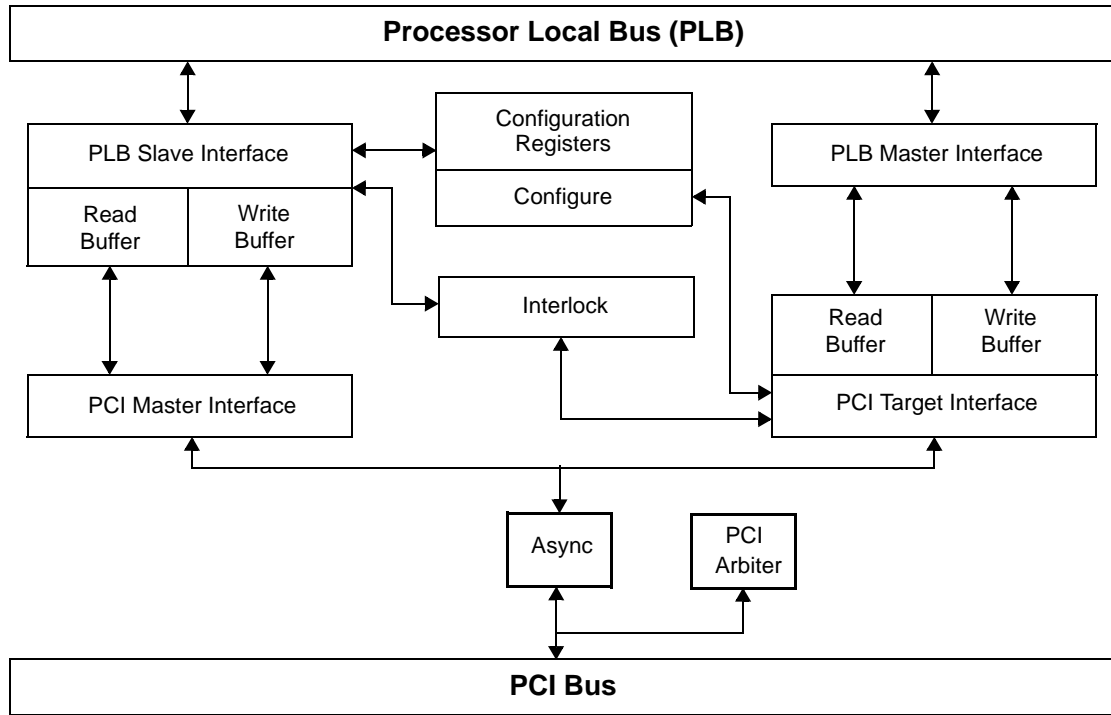

Figure 17-1. PCI Bridge Block Diagram

17.1.3 Byte Ordering

The PCI bridge configuration register address space must be treated as little endian, as required by *PCI Specification, Version 2.2*. In most cases data memory areas in PCI address space will be configured and used in little endian format. To provide for this, PCI configuration space and memory map regions should be defined as little endian memory space by means of the corresponding entry in the PPC405GP CPU's MMU or by means of the appropriate memory region bit in the Storage Little-Endian Register (SLER) if the MMU is not being used. Because the endianness attribute in the SLER can only be applied to 128MB memory regions, this method of defining little endian memory space for PCI must be carefully considered in defining a system memory map.

Byte ordering and management of little endian memory space from a PowerPC CPU point of view is described in detail in "Byte Ordering" on page 3-108. PowerPC architecture and CoreConnect bus architecture both use a bit naming convention in which the most significant bit (msb) name incorporates the numeral 0 and the least significant bit (lsb) name for a 32-bit vector incorporates the numeral 31. Table 17-1 shows the correspondence of address bit-naming conventions for PowerPC, CoreConnect PLB, and PCI interface.

Preliminary User's Manual**Table 17-1. PowerPC, CoreConnect PLB, and PCI Address Bit-Naming Conventions**

Functional Unit/Interface	Word Address	Byte Address
PPC405GP Processor Core Address	A0:29	A30:31
CoreConnect — PLB Address Bus	PLB_ABus0:29	PLB_ABus30:31
PCI Address Bus	AD31:2	AD1:0

Table 17-2 shows the correspondence of data bus bit naming conventions and data lane connections for PowerPC, CoreConnect PLB, and PCI interface. Note that within a data lane (column), the data signal naming indicates that, for example, AD31 is connected to PLB Write Data24.

Table 17-2. PowerPC, CoreConnect PLB, and PCI Data Bus Bit-Naming Conventions

Functional Unit/ Interface	Most Significant Byte (MSB)	↔	↔	Least Significant Byte (LSB)
Data Byte Value (0xnn)	11	22	33	44
Little Endian Byte Address (0bnn)	11	10	01	00
PPC405GP Processor Core (Write) Data Bus	Data24:31	Data16:23	Data8:15	Data0:7
CoreConnect — PLB Write Data Bus — Byte Group	PLB Write Data24:31	PLB Write Data16:23	PLB Write Data8:15	PLB Write Data0:7
PLB Byte Enable	PLB_BE3	PLB_BE2	PLB_BE1	PLB_BE0
PCI Byte Enable	C/BE3	C/BE2	C/BE1	C/BE0
PCI Data Bus — Byte Group	AD31:24	AD23:16	AD15:8	AD7:0
Note 1: Logical data work (32-bit word) == 0x11223344				
Note 2: 405 CPU performing either:				
<ul style="list-style-type: none"> • Store word to little endian memory space • Store word—byte reversed—to big endian address space 				

17.1.4 Reference Information

Subject	Pointer
PLB Overview	Chapter 2, "On-Chip Bus"
Register Summary	Chapter 25, "Register Summary"
Clocking	Chapter 7, "Clocking"
PCI	<i>PCI Specification, Version 2.2</i>

17.2 PCI Bridge Functional Blocks

The following sections describe the PCI bridges and the associated arbiter.

17.2.1 PLB-to-PCI Half-Bridge

As shown in Figure 17-2, the 64-bit PLB slave interface and PCI master interface function together as a PLB-to-PCI half-bridge to enable PLB master devices to access PCI target devices. The half-bridge configuration contains a 32-byte write post buffer and a 64-byte read prefetch buffer.

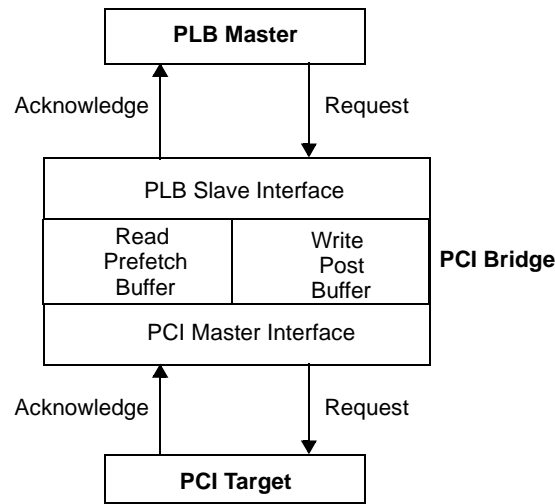

Figure 17-2. PLB-to-PCI Half-Bridge Block Diagram

Preliminary User's Manual**17.2.2 PCI-to-PLB Half-Bridge**

As shown in Figure 17-3, the PCI target interface and 64-bit PLB master interface function together as a PCI-to-PLB half-bridge to enable PCI master devices to access PLB slave devices. The half-bridge configuration contains a 64-byte write post buffer and a 96-byte read prefetch buffer.

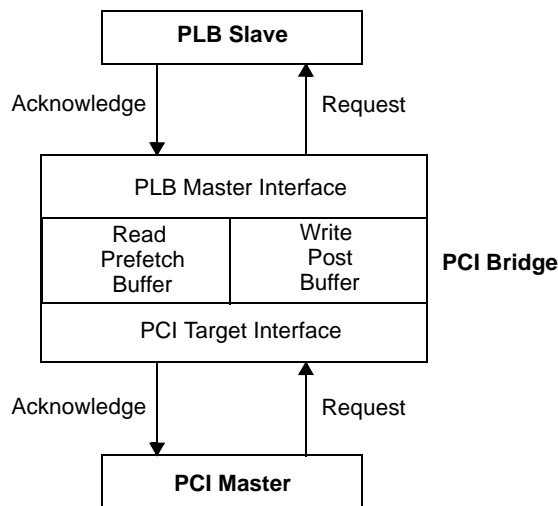

Figure 17-3. PCI-to-PLB Half-Bridge Block Diagram

17.2.3 PCI Arbiter

The internal arbiter can be used with up to six external PCI masters (six $\overline{\text{Req}}/\overline{\text{Gnt}}$ pairs) or can be disabled. When the internal arbiter is disabled, there is one $\overline{\text{Req}}/\overline{\text{Gnt}}$ pair that must be attached to an external arbiter. A strapping pin determines whether the internal arbiter is enabled or not. Priority is round-robin (rotating). Priority switches when a master begins a transfer by asserting $\overline{\text{Frame}}$. Each block keeps a priority bit that only switches if its highest priority requestor receives a grant. Assuming that all priority bits are initially cleared and all requests are active, an example rotation would be PPC405GP 3, 1, 5, 0, 4, 2. *PCI Specification*, Version 2.2 requires that all PCI devices three-state their pins during reset. The PPC405GP PCI arbiter supports bus parking during normal operation.

Figure 17-4 shows the logical arbitration structure.

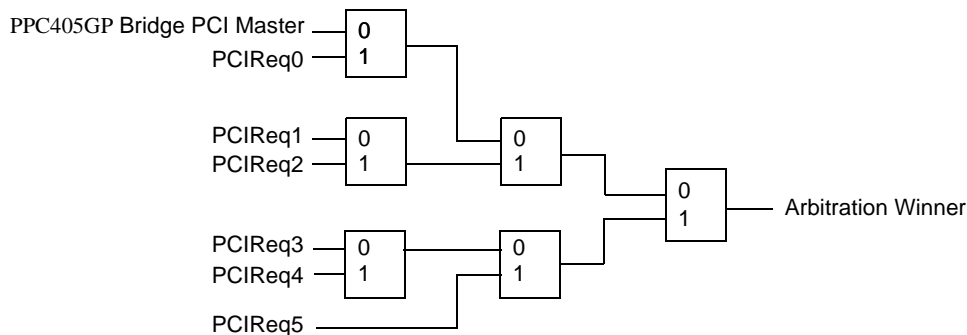

Figure 17-4. Arbitration Structure

17.3 PCI Bridge Address Mapping

The following sections describe the address maps supported by the PCI bridge.

17.3.1 PLB-to-PCI Address Mapping

The PCI bridge responds as a slave on the PLB bus in several address ranges. These ranges enable a PLB master to configure the PCI bridge, and to cause the PCI bridge to generate memory, I/O, configuration, interrupt acknowledge, and special cycles to the PCI bus. Table 17-3 shows the address map from the view of the PLB, that is, as decoded by the PCI bridge as a PLB slave.

Table 17-3. PLB Address Map

PLB Address Range	Description	PCI Address Range
0xE8000000–0xE800FFFF	PCI I/O Accesses to this range are translated to an I/O access on PCI in the range 0 to 64KB – 1.	0x00000000–0x0000FFFF
0xE8010000–0xE87FFFFF	Reserved PCI bridge does not respond. (Other bridges use this space for non-contiguous I/O.)	
0xE8800000–0xEBFFFFFF	PCI I/O Accesses to this range are translated to an I/O access on PCI in the range 8MB to 64MB – 1.	0x00800000–0x03FFFFFF
0xEC000000–0xEEBFFFFFFF	Reserved PCI bridge does not respond	
0xEEC00000–0xEECFFFFFFF	PCIC0_CFGADDR and PCIC0_CFGDATA 0xEEC00000: PCIC0_CFGADDR 0xEEC00004: PCIC0_CFGDATA 0xEEC00008–0xEECFFFFFFF: Reserved (can mirror PCIC0_CFGADDR and PCIC0_CFGDATA).	
0xEED00000–0xEEDFFFFFFF	PCI Interrupt Acknowledge and Special Cycle 0xEED00000 read: Interrupt Acknowledge 0xEED00000 write: Special Cycle 0xEED00004–0xEEDFFFFFFF: Reserved (can mirror Interrupt Acknowledge and Special Cycle).	
0xEEEE0000–0xEF3FFFFFFF	Reserved PCI bridge does not respond.	

Preliminary User's Manual**Table 17-3. PLB Address Map (continued)**

PLB Address Range	Description	PCI Address Range
0xEF400000–0xEF4FFFFFF	PCI Bridge Local Configuration Registers 0xEF400000: PCIL0_PMM0LA 0xEF400004: PCIL0_PMM0MA 0xEF400008: PCIL0_PMM0PCILA 0xEF40000C: PCIL0_PMM0PCIHA 0xEF400010: PCIL0_PMM1LA 0xEF400014: PCIL0_PMM1MA 0xEF400018: PCIL0_PMM1PCILA 0xEF40001C: PCIL0_PMM1PCIHA 0xEF400020: PCIL0_PMM2LA 0xEF400024: PCIL0_PMM2MA 0xEF400028: PCIL0_PMM2PCILA 0xEF40002C: PCIL0_PMM2PCIHA 0xEF400030: PCIL0_PTM1MS 0xEF400034: PCIL0_PTM1LA 0xEF400038: PCIL0_PTM2MS 0xEF40003C: PCIL0_PTM2LA 0xF400040–0xEF4FFFFFF: Reserved (can mirror PCI local registers)	
0x00000000–0xFFFFFFFF ^{/h*}	PCI Memory—Range 0 PMM 0 registers map a region in PLB space to a region in PCI memory space. The address ranges are fully programmable. The PCI address is 64 bits.	0x0000000000000000–0xFFFFFFFFFFFFFFFF
0x00000000–0xFFFFFFFF*	PCI Memory—Range 1 PMM 1 registers map a region in PLB space to a region in PCI memory space. The address ranges are fully programmable. The PCI address is 64 bits.	0x0000000000000000–0xFFFFFFFFFFFFFFFF
0x00000000–0xFFFFFFFF*	PCI Memory—Range 2 PMM 2 registers map a region in PLB space to a region in PCI memory space. The address ranges are fully programmable. The PCI address is 64 bits.	0x0000000000000000–0xFFFFFFFFFFFFFFFF

* Memory map ranges are fully programmable. The ranges must not overlap with each other or conflict with any other memory mappings.

Three PCI bridge address ranges, associated with PLB masters in PLB space, are mapped to PCI memory space: PCI master map (PMM) 0, PMM1, and PMM2.

Each PMM is configured using the following registers (n is 0, 1, or 2, corresponding with PMM0, PMM1, and PMM2, respectively):

- PMMnLocal Address (PCIL0_PMMnLA)
- PMMnMask/Attribute (PCIL0_PMMnMA)
- PMMnPCI Low Address (PCIL0_PMMnPCILA)
- PMMnPCI High Address (PCIL0_PMMnPCIHA)

The location of each PMM in PLB space is programmable, using the PCIL0_PMMnLA registers. The PLB address range assigned to each PMM should not overlap any other PLB address space range that is used or reserved. Overlapping results in undefined behavior.

The range of PCI memory address space associated with each PMM is also programmable, and is a 64-bit address space to enable address translation between the PCI bus and the PLB. The PCIL0_PMMnPCILA registers contain the low-order word of a PCI address; the PCIL0_PMMnPCIHA registers contain the high-order word of a PCI address. If the high-order word of a PCI address is greater than 0, the PCI bridge generates dual address cycles to the PCI.

The size of each PMM is programmable, using the mask portion of the PCIL0_PMMnMA registers. The size is a power of 2, ranging from 4KB–4GB. The PLB and PCI address spaces for each PMM are aligned to the size contained in the associated PCIL0_PMMnMA registers.

The attribute portion of the PCIL0_PMMnMA registers specify whether the associated PMM is enabled or disabled, and marked as prefetchable or not prefetchable.

Address ranges and attributes should be initialized before a PMM is enabled.

Figure 17-5 shows the detail of the PMM register sets used to map PLB memory regions to PCI address space.

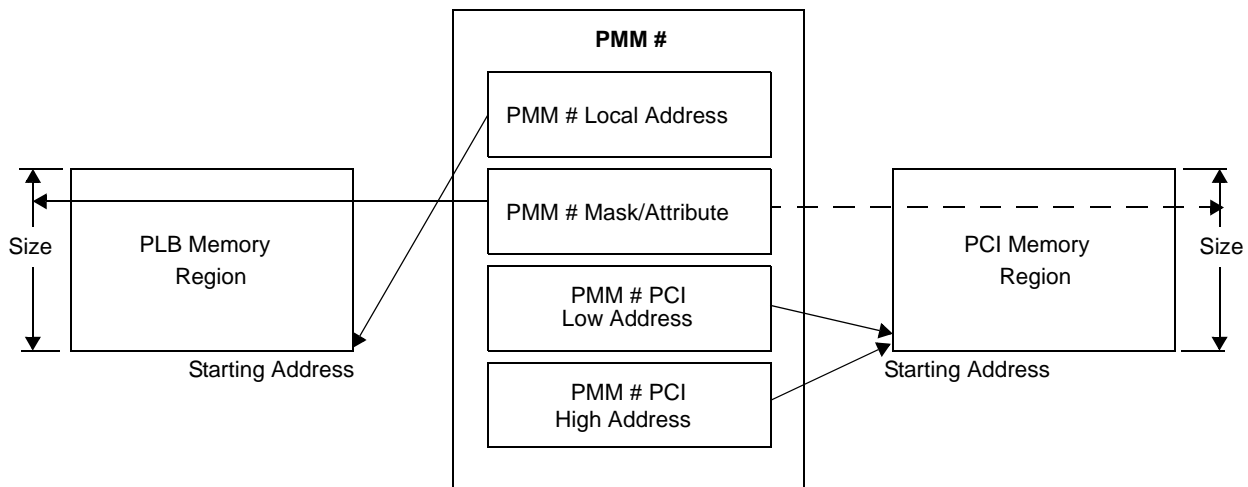

Figure 17-5. PMM Register Sets Map PLB Address Space to PCI Address Space

17.3.2 PCI-to-PLB Address Mapping

The PCI bridge responds as a PCI target for memory accesses and configuration Type 0 accesses. Table 17-4 shows the PCI memory address map from the view of PCI, that is, as decoded by the PCI bridge as a PCI target.

Table 17-4. PCI Memory Address Map

PCI Memory Address	Description	PLB Address
0x00000000–0xFFFFFFFF	System Memory or ROM—Range 0 PTM 1 maps a region of PCI memory space to PLB space, which can map to system memory or ROM. Size and location is programmable. The space supports address translation between the PCI and the PLB.	0x00000000–0xFFFFFFFF
0x00000000–0xFFFFFFFF	System Memory or ROM—Range 1 PTM 2 maps a region of PCI memory space to PLB space, which can map to system memory or ROM. Size and location is programmable. The space supports address translation between the PCI and the PLB.	0x00000000–0xFFFFFFFF

Preliminary User's Manual**17.3.3 PCI Target Map Configuration**

Two PCI bridge address ranges in PCI memory space are mapped to PLB space: PCI target map (PTM1) and PTM2 (PTM0 is reserved).

Each PTM is configured using the following registers (n is 1 or 2, corresponding with PTM1 and PTM2, respectively).

- PTMnMemory Size (PCIL0_PTMnMS)
- PTMnLocal Address (PCIL0_PTMnLA)
- PTMnBAR (PCIL0_PTMnBAR)

The size of each PTM is programmable, using the PCIL0_PTMnMS registers. The size is a power of 2, and ranges from 4KB–4GB. The PLB and PCI address spaces for each PTM are aligned to this size.

The address range of PLB space accessed through each PTM is also programmable, enabling address translation between the PCI bus and the PLB. The PLB address range is defined in the PCIL0_PTMnLA registers.

The location of each PTM in PCI memory space is programmable, using the PCIPCI0_PTMnBAR registers.

The PTMs are enabled and disabled using PCIC0_CMD[MA]. PTM address ranges and sizes should be initialized before being enabled. If the PCI bridge is not the host bridge, the local processor must initialize the PTM size before enabling host configuration setting the Host Configuration Enable (HCE) field of the Bridge Options 2 register (PCIC0_BRDGOPT2). This ensures that the host experiences proper behavior from the PCIL0_PTMnBAR registers. Note that PTM1 is always enabled. The PTM1 registers must always be initialized.

Figure 17-6 shows the detail of the PMM/BAR register sets used to map PCI memory regions to PLB address space.

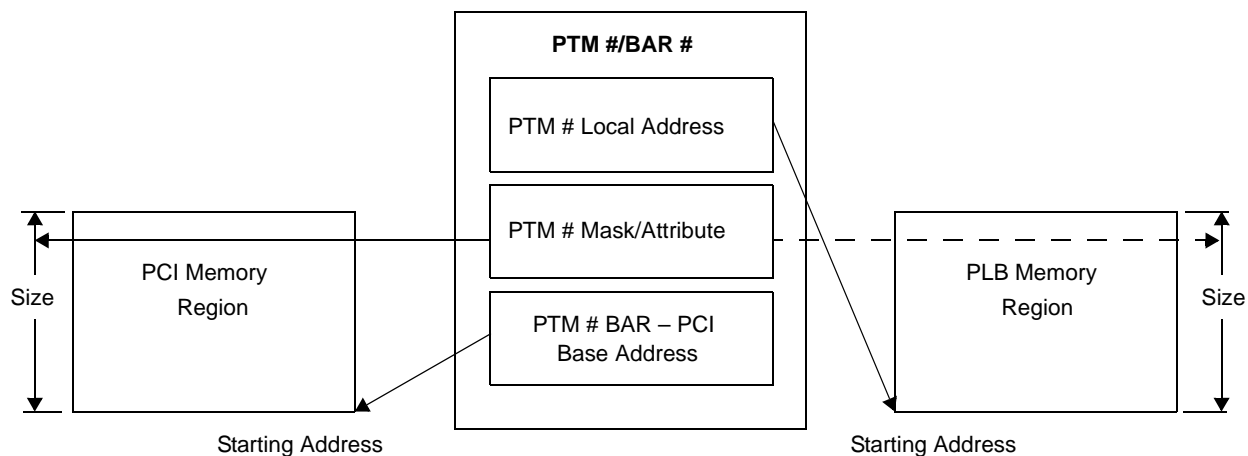

Figure 17-6. PTM Register Sets Map PCI Address Space to PLB Address Space

17.4 PCI Bridge Transaction Handling

The following sections discuss PCI bridge transactions and completion ordering.

17.4.1 PLB-to-PCI Transaction Handling

This section describes how the PCI bridge responds to read and write requests from a PLB master. The PCI bridge decodes and accepts PLB transactions to different address ranges resulting in the generation of memory, I/O, configuration, interrupt acknowledge and special cycles on the PCI bus.

Table 17-5. Transaction Mapping: PLB → PCI

PLB Transaction PLB Master → Bridge (PLB Slave Interface)	Bridge Mapping and Qualifications	PCI Transaction Bridge (PCI Master Interface) → PCI Target
Single-beat 1 → 8-byte Read	64KB or 56MB PCI I/O address range	I/O Read
Single-beat 1 → 8-byte Write	64KB or 56MB PCI I/O address range	I/O Write
Single-Beat 1 → 8-byte Read	Access to PCIC0_CFGDATA register	Configuration Read (Type 0, 1)
Single-Beat 1 → 8-byte Write	Access to PCIC0_CFGDATA register	Configuration Write (Type 0, 1)
Single-Beat 1 → 8-byte Read	PLB address decodes to PMM0, PMM1, or PMM2, nonprefetchable	Memory Read
Burst Read	PLB address decodes to PMM0, PMM1, or PMM2, nonprefetchable	Memory Read
PLB 4-word and 8-word Line Reads	PLB address decodes to PMM0, PMM1, or PMM2	Memory Read Line
Single-Beat 1 → 4-byte Read	PLB address decodes to PMM0, PMM1, or PMM2, prefetchable	Memory Read Multiple
Burst Read	PLB address decodes to PMM0, PMM1, or PMM2, prefetchable	Memory Read Multiple
Single-Beat 1 → 4-byte Write	PLB address decodes to PMM0, PMM1, or PMM2	Memory Write
Burst Write	PLB address decodes to PMM0, PMM1, or PMM2	Memory Write
Single-Beat 1 → 4-byte Read	Address 0xEED00000	Interrupt Acknowledge
Single-Beat 1 → 4-byte Write	Address 0xEED00000	Special Cycle
—	Not supported	Memory Write and Invalidate
—	Not supported	Memory Write Line

Preliminary User's Manual

17.4.1.1 PCI Master Commands

The type of cycle generated to the PCI bus depends on the PLB address, the type of PLB transfer, and the data size. The following sections describe the transaction types supported and outlines the translation of commands from one bus to the other.

The terms “single beat” or “1–8-byte,” in reference to PLB transfers, refer to the M_size=0000 transaction type.

PCI bridge initiates the following commands as a PCI master:

- I/O Read and I/O Write

This command is generated in response to PLB 1–8-byte read or write requests that decode to one of the two PCI I/O spaces.

- Configuration Read and Configuration Write (type 0 and type 1)

This command is generated in response to PLB 1–8-byte read or write requests that decode to the PCIC0_CFGDATA register.

- Memory Read

This command is generated in response to PLB 1–8-byte reads or byte and halfword burst reads that decode to one of the three PMMs when the PMM is marked as nonprefetchable.

- Memory Read Line

This command is generated in response to PLB 4- and 8-word line reads or word and doubleword reads of 32 bytes or less that decode to one of the three PMMs.

- Memory Read Multiple

This command is generated in response to PLB 1–8-byte reads or byte and halfword burst reads that decode to one of the three PMMs when the PMM is marked as prefetchable. This command is also generated in response to word and doubleword burst reads of greater than 32 bytes that decode to one of the three PMMs. For prefetches, the PCI bridge bursts up to a 64 bytes from the PCI.

- Memory Write

This command is generated in response to PLB 1–8-byte writes or burst writes to one of the three PMMs.

- Interrupt Acknowledge

This command is generated in response to a PLB 1–8-byte read from address 0xEED00000.

- Special Cycle

This command is generated in response to a PLB 1–8-byte write to address 0xEED00000.

The Memory Write and Invalidate command is not generated. All PCI memory writes are performed with Memory Write.

The PLB slave responds as a 64-bit device to word and doubleword bursts. All other commands receive a 32-bit response.

The PCI bridge supports PLB size 1–8-byte encodings. Burst reads of all sizes are also supported. Read line sizes greater than eight words are not supported, and no line writes are supported. The PCI bridge posts all writes which are decoded to PCI memory and PCI I/O space. Posted data is kept in internal write buffers until it can be transferred to the PCI bus. All other writes and all reads are connected, that is, they complete on the PCI bus before completing on the PLB.

17.4.1.2 PLB Slave Read Handling

PLB master read requests are decoded into four types: PCI Memory, I/O, Configuration, and Interrupt Acknowledge. If the request falls within any of these ranges, and is a supported command type, the bridge claims the cycle initially by asserting a PLB wait signal (as opposed to a PLB address acknowledge signal). The bridge must first gain access to the PCI bus before acknowledging a PLB read request. The specific timing of the address acknowledge is dependent upon the type of transfer. All posted writes must be flushed before a read is allowed to complete.

For PLB line reads, the PCI bridge must wait for all read data to be received before acknowledging the PLB request. This is because PCI targets are allowed to disconnect in the middle of a transfer, and the PLB requires line transfers to be atomic. If the system can guarantee that PCI targets do not disconnect these reads, PCIC0_BRDGOPT1[APLRM] can be set to 1. In this mode, line read performance is improved by having the bridge PLB slave assert an address acknowledge signal and begin its data tenure as soon as the first word is received on the PCI bus. If the above guarantee cannot be made, the setting of this bit could hang the bridge.

If the PCI cycle Master Aborts, all beats of read data are returned as 0xFFFFFFFF.

PLB master reads to the PCI bridge configuration registers are allowed to execute regardless of whether any write data is posted in the bridge. The configuration registers are described in “PCI Bridge Configuration Registers” on page 17-403.

17.4.1.3 Prefetching

When the PCI bridge receives a PLB 1–8-byte or word or doubleword burst read request that decodes to a PMM marked as nonprefetchable. The PCI bridge runs a single beat read to the PCI. If the PCI cycle is retried, the PLB cycle is re arbitrated.

When the PCI bridge receives a PLB 1–8-byte read request that decodes to a PMM marked as prefetchable, the PCI bridge burst reads up to a 64 bytes from the PCI and saves the data in the PLB slave read prefetch buffer. Less than 64 bytes can be read if the PCI target disconnects, or if the PCI bridge PCI master disconnects due to a master latency time out. Note that PCI bridge prefetching is not affected by memory management page boundaries (PLB_Guarded is ignored). If a subsequent PLB 1–8-byte or byte or halfword burst read is contained in the prefetch buffer, the data is returned to the PLB directly from the prefetch buffer, and no cycle is generated on the PCI.

If a PLB read to the PCI bridge occurs while the PCI bridge is prefetching and does not hit in the prefetch buffer, then the PLB read is re arbitrated. After prefetching completes, any PLB read (of any type or address range) to the PCI bridge that does not hit in the prefetch buffer causes the prefetch buffer to be emptied, and a new PCI read to begin. PLB writes, including configuration writes, will invalidate the prefetch buffer.

17.4.1.4 PLB Slave Write Handling

PLB master write requests are decoded into four types: PCI Memory (one of three PMM ranges), PCI I/O, PCI Configuration, or Special Cycles. If the request falls within any of these ranges, and is a supported command type, the bridge claims the cycle by asserting a PLB wait signal. If the write is connected, or translates to a PCI Configuration or Special Cycle, the bridge must gain access to the PCI bus and successfully transfer the data before it may assert a PLB address acknowledge signal. If the address is to PCI I/O or memory, the bridge immediately asserts a PLB address acknowledge signal and posts the write if there is sufficient buffer space.

Preliminary User's Manual

Internal configuration writes are not allowed to execute if posted write data exists in either the PCI slave write buffer or the PLB slave write buffer. The internal configuration mechanism is described in “PCI Bridge Configuration Registers” on page 17-403.

PLB Slave Write Post Buffer

The PCI bridge has a 32-byte write post buffer that may contain four separate single-beat PLB write transactions or one burst. New PLB write requests are re-arbitrated if there is not enough room in the write post buffer.

The buffers are not snooped, and are always completed on the PCI bus in the same order as they are received on the PLB bus.

Each write buffer entry preserves the master ID and drives the appropriate PLB bus busy signal until the write is deallocated (it completes on the PCI bus). It is recommended that PLB masters do not use PLB bus busy signal. Instead, PLB masters generating cycles to the PCI should use the standard PCI mechanisms for data coherency.

17.4.1.5 Aborted PLB Requests

The PCI bridge aborts PLB reads only.

A PLB master accessing the PCI bridge can abort PLB write cycles only under the following conditions:

- The PCI bridge re-arbitrates the cycle.
- The PCI bridge does not see the cycle because the PLB bus is granted to some other master. A CPU/System Memory interface is expected to do this when a CPU cycle is pending to PCI bridge, but a PLB Master requests system memory access requiring snooping.

Note: If a PLB master aborts the write cycle at any other time, the results are undefined and the bus may hang.

17.4.1.6 Retried PCI Reads

The PCI specification requires that a PCI master must repeat any read that is retried. The PCI bridge adheres to this requirement. It is only mentioned here because, under certain conditions with respect to aborted PLB reads, the PCI bridge must execute a PCI read and discard the data.

17.4.2 PCI-to-PLB Transaction Handling

This section describes how PCI bridge handles read and write requests from a PCI master device. PCI bridge responds as a PCI target to PCI memory transactions when the PCI address is in one of the two PTM ranges and PCIC0_CMD[MA] = 1. PCI bridge responds by claiming the PCI cycle and mastering a cycle on the PLB.

PCI bridge is also a PCI target for configuration cycles when its PCIIDSel pin is active. PCI bridge will master abort if a configuration cycle is run to itself.

Table 17-6. Transaction Mapping: PCI → PLB

PCI Transaction PCI Master → Bridge (PCI Target Interface)	Bridge Mapping and Qualifications	PLB Transaction Bridge (PLB Master Interface) → PLB Slave
Single-Beat Memory Read	PCI address decodes to PTM1/BAR1 or PTM2/BAR2, memory access flag	8-byte or doubleword burst read
Burst Memory Read	PCI address decodes to PTM1/BAR1 or PTM2/BAR2, memory access flag	8-byte or doubleword burst read
Memory Read Line	PCI address decodes to PTM1/BAR1 or PTM2/BAR2, memory access flag	Doubleword burst read
Memory Read Multiple	PCI address decodes to PTM1/BAR1 or PTM2/BAR2, memory access flag	Doubleword burst read
Memory Read	PCI address decodes to PTM1/BAR1 or PTM2/BAR2, memory access flag	Doubleword burst read
Single-Beat Memory Write	PCI address decodes to PTM1/BAR1 or PTM2/BAR2, memory access flag	1 → 8-byte write
Single-Beat Memory Write and Invalidate	PCI address decodes to PTM1/BAR1 or PTM2/BAR2, memory access flag	1 → 8-byte write
Burst Memory Write	PCI address decodes to PTM1/BAR1 or PTM2/BAR2, memory access flag	Doubleword burst write
Burst Memory Write and Invalidate	PCI address decodes to PTM1/BAR1 or PTM2/BAR2, memory access flag	Doubleword burst write
—	Not supported	Memory line reads
—	Not supported	Memory line writes

Preliminary User's Manual

17.4.2.1 PLB Master Commands

PCI bridge generates PLB transactions based on the type and length of received PCI transactions. The following sections describe the transaction types supported and outline the translation of commands from one bus to the other.

The term “single-beat” refers to the M_size = 0000 transaction type. PCI slave devices are referred to as “targets.”

PCI bridge initiates the following PLB master commands:

- **8-Byte Read:**
Generated in response to single beat or burst Memory Read commands from the PCI bus.
- **Doubleword Burst Read:**
Generated in response to Memory Read Line and Memory Read Multiple commands on the PCI bus. PCI bridge can also be programmed to perform doubleword bursts on behalf of Memory Read.
- **1–8-Byte Write:**
Generated in response to single-beat (1–4 byte) Memory Write commands on the PCI bus; also generated when the PCI master uses non-contiguous byte enables (see “Byte Enable Handling” on page 17-401).
- **Doubleword Burst Write:**
Generated in response to burst Memory Write and Memory Write and Invalidate commands on the PCI bus.

The PLB treats Memory Write and Memory Write and Invalidate identically (nothing on the PLB distinguishes a Memory Write from a Memory Write and Invalidate.)

PCI bridge does not generate line reads or line writes on the PLB.

17.4.2.2 Handling of Reads from PCI Masters

PCI bridge responds to PCI Memory Read, Memory Read Line, and Memory Read Multiple commands. The PCI bridge initiates all PLB reads as single-beat or doubleword burst transfers.

Memory Read generates a PLB single-beat doubleword read. Memory Read Line and Memory Read Multiple commands generate PLB doubleword bursts. For Memory Read Line, PCI bridge encodes a burst length on the byte enable pins of the PLB that corresponds to the number of doublewords from the start address to the end of a word boundary and terminates when the encoded number of words has been transferred. This is called a PLB fixed length burst. If the starting address is the last doubleword on a word boundary (typically, this should not occur), PCI bridge executes a single-beat read. For Memory Read Multiple, PCI bridge sets the byte enables to 0s, indicating a variable length burst.

The PCI target can be programmed to treat Memory Reads as Memory Read Line commands or Memory Read Multiple commands in terms of PLB read behavior.

The PCI bridge guarantees the PCI initial target latency requirement by retrying the PCI cycle if read data is not immediately available in the read buffer. Subsequent latency is programmable using PCIC0_BRDGOPT2[STLD].

The PCI bridge master latency timer can limit the length of read bursts using PCIC0_BRDGOPT1[MLTC]. The timer limits the duration of a burst to the programmed value in units of PLB clock cycles.

Read Buffer

The PCI bridge read buffer stores all read data (including delayed read and prefetched data) when the data is received from the PLB, before it is passed to the PCI. The 96-byte read buffer can store one transaction.

Delayed Reads

A delayed read is queued if a PCI master requests a read while PCI master writes are posted. Posted writes are completed on the PLB before the read is run. PCI bridge continues to post PCI master writes (if buffer space is available) while a delayed read is in progress. Such writes complete on the PLB after the read, even though they complete on the PCI before the read.

A delayed read is also queued if data is not immediately available in the read buffer and a delayed read does not already exist.

When a PCI master returns for a previously requested delayed read, the data is passed out of the read buffer. While the PCI master accepts delayed read data, the PCI bridge can begin to prefetch more read data, if the PCI master posted write buffer is empty. See "Read Prefetching" on page 17-401 for more details.

Any data remaining in the read buffer after delayed read data has been passed to a PCI master is marked as prefetch data and discarded upon a write in either direction.

PCI bridge can hold one delayed read transaction. PCI bridge retries all other PCI master reads until the delayed read completes on the PCI. The read buffer discards data from a delayed read under only one condition. The PCI discard timer is used to track the amount of time it takes for a PCI master to re-request the read. If the PCI master does not re-request the read in 2^{15} PCI clocks (about one millisecond for a 33 MHz PCI clock), PCI bridge discards the delayed read data. This timer begins counting at the beginning of the initial PCI cycle (delayed read request). If PCI bridge is used in a system on which the PLB target (memory) maximum latency (including PLB arbitration) is a significant portion of the timer duration, the timer can expire despite normal bus operation. One solution to this problem is to disable the PCI Discard Timer.

If a delayed read is burst terminated on the PLB (a rare occurrence), PCI bridge will not repeat the request until the PCI master re-requests and only then if the PCI master requests more data than is already buffered.

Preliminary User's Manual

Read Prefetching

PCI bridge attempts to prefetch data to maximize burst throughput on PCI read requests. Read prefetching occurs only in response to Memory Read Multiple commands or Memory Read, if the PCI target is programmed to treat them as Memory Read Multiple (Memory Read Line causes prefetching to the next word boundary only). This prefetch buffer is 96 bytes.

If a PCI master reads from the read buffer while a PLB read is in progress, data is passed to PCI as it is being filled from the PLB. If the read buffer goes empty long enough for the PCI subsequent latency timer to expire, the PCI is target disconnected. If the read buffer fills up, the PLB cycle is master terminated. The bridge PLB master will not attempt to reacquire the PLB bus if its posted write buffer is not empty.

Prefetched data is discarded if a write is accepted from either the PLB or the PCI. A PCI master read that misses the prefetch buffer also causes current read data to be discarded and the new request to be serviced.

Byte Enable Handling

PCI byte enables are treated as don't cares for PCI reads. The PCI bridge performs doubleword burst or single-beat doubleword reads on the PLB, regardless of the byte enables presented by the requesting PCI master.

Note: This rule assumes that all PLB memory is prefetchable and that all PLB memory accesses are nondestructive.

17.4.2.3 Handling Writes from PCI Masters

PCI bridge responds to Memory Write and Memory Write and Invalidate commands. All PCI master writes are posted. A 64-byte write buffer is used for this purpose. The write buffer accepts up to two separate PCI write transactions. Two single-beat writes, one burst write, or a combination of a single-beat and a burst writes can be posted. If the write buffer is full, new writes are retried until buffer space becomes available.

Note: The maximum of two posted transactions is as viewed from the PCI master. The number of writes performed on the PLB can be more than two, depending on the setting of byte enables of write burst data. See "Byte Enable Handling" on page 17-401.

The PCI bridge begins a PLB write request as soon as a PCI master write has completed on the PCI bus, or a bursting PCI master has written at least six words of data. The PCI bridge continues to receive data from a bursting PCI master as it transfers data to the PLB. If the write post buffer fills, the PCI master is target disconnected. If the write post buffer empties, the PLB cycle is master terminated.

Writes are executed in the same order they are received.

Byte Enable Handling

The PLB does not support non-contiguous byte enables, whereas the PCI bus does. The PLB supports the use of byte enables only for non-line, non-burst transactions, whereas the PCI bus supports any combination of byte enables for any data phase. Therefore, when a PCI master presents a data phase without all byte enables asserted, the bridge disconnects and treats that data phase as one or two single-beat writes on PLB, depending on whether or not byte enables are non-contiguous.

Masters presenting writes without all byte enables asserted experience degraded performance.

17.4.2.4 Miscellaneous

The PCI target forces single-beat transfers when reserved burst or cache line wrap order is used.

The PCI target causes master abort of reserved command encodings, and does not respond to I/O, interrupt acknowledge, or special cycle commands.

The PLB master does not abort requests.

17.4.3 Completion Ordering

PCI bridge implements the following completion ordering rules:

1. PCI master writes are accepted if there is room in the PCI write post buffer.
2. New PCI master reads are accepted if there is no delayed read (DRR or DRC) in progress:
 - a. If PCI write post buffer is empty and read data is not buffered, then begin a delayed read (enter DRR state).
 - b. If PCI write post buffer is not empty, then begin delayed read (enter DRR state).

Delayed reads are handled as follows:

- a. While in DRR state, retry all PCI master reads. Wait for all PCI master writes if any that were posted before entering DRR state to complete on PLB.
 - b. Execute PLB read, enter DRC state.
 - c. While in DRC state, retry all PCI master reads if the address does not match. If it does match, pass the read data to the PCI master. If data is passed, exit the DRC state.
3. PLB master writes are accepted if there is room in the PLB write post buffer.
 4. PLB master reads are accepted if the PLB write post buffer and the PCI write post buffer are both empty.

17.4.3.1 PCI Producer-Consumer Model

The PCI Producer-Consumer model is followed with one exception: PCI master reads do not flush PLB writes and PCI master writes do not cause PLB prefetched read data to be discarded. If the “flag” is stored in system memory (PLB side), but the “data” is stored in a PCI target, the control software must manually force coherency. This can be done by following two rules:

1. To ensure data written by a PLB master has reached the intended PCI target, the PLB master should execute a read from PCI, to any nondestructive address. This is only necessary if the write is postable.
2. To ensure data read by a PLB master is current (rather than old prefetched data), the PLB master should execute a read from PCI to any other nondestructive address. This is only necessary if the read is prefetchable.

Preliminary User's Manual**17.4.4 Collision Resolution**

The PCI bridge must resolve collisions when a PLB master and a PCI master attempt accesses through the PCI bridge at the same time. Table 17-7 summarizes collision resolution.

In general, PLB postable writes are always accepted (if buffer space is available), and passed to the PCI when given the chance. PCI master writes are always accepted (if buffer space is available), but cause PLB reads and non-postable writes to be rearbitrated to clear the path to the PLB. PLB reads and non-postable writes proceed as long as there is no PCI master activity, which causes the PLB cycle to be rearbitrated. PCI master reads are always allowed to proceed, and cause PLB reads and non-postable writes to be rearbitrated.

Internal configuration accesses have their own rules. Configuration writes are not allowed to complete while any write data is posted in the PCI bridge, or while the PCI master is prefetching. Otherwise, there are no restrictions. Configuration reads have no restrictions; however, only one internal configuration access (PLB or PCI side) may be serviced at a time.

Table 17-7. Collision Resolution

Access Type	PLB Read from PCI	PLB Postable Write to PCI	PLB Non-postable Write to PCI
PCI Write to PLB	Rearbitrate PLB master (reads flush writes)	No conflict	Rearbitrate PLB master
PCI Read from PLB	Rearbitrate PLB master	No conflict	Rearbitrate PLB master

17.5 PCI Bridge Configuration Registers

The PCI bridge has two sets of configuration registers for configuring the bridge, handling errors, and reporting status. Local configuration registers control PLB functions, and are accessed only from the PLB. The PCI configuration registers control PCI functions, and can be accessed from the PLB and the PCI. In addition, the mechanism used to access the bridge configuration registers may also be used to configure other devices on the PCI bus.

17.5.1 PCI Bridge Register Summary

Table 17-8 provides a summary of all of the PCI bridge registers. The registers are discussed in detail in the following sections. See Chapter 8, "Reset and Initialization," for register reset values.

Table 17-8. Directly Accessed MMIO Registers

Register	Address	Access	Description	Page
PCIL0_PMM0LA	0xEF400000	R/W	PMM 0 Local Address	17-406
PCIL0_PMM0MA	0xEF400004	R/W	PMM 0 Mask/Attribute	17-410
PCIL0_PMM0PCILA	0xEF400008	R/W	PMM 0 PCI Low Address	17-407
PCIL0_PMM0PCIHA	0xEF40000C	R/W	PMM 0 PCI High Address	17-407
PCIL0_PMM1LA	0xEF400010	R/W	PMM 1 Local Address	17-408
PCIL0_PMM1MA	0xEF400014	R/W	PMM 1 Mask/Attribute	17-406
PCIL0_PMM1PCILA	0xEF400018	R/W	PMM 1 PCI Low Address	17-409
PCIL0_PMM1PCIHA	0xEF40001C	R/W	PMM 1 PCI High Address	17-409
PCIL0_PMM2LA	0xEF400020	R/W	PMM 2 Local Address	17-409
PCIL0_PMM2MA	0xEF400024	R/W	PMM 2 Mask/Attribute	17-410

Table 17-8. Directly Accessed MMIO Registers (continued)

Register	Address	Access	Description	Page
PCIL0_PMM2PCILA	0xEF400028	R/W	PMM 2 PCI Low Address	17-410
PCIL0_PMM2PCIHA	0xEF40002C	R/W	PMM 2 PCI High Address	17-411
PCIL0_PTM1MS	0xEF400030	R/W	PTM 1 Memory Size/Attribute	17-411
PCIL0_PTM1LA	0xEF400034	R/W	PTM 1 Local Address	17-412
PCIL0_PTM2MS	0xEF400038	R/W	PTM 2 Memory Size/Attribute	17-412
PCIL0_PTM2LA	0xEF40003C	R/W	PTM 2 Local Address	17-413

Table 17-9. PCI Configuration Address and Data Registers

Register	Address	Access	Description
PCIC0_CFGADDR	0xEEC00000	R/W	PCI Configuration Address Register
PCIC0_CFGDATA	0xEEC00004	R/W	PCI Configuration Data Register

Table 17-10. PCI Configuration Register Offsets

Register	Offset	Access		Description
		PLB	PCI	
PCIC0_VENDID	0x01–0x00	R/W	R	PCI Vendor ID
PCIC0_DEVID	0x03–0x02	R/W	R	PCI Device ID
PCIC0_CMD	0x05–0x04	R/W	R/W	PCI Command Register
PCIC0_STATUS	0x07–0x06	R/W	R/W	PCI Status Register
PCIC0_REVID	0x08	R/W	R/W	PCI Revision ID
PCIC0_PCICLS	0x0B–0x09	R/W	R	PCI Class Register
PCIC0_CACHELS	0x0C	R	R	PCI Cache Line Size
PCIC0_LATTIM	0x0D	R/W	R/W	PCI Latency Timer
PCIC0_HDTYPE	0x0E	R	R	PCI Header Type
PCIC0_BIST	0x0F	R	R	PCI Built In Self Test Control
Reserved PCI BAR	0x13–0x10	R	R	Reserved, PCI BAR
PCIC0_PTM1BAR	0x17–0x14	R/W	R/W	PCI PTM 1 BAR
PCIC0_PTM2BAR	0x1B–0x18	R/W	R/W	PCI PTM 2 BAR
Reserved PCI BAR	0x1F–0x1C	R	R	Reserved PCI BAR. Refer to <i>PCI Specification</i> , Version 2.2 for more information on values.
Reserved PCI BAR	0x23–0x20	R	R	Reserved PCI BAR. Refer to <i>PCI Specification</i> , Version 2.2 for more information on values.
Reserved PCI BAR	0x27–0x24	R	R	Reserved PCI BAR. Refer to <i>PCI Specification</i> , Version 2.2 for more information on values.
Reserved Cardbus CIS Pointer	0x2B–0x28	R	R	Reserved Cardbus CIS Pointer. Refer to <i>PCI Specification</i> , Version 2.2 for more information on values.
PCIC0_SBSYSVID	0x2D–0x2C	R/W	R	PCI Subsystem Vendor ID
PCIC0_SBSYSID	0x2F–0x2E	R/W	R	PCI Subsystem ID

Preliminary User's Manual**Table 17-10. PCI Configuration Register Offsets (continued)**

Register	Offset	Access		Description
		PLB	PCI	
Reserved Exp ROM Base Addr	0x33–0x30	R	R	Reserved Expansion ROM Base Address. Refer to <i>PCI Specification, Version 2.2</i> for more information on values.
PCIC0_CAP	0x34	R	R	PCI Capabilities Pointer
Reserved	0x3B–0x35	R	R	Reserved
PCIC0_INTLN	0x3C	R/W	R/W	PCI Interrupt Line
PCIC0_INTPN	0x3D	R	R	PCI Interrupt Pin
PCIC0_MINGNT	0x3E	R	R	PCI Minimum Grant
PCIC0_MAXLTNCY	0x3F	R	R	PCI Maximum Latency
PCIC0_PCIICS	0x44	R/W	R/W	PCI Interrupt Control/Status
PCIC0_ERREN	0x48	R/W	R/W	Error Enable
PCIC0_ERRSTS	0x49	R/W	R/W	Error Status
PCIC0_BRDGOPT1	0x4B–0x4A	R/W	R/W	PCI Bridge Options 1
PCIC0_PLBBESR0	0x4F–0x4C	R/W	R/W	PLB Slave Error Syndrome 0
PCIC0_PLBBESR1	0x53–0x50	R/W	R/W	PLB Slave Error Syndrome 1
PCIC0_PLBBEAR	0x57–0x54	R/W	R/W	PLB Slave Error Address Register
PCIC0_CAPID	0x58	R	R	Capability Identifier
PCIC0_NEXTIPTR	0x59	R	R	Next Item Pointer
PCIC0_PMC	0x5B–0x5A	R	R	Power Management Capabilities
PCIC0_PMCSR	0x5D–0x5C	R/W	R/W	Power Management Control Status
PCIC0_PMCSRSE	0x5E	R	R	PMCSR PCI-to-PCI Bridge Support Extensions
PCIC0_DATA	0x5F	R	R	Data
PCIC0_BRDGOPT2	0x63–0x60	R/W	R/W	PCI Bridge Options 2
PCIC0_PMSCRR	0x64	R/W	R/W	Power Management State Change Request Register

17.5.2 PCI Bridge Local Configuration Registers

The PCI bridge local configuration registers have fixed addresses in PLB space and must be accessed using single beat PLB read or write cycles of the same size as shown in the register descriptions.

Failure to access all bytes of a particular register could produce unexpected results. Reading of reserved bit locations produces unpredictable values. Software must use appropriate masks to extract the desired bits. Writes must preserve the values of reserved bit positions by first reading the register, merging the new value, and writing the result.

17.5.2.1 PMM 0 Local Address Register (PCIL0_PMM0LA)

PCIL0_PMM0LA defines the PLB starting address of range 0 in PLB space that is mapped to PCI memory. Only bits that are 1 in the PCIL0_PMM0MA are used to determine the starting address; all other bits are don't cares. Only bits 31:12 are writable. Bits 11:0 are always 0.



Figure 17-7. PMM 0 Local Address Register (PCIL0_PMM0LA)

31:12	WLA	Writable PLB Local Address
11:0		PLB Local Address Always 0

17.5.2.2 PMM 0 Mask/Attribute Register (PCIL0_PMM0MA)

PCIL0_PMM0MA controls the size and attributes of the PLB space mapped to PCI memory for range 0.

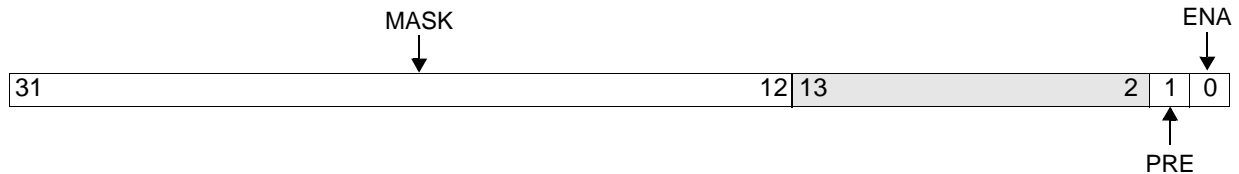

Figure 17-8. PMM 0 Mask/Attribute Register (PCIL0_PMM0MA)

31:12	MASK	The mask bits determine the size of the address map range.	The mask must be of the form 111...0000. Bits set to 1 cause the corresponding PCIL0_PMM0LA bits to be compared with incoming PLB addresses. Note that the minimum range size is 4KB, and valid ranges are powers of 2. For example, a 128MB range would be encoded as 0xF8000 and a 4KB range would be encoded as all ones.
11:2		Reserved	Returns 0 when read.
1	PRE	Read Prefetching Enable 1 Read prefetching is enabled.	If read prefetch is enabled, the PCI bridge prefetches 64 bytes from PCI memory in response to a PLB single-beat, byte-burst, or half word burst read from PMM 0.
0	ENA	PLB to PCI Memory Mapping Enable 1 Memory mapping is enabled.	Note that PCIL0_PMM0LA, PCIL0_PMM0PCIHA, and PCIL0_PMM0PCILA must be initialized before enabling.

Preliminary User's Manual**17.5.2.3 PMM 0 PCI Low Address Register (PCIL0_PMM0PCILA)**

PCIL0_PMM0PCILA defines the low-order 32 bits of the PCI address generated in response to a PLB access to range 0. Only bits that are 1 in PCIL0_PMM0MA are passed to the PCI address. The other (least significant) bits of the PCI address are passed through from the PLB address. Only bits 31:12 are writable. Bits 11:0 are always 0.

**Figure 17-9. PMM 0 PCI Low Address Register (PCIL0_PMM0PCILA)**

31:12	WLA	Writable PCI Low Address
11:0		PCI Low Address Always 0

17.5.2.4 PMM 0 PCI High Address Register (PCIL0_PMM0PCIHA)

PCIL0_PMM0PCIHA defines the high-order 32 bits of the PCI address generated in response to a PLB access to range 0. If PCIL0_PMM0PCIHA is greater than 0, the PCI bridge generates a PCI dual address cycle using the value in PCIL0_PMM0PCIHA as the high-order 32 bits of the PCI address.

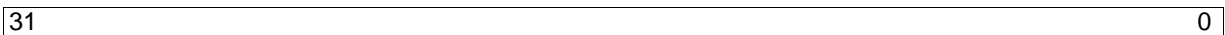
**Figure 17-10. PMM 0 High Address Register (PCIL0_PMM0PCIHA)**

31:0		PCI High Address
------	--	------------------

17.5.2.5 PMM 1 Local Address Register (PCIL0_PMM1LA)

PCIL0_PMM1LA defines the PLB starting address of range 1 in PLB space that is mapped to PCI memory. See “PMM 0 Local Address Register (PCIL0_PMM0LA)” on page 17-406.

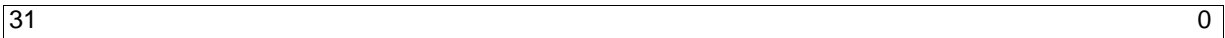

Figure 17-11. PMM 1 Local Address Register (PCIL0_PMM1LA)

31:0		PLB Local Address
------	--	-------------------

17.5.2.6 PMM 1 Mask/Attribute Register (PCIL0_PMM1MA)

PCIL0_PMM1MA defines the size and attributes of range 1 in PLB space that is mapped to PCI memory. See “PMM 0 Mask/Attribute Register (PCIL0_PMM0MA)” on page 17-406.



Figure 17-12. PMM 1 Mask/Attribute Register (PCIL0_PMM1MA)

31:12	MASK	The mask bits determine the size of the address map range.	The mask must be of the form 111....0000. Bits set to 1 cause the corresponding PCIL0_PMM1LA bits to be compared with incoming PLB addresses. Note that the minimum range size is 4KB, and valid ranges are powers of 2. For example, a 128MB range would be encoded as 0xF8000 and a 4KB range would be encoded as 0x11111.
11:2		Reserved	Returns 0 when read.
1	PRE	Read Prefetching Enable 1 Read prefetching is enabled.	If read prefetch is enabled, the PCI bridge prefetches 64 bytes from PCI memory in response to a PLB single-beat, byte-burst, or half word burst read from PMM 0.
0	ENA	PLB to PCI Memory Mapping Enable 1 Memory mapping is enabled.	Note that PCIL0_PMM1LA, PCIL0_PMM1PCIHA, and PCIL0_PMM1PCILA must be initialized before enabling.

Preliminary User's Manual**17.5.2.7 PMM 1 PCI Low Address Register (PCIL0_PMM1PCILA)**

PCIL0_PMM1PCILA defines the low-order 32 bits of the PCI address generated in response to a PLB access to range 1. See “PMM 0 PCI Low Address Register (PCIL0_PMM0PCILA)” on page 17-407.

**Figure 17-13. PMM 1 PCI Low Address Register (PCIL0_PMM1PCILA)**

31:12	WLA	Writable PCI Low Address
11:0		PCI Low Address Always 0

17.5.2.8 PMM 1 PCI High Address Register (PCIL0_PMM1PCIHA)

PCIL0_PMM1PCIHA defines the high-order 32 bits of the PCI address generated in response to a PLB access to range 1. See “PMM 0 PCI High Address Register (PCIL0_PMM0PCIHA)” on page 17-407.

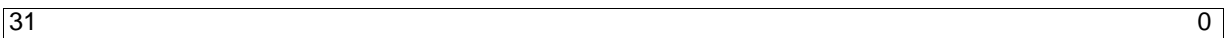
**Figure 17-14. PMM 0 High Address Register (PCIL0_PMM0PCIHA)**

31:0		PCI High Address
------	--	------------------

17.5.2.9 PMM 2 Local Address Register (PCIL0_PMM2LA)

PCIL0_PMM2LA defines the PLB starting address of range 2 in PLB space that is mapped to PCI memory. See “PMM 0 Local Address Register (PCIL0_PMM0LA)” on page 17-406.

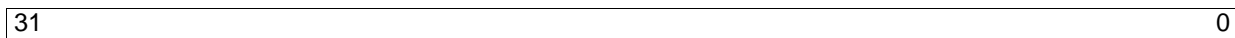
**Figure 17-15. PMM 2 Local Address Register (PCIL0_PMM2LA)**

31:0		PLB Local Address
------	--	-------------------

17.5.2.10 PMM 2 Mask/Attribute Register (PCIL0_PMM2MA)

PCIL0_PMM2MA defines the size and attributes of range 2 in PLB space that is mapped to PCI memory. See “PMM 0 Mask/Attribute Register (PCIL0_PMM0MA)” on page 17-406.

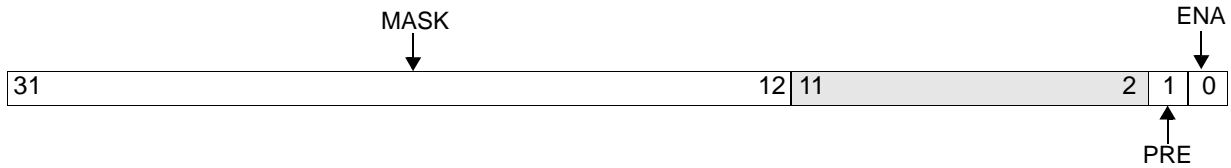

Figure 17-16. PMM 2 Mask/Attribute Register (PCIL0_PMM2MA)

31:12	MASK	The mask bits determine the size of the address map range.	The mask must be of the form 111....0000. Bits set to 1 cause the corresponding PCIL0_PMM2LA bits to be compared with incoming PLB addresses. Note that the minimum range size is 4KB, and valid ranges are powers of 2. For example, a 128MB range would be encoded as 0xF8000 and a 4KB range would be encoded as 0x11111.
11:2		Reserved	Returns 0 when read.
1	PRE	Read Prefetching Enable 1 Read prefetching is enabled.	If read prefetch is enabled, the PCI bridge prefetches 64 bytes from PCI memory in response to a PLB single-beat, byte-burst, or half word burst read from PMM 0.
0	ENA	PLB to PCI Memory Mapping Enable 1 Memory mapping is enabled.	Note that PCIL0_PMM2LA, PCIL0_PMM2PCIHA, and PCIL0_PMM2PCILA must be initialized before enabling.

17.5.2.11 PMM 2 PCI Low Address Register (PCIL0_PMM2PCILA)

PCIL0_PMM2PCILA defines the low-order 32 bits of the PCI address generated in response to a PLB access to range 2. See “PMM 0 PCI Low Address Register (PCIL0_PMM0PCILA)” on page 17-407.

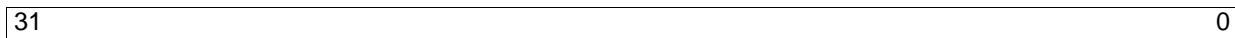

Figure 17-17. PMM 2 PCI Low Address Register (PCIL0_PMM2PCILA)

31:12	WLA	Writable PCI Low Address	
11:0		PCI Low Address	Always 0

Preliminary User's Manual**17.5.2.12 PMM 2 PCI High Address Register (PCIL0_PMM2PCIHA)**

PCIL0_PMM2PCIHA defines the high-order 32 bits of the PCI address generated in response to PLB access to range 2. See “PMM 0 PCI High Address Register (PCIL0_PMM0PCIHA)” on page 17-407.

**Figure 17-18. PMM 2 PCI High Address Register (PCIL0_PMM2PCIHA)**

31:0		PCI High Address
------	--	------------------

17.5.2.13 PTM 1 Memory Size/Attribute Register (PCIL0_PTM1MS)

PCIL0_PTM1MS defines the size and attributes of the of PCI memory region mapped to local (PLB) space through PTM 1. PCIL0_PTM1MS affects the operation of PCI PTM 1 BAR.

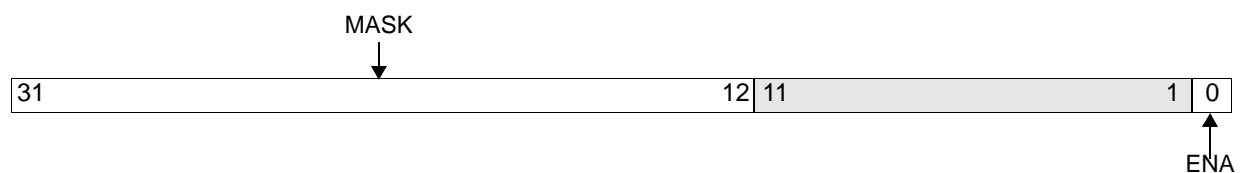
**Figure 17-19. PTM 1 Memory Size/Attribute Register (PCIL0_PTM1MS)**

31:12	MASK	Defines the size of the region of PCI memory space that is mapped to local (PLB) space using PTM 1.	The minimum range size is 4KB. Valid ranges are always a power of 2. For example, a value of 0xFF000000 indicates that the region contains 16MB.
11:1		Reserved	Returns 0 when read.
0	ENA	Determines if range 1 is enabled to map PCI memory space to PLB space.	

17.5.2.14 PTM 1 Local Address Register (PCIL0_PTM1LA)

PCIL0_PTM1LA defines the local (PLB) address that is generated in response to a PCI access to local (PLB) space through PTM 1. Only bits that are 1 in PCIL0_PTM1MS are passed to the PLB address. The other (least significant) bits of the PLB address are passed through from the PCI address. Only bits 31:12 are writable. Bits 11:0 are always 0.



Figure 17-20. PTM 2 Local Address Register (PCIL0_PTM1LA)

31:12	WLA	Writable PTM 1 Local Address	Writable
11:0		PTM 1 Local Address	Always 0

17.5.2.15 PTM 2 Memory Size/Attribute Register (PCIL0_PTM2MS)

PCIL0_PTM2MS defines the size of the region of PCI memory space mapped to local (PLB) space through PTM 2.

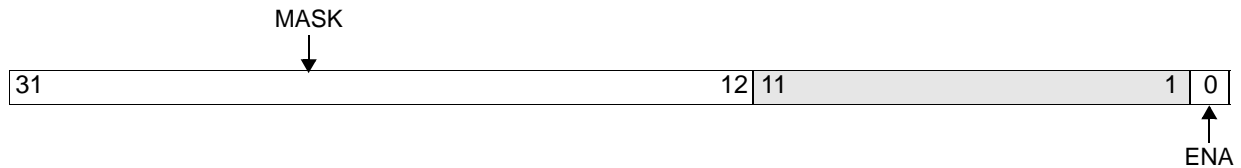

Figure 17-21. PTM 2 Memory Size/Attribute Register (PCIL0_PTM2MS)

31:12	MASK	Defines the size of the region of PCI memory space mapped to local (PLB) space using PTM 2.	The minimum range size is 4KB. Valid ranges are always a power of 2. For example, a value of 0xFF000000 indicates that the region contains 16MB.
11:1		Reserved.	Returns 0 when read.
0	ENA	Determines if range 2 is enabled to map PCI memory space to PLB space.	When ENA is disabled, PCIC0_PTM2BAR cannot be written. Set PCIC0_PTM2BAR to 0 before disabling ENA.

Preliminary User's Manual**17.5.2.16 PTM 2 Local Address Register (PCIL0_PTM2LA)**

This register defines the local (PLB) address generated in response to a PCI access to local (PLB) space through PTM 2. See “PTM 1 Local Address Register (PCIL0_PTM1LA)” on page 17-412 for more information.

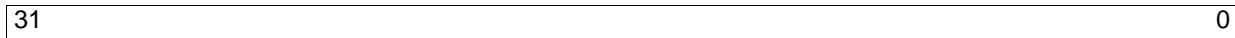
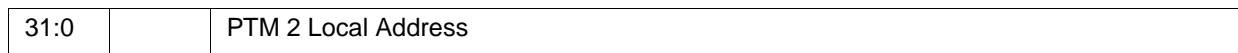

Figure 17-22. PTM 2 Local Address Register (PCIL0_PTM2LA)

**17.5.3 PCI Configuration Registers**

The PCI configuration registers can be accessed from both the PLB and PCI buses.

PLB side configuration is supported using the mechanism defined in the *PCI Local Bus Specification Version 2.2*. This mechanism uses PCIC0_CFGADDR and PCIC0_CFGDATA to access the configuration registers indirectly. These registers reside at addresses 0xEEC00000 and 0xEEC00004, respectively.

To access (from the PLB side) the configuration space of other devices on the PCI bus, write a value to PCIC0_CFGADDR that specifies the following:

- Bus number
- Device number on that bus
- Register number to be accessed

The value must also set PCIC0_CFGADDR[EN] = 1. An access to PCIC0_CFGDATA then results in a configuration cycle on the PCI bus.

To access the bridge configuration registers from the PLB side, use the same mechanism as described above, but set PCIC0_CFGADDR[BN, DN] = 0. The bridge is assumed to reside on PCI bus 0 and to have a device number of 0.

The bridge configuration registers can be accessed from the PCI side by Type 0 configuration reads or writes, with the PCIIDSel pin asserted to the bridge. There are some restrictions on PCI side accesses that are noted in the register descriptions that follow.

PCIC0_CFGADDR and CONFIG_DATA should be accessed with single-beat PLB commands. All registers are byte addressable. Reading of reserved bit locations produces unpredictable values. Software must use appropriate masks to extract the desired bits. Writes must preserve the values of reserved bit positions by first reading the register, merging the new value, and writing the result.

17.5.3.1 PCI Configuration Address Register (PCIC0_CFGADDR)

PCIC0_CFGADDR controls the type of cycle generated when PCIC0_CFGDATA is accessed. Its fields are shown in Figure 17-23.

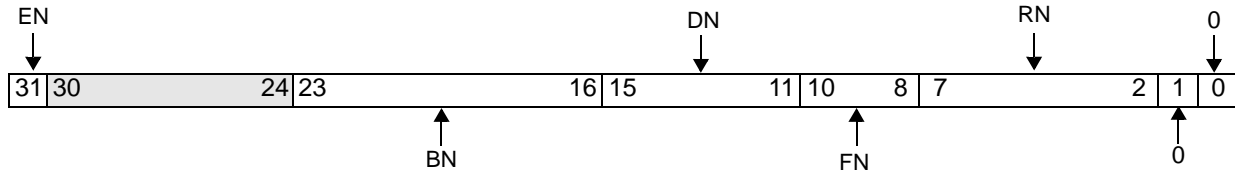

Figure 17-23. PCI Configuration Address Register (PCIC0_CFGADDR)

31	EN	Enable 0 Disabled 1 Enabled
30:24		Reserved
23:16	BN	Bus Number
15:11	DN	Device Number
10:8	FN	Function Number
7:2	RN	Register Number
1	0	
0	0	

See the *PCI Local Bus Specification Version 2.2* for details about how the fields are used.

17.5.3.2 PCI Configuration Data Register (PCIC0_CFGDATA)

Accessing PCIC0_CFGDATA causes one of three things to happen, depending on the value of PCIC0_CFGADDR.

1. Generation of a Type 0 configuration cycle on the PCI bus (PCIC0_CFGADDR[BN] = 0, PCIC0_CFGADDR[DN] > 0).
2. Generation of a Type 1 configuration cycle on the PCI bus (PCIC0_CFGADDR[BN] > 0).
3. Access of a PCI bridge PCI configuration register (PCIC0_CFGADDR[BN, DN] = 0).

Preliminary User's Manual

Figure 17-24 illustrates the PCIC0_CFGDATA register.



Figure 17-24. PCI Configuration Data Register (PCIC0_CFGDATA)

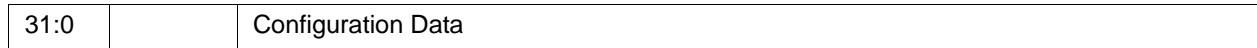

17.5.3.3 PCI Vendor ID Register (PCIC0_VENDID)

PCIC0_VENDID identifies the manufacturer of a PCI device. This register contains 0x1014 (index 0x00 = 0x14, index 0x01 = 0x10) at reset. This vendor ID is assigned for all AMCC PCI devices. The local CPU (PLB master) can write a different value to this register.

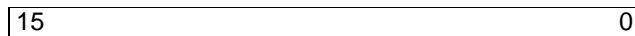
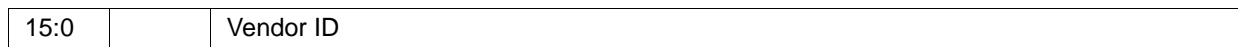

Figure 17-25. PCI Vendor ID Register (PCIC0_VENDID)



17.5.3.4 PCI Device ID Register (PCIC0_DEVID)

PCIC0_DEVID identifies the PCI device. This value is 0x0156 (index 0x03 = 0x01, index 0x02 = 0x56) at reset. The local CPU (PLB master) can write a different value to this register.

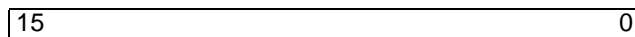
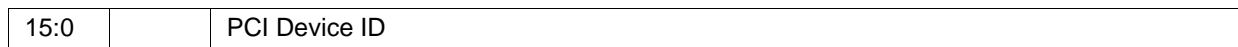

Figure 17-26. PCI Device ID Register (PCIC0_DEVID)



17.5.3.5 PCI Command Register (PCIC0_CMD)

PCIC0_CMD controls the operation of the PCI bridge on the PCI bus. Figure 17-27 describes the bits.

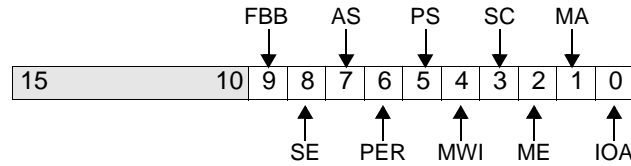

Figure 17-27. PCI Command Register (PCIC0_CMD)

15:10		Reserved	.
9	FBB	Fast Back-to-Back Write Enable	Enables PCI masters to perform fast back-to-back transactions. Because the PCI bridge does not perform fast back-to-back transactions; FBB is read-only and returns 0 when read.
8	SE	PCISerr Enable 0 Disabled 1 Enabled	Enables driving PCISerr when a PCI bus parity error is detected when the PCI bridge is the PCI target. PCIC0_CMD[PER] must be enabled for address parity errors. PCIC0_CMD[PER] and PCIC0_ERREN[WDPE] must be enabled for write data parity errors.
7	AS	Address stepping wait states.	The PCI bridge does not address step (except for address stepping when generating a Config Type 0 cycle); AS is read-only and returns 0 when read.
6	PER	Parity error response 0 Disabled 1 Enabled	This bit is enabled for all types of PCI bus parity errors, including the following: <ul style="list-style-type: none"> • PCI data bus parity errors while PCI is master. • PCI data bus parity errors while PCI is target. • PCI address bus parity errors. When parity error response is disabled, detection of these errors is masked and PCIPerr (PERR#) is not asserted, although parity is still generated.
5	PS	Palette Snooping	Enable special palette snooping. The PCI bridge is not a VGA device; PS is read-only and returns 0 when read.
4	MWI	Memory Write and Invalidate Enable	The PCI bridge does not generate this command; MWI is read-only and returns 0 when read.
3	SC	Special Cycle Operations Enable	The PCI bridge never monitors special cycles; SC is read-only and returns 0 when read.

Preliminary User’s Manual

2	ME	Master Enable 0 Disabled 1 Enabled	Enables PCI bridge-to-master cycles on the PCI bus. When ME is 0, the PCI bridge only responds as a PLB slave to PCIC0_CFGADDR, PCIC0_CFGDATA, and PCI bridge local configuration register access. Except for configuration cycles, the PCI bridge cannot master cycles to the PCI bus. If the pin strapping setting reflected in CPC0_PSR[RL] = 1, ME resets to 1.
1	MA	Memory Access 0 Disabled 1 Enabled	Controls PCI bridge response as a PCI memory target. MA is disabled at reset.
0	IOA	I/O Access	Controls the PCI bridge response as a PCI I/O target. The PCI bridge does not respond to I/O space accesses; IOA is read-only and returns 0 when read.

17.5.3.6 PCI Status Register (PCIC0_STATUS)

PCIC0_STATUS is a read/bit-reset register used to record status information for PCI bus events. Bits in PCIC0_STATUS are set only as a result of specific events occurring on the PCI bus. They are reset by writing a 1 to the desired bit. Writing a 0 to a bit location leaves that bit unchanged.

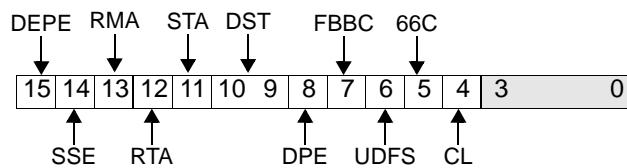

Figure 17-28. PCI Status Register (PCIC0_STATUS)

15	DEPE	Detected Parity Error Write 1 to clear.	The PCI bridge sets DEPE when the PCI bridge detects a PCI bus parity error, regardless of the setting of any enable bits (DEPE is non-maskable). The following events set DEPE: <ul style="list-style-type: none"> • PCI address bus parity error detected when PCI bridge is a target. • PCI data bus parity error detected when a PCI master writes to PLB memory (PCI bridge is the target). • PCI data bus parity error detected when PCI bridge masters a PCI read cycle.
14	SSE	Signaled System Error Write 1 to clear.	The PCI bridge sets SSE if the PCI bridge asserts PCISerr (see “Error Handling” on page 17-439 for causes of PCISerr assertion).

13	RMA	Received Master Abort Write 1 to clear.	The PCI bridge sets RMA when a PCI cycle for which the PCI bridge is the master is terminated with master abort.
12	RTA	Received Target Abort Write 1 to clear.	The PCI bridge sets RTA when a PCI cycle for which it is the master is terminated with target abort.
11	STA	Signaled Target Abort Write 1 to clear.	The PCI bridge sets STA when a PCI cycle for which it is the target is terminated with target abort.
10:9	DST	PCIDevSel Response Timing Read-only.	The PCI bridge asserts <u>PCIDevSel</u> on the second clock after <u>PCIFrame</u> is asserted (called medium response time). Read-only; always returns 0b01 when read.
8	DPE	Data Parity Error Detected Write 1 to clear.	DPE is set when the following conditions are met: <ul style="list-style-type: none"> • The PCI bridge detects a data parity error (<u>PCIPErr</u> is asserted) when the PCI bridge is the master on a PCI read cycle, or is the master when it samples <u>PCIPErr</u> asserted on a PCI write cycle. • <u>PCIC0_CMD[PER]</u> = 1.
7	FBBC	Fast Back-to-Back Capable Read-only; returns 0 when read.	Indicates that the PCI target can accept fast back-to-back transactions when the transactions are not to the same agent. The PCI bridge target does not accept this type of fast back-to-back transaction.
6	UDFS	UDF Supported Read-only; returns 0 when read.	Indicates device support of user-definable features. The PCI bridge does not support user-definable features.
5	66C	66 MHz Capable 0 At reset 1 PCI bridge is configured for 66MHz operation.	Indicates that the device can run at 66 MHz. The PCI bridge can be configured to run at 33 MHz max or 66 MHz. The local CPU (PLB master) sets 66C to 1 if PCI bridge is configured for 66 MHz operation.
4	CL	Capabilities List This bit is read only and returns 1 when read.	Indicates that the value at offset 0x34 is a pointer in configuration space to a linked list of new capabilities.
3:0		Reserved	These bits return 0s when read.

Preliminary User's Manual**17.5.3.7 PCI Revision ID Register (PCIC0_REVID)**

PCIC0_REVID holds the current incremental revision number. The reset value is the version number of the PCI bridge macro (first version is 00). However, the local CPU (PLB master) can write a value to this register.

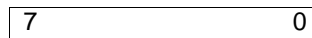
**Figure 17-29. PCI Revision ID Register (PCIC0_REVID)**

7:0		Revision ID	Revision level of device.
-----	--	-------------	---------------------------

17.5.3.8 PCI Class Register (PCIC0_CLS)

This register holds the class code. This register is 0x060000 at reset, which indicates that the PCI bridge is a bridge device located between the PLB and the PCI bus; however, the local CPU (PLB master) can write a value to this register for the case where PCI bridge is not the host bridge.

Class information is defined in the *PCI Local Bus Specification, Version 2.2*.

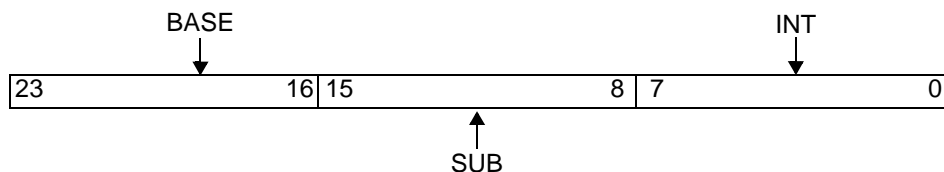
**Figure 17-30. PCI Class Register (PCIC0_CLS)**

23:16	BASE	Base Class	Reset to 0x06, which indicates bridge device. Users of the RISCWatch debugger must use the PCIC0_BASECC register to access this field.
15:8	SUB	Subclass	Reset to 00, which indicates host bridge. Users of the RISCWatch debugger must use the PCIC0_SUBCLS register to access this field.
7:0	INT	Interface Class	Reset to 00. Users of the RISCWatch debugger must use the PCIC0_INTCLS register to access this field.

17.5.3.9 PCI Cache Line Size Register (PCIC0_CACHELS)

PCIC0_CACHELS determines the size of a PCI cache line. PCI bridge does not support a PCI cache. Therefore, this register is read-only and returns 0x00 when read.



Figure 17-31. PCI Cache Line Size Register (PCIC0_CACHELS)

7:0		PCI Cache Line Size
-----	--	---------------------

17.5.3.10 PCI Latency Timer Register (PCIC0_LATTIM)

PCIC0_LATTIM holds the value of the PCI latency timer. The granularity of the latency timer is 8 PCI cycles. Therefore, the 3 low-order bits of this register are read-only and return 0x111.

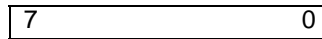

Figure 17-32. PCI Latency Timer Register (PCIC0_LATTIM)

7:0		PCI Latency Timer
-----	--	-------------------

PCI Local Bus Specification Version 2.2 specifies that PCI masters capable of multi-beat bursts must, after losing their PCI grant, get off the bus when PCIC0_LATTIM has decremented to 0.

The actual number of clock cycles to disconnect varies somewhat when in asynchronous mode. If PCIC0_LATTIM is programmed in asynchronous mode to a value that is less than 64, the PCI bridge PCI master interface could timeout, regardless of the state of its grant line.

In asynchronous mode, the PCI master starts its timer and can timeout regardless of the state of the PCI grant. This is strictly a performance issue and does not limit functionality or affect data integrity.

Several factors affect the frequency of timeouts.

- The amount of PCI bus traffic. In moderate to heavily loaded systems, this is less of an issue because a PCI master tends to lose its grant more often after gaining the bus.
- Fast targets that introduce few or no wait states reduce the chances of timeouts occurring.

Preliminary User's Manual**17.5.3.11 PCI Header Type Register (PCIC0_HDTYPE)**

PCIC0_HDTYPE (bits 0:6) identifies the second part of the PCI header, which begins at offset 0x10. It also determines whether a device contains multiple functions (bit 7). The PCI bridge implements the standard header and is not a multi-function device; therefore, PCIC0_HDTYPE is read-only and returns 0x00 when read.

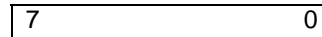
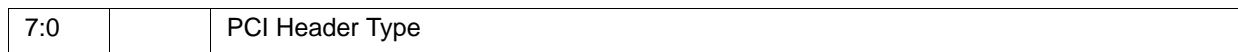
**Figure 17-33. PCI Header Type Register (PCIC0_HDTYPE)****17.5.3.12 PCI Built-In Self Test (BIST) Control Register (PCIC0_BIST)**

PCIC0_BIST is used for control and status of BIST. PCI bridge does not implement BIST. PCIBIST is read-only and returns 0x00 when read.

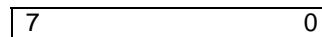
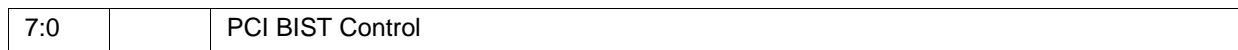
**Figure 17-34. PCI Built-in Self Test Control Register (PCIC0_BIST)**

17.5.3.13 Unused PCI Base Address Register Space

PCI base address register space is defined to begin at offset 0x10; however, the first 32 bits of this space are unused by PCI bridge, and the defined base address registers begin at offset 0x14.

17.5.3.14 PCI PTM 1 BAR (PCIC0_PTM1BAR)

PCIC0_PTM1BAR defines a space in PCI memory space mapped to PLB space (system memory or ROM).

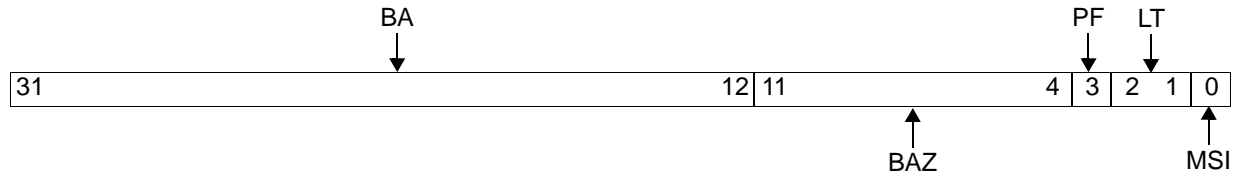
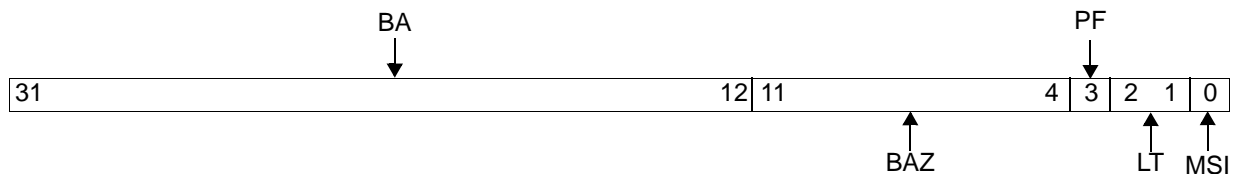

Figure 17-35. PCI PTM 1 BAR Register (PCIC0_PTM1BAR)

31:12	BA	Base Address These bits determine where in PCI memory address space this region is located.	Only corresponding bits in PCIL0_PTM1MS that are set to 1 are writable. Bits in PCIL0_PTM1MS that are set to 0 cause the corresponding Base Address register bits to be always 0. PCIL0_PTM1MS must be initialized by a PLB master before any PCI device is allowed to configure this register.
11:4	BAZ	Base Address Always Zero	BAZ = 0x00 because the minimum size of this range is 4KB.
3	PF	Prefetchable	PF = 1 to indicate that prefetching is allowed.
2:1	LT	Location Type	LT = 0b00 to indicate that the memory space can be located anywhere in the 32-bit address space.
0	MSI	Memory Space Indicator	MSI = 0 to indicate memory space, rather than I/O space.

Preliminary User's Manual**17.5.3.15 PCI PTM 2 BAR (PCIC0_PTM2BAR)**

PCIC0_PTM2BAR defines a second space in PCI memory space that is mapped to PLB space (system memory or ROM). Note that if PCIC0_PTM2BAR is disabled using PCIL0_PTM2MS, PCIC0_PTM2BAR cannot be written. Set PCIC0_PTM2BAR to 0 before disabling this bit. If disabled in this way, reads to PCIC0_PTM2BAR always return 0.

**Figure 17-36. PCI PTM 2 BAR Register (PCIC0_PTM2BAR)**

31:12	BA	Base Address These bits determine where in PCI Memory address space this region is located.	Only corresponding bits in PCIL0_PTM2MS that are set to 1 are writable. Bits in PCIL0_PTM2MS that are set to 0 cause the corresponding Base Address register bits to be always 0. PCIL0_PTM2MS must be initialized by a PLB master before any PCI device can configure this register.
11:4	BAZ	Base Address Always Zero	BAZ = 0x00 because the minimum size of this range is 4KB.
3	PF	Prefetchable	PF = 1 to indicate that prefetching is allowed.
2:1	LT	Location Type	LT = 0b00 to indicate that the memory space can be located anywhere in the 32-bit address space.
0	MSI	Memory Space Indicator	MSI = 0 to indicate memory space, rather than I/O space.

17.5.3.16 PCI Subsystem Vendor ID Register (PCIC0_SBSYSVID)

PCIC0_SBSYSVID holds the vendor ID for a subsystem or add-in board.

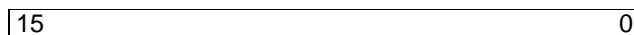
**Figure 17-37. PCI Subsystem Vendor ID Register (PCIC0_SBSYSVID)**

15:0	PCI Subsystem Vendor ID
------	-------------------------

17.5.3.17 PCI Subsystem ID Register (PCIC0_SBSYSID)

PCIC0_SBSYSID holds the device ID of a subsystem or add-in board.

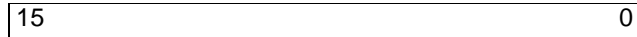

Figure 17-38. PCI Subsystem ID Register (PCIC0_SBSYSID)

15:0		PCI Subsystem ID
------	--	------------------

17.5.3.18 PCI Capabilities Pointer (PCIC0_CAP)

PCIC0_CAP contains an 8-bit pointer in configuration space to the next capability. This data structure is indicated by PCIC0_STATUS[CL]. PCIC0_CAP points to the first item in the list of capabilities at address offset 0x58, which is the PCI power management capability structure.

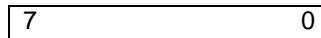

Figure 17-39. PCI Capabilities Pointer (PCIC0_CAP)

7:0		PCI Capabilities Pointer
-----	--	--------------------------

17.5.3.19 PCI Interrupt Line Register (PCIC0_INTLN)

PCIC0_INTLN contains interrupt line routing information.

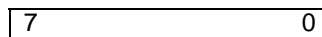

Figure 17-40. PCI Interrupt Line Register (PCIC0_INTLN)

7:0		PCI Interrupt Line
-----	--	--------------------

Preliminary User's Manual**17.5.3.20 PCI Interrupt Pin Register (PCIC0_INTPN)**

PCIC0_INTPN specifies the PCI interrupt line that the device uses. The value 0x01 indicates INTA#.

**Figure 17-41. PCI Interrupt Pin Register (PCIC0_INTPN)**

7:0	PCI Interrupt Pin
-----	-------------------

17.5.3.21 PCI Minimum Grant Register (PCIC0_MINGNT)

PCIC0_MINGNT specifies the burst period length of a PCI device. PCIC0_MINGNT is read-only and returns 0x00 when read.

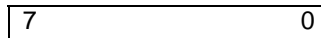
**Figure 17-42. PCI Minimum Grant Register (PCIC0_MINGNT)**

7:0	PCI Minimum Grant
-----	-------------------

17.5.3.22 PCI Maximum Latency Register (PCIC0_MAXLTNCY)

PCIC0_MAXLTNCY specifies how often a PCI device needs to access to the PCI bus. PCIC0_MAXLTNCY is read-only and returns 0x00 when read.

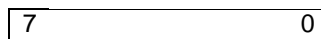
**Figure 17-43. PCI Maximum Latency Register (PCIC0_MAXLTNCY)**

7:0	PCI Maximum Latency
-----	---------------------

17.5.3.23 PCI Interrupt Control/Status Register (PCIC0_ICS)

A PLB master or a PCI master device may generate an interrupt to the PCI bus by writing a 1 to bit 0. Clearing this bit clears the interrupt. Bit 0 also reports the status of the interrupt. A value of 1 means that the interrupt is asserted, a value of 0 means that the interrupt is deasserted.



Figure 17-44. PCI Interrupt Control/Status Register

7:1		Reserved	These bits return 0 when read.
0	API	Assert PCI interrupt	When software sets this bit, the PCI bridge asserts its Interrupt pin.

17.5.3.24 Error Enable Register (PCIC0_ERREN)

ERREN enables detection and reporting of various errors for the PCI bridge (see “Error Handling” on page 17-439).

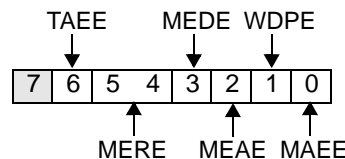

Figure 17-45. Error Enable Register (PCIC0_ERREN)

7		Reserved	
6	TAE	Target Abort Error Enable 0 Disabled 1 Enabled	While the PCI bridge is the PCI master, this bit enables the detection of a target abort as an error condition. If TAE is enabled, the PCI bridge reports PLB bus errors.
5:4	MERE	PLB Bus Error Response Enable 00 No action is taken. 01 The PCI target should drive <u>PCISerr</u> on the PCI bus. 10 Target should target abort the offending read. 11 Indicates the PCI target should drive <u>PCISerr</u> and target abort.	MERE controls the response taken by the PCI bridge on the PCI bus (as the PCI target) when PLB bus errors are asserted to the PCI bridge PLB master. Note: Only reads can be target aborted. Note: Modes 10 and 11 cannot be used in asynchronous mode.
3	MEDE	PLB Master Error Detection Enable 0 Disables detection of PLB master errors. 1 Enables detection of PLB master errors.	MEDE enables the detection of PLB bus errors when the PCI bridge is a PLB master.

Preliminary User’s Manual

2	MEAE	PLB Bus Error Assertion Enable 0 Disabled 1 Enabled	MEAE enables the reporting of a PLB bus error when the PCI bridge is a PLB slave.
1	WDPE	Write Data Parity PCISerr Enable 0 Disabled 1 Enabled.	The PCI bridge drives PCISerr when a data parity error is detected on a write cycle when the PCI bridge is the PCI target. PCIC0_CMD[SE] must also be 1.
0	MAEE	Master Abort Error Enable 0 Disabled 1 Enabled	MAEE enables the detection of a master abort as an error condition when the PCI bridge is the master. The PCI bridge drives SI_MErr on the PLB bus in response to a master abort. If this bit is disabled, driving of SI_Merr in response to master abort is masked.

17.5.3.25 Error Status Register (PCIC0_ERRSTS)

PCIC0_ERRSTS contains status for detected error conditions (see “Error Handling” on page 17-439). Bits in PCIC0_ERRSTS can be set to 1 only as the result of a system error. Writing a 1 to a PCIC0_ERRSTS bit clears the bit. Writing a 0 to a bit leaves that bit unchanged.

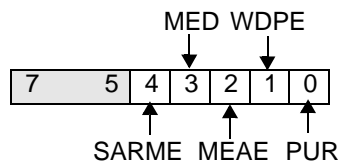

Figure 17-46. Error Status Register (PCIC0_ERRSTS)

7:5		Reserved	
4	SARME	PCISerr Asserted on Received PLB Bus Error	Set when PCI bridge asserts PCISerr on the PCI bus in response to PCI bridge receiving a PLB bus error while PLB master.
3	MED	PLB Bus Error Detected 1 Error detected	Set when a PLB bus error signal is asserted when PCI bridge is the PLB master. MED is set regardless of whether the PCI bridge is enabled to treat this as an error condition (the setting of MED is not maskable).
2	MEAE	PLB Bus Error Assertion Event 1 An PCI bridge error, which can cause a PLB bus error, occurred.	Set when an error occurs that would cause PCI bridge (as PLB slave) to assert a PLB bus error signal. MEAE is set regardless of whether the the PLB bus error assertion is enabled (the setting of MEAE is not maskable).

1	WDPE	PCISerr on Write Data Parity Error	Set when the PCI bridge drives PCISerr in response to a data parity error detected on a PCI write to PLB memory. PCIPerr is also driven.
0	PUR	PLB Unsupported Request	Set when the PCI bridge is a PLB slave and detects an unsupported request from a PLB master to an address range that PCI bridge decodes. The PCI bridge allows such requests to time out.

17.5.3.26 Bridge Options 1 Register (PCIC0_BRDGOPT1)

PCIC0_BRDGOPT1 controls various operating parameters of the PCI bridge. The parameters must be initialized before PCI masters access the PCI bridge.

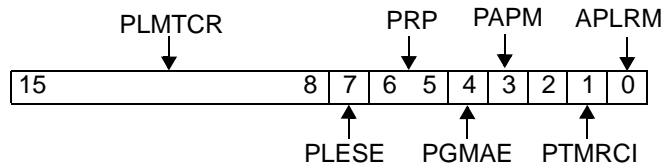

Figure 17-47. Bridge Options 1 Register (PCIC0_BRDGOPT1)

15:8	PMLTCR	PLB Master Latency Timer Count Register	PMLTCR contains the value used by the PLB master to load its latency timer. The granularity of this timer is 16 PLB cycles; therefore, the low-order bits of this register are read-only and are hardwired to 1.
7	PLESE	PLB Lock Error Status Enable 0 Slave error locking is disabled. 1 Slave error locking is enabled.	PLESE controls the handling of slave error locking.
6:5	PRP	PLB Request Priority 11 Highest 10 Next highest 01 Next highest 00 Lowest	PRP controls the request priority for PLB accesses.
4	PGMAE	PLB Guarded Memory Access Enable 0 Bridge PLB master memory accesses are unguarded. 1 Bridge PLB master memory accesses are guarded.	PGMAE controls whether PLB accesses are guarded or unguarded.
3	PAPM	PCI Arbiter Park Mode 0 The arbiter parks on requester 0 (the bridge PCI master). 1 The arbiter parks on the last master granted the bus.	PAPM defines how the internal PCI arbiter handles bus parking.

Preliminary User's Manual

2:1	PTMRCI	PCI Target Memory Read Command Interpretation 00 Memory Read 01 Memory Read Line 10 Memory Read Multiples 11 Reserved	PTMRCI enables the PCI bridge to be forced to treat a PCI memory read as a memory read multiple, or as a memory read line, with respect to the burst size implied by the read commands. This is for masters that use memory read for multiple beat bursts.
0	APLRM	Atomic PLB Line Read Mode 0 1 PLB slave asserts Addrack and begins its data tenure immediately after the PCI master receives the first read data word.	APLRM controls the behavior of the bridge PLB slave with respect to PLB line reads. APLRM must not be set to 1 unless all PCI target devices can guarantee no disconnects for PLB line reads.

17.5.3.27 PLB Slave Error Syndrome Register 0 (PCIC0_PLBBESR0)

PCIC0_PLBBESR0 stores information about errors reported by the PCI bridge PLB slave. There are four groups of errors, one each for PLB masters 0–3. PCIC0_PLBBESR0[MxET] fields (x represents a particular PLB master ID) contain information about the type of error. PCI parity errors set PCIC0_PLBBESR0[MxET] to 0b001. Master and target aborts set PCIC0_PLBBESR0[MxET] to 0b101 (non-configured bank error). The PCIC0_PLBBESR0[MxRWS] fields show whether the transaction causing the error was a read or write.

Each error field can be locked by PCIC0_PLBBESR0[MxFL], which is set by a PLB lock error signal to the bridge PLB slave. If the PCIC0_PLBBESR0[MxFL] field associated with a master is 0, the PLB lock error signal is driven high to the bridge PLB slave, and an error associated with that master occurs. The error is then reported, and PCIC0_PLBBESR0[MxFL] is set. Subsequent errors do not set PCIC0_PLBBESR0 fields for that master until PCIC0_PLBBESR0[MxFL] is cleared. If PCIC0_PLBBESR0[MxFL] = 0, and the PLB lock error signal is low, the error is reported, and PCIC0_PLBBESR0[MxFL] is not set. Additional errors are also reported. Only software can clear PCIC0_PLBBESR0[MxFL].

Writing 1 to a PCIC0_PLBBESR0 field clears the field.

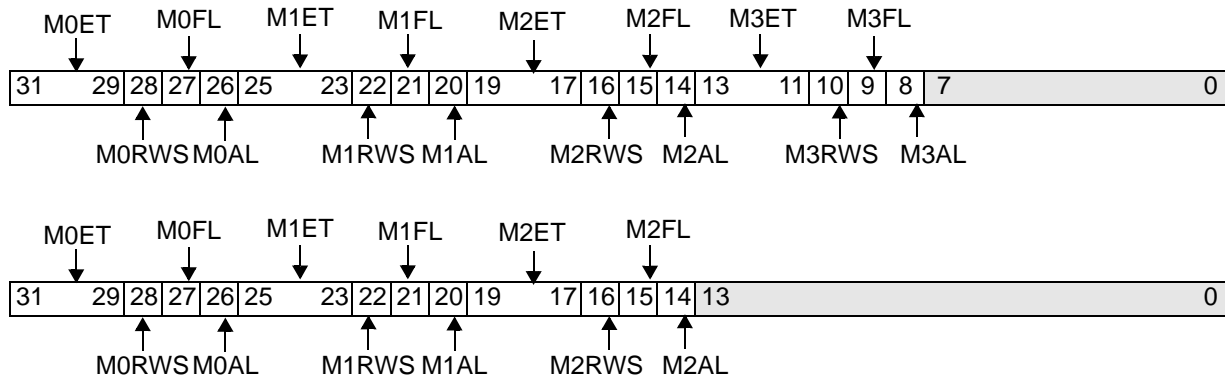

Figure 17-48. PLB Slave Error Syndrome Register 0 (PCIC0_PLBBESR0)

31:29	M0ET	Master 0 Error Type 000 No Error 001 Parity Error 010 Reserved 011 Reserved 100 Reserved 101 Non-configured Bank Error 110 Reserved 111 Reserved
28	M0RWS	Master 0 Read/Write Status 0 Error operation was a write 1 Error operation was a read
27	M0FL	Master 0 PCIC0_PLBBESR0 Field Lock 0 PCIC0_PLBB ESR0 unlocked 1 PCIC0_PLBB ESR0 locked
26	M0AL	Master 0 PCIC0_PLBBEAR Address Lock 0 PCIC0_PLBBEAR unlocked by Master 0 1 PCIC0_PLBBEAR locked by Master 0
25:23	M1ET	Master 1 Error Type See PCIC0_PLBBESR0[M0ET]
22	M1RWS	Master 1 Read/Write Status 0 Error operation was a write 1 Error operation was a read
21	M1FL	Master 1 PCIC0_PLBBESR0 Field Lock 0 PCIC0_PLBB ESR0 unlocked 1 PCIC0_PLBB ESR0 locked
20	M1AL	Master 1 PCIC0_PLBBEAR Address Lock 0 PCIC0_PLBBEAR unlocked by Master 1 1 PCIC0_PLBBEAR locked by Master 1
19:17	M2ET	Master 2 Error Type See PCIC0_PLBBESR0[M0ET]
16	M2RWS	Master 2 Read/Write Status 0 Error operation was a write 1 Error operation was a read

Preliminary User's Manual

15	M2FL	Master 2 PCIC0_PLBBESR0 Field Lock 0 PCIC0_PLBB ESR0 unlocked 1 PCIC0_PLBB ESR0 locked
14	M2AL	Master 2 PCIC0_PLBBEAR Address Lock 0 PCIC0_PLBBEAR unlocked by Master 2 1 PCIC0_PLBBEAR locked by Master 2
13:11	M3ET	Master 3 Error Type See PCIC0_PLBBESR0[M0ET]
10	M3RWS	Master 3 Read/Write Status 0 Error operation was a write 1 Error operation was a read
9	M3FL	Master 3 PCIC0_PLBBESR0 Field Lock 0 PCIC0_PLBBESR0 unlocked 1 PCIC0_PLBBESR0 locked
8	M3AL	Master 3 PCIC0_PLBBEAR Address Lock 0 PCIC0_PLBBEAR Unlocked by Master 2 1 PCIC0_PLBBEAR Locked by Master 2
7:0		Reserved

17.5.3.28 PLB Slave Error Syndrome Register 1 (PCIC0_PLBBESR1)

PCIC0_PLBBESR1 stores information about errors reported by the bridge PLB slave. There are four groups of errors, one each for PLB masters 4–7. See “PLB Slave Error Syndrome Register 0 (PCIC0_PLBBESR0)” on page 17-429 for additional information about the fields of this register.

Only software can clear PCIC0_PLBBESR1[MxFL]. The PCIC0_PLBBESR1[MxAL] fields control the and PCIC0_PLBBESR0 and PCIC0_PLBBESR1 in the same way. Writing a 1 to a field of the PCIC0_PLBBESRx clears the bit.

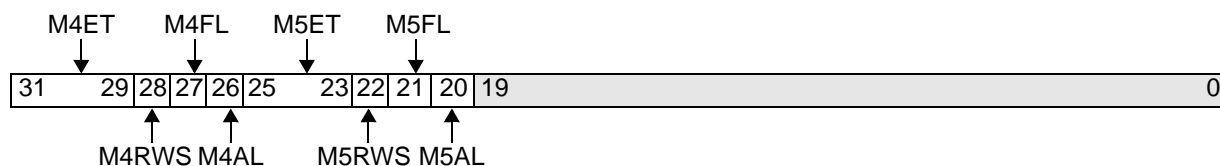
**Figure 17-49. PLB Slave Error Syndrome 1 (PCIC0_PLBBESR1)**

31:29	M4ET	Master 4 Error Type 000 No Error 001 Parity Error 010 Reserved 011 Reserved 100 Reserved 101 Non-configured Bank Error 110 Reserved 111 Reserved
-------	------	--

28	M4RWS	Master 4 Read/Write Status 0 Write error operation 1 Read error operation
27	M4FL	Master 4 PCIC0_PLBBESR1 Field Lock 0 PCIC0_PLBBESR1 unlocked 1 PCIC0_PLBBESR1 locked
26	M4AL	Master 4 PCIC0_PLBBEAR Address Lock 0 PCIC0_PLBBEAR unlocked by Master 4 1 PCIC0_PLBBEAR locked by Master 4
25:23	M5ET	Master 5 Error Type See PCIC0_PLBBESR1[M4ET]
22	M5RWS	Master 5 Read/Write Status 0 Write error operation 1 Read error operation
21	M5FL	Master 5 PCIC0_PLBBESR1 Field Lock 0 PCIC0_PLBBESR1 Unlocked 1 PCIC0_PLBBESR1 Locked
20	M5AL	Master 5 PCIC0_PLBBEAR Address Lock 0 PCIC0_PLBBEAR unlocked by Master 5 1 PCIC0_PLBBEAR locked by Master 5
19:0		Reserved

17.5.3.29 PLB Slave Error Address Register (PCIC0_PLBBEAR)

PCIC0_PLBBEAR contains addresses associated with errors, as indicated by the PLB slave asserting SI_MErr for transactions initiated by the PCI bridge on the PCI bus. PCIC0_PLBBEAR is read-only.

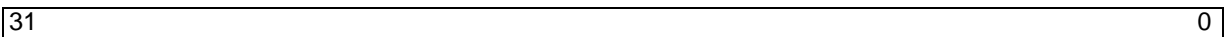
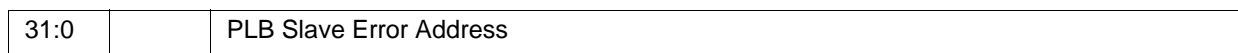
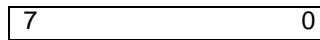

Figure 17-50. PLB Slave Error Address Register (PCIC0_PLBBEAR)



Preliminary User's Manual**17.5.3.30 Capability Identifier (PCIC0_CAPID)**

When PCIC0_CAPID contains 0x01, the PCI bridge supports power management and the data structure currently being pointed to is the PCI power management capability structure.

**Figure 17-51. Capability Identifier (PCIC0_CAPID)**

7:0		PCI Capability Identifier
-----	--	---------------------------

17.5.3.31 Next Item Pointer (PCIC0_NEXTIPTR)

PCIC0_NEXTIPTR describes the location of the next item in the capability list of the function. PCIC0_NEXTIPTR is set to 0x00 to indicate that this is the last item on the capability list.

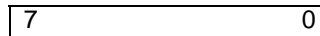
**Figure 17-52. Next Item Pointer (PCIC0_NEXTIPTR)**

7:0		PCI Next Item Pointer
-----	--	-----------------------

17.5.3.32 Power Management Capabilities (PCIC0_PMC)

PCIC0_PMC provides information about the capabilities of the function related to power management. A value of 0x0202 indicates no specific capabilities.

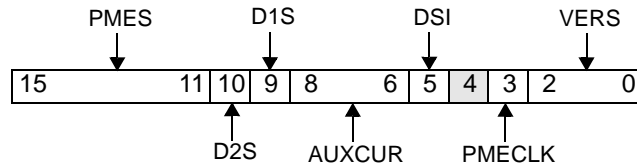

Figure 17-53. Power Management Capabilities Register (PCIC0_PMC)

15:11	PMES	PME Support	The PCI bridge does not support PME#; therefore, PMES is hardwired to 0b00000.
10	D2S	D2 Support Determines if the D2 power management state is supported.	The PCI bridge does not support the D2 power management state; therefore, D2S is hardwired to 0.
9	D1S	D1 Support Determines if the D1 power management state is supported.	The PCI bridge supports the D1 power management state; therefore, D1S is hardwired to 1.
8:6	AUXCUR	Auxiliary Current Support	The PCI bridge does not support Aux_Current; therefore, AUXCUR is hardwired to 0b000.
5	DSI	Device Specific Initialization 0 after reset	This bit indicates whether special initialization of this function is required (beyond the standard PCI configuration header) before the generic class device driver is able to use it.
4		Reserved	Always read as 0.
3	PMECLK		This bit is hardwired to 0 indicating that the function does not support PME# generation in any state.
2:0	VERS		Returns 0b010 on reads, indicating that PMC complies with Revision 1.1 of <i>PCI Power Management Interface Specification</i> .

Preliminary User's Manual**17.5.3.33 Power Management Control/Status Register (PCIC0_PMCSR)**

PCIC0_PMCSR is used to manage the PCI power management state and to enable and monitor PMEs.

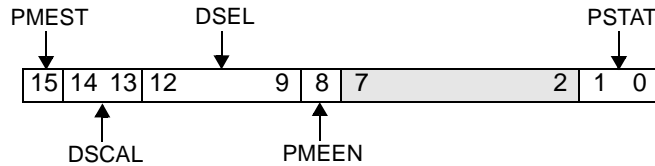

Figure 17-54. Power Management Control/Status Register (PCIC0_PMCSR)

15	PMEST		The PCI bridge does not support PME#; therefore, PMEST is hardwired to 0.
14:13	DSCAL		The PCI bridge does not support data register; therefore, DSCAL is hardwired to 0b00.
12:9	DSEL		The PCI bridge does not support a data register; therefore, DSEL is hardwired to 0b0000.
8	PMEEN		The PCI bridge does not support PME generation; therefore, PMEEN is hardwired to 0.
7:2		Reserved	Returns 0 when read.
1:0	PSTAT	Determine the current power state of a function and sets the function into a new power state. 00 D0 01 D1 10 D2 11 D3 Hot	If software attempts to write a value for an unsupported power state to PSTAT, its value does not change. Writing this field may change PCIC0_PMSCRR.

17.5.3.34 PMCSR PCI-to-PCI Bridge Support Extensions (PCIC0_PMCSRBSE)

PCIC0_PMCSRBSE is required for all PCI-to-PCI bridges. The PCI bridge in not a PCI-to-PCI bridge; therefore, it returns 0 when this register is read.



Figure 17-55. PMCSR PCI to PCI Bridge Support Extensions (PCIC0_PMCSRBSE)

7:0	PCI to PCI Bridge Support Extensions
-----	--------------------------------------

17.5.3.35 PCI Data Register (PCIC0_DATA)

PCIC0_DATA is an optional register that provides a mechanism for the function to report state dependent operating data such as power consumed or heat dissipation. The PCI bridge does not implement this register; therefore, it returns 0 when this register is read.

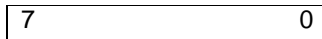

Figure 17-56. PCI Data (PCIC0_DATA)

7:0	PCI Data
-----	----------

Preliminary User's Manual**17.5.3.36 Bridge Options 2 Register (PCIC0_BRDGOPT2)**

PCIC0_BRDGOPT2 controls various operating parameters of the PCI bridge.



Figure 17-57. Bridge Options 2 Register (PCIC0_BRDGOPT2)

15:14		Reserved	
13	EWPCI	External Write to PCI Command Interrupt 0 No write to PCIC0_CMD has occurred. 1 External PCI master has written to PCIC0_CMD.	Software can set or clear this bit. Setting this bit also causes UIC0_SR[PCIIS] to be set.
12	DPR	Drive PCI Reset 0 Normal <u>operation</u> 1 Causes PCIReset pin to be asserted.	Software that asserts this bit must leave it asserted long enough to guarantee the PCI pulse width requirements. DPR does not reset PLB bus interface registers or PCI <u>bridge registers</u> . PCIReset is also asserted when the PCI bridge is reset.
11:8	PSTLTD	Subsequent Target Latency Timer Duration Specifies the number of PCI clocks that a PCI master burst can be held in a wait state before a target disconnect is initiated.	Only set on reads. In synchronous mode, PSTLTD equals the maximum number of PCI clocks to disconnect. In asynchronous mode, PSTLTD plus 3 equals the maximum number of PCI clocks to disconnect. The asynchronous value must be 2 or less.
7:3		Reserved	
2	PDTD	PCI Discard Timer Disable 0 Disabled 1 Enabled	When enabled, the PCI bridge never discards delayed read data.
1		Reserved	
0	HCE	Host Configuration Enable 0 Disabled 1 Enabled	HCE controls host PCI access to the PCI bridge configuration registers. All host attempts to access the PCI bridge PCI configuration registers are retried. This give the local CPU (PLB master) time to initialize them before the host sees them.

In synchronous mode, the PCI subsequent target latency timer duration equals the maximum number of PCI clocks to disconnect. In asynchronous mode, PCI subsequent target latency timer duration plus 3 equals the maximum number of PCI clocks to disconnect. The asynchronous value must be 2 or less.

17.5.3.37 Power Management State Change Request Register (PCIC0_PMSCRR)

PCIC0_PMSCRR provides a method of informing the local processor of a power management state change request and prevents the completion of the write to PCIC0_PMCSR until the local processor indicates it is ready for the state change. All writes to PCIC0_PMCSR are retried until the local processor sets PCIC0_PMSCRR[APW] = 1. PCIC0_PMSCRR is used with the registers in the capability structure for power management. Descriptions of each bit are shown in Figure 17-58.

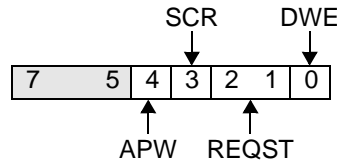

Figure 17-58. Power Management State Change Request Register (PCIC0_PMSCRR)

7:5		Reserved	Always read as 0.
4	APW	Accept PCIC0_PMCSR Writes Always 1 if DWE is 0.	The local processor sets APW when the local processor is ready to change the power management state. APW is cleared when the host configuration writes to the PCIC0_PMCSR register is accepted. The local processor can write 0 to APW.
3	SCR	State Change Request	The PCI bridge sets SCR when a host writes PCIC0_PMCSR to request a power management state change. This drives an interrupt to the local processor informing it of a state change request. The local processor must simultaneously clear SCR and set APW = 1 when the local processor is ready to change the state. After SCR is cleared, new requests are not detected until the outstanding delayed write is accepted. The local processor can set SCR = 1. Note that any host side write to any byte (0x5C–0x5F) is considered a power state change request.
2:1	REQST	Request State	Indicates the new power management state requested by a delayed host write to PCIC0_PMCSR. This field is read-only from the PLB side.

Preliminary User's Manual

0	DWE	Delayed Write Enable 0 Immediate write 1 Delayed write	When DWE is set to 1, any configuration write to the PCIC0_PMCSR is completed as a delayed write. All writes to PCIC0_PMCSR are retried until the local processor sets the "Accept PCIC0_PMCSR Write bit" (bit 4). When 0, any configuration write to the PCIC0_PMCSR is completed immediately. DWE is a don't care if a host write to PCIC0_PMCSR requests a state change from D3hot to D0.
---	-----	--	--

17.6 Error Handling

The PCI bridge detects and reports several types of errors, which are reported to the PLB or the PCI. Status information is saved in the configuration registers to enable error type determination.

All errors are associated with either a cycle on the PLB or a cycle on the PCI bus.

Each error that can be detected is associated with a mask. If the mask is set, detection of that error condition is disabled. There are also masks for the PCISErr, PCIPErr, and PLB bus error signals that prevent reporting of any error by these signals. The masks do not prevent error detection.

The error types are as follows:

- PLB unsupported transfer type
- PCI master abort generated (while PCI master)
- PCI target abort received (while PCI master)
- PCI target data bus parity error detection
- PCI master data bus parity error detection
- PCI target address parity error detection
- PLB bus error detection

The following sections describe in detail how these errors are generated, what actions are taken for each, and how to reset a given error.

17.6.1 PLB Unsupported Transfer Type

This error occurs when the bridge PLB slave encounters an unsupported PLB transfer type. Table 17-11 outlines transfers not supported by the bridge PLB slave.

Table 17-11. PLB Unsupported Transfer Types

PLB Transaction	PCI Address Space
4- and 8-word line read/write	Nonmemory
16-word line read/write	Any
Burst	Nonmemory

Upon detection of this error, the bridge sets PCIC0_ERRSTS[PUR] = 1.

17.6.2 PCI Master Abort

This error is generated by the bridge PCI master when no target responds with $\overline{\text{PCIDevSel}}$ within the required time-out window and error detection is enabled. The bridge PLB slave may assert a PLB bus error signal on the PLB in response to this error, as explained below.

Two masks are associated with a PCI master abort. $\text{PCIC0_ERREN}[\text{MAEE}]$ masks error reporting. If the error is detected, a PLB bus error signal is asserted if $\text{PCIC0_ERREN}[\text{MAEE}] = 1$. For reads, the bridge PLB slave still completes the transfer on the PLB, but drives 1s on the read data bus and the appropriate PLB bus error signal for each data beat. For posted writes, a PLB bus error is asserted for 1 cycle, asynchronously to the corresponding write data beat on the PLB. For connected writes, a PLB bus error signal is asserted with the data transfer, and the data is discarded. If $\text{PCIC0_ERREN}[\text{MAEE}] = 0$, error reporting is masked. No PLB bus error signal is asserted, regardless of the setting of $\text{PCIC0_ERREN}[\text{MEAE}]$.

The following status bits are set:

1. If a master abort is signalled, $\text{PCIC0_STATUS}[\text{RMA}] = 1$. Setting of this field is non-maskable. Writing a 1 to $\text{PCIC0_STATUS}[\text{RMA}]$ resets the field.
2. If master abort is detected as an error, $\text{PCIC0_ERRS}[\text{MEAE}]$ is set to 1 to indicate an event that would cause a PLB bus error to be asserted by the bridge PLB slave, regardless of the setting of $\text{PCIC0_ERREN}[\text{MEAE}]$. This field can be reset by writing a 1 to $\text{PCIC0_ERREN}[\text{MEAE}]$.
3. PCIC0_PLBBEAR and PCIC0_PLBBESRx are updated as follows:

The address of the aborted request is saved in PCIC0_PLBBEAR if all $\text{PCIC0_PLBBESRx}[\text{MxAL}] = 0$ (PCIC0_PLBBEAR is unlocked). If all $\text{PCIC0_PLBBESRx}[\text{MxFL}] = 0$, $\text{PCIC0_PLBBESRx}[\text{MxET}] = 0b101$ to indicate a non-configured bank error; and $\text{PCIC0_PLBBESRx}[\text{MxRWS}]$ is set to 0 on a write, 1 on a read. If $\text{PCIC0_ERREN}[\text{MAEE}] = 0$ or $\text{PCIC0_ERREN}[\text{MEAE}] = 0$, no PCIC0_PLBBEAR or PCIC0_PLBBESRx update is performed.

17.6.3 Bridge PCI Master Receives Target Abort While PCI Bus Master

This error is generated when the bridge PCI master receives a target abort while mastering a cycle on the PCI bus. Upon detection of this error, the bridge PLB slave may assert a PLB bus error signal on the PLB in response to this error, as explained below.

Two masks are associated with a target abort. $\text{PCIC0_ERREN}[\text{TAE}]$ masks error reporting. If the error is detected, a PLB bus error signal is asserted if $\text{PCIC0_ERREN}[\text{TAE}] = 1$. For reads, the bridge PLB slave still completes the transfer on the PLB and drives the appropriate PLB bus error line for each data beat (note that for line reads, a PLB bus error signal is asserted for all data beats). For posted writes, if $\text{PCIC0_ERREN}[\text{TAE}] = 1$, the bridge PLB slave asserts a PLB bus error for 1 cycle, asynchronously to the corresponding write data beat on the PLB. For connected writes, a PLB bus error signal is asserted with the data transfer, and the data is discarded. If $\text{PCIC0_ERREN}[\text{TAE}] = 0$, error reporting is masked. No PLB bus error signal is asserted, regardless of the setting of $\text{PCIC0_ERREN}[\text{MEAE}]$. If prefetching is occurring when a target abort is received, data preceding the target abort is kept in a prefetch buffer.

The following status bits are set:

1. If a target abort is received, $\text{PCIC0_STATUS}[\text{RTA}] = 1$. Setting this field is non-maskable. Writing a 1 to $\text{PCIC0_STATUS}[\text{RTA}]$ clears the field.
2. If a target abort is detected as an error, $\text{PCIC0_ERRSTS}[\text{MEAE}] = 1$ to indicate an event that would cause the bridge PLB slave to assert a PLB bus error signal, regardless of the setting of $\text{PCIC0_ERREN}[\text{MEAE}]$. Writing a 1 to $\text{PCIC0_ERRSTS}[\text{MEAE}]$ resets the field.

Preliminary User's Manual

3. PCIC0_PLBBEAR and PCIC0_PLBBESRx are updated as follows:

The address of the aborted request is saved in PCIC0_PLBBEAR if all PCIC0_PLBBESRx[MxAL] = 1 (PCIC0_PLBBEAR is unlocked). If all PCIC0_PLBBESRx[MxFL] = 1, PCIC0_PLBBESRx[MxET] = 0b101 to indicate a nonconfigured bank error, and PCIC0_PLBBESRx[MxRWS] is set to 0 on a write, or to 1 on a read. If PCIC0_ERREN[MAEE] = 0 or PCIC0_ERREN[MEAE] = 0, no PCIC0_PLBBEAR or PCIC0_PLBBESRx update is performed.

17.6.4 PCI Target Data Bus Parity Error Detection

This error is generated when the bridge PCI target detects a data bus parity error on write data from a PCI master doing a write cycle to PLB memory. PCI uses even parity.

Setting PCIC0_CMD[PER] = 0 masks this error.

The following status bits are set:

1. PCIC0_STATUS[DEPE] = 1 to indicate a PCI bus parity error. Setting this field is non-maskable. Writing a 1 to PCIC0_STATUS[DEPE] clears the field.
2. PCIC0_STATUS[SSE] = 1 if PCIC0_ERREN[WDPE] = 1. Writing a 1 to PCIC0_STATUS[SSE] clears the field.
3. PCIC0_ERRSTS[WDPE] = 1 if PCIC0_ERREN[WDPE] = 1. Writing a 1 to PCIC0_ERRSTS[WDPE] clears the field.

17.6.5 PCI Master Data Bus Parity Error Detection

This error is generated when a data bus parity error is detected on the PCI bus during a cycle mastered by the bridge PCI master. The bridge PCI master checks parity on read cycles and samples PCIPErr on write cycles. The bridge PCI master may assert PCIPErr if the master detects a parity error on a read. PCI uses even parity.

Setting PCIC0_CMD[PER] = 0 masks this error. PCIC0_STATUS[DEPE] = 1. If a parity error is detected, writing a 1 to PCIC0_STATUS[DEPE] = 1 clears the field.

If PCIC0_ERREN[MEAE] = 1 and the error is detected as described, the PLB slave asserts a PLB error signal on the PLB in response to the error. For reads, a PLB bus error is asserted for each data beat in which bad parity was detected. For writes, a PLB bus error is asserted for each data beat in which bad parity was detected, but asynchronously to the actual transfer of write data on the PLB.

The following status bits are set:

1. PCIC0_STATUS[DEPE] = 1 if the bridge PCI master detects bad parity on read data, regardless of the state of PCIC0_CMD[PER]. Writing a 1 to PCIC0_STATUS[DEPE] clears the field.
2. If a data bus parity error is detected as an error, PCIC0_ERRSTS[MEAE] = 1 to indicate an event that would cause a PLB bus error signal to be asserted by the bridge PLB slave, regardless of the state of PCIC0_ERREN[MEAE]. Writing a 1 to PCIC0_ERRSTS[MEAE] = 1 clears the field.
3. PCIC0_PLBBEAR and the PCIC0_PLBBESRx are updated as follows:

The address of the PCI transaction where parity errors occurred is saved in the PCIC0_PLBBEAR. PCIC0_PLBBEAR is set if all PCIC0_PLBBESRx[MxAL] = 1 (PCIC0_PLBBEAR is unlocked). If PCIC0_PLBBESRx[MxFL] = 1, PCIC0_PLBBESRx[MxET] = 0b001 to indicate a parity error, and PCIC0_PLBBESRx[MxRWS] is set to 0 on a write, 1 on a read. If PCIC0_CMD[PER] = 0 or PCIC0_ERRSTS[MEAE] = 0, no PCIC0_PLBBEAR or PCIC0_PLBBESRx update is performed.

Note: For clock ratios greater than 2:1 (independent of asynchronous/synchronous mode), the PCI bridge detects errors but does not assert a PLB bus error signal or log the error in PCIC0_PLBBEAR, PCIC0_PLBBESRx, and PCIC0_ERRSTS[MEAE].

17.6.6 PCI Address Bus Parity Error While PCI Target

This error occurs when a PCI address bus parity error is detected during the address phase of a cycle in which the bridge is the PCI target. PCI uses even parity.

Setting PCIC0_CMD[PER] = 0 masks this error. This error does not have an explicit status bit, however the following actions are taken:

1. PCIC0_STATUS[SSE] = 1 to indicate assertion of $\overline{\text{PCISErr}}$, if the mask at PCIC0_CMD[SE] = 1. Writing a 1 to PCIC0_STATUS[SSE] clears the field.
2. PCIC0_STATUS[DEPE] = 1 to indicate a PCI bus parity error, regardless of the state of PCIC0_CMD[PER]. PCIC0_STATUS[DEPE] = 1 when any type of PCI parity error is detected. Writing a 1 to PCIC0_STATUS[DEPE] clears the field.

17.6.7 PLB Master Bus Error Detection

This error occurs when the bridge PLB master detects a PLB bus error. If the bridge PLB master receives a PLB bus error while mastering a read, the master associates the error with the currently executing read. If the master receives a PLB bus error while mastering a write or while idle, the master associates the error with a write.

PLB bus error detection is masked by PCIC0_ERREN[MEDE] = 0. If PCIC0_ERREN[MEDE] = 1, PLB bus error detection is enabled.

PCIC0_ERREN[MERE] controls the response of the bridge PCI target to PLB bus error detection. If PCIC0_ERREN[MERE] = 10 or 11, the bridge PCI target will execute a target abort. If PCIC0_ERREN[MERE] = 01 or 11, the bridge PCI target asserts $\overline{\text{PCISErr}}$ and allows the transaction to continue. If PCIC0_ERREN[MERE] = 11, the bridge PCI target both target aborts and asserts $\overline{\text{PCISErr}}$.

The following status bits are set:

1. If the bridge PCI target executes a target abort, PCIC0_STATUS[STA] = 1. The setting of PCIC0_STATUS[STA] in such an event is non-maskable. Writing a 1 to PCIC0_STATUS[STA] clears the field.
2. If the bridge PCI target asserts $\overline{\text{PCISErr}}$, PCIC0_STATUS[SSE] = 1. The setting of PCIC0_STATUS[SSE] is non-maskable. Writing a 1 to PCIC0_STATUS[SSE] clears the field.
3. If the bridge PCI target asserts $\overline{\text{PCISErr}}$, PCIC0_ERRSTS[SARME] = 1 to indicate that the bridge PCI target asserted $\overline{\text{PCISErr}}$ in response to a received PLB bus error signal. The setting of PCIC0_ERRSTS[SARME] is non-maskable. Writing a 1 to PCIC0_ERRSTS[SARME] clears the field.
4. PCIC0_ERRSTS[MED] = 1 to indicate that the bridge PLB master received a PLB bus error signal. Setting of PCIC0_ERRSTS[MED] is non-maskable. Writing a 1 to PCIC0_ERRSTS[MED] clears the field.

Preliminary User's Manual

17.7 PCI Bridge Clocking Configuration

See “PCI Clocking” on page 7-189 for detailed information regarding the choice and setup involved with both synchronous and asynchronous PCI clocking modes.

17.8 PCI Power Management Interface

The PCI bridge supports *PCI Power Management Interface Specification* Revision 1.1 (PCI-PM).

17.8.1 Capabilities and Power Management Status and Control Registers

The PCI bridge has a capabilities structure in the PCI configuration space that indicates that the PCI bridge core is PCI Power Management capable. The capabilities structure includes the following registers:

- PCIC0_CAPID, value 0x01, indicates Power Management
- PCIC0_NEXTIPTR, points to next capabilities structure
- PCIC0_PMC, value 0x0202, indicates no specific capabilities
- PCIC0_PMCSR, indicates hold the current PowerState
- PCIC0_PMCSR_BSE, value 0x00, unused in PCI-to-PCI bridge
- PCIC0_Data, value 0x00, not used
- See “PCI Configuration Registers” on page 17-413 for details.

17.8.2 Power State Control

The current power management state is reported by reading PCIC0_PMCSR. The PCI bridge supports states D0, D1, D3hot, and D3cold. State D2 is not supported. When the state is not D0, the PCI bridge is masked from being a master or a memory or I/O target on the PCI bus. The PCI bridge can still be a config target. Thus, accesses claimed by the PCI bridge when in state D0 are no longer claimed, resulting in master aborts on the PLB or PCI if such an access is attempted. Note that this mask is independent of the state of the PCI Command register.

17.8.3 Changing Power States

The PCI bridge has two registers that control changing the power state. The host requests a change in the power state by writing to the PCIC0_PMCSR. The other register is PCIC0_PMSCRR, which provides a method of informing the local processor of a state change request and of preventing completion of the write to the PCIC0_PMCSR until the local processor indicates that it is ready for the state change.

Power state changes are handled as follows:

- If a host write to PCIC0_PMCSR requests an unsupported state change (such as a change to D2), the write is accepted but is ignored (no state change occurs).
- If a host write to PCIC0_PMCSR requests a change from D3hot to D0, the write is accepted. Then, the PCI bridge asserts the power management reset signal, which causes the entire SOC to be reset.

Note: The PCI bridge assumes that any requested state change from D3hot is always to D0.

- All other change requests are handled with the following sequence:

- 1.The host requests a new power state by a PCI write to the PCIC0_PMCSR.
- 2.The host PCI write is retried (unless PCIC0_PMSCRR[DWE] = 0).
- 3.The host PCI write (retried or not) sets PCIC0_PMSCRR[SCR] = 1, which drives an interrupt to the local processor.
- 4.The local processor recognizes the interrupt. The local processor checks PCIC0_PMSCRR[SCR, REQST] to determine the nature of the request.
- 5.The local processor proceeds to power down the subsystem if the requested state is valid.
- 6.When the subsystem has been powered down and is ready to change state, the local processor clears the PCIC0_PMSCRR[SCR] and sets PCIC0_PMSCRR[APW] = 1.
- 7.When the host PCI write reoccurs:
 - It is accepted.
 - PCIC0_PMCSR is updated (only if the transition is valid).
 - PCIC0_PMSCRR[APW] = 0, unless PCIC0_PMSCRR[DWE] = 0, in which case PCIC0_PMSCRR[APW] = 1 always.
 - The PCI bridge enters a new power state.

The PCI bridge operates with the clock power management (CPM) logic to enable the bridge to be put into sleep mode under control of software. See Chapter 13, “Clock and Power Management” for discussion of the CPM function.

17.9 PCI Bridge Reset and Initialization

The following sections discuss resetting and initializing the PCI bridge.

17.9.1 Address Map Initialization

When the PCI bridge is the PCI master, it can generate memory, I/O, configuration, interrupt acknowledge, and special cycles. The method of cycle generation, and the associated address ranges, are fixed, except for memory cycles. PCI memory cycles are generated when the PCI bridge detects a cycle in one of three specified PLB address ranges. The sizes and address spaces of these ranges are specified using the PMM registers. Also, the address of the resulting PCI memory cycle can be an offset from the PLB address (address translation occurs). This translation is also specified in the PMM registers. The PMM registers *do not* default to usable values following reset; they must be initialized before attempting to generate PCI memory cycles.

When the PCI bridge is a target on the PCI bus, the PCI bridge can respond to memory cycles. The memory cycle address ranges that the PCI bridge responds to are specified in PCIC0_PTM1BAR and PCIC0_PTM2BAR. These registers are typically initialized as part of the standard PCI initialization process.

Figure 17-59 shows the desired address map. System memory resides from 0x00000000–0x0FFF FFFF in the CPU/PLB address space, which is accessible from the PCI in the same address space (PCI bridge as a memory target) as defined by PTM1/BAR1. PTM2/BAR2 is disabled in this example. The CPU/PLB master has two spaces in which to access PCI Memory space. Range 0 is 0x20000000 to 0x27FFFFFFF and is mapped to the same address on the PCI bus, and is nonprefetchable. Range 1 is 0x28000000 to 0x2BFFFFFFF, and is translated to address range 0x30000000 to 0x33FFFFFFF of PCI memory space. Range 2 is disabled.

Preliminary User's Manual

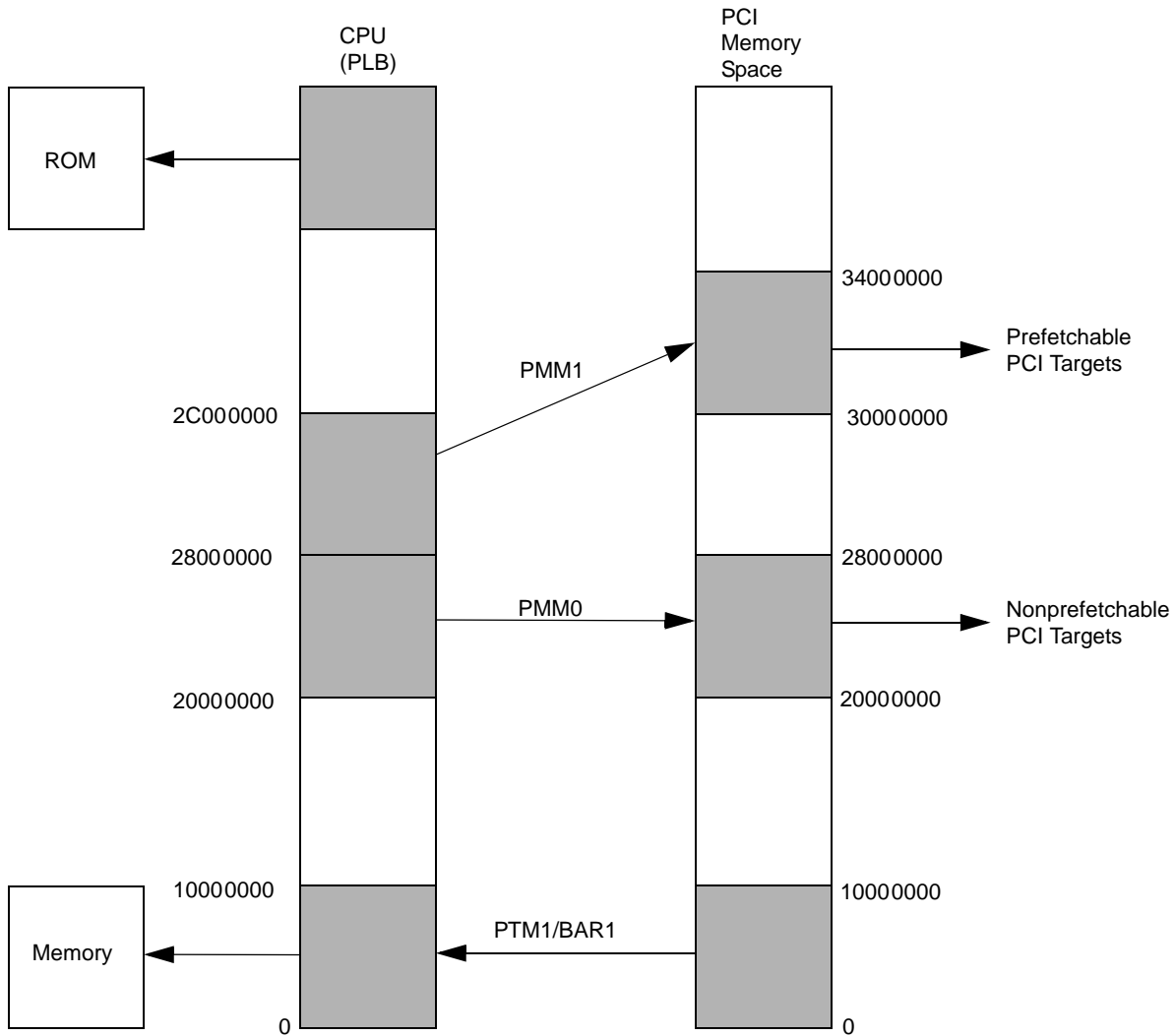

Figure 17-59. Example Address Map

The following register values provide the address map shown in Figure 17-59:

Table 17-12. Address Map Register Values

Register Name	Value	Comments
PCIL0_PMM0LA	0x20000000	
PCIL0_PMM0MA	0xF8000001	128MB; enabled; read prefetching not allowed.
PCIL0_PMM0PCILA	0x20000000	
PCIL0_PMM0PCIHA	0x00000000	
PCIL0_PMM1LA	0x28000000	
PCIL0_PMM1MA	0xFC000003	64MB; enabled; prefetching allowed.
PCIL0_PMM1PCILA	0x30000000	
PCIL0_PMM1PCIHA	0x00000000	

Table 17-12. Address Map Register Values (continued)

Register Name	Value	Comments
PCIL0_PMM2LA	0x00000000	
PCIL0_PMM2MA	0x00000000	Not enabled.
PCIL0_PMM2PCILA	0x00000000	
PCIL0_PMM2PCIHA	0x00000000	
PCIL0_PTM1MSr	0xF0000001	256MB; enabled.
PCIL0_PTM1LA	0x00000000	
PCIL0_PTM2MS	0x00000000	Not enabled.
PCIL0_PTM2LA	0x00000000	
PCIC0_PTM1BAR	0x00000008	PCI memory space; address decode starts at PCI address 0x0000 0000.
PCIC0_PTM2BAR	0x00000000	

17.9.2 Other Configuration Register Initialization

Additional register initialization is required, as follows:

- Error handling is initially disabled (error detection is masked). If error handling is to be enabled, PCIC0_ERREN must be initialized appropriately.
- PCIC0_BRDGOPT1 contains options for controlling the PLB. Its default values can be used.
- PCIC0_BRDGOPT2 contains options for controlling the PCI bus. Its default values assume that the PCI is run synchronously to the PLB, and that the PCI bridge is the primary host bridge. If the PCI bridge is used otherwise, the values must be changed accordingly.

Note: PCI devices that are targets and support delayed reads may be attached to the PCI bus. To ensure that the PPC405GP does not deadlock when accessing such devices, the PLB priority of the PCI and of all the PLB masters that access PCI space must be set to the same value, and the arbitration mode within the PLB arbiter must be set to fair mode. Since the processor data cache unit has dynamic PLB priority, the higher priority value of the DCU must be the same as the PCI. For additional information on setting PLB priorities see “PLB Master Assignments” on page 2-64.

Preliminary User's Manual

17.9.3 Target Bridge Initialization

The PCI bridge can also respond as a configuration target; however, the PCI bridge only responds as a configuration target when the PCIIDSel pin is attached, rather than pulled inactive. Note that if the size and local address of these ranges are not strapped to desired values at reset, the local CPU must specify them by setting the PTM Memory Size and Local Address registers before initializing PCIC0_PTM1BAR and PCIC0_PTM2BAR.

The local CPU must update the following registers (if the default value is not suitable or they were not strapped to appropriate values at reset) before setting the Host Config Enable bit:

- The address map registers (see “Address Map Initialization” on page 17-444)
- PCIC0_VENDID
- PCIC0_DEVID
- PCIC0_REVID
- PCIC0_CLS
- PCIC0_SBSYSID
- PCIC0_SBSYSVID

17.9.4 Local Processor Boot from PCI Memory

The PCI bridge has a mode that enables a PLB master to access a PCI memory range without initial configuration cycles. This mode is enabled when CPC0_PSR[RL] = 1. System designers can use this mode to enable a processor to access a boot ROM in PCI memory space.

The PCI bridge comes out of reset with PMM0 enabled and programmed for the address range, 0xFFFFE0000–0xFFFFFFFF. Also, PCIC0_CMD[ME] = 1 after reset. Note that enabling PCI boot mode does not prevent subsequent updates to the PMM0 registers.

Note: The PPC405GP allows booting from PCI memory. See Chapter 9, “Pin Strapping and Sharing” for more information.

17.9.5 Type 0 Configuration Cycles for Other Devices

Twenty-one devices can be accessed using the PCIIDSel mechanism. The PCI master asserts 1 bit of AD(31:11) for type 0 configuration cycles based on the value in the Device Number field. The mapping is as follows:

- If device number is 1, AD(11) is asserted
- If device number is 2, AD(12) is asserted
- .
- .
- .
- If device number is 21, AD(31) is asserted

If device number contains a value of 22–31, no bit of AD(31:11) is asserted.

17.10 Timing Diagrams

This section contains timing diagrams of several different PCI bridge operations. The following paragraphs describe each diagram in detail. Each description assumes basic knowledge of PCI and PLB protocols.

Each operation is shown in both synchronous and asynchronous modes. The PCI is clocked at 33 MHz in synchronous mode and 66 MHz in asynchronous mode. The PLB is clocked at 100 MHz in all cases.

The SDRAM uses a 32-bit, PC100 memory interface configured for $\overline{\text{CAS}}$ latency of 2, command leadoff of 2, and RAS to CAS delay (T_{rcd}) of 2. All memory accesses are page idle, unless indicated otherwise.

Note: The PLB signals shown in the following timing diagrams are not externally accessible. They are included for information purposes and as an aid to understanding the PCI operations. For more information on these signals, refer to *Processor Local Bus Architecture Specifications*.

17.10.1 PCI Timing Diagram Descriptions

The following sections briefly describe each of the timing diagrams that follow the descriptions. Each description covers both the asynchronous and synchronous clocking modes for that operation. The timing diagrams then follow with all of the asynchronous diagrams grouped together followed by all of the synchronous diagrams grouped together.

17.10.1.1 PCI Master Burst Read From SDRAM

Figure 17-60 (asynchronous) and Figure 17-67 (synchronous) show a PCI Master executing a 128-byte Read Multiple from SDRAM. PCI bridge retries the initial request and performs a delayed read. PCI bridge executes a variable-length, doubleword read burst on PLB to SDRAM, filling its 96-byte read buffer. The read is a page hit. When the PCI master re-requests its read, PCI bridge begins bursting out of its read buffer, while continuing to prefetch from SDRAM.

17.10.1.2 PCI Master Burst Write To SDRAM

Figure 17-61 and Figure 17-68 show a PCI Master executing a 128-byte Write to SDRAM. PCI bridge accepts several beats of data into its 64-byte write buffer before executing variable-length, doubleword write bursts on PLB to SDRAM. The final write burst is fixed-length, since the PCI write has completed, and PCI bridge knows the exact burst length.

17.10.1.3 CPU Read From PCI Memory Slave, Nonprefetching

In Figure 17-62 and Figure 17-69, a PLB Master (CPU) executes a single-beat 64-bit read from a region of PCI memory marked as nonprefetchable. PCI bridge responds as a 32-bit PLB slave, so the CPU executes conversion cycles for each read. PCI bridge executes a single-beat PCI read for both PLB read requests.

17.10.1.4 CPU Read From PCI Memory Slave, Prefetching

In Figure 17-63 and Figure 17-70, a PLB Master (CPU) executes 8, 64-bit, single-beat reads from a region of PCI memory marked as prefetchable. The first PLB read causes PCI bridge to execute a 64-byte Read Multiple to fill its 64-byte read prefetch buffer. The data for subsequent PLB reads is provided from the read buffer and no PCI cycles are generated. PCI bridge responds as a 32-bit PLB slave, so the CPU executes conversion cycles for each read.

Preliminary User's Manual

17.10.1.5 CPU Write To PCI Memory Slave

Figure 17-64 and Figure 17-71 show a PLB Master (CPU) executing 4, 64-bit, single-beat writes to PCI memory. PCI bridge responds as a 32-bit slave, so the CPU executes conversion cycles for each write. PCI bridge posts the writes in its 4-entry write buffer, and executes a PCI single-beat Memory Write for each request.

17.10.1.6 PCI Memory To SDRAM DMA Transfer

Figure 17-65 and Figure 17-72 show a DMA transfer of data from PCI memory to SDRAM. The DMA PLB Master executes a 4-doubleword read burst to PCI bridge followed by a 4-doubleword write burst to SDRAM. For the read, PCI bridge executes a 32-byte PCI Read Line.

17.10.1.7 SDRAM To PCI Memory DMA Transfer

Figure 17-66 and Figure 17-73 show a DMA transfer of data from SDRAM to PCI memory. The DMA PLB Master executes a 4-doubleword read burst from SDRAM followed by a 4-doubleword write burst to PCI memory. PCI bridge then executes a 32-byte write on the PCI bus.

17.10.2 Asynchronous

The following diagrams are for asynchronous clocking mode. Note that all of the diagrams flow across multiple pages. Each diagram begins with cycle 1 on the left facing page.

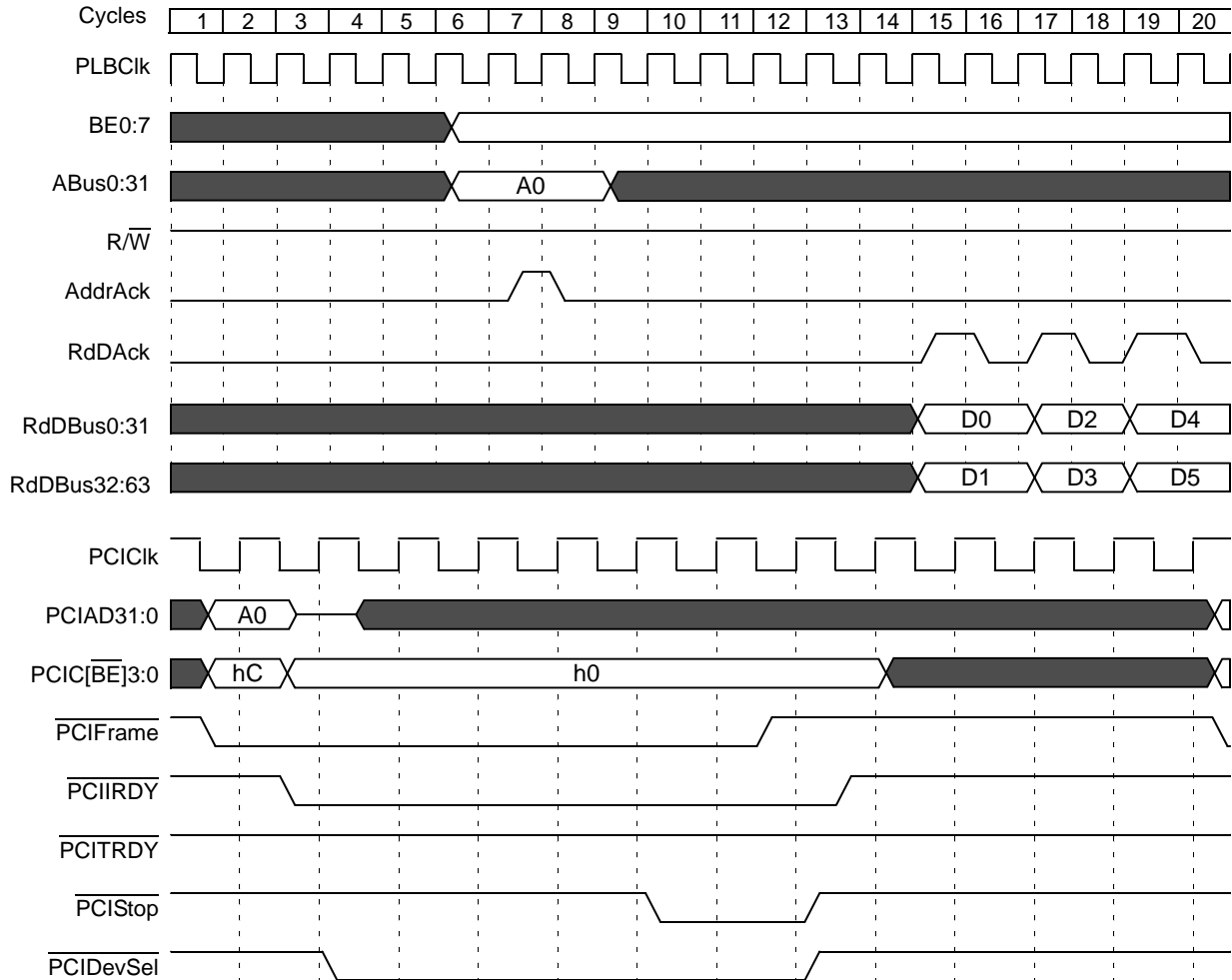

Figure 17-60. PCI Master Burst Read From SDRAM

Preliminary User's Manual

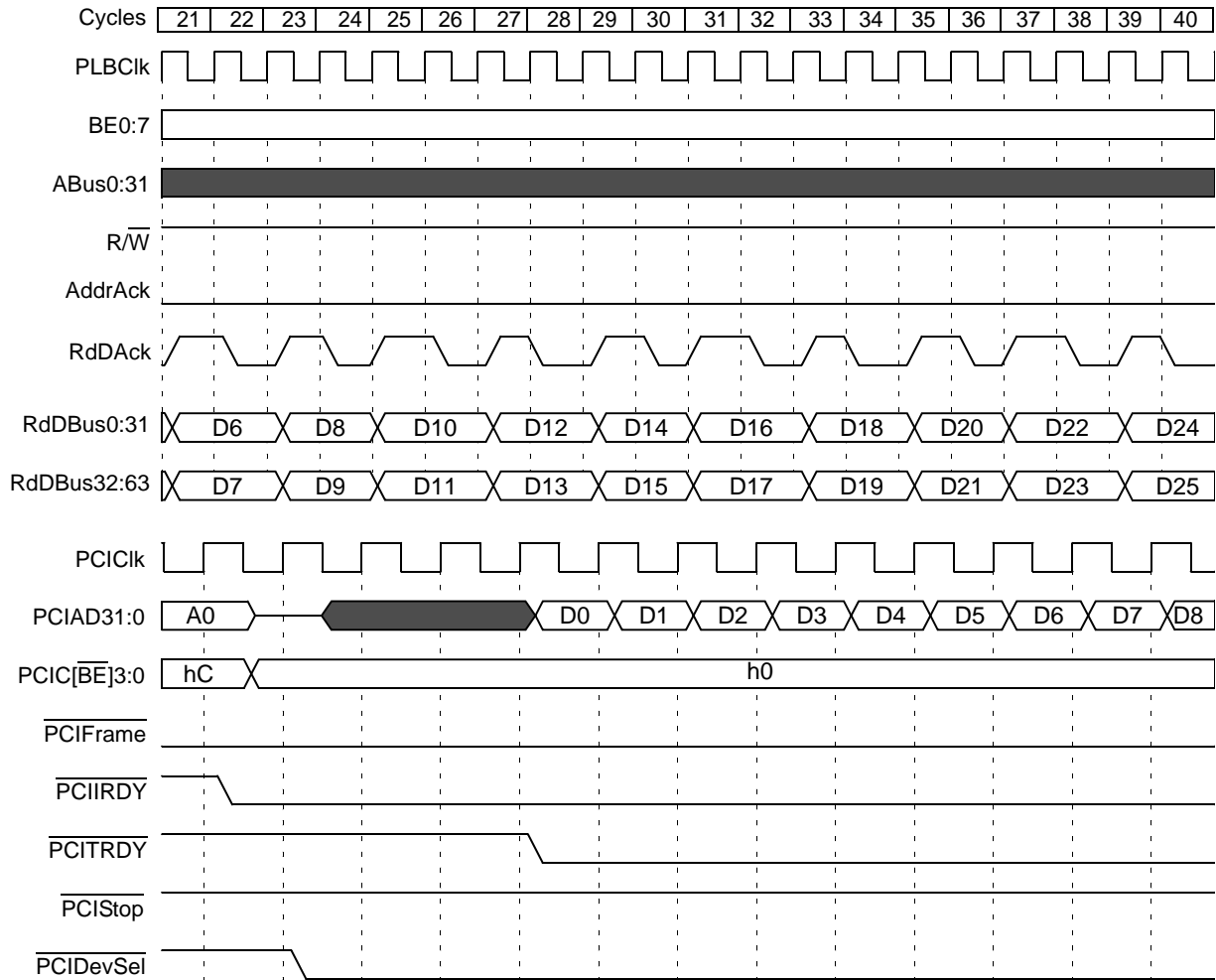

Figure 17-60. PCI Master Burst Read From SDRAM (Continued)

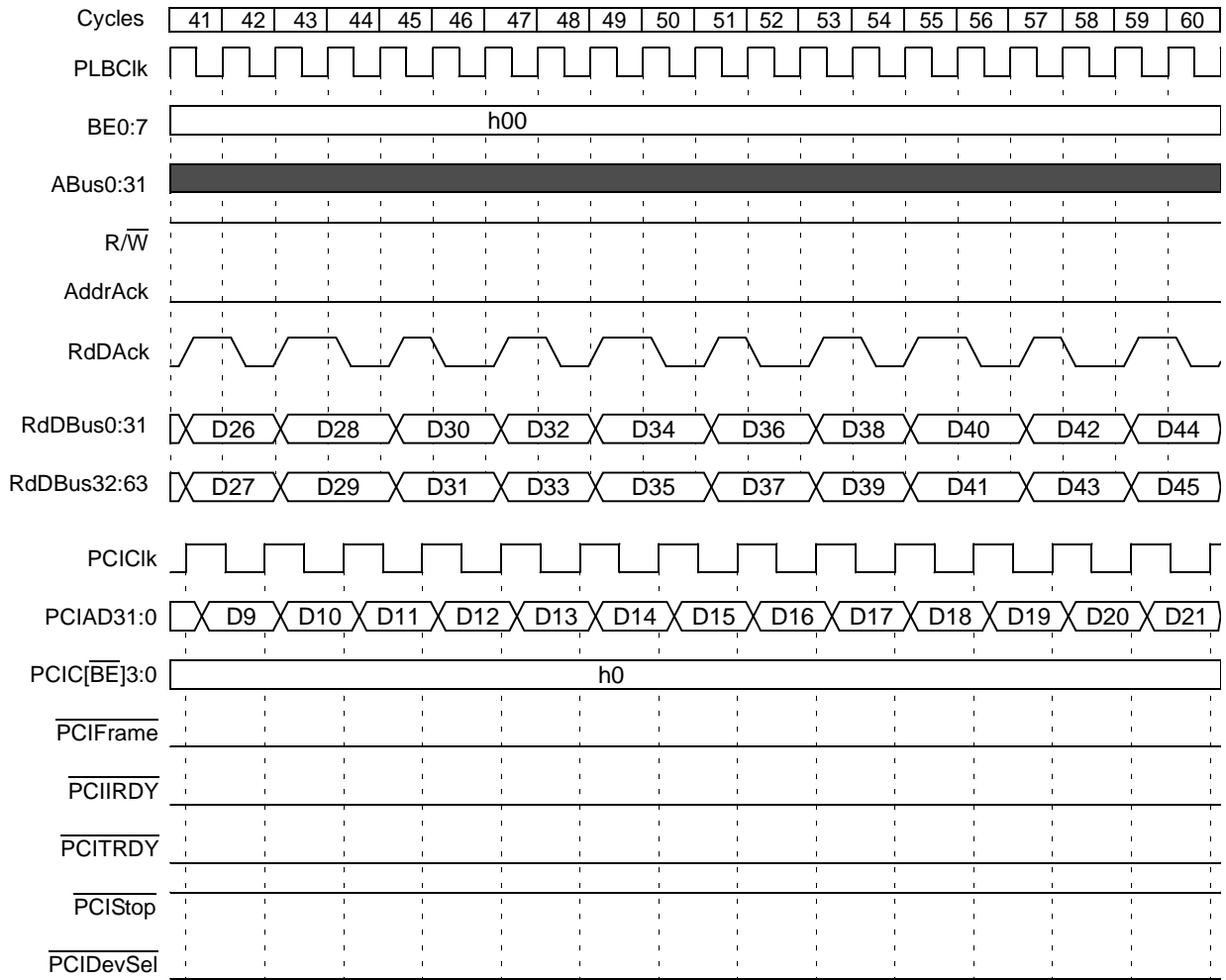

Figure 17-60. PCI Master Burst Read From SDRAM (Continued)

Preliminary User's Manual

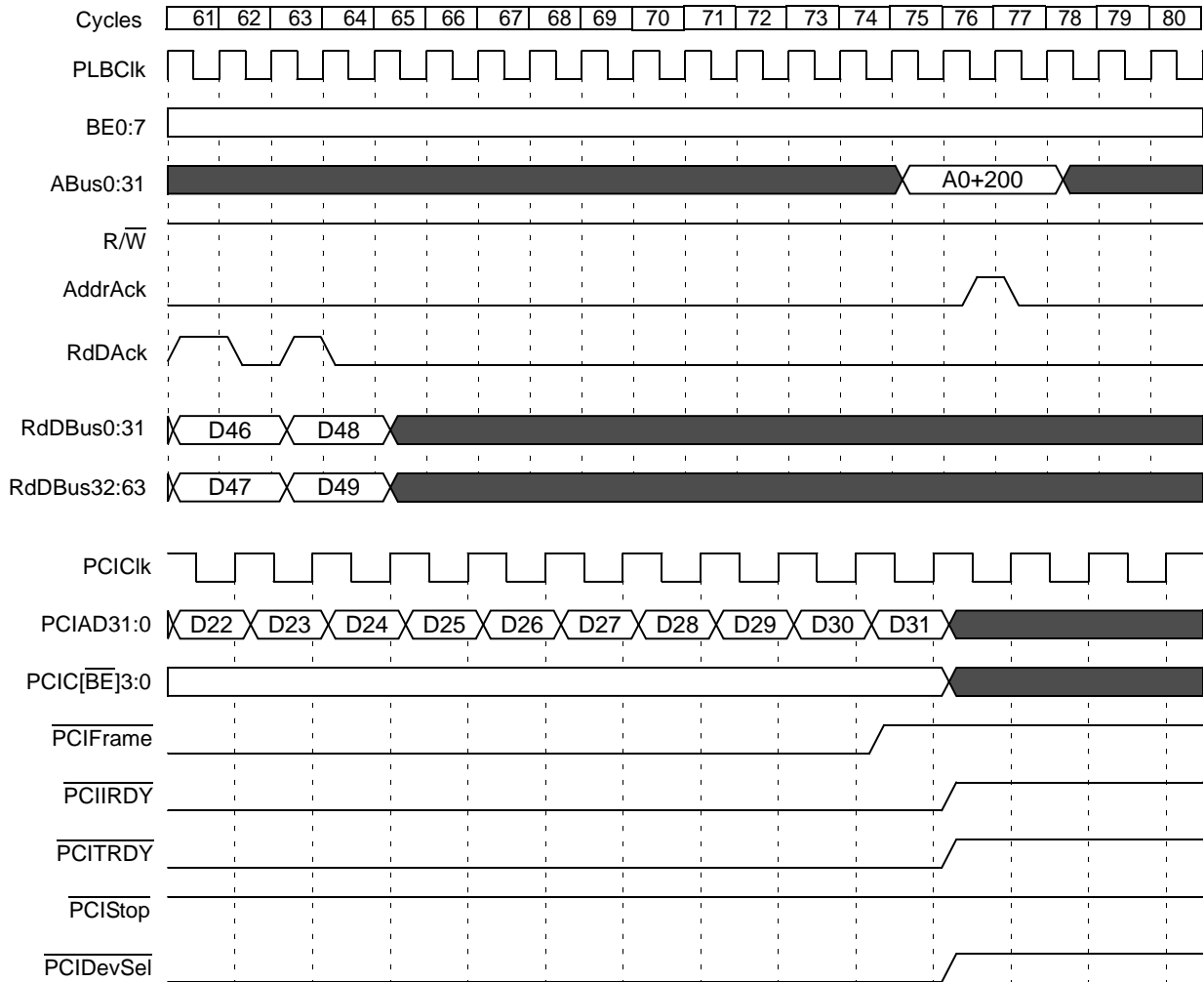

Figure 17-60. PCI Master Burst Read From SDRAM (Continued)

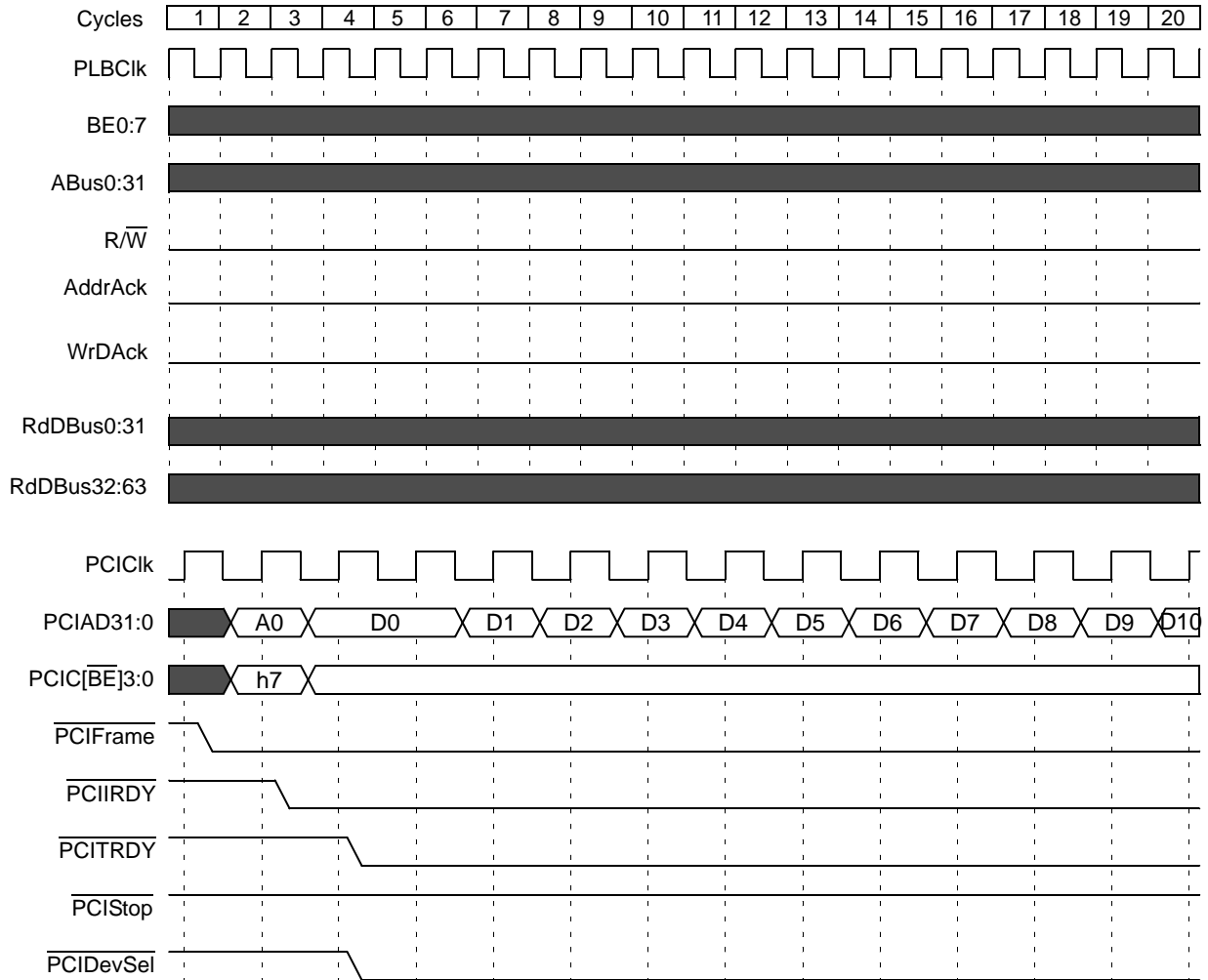

Figure 17-61. PCI Master Burst Write To SDRAM

Preliminary User's Manual

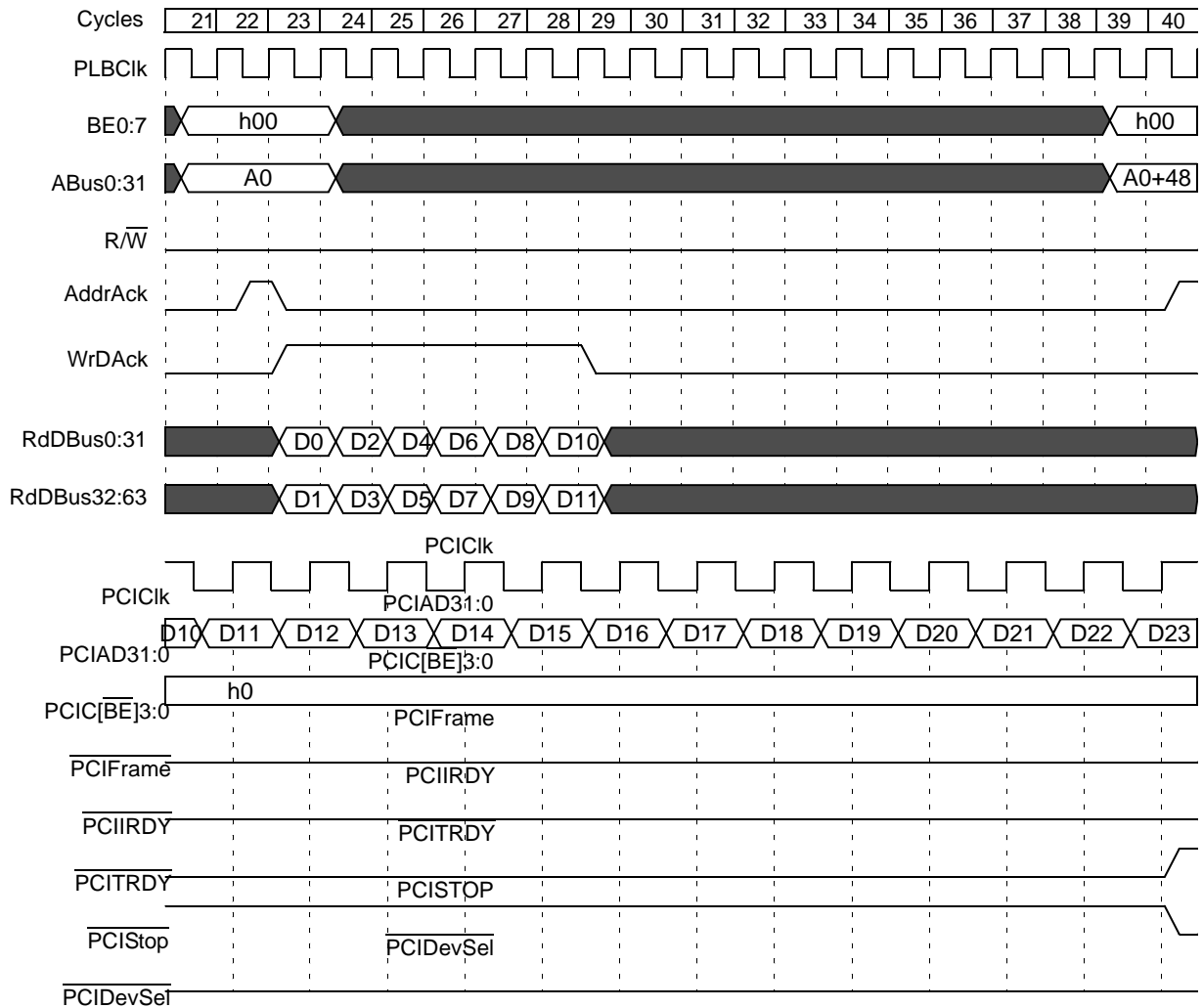

Figure 17-61. PCI Master Burst Write To SDRAM (Continued)

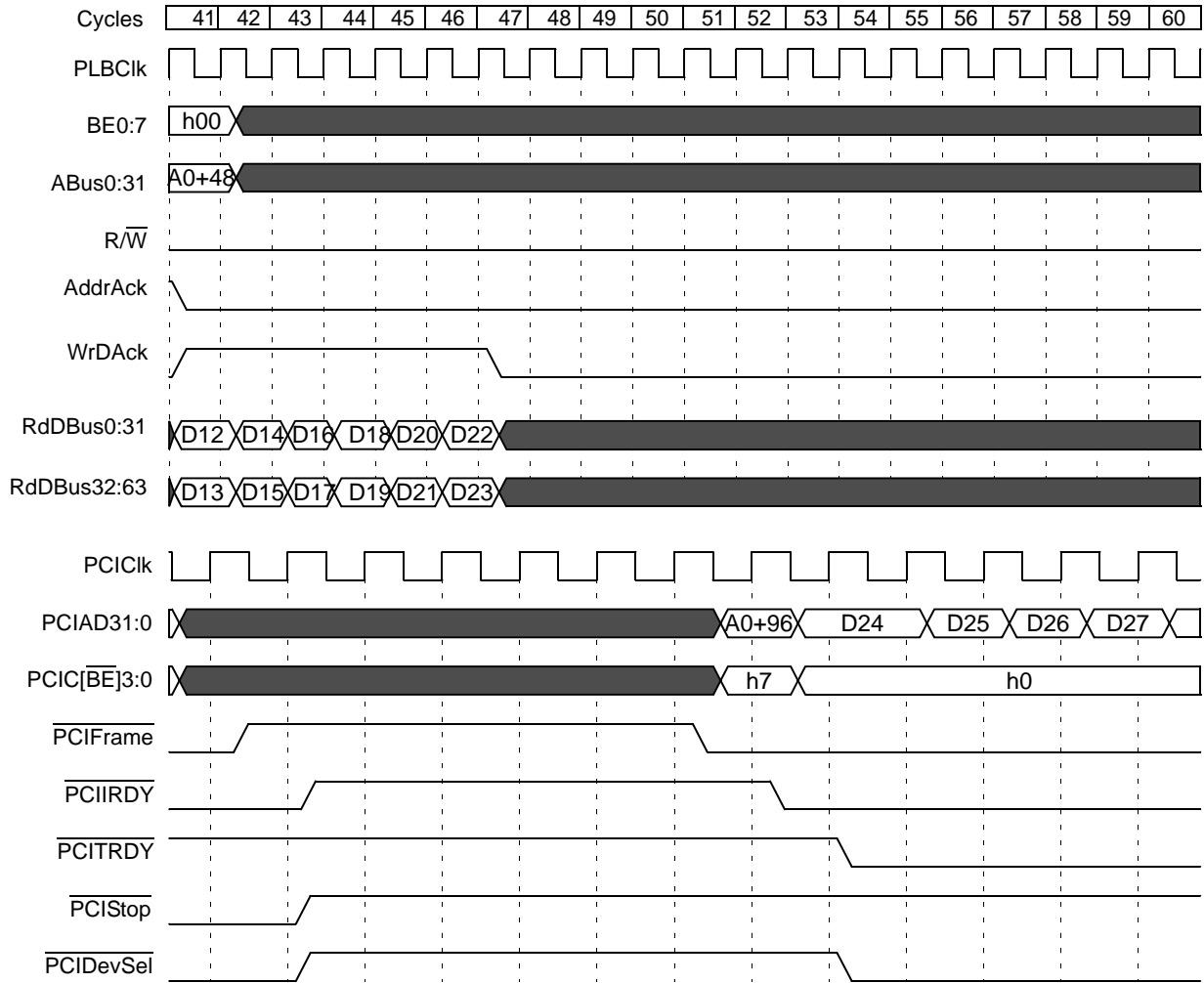

Figure 17-61. PCI Master Burst Write To SDRAM (Continued)

Preliminary User's Manual

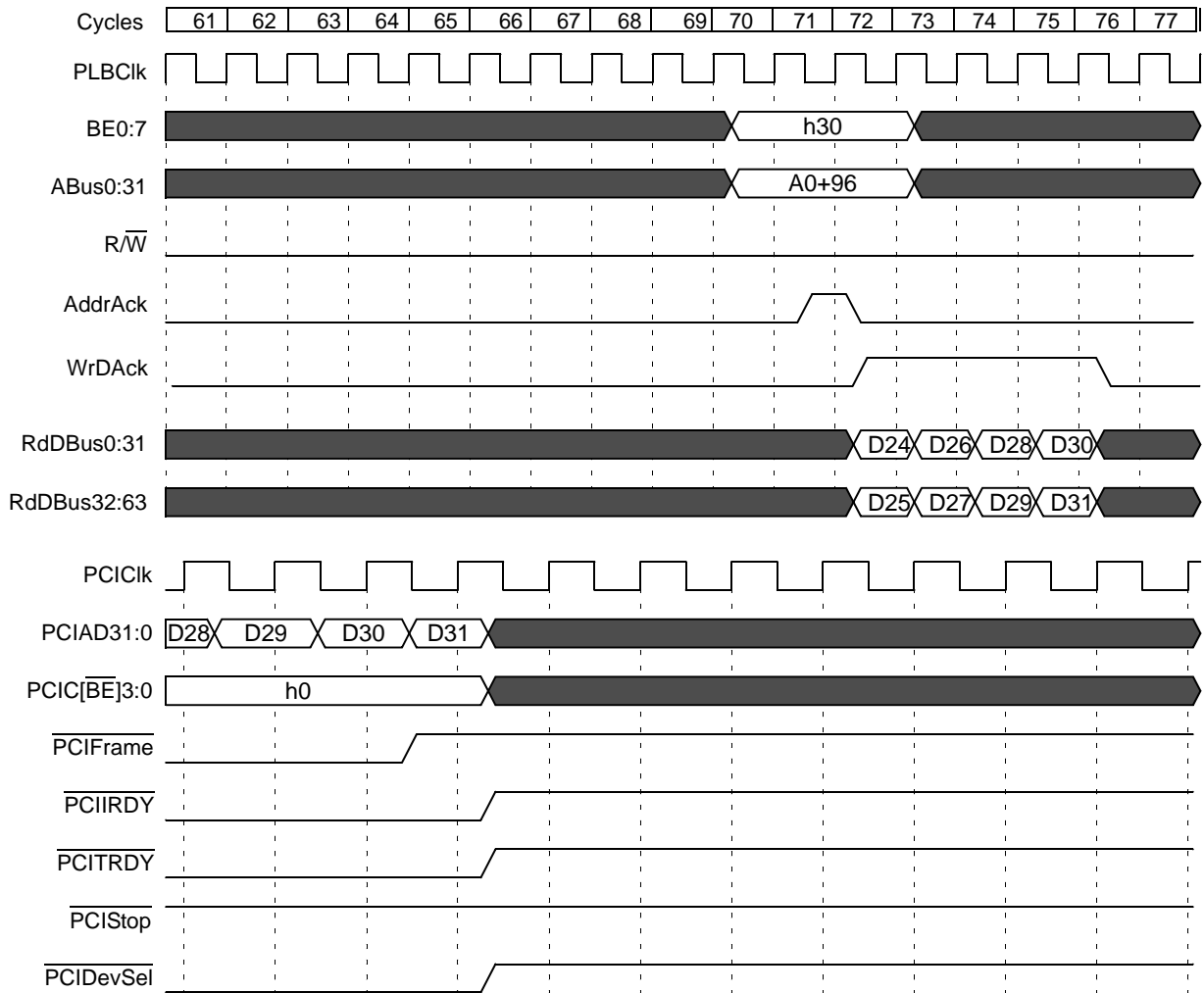

Figure 17-61. PCI Master Burst Write To SDRAM (Continued)

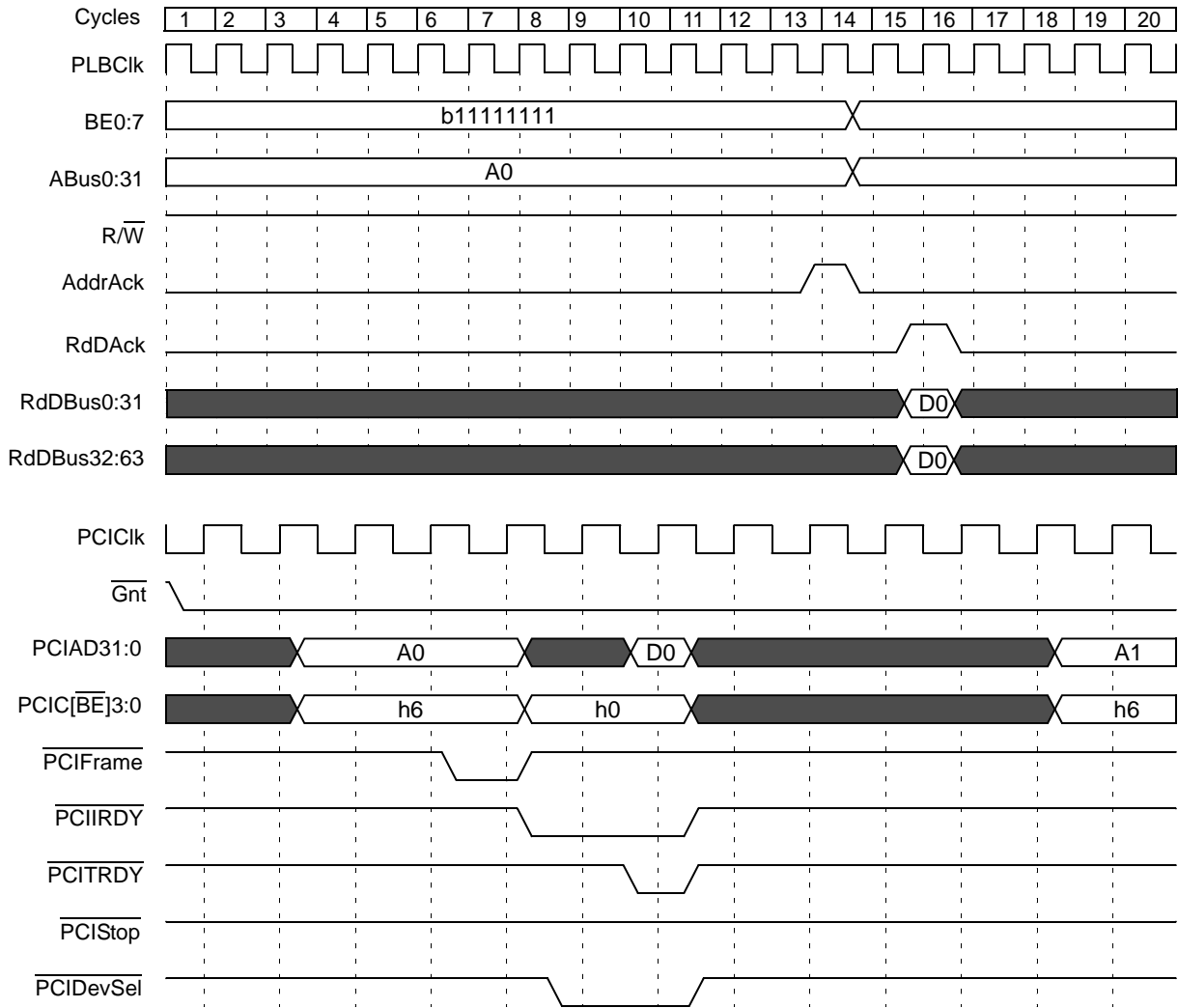

Figure 17-62. CPU Read From PCI Memory Slave, Nonprefetching

Preliminary User's Manual

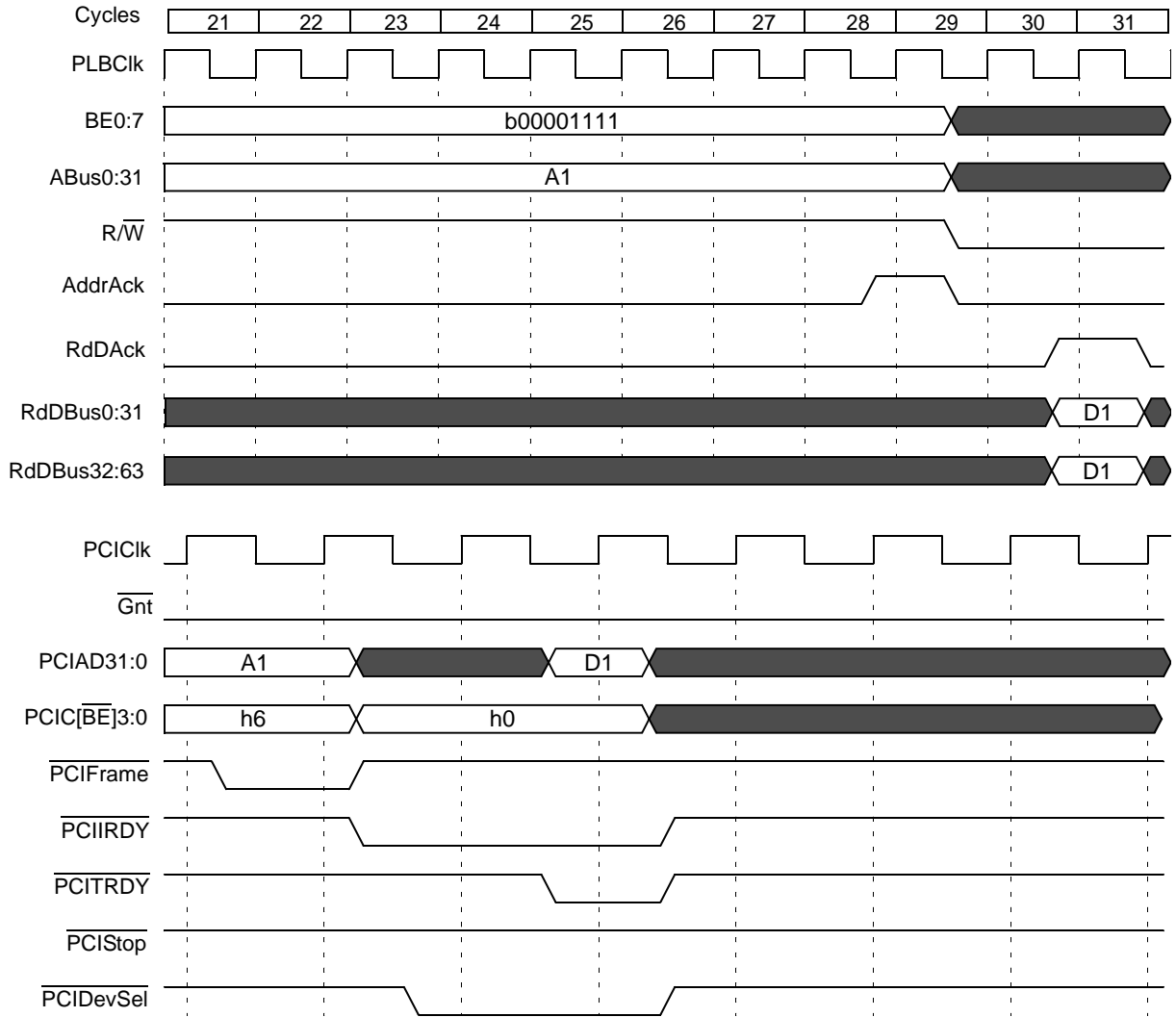

Figure 17-62. CPU Read From PCI Memory Slave, Nonprefetching (Continued)

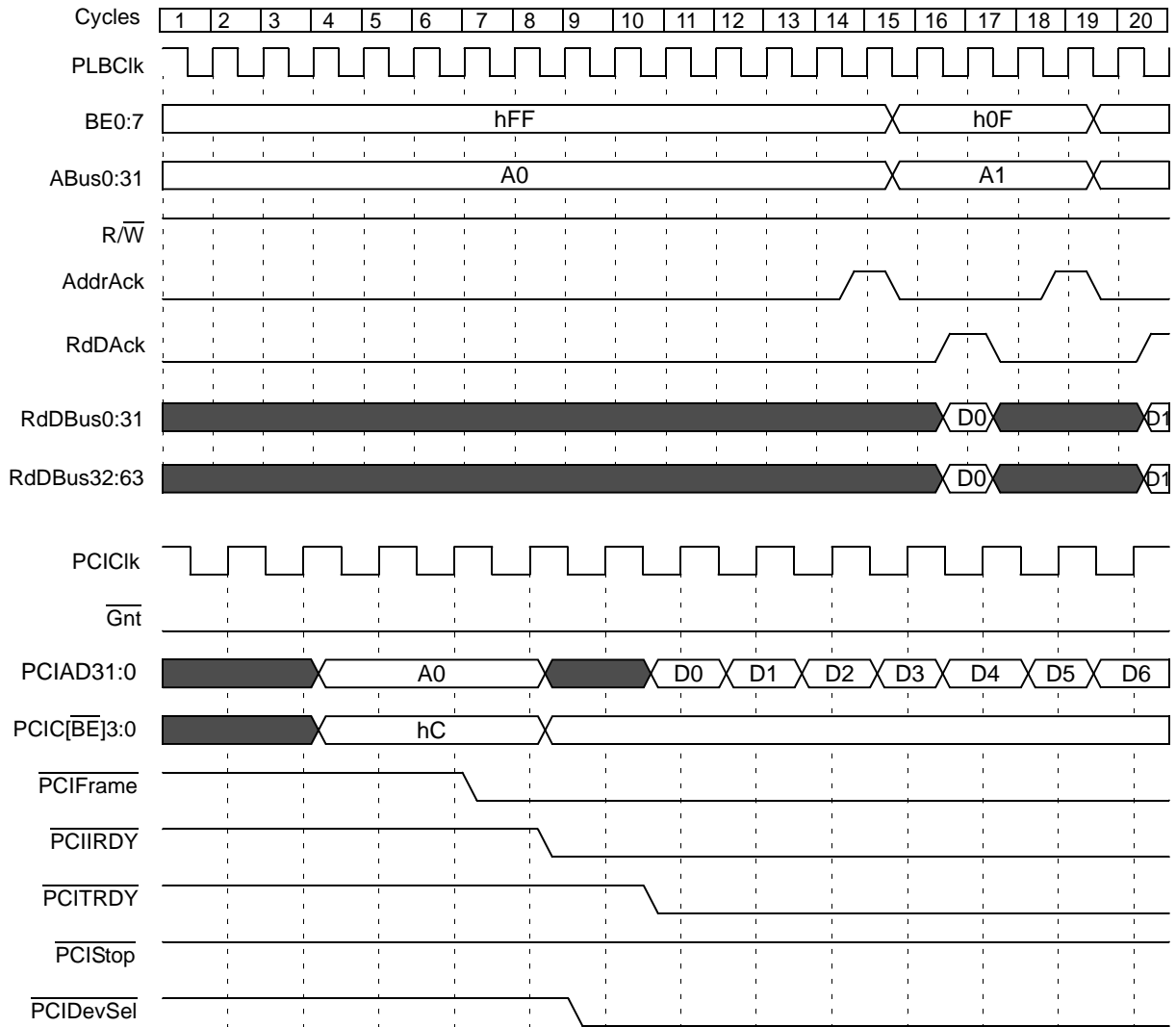

Figure 17-63. CPU Read From PCI Memory Slave, Prefetching

Preliminary User's Manual

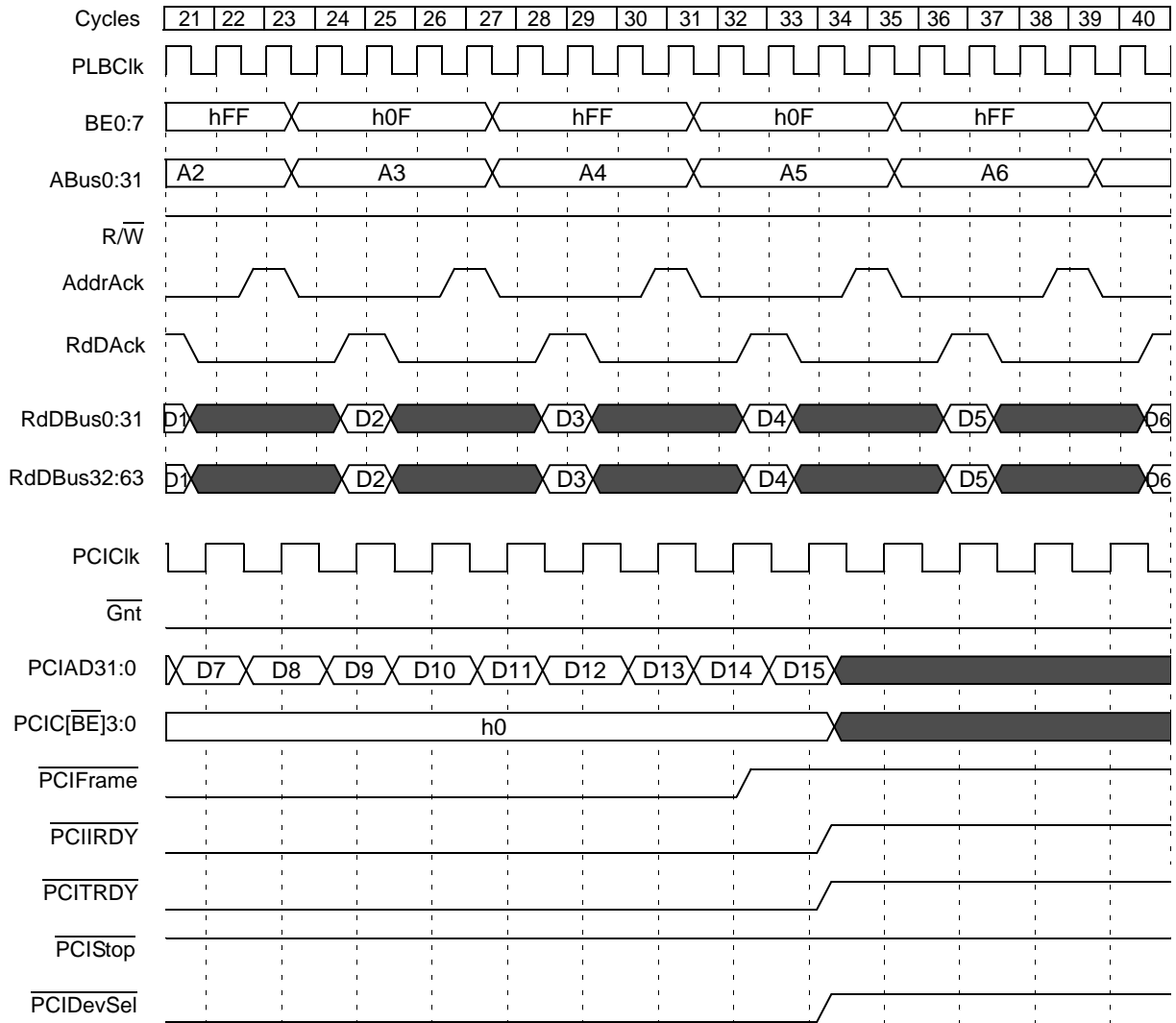

Figure 17-63. CPU Read From PCI Memory Slave, Prefetching (Continued)

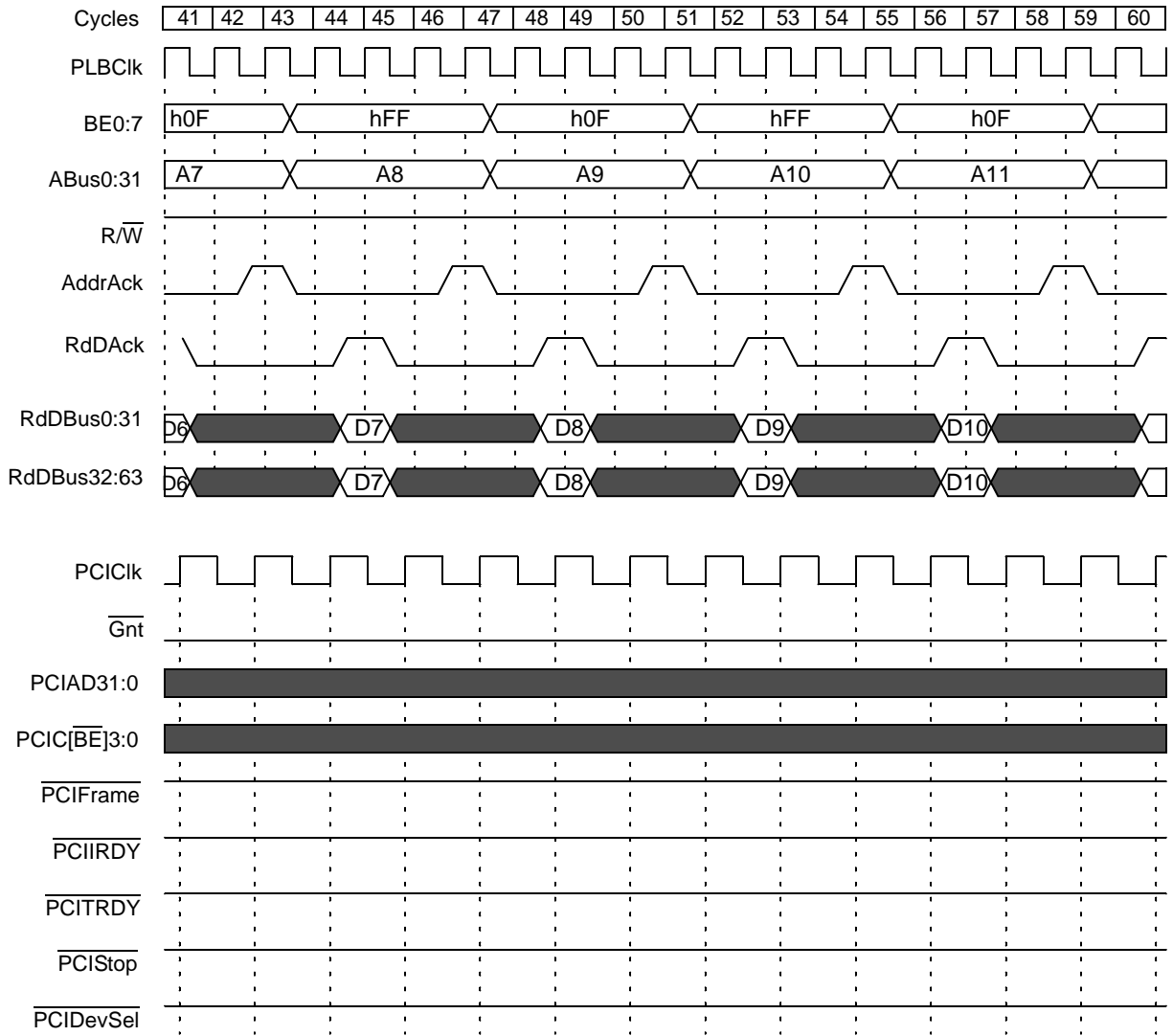

Figure 17-63. CPU Read From PCI Memory Slave, Prefetching (Continued)

Preliminary User's Manual

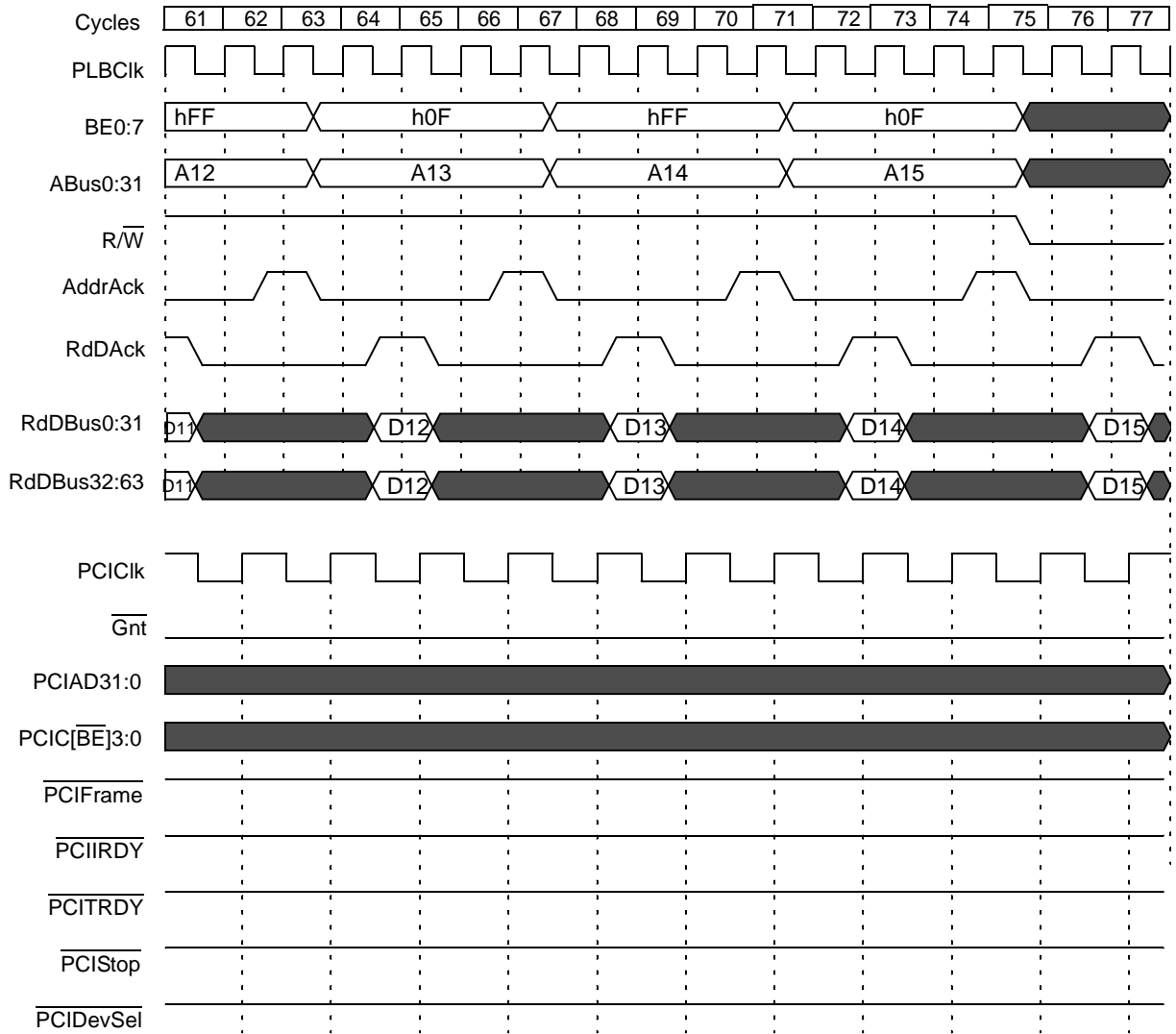

Figure 17-63. CPU Read From PCI Memory Slave, Prefetching (Continued)

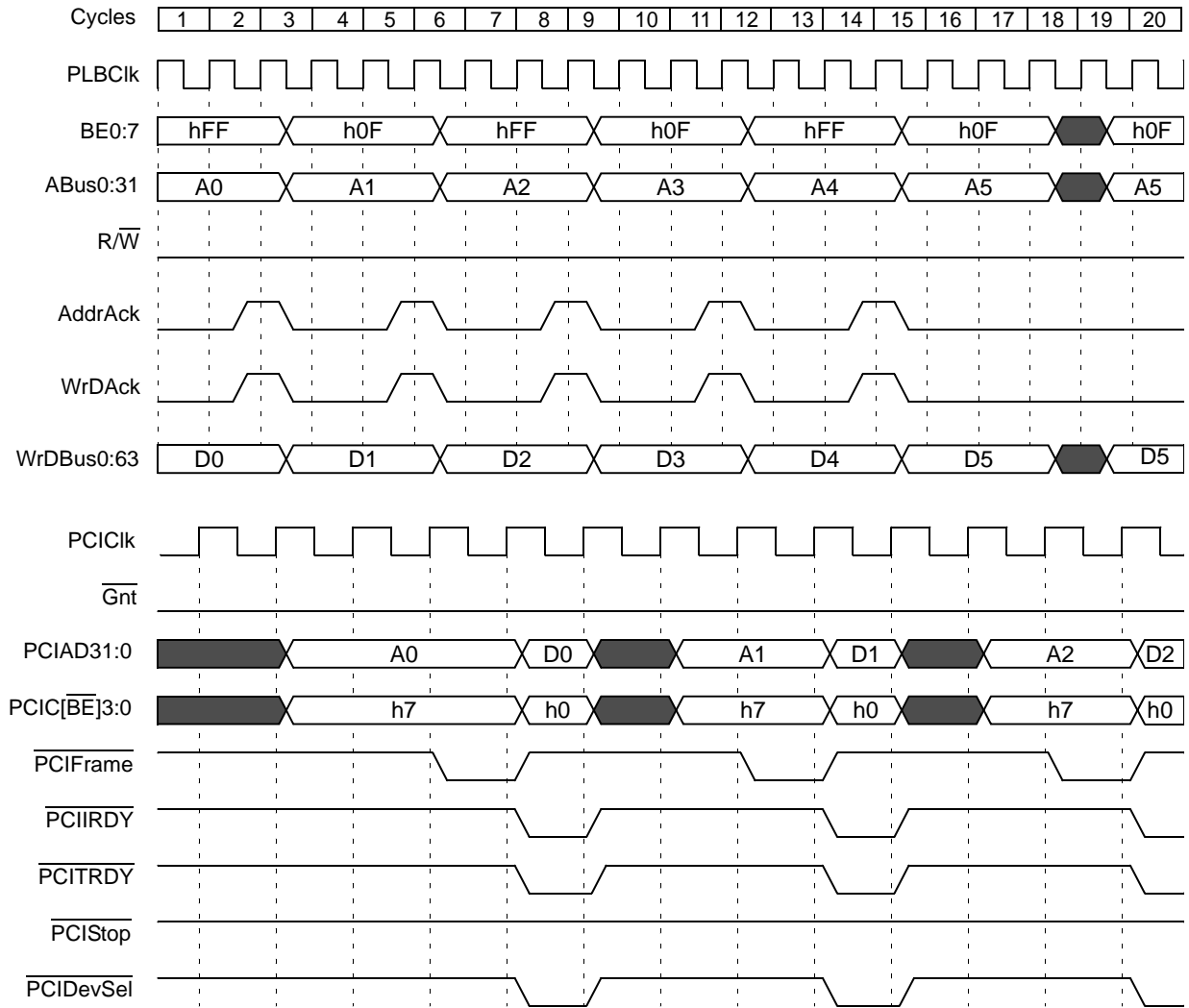

Figure 17-64. CPU Write To PCI Memory Slave

Preliminary User's Manual

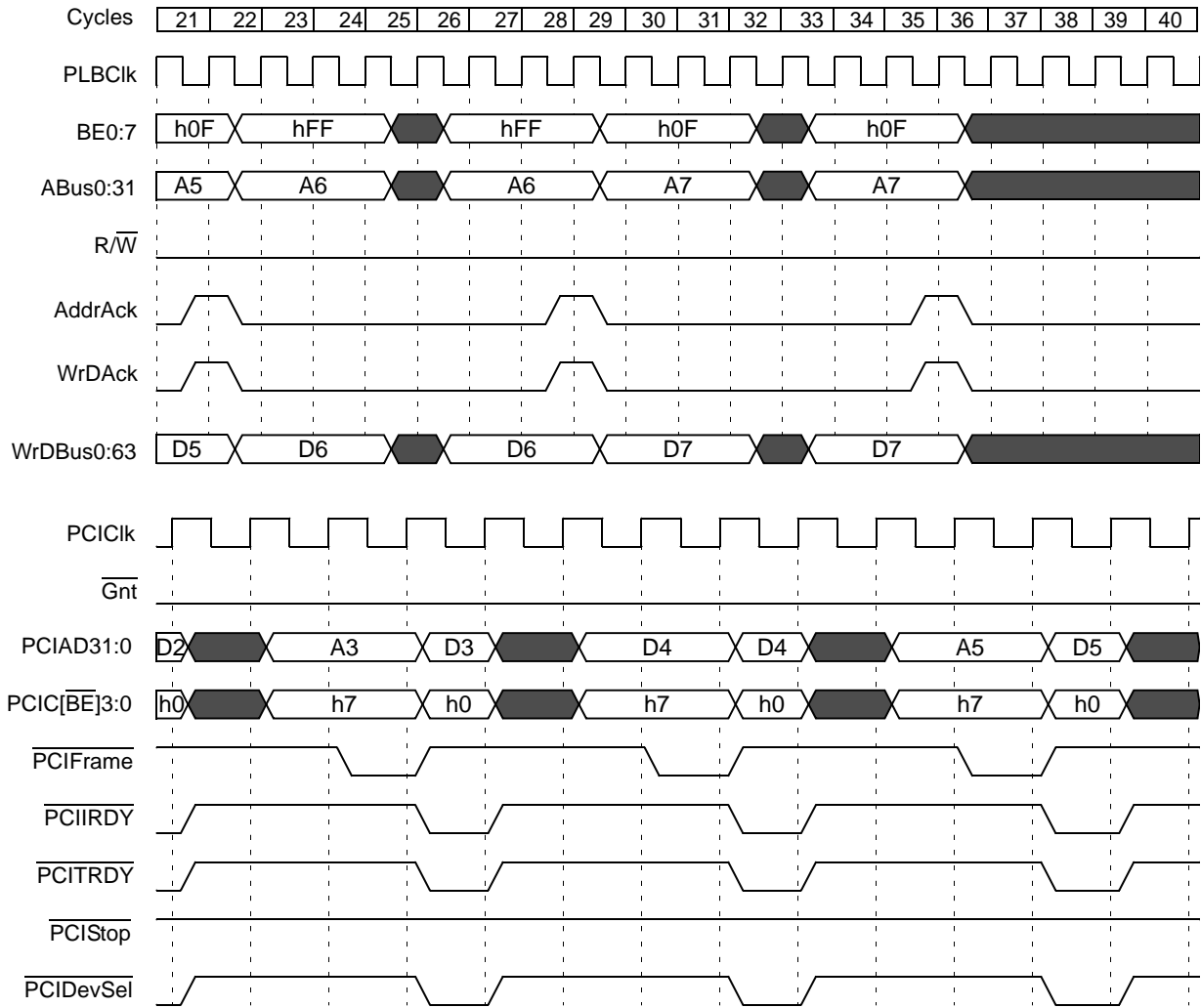

Figure 17-64. CPU Write To PCI Memory Slave (Continued)

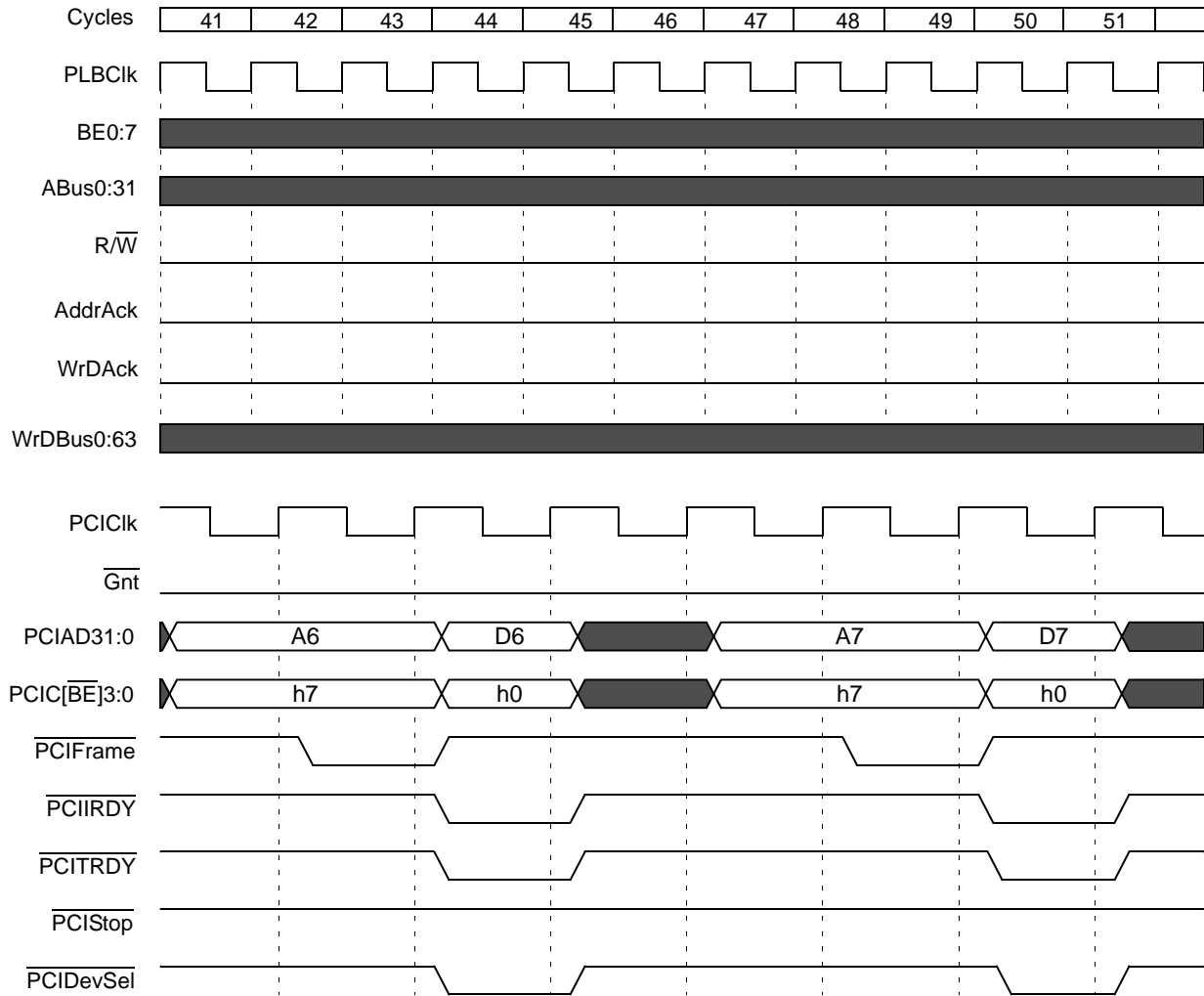

Figure 17-64. CPU Write To PCI Memory Slave (Continued)

Preliminary User's Manual

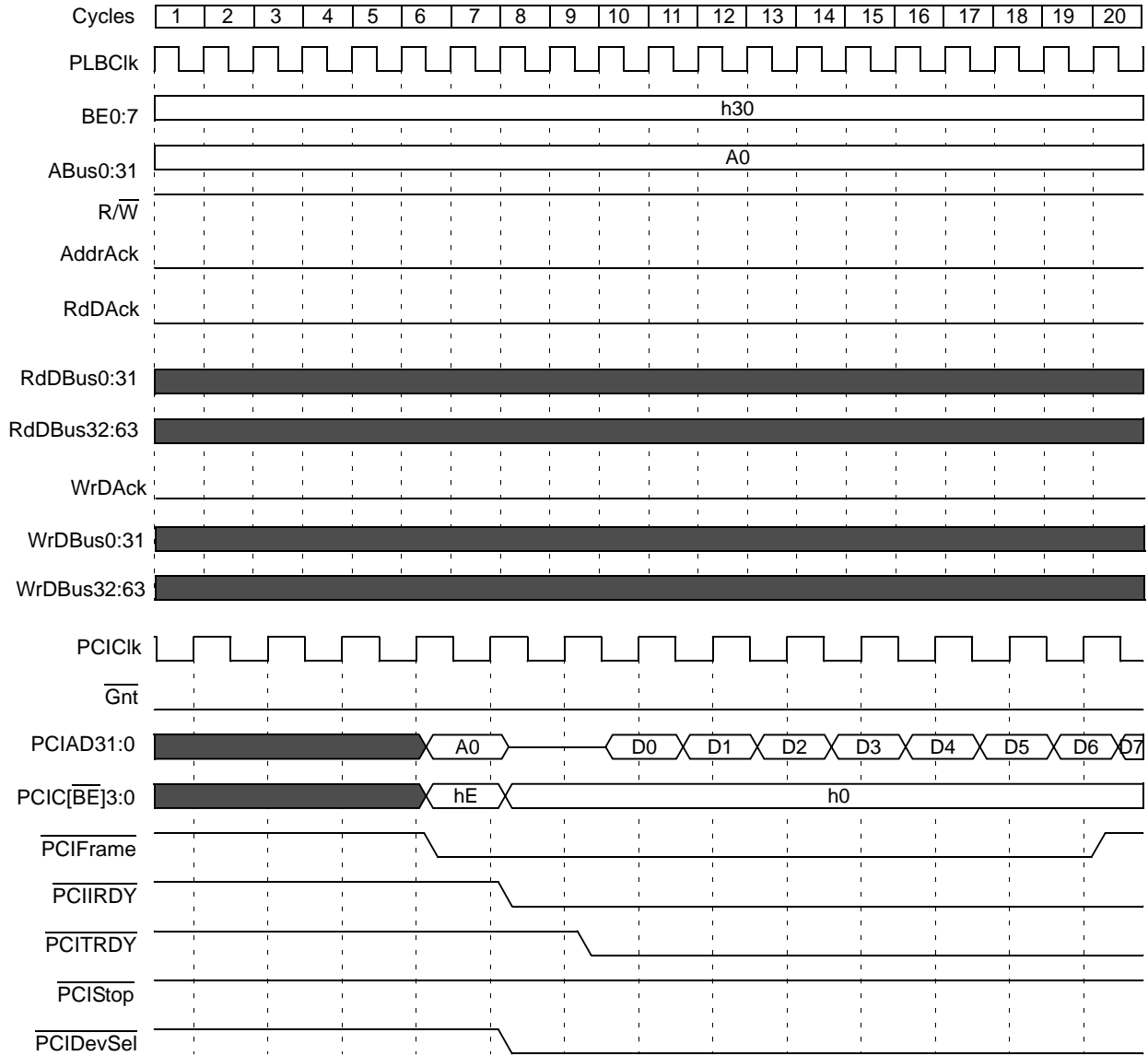

Figure 17-65. PCI Memory To SDRAM DMA Transfer

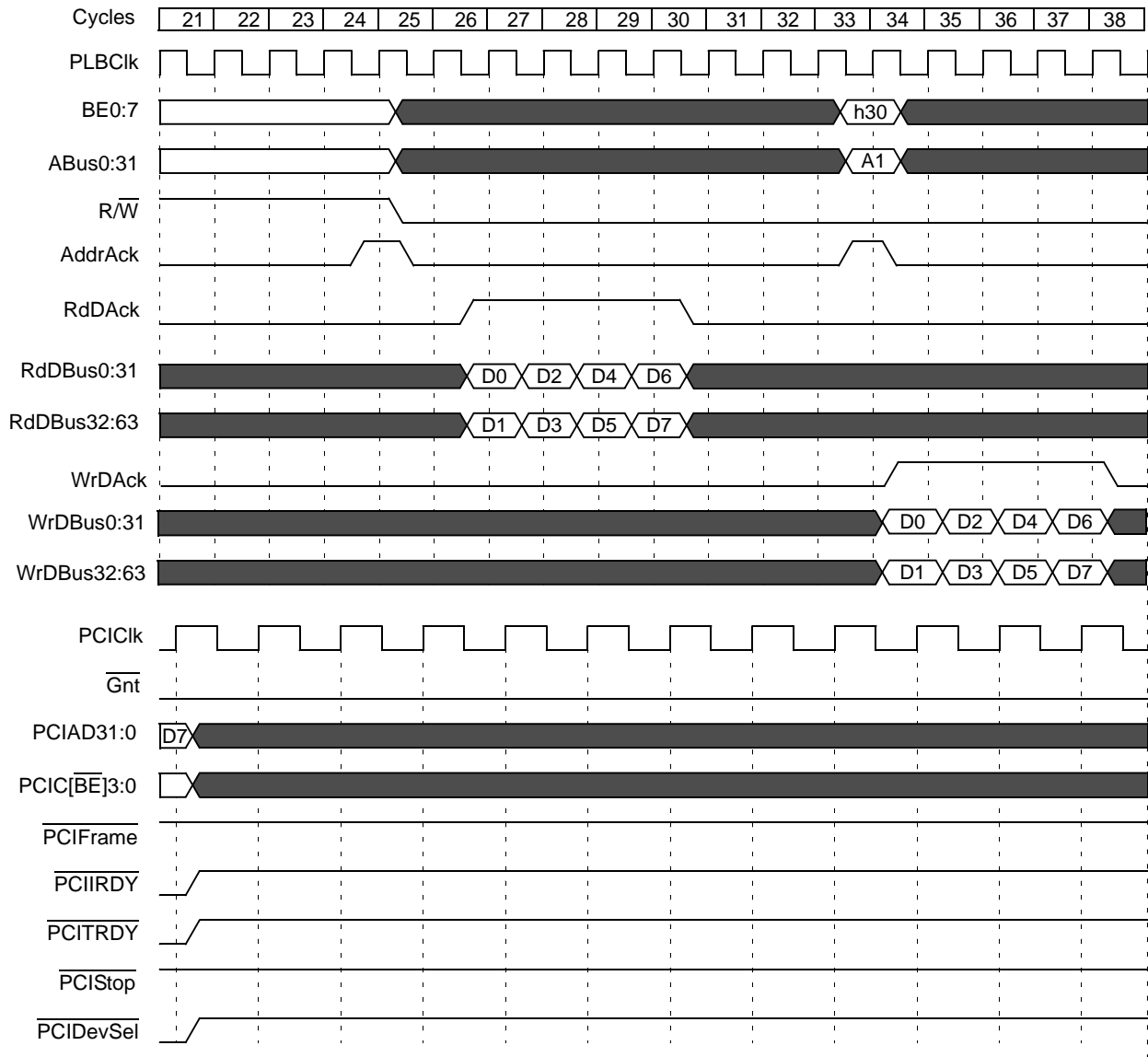

Figure 17-65. PCI Memory To SDRAM DMA Transfer (Continued)

Preliminary User's Manual

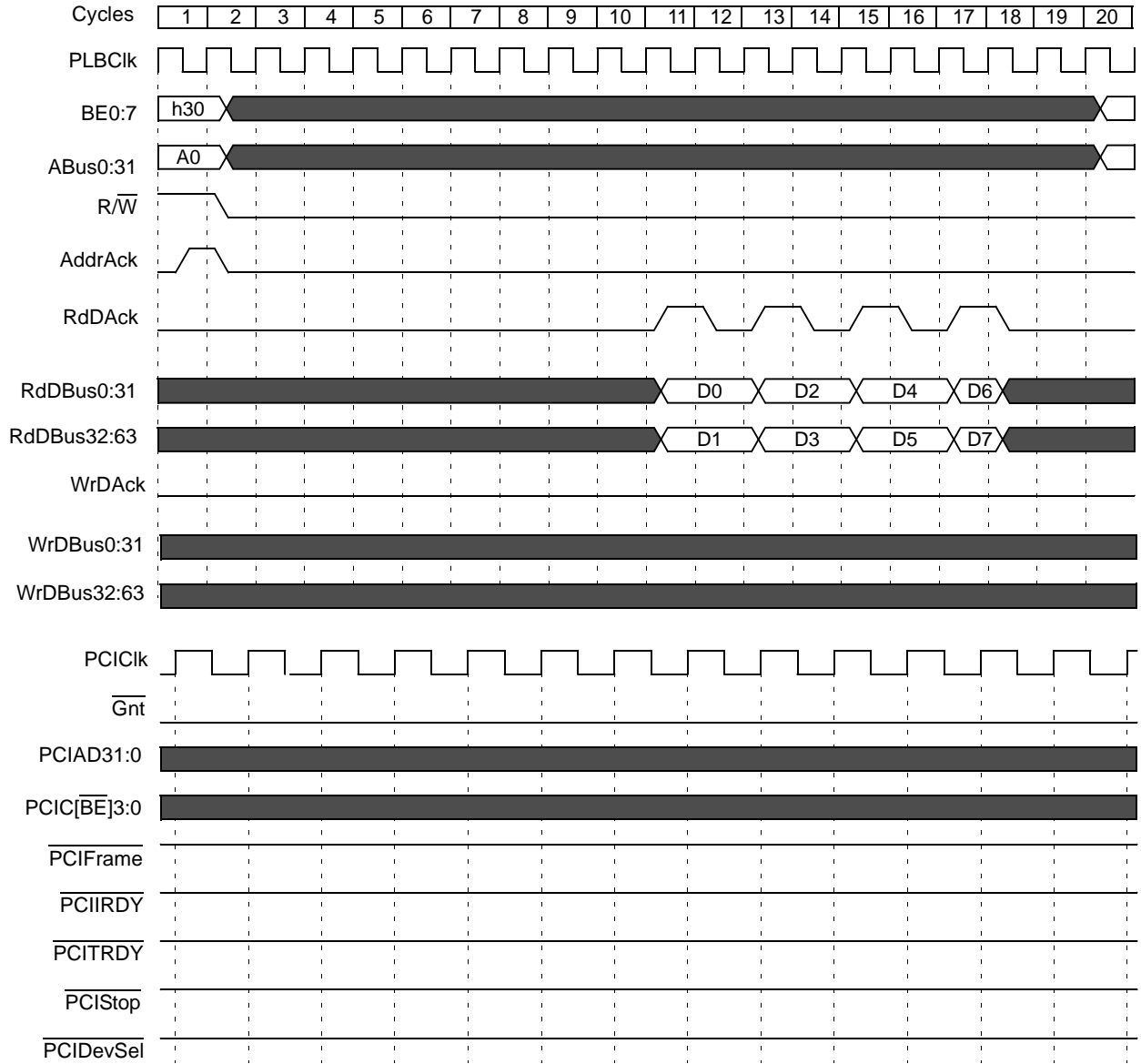

Figure 17-66. SDRAM To PCI Memory DMA Transfer

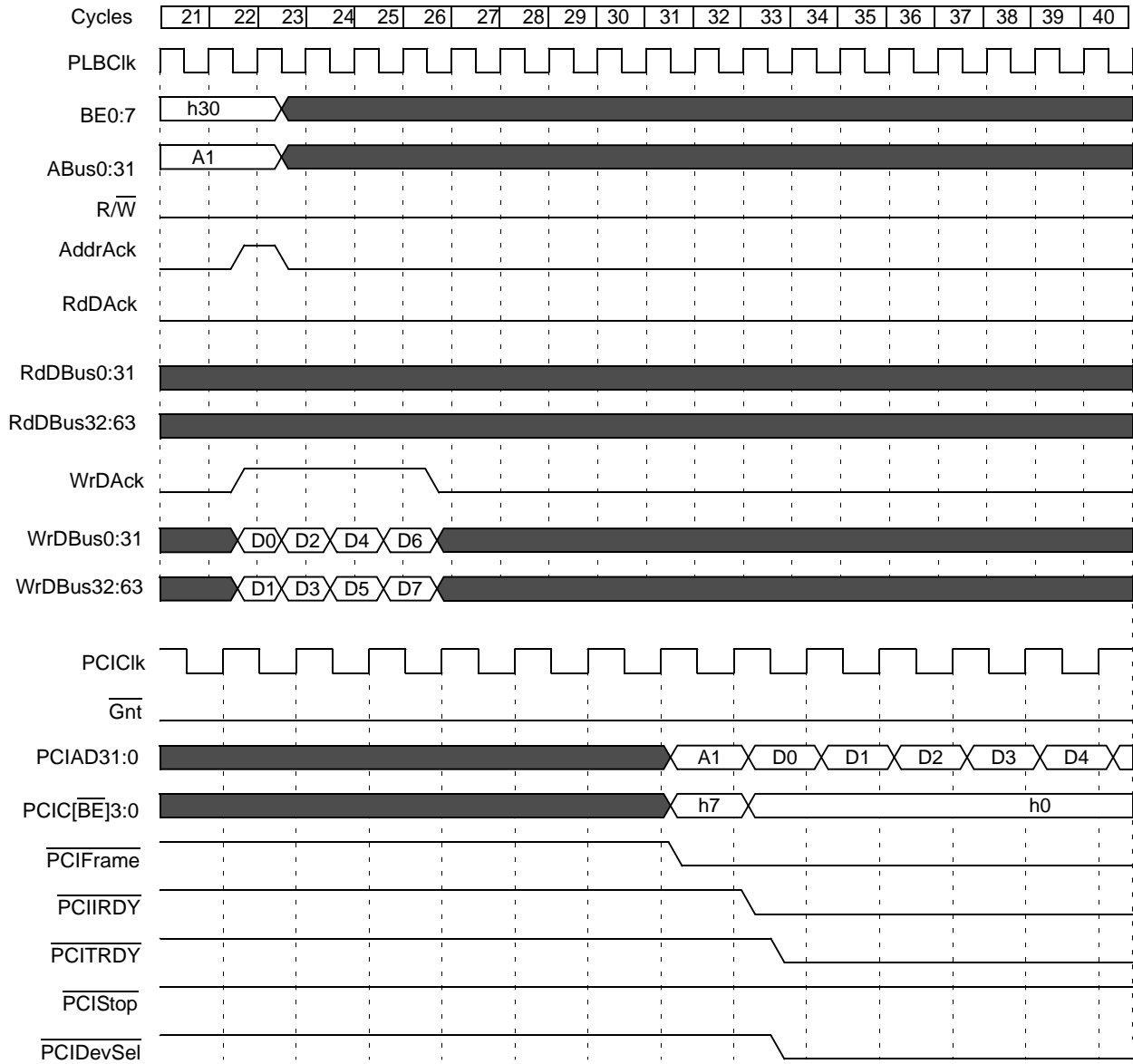

Figure 17-66. SDRAM To PCI Memory DMA Transfer (Continued)

Preliminary User's Manual

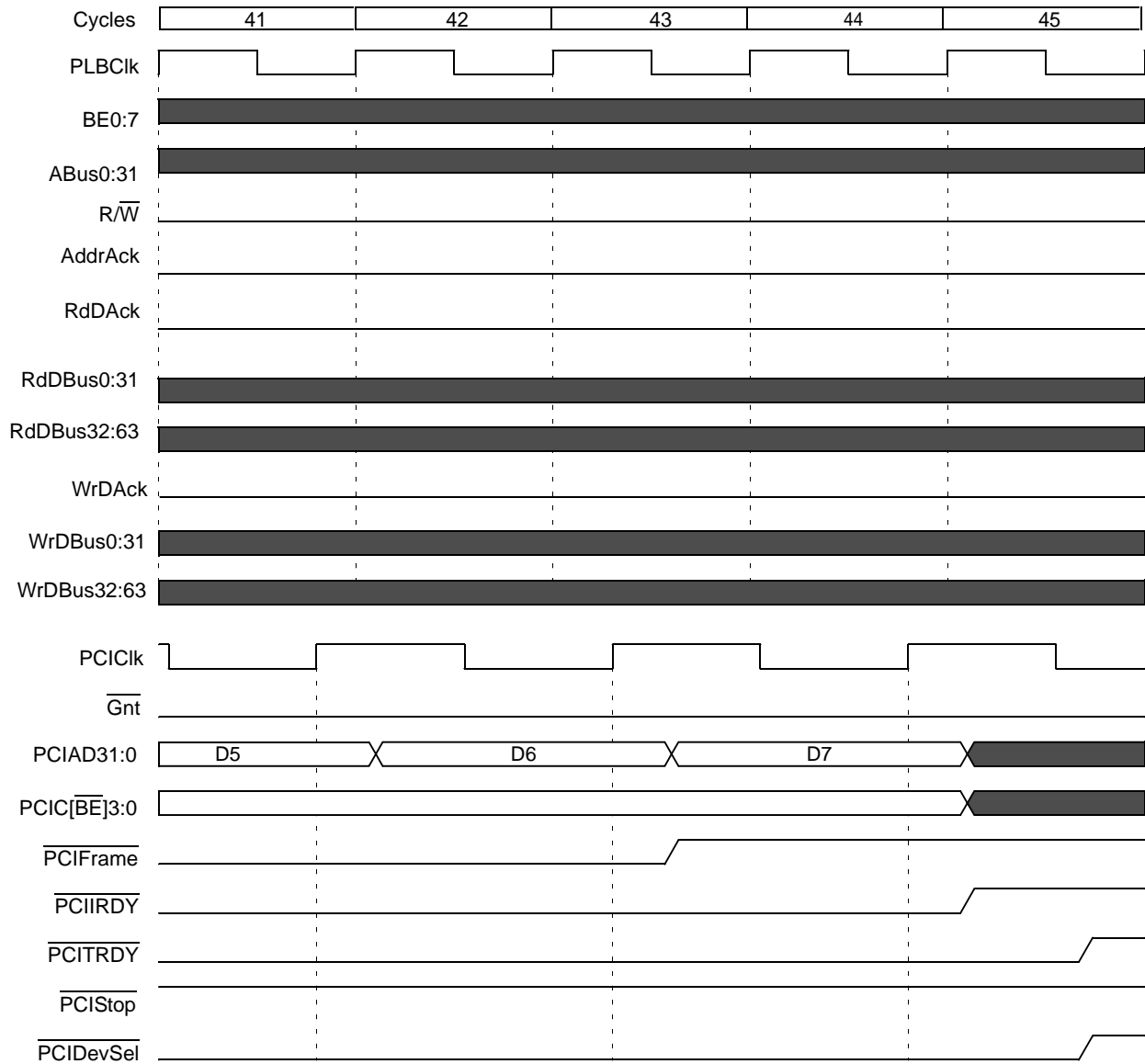

Figure 17-66. SDRAM To PCI Memory DMA Transfer (Continued)

17.10.3 Synchronous

The following diagrams are for synchronous clocking mode. Note that all of the diagrams flow across multiple pages. Each diagram begins with cycle 1 on the left facing page.

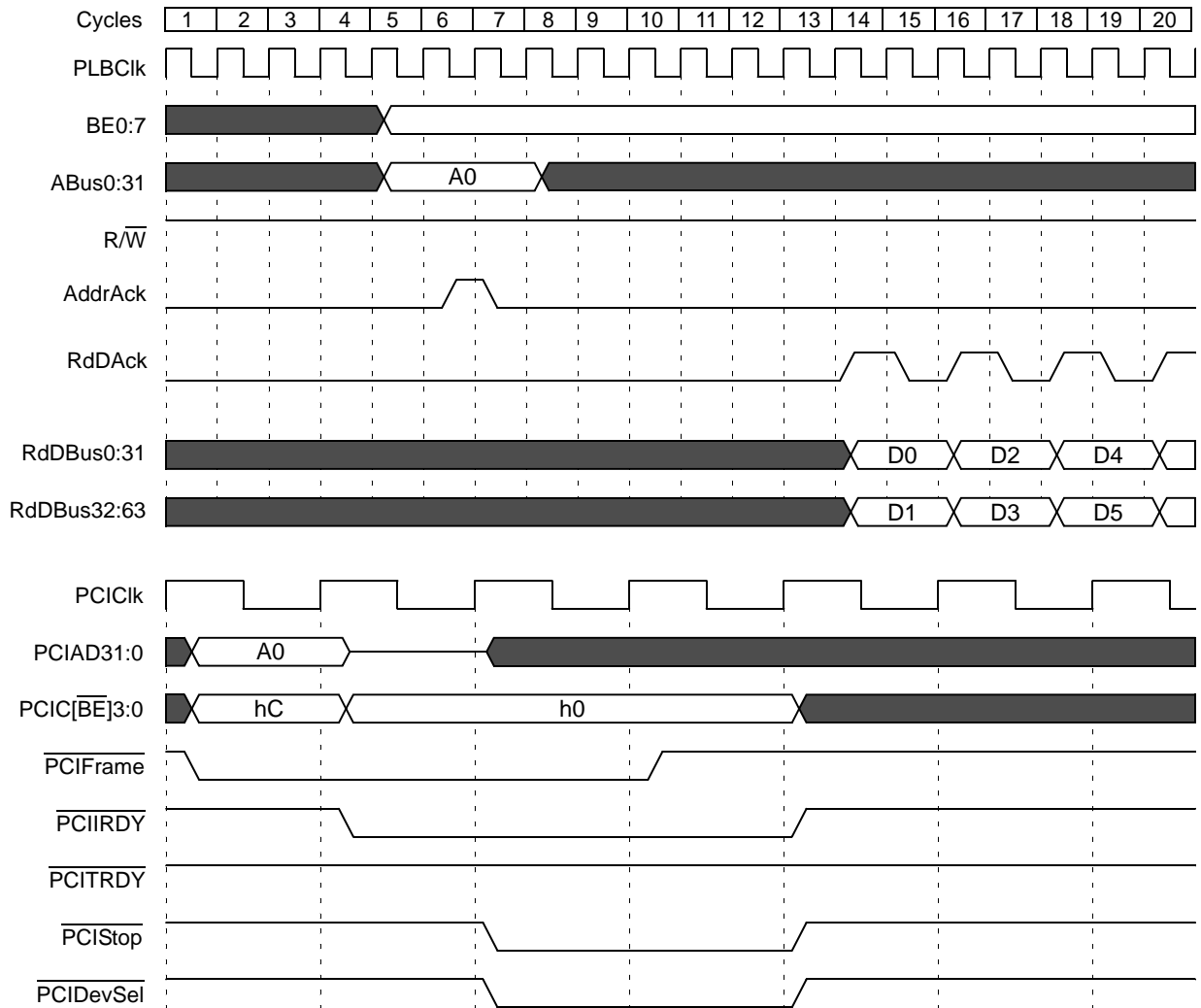

Figure 17-67. PCI Master Burst Read From SDRAM

Preliminary User's Manual

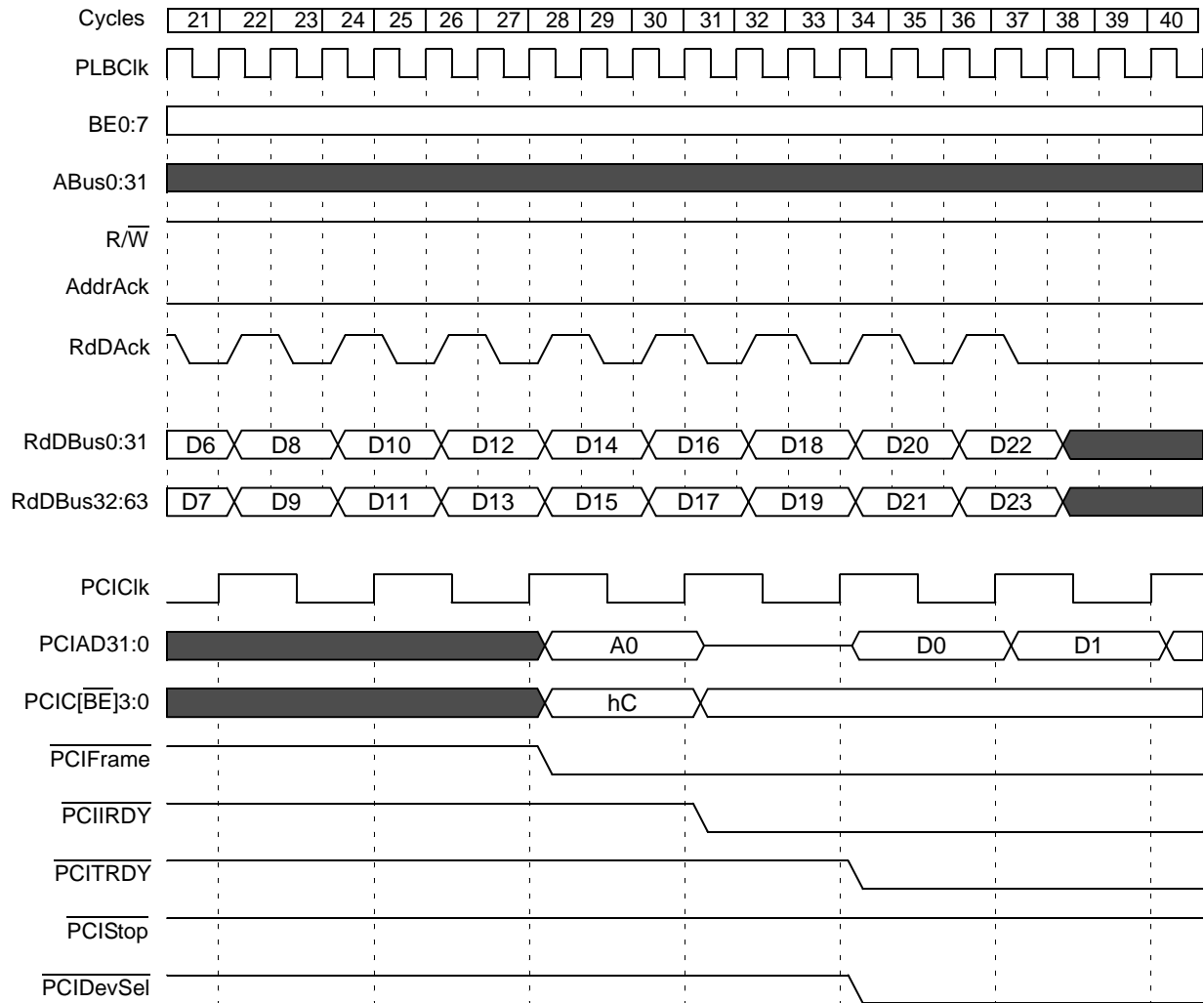

Figure 17-67. PCI Master Burst Read From SDRAM (Continued)

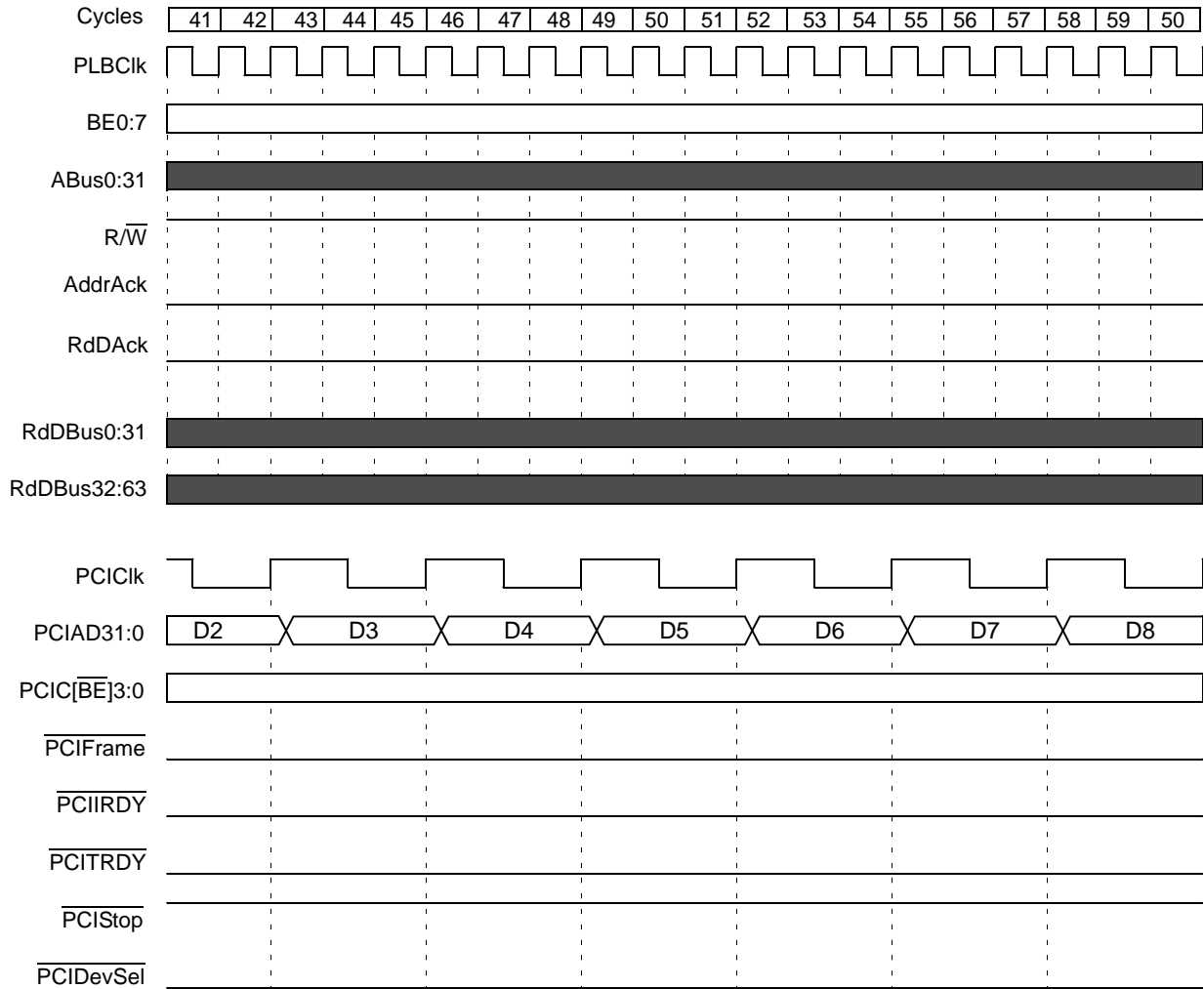

Figure 17-67. PCI Master Burst Read From SDRAM (Continued)

Preliminary User's Manual

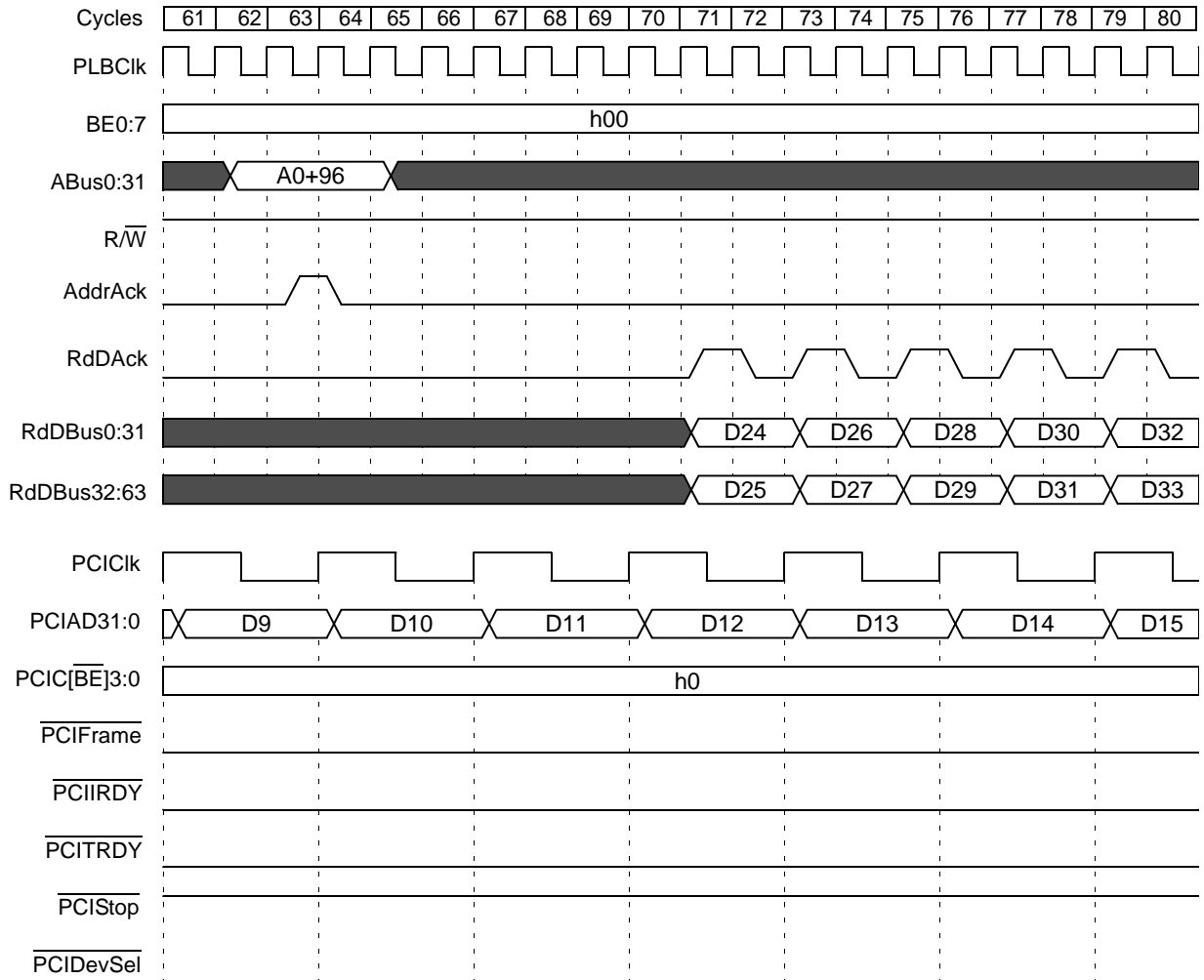

Figure 17-67. PCI Master Burst Read From SDRAM (Continued)

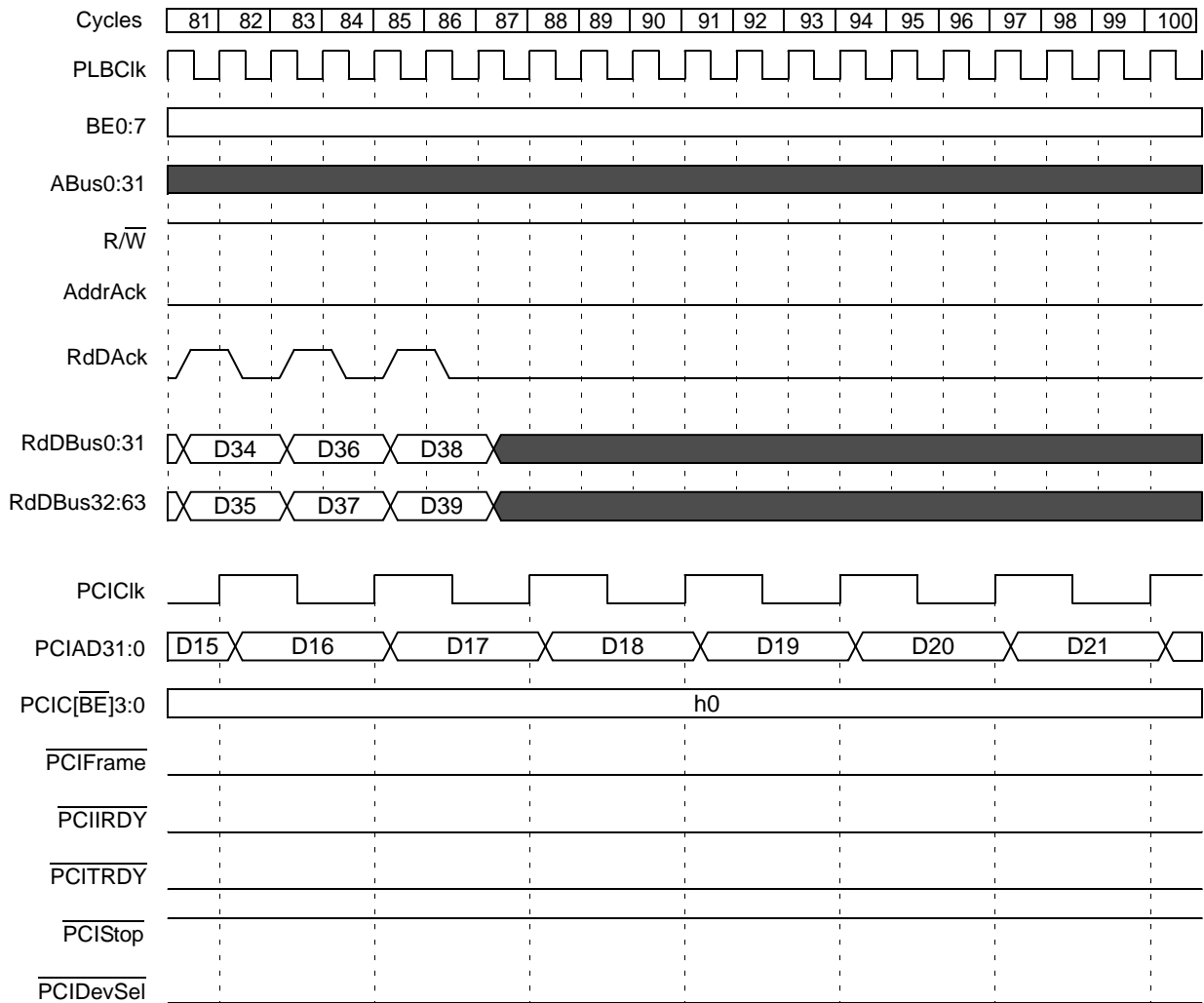

Figure 17-67. PCI Master Burst Read From SDRAM (Continued)

Preliminary User's Manual

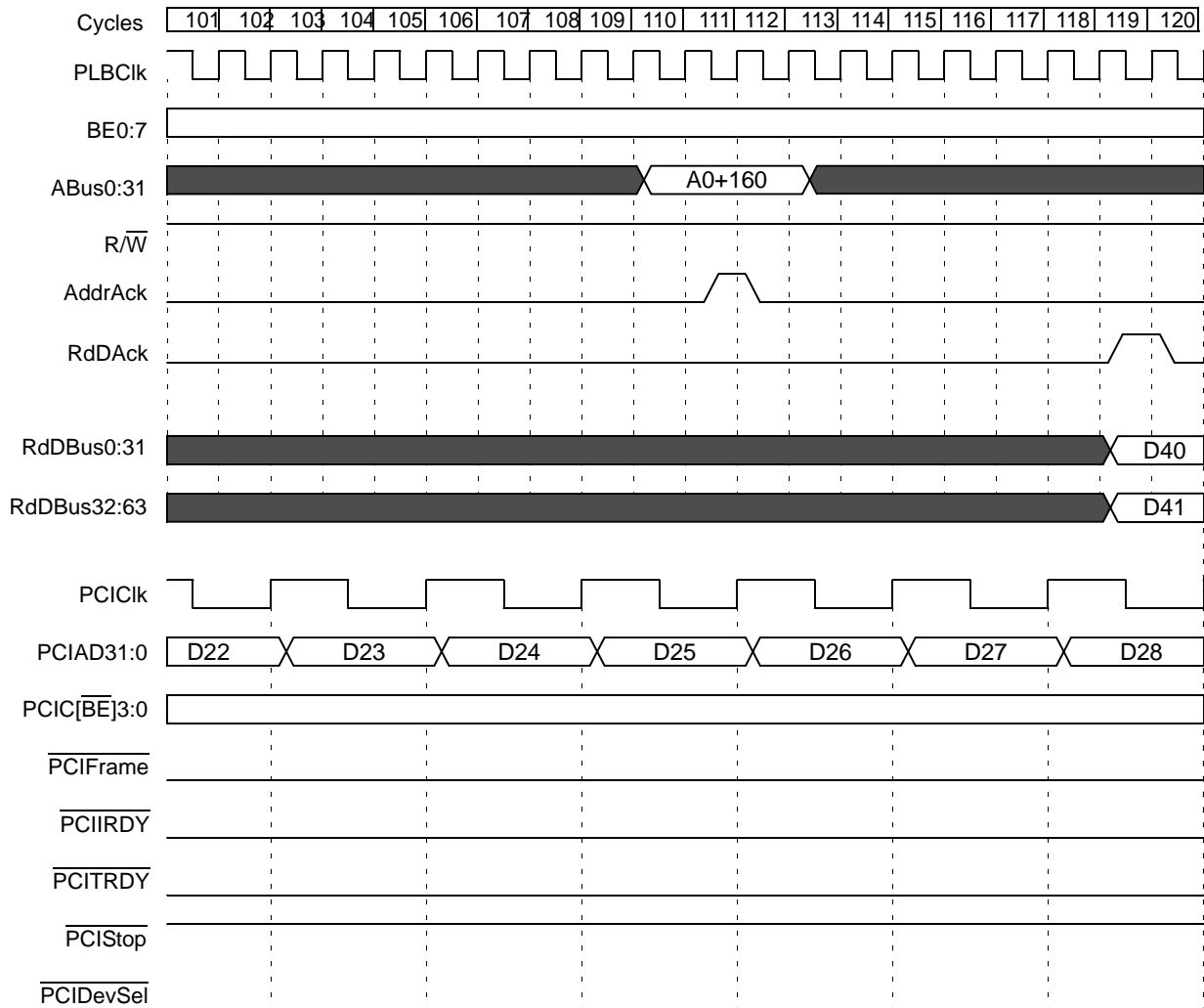

Figure 17-67. PCI Master Burst Read From SDRAM (Continued)

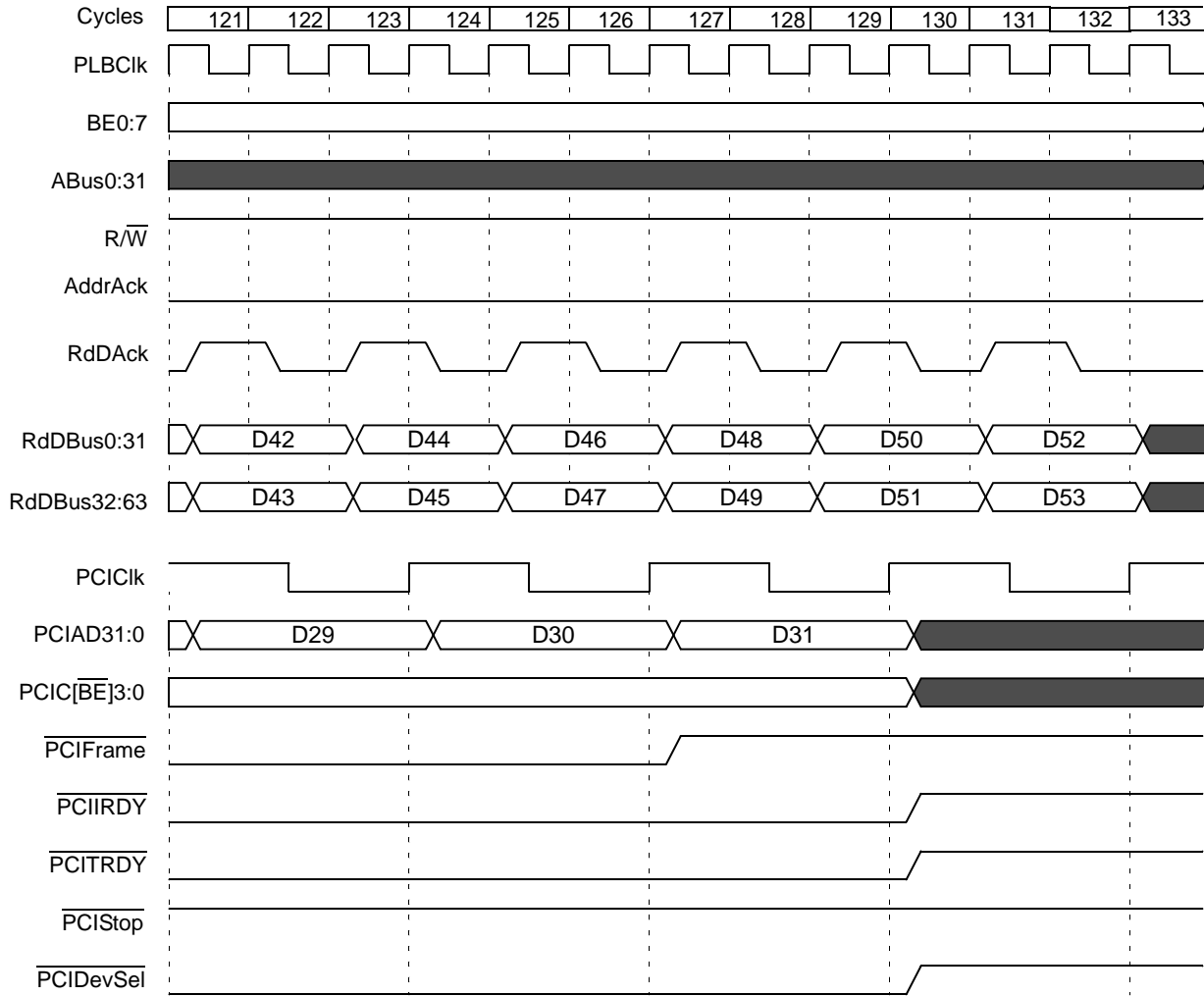

Figure 17-67. PCI Master Burst Read From SDRAM (Continued)

Preliminary User's Manual

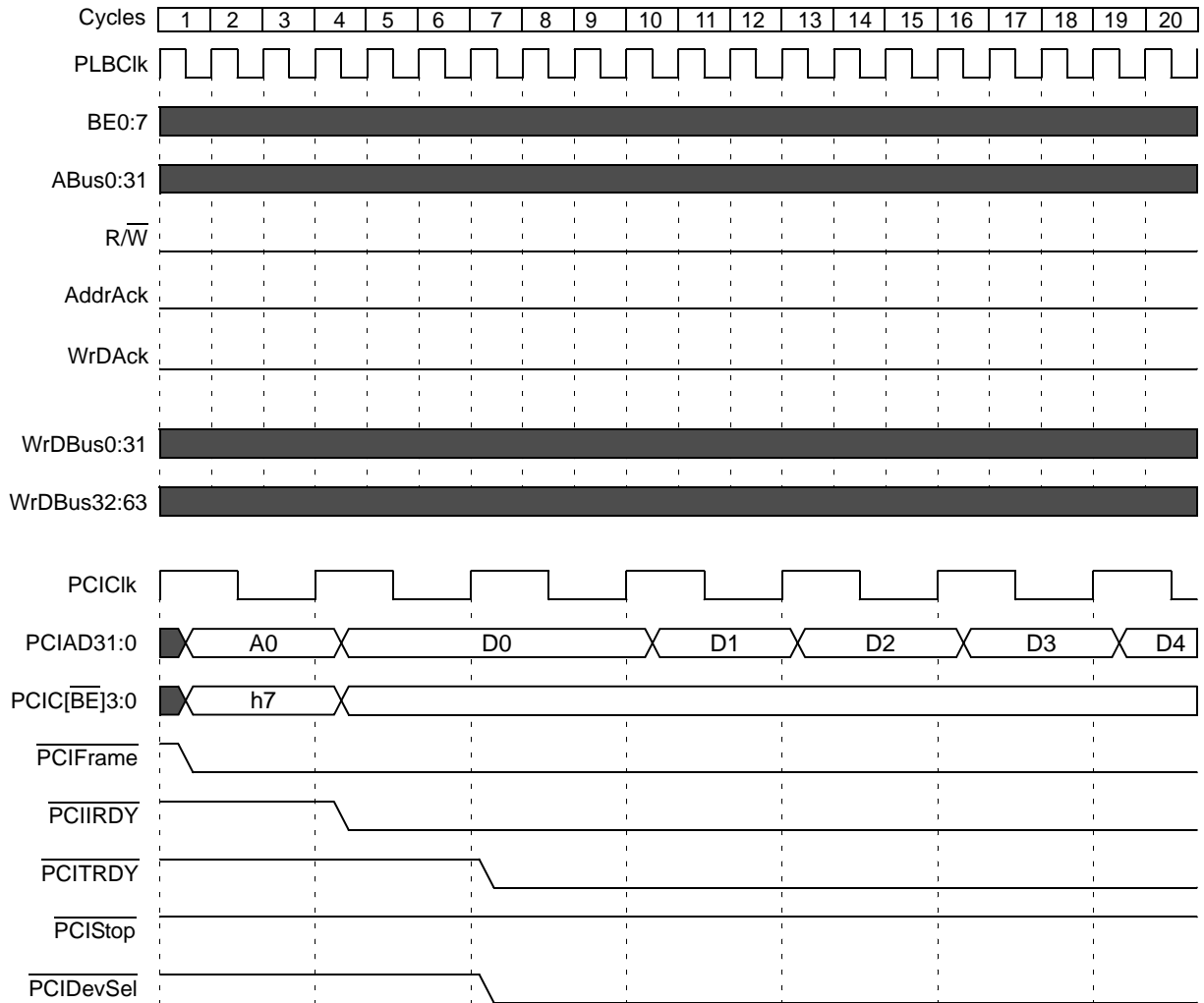

Figure 17-68. PCI Master Burst Write To SDRAM

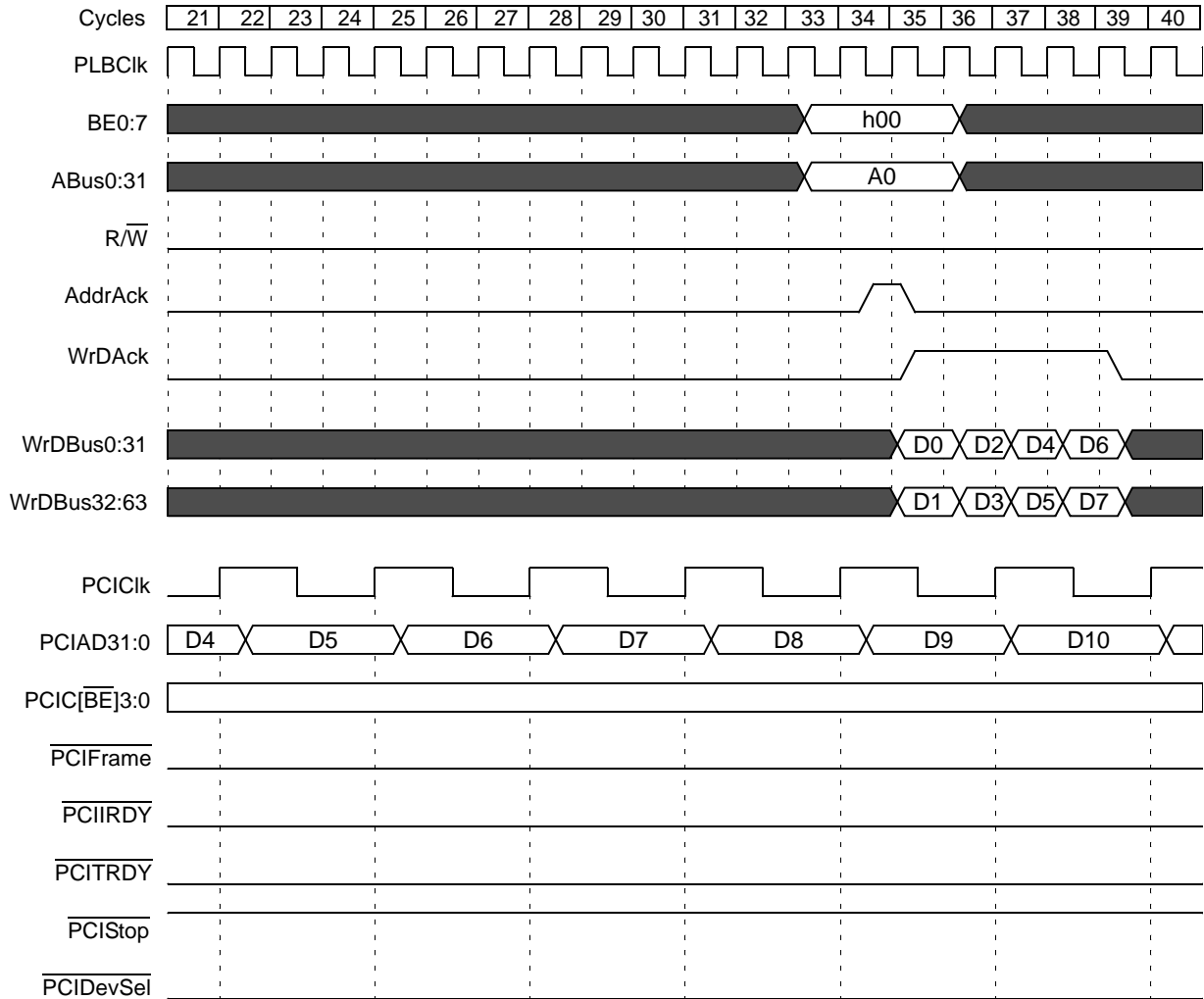

Figure 17-68. PCI Master Burst Write To SDRAM (Continued)

Preliminary User's Manual

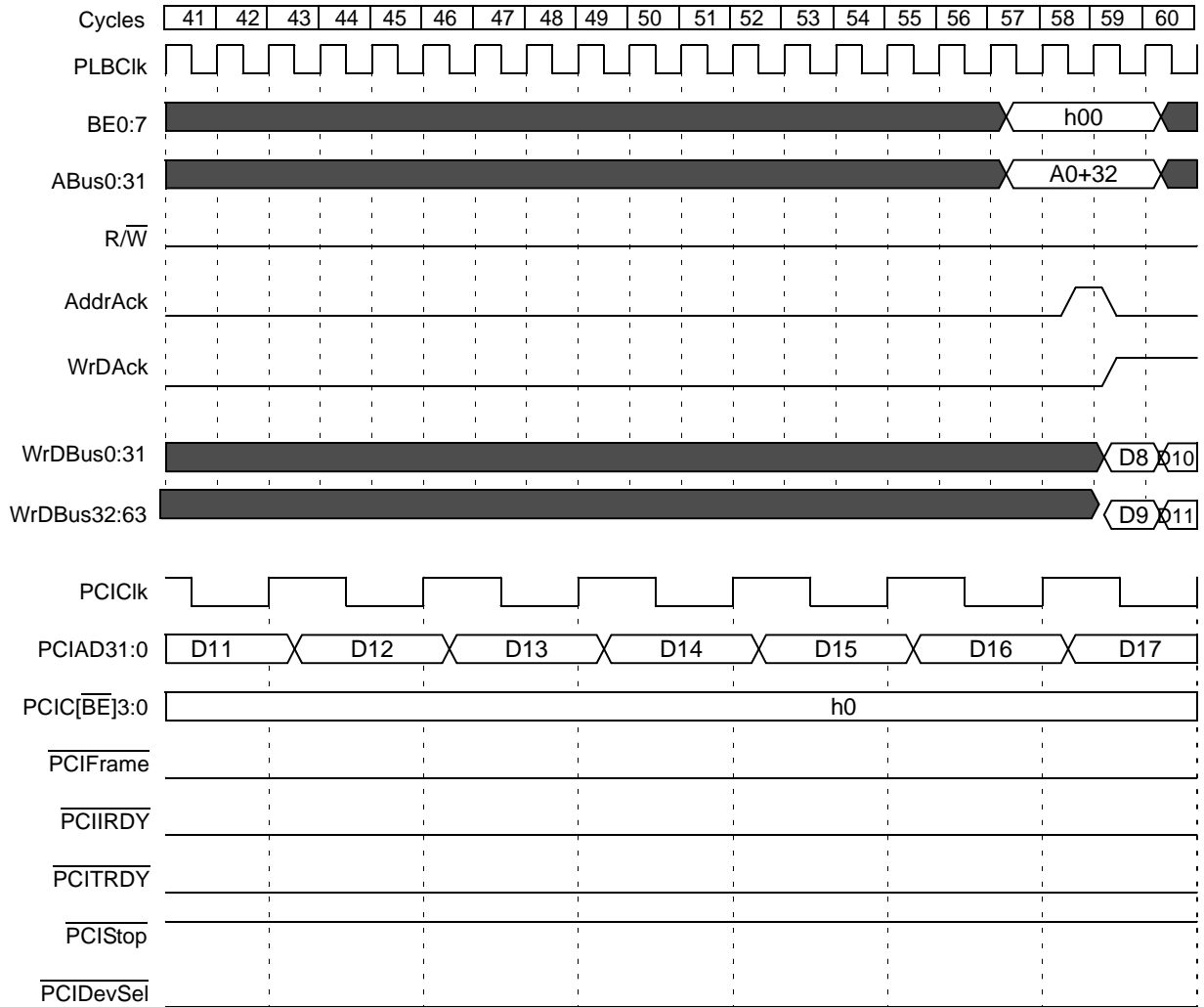

Figure 17-68. PCI Master Burst Write To SDRAM (Continued)

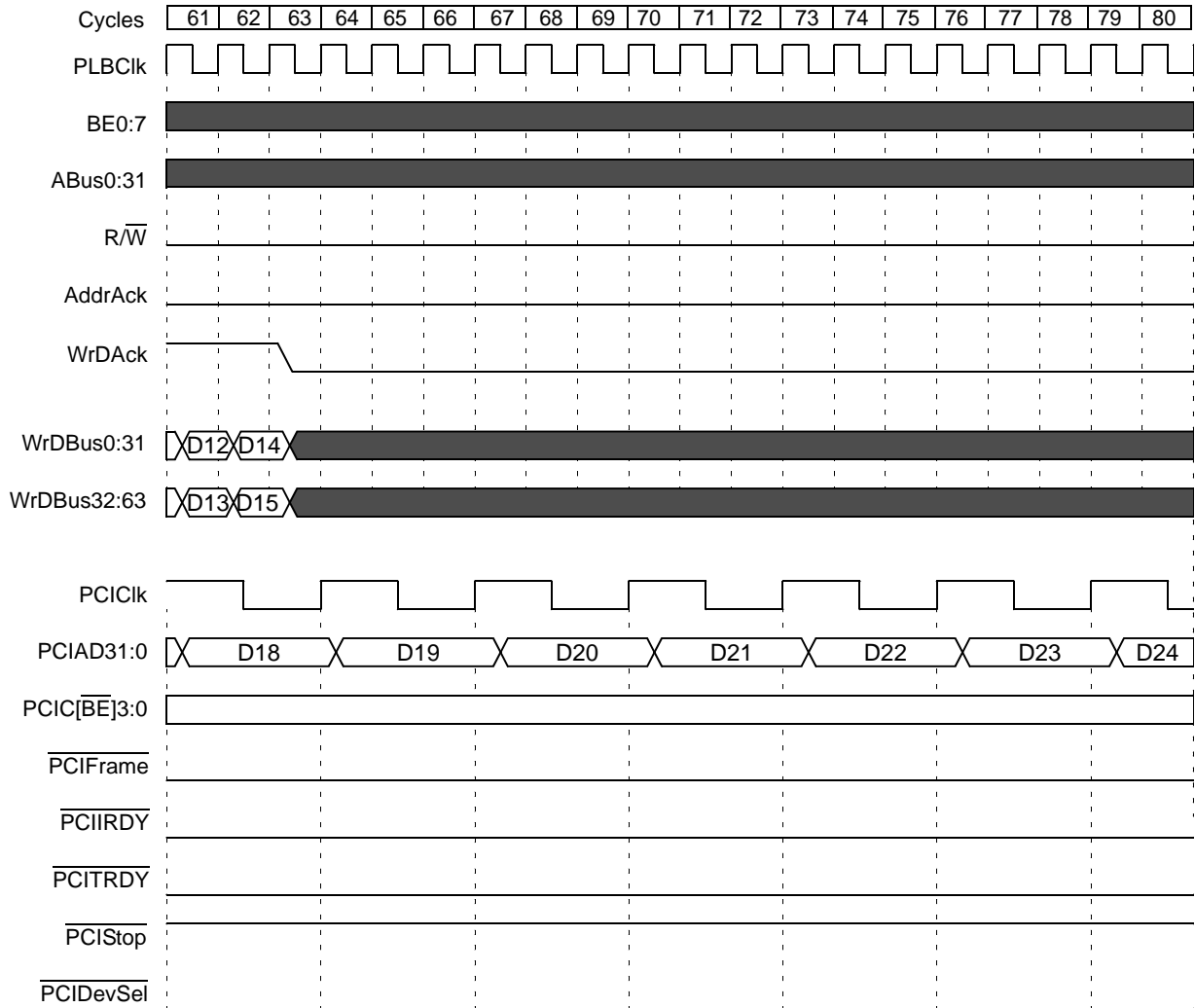

Figure 17-68. PCI Master Burst Write To SDRAM (Continued)

Preliminary User's Manual

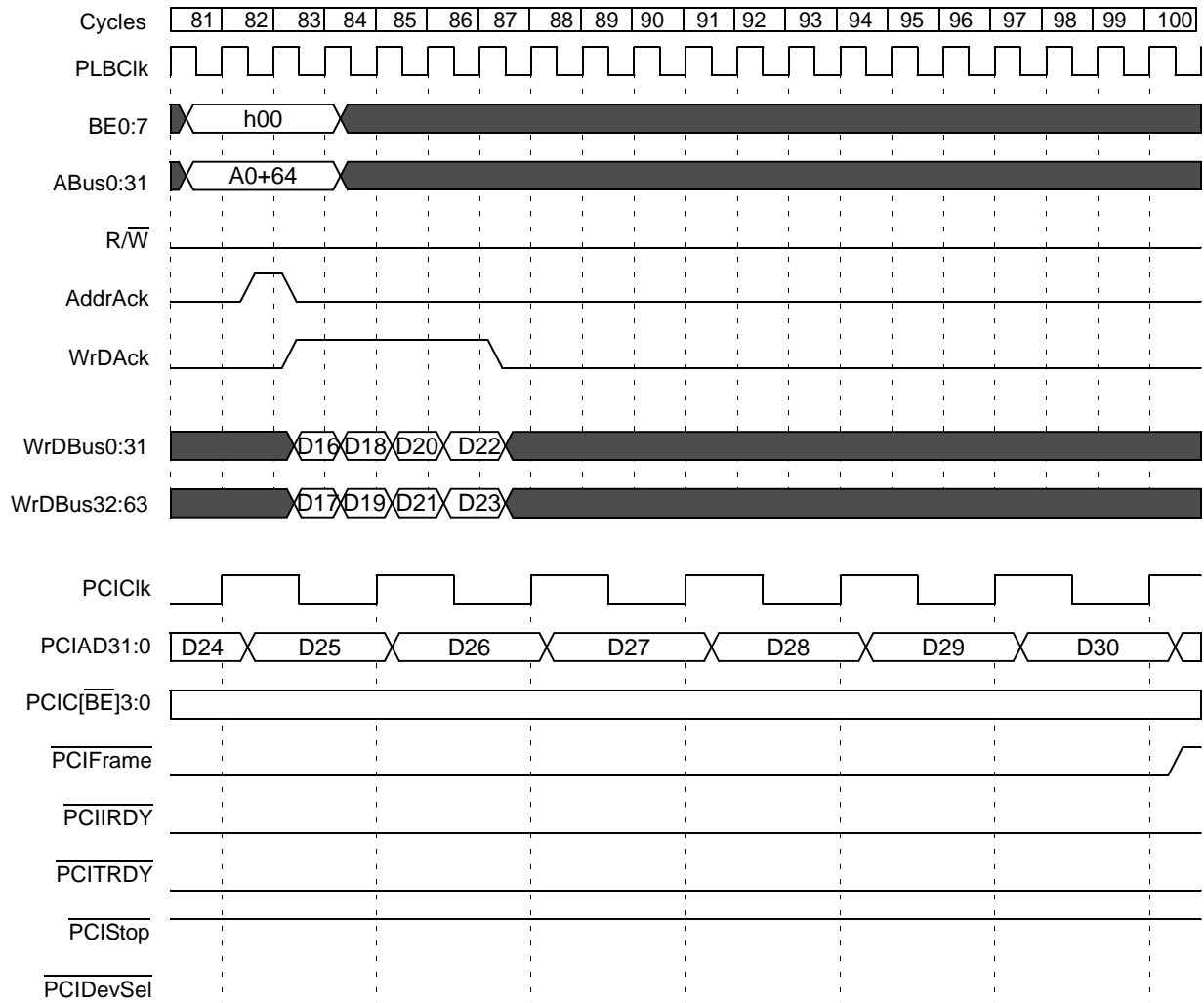

Figure 17-68. PCI Master Burst Write To SDRAM (Continued)

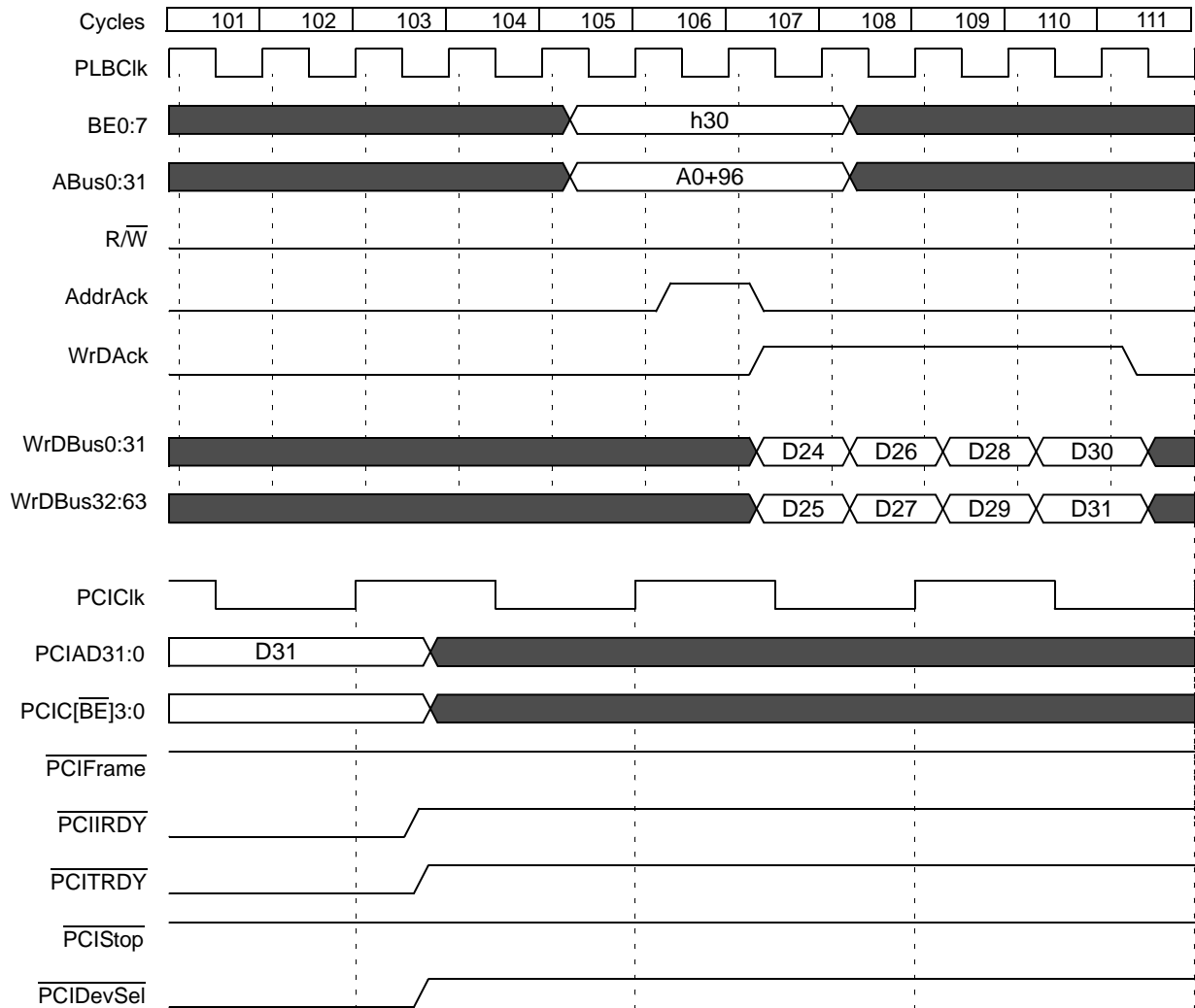

Figure 17-68. PCI Master Burst Write To SDRAM (Continued)

Preliminary User's Manual

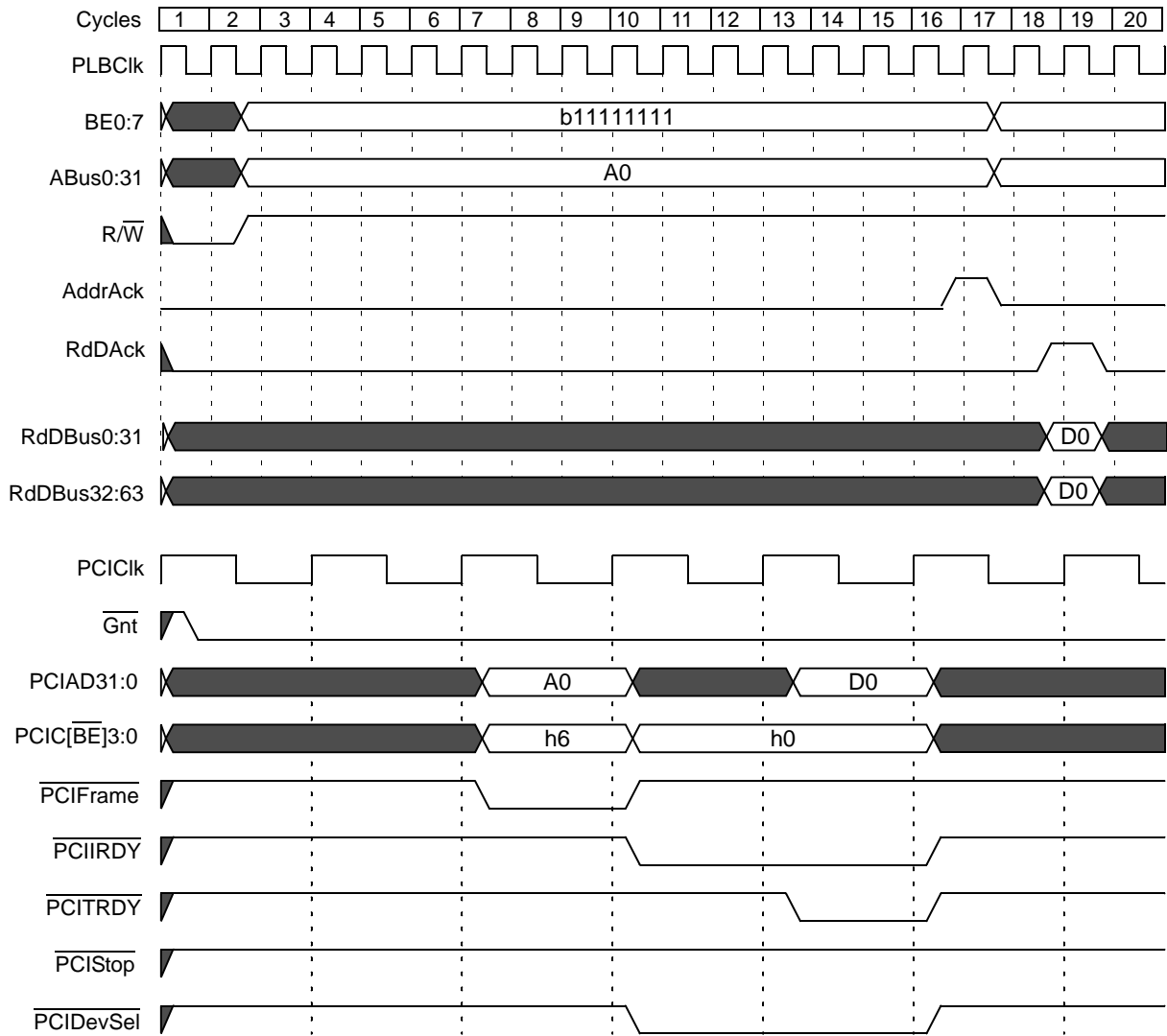

Figure 17-69. CPU Read From PCI Memory Slave, Nonprefetching

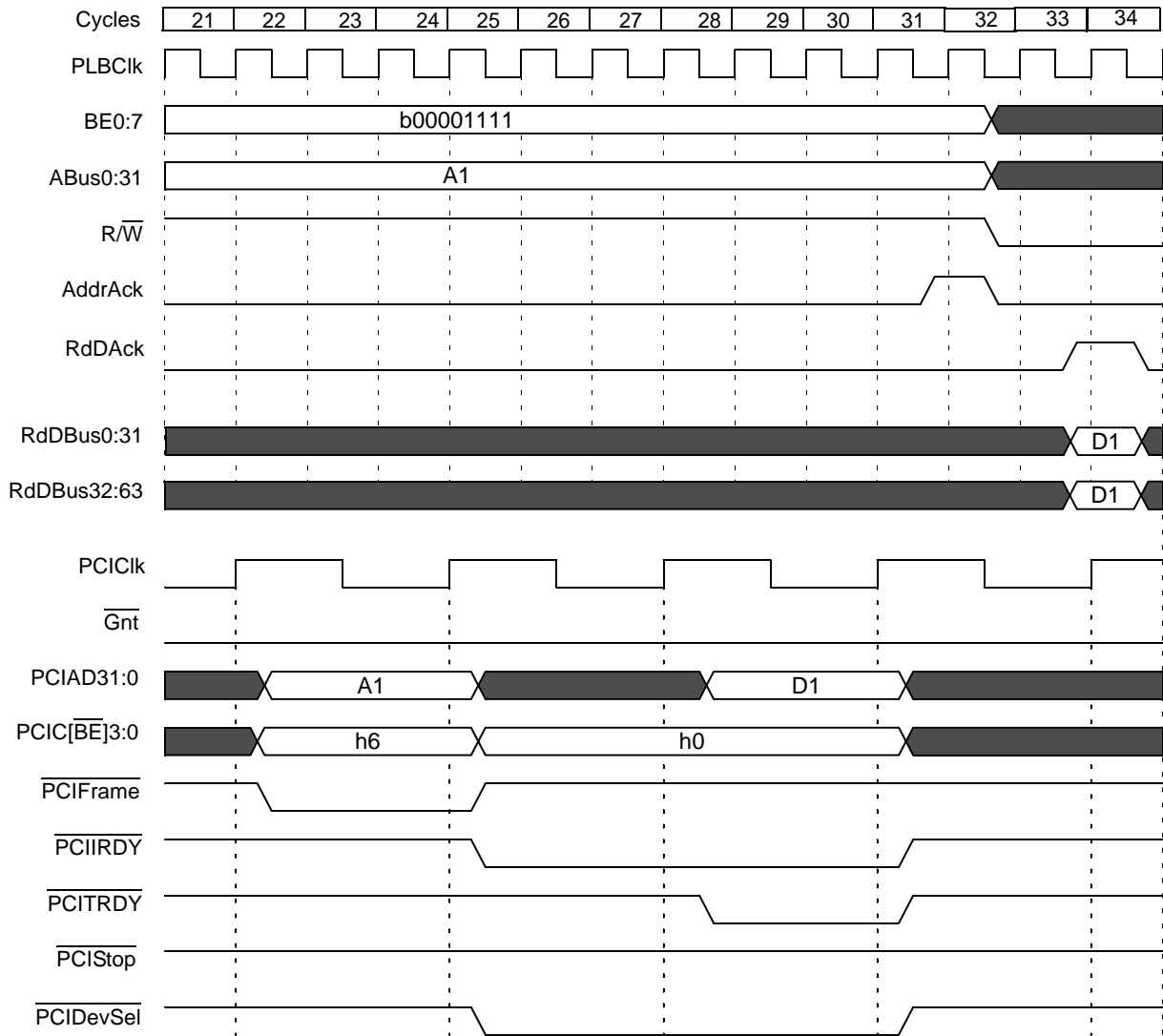

Figure 17-69. CPU Read From PCI Memory Slave, Nonprefetching (Continued)

Preliminary User's Manual

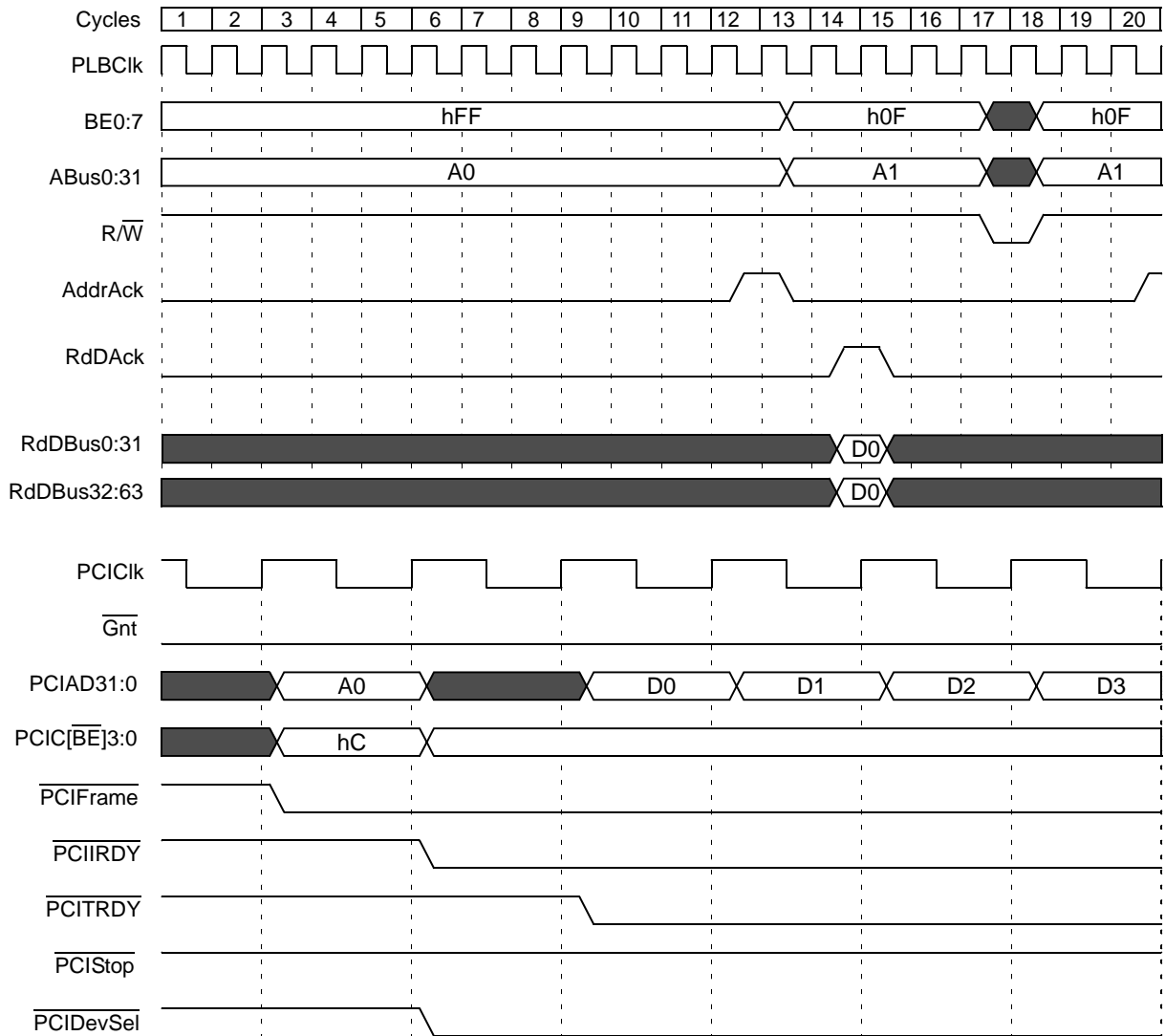

Figure 17-70. CPU Read From PCI Memory Slave, Prefetching

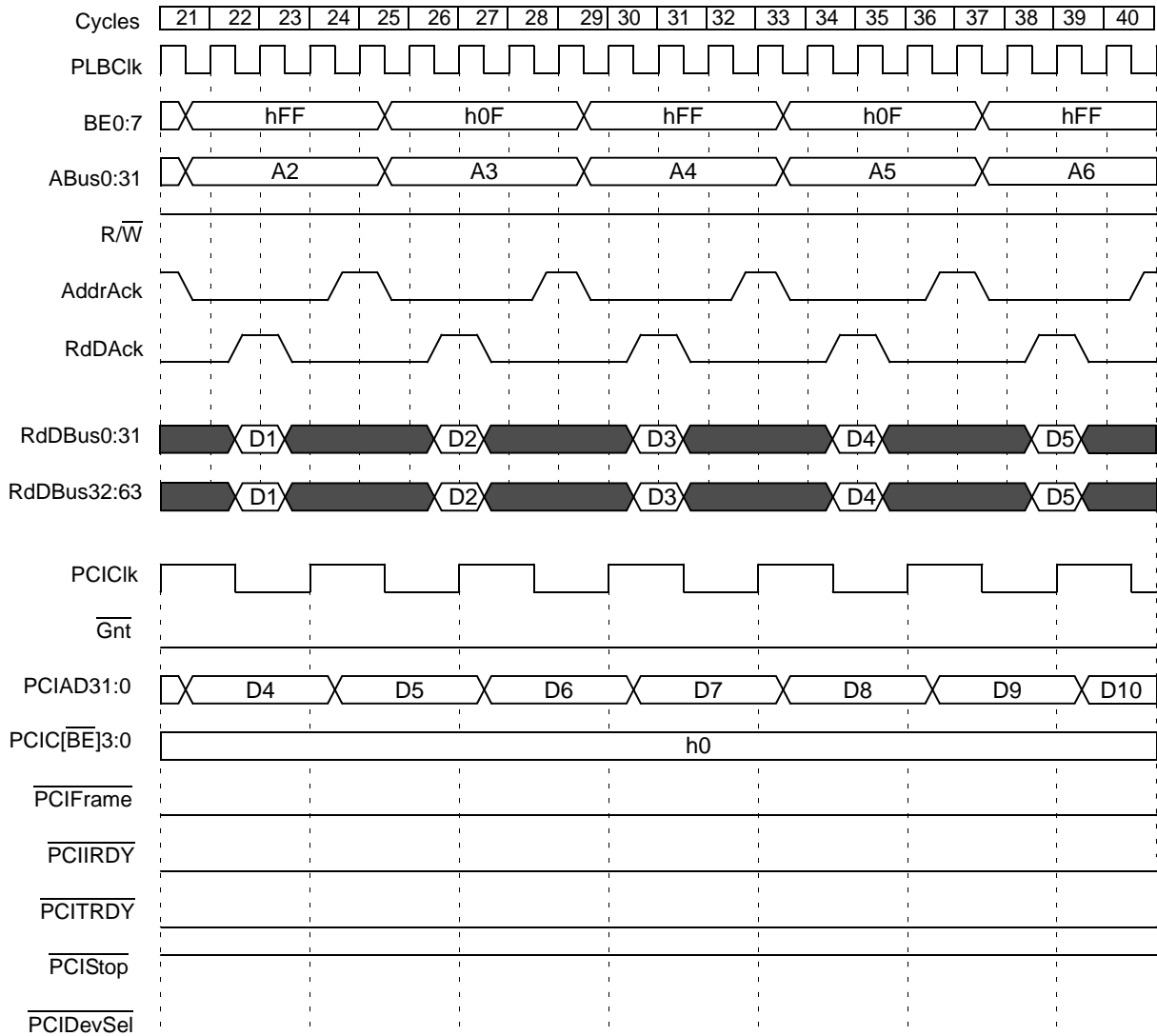

Figure 17-70. CPU Read From PCI Memory Slave, Prefetching (Continued)

Preliminary User's Manual

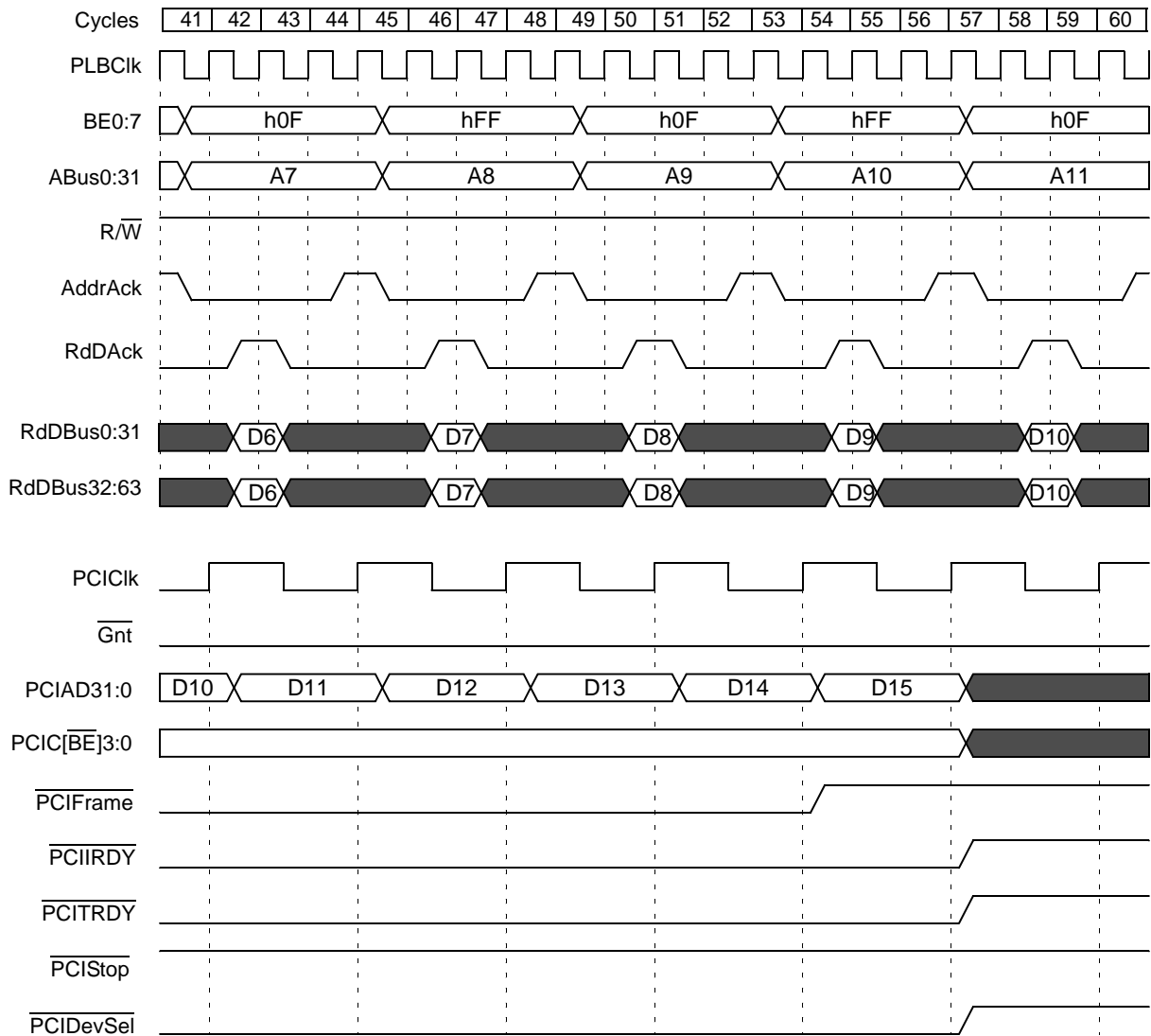

Figure 17-70. CPU Read From PCI Memory Slave, Prefetching (Continued)

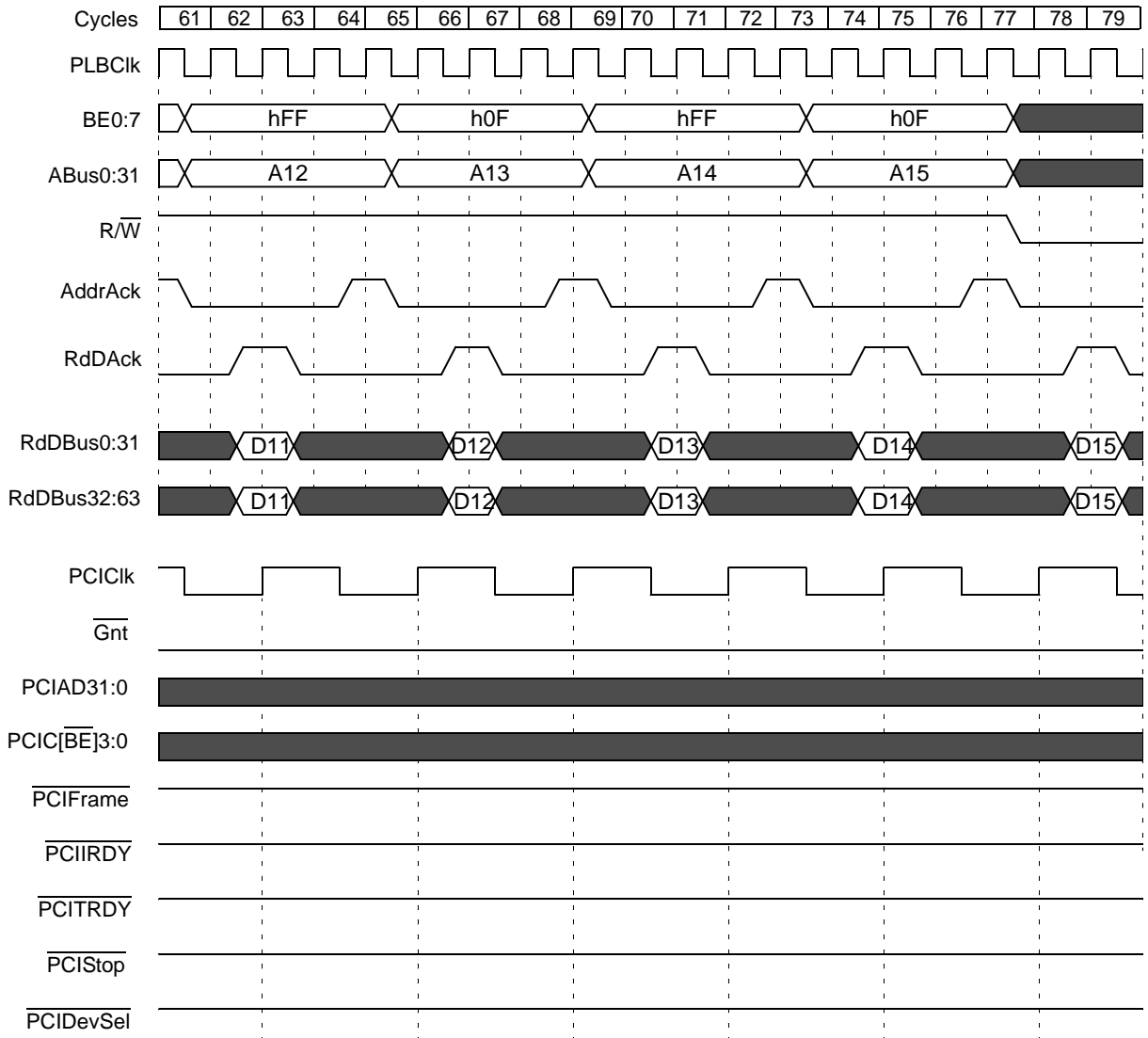

Figure 17-70. CPU Read From PCI Memory Slave, Prefetching (Continued)

Preliminary User's Manual

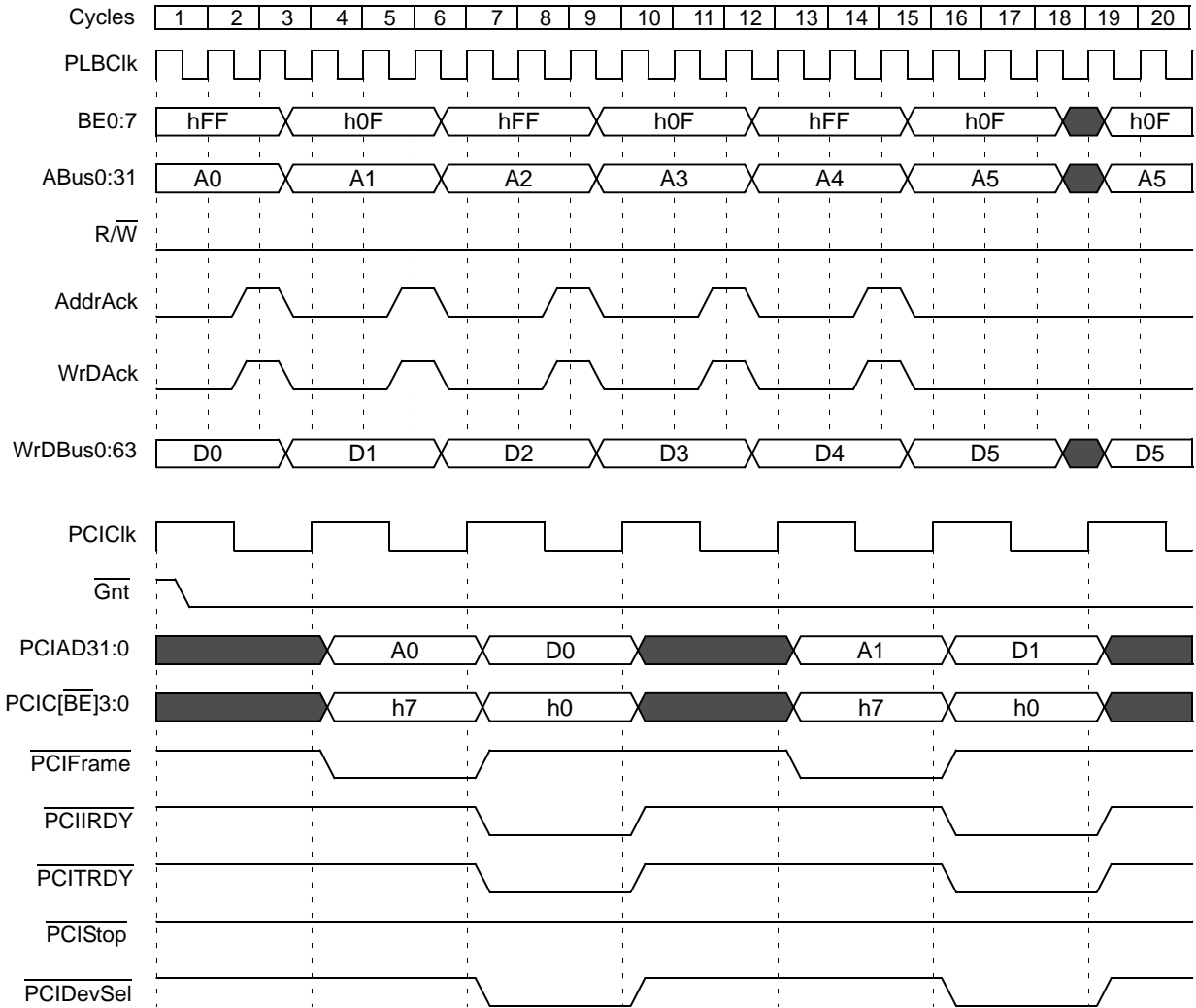

Figure 17-71. CPU Write To PCI Memory Slave

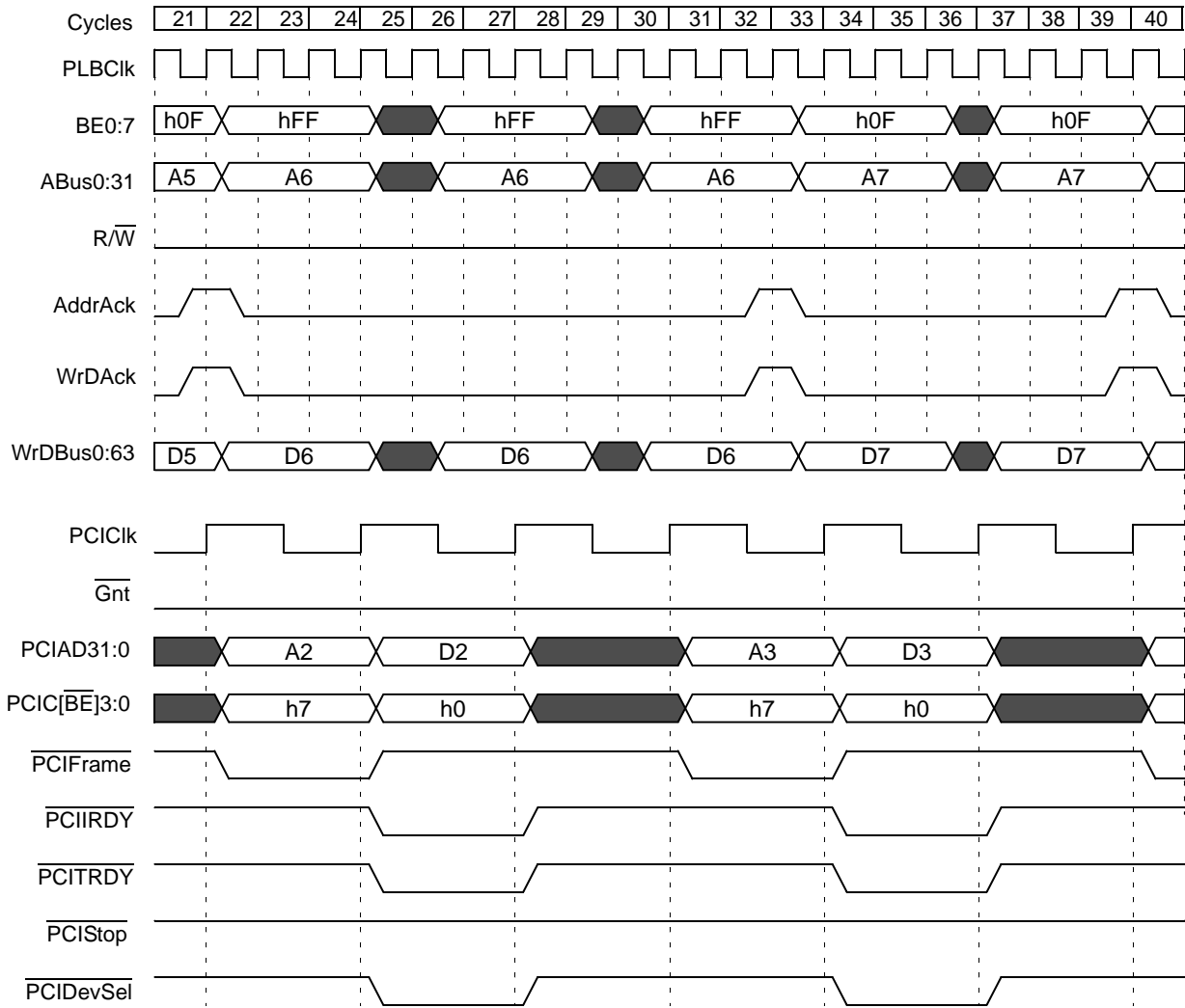

Figure 17-71. CPU Write To PCI Memory Slave (Continued)

Preliminary User's Manual

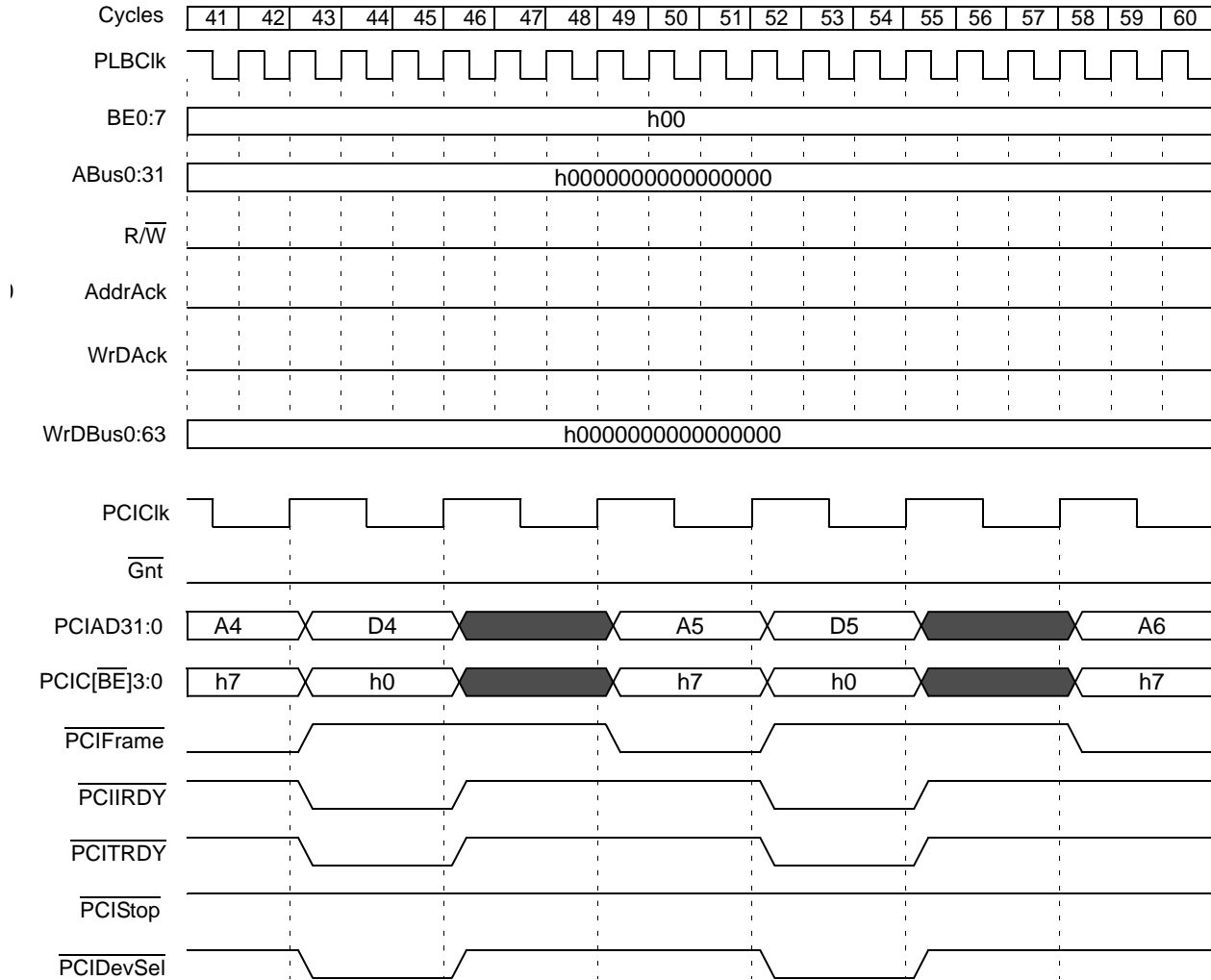

Figure 17-71. CPU Write To PCI Memory Slave (Continued)

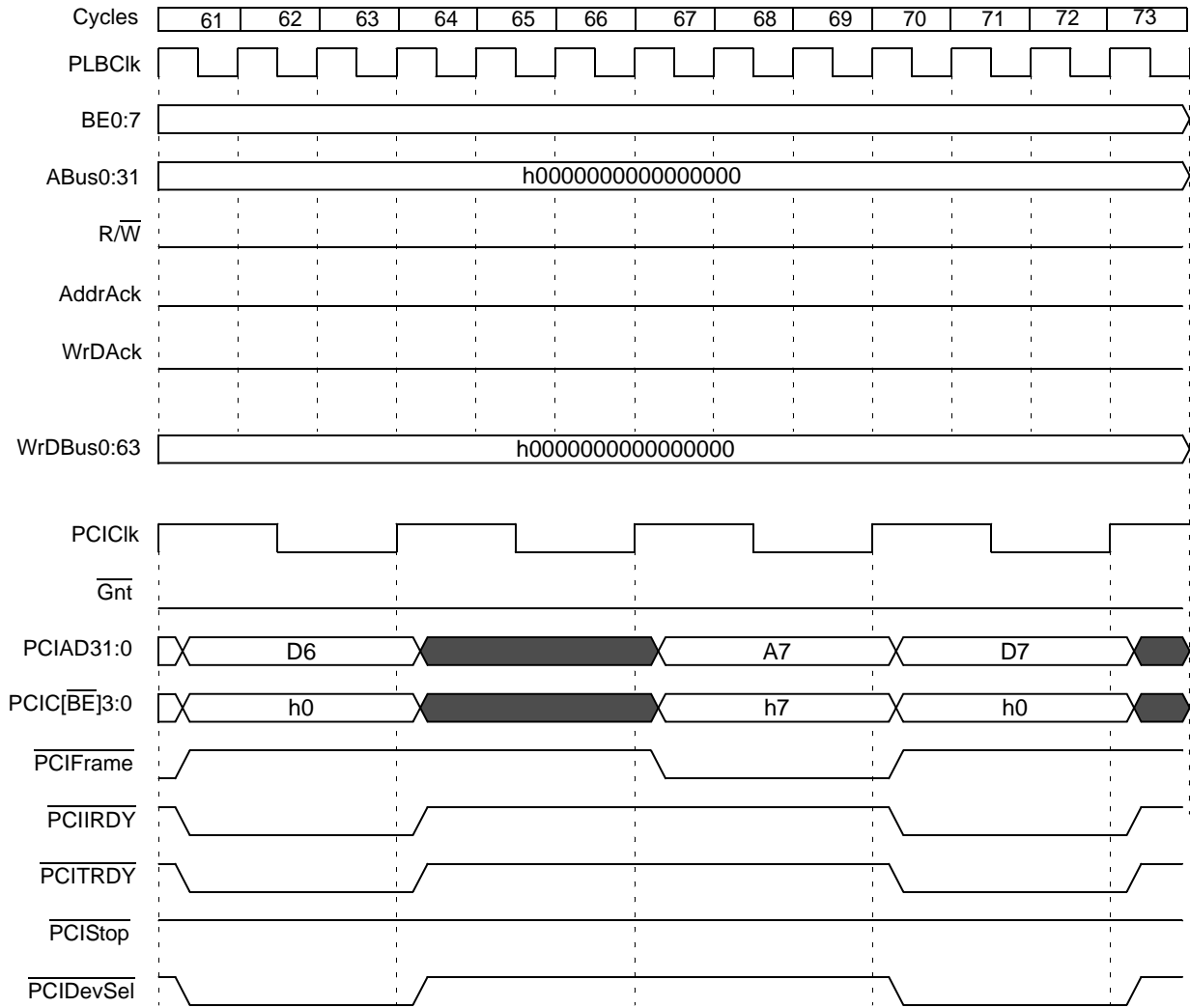

Figure 17-71. CPU Write To PCI Memory Slave (Continued)

Preliminary User's Manual

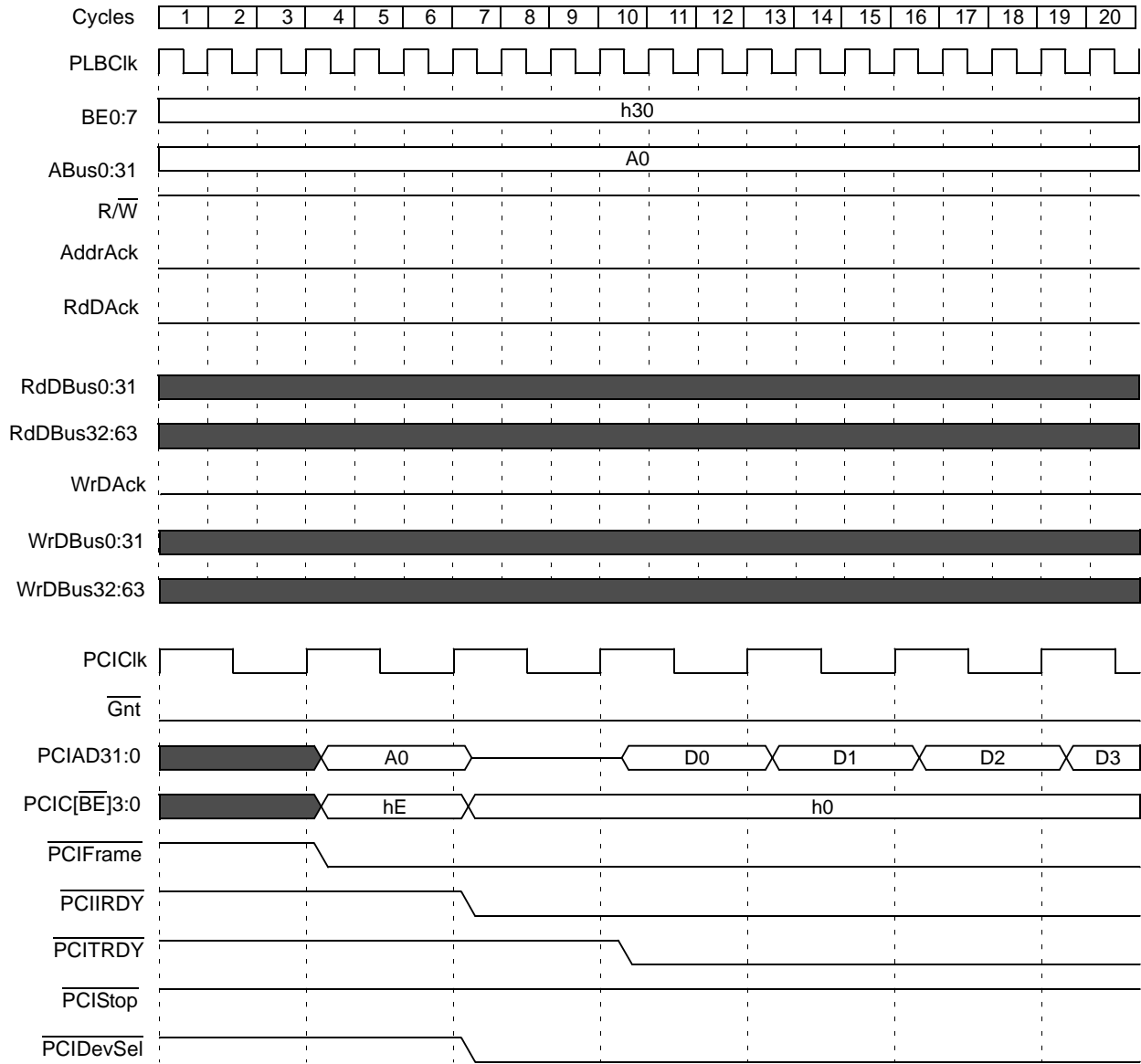

Figure 17-72. PCI Memory To SDRAM DMA Transfer

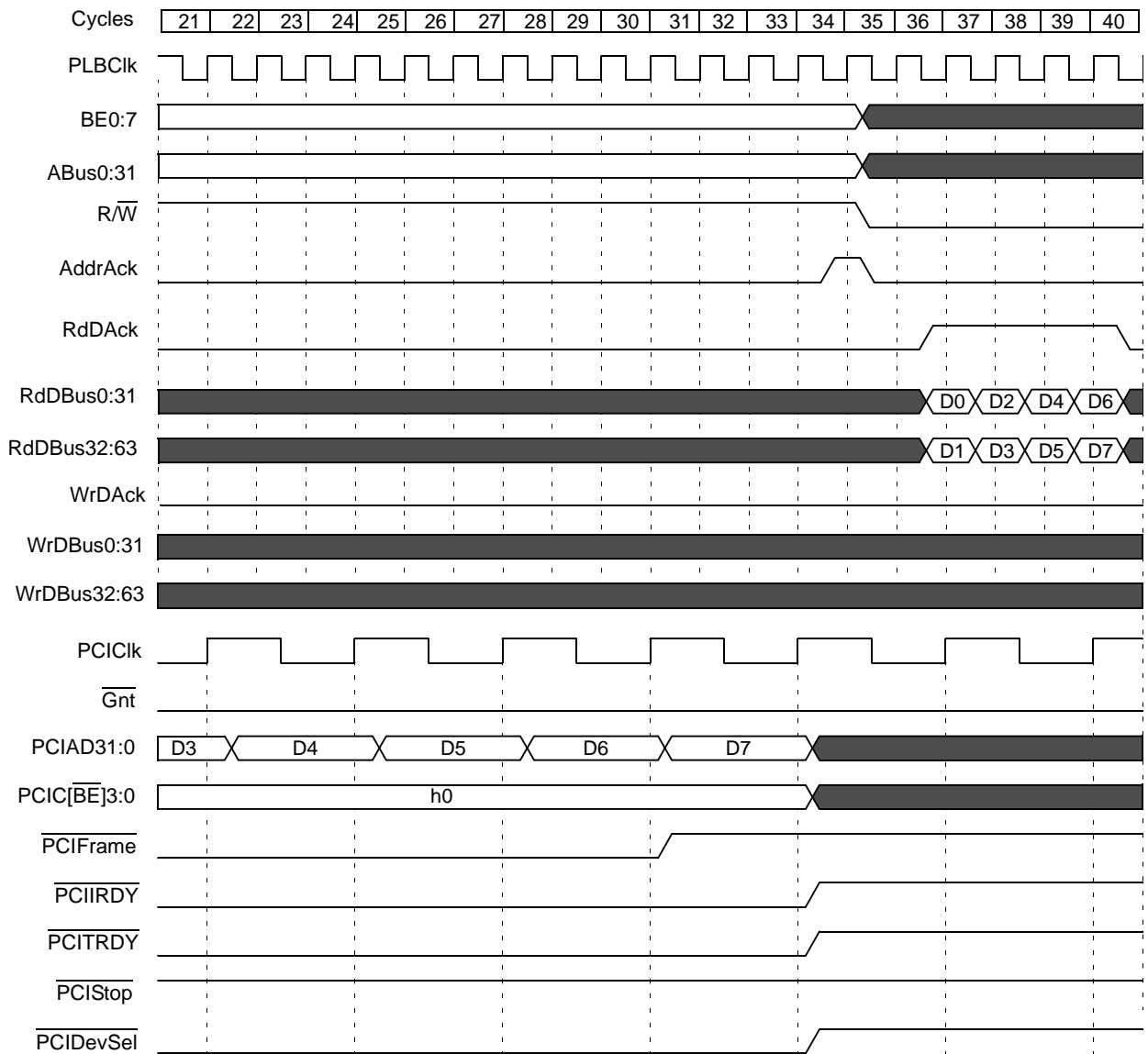

Figure 17-72. PCI Memory To SDRAM DMA Transfer (Continued)

Preliminary User's Manual

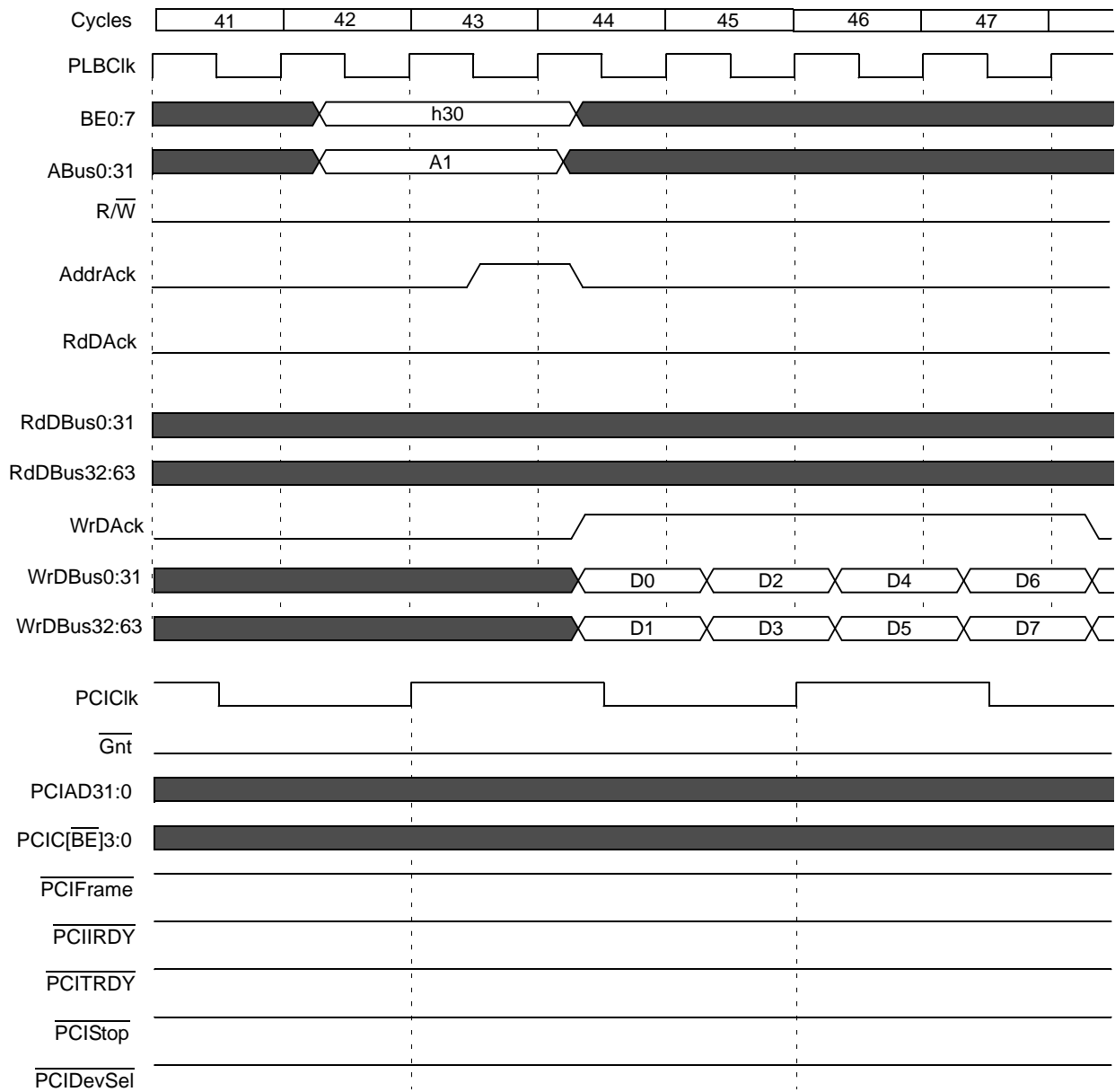

Figure 17-72. PCI Memory To SDRAM DMA Transfer (Continued)

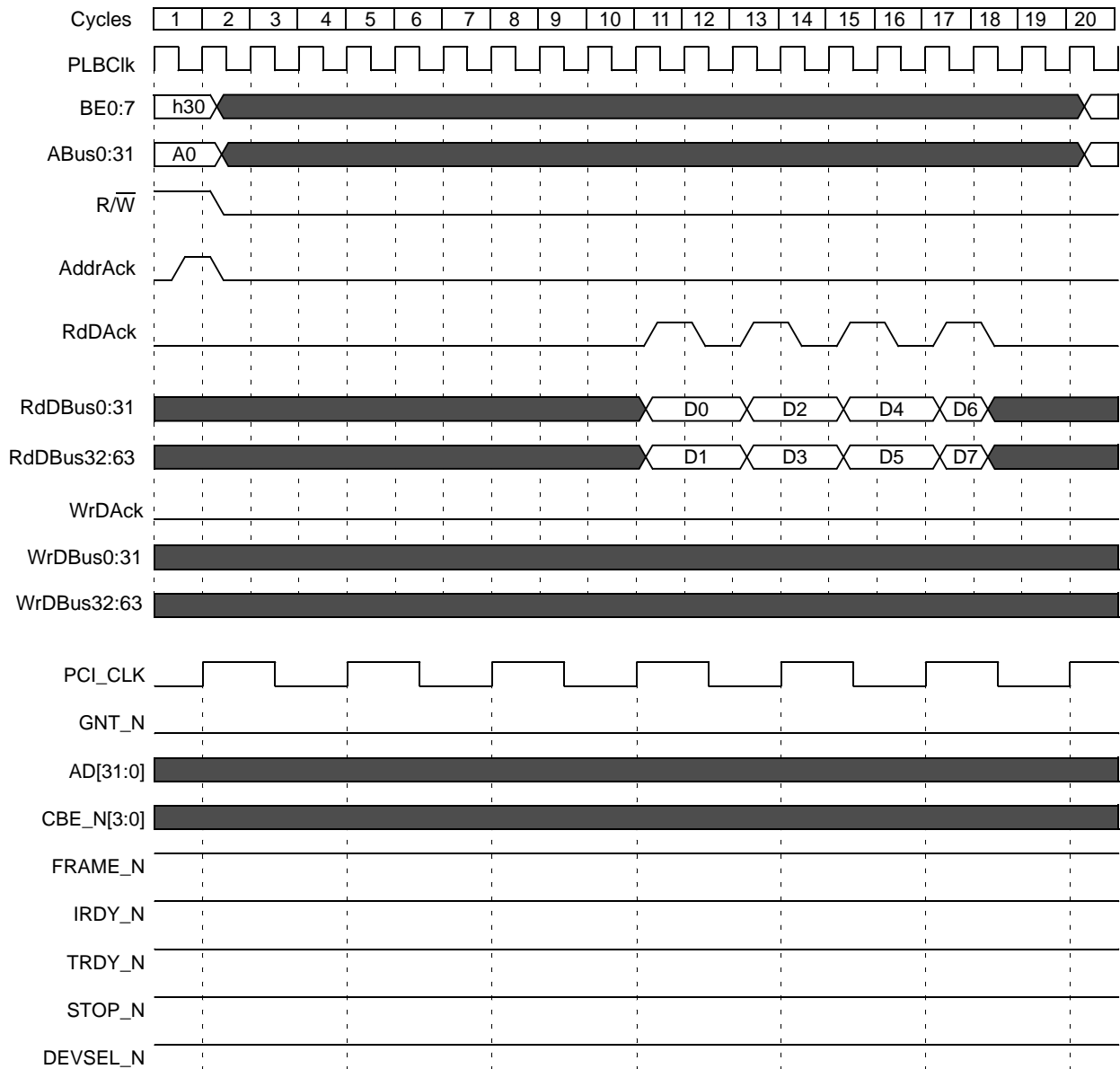

Figure 17-73. SDRAM To PCI Memory DMA Transfer

Preliminary User's Manual

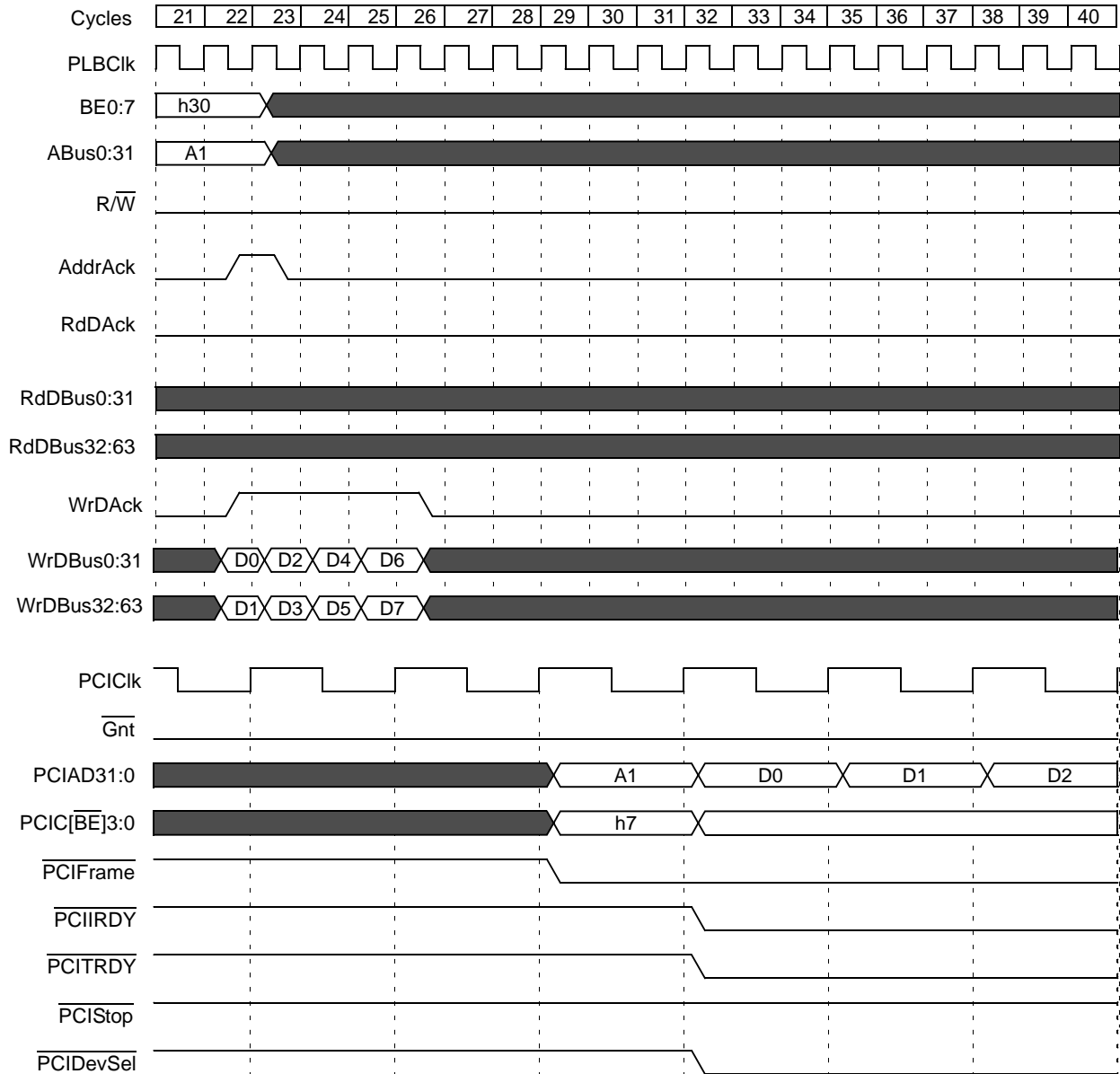

Figure 17-73. SDRAM To PCI Memory DMA Transfer (Continued)

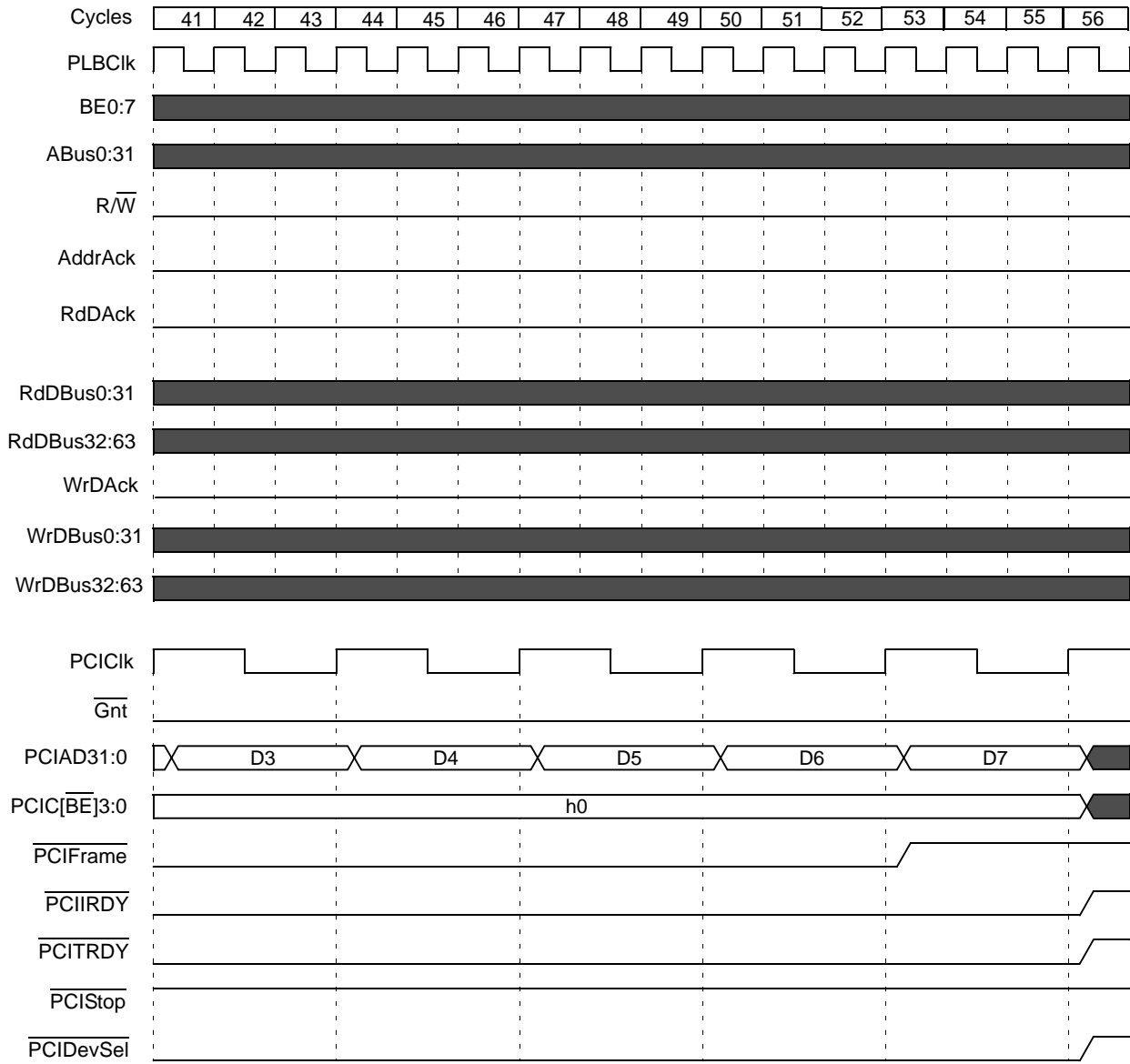

Figure 17-73. SDRAM To PCI Memory DMA Transfer (Continued)

Chapter 18. Direct Memory Access Controller

The direct memory access (DMA) controller is a processor local bus (PLB) and on-chip peripheral bus (OPB) master that supports the autonomous transfer of data between memory and peripherals and from memory to memory. The controller provides four DMA channels, each of which has an independent set of configuration registers. Each channel has its own control, source address, destination address, count, and scatter/gather address registers. After these registers are programmed by the PPC405GP, the DMA controller performs the requested data transfer without the need for processor intervention.

The four DMA channels also support scatter/gather transfers. During a scatter/gather transfer, the configuration registers for a particular DMA channel are automatically loaded from a data structure in memory instead of being individually programmed. Because the scatter/gather address register is updated in this process, the channel can optionally reconfigure itself for another transfer when the current one completes.

As master on both the PLB and OPB, the DMA controller can read and write any address accessible by the PPC405GP. This includes memory and memory-mapped peripherals on the EBC interface, SDRAM memory and PCI addresses that have been mapped into PLB address space. The DMA controller can also service DMA peripherals attached to the EBC using the DMAReqn, DMAAckn and EOTn[TCn] I/Os, along with the OPB-attached UART0.

18.1 External Interface Signals

Figure 18-1 illustrates the external I/Os associated with the DMA controller and the EBC I/Os used during external peripheral transfers. External peripheral and EBC device-paced memory transfers request service from the DMA controller by driving a DMA request line (DMAReq0-3) active. For peripheral mode transfers the DMA controller acknowledges the request and transfers data by asserting a DMA acknowledge signal (DMAAck0-3). In contrast, an EBC device-paced memory-to-memory transfer occurs when the chip select (PerCSn) associated with the memory location is driven active. The timing of PerCSn and the other EBC I/Os is determined by the Bank Access Parameter Register (EBC0_BnAP) for the particular memory location. See Chapter 16, “External Bus Controller” for details on EBC configuration and timings.

Table 18-1. DMA Controller External I/Os

Signal	Usage
DMAReqn	DMA Request, used to request either a peripheral mode transfer or an EBC device-paced memory-to-memory transfer.
DMAAckn	DMA Acknowledge, instructs an EBC-attached DMA peripheral to transfer data.
EOTn[TCn]	End of Transfer or Terminal Count. Used to stop the channel when programmed as EOT. When configured as TC, goes active when the channel transfer count register (DMA0_CTn) reaches zero.

Note: The active level (polarity) of the DMAReqn, DMAAckn, and EOTn[TCn] signals is individually programmable. See “DMA Polarity Configuration Register (DMA0_POL)” on page 18-505.. Operating information and timing waveforms are presented generically for active-high signals.

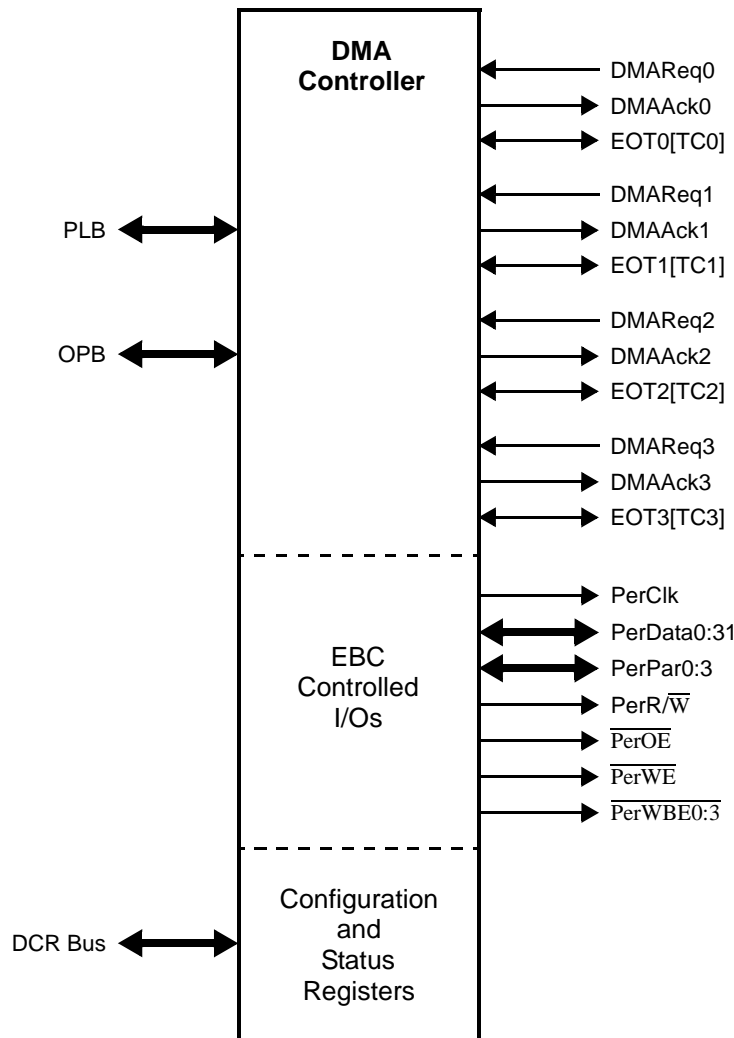

Figure 18-1. DMA Controller External Bus Control Signals

18.2 Functional Overview

As a specialized controller, the DMA unit provides system designers and programmers with a highly efficient method of moving data. During any DMA transfer the controller always buffers data read from the source prior to writing the data to the destination. Since many buses, including the internal PLB and the SDRAM interface, provide substantially better performance when bursting data, the DMA controller includes a 32-byte (4 doubleword) buffer. This buffer is enabled on a per-channel basis by setting DMA0_CRn[BEN] and serves to minimize the number of discrete memory transactions. Each of the four DMA channels is configurable for either peripheral or memory-to-memory transfers.

Preliminary User's Manual

18.2.1 Peripheral Mode Transfers

Peripherals are either devices attached to the EBC interface via the DMAReqn and DMAAckn lines, or the internal serial port (UART0). Memory is any address accessible from the PLB, including PLB-mapped PCI address space, SDRAM memory, and memory and memory-mapped devices on the peripheral bus. During a peripheral mode transfer the peripheral requests a DMA transfer by asserting a DMA request line. For UART0, this signal is internal to the PPC405GP, while external peripherals use one of the DMAReqn lines. When the requesting channel has the highest priority of any active channel, the requesting device receives a DMA acknowledge. In the case of external peripherals, the appropriate DMAAckn line is driven to the active state, with the timing specified in the DMA Control Register for the channel (DMA0_CRn).

There are two types of peripheral mode transfers: peripheral-to-memory and memory-to-peripheral. A peripheral-to-memory transfer reads data from a DMA device, while a memory-to-peripheral transfer writes data. In both cases, the peripheral interface never bursts and data is transferred at the width of the peripheral. If the DMA buffer is disabled for the active channel (DMA0_CRn[BEN]=0), each peripheral transfer causes a corresponding memory operation.

When buffering is enabled during a peripheral-to-memory transfer, data is collected until the 32-byte buffer is full, the peripheral deasserts DMAReqn, a higher priority DMA request becomes pending, or the channel completes. The buffer contents are then written to the target memory as efficiently as possible. If the initial programming of the channel's destination address register (DMA0_DAn) is 32-byte aligned, the buffer is emptied in one burst operation to the target memory.

Memory-to-peripheral transfers differ since the amount of data that will be requested by the peripheral is unknown. If the DMA buffer is disabled (DMA0_CRn[BEN]=0) a discrete source memory read occurs for each element in the DMA transfer. Since this is inefficient, the buffer should only be disabled for low data rate transfers or when the source memory is FIFO-like, and reads are therefore destructive. When the 32-byte buffer is enabled the controller uses the setting in DMA0_CRn[PF] to prefetch 1, 2, or 4 64-bit doublewords from the source memory. The DMA controller provides data from the buffer until the peripheral deasserts its request, the channel is interrupted by one of higher priority, or the transfer completes. Whenever any of these conditions occurs any unused data in the DMA buffer is discarded.

18.2.2 Memory-to-Memory Transfers

The DMA controller can perform either device-paced (hardware-initiated) or software-initiated memory-to-memory transfers. Device-paced memory transfers function identically to peripheral mode transfers, except that a chip select (PerCSn) serves as the DMA acknowledge instead of a DMAAckn output. As with peripheral mode transfers, bursts never occur on the device-paced side of the transaction.

Software-initiated memory-to-memory transfers between memories with fixed timings provide the best overall performance. During a software-initiated transfer the DMA controller knows the exact amount of data to be transferred. As a result, when the 32-byte DMA buffer is enabled (DMA0_CRn[BEN]=1) the controller uses bursts as much as possible. To ensure the highest bandwidth, source and destination addresses should be aligned on 32-byte boundaries.

There are three cases that limit the ability to burst during software-initiated memory-to-memory transfers. Bursting is not possible from the source memory when the source address increment is zero (DMA0_CRn[SAI]=0). Similarly, the DMA controller does not burst to the destination when the destination address increment is zero (DMA0_CRn[DAI]=0). Finally, the DMA controller cannot burst to or from any address that maps to a device-paced (EBC0_BnAP[RE]=1) EBC chip select (PerCSn).

18.2.3 Scatter/Gather Transfers

Each of the four DMA channels supports scatter/gather transfers. This scatter/gather capability allows the chaining of multiple DMA controller operations within a channel. During a normal DMA operation software must program the control, source address, destination address, and count registers for each transfer. Scatter/gather transfers differ in that these registers are automatically loaded from a linked list data structure in system memory. When a channel completes one transfer the DMA controller loads the next set of configuration values into the channel's registers and the channel continues with the new programmings.

18.3 Configuration and Status Registers

Table 18-2 on page 18-504 lists the DMA configuration and status registers, each of which is accessed using the `mtdcr` and `mfocr` instructions. As example, the following assembly code writes DMA0_CR0 and then reads DMA0_SR:

```
#define DMA0_CR0  0x100
#define DMA0_SR   0x120

        mtdcr    DMA0_CR0,r3          ! write r3 to channel 0 control register
        mfocr    r4,DMA0_SR          ! read contents of status register into r4
```

The DMA configuration and status registers are readable at any time. However, because each register read requires a separate operation, it is not possible to guarantee that the values read from multiple registers correspond to a state that ever existed in the DMA controller. To illustrate, consider software that reads the destination address for channel 0 (DMA0_DA0) and then the count for channel 0 (DMA0_CT0). If the DMA controller updates the count between these two operations, the values read differ from what is expected.

While reads can occur at any time, software must not write the configuration registers for any channel that is currently enabled (DMA0_CRn[CE]=1). The only exception is that a channel may be disabled by reading the channel control register, clearing the channel enable bit, and then writing the new value to the control register. Once a channel is disabled, all of its configuration registers may be reprogrammed as desired.

Table 18-2. DMA Controller Configuration and Status Registers

Mnemonic	DCR Address	Access	Description	Page
DMA0_CR0	0x100	R/W	DMA Channel Control Register 0	18-508
DMA0_CT0	0x101	R/W	DMA Count Register 0	18-511
DMA0_DA0	0x102	R/W	DMA Destination Address Register 0	18-511
DMA0_SA0	0x103	R/W	DMA Source Address Register 0	18-510
DMA0_SG0	0x104	R/W	DMA Scatter/Gather Descriptor Address Register 0	18-512
DMA0_CR1	0x108	R/W	DMA Channel Control Register 1	18-508
DMA0_CT1	0x109	R/W	DMA Count Register 1	18-508
DMA0_DA1	0x10A	R/W	DMA Destination Address Register 1	18-511
DMA0_SA1	0x10B	R/W	DMA Source Address Register 1	18-510
DMA0_SG1	0x10C	R/W	DMA Scatter/Gather Descriptor Address Register 1	18-512
DMA0_CR2	0x110	R/W	DMA Channel Control Register 2	18-508
DMA0_CT2	0x111	R/W	DMA Count Register 2	18-511
DMA0_DA2	0x112	R/W	DMA Destination Address Register 2	18-511
DMA0_SA2	0x113	R/W	DMA Source Address Register 2	18-510
DMA0_SG2	0x114	R/W	DMA Scatter/Gather Descriptor Address Register 2	18-512
DMA0_CR3	0x118	R/W	DMA Channel Control Register 3	18-508

Preliminary User's Manual**Table 18-2. DMA Controller Configuration and Status Registers (continued)**

Mnemonic	DCR Address	Access	Description	Page
DMA0_CT3	0x119	R/W	DMA Count Register 3	18-511
DMA0_DA3	0x11A	R/W	DMA Destination Address Register 3	18-511
DMA0_SA3	0x11B	R/W	DMA Source Address Register 3	18-510
DMA0_SG3	0x11C	R/W	DMA Scatter/Gather Descriptor Address Register 3	18-512
DMA0_SR	0x120	R/Clear	DMA Status Register	18-507
DMA0_SGC	0x123	R/W	DMA Scatter/Gather Command Register	18-512
DMA0_SLP	0x125	R/W	DMA Sleep Mode Register	18-506
DMA0_POL	0x126	R/W	DMA Polarity Configuration Register	18-505

18.3.1 DMA Polarity Configuration Register (DMA0_POL)

DMA0_POL is used to set the polarity (active state) of the external DMA I/O signals: DMAReqn, DMAAckn, and EOTn[TCn]. As shown in Figure 18-1, if a bit in DMA0_POL is 0, the corresponding signal is active high, otherwise the signal is active low.

Whenever any of the EOT polarities are changed (DMA0_POL[EnP], software must subsequently clear the corresponding EOT status bits in DMA0_SR[TS0:3] before enabling the associated DMA channel. This is necessary to prevent a channel from being disabled because of an incorrect EOT status stored in the status bits.

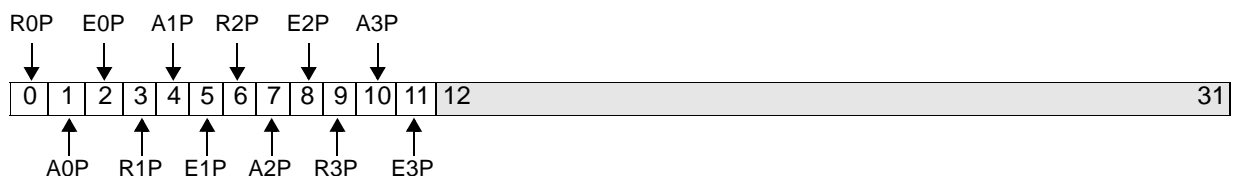
**Figure 18-2. DMA Polarity Configuration Register (DMA0_POL)**

0	R0P	DMAReq0 Polarity 0 DMAReq0 is active high 1 DMAReq0 is active low
1	A0P	DMAAck0 Polarity 0 DMAAck0 is active high 1 DMAAck0 is active low
2	E0P	EOT0[TC0] Polarity 0 EOT0[TC0] is active high 1 EOT0[TC0] is active low
3	R1P	DMAReq1 Polarity 0 DMAReq1 is active high 1 DMAReq1 is active low
4	A1P	DMAAck1 Polarity 0 DMAAck1 is active high 1 DMAAck1 is active low
5	E1P	EOT1[TC1] Polarity 0 EOT1[TC1] is active high 1 EOT1[TC1] is active low

6	R2P	DMAReq2 Polarity 0 DMAReq2 is active high 1 DMAReq2 is active low
7	A2P	DMAAck2 Polarity 0 DMAAck2 is active high 1 DMAAck2 is active low
8	E2P	EOT2[TC2] Polarity 0 EOT2[TC2] is active high 1 EOT2[TC2] is active low
9	R3P	DMAReq3 Polarity 0 DMAReq3 is active high 1 DMAReq3 is active low
10	A3P	DMAAck3 Polarity 0 DMAAck3 is active high 1 DMAAck3 is active low
11	E3P	EOT3[TC3] Polarity 0 EOT3[TC3] is active high 1 EOT3[TC3] is active low
12:31		Reserved

18.3.2 DMA Sleep Mode Register (DMA0_SLP)

DMA0_SLP enables the DMA controller to enter sleep (low-power) mode and programs the number of PLB clock cycles to wait when the controller is idle before going to sleep. The DMA controller only goes to sleep when no DMA channels are enabled and no configuration or status (DCR) register operations are in progress. Reading or writing any of the DMA control or status register awakens the DMA controller.

To enable sleep mode, set DMA0_SLP[SME] and CPM0_ER[DMA]. When sleep mode is enabled and the DMA controller becomes idle, the 10-bit idle timer begins counting down from the programmed value. Only the upper 5 bits of the idle counter are programmable; the lower 5 bits are hardcoded to 0b11111. Therefore, the minimum granularity of the idle timer is 32 PLB clock cycles. When the counter reaches 0, the controller is placed in sleep mode.

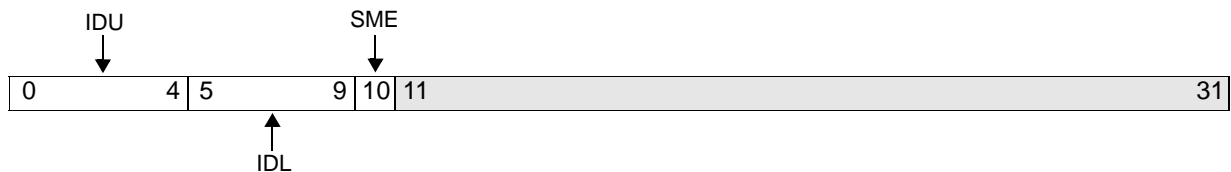

Figure 18-3. DMA Sleep Mode Register (DMA0_SLP)

0:4	IDU	Idle Timer Upper 0–31	Upper 5-bits of the idle timer.
5:9	IDL	Idle Timer Lower Hardcoded to 0b11111	Lower 5-bit portion of the idle timer. Writing this field has no effect.
10	SME	Sleep Mode Enable 0 Sleep disabled 1 Sleep enabled	If SME=1, also set CPM0_ER[DMA] to enable the clock and power management logic to put the DMA controller to sleep.
11:31		Reserved	

Preliminary User's Manual**18.3.3 DMA Status Register (DMA0_SR)**

As shown in Figure 18-4, DMA0_SR provides status information for each of the DMA channels. Bits in DMA0_SR are set in hardware, and can be either read or cleared by software. Clearing is performed by writing a word to DMA0_SR containing a 1 in any bit position to be cleared and 0 in all other bit positions.

The terminal count status (DMA0_SR[CSn]), end of transfer status (DMA0_SR[TSn]), and error status (DMA0_SR[RIn]) must be cleared for a DMA channel to operate. If a scatter/gather operation generates an interrupt for any of these conditions, the channel pauses until software clears any associated status fields in DMA0_SR.

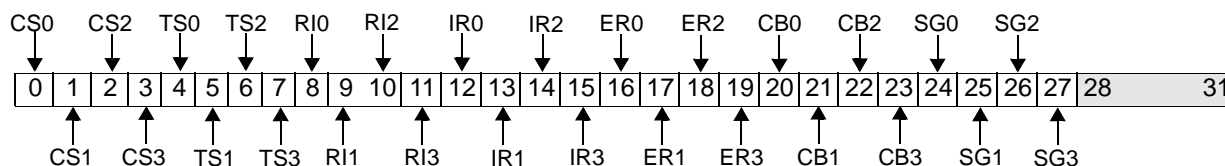
**Figure 18-4. DMA Status Register (DMA0_SR)**

0:3	CS[0:3]	Channel 0–3 Terminal Count Status 0 Terminal count has not occurred 1 Terminal count has been reached	Set when the transfer count reaches 0.
4:7	TS[0:3]	Channel 0–3 End of Transfer Status 0 End of transfer has not been requested 1 End of transfer has been requested	Only valid for channels with DMA0_CRn[ETD]=0.
8:11	RI[0:3]	Channel 0–3 Error Status 0 No error 1 Error occurred	See “Errors” on page 18-513 for more information.
12:15	IR[0:3]	Internal DMA Request 0 No internal DMA request pending 1 Internal DMA request is pending	
16:19	ER[0:3]	External DMA Request 0 No external DMA request pending 1 External DMA request is pending	
20:23	CB[0:3]	Channel Busy 0 Channel is idle 1 Channel currently active	
24:27	SG[0:3]	Scatter/Gather Status 0 No scatter/gather operation in progress 1 Scatter/gather operation in progress	
28:31		Reserved	

18.3.4 DMA Channel Control Registers (DMA0_CR0–DMA0_CR3)

DMA0_CR0–DMA0_CR3 are used to configure and enable their respective DMA channels. Before a DMA channel can transfer data, the channel control, source address, destination address, and transfer count registers must be programmed. If a DMA channel is programmed for scatter/gather transfers (DMA_SGC[SSGn]=1) the DMA channel control register is automatically loaded from memory. For additional details, see “Scatter/Gather Transfers” on page 18-515.

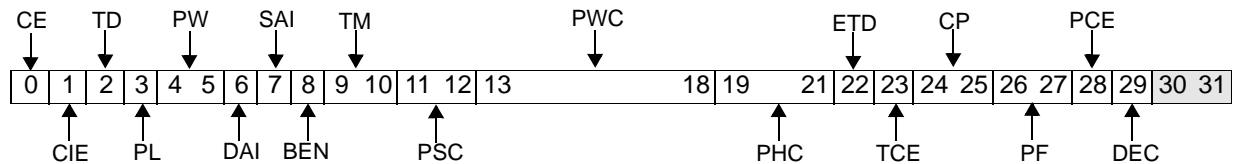

Figure 18-5. DMA Channel Control Registers (DMA0_CR0–DMA0_CR3)

0	CE	Channel Enable 0 Channel is disabled 1 Channel is enabled	This field is automatically cleared when the transfer completes or an error occurs.
1	CIE	Channel Interrupt Enable 0 Disable interrupts from this channel 1 Enable interrupts from this channel	When enabled, interrupts are generated for terminal count, end of transfer, and errors conditions. See “DMA Interrupts” on page 18-514.
2	TD	In peripheral mode: 0 Transfers are from memory-to-peripheral 1 Transfers are from peripheral-to-memory In device-paced memory-to-memory mode: 0 Peripheral is at the destination address 1 Peripheral is at the source address	TD is not used (don't care) for software-initiated memory-to-memory transfers.
3	PL	Peripheral Location 0 External peripheral (EBC) bus 1 OPB (UART0)	
4:5	PW	Peripheral Width/Memory alignment 00 Byte (8 bits) 01 Halfword (16 bits) 10 Word (32 bits) 11 Doubleword (64 bits) memory-to-memory transfers only	Transfer width equals peripheral width for peripherals.
6	DAI	Destination Address Increment 0 Do not increment destination address 1 After each data transfer increment the destination address by: 1, if the transfer width is a byte (8 bits) 2, if the transfer width is a halfword (16 bits) 4, if the transfer width is a word (32 bits) 8, if the transfer width is a doubleword (64 bit)	

Preliminary User's Manual

7	SAI	Source Address Increment 0 Do not increment source address 1 After each data transfer increment the source address by: 1, if the transfer width is a byte (8 bits) 2, if the transfer width is a halfword (16 bits) 4, if the transfer width is a word (32 bits) 8, if the transfer width is a doubleword (64 bit)	
8	BEN	Buffer Enable 0 Disable DMA 32-byte buffer 1 Enable DMA 32-byte buffer	If BEN=0, discrete read and write operations occur for each data transfer.
9:10	TM	Transfer mode 00 Peripheral 01 Reserved 10 Software-initiated memory-to-memory 11 Device-paced memory-to-memory	
11:12	PSC	Peripheral Setup Cycles 0–3	Number of PerClk cycles that the EBC peripheral bus is idle from the last peripheral bus transaction until DMAAckn is active. Used only for the peripheral side of peripheral mode transfers.
13:18	PWC	Peripheral Wait Cycles 0–63	DMAAckn remains active for PWC + 1 PerClk cycles. Used only for the peripheral side of peripheral mode transfers.
19:21	PHC	Peripheral Hold Cycles 0–7	The number of PerClk cycles from the time DMAAckn becomes inactive until the peripheral bus is available for the next bus access. Used only for the peripheral side of peripheral mode transfers.
22	ETD	End-of-Transfer/Terminal Count (EOTn[TCn]) Pin Direction 0 EOTn[TCn] is an EOT input 1 EOTn[TCn] is a TC output	ETD must be set to 1 if the channel is configured for software-initiated memory-to-memory transfers.
23	TCE	Terminal Count (TC) Enable 0 Channel does not stop when TC is reached 1 Channel stops when TC is reached	If TCE=1, it is required that ETD=1.
24:25	CP	Channel Priority 00 Low priority 01 Medium low priority 10 Medium high priority 11 High priority	Actively requesting channels of the same priority are prioritized by channel number; channel 0 has the highest priority. See "Channel Priorities" on page 18-513 for more information.
26:27	PF	Memory Read Prefetch Transfer 00 Prefetch 1 doubleword 01 Prefetch 2 doublewords 10 Prefetch 4 doublewords 11 Reserved	Used only during memory-to-peripheral and device-paced memory-to-memory transfers. To enable prefetching it is required that BEN=1.

28	PCE	Parity Check Enable 0 Disable parity checking 1 Enable parity checking	Enables parity checking for peripheral mode transfers. See “Data Parity During DMA Peripheral Transfers” on page 18-513.
29	DEC	Address Decrement 0 SAI and DAI fields control memory address incrementing. 1 After each data transfer the memory address is decremented by the transfer width.	If DEC=1, it is required that BEN=0. This field is valid only for peripheral mode transfers (TM=00).
30:31		Reserved	

18.3.5 DMA Source Address Registers (DMA0_SA0–DMA0_SA3)

DMA0_SA0–DMA0_SA3 contain source addresses for memory-to-memory and memory-to-peripheral transfers. If a DMA channel is setup for scatter/gather transfers (DMA_SGC[SSGn]=1), the associated source address register is automatically loaded from memory. For additional details, see “Scatter/Gather Transfers” on page 18-515.

The source address must be aligned at the transfer width programmed in DMA0_CRn[TW]. Otherwise, the error bit (DMA0_SR[RIn]) is set for the channel and no transfer occurs. If the source address increment bit in the channel control register is set (DMA0_CRn[SAI]), the address is incremented by the transfer width after each data transfer. In contrast, if the channel is performing a memory-to-peripheral transfer and the address decrement bit is set (DMA0_CRn[DEC]=1), the address is decremented by the transfer width after each transfer.

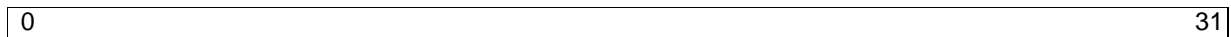

Figure 18-6. DMA Source Address Registers (DMA0_SA0–DMA0_SA3)

0:31		Source address for memory-to-memory and memory-to-peripheral transfers.
------	--	---

Preliminary User's Manual**18.3.6 DMA Destination Address Registers (DMA0_DA0–DMA0_DA3)**

DMA0_DA0–DMA0_DA3 contain the destination address for memory-to-memory and peripheral-to-memory transfers. When a DMA channel is configured for scatter/gather transfers (DMA_SGC[SSGn]=1), the destination address register is automatically loaded from memory. For additional details see “Scatter/Gather Transfers” on page 18-515.

The destination address must be aligned at the transfer width programmed in DMA0_CRn[TW]. Otherwise, the error bit (DMA0_SR[RIn]) is set for the channel and no transfer occurs. If the destination address increment bit in the channel's control register is set (DMA0_CRn[DAI]) the address is incremented by the transfer width after each data transfer. However, if the channel is performing a peripheral-to-memory transfer and the address decrement bit is set (DMA0_CRn[DEC]=1), the destination address is decremented by the transfer width after each transfer.

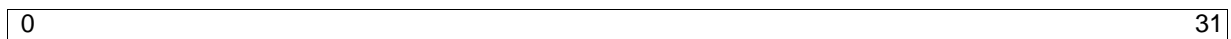
**Figure 18-7. DMA Destination Address Registers (DMA0_DA0–DMA0_DA3)**

0:31		Destination address for memory-to-memory and peripheral-to-memory transfers.
------	--	--

18.3.7 DMA Count Registers (DMA0_CT0–DMA0_CT3)

DMA0_CT0–DMA0_CT3 contain the number of transfers left in the DMA transaction for their respective channels when EOTn[TCn] is programmed as a terminal count output. When EOTn[TCn] is programmed as an end-of-transfer input (DMA0_CRn[ETD]=0), DMA0_CTn continues to count down past zero until EOTn is asserted.

If a DMA channel is setup for scatter/gather transfers (DMA_SGC[SSGn]=1), the count register is automatically loaded from memory. For additional details see “Scatter/Gather Transfers” on page 18-515.

The value in the DMA count register is interpreted as the number of *transfers* of the width specified in DMA0_CRn[PW], *not* the total number of bytes. The maximum number of transfers is 64 K, and each transfer can be either 1, 2, 4, or 8 bytes as programmed in DMA0_CR[PW]. The maximum count of 64 K transfers is programmed by writing zero to DMA0_CTn.

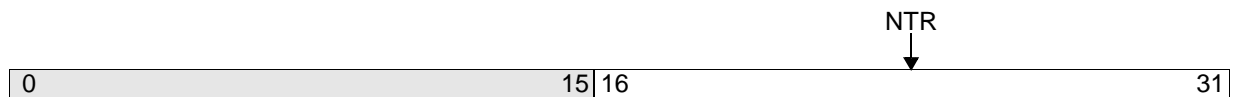
**Figure 18-8. DMA Count Registers (DMA0_CT0–DMA0_CT3)**

0:15		Reserved
16:31	NTR	Number of transfers remaining

18.3.8 DMA Scatter/Gather Descriptor Address Registers (DMA0_SG0–DMA0_SG3)

When a DMA channel is setup for scatter/gather transfers (DMA_SGC[SSGn]=1), the Scatter/Gather Descriptor Address Register (DMA0_SGn) contains the memory address of the next scatter/gather descriptor table. Prior to starting a scatter/gather transfer, software must write the address of the channel's descriptor table to DMA0_SGn. Once the scatter/gather transfer starts, DMA0_SGn is automatically updated from the descriptor table. For additional details see "Scatter/Gather Transfers" on page 18-515.



Figure 18-9. DMA Scatter/Gather Descriptor Address Registers (DMA0_SG0–DMA0_SG3)

0:31	Address of next scatter/gather descriptor table.
------	--

18.3.9 DMA Scatter/Gather Command Register (DMA0_SGC)

DMA0_SGC[SSGn] are the start scatter/gather enable bits for channels 0 to 3. DMA0_SGC[EMn] are the corresponding enable mask bits for DMA0_SGC[SSGn]. Setting DMA0_SGC[EMn] = 1 causes the selected channel to begin a scatter/gather operation, while writing a 0 stops the scatter/gather operation. To start or stop a specific scatter/gather channel, the corresponding DMA0_SGC[EMn] bit must be set to 1; otherwise, DMA0_SGC holds the previous value. Note that halting a scatter/gather transfer does not stop the transfer currently in progress.

Upon completion of a scatter/gather sequence of transfers, the DMA controller clears DMA0_SGC[SSGn].

If an error occurs when the DMA controller is reading the scatter/gather descriptor table, DMA0_SGC[SSGn] is cleared for the affected channel, and the channel error status bit (DMA0_SR[RIn]) is set.

For additional details see "Scatter/Gather Transfers" on page 18-515.

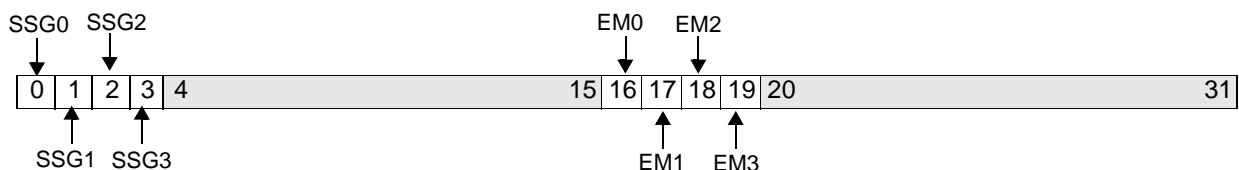

Figure 18-10. DMA Scatter/Gather Command Register (DMA0_SGC)

0:3	SSG[0:3]	Start Scatter/Gather for channels 0-3. 0 Scatter/gather support is disabled 1 Scatter/gather support is enabled	To start a scatter/gather operation for channel n, EM[n] must also be set.
4:15		Reserved	
16:19	EM[0:3]	Enable Mask for channels 0-3. 0 Writes to SSG[n] are ignored 1 Allow writing to SSG[n]	To write SSG[n], EM[n] must be set. Otherwise, writing SSG[n] has no effect.
20:31		Reserved	

Preliminary User's Manual**18.4 Channel Priorities**

The priority of DMA transfers is controlled on a per-channel basis by the channel priority field in the channel control register. Table 18-3 shows the different priority settings for DMA0_CRn[PW].

Table 18-3. DMA Transfer Priorities

DMA0_CRn[CP]	Priority Level
0b00	Low
0b01	Medium Low
0b10	Medium High
0b11	High

These priorities serve two purposes. First, the DMA controller arbitrates among all actively requesting channels and selects the highest priority channel for service. If multiple channels request at the same priority, the arbiter selects the lowest numbered channel for service.

DMA0_CRn[CP] determines the priority of the internal PLB transactions that the DMA controller uses to read and write data.

18.5 Data Parity During DMA Peripheral Transfers

The DMA controller works with the peripheral bus controller (EBC) to generate and check parity during peripheral mode DMA transfers. When DMA0_CRn[PCE] = 1, parity checking is enabled for peripheral mode transfers on channel n.

During memory-to-memory transfers, any data error checking and correction depends on the configuration of the relevant memory controller. For example, if ECC is enabled on the SDRAM controller, only uncorrectable errors are reported to the DMA controller. Similarly, an EBC memory bank with parity enabled will report an error if a parity error is encountered during a memory read operation. See “Peripheral Bank Access Parameters (EBC0_BnAP)” on page 16-377 for more information on peripheral bus parity checking.

18.6 Errors

The DMA controller detects and reports three types of errors: address alignment, PLB timeout and slave errors. The DMA controller reports errors through the channel error status bit in the DMA status register (DMA0_SR[RIn]). If the error status bit for a channel is set, the channel enable bit (DMA0_CRn[CE]) is cleared, disabling the channel. An interrupt signal is also presented to the interrupt controller if DMA0_CRn[CIE] is set. See “DMA Interrupts” on page 18-514 for more information on interrupt processing.

When the DMA controller has multiple channels active, an error may be reported on the current channel which was in actuality caused by a previously active channel. This causes the current channel to have its error status bit set. Therefore, for deterministic error analysis with multiple DMA channels active the PLB slave bus controller's error status registers (the bus error address register in particular), must be queried to isolate the actual channel which encountered the error. In any case, the channel causing the errors will eventually cause all active channels, including itself, to be disabled.

18.6.1 Address Alignment Error

The source address (DMA0_SAn) and destination address (DMA0_DAn) registers must be aligned to the programmed transfer width (DMA0_CRn[TW]). The address alignment rules are outlined in Table 18-4. In addition, when a channel is configured for scatter/gather transfers, the scatter/gather table must be word-aligned. If the source, destination and scatter/gather address registers are not appropriately aligned an error occurs immediately after the channel is enabled.

Table 18-4. Address Alignment Requirements

DMA0_CRn[PW] Setting	Required Alignment for DMA0_SAn and DMA0_DAn
0b00	Byte (8-bit)
0b01	Halfword (16-bit)
0b10	Word (32-bit)
0b11	Doubleword (64-bit)

18.6.2 PLB Timeout

The DMA controller uses PLB operations to read and write memory. A PLB timeout results if the DMA controller attempts to access a non-existent memory location. This will occur if the source, destination or scatter/gather address registers do not map to valid memory locations.

18.6.3 Slave Errors

If the DMA controller detects an error from a PLB slave, it finishes any active read/write pair transfer on the channel and then reports an error. An SDRAM uncorrectable ECC error and an EBC bank protection error are examples of PLB slave errors.

18.7 DMA Interrupts

Each DMA channel can generate interrupts for end of transfer, terminal count and error conditions. Interrupts from a particular DMA channel are enabled by setting the channel enable bit in the channel's control register (DMA0_CRn[CIE]=1). When an interrupt occurs for a given channel, the DMA controller sends a signal to the Universal Interrupt Controller. For the PPC405GP's CPU to take an exception, interrupts from the particular DMA channel must be enabled in the interrupt controller's interrupt enable register (UIC0_ER). Also, the CPU's machine state register's interrupt enable bit must be enabled for the appropriate interrupt type (critical or non-critical), MSR[EE,CE]. See Chapter 10, "Interrupt Controller Operations" for more information on interrupt controller processing.

For DMA channels with interrupts enabled (DMA0_CRn[CIE]=1) and not performing a scatter/gather transfer an interrupt is generated while any of the following are true:

- DMA0_CRn[TCE]=1 and DMA0_SR[CSn]=1
- DMA0_SR[TSn]=1
- DMA0_SR[RIn]=1

Preliminary User's Manual

When a channel is performing a scatter/gather transfer, interrupt generation is further qualified by the TCI, ETI and ERI bits loaded from the descriptor table (see Table 18-5, "Scatter/Gather Descriptor Table," on page 18-515). Any of the following conditions cause an interrupt during a scatter/gather transfer when interrupts are enabled for the channel (DMA0_CRn[CIE=1]):

TCI=1 and DMA0_CRn[TCE]=1 and DMA0_SR[CSn]=1
 ETI=1 and DMA0_SR[TSn]=1
 ERI=1 and DMA0_SR[RIn]=1

For both normal DMA and scatter/gather transfers the interrupt remains active until the appropriate bits are cleared in the DMA Status Register (DMA0_SR). In addition, interrupts from a channel performing a scatter/gather transfer cause the channel to pause until the interrupt is cleared.

18.8 Scatter/Gather Transfers

With a normal DMA transfer it is necessary to program a channel's control, source, destination, and count registers for each transfer. The scatter/gather capability of the DMA controller provides a more efficient solution for applications that require multiple transactions on a single DMA channel. Instead of individually programming a channel's registers, software creates a set (linked list) of descriptor tables in system memory. Table 18-5 illustrates the required table format.

Table 18-5. Scatter/Gather Descriptor Table

Memory Address	Byte 0 (MSB)	Byte 1	Byte 2	Byte 3 (LSB)
x (word aligned)	DMA Channel Control Word			
x + 4	Source Address			
x + 8	Destination Address			
x + 12	LK		TCI	ETI
			ERI	Count
x + 16	Next Scatter/Gather Descriptor Table Address			

Table 18-6 details the usage of the bit fields in the scatter/gather table.

Table 18-6. Bit Fields in the Scatter/Gather Descriptor Table

Bit	Mnemonic	Description
0	LK	Link 0 This is the last descriptor. 1 Fetch next descriptor from address DMA0_SGn when the channel completes
2	TCI	Enable Terminal Count Interrupt 0 Do not interrupt when terminal count occurs 1 Allow an interrupt when terminal count occurs
3	ETI	Enable End of Transfer Interrupt 0 Do not interrupt when end of transfer occurs 1 Allow an interrupt when end of transfer occurs.
4	ERI	Enable Error Interrupt 0 Do not interrupt if an error occurs 1 Allow an interrupt if an error occurs

To configure a channel for a scatter/gather transfer the DMA Scatter/Gather Descriptor Address Register (DMA0_SGn) for the channel is set to the address of the first descriptor table, which must be word-aligned. To begin the scatter/gather transfer, software then writes a start scatter/gather and enable mask to the Scatter/Gather Command Register (DMA0_SGC). The DMA controller then reads the descriptor table at address DMA0_SGn and updates the DMA controller registers as shown in Table 18-7. Upon receiving the data from the scatter/gather descriptor table, the channel's terminal count status bit (DMA0_SR[TCn]) is automatically cleared.

Table 18-7. DMA Registers Loaded from Scatter/Gather Descriptor Table

Descriptor Table Entry	Register Loaded
Channel Control Word	DMA0_CRn
Source Address	DMA0_SAn
Destination Address	DMA0_DAn
Count	DMA0_CTn
Next Descriptor Address	DMA0_SGn

After loading the channel's registers from the descriptor table, the transfer functions as a normal non-scatter/gather operation.

If the channel control word loaded from the descriptor table enables interrupts for the channel (DMA0_CRn[CIE]=1), the TCI, ETI, and ERI bits further qualify the generation of interrupts. See "DMA Interrupts" on page 18-514 for more information on scatter/gather interrupts.

If the LK (link) bit was not set the scatter/gather process stops when the current transfer completes. Otherwise, the DMA controller reads the descriptor table at address DMA0_SGn and the process repeats.

18.9 Programming the DMA Controller

Before the DMA controller can transfer data it must be configured, both globally and on a per-channel basis. Global registers include DMA0_POL and DMA0_SLP. For most applications, these registers should be configured when the DMA controller is initialized. To prevent spurious activity resulting from changing the active level for DMAReqn, DMAAckn, or EOTn[TCn], a channel configuration in tDMA0_POL should not be altered when the channel is enabled (DMA0_CRn[CE]=1).

The channel registers are DMA0_CRn, DMA0_SAn, DMA0_DAn, DMA0_CTn, and DMA0_SGn. The type of DMA transfer determines which of these registers must be programmed and what causes the channel to start. In all cases, DMA0_SR[CSn, TSn, RIn] must be cleared, or the channel will not start.

The programming information that follows assumes that the DMA controller is operating in non-scatter/gather mode. For scatter/gather transfers, the channel configuration data must be written into a set of descriptor tables in system memory, as described in "Scatter/Gather Transfers" on page 18-515.

Preliminary User's Manual

18.9.1 Peripheral Mode Transfers

DMA peripherals are either devices attached to the EBC interface using the DMAReqn and DMAAckn lines, or the internal serial port (UART0). During a peripheral mode transfer an external peripheral asserts DMAReqn to request a DMA transfer. For metastability protection, DMAReqn is double-latched in the DMA on assertion, and sampled with a single latch on deassertion.

Timings on the memory-access portion of peripheral mode DMA transfers are governed by the configuration of the associated memory controller. In contrast, timing during the peripheral portion of the transfer is controlled by DMA0_CRn[PSC, PWC, PHC]. The effect of these parameters on peripheral timings is illustrated in Figure 18-11 and Figure 18-12 on page 18-518. Although shown as active high, the polarity (active state) of DMAReqn, DMAAckn, and EOTn[TCn] are programmable using DMA0_POL.

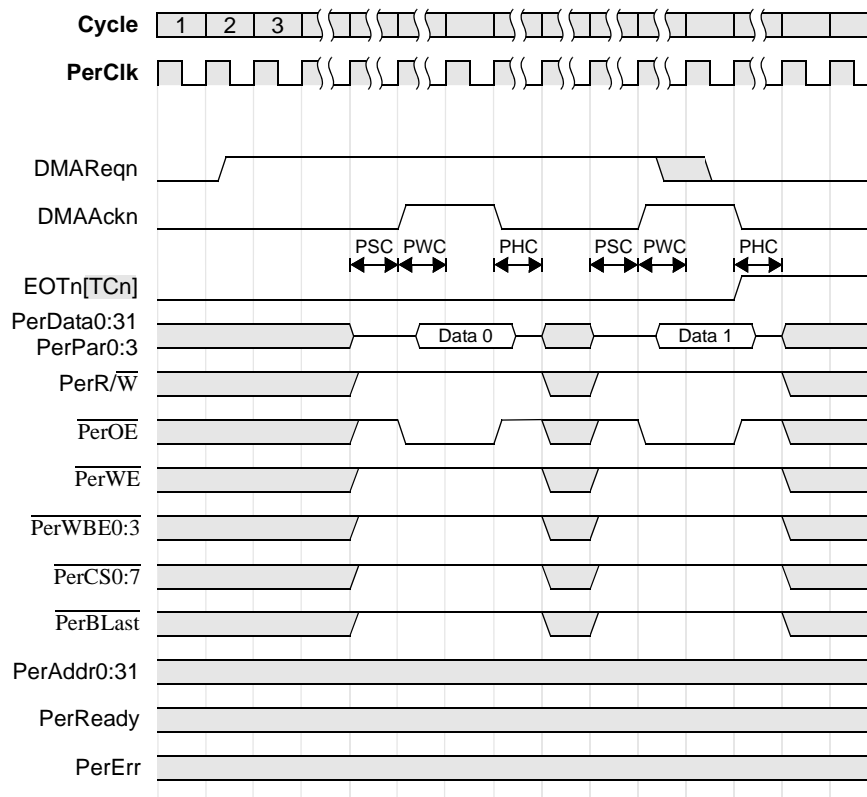

Figure 18-11. Peripheral-to-Memory DMA Transfer

Peripheral setup cycles (DMA0_CRn[PSC]) provide a delay between any previous operation on the peripheral bus and DMAAckn becoming active. Following the setup time DMAAckn is driven active for (DMA0_CRn[PWC] + 1) PerClk cycles, until the rising edge of PerClk immediately before DMAAckn goes inactive. During peripheral-to-memory transfers read data from the peripheral is sampled on the rising PerClk edge where DMAAckn goes inactive. After DMAAckn becomes inactive the peripheral bus is held idle for DMA0_CRn[PHC] PerClk cycles.

The second transfer in Figure 18-11 illustrates the required DMAReqn timing to prevent a subsequent DMA transfer. For all peripheral mode transfers DMAReqn must be sampled inactive at the end of the last PerClk cycle where DMAAckn is active.

The EOTn[TCn] I/O can be configured either as an end of transfer input (DMA0_CRn[ETD]=0) or a terminal count output (DMA0_CRn[ETD]=1). When programmed as a terminal count output, EOTn[TCn] is asserted in the cycle after DMAAckn became inactive and the channel's count register (DMA0_CTn) reached zero. EOTn[TCn] remains active until the terminal count status bit is cleared in the DMA status register (DMA0_SR[CSn]).

If EOTn[TCn] is configured as an end of transfer input (DMA0_CRn[ETD]=0), EOTn[TCn] must be sampled during the last DMAAckn cycle. If the channel is configured for scatter/gather transfers EOTn[TCn] should be immediately deasserted to prevent the subsequent transfer from ending prematurely. Figure 18-12 shows the required timing.

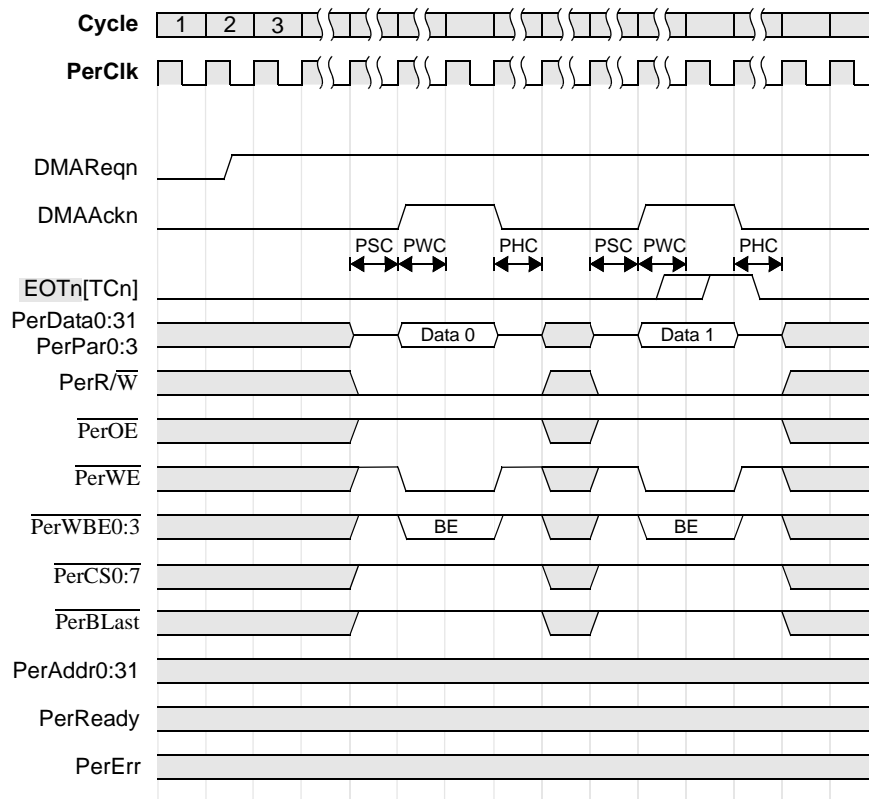

Figure 18-12. Memory-to-Peripheral DMA Transfer

For both peripheral-to-memory and memory-to-peripheral transfers the transfer width (DMA0_CR[PW]) must be set to the data bus width of the peripheral. This is because the DMA controller does not pack or unpack data on the peripheral side of transaction.

Peripheral-to-Memory Transfer

To perform a peripheral-to-memory DMA transfer from an EBC-attached DMA peripheral:

1. Set destination address register (DMA0_DAn) to the desired memory location. The address must be aligned to the programmed transfer width (DMA0_CRn[PW]), otherwise an alignment error will occur.
2. Program the count register (DMA0_CTn) for the number of transfers.
3. Clear the channel's status bits in the DMA status register (DMA0_SR).
4. In the channel control register (DMA0_CRn):
 - a. Optionally enable the DMA buffer, BEN=1.

Preliminary User's Manual

- b. Optionally enable parity checking, PCE=1.
- c. Set the destination address increment, DAI=1.
- d. Set the transfer mode to peripheral, TM=0b00.
- e. Set the peripheral location to external, PL=0.
- f. Set the transfer direction to peripheral-to-memory, TD=1.
- g. Enable the channel CE=1.

Once the DMA channel is active, the peripheral initiates a transfer by activating the DMAREqn pin for the channel. The PPC405GP then activates the DMAAckn pin to read data from the peripheral. This continues until either a terminal count or end of transfer condition occurs.

Memory-to-Peripheral Transfer

To perform a memory-to-peripheral DMA transfer to an EBC-attached DMA peripheral:

1. Set source address register (DMA0_SAn) to the desired memory location. The address must be aligned to the programmed transfer width (DMA0_CRn[PW]), otherwise an alignment error will occur.
2. Program the count register (DMA0_CTn) for the number of transfers.
3. Clear the channel's status bits in the DMA status register (DMA0_SR).
4. In the channel control register (DMA0_CRn):
 - a. Optionally enable the DMA buffer, BEN=1, and set the desired prefetch count, PF.
 - b. Optionally enable parity generation, PCE=1.
 - c. Set the source address increment, SAI=1.
 - d. Set the transfer mode to peripheral, TM=0b00.
 - e. Set the peripheral location to external, PL=0.
 - f. Set the transfer direction to memory-to-peripheral TD=0.
 - g. Enable the channel, CE=1.

Once the DMA channel is active, the peripheral initiates a transfer by activating the DMAREqn pin for the channel. The PPC405GP then reads the source memory and subsequently activates the DMAAckn pin to write data to the peripheral. This continues until either a terminal count or end of transfer condition occurs.

18.9.2 Memory-to-Memory Transfers

Memory-to-memory transfers can be initiated either by software or by an external device. If initiated via software, the transfer begins as soon as the channel is configured and enabled. When initiated by hardware (also known as a device-paced memory-to-memory transfer), software configures the channel for a memory-to-memory move and transfers begin when an external device places an active request on the channel request line, DMAReqn.

Hardware-Initiated (Device-Paced) Memory-to-Memory Transfers

To perform a device-paced memory-to-memory DMA transfer:

1. Set the transfer width (DMA0_CRn[PW]) to the width of the device-paced memory.
2. Set the source (DMA0_SAn) and destination (DMA0_DAn) address registers to the desired memory locations. These addresses must be aligned to the programmed transfer width (DMA0_CRn[PW]), otherwise an alignment error will occur.
3. Program the count register (DMA0_CTn) for the number of transfers.
4. Clear the channel's status bits in the DMA status register (DMA0_SR).
5. In the channel control register (DMA0_CRn):
 - a. Optionally enable the DMA buffer, BEN=1, and set the desired prefetch count, PF.
 - b. If the device-paced memory is at the source memory location set PL=1.
 - c. Set the source address increment, SAI, and destination address increment, DAI, as desired.
 - d. Set the transfer mode to device-paced memory-to-memory, TM=0b11.
 - e. Enable the channel, CE=1.

Once the DMA channel is configured for this mode, the external device initiates a transfer by activating the DMAReqn input. The PPC405GP then reads the source memory, buffers the data in the DMA controller and then outputs the data to the destination memory address. Transfers continue as long as the controlling device maintains an active signal on DMAReqn and the channel count register (DMA0_CTn) is non-zero. To pause a device paced memory-to-memory transfer, the controlling device must deassert DMAReqn one PerClk cycle before the last cycle in the device-paced memory access.

Preliminary User's Manual

18.9.3 Software-Initiated Memory-to-Memory Transfers (Non-Deviced Paced)

To perform a software-initiated memory-to-memory DMA transfer:

1. Set the transfer width (DMA0_CRn[PW]) as desired.
2. Set the source (DMA0_SAn) and destination (DMA0_DAn) address registers to the desired memory locations. These addresses must be aligned to the programmed transfer width (DMA0_CRn[PW]), otherwise an alignment error will occur.
3. Program the count register (DMA0_CTn) for the number of transfers.
4. Clear the channel's status bits in the DMA status register (DMA0_SR).
5. In the channel control register (DMA0_CRn):
 - a. Optionally enable the DMA buffer, BEN=1.
 - b. Set the source address increment, SAI, and destination address increment, DAI, as desired.
 - c. Set the transfer mode to software-initiated memory-to-memory, TM=0b10.
 - d. Enable the channel, CE=1.

Once the channel is enable the DMA controller transfers data from source to destination until the channel count reaches zero. Note that memory-to-memory transfers initiated by software do not use DMAReqn or DMAAckn.

Chapter 19. Ethernet Media Access Controller

The PPC405GP Ethernet media access controller (EMAC) is a generic implementation of the Ethernet Media Access Control (MAC) protocol designed to ANSI/IEEE Std 802.3 and IEEE 802.3u supplement. EMAC supports half-duplex (CSMA/CD) and full-duplex operation for 10-Mbps and 100-Mbps operations.

EMAC provides two on-chip peripheral bus (OPB) slave interfaces. The first OPB interface provides access to the EMAC configuration and status registers. The PLB/OPB bridge enables the processor core to access these registers.

The second OPB interface is used to exchange packet information with the memory access layer (MAL). The MAL is a multi-channel, intermediate hardware layer that resides between packet-based communication cores (such as EMAC) and external memory (such as SDRAM or SRAM). The MAL transfers packet information and status between the EMAC and external memory separately for each of the three EMAC channels (one receive and two transmit). Software (a device driver) maintains a buffer descriptor ring and a set of data buffers in external memory for each channel, and manages the exchange of packet data between the data buffers and the software protocol.

The MAL performs functions such as arbitration between service requests, handling the buffer descriptor memory structure, updating the descriptor status/control fields at the end of packet transfer, and so on. EMAC supports unlimited burst length transactions on the MAL interface.

EMAC uses a media independent interface (MII) to communicate with standard physical interface devices (PHYs).

EMAC uses independent receive and transmit FIFOs. Programmable FIFO thresholds minimize overflows and underruns, and can launch integrated IEEE 802.3x pause packets for flow control.

As part of the remote monitoring (RMON) and management information base (MIB) defined in IEEE 802.3z, the EMAC contains registers that count the number of octets transmitted and received.

Figure 19-1 illustrates EMAC in a typical Ethernet application.

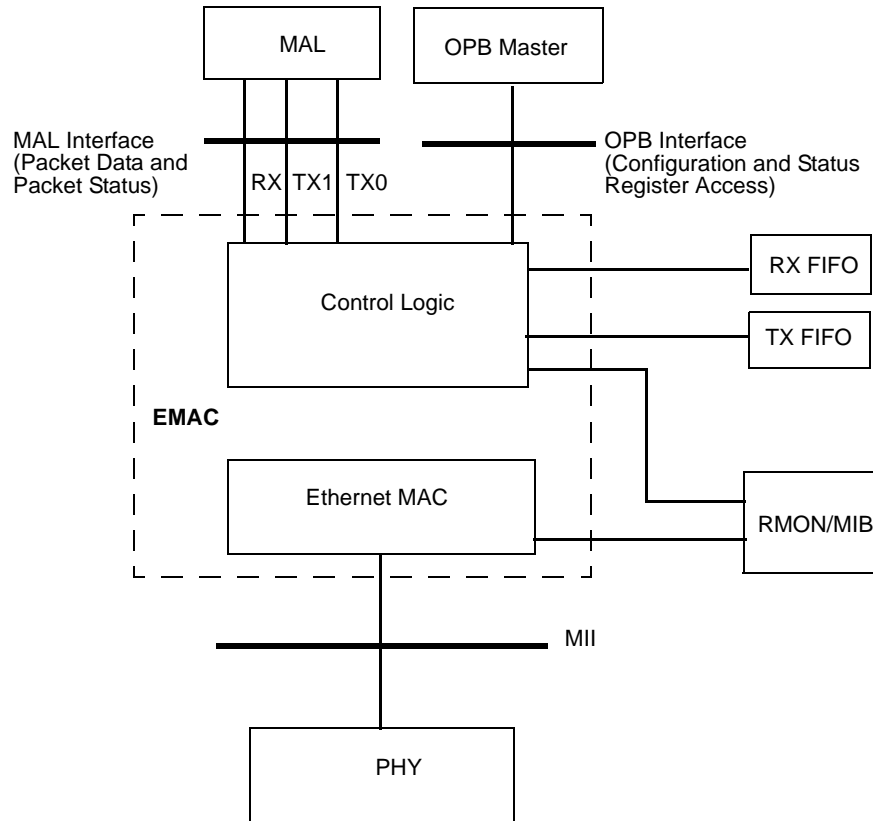

Figure 19-1. EMAC in a Typical Ethernet Application

Note: EMAC is connected to an OPB, to which the OPB master and MAL are also connected. EMAC transmit channels operate independently from the receive channel.

Preliminary User's Manual

19.1 EMAC Features

The EMAC features:

- Dual speed (10/100 Mbps) CSMA/CD (half-duplex) and full-duplex Ethernet MAC designed to ANSI/IEEE Std. 802.3 and IEEE 802.3u supplement.
- Automatic source address insertion or replacement for transmitted packets is a programmable option.
- Automatic stripping of frame padding bytes and frame check sequence (FCS) is a programmable option.
 - Note:** When padding bytes are stripped, the padding and FCS field are removed. FCS stripping removes only the FCS field.
- FCS control for transmit/receive packets.
- Access to registers with support for burst processing.
- MAL for packet moving having one-cycle MAL slave latency.
- Independent, large (2 KB) transmit and (4 KB) receive FIFOs with programmable thresholds to minimize overruns and underruns.
- Multiple packet handling in transmit and receive FIFOs.
- Unicast, multicast, broadcast, and promiscuous address filtering capabilities.
- Two 64-bit hash filters for unicast and multicast packets.
- Automatic retransmission of collided packets.
- Rejection of runt packets before providing them to MAL.
- MII for connection to a variety of PHY layer devices.
- Programmable inter-packet gap to enable tuning for better system performance.
- Compatibility with IEEE 802.3x standard packet-based flow control, including self-assembled control pause packet transmitting.
- Support for VLAN tag ID compatible with IEEE Draft 802.3ac/D1.0 standard.
- VLAN tag insertion or replacement for transmit packets is a programmable option.
- Wake on LAN (WOL) handling.
- Programmable internal and external loop-back capabilities.
- Extensive error/status vector generation for each processed packet.
- Power management using a clock and power management (CPM) unit.

19.2 EMAC Operation

The EMAC hardware components and its internal structure are illustrated in the block diagram in Figure 19-2.

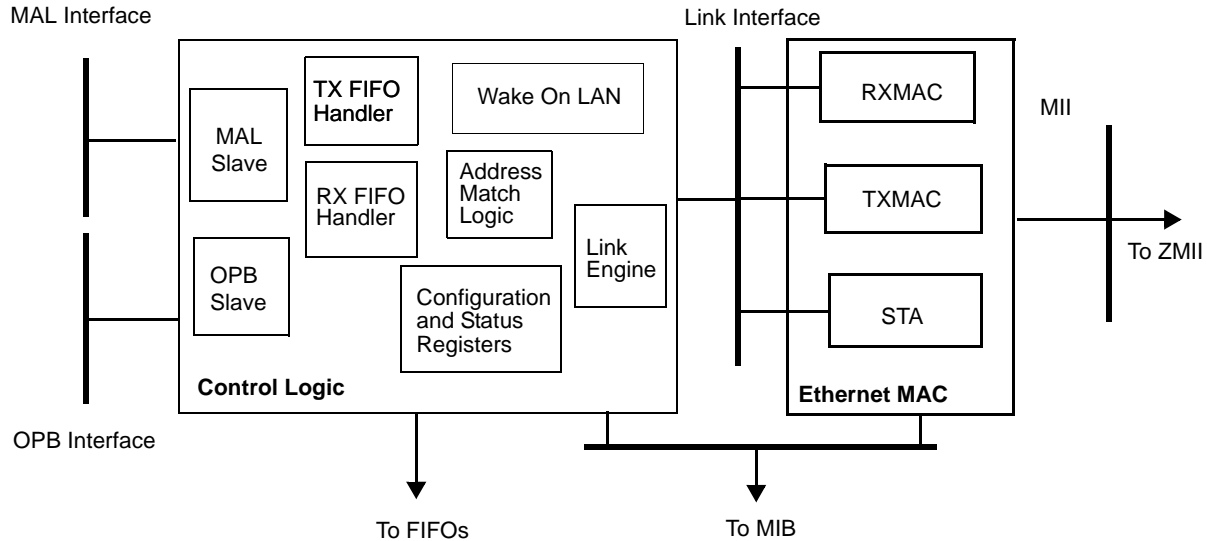

Figure 19-2. Internal EMAC Structure

The control logic sub-block implements the following functions:

- OPB slave device
- MAL slave device
- FIFO management logic
- Ethernet address and pause packet match logic
- Register file for FIFOs and Ethernet MAC handler management
- Logic for support of WOL technology

The Ethernet MAC sub-block implements the following functions:

- Transmit MAC Handler (TXMAC)
- Receive MAC Handler (RXMAC)
- MII management function unit (STA)

These functions are described in the following sections.

19.2.1 MAL Slave Logic

The MAL slave (MALS) logic controls MAL transactions. MALS transfers TX and RX data between MAL and the OPB on one side, and the EMAC FIFO handlers on the other side. MALS is a dedicated MAL slave.

19.2.2 OPB Slave Logic

The OPB slave (OPBS) logic controls all OPB transactions between the processor core and the EMAC configuration and status registers.

Preliminary User's Manual

19.2.3 Ethernet Address Match Logic

Address match logic checks the destination address of received packets against a set of predefined addresses specified by the current address filtering mode. EMAC contains one unicast (individual address) register, two hash tables for filtering individual and group address, and logic for detecting broadcast address (all ones). EMAC supports promiscuous mode and multicast promiscuous mode.

This logic also checks the destination address of the incoming packet against a special multicast address used for control (pause) packet recognition.

All checks for address matching are performed only after the entire destination address field is received (except for promiscuous and multicast promiscuous modes).

19.2.4 Configuration and Status Registers

Configuration and status registers define the EMAC configuration and reflect error/status of recent transmitted or received packets.

19.2.5 Wake On LAN Logic

EMAC supports Wake On LAN (WOL) technology, an industry standard described in the *Wired for Management (WFM)* specification. This technology allows a sleeping or powered-off network node to be awakened with a special packet called a Magic Packet. In the PPC405GP, with WOL mode enabled, the EMAC discards all incoming packets and does not request data from the MAL for transmission. When a magic packet is detected, the EMAC generates an interrupt on UIC0 Interrupt 9, called Ethernet WOL.

19.2.6 Ethernet MAC

The Ethernet MAC logic supports MII.

19.2.7 EMAC Loopback Modes

EMAC supports the external and internal loop-back modes illustrated in Figure 19-3.

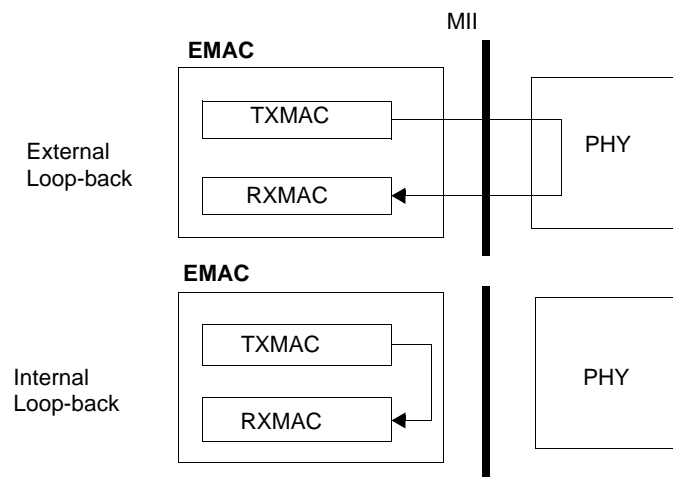

Figure 19-3. EMAC Loopback Modes

External loop-back mode uses the PHY device. To EMAC, external loop-back is identical to full-duplex operation. Configuring EMAC to operate in a full-duplex mode enables external loop-back. EMAC does not need an external loopback configuration signal.

In internal loopback mode, data from the EMAC transmit channel is routed to the EMAC receive channel. The loopback mode functions correctly with or without a connected PHY. In internal loopback mode, EMAC does not activate (monitor) any MII signals. Transmit channel signals are buffered internally to the receive channel. However, if internal loopback is used without a PHY, the EMAC transmit and receive clocks must be provided by another means. In internal loopback mode, the EMAC transmit clock and receive clock must be sourced from a single clock.

Preliminary User's Manual

19.3 EMAC Transmit Operation

The transmit part of EMAC handles packet transmission from the MAL device to the MII. At the end of a transmission process, EMAC provides a status/error word which allows monitoring the transmission operation.

EMAC implements dual MAL transmit channels (two transmit channels are allocated within MAL) to support efficient use of the transmit FIFO. Both channels share resources inside the EMAC. The transmit channels can be configured to independently request packets from MAL and drive them into the transmit FIFO, or to function as a single channel (in dependent mode).

19.3.1 Arbitration Between TX Channels

Because the transmit channels (referred to as TX Channel 0 and TX Channel 1) drive data into one FIFO, they cannot request packet data from MAL at the same time. MAL ensures that only one EMAC transmit channel is active at a given time.

19.3.2 Independent Mode

In independent mode, each EMAC transmit channel independently requests packets from MAL. Each channel can be configured to work in either single packet or multiple packet mode.

In single packet mode, $EMAC0_MR1[TR0] = 00$ and $EMAC0_MR1[TR1] = 00$. The channel requests one packet from MAL and resets $EMAC0_TMR0[GNP0, GNP1]$ as appropriate. The channel asks for service again only after $EMAC0_TMR0[GNP0] = 1$ or $EMAC0_TMR0[GNP1] = 1$ (set by the device driver).

In multiple packet mode, $EMAC0_MR1[TR0] = 01$ and $EMAC0_MR1[TR1] = 01$. After the channel finishes transferring a packet, the channel asks MAL for the next packet as soon as the other channel is in its Idle Phase and there is enough room in the FIFO. The channel continues to request more packets until one of the following events occur:

- The channel receives notification from MAL that the next buffer descriptor is not marked ready for transmission. When this occurs, the channel sets $EMAC0_TMR0[GNP0, GNP1] = 0$, as appropriate, and waits for software to reactivate the channel by setting $EMAC0_TMR0[GNP0] = 1$ or $EMAC0_TMR0[GNP1] = 1$.
- A transmit error or signal quality error (SQE) occurs and the corresponding interrupt is not masked in the $EMAC0_ISR$. After such an error, the channel sets $EMAC0_TMR0[GNP0, GNP1] = 0$, as appropriate, and sets $EMAC0_ISR[DB0] = 1$ or $EMAC0_ISR[DB1] = 1$ (the $EMAC0_ISR$ field that is set depends on which channel is active) and the corresponding $EMAC0_ISR$ error. The channel does not request service again until $EMAC0_TMR0[GNP0] = 1$ or $EMAC0_TMR0[GNP1] = 1$ and $EMAC0_ISR[DB0] = 0$ or $EMAC0_ISR[DB1] = 0$ (again, depending on channel).

In independent mode, if both channels are configured to work in multiple packet mode and both $EMAC0_TMR0[GNP0] = 1$ and $EMAC0_TMR0[GNP1] = 1$ at the same time, the channels operate in a sequential repeating manner as long as no errors occur.

19.3.3 Dependent Mode

In dependent mode, $EMAC0_MR1[TR0] = 10$ and $EMAC0_MR1[TR1] = 10$. The two TX channels act as if they were one channel, sharing $EMAC0_TMR0[GNPD]$. When $EMAC0_TMR0[GNPD] = 1$, the channel specified by $EMAC0_TMR0[FC]$ starts requesting MAL service. Then, both channels continue to request packets from MAL in an alternating, sequential, repeating manner, until one of the following occurs:

- One of the channels receives notification from MAL that the next buffer descriptor is not marked ready for transmission. When this occurs, EMAC clears EMAC0_TMR0[GNPD]. At this point, neither channel requests a packet from MAL until EMAC0_TMR0[GNPD] back to 1. The first channel to request a new packet from MAL when this occurs is the channel that received notification from MAL that no packets were ready to transmit (regardless of the setting of EMAC0_TMR0[FC]). Further requests continue in an alternating, repeating manner.
- Either a transmit error or an SQE occurs on one of the channels and the corresponding interrupt is not masked in the EMAC0_ISR. One of the following scenarios can occur.
 - If the other channel has not yet requested MAL service when the channel for which the error occurred receives notification from MAL that the transmit operation has completed, EMAC0_TMR0[GNPD] is cleared (EMAC0_TMR0[GNPD] = 0) and the EMAC0_ISR[DBDM] is immediately set (EMAC_ISR[DBDM]=1).
 - If the other channel was receiving data from MAL, it initiates early termination. If a second packet was being transmitted on the media, it is stopped. In these cases, EMAC0_TMR0[GNPD] is cleared (EMAC0_TMR0[GNPD] = 0) and the EMAC0_ISR[DBDM] = 1 only after notification from MAL that the transmit operation has completed has been received for the second channel.

At this point, neither channel activates a request to MAL until EMAC0_TMR0[GNPD] = 1 and EMAC0_ISR[DBDM] = 0. The channel specified by EMAC0_TMR0[FC] is the first to request service from MAL. Subsequent requests continue in an alternating, sequential manner.

19.3.3.1 MAL TX Descriptor Control/Status Field

For each transmitted packet, MAL uses the descriptor control/status field of the buffer descriptor to provide EMAC with control information (write), and to obtain packet status from EMAC after transmission is complete (read). Software writes the control bits in the buffer descriptor before packet transmission, and reads the status bits from the buffer descriptor after packet transmission has completed. See “Buffer Descriptor Overview” on page 20-579 for more information on the buffer descriptor structure.

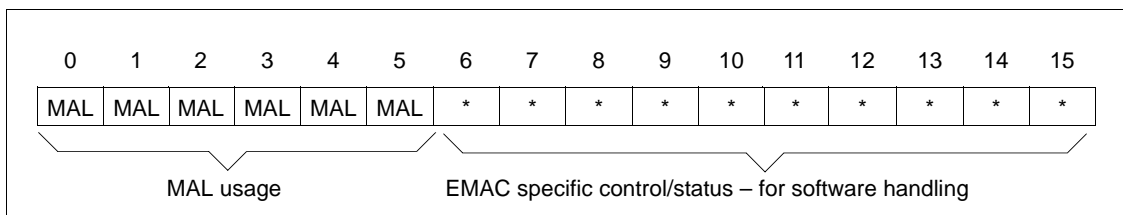

Figure 19-4. MAL TX Descriptor Control/Status Field

Bits	Bit Name	Bit Description	Mode
0:5	MAL Usage	See “Transmit Status/Control Field Format” on page 20-587.	R
TX Control Information (Write Access)			
6	Generate FCS	0 FCS is not generated by EMAC. 1 EMAC calculates and adds the FCS field to the packet to be transmitted.	W
7	Generate padding	0 Padding is not generated by EMAC. 1 EMAC adds the padding field to the packet to be transmitted (only when Generate FCS is also set).	W

Preliminary User's Manual

Bits	Bit Name	Bit Description	Mode
8	Insert source address	0 EMAC will not insert source address. 1 EMAC inserts the source address field into the packet to be transmitted using the content of the Individual Address High (EMAC0_IAHR) and Individual Address Low (EMAC0_IALR) Registers.	W
9	Replace source address	0 EMAC will not replace source address. 1 EMAC replaces the source address field in the packet to be transmitted using the content of the Individual Address High (EMAC0_IAHR) and Individual Address Low (EMAC0_IALR) Registers.	W
10	Insert VLAN Tag	0 EMAC will not insert a VLAN tag. 1 EMAC inserts the VLAN Tag field into the packet to be transmitted using the content of the VLAN TPID register (EMAC0_VTPID).	W
11	Replace VLAN Tag	0 EMAC will not replace the VLAN tag. 1 EMAC replaces the VLAN Tag field in the packet to be transmitted using the content of the VLAN TPID register (EMAC0_VTPID).	W
TX Status Information (Read Access)			
6	Bad FCS on transmitted frame	0 FCS was correct in the transmitted packet. 1 Indicates that a bad FCS was found in the transmitted packet.	R
7	Bad previous packet in dependent mode	0 Packet transmission OK. 1 Indicates that a Descriptor Error, Transmit Error, or SQE Error occurred in the previously transmitted frame. This bit will only be activated in dependent mode.	R
8	Loss of carrier sense	0 No loss of carrier. 1 During the transmission of a frame, the PHY_CRIS input was de-asserted after it previously was asserted, or it was not asserted at all.	R
9	Excessive deferral	0 No excessive deferral. 1 Indicates that the current frame has been deferred for an excessive period of time. Applicable only in half duplex mode. The value of this period in bit times is calculated in the following ways: For 10/100 Mbps operation it is: 2 x (maxFrameSize x 8) bit times.	R
10	Excessive collisions	0 Less than 16 collisions. 1 Indicates that the current frame transmission had ended with a collision on the 16th consecutive attempt. Applicable only in half-duplex mode.	R
11	Late collision	0 No late collision. 1 Frame collided outside of the collision window. Applicable only in half-duplex mode.	R
12	Multiple collision	0 More than 1 but less than 16 collisions did not occur. 1 Transmitted frame collided more than once but less than 16 times. Applicable only in half-duplex mode.	R
13	Single collision	0 Single collision did not occur. 1 Activates if transmitted frame collided once. Applicable only in half-duplex mode.	R

Bits	Bit Name	Bit Description	Mode
14	Underrun	0 Underrun did not occur. 1 Frame transmission was aborted because of underrun; data from the Transmit FIFO was not valid in time to allow continuous data transmission on the MII.	R
15	SQE	0 Signal Quality Error did not occur. 1 Signal Quality Error test failed during packet transmission. Applicable only in half -duplex mode during 10 Mbps operation.	R

19.3.3.2 Early Packet Termination during Transmit

EMAC can initiate early packet termination during transmit, terminating packet transmission before MAL finishes transferring all packet data from memory to the EMAC transmit FIFO. Early packet information is typically used when error conditions force the EMAC to abort a transmission.

EMAC performs early termination on the MAL interface if any of the following conditions occur:

- Underrun in the transmit FIFO.
- Excessive collisions.
- Excessive deferral.
- Late collision.

19.3.3.3 Empty Packets

EMAC treats empty packets as if a normal packet had been written, but does not write data to the transmit FIFO. A status word of all 0s is returned after an empty packet. EMAC expects that for word-aligned packets, MAL activates the related word transfer indication during the last data transfer, rather than providing an empty packet indication.

19.3.3.4 Automatic Retransmission of Colliding Packets

EMAC automatically retransmits packets that collide on the MII. The transmit FIFO always preserves the first 64 bytes of a packet until it receives an indication that the collision window has passed. Otherwise, if a collision was detected within the collision window, the packet is retransmitted without a new request from MAL.

Preliminary User's Manual

19.3.3.5 Inter-Packet Gap (IPG) Tuning

EMAC supports user-programmable IPG length using the EMAC0_IPGVR register, which contains one-third of the IPG value. Changing the contents of EMAC0_IPGVR enables the user to adjust the fairness or aggressiveness of EMAC on the medium. Programming a lower number (but not less than four) causes EMAC becomes more aggressive on the media. This can result in EMAC capturing the network by forcing less aggressive nodes to defer. Programming a larger number of bit times causes EMAC to becomes less aggressive on the network; it might defer more often than normal. EMAC performance might decrease as the IPG period is increased from the default value, but the resulting behavior can improve media performance by reducing the occurrence of collisions.

19.3.3.6 Full-Duplex Operation

Full-duplex operation allows simultaneous transmit and receive activity on the MII. Software can set EMAC0_MR1[FDE] = 1 to enable full-duplex mode. During full-duplex operation, the following changes occur in EMAC functionality.

- Transmission is not deferred while receive is active.
- The IPG counter, which controls transmit deferral during the IPG between back-to-back transmits, is started when transmit activity for the first packet ends, instead of when transmit and carrier activity end.
- SQE test is not performed.
- Collision indication is ignored.

19.3.3.7 Packet Content Configuration Options

EMAC can modify the content of the packet coming from MAL before issuing it to the MII. Figure 19-5 illustrates possible changes in the transmit packet format.

Packet as delivered to EMAC by MAL

DA	SA (optional)	Length/Type	Data	FCS (optional)
----	------------------	-------------	------	-------------------

Packet as delivered by EMAC on the MII

Preamble	SPD	DA	SA	Length/Type	Data	Padding (if needed)	FCS
----------	-----	----	----	-------------	------	------------------------	-----

Preamble - combination of alternative 0s and 1s (7 bytes)

SPD - Start Of Packet delimiter (1 byte)

DA - Destination Address (6 bytes)

SA - Source Address (6 bytes)

Length/Type - length of data field / type definition (Ethernet) (2 bytes)

Data - data field including padding if needed in short packets

Padding (optional) - needed to pad the packet to the minimum packet size

FCS - Cycle Redundancy Check (4 bytes)

Figure 19-5. Transmit Packet Structure (Excluding VLAN Tagged and Control Packets)

The following options, unless mutually exclusive, can be set for each packet, and can be provided as a part of command write transactions from MAL (see “MAL TX Descriptor Control/Status Field” on page 19-530).

- Automatic data padding for short transmit packets

EMAC pads the transmit packet with extra bytes between the data and the FCS field to reach a total length of 64 bytes (including FCS). This feature is supported only when the packet coming from the transmit FIFO does not contain the FCS. Automatic padding enables software to avoid sending padding as a part of the packet data field, and, therefore, reduces the amount of data transferred on the system bus during the short packet transmission.

- Source address insertion

EMAC adds the source address (SA) field to the transmitted packet. EMAC uses the contents of the Individual Address High (EMAC0_ISAH) and Individual Address Low (EMAC0_ISAL) registers for the source address value. *This option is mutually exclusive with source address replacement.*

- Source address replacement

EMAC replaces the source address received from the transmit FIFO with the contents of EMAC0_ISAH and EMAC0_ISAL. *This option is mutually exclusive with source address insertion.*

- Add four FCS bytes

EMAC calculates the FCS for the transmitted packet. The FCS is appended to data coming from the Transmit FIFO or padding bytes (if added).

- VLAN Tag insertion

EMAC adds the content of the VLAN Tag field to the transmitted packet (see “VLAN Support” on page 19-542). EMAC uses the content of the VLAN TPID (EMAC0_VTPID) and VLAN TCI (EMAC0_VTCI) registers for the VLAN Tag value. This feature is supported only when the packet from the transmit FIFO does not contain an FCS. *This option is mutually exclusive with VLAN tag replacement.*

- VLAN Tag replacement.

EMAC replaces the content of the VLAN Tag field in the transmitted packet. EMAC uses the contents of EMAC0_VTPID and EMAC0_VTCI for the VLAN Tag value. This feature is supported only when the packet from the transmit FIFO does not contain an FCS. *This option is mutually exclusive with VLAN tag insertion.*

Table 19-1 summarizes the possible options for adding FCS and source address to the transmitted packet.

Table 19-1. FCS/SA Enable - Possible Configurations

Configuration Options			EMAC Action		
Generate FCS	Insert SA	Replace SA	Add FCS	Add SA	Replace SA
0	Don't care	Don't care	N	N	N
1	0	0	Y	N	N
1	0	1	Y	N	Y
1	1	0	Y	Y	N

Preliminary User’s Manual

Table 19-2 summarizes the possible options for adding FCS and padding to the transmitted packet.

Table 19-2. FCS/Pad Enable - Possible Configurations

Configuration Options		EMAC Action	
Generate FCS	Generate Pad	Add FCS	Add Pad
0	Don't care	N	N
1	0	Y	N
1	1	Y	Y

Table 19-3 summarizes the possible options for adding FCS and VLAN Tag to the transmitted packet.

Table 19-3. FCS/VLAN Tag Enable - Possible Configurations

Configuration Options			EMAC Action		
Generate FCS	Insert VLAN Tag	Replace VLAN Tag	Add FCS	Insert VLAN Tag	Replace VLAN Tag
0	Don't care	Don't care	N	N	N
1	0	0	Y	N	N
1	0	1	Y	N	Y
1	1	0	Y	Y	N

19.4 EMAC Receive Operation

The receive part of EMAC is responsible for receiving packets coming from the physical layer (PHY) device and forwarding them to the receive channel of the attached MAL. At the end of the reception process, EMAC provides a status/error word that enables software to monitor the receive operation.

19.4.1 EMAC – MAL RX Packet Transfer Flow

EMAC initiates request for service from MAL when the number of occupied entries in the receive FIFO reaches the low water mark specified in EMAC0_RWMR[RLWM].

19.4.2 MAL RX Descriptor Status

For each packet that is received, MAL obtains status from EMAC after reception is complete, and writes this information into the buffer descriptor status/control field. Software uses this information to monitor the status of received packets. See “Buffer Descriptor Overview” on page 20-579 for more information on the buffer descriptor structure.

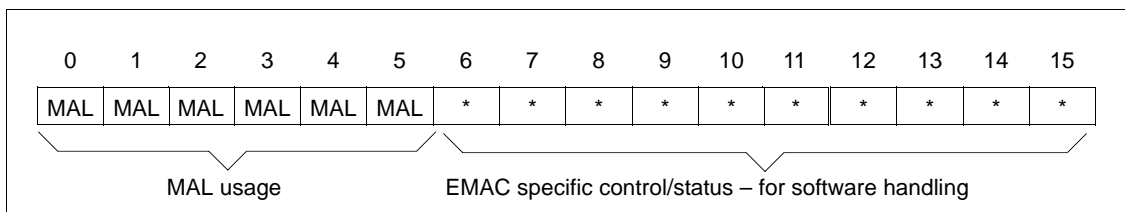

Figure 19-6. MAL RX Descriptor Control/Status Field

Bits	Bit Name	Bit Description	Mode
0:5	MAL Usage	See "Receive Status/Control Field Format" on page 20-588.	R
RX Status Information (Read Access)			
6	Overrun Error	0 No overrun error. 1 EMAC detected an overrun error. An overrun error occurs if the flow of received data to the RX FIFO is corrupted because of insufficient empty space.	R
7	Pause Packet	0 Received packet is not a control pause packet. 1 Received packet is a control pause packet.	R
8	Bad Packet	0 No packet errors. 1 Early termination caused by packet error.	R
9	Runt Packet	0 Duration of PHY_RX_DV signal OK. 1 Duration of PHY_RX_DV signal greater than ShortEventMax Time constant and less than collision windows.	R
10	Short Event	0 Duration of PHY_RX_DV signal OK. 1 Duration of PHY_RX_DV signal was less than ShortEventMaxTime constant	R
11	Alignment Error	0 Received packet length OK. 1 Received packet length not an integral number of octets.	R
12	Bad FCS	0 FCS OK. 1 The FCS value does not match the FCS value calculated by EMAC.	R
13	Packet Too Long	0 Received packet length OK. 1 Received packet length exceeds maximum packet length. • 1518 octets for standard packet • 1522 octets for VLAN tagged packet Data following the maximum packet length is not transferred to MAL	R
14	Out of Range Error	0 Received packet length field value OK. 1 Received packet length field value greater than maximum allowed LLC data size. The maximum allowed logical link control (LLC) data size is greater than 1500 and less than 1536.	R
15	In Range Error	Refer to Table 19-4 for a description of conditions for activating this status bit.	R

Table 19-4. In Range Length Error Behavior for Various Packet Lengths

Programmed Length (Bytes)	Actual Length	EMAC Action
Less than 46 (42 if VLAN Tagged packet)	Differs from 46 (42 in case of VLAN Tagged packet)	In range length error is activated
Less than 46 (42 if VLAN Tagged packet)	46 (42 in case of VLAN Tagged packet)	In range length error is not activated
Greater than or equal to 46 (42 if VLAN Tagged packet) and less than or equal to 1500	Equals the length field value	In range length error is not activated
Greater than or equal to 46 (42 if VLAN Tagged packet) and less than or equal to 1500	Differs from the length field value	In range length error is activated

Preliminary User's Manual

19.4.3 Early Packet Termination during Receive

Early packet termination occurs when packet reception is aborted by EMAC before the packet data transfer to MAL is completed.

EMAC performs early termination in the following cases.

- An overrun occurs in the receive FIFO
- Packet is too long and the Receive Oversize Packet option is not enabled (EMAC0_RMR[ROP] = 0)

19.4.4 Discarding Packets During Receive

Receive packets can be discarded if certain error conditions are detected. EMAC behavior depends on whether the packet to be discarded is already being output to MAL. If the packet containing the error is not being provided to MAL when the discard condition is detected, the packet is flushed from the Receive FIFO. In this case, EMAC does not provide status information to MAL. If the packet containing the error is already being output to MAL, EMAC initiates an early packet termination procedure, as described in “Early Packet Termination during Receive.”

Each receive discard condition can be individually controlled using appropriate settings, as described in “Receive Mode Register (EMAC0_RMR)” on page 19-553.

19.4.5 WOL Support

WOL logic in EMAC supports WOL technology, an industry standard in the Wired for Management (WFM) Specification. WOL remotely awakens sleeping or powered-off nodes on a network. To wake up a node, a specific packet, called a *magic packet*, is sent to the network node. When so configured, EMAC monitors the incoming bit stream for magic packets.

The magic packet, also called a wake-up packet, contains a unique data field not normally expected in LAN traffic. When a WOL-enabled adapter on a powered-off client decodes this data field, a wake-up signal is generated. In the PPC405GP, with WOL mode enabled, EMAC discards all incoming packets and does not request data from the MAL for transmission. When a magic packet is detected, EMAC generates an Ethernet WOL interrupt on UIC interrupt 9.

Figure 19-7 shows the wake-up packet format. The key to the wake-up packet is the MAC address of the target client, which is repeated 16 times. This pattern of 16 addresses in the data field is not expected to occur in any packet except the wake-up packet.

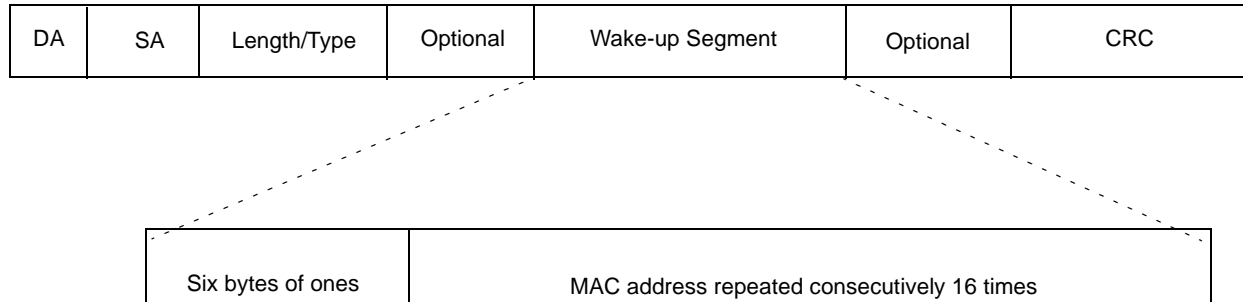

DA - destination address (6bytes) - UAA or Broadcast address
 SA - source address (6 bytes)
 Length/Type - length of data field (802.3)/type definition (Ethernet) (2 bytes)
 optional - for example, IP header
 CRC - Cycle Redundancy Check (4 bytes)

Figure 19-7. Wake-Up Packet Format

The destination address can be a specific address, called the universally administered address (UAA), or a broadcast address. If the destination address is a UAA, the wake-up packet is sent only to the client at that address. However, because the client is powered off and is no longer transmitting, some protocols remove the client MAC address from routing tables and internal caches at other nodes. In this case, wake-up packets addressed to a target client are discarded because nodes and routers do not know where to send them. The solution to this problem is to use a broadcast address. A directed broadcast has a valid network address and a broadcast host address. Network routers and nodes forward directed broadcasts to the appropriate network, where it is seen as a MAC-level broadcast and detected by the powered-off client.

19.4.5.1 EMAC WOL Support

EMAC enters WOL mode when EMAC0_MR0[WKE] = 1.

WOL mode should only be changed while EMAC0_MR0[RXI] = 1 and EMAC0_MR0[RXE] = 0. After EMAC0_MR0[WKE] = 1, EMAC0_MR0[RXE] can be set to 1.

A reset (soft or hard) should be issued before programming EMAC to WOL mode. In to WOL mode, EMAC does not propagate any received packets to MAL. Also, EMAC transmit channels do not request data from MAL.

Preliminary User's Manual**19.5 Flow Control**

For efficient system performance, EMAC implements full-duplex flow control by handling specific MAC control packets contained in the pause opcode. EMAC supports flow control as defined in the IEEE 802.3x-1997 standard.

19.5.1 MAC Control Packet

The flow control mechanism enables receive FIFO control logic to automatically notify the node transmitting packets to suspend transmission for a defined period of time. The pause control packet has a fixed length defined as follows:

MinFrameSize – 32 bits (60 bytes)

MAC control packets have a unique value of 0x8808 in the length/type field, and share the same packet format as normal Ethernet packets, except that the data field consists of an opcode field and a parameter field. The opcode field contains an opcode command and the parameter field contains a value associated with the opcode command (0x0001). The only opcode command defined by IEEE 802.3x is the pause opcode; the parameter field for the pause opcode defines the pause time. MAC control packets containing a pause opcode, also called pause packets, can have a destination address equal to a reserved multicast address, or can be the address of the receive station itself. The reserved multicast address is 0x0180C2000001.

Figure 19-8 illustrates the control packet format.

Preamble	SPD	DA	SA	Length/ Type	Opcode	Timer Value Field	Reserved	FCS
----------	-----	----	----	-----------------	--------	----------------------	----------	-----

Preamble - Alternating zeroes and ones (7 bytes)

SPD (Start Of Packet Delimiter), 1 byte

DA (Destination Address) = 0x0180C2000001

SA (Source Address) = Universally Administered Address (UAA)

Length/Type = 0x8808

Opcode Field = 0x0001

Timer Value Field = PauseValue

Reserved = zeroes (42 bytes)

FCS = calculated FCS

Figure 19-8. Control Packet Format

The timer value field contains the value of the delay interval in resolution of *pause_quanta*, defined in IEEE 802.3x as follows: “MAC Control Parameter[s] (*pause_time*) is a 2-octet, unsigned integer containing the length of time for which the receiving station is requested to inhibit data packet transmission. The field is transmitted most-significant octet first, and least-significant octet second. The *pause_time* is measured in units of *pause_quanta*, equal to 512 bit times. The range of possible *pause_time* is 0 to 65535 *pause_quanta*.”

19.5.2 Control Packet Transmission

Two options initiate the pause packet transmission from EMAC. The transmitted pause packet forces the node, with the destination address specified, to temporarily suspend the transmission of packets to EMAC.

- Software initiated

The packet transferred to EMAC by MAL for transmission is a pause packet created by software. EMAC transmits this as a normal packet.

- Automatic flow control initiated

The EMAC integrated flow control mechanism detects the need for and then transmits a control (pause) packet automatically. When building the control packet, EMAC obtains the SA (source address) field from EMAC0_IAHR and EMAC0_IALR, and the timer value from the Pause Timer Register (EMAC0_PTR[TVF]). The contents of the other fields in the packet are shown in Figure 19-8.

19.5.3 Integrated Flow Control

To enable integrated flow control in full-duplex mode, set EMAC0_MR1[EIFC] = 1. When the receive FIFO reaches a predefined threshold level (called a high water mark and specified by EMAC0_RWMR[RHWM]), an internal request for control (pause) packet transmission is activated. EMAC sends a control (pause) packet when a new packet enters the receive FIFO and the number of vacant entries in the Receive FIFO is less than the high water mark. When the receive FIFO reaches another predefined threshold level (the low water mark, specified by EMAC0_RWMR[RLWM]), a new internal request for a pause packet transmission, with a pause timer value of 0, is activated. EMAC sends a pause packet, with a pause timer value of 0, only once, and only if a pause packet with a non-zero value in the pause timer was transmitted earlier.

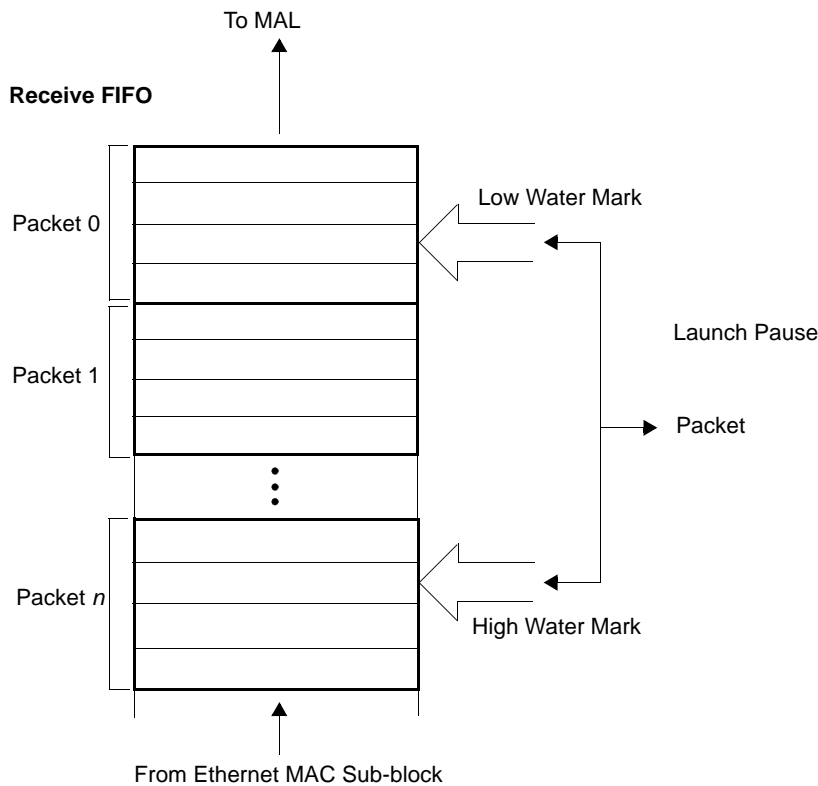

Figure 19-9. Integrated Flow Control Mechanism

Preliminary User's Manual

19.5.4 Control Packet Reception

In the receive path, EMAC can be configured to respond to pause packets, or ignore them, as specified by EMAC0_MR1[APP]. When response to pause packets is enabled and EMAC detects a valid MAC control packet with a pause opcode, EMAC stores the value of the timer value field. The received packet is considered a valid control packet only if no error was detected during the packet reception. If, at the end of packet reception, the packet is considered valid, EMAC launches a pause operation state machine, as specified in the IEEE P802.3x standard. Figure 19-10 illustrates the pause operation state machine.

If a control (pause) packet is received while another packet is transmitted, the ongoing transmission process is completed and the transmitter is paused. If other packets are in the transmit FIFO, their transmission is delayed until the pause timer expires. EMAC normally does not pass the MAC control packets to MAL unless EMAC0_RMR[PPP] = 1.

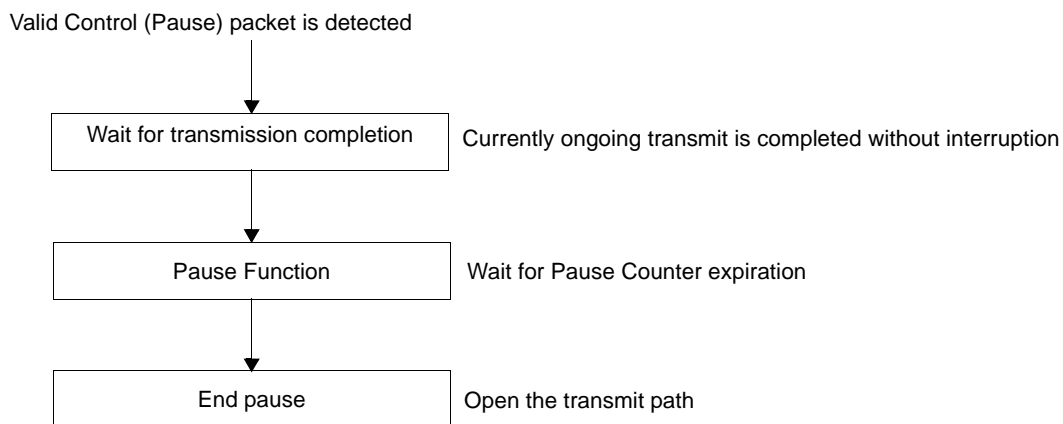

Figure 19-10. Pause Operation State Machine

In the Pause Function state, EMAC decrements its internal pause timer, which was set to the timer value field of the received control packet.

Note 1: The transmission of control (pause) packets is not affected by the reception of a receive control (pause) packet. Received control (pause) packets inhibit only the transmission of regular packets from the Transmit FIFO.

Note 2: Receipt of a new valid control (pause) packet causes the pause timer of EMAC to be reloaded with the contents of the timer value field of the recently received packet, regardless of the current pause timer setting. This indicates new pause operations take precedence over earlier pause operations.

19.6 VLAN Support

EMAC can handle VLAN tagged packets, as specified in IEEE Draft P802.3ac/D1.0a standard when EMAC0_MR1[VLE] = 1.

A tagged MAC frame is an extension of the standard MAC packet. The extension for VLAN tag support consists of a 4-octet VLAN tag inserted between the end of the source address and the beginning of the length/type fields of the MAC packet.

The VLAN tag consists of two fields:

- A 2-octet constant Type field value equal to the VLAN Tag Protocol Identifier (0x8100)
- A 2-octet field containing Tag Control Information (TCI)

The MAC client data and FCS fields of the basic MAC packet follow the VLAN tag. The length of the packet is extended by four octets by the VLAN tag (up to 1522 bytes). The FCS is calculated over all fields from the destination address through the end of the MAC client data or pad (if present); that is, all fields except the preamble, SPD, and FCS.

Figure 19-11 illustrates the Tagged MAC Frame format.

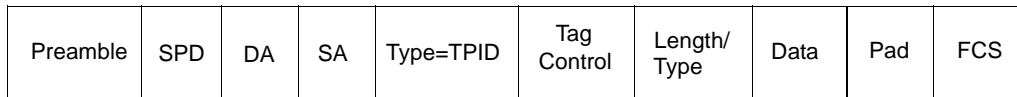

Preamble – Alternating 0s and 1s (7 bytes)
 SPD (Start Of Packet Delimiter) 1 byte
 DA (Destination Address) 6 bytes
 SA (Source Address) 6 bytes
 TPID (Tag Protocol Identifier, 2 bytes) = 0x8100
 TCI (Tag Control Information) 2 bytes
 Length/Type 2 bytes
 Data (42–1500 bytes)
 Pad (Optional field)
 FCS – Calculated FCS

Figure 19-11. Tagged MAC Packet Format

Figure 19-12 illustrates the structure of the TCI field.

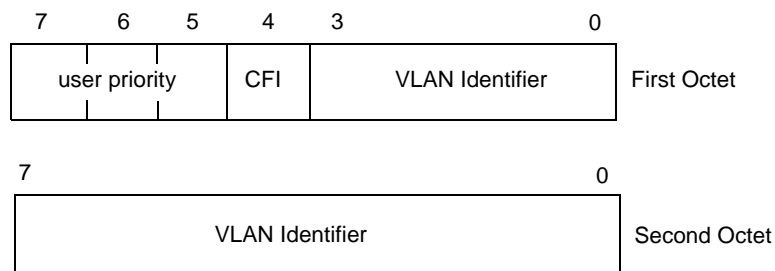

CFI is a Canonical Format Indicator (always 1 for Ethernet media)

Figure 19-12. Tag Control Information Field Structure

Preliminary User's Manual

19.6.1 VLAN Tagged Packet Transmission

When EMAC0_MR1[VLE] = 1, the following configuration options are available, depending on the content of the appropriate bits in the MAL control word (see section 19.3.3.1, "MAL TX Descriptor Control/Status Field," on page 530):

- The Generate FCS bit (bit 6) is not set or both Insert VLAN Tag and Replace VLAN Tag bits (bits 10 and 11, respectively) are not set: EMAC transmits the packet without any changes
- Bit 6 is set and bit 10 is also set: EMAC will insert TPID and Tag control information for the transmitting packet using the content of EMAC0_VTPID and EMAC0_VTCI, respectively
- Bit 6 is set and bit 11 is also set: EMAC will replace TPID and Tag control information for the transmitting packet using the content of EMAC0_VTPID and EMAC0_VTCI, respectively

19.6.2 VLAN Tagged Packet Reception

If EMAC0_MR1[VLE] = 1, EMAC parses the VLAN Tag unique type/length in the incoming packet during the receive process. If the VLAN Tag is equal to the value stored in EMAC0_VTPID, EMAC continues the receive process and allows the received packet to contain up to 1522 octets. Otherwise, the receive process is continued unless the length is greater than 1518 bytes.

19.6.3 Address Match Mechanism

The address match (or filtering) mechanism is a hardware aid that reduces the average amount of CPU cycles required to determine whether an incoming packet should be accepted.

EMAC uses various address filters for incoming packets by using the following address recognition modes.

- Individual mode (also referred to as physical)
- Multicast mode (also referred to as group)
- Broadcast mode (an all-ones group address)
- Promiscuous mode
- Promiscuous multicast mode
- WOL mode

A flowchart for address recognition of received packets is shown in Figure 19-13 on page 19-545. If the least significant bit (LSb) of the first byte of the destination address (DA) is 0, the packet is considered individual. If the first bit received is 1, the packet is considered multicast. When the DA field contains all 1s, the packet is broadcast, a special type of multicast.

19.6.3.1 Non-WOL Mode

When EMAC operates in single individual mode ($\text{EMAC0_RMR}[\text{IAE}] = 1$), the DA of the received packet is compared to the physical address stored in EMAC0_IAHR and EMAC0_IALR .

When EMAC operates in multiple individual mode ($\text{EMAC0_RMR}[\text{MIAE}] = 1$), EMAC performs a calculation on the contents of the DA field (logical address filter) to determine whether or not to accept the packet.

When EMAC operates in promiscuous mode ($\text{EMAC0_RMR}[\text{PME}] = 1$), all properly formed packets are received, regardless of the content of the DA field.

When EMAC operates in multicast promiscuous mode ($\text{EMAC0_RMR}[\text{PMME}] = 1$), all multicast packets are received, regardless of the content of the DA field.

When EMAC operates in broadcast address mode ($\text{EMAC0_RMR}[\text{BAE}] = 1$), EMAC performs an address compare on received packets with broadcast addresses.

When EMAC operates in multicast address mode ($\text{EMAC0_RMR}[\text{MAE}] = 1$), EMAC performs a calculation on the contents of the DA field (logical address filter) as in multiple individual mode, in order to determine whether or not the packet should be accepted.

The logical address filter hardware implements a hash code searching technique commonly used by programmers. The hardware maps the DA of the incoming packet into one of 64 categories corresponding to 64 bits stored in the EMAC0_IAHT1 – EMAC0_IAHT4 or EMAC0_GAHT1 – EMAC0_GAHT4 registers. The hardware accepts or rejects the packet, depending on the state of the corresponding bit in the EMAC0_IAHT1 – EMAC0_IAHT4 or EMAC0_GAHT1 – EMAC0_GAHT4 registers corresponding to the selected category.

Figure 19-14 on page 19-546 shows the details of the hardware mapping algorithm. The example depicts multiple individual address mode, but with changes can be used for the multicast address mode.

If the most significant bit (MSb) of an incoming address is 0, the address is individual and is passed to the individual address filter. If the MSb of an incoming address is 1, the address is multicast and is passed to the multicast address filter. The individual/multicast address filter is a 64-bit mask composed of the EMAC0_IAHT1 – EMAC0_IAHT4 or EMAC0_GAHT1 – EMAC0_GAHT4 registers (each register contains 16 bits of a 64-bit mask). The incoming address is sent through the FCS circuit. After the 48 address bits have gone through the FCS circuit, the high-order 6 bits of the resulting FCS (32-bit CRC) are used to select a the 64-bit positions in the individual/multicast address filter. If the selected filter bit is a 1, the address is accepted.

Note: The individual/multicast address filter ensures only that there is a possibility that the incoming packet belongs to this node. To determine if the packet belongs to the node, the incoming individual/multicast address propagated to the main memory is compared by software to the list of logical addresses to be accepted by this node.

For software, the task of mapping an individual/multicast address to one of 64 bit positions requires a program that uses the same CRC algorithm to calculate the hash.

Preliminary User's Manual

19.6.3.2 WOL Mode

In WOL mode (EMAC0_MR0[WKE] = 1), EMAC operates only with the broadcast or individual address in the destination address field.

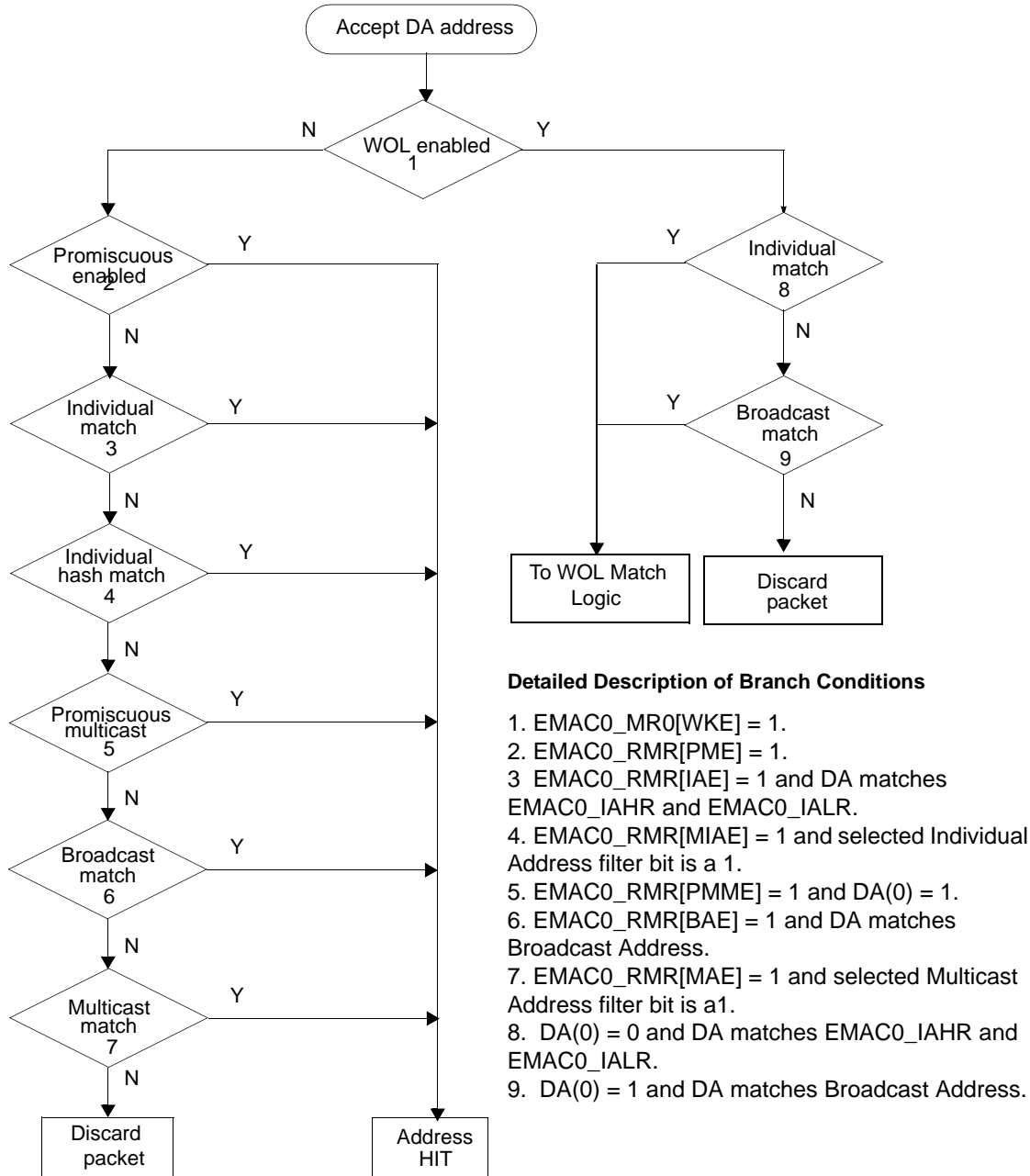

Figure 19-13. Receive Address Recognition Flowchart

The example in Figure 19-14 shows that the received individual address maps into category 24, and that bit 8 in EMAC0_IAHT2 is set. The match indication is activated and the packet should be accepted.

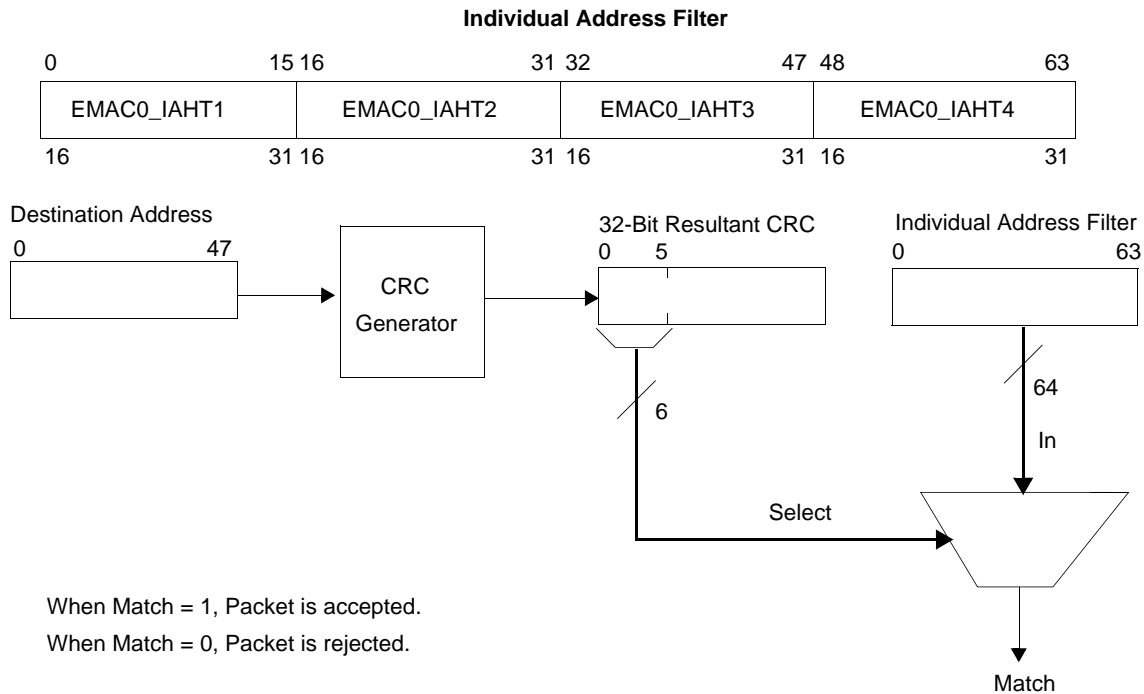

Figure 19-14. Ethernet Address Filter Operation

19.7 EMAC Registers

This section describes the EMAC registers, which are listed in Table 19-5. The EMAC registers are accessed using the OPB slave interface. Access to these memory-mapped I/O (MMIO) registers should be word-aligned.

Table 19-5. EMAC0 Register Summary

Register Name	Address	Write Access	Power-on Reset Value	Access	Page
EMAC0_MR0	0xEF600800	See description in "Scenario 1" on page 19-571	0xC0000000	R/W	19-551
EMAC0_MR1	0xEF600804	Reset	0x00000000	R/W	19-549
EMAC0_TMR0	0xEF600808	See description on page 19-551	0x00000000	R/W	19-551
EMAC0_TMR1	0xEF60080C	See description on page 19-552	0x380F0000	R/W	19-552
EMAC0_RMR	0xEF600810	Reset	0x00000000	R/W	19-553
EMAC0_ISR	0xEF600814	Always	0x00000000	R/W	19-555
EMAC0_ISER	0xEF600818	Reset	0x00000000	R/W	19-557
EMAC0_IAHR	0xEF60081C	Reset, R, T	0x00000000	R/W	19-560
EMAC0_IALR	0xEF600820	Reset, R, T	0x00000000	R/W	19-560
EMAC0_VTPID	0xEF600824	Reset, R, T	0x00008808	R/W	19-561

Note: See "Reset and Initialization" on page 19-571 for definitions of letters in the Write Access column.

Preliminary User's Manual**Table 19-5. EMAC0 Register Summary (continued)**

Register Name	Address	Write Access	Power-on Reset Value	Access	Page
EMAC0_VTCI	0xEF600828	Reset, R, T	0x00000000	R/W	19-561
EMAC0_PTR	0xEF60082C	Reset, T	0x0000FFFF	R/W	19-562
EMAC0_IAHT1	0xEF600830	Reset, R	0x00000000	R/W	19-562
EMAC0_IAHT2	0xEF600834	Reset, R	0x00000000	R/W	19-562
EMAC0_IAHT3	0xEF600838	Reset, R	0x00000000	R/W	19-562
EMAC0_IAHT4	0xEF60083C	Reset, R	0x00000000	R/W	19-562
EMAC0_GAHT1	0xEF600840	Reset, R	0x00000000	R/W	19-563
EMAC0_GAHT2	0xEF600844	Reset, R	0x00000000	R/W	19-563
EMAC0_GAHT3	0xEF600848	Reset, R	0x00000000	R/W	19-563
EMAC0_GAHT4	0xEF60084C	Reset, R	0x00000000	R/W	19-563
EMAC0_LSAH	0xEF600850	Not applicable	0x00000000	R	19-563
EMAC0_LSAL	0xEF600854	Not applicable	0x00000000	R	19-564
EMAC0_IPGVR	0xEF600858	Reset, T	0x00000004	R/W	19-564
EMAC0_STACR	0xEF60085C	See description on page 19-565	0x00008000	R/W	19-565
EMAC0_TRTR	0xEF600860	See description on page 19-566	0x00000000	R/W	19-566
EMAC0_RWMR	0xEF600864	Reset	0x04001000	R/W	19-567
EMAC0_OCTX	0xEF600868	Not applicable	0x00000000	R	19-568
EMAC0_OCRX	0xEF60086C	Not applicable	0x00000000	R	19-568

Note: See "Reset and Initialization" on page 19-571 for definitions of letters in the Write Access column.

19.7.1 Mode Register 0 (EMAC0_MR0)

EMAC0_MR0 defines the operating modes of the EMAC, which can be changed at any time during EMAC operation.

Both PHY clocks, PHYTxClk and PHYRxClk, must be active prior to requesting a soft reset through EMAC0_MR0[SRST]. If the PHY clocks are inactive, the soft reset never completes, even if the clocks subsequently become active. Therefore, software should poll EMAC0_MR0[SRST] only for a limited time waiting for the EMAC to complete its reset. If the EMAC does not reset, the PHY clocks are probably inactive. If this occurs, the application should wait until the PHY clocks are running and issues a new reset request through EMAC0_MR0[SRST].

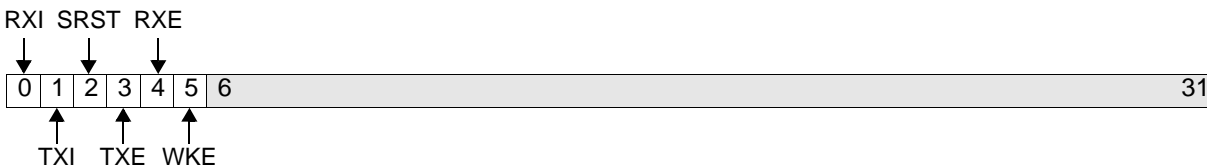

Figure 19-15. Mode Register 0 (EMAC0_MR0)

0	RXI	Receive MAC Idle 0 RX MAC processing packet 1 RX MAC idle; RX packet processing complete	Read-only
1	TXI	Transmit MAC Idle 0 TX MAC processing packet 1 TX MAC idle; TX packet processing complete	Read-only
2	SRST	Soft Reset 0 No effect 1 Soft reset in progress	If EMAC0_MR0[SRST] = 1, writing to any EMAC register, and reading any other bit in this register, is not supported.
3	TXE	Transmit MAC Enable 0 TX MAC is disabled 1 TX MAC is enabled	
4	RXE	Receive MAC Enable 0 RX MAC is disabled 1 RX MAC is enabled	
5	WKE	Wake-Up Enable 0 Incoming packets are not examined for wake-up packet 1 Examine incoming packets for wake-up packet	Software can change EMAC0_MR0[WKE] only while EMAC0_MR0[RXI] = 1 and EMAC0_MR0[RXE] = 0.
6:31		Reserved	

Preliminary User's Manual**19.7.2 Mode Register 1 (EMAC0_MR1)**

EMAC0_MR1 defines the EMAC operating modes, which can be changed only after a reset.

Software can use EMAC0_MR1[FDE] and proper programming of the attached PHY to activate external loop-back mode.

When EMAC0_MR1[FDE, ILE] = 1, EMAC wraps transmitted packets back to the receive FIFO without accessing the MII.

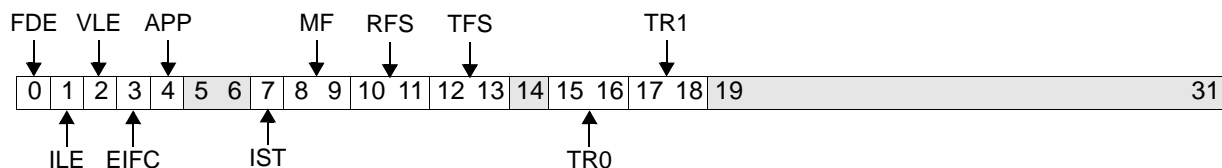

Figure 19-16. Mode Register 1 (EMAC0_MR1)

0	FDE	Full-Duplex Enable 0 Disable simultaneous transmit and receive 1 Enable simultaneous transmit and receive	
1	ILE	Internal Loop-back Enable 0 No wrap back 1 Transmitted packets wrapped back to receive FIFO	Full Duplex must also be set (EMAC0_MR1[FDE]=1).
2	VLE	VLAN Enable 0 Disable processing of VLAN Tags 1 Enable processing of VLAN Tags	
3	EIFC	Enable Integrated Flow Control 0 Disable integrated flow control mechanism 1 Enable integrated flow control mechanism	Refer to “Flow Control” on page 19-539 for more details. Set EMAC0_MR1[EIFC] = 0 in half-duplex mode.
4	APP	Allow Pause Packet 0 Disables processing of incoming control (pause) packets 1 Enables processing of incoming control (pause) packets	
5:6		Reserved	Always zero
7	IST	Ignore SQE test 0 Wait for end of SQE test period before activation of valid signal 1 Do not wait for end of SQE test period before activation of valid signal	EMAC0_MR1[IST] = 0 only during half-duplex operation on 10 Mbps media.

8:9	MF	Medium Frequency 00 10 Mbps (Ethernet mode) 01 100 Mbps (Fast Ethernet mode) 10 Reserved 11 Reserved	Defines the possible operational frequency on the MII interface.
10:11	RFS	Receive (RX) FIFO Size 00 512 bytes 01 1 KB 10 2 KB 11 4 KB	
12:13	TFS	Transmit (TX) FIFO Size 00 Reserved 01 1 KB 10 2 KB 11 Reserved	7
14		Reserved	Always 0
15:16	TR0	Transmit Request 0 00 Single packet 01 Multiple packets 10 Dependent mode (bits 17:18 must also be programmed to 10) 11 Reserved	Defines the different modes for using transmit channel 0 of EMAC.
17:18	TR1	Transmit Request 1 00 Single packet 01 Multiple packets 10 Dependent mode (bits 15:16 must also be programmed to 10) 11 Reserved	Defines the different modes for using transmit channel 1 of EMAC.
19:31		Reserved	

Preliminary User's Manual**19.7.3 Transmit Mode Register 0 (EMAC0_TMR0)**

EMAC0_TMR0 defines EMAC operating modes during transmit operations (see “EMAC Transmit Operation” on page 19-529).

EMAC0_TMR0[GNP0, GNP1, GNPD] are self-clearing. Writing 0 to these fields has no effect.

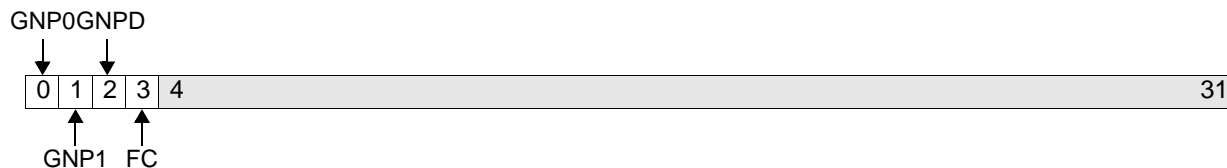

Figure 19-17. Transmit Mode Register 0 (EMAC0_TMR0)

0	GNP0	Get New Packet 0 0 Writing 0 has no effect. 1 Packet ready for transmission on TX Channel 0	EMAC0_TMR0[GNP0] = 0 if EMAC is programmed in dependent mode.
1	GNP1	Get New Packet 1 0 Writing 0 has no effect. 1 Packet ready for transmission on TX Channel 1	EMAC0_TMR0[GNP1] = 0 if EMAC is programmed in dependent mode.
2	GNPD	Get New Packet for Dependent Mode 0 Writing 0 to this bit has no effect 1 Packet ready for transmission in dependent mode	EMAC0_TMR0[GNPD] = 0 if EMAC is not programmed in dependent mode. EMAC0_TMR0[GNPD] = 1 activates the EMAC transmit path in dependent mode.
3	FC	First Channel 0 Activate TX Channel 0 first when GNPD is 1 1 Activate TX Channel 1 first when GNPD is 1	EMAC0_TMR0[FC] is only meaningful in dependent mode, after resetting EMAC0_ISR[DBDM]. EMAC0_TMR0[FC] = 0 if EMAC is not programmed in dependent mode.
4:31		Reserved	

19.7.4 Transmit Mode Register 1 (EMAC0_TMR1)

EMAC0_TMR1 defines conditions for activation of MAL service requests during transmit operations (see “EMAC Transmit Operation” on page 19-529).

19.7.4.1 Low-Priority Requests

EMAC requests low priority service from MAL when the number of vacant entries in the transmit FIFO exceeds the decimal transmit low request (TLR) value.

EMAC0_TMR1[TLR] must at least equal $((MAL\ Burst\ Limit / 2) + 1)$. For example, if MAL supports 16-word bursts, the decimal TLR value should be at least 9.

Note: In the PPC405GP, all MAL channels are capable of 16 word bursts.

To avoid a deadlock, the sum of EMAC0_TMR1[TLR] and EMAC0_TRTR[TRT] must be at least 4 smaller than the transmit FIFO size specified by EMAC0_MR1[TFS].

19.7.4.2 Urgent-Priority Requests

EMAC requests urgent priority service from MAL if the following conditions occur:

- EMAC begins transmitting the packet to the media before the entire packet is placed in the TX FIFO
- The number of vacant entries for the currently transmitting packet exceeds the decimal TUR value

Software must coordinate the value of EMAC0_TMR1[TUR] with the value of EMAC0_MR1[TFS]. The value of EMAC0_TMR1[TUR] must be smaller than that of EMAC0_MR1[TFS] so that the array address encoded in EMAC0_TMR1[TUR] can access the full 66-bit wide array.

The binary value of EMAC0_TMR1[TUR] must be greater than that of EMAC0_TMR1[TLR].

The EMAC0_TMR1 contents can be changed only when EMAC0_TMR0[GNP0, GNP1, GNPD] = 0.

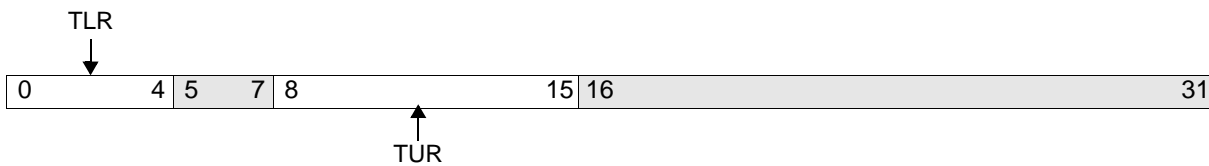

Figure 19-18. Transmit Mode Register 1 (EMAC0_TMR1)

0:4	TLR	Transmit Low Request
5:7		Reserved
8:15	TUR	Transmit Urgent Request
16:31		Reserved

Preliminary User's Manual**19.7.5 Receive Mode Register (EMAC0_RMR)**

EMAC0_RMR defines EMAC operating modes during receive operations.

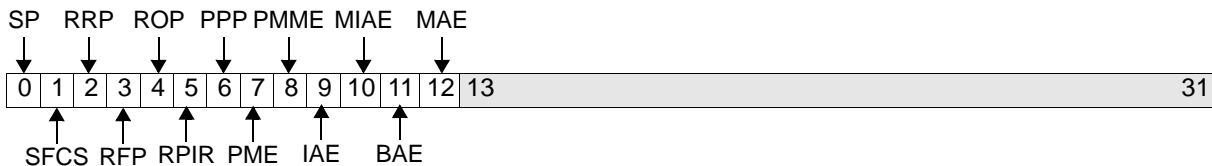

Figure 19-19. Receive Mode Register (EMAC0_RMR)

0	SP	Strip Padding 0 Do not strip pad bytes from the received packet. 1 Strip pad/FCS bytes from the received packet.	
1	SFCS	Strip FCS 0 Do not strip FCS bytes from the received packet. 1 Strip FCS bytes from the received packet.	
2	RRP	Receive Runt Packets 0 Discard packets less than 64 bytes in length. 1 Receive packets less than 64 bytes in length.	
3	RFP	Allow Receive Packets with a FCS Error 0 Discard packets containing a FCS error. 1 Receive packets containing a FCS error.	
4	ROP	Receive Oversize Packet 0 Discard packets that activate Packet Is Too Long error. 1 Receive packets that activate Packet Is Too Long error.	
5	RPIR	Receive Packets with In Range Error 0 Discard packets that activate In Range Error. 1 Receive packets that activate In Range Error.	
6	PPP	Propagate Pause Packet 0 Do not propagate incoming pause packet to MAL; remove packet from FIFO. 1 Propagate incoming pause packet to MAL.	When PPP is enabled, the EMAC must either have the PMM (promiscuous Multicast Mode) enabled or the MAE bit enabled with the proper hash register value; otherwise, the EMAC will not propagate the pause packet to the MAL.
7	PME	Promiscuous Mode Enable 0 Do not enable promiscuous mode. 1 Accept all packets.	

8	PMME	Promiscuous Multicast Mode Enable 0 Do not accept all multicast packets. 1 Accept all multicast packets.
9	IAE	Individual Address Enable 0 Do not compare address of received packets with content of individual address register. 1 Compare address of received packets with content of individual address register.
10	MIAE	Multiple Individual Address Enable 0 Do not compare address of received packets with hash table of individual addresses. 1 Compare address of received packets with hash table of individual addresses.
11	BAE	Broadcast Address Enable 0 Do not compare address of received packets with broadcast addresses. 1 Compare address of received packets with broadcast addresses.
12	MAE	Multicast Address Enable 0 Do not compare address of received packets with multicast addresses. 1 Compare address of received packets with multicast addresses.
13:31		Reserved

Preliminary User's Manual**19.7.6 Interrupt Status Register (EMAC0_ISR)**

EMAC generates a distinct interrupt as an event indication. The interrupt is routed to the chip UIC. This interrupt is generated from the content of the EMAC0_ISR. The content of the EMAC0_ISR is first ANDed with the corresponding mask bits in the EMAC0_ISEI; the resulting bits are then logically ORed to produce the interrupt signal. Thus, if any of the resulting bits is a 1, an interrupt is generated.

Note: EMAC activates its interrupt signal only after an indication that status for the current packet was accepted by MAL (with the exception of “MMA Operation Succeed/MMA Operation Failed,” which causes unconditional activation of interrupt, if it is not masked).

The interrupt indication is cleared by writing 1 to the related bit in the EMAC0_ISR; writing 0 has no effect.

The event indication signal is cleared when all non-masked event indication bits are cleared.

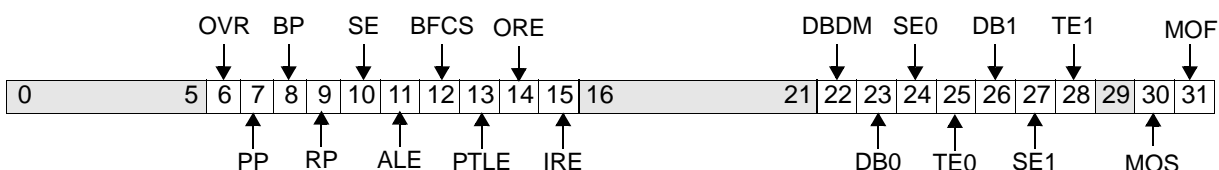

Figure 19-20. Interrupt Status Register (EMAC0_ISR)

0:5		Reserved	
6	OVR	Overrun 0 No overrun error 1 Overrun error during reception of recent packet	
7	PP	Pause Packet 0 Received packet is not a control pause packet 1 Received packet is a control pause packet	
8	BP	Bad Packet 0 Receive operation OK 1 Early termination was initiated because of a packet error	
9	RP	Runt Packet 0 No Runt packets received 1 Runt packet received	Set when EMAC0_RMR[RRP] = 1 and the duration of PHY_RX_DV signal was greater than ShortEventMaxTime constant and less than the collision window.
10	SE	Short Event 0 No short events 1 Duration of PHY_RX_DV signal less than ShortEventMaxTime constant	
11	ALE	Alignment Error 0 No alignment error in received packet 1 Alignment error in received packet	The packet contained an odd number of nibbles (4 bits).

12	BFCS	Bad FCS 0 No FCS error in received packet 1 Packet with an FCS error received	Set if EMAC0_RMR[RFP] = 1.
13	PTLE	Packet Too Long Error 0 No oversized packets received 1 Oversized packet received	Set if EMAC0_RMR[ROP] = 1 and the received packet length exceeded the maximum allowed value: <ul style="list-style-type: none"> • 1518 octets for standard packet (checked only if the length/type field of the transmitted packet contained length value) • 1522 octets for VLAN tagged packet (checked only if the length/type field of the transmitted packet contained length value and jumbo support is disabled)
14	ORE	Out Of Range Error 0 Received packet length field value OK 1 Received packet length field value greater than the maximum allowed LLC data size	Indicates that received packet has a length field value greater than the maximum allowed logical link control (LLC) data size (greater than 1500 and less than 1536).
15	IRE	In Range Error 0 Received packet does not contain an In Range Error 1 Received packet contains an In Range Error	
16:21		Reserved	
22	DBDM	Dead Bit Dependent Mode 0 No transmit error or SQE in dependent mode 1 Transmit error or SQE has occurred while in dependent mode	If EMAC0_ISR[DBDM] = 1, EMAC does not request MAL service, even if EMAC0_TMR0[GNPD] = 1. EMAC0_ISR[DBDM] does not affect EMC_INT.
23	DB0	Dead Bit 0 0 No transmit error or SQE for TX Channel 0 while not in dependent mode 1 Transmit error or SQE has occurred for TX Channel 0 while not in dependent mode	If EMAC0_ISR[DB0] = 1, EMAC does not request service for TX Channel 0 from MAL, even if EMAC0_TMR0[GNP0] = 1. EMAC0_ISR[DB0] does not affect EMC_INT.
24	SE0	SQE Error 0 0 No SQEs on TX Channel 0 1 SQE test failure during transmission of a packet from TX Channel 0	Applicable only in half-duplex mode during 10 Mbps operations; 0 in all other modes.
25	TE0	Transmit Error 0 0 TX Channel 0 transmission OK 1 TX Channel 0 transmission aborted	EMAC aborts the transmitted packet if one of the following events takes place: <ul style="list-style-type: none"> • Late collision detection • Excessive collision detection • Excessive deferral • TX FIFO underrun • Loss of carrier sense

Preliminary User’s Manual

26	DB1	Dead Bit 1 0 No transmit error or SQE for TX Channel 1 while not in dependent mode 1 Transmit error or a SQE has occurred for TX Channel 1 while not in dependent mode	If this bit is set, EMAC does not request MAL service for TX Channel 1 even if EMAC0_TMR1[GNP1] = 1. EMAC0_ISR[DB1] does not affect EMC_INT.
27	SE1	SQE Error 1 0 No Signal Quality Errors on TX Channel 1 1 Signal Quality Error test failure during transmission of a packet from TX Channel 1	Applicable only in half-duplex mode during 10 Mbps operations; 0 in all other modes.
28	TE1	Transmit Error 1 0 TX Channel 1 transmission OK 1 TX Channel 1 transmission aborted	EMAC aborts the transmitted packet if one of the following events takes place: <ul style="list-style-type: none"> • Late collision detection • Excessive collision detection • Excessive deferral • TX FIFO underrun • Loss of carrier sense
29		Reserved	Always 0
30	MOS	MMA Operation Succeeded 0 MMA_CONTROL addressed on the OPB 1 PHY transfer valid	The device driver should poll assertion of EMAC0_ISR[MOS] or EMAC0_ISR[MOF] before issuing a new command or before using data read from the PHY.
31	MOF	MMA Operation Failed 0 MMA_CONTROL addressed on the OPB 1 PHY transfer <i>not</i> valid	The device driver should poll assertion of EMAC0_ISR[MOF] or EMAC0_ISR[MOS] before issuing a new command or before using data read from the PHY.

19.7.7 Interrupt Status Enable Register (EMAC0_ISR)

EMAC0_ISR indicates which conditions in the EMAC0_ISR can generate an interrupt.

Each masking bit in the EMAC0_ISR corresponds to a related bit in the EMAC0_ISR. If a mask bit is set to 1, the corresponding status bit, when set, causes an interrupt to be generated. Setting a mask bit to 0 suppresses interrupt generation for the associated condition.

Mask bits for reserved bits in the EMAC0_ISR are not implemented, have no effect on write, and return 0 on read.

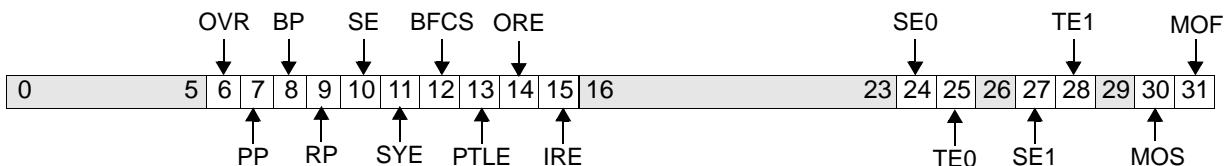

Figure 19-21. Interrupt Status Enable Register (EMAC0_ISR)

0:5	Reserved
-----	----------

6	OVR	Overrun 0 Overrun error will not generate an interrupt. 1 Overrun error will generate an interrupt.
7	PP	Pause Packet 0 Received control pause packet will not generate an interrupt. 1 Received control pause packet will generate an interrupt.
8	BP	Bad Packet 0 Early termination on received packet will not generate an interrupt. 1 Early termination on received packet will generate an interrupt.
9	RP	Runt Packet 0 Received runt packet will not generate an interrupt. 1 Received runt packet will generate an interrupt.
10	SE	Short Event 0 Short event during receive will not generate an interrupt. 1 Short event during receive will generate an interrupt.
11	ALE	Alignment Error 0 Alignment error in received packet will not generate an interrupt. 1 Alignment error in received packet will generate an interrupt.
12	BFCS	Bad FCS 0 FCS error in received packet will not generate an interrupt. 1 FCS error in received packet will generate an interrupt.
13	PTLE	Packet Too Long Error 0 Oversized packets received will not generate an interrupt. 1 Oversized packet received will generate an interrupt.
14	ORE	Out Of Range Error 0 Out of range error on received packet will not generate an interrupt. 1 Out of range error on received packet will generate an interrupt.
15	IRE	In Range Error 0 In range error on received packet will not generate an interrupt. 1 In range error on received packet will generate an interrupt.
16:23		Reserved

Preliminary User's Manual

24	SE0	SQE Error 0 0 SQE error on TX Channel 0 will not generate an interrupt. 1 SQE error on TX Channel 0 will generate an interrupt.
25	TE0	Transmit Error 0 0 TX error on TX Channel 0 will not generate an interrupt. 1 TX error on TX Channel 0 will generate an interrupt.
26		Reserved
27	SE1	SQE Error 1 0 SQE error on TX Channel 1 will not generate an interrupt. 1 SQE error on TX Channel 1 will generate an interrupt.
28	TE1	Transmit Error 1 0 TX error on TX Channel 1 will not generate an interrupt. 1 TX error on TX Channel 1 will generate an interrupt.
29		Reserved
30	MOS	MMA Operation Succeeded 0 Successful MMA Operation with a PHY will not generate an interrupt. 1 Successful MMA Operation with a PHY will generate an interrupt.
31	MOF	MMA Operation Failed 0 Unsuccessful MMA Operation with a PHY will not generate an interrupt. 1 Unsuccessful MMA Operation with a PHY will generate an interrupt.

19.7.8 Individual Address High (EMAC0_IAHR)

EMAC0_IAHR contains the high-order halfword of the station unique individual address.

During packet reception, if EMAC is programmed in individual address match mode (EMAC0_RMR[IAE] = 1), the contents of EMAC0_IAHR are concatenated with the content of EMAC0_IALR to form a composite address that is compared with the destination address of the received packet. If addresses match, the packet is transferred to MAL.

During packet transmission, EMAC0_IAHR is used in source address inclusion/replacement and as the source address field in the self-assembled control (pause) packet.

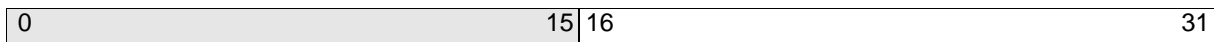

Figure 19-22. Individual Address High Register (EMAC0_IAHR)

0:15		Reserved	
16:31		High-order halfword of the station unique individual address	This field contains bits 0:15 of the station address (bit 0 is the most significant bit).

19.7.9 Individual Address Low (EMAC0_IALR)

EMAC0_IALR contains the low-order word of the station unique individual address.

During packet reception, EMAC0_IALR is compared with the corresponding address bits of the received packet.

During packet transmission, EMAC0_IALR is used in source address inclusion/replacement and as the source address field in the self-assembled control (pause) packet.

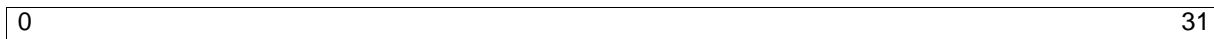

Figure 19-23. Individual Address Low Register (EMAC0_IALR)

0:31		Low-order bits of Receive Individual Address or Transmit Source Address
------	--	---

Preliminary User's Manual**19.7.10 VLAN TPID Register (EMAC0_VTPID)**

EMAC0_VTPID contains the value of the VLAN TPID (Tag Protocol Identifier) field.

During packet reception, packet bytes 13 and 14 are compared to the content of this register to check whether the packet is tagged with a VLAN ID.

During packet transmission, EMAC uses EMAC0_VTPID when VLAN Tag replacement or VLAN Tag inclusion mode is chosen.

The value of this register must be a Type field (8100).

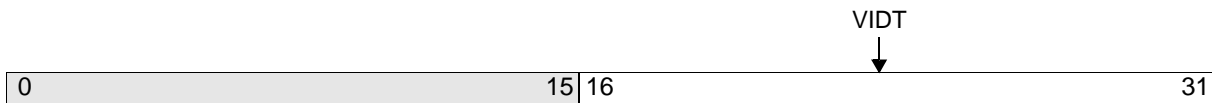

Figure 19-24. VLAN TPID Register (EMAC0_VTPID)

0:15		Reserved
16:31	VIDT	VLAN ID tag

19.7.11 VLAN TCI Register (EMAC0_VTCI)

EMAC0_VTCI contains the value of the VLAN TCI (Tag Control Information) field.

During packet transmission, EMAC uses EMAC0_VTCI when VLAN Tag replacement or VLAN Tag inclusion mode is chosen.

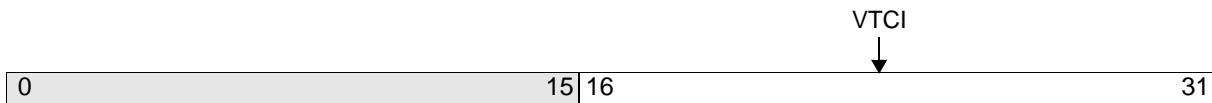

Figure 19-25. VLAN TCI Register (EMAC0_VTCI)

0:15		Reserved
16:31	VTCI	VLAN TCI tag

19.7.12 Pause Timer Register (EMAC0_PTR)

EMAC0_PTR defines the time period for which the pause function is enabled. EMAC uses EMAC0_PTR[TVR] as the timer value field of control (pause) packets (see “Control Packet Transmission” on page 19-540). Each bit corresponds to 512 bit times.

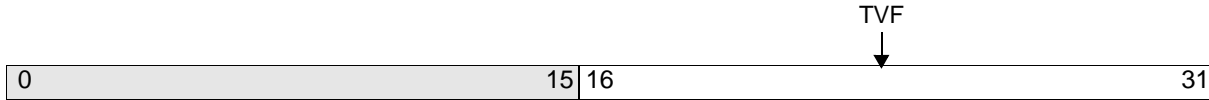

Figure 19-26. Pause Timer Register (EMAC0_PTR)

0:15		Reserved
16:31	TVF	Timer Value Field

19.7.13 Individual Address Hash Tables 1–4 (EMAC0_IAHT1–EMAC0_IAHT4)

These registers are used in the hash table function of the multiple individual addressing mode.

See “Address Match Mechanism” on page 19-543 for more information. See Figure 19-14 on page 19-546 for bit mapping information.

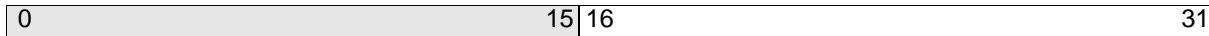

Figure 19-27. Individual Address Hash Tables 1–4 (EMAC0_IAHT1–EMAC0_IAHT4)

0:15		Reserved
16:31		Individual Address Hash Number

Preliminary User's Manual**19.7.14 Group Address Hash Tables 1–4 (EMAC0_GAHT1–EMAC0_GAHT4)**

These registers are used in the hash table function of the group addressing mode.

See “Address Match Mechanism” on page 19-543 for more information. See Figure 19-14 on page 19-546 for bit mapping information.

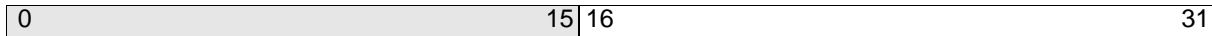

Figure 19-28. Group Address Hash Tables 1–4 (EMAC0_GAHT1–EMAC0_GAHT4)

0:15		Reserved
16:31		Group Address Hash Number

19.7.15 Last Source Address High (EMAC0_LSAH)

EMAC0_LSAH contains the high-order halfword of the source address of the last “good” received packet. The packet is considered to be “good” if EMAC is programmed to provide this packet to MAL.

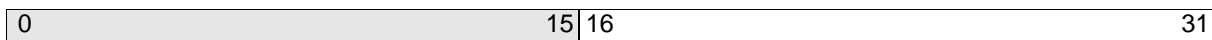

Figure 19-29. Last Source Address High Register (EMAC0_LSAH)

0:15		Reserved
16:31		Last Source Address High-Order Halfword

19.7.16 Last Source Address Low (EMAC0_LSAL)

EMAC0_LSAL contains the low-order word of the source address of the last “good” received packet. The packet is considered “good” if EMAC is programmed to provide this packet to MAL.



Figure 19-30. Last Source Address Low Register (EMAC0_LSAL)

0:31		Last Source Address Low-Order Word
------	--	------------------------------------

19.7.17 Inter-Packet Gap Value Register (EMAC0_IPGVR)

EMAC0_IPGVR contains the value of one-third of the inter-packet gap (IPG) for the next packet to be transmitted. (“Frame” is synonymous with “packet.”)

The resolution of each bit is 8-bit times. The minimum value in the register is four, causing a minimum IPG period of 96-bit times).



Figure 19-31. Inter-Packet Gap Value Register (EMAC0_IPGVR)

0:25		Reserved
26:31		Inter-Packet Gap

Preliminary User's Manual**19.7.18 STA Control Register (EMAC0_STACR)**

EMAC0_STACR controls the MII Management interface. The software must follow the following steps during access to the EMAC0_STACR:

1. Software polls EMAC0_STACR[OC], waiting for it to be set by EMAC.

EMAC sets EMAC0_STACR[OC] = 0 when the EMAC0_STACR is written to.

EMAC then sets EMAC0_STACR[OC] = 1 to indicate that the data has been written to the PHY, or the data read from the PHY is valid. The device driver should poll for EMAC0_STACR[OC] = 1 before issuing a new command, or before using data read from the PHY.

2. The software can perform read/write access to the EMAC0_STACR.
3. EMAC clears EMAC0_STACR[OC] (sets EMAC0_STACR[OC] = 0) and starts activity on the MII management interface.
4. Return to step 1.

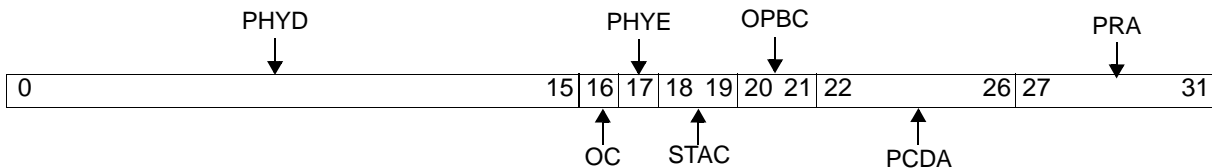

Figure 19-32. STA Control Register (EMAC0_STACR)

0:15	PHYD	PHY data	Data to be sent to the PHY if the command is a write, or data is read from the PHY if the command is a read.
16	OC	Operation Complete 0 EMAC0_STACR is addressed 1 PHY data transfer complete	
17	PHYE	PHY Error 0 Successful read transaction 1 Read transaction was not successful	EMAC0_STACR[PHYE] = 0 when a read is successful.
18:19	STAC	STA Command 00 Reserved 01 Read 10 Write 11 Reserved	EMAC sets EMAC0_STACR[STAC] = 0 when the command is completed.
20:21	OPBC	OPB Bus Clock Frequency 00 50 MHz 01 66 MHz 10 83 MHz 11 100 MHz	EMAC0_STACR[OPBC] is used to generate the Management Data Clock (EMCMDClk). When the operational frequency differs from those in the list, then the next greater frequency should be chosen.
22:26	PCDA	PHY Command Destination Address	
27:31	PRA	PHY Register Address	

19.7.19 Transmit Request Threshold Register (EMAC0_TRTR)

EMAC0_TRTR defines the conditions that cause EMAC to initiate transmission to the Ethernet MAC sub-block, and for requesting service from MAL.

EMAC0_TRTR[TRT] defines the number of occupied entries in the transmit FIFO that should be written before the transmit FIFO control logic initiates a transmit request to the Ethernet MAC sub-block.

If an entire packet is already located in the transmit FIFO, EMAC initiates a transmit regardless of the programmed value.

The software must coordinate the value of EMAC0_TRTR[TRT] with the transmit FIFO size specified in EMAC0_MR1[TFS].

To avoid deadlock, the sum of EMAC0_TMR1[TLR] and EMAC0_TRTR[TRT] must be smaller, by at least 4, than the transmit FIFO specified in EMAC0_MR1[TFS].

To avoid an underrun, program this threshold to a high enough value.

In half-duplex mode, in case of collision, to allow packet re-transmission without involving MAL, EMAC preserves the necessary space in the Transmit FIFO unless it gets an indication that the collision window has elapsed.

The EMAC0_TRTR can be written only while EMAC0_MR0[TXI] = 1.



Figure 19-33. Transmit Request Threshold Register (EMAC0_TRTR)

0:4	TRT	Transmit Request Threshold The following number of bytes must be placed in the Transmit FIFO before initiating a transmit request. 00000 64 bytes 00001 128 bytes 00010 192 bytes 00011 256 bytes . . . 11111 2048 bytes
5:31		Reserved

Preliminary User's Manual**19.7.20 Receive Low/High Water Mark Register (EMAC0_RWMR)**

The EMAC0_RWMR defines the conditions that cause EMAC to activate a low or urgent priority MAL request, and that manage flow control.

EMAC activates a low priority request if the number of occupied entries in the receive FIFO is greater than or equal to the content of EMAC0_RWMR[RLWM] (the receive low water mark is reached). A request for a pause packet with a pause_value of 0 is also issued when the receive low water mark is reached.

Software must coordinate the value of EMAC0_RWMR[RLWM] with the value of EMAC0_MR1[RFS]. EMAC0_RWMR[RLWM] should be smaller than EMAC0_MR1[RFS] and larger than the MAL burst length.

Note: In the PPC405GP, the MAL burst length is 16 words for all channels.

If the entire packet is already in the receive FIFO, EMAC initiates a low priority request regardless of the programmed value.

EMAC activates an urgent priority request if the number of occupied entries in the Receive FIFO is greater than or equal to EMAC0_RWMR[RHWM] (the receive high water mark is reached). A request for a pause packet is also issued when the receive high water mark is reached.

Software must coordinate the value of EMAC0_RWMR[RHWM] with the value of EMAC0_MR1[RFS]. EMAC0_RWMR[RHWM] should be greater than the value of EMAC0_RWMR[RLWM] and less than the size of the receive FIFO.

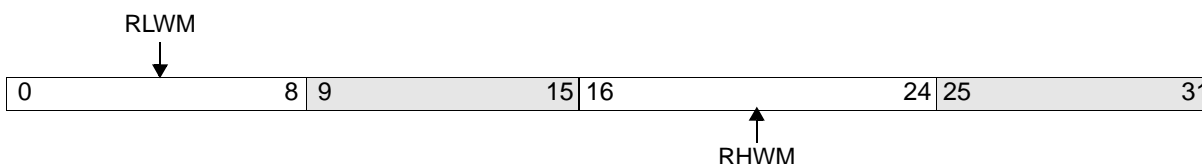

Figure 19-34. Receive Low/High Water Mark Register (EMAC0_RWMR)

0:8	RLWM	Receive Low Water Mark
9:15		Reserved
16:24	RHWM	Receive High Water Mark
25:31		Reserved

19.7.21 Number of Octets Transmitted (EMAC0_OCTX)

The read-only EMAC0_OCTX register contains the number of transmitted octets.

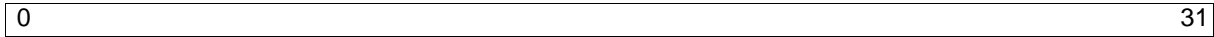

Figure 19-35. Number of Octets Transmitted (EMAC0_OCTX)

0:31	OCTX	Number of octets (bytes) transmitted.
------	------	---------------------------------------

19.7.22 Number of Octets Received (EMAC0_OCRX)

The read-only EMAC0_OCRX register contains the number of received octets.

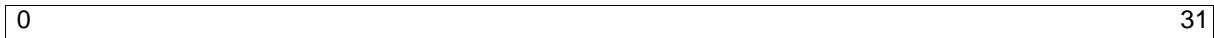

Figure 19-36. Number of Octets Received (EMAC0_OCRX)

0:31	OCRX	Number of octets (bytes) received.
------	------	------------------------------------

19.8 MII

EMAC implements all MII functionality in accordance with Clause 22 in the IEEE Std. 802.3u.

The MII is a reconciliation sublayer interface which allows a variety of PHYs to be attached to the EMAC Ethernet MAC without future upgrade problems.

Preliminary User's Manual**19.8.1 MII Station Management Interface**

The EMAC MII station management unit (STA) implements a specific protocol and a special packet format to exchange management packets with the registers of the attached PHY. EMAC automatically generates MII management packets, which conform to Clause 22 in IEEE Std. 802.3u. EMAC uses the EMAC0_STACR for generation of the management packet. Figure 19-37 illustrates the interface.

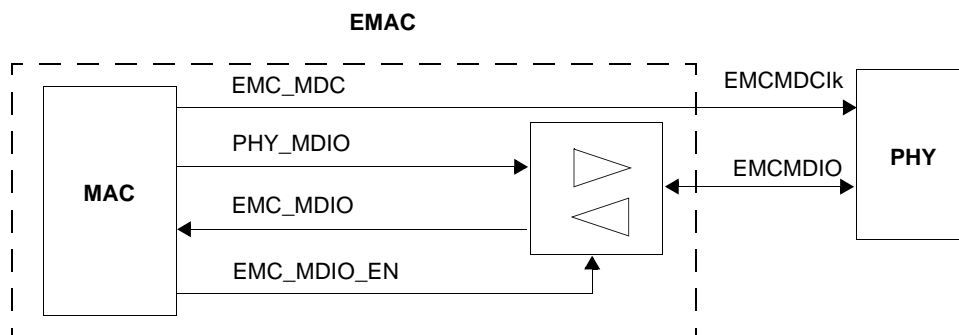

Figure 19-37. Management Interface with PHY

19.8.2 EMAC – MII

See *PPC405GP Data Sheet* for information.

19.9 MAL – EMAC Packet Transfer Flow

The packet transfer flow consists of three phases. These three phases are used to define the details of the EMAC-MAL protocol.

1. Packet phase - EMAC initiates a packet transfer operation. The packet transfer is started by a command write. During command write MAL provides control information for EMAC on a per-packet basis. Following the command write, MAL begins the data transfer, during which MAL transfers data between the buffers located in the system's memory and EMAC. In transmit, the data is transferred from the system's memory to EMAC, while in receive, the data is transferred from EMAC to the system's memory buffers.
 - EMAC remains in the packet phase until the data transfer has been completed or a ready status can be returned to MAL. The packet phase ends when EMAC deasserts the FRAME signal associated with the related channel (receive/transmit).
 - The packet phase is defined by activity of an appropriate FRAME signal.
2. Status phase - This is the second phase of the packet transfer. Following the de-assertion of the FRAME signal, EMAC switches to the status phase. At this stage, EMAC uses an appropriate signal as a request for service which is interpreted by MAL as a request for status read.
3. Idle phase - EMAC moves into the idle phase following a reset or after status was transferred (end of status phase). During the idle phase, EMAC cannot send any signals to MAL, nor can MAL send any active signals to EMAC. EMAC exits the idle phase by asserting the FRAME signal (and entering the packet phase described above). Idle phase can be skipped when EMAC operates in multiple transfer mode.

Figure 19-38 illustrates the different phases in the EMAC-MAL communication.

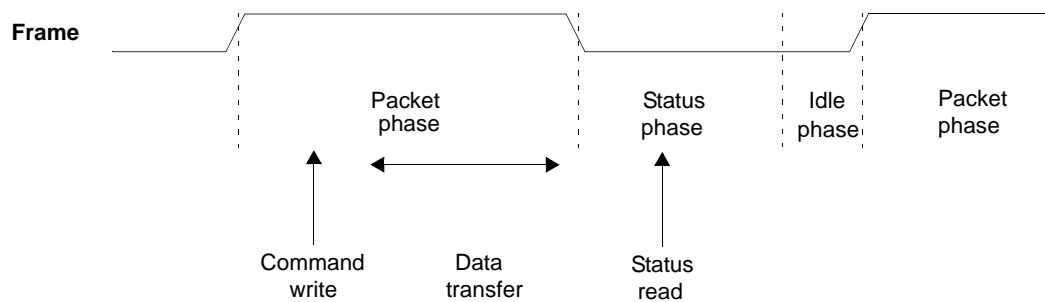

Figure 19-38. EMAC-MAL Communication Phases

During the packet and status phases EMAC signals a request for service by driving its arbitration level signal to a non-idle level.

19.10 Programming Notes

Certain combinations in device drivers are not allowed when writing to EMAC registers. When creating device drivers, ensure that the following guidelines are used:

- In dependent mode, EMAC0_MR1[TR0] must be equal EMAC0_MR1[TR1]
- When internal loopback is enabled (EMAC0_MR1[ILE] = 1), EMAC must be configured in full-duplex mode (EMAC0_MR1[FDE] =1)
- EMAC0_MR1[IST] =0 only when EMAC0_MR1[MF] = 00 and EMAC0_MR1[FDE] =0
- In dependent mode, EMAC0_ISER[SE0, TE0] must equal EMAC0_ISER[SE1, TE1]
- EMAC0_MR1[EIFC] =0 if EMAC0_MR1[FDE] =0
- EMAC0_TMR1[TLR] must be greater than the MAL burst size in entries (6 for MAL)
- EMAC0_TMR1[TUR] must be greater or equal to EMAC0_TMR1[TLR] and less than the Transmit FIFO size in entries (EMAC0_MR1[TFS])
- To avoid deadlock, the sum of EMAC0_TMR1[TLR] and the EMAC0_TRTR[TRT] must be at least four less than the Transmit FIFO size specified in EMAC0_MR1[TFS]
- EMAC0_RWMR[RLWM] must be greater than the MAL burst size in entries (six for MAL)
- EMAC0_RWMR[RHWM] must be greater than EMAC0_RWMR[RLWM]
- EMAC0_RWMR[RHWM] must be less than the Receive FIFO size in entries (EMAC0_MR1[RFS])

Preliminary User's Manual

19.10.1 Reset and Initialization

The EMAC must be initialized after a reset, or before performing configuration changes. The following types of reset operations can be applied to EMAC.

- **Hard Reset.** When RESET input is asserted, EMAC aborts all on-going activities unconditionally, initializes all internal state machines, counters, registers, and flushes transmit and receive FIFOs. To be recognized, the reset signal must be asserted for at least two cycles of the slowest clock domain inside EMAC (indicating that the hard reset must be at least 800 ns).
- **Soft Reset.** Software first should reset the appropriate MAL channels and then begin a soft reset by setting EMAC0_MR0[SRST] = 1. In response to the soft reset, EMAC aborts all on-going activities unconditionally, initializes all internal state machines, counters, registers, and flushes transmit and receive FIFOs. After EMAC finishes all activities related to the soft reset processing, EMAC0_MR0[SRST] = 0.
- **Smart Reset.** The software initializes smart reset mode by writing 0 to EMAC0_MR0[TXE] or EMAC0_MR0[RXE], or to both. In this case, the Ethernet MAC sub-block completes on-going activity (receive, transmit, or both) and then goes to the related Idle state (indicated by setting either EMAC0_MR0[TXI] = 1 or EMAC0_MR0[RXI] = 1, or both). In this case, the control logic sub-block of EMAC is still accessible for OPB and MAL transactions.

Before performing the necessary configuration changes in EMAC, the software must follow one of the following scenarios. Then the EMAC can be properly configured.

19.10.1.1 Scenario 1

- Hard/soft reset was activated.
- During hard/soft reset, EMAC0_MR0[TXE] and EMAC0_MR0[RXE] are reset.
- Software detects that the EMAC0_MR0[SRST] is reset (after soft reset only).
- Software keeps EMAC0_TMR0[GNP0, GNP1] = 0.
- The software can change one or more fields in registers marked with a Reset write access mode in Table 19-5, "EMAC0 Register Summary," on page 19-546 (actually, all EMAC registers are accessible in this scenario).
- The software initializes EMAC0_TMR0[GNP0, GNP1] as appropriate.
- The software configures EMAC0_MR0[TXE, RXE].

19.10.1.2 Scenario 2

- Software sets EMAC0_MR0[TXE] = 0.
- The TXMAC component of the Ethernet MAC sub-block completes on-going activity and then sets EMAC0_MR0[TXI] = 1 to enter the related Idle state.
- Software detects EMAC0_MR0[TXI] = 1.
- Software performs the necessary EMAC configuration, keeping EMAC0_MR0[TXE] = 0. The software can access only part of the EMAC registers marked with write access mode T in Table 19-5, "EMAC0 Register Summary," on page 19-546.
- After all configuration is done, software can set EMAC0_MR0[TXE] = 1.

Note: When Scenario 2 occurs, EMAC can still receive packets if EMAC0_MR0[RXE] = 1. Scenarios 2 and 3 can occur simultaneously.

19.10.1.3 Scenario 3

- Software sets EMAC0_MR0[RXE] = 0.
- The RXMAC component of the Ethernet MAC sub-block completes on-going activity and then sets EMAC0_MR0[RXI] = 1 to enter the related Idle state.
- Software detects EMAC0_MR0[RXI] = 1.
- Software performs the necessary EMAC configuration, keeping EMAC0_MR0[RXE] = 0. The software can access only part of EMAC registers marked with write access mode R in Table 19-5, “EMAC0 Register Summary,” on page 19-546.
- After all configuration is done, software can set EMAC0_MR0[RXE] = 1.

Note: When Scenario 3 occurs, EMAC can still transmit packets if EMAC0_MR0[TXE] = 1. Scenarios 2 and 3 can occur simultaneously.

Chapter 20. Memory Access Layer

The Memory Access Layer (MAL) is a hardware core that manages data transfers between packet-oriented communications cores, also known as COMMACs (communications media access controllers), and memory. To communicate with software device drivers, MAL utilizes a buffer descriptor ring structure in memory. A software device driver uses the buffer descriptor structure to inform MAL about buffer locations and packet or buffer status. MAL uses the buffer descriptors to convey packet transfer status from the COMMAC core back to the software device driver. Each MAL channel requires its own buffer descriptor table ring structure in memory.

In the PPC405GP MAL manages the transfer of packets between the Ethernet Media Access Controller (EMAC). The primary function of MAL is to move packets directly between memory and a COMMAC core with minimal involvement of the processor core.

20.1 MAL Features

MAL has the following features:

- No restrictions on buffer alignment
- Aligned bus accesses to enable burst operation with external memories
- Configurable receive buffer size (configurable per channel)
- No minimum transmit buffer size
- Maximum buffer sizes of 4095 bytes (transmit) and 4080 bytes (receive)
- Up to 256 descriptors in the buffer descriptor table per channel
- Configures COMMAC according to commands specified in the descriptor status/control field
- Updates the descriptor status/control field at the end of packet transfer according to the status received from COMMAC
- Buffer-based interrupt capabilities for each channel
- Concurrent operation of transmit and receive channels
- Configuration using Device Control Registers (DCRs)
- Programmable PLB arbitration priority
- PLB/OPB error detection

Figure 20-1 illustrates a general system structure overview of an embedded PowerPC processor core integrated with a packet oriented communication core. For the PPC405GP, the sole COMMAC is EMAC.

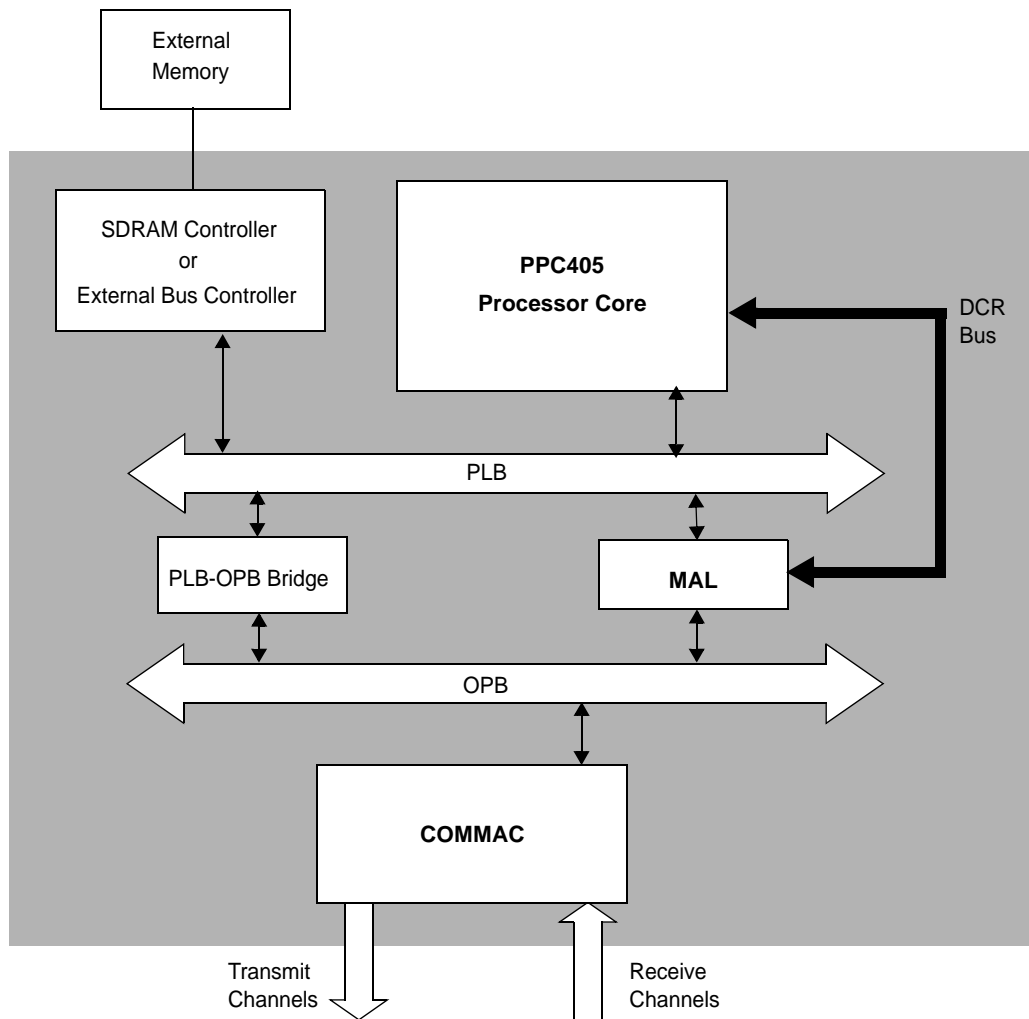

Figure 20-1. General MAL Structure

COMMACHs are configured and controlled by the processor core using the OPB without MAL intervention. Packet data to be transmitted and received are stored in buffers in external memory. The MAL processes buffer descriptors and provides all data access facilities to the COMMACHs.

The MAL is not aware of COMMACHs such as EMAC as an entity. It is only aware of the COMMACH's channels. In the PPC405GP, EMAC contains two transmit channels and one receive channel. Transmit and receive operations can be performed simultaneously by MAL (full duplex). When a channel wins arbitration, MAL transfers data between system memory and the COMMACH. MAL and the software driver maintain separate, dedicated buffer descriptor tables for each channel to maintain channel, packet, and buffer status. Packets can be constructed from one data buffer, or from several data buffers, which is known as buffer chaining.

Preliminary User's Manual**20.1.1 MAL Internal Structure**

Figure 20-2 illustrates the internal structure of MAL.

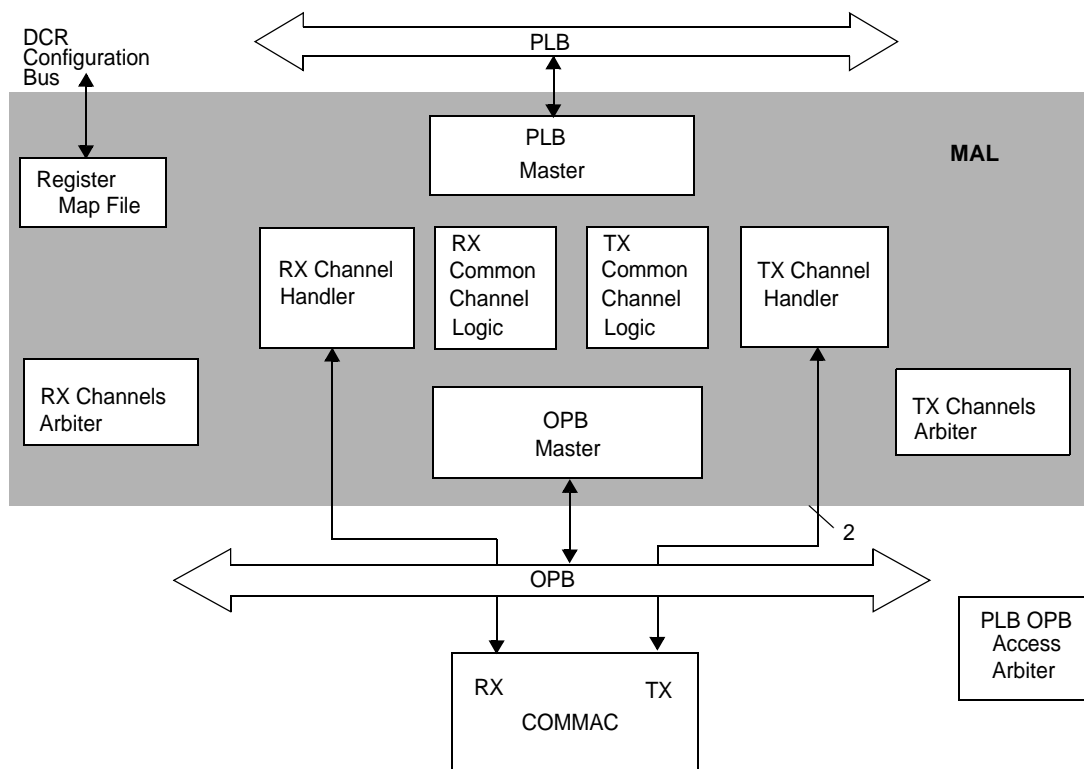

Figure 20-2. MAL Internal Structure

20.1.1.1 PLB Master

The PLB Master performs PLB transactions for MAL, and is used to transfer data between a COMM MAC and memory, fetch buffer descriptors, and communicate status regarding data transfer.

20.1.1.2 OPB Master

The OPB Master performs OPB transactions for MAL, and is used to transfer data between a COMM MAC and memory.

20.1.1.3 Transmit Channel Handler

The transmit channel handler is a dedicated section for each transmit channel. It keeps a record of the descriptor information and the current state of each channel.

20.1.1.4 Receive Channel Handler

The receive channel handler is a dedicated section for each receive channel. It keeps a record of the descriptor information and the current state of each channel.

20.1.1.5 Transmit Channel Arbiter

The transmit channel arbiter, connected to request lines from each transmit channel, arbitrates between the transmit channels and decides which channel gains access to the transmit common channel logic.

20.1.1.6 Receive Channel Arbiter

The receive channel arbiter, connected to request lines from each receive channel, arbitrates between the receive channels and decides which channel gains access to the receive common channel logic.

20.1.1.7 Transmit Common Channel Logic

The transmit common channel logic is shared by all transmit channels. It services a single transmit channel at a time (selected by the transmit arbiter). This logic activates the PLB and OPB masters for data and buffer descriptor transactions.

20.1.1.8 Receive Common Channel Logic

The receive common channel logic is shared by all receive channels. It services a single receive channel at a time (selected by the receive arbiter). This logic activates the PLB and OPB masters for data and buffer descriptor transactions.

20.1.1.9 Register Map File

The register map file is used to configure MAL and read its status registers. Software accesses the MAL register file using the **mtdcr** and **mfdcr** instructions.

20.2 Transmit and Receive Operations

The device driver is responsible for configuring MAL before a COMMAC can begin requesting MAL to process packets of data. The device driver should ensure that channels are not enabled during reconfiguration; otherwise, fatal errors may occur.

For more information about the MAL software interface, see “MAL Programming Notes” on page 20-589.

Preliminary User's Manual

Figure 20-3 describes the software and hardware operations involved in a typical transmit operation.

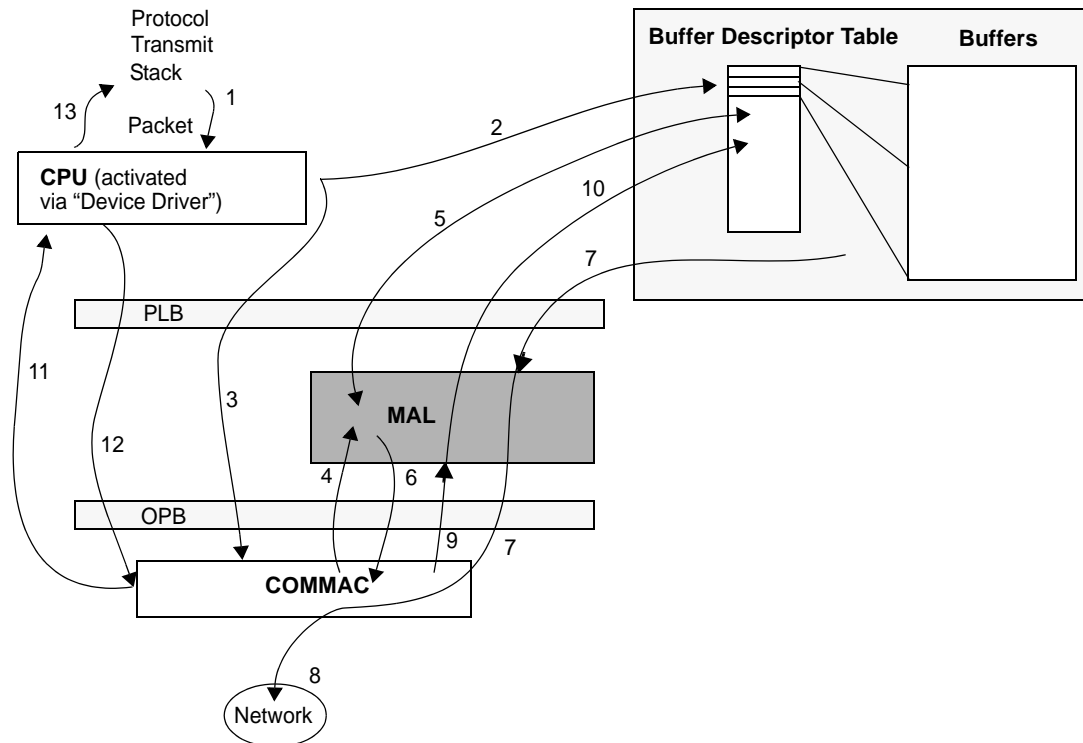

The numbered steps are described as follows:

1. The protocol stack (high-level software layer) initiates a packet transmit.
2. Software device driver parses the protocol stack buffer into descriptor table entries and buffers.
3. Software device driver instructs the COMMAC to process a new transmit packet.
4. The COMMAC channel requests MAL to process a new packet.
5. MAL fetches descriptor information.
6. MAL writes control information into the COMMAC and initiates the data move.
7. Packet data is transferred from memory into the COMMAC (the COMMAC controls the pace of the data transfer).
8. The packet is transmitted on the media (steps 7 and 8 can overlap).
9. The COMMAC requests that MAL read the packet status.
10. The status read by MAL is written back into a buffer descriptor.
11. Software is interrupted (if interrupt conditions are met) by the COMMAC or by the MAL end-of-buffer interrupt.
12. Software clears the interrupt status bits in the COMMAC and in MAL.
13. Software informs the protocol stack that transmission is complete.

Figure 20-3. Transmit Operation

Figure 20-4 describes the software and hardware operations when receiving a typical packet.

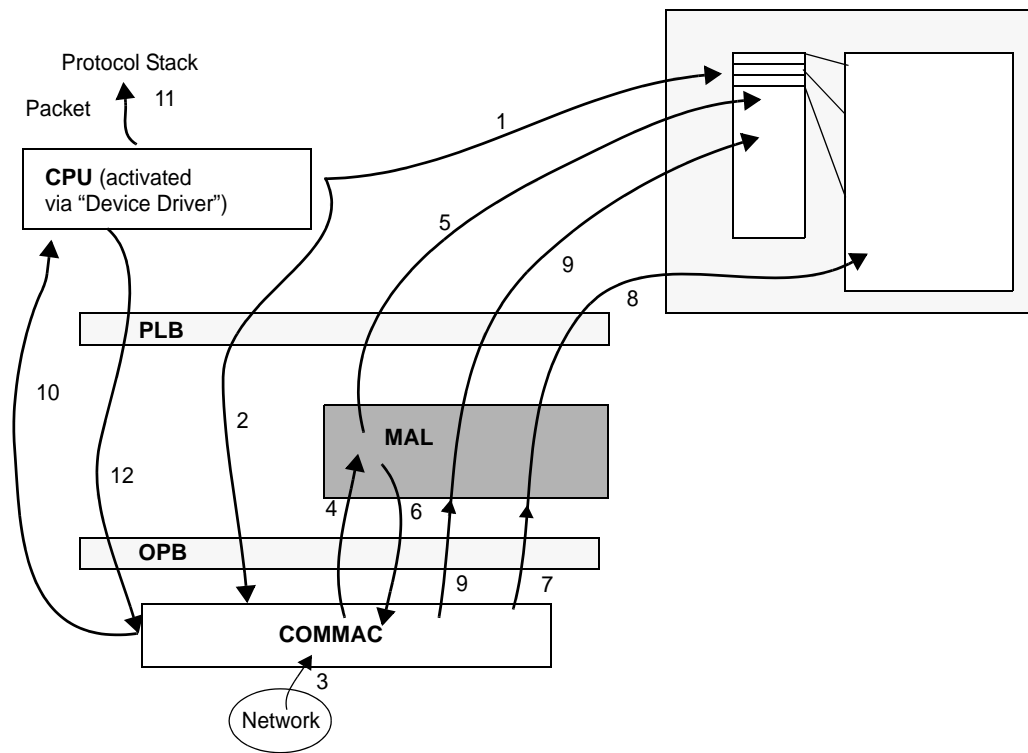

The numbered steps are described as follows:

1. Software device driver initializes the receive buffer descriptors.
2. Software device driver enables the COMMAC to process a new packet.
3. A packet is received from the network (steps 2 and 3 can change in order).
4. The COMMAC channel requests that MAL process a new packet.
5. MAL fetches receive buffer information from the descriptor table.
6. MAL writes the control word from the descriptor to the COMMAC and initiates the data transfer.
7. The COMMAC channel fills its FIFO storage.
8. MAL stores the packet in system memory buffers pointed to by the descriptors.
9. MAL reads status information from the COMMAC and writes it to the buffer descriptors.
10. Software device driver is interrupted (if interrupt conditions are met) by the COMMAC or by the MAL end-of-buffer interrupt.
11. The receive packet is passed to the protocol stack.
12. Software clears the receive buffer descriptor positions allowing them to be used again.

Figure 20-4. Receive Operation

Note: The description in Figure 20-4 is the general scheme for MAL operation in the software environment. The device driver should follow recommendations from "MAL Programming Notes" on page 20-589.

Preliminary User's Manual

20.3 Buffer Descriptor Overview

The software interface for buffer descriptor (BD) processing consists of a set of registers within MAL and a set of circular queues in memory. Each transmit and receive COMMAC channel has a descriptor table that contains buffer location and status information allocated to the channel.

Note: Since MAL uses a flat addressing scheme on the PLB, the physical memory that holds descriptor tables and buffers can be allocated anywhere in the address space where memory is possible. Also, it is not necessary to place buffer descriptor tables and buffers in the same physical memory.

During its operation, MAL is able to modify the contents of memory directly without processor core knowledge. If the processor core does not provide hardware enforced data cache coherency or data cache snooping (the processor core does not), data cache coherency is the responsibility of the software device driver. To simplify device driver software, the MAL buffer descriptor tables should be placed in non-cached memory when possible. If this is not possible, the software driver must maintain cache coherency of the buffer descriptor tables by performing data cache flushes or invalidates when appropriate. When descriptors are in cached memory, the driver software must be aware that multiple descriptors are present in a single cache line and that cache invalidate or flush operations will be performed on multiple descriptors at the same time. This is significant because a cache line flush done by the driver to force a descriptor from the data cache to physical memory could corrupt another descriptor that occupies the same data cache line and is simultaneously being updated in physical memory by MAL.

Data buffers, in contrast, should be placed in cachable memory if possible. The software driver can easily maintain cache coherency of data buffers if:

- All buffers are aligned on a data cache line boundary
- All buffers are a multiple of a data cache line in size

Note: The data cache line size and alignment in the PPC405GP is 32 bytes.

Before using a received packet, the software driver must invalidate the memory occupied by the buffer in the data cache for the length specified in the receive buffer descriptor data length field. Before transmitting a packet the software driver must flush the data buffer from the data cache before setting the Ready bit in the transmit buffer descriptor.

The software device driver fills the buffers pointed to by transmit buffer descriptors with packets to be transmitted, and/or provides empty buffers pointed to by receive buffer descriptors to be filled with received packets. Meanwhile, the hardware processes the descriptors, transfers the packet data to/from the COMMAC, and updates the status fields of the descriptors.

Each individual transmit or receive channel has its own buffer descriptor table. They are managed independently of each other. This section describes the individual transmit and receive interfaces.

Packet data associated with each transmit or receive channel is stored in buffers. Each buffer has an entry dedicated to it in one of the channel's buffer descriptor tables. MAL has a Channel Table Pointer Register for each of its channels. The COMMAC (EMAC in the PPC405GP) device driver sets the contents of these registers to point to the starting address of the buffer descriptor table for the associated channel.

Note: Buffer descriptor tables must start on a 4-KB boundary.

The buffer descriptor table forms a circular queue with a programmable length. The last descriptor in the table is defined by setting the Wrap bit in the status/control field (see "Status/Control Field Format" on page 20-586). If there is no Wrap bit set in the table, then MAL automatically wraps after processing 256 descriptors (the maximum number of descriptors allow per channel).

The buffer descriptor format, illustrated in Figure 20-5, is the same for all COMMACs, and has the same structure for transmit and receive. The most significant halfword in each buffer descriptor contains a status/control halfword. This field contains two parts: the first part (6 bits) is BD handling information used by the MAL for descriptor processing, the second field (10 bits) is content specific for each COMMAC. The second halfword determines the data length referenced in this buffer descriptor. The second word in the buffer descriptor contains a 32 bit data buffer pointer that points to the actual data buffer in memory. It is suggested that each data buffer start on a cache line boundary and be a multiple of a cache line in size, if the buffer is in cachable memory. (The cache line size in the PPC405 processor core is 32 bytes.)

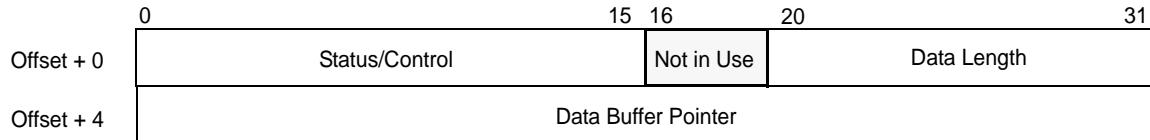

Figure 20-5. Buffer Descriptor Structure

A packet may be stored in as many buffers as necessary (transmit or receive). Each buffer has a maximum length of (4KB–16) bytes. In transmit channels, the buffer descriptor length field is written by the device driver and defines the number of bytes in the data buffer that is identified by the data buffer pointer. In receive channels, the buffer descriptor length field is written by MAL and defines the number of bytes written by MAL to the buffer that is identified by the data buffer pointer (see “Receive Software Interface” on page 20-584).

When processing a packet, MAL does not assume that all buffers of the current packet are already valid. It expects the buffers to be ready in due time to be transmitted or received. Failure of the software to provide the descriptors in due time may result in an error.

Preliminary User's Manual

Figure 20-6 describes the structure of the packet in memory.

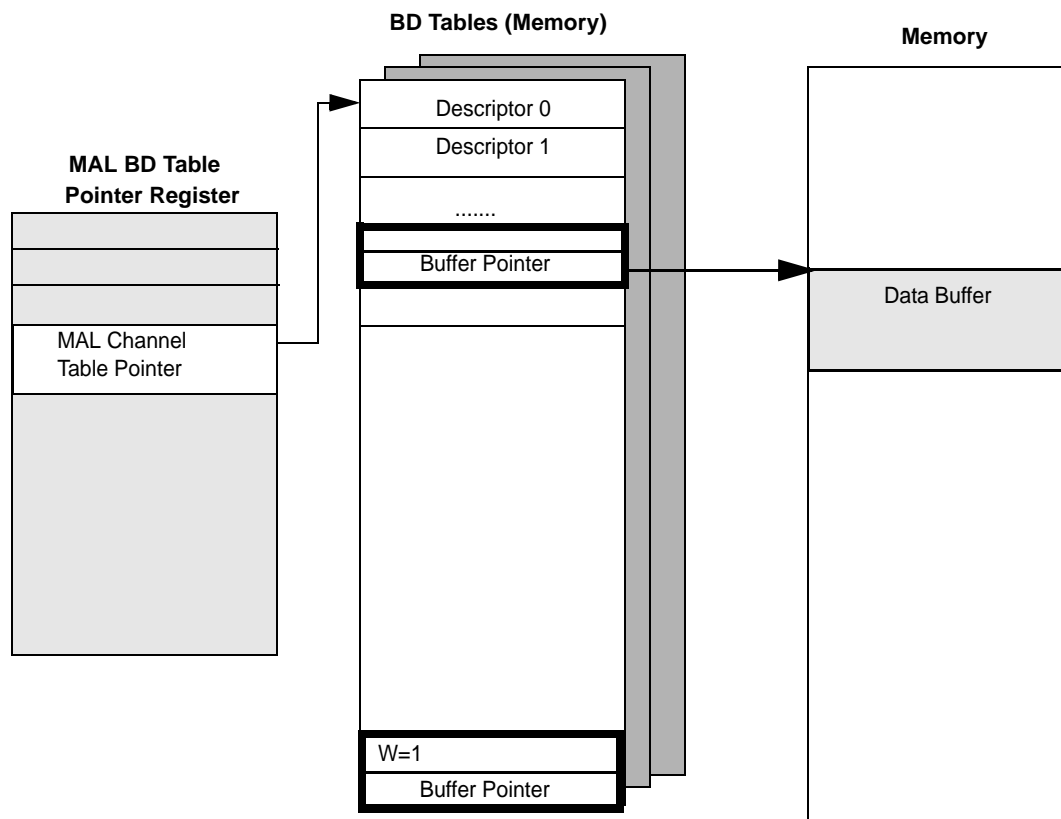

* W=1 means the wrap bit is set for this descriptor

Figure 20-6. Packet Structure in Memory

20.4 Transmit Software Interface

Once a channel is enabled in MAL (this is done by setting the appropriate bit in the Channel Active Register), a channel may request service from MAL. When the first transmit request comes in from a COMMACH transmit channel, MAL finds the starting address of the buffer descriptor table for the channel by looking in the corresponding Transmit Channel Table Pointer Register. If the first descriptor is marked as ready, MAL will start processing the associated buffer.

When MAL begins processing a packet, it writes the contents of the descriptor status/control field into the COMMACH. This information, (depending on communication core implementation), may be used by the communication core to configure each packet transfer.

Once all data from the current buffer has been transferred to the communication core on the channel, MAL moves on to the next buffer descriptor in the table.

If a given buffer descriptor indicates that it contains the last section of the current packet, MAL informs the channel that the last data transferred to the channel completed the transfer of a data packet. At this point, the COMMACH asks MAL to read the packet status. MAL then writes this information back into the status/control field of the last buffer descriptor of the packet.

The COMMAC channel may request that MAL process the next buffer descriptor and the same packet handling process will be initiated. The first descriptor in the next packet follows the descriptor marked “last” in the previous packet.

20.4.1 Wrapping the BD Table for Transmit

When MAL processes a buffer descriptor (while handling a packet for a COMMAC channel), it may encounter a Wrap indication within a buffer descriptor control field. This causes MAL to go back to the beginning of the buffer descriptor table for the next descriptor table entry. (This will also happen when MAL reaches the maximum number of descriptors.) The wrapping of the BD table, like all other BD table handling processes, is transparent to the COMMAC.

20.4.2 Continuous Mode for Transmit

After transmitting the data pointed to by a buffer descriptor, MAL clears the Ready bit in the buffer descriptor control/status field. In this way, MAL will not process the same buffer descriptor again until software has filled the buffer with valid data and set the Ready bit in the descriptor again. While the Continuous Mode (CM) bit is set in the status/control field, MAL will not clear the Ready bit. The Continuous Mode allows re-transmission of the current data buffer without software intervention. This mode is generally used by protocols in which frequent re-transmission is an integral part of the protocol itself. In such cases, re-transmission can be performed without software intervention.

20.4.3 Back Up a Packet for Transmit

MAL is capable of re-transmitting the last packet (“back up a packet”) following a request from a COMMAC. If re-transmission is requested by the COMMAC, it must be assured that all the buffers of the re-transmitted packet are available and were not re-processed by the device driver. In regular operation, MAL resets the Ready bit of each buffer descriptor when finished processing the descriptor. When MAL is requested by the COMMAC to retransmit the last packet (the Back Up a Packet bit in the COMMAC transmit channel Status Halfword is set), MAL doesn't reset the READY bit in the last processed buffer descriptor, activate the end of packet interrupt, or write the status back to the descriptor in the memory. MAL also doesn't consider this as an end of packet event.

On the next service request from the same channel, MAL will start transmitting the packet again, starting from the first descriptor.

Note: The last processed buffer descriptor can be either the last descriptor of the packet or, in case of early packet termination, the buffer descriptor that was being processed when the transmit channel initiated the early packet termination. MAL will retransmit the backed-up packet regardless of the Ready bit value.

During retransmission of a backed-up packet, MAL may use descriptors on which the Ready bit was already cleared. Therefore, the device driver should not reuse descriptors before the Ready bit of the last descriptor is cleared.

Note: In the case of descriptor not valid, which is the first one in transmit channel, COMMAC is not allowed to return a status that contains a Back-Up a Packet request.

Preliminary User's Manual

20.4.4 Descriptor Not Valid for Transmit

When MAL accesses a buffer descriptor, it checks whether or not the Ready bit is set. If the Ready bit is not set, two cases apply (special treatment of the READY bit is performed in the case of Back-up a packet):

For the case when the READY bit is not set:

- If the descriptor is the first descriptor of the packet MAL informs the channel that data is currently unavailable. Further handling of this scenario is COMMAC-specific. The channel might either instruct MAL to access the same buffer descriptor periodically (by keeping its service request to MAL active) until it becomes ready, or 'give up' on the descriptor, completing the end-of-packet protocol with MAL. The channel might also indicate the buffer descriptor status to the device driver via an interrupt. However, in this case the COMMAC should eventually complete the packet transfer protocol with MAL. Following a descriptor not valid indication, the MAL BD pointer continues pointing to the same location in the BD table. The next time a descriptor read is initiated by the COMMAC, MAL will search for the buffer in the same location.
- If the descriptor is not the first descriptor of the packet, it is considered a descriptor error. MAL deactivates the channel and from its point of view, the processing of the current packet has ended. Software may learn about this situation from one of two MAL interrupts (or from both). The first one is a nonmaskable interrupt that indicates the number of the transmit channel, in which the descriptor error had occurred (interrupt bit for each transmit channel, see "MAL Interrupt Enable Register (MAL0_IER)" on page 20-603). The second one is a maskable interrupt which indicates a descriptor error event, regardless the channel number (one interrupt bit for all the channels, see "MAL Error Status Register (MAL0_ESR)" on page 20-601). For more information about error handling, see "Error Handling" on page 20-591.

For the case of a back-up packet:

- When the current transmitted packet is a backed-up packet, all descriptors except the last, are valid even if the READY bit is not set. In this case, (not the last descriptor) MAL processes the packet descriptors regardless the READY bit value. If the READY bit of the last descriptor in the backed-up packet is not set, MAL treats it as a descriptor error. MAL handles the descriptor error as described above for the case when the packet is not a backed-up packet.

20.4.5 Scroll Descriptors for Transmit

MAL may be configured by software, in the case of early packet termination, to scroll in the buffer descriptor table to the first descriptor of the next packet.

When a multiple-buffer packet is terminated early by the COMMAC, while MAL is processing a buffer which is not the last buffer in the packet, MAL can operate in one of the following ways:

The MAL Scroll Descriptor in the configuration register is set:

- In this case MAL will read the status word from the COMMAC channel. Then MAL will reset the READY bit in all the remaining buffer descriptors of the current packet. In addition, MAL will write the status to all the buffer descriptors. On the next service of this channel, MAL will fetch the first descriptor of the next packet.

The MAL Scroll Descriptor in the configuration register is clear:

- In this case MAL will read the Status word from the COMMAC channel. Then MAL will terminate the current channel service by resetting the READY bit of the last processed buffer descriptor (the one in which there was an early termination) and will write the status only to this descriptor. On the next service of this channel, MAL will fetch the next descriptor in the current packet. In this case, the software is responsible to monitor the MAL location in the buffer descriptor table.

In the case that the COMMAC requests a re-transmit of the early terminated packet (when the “backup” bit in the COMMAC status is set), MAL will re-transmit the packet regardless of the MAL Scroll Descriptor bit.

20.5 Receive Software Interface

MAL uses the receive channel buffer descriptors in a manner similar to that used for transmission. Once a receive COMMAC channel requests that a new packet be processed, MAL starts processing the channel's next buffer descriptor in the table. Once a channel is enabled in MAL, the channel may request MAL service. When it does, MAL accesses the first buffer descriptor (in that channel's buffer descriptor table) that is pointed to by the COMMAC channel table pointer register. If that descriptor is ready (empty for receive), MAL will start processing the buffer.

When it begins processing each packet, MAL writes the contents of the status/control field into the COMMAC. This information (defined by the COMMAC implementation) can be used by the COMMAC for a per-packet configuration.

Once data is received from the memory, MAL moves the data from the receive channel FIFO into the data buffer pointed to by the first buffer descriptor. The current buffer descriptor may be closed for two reasons: there is no more room left in the buffer, or the COMMAC channel indicated that the packet reception ended. If additional buffering space is needed for the current packet, MAL moves on to the next buffer descriptor. As each buffer descriptor is closed, MAL updates the length field with the actual amount of bytes written into the buffer. The maximum buffer length for each channel is defined by a configuration register (see “Receive Channel Buffer Size Register (MAL0_RCBS0)” on page 20-606). The maximal receive buffer length is defined per channel.

Once the COMMAC channel indicates that the packet reception has ended, it is expected to request that MAL update the received packet status in the BD status/control field. MAL updates the packet status and notifies the COMMAC. At this point the packet is considered received and the COMMAC may request that MAL begin the process of receiving a new packet. The first buffer of the next packet is the buffer in the BD table that followed the last descriptor of the previous packet.

20.5.1 Wrapping the BD Table for Receive

When MAL processes the buffer descriptor, it may encounter a Wrap indication within a buffer descriptor control field. This causes MAL to go back to the head of the channel's buffer descriptor for the next buffer descriptor. This also happens when MAL reaches the maximal number of descriptors.

Preliminary User's Manual

20.5.2 Continuous Mode for Receive

After using a buffer descriptor, MAL sets the buffer descriptor control to the Not-Empty state. In this way, MAL will not use the same buffer descriptor a second time until the software has processed the not-empty buffer descriptor and set it to Empty again. MAL will not clear the Empty bit while the Continuous Mode (CM) bit is set in the status/control field. The Continuous Mode is generally used by protocols where frequent collisions are an integral part of the protocol itself (forcing the COMMAC to abort a reception process and restart). In such cases, re-reception can be performed without software intervention.

20.5.3 Descriptor Not Valid for Receive

When MAL accesses a buffer descriptor it may find that the Empty bit is not set. In the case of an receive channel descriptor, this situation is considered as a descriptor error. MAL deactivates the channel and from its point of view, the processing of the current packet has ended. Software may learn about this situation from one of two MAL interrupts (or from both):

- An RXDE interrupt with the MAL0_RXDEIR indicating which channel caused the interrupt
- An SERR interrupt (system error) with one interrupt bit for all channels in the MAL0_ESR

For more about error handling, see “Error Handling” on page 20-591.

20.5.4 Buffer Length for Receive

The maximum length of an receive buffer descriptor is predetermined for all receive descriptors in each channel. The data-length value is programmable through a set of MAL registers (see “MAL Registers” on page 20-596). The actual data length field within the receive buffer descriptor is written by MAL. If the buffer is completely filled up, the value written matches the value programmed into the matching receive channel Descriptor data-length register. If the buffer is only partially filled up (for example, when the receive packet ended before running out of buffer space), the actual amount of space filled is written into the length field.

20.6 Descriptor Buffer Status/Control Fields

The following sections details the status/control field bits. The information fields within the status/control field can be divided as follows:

- Information from a software device driver directed to MAL and COMMAC
- Information from MAL and COMMAC directed to software
- Status/control field handling
- Status/control field format
- Transmit status/control field format
- Receive status/control field format

20.6.1 Information from a Software Device Driver Directed To MAL and COMMAC

- MAL-related buffer descriptor processing information:
 - Buffer Ready/Not Ready (determines the validity of the buffer).
 - Wrap to top of table or continue to next descriptor.
 - In a transmit buffer descriptor – Is the current buffer the last one in the packet?
 - Continuous or normal mode; that is, should MAL change the Ready/Not Ready value?
- COMMAC channel configuration information:
 - Should the channel generate an interrupt following the end of packet processing.
 - Protocol specific configuration.

20.6.2 Information from MAL and COMMAC Directed to Software

- MAL generated status information:
 - Buffer Ready/Not Ready (passes the buffer handling to software).
 - In receive buffer descriptor - Is the current buffer the first one in the packet?
 - In receive buffer descriptor - Is the current buffer the last one in the packet?
- COMMAC channel generated status information:
 - Protocol specific error and status information (transmit and receive).

20.6.3 Status/Control Field Handling

When MAL accesses a new buffer descriptor, the status/control word is written to the COMMAC channel. This allows the channel to configure itself for the current packet.

For all “intermediate” buffer descriptors (all descriptors that do not contain the packet’s ending), the status/control field is written by MAL (rather than the COMMAC). In this case, the status/control field indicates that the current buffer is not the last one in the current packet.

As MAL finishes processing the last buffer descriptor in a given packet, it reads the channel’s status (via an OPB transaction) and writes it into the buffer descriptor’s status/control field.

In effect, since all of the various control and status fields do not overlap, the status/control halfword is read/written as a whole. Each agent (MAL, COMMAC channel, and software) reads the entire status/control halfword, relates to specific fields of interest, and updates another subset of fields within the same halfword. While an agent modifies its related fields, all other fields remain unchanged.

20.6.4 Status/Control Field Format

The status/control halfword is divided into COMMAC channel data and MAL related data. As explained above, the MAL related fields are either aimed at controlling MAL or written by MAL for use by the software. The MAL fields are of no interest to the COMMAC (except the Ready and Empty bits).

The same applies to the COMMAC channel fields. The COMMAC related fields are either aimed at controlling the COMMAC or written by COMMAC for use by the software. These fields are of no interest to MAL.

MAL will not manipulate the COMMAC related fields, and COMMAC is not allowed to manipulate the MAL related fields.

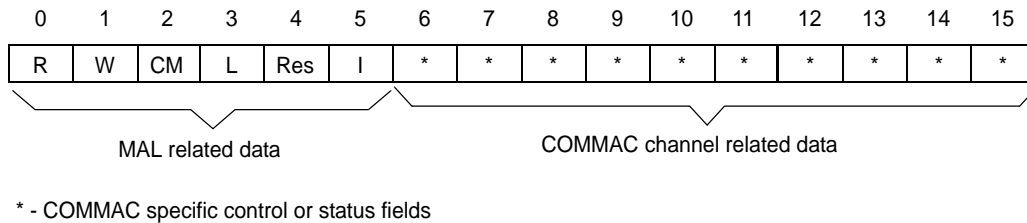
Preliminary User's Manual**20.6.5 Transmit Status/Control Field Format****Figure 20-7. Transmit Status/Control Field**

Note: The bit numbering in Figure 20-7 relates to the Buffer Descriptor's fullword which contains both the status/control and the length fields.

20.6.5.1 Bit 0 – R – Ready

This bit is set by the device driver and is cleared by MAL.

The device driver sets this bit after preparing the buffer for transmission.

MAL clears this bit when finish processing the buffer descriptor. MAL doesn't clear the Ready bit in the case of backing-up a packet request and in case of continuous mode (see "Back Up a Packet for Transmit" on page 20-582 and "Continuous Mode for Transmit" on page 20-582).

20.6.5.2 Bit 1 – W – Wrap

0 – This is not the last data buffer descriptor in the buffer descriptor table.

1 – This is the last data buffer descriptor in the buffer descriptor table. After this buffer has been used, MAL will transmit data from the first descriptor buffer in the table.

This bit is controlled by software only. It controls MAL activities, and does not affect the COMMAC channel.

20.6.5.3 Bit 2 – CM – Continuous Mode

0 – Normal Operation

1 – Continuous Operation. After this buffer descriptor is closed, the R-bit is not cleared by MAL. This ensures that the data buffer is ready for transmission when MAL next accesses this buffer descriptor. However, the R-bit is cleared if an error occurs during transmission.

This bit is controlled by software only. It controls MAL activities and does not affect the COMMAC channel.

20.6.5.4 Bit 3 – L – Last

0 – This is not the last buffer in the current packet.

1 – This is the last buffer in the current packet.

This bit is controlled by software only. It controls MAL activities, and does not affect the COMMAC channel.

20.6.5.5 Bit 4 – Reserved

This bit is reserved. It is assumed that this bit is set to zero by the software.

20.6.5.6 Bit 5 – I – Interrupt

1 – After finishing processing the current buffer, if this bit is 1, the end of buffer field in the End of Buffer Interrupt Status Register is set and the end of buffer interrupt is asserted.

0 – There is no action taken by MAL once it reaches the end of the current buffer.

MAL asserts the end of buffer interrupt after it updates the buffer descriptor's status field.

This bit is controlled by software only. It controls the MAL activities and does not affect the COMMAC.

20.6.5.7 Bits 6 to 15

These bits are COMMAC specific and may contain control fields generated by the software in order to control the COMMAC channel. They may also contain status fields, generated by the COMMAC channel, that will be processed by software.

20.6.6 Receive Status/Control Field Format

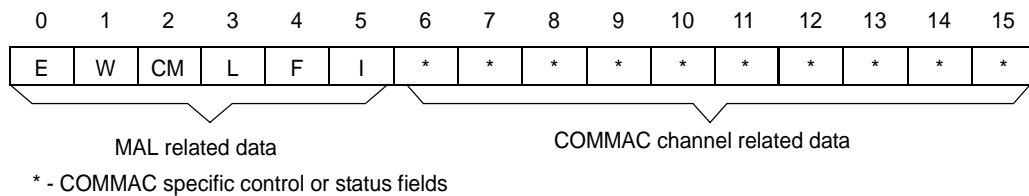

Figure 20-8. Receive Status/Control Field

Note: The bit numbering in Figure 20-8 relates to the buffer descriptor's fullword which contains both the status/control and the length fields.

20.6.6.1 Bit 0 – E – Empty

0 – The data buffer associated with this buffer descriptor has been filled with received data, or data reception has been aborted due to an error condition. Software is free to examine or write to any fields of this buffer descriptor. While this bit is set to Not Empty, MAL will not use this buffer descriptor again.

1 – The data buffer associated with this buffer descriptor is empty, or reception is currently in progress. This buffer descriptor and its associated receive buffer are owned by MAL. Once the E-bit is set, software should not write to any fields of this Receive buffer descriptor.

MAL clears this bit after the buffer has been filled with received data **or** after an error is encountered. Software sets this bit to Empty after preparing the buffer for reception. This bit controls MAL and software activities. See "Bit 2 – CM – Continuous Mode" on page 20-589.

20.6.6.2 Bit 1 – W – Wrap

0 – This is not the last data buffer descriptor in the buffer descriptor table.

1 – This is the last data buffer descriptor in the buffer descriptor table. After this buffer has been used, MAL will transfer data to the first buffer descriptor in the table.

This bit is controlled by software only. It controls MAL activities and does not affect the COMMAC channel.

Preliminary User's Manual

20.6.6.3 Bit 2 – CM – Continuous Mode

0 – Normal Operation

1 – Continuous Operation. After this buffer descriptor is closed, the E-bit is not cleared by MAL. This ensures that the data buffer is ready to receive data when MAL next accesses its buffer descriptor. However, the E-bit is cleared if an error occurs during reception.

This bit is controlled by software only. It controls MAL activities and does not affect the COMMAC channel.

20.6.6.4 Bit 3 – L – Last

0 – This is not the last buffer in the current packet.

1 – This is the last buffer in the current packet.

This bit is updated by MAL following the activity of the channel.

20.6.6.5 Bit 4 – F – First

0 – This is not the first buffer in the current packet.

1 – This is the first buffer in the current packet.

This bit is updated by MAL following the activity of the channel.

20.6.6.6 Bit 5 – I – Interrupt

1 – After finish processing the current buffer, if this bit is 1, the end of buffer field in the End of Buffer Interrupt Status Register is set and the end of buffer interrupt is asserted.

0 – No action is taken by MAL at the end of the current buffer.

MAL asserts the end of buffer interrupt after updating the buffer descriptor's status field.

This bit is controlled by software only. It controls MAL activities and does not affect the COMMAC.

20.6.6.7 Bits 6 to 15

These bits are COMMAC-specific and they may contain control fields generated by the software in order to control the COMMAC channel. They may also contain status fields generated by the COMMAC channel to be processed by software.

20.7 MAL Programming Notes

The following sections contain information about programming the MAL.

20.7.1 MAL Initialization

MAL initialization includes two parts: configuration and channel activation.

Configuration involves two steps:

- MAL configuration - This step is done only after a power on reset or after a MAL soft reset. The following registers are involved:
 - MAL0_CFG. This register defines MAL operation on the PLB and OPB.
 - MAL0_IER. This register is used to enable interrupts for various MAL error conditions.
- Channel specific configuration - This information can be changed only when the associated channel is not active. (The bit for the channel in the channel active set registers, is cleared.) The following registers are involved:
 - MAL0_RCBSn – (one register for each receive channel). This register defines the length of the RX buffers in memory.
 - MAL0_TXCTPnR or MAL0_RXCTPnR – (one register for each channel). These registers are programmed with the memory address of the first buffer descriptor table entry for the channel.

Setting the channel specific configuration can be done as part of MAL initialization or as part of the COMMAC initialization process. In order to activate a channel, the following actions should be taken:

- The channel has to be configured in MAL
- The related bit in channel active set register (MAL0_TXCASR or MAL0_RXCASR) has to be set
- The channel operation must be enabled (COMMAC configuration)

20.7.2 Interrupts

MAL has five interrupt lines (in the PPC405GP, all are connected to the UIC). Two interrupt lines, one for transmit and one for RX, are used for interrupt events during packet transfer. An additional two interrupt lines, one for transmit and one for RX, are used to report descriptor errors on a per-channel basis. The fifth interrupt is used to report MAL errors.

- TXEOB interrupt line is used to report end of buffer or end of packet for a specific transmit channel. A bit for the related channel is set in the MAL0_TXEOBISR. See “End of Buffer Interrupt Status Registers” on page 20-600.
- RXEOB interrupt line is used to report end of buffer or end of packet for a specific RX channel. A bit for the related channel is set in the MAL0_RXEOBISR. See “End of Buffer Interrupt Status Registers” on page 20-600.
- TXDE interrupt line is used to indicate a descriptor error event in a specific transmit channel descriptor table. A bit for the related channel is asserted in the MAL0_TXDEIR. See “Descriptor Error Interrupt Registers (MAL0_TXDEIR, MAL0_RXDEIR)” on page 20-604.
- RXDE interrupt line is used to indicate a descriptor error event in a specific RX channel descriptor table. A bit for the related channel is asserted in the MAL0_RXDEIR. See “Descriptor Error Interrupt Registers (MAL0_TXDEIR, MAL0_RXDEIR)” on page 20-604.
- SERR interrupt is used to report a system error indicated by MAL. For more information on handling the SERR interrupts, see “Error Handling” on page 20-591 and “Error Registers” on page 20-601.

Preliminary User's Manual

20.7.3 Error Handling

MAL handles errors on a per-channel basis. Within a COMMAC channel, errors may arise from the COMMAC (detected as an OPB error), or from the memory access operations involved in MAL activity (detected as a PLB/descriptor error).

When a bus error occurs, MAL is notified by an OPB or PLB error signal. OPB errors are related to a specific channel and therefore channel operation is stopped. In the case of a PLB error, MAL cannot identify which channel is involved, therefore channel operation is not stopped. When a descriptor error occurs, MAL can again identify the channel involved, so channel operation is stopped. MAL stops channel operation by clearing the associated bit in the MAL0_TXCASR or MAL0_RSCASR register.

MAL keeps a record of the channels that experience errors and are made inactive. It also keeps a record of the characteristics of the first (or last) error detected (see “End of Buffer Interrupt Status Registers” on page 20-600).

20.7.3.1 Error Detection

The MAL communication, both with COMMACs and with memory, is carried out via the OPB or PLB. As long as this bus communication is error-free and no descriptor errors are detected, MAL maintains normal activity with the channels set by the processor as active in the Channel Active Registers.

When an error is detected while performing a transfer for a channel, MAL asserts a maskable interrupt signal. If the identity of the channel is known (as is the case for OPB errors or descriptor errors) then MAL immediately halts the dialogue with the channel. No further transactions are made, and that channel is registered by MAL as a nonactive channel. MAL resets the channel by resetting its active bit in the Channel Active Register. Software must access the Channel Active Register in order to reactivate the channel.

If the identity of the channel that caused the error is not known (as is the case for PLB errors) then MAL continues to work normally. Error resolution and channel deactivation are the responsibility of the software.

20.7.3.2 Indicated Errors

Error description is stored in the Error Status Register (MAL0_ESR), (see “MAL Error Status Register (MAL0_ESR)” on page 20-601).

- **Descriptor Error**

A descriptor error is a data error recognized during access to the descriptor table. The error can occur during transmit or receive.

For receive channels, a descriptor error occurs when MAL accesses a descriptor in which the Empty bit is cleared.

For transmit channels, a descriptor error occurs when MAL accesses a descriptor in which the Ready bit is cleared. The following cases are exceptions.

- On access to the first buffer descriptor in a transmit packet.
- On access to a buffer descriptor that is not the last descriptor in a backed-up packet.

As a result of this error, the following actions are taken by MAL:

- The Active bit of the related channel is reset and the channel activity is halted until software reactivates channel activity.

- The associated bit in the transmit Descriptor Interrupt Error Register (MAL0_TXDEIR) or RX Descriptor Error Register (MAL0_RXDEIR) is set, causing a nonmaskable TXDE interrupt or RXDE interrupt respectively.
- When the channel is reactivated, MAL points to the descriptor at the head of the BD table.
- **OPB Non-Fullword Error**

This error indicates that a non-fullword acknowledge was asserted by a slave.

Following this error, the active bit of the associated channel is reset and channel activity is halted until it is reactivated by software. When the channel is reactivated, MAL points to the descriptor at the head of the BD table.
- **OPB Time-Out Error**

This error indicates that an OPB time-out error was reported by the OPB arbiter.

Following this error, the active bit of the associated channel is reset and channel activity is halted until reactivated by software. When the channel is reactivated, MAL points to the descriptor at the head of the BD table.
- **OPB Error**

This error indicates that an OPB error was detected.

Following this error, the active bit of the associated channel is reset and channel activity is halted until reactivated by software. When the channel is reactivated, MAL points to the descriptor at the head of the BD table.
- **PLB Error**

This error indicates that a PLB error was detected (from the PLB slave).

In this case, MAL cannot determine which channel caused the error. Therefore, operation is not halted for any of the channels.

20.7.3.3 Error Handling Registers

MAL error handling logic includes two registers.

- **Error Status Register (MAL0_ESR)**

This register holds information about the error that occurred and the interrupt status. The register includes the following fields:

Error status – This field holds the error information. The information includes the number of the channel on which the error occurred (if known) and the type of the error. The error can be either the last detected error or a locked error if “Locked error mode” is active. See “Operational Error Modes” on page 20-593 for description of the Locked error mode.

The error status field includes an “Error Valid” bit which indicates whether there is valid error information in the error status field or not. The error status field is not valid when the “Error Valid” bit is cleared (by writing 1 to this bit).

Preliminary User's Manual

Interrupt status – Every error detected by MAL sets a related bit in the interrupt status field. Software can clear an interrupt status bit by writing 1 to the bit to be cleared. The bits in this field are accumulative which allows more than one interrupt to be indicated in the register.

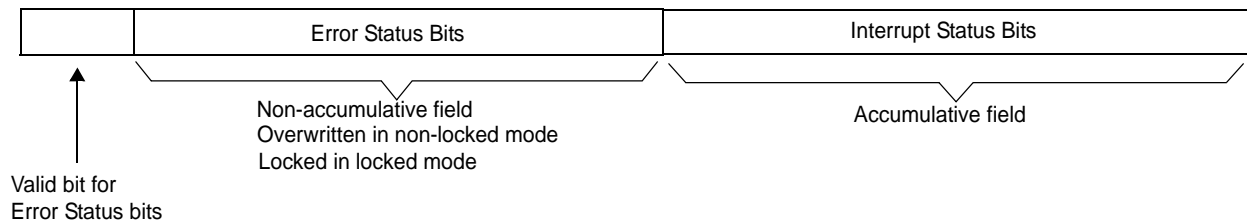

Figure 20-9. Error Status Register Field

20.7.3.4 Operational Error Modes

MAL can operate in two different error handling modes:

- **Locked Error Mode:** Information about the error is written to the Error Status Register, and the Valid bit in that register is set. Information in the Error Status field of the register stays locked until software unlocks it by resetting the error Valid bit. The Interrupt Status bits of the Error Status Register are not locked in this mode, so software can find out if more errors occur. However, the Error Status field applies only to the first error that is locked.
- **Non-Locked Error Mode:** Information about the error is written in the Error Status Register, and the error Valid bit is set. Each new error will be overwritten, so the information in the Error Status Field is valid only for the last error that occurred.

In both modes, each error written in the error description field will set the error Valid bit, and it is the responsibility of software to reset this bit.

The error handling mode is programmed in the MAL Configuration Register (see “MAL Configuration Register (MAL0_CFG)” on page 20-597).

20.7.3.5 Resolution of an Error Situation

When MAL encounters an error, it reacts as follows:

- Writes information about the error in the Error Status Register (ESR). This information includes the channel ID of the channel which caused the error (if known), the bus on which the error occurred, and the kind of error that occurred.
- Resets the channel that caused the error (if known) in the Channel Active Register.
- Updates the Interrupt Status bits in the MAL0_ESR. Then, depending on the mask defined in MAL0_IER (Interrupt Enable Register), it may send an interrupt to software (in PPC405GP, it sends it to the Universal Interrupt Controller).

After receiving an interrupt from MAL, software can analyze the error information read from the Error Status Register. Software can restart channel activity by setting the associated bit in the Channel Active Register.

When a channel is stopped and restarted, MAL starts processing descriptors from the first descriptor in the channel descriptor table. Therefore, software may also update the value of the other channel related registers (see “Channel Table Pointer Registers (MAL0_TXCTPxR, MAL0_RXCTPxR)” on page 20-605) in order to continue from the same buffer in memory.

In the case of PLB errors, MAL does not know which channel caused the error. It is the responsibility of the software to analyze the MAL error registers and the PLB slave error registers to determine which channel caused the error. Software should reset the channel within MAL, resolve the problem, and then reactivate the channel.

See Figure 20-10 on page 20-595 for a flow chart illustrating the steps MAL performs when resolving an error situation.

Preliminary User's Manual

20.7.3.6 Interrupts To Software

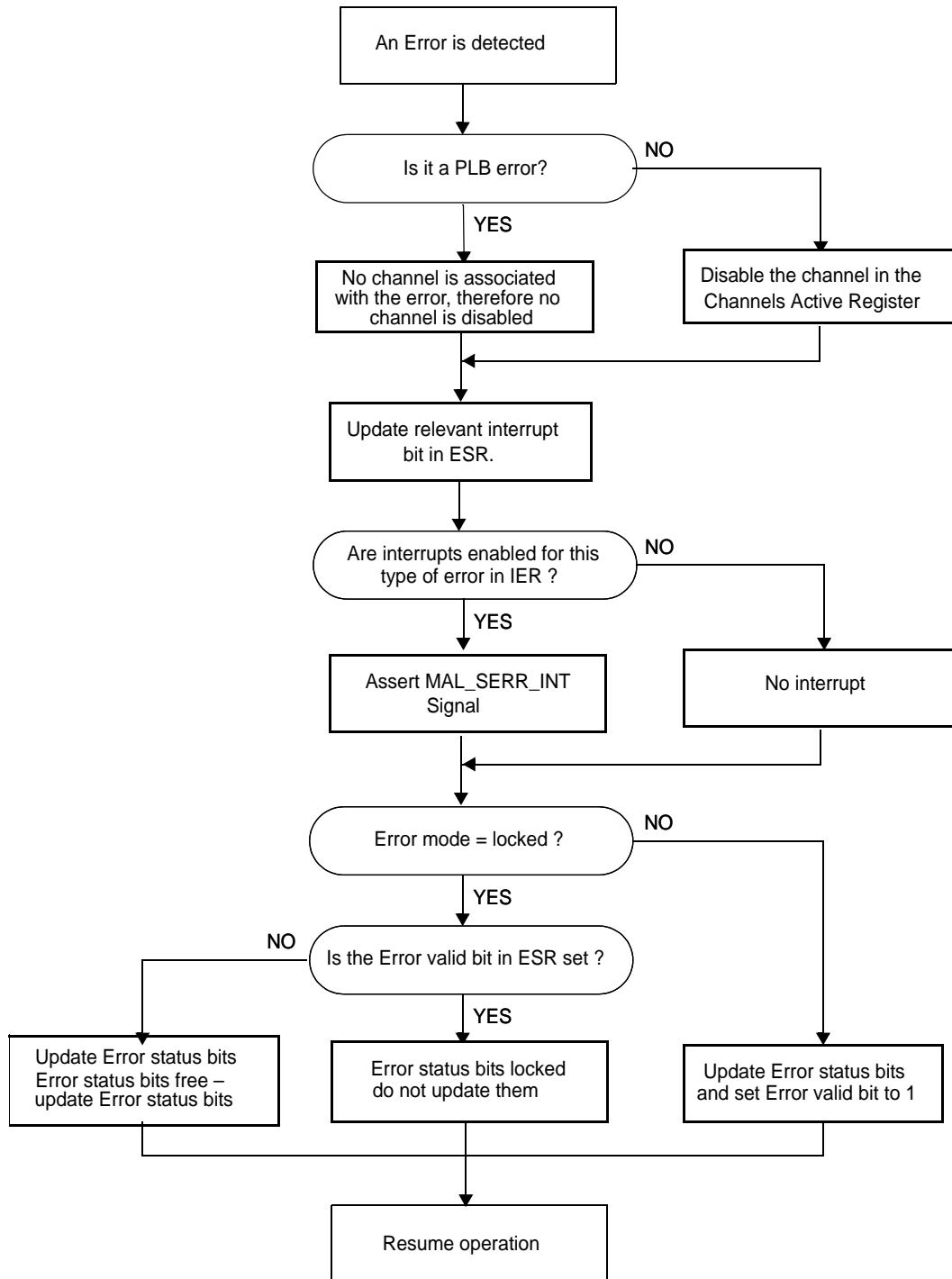

Figure 20-10. MAL Error Processing

Figure 20-10 on page 20-595 describes MAL actions once an error is detected. Note that the actual decisions MAL makes may be in a different order than represented by this figure. In any case, the device driver should consider that all of the MAL actions are performed at the same time.

20.8 MAL Registers

The MAL registers are Device Control Registers (DCRs).

- Unless otherwise specified, all register fields are initialized at chip reset to 0.
- Reserved fields are read as undefined and must be written as 0s.

Table 20-1. MAL Register Summary

Register	DCR Number	Access	Description
MAL0_CFG	0x180	R/W	Configuration Register
MAL0_ESR	0x181	R/Clear	Error Status Register
MAL0_IER	0x182	R/W	Interrupt Enable Register
MAL0_TXCASR	0x184	R/W	Transmit Channel Active Set Register
MAL0_TXCARR	0x185	R/W	Transmit Channel Active Reset Register
MAL0_TXEOBISR	0x186	R/Clear	Transmit End of Buffer Interrupt Status Register
MAL0_TXDEIR	0x187	R/Clear	Transmit Descriptor Error Interrupt Register
MAL0_RXCASR	0x190	R/W	Receive Channel Active Set Register
MAL0_RXCARR	0x191	R/W	Receive Channel Active Reset Register
MAL0_RXEOBISR	0x192	R/Clear	Receive End of Buffer Interrupt Status Register
MAL0_RXDEIR	0x193	R/Clear	Receive Descriptor Error Interrupt Register
MAL0_TXCTP n R	0x1A0–0x1A3	R/W	Transmit Channel n Table Pointer Register; MAL0 has 2 transmit channels
MAL0_RXCTP0R	0x1C0	R/W	Receive Channel 0 Table Pointer Register
MAL0_RCBS0	0x1E0	R/W	Receive Channel 0 Buffer Size Register

Preliminary User's Manual**20.8.1 MAL Configuration Register (MAL0_CFG)**

This register defines the operational mode of MAL. Unless a configuration change is required during system operation, the configuration register needs to be set only during system initialization.

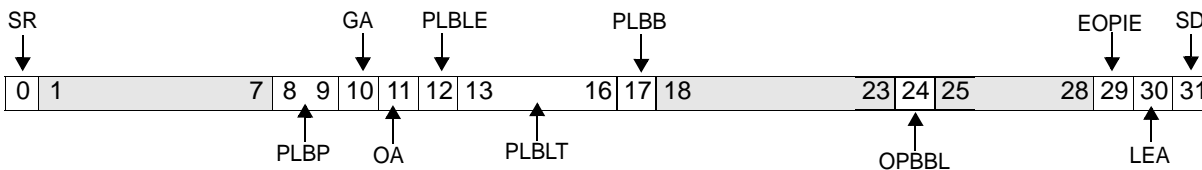
**Figure 20-11. MAL Configuration Register (MAL0_CFG)**

0	SR	MAL Software Reset 0 MAL reset is complete 1 Reset the MAL	Generates a general reset to MAL through a software command. After setting this bit, MAL hardware (registers, interface and internal state machines) returns to the power-on reset value. The software writes 1 to this bit in order to drive MAL to the reset state. The bit is cleared by the hardware when the reset is completed (one system clock).
1:7		Reserved	
8:9	PLBP	PLB Priority 00 Lowest 01 10 11 Highest	Determines the priority of MAL requests on the PLB.
10	GA	Guarded Active 0 GUARDED signal not applied to the PLB slave 1 GUARDED signal applied to the PLB slave	When this bit is set, MAL applies the GUARDED signal to the PLB slave when it is the initiator on the bus. When set, the slave can access all the memory in the current page as well as the subsequent page.
11	OA	Ordered Active 0 ORDERED signal not applied to the PLB slave 1 ORDERED signal applied to the PLB slave	When this bit is set, MAL applies the ORDERED signal to the PLB slave when it is initiator on the bus during data write transactions. Note that the ORDERED signal is always driven active during status write transactions.
12	PLBLE	PLB Lock Error 0 LOCKERROR signal not applied to the PLB slave 1 LOCKERROR signal applied to the PLB slave	When this bit is set, MAL applies the LOCKERROR signal to the PLB slave when it is the initiator during PLB transactions.
13:16	PLBBLT	PLB Latency Timer	Determines the number of cycles allowed for burst transactions on the PLB.

17	PLBB	PLB Burst 0 Burst transactions not allowed 1 Burst transactions allowed	When this bit is reset, MAL is not allowed to perform burst transactions.
18:23		Reserved	
24	OPBBL	OPB Bus Lock 0 OPB not locked 1 OPB locked	When this bit is set, MAL locks the OPB during data transfers to and from the COMMACs.
25:28		Reserved	
29	EOPIE	End of Packet Interrupt Enable 0 Generate interrupt on every end-of-packet only if the buffers I bit is set 1 Generate interrupt is on every end-of-packet	When this bit is set, an interrupt is generated on every end of packet (both transmit and receive). When clear, end of packet/buffer interrupt is generated only if the buffers I bit is set (1). Note: An interrupt is generated for every descriptor on which the I bit is set, regardless of the state of the EOPIE bit.
30	LEA	Locked Error Active 0 Handle errors in a non-locked mode 1 Handle errors in locked mode	Determines MAL's error handling mode. When this bit is set, MAL will handle errors in the locked mode, otherwise it will handle errors in a non-locked mode.
31	SD	MAL Scroll Descriptor 0 Do not scroll to the first descriptor of the next packet 1 Scroll to the first descriptor of the next packet	Determines whether or not MAL should scroll to the first descriptor of the next packet, following an early packet termination initiated by the related COMMAC. When set, Scrolling mode is active.

20.8.2 Channel Active Set and Reset Registers

For the Channel Active Set/Reset Registers (MAL0_TXCASR, MAL0_TXCARR, MAL0_RXCASR, and MAL0_RXCARR,) each bit represents its associated channel (bit 0 for channel 0, and so on). When a bit is set to 1, the channel is enabled for operation. When a bit is set to 0, the channel is disabled and MAL ignores any requests for service on the channel. If a channel is active when its enable bit is set to 0, MAL stops processing the current packet. After the enable bit associated with a channel is set to 0, MAL goes back to the top of the channel descriptor table (pointed to by MAL0_TXCPTxRor MAL0_RXCPTxR).

- To enable a channel:
 - Write a 1 to its corresponding bit in MAL0_CASR.
 - Multiple channels can be enabled with a single MAL0_CASR register write.
- To stop and reset a channel:
 - Write a 1 to the corresponding bit in MAL0_CARR.
 - Writing a 0 to bits in MAL0_CARR has no effect.
 - Multiple channels can be reset with one MAL0_CARR register write.

Preliminary User's Manual

MAL also clears the enable bit associated with a channel after an error occurs on the channel. The Channel Active Set/Reset Registers can be read to determine the currently active channels.

0	1	2	31
---	---	---	----

Figure 20-12. TX Channel_Active Set Register (MAL0_TXCASR)

0:1		Transmit Channel Active Set	Each bit represents its related channel (bit 0 for channel 0, and so on). When 1 is written to the bit, channel operation is enabled. MAL0 has two transmit channels.
2:31		Reserved	

0	1	2	31
---	---	---	----

Figure 20-13. TX Channel Active Reset Register (MAL0_TXCARR)

0:1		Transmit Channel Active Reset	Each bit represents its related channel (bit 0 for channel 0, and so on). When 1 is written to the bit, channel operation is disabled. MAL0 has two transmit channels.
2:31		Reserved	

0	1	31
---	---	----

Figure 20-14. RX Channel_Active Set Register (MAL0_RXCASR)

0		Receive Channel Active Set	Each bit represents its related channel (bit 0 for channel 0, and so on). When 1 is written to the bit, channel operation is enabled. MAL0 has one receive channel.
1:31		Reserved	



Figure 20-15. RX Channel_Active Reset Register (MAL0_RXCARR)

0		Receive Channel Active Reset	Each bit represents its related channel (bit 0 for channel 0, and so on). When 1 is written to the bit, channel operation is disabled. MAL0 has one receive channel.
1:31		Reserved	

20.8.2.1 End of Buffer Interrupt Status Registers

Each bit in the end of buffer interrupt status registers (MAL0_TXEOBISR and MAL0_RXEOBISR) is associated with the descriptor buffer table of a channel.

MAL0_TXEOBISR contains the end of buffer status bits for each transmit channel. MAL0_RXEOBISR contains the end of buffer status bits for the receive channels. The mechanism for both registers is identical.

MAL sets a bit associated with a channel bit under any of the following conditions:

- When MAL finishes the processing of a buffer (writes back the status to the current descriptor), the related bit in this register is set if the I bit in the descriptor status is set.
- When MAL finishes the processing of a packet (writes back the status of the last buffer of the packet) and MAL0_MCR[EOPIE] is set.

Note: If MAL finishes processing a packet that is backed up, MAL does not consider it as an end of packet. Therefore, MAL does not set the appropriate channel bit in the end of buffer interrupt status registers.

- When the Bad Packet bit is set in the COMMAC channel status halfword.

The device driver resets the interrupt by writing a 1 to the related bit. Writing a 0 has no effect.



Figure 20-16. TX End of Buffer Interrupt Status Register (MAL0_TXEOBISR)

0:1		Transmit Channel End-of-Buffer Interrupt	Each bit represents its related channel (bit 0 for channel 0, and so on). Writing 1 to a bit clears it. MAL0 has two transmit channels.
2:31		Reserved	

Preliminary User's Manual

0			31
---	--	--	----

Figure 20-17. RX End of Buffer Interrupt Status Register (MAL0_RXEOBISR)

0		Receive Channel End-of-Buffer Interrupt	Each bit represents its related channel (bit 0 for channel 0, and so on). Writing 1 to a bit clears it. MAL0 has one receive channel.
1:31		Reserved	

The following paragraphs describe MAL error registers. For more information about MAL errors, see “Error Handling” on page 20-591.

20.8.3 MAL Error Status Register (MAL0_ESR)

This register holds the information about the error that occurred and the interrupts status. The register includes the following fields:

- **Error status bits** – This field holds the error information. The information includes the number of the channel on which the error occurred (if known) and the type of the error. The error can be either the last detected error or a locked error if “Locked error mode” is active. (See “Operational Error Modes” on page 20-593 for description of the Locked error mode.)

The error status field includes an “Error Valid” bit which indicates whether there is an error information in the error status field or not. The error status bits are not valid when the “Error Valid” bit is cleared (by writing 1 to this bit).

- **Interrupt status bits** – Every error detected by MAL sets a related bit in the interrupt status field. The interrupt status bits may be cleared by software by writing 1 to the bit to be cleared. The bits in this field are accumulative (more than one interrupt may be indicated here). These bits are masked by the IER (Interrupt Enable Register) to create a maskable interrupt, which is implemented by the MAL_SERR_INT signal (connected to the UIC on the PPC405GP).

Note: In order to reset the interrupt bits and the Error valid bit in the Error Status register, 1 must be written to the related bit. Writing 0 has no effect.

More than one bit can be cleared at a time and only R/W bits can be reset.

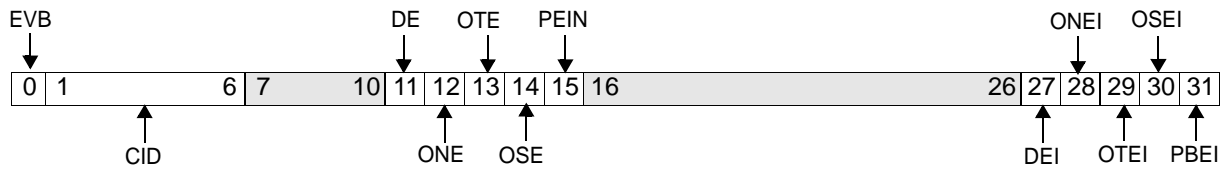

Figure 20-18. MAL Error Status Register (MAL0_ESR)

0	EVB	Error Valid Bit 0 Bit 1:15 are available for latching new error information. 1 Bits 1:15 contain last error. A new error cannot be latched.	When this bit is set, bits 1-6 include the ID of the erroneous channel (in case of OPB errors). Bits 11-15 indicate the type of error. In non-locked mode, the error indication describes the last error that had occurred. In locked mode, the error is the first one that had occurred after this bit was cleared. This bit is set when an error occurs and remains set until reset by the software. In locked mode, new errors cannot be latched in the error lock indication fields if this bit is set
1:6	CID	Channel ID	This field contains the number of the channel which caused the locked error. Bit 1 indicates whether the channel ID represents an RX channel (1) or a TX channel (0). Bits 2:6 indicates the number of the channel that caused the error. Note: An error on the PLB cannot be related to a channel. The error condition may be resolved by using the error information optionally locked in the PLB slave.
7:10		Reserved	
11	DE	Descriptor Error 0 No error 1 Non-valid descriptor	Indicates that the error is a non-valid descriptor, which is <i>not</i> the first descriptor in a TX packet.
12	ONE	OPB Non-fullword Error 0 No error 1 Non-fullword asserted	Indicates that the error is a non-fullword acknowledge asserted by an OPB slave.
13	OTE	OPB Timeout Error 0 No error 1 OPB timeout	Indicates the error is an OPB timeout.
14	OSE	OPB Slave Error 0 No error 1 OPB slave error	Indicates the error is an error indication asserted by an OPB slave.
15	PEIN	PLB Bus Error Indication 0 No error 1 PLB bus error	When this bit is set, the detected error is a PLB error. There is no meaning to the Channel ID field in this case.
16:26		Reserved	

Preliminary User’s Manual

27	DEI	Descriptor Error Interrupt 0 No error 1 Descriptor data error recognized	A descriptor data error is recognized during access to the descriptor table. This error indication is asserted when a non-valid descriptor is accessed, which is <i>not</i> the first descriptor in a TX packet. Set condition for this bit generates a maskable interrupt.
28	ONEI	OPB Non-fullword Error Interrupt 0 No error 1 Non-fullword acknowledgment from a slave	This bit is set following a non-fullword acknowledgment coming from a slave. Set condition for this bit generates a maskable interrupt.
29	OTEI	OPB Timeout Error Interrupt 0 No error 1 OPB time-out	This bit is set following an OPB time out error indication. Set condition for this bit generates a maskable interrupt.
30	OSEI	OPB Slave Error Interrupt 0 No error 1 OPB error from a slave	This bit is set following an OPB error indicated by the slave. Set condition for this bit generates a maskable interrupt.
31	PBEI	PLB Bus Error Interrupt 0 No error 1 PLB error indication	This bit is set following a PLB error indication (from the PLB slave). Set condition for this bit generates a maskable interrupt.

20.8.4 MAL Interrupt Enable Register (MAL0_IER)

Each bit in the following register, when it is set, enables assertion of the interrupt signal (MAL0_SERR_INT) when the associated bit is set in MAL0_ESR.

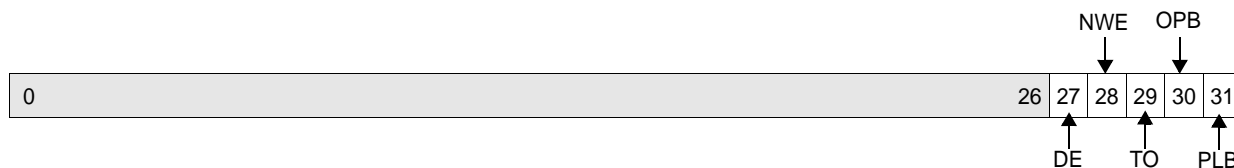

0:26		Reserved	
27	DE	Descriptor Error	When set, this bit enables the descriptor error (descriptor not valid) interrupt.
28	NWE	Non_W_Err_Int_Enable	When set, this bit enables OPB non-word transfer error interrupt.
29	TO	Time_Out_Int_Enable	When set, this bit enables OPB time-out error interrupt.
30	OPB	OPB_Err_Int_Enable	When set, this bit enables the OPB Slave error interrupt.
31	PLB	PLB_Err_Int_Enable	When set, this bit enables the PLB error interrupt.

20.8.5 Descriptor Error Interrupt Registers (MAL0_TXDEIR, MAL0_RXDEIR)

Each bit in the following registers is related to a channel descriptor buffer table. Each bit indicates a descriptor data error related to a certain channel.

MAL0_TXDEIR contains the descriptor errors bits of the transmit channels. The MAL0_RXDEIR contains the descriptor errors bits of the receive channels. The mechanism (as described below) for both registers is the same.

MAL sets the bit associated with a channel bit when a descriptor data error was recognized during access to the descriptor table of a specific channel (see “Descriptor Error” on page 20-591).

The device driver resets the interrupt by writing a 1 to the related bit. Writing a 0 has no effect. When one or more of the MAL0_TXDEIR bits is set, the MAL_TX_DESC_ERR_INT bit is set. When one or more of the MAL0_RXDEIR bits is set, the MAL_RX_DESC_ERR_INT signal is set (attached to UIC on the PPC405GP).



Figure 20-20. TX Descriptor Error Interrupt Register (MAL0_TXDEIR)

0:1		Transmit Descriptor Error Interrupt	Each bit represents its related channel (bit 0 for channel 0, and so on). When one or more bits are set to 1, MAL_DESC_ERR_INT is set. Writing 1 to a bit clears it. MAL0 has two transmit channels.
2:31		Reserved	



Figure 20-21. RX Descriptor Error Interrupt Register (MAL0_RXDEIR)

0		Receive Descriptor Error Interrupt	Each bit represents its related channel (bit 0 for channel 0, and so on). When one or more bits are set, MAL_DESC_ERR_INT is set. Writing 1 to a bit clears it. MAL0 has one receive channel.
1:31		Reserved	

Preliminary User’s Manual

20.8.6 Channel Table Pointer Registers (MAL0_TXCTPxR, MAL0_RXCTPxR)

MAL uses receive channel table pointer registers, one for each receive channel, and transmit channel table pointer registers, one for each transmit channel. The channel table pointer registers point to the base address, in memory, of the descriptor buffer table used by each channel.

Note 1: Bits 0–12 of the MAL0_TXCTPxR registers are mapped to the same physical register. Writing into any of these registers overwrites bits 0–12 in all MAL0_TXCTPxR registers; read operations have no effect. Similarly, bits 0–12 of the MAL0_RXCTPxR registers are mapped to the same physical register. Writing into any of these registers overwrites bits 0–12 in all MAL0_RXCTPxR registers, Read operations have no effect.

Note 2: When changing the value of any MAL0_TXCTPxR registers, all transmit channels must be idle. To verify that a channel is idle, check the Transmit Idle bit of the device. Another way to ensure that the channels are idle is to disable the channels before changing the MAL0_TXCTPxR register, and then reenale them once the MAL0_TXCTPxR register is set to its new value.

The transmit and receive channel table pointer registers have identical formats, as shown in Figure 20-22 and Figure 20-23. There are two transmit channel table pointer registers, and one receive channel table pointer register.

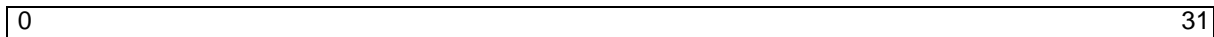

Figure 20-22. TX Channel Table Pointer Registers (MAL0_TXCTPxR)

0:31		Channel Table Pointer	Pointer to the base address of the buffer descriptor table used by the channel. The value entered should point to a location in memory accommodating an aligned doubleword (the three least significant bits of the pointer must be 000). MAL0 has two transmit channels.
------	--	-----------------------	--

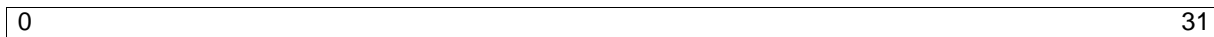

Figure 20-23. RX Channel Table Pointer Register (MAL0_RXCTPxR)

0:31		Channel Table Pointer	Pointer to the base address of the buffer descriptor table used by the channel. The value should point to a location in memory accommodating an aligned doubleword (the three least significant bits of the pointer must be 000). MAL0 has one receive channel.
------	--	-----------------------	--

The Table Pointer Registers retain their value following Soft Reset or Channel Reset.

20.9 Receive Channel Buffer Size Register (MAL0_RCBS0)

Each receive channel has a fixed buffer length. MAL0_RCBS0 is configured by the device driver to specify the length of the buffer. This size is the maximum number of bytes that can be stored in the buffer. Multiple buffers are used to store an incoming packet if the length of the incoming packet data is greater than the buffer length for the channel, as defined by the associated register for the channel.

The buffer length for a channel can be from 16 bytes to (4KB – 16) bytes, in 16-byte increments. This length is represented by a 8-bit field.

The receive buffer size, in bytes, is calculated as:

$$\text{Receive Channel Buffer Size} \times 16$$

Figure 20-24 illustrates the MAL0_RCBS0 register.



Figure 20-24. RX Channel Buffer Size Register (MAL0_RCBS0)

0:23		Reserved	
24:31		Receive Channel Buffer Size	MAL0 has one receive channel.

Preliminary User's Manual

Chapter 21. Serial Port Operations

The PPC405GP contains two universal asynchronous receiver/transmitters (UARTs) that provide full-duplex serial interfaces to serial peripheral devices. Each UART is compatible with the 16550 chip, and includes a 16-byte transmit and a 16-byte receive FIFO.

Features of the UARTs include:

- 16550 compatibility
- 16-byte send FIFO, 16-byte receive FIFO
- Full duplex operation
- Programmable baud rate generator
- Supports 5- to 8-bit characters, 1 or 2 stop bits, even, odd, or no parity
- One 8-wire interface (UART0) and one 4-wire interface (UART1)

The UART performs serial-to-parallel conversion on data characters received from a peripheral device, and parallel-to-serial conversion on data characters received from the processor. The processor can read the complete status of the UART at any time during the functional operation. Status information reported includes the type and condition of the transfer operations being performed by the UART, as well as any error conditions, such as parity, overrun, framing, and break interrupt.

This UART is functionally identical to 16450 in character mode (on power up it will be in this mode), and can be put into FIFO mode to relieve the processor of excessive software overhead. Here, internal FIFOs are activated allowing 16 bytes (plus 3 bits per byte of error data in the RCVR FIFO) to be stored in both receive and transmit modes.

The two UARTs can be clocked individually from either an external serial clock or from an internally generated serial clock. The sources of the UART serial clock inputs are selected in Chip Control Register 0 (CPC0_CR0[U0EC, U1EC]). A programmable baud rate generator can divide the UART serial clock input by a divisor of 1 to ($2^{16} - 1$) and produce the $16\times$ clock required for driving the UART internal transmitter and receiver logic. The internal serial clock input is derived from the CPU clock by a divisor specified in CPC0_CR0[UDIV].

Each UART has an interrupt system that can be programmed to the user's requirements, helping to minimize the computing required to handle the communications link. UART interrupts are capable of triggering an interrupt request to the PPC405GP interrupt controller.

21.1 Functional Description

- Runs 16550 software
- Registers are fully compatible with the 16550 register set
- After reset, UARTs revert to 16450 compatibility (16450 has no FIFOs)
- Complete status reporting capability
- Transmitter and receiver are each buffered with 16-byte FIFOs when FIFO mode selected
- Can add/delete standard asynchronous communication bits such as start, stop, and parity to/from the serial data

- When in character mode, holding and shift registers eliminate the need for precise synchronization between the processor and serial data
- Full prioritized interrupt system controls
- Independently controlled transmit, receive, line status, and data set interrupts
- Programmable baud rate generator divides the UART serial clock input by 1 to $(2^{16}-1)$ and generates the $16\times$ clock:

$$\text{Baud rate (bps)} = (\text{Serial Clock Input}) / (16 \times \text{Decimal Divisor})$$

- Receiver uses 5-way oversampling as follows: it samples each serial bit five times, and if at least three of the samples are 1s, the bit is determined to be a 1, otherwise it is a 0
- Fully programmable serial-interface characteristics:
 - 5-, 6-, 7-, or 8-bit characters
 - Even, odd, or no parity bit generation and detection
 - 1-, 1.5-, or 2-stop bit generation
 - Variable baud rate
- Line break generation and detection, and false start bit detection
- Internal diagnostic capability:
 - Loopback controls for communications link fault isolation
 - Break, parity, overrun, framing error simulation

21.2 Serial Input Clocking

The two UARTs can be clocked individually from either an external serial clock or from an internally generated serial clock. The internally generated serial clock is derived from the CPU clock, and is set to CPU/n , where n ranges from 1 to 32. The divisor n is programmed by setting a value of 0 to 31 in `CPC0_CR0[UDIV]` (see “Chip Control Register 0 (CPC0_CR0)” on page 7-194).

The choice of serial clock frequency affects the serial communications error rate. If an external clock of 1.8432 MHz (or some multiple of this frequency) is used, the error rate approaches zero. Unless `SysClk` is chosen as an integer multiple of 1.8432 MHz, using the internally generated UART clock typically results in a small error in the baud rate, as shown in Table 21-1.

The optimum serial clock frequency is then determined using the following relationship:

$$\text{Serial Clock} = \text{Baud Rate} \times 16 \times \text{UART Divisor}$$

where UART Divisor is controlled by `UARTx_DLL` and `UARTx_DLM`

Acceptable baud rates are always integral multiples of 300 (for example, $1200 = 4 \times 300$). Table 21-1 shows optimum UART divisor and CPU divide ratios for a range of possible baud rates. This information is provided for several different CPU clock frequencies. The UART divisor is programmed in `UARTx_DLM` and

Preliminary User's Manual

UARTx_DLL (see “Divisor Latch LSB and MSB Registers (UARTx_DLL, UARTx_DLM)” on page 21-622). The value range is 1 to $(2^{16} - 1) = 65535$.

Table 21-1. Baud Rate Settings

Desired Baud Rate (bps)	CPU:UART Divide Ratio	Serial Clock Frequency (MHz)	Minimum OPB Frequency (MHz)	UART Divisor	Actual Baud Rate (bps)	Error (%)
CPU Clock = 150MHz						
1200	13	11.5380	23.6220	601	1199.92	0.01
2400	21	7.1429	14.4927	186	2400.15	0.01
4800	21	7.1429	14.4927	93	4800.31	0.01
9600	16	9.3750	19.1082	61	9605.53	0.06
19200	14	10.7140	21.8978	35	19132.65	0.35
28800	13	11.5380	23.6220	25	28846.15	0.16
33600	9	16.6670	34.4827	31	33602.15	0.01
38400	9	16.6670	34.4827	27	38580.25	0.47
57600	18	8.3333	16.9491	9	57870.37	0.47
115200	9	16.6670	34.4827	9	115740.74	0.47
307200	30	5.0000	10.1010	1	312500.00	1.73
CPU Clock = 166.66 MHz						
1200	31	5.3763	10.8695	280	1200.08	0.01
2400	31	5.3763	10.8695	140	2400.15	0.01
4800	31	5.3763	10.8695	70	4800.31	0.01
9600	31	5.3763	10.8695	35	9600.61	0.01
19200	32	5.2083	10.5263	17	19148.28	0.27
28800	19	8.7719	17.8571	19	28855.03	0.19
33600	31	5.3763	10.8695	10	33602.15	0.01
38400	17	9.8039	20.0000	16	38296.57	0.27
57600	30	5.5556	11.2359	6	57870.37	0.47
115200	30	5.5556	11.2359	3	115740.74	0.47
307200	17	9.8039	20.0000	2	306372.55	0.27
CPU Clock = 200MHz						
1200	11	18.1820	37.7358	947	1199.96	0.003
2400	28	7.1429	13.9860	186	2400.15	0.01
4800	28	7.1429	13.9860	93	4800.31	0.01
9600	14	14.2860	29.4117	93	9600.61	0.01
19200	31	6.4516	13.0718	21	19201.23	0.01
28800	31	6.4516	13.0718	14	28801.84	0.01
33600	31	6.4516	13.0718	12	33602.15	0.01
38400	25	8.0000	16.2601	13	38461.54	0.16
57600	31	6.4516	13.0718	7	57603.69	0.01
115200	12	16.6670	34.4827	9	115740.74	0.47
307200	20	10.0000	20.4081	2	312500.00	1.73

Table 21-1. Baud Rate Settings (continued)

Desired Baud Rate (bps)	CPU:UART Divide Ratio	Serial Clock Frequency (MHz)	Minimum OPB Frequency (MHz)	UART Divisor	Actual Baud Rate (bps)	Error (%)
CPU Clock = 266MHz						
1200	19	14.0351	28.8809	731	1199.99	-0.00
2400	31	8.6021	17.5054	224	2400.15	0.01
4800	28	9.5238	19.4175	124	4800.31	0.01
9600	28	9.5238	19.4175	62	9600.61	0.01
19200	28	9.5238	19.4175	31	19201.23	0.01
28800	29	9.1954	18.7353	20	28735.63	-0.22
33600	31	8.6021	17.5054	16	33602.15	0.01
38400	31	8.6021	17.5054	14	38402.46	0.01
57600	29	9.1954	18.7353	10	57471.26	-0.22
115200	29	9.1954	18.7353	5	114942.53	-0.22
307200	27	9.8765	20.1511	2	308641.97	0.47
CPU Clock = 333MHz						
1200	27	12.3457	25.3165	643	1200.01	0.00
2400	31	10.7527	21.9780	280	2400.15	0.01
4800	31	10.7527	21.9780	140	4800.31	0.01
9600	31	10.7527	21.9780	70	9600.61	0.01
19200	31	10.7527	21.9780	35	19201.23	0.01
28800	29	11.4943	23.5294	25	28735.63	-0.22
33600	31	10.7527	21.9780	20	33602.15	0.01
38400	17	19.6078	40.8163	32	38296.57	-.027
57600	30	11.1111	22.7273	12	57870.37	0.47
115200	30	11.1111	22.7273	6	115740.74	0.47
307200	17	19.6078	40.8163	4	306372.55	-.027
CPU Clock = 400MHz						
1200	22	18.1818	37.7358	947	1199.96	-0.00
2400	31	12.9032	26.4901	336	2400.15	0.01
4800	31	12.9032	26.4901	168	4800.31	0.01
9600	31	12.9032	26.4901	84	9600.61	0.01
19200	31	12.9032	26.4901	42	19201.23	0.01
28800	31	12.9032	26.4901	28	28801.84	0.01
33600	31	12.9032	26.4901	24	33602.15	0.01
38400	31	12.9032	26.4901	21	38402.46	0.01
57600	31	12.9032	26.4901	14	57603.69	0.01
115200	31	12.9032	26.4901	7	115207.37	0.10
307200	27	14.8148	30.5344	3	308641.98	0.47

Preliminary User's Manual**21.3 UART Registers**

UART registers are accessed using memory locations 0xEF600xyy, where x = 3 for UART 0, and x = 4 for UART 1.

Table 21-2. UART Configuration Registers

UART Register	Address	R/W	Description	Reset
UART _x _RBR	EF600x00 ¹	R	UART x Receiver Buffer Register	
UART _x _THR	EF600x00 ¹	W	UART x Transmitter Holding Register	
UART _x _IER	EF600x01 ¹	R/W	UART x Interrupt Enable Register	0000 0000
UART _x _IIR	EF600x02	R	UART x Interrupt Identification Register	0000 0001
UART _x _FCR	EF600x02	W	UART x FIFO Control Register	0000 0000
UART _x _LCR	EF600x03	R/W	UART x Line Control Register	0000 0000
UART _x _MCR	EF600x04	R/W	UART x Modem Control Register	0000 0000
UART _x _LSR	EF600x05	R/W	UART x Line Status Register	0110 0000
UART _x _MSR	EF600x06	R/W	UART x Modem Status Register	xxxx 0000
UART _x _SCR	EF600x07	R/W	UART x Scratch Register	
UART _x _DLL	EF600x00 ¹	R/W	UART x Divisor Latch (LSB)	
UART _x _DLM	EF600x01 ¹	R/W	UART x Divisor Latch (MSB)	
1. UART _x _LCR[DLAB] controls the function accessed through registers EF600X00 and EF600X01. When UART _x _LCR[DLAB] is 0, access is enabled to the Receiver/Transmitter registers and the Interrupt Enable register. When UART _x _LCR[DLAB] is a 1, access is enabled to the Divisor Latch registers.				

In PPC405GP there are two UARTs, designated 0 (8-wire interface) and 1 (4-wire interface). In the following sections, the registers are specified with generic names, where x represents 0 or 1. For example, the Line Control Register appears as a UART_x_LCR.

For UART1, two of the four wires are TX and RX. The remaining two wires can be programmed as a combination of DTR and DSR, or CTS and RTS in CPC0_CR0(DCS, RDS). DCD and RI are not available on the 4-wire interface.

21.3.1 Receiver Buffer Registers (UARTx_RBR)

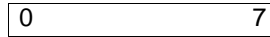

Figure 21-1. UART Receiver Buffer Registers (UARTx_RBR)

0:7		Data bit
Note: UARTx_RBR is shown in standard PowerPC bit notation, where 0 is the MSb and 7 is the LSb.		

21.3.2 Transmitter Holding Registers (UARTx_THR)

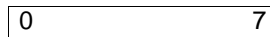
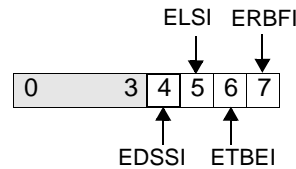

Figure 21-2. UART Transmitter Holding Registers (UARTx_THR)

0:7		Data bit
Note: UARTx_THR is shown in standard PowerPC bit notation, where 0 is the MSb and 7 is the LSb.		

Preliminary User's Manual**21.3.3 Interrupt Enable Registers (UARTx_IER)**

UARTx_IER enables five UART interrupts on four priority levels. Any of the five interrupts can be used to report a UART interrupt to the PPC405GP interrupt controller. Each interrupt can be enabled by setting its appropriate bit. Resetting UARTx_IER[EDSSI, ELSI, ETBEI, ERBFI] completely disables the UART interrupts. Disabling an interrupt prevents it from being shown as active in the UARTx_IIR and prevents it from signaling a UART interrupt to the PPC405GP UIC. See Table 21-3, "Interrupt Priority Level," on page 21-614, for information about the interrupts.

**Figure 21-3. UART Interrupt Enable Registers (UARTx_IER)**

0:3		Reserved	Always 0.
4	EDSSI	Enable Modem Status Interrupt 0 Disable modem status interrupt 1 Enable modem status interrupt	
5	ELSI	Enable Receiver Line Status Interrupt 0 Disable receiver line status interrupt 1 Enable receiver line status interrupt	
6	ETBEI	Enable Transmitter Holding Register Empty Interrupt 0 Disable transmitter holding register empty interrupt 1 Enable transmitter holding register empty interrupt	
7	ERBFI	Enable Received Data Available Interrupt 0 Disable received data available interrupt 1 Enable received data available interrupt	In FIFO mode, timeout interrupts follow the enable/disable state of ERDAI.
Note: UARTx_IER is shown in standard PowerPC bit notation, where 0 is the MSb and 7 is the LSb			

21.3.4 Interrupt Identification Registers (UARTx_IIR)

The UART prioritizes interrupts into four levels, which are recorded in UARTx_IIR. The interrupt types, in the order of their priority are as follows:

1. Receiver line status
2. Received data available and character timeout indication
3. Transmitter holding register empty
4. Modem status

Table 21-3 lists the interrupt priority levels.

Table 21-3. Interrupt Priority Level

IIR Bit 4	IIR Bit 5	IIR Bit 6	Priority Level	Interrupt Type	Interrupt Source	Interrupt Reset Control
0	1	1	1	Receiver Line Status	Overrun, Parity or Framing Error, or Break Interrupt.	Read LSR.
0	1	0	2	Received Data Available	Receiver data available or trigger level reached.	Read RBR, or FIFO drops below trigger level.
1	1	0	2	Character Timeout Indication	No characters have been removed from or input to the receiver FIFO during the last four character times and it contains at least one character during this time.	Read RBR.
0	0	1	3	Transmitter Holding Register Empty	Transmitter Holding Register Empty.	Read IIR (if source of interrupt) or write THR.
0	0	0	4	Modem Status	Clear to Send, Data Set Ready, Ring Indicator or Data Carrier Detect.	Read MSR.

When the processor accesses UARTx_IIR, the UART records new interrupts, but does not change its current contents until the access by the processor is complete. The UART indicates the highest priority interrupt pending to the PPC405GP interrupt controller using UARTx_IIR.

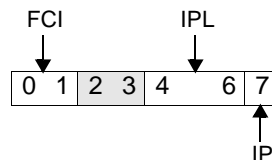

Preliminary User's Manual**Figure 21-4. UART Interrupt Identification Registers (UARTx_IIR)**

0:1	FCI	FIFO Control Indicator 00 FIFOs disabled (UARTx_FCR[FE] = 0) 01 Reserved 10 Reserved 11 FIFOs enabled (UARTx_FCR[FE] = 1)	
2:3		Reserved	
4:6	IPL	Interrupt Priority Level 000 Priority level 4 001 Priority level 3 010 Priority level 2 011 Priority level 1 100 Reserved 101 Reserved 110 Priority level 2 111 Reserved	See Table 21-3. Note: Priority 1 is highest priority.
7	IP	Interrupt Pending 0 Interrupt is pending 1 No interrupt pending	When set to 0, IIR contents can be used as a pointer to the appropriate interrupt service routine.
Note: UARTx_IIR is shown in standard PowerPC bit notation, where 0 is the MSb and 7 is the LSb.			

21.3.5 FIFO Control Registers (UARTx_FCR)

UARTx_FCR has the same address as UARTx_IIR, and is a write-only register. UARTx_FCR is used to perform FIFO control operations, such as selecting the DMA signaling type, setting the receiver FIFO trigger levels, clearing the FIFOs, and enabling the FIFO.

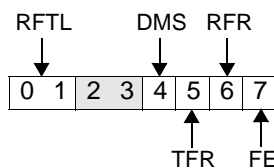
**Figure 21-5. UART FIFO Control Registers (UARTx_FCR)**

0:1	RFTL	Receiver FIFO Trigger Level 00 1 byte 01 4 bytes 10 8 bytes 11 14 bytes	
2:3		Reserved	
4	DMS	DMA Mode Select 0 Mode 0 = single transfer 1 Mode 1 = multiple transfers	Select single or multiple transfer mode if UARTx_FCR[7] = 1.

5	TFR	Transmitter FIFO Reset 0 Operation complete 1 Reset the transmitter FIFO	A 1 written to this bit clears all bytes in the transmitter FIFO and resets all of its counter logic to 0. The transmitter shift register is not cleared. This bit is self-clearing.
6	RFR	Receiver FIFO Reset 0 Operation complete 1 Reset the receiver FIFO	A 1 written to this bit clears all bytes in the receiver FIFO and resets all of its counter logic to 0. The receiver shift register is not cleared. This bit is self-clearing.
7	FE	FIFO Enable 0 Disable FIFOs 1 Enable FIFOs	When set to 1, both the receiver and transmitter FIFOs are enabled. When set to 0, both receiver and transmitter FIFOs are reset. Data is automatically cleared from both FIFOs when changing to and from FIFO and 16450 modes. Programming other bits will be ignored if this bit is not a 1.
Note: UARTx_FCR is shown in standard PowerPC bit notation, where 0 is the MSb and 7 is the LSb.			

Preliminary User's Manual**21.3.6 Line Control Registers (UARTx_LCR)**

UARTx_LCR specifies the format of the asynchronous data communications exchange. Read capability simplifies system programming, and eliminates the need for separate storage of the line characteristics in system memory.

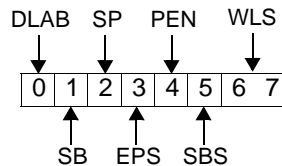
**Figure 21-6. UART Line Control Registers (UARTx_LCR)**

0	DLAB	Divisor Latch Access Bit 0 Address RBR, THR and IER with LTADR2-0 for read or write operation 1 Address Divisor Latches with LTADR2-0 for read or write operation	
1	SB	Set Break 0 Disable Break 1 Enable Break	Causes a break condition to be transmitted to the UART when the core is receiving. SOUT is forced to the spacing state (0). This bit acts only on SOUT and has no effect on the transmitter logic.
2	SP	Sticky Parity 0 Disable sticky parity 1 Enable sticky parity	If UARTx_LCR[EPS] = 1 and UARTx_LCR[PEN] = 1, the parity bit is transmitted and checked as 0. If UARTx_LCR [EPS] = 0 and UARTx_LCR[PEN] = 1, the parity bit is transmitted and checked as 1.
3	EPS	Even Parity Select 0 Generate odd parity 1 Generate even parity	This bit is significant only if UARTx_LCR[PEN] = 1.
4	PEN	Parity Enable 0 Disable parity checking 1 Enable parity checking	
5	SBS	Stop Bit Select 0 Characters have 1 stop bit 1 Characters have 1.5 or 2 stop bits	If UARTx_LCR[WLS] = 00, characters have 1.5 stop bits. For any other value of UARTx_LCR[WLS], characters have 2 stop bits. The receiver checks the first stop bit only, regardless of how many stop bits are selected.
6:7	WLS0, WLS1	Word Length Select Bits 0,1 00 Use 5-bit characters 01 Use 6-bit characters 10 Use 7-bit characters 11 Use 8-bit characters	
Note: UARTx_LCR is shown in standard PowerPC bit notation, where 0 is the MSb and 7 is the LSb.			

21.3.7 Modem Control Registers (UARTx_MCR)

UARTx_MCR controls the interface between the modem, data set, or peripheral device emulating a modem, and the UART.

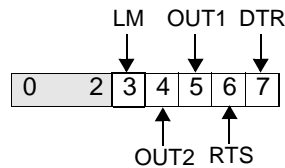

Figure 21-7. UART Modem Control Registers (UARTx_MCR)

0:2		Reserved	Always 0.
3	LOOP	<p>Loopback Mode</p> <p>0 Disabled</p> <p>1 Enabled</p>	<p>Provides a local loopback feature for diagnostic testing of the UART. The following occurs:</p> <ol style="list-style-type: none"> 1. SOUT is set to the marking state (logic 1) SIN is disconnected. 2. The output of the transmitter shift register feeds the input of the receiver shift register. 3. The four modem control inputs \overline{DSR}, \overline{CTS}, \overline{RI}, and \overline{DCD} are disconnected. 4. The four modem control outputs \overline{DTR}, \overline{RTS}, $\overline{OUT1}$, and $\overline{OUT2}$ are set to a logic 1 (their inactive state). 5. The four modem control outputs are connected internally to the four modem control inputs. <p>Transmitted data is immediately received to verify the UART transmit and receive data paths.</p> <p>Receiver and transmitter interrupts are operational. Their sources are external to the UART. Also operational are the modem control interrupts, but their source is the low-order 4 bits of UARTx_MCR instead of the modem control inputs to the UART. UARTx_IER still controls the interrupts.</p>
4	OUT2	<p>User Output 2</p> <p>0 $\overline{OUT2}$ inactive (1)</p> <p>1 $\overline{OUT2}$ active (0)</p>	May be written or read, but provides no function.
5	OUT1	<p>User Output 1</p> <p>0 $\overline{OUT1}$ inactive (1)</p> <p>1 $\overline{OUT1}$ active (0)</p>	May be written or read, but provides no function.
6	RTS	<p>Request To Send</p> <p>0 \overline{RTS} inactive (1)</p> <p>1 \overline{RTS} active (0)</p>	
7	DTR	<p>Data Terminal Ready</p> <p>0 \overline{DTR} inactive (1)</p> <p>1 \overline{DTR} active (0)</p>	

Note: UARTx_MCR is shown in standard PowerPC bit notation, where 0 is the MSb and 7 is the LSb.

Preliminary User's Manual**21.3.8 Line Status Registers (UARTx_LSR)**

UARTx_LSR stores data transfer information. Bits 3 through 6 are conditions that produce a receiver line status interrupt whenever the condition corresponding to the active bit is detected and the interrupt is enabled. This register is intended for read operations only and writing is not recommended.

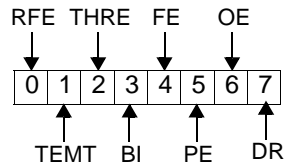
**Figure 21-8. UART Line Status Registers (UARTx_LSR)**

0	RFE	Receiver FIFO Error Indicator 0 In FIFO mode, reset to 0 when the processor reads the UARTx_LSR, provided there are no subsequent errors in the FIFO. 1 There are one or more instances of parity error, framing error or break indication in the FIFO.	Always 0 in 16450 mode.
1	TEMT	Transmitter Empty Indicator 0 Reset to 0 whenever the THR or the transmitter shift register contain a character. In FIFO mode, it is reset to 0 whenever the transmitter FIFO or the transmitter shift register contain a character. 1 Set to 1 when the THR and the Transmitter shift register are both empty. In FIFO mode, it is set to 1 when the transmitter FIFO and the transmitter shift register are both empty.	
2	THRE	Transmitter Holding Register Empty Indicator 0 Concurrent reset to 0 with the loading of the THR by the processor. In FIFO mode it is reset to 0 when at least one byte is written to the transmitter FIFO. 1 Set to 1 when the UART is ready to accept a new character for transmission. In FIFO mode, this bit is set when the transmitter FIFO is empty.	When UARTx_IER[THRE] = 1, the UART issues an interrupt to the UIC. This bit is set to 1 when a character is transferred from the THR to the transmitter shift register.

3	BI	<p>Break Interrupt Indicator</p> <p>0 Reset to 0 whenever processor reads Line Status Register (LSR).</p> <p>1 Set to 1 whenever the received data input is held at the spacing level (0) for longer than a full word transmission time.</p>	<p>The word transmission time is the time required for the start bit, data bits (can be 5–8 bits), parity and stop bits. In FIFO mode, this error is reported to the processor when the character associated with the error is at the top of the FIFO. Only one 0 character is loaded into the receiver FIFO when a break occurs. After the next valid start bit is received and is in the marking state, the next character transfer is enabled. The error causes a Receiver Line Status Interrupt.</p>
4	FE	<p>Framing Error Indicator.</p> <p>0 Reset to 0 whenever processor reads LSR.</p> <p>1 Set to 1 whenever stop bit following the last data bit or parity bit is detected as 0 (spacing level). Indicates that a valid stop bit was not found in the received character.</p>	<p>Error causes a Receiver Line Status Interrupt.</p>
5	PE	<p>Parity Error Indicator.</p> <p>0 Reset to 0 whenever processor reads UARTx_LSR.</p> <p>1 Indicates that the received data character does not have the correct parity as determined by the even parity select bit (UARTx_LCR.[EPS]). Set to 1 upon detection of a parity error.</p>	<p>In FIFO mode, this error is revealed to the processor when the character this error is associated with is at the top of the FIFO. Error causes a Receiver Line Status Interrupt.</p>
6	OE	<p>Overrun Error Indicator.</p> <p>0 Reset to 0 whenever processor reads UARTx_LSR.</p> <p>1 Data in the RBR was read by the processor before the next character was transferred into the UARTx_RBR, hence the original data was lost.</p>	<p>In FIFO mode, if the incoming data continues to fill the FIFO beyond the trigger level, an OE occurs only after the FIFO is completely full and the entire next character has been received in the receiver shift register. The processor is informed of the OE immediately upon occurrence. The character in the shift register will be overwritten and will not be transferred to the FIFO. Error causes a Receiver Line Status Interrupt.</p>
7	DR	<p>Receiver Data Ready Indicator.</p> <p>0 Reset to 0 when all data has been read from the receiver FIFO or the UARTx_RBR.</p> <p>1 An entire incoming character has been received into the UARTx_RBR or receiver FIFO.</p>	

Note: UARTx_LSR is shown in standard PowerPC bit notation, where 0 is the MSb and 7 is the LSb.

Preliminary User's Manual**21.3.9 Modem Status Registers (UARTx_MSR)**

UARTx_MSR indicates the state of the modem (or peripheral device) control lines, and indicates whether any modem (or peripheral device) control lines have changed state.

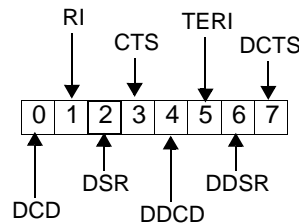
**Figure 21-9. UART Modem Status Registers (UARTx_MSR)**

0	DCD	Data Carrier Detect	In loopback mode (UARTx_MCR[LOOP] is 1), it is equivalent to UARTx_MCR[OUT2].
1	RI	Complement of Ring Indicator	In loopback mode (UARTx_MCR[LOOP] is 1), it is equivalent to UARTx_MCR[OUT1].
2	DSR	Complement of Data Set Ready	In loopback mode (UARTx_MCR[LOOP] is 1), it is equivalent to UARTx_MCR[DTR].
3	CTS	Complement of Clear To Send	In loopback mode (UARTx_MCR[LOOP] is 1), it is equivalent to UARTx_MCR[RTS].
4	DDCD	Delta Data Carrier Detect 0 Set when processor reads the Modem Status Register 1 DCD input changed state	Indicates that the $\overline{\text{DCD}}$ input to the UART has changed state since the processor last read the Modem Status Register. A modem status interrupt is generated.
5	TERI	Trailing Edge of Ring Indicator 0 Set when processor reads the Modem Status Register 1 RI input changed from 0 to 1	Indicates that the $\overline{\text{RI}}$ input to the UART changed from 0 to 1 since the processor last read the Modem Status Register. A modem status interrupt is generated.
6	DDSR	Delta Data Set Ready 0 Set when processor reads the Modem Status Register 1 DSR input changed state	Indicates that the $\overline{\text{DSR}}$ input to the UART has changed state since the processor last read the Modem Status Register. A modem status interrupt is generated.
7	DCTS	Delta Clear To Send 0 Set when processor reads the Modem Status Register 1 CTS input changed state	Indicates that the $\overline{\text{CTS}}$ input to the UART has changed state since the processor last read the Modem Status Register. A modem status interrupt is generated.
Note: UARTx_MSR is shown in standard PowerPC bit notation, where 0 is the MSb and 7 is the LSb.			

21.3.10 Scratchpad Registers (UARTx_SCR)

A scratchpad register intended for use by the programmer as a temporary data location is provided in this UART. It does not control the UART operation in any way.



Figure 21-10. Scratchpad Registers (UARTx_SCR)

0:7		Data bits
Note: UARTx_SCR is shown in standard PowerPC bit notation, where 0 is the MSb and 7 is the LSb.		

21.3.11 Divisor Latch LSB and MSB Registers (UARTx_DLL, UARTx_DLM)

The divisor latches are used to program the UART divisor used in generating the baud clock. A 16-bit divisor may be programmed through these registers. Access to these registers is provided by setting UARTx_LCR[DLAB] = 1. These registers have a power-on reset value of 0.

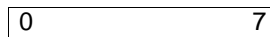

Figure 21-11. UART Baud-Rate Divisor Latch (MSB) Registers (UARTx_DLM)

0:7		Data bits
Note: UARTx_DLM is shown in standard PowerPC bit notation, where 0 is the MSb and 7 is the LSb.		

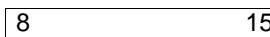

Figure 21-12. UART Baud-Rate Divisor Latch (LSB) Registers (UARTx_DLL)

8:15		Data bits
Note: UARTx_DLL is shown in standard PowerPC bit notation, where 0 is the MSb and 7 is the LSb.		

Preliminary User's Manual

The UART divisor is calculated using the following formula:

$$\text{UART Divisor} = \text{Serial Input Clock} / (16 \times \text{Baud Rate})$$

For example, if the serial input clock= 11.0592 MHz and a baud rate of 9600bps is required:

$$\begin{aligned} \text{UART Divisor} &= \text{Serial Input Clock} / (16 \times \text{Baud Rate}) \\ &= 11,059,200 / (16 \times 9600) \\ &= 72 = 0x48 \end{aligned}$$

For this example, UARTx_DLM should be programmed to 0 and UARTx_DLL register should be programmed to 0x48. Due to the error introduced by rounding, some baud rates cannot be generated at certain serial input clock frequencies. Table 21-4 lists some common baud rates and their corresponding Divisor Latch register values with a serial input clock of 11.0592 MHz.

Table 21-4. Divisor Latch Settings for Certain Baud Rates

Baud Rate (bps)	Divisor Latch MSB	Divisor Latch LSB
9600	0x00	0x48
19200	0x00	0x24
28800	0x00	0x18
38400	0x00	0x12
57600	0x00	0x0C

21.4 FIFO Operation

There are two modes of FIFO operation, interrupt mode and polled mode.

21.4.1 Interrupt Mode

Receiver and transmitter interrupts can occur in interrupt mode.

21.4.1.1 Receiver Interrupts

Receiver interrupts occur as described below when the receiver FIFO and receiver interrupts are enabled by setting UARTx_FCR[FE] = 1 and UARTx_IER[ERBFI] = 1.

The received data available interrupt is issued when the number of characters in the FIFO has reached the trigger level programmed into UARTx_FCR. This interrupt is cleared (set to 0) when the FIFO character count drops below this trigger level.

The received data available indicator is issued when the number of characters in the FIFO has reached the trigger level programmed into UARTx_FCR. This indicator is reset to 0 when the FIFO character count drops below this trigger level.

The receiver line status interrupt (UARTx_IIR = 0xC6) is a top priority interrupt, whereas the received data available interrupt (UARTx_IIR = 0xC4) is a second priority interrupt.

Data Ready (UARTx_LSR[DR]) is when a character is transferred from the shift register to the receiver FIFO. This bit is reset when the FIFO is empty.

Receiver timeout interrupts will occur as described below when the receiver FIFO and receiver interrupts are enabled by setting UARTx_FCR[FE] = 1 and UARTx_IER[ERBFI] = 1.

A FIFO timeout occurs when at least one character is in the receiver FIFO, no serial characters have been received for four serial character time periods, and the processor has not read the FIFO for four serial character time periods. A serial character time period is as follows:

$$1/(\text{baud rate}) \times (\text{number of start bits} + \text{word length} + \text{number of parity bits} + \text{number of stop bits})$$

For example, the serial character time period for an 8-bit word with one parity bit, two stop bits at 56K baud is:

$$1/(56000) \times (1 + 8 + 1 + 2) = 214.3\mu\text{s}$$

Therefore, the timeout would occur after 857.1 μs , if the above conditions hold.

When a timeout interrupt has occurred, it is cleared and the timer is reset when the processor reads one character from the receiver FIFO.

When a timeout interrupt has not occurred, the timer is reset after a new serial character is received or the processor reads the receiver FIFO.

21.4.1.2 Transmitter Interrupts

Transmitter interrupts occur when the transmitter FIFO and transmitter interrupts are enabled (UARTx_FCR[FE] = 1 and UARTx_IER[ETBEI] = 1).

The transmitter holding register interrupt (UARTx_IIR = 0xC2) occurs when transmit FIFO is empty, and is cleared as soon as the transmitter holding register is written to or the IIR is read. One to 16 characters may be written to the transmitter FIFO while servicing this interrupt.

The transmitter FIFO empty indications are delayed by one character time minus the last stop bit time whenever the following event occurs: UARTx_LSR[THRE] = 1 and there were less than two bytes simultaneously present in the transmit FIFO since the last UARTx_LSR[THRE] = 1. If UARTx_FCR[FE] = 1 (FIFOs enabled), the first transmitter interrupt after changing UARTx_FCR[FE] is immediate.

Receiver FIFO trigger level interrupts, received data available interrupts, and character timeouts all have equivalent second interrupt priority. Current transmitter holding register empty interrupt and Transmit FIFO empty have equivalent third interrupt priority.

21.4.2 Polled Mode

When UARTx_FCR[FE] = 1 (FIFOs enabled), and UARTx_IER[5:7] are all set to 0 (interrupts disabled), the UART is in FIFO polled mode of operation. The receiver and transmitter are controlled separately, so either can be in polled mode of operation. In polled mode, the user program must check the UARTx_LSR to see the status of the receiver and/or transmitter.

UARTx_LSR[BI, FE, PE, OE] specifies which errors (if any) have occurred. Character status errors are handled in the same way as in interrupt mode. Since UARTx_IER[ELSI] = 0, the IIR is not affected.

UARTx_LSR[DR] is set as long as there is at least one character in the receiver FIFO. UARTx_LSR[THRE] indicates if the transmitter FIFO is empty. UARTx_LSR[TEMT] indicates if the transmitter FIFO and the transmitter shift register are empty. UARTx_LSR[RFE] indicates if there are any errors in the receiver FIFO.

Preliminary User's Manual

In FIFO polled mode, there are no character timeout or trigger levels; however, the FIFOs are still capable of holding characters.

21.5 UART and Sleep Mode

Both UARTs can be placed in sleep mode via the UART sleep bits in the CPC0_ER register (CPC0_ER[UART0:UART1]). The most common usage would be to save a little power if one or both of the UARTs were not going to be used.

Using sleep mode dynamically requires careful software control to make sure the UARTs are idle before putting them to sleep.

21.6 DMA Operation

The DMA controller can be configured to perform DMA operations using UART0, which appears as an 8-bit peripheral to the DMA controller. When selected, the UART receiver is internally wired to the DMAReq and DMAAck signals of DMA channel 2, and the transmitter is internally wired to the DMAReq and DMAAck signals of DMA channel 3.

The UART can be operated in FIFO mode or non-FIFO mode. In FIFO mode, the transfers can be done as single transfers (DMA mode 0) or multiple transfers (DMA mode 1), depending on the setting of the DMS field in the FIFO Control Register (FCR). In non-FIFO mode, DMA transfers are performed using single transfers, using the UART's DMA mode 0. For more information on general DMA programming, see Chapter 18., "Direct Memory Access Controller," on page 18-501.

21.6.1 Chip Control Register 0 (CPC0_CR0)

Only CPC0_CR0 fields related to UART are shown in Figure 21-13. Other unrelated functions are not shown here.

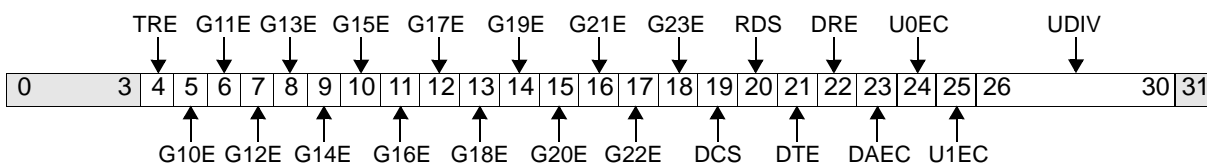

Figure 21-13. Chip Control Register 0 (CPC0_CR0)

0:3		Reserved
4	TRE	CPU Trace Enable 0 GPIO1-9 are enabled 1 GPIO1-9 are disabled Trace interface cannot be used when GPIO is enabled.
5	G10E	GPIO 10 <u>Enable</u> 0 Enable <u>PerCS1</u> as a chip select 1 Enable PerCS1 as GPIO10
6	G11E	GPIO 11 <u>Enable</u> 0 Enable <u>PerCS2</u> as a chip select 1 Enable PerCS2 as GPIO11

7	G12E	GPIO 12 <u>Enable</u> 0 Enable <u>PerCS3</u> as a chip select 1 Enable <u>PerCS3</u> as GPIO12	
8	G13E	GPIO 13 <u>Enable</u> 0 Enable <u>PerCS4</u> as a chip select 1 Enable <u>PerCS4</u> as GPIO13	
9	G14E	GPIO 14 <u>Enable</u> 0 Enable <u>PerCS5</u> as a chip select 1 Enable <u>PerCS5</u> as GPIO14	
10	G15E	GPIO 15 <u>Enable</u> 0 Enable <u>PerCS6</u> as a chip select 1 Enable <u>PerCS6</u> as GPIO15	
11	G16E	GPIO 16 <u>Enable</u> 0 Enable <u>PerCS7</u> as a chip select 1 Enable <u>PerCS7</u> as GPIO16	
12	G17E	GPIO 17 <u>Enable</u> 0 Enable interrupt IRQ0 as an interrupt 1 Enable interrupt IRQ0 as GPIO17	<p>The purpose of G17E through G23E is to isolate the interrupt controller from activity on a shared pin when that pin is being used as a GPIO. For instance, when G17E is set to a 1, IRQ0 at the UIC will always be forced to a zero.</p> <p>Note: Setting G17E to a 0 will not prevent GPIO channel 17 (if configured as an output) from creating contention with the off-chip source of the IRQ input. Therefore, be sure to leave the shared GPIO channel disabled when using the pin as an interrupt input.</p>
13	G18E	GPIO 18 <u>Enable</u> 0 Enable interrupt IRQ1 as an interrupt 1 Enable interrupt IRQ1 as GPIO18	
14	G19E	GPIO 19 <u>Enable</u> 0 Enable interrupt IRQ2 as an interrupt 1 Enable interrupt IRQ2 as GPIO19	
15	G20E	GPIO 20 <u>Enable</u> 0 Enable interrupt IRQ3 as an interrupt 1 Enable interrupt IRQ3 as GPIO20	
16	G21E	GPIO 21 <u>Enable</u> 0 Enable interrupt IRQ4 as an interrupt 1 Enable interrupt IRQ4 as GPIO21	
17	G22E	GPIO 22 <u>Enable</u> 0 Enable interrupt IRQ5 as an interrupt 1 Enable interrupt IRQ5 as GPIO22	
18	G23E	GPIO 23 <u>Enable</u> 0 Enable interrupt IRQ6 as an interrupt 1 Enable interrupt IRQ6 as GPIO23	
19	DCS	DSR/CTS select for UART1 0 DSR is selected. 1 CTS is selected.	

Preliminary User's Manual

20	RDS	RTS/DTR select for UART1 0 RTS is selected. 1 DTR is selected.	
21	DTE	DMA Transmit Enable for UART0 0 DMA transmit channel is disabled. 1 DMA transmit channel is enabled.	
22	DRE	DMA Receive Enable for UART0 0 DMA receive channel is disabled. 1 DMA receive channel is enabled.	
23	DAEC	DMA Allow Enable Clear for UART0 0 DTE and DRE for UART0 are not cleared when the UART receives a corresponding terminal count. 1 DTE and DRE for UART0 are cleared when the UART receives a corresponding terminal count.	
24	U0EC	Select External Clock for UART0 0 UART0 uses the internally derived serial clock 1 UART0 uses the external UARTSerClk input	
25	U1EC	Select External Clock for UART1 0 UART1 uses the internally derived serial clock 1 UART1 uses the external UARTSerClk input	
26:30	UDIV	UART Internal Clock Divisor 00000 Divide by 1 00001 Divide by 2 00010 Divide by 3 . . . 11110 Divide by 31 11111 Divide by 32	UDIV specifies the divisor of the CPU clock frequency used to derive a UART serial clock frequency. For example, if the CPU is running at 200MHz, a divider value of 20 sets the serial clock frequency to 10MHz. Note: The serial clock frequency must be less than 1/2 the OPB frequency
31		Reserved	

21.6.2 Transmitter DMA Mode

The UART0 Transmit Channel Enable field of the Chip Control Register 0, CPC0_CR0[DTE], controls the use of the serial port transmitter as a DMA destination. For the transmitter in DMA mode 0 (UARTx_FCR[DMS] = 0), when the FIFOs are disabled or the FIFOs are enabled and there are no characters in the TX FIFO or Transmit Holding Register (THR), the DMA request goes active. Once activated, the DMA request goes inactive after the first character is loaded into the TX FIFO or THR. For the transmitter in DMA mode 1 (UARTx_FCR[DMS] = 1), when FIFOs are enabled and there is at least one unfilled position in the TX FIFO, the DMA request goes active. This signal will become inactive when the TX FIFO is completely full. To operate in this mode, DMA Channel Control Register 3 (DMA0_CR3) must be configured to accept DMA requests from an internal source. Setting the Peripheral Location (PL) bit of the DMA0_CR3 to a logic 1 configures the DMA channel to accept DMA requests from UART0. Other DMA registers and register fields must be programmed appropriately, see Chapter 18., "Direct Memory Access Controller," on page 18-501 for more information.

Table 21-5. UART0 Transmitter DMA Mode Register Field Settings

Register [Field]	Meaning
CPC0_CR0[DTE]=1	UART0 DMA Transmit channel is enabled using DMA channel 3.
CPC0_CR0[DAEC]	Set to 0 to not clear CPC0_CR0[DTE] enable when terminal count is reached, set to 1 to clear enable when terminal count is reached.
DMA0_CR3[TD]=0	DMA Channel 3 transfer direction is from memory to peripheral.
DMA0_CR3[PL]=1	DMA Channel 3 peripheral is on the OPB (UART0).
DMA0_CR3[PW]=00	Peripheral width is byte (8 bits).
DMA0_CR3[TM]=00	DMA Channel 3 is in peripheral mode.
DMA0_CR3[PWC]=000010	Peripheral Wait cycles, how long the internal DMAck is active. Three cycles are required.
DMA0_CR3[PHC]=000	Peripheral Hold Cycles are 0.
DMA0_CR3[ETD]=1	EOT/TC is programmed as terminal count output.
UART0_FCR[DMS]	Set to 0 for a single DMA transfer or 1 for multiple DMA transfers.

Note: When using DMA Channel 3 for UART0 transmitter transfers, external DMA transfers cannot be performed on this channel.

Preliminary User's Manual**21.6.3 Receiver DMA Mode**

The UART0 Receive Enable field of the Chip Control Register 0, CPC0_CR0[DTE], controls the use of the serial port receiver as a DMA source. For the receiver in DMA mode 0 (UARTx_FCR[DMS] = 0), when there is at least one character in the RX FIFO or Receive Buffer Register, RBR, the DMA request goes active. Once activated, the DMA request goes inactive when there are no more characters in the FIFO or RBR. For the receiver in DMA mode 1 (UARTx_FCR[DMS] = 1), when the FIFOs are enabled and the trigger level or the timeout has been reached, the DMA request goes active. Once activated, it will go inactive when there are no more characters in the RX FIFO or RBR. To operate in this mode, DMA Channel Control Register 2 (DMA0_CR2) must be configured to accept DMA requests from an internal source. Setting the Peripheral Location (PL) bit of DMA0_CR2 to a logic 1 configures DMA channel to accept DMA requests from UART0. Other DMA registers and register fields must be programmed appropriately, see Chapter 18., "Direct Memory Access Controller," on page 18-501 for more information.

Table 21-6. UART0 Receiver DMA Mode Register Field Settings

Register [Field]	Meaning
CPC0_CR0[DRE]=1	UART0 DMA Receiver channel is enabled using DMA channel 2.
CPC0_CR0[DAEC]	Set to 0 to not clear CPC0_CR0[DRE] enable when terminal count is reached, set to 1 to clear enable when terminal count is reached.
DMA0_CR2[TD]=1	DMA Channel 2 transfer direction is from peripheral to memory.
DMA0_CR2[PL]=1	DMA Channel 2 peripheral is on the OPB (UART0).
DMA0_CR2[PW]=00	Peripheral width is byte (8 bits).
DMA0_CR2[TM]=00	DMA Channel 2 is in peripheral mode.
DMA0_CR2[PWC]=000010	Peripheral Wait cycles (how long the internal DMAAck is active). Three cycles are required.
DMA0_CR2[PHC]=000	Peripheral Hold Cycles are 0.
DMA0_CR2[ETD]=1	EOT/TC is programmed as terminal count output.
UART0_FCR[DMS]	Set to 0 for a single DMA transfer or 1 for multiple DMA transfers.

Note: When using DMA Channel 2 for UART0 receiver transfers, external DMA transfers cannot be performed on this channel.

Chapter 22. IIC Bus Interface

The PPC405GP provides an inter-integrated circuit (IIC) bus interface designed to specifications contained in the Philips® Semiconductors document *The I²C-bus and how to use it (including specifications)* (1995 update).

The IIC bus is a two-wire, bi-directional, open-drain, low-speed serial interface. The serial clock (IICSCL) and serial data (IICSDA) lines are bidirectional, to support multiple bus masters and to mix high- and low-speed devices on the same bus.

The IIC interface (referred to as IIC to distinguish it from the Philips I²C bus) supports the following standard and enhanced features:

- 100-kHz and 400-kHz operation
- 8-bit data transfers
- 7-bit and 10-bit addressing
- Slave transmitter and receiver
- Master transmitter and receiver
- Multiple bus masters

The IIC interface can switch between 7-bit and 10-bit addressing under program control.

22.1 Addressing

The IIC interface supports 7-bit and 10-bit addressing for master and slave transfers.

Addressing is described in detail in “IIC0 Low Master Address Register (IIC0_LMADR)” on page 22-636, “IIC0 High Master Address Register (IIC0_HMADR)” on page 22-637, “IIC0 Low Slave Address Register (IIC0_LSADR)” on page 22-645, and “IIC0 High Slave Address Register (IIC0_HSADR)” on page 22-646.

Descriptions of addressing modes and address formats follow.

22.1.1 Addressing Modes

For master transfers, the address mode (AMD) field of the IIC Control register (IIC0_CNTL) controls whether 7-bit or 10-bit addresses are used. If IIC0_CNTL[AMD] = 0, addresses contain 7 bits; if IIC0_CNTL[AMD] = 1, addresses contain 10 bits.

For slave transfers, the contents of the IIC0 High Slave Address register (IIC0_HSADR) determines whether 7-bit or 10-bit addressing is used. If IIC0_HSADR = 0b00000000, 7-bit addressing is used. If 10-bit addressing is to be used for slave transfers, IIC0_HSADR = 0b11110yyx, where yy contains the high-order bits of the 10-bit address, and x is a don't care.

Programming Note: For slave transfers, IIC0_CNTL[AMD] does not control addressing mode.

22.1.2 Seven-Bit Addresses

Figure 22-1 illustrates a 7-bit address. For master transfers, the address bits 0 through 6 (A0:A6) are read from IIC0_LMADR. For slave transfers, A0:A6 are read from IIC0_LSADR. Bit 7 of address byte 0 contains a transfer type bit provided by the IIC interface.

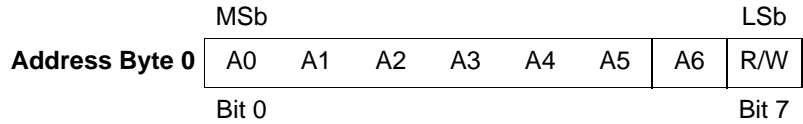

Figure 22-1. 7-Bit Addressing

22.1.3 Ten-Bit Addresses

Figure 22-2 illustrates a 10-bit address. A0:A1 of address byte 0 are read from IIC0_HMADR[A6:A7] (for master transfers) or IIC0_HSADR[A6:A7] (for slave transfers). These are the two highest-order address bits transmitted on the IIC bus. Bit 7 of address byte 0 contains a transfer type bit provided by the IIC interface.

For 10-bit addressing for master or slave transfers, respectively, IIC0_HMADR[A0:A4] and IIC0_HSADR [A0:A4] must contain 0b11110.

The low-order byte of the 10-bit address, contained in A0:A7 of address byte 1, are read from IIC0_LMADR or IIC0_LSADR for master or slave transfers, respectively.

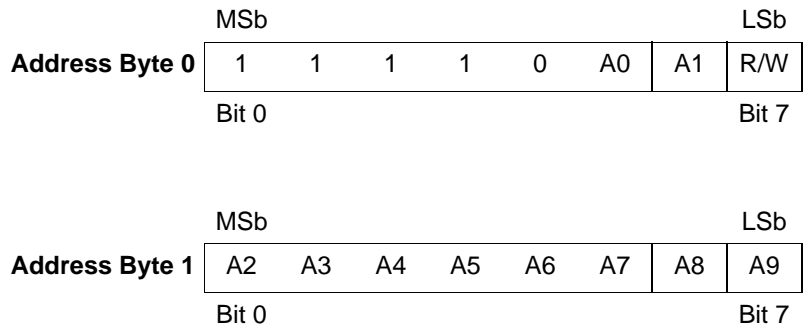

Figure 22-2. 10-Bit Addressing

Preliminary User's Manual**22.2 IIC Registers**

IIC registers are accessed at memory locations 0xEF600500–0xEF600510 in the PPC405GP.

Table 22-1 lists the IIC registers. Descriptions of the registers, in the listed order, follow in “IIC Register Descriptions” on page 22-634.

Table 22-1. IIC Registers

Register	Mnemonic	PPC405GP Memory Map	Address	Access	Effect of Reset	Bits
IIC0 Master Data Buffer	IIC0_MDBUF	0xEF60 0500	0x0	R/W	Cleared	8,16
Reserved		0xEF60 0501	0x1			
IIC0 Slave Data Buffer	IIC0_SDBUF	0xEF60 0502	0x2	R/W	Cleared	8,16
IIC0 Reserved		0xEF60 0503	0x3			
IIC0 Low Master Address	IIC0_LMADR	0xEF60 0504	0x4	R/W	No	8
IIC0 High Master Address	IIC0_HMADR	0xEF60 0505	0x5	R/W	No	8
IIC0 Control	IIC0_CNTL	0xEF60 0506	0x6	R/W	Cleared	8
IIC0 Mode Control	IIC0_MDCNTL	0xEF60 0507	0x7	R/W	Cleared	8
IIC0 Status	IIC0_STS	0xEF60 0508	0x8	R/W	Cleared	8
IIC0 Extended Status	IIC0_EXTSTS	0xEF60 0509	0x9	R/W	Cleared	8
IIC0 Low Slave Address	IIC0_LSADR	0xEF60 050A	0xA	R/W	No	8
IIC0 High Slave Address	IIC0_HSADR	0xEF60 050B	0xB	R/W	No	8
IIC0 Clock Divide	IIC0_CLKDIV	0xEF60 050C	0xC	R/W	Cleared	8
IIC0 Interrupt Mask	IIC0_INTRMSK	0xEF60 050D	0xD	R/W	Cleared	8
IIC0 Transfer Count	IIC0_XFRCNT	0xEF60 050E	0xE	R/W	Cleared	8
IIC0 Extended Control and Slave Status	IIC0_XTCNTLSS	0xEF60 050F	0xF	R/W	Cleared	8
IIC0 Direct Control	IIC0_DIRECTCNTL	0xEF60 0510	0x10	R/W	0x0f	4

22.3 IIC Register Descriptions

The following sections contains the bit definitions for the various registers in the IIC interface.

22.3.1 IIC0 Master Data Buffer (IIC0_MDBUF)

The IIC0 Master Data Buffer (IIC0_MDBUF) is a 1-byte × 4-byte first-in/first-out (FIFO) buffer. A byte written to IIC0_MDBUF is placed into the fourth FIFO stage. If the third FIFO stage is empty, the data is moved into the third stage at the next OPB clock. This process is repeated for the second and first FIFO stages at each successive OPB clock. The byte moves through the buffer until it reaches the deepest unoccupied stage of the FIFO. The buffer data is either written on the IIC bus when the IIC interface performs a write, or is received from the IIC bus when the IIC interface performs a read.

Figure 22-3 illustrates the IIC0_MDBUF.

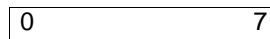

Figure 22-3. IIC0 Master Data Buffer (IIC0_MDBUF)

0		Data bit
1		Data bit
2		Data bit
3		Data bit
4		Data bit
5		Data bit
6		Data bit
7		Data bit

IIC0_MDBUF is cleared (flushed and set to empty) whenever the IIC interface is reset, or IIC0_MDCNTL[FMDB] = 1. Figure 22-4 shows the four FIFO stages.

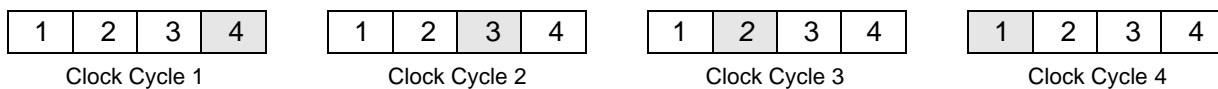

Figure 22-4. FIFO Stages

When IIC0_MDBUF is written with a byte, the byte is placed in the FIFO. The hardware pushes the byte into the deepest unoccupied stage in the FIFO and advances one FIFO stage per clock. Thus, if the FIFO is empty, four clocks are needed (one per stage) for the byte to walk to the first stage of the FIFO. This timing is important to consider when reading the IIC0_MDBUF immediately after data is written. When a master transfer is requested, the IIC interface handles this latency.

If a byte is written to IIC0_MDBUF while the FIFO is full, the byte is discarded and not placed into the FIFO.

Preliminary User's Manual

If IIC0_MDBUF is written with two bytes in a halfword access, and there is space in the FIFO, byte 0 of the halfword is placed ahead of byte 1 in the FIFO. The MSB, byte 0, is written to the IIC bus first, followed by the LSB, byte 1.

IIC0_MDBUF receives data from the IIC bus when the requested master transfer is a read. The first byte received is the first byte read by software from IIC0_MDBUF.

For halfword reads the first byte received is MSB, byte 0, and the following byte is LSB, byte 1. When an empty FIFO is read, the byte (or halfword) most recently read is returned.

Care must be taken not to start a requested master operation while there is data in IIC0_MDBUF. If, for example, a master read transfer is requested and obsolete data is in IIC0_MDBUF, the obsolete data would be presented, to the requesting software, as data read by the requested transfer.

22.3.2 IIC0 Slave Data Buffer (IIC0_SDBUF)

The IIC0 Slave Data Buffer (IIC0_SDBUF) is a copy of IIC0_MDBUF. The data contained in the slave buffer is either received from the IIC bus when the IIC interface is addressed as a slave during a write, or is written on the IIC bus when the IIC interface is addressed as a slave during a read operation.

IIC0_SDBUF works in the same way as IIC0_MDBUF, except that IIC0_SDBUF is used only to store data sent or received in slave transfers on the IIC bus. This enables overlapping slave and master transfers on the IIC bus.

Bit assignments for the IIC0_MDBUF and IIC0_SDBUF are identical, as illustrated in Figure 22-5.

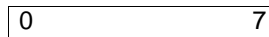
**Figure 22-5. IIC0 Slave Data Buffer (IIC0_SDBUF)**

0		Data bit
1		Data bit
2		Data bit
3		Data bit
4		Data bit
5		Data bit
6		Data bit
7		Data bit

IIC0_SDBUF is cleared (flushed and set to empty) whenever the IIC interface is reset, or IIC0_MDCNTL[FSBD] = 1.

22.3.3 IIC0 Low Master Address Register (IIC0_LMADR)

The IIC0 Low Master Address (IIC0_LMADR) and IIC0 High Master Address Register (IIC0_HMADR) form addresses that the IIC interface transmits on the IIC bus.

Programming Note: IIC0_HMADR is used only for 10-bit addressing.

When IIC0_CNTL[AMD] = 0 (7-bit addressing), only IIC0_LMADR is written. IIC0_LMADR[A0:A6] form the address transmitted on the IIC bus; IIC0_LMADR[A7] is a don't care. When IIC0_CNTL[AMD] = 1 (10-bit addressing), IIC0_LMADR[A0:A7] form the second byte address transmitted on the IIC bus.

Figure 22-6 illustrates the IIC0_LMADR.

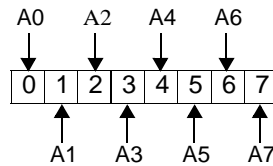

Figure 22-6. IIC0 Low Master Address Register (IIC0_LMADR)

0	A0	Address bit 0	
1	A1	Address bit 1	
2	A2	Address bit 2	
3	A3	Address bit 3	
4	A4	Address bit 4	
5	A5	Address bit 5	
6	A6	Address bit 6	LSb for 7-bit addresses
7	A7	Address bit 7	LSb for 10-bit addresses; don't care for 7-bit addresses

Preliminary User's Manual**22.3.4 IIC0 High Master Address Register (IIC0_HMADR)**

IIC0 High Master Address Register (IIC0_HMADR) is not used for 7-bit addressing.

When IIC0_CNTL[AMD] = 1 (10-bit addressing), IIC0_HMADR must be programmed to 0b1111 0yyx, where yy are the high-order bits of a 10-bit address and x is a don't care.

Thus, in 10-bit address mode, IIC0_HMADR[A5:A6] are the two highest-order bits of the 10-bit address and IIC0_HMADR[A7] is a don't care. IIC0_LMADR contains the low-order byte of the 10-bit address.

Figure 22-7 illustrates the IIC0_HMADR.

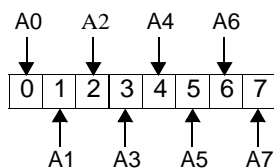

Figure 22-7. IIC0 High Master Address Register (IIC0_HMADR)

0	A0	Address bit 0	1 for 10-bit addresses
1	A1	Address bit 1	1 for 10-bit addresses
2	A2	Address bit 2	1 for 10-bit addresses
3	A3	Address bit 3	1 for 10-bit addresses
4	A4	Address bit 4	0 for 10-bit addresses
5	A5	Address bit 5	MSb for 10-bit addresses
6	A6	Address bit 6	Next to MSb for 10-bit addresses
7	A7	Address bit 7	Don't care for 10-bit addresses

22.3.5 IIC0 Control Register (IIC0_CNTL)

The IIC0 Control Register (IIC0_CNTL) starts and stops IIC interface master transfers on the IIC bus. When a transfer begins, the IIC interface uses the values in IIC0_CNTL to determine the type and size of the transfer.

Programming Note: IIC0_CNTL *must* be the last register programmed. Whenever IIC0_CNTL[PT] = 1, the IIC interface attempts to perform the requested transfer, using values set in other registers. Note that not all IIC registers must be programmed before performing each transfer.

During transfers, and after transfers finish, software can read the IIC0_STS and IIC0_EXTSTS registers to determine the state of the IIC interface and the IIC bus.

Only IIC0_CNTL[PT] is cleared when a requested master transfer is complete; the remaining bits are not affected.

Figure 22-8 illustrates the IIC0_CNTL.

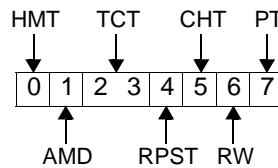

Figure 22-8. IIC0 Control Register (IIC0_CNTL)

0	HMT	Halt Master Transfer 0 Normal transfer operation. 1 Issue Stop signal on the IIC bus as soon as possible to halt master transfer.	If no transfer is in progress, no action is taken. IIC0_CNTL[PT] need not be set. If IIC0_MDCNTL[EINT] = 1, an interrupt is generated.
1	AMD	Addressing Mode 0 Use 7-bit addressing. 1 Use 10-bit addressing.	Does not affect slave transfers.
2:3	TCT	Transfer Count 00 Transfer one byte. 01 Transfer two bytes. 10 Transfer three bytes. 11 Transfer four bytes.	
4	RPST	Repeated Start 0 Normal start operation 1 Use repeated Start function to start transfer.	
5	CHT	Chain Transfer 0 Transfer is only or last transfer. 1 Transfer is one of a sequence of transfers (but not last in sequence).	Completion of a requested transfer causes a Stop signal to be issued on the IIC bus.
6	RW	Read/Write 0 Transfer is a write. 1 Transfer is a read.	
7	PT	Pending Transfer 0 Most recent requested transfer is complete. 1 Start transfer if bus is free.	

Preliminary User's Manual

Table 22-2 summarizes IIC interface operation for settings of IIC0_CNTL[HMT, RPST, CHT, PT] x is a don't care.

Table 22-2. IIC Response to IIC0_CNTL Field Settings

IIC0_CNTL Fields				Resulting Action on IIC Bus and Inside IIC Interface
HMT	RPST	CHT	PT	
0	x	x	0	No action taken
0	0	1	1	Start, Transfer, ACK on last byte, Pause
0	0	0	1	Start, Transfer, NACK on last byte, Stop
1	x	x	x	NACK on current byte, Stop
0	1	x	1	Start, Transfer, NACK on last byte, Wait

Settings of IIC0_CNTL[HMT, RPST, CHT, PT] result in the following actions.

Start	IIC Start condition generated, if the IIC interface was stopped or waiting.
Stop	IIC Stop condition generated; IIC interface enters the Stop condition.
ACK	IIC Acknowledge condition generated.
NACK	IIC Not Acknowledge condition generated, if performing a read.
Transfer	Requested bytes are transferred.
Pause	IIC interface enters the Pause state.
Wait	IIC interface enters the Wait state.

IIC0_CNTL[HMT] overrides IIC0_CNTL[RPST, CHT].

IIC0_CNTL[RPST, PT] overrides IIC0_CNTL[CHT].

22.3.6 IIC0 Mode Control Register (IIC0_MDCNTL)

The IIC0 Mode Control Register (IIC0_MDCNTL) sets the major modes of operation on the IIC bus. In addition, IIC0_MDCNTL can force the data buffers into the empty state.

In typical applications, IIC0_MDCNTL is configured once, during software initialization. Applications providing complex error handling may reconfigure this register more often.

Programming Note: IIC0_CLKDIV must be initialized before IIC0_MDCNTL. IIC0_LSADR and IIC0_HSADR should also be configured before IIC0_MDCNTL.

Note that the IIC hardware does not implement time-out functions on the IIC bus. Such functions must be implemented, in software, by setting IIC0_CNTL[HMT] = 1, or setting IIC0_XTCNTLSS[SRST] = 1.

Regarding IIC0_MDCNTL[HSCL], a "slave not ready" condition occurs during a slave receive operation, if a slave has no free space in its slave data buffer at the start of a write operation, or if the slave data buffer fills during the write. In a slave transmit operation, a slave not ready condition occurs if a slave has no data in its slave data buffer at the start of a read operation, or if the slave data buffer becomes empty during the read.

Using IIC0_MDCNTL[HSCL] to handle slave not ready conditions can affect system performance. A slave holding the IIC_SCL signal low guarantees data delivery to or from the requesting master, but prevents other masters from performing transfers over the IIC bus. There is no general rule for handling slave not ready conditions; each system has its own requirements.

Figure 22-9 illustrates the IIC0_MDCNTL.

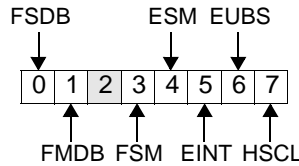

Figure 22-9. IIC0 Mode Control Register (IIC0_MDCNTL)

0	FSDB	Flush Slave Data Buffer 0 Normal operation 1 Set slave data buffer to empty.	Cleared after buffer is emptied.
1	FMDB	Flush Master Data Buffer 0 Normal operation 1 Set master data buffer to empty.	Cleared after buffer is emptied.
2		Reserved	
3	FSM	Fast/Standard Mode 0 IIC transfers run at 100 kHz (standard mode). 1 IIC transfers run at 400 kHz (fast mode).	
4	ESM	Enable Slave Mode 0 Slave transfers are ignored. 1 Slave transfers are enabled.	Program IIC0_LSADR and IIC0_HSADR before setting this field.
5	EINT	Enable Interrupt 0 Interrupts are disabled. 1 Enables interrupts for interrupts enabled in IIC0_INTRMSK.	
6	EUBS	Exit Unknown IIC Bus State 0 Normal operation. 1 IIC bus control state machine exits unknown bus state, if in an unknown state.	If the IIC bus control state machine is in a known state, setting IIC0_MDCNTL[EUBS] = 1 has no effect.
7	HSCL	Hold IIC Serial Clock Low 0 If slave is not ready, issue a NACK in response to slave transfer request. 1 If slave is not ready, hold the IIC_SCL signal low until slave is ready.	This field is used only when in slave mode.

Preliminary User's Manual**22.3.7 IIC0 Status Register (IIC0_STS)**

The IIC0 Status register (IIC0_STS) provides a summary of the state of the IIC interface and the status of any previously requested master transfer.

During and after transfers, software can read the IIC0_STS and IIC0_EXTSTS registers to determine the state of the IIC interface and the IIC bus.

Programming Note: IIC0_STS should be the first register read by an interrupt or error handler routine. IIC0_STS can also be read in a polling loop if software does not use the IIC interrupts.

Software must clear IIC0_STS before requesting another master transfer, except for IIC0_STS[SSS]. Because IIC0_STS[SSS] involves slave transfers, it can remain set.

Figure 22-10 illustrates IIC0_STS.

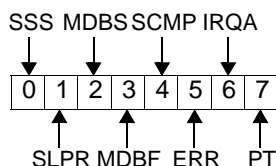

Figure 22-10. IIC0 Status Register (IIC0_STS)

0	SSS	Slave Status Set 0 No slave operations are in progress. 1 Slave operation is in progress.	Read-only; this field is set when any of the following fields are set: IIC0_XTCNTLSS[SR, SRRS, SWC, SWRS].
1	SLPR	Sleep Request 0 Normal operation. 1 Sleep mode (CPC0_ER[IIC] = 1).	Read-only. The IIC interface is awakened when a start signal is detected on the IIC bus or when the CPC0_ER[IIC] is cleared.
2	MDBS	Master Data Buffer Status 0 Master data buffer is empty. 1 Master data buffer contains data.	Read-only.
3	MDBF	Master Data Buffer Full 0 Master data buffer is not full. 1 Master data buffer is full.	Read-only.
4	SCMP	Stop Complete 0 No request to halt transfer, or master data transfer, is complete. 1 Request to halt transfer, or master data transfer, is complete.	To clear IIC0_STS[SCMP], set IIC0_STS[SCMP] = 1.
5	ERR	Error 0 No error has occurred. 1 One of the following fields is set: IIC0_EXTSTS[LA, ICT, XFRA] = 1.	Read-only.
6	IRQA	IRQ Active 0 No IIC interrupt has been sent to the universal interrupt controller (UIC). 1 An IIC interrupt has been sent to the UIC.	To clear IIC0_STS[IRQA], set IIC0_STS[IRQA] = 1. If IIC0_MDCNTL[EINT] = 0, then IIC0_STS[IRQA] is not set.

7	PT	Pending Transfer 0 No transfer is pending, or transfer is in progress. 1 Transfer is pending.	Read-only.
---	----	---	------------

The Error and Pending Transfer, IIC0_STS[ERR, PT], bit fields indicate the success or failure of the requested transfer. Table 22-3 interprets the transfer status for all possible combinations of the IIC0_STS[ERR,PT] bit fields.

Table 22-3. IIC0_STS[ERR, PT] Decoding

ERR	PT	Status
0	0	Requested transfer completed without errors
0	1	Requested transfer is in progress; no errors were detected
1	0	Requested transfer is complete, but not all data was transferred
1	1	Requested transfer is in progress; but an error was detected

Programming Note: Software should not take any action regarding a master transfer unless all pending transfers are completed, IIC0_STS[PT] = 0.

If an error requires the IIC interface to send a Stop, the Stop Complete bit field is set, IIC0_STS[SCMP] = 1. Note that slave operations should be serviced regardless of the state of a requested master transfer.

IIC0_MDCNTL[EUBS] must be set after a reset before the IIC interface can be placed in sleep mode. The IIC interface is placed in sleep mode by setting the CPC0_ER[IIC] via software. Awaking the IIC interface is possible directly through software by clearing the CPC0_ER[IIC] or indirectly by detecting a Start condition on the IIC bus. When a Start condition is detected, the IIC interface is awakened, and CPC0_SR[IIC] and IIC0_STS[SLPR] are cleared.

The IIC0_STS[MDBS, MDBF] contain the current status of the Master Data Buffer, IIC0_MDBUF. When the IIC0_MDBUF contains data, IIC0_STS[MDBS] is set. When the IIC0_MDBUF is full, IIC0_STS[MDBF] is set.

The state of the IIC0_MDBUF is not instantly recorded by the IIC0_STS[MDBS, MDBF]. The delay depends on the size of the buffer access. For halfword accesses, these fields are valid on the third OPB clock following the transfer. For byte accesses, these fields are valid on the second OPB clock following the transfer.

Preliminary User's Manual**22.3.8 IIC0 Extended Status Register (IIC0_EXTSTS)**

The IIC0 Extended Status register (IIC0_EXTSTS) reports additional IIC status.

During and after transfers, software can read the IIC0_STS and IIC0_EXTSTS registers to determine the state of the IIC interface and the IIC bus.

Figure 22-11 illustrates the IIC0_EXTSTS.

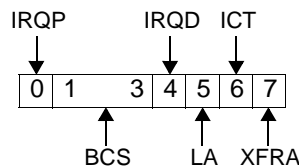

Figure 22-11. IIC0 Extended Status Register (IIC0_EXTSTS)

0	IRQP	<p>IRQ Pending</p> <p>0 No IRQ is pending.</p> <p>1 An IRQ is active, another IRQ is on-deck, and another interrupt-generating condition has occurred.</p>	<ul style="list-style-type: none"> • IIC0_EXTSTS[IRQP] might be set momentarily while an IRQ moves from the Pending to the On-deck state. • An interrupt remains pending, IIC0_EXTSTS[IRQP]=1, until the current on-deck interrupt becomes active, IIC0_EXTSTS[IRQD]=0 and IIC0_STS[IRQA]=1. • Writing 1 to IIC0_EXTSTS[IRQP] clears the field. • When the IIC interrupt is disabled, IIC0_MDCNTL[IRQP] = 0, IIC0_EXTSTS[IRQP] should be ignored.
1:3	BCS	<p>Bus Control State</p> <p>000 Unused; if this value is read, a major IIC hardware problem occurred.</p> <p>001 Slave-selected state; the IIC interface has detected and decoded a slave transfer request on the IIC bus.</p> <p>010 Slave Transfer state; the IIC interface has detected but has not decoded a slave transfer request on the IIC bus.</p> <p>011 Master Transfer state; entered after a master transfer request has started on the IIC bus.</p> <p>100 Free Bus state; the bus is free and no transfer request is pending.</p> <p>101 Busy Bus state; the bus is busy.</p> <p>110 Unknown state; value after IIC reset.</p> <p>111 Unused; if this value is read, a major IIC hardware problem occurred.</p>	Read-only.

4	IRQD	<p>IRQ On-Deck 0 No IRQ is on-deck. 1 An interrupt is active, and another interrupt-generating condition has occurred.</p>	<ul style="list-style-type: none"> • IIC0_EXTSTS[IRQD] might be set momentarily while an IRQ moves from the On-deck to the Active state. • An interrupt remains on-deck, IIC0_EXTSTS[IRQD] = 1, until the current active interrupt is no longer active, IIC0_STS[IRQA] = 0. • If IIC0_EXTSTS[IRQP] = 1, IIC0_EXTSTS[IRQD] is set on the next OPB clock. • Writing 1 to IIC0_EXTSTS[IRQD] clears the field. • When the IIC interrupt is disabled, IIC0_EXTSTS[IRQP]=0, IIC0_EXTSTS[IRQD] should be ignored.
5	LA	<p>Lost Arbitration 0 Normal operation. 1 Loss of arbitration has ended the requested master transfer.</p>	<ul style="list-style-type: none"> • If arbitration is lost, any requested master transaction may have terminated prematurely. Read data may be incomplete and not all write data may have been written. • If arbitration is lost during a repeat start, the master may not own the IIC bus.
6	ICT	<p>Incomplete Transfer 0 Normal operation. 1 Some of the bytes of the requested master transfer were not transferred.</p>	<p>For an incomplete transfer, read the transfer count, IIC0_XFRCNT, to determine how bytes were transferred.</p>
7	XFRA	<p>Transfer Aborted 0 No transfer is pending, or transfer is in progress. 1 A requested master transfer was aborted by a NACK during the transfer of the address byte, or was aborted because arbitration was lost. Lost arbitration can be caused by the loss of data during the transfer of the second or subsequent data byte.</p>	<p>Transfer aborted. When set to a 1, a requested master transfer was aborted by a NOT acknowledge during the transfer of the address byte. It is also set to a 1 when a requested master transfer loses data. Lost arbitration can be caused by the loss of data during the transfer of the second or subsequent data byte.</p>

IIC0_EXTSTS[IRQP, IRQD] and IIC0_STS[IRQA] provide a FIFO for storing interrupts. A new interrupt is considered pending, and remains pending while an on-deck interrupt is present. Once the on-deck interrupt becomes active, the pending interrupt moves on-deck, and remains on-deck until there is no active interrupt. When the active interrupt is cleared, the on-deck (initially pending) interrupt becomes active.

Programming Note: An active interrupt remains active until software clears it.

IIC0_EXTSTS[BCS] indicates the state of the IIC interface. The field is read-only.

IIC0_EXTSTS[LA, ICT, XFRA] are cleared when IIC0_CNTL[PT] = 1.

Writing 1 to IIC0_EXTSTS[IRQP, IRQD, LA, ICT, XFRA] clears these fields.

Preliminary User's Manual**22.3.9 IIC0 Low Slave Address Register (IIC0_LSADR)**

The IIC0 Low Slave Address Register (IIC0_LSADR) and IIC0 High Slave Address Register (IIC0_HSADR) program the slave address of the IIC interface. IIC0_HSADR is used only for 10-bit addressing, and is not programmed in 7-bit addressing mode.

When 7-bit addressing is used, IIC0_LSADR is written with the slave address; IIC0_HSADR must be written with zeros. For 7-bit addressing, IIC0_LSADR[A0:A6] contain the address transmitted on the IIC bus; IIC0_LSADR[A7] is a don't care.

When 10-bit addressing is used, IIC0_LSADR[A0:A7] contain the second address byte transmitted on the IIC bus.

Figure 22-6 illustrates the IIC0_LSADR.

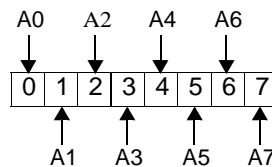

Figure 22-12. IIC0 Low Slave Address Register (IIC0_LSADR)

0	A0	Address bit 0	
1	A1	Address bit 1	
2	A2	Address bit 2	
3	A3	Address bit 3	
4	A4	Address bit 4	
5	A5	Address bit 5	
6	A6	Address bit 6	LSb for 7-bit addresses
7	A7	Address bit 7	LSb for 10-bit addresses; don't care for 7-bit addresses

22.3.10 IIC0 High Slave Address Register (IIC0_HSADR)

For 7-bit addressing, set IIC0 High Slave Address Register (IIC0_HSADR) to 0.

To enable 10-bit slave addressing, IIC0_HSADR must be programmed to 0b1111 0yyx, where yy are the high-order bits of a 10-bit address and x is a don't care.

Programming Note: IIC0_HSADR is used only for 10-bit addressing, and should be set to 0 for 7-bit addressing mode.

Thus, in 10-bit address mode, IIC0_HSADR[A6:A7] contain the two highest -order bits of the 10-bit address; IIC0_HSADR[A7] is a don't care. IIC0_LSADR contains the low-order byte of the 10-bit address.

Figure 22-13 illustrates the IIC0_HSADR.

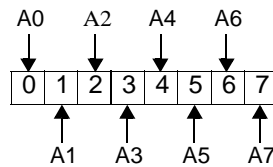

Figure 22-13. IIC0 High Slave Address Register (IIC0_HSADR)

0	A0	Address bit 0	1 for 10-bit addresses
1	A1	Address bit 1	1 for 10-bit addresses
2	A2	Address bit 2	1 for 10-bit addresses
3	A3	Address bit 3	1 for 10-bit addresses
4	A4	Address bit 4	0 for 10-bit addresses
5	A5	Address bit 5	MSb for 10-bit addresses
6	A6	Address bit 6	Next to MSb for 10-bit addresses
7	A7	Address bit 7	Don't care for 10-bit addresses

Thus, in 10-bit address mode, bits 0:6 are used to decode the first address byte that was transmitted on the IIC bus, and bit 7 is in a *don't care* state.

Preliminary User's Manual**22.3.11 IIC0 Clock Divide Register (IIC0_CLKDIV)**

The IIC0 Clock Divide Register (IIC0_CLKDIV) establishes a reference between the OPB clock and the IIC bus serial clock.

Programming Note: IIC0_CLKDIV must be initialized before IIC0_MDCTRL. Until IIC0_CLKDIV is initialized, all IIC bus activity is ignored.

Figure 22-14 illustrates the IIC0_CLKDIV.

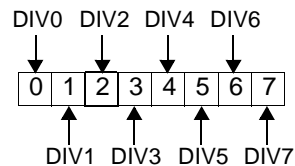

Figure 22-14. IIC0 Clock Divide Register (IIC0_CLKDIV)

0	DIV0	Divisor bit 0
1	DIV1	Divisor bit 1
2	DIV2	Divisor bit 2
3	DIV3	Divisor bit 3
4	DIV4	Divisor bit 4
5	DIV5	Divisor bit 5
6	DIV6	Divisor bit 6
7	DIV7	Divisor bit 7

IIC0_CLKDIV divides PPC405GP's on-chip peripheral bus (OPB) clock to form the base clock for the IIC bus.

Table 22-4 lists the divisor values for several OPB frequency ranges. These divisor values apply for standard and fast mode. Select the divisor value by matching the OPB clock frequency to the corresponding frequency range in Table 22-4. For example, if the OPB clock frequency is 50MHz, select a divisor value of 0x4.

Table 22-4. IIC0 Clock Divide Programming

OPB Frequency Range (MHz)	Divisor Value
20	0x1
$20 < f \leq 30$	0x2
$30 < f \leq 40$	0x3
$40 < f \leq 50$	0x4
$50 < f \leq 60$	0x5

22.3.12 IIC0 Interrupt Mask Register (IIC0_INTRMSK)

The IIC0 Interrupt Mask Register (IIC0_INTRMSK) specifies which conditions can generate an IIC interrupt when the IIC interrupt is enabled, IIC0_MDCNTL[EINT]=1.

Figure 22-15 illustrates the IIC0_INTRMSK.

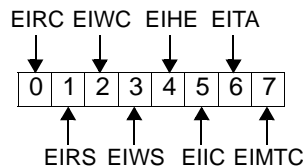

Figure 22-15. IIC0 Interrupt Mask Register (IIC0_INTRMSK)

0	EIRC	Enable IRQ on Slave Read Complete 0 Disable 1 Enable	The interrupt is activated upon receipt of a Stop during a slave read on the IIC bus. IIC0_XTCNTLSS[SRCS] = 1 indicates a Slave Read Complete.
1	EIRS	Enable IRQ on Slave Read Needs Service 0 Disable 1 Enable	The interrupt is activated upon receipt of a slave read on the IIC bus and the slave buffer was empty or went empty and more data was requested on the IIC bus. Note: IIC0_XTCNTLSS[SRS] = 1 indicates a Slave Read Needs Service.
2	EIWC	Enable IRQ on Slave Write Complete 0 Disable 1 Enable	The interrupt is activated upon receipt of a Stop during a slave write on the IIC bus. Note: IIC0_XTCNTLSS[SWC] = 1 indicates a Slave Write Complete.
3	EIWS	Enable IRQ on Slave Write Needs Service 0 Disable 1 Enable	The interrupt is activated when the slave buffer becomes full during a slave write on the IIC bus. Note: IIC0_XTCNTLSS[SWS] = 1 indicates a Slave Write Needs Service.
4	EIHE	Enable IRQ on Halt Executed 0 Disable 1 Enable	
5	EIIC	Enable IRQ on Incomplete Transfer 0 Disable 1 Enable	
6	EITA	Enable IRQ on Transfer Aborted 0 Disable 1 Enable	
7	EIMTC	Enable IRQ on Requested Master Transfer Complete 0 Disable 1 Enable	

Preliminary User's Manual**22.3.13 IIC0 Transfer Count Register (IIC0_XFRCNT)**

The IIC0 Transfer Count Register (IIC0_XFRCNT) reports the number of bytes transferred on the IIC bus during a master or a slave operation.

Figure 22-16 illustrates the IIC0_XFRCNT.

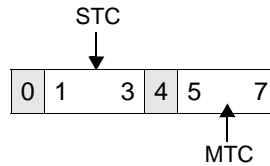

Figure 22-16. IIC0 Transfer Count Register (IIC0_XFRCNT)

0		Reserved
1:3	STC	Slave Transfer Count 000 0 bytes transferred 001 1 byte transferred 010 2 bytes transferred 011 3 bytes transferred 100 4 bytes transferred 101 Reserved 110 Reserved 111 Reserved
4		Reserved
5:7	MTC	Master Transfer Count 000 0 bytes transferred 001 1 byte transferred 010 2 bytes transferred 011 3 bytes transferred 100 4 bytes transferred 101 Reserved 110 Reserved 111 Reserved

IIC0_XFRCNT[MTC] is cleared when there is a pending transfer, IIC0_CNTL[PT] = 1.

IIC0_XFRCNT[STC] is cleared when:

- A slave operation starts on the IIC bus
- Software indicates the slave does not need service by clearing IIC0_XTCNTLSS[SRS] or IIC0_XTCNTLSS[SWS].

22.3.14 IIC0 Extended Control and Slave Status Register (IIC0_XTCNTLSS)

The IIC0 Extended Control and Slave Status Register (IIC0_XTCNTLSS) provides additional control of IIC interface functions and reports the status of slave operations.

Figure 22-17 illustrates the IIC0_XTCNTLSS.

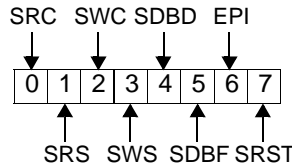

Figure 22-17. IIC0 Extended Control and Slave Status Register (IIC0_XTCNTLSS)

0	SRC	Slave Read Complete 0 Normal operation, or IIC0_MDCNTL[HSCL] = 0, IIC0_SDBUF is empty, and a read operation is in progress. 1 A NACK or Stop condition was received over the IIC bus, or a repeated Start condition ended a read operation.	Check whether the read operation emptied IIC0_SDBUF.
1	SRS	Slave Read Needs Service 0 Normal operation or slave read does not need service. 1 IIC0_SDBUF is empty, and a read operation was requested on the IIC bus. The set condition may also indicate that IIC0_SDBUF is empty due to a slave read and additional data is requested by the master.	1. If IIC0_MDCNTL[HSCL]=0 and IIC0_SDBUF contains no data, the slave will issue a NACK and IIC0_XTCNTLSS[SRS] is set. 2. If IIC0_MDCNTL[HSCL]=0, and IIC0_SDBUF contains data, the slave will send the data. IIC0_XTCNTLSS[SRS] is not set unless the master request additional data. 3. If IIC0_MDCNTL[HSCL]=0, and IIC0_SDBUF contains no data, the slave will hold IIC_SCL low to indicate the slave is busy. IIC0_XTCNTLSS[SRS] is set until the IIC0_SDBUF is filled. Once filled, IIC_SCL is released, IIC0_XTCNTLSS[SRS] is cleared, and the slave sends the data. 4. If IIC0_MDCNTL[HSCL]=1, and IIC0_SDBUF contains data, the slave will send the data. IIC0_XTCNTLSS[SRS] is not set unless the master requests additional data.
2	SWC	Slave Write Complete 0 Normal operation or slave write in progress. 1 A Stop signal was received during a write operation, or a repeated Start condition ended a write operation.	

Preliminary User's Manual

3	SWS	Slave Write Needs Service 0 Normal operation or slave write does not need service. 1 IIC0_SDBUF is full during a slave write.	1. If IIC0_MDCNTL[HSCL] = 1 and IIC0_SDBUF is full, the slave will hold IIC_SCL low to indicate the slave is busy. IIC0_XTCNTLSS[SWS] is set until IIC0_SDBUF is empty. Once empty, IIC_SCL is released, IIC0_XTCNTLSS[SWS] is cleared, and the slave receives the data. 2. If IIC0_MDCNTL[HSCL] = 0 and IIC0_SDBUF is full, the slave will issue a NACK and IIC0_XTCNTLSS[SWS] is set.
4	SDBD	Slave Data Buffer Has Data 0 IIC0_SDBUF is empty 1 IIC0_SDBUF contains data	Read-only
5	SDBF	Slave Data Buffer Full 0 IIC0_SDBUF is not full 1 IIC0_SDBUF is full	Read-only
6	EPI	Enable pulsed IRQ. When set to a logic: 0 The IIC_IRQ signal stays active until the IRQ active bit, staus(1) is cleared. 1 The IIC_IRQ signal goes active for one clock period.	
7	SRST	Soft Reset 0 Normal operation 1 Soft reset	

Writing a 1 to IIC0_XTCNTLSS[*SRC*, *SRS*, *SWC*, *SWS*] clears these fields.

Care must be used when changing IIC0_XTCNTLSS[EPI]. If this field changes (from 1 to 0 or from 0 to 1) while an interrupt is active, the IIC interrupt signal is asserted to the universal interrupt controller (UIC).

The IIC0_XTCNTLSS[SDBD, SDBF] contain the current status of the Slave Data Buffer, IIC0_SDBUF. When the IIC0_SDBUF contains data, IIC0_XTCNTLSS[SDBD] is set. When the IIC0_SDBF is full, IIC0_XTCNTLSS[SDBF] is set.

The state of the IIC0_SDBUF is not instantly recorded by the IIC0_XTCNTL[SDBD, SDBF]. The delay depends on the size of the buffer access. For half-word accesses, these fields are valid on the third OPB clock following the transfer. For byte accesses, these fields are valid on the second OPB clock following the transfer.

If any of the following fields: IIC0_XTCNTLSS[*SRC*, *SRS*, *SWC*, *SWS*] = 1 and IIC0_MDCNTL[HSCL] = 0; no new slave operations will be accepted over the IIC bus. A NACK is issued until the slave service bits and the slave complete bits are cleared: IIC0_XTCNTLSS[*SRC*, *SRS*, *SWC*, *SWS*] = 0.

Soft reset, IIC0_XTCNTLSS[SRST], provides a last means of recovery from IIC interface or IIC bus failure. Once enabled, soft reset completely resets the IIC interface. All IIC registers are affected. All transmissions from the IIC interface are terminated. Enabling soft reset during an IIC transmission may improperly terminate the transmission and hang the IIC bus.

22.3.15 IIC0 Direct Control Register (IIC0_DIRECTCNTL)

The IIC0 Direct Control Register (IIC0_DIRECTCNTL), which controls and monitors the IIC serial clock (IIC0_SCL) and serial data (IIC0_SDA) signal, is used for error recovery when a malfunction is detected on the IIC interface.

Figure 22-18 illustrates the IIC0_DIRECTCNTL.

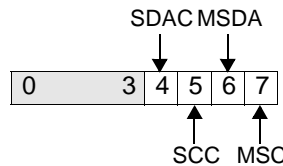

Figure 22-18. IIC0 Direct Control Register (IIC0_DIRECTCNTL)

0:3		Reserved	
4	SDAC	IICSDA Output Control Directly controls the IICSDA output. 0 IICSDA is a logic 0 1 IICSDA is a logic 1	
5	SCC	IIC0_SCL Output Control Directly controls the IIC0_SCL output 0 IIC0_SCL is a logic 0 1 IIC0_SCL is a logic 1	
6	MSDA	Monitor IICSDA Used to monitor the IICSDA input 0 IICSDA is a logic 0 1 IICSDA is a logic 1	Read-only
7	MSC	Monitor IIC0_SCL. Used to monitor the IIC0_SCL input. 0 IIC0_SCL is a logic 0 1 IIC0_SCL is a logic 1	Read-only

IIC0_DIRECTCNTL[SDAC, SCC] can be written to control the IICSDA and IIC0_SCL signals. When controlling the IICSDA and IIC0_SCL signals directly, the IIC controller must be placed in the reset state, IIC0_XTCNTLSS[SRST] = 1.

IIC0_DIRECTCNTL[MSDA, MSC] are used to verify that IIC0_DIRECTCNTL[SDAC, SCC] were written successfully, and that the IIC0_SCL signals can be controlled. If IIC0_DIRECTCNTL[MSDA, MSC] do not correspond to IIC0_DIRECTCNTL[SDAC, SCC], respectively, toggle IIC0_SCL repeatedly to regain control.

IIC0_DIRECTCNTL[SDAC, SCC, MSDA, MSC] = 1 after a chip or system reset. A Soft Reset, IIC0_XTCNTLSS[SRST] = 1, does not affect the state IIC0_DIRECTCNTL.

Preliminary User's Manual

22.4 Interrupt Handling

The IIC interface can handle interrupts in two ways. The processor can poll IIC0_STS[SSS, PT]. Alternatively, software can use IIC interface interrupts, IIC0_MDCNTL[EINT] and the interrupt mask bits in the IIC0_INTRMSK control interrupts. IIC0_XTCNTLSS[EPI] controls whether the IIC IRQ is set at a 1-clock pulse or at a constant level.

The IIC controller guarantees that the interrupt is activated after the state of the has been set to ensure that interrupt handlers read stable values from the IIC interface registers. IIC interrupts can generate interrupt requests to the UIC. If enabled properly in the UIC, an IIC interrupt can interrupt the processor core. See “Interrupt Handling in the Processor Core” on page 0-235 for more information.

Because a master operation can have one interrupt and a slave operation can have two interrupts, the IIC interface can queue up to three interrupts. The current interrupt is referred to as the *active* interrupt. The first interrupt in the queue is referred to as the *on-deck* interrupt; the second queued interrupt is called the *pending* interrupt. The queue holds multiple interrupts until the active interrupt is cleared by writing a 1 to IIC0_STS[IRQA]. When an active interrupt is cleared, the on-deck interrupt becomes the active interrupt and the pending interrupt becomes the on-deck interrupt.

Status associated with an IIC interrupt is immediately set in its corresponding register. Thus, an interrupt handler can see the status for the current and the queued interrupts. This can occur if, for example, the interrupt handler is itself interrupted before reading any status in the IIC registers. If a second or third interrupt occurs before the interrupt handler regains control, the status seen at this time will include status associated with all three interrupting conditions. In this case, the interrupt handler cannot determine the first interrupting condition; all the interrupts will appear to have been merged. Note that if the interrupt handler is intelligent enough to handle and clear all conditions currently set in the status, instead of choosing only one interrupt and servicing it, the routine would not see status for the subsequent interrupts.

A more typical situation involves the case where an interrupt handler has read the IIC status for the active interrupt and a second (on-deck) interrupt occurs. In this case, the status changed after it was first read by the interrupt handler. Because status bits are cleared by writing a 1, no ill effects, such as lost status information, result from this case. To illustrate, consider that the interrupt handler might have read IIC0_XTCNTLSS = 0x10 when the first interrupt occurred. Then, sometime later, the routine clears this status by writing 0x10 back to the IIC0_XTCNTLSS. If the slave write operation completes while the register is read and written, the register will contain a 0x30 when the 0x10 is written. Because writing 0 to a bit has no effect after it is set to 1, the slave write complete status is not lost.

Under certain conditions, the IIC interface merges slave read (write) needs service and slave read (write) complete interrupts into one interrupt. If a slave read (write) needs service interrupt is active, or queued, and a slave read (write) complete interrupt occurs, and IIC0_XTCNTLSS has not yet been read, the two interrupts are merged into a single interrupt. This merge function is performed in the IIC interface logic, and is not under software control.

22.5 General Considerations

1. After a reset, the IIC interface enters the unknown IIC bus state. This state is exited when either activity is seen on the bus or when the exit unknown IIC bus state bit, in the mode control register, is set to a 1. If the IIC interface is being used in a single master system as the master, then the exit unknown IIC bus state bit must be used to force the logic out of the unknown state.
2. Once a byte is written into either the master or slave buffer, a total of four OPB clock periods must occur before the data can be read. Flushing the master or slave buffer also requires four OPB clock periods to complete.
3. The master and slave buffers are actually 4×1 byte-wide FIFOs. Exercise care when using master and slave buffers. As an example, consider the case where one byte of data is written on the IIC bus. The data is first written into the master or slave buffer. After four OPB clock cycles the data is placed on the IIC bus. There is no way to verify data in the buffer without disturbing the IIC transaction. The act of verification requires removing the data. If the data is removed, invalid data is placed on the IIC bus.
4. Use care when monitoring the IIC0_XCNTLSS[SDBD] or IIC0_STS[MDBS] to determine when data is present. These bits are set to 1 when the buffer contains data in any stage. Consider the case where the master buffer is empty prior to being loaded with a byte received over the IIC bus. The byte enters the fourth stage of the buffer and the IIC0_STS[MDBS] is set to 1. Stages 1, 2, and 3 do not contain data. Therefore, the data is not available for four OPB clock cycles. Any attempt to prematurely read the data yields invalid data.
5. When responding to a slave needs service request, manage the data first. Read data out of the slave buffer, IIC0_SDBUF, for slave reads or write data into the IIC0_SDBUF for slave writes. Next clear the slave needs service request. For reads, clear IIC0_XTCNTLSS[SRS]. For writes, clear IIC0_XTCNTLSS[SWS]. Last, clear the active interrupt, IIC0_STS[IRQA] = 0.
6. There is no timeout function implemented in the IIC interface. If this type of error recovery function is needed, it must be implemented in software.
7. Avoid the situations listed in Section 7.2 of the *Philips Semiconductors I²C Specification*, dated 1995. For your convenience, the section is summarized as follows:

If multiple masters can be simultaneously involved in a transfer to the same address, or device, then the design of the system must be done in such a way that arbitration between:

 - A repeated Start condition and a data bit does not occur.
 - A Stop condition and a data bit does not occur.
 - A repeated Start condition and a Stop condition does not occur.

One example of a not allowed case would be if one master were to write 1 byte while another device wrote 2 bytes to the same device. In this situation, the first master would issue a Stop while the second master sends the MSb of the second data byte.

Chapter 23. GPIO Operations

This chapter describes the General Purpose I/O (GPIO) controller located on the on-chip peripheral bus (OPB) of the PPC405GP. The GPIO controller allows flexible control of up to 23 multiplexed I/Os with user-defined functions.

23.1 GPIO Controller Overview

The GPIO Controller is an OPB macro that controls up to 23 bidirectional module I/O pins with user-programmable functions. Each of these IOs are multiplexed with other signals to reduce the quantity of module I/O on the PPC405GP package. Control for this multiplexing is performed using the CPC0_CR0 register. See “External Module Signals” on page 23-657 for more information.

The GPIO outputs can be programmed to emulate an open drain driver.

All module I/O inputs are synchronized to the OPBCLK before being stored in the Input register.

All registers, except the Input Register, are both read and write accessible. The Input register is read-only. Registers provide direct control of all GPIO Controller functions.

All register bits and core input and output signals maintain a bit-for-bit correspondence. For example, GPIO_Out[20] is controlled by GPIO0_OR Register Bit 20.

23.2 Features

The GPIO Controller has the following features:

- Direct control of all functions from registers programmed via memory-mapped addresses
- Control of 23 bidirectional GPIO module pins
 - Each GPIO output has programmable three-state control
 - Each GPIO output is separately programmable to emulate an open drain driver
 - Each GPIO input is observable from a register bit

23.3 GPIO Interface Signals

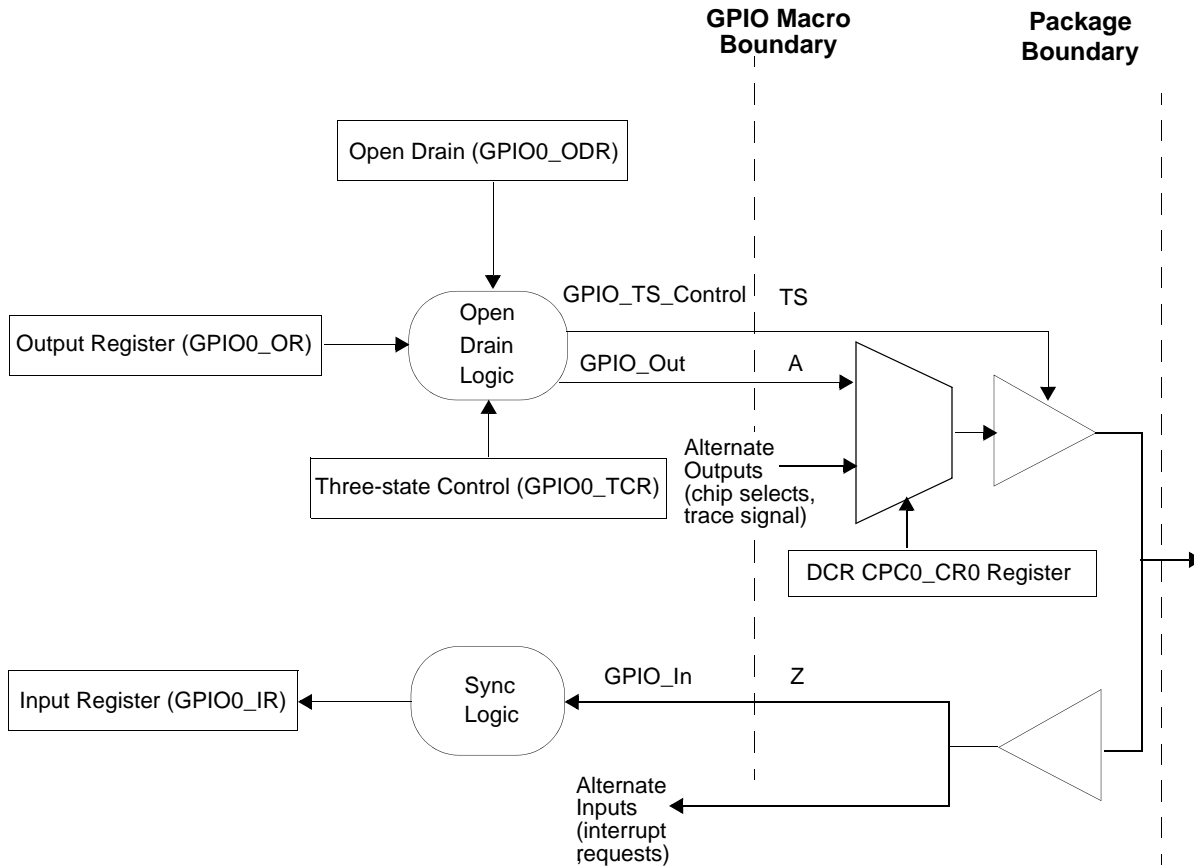

Figure 23-1. GPIO Functional Block Diagram

The following sections discuss the GPIO interface signals.

Preliminary User's Manual**23.3.1 External Macro Signals**

All registers within the GPIO Controller are synchronous to OPBCLK, and all GPIO_In inputs are synchronized to OPBCLK before being stored.

Table 23-1. Macro I/O Interface Signals

Signal Name	I/O	Function
GPIO_In(1:23)	I	Input to the GPIO Controller directly from Pin Z (Receiver Output). The bi-directional three-state driver books must be in the high impedance state in order to receive valid data as input from off chip.
GPIO_Out(1:23)	O	Data outputs from the GPIO Controller. These signals are designed to tie directly to Pin A (Driver Data Input).
GPIO_TS_Control(1:23)	O	Three-state control outputs from the GPIO Controller macro. These signals are designed to tie directly to each corresponding module I/O Pin TS (Driver Three-State Control). 0 = High Impedance 1 = Active (drive GPIO_Out signal)

23.3.2 External Module Signals

The GPIO signals do not have dedicated module pins. The module pins, used by the GPIO signals, are shared (multiplexed) with other signals. The Chip Control Register 0 (CPC0_CR0) controls the way in which the signal on a shared pin is interpreted. The following sections provide details of the CPC0_CR0 register bit settings and the function of the GPIO registers.

The GPIO signals are multiplexed with the following signals:

- 9 instruction trace signals
- 7 of the 8 EBC chip selects
- 7 external interrupt request inputs

Multiplexing is controlled by the setting of CPC0_CR0[0:31] as shown in Figure 23-2.

**Figure 23-2. CPC0_CR0 Bits Controlling GPIO**

4	TRE	CPU Trace Enable 0 GPIO1-9 are enabled 1 GPIO1-9 are disabled	Trace interface cannot be used when GPIO is enabled.
5	G10E	GPIO 10 Enable 0 Enable $\overline{\text{PerCS1}}$ as a chip select 1 Enable $\overline{\text{PerCS1}}$ as GPIO10	
6	G11E	GPIO 11 Enable 0 Enable $\overline{\text{PerCS2}}$ as a chip select 1 Enable $\overline{\text{PerCS2}}$ as GPIO11	

Figure 23-2. CPC0_CR0 Bits Controlling GPIO (continued)

7	G12E	GPIO 12 Enable 0 Enable <u>PerCS3</u> as a chip select 1 Enable PerCS3 as GPIO12	
8	G13E	GPIO 13 Enable 0 Enable <u>PerCS4</u> as a chip select 1 Enable PerCS4 as GPIO13	
9	G14E	GPIO 14 Enable 0 Enable <u>PerCS5</u> as a chip select 1 Enable <u>PerCS5</u> as GPIO14	
10	G15E	GPIO 15 Enable 0 Enable <u>PerCS6</u> as a chip select 1 Enable <u>PerCS6</u> as GPIO15	
11	G16E	GPIO 16 Enable 0 Enable <u>PerCS7</u> as a chip select 1 Enable PerCS7 as GPIO16	
12	G17E	GPIO 17 Enable 0 Enable interrupt IRQ0 as an interrupt 1 Enable interrupt IRQ0 as GPIO17	<p>The purpose of G17E through G23E is to isolate the interrupt controller from activity on a shared pin when that pin is being used as a GPIO. For instance, when G17E is set to a 1, IRQ0 at the UIC will always be forced to a zero.</p> <p>Note: Setting G17E to a 0 will not prevent GPIO channel 17 (if configured as an output) from creating contention with the off-chip source of the IRQ input. Therefore, be sure to leave the shared GPIO channel disabled when using the pin as an interrupt input.</p>
13	G18E	GPIO 18 Enable 0 Enable interrupt IRQ1 as an interrupt 1 Enable interrupt IRQ1 as GPIO18	
14	G19E	GPIO 19 Enable 0 Enable interrupt IRQ2 as an interrupt 1 Enable interrupt IRQ2 as GPIO19	
15	G20E	GPIO 20 Enable 0 Enable interrupt IRQ3 as an interrupt 1 Enable interrupt IRQ3 as GPIO20	
16	G21E	GPIO 21 Enable 0 Enable interrupt IRQ4 as an interrupt 1 Enable interrupt IRQ4 as GPIO21	
17	G22E	GPIO 22 Enable 0 Enable interrupt IRQ5 as an interrupt 1 Enable interrupt IRQ5 as GPIO22	
18	G23E	GPIO 23 Enable 0 Enable interrupt IRQ6 as an interrupt 1 Enable interrupt IRQ6 as GPIO23	

Preliminary User's Manual

In all cases when a pin is used as a GPIO, it is necessary to configure the appropriate bit in this register as well as the GPIO registers located in the GPIO controller.

23.4 Clock and Power Management

The GPIO Controller macro supports Clock and Power Management. Unconditional Sleep (Class 1) power management is implemented, and is enabled by setting the CPC0_ER[GPIO] bit.

23.5 GPIO Register Overview

Table 23-2 contains a summary of the GPIO registers.

Table 23-2. GPIO Register Summary

Mnemonic	Address	Access	Description
GPIO0_OR	0xEF600700	R/W	GPIO Output
GPIO0_TCR	0xEF600704	R/W	GPIO Three-State Control
GPIO0_ODR	0xEF600718	R/W	GPIO Open Drain
GPIO0_IR	0xEF60071C	R	GPIO Input
Note: GPIO registers are memory-mapped and accessed using load/store instructions at the register address.			

23.5.1 GPIO Register Reset Values

When a system reset occurs, each register in the GPIO macro, except GPIO0_IR, is reset to 0. All outputs are in the high impedance state. GPIO0_IR is not reset because it is always clocked and always follows the GPIO_In state.

23.5.2 Detailed Register Description

The following sections provide a bit description of the GPIO registers. All registers are accessed from the OPB. The GPIO0_IR register is read-only; all other registers are both read and write accessible.

0	1	2	3	4	5	6	7	8	9	10	11	12	13	14	15	16	17	18	19	20	21	22	23	24	31
---	---	---	---	---	---	---	---	---	---	----	----	----	----	----	----	----	----	----	----	----	----	----	----	----	----

Figure 23-3. GPIO Registers

0		Reserved
1:23		GPIO register bits
24:31		Reserved

23.5.2.1 GPIO Output Register (GPIO0_OR)

The state of each bit in the GPIO0_OR Register may be reflected in the corresponding GPIO Controller macro output signal GPIO_Out.

23.5.2.2 GPIO Three-State Control Register (GPIO0_TCR)

Each bit in the GPIO0_TCR Register controls the corresponding GPIO_TS_Control macro output signal. Each bit in the GPIO0_TCR Register controls the corresponding GPIO_TS_Control macro output signal.

When 0, GPIO_TS_Control forces the module I/O drivers into the high impedance state.

The state of the GPIO_Out signal driving Pin A (Driver Data Input) of the module I/O three-state driver is irrelevant when the driver is in the high impedance state. High impedance takes precedence over data output signals.

23.5.2.3 GPIO Open Drain Register (GPIO0_ODR)

The GPIO0_ODR configures the module I/O three-state driver to emulate open drain drivers on a bit-by-bit basis. This is done by controlling the GPIO_Out and GPIO_TS_Control signals, via the GPIO0_OR and GPIO0_TCR registers, respectively.

When programmed to 1, each bit in the GPIO0_ODR forces the corresponding GPIO_Out signal to 0 and the corresponding GPIO_TS_Control signal to the inverted GPIO_Out signal. In this case, the value of the corresponding bit in the GPIO0_TCR register is ignored. The open drain logic is shown in Table 23-3, "GPIO0_ODR Control Logic," on page 23-660.

When emulating an open drain driver, the module I/O driver never drives a 1 level. It either drives a 0 level or it is in the high impedance state emulating an open drain 1 level.

Table 23-3. GPIO0_ODR Control Logic

GPIO0_ODR Bit	GPIO0_OR Bit	GPIO_Out Macro Output	GPIO0_TCR Bit	GPIO_TS_Control Macro Output	Module I/O Three-State Driver
0	x	x	0	0	Forced to high impedance state
0	0	0	1	1	Driving 0
0	1	1	1	1	Driving 1
1	0	0	x	1	Driving 0
1	1	0	x	0	Forced to high impedance state

23.5.2.4 GPIO Input Register (GPIO0_IR)

The state of each bit in the GPIO0_IR Register reflects the corresponding GPIO Controller macro input signal GPIO_In. All GPIO_In signals are synchronized to OPBclk before being stored in the GPIO0_IR Register. The GPIO0_IR Register is read-only and does not change during a read access.

All bi-directional three-state drivers must be in the high impedance state in order to receive valid data as input from off chip.

Part V. Reference

Preliminary User's Manual

Chapter 24. Instruction Set

Descriptions of the PPC405GP instructions follow. Each description contains the following elements:

- Instruction names (mnemonic and full)
- Instruction syntax
- Instruction format diagram
- Pseudocode description
- Prose description
- Registers altered
- Architecture notes identifying the associated PowerPC Architecture component

Where appropriate, instruction descriptions list invalid instruction forms and exceptions, and provide programming notes.

24.1 Instruction Set Portability

To support embedded real-time applications, the instruction sets of the PPC405GP and other AMCC PowerPC 400 Series embedded controllers implement the AMCC PowerPC Embedded Environment, which is not part of the PowerPC Architecture defined in *The PowerPC Architecture: A Specification for a New Family of RISC Processors*.

Programs using these instructions are not portable to PowerPC implementations that do not implement the AMCC PowerPC Embedded Environment.

The PPC405GP implements a number of implementation-specific instructions that are not part of the PowerPC Architecture or the AMCC PowerPC Embedded Environment, which are listed in Table 24-1. In the table, the syntax “[o]” indicates that an instruction has an “o” form, which updates the XER[SO,OV] fields, and a “non-o” form. The syntax “[.]” indicates that an instruction has a “record” form, which updates CR[CR0], and a “non-record” form.

Table 24-1. Implementation-Specific Instructions

dccci	macchw[o][.]	mfdcr	nmacchw[o][.]	rfci
dcread	macchws[o][.]	mtdcr	nmacchws[o][.]	tlbre
iccci	macchwsu[o][.]	mulchw[.]	nmachhw[o][.]	tlbsx[.]
icread	macchwu[o][.]	mulchwu[.]	nmachhws[o][.]	tlbwe
	machhw[o][.]	mulhhw[.]	nmaclhw[o][.]	wrtee
	machhws[o][.]	mulhhwu[.]	nmaclhws[o][.]	wrteei
	machhwsu[o][.]	mullhw[.]		
	machhwu[o][.]	mullhwu[.]		
	maclhw[o][.]			
	maclhws[o][.]			
	maclhwsu[o][.]			
	maclhwu[o][.]			

24.2 Instruction Formats

For more detailed information about instruction formats, including a summary of instruction field usage and instruction format diagrams for the PPC405GP, see “Instruction Formats” on page 24-664.

Instructions are four bytes long. Instruction addresses are always word-aligned.

Instruction bits 0 through 5 always contain the primary opcode. Many instructions have an extended opcode in another field. The remaining instruction bits contain additional fields. All instruction fields belong to one of the following categories:

- **Defined**

These instructions contain values, such as opcodes, that cannot be altered. The instruction format diagrams specify the values of defined fields.

- **Variable**

These fields contain operands, such as general purpose register selectors and immediate values, that may vary from execution to execution. The instruction format diagrams specify the operands in variable fields.

- **Reserved**

Bits in a reserved field should be set to 0. In the instruction format diagrams, reserved fields are shaded.

If any bit in a defined field does not contain the expected value, the instruction is illegal and an illegal instruction exception occurs. If any bit in a reserved field does not contain 0, the instruction form is invalid and its result is architecturally undefined. Unless otherwise noted, the execute all invalid instruction forms without causing an illegal instruction exception.

24.3 Pseudocode

The pseudocode that appears in the instruction descriptions provides a semi-formal language for describing instruction operations.

The pseudocode uses the following notation:

=	Assignment
^	AND logical operator
¬	NOT logical operator
∨	OR logical operator
⊕	Exclusive-OR (XOR) logical operator
+	Twos complement addition
–	Twos complement subtraction, unary minus
×	Multiplication
÷	Division yielding a quotient
%	Remainder of an integer division; (33 % 32) = 1.
	Concatenation
=, ≠	Equal, not equal relations

Preliminary User's Manual

<, >	Signed comparison relations
\lessdot , \gtrdot	Unsigned comparison relations
if...then...else...	Conditional execution; if <i>condition</i> then <i>a</i> else <i>b</i> , where <i>a</i> and <i>b</i> represent one or more pseudocode statements. Indenting indicates the ranges of <i>a</i> and <i>b</i> . If <i>b</i> is null, the else does not appear.
do	Do loop. “to” and “by” clauses specify incrementing an iteration variable; “while” and “until” clauses specify terminating conditions. Indenting indicates the scope of a loop.
leave	Leave innermost do loop or do loop specified in a leave statement.
n	A decimal number
0xn	A hexadecimal number
0bn	A binary number
FLD	An instruction or register field
FLD _b	A bit in a named instruction or register field
FLD _{b:b}	A range of bits in a named instruction or register field
FLD _{b,b,...}	A list of bits, by number or name, in a named instruction or register field
REG _b	A bit in a named register
REG _{b:b}	A range of bits in a named register
REG _{b,b,...}	A list of bits, by number or name, in a named register
REG[FLD]	A field in a named register
REG[FLD, FLD...]	A list of fields in a named register
REG[FLD:FLD]	A range of fields in a named register
GPR(r)	General Purpose Register (GPR) <i>r</i> , where $0 \leq r \leq 31$.
(GPR(r))	The contents of GPR <i>r</i> , where $0 \leq r \leq 31$.
DCR(DCRN)	A Device Control Register (DCR) specified by the DCRF field in an mfdcr or mtdcr instruction
SPR(SPRN)	An SPR specified by the SPRF field in an mfspr or mtspr instruction
TBR(TBRN)	A Time Base Register (TBR) specified by the TBRF field in an mftb instruction
GPRs	RA, RB, ...
(Rx)	The contents of a GPR, where <i>x</i> is A, B, S, or T
(RA 0)	The contents of the register RA or 0, if the RA field is 0.
c _{0:3}	A four-bit object used to store condition results in compare instructions.
"b	The bit or bit value <i>b</i> is replicated <i>n</i> times.
xx	Bit positions which are don't-cares.
CEIL(x)	Least integer $\geq x$.
EXTS(x)	The result of extending <i>x</i> on the left with sign bits.

PC	Program counter.
RESERVE	Reserve bit; indicates whether a process has reserved a block of storage.
CIA	Current instruction address; the 32-bit address of the instruction being described by a sequence of pseudocode. This address is used to set the next instruction address (NIA). Does not correspond to any architected register.
NIA	Next instruction address; the 32-bit address of the next instruction to be executed. In pseudocode, a successful branch is indicated by assigning a value to NIA. For instructions that do not branch, the NIA is CIA +4.
MS(addr, n)	The number of bytes represented by <i>n</i> at the location in main storage represented by <i>addr</i> .
EA	Effective address; the 32-bit address, derived by applying indexing or indirect addressing rules to the specified operand, that specifies an location in main storage.
EA _b	A bit in an effective address.
EA _{b:b}	A range of bits in an effective address.
ROTL((RS),n)	Rotate left; the contents of RS are shifted left the number of bits specified by <i>n</i> .
MASK(MB,ME)	Mask having 1s in positions MB through ME (wrapping if MB > ME) and 0s elsewhere.
instruction(EA)	An instruction operating on a data or instruction cache block associated with an EA.

24.3.1 Operator Precedence

Table 24-2 lists the pseudocode operators and their associativity in descending order of precedence:

Table 24-2. Operator Precedence

Operators	Associativity
REG _b , REG[FLD], function evaluation	Left to right
ⁿ b	Right to left
¬, – (unary minus)	Right to left
×, ÷	Left to right
+, –	Left to right
	Left to right
=, ≠, <, >, < ^u , > ^u	Left to right
∧, ⊕	Left to right
∨	Left to right
←	None

Preliminary User's Manual

24.4 Register Usage

Each instruction description lists the registers altered by the instruction. Some register changes are explicitly detailed in the instruction description (for example, the target register of a load instruction). Other registers are changed, with the details of the change not included in the instruction description. This category frequently includes the Condition Register (CR) and the Fixed-point Exception Register (XER). For discussion of the CR, see “Condition Register (CR)” on page 3-91. For discussion of XER, see “Fixed Point Exception Register (XER)” on page 3-87.

24.5 Alphabetical Instruction Listing

The following pages list the instructions available in the PPC405GP in alphabetical order.

add
Add

add	RT, RA, RB	OE=0, Rc=0
add.	RT, RA, RB	OE=0, Rc=1
addo	RT, RA, RB	OE=1, Rc=0
addo.	RT, RA, RB	OE=1, Rc=1

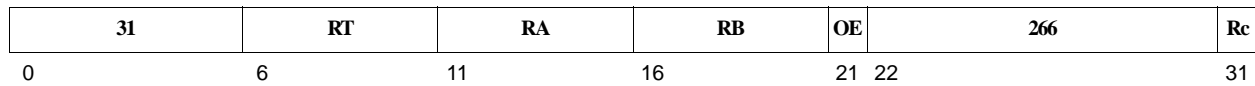

$(RT) \leftarrow (RA) + (RB)$

The sum of the contents of register RA and the contents of register RB is placed into register RT.

Registers Altered

- RT
- CR[CR0]_{LT, GT, EQ, SO} if Rc contains 1
- XER[SO, OV] if OE contains 1

Architecture Note

This instruction is part of the PowerPC User Instruction Set Architecture.

Preliminary User's Manual**addc**
Add Carrying

addc	RT, RA, RB	OE=0, Rc=0
addc.	RT, RA, RB	OE=0, Rc=1
addco	RT, RA, RB	OE=1, Rc=0
addco.	RT, RA, RB	OE=1, Rc=1

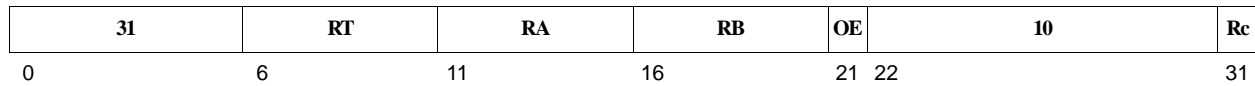

```

(RT) ← (RA) + (RB)
if (RA) + (RB)  $\geq$   $2^{32} - 1$  then
  XER[CA] ← 1
else
  XER[CA] ← 0

```

The sum of the contents of register RA and register RB is placed into register RT.

XER[CA] is set to a value determined by the unsigned magnitude of the result of the add operation.

Registers Altered

- RT
- XER[CA]
- CR[CR0]_{LT, GT, EQ, SO} if Rc contains 1
- XER[SO, OV] if OE contains 1

Architecture Note

This instruction is part of the PowerPC User Instruction Set Architecture.

adde
Add Extended

adde	RT, RA, RB	OE=0, Rc=0
adde.	RT, RA, RB	OE=0, Rc=1
addeo	RT, RA, RB	OE=1, Rc=0
addeo.	RT, RA, RB	OE=1, Rc=1

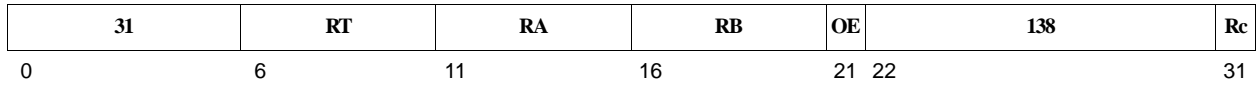

```

(RT) ← (RA) + (RB) + XER[CA]
if (RA) + (RB) + XER[CA] > 232 - 1 then
    XER[CA] ← 1
else
    XER[CA] ← 0
    
```

The sum of the contents of register RA, register RB, and XER[CA] is placed into register RT.
 XER[CA] is set to a value determined by the unsigned magnitude of the result of the add operation.

Registers Altered

- RT
- XER[CA]
- CR[CR0]_{LT, GT, EQ, SO} if Rc contains 1
- XER[SO, OV] if OE contains 1

Architecture Note

This instruction is part of the PowerPC User Instruction Set Architecture.

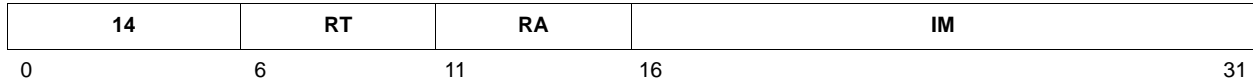
addi RT, RA, IM

$$(RT) \leftarrow (RA|0) + \text{EXTS}(IM)$$

If the RA field is 0, the IM field, sign-extended to 32 bits, is placed into register RT.

If the RA field is nonzero, the sum of the contents of register RA and the contents of the IM field, sign-extended to 32 bits, is placed into register RT.

Registers Altered

- RT

Programming Note

To place an immediate, sign-extended value into the GPR specified by RT, set RA = 0.

Architecture Note

This instruction is part of the PowerPC User Instruction Set Architecture.

Table 24-3. Extended Mnemonics for addi

Mnemonic	Operands	Function	Other Registers Altered
la	RT, D(RA)	Load address (RA ≠ 0); D is an offset from a base address that is assumed to be (RA). (RT) ← (RA) + EXTS(D) <i>Extended mnemonic for</i> addi RT,RA,D	
li	RT, IM	Load immediate. (RT) ← EXTS(IM) <i>Extended mnemonic for</i> addi RT,0,IM	
subi	RT, RA, IM	Subtract EXTS(IM) from (RA 0). Place result in RT. <i>Extended mnemonic for</i> addi RT,RA,-IM	

addic

Add Immediate Carrying

addic RT, RA, IM

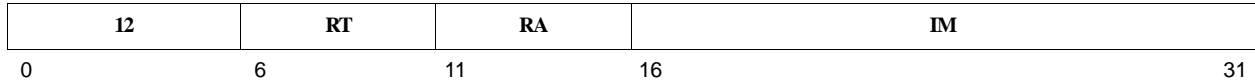

```
(RT) ← (RA) + EXTS(IM)
if (RA) + EXTS(IM) > 232 - 1 then
    XER[CA] ← 1
else
    XER[CA] ← 0
```

The sum of the contents of register RA and the contents of the IM field, sign-extended to 32 bits, is placed into register RT.

XER[CA] is set to a value determined by the unsigned magnitude of the result of the add operation.

Registers Altered

- RT
- XER[CA]

Architecture Note

This instruction is part of the PowerPC User Instruction Set Architecture.

Table 24-4. Extended Mnemonics for addic

Mnemonic	Operands	Function	Other Registers Altered
subic	RT, RA, IM	Subtract EXTS(IM) from (RA) Place result in RT; place carry-out in XER[CA]. <i>Extended mnemonic for</i> addic RT,RA,-IM	

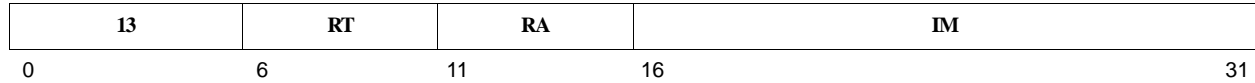
addic. RT, RA, IM

```

(RT) ← (RA) + EXTS(IM)
if (RA) + EXTS(IM) > 232 - 1 then
  XER[CA] ← 1
else
  XER[CA] ← 0

```

The sum of the contents of register RA and the contents of the IM field, sign-extended to 32 bits, is placed into register RT.

XER[CA] is set to a value determined by the unsigned magnitude of the result of the add operation.

Registers Altered

- RT
- XER[CA]
- CR[CR0]_{LT, GT, EQ, SO}

Programming Note

addic. is one of three instructions that implicitly update CR[CR0] without having an RC field. The other instructions are **andi.** and **andis.**

Architecture Note

This instruction is part of the PowerPC User Instruction Set Architecture.

Table 24-5. Extended Mnemonics for addic.

Mnemonic	Operands	Function	Other Registers Altered
subic.	RT, RA, IM	Subtract EXTS(IM) from (RA). Place result in RT; place carry-out in XER[CA]. <i>Extended mnemonic for</i> addic. RT,RA,-IM	CR[CR0]

addis

Add Immediate Shifted

addis RT, RA, IM

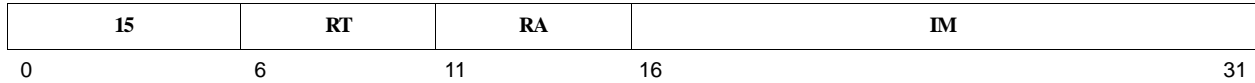

$$(RT) \leftarrow (RA|0) + (IM \parallel 160)$$

If the RA field is 0, the IM field is concatenated on its right with sixteen 0-bits and placed into register RT.

If the RA field is nonzero, the contents of register RA are added to the contents of the extended IM field. The sum is stored into register RT.

Registers Altered

- RT

Programming Note

An **addi** instruction stores a sign-extended 16-bit value in a GPR. An **addis** instruction followed by an **ori** instruction stores an arbitrary 32-bit value in a GPR, as shown in the following example:

```
addis    RT, 0, high 16 bits of value
ori     RT, RT, low 16 bits of value
```

Architecture Note

This instruction is part of the PowerPC User Instruction Set Architecture.

Table 24-6. Extended Mnemonics for addis

Mnemonic	Operands	Function	Other Registers Altered
lis	RT, IM	Load immediate shifted. (RT) ← (IM 160) <i>Extended mnemonic for addis RT,0,IM</i>	
subis	RT, RA, IM	Subtract (IM 160) from (RA 0). Place result in RT. <i>Extended mnemonic for addis RT,RA,-IM</i>	

addme	RT, RA	OE=0, Rc=0
addme.	RT, RA	OE=0, Rc=1
addmeo	RT, RA	OE=1, Rc=0
addmeo.	RT, RA	OE=1, Rc=1

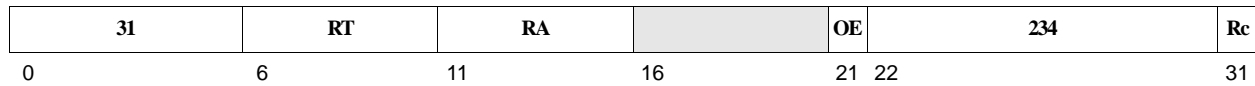

```

(RT) ← (RA) + XER[CA] + (-1)
if (RA) + XER[CA] + 0xFFFF FFFF > 232 - 1 then
    XER[CA] ← 1
else
    XER[CA] ← 0

```

The sum of the contents of register RA, XER[CA], and -1 is placed into register RT.

XER[CA] is set to a value determined by the unsigned magnitude of the result of the add operation.

Registers Altered

- RT
- XER[CA]
- CR[CR0]_{LT, GT, EQ, SO} if Rc contains 1
- XER[SO, OV] if OE contains 1

Invalid Instruction Forms

- Reserved fields

Architecture Note

This instruction is part of the PowerPC User Instruction Set Architecture.

addze

Add to Zero Extended

addze	RT, RA	OE=0, Rc=0
addze.	RT, RA	OE=0, Rc=1
addzeo	RT, RA	OE=1, Rc=0
addzeo.	RT, RA	OE=1, Rc=1

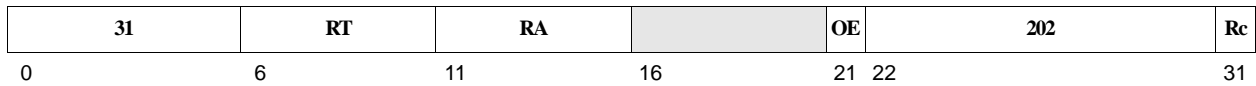

```

(RT) ← (RA) + XER[CA]
if (RA) + XER[CA] u > 232 - 1 then
    XER[CA] ← 1
else
    XER[CA] ← 0
    
```

The sum of the contents of register RA and XER[CA] is placed into register RT.

XER[CA] is set to a value determined by the unsigned magnitude of the result of the add operation.

Registers Altered

- RT
- XER[CA]
- CR[CR0]_{LT, GT, EQ, SO} if Rc contains 1
- XER[SO, OV] if OE contains 1

Invalid Instruction Forms

- Reserved fields

Architecture Note

This instruction is part of the PowerPC User Instruction Set Architecture.

and RA, RS, RB Rc=0
and. RA, RS, RB Rc=1

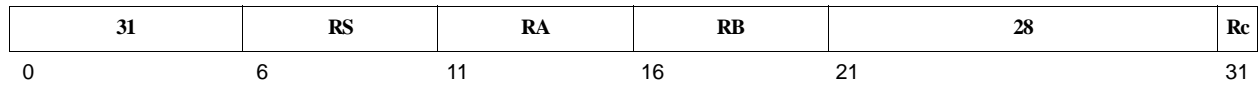

$(RA) \leftarrow (RS) \wedge (RB)$

The contents of register RS are ANDed with the contents of register RB; the result is placed into register RA.

Registers Altered

- RA
- CR[CR0]_{LT, GT, EQ, SO} if Rc contains 1

Architecture Note

This instruction is part of the PowerPC User Instruction Set Architecture.

andc

AND with Complement

andc RA,RS,RB Rc=0
andc. RA,RS,RB Rc=1

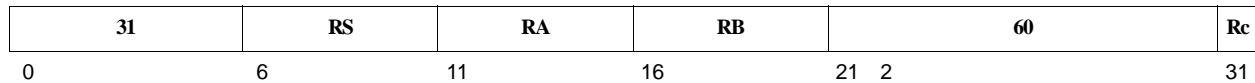

$$(RA) \leftarrow (RS) \wedge \neg(RB)$$

The contents of register RS are ANDed with the ones complement of the contents of register RB; the result is placed into register RA.

Registers Altered

- RA
- CR[CR0]_{LT, GT, EQ, SO} if Rc contains 1

Architecture Note

This instruction is part of the PowerPC User Instruction Set Architecture.

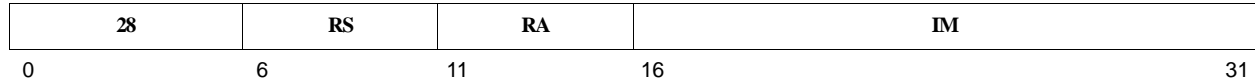
andi. RA, RS, IM

$$(RA) \leftarrow (RS) \wedge (^{16}0 \parallel IM)$$

The IM field is extended to 32 bits by concatenating 16 0-bits on its left. The contents of register RS is ANDed with the extended IM field; the result is placed into register RA.

Registers Altered

- RA
- CR[CR0]_{LT, GT, EQ, SO}

Programming Note

The **andi.** instruction can test whether any of the 16 least-significant bits in a GPR are 1-bits.

andi. is one of three instructions that implicitly update CR[CR0] without having an Rc field. The other instructions are **addic.** and **andis..**

Architecture Note

This instruction is part of the PowerPC User Instruction Set Architecture.

andis.

AND Immediate Shifted

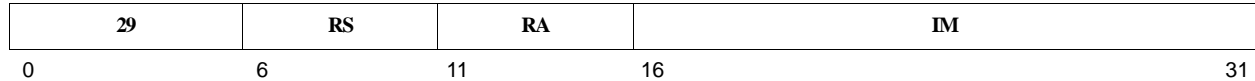
andis. RA, RS, IM

$$(RA) \leftarrow (RS) \wedge (IM \parallel 160)$$

The IM field is extended to 32 bits by concatenating 16 0-bits on its right. The contents of register RS are ANDed with the extended IM field; the result is placed into register RA.

Registers Altered

- RA
- CR[CR0]_{LT, GT, EQ, SO}

Programming Note

The **andis.** instruction can test whether any of the 16 most-significant bits in a GPR are 1-bits.

andis. is one of three instructions that implicitly update CR[CR0] without having an Rc field. The other instructions are **addic.** and **andi..**

Architecture Note

This instruction is part of the PowerPC User Instruction Set Architecture.

b	target	AA=0, LK=0
ba	target	AA=1, LK=0
bl	target	AA=0, LK=1
bla	target	AA=1, LK=1

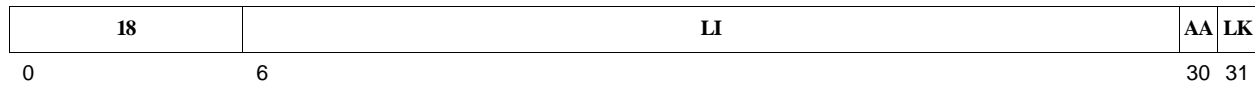

```

If AA = 1 then
  LI ← target6:29
  NIA ← EXTS(LI || 200)
else
  LI ← (target – CIA)6:29
  NIA ← CIA + EXTS(LI || 200)
if LK = 1 then
  (LR) ← CIA + 4
PC ← NIA

```

The next instruction address (NIA) is the effective address of the branch. The NIA is formed by adding a displacement to a base address. The displacement is obtained by concatenating two 0-bits to the right of the LI field and sign-extending the result to 32 bits.

If the AA field contains 0, the base address is the address of the branch instruction, which is also the current instruction address (CIA). If the AA field contains 1, the base address is 0.

Program flow is transferred to the NIA.

If the LK field contains 1, then (CIA + 4) is placed into the LR.

Registers Altered

- LR if LK contains 1

Architecture Note

This instruction is part of the PowerPC User Instruction Set Architecture.

bc

Branch Conditional

bc	BO, BI, target	AA=0, LK=0
bca	BO, BI, target	AA=1, LK=0
bcl	BO, BI, target	AA=0, LK=1
bcla	BO, BI, target	AA=1, LK=1

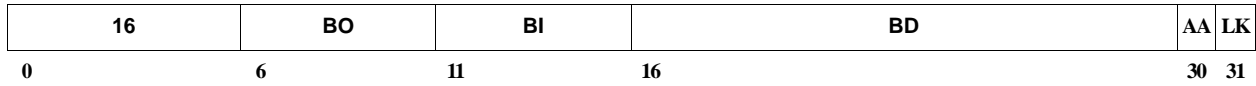

```

if BO2 = 0 then
    CTR ← CTR - 1
if (BO2 = 1 ∨ ((CTR = 0) = BO3)) ∧ (BO0 = 1 ∨ (CRBI = BO1)) then
    if AA = 1 then
        BD ← target16:29
        NIA ← EXTS(BD || 20)
    else
        BD ← (target - CIA)16:29
        NIA ← CIA + EXTS(BD || 20)
    else
        NIA ← CIA + 4
if LK = 1 then
    (LR) ← CIA + 4
PC ← NIA
    
```

If bit 2 of the BO field contains 0, the CTR decrements.

The BI field specifies a bit in the CR to be used as the condition of the branch.

The next instruction address (NIA) is the effective address of the branch. The NIA is formed by adding a displacement to a base address. The displacement is obtained by concatenating two 0-bits to the right of the BD field and sign-extending the result to 32 bits.

If the AA field contains 0, the base address is the address of the branch instruction, which is also the current instruction address (CIA). If the AA field contains 1, the base address is 0.

The BO field controls options that determine when program flow is transferred to the NIA. The BO field also controls branch prediction, a performance-improvement feature. See “Branch Prediction” on page 3-117 for a complete discussion.

If the LK field contains 1, then (CIA + 4) is placed into the LR.

Registers Altered

- CTR if BO₂ contains 0
- LR if LK contains 1

Architecture Note

This instruction is part of the PowerPC User Instruction Set Architecture.

Table 24-7. Extended Mnemonics for bc, bca, bcl, bcla

Mnemonic	Operands	Function	Other Registers Altered
bdnz	target	Decrement CTR; branch if CTR \neq 0. <i>Extended mnemonic for</i> bc 16,0,target	
bdnza		<i>Extended mnemonic for</i> bca 16,0,target	
bdnzl		<i>Extended mnemonic for</i> bcl 16,0,target	(LR) \leftarrow CIA + 4.
bdnzla		<i>Extended mnemonic for</i> bcla 16,0,target	(LR) \leftarrow CIA + 4.
bdnzf	cr_bit, target	Decrement CTR. Branch if CTR \neq 0 AND CR _{cr_bit} = 0. <i>Extended mnemonic for</i> bc 0,cr_bit,target	
bdnzfa		<i>Extended mnemonic for</i> bca 0,cr_bit,target	
bdnzfl		<i>Extended mnemonic for</i> bcl 0,cr_bit,target	(LR) \leftarrow CIA + 4.
bdnzfla		<i>Extended mnemonic for</i> bcla 0,cr_bit,target	(LR) \leftarrow CIA + 4.
bdnzt	cr_bit, target	Decrement CTR. Branch if CTR \neq 0 AND CR _{cr_bit} = 1. <i>Extended mnemonic for</i> bc 8,cr_bit,target	
bdnzta		<i>Extended mnemonic for</i> bca 8,cr_bit,target	
bdnztl		<i>Extended mnemonic for</i> bcl 8,cr_bit,target	(LR) \leftarrow CIA + 4.
bdnztla		<i>Extended mnemonic for</i> bcla 8,cr_bit,target	(LR) \leftarrow CIA + 4.
bdz	target	Decrement CTR; branch if CTR = 0. <i>Extended mnemonic for</i> bc 18,0,target	
bdza		<i>Extended mnemonic for</i> bca 18,0,target	
bdzl		<i>Extended mnemonic for</i> bcl 18,0,target	(LR) \leftarrow CIA + 4.
bdzla		<i>Extended mnemonic for</i> bcla 18,0,target	(LR) \leftarrow CIA + 4.

Table 24-7. Extended Mnemonics for bc, bca, bcl, bcla (continued)

Mnemonic	Operands	Function	Other Registers Altered
bdzf	cr_bit, target	Decrement CTR. Branch if CTR = 0 AND CR _{cr_bit} = 0. <i>Extended mnemonic for</i> bc 2,cr_bit,target	
bdzfa		<i>Extended mnemonic for</i> bca 2,cr_bit,target	
bdzfl		<i>Extended mnemonic for</i> bcl 2,cr_bit,target	(LR) ← CIA + 4.
bdzfla		<i>Extended mnemonic for</i> bcla 2,cr_bit,target	(LR) ← CIA + 4.
bdzt	cr_bit, target	Decrement CTR. Branch if CTR = 0 AND CR _{cr_bit} = 1. <i>Extended mnemonic for</i> bc 10,cr_bit,target	
bdzta		<i>Extended mnemonic for</i> bca 10,cr_bit,target	
bdztl		<i>Extended mnemonic for</i> bcl 10,cr_bit,target	(LR) ← CIA + 4.
bdzfla		<i>Extended mnemonic for</i> bcla 10,cr_bit,target	(LR) ← CIA + 4.
beq	[cr_field,] target	Branch if equal. Use CR0 if cr_field is omitted. <i>Extended mnemonic for</i> bc 12,4*cr_field+2,target	
beqa		<i>Extended mnemonic for</i> bca 12,4*cr_field+2,target	
beql		<i>Extended mnemonic for</i> bcl 12,4*cr_field+2,target	(LR) ← CIA + 4.
beqla		<i>Extended mnemonic for</i> bcla 12,4*cr_field+2,target	(LR) ← CIA + 4.
bf	cr_bit, target	Branch if CR _{cr_bit} = 0. <i>Extended mnemonic for</i> bc 4,cr_bit,target	
bfa		<i>Extended mnemonic for</i> bca 4,cr_bit,target	
bfl		<i>Extended mnemonic for</i> bcl 4,cr_bit,target	LR
bfla		<i>Extended mnemonic for</i> bcla 4,cr_bit,target	LR

Table 24-7. Extended Mnemonics for bc, bca, bcl, bcla (continued)

Mnemonic	Operands	Function	Other Registers Altered
bge	[cr_field,] target	Branch if greater than or equal. Use CR0 if cr_field is omitted. <i>Extended mnemonic for</i> bc 4,4*cr_field+0,target	
bgea		<i>Extended mnemonic for</i> bca 4,4*cr_field+0,target	
bgel		<i>Extended mnemonic for</i> bcl 4,4*cr_field+0,target	LR
bgea		<i>Extended mnemonic for</i> bcla 4,4*cr_field+0,target	LR
bgt	[cr_field,] target	Branch if greater than. Use CR0 if cr_field is omitted. <i>Extended mnemonic for</i> bc 12,4*cr_field+1,target	
bgt		<i>Extended mnemonic for</i> bca 12,4*cr_field+1,target	
bgtl		<i>Extended mnemonic for</i> bcl 12,4*cr_field+1,target	LR
bgtla		<i>Extended mnemonic for</i> bcla 12,4*cr_field+1,target	LR
ble	[cr_field,] target	Branch if less than or equal. Use CR0 if cr_field is omitted. <i>Extended mnemonic for</i> bc 4,4*cr_field+1,target	
blea		<i>Extended mnemonic for</i> bca 4,4*cr_field+1,target	
blel		<i>Extended mnemonic for</i> bcl 4,4*cr_field+1,target	LR
blela		<i>Extended mnemonic for</i> bcla 4,4*cr_field+1,target	LR
blt	[cr_field,] target	Branch if less than Use CR0 if cr_field is omitted. <i>Extended mnemonic for</i> bc 12,4*cr_field+0,target	
blt		<i>Extended mnemonic for</i> bca 12,4*cr_field+0,target	
bltl		<i>Extended mnemonic for</i> bcl 12,4*cr_field+0,target	(LR) ← CIA + 4.
bltla		<i>Extended mnemonic for</i> bcla 12,4*cr_field+0,target	(LR) ← CIA + 4.

Table 24-7. Extended Mnemonics for bc, bca, bcl, bcla (continued)

Mnemonic	Operands	Function	Other Registers Altered
bne	[cr_field,] target	Branch if not equal. Use CR0 if cr_field is omitted. <i>Extended mnemonic for</i> bc 4,4*cr_field+2,target	
bnea		<i>Extended mnemonic for</i> bca 4,4*cr_field+2,target	
bnel		<i>Extended mnemonic for</i> bcl 4,4*cr_field+2,target	(LR) ← CIA + 4.
bnela		<i>Extended mnemonic for</i> bcla 4,4*cr_field+2,target	(LR) ← CIA + 4.
bng	[cr_field,] target	Branch if not greater than. Use CR0 if cr_field is omitted. <i>Extended mnemonic for</i> bc 4,4*cr_field+1,target	
bnga		<i>Extended mnemonic for</i> bca 4,4*cr_field+1,target	
bngl		<i>Extended mnemonic for</i> bcl 4,4*cr_field+1,target	(LR) ← CIA + 4.
bngla		<i>Extended mnemonic for</i> bcla 4,4*cr_field+1,target	(LR) ← CIA + 4.
bnl	[cr_field,] target	Branch if not less than; use CR0 if cr_field is omitted. <i>Extended mnemonic for</i> bc 4,4*cr_field+0,target	
bnla		<i>Extended mnemonic for</i> bca 4,4*cr_field+0,target	
bnll		<i>Extended mnemonic for</i> bcl 4,4*cr_field+0,target	(LR) ← CIA + 4.
bnlla		<i>Extended mnemonic for</i> bcla 4,4*cr_field+0,target	(LR) ← CIA + 4.
bns	[cr_field,] target	Branch if not summary overflow. Use CR0 if cr_field is omitted. <i>Extended mnemonic for</i> bc 4,4*cr_field+3,target	
bnsa		<i>Extended mnemonic for</i> bca 4,4*cr_field+3,target	
bnsl		<i>Extended mnemonic for</i> bcl 4,4*cr_field+3,target	(LR) ← CIA + 4.
bnsla		<i>Extended mnemonic for</i> bcla 4,4*cr_field+3,target	(LR) ← CIA + 4.

Table 24-7. Extended Mnemonics for bc, bca, bcl, bcla (continued)

Mnemonic	Operands	Function	Other Registers Altered
bnu	[cr_field,] target	Branch if not unordered. Use CR0 if cr_field is omitted. <i>Extended mnemonic for</i> bc 4,4*cr_field+3,target	
bnua		<i>Extended mnemonic for</i> bca 4,4*cr_field+3,target	
bnul		<i>Extended mnemonic for</i> bcl 4,4*cr_field+3,target	(LR) ← CIA + 4.
bnula		<i>Extended mnemonic for</i> bcla 4,4*cr_field+3,target	(LR) ← CIA + 4.
bso	[cr_field,] target	Branch if summary overflow. Use CR0 if cr_field is omitted. <i>Extended mnemonic for</i> bc 12,4*cr_field+3,target	
soa		<i>Extended mnemonic for</i> bca 12,4*cr_field+3,target	
sol		<i>Extended mnemonic for</i> bcl 12,4*cr_field+3,target	(LR) ← CIA + 4.
sola		<i>Extended mnemonic for</i> bcla 12,4*cr_field+3,target	(LR) ← CIA + 4.
bt	cr_bit, target	Branch if CR _{cr_bit} = 1. <i>Extended mnemonic for</i> bc 12,cr_bit,target	
bta		<i>Extended mnemonic for</i> bca 12,cr_bit,target	
btl		<i>Extended mnemonic for</i> bcl 12,cr_bit,target	(LR) ← CIA + 4.
btla		<i>Extended mnemonic for</i> bcla 12,cr_bit,target	(LR) ← CIA + 4.
bun	[cr_field], target	Branch if unordered. Use CR0 if cr_field is omitted. <i>Extended mnemonic for</i> bc 12,4*cr_field+3,target	
buna		<i>Extended mnemonic for</i> bca 12,4*cr_field+3,target	
bunl		<i>Extended mnemonic for</i> bcl 12,4*cr_field+3,target	(LR) ← CIA + 4.
bunla		<i>Extended mnemonic for</i> bcla 12,4*cr_field+3,target	(LR) ← CIA + 4.

bcctr

Branch Conditional to Count Register

bcctr BO, BI LK=0
bcctrl BO, BI LK=1

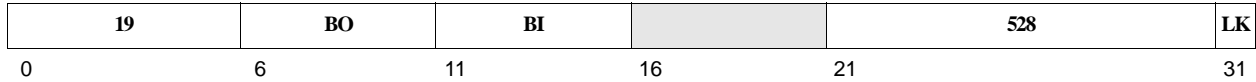

```

if BO2 = 0 then
    CTR ← CTR – 1
if (BO2 = 1 ∨ ((CTR = 0) = BO3)) ∧ (BO0 = 1 ∨ (CRBI = BO1)) then
    NIA ← CTR0:29 || 20
else
    NIA ← CIA + 4
if LK = 1 then
    (LR) ← CIA + 4
PC ← NIA
    
```

The BI field specifies a bit in the CR to be used as the condition of the branch.

The next instruction address (NIA) is the target address of the branch. The NIA is formed by concatenating the 30 most significant bits of the CTR with two 0-bits on the right.

The BO field controls options that determine when program flow is transferred to the NIA. The BO field also controls branch prediction, a performance-improvement feature. See “Branch Prediction” on page 3-117 for a complete discussion.

If the LK field contains 1, then (CIA + 4) is placed into the LR.

Registers Altered

- CTR if BO₂ contains 0
- LR if LK contains 1

Invalid Instruction Forms

- Reserved fields
- If bit 2 of the BO field contains 0, the instruction form is invalid, but the pseudocode applies. If the branch condition is true, the branch is taken; the NIA is the contents of the CTR after it is decremented.

Architecture Note

This instruction is part of the PowerPC User Instruction Set Architecture.

Table 24-8. Extended Mnemonics for bcctr, bcctrl

Mnemonic	Operands	Function	Other Registers Altered
bctr		Branch unconditionally to address in CTR. <i>Extended mnemonic for</i> bcctr 20,0	
bcctrl		<i>Extended mnemonic for</i> bcctrl 20,0	(LR) ← CIA + 4.
beqctr	[cr_field]	Branch, if equal, to address in CTR Use CR0 if cr_field is omitted. <i>Extended mnemonic for</i> bcctr 12,4*cr_field+2	
beqctrl		<i>Extended mnemonic for</i> bcctrl 12,4*cr_field+2	(LR) ← CIA + 4.
bfctr	cr_bit	Branch, if CR _{cr_bit} = 0, to address in CTR. <i>Extended mnemonic for</i> bcctr 4,cr_bit	
bfctrl		<i>Extended mnemonic for</i> bcctrl 4,cr_bit	(LR) ← CIA + 4.
bgectr	[cr_field]	Branch, if greater than or equal, to address in CTR. Use CR0 if cr_field is omitted. <i>Extended mnemonic for</i> bcctr 4,4*cr_field+0	
bgectrl		<i>Extended mnemonic for</i> bcctrl 4,4*cr_field+0	(LR) ← CIA + 4.
bgtctr	[cr_field]	Branch, if greater than, to address in CTR. Use CR0 if cr_field is omitted. <i>Extended mnemonic for</i> bcctr 12,4*cr_field+1	
bgtctrl		<i>Extended mnemonic for</i> bcctrl 12,4*cr_field+1	(LR) ← CIA + 4.
blectr	[cr_field]	Branch, if less than or equal, to address in CTR. Use CR0 if cr_field is omitted. <i>Extended mnemonic for</i> bcctr 4,4*cr_field+1	
blectrl		<i>Extended mnemonic for</i> bcctrl 4,4*cr_field+1	(LR) ← CIA + 4.
bltctr	[cr_field]	Branch, if less than, to address in CTR. Use CR0 if cr_field is omitted. <i>Extended mnemonic for</i> bcctr 12,4*cr_field+0	
bltctrl		<i>Extended mnemonic for</i> bcctrl 12,4*cr_field+0	(LR) ← CIA + 4.

bcctr

Branch Conditional to Count Register

Table 24-8. Extended Mnemonics for bcctr, bcctrl (continued)

Mnemonic	Operands	Function	Other Registers Altered
bnectr	[cr_field]	Branch, if not equal, to address in CTR. Use CR0 if cr_field is omitted. <i>Extended mnemonic for</i> bcctr 4,4*cr_field+2	
bnectrl		<i>Extended mnemonic for</i> bcctrl 4,4*cr_field+2	(LR) ← CIA + 4.
bngctr	[cr_field]	Branch, if not greater than, to address in CTR. Use CR0 if cr_field is omitted. <i>Extended mnemonic for</i> bcctr 4,4*cr_field+1	
bngctrl		<i>Extended mnemonic for</i> bcctrl 4,4*cr_field+1	(LR) ← CIA + 4.
bnlctr	[cr_field]	Branch, if not less than, to address in CTR. Use CR0 if cr_field is omitted. <i>Extended mnemonic for</i> bcctr 4,4*cr_field+0	
bnlctrl		<i>Extended mnemonic for</i> bcctrl 4,4*cr_field+0	(LR) ← CIA + 4.
bnsctr	[cr_field]	Branch, if not summary overflow, to address in CTR. Use CR0 if cr_field is omitted. <i>Extended mnemonic for</i> bcctr 4,4*cr_field+3	
bnsctrl		<i>Extended mnemonic for</i> bcctrl 4,4*cr_field+3	(LR) ← CIA + 4.
bnuctr	[cr_field]	Branch, if not unordered, to address in CTR; use CR0 if cr_field is omitted. <i>Extended mnemonic for</i> bcctr 4,4*cr_field+3	
bnuctrl		<i>Extended mnemonic for</i> bcctrl 4,4*cr_field+3	(LR) ← CIA + 4.
bsocctr	[cr_field]	Branch, if summary overflow, to address in CTR. Use CR0 if cr_field is omitted. <i>Extended mnemonic for</i> bcctr 12,4*cr_field+3	
bsocctrl		<i>Extended mnemonic for</i> bcctrl 12,4*cr_field+3	(LR) ← CIA + 4.
btctr	cr_bit	Branch if CR _{cr_bit} = 1 to address in CTR. <i>Extended mnemonic for</i> bcctr 12,cr_bit	
btctrl		<i>Extended mnemonic for</i> bcctrl 12,cr_bit	(LR) ← CIA + 4.

Table 24-8. Extended Mnemonics for bcctr, bcctrl (continued)

Mnemonic	Operands	Function	Other Registers Altered
bunctr	[cr_field]	Branch if unordered to address in CTR. Use CR0 if cr_field is omitted. <i>Extended mnemonic for</i> bcctr 12,4*cr_field+3	
bunctrl		<i>Extended mnemonic for</i> bcctrl 12,4*cr_field+3	(LR) ← CIA + 4.

bclr

Branch Conditional to Link Register

bclr BO, BI LK=0
bclrl BO, BI LK=1

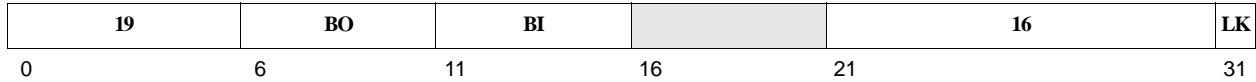

```

if BO2 = 0 then
    CTR ← CTR – 1
if (BO2 = 1 ∨ ((CTR = 0) = BO3)) ∧ (BO0 = 1 ∨ (CRBI = BO1)) then
    NIA ← LR0:29 || 20
else
    NIA ← CIA + 4
if LK = 1 then
    (LR) ← CIA + 4
PC ← NIA
    
```

If bit 2 of the BO field contains 0, the CTR is decremented.

The BI field specifies a bit in the CR to be used as the condition of the branch.

The next instruction address (NIA) is the target address of the branch. The NIA is formed by concatenating the 30 most significant bits of the LR with two 0-bits on the right.

The BO field controls options that determine when program flow is transferred to the NIA. The BO field also controls branch prediction, a performance-improvement feature. See “Branch Prediction” on page 3-117 for a complete discussion.

If the LK field contains 1, then (CIA + 4) is placed into the LR.

Registers Altered

- CTR if BO₂ contains 0
- LR if LK contains 1

Invalid Instruction Forms

- Reserved fields

Architecture Note

This instruction is part of the PowerPC User Instruction Set Architecture.

Table 24-9. Extended Mnemonics for bclr, bclrl

Mnemonic	Operands	Function	Other Registers Altered
blr		Branch unconditionally to address in LR. <i>Extended mnemonic for</i> bclr 20,0	
bclrl		<i>Extended mnemonic for</i> bclrl 20,0	(LR) ← CIA + 4.

Table 24-9. Extended Mnemonics for bclr, bclrl (continued)

Mnemonic	Operands	Function	Other Registers Altered
bdnzlr		Decrement CTR. Branch if CTR \neq 0 to address in LR. <i>Extended mnemonic for</i> bclr 16,0	
bdnzlrl		<i>Extended mnemonic for</i> bclrl 16,0	(LR) \leftarrow CIA + 4.
bdnzflr	cr_bit	Decrement CTR. Branch if CTR \neq 0 AND CR _{cr_bit} = 0 to address in LR. <i>Extended mnemonic for</i> bclr 0,cr_bit	
bdnzflrl		<i>Extended mnemonic for</i> bclrl 0,cr_bit	(LR) \leftarrow CIA + 4.
bdnztlr	cr_bit	Decrement CTR. Branch if CTR \neq 0 AND CR _{cr_bit} = 1 to address in LR. <i>Extended mnemonic for</i> bclr 8,cr_bit	
bdnztlrl		<i>Extended mnemonic for</i> bclrl 8,cr_bit	(LR) \leftarrow CIA + 4.
bdzlr		Decrement CTR. Branch if CTR = 0 to address in LR. <i>Extended mnemonic for</i> bclr 18,0	
bdzlrl		<i>Extended mnemonic for</i> bclrl 18,0	(LR) \leftarrow CIA + 4.
bdzflr	cr_bit	Decrement CTR. Branch if CTR = 0 AND CR _{cr_bit} = 0 to address in LR. <i>Extended mnemonic for</i> bclr 2,cr_bit	
bdzflrl		<i>Extended mnemonic for</i> bclrl 2,cr_bit	(LR) \leftarrow CIA + 4.
bdztlr	cr_bit	Decrement CTR. Branch if CTR = 0 AND CR _{cr_bit} = 1 to address in LR. <i>Extended mnemonic for</i> bclr 10,cr_bit	
bdztlrl		<i>Extended mnemonic for</i> bclrl 10,cr_bit	(LR) \leftarrow CIA + 4.
beqlr	[cr_field]	Branch if equal to address in LR. Use CR0 if cr_field is omitted. <i>Extended mnemonic for</i> bclr 12,4*cr_field+2	
beqlrl		<i>Extended mnemonic for</i> bclrl 12,4*cr_field+2	(LR) \leftarrow CIA + 4.

Table 24-9. Extended Mnemonics for bclr, bclrl (continued)

Mnemonic	Operands	Function	Other Registers Altered
bflr	cr_bit	Branch if CR _{cr_bit} = 0 to address in LR. <i>Extended mnemonic for</i> bclr 4,cr_bit	
bflrl		<i>Extended mnemonic for</i> bclrl 4,cr_bit	(LR) ← CIA + 4.
bgehr	[cr_field]	Branch, if greater than or equal, to address in LR. Use CR0 if cr_field is omitted. <i>Extended mnemonic for</i> bclr 4,4*cr_field+0	
bgehrl		<i>Extended mnemonic for</i> bclrl 4,4*cr_field+0	(LR) ← CIA + 4.
bgthr	[cr_field]	Branch, if greater than, to address in LR. Use CR0 if cr_field is omitted. <i>Extended mnemonic for</i> bclr 12,4*cr_field+1	
bgthrl		<i>Extended mnemonic for</i> bclrl 12,4*cr_field+1	(LR) ← CIA + 4.
blehr	[cr_field]	Branch, if less than or equal, to address in LR. Use CR0 if cr_field is omitted. <i>Extended mnemonic for</i> bclr 4,4*cr_field+1	
blehrl		<i>Extended mnemonic for</i> bclrl 4,4*cr_field+1	(LR) ← CIA + 4.
blthr	[cr_field]	Branch, if less than, to address in LR. Use CR0 if cr_field is omitted. <i>Extended mnemonic for</i> bclr 12,4*cr_field+0	
blthrl		<i>Extended mnemonic for</i> bclrl 12,4*cr_field+0	(LR) ← CIA + 4.
bnelr	[cr_field]	Branch, if not equal, to address in LR. Use CR0 if cr_field is omitted. <i>Extended mnemonic for</i> bclr 4,4*cr_field+2	
bnelrl		<i>Extended mnemonic for</i> bclrl 4,4*cr_field+2	(LR) ← CIA + 4.
bnglr	[cr_field]	Branch, if not greater than, to address in LR. Use CR0 if cr_field is omitted. <i>Extended mnemonic for</i> bclr 4,4*cr_field+1	
bnglrl		<i>Extended mnemonic for</i> bclrl 4,4*cr_field+1	(LR) ← CIA + 4.

Table 24-9. Extended Mnemonics for bclr, bclrl (continued)

Mnemonic	Operands	Function	Other Registers Altered
bnllr	[cr_field]	Branch, if not less than, to address in LR. Use CR0 if cr_field is omitted. <i>Extended mnemonic for</i> bclr 4,4*cr_field+0	
bnllrl		<i>Extended mnemonic for</i> bclrl 4,4*cr_field+0	(LR) ← CIA + 4.
bnslr	[cr_field]	Branch if not summary overflow to address in LR. Use CR0 if cr_field is omitted. <i>Extended mnemonic for</i> bclr 4,4*cr_field+3	
bnsrl		<i>Extended mnemonic for</i> bclrl 4,4*cr_field+3	(LR) ← CIA + 4.
bnulr	[cr_field]	Branch if not unordered to address in LR. Use CR0 if cr_field is omitted. <i>Extended mnemonic for</i> bclr 4,4*cr_field+3	
bnulrl		<i>Extended mnemonic for</i> bclrl 4,4*cr_field+3	(LR) ← CIA + 4.
bsolr	[cr_field]	Branch if summary overflow to address in LR. Use CR0 if cr_field is omitted. <i>Extended mnemonic for</i> bclr 12,4*cr_field+3	
bsolrl		<i>Extended mnemonic for</i> bclrl 12,4*cr_field+3	(LR) ← CIA + 4.
btlr	cr_bit	Branch if CR _{cr_bit} = 1 to address in LR. <i>Extended mnemonic for</i> bclr 12,cr_bit	
btlrl		<i>Extended mnemonic for</i> bclrl 12,cr_bit	(LR) ← CIA + 4.
bunlr	[cr_field]	Branch if unordered to address in LR. Use CR0 if cr_field is omitted. <i>Extended mnemonic for</i> bclr 12,4*cr_field+3	
bunlrl		<i>Extended mnemonic for</i> bclrl 12,4*cr_field+3	(LR) ← CIA + 4.

cmp
Compare

cmp BF, 0, RA, RB

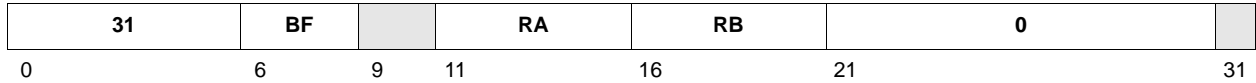

```

c0:3 ← 40
if (RA) < (RB) then c0 ← 1
if (RA) > (RB) then c1 ← 1
if (RA) = (RB) then c2 ← 1
c3 ← XER[SO]
n ← BF
CR[CRn] ← c0:3
    
```

The contents of register RA are compared with the contents of register RB using a 32-bit signed compare.

The CR field specified by the BF field is updated to reflect the results of the compare and the value of XER[SO] is placed into the same CR field.

If instruction bit 31 contains 1, the contents of CR[CR0] are undefined.

Registers Altered

- CR[CRn] where n is specified by the BF field

Invalid Instruction Forms

- Reserved fields

Programming Note

The PowerPC Architecture defines this instruction as **cmp BF,L,RA,RB**, where L selects operand size for 64-bit PowerPC implementations. For all 32-bit PowerPC implementations, L = 0 is required (L = 1 is an invalid form); hence for PPC405GP, use of the extended mnemonic **cmpw BF,RA,RB** is recommended.

Architecture Note

This instruction is part of the PowerPC User Instruction Set Architecture.

Table 24-10. Extended Mnemonics for cmp

Mnemonic	Operands	Function	Other Registers Altered
cmpw	[BF,] RA, RB	Compare Word; use CR0 if BF is omitted. <i>Extended mnemonic for</i> cmp BF,0,RA,RB	

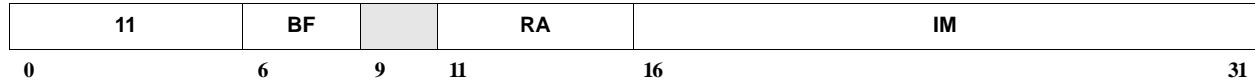
cmpi BF, 0, RA, IM

```

c0:3 ← 40
if (RA) < EXTS(IM) then c0 ← 1
if (RA) > EXTS(IM) then c1 ← 1
if (RA) = EXTS(IM) then c2 ← 1
c3 ← XER[SO]
n ← BF
CR[CRn] ← c0:3

```

The IM field is sign-extended to 32 bits. The contents of register RA are compared with the extended IM field, using a 32-bit signed compare.

The CR field specified by the BF field is updated to reflect the results of the compare and the value of XER[SO] is placed into the same CR field.

Registers Altered

- CR[CRn] where *n* is specified by the BF field

Invalid Instruction Forms

- Reserved fields

Programming Note

The PowerPC Architecture defines this instruction as **cmpi BF,L,RA,IM**, where L selects operand size for 64-bit PowerPC implementations. For all 32-bit PowerPC implementations, L = 0 is required (L = 1 is an invalid form); hence for the PPC405GP, use of the extended mnemonic **cmpwi BF,RA,IM** is recommended.

Architecture Note

This instruction is part of the PowerPC User Instruction Set Architecture.

Table 24-11. Extended Mnemonics for cmpi

Mnemonic	Operands	Function	Other Registers Altered
cmpwi	[BF,] RA, IM	Compare Word Immediate. Use CR0 if BF is omitted. <i>Extended mnemonic for</i> cmpi BF,0,RA,IM	

cmpl BF, 0, RA, RB

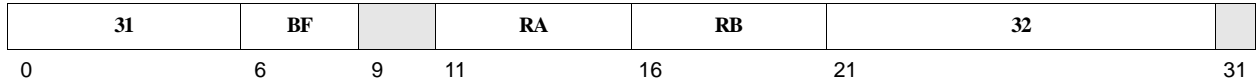

```

c0:3 ← 40
if (RA) <u (RB) then c0 ← 1
if (RA) >u (RB) then c1 ← 1
if (RA) = (RB) then c2 ← 1
c3 ← XER[SO]
n ← BF
CR[CRn] ← c0:3
    
```

The contents of register RA are compared with the contents of register RB, using a 32-bit unsigned compare.

The CR field specified by the BF field is updated to reflect the results of the compare and the value of XER[SO] is placed into the same CR field.

If instruction bit 31 contains 1, the contents of CR[CR0] are undefined.

Registers Altered

- CR[CRn] where n is specified by the BF field

Invalid Instruction Forms

- Reserved fields

Programming Notes

The PowerPC Architecture defines this instruction as **cmpl BF,L,RA,RB**, where L selects operand size for 64-bit PowerPC implementations. For all 32-bit PowerPC implementations, L = 0 is required (L = 1 is an invalid form); hence for PPC405GP, use of the extended mnemonic **cmplw BF,RA,RB** is recommended.

Architecture Note

This instruction is part of the PowerPC User Instruction Set Architecture.

Table 24-12. Extended Mnemonics for cmpl

Mnemonic	Operands	Function	Other Registers Altered
cmplw	[BF,] RA, RB	Compare Logical Word. Use CR0 if BF is omitted. <i>Extended mnemonic for cmpl BF,0,RA,RB</i>	

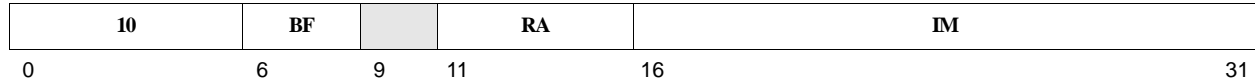
cmpli BF, 0, RA, IM

```

c0:3 ← 40
if (RA) <u (160 || IM) then c0 ← 1
if (RA) >u (160 || IM) then c1 ← 1
if (RA) = (160 || IM) then c2 ← 1
c3 ← XER[SO]
n ← BF
CR[CRn] ← c0:3

```

The IM field is extended to 32 bits by concatenating 16 0-bits to its left. The contents of register RA are compared with IM using a 32-bit unsigned compare.

The CR field specified by the BF field is updated to reflect the results of the compare and the value of XER[SO] is placed into the same CR field.

Registers Altered

- CR[CR_n] where *n* is specified by the BF field

Invalid Instruction Forms

- Reserved fields

Programming Note

The PowerPC Architecture defines this instruction as **cmpli BF,L,RA,IM**, where L selects operand size for 64-bit PowerPC implementations. For all 32-bit PowerPC implementations, L = 0 is required (L = 1 is an invalid form); hence for the PPC405GP, use of the extended mnemonic **cmplwi BF,RA,IM** is recommended.

Architecture Note

This instruction is part of the PowerPC User Instruction Set Architecture.

Table 24-13. Extended Mnemonics for cmpli

Mnemonic	Operands	Function	Other Registers Changed
cmplwi	[BF,] RA, IM	Compare Logical Word Immediate. Use CR0 if BF is omitted. <i>Extended mnemonic for</i> cmpli BF,0,RA,IM	

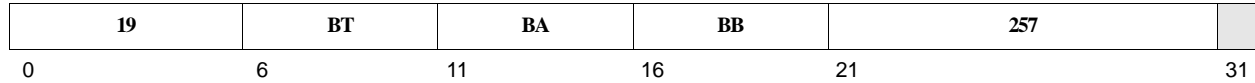
crand BT, BA, BB

$$CR_{BT} \leftarrow CR_{BA} \wedge CR_{BB}$$

The CR bit specified by the BA field is ANDed with the CR bit specified by the BB field; the result is placed into the CR bit specified by the BT field.

Registers Altered

- CR

Invalid Instruction Forms

- Reserved fields

Architecture Note

This instruction is part of the PowerPC User Instruction Set Architecture.

crandc

Condition Register AND with Complement

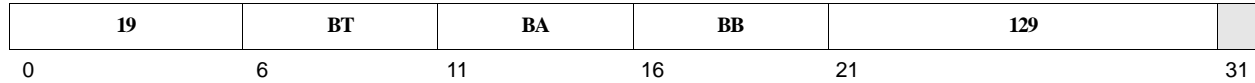
crandc BT, BA, BB

$$CR_{BT} \leftarrow CR_{BA} \wedge \neg CR_{BB}$$

The CR bit specified by the BA field is ANDed with the ones complement of the CR bit specified by the BB field; the result is placed into the CR bit specified by the BT field.

Registers Altered

- CR

Invalid Instruction Forms

- Reserved fields

Architecture Note

This instruction is part of the PowerPC User Instruction Set Architecture.

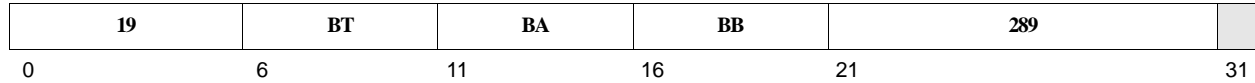
creqv BT, BA, BB

$$CR_{BT} \leftarrow \neg(CR_{BA} \oplus CR_{BB})$$

The CR bit specified by the BA field is XORed with the CR bit specified by the BB field; the ones complement of the result is placed into the CR bit specified by the BT field.

Registers Altered

- CR

Invalid Instruction Forms

- Reserved fields

Architecture Note

This instruction is part of the PowerPC User Instruction Set Architecture.

Table 24-14. Extended Mnemonics for creqv

Mnemonic	Operands	Function	Other Registers Altered
crset	bx	CR set. <i>Extended mnemonic for creqv bx,bx,bx</i>	

crnand

Condition Register NAND

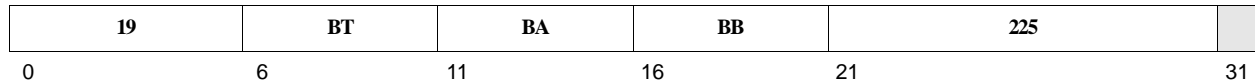
crnand BT, BA, BB

$$CR_{BT} \leftarrow \neg(CR_{BA} \wedge CR_{BB})$$

The CR bit specified by the BA field is ANDed with the CR bit specified by the BB field; the ones complement of the result is placed into the CR bit specified by the BT field.

Registers Altered

- CR

Invalid Instruction Forms

- Reserved fields

Architecture Note

This instruction is part of the PowerPC User Instruction Set Architecture.

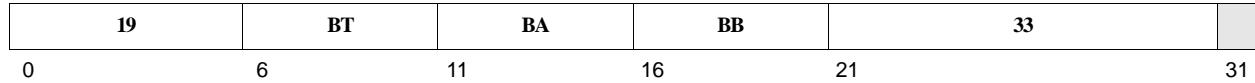
crnor BT, BA, BB

$$CR_{BT} \leftarrow \neg(CR_{BA} \vee CR_{BB})$$

The CR bit specified by the BA field is ORed with the CR bit specified by the BB field; the ones complement of the result is placed into the CR bit specified by the BT field.

Registers Altered

- CR

Invalid Instruction Forms

- Reserved fields

Architecture Note

This instruction is part of the PowerPC User Instruction Set Architecture.

Table 24-15. Extended Mnemonics for crnor

Mnemonic	Operands	Function	Other Registers Altered
crnot	bx, by	CR not. <i>Extended mnemonic for crnor bx,by,by</i>	

cror

Condition Register OR

cror BT, BA, BB

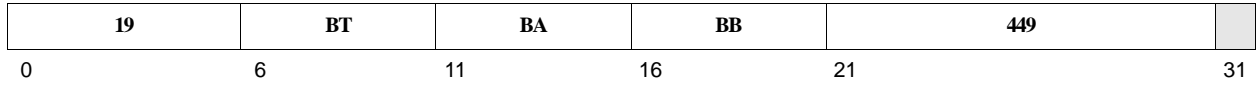

$$CR_{BT} \leftarrow CR_{BA} \vee CR_{BB}$$

The CR bit specified by the BA field is ORed with the CR bit specified by the BB field; the result is placed into the CR bit specified by the BT field.

Registers Altered

- CR

Invalid Instruction Forms

- Reserved fields

Architecture Note

This instruction is part of the PowerPC User Instruction Set Architecture.

Table 24-16. Extended Mnemonics for cror

Mnemonic	Operands	Function	Other Registers Altered
crmove	bx, by	CR move. <i>Extended mnemonic for cror bx,by,by</i>	

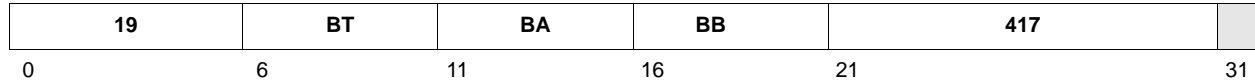
crorc BT, BA, BB

$$CR_{BT} \leftarrow CR_{BA} \vee \neg CR_{BB}$$

The condition register (CR) bit specified by the BA field is ORed with the ones complement of the CR bit specified by the BB field; the result is placed into the CR bit specified by the BT field.

Registers Altered

- CR

Invalid Instruction Forms

- Reserved fields

Architecture Note

This instruction is part of the PowerPC User Instruction Set Architecture.

crxor

Condition Register XOR

crxor BT, BA, BB

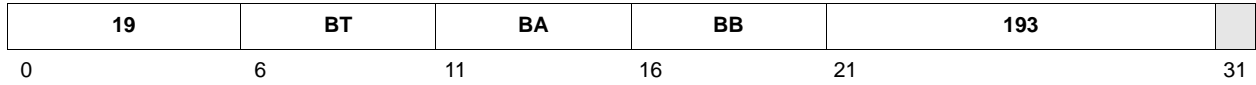

$$CR_{BT} \leftarrow CR_{BA} \oplus CR_{BB}$$

The CR bit specified by the BA field is XORed with the CR bit specified by the BB field; the result is placed into the CR bit specified by the BT field.

Registers Altered

- CR

Invalid Instruction Forms

- Reserved fields

Architecture Note

This instruction is part of the PowerPC User Instruction Set Architecture.

Table 24-17. Extended Mnemonics for crxor

Mnemonic	Operands	Function	Other Registers Altered
crclr	bx	Condition register clear. <i>Extended mnemonic for crxor bx,bx,bx</i>	

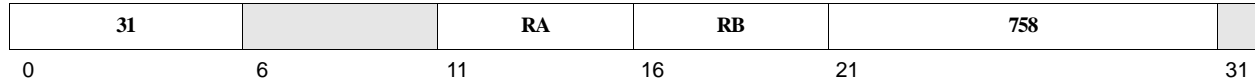
dcba RA, RB

$$EA \leftarrow (RA|0) + (RB)$$

$$DCBA(EA)$$

An effective address (EA) is formed by adding an index to a base address. The index is the contents of register RB. The base address is 0 if the RA field is 0 and is the contents of register RA otherwise.

If the data block at the EA is in the data cache and the EA is marked as cachable and non-write-through, the data in the cache block is architecturally undefined. For the PPC405GP, the cache data block is set to 0.

If the data block at the EA is not in the data cache and the EA is marked as cachable and not marked as write-through, a cache block is established and set to an architecturally-undefined value. Note that no data is read from main storage, as described in the programming note.

If the data block at the EA is marked as non-cachable, a no-op occurs.

If the data block at the EA is in the data cache and marked as write-through, architecturally the data in the cache block can be left unmodified. Alternatively, the data block at the EA can be undefined in the data cache and in main storage. For the PPC405GP, a no-op occurs.

If the data block at the EA is not in the data cache and marked as write-through, architecturally the instruction can establish a cache block and set the block to 0, or a no-op can occur. For the PPC405GP, a no-op occurs.

If instruction bit 31 contains 1, the contents of CR[CR0] are undefined.

Registers Altered

- None

Invalid Instruction Forms

- Reserved fields

Programming Notes

Because **dcba** can establish an address in the data cache without copying the contents of that address from main storage, the address established can be invalid with respect to main storage. A subsequent operation may cause the address to be copied back to main storage, for example, to make room for a new cache block; a machine check exception could occur under these circumstances.

dcba provides a hint that a block of storage will soon be stored to or no longer needed; there is no need to retain the data in the block. Establishing the line in the cache, without reading from main storage, improves performance.

Exceptions

This instruction is considered a “store” with respect to data storage exceptions. However, this instruction does not cause data storage exceptions or data TLB-miss exceptions. If conditions occur that would otherwise cause such exceptions, **dcba** is treated as a no-op.

dcba

Data Cache Block Allocate

This instruction is considered a “store” with respect to data address compare (DAC) debug exceptions. See “Data Storage Interrupt” on page 0-249.

Architecture Note

This instruction is part of the AMCC PowerPC Embedded Virtual Environment.

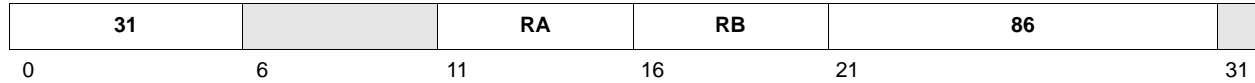
dcbf RA, RB

$$EA \leftarrow (RA|0) + (RB)$$

$$DCBF(EA)$$

An effective address (EA) is formed by adding an index to a base address. The index is the contents of register RB. The base address is 0 if the RA field is 0 and is the contents of register RA otherwise.

If the data block corresponding to the EA is in the data cache and marked as modified (stored into), the data block is copied back to main storage and then marked invalid in the data cache. If the data block is not marked as modified, it is simply marked invalid in the data cache. The operation is performed whether or not the EA is marked as cachable.

If the data block at the EA is not in the data cache, no operation is performed.

If instruction bit 31 contains 1, the contents of CR[CR0] are undefined.

Registers Altered

- None

Invalid Instruction Forms

- Reserved fields

Exceptions

This instruction is considered a “load” with respect to data storage exceptions. See “Data Storage Interrupt” on page 0-249.

This instruction is considered a “store” with respect to data address compare (DAC) debug exceptions. See “Debug Interrupt” on page 0-257.

Architecture Note

This instruction is part of the AMCC PowerPC Embedded Virtual Environment.

dcbi

Data Cache Block Invalidate

dcbi RA, RB

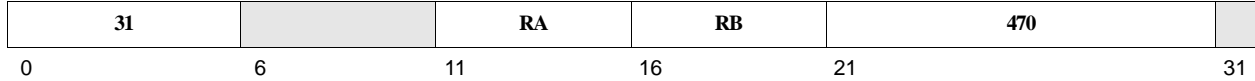

$$EA \leftarrow (RA|0) + (RB)$$

$$DCBI(EA)$$

An effective address (EA) is formed by adding an index to a base address. The index is the contents of register RB. The base address is 0 if the RA field is 0 and is the contents of register RA otherwise.

If the data block at the EA is in the data cache, the data block is marked invalid, regardless of whether or not the EA is marked as cachable. If modified data existed in the data block prior to the operation of this instruction, that data is lost.

If the data block at the EA is not in the data cache, no operation is performed.

If instruction bit 31 contains 1, the contents of CR[CR0] are undefined.

Registers Altered

- None

Invalid Instruction Forms

- Reserved fields

Programming Notes

Execution of this instruction is privileged.

Exceptions

This instruction is considered a “store” with respect to data storage exceptions. See “Data Storage Interrupt” on page 0-249.

This instruction is considered a “store” with respect to data address compare (DAC) debug exceptions. See “Debug Interrupt” on page 0-257.

Architecture Note

This instruction is part of the AMCC PowerPC Embedded Operating Environment.

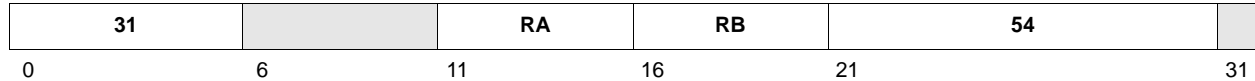
dcbst RA, RB

$$EA \leftarrow (RA|0) + (RB)$$

$$DCBST(EA)$$

An effective address (EA) is formed by adding an index to a base address. The index is the contents of register RB. The base address is 0 if the RA field is 0, and is the contents of register RA otherwise.

If the data block at the EA is in the data cache and marked as modified, the data block is copied back to main storage and marked as unmodified in the data cache.

If the data block at the EA is in the data cache, and is not marked as modified, or if the data block at the EA is not in the data cache, no operation is performed.

The operation specified by this instruction is performed whether or not the EA is marked as cachable.

If instruction bit 31 contains 1, the contents of CR[CR0] are undefined.

Registers Altered

- None

Invalid Instruction Forms

- Reserved fields

Exceptions

This instruction is considered a “load” with respect to data storage exceptions. See “Data Storage Interrupt” on page 0-249.

This instruction is considered a “store” with respect to data address compare (DAC) debug exceptions. See “Debug Interrupt” on page 0-257.

Architecture Note

This instruction is part of the AMCC PowerPC Embedded Virtual Environment.

dcbt

Data Cache Block Touch

dcbt RA, RB

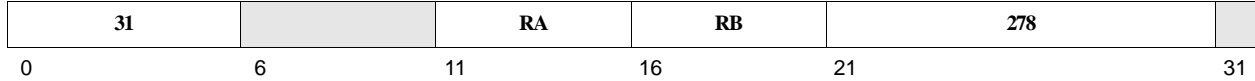

$$EA \leftarrow (RA|0) + (RB)$$

$$DCBT(EA)$$

An effective address (EA) is formed by adding an index to a base address. The index is the contents of register RB. The base address is 0 when the RA field is 0, and is the contents of register RA otherwise.

If the data block at the EA is not in the data cache and the EA is marked as cachable, the block is read from main storage into the data cache.

If the data block at the EA is in the data cache, or if the EA is marked as non-cachable, no operation is performed.

This instruction is not allowed to cause data storage exceptions or data TLB miss exceptions. If execution of the instruction would cause such an exception, then no operation is performed, and no exception occurs.

If instruction bit 31 contains 1, the contents of CR[CR0] are undefined.

Registers Altered

- None

Invalid Instruction Forms

- Reserved fields

Programming Notes

The **dcbt** instruction allows a program to begin a cache block fetch from main storage before the program needs the data. The program can later load data from the cache into registers without incurring the latency of a cache miss.

Exceptions

This instruction is considered a “load” with respect to data storage exceptions. See “Data Storage Interrupt” on page 0-249.

This instruction is considered a “load” with respect to data address compare (DAC) debug exceptions. See “Debug Interrupt” on page 0-257.

Architecture Note

This instruction is part of the AMCC PowerPC Embedded Virtual Environment.

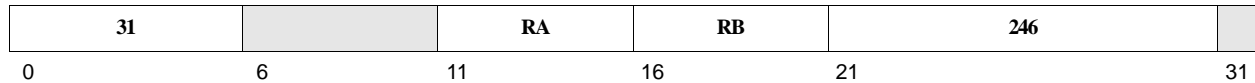
dcbtst RA, RB

$$EA \leftarrow (RA|0) + (RB)$$

$$DCBTST(EA)$$

An effective address (EA) is formed by adding an index to a base address. The index is the contents of register RB. The base address is 0 if the RA field is 0 and is the contents of register RA otherwise.

If the data block at the EA is not in the data cache and the EA address is marked as cachable, the data block is loaded into the data cache.

If the EA is marked as non-cachable, or if the data block at the EA is in the data cache, no operation is performed.

This instruction is not allowed to cause data storage exceptions or data TLB miss exceptions. If execution of the instruction would cause such an exception, then no operation is performed, and no exception occurs.

If instruction bit 31 contains 1, the contents of CR[CR0] are undefined.

Registers Altered

- None

Invalid Instruction Forms

- Reserved fields

Programming Notes

The **dcbtst** instruction allows a program to begin a cache block fetch from main storage before the program needs the data. The program can later store data from GPRs into the cache block, without incurring the latency of a cache miss.

Architecturally, **dcbtst** brings data into the cache in “Exclusive” mode, which allows the program to alter the cached data. “Exclusive” mode is part of the MESI protocol for multi-processor systems, and is not implemented. The implementation of the **dcbtst** instruction is identical to the implementation of the **dcbt** instruction.

Exceptions

This instruction is considered a “load” with respect to data storage exceptions. See “Data Storage Interrupt” on page 0-249.

This instruction is considered a “load” with respect to data address compare (DAC) debug exceptions. See “Debug Interrupt” on page 0-257.

Architecture Note

This instruction is part of the AMCC PowerPC Embedded Virtual Environment.

dcbz

Data Cache Block Set to Zero

dcbz RA, RB

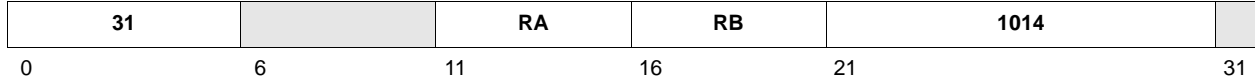

$$EA \leftarrow (RA|0) + (RB)$$

$$DCBZ(EA)$$

An effective address (EA) is formed by adding an index to a base address. The index is the contents of register RB. The base address is 0 if the RA field is 0 and is the contents of register RA otherwise.

If the data block at the EA is in the data cache and the EA is marked as cachable and non-write-through, the data in the cache block is set to 0.

If the data block at the EA is not in the data cache and the EA is marked as cachable and non-write-through, a cache block is established and set to 0. Note that nothing is read from main storage, as described in the programming note.

If the data block at the EA is marked as either write-through or as non-cachable, an alignment exception occurs.

If instruction bit 31 contains 1, the contents of CR[CR0] are undefined.

Registers Altered

- None

Invalid Instruction Forms

- Reserved fields

Programming Notes

Because **dcbz** can establish an address in the data cache without copying the contents of that address from main storage, the address established may be invalid with respect to the storage subsystem. A subsequent operation may cause the address to be copied back to main storage, for example, to make room for a new cache block; a machine check exception could occur under these circumstances.

If **dcbz** is attempted to an EA which is marked as non-cachable, the software alignment exception handler should emulate the instruction by storing zeros to the block in main storage. If a data block corresponding to the EA exists in the cache, but the EA is non-cachable, stores (including **dcbz**) to that address are considered programming errors (the cache block should previously have been flushed).

If the EA is marked as write-through, the software alignment exception handler should emulate the instruction by storing zeros to the block in main storage. An EA that is marked as write-through required should also be marked as cachable; when **dcbz** is attempted to such an address, the alignment exception handler should maintain coherency of cache and memory.

Exceptions

An alignment exception occurs if the EA is marked as non-cachable or as write-through.

This instruction is considered a “store” with respect to data storage exceptions. See “Data Storage Interrupt” on page 0-249.

This instruction is considered a “store” with respect to data address compare (DAC) debug exceptions. See “Debug Interrupt” on page 0-257.

Architecture Note

This instruction is part of the AMCC PowerPC Embedded Virtual Environment.

dccci

Data Cache Congruence Class Invalidate

dccci RA, RB

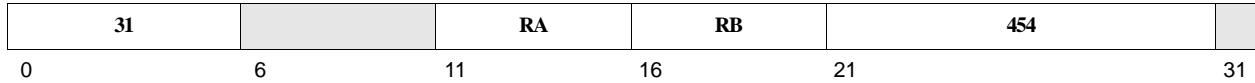

$$EA \leftarrow (RA|0) + (RB)$$

$$DCCCI(EA)$$

An effective address (EA) is formed by adding an index to a base address. The index is the contents of register RB. The base address is 0 if the RA field is 0 and is the contents of register RA otherwise.

Both cache lines in the congruence class specified by EA_{18:26} are invalidated, whether or not they match the EA. If modified data existed in the cache congruence class before the operation of this instruction, that data is lost.

The operation specified by this instruction is performed whether or not the EA is marked as cachable.

If instruction bit 31 contains 1, the contents of CR[CR0] are undefined.

Registers Altered

- None

Invalid Instruction Forms

- Reserved fields

Programming Note

Execution of this instruction is privileged.

This instruction is intended for use in the power-on reset routine to invalidate the entire data cache tag array before enabling the data cache. A series of **dccci** instruction should be executed, one for each congruence class. Cachability can then be enabled.

Exceptions

See “Access Protection for Cache Control Instructions” on page 6-175.

The execution of an **dccci** instruction can cause a data TLB miss exception, at the specified EA, regardless of the non-specific intent of that EA.

This instruction does not cause data address compare (DAC) debug exceptions. See “Debug Interrupt” on page 0-257.

Architecture Note

This instruction is implementation-specific and may not be portable to other implementations.

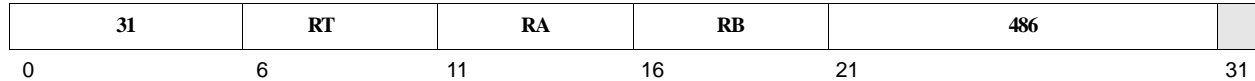
dcread RT, RA, RB

$$EA \leftarrow (RA|0) + (RB)$$

if ((CCR0[CIS] = 0) \wedge (CCR0[CWS] = 0)) then (RT) \leftarrow (d-cache data, way A)

if ((CCR0[CIS] = 0) \wedge (CCR0[CWS] = 1)) then (RT) \leftarrow (d-cache data, way B)

if ((CCR0[CIS] = 1) \wedge (CCR0[CWS] = 0)) then (RT) \leftarrow (d-cache tag, way A)

if ((CCR0[CIS] = 1) \wedge (CCR0[CWS] = 1)) then (RT) \leftarrow (d-cache tag, way B)

An effective address (EA) is formed by adding an index to a base address. The index is the contents of register RB. The base address is 0 if the RA field is 0 and is the contents of register RA otherwise.

This instruction is a debugging tool for reading the data cache entries for the congruence class specified by EA_{18:26}. The cache information is read into register RT.

If CCR0[CIS] = 0, the information is a word of data cache array data from the addressed congruence class. The word is specified by EA_{27:29}. If EA_{30:31} are not 00, an alignment exception occurs. If CCR0[CWS] = 0, the data is from the A-way; otherwise, the data is from the B-way.

If CCR0[CIS] = 1, the information is a cache tag from the addressed congruence class. If CCR0[CWS] = 0, the tag is from the A-way; otherwise the tag is from the B-way.

Data cache tag information is placed into register RT as shown:

0:19	TAG	Cache Tag
20:25		Reserved
26	D	Cache Line Dirty 0 Not dirty 1 Dirty
27	V	Cache Line Valid 0 Not valid 1 Valid
28:30		Reserved
31	LRU	Least Recently Used (LRU) 0 A-way LRU 1 B-way LRU

If instruction bit 31 contains 1, the contents of CR[CR0] are undefined.

Registers Altered

- RT

Invalid Instruction Forms

- Reserved fields

dcread

Data Cache Read

Programming Note

Execution of this instruction is privileged.

Exceptions

If EA is not word-aligned, an alignment exception occurs.

This instruction is considered a “load” with respect to data storage exceptions, but cannot cause a data storage exception. See “Access Protection for Cache Control Instructions” on page 6-175.

The execution of an **dcread** instruction can cause a data TLB miss exception, at the specified EA, regardless of the non-specific intent of that effective address.

This instruction is considered a “load” with respect to data address compare (DAC) debug exceptions. See “Debug Interrupt” on page 0-257.

Architecture Note

This instruction is implementation-specific and may not be portable to other implementations.

divw	RT, RA, RB	OE=0, Rc=0
divw.	RT, RA, RB	OE=0, Rc=1
divwo	RT, RA, RB	OE=1, Rc=0
divwo.	RT, RA, RB	OE=1, Rc=1

31	RT	RA	RB	OE	491	Rc
0	6	11	16	21 22		31

$$(RT) \leftarrow (RA) \div (RB)$$

The contents of register RA are divided by the contents of register RB. The quotient is placed into register RT.

Both the dividend and the divisor are interpreted as signed integers. The quotient is the unique signed integer that satisfies:

$$\text{dividend} = (\text{quotient} \times \text{divisor}) + \text{remainder}$$

where the remainder has the same sign as the dividend and its magnitude is less than that of the divisor.

If an attempt is made to perform $(0x8000\ 0000 \div -1)$ or $(n \div 0)$, the contents of register RT are undefined; if the Rc field also contains 1, the contents of $CR[CR0]_{LT, GT, EQ}$ are undefined. Either invalid division operation sets $XER[OV, SO]$ to 1 if the OE field contains 1.

Registers Altered

- RT
- $CR[CR0]_{LT, GT, EQ, SO}$ if Rc contains 1
- $XER[OV, SO]$ if OE contains 1

Programming Note

The 32-bit remainder can be calculated using the following sequence of instructions:

```
divw    RT,RA,RB        # RT = quotient
mullw   RT,RT,RB        # RT = quotient × divisor
subf    RT,RT,RA        # RT = remainder
```

The sequence does not calculate correct results for the invalid divide operations.

Architecture Note

This instruction is part of the PowerPC User Instruction Set Architecture.

divwu

Divide Word Unsigned

divwu	RT, RA, RB	OE=0, Rc=0
divwu.	RT, RA, RB	OE=0, Rc=1
divwuo	RT, RA, RB	OE=1, Rc=0
divwuo.	RT, RA, RB	OE=1, Rc=1

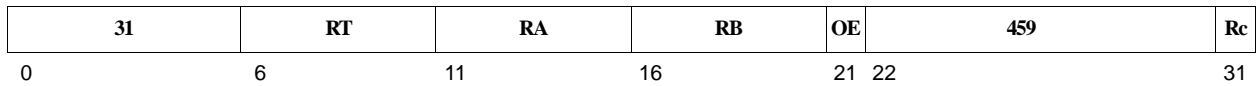

$$(RT) \leftarrow (RA) \div (RB)$$

The contents of register RA are divided by the contents of register RB. The quotient is placed into register RT.

The dividend and the divisor are interpreted as unsigned integers. The quotient is the unique unsigned integer that satisfies:

$$\text{dividend} = (\text{quotient} \times \text{divisor}) + \text{remainder}$$

If an attempt is made to perform ($n \div 0$), the contents of register RT are undefined; if the Rc also contains 1, the contents of CR[CR0]_{LT, GT, EQ} are also undefined. The invalid division operation also sets XER[OV, SO] to 1 if the OE field contains 1.

Registers Altered

- RT
- CR[CR0]_{LT, GT, EQ, SO} if Rc contains 1
- XER[OV, SO] if OE contains 1

Programming Note

The 32-bit remainder can be calculated using the following sequence of instructions

divwu	RT,RA,RB	# RT = quotient
mullw	RT,RT,RB	# RT = quotient × divisor
subf	RT,RT,RA	# RT = remainder

This sequence does not calculate the correct result if the divisor is zero.

Architecture Note

This instruction is part of the PowerPC User Instruction Set Architecture.

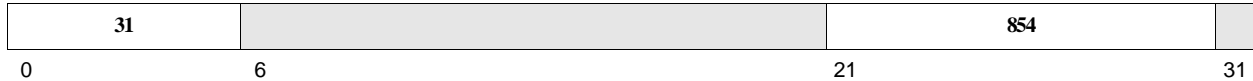
eieio

The **eieio** instruction ensures that all loads and stores preceding **eieio** complete with respect to main storage before any loads and stores following **eieio** access main storage.

If instruction bit 31 contains 1, the contents of CR[CR0] are undefined.

Registers Altered

- None

Invalid Instruction Forms

- Reserved fields

Programming Note

Architecturally, **eieio** orders storage access, not instruction completion. Therefore, non-storage operations after **eieio** could complete before storage operations that were before **eieio**. The **sync** instruction guarantees ordering of both instruction completion and storage access. For the PPC405GP, the **eieio** instruction is implemented to behave as a **sync** instruction.

To write code that is portable between various PowerPC implementations, programmers should use the mnemonic that corresponds to the desired behavior.

Architecture Note

This instruction is part of the AMCC PowerPC Embedded Virtual Environment.

eqv
Equivalent

eqv RA, RS, RB Rc=0
eqv. RA, RS, RB Rc=1

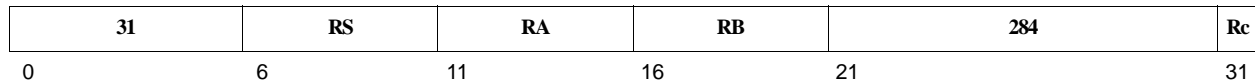

$(RA) \leftarrow \neg((RS) \oplus (RB))$

The contents of register RS are XORed with the contents of register RB; the ones complement of the result is placed into register RA.

Registers Altered

- RA
- CR[CR0]_{LT, GT, EQ, SO} if Rc contains 1

Architecture Note

This instruction is part of the PowerPC User Instruction Set Architecture.

extsb RA, RS Rc=0
extsb. RA, RS Rc=1

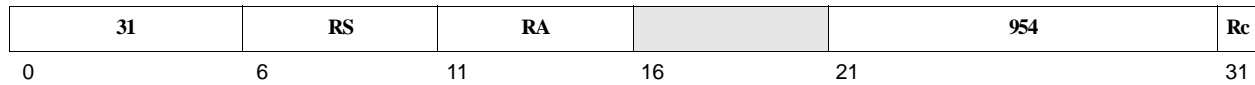

$(RA) \leftarrow \text{EXTS}(RS)_{24:31}$

The least significant byte of register RS is sign-extended to 32 bits by replicating bit 24 of the register into bits 0 through 23 of the result. The result is placed into register RA.

Registers Altered

- RA
- CR[CR0]_{LT, GT, EQ, SO} if Rc contains 1

Invalid Instruction Forms

- Reserved fields

Architecture Note

This instruction is part of the PowerPC User Instruction Set Architecture.

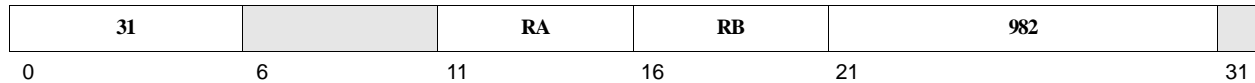
icbi RA, RB

$$EA \leftarrow (RA|0) + (RB)$$

$$ICBI(EA)$$

An effective address (EA) is formed by adding an index to a base address. The index is the contents of register RB. The base address is 0 if the RA field is 0 and is the contents of register RA otherwise.

If the instruction block at the EA is in the instruction cache, the cache block is marked invalid.

If the instruction block at the EA is not in the instruction cache, no additional operation is performed.

The operation specified by this instruction is performed whether or not the EA is marked as cachable in the ICCR.

If instruction bit 31 contains 1, the contents of CR[CR0] are undefined.

Registers Altered

- None

Invalid Instruction Forms

- Reserved fields

Programming Note

Instruction cache operations use MSR[DR], not MSR[IR], to determine translation of their operands.

When data translation is disabled, cachability for the EA of the operand of instruction cache operations is determined by the ICCR, not the DCCR.

Exceptions

Instruction storage exceptions and instruction-side TLB miss exceptions are associated with instruction *fetching*, not with instruction execution. Exceptions that occur during the *execution* of instruction cache operations cause data-side exceptions (data storage exceptions and data TLB miss exceptions).

This instruction is considered a “load” with respect to data storage exceptions. See “Data Storage Interrupt” on page 0-249.

This instruction is considered a “load” with respect to data address compare (DAC) debug exceptions.

Architecture Note

This instruction is part of the AMCC PowerPC Embedded Virtual Environment.

icbt

Instruction Cache Block Touch

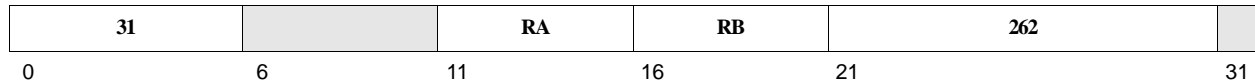
icbt RA, RB

$$EA \leftarrow (RA[0] + (RB))$$

$$ICBT(EA)$$

An effective address (EA) is formed by adding an index to a base address. The index is the contents of register RB. The base address is 0 if the RA field is 0 and is the contents of register RA otherwise.

If the instruction block at the EA is not in the instruction cache, and is marked as cachable, the instruction block is loaded into the instruction cache.

If the instruction block at the EA is in the instruction cache, or if the EA is marked as non-cachable, no operation is performed.

If instruction bit 31 contains 1, the contents of CR[CR0] are undefined.

Registers Altered

- None

Invalid Instruction Forms

- Reserved fields

Programming Notes

This instruction allows a program to begin a cache block fetch from main storage before the program needs the instruction. The program can later branch to the instruction address and fetch the instruction from the cache without incurring the latency of a cache miss.

Instruction cache operations use MSR[DR], not MSR[IR], to determine translation of their operands. When data translation is disabled, cachability for the effective address of the operand of instruction cache operations is determined by the ICCR, not the DCCR.

Exceptions

Instruction storage exceptions and instruction-side TLB miss exceptions are associated with instruction *fetching*, not with instruction execution. Exceptions occurring during *execution* of instruction cache operations cause data storage and data TLB miss exceptions.

If the execution of an **icbt** instruction would cause a data TLB miss exception, no operation is performed and no exception occurs.

This instruction is considered a “load” with respect to protection exceptions, but cannot cause data storage exceptions. This instruction is also considered a “load” with respect to data address compare (DAC) debug exceptions.

Architecture Note

This instruction is part of the AMCC PowerPC Embedded Operating Environment.

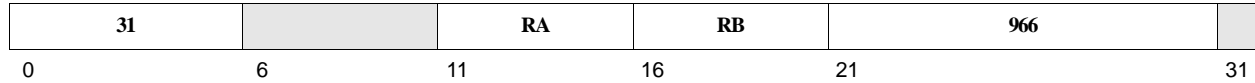
iccci RA, RB

EA ← (RA|0) + (RB)
 ICCI(ICU cache array)

This instruction invalidates the entire ICU cache array. The EA is not used; previous implementations have used the EA for protection checks. The instruction form is maintained for software and tool compatibility.

Registers Altered

- None

Invalid Instruction Forms

- Reserved fields

Programming Notes

Execution of this instruction is privileged.

This instruction is intended for use in the power-on reset routine to invalidate the entire cache tag array before enabling the cache. Cachability can then be enabled.

Architecture Note

This instruction is implementation-specific and may not be portable to other implementations.

icread

Instruction Cache Read

icread RA, RB

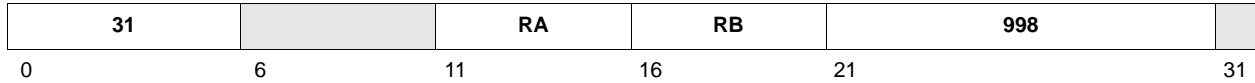

```
EA ← (RA|0) + (RB)
if ((CCR0[CIS] = 0) ∧ (CCR0[CWS] = 0)) then (ICDBDR) ← (i-cache data, way A)
if ((CCR0[CIS] = 0) ∧ (CCR0[CWS] = 1)) then (ICDBDR) ← (i-cache data, way B)
if ((CCR0[CIS] = 1) ∧ (CCR0[CWS] = 0)) then (ICDBDR) ← (i-cache tag, way A)
if ((CCR0[CIS] = 1) ∧ (CCR0[CWS] = 1)) then (ICDBDR) ← (i-cache tag, way B)
```

An effective address (EA) is formed by adding an index to a base address. The index is the contents of register RB. The base address is 0 if the RA field is 0 and is the contents of register RA otherwise.

This instruction is a debugging tool for reading the instruction cache entries for the congruence class specified by EA_{18:26}. The cache information is read into the Instruction Cache Debug Data Register (ICDBDR), from where it can be read into a GPR using the extended mnemonic **mficdbdr**.

If CCR0[CIS] = 0, the information is a word of instruction cache data from the addressed line. The word is specified by EA_{27:29}. If CCR0[CWS] = 0, the data is from the A-way, otherwise from the B-way.

If (CCR0[CIS] = 1), the information is a cache tag from the addressed congruence class. If (CCR0[CWS] = 0), the tag is from the A-way, otherwise from the B-way.

Instruction cache tag information is placed in the ICDBDR as shown:

0:21	TAG	Cache Tag
22:26		Reserved
27	V	Cache Line Valid 0 Not valid 1 Valid
28:30		Reserved
31	LRU	Least Recently Used (LRU) 0 A-way LRU 1 B-way LRU

If instruction bit 31 contains 1, the contents of CR[CR0] are undefined.

Registers Altered

- ICDBDR

Invalid Instruction Forms

- Reserved fields

Programming Note

Execution of this instruction is privileged.

The instruction pipeline does not automatically wait for data from **icread** to arrive at the ICDBDR before attempting to use the contents of the ICDBDR. Therefore, insert an **isync** instruction between **icread** and **mficbdr**.

```
icread r5,r6 # read cache information
isync      # ensure completion of icread
mficbdr r7 # move information to GPR
```

Instruction cache operations use MSR[DR], not MSR[IR], to determine translation of their operands. When data translation is disabled, cachability for the EA of the operand of instruction cache operations is determined by the ICCR, not the DCCR.

Exceptions

Instruction storage exceptions and instruction-side TLB miss exceptions are associated with instruction *fetching*, not with instruction execution. Exceptions that occur during the *execution* of instruction cache operations cause data-side exceptions (data storage exceptions and data TLB miss exceptions).

The execution of **icread** can cause a data TLB miss exception, at the specified EA, regardless of the non-specific intent of that EA.

This instruction is considered a “load” and cannot cause a data storage exception.

This instruction is considered a “load” with respect to data address compare (DAC) debug exceptions, but will not cause DAC debug events.

Architecture Note

This instruction is implementation-specific and may not be portable to other implementations.

isync

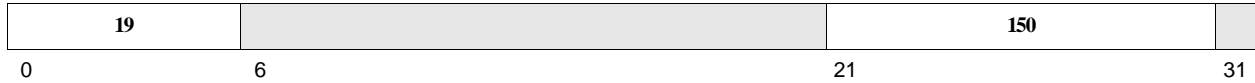

The **isync** instruction is a context synchronizing instruction.

isync provides an ordering function for the effects of all instructions executed by the processor. Executing **isync** insures that all instructions preceding the **isync** instruction execute before **isync** completes, except that storage accesses caused by those instructions need not have completed.

No subsequent instructions are initiated by the processor until **isync** completes. Finally, execution of **isync** causes the processor to discard any prefetched instructions, with the effect that subsequent instructions are fetched and executed in the context established by the instructions preceding **isync**.

isync has no effect on caches.

If instruction bit 31 contains 1, the contents of CR[CR0] are undefined.

Registers Altered

- None

Invalid Instruction Forms

- Reserved fields

Programming Note

See the discussion of context synchronizing instructions in “Synchronization” on page 3-124.

The following code example illustrates the necessary steps for self-modifying code. This example assumes that `addr1` is both data and instruction cachable.

```

stw      regN, addr1      # data in regN is to become an instruction at addr1
dcbst   addr1            # forces data from the data cache to memory
sync    # wait until the data actually reaches the memory
icbi    addr1            # the previous value at addr1 might already be in
                        # the instruction cache; invalidate in the cache
isync   # the previous value at addr1 might already have been
                        # pre-fetched into the queue; invalidate the queue
                        # so that the instruction must be re-fetched
    
```

Architecture Note

This instruction is part of the AMCC PowerPC Embedded Virtual Environment.

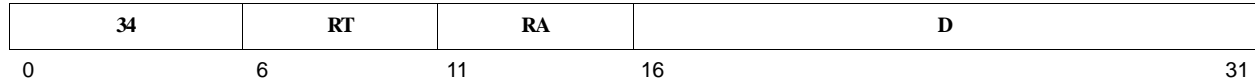
lbz RT, D(RA)

$$EA \leftarrow (RA|0) + \text{EXTS}(D)$$

$$(RT) \leftarrow {}^{24}0 \parallel \text{MS}(EA,1)$$

An effective address (EA) is formed by adding a displacement to a base address. The displacement is obtained by sign-extending the 16-bit D field to 32 bits. The base address is 0 if the RA field is 0 and is the contents of register RA otherwise.

The byte at the EA is extended to 32 bits by concatenating 24 0-bits to its left. The result is placed into register RT.

Registers Altered

- RT

Architecture Note

This instruction is part of the PowerPC User Instruction Set Architecture.

lbzu

Load Byte and Zero with Update

lbzu RT, D(RA)

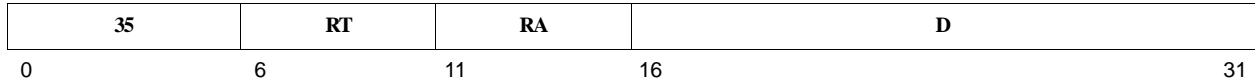

$$EA \leftarrow (RA|0) + \text{EXTS}(D)$$

$$(RA) \leftarrow EA$$

$$(RT) \leftarrow {}^{24}0 \parallel \text{MS}(EA,1)$$

An effective address (EA) is formed by adding a displacement to a base address. The displacement is obtained by sign-extending the 16-bit D field to 32 bits. The base address is 0 if the RA field is 0 and is the contents of register RA otherwise. The EA is placed into register RA.

The byte at the EA is extended to 32 bits by concatenating 24 0-bits to its left. The result is placed into register RT.

Registers Altered

- RA
- RT

Invalid Instruction Forms

- RA=RT
- RA=0

Architecture Note

This instruction is part of the PowerPC User Instruction Set Architecture.

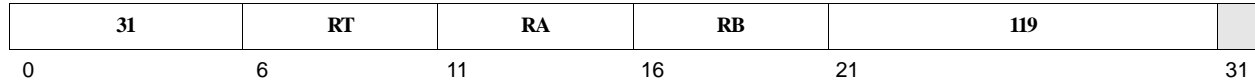
lbzux RT, RA, RB

$$EA \leftarrow (RA|0) + (RB)$$

$$(RA) \leftarrow EA$$

$$(RT) \leftarrow {}^{24}0 \parallel MS(EA,1)$$

An effective address (EA) is formed by adding an index to a base address. The index is the contents of register RB. The base address is 0 if the RA field is 0 and is the contents of register RA otherwise. The EA is placed into register RA.

The byte at the EA is extended to 32 bits by concatenating 24 0-bits to its left. The result is placed into register RT.

If instruction bit 31 contains 1, the contents of CR[CR0] are undefined.

Registers Altered

- RA
- RT

Invalid Instruction Forms

- Reserved fields
- RA=RT
- RA=0

Architecture Note

This instruction is part of the PowerPC User Instruction Set Architecture.

lbzx

Load Byte and Zero Indexed

lbzx RT,RA, RB

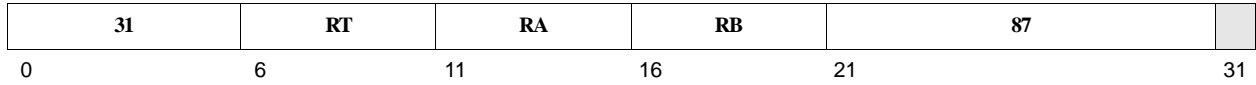

$$EA \leftarrow (RA|0) + (RB)$$

$$(RT) \leftarrow {}^{24}0 \parallel MS(EA,1)$$

An effective address (EA) is formed by adding an index to a base address. The index is the contents of register RB. The base address is 0 if the RA field is 0 and is the contents of register RA otherwise.

The byte at the EA is extended to 32 bits by concatenating 24 0-bits to its left. The result is placed into register RT.

If instruction bit 31 contains 1, the contents of CR[CR0] are undefined.

Registers Altered

- RT

Invalid Instruction Forms

- Reserved fields

Architecture Note

This instruction is part of the PowerPC User Instruction Set Architecture.

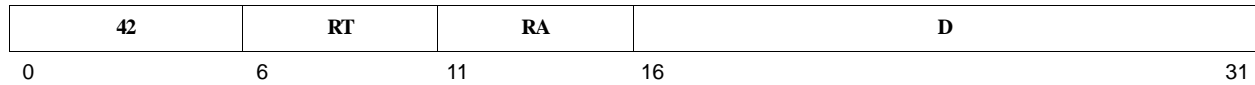
lha RT, D(RA)

$$EA \leftarrow (RA|0) + \text{EXTS}(D)$$

$$(RT) \leftarrow \text{EXTS}(\text{MS}(EA,2))$$

An effective address (EA) is formed by adding a displacement to a base address. The displacement is obtained by sign-extending the 16-bit D field to 32 bits. The base address is 0 if the RA field is 0 and is the contents of register RA otherwise.

The halfword at the EA is sign-extended to 32 bits and placed into register RT.

Registers Altered

- RT

Architecture Note

This instruction is part of the PowerPC User Instruction Set Architecture.

lhau

Load Halfword Algebraic with Update

lhau RT, D(RA)

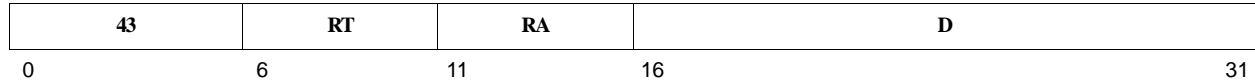

$$EA \leftarrow (RA) + \text{EXTS}(D)$$

$$(RA) \leftarrow EA$$

$$(RT) \leftarrow \text{EXTS}(\text{MS}(EA, 2))$$

An effective address (EA) is formed by adding a displacement to the base address in register RA. The displacement is obtained by sign-extending the 16-bit D field to 32 bits. The EA is placed into register RA.

The halfword at the EA is sign-extended to 32 bits and placed into register RT.

Registers Altered

- RA
- RT

Invalid Instruction Forms

- RA = RT
- RA = 0

Architecture Note

This instruction is part of the PowerPC User Instruction Set Architecture.

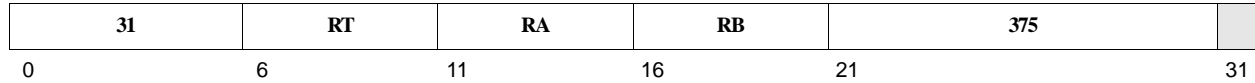
lhaux RT, RA, RB

$$EA \leftarrow (RA) + (RB)$$

$$(RA) \leftarrow EA$$

$$(RT) \leftarrow \text{EXTS}(\text{MS}(EA,2))$$

An effective address (EA) is formed by adding an index to the base address in register RA. The index is the contents of register RB. The EA is placed into register RA.

The halfword at the EA is sign-extended to 32 bits and placed into register RT.

If instruction bit 31 contains 1, the contents of CR[CR0] are undefined.

Registers Altered

- RA
- RT

Invalid Instruction Forms

- Reserved fields
- RA = RT
- RA = 0

Architecture Note

This instruction is part of the PowerPC User Instruction Set Architecture.

lhax

Load Halfword Algebraic Indexed

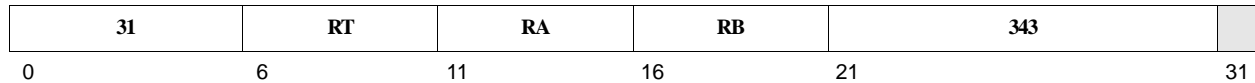
lhax RT, RA, RB

$$EA \leftarrow (RA|0) + (RB)$$

$$(RT) \leftarrow \text{EXTS}(\text{MS}(EA,2))$$

An effective address (EA) is formed by adding an index to a base address. The index is the contents of register RB. The base address is 0 if the RA field is 0 and is the contents of register RA otherwise.

The halfword at the EA is sign-extended to 32 bits and placed into register RT.

If instruction bit 31 contains 1, the contents of CR[CR0] are undefined.

Registers Altered

- RT

Invalid Instruction Forms

- Reserved fields

Architecture Note

This instruction is part of the PowerPC User Instruction Set Architecture.

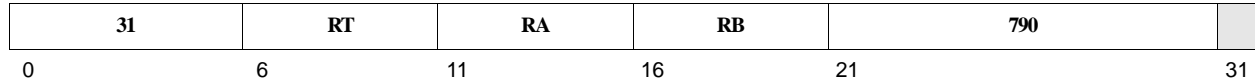
lhbrx RT, RA, RB

$$EA \leftarrow (RA|0) + (RB)$$

$$(RT) \leftarrow {}^{16}0 \parallel MS(EA+1,1) \parallel MS(EA,1)$$

An effective address (EA) is formed by adding an index to a base address. The index is the contents of register RB. The base address is 0 if the RA field is 0 and is the contents of register RA otherwise.

The halfword at the EA is byte-reversed. The resulting halfword is extended to 32 bits by concatenating 16 0-bits to its left. The result is placed into register RT.

If instruction bit 31 contains 1, the contents of CR[CR0] are undefined.

Registers Altered

- RT

Invalid Instruction Forms

- Reserved fields

Architecture Note

This instruction is part of the PowerPC User Instruction Set Architecture.

lhz

Load Halfword and Zero

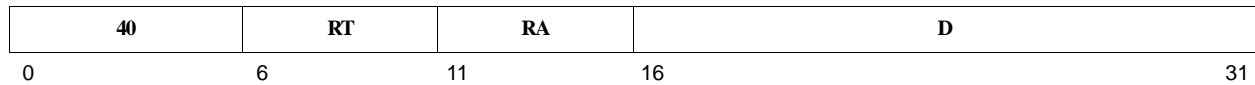
lhz RT, D(RA)

$$EA \leftarrow (RA|0) + \text{EXTS}(D)$$

$$(RT) \leftarrow {}^{16}0 \parallel \text{MS}(EA,2)$$

An effective address (EA) is formed by adding a displacement to a base address. The displacement is obtained by sign-extending the 16-bit D field to 32 bits. The base address is 0 if the RA field is 0 and is the contents of register RA otherwise.

The halfword at the EA is extended to 32 bits by concatenating 16 0-bits to its left. The result is placed into register RT.

Registers Altered

- RT

Architecture Note

This instruction is part of the PowerPC User Instruction Set Architecture.

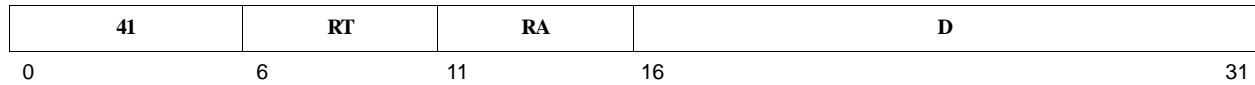
lhzu RT, D(RA)

$$EA \leftarrow (RA) + \text{EXTS}(D)$$

$$(RA) \leftarrow EA$$

$$(RT) \leftarrow {}^{16}0 \parallel \text{MS}(EA, 2)$$

An effective address (EA) is formed by adding a displacement to the base address in register RA. The displacement is obtained by sign-extending the 16-bit D field to 32 bits. The EA is placed into register RA.

The halfword at the EA is extended to 32 bits by concatenating 16 0-bits to its left. The result is placed into register RT.

Registers Altered

- RA
- RT

Invalid Instruction Forms

- RA = RT
- RA = 0

Architecture Note

This instruction is part of the PowerPC User Instruction Set Architecture.

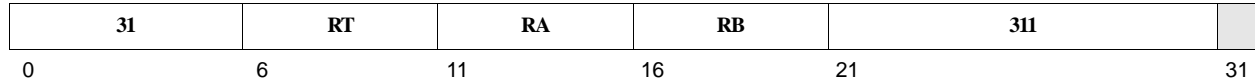
lhzux RT, RA, RB

$EA \leftarrow (RA) + (RB)$
 $(RA) \leftarrow EA$
 $(RT) \leftarrow {}^{16}0 \parallel MS(EA,2)$

An effective address (EA) is formed by adding an index to the base address in register RA. The index is the contents of register RB. The EA is placed into register RA.

The halfword at the EA is extended to 32 bits by concatenating 16 0-bits to its left. The result is placed into register RT.

If instruction bit 31 contains 1, the contents of CR[CR0] are undefined.

Registers Altered

- RA
- RT

Invalid Instruction Forms

- Reserved fields
- RA = RT
- RA = 0

Architecture Note

This instruction is part of the PowerPC User Instruction Set Architecture.

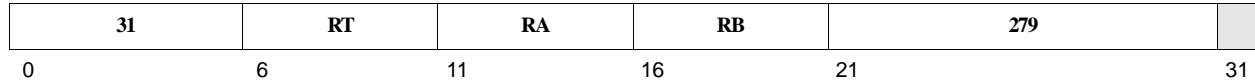
lhzx RT, RA, RB

$$EA \leftarrow (RA|0) + (RB)$$

$$(RT) \leftarrow {}^{16}0 \parallel MS(EA,2)$$

An effective address (EA) is formed by adding an index to a base address. The index is the contents of register RB. The base address is 0 if the RA field is 0 and is the contents of register RA otherwise.

The halfword at the EA is extended to 32 bits by concatenating 16 0-bits to its left. The result is placed into register RT.

If instruction bit 31 contains 1, the contents of CR[CR0] are undefined.

Registers Altered

- RT

Invalid Instruction Forms

- Reserved fields

Architecture Note

This instruction is part of the PowerPC User Instruction Set Architecture.

lww

Load Multiple Word

lww RT, D(RA)

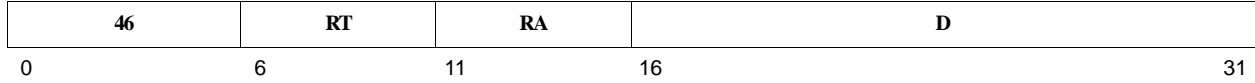

```
EA ← (RA|0) + EXTS(D)
r ← RT
do while r ≤ 31
  if ((r ≠ RA) ∨ (r = 31)) then
    (GPR(r)) ← MS(EA,4)
  r ← r + 1
  EA ← EA + 4
```

An effective address (EA) is formed by adding a displacement to a base address. The displacement is obtained by sign-extending the 16-bit D field in the instruction to 32 bits. The base address is 0 if the RA field is 0 and is the contents of register RA otherwise.

A series of consecutive words starting at the EA are loaded into a set of consecutive GPRs, starting with register RT and continuing to and including GPR(31). Register RA is not altered by this instruction (unless RA is GPR(31), which is an invalid form of this instruction). The word which would have been placed into register RA is discarded.

Registers Altered

- RT through GPR(31).

Invalid Instruction Forms

- RA is in the range of registers to be loaded, including the case RA = RT = 0.

Architecture Note

This instruction is part of the PowerPC User Instruction Set Architecture.

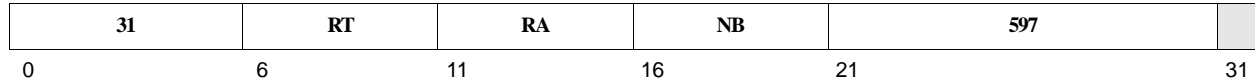
lswi RT, RA, NB

```

EA ← (RA|0)
if NB = 0 then
  CNT ← 32
else
  CNT ← NB
n ← CNT
RFINAL ← ((RT + CEIL(CNT/4) - 1) % 32)
r ← RT - 1
i ← 0
do while n > 0
  if i = 0 then
    r ← r + 1
    if r = 32 then
      r ← 0
    if ((r ≠ RA) ∨ (r = RFINAL)) then
      (GPR(r)) ← 0
  if ((r ≠ RA) ∨ (r = RFINAL)) then
    (GPR(r)i:i+7) ← MS(EA,1)
  i ← i + 8
  if i = 32 then
    i ← 0
  EA ← EA + 1
  n ← n - 1

```

An effective address (EA) is determined by the RA field. If the RA field contains 0, the EA is 0. Otherwise, the EA is the contents of register RA.

The NB field specifies the byte count CNT. If the NB field contains 0, the byte count is CNT = 32. Otherwise, the byte count is CNT = NB.

A series of CNT consecutive bytes in main storage, starting at the EA, are loaded into CEIL(CNT/4) consecutive GPRs, four bytes per GPR, until the byte count is exhausted. Bytes are loaded into GPRs; the byte at the lowest address is loaded into the most significant byte. Bits to the right of the last byte loaded into the last GPR are set to 0.

The set of loaded GPRs starts at register RT, continues consecutively through GPR(31), and wraps to register 0, loading until the byte count is exhausted, which occurs in register R_{FINAL}. Register RA is not altered (unless RA = R_{FINAL}, an invalid form of this instruction). Bytes which would have been loaded into register RA are discarded.

If instruction bit 31 contains 1, the contents of CR[CR0] are undefined.

Registers Altered

- RT and subsequent GPRs as described above.

lswi

Load String Word Immediate

Invalid Instruction Forms

- Reserved fields
- RA is in the range of registers to be loaded
- RA = RT = 0

Architecture Note

This instruction is part of the PowerPC User Instruction Set Architecture.

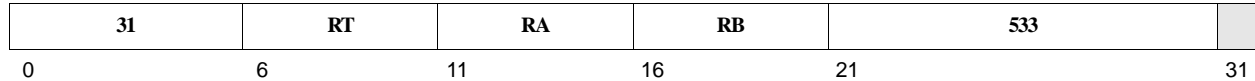
lswx RT, RA, RB

```

EA ← (RA|0) + (RB)
CNT ← XER[TBC]
n ← CNT
RFINAL ← ((RT + CEIL(CNT/4) – 1) % 32)
r ← RT – 1
i ← 0
do while n > 0
  if i = 0 then
    r ← r + 1
    if r = 32 then
      r ← 0
    if (((r ≠ RA) ∧ (r ≠ RB)) ∨ (r = RFINAL)) then
      (GPR(r)) ← 0
  if (((r ≠ RA) ∧ (r ≠ RB)) ∨ (r = RFINAL)) then
    (GPR(r)i:i+7) ← MS(EA,1)
  i ← i + 8
  if i = 32 then
    i ← 0
  EA ← EA + 1
  n ← n – 1

```

An effective address (EA) is formed by adding an index to a base address. The index is the contents of register RB. The base address is 0 if the RA field is 0 and is the contents of register RA otherwise.

A byte count CNT is obtained from XER[TBC].

A series of CNT consecutive bytes in main storage, starting at the EA, are loaded into CEIL(CNT/4) consecutive GPRs, four bytes per GPR, until the byte count is exhausted. Bytes are loaded into GPRs; the byte having the lowest address is loaded into the most significant byte. Bits to the right of the last byte loaded in the last GPR used are set to 0.

The set of consecutive GPRs loaded starts at register RT, continues through GPR(31), and wraps to register 0, loading until the byte count is exhausted, which occurs in register R_{FINAL}. Register RA is not altered (unless RA = R_{FINAL}, which is an invalid form of this instruction). Register RB is not altered (unless RB = R_{FINAL}, which is an invalid form of this instruction). Bytes which would have been loaded into registers RA or RB are discarded.

If XER[TBC] is 0, the byte count is 0 and the contents of register RT are undefined.

If instruction bit 31 contains 1, the contents of CR[CR0] are undefined.

Registers Altered

- RT and subsequent GPRs as described above.

Invalid Instruction Forms

- Reserved fields

lswx

Load String Word Indexed

- RA or RB is in the range of registers to be loaded.
- RA = RT = 0

Programming Note

If XER[TBC] = 0, the contents of register RT are unchanged and **lswx** is treated as a no-op.

The PowerPC Architecture states that, if XER[TBC] = 0 and if the EA is such that a precise data exception would normally occur (if not for the zero length), **lswx** is treated as a no-op and the precise exception will not occur. Data storage exceptions and alignment exceptions are examples of precise data exceptions.

However, the PowerPC Architecture makes no statement regarding imprecise exceptions related to **lswx** with XER[TBC] = 0. The PPC405GP generates an imprecise exception (machine check) on this instruction when all of the following conditions are true:

- The instruction passes all protection bounds checking
- The address is cachable
- The address is passed to the data cache
- The address misses in the data cache (resulting in a line fill request)
- The address encounters some form of bus error

Architecture Note

This instruction is part of the PowerPC User Instruction Set Architecture.

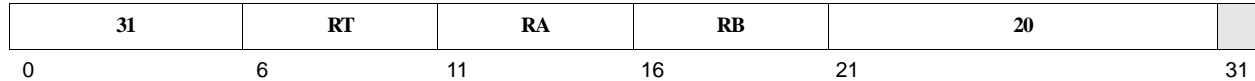
lwarx RT, RA, RB

$EA \leftarrow (RA|0) + (RB)$
 $RESERVE \leftarrow 1$
 $(RT) \leftarrow MS(EA,4)$

An effective address (EA) is formed by adding an index to a base address. The index is the contents of register RB. The base address is 0 if the RA field is 0 and is the contents of register RA otherwise.

The word at the EA is placed into register RT.

If instruction bit 31 contains 1, the contents of CR[CR0] are undefined.

Execution of the **lwarx** instruction sets the reservation bit.

Registers Altered

- RT

Invalid Instruction Forms

- Reserved fields

Programming Note

lwarx and the **stwcx.** instruction should be paired in a loop, as shown in the following example, to create the effect of an atomic operation to a memory area used as a semaphore between asynchronous processes. Only **lwarx** can set the reservation bit to 1. **stwcx.** sets the reservation bit to 0 upon its completion, whether or not **stwcx.** sent (RS) to memory. CR[CR0]_{EQ} must be examined to determine whether (RS) was sent to memory.

```

loop: lwarx # read the semaphore from memory; set reservation
      "alter" # change the semaphore bits in register as required
      stwcx. # attempt to store semaphore; reset reservation
      bne loop # an asynchronous process has intervened; try again

```

If the asynchronous process in the code example had paired **lwarx** with a store other than **stwcx.**, the reservation bit would not have been cleared in the asynchronous process, and the code example would have overwritten the semaphore.

Exceptions

An alignment exception occurs if the EA is not word-aligned.

Architecture Note

This instruction is part of the PowerPC User Instruction Set Architecture.

lwbrx

Load Word Byte-Reverse Indexed

lwbrx RT, RA, RB

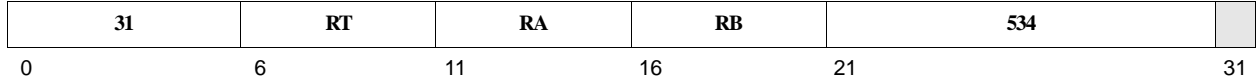

$$EA \leftarrow (RA|0) + (RB)$$

$$(RT) \leftarrow MS(EA+3,1) \parallel MS(EA+2,1) \parallel MS(EA+1,1) \parallel MS(EA,1)$$

An effective address (EA) is formed by adding an index to a base address. The index is the contents of register RB. The base address is 0 if the RA field is 0 and is the contents of register RA otherwise.

The word at the EA is byte-reversed: the least significant byte becomes the most significant byte, the next least significant byte becomes the next most significant byte, and so on. The resulting word is placed into register RT.

If instruction bit 31 contains 1, the contents of CR[CR0] are undefined.

Registers Altered

- RT

Invalid Instruction Forms

- Reserved fields

Architecture Note

This instruction is part of the PowerPC User Instruction Set Architecture.

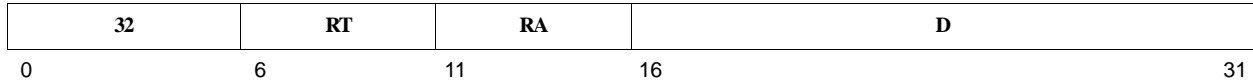
lwz RT, D(RA)

$$EA \leftarrow (RA|0) + \text{EXTS}(D)$$

$$(RT) \leftarrow \text{MS}(EA, 4)$$

An effective address (EA) is formed by adding a displacement to a base address. The displacement is obtained by sign-extending the 16-bit D field to 32 bits. The base address is 0 if the RA field is 0 and is the contents of register RA otherwise.

The word at the EA is placed into register RT.

Registers Altered

- RT

Architecture Note

This instruction is part of the PowerPC User Instruction Set Architecture.

lwzu

Load Word and Zero with Update

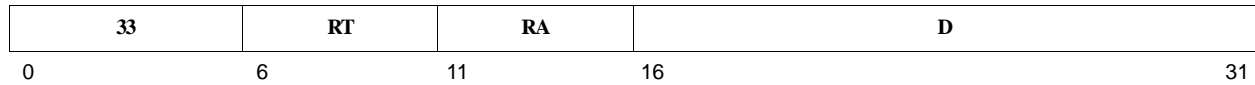
lwzu RT, D(RA)

$$EA \leftarrow (RA) + \text{EXTS}(D)$$

$$(RA) \leftarrow EA$$

$$(RT) \leftarrow \text{MS}(EA, 4)$$

An effective address (EA) is formed by adding a displacement to the base address in register RA. The displacement is obtained by sign-extending the 16-bit D field to 32 bits. The EA is placed into register RA.

The word at the EA is placed into register RT.

Registers Altered

- RA
- RT

Invalid Instruction Forms

- RA = RT
- RA = 0

Architecture Note

This instruction is part of the PowerPC User Instruction Set Architecture.

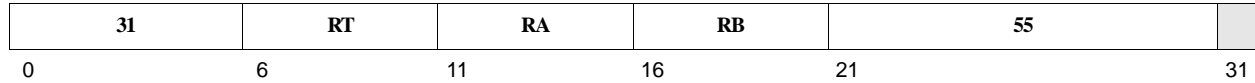
lwzux RT, RA, RB

$$EA \leftarrow (RA) + (RB)$$

$$(RA) \leftarrow EA$$

$$(RT) \leftarrow MS(EA,4)$$

An effective address (EA) is formed by adding an index to the base address in register RA. The index is the contents of register RB. The EA is placed into register RA.

The word at the EA is placed into register RT.

If instruction bit 31 contains 1, the contents of CR[CR0] are undefined.

Registers Altered

- RA
- RT

Invalid Instruction Forms

- Reserved fields
- RA = RT
- RA = 0

Architecture Note

This instruction is part of the PowerPC User Instruction Set Architecture.

lwzx

Load Word and Zero Indexed

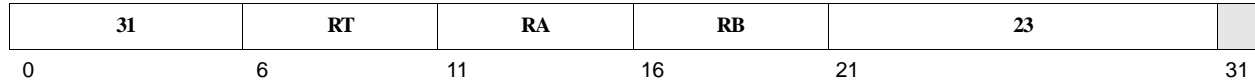
lwzx RT, RA, RB

$$EA \leftarrow (RA|0) + (RB)$$

$$(RT) \leftarrow MS(EA,4)$$

An effective address (EA) is formed by adding an index to a base address. The index is the contents of register RB. The base address is 0 if the RA field is 0 and is the contents of register RA otherwise.

The word at the EA is placed into register RT.

If instruction bit 31 contains 1, the contents of CR[CR0] are undefined.

Registers Altered

- RT

Invalid Instruction Forms

- Reserved fields

Architecture Note

This instruction is part of the PowerPC User Instruction Set Architecture.

Preliminary User's Manual

macchw	RT, RA, RB	OE=0, Rc=0
macchw.	RT, RA, RB	OE=0, Rc=1
macchwo	RT, RA, RB	OE=1, Rc=0
macchwo.	RT, RA, RB	OE=1, Rc=1

4	RT	RA	RB	OE	172	Rc
0	6	11	16	21 22		31

$$\text{prod}_{0:31} \leftarrow (\text{RA})_{16:31} \times (\text{RB})_{0:15} \text{ signed}$$

$$\text{temp}_{0:32} \leftarrow \text{prod}_{0:31} + (\text{RT})$$

$$(\text{RT}) \leftarrow \text{temp}_{1:32}$$

The low-order halfword of RA is multiplied by the high-order halfword of RB. The signed product is summed with the contents of RT and the sum is stored in a 33-bit temporary register. The contents of RT are replaced by the low-order 32 bits of the temporary register.

Registers Altered

- RT
- CR[CR0]_{LT, GT, EQ, SO} if Rc contains 1
- XER[SO, OV] if OE contains 1

Architecture Note

This instruction is part of the Multiply-Accumulate instruction set extensions and complies with the architectural requirements for APUs of the AMCC PowerPC Embedded Environment. As such, it is not part of the PowerPC Architecture, nor is it part of the AMCC PowerPC Embedded Environment. Programs that use this instruction may not be portable to other implementations.

macchws

Multiply Accumulate Cross Halfword to Word Saturate Signed

macchws	RT, RA, RB	OE=0, Rc=0
macchws.	RT, RA, RB	OE=0, Rc=1
macchwso	RT, RA, RB	OE=1, Rc=0
macchwso.	RT, RA, RB	OE=1, Rc=1

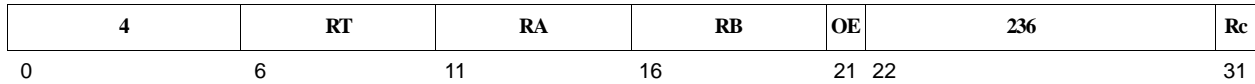

```

prod0:31 ← (RA)16:31 × (RB)0:15 signed
temp0:32 ← prod0:31 + (RT)
if ((prod0 = RT0) ∧ (RT0 ≠ temp1)) then (RT) ← (RT0 || 31(¬RT0))
else (RT) ← temp1:32
    
```

The low-order halfword of RA is multiplied by the high-order halfword of RB. The signed product is summed with the contents of RT and the sum is stored in a 33-bit temporary register.

If a result does not overflow, the low-order 32 bits of the temporary register are stored in RT.

If a result overflows, the returned result is the nearest representable value. Thus, if a result is less than -2^{31} , the value stored in RT is -2^{31} . Likewise, if a result is greater than $2^{31} - 1$, the value stored in RT is $2^{31} - 1$.

Registers Altered

- RT
- CR[CR0]_{LT, GT, EQ, SO} if Rc contains 1
- XER[SO, OV] if OE contains 1

Architecture Note

This instruction is part of the Multiply-Accumulate instruction set extensions and complies with the architectural requirements for APUs of the AMCC PowerPC Embedded Environment. As such, it is not part of the PowerPC Architecture, nor is it part of the AMCC PowerPC Embedded Environment. Programs that use this instruction may not be portable to other implementations.

macchwsu	RT, RA, RB	OE=0, Rc=0
macchwsu.	RT, RA, RB	OE=0, Rc=1
macchwsuo	RT, RA, RB	OE=1, Rc=0
macchwsuo.	RT, RA, RB	OE=1, Rc=1

4	RT	RA	RB	OE	204	Rc
0	6	11	16	21 22		31

$$\text{prod}_{0:31} \leftarrow (\text{RA})_{16:31} \times (\text{RB})_{0:15} \text{ unsigned}$$

$$\text{temp}_{0:32} \leftarrow \text{prod}_{0:31} + (\text{RT})$$

$$(\text{RT}) \leftarrow (\text{temp}_{1:32} \vee {}^{32}\text{temp}_0)$$

The low-order halfword of RA is multiplied by the high-order halfword of RB. The unsigned product is summed with the contents of RT and the sum is stored in a 33-bit temporary register.

If a result does not overflow, the low-order 32 bits of the temporary register are stored in RT.

If a result overflows, the returned result is the nearest representable value. Thus, if a result is greater than $2^{32} - 1$, the value stored in RT is $2^{32} - 1$.

Registers Altered

- RT
- CR[CR0]_{LT, GT, EQ, SO} if Rc contains 1
- XER[SO, OV] if OE contains 1

Architecture Note

This instruction is part of the Multiply-Accumulate instruction set extensions and complies with the architectural requirements for APUs of the AMCC PowerPC Embedded Environment. As such, it is not part of the PowerPC Architecture, nor is it part of the AMCC PowerPC Embedded Environment. Programs that use this instruction may not be portable to other implementations.

macchwu

Multiply Accumulate Cross Halfword to Word Modulo Unsigned

macchwu	RT, RA, RB	OE=0, Rc=0
macchwu.	RT, RA, RB	OE=0, Rc=1
macchwuo	RT, RA, RB	OE=1, Rc=0
macchwuo.	RT, RA, RB	OE=1, Rc=1

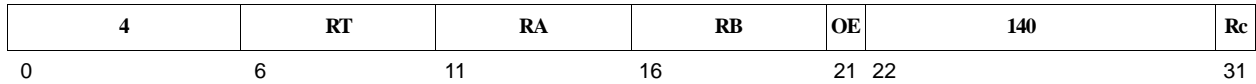

$$\text{prod}_{0:31} \leftarrow (\text{RA})_{16:31} \times (\text{RB})_{0:15} \text{ unsigned}$$

$$\text{temp}_{0:32} \leftarrow \text{prod}_{0:31} + (\text{RT})$$

$$(\text{RT}) \leftarrow \text{temp}_{1:32}$$

The low-order halfword of RA is multiplied by the high-order halfword of RB. The unsigned product is summed with the contents of RT and the sum is stored in a 33-bit temporary register. The contents of RT are replaced by the low-order 32 bits of the temporary register.

Registers Altered

- RT
- CR[CR0]_{LT, GT, EQ, SO} if Rc contains 1
- XER[SO, OV] if OE contains 1

Architecture Note

This instruction is part of the Multiply-Accumulate instruction set extensions and complies with the architectural requirements for APUs of the AMCC PowerPC Embedded Environment. As such, it is not part of the PowerPC Architecture, nor is it part of the AMCC PowerPC Embedded Environment. Programs that use this instruction may not be portable to other implementations.

Preliminary User's Manual

machhw	RT, RA, RB	OE=0, Rc=0
machhw.	RT, RA, RB	OE=0, Rc=1
machhwo	RT, RA, RB	OE=1, Rc=0
machhwo.	RT, RA, RB	OE=1, Rc=1

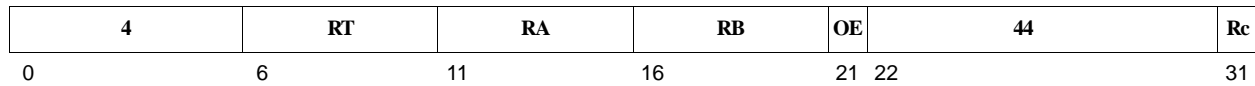

$$\text{prod}_{0:31} \leftarrow (\text{RA})_{0:15} \times (\text{RB})_{0:15} \text{ signed}$$

$$\text{temp}_{0:32} \leftarrow \text{prod}_{0:31} + (\text{RT})$$

$$(\text{RT}) \leftarrow \text{temp}_{1:32}$$

The high-order halfword of RA is multiplied by the high-order halfword of RB. The signed product is summed with the contents of RT and the sum is stored in a 33-bit temporary register. The contents of RT are replaced by the low-order 32 bits of the temporary register.

Registers Altered

- RT
- CR[CR0]_{LT, GT, EQ, SO} if Rc contains 1
- XER[SO, OV] if OE contains 1

Architecture Note

This instruction is part of the Multiply-Accumulate instruction set extensions and complies with the architectural requirements for APUs of the AMCC PowerPC Embedded Environment. As such, it is not part of the PowerPC Architecture, nor is it part of the AMCC PowerPC Embedded Environment. Programs that use this instruction may not be portable to other implementations.

machhws

Multiply Accumulate High Halfword to Word Saturate Signed

machhws	RT, RA, RB	OE=0, Rc=0
machhws.	RT, RA, RB	OE=0, Rc=1
machhwso	RT, RA, RB	OE=1, Rc=0
machhwso.	RT, RA, RB	OE=1, Rc=1

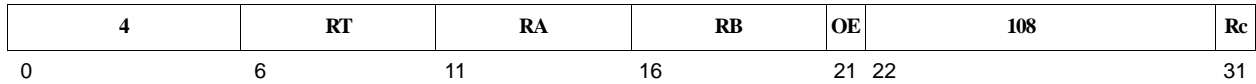

```

prod0:31 ← (RA)0:15 × (RB)0:15 signed
temp0:32 ← prod0:31 + (RT)
if ((prod0 = RT0) ∧ (RT0 ≠ temp1)) then (RT) ← (RT0 || 31(¬RT0))
else (RT) ← temp1:32
    
```

The high-order halfword of RA is multiplied by the high-order halfword of RB. The signed product is summed with the contents of RT and the sum is stored in a 33-bit temporary register.

If a result does not overflow, the low-order 32 bits of the temporary register are stored in RT.

If a result overflows, the returned result is the nearest representable value. Thus, if a result is less than -2^{31} , the value stored in RT is -2^{31} . Likewise, if a result is greater than $2^{31} - 1$, the value stored in RT is $2^{31} - 1$.

Registers Altered

- RT
- CR[CR0]_{LT, GT, EQ, SO} if Rc contains 1
- XER[SO, OV] if OE contains 1

Architecture Note

This instruction is part of the Multiply-Accumulate instruction set extensions and complies with the architectural requirements for APUs of the AMCC PowerPC Embedded Environment. As such, it is not part of the PowerPC Architecture, nor is it part of the AMCC PowerPC Embedded Environment. Programs that use this instruction may not be portable to other implementations.

machhwsu	RT, RA, RB	OE=0, Rc=0
machhwsu.	RT, RA, RB	OE=0, Rc=1
machhwsuo	RT, RA, RB	OE=1, Rc=0
machhwsuo.	RT, RA, RB	OE=1, Rc=1

4	RT	RA	RB	OE	76	Rc
0	6	11	16	21 22		31

$$\text{prod}_{0:31} \leftarrow (\text{RA})_{0:15} \times (\text{RB})_{0:15} \text{ unsigned}$$

$$\text{temp}_{0:32} \leftarrow \text{prod}_{0:31} + (\text{RT})$$

$$(\text{RT}) \leftarrow (\text{temp}_{1:32} \vee {}^{32}\text{temp}_0)$$

The high-order halfword of RA is multiplied by the high-order halfword of RB. The unsigned product is summed with the contents of RT and the sum is stored in a 33-bit temporary register.

If a result does not overflow, the low-order 32 bits of the temporary register are stored in RT.

If a result overflows, the returned result is the nearest representable value. Thus, if a result is greater than $2^{32} - 1$, the value stored in RT is $2^{32} - 1$.

Registers Altered

- RT
- CR[CR0]_{LT, GT, EQ, SO} if Rc contains 1
- XER[SO, OV] if OE contains 1

Architecture Note

This instruction is part of the Multiply-Accumulate instruction set extensions and complies with the architectural requirements for APUs of the AMCC PowerPC Embedded Environment. As such, it is not part of the PowerPC Architecture, nor is it part of the AMCC PowerPC Embedded Environment. Programs that use this instruction may not be portable to other implementations.

machhwu

Multiply Accumulate High Halfword to Word Modulo Unsigned

machhwu	RT, RA, RB	OE=0, Rc=0
machhwu.	RT, RA, RB	OE=0, Rc=1
machhwuo	RT, RA, RB	OE=1, Rc=0
machhwuo.	RT, RA, RB	OE=1, Rc=1

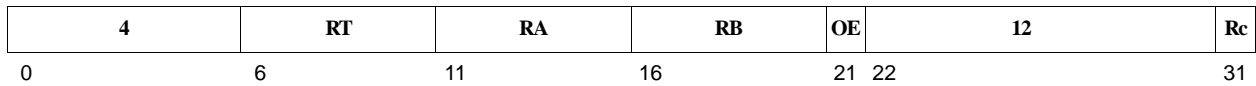

$$prod_{0:31} \leftarrow (RA)_{0:15} \times (RB)_{0:15} \text{ unsigned}$$

$$temp_{0:32} \leftarrow prod_{0:31} + (RT)$$

$$(RT) \leftarrow temp_{1:32}$$

The high-order halfword of RA is multiplied by the high-order halfword of RB. The unsigned product is summed with the contents of RT and the sum is stored in a 33-bit temporary register. The contents of RT are replaced by the low-order 32 bits of the temporary register.

Registers Altered

- RT
- CR[CR0]_{LT, GT, EQ, SO} if Rc contains 1
- XER[SO, OV] if OE contains 1

Architecture Note

This instruction is part of the Multiply-Accumulate instruction set extensions and complies with the architectural requirements for APUs of the AMCC PowerPC Embedded Environment. As such, it is not part of the PowerPC Architecture, nor is it part of the AMCC PowerPC Embedded Environment. Programs that use this instruction may not be portable to other implementations.

Preliminary User's Manual

maclhw	RT, RA, RB	OE=0, Rc=0
maclhw.	RT, RA, RB	OE=0, Rc=1
maclhwo	RT, RA, RB	OE=1, Rc=0
maclhwo.	RT, RA, RB	OE=1, Rc=1

4	RT	RA	RB	OE	428	Rc
0	6	11	16	21 22		31

$prod_{0:31} \leftarrow (RA)_{16:31} \times (RB)_{16:31}$ signed

$temp_{0:32} \leftarrow prod_{0:31} + (RT)$

$(RT) \leftarrow temp_{1:32}$

The low-order halfword of RA is multiplied by the low-order halfword of RB. The signed product is summed with the contents of RT and the sum is stored in a 33-bit temporary register. The contents of RT are replaced by the low-order 32 bits of the temporary register.

Registers Altered

- RT
- CR[CR0]_{LT, GT, EQ, SO} if Rc contains 1
- XER[SO, OV] if OE contains 1

Architecture Note

This instruction is part of the Multiply-Accumulate instruction set extensions and complies with the architectural requirements for APUs of the AMCC PowerPC Embedded Environment. As such, it is not part of the PowerPC Architecture, nor is it part of the AMCC PowerPC Embedded Environment. Programs that use this instruction may not be portable to other implementations.

maclhws

Multiply Accumulate Low Halfword to Word Saturate Signed

maclhws	RT, RA, RB	OE=0, Rc=0
maclhws.	RT, RA, RB	OE=0, Rc=1
maclhwso	RT, RA, RB	OE=1, Rc=0
maclhwso.	RT, RA, RB	OE=1, Rc=1

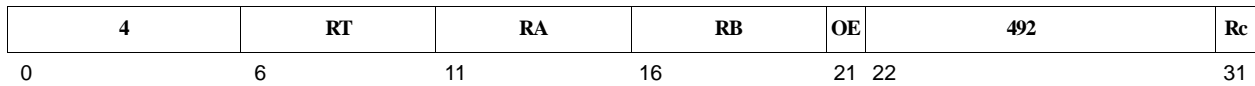

```

prod0:31 ← (RA)16:31 × (RB)16:31 signed
temp0:32 ← prod0:31 + (RT)
if ((prod0 = RT0) ∧ (RT0 ≠ temp1)) then (RT) ← (RT0 || 31(¬RT0))
else (RT) ← temp1:32
    
```

The low-order halfword of RA is multiplied by the low-order halfword of RB. The signed product is summed with the contents of RT and the sum is stored in a 33-bit temporary register.

If a result does not overflow, the low-order 32 bits of the temporary register are stored in RT.

If a result overflows, the returned result is the nearest representable value. Thus, if a result is less than -2^{31} , the value stored in RT is -2^{31} . Likewise, if a result is greater than $2^{31} - 1$, the value stored in RT is $2^{31} - 1$.

Registers Altered

- RT
- CR[CR0]_{LT, GT, EQ, SO} if Rc contains 1
- XER[SO, OV] if OE contains 1

Architecture Note

This instruction is part of the Multiply-Accumulate instruction set extensions and complies with the architectural requirements for APUs of the AMCC PowerPC Embedded Environment. As such, it is not part of the PowerPC Architecture, nor is it part of the AMCC PowerPC Embedded Environment. Programs that use this instruction may not be portable to other implementations.

Preliminary User's Manual

maclhwsu	RT, RA, RB	OE=0, Rc=0
maclhwsu.	RT, RA, RB	OE=0, Rc=1
maclhwsuo	RT, RA, RB	OE=1, Rc=0
maclhwsuo.	RT, RA, RB	OE=1, Rc=1

4	RT	RA	RB	OE	460	Rc
0	6	11	16	21 22		31

$$\text{prod}_{0:31} \leftarrow (\text{RA})_{16:31} \times (\text{RB})_{16:31} \text{ unsigned}$$

$$\text{temp}_{0:32} \leftarrow \text{prod}_{0:31} + (\text{RT})$$

$$(\text{RT}) \leftarrow (\text{temp}_{1:32} \vee {}^{32}\text{temp}_0)$$

The low-order halfword of RA is multiplied by the low-order halfword of RB. The unsigned product is summed with the contents of RT and the sum is stored in a 33-bit temporary register.

If a result does not overflow, the low-order 32 bits of the temporary register are stored in RT.

If a result overflows, the returned result is the nearest representable value. Thus, if a result is greater than $2^{32} - 1$, the value stored in RT is $2^{32} - 1$.

Registers Altered

- RT
- CR[CR0]_{LT, GT, EQ, SO} if Rc contains 1
- XER[SO, OV] if OE contains 1

Architecture Note

This instruction is part of the Multiply-Accumulate instruction set extensions and complies with the architectural requirements for APUs of the AMCC PowerPC Embedded Environment. As such, it is not part of the PowerPC Architecture, nor is it part of the AMCC PowerPC Embedded Environment. Programs that use this instruction may not be portable to other implementations.

maclhwu

Multiply Accumulate Low Halfword to Word Modulo Unsigned

maclhwu	RT, RA, RB	OE=0, Rc=0
maclhwu.	RT, RA, RB	OE=0, Rc=1
maclhwuo	RT, RA, RB	OE=1, Rc=0
maclhwuo.	RT, RA, RB	OE=1, Rc=1

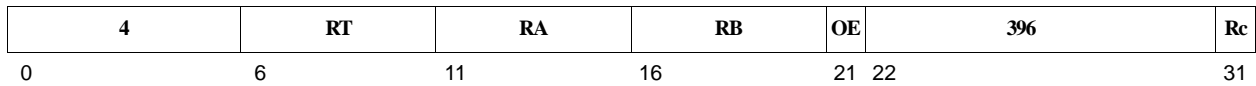

$$prod_{0:31} \leftarrow (RA)_{16:31} \times (RB)_{16:31} \text{ unsigned}$$

$$temp_{0:32} \leftarrow prod_{0:31} + (RT)$$

$$(RT) \leftarrow temp_{1:32}$$

The low-order halfword of RA is multiplied by the low-order halfword of RB. The unsigned product is summed with the contents of RT and the sum is stored in a 33-bit temporary register. The contents of RT are replaced by the low-order 32 bits of the temporary register.

Registers Altered

- RT
- CR[CR0]_{LT, GT, EQ, SO} if Rc contains 1
- XER[SO, OV] if OE contains 1

Architecture Note

This instruction is part of the Multiply-Accumulate instruction set extensions and complies with the architectural requirements for APUs of the AMCC PowerPC Embedded Environment. As such, it is not part of the PowerPC Architecture, nor is it part of the AMCC PowerPC Embedded Environment. Programs that use this instruction may not be portable to other implementations.

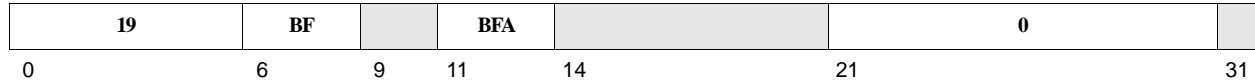
mcrf BF, BFA $m \leftarrow \text{BFA}$ $n \leftarrow \text{BF}$ $(\text{CR}[\text{CR}_n]) \leftarrow (\text{CR}[\text{CR}_m])$

The contents of the CR field specified by the BFA field are placed into the CR field specified by the BF field.

Registers Altered

- $\text{CR}[\text{CR}_n]$ where n is specified by the BF field.

Invalid Instruction Forms

- Reserved fields

Architecture Note

This instruction is part of the PowerPC User Instruction Set Architecture.

mcrxr

Move to Condition Register from XER

mcrxr **BF**

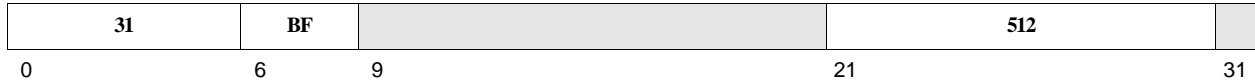

$n \leftarrow \text{BF}$
 $(\text{CR}[\text{CR}_n]) \leftarrow \text{XER}_{0:3}$
 $\text{XER}_{0:3} \leftarrow 40$

The contents of $\text{XER}_{0:3}$ are placed into the CR field specified by the BF field. $\text{XER}_{0:3}$ are then set to 0.

This transfer is positional, by bit number, so the mnemonics associated with each bit are changed. See Table 24-18 for clarification.

Table 24-18. Transfer Bit Mnemonic Assignment

Bit	XER Usage	CR Usage
0	SO	LT
1	OV	GT
2	CA	EQ
3	Reserved	SO

If instruction bit 31 contains 1, the contents of $\text{CR}[\text{CR}_0]$ are undefined.

Registers Altered

- $\text{CR}[\text{CR}_n]$ where n is specified by the BF field.
- $\text{XER}[\text{SO}, \text{OV}, \text{CA}]$

Invalid Instruction Forms

- Reserved fields

Architecture Note

This instruction is part of the PowerPC User Instruction Set Architecture.

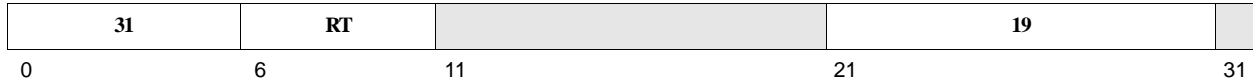
mfcrr RT $(RT) \leftarrow (CR)$

The contents of the CR are placed into register RT.

If instruction bit 31 contains 1, the contents of CR[CR0] are undefined.

Registers Altered

- RT

Invalid Instruction Forms

- Reserved fields

Architecture Note

This instruction is part of the PowerPC User Instruction Set Architecture.

mfdcr

Move from Device Control Register

mfdcr RT, DCRN

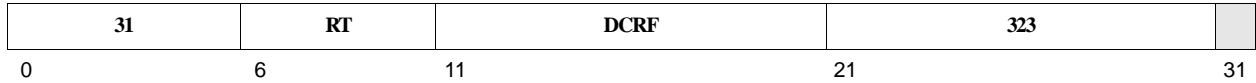

$$\begin{aligned} \text{DCRN} &\leftarrow \text{DCRF}_{5:9} \parallel \text{DCRF}_{0:4} \\ (\text{RT}) &\leftarrow (\text{DCR}(\text{DCRN})) \end{aligned}$$

The contents of the DCR specified by the DCRF field are placed into register RT.

If instruction bit 31 contains 1, the contents of CR[CR0] are undefined.

Registers Altered

- RT

Invalid Instruction Forms

- Reserved fields
- Invalid DCRF values

Programming Note

Execution of this instruction is privileged.

The DCR number (DCRN) specified in the assembler language coding of **mfdcr** refers to a DCR number. The assembler handles the unusual register number encoding to generate the DCRF field.

Architecture Note

This instruction is implementation-specific and may not be portable to other implementations.

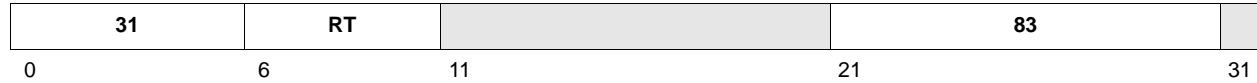
mfmsr RT $(RT) \leftarrow (MSR)$

The contents of the MSR are placed into register RT.

If instruction bit 31 contains 1, the contents of CR[CR0] are undefined.

Registers Altered

- RT

Invalid Instruction Forms

- Reserved fields

Programming Note

Execution of this instruction is privileged.

Architecture Note

This instruction is part of the AMCC PowerPC Embedded Operating Environment.

mfspr

Move From Special Purpose Register

mfspr RT, SPRN

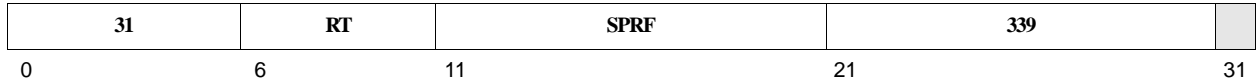

$$\text{SPRN} \leftarrow \text{SPRF}_{5:9} \parallel \text{SPRF}_{0:4}$$

$$(\text{RT}) \leftarrow (\text{SPR}(\text{SPRN}))$$

The contents of the SPR specified by the SPRF field are placed into register RT. See “Special Purpose Registers” on page 25-863 for a listing of SPR mnemonics and corresponding SPRN and SPRF values.

If instruction bit 31 contains 1, the contents of CR[CR0] are undefined.

Registers Altered

- RT

Invalid Instruction Forms

- Reserved fields
- Invalid SPRF values

Programming Note

Execution of this instruction is privileged if instruction bit 11 contains 1. See “Privileged Mode Operation” on page 3-122.

The SPR number (SPRN) specified in the assembler language coding of **mfspir** refers to an SPR number (see “Special Purpose Registers” on page 25-863 for a list of SPRN values). The assembler handles the unusual register number encoding to generate the SPRF field. Also, see “Privileged SPRs” on page 3-123 for information about privileged SPRs.

Architecture Note

This instruction is part of the PowerPC User Instruction Set Architecture.

Table 24-19. Extended Mnemonics for mfspr

Mnemonic	Operands	Function	Other Registers Changed
mfccr0 mfctr mfdac1 mfdac2 mfdear mfdbcr0 mfdbcr1 mfdbsr mfdccr mfdcwr mfdvc1 mfdvc2 mfesr mfevpr mfiac1 mfiac2 mfiac3 mfiac4 mficcr mficdbdr mflr mfpid mfpit mfpvr mfsgl mfsler mfsprg0 mfsprg1 mfsprg2 mfsprg3 mfsprg4 mfsprg5 mfsprg6 mfsprg7 mfstr0 mfstr1 mfstr2 mfstr3 mfsu0r mftcr mftsr mfxer mfzpr	RT	Move from special purpose register SPRN. <i>Extended mnemonic for</i> mfspr RT,SPRN See “Special Purpose Registers” on page 25-863 for a list of valid SPRN values.	

mftb

Move From Time Base

mftb RT, TBRN

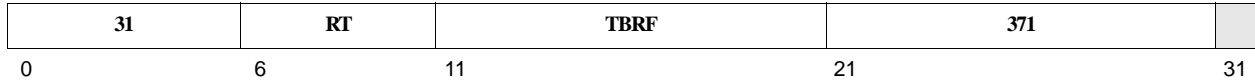

$$TBRN \leftarrow TBRF_{5:9} \parallel TBRF_{0:4}$$

$$(RT) \leftarrow (TBR(TBRN))$$

The contents of the time base register (TBR) specified by the TBRF field are placed into register RT. The following table lists the TBRN and TBRF values.

Table 24-20. Extended Mnemonics for mftb

Register Mnemonic	Register Name	TBRN		TBRF	Access
		Decimal	Hex		
TBL	Time Base Lower	268	0x10C	0x188	Read-only
TBU	Time Base Upper	269	0x10D	0x1A8	Read-only

If TBRN is a value other than those listed in the table, the results are boundedly undefined.

Registers Altered

- RT

Invalid Instruction Forms

- Reserved fields
- Invalid TBRF values

Programming Notes

The mnemonic **mftb** serves as both a hardware mnemonic and an extended mnemonic. The assembler recognizes an **mftb** mnemonic having two operands as the hardware form; an **mftb** mnemonic having one operand is recognized as the extended form.

The TBR number (TBRN) specified in the assembler language coding of the **mftb** instruction refers to a TBR number listed in the preceding table. The assembler handles the unusual register number encoding to generate the TBRF field.

Architecture Note

This instruction is part of the AMCC PowerPC Embedded Virtual Environment.

Table 24-21. Extended Mnemonics for mftb

Mnemonic	Operands	Function	Other Registers Altered
mftb	RT	Move the contents of TBL into RT. <i>Extended mnemonic for</i> mftb RT,TBL	
mftbu	RT	Move the contents of TBU into RT. <i>Extended mnemonic for</i> mftb RT,TBU	

mtcrf

Move to Condition Register Fields

mtcrf FXM, RS

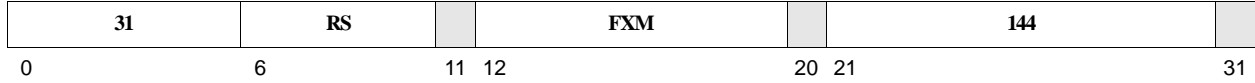

$$\text{mask} \leftarrow {}^4(\text{FXM}_0) \parallel {}^4(\text{FXM}_1) \parallel \dots \parallel {}^4(\text{FXM}_6) \parallel {}^4(\text{FXM}_7)$$

$$(\text{CR}) \leftarrow ((\text{RS}) \wedge \text{mask}) \vee ((\text{CR}) \wedge \neg \text{mask})$$

Some or all of the contents of register RS are placed into the CR as specified by the FXM field.

Each bit in the FXM field controls the copying of 4 bits in register RS into the corresponding bits in the CR. The correspondence between the bits in the FXM field and the bit copying operation is shown in the following table:

FXM Bit Number	Bits Controlled
0	0:3
1	4:7
2	8:11
3	12:15
4	16:19
5	20:23
6	24:27
7	28:31

If instruction bit 31 contains 1, the contents of CR[CR0] are undefined.

Registers Altered

- CR

Invalid Instruction Forms

- Reserved fields

Architecture Note

This instruction is part of the PowerPC User Instruction Set Architecture.

Table 24-22. Extended Mnemonics for mtcrrf

Mnemonic	Operands	Function	Other Registers Altered
mtcrf	RS	Move to CR. <i>Extended mnemonic for mtcrrf 0xFF,RS</i>	

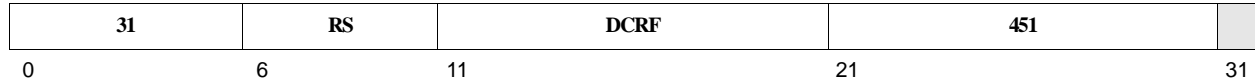
mtdcr DCRN, RS

$$\text{DCRN} \leftarrow \text{DCRF}_{5:9} \parallel \text{DCRF}_{0:4}$$

$$(\text{DCR}(\text{DCRN})) \leftarrow (\text{RS})$$

The contents of register RS are placed into the DCR specified by the DCRF field.

If instruction bit 31 contains 1, the contents of CR[CR0] are undefined.

Registers Altered

- DCR(DCRN)

Invalid Instruction Forms

- Reserved fields
- Invalid DCRF values

Programming Note

Execution of this instruction is privileged.

The DCR number (DCRN) specified in the assembler language coding of **mtdcr** refers to a DCR number. The assembler handles the unusual register number encoding to generate the DCRF field.

Architecture Note

This instruction is implementation-specific and may not be portable to other implementations.

mtmsr

Move To Machine State Register

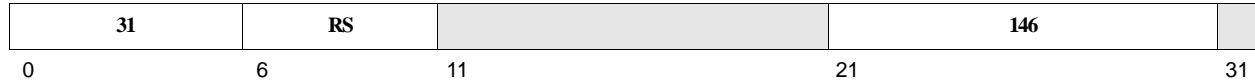
mtmsr RS $(MSR) \leftarrow (RS)$

The contents of register RS are placed into the MSR.

If instruction bit 31 contains 1, the contents of CR[CR0] are undefined.

Registers Altered

- MSR

Invalid Instruction Forms

- Reserved fields

Programming Note

The **mtmsr** instruction is privileged and execution synchronizing.

Architecture Note

This instruction is part of the AMCC PowerPC Embedded Operating Environment.

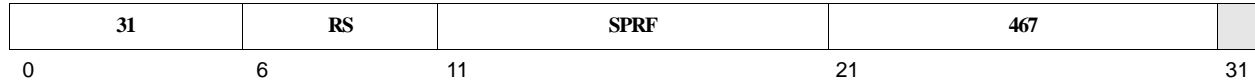
mtspr SPRN, RS

$$\text{SPRN} \leftarrow \text{SPRF}_{5:9} \parallel \text{SPRF}_{0:4}$$

$$(\text{SPR}(\text{SPRN})) \leftarrow (\text{RS})$$

The contents of register RS are placed into register RT. See “Special Purpose Registers” on page 25-863 for a listing of SPR mnemonics and corresponding SPRN and SPRF values.

If instruction bit 31 contains 1, the contents of CR[CR0] are undefined.

Registers Altered

- SPR(SPRN)

Invalid Instruction Forms

- Reserved fields
- Invalid SPRF values

Programming Note

Execution of this instruction is privileged if instruction bit 11 is a 1. See “Privileged SPRs” on page 3-123 for more information.

The SPR number (SPRN) specified in the assembler language coding of the **mtspr** instruction refers to an SPR number (see “Special Purpose Registers” on page 25-863 for a list of SPRN values). The assembler handles the unusual register number encoding to generate the SPRF field.

Architecture Note

This instruction is part of the PowerPC User Instruction Set Architecture.

Table 24-23. Extended Mnemonics for mtspr

Mnemonic	Operands	Function	Other Registers Altered
mtccr0 mtctr mtdac1 mtdac2 mtdbcr0 mtdbcr1 mtdbsr mtdccr mtdcwr mtdear mtdvc1 mtdvc2 mtesr mtevpr mtiac1 mtiac2 mtiac3 mtiac4 mticcr mticdbdr mtr mtpid mtpit mtpvr mtsgr mtsler mtsprg0 mtsprg1 mtsprg2 mtsprg3 mtsprg4 mtsprg5 mtsprg6 mtsprg7 mtsrr0 mtsrr1 mtsrr2 mtsrr3 mtsu0r mttcr mttsr mtxer mtzpr	RS	Move to special purpose register SPRN. <i>Extended mnemonic for mtspr SPRN,RS</i> See "Special Purpose Registers" on page 25-863 for a list of valid SPRN values.	

mulchw RT, RA, RB Rc=0
mulchw. RT, RA, RB Rc=1

4	RT	RA	RB	168	Rc
0	6	11	16	21	31

$(RT)_{0:31} \leftarrow (RA)_{16:31} \times (RB)_{0:15}$ signed

The low-order halfword of RA is multiplied by the high-order halfword of RB. The resulting signed product replaces the contents of RT.

Registers Altered

- RT
- CR[CR0]_{LT, GT, EQ, SO} if Rc contains 1

Architecture Note

This instruction is part of the Multiply-Accumulate instruction set extensions and complies with the architectural requirements for APUs of the AMCC PowerPC Embedded Environment. As such, it is not part of the PowerPC Architecture, nor is it part of the AMCC PowerPC Embedded Environment. Programs that use this instruction may not be portable to other implementations.

mulchwu

Multiply Cross Halfword to Word Unsigned

mulchwu RT, RA, RB Rc=0
mulchwu. RT, RA, RB Rc=1

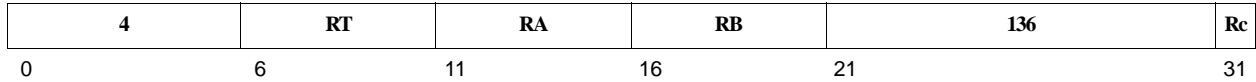

$$(RT)_{0:31} \leftarrow (RA)_{16:31} \times (RB)_{0:15} \text{ unsigned}$$

The low-order halfword of RA is multiplied by the high-order halfword of RB. The resulting unsigned product replaces the contents of RT.

Registers Altered

- RT
- CR[CR0]_{LT, GT, EQ, SO} if Rc contains 1

Architecture Note

This instruction is part of the Multiply-Accumulate instruction set extensions and complies with the architectural requirements for APUs of the AMCC PowerPC Embedded Environment. As such, it is not part of the PowerPC Architecture, nor is it part of the AMCC PowerPC Embedded Environment. Programs that use this instruction may not be portable to other implementations.

Preliminary User's Manual

mulhww RT, RA, RB Rc=0
mulhww. RT, RA, RB Rc=1

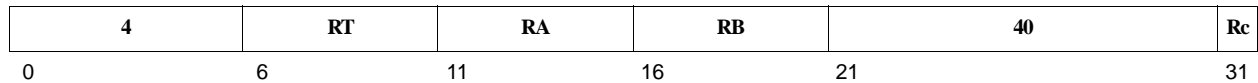

$(RT)_{0:31} \leftarrow (RA)_{0:15} \times (RB)_{0:15}$ signed

The high-order halfword of RA is multiplied by the high-order halfword of RB. The resulting signed product replaces the contents of RT.

Registers Altered

- RT
- CR[CR0]_{LT, GT, EQ, SO} if Rc contains 1

Architecture Note

This instruction is part of the Multiply-Accumulate instruction set extensions and complies with the architectural requirements for APUs of the AMCC PowerPC Embedded Environment. As such, it is not part of the PowerPC Architecture, nor is it part of the AMCC PowerPC Embedded Environment. Programs that use this instruction may not be portable to other implementations.

mulhwwu

Multiply High Halfword to Word Unsigned

mulhwwu RT, RA, RB Rc=0
mulhwwu. RT, RA, RB Rc=1

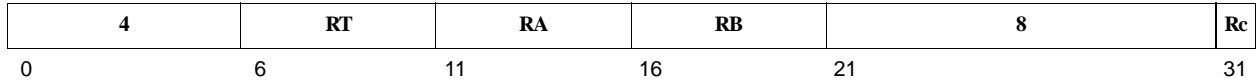

$$(RT)_{0:31} \leftarrow (RA)_{0:15} \times (RB)_{0:15} \text{ unsigned}$$

The high-order halfword of RA is multiplied by the high-order halfword of RB. The resulting unsigned product replaces the contents of RT.

Registers Altered

- RT
- CR[CR0]_{LT, GT, EQ, SO} if Rc contains 1

Architecture Note

This instruction is part of the Multiply-Accumulate instruction set extensions and complies with the architectural requirements for APUs of the AMCC PowerPC Embedded Environment. As such, it is not part of the PowerPC Architecture, nor is it part of the AMCC PowerPC Embedded Environment. Programs that use this instruction may not be portable to other implementations.

mullhw RT, RA, RB Rc=0
mullhw. RT, RA, RB Rc=1

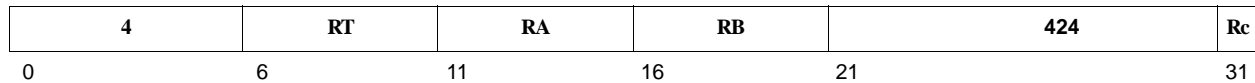

$(RT)_{0:31} \leftarrow (RA)_{16:31} \times (RB)_{16:31}$ signed

The low-order halfword of RA is multiplied by the low-order halfword of RB. The resulting signed product replaces the contents of RT.

Registers Altered

- RT
- CR[CR0]_{LT, GT, EQ, SO} if Rc contains 1

Architecture Note

This instruction is part of the Multiply-Accumulate instruction set extensions and complies with the architectural requirements for APUs of the AMCC PowerPC Embedded Environment. As such, it is not part of the PowerPC Architecture, nor is it part of the AMCC PowerPC Embedded Environment. Programs that use this instruction may not be portable to other implementations.

mullhwu

Multiply Low Halfword to Word Unsigned

mullhwu RT, RA, RB OE=0, Rc=0
mullhwu. RT, RA, RB OE=0, Rc=1

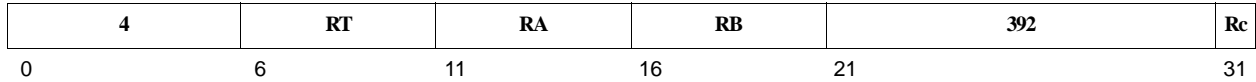

$$(RT)_{0:31} \leftarrow (RA)_{16:31} \times (RB)_{16:31} \text{ unsigned}$$

The low-order halfword of RA is multiplied by the low-order halfword of RB. The resulting unsigned product replaces the contents of RT.

Registers Altered

- RT
- CR[CR0]_{LT, GT, EQ, SO} if Rc contains 1

Architecture Note

This instruction is part of the Multiply-Accumulate instruction set extensions and complies with the architectural requirements for APUs of the AMCC PowerPC Embedded Environment. As such, it is not part of the PowerPC Architecture, nor is it part of the AMCC PowerPC Embedded Environment. Programs that use this instruction may not be portable to other implementations.

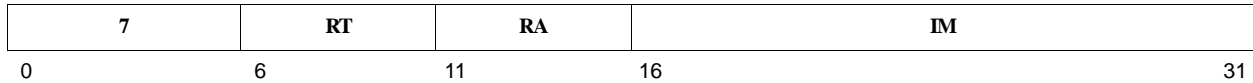
mulli RT, RA, IM

$$\text{prod}_{0:47} \leftarrow (\text{RA}) \times \text{EXTS}(\text{IM}) \text{ signed}$$

$$(\text{RT}) \leftarrow \text{prod}_{16:47}$$

The 48-bit product of register RA and the sign-extended IM field is formed. Both register RA and the IM field are interpreted as signed quantities. The least significant 32 bits of the product are placed into register RT.

Registers Altered

- RT

Programming Note

The least significant 32 bits of the product are correct, regardless of whether register RA and field IM are interpreted as signed or unsigned numbers.

Architecture Note

This instruction is part of the PowerPC User Instruction Set Architecture.

mullw

Multiply Low Word

mullw	RT, RA, RB	OE=0, Rc=0
mullw.	RT, RA, RB	OE=0, Rc=1
mullwo	RT, RA, RB	OE=1, Rc=0
mullwo.	RT, RA, RB	OE=1, Rc=1

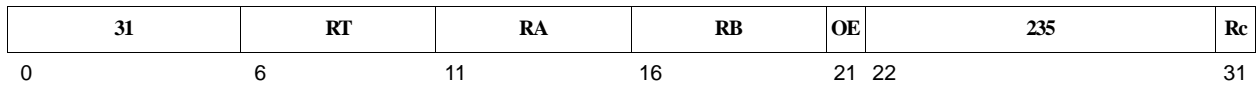

$$\text{prod}_{0:63} \leftarrow (\text{RA}) \times (\text{RB}) \text{ signed}$$

$$(\text{RT}) \leftarrow \text{prod}_{32:63}$$

The 64-bit signed product of register RA and register RB is formed. The least significant 32 bits of the result is placed into register RT.

If the signed product cannot be represented in 32 bits and OE=1, XER[SO, OV] are set to 1.

Registers Altered

- RT
- CR[CR0]_{LT, GT, EQ, SO} if Rc contains 1
- XER[SO, OV] if OE=1

Programming Note

The least significant 32 bits of the product are correct, regardless of whether register RA and register RB are interpreted as signed or unsigned numbers. The overflow indication is correct only if the operands are regarded as signed numbers.

Architecture Note

This instruction is part of the PowerPC User Instruction Set Architecture.

nand RA, RS, RB Rc=0
nand. RA, RS, RB Rc=1

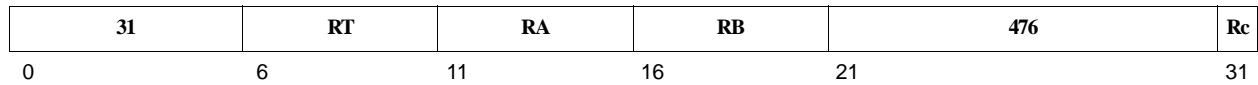

$$(RA) \leftarrow \neg((RS) \wedge (RB))$$

The contents of register RS is ANDed with the contents of register RB; the ones complement of the result is placed into register RA.

Registers Altered

- RA
- CR[CR0]_{LT, GT, EQ, SO} if Rc contains 1

Architecture Note

This instruction is part of the PowerPC User Instruction Set Architecture.

neg
Negate

neg	RT, RA	OE=0, Rc=0
neg.	RT, RA	OE=0, Rc=1
nego	RT, RA	OE=1, Rc=0
nego.	RT, RA	OE=1, Rc=1

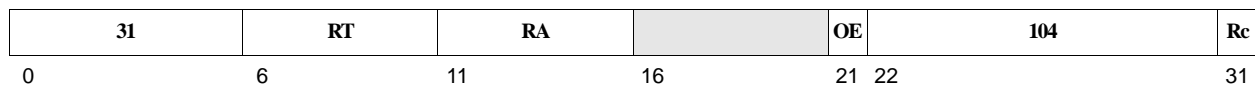

$$(RT) \leftarrow \neg(RA) + 1$$

The two's complement of the contents of register RA are placed into register RT.

Registers Altered

- RT
- CR[CR0]_{LT, GT, EQ, SO} if Rc contains 1
- XER[SO, OV] if OE=1

Invalid Instruction Forms

- Reserved fields

Architecture Note

This instruction is part of the PowerPC User Instruction Set Architecture.

nmacchw	RT, RA, RB	OE=0, Rc=0
nmacchw.	RT, RA, RB	OE=0, Rc=1
nmacchwo	RT, RA, RB	OE=1, Rc=0
nmacchwo.	RT, RA, RB	OE=1, Rc=1

4	RT	RA	RB	OE	174	Rc
0	6	11	16	21 22		31

$$\text{nprod}_{0:31} \leftarrow -((\text{RA})_{16:31} \times (\text{RB})_{0:15}) \text{ signed}$$

$$\text{temp}_{0:32} \leftarrow \text{nprod}_{0:31} + (\text{RT})$$

$$(\text{RT}) \leftarrow \text{temp}_{1:32}$$

The low-order halfword of RA is multiplied by the high-order halfword of RB. The negated signed product is summed with the contents of RT and the sum is stored in a 33-bit temporary register. The contents of RT are replaced by the low-order 32 bits of the temporary register.

Registers Altered

- RT
- CR[CR0]_{LT, GT, EQ, SO} if Rc contains 1

Architecture Note

This instruction is part of the Multiply-Accumulate instruction set extensions and complies with the architectural requirements for APUs of the AMCC PowerPC Embedded Environment. As such, it is not part of the PowerPC Architecture, nor is it part of the AMCC PowerPC Embedded Environment. Programs that use this instruction may not be portable to other implementations.

nmacchws

Negative Multiply Accumulate Cross Halfword to Word Saturate

nmacchws	RT, RA, RB	OE=0, Rc=0
nmacchws.	RT, RA, RB	OE=0, Rc=1
nmacchwso	RT, RA, RB	OE=1, Rc=0
nmacchwso.	RT, RA, RB	OE=1, Rc=1

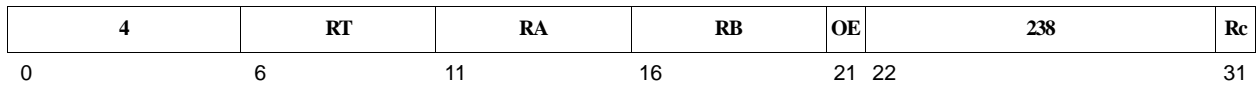

```

nprod0:31 ← -((RA)16:31 × (RB)0:15 signed)
temp0:32 ← nprod0:31 + (RT)
if ((nprod0 = RT0) ∧ (RT0 ≠ temp1)) then (RT) ← (RT0 || 31(¬RT0))
else (RT) ← temp1:32
    
```

The low-order halfword of RA is multiplied by the high-order halfword of RB. The negated signed product is summed with the contents of RT and the sum is stored in a 33-bit temporary register.

If a result does not overflow, the low-order 32 bits of the temporary register are stored in RT.

If a result overflows, the returned result is the nearest representable value. Thus, if a result is less than -2^{31} , the value stored in RT is -2^{31} . Likewise, if a result is greater than $2^{31} - 1$, the value stored in RT is $2^{31} - 1$.

Registers Altered

- RT
- CR[CR0]_{LT, GT, EQ, SO} if Rc contains 1
- XER[SO, OV] if OE contains 1

Architecture Note

This instruction is part of the Multiply-Accumulate instruction set extensions and complies with the architectural requirements for APUs of the AMCC PowerPC Embedded Environment. As such, it is not part of the PowerPC Architecture, nor is it part of the AMCC PowerPC Embedded Environment. Programs that use this instruction may not be portable to other implementations.

Preliminary User's Manual

nmachhw	RT, RA, RB	OE=0, Rc=0
nmachhw.	RT, RA, RB	OE=0, Rc=1
nmachhwo	RT, RA, RB	OE=1, Rc=0
nmachhwo.	RT, RA, RB	OE=1, Rc=1

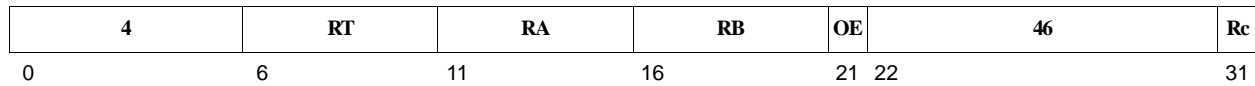

$$\text{nprod}_{0:31} \leftarrow -((\text{RA})_{0:15} \times (\text{RB})_{0:15}) \text{ signed}$$

$$\text{temp}_{0:32} \leftarrow \text{nprod}_{0:31} + (\text{RT})$$

$$(\text{RT}) \leftarrow \text{temp}_{1:32}$$

The high-order halfword of RA is multiplied by the high-order halfword of RB. The negated signed product is summed with the contents of RT and the sum is stored in a 33-bit temporary register. The contents of RT are replaced by the low-order 32 bits of the temporary register.

Registers Altered

- RT
- CR[CR0]_{LT, GT, EQ, SO} if Rc contains 1
- XER[SO, OV] if OE contains 1

Architecture Note

This instruction is part of the Multiply-Accumulate instruction set extensions and complies with the architectural requirements for APUs of the AMCC PowerPC Embedded Environment. As such, it is not part of the PowerPC Architecture, nor is it part of the AMCC PowerPC Embedded Environment. Programs that use this instruction may not be portable to other implementations.

nmachhws

Negative Multiply Accumulate High Halfword to Word Saturate

nmachhws	RT, RA, RB	OE=0, Rc=0
nmachhws.	RT, RA, RB	OE=0, Rc=1
nmachhws0	RT, RA, RB	OE=1, Rc=0
nmachhws0.	RT, RA, RB	OE=1, Rc=1

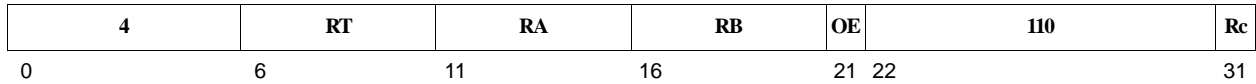

```

nprod0:31 ← -((RA)0:15 × (RB)0:15) signed
temp0:32 ← nprod0:31 + (RT)
if ((nprod0 = RT0) ∧ (RT0 ≠ temp1)) then (RT) ← (RT0 || 31(¬RT0))
else (RT) ← temp1:32
    
```

The high-order halfword of RA is multiplied by the high-order halfword of RB. The negated signed product is summed with the contents of RT and the sum is stored in a 33-bit temporary register.

If a result does not overflow (i.e., it is accurately representable in 32 bits), the low-order 32 bits of the temporary register are stored in RT.

If a result overflows, the returned result is the nearest representable value. Thus, if a result is less than -2^{31} , the value stored in RT is -2^{31} . Likewise, if a result is greater than $2^{31} - 1$, the value stored in RT is $2^{31} - 1$.

Registers Altered

- RT
- CR[CR0]_{LT, GT, EQ, SO} if Rc contains 1
- XER[SO, OV] if OE contains 1

Architecture Note

This instruction is part of the Multiply-Accumulate instruction set extensions and complies with the architectural requirements for APUs of the AMCC PowerPC Embedded Environment. As such, it is not part of the PowerPC Architecture, nor is it part of the AMCC PowerPC Embedded Environment. Programs that use this instruction may not be portable to other implementations.

nmaclhw	RT, RA, RB	OE=0, Rc=0
nmaclhw.	RT, RA, RB	OE=0, Rc=1
nmaclhwo	RT, RA, RB	OE=1, Rc=0
nmachlwo.	RT, RA, RB	OE=1, Rc=1

4	RT	RA	RB	OE	430	Rc
0	6	11	16	21 22		31

$$\text{nprod}_{0:31} \leftarrow -((\text{RA})_{16:31} \times (\text{RB})_{16:31}) \text{ signed}$$

$$\text{temp}_{0:32} \leftarrow \text{nprod}_{0:31} + (\text{RT})$$

$$(\text{RT}) \leftarrow \text{temp}_{1:32}$$

The low-order halfword of RA is multiplied by the low-order halfword of RB. The negated signed product is summed with the contents of RT and the sum is stored in a 33-bit temporary register. The contents of RT are replaced by the low-order 32 bits of the temporary register.

Registers Altered

- RT
- CR[CR0]_{LT, GT, EQ, SO} if Rc contains 1
- XER[SO, OV] if OE contains 1

Architecture Note

This instruction is part of the Multiply-Accumulate instruction set extensions and complies with the architectural requirements for APUs of the AMCC PowerPC Embedded Environment. As such, it is not part of the PowerPC Architecture, nor is it part of the AMCC PowerPC Embedded Environment. Programs that use this instruction may not be portable to other implementations.

nmaclhws

Negative Multiply Accumulate High Halfword to Word Saturate

nmaclhws	RT, RA, RB	OE=0, Rc=0
nmaclhws.	RT, RA, RB	OE=0, Rc=1
nmaclhwso	RT, RA, RB	OE=1, Rc=0
nmachlwso.	RT, RA, RB	OE=1, Rc=1

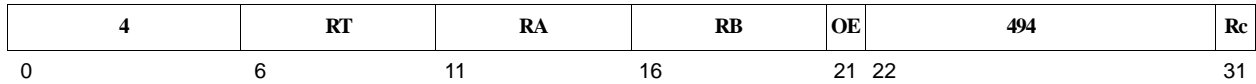

```

nprod0:31 ← -((RA)16:31 × (RB)16:31) signed
temp0:32 ← nprod0:31 + (RT)
if ((nprod0 = RT0) ∧ (RT0 ≠ temp1)) then (RT) ← (RT0 || 31(¬RT0))
else (RT) ← temp1:32
    
```

The low-order halfword of RA is multiplied by the low-order halfword of RB. The negated signed product is summed with the contents of RT and the sum is stored in a 33-bit temporary register.

If a result does not overflow, the low-order 32 bits of the temporary register are stored in RT.

If a result overflows, the returned result is the nearest representable value. Thus, if a result is less than -2^{31} , the value stored in RT is -2^{31} . Likewise, if a result is greater than $2^{31} - 1$, the value stored in RT is $2^{31} - 1$.

Registers Altered

- RT
- CR[CR0]_{LT, GT, EQ, SO} if Rc contains 1
- XER[SO, OV] if OE contains 1

Architecture Note

This instruction is part of the Multiply-Accumulate instruction set extensions and complies with the architectural requirements for APUs of the AMCC PowerPC Embedded Environment. As such, it is not part of the PowerPC Architecture, nor is it part of the AMCC PowerPC Embedded Environment. Programs that use this instruction may not be portable to other implementations.

nor RA, RS, RB Rc=0
nor. RA, RS, RB Rc=1

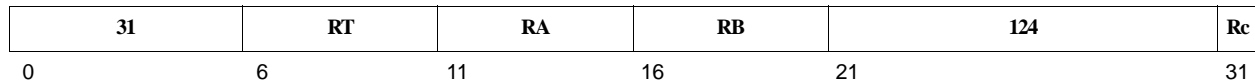

$$(RA) \leftarrow \neg((RS) \vee (RB))$$

The contents of register RS is ORed with the contents of register RB; the ones complement of the result is placed into register RA.

Registers Altered

- RA
- CR[CR0]_{LT, GT, EQ, SO} if Rc contains 1

Architecture Note

This instruction is part of the PowerPC User Instruction Set Architecture.

Table 24-24. Extended Mnemonics for nor, nor.

Mnemonic	Operands	Function	Other Registers Altered
not	RA, RS	Complement register. (RA) $\leftarrow \neg(RS)$ <i>Extended mnemonic for nor RA,RS,RS</i>	
not.		<i>Extended mnemonic for nor. RA,RS,RS</i>	CR[CR0]

or
OR

or RA, RS, RB Rc=0
or. RA, RS, RB Rc=1

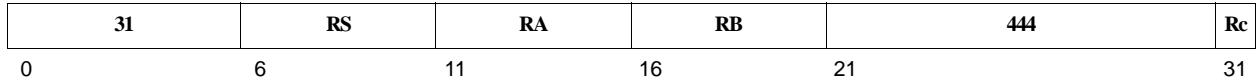

$(RA) \leftarrow (RS) \vee (RB)$

The contents of register RS is ORed with the contents of register RB; the result is placed into register RA.

Registers Altered

- RA
- CR[CR0]_{LT, GT, EQ, SO} if Rc contains 1

Architecture Note

This instruction is part of the PowerPC User Instruction Set Architecture.

Table 24-25. Extended Mnemonics for or, or.

Mnemonic	Operands	Function	Other Registers Altered
mr	RT, RS	Move register. (RT) ← (RS) <i>Extended mnemonic for or RT,RS,RS</i>	
mr.		<i>Extended mnemonic for or. RT,RS,RS</i>	CR[CR0]

orc RA, RS, RB Rc=0
orc. RA, RS, RB Rc=1

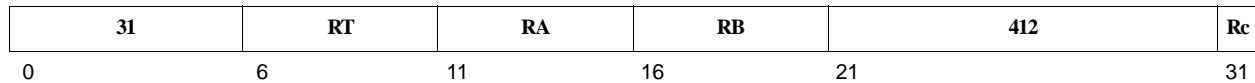

$$(RA) \leftarrow (RS) \vee \neg(RB)$$

The contents of register RS is ORed with the ones complement of the contents of register RB; the result is placed into register RA.

Registers Altered

- RA
- CR[CR0]_{LT, GT, EQ, SO} if Rc contains 1

Architecture Note

This instruction is part of the PowerPC User Instruction Set Architecture.

ori
OR Immediate

ori RA, RS, IM

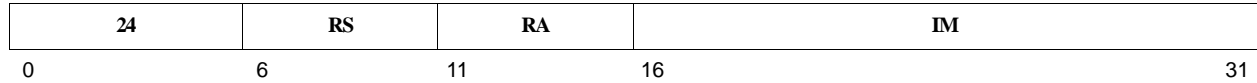

$$(RA) \leftarrow (RS) \vee (^{16}0 \parallel IM)$$

The IM field is extended to 32 bits by concatenating 16 0-bits on the left. Register RS is ORed with the extended IM field; the result is placed into register RA.

Registers Altered

- RA

Architecture Note

This instruction is part of the PowerPC User Instruction Set Architecture.

Table 24-26. Extended Mnemonics for ori

Mnemonic	Operands	Function	Other Registers Changed
nop		Preferred no-op; triggers optimizations based on no-ops. <i>Extended mnemonic for</i> ori 0,0,0	

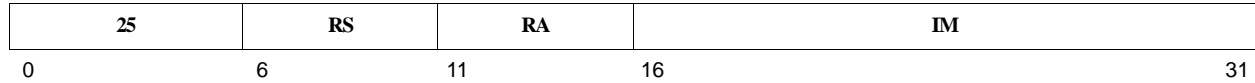
oris RA, RS, IM

$$(RA) \leftarrow (RS) \vee (IM \parallel 160)$$

The IM Field is extended to 32 bits by concatenating 16 0-bits on the right. Register RS is ORed with the extended IM field and the result is placed into register RA.

Registers Altered

- RA

Architecture Note

This instruction is part of the PowerPC User Instruction Set Architecture.

rfti

Return From Critical Interrupt

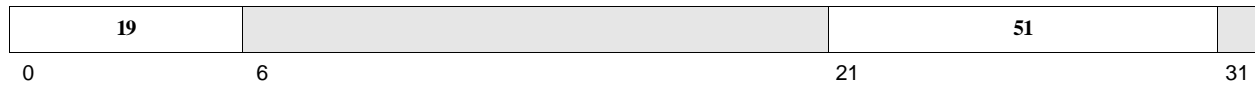
rfti

(PC) ← (SRR2)
(MSR) ← (SRR3)

The program counter (PC) is restored with the contents of SRR2 and the MSR is restored with the contents of SRR3.

Instruction execution returns to the address contained in the PC.

Registers Altered

- MSR

Programming Note

Execution of this instruction is privileged and context-synchronizing.

Architecture Note

This instruction part of the AMCC PowerPC Embedded Operating Environment.

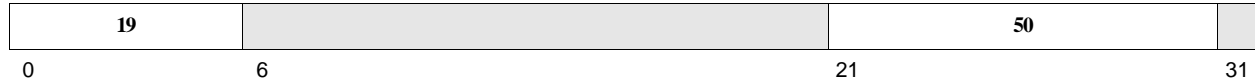
rfi

(PC) ← (SRR0)
(MSR) ← (SRR1)

The program counter (PC) is restored with the contents of SRR0 and the MSR is restored with the contents of SRR1.

Instruction execution returns to the address contained in the PC.

Registers Altered

- MSR

Invalid Instruction Forms

- Reserved fields

Programming Note

Execution of this instruction is privileged and context-synchronizing.

Architecture Note

This instruction is part of the AMCC PowerPC Embedded Operating Environment.

rlwimi

Rotate Left Word Immediate then Mask Insert

rlwimi RA, RS, SH, MB, ME Rc=0
rlwimi. RA, RS, SH, MB, ME Rc=1

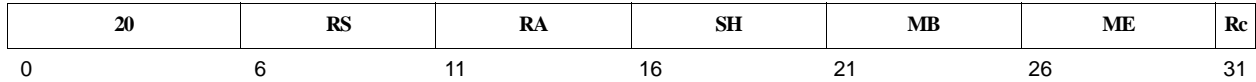

$$r \leftarrow \text{ROTL}((RS), SH)$$

$$m \leftarrow \text{MASK}(MB, ME)$$

$$(RA) \leftarrow (r \wedge m) \vee ((RA) \wedge \neg m)$$

The contents of register RS are rotated left by the number of bit positions specified in the SH field. A mask is generated, having 1-bits starting at the bit position specified in the MB field and ending in the bit position specified by the ME field, with 0-bits elsewhere.

If the starting point of the mask is at a higher bit position than the ending point, the 1-bits portion of the mask wraps from the highest bit position back around to the lowest. The rotated data is inserted into register RA, in positions corresponding to the bit positions in the mask that contain a 1-bit.

Registers Altered

- RA
- CR[CR0]_{LT, GT, EQ, SO} if Rc contains 1

Architecture Note

This instruction is part of the PowerPC User Instruction Set Architecture.

Table 24-27. Extended Mnemonics for rlwimi, rlwimi.

Mnemonic	Operands	Function	Other Registers Altered
inslwi	RA, RS, n, b	Insert from left immediate (n > 0). $(RA)_{b:b+n-1} \leftarrow (RS)_{0:n-1}$ <i>Extended mnemonic for</i> rlwimi RA,RS,32-b,b,b+n-1	
inslwi.		<i>Extended mnemonic for</i> rlwimi. RA,RS,32-b,b,b+n-1	CR[CR0]
insrwi	RA, RS, n, b	Insert from right immediate. (n > 0) $(RA)_{b:b+n-1} \leftarrow (RS)_{32-n:31}$ <i>Extended mnemonic for</i> rlwimi RA,RS,32-b-n,b,b+n-1	
insrwi.		<i>Extended mnemonic for</i> rlwimi. RA,RS,32-b-n,b,b+n-1	CR[CR0]

rlwinm RA, RS, SH, MB, ME Rc=0
rlwinm. RA, RS, SH, MB, ME Rc=1

21	RS	RA	SH	MB	ME	Rc
0	6	11	16	21	26	31

$r \leftarrow \text{ROTL}((RS), SH)$
 $m \leftarrow \text{MASK}(MB, ME)$
 $(RA) \leftarrow r \wedge m$

The contents of register RS are rotated left by the number of bit positions specified in the SH field. A mask is generated, having 1-bits starting at the bit position specified in the MB field and ending in the bit position specified by the ME field with 0-bits elsewhere.

If the starting point of the mask is at a higher bit position than the ending point, the 1-bits portion of the mask wraps from the highest bit position back around to the lowest. The rotated data is ANDed with the generated mask; the result is placed into register RA.

Registers Altered

- RA
- CR[CR0]_{LT, GT, EQ, SO} if Rc contains 1

Architecture Note

This instruction is part of the PowerPC User Instruction Set Architecture.

Table 24-28. Extended Mnemonics for rlwinm, rlwinm.

Mnemonic	Operands	Function	Other Registers Altered
clrlwi	RA, RS, n	Clear left immediate. ($n < 32$) $(RA)_{0:n-1} \leftarrow {}^n0$ <i>Extended mnemonic for</i> rlwinm RA,RS,0,n,31	
clrlwi.		<i>Extended mnemonic for</i> rlwinm. RA,RS,0,n,31	CR[CR0]
clrlslwi	RA, RS, b, n	Clear left and shift left immediate. $(n \leq b < 32)$ $(RA)_{b-n:31-n} \leftarrow (RS)_{b:31}$ $(RA)_{32-n:31} \leftarrow {}^n0$ $(RA)_{0:b-n-1} \leftarrow {}^{b-n}0$ <i>Extended mnemonic for</i> rlwinm RA,RS,n,b-n,31-n	
clrlslwi.		<i>Extended mnemonic for</i> rlwinm. RA,RS,n,b-n,31-n	CR[CR0]

rlwinm

Rotate Left Word Immediate then AND with Mask

Table 24-28. Extended Mnemonics for rlwinm, rlwinm. (continued)

Mnemonic	Operands	Function	Other Registers Altered
clrrwi	RA, RS, n	Clear right immediate. ($n < 32$) $(RA)_{32-n:31} \leftarrow ^n0$ <i>Extended mnemonic for</i> rlwinm RA,RS,0,0,31-n	
clrrwi.		<i>Extended mnemonic for</i> rlwinm. RA,RS,0,0,31-n	CR[CR0]
extlwi	RA, RS, n, b	Extract and left justify immediate. ($n > 0$) $(RA)_{0:n-1} \leftarrow (RS)_{b:b+n-1}$ $(RA)_{n:31} \leftarrow ^{32-n}0$ <i>Extended mnemonic for</i> rlwinm RA,RS,b,0,n-1	
extlwi.		<i>Extended mnemonic for</i> rlwinm. RA,RS,b,0,n-1	CR[CR0]
extrwi	RA, RS, n, b	Extract and right justify immediate. ($n > 0$) $(RA)_{32-n:31} \leftarrow (RS)_{b:b+n-1}$ $(RA)_{0:31-n} \leftarrow ^{32-n}0$ <i>Extended mnemonic for</i> rlwinm RA,RS,b+n,32-n,31	
extrwi.		<i>Extended mnemonic for</i> rlwinm. RA,RS,b+n,32-n,31	CR[CR0]
rotlwi	RA, RS, n	Rotate left immediate. $(RA) \leftarrow \text{ROTL}((RS), n)$ <i>Extended mnemonic for</i> rlwinm RA,RS,n,0,31	
rotlwi.		<i>Extended mnemonic for</i> rlwinm. RA,RS,n,0,31	CR[CR0]
rotrwi	RA, RS, n	Rotate right immediate. $(RA) \leftarrow \text{ROTL}((RS), 32-n)$ <i>Extended mnemonic for</i> rlwinm RA,RS,32-n,0,31	
rotrwi.		<i>Extended mnemonic for</i> rlwinm. RA,RS,32-n,0,31	CR[CR0]
slwi	RA, RS, n	Shift left immediate. ($n < 32$) $(RA)_{0:31-n} \leftarrow (RS)_{n:31}$ $(RA)_{32-n:31} \leftarrow ^n0$ <i>Extended mnemonic for</i> rlwinm RA,RS,n,0,31-n	
slwi.		<i>Extended mnemonic for</i> rlwinm. RA,RS,n,0,31-n	CR[CR0]

Table 24-28. Extended Mnemonics for rlwinm, rlwinm. (continued)

Mnemonic	Operands	Function	Other Registers Altered
srwi	RA, RS, n	Shift right immediate. ($n < 32$) $(RA)_{n:31} \leftarrow (RS)_{0:31-n}$ $(RA)_{0:n-1} \leftarrow ^n0$ <i>Extended mnemonic for</i> rlwinm RA,RS,32-n,n,31	
srwi.		<i>Extended mnemonic for</i> rlwinm. RA,RS,32-n,n,31	CR[CR0]

rlwnm

Rotate Left Word then AND with Mask

rlwnm RA, RS, RB, MB, ME Rc=0
rlwnm. RA, RS, RB, MB, ME Rc=1

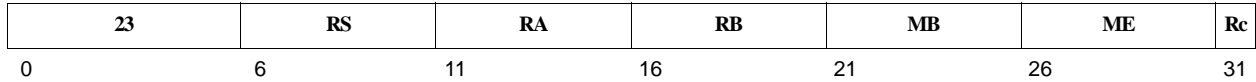

$$r \leftarrow \text{ROTL}((RS), (RB)_{27:31})$$

$$m \leftarrow \text{MASK}(MB, ME)$$

$$(RA) \leftarrow r \wedge m$$

The contents of register RS are rotated left by the number of bit positions specified by the contents of register RB_{27:31}. A mask is generated, having 1-bits starting at the bit position specified in the MB field and ending in the bit position specified by the ME field with 0-bits elsewhere.

If the starting point of the mask is at a higher bit position than the ending point, the ones portion of the mask wraps from the highest bit position back to the lowest. The rotated data is ANDed with the generated mask and the result is placed into register RA.

Registers Altered

- RA
- CR[CR0]_{LT, GT, EQ, SO} if Rc contains 1

Architecture Note

This instruction is part of the PowerPC User Instruction Set Architecture.

Table 24-29. Extended Mnemonics for rlwnm, rlwnm.

Mnemonic	Operands	Function	Other Registers Altered
rotlw	RA, RS, RB	Rotate left. $(RA) \leftarrow \text{ROTL}((RS), (RB)_{27:31})$ <i>Extended mnemonic for</i> rlwnm RA,RS,RB,0,31	
rotlw.		<i>Extended mnemonic for</i> rlwnm. RA,RS,RB,0,31	CR[CR0]

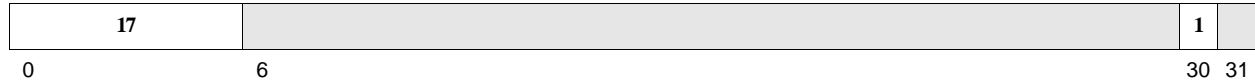
sc

$(SRR1) \leftarrow (MSR)$
 $(SRR0) \leftarrow (PC)$
 $PC \leftarrow EVPR_{0:15} \parallel 0x0C00$
 $(MSR[WE, EE, PR, DR, IR]) \leftarrow 0$

A system call exception is generated. The contents of the MSR are copied into SRR1 and (4 + address of **sc** instruction) is placed into SRR0.

The program counter (PC) is then loaded with the exception vector address. The exception vector address is calculated by concatenating the high halfword of the Exception Vector Prefix Register (EVPR) to the left of 0x0C00.

The MSR[WE, EE, PR, DR, IR] bits are set to 0.

Program execution continues at the new address in the PC.

The **sc** instruction is context synchronizing.

Registers Altered

- SRR0
- SRR1
- MSR[WE, EE, PR, DR, IR]

Invalid Instruction Forms

- Reserved fields

Architecture Note

This instruction is part of the PowerPC User Instruction Set Architecture.

slw
Shift Left Word

slw RA, RS, RB Rc=0
slw. RA, RS, RB Rc=1

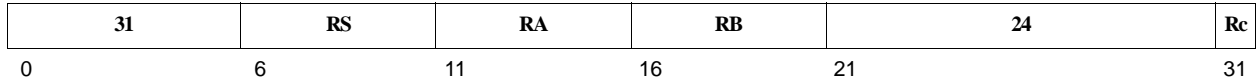

```

n ← (RB)27:31
r ← ROTL((RS), n)
if (RB)26 = 0 then
    m ← MASK(0, 31 – n)
else
    m ← 320
(RA) ← r ∧ m
    
```

The contents of register RS are shifted left by the number of bits specified by the contents of register RB_{27:31}. Bits shifted left out of the most significant bit are lost, and 0-bits fill vacated bit positions on the right. The result is placed into register RA.

If RB₂₆ = 1, register RA is set to zero.

Registers Altered

- RA
- CR[CR0]_{LT, GT, EQ, SO} if Rc contains 1

Architecture Note

This instruction is part of the PowerPC User Instruction Set Architecture.

sraw RA, RS, RB Rc=0
sraw. RA, RS, RB Rc=1

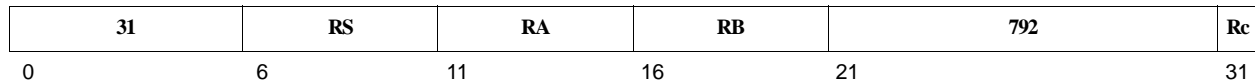

```

n ← (RB)27:31
r ← ROTL((RS), 32 – n)
if (RB)26 = 0 then
  m ← MASK(n, 31)
else
  m ← 320
s ← (RS)0
(RA) ← (r ∧ m) ∨ (32s ∧ ¬m)
XER[CA] ← s ∧ ((r ∧ ¬m) ≠ 0)

```

The contents of register RS are shifted right by the number of bits specified the contents of register RB_{27:31}. Bits shifted out of the least significant bit are lost. Register RS₀ is replicated to fill the vacated positions on the left. The result is placed into register RA.

If register RS contains a negative number and any 1-bits were shifted out of the least significant bit position, XER[CA] is set to 1; otherwise, it is set to 0.

If bit 26 of register RB contains 1, register RA and XER[CA] are set to bit 0 of register RS.

Registers Altered

- RA
- XER[CA]
- CR[CR0]_{LT, GT, EQ, SO} if Rc contains 1

Architecture Note

This instruction is part of the PowerPC User Instruction Set Architecture.

srawi

Shift Right Algebraic Word Immediate

srawi RA, RS, SH Rc=0
srawi. RA, RS, SH Rc=1

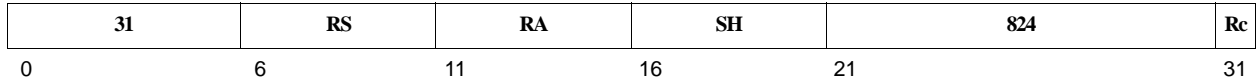

```

n ← SH
r ← ROTL((RS), 32 - n)
m ← MASK(n, 31)
s ← (RS)0
(RA) ← (r ∧ m) ∨ (32s ∧ ¬m)
XER[CA] ← s ∧ ((r ∧ ¬m)≠0)
    
```

The contents of register RS are shifted right by the number of bits specified in the SH field. Bits shifted out of the least significant bit are lost. Bit RS₀ is replicated to fill the vacated positions on the left. The result is placed into register RA.

If register RS contains a negative number and any 1-bits were shifted out of the least significant bit position, XER[CA] is set to 1; otherwise, it is set to 0.

Registers Altered

- RA
- XER[CA]
- CR[CR0]_{LT, GT, EQ, SO} if Rc contains 1

Architecture Note

This instruction is part of the PowerPC User Instruction Set Architecture.

srw RA, RS, RB Rc=0
srw. RA, RS, RB Rc=1

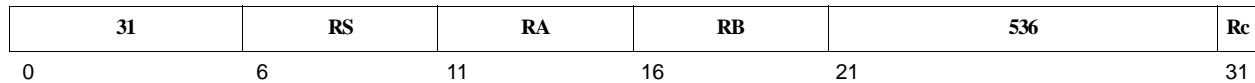

```

n ← (RB)27:31
r ← ROTL((RS), 32 – n)
if (RB)26 = 0 then
  m ← MASK(n, 31)
else
  m ← 320
(RA) ← r ∧ m

```

The contents of register RS are shifted right by the number of bits specified the contents of register RB_{27:31}. Bits shifted right out of the least significant bit are lost, and 0-bits fill the vacated bit positions on the left. The result is placed into register RA.

If bit 26 of register RB contains a one, register RA is set to 0.

Registers Altered

- RA
- CR[CR0]_{LT, GT, EQ, SO} if Rc contains 1

Architecture Note

This instruction is part of the PowerPC User Instruction Set Architecture.

stb

Store Byte

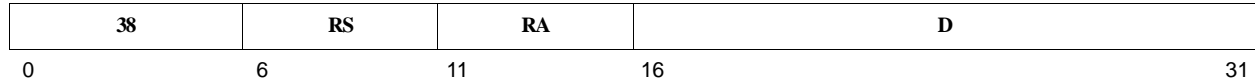
stb RS, D(RA)

$$EA \leftarrow (RA|0) + \text{EXTS}(D)$$

$$MS(EA, 1) \leftarrow (RS)_{24:31}$$

An effective address (EA) is formed by adding a displacement to a base address. The displacement is obtained by sign-extending the 16-bit D field to 32 bits. The base address is 0 when the RA field is 0, and is the contents of register RA otherwise.

The least significant byte of register RS is stored into the byte at the EA.

Registers Altered

- None

Architecture Note

This instruction is part of the PowerPC User Instruction Set Architecture.

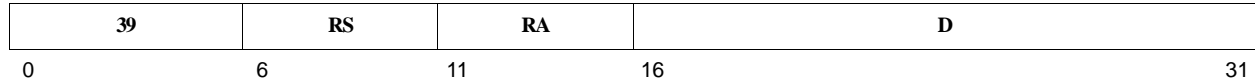
stbu RS, D(RA)

$$EA \leftarrow (RA) + \text{EXTS}(D)$$

$$MS(EA, 1) \leftarrow (RS)_{24:31}$$

$$(RA) \leftarrow EA$$

An effective address (EA) is formed by adding a displacement to the base address in register RA. The displacement is obtained by sign-extending the 16-bit D field to 32 bits. The EA is placed into register RA.

The least significant byte of register RS is stored into the byte at the EA.

Registers Altered

- RA

Invalid Instruction Forms

RA = 0

Architecture Note

This instruction is part of the PowerPC User Instruction Set Architecture.

stbx

Store Byte with Update Indexed

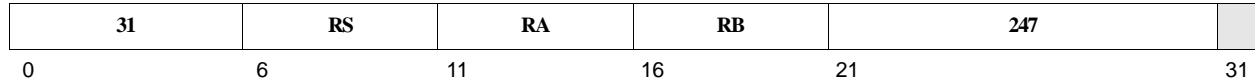
stbx RS, RA, RB

$$EA \leftarrow (RA) + (RB)$$

$$MS(EA, 1) \leftarrow (RS)_{24:31}$$

$$(RA) \leftarrow EA$$

An effective address (EA) is formed by adding an index to the base address in register RA. The index is the contents of register RB. The EA is placed into register RA.

The least significant byte of register RS is stored into the byte at the EA.

If instruction bit 31 contains 1, the contents of CR[CR0] are undefined.

Registers Altered

- RA

Invalid Instruction Forms

- Reserved fields
- RA = 0

Architecture Note

This instruction is part of the PowerPC User Instruction Set Architecture.

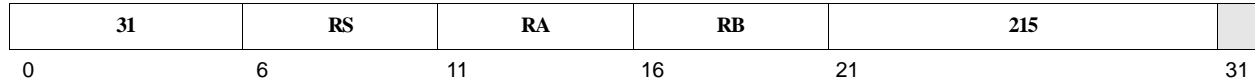
stbx RS, RA, RB

$$EA \leftarrow (RA|0) + (RB)$$

$$MS(EA, 1) \leftarrow (RS)_{24:31}$$

An effective address (EA) is formed by adding an index to a base address. The index is the contents of register RB. The base address is 0 when the RA field is 0, and is the contents of register RA otherwise.

The least significant byte of register RS is stored into the byte at the EA.

If instruction bit 31 contains 1, the contents of CR[CR0] are undefined.

Registers Altered

- None

Invalid Instruction Forms

- Reserved fields

Architecture Note

This instruction is part of the PowerPC User Instruction Set Architecture.

sth

Store Halfword

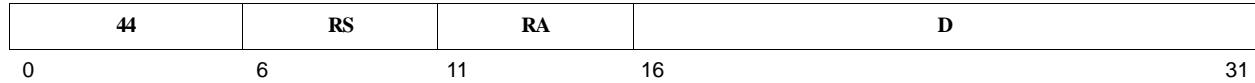
sth RS, D(RA)

$$EA \leftarrow (RA|0) + \text{EXTS}(D)$$

$$MS(EA, 2) \leftarrow (RS)_{16:31}$$

An effective address (EA) is formed by adding a displacement to a base address. The displacement is obtained by sign-extending the 16-bit D field to 32 bits. The base address is 0 when the RA field is 0 and is the contents of register RA otherwise.

The least significant halfword of register RS is stored into the halfword at the EA in main storage.

Registers Altered

- None

Architecture Note

This instruction is part of the PowerPC User Instruction Set Architecture.

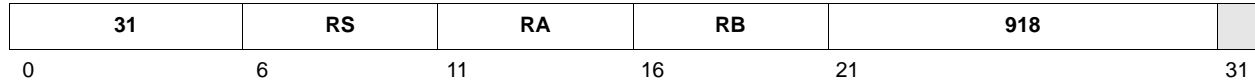
sthbrx RS, RA, RB

$$EA \leftarrow (RA|0) + (RB)$$

$$MS(EA, 2) \leftarrow (RS)_{24:31} \parallel (RS)_{16:23}$$

An effective address (EA) is formed by adding an index to a base address. The index is the contents of register RB. The base address is 0 when the RA field is 0, and is the contents of register RA otherwise.

The least significant halfword of register RS is byte-reversed. The result is stored into the halfword at the EA.

If instruction bit 31 contains 1, the contents of CR[CR0] are undefined.

Registers Altered

- None

Invalid Instruction Forms

- Reserved fields

Architecture Note

This instruction is part of the PowerPC User Instruction Set Architecture.

sth

Store Halfword with Update

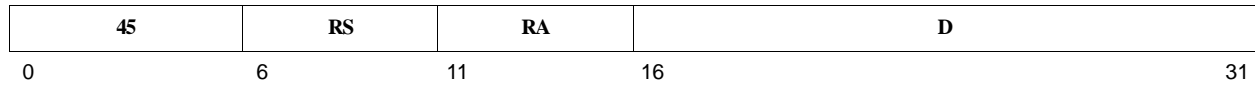
sth RS, D(RA)

$EA \leftarrow (RA) + \text{EXTS}(D)$
 $MS(EA, 2) \leftarrow (RS)_{16:31}$
 $(RA) \leftarrow EA$

An effective address (EA) is formed by adding a displacement to the base address in register RA. The displacement is obtained by sign-extending the 16-bit D field to 32 bits. The EA is placed into register RA.

The least significant halfword of register RS is stored into the halfword at the EA.

Registers Altered

- RA

Invalid Instruction Forms

- RA = 0

Architecture Note

This instruction is part of the PowerPC User Instruction Set Architecture.

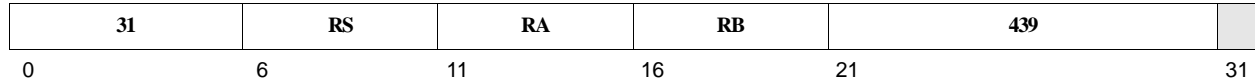
sthux RS, RA, RB

$$EA \leftarrow (RA) + (RB)$$

$$MS(EA, 2) \leftarrow (RS)_{16:31}$$

$$(RA) \leftarrow EA$$

An effective address (EA) is formed by adding an index to the base address in register RA. The index is the contents of register RB. The EA is placed into register RA.

The least significant halfword of register RS is stored into the halfword at the EA.

If instruction bit 31 contains 1, the contents of CR[CR0] are undefined.

Registers Altered

- RA

Invalid Instruction Forms

- Reserved fields
- RA = 0

Architecture Note

This instruction is part of the PowerPC User Instruction Set Architecture.

sthx

Store Halfword Indexed

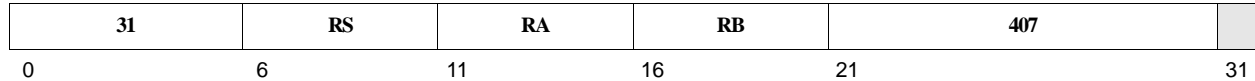
sthx RS, RA, RB

$$EA \leftarrow (RA|0) + (RB)$$

$$MS(EA, 2) \leftarrow (RS)_{16:31}$$

An effective address (EA) is formed by adding an index to a base address. The index is the contents of register RB. The base address is 0 when the RA field is 0, and is the contents of register RA otherwise.

The least significant halfword of register RS is stored into the halfword at the EA.

If instruction bit 31 contains 1, the contents of CR[CR0] are undefined.

Registers Altered

- None

Invalid Instruction Forms

- Reserved fields

Architecture Note

This instruction is part of the PowerPC User Instruction Set Architecture.

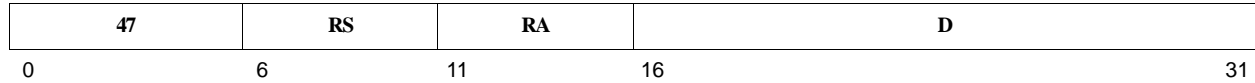
stmw RS, D(RA)

```

EA ← (RA|0) + EXTS(D)
r ← RS
do while r ≤ 31
  MS(EA, 4) ← (GPR(r))
  r ← r + 1
  EA ← EA + 4

```

An effective address (EA) is formed by adding a displacement to a base address. The displacement is obtained by sign-extending the 16-bit D field to 32 bits. The base address is 0 when the RA field is 0, and is the contents of register RA otherwise.

The contents of a series of consecutive registers, starting with register RS and continuing through GPR(31), are stored into consecutive words starting at the EA.

Registers Altered

- None

Architecture Note

This instruction is part of the PowerPC User Instruction Set Architecture.

stswi

Store String Word Immediate

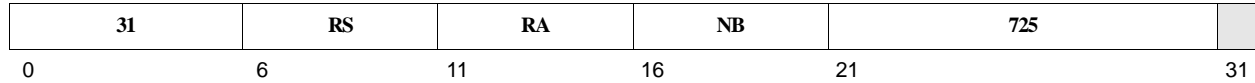
stswi RS, RA, NB

```

EA ← (RA|0)
if NB = 0 then
  n ← 32
else
  n ← NB
r ← RS - 1
i ← 0
do while n > 0
  if i = 0 then
    r ← r + 1
  if r = 32 then
    r ← 0
  MS(EA,1) ← (GPR(r)i:i+7)
  i ← i + 8
  if i = 32 then
    i ← 0
  EA ← EA + 1
  n ← n - 1

```

An effective address (EA) is determined by the RA field. If the RA field contains 0, the EA is 0; otherwise, the EA is the contents of register RA.

A byte count is determined by the NB field. If the NB field contains 0, the byte count is 32; otherwise, the byte count is the contents of the NB field.

The contents of a series of consecutive GPRs (starting with register RS, continuing through GPR(31), wrapping to GPR(0), and continuing to the final byte count) are stored, starting at the EA. The bytes in each GPR are accessed starting with the most significant byte. The byte count determines the number of transferred bytes.

If instruction bit 31 contains 1, the contents of CR[CR0] are undefined.

Registers Altered

- None

Architecture Note

This instruction is part of the PowerPC User Instruction Set Architecture.

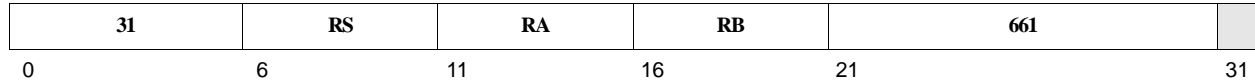
stswx RS, RA, RB

```

EA ← (RA|0) + (RB)
n ← XER[TBC]
r ← RS - 1
i ← 0
do while n > 0
  if i = 0 then
    r ← r + 1
  if r = 32 then
    r ← 0
  MS(EA, 1) ← (GPR(r)i:i+7)
  i ← i + 8
  if i = 32 then
    i ← 0
  EA ← EA + 1
  n ← n - 1

```

An effective address (EA) is formed by adding an index to a base address. The index is the contents of register RB. The base address is 0 when the RA field is 0, and is the contents of register RA otherwise.

A byte count is contained in XER[TBC].

The contents of a series of consecutive GPRs (starting with register RS, continuing through GPR(31), wrapping to GPR(0), and continuing to the final byte count) are stored, starting at the EA. The bytes in each GPR are accessed starting with the most significant byte. The byte count determines the number of transferred bytes.

If instruction bit 31 contains 1, the contents of CR[CR0] are undefined.

Registers Altered

- None

Invalid Instruction Forms

- Reserved fields

Programming Note

If XER[TBC] = 0, **stswx** is treated as a no-op.

The PowerPC Architecture states that if XER[TBC] = 0 and if the EA is such that a precise data exception would normally occur (if not for the zero length), **stswx** is treated as a no-op and the precise exception will not occur. Data storage exceptions and alignment exceptions are examples of precise data exceptions.

However, the architecture makes no statement regarding imprecise exceptions related to **stswx** when XER[TBC] = 0. AMCC PowerPC embedded processors generate an imprecise exception (machine check) on this instruction when all of the following conditions are true:

- The instruction passes all protection bounds checking

stswx

Store String Word Indexed

- The address is cachable
- The address is passed to the data cache
- The address misses in the data cache (resulting in a line fill request)
- The address encounters some form of bus error (non-configured, for example)

Architecture Note

This instruction is part of the PowerPC User Instruction Set Architecture.

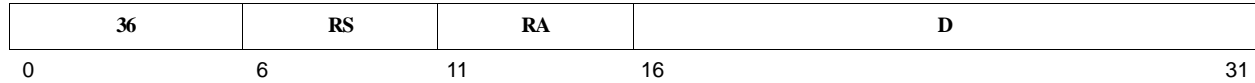
stw RS, D(RA)

$$EA \leftarrow (RA|0) + \text{EXTS}(D)$$

$$MS(EA, 4) \leftarrow (RS)$$

An effective address (EA) is formed by adding a displacement to a base address. The displacement is obtained by sign-extending the 16-bit D field to 32 bits. The base address is 0 when the RA field is 0, and is the contents of register RA otherwise.

The contents of register RS are stored at the EA.

Registers Altered

- None

Architecture Note

This instruction is part of the PowerPC User Instruction Set Architecture.

stwbrx

Store Word Byte-Reverse Indexed

stwbrx RS, RA, RB

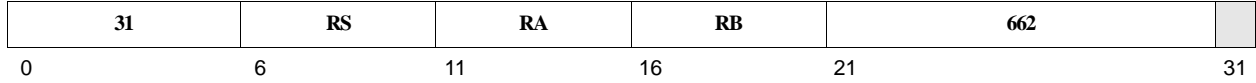

$$EA \leftarrow (RA|0) + (RB)$$

$$MS(EA, 4) \leftarrow (RS)_{24:31} \parallel (RS)_{16:23} \parallel (RS)_{8:15} \parallel (RS)_{0:7}$$

An EA is formed by adding an index to a base address. The index is the contents of register RB. The base address is 0 when the RA field is 0, and is the contents of register RA otherwise.

The contents of register RS are byte-reversed: the least significant byte becomes the most significant byte, the next least significant byte becomes the next most significant byte, and so on. The result is stored into the word at the EA.

If instruction bit 31 contains 1, the contents of CR[CR0] are undefined.

Registers Altered

- None

Invalid Instruction Forms

- Reserved fields

Architecture Note

This instruction is part of the PowerPC User Instruction Set Architecture.

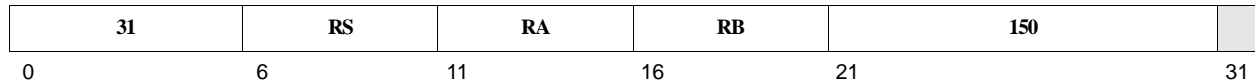
stwcx. RS, RA, RB

```

EA ← (RA|0) + (RB)
if RESERVE = 1 then
    MS(EA, 4) ← (RS)
    RESERVE ← 0
    (CR[CR0]) ← 200 || 1 || XERSO
else
    (CR[CR0]) ← 200 || 0 || XERSO

```

An effective address (EA) is formed by adding an index to a base address. The index is the contents of register RB. The base address is 0 when the RA field is 0, and is the contents of register RA otherwise.

If the reservation bit contains 1 when the instruction is executed, the contents of register RS are stored into the word at the EA and the reservation bit is cleared. If the reservation bit contains 0 when the instruction is executed, no store operation is performed.

CR[CR0] is set as follows:

- CR[CR0]_{LT, GT} are cleared
- CR[CR0]_{EQ} is set to the state of the reservation bit at the start of the instruction
- CR[CR0]_{SO} is set to the contents of the XER[SO] bit

Registers Altered

- CR[CR0]_{LT, GT, EQ, SO}

Programming Note

lwarx and the **stwcx.** instruction should be paired in a loop, as shown in the following example, to create the effect of an atomic operation to a memory area used as a semaphore between asynchronous processes. Only **lwarx** can set the reservation bit to 1. **stwcx.** sets the reservation bit to 0 upon its completion, whether or not **stwcx.** sent (RS) to memory. CR[CR0]_{EQ} must be examined to determine whether (RS) was sent to memory.

```

loop: lwarx # read the semaphore from memory; set reservation
      "alter" # change the semaphore bits in register as required
      stwcx. # attempt to store semaphore; reset reservation
      bne loop # an asynchronous process has intervened; try again

```

If the asynchronous process in the code example had paired **lwarx** with a store other than **stwcx.**, the reservation bit would not have been cleared in the asynchronous process, and the code example would have overwritten the semaphore.

Exceptions

An alignment exception occurs if the EA is not word-aligned.

stwcx.

Store Word Conditional Indexed

Architecture Note

This instruction is part of the PowerPC User Instruction Set Architecture.

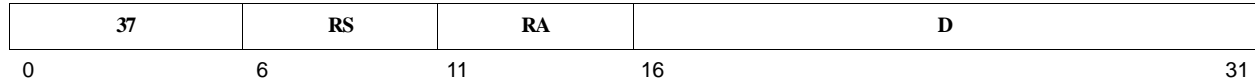
stwu RS, D(RA)

$$EA \leftarrow (RA) + \text{EXTS}(D)$$

$$\text{MS}(EA, 4) \leftarrow (RS)$$

$$(RA) \leftarrow EA$$

An effective address (EA) is formed by adding a displacement to the base address in register RA. The displacement is obtained by sign-extending the 16-bit D field to 32 bits. The EA is placed into register RA.

The contents of register RS are stored into the word at the EA.

Registers Altered

- RA

Invalid Instruction Forms

- RA = 0

Architecture Note

This instruction is part of the PowerPC User Instruction Set Architecture.

stwux

Store Word with Update Indexed

stwux RS, RA, RB

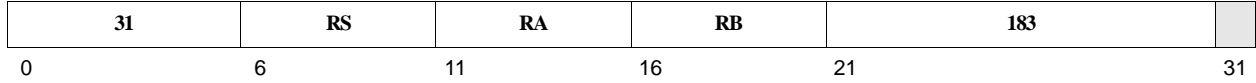

$EA \leftarrow (RA) + (RB)$
 $MS(EA, 4) \leftarrow (RS)$
 $(RA) \leftarrow EA$

An effective address (EA) is formed by adding an index to the base address in register RA. The index is the contents of register RB. The EA is placed into register RA.

The contents of register RS are stored into the word at the EA.

If instruction bit 31 contains 1, the contents of CR[CR0] are undefined.

Registers Altered

- RA

Invalid Instruction Forms

- Reserved fields
- RA = 0

Architecture Note

This instruction is part of the PowerPC User Instruction Set Architecture.

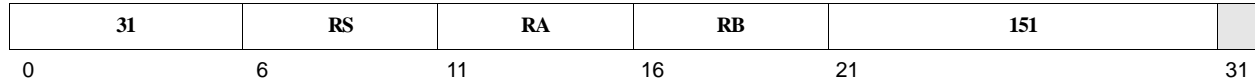
stwx RS, RA, RB

$$EA \leftarrow (RA|0) + (RB)$$

$$MS(EA,4) \leftarrow (RS)$$

An effective address (EA) is formed by adding an index to a base address. The index is the contents of register RB. The base address is 0 when the RA field is 0, and is the contents of register RA otherwise.

The contents of register RS are stored into the word at the EA.

If instruction bit 31 contains 1, the contents of CR[CR0] are undefined.

Registers Altered

- None

Invalid Instruction Forms

- Reserved fields

Architecture Note

This instruction is part of the PowerPC User Instruction Set Architecture.

subf

Subtract From

subf	RT, RA, RB	OE=0, Rc=0
subf.	RT, RA, RB	OE=0, Rc=1
subfo	RT, RA, RB	OE=1, Rc=0
subfo.	RT, RA, RB	OE=1, Rc=1

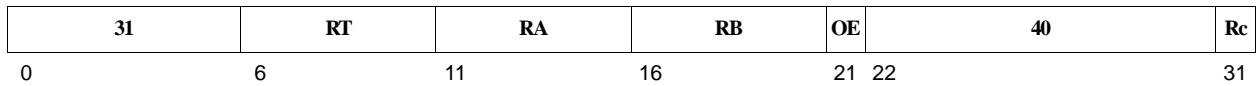

$$(RT) \leftarrow \neg(RA) + (RB) + 1$$

The sum of the ones complement of register RA, register RB, and 1 is stored into register RT.

Registers Altered

- RT
- CR[CR0]_{LT, GT, EQ, SO} if Rc contains 1
- XER[SO, OV] if OE contains 1

Architecture Note

This instruction is part of the PowerPC User Instruction Set Architecture.

Table 24-30. Extended Mnemonics for subf, subf., subfo, subfo.

Mnemonic	Operands	Function	Other Registers Altered
sub	RT, RA, RB	Subtract (RB) from (RA). $(RT) \leftarrow \neg(RB) + (RA) + 1.$ <i>Extended mnemonic for subf RT,RB,RA</i>	
sub.		<i>Extended mnemonic for subf. RT,RB,RA</i>	CR[CR0]
subo		<i>Extended mnemonic for subfo RT,RB,RA</i>	XER[SO, OV]
subo.		<i>Extended mnemonic for subfo. RT,RB,RA</i>	CR[CR0] XER[SO, OV]

subfc	RT, RA, RB	OE=0, Rc=0
subfc.	RT, RA, RB	OE=0, Rc=1
subfco	RT, RA, RB	OE=1, Rc=0
subfco.	RT, RA, RB	OE=1, Rc=1

31	RT	RA	RB	OE	8	Rc
0	6	11	16	21 22		31

```

(RT) ← ¬(RA) + (RB) + 1
if ¬(RA) + (RB) + 1 > 232 - 1 then
  XER[CA] ← 1
else
  XER[CA] ← 0

```

The sum of the ones complement of register RA, register RB, and 1 is stored into register RT.

XER[CA] is set to a value determined by the unsigned magnitude of the result of the subtract operation.

Registers Altered

- RT
- XER[CA]
- CR[CR0]_{LT, GT, EQ, SO} if Rc contains 1
- XER[SO, OV] if OE contains 1

Architecture Note

This instruction is part of the PowerPC User Instruction Set Architecture.

Table 24-31. Extended Mnemonics for subfc, subfc., subfco, subfco.

Mnemonic	Operands	Function	Other Registers Altered
subc	RT, RA, RB	Subtract (RB) from (RA). (RT) ← ¬(RB) + (RA) + 1. Place carry-out in XER[CA]. <i>Extended mnemonic for subfc RT, RB, RA</i>	
subc.		<i>Extended mnemonic for subfc. RT, RB, RA</i>	CR[CR0]
subco		<i>Extended mnemonic for subfco RT, RB, RA</i>	XER[SO, OV]
subco.		<i>Extended mnemonic for subfco. RT, RB, RA</i>	CR[CR0] XER[SO, OV]

subfe

Subtract From Extended

subfe	RT, RA, RB	OE=0, Rc=0
subfe.	RT, RA, RB	OE=0, Rc=1
subfeo	RT, RA, RB	OE=1, Rc=0
subfeo.	RT, RA, RB	OE=1, Rc=1

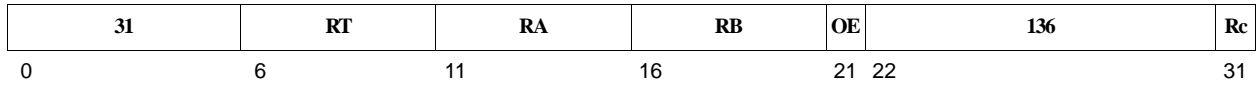

```

(RT) ← ¬(RA) + (RB) + XER[CA]
if ¬(RA) + (RB) + XER[CA] ≥ 232 - 1 then
    XER[CA] ← 1
else
    XER[CA] ← 0
    
```

The sum of the ones complement of register RA, register RB, and XER[CA] is placed into register RT. XER[CA] is set to a value determined by the unsigned magnitude of the result of the subtract operation.

Registers Altered

- RT
- XER[CA]
- CR[CR0]_{LT, GT, EQ, SO} if Rc contains 1
- XER[SO, OV] if OE contains 1

Architecture Note

This instruction is part of the PowerPC User Instruction Set Architecture.

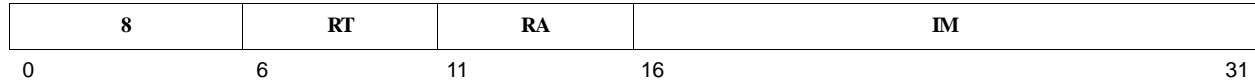
subfic RT, RA, IM

```

(RT) ← ¬(RA) + EXTS(IM) + 1
if ¬(RA) + EXTS(IM) + 1 > 232 - 1 then
  XER[CA] ← 1
else
  XER[CA] ← 0

```

The sum of the ones complement of RA, the IM field sign-extended to 32 bits, and 1 is placed into register RT.

XER[CA] is set to a value determined by the unsigned magnitude of the result of the subtract operation.

Registers Altered

- RT
- XER[CA]

Architecture Note

This instruction is part of the PowerPC User Instruction Set Architecture.

subfme

Subtract from Minus One Extended

subfme	RT, RA	OE=0, Rc=0
subfme.	RT, RA	OE=0, Rc=1
subfmeo	RT, RA	OE=1, Rc=0
subfmeo.	RT, RA	OE=1, Rc=1

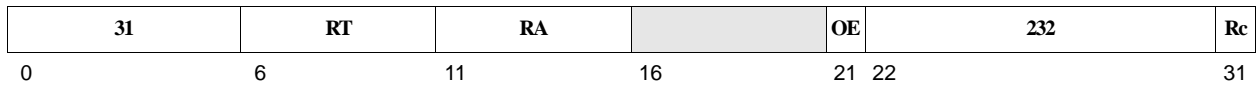

```

(RT) ← ¬(RA) – 1 + XER[CA]
if ¬(RA) + 0xFFFF FFFF + XER[CA] > 232 – 1 then
    XER[CA] ← 1
else
    XER[CA] ← 0
    
```

The sum of the ones complement of register RA, -1, and XER[CA] is placed into register RT.

XER[CA] is set to a value determined by the unsigned magnitude of the result of the subtract operation.

Registers Altered

- RT
- CR[CR0]_{LT, GT, EQ, SO} if Rc contains 1
- XER[SO, OV] if OE contains 1
- XER[CA]

Invalid Instruction Forms

- Reserved fields

Architecture Note

This instruction is part of the PowerPC User Instruction Set Architecture.

subfze	RT, RA	OE=0, Rc=0
subfze.	RT, RA	OE=0, Rc=1
subfzeo	RT, RA	OE=1, Rc=0
subfzeo.	RT, RA	OE=1, Rc=1

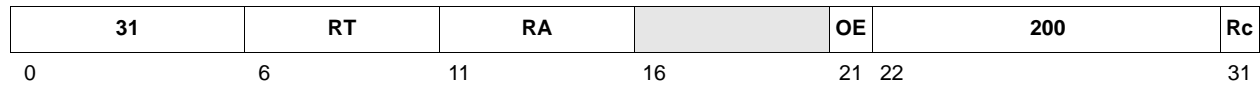

```

(RT) ← ¬(RA) + XER[CA]
if ¬(RA) + XER[CA]  $\geq$  232 - 1 then
    XER[CA] ← 1
else
    XER[CA] ← 0

```

The sum of the ones complement of register RA and XER[CA] is stored into register RT.

XER[CA] is set to a value determined by the unsigned magnitude of the result of the subtract operation.

Registers Altered

- RT
- XER[CA]
- CR[CR0]_{LT, GT, EQ, SO} if Rc contains 1
- XER[SO, OV] if OE contains 1

Invalid Instruction Forms

- Reserved fields

Architecture Note

This instruction is part of the PowerPC User Instruction Set Architecture.

sync
Synchronize

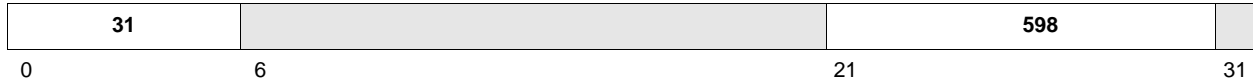
sync

The **sync** instruction guarantees that all instructions initiated by the processor preceding **sync** will complete before **sync** completes, and that no subsequent instructions will be initiated by the processor until after **sync** completes. When **sync** completes, all storage accesses that were initiated by the processor before the **sync** instruction will have been completed with respect to all mechanisms that access storage.

If instruction bit 31 contains 1, the contents of CR[CR0] are undefined.

Registers Altered

- None.

Invalid Instruction Forms

- Reserved fields

Programming Note

Architecturally, the **eiio** instruction orders storage access, not instruction completion. Therefore, non-storage operations that follow **eiio** could complete before storage operations that precede **eiio**. The **sync** instruction guarantees ordering of instruction completion and storage access. For the PPC405GP, the **eiio** instruction is implemented to behave as a **sync** instruction.

To write code that is portable between various PowerPC implementations, programmers should use the mnemonic that corresponds to the desired behavior.

Architecture Note

This instruction is part of the PowerPC User Instruction Set Architecture.

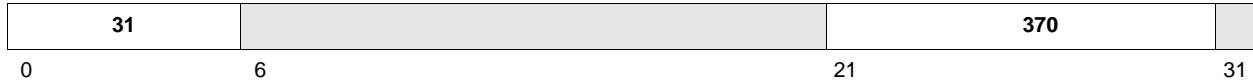
tlbia

All of the entries in the TLB are invalidated and become unavailable for translation by clearing the valid (V) bit in the TLBHI portion of each TLB entry. The rest of the fields in the TLB entries are unmodified.

Registers Altered

- None.

Invalid Instruction Forms

- None.

Programming Note

This instruction is privileged. Translation is not required to be active during the execution of this instruction. The effects of the invalidation are not guaranteed to be visible to the programming model until the completion of a context synchronizing operation.

Architecture Note

This instruction is part of the AMCC PowerPC Embedded Operating Environment.

tlbre

TLB Read Entry

tlbre RT, RA, WS

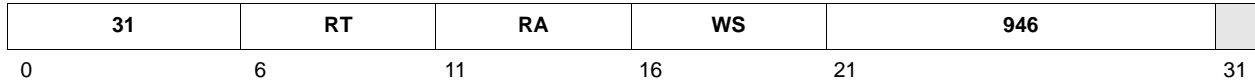

```

if WS4 = 1
    (RT) ← TLBLO[(RA26:31)]
else
    (RT) ← TLBHI[(RA26:31)]
    (PID) ← TID from TLB[(RA26:31)]
    
```

The contents of the selected TLB entry is placed into register RT (and possibly into PID).

Bits 26:31 of the contents of RA is used as an index into the TLB. If this index specifies a TLB entry that does not exist, the results are undefined.

The WS field specifies which portion (TLBHI or TLBLO) of the entry is loaded into RT. If TLBHI is being accessed, the PID SPR is set to the value of the TID field in the TLB entry.

If the WS field is not 0 or 1, the instruction form is invalid and the result is undefined.

If instruction bit 31 contains 1, the contents of CR[CR0] are undefined.

Registers Altered

- RT
- PID (if WS = 0)

Invalid Instruction Forms

- Reserved fields
- Invalid WS value

Programming Notes

This instruction is privileged. Translation is not required to be active during the execution of this instruction.

The contents of RT after the execution of this instruction are interpreted as follows:

```

If WS = 0 (TLBHI):
    RT[0:21] ← EPN[0:21]
    RT[22:24] ← SIZE[0:2]
    RT[25] ← V
    RT[26] ← E
    RT[27] ← UO
    RT[28:31] ← 0
    PID[24:31] ← TID[0:7]; (note that the TID is copied to the PID, not to RT)
If WS = 1 (TLBLO):
    RT[0:21] ← RPN[0:21]
    RT[22:23] ← EX,WR
    RT[24:27] ← ZSEL[0:3]
    RT[28:31] ← WIMG
    
```

Architecture Note

This instruction part of the AMCC PowerPC Embedded Operating Environment.

Table 24-32. Extended Mnemonics for tlbre

Mnemonic	Operands	Function	Other Registers Altered
tlbrehi	RT, RA	Load TLBHI portion of the selected TLB entry into RT. Load the PID register with the contents of the TID field of the selected TLB entry. $(RT) \leftarrow TLBHI[(RA)]$ $(PID) \leftarrow TLB[(RA)]_{TID}$ <i>Extended mnemonic for</i> tlbre RT,RA,0	
tlbrelo	RT, RA	Load TLBLO portion of the selected TLB entry into RT. $(RT) \leftarrow TLBLO[(RA)]$ <i>Extended mnemonic for</i> tlbre RT,RA,1	

tlbsx

TLB Search Indexed

tlbsx RT, RA, RB Rc=0
tlbsx. RT, RA, RB Rc=1

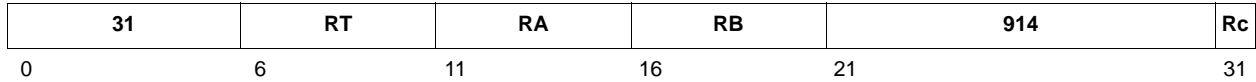

```
EA ← (RA|0) + (RB)
if Rc = 1
    CR[CR0]LT ← 0
    CR[CR0]GT ← 0
    CR[CR0]SO ← XER[SO]
if Valid TLB entry matching EA and PID is in the TLB then
    (RT) ← Index of matching TLB Entry
    if Rc = 1
        CR[CR0]EQ ← 1
else
    (RT) Undefined
    if Rc = 1
        CR[CR0]EQ ← 0
```

An effective address is formed by adding an index to a base address. The index is the contents of register RB. The base address is 0 if the RA field is 0 and is the contents of register RA otherwise.

The TLB is searched for a valid entry which translates EA and PID. See XREF for details. The record bit (Rc) specifies whether the results of the search will affect CR[CR0] as shown above. The intention is that CR[CR0]_{EQ} can be tested after a **tlbsx.** instruction if there is a possibility that the search may fail.

Registers Altered

- CR[CR0]_{LT, GT, EQ, SO} if Rc contains 1

Invalid Instruction Forms

- None.

Programming Note

This instruction is privileged. Translation is not required to be active during the execution of this instruction.

Architecture Note

This instruction part of the AMCC PowerPC Embedded Operating Environment.

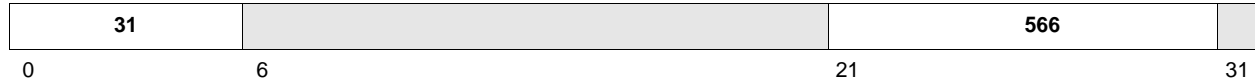
tlbsync

The **tlbsync** instruction is provided in the PowerPC architecture to support synchronization of TLB operations among the processors of a multi-processor system. In the PPC405GP, this instruction performs no operation, and is provided to facilitate code portability.

Registers Altered

- None.

Invalid Instruction Forms

- None.

Programming Notes

This instruction is privileged. Translation is not required to be active during the execution of this instruction.

Since the PPC405GP does not support tightly-coupled multiprocessor systems, **tlbsync** performs no operation.

Architecture Note

This instruction is part of the AMCC PowerPC Embedded Operating Environment.

tlbwe

TLB Write Entry

tlbwe RS, RA, WS

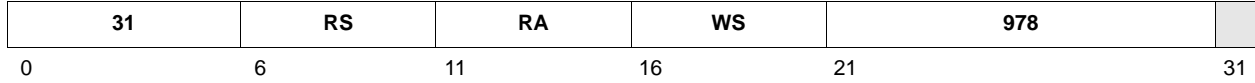

```

if WS4 = 1
    TLBLO[(RA26:31)] ← (RS)
else
    TLBHI[(RA26:31)] ← (RS)
    TID of TLB[(RA26:31)] ← (PID24:31)
    
```

The contents of the selected TLB entry is replaced with the contents of register RS (and possibly PID).

Bits 26:31 of the contents of RA are used as an index into the TLB. If this index specifies a TLB entry that does not exist, the results are undefined.

The WS field specifies which portion (TLBHI or TLBLO) of the entry is replaced from RS. For instructions that specify TLBHI, the TID field in the TLB entry is supplied from PID_{24:31}.

If the WS field is not 0 or 1, the instruction form is invalid and the result is undefined.

If instruction bit 31 contains 1, the contents of CR[CR0] are undefined.

Registers Altered

- None.

Invalid Instruction Forms

- Reserved fields
- Invalid WS value

Programming Notes

This instruction is privileged. Translation is not required to be active during the execution of this instruction.

The effects of this update are not guaranteed to be visible to the programming model until the completion of a context synchronizing operation. For example, updating a zone selection field within the TLB while in supervisor code should be followed by an **isync** instruction (or other context synchronizing operation) to guarantee that the desired translation and protection domains are used.

tlbwe writes the TLB fields from RS and the PID as follows:

```

If WS = 0 (TLBHI):
    EPN[0:21] ← RS[0:21]
    SIZE[0:2] ← RS[22:24]
    V ← RS[25]
    E ← RS[26]
    U0 ← RS[27]
    TID[0:7] ← PID[24:31]; (note that the TID is written from the PID, not RS)
    
```

If WS = 1 (TLBLO):
 $RPN[0:21] \leftarrow RT[0:21]$
 $EX, WR \leftarrow RS[22:23]$
 $ZSEL[0:3] \leftarrow RS[24:27]$
 $WIMG \leftarrow RS[28:31]$

Architecture Note

This instruction part of the AMCC PowerPC Embedded Operating Environment.

Table 24-33. Extended Mnemonics for tlbwe

Mnemonic	Operands	Function	Other Registers Altered
tlbwehi	RS, RA	Write TLBHI portion of the selected TLB entry from RS. Write the TID register of the selected TLB entry from the PID register. $TLBHI[(RA)] \leftarrow (RS)$ $TLB[(RA)]_{TID} \leftarrow (PID_{24:31})$ <i>Extended mnemonic for</i> tlbwe RS,RA,0	
tlbwelo	RS, RA	Write TLBLO portion of the selected TLB entry from RS. $TLBLO[(RA)] \leftarrow (RS)$ <i>Extended mnemonic for</i> tlbwe RS,RA,1	

tw

Trap Word

tw TO, RA, RB

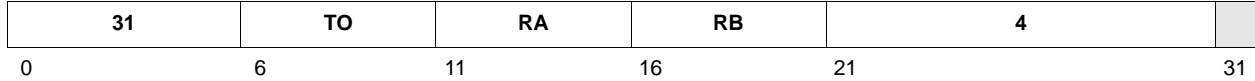

if (((RA) < (RB) ^ TO₀ = 1) ∨
 ((RA) > (RB) ^ TO₁ = 1) ∨
 ((RA) = (RB) ^ TO₂ = 1) ∨
 ((RA) ^u < (RB) ^ TO₃ = 1) ∨
 ((RA) ^u > (RB) ^ TO₄ = 1)) then TRAP (see details below)

Register RA is compared with register RB. If any comparison condition selected by the TO field is true, a TRAP occurs. The behavior of a TRAP depends upon the debug mode of the processor, as described below:

- If TRAP is not enabled as a debug event (DBCR[TDE] = 0 or DBCR[EDM, IDM] = 0,0):

TRAP causes a program interrupt. See “Program Interrupt” on page 0-253.

(SRR0) ← address of **tw** instruction
 (SRR1) ← (MSR)
 (ESR[PTR]) ← 1
 (MSR[WE, EE, PR, DR, IR]) ← 0
 PC ← EVPR_{0:15} || 0x0700

- If TRAP is enabled as an external debug event (DBCR[TDE] = 1 and DBCR[EDM] = 1):

TRAP goes to the debug stop state, to be handled by an external debugger with hardware control.

(DBSR[TIE]) ← 1

In addition, if TRAP is also enabled as an internal debug event (DBCR[IDM] = 1) and debug exceptions are disabled (MSR[DE] = 0), then report an imprecise event:

(DBSR[IDE]) ← 1
 PC ← address of **tw** instruction

- If TRAP is enabled as an internal debug event and *not* an external debug event (DBCR[TDE] = 1 and DBCR[EDM, IDM] = 0,1) and debug exceptions are enabled (MSR[DE] = 1):

TRAP causes a debug interrupt. See “Debug Interrupt” on page 0-257.

(SRR2) ← address of **tw** instruction
 (SRR3) ← (MSR)
 (DBSR[TIE]) ← 1
 (MSR[WE, EE, PR, CE, DE, DR, IR]) ← 0
 PC ← EVPR_{0:15} || 0x2000

- If TRAP is enabled as an internal debug event and *not* an external debug event (DBCR[TDE] = 1 and DBCR[EDM, IDM] = 0,1) and Debug Exceptions are disabled (MSR[DE] = 0):

TRAP reports the debug event as an *imprecise* event and causes a program interrupt. See “Program Interrupt” on page 0-253.

(SRR0) ← address of **tw** instruction
 (SRR1) ← (MSR)
 (ESR[PTR]) ← 1
 (DBSR[TIE,IDE]) ← 1,1
 (MSR[WE, EE, PR, DR, IR]) ← 0
 PC ← EVPR_{0:15} || 0x0700

If instruction bit 31 contains 1, the contents of CR[CR0] are undefined.

Registers Altered

- None

Invalid Instruction Forms

- Reserved fields

Programming Note

This instruction is inserted into the execution stream by a debugger to implement breakpoints, and is not typically used by application code.

Architecture Note

This instruction is part of the PowerPC User Instruction Set Architecture.

Table 24-34. Extended Mnemonics for tw

Mnemonic	Operands	Function	Other Registers Altered
trap		Trap unconditionally. <i>Extended mnemonic for</i> tw 31,0,0	
tw eq	RA, RB	Trap if (RA) equal to (RB). <i>Extended mnemonic for</i> tw 4,RA,RB	
tw ge	RA, RB	Trap if (RA) greater than or equal to (RB). <i>Extended mnemonic for</i> tw 12,RA,RB	
tw gt	RA, RB	Trap if (RA) greater than (RB). <i>Extended mnemonic for</i> tw 8,RA,RB	
tw le	RA, RB	Trap if (RA) less than or equal to (RB). <i>Extended mnemonic for</i> tw 20,RA,RB	
tw lge	RA, RB	Trap if (RA) logically greater than or equal to (RB). <i>Extended mnemonic for</i> tw 5,RA,RB	
tw lgt	RA, RB	Trap if (RA) logically greater than (RB). <i>Extended mnemonic for</i> tw 1,RA,RB	
tw lle	RA, RB	Trap if (RA) logically less than or equal to (RB). <i>Extended mnemonic for</i> tw 6,RA,RB	

tw

Trap Word

Table 24-34. Extended Mnemonics for tw (continued)

Mnemonic	Operands	Function	Other Registers Altered
twllt	RA, RB	Trap if (RA) logically less than (RB). <i>Extended mnemonic for</i> tw 2,RA,RB	
twlng	RA, RB	Trap if (RA) logically not greater than (RB). <i>Extended mnemonic for</i> tw 6,RA,RB	
twlnl	RA, RB	Trap if (RA) logically not less than (RB). <i>Extended mnemonic for</i> tw 5,RA,RB	
twlt	RA, RB	Trap if (RA) less than (RB). <i>Extended mnemonic for</i> tw 16,RA,RB	
twne	RA, RB	Trap if (RA) not equal to (RB). <i>Extended mnemonic for</i> tw 24,RA,RB	
twng	RA, RB	Trap if (RA) not greater than (RB). <i>Extended mnemonic for</i> tw 20,RA,RB	
twnl	RA, RB	Trap if (RA) not less than (RB). <i>Extended mnemonic for</i> tw 12,RA,RB	

twi TO, RA, IM

3	TO	RA	IM
0	6	11	16
			31

if (((RA) < EXTS(IM) \wedge TO₀ = 1) \vee
 ((RA) > EXTS(IM) \wedge TO₁ = 1) \vee
 ((RA) = EXTS(IM) \wedge TO₂ = 1) \vee
 ((RA) $\overset{u}{<}$ EXTS(IM) \wedge TO₃ = 1) \vee
 ((RA) $\overset{s}{>}$ EXTS(IM) \wedge TO₄ = 1)) then TRAP (see details below)

Register RA is compared with the IM field, which has been sign-extended to 32 bits. If any comparison condition selected by the TO field is true, a TRAP occurs. The behavior of a TRAP depends upon the Debug Mode of the processor, as described below:

- If TRAP is not enabled as a debug event (DBCR[TDE] = 0 or DBCR[EDM, IDM] = 0,0):

TRAP causes a program interrupt. See “Program Interrupt” on page 0-253.

(SRR0) \leftarrow address of **twi** instruction
 (SRR1) \leftarrow (MSR)
 (ESR[PTR]) \leftarrow 1
 (MSR[WE, EE, PR, DR, IR]) \leftarrow 0
 PC \leftarrow EVPR_{0:15} || 0x0700

- If TRAP is enabled as an External debug event (DBCR[TDE] = 1 and DBCR[EDM] = 1):

TRAP goes to the Debug Stop state, to be handled by an external debugger with hardware control of the PPC405GP.

(DBSR[TIE]) \leftarrow 1
 In addition, if TRAP is also enabled as an Internal debug event (DBCR[IDM] = 1)
 and Debug Exceptions are disabled (MSR[DE] = 0), then report an imprecise event:
 (DBSR[IDE]) \leftarrow 1
 PC \leftarrow address of **twi** instruction

- If TRAP is enabled as an Internal debug event and *not* an External debug event (DBCR[TDE] = 1 and DBCR[EDM, IDM] = 0,1) and Debug Exceptions are enabled (MSR[DE] = 1):

TRAP causes a Debug interrupt. See “Debug Interrupt” on page 0-257.

(SRR2) \leftarrow address of **twi** instruction
 (SRR3) \leftarrow (MSR)
 (DBSR[TIE]) \leftarrow 1
 (MSR[WE, EE, PR, CE, DE, DR, IR]) \leftarrow 0
 PC \leftarrow EVPR_{0:15} || 0x2000

- If TRAP is enabled as an Internal debug event and *not* an External debug event (DBCR[TDE] = 1 and DBCR[EDM, IDM] = 0,1) and Debug Exceptions are disabled (MSR[DE] = 0):

TRAP will report the debug event as an *imprecise* event and will cause a Program interrupt. See “Program Interrupt” on page 0-253.

twi

Trap Word Immediate

(SRR0) ← address of **twi** instruction
 (SRR1) ← (MSR)
 (ESR[PTR]) ← 1
 (DBSR[TIE,IDE]) ← 1,1
 (MSR[WE, EE, PR, DR, IR]) ← 0
 PC ← EVPR_{0:15} || 0x0700

Registers Altered

- None

Programming Note

This instruction is inserted into the execution stream by a debugger to implement breakpoints, and is not typically used by application code.

Architecture Note

This instruction is part of the PowerPC User Instruction Set Architecture.

Table 24-35. Extended Mnemonics for twi

Mnemonic	Operands	Function	Other Registers Altered
tweqi	RA, IM	Trap if (RA) equal to EXTS(IM). <i>Extended mnemonic for</i> twi 4,RA,IM	
twgei	RA, IM	Trap if (RA) greater than or equal to EXTS(IM). <i>Extended mnemonic for</i> twi 12,RA,IM	
twgti	RA, IM	Trap if (RA) greater than EXTS(IM). <i>Extended mnemonic for</i> twi 8,RA,IM	
twlei	RA, IM	Trap if (RA) less than or equal to EXTS(IM). <i>Extended mnemonic for</i> twi 20,RA,IM	
twlgei	RA, IM	Trap if (RA) logically greater than or equal to EXTS(IM). <i>Extended mnemonic for</i> twi 5,RA,IM	
twlgti	RA, IM	Trap if (RA) logically greater than EXTS(IM). <i>Extended mnemonic for</i> twi 1,RA,IM	
twllei	RA, IM	Trap if (RA) logically less than or equal to EXTS(IM). <i>Extended mnemonic for</i> twi 6,RA,IM	
twllti	RA, IM	Trap if (RA) logically less than EXTS(IM). <i>Extended mnemonic for</i> twi 2,RA,IM	
twlngi	RA, IM	Trap if (RA) logically not greater than EXTS(IM). <i>Extended mnemonic for</i> twi 6,RA,IM	

Table 24-35. Extended Mnemonics for twi (continued)

Mnemonic	Operands	Function	Other Registers Altered
twlnli	RA, IM	Trap if (RA) logically not less than EXTS(IM). <i>Extended mnemonic for</i> twi 5,RA,IM	
twlti	RA, IM	Trap if (RA) less than EXTS(IM). <i>Extended mnemonic for</i> twi 16,RA,IM	
twnei	RA, IM	Trap if (RA) not equal to EXTS(IM). <i>Extended mnemonic for</i> twi 24,RA,IM	
twngi	RA, IM	Trap if (RA) not greater than EXTS(IM). <i>Extended mnemonic for</i> twi 20,RA,IM	
twnli	RA, IM	Trap if (RA) not less than EXTS(IM). <i>Extended mnemonic for</i> twi 12,RA,IM	

wrtee

Write External Enable

wrtee RS

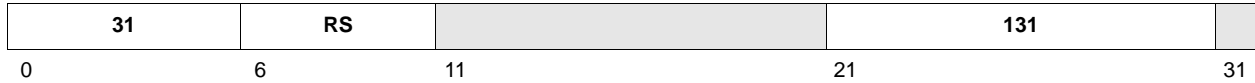

$$MSR[EE] \leftarrow (RS)_{16}$$

The MSR[EE] is set to the value specified by bit 16 of register RS.

If instruction bit 31 contains 1, the contents of CR[CR0] are undefined.

Registers Altered

- MSR[EE]

Invalid Instruction Forms:

- Reserved fields

Programming Note

Execution of this instruction is privileged.

This instruction is used to provide atomic update of MSR[EE]. Typical usage is:

```
mfmsr Rn    #save EE in Rn[16]
wrteei 0    #Turn off EE
•          #Code with EE disabled
•
•
wrtee Rn    #restore EE without affecting any MSR changes that occurred in the disabled code
```

Architecture Note

This instruction part of the AMCC PowerPC Embedded Operating Environment.

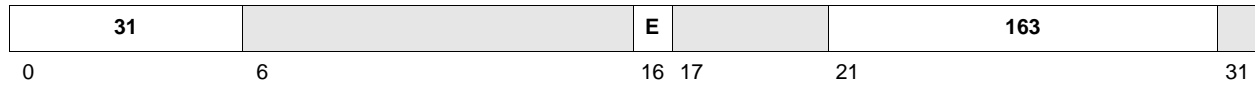
wrteei E

MSR[EE] ← E

MSR[EE] is set to the value specified by the E field.

If instruction bit 31 contains 1, the contents of CR[CR0] are undefined.

Registers Altered

- MSR[EE]

Invalid Instruction Forms:

- Reserved fields

Programming Note

Execution of this instruction is privileged.

This instruction is used to provide an atomic update of MSR[EE]. Typical usage is:

```
mfmsr Rn    #save EE in Rn[16]
wrteei 0    #Turn off EE
•          #Code with EE disabled
•
•
wrtee Rn    #restore EE without affecting any MSR changes that occurred in the disabled code
```

Architecture Note

This instruction part of the AMCC PowerPC Embedded Operating Environment.

xor
XOR

xor RA, RS, RB Rc=0
xor. RA, RS, RB Rc=1

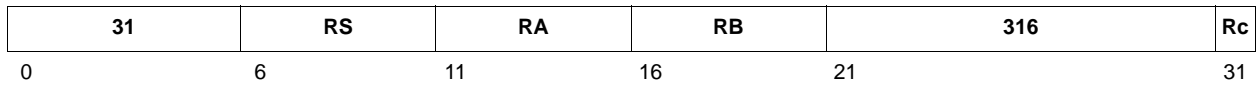

$$(RA) \leftarrow (RS) \oplus (RB)$$

The contents of register RS are XORed with the contents of register RB; the result is placed into register RA.

Registers Altered

- CR[CR0]_{LT, GT, EQ, SO} if Rc contains 1
- RA

Architecture Note

This instruction part of the AMCC PowerPC Embedded Operating Environment.

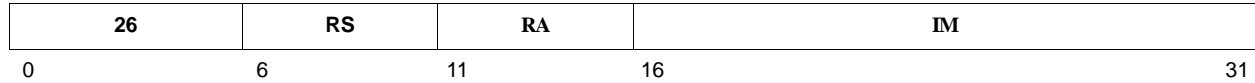
xori RA, RS, IM

$$(RA) \leftarrow (RS) \oplus (^{16}0 \parallel IM)$$

The IM field is extended to 32 bits by concatenating 16 0-bits on the left. The contents of register RS are XORed with the extended IM field; the result is placed into register RA.

Registers Altered

- RA

Architecture Note

This instruction is part of the PowerPC User Instruction Set Architecture.

xoris

XOR Immediate Shifted

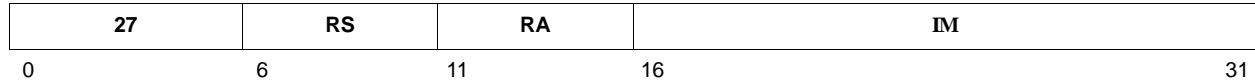
xoris RA, RS, IM

$$(RA) \leftarrow (RS) \oplus (IM \parallel 160)$$

The IM field is extended to 32 bits by concatenating 16 0-bits on the right. The contents of register RS are XORed with the extended IM field; the result is placed into register RA.

Registers Altered

- RA

Architecture Note

This instruction is part of the PowerPC User Instruction Set Architecture.

Chapter 25. Register Summary

The registers are grouped into categories, based on access mode: General Purpose Registers (GPRs), Special Purpose Registers (SPRs), Time Base Registers (TBRs), the Machine State Register (MSR), the Condition Register (CR), Device Control Registers (DCRs), and memory-mapped I/O (MMIO) registers.

25.1 Reserved Registers

Any register numbers not listed in the tables which follow are *reserved*, and should be neither read nor written. These reserved register numbers may be used for additional functions in future processors.

25.2 Reserved Fields

For all registers having fields marked as reserved, the reserved fields should be written as *zero* and read as *undefined*. That is, when writing to a reserved field, write a 0 to the field. When reading from a reserved field, ignore the field.

It is good coding practice to perform the initial write to a register with reserved fields as described in the preceding paragraph, and to perform all subsequent writes to the register using a read-modify-write strategy: read the register, alter desired fields with logical instructions, and then write the register.

25.3 General Purpose Registers

The PPC405GP processor core provides 32 General Purpose Registers (GPRs). The contents of these registers can be loaded from memory using load instructions and stored to memory using store instructions. GPRs are also addressed by all integer instructions.

Table 25-1. PPC405GP General Purpose Registers

Mnemonic	Register Name	GPR Number		Access
		Decimal	Hex	
R0–R31	General Purpose Register 0–31	0–31	0x0–0x1F	Read/Write

25.4 Machine State Register and Condition Register

Because these registers are accessed using special instructions, they do not require addressing.

25.5 Special Purpose Registers

Special Purpose Registers (SPRs), which are part of the PowerPC Embedded Environment, are accessed using the **mtspr** and **mfspr** instructions. SPRs control the use of the debug facilities, timers, interrupts, storage control attributes, and other architected processor resources.

Table 25-2 shows the mnemonics, names, and numbers of the SPRs. The columns under “SPRN” list the register numbers used as operands in assembler language coding of the **mfspr** and **mtspr** instructions. The

column labeled “SPRF” lists the corresponding fields contained in the *machine code* of **mf spr** and **mt spr**. The SPRN field contains the five-bit subfields of the SPRF field, which are *reversed* in the machine code for the **mf spr** and **mt spr** instructions ($SPRN \leftarrow SPRF_{5:9} \parallel SPRF_{0:4}$) for compatibility with the POWER Architecture. Note that the assembler handles the special coding transparently.

All SPRs are privileged, except the Count Register (CTR), the Link Register (LR), SPR General Purpose Registers (SPRG4–SPRG7, read-only), User SPR General Purpose Register (USPRG0), and the Fixed-point Exception Register (XER). Note that access to the Time Base Lower (TBL) and Time Base Upper (TBU) registers, when addressed as SPRs, is write-only and privileged. However, when addressed as Time Base Registers (TBRs), read access to these registers is not privileged. See “Time Base Registers” on page 25-865 for more information.

Table 25-2 lists the SPRs, their mnemonics and names, their numbers (SPRN) and the corresponding SPRF numbers, and access. All SPR numbers not listed are reserved, and should be neither read nor written.

Table 25-2. Special Purpose Registers

Mnemonic	Register Name	SPRN		SPRF	Access
		Decimal	Hex		
CCR0	Core Configuration Register 0	947	0x3B3	0x27D	Read/Write
CTR	Count Register	9	0x009	0x120	Read/Write
DAC1	Data Address Compare 1	1014	0x3F6	0x2DF	Read/Write
DAC2	Data Address Compare 2	1015	0x3F7	0x2FF	Read/Write
DBCR0	Debug Control Register 0	1010	0x3F2	0x25F	Read/Write
DBCR1	Debug Control Register 1	957	0x3BD	0x3BD	Read/Write
DBSR	Debug Status Register	1008	0x3F0	0x21F	Read/Clear
DCCR	Data Cache Cachability Register	1018	0x3FA	0x35F	Read/Write
DCWR	Data Cache Write-through Register	954	0x3BA	0x35D	Read/Write
DVC1	Data Value Compare 1	950	0x3B6	0x2DD	Read/Write
DVC2	Data Value Compare 2	951	0x3B7	0x2FD	Read/Write
DEAR	Data Error Address Register	981	0x3D5	0x2BE	Read/Write
ESR	Exception Syndrome Register	980	0x3D4	0x29E	Read/Write
EVPR	Exception Vector Prefix Register	982	0x3D6	0x2DE	Read/Write
IAC1	Instruction Address Compare 1	1012	0x3F4	0x29F	Read/Write
IAC2	Instruction Address Compare 2	1013	0x3F5	0x2B5	Read/Write
IAC3	Instruction Address Compare 3	948	0x3B4	0x29D	Read/Write
IAC4	Instruction Address Compare 4	949	0x3B5	0x2BD	Read/Write
ICCR	Instruction Cache Cachability Register	1019	0x3FB	0x37F	Read/Write
ICDBDR	Instruction Cache Debug Data Register	979	0x3D3	0x27E	Read-only
LR	Link Register	8	0x008	0x100	Read/Write
PID	Process ID	945	0x3B1	0x23D	Read/Write
PIT	Programmable Interval Timer	987	0x3DB	0x37E	Read/Write
PVR	Processor Version Register	287	0x11F	0x3E8	Read-only
SGR	Storage Guarded Register	953	0x3B9	0x33D	Read/Write
SLER	Storage Little Endian Register	955	0x3BB	0x37D	Read/Write

Preliminary User's Manual**Table 25-2. Special Purpose Registers (continued)**

Mnemonic	Register Name	SPRN		SPRF	Access
		Decimal	Hex		
SPRG0	SPR General 0	272	0x110	0x208	Read/Write
SPRG1	SPR General 1	273	0x111	0x228	Read/Write
SPRG2	SPR General 2	274	0x112	0x248	Read/Write
SPRG3	SPR General 3	275	0x113	0x268	Read/Write
SPRG4	SPR General 4	260	0x104	0x088	Read-only
SPRG4	SPR General 4	276	0x114	0x288	Read/Write
SPRG5	SPR General 5	261	0x105	0x0A8	Read-only
SPRG5	SPR General 5	277	0x115	0x2A8	Read/Write
SPRG6	SPR General 6	262	0x106	0x0C8	Read-only
SPRG6	SPR General 6	278	0x116	0x2C8	Read/Write
SPRG7	SPR General 7	263	0x107	0x0E8	Read-only
SPRG7	SPR General 7	279	0x117	0x2E8	Read/Write
SRR0	Save/Restore Register 0	26	0x01A	0x340	Read/Write
SRR1	Save/Restore Register 1	27	0x01B	0x360	Read/Write
SRR2	Save/Restore Register 2	990	0x3DE	0x3DE	Read/Write
SRR3	Save/Restore Register 3	991	0x3DF	0x3FE	Read/Write
SU0R	Storage User-defined 0 Register	956	0x3BC	0x39D	Read/Write
TBL	Time Base Lower	284	0x11C	0x388	Write-only
TBU	Time Base Upper	285	0x11D	0x3A8	Write-only
TCR	Timer Control Register	986	0x3DA	0x35E	Read/Write
TSR	Timer Status Register	984	0x3D8	0x31E	Read/Clear
USPRG0	User SPR General 0	256	0x100	0x008	Read/Write
XER	Fixed Point Exception Register	1	0x001	0x020	Read/Write
ZPR	Zone Protection Register	944	0x3B0	0x21D	Privileged

25.6 Time Base Registers

The PowerPC Architecture provides a 64-bit time base. Chapter 11, “Timer Facilities,” describes the architected time base. In the PPC405GP, the time base is implemented as two 32-bit time base registers (TBRs). The low-order 32 bits of the time base are read from the TBL and the high-order 32 bits are read from the TBU.

User-mode access to the TBRs is read-only, and there is no explicitly privileged read access to the time base.

The **mftb** instruction reads from TBL and TBU. (Writing the time base is accomplished by moving the contents of a GPR to a pair of SPRs, which are also called TBL and TBU, using the **mtspr** instruction.)

Table 25-3 shows the mnemonics, names, and numbers of the TBRs. The columns under “TBRN” list the register numbers used as operands in assembler language coding of the **mftb** and **mtspr** instructions. The column labeled “TBRF” lists the corresponding fields contained in the *machine code* of **mftb** and **mtspr**. The TBRN field contains two five-bit subfields of the TBRF field; the subfields are *reversed* in the machine code

for the **mftb** and **mtspr** instructions ($TBRN \leftarrow TBRF_{5:9} \parallel TBRF_{0:4}$). Note that the assembler handles the special coding transparently.

Table 25-3. Time Base Registers

Mnemonic	Register Name	TBRN		TBRF	Access
		Decimal	Hex		
TBL	Time Base Lower (Read-only)	268	0x10C	0x188	Read-only
TBU	Time Base Upper (Read-only)	269	0x10D	0x1A8	Read-only

25.7 Device Control Registers

Device Control Registers (DCRs) are on-chip registers that are architecturally outside of the processor core. They are used to control, configure, and hold status for various functional units. DCRs are accessed using the **mfdcr** and **mtdcr** instructions.

The **mfdcr** and **mtdcr** instructions are privileged, for all DCR numbers. Therefore, all DCR accesses are privileged. All DCR numbers are reserved, and should be neither read nor written.

25.7.1 Directly Addressed DCRs

The DCRs in Table 25-4 are directly accessed; that is, they are accessed using their DCR numbers.

Table 25-4. Directly Accessed DCRs

Register	DCR Number	Access	Description
DCRs Used for Indirect Access			
SDRAM0_CFGADDR	0x010	R/W	Memory Controller Address Register
SDRAM0_CFGDATA	0x011	R/W	Memory Controller Data Register
EBC0_CFGADDR	0x012	R/W	Peripheral Controller Address Register
EBC0_CFGDATA	0x013	R/W	Peripheral Controller Data Register
DCP0_CFGADDR	0x014	R/W	Decompression Controller Address Register
DCP0_CFGDATA	0x015	R/W	Decompression Controller Data Register
On-Chip Memory			
OCM0_ISARC	0x018	R/W	OCM Instruction-Side Address Range Compare Register
OCM0_ISCNTL	0x019	R/W	OCM Instruction-Side Control Register
OCM0_DSARC	0x01A	R/W	OCM Data-Side Address Range Compare Register
OCM0_DSCNTL	0x01B	R/W	OCM Data-Side Control Register
On-Chip Buses			
PLB0_BESR	0x084	R/Clear	PLB Bus Error Status Register
PLB0_BEAR	0x086	R	PLB Bus Error Address Register
PLB0_ACR	0x087	R/W	PLB Arbiter Control Register
POB0_BESR0	0x0A0	R/Clear	PLB to OPB Bus Error Status Register 0
POB0_BEAR	0x0A2	R	PLB to OPB Bus Error Address Register

Preliminary User's Manual**Table 25-4. Directly Accessed DCRs (continued)**

Register	DCR Number	Access	Description
POB0_BESR1	0x0A4	R/Clear	PLB to OPB Bus Error Status Register 1
Clocking, Power Management, and Chip Control			
CPC0_PLLMR	0x0B0	R	PLL Mode Register
CPC0_CR0	0x0B1	R/W	Chip Control Register 0
CPC0_CR1	0x0B2	R/W	Chip Control Register 1
CPC0_PSR	0x0B4	R	Chip Pin Strapping Register
CPC0_JTAGID	0x0B5	R	JTAG ID Register
CPC0_SR	0x0B8	R	CPM Status Register
CPC0_ER	0x0B9	R/W	CPM Enable Register
CPC0_FR	0x0BA	R/W	CPM Force Register
Universal Interrupt Controllers			
UIC0_SR	0x0C0	R/Clear	UIC0 Status Register
UIC0_ER	0x0C2	R/W	UIC0 Enable Register
UIC0_CR	0x0C3	R/W	UIC0 Critical Register
UIC0_PR	0x0C4	R/W	UIC0 Polarity Register
UIC0_TR	0x0C5	R/W	UIC0 Triggering Register
UIC0_MSR	0x0C6	R	UIC0 Masked Status Register
UIC0_VR	0x0C7	R	UIC0 Vector Register
UIC0_VCR	0x0C8	W	UIC0 Vector Configuration Register
Direct Memory Access			
DMA0_CR0	0x100	R/W	DMA Channel Control Register 0
DMA0_CT0	0x101	R/W	DMA Count Register 0
DMA0_DA0	0x102	R/W	DMA Destination Address Register 0
DMA0_SA0	0x103	R/W	DMA Source Address Register 0
DMA0_SG0	0x104	R/W	DMA Scatter/Gather Descriptor Address Register 0
DMA0_CR1	0x108	R/W	DMA Channel Control Register 1
DMA0_CT1	0x109	R/W	DMA Count Register 1
DMA0_DA1	0x10A	R/W	DMA Destination Address Register 1
DMA0_SA1	0x10B	R/W	DMA Source Address Register 1
DMA0_SG1	0x10C	R/W	DMA Scatter/Gather Descriptor Address Register 1
DMA0_CR2	0x110	R/W	DMA Channel Control Register 2
DMA0_CT2	0x111	R/W	DMA Count Register 2
DMA0_DA2	0x112	R/W	DMA Destination Address Register 2
DMA0_SA2	0x113	R/W	DMA Source Address Register 2
DMA0_SG2	0x114	R/W	DMA Scatter/Gather Descriptor Address Register 2
DMA0_CR3	0x118	R/W	DMA Channel Control Register 3
DMA0_CT3	0x119	R/W	DMA Count Register 3
DMA0_DA3	0x11A	R/W	DMA Destination Address Register 3
DMA0_SA3	0x11B	R/W	DMA Source Address Register 3
DMA0_SG3	0x11C	R/W	DMA Scatter/Gather Descriptor Address
DMA0_SR	0x120	R/Clear	DMA Status Register
DMA0_SGC	0x123	R/W	DMA Scatter/Gather Command Register

Table 25-4. Directly Accessed DCRs (continued)

Register	DCR Number	Access	Description
DMA0_SLP	0x125	R/W	DMA Sleep Mode Register
DMA0_POL	0x126	R/W	DMA Polarity Configuration Register
Memory Access Layer			
MAL0_CFG	0x180	R/W	MAL Configuration Register
MAL0_ESR	0x181	R/Clear	Error Status Register
MAL0_IER	0x182	R/W	Interrupt Enable Register
MAL0_TXCASR	0x184	R/W	Tx Channel Active Register (Set)
MAL0_TXCARR	0x185	R/W	Tx Channel Active Register (Reset)
MAL0_TXEOBISR	0x186	R/Clear	Tx End of Buffer Interrupt Status Register
MAL0_TXDEIR	0x187	R/Clear	Tx Descriptor Error Interrupt Register
MAL0_RXCASR	0x190	R/W	Rx Channel Active Register (Set)
MAL0_RXCARR	0x191	R/W	Rx Channel Active Register (Reset)
MAL0_RXEOBISR	0x192	R/Clear	Rx End of Buffer Interrupt Status Register
MAL0_RXDEIR	0x193	R/Clear	Rx Descriptor Error Interrupt Register
MAL0_TXCTP0R	0x1A0	R/W	Channel Tx 0 Channel Table Pointer Register
MAL0_TXCTP1R	0x1A1	R/W	Channel Tx 1 Channel Table Pointer Register
MAL0_RCBS0	0x1E0	R/W	Channel RX 0 Channel Buffer Size Register

25.7.2 Indirectly Accessed DCRs

The DCRs for the SDRAM controller, external bus controller (EBC), and decompression controller, are indirectly accessed.

The following general procedure can be used to access the indirectly accessed DCRs:

1. Write an offset to an address DCR.
2. Read data dfrom or write data to a data DCR.

Detailed procedures for indirectly accessing the DCRs for the specific peripherals follow.

Preliminary User's Manual**25.7.2.1 Indirect Access of SDRAM Controller DCRs**

The following procedure accesses the SDRAM controller DCRs.

1. Write the offset to the Memory Controller Address Register (SDRAM0_CFGADDR).
2. Read data from or write data to the Memory Controller Data Register (SDRAM0_CFGDATA).

Table 25-5. SDRAM Controller DCR Usage

Register	DCR Number	Access	Description
SDRAM0_CFGADDR	0x010	R/W	Memory Controller Address Register
SDRAM0_CFGDATA	0x011	R/W	Memory Controller Data Register

Table 25-6. Offsets for SDRAM Controller Registers

Register	Offset	R/W	Description
SDRAM0_BESR0	0x00	R/Clear	Bus Error Syndrome Register 0
SDRAM0_BESR1	0x08	R/Clear	Bus Error Syndrome Register 1
SDRAM0_BEAR	0x10	R/W	Bus Error Address Register
SDRAM0_CFG	0x20	R/W	Memory Controller Options 1
SDRAM0_RTR	0x30	R/W	Refresh Timer Register
SDRAM0_PMIT	0x34	R/W	Power Management Idle Timer
SDRAM0_B0CR	0x40	R/W	Memory Bank 0 Configuration Register
SDRAM0_B1CR	0x44	R/W	Memory Bank 1 Configuration Register
SDRAM0_B2CR	0x48	R/W	Memory Bank 2 Configuration Register
SDRAM0_B3CR	0x4C	R/W	Memory Bank 3 Configuration Register
SDRAM0_B4CR	0x50	R/W	Memory Bank 4 Configuration Register
SDRAM0_B5CR	0x54	R/W	Memory Bank 5 Configuration Register
SDRAM0_B6CR	0x58	R/W	Memory Bank 6 Configuration Register
SDRAM0_B7CR	0x5C	R/W	Memory Bank 7 Configuration Register
SDRAM0_TR	0x80	R/W	SDRAM Timing Register 1
SDRAM0_ECCCFG	0x94	R/W	ECC Configuration
SDRAM0_ECCESR	0x98	R/Clear	ECC Error Status Register

25.7.2.2 Indirect Access of EBC DCRs

The following procedure accesses the EBC DCRs.

1. Write the offset to the Peripheral Controller Address Register (EBC0_CFGADDR).
2. Read data from or write data to the Peripheral Controller Data Register (EBC0_CFGDATA).

Table 25-7. EBC DCR Usage

Register	DCR Number	Access	Description
EBC0_CFGADDR	0x012	R/W	Peripheral Controller Address Register
EBC0_CFGDATA	0x013	R/W	Peripheral Controller Data Register

Table 25-8. Offsets for EBC Registers

Register	Offset	Access	Description
EBC0_B0CR	0x00	R/W	Peripheral Bank 0 Configuration Register
EBC0_B1CR	0x01	R/W	Peripheral Bank 1 Configuration Register
EBC0_B2CR	0x02	R/W	Peripheral Bank 2 Configuration Register
EBC0_B3CR	0x03	R/W	Peripheral Bank 3 Configuration Register
EBC0_B4CR	0x04	R/W	Peripheral Bank 4 Configuration Register
EBC0_B5CR	0x05	R/W	Peripheral Bank 5 Configuration Register
EBC0_B6CR	0x06	R/W	Peripheral Bank 6 Configuration Register
EBC0_B7CR	0x07	R/W	Peripheral Bank 7 Configuration Register
EBC0_B0AP	0x10	R/W	Peripheral Bank 0 Access Parameters
EBC0_B1AP	0x11	R/W	Peripheral Bank 1 Access Parameters
EBC0_B2AP	0x12	R/W	Peripheral Bank 2 Access Parameters
EBC0_B3AP	0x13	R/W	Peripheral Bank 3 Access Parameters
EBC0_B4AP	0x14	R/W	Peripheral Bank 4 Access Parameters
EBC0_B5AP	0x15	R/W	Peripheral Bank 5 Access Parameters
EBC0_B6AP	0x16	R/W	Peripheral Bank 6 Access Parameters
EBC0_B7AP	0x17	R/W	Peripheral Bank 7 Access Parameters
EBC0_BEAR	0x20	R/W	Peripheral Bus Error Address Register
EBC0_BESR0	0x21	R/W	Peripheral Bus Error Status Register 0
EBC0_BESR1	0x22	R/W	Peripheral Bus Error Status Register 1
EBC0_CFG	0x23	R/W	External Peripheral Control Register

Preliminary User's Manual**25.7.2.3 Indirect Access of Decompression Controller DCRs**

The following procedure accesses the decompression controller DCRs.

1. Write the offset to the Decompression Controller Address Register (DCP0_CFGADDR).
2. Read data from or write data to the Decompression Controller Data Register (DCP0_CFGDATA).

Table 25-9. Decompression Controller DCR Usage

Register	DCR Number	Access	Description
DCP0_CFGADDR	0x014	R/W	Decompression Controller Address Register
DCP0_CFGDATA	0x015	R/W	Decompression Controller Data Register

Table 25-10. Offsets for Decompression Controller Registers

Register	Offset	R/W	Description
DCP0_ITOR0	0x00	R/W	Index Table Origin Register 0
DCP0_ITOR1	0x01	R/W	Index Table Origin Register 1
DCP0_ITOR2	0x02	R/W	Index Table Origin Register 2
DCP0_ITOR3	0x03	R/W	Index Table Origin Register 3
DCP0_ADDR0	0x04	R/W	Address Decode Definition Register 0
DCP0_ADDR1	0x05	R/W	Address Decode Definition Register 1
DCP0_CFG	0x40	R/W	Decompression Controller Configuration Register
DCP0_ID	0x41	R	Decompression Controller ID Register
DCP0_VER	0x42	R	Decompression Controller Version Number Register
DCP0_PLBBEAR	0x50	R	Bus Error Address Register (PLB address)
DCP0_MEMBEAR	0x51	R	Bus Error Address Register (DCP to EBC address)
DCP0_ESR	0x52	R/Clear	Bus Error Status Register 0 (masters 0-3)
DCP0_RAM0– DCP0_RAM3FF	0x400–0x7FF	R/W	Decode Tables

25.8 Memory-Mapped Input/Output Registers

Some registers associated with on-chip peripherals are memory-mapped input/output (MMIO) registers. Such registers are mapped into the system memory space and are accessed using load/store instructions.

25.8.1 Directly Accessed MMIO Registers

Directly-accessed MMIO registers are accessed using load/store instructions that contain the register addresses. Table 25-11 lists the directly-accessed MMIO registers.

Table 25-11. Directly Accessed MMIO Registers

Register	Address	Access	Description
MMIO Registers Used for Indirect Access			
PCIC0_CFGADDR	0xEEC00000	R/W	PCI Configuration Address Register
PCIC0_CFGDATA	0xEEC00004	R/W	PCI Configuration Data Register
PCI-to-PLB Bridge			
PCIL0_PMM0LA	0xEF400000	R/W	PMM 0 Local Address
PCIL0_PMM0MA	0xEF400004	R/W	PMM 0 Mask/Attribute
PCIL0_PMM0PCILA	0xEF400008	R/W	PMM 0 PCI Low Address
PCIL0_PMM0PCIHA	0xEF40000C	R/W	PMM 0 PCI High Address
PCIL0_PMM1LA	0xEF400010	R/W	PMM 1 Local Address
PCIL0_PMM1MA	0xEF400014	R/W	PMM 1 Mask/Attribute
PCIL0_PMM1PCILA	0xEF400018	R/W	PMM 1 PCI Low Address
PCIL0_PMM1PCIHA	0xEF40001C	R/W	PMM 1 PCI High Address
PCIL0_PMM2LA	0xEF400020	R/W	PMM 2 Local Address
PCIL0_PMM2MA	0xEF400024	R/W	PMM 2 Mask/Attribute
PCIL0_PMM2PCILA	0xEF400028	R/W	PMM 2 PCI Low Address
PCIL0_PMM2PCIHA	0xEF40002C	R/W	PMM 2 PCI High Address
PCIL0_PTM1MS	0xEF400030	R/W	PTM 1 Memory Size
PCIL0_PTM1LA	0xEF400034	R/W	PTM 1 Local Address
PCIL0_PTM2MS	0xEF400038	R/W	PTM 2 Memory Size
PCIL0_PTM2LA	0xEF40003C	R/W	PTM 2 Local Address
Serial Ports			
UART0_RBR	0xEF600300	R	UART 0 Receiver Buffer Register Note: Set UART0_LCR[DLAB] = 0 to access.
UART0_THR		W	UART 0 Transmitter Holding Register Note: Set UART0_LCR[DLAB] = 0 to access.
UART0_DLL		R/W	UART 0 Baud-rate Divisor Latch LSB Note: Set UART0_LCR[DLAB] = 1 to access.
UART0_IER	0xEF600301	R/W	UART 0 Interrupt Enable Register Note: Set UART0_LCR[DLAB] = 0 to access.
UART0_DLM		R/W	UART 0 Baud-rate Divisor Latch MSB Note: Set UART0_LCR[DLAB] = 1 to access.
UART0_IIR	0xEF600302	R	UART 0 Interrupt Identification Register
UART0_FCR	0xEF600302	W	UART 0 FIFO Control Register

Preliminary User's Manual**Table 25-11. Directly Accessed MMIO Registers (continued)**

Register	Address	Access	Description
UART0_LCR	0xEF600303	R/W	UART 0 Line Control Register
UART0_MCR	0xEF600304	R/W	UART 0 Modem Control Register
UART0_LSR	0xEF600305	R/W	UART 0 Line Status Register
UART0_MSR	0xEF600306	R/W	UART 0 Modem Status Register
UART0_SCR	0xEF600307	R/W	UART 0 Scratch Register
UART1_RBR	0xEF600400	R	UART 1 Receiver Buffer Register Note: Set UART1_LCR[DLAB] = 0 to access.
UART1_THR		W	UART 1 Transmitter Holding Register Note: Set UART1_LCR[DLAB] = 0 to access.
UART1_DLL		R/W	UART 1 Baud-rate Divisor Latch LSB Note: Set UART1_LCR[DLAB] = 1 to access.
UART1_IER	0xEF600401	R/W	UART 1 Interrupt Enable Register Note: Set UART1_LCR[DLAB] = 0 to access.
UART1_DLM		R/W	UART 1 Baud-rate Divisor Latch MSB Note: Set UART1_LCR[DLAB] = 1 to access.
UART1_IIR	0xEF600402	R	UART 1 Interrupt Identification Register
UART1_FCR	0xEF600402	W	UART 1 FIFO Control Register
UART1_LCR	0xEF600403	R/W	UART 1 Line Control Register
UART1_MCR	0xEF600404	R/W	UART 1 Modem Control Register
UART1_LSR	0xEF600405	R/W	UART 1 Line Status Register
UART1_MSR	0xEF600406	R/W	UART 1 Modem Status Register
UART1_SCR	0xEF600407	R/W	UART 1 Scratch Register
Inter-Integrated Circuit			
IIC0_MDBUF	0xEF600500	R/W	IIC0 Master Data Buffer
IIC0_SDBUF	0xEF600502	R/W	IIC0 Slave Data Buffer
IIC0_LMADR	0xEF600504	R/W	IIC0 Low Master Address
IIC0_HMADR	0xEF600505	R/W	IIC0 High Master Address
IIC0_CNTL	0xEF600506	R/W	IIC0 Control
IIC0_MDCNTL	0xEF600507	R/W	IIC0 Mode Control
IIC0_STS	0xEF600508	R/W	IIC0 Status
IIC0_EXTSTS	0xEF600509	R/W	IIC0 Extended Status
IIC0_LSADR	0xEF60050A	R/W	IIC0 Low Slave Address
IIC0_HSADR	0xEF60050B	R/W	IIC0 High Slave Address
IIC0_CLKDIV	0xEF60050C	R/W	IIC0 Clock Divide
IIC0_INTRMSK	0xEF60050D	R/W	IIC0 Interrupt Mask
IIC0_XFRCNT	0xEF60050E	R/W	IIC0 Transfer Count
IIC0_XTCNTLSS	0xEF60050F	R/W	IIC0 Extended Control and Slave Status
IIC0_DIRECTCNTL	0xEF600510	R/W	IIC0 Direct Control
OPB Arbiter			
OPBA0_PR	0xEF600600	R/W	OPB Arbiter Priority Register
OPBA0_CR	0xEF600601	R/W	OPB Arbiter Control Register

Table 25-11. Directly Accessed MMIO Registers (continued)

Register	Address	Access	Description
General-Purpose I/O			
GPIO0_OR	0xEF600700	R/W	GPIO0 Output Register
GPIO0_TCR	0xEF600704	R/W	GPIO0 Three-State Control Register
GPIO0_ODR	0xEF600718	R/W	GPIO0 Open Drain Register
GPIO0_IR	0xEF60071C	R	GPIO0 Input Register
Ethernet			
EMAC0_MR0	0xEF600800	R/W	Mode Register 0
EMAC0_MR1	0xEF600804	R/W	Mode Register 1
EMAC0_TMR0	0xEF600808	R/W	Transmit Mode Register 0
EMAC0_TMR1	0xEF60080C	R/W	Transmit Mode Register 1
EMAC0_RMR	0xEF600810	R/W	Receive Mode Register
EMAC0_ISR	0xEF600814	R/W	Interrupt Status Register
EMAC0_ISER	0xEF600818	R/W	Interrupt Status Enable Register
EMAC0_IAHR	0xEF60081C	R/W	Individual Address High
EMAC0_IALR	0xEF600820	R/W	Individual Address Low
EMAC0_VTPID	0xEF600824	R/W	VLAN TPID Register
EMAC0_VTCI	0xEF600828	R/W	VLAN TCI Register
EMAC0_PTR	0xEF60082C	R/W	Pause Timer Register
EMAC0_IAHT1	0xEF600830	R/W	Individual Address Hash Table 1
EMAC0_IAHT2	0xEF600834	R/W	Individual Address Hash Table 2
EMAC0_IAHT3	0xEF600838	R/W	Individual Address Hash Table 3
EMAC0_IAHT4	0xEF60083C	R/W	Individual Address Hash Table 4
EMAC0_GAHT1	0xEF600840	R/W	Group Address Hash Table 1
EMAC0_GAHT2	0xEF600844	R/W	Group Address Hash Table 2
EMAC0_GAHT3	0xEF600848	R/W	Group Address Hash Table 3
EMAC0_GAHT4	0xEF60084C	R/W	Group Address Hash Table 4
EMAC0_LSAH	0xEF600850	R	Last Source Address High
EMAC0_LSAL	0xEF600854	R	Last Source Address Low
EMAC0_IPGVR	0xEF600858	R/W	Inter-Packet Gap Value Register
EMAC0_STACR	0xEF60085C	R/W	STA Control Register
EMAC0_TRTR	0xEF600860	R/W	Transmit Request Threshold Register
EMAC0_RWMR	0xEF600864	R/W	Receive Low/High Water Mark Register
EMAC0_OCTX	0xEF600868	R/W	Number of Octets Transmitted Register
EMAC0_OCRX	0xEF60086C	R/W	Number of Octets Received Register

Preliminary User's Manual**25.8.2 Indirectly Accessed MMIO Registers**

The PCI configuration registers, listed in Table 25-13, are indirectly accessed.

The following procedure accesses the PCI configuration registers, using the address and data registers listed in Table 25-12:

1. OR the Enable, Bus, Device, and Function fields of the PCI Configuration Address Register (PCIC0_CFGADDR) with the high-order 6 bits of the offset from Table 25-13 and write the result to the PCIC0_CFGADDR.
2. OR the low-order 2 bits of the offset from Table 25-13 with the address of the PCI Configuration Data Register (PCIC0_CFGDATA) to form an address.

Read data from or write data to the address.

Table 25-12. PCI Configuration Address and Data Registers

Register	Address	Access	Description
PCIC0_CFGADDR	0xEEC00000	R/W	PCI Configuration Address Register
PCIC0_CFGDATA	0xEEC00004	R/W	PCI Configuration Data Register

Table 25-13. PCI Configuration Registers

Register	Offset	Access		Description
		PLB	PCI	
PCIC0_VENDID	0x01–0x00	R/W	R	PCI Vendor ID
PCIC0_DEVID	0x03–0x02	R/W	R	PCI Device ID
PCIC0_CMD	0x05–0x04	R/W	R/W	PCI Command Register
PCIC0_STATUS	0x07–0x06	R/W	R/W	PCI Status Register
PCIC0_REVID	0x08	R/W	R/W	PCI Revision ID
PCIC0_CLS	0x0B–0x09	R/W	R	PCI Class Register
PCIC0_CACHELS	0x0C	R	R	PCI Cache Line Size
PCIC0_LATTIM	0x0D	R/W	R/W	PCI Latency Timer
PCIC0_HDTYPE	0x0E	R	R	PCI Header Type
PCIC0_BIST	0x0F	R	R	PCI Built In Self Test Control
PCIC0_BAR0	0x13–0x10	R	R	PCI Reserved BAR 0
PCIC0_PTM1BAR	0x17–0x14	R/W	R/W	PCI PTM 1 BAR
PCIC0_PTM2BAR	0x1B–0x18	R/W	R/W	PCI PTM 2 BAR
PCIC0_BAR3	0x1F–0x1C	—	—	PCI Reserved BAR 3
PCIC0_BAR4	0x23–0x20	—	—	PCI Reserved BAR 4
PCIC0_BAR5	0x27–0x24	—	—	PCI Reserved BAR 5
PCIC0_CISPTR	0x2B–0x28	—	—	Unused Cardbus CIS Pointer
PCIC0_SBSYSVID	0x2D–0x2C	R/W	R	PCI Subsystem Vendor ID
PCIC0_SBSYSID	0x2F–0x2E	R/W	R	PCI Subsystem ID
PCIC0_EROMBA	0x33–0x30	—	—	Unused Expansion ROM Base Address
PCIC0_CAP	0x34	R	R	PCI Capabilities Pointer
PCIC0_INTLN	0x3C	R/W	R/W	PCI Interrupt Line
PCIC0_INTPN	0x3D	R	R	PCI Interrupt Pin
PCIC0_MINGNT	0x3E	R	R	PCI Minimum Grant

Table 25-13. PCI Configuration Registers (continued)

Register	Offset	Access		Description
		PLB	PCI	
PCIC0_MAXLTNCY	0x3F	R	R	PCI Maximum Latency
PCIC0_ICS	0x44	R/W	R/W	PCI Interrupt Control/Status
PCIC0_ERREN	0x48	R/W	R/W	Error Enable
PCIC0_ERRSTS	0x49	R/W	R/W	Error Status
PCIC0_BRDGOPT1	0x4B–0x4A	R/W	R/W	PCI Bridge Options 1
PCIC0_PLBBESR0	0x4F–0x4C	R/W	R/W	PLB Slave Error Syndrome 0
PCIC0_PLBBESR1	0x53–0x50	R/W	R/W	PLB Slave Error Syndrome 1
PCIC0_PLBBEAR	0x57–0x54	R/W	R/W	PLB Slave Error Address Register
PCIC0_CAPID	0x58	R	R	Capability Identifier
PCIC0_NEXTIPTR	0x59	R	R	Next Item Pointer
PCIC0_PMC	0x5B–0x5A	R	R	Power Management Capabilities
PCIC0_PMCSR	0x5D–0x5C	R/W	R/W	Power Management Control Status
PCIC0_PMCSRBSE	0x5E	R	R	PMCSR PCI to PCI Bridge Support Extensions
PCIC0_DATA	0x5F	—	—	Unused Data
PCIC0_BRDGOPT2	0x63–0x60	R/W	R/W	PCI Bridge Options 2
PCIC0_PMSCRR	0x64	R/W	R/W	Power Management State Change Request Register

Preliminary User's Manual

25.9 Alphabetical Listing of Processor Core Registers

The following pages list the registers available in the processor core. For each register, the following information is supplied:

- Register mnemonic and name
- Cross-reference to a detailed register description
- Register type (SPR or TBR; the names of CR, GPR0–31, and MSR are the same as their register types)
- Register number (address)
- A diagram illustrating the register fields (all register fields have mnemonics, unless there is only one field)
- A table describing the register fields, giving field mnemonic, field bit location, field name, and the function associated with various field values

CCR0

Core Configuration Register 0

SPR 0x3B3

See "Core Configuration Register 0 (CCR0)" on page 144.

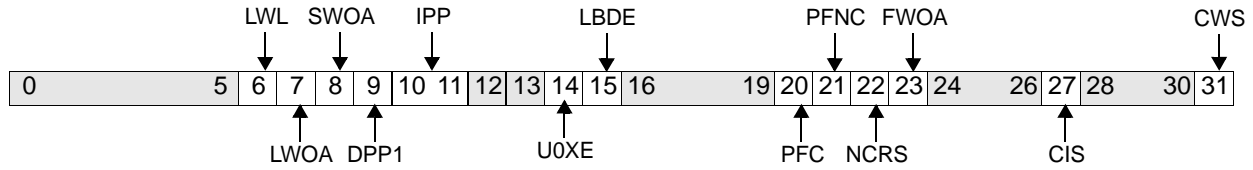

Figure 25-1. Core Configuration Register 0 (CCR0)

0:5		Reserved
6	LWL	Load Word as Line 0 The DCU performs load misses or non-cachable loads as words, halfwords, or bytes, as requested 1 For load misses or non-cachable loads, the DCU moves eight words (including the target word) into the line fill buffer
7	LWOA	Load Without Allocate 0 Load misses result in line fills 1 Load misses do not result in a line fill, but in non-cachable loads
8	SWOA	Store Without Allocate 0 Store misses result in line fills 1 Store misses do not result in line fills, but in non-cachable stores
9	DPP1	DCU PLB Priority Bit 1 0 DCU PLB priority 0 on bit 1 1 DCU PLB priority 1 on bit 1 Note: DCU logic dynamically controls DCU priority bit 0.
10:11	IPP	ICU PLB Priority Bits 0:1 00 Lowest ICU PLB priority 01 Next to lowest ICU PLB priority 10 Next to highest ICU PLB priority 11 Highest ICU PLB priority
12:13		Reserved
14	U0XE	Enable U0 Exception 0 Disables the U0 exception 1 Enables the U0 exception
15	LBDE	Load Debug Enable 0 Load data is invisible on data-side (on-chip memory (OCM)) 1 Load data is visible on data-side OCM
16:19		Reserved
20	PFC	ICU Prefetching for Cachable Regions 0 Disables prefetching for cachable regions 1 Enables prefetching for cachable regions

Preliminary User's Manual

21	PFNC	ICU Prefetching for Non-Cachable Regions 0 Disables prefetching for non-cachable regions 1 Enables prefetching for non-cachable regions
22	NCRS	Non-cachable ICU request size 0 Requests are for four-word lines 1 Requests are for eight-word lines
23	FWOA	Fetch Without Allocate 0 An ICU miss results in a line fill. 1 An ICU miss does not cause a line fill, but results in a non-cachable fetch.
24:26		Reserved
27	CIS	Cache Information Select 0 Information is cache data. 1 Information is cache tag.
28:30		Reserved
31	CWS	Cache Way Select 0 Cache way is A. 1 Cache way is B.

See "Condition Register (CR)" on page 91.

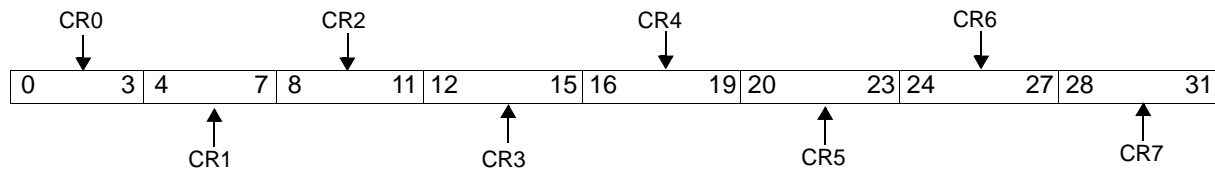

Figure 25-2. Condition Register (CR)

0:3	CR0	Condition Register Field 0
4:7	CR1	Condition Register Field 1
8:11	CR2	Condition Register Field 2
12:15	CR3	Condition Register Field 3
16:19	CR4	Condition Register Field 4
20:23	CR5	Condition Register Field 5
24:27	CR6	Condition Register Field 6
28:31	CR7	Condition Register Field 7

SPR 0x009

See "Count Register (CTR)" on page 85.

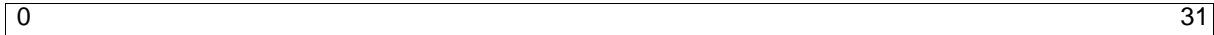

Figure 25-3. Count Register (CTR)

0:31		Count	Used as count for branch conditional with decrement instructions, or as address for branch-to-counter instructions.
------	--	-------	---

DAC1–DAC2

Data Address Compare Registers

SPR 0x3F6–0x3F7

See “Data Address Compare Registers (DAC1–DAC2)” on page 293.

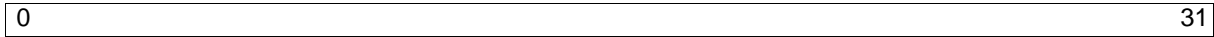
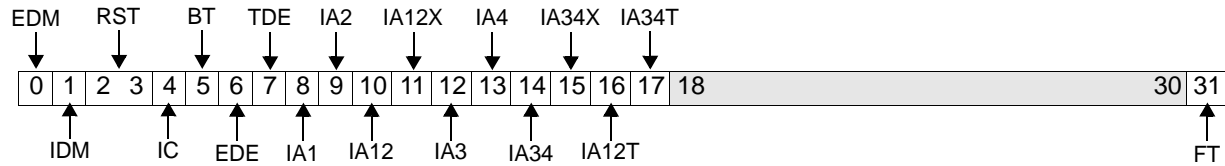

Figure 25-4. Data Address Compare Registers (DAC1–DAC2)

0:31		Data Address Compare (DAC) byte address	DBCRO[D1S] determines which address bits are examined.
------	--	---	--

SPR 0x3F2

See “Debug Control Registers” on page 287.

**Figure 25-5. Debug Control Register 0 (DBCR0)**

0	EDM	External Debug Mode 0 Disabled 1 Enabled	
1	IDM	Internal Debug Mode 0 Disabled 1 Enabled	
2:3	RST	Reset 00 No action 01 Core reset 10 Chip reset 11 System reset	Causes a processor reset request when set by software.
Attention: Writing 01, 10, or 11 to this field causes a processor reset request.			
4	IC	Instruction Completion Debug Event 0 Disabled 1 Enabled	
5	BT	Branch Taken Debug Event 0 Disabled 1 Enabled	
6	EDE	Exception Debug Event 0 Disabled 1 Enabled	
7	TDE	Trap Debug Event 0 Disabled 1 Enabled	
8	IA1	IAC 1 Debug Event 0 Disabled 1 Enabled	
9	IA2	IAC 2 Debug Event 0 Disabled 1 Enabled	
10	IA12	Instruction Address Range Compare 1–2 0 Disabled 1 Enabled	Registers IAC1 and IAC2 define an address range used for IAC address comparisons.
11	IA12X	Enable Instruction Address Exclusive Range Compare 1–2 0 Inclusive 1 Exclusive	Selects the range defined by IAC1 and IAC2 to be inclusive or exclusive.

DBCR0 (cont.)

Debug Control Register 0

Preliminary User's Manual

12	IA3	IAC 3 Debug Event 0 Disabled 1 Enabled	
13	IA4	IAC 4 Debug Event 0 Disabled 1 Enabled	
14	IA34	Instruction Address Range Compare 3–4 0 Disabled 1 Enabled	Registers IAC3 and IAC4 define an address range used for IAC address comparisons.
15	IA34X	Instruction Address Exclusive Range Compare 3–4 0 Inclusive 1 Exclusive	Selects range defined by IAC3 and IAC4 to be inclusive or exclusive.
16	IA12T	Instruction Address Range Compare 1-2 Toggle 0 Disabled 1 Enable	Toggles range 12 inclusive, exclusive DBCR[IA12X] on debug event.
17	IA34T	Instruction Address Range Compare 3–4 Toggle 0 Disabled 1 Enable	Toggles range 34 inclusive, exclusive DBCR[IA34X] on debug event.
18:30		Reserved	
31	FT	Freeze timers on debug event 0 Timers not frozen 1 Timers frozen	

SPR 0x3BD

See “Debug Control Registers” on page 287.

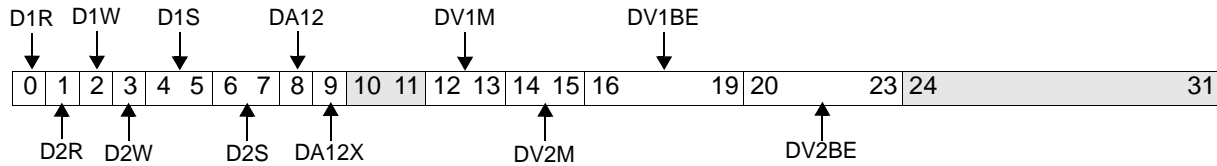
**Figure 25-6. Debug Control Register 1 (DBCR1)**

0	D1R	DAC1 Read Debug Event 0 Disabled 1 Enabled	
1	D2R	DAC 2 Read Debug Event 0 Disabled 1 Enabled	
2	D1W	DAC 1 Write Debug Event 0 Disabled 1 Enabled	
3	D2W	DAC 2 Write Debug Event 0 Disabled 1 Enabled	
4:5	D1S	DAC 1 Size 00 Compare all bits 01 Ignore lsb (least significant bit) 10 Ignore two lsbs 11 Ignore five lsbs	Address bits used in the compare: Byte address Halfword address Word address Cache line (8-word) address
6:7	D2S	DAC 2 Size 00 Compare all bits 01 Ignore lsb (least significant bit) 10 Ignore two lsbs 11 Ignore five lsbs	Address bits used in the compare: Byte address Halfword address Word address Cache line (8-word) address
8	DA12	Enable Data Address Range Compare 1:2 0 Disabled 1 Enabled	Registers DAC1 and DAC2 define an address range used for DAC address comparisons
9	DA12X	Data Address Exclusive Range Compare 1:2 0 Inclusive 1 Exclusive	Selects range defined by DAC1 and DAC2 to be inclusive or exclusive
10:11		Reserved	

DBCR1 (cont.)

Debug Control Register 1

12:13	DV1M	Data Value Compare 1 Mode 00 Undefined 01 AND 10 OR 11 AND-OR	Type of data comparison used: All bytes selected by DBCR1[DV1BE] must compare to the appropriate bytes of DVC1. One of the bytes selected by DBCR1[DV1BE] must compare to the appropriate bytes of DVC1. The upper halfword or lower halfword must compare to the appropriate halfword in DVC1. When performing halfword compares set DBCR1[DV1BE] = 0011, 1100, or 1111.
14:15	DV2M	Data Value Compare 2 Mode 00 Undefined 01 AND 10 OR 11 AND-OR	Type of data comparison used All bytes selected by DBCR1[DV2BE] must compare to the appropriate bytes of DVC2. One of the bytes selected by DBCR1[DV2BE] must compare to the appropriate bytes of DVC2. The upper halfword or lower halfword must compare to the appropriate halfword in DVC2. When performing halfword compares set DBCR1[DV2BE] = 0011, 1100, or 1111.
16:19	DV1BE	Data Value Compare 1 Byte 0 Disabled 1 Enabled	Selects which data bytes to use in data value comparison
20:23	DV2BE	Data Value Compare 2 Byte 0 Disabled 1 Enabled	Selects which data bytes to use in data value comparison
24:31		Reserved	

SPR 0x3F0 Read/Clear

See “Debug Status Register (DBSR)” on page 291.

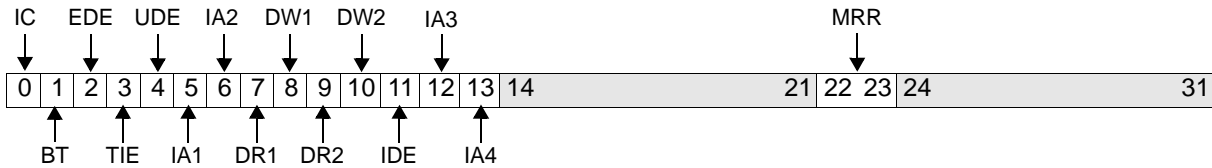
**Figure 25-7. Debug Status Register (DBSR)**

0	IC	Instruction Completion Debug Event 0 Event did not occur 1 Event occurred
1	BT	Branch Taken Debug Event 0 Event did not occur 1 Event occurred
2	EDE	Exception Debug Event 0 Event did not occur 1 Event occurred
3	TIE	Trap Instruction Debug Event 0 Event did not occur 1 Event occurred
4	UDE	Unconditional Debug Event 0 Event did not occur 1 Event occurred
5	IA1	IAC1 Debug Event 0 Event did not occur 1 Event occurred
6	IA2	IAC2 Debug Event 0 Event did not occur 1 Event occurred
7	DR1	DAC1 Read Debug Event 0 Event did not occur 1 Event occurred
8	DW1	DAC1 Write Debug Event 0 Event did not occur 1 Event occurred
9	DR2	DAC2 Read Debug Event 0 Event did not occur 1 Event occurred
10	DW2	DAC2 Write Debug Event 0 Event did not occur 1 Event occurred

DBSR (cont.)

Debug Status Register

11	IDE	Imprecise Debug Event 0 No circumstance that would cause a debug event (if MSR[DE] = 1) occurred 1 A debug event would have occurred, but debug exceptions were disabled (MSR[DE] = 0)	
12	IA3	IAC3 Debug Event 0 Event did not occur 1 Event occurred	
13	IA4	IAC4 Debug Event 0 Event did not occur 1 Event occurred	
14:21		Reserved	
22:23	MRR	Most Recent Reset 00 No reset has occurred since last cleared by software. 01 Core reset 10 Chip reset 11 System reset	This field is set to a value, indicating the type of reset, when a reset occurs.
24:31		Reserved	

SPR 0x3FA

See “Real-Mode Storage Attribute Control” on page 177.

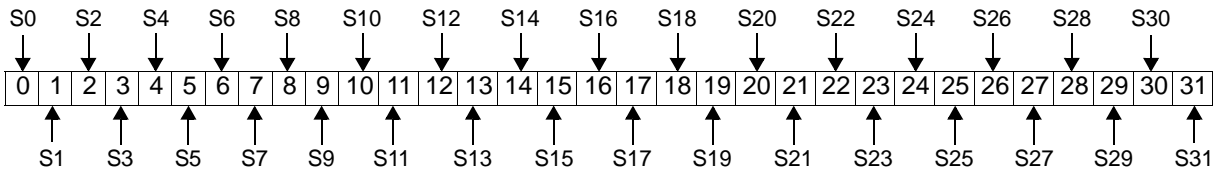
**Figure 25-8. Data Cache Cachability Register (DCCR)**

0	S0	0 Noncachable 1 Cachable	0x0000 0000–0x07FF FFFF
1	S1	0 Noncachable 1 Cachable	0x0800 0000–0x0FFF FFFF
2	S2	0 Noncachable 1 Cachable	0x1000 0000–0x17FF FFFF
3	S3	0 Noncachable 1 Cachable	0x1800 0000–0x1FFF FFFF
4	S4	0 Noncachable 1 Cachable	0x2000 0000–0x27FF FFFF
5	S5	0 Noncachable 1 Cachable	0x2800 0000–0x2FFF FFFF
6	S6	0 Noncachable 1 Cachable	0x3000 0000–0x37FF FFFF
7	S7	0 Noncachable 1 Cachable	0x3800 0000–0x3FFF FFFF
8	S8	0 Noncachable 1 Cachable	0x4000 0000–0x47FF FFFF
9	S9	0 Noncachable 1 Cachable	0x4800 0000–0x4FFF FFFF
10	S10	0 Noncachable 1 Cachable	0x5000 0000–0x57FF FFFF
11	S11	0 Noncachable 1 Cachable	0x5800 0000–0x5FFF FFFF
12	S12	0 Noncachable 1 Cachable	0x6000 0000–0x67FF FFFF
13	S13	0 Noncachable 1 Cachable	0x6800 0000–0x6FFF FFFF
14	S14	0 Noncachable 1 Cachable	0x7000 0000–0x77FF FFFF
15	S15	0 Noncachable 1 Cachable	0x7800 0000–0x7FFF FFFF
16	S16	0 Noncachable 1 Cachable	0x8000 0000–0x87FF FFFF

DCCR (cont.)

Data Cache Cacheability Register

Preliminary User's Manual

17	S17	0 Noncachable 1 Cachable	0x8800 0000–0x8FFF FFFF
18	S18	0 Noncachable 1 Cachable	0x9000 0000–0x97FF FFFF
19	S19	0 Noncachable 1 Cachable	0x9800 0000–0x9FFF FFFF
20	S20	0 Noncachable 1 Cachable	0xA000 0000–0xA7FF FFFF
21	S21	0 Noncachable 1 Cachable	0xA800 0000–0xAFFF FFFF
22	S22	0 Noncachable 1 Cachable	0xB000 0000–0xB7FF FFFF
23	S23	0 Noncachable 1 Cachable	0xB800 0000–0xBFFF FFFF
24	S24	0 Noncachable 1 Cachable	0xC000 0000–0xC7FF FFFF
25	S25	0 Noncachable 1 Cachable	0xC800 0000–0xCFFF FFFF
26	S26	0 Noncachable 1 Cachable	0xD000 0000–0xD7FF FFFF
27	S27	0 Noncachable 1 Cachable	0xD800 0000–0xDFFF FFFF
28	S28	0 Noncachable 1 Cachable	0xE000 0000–0xE7FF FFFF
29	S29	0 Noncachable 1 Cachable	0xE800 0000–0xEFFF FFFF
30	S30	0 Noncachable 1 Cachable	0xF000 0000–0xF7FF FFFF
31	S31	0 Noncachable 1 Cachable	0xF800 0000–0xFFFF FFFF

SPR 0x3BA

See “Real-Mode Storage Attribute Control” on page 177.

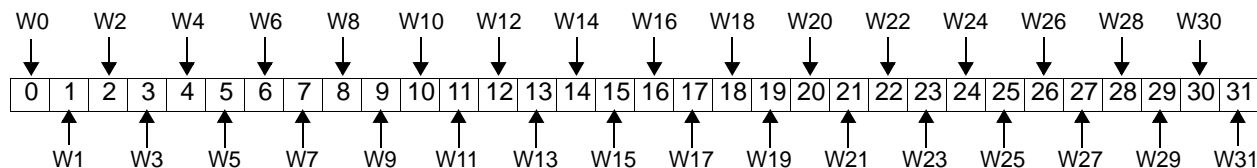

Figure 25-9. Data Cache Write-through Register (DCWR)

0	W0	0 Write-back 1 Write-through	0x0000 0000–0x07FF FFFF
1	W1	0 Write-back 1 Write-through	0x0800 0000–0x0FFF FFFF
2	W2	0 Write-back 1 Write-through	0x1000 0000–0x17FF FFFF
3	W3	0 Write-back 1 Write-through	0x1800 0000–0x1FFF FFFF
4	W4	0 Write-back 1 Write-through	0x2000 0000–0x27FF FFFF
5	W5	0 Write-back 1 Write-through	0x2800 0000–0x2FFF FFFF
6	W6	0 Write-back 1 Write-through	0x3000 0000–0x37FF FFFF
7	W7	0 Write-back 1 Write-through	0x3800 0000–0x3FFF FFFF
8	W8	0 Write-back 1 Write-through	0x4000 0000–0x47FF FFFF
9	W9	0 Write-back 1 Write-through	0x4800 0000–0x4FFF FFFF
10	W10	0 Write-back 1 Write-through	0x5000 0000–0x57FF FFFF
11	W11	0 Write-back 1 Write-through	0x5800 0000–0x5FFF FFFF
12	W12	0 Write-back 1 Write-through	0x6000 0000–0x67FF FFFF
13	W13	0 Write-back 1 Write-through	0x6800 0000–0x6FFF FFFF
14	W14	0 Write-back 1 Write-through	0x7000 0000–0x77FF FFFF
15	W15	0 Write-back 1 Write-through	0x7800 0000–0x7FFF FFFF
16	W16	0 Write-back 1 Write-through	0x8000 0000–0x87FF FFFF

DCWR (cont.)

Data Cache Write-through Register

Preliminary User's Manual

17	W17	0 Write-back 1 Write-through	0x8800 0000–0x8FFF FFFF
18	W18	0 Write-back 1 Write-through	0x9000 0000–0x97FF FFFF
19	W19	0 Write-back 1 Write-through	0x9800 0000–0x9FFF FFFF
20	W20	0 Write-back 1 Write-through	0xA000 0000–0xA7FF FFFF
21	W21	0 Write-back 1 Write-through	0xA800 0000–0xAFFF FFFF
22	W22	0 Write-back 1 Write-through	0xB000 0000–0xB7FF FFFF
23	W23	0 Write-back 1 Write-through	0xB800 0000–0xBFFF FFFF
24	W24	0 Write-back 1 Write-through	0xC000 0000–0xC7FF FFFF
25	W25	0 Write-back 1 Write-through	0xC800 0000–0xCFFF FFFF
26	W26	0 Write-back 1 Write-through	0xD000 0000–0xD7FF FFFF
27	W27	0 Write-back 1 Write-through	0xD800 0000–0xDFFF FFFF
28	W28	0 Write-back 1 Write-through	0xE000 0000–0xE7FF FFFF
29	W29	0 Write-back 1 Write-through	0xE800 0000–0xEFFF FFFF
30	W30	0 Write-back 1 Write-through	0xF000 0000–0xF7FF FFFF
31	W31	0 Write-back 1 Write-through	0xF800 0000–0xFFFF FFFF

SPR 0x3D5

See “Data Exception Address Register (DEAR)” on page 246.

0	31
---	----

Figure 25-10. Data Exception Address Register (DEAR)

0:31	Address of Data Error (synchronous)
------	-------------------------------------

SPR 0x3B6–0x3B7

See “Data Value Compare Registers (DVC1–DVC2)” on page 293.

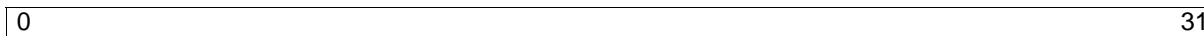
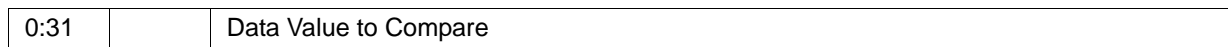

Figure 25-11. Data Value Compare Registers (DVC1–DVC2)



SPR 0x3D4

See “Exception Syndrome Register (ESR)” on page 244.

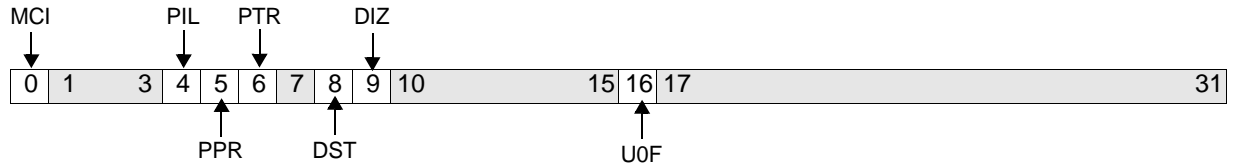

Figure 25-12. Exception Syndrome Register (ESR)

0	MCI	Machine check—instruction 0 Instruction machine check did not occur. 1 Instruction machine check occurred.
1:3		Reserved
4	PIL	Program interrupt—illegal 0 Illegal Instruction error did not occur. 1 Illegal Instruction error occurred.
5	PPR	Program interrupt—privileged 0 Privileged instruction error did not occur. 1 Privileged instruction error occurred.
6	PTR	Program interrupt—trap 0 Trap with successful compare did not occur. 1 Trap with successful compare occurred.
7		Reserved
8	DST	Data storage interrupt—store fault 0 Excepting instruction was not a store. 1 Excepting instruction was a store (includes dcbi , dcbz , and dccci).
9	DIZ	Data/instruction storage interrupt—zone fault 0 Excepting condition was not a zone fault. 1 Excepting condition was a zone fault.
10:15		Reserved
16	UOF	Data storage interrupt—U0 fault 0 Excepting instruction did not cause a U0 fault. 1 Excepting instruction did cause a U0 fault.
17:31		Reserved

EVPR

Exception Vector Prefix Register

SPR 0x3D6

See "Exception Vector Prefix Register (EVPR)" on page 243.

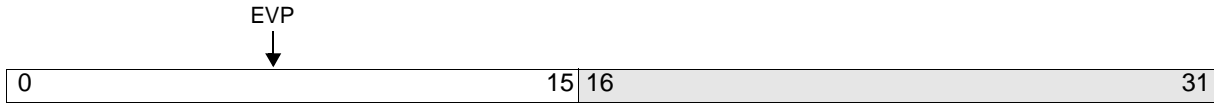

Figure 25-13. Exception Vector Prefix Register (EVPR)

0:15	EVP	Exception Vector Prefix
16:31		Reserved

See "General Purpose Registers (R0-R31)" on page 83.

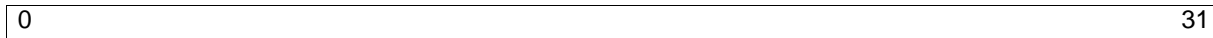

Figure 25-14. General Purpose Registers (R0-R31)



IAC1–IAC4

Instruction Address Compare Registers

SPR 0x3F4–0x3F5

See “Instruction Address Compare Registers (IAC1–IAC4)” on page 292.

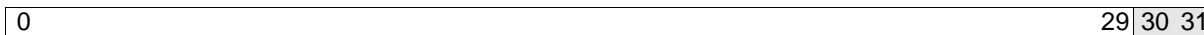
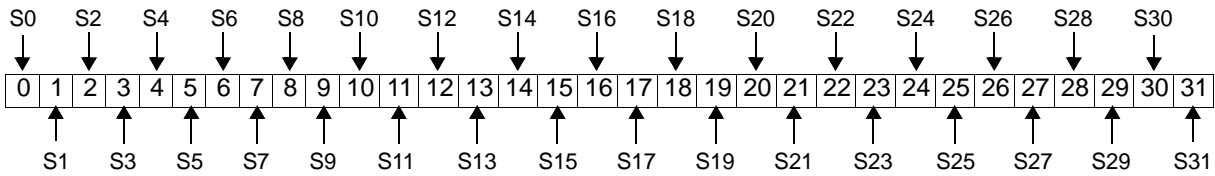

Figure 25-15. Instruction Address Compare Registers (IAC1–IAC4)

0:29		Instruction Address Compare word address	Omit two low-order bits of complete address.
30:31		Reserved	

SPR 0x3FB

See “Real-Mode Storage Attribute Control” on page 177.

**Figure 25-16. Instruction Cache Cachability Register (ICCR)**

0	S0	0 Noncachable 1 Cachable	0x0000 0000–0x07FF FFFF
1	S1	0 Noncachable 1 Cachable	0x0800 0000–0x0FFF FFFF
2	S2	0 Noncachable 1 Cachable	0x1000 0000–0x17FF FFFF
3	S3	0 Noncachable 1 Cachable	0x1800 0000–0x1FFF FFFF
4	S4	0 Noncachable 1 Cachable	0x2000 0000–0x27FF FFFF
5	S5	0 Noncachable 1 Cachable	0x2800 0000–0x2FFF FFFF
6	S6	0 Noncachable 1 Cachable	0x3000 0000–0x37FF FFFF
7	S7	0 Noncachable 1 Cachable	0x3800 0000–0x3FFF FFFF
8	S8	0 Noncachable 1 Cachable	0x4000 0000–0x47FF FFFF
9	S9	0 Noncachable 1 Cachable	0x4800 0000–0x4FFF FFFF
10	S10	0 Noncachable 1 Cachable	0x5000 0000–0x57FF FFFF
11	S11	0 Noncachable 1 Cachable	0x5800 0000–0x5FFF FFFF
12	S12	0 Noncachable 1 Cachable	0x6000 0000–0x67FF FFFF
13	S13	0 Noncachable 1 Cachable	0x6800 0000–0x6FFF FFFF
14	S14	0 Noncachable 1 Cachable	0x7000 0000–0x77FF FFFF
15	S15	0 Noncachable 1 Cachable	0x7800 0000–0x7FFF FFFF
16	S16	0 Noncachable 1 Cachable	0x8000 0000–0x87FF FFFF

ICCR (cont.)

Instruction Cache Cacheability Register

Preliminary User's Manual

17	S17	0 Noncachable 1 Cachable	0x8800 0000–0x8FFF FFFF
18	S18	0 Noncachable 1 Cachable	0x9000 0000–0x97FF FFFF
19	S19	0 Noncachable 1 Cachable	0x9800 0000–0x9FFF FFFF
20	S20	0 Noncachable 1 Cachable	0xA000 0000–0xA7FF FFFF
21	S21	0 Noncachable 1 Cachable	0xA800 0000–0xAFFF FFFF
22	S22	0 Noncachable 1 Cachable	0xB000 0000–0xB7FF FFFF
23	S23	0 Noncachable 1 Cachable	0xB800 0000–0xBFFF FFFF
24	S24	0 Noncachable 1 Cachable	0xC000 0000–0xC7FF FFFF
25	S25	0 Noncachable 1 Cachable	0xC800 0000–0xCFFF FFFF
26	S26	0 Noncachable 1 Cachable	0xD000 0000–0xD7FF FFFF
27	S27	0 Noncachable 1 Cachable	0xD800 0000–0xDFFF FFFF
28	S28	0 Noncachable 1 Cachable	0xE000 0000–0xE7FF FFFF
29	S29	0 Noncachable 1 Cachable	0xE800 0000–0xEFFF FFFF
30	S30	0 Noncachable 1 Cachable	0xF000 0000–0xF7FF FFFF
31	S31	0 Noncachable 1 Cachable	0xF800 0000–0xFFFF FFFF

Preliminary User's Manual**SPR 0x3D3 Read-Only**

See "ICU Debugging" on page 147.

0		31
---	--	----

Figure 25-17. Instruction Cache Debug Data Register (ICDBDR)

0:31		Instruction cache information	See icread on page -708.
------	--	-------------------------------	---------------------------------

ICU tag information is placed into the ICDBDR as shown:

0:21	TAG	Cache Tag
22:26		Reserved
27	V	Cache Line Valid 0 Not valid 1 Valid
28:30		Reserved
31	LRU	Least Recently Used (LRU) 0 A-way LRU 1 B-way LRU

SPR 0x008

See “Link Register (LR)” on page 86.

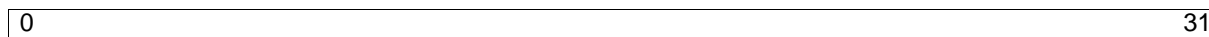

Figure 25-18. Link Register (LR)

0:31		Link Register contents	If (LR) represents an instruction address, LR _{30:31} should be 0.
------	--	------------------------	---

See “Machine State Register (MSR)” on page 240.

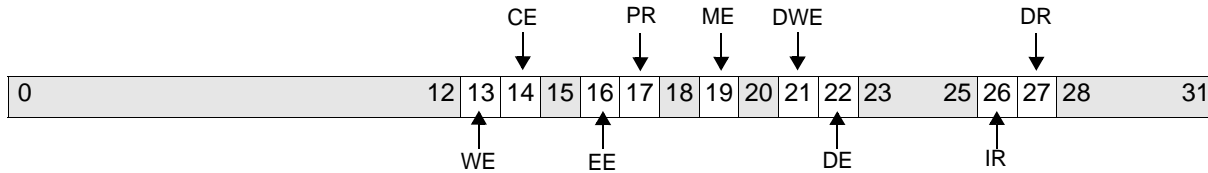

Figure 25-19. Machine State Register (MSR)

0:12		Reserved	
13	WE	Wait State Enable 0 The processor is not in the wait state. 1 The processor is in the wait state.	If MSR[WE] = 1, the processor remains in the wait state until an interrupt is taken, a reset occurs, or an external debug tool clears WE.
14	CE	Critical Interrupt Enable 0 Critical interrupts are disabled. 1 Critical interrupts are enabled.	Controls the critical interrupt input and watchdog timer first time-out interrupts.
15		Reserved	
16	EE	External Interrupt Enable 0 Asynchronous interrupts (external to the processor core) are disabled. 1 Asynchronous interrupts are enabled.	Controls the non-critical external interrupt input, PIT, and FIT interrupts.
17	PR	Problem State 0 Supervisor state (all instructions allowed). 1 Problem state (some instructions not allowed).	
18		Reserved	
19	ME	Machine Check Enable 0 Machine check interrupts are disabled. 1 Machine check interrupts are enabled.	
20		Reserved	
21	DWE	Debug Wait Enable 0 Debug wait mode is disabled. 1 Debug wait mode is enabled.	
22	DE	Debug Interrupts Enable 0 Debug interrupts are disabled. 1 Debug interrupts are enabled.	
23:25		Reserved	
26	IR	Instruction Relocate 0 Instruction address translation is disabled. 1 Instruction address translation is enabled.	
27	DR	Data Relocate 0 Data address translation is disabled. 1 Data address translation is enabled.	
28:31		Reserved	

SPR 0x3B1

See “Address Translation” on page 161.



Figure 25-20. Process ID (PID)

0:23		Reserved
24:31		Process ID

PVR

Processor Version Register

SPR 0x11F Read-Only

See "Processor Version Register (PVR)" on page 91.

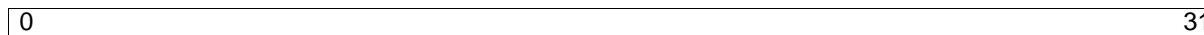
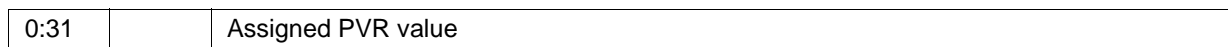

Figure 25-22. Processor Version Register (PVR)



SPR 0x3B9

See “Real-Mode Storage Attribute Control” on page 177.

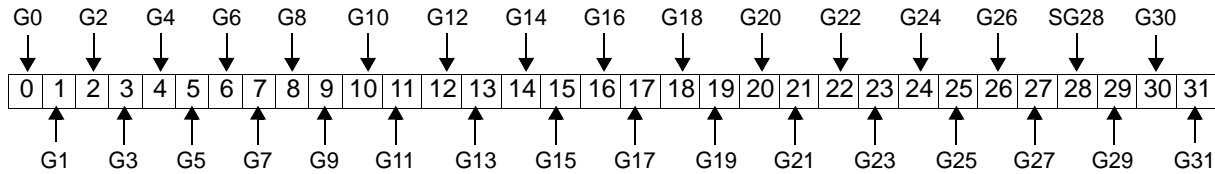

Figure 25-23. Storage Guarded Register (SGR)

0	G0	0 Normal 1 Guarded	0x0000 0000–0x07FF FFFF
1	G1	0 Normal 1 Guarded	0x0800 0000–0x0FFF FFFF
2	G2	0 Normal 1 Guarded	0x1000 0000–0x17FF FFFF
3	G3	0 Normal 1 Guarded	0x1800 0000–0x1FFF FFFF
4	G4	0 Normal 1 Guarded	0x2000 0000–0x27FF FFFF
5	G5	0 Normal 1 Guarded	0x2800 0000–0x2FFF FFFF
6	G6	0 Normal 1 Guarded	0x3000 0000–0x37FF FFFF
7	G7	0 Normal 1 Guarded	0x3800 0000–0x3FFF FFFF
8	G8	0 Normal 1 Guarded	0x4000 0000–0x47FF FFFF
9	G9	0 Normal 1 Guarded	0x4800 0000–0x4FFF FFFF
10	G10	0 Normal 1 Guarded	0x5000 0000–0x57FF FFFF
11	G11	0 Normal 1 Guarded	0x5800 0000–0x5FFF FFFF
12	G12	0 Normal 1 Guarded	0x6000 0000–0x67FF FFFF
13	G13	0 Normal 1 Guarded	0x6800 0000–0x6FFF FFFF
14	G14	0 Normal 1 Guarded	0x7000 0000–0x77FF FFFF
15	G15	0 Normal 1 Guarded	0x7800 0000–0x7FFF FFFF
16	G16	0 Normal 1 Guarded	0x8000 0000–0x87FF FFFF

SGR (cont.)

Storage Guarded Register

Preliminary User's Manual

17	G17	0 Normal 1 Guarded	0x8800 0000–0x8FFF FFFF
18	G18	0 Normal 1 Guarded	0x9000 0000–0x97FF FFFF
19	G19	0 Normal 1 Guarded	0x9800 0000–0x9FFF FFFF
20	G20	0 Normal 1 Guarded	0xA000 0000–0xA7FF FFFF
21	G21	0 Normal 1 Guarded	0xA800 0000–0xAFFF FFFF
22	G22	0 Normal 1 Guarded	0xB000 0000–0xB7FF FFFF
23	G23	0 Normal 1 Guarded	0xB800 0000–0xBFFF FFFF
24	G24	0 Normal 1 Guarded	0xC000 0000–0xC7FF FFFF
25	G25	0 Normal 1 Guarded	0xC800 0000–0xCFFF FFFF
26	G26	0 Normal 1 Guarded	0xD000 0000–0xD7FF FFFF
27	G27	0 Normal 1 Guarded	0xD800 0000–0xDFFF FFFF
28	G28	0 Normal 1 Guarded	0xE000 0000–0xE7FF FFFF
29	G29	0 Normal 1 Guarded	0xE800 0000–0xEFFF FFFF
30	G30	0 Normal 1 Guarded	0xF000 0000–0xF7FF FFFF
31	G31	0 Normal 1 Guarded	0xF800 0000–0xFFFF FFFF

SPR 0x3BB

See “Real-Mode Storage Attribute Control” on page 177.

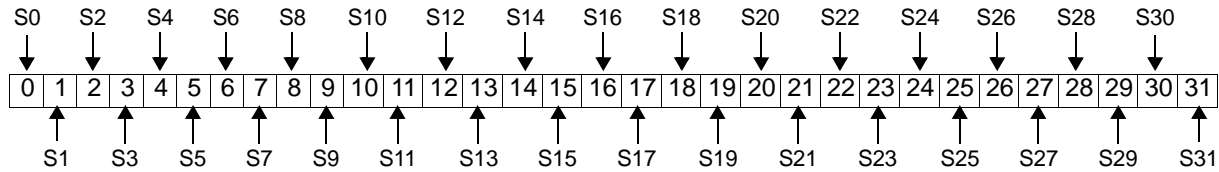

Figure 25-24. Storage Little-Endian Register (SLER)

0	S0	0 Big endian 1 Little endian	0x0000 0000–0x07FF FFFF
1	S1	0 Big endian 1 Little endian	0x0800 0000–0x0FFF FFFF
2	S2	0 Big endian 1 Little endian	0x1000 0000–0x17FF FFFF
3	S3	0 Big endian 1 Little endian	0x1800 0000–0x1FFF FFFF
4	S4	0 Big endian 1 Little endian	0x2000 0000–0x27FF FFFF
5	S5	0 Big endian 1 Little endian	0x2800 0000–0x2FFF FFFF
6	S6	0 Big endian 1 Little endian	0x3000 0000–0x37FF FFFF
7	S7	0 Big endian 1 Little endian	0x3800 0000–0x3FFF FFFF
8	S8	0 Big endian 1 Little endian	0x4000 0000–0x47FF FFFF
9	S9	0 Big endian 1 Little endian	0x4800 0000–0x4FFF FFFF
10	S10	0 Big endian 1 Little endian	0x5000 0000–0x57FF FFFF
11	S11	0 Big endian 1 Little endian	0x5800 0000–0x5FFF FFFF
12	S12	0 Big endian 1 Little endian	0x6000 0000–0x67FF FFFF
13	S13	0 Big endian 1 Little endian	0x6800 0000–0x6FFF FFFF
14	S14	0 Big endian 1 Little endian	0x7000 0000–0x77FF FFFF
15	S15	0 Big endian 1 Little endian	0x7800 0000–0x7FFF FFFF
16	S16	0 Big endian 1 Little endian	0x8000 0000–0x87FF FFFF

SLER (cont.)

Storage Little-Endian Register

17	S17	0 Big endian 1 Little endian	0x8800 0000–0x8FFF FFFF
18	S18	0 Big endian 1 Little endian	0x9000 0000–0x97FF FFFF
19	S19	0 Big endian 1 Little endian	0x9800 0000–0x9FFF FFFF
20	S20	0 Big endian 1 Little endian	0xA000 0000–0xA7FF FFFF
21	S21	0 Big endian 1 Little endian	0xA800 0000–0xAFFF FFFF
22	S22	0 Big endian 1 Little endian	0xB000 0000–0xB7FF FFFF
23	S23	0 Big endian 1 Little endian	0xB800 0000–0xBFFF FFFF
24	S24	0 Big endian 1 Little endian	0xC000 0000–0xC7FF FFFF
25	S25	0 Big endian 1 Little endian	0xC800 0000–0xCFFF FFFF
26	S26	0 Big endian 1 Little endian	0xD000 0000–0xD7FF FFFF
27	S27	0 Big endian 1 Little endian	0xD800 0000–0xDFFF FFFF
28	S28	0 Big endian 1 Little endian	0xE000 0000–0xE7FF FFFF
29	S29	0 Big endian 1 Little endian	0xE800 0000–0xEFFF FFFF
30	S30	0 Big endian 1 Little endian	0xF000 0000–0xF7FF FFFF
31	S31	0 Big endian 1 Little endian	0xF800 0000–0xFFFF FFFF

Preliminary User's Manual

SPR 0x104–0x107 (User Read-only); 0x110–0x117 (Privileged Read/Write)

See “Special Purpose Register General (SPRG0–SPRG7)” on page 90.

0		31
---	--	----

Figure 25-25. Special Purpose Registers General (SPRG0–SPRG7)

0:31		General data	Software value; no hardware usage.
------	--	--------------	------------------------------------

SRR0

Save/Restore Register 0

SPR 0x01A

See "Save/Restore Registers 0 and 1 (SRR0–SRR1)" on page 242.



Figure 25-26. Save/Restore Register 0 (SRR0)

0:29		SRR0 receives an instruction address when a non-critical interrupt is taken; the Program Counter is restored from SRR0 when rfi executes.
30:31		Reserved

SPR 0x01B

See “Save/Restore Registers 0 and 1 (SRR0–SRR1)” on page 242.

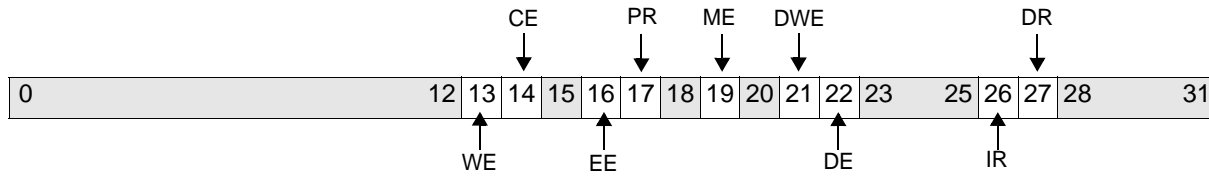

Figure 25-27. Save/Restore Register 1 (SRR1)

0:31	SRR1 receives a copy of the MSR when an interrupt is taken; the MSR is restored from SRR1 when <i>rfi</i> executes.
------	---

SRR2

Save/Restore Register 2

SPR 0x3DE

See "Save/Restore Registers 2 and 3 (SRR2–SRR3)" on page 243.

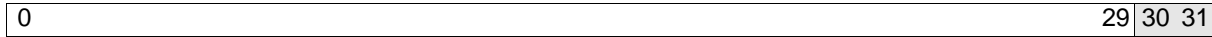

Figure 25-28. Save/Restore Register 2 (SRR2)

0:29		SRR2 receives an instruction address when a critical interrupt is taken; the Program Counter is restored from SRR2 when rfci executes.
30:31		Reserved

SPR 0x3DF

See “Save/Restore Registers 2 and 3 (SRR2–SRR3)” on page 243.

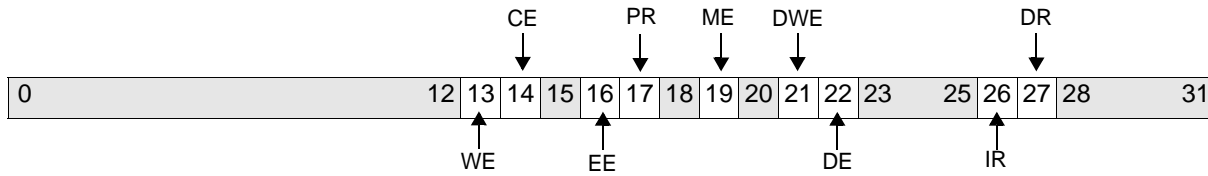

Figure 25-29. Save/Restore Register 3 (SRR3)

0:31	SRR3 receives a copy of the MSR when a critical interrupt is taken; the MSR is restored from SRR3 when <code>rfci</code> executes.
------	--

SU0R

Storage User-Defined 0 Register

SPR 0x3BC

See “Real-Mode Storage Attribute Control” on page 177.

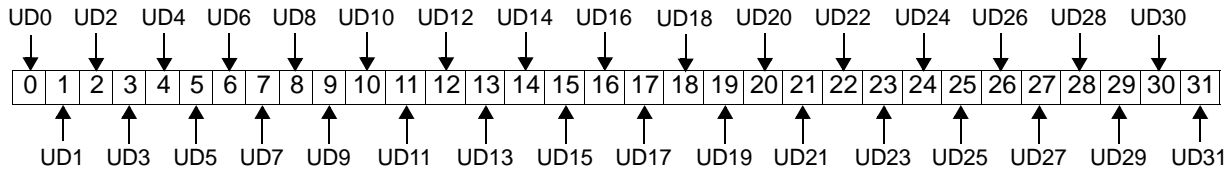

Figure 25-30. Storage User-defined 0 Register (SU0R)

0	UD0	0 Storage compression is off 1 Storage compression is on	0x0000 0000–0x07FF FFFF
1	UD1	0 Storage compression is off 1 Storage compression is on	0x0800 0000–0x0FFF FFFF
2	UD2	0 Storage compression is off 1 Storage compression is on	0x1000 0000–0x17FF FFFF
3	UD3	0 Storage compression is off 1 Storage compression is on	0x1800 0000–0x1FFF FFFF
4	UD4	0 Storage compression is off 1 Storage compression is on	0x2000 0000–0x27FF FFFF
5	UD5	0 Storage compression is off 1 Storage compression is on	0x2800 0000–0x2FFF FFFF
6	UD6	0 Storage compression is off 1 Storage compression is on	0x3000 0000–0x37FF FFFF
7	UD7	0 Storage compression is off 1 Storage compression is on	0x3800 0000–0x3FFF FFFF
8	UD8	0 Storage compression is off 1 Storage compression is on	0x4000 0000–0x47FF FFFF
9	UD9	0 Storage compression is off 1 Storage compression is on	0x4800 0000–0x4FFF FFFF
10	UD10	0 Storage compression is off 1 Storage compression is on	0x5000 0000–0x57FF FFFF
11	UD11	0 Storage compression is off 1 Storage compression is on	0x5800 0000–0x5FFF FFFF
12	UD12	0 Storage compression is off 1 Storage compression is on	0x6000 0000–0x67FF FFFF
13	UD13	0 Storage compression is off 1 Storage compression is on	0x6800 0000–0x6FFF FFFF
14	UD14	0 Storage compression is off 1 Storage compression is on	0x7000 0000–0x77FF FFFF
15	UD15	0 Storage compression is off 1 Storage compression is on	0x7800 0000–0x7FFF FFFF
16	UD16	0 Storage compression is off 1 Storage compression is on	0x8000 0000–0x87FF FFFF

Preliminary User's Manual

17	UD17	0 Storage compression is off 1 Storage compression is on	0x8800 0000–0x8FFF FFFF
18	UD18	0 Storage compression is off 1 Storage compression is on	0x9000 0000–0x97FF FFFF
19	UD19	0 Storage compression is off 1 Storage compression is on	0x9800 0000–0x9FFF FFFF
20	UD20	0 Storage compression is off 1 Storage compression is on	0xA000 0000–0xA7FF FFFF
21	UD21	0 Storage compression is off 1 Storage compression is on	0xA800 0000–0xAFFF FFFF
22	UD22	0 Storage compression is off 1 Storage compression is on	0xB000 0000–0xB7FF FFFF
23	UD23	0 Storage compression is off 1 Storage compression is on	0xB800 0000–0xBFFF FFFF
24	UD24	0 Storage compression is off 1 Storage compression is on	0xC000 0000–0xC7FF FFFF
25	UD25	0 Storage compression is off 1 Storage compression is on	0xC800 0000–0xCFFF FFFF
26	UD26	0 Storage compression is off 1 Storage compression is on	0xD000 0000–0xD7FF FFFF
27	UD27	0 Storage compression is off 1 Storage compression is on	0xD800 0000–0xDFFF FFFF
28	UD28	0 Storage compression is off 1 Storage compression is on	0xE000 0000–0xE7FF FFFF
29	UD29	0 Storage compression is off 1 Storage compression is on	0xE800 0000–0xEFFF FFFF
30	UD30	0 Storage compression is off 1 Storage compression is on	0xF000 0000–0xF7FF FFFF
31	UD31	0 Storage compression is off 1 Storage compression is on	0xF800 0000–0xFFFF FFFF

TBL

Time Base Lower

TBR 0x10C (Read-only); SPR 0x11C (Privileged write-only)

See "Time Base" on page 272.

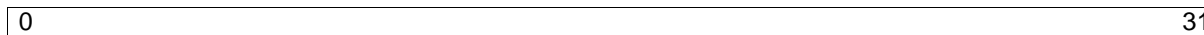

Figure 25-31. Time Base Lower (TBL)

0:31		Time Base Lower	Current count; low-order 32 bits of time base.
------	--	-----------------	--

TBR 0x10D (Read-only); SPR 0x11D (Privileged write-only)

See “Time Base” on page 272.

0		31
---	--	----

Figure 25-32. Time Base Upper (TBU)

0:31		Time Base Upper	Current count, high-order 32 bits of time base.
------	--	-----------------	---

TCR

Timer Control Register

SPR 0x3DA

See "Timer Control Register (TCR)" on page 279.

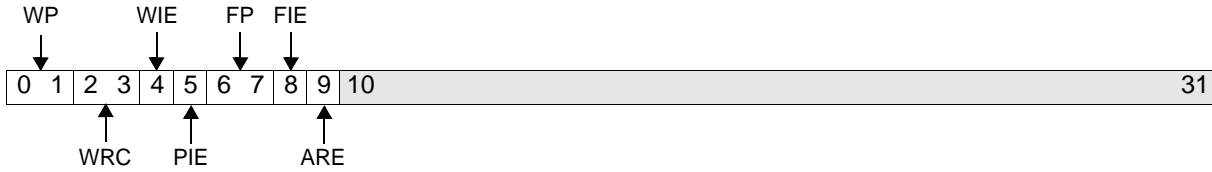
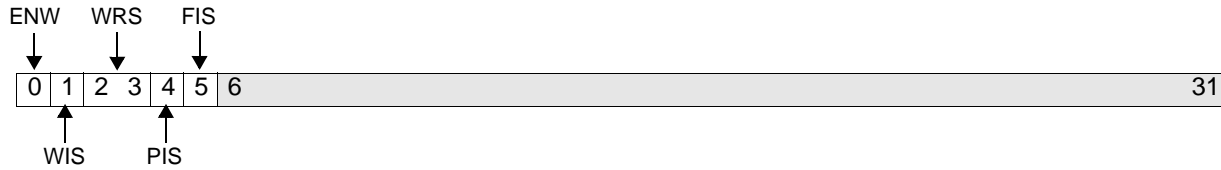

Figure 25-33. Timer Control Register (TCR)

0:1	WP	Watchdog Period 00 2 ¹⁷ clocks 01 2 ²¹ clocks 10 2 ²⁵ clocks 11 2 ²⁹ clocks	
2:3	WRC	Watchdog Reset Control 00 No Watchdog reset will occur. 01 Core reset will be forced by the Watchdog. 10 Chip reset will be forced by the Watchdog. 11 System reset will be forced by the Watchdog.	TCR[WRC] resets to 00. This field can be set by software, but cannot be cleared by software, except by a software-induced reset.
4	WIE	Watchdog Interrupt Enable 0 Disable watchdog interrupt. 1 Enable watchdog interrupt.	
5	PIE	PIT Interrupt Enable 0 Disable PIT interrupt. 1 Enable PIT interrupt.	
6:7	FP	FIT Period 00 2 ⁹ clocks 01 2 ¹³ clocks 10 2 ¹⁷ clocks 11 2 ²¹ clocks	
8	FIE	FIT Interrupt Enable 0 Disable FIT interrupt. 1 Enable FIT interrupt.	
9	ARE	Auto Reload Enable 0 Disable auto reload. 1 Enable auto reload.	Disables on reset.
10:31		Reserved	

SPR 0x3D8 Read/Clear

See "Timer Status Register (TSR)" on page 278.

**Figure 25-34. Timer Status Register (TSR)**

0	ENW	Enable Next Watchdog 0 Action on next watchdog event is to set TSR[ENW] = 1. 1 Action on next watchdog event is governed by TSR[WIS].	Software must reset TSR[ENW] = 0 after each watchdog timer event.
1	WIS	Watchdog Interrupt Status 0 No Watchdog interrupt is pending. 1 Watchdog interrupt is pending.	
2:3	WRS	Watchdog Reset Status 00 No Watchdog reset has occurred. 01 Core reset was forced by the watchdog. 10 Chip reset was forced by the watchdog. 11 System reset was forced by the watchdog.	
4	PIS	PIT Interrupt Status 0 No PIT interrupt is pending. 1 PIT interrupt is pending.	
5	FIS	FIT Interrupt Status 0 No FIT interrupt is pending. 1 FIT interrupt is pending.	
6:31		Reserved	

USPRG0

User Special Purpose Register General 0

SPR 0x100 (User R/W)

See “Special Purpose Register General (SPRG0–SPRG7)” on page 90.



Figure 25-35. User SPR General 0 (USPRG0)

0:31	General data	Software value; no hardware usage.
------	--------------	------------------------------------

SPR 0x001

See “Fixed Point Exception Register (XER)” on page 87.

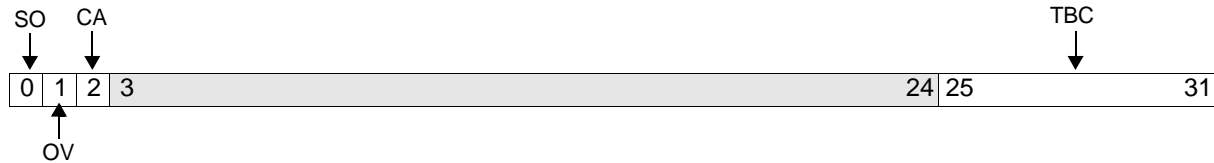

Figure 25-36. Fixed Point Exception Register (XER)

0	SO	Summary Overflow 0 No overflow has occurred. 1 Overflow has occurred.	Can be <i>set</i> by mtspr or by using “o” form instructions; can be <i>reset</i> by mtspr or by mcrxr .
1	OV	Overflow 0 No overflow has occurred. 1 Overflow has occurred.	Can be <i>set</i> by mtspr or by using “o” form instructions; can be <i>reset</i> by mtspr , by mcrxr , or “o” form instructions.
2	CA	Carry 0 Carry has not occurred. 1 Carry has occurred.	Can be <i>set</i> by mtspr or arithmetic instructions that update the CA field; can be <i>reset</i> by mtspr , by mcrxr , or by arithmetic instructions that update the CA field.
3:24		Reserved	
25:31	TBC	Transfer Byte Count	Used by lswx and stswx ; written by mtspr .

ZPR

Zone Protection Register

SPR 0x3B0

See “Zone Protection” on page 173.

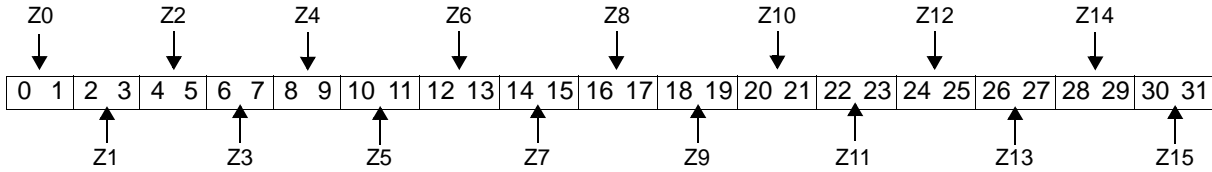

Figure 25-37. Zone Protection Register (ZPR)

0:1	Z0	TLB page access control for all pages in this zone.										
		<table border="0"> <tr> <td>In the problem state (MSR[PR] = 1):</td> <td>In the supervisor state (MSR[PR] = 0):</td> </tr> <tr> <td>00 No access</td> <td>00 Access controlled by applicable TLB_entry[EX, WR]</td> </tr> <tr> <td>01 Access controlled by applicable TLB_entry[EX, WR]</td> <td>01 Access controlled by applicable TLB_entry[EX, WR]</td> </tr> <tr> <td>10 Access controlled by applicable TLB_entry[EX, WR]</td> <td>10 Accessed as if execute and write permissions (TLB_entry[EX, WR]) are granted</td> </tr> <tr> <td>11 Accessed as if execute and write permissions (TLB_entry[EX, WR]) are granted</td> <td>11 Accessed as if execute and write permissions (TLB_entry[EX, WR]) are granted</td> </tr> </table>	In the problem state (MSR[PR] = 1):	In the supervisor state (MSR[PR] = 0):	00 No access	00 Access controlled by applicable TLB_entry[EX, WR]	01 Access controlled by applicable TLB_entry[EX, WR]	01 Access controlled by applicable TLB_entry[EX, WR]	10 Access controlled by applicable TLB_entry[EX, WR]	10 Accessed as if execute and write permissions (TLB_entry[EX, WR]) are granted	11 Accessed as if execute and write permissions (TLB_entry[EX, WR]) are granted	11 Accessed as if execute and write permissions (TLB_entry[EX, WR]) are granted
In the problem state (MSR[PR] = 1):	In the supervisor state (MSR[PR] = 0):											
00 No access	00 Access controlled by applicable TLB_entry[EX, WR]											
01 Access controlled by applicable TLB_entry[EX, WR]	01 Access controlled by applicable TLB_entry[EX, WR]											
10 Access controlled by applicable TLB_entry[EX, WR]	10 Accessed as if execute and write permissions (TLB_entry[EX, WR]) are granted											
11 Accessed as if execute and write permissions (TLB_entry[EX, WR]) are granted	11 Accessed as if execute and write permissions (TLB_entry[EX, WR]) are granted											
2:3	Z1	See the description of Z0.										
4:5	Z2	See the description of Z0.										
6:7	Z3	See the description of Z0.										
8:9	Z4	See the description of Z0.										
10:11	Z5	See the description of Z0.										
12:13	Z6	See the description of Z0.										
14:15	Z7	See the description of Z0.										
16:17	Z8	See the description of Z0.										
18:19	Z9	See the description of Z0.										
20:21	Z10	See the description of Z0.										
22:23	Z11	See the description of Z0.										
24:25	Z12	See the description of Z0.										
26:27	Z13	See the description of Z0.										
28:29	Z14	See the description of Z0.										
30:31	Z15	See the description of Z0.										

25.10 Alphabetical Listing of Chip Control and Peripheral Registers

This section lists the chip control and peripheral registers available in the PPC405GP.

Chip Control Register

DCR 0x0B1

See “Chip Control Register 0 (CPC0_CR0)” on page 194.

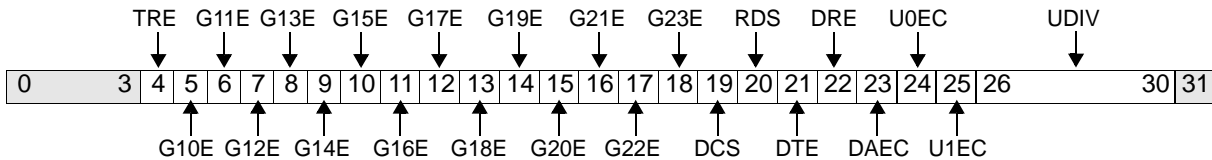

Figure 25-38. Chip Control Register 0 (CPC0_CR0)

0:3		Reserved
4	TRE	CPU Trace Enable 0 GPIO1-9 are enabled 1 GPIO1-9 are disabled Trace interface cannot be used when GPIO is enabled.
5	G10E	GPIO 10 <u>Enable</u> 0 Enable <u>PerCS1</u> as a chip select 1 Enable <u>PerCS1</u> as GPIO10
6	G11E	GPIO 11 <u>Enable</u> 0 Enable <u>PerCS2</u> as a chip select 1 Enable <u>PerCS2</u> as GPIO11
7	G12E	GPIO 12 <u>Enable</u> 0 Enable <u>PerCS3</u> as a chip select 1 Enable <u>PerCS3</u> as GPIO12
8	G13E	GPIO 13 <u>Enable</u> 0 Enable <u>PerCS4</u> as a chip select 1 Enable <u>PerCS4</u> as GPIO13
9	G14E	GPIO 14 <u>Enable</u> 0 Enable <u>PerCS5</u> as a chip select 1 Enable <u>PerCS5</u> as GPIO14
10	G15E	GPIO 15 <u>Enable</u> 0 Enable <u>PerCS6</u> as a chip select 1 Enable <u>PerCS6</u> as GPIO15
11	G16E	GPIO 16 <u>Enable</u> 0 Enable <u>PerCS7</u> as a chip select 1 Enable <u>PerCS7</u> as GPIO16

12	G17E	GPIO 17 Enable 0 Enable interrupt IRQ0 as an interrupt 1 Enable interrupt IRQ0 as GPIO17	The purpose of G17E through G23E is to isolate the interrupt controller from activity on a shared pin when that pin is being used as a GPIO. For instance, when G17E is set to a 1, IRQ0 at the UIC will always be forced to a zero. Note: Setting G17E to a 0 will not prevent GPIO channel 17 (if configured as an output) from creating contention with the off-chip source of the IRQ input. Therefore, be sure to leave the shared GPIO channel disabled when using the pin as an interrupt input.
13	G18E	GPIO 18 Enable 0 Enable interrupt IRQ1 as an interrupt 1 Enable interrupt IRQ1 as GPIO18	
14	G19E	GPIO 19 Enable 0 Enable interrupt IRQ2 as an interrupt 1 Enable interrupt IRQ2 as GPIO19	
15	G20E	GPIO 20 Enable 0 Enable interrupt IRQ3 as an interrupt 1 Enable interrupt IRQ3 as GPIO20	
16	G21E	GPIO 21 Enable 0 Enable interrupt IRQ4 as an interrupt 1 Enable interrupt IRQ4 as GPIO21	
17	G22E	GPIO 22 Enable 0 Enable interrupt IRQ5 as an interrupt 1 Enable interrupt IRQ5 as GPIO22	
18	G23E	GPIO 23 Enable 0 Enable interrupt IRQ6 as an interrupt 1 Enable interrupt IRQ6 as GPIO23	
19	DCS	DSR/CTS select for UART1 0 DSR is selected. 1 CTS is selected.	
20	RDS	RTS/DTR select for UART1 0 RTS is selected. 1 DTR is selected.	
21	DTE	DMA Transmit Enable for UART0 0 DMA transmit channel is disabled. 1 DMA transmit channel is enabled.	
22	DRE	DMA Receive Enable for UART0 0 DMA receive channel is disabled. 1 DMA receive channel is enabled.	
23	DAEC	DMA Allow Enable Clear for UART0 0 DTE and DRE for UART0 are not cleared when the UART receives a corresponding terminal count. 1 DTE and DRE for UART0 are cleared when the UART receives a corresponding terminal count.	

24	U0EC	Select External Clock for UART0 0 UART0 uses the internally derived serial clock 1 UART0 uses the external UARTSerClk input	
25	U1EC	Select External Clock for UART1 0 UART1 uses the internally derived serial clock 1 UART1 uses the external UARTSerClk input	
26:30	UDIV	UART Internal Clock Divisor 00000 Divide by 1 00001 Divide by 2 00010 Divide by 3 11110 Divide by 31 11111 Divide by 32	UDIV specifies the divisor of the CPU clock frequency used to derive a UART serial clock frequency. For example, if the CPU is running at 200MHz, a divider value of 20 sets the serial clock frequency to 10MHz. Note: The serial clock frequency must be less than 1/2 the OPB frequency
31		Reserved	

CPC0_CR1

Chip Control Register 1

DCR 0x0B2

See “Chip Control Register 1 (CPC0_CR1)” on page 196.

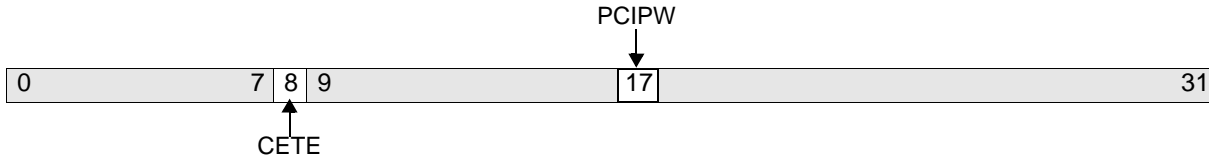

Figure 25-39. Chip Control Register 1 (CPC0_CR1)

0:7		Reserved
8	CETE	CPU External Timer Enable 0 CPU timers increment at CPU clock frequency. 1 CPU timers increment at frequency of TmrClk input.
9:16		Reserved
17	PCIPW	PCI Interrupt/Peripheral Write Enable Select 0 Enable $\overline{\text{PCIINT}}[\overline{\text{PerWE}}]$ as $\overline{\text{PCIINT}}$. 1 Enable $\text{PCIINT}[\text{PerWE}]$ as PerWE .
18:31		Reserved

DCR 0x0B9

See “CPM Enable Register (CPC0_ER)” on page 305.

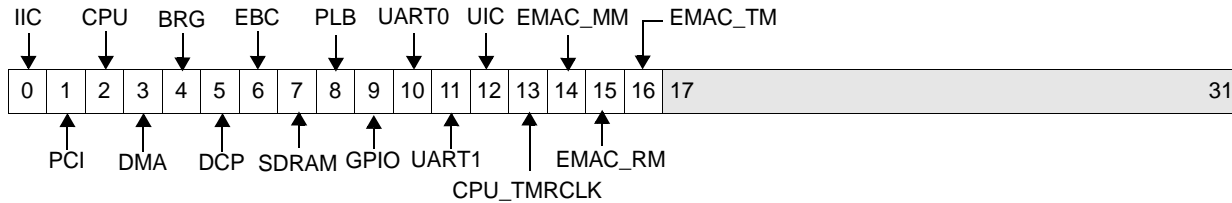

Figure 25-40. CPM Enable Register (CPC0_ER)

0	IIC	IIC Interface	Class 3
1	PCI	PCI Bridge	Class 3
2	CPU	Processor Core	Class 2
3	DMA	DMA Controller	Class 2
4	BRG	PLB to OPB Bridge	Class 2
5	DCP	CodePack	Class 2
6	EBC	ROM/SRAM Peripheral Controller	Class 2
7	SDRAM	SDRAM Memory Controller	Class 2
8	PLB	PLB Bus Arbiter	Class 2
9	GPIO	General Purpose Interrupt Controller	Class 1
10	UART0	Serial Port 0	Class 1
11	UART1	Serial Port 1	Class 1
12	UIC	Universal Interrupt Controller	Class 1
13	CPU_TMRCLK	CPU Timers	Class 1
14	EMAC_MM	Ethernet MM Unit	Class 1
15	EMAC_RM	Ethernet RM Unit	Class 1
16	EMAC_TM	Ethernet TM Unit	Class 1
17:31		Reserved	

CPC0_FR

CPM Force Register

DCR 0x0BA

See "CPM Force Register (CPC0_FR)" on page 305.

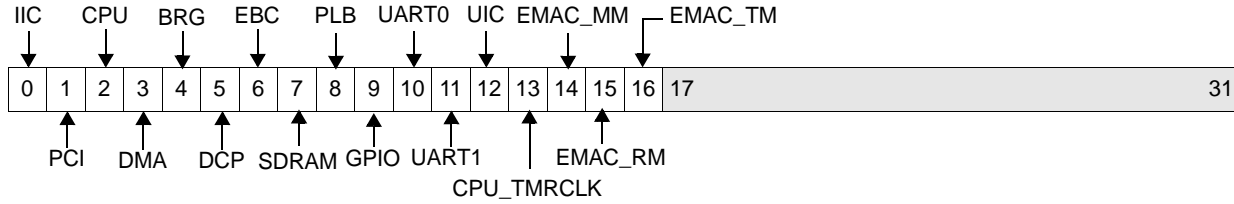

Figure 25-41. CPM Force Register (CPC0_FR)

0	IIC	IIC Interface	Class 3
1	PCI	PCI Bridge	Class 3
2	CPU	Processor Core	Class 2
3	DMA	DMA Controller	Class 2
4	BRG	PLB to OPB Bridge	Class 2
5	DCP	CodePack	Class 2
6	EBC	ROM/SRAM Peripheral Controller	Class 2
7	SDRAM	SDRAM Memory Controller	Class 2
8	PLB	PLB Bus Arbiter	Class 2
9	GPIO	General Purpose Interrupt Controller	Class 1
10	UART0	Serial Port 0	Class 1
11	UART1	Serial Port 1	Class 1
12	UIC	Universal Interrupt Controller	Class 1
13	CPU_TMRCLK	CPU Timers	Class 1
14	EMAC_MM	Ethernet MM Unit	Class 1
15	EMAC_RM	Ethernet RM Unit	Class 1
16	EMAC_TM	Ethernet TM Unit	Class 1
17:31		Reserved	

DCR 0x0B5 Read-Only

See “JTAG ID Register (CPC0_JTAGID)” on page 283.

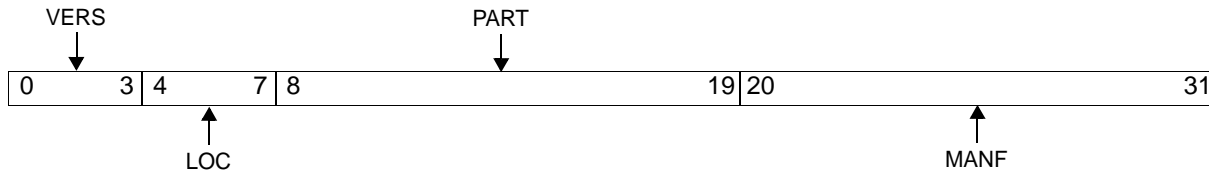

Figure 25-42. JTAG ID Register (CPC0_JTAGID)

0:3	VERS	Version
4:7	LOC	Developer Location
8:19	PART	Part Number
20:31	MANF	Manufacturer Identifier

DCR 0x0B

See "PLL Mode Register (CPC0_PLLMR)" on page 192.

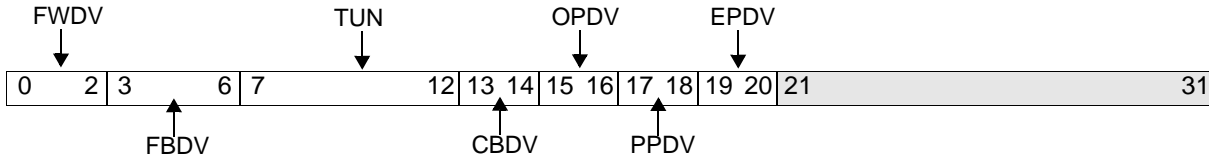

Figure 25-43. PLL Mode Register (CPC0_PLLMR)

0:2	FWDV	<p>Forward Divisor</p> <p>000 Forward divisor is 8. 001 Forward divisor is 7. 010 Forward divisor is 6. 011 Forward divisor is 5. 100 Forward divisor is 4. 101 Forward divisor is 3. 110 Forward divisor is 2. 111 Forward divisor is 1.</p>	<p>PLLOUTA Value:</p> <p>50 MHz–100 MHz 58 MHz–114 MHz 66 MHz–134 MHz 80 MHz–160 MHz 100 MHz–200 MHz 133 MHz–267 MHz 200 MHz–400 MHz 400 MHz–800 MHz</p> <p>Note: PLLOUTA is the CPU clock.</p>
3:6	FBDV	<p>Feedback Divisor</p> <p>0000 Feedback divisor is 16. 0001 Feedback divisor is 1. 0010 Feedback divisor is 2. 0011 Feedback divisor is 3. 0100 Feedback divisor is 4. 0101 Feedback divisor is 5. 0110 Feedback divisor is 6. 0111 Feedback divisor is 7. 1000 Feedback divisor is 8. 1001 Feedback divisor is 9. 1010 Feedback divisor is 10. 1011 Feedback divisor is 11. 1100 Feedback divisor is 12. 1101 Feedback divisor is 13. 1110 Feedback divisor is 14. 1111 Feedback divisor is 15.</p>	
7:12	TUN	<p>TUNE[5:0] Field</p>	<p>Note: The tune bits adjust parameters that control PLL jitter. The recommended values minimize jitter for the PLL. These bits are shown for information only, and do not require modification except in special clocking circumstances, such as spread spectrum clocking. For details on the use of spread spectrum clock generators (SSCGs), visit the technical documents area of the AMCC PowerPC web site.</p>

Preliminary User's Manual

13:14	CBDV	CPU:PLB Frequency Divisor 00 CPU:PLB divisor is 1 01 CPU:PLB divisor is 2 10 CPU:PLB divisor is 3 11 CPU:PLB divisor is 4	
15:16	OPDV	OPB–PLB Frequency Divisor 00 OPB–PLB divisor is 1 01 OPB–PLB divisor is 2 10 OPB–PLB divisor is 3 11 OPB–PLB divisor is 4	
17:18	PPDV	PCI–PLB Frequency Divisor 00 PCI–PLB divisor is 1 01 PCI–PLB divisor is 2 10 PCI–PLB divisor is 3 11 PCI–PLB divisor is 4	See “PCI Clocks” on page 7-190 for details regarding asynchronous PCI clocking and how it relates to synchronous clocking.
19:20	EPDV	External Bus–PLB Frequency Divisor 00 External bus–PLB divisor ratio is 2:1 01 External bus–PLB divisor ratio is 3:1 10 External bus–PLB divisor ratio is 4:1 11 External bus–PLB divisor ratio is 5:1	
21:31		Reserved	

CPC0_PSR

Chip Pin Strapping Register

DCR 0x0B4

See "Chip Pin Strapping Register (CPC0_PSR)" on page 215.

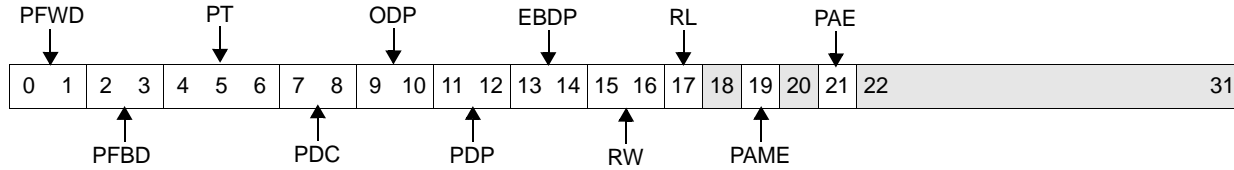

Figure 25-44. Chip Pin Strapping Register (CPC0_PSR)

0:1	PFWD	PLL Forward Divider 00 Bypass Mode 01 Divide by 3 10 Divide by 4 11 Divide by 6	
2:3	PFBBD	PLL Feedback Divider 00 Divide By 1 01 Divide By 2 10 Divide By 3 11 Divide By 4	
4:6	PT	PLL Tuning 000 Choice 1; TUNE[5:0] = 010001 001 Choice 2; TUNE[5:0] = 010010 010 Choice 3; TUNE[5:0] = 010011 011 Choice 4; TUNE[5:0] = 010100 100 Choice 5; TUNE[5:0] = 010101 101 Choice 6; TUNE[5:0] = 010110 110 Choice 7; TUNE[5:0] = 010111 111 Choice 8; TUNE[5:0] = 100100	Note: The tune bits adjust parameters that control PLL jitter. The recommended values minimize jitter for the PLL. These bits are shown for information only, and do not require modification except in special clocking circumstances, such as spread spectrum clocking. For details on the use of spread spectrum clock generators (SSCGs), visit the technical documents area of the AMCC PowerPC web site.
7:8	PDC	PLB Divider from CPU 00 Divide By 1 01 Divide By 2 10 Divide By 3 11 Divide By 4	
9:10	ODP	OPB Divider from PLB 00 Divide By 1 01 Divide By 2 10 Divide By 3 11 Divide By 4	
11:12	PDP	PCI Divider from PLB 00 Divide By 1 01 Divide By 2 10 Divide By 3 11 Divide By 4	

13:14	EBDP	External Bus Divider from PLB 00 Divide By 2 01 Divide By 3 10 Divide By 4 11 Divide By 5
15:16	RW	ROM Width 00 8-bit ROM 01 16-bit ROM 10 32-bit ROM 11 Reserved
17	RL	ROM Location 0 405GP Peripheral Attach 1 405GP PCI Attach
18		Reserved
19	PAME	PCI Asynchronous Mode Enable 0 Synchronous PCI Mode 1 Asynchronous Mode
20		Reserved
21	PAE	PCI Arbiter Enable 0 Internal Arbiter Disabled 1 Internal Arbiter Enabled
22:31		Reserved

CPC0_SR

CPM Status Register

DCR 0x0B8 Read-Only

See "CPM Status Register (CPC0_SR)" on page 305.

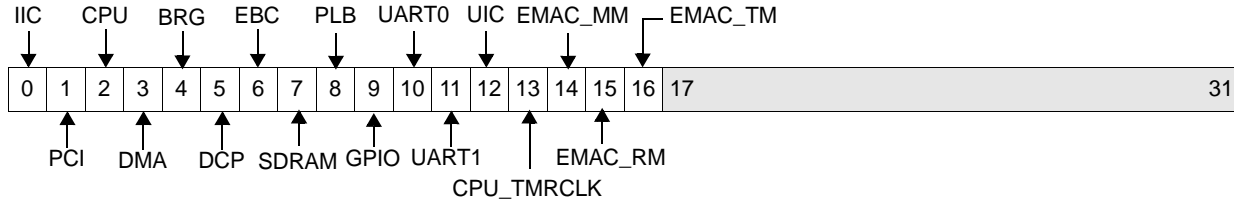
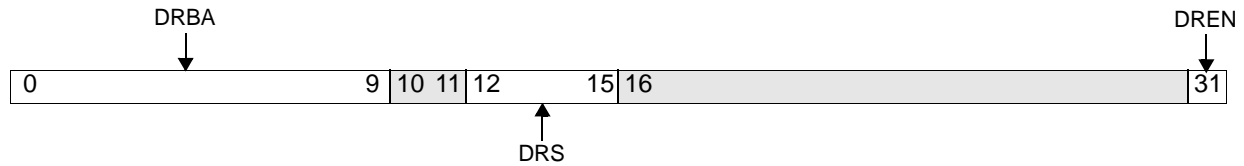

Figure 25-45. CPM Status Register (CPC0_SR)

0	IIC	IIC Interface	Class 3
1	PCI	PCI Bridge	Class 3
2	CPU	Processor Core	Class 2
3	DMA	DMA Controller	Class 2
4	BRG	PLB to OPB Bridge	Class 2
5	DCP	CodePack	Class 2
6	EBC	ROM/SRAM Peripheral Controller	Class 2
7	SDRAM	SDRAM Memory Controller	Class 2
8	PLB	PLB Bus Arbiter	Class 2
9	GPIO	General Purpose Interrupt Controller	Class 1
10	UART0	Serial Port 0	Class 1
11	UART1	Serial Port 1	Class 1
12	UIC	Universal Interrupt Controller	Class 1
13	CPU_TMRCLK	CPU Timers	Class 1
14	EMAC_MM	Ethernet MM Unit	Class 1
15	EMAC_RM	Ethernet RM Unit	Class 1
16	EMAC_TM	Ethernet TM Unit	Class 1
17:31		Reserved	

DCR Accessed using DCP0_CFGADDR, DCP0_CFGDATA; Offset 0x04–0x05

See “Decompression Address Decode Definition Registers (DCP0_ADDR0–DCP0_ADDR1)” on page 311.



Address Decode Definition Registers (DCP0_ADDR0–DCP0_ADDR1)

0:9	DRBA	Decode Region Base Address	High-order decode region address bits
10:11		Reserved	
12:15	DRS	Decode Region Size 0000–0100 Reserved 0101 4MB 0110 8MB 0111 16MB 1000 32MB 1001 64MB 1010 128MB 1011 256MB 1100 512MB 1101 1GB 1110 2GB 1111 4GB	
16:30		Reserved	
31	DREN	Enable Decode Region 0 Decoding is disabled for region 1 Decoding is enabled for region.	

DCP0_CFG

Decompression Core Configuration Register

DCR Accessed using DCP0_CFGADDR, DCP0_CFGDATA; Offset 0x40

See "Decompression Configuration Register (DCP0_CFG)" on page 311.

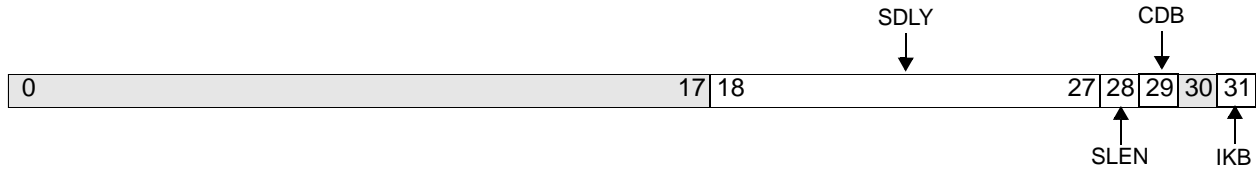

Figure 25-46. Decompression Controller Configuration Register (DCP0_CFG)

0:17		Reserved	
18:27	SLDY	Sleep Delay	Sleep delay
28	SLEN	Sleep Enable 0 Disable sleep 1 Enable sleep	
29	CDB	Clear Decompression Buffer 0 Normal operation 1 Clear decompression buffer	Self-clearing; always reads 0
30		Reserved	
31	IKB	Enable Decompression 0 Decompression is enabled; U0 storage attribute is recognized 1 Decompression is disabled; U0 storage attribute is ignored	

Preliminary User's Manual**DCR 0x014**

See “Decompression Controller Registers” on page 309.

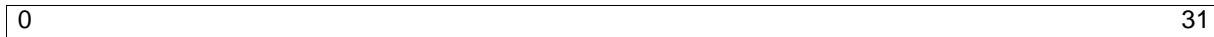

Figure 25-47. Decompression Controller Address Register (DCP0_CFGADDR)

0:31	Offset of indirectly-accessed DCR
------	-----------------------------------

DCP0_CFGDATA

Decompression Controller Data Register

DCR 0x015

See "Decompression Controller Registers" on page 309.

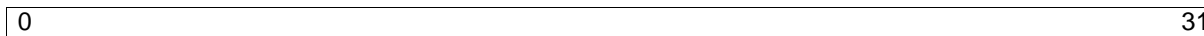

Figure 25-48. Decompression Controller Configuration Data Register (DCP0_CFGDATA)

0:31	Data from indirectly-accessed DCR
------	-----------------------------------

DCR Accessed using DCP0_CFGADDR, DCP0_CFGDATA; Offset 0x52 Read/Clear

See “Decompression Controller Error Status Register 0 (DCP0_ESR)” on page 314.

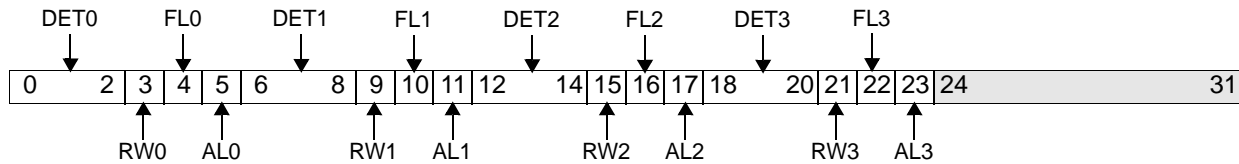

Figure 25-49. Decompression Controller Error Status Register 0 (DCP0_ESR)

0:2	DET0	Decompression Error Type for Master 0 000 Time-out during ITE fetch 001 Time-out during block fetch 010 Memory controller error during ITE fetch 011 Memory controller error during block fetch 100–111 Reserved	Master 0 is the processor core instruction cache unit (ICU).
3	RW0	Read/Write Status for Master 0 0 Error operation was a write 1 Error operation was a read	This implementation only reports errors for compressed reads.
4	FL0	DCP0_ESR Field Lock for Master 0 0 DCP0_ESR fields are unlocked 1 DCP0_ESR fields are locked	DCP0_ESR register fields are locked when the PLB_lockErr signal was active in the cycle in which the error occurred.
5	AL0	DCP0_MEMBEAR/DCP0_PLBBEAR Address Lock for Master 0 0 Master has not locked DCP0_MEMBEAR and DCP0_PLBBEAR 1 Master has locked DCP0_MEMBEAR and DCP0_PLBBEAR	DCP0_MEMBEAR and DCP0_PLBBEAR are locked to this master address when the PLB_lockErr signal was active in the cycle in which the error occurred.
6:8	DET1	Decompression Error Type for Master 1	See description for DCP0_ESR[DET0]. Master1 is the processor core data cache unit (DCU).
9	RW1	Read/Write Status for Master 1 0 Error operation was a write 1 Error operation was a read	This implementation only reports errors for compressed reads.
10	FL1	DCP0_ESR Field Lock for Master 1 0 DCP0_ESR fields are unlocked 1 DCP0_ESR fields are locked	DCP0_ESR register fields are locked when the PLB_lockErr signal was active in the cycle in which the error occurred.
11	AL1	DCP0_MEMBEAR/DCP0_PLBBEAR Address Lock for Master 1 0 Master has not locked DCP0_MEMBEAR and DCP0_PLBBEAR 1 Master has locked DCP0_MEMBEAR and DCP0_PLBBEAR	DCP0_MEMBEAR and DCP0_PLBBEAR are locked to this master address when the PLB_lockErr signal was active in the cycle in which the error occurred.

DCP0_ESR (cont.)

Decompression Controller Bus Error Status Register 0

Preliminary User's Manual

12:14	DET2	Decompression Error Type for Master 2	See description for DCP0_ESR[DET0]. Master 2 is the external master.
15	RW2	Read/Write Status for Master 2 0 Error operation was a write 1 Error operation was a read	This implementation only reports errors for compressed reads.
16	FL2	DCP0_ESR Field Lock for Master 2 0 DCP0_ESR fields are unlocked 1 DCP0_ESR fields are locked	DCP0_ESR register fields are locked when the PLB_lockErr signal was active in the cycle in which the error occurred.
17	AL2	DCP0_MEMBEAR/DCP0_PLBBEAR Address Lock for Master 2 0 Master has not locked DCP0_MEMBEAR and DCP0_PLBBEAR 1 Master has locked DCP0_MEMBEAR and DCP0_PLBBEAR	DCP0_MEMBEAR and DCP0_PLBBEAR are locked to this master address when the PLB_lockErr signal was active in the cycle in which the error occurred.
18:20	DET3	Decompression Error Type for Master 3	See description for DCP0_ESR[DET0]. Master 3 is PCI.
21	RW3	Read/Write Status for Master 3 0 Error operation was a write 1 Error operation was a read	This implementation only reports errors for compressed reads.
22	FL3	DCP0_ESR Field Lock for Master 3 0 DCP0_ESR fields are unlocked 1 DCP0_ESR fields are locked	DCP0_ESR register fields are locked when the PLB_lockErr signal was active in the cycle in which the error occurred.
23	AL3	DCP0_MEMBEAR/DCP0_PLBBEAR Address Lock for Master 3 0 Master has not locked DCP0_MEMBEAR and DCP0_PLBBEAR 1 Master has locked DCP0_MEMBEAR and DCP0_PLBBEAR	DCP0_MEMBEAR and DCP0_PLBBEAR are locked to this master address when the PLB_lockErr signal was active in the cycle in which the error occurred.
24:31		Reserved	

DCR Accessed using DCP0_CFGADDR, DCP0_CFGDATA; Offset 0x41 Read-Only

See “Decompression Controller ID Register (DCP0_ID)” on page 312.

0	31
---	----

Figure 25-50. Decompression Controller ID Register (DCP0_ID)

0:31	Decompression Controller ID	Read-only, value is 0000504D
------	-----------------------------	------------------------------

DCR Accessed using DCP0_CFGADDR, DCP0_CFGDATA; Offset 0x00–0x03

See “Index Table Origin Registers (DCP0_ITOR0–DCP0_ITOR3)” on page 310.



Figure 25-51. Decompression Index Table Origin Registers (DCP0_ITOR0–DCP0_ITOR3)

0:20		Reserved
21:31	ITO	Index Table Origin High-order index table address bits

Preliminary User's Manual

DCR Accessed using DCP0_CFGADDR, DCP0_CFGDATA; Offset 0x51 Read-Only

See “Decompression Controller Bus Error Address Register (DCP0_MEMBEAR)” on page 313.

0		31
---	--	----

Figure 25-52. Decompression Controller Bus Error Address Register (DCP0_MEMBEAR)

0:31		Address of SDRAM or EBC Error
------	--	-------------------------------

DCP0_PLBBEAR

Decompression Controller PLB Error Address Register

DCR Accessed using DCP0_CFGADDR, DCP0_CFGDATA; Offset 0x50 Read-Only

See “Decompression Controller PLB Error Address Register (DCP0_PLBBEAR)” on page 313.



Figure 25-53. Decompression Controller PLB Error Address Register (DCP0_PLBBEAR)

0:31	Address of PLB Error
------	----------------------

DCR 0x400–0x7FF

See “Decompression Controller Registers” on page 309.

These registers store decode tables for the decompression controller.

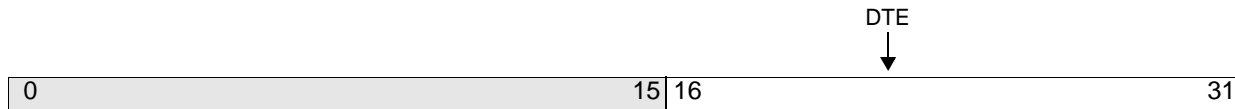

Figure 25-54. Decompression Decode Table Entries (DCP0_RAM0–DCP0_RAM3FF)

0:15		Reserved
16:31	DTE	Decode Table Entry

DCP0_VER

Decompression Controller Version Register

DCR Accessed using DCP0_CFGADDR, DCP0_CFGDATA; Offset 0x42 Read-Only

See “Decompression Controller Version Register (DCP0_VER)” on page 312.



Figure 25-55. Decompression Controller Version Register (DCP0_VER)

0:31		Decompression ControllerVersion	Read-only, value is 0x00000200
------	--	---------------------------------	--------------------------------

DMA Registers
DCR 0x100, 0x108, 0x110, 0x118

See “DMA Channel Control Registers (DMA0_CR0–DMA0_CR3)” on page 508.

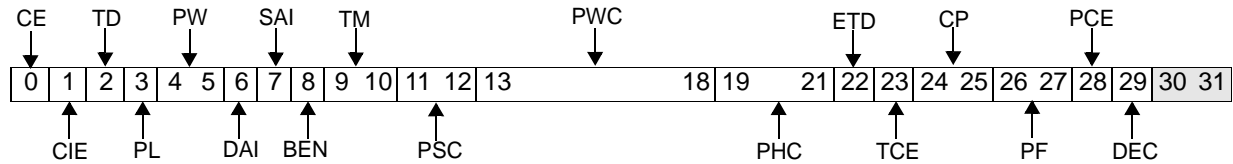

Figure 25-56. DMA Channel Control Registers (DMA0_CR0–DMA0_CR3)

0	CE	Channel Enable 0 Channel is disabled 1 Channel is enabled	This field is automatically cleared when the transfer completes or an error occurs.
1	CIE	Channel Interrupt Enable 0 Disable interrupts from this channel 1 Enable interrupts from this channel	When enabled, interrupts are generated for terminal count, end of transfer, and errors conditions. See “DMA Interrupts” on page 18-514.
2	TD	In peripheral mode: 0 Transfers are from memory-to-peripheral 1 Transfers are from peripheral-to-memory In device-paced memory-to-memory mode: 0 Peripheral is at the destination address 1 Peripheral is at the source address	TD is not used (don't care) for software-initiated memory-to-memory transfers.
3	PL	Peripheral Location 0 External peripheral (EBC) bus 1 OPB (UART0)	
4:5	PW	Peripheral Width/Memory alignment 00 Byte (8 bits) 01 Halfword (16 bits) 10 Word (32 bits) 11 Doubleword (64 bits) memory-to-memory transfers only	Transfer width equals peripheral width for peripherals.
6	DAI	Destination Address Increment 0 Do not increment destination address 1 After each data transfer increment the destination address by: 1, if the transfer width is a byte (8 bits) 2, if the transfer width is a halfword (16 bits) 4, if the transfer width is a word (32 bits) 8, if the transfer width is a doubleword (64 bit)	
7	SAI	Source Address Increment 0 Do not increment source address 1 After each data transfer increment the source address by: 1, if the transfer width is a byte (8 bits) 2, if the transfer width is a halfword (16 bits) 4, if the transfer width is a word (32 bits) 8, if the transfer width is a doubleword (64 bit)	
8	BEN	Buffer Enable 0 Disable DMA 32-byte buffer 1 Enable DMA 32-byte buffer	If BEN=0, discrete read and write operations occur for each data transfer.

9:10	TM	Transfer mode 00 Peripheral 01 Reserved 10 Software-initiated memory-to-memory 11 Device-paced memory-to-memory	
11:12	PSC	Peripheral Setup Cycles 0–3	Number of PerClk cycles that the EBC peripheral bus is idle from the last peripheral bus transaction until DMAAckn is active. Used only for the peripheral side of peripheral mode transfers.
13:18	PWC	Peripheral Wait Cycles 0–63	DMAAckn remains active for PWC + 1 PerClk cycles. Used only for the peripheral side of peripheral mode transfers.
19:21	PHC	Peripheral Hold Cycles 0–7	The number of PerClk cycles from the time DMAAckn becomes inactive until the peripheral bus is available for the next bus access. Used only for the peripheral side of peripheral mode transfers.
22	ETD	End-of-Transfer/Terminal Count (EOTn[TCn]) Pin Direction 0 EOTn[TCn] is an EOT input 1 EOTn[TCn] is a TC output	ETD must be set to 1 if the channel is configured for software-initiated memory-to-memory transfers.
23	TCE	Terminal Count (TC) Enable 0 Channel does not stop when TC is reached 1 Channel stops when TC is reached	If TCE=1, it is required that ETD=1.
24:25	CP	Channel Priority 00 Low priority 01 Medium low priority 10 Medium high priority 11 High priority	Actively requesting channels of the same priority are prioritized by channel number; channel 0 has the highest priority. See “Channel Priorities” on page 18-513 for more information.
26:27	PF	Memory Read Prefetch Transfer 00 Prefetch 1 doubleword 01 Prefetch 2 doublewords 10 Prefetch 4 doublewords 11 Reserved	Used only during memory-to-peripheral and device-paced memory-to-memory transfers. To enable prefetching it is required that BEN=1.
28	PCE	Parity Check Enable 0 Disable parity checking 1 Enable parity checking	Enables parity checking for peripheral mode transfers. See “Data Parity During DMA Peripheral Transfers” on page 18-513.
29	DEC	Address Decrement 0 SAI and DAI fields control memory address incrementing. 1 After each data transfer the memory address is decremented by the transfer width.	If DEC=1, it is required that BEN=0. This field is valid only for peripheral mode transfers (TM=00).
30:31		Reserved	

DCR 0x101, 0x109, 0x111, 0x119

See “DMA Count Registers (DMA0_CT0–DMA0_CT3)” on page 511.

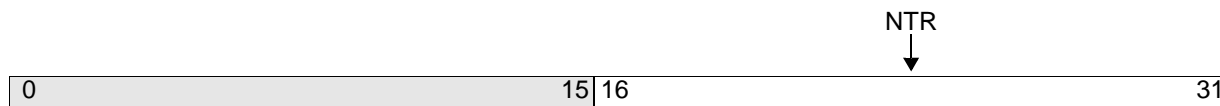

Figure 25-57. DMA Count Registers (DMA0_CT0–DMA0_CT3)

0:15		Reserved
16:31	NTR	Number of transfers remaining

DCR 0x102, 0x10A, 0x112, 0x11A

See “DMA Destination Address Registers (DMA0_DA0–DMA0_DA3)” on page 511.

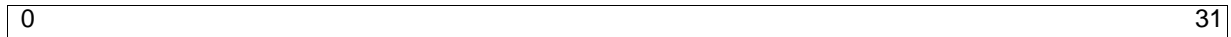
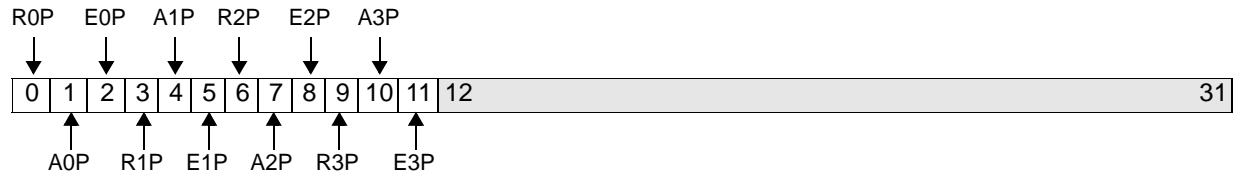

Figure 25-58. DMA Destination Address Registers (DMA0_DA0–DMA0_DA3)

0:31	Destination address for memory-to-memory and peripheral-to-memory transfers.
------	--

DCR 0x126

See “DMA Polarity Configuration Register (DMA0_POL)” on page 505.

**Figure 25-59. DMA Polarity Configuration Register (DMA0_POL)**

0	R0P	DMAReq0 Polarity 0 DMAReq0 is active high 1 DMAReq0 is active low
1	A0P	DMAAck0 Polarity 0 DMAAck0 is active high 1 DMAAck0 is active low
2	E0P	EOT0[TC0] Polarity 0 EOT0[TC0] is active high 1 EOT0[TC0] is active low
3	R1P	DMAReq1 Polarity 0 DMAReq1 is active high 1 DMAReq1 is active low
4	A1P	DMAAck1 Polarity 0 DMAAck1 is active high 1 DMAAck1 is active low
5	E1P	EOT1[TC1] Polarity 0 EOT1[TC1] is active high 1 EOT1[TC1] is active low
6	R2P	DMAReq2 Polarity 0 DMAReq2 is active high 1 DMAReq2 is active low
7	A2P	DMAAck2 Polarity 0 DMAAck2 is active high 1 DMAAck2 is active low
8	E2P	EOT2[TC2] Polarity 0 EOT2[TC2] is active high 1 EOT2[TC2] is active low
9	R3P	DMAReq3 Polarity 0 DMAReq3 is active high 1 DMAReq3 is active low
10	A3P	DMAAck3 Polarity 0 DMAAck3 is active high 1 DMAAck3 is active low
11	E3P	EOT3[TC3] Polarity 0 EOT3[TC3] is active high 1 EOT3[TC3] is active low
12:31		Reserved

DCR 0x103, 0x10B, 0x113, 0x11B

See “DMA Source Address Registers (DMA0_SA0–DMA0_SA3)” on page 510.

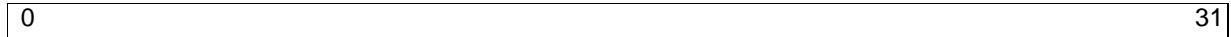

Figure 25-60. DMA Source Address Registers (DMA0_SA0–DMA0_SA3)

0:31	Source address for memory-to-memory and memory-to-peripheral transfers.
------	---

Preliminary User's Manual

DCR 0x104, 0x10C, 0x114, 0x11C

See “DMA Scatter/Gather Descriptor Address Registers (DMA0_SG0–DMA0_SG3)” on page 512.

0	31
---	----

Figure 25-61. DMA Scatter/Gather Descriptor Address Registers (DMA0_SG0–DMA0_SG3)

0:31	Address of next scatter/gather descriptor table.
------	--

DMA0_SGC

DMA Scatter/Gather Command Register

DCR 0x123

See "DMA Scatter/Gather Command Register (DMA0_SGC)" on page 512.

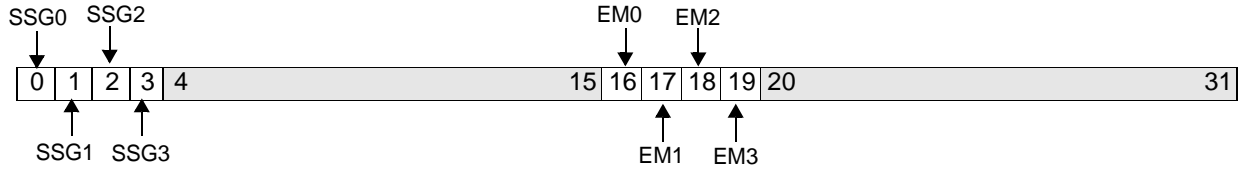
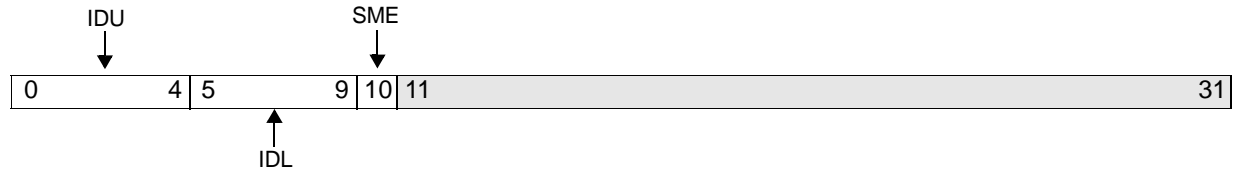

Figure 25-62. DMA Scatter/Gather Command Register (DMA0_SGC)

0:3	SSG[0:3]	Start Scatter/Gather for channels 0-3. 0 Scatter/gather support is disabled 1 Scatter/gather support is enabled	To start a scatter/gather operation for channel n, EM[n] must also be set.
4:15		Reserved	
16:19	EM[0:3]	Enable Mask for channels 0-3. 0 Writes to SSG[n] are ignored 1 Allow writing to SSG[n]	To write SSG[n], EM[n] must be set. Otherwise, writing SSG[n] has no effect.
20:31		Reserved	

DCR 0x125

See “DMA Sleep Mode Register (DMA0_SLP)” on page 506.

**Figure 25-63. DMA Sleep Mode Register (DMA0_SLP)**

0:4	IDU	Idle Timer Upper 0–31	Upper 5-bits of the idle timer.
5:9	IDL	Idle Timer Lower Hardcoded to 0b11111	Lower 5-bit portion of the idle timer. Writing this field has no effect.
10	SME	Sleep Mode Enable 0 Sleep disabled 1 Sleep enabled	If SME=1, also set CPM0_ER[DMA] to enable the clock and power management logic to put the DMA controller to sleep.
11:31		Reserved	

DMA0_SR

DMA Status Register

DCR 0x120

See “DMA Scatter/Gather Command Register (DMA0_SGC)” on page 512.

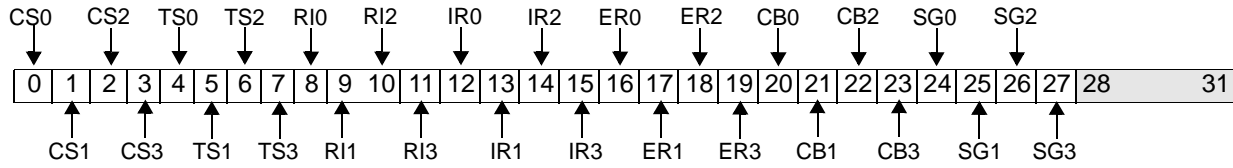

Figure 25-64. DMA Status Register (DMA0_SR)

0:3	CS[0:3]	Channel 0–3 Terminal Count Status 0 Terminal count has not occurred 1 Terminal count has been reached	Set when the transfer count reaches 0.
4:7	TS[0:3]	Channel 0–3 End of Transfer Status 0 End of transfer has not been requested 1 End of transfer has been requested	Only valid for channels with DMA0_CRn[ETD]=0.
8:11	RI[0:3]	Channel 0–3 Error Status 0 No error 1 Error occurred	See “Errors” on page 18-513 for more information.
12:15	IR[0:3]	Internal DMA Request 0 No internal DMA request pending 1 Internal DMA request is pending	
16:19	ER[0:3]	External DMA Request 0 No external DMA request pending 1 External DMA request is pending	
20:23	CB[0:3]	Channel Busy 0 Channel is idle 1 Channel currently active	
24:27	SG[0:3]	Scatter/Gather Status 0 No scatter/gather operation in progress 1 Scatter/gather operation in progress	
28:31		Reserved	

Preliminary User's Manual

EBC Register

DCR Accessed using EBC0_CFGADDR; EBC0_CFGDATA; Offset 0x20 Read-Only

See "Peripheral Bus Error Address Register (EBC0_BEAR)" in Chapter 16: External Bus Controller of the 405GP User's Manual.

0		31
---	--	----

Figure 25-65. Peripheral Bus Error Address Register (EBC0_BEAR)

0:31	Address of Bus Error (asynchronous)
------	-------------------------------------

EBC0_BESR0

Peripheral Bus Error Status Register 0

DCR Accessed using EBC0_CFGADDR; EBC0_CFGDATA; Offset 0x21

See "Peripheral Bus Error Status Register 0 (EBC0_BESR0)" in Chapter 16: External Bus Controller of the 405GP User's Manual.

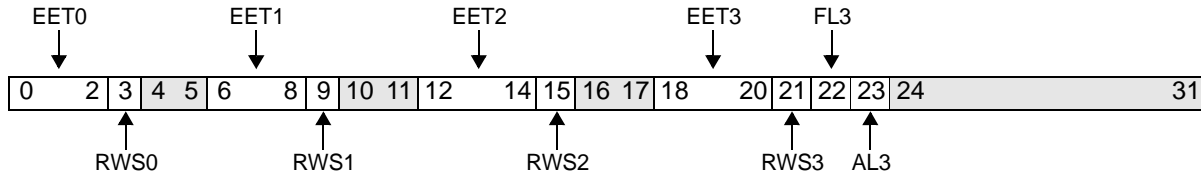

Figure 25-66. Peripheral Bus Error Status Register 0 (EBC0_BESR0)

0:2	EET0	Error type for master 0 000 No error 001 Parity error 010 Reserved 011 Reserved 100 Protection error 101 Reserved 110 External bus input error 111 External bus timeout error	Master 0 is the instruction cache unit.
3	RWS0	Read/write status for master 0 0 Error operation was a write operation 1 Error operation was a read operation	
4:5		Reserved	
6:8	EET1	Error type for master 1 000 No error 001 Parity error 010 Reserved 011 Reserved 100 Protection error 101 Reserved 110 External bus input error 111 External bus timeout error	Master 1 is the data cache unit.
9	RWS1	Read/write status for master 1 0 Error operation was a write operation 1 Error operation was a read operation	
10:11		Reserved	
12:14	EET2	Error type for master 2 000 No error 001 Parity error 010 Reserved 011 Reserved 100 Protection error 101 Reserved 110 External bus input error 111 External bus timeout error	Master 2 is the external bus master.
15	RWS2	Read/write status for master 2 0 Error operation was a write operation 1 Error operation was a read operation	
16:17		Reserved	

Preliminary User's Manual

18:20	EET3	Error type for master 3 000 No error 001 Parity error 010 Reserved 011 Reserved 100 Protection error 101 Reserved 110 External bus input error 111 External bus timeout error	Master 3 is the PCI bridge.
21	RWS3	Read/write status for master 3 0 Error operation was a write operation 1 Error operation was a read operation	
22	FL3	Field lock for master 3 0 EET3 and RWS3 fields are unlocked 1 EET3 and RWS3 fields are locked	
23	AL3	EBC0_BEAR address lock for master 3 0 EBC0_BEAR address unlocked 1 EBC0_BEAR address locked	
24:31		Reserved	

EBC0_BESR1

Peripheral Bus Error Status Register 1

DCR Accessed using EBC0_CFGADDR; EBC0_CFGDATA; Offset 0x22

See "Peripheral Bus Error Status Register 1 (EBC0_BESR1)" in Chapter 16: External Bus Controller of the 405GP User's Manual.

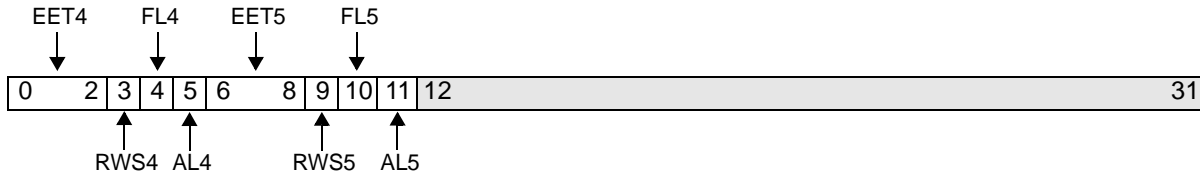

Figure 25-67. Peripheral Bus Error Status Register 1 (EBC0_BESR1)

0:2	EET4	Error type for master 4 000 No error 001 Parity error 010 Reserved 011 Reserved 100 Protection error 101 Reserved 110 External bus input error 111 External bus timeout error	Master 4 is the MAL.
3	RWS4	Read/write status for master 4 0 Error operation was a write operation 1 Error operation was a read operation	
4	FL4	Field lock for master 4 0 EET4 and RWS4 fields are unlocked 1 EET4 and RWS4 fields are locked	
5	AL4	EBC0_BEAR address lock for master 4 0 EBC0_BEAR address unlocked 1 EBC0_BEAR address locked	
6:8	EET5	Error type for master 5 000 No error 001 Parity error 010 Reserved 011 Reserved 100 Protection error 101 Reserved 110 External bus input error 111 External bus timeout error	Master 5 is the DMA controller.
9	RWS5	Read/write status for master 5 0 Error operation was a write operation 1 Error operation was a read operation	
10	FL5	Field lock for master 5 0 EET5 and RWS5 fields are unlocked 1 EET5 and RWS5 fields are locked	
11	AL5	EBC0_BEAR address lock for master 5 0 EBC0_BEAR address unlocked 1 EBC0_BEAR address locked	
12:31		Reserved	

DCR Accessed using EBC0_CFGADDR; EBC0_CFGDATA; Offset 0x10–0x17

See “Peripheral Bank Access Parameters (EBC0_BnAP)” in Chapter 16: External Bus Controller of the 405GP User's Manual.

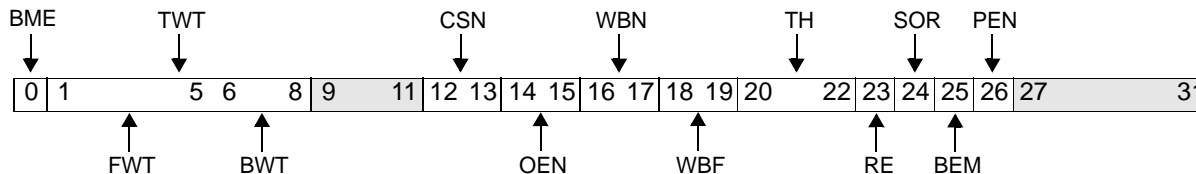

Figure 25-68. Peripheral Bank Access Parameters (EBC0_B0AP–EBC0_B7AP)

0	BME	Burst Mode Enable 0 Bursting is disabled 1 Bursting is enabled	
1:8	TWT	Transfer Wait 0–255 PerClk cycles	Wait states on all transfers when BME=0.
1:5	FWT	First Wait 0–31 PerClk cycles	If BME=1, number of wait states on the first transfer of a burst.
6:8	BWT	Burst Wait 0–7 PerClk cycles	If BME=1, number of wait states on non-first transfers of a burst.
9:11		Reserved	
12:13	CSN	Chip Select On Timing 0–3 PerClk cycles	Number of cycles from peripheral address driven to $\overline{\text{PerCSn}}$ low.
14:15	OEN	Output Enable On Timing 0–3 PerClk cycles	Number of cycles from $\overline{\text{PerCSn}}$ low to $\overline{\text{PerOE}}$ low.
16:17	WBN	Write Byte Enable On Timing 0–3 PerClk cycles	If BEM=0, number of cycles from $\overline{\text{PerCSn}}$ low to $\overline{\text{PerWBE0:3}}$ active.
18:19	WBF	Write Byte Enable Off Timing 0–3 PerClk cycles	If BEM=0 and RE=0, number of cycles $\overline{\text{PerWBE}}$ becomes inactive prior to $\overline{\text{PerCSn}}$ inactive.
20:22	TH	Transfer Hold 0–7 PerClk cycles	Contains the number of hold cycles inserted at the end of a transfer.
23	RE	Ready Enable 0 PerReady is disabled 1 PerReady is enabled	
24	SOR	Sample on Ready 0 Data transfer occurs one PerClk cycle after PerReady is sampled active 1 Data transfer occurs in the same PerClk cycle that PerReady becomes active	
25	BEM	Byte Enable Mode 0 $\overline{\text{PerWBE0:3}}$ are only active for write cycles 1 $\overline{\text{PerWBE0:3}}$ are active for read and write cycles	If BEM=0, $\overline{\text{PerWBE0:3}}$ timing is controlled by WBN and WBF. If BEM=1, $\overline{\text{PerWBE0:3}}$ has the same timing as $\overline{\text{PerAddr0:31}}$.
26	PEN	Parity Enable 0 Disable parity checking 1 Enable parity checking	The EBC implements odd parity.
27:31		Reserved	

DCR Accessed using EBC0_CFGADDR; EBC0_CFGDATA; Offset 0x00–0x07

See “Peripheral Bank Configuration Registers (EBC0_BnCR)” in Chapter 16: External Bus Controller of the 405GP User's Manual.

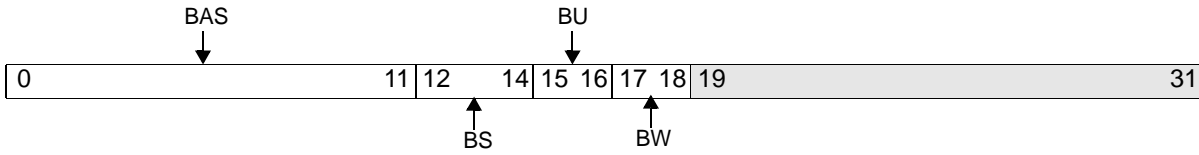

Figure 25-69. Peripheral Bank Configuration Registers (EBC0_B0CR–EBC0_B7CR)

0:11	BAS	Base Address Select	Specifies the bank starting address, which must be a multiple of the bank size.
12:14	BS	Bank Size 000 1 MB bank 001 2 MB bank 010 4 MB bank 011 8 MB bank 100 16 MB bank 101 32 MB bank 110 64 MB bank 111 128 MB bank	
15:16	BU	Bank Usage 00 Disabled 01 Read-only 10 Write-only 11 Read/Write	Specifies the type of accesses allowed for the bank. A protect error occurs if a write is attempted to a read-only bank or a read from a write-only bank.
17:18	BW	Bus Width 00 8-bit bus 01 16-bit bus 10 32-bit bus 11 Reserved	The boot ROM must be attached to bank 0. Its bus width is controlled by strapping pins.
19:31		Reserved	

DCR Accessed using EBC0_CFGADDR; EBC0_CFGDATA; Offset 0x23

See “EBC Configuration Register (EBC0_CFG)” in Chapter 16: External Bus Controller of the 405GP User's Manual.

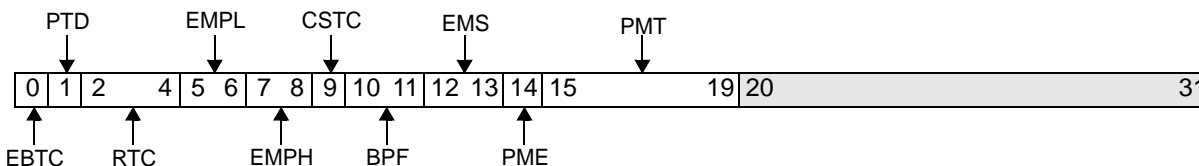

Figure 25-70. EBC Configuration Register (EBC0_CFG)

0	EBTC	External Bus Three-State Control 0 Address, data and control signals are high-Z between EBC transfers. 1 Between EBC transfers the peripheral data bus, address bus and control signals are driven.	Default after reset is EBTC=1. See “Effect of Driver Enable Programming on EBC Signal States” on page 355.
1	PTD	Device-Paced Time-out Disable 0 Enabled time-outs 1 Disable time-outs	If PTD=1, the EBC waits indefinitely for assertion of PerReady during device-paced accesses.
2:4	RTC	Ready Timeout Count 000 16 PerClk cycles 001 32 PerClk cycles 010 64 PerClk cycles 011 128 PerClk cycles 100 256 PerClk cycles 101 512 PerClk cycles 110 1024 PerClk cycles 111 2048 PerClk cycles	When PTD=0, the number of cycles from PerAddr0:31 changing until a timeout error occurs.
5:6	EMPL	External Master Priority Low 00 Low 01 Medium low 10 Medium high 11 High	The PLB priority for external master initiated transfers when the external master hold priority input is low (HoldPri=0).
7:8	EMPH	External Master Priority High 00 Low 01 Medium low 10 Medium high 11 High	The PLB priority for external master initiated transfers when the external master hold priority input is high (HoldPri=1).
9	CSTC	Chip Select Three-state Control 0 PerCS0:7 are high-Z between EBC transfers and when an external master is active (HoldAck=1). 1 PerCS0:7 are always driven.	Default after reset is CSTC=1. See “Effect of Driver Enable Programming on EBC Signal States” on page 355.
10:11	BPF	Burst Prefetch 00 Prefetch 1 doubleword 01 Prefetch 2 doublewords 10 Prefetch 4 doublewords 11 Reserved	Controls the amount of data prefetching when the EBC is servicing a PLB burst read. For most applications set this field to 0b00.

12:13	EMS	External Master Size 00 8-bit 01 16-bit 10 32-bit 11 No external master attached	Width of the attached external master.
14	PME	Power Management Enable 0 Disabled 1 Enabled	
15:19	PMT	Power Management Timer 0000–1111	The EBC makes a sleep request to the Clock and Power Management unit when PME=1 and the EBC has been idle for $32 \times \text{PMT}$ PerClk cycles.
20:31		Reserved	

Preliminary User's Manual**DCR 0x012**

See “EBC Registers” in *Chapter 16: External Bus Controller of the 405GP User's Manual*.

0	31
---	----

Figure 25-71. EBC Configuration Address Register (EBC0_CFGADDR)

0:31	Offset of indirectly-accessed DCR
------	-----------------------------------

DCR 0x013

See “EBC Registers” in *Chapter 16: External Bus Controller of the 405GP User's Manual*.



Figure 25-72. EBC Configuration Data Register (EBC0_CFGDATA)

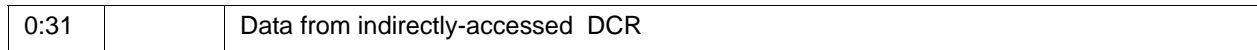

Preliminary User's Manual

Special Register

MMIO 0xEF600840–0xEF60084C

See “Group Address Hash Tables 1–4 (EMAC0_GAHT1–EMAC0_GAHT4)” on page 563.

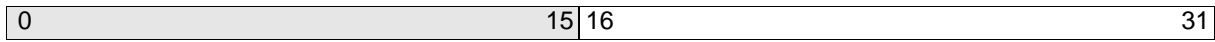

Figure 25-73. Group Address Hash Tables 1–4 (EMAC0_GAHT1–EMAC0_GAHT4)

0:15		Reserved
16:31		Group Address Hash Number

EMAC0_IAHR

Individual Address High Register

MMIO 0xEF60081C

See "Individual Address High (EMAC0_IAHR)" on page 560.

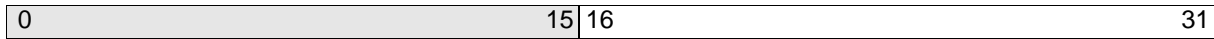

Figure 25-74. Individual Address High Register (EMAC0_IAHR)

0:15		Reserved	
16:31		High-order halfword of the station unique individual address	This field contains bits 0:15 of the station address (bit 0 is the most significant bit).

MMIO 0xEF600830–0xEF60083C

See “Individual Address Hash Tables 1–4 (EMAC0_IAHT1–EMAC0_IAHT4)” on page 562.

0	15	16	31
---	----	----	----

Figure 25-75. Individual Address Hash Tables 1–4 (EMAC0_IAHT1–EMAC0_IAHT4)

0:15		Reserved
16:31		Individual Address Hash Number

EMAC0_IALR

Individual Address Low Register

MMIO 0xEF600820

See "Individual Address Low (EMAC0_IALR)" on page 560.

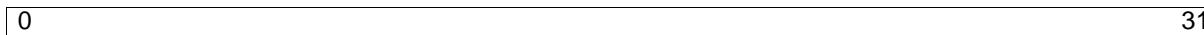

Figure 25-76. Individual Address Low Register (EMAC0_IALR)

0:31	Low-order bits of Receive Individual Address or Transmit Source Address
------	---

MMIO 0xEF600858

See “Inter-Packet Gap Value Register (EMAC0_IPGVR)” on page 564.



Figure 25-77. Inter-Packet Gap Value Register (EMAC0_IPGVR)

0:25		Reserved
26:31		Inter-Packet Gap

EMAC0_ISR

Interrupt Status Enable Register

MMIO 0xEF600818

See "Interrupt Status Enable Register (EMAC0_ISR)" on page 557.

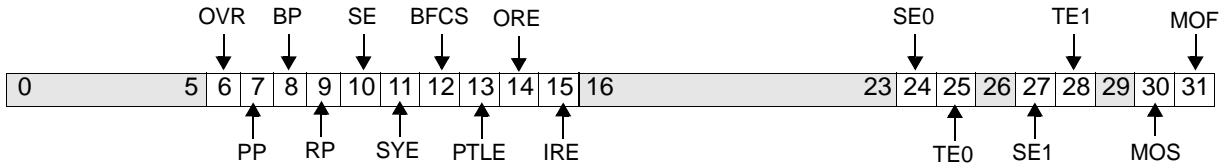

Figure 25-78. Interrupt Status Enable Register (EMAC0_ISR)

0:5		Reserved
6	OVR	Overrun 0 Overrun error will not generate an interrupt. 1 Overrun error will generate an interrupt.
7	PP	Pause Packet 0 Received control pause packet will not generate an interrupt. 1 Received control pause packet will generate an interrupt.
8	BP	Bad Packet 0 Early termination on received packet will not generate an interrupt. 1 Early termination on received packet will generate an interrupt.
9	RP	Runt Packet 0 Received runt packet will not generate an interrupt. 1 Received runt packet will generate an interrupt.
10	SE	Short Event 0 Short event during receive will not generate an interrupt. 1 Short event during receive will generate an interrupt.
11	ALE	Alignment Error 0 Alignment error in received packet will not generate an interrupt. 1 Alignment error in received packet will generate an interrupt.
12	BFCS	Bad FCS 0 FCS error in received packet will not generate an interrupt. 1 FCS error in received packet will generate an interrupt.

13	PTLE	Packet Too Long Error 0 Oversized packets received will not generate an interrupt. 1 Oversized packet received will generate an interrupt.
14	ORE	Out Of Range Error 0 Out of range error on received packet will not generate an interrupt. 1 Out of range error on received packet will generate an interrupt.
15	IRE	In Range Error 0 In range error on received packet will not generate an interrupt. 1 In range error on received packet will generate an interrupt.
16:23		Reserved
24	SE0	SQE Error 0 0 SQE error on TX Channel 0 will not generate an interrupt. 1 SQE error on TX Channel 0 will generate an interrupt.
25	TE0	Transmit Error 0 0 TX error on TX Channel 0 will not generate an interrupt. 1 TX error on TX Channel 0 will generate an interrupt.
26		Reserved
27	SE1	SQE Error 1 0 SQE error on TX Channel 1 will not generate an interrupt. 1 SQE error on TX Channel 1 will generate an interrupt.
28	TE1	Transmit Error 1 0 TX error on TX Channel 1 will not generate an interrupt. 1 TX error on TX Channel 1 will generate an interrupt.
29		Reserved
30	MOS	MMA Operation Succeeded 0 Successful MMA Operation with a PHY will not generate an interrupt. 1 Successful MMA Operation with a PHY will generate an interrupt.
31	MOF	MMA Operation Failed 0 Unsuccessful MMA Operation with a PHY will not generate an interrupt. 1 Unsuccessful MMA Operation with a PHY will generate an interrupt.

EMAC0_ISR

Interrupt Status Register

MMIO 0xEF600818

See "Interrupt Status Register (EMAC0_ISR)" on page 555.

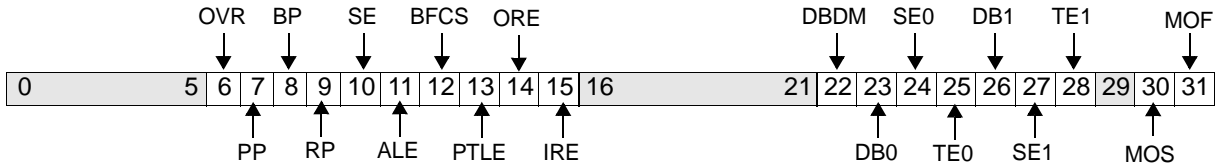

Figure 25-79. Interrupt Status Register (EMAC0_ISR)

0:5		Reserved	
6	OVR	Overrun 0 No overrun error 1 Overrun error during reception of recent packet	
7	PP	Pause Packet 0 Received packet is not a control pause packet 1 Received packet is a control pause packet	
8	BP	Bad Packet 0 Receive operation OK 1 Early termination was initiated because of a packet error	
9	RP	Runt Packet 0 No Runt packets received 1 Runt packet received	Set when EMAC0_RMR[RRP] = 1 and the duration of PHY_RX_DV signal was greater than ShortEventMaxTime constant and less than the collision window.
10	SE	Short Event 0 No short events 1 Duration of PHY_RX_DV signal less than ShortEventMaxTime constant	
11	ALE	Alignment Error 0 No alignment error in received packet 1 Alignment error in received packet	The packet contained an odd number of nibbles (4 bits).
12	BFCS	Bad FCS 0 No FCS error in received packet 1 Packet with an FCS error received	Set if EMAC0_RMR[RFP] = 1.

13	PTLE	Packet Too Long Error 0 No oversized packets received 1 Oversized packet received	Set if EMAC0_RMR[ROP] = 1 and the received packet length exceeded the maximum allowed value: <ul style="list-style-type: none"> • 1518 octets for standard packet (checked only if the length/type field of the transmitted packet contained length value) • 1522 octets for VLAN tagged packet (checked only if the length/type field of the transmitted packet contained length value and jumbo support is disabled)
14	ORE	Out Of Range Error 0 Received packet length field value OK 1 Received packet length field value greater than the maximum allowed LLC data size	Indicates that received packet has a length field value greater than the maximum allowed logical link control (LLC) data size (greater than 1500 and less than 1536).
15	IRE	In Range Error 0 Received packet does not contain an In Range Error 1 Received packet contains an In Range Error	
16:21		Reserved	
22	DBDM	Dead Bit Dependent Mode 0 No transmit error or SQE in dependent mode 1 Transmit error or SQE has occurred while in dependent mode	If EMAC0_ISR[DBDM] = 1, EMAC does not request MAL service, even if EMAC0_TMR0[GNPD] = 1. EMAC0_ISR[DBDM] does not affect EMC_INT.
23	DB0	Dead Bit 0 0 No transmit error or SQE for TX Channel 0 while not in dependent mode 1 Transmit error or SQE has occurred for TX Channel 0 while not in dependent mode	If EMAC0_ISR[DB0] = 1, EMAC does not request service for TX Channel 0 from MAL, even if EMAC0_TMR0[GNP0] = 1. EMAC0_ISR[DB0] does not affect EMC_INT.
24	SE0	SQE Error 0 0 No SQEs on TX Channel 0 1 SQE test failure during transmission of a packet from TX Channel 0	Applicable only in half-duplex mode during 10 Mbps operations; 0 in all other modes.
25	TE0	Transmit Error 0 0 TX Channel 0 transmission OK 1 TX Channel 0 transmission aborted	EMAC aborts the transmitted packet if one of the following events takes place: <ul style="list-style-type: none"> • Late collision detection • Excessive collision detection • Excessive deferral • TX FIFO underrun • Loss of carrier sense
26	DB1	Dead Bit 1 0 No transmit error or SQE for TX Channel 1 while not in dependent mode 1 Transmit error or a SQE has occurred for TX Channel 1 while not in dependent mode	If this bit is set, EMAC does not request MAL service for TX Channel 1 even if EMAC0_TMR1[GNP1] = 1. EMAC0_ISR[DB1] does not affect EMC_INT.

27	SE1	SQE Error 1 0 No Signal Quality Errors on TX Channel 1 1 Signal Quality Error test failure during transmission of a packet from TX Channel 1	Applicable only in half-duplex mode during 10 Mbps operations; 0 in all other modes.
28	TE1	Transmit Error 1 0 TX Channel 1 transmission OK 1 TX Channel 1 transmission aborted	EMAC aborts the transmitted packet if one of the following events takes place: <ul style="list-style-type: none"> • Late collision detection • Excessive collision detection • Excessive deferral • TX FIFO underrun • Loss of carrier sense
29		Reserved	Always 0
30	MOS	MMA Operation Succeeded 0 MMA_CONTROL addressed on the OPB 1 PHY transfer valid	The device driver should poll assertion of EMAC0_ISR[MOS] or EMAC0_ISR[MOF] before issuing a new command or before using data read from the PHY.
31	MOF	MMA Operation Failed 0 MMA_CONTROL addressed on the OPB 1 PHY transfer <i>not</i> valid	The device driver should poll assertion of EMAC0_ISR[MOF] or EMAC0_ISR[MOS] before issuing a new command or before using data read from the PHY.

MMIO 0xEF600850

See “Last Source Address High (EMAC0_LSAH)” on page 563.

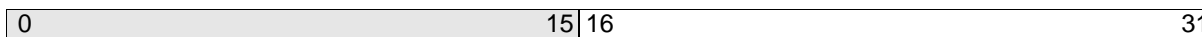
**Figure 25-80. Last Source Address High Register (EMAC0_LSAH)**

0:15		Reserved
16:31		Last Source Address High-Order Halfword

EMAC0_LSAL

Last Source Address Low

MMIO 0xEF600854

See “Last Source Address Low (EMAC0_LSAL)” on page 564.

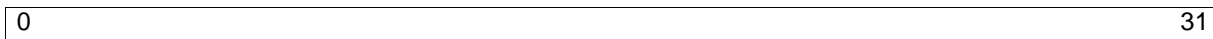
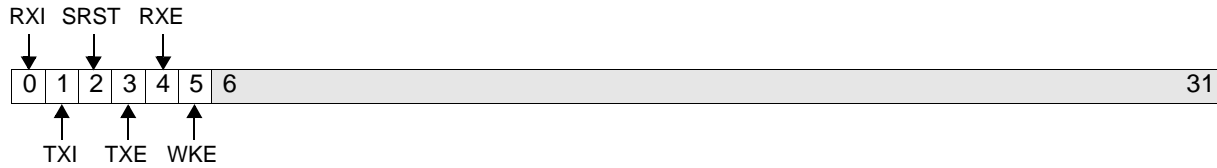

Figure 25-81. Last Source Address Low Register (EMAC0_LSAL)

0:31		Last Source Address Low-Order Word
------	--	------------------------------------

MMIO 0xEF60 0800

See “Mode Register 0 (EMAC0_MR0)” on page 548.

**Figure 25-82. Mode Register 0 (EMAC0_MR0)**

0	RXI	Receive MAC Idle 0 RX MAC processing packet 1 RX MAC idle; RX packet processing complete	Read-only
1	TXI	Transmit MAC Idle 0 TX MAC processing packet 1 TX MAC idle; TX packet processing complete	Read-only
2	SRST	Soft Reset 0 No effect 1 Soft reset in progress	If EMAC0_MR0[SRST] = 1, writing to any EMAC register, and reading any other bit in this register, is not supported.
3	TXE	Transmit MAC Enable 0 TX MAC is disabled 1 TX MAC is enabled	
4	RXE	Receive MAC Enable 0 RX MAC is disabled 1 RX MAC is enabled	
5	WKE	Wake-Up Enable 0 Incoming packets are not examined for wake-up packet 1 Examine incoming packets for wake-up packet	Software can change EMAC0_MR0[WKE] only while EMAC0_MR0[RXI] = 1 and EMAC0_MR0[RXE] = 0.
6:31		Reserved	

MMIO 0xEF60 0804

See "Mode Register 1 (EMAC0_MR1)" on page 549.

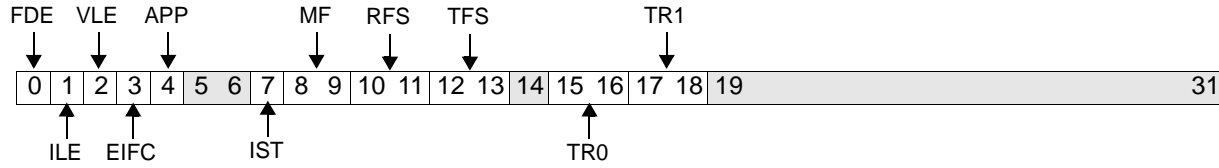

Figure 25-83. Mode Register 1 (EMAC0_MR1)

0	FDE	Full-Duplex Enable 0 Disable simultaneous transmit and receive 1 Enable simultaneous transmit and receive	
1	ILE	Internal Loop-back Enable 0 No wrap back 1 Transmitted packets wrapped back to receive FIFO	Full Duplex must also be set (EMAC0_MR1[FDE]=1).
2	VLE	VLAN Enable 0 Disable processing of VLAN Tags 1 Enable processing of VLAN Tags	
3	EIFC	Enable Integrated Flow Control 0 Disable integrated flow control mechanism 1 Enable integrated flow control mechanism	Refer to "Flow Control" on page 19-539 for more details. Set EMAC0_MR1[EIFC] = 0 in half-duplex mode.
4	APP	Allow Pause Packet 0 Disables processing of incoming control (pause) packets 1 Enables processing of incoming control (pause) packets	
5:6		Reserved	Always zero
7	IST	Ignore SQE test 0 Wait for end of SQE test period before activation of valid signal 1 Do not wait for end of SQE test period before activation of valid signal	EMAC0_MR1[IST] = 0 only during half-duplex operation on 10 Mbps media.
8:9	MF	Medium Frequency 00 10 Mbps (Ethernet mode) 01 100 Mbps (Fast Ethernet mode) 10 Reserved 11 Reserved	Defines the possible operational frequency on the MII interface.
10:11	RFS	Receive (RX) FIFO Size 00 512 bytes 01 1 KB 10 2 KB 11 4 KB	

12:13	TFS	Transmit (TX) FIFO Size 00 Reserved 01 1 KB 10 2 KB 11 Reserved	
14		Reserved	Always 0
15:16	TR0	Transmit Request 0 00 Single packet 01 Multiple packets 10 Dependent mode (bits 17:18 must also be programmed to 10) 11 Reserved	Defines the different modes for using transmit channel 0 of EMAC.
17:18	TR1	Transmit Request 1 00 Single packet 01 Multiple packets 10 Dependent mode (bits 15:16 must also be programmed to 10) 11 Reserved	Defines the different modes for using transmit channel 1 of EMAC.
19:31		Reserved	

EMAC0_OCRX

Number of Octets Received

MMIO 0xEF60086C

See “Number of Octets Received (EMAC0_OCRX)” on page 568.

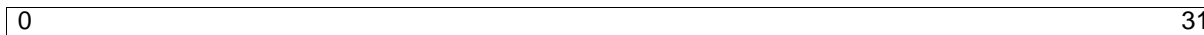

Figure 25-84. Number of Octets Received (EMAC0_OCRX)

0:31	OCRX	Number of octets (bytes) received.
------	------	------------------------------------

MMIO 0xEF600868

See “Number of Octets Transmitted (EMAC0_OCTX)” on page 568.

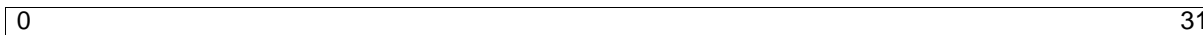

Figure 25-85. Number of Octets Transmitted (EMAC0_OCTX)

0:31	OCTX	Number of octets (bytes) transmitted.
------	------	---------------------------------------

EMAC0_PTR

Pause Timer Register

MMIO 0xEF60082C

See "Pause Timer Register (EMAC0_PTR)" on page 562.

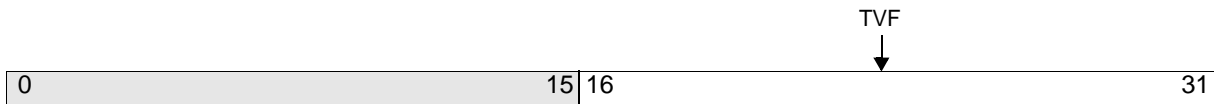

Figure 25-86. Pause Timer Register (EMAC0_PTR)

0:15		Reserved
16:31	TVF	Timer Value Field

8	PMME	Promiscuous Multicast Mode Enable 0 Do not accept all multicast packets. 1 Accept all multicast packets.
9	IAE	Individual Address Enable 0 Do not compare address of received packets with content of individual address register. 1 Compare address of received packets with content of individual address register.
10	MIAE	Multiple Individual Address Enable 0 Do not compare address of received packets with hash table of individual addresses. 1 Compare address of received packets with hash table of individual addresses.
11	BAE	Broadcast Address Enable 0 Do not compare address of received packets with broadcast addresses. 1 Compare address of received packets with broadcast addresses.
12	MAE	Multicast Address Enable 0 Do not compare address of received packets with multicast addresses. 1 Compare address of received packets with multicast addresses.
13:31		Reserved

MMIO 0xEF600864

See "Receive Low/High Water Mark Register (EMAC0_RWMR)" on page 567.

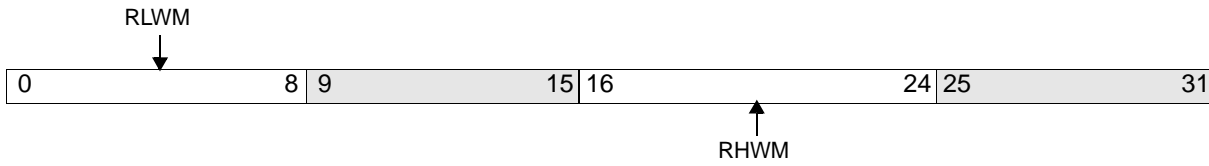

Figure 25-88. Receive Low/High Water Mark Register (EMAC0_RWMR)

0:8	RLWM	Receive Low Water Mark
9:15		Reserved
16:24	RHWM	Receive High Water Mark
25:31		Reserved

MMIO 0xEF60085C

See "STA Control Register (EMAC0_STACR)" on page 565.

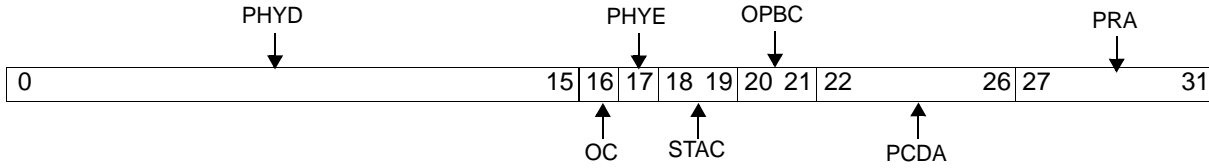
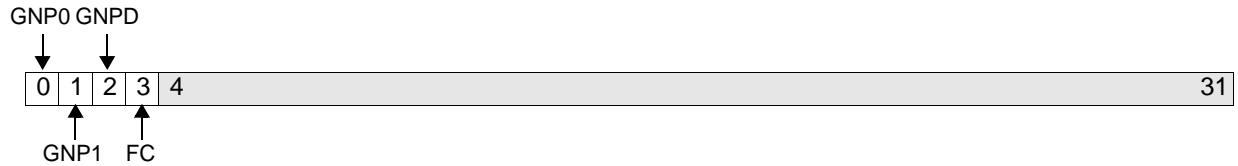

Figure 25-89. STA Control Register (EMAC0_STACR)

0:15	PHYD	PHY data	Data to be sent to the PHY if the command is a write, or data is read from the PHY if the command is a read.
16	OC	Operation Complete 0 EMAC0_STACR is addressed 1 PHY data transfer complete	
17	PHYE	PHY Error 0 Successful read transaction 1 Read transaction was not successful	EMAC0_STACR[PHYE] = 0 when a read is successful.
18:19	STAC	STA Command 00 Reserved 01 Read 10 Write 11 Reserved	EMAC sets EMAC0_STACR[STAC] = 0 when the command is completed.
20:21	OPBC	OPB Bus Clock Frequency 00 50 MHz 01 66 MHz 10 83 MHz 11 100 MHz	EMAC0_STACR[OPBC] is used to generate the Management Data Clock (EMCMDClk). When the operational frequency differs from those in the list, then the next greater frequency should be chosen.
22:26	PCDA	PHY Command Destination Address	
27:31	PRA	PHY Register Address	

MMIO 0xEF600808

See "Transmit Mode Register 0 (EMAC0_TMR0)" on page 551.

**Figure 25-90. Transmit Mode Register 0 (EMAC0_TMR0)**

0	GNP0	Get New Packet 0 0 Writing 0 has no effect. 1 Packet ready for transmission on TX Channel 0	EMAC0_TMR0[GNP0] = 0 if EMAC is programmed in dependent mode.
1	GNP1	Get New Packet 1 0 Writing 0 has no effect. 1 Packet ready for transmission on TX Channel 1	EMAC0_TMR0[GNP1] = 0 if EMAC is programmed in dependent mode.
2	GNPD	Get New Packet for Dependent Mode 0 Writing 0 to this bit has no effect 1 Packet ready for transmission in dependent mode	EMAC0_TMR0[GNPD] = 0 if EMAC is not programmed in dependent mode. EMAC0_TMR0[GNPD] = 1 activates the EMAC transmit path in dependent mode.
3	FC	First Channel 0 Activate TX Channel 0 first when GNPD is 1 1 Activate TX Channel 1 first when GNPD is 1	EMAC0_TMR0[FC] is only meaningful in dependent mode, after resetting EMAC0_ISR[DBDM]. EMAC0_TMR0[FC] = 0 if EMAC is not programmed in dependent mode.
4:31		Reserved	

EMAC0_TMR1

Transmit Mode Register 1

MMIO 0xEF60080C

See "Transmit Mode Register 1 (EMAC0_TMR1)" on page 552.

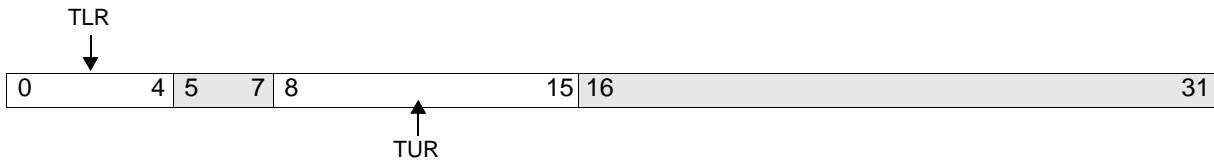

Figure 25-91. Transmit Mode Register 1 (EMAC0_TMR1)

0:4	TLR	Transmit Low Request
5:7		Reserved
8:15	TUR	Transmit Urgent Request
16:31		Reserved

MMIO 0xEF600860

See “Transmit Request Threshold Register (EMAC0_TRTR)” on page 566.

**Figure 25-92. Transmit Request Threshold Register (EMAC0_TRTR)**

0:4	TRT	Transmit Request Threshold The following number of bytes must be placed in the Transmit FIFO before initiating a transmit request. 00000 64 bytes 00001 128 bytes 00010 192 bytes 00011 256 bytes . . . 11111 2048 bytes
5:31		Reserved

MMIO 0xEF600828

See "VLAN TCI Register (EMAC0_VTCI)" on page 561.

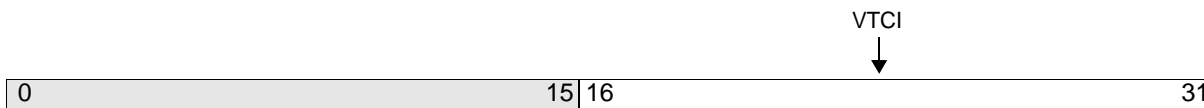

Figure 25-93. VLAN TCI Register (EMAC0_VTCI)

0:15		Reserved
16:31	VTCI	VLAN TCI tag

MMIO 0xEF600824

See “VLAN TPID Register (EMAC0_VTPID)” on page 561.

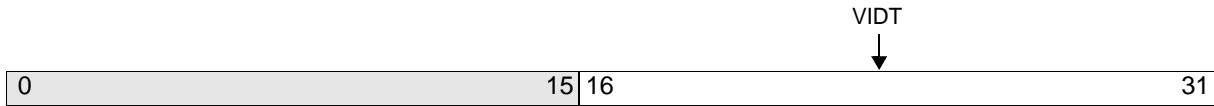

Figure 25-94. VLAN TPID Register (EMAC0_VTPID)

0:15		Reserved
16:31	VIDT	VLAN ID tag

GPIO0_IR

GPIO Input Register

GPIO Register

MMIO 0xEF60071C Read-Only

See "GPIO Input Register (GPIO0_IR)" on page 660.

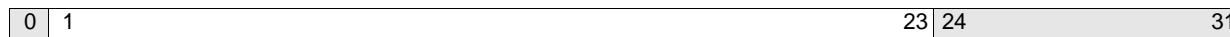

Figure 25-95. GPIO Input Register (GPIO0_IR)

0		Reserved
1:23		GPIO register bits
24:31		Reserved

GPIO0_OR

GPIO Output Register

MMIO 0xEF600700

See “GPIO Output Register (GPIO0_OR)” on page 660.

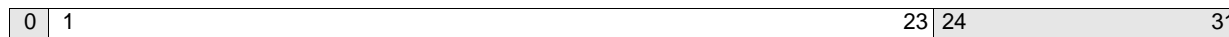

Figure 25-97. GPIO Output Register (GPIO0_OR)

0		Reserved
1:23		GPIO register bits
24:31		Reserved

GPIO0_OR

MMIO 0xEF60050C

See "IIC0 Clock Divide Register (IIC0_CLKDIV)" on page 647.

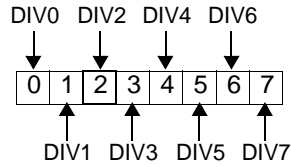
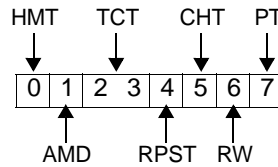

Figure 25-99. IIC0 Clock Divide Register (IIC0_CLKDIV)

0	DIV0	Divisor bit 0
1	DIV1	Divisor bit 1
2	DIV2	Divisor bit 2
3	DIV3	Divisor bit 3
4	DIV4	Divisor bit 4
5	DIV5	Divisor bit 5
6	DIV6	Divisor bit 6
7	DIV7	Divisor bit 7

MMIO 0xEF600506

See "IIC0 Control Register (IIC0_CNTL)" on page 638.

**Figure 25-100. IIC0 Control Register (IIC0_CNTL)**

0	HMT	Halt Master Transfer 0 Normal transfer operation. 1 Issue Stop signal on the IIC bus as soon as possible to halt master transfer.	If no transfer is in progress, no action is taken. IIC0_CNTL[PT] need not be set. If IIC0_MDCNTL[EINT] = 1, an interrupt is generated.
1	AMD	Addressing Mode 0 Use 7-bit addressing. 1 Use 10-bit addressing.	Does not affect slave transfers.
2:3	TCT	Transfer Count 00 Transfer one byte. 01 Transfer two bytes. 10 Transfer three bytes. 11 Transfer four bytes.	
4	RPST	Repeated Start 0 Normal start operation 1 Use repeated Start function to start transfer.	
5	CHT	Chain Transfer 0 Transfer is only or last transfer. 1 Transfer is one of a sequence of transfers (but not last in sequence).	Completion of a requested transfer causes a Stop signal to be issued on the IIC bus.
6	RW	Read/Write 0 Transfer is a write. 1 Transfer is a read.	
7	PT	Pending Transfer 0 Most recent requested transfer is complete. 1 Start transfer if bus is free.	

MMIO 0xEF600510

See "IIC0 Direct Control Register (IIC0_DIRECTCNTL)" on page 652.

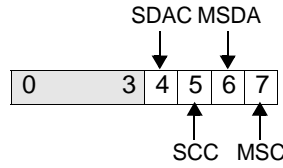

Figure 25-101. IIC0 Direct Control Register (IIC0_DIRECTCNTL)

0:3		Reserved	
4	SDAC	IICSDA Output Control Directly controls the IICSDA output. 0 IICSDA is a logic 0 1 IICSDA is a logic 1	
5	SCC	IIC SCL Output Control Directly controls the IIC SCL output 0 IIC SCL is a logic 0 1 IIC SCL is a logic 1	
6	MSDA	Monitor IICSDA Used to monitor the IICSDA input 0 IICSDA is a logic 0 1 IICSDA is a logic 1	Read-only
7	MSC	Monitor IIC SCL. Used to monitor the IIC SCL input. 0 IIC SCL is a logic 0 1 IIC SCL is a logic 1	Read-only

MMIO 0xEF600509

See “IIC0 Extended Control and Slave Status Register (IIC0_XTCNTLSS)” on page 650.

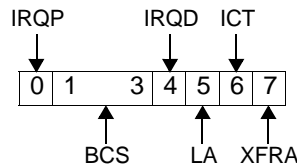

Figure 25-102. IIC0 Extended Status Register (IIC0_EXTSTS)

0	IRQP	<p>IRQ Pending</p> <p>0 No IRQ is pending.</p> <p>1 An IRQ is active, another IRQ is on-deck, and another interrupt-generating condition has occurred.</p>	<ul style="list-style-type: none"> • IIC0_EXTSTS[IRQP] might be set momentarily while an IRQ moves from the Pending to the On-deck state. • An interrupt remains pending, IIC0_EXTSTS[IRQP]=1, until the current on-deck interrupt becomes active, IIC0_EXTSTS[IRQD]=0 and IIC0_STS[IRQA]=1. • Writing 1 to IIC0_EXTSTS[IRQP] clears the field. • When the IIC interrupt is disabled, IIC0_MDCNTL[IRQP] = 0, IIC0_EXTSTS[IRQP] should be ignored.
1:3	BCS	<p>Bus Control State</p> <p>000 Unused; if this value is read, a major IIC hardware problem occurred.</p> <p>001 Slave-selected state; the IIC interface has detected and decoded a slave transfer request on the IIC bus.</p> <p>010 Slave Transfer state; the IIC interface has detected but has not decoded a slave transfer request on the IIC bus.</p> <p>011 Master Transfer state; entered after a master transfer request has started on the IIC bus.</p> <p>100 Free Bus state; the bus is free and no transfer request is pending.</p> <p>101 Busy Bus state; the bus is busy.</p> <p>110 Unknown state; value after IIC reset.</p> <p>111 Unused; if this value is read, a major IIC hardware problem occurred.</p>	Read-only.

4	IRQD	<p>IRQ On-Deck 0 No IRQ is on-deck. 1 An interrupt is active, and another interrupt-generating condition has occurred.</p>	<ul style="list-style-type: none"> • IIC0_EXTSTS[IRQD] might be set momentarily while an IRQ moves from the On-deck to the Active state. • An interrupt remains on-deck, IIC0_EXTSTS[IRQD] = 1, until the current active interrupt is no longer active, IIC0_STS[IRQA] = 0. • If IIC0_EXTSTS[IRQP] = 1, IIC0_EXTSTS[IRQD] is set on the next OPB clock. • Writing 1 to IIC0_EXTSTS[IRQD] clears the field. • When the IIC interrupt is disabled, IIC0_EXTSTS[IRQP]=0, IIC0_EXTSTS[IRQD] should be ignored.
5	LA	<p>Lost Arbitration 0 Normal operation. 1 Loss of arbitration has ended the requested master transfer.</p>	<ul style="list-style-type: none"> • If arbitration is lost, any requested master transaction may have terminated prematurely. Read data may be incomplete and not all write data may have been written. • If arbitration is lost during a repeat start, the master may not own the IIC bus.
6	ICT	<p>Incomplete Transfer 0 Normal operation. 1 Some of the bytes of the requested master transfer were not transferred.</p>	<p>For an incomplete transfer, read the transfer count, IIC0_XFRCNT, to determine how bytes were transferred.</p>
7	XFRA	<p>Transfer Aborted 0 No transfer is pending, or transfer is in progress. 1 A requested master transfer was aborted by a NACK during the transfer of the address byte, or was aborted because arbitration was lost. Lost arbitration can be caused by the loss of data during the transfer of the second or subsequent data byte.</p>	<p>Transfer aborted. When set to a 1, a requested master transfer was aborted by a NOT acknowledge during the transfer of the address byte. It is also set to a 1 when a requested master transfer loses data. Lost arbitration can be caused by the loss of data during the transfer of the second or subsequent data byte.</p>

MMIO 0xEF600505

See “IIC0 High Master Address Register (IIC0_HMADR)” on page 637.

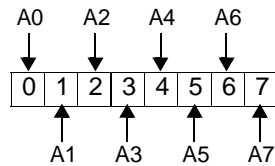

Figure 25-103. IIC0 High Master Address Register (IIC0_HMADR)

0	A0	Address bit 0	1 for 10-bit addresses
1	A1	Address bit 1	1 for 10-bit addresses
2	A2	Address bit 2	1 for 10-bit addresses
3	A3	Address bit 3	1 for 10-bit addresses
4	A4	Address bit 4	0 for 10-bit addresses
5	A5	Address bit 5	MSb for 10-bit addresses
6	A6	Address bit 6	Next to MSb for 10-bit addresses
7	A7	Address bit 7	Don't care for 10-bit addresses

IIC0_HSADR

IIC0 High Slave Address

MMIO 0xEF60050B

See "IIC0 High Slave Address Register (IIC0_HSADR)" on page 646.

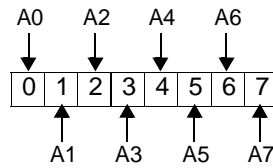

Figure 25-104. IIC0 High Slave Address Register (IIC0_HSADR)

0	A0	Address bit 0	1 for 10-bit addresses
1	A1	Address bit 1	1 for 10-bit addresses
2	A2	Address bit 2	1 for 10-bit addresses
3	A3	Address bit 3	1 for 10-bit addresses
4	A4	Address bit 4	0 for 10-bit addresses
5	A5	Address bit 5	MSb for 10-bit addresses
6	A6	Address bit 6	Next to MSb for 10-bit addresses
7	A7	Address bit 7	Don't care for 10-bit addresses

MMIO 0xEF60050D

See "IIC0 Interrupt Mask Register (IIC0_INTRMSK)" on page 648.

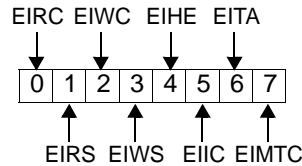

Figure 25-105. IIC0 Interrupt Mask Register (IIC0_INTRMSK)

0	EIRC	Enable IRQ on Slave Read Complete 0 Disable 1 Enable	The interrupt is activated upon receipt of a Stop during a slave read on the IIC bus. IIC0_XTCNTLSS[SRCS] = 1 indicates a Slave Read Complete.
1	EIRS	Enable IRQ on Slave Read Needs Service 0 Disable 1 Enable	The interrupt is activated upon receipt of a slave read on the IIC bus and the slave buffer was empty or went empty and more data was requested on the IIC bus. Note: IIC0_XTCNTLSS[SRS] = 1 indicates a Slave Read Needs Service.
2	EIWC	Enable IRQ on Slave Write Complete 0 Disable 1 Enable	The interrupt is activated upon receipt of a Stop during a slave write on the IIC bus. Note: IIC0_XTCNTLSS[SWC] = 1 indicates a Slave Write Complete.
3	EIWS	Enable IRQ on Slave Write Needs Service 0 Disable 1 Enable	The interrupt is activated when the slave buffer becomes full during a slave write on the IIC bus. Note: IIC0_XTCNTLSS[SWS] = 1 indicates a Slave Write Needs Service.
4	EIHE	Enable IRQ on Halt Executed 0 Disable 1 Enable	
5	EIIC	Enable IRQ on Incomplete Transfer 0 Disable 1 Enable	
6	EITA	Enable IRQ on Transfer Aborted 0 Disable 1 Enable	
7	EIMTC	Enable IRQ on Requested Master Transfer Complete 0 Disable 1 Enable	

IIC0_LMADR

IIC0 Low Master Address

MMIO 0xEF600504

See "IIC0 Low Master Address Register (IIC0_LMADR)" on page 636.

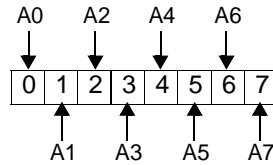

Figure 25-106. IIC0 Low Master Address Register (IIC0_LMADR)

0	A0	Address bit 0	
1	A1	Address bit 1	
2	A2	Address bit 2	
3	A3	Address bit 3	
4	A4	Address bit 4	
5	A5	Address bit 5	
6	A6	Address bit 6	LSb for 7-bit addresses
7	A7	Address bit 7	LSb for 10-bit addresses; don't care for 7-bit addresses

MMIO 0xEF60050A

See “IIC0 Low Slave Address Register (IIC0_LSADR)” on page 645.

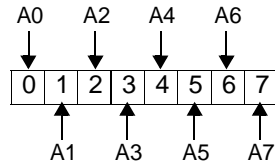

Figure 25-107. IIC0 Low Slave Address Register (IIC0_LSADR)

0	A0	Address bit 0	
1	A1	Address bit 1	
2	A2	Address bit 2	
3	A3	Address bit 3	
4	A4	Address bit 4	
5	A5	Address bit 5	
6	A6	Address bit 6	LSb for 7-bit addresses
7	A7	Address bit 7	LSb for 10-bit addresses; don't care for 7-bit addresses

IIC0_MDBUF

IIC0 Master Data Buffer

MMIO 0xEF600500

See “IIC0 Master Data Buffer (IIC0_MDBUF)” on page 634.

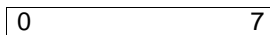
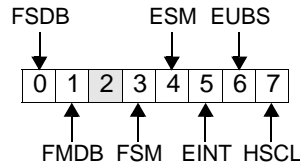

Figure 25-108. IIC0 Master Data Buffer (IIC0_MDBUF)

0		Data bit
1		Data bit
2		Data bit
3		Data bit
4		Data bit
5		Data bit
6		Data bit
7		Data bit

MMIO 0xEF600507

See "IIC0 Mode Control Register (IIC0_MDCNTL)" on page 639.

**Figure 25-109. IIC0 Mode Control Register (IIC0_MDCNTL)**

0	FSDB	Flush Slave Data Buffer 0 Normal operation 1 Set slave data buffer to empty.	Cleared after buffer is emptied.
1	FMDB	Flush Master Data Buffer 0 Normal operation 1 Set master data buffer to empty.	Cleared after buffer is emptied.
2		Reserved	
3	FSM	Fast/Standard Mode 0 IIC transfers run at 100 kHz (standard mode). 1 IIC transfers run at 400 kHz (fast mode).	
4	ESM	Enable Slave Mode 0 Slave transfers are ignored. 1 Slave transfers are enabled.	Program IIC0_LSADR and IIC0_HSADR before setting this field.
5	EINT	Enable Interrupt 0 Interrupts are disabled. 1 Enables interrupts for interrupts enabled in IIC0_INTRMSK.	
6	EUBS	Exit Unknown IIC Bus State 0 Normal operation. 1 IIC bus control state machine exits unknown bus state, if in an unknown state.	If the IIC bus control state machine is in a known state, setting IIC0_MDCNTL[EUBS] = 1 has no effect.
7	HSCL	Hold IIC Serial Clock Low 0 If slave is not ready, issue a NACK in response to slave transfer request. 1 If slave is not ready, hold the IIC_SCL signal low until slave is ready.	This field is used only when in slave mode.

IIC0_SDBUF

IIC0 SLave Data Buffer

MMIO 0xEF600502

See "IIC0 Slave Data Buffer (IIC0_SDBUF)" on page 635.

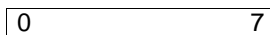
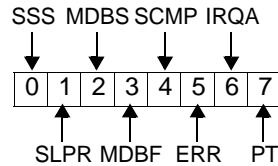

Figure 25-110. IIC0 Slave Data Buffer (IIC0_SDBUF)

0		Data bit
1		Data bit
2		Data bit
3		Data bit
4		Data bit
5		Data bit
6		Data bit
7		Data bit

MMIO 0xEF600508

See “IIC0 Status Register (IIC0_STS)” on page 641.

**Figure 25-111. IIC0 Status Register (IIC0_STS)**

0	SSS	Slave Status Set 0 No slave operations are in progress. 1 Slave operation is in progress.	Read-only; this field is set when any of the following fields are set: IIC0_XTCNTLSS[<i>SRC</i> , <i>SRRS</i> , <i>SWC</i> , <i>SWRS</i>].
1	SLPR	Sleep Request 0 Normal operation. 1 Sleep mode (CPC0_ER[IIC] = 1).	Read-only. The IIC interface is awakened when a start signal is detected on the IIC bus or when the CPC0_ER[IIC] is cleared.
2	MDDBS	Master Data Buffer Status 0 Master data buffer is empty. 1 Master data buffer contains data.	Read-only.
3	MDBF	Master Data Buffer Full 0 Master data buffer is not full. 1 Master data buffer is full.	Read-only.
4	SCMP	Stop Complete 0 No request to halt transfer, or master data transfer, is complete. 1 Request to halt transfer, or master data transfer, is complete.	To clear IIC0_STS[SCMP], set IIC0_STS[SCMP] = 1.
5	ERR	Error 0 No error has occurred. 1 One of the following fields is set: IIC0_EXTSTS[<i>LA</i> , <i>ICT</i> , <i>XFRA</i>] = 1.	Read-only.
6	IRQA	IRQ Active 0 No IIC interrupt has been sent to the universal interrupt controller (UIC). 1 An IIC interrupt has been sent to the UIC.	To clear IIC0_STS[IRQA], set IIC0_STS[IRQA] = 1. If IIC0_MDCNTL[EINT] = 0, then IIC0_STS[IRQA] is not set.
7	PT	Pending Transfer 0 No transfer is pending, or transfer is in progress. 1 Transfer is pending.	Read-only.

MMIO 0xEF60050E

See "IIC0 Transfer Count Register (IIC0_XFRCNT)" on page 649.

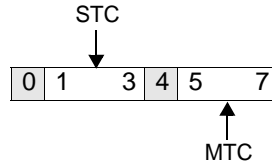

Figure 25-112. IIC0 Transfer Count Register (IIC0_XFRCNT)

0		Reserved
1:3	STC	Slave Transfer Count 000 0 bytes transferred 001 1 byte transferred 010 2 bytes transferred 011 3 bytes transferred 100 4 bytes transferred 101 Reserved 110 Reserved 111 Reserved
4		Reserved
5:7	MTC	Master Transfer Count 000 0 bytes transferred 001 1 byte transferred 010 2 bytes transferred 011 3 bytes transferred 100 4 bytes transferred 101 Reserved 110 Reserved 111 Reserved

MMIO 0xEF60050F

See “IIC0 Extended Control and Slave Status Register (IIC0_XTCNTLSS)” on page 650.

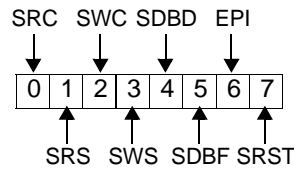

Figure 25-113. IIC0 Extended Control and Slave Status Register (IIC0_XTCNTLSS)

0	SRC	<p>Slave Read Complete</p> <p>0 Normal operation, or IIC0_MDCNTL[HSCL] = 0, IIC0_SDBUF is empty, and a read operation is in progress.</p> <p>1 A NACK or Stop condition was received over the IIC bus, or a repeated Start condition ended a read operation.</p>	<p>Check whether the read operation emptied IIC0_SDBUF.</p>
1	SRS	<p>Slave Read Needs Service</p> <p>0 Normal operation or slave read does not need service.</p> <p>1 IIC0_SDBUF is empty, and a read operation was requested on the IIC bus. The set condition may also indicate that IIC0_SDBUF is empty due to a slave read and additional data is requested by the master.</p>	<p>1. If IIC0_MDCNTL[HSCL]=0 and IIC0_SDBUF contains no data, the slave will issue a NACK and IIC0_XTCNTLSS[SRS] is set.</p> <p>2. If IIC0_MDCNTL[HSCL]=0, and IIC0_SDBUF contains data, the slave will send the data. IIC0_XTCNTLSS[SRS] is not set unless the master request additional data.</p> <p>3. If IIC0_MDCNTL[HSCL]=0, and IIC0_SDBUF contains no data, the slave will hold IIC0_SCL low to indicate the slave is busy. IIC0_XTCNTLSS[SRS] is set until the IIC0_SDBUF is filled. Once filled, IIC0_SCL is released, IIC0_XTCNTLSS[SRS] is cleared, and the slave sends the data.</p> <p>4. If IIC0_MDCNTL[HSCL]=1, and IIC0_SDBUF contains data, the slave will send the data. IIC0_XTCNTLSS[SRS] is not set unless the master requests additional data.</p>
2	SWC	<p>Slave Write Complete</p> <p>0 Normal operation or slave write in progress.</p> <p>1 A Stop signal was received during a write operation, or a repeated Start condition ended a write operation.</p>	

IIC0_XTCNTLSS (cont.)

IIC0 Extended Control and Slave Status

3	SWS	<p>Slave Write Needs Service</p> <p>0 Normal operation or slave write does not need service.</p> <p>1 IIC0_SDBUF is full during a slave write.</p>	<p>1. If IIC0_MDCNTL[HSCL] = 1 and IIC0_SDBUF is full, the slave will hold IIC_SCL low to indicate the slave is busy. IIC0_XTCNTLSS[SWS] is set until IIC0_SDBUF is empty. Once empty, IIC_SCL is released, IIC0_XTCNTLSS[SWS] is cleared, and the slave receives the data.</p> <p>2. If IIC0_MDCNTL[HSCL] = 0 and IIC0_SDBUF is full, the slave will issue a NACK and IIC0_XTCNTLSS[SWS] is set.</p>
4	SDBD	<p>Slave Data Buffer Has Data</p> <p>0 IIC0_SDBUF is empty</p> <p>1 IIC0_SDBUF contains data</p>	Read-only
5	SDBF	<p>Slave Data Buffer Full</p> <p>0 IIC0_SDBUF is not full</p> <p>1 IIC0_SDBUF is full</p>	Read-only
6	EPI	<p>Enable pulsed IRQ. When set to a logic:</p> <p>0 The IIC_IRQ signal stays active until the IRQ active bit, staus(1) is cleared.</p> <p>1 The IIC_IRQ signal goes active for one clock period.</p>	
7	SRST	<p>Soft Reset</p> <p>0 Normal operation</p> <p>1 Soft reset</p>	

DCR 0x180

See “MAL Configuration Register (MAL0_CFG)” on page 597.

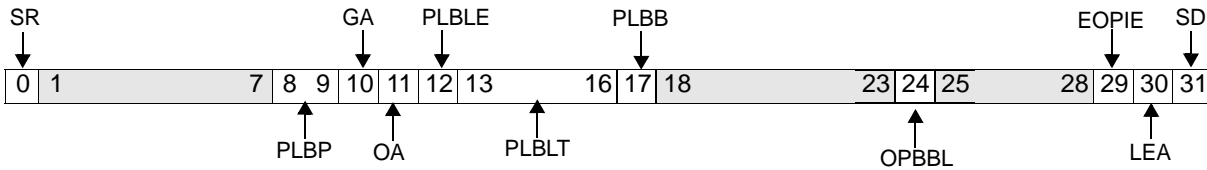
**Figure 25-114. MAL Configuration Register (MAL0_CFG)**

0	SR	MAL Software Reset 0 MAL reset is complete 1 Reset the MAL	Generates a general reset to MAL through a software command. After setting this bit, MAL hardware (registers, interface and internal state machines) returns to the power-on reset value. The software writes 1 to this bit in order to drive MAL to the reset state. The bit is cleared by the hardware when the reset is completed (one system clock).
1:7		Reserved	
8:9	PLBP	PLB Priority 00 Lowest 01 10 11 Highest	Determines the priority of MAL requests on the PLB.
10	GA	Guarded Active 0 GUARDED signal not applied to the PLB slave 1 GUARDED signal applied to the PLB slave	When this bit is set, MAL applies the GUARDED signal to the PLB slave when it is the initiator on the bus. When set, the slave can access all the memory in the current page as well as the subsequent page.
11	OA	Ordered Active 0 ORDERED signal not applied to the PLB slave 1 ORDERED signal applied to the PLB slave	When this bit is set, MAL applies the ORDERED signal to the PLB slave when it is initiator on the bus during data write transactions. Note that the ORDERED signal is always driven active during status write transactions.
12	PLBLE	PLB Lock Error 0 LOCKERROR signal not applied to the PLB slave 1 LOCKERROR signal applied to the PLB slave	When this bit is set, MAL applies the LOCKERROR signal to the PLB slave when it is the initiator during PLB transactions.
13:16	PLBLT	PLB Latency Timer	Determines the number of cycles allowed for burst transactions on the PLB.
17	PLBB	PLB Burst 0 Burst transactions not allowed 1 Burst transactions allowed	When this bit is reset, MAL is not allowed to perform burst transactions.

18:23		Reserved	
24	OPBBL	OPB Bus Lock 0 OPB not locked 1 OPB locked	When this bit is set, MAL locks the OPB during data transfers to and from the COMMACs.
25:28		Reserved	
29	EOPIE	End of Packet Interrupt Enable 0 Generate interrupt on every end-of-packet only if the buffers I bit is set 1 Generate interrupt is on every end-of-packet	When this bit is set, an interrupt is generated on every end of packet (both transmit and receive). When clear, end of packet/buffer interrupt is generated only if the buffers I bit is set (1). Note: An interrupt is generated for every descriptor on which the I bit is set, regardless of the state of the EOPIE bit.
30	LEA	Locked Error Active 0 Handle errors in a non-locked mode 1 Handle errors in locked mode	Determines MAL's error handling mode. When this bit is set, MAL will handle errors in the locked mode, otherwise it will handle errors in a non-locked mode.
31	SD	MAL Scroll Descriptor 0 Do not scroll to the first descriptor of the next packet 1 Scroll to the first descriptor of the next packet	Determines whether or not MAL should scroll to the first descriptor of the next packet, following an early packet termination initiated by the related COMMAC. When set, Scrolling mode is active.

DCR 0x181 Read/Clear

See “MAL Error Status Register (MAL0_ESR)” on page 601.

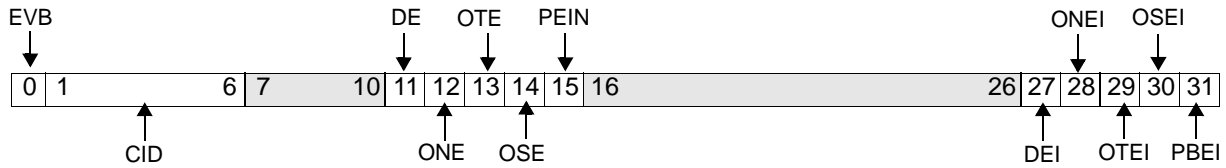

Figure 25-115. MAL Error Status Register (MAL0_ESR)

0	EVB	<p>Error Valid Bit</p> <p>0 Bit 1:15 are available for latching new error information.</p> <p>1 Bits 1:15 contain last error. A new error cannot be latched.</p>	<p>When this bit is set, bits 1-6 include the ID of the erroneous channel (in case of OPB errors). Bits 11-15 indicate the type of error.</p> <p>In non-locked mode, the error indication describes the last error that had occurred. In locked mode, the error is the first one that had occurred after this bit was cleared. This bit is set when an error occurs and remains set until reset by the software. In locked mode, new errors cannot be latched in the error lock indication fields if this bit is set</p>
1:6	CID	<p>Channel ID</p>	<p>This field contains the number of the channel which caused the locked error. Bit 1 indicates whether the channel ID represents an RX channel (1) or a TX channel (0).</p> <p>Bits 2:6 indicates the number of the channel that caused the error.</p> <p>Note: An error on the PLB cannot be related to a channel. The error condition may be resolved by using the error information optionally locked in the PLB slave.</p>
7:10		<p>Reserved</p>	
11	DE	<p>Descriptor Error</p> <p>0 No error</p> <p>1 Non-valid descriptor</p>	<p>Indicates that the error is a non-valid descriptor, which is <i>not</i> the first descriptor in a TX packet.</p>
12	ONE	<p>OPB Non-fullword Error</p> <p>0 No error</p> <p>1 Non-fullword asserted</p>	<p>Indicates that the error is a non-fullword acknowledge asserted by an OPB slave.</p>
13	OTE	<p>OPB Timeout Error</p> <p>0 No error</p> <p>1 OPB timeout</p>	<p>Indicates the error is an OPB timeout.</p>
14	OSE	<p>OPB Slave Error</p> <p>0 No error</p> <p>1 OPB slave error</p>	<p>Indicates the error is an error indication asserted by an OPB slave.</p>

15	PEIN	PLB Bus Error Indication 0 No error 1 PLB bus error	When this bit is set, the detected error is a PLB error. There is no meaning to the Channel ID field in this case.
16:26		Reserved	
27	DEI	Descriptor Error Interrupt 0 No error 1 Descriptor data error recognized	A descriptor data error is recognized during access to the descriptor table. This error indication is asserted when a non-valid descriptor is accessed, which is <i>not</i> the first descriptor in a TX packet. Set condition for this bit generates a maskable interrupt.
28	ONEI	OPB Non-fullword Error Interrupt 0 No error 1 Non-fullword acknowledgment from a slave	This bit is set following a non-fullword acknowledgment coming from a slave. Set condition for this bit generates a maskable interrupt.
29	OTEI	OPB Timeout Error Interrupt 0 No error 1 OPB time-out	This bit is set following an OPB time out error indication. Set condition for this bit generates a maskable interrupt.
30	OSEI	OPB Slave Error Interrupt 0 No error 1 OPB error from a slave	This bit is set following an OPB error indicated by the slave. Set condition for this bit generates a maskable interrupt.
31	PBEI	PLB Bus Error Interrupt 0 No error 1 PLB error indication	This bit is set following a PLB error indication (from the PLB slave). Set condition for this bit generates a maskable interrupt.

DCR 0x182 Read/Only

See "MAL Interrupt Enable Register (MAL0_IER)" on page 603.

**Figure 25-116. MAL Interrupt Enable Register (MAL0_IER)**

Figure 25-116. MAL Interrupt Enable Register (MAL0_IER)			
0:26		Reserved	
27	DE	Descriptor Error	When set, this bit enables the descriptor error (descriptor not valid) interrupt.
28	NWE	Non_W_Err_Int_Enable	When set, this bit enables OPB non-word transfer error interrupt.
29	TO	Time_Out_Int_Enable	When set, this bit enables OPB time-out error interrupt.
30	OPB	OPB_Err_Int_Enable	When set, this bit enables the OPB Slave error interrupt.
31	PLB	PLB_Err_Int_Enable	When set, this bit enables the PLB error interrupt.

MAL0_RCBS0

MAL Receive Channel Buffer Size Register

DCR 0x1E0

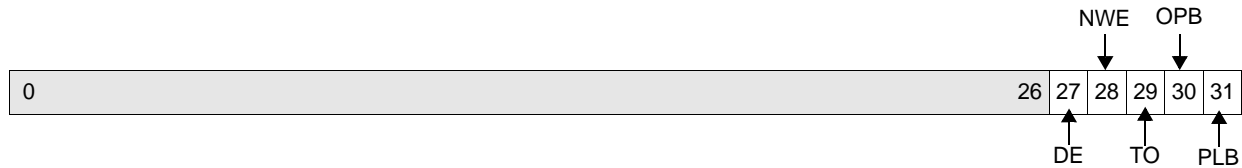
See "Buffer Length for Receive" on page 585.



Figure 25-117. RX Channel Buffer Size Register (MAL0_RCBS0)

0:23		Reserved
24:31		Receive Channel Buffer Size MAL0 has one receive channel.

DCR 0x191

See "Channel Active Set and Reset Registers" on page 598.

0	1	31
---	---	----

Figure 25-118. RX Channel_Active Reset Register (MAL0_RXCARR)

0		Receive Channel Active Reset	Each bit represents its related channel (bit 0 for channel 0, and so on). When 1 is written to the bit, channel operation is disabled. MAL0 has one receive channel.
1:31		Reserved	

MAL0_RXCASR

MAL Receive Channel Active Set Register

DCR 0x190

See "Channel Active Set and Reset Registers" on page 598.



Figure 25-119. RX Channel_Active Set Register (MAL0_RXCASR)

0		Receive Channel Active Set	Each bit represents its related channel (bit 0 for channel 0, and so on). When 1 is written to the bit, channel operation is enabled. MAL0 has one receive channel.
1:31		Reserved	

DCR 0x1C0

See “Channel Table Pointer Registers (MAL0_TXCTPxR, MAL0_RXCTPxR)” on page 605.

0		31
---	--	----

Figure 25-120. RX Channel Table Pointer Register (MAL0_RXCTPxR)

0:31		Channel Table Pointer	<p>Pointer to the base address of the buffer descriptor table used by the channel. The value should point to a location in memory accommodating an aligned doubleword (the three least significant bits of the pointer must be 000). MAL0 has one receive channel.</p>
------	--	-----------------------	--

MAL0_RXDEIR

MAL Receive Descriptor Interrupt Register

DCR 0x193 Read/Clear

See “Descriptor Error Interrupt Registers (MAL0_TXDEIR, MAL0_RXDEIR)” on page 604.



Figure 25-121. RX Descriptor Error Interrupt Register (MAL0_RXDEIR)

0	1	31
0		Receive Descriptor Error Interrupt Each bit represents its related channel (bit 0 for channel 0, and so on). When one or more bits are set, MAL_DESC_ERR_INT is set. Writing 1 to a bit clears it. MAL0 has one receive channel.
1:31		Reserved

Preliminary User's Manual**DCR 0x192 Read/Clear**

See “End of Buffer Interrupt Status Registers” on page 600.



Figure 25-122. RX End of Buffer Interrupt Status Register (MAL0_RXEOBISR)

0		Receive Channel End-of-Buffer Interrupt	Each bit represents its related channel (bit 0 for channel 0, and so on). Writing 1 to a bit clears it. MAL0 has one receive channel.
1:31		Reserved	

MAL0_TXCARR

MAL Transmit Channel Active Reset Register

DCR 0x185

See "Channel Active Set and Reset Registers" on page 598.



Figure 25-123. TX Channel Active Reset Register (MAL0_TXCARR)

0:1		Transmit Channel Active Reset	Each bit represents its related channel (bit 0 for channel 0, and so on). When 1 is written to the bit, channel operation is disabled. MAL0 has two transmit channels.
2:31		Reserved	

DCR 0x184

See “Channel Active Set and Reset Registers” on page 598.



Figure 25-124. TX Channel_Active Set Register (MAL0_TXCASR)

0:1		Transmit Channel Active Set	Each bit represents its related channel (bit 0 for channel 0, and so on). When 1 is written to the bit, channel operation is enabled. MAL0 has two transmit channels.
2:31		Reserved	

MAL0_TXCTPxR

MAL Transmit Channel Pointer Registers

DCR 0x1A0–0x1A1 Read/Write

See “Channel Table Pointer Registers (MAL0_TXCTPxR, MAL0_RXCTPxR)” on page 605.



Figure 25-125. TX Channel Table Pointer Registers (MAL0_TXCTPxR)

0:31		Channel Table Pointer	Pointer to the base address of the buffer descriptor table used by the channel. The value entered should point to a location in memory accommodating an aligned doubleword (the three least significant bits of the pointer must be 000). MAL0 has two transmit channels.
------	--	-----------------------	---

DCR 0x187 Read/Clear

See “Descriptor Error Interrupt Registers (MAL0_TXDEIR, MAL0_RXDEIR)” on page 604.

0	1	2	31
---	---	---	----

Figure 25-126. TX Descriptor Error Interrupt Register (MAL0_TXDEIR)

0:1		Transmit Descriptor Error Interrupt	Each bit represents its related channel (bit 0 for channel 0, and so on). When one or more bits are set to 1, MAL_DESC_ERR_INT is set. Writing 1 to a bit clears it. MAL0 has two transmit channels.
2:31		Reserved	

MAL0_TXEOBISR

MAL Transmit End of Buffer Interrupt Status Register

DCR 0x186 Read/Clear

See “End of Buffer Interrupt Status Registers” on page 600.



Figure 25-127. TX End of Buffer Interrupt Status Register (MAL0_TXEOBISR)

0:1		Transmit Channel End-of-Buffer Interrupt	Each bit represents its related channel (bit 0 for channel 0, and so on). Writing 1 to a bit clears it. MAL0 has two transmit channels.
2:31		Reserved	

M

On-Chip Memory Controller Registers

DCR 0x01A

See “OCM Data-Side Address Range Compare Register (OCM0_DSARC)” on page 159.

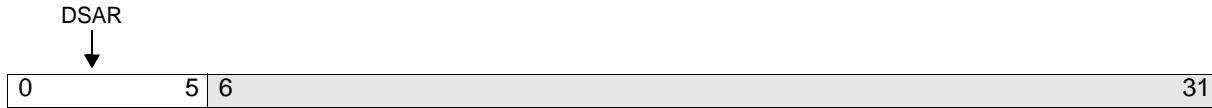

Figure 25-128. OCM Data-Side Address Range Compare Register (OCM0_DSARC)

0:5	DSAR	Data-side OCM address range
6:31		Reserved

OCM0_DSCNTL

OCM Data-Side Address Control Register

DCR 0x01B

See "OCM Data-Side Control Register (OCM0_DSCNTL)" on page 159.

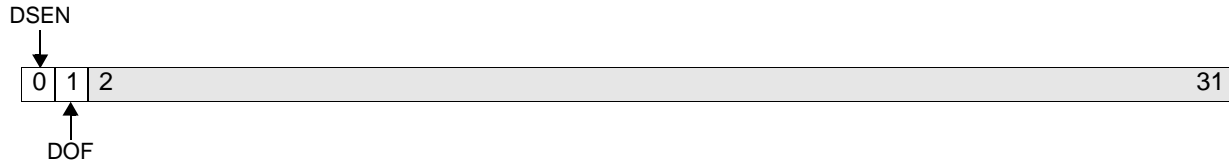

Figure 25-129. OCM Data-Side Control Register (OCM0_DSCNTL)

0	DSEN	Data-Side OCM Enable 0 Data-side OCM accesses are disabled. 1 Data-side OCM accesses are enabled.
1	DOF	This field should remain set to 1.
2:31		Reserved

DCR 0x018

See "OCM Instruction-Side Address Range Compare Register (OCM0_ISARC)" on page 157.

**Figure 25-130. OCM Instruction-Side Address Range Compare Register (OCM0_ISARC)**

0:5	ISAR	Instruction-side OCM address range
6:31		Reserved

OCM0_ISCNTL

OCM Instruction-Side Control Register

DCR 0x019

See “OCM Instruction-Side Control Register (OCM0_ISCNTL)” on page 158.

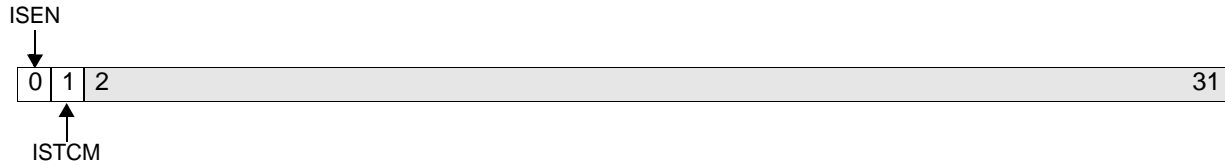

Figure 25-131. OCM Instruction-Side Control Register (OCM0_ISCNTL)

0	ISEN	Instruction-Side OCM Enable 0 Instruction-side OCM accesses are disabled. 1 Instruction-side OCM accesses are enabled.	
1	ISTCM	Instruction-Side Two Cycle Mode 0 Instruction-side OCM accesses are returned in one cycle. 1 Instruction-side OCM accesses are returned in two cycles.	OCM0_ISCNTL[ISTCM], which has a reset value of 1, should be set to OCM0_ISCNTL[ISTCM] = 0 during chip initialization.
2:31		Reserved	

OPB Arbiter Register

MMIO 0xEF600600

See “OPB Arbiter Control Register (OPBA0_CR)” on page 75.

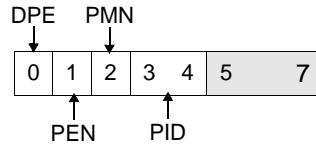
**Figure 25-132. OPB Arbiter Control Register (OPBA0_CR)**

0	DPE	Dynamic Priority Enable 0 Dynamic priority disabled 1 Dynamic priority enabled	When DPE = 1, the OPB arbiter uses an approximately fair arbitration algorithm.
1	PEN	Park Enable 0 Park disabled 1 Park enabled	
2	PMN	Park on Master Not Last 0 Park on last master last 1 Park on master specified by PID	
3:4	PID	Parked Master ID 00 DMA 01 Unused 10 OPB to PLB bridge 11 Unused	
5:7		Reserved	

OPBA0_PR

OPB Arbiter Priority Register

MMIO 0xEF600601

See "OPB Arbiter Priority Register (OPBA0_PR)" on page 76.

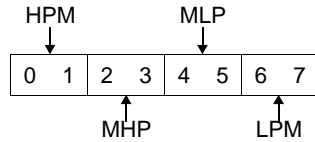

Figure 25-133. OPB Arbiter Priority Register (OPBA0_PR)

0:1	HPM	High Priority Master ID 00 Master ID 0 01 Master ID 1 10 Master ID 2 11 Master ID 3
2:3	MHP	Medium High Priority Master ID 00 Master ID 0 01 Master ID 1 10 Master ID 2 11 Master ID 3
4:5	MLP	Medium Low Priority Master ID 00 Master ID 0 01 Master ID 1 10 Master ID 2 11 Master ID 3
6:7	LPM	Low Priority Master ID 00 Master ID 0 01 Master ID 1 10 Master ID 2 11 Master ID 3

Accessed using PCIC0_CFGADDR, PCIC0_CFGDATA; offset 0x10 Read-Only

See “Unused PCI Base Address Register Space” on page 422.

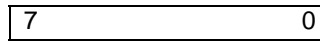

Figure 25-134. PCI Base Address Register (PCIC0_BAR0)

7:0		PCI Base Address	Unimplemented; always returns 0.
-----	--	------------------	----------------------------------

PCIC0_BIST

PCI Built In Self Test Control

Accessed using PCIC0_CFGADDR, PCIC0_CFGDATA; offset 0x0F Read-Only

See “PCI Built-In Self Test (BIST) Control Register (PCIC0_BIST)” on page 421.

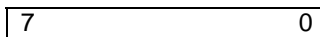

Figure 25-135. PCI Built-in Self Test Control Register (PCIC0_BIST)

7:0	PCI BIST Control
-----	------------------

Accessed using PCIC0_CFGADDR, PCIC0_CFGDATA; offset 0x4B–0x4A

See “Bridge Options 1 Register (PCIC0_BRDGOPT1)” on page 428.

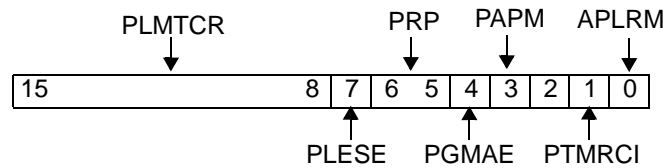

Figure 25-136. Bridge Options 1 Register (PCIC0_BRDGOPT1)

15:8	PMLTCR	PLB Master Latency Timer Count Register	PMLTCR contains the value used by the PLB master to load its latency timer. The granularity of this timer is 16 PLB cycles; therefore, the low-order bits of this register are read-only and are hardwired to 1.
7	PLESE	PLB Lock Error Status Enable 0 Slave error locking is disabled. 1 Slave error locking is enabled.	PLESE controls the handling of slave error locking.
6:5	PRP	PLB Request Priority 11 Highest 10 Next highest 01 Next highest 00 Lowest	PRP controls the request priority for PLB accesses.
4	PGMAE	PLB Guarded Memory Access Enable 0 Bridge PLB master memory accesses are unguarded. 1 Bridge PLB master memory accesses are guarded.	PGMAE controls whether PLB accesses are guarded or unguarded.
3	PAPM	PCI Arbiter Park Mode 0 The arbiter parks on requester 0 (the bridge PCI master). 1 The arbiter parks on the last master granted the bus.	PAPM defines how the internal PCI arbiter handles bus parking.
2:1	PTMRCI	PCI Target Memory Read Command Interpretation 00 Memory Read 01 Memory Read Line 10 Memory Read Multiples 11 Reserved	PTMRCI enables the PCI bridge to be forced to treat a PCI memory read as a memory read multiple, or as a memory read line, with respect to the burst size implied by the read commands. This is for masters that use memory read for multiple beat bursts.
0	APLRM	Atomic PLB Line Read Mode 0 1 PLB slave asserts Addrack and begins its data tenure immediately after the PCI master receives the first read data word.	APLRM controls the behavior of the bridge PLB slave with respect to PLB line reads. APLRM must not be set to 1 unless all PCI target devices can guarantee no disconnects for PLB line reads.

Accessed using PCIC0_CFGADDR, PCIC0_CFGDATA; offset 0x61–0x60

See “Bridge Options 2 Register (PCIC0_BRDGOPT2)” on page 437.

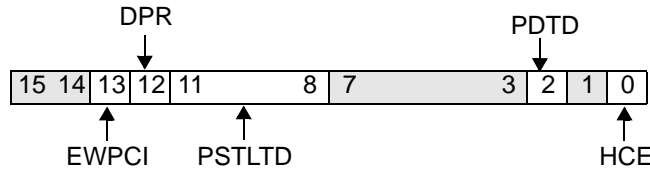

Figure 25-137. Bridge Options 2 Register (PCIC0_BRDGOPT2)

15:14		Reserved	
13	EWPCI	External Write to PCI Command Interrupt 0 No write to PCIC0_CMD has occurred. 1 External PCI master has written to PCIC0_CMD.	Software can set or clear this bit. Setting this bit also causes UIC0_SR[PCIIS] to be set.
12	DPR	Drive PCI Reset 0 Normal <u>operation</u> 1 Causes PCIReset pin to be asserted.	Software that asserts this bit must leave it asserted long enough to guarantee the PCI pulse width requirements. DPR does not reset PLB bus interface registers or PCI bridge registers. PCIReset is also asserted when the PCI bridge is reset.
11:8	PSTLTD	Subsequent Target Latency Timer Duration Specifies the number of PCI clocks that a PCI master burst can be held in a wait state before a target disconnect is initiated.	Only set on reads. In synchronous mode, PSTLTD equals the maximum number of PCI clocks to disconnect. In asynchronous mode, PSTLTD plus 3 equals the maximum number of PCI clocks to disconnect. The asynchronous value must be 2 or less.
7:3		Reserved	
2	PDTD	PCI Discard Timer Disable 0 Disabled 1 Enabled	When enabled, the PCI bridge never discards delayed read data.
1		Reserved	
0	HCE	Host Configuration Enable 0 Disabled 1 Enabled	HCE controls host PCI access to the PCI bridge configuration registers. All host attempts to access the PCI bridge PCI configuration registers are retried. This give the local CPU (PLB master) time to initialize them before the host sees them.

Accessed using PCIC0_CFGADDR, PCIC0_CFGDATA; offset 0x0C Read-Only

See “PCI Cache Line Size Register (PCIC0_CACHELS)” on page 420.

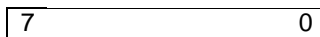

Figure 25-138. PCI Cache Line Size Register (PCIC0_CACHELS)

7:0	PCI Cache Line Size
-----	---------------------

PCIC0_CAP

PCI Capabilities Pointer

Accessed using PCIC0_CFGADDR, PCIC0_CFGDATA; offset 0x34 Read-Only

See "PCI Capabilities Pointer (PCIC0_CAP)" on page 424.

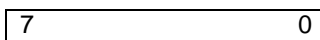
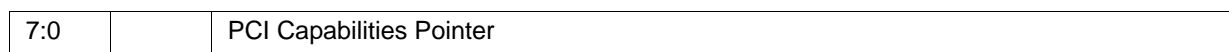

Figure 25-139. PCI Capabilities Pointer (PCIC0_CAP)



Accessed using PCIC0_CFGADDR, PCIC0_CFGDATA; offset 0x58 Read-Only

See "Capability Identifier (PCIC0_CAPID)" on page 433.

7	0
---	---

Figure 25-140. Capability Identifier (PCIC0_CAPID)

7:0	PCI Capability Identifier
-----	---------------------------

PCIC0_CFGADDR

PCI Configuration Address Register

0xEEC00000

See "PCI Configuration Address Register (PCIC0_CFGADDR)" on page 414.

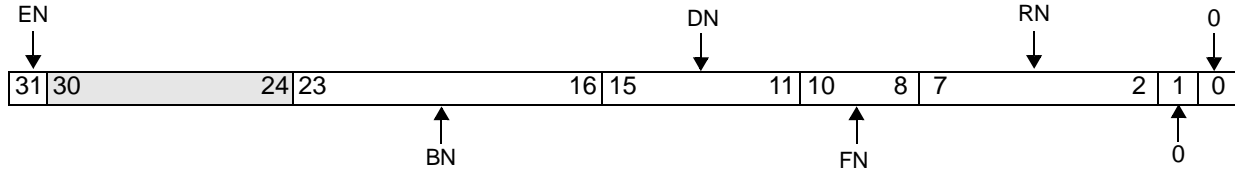

Figure 25-141. PCI Configuration Address Register (PCIC0_CFGADDR)

31	EN	Enable 0 Disabled 1 Enabled
30:24		Reserved
23:16	BN	Bus Number
15:11	DN	Device Number
10:8	FN	Function Number
7:2	RN	Register Number
1	0	
0	0	

0xEEC00004

See “PCI Configuration Data Register (PCIC0_CFGDATA)” on page 414.

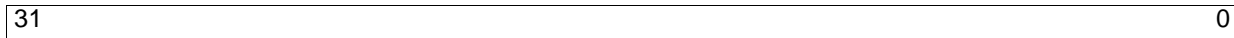
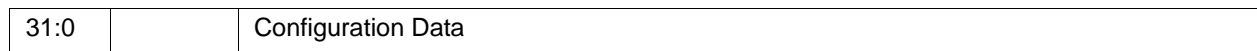

Figure 25-142. PCI Configuration Data Register (PCIC0_CFGDATA)



PCIC0_CLS

PCI Class Register

Accessed using PCIC0_CFGADDR, PCIC0_CFGDATA; offset 0x09 Read-Only (PCI), R/W (PLB)

See "PCI Class Register (PCIC0_CLS)" on page 419.

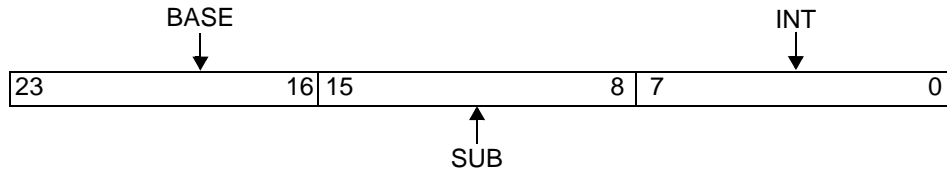

Figure 25-143. PCI Class Register (PCIC0_CLS)

23:16	BASE	Base Class	Reset to 0x06, which indicates bridge device. Users of the RISCWatch debugger must use the PCIC0_BASEECC register to access this field.
15:8	SUB	Subclass	Reset to 00, which indicates host bridge. Users of the RISCWatch debugger must use the PCIC0_SUBCLS register to access this field.
7:0	INT	Interface Class	Reset to 00. Users of the RISCWatch debugger must use the PCIC0_INTCLS register to access this field.

Accessed using PCIC0_CFGADDR, PCIC0_CFGDATA; offset 0x05–0x04

See “PCI Command Register (PCIC0_CMD)” on page 416.

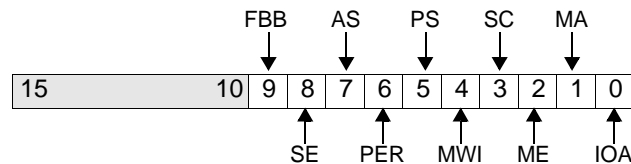

Figure 25-144. PCI Command Register (PCIC0_CMD)

15:10		Reserved	.
9	FBB	Fast Back-to-Back Write Enable	Enables PCI masters to perform fast back-to-back transactions. Because the PCI bridge does not perform fast back-to-back transactions; FBB is read-only and returns 0 when read.
8	SE	PCISERR Enable 0 Disabled 1 Enabled	Enables driving PCISERR when a PCI bus parity error is detected when the PCI bridge is the PCI target. PCIC0_CMD[PER] must be enabled for address parity errors. PCIC0_CMD[PER] and PCIC0_ERREN[WDPE] must be enabled for write data parity errors.
7	AS	Address stepping wait states.	The PCI bridge does not address step (except for address stepping when generating a Config Type 0 cycle); AS is read-only and returns 0 when read.
6	PER	Parity error response 0 Disabled 1 Enabled	This bit is enabled for all types of PCI bus parity errors, including the following: <ul style="list-style-type: none"> • PCI data bus parity errors while PCI is master. • PCI data bus parity errors while PCI is target. • PCI address bus parity errors. When parity error response is disabled, detection of these errors is masked and PCIPErr (PERR#) is not asserted, although parity is still generated.
5	PS	Palette Snooping	Enable special palette snooping. The PCI bridge is not a VGA device; PS is read-only and returns 0 when read.
4	MWI	Memory Write and Invalidate Enable	The PCI bridge does not generate this command; MWI is read-only and returns 0 when read.
3	SC	Special Cycle Operations Enable	The PCI bridge never monitors special cycles; SC is read-only and returns 0 when read.

2	ME	Master Enable 0 Disabled 1 Enabled	Enables PCI bridge-to-master cycles on the PCI bus. When ME is 0, the PCI bridge only responds as a PLB slave to PCIC0_CFGADDR, PCIC0_CFGDATA, and PCI bridge local configuration register access. Except for configuration cycles, the PCI bridge cannot master cycles to the PCI bus. If the pin strapping setting reflected in CPC0_PSR[RL] = 1, ME resets to 1.
1	MA	Memory Access 0 Disabled 1 Enabled	Controls PCI bridge response as a PCI memory target. MA is disabled at reset.
0	IOA	I/O Access	Controls the PCI bridge response as a PCI I/O target. The PCI bridge does not respond to I/O space accesses; IOA is read-only and returns 0 when read.

Accessed using PCIC0_CFGADDR, PCIC0_CFGDATA; offset 0x5F Read-Only

See "PCI Data Register (PCIC0_DATA)" on page 436.

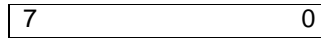

Figure 25-145. PCI Data (PCIC0_DATA)



PCIC0_DEVID

PCI Device ID

Accessed using PCIC0_CFGADDR, PCIC0_CFGDATA; offset 0x03–0x02 Read-Only (PCI), R/W (PLB)

See “PCI Device ID Register (PCIC0_DEVID)” on page 415.

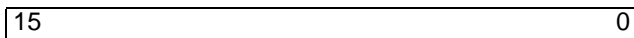
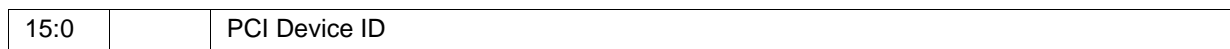

Figure 25-146. PCI Device ID Register (PCIC0_DEVID)



Accessed using PCIC0_CFGADDR, PCIC0_CFGDATA; offset 0x48

See “Error Enable Register (PCIC0_ERREN)” on page 426.

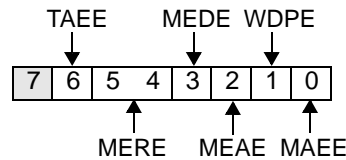

Figure 25-147. Error Enable Register (PCIC0_ERREN)

7		Reserved	
6	TAE	Target Abort Error Enable 0 Disabled 1 Enabled	While the PCI bridge is the PCI master, this bit enables the detection of a target abort as an error condition. If TAE is enabled, the PCI bridge reports PLB bus errors.
5:4	MERE	PLB Bus Error Response Enable 00 No action is taken. 01 The PCI target should drive <u>PCISerr</u> on the PCI bus. 10 Target should target abort the offending read. 11 Indicates the PCI target should drive <u>PCISerr</u> and target abort.	MERE controls the response taken by the PCI bridge on the PCI bus (as the PCI target) when PLB bus errors are asserted to the PCI bridge PLB master. Note: Only reads can be target aborted. Note: Modes 10 and 11 cannot be used in asynchronous mode.
3	MEDE	PLB Master Error Detection Enable 0 Disables detection of PLB master errors. 1 Enables detection of PLB master errors.	MEDE enables the detection of PLB bus errors when the PCI bridge is a PLB master.
2	MEAE	PLB Bus Error Assertion Enable 0 Disabled 1 Enabled	MEAE enables the reporting of a PLB bus error when the PCI bridge is a PLB slave.
1	WDPE	Write Data Parity <u>PCISerr</u> Enable 0 Disabled 1 Enabled.	The PCI bridge drives <u>PCISerr</u> when a data parity error is detected on a write cycle when the PCI bridge is the PCI target. PCIC0_CMD[SE] must also be 1.
0	MAEE	Master Abort Error Enable 0 Disabled 1 Enabled	MAEE enables the detection of a master abort as an error condition when the PCI bridge is the master. The PCI bridge drives SI_MErr on the PLB bus in response to a master abort. If this bit is disabled, driving of SI_MErr in response to master abort is masked.

PCIC0_ERRSTS

PCI Error Status

Accessed using PCIC0_CFGADDR, PCIC0_CFGDATA; offset 0x49

See "Error Status Register (PCIC0_ERRSTS)" on page 427.

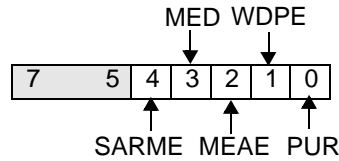

Figure 25-148. Error Status Register (PCIC0_ERRSTS)

7:5		Reserved	
4	SARME	PCISerr Asserted on Received PLB Bus Error	Set when PCI bridge asserts PCISerr on the PCI bus in response to PCI bridge receiving a PLB bus error while PLB master.
3	MED	PLB Bus Error Detected 1 Error detected	Set when a PLB bus error signal is asserted when PCI bridge is the PLB master. MED is set regardless of whether the PCI bridge is enabled to treat this as an error condition (the setting of MED is not maskable).
2	MEAE	PLB Bus Error Assertion Event 1 An PCI bridge error, which can cause a PLB bus error, occurred.	Set when an error occurs that would cause PCI bridge (as PLB slave) to assert a PLB bus error signal. MEAE is set regardless of whether the the PLB bus error assertion is enabled (the setting of MEAE is not maskable).
1	WDPE	PCISerr on Write Data Parity Error	Set when the PCI bridge drives PCISerr in response to a data parity error detected on a PCI write to PLB memory. PCIPerr is also driven.
0	PUR	PLB Unsupported Request	Set when the PCI bridge is a PLB slave and detects an unsupported request from a PLB master to an address range that PCI bridge decodes. The PCI bridge allows such requests to time out.

Accessed using PCIC0_CFGADDR, PCIC0_CFGDATA; offset 0x0E Read-Only

See “PCI Header Type Register (PCIC0_HDTYPE)” on page 421.

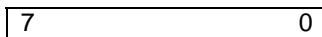

Figure 25-149. PCI Header Type Register (PCIC0_HDTYPE)

7:0		PCI Header Type
-----	--	-----------------

PCIC0_ICS

PCI Interrupt Control/Status

Accessed using PCIC0_CFGADDR, PCIC0_CFGDATA; offset 0x44

See "PCI Interrupt Control/Status Register (PCIC0_ICS)" on page 426.



Figure 25-150. PCI Interrupt Control/Status Register

7:1		Reserved	These bits return 0 when read.
0	API	Assert PCI interrupt	When software sets this bit, the PCI bridge asserts its Interrupt pin.

Accessed using PCIC0_CFGADDR, PCIC0_CFGDATA; offset 0x3C

See “PCI Interrupt Line Register (PCIC0_INTLN)” on page 424.

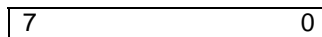

Figure 25-151. PCI Interrupt Line Register (PCIC0_INTLN)

7:0		PCI Interrupt Line
-----	--	--------------------

Accessed using PCIC0_CFGADDR, PCIC0_CFGDATA; offset 0x3D Read-Only

See "PCI Interrupt Pin Register (PCIC0_INTPN)" on page 425.

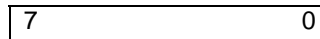

Figure 25-152. PCI Interrupt Pin Register (PCIC0_INTPN)

7:0	PCI Interrupt Pin
-----	-------------------

Accessed using PCIC0_CFGADDR, PCIC0_CFGDATA; offset 0x0D

See "PCI Latency Timer Register (PCIC0_LATTIM)" on page 420.



Figure 25-153. PCI Latency Timer Register (PCIC0_LATTIM)

7:0	PCI Latency Timer
-----	-------------------

PCIC0_MAXLTNCY

PCI Maximum Latency

Accessed using PCIC0_CFGADDR, PCIC0_CFGDATA; offset 0x3F Read-Only

See “PCI Maximum Latency Register (PCIC0_MAXLTNCY)” on page 425.

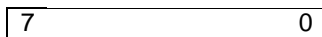

Figure 25-154. PCI Maximum Latency Register (PCIC0_MAXLTNCY)

7:0		PCI Maximum Latency
-----	--	---------------------

Accessed using PCIC0_CFGADDR, PCIC0_CFGDATA; offset 0x3E Read-Only

See “PCI Minimum Grant Register (PCIC0_MINGNT)” on page 425.

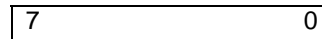

Figure 25-155. PCI Minimum Grant Register (PCIC0_MINGNT)

7:0	PCI Minimum Grant
-----	-------------------

Accessed using PCIC0_CFGADDR, PCIC0_CFGDATA; offset 0x59 Read-Only

See "Next Item Pointer (PCIC0_NEXTIPTR)" on page 433.

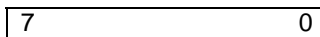

Figure 25-156. Next Item Pointer (PCIC0_NEXTIPTR)

7:0	PCI Next Item Pointer
-----	-----------------------

Accessed using PCIC0_CFGADDR, PCIC0_CFGDATA; offset 0x57–0x54

See “PLB Slave Error Address Register (PCIC0_PLBBEAR)” on page 432.



Figure 25-157. PLB Slave Error Address Register (PCIC0_PLBBEAR)

31:0	PLB Slave Error Address
------	-------------------------

PCIC0_PLBBESR0

PLB Slave Error Syndrome Register 0

Accessed using PCIC0_CFGADDR, PCIC0_CFGDATA; offset 0x4F–0x4C

See “PLB Slave Error Syndrome Register 0 (PCIC0_PLBBESR0)” on page 429.

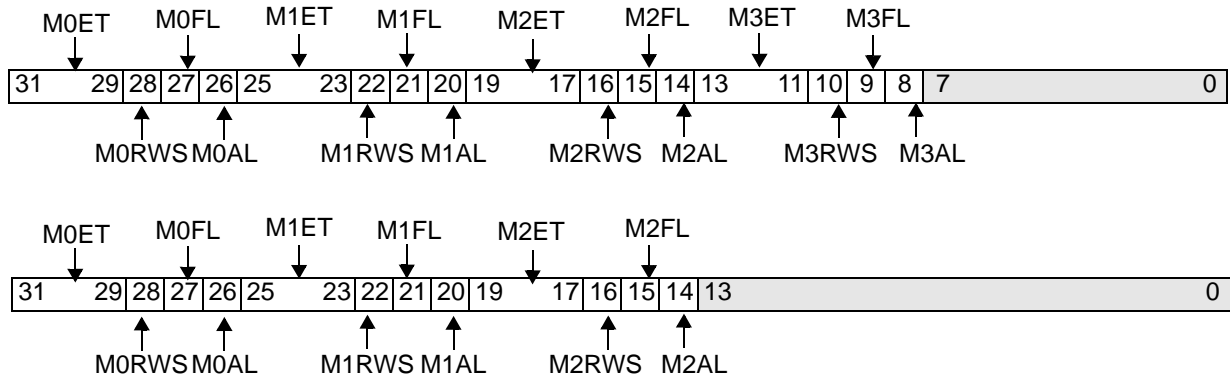

Figure 25-158. PLB Slave Error Syndrome Register 0 (PCIC0_PLBBESR0)

31:29	M0ET	Master 0 Error Type 000 No Error 001 Parity Error 010 Reserved 011 Reserved 100 Reserved 101 Non-configured Bank Error 110 Reserved 111 Reserved
28	M0RWS	Master 0 Read/Write Status 0 Error operation was a write 1 Error operation was a read
27	M0FL	Master 0 PCIC0_PLBBESR0 Field Lock 0 PCIC0_PLBB ESR0 unlocked 1 PCIC0_PLBB ESR0 locked
26	M0AL	Master 0 PCIC0_PLBBEAR Address Lock 0 PCIC0_PLBBEAR unlocked by Master 0 1 PCIC0_PLBBEAR locked by Master 0
25:23	M1ET	Master 1 Error Type See PCIC0_PLBBESR0[M0ET]
22	M1RWS	Master 1 Read/Write Status 0 Error operation was a write 1 Error operation was a read
21	M1FL	Master 1 PCIC0_PLBBESR0 Field Lock 0 PCIC0_PLBB ESR0 unlocked 1 PCIC0_PLBB ESR0 locked
20	M1AL	Master 1 PCIC0_PLBBEAR Address Lock 0 PCIC0_PLBBEAR unlocked by Master 1 1 PCIC0_PLBBEAR locked by Master 1
19:17	M2ET	Master 2 Error Type See PCIC0_PLBBESR0[M0ET]

Preliminary User's Manual

16	M2RWS	Master 2 Read/Write Status 0 Error operation was a write 1 Error operation was a read
15	M2FL	Master 2 PCIC0_PLBBESR0 Field Lock 0 PCIC0_PLBB ESR0 unlocked 1 PCIC0_PLBB ESR0 locked
14	M2AL	Master 2 PCIC0_PLBBEAR Address Lock 0 PCIC0_PLBBEAR unlocked by Master 2 1 PCIC0_PLBBEAR locked by Master 2
13:11	M3ET	Master 3 Error Type See PCIC0_PLBBESR0[M0ET]
10	M3RWS	Master 3 Read/Write Status 0 Error operation was a write 1 Error operation was a read
9	M3FL	Master 3 PCIC0_PLBBESR0 Field Lock 0 PCIC0_PLBBESR0 unlocked 1 PCIC0_PLBBESR0 locked
8	M3AL	Master 3 PCIC0_PLBBEAR Address Lock 0 PCIC0_PLBBEAR Unlocked by Master 2 1 PCIC0_PLBBEAR Locked by Master 2
7:0		Reserved

PCIC0_PLBBESR1

PLB Slave Error Syndrome Register 1

Accessed using PCIC0_CFGADDR, PCIC0_CFGDATA; offset 0x53–0x50

See “PLB Slave Error Syndrome Register 1 (PCIC0_PLBBESR1)” on page 431.

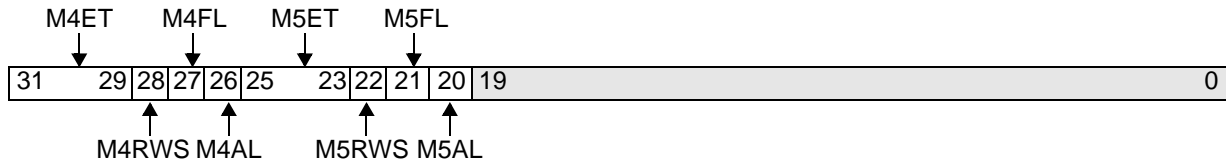

Figure 25-159. PLB Slave Error Syndrome 1 (PCIC0_PLBBESR1)

31:29	M4ET	Master 4 Error Type 000 No Error 001 Parity Error 010 Reserved 011 Reserved 100 Reserved 101 Non-configured Bank Error 110 Reserved 111 Reserved
28	M4RWS	Master 4 Read/Write Status 0 Write error operation 1 Read error operation
27	M4FL	Master 4 PCIC0_PLBBESR1 Field Lock 0 PCIC0_PLBBESR1 unlocked 1 PCIC0_PLBBESR1 locked
26	M4AL	Master 4 PCIC0_PLBBEAR Address Lock 0 PCIC0_PLBBEAR unlocked by Master 4 1 PCIC0_PLBBEAR locked by Master 4
25:23	M5ET	Master 5 Error Type See PCIC0_PLBBESR1[M4ET]
22	M5RWS	Master 5 Read/Write Status 0 Write error operation 1 Read error operation
21	M5FL	Master 5 PCIC0_PLBBESR1 Field Lock 0 PCIC0_PLBBESR1 Unlocked 1 PCIC0_PLBBESR1 Locked
20	M5AL	Master 5 PCIC0_PLBBEAR Address Lock 0 PCIC0_PLBBEAR unlocked by Master 5 1 PCIC0_PLBBEAR locked by Master 5
19:0		Reserved

Accessed using PCIC0_CFGADDR, PCIC0_CFGDATA; offset 0x5A (Read-Only)

See “Power Management Capabilities (PCIC0_PMC)” on page 434.

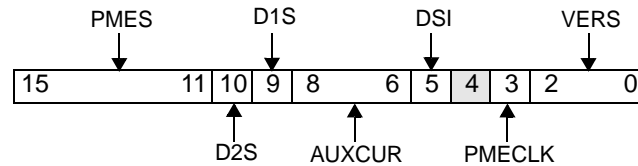

Figure 25-160. Power Management Capabilities Register (PCIC0_PMC)

15:11	PMES	PME Support	The PCI bridge does not support PME#; therefore, PMES is hardwired to 0b00000.
10	D2S	D2 Support Determines if the D2 power management state is supported.	The PCI bridge does not support the D2 power management state; therefore, D2S is hardwired to 0.
9	D1S	D1 Support Determines if the D1 power management state is supported.	The PCI bridge supports the D1 power management state; therefore, D1S is hardwired to 1.
8:6	AUXCUR	Auxiliary Current Support	The PCI bridge does not support Aux_Current; therefore, AUXCUR is hardwired to 0b000.
5	DSI	Device Specific Initialization 0 after reset	This bit indicates whether special initialization of this function is required (beyond the standard PCI configuration header) before the generic class device driver is able to use it.
4		Reserved	Always read as 0.
3	PMECLK		This bit is hardwired to 0 indicating that the function does not support PME# generation in any state.
2:0	VERS		Returns 0b010 on reads, indicating that PMC complies with Revision 1.1 of <i>PCI Power Management Interface Specification</i> .

PCIC0_PMCSR

PCI Power Management Control Status

Accessed using PCIC0_CFGADDR, PCIC0_CFGDATA; offset 0x5D–0x5C

See “Power Management Control/Status Register (PCIC0_PMCSR)” on page 435.

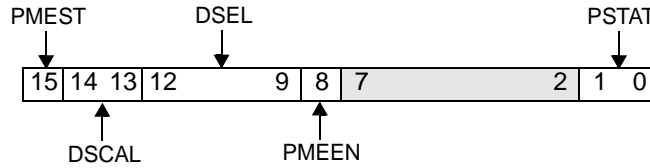

Figure 25-161. Power Management Control/Status Register (PCIC0_PMCSR)

15	PMEST		The PCI bridge does not support PME#; therefore, PMEST is hardwired to 0.
14:13	DSCAL		The PCI bridge does not support data register; therefore, DSCAL is hardwired to 0b00.
12:9	DSEL		The PCI bridge does not support a data register; therefore, DSEL is hardwired to 0b0000.
8	PMEEN		The PCI bridge does not support PME generation; therefore, PMEEN is hardwired to 0.
7:2		Reserved	Returns 0 when read.
1:0	PSTAT	Determine the current power state of a function and sets the function into a new power state. 00 D0 01 D1 10 D2 11 D3 Hot	If software attempts to write a value for an unsupported power state to PSTAT, its value does not change. Writing this field may change PCIC0_PMSCRR.

Preliminary User's Manual

Accessed using PCIC0_CFGADDR, PCIC0_CFGDATA; offset 0x5E Read-Only

See "PMCSR PCI-to-PCI Bridge Support Extensions (PCIC0_PMCSRBSE)" on page 436.



Figure 25-162. PMCSR PCI to PCI Bridge Support Extensions (PCIC0_PMCSRBSE)

7:0	PCI to PCI Bridge Support Extensions
-----	--------------------------------------

PCIC0_PMSCRR

PCI Power Management State Change Request Register

Accessed using PCIC0_CFGADDR, PCIC0_CFGDATA; offset 0x64

See "Power Management State Change Request Register (PCIC0_PMSCRR)" on page 438.

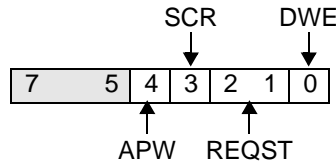

Figure 25-163. Power Management State Change Request Register (PCIC0_PMSCRR)

7:5		Reserved	Always read as 0.
4	APW	Accept PCIC0_PMCSR Writes Always 1 if DWE is 0.	The local processor sets APW when the local processor is ready to change the power management state. APW is cleared when the host configuration writes to the PCIC0_PMCSR register is accepted. The local processor can write 0 to APW.
3	SCR	State Change Request	The PCI bridge sets SCR when a host writes PCIC0_PMCSR to request a power management state change. This drives an interrupt to the local processor informing it of a state change request. The local processor must simultaneously clear SCR and set APW = 1 when the local processor is ready to change the state. After SCR is cleared, new requests are not detected until the outstanding delayed write is accepted. The local processor can set SCR = 1. Note that any host side write to any byte (0x5C–0x5F) is considered a power state change request.
2:1	REQST	Request State	Indicates the new power management state requested by a delayed host write to PCIC0_PMCSR. This field is read-only from the PLB side.
0	DWE	Delayed Write Enable 0 Immediate write 1 Delayed write	When DWE is set to 1, any configuration write to the PCIC0_PMCSR is completed as a delayed write. All writes to PCIC0_PMCSR are retried until the local processor sets the "Accept PCIC0_PMCSR Write bit" (bit 4). When 0, any configuration write to the PCIC0_PMCSR is completed immediately. DWE is a don't care if a host write to PCIC0_PMCSR requests a state change from D3hot to D0.

Accessed using PCIC0_CFGADDR, PCIC0_CFGDATA; offset 0x17–0x14

See “PCI PTM 1 BAR (PCIC0_PTM1BAR)” on page 422.

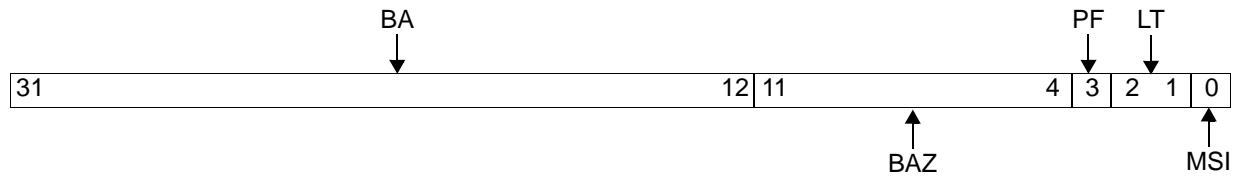

Figure 25-164. PCI PTM 1 BAR Register (PCIC0_PTM1BAR)

31:12	BA	Base Address These bits determine where in PCI memory address space this region is located.	Only corresponding bits in PCIL0_PTM1MS that are set to 1 are writable. Bits in PCIL0_PTM1MS that are set to 0 cause the corresponding Base Address register bits to be always 0. PCIL0_PTM1MS must be initialized by a PLB master before any PCI device is allowed to configure this register.
11:4	BAZ	Base Address Always Zero	BAZ = 0x00 because the minimum size of this range is 4KB.
3	PF	Prefetchable	PF = 1 to indicate that prefetching is allowed.
2:1	LT	Location Type	LT = 0b00 to indicate that the memory space can be located anywhere in the 32-bit address space.
0	MSI	Memory Space Indicator	MSI = 0 to indicate memory space, rather than I/O space.

PCIC0_PTM2BAR

PCI PTM 2 Base Address Range

Accessed using PCIC0_CFGADDR, PCIC0_CFGDATA; offset 0x1B–0x18

See “PCI PTM 2 BAR (PCIC0_PTM2BAR)” on page 423.

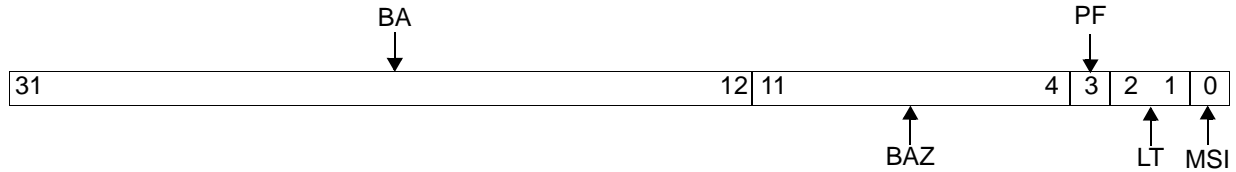

Figure 25-165. PCI PTM 2 BAR Register (PCIC0_PTM2BAR)

31:12	BA	Base Address These bits determine where in PCI Memory address space this region is located.	Only corresponding bits in PCIL0_PTM2MS that are set to 1 are writable. Bits in PCIL0_PTM2MS that are set to 0 cause the corresponding Base Address register bits to be always 0. PCIL0_PTM2MS must be initialized by a PLB master before any PCI device can configure this register.
11:4	BAZ	Base Address Always Zero	BAZ = 0x00 because the minimum size of this range is 4KB.
3	PF	Prefetchable	PF = 1 to indicate that prefetching is allowed.
2:1	LT	Location Type	LT = 0b00 to indicate that the memory space can be located anywhere in the 32-bit address space.
0	MSI	Memory Space Indicator	MSI = 0 to indicate memory space, rather than I/O space.

Accessed using PCIC0_CFGADDR, PCIC0_CFGDATA; offset 0x08 Read-Only

See "PCI Revision ID Register (PCIC0_REVID)" on page 419.

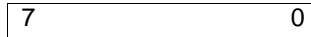

Figure 25-166. PCI Revision ID Register (PCIC0_REVID)

7:0	Revision ID	Revision level of device.
-----	-------------	---------------------------

Accessed using PCIC0_CFGADDR, PCIC0_CFGDATA; Offset 0x2D–0x2C

See “PCI Subsystem ID Register (PCIC0_SBSYSID)” on page 424.

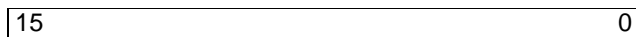

Figure 25-167. PCI Subsystem ID Register (PCIC0_SBSYSID)

15:0	PCI Subsystem ID
------	------------------

Accessed using PCIC0_CFGADDR, PCIC0_CFGDATA; Offset 0x2F–0x2E

See “PCI Subsystem Vendor ID Register (PCIC0_SBSYSVID)” on page 423.



Figure 25-168. PCI Subsystem Vendor ID Register (PCIC0_SBSYSVID)

15:0	PCI Subsystem Vendor ID
------	-------------------------

Accessed using PCIC0_CFGADDR, PCIC0_CFGDATA; offset 0x07–0x06

See “PCI Status Register (PCIC0_STATUS)” on page 417.

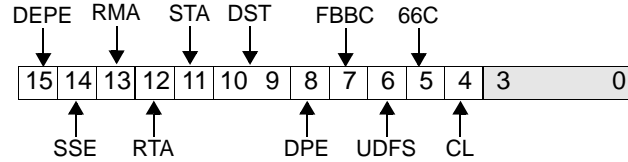

Figure 25-169. PCI Status Register (PCIC0_STATUS)

15	DEPE	Detected Parity Error Write 1 to clear.	The PCI bridge sets DEPE when the PCI bridge detects a PCI bus parity error, regardless of the setting of any enable bits (DEPE is non-maskable). The following events set DEPE: <ul style="list-style-type: none"> • PCI address bus parity error detected when PCI bridge is a target. • PCI data bus parity error detected when a PCI master writes to PLB memory (PCI bridge is the target). • PCI data bus parity error detected when PCI bridge masters a PCI read cycle.
14	SSE	Signaled System Error Write 1 to clear.	The PCI bridge sets SSE if the PCI bridge asserts PCISerr (see “Error Handling” on page 17-439 for causes of PCISerr assertion).
13	RMA	Received Master Abort Write 1 to clear.	The PCI bridge sets RMA when a PCI cycle for which the PCI bridge is the master is terminated with master abort.
12	RTA	Received Target Abort Write 1 to clear.	The PCI bridge sets RTA when a PCI cycle for which it is the master is terminated with target abort.
11	STA	Signaled Target Abort Write 1 to clear.	The PCI bridge sets STA when a PCI cycle for which it is the target is terminated with target abort.
10:9	DST	PCIDevSel Response Timing Read-only.	The PCI bridge asserts PCIDevSel on the second clock after PCIFrame is asserted (called medium response time). Read-only; always returns 0b01 when read.
8	DPE	Data Parity Error Detected Write 1 to clear.	DPE is set when the following conditions are met: <ul style="list-style-type: none"> • The PCI bridge detects a data parity error (PCIPerr is asserted) when the PCI bridge is the master on a PCI read cycle, or is the master when it samples PCIPerr asserted on a PCI write cycle. • PCIC0_CMD[PER] = 1.

Preliminary User's Manual

7	FBBC	Fast Back-to-Back Capable Read-only; returns 0 when read.	Indicates that the PCI target can accept fast back-to-back transactions when the transactions are not to the same agent. The PCI bridge target does not accept this type of fast back-to-back transaction.
6	UDFS	UDF Supported Read-only; returns 0 when read.	Indicates device support of user-definable features. The PCI bridge does not support user-definable features.
5	66C	66 MHz Capable 0 At reset 1 PCI bridge is configured for 66MHz operation.	Indicates that the device can run at 66 MHz. The PCI bridge can be configured to run at 33 MHz max or 66 MHz. The local CPU (PLB master) sets 66C to 1 if PCI bridge is configured for 66 MHz operation.
4	CL	Capabilities List This bit is read only and returns 1 when read.	Indicates that the value at offset 0x34 is a pointer in configuration space to a linked list of new capabilities.
3:0		Reserved	These bits return 0s when read.

PCIC0_VENDID

PCI Vendor ID

Accessed using PCIC0_CFGADDR, PCIC0_CFGDATA; Offset 0x01–0x00 Read-Only (PCI), R/W (PLB)

See “PCI Vendor ID Register (PCIC0_VENDID)” on page 415.



Figure 25-170. PCI Vendor ID Register (PCIC0_VENDID)

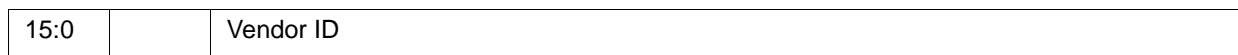

MMIO 0xEF400000

See “PMM 0 Local Address Register (PCIL0_PMM0LA)” on page 406.



Figure 25-171. PMM 0 Local Address Register (PCIL0_PMM0LA)

31:12	WLA	Writable PLB Local Address
11:0		PLB Local Address Always 0

MMIO 0xEF400004

See “PMM 0 Mask/Attribute Register (PCIL0_PMM0MA)” on page 406.

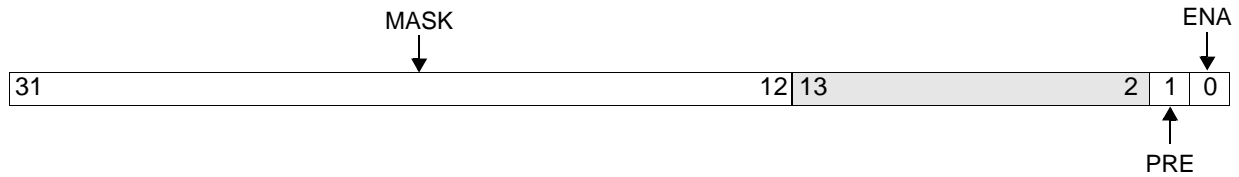

Figure 25-172. PMM 0 Mask/Attribute Register (PCIL0_PMM0MA)

31:12	MASK	The mask bits determine the size of the address map range.	The mask must be of the form 111...0000. Bits set to 1 cause the corresponding PCIL0_PMM0LA bits to be compared with incoming PLB addresses. Note that the minimum range size is 4KB, and valid ranges are powers of 2. For example, a 128MB range would be encoded as 0xF8000 and a 4KB range would be encoded as all ones.
11:2		Reserved	Returns 0 when read.
1	PRE	Read Prefetching Enable 1 Read prefetching is enabled.	If read prefetch is enabled, the PCI bridge prefetches 64 bytes from PCI memory in response to a PLB single-beat, byte-burst, or half word burst read from PMM 0.
0	ENA	PLB to PCI Memory Mapping Enable 1 Memory mapping is enabled.	Note that PCIL0_PMM0LA, PCIL0_PMM0PCIHA, and PCIL0_PMM0PCILA must be initialized before enabling.

MMIO 0xEF40000C

See "PMM 0 PCI High Address Register (PCIL0_PMM0PCIHA)" on page 407.

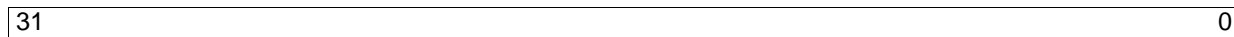
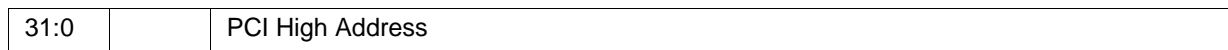

Figure 25-173. PMM 1 PCI High Address Register (PCIL0_PMM1PCIHA)



MMIO 0xEF400008

See "PMM 0 PCI Low Address Register (PCIL0_PMM0PCILA)" on page 407.



Figure 25-174. PMM 0 PCI Low Address Register (PCIL0_PMM0PCILA)

31:12	WLA	Writable PCI Low Address	
11:0		PCI Low Address	Always 0

MMIO 0xEF400010

See “PMM 1 Local Address Register (PCIL0_PMM1LA)” on page 408.

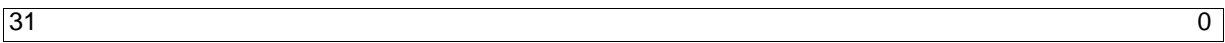
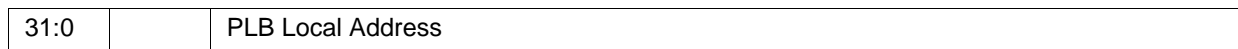

Figure 25-175. PMM 1 Local Address Register (PCIL0_PMM1LA)



MMIO 0xEF400014

See "PMM 1 Mask/Attribute Register (PCIL0_PMM1MA)" on page 408.

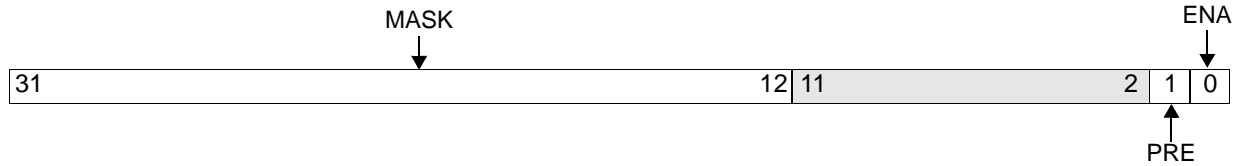

Figure 25-176. PMM 1 Mask/Attribute Register (PCIL0_PMM1MA)

31:12	MASK	The mask bits determine the size of the address map range.	The mask must be of the form 111....0000. Bits set to 1 cause the corresponding PCIL0_PMM1LA bits to be compared with incoming PLB addresses. Note that the minimum range size is 4KB, and valid ranges are powers of 2. For example, a 128MB range would be encoded as 0xF8000 and a 4KB range would be encoded as 0x11111.
11:2		Reserved	Returns 0 when read.
1	PRE	Read Prefetching Enable 1 Read prefetching is enabled.	If read prefetch is enabled, the PCI bridge prefetches 64 bytes from PCI memory in response to a PLB single-beat, byte-burst, or half word burst read from PMM 0.
0	ENA	PLB to PCI Memory Mapping Enable 1 Memory mapping is enabled.	Note that PCIL0_PMM1LA, PCIL0_PMM1PCIHA, and PCIL0_PMM1PCILA must be initialized before enabling.

MMIO 0xEF40001C

See “PMM 1 PCI High Address Register (PCIL0_PMM1PCIHA)” on page 409.

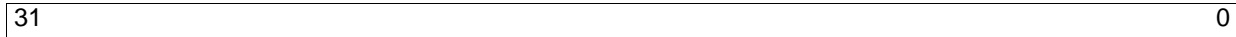

Figure 25-177. PMM 1 PCI High Address Register (PCIL0_PMM1PCIHA)



MMIO 0xEF400018

See “PMM 1 PCI Low Address Register (PCIL0_PMM1PCILA)” on page 409.

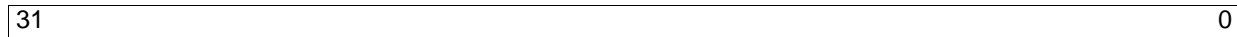
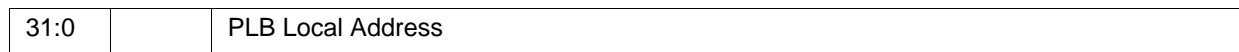

Figure 25-178. PMM 1 PCI Low Address Register (PCIL0_PMM1PCILA)

31:12	WLA	Writable PCI Low Address	
11:0		PCI Low Address	Always 0

MMIO 0xEF400020

See "PMM 2 Local Address Register (PCIL0_PMM2LA)" on page 409.

**Figure 25-179. PMM 2 Local Address Register (PCIL0_PMM2LA)**

MMIO 0xEF400024

See "PMM 2 Mask/Attribute Register (PCIL0_PMM2MA)" on page 410.

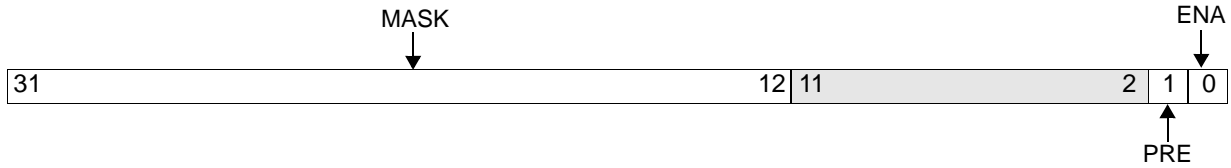

Figure 25-180. PMM 2 Mask/Attribute Register (PCIL0_PMM2MA)

31:12	MASK	The mask bits determine the size of the address map range.	The mask must be of the form 111....0000. Bits set to 1 cause the corresponding PCIL0_PMM2LA bits to be compared with incoming PLB addresses. Note that the minimum range size is 4KB, and valid ranges are powers of 2. For example, a 128MB range would be encoded as 0xF8000 and a 4KB range would be encoded as 0x11111.
11:2		Reserved	Returns 0 when read.
1	PRE	Read Prefetching Enable 1 Read prefetching is enabled.	If read prefetch is enabled, the PCI bridge prefetches 64 bytes from PCI memory in response to a PLB single-beat, byte-burst, or half word burst read from PMM 0.
0	ENA	PLB to PCI Memory Mapping Enable 1 Memory mapping is enabled.	Note that PCIL0_PMM2LA, PCIL0_PMM2PCIHA, and PCIL0_PMM2PCILA must be initialized before enabling.

MMIO 0xEF40002C

See “PMM 2 PCI High Address Register (PCIL0_PMM2PCIHA)” on page 411.

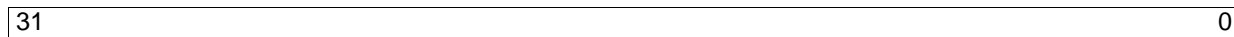

Figure 25-181. PMM 2 PCI High Address Register (PCIL0_PMM2PCIHA)

31:0	PCI High Address
------	------------------

MMIO 0xEF400028

See “PMM 2 PCI Low Address Register (PCIL0_PMM2PCILA)” on page 410.



Figure 25-182. PMM 2 PCI Low Address Register (PCIL0_PMM2PCILA)

31:12	WLA	Writable PCI Low Address
11:0		PCI Low Address Always 0

MMIO 0xEF400034

See “PTM 1 Local Address Register (PCIL0_PTM1LA)” on page 412.



Figure 25-183. PTM 2 Local Address Register (PCIL0_PTM1LA)

31:12	WLA	Writable PTM 1 Local Address	Writable
11:0		PTM 1 Local Address	Always 0

MMIO 0xEF400030

See "PTM 1 Memory Size/Attribute Register (PCIL0_PTM1MS)" on page 411.

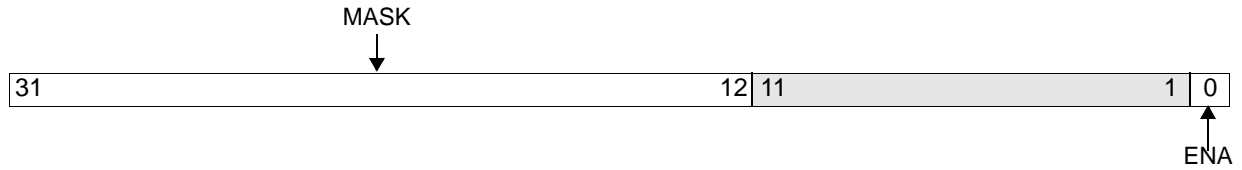

Figure 25-184. PTM 1 Memory Size/Attribute Register (PCIL0_PTM1MS)

31:12	MASK	Defines the size of the region of PCI memory space that is mapped to local (PLB) space using PTM 1.	The minimum range size is 4KB. Valid ranges are always a power of 2. For example, a value of 0xFF000000 indicates that the region contains 16MB.
11:1		Reserved	Returns 0 when read.
0	ENA	Determines if range 1 is enabled to map PCI memory space to PLB space.	

MMIO 0xEF40003C

See "PTM 2 Local Address Register (PCIL0_PTM2LA)" on page 413.

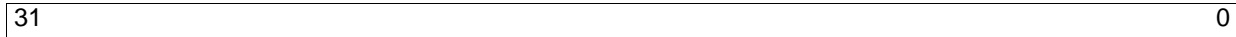

Figure 25-185. PTM 2 Local Address Register (PCIL0_PTM2LA)



MMIO 0xEF400038

See "PTM 2 Memory Size/Attribute Register (PCIL0_PTM2MS)" on page 412.

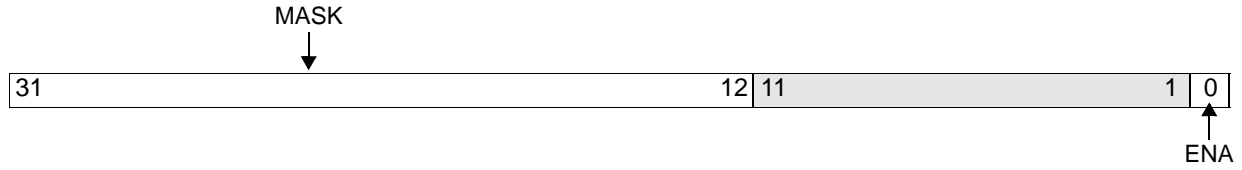

Figure 25-186. PTM 2 Memory Size/Attribute Register (PCIL0_PTM2MS)

31:12	MASK	Defines the size of the region of PCI memory space mapped to local (PLB) space using PTM 2.	The minimum range size is 4KB. Valid ranges are always a power of 2. For example, a value of 0xFF000000 indicates that the region contains 16MB.
11:1		Reserved.	Returns 0 when read.
0	ENA	Determines if range 2 is enabled to map PCI memory space to PLB space.	When ENA is disabled, PCIC0_PTM2BAR cannot be written. Set PCIC0_PTM2BAR to 0 before disabling ENA.

PLB Register

DCR 0x087

See "PLB Arbiter Control Register (PLB0_ACR)" on page 67.

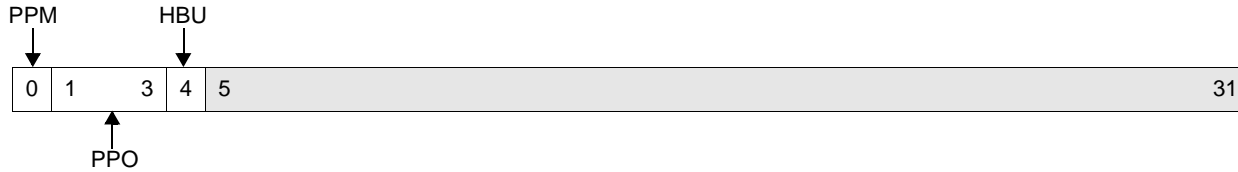
**Figure 25-187. PLB Arbiter Control Register (PLB0_ACR)**

0	PPM	PLB Priority Mode 0 Fixed 1 Fair
1:3	PPO	PLB Priority Order 000 Masters 0, 1, 2, 3, 4, 5 001 Masters 1, 2, 3, 4, 5, 0 010 Masters 2, 3, 4, 5, 0, 1 011 Masters 3, 4, 5, 0, 1, 2 100 Masters 4, 5, 0, 1, 2, 3 101 Masters 5, 0, 1, 2, 3, 4 110 Reserved 111 Reserved
4	HBU	High Bus Utilization 0 Disabled 1 Enabled
5:31		Reserved

PLB0_BEAR

PLB Error Address Register

DCR 0x086 Read-Only

See “PLB Error Address Register (PLB0_BEAR)” on page 69.

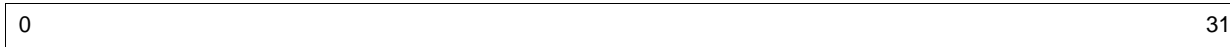

Figure 25-188. PLB Error Address Register (PLB0_BEAR)

0:31	Address of bus timeout error
------	------------------------------

DCR 0x084 Read/Clear

See "PLB Error Status Register (PLB0_BESR)" on page 69.

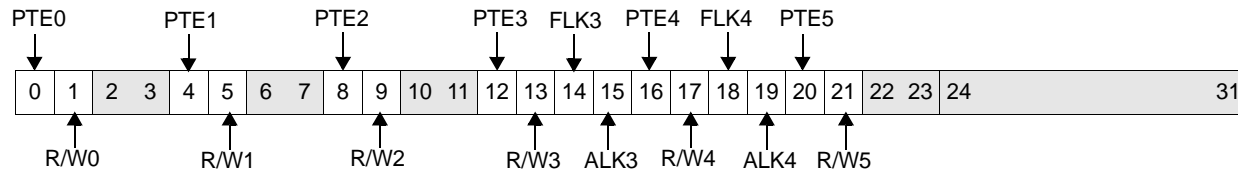

Figure 25-189. PLB Error Status Register (PLB0_BESR)

0	PTE0	Master 0 PLB Timeout Error Status 0 No master 0 timeout error 1 Master 0 timeout error	Master 0 is the processor core ICU.
1	R/W0	Master 0 Read/Write Status 0 Master 0 error operation was a write 1 Master 0 ICU error operation was a read	
2:3		Reserved	
4	PTE1	Master 1 PLB Timeout Error Status 0 No master 1 timeout error 1 Master 1 timeout error	Master 1 is the processor core DCU.
5	R/W1	Master 1 Read/Write Status 0 Master 1 error operation was a write 1 Master 1 error operation was a read	
6:7		Reserved	
8	PTE2	Master 2 PLB Timeout Error Status 0 No master 2 timeout error 1 Master 2 timeout error	Master 2 is the external master.
9	R/W2	Master 2 Read/Write Status 0 Master 2 error operation was a write 1 Master 2 error operation was a read	
10:11		Reserved	
12	PTE3	Master 3 PLB Timeout Error Status 0 No Master 3 timeout error 1 Master 3 timeout error	Master 3 is PCI.
13	R/W3	Master 3 Read/Write Status 0 Master 3 error operation was a write 1 Master 3 error operation was a read	
14	FLK3	Master 3 PLB0_BESR Field Lock 0 Master 3 PLB0_BESR field is unlocked 1 Master 3 PLB0_BESR field is locked	
15	ALK3	Master 3 PLB0_BEAR Address Lock 0 Master 3 PLB0_BEAR is unlocked 1 Master 3 PLB0_BEAR is locked	
16	PTE4	Master 4 PLB Timeout Error Status 0 No master 4 timeout error 1 Master 4 timeout error	Master 4 is MAL.
17	R/W4	Master 4 Read/Write Status 0 Master 4 error operation was a write 1 Master 4 error operation was a read	

PLB0_BESR (cont.)

PLB Error Status Register

Preliminary User's Manual

18	FLK4	Master 4 PLB0_BESR Field Lock 0 Master 4 PLB0_BESR field is unlocked 1 Master 4 field is locked
19	ALK4	Master 4 PLB0_BEAR Address Lock 0 Master 4 PLB0_BEAR is unlocked 1 Master 4 PLB0_BEAR is locked
20	PTE5	Master 5 PLB Timeout Error Status Master 5 is DMA. 0 No master 5 timeout error 1 Master 5 timeout error
21	R/W5	Master 5 Read/Write Status 0 Master 5 error operation was a write 1 Master 5 error operation was a read
22:31		Reserved

POB0_BEAR Register

DCR 0x0A2 Read-Only

See “Bridge Error Address Register (POB0_BEAR)” on page 71.

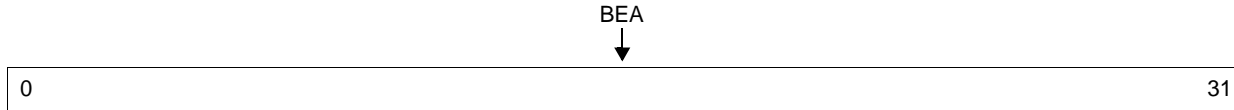

Figure 25-190. Bridge Error Address Register (POB0_BEAR)

0:31	BEA	Address of bus error
------	-----	----------------------

POB0_BESR0

Bridge Error Status Register 0

DCR 0x0A0 Read/Clear

See "Bridge Error Status Registers (POB0_BESR0–POB0_BESR1)" on page 72.

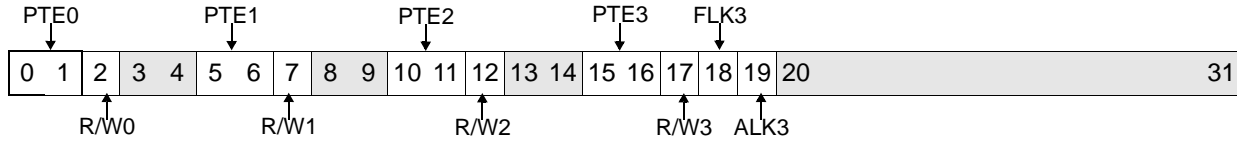

Figure 25-191. Bridge Error Status Register 0 (POB0_BESR0)

0:1	PTE0	PLB Timeout Error Status Master 0 00 No master 0 error occurred 01 Master 0 timeout error occurred 10 Master 0 slave error occurred 11 Reserved	Master 0 is the processor core ICU.
2	R/W0	Read Write Status Master 0 0 Master 0 error operation is a write 1 Master 0 error operation is a read	
3:4		Reserved	
5:6	PTE1	PLB Timeout Error Status Master 1 00 No master 1 error occurred 01 Master 1 timeout error occurred 10 Master 1 slave error occurred 11 Reserved	Master 1 is the processor core DCU.
7	R/W1	Read/Write Status Master 1 0 Master 1 error operation is a write 1 Master 1 error operation is a read	
8:9		Reserved	
10:11	PTE2	PLB Timeout Error Status Master 2 00 No master 2 error occurred 01 Master 2 timeout error occurred 10 Master 2 slave error occurred 11 Reserved	Master 2 is the external master.
12	R/W2	Read/Write Status Master 2 0 Master 2 error operation is a write 1 Master 2 error operation is a read	
13:14		Reserved	
15:16	PTE3	PLB Timeout Error Status Master 3 00 No master 3 error occurred 01 Master 3 timeout error occurred 10 Master 3 slave error occurred 11 Reserved	Master 3 is PCI.
17	R/W3	Read/Write Status Master 3 0 Master 3 error operation is a write 1 Master 3 error operation is a read	

18	FLK3	POB0_BESR0 Field Lock Master 3 0 Master 3 POB0_BESR0 field is unlocked 1 Master 3 POB0_BESR0 field is locked
19	ALK3	POB0_BEAR Address Lock Master 3 0 Master 3 POB0_BEAR address is unlocked 1 Master 3 POB0_BEAR address is locked
20:31		Reserved

POB0_BESR1

Bridge Error Status Register 1

DCR 0x0A4 Read/Clear

See "Bridge Error Status Registers (POB0_BESR0–POB0_BESR1)" on page 72.

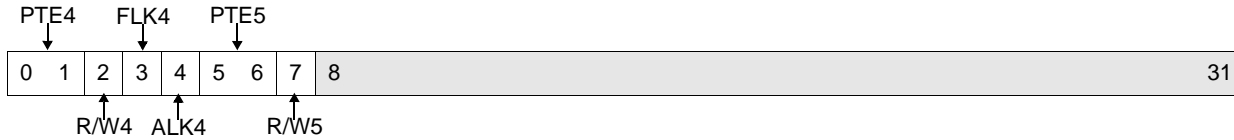

Figure 25-192. Bridge Error Status Register 1 (POB0_BESR1)

0:1	PTE4	PLB Timeout Error Status Master 4 00 No Master 4 error occurred 01 Master 4 timeout error occurred 10 Master 4 slave error occurred 11 Reserved	Master 4 is MAL.
2	R/W4	Read/Write Status Master 4 0 Master 4 error operation is a write 1 Master 4 error operation is a read	
3	FLK4	POB0_BESR1 Field Lock Master 4 0 Master 4 POB0_BESR1 field is unlocked 1 Master 4 POB0_BESR1 field is locked	
4	ALK4	POB0_BEAR Address Lock Master 4 0 Master 4 POB0_BEAR address is unlocked 1 Master 4 POB0_BEAR address is locked	
5:6	PTE5	PLB Timeout Error Status Master 5 00 No Master 5 error occurred 01 Master 5 timeout error occurred 10 Master 5 slave error occurred 11 Reserved	Master 5 is DMA.
7	R/W5	Read/Write Status Master 5 0 Master 5 error operation is a write 1 Master 5 error operation is a read	
8:31		Reserved	

SDRAM Registers

DCR Accessed using SDRAM0_CFGADDR; SDRAM0_CFGDATA; Offset 0x40–0x4C

See “Memory Bank 0–3 Configuration (SDRAM0_B0CR–SDRAM0_B3CR)” on page 332.

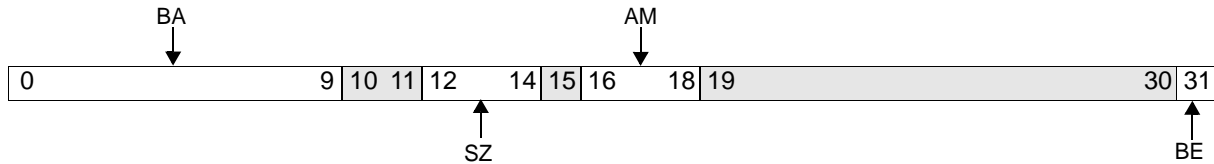

**Figure 25-193. Memory Bank 0–3 Configuration Registers
(SDRAM0_B0CR–SDRAM0_B3CR)**

0:9	BA	Base Address	The base address must be aligned on a boundary that matches the size of the region defined in the SZ field. For example, a 4 MB region must begin on an address that is divisible by 4 MB.
10:11		Reserved	
12:14	SZ	Size 000 4M byte 001 8M byte 010 16M byte 011 32M byte 100 64M byte 101 128M byte 110 256M byte 111 Reserved	
15		Reserved	
16:18	AM	Addressing Mode 000 Mode 1 001 Mode 2 010 Mode 3 011 Mode 4 100 Mode 5 101 Mode 6 110 Mode 7 111 Reserved	See Table 15-4, “SDRAM Addressing Modes,” on page 15-333.
19:30		Reserved	
31	BE	Memory Bank Enable 0 Bank is disabled 1 Bank is enabled	

SDRAM0_BEAR

PLB Master Bus Error Address Register

DCR Accessed using SDRAM0_CFGADDR; SDRAM0_CFGDATA; Offset 0x10

See "Bus Error Address Register (SDRAM0_BEAR)" on page 345.

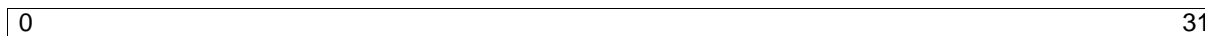

Figure 25-194. Bus Error Address Register (SDRAM0_BEAR)

0:31	Address of Bus Error.
------	-----------------------

Preliminary User's Manual

DCR Accessed using SDRAM0_CFGADDR; SDRAM0_CFGDATA; Offset 0x00 Read/Clear

See “Bus Error Syndrome Register 0 (SDRAM0_BESR0)” on page 345.

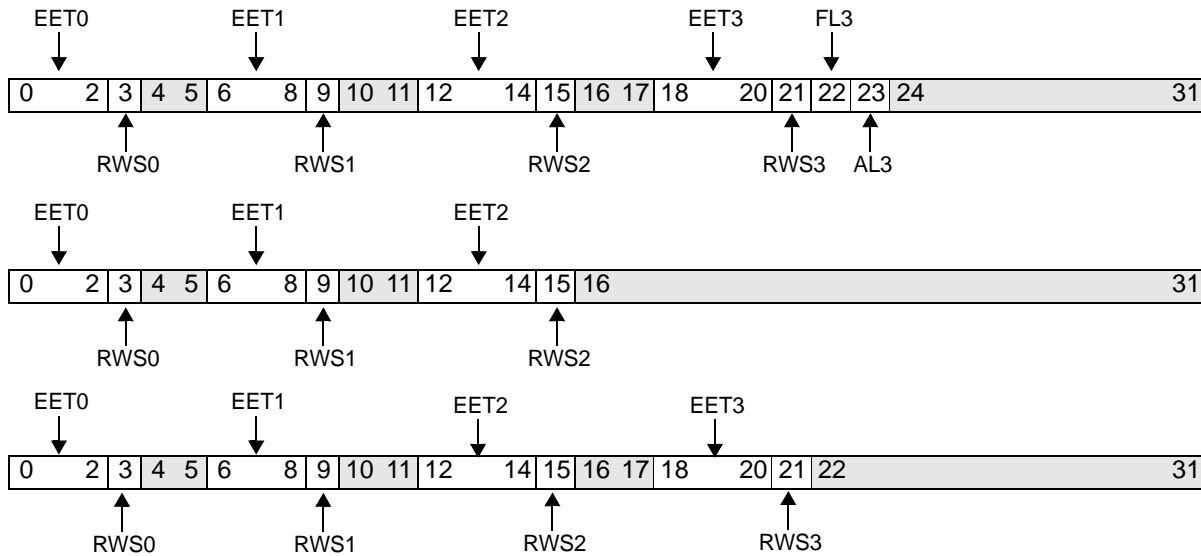

Figure 25-195. Bus Error Syndrome Register 0 (SDRAM0_BESR0)

0:2	EET0	Error type for master 0 000 No error 001 Reserved 01X ECC uncorrectable error 1XX Reserved	Master 0 is the processor instruction fetcher.
3	RWS0	Read/write status for master 0 0 Error operation was a write operation 1 Error operation was a read operation	
4:5		Reserved	
6:8	EET1	Error type for master 1 000 No error 001 Reserved 01X ECC uncorrectable error 1XX Reserved	Master 1 is the processor data side.
9	RWS1	Read/write status for master 1 0 Error operation was a write operation 1 Error operation was a read operation	
10:11		Reserved	
12:14	EET2	Error type for master 2 000 No error 001 Reserved 01X ECC uncorrectable error 1XX Reserved	Master 2 is the external bus master.
15	RWS2	Read/write status for master 2 0 Error operation was a write operation 1 Error operation was a read operation	
16:17		Reserved	

SDRAM0_BESR0 (cont.)

Bus Error Syndrome Register 0

18:20	EET3	Error type for master 3 000 No error 001 Reserved 01X ECC uncorrectable error 1XX Reserved	Master 3 is the PCI bridge.
21	RWS3	Read/write status for master 3 0 Error operation was a write operation 1 Error operation was a read operation	
22	FL3	Field lock for master 3 0 EET3 and RWS3 fields are unlocked 1 EET3 and RWS3 fields are locked	
23	AL3	SDRAM0_BEAR address lock for master 3 0 SDRAM0_BEAR address unlocked 1 SDRAM0_BEAR address locked	
24:31		Reserved	

DCR Accessed using SDRAM0_CFGADDR; SDRAM0_CFGDATA; Offset 0x08 Read/Clear

See “Bus Error Syndrome Register 1 (SDRAM0_BESR1)” on page 347.

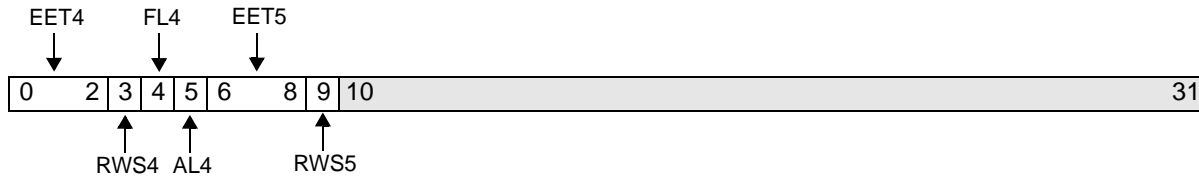
**Figure 25-196. Bus Error Status Register 1 (SDRAM0_BESR1)**

0:2	EET4	Error type for master 4 000 No error 001 Reserved 01X ECC uncorrectable error 1XX Reserved	Master 4 is the MAL.
3	RWS4	Read/write status for master 4 0 Error operation was a write operation 1 Error operation was a read operation	
4	FL4	Field lock for master 4 0 EET4 and RWS4 fields are unlocked 1 EET4 and RWS4 fields are locked	
5	AL4	SDRAM0_BEAR address lock for master 4 0 SDRAM0_BEAR address unlocked 1 SDRAM0_BEAR address locked	
6:8	EET5	Error type for master 5 000 No error 001 Reserved 01X ECC uncorrectable error 1XX Reserved	Master 5 is the DMA controller.
9	RWS5	Read/write status for master 5 0 Error operation was a write operation 1 Error operation was a read operation	
10:31		Reserved	

SDRAM0_CFG

Memory Controller Configuration Register

DCR Accessed using SDRAM0_CFGADDR; SDRAM0_CFGDATA; Offset 0x20

See "Memory Controller Configuration Register (SDRAM0_CFG)" on page 330.

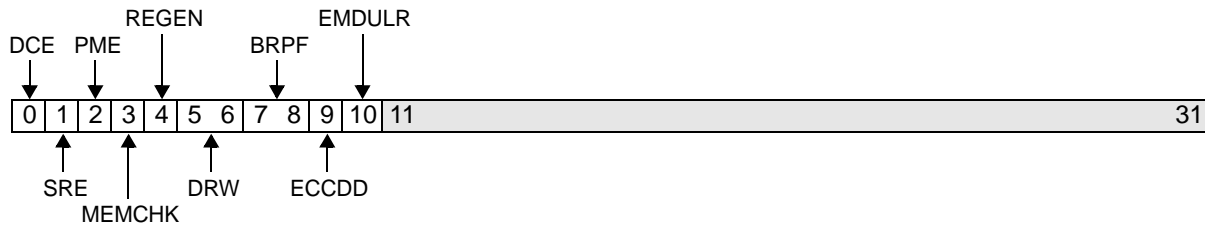

Figure 25-197. Memory Controller Configuration (SDRAM0_CFG)

0	DCE	SDRAM Controller Enable 0 Disable 1 Enable	All SDRAM controller configuration registers must be initialized and valid prior to setting DCE.
1	SRE	Self-Refresh Enable 0 Disable 1 Enable	See "Self-Refresh" on page 348.
2	PME	Power Management Enable 0 Disable 1 Enabled	See "Power Management" on page 348.
3	MEMCHK	Memory Data Error Checking 0 None 1 ECC	See "Error Checking and Correction (ECC)" on page 341.
4	REGEN	Registered Memory Enable 0 Disabled 1 Enabled	
5:6	DRW	SDRAM Width 00 32-bit 01 Reserved 10 Reserved 11 Reserved	Must be set to 0b00.
7:8	BRPF	Burst Read Prefetch Granularity 00 Reserved 01 16 bytes 10 32 bytes 11 Reserved	Most applications should set this field to 0b01.
9	ECCDD	ECC Driver Disable 0 Check bit data output on ECC0:7. 1 ECC0:7 are placed in high impedance.	Regardless of whether ECC checking is enabled, SDRAM writes cause the chip to write check bit data on ECC0:7. If ECC is unused, setting ECCDD = 1 disables these drivers.
10	EMDULR	Enable Memory Data Unless Read 0 MemData0:31 are placed in high impedance unless a memory write is being performed. 1 MemData0:31 are driven unless a memory read is being performed.	
11:31		Reserved	

DCR 0x010

See "Accessing SDRAM Registers" on page 328.

0	31
---	----

Figure 25-198. SDRAM Configuration Address Register (SDRAM0_CFGADDR)

0:31	Offset of indirectly-accessed DCR
------	-----------------------------------

DCR 0x011

See "Accessing SDRAM Registers" on page 328.

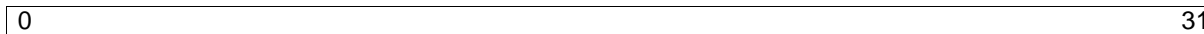
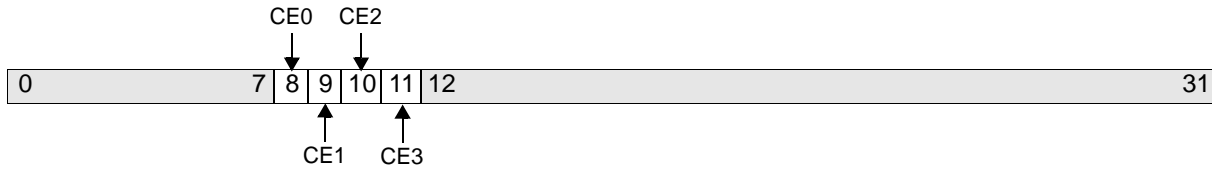

Figure 25-199. SDRAM Configuration Data Register (SDRAM0_CFGDATA)

0:31	Data from indirectly-accessed DCR
------	-----------------------------------

Offset 0x94 DCR Accessed using SDRAM0_CFGADDR; SDRAM0_CFGDATA; Offset 0x94

See “ECC Configuration Register (SDRAM0_ECCCFG)” on page 342.

**Figure 25-200. ECC Configuration Register (SDRAM0_ECCCFG)**

0:7		Reserved
8	CE0	ECC Correction Enable for Bank 0. 0 Disabled 1 Enabled
9	CE1	ECC Correction Enable for Bank 1. 0 Disabled 1 Enabled
10	CE2	ECC Correction Enable for Bank 2. 0 Disabled 1 Enabled
11	CE3	ECC Correction Enable for Bank 3. 0 Disabled 1 Enabled
12:31		Reserved

DCR Accessed using SDRAM0_CFGADDR; SDRAM0_CFGDATA; Offset 0x98 Read/Clear

See "ECC Error Status Register (SDRAM0_ECCESR)" on page 344.

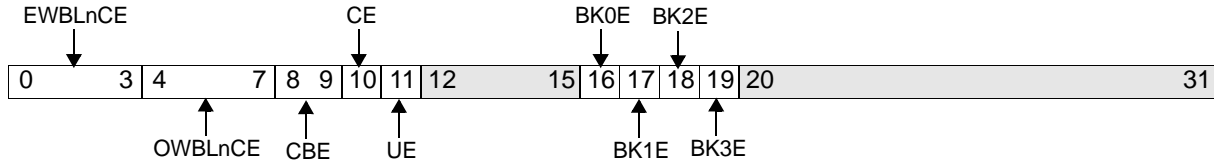

Figure 25-201. ECC Error Status Register (SDRAM0_ECCESR)

0:3	EWBLnCE	Even Word Byte Lane n Corrected Error 0000 No error 0001 Error occurred in byte lane 0 0010 Error occurred in byte lane 1 0100 Error occurred in byte lane 2 1000 Error occurred in byte lane 3	Because only one byte lane corrected error can occur at a time, field values containing more than one 1 do not occur.
4:7	OWBLnCE	Odd Word Byte Lane n Corrected Error 0000 No error 0001 Error occurred in byte lane 0 0010 Error occurred in byte lane 1 0100 Error occurred in byte lane 2 1000 Error occurred in byte lane 3	Because only one byte lane corrected error can occur at a time, field values containing more than one 1 do not occur.
8:9	CBE	Error Detected in Check bits 00 No error 01 Error in lower check bits 10 Error in upper check bits 11 Error in both sets of check bits	
10	CE	Correctable Error	
11	UE	Uncorrectable Error	
12:15		Reserved	
16	BK0E	Bank 0 Error 0 No error 1 Error occurred in bank 0	
17	BK1E	Bank 0 Error 0 No error 1 Error occurred in bank 1	
18	BK2E	Bank 0 Error 0 No error 1 Error occurred in bank 2	
19	BK3E	Bank 0 Error 0 No error 1 Error occurred in bank 3	
20:31		Reserved	

DCR Accessed using SDRAM0_CFGADDR; SDRAM0_CFGDATA; Offset 0x34

See “Power Management Idle Timer (SDRAM0_PMIT)” on page 349.

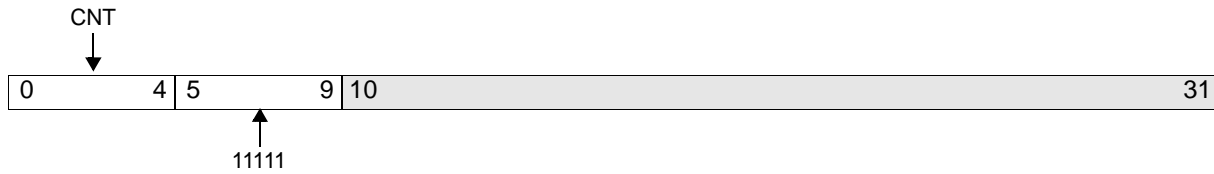

Figure 25-202. Power Management Idle Timer (SDRAM0_PMIT)

0:4	CNT	Cycle Count Before Sleep Request (0b00000–0b11111)	If CNT = 0b00000, the SDRAM clock must be idle for 32 cycles before the SDRAM controller asserts a sleep request.
5:9		Always 0b11111	
10:31		Reserved	

SDRAM0_RTR

Refresh Timer Register

DCR Accessed using SDRAM0_CFGADDR; SDRAM0_CFGDATA; Offset 0x30

See "Refresh Timer Register (SDRAM0_RTR)" on page 341.

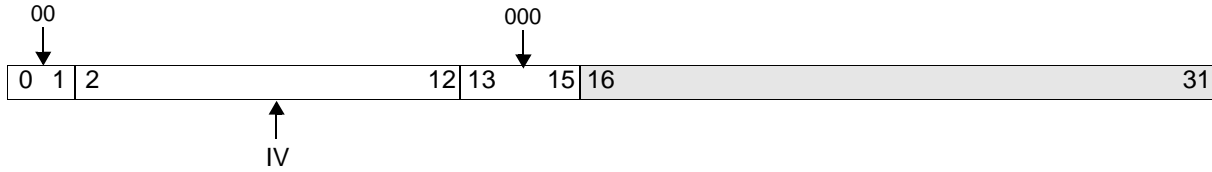
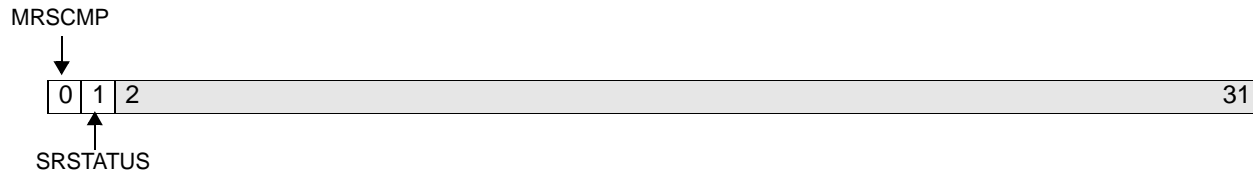

Figure 25-203. Refresh Timing Register (SDRAM0_RTR)

0:1		Always 0b00
2:12	IV	Interval Including bits 0:1 and 13:15, the value of the high-order halfword of the register can range from 0x0000–0x3BF8
13:15		Always 0b000
16:31		Reserved

DCR Accessed using SDRAM0_CFGADDR; SDRAM0_CFGDATA; Offset 0x24

See “Memory Controller Status (SDRAM0_STATUS)” on page 331.

**Figure 25-204. Memory Controller Status (SDRAM0_STATUS)**

0	MRSCMP	Mode Register Set Complete 0 MRS not complete 1 MRS completed	Set to 1 when the SDRAM controller completes the Mode Register Set Command, which results from setting SDRAM0_CFG[DCE]. Clearing SDRAM0_CFG[DCE] causes this bit to clear in the following MemClkOut1:0 cycle.
1	SRSTATUS	Self-Refresh State 0 Not in Self-Refresh Mode 1 Self-Refresh Mode	See “Self-Refresh” on page 348.
2:31		Reserved	

SDRAM0_TR

SDRAM Timing Register

DCR Accessed using SDRAM0_CFGADDR; SDRAM0_CFGDATA; Offset 0x80

See "SDRAM Timing Register (SDRAM0_TR)" on page 335.

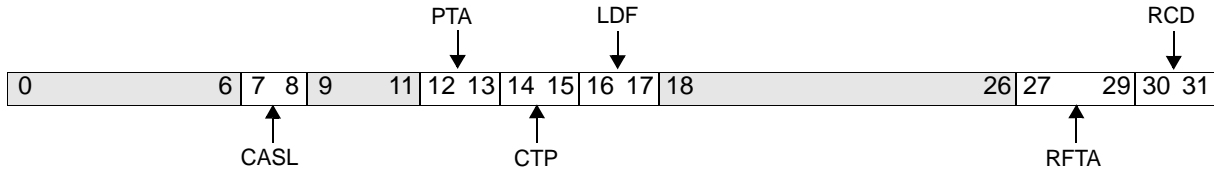

Figure 25-205. SDRAM Timing Register (SDRAM0_TR)

0:6		Reserved
7:8	CASL	SDRAM $\overline{\text{CAS}}$ latency. 00 Reserved 01 2 MemClkOut1:0 cycles 10 3 MemClkOut1:0 cycles 11 4 MemClkOut1:0 cycles
9:11		Reserved
12:13	PTA	SDRAM Precharge Command to next Activate Command minimum. 00 Reserved 01 2 MemClkOut1:0 cycles 10 3 MemClkOut1:0 cycles 11 4 MemClkOut1:0 cycles
14:15	CTP	SDRAM Read / Write Command to Precharge Command minimum. 00 Reserved 01 2 MemClkOut1:0 cycles 10 3 MemClkOut1:0 cycles 11 4 MemClkOut1:0 cycles
16:17	LDF	SDRAM Command Leadoff. 00 Reserved 01 2 MemClkOut1:0 cycles 10 3 MemClkOut1:0 cycles 11 4 MemClkOut1:0 cycles
18:26		Reserved
27:29	RFTA	SDRAM $\overline{\text{CAS}}$ before $\overline{\text{RAS}}$ Refresh Command to next Activate Command minimum. 000 4 MemClkOut1:0 cycles 001 5 MemClkOut1:0 cycles 010 6 MemClkOut1:0 cycles 011 7 MemClkOut1:0 cycles 100 8 MemClkOut1:0 cycles 101 9 MemClkOut1:0 cycles 110 10 MemClkOut1:0 cycles 111 Reserved

30:31	RCD	SDRAM RAS to CAS Delay 00 Reserved 01 2 MemClkOut1:0 cycles 10 3 MemClkOut1:0 cycles 11 4 MemClkOut1:0 cycles
-------	-----	---

UARTx_DLL

UART Baud-Rate Divisor Latch LSB Registers

UART Registers

MMIO 0xEF600300 (UART0), 0xEF600400 (UART1)

See "UART Baud-Rate Divisor Latch (LSB) Registers (UARTx_DLL)" on page 622.



Figure 25-206. UART Baud-Rate Divisor Latch (LSB) Registers (UARTx_DLL)

8:15		Data bits
Note: UARTx_DLL is shown in standard PowerPC bit notation, where 0 is the MSb and 7 is the LSb.		

MMIO 0xEF600301 (UART0), 0xEF600401 (UART1)

See “UART Baud-Rate Divisor Latch (MSB) Registers (UARTx_DLM)” on page 622.

0	7
---	---

Figure 25-207. UART Baud-Rate Divisor Latch (MSB) Registers (UARTx_DLM)

0:7	Data bits
Note: UARTx_DLM is shown in standard PowerPC bit notation, where 0 is the MSb and 7 is the LSb.	

UARTx_FCR

UART FIFO Control Registers

MMIO 0xEF600302 (UART0), 0xEF600402 (UART1) Write-Only

See "FIFO Control Registers (UARTx_FCR)" on page 615.

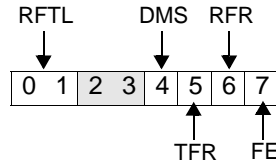
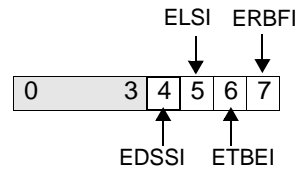

Figure 25-208. UART FIFO Control Registers (UARTx_FCR)

0:1	RFTL	Receiver FIFO Trigger Level 00 1 byte 01 4 bytes 10 8 bytes 11 14 bytes	
2:3		Reserved	
4	DMS	DMA Mode Select 0 Mode 0 = single transfer 1 Mode 1 = multiple transfers	Select single or multiple transfer mode if UARTx_FCR[7] = 1.
5	TFR	Transmitter FIFO Reset 0 Operation complete 1 Reset the transmitter FIFO	A 1 written to this bit clears all bytes in the transmitter FIFO and resets all of its counter logic to 0. The transmitter shift register is not cleared. This bit is self-clearing.
6	RFR	Receiver FIFO Reset 0 Operation complete 1 Reset the receiver FIFO	A 1 written to this bit clears all bytes in the receiver FIFO and resets all of its counter logic to 0. The receiver shift register is not cleared. This bit is self-clearing.
7	FE	FIFO Enable 0 Disable FIFOs 1 Enable FIFOs	When set to 1, both the receiver and transmitter FIFOs are enabled. When set to 0, both receiver and transmitter FIFOs are reset. Data is automatically cleared from both FIFOs when changing to and from FIFO and 16450 modes. Programming other bits will be ignored if this bit is not a 1.
<p>Note: UARTx_FCR is shown in standard PowerPC bit notation, where 0 is the MSb and 7 is the LSb.</p>			

MMIO 0xEF600301 (UART0), xEF600401 (UART1)

See "Interrupt Enable Registers (UARTx_IER)" on page 613.

**Figure 25-209. UART Interrupt Enable Registers (UARTx_IER)**

0:3		Reserved	Always 0.
4	EDSSI	Enable Modem Status Interrupt 0 Disable modem status interrupt 1 Enable modem status interrupt	
5	ELSI	Enable Receiver Line Status Interrupt 0 Disable receiver line status interrupt 1 Enable receiver line status interrupt	
6	ETBEI	Enable Transmitter Holding Register Empty Interrupt 0 Disable transmitter holding register empty interrupt 1 Enable transmitter holding register empty interrupt	
7	ERBFI	Enable Received Data Available Interrupt 0 Disable received data available interrupt 1 Enable received data available interrupt	In FIFO mode, timeout interrupts follow the enable/disable state of ERDAI.
Note: UARTx_IER is shown in standard PowerPC bit notation, where 0 is the MSb and 7 is the LSb			

UARTx_IIR

UART Interrupt Identification Registers

MMIO 0xEF600302 (UART0), 0xEF600402 (UART1) Read-Only

See "Interrupt Identification Registers (UARTx_IIR)" on page 614.

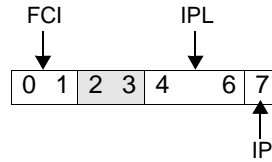

Figure 25-210. UART Interrupt Identification Registers (UARTx_IIR)

0:1	FCI	FIFO Control Indicator 00 FIFOs disabled (UARTx_FCR[FE] = 0) 01 Reserved 10 Reserved 11 FIFOs enabled (UARTx_FCR[FE] = 1)	
2:3		Reserved	
4:6	IPL	Interrupt Priority Level 000 Priority level 4 001 Priority level 3 010 Priority level 2 011 Priority level 1 100 Reserved 101 Reserved 110 Priority level 2 111 Reserved	See Table 21-3. Note: Priority 1 is highest priority.
7	IP	Interrupt Pending 0 Interrupt is pending 1 No interrupt pending	When set to 0, IIR contents can be used as a pointer to the appropriate interrupt service routine.
Note: UARTx_IIR is shown in standard PowerPC bit notation, where 0 is the MSb and 7 is the LSb.			

MMIO 0xEF600303 (UART0), 0xEF600403 (UART1)

See “Line Control Registers (UARTx_LCR)” on page 617.

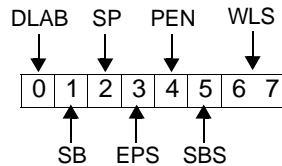

Figure 25-211. UART Line Control Registers (UARTx_LCR)

0	DLAB	Divisor Latch Access Bit 0 Address RBR, THR and IER with LTADR2-0 for read or write operation 1 Address Divisor Latches with LTADR2-0 for read or write operation	
1	SB	Set Break 0 Disable Break 1 Enable Break	Causes a break condition to be transmitted to the UART when the core is receiving. SOUT is forced to the spacing state (0). This bit acts only on SOUT and has no effect on the transmitter logic.
2	SP	Sticky Parity 0 Disable sticky parity 1 Enable sticky parity	If UARTx_LCR[EPS] = 1 and UARTx_LCR[PEN] = 1, the parity bit is transmitted and checked as 0. If UARTx_LCR [EPS] = 0 and UARTx_LCR[PEN] = 1, the parity bit is transmitted and checked as 1.
3	EPS	Even Parity Select 0 Generate odd parity 1 Generate even parity	This bit is significant only if UARTx_LCR[PEN] = 1.
4	PEN	Parity Enable 0 Disable parity checking 1 Enable parity checking	
5	SBS	Stop Bit Select 0 Characters have 1 stop bit 1 Characters have 1.5 or 2 stop bits	If UARTx_LCR[WLS] = 00, characters have 1.5 stop bits. For any other value of UARTx_LCR[WLS], characters have 2 stop bits. The receiver checks the first stop bit only, regardless of how many stop bits are selected.
6:7	WLS0, WLS1	Word Length Select Bits 0,1 00 Use 5-bit characters 01 Use 6-bit characters 10 Use 7-bit characters 11 Use 8-bit characters	
Note: UARTx_LCR is shown in standard PowerPC bit notation, where 0 is the MSb and 7 is the LSb.			

UARTx_LSR

UART Line Status Registers

MMIO 0xEF600305 (UART0), 0xEF600405 (UART1)

See “Line Status Registers (UARTx_LSR)” on page 619.

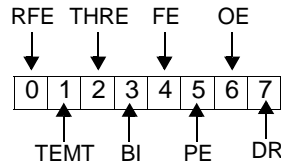

Figure 25-212. UART Line Status Registers (UARTx_LSR)

0	RFE	Receiver FIFO Error Indicator 0 In FIFO mode, reset to 0 when the processor reads the UARTx_LSR, provided there are no subsequent errors in the FIFO. 1 There are one or more instances of parity error, framing error or break indication in the FIFO.	Always 0 in 16450 mode.
1	TEMT	Transmitter Empty Indicator 0 Reset to 0 whenever the THR or the transmitter shift register contain a character. In FIFO mode, it is reset to 0 whenever the transmitter FIFO or the transmitter shift register contain a character. 1 Set to 1 when the THR and the Transmitter shift register are both empty. In FIFO mode, it is set to 1 when the transmitter FIFO and the transmitter shift register are both empty.	
2	THRE	Transmitter Holding Register Empty Indicator 0 Concurrent reset to 0 with the loading of the THR by the processor. In FIFO mode it is reset to 0 when at least one byte is written to the transmitter FIFO. 1 Set to 1 when the UART is ready to accept a new character for transmission. In FIFO mode, this bit is set when the transmitter FIFO is empty.	When UARTx_IER[THRE] = 1, the UART issues an interrupt to the UIC. This bit is set to 1 when a character is transferred from the THR to the transmitter shift register.
3	BI	Break Interrupt Indicator 0 Reset to 0 whenever processor reads Line Status Register (LSR). 1 Set to 1 whenever the received data input is held at the spacing level (0) for longer than a full word transmission time.	The word transmission time is the time required for the start bit, data bits (can be 5–8 bits), parity and stop bits. In FIFO mode, this error is reported to the processor when the character associated with the error is at the top of the FIFO. Only one 0 character is loaded into the receiver FIFO when a break occurs. After the next valid start bit is received and is in the marking state, the next character transfer is enabled. The error causes a Receiver Line Status Interrupt.

4	FE	<p>Framing Error Indicator.</p> <p>0 Reset to 0 whenever processor reads LSR.</p> <p>1 Set to 1 whenever stop bit following the last data bit or parity bit is detected as 0 (spacing level). Indicates that a valid stop bit was not found in the received character.</p>	<p>Error causes a Receiver Line Status Interrupt.</p>
5	PE	<p>Parity Error Indicator.</p> <p>0 Reset to 0 whenever processor reads UARTx_LSR.</p> <p>1 Indicates that the received data character does not have the correct parity as determined by the even parity select bit (UARTx_LCR.[EPS]). Set to 1 upon detection of a parity error.</p>	<p>In FIFO mode, this error is revealed to the processor when the character this error is associated with is at the top of the FIFO. Error causes a Receiver Line Status Interrupt.</p>
6	OE	<p>Overrun Error Indicator.</p> <p>0 Reset to 0 whenever processor reads UARTx_LSR.</p> <p>1 Data in the RBR was read by the processor before the next character was transferred into the UARTx_RBR, hence the original data was lost.</p>	<p>In FIFO mode, if the incoming data continues to fill the FIFO beyond the trigger level, an OE occurs only after the FIFO is completely full and the entire next character has been received in the receiver shift register. The processor is informed of the OE immediately upon occurrence. The character in the shift register will be overwritten and will not be transferred to the FIFO. Error causes a Receiver Line Status Interrupt.</p>
7	DR	<p>Receiver Data Ready Indicator.</p> <p>0 Reset to 0 when all data has been read from the receiver FIFO or the UARTx_RBR.</p> <p>1 An entire incoming character has been received into the UARTx_RBR or receiver FIFO.</p>	
<p>Note: UARTx_LSR is shown in standard PowerPC bit notation, where 0 is the MSb and 7 is the LSb.</p>			

UARTx_MCR

UART Modem Control Registers

MMIO 0xEF600304 (UART0), 0xEF600404 (UART1)

See "Modem Control Registers (UARTx_MCR)" on page 618.

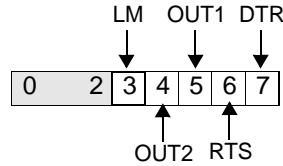

Figure 25-213. UART Modem Control Registers (UARTx_MCR)

0:2		Reserved	Always 0.
3	LOOP	<p>Loopback Mode</p> <p>0 Disabled</p> <p>1 Enabled</p>	<p>Provides a local loopback feature for diagnostic testing of the UART. The following occurs:</p> <ol style="list-style-type: none"> 1. SOUT is set to the marking state (logic 1) SIN is disconnected. 2. The output of the transmitter shift register feeds the input of the receiver shift register. 3. The four modem control inputs \overline{DSR}, \overline{CTS}, \overline{RI}, and \overline{DCD} are disconnected. 4. The four modem control outputs \overline{DTR}, \overline{RTS}, $\overline{OUT1}$, and $\overline{OUT2}$ are set to a logic 1 (their inactive state). 5. The four modem control outputs are connected internally to the four modem control inputs. <p>Transmitted data is immediately received to verify the UART transmit and receive data paths.</p> <p>Receiver and transmitter interrupts are operational. Their sources are external to the UART. Also operational are the modem control interrupts, but their source is the low-order 4 bits of UARTx_MCR instead of the modem control inputs to the UART. UARTx_IER still controls the interrupts.</p>
4	OUT2	<p>User Output 2</p> <p>0 $\overline{OUT2}$ inactive (1)</p> <p>1 $\overline{OUT2}$ active (0)</p>	May be written or read, but provides no function.
5	OUT1	<p>User Output 1</p> <p>0 $\overline{OUT1}$ inactive (1)</p> <p>1 $\overline{OUT1}$ active (0)</p>	May be written or read, but provides no function.
6	RTS	<p>Request To Send</p> <p>0 \overline{RTS} inactive (1)</p> <p>1 \overline{RTS} active (0)</p>	
7	DTR	<p>Data Terminal Ready</p> <p>0 \overline{DTR} inactive (1)</p> <p>1 \overline{DTR} active (0)</p>	

Note: UARTx_MCR is shown in standard PowerPC bit notation, where 0 is the MSb and 7 is the LSb.

MMIO 0xEF600306 (UART0), 0xEF600406 (UART1)

See “Modem Status Registers (UARTx_MSR)” on page 621.

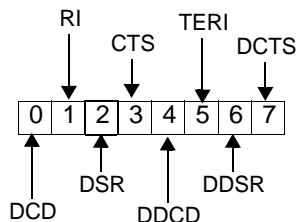

Figure 25-214. UART Modem Status Registers (UARTx_MSR)

0	DCD	Data Carrier Detect	In loopback mode (UARTx_MCR[LOOP] is 1), it is equivalent to UARTx_MCR[OUT2].
1	RI	Complement of Ring Indicator	In loopback mode (UARTx_MCR[LOOP] is 1), it is equivalent to UARTx_MCR[OUT1].
2	DSR	Complement of Data Set Ready	In loopback mode (UARTx_MCR[LOOP] is 1), it is equivalent to UARTx_MCR[DTR].
3	CTS	Complement of Clear To Send	In loopback mode (UARTx_MCR[LOOP] is 1), it is equivalent to UARTx_MCR[RTS].
4	DDCD	Delta Data Carrier Detect 0 Set when processor reads the Modem Status Register 1 DCD input changed state	Indicates that the $\overline{\text{DCD}}$ input to the UART has changed state since the processor last read the Modem Status Register. A modem status interrupt is generated.
5	TERI	Trailing Edge of Ring Indicator 0 Set when processor reads the Modem Status Register 1 RI input changed from 0 to 1	Indicates that the $\overline{\text{RI}}$ input to the UART changed from 0 to 1 since the processor last read the Modem Status Register. A modem status interrupt is generated.
6	DDSR	Delta Data Set Ready 0 Set when processor reads the Modem Status Register 1 DSR input changed state	Indicates that the $\overline{\text{DSR}}$ input to the UART has changed state since the processor last read the Modem Status Register. A modem status interrupt is generated.
7	DCTS	Delta Clear To Send 0 Set when processor reads the Modem Status Register 1 CTS input changed state	Indicates that the $\overline{\text{CTS}}$ input to the UART has changed state since the processor last read the Modem Status Register. A modem status interrupt is generated.
Note: UARTx_MSR is shown in standard PowerPC bit notation, where 0 is the MSb and 7 is the LSb.			

UARTx_RBR

UART Receiver Buffer Registers

MMIO 0xEF600300 (UART0), 0xEF600400 (UART1) Read-Only

See "Receiver Buffer Registers (UARTx_RBR)" on page 612.

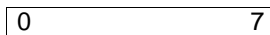

Figure 25-215. UART Receiver Buffer Registers (UARTx_RBR)

0:7	Data bit
<p>Note: UARTx_RBR is shown in standard PowerPC bit notation, where 0 is the MSb and 7 is the LSb.</p>	

MMIO 0xEF600307 (UART0), 0xEF600407 (UART1)

See "Scratchpad Registers (UARTx_SCR)" on page 622.

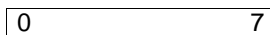

Figure 25-216. Scratchpad Registers (UARTx_SCR)

0:7	Data bits
Note: UARTx_SCR is shown in standard PowerPC bit notation, where 0 is the MSb and 7 is the LSb.	

UARTx_THR

UART Transmitter Holding Registers

MMIO 0xEF600300 (UART0), 0xEF600400 (UART1) Write-Only

See “Transmitter Holding Registers (UARTx_THR)” on page 612.

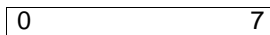
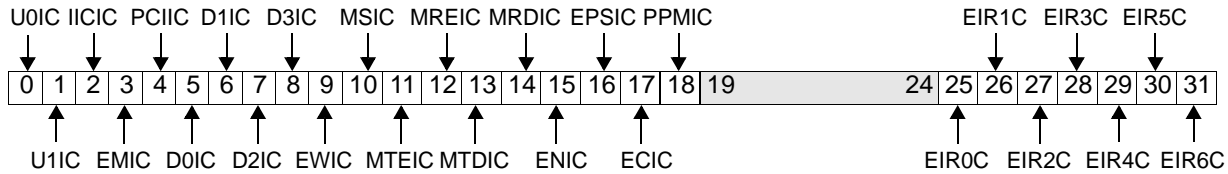

Figure 25-217. UART Transmitter Holding Registers (UARTx_THR)

0:7		Data bit
<p>Note: UARTx_THR is shown in standard PowerPC bit notation, where 0 is the MSb and 7 is the LSb.</p>		

DCR 0x0C3

See “UIC Critical Register (UIC0_CR)” on page 229.

**Figure 25-218. UIC Critical Register (UIC0_CR)**

0	U0IC	UART0 Interrupt Class 0 UART0 interrupt is non-critical. 1 UART0 interrupt is critical.
1	U1IC	UART1 Interrupt Class 0 UART1 interrupt is non-critical. 1 UART1 interrupt is critical.
2	IICIC	IIC Interrupt Class 0 IIC interrupt is non-critical. 1 IIC interrupt is critical.
3	EMIC	External Master Interrupt Class 0 External master interrupt is non-critical. 1 External master interrupt is critical.
4	PCIIC	PCI Interrupt Class 0 PCI interrupt is non-critical. 1 PCI interrupt is critical.
5	D0IC	DMA Channel 0 Interrupt Class 0 DMA channel 0 interrupt is non-critical. 1 DMA channel 0 interrupt is critical.
6	D1IC	DMA Channel 1 Interrupt Class 0 DMA channel 1 interrupt is non-critical. 1 DMA channel 1 interrupt is critical.
7	D2IC	DMA Channel 2 Interrupt Class 0 DMA channel 2 interrupt is non-critical. 1 DMA channel 2 interrupt is critical.
8	D3IC	DMA Channel 3 Interrupt Class 0 DMA channel 3 interrupt is non-critical. 1 DMA channel 3 interrupt is critical.
9	EWIC	Ethernet Wake-up Interrupt Class 0 Ethernet wake-up interrupt is non-critical. 1 Ethernet wake-up interrupt is critical.
10	MSIC	MAL SERR Interrupt Class 0 MAL SERR interrupt is non-critical. 1 MAL SERR interrupt is critical.
11	MTEIC	MAL TX EOB Interrupt Class 0 MAL TX EOB interrupt is non-critical. 1 MAL TX EOB interrupt is critical.

12	MREIC	MAL RX EOB Interrupt Class 0 MAL RX EOB interrupt is non-critical. 1 MAL RX EOB interrupt is critical.
13	MTDIC	MAL TX DE Interrupt Class 0 MAL TX DE interrupt is non-critical. 1 MAL TX DE interrupt is critical.
14	MRDIC	MAL RX DE Interrupt Class 0 MAL RX DE interrupt is non-critical. 1 MAL RX DE interrupt is critical.
15	EIC	Ethernet Interrupt Class 0 An Ethernet interrupt is non-critical. 1 An Ethernet interrupt is critical.
16	EPSIC	External PCI SERR Interrupt Class 0 External PCI SERR interrupt is non-critical. 1 External PCI SERR interrupt is critical.
17	ECIC	ECC Correctable Error Interrupt Class 0 ECC correctable error interrupt is non-critical. 1 ECC correctable error interrupt is critical.
18	PPMIC	PCI Power management Interrupt Class 0 PCI power management interrupt is non-critical. 1 PCI power management interrupt is critical.
19:24		Reserved
25	EIR0C	External IRQ 0 Class 0 An external IRQ 0 interrupt is non-critical. 1 An external IRQ 0 interrupt is critical.
26	EIR1C	External IRQ 1 Class 0 An external IRQ 1 interrupt is non-critical. 1 An external IRQ 1 interrupt is critical.
27	EIR2C	External IRQ 2 Class 0 An external IRQ 2 interrupt is non-critical. 1 An external IRQ 2 interrupt is critical.
28	EIR3C	External IRQ 3 Class 0 An external IRQ 3 interrupt is non-critical. 1 An external IRQ 3 interrupt is critical.
29	EIR4C	External IRQ 4 Class 0 An external IRQ 4 interrupt is non-critical. 1 An external IRQ 4 interrupt is critical.
30	EIR5C	External IRQ 5 Class 0 An external IRQ 5 interrupt is non-critical. 1 An external IRQ 5 interrupt is critical.
31	EIR6C	External IRQ 6 Class 0 An external IRQ 6 interrupt is non-critical. 1 An external IRQ 6 interrupt is critical.

DCR 0x0C2

See “UIC Enable Register (UIC0_ER)” on page 224.

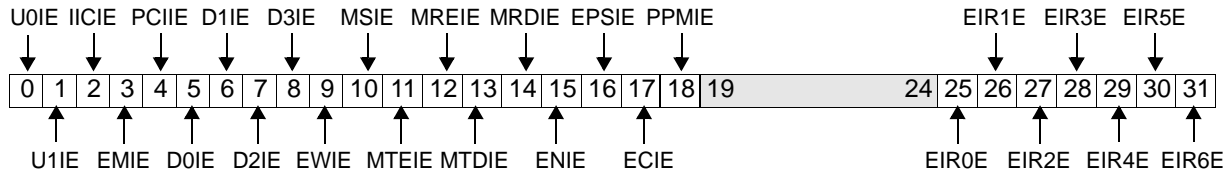
**Figure 25-219. UIC Enable Register (UIC0_ER)**

0	U0IE	UART0 Interrupt Enable 0 UART0 interrupt is disabled. 1 UART0 interrupt is enabled.	
1	U1IE	UART1 Interrupt Enable 0 UART1 interrupt is disabled. 1 UART1 interrupt is enabled.	
2	IICIE	IIC Interrupt Enable 0 IIC interrupt is disabled. 1 IIC interrupt is enabled.	
3	EMIE	External Master Interrupt Enable 0 External master interrupt is disabled. 1 External master interrupt is enabled.	
4	PCIIE	PCI Interrupt Enable 0 PCI interrupt is disabled. 1 PCI interrupt is enabled.	Enables a PCI interrupt when an external write to PCIC0_CMD is performed.
5	D0IE	DMA Channel 0 Interrupt Enable 0 DMA channel 0 interrupt is disabled. 1 DMA channel 0 interrupt is enabled.	
6	D1IE	DMA Channel 1 Interrupt Enable 0 DMA channel 1 interrupt is disabled. 1 DMA channel 1 interrupt is enabled.	
7	D2IE	DMA Channel 2 Interrupt Enable 0 DMA channel 2 interrupt is disabled. 1 DMA channel 2 interrupt is enabled.	
8	D3IE	DMA Channel 3 Interrupt Enable 0 DMA channel 3 interrupt is disabled. 1 DMA channel 3 interrupt is enabled.	
9	EWIE	Ethernet Wake-up Interrupt Enable 0 Ethernet wake-up interrupt is disabled. 1 Ethernet wake-up interrupt is enabled.	
10	MSIE	MAL SERR Interrupt Enable 0 MAL SERR interrupt is disabled. 1 MAL SERR interrupt is enabled.	
11	MTEIE	MAL TX EOB Interrupt Enable 0 MAL TX EOB interrupt is disabled. 1 MAL TX EOB interrupt is enabled.	

UIC0_ER (cont.)

UIC Interrupt Enable Register

12	MREIE	MAL RX EOB Interrupt Enable 0 MAL RX EOB interrupt is disabled. 1 MAL RX EOB interrupt is enabled.
13	MTDIE	MAL TX DE Interrupt Enable 0 MAL TX DE interrupt is disabled. 1 MAL TX DE interrupt is enabled.
14	MRDIE	MAL RX DE Interrupt Enable 0 MAL RX DE interrupt is disabled. 1 MAL RX DE interrupt is enabled.
15	EIE	Ethernet Interrupt Enable 0 An Ethernet interrupt is disabled. 1 An Ethernet interrupt is enabled.
16	EPSIE	External PCI SERR Interrupt Enable 0 External PCI SERR interrupt is disabled. 1 External PCI SERR interrupt is enabled.
17	ECIE	ECC Correctable Error Interrupt Enable 0 ECC correctable error interrupt is disabled. 1 ECC correctable error interrupt is enabled.
18	PPMI	PCI Power management Interrupt Enable 0 PCI power management interrupt is disabled. 1 PCI power management interrupt is enabled.
19:24		Reserved
25	EIR0E	External IRQ 0 Interrupt Enable 0 An external IRQ 0 interrupt is disabled. 1 An external IRQ 0 interrupt is enabled.
26	EIR1E	External IRQ 1 Interrupt Enable 0 An external IRQ 1 interrupt is disabled. 1 An external IRQ 1 interrupt is enabled.
27	EIR2E	External IRQ 2 Interrupt Enable 0 An external IRQ 2 interrupt is disabled. 1 An external IRQ 2 interrupt is enabled.
28	EIR3E	External IRQ 3 Interrupt Enable 0 An external IRQ 3 interrupt is disabled. 1 An external IRQ 3 interrupt is enabled.
29	EIR4E	External IRQ 4 Interrupt Enable 0 An external IRQ 4 interrupt is disabled. 1 An external IRQ 4 interrupt is enabled.
30	EIR5E	External IRQ 5 Interrupt Enable 0 An external IRQ 5 interrupt is disabled. 1 An external IRQ 5 interrupt is enabled.
31	EIR6E	External IRQ 6 Interrupt Enable 0 An external IRQ 6 interrupt is disabled. 1 An external IRQ 6 interrupt is enabled.

DCR 0x0C6 Read-Only

See “UIC Masked Status Register (UIC0_MSR)” on page 237.

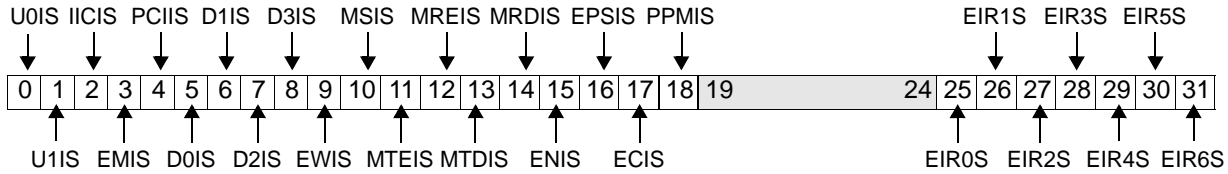
**Figure 25-220. UIC Masked Status Register (UIC0_MSR)**

0	U0IS	UART0 Masked Interrupt Status 0 A UART0 interrupt has not occurred. 1 A UART0 interrupt occurred.
1	U1IS	UART1 Masked Interrupt Status 0 A UART1 interrupt has not occurred. 1 A UART1 interrupt occurred.
2	IICIS	IIC Masked Interrupt Status 0 An IIC interrupt has not occurred. 1 An IIC interrupt occurred.
3	EMIS	External Master Masked Interrupt Status 0 An external master interrupt has not occurred. 1 An external master interrupt occurred.
4	PCIIS	PCI Masked Interrupt Status 0 A PCI interrupt has not occurred. 1 A PCI interrupt occurred.
5	D0IS	DMA Channel 0 Masked Interrupt Status 0 A DMA channel 0 interrupt has not occurred. 1 A DMA channel 0 interrupt occurred.
6	D1IS	DMA Channel 1 Masked Interrupt Status 0 A DMA channel 1 interrupt has not occurred. 1 A DMA channel 1 interrupt occurred.
7	D2IS	DMA Channel 2 Masked Interrupt Status 0 A DMA channel 2 interrupt has not occurred. 1 A DMA channel 2 interrupt occurred.
8	D3IS	DMA Channel 3 Masked Interrupt Status 0 A DMA channel 3 interrupt has not occurred. 1 A DMA channel 3 interrupt occurred.
9	EWIS	Ethernet Wake-up Masked Interrupt Status 0 An Ethernet wake-up interrupt has not occurred. 1 An Ethernet wake-up interrupt occurred.
10	MSIS	MAL SERR Masked Interrupt Status 0 A MAL SERR interrupt has not occurred. 1 A MAL SERR interrupt occurred.

11	MTEIS	MAL TX EOB Masked Interrupt Status 0 A MAL TX EOB interrupt has not occurred. 1 A MAL TX EOB interrupt occurred.
12	MREIS	MAL RX EOB Masked Interrupt Status 0 A MAL RX EOB interrupt has not occurred. 1 A MAL RX EOB interrupt occurred.
13	MTDIS	MAL TX DE Masked Interrupt Status 0 A MAL TX DE interrupt has not occurred. 1 A MAL TX DE interrupt occurred.
14	MRDIS	MAL RX DE Masked Interrupt Status 0 A MAL RX DE interrupt has not occurred. 1 A MAL RX DE interrupt occurred.
15	EIS	Ethernet Masked Interrupt Status 0 An Ethernet interrupt has not occurred. 1 An Ethernet interrupt occurred.
16	EPSIE	External PCI SERR Masked Interrupt Status 0 An external PCI SERR interrupt has not occurred. 1 An external PCI SERR interrupt occurred.
17	ECIS	ECC Correctable Error Masked Interrupt Status 0 An ECC correctable error interrupt did not occur. 1 An ECC correctable error interrupt occurred.
18	PPMIS	PCI Power Management Masked Interrupt Status 0 A PCI power management interrupt did not occur. 1 A PCI power management interrupt occurred.
19:24		Reserved
25	EIR0E	External IRQ 0 Masked Status 0 An external IRQ 0 interrupt has not occurred. 1 An external IRQ 0 interrupt occurred.
26	EIR1S	External IRQ 1 Masked Status 0 An external IRQ 1 interrupt has not occurred. 1 An external IRQ 1 interrupt occurred.
27	EIR2S	External IRQ 2 Masked Status 0 An external IRQ 2 interrupt has not occurred. 1 An external IRQ 2 interrupt occurred.
28	EIR3S	External IRQ 3 Masked Status 0 An external IRQ 3 interrupt has not occurred. 1 An external IRQ 3 interrupt occurred.

29	EIR4S	External IRQ 4 Masked Status 0 An external IRQ 4 interrupt has not occurred. 1 An external IRQ 4 interrupt occurred.
30	EIR5S	External IRQ 5 Masked Status 0 An external IRQ 5 interrupt has not occurred. 1 An external IRQ 5 interrupt occurred.
31	EIR6S	External IRQ 6 Masked Status 0 An external IRQ 6 interrupt has not occurred. 1 An external IRQ 6 interrupt occurred.

UIC0_PR

UIC Polarity Register

DCR 0x0C4

See “UIC Polarity Register (UIC0_PR)” on page 231.

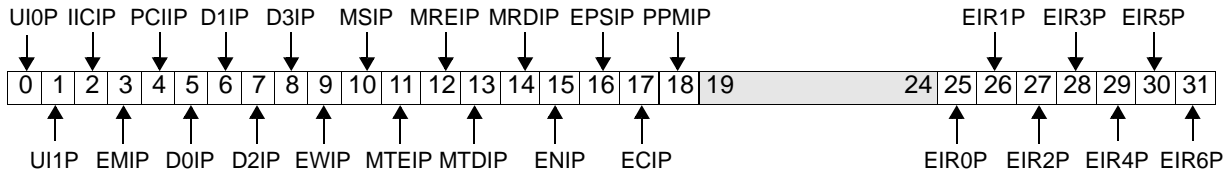

Figure 25-221. UIC Polarity Register (UIC0_PR)

0	U0IP	UART0 Interrupt Polarity 0 UART0 interrupt has negative polarity. 1 UART0 interrupt has positive polarity.	Must be set to 1.
1	U1IP	UART1 Interrupt Polarity 0 UART1 interrupt has negative polarity. 1 UART1 interrupt has positive polarity.	Must be set to 1.
2	IICIP	IIC Interrupt Polarity 0 IIC interrupt has negative polarity. 1 IIC interrupt has positive polarity.	Must be set to 1.
3	EMIP	External Master Interrupt Polarity 0 External master interrupt has negative polarity. 1 External master interrupt has positive polarity.	Must be set to 1.
4	PCIIP	PCI Interrupt Polarity 0 PCI interrupt has negative polarity. 1 PCI interrupt has positive polarity.	Must be set to 1.
5	D0IP	DMA Channel 0 Interrupt Polarity 0 DMA channel 0 interrupt has negative polarity. 1 DMA channel 0 interrupt has positive polarity.	Must be set to 1.
6	D1IP	DMA Channel 1 Interrupt Polarity 0 DMA channel 1 interrupt has negative polarity. 1 DMA channel 1 interrupt has positive polarity.	Must be set to 1.
7	D2IP	DMA Channel 2 Interrupt Polarity 0 DMA channel 2 interrupt has negative polarity. 1 DMA channel 2 interrupt has positive polarity.	Must be set to 1.
8	D3IP	DMA Channel 3 Interrupt Polarity 0 DMA channel 3 interrupt has negative polarity. 1 DMA channel 3 interrupt has positive polarity.	Must be set to 1.
9	EWIP	Ethernet Wake-up Interrupt Polarity 0 Ethernet wake-up interrupt has negative polarity. 1 Ethernet wake-up interrupt has positive polarity.	Must be set to 1.
10	MSIP	MAL SERR Interrupt Polarity 0 MAL SERR interrupt has negative polarity. 1 MAL SERR interrupt has positive polarity.	Must be set to 1.
11	MTEIP	MAL TX EOB Interrupt Polarity 0 MAL TX EOB interrupt has negative polarity. 1 MAL TX EOB interrupt has positive polarity.	Must be set to 1.

12	MREIP	MAL RX EOB Interrupt Polarity 0 MAL RX EOB interrupt has negative polarity. 1 MAL RX EOB interrupt has positive polarity.	Must be set to 1.
13	MTDIP	MAL TX DE Interrupt Polarity 0 MAL TX DE interrupt has negative polarity. 1 MAL TX DE interrupt has positive polarity.	Must be set to 1.
14	MRDIP	MAL RX DE Interrupt Polarity 0 MAL RX DE interrupt has negative polarity. 1 MAL RX DE interrupt has positive polarity.	Must be set to 1.
15	EIP	Ethernet Interrupt Polarity 0 An Ethernet interrupt has negative polarity. 1 An Ethernet interrupt has positive polarity.	Must be set to 1.
16	EPSIP	External PCI SERR Interrupt Polarity 0 External PCI SERR interrupt has negative polarity. 1 External PCI SERR interrupt has positive polarity.	Must be set to 1.
17	ECIP	ECC Correctable Error Interrupt Polarity 0 ECC correctable error interrupt has negative polarity. 1 ECC correctable error interrupt has positive polarity.	Must be set to 1.
18	PPMIC	PCI Power management Interrupt Polarity 0 PCI power management interrupt has negative polarity. 1 PCI power management interrupt has positive polarity.	Must be set to 1.
19:24		Reserved	
25	EIR0P	External IRQ 0 Polarity 0 An external IRQ 0 interrupt has negative polarity. 1 An external IRQ 0 interrupt has positive polarity.	
26	EIR1P	External IRQ 1 Polarity 0 An external IRQ 1 interrupt has negative polarity. 1 An external IRQ 1 interrupt has positive polarity.	
27	EIR2P	External IRQ 2 Polarity 0 An external IRQ 2 interrupt has negative polarity. 1 An external IRQ 2 interrupt has positive polarity.	
28	EIR3P	External IRQ 3 Polarity 0 An external IRQ 3 interrupt has negative polarity. 1 An external IRQ 3 interrupt has positive polarity.	
29	EIR4P	External IRQ 4 Polarity 0 An external IRQ 4 interrupt has negative polarity. 1 An external IRQ 4 interrupt has positive polarity.	
30	EIR5P	External IRQ 5 Polarity 0 An external IRQ 5 interrupt has negative polarity. 1 An external IRQ 5 interrupt has positive polarity.	
31	EIR6P	External IRQ 6 Polarity 0 An external IRQ 6 interrupt has negative polarity. 1 An external IRQ 6 interrupt has positive polarity.	

UIC0_SR

UIC Status Register

DCR 0x0C0 Read/Clear

See “UIC Status Register (UIC0_SR)” on page 222.

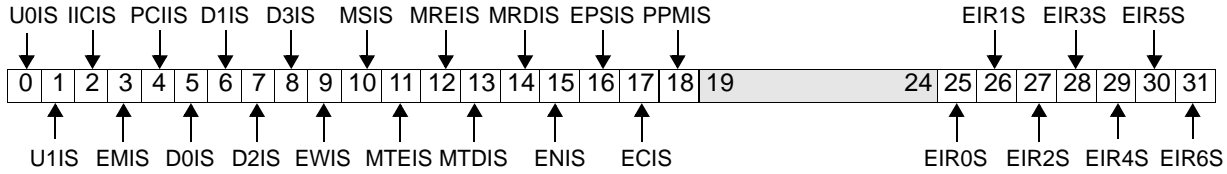

Figure 25-222. UIC Status Register (UIC0_SR)

0	U0IS	UART0 Interrupt Status 0 A UART0 interrupt has not occurred. 1 A UART0 interrupt occurred.	
1	U1IS	UART1 Interrupt Status 0 A UART1 interrupt has not occurred. 1 A UART1 interrupt occurred.	
2	IICIS	IIC Interrupt Status 0 An IIC interrupt has not occurred. 1 An IIC interrupt occurred.	
3	EMIS	External Master Interrupt Status 0 An external master interrupt has not occurred. 1 An external master interrupt occurred.	
4	PCIIS	PCI Interrupt Status 0 A PCI interrupt has not occurred. 1 A PCI interrupt occurred.	An external write to PCIC0_CMD causes UIC0_SR[PCIIS] to be set.
5	D0IS	DMA Channel 0 Interrupt Status 0 A DMA channel 0 interrupt has not occurred. 1 A DMA channel 0 interrupt occurred.	
6	D1IS	DMA Channel 1 Interrupt Status 0 A DMA channel 1 interrupt has not occurred. 1 A DMA channel 1 interrupt occurred.	
7	D2IS	DMA Channel 2 Interrupt Status 0 A DMA channel 2 interrupt has not occurred. 1 A DMA channel 2 interrupt occurred.	
8	D3IS	DMA Channel 3 Interrupt Status 0 A DMA channel 3 interrupt has not occurred. 1 A DMA channel 3 interrupt occurred.	
9	EWIS	Ethernet Wake-up Interrupt Status 0 An Ethernet wake-up interrupt has not occurred. 1 An Ethernet wake-up interrupt occurred.	

10	MSIS	MAL SERR Interrupt Status 0 A MAL SERR interrupt has not occurred. 1 A MAL SERR interrupt occurred.	
11	MTEIS	MAL TX EOB Interrupt Status 0 A MAL TX EOB interrupt has not occurred. 1 A MAL TX EOB interrupt occurred.	
12	MREIS	MAL RX EOB Interrupt Status 0 A MAL RX EOB interrupt has not occurred. 1 A MAL RX EOB interrupt occurred.	
13	MTDIS	MAL TX DE Interrupt Status 0 A MAL TX DE interrupt has not occurred. 1 A MAL TX DE interrupt occurred.	
14	MRDIS	MAL RX DE Interrupt Status 0 A MAL RX DE interrupt has not occurred. 1 A MAL RX DE interrupt occurred.	
15	EIS	Ethernet Interrupt Status 0 An Ethernet interrupt has not occurred. 1 An Ethernet interrupt occurred.	
16	EPSIS	External PCI SERR Interrupt Status 0 An external PCI SERR interrupt has not occurred. 1 An external PCI SERR interrupt occurred.	If enabled, a PCI SERR interrupt occurs whenever the PCI SERR signal is asserted, either by the PCI bridge or by an external device.
17	ECIS	ECC Correctable Error Interrupt Status 0 An ECC correctable error interrupt did not occur. 1 An ECC correctable error interrupt occurred.	
18	PPMIS	PCI Power Management Interrupt Status 0 A PCI power management interrupt did not occur. 1 A PCI power management interrupt occurred.	
19:24		Reserved	
25	EIR0S	External IRQ 0 Status 0 An external IRQ 0 interrupt has not occurred. 1 An external IRQ 0 interrupt occurred.	
26	EIR1S	External IRQ 1 Status 0 An external IRQ 1 interrupt has not occurred. 1 An external IRQ 1 interrupt occurred.	
27	EIR2S	External IRQ 2 Status 0 An external IRQ 2 interrupt has not occurred. 1 An external IRQ 2 interrupt occurred.	

28	EIR3S	External IRQ 3 Status 0 An external IRQ 3 interrupt has not occurred. 1 An external IRQ 3 interrupt occurred.
29	EIR4S	External IRQ 4 Status 0 An external IRQ 4 interrupt has not occurred. 1 An external IRQ 4 interrupt occurred.
30	EIR5S	External IRQ 5 Status 0 An external IRQ 5 interrupt has not occurred. 1 An external IRQ 5 interrupt occurred.
31	EIR6S	External IRQ 6 Status 0 An external IRQ 6 interrupt has not occurred. 1 An external IRQ 6 interrupt occurred.

DCR 0x0C5

See “UIC Trigger Register (UIC0_TR)” on page 233.

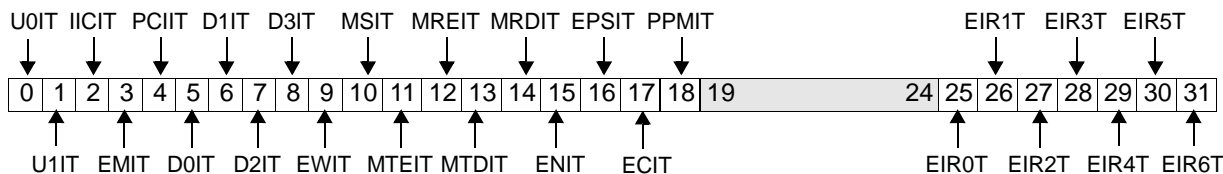
**Figure 25-223. UIC Trigger Register (UIC0_TR)**

0	U0IT	UART0 Interrupt Trigger 0 UART0 interrupt is level-sensitive. 1 UART0 interrupt is edge-sensitive.	Must be set to 0.
1	U1IT	UART1 Interrupt Trigger 0 UART1 interrupt is level-sensitive. 1 UART1 interrupt is edge-sensitive.	Must be set to 0.
2	IICIT	IIC Interrupt Trigger 0 IIC interrupt is level-sensitive. 1 IIC interrupt is edge-sensitive.	Must be set to 0.
3	EMIT	External Master Interrupt Trigger 0 External master interrupt is level-sensitive. 1 External master interrupt is edge-sensitive.	Must be set to 1.
4	PCIIT	PCI Interrupt Trigger 0 PCI interrupt is level-sensitive. 1 PCI interrupt is edge-sensitive.	Must be set to 0.
5	D0IT	DMA Channel 0 Interrupt Trigger 0 DMA channel 0 interrupt is level-sensitive. 1 DMA channel 0 interrupt is edge-sensitive.	Must be set to 0.
6	D1IT	DMA Channel 1 Interrupt Trigger 0 DMA channel 1 interrupt is level-sensitive. 1 DMA channel 1 interrupt is edge-sensitive.	Must be set to 0.
7	D2IT	DMA Channel 2 Interrupt Trigger 0 DMA channel 2 interrupt is level-sensitive. 1 DMA channel 2 interrupt is edge-sensitive.	Must be set to 0.
8	D3IT	DMA Channel 3 Interrupt Trigger 0 DMA channel 3 interrupt is level-sensitive. 1 DMA channel 3 interrupt is edge-sensitive.	Must be set to 0.

9	EWIT	Ethernet Wake-up Interrupt Trigger 0 Ethernet wake-up interrupt is level-sensitive. 1 Ethernet wake-up interrupt is edge-sensitive.	Must be set to 0.
10	MSIT	MAL SERR Interrupt Trigger 0 MAL SERR interrupt is level-sensitive. 1 MAL SERR interrupt is edge-sensitive.	Must be set to 0.
11	MTEIT	MAL TX EOB Interrupt Trigger 0 MAL TX EOB interrupt is level-sensitive. 1 MAL TX EOB interrupt is edge-sensitive.	Must be set to 0.
12	MREIT	MAL RX EOB Interrupt Trigger 0 MAL RX EOB interrupt is level-sensitive. 1 MAL RX EOB interrupt is edge-sensitive.	Must be set to 0.
13	MTDIT	MAL TX DE Interrupt Trigger 0 MAL TX DE interrupt is level-sensitive. 1 MAL TX DE interrupt is edge-sensitive.	Must be set to 0.
14	MRDIT	MAL RX DE Interrupt Trigger 0 MAL RX DE interrupt is level-sensitive. 1 MAL RX DE interrupt is edge-sensitive.	Must be set to 0.
15	EIT	Ethernet Interrupt Trigger 0 An Ethernet interrupt is level-sensitive. 1 An Ethernet interrupt is edge-sensitive.	Must be set to 0.
16	EPSIT	External PCI SERR Interrupt Trigger 0 External PCI SERR interrupt is level-sensitive. 1 External PCI SERR interrupt is edge-sensitive.	Must be set to 0.
17	ECIT	ECC Correctable Error Interrupt Trigger 0 ECC correctable error interrupt is level-sensitive. 1 ECC correctable error interrupt is edge-sensitive.	Must be set to 0.
18	PPMIT	PCI Power management Interrupt Trigger 0 PCI power management interrupt is level-sensitive. 1 PCI power management interrupt is edge-sensitive.	Must be set to 0.
19:24		Reserved	
25	EIR0T	External IRQ 0 Trigger 0 An external IRQ 0 interrupt is level-sensitive. 1 An external IRQ 0 interrupt is edge-sensitive.	
26	EIR1T	External IRQ 1 Trigger 0 An external IRQ 1 interrupt is level-sensitive. 1 An external IRQ 1 interrupt is edge-sensitive.	

27	EIR2T	External IRQ 2 Trigger 0 An external IRQ 2 interrupt is level-sensitive. 1 An external IRQ 2 interrupt is edge-sensitive.
28	EIR3T	External IRQ 3 Trigger 0 An external IRQ 3 interrupt is level-sensitive. 1 An external IRQ 3 interrupt is edge-sensitive.
29	EIR4T	External IRQ 4 Trigger 0 An external IRQ 4 interrupt is level-sensitive. 1 An external IRQ 4 interrupt is edge-sensitive.
30	EIR5T	External IRQ 5 Trigger 0 An external IRQ 5 interrupt is level-sensitive. 1 An external IRQ 5 interrupt is edge-sensitive.
31	EIR6T	External IRQ 6 Trigger 0 An external IRQ 6 interrupt is level-sensitive. 1 An external IRQ 6 interrupt is edge-sensitive.

UIC0_VCR

UIC Vector Configuration Register

DCR 0x0C8 Write-Only

See “UIC Vector Configuration Register (UIC0_VCR)” on page 242.

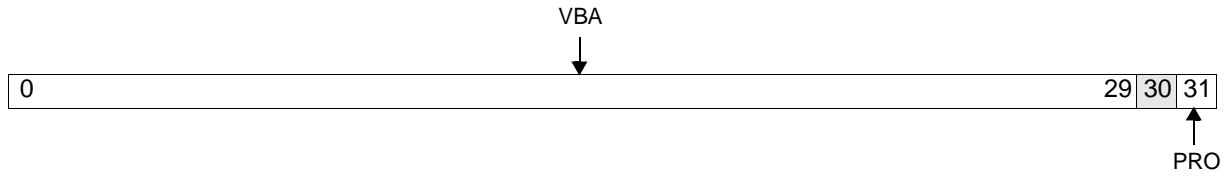

Figure 25-224. UIC Vector Configuration Register (UIC0_VCR)

0:29	VBA	Vector Base Address
30		Reserved
31	PRO	Priority Ordering 0 UIC0_SR[31] is the highest priority interrupt. 1 UIC0_SR[0] is the highest priority interrupt. Note: Vector generation is not performed for non-critical interrupts.

DCR 0x0C7 Read-Only

See “UIC Vector Register (UIC0_VR)” on page 243.



Figure 25-225. UIC Vector Register (UIC0_VR)

0:31	VBA	Interrupt Vector
------	-----	------------------

Preliminary User's Manual

Chapter 26. Signal Summary

This chapter provides detailed information on the PPC405GP I/O signals.

26.1 Signals Listed Alphabetically

Table 26-1 lists the PPC405GP signals in alphabetical order. For each signal there is an indication of the interface group to which it belongs and a page reference to the description of the signal in Table 26-2, "Signal Descriptions," on page 26-1153.

Multiplexed signals are shown in brackets following the first signal name assigned to each multiplexed ball (for example, IRQ0:6[GPIO17:23]). Active-low signals are shown with an overbar on the signal name (for example, ExtAck).

Table 26-1. Alphabetical Signal List

Signal Name	Interface	Page
BA1:0	SDRAM	1155
<u>BankSel0:3</u>	SDRAM	1155
BusReq	External Master Peripheral	1156
<u>CAS</u>	SDRAM	1155
ClkEn0:1	SDRAM	1155
DMAAck0:3	External Slave Peripheral	1156
DMAReq0:3	External Slave Peripheral	1156
DQM0:3	SDRAM	1155
DQMCB	SDRAM	1155
DrvrInh1:2	System	1158
ECC0:7	SDRAM	1155
EMCMDClk	Ethernet	1154
EOT0:3[TC0:3]	External Slave Peripheral	1156
EMCMDIO[PHYMDIO]	Ethernet	1155
EMCTxD0:3	Ethernet	1154
EMCTxEn	Ethernet	1154
EMCTxErr	Ethernet	1154
<u>ExtAck</u>	External Master Peripheral	1156
<u>ExtReq</u>	External Master Peripheral	1156
<u>ExtReset</u>	External Master Peripheral	1156
GPIO1:2[TS1E:TS2E]	System	1158

Table 26-1. Alphabetical Signal List

Signal Name	Interface	Page
GPIO3:4[TS10:TS20]	System	1150
GPIO5:8[TS3:6]	System	1150
GPIO9[TrcClk]	System	1150
$\overline{\text{Halt}}$	System	1157
HoldAck	External Master Peripheral	1156
HoldPri	External Master Peripheral	1156
HoldReq	External Master Peripheral	1156
IIC_SCL	Internal Peripheral	1157
IIC_SDA	Internal Peripheral	1157
IRQ0:6[GPIO17:23]	Interrupts	1150
MemAddr0:12	SDRAM	1155
MemClkOut0:1	SDRAM	1155
MemData0:31	SDRAM	1155
PCIAD0:31	PCI	1153
PCIC0:3[BE0:3]	PCI	1153
PCIClk	PCI	1153
$\overline{\text{PCIDevSel}}$	PCI	1153
PCIIDSel	PCI	1153
$\overline{\text{PCIFrame}}$	PCI	1153
$\overline{\text{PCIGnt0[Req]}}$	PCI	1154
PCIGnt1:5	PCI	1154
$\overline{\text{PCIINT[PerWE]}}$	PCI	1154
$\overline{\text{PCIIRDY}}$	PCI	1153
PCIParity	PCI	1153
PCIPErr	PCI	1153
$\overline{\text{PCIReq0[Gnt]}}$	PCI	1154
PCIReq1:5	PCI	1154
$\overline{\text{PCIReset}}$	PCI	1153
$\overline{\text{PCISerr}}$	PCI	1153
$\overline{\text{PCIStop}}$	PCI	1153
$\overline{\text{PCITRDY}}$	PCI	1153

Preliminary User's Manual**Table 26-1. Alphabetical Signal List**

Signal Name	Interface	Page
PerAddr0:31	External Slave Peripheral	1155
$\overline{\text{PerBLast}}$	External Slave Peripheral	1156
PerClk	External Master Peripheral	1156
PerCS0	External Slave Peripheral	1155
$\overline{\text{PerCS1:7}}[\text{GPIO10:16}]$	External Slave Peripheral	1151
PerData0:31	External Slave Peripheral	1155
PerErr	External Master Peripheral	1156
$\overline{\text{PerOE}}$	External Slave Peripheral	1155
PerPar0:3	External Slave Peripheral	1155
PerReady	External Slave Peripheral	1156
$\overline{\text{PerR/W}}$	External Slave Peripheral	1156
$\overline{\text{PerWBE0:3}}$	External Slave Peripheral	1155
PHYCol	Ethernet	1154
PHYRxClk	Ethernet	1154
PHYCrS	Ethernet	1154
PHYRxD0:3	Ethernet	1154
PHYRxDV	Ethernet	1154
PHYRxErr	Ethernet	1154
PHYTxClk	Ethernet	1154
$\overline{\text{RAS}}$	SDRAM	1155
RcvrInh	System	1158
SysClk	System	1157
SysErr	System	1157
$\overline{\text{SysReset}}$	System	1157
TCK	JTAG	1157
TDI	JTAG	1157
TDO	JTAG	1157
TestEn	System	1158
TmrClk	System	1158
TMS	JTAG	1157
$\overline{\text{TRST}}$	JTAG	1157

Table 26-1. Alphabetical Signal List

Signal Name	Interface	Page
$\overline{\text{UART0_CTS}}$	Internal Peripheral	1157
$\overline{\text{UART0_DCD}}$	Internal Peripheral	1157
$\overline{\text{UART0_DSR}}$	Internal Peripheral	1157
$\overline{\text{UART0_DTR}}$	Internal Peripheral	1157
$\overline{\text{UART0_RI}}$	Internal Peripheral	1157
$\overline{\text{UART0_RTS}}$	Internal Peripheral	1157
UART0_Rx	Internal Peripheral	1156
UART0_Tx	Internal Peripheral	1156
$\overline{\text{UART1_DSR}}[\overline{\text{UART1_CTS}}]$	Internal Peripheral	1157
$\overline{\text{UART1_RTS}}[\overline{\text{UART1_DTR}}]$	Internal Peripheral	1157
UART1_Rx	Internal Peripheral	1157
UART1_Tx	Internal Peripheral	1157
UARTSerClk	Internal Peripheral	1156
$\overline{\text{WE}}$	SDRAM	1155

Preliminary User's Manual**26.2 Signal Descriptions**

Each I/O signal is listed with the other signals in the same interface group.

Multiplexed signals are shown in brackets following the first signal name assigned to each multiplexed ball (for example, $\overline{\text{IRQ0:6}}[\text{GPIO17:23}]$). Active-low signals are shown with an overbar on the signal name (for example, $\overline{\text{ExtAck}}$).

Table 26-2. Signal Descriptions

Signal Name	I/O	Function
PCI Interface		
PCIAD0:31	I/O	PCI Address/Data Bus. Multiplexed address and data bus
PCIC0:3[$\overline{\text{BE0:3}}$]	I/O	PCI C (bus command) or Byte enable
PCIParity	I/O	PCI parity. Parity is even across PCIAD0:31 and PCIC0:3[$\overline{\text{BE0:3}}$]. PCIParity is valid one cycle after either an address or data phase. The PCI device that drives PCIAD0:31 is responsible for driving PCIParity on the next PCI bus clock.
$\overline{\text{PCIFrame}}$	I/O	$\overline{\text{PCIFrame}}$ is driven by the current PCI bus master to indicate beginning and duration of a PCI access.
$\overline{\text{PCIIRDY}}$	I/O	$\overline{\text{PCIIRDY}}$ is driven by the current PCI bus master. Assertion of $\overline{\text{PCIIRDY}}$ indicates that the PCI initiator is ready to transfer data.
$\overline{\text{PCITRDY}}$	I/O	The target of the current PCI transaction drives $\overline{\text{PCITRDY}}$. Assertion of $\overline{\text{PCITRDY}}$ indicates that the PCI target is ready to transfer data.
$\overline{\text{PCIStop}}$	I/O	The target of the current PCI transaction may assert $\overline{\text{PCIStop}}$ to indicate to the requesting PCI master that it wants to end the current transaction.
$\overline{\text{PCIDevSel}}$	I/O	$\overline{\text{PCIDevSel}}$ is driven by the target of the current PCI transaction. A PCI target asserts $\overline{\text{PCIDevSel}}$ when it has decoded an address and command encoding and claims the transaction.
PCIIDSel	I	PCIIDSel is used during configuration cycles to select the PCI slave interface for configuration
$\overline{\text{PCISErr}}$	I/O	$\overline{\text{PCISErr}}$ is used for reporting address parity errors or catastrophic failures detected by a PCI target.
$\overline{\text{PCIPErr}}$	I/O	$\overline{\text{PCIPErr}}$ is used for reporting data parity errors on PCI transactions. $\overline{\text{PCIPErr}}$ is driven active by the device receiving PCIAD0:31, PCIC0:3[$\overline{\text{BE0:3}}$], and PCIParity, two PCI clocks following the data in which bad parity is detected.
PCIClk	I	PCIClk is used as the asynchronous PCI clock when in Async mode. It is unused when the PCI interface is operated synchronously with the PLB bus.
$\overline{\text{PCIReset}}$	O	PCI specific reset

Table 26-2. Signal Descriptions (continued)

Signal Name	I/O	Function
$\overline{\text{PCIINT}}[\overline{\text{PerWE}}]$	O	PCI interrupt or Peripheral write enable. $\overline{\text{PerWE}}$ is low when any $\overline{\text{PerWBE0:3}}$ signal is low.
$\overline{\text{PCIReq0}}[\overline{\text{Gnt}}]$	I	$\overline{\text{PCIReq0}}$ when internal arbiter is used or $\overline{\text{Gnt}}$ when external arbiter is used.
$\overline{\text{PCIReq1:5}}$	I	$\overline{\text{PCIReq1:5}}$ input when internal arbiter is used
$\overline{\text{PCIGnt0}}[\overline{\text{Req}}]$	O	$\overline{\text{PCIGnt0}}$ when internal arbiter is used or $\overline{\text{Req}}$ when external arbiter is used.
$\overline{\text{PCIGnt1:5}}$	O	$\overline{\text{PCIGnt1:5}}$ output when internal arbiter is used.
Ethernet Interface		
PHYRxD3:0	I	Received data. A nibble-wide bus from the physical layer device (PHY). The data is synchronous with the PHYRxClk.
EMCTxD3:0	O	Transmit data. A nibble-wide bus towards the network. The data is synchronous to the PHYTxClk.
PHYRxErr	I	Receive Error. This signal comes from the PHY and is synchronous with the PHYRxClk.
PHYRxClk	I	Receiver Medium clock. This signal is generated by the PHY.
PHYRxDV	I	Receive Data Valid. Data on the Data Bus is valid when this signal is activated. Deassertion of this signal indicates end of the frame reception.
PHYCrS	I	Carrier Sense signal from the PHY. This is an asynchronous signal.
EMCTxErr	O	Transmit Error. This signal is driven by EMAC and is connected to the PHY. This signal informs the PHY that an error was detected. This signal is synchronous to the PHYTxClk.
EMCTxEn	O	Transmit Data Enabled. EMCTxEnl is driven by EMAC to the PHY. Data is valid during the active state. Deassertion of EMCTxEn indicates end of frame transmission. This signal is synchronous to the PHYTxClk.
PHYTxClk	I	This clock comes from the PHY and is the Medium Transmit clock.
PHYCol	I	Collision signal from the PHY. This is an asynchronous signal.
EMCMDClk	O	Management Data Clock. The EMCMDClk is sourced to the PHY. This clock has a period of 400 ns. EMCMDClk is derived from the OPB frequency. EMAC0_STACR[OPBC] must be set appropriately. Management information is transferred synchronously with respect to this clock.

Preliminary User's Manual**Table 26-2. Signal Descriptions (continued)**

Signal Name	I/O	Function
EMCMDIO[PHYMDIO]	I/O	Management Data Input/Output is a bidirectional signal between EMAC and the PHY. It is used to transfer control and status information.
SDRAM Interface		
MemData0:31	I/O	Memory data bus
MemAddr0:12	O	Memory address bus
BA1:0	O	Bank Address supporting up to 4 internal banks
$\overline{\text{RAS}}$	O	Row Address Strobe
$\overline{\text{CAS}}$	O	Column Address Strobe
DQM0:3	O	DQM for byte lanes 0, 1, 2, and 3.
DQMCB	O	DQM for ECC check bits
ECC0:7	I/O	ECC check bits 0:7
$\overline{\text{BankSel0:3}}$	O	Select up to four external SDRAM banks
$\overline{\text{WE}}$	O	Write Enable
ClkEn0:1	O	ClkEn0:1 provide duplicate clock enables for MemClkOut0:1.
MemClkOut0:1	O	Duplicate SDRAM clock outputs. In limited cases, this allows glueless SDRAM attach without requiring the signal to be repowered by a PLL or zero-delay buffer.
External Slave Peripheral Interface		
PerData0:31	I/O	Peripheral data bus used by PPC405GP when not in external master mode, otherwise used by external master
PerAddr0:31	I/O	Peripheral address bus used by PPC405GP when not in external master mode, otherwise used by external master.
PerPar0:3	I/O	Peripheral byte parity signals
$\overline{\text{PerWBE0:3}}$	I/O	As outputs, these signals can act as byte-enables which are valid for an entire cycle or as write-byte-enables which are valid for each byte on each data transfer, allowing partial word transactions. As outputs, the signals are used by the peripheral controller or DMA controller, depending upon the type of transfer involved. These signals are used as inputs when an external bus master owns the external interface
$\overline{\text{PerCS0}}$	O	Peripheral chip select 0
$\overline{\text{PerCS1:7}}$ [GPIO10:16]	O [I/O]	Seven additional peripheral chip selects or General Purpose I/O - To access this function, software must toggle a DCR bit.
$\overline{\text{PerOE}}$	O	Used by either peripheral controller or DMA controller depending upon the type of transfer involved.

Table 26-2. Signal Descriptions (continued)

Signal Name	I/O	Function
PerR \overline{W}	I/O	Used by PPC405GP when not in external master mode, otherwise used by external master. As output, the signal is used by either peripheral controller or DMA controller depending upon the type of transfer involved.
PerReady	I	Used by a peripheral slave to indicate it is ready to transfer data
PerBLast	I/O	Used by PPC405GP when not in external master mode, otherwise used by external master.
DMAReq0:3	I	Used by slave peripherals to indicate that they are prepared to transfer data.
DMAAck0:3	O	Used by PPC405GP to indicate that data transfers have occurred.
EOT0:3[TC0:3]	I/O	End Of Transfer or Terminal Count
External Master Peripheral Interface		
PerClk	O	Peripheral clock to be used by an external master and by synchronous peripheral slaves
ExtReset	O	Peripheral reset to be used by an external master and by synchronous peripheral slaves
HoldReq	I	Hold Request, used by an external master to request ownership of the peripheral bus
HoldAck	O	Hold Acknowledge, used by PPC405GP to transfer ownership of peripheral bus to an external master
ExtReq	I	Used by an external master to indicate it is prepared to transfer data
ExtAck	O	Used by PPC405GP to indicate that a data transfer occurred.
HoldPri	I	Used by an external master to indicate the priority of a given transfer (0 = high, 1 = low)
BusReq	O	Used when PPC405GP needs to regain control of peripheral interface from an external Master
PerErr	I	Used to record external Master errors and external slave peripheral errors
Internal Peripheral Interface		
UARTSerClk	I	Serial Clock provides an alternative clock to the internally generated serial clock. Used when internally generated baud rates are not satisfactory. This input can be connected to UART0, using CPC0_CR0[U0EC] = 1, or UART1, using CPC0_CR0[U1EC] = 1, or both (CPC0_CR0[U0EC, U1EC] = 1.
UART0_Rx	I	UART0 Serial in data
UART0_Tx	O	UART0 Serial out data

Preliminary User's Manual**Table 26-2. Signal Descriptions (continued)**

Signal Name	I/O	Function
$\overline{\text{UART0_DCD}}$	I	UART0 Data Carrier Detect
$\overline{\text{UART0_DSR}}$	I	UART0 Data Set Ready
$\overline{\text{UART0_CTS}}$	I	UART0 Clear To Send
$\overline{\text{UART0_DTR}}$	O	UART0 Data Terminal Ready
$\overline{\text{UART0_RTS}}$	O	UART0 Request To Send
$\overline{\text{UART0_RI}}$	I	UART0 Ring Indicator
UART1_Rx	I	UART1 Serial In data.
UART1_Tx	O	UART1 Serial Out data
$\overline{\text{UART1_DSR}}[\overline{\text{UART1_CTS}}]$	I	UART1 Data Set Ready or UART1 Clear To Send. To access this function, software must toggle a DCR bit.
$\overline{\text{UART1_RTS}}[\overline{\text{UART1_DTR}}]$	O	UART1 Request To Send or UART1 Data Terminal Ready. To access this function, software must toggle a DCR bit.
IIC_SCL	I/O	IIC Serial Clock
IIC_SDA	I/O	IIC Serial Data
Interrupts Interface		
IRQ0:6[GPI017:23]	I [I/O]	Interrupt requests 0–6 or General Purpose I/O. To access this function, software must toggle a DCR bit.
JTAG Interface		
TDI	I	Test data in
TMS	I	JTAG test mode select
TDO	O	Test data out
TCK	I	JTAG test clock
$\overline{\text{TRST}}$	I	JTAG reset
System Interface		
SysClk	I	Main system clock input
$\overline{\text{SysReset}}$	I/O	Main system reset. This signal may be redriven by the PPC405GP to allow a system reset to occur.
SysErr	O	Asserted when a machine check exception is generated.
Halt	I	Halt from external debugger.

Table 26-2. Signal Descriptions (continued)

Signal Name	I/O	Function
GPIO1:2[TS1E:TS2E]	I/O [O]	General Purpose I/O or Even Trace execution status. To access this function, software must toggle a DCR bit.
GPIO3:4[TS1O:TS2O]	I/O [O]	General Purpose I/O or Odd Trace execution status. To access this function, software must toggle a DCR bit.
GPIO5:8[TS3:6]	I/O [O]	General Purpose I/O or Trace status. To access this function, software must toggle a DCR bit.
GPIO9[TrcClk]	I/O [O]	General Purpose I/O or Trace interface clock.
TestEn	I	Test Enable. Reserved for manufacturing test.
RcvrInh	I	Receiver Inhibit. Reserved for manufacturing test.
$\overline{\text{DrvrInh1}}$ $\overline{\text{DrvrInh2}}$	I	Driver Inhibit 1 and 2. Reserved for manufacturing test.
TmrClk	I	Timer clock. TmrClk is an alternative clock source for the timer facilities. Used when the allowable timer clock intervals provided by the CPU clock are not satisfactory. Enabled when CPC0_CR1[CETE] = 1.

Preliminary User's Manual**Appendix A. Instruction Summary**

This appendix contains PPC405GP instructions summarized alphabetically and by opcode.

“Instruction Set and Extended Mnemonics – Alphabetical” lists all PPC405GP mnemonics, including extended mnemonics, alphabetically. A short functional description is included for each mnemonic.

“Instructions Sorted by Opcode” on page A-1192, lists all PPC405GP instructions, sorted by primary and secondary opcodes. Extended mnemonics are not included in the opcode list.

“Instruction Formats” on page A-1199, illustrates the PPC405GP instruction forms (allowed arrangements of fields within instructions).

A.1 Instruction Set and Extended Mnemonics – Alphabetical

Table A-1 summarizes the PPC405GP instruction set, including required extended mnemonics. All mnemonics are listed alphabetically, without regard to whether the mnemonic is realized in hardware or software. When an instruction supports multiple hardware mnemonics (for example, b, ba, bl, bla are all forms of b), the instruction is alphabetized under the root form. The hardware instructions are described in detail in Chapter 24, “Instruction Set,” which is also alphabetized under the root form. Chapter 24 also describes the instruction operands and notation.

Note the following for the branch conditional mnemonic:

Bit 4 of the BO field provides a hint about the most likely outcome of a conditional branch. (See “Branch Prediction” on page 3-117 for a detailed description of branch prediction.) Assemblers should set BO4 = 0 unless a specific reason exists otherwise. In the BO field values specified in the table below, BO4 = 0 has always been assumed. The assembler must allow the programmer to specify branch prediction. To do this, the assembler supports a suffixes for the conditional branch mnemonics:

- + Predict branch to be taken.
- Predict branch not to be taken.

As specific examples, **bc** also could be coded as **bc+** or **bc-**, and **bne** also could be coded **bne+** or **bne-**. These alternate codings set BO4 = 1 only if the requested prediction differs from the standard prediction. See “Branch Prediction” on page 3-117 for more information.

Table A-1. PPC405GP Instruction Syntax Summary

Mnemonic	Operands	Function	Other Registers Changed	Page
add	RT, RA, RB	Add (RA) to (RB). Place result in RT.		668
add.			CR[CR0]	
addo			XER[SO, OV]	
addo.			CR[CR0] XER[SO, OV]	

Table A-1. PPC405GP Instruction Syntax Summary (continued)

Mnemonic	Operands	Function	Other Registers Changed	Page
addc	RT, RA, RB	Add (RA) to (RB). Place result in RT. Place carry-out in XER[CA].		669
addc.			CR[CR0]	
addco			XER[SO, OV]	
addco.			CR[CR0] XER[SO, OV]	
adde	RT, RA, RB	Add XER[CA], (RA), (RB). Place result in RT. Place carry-out in XER[CA].		670
adde.			CR[CR0]	
addeo			XER[SO, OV]	
addeo.			CR[CR0] XER[SO, OV]	
addi	RT, RA, IM	Add EXTS(IM) to (RA 0). Place result in RT.		671
addic	RT, RA, IM	Add EXTS(IM) to (RA 0). Place result in RT. Place carry-out in XER[CA].		672
addic.	RT, RA, IM	Add EXTS(IM) to (RA 0). Place result in RT. Place carry-out in XER[CA].	CR[CR0]	673
addis	RT, RA, IM	Add (IM ¹⁶ 0) to (RA 0). Place result in RT.		674
addme	RT, RA	Add XER[CA], (RA), (-1). Place result in RT. Place carry-out in XER[CA].		675
addme.			CR[CR0]	
addmeo			XER[SO, OV]	
addmeo.			CR[CR0] XER[SO, OV]	
addze	RT, RA	Add XER[CA] to (RA). Place result in RT. Place carry-out in XER[CA].		676
addze.			CR[CR0]	
addzeo			XER[SO, OV]	
addzeo.			CR[CR0] XER[SO, OV]	
and	RA, RS, RB	AND (RS) with (RB). Place result in RA.		677
and.			CR[CR0]	
andc	RA, RS, RB	AND (RS) with \bar{y} (RB). Place result in RA.		678
andc.			CR[CR0]	
andi.	RA, RS, IM	AND (RS) with (¹⁶ 0 IM). Place result in RA.	CR[CR0]	679
andis.	RA, RS, IM	AND (RS) with (IM ¹⁶ 0). Place result in RA.	CR[CR0]	680

Preliminary User's Manual

Table A-1. PPC405GP Instruction Syntax Summary (continued)

Mnemonic	Operands	Function	Other Registers Changed	Page
b	target	Branch unconditional relative. LI = (target – CIA) _{6:29} NIA = CIA + EXTS(LI 20)		681
ba		Branch unconditional absolute. LI = target _{6:29} NIA = EXTS(LI 20)		
bl		Branch unconditional relative. LI = (target – CIA) _{6:29} NIA = CIA + EXTS(LI 20)	(LR) · CIA + 4.	
bla		Branch unconditional absolute. LI = target _{6:29} NIA = EXTS(LI 20)	(LR) · CIA + 4.	
bc	BO, BI, target	Branch conditional relative. BD = (target – CIA) _{16:29} NIA = CIA + EXTS(BD 20)	CTR if BO ₂ = 0.	682
bca		Branch conditional absolute. BD = target _{16:29} NIA = EXTS(BD 20)	CTR if BO ₂ = 0.	
bcl		Branch conditional relative. BD = (target – CIA) _{16:29} NIA = CIA + EXTS(BD 20)	CTR if BO ₂ = 0. (LR) · CIA + 4.	
bcla		Branch conditional absolute. BD = target _{16:29} NIA = EXTS(BD 20)	CTR if BO ₂ = 0. (LR) · CIA + 4.	
bcctr	BO, BI	Branch conditional to address in CTR. Using (CTR) at exit from instruction, NIA = CTR _{0:29} 20.	CTR if BO ₂ = 0.	688
bcctrl			CTR if BO ₂ = 0. (LR) · CIA + 4.	
bclr	BO, BI	Branch conditional to address in LR. Using (LR) at entry to instruction, NIA = LR _{0:29} 20.	CTR if BO ₂ = 0.	692
bctrl			CTR if BO ₂ = 0. (LR) · CIA + 4.	
bctr		Branch unconditionally to address in CTR. <i>Extended mnemonic for bcctr 20,0</i>		688
bctrl		<i>Extended mnemonic for bcctrl 20,0</i>	(LR) · CIA + 4.	
bdnz	target	Decrement CTR. Branch if CTR $\frac{1}{4}$ 0. <i>Extended mnemonic for bc 16,0,target</i>		682
bdnza		<i>Extended mnemonic for bca 16,0,target</i>		
bdnzl		<i>Extended mnemonic for bcl 16,0,target</i>	(LR) · CIA + 4.	
bdnzla		<i>Extended mnemonic for bcla 16,0,target</i>	(LR) · CIA + 4.	

Table A-1. PPC405GP Instruction Syntax Summary (continued)

Mnemonic	Operands	Function	Other Registers Changed	Page
bdnzlr		Decrement CTR. Branch if CTR $\frac{1}{4}$ 0 to address in LR. <i>Extended mnemonic for</i> bclr 16,0		692
bdnzlrl		<i>Extended mnemonic for</i> bclrl 16,0	(LR) · CIA + 4.	
bdnzf	cr_bit, target	Decrement CTR. Branch if CTR $\frac{1}{4}$ 0 AND CRcr_bit = 0. <i>Extended mnemonic for</i> bc 0,cr_bit,target		682
bdnzfa		<i>Extended mnemonic for</i> bca 0,cr_bit,target		
bdnzfl		<i>Extended mnemonic for</i> bcl 0,cr_bit,target	(LR) · CIA + 4.	
bdnzfla		<i>Extended mnemonic for</i> bcla 0,cr_bit,target	(LR) · CIA + 4.	
bdnzflr	cr_bit	Decrement CTR. Branch if CTR $\frac{1}{4}$ 0 AND CRcr_bit = 0 to address in LR. <i>Extended mnemonic for</i> bclr 0,cr_bit		692
bdnzflrl		<i>Extended mnemonic for</i> bclrl 0,cr_bit	(LR) · CIA + 4.	
bdnzf	cr_bit, target	Decrement CTR. Branch if CTR $\frac{1}{4}$ 0 AND CRcr_bit = 1. <i>Extended mnemonic for</i> bc 8,cr_bit,target		682
bdnzfa		<i>Extended mnemonic for</i> bca 8,cr_bit,target		
bdnzfl		<i>Extended mnemonic for</i> bcl 8,cr_bit,target	(LR) · CIA + 4.	
bdnzfla		<i>Extended mnemonic for</i> bcla 8,cr_bit,target	(LR) · CIA + 4.	
bdnzflr	cr_bit	Decrement CTR. Branch if CTR $\frac{1}{4}$ 0 AND CRcr_bit = 1 to address in LR. <i>Extended mnemonic for</i> bclr 8,cr_bit		692
bdnzflrl		<i>Extended mnemonic for</i> bclrl 8,cr_bit	(LR) · CIA + 4.	

Preliminary User's Manual

Table A-1. PPC405GP Instruction Syntax Summary (continued)

Mnemonic	Operands	Function	Other Registers Changed	Page
bdz	target	Decrement CTR. Branch if CTR = 0. <i>Extended mnemonic for</i> bc 18,0,target		682
bdza		<i>Extended mnemonic for</i> bca 18,0,target		
bdzl		<i>Extended mnemonic for</i> bcl 18,0,target	(LR) · CIA + 4.	
bdzla		<i>Extended mnemonic for</i> bcla 18,0,target	(LR) · CIA + 4.	
bdzlr		Decrement CTR. Branch if CTR = 0 to address in LR. <i>Extended mnemonic for</i> bclr 18,0		692
bdzlrl		<i>Extended mnemonic for</i> bclrl 18,0	(LR) · CIA + 4.	
bdzfb	cr_bit, target	Decrement CTR. Branch if CTR = 0 AND CRcr_bit = 0. <i>Extended mnemonic for</i> bc 2,cr_bit,target		682
bdzfa		<i>Extended mnemonic for</i> bca 2,cr_bit,target		
bdzfl		<i>Extended mnemonic for</i> bcl 2,cr_bit,target	(LR) · CIA + 4.	
bdzfla		<i>Extended mnemonic for</i> bcla 2,cr_bit,target	(LR) · CIA + 4.	
bdzflr	cr_bit	Decrement CTR. Branch if CTR = 0 AND CRcr_bit = 0 to address in LR. <i>Extended mnemonic for</i> bclr 2,cr_bit		692
bdzflrl		<i>Extended mnemonic for</i> bclrl 2,cr_bit	(LR) · CIA + 4.	
bdztd	cr_bit, target	Decrement CTR. Branch if CTR = 0 AND CRcr_bit = 1. <i>Extended mnemonic for</i> bc 10,cr_bit,target		682
bdztda		<i>Extended mnemonic for</i> bca 10,cr_bit,target		
bdztdl		<i>Extended mnemonic for</i> bcl 10,cr_bit,target	(LR) · CIA + 4.	
bdztdla		<i>Extended mnemonic for</i> bcla 10,cr_bit,target	(LR) · CIA + 4.	

Table A-1. PPC405GP Instruction Syntax Summary (continued)

Mnemonic	Operands	Function	Other Registers Changed	Page
bdztlr	cr_bit	Decrement CTR. Branch if CTR = 0 AND CRcr_bit = 1 to address in LR. <i>Extended mnemonic for bclr 10,cr_bit</i>		692
bdztlrl		<i>Extended mnemonic for bclrl 10,cr_bit</i>	(LR) - CIA + 4.	
beq	[cr_field], target	Branch if equal. Use CR0 if cr_field is omitted. <i>Extended mnemonic for bc 12,4*cr_field+2,target</i>		682
beqa		<i>Extended mnemonic for bca 12,4*cr_field+2,target</i>		
beql		<i>Extended mnemonic for bcl 12,4*cr_field+2,target</i>	(LR) - CIA + 4.	
beqla		<i>Extended mnemonic for bcla 12,4*cr_field+2,target</i>	(LR) - CIA + 4.	
beqctr	[cr_field]	Branch if equal to address in CTR. Use CR0 if cr_field is omitted. <i>Extended mnemonic for bcctr 12,4*cr_field+2</i>		688
beqctrl		<i>Extended mnemonic for bcctrl 12,4*cr_field+2</i>	(LR) - CIA + 4.	
beqlr	[cr_field]	Branch if equal to address in LR. Use CR0 if cr_field is omitted. <i>Extended mnemonic for bclr 12,4*cr_field+2</i>		692
beqlrl		<i>Extended mnemonic for bclrl 12,4*cr_field+2</i>	(LR) - CIA + 4.	
bf	cr_bit, target	Branch if CRcr_bit = 0. <i>Extended mnemonic for bc 4,cr_bit,target</i>		682
bfa		<i>Extended mnemonic for bca 4,cr_bit,target</i>		
bfl		<i>Extended mnemonic for bcl 4,cr_bit,target</i>	(LR) - CIA + 4.	
bfla		<i>Extended mnemonic for bcla 4,cr_bit,target</i>	(LR) - CIA + 4.	
bfctr	cr_bit	Branch if CRcr_bit = 0 to address in CTR. <i>Extended mnemonic for bcctr 4,cr_bit</i>		688
bfctrl		<i>Extended mnemonic for bcctrl 4,cr_bit</i>	(LR) - CIA + 4.	
bflr	cr_bit	Branch if CRcr_bit = 0 to address in LR. <i>Extended mnemonic for bclr 4,cr_bit</i>		692
bflrl		<i>Extended mnemonic for bclrl 4,cr_bit</i>	(LR) - CIA + 4.	

Preliminary User's Manual

Table A-1. PPC405GP Instruction Syntax Summary (continued)

Mnemonic	Operands	Function	Other Registers Changed	Page
bge	[cr_field], target	Branch if greater than or equal. Use CR0 if cr_field is omitted. <i>Extended mnemonic for</i> bc 4,4*cr_field+0,target		682
bgea		<i>Extended mnemonic for</i> bca 4,4*cr_field+0,target		
bgel		<i>Extended mnemonic for</i> bcl 4,4*cr_field+0,target	(LR) · CIA + 4.	
bgea		<i>Extended mnemonic for</i> bcla 4,4*cr_field+0,target	(LR) · CIA + 4.	
bgectr	[cr_field]	Branch if greater than or equal to address in CTR. Use CR0 if cr_field is omitted. <i>Extended mnemonic for</i> bcctr 4,4*cr_field+0		688
bgectrl		<i>Extended mnemonic for</i> bcctrl 4,4*cr_field+0	(LR) · CIA + 4.	
bgehr	[cr_field]	Branch if greater than or equal to address in LR. Use CR0 if cr_field is omitted. <i>Extended mnemonic for</i> bclr 4,4*cr_field+0		692
bgehr		<i>Extended mnemonic for</i> bclrl 4,4*cr_field+0	(LR) · CIA + 4.	
bgt	[cr_field], target	Branch if greater than. Use CR0 if cr_field is omitted. <i>Extended mnemonic for</i> bc 12,4*cr_field+1,target		682
bgt		<i>Extended mnemonic for</i> bca 12,4*cr_field+1,target		
bgt		<i>Extended mnemonic for</i> bcl 12,4*cr_field+1,target	(LR) · CIA + 4.	
bgt		<i>Extended mnemonic for</i> bcla 12,4*cr_field+1,target	(LR) · CIA + 4.	
bgtctr	[cr_field]	Branch if greater than to address in CTR. Use CR0 if cr_field is omitted. <i>Extended mnemonic for</i> bcctr 12,4*cr_field+1		688
bgtctrl		<i>Extended mnemonic for</i> bcctrl 12,4*cr_field+1	(LR) · CIA + 4.	
bgtlr	[cr_field]	Branch if greater than to address in LR. Use CR0 if cr_field is omitted. <i>Extended mnemonic for</i> bclr 12,4*cr_field+1		692
bgtlr		<i>Extended mnemonic for</i> bclrl 12,4*cr_field+1	(LR) · CIA + 4.	

Table A-1. PPC405GP Instruction Syntax Summary (continued)

Mnemonic	Operands	Function	Other Registers Changed	Page
ble	[cr_field], target	Branch if less than or equal. Use CR0 if cr_field is omitted. <i>Extended mnemonic for bc 4,4*cr_field+1,target</i>		682
blea		<i>Extended mnemonic for bca 4,4*cr_field+1,target</i>		
blel		<i>Extended mnemonic for bcl 4,4*cr_field+1,target</i>	(LR) · CIA + 4.	
blela		<i>Extended mnemonic for bcla 4,4*cr_field+1,target</i>	(LR) · CIA + 4.	
blectr	[cr_field]	Branch if less than or equal to address in CTR. Use CR0 if cr_field is omitted. <i>Extended mnemonic for bcctr 4,4*cr_field+1</i>		688
blectrl		<i>Extended mnemonic for bcctrl 4,4*cr_field+1</i>	(LR) · CIA + 4.	
blelr	[cr_field]	Branch if less than or equal to address in LR. Use CR0 if cr_field is omitted. <i>Extended mnemonic for bclr 4,4*cr_field+1</i>		692
blelrl		<i>Extended mnemonic for bclrl 4,4*cr_field+1</i>	(LR) · CIA + 4.	
blr		Branch unconditionally to address in LR. <i>Extended mnemonic for bclr 20,0</i>		692
blrl		<i>Extended mnemonic for bclrl 20,0</i>	(LR) · CIA + 4.	
blt	[cr_field], target	Branch if less than. Use CR0 if cr_field is omitted. <i>Extended mnemonic for bc 12,4*cr_field+0,target</i>		682
blta		<i>Extended mnemonic for bca 12,4*cr_field+0,target</i>		
bltl		<i>Extended mnemonic for bcl 12,4*cr_field+0,target</i>	(LR) · CIA + 4.	
bltla		<i>Extended mnemonic for bcla 12,4*cr_field+0,target</i>	(LR) · CIA + 4.	
bltctr	[cr_field]	Branch if less than to address in CTR. Use CR0 if cr_field is omitted. <i>Extended mnemonic for bcctr 12,4*cr_field+0</i>		688
bltctrl		<i>Extended mnemonic for bcctrl 12,4*cr_field+0</i>	(LR) · CIA + 4.	

Preliminary User's Manual

Table A-1. PPC405GP Instruction Syntax Summary (continued)

Mnemonic	Operands	Function	Other Registers Changed	Page
bltr	[cr_field]	Branch if less than to address in LR. Use CR0 if cr_field is omitted. <i>Extended mnemonic for</i> bclr 12,4*cr_field+0		692
bltrl		<i>Extended mnemonic for</i> bclrl 12,4*cr_field+0	(LR) - CIA + 4.	
bne	[cr_field], target	Branch if not equal. Use CR0 if cr_field is omitted. <i>Extended mnemonic for</i> bc 4,4*cr_field+2,target		682
bnea		<i>Extended mnemonic for</i> bca 4,4*cr_field+2,target		
bnel		<i>Extended mnemonic for</i> bcl 4,4*cr_field+2,target	(LR) - CIA + 4.	
bnela		<i>Extended mnemonic for</i> bcla 4,4*cr_field+2,target	(LR) - CIA + 4.	
bnctr	[cr_field]	Branch if not equal to address in CTR. Use CR0 if cr_field is omitted. <i>Extended mnemonic for</i> bcctr 4,4*cr_field+2		688
bnctrl		<i>Extended mnemonic for</i> bcctrl 4,4*cr_field+2	(LR) - CIA + 4.	
bnelr	[cr_field]	Branch if not equal to address in LR. Use CR0 if cr_field is omitted. <i>Extended mnemonic for</i> bclr 4,4*cr_field+2		692
bnelrl		<i>Extended mnemonic for</i> bclrl 4,4*cr_field+2	(LR) - CIA + 4.	
bng	[cr_field], target	Branch if not greater than. Use CR0 if cr_field is omitted. <i>Extended mnemonic for</i> bc 4,4*cr_field+1,target		682
bnga		<i>Extended mnemonic for</i> bca 4,4*cr_field+1,target		
bngl		<i>Extended mnemonic for</i> bcl 4,4*cr_field+1,target	(LR) - CIA + 4.	
bngla		<i>Extended mnemonic for</i> bcla 4,4*cr_field+1,target	(LR) - CIA + 4.	
bngctr	[cr_field]	Branch if not greater than to address in CTR. Use CR0 if cr_field is omitted. <i>Extended mnemonic for</i> bcctr 4,4*cr_field+1		688
bngctrl		<i>Extended mnemonic for</i> bcctrl 4,4*cr_field+1	(LR) - CIA + 4.	

Table A-1. PPC405GP Instruction Syntax Summary (continued)

Mnemonic	Operands	Function	Other Registers Changed	Page
bnglr	[cr_field]	Branch if not greater than to address in LR. Use CR0 if cr_field is omitted. <i>Extended mnemonic for</i> bclr 4,4*cr_field+1		692
bnglrl		<i>Extended mnemonic for</i> bclrl 4,4*cr_field+1	(LR) · CIA + 4.	
bni	[cr_field], target	Branch if not less than. Use CR0 if cr_field is omitted. <i>Extended mnemonic for</i> bc 4,4*cr_field+0,target		682
bnla		<i>Extended mnemonic for</i> bca 4,4*cr_field+0,target		
bnll		<i>Extended mnemonic for</i> bcl 4,4*cr_field+0,target	(LR) · CIA + 4.	
bnlla		<i>Extended mnemonic for</i> bcla 4,4*cr_field+0,target	(LR) · CIA + 4.	
bnlctr	[cr_field]	Branch if not less than to address in CTR. Use CR0 if cr_field is omitted. <i>Extended mnemonic for</i> bcctr 4,4*cr_field+0		688
bnlctrl		<i>Extended mnemonic for</i> bcctrl 4,4*cr_field+0	(LR) · CIA + 4.	
bnllr	[cr_field]	Branch if not less than to address in LR. Use CR0 if cr_field is omitted. <i>Extended mnemonic for</i> bclr 4,4*cr_field+0		692
bnllrl		<i>Extended mnemonic for</i> bclrl 4,4*cr_field+0	(LR) · CIA + 4.	
bns	[cr_field], target	Branch if not summary overflow. Use CR0 if cr_field is omitted. <i>Extended mnemonic for</i> bc 4,4*cr_field+3,target		682
bnsa		<i>Extended mnemonic for</i> bca 4,4*cr_field+3,target		
bnsi		<i>Extended mnemonic for</i> bcl 4,4*cr_field+3,target	(LR) · CIA + 4.	
bnsla		<i>Extended mnemonic for</i> bcla 4,4*cr_field+3,target	(LR) · CIA + 4.	
bnsctr	[cr_field]	Branch if not summary overflow to address in CTR. Use CR0 if cr_field is omitted. <i>Extended mnemonic for</i> bcctr 4,4*cr_field+3		688
bnsctrl		<i>Extended mnemonic for</i> bcctrl 4,4*cr_field+3	(LR) · CIA + 4.	

Preliminary User's Manual

Table A-1. PPC405GP Instruction Syntax Summary (continued)

Mnemonic	Operands	Function	Other Registers Changed	Page
bnslr	[cr_field]	Branch if not summary overflow to address in LR. Use CR0 if cr_field is omitted. <i>Extended mnemonic for</i> bclr 4,4*cr_field+3		692
bnsrlr		<i>Extended mnemonic for</i> bclr 4,4*cr_field+3	(LR) · CIA + 4.	
bnu	[cr_field], target	Branch if not unordered. Use CR0 if cr_field is omitted. <i>Extended mnemonic for</i> bc 4,4*cr_field+3,target		682
bnua		<i>Extended mnemonic for</i> bca 4,4*cr_field+3,target		
bnul		<i>Extended mnemonic for</i> bcl 4,4*cr_field+3,target	(LR) · CIA + 4.	
bnula		Extended mnemonic for bcla 4,4*cr_field+3,target	(LR) · CIA + 4.	
bnuctr	[cr_field]	Branch if not unordered to address in CTR. Use CR0 if cr_field is omitted. <i>Extended mnemonic for</i> bcctr 4,4*cr_field+3		688
bnuctrl		<i>Extended mnemonic for</i> bcctr 4,4*cr_field+3	(LR) · CIA + 4.	
bnulr	[cr_field]	Branch if not unordered to address in LR. Use CR0 if cr_field is omitted. <i>Extended mnemonic for</i> bclr 4,4*cr_field+3		692
bnulrl		<i>Extended mnemonic for</i> bclr 4,4*cr_field+3	(LR) · CIA + 4.	
bso	[cr_field], target	Branch if summary overflow. Use CR0 if cr_field is omitted. <i>Extended mnemonic for</i> bc 12,4*cr_field+3,target		682
bsoa		<i>Extended mnemonic for</i> bca 12,4*cr_field+3,target		
bsol		<i>Extended mnemonic for</i> bcl 12,4*cr_field+3,target	(LR) · CIA + 4.	
bsola		<i>Extended mnemonic for</i> bcla 12,4*cr_field+3,target	(LR) · CIA + 4.	
bsoctr	[cr_field]	Branch if summary overflow to address in CTR. Use CR0 if cr_field is omitted. <i>Extended mnemonic for</i> bcctr 12,4*cr_field+3		688
bsoctrl		<i>Extended mnemonic for</i> bcctr 12,4*cr_field+3	(LR) · CIA + 4.	

Table A-1. PPC405GP Instruction Syntax Summary (continued)

Mnemonic	Operands	Function	Other Registers Changed	Page
bsolr	[cr_field]	Branch if summary overflow to address in LR. Use CR0 if cr_field is omitted. <i>Extended mnemonic for</i> bclr 12,4*cr_field+3		692
bsolrl		<i>Extended mnemonic for</i> bclrl 12,4*cr_field+3	(LR) - CIA + 4.	
bt	cr_bit, target	Branch if CRcr_bit = 1. <i>Extended mnemonic for</i> bc 12,cr_bit,target		682
bta		<i>Extended mnemonic for</i> bca 12,cr_bit,target		
btl		<i>Extended mnemonic for</i> bcl 12,cr_bit,target	(LR) - CIA + 4.	
btla		<i>Extended mnemonic for</i> bcla 12,cr_bit,target	(LR) - CIA + 4.	
btctr	cr_bit	Branch if CRcr_bit = 1 to address in CTR. <i>Extended mnemonic for</i> bcctr 12,cr_bit		688
btctrl		<i>Extended mnemonic for</i> bcctrl 12,cr_bit	(LR) - CIA + 4.	
btlr	cr_bit	Branch if CRcr_bit = 1, to address in LR. <i>Extended mnemonic for</i> bclr 12,cr_bit		692
btlrl		<i>Extended mnemonic for</i> bclrl 12,cr_bit	(LR) - CIA + 4.	
bun	[cr_field], target	Branch if unordered. Use CR0 if cr_field is omitted. <i>Extended mnemonic for</i> bc 12,4*cr_field+3,target		682
buna		<i>Extended mnemonic for</i> bca 12,4*cr_field+3,target		
bunl		<i>Extended mnemonic for</i> bcl 12,4*cr_field+3,target	(LR) - CIA + 4.	
bunla		<i>Extended mnemonic for</i> bcla 12,4*cr_field+3,target	(LR) - CIA + 4.	
bunctr	[cr_field]	Branch if unordered to address in CTR. Use CR0 if cr_field is omitted. <i>Extended mnemonic for</i> bcctr 12,4*cr_field+3		688
bunctrl		<i>Extended mnemonic for</i> bcctrl 12,4*cr_field+3	(LR) - CIA + 4.	

Preliminary User's Manual

Table A-1. PPC405GP Instruction Syntax Summary (continued)

Mnemonic	Operands	Function	Other Registers Changed	Page
bunlr	[cr_field]	Branch if unordered, to address in LR. Use CR0 if cr_field is omitted. <i>Extended mnemonic for bclr 12,4*cr_field+3</i>		692
bunlrl		<i>Extended mnemonic for bclrl 12,4*cr_field+3</i>	(LR) - CIA + 4.	
clrlwi	RA, RS, n	Clear left immediate. (n < 32) (RA) _{0:n-1} = 0 <i>Extended mnemonic for rlwinm RA,RS,0,n,31</i>		809
clrlwi.		<i>Extended mnemonic for rlwinm. RA,RS,0,n,31</i>	CR[CR0]	
clrlslwi	RA, RS, b, n	Clear left and shift left immediate. (n & b < 32) (RA) _{b-n:31-n} = (RS) _{b:31} (RA) _{32-n:31} = 0 (RA) _{0:b-n-1} = b-n <i>Extended mnemonic for rlwinm RA,RS,n,b-n,31-n</i>		809
clrlslwi.		<i>Extended mnemonic for rlwinm. RA,RS,n,b-n,31-n</i>	CR[CR0]	
clrrwi	RA, RS, n	Clear right immediate. (n < 32) (RA) _{32-n:31} = 0 <i>Extended mnemonic for rlwinm RA,RS,0,0,31-n</i>		809
clrrwi.		<i>Extended mnemonic for rlwinm. RA,RS,0,0,31-n</i>	CR[CR0]	
cmp	BF, 0, RA, RB	Compare (RA) to (RB), signed. Results in CR[CRn], where n = BF.		696
cmpi	BF, 0, RA, IM	Compare (RA) to EXTS(IM), signed. Results in CR[CRn], where n = BF.		697
cmpl	BF, 0, RA, RB	Compare (RA) to (RB), unsigned. Results in CR[CRn], where n = BF.		698
cmpli	BF, 0, RA, IM	Compare (RA) to (¹⁶ 0 IM), unsigned. Results in CR[CRn], where n = BF.		699
cmplw	[BF,] RA, RB	Compare Logical Word. Use CR0 if BF is omitted. <i>Extended mnemonic for cmpl BF,0,RA,RB</i>		699
cmplwi	[BF,] RA, IM	Compare Logical Word Immediate. Use CR0 if BF is omitted. <i>Extended mnemonic for cmpli BF,0,RA,IM</i>		699
cmpw	[BF,] RA, RB	Compare Word. Use CR0 if BF is omitted. <i>Extended mnemonic for cmp BF,0,RA,RB</i>		696

Table A-1. PPC405GP Instruction Syntax Summary (continued)

Mnemonic	Operands	Function	Other Registers Changed	Page
cmpwi	[BF,] RA, IM	Compare Word Immediate. Use CR0 if BF is omitted. <i>Extended mnemonic for cmpi BF,0,RA,IM</i>		699
cntlzw	RA, RS	Count leading zeros in RS. Place result in RA.		700
cntlzw.			CR[CR0]	
crand	BT, BA, BB	AND bit (CR _{BA}) with (CR _{BB}). Place result in CR _{BT} .		701
crandc	BT, BA, BB	AND bit (CR _{BA}) with \bar{y} (CR _{BB}). Place result in CR _{BT} .		702
crclr	bx	Condition register clear. <i>Extended mnemonic for crxor bx,bx,bx</i>		708
creqv	BT, BA, BB	Equivalence of bit CR _{BA} with CR _{BB} . $CR_{BT} = \bar{y}(CR_{BA} \dot{\vee} CR_{BB})$		703
crmove	bx, by	Condition register move. <i>Extended mnemonic for cror bx,by,by</i>		706
crnand	BT, BA, BB	NAND bit (CR _{BA}) with (CR _{BB}). Place result in CR _{BT} .		704
crnor	BT, BA, BB	NOR bit (CR _{BA}) with (CR _{BB}). Place result in CR _{BT} .		705
crnot	bx, by	Condition register not. <i>Extended mnemonic for crnor bx,by,by</i>		705
cror	BT, BA, BB	OR bit (CR _{BA}) with (CR _{BB}). Place result in CR _{BT} .		706
crorc	BT, BA, BB	OR bit (CR _{BA}) with \bar{y} (CR _{BB}). Place result in CR _{BT} .		707
crset	bx	Condition register set. <i>Extended mnemonic for creqv bx,bx,bx</i>		703
crxor	BT, BA, BB	XOR bit (CR _{BA}) with (CR _{BB}). Place result in CR _{BT} .		708
dcba	RA, RB	Speculatively establish the data cache block which contains the effective address (RA 0) + (RB).		709
dcbf	RA, RB	Flush (store, then invalidate) the data cache block which contains the effective address (RA 0) + (RB).		711
dcbi	RA, RB	Invalidate the data cache block which contains the effective address (RA 0) + (RB).		712
dcbst	RA, RB	Store the data cache block which contains the effective address (RA 0) + (RB).		713
dcbt	RA, RB	Load the data cache block which contains the effective address (RA 0) + (RB).		714
dcbtst	RA, RB	Load the data cache block which contains the effective address (RA 0) + (RB).		715

Preliminary User's Manual

Table A-1. PPC405GP Instruction Syntax Summary (continued)

Mnemonic	Operands	Function	Other Registers Changed	Page
dcbz	RA, RB	Zero the data cache block which contains the effective address (RA 0) + (RB).		716
dccci	RA, RB	Invalidate the data cache congruence class associated with the effective address (RA 0) + (RB).		718
dcread	RT, RA, RB	Read either tag or data information from the data cache congruence class associated with the effective address (RA 0) + (RB). Place the results in RT.		719
divw	RT, RA, RB	Divide (RA) by (RB), signed. Place result in RT.		721
divw.			CR[CR0]	
divwo			XER[SO, OV]	
divwo.			CR[CR0] XER[SO, OV]	
divwu	RT, RA, RB	Divide (RA) by (RB), unsigned. Place result in RT.		722
divwu.			CR[CR0]	
divwuo			XER[SO, OV]	
divwuo.			CR[CR0] XER[SO, OV]	
eieio		Storage synchronization. All loads and stores that precede the eieio instruction complete before any loads and stores that follow the instruction access main storage. Implemented as sync, which is more restrictive.		723
eqv	RA, RS, RB	Equivalence of (RS) with (RB). $(RA) = \bar{y}((RS) \bar{y} (RB))$		724
eqv.			CR[CR0]	
extlwi	RA, RS, n, b	Extract and left justify immediate. (n > 0) $(RA)_{0:n-1} = (RS)_{b:b+n-1}$ $(RA)_{n:31} = 32-n_0$ <i>Extended mnemonic for</i> <i>rlwinm RA,RS,b,0,n-1</i>		722
extlwi.			<i>Extended mnemonic for</i> <i>rlwinm. RA,RS,b,0,n-1</i>	
extrwi	RA, RS, n, b	Extract and right justify immediate. (n > 0) $(RA)_{32-n:31} = (RS)_{b:b+n-1}$ $(RA)_{0:31-n} = 32-n_0$ <i>Extended mnemonic for</i> <i>rlwinm RA,RS,b+n,32-n,31</i>		809
extrwi.			<i>Extended mnemonic for</i> <i>rlwinm. RA,RS,b+n,32-n,31</i>	
extsb	RA, RS	Extend the sign of byte (RS) _{24:31} . Place the result in RA.		725
extsb.			CR[CR0]	
extsh	RA, RS	Extend the sign of halfword (RS) _{16:31} . Place the result in RA.		726
extsh.			CR[CR0]	
icbi	RA, RB	Invalidate the instruction cache block which contains the effective address (RA 0) + (RB).		727

Table A-1. PPC405GP Instruction Syntax Summary (continued)

Mnemonic	Operands	Function	Other Registers Changed	Page
icbt	RA, RB	Load the instruction cache block which contains the effective address (RA 0) + (RB).		728
iccci	RA, RB	Invalidate instruction cache.		729
icread	RA, RB	Read either tag or data information from the instruction cache congruence class associated with the effective address (RA 0) + (RB). Place the results in ICDBDR.		730
inslwi	RA, RS, n, b	Insert from left immediate. (n > 0) $(RA)_{b:b+n-1} \leftarrow (RS)_{0:n-1}$ <i>Extended mnemonic for</i> rlwimi RA,RS,32-b,b,b+n-1		808
inslwi.		<i>Extended mnemonic for</i> rlwimi. RA,RS,32-b,b,b+n-1	CR[CR0]	
insrwi	RA, RS, n, b	Insert from right immediate. (n > 0) $(RA)_{b:b+n-1} \leftarrow (RS)_{32-n:31}$ <i>Extended mnemonic for</i> rlwimi RA,RS,32-b-n,b,b+n-1		808
insrwi.		<i>Extended mnemonic for</i> rlwimi. RA,RS,32-b-n,b,b+n-1	CR[CR0]	
isync		Synchronize execution context by flushing the prefetch queue.		732
la	RT, D(RA)	Load address. (RA \neq 0) D is an offset from a base address that is assumed to be (RA). $(RT) \leftarrow (RA) + \text{EXTS}(D)$ <i>Extended mnemonic for</i> addi RT,RA,D		671
lbz	RT, D(RA)	Load byte from EA = (RA 0) + EXTS(D) and pad left with zeroes, $(RT) \leftarrow {}^{24}0 \parallel \text{MS}(\text{EA},1)$.		733
lbzu	RT, D(RA)	Load byte from EA = (RA 0) + EXTS(D) and pad left with zeroes, $(RT) \leftarrow {}^{24}0 \parallel \text{MS}(\text{EA},1)$. Update the base address, $(RA) \leftarrow \text{EA}$.		734
lbzux	RT, RA, RB	Load byte from EA = (RA 0) + (RB) and pad left with zeroes, $(RT) \leftarrow {}^{24}0 \parallel \text{MS}(\text{EA},1)$. Update the base address, $(RA) \leftarrow \text{EA}$.		735
lbzx	RT, RA, RB	Load byte from EA = (RA 0) + (RB) and pad left with zeroes, $(RT) \leftarrow {}^{24}0 \parallel \text{MS}(\text{EA},1)$.		736
lha	RT, D(RA)	Load halfword from EA = (RA 0) + EXTS(D) and sign extend, $(RT) \leftarrow \text{EXTS}(\text{MS}(\text{EA},2))$.		737

Preliminary User's Manual

Table A-1. PPC405GP Instruction Syntax Summary (continued)

Mnemonic	Operands	Function	Other Registers Changed	Page
lhau	RT, D(RA)	Load halfword from EA = (RA 0) + EXTS(D) and sign extend, (RT) ← EXTS(MS(EA,2)). Update the base address, (RA) ← EA.		738
lhaux	RT, RA, RB	Load halfword from EA = (RA 0) + (RB) and sign extend, (RT) ← EXTS(MS(EA,2)). Update the base address, (RA) ← EA.		739
lhax	RT, RA, RB	Load halfword from EA = (RA 0) + (RB) and sign extend, (RT) ← EXTS(MS(EA,2)).		740
lhbrx	RT, RA, RB	Load halfword from EA = (RA 0) + (RB), then reverse byte order and pad left with zeroes, (RT) ← ¹⁶ 0 MS(EA+1,1) MS(EA,1).		741
lhz	RT, D(RA)	Load halfword from EA = (RA 0) + EXTS(D) and pad left with zeroes, (RT) ← ¹⁶ 0 MS(EA,2).		742
lhzu	RT, D(RA)	Load halfword from EA = (RA 0) + EXTS(D) and pad left with zeroes, (RT) ← ¹⁶ 0 MS(EA,2). Update the base address, (RA) ← EA.		743
lhzux	RT, RA, RB	Load halfword from EA = (RA 0) + (RB) and pad left with zeroes, (RT) ← ¹⁶ 0 MS(EA,2). Update the base address, (RA) ← EA.		744
lhzx	RT, RA, RB	Load halfword from EA = (RA 0) + (RB) and pad left with zeroes, (RT) ← ¹⁶ 0 MS(EA,2).		745
li	RT, IM	Load immediate. (RT) ← EXTS(IM) <i>Extended mnemonic for addi RT,0,value</i>		671
lis	RT, IM	Load immediate shifted. (RT) ← (IM ¹⁶ 0) <i>Extended mnemonic for addis RT,0,value</i>		674
lmw	RT, D(RA)	Load multiple words starting from EA = (RA 0) + EXTS(D). Place into consecutive registers RT through GPR(31). RA is not altered unless RA = GPR(31).		746

Table A-1. PPC405GP Instruction Syntax Summary (continued)

Mnemonic	Operands	Function	Other Registers Changed	Page
lswi	RT, RA, NB	Load consecutive bytes from EA=(RA 0). Number of bytes n=32 if NB=0, else n=NB. Stack bytes into words in CEIL(n/4) consecutive registers starting with RT, to RFINAL - ((RT + CEIL(n/4) - 1) % 32). GPR(0) is consecutive to GPR(31). RA is not altered unless RA = RFINAL.		747
lswx	RT, RA, RB	Load consecutive bytes from EA=(RA 0)+(RB). Number of bytes n=XER[TBC]. Stack bytes into words in CEIL(n/4) consecutive registers starting with RT, to RFINAL - ((RT + CEIL(n/4) - 1) % 32). GPR(0) is consecutive to GPR(31). RA is not altered unless RA = RFINAL. RB is not altered unless RB = RFINAL. If n=0, content of RT is undefined.		749
lwarx	RT, RA, RB	Load word from EA = (RA 0) + (RB) and place in RT, (RT) - MS(EA,4). Set the Reservation bit.		751
lwbrx	RT, RA, RB	Load word from EA = (RA 0) + (RB) then reverse byte order, (RT) - MS(EA+3,1) MS(EA+2,1) MS(EA+1,1) MS(EA,1).		752
lwz	RT, D(RA)	Load word from EA = (RA 0) + EXTS(D) and place in RT, (RT) - MS(EA,4).		753
lwzu	RT, D(RA)	Load word from EA = (RA 0) + EXTS(D) and place in RT, (RT) - MS(EA,4). Update the base address, (RA) - EA.		754
lwzux	RT, RA, RB	Load word from EA = (RA 0) + (RB) and place in RT, (RT) - MS(EA,4). Update the base address, (RA) - EA.		755
lwzx	RT, RA, RB	Load word from EA = (RA 0) + (RB) and place in RT, (RT) - MS(EA,4).		756
macchw	RT, RA, RB	prod0:31 - (RA)16:31 x (RB)0:15 signed temp0:32 - prod0:31 + (RT) (RT) - temp1:32		757
macchw.			CR[CR0]	
macchwo			XER[SO, OV]	
macchwo.			CR[CR0] XER[SO, OV]	

Preliminary User's Manual

Table A-1. PPC405GP Instruction Syntax Summary (continued)

Mnemonic	Operands	Function	Other Registers Changed	Page
macchws	RT, RA, RB	prod0:31 - (RA)16:31 x (RB)0:15 signed temp0:32 - prod0:31 + (RT) if ((prod0 = RT0) \bar{y} (RT0 $\frac{1}{4}$ temp1)) then (RT) - (RT0 31(\bar{y} RT0)) else (RT) - temp1:32		758
macchws.			CR[CR0]	
macchwso			XER[SO, OV]	
macchwso.			CR[CR0] XER[SO, OV]	
macchwsu	RT, RA, RB	prod0:31 - (RA)16:31 x (RB)0:15 unsigned temp0:32 - prod0:31 + (RT) (RT) - (temp1:32 / 32temp0)		759
macchwsu.			CR[CR0]	
macchwso			XER[SO, OV]	
macchwso.			CR[CR0] XER[SO, OV]	
macchwu	RT, RA, RB	prod0:31 - (RA)16:31 x (RB)0:15 unsigned temp0:32 - prod0:31 + (RT) (RT) - temp1:32		760
macchwu.			CR[CR0]	
macchwuo			XER[SO, OV]	
macchwuo.			CR[CR0] XER[SO, OV]	
machhw	RT, RA, RB	prod0:15 - (RA)16:31 x (RB)0:15 signed temp0:32 - prod0:31 + (RT) (RT) - temp1:32		761
machhw.			CR[CR0]	
machhwo			XER[SO, OV]	
machhwo.			CR[CR0] XER[SO, OV]	
machhws	RT, RA, RB	prod0:31 - (RA)0:15 x (RB)0:15 signed temp0:32 - prod0:31 + (RT) if ((prod0 = RT0) \bar{y} (RT0 $\frac{1}{4}$ temp1)) then (RT) - (RT0 31(\bar{y} RT0)) else (RT) - temp1:32		762
machhws.			CR[CR0]	
machhwso			XER[SO, OV]	
machhwso.			CR[CR0] XER[SO, OV]	
machhwsu	RT, RA, RB	prod0:31 - (RA)0:15 x (RB)0:15 unsigned temp0:32 - prod0:31 + (RT) (RT) - (temp1:32 / 32temp0)		763
machhwsu.			CR[CR0]	
machhwso			XER[SO, OV]	
machhwso.			CR[CR0] XER[SO, OV]	
machhwu	RT, RA, RB	prod0:31 - (RA)0:15 x (RB)0:15 unsigned temp0:32 - prod0:31 + (RT) (RT) - temp1:32		764
machhwu.			CR[CR0]	
machhwuo			XER[SO, OV]	
machhwuo.			CR[CR0] XER[SO, OV]	
maclhw	RT, RA, RB	prod0:31 - (RA)16:31 x (RB)16:31 signed temp0:32 - prod0:31 + (RT) (RT) - temp1:32		765
maclhw.			CR[CR0]	
maclhwo			XER[SO, OV]	
maclhwo.			CR[CR0] XER[SO, OV]	

Table A-1. PPC405GP Instruction Syntax Summary (continued)

Mnemonic	Operands	Function	Other Registers Changed	Page
maclhws	RT, RA, RB	prod0:31 · (RA)16:31 x (RB)16:31 signed temp0:32 · prod0:31 + (RT) if ((prod0 = RT0) \bar{y} (RT0 $\frac{1}{4}$ temp1)) then (RT) · (RT0 \parallel 31(\bar{y} RT0)) else (RT) · temp1:32		766
maclhws.			CR[CR0]	
maclhws0			XER[SO, OV]	
maclhws0.			CR[CR0] XER[SO, OV]	
maclhwsu	RT, RA, RB	prod0:31 · (RA)16:31 x (RB)16:31 unsigned temp0:32 · prod0:31 + (RT) (RT) · (temp1:32 / 32temp0)		767
maclhwsu.			CR[CR0]	
maclhwsuo			XER[SO, OV]	
maclhwsuo.			CR[CR0] XER[SO, OV]	
maclhwu	RT, RA, RB	prod0:31 · (RA)16:31 x (RB)16:31 unsigned temp0:32 · prod0:31 + (RT) (RT) · temp1:32		768
maclhwu.			CR[CR0]	
maclhwu0			XER[SO, OV]	
maclhwu0.			CR[CR0] XER[SO, OV]	
mcrf	BF, BFA	Move CR field, (CR[CRn]) · (CR[CRm]) where m · BFA and n · BF.		769
mcrxr	BF	Move XER[0:3] into field CRn, where n · BF. CR[CRn] · (XER[SO, OV, CA]). (XER[SO, OV, CA]) · ³⁰ 0.		770
mfcr	RT	Move from CR to RT, (RT) · (CR).		771
mfocr	RT, DCRN	Move from DCR to RT, (RT) · (DCR(DCRN)).		772
mfmsr	RT	Move from MSR to RT, (RT) · (MSR).		773

Preliminary User's Manual

Table A-1. PPC405GP Instruction Syntax Summary (continued)

Mnemonic	Operands	Function	Other Registers Changed	Page
mfccr0 mfctr mfdac1 mfdac2 mfdear mfdbcr0 mfdbcr1 mfdbsr mfdccr mfdcwr mfdvc1 mfdvc2 mfesr mfevpr mfiac1 mfiac2 mfiac3 mfiac4 mficcr mficbdr mflr mfpid mfpit mfpvr mfsgr mfsler mfsprg0 mfsprg1 mfsprg2 mfsprg3 mfsprg4 mfsprg5 mfsprg6 mfsprg7 mfsrr0 mfsrr1 mfsrr2 mfsrr3 mfsu0r mftcr mftsr mfxer mfzpr	RT	Move from special purpose register (SPR) SPRN. <i>Extended mnemonic for mfspr RT,SPRN</i> See Table 25.5, "Special Purpose Registers," on page 25-863 for listing of valid SPRN values.		781
mfspr	RT, SPRN	Move from SPR to RT, (RT) - (SPR(SPRN)).		774
mftb	RT, TBRN	Move from TBR to RT, (RT) - (TBR(TBRN)).		776
mftb	RT	Move the contents of TBL into RT, (RT) - (TBL) <i>Extended mnemonic for mftb RT,TBL</i>		776

Table A-1. PPC405GP Instruction Syntax Summary (continued)

Mnemonic	Operands	Function	Other Registers Changed	Page
mftbu	RT	Move the contents of TBU into RT, (RT) ← (TBU) <i>Extended mnemonic for mftb RT,TBU</i>		776
mr	RT, RS	Move register. (RT) ← (RS) <i>Extended mnemonic for or RT,RS,RS</i>		802
mr.		<i>Extended mnemonic for or. RT,RS,RS</i>	CR[CR0]	
mtcr	RS	Move to Condition Register. <i>Extended mnemonic for mtcrf 0xFF,RS</i>		778
mtcrf	FXM, RS	Move some or all of the contents of RS into CR as specified by FXM field, mask = $4(\text{FXM}_0) \parallel 4(\text{FXM}_1) \parallel \dots \parallel$ $4(\text{FXM}_6) \parallel 4(\text{FXM}_7)$. (CR) ← ((RS) & mask) (CR) & ~mask).		778
mtdcr	DCRN, RS	Move to DCR from RS, (DCR(DCRN)) ← (RS).		779
mtmsr	RS	Move to MSR from RS, (MSR) ← (RS).		780

Preliminary User's Manual

Table A-1. PPC405GP Instruction Syntax Summary (continued)

Mnemonic	Operands	Function	Other Registers Changed	Page
mtccr0 mtctr mtdac1 mtdac2 mtdbcr0 mtdbcr1 mtdbsr mtdccr mtdear mtdcwr mtdvc1 mtdvc2 mtesr mtevpr mtiac1 mtiac2 mtiac3 mtiac4 mticcr mticbdr mtlr mtpid mtpit mtpvr mtsgr mtsler metsprg0 metsprg1 metsprg2 metsprg3 metsprg4 metsprg5 metsprg6 metsprg7 mtsrr0 mtsrr1 mtsrr2 mtsrr3 mtsuo0r mttbl mttbu mttcr mttsr mtxer mtzpr	RS	Move to SPR SPRN. <i>Extended mnemonic for metspr SPRN,RS</i> See Table 25.5, "Special Purpose Registers," on page 25-863 for listing of valid SPRN values.		781
mtspr	SPRN, RS	Move to SPR from RS, (SPR(SPRN)) - (RS).		781
mulchw	RT, RA, RB	(RT) _{0:31} - (RA) _{16:31} x (RB) _{0:15} signed		783
mulchw.			CR[CR0]	
mulchwu	RT, RA, RB	(RT) _{0:31} - (RA) _{16:31} x (RB) _{0:15} unsigned		784
mulchwu.			CR[CR0]	

Table A-1. PPC405GP Instruction Syntax Summary (continued)

Mnemonic	Operands	Function	Other Registers Changed	Page
mulhhw	RT, RA, RB	$(RT)_{0:31} \leftarrow (RA)_{0:15} \times (RB)_{0:15}$ signed		785
mulhhw.			CR[CR0]	
mulhhwu	RT, RA, RB	$(RT)_{0:31} \leftarrow (RA)_{0:15} \times (RB)_{0:15}$ unsigned		786
mulhhwu.			CR[CR0]	
mullhw	RT, RA, RB	$(RT)_{0:31} \leftarrow (RA)_{16:31} \times (RB)_{16:31}$ signed		787
mullhw.			CR[CR0]	
mullhwu	RT, RA, RB	$(RT)_{16:31} \leftarrow (RA)_{16:31} \times (RB)_{16:31}$ unsigned		788
mullhwu.			CR[CR0]	
mulhw	RT, RA, RB	Multiply (RA) and (RB), signed. Place high-order result in RT. $prod_{0:63} \leftarrow (RA) \times (RB)$ (signed). $(RT) \leftarrow prod_{0:31}$.		789
mulhw.			CR[CR0]	
mulhwu	RT, RA, RB	Multiply (RA) and (RB), unsigned. Place high-order result in RT. $prod_{0:63} \leftarrow (RA) \times (RB)$ (unsigned). $(RT) \leftarrow prod_{0:31}$.		790
mulhwu.			CR[CR0]	
mulli	RT, RA, IM	Multiply (RA) and IM, signed. Place low-order result in RT. $prod_{0:47} \leftarrow (RA) \times IM$ (signed) $(RT) \leftarrow prod_{16:47}$		791
mullw	RT, RA, RB	Multiply (RA) and (RB), signed. Place low-order result in RT. $prod_{0:63} \leftarrow (RA) \times (RB)$ (signed). $(RT) \leftarrow prod_{32:63}$.		792
mullw.			CR[CR0]	
mullwo			XER[SO, OV]	
mullwo.			CR[CR0] XER[SO, OV]	
nand	RA, RS, RB	NAND (RS) with (RB). Place result in RA.		793
nand.			CR[CR0]	
neg	RT, RA	Negative (twos complement) of RA. $(RT) \leftarrow \bar{y}(RA) + 1$		794
neg.			CR[CR0]	
nego			XER[SO, OV]	
nego.			CR[CR0] XER[SO, OV]	
nmacchw	RT, RA, RB	$nprod_{0:31} \leftarrow \neg((RA)_{16:31} \times (RB)_{0:15})$ signed $temp_{0:32} \leftarrow nprod_{0:31} + (RT)$ $(RT) \leftarrow temp_{1:32}$		795
nmacchw.			CR[CR0]	
nmacchwo			XER[SO, OV]	
nmacchwo.			CR[CR0] XER[SO, OV]	
nmacchws	RT, RA, RB	$nprod_{0:31} \leftarrow \neg((RA)_{16:31} \times (RB)_{0:15})$ signed $temp_{0:32} \leftarrow nprod_{0:31} + (RT)$ if $((nprod_{0:31} = RT_{0:31}) \bar{y} (RT_{0:31} \neq temp_{1:32}))$ then $(RT) \leftarrow (RT_{0:31} \parallel 31(\bar{y}RT_{0:31}))$ else $(RT) \leftarrow temp_{1:32}$		796
nmacchws.			CR[CR0]	
nmacchwso			XER[SO, OV]	
nmacchwso.			CR[CR0] XER[SO, OV]	

Preliminary User's Manual

Table A-1. PPC405GP Instruction Syntax Summary (continued)

Mnemonic	Operands	Function	Other Registers Changed	Page
nmachhw	RT, RA, RB	nprod0:31 - ((RA)0:15 x (RB)0:15) signed temp0:32 - nprod0:31 + (RT) (RT) - temp1:32		797
nmachhw.			CR[CR0]	
nmachhwo			XER[SO, OV]	
nmachhwo.			CR[CR0] XER[SO, OV]	
nmachhws	RT, RA, RB	nprod0:31 - ((RA)0:15 x (RB)0:15) signed temp0:32 - nprod0:31 + (RT) if ((nprod0 = RT0) \bar{y} (RT0 $\frac{1}{4}$ temp1)) then (RT) - (RT0 31(\bar{y} RT0)) else (RT) - temp1:32		799
nmachhws.			CR[CR0]	
nmachhwso			XER[SO, OV]	
nmachhwso.			CR[CR0] XER[SO, OV]	
nmachlw	RT, RA, RB	nprod0:31 - ((RA)16:31 x (RB)16:31) signed temp0:32 - nprod0:31 + (RT) if ((nprod0 = RT0) \bar{y} (RT0 $\frac{1}{4}$ temp1)) then (RT) - (RT0 31(\bar{y} RT0)) else (RT) - temp1:32		800
nmachlw.			CR[CR0]	
nmachlwo			XER[SO, OV]	
nmachlwo.			CR[CR0] XER[SO, OV]	
nmachlws	RT, RA, RB	nprod0:31 - ((RA)0:15 x (RB)0:15) signed temp0:32 - nprod0:31 + (RT) if ((nprod0 = RT0) \bar{y} (RT0 $\frac{1}{4}$ temp1)) then (RT) - (RT0 31(\bar{y} RT0)) else (RT) - temp1:32		798
nmachlws.			CR[CR0]	
nmachlwso			XER[SO, OV]	
nmachlwso.			CR[CR0] XER[SO, OV]	
nop		Preferred no-op, triggers optimizations based on no-ops. <i>Extended mnemonic for ori 0,0,0</i>		796
nor	RA, RS, RB	NOR (RS) with (RB). Place result in RA.		801
nor.			CR[CR0]	
not	RA, RS	Complement register. (RA) - \bar{y} (RS) <i>Extended mnemonic for nor RA,RS,RS</i>		801
not.			CR[CR0]	
or	RA, RS, RB	OR (RS) with (RB). Place result in RA.		796
or.			CR[CR0]	
orc	RA, RS, RB	OR (RS) with \bar{y} (RB). Place result in RA.		796
orc.			CR[CR0]	
ori	RA, RS, IM	OR (RS) with (¹⁶ 0 IM). Place result in RA.		796
oris	RA, RS, IM	OR (RS) with (IM ¹⁶ 0). Place result in RA.		796
rfci		Return from critical interrupt (PC) - (SRR2). (MSR) - (SRR3).		806

Table A-1. PPC405GP Instruction Syntax Summary (continued)

Mnemonic	Operands	Function	Other Registers Changed	Page
rfi		Return from interrupt. (PC) ← (SRR0). (MSR) ← (SRR1).		807
rlwimi	RA, RS, SH, MB, ME	Rotate left word immediate, then insert according to mask. r ← ROTL((RS), SH) m ← MASK(MB, ME) (RA) ← (r ∨ m) / ((RA) ∨ m)		808
rlwimi.			CR[CR0]	
rlwinm	RA, RS, SH, MB, ME	Rotate left word immediate, then AND with mask. r ← ROTL((RS), SH) m ← MASK(MB, ME) (RA) ← (r ∨ m)		809
rlwinm.			CR[CR0]	
rlwnm	RA, RS, RB, MB, ME	Rotate left word, then AND with mask. r ← ROTL((RS), (RB) _{27:31}) m ← MASK(MB, ME) (RA) ← (r ∨ m)		812
rlwnm.			CR[CR0]	
rotlw	RA, RS, RB	Rotate left. (RA) ← ROTL((RS), (RB) _{27:31}) <i>Extended mnemonic for rlwnm RA,RS,RB,0,31</i>		812
rotlw.			<i>Extended mnemonic for rlwnm. RA,RS,RB,0,31</i>	
rotlwi	RA, RS, n	Rotate left immediate. (RA) ← ROTL((RS), n) <i>Extended mnemonic for rlwinm RA,RS,n,0,31</i>		809
rotlwi.			<i>Extended mnemonic for rlwinm. RA,RS,n,0,31</i>	
rotrwi	RA, RS, n	Rotate right immediate. (RA) ← ROTL((RS), 32-n) <i>Extended mnemonic for rlwinm RA,RS,32-n,0,31</i>		809
rotrwi.			<i>Extended mnemonic for rlwinm. RA,RS,32-n,0,31</i>	
sc		System call exception is generated. (SRR1) ← (MSR) (SRR0) ← (PC) PC ← EVPR0:15 x'0C00' (MSR[WE, PR, EE, PE, DR, IR]) ← 0		813
slw	RA, RS, RB	Shift left (RS) by (RB) _{27:31} . n ← (RB) _{27:31} . r ← ROTL((RS), n). if (RB) ₂₆ = 0 then m ← MASK(0, 31 – n) else m ← 320. (RA) ← r ∨ m.		814
slw.			CR[CR0]	

Preliminary User's Manual

Table A-1. PPC405GP Instruction Syntax Summary (continued)

Mnemonic	Operands	Function	Other Registers Changed	Page
slwi	RA, RS, n	Shift left immediate. ($n < 32$) $(RA)_{0:31-n} \leftarrow (RS)_{n:31}$ $(RA)_{32-n:31} \leftarrow n0$ <i>Extended mnemonic for</i> rlwinm RA,RS,n,0,31-n		809
slwi.		<i>Extended mnemonic for</i> rlwinm. RA,RS,n,0,31-n	CR[CR0]	
sraw	RA, RS, RB	Shift right algebraic (RS) by $(RB)_{27:31}$. $n \leftarrow (RB)_{27:31}$. $r \leftarrow \text{ROTL}((RS), 32 - n)$. if $(RB)_{26} = 0$ then $m \leftarrow \text{MASK}(n, 31)$ else $m \leftarrow 320$. $s \leftarrow (RS)_0$. $(RA) \leftarrow (r \hat{\vee} m) / ({}^{32}s \hat{\vee} \hat{\vee} m)$. $\text{XER[CA]} \leftarrow s \hat{\vee} ((r \hat{\vee} \hat{\vee} m)_{\%} 0)$.		815
sraw.			CR[CR0]	
srawi	RA, RS, SH	Shift right algebraic (RS) by SH. $n \leftarrow \text{SH}$. $r \leftarrow \text{ROTL}((RS), 32 - n)$. $m \leftarrow \text{MASK}(n, 31)$. $s \leftarrow (RS)_0$. $(RA) \leftarrow (r \hat{\vee} m) / ({}^{32}s \hat{\vee} \hat{\vee} m)$. $\text{XER[CA]} \leftarrow s \hat{\vee} ((r \hat{\vee} \hat{\vee} m)_{\%} 0)$.		816
srawi.			CR[CR0]	
srw	RA, RS, RB	Shift right (RS) by $(RB)_{27:31}$. $n \leftarrow (RB)_{27:31}$. $r \leftarrow \text{ROTL}((RS), 32 - n)$. if $(RB)_{26} = 0$ then $m \leftarrow \text{MASK}(n, 31)$ else $m \leftarrow 320$. $(RA) \leftarrow r \hat{\vee} m$.		817
srw.			CR[CR0]	
srwi	RA, RS, n	Shift right immediate. ($n < 32$) $(RA)_{n:31} \leftarrow (RS)_{0:31-n}$ $(RA)_{0:n-1} \leftarrow n0$ <i>Extended mnemonic for</i> rlwinm RA,RS,32-n,n,31		809
srwi.		<i>Extended mnemonic for</i> rlwinm. RA,RS,32-n,n,31	CR[CR0]	
stb	RS, D(RA)	Store byte $(RS)_{24:31}$ in memory at $\text{EA} = (\text{RA} 0) + \text{EXTS}(D)$.		818
stbu	RS, D(RA)	Store byte $(RS)_{24:31}$ in memory at $\text{EA} = (\text{RA} 0) + \text{EXTS}(D)$. Update the base address, $(\text{RA}) \leftarrow \text{EA}$.		819
stbux	RS, RA, RB	Store byte $(RS)_{24:31}$ in memory at $\text{EA} = (\text{RA} 0) + (\text{RB})$. Update the base address, $(\text{RA}) \leftarrow \text{EA}$.		820
stbx	RS, RA, RB	Store byte $(RS)_{24:31}$ in memory at $\text{EA} = (\text{RA} 0) + (\text{RB})$.		821
sth	RS, D(RA)	Store halfword $(RS)_{16:31}$ in memory at $\text{EA} = (\text{RA} 0) + \text{EXTS}(D)$.		822

Table A-1. PPC405GP Instruction Syntax Summary (continued)

Mnemonic	Operands	Function	Other Registers Changed	Page
sthbrx	RS, RA, RB	Store halfword (RS) _{16:31} byte-reversed in memory at EA = (RA 0) + (RB). MS(EA, 2) · (RS) _{24:31} (RS) _{16:23}		823
sthu	RS, D(RA)	Store halfword (RS) _{16:31} in memory at EA = (RA 0) + EXTS(D). Update the base address, (RA) · EA.		824
sthux	RS, RA, RB	Store halfword (RS) _{16:31} in memory at EA = (RA 0) + (RB). Update the base address, (RA) · EA.		825
sthx	RS, RA, RB	Store halfword (RS) _{16:31} in memory at EA = (RA 0) + (RB).		826
stmw	RS, D(RA)	Store consecutive words from RS through GPR(31) in memory starting at EA = (RA 0) + EXTS(D).		827
stswi	RS, RA, NB	Store consecutive bytes in memory starting at EA=(RA 0). Number of bytes n=32 if NB=0, else n=NB. Bytes are unstacked from CEIL(n/4) consecutive registers starting with RS. GPR(0) is consecutive to GPR(31).		828
stswx	RS, RA, RB	Store consecutive bytes in memory starting at EA=(RA 0)+(RB). Number of bytes n=XER[TBC]. Bytes are unstacked from CEIL(n/4) consecutive registers starting with RS. GPR(0) is consecutive to GPR(31).		829
stw	RS, D(RA)	Store word (RS) in memory at EA = (RA 0) + EXTS(D).		831
stwbrx	RS, RA, RB	Store word (RS) byte-reversed in memory at EA = (RA 0) + (RB). MS(EA, 4) · (RS) _{24:31} (RS) _{16:23} (RS) _{8:15} (RS) _{0:7}		832
stwcx.	RS, RA, RB	Store word (RS) in memory at EA = (RA 0) + (RB) only if reservation bit is set. if RESERVE = 1 then MS(EA, 4) · (RS) RESERVE · 0 (CR[CR0]) · ² 0 1 XER _{so} else (CR[CR0]) · ² 0 0 XER _{so} .		833
stwu	RS, D(RA)	Store word (RS) in memory at EA = (RA 0) + EXTS(D). Update the base address, (RA) · EA.		835
stwux	RS, RA, RB	Store word (RS) in memory at EA = (RA 0) + (RB). Update the base address, (RA) · EA.		836

Preliminary User's Manual

Table A-1. PPC405GP Instruction Syntax Summary (continued)

Mnemonic	Operands	Function	Other Registers Changed	Page
stwx	RS, RA, RB	Store word (RS) in memory at EA = (RA 0) + (RB).		837
sub	RT, RA, RB	Subtract (RB) from (RA). (RT) = $\bar{y}(RB) + (RA) + 1$. <i>Extended mnemonic for subf RT,RB,RA</i>		838
sub.		<i>Extended mnemonic for subf. RT,RB,RA</i>	CR[CR0]	
subo		<i>Extended mnemonic for subfo RT,RB,RA</i>	XER[SO, OV]	
subo.		<i>Extended mnemonic for subfo. RT,RB,RA</i>	CR[CR0] XER[SO, OV]	
subc	RT, RA, RB	Subtract (RB) from (RA). (RT) = $\bar{y}(RB) + (RA) + 1$. Place carry-out in XER[CA]. <i>Extended mnemonic for subfc RT,RB,RA</i>		839
subc.		<i>Extended mnemonic for subfc. RT,RB,RA</i>	CR[CR0]	
subco		<i>Extended mnemonic for subfco RT,RB,RA</i>	XER[SO, OV]	
subco.		<i>Extended mnemonic for subfco. RT,RB,RA</i>	CR[CR0] XER[SO, OV]	
subf	RT, RA, RB	Subtract (RA) from (RB). (RT) = $\bar{y}(RA) + (RB) + 1$.		838
subf.			CR[CR0]	
subfo			XER[SO, OV]	
subfo.			CR[CR0] XER[SO, OV]	
subfc	RT, RA, RB	Subtract (RA) from (RB). (RT) = $\bar{y}(RA) + (RB) + 1$. Place carry-out in XER[CA].		839
subfc.			CR[CR0]	
subfco			XER[SO, OV]	
subfco.			CR[CR0] XER[SO, OV]	
subfe	RT, RA, RB	Subtract (RA) from (RB) with carry-in. (RT) = $\bar{y}(RA) + (RB) + XER[CA]$. Place carry-out in XER[CA].		840
subfe.			CR[CR0]	
subfeo			XER[SO, OV]	
subfeo.			CR[CR0] XER[SO, OV]	
subfic	RT, RA, IM	Subtract (RA) from EXTS(IM). (RT) = $\bar{y}(RA) + EXTS(IM) + 1$. Place carry-out in XER[CA].		841
subfme	RT, RA, RB	Subtract (RA) from (-1) with carry-in. (RT) = $\bar{y}(RA) + (-1) + XER[CA]$. Place carry-out in XER[CA].		842
subfme.			CR[CR0]	
subfmeo			XER[SO, OV]	
subfmeo.			CR[CR0] XER[SO, OV]	

Table A-1. PPC405GP Instruction Syntax Summary (continued)

Mnemonic	Operands	Function	Other Registers Changed	Page
subfze	RT, RA, RB	Subtract (RA) from zero with carry-in. (RT) = \bar{y} (RA) + XER[CA]. Place carry-out in XER[CA].		843
subfze.			CR[CR0]	
subfzeo			XER[SO, OV]	
subfzeo.			CR[CR0] XER[SO, OV]	
subi	RT, RA, IM	Subtract EXTS(IM) from (RA 0). Place result in RT. <i>Extended mnemonic for addi RT,RA,-IM</i>		671
subic	RT, RA, IM	Subtract EXTS(IM) from (RA). Place result in RT. Place carry-out in XER[CA]. <i>Extended mnemonic for addic RT,RA,-IM</i>		672
subic.	RT, RA, IM	Subtract EXTS(IM) from (RA). Place result in RT. Place carry-out in XER[CA]. <i>Extended mnemonic for addic. RT,RA,-IM</i>	CR[CR0]	673
subis	RT, RA, IM	Subtract (IM ¹⁶ 0) from (RA 0). Place result in RT. <i>Extended mnemonic for addis RT,RA,-IM</i>		674
sync		Synchronization. All instructions that precede sync complete before any instructions that follow sync begin. When sync completes, all storage accesses initiated prior to sync will have completed.		844
tlbia		All TLB entries are invalidated and become unavailable for translation by clearing the valid (V) bit in the TLBHI portion of each TLB entry. The rest of the TLB fields unmodified.		845
tlbre	RT, RA, WS	If WS = 0: Load TLBHI of the selected TLB entry into RT. Load PID with the contents of the TID field of the selected TLB entry. (RT) = TLBHI[(RA)] (PID) = TLB[(RA)]TID If WS = 1: Load TLBLO portion of the selected TLB entry into RT. (RT) = TLBLO[(RA)]		846
tlbrehi	RT, RA	Load TLBHI of the selected TLB entry into RT. Load PID with the contents of the TID field of the selected TLB entry. (RT) = TLBHI[(RA)] (PID) = TLB[(RA)]TID <i>Extended mnemonic for tlbre RT,RA,0</i>		846

Preliminary User's Manual

Table A-1. PPC405GP Instruction Syntax Summary (continued)

Mnemonic	Operands	Function	Other Registers Changed	Page
tlbrelo	RT, RA	Load TLBLO of the selected TLB entry into RT. (RT) ← TLBLO[(RA)] <i>Extended mnemonic for tlbre RT,RA,1</i>		846
tlbsx	RT, RA, RB	Search the TLB for a valid entry that translates the EA. EA = (RA 0) + (RB). If found, (RT) ← Index of TLB entry. If not found, (RT) Undefined.		848
tlbsx.		If found, (RT) ← Index of TLB entry. CR[CR0]EQ ← 1. If not found, (RT) Undefined. CR[CR0]EQ ← 1.	CR[CR0]LT,GT,S O	
tlbsync		tlbsync does not complete until all previous TLB-update instructions executed by this processor have been received and completed by all other processors. For the PPC405GP, tlbsync is a no-op.		849
tlbwe	RS, RA, WS	If WS = 0: Write TLBHI of the selected TLB entry from RS. Write the TID field of the selected TLB entry from the PID register. TLBHI[(RA)] ← (RS) TLB[(RA)]TID ← (PID)24:31 If WS = 1: Write TLBLO portion of the selected TLB entry from RS. TLBLO[(RA)] ← (RS)		850
tlbwehi	RS, RA	Write TLBHI of the selected TLB entry from RS. Write the TID field of the selected TLB entry from the PID register. TLBHI[(RA)] ← (RS) TLB[(RA)]TID ← (PID)24:31 <i>Extended mnemonic for tlbwe RS,RA,0</i>		850
tlbwelo	RS, RA	Write TLBLO of the selected TLB entry from RS. TLBLO[(RA)] ← (RS) <i>Extended mnemonic for tlbwe RS,RA,1</i>		850

Table A-1. PPC405GP Instruction Syntax Summary (continued)

Mnemonic	Operands	Function	Other Registers Changed	Page
trap		Trap unconditionally. <i>Extended mnemonic for</i> tw 31,0,0		852
tw eq	RA, RB	Trap if (RA) equal to (RB). <i>Extended mnemonic for</i> tw 4,RA,RB		
tw ge		Trap if (RA) greater than or equal to (RB). <i>Extended mnemonic for</i> tw 12,RA,RB		
tw gt		Trap if (RA) greater than (RB). <i>Extended mnemonic for</i> tw 8,RA,RB		
tw le		Trap if (RA) less than or equal to (RB). <i>Extended mnemonic for</i> tw 20,RA,RB		
tw lge		Trap if (RA) logically greater than or equal to (RB). <i>Extended mnemonic for</i> tw 5,RA,RB		
tw lgt		Trap if (RA) logically greater than (RB). <i>Extended mnemonic for</i> tw 1,RA,RB		
tw lle		Trap if (RA) logically less than or equal to (RB). <i>Extended mnemonic for</i> tw 6,RA,RB		
tw llt		Trap if (RA) logically less than (RB). <i>Extended mnemonic for</i> tw 2,RA,RB		
tw lng		Trap if (RA) logically not greater than (RB). <i>Extended mnemonic for</i> tw 6,RA,RB		
tw lnl		Trap if (RA) logically not less than (RB). <i>Extended mnemonic for</i> tw 5,RA,RB		
tw lt		Trap if (RA) less than (RB). <i>Extended mnemonic for</i> tw 16,RA,RB		
tw ne		Trap if (RA) not equal to (RB). <i>Extended mnemonic for</i> tw 24,RA,RB		
tw ng		Trap if (RA) not greater than (RB). <i>Extended mnemonic for</i> tw 20,RA,RB		
tw nl		Trap if (RA) not less than (RB). <i>Extended mnemonic for</i> tw 12,RA,RB		
tw	TO, RA, RB	Trap exception is generated if, comparing (RA) with (RB), any condition specified by TO is true.		852

Preliminary User's Manual

Table A-1. PPC405GP Instruction Syntax Summary (continued)

Mnemonic	Operands	Function	Other Registers Changed	Page
tweqi	RA, IM	Trap if (RA) equal to EXTS(IM). <i>Extended mnemonic for twi 4,RA,IM</i>		855
twgei		Trap if (RA) greater than or equal to EXTS(IM). <i>Extended mnemonic for twi 12,RA,IM</i>		
twgti		Trap if (RA) greater than EXTS(IM). <i>Extended mnemonic for twi 8,RA,IM</i>		
twlei		Trap if (RA) less than or equal to EXTS(IM). <i>Extended mnemonic for twi 20,RA,IM</i>		
twlgei		Trap if (RA) logically greater than or equal to EXTS(IM). <i>Extended mnemonic for wi 5,RA,IM</i>		
twlgti		Trap if (RA) logically greater than EXTS(IM). <i>Extended mnemonic for twi 1,RA,IM</i>		
twllei		Trap if (RA) logically less than or equal to EXTS(IM). <i>Extended mnemonic for twi 6,RA,IM</i>		
twllti		Trap if (RA) logically less than EXTS(IM). <i>Extended mnemonic for twi 2,RA,IM</i>		
twlngi		Trap if (RA) logically not greater than EXTS(IM). <i>Extended mnemonic for twi 6,RA,IM</i>		
twlnli		Trap if (RA) logically not less than EXTS(IM). <i>Extended mnemonic for twi 5,RA,IM</i>		
twlti		Trap if (RA) less than EXTS(IM). <i>Extended mnemonic for twi 16,RA,IM</i>		
twnei		Trap if (RA) not equal to EXTS(IM). <i>Extended mnemonic for twi 24,RA,IM</i>		
twngi		Trap if (RA) not greater than EXTS(IM). <i>Extended mnemonic for twi 20,RA,IM</i>		
twnli		Trap if (RA) not less than EXTS(IM). <i>Extended mnemonic for twi 12,RA,IM</i>		
twi		TO, RA, IM		
wrttee	RS	Write value of RS ₁₆ to MSR[EE].		858
wrtteei	E	Write value of E to MSR[EE].		859

Table A-1. PPC405GP Instruction Syntax Summary (continued)

Mnemonic	Operands	Function	Other Registers Changed	Page
xor	RA, RS, RB	XOR (RS) with (RB). Place result in RA.		860
xor.			CR[CR0]	
xori	RA, RS, IM	XOR (RS) with (¹⁶ 0 IM). Place result in RA.		861
xoris	RA, RS, IM	XOR (RS) with (IM ¹⁶ 0). Place result in RA.		862

A.2 Instructions Sorted by Opcode

All instructions are four bytes long and word aligned. All instructions have a primary opcode field (shown as field OPCD in Figure A-1 through Figure A-9, beginning on page A-1201) in bits 0:5. Some instructions also have a secondary opcode field (shown as field XO in Figure A-1 through Figure A-9). PPC405GP instructions, sorted by primary and secondary opcode, are listed in Table A-2.

The “Form” indicated in the table refers to the arrangement of valid field combinations within the four-byte instruction. See “Instruction Formats” on page A-1199, for the field layouts of each form.

Form X has a 10-bit secondary opcode field, while form XO uses only the low-order 9-bits of that field. Form XO uses the high-order secondary opcode bit (the tenth bit) as a variable; therefore, every form XO instruction really consumes two secondary opcodes from the 10-bit secondary-opcode space. The implicitly consumed secondary opcode is listed in parentheses for form XO instructions in the table below.

Table A-2. PPC405GP Instructions by Opcode

Primary Opcode	Secondary Opcode	Form	Mnemonic	Operands	Page
3		D	twi	TO, RA, IM	855
4	8	X	mulhww	RT, RA, RB	786
			mulhww.		
4	12 (524)	XO	machww	RT, RA, RB	760
			machww.		
			machwwo		
			machwwo.		
4	40	X	mulhww	RT, RA, RB	785
			mulhww.		
4	44 (556)	XO	machww	RT, RA, RB	761
			machww.		
			machwwo		
			machwwo.		
4	46 (558)	XO	nmachww	RT, RA, RB	797
			nmachww.		
			nmachwwo		
			nmachwwo.		

Preliminary User's Manual

Table A-2. PPC405GP Instructions by Opcode (continued)

Primary Opcode	Secondary Opcode	Form	Mnemonic	Operands	Page
4	76 (588)	XO	machwsu	RT, RA, RB	759
			machwsu.		
			machwsuo		
			machwsuo.		
4	108 (620)	XO	machws	RT, RA, RB	762
			machws.		
			machwso		
			machwso.		
4	110 (622)	XO	nmachws	RT, RA, RB	798
			nmachws.		
			nmachwso		
			nmachwso.		
4	136	X	mulchwu	RT, RA, RB	784
			mulchwu.		
4	140 (652)	XO	macchwu	RT, RA, RB	760
			macchwu.		
			macchwuo		
			macchwuo.		
4	168	X	mulchw	RT, RA, RB	783
			mulchw.		
4	172 (684)	XO	macchw	RT, RA, RB	757
			macchw.		
			macchwo		
			macchwo.		
4	174 (686)	XO	nmacchw	RT, RA, RB	795
			nmacchw.		
			nmacchwo		
			nmacchwo.		
4	204 (716)	XO	macchwsu	RT, RA, RB	759
			macchwsu.		
			macchwsuo		
			macchwsuo.		
4	236 (748)	XO	macchws	RT, RA, RB	758
			macchws.		
			macchwso		
			macchwso.		
4	238 (750)	XO	nmacchws	RT, RA, RB	796
			nmacchws.		
			nmacchwso		
			nmacchwso.		
4	392	X	mullhwu	RT, RA, RB	790
			mullhwu.		

Table A-2. PPC405GP Instructions by Opcode (continued)

Primary Opcode	Secondary Opcode	Form	Mnemonic	Operands	Page
4	396 (908)	XO	maclhwu	RT, RA, RB	768
			maclhwu.		
			maclhwuo		
			maclhwuo.		
4	424	X	mullhw	RT, RA, RB	789
			mullhw.		
4	428 (940)	XO	maclhw	RT, RA, RB	765
			maclhw.		
			maclhwo		
			maclhwo.		
4	430 (942)	XO	nmaclhw	RT, RA, RB	799
			nmaclhw.		
			nmaclhwo		
			nmaclhwo.		
4	492 (972)	XO	maclhws	RT, RA, RB	766
			maclhws.		
			maclhwso		
			maclhwso.		
4	460 (1004)	XO	maclhwsu	RT, RA, RB	767
			maclhwsu.		
			maclhwsuo		
			maclhwsuo.		
4	494 (1006)	XO	nmaclhws	RT, RA, RB	800
			nmaclhws.		
			nmaclhwso		
			nmaclhwso.		
7		D	mulli	RT, RA, IM	791
8		D	subfic	RT, RA, IM	841
10		D	cmpli	BF, 0, RA, IM	699
11		D	cmpi	BF, 0, RA, IM	697
12		D	addic	RT, RA, IM	672
13		D	addic.	RT, RA, IM	673
14		D	addi	RT, RA, IM	671
15		D	addis	RT, RA, IM	674
16		B	bc	BO, BI, target	682
			bca		
			bcl		
			bcla		
17		SC	sc		813

Preliminary User's Manual

Table A-2. PPC405GP Instructions by Opcode (continued)

Primary Opcode	Secondary Opcode	Form	Mnemonic	Operands	Page
18		I	b	target	681
			ba		
			bl		
			bla		
19	0	XL	mcrf	BF, BFA	769
19	16	XL	bclr	BO, BI	692
			bclrl		
19	33	XL	crnor	BT, BA, BB	705
19	50	XL	rfi		807
19	51	XL	rfci		806
19	129	XL	crandc	BT, BA, BB	702
19	150	XL	isync		732
19	193	XL	crxor	BT, BA, BB	708
19	225	XL	crnand	BT, BA, BB	704
19	257	XL	crand	BT, BA, BB	701
19	289	XL	creqv	BT, BA, BB	703
19	417	XL	crorc	BT, BA, BB	707
19	449	XL	cror	BT, BA, BB	706
19	528	XL	bcctr	BO, BI	688
			bcctrl		
20		M	rlwimi	RA, RS, SH, MB, ME	808
			rlwimi.		
21		M	rlwinm	RA, RS, SH, MB, ME	809
			rlwinm.		
23		M	rlwnm	RA, RS, RB, MB, ME	812
			rlwnm.		
24		D	ori	RA, RS, IM	804
25		D	oris	RA, RS, IM	805
26		D	xori	RA, RS, IM	861
27		D	xoris	RA, RS, IM	862
28		D	andi.	RA, RS, IM	679
29		D	andis.	RA, RS, IM	680
31	0	X	cmp	BF, 0, RA, RB	696
31	4	X	tw	TO, RA, RB	852
31	8 (520)	XO	subfc	RT, RA, RB	839
			subfc.		
			subfco		
			subfco.		
31	10 (522)	XO	addc	RT, RA, RB	669
			addc.		
			addco		
			addco.		

Table A-2. PPC405GP Instructions by Opcode (continued)

Primary Opcode	Secondary Opcode	Form	Mnemonic	Operands	Page
31	11	XO	mulhwu	RT, RA, RB	788
			mulhwu.		
31	19	X	mfcrr	RT	771
31	20	X	lwarx	RT, RA, RB	751
31	23	X	lwzxx	RT, RA, RB	756
31	24	X	slw	RA, RS, RB	831
			slw.		
31	26	X	cntlzw	RA, RS	700
			cntlzw.		
31	28	X	and	RA, RS, RB	677
			and.		
31	32	X	cmpl	BF, 0, RA, RB	698
31	40 (552)	XO	subf	RT, RA, RB	838
			subf.		
			subfo		
			subfo.		
31	54	X	dcbst	RA, RB	713
31	55	X	lwzux	RT, RA, RB	755
31	60	X	andc	RA, RS, RB	678
			andc.		
31	75	XO	mulhw	RT, RA, RB	787
			mulhw.		
31	83	X	mfmsr	RT	773
31	86	X	dcbf	RA, RB	711
31	87	X	lbzxx	RT, RA, RB	736
31	104 (616)	XO	neg	RT, RA	794
			neg.		
			nego		
			nego.		
31	119	X	lbzux	RT, RA, RB	735
31	124	X	nor	RA, RS, RB	801
			nor.		
31	131	X	wrttee	RS	858
31	136 (648)	XO	subfe	RT, RA, RB	840
			subfe.		
			subfeo		
			subfeo.		
31	138 (650)	XO	adde	RT, RA, RB	670
			adde.		
			addeo		
			addeo.		
31	144	XFX	mtcrf	FXM, RS	778

Preliminary User's Manual

Table A-2. PPC405GP Instructions by Opcode (continued)

Primary Opcode	Secondary Opcode	Form	Mnemonic	Operands	Page
31	146	X	mtmsr	RS	780
31	150	X	stwcx.	RS, RA, RB	833
31	151	X	stwx	RS, RA, RB	837
31	163	X	wrteei	E	859
31	183	X	stwux	RS, RA, RB	836
31	200 (712)	XO	subfze	RT, RA, RB	843
			subfze.		
			subfzeo		
			subfzeo.		
31	202 (714)	XO	addze	RT, RA	676
			addze.		
			addzeo		
			addzeo.		
31	215	X	stbx	RS, RA, RB	821
31	232 (744)	XO	subfme	RT, RA, RB	842
			subfme.		
			subfmeo		
			subfmeo.		
31	234 (746)	XO	addme	RT, RA	675
			addme.		
			addmeo		
			addmeo.		
31	235 (747)	XO	mullw	RT, RA, RB	792
			mullw.		
			mullwo		
			mullwo.		
31	246	X	dcbtst	RA, RB	715
31	247	X	stbux	RS, RA, RB	820
31	262	X	icbt	RA, RB	728
31	266 (778)	XO	add	RT, RA, RB	668
			add.		
			addo		
			addo.		
31	278	X	dcbt	RA, RB	714
31	279	X	lhzx	RT, RA, RB	745
31	284	X	eqv	RA, RS, RB	724
			eqv.		
31	311	X	lhzux	RT, RA, RB	744
31	316	X	xor	RA, RS, RB	860
			xor.		
31	323	AFX	mfdcr	RT, DCRN	772
31	339	AFX	mfspr	RT, SPRN	774

Table A-2. PPC405GP Instructions by Opcode (continued)

Primary Opcode	Secondary Opcode	Form	Mnemonic	Operands	Page
31	343	X	lhax	RT, RA, RB	740
31	370	X	tlbia		845
31	371	AFX	mftb	RT, TBRN	776
31	375	X	lhaux	RT, RA, RB	739
31	407	X	sthx	RS, RA, RB	826
31	412	X	orc	RA, RS, RB	803
			orc.		
31	439	X	sthux	RS, RA, RB	825
31	444	X	or	RA, RS, RB	802
			or.		
31	451	AFX	mtdcr	DCRN, RS	779
31	454	X	dccci	RA, RB	718
31	459 (971)	XO	divwu	RT, RA, RB	722
			divwu.		
			divwuo		
			divwuo.		
31	467	AFX	mtspr	SPRN, RS	781
31	470	X	dcbi	RA, RB	712
31	476	X	nand	RA, RS, RB	793
			nand.		
31	486	X	dcread	RT, RA, RB	719
31	491 (1003)	XO	divw	RT, RA, RB	721
			divw.		
			divwo		
			divwo.		
31	512	X	mcrxr	BF	770
31	533	X	lswx	RT, RA, RB	749
31	534	X	lwbrx	RT, RA, RB	752
31	536	X	srw	RA, RS, RB	817
			srw.		
31	566	X	tlbsync		849
31	597	X	lswi	RT, RA, NB	747
31	598	X	sync		844
31	661	X	stswx	RS, RA, RB	829
31	662	X	stwbrx	RS, RA, RB	832
31	725	X	stswi	RS, RA, NB	828
31	758	X	dcba	RA, RB	709
31	790	X	lhbrx	RT, RA, RB	741
31	792	X	sraw	RA, RS, RB	815
			sraw.		
31	824	X	srawi	RA, RS, SH	816
			srawi.		

Preliminary User's Manual

Table A-2. PPC405GP Instructions by Opcode (continued)

Primary Opcode	Secondary Opcode	Form	Mnemonic	Operands	Page
31	854	X	eieio		723
31	914	X	tlbsx	RT, RA, RB	848
			tlbsx.		
31	918	X	sthbrx	RS, RA, RB	823
31	922	X	extsh	RA, RS	726
			extsh.		
31	946	X	tlbre	RT, RA, WS	846
31	954	X	extsb	RA, RS	725
			extsb.		
31	966	X	iccci	RA, RB	729
31	978	X	tlbwe	RS, RA, WS	850
31	982	X	icbi	RA, RB	727
31	998	X	icread	RA, RB	730
31	1014	X	dcbz	RA, RB	716
32		D	lwz	RT, D(RA)	753
33		D	lwzu	RT, D(RA)	754
34		D	lbz	RT, D(RA)	733
35		D	lbzu	RT, D(RA)	734
36		D	stw	RS, D(RA)	831
37		D	stwu	RS, D(RA)	835
38		D	stb	RS, D(RA)	818
39		D	stbu	RS, D(RA)	819
40		D	lhz	RT, D(RA)	742
41		D	lhzu	RT, D(RA)	743
42		D	lha	RT, D(RA)	737
43		D	lhau	RT, D(RA)	738
44		D	sth	RS, D(RA)	822
45		D	sthu	RS, D(RA)	824
46		D	lmw	RT, D(RA)	746
47		D	stmw	RS, D(RA)	827

A.3 Instruction Formats

Instructions are four bytes long. Instruction addresses are always word-aligned.

Instruction bits 0 through 5 always contain the primary opcode. Many instructions have an extended opcode in another field. Remaining instruction bits contain additional fields. All instruction fields belong to one of the following categories:

- Defined

These instructions contain values, such as opcodes, that cannot be altered. The instruction format diagrams specify the values of defined fields.

- Variable

These fields contain operands, such as GPR selectors and immediate values, that can vary from execution to execution. The instruction format diagrams specify the operands in the variable fields.

- Reserved

Bits in reserved fields should be set to 0. In the instruction format diagrams, /, //, or /// indicate reserved fields.

If any bit in a defined field does not contain the expected value, the instruction is illegal and an illegal instruction exception occurs. If any bit in a reserved field does not contain 0, the instruction form is invalid; its result is architecturally undefined. The PPC405GP executes all invalid instruction forms without causing an illegal instruction exception.

A.3.1 Instruction Fields

PPC405GP instructions contain various combinations of the following fields, as indicated in the instruction format diagrams that follow the field definitions. Numbers, enclosed in parentheses, that follow the field names indicate bit positions; bit fields are indicated by starting and stopping bit positions separated by colons.

AA (30)	Absolute address bit.
	0 The immediate field represents an address relative to the current instruction address (CIA). The effective address (EA) of the branch is either the sum of the LI field sign-extended to 32 bits and the branch instruction address, or the sum of the BD field sign-extended to 32 bits and the branch instruction address.
	1 The immediate field represents an absolute address. The EA of the branch is either the LI field or the BD field, sign-extended to 32 bits.
BA (11:15)	Specifies a bit in the CR used as a source of a CR-logical instruction.
BB (16:20)	Specifies a bit in the CR used as a source of a CR-logical instruction.
BD (16:29)	An immediate field specifying a 14-bit signed twos complement branch displacement. This field is concatenated on the right with 0b00 and sign-extended to 32 bits.
BF (6:8)	Specifies a field in the CR used as a target in a compare or mcrf instruction.
BFA (11:13)	Specifies a field in the CR used as a source in a mcrf instruction.
BI (11:15)	Specifies a bit in the CR used as a source for the condition of a conditional branch instruction.
BO (6:10)	Specifies options for conditional branch instructions. See "BO Field on Conditional Branches" on page 3-116.
BT (6:10)	Specifies a bit in the CR used as a target as the result of a CR-Logical instruction.
D (16:31)	Specifies a 16-bit signed twos-complement integer displacement for load/store instructions.
DCRN (11:20)	Specifies a device control register (DCR).
FXM (12:19)	Field mask used to identify CR fields to be updated by the mtrcf instruction.
IM (16:31)	An immediate field used to specify a 16-bit value (either signed integer or unsigned).
LI (6:29)	An immediate field specifying a 24-bit signed twos complement branch displacement; this field is concatenated on the right with b'00' and sign-extended to 32 bits.
LK (31)	Link bit.
	0 Do not update the link register (LR).
	1 Update the LR with the address of the next instruction.
MB (21:25)	Mask begin.
	Used in rotate-and-mask instructions to specify the beginning bit of a mask.
ME (26:30)	Mask end.

Preliminary User's Manual

	Used in rotate-and-mask instructions to specify the ending bit of a mask.
NB (16:20)	Specifies the number of bytes to move in an immediate string load or store.
OPCD (0:5)	Primary opcode. Primary opcodes, in decimal, appear in the instruction format diagrams presented with individual instructions. The OPCD field name does not appear in instruction descriptions.
OE (21)	Enables setting the OV and SO fields in the fixed-point exception register (XER) for extended arithmetic.
RA (11:15)	A GPR used as a source or target.
RB (16:20)	A GPR used as a source.
Rc (31)	Record bit. 0 Do not set the CR. 1 Set the CR to reflect the result of an operation. See "Condition Register (CR)" on page 3-91 for a further discussion of how the CR bits are set.
RS (6:10)	A GPR used as a source.
RT (6:10)	A GPR used as a target.
SH (16:20)	Specifies a shift amount.
SPRF (11:20)	Specifies a special purpose register (SPR).
TO (6:10)	Specifies the conditions on which to trap, as described under tw and twi instructions.
XO (21:30)	Extended opcode for instructions without an OE field. Extended opcodes, in decimal, appear in the instruction format diagrams presented with individual instructions. The XO field name does not appear in instruction descriptions.
XO (22:30)	Extended opcode for instructions with an OE field. Extended opcodes, in decimal, appear in the instruction format diagrams presented with individual instructions. The XO field name does not appear in instruction descriptions.

A.3.2 Instruction Format Diagrams

The instruction formats (also called "forms") illustrated in Figure A-1 through Figure A-9 are valid combinations of instruction fields. Table A-2 on page A-1192 indicates which "form" is utilized by each PPC405GP opcode. Fields indicated by slashes (/, //, or ///) are reserved. The figures are adapted from the PowerPC User Instruction Set Architecture.

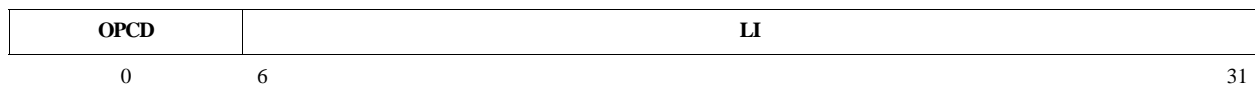
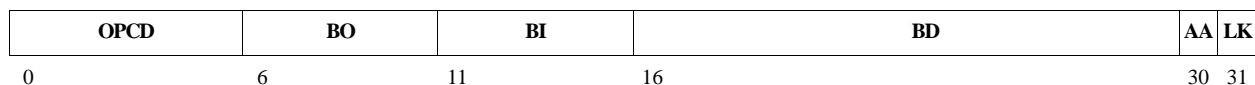
A.3.2.1 I-Form**Figure A-1. I Instruction Format****A.3.2.2 B-Form****Figure A-2. B Instruction Format**

A.3.2.3 SC-Form

OPCD	///	///	///	1 /
0	6	11	16	30 31

Figure A-3. SC Instruction Format

A.3.2.4 D-Form

OPCD	RT	RA	D
OPCD	RS	RA	SI
OPCD	RS	RA	D
OPCD	RS	RA	UI
OPCD	BF / L	RA	SI
OPCD	BF / L	RA	UI
OPCD	TO	RA	SI
0	6	11	16
			31

Figure A-4. D Instruction Format

Preliminary User's Manual**A.3.2.5 X-Form**

OPCD	RT			RA		RB		XO	Rc
OPCD	RT			RA		RB		XO	/
OPCD	RT			RA		NB		XO	/
OPCD	RT			RA		WS		XO	/
OPCD	RT			///		RB		XO	/
OPCD	RT			///		///		XO	/
OPCD	RS			RA		RB		XO	Rc
OPCD	RS			RA		RB		XO	1
OPCD	RS			RA		RB		XO	/
OPCD	RS			RA		NB		XO	/
OPCD	RS			RA		WS		XO	/
OPCD	RS			RA		SH		XO	Rc
OPCD	RS			RA		///		XO	Rc
OPCD	RS			///		RB		XO	/
OPCD	RS			///		///		XO	/
OPCD	BF	/	L	RA		RB		XO	/
OPCD	BF	//		BFA	//	///		XO	Rc
OPCD	BF	//		///		///		XO	/
OPCD	BF	//		///		U		XO	Rc
OPCD	BF	//		///		///		XO	/
OPCD	TO			RA		RB		XO	/
OPCD	BT			///		///		XO	Rc
OPCD	///			RA		RB		XO	/
OPCD	///			///		///		XO	/
OPCD	///			///	E	//		XO	/
0	6			11		16		21	31

Figure A-5. X Instruction Format**A.3.2.6 XL-Form**

OPCD	BT			BA		BB		XO	/
OPCD	BC			BI		///		XO	LK
OPCD	BF	//		BFA	//	///		XO	/
OPCD	///			///		///		XO	/
0	6			11		16		21	31

Figure A-6. XL Instruction Format

A.3.2.7 XFX-Form

OPCD	RT	SPRF		XO	/
OPCD	RT	DCRF		XO	/
OPCD	RT	/	FXM	/	/
OPCD	RS	SPRF		XO	/
OPCD	RS	DCRF		XO	/
0	6	11	16	21	31

Figure A-7. XFX Instruction Format

A.3.2.8 X0-Form

OPCD	RT	RA	RB	OE	XO	Rc
OPCD	RT	RA	RB	OE	XO	Rc
OPCD	RT	RA	///	/	XO	Rc
0	6	11	16	21	22	31

Figure A-8. XO Instruction Format

A.3.2.9 M-Form

OPCD	RS	RA	RB	MB	ME	Rc
OPCD	RS	RA	SH	MB	ME	Rc
0	6	11	16	21	26	31

Figure A-9. M Instruction Format

Preliminary User's Manual**Appendix B. Instructions by Category**

Chapter 24, "Instruction Set," contains detailed descriptions of the instructions, their operands, and notation.

Table B-1 summarizes the instruction categories in the PPC405GPr instruction set. The instructions within each category are listed in subsequent tables.

Table B-1. PPC405GPr Instruction Set Categories

Storage Reference	load, store
Arithmetic and Logical	add, subtract, negate, multiply, divide, and, andc, or, orc, xor, nand, nor, xnor, sign extension, count leading zeros, multiply accumulate
Comparison	compare, compare logical, compare immediate
Branch	branch, branch conditional, branch to LR, branch to CTR
CR Logical	crand, crandc, cror, crorc, crnand, crnor, crxor, crxnor, move CR field
Rotate/Shift	rotate and insert, rotate and mask, shift left, shift right
Cache Control	invalidate, touch, zero, flush, store, read
Interrupt Control	write to external interrupt enable bit, move to/from MSR, return from interrupt, return from critical interrupt
Processor Management	system call, synchronize, trap, move to/from DCRs, move to/from SPRs, move to/from CR

B.1 Implementation-Specific Instructions

To meet the functional requirements of processors for embedded systems and real-time applications, the PPC405GPr defines the implementation-specific instructions summarized in Table B-2.

Table B-2. Implementation-specific Instructions

Mnemonic	Operands	Function	Other Registers Changed	Page
dccci	RA, RB	Invalidate the data cache congruence class associated with the effective address (EA) (RA 0) + (RB).		718
dcread	RT, RA, RB	Read either tag or data information from the data cache congruence class associated with the EA (RA 0) + (RB). Place the results in RT.		719
iccci	RA, RB	Invalidate instruction cache.		729
icread	RA, RB	Read either tag or data information from the instruction cache congruence class associated with the EA (RA 0) + (RB). Place the results in ICDBDR.		730

Table B-2. Implementation-specific Instructions (continued)

Mnemonic	Operands	Function	Other Registers Changed	Page
macchw	RT, RA, RB	$prod_{0:31} \leftarrow (RA)_{16:31} \times (RB)_{0:15}$ signed $temp_{0:32} \leftarrow prod_{0:31} + (RT)$ $(RT) \leftarrow temp_{1:32}$		757
macchw.			CR[CR0]	
macchwo			XER[SO, OV]	
macchwo.			CR[CR0] XER[SO, OV]	
macchws	RT, RA, RB	$prod_{0:31} \leftarrow (RA)_{16:31} \times (RB)_{0:15}$ signed $temp_{0:32} \leftarrow prod_{0:31} + (RT)$ if $((prod_0 = RT_0) \wedge (RT_0 \neq temp_1))$ then $(RT) \leftarrow (RT_0 \parallel^{31}(\neg RT_0))$ else $(RT) \leftarrow temp_{1:32}$		758
macchws.			CR[CR0]	
macchwso			XER[SO, OV]	
macchwso.			CR[CR0] XER[SO, OV]	
macchwsu	RT, RA, RB	$prod_{0:31} \leftarrow (RA)_{16:31} \times (RB)_{0:15}$ unsigned $temp_{0:32} \leftarrow prod_{0:31} + (RT)$ $(RT) \leftarrow (temp_{1:32} \vee^{32} temp_0)$		759
macchwsu.			CR[CR0]	
macchwsuo			XER[SO, OV]	
macchwsuo.			CR[CR0] XER[SO, OV]	
macchwu	RT, RA, RB	$prod_{0:31} \leftarrow (RA)_{16:31} \times (RB)_{0:15}$ unsigned $temp_{0:32} \leftarrow prod_{0:31} + (RT)$ $(RT) \leftarrow temp_{1:32}$		760
macchwu.			CR[CR0]	
macchwuo			XER[SO, OV]	
macchwuo.			CR[CR0] XER[SO, OV]	
machhw	RT, RA, RB	$prod_{0:15} \leftarrow (RA)_{16:31} \times (RB)_{0:15}$ signed $temp_{0:32} \leftarrow prod_{0:31} + (RT)$ $(RT) \leftarrow temp_{1:32}$		761
machhw.			CR[CR0]	
machhwo			XER[SO, OV]	
machhwo.			CR[CR0] XER[SO, OV]	
machhws	RT, RA, RB	$prod_{0:31} \leftarrow (RA)_{0:15} \times (RB)_{0:15}$ signed $temp_{0:32} \leftarrow prod_{0:31} + (RT)$ if $((prod_0 = RT_0) \wedge (RT_0 \neq temp_1))$ then $(RT) \leftarrow (RT_0 \parallel^{31}(\neg RT_0))$ else $(RT) \leftarrow temp_{1:32}$		762
machhws.			CR[CR0]	
machhwso			XER[SO, OV]	
machhwso.			CR[CR0] XER[SO, OV]	
machwsu	RT, RA, RB	$prod_{0:31} \leftarrow (RA)_{0:15} \times (RB)_{0:15}$ unsigned $temp_{0:32} \leftarrow prod_{0:31} + (RT)$ $(RT) \leftarrow (temp_{1:32} \vee^{32} temp_0)$		763
machwsu.			CR[CR0]	
machwsuo			XER[SO, OV]	
machwsuo.			CR[CR0] XER[SO, OV]	

Preliminary User's Manual**Table B-2. Implementation-specific Instructions (continued)**

Mnemonic	Operands	Function	Other Registers Changed	Page
machwu	RT, RA, RB	$\text{prod}_{0:31} \leftarrow (\text{RA})_{0:15} \times (\text{RB})_{0:15}$ unsigned $\text{temp}_{0:32} \leftarrow \text{prod}_{0:31} + (\text{RT})$ $(\text{RT}) \leftarrow \text{temp}_{1:32}$		764
machwu.			CR[CR0]	
machwuo			XER[SO, OV]	
machwuo.			CR[CR0] XER[SO, OV]	
maclhw	RT, RA, RB	$\text{prod}_{0:31} \leftarrow (\text{RA})_{16:31} \times (\text{RB})_{16:31}$ signed $\text{temp}_{0:32} \leftarrow \text{prod}_{0:31} + (\text{RT})$ $(\text{RT}) \leftarrow \text{temp}_{1:32}$		765
maclhw.			CR[CR0]	
maclhwo			XER[SO, OV]	
maclhwo.			CR[CR0] XER[SO, OV]	
maclhws	RT, RA, RB	$\text{prod}_{0:31} \leftarrow (\text{RA})_{16:31} \times (\text{RB})_{16:31}$ signed $\text{temp}_{0:32} \leftarrow \text{prod}_{0:31} + (\text{RT})$ if $((\text{prod}_0 = \text{RT}_0) \wedge (\text{RT}_0 \neq \text{temp}_1))$ then $(\text{RT}) \leftarrow (\text{RT}_0 \parallel^{31} (\neg \text{RT}_0))$ else $(\text{RT}) \leftarrow \text{temp}_{1:32}$		766
maclhws.			CR[CR0]	
maclhws0			XER[SO, OV]	
maclhws0.			CR[CR0] XER[SO, OV]	
maclhwsu	RT, RA, RB	$\text{prod}_{0:31} \leftarrow (\text{RA})_{16:31} \times (\text{RB})_{16:31}$ unsigned $\text{temp}_{0:32} \leftarrow \text{prod}_{0:31} + (\text{RT})$ $(\text{RT}) \leftarrow (\text{temp}_{1:32} \vee^{32} \text{temp}_0)$		767
maclhwsu.			CR[CR0]	
maclhwsuo			XER[SO, OV]	
maclhwsuo.			CR[CR0] XER[SO, OV]	
maclhwu	RT, RA, RB	$\text{prod}_{0:31} \leftarrow (\text{RA})_{16:31} \times (\text{RB})_{16:31}$ unsigned $\text{temp}_{0:32} \leftarrow \text{prod}_{0:31} + (\text{RT})$ $(\text{RT}) \leftarrow \text{temp}_{1:32}$		768
maclhwu.			CR[CR0]	
maclhwuo			XER[SO, OV]	
maclhwuo.			CR[CR0] XER[SO, OV]	
mulchw	RT, RA, RB	$(\text{RT})_{0:31} \leftarrow (\text{RA})_{16:31} \times (\text{RB})_{0:15}$ signed		783
mulchw.			CR[CR0]	
mulchwu	RT, RA, RB	$(\text{RT})_{0:31} \leftarrow (\text{RA})_{16:31} \times (\text{RB})_{0:15}$ unsigned		784
mulchwu.			CR[CR0]	
mulhhw	RT, RA, RB	$(\text{RT})_{0:31} \leftarrow (\text{RA})_{0:15} \times (\text{RB})_{0:15}$ signed		785
mulhhw.			CR[CR0]	
mulhhwu	RT, RA, RB	$(\text{RT})_{0:31} \leftarrow (\text{RA})_{0:15} \times (\text{RB})_{0:15}$ unsigned		786
mulhhwu.			CR[CR0]	
mullhw	RT, RA, RB	$(\text{RT})_{0:31} \leftarrow (\text{RA})_{16:31} \times (\text{RB})_{16:31}$ signed		789
mullhw.			CR[CR0]	

Table B-2. Implementation-specific Instructions (continued)

Mnemonic	Operands	Function	Other Registers Changed	Page
mullhw	RT, RA, RB	$(RT)_{16:31} \leftarrow (RA)_{0:15} \times (RB)_{16:31}$ unsigned		790
mullhw.			CR[CR0]	
nmacchw	RT, RA, RB	$nprod_{0:31} \leftarrow -((RA)_{16:31} \times (RB)_{0:15})$ signed $temp_{0:32} \leftarrow nprod_{0:31} + (RT)$ $(RT) \leftarrow temp_{1:32}$		795
nmacchw.			CR[CR0]	
nmacchwo			XER[SO, OV]	
nmacchwo.			CR[CR0] XER[SO, OV]	
nmacchws	RT, RA, RB	$nprod_{0:31} \leftarrow -((RA)_{16:31} \times (RB)_{0:15})$ signed $temp_{0:32} \leftarrow nprod_{0:31} + (RT)$ if $((nprod_0 = RT_0) \wedge (RT_0 \neq temp_1))$ then $(RT) \leftarrow (RT_0 \parallel^{31} (\neg RT_0))$ else $(RT) \leftarrow temp_{1:32}$		796
nmacchws.			CR[CR0]	
nmacchwso			XER[SO, OV]	
nmacchwso.			CR[CR0] XER[SO, OV]	
nmachhw	RT, RA, RB	$nprod_{0:31} \leftarrow -((RA)_{0:15} \times (RB)_{0:15})$ signed $temp_{0:32} \leftarrow nprod_{0:31} + (RT)$ $(RT) \leftarrow temp_{1:32}$		797
nmachhw.			CR[CR0]	
nmachhwo			XER[SO, OV]	
nmachhwo.			CR[CR0] XER[SO, OV]	
nmachhws	RT, RA, RB	$nprod_{0:31} \leftarrow -((RA)_{0:15} \times (RB)_{0:15})$ signed $temp_{0:32} \leftarrow nprod_{0:31} + (RT)$ if $((nprod_0 = RT_0) \wedge (RT_0 \neq temp_1))$ then $(RT) \leftarrow (RT_0 \parallel^{31} (\neg RT_0))$ else $(RT) \leftarrow temp_{1:32}$		798
nmachhws.			CR[CR0]	
nmachhwso			XER[SO, OV]	
nmachhwso.			CR[CR0] XER[SO, OV]	
nmaclhw	RT, RA, RB	$nprod_{0:31} \leftarrow -((RA)_{16:31} \times (RB)_{16:31})$ signed $temp_{0:32} \leftarrow nprod_{0:31} + (RT)$ $(RT) \leftarrow temp_{1:32}$		799
nmaclhw.			CR[CR0]	
nmaclhwo			XER[SO, OV]	
nmaclhwo.			CR[CR0] XER[SO, OV]	
nmaclhws	RT, RA, RB	$nprod_{0:31} \leftarrow -((RA)_{16:31} \times (RB)_{16:31})$ signed $temp_{0:32} \leftarrow nprod_{0:31} + (RT)$ if $((nprod_0 = RT_0) \wedge (RT_0 \neq temp_1))$ then $(RT) \leftarrow (RT_0 \parallel^{31} (\neg RT_0))$ else $(RT) \leftarrow temp_{1:32}$		800
nmaclhws.			CR[CR0]	
nmaclhwso			XER[SO, OV]	
nmaclhwso.			CR[CR0] XER[SO, OV]	

Preliminary User's Manual**B.2 Instructions in the AMCC PowerPC Embedded Environment**

To meet the functional requirements of processors for embedded systems and real-time applications, the AMCC PowerPC Embedded Environment defines instructions that are not part of the PowerPC Architecture.

Table B-3 summarizes the PPC405GP instructions in the PowerPC Embedded Environment.

Table B-3. Instructions in the AMCC PowerPC Embedded Environment

Mnemonic	Operands	Function	Other Registers Changed	Page
dcba	RA, RB	Speculatively establish the data cache block which contains the EA (RA 0) + (RB).		709
dcbf	RA, RB	Flush (store, then invalidate) the data cache block which contains the EA (RA 0) + (RB).		711
dcbi	RA, RB	Invalidate the data cache block which contains the EA (RA 0) + (RB).		712
dcbst	RA, RB	Store the data cache block which contains the EA (RA 0) + (RB).		713
dcbt	RA, RB	Load the data cache block which contains the EA (RA 0) + (RB).		714
dcbtst	RA, RB	Load the data cache block which contains the EA (RA 0) + (RB).		715
dcbz	RA, RB	Zero the data cache block which contains the EA (RA 0) + (RB).		716
eieio		Storage synchronization. All loads and stores that precede the eieio instruction complete before any loads and stores that follow the instruction access main storage. Implemented as sync , which is more restrictive.		723
icbi	RA, RB	Invalidate the instruction cache block which contains the EA (RA 0) + (RB).		727
icbt	RA, RB	Load the instruction cache block which contains the EA (RA 0) + (RB).		728
isync		Synchronize execution context by flushing the prefetch queue.		732
mfocr	RT, DCRN	Move from DCR to RT, (RT) ← (DCR(DCRN)).		772
mfmsr	RT	Move from MSR to RT, (RT) ← (MSR).		773
mfmspr	RT, SPRN	Move from SPR to RT, (RT) ← (SPR(SPRN)). Privileged for all SPRs except LR, CTR, TBHU, TBLU, and XER.		774

Table B-3. Instructions in the AMCC PowerPC Embedded Environment (continued)

Mnemonic	Operands	Function	Other Registers Changed	Page
mftb	RT	Move the contents of a Time Base Register (TBR) into RT, $TBRN \leftarrow TBRF_{5:9} \parallel TBRF_{0:4}$ $(RT) \leftarrow (TBR(TBRN))$		776
mtdcr	DCRN, RS	Move to DCR from RS, $(DCR(DCRN)) \leftarrow (RS)$.		779
mtmsr	RS	Move to MSR from RS, $(MSR) \leftarrow (RS)$.		780
mtspr	SPRN, RS	Move to SPR from RS, $(SPR(SPRN)) \leftarrow (RS)$. Privileged for all SPRs except LR, CTR, and XER.		781
rfdi		Return from critical interrupt $(PC) \leftarrow (SRR2)$. $(MSR) \leftarrow (SRR3)$.		806
rfdi		Return from interrupt. $(PC) \leftarrow (SRR0)$. $(MSR) \leftarrow (SRR1)$.		807
tlbia		All of the entries in the TLB are invalidated and become unavailable for translation by clearing the valid (V) bit in the TLBHI portion of each TLB entry. The rest of the fields in the TLB entries are unmodified.		845
tlbre	RT, RA, WS	If WS = 0: Load TLBHI portion of the selected TLB entry into RT. Load the PID register with the contents of the TID field of the selected TLB entry. $(RT) \leftarrow TLBHI[(RA)]$ $(PID) \leftarrow TLB[(RA)]_{TID}$ If WS = 1: Load TLBLO portion of the selected TLB entry into RT. $(RT) \leftarrow TLBLO[(RA)]$		846
tlbsx	RT, RA, RB	Search the TLB array for a valid entry which translates the EA $EA = (RA 0) + (RB)$. If found, $(RT) \leftarrow$ Index of TLB entry. If not found, (RT) Undefined.		848
tlbsx.		If found, $(RT) \leftarrow$ Index of TLB entry. $CR[CR0]_{EQ} \leftarrow 1$. If not found, (RT) Undefined. $CR[CR0]_{EQ} \leftarrow 1$.	CR[CR0] _{LT,GT,SO}	

Preliminary User's Manual**Table B-3. Instructions in the AMCC PowerPC Embedded Environment (continued)**

Mnemonic	Operands	Function	Other Registers Changed	Page
tlbsync		tlbsync does not complete until all previous TLB-update instructions executed by this processor have been received and completed by all other processors. For the PPC405GPr, tlbsync is a no-op.		849
tlbwe	RS, RA, WS	If WS = 0: Write TLBHI portion of the selected TLB entry from RS. Write the TID field of the selected TLB entry from the PID register. $TLBHI[(RA)] \leftarrow (RS)$ $TLB[(RA)]_{TID} \leftarrow (PID)_{24:31}$ If WS = 1: Write TLBLO portion of the selected TLB entry from RS. $TLBLO[(RA)] \leftarrow (RS)$		850
wrtee	RS	Write value of RS_{16} to MSR[EE].		858
wrteei	E	Write value of E to MSR[EE].		859

B.3 Privileged Instructions

Table B-4 lists instructions that are under control of the MSR[PR] bit. These instructions are not allowed to be executed when MSR[PR] = 1:

Table B-4. Privileged Instructions

Mnemonic	Operands	Function	Other Registers Changed	Page
dcbi	RA, RB	Invalidate the data cache block which contains the EA $(RA 0) + (RB)$.		712
dccci	RA, RB	Invalidate the data cache congruence class associated with the EA $(RA 0) + (RB)$.		718
dcread	RT, RA, RB	Read either tag or data information from the data cache congruence class associated with the EA $(RA 0) + (RB)$. Place the results in RT.		719
iccci	RA, RB	Invalidate instruction cache.		729
icread	RA, RB	Read either tag or data information from the instruction cache congruence class associated with the EA $(RA 0) + (RB)$. Place the results in ICDBDR.		730
mfdcr	RT, DCRN	Move from DCR to RT, $(RT) \leftarrow (DCR(DCRN))$.		772
mfmsr	RT	Move from MSR to RT, $(RT) \leftarrow (MSR)$.		773

Table B-4. Privileged Instructions (continued)

Mnemonic	Operands	Function	Other Registers Changed	Page
mfspr	RT, SPRN	Move from SPR to RT, (RT) ← (SPR(SPRN)). Privileged for all SPRs except LR, CTR, TBHU, TBLU, and XER.		774
mtdcr	DCRN, RS	Move to DCR from RS, (DCR(DCRN)) ← (RS).		779
mtmsr	RS	Move to MSR from RS, (MSR) ← (RS).		780
mtspr	SPRN, RS	Move to SPR from RS, (SPR(SPRN)) ← (RS). Privileged for all SPRs except LR, CTR, and XER.		781
rfdi		Return from critical interrupt (PC) ← (SRR2). (MSR) ← (SRR3).		806
rfdi		Return from interrupt. (PC) ← (SRR0). (MSR) ← (SRR1).		807
tlbre	RT, RA,WS	If WS = 0: Load TLBHI portion of the selected TLB entry into RT. Load the PID register with the contents of the TID field of the selected TLB entry. (RT) ← TLBHI[(RA)] (PID) ← TLB[(RA)] _{TID} If WS = 1: Load TLBLO portion of the selected TLB entry into RT. (RT) ← TLBLO[(RA)]		846
tlbsx	RT,RA,RB	Search the TLB array for a valid entry which translates the EA EA = (RA 0) + (RB). If found, (RT) ← Index of TLB entry. If not found, (RT) Undefined.		848
tlbsx.		If found, (RT) ← Index of TLB entry. CR[CR0] _{EQ} ← 1. If not found, (RT) Undefined. CR[CR0] _{EQ} ← 1.	CR[CR0] _{LT,GT,SO}	

Preliminary User's Manual**Table B-4. Privileged Instructions (continued)**

Mnemonic	Operands	Function	Other Registers Changed	Page
tlbwe	RS, RA,WS	If WS = 0: Write TLBHI portion of the selected TLB entry from RS. Write the TID field of the selected TLB entry from the PID register. TLBHI[(RA)] ← (RS) TLB[(RA)] _{TID} ← (PID) _{24:31} If WS = 1: Write TLBLO portion of the selected TLB entry from RS. TLBLO[(RA)] ← (RS)		850
wrtee	RS	Write value of RS ₁₆ to the External Enable bit (MSR[EE]).		858
wrteei	E	Write value of E to the External Enable bit (MSR[EE]).		859

B.4 Assembler Extended Mnemonics

In the appendix “Assembler Extended Mnemonics” of the PowerPC Architecture, it is required that a PowerPC assembler support at least a minimal set of extended mnemonics. These mnemonics encode to the opcodes of other instructions; the only benefit of extended mnemonics is improved usability. Code using extended mnemonics can be easier to write and to understand. Table B-5 lists the extended mnemonics required for the PPC405GPr.

Note for every Branch Conditional mnemonic:

Bit 4 of the BO field provides a hint about the most likely outcome of a conditional branch. (“Branch Prediction” on page 3-117 describes branch prediction). Assemblers should set BO₄ = 0 unless a specific reason exists otherwise. In the BO field values specified in the following table, BO₄ = 0 has always been assumed. The assembler must allow the programmer to specify branch prediction. To do this, the assembler will support a suffix to every conditional branch mnemonic, as follows:

+ Predict branch to be taken.

– Predict branch not to be taken.

As specific examples, **bc** also could be coded as **bc+** or **bc–**, and **bne** also could be coded **bne+** or **bne–**. These alternate codings set BO₄ = 1 only if the requested prediction differs from the standard prediction (see “Branch Prediction” on page 3-117).

Table B-5. Extended Mnemonics for PPC405GPr

Mnemonic	Operands	Function	Other Registers Changed	Page
bctr		Branch unconditionally to address in CTR. <i>Extended mnemonic for</i> bcctr 20,0		688
bctrl		<i>Extended mnemonic for</i> bcctrl 20,0	(LR) ← CIA + 4	

Table B-5. Extended Mnemonics for PPC405GPr (continued)

Mnemonic	Operands	Function	Other Registers Changed	Page
bdnz	target	Decrement CTR. Branch if CTR \neq 0. <i>Extended mnemonic for</i> bc 16,0,target		682
bdnza		<i>Extended mnemonic for</i> bca 16,0,target		
bdnzl		<i>Extended mnemonic for</i> bcl 16,0,target	(LR) \leftarrow CIA + 4.	
bdnzla		<i>Extended mnemonic for</i> bcla 16,0,target	(LR) \leftarrow CIA + 4.	
bdnzlr		Decrement CTR. Branch, if CTR \neq 0, to address in LR. <i>Extended mnemonic for</i> bclr 16,0		692
bdnzlrl		<i>Extended mnemonic for</i> bclrl 16,0	(LR) \leftarrow CIA + 4.	
bdnzf	cr_bit, target	Decrement CTR. Branch if CTR \neq 0 AND CR _{cr_bit} = 0. <i>Extended mnemonic for</i> bc 0,cr_bit,target		682
bdnzfa		<i>Extended mnemonic for</i> bca 0,cr_bit,target		
bdnzfl		<i>Extended mnemonic for</i> bcl 0,cr_bit,target	(LR) \leftarrow CIA + 4.	
bdnzfla		<i>Extended mnemonic for</i> bcla 0,cr_bit,target	(LR) \leftarrow CIA + 4.	
bdnzflr	cr_bit	Decrement CTR. Branch, if CTR \neq 0 AND CR _{cr_bit} = 0, to address in LR. <i>Extended mnemonic for</i> bclr 0,cr_bit		692
bdnzflrl		<i>Extended mnemonic for</i> bclrl 0,cr_bit	(LR) \leftarrow CIA + 4.	
bdnzf	cr_bit, target	Decrement CTR. Branch if CTR \neq 0 AND CR _{cr_bit} = 1. <i>Extended mnemonic for</i> bc 8,cr_bit,target		682
bdnzta		<i>Extended mnemonic for</i> bca 8,cr_bit,target		
bdnztl		<i>Extended mnemonic for</i> bcl 8,cr_bit,target	(LR) \leftarrow CIA + 4.	
bdnztla		<i>Extended mnemonic for</i> bcla 8,cr_bit,target	(LR) \leftarrow CIA + 4.	

Preliminary User's Manual

Table B-5. Extended Mnemonics for PPC405GPr (continued)

Mnemonic	Operands	Function	Other Registers Changed	Page
bdnztlr	cr_bit	Decrement CTR. Branch, if CTR \neq 0 AND CR _{cr_bit} = 1, to address in LR. <i>Extended mnemonic for</i> bclr 8,cr_bit		692
bdnztlrl		<i>Extended mnemonic for</i> bclrl 8,cr_bit	(LR) \leftarrow CIA + 4.	
bdz	target	Decrement CTR. Branch if CTR = 0. <i>Extended mnemonic for</i> bc 18,0,target		682
bdza		<i>Extended mnemonic for</i> bca 18,0,target		
bdzli		<i>Extended mnemonic for</i> bcl 18,0,target	(LR) \leftarrow CIA + 4.	
bdzla		<i>Extended mnemonic for</i> bcla 18,0,target	(LR) \leftarrow CIA + 4.	
bdzlr		Decrement CTR. Branch, if CTR = 0, to address in LR. <i>Extended mnemonic for</i> bclr 18,0		692
bdzlrli		<i>Extended mnemonic for</i> bclrl 18,0	(LR) \leftarrow CIA + 4.	
bdzfb	cr_bit, target	Decrement CTR. Branch if CTR = 0 AND CR _{cr_bit} = 0. <i>Extended mnemonic for</i> bc 2,cr_bit,target		682
bdzfa		<i>Extended mnemonic for</i> bca 2,cr_bit,target		
bdzfl		<i>Extended mnemonic for</i> bcl 2,cr_bit,target	(LR) \leftarrow CIA + 4.	
bdzfla		<i>Extended mnemonic for</i> bcla 2,cr_bit,target	(LR) \leftarrow CIA + 4.	
bdzflr	cr_bit	Decrement CTR. Branch, if CTR = 0 AND CR _{cr_bit} = 0 to address in LR. <i>Extended mnemonic for</i> bclr 2,cr_bit		692
bdzflrli		<i>Extended mnemonic for</i> bclrl 2,cr_bit	(LR) \leftarrow CIA + 4.	

Table B-5. Extended Mnemonics for PPC405GPr (continued)

Mnemonic	Operands	Function	Other Registers Changed	Page
bdzt	cr_bit, target	Decrement CTR. Branch if CTR = 0 AND CR _{cr_bit} = 1. <i>Extended mnemonic for</i> bc 10,cr_bit,target		682
bdzta		<i>Extended mnemonic for</i> bca 10,cr_bit,target		
bdztl		<i>Extended mnemonic for</i> bcl 10,cr_bit,target	(LR) ← CIA + 4.	
bdztle		<i>Extended mnemonic for</i> bcla 10,cr_bit,target	(LR) ← CIA + 4.	
bdztlr	cr_bit	Decrement CTR. Branch, if CTR = 0 AND CR _{cr_bit} = 1, to address in LR. <i>Extended mnemonic for</i> bclr 10,cr_bit		692
bdztlrl		<i>Extended mnemonic for</i> bclrl 10,cr_bit	(LR) ← CIA + 4.	
beq	[cr_field,] target	Branch if equal. Use CR0 if cr_field is omitted. <i>Extended mnemonic for</i> bc 12,4*cr_field+2,target		682
beqa		<i>Extended mnemonic for</i> bca 12,4*cr_field+2,target		
beql		<i>Extended mnemonic for</i> bcl 12,4*cr_field+2,target	(LR) ← CIA + 4.	
beqla		<i>Extended mnemonic for</i> bcla 12,4*cr_field+2,target	(LR) ← CIA + 4.	
beqctr	[cr_field]	Branch, if equal, to address in CTR. Use CR0 if cr_field is omitted. <i>Extended mnemonic for</i> bcctr 12,4*cr_field+2		688
beqctrl		<i>Extended mnemonic for</i> bcctrl 12,4*cr_field+2	(LR) ← CIA + 4.	
beqlr	[cr_field]	Branch, if equal, to address in LR. Use CR0 if cr_field is omitted. <i>Extended mnemonic for</i> bclr 12,4*cr_field+2		692
beqlrl		<i>Extended mnemonic for</i> bclrl 12,4*cr_field+2	(LR) ← CIA + 4.	

Preliminary User's Manual

Table B-5. Extended Mnemonics for PPC405GPr (continued)

Mnemonic	Operands	Function	Other Registers Changed	Page
bf	cr_bit, target	Branch if CR _{cr_bit} = 0. <i>Extended mnemonic for</i> bc 4,cr_bit,target		682
bfa		<i>Extended mnemonic for</i> bca 4,cr_bit,target		
bfl		<i>Extended mnemonic for</i> bcl 4,cr_bit,target	(LR) ← CIA + 4.	
bfla		<i>Extended mnemonic for</i> bcla 4,cr_bit,target	(LR) ← CIA + 4.	
bfctr	cr_bit	Branch, if CR _{cr_bit} = 0, to address in CTR. <i>Extended mnemonic for</i> bcctr 4,cr_bit		688
bfctrl		<i>Extended mnemonic for</i> bcctrl 4,cr_bit	(LR) ← CIA + 4.	
bflr	cr_bit	Branch, if CR _{cr_bit} = 0, to address in LR. <i>Extended mnemonic for</i> bclr 4,cr_bit		692
bflrl		<i>Extended mnemonic for</i> bclrl 4,cr_bit	(LR) ← CIA + 4.	
bge	[cr_field,] target	Branch if greater than or equal. Use CR0 if cr_field is omitted. <i>Extended mnemonic for</i> bc 4,4*cr_field+0,target		682
bgea		<i>Extended mnemonic for</i> bca 4,4*cr_field+0,target		
bgel		<i>Extended mnemonic for</i> bcl 4,4*cr_field+0,target	(LR) ← CIA + 4.	
bgea		<i>Extended mnemonic for</i> bcla 4,4*cr_field+0,target	(LR) ← CIA + 4.	
bgctr	[cr_field]	Branch, if greater than or equal, to address in CTR. Use CR0 if cr_field is omitted. <i>Extended mnemonic for</i> bcctr 4,4*cr_field+0		688
bgctrl		<i>Extended mnemonic for</i> bcctrl 4,4*cr_field+0	(LR) ← CIA + 4.	
bgelr	[cr_field]	Branch, if greater than or equal, to address in LR. Use CR0 if cr_field is omitted. <i>Extended mnemonic for</i> bclr 4,4*cr_field+0		692
bgelrl		<i>Extended mnemonic for</i> bclrl 4,4*cr_field+0	(LR) ← CIA + 4.	

Table B-5. Extended Mnemonics for PPC405GPr (continued)

Mnemonic	Operands	Function	Other Registers Changed	Page
bgt	[cr_field,] target	Branch if greater than. Use CR0 if cr_field is omitted. <i>Extended mnemonic for</i> bc 12,4*cr_field+1,target		682
bgta		<i>Extended mnemonic for</i> bca 12,4*cr_field+1,target		
bgtl		<i>Extended mnemonic for</i> bcl 12,4*cr_field+1,target	(LR) ← CIA + 4.	
bgtla		<i>Extended mnemonic for</i> bcla 12,4*cr_field+1,target	(LR) ← CIA + 4.	
bgtctr	[cr_field]	Branch, if greater than, to address in CTR. Use CR0 if cr_field is omitted. <i>Extended mnemonic for</i> bcctr 12,4*cr_field+1		688
bgtctrl		<i>Extended mnemonic for</i> bcctrl 12,4*cr_field+1	(LR) ← CIA + 4.	
bgtlr	[cr_field]	Branch, if greater than, to address in LR. Use CR0 if cr_field is omitted. <i>Extended mnemonic for</i> bclr 12,4*cr_field+1		692
bgtlrl		<i>Extended mnemonic for</i> bclrl 12,4*cr_field+1	(LR) ← CIA + 4.	
ble	[cr_field,] target	Branch if less than or equal. Use CR0 if cr_field is omitted. <i>Extended mnemonic for</i> bc 4,4*cr_field+1,target		682
blea		<i>Extended mnemonic for</i> bca 4,4*cr_field+1,target		
blel		<i>Extended mnemonic for</i> bcl 4,4*cr_field+1,target	(LR) ← CIA + 4.	
blela		<i>Extended mnemonic for</i> bcla 4,4*cr_field+1,target	(LR) ← CIA + 4.	
blectr	[cr_field]	Branch, if less than or equal, to address in CTR. Use CR0 if cr_field is omitted. <i>Extended mnemonic for</i> bcctr 4,4*cr_field+1		688
blectrl		<i>Extended mnemonic for</i> bcctrl 4,4*cr_field+1	(LR) ← CIA + 4.	
blelr	[cr_field]	Branch, if less than or equal, to address in LR. Use CR0 if cr_field is omitted. <i>Extended mnemonic for</i> bclr 4,4*cr_field+1		692
blelrl		<i>Extended mnemonic for</i> bclrl 4,4*cr_field+1	(LR) ← CIA + 4.	

Preliminary User's Manual

Table B-5. Extended Mnemonics for PPC405GPr (continued)

Mnemonic	Operands	Function	Other Registers Changed	Page
blr		Branch, unconditionally, to address in LR. <i>Extended mnemonic for</i> bclr 20,0		692
blrl		<i>Extended mnemonic for</i> bclrl 20,0	(LR) ← CIA + 4.	
blt	[cr_field,] target	Branch if less than. Use CR0 if cr_field is omitted. <i>Extended mnemonic for</i> bc 12,4*cr_field+0,target		682
blta		<i>Extended mnemonic for</i> bca 12,4*cr_field+0,target		
bltl		<i>Extended mnemonic for</i> bcl 12,4*cr_field+0,target	(LR) ← CIA + 4.	
bltla		<i>Extended mnemonic for</i> bcla 12,4*cr_field+0,target	(LR) ← CIA + 4.	
bltctr	[cr_field]	Branch, if less than, to address in CTR. Use CR0 if cr_field is omitted. <i>Extended mnemonic for</i> bcctr 12,4*cr_field+0		688
bltctrl		<i>Extended mnemonic for</i> bcctrl 12,4*cr_field+0	(LR) ← CIA + 4.	
bltlr	[cr_field]	Branch, if less than, to address in LR. Use CR0 if cr_field is omitted. <i>Extended mnemonic for</i> bclr 12,4*cr_field+0		692
bltlrl		<i>Extended mnemonic for</i> bclrl 12,4*cr_field+0	(LR) ← CIA + 4.	
bne	[cr_field,] target	Branch if not equal. Use CR0 if cr_field is omitted. <i>Extended mnemonic for</i> bc 4,4*cr_field+2,target		682
bnea		<i>Extended mnemonic for</i> bca 4,4*cr_field+2,target		
bnel		<i>Extended mnemonic for</i> bcl 4,4*cr_field+2,target	(LR) ← CIA + 4.	
bnela		<i>Extended mnemonic for</i> bcla 4,4*cr_field+2,target	(LR) ← CIA + 4.	
bnectr	[cr_field]	Branch, if not equal, to address in CTR. Use CR0 if cr_field is omitted. <i>Extended mnemonic for</i> bcctr 4,4*cr_field+2		688
bnectrl		<i>Extended mnemonic for</i> bcctrl 4,4*cr_field+2	(LR) ← CIA + 4.	

Table B-5. Extended Mnemonics for PPC405GPr (continued)

Mnemonic	Operands	Function	Other Registers Changed	Page
bnelr	[cr_field]	Branch, if not equal, to address in LR. Use CR0 if cr_field is omitted. <i>Extended mnemonic for</i> bclr 4,4*cr_field+2		692
bnelrl		<i>Extended mnemonic for</i> bclrl 4,4*cr_field+2	(LR) ← CIA + 4.	
bng	[cr_field,] target	Branch, if not greater than. Use CR0 if cr_field is omitted. <i>Extended mnemonic for</i> bc 4,4*cr_field+1,target		682
bnga		<i>Extended mnemonic for</i> bca 4,4*cr_field+1,target		
bngl		<i>Extended mnemonic for</i> bcl 4,4*cr_field+1,target	(LR) ← CIA + 4.	
bngla		<i>Extended mnemonic for</i> bcla 4,4*cr_field+1,target	(LR) ← CIA + 4.	
bngctr	[cr_field]	Branch, if not greater than, to address in CTR. Use CR0 if cr_field is omitted. <i>Extended mnemonic for</i> bcctr 4,4*cr_field+1		688
bngctrl		<i>Extended mnemonic for</i> bcctrl 4,4*cr_field+1	(LR) ← CIA + 4.	
bnglr	[cr_field]	Branch, if not greater than, to address in LR. Use CR0 if cr_field is omitted. <i>Extended mnemonic for</i> bclr 4,4*cr_field+1		692
bnglrl		<i>Extended mnemonic for</i> bclrl 4,4*cr_field+1	(LR) ← CIA + 4.	
bnl	[cr_field,] target	Branch if not less than. Use CR0 if cr_field is omitted. <i>Extended mnemonic for</i> bc 4,4*cr_field+0,target		682
bnla		<i>Extended mnemonic for</i> bca 4,4*cr_field+0,target		
bnll		<i>Extended mnemonic for</i> bcl 4,4*cr_field+0,target	(LR) ← CIA + 4.	
bnlla		<i>Extended mnemonic for</i> bcla 4,4*cr_field+0,target	(LR) ← CIA + 4.	
bnlctr	[cr_field]	Branch, if not less than, to address in CTR. Use CR0 if cr_field is omitted. <i>Extended mnemonic for</i> bcctr 4,4*cr_field+0		688
bnlctrl		<i>Extended mnemonic for</i> bcctrl 4,4*cr_field+0	(LR) ← CIA + 4.	

Preliminary User's Manual

Table B-5. Extended Mnemonics for PPC405GPr (continued)

Mnemonic	Operands	Function	Other Registers Changed	Page
bnlrr	[cr_field]	Branch, if not less than, to address in LR. Use CR0 if cr_field is omitted. <i>Extended mnemonic for</i> bclr 4,4*cr_field+0		692
bnlrlr		<i>Extended mnemonic for</i> bclr 4,4*cr_field+0	(LR) ← CIA + 4.	
bns	[cr_field,] target	Branch if not summary overflow. Use CR0 if cr_field is omitted. <i>Extended mnemonic for</i> bc 4,4*cr_field+3,target		682
bnsa		<i>Extended mnemonic for</i> bca 4,4*cr_field+3,target		
bnsi		<i>Extended mnemonic for</i> bcl 4,4*cr_field+3,target	(LR) ← CIA + 4.	
bnsia		<i>Extended mnemonic for</i> bcla 4,4*cr_field+3,target	(LR) ← CIA + 4.	
bnsctr	[cr_field]	Branch, if not summary overflow, to address in CTR. Use CR0 if cr_field is omitted. <i>Extended mnemonic for</i> bcctr 4,4*cr_field+3		688
bnsctrl		<i>Extended mnemonic for</i> bcctrl 4,4*cr_field+3	(LR) ← CIA + 4.	
bnslr	[cr_field]	Branch, if not summary overflow, to address in LR. Use CR0 if cr_field is omitted. <i>Extended mnemonic for</i> bclr 4,4*cr_field+3		692
bnsrlr		<i>Extended mnemonic for</i> bclr 4,4*cr_field+3	(LR) ← CIA + 4.	
bnu	[cr_field,] target	Branch if not unordered. Use CR0 if cr_field is omitted. <i>Extended mnemonic for</i> bc 4,4*cr_field+3,target		682
bnua		<i>Extended mnemonic for</i> bca 4,4*cr_field+3,target		
bnul		<i>Extended mnemonic for</i> bcl 4,4*cr_field+3,target	(LR) ← CIA + 4.	
bnula		<i>Extended mnemonic for</i> bcla 4,4*cr_field+3,target	(LR) ← CIA + 4.	
bnuctr	[cr_field]	Branch, if not unordered, to address in CTR. Use CR0 if cr_field is omitted. <i>Extended mnemonic for</i> bcctr 4,4*cr_field+3		688
bnuctrl		<i>Extended mnemonic for</i> bcctrl 4,4*cr_field+3	(LR) ← CIA + 4.	

Table B-5. Extended Mnemonics for PPC405GPr (continued)

Mnemonic	Operands	Function	Other Registers Changed	Page
bnulr	[cr_field]	Branch, if not unordered, to address in LR. Use CR0 if cr_field is omitted. <i>Extended mnemonic for</i> bclr 4,4*cr_field+3		692
bnulrl		<i>Extended mnemonic for</i> bclrl 4,4*cr_field+3	(LR) ← CIA + 4.	
bso	[cr_field,] target	Branch if summary overflow. Use CR0 if cr_field is omitted. <i>Extended mnemonic for</i> bc 12,4*cr_field+3,target		682
bsoa		<i>Extended mnemonic for</i> bca 12,4*cr_field+3,target		
bsol		<i>Extended mnemonic for</i> bcl 12,4*cr_field+3,target	(LR) ← CIA + 4.	
bsola		<i>Extended mnemonic for</i> bcla 12,4*cr_field+3,target	(LR) ← CIA + 4.	
bsoctr	[cr_field]	Branch, if summary overflow, to address in CTR. Use CR0 if cr_field is omitted. <i>Extended mnemonic for</i> bcctr 12,4*cr_field+3		688
bsoctrl		<i>Extended mnemonic for</i> bcctrl 12,4*cr_field+3	(LR) ← CIA + 4.	
bsolr	[cr_field]	Branch, if summary overflow, to address in LR. Use CR0 if cr_field is omitted. <i>Extended mnemonic for</i> bclr 12,4*cr_field+3		692
bsolrl		<i>Extended mnemonic for</i> bclrl 12,4*cr_field+3	(LR) ← CIA + 4.	
bt	cr_bit, target	Branch if CR _{cr_bit} = 1. <i>Extended mnemonic for</i> bc 12,cr_bit,target		682
bta		<i>Extended mnemonic for</i> bca 12,cr_bit,target		
btl		<i>Extended mnemonic for</i> bcl 12,cr_bit,target	(LR) ← CIA + 4.	
btla		<i>Extended mnemonic for</i> bcla 12,cr_bit,target	(LR) ← CIA + 4.	
btctr	cr_bit	Branch if CR _{cr_bit} = 1, to address in CTR. <i>Extended mnemonic for</i> bcctr 12,cr_bit		688
btctrl		<i>Extended mnemonic for</i> bcctrl 12,cr_bit	(LR) ← CIA + 4.	

Preliminary User's Manual

Table B-5. Extended Mnemonics for PPC405GPr (continued)

Mnemonic	Operands	Function	Other Registers Changed	Page
btlr	cr_bit	Branch, if $CR_{cr_bit} = 1$, to address in LR. <i>Extended mnemonic for</i> bclr 12,cr_bit		692
btlrl		<i>Extended mnemonic for</i> bclrl 12,cr_bit	(LR) ← CIA + 4.	
bun	[cr_field,] target	Branch if unordered. Use CR0 if cr_field is omitted. <i>Extended mnemonic for</i> bc 12,4*cr_field+3,target		682
buna		<i>Extended mnemonic for</i> bca 12,4*cr_field+3,target		
bunl		<i>Extended mnemonic for</i> bcl 12,4*cr_field+3,target	(LR) ← CIA + 4.	
bunla		<i>Extended mnemonic for</i> bcla 12,4*cr_field+3,target	(LR) ← CIA + 4.	
bunctr	[cr_field]	Branch, if unordered, to address in CTR. Use CR0 if cr_field is omitted. <i>Extended mnemonic for</i> bcctr 12,4*cr_field+3		688
bunctrl		<i>Extended mnemonic for</i> bcctrl 12,4*cr_field+3	(LR) ← CIA + 4.	
bunlr	[cr_field]	Branch, if unordered, to address in LR. Use CR0 if cr_field is omitted. <i>Extended mnemonic for</i> bclr 12,4*cr_field+3		692
bunlrl		<i>Extended mnemonic for</i> bclrl 12,4*cr_field+3	(LR) ← CIA + 4.	
clrlwi	RA, RS, n	Clear left immediate. ($n < 32$) $(RA)_{0:n-1} \leftarrow n_0$ <i>Extended mnemonic for</i> rlwinm RA,RS,0,n,31		809
clrlwi.		<i>Extended mnemonic for</i> rlwinm. RA,RS,0,n,31	CR[CR0]	
clrlslwi	RA, RS, b, n	Clear left and shift left immediate. ($n \leq b < 32$) $(RA)_{b-n:31-n} \leftarrow (RS)_{b:31}$ $(RA)_{32-n:31} \leftarrow n_0$ $(RA)_{0:b-n-1} \leftarrow b-n_0$ <i>Extended mnemonic for</i> rlwinm RA,RS,n,b-n,31-n		809
clrlslwi.		<i>Extended mnemonic for</i> rlwinm. RA,RS,n,b-n,31-n	CR[CR0]	

Table B-5. Extended Mnemonics for PPC405GPr (continued)

Mnemonic	Operands	Function	Other Registers Changed	Page
clrrwi	RA, RS, n	Clear right immediate. ($n < 32$) $(RA)_{32-n:31} \leftarrow {}^n0$ <i>Extended mnemonic for</i> rlwinm RA,RS,0,0,31-n		809
clrrwi.		<i>Extended mnemonic for</i> rlwinm. RA,RS,0,0,31-n	CR[CR0]	
cmplw	[BF,] RA, RB	Compare Logical Word. Use CR0 if BF is omitted. <i>Extended mnemonic for</i> cmpl BF,0,RA,RB		698
cmplwi	[BF,] RA, IM	Compare Logical Word Immediate. Use CR0 if BF is omitted. <i>Extended mnemonic for</i> cmpli BF,0,RA,IM		699
cmpw	[BF,] RA, RB	Compare Word. Use CR0 if BF is omitted. <i>Extended mnemonic for</i> cmp BF,0,RA,RB		696
cmpwi	[BF,] RA, IM	Compare Word Immediate. Use CR0 if BF is omitted. <i>Extended mnemonic for</i> cmpi BF,0,RA,IM		697
crclr	bx	Condition register clear. <i>Extended mnemonic for</i> crxor bx,bx,bx		708
crmmove	bx, by	Condition register move. <i>Extended mnemonic for</i> cror bx,by,by		706
crnot	bx, by	Condition register not. <i>Extended mnemonic for</i> crnor bx,by,by		705
crset	bx	Condition register set. <i>Extended mnemonic for</i> creqv bx,bx,bx		703
extlwi	RA, RS, n, b	Extract and left justify immediate. ($n > 0$) $(RA)_{0:n-1} \leftarrow (RS)_{b:b+n-1}$ $(RA)_{n:31} \leftarrow {}^{32-n}0$ <i>Extended mnemonic for</i> rlwinm RA,RS,b,0,n-1		809
extlwi.		<i>Extended mnemonic for</i> rlwinm. RA,RS,b,0,n-1	CR[CR0]	

Preliminary User's Manual

Table B-5. Extended Mnemonics for PPC405GPr (continued)

Mnemonic	Operands	Function	Other Registers Changed	Page
extrwi	RA, RS, n, b	Extract and right justify immediate. ($n > 0$) $(RA)_{32-n:31} \leftarrow (RS)_{b:b+n-1}$ $(RA)_{0:31-n} \leftarrow 32-n0$ <i>Extended mnemonic for</i> rlwinm RA,RS,b+n,32-n,31		809
extrwi.		<i>Extended mnemonic for</i> rlwinm. RA,RS,b+n,32-n,31	CR[CR0]	
inslwi	RA, RS, n, b	Insert from left immediate. ($n > 0$) $(RA)_{b:b+n-1} \leftarrow (RS)_{0:n-1}$ <i>Extended mnemonic for</i> rlwimi RA,RS,32-b,b,b+n-1		808
inslwi.		<i>Extended mnemonic for</i> rlwimi. RA,RS,32-b,b,b+n-1	CR[CR0]	
insrwi	RA, RS, n, b	Insert from right immediate. ($n > 0$) $(RA)_{b:b+n-1} \leftarrow (RS)_{32-n:31}$ <i>Extended mnemonic for</i> rlwimi RA,RS,32-b-n,b,b+n-1		808
insrwi.		<i>Extended mnemonic for</i> rlwimi. RA,RS,32-b-n,b,b+n-1	CR[CR0]	
la	RT, D(RA)	Load address. ($RA \neq 0$) D is an offset from a base address that is assumed to be (RA). $(RT) \leftarrow (RA) + EXTS(D)$ <i>Extended mnemonic for</i> addi RT,RA,D		671
li	RT, IM	Load immediate. $(RT) \leftarrow EXTS(IM)$ <i>Extended mnemonic for</i> addi RT,0,value		671
lis	RT, IM	Load immediate shifted. $(RT) \leftarrow (IM \parallel 160)$ <i>Extended mnemonic for</i> addis RT,0,value		674

Table B-5. Extended Mnemonics for PPC405GPr (continued)

Mnemonic	Operands	Function	Other Registers Changed	Page
mfccr0 mfctr mfdac1 mfdac2 mfdear mfdbcr0 mfdbcr1 mfdbsr mfdccr mfdcwr mfdvc1 mfdvc2 mfesr mfevpr mfiac1 mfiac2 mfiac3 mfiac4 mficcr mficbdr mflr mfpid mfpit mfpvr mfsgr mfsler mfsprg0 mfsprg1 mfsprg2 mfsprg3 mfsprg4 mfsprg5 mfsprg6 mfsprg7 mfsrc0 mfsrc1 mfsrc2 mfsrc3 mfsu0r mftcr mftsr mfxer mfzpr	RT	Move from special purpose register (SPR) SPRN. <i>Extended mnemonic for</i> mfsrc RT,SPRN See Table 25.5, "Special Purpose Registers," on page 25-863 for listing of valid SPRN values.		774
mftb	RT	Move the contents of TBL into RT, (RT) ← (TBL) <i>Extended mnemonic for</i> mftb RT,TBL		776
mftbu	RT	Move the contents of TBU into RT, (RT) ← (TBU) <i>Extended mnemonic for</i> mftb RT,TBU		776

Preliminary User's Manual

Table B-5. Extended Mnemonics for PPC405GPr (continued)

Mnemonic	Operands	Function	Other Registers Changed	Page
mr	RT, RS	Move register. (RT) ← (RS) <i>Extended mnemonic for or RT,RS,RS</i>		802
mr.		<i>Extended mnemonic for or. RT,RS,RS</i>	CR[CR0]	
mtcr	RS	Move to Condition Register. <i>Extended mnemonic for mtcrf 0xFF,RS</i>		778

Table B-5. Extended Mnemonics for PPC405GPr (continued)

Mnemonic	Operands	Function	Other Registers Changed	Page
mtccr0 mtctr mtdac1 mtdac2 mtdbcr0 mtdbcr1 mtdbsr mtdccr mtdear mtdcwr mtdvc1 mtdvc2 mtesr mtevpr mtiac1 mtiac2 mtiac3 mtiac4 mticcr mticbdr mtlr mtpid mtpit mtpvr mtsgr mtsler mtsprg0 mtsprg1 mtsprg2 mtsprg3 mtsprg4 mtsprg5 mtsprg6 mtsprg7 mtsrr0 mtsrr1 mtsrr2 mtsrr3 mtsu0r mtctr mttsr mtxer mtzpr	RS	Move to SPR SPRN. <i>Extended mnemonic for</i> mtspr SPRN,RS See Table 25.5, "Special Purpose Registers," on page 25-863 for listing of valid SPRN values.		781
nop		Preferred no-op; triggers optimizations based on no-ops. <i>Extended mnemonic for</i> ori 0,0,0		804

Preliminary User's Manual

Table B-5. Extended Mnemonics for PPC405GPr (continued)

Mnemonic	Operands	Function	Other Registers Changed	Page
not	RA, RS	Complement register. (RA) $\leftarrow \neg(\text{RS})$ <i>Extended mnemonic for</i> nor RA,RS,RS		801
not.		<i>Extended mnemonic for</i> nor. RA,RS,RS	CR[CR0]	
rotlw	RA, RS, RB	Rotate left. (RA) $\leftarrow \text{ROTL}((\text{RS}), (\text{RB})_{27:31})$ <i>Extended mnemonic for</i> rlwnm RA,RS,RB,0,31		812
rotlw.		<i>Extended mnemonic for</i> rlwnm. RA,RS,RB,0,31	CR[CR0]	
rotlwi	RA, RS, n	Rotate left immediate. (RA) $\leftarrow \text{ROTL}((\text{RS}), n)$ <i>Extended mnemonic for</i> rlwinm RA,RS,n,0,31		809
rotlwi.		<i>Extended mnemonic for</i> rlwinm. RA,RS,n,0,31	CR[CR0]	
rotzwi	RA, RS, n	Rotate right immediate. (RA) $\leftarrow \text{ROTR}((\text{RS}), 32-n)$ <i>Extended mnemonic for</i> rlwinm RA,RS,32-n,0,31		809
rotzwi.		<i>Extended mnemonic for</i> rlwinm. RA,RS,32-n,0,31	CR[CR0]	
slwi	RA, RS, n	Shift left immediate. ($n < 32$) (RA) _{0:31-n} \leftarrow (RS) _{n:31} (RA) _{32-n:31} \leftarrow ⁿ 0 <i>Extended mnemonic for</i> rlwinm RA,RS,n,0,31-n		809
slwi.		<i>Extended mnemonic for</i> rlwinm. RA,RS,n,0,31-n	CR[CR0]	
srwi	RA, RS, n	Shift right immediate. ($n < 32$) (RA) _{n:31} \leftarrow (RS) _{0:31-n} (RA) _{0:n-1} \leftarrow ⁿ 0 <i>Extended mnemonic for</i> rlwinm RA,RS,32-n,n,31		809
srwi.		<i>Extended mnemonic for</i> rlwinm. RA,RS,32-n,n,31	CR[CR0]	

Table B-5. Extended Mnemonics for PPC405GPr (continued)

Mnemonic	Operands	Function	Other Registers Changed	Page
sub	RT, RA, RB	Subtract (RB) from (RA). (RT) ← ¬(RB) + (RA) + 1. <i>Extended mnemonic for subf RT,RB,RA</i>		838
sub.		<i>Extended mnemonic for subf. RT,RB,RA</i>	CR[CR0]	
subo		<i>Extended mnemonic for subfo RT,RB,RA</i>	XER[SO, OV]	
subo.		<i>Extended mnemonic for subfo. RT,RB,RA</i>	CR[CR0] XER[SO, OV]	
subc	RT, RA, RB	Subtract (RB) from (RA). (RT) ← ¬(RB) + (RA) + 1. Place carry-out in XER[CA]. <i>Extended mnemonic for subfc RT,RB,RA</i>		839
subc.		<i>Extended mnemonic for subfc. RT,RB,RA</i>	CR[CR0]	
subco		<i>Extended mnemonic for subfco RT,RB,RA</i>	XER[SO, OV]	
subco.		<i>Extended mnemonic for subfco. RT,RB,RA</i>	CR[CR0] XER[SO, OV]	
subi	RT, RA, IM	Subtract EXTS(IM) from (RA 0). Place result in RT. <i>Extended mnemonic for addi RT,RA,-IM</i>		671
subic	RT, RA, IM	Subtract EXTS(IM) from (RA). Place result in RT. Place carry-out in XER[CA]. <i>Extended mnemonic for addic RT,RA,-IM</i>		672
subic.	RT, RA, IM	Subtract EXTS(IM) from (RA). Place result in RT. Place carry-out in XER[CA]. <i>Extended mnemonic for addic. RT,RA,-IM</i>	CR[CR0]	673
subis	RT, RA, IM	Subtract (IM ¹⁶ 0) from (RA 0). Place result in RT. <i>Extended mnemonic for addis RT,RA,-IM</i>		674

Preliminary User's Manual

Table B-5. Extended Mnemonics for PPC405GPr (continued)

Mnemonic	Operands	Function	Other Registers Changed	Page
tweqi	RA, IM	Trap if (RA) equal to EXTS(IM). <i>Extended mnemonic for</i> twi 4,RA,IM		855
twgei		Trap if (RA) greater than or equal to EXTS(IM). <i>Extended mnemonic for</i> twi 12,RA,IM		
twgti		Trap if (RA) greater than EXTS(IM). <i>Extended mnemonic for</i> twi 8,RA,IM		
twlei		Trap if (RA) less than or equal to EXTS(IM). <i>Extended mnemonic for</i> twi 20,RA,IM		
twlgei		Trap if (RA) logically greater than or equal to EXTS(IM). <i>Extended mnemonic for</i> twi 5,RA,IM		
twlgti		Trap if (RA) logically greater than EXTS(IM). <i>Extended mnemonic for</i> twi 1,RA,IM		
twllei		Trap if (RA) logically less than or equal to EXTS(IM). <i>Extended mnemonic for</i> twi 6,RA,IM		
twllti		Trap if (RA) logically less than EXTS(IM). <i>Extended mnemonic for</i> twi 2,RA,IM		
twlngi		Trap if (RA) logically not greater than EXTS(IM). <i>Extended mnemonic for</i> twi 6,RA,IM		
twlnli		Trap if (RA) logically not less than EXTS(IM). <i>Extended mnemonic for</i> twi 5,RA,IM		
twlti		Trap if (RA) less than EXTS(IM). <i>Extended mnemonic for</i> twi 16,RA,IM		
twnei		Trap if (RA) not equal to EXTS(IM). <i>Extended mnemonic for</i> twi 24,RA,IM		
twngi		Trap if (RA) not greater than EXTS(IM). <i>Extended mnemonic for</i> twi 20,RA,IM		
twnli		Trap if (RA) not less than EXTS(IM). <i>Extended mnemonic for</i> twi 12,RA,IM		

B.5 Storage Reference Instructions

The PPC405GP uses load and store instructions to transfer data between memory and the general purpose registers. Load and store instructions operate on byte, halfword and word data. The storage reference instructions also support loading or storing multiple registers, character strings, and byte-reversed data. Table B-6 shows the storage reference instructions available for use in the PPC405GP.

Table B-6. Storage Reference Instructions

Mnemonic	Operands	Function	Other Registers Changed	Page
lbz	RT, D(RA)	Load byte from EA = (RA 0) + EXTS(D) and pad left with zeroes, (RT) \leftarrow $^{24}0 \parallel MS(EA,1)$.		733
lbzu	RT, D(RA)	Load byte from EA = (RA 0) + EXTS(D) and pad left with zeroes, (RT) \leftarrow $^{24}0 \parallel MS(EA,1)$. Update the base address, (RA) \leftarrow EA.		734
lbzux	RT, RA, RB	Load byte from EA = (RA 0) + (RB) and pad left with zeroes, (RT) \leftarrow $^{24}0 \parallel MS(EA,1)$. Update the base address, (RA) \leftarrow EA.		735
lbzx	RT, RA, RB	Load byte from EA = (RA 0) + (RB) and pad left with zeroes, (RT) \leftarrow $^{24}0 \parallel MS(EA,1)$.		736
lha	RT, D(RA)	Load halfword from EA = (RA 0) + EXTS(D) and sign extend, (RT) \leftarrow EXTS(MS(EA,2)).		737
lhau	RT, D(RA)	Load halfword from EA = (RA 0) + EXTS(D) and sign extend, (RT) \leftarrow EXTS(MS(EA,2)). Update the base address, (RA) \leftarrow EA.		738
lhaux	RT, RA, RB	Load halfword from EA = (RA 0) + (RB) and sign extend, (RT) \leftarrow EXTS(MS(EA,2)). Update the base address, (RA) \leftarrow EA.		739
lhax	RT, RA, RB	Load halfword from EA = (RA 0) + (RB) and sign extend, (RT) \leftarrow EXTS(MS(EA,2)).		740
lhbrx	RT, RA, RB	Load halfword from EA = (RA 0) + (RB), then reverse byte order and pad left with zeroes, (RT) \leftarrow $^{16}0 \parallel MS(EA+1,1) \parallel MS(EA,1)$.		741
lhz	RT, D(RA)	Load halfword from EA = (RA 0) + EXTS(D) and pad left with zeroes, (RT) \leftarrow $^{16}0 \parallel MS(EA,2)$.		742

Preliminary User's Manual**Table B-6. Storage Reference Instructions (continued)**

Mnemonic	Operands	Function	Other Registers Changed	Page
lhzu	RT, D(RA)	Load halfword from EA = (RA 0) + EXTS(D) and pad left with zeroes, (RT) \leftarrow $^{16}0$ MS(EA,2). Update the base address, (RA) \leftarrow EA.		743
lhzux	RT, RA, RB	Load halfword from EA = (RA 0) + (RB) and pad left with zeroes, (RT) \leftarrow $^{16}0$ MS(EA,2). Update the base address, (RA) \leftarrow EA.		744
lhzx	RT, RA, RB	Load halfword from EA = (RA 0) + (RB) and pad left with zeroes, (RT) \leftarrow $^{16}0$ MS(EA,2).		745
lmw	RT, D(RA)	Load multiple words starting from EA = (RA 0) + EXTS(D). Place into consecutive registers, RT through GPR(31). RA is not altered unless RA = GPR(31).		746
lswi	RT, RA, NB	Load consecutive bytes from EA = (RA 0). Number of bytes $n = 32$ if NB = 0, else $n = NB$. Stack bytes into words in CEIL($n/4$) consecutive registers starting with RT, to $R_{FINAL} \leftarrow ((RT + CEIL(n/4) - 1) \% 32)$. GPR(0) is consecutive to GPR(31). RA is not altered unless RA = R_{FINAL} .		747
lswx	RT, RA, RB	Load consecutive bytes from EA=(RA 0)+(RB). Number of bytes $n = XER[TBC]$. Stack bytes into words in CEIL($n/4$) consecutive registers starting with RT, to $R_{FINAL} \leftarrow ((RT + CEIL(n/4) - 1) \% 32)$. GPR(0) is consecutive to GPR(31). RA is not altered unless RA = R_{FINAL} . RB is not altered unless RB = R_{FINAL} . If $n=0$, content of RT is undefined.		749
lwarx	RT, RA, RB	Load word from EA = (RA 0) + (RB) and place in RT, (RT) \leftarrow MS(EA,4). Set the Reservation bit.		751
lwbrx	RT, RA, RB	Load word from EA = (RA 0) + (RB) then reverse byte order, (RT) \leftarrow MS(EA+3,1) MS(EA+2,1) MS(EA+1,1) MS(EA,1).		752
lwz	RT, D(RA)	Load word from EA = (RA 0) + EXTS(D) and place in RT, (RT) \leftarrow MS(EA,4).		753

Table B-6. Storage Reference Instructions (continued)

Mnemonic	Operands	Function	Other Registers Changed	Page
lwzu	RT, D(RA)	Load word from EA = (RA 0) + EXTS(D) and place in RT, (RT) ← MS(EA,4). Update the base address, (RA) ← EA.		754
lwzux	RT, RA, RB	Load word from EA = (RA 0) + (RB) and place in RT, (RT) ← MS(EA,4). Update the base address, (RA) ← EA.		755
lwzx	RT, RA, RB	Load word from EA = (RA 0) + (RB) and place in RT, (RT) ← MS(EA,4).		756
stb	RS, D(RA)	Store byte (RS) _{24:31} in memory at EA = (RA 0) + EXTS(D).		818
stbu	RS, D(RA)	Store byte (RS) _{24:31} in memory at EA = (RA 0) + EXTS(D). Update the base address, (RA) ← EA.		819
stbux	RS, RA, RB	Store byte (RS) _{24:31} in memory at EA = (RA 0) + (RB). Update the base address, (RA) ← EA.		820
stbx	RS, RA, RB	Store byte (RS) _{24:31} in memory at EA = (RA 0) + (RB).		821
sth	RS, D(RA)	Store halfword (RS) _{16:31} in memory at EA = (RA 0) + EXTS(D).		822
sthbrx	RS, RA, RB	Store halfword (RS) _{16:31} byte-reversed in memory at EA = (RA 0) + (RB). MS(EA, 2) ← (RS) _{24:31} (RS) _{16:23}		823
sthu	RS, D(RA)	Store halfword (RS) _{16:31} in memory at EA = (RA 0) + EXTS(D). Update the base address, (RA) ← EA.		824
sthux	RS, RA, RB	Store halfword (RS) _{16:31} in memory at EA = (RA 0) + (RB). Update the base address, (RA) ← EA.		825
sthx	RS, RA, RB	Store halfword (RS) _{16:31} in memory at EA = (RA 0) + (RB).		826
stmw	RS, D(RA)	Store consecutive words from RS through GPR(31) in memory starting at EA = (RA 0) + EXTS(D).		827

Preliminary User's Manual**Table B-6. Storage Reference Instructions (continued)**

Mnemonic	Operands	Function	Other Registers Changed	Page
stswi	RS, RA, NB	Store consecutive bytes in memory starting at EA=(RA 0). Number of bytes $n = 32$ if NB = 0, else $n = NB$. Bytes are unstacked from CEIL($n/4$) consecutive registers starting with RS. GPR(0) is consecutive to GPR(31).		828
stswx	RS, RA, RB	Store consecutive bytes in memory starting at EA=(RA 0)+(RB). Number of bytes $n = XER[TBC]$. Bytes are unstacked from CEIL($n/4$) consecutive registers starting with RS. GPR(0) is consecutive to GPR(31).	806	829
stw	RS, D(RA)	Store word (RS) in memory at EA = (RA 0) + EXTS(D).	806	831
stwbrx	RS, RA, RB	Store word (RS) byte-reversed in memory at EA = (RA 0) + (RB). $MS(EA, 4) \leftarrow (RS)_{24:31} \parallel (RS)_{16:23} \parallel (RS)_{8:15} \parallel (RS)_{0:7}$	806	832
stwcx.	RS, RA, RB	Store word (RS) in memory at EA = (RA 0) + (RB) only if the reservation bit is set. if RESERVE = 1 then $MS(EA, 4) \leftarrow (RS)$ RESERVE $\leftarrow 0$ $(CR[CR0]) \leftarrow {}^20 \parallel 1 \parallel XER_{so}$ else $(CR[CR0]) \leftarrow {}^20 \parallel 0 \parallel XER_{so}$.	806	833
stwu	RS, D(RA)	Store word (RS) in memory at EA = (RA 0) + EXTS(D). Update the base address, (RA) \leftarrow EA.	806	835
stwux	RS, RA, RB	Store word (RS) in memory at EA = (RA 0) + (RB). Update the base address, (RA) \leftarrow EA.	806	836
stwx	RS, RA, RB	Store word (RS) in memory at EA = (RA 0) + (RB).	806	837

B.6 Arithmetic and Logical Instructions

Table B-7 lists the arithmetic and logical instructions. Arithmetic operations are performed on integer or ordinal operands stored in registers. Instructions using two operands are defined in a three-operand format, where the operation is performed on the operands stored in two registers, and the result is placed in a third register. Instructions using one operand are defined in a two-operand format, where the operation is performed on the operand in one register, and the result is placed in another register. Several instructions have immediate formats, in which one operand is coded as part of the instruction itself. Most arithmetic and logical instructions can optionally set the Condition Register (CR) based on the outcome of the instruction.

Table B-7. Arithmetic and Logical Instructions

Mnemonic	Operands	Function	Other Registers Changed	Page
add	RT, RA, RB	Add (RA) to (RB). Place result in RT.		668
add.			CR[CR0]	
addo			XER[SO, OV]	
addo.			CR[CR0] XER[SO, OV]	
addc	RT, RA, RB	Add (RA) to (RB). Place result in RT. Place carry-out in XER[CA].		669
addc.			CR[CR0]	
addco			XER[SO, OV]	
addco.			CR[CR0] XER[SO, OV]	
adde	RT, RA, RB	Add XER[CA], (RA), (RB). Place result in RT. Place carry-out in XER[CA].		671
adde.			CR[CR0]	
addeo			XER[SO, OV]	
addeo.			CR[CR0] XER[SO, OV]	
addi	RT, RA, IM	Add EXTS(IM) to (RA 0). Place result in RT.		671
addic	RT, RA, IM	Add EXTS(IM) to (RA 0). Place result in RT. Place carry-out in XER[CA].		672
addic.	RT, RA, IM	Add EXTS(IM) to (RA 0). Place result in RT. Place carry-out in XER[CA].	CR[CR0]	673
addis	RT, RA, IM	Add (IM ¹⁶ 0) to (RA 0). Place result in RT.		674
addme	RT, RA	Add XER[CA], (RA), (-1). Place result in RT. Place carry-out in XER[CA].		675
addme.			CR[CR0]	
addmeo			XER[SO, OV]	
addmeo.			CR[CR0] XER[SO, OV]	

Preliminary User's Manual**Table B-7. Arithmetic and Logical Instructions (continued)**

Mnemonic	Operands	Function	Other Registers Changed	Page
addze	RT, RA	Add XER[CA] to (RA). Place result in RT. Place carry-out in XER[CA].		676
addze.			CR[CR0]	
addzeo			XER[SO, OV]	
addzeo.			CR[CR0] XER[SO, OV]	
and	RA, RS, RB	AND (RS) with (RB). Place result in RA.		677
and.			CR[CR0]	
andc	RA, RS, RB	AND (RS) with \neg (RB). Place result in RA.		678
andc.			CR[CR0]	
andi.	RA, RS, IM	AND (RS) with ($^{16}0 \parallel$ IM). Place result in RA.	CR[CR0]	679
andis.	RA, RS, IM	AND (RS) with (IM \parallel $^{16}0$). Place result in RA.	CR[CR0]	680
cntlzw	RA, RS	Count leading zeros in RS. Place result in RA.		700
cntlzw.			CR[CR0]	
divw	RT, RA, RB	Divide (RA) by (RB), signed. Place result in RT.		721
divw.			CR[CR0]	
divwo			XER[SO, OV]	
divwo.			CR[CR0] XER[SO, OV]	
divwu	RT, RA, RB	Divide (RA) by (RB), unsigned. Place result in RT.		722
divwu.			CR[CR0]	
divwuo			XER[SO, OV]	
divwuo.			CR[CR0] XER[SO, OV]	
eqv	RA, RS, RB	Equivalence of (RS) with $\overline{(RB)}$. (RA) $\leftarrow \neg((RS) \oplus (RB))$		724
eqv.			CR[CR0]	
extsb	RA, RS	Extend the sign of byte (RS) _{24:31} . Place the result in RA.		725
extsb.			CR[CR0]	
extsh	RA, RS	Extend the sign of halfword (RS) _{16:31} . Place the result in RA.		726
extsh.			CR[CR0]	
mulhw	RT, RA, RB	Multiply (RA) and (RB), signed. Place hi-order result in RT. $prod_{0:63} \leftarrow (RA) \times (RB)$ (signed). (RT) $\leftarrow prod_{0:31}$.		789
mulhw.			CR[CR0]	

Table B-7. Arithmetic and Logical Instructions (continued)

Mnemonic	Operands	Function	Other Registers Changed	Page
mulhwu	RT, RA, RB	Multiply (RA) and (RB), unsigned. Place hi-order result in RT. $prod_{0:63} \leftarrow (RA) \times (RB)$ (unsigned). $(RT) \leftarrow prod_{0:31}$.		790
mulhwu.			CR[CR0]	
mulli	RT, RA, IM	Multiply (RA) and IM, signed. Place lo-order result in RT. $prod_{0:47} \leftarrow (RA) \times IM$ (signed) $(RT) \leftarrow prod_{16:47}$		791
mulw	RT, RA, RB	Multiply (RA) and (RB), signed. Place lo-order result in RT. $prod_{0:63} \leftarrow (RA) \times (RB)$ (signed). $(RT) \leftarrow prod_{32:63}$.		792
mulw.			CR[CR0]	
mulwo			XER[SO, OV]	
mulwo.			CR[CR0] XER[SO, OV]	
nand	RA, RS, RB	NAND (RS) with (RB). Place result in RA.		793
nand.			CR[CR0]	
neg	RT, RA	Negative (two's complement) of RA. $(RT) \leftarrow \neg(RA) + 1$		794
neg.			CR[CR0]	
nego			XER[SO, OV]	
nego.			CR[CR0] XER[SO, OV]	
nor	RA, RS, RB	NOR (RS) with (RB). Place result in RA.		801
nor.			CR[CR0]	
or	RA, RS, RB	OR (RS) with (RB). Place result in RA.		796
or.			CR[CR0]	
orc	RA, RS, RB	OR (RS) with $\neg(RB)$. Place result in RA.		796
orc.			CR[CR0]	
ori	RA, RS, IM	OR (RS) with ($^{16}0 \parallel IM$). Place result in RA.		804
oris	RA, RS, IM	OR (RS) with ($IM \parallel ^{16}0$). Place result in RA.		805
subf	RT, RA, RB	Subtract (RA) from (RB). $(RT) \leftarrow \neg(RA) + (RB) + 1$.		838
subf.			CR[CR0]	
subfo			XER[SO, OV]	
subfo.			CR[CR0] XER[SO, OV]	

Preliminary User's Manual**Table B-7. Arithmetic and Logical Instructions (continued)**

Mnemonic	Operands	Function	Other Registers Changed	Page
subfc	RT, RA, RB	Subtract (RA) from (RB). (RT) \leftarrow \neg (RA) + (RB) + 1. Place carry-out in XER[CA].		839
subfc.			CR[CR0]	
subfco			XER[SO, OV]	
subfco.			CR[CR0] XER[SO, OV]	
subfe	RT, RA, RB	Subtract (RA) from (RB) with carry-in. (RT) \leftarrow \neg (RA) + (RB) + XER[CA]. Place carry-out in XER[CA].		840
subfe.			CR[CR0]	
subfeo			XER[SO, OV]	
subfeo.			CR[CR0] XER[SO, OV]	
subfic	RT, RA, IM	Subtract (RA) from EXTS(IM). (RT) \leftarrow \neg (RA) + EXTS(IM) + 1. Place carry-out in XER[CA].		841
subfme	RT, RA, RB	Subtract (RA) from (-1) with carry-in. (RT) \leftarrow \neg (RA) + (-1) + XER[CA]. Place carry-out in XER[CA].		842
subfme.			CR[CR0]	
subfmeo			XER[SO, OV]	
subfmeo.			CR[CR0] XER[SO, OV]	
subfze	RT, RA, RB	Subtract (RA) from zero with carry-in. (RT) \leftarrow \neg (RA) + XER[CA]. Place carry-out in XER[CA].		842
subfze.			CR[CR0]	
subfzeo			XER[SO, OV]	
subfzeo.			CR[CR0] XER[SO, OV]	
xor	RA, RS, RB	XOR (RS) with (RB). Place result in RA.		860
xor.			CR[CR0]	
xori	RA, RS, IM	XOR (RS) with ($^{16}0$ IM). Place result in RA.		861
xoris	RA, RS, IM	XOR (RS) with (IM $^{16}0$). Place result in RA.		862

B.7 Condition Register Logical Instructions

CR logical instructions combine the results of several comparisons without incurring the overhead of conditional branching. These instructions can significantly improve code performance if multiple conditions are tested before making a branch decision. Table B-8 summarizes the CR logical instructions.

Table B-8. Condition Register Logical Instructions

Mnemonic	Operands	Function	Other Registers Changed	Page
crand	BT, BA, BB	AND bit (CR_{BA}) with (CR_{BB}). Place result in CR_{BT} .		701
crandc	BT, BA, BB	AND bit (CR_{BA}) with $\neg(CR_{BB})$. Place result in CR_{BT} .		702
creqv	BT, BA, BB	Equivalence of bit CR_{BA} with CR_{BB} . $CR_{BT} \leftarrow \neg(CR_{BA} \oplus CR_{BB})$		703
crnand	BT, BA, BB	NAND bit (CR_{BA}) with (CR_{BB}). Place result in CR_{BT} .		704
crnor	BT, BA, BB	NOR bit (CR_{BA}) with (CR_{BB}). Place result in CR_{BT} .		705
cror	BT, BA, BB	OR bit (CR_{BA}) with (CR_{BB}). Place result in CR_{BT} .		706
crorc	BT, BA, BB	OR bit (CR_{BA}) with $\neg(CR_{BB})$. Place result in CR_{BT} .		707
crxor	BT, BA, BB	XOR bit (CR_{BA}) with (CR_{BB}). Place result in CR_{BT} .		708
mcrf	BF, BFA	Move CR field, $(CR[CR_n]) \leftarrow (CR[CR_m])$ where $m \leftarrow BFA$ and $n \leftarrow BF$.		769

Preliminary User's Manual**B.8 Branch Instructions**

The architecture provides conditional and unconditional branches to any storage location. The conditional branch instructions test condition codes set previously and branch accordingly. Conditional branch instructions may decrement and test the Count Register (CTR) as part of determination of the branch condition and may save the return address in the Link Register (LR). The target address for a branch may be a displacement from the current instruction address (CIA), or may be contained in the LR or CTR, or may be an absolute address.

Table B-9. Branch Instructions

Mnemonic	Operands	Function	Other Registers Changed	Page
b	target	Branch unconditional relative. LI ← (target – CIA) _{6:29} NIA ← CIA + EXTS(LI ² 0)		681
ba		Branch unconditional absolute. LI ← target _{6:29} NIA ← EXTS(LI ² 0)		
bl		Branch unconditional relative. LI ← (target – CIA) _{6:29} NIA ← CIA + EXTS(LI ² 0)	(LR) ← CIA + 4.	
bla		Branch unconditional absolute. LI ← target _{6:29} NIA ← EXTS(LI ² 0)	(LR) ← CIA + 4.	
bc	BO, BI, target	Branch conditional relative. BD ← (target – CIA) _{16:29} NIA ← CIA + EXTS(BD ² 0)	CTR if BO ₂ = 0.	682
bca		Branch conditional absolute. BD ← target _{16:29} NIA ← EXTS(BD ² 0)	CTR if BO ₂ = 0.	
bcl		Branch conditional relative. BD ← (target – CIA) _{16:29} NIA ← CIA + EXTS(BD ² 0)	CTR if BO ₂ = 0. (LR) ← CIA + 4.	
bcla		Branch conditional absolute. BD ← target _{16:29} NIA ← EXTS(BD ² 0)	CTR if BO ₂ = 0. (LR) ← CIA + 4.	
bcctr	BO, BI	Branch conditional to address in CTR. Using (CTR) at exit from instruction, NIA ← CTR _{0:29} ² 0.	CTR if BO ₂ = 0.	688
bcctrl			CTR if BO ₂ = 0. (LR) ← CIA + 4.	
bclr	BO, BI	Branch conditional to address in LR. Using (LR) at entry to instruction, NIA ← LR _{0:29} ² 0.	CTR if BO ₂ = 0.	692
bclrl			CTR if BO ₂ = 0. (LR) ← CIA + 4.	

B.9 Comparison Instructions

Comparison instructions perform arithmetic and logical comparisons between two operands and set one of the eight condition code register fields based on the outcome of the comparison. Table B-10 shows the comparison instructions supported by the PPC405GPr.

Table B-10. Comparison Instructions

Mnemonic	Operands	Function	Other Registers Changed	Page
cmp	BF, 0, RA, RB	Compare (RA) to (RB), signed. Results in CR[CRn], where $n = BF$.		696
cmpi	BF, 0, RA, IM	Compare (RA) to EXTS(IM), signed. Results in CR[CRn], where $n = BF$.		697
cmpl	BF, 0, RA, RB	Compare (RA) to (RB), unsigned. Results in CR[CRn], where $n = BF$.		698
cmpli	BF, 0, RA, IM	Compare (RA) to ($160 \parallel IM$), unsigned. Results in CR[CRn], where $n = BF$.		699

Preliminary User's Manual**B.10 Rotate and Shift Instructions**

Rotate and shift instructions rotate and shift operands which are stored in the general purpose registers. Rotate instructions can also mask rotated operands. Table B-11 shows the PPC405GP rotate and shift instructions.

Table B-11. Rotate and Shift Instructions

Mnemonic	Operands	Function	Other Registers Changed	Page
rlwimi	RA, RS, SH, MB, ME	Rotate left word immediate, then insert according to mask. $r \leftarrow \text{ROTL}((RS), SH)$ $m \leftarrow \text{MASK}(MB, ME)$ $(RA) \leftarrow (r \wedge m) \vee ((RA) \wedge \neg m)$	CR[CR0]	808
rlwimi.				
rlwinm	RA, RS, SH, MB, ME	Rotate left word immediate, then AND with mask. $r \leftarrow \text{ROTL}((RS), SH)$ $m \leftarrow \text{MASK}(MB, ME)$ $(RA) \leftarrow (r \wedge m)$	CR[CR0]	809
rlwinm.				
rlwnm	RA, RS, RB, MB, ME	Rotate left word, then AND with mask. $r \leftarrow \text{ROTL}((RS), (RB)_{27:31})$ $m \leftarrow \text{MASK}(MB, ME)$ $(RA) \leftarrow (r \wedge m)$	CR[CR0]	812
rlwnm.				
slw	RA, RS, RB	Shift left (RS) by $(RB)_{27:31}$. $n \leftarrow (RB)_{27:31}$. $r \leftarrow \text{ROTL}((RS), n)$. if $(RB)_{26} = 0$ then $m \leftarrow \text{MASK}(0, 31 - n)$ else $m \leftarrow {}^{32}0$. $(RA) \leftarrow r \wedge m$.	CR[CR0]	814
slw.				
sraw	RA, RS, RB	Shift right algebraic (RS) by $(RB)_{27:31}$. $n \leftarrow (RB)_{27:31}$. $r \leftarrow \text{ROTL}((RS), 32 - n)$. if $(RB)_{26} = 0$ then $m \leftarrow \text{MASK}(n, 31)$ else $m \leftarrow {}^{32}0$. $s \leftarrow (RS)_0$. $(RA) \leftarrow (r \wedge m) \vee ({}^{32}s \wedge \neg m)$. $\text{XER}[CA] \leftarrow s \wedge ((r \wedge \neg m) \neq 0)$.	CR[CR0]	815
sraw.				
srawi	RA, RS, SH	Shift right algebraic (RS) by SH. $n \leftarrow SH$. $r \leftarrow \text{ROTL}((RS), 32 - n)$. $m \leftarrow \text{MASK}(n, 31)$. $s \leftarrow (RS)_0$. $(RA) \leftarrow (r \wedge m) \vee ({}^{32}s \wedge \neg m)$. $\text{XER}[CA] \leftarrow s \wedge ((r \wedge \neg m) \neq 0)$.	CR[CR0]	816
srawi.				
srw	RA, RS, RB	Shift right (RS) by $(RB)_{27:31}$. $n \leftarrow (RB)_{27:31}$. $r \leftarrow \text{ROTL}((RS), 32 - n)$. if $(RB)_{26} = 0$ then $m \leftarrow \text{MASK}(n, 31)$ else $m \leftarrow {}^{32}0$. $(RA) \leftarrow r \wedge m$.	CR[CR0]	817
srw.				

B.11 Cache Control Instructions

Cache control instructions allow the user to indirectly control the contents of the data and instruction caches. The user may fill, flush, invalidate and zero blocks (16-byte lines) in the data cache. The user may also invalidate congruence classes in both caches and invalidate individual lines in the instruction cache.

Table B-12. Cache Control Instructions

Mnemonic	Operands	Function	Other Registers Changed	Page
dcba	RA, RB	Speculatively establish the data cache block which contains the EA (RA 0) + (RB).		709
dcbf	RA, RB	Flush (store, then invalidate) the data cache block which contains the EA (RA 0) + (RB).		711
dcbi	RA, RB	Invalidate the data cache block which contains the EA (RA 0) + (RB).		712
dcbst	RA, RB	Store the data cache block which contains the EA (RA 0) + (RB).		713
dcbt	RA, RB	Load the data cache block which contains the EA (RA 0) + (RB).		714
dcbtst	RA, RB	Load the data cache block which contains the EA (RA 0) + (RB).		715
dcbz	RA, RB	Zero the data cache block which contains the EA (RA 0) + (RB).		716
dccci	RA, RB	Invalidate the data cache congruence class associated with the EA (RA 0) + (RB).		718
dcread	RT, RA, RB	Read either tag or data information from the data cache congruence class associated with the EA (RA 0) + (RB). Place the results in RT.		719
icbi	RA, RB	Invalidate the instruction cache block which contains the EA (RA 0) + (RB).		727
icbt	RA, RB	Load the instruction cache block which contains the EA (RA 0) + (RB).		728
iccci	RA, RB	Invalidate instruction cache.		729
icread	RA, RB	Read either tag or data information from the instruction cache congruence class associated with the EA (RA 0) + (RB). Place the results in ICDBDR.		730

Preliminary User's Manual**B.12 Interrupt Control Instructions**

The interrupt control instructions allow the user to move data between general purpose registers and the machine state register, return from interrupts and enable or disable maskable external interrupts. Table B-13 shows the interrupt control instruction set.

Table B-13. Interrupt Control Instructions

Mnemonic	Operands	Function	Other Registers Changed	Page
mfmsr	RT	Move from MSR to RT, (RT) ← (MSR).		773
mtmsr	RS	Move to MSR from RS, (MSR) ← (RS).		780
rfci		Return from critical interrupt (PC) ← (SRR2). (MSR) ← (SRR3).		806
rfi		Return from interrupt. (PC) ← (SRR0). (MSR) ← (SRR1).		806
wrtee	RS	Write value of RS ₁₆ to the External Enable bit (MSR[EE]).		858
wrteei	E	Write value of E to the External Enable bit (MSR[EE]).		859

B.13 TLB Management Instructions

The TLB management instructions read and write entries of the TLB array in the MMU, search the TLB array for an entry which will translate a given address, invalidate all TLB entries, and synchronize TLB updates with other processors.

Table B-14. TLB Management Instructions

Mnemonic	Operands	Function	Other Registers Changed	Page
tibia		All of the entries in the TLB are invalidated and become unavailable for translation by clearing the valid (V) bit in the TLBHI portion of each TLB entry. The rest of the fields in the TLB entries are unmodified.		845
tlbre	RT, RA, WS	If WS = 0: Load TLBHI portion of the selected TLB entry into RT. Load the PID register with the contents of the TID field of the selected TLB entry. (RT) ← TLBHI[(RA)] (PID) ← TLB[(RA)] _{TID} If WS = 1: Load TLBLO portion of the selected TLB entry into RT. (RT) ← TLBLO[(RA)]		846

Table B-14. TLB Management Instructions (continued)

Mnemonic	Operands	Function	Other Registers Changed	Page
tlbsx	RT,RA,RB	Search the TLB array for a valid entry which translates the EA EA = (RA 0) + (RB). If found, (RT) ← Index of TLB entry. If not found, (RT) Undefined.		848
tlbsx.		If found, (RT) ← Index of TLB entry. CR[CR0] _{EQ} ← 1. If not found, (RT) Undefined. CR[CR0] _{EQ} ← 1.	CR[CR0] _{LT,GT,SO}	
tlbsync		tlbsync does not complete until all previous TLB-update instructions executed by this processor have been received and completed by all other processors. For the PPC405GPr, tlbsync is a no-op.		849
tlbwe	RS, RA,WS	If WS = 0: Write TLBHI portion of the selected TLB entry from RS. Write the TID field of the selected TLB entry from the PID register. TLBHI[(RA)] ← (RS) TLB[(RA)] _{TID} ← (PID) _{24:31} If WS = 1: Write TLBLO portion of the selected TLB entry from RS. TLBLO[(RA)] ← (RS)		850

Preliminary User's Manual**B.14 Processor Management Instructions**

The processor management instructions move data between GPRs and SPRs and DCRs in the PPC405GP; these instructions also provide traps, system calls and synchronization controls.

Table B-15. Processor Management Instructions

Mnemonic	Operands	Function	Other Registers Changed	Page
eieio		Storage synchronization. All loads and stores that precede the eieio instruction complete before any loads and stores that follow the instruction access main storage. Implemented as sync , which is more restrictive.		723
isync		Synchronize execution context by flushing the prefetch queue.		732
mcrxr	BF	Move XER[0:3] into field CR _n , where $n \leftarrow \text{BF}$. $\text{CR}[\text{CR}_n] \leftarrow (\text{XER}[\text{SO}, \text{OV}, \text{CA}])$. $(\text{XER}[\text{SO}, \text{OV}, \text{CA}]) \leftarrow {}^30$.		770
mfcrr	RT	Move from CR to RT, $(\text{RT}) \leftarrow (\text{CR})$.		770
mfdcr	RT, DCRN	Move from DCR to RT, $(\text{RT}) \leftarrow (\text{DCR}(\text{DCRN}))$.		772
mfspr	RT, SPRN	Move from SPR to RT, $(\text{RT}) \leftarrow (\text{SPR}(\text{SPRN}))$.		774
mtcrf	FXM, RS	Move some or all of the contents of RS into CR as specified by FXM field, $\text{mask} \leftarrow {}^4(\text{FXM}_0) \parallel {}^4(\text{FXM}_1) \parallel \dots \parallel {}^4(\text{FXM}_6) \parallel {}^4(\text{FXM}_7)$. $(\text{CR}) \leftarrow ((\text{RS}) \wedge \text{mask}) \vee (\text{CR}) \wedge \neg \text{mask}$.		778
mtdcr	DCRN, RS	Move to DCR from RS, $(\text{DCR}(\text{DCRN})) \leftarrow (\text{RS})$.		779
mtspr	SPRN, RS	Move to SPR from RS, $(\text{SPR}(\text{SPRN})) \leftarrow (\text{RS})$.		781
sc		System call exception is generated. $(\text{SRR1}) \leftarrow (\text{MSR})$ $(\text{SRR0}) \leftarrow (\text{PC})$ $\text{PC} \leftarrow \text{EVPR}_{0:15} \parallel 0x0C00$ $(\text{MSR}[\text{WE}, \text{PR}, \text{EE}, \text{PE}, \text{DR}, \text{IR}]) \leftarrow 0$		813
sync		Synchronization. All instructions that precede sync complete before any instructions that follow sync begin. When sync completes, all storage accesses initiated before sync will have completed.		844
tw	TO, RA, RB	Trap exception is generated if, comparing (RA) with (RB), any condition specified by TO is true.		852
twi	TO, RA, IM	Trap exception is generated if, comparing (RA) with EXTS(IM), any condition specified by TO is true.		855

Appendix C. Code Optimization and Instruction Timings

The code optimization guidelines in “Code Optimization Guidelines” and the information describing instruction timings in “Instruction Timings,” on page C-1251 can help compiler, system, and application programmers produce high-performance code and determine accurate execution times.

C.1 Code Optimization Guidelines

The following guidelines can help to reduce program execution times.

C.1.1 Condition Register Bits for Boolean Variables

Compilers can use Condition Register (CR) bits to store boolean variables, where 0 and 1 represent False and True values, respectively. This generally improves performance, compared to using General Purpose Registers (GPRs) to store boolean variables. Most common operations on boolean variables can be accomplished using the CR Logical instructions.

C.1.2 CR Logical Instruction for Compound Branches

For example, consider the following pseudocode:

```
if (Var28 || Var29 || Var30 || Var 31) branch to target
```

Var28–Var31 are boolean variables, maintained as bits in the CR[CR7] field (CR_{28:31}). The value 1 represents True; 0 represents False.

This could be coded with branches as:

```
bt    28, target
bt    29, target
bt    30, target
bt    31, target
```

Generally faster, functionally equivalent code, using CR Logical instructions, follows:

```
crcr  2, 28, 29
cror  2, 2, 30
cror  2, 2, 31
bt    2, target
```

C.1.3 Floating-Point Emulation

Two ways of handling floating-point emulation are available.

The preferred method is a call interface to subroutines in a floating-point emulation run-time library.

Alternatively, code can use the PowerPC floating point instructions. The PPC405GPr, an integer processor, does not recognize these instructions and will take an illegal instruction interrupt. The interrupt handler can be written to determine the instruction opcode and execute appropriate (integer-based) library routines to provide the equivalent function.

Because this method adds interrupt context switching time to the execution time of library routines that would have been called directly by the preferred method, it is not preferred. However, this method supports code that contains PowerPC floating-point instructions.

C.1.4 Cache Usage

Code and data can be organized, based on the size and structure of the instruction and data cache arrays, to minimize cache misses.

In the cache arrays, any two addresses in which $A_{m:26}$ (the index) are the same, but which differ in $A_{0:m-1}$ (the tag), are called congruent. (This describes a two-way set-associative cache.) $A_{27:31}$ define the 32 bytes in a cache line, the smallest object that can be brought into the cache. Only two congruent lines can be in the cache simultaneously; accessing a third congruent line causes the removal from the cache of one of the two lines previously there

Table C-1 illustrates the value of m and the index size for the various cache array sizes.

Table C-1. Cache Sizes, Tag Fields, and Lines

Array Size	Instruction Cache Array			Data Cache Array		
	m (Tag Field Bits)	n (Lines)	Index Bits	m (Tag Field Bits)	n (Lines)	Index Bits
0KB	—	—	—	—	—	—
4KB	22 (0:21)	64	21:26	21 (0:20)	64	21:26
8KB	22 (0:21)	128	20:26	20 (0:19)	128	20:26
16KB	22 (0:21)	256	19:26	19 (0:18)	256	19:26
32KB	22 (0:21)	512	18:26	18 (0:17)	512	18:26

Moving new code and data into the cache arrays occurs at the speed of external memory. Much faster execution is possible when all code and data is available in the cache. Organizing code to uniformly use $A_{m:26}$ minimizes the use of congruent addresses.

C.1.5 CR Dependencies

For CR-setting arithmetic, compare, CR-logical, and logical instructions, and the CR-setting **mcrf**, **mcrxr**, and **mtrcrf** instructions, put two instructions between the CR-setting instruction and a Branch instruction that uses a bit in the CR field set by the CR-setting instruction.

C.1.6 Branch Prediction

Use the Y-bit in branch instructions to force proper branch prediction when there is a more likely prediction than the standard prediction. See “Branch Prediction” on page 3-117 for a more information about branch prediction.

C.1.7 Alignment

For speed, align all accesses on the appropriate operand-size boundary. For example, load/store word operands should be word-aligned, and so on. Hardware does not trap unaligned accesses; instead, two accesses are performed for a load or store of an unaligned operand that crosses a word boundary. Unaligned accesses that do not cross word boundaries are performed in one access.

Align branch targets that are unlikely to be hit by “fall-through” code on cache line boundaries (such as the address of functions such as **strcpy**), to minimize the number of unused instructions in cache line fills.

Preliminary User's Manual

C.2 Instruction Timings

The following timing descriptions consider only “first order” effects of cache misses in the ICU (instruction-side) and DCU (data-side) arrays.

The timing descriptions *do not* provide complete descriptions of the performance penalty associated with cache misses; the timing descriptions do not consider bus contention between the instruction-side and the data-side, or the time associated with performing line fills or flushes. Unless specifically stated otherwise, the number of cycles apply to systems having zero-wait memory access.

C.2.1 General Rules

Instructions execute in order.

All instructions, assuming cache hits, execute in one cycle, except:

- Divide instructions execute in 35 clock cycles.
- Branches execute in one or three clock cycles, as described in “Branches.”
- MAC and multiply instructions execute in one to five cycles as described in “Multiplies.”
- Aligned load/store instructions that hit in the cache execute in one clock cycle/word. See “Alignment” for information on execution timings for unaligned load/stores.
- In isolation, a data cache control instruction takes two cycles in the processor pipeline. However, subsequent DCU accesses are stalled until a cache control instruction finishes accessing the data cache array.

Note: Note that subsequent DCU accesses do not remain stalled while transfers associated with previous data cache control instructions continue on the PLB.

C.2.2 Branches

Branch instructions are decoded in prefetch buffer 0 (PFB0) and the decode stage of the instruction pipeline. Branch targets, whether the branch is known or predicted taken, can be fetched from the PFB0 and DCD stages. Incorrectly predicted branches can be corrected from the DCD or EXE (execute) stages of the pipeline.

Branches can be known taken or known not taken, or can have address or condition dependencies. Branches having address dependencies are never predicted taken. The directions of conditional branches having no address dependencies are statically predicted.

Conditional branches may depend on the results of an instruction that is changing the CR or the CTR.

Address dependencies can occur when:

- A **bclr** instruction that is known taken, or unresolved, follows (immediately, or separated by only one instruction) a link updating instruction (**mtlr** or a branch and link).
- A **bcctr** instruction that is known taken, or unresolved, follows (immediately, or separated by only one instruction) a counter updating instruction (**mtctr** or a branch that decrements the counter).

Instruction timings for branch instructions follow:

- A branch known not taken (BKNT) executes in one clock cycle. By definition a BKNT does not have address or condition dependencies.

- A branch known taken (BKT) by definition has no condition dependencies, but can have address dependencies. A BKT without address dependencies can execute in one clock cycle if it is first decoded from the PFB0 stage, or in two clock cycles if it is first decoded in the DCD stage. A BKT having address dependencies can execute in two clock cycles if there is one instruction between the branch and the address dependency, or in three clock cycles if there are no instructions between the branch and address dependency.
- A branch predicted not taken (BPNT), which must have condition dependencies, executes in one clock cycle if the prediction is correct. If the prediction is incorrect, the branch can take two or three cycles. If there was one instruction between the branch and the instruction causing the condition dependency, the branch executes in two cycles. If there were no instructions between the branch and the instruction causing the condition dependency, the branch executes in three clock cycles.
- A branch that is correctly predicted taken (BPT), which must have condition dependencies, executes in one clock cycle, if it is first decoded from the PFB0 stage, or two clock cycles if it is first decoded in the DCD stage. If the prediction is incorrect, the branch can take two or three cycles. If there is one instruction between the branch and the instruction causing the condition dependency, the branch executes in two cycles. If there are no instructions between the branch and the instruction causing the condition dependency, the branch executes in three clock cycles.

C.2.3 Multiplies

For multiply instructions having two word operands, hardware internal to the core automatically detects smaller operand sizes (by examining sign bit extension) to reduce the number of cycles necessary to complete the multiplication.

The PPC405GPr also supports multiply accumulate (MAC) instructions and multiply instructions having halfword operands.

Word and halfword multiply instructions are pipelined in the execution unit and use the same multiplication hardware. Because these instructions are pipelined in the execution stage they have latency and reissue rate cycle numbers. Under conditions to be described, a second multiply or MAC instruction can begin execution before the first multiply or MAC instruction completes. When these conditions are met, the reissue rate cycle numbers should be used; otherwise, the latency cycle numbers should be used. (A MAC or multiply instruction can follow another MAC or a multiply and still meet the conditions that support the use of the reissue rate cycle numbers.

Use reissue rate cycle numbers for multiply or MAC instructions that are followed by another multiply or MAC instruction, and do not have an operand dependency from a previous multiply or MAC instruction. However, one operand dependency is allowed for reissue rate cycle numbers. Internal forwarding logic allows the accumulate value of a first MAC instruction to be used as the accumulate value of a second MAC instruction without affecting the reissue rate.

Use latency cycle numbers for multiply or MAC instructions that are not followed by another multiply or MAC, or that have an operand dependency from a previous multiply or MAC instruction. However, accumulate-only dependencies between adjacent MAC instructions use reissue rate cycle numbers.

An operand dependency exists when a second multiply or MAC instruction depends on the result of a first multiply or MAC instruction.

Preliminary User's Manual

Table C-2 summarizes the multiply and MAC instruction timings. In the table, the syntax “[o]” indicates that the instruction has an “o” form that updates XER[SO,OV], and a “non-o” form. The syntax “[.]” indicates that the instruction has a “record” form that updates CR[CR0], and a “non-record” form.

Table C-2. Multiply and MAC Instruction Timing

Operation	Reissue Rate Cycles	Latency Cycles
MAC		
MAC and negative MAC instructions	1	2
Halfword × Halfword		
mullhw [.], mullhwu [.], mulhhw [.], mulhhwu [.], mulchw [.], mulchwu [.]	1	2
mulli [.], mullw [o][.], mulhw [.], mulhwu [.]	2	3
Halfword × Word		
mulli [.], mullw [o][.], mulhw [.], mulhwu [.]	2	3
Word × Word		
mullw [o][.], mulhw [.], mulhwu [.]	4	5

C.2.4 Scalar Load Instructions

Generally, the PPC405GPr executes cachable load instructions that hit in the data cache array or line fill buffer, or noncachable load instructions that hit in the line fill buffer (when enabled), in one cycle. However, the pipelined nature of load instructions can even cause loads that hit in the cache or line fill buffer to appear to take extra cycles under some conditions.

If a load is followed by an instruction that uses the load target as an operand, a load-use dependency exists. When the load target is returned, it is forwarded to the operand register of the “using” instruction. This forwarding results in an additional cycle of latency to a load immediately followed by a “using” instruction, causing the load to appear to execute in two cycles.

Because the PPC405GPr can execute instructions that follow load misses if no load-use dependency exists, the load and the “using” instruction should be separated by two “non-using” instructions when possible. If only one instruction can be placed between the load and the “using” instruction, the load appears to execute in two cycles.

C.2.5 Scalar Store Instructions

Cachable stores that miss in the DCU, and noncachable stores, are queued in the data cache so that the store appears to execute in a single cycle if operand-aligned. Under certain conditions, the DCU can pipeline up to three store instructions. (See Chapter 4, “Cache Operations,” for more information.) **stwcx**. instructions that do not cause alignment errors execute in two cycles.

C.2.6 Alignment in Scalar Load and Store Instructions

The PPC405GPr requires an extra cycle to execute scalar loads and stores having unaligned big or little endian data (except for **lwarx** and **stwcx.**, which require word-aligned operands). If the target data is not operand aligned, and the sum of the least two significant bits of the effective address (EA) and the byte count is greater than four, the PPC405GPr decomposes a load or store scalar into two load or store operations. That is, the PPC405GPr never presents the DCU with a request for a transfer that crosses a word boundary. For example, a **lwz** with an EA of 0b11 causes the PPC405GPr to decompose the **lwz** into two load operations. The first load operation is for a byte at the starting effective address; the second load operation is for three bytes, starting at the next word address.

C.2.7 String and Multiple Instructions

Calculating execution times for string and multiple instructions (**lmw** and **stmw**) instructions requires an understanding of data alignment, and of the behavior of the string instructions with respect to alignment.

In the following example, the string contains 21 bytes. The first three bytes do not begin on a word boundary, and the final two bytes do not end on a word boundary. The PPC405GPr handles any unaligned leading bytes as a special case, then moves as many bytes as aligned words as possible, and finally handles any unaligned trailing bytes as a special case.

In the following example, arrows indicate word boundaries (the address is an exact multiple of four); shaded boxes represent unaligned bytes.

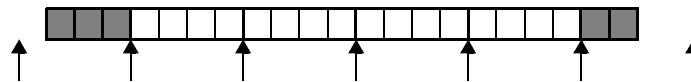

The execution time of the string instruction is the sum of the:

1. Cycles required to handle unaligned leading bytes; if any, add one clock cycle.

In the example, there are unaligned leading bytes; this transfer adds one clock cycle.

2. Cycles required to handle the number of word-aligned transfers required. Assuming data cache hits, each word-aligned transfer requires one clock cycle.

In the example, there are four aligned words; this transfer requires four clock cycles.

3. Cycles required to handle unaligned trailing bytes; if any, add one clock cycle.

In the example, there are unaligned trailing bytes; this transfer adds one clock cycle.

A string instruction operating on the example 21-byte string requires six clock cycles.

C.2.8 Loads and Store Misses

Cachable stores that miss in the DCU, and noncachable stores, are queued internally in the DCU so that the store instruction appears to execute in one cycle. Under certain conditions, the DCU can pipeline up to three store instructions. (See the Chapter 4, "Cache Operations," for more information.)

Because the PPC405GPr can execute instructions that follow load misses if no load-use dependency exists, the load and the "using" instruction should be separated by "non-using" instructions whenever possible. The number of load miss penalty cycles incurred by a load that misses in the DCU or DCU line fill buffer is reduced by one cycle for every non-use instruction following the load. When the number of non-use instructions following the load is equal to or greater than the number of cycles that it takes to obtain the load

Preliminary User's Manual

data, the load instruction appears to execute in a single cycle. The number of cycles that it takes to obtain load data when it misses in the data cache and line fill buffer depends on whether operand forwarding is enabled or disabled and the system memory timing.

C.2.9 Instruction Cache Misses

Refer to “Instruction Processing” on page 3-114 for detailed information about the instruction queue and instruction fetching. Table C-3 illustrates instruction cache penalties for cachable and noncachable fetches that miss in the ICU array and line fill buffer.

Table C-3. Instruction Cache Miss Penalties

Type of ICU Request	Miss Penalty Cycles
Sequential	3
Branch Taken from DCD	5
Branch Taken from PFB0	4

Table C-3 assumes that:

- The PPC405GPr and processor local bus (PLB) run at the same frequency
- The PLB returns an address acknowledge during the first cycle in which the DCU asserts the PLB request
- The target instruction is returned in the cycle following the address acknowledge cycle

The penalty cycles shown for sequential ICU requests assume that the DCD stage and pre-fetch queue are filled with single-cycle nonbranching instructions or BKNT branch instructions. The penalty cycles for the remaining two rows are for taken branches from DCD and PFB0, respectively.

Preliminary User's Manual**Revision Log**

Revision Date	Rev #	Contents of Modification
03/22/06	1.02	<p>Section 19.10 Programming Notes bullet 3 error.</p> <p>Is:</p> <p>EMAC0_MR1[IST] =0 only when EMAC0_MR1[MF] = 10 and EMAC0_MR1[FDE] =0</p> <p>Should be:</p> <p>EMAC0_MR1[IST] =0 only when EMAC0_MR1[MF] = 00 and EMAC0_MR1[FDE] =0</p> <p>Figure 20-15, Figure 25-118. RX Channel_Active Reset Register (MAL0_RXCARR);</p> <p>2nd sentence of the description says:</p> <p>"When 0 is written to the bit, channel operation is disabled."</p> <p>Should say:</p> <p>"When 1 is written to the bit, channel operation is disabled."</p>
12/16/05	1.01	<p>Reformatted to AMCC format</p> <p>Location in text:</p> <p>Section 20.4 Buffer Descriptor Overview page 20-7</p> <p>Original text:</p> <p>Note: Buffer descriptor tables must start on a 4-KB boundary.</p> <p>Updated text:</p> <p>Note: Buffer descriptors must be 8 byte aligned.</p> <p>In Figure 22-17 and Figure 25-113 the description of IIC0_XTCNTLSS[EPI] is incorrect.</p> <p>First line of current description:</p> <p>"Enable Pulsed IRQ on Transfer Aborted"</p> <p>First line of description should be:</p> <p>"Enable Pulsed IRQ"</p> <p>The following is the complete description from the IIC core manual:</p> <p>"Enable pulsed IRQ. When set to a logic '1', the IIC_IRQ signal goes active for one clock period. When set to a logic '0', the IIC_IRQ signal stays active until the IRQ active bit, staus(1) is cleared."</p>
08/05/03		Fixed table of contents
06/09/03		Minor fixes to EBC chapter
03/07/03		Updates to Pin strapping chapter
03/06/03		Updates to PCI chapter concerning PLB priority setting
03/02/03		Updates to GPIO register, physical address map, and chip control registers

Preliminary User's Manual**Index****A**

AA field

- conditional branches 10-116
- unconditional branches 10-115

access protection

- cache instructions 6-175
- string instructions 6-176
- virtual mode 6-172

add 27-668

add. 27-668

addc 27-669

addc. 27-669

addco 27-669

addco. 27-669

adde 27-670

adde. 27-670

addeo 27-670

addeo. 27-670

addi 27-671

addic 27-672

addic. 27-673

addis 27-674

addme 27-675

addme. 27-675

addmeo 27-675

addmeo. 27-675

addo 27-668

addo. 27-668

addze 27-676

addze. 27-676

addzeo 27-676

addzeo. 27-676

alignment

- for cache control instructions 10-107
- for storage reference instructions 10-107
- of data types 10-106

alignment interrupts

- causes of 10-107
- register settings 11-263
- summary 11-263

and 27-677

and. 27-677

andc 27-678

andc. 27-678

andi. 27-679

andis. 27-680

arithmetic instructions 10-129

B

b 27-681

ba 27-681

bc 27-682

bca 27-682

bcctr 27-688

bcctrl 27-688

bcl 27-682

bcla 27-682

bclr 27-692

bcrl 27-692

bctr 27-689

bctrl 27-689

bdnz 27-683

bdnza 27-683

bdnzf 27-683

bdnzfa 27-683

bdnzfl 27-683

bdnzfla 27-683

bdnzflr 27-693

bdnzflrl 27-693

bdnzl 27-683

bdnzla 27-683

bdnzlr 27-693

bdnzlrl 27-693

bdnzt 27-683

bdnzta 27-683

bdnztl 27-683

bdnztla 27-683

bdnztlr 27-693

bdnztlrl 27-693

bdz 27-683

bdza 27-683

bdzf 27-684

bdzfa 27-684

bdzfl 27-684

bdzfla 27-684

bdzflr 27-693

bdzflrl 27-693

bdzl 27-683

bdzla 27-683

bdzlr 27-693

bdzlrl 27-693

bdzt 27-684

bdzta 27-684

bdztl 27-684

bdztla 27-684

bdztlr 27-693

bdztlrl 27-693

beq 27-684

beqa 27-684

beqctr 27-689

beqctrl 27-689

beql 27-684

beqlr 27-693

- beqrlr 27-693
- bf 27-684
- bfa 27-684
- bfctr 27-689
- bfctrl 27-689
- bfl 27-684
- bfla 27-684
- bflr 27-694
- bflrl 27-694
- bge 27-685
- bgea 27-685
- bgectrl 27-689
- bgel 27-685
- bgela 27-685
- bgelr 27-694
- bgelrl 27-694
- bgrctr 27-689
- bgt 27-685
- bgta 27-685
- bgtctr 27-689
- bgtctrl 27-689
- bgtl 27-685
- bgtla 27-685
- bgtlr 27-694
- bgtlrl 27-694
- BI field
 - conditional branches 10-116
- big endian
 - alignment 10-107
 - mapping 10-109
 - storage regions
 - byte-reverse instructions ??-10-113
- bl 27-681
- bla 27-681
- ble 27-685
- blea 27-685
- blectr 27-689
- blectrl 27-689
- blel 27-685
- blela 27-685
- blelr 27-694
- blelrl 27-694
- blr 27-692
- blrl 27-692
- blt 27-685
- blta 27-685
- bltctr 27-689
- bltctrl 27-689
- bltl 27-685
- bltla 27-685
- bltlr 27-694
- bltlrl 27-694
- bne 27-686
- bnea 27-686
- bnctr 27-690
- bnctrl 27-690
- bnel 27-686
- bnela 27-686
- bnelr 27-694
- bnelrl 27-694
- bng 27-686
- bnga 27-686
- bngctr 27-690
- bngctrl 27-690
- bngl 27-686
- bngla 27-686
- bnglr 27-694
- bnglrl 27-694
- bnl 27-686
- bnla 27-686
- bnlctr 27-690
- bnlctrl 27-690
- bnll 27-686
- bnlla 27-686
- bnllr 27-695
- bnllrl 27-695
- bns 27-686
- bnsa 27-686
- bnsctr 27-690
- bnsctrl 27-690
- bnsi 27-686
- bnsia 27-686
- bnslr 27-695
- bnslrl 27-695
- bnu 27-687
- bnu a 27-687
- bnuctr 27-690
- bnuctrl 27-690
- bnul 27-687
- bnula 27-687
- bnulr 27-695
- bnulrl 27-695
- BO field
 - conditional branches 10-116
- branch instructions 10-131
- branch prediction 10-117, 30-1159, 31-1213
 - controlling through mnemonics 10-118
- branching control
 - AA field on conditional branches 10-116
 - AA field on unconditional branches 10-115
 - BI field on conditional branches 10-116
 - BO field on conditional branches 10-116
 - branch prediction 10-117
- bso 27-687

Preliminary User's Manual

- bsoa 27-687
- bsoctr 27-690
- bsoctrl 27-690
- bsol 27-687
- bsola 27-687
- bsolr 27-695
- bsolrl 27-695
- bt 27-687
- bta 27-687
- btctr 27-690
- btctrl 27-690
- btl 27-687
- btla 27-687
- btlr 27-695
- btlrl 27-695
- bun 27-687
- buna 27-687
- bunctr 27-691
- bunctrl 27-691
- bunl 27-687
- bunla 27-687
- bunlr 27-695
- bunlrl 27-695
- byte ordering
 - little endian
 - supported 10-110
 - overview 10-108
- byte reversal
 - during load/store access 10-112
- byte-reverse instructions
 - augmented by endian (E) storage attribute 10-114
 - compare to endian (E) storage attribute 10-113
- C**
- cache
 - instructions
 - DAC debug events 13-299
- cache control instructions
 - access protection 6-175
- cache line fills
 - DCU 4-140
- cache organization
 - DCU 4-139
 - ICU 4-136
- caches. See ICU;DCU
- caching inhibited (I) storage attribute
 - for data accesses, controlled by DCCR 6-178
 - for instruction fetches, controlled by ICCR 6-178
 - virtual mode 6-165
- CCR0 28-878
- character mode
 - NS16450 23-607
- clrslwi 27-809
- clrslwi. 27-809
- clrlwi 27-809
- clrlwi. 27-809
- clrrwi 27-810
- clrrwi. 27-810
- cmp 27-696
- cmpi 27-697
- cmpl 27-698
- cmpli 27-699
- cmplw 27-698
- cmplwi 27-699
- cmpw 27-696
- cmpwi 27-697
- cntlzw 27-700
- cntlzw. 27-700
- compare instructions
 - in core, listed 10-130
- conditional branches
 - AA field 10-116
 - BI field 10-116
 - BO field 10-116
 - mnemonics used to control prediction 10-118
- context synchronization
 - defined 10-124
 - for ITLB 6-167
- context, defined 10-124
- conventions
 - notational 5-47
- CPC0_CR1 28-928
- CPC0_ER 28-929
- CPC0_FR 28-930
- CPC0_JTAGID 28-931
- CPC0_PLLMR 28-932
- CPC0_PSR 28-934
- CPC0_SR 28-936
- CR 28-880
- CR (Condition Register)
 - arithmetic and logical instructions 10-129
 - compare instructions 10-130
 - CR0 field ??-10-94
 - logical instructions 10-130
- crand 27-701
- crandc 27-702
- crclr 27-708
- creqv 27-703
- critical input interrupts 11-257
 - register settings 11-258
- crmove 27-706
- crnand 27-704
- crnor 27-705

- crnot 27-705
- cror 27-706
- crorc 27-707
- crset 27-703
- crxor 27-708
- CTR 17-332, 28-881
- CTR (Count Register)
 - branch instructions 10-131
- D**
- DAC1 13-293
- DAC1–DAC2 13-293, 28-882
- Data Address Compare Register (DAC1) 13-293
- data alignment
 - overview 10-106
- Data Exception Address Register. *See* DEAR
- data machine check interrupts
 - register settings 11-259
- data storage interrupts
 - causes 11-259
 - described 6-169
 - register settings 11-260
- data TLB. *See* DTLB
- data types
 - illustrated 10-106
- DBCR0 28-883, 28-885
- DBSR 13-291, 28-887
- dcba
 - functions 4-143
- dcbf 27-711
 - functions 4-143
- dcbi 27-712
 - functions 4-143
- dcbst 27-713
 - functions 4-143
- dcbt 27-714
 - functions 4-143
- dcbtst
 - functions 4-144
- dcbz 27-716
 - functions 4-144
- dccci 27-718
 - functions 4-144
- DCCR 28-889
- DCP0_ADDR0–DCP0_ADDR1 28-937
- DCP0_CFG 28-938
- DCP0_CFGADDR 28-939
- DCP0_CFGDATA 28-940
- DCP0_ESR 28-941
- DCP0_ID 28-943
- DCP0_ITOR0–DCP0_ITOR3 28-944
- DCP0_MEMBEAR 28-945
- DCP0_PLBBEAR 15-313, 28-946
- DCP0_RAM0–DCP0_RAM3FF 28-947
- DCP0_VER 28-948
- dcread 27-719
 - as debugging tool 4-148
 - functions 4-144
- DCRs (device control registers)
 - indirectly accessed 10-99, 28-868
 - instructions for reading 10-124
- DCU (data cache unit)
 - cachability control 4-141
 - cache line fills 4-140
 - coherency 4-142
 - debugging 4-148
 - instructions 4-143
 - load strategies 4-141
 - organization 4-139
 - performance 4-149
 - pipeline stalls 4-149
 - priority changes 4-150
 - sequential caching 4-151
 - simultaneous cache operations 4-150
 - write strategies 4-140
- DCWR 28-891
- DEAR 28-893
- DEAR (Data Exception Address Register)
 - illustrated 11-257
- debug interrupts
 - register settings 11-268
- debugging
 - boundary scan chain 13-282
 - DCU 4-148
 - debug events 13-294
 - debug interfaces 13-281
 - JTAG test access port 13-281
 - trace status port 13-284
 - development tools 13-281
 - ICU 4-147
 - modes 13-284
 - external 13-285
 - internal 13-284
 - real-time trace 13-286
 - processor control 13-286
 - processor status 13-287
- decompression controller
 - indirect access of DCRs 10-101, 28-871
 - offsets for DCRs 10-101, 28-871
- device-paced transfers 18-362
- divw 27-721
- divw. 27-721
- divwo 27-721
- divwo. 27-721

Preliminary User's Manual

- divwu 27-722
- divwu. 27-722
- divwuo 27-722
- divwuo. 27-722
- DMA operations
 - arbitration transfer priorities 20-513
 - data parity 20-513
 - errors 20-513
 - interrupts 20-514
- DMA0_CR0-DMA0_CR3 20-508, 28-949
- DMA0_CT0-DMA0_CT3 20-511, 28-951
- DMA0_DA0-DMA0_DA3 20-511, 28-952
- DMA0_POL 28-953
- DMA0_SA0-DMA0_SA3 20-510
- DMA0_SA0-DMA0_SA3 28-954
- DMA0_SG0-DMA0_SG3 20-512
- DMA0_SG0-DMA0_SG3 28-955
- DMA0_SGC 20-512, 28-956
- DMA0_SLP 28-957
- DMA0_SR 20-507, 28-958
- DTLB (data translation lookaside buffer)
 - accesses 6-167
 - miss interrupts 6-170, 11-267
 - summary 6-167
- E**
- EA (effective address)
 - translation to RA, illustrated 6-162
- EBC
 - signals 18-352
- EBC (external bus controller)
 - DCRs
 - access procedures, overview 10-99, 28-868
 - offsets 28-870
- EBC0_BEAR 28-959
- EBC0_BESR0 28-960
- EBC0_BESR1 28-962
- EBC0_BnAP 28-963
- EBC0_BnCR 28-964
- EBC0_CFG 28-965
- EBC0_CFGADDR 28-967
- EBC0_CFGDATA 28-968
- eieio 27-723
- EMAC0_GAHT1-EMAC0_GAHT4 28-969
- EMAC0_IAHR 28-970
- EMAC0_IAHT1-EMAC0_IAHT4 28-971
- EMAC0_IALR 28-972
- EMAC0_IPGVR 28-973
- EMAC0_ISER 28-974
- EMAC0_ISR 28-976
- EMAC0_LSAH 28-979
- EMAC0_LSAL 28-980
- EMAC0_MR0 28-981, 28-982
- EMAC0_OCRX 28-984
- EMAC0_OCTX 28-985
- EMAC0_PTR 28-986
- EMAC0_RMR 28-987
- EMAC0_RWMR 28-989
- EMAC0_STACR 28-990
- EMAC0_TMR0 28-991
- EMAC0_TMR1 28-992
- EMAC0_TRTR 28-993
- EMAC0_VTCI 28-994
- EMAC0_VTPID 28-995
- embedded processors
 - instruction set 10-128
- endian (E) storage attribute
 - and byte-reverse load/store instructions 10-114
 - controlled by SLER 6-179
 - and little endian 10-110
 - when controlled by TLB 6-166
- eqv 27-724
- eqv. 27-724
- ESR 28-895
- ESR (Exception Status Register)
 - usage for program interrupts 11-264
- ESR (Exception Syndrome Register)
 - illustrated 11-255
- EVPR 28-896
- EVPR (Exception Vector Prefix Register)
 - illustrated 11-254
- Exception Syndrome Register. *See* ESR
- Exception Vector Prefix Register. *See* EVPR
- exceptions
 - handling, and MSR bits 10-122
 - registers during debug exceptions 11-269
- execution synchronization, defined 10-126
- extended memonics
 - beqlr 27-693
- extended menmonics
 - blectrl 27-689
 - bnlctrl 27-690
- extended mnemoniccd
 - bngla 27-686
- extended mnemonics
 - alphabetical 31-1213
 - bctr 27-689
 - bctrl 27-689
 - bdnz 27-683
 - bdnza 27-683
 - bdnzf 27-683
 - bdnzfa 27-683
 - bdnzfkr 27-693
 - bdnzfl 27-683

bdnzfla 27-683
bdnzflrl 27-693
bdnzl 27-683
bdnzla 27-683
bdnzlr 27-693
bdnzlrl 27-693
bdnzt 27-683
bdnzta 27-683
bdnztl 27-683
bdnztla 27-683
bdnztlr 27-693
bdnztlrl 27-693
bdz 27-683
bdza 27-683
bdzf 27-684
bdzfa 27-684
bdzfl 27-684
bdzfla 27-684
bdzflr 27-693
bdzflrl 27-693
bdzl 27-683
bdzla 27-683
bdzlr 27-693
bdzlrl 27-693
bdzt 27-684
bdzta 27-684
bdztl 27-684
bdztla 27-684
bdztlr 27-693
bdztlrl 27-693
beq 27-684
beqa 27-684
beqctr 27-689
beqctrl 27-689
beql 27-684
beqlrl 27-693
bf 27-684
bfa 27-684
bfctr 27-689
bfctrl 27-689
bfl 27-684
bfla 27-684
bfllr 27-694
bfllrl 27-694
bge 27-685
bgea 27-685
bgectr 27-689
bgectrl 27-689
bgel 27-685
bgela 27-685
bgelr 27-694
bgelrl 27-694
bgt 27-685
bgta 27-685
bgctr 27-689
bgctrl 27-689
bgtl 27-685
bgtla 27-685
bgtlr 27-694
bgtlrl 27-694
ble 27-685
blea 27-685
blectr 27-689
blel 27-685
blela 27-685
blelr 27-694
blelrl 27-694
blr 27-692
blrl 27-692
blt 27-685
blta 27-685
bltctr 27-689
bltctrl 27-689
bltl 27-685
bltla 27-685
bltlr 27-694
bltlrl 27-694
bne 27-686
bnea 27-686
bnectrl 27-690
bnel 27-686
bnela 27-686
bnelr 27-694
bnelrl 27-694
bng 27-686
bnga 27-686
bngctr 27-690
bngctrl 27-690
bngl 27-686
bnglr 27-694
bnglrl 27-694
bni 27-686
bnla 27-686
bnlctr 27-690
bnll 27-686
bnlla 27-686
bnllr 27-695
bnllrl 27-695
bns 27-686
bnsa 27-686
bnsctr 27-690
bnsctrl 27-690
bnsi 27-686
bnsia 27-686

Preliminary User's Manual

bnsr 27-695
 bnsrl 27-695
 bnu 27-687
 bnuar 27-687
 bnuctr 27-690
 bnuctrl 27-690
 bnul 27-687
 bnula 27-687
 bnulr 27-695
 bnulrl 27-695
 bsar 27-695
 bso 27-687
 bsoar 27-687
 bsoctr 27-690
 bsoctrl 27-690
 bsol 27-687
 bsola 27-687
 bsolrl 27-695
 bt 27-687
 bta 27-687
 btctr 27-690
 btctrl 27-690
 btl 27-687
 btla 27-687
 btlr 27-695
 btllr 27-695
 bun 27-687
 buna 27-687
 bunctr 27-691
 bunctrl 27-691
 bunl 27-687
 bunla 27-687
 bunlr 27-695
 bunlrl 27-695
 clrlslwi 27-809
 clrlslwi. 27-809
 clrlwi 27-809
 clrlwi. 27-809
 clrrwi 27-810
 clrrwi. 27-810
 cmplw 27-698
 cmplwi 27-699
 cmpw 27-696
 cmpwi 27-697
 crclr 27-708
 crmove 27-706
 crnot 27-705
 crset 27-703
 explained 10-133
 extlwi 27-810
 extlwi. 27-810
 extrwi 27-810
 extrwi. 27-810
 for addi 27-671
 for addic 27-672
 for addic. 27-673, 27-777
 for addis 27-674
 for bc, bca, bcl, bcla 27-683
 for bcctr, bcctrl 27-689
 for bcl, bclrl 27-692
 for cmp 27-696
 for cmpi 27-697
 for cmpl 27-698
 for cmpli 27-699
 for creqv 27-703
 for crnor 27-705
 for cror 27-706
 for crxor 27-708
 for mfspr 27-775
 for mtrcrf 27-778
 for mtspr 27-782
 for nor, nor. 27-801
 for or, or. 27-802
 for ori 27-804
 for rlwimi, rlwimi. 27-808
 for rlwinm, rlwinm. 27-809
 for rlwnm, rlwnm. 27-812
 for subf, subf., subfo, subfo. 27-838
 for subfc, subfc., subfco, subfco. 27-839
 for tlbre 27-847
 for tw 27-853
 for twi 27-856
 inslwi 27-808
 inslwi. 27-808
 insrwi 27-808
 insrwi. 27-808
 li 27-671
 lis 27-674
 mftb 27-777
 mftbu 27-777
 mr 27-802
 mr. 27-802
 mtrcr 27-778
 nop 27-804
 not 27-801
 not. 27-801
 rotlw 27-812
 rotlw. 27-812
 rotlwi 27-810
 rotlwi. 27-810
 rotrwi 27-810
 rotrwi. 27-810
 slwi 27-810
 slwi. 27-810

- srwi 27-811
 - srwi. 27-811
 - sub 27-838
 - sub. 27-838
 - subc 27-839
 - subc. 27-839
 - subco 27-839
 - subco. 27-839
 - subi 27-671
 - subic 27-672
 - subic. 27-673
 - subis 27-674
 - subo 27-838
 - subo. 27-838
 - tblrehi 27-847
 - tblrelo 27-847
 - tblwehi 27-851
 - tblwelo 27-851
 - trap 27-853
 - tweq 27-853
 - tweqi 27-856
 - twge 27-853
 - twgei 27-856
 - twgle 27-853
 - twgt 27-853
 - twgti 27-856
 - twle 27-853
 - twlei 27-856
 - twlgei 27-856
 - twlgt 27-853
 - twlgti 27-856
 - twlle 27-853
 - twllei 27-856
 - twllt 27-854
 - twllti 27-856
 - twlng 27-854
 - twlngi 27-856
 - twlnl 27-854
 - twlnli 27-857
 - twlt 27-854
 - twlti 27-857
 - twne 27-854
 - twnei 27-857
 - twng 27-854
 - twngi 27-857
 - twnl 27-854
 - twnli 27-857
 - extended mnemonics for
 - tlbre 27-851
 - external bus controller
 - signals 18-352
 - external bus controller. See EBC
 - external bus master 18-368
 - arbitration 18-369
 - interface 18-368
 - external interrupts
 - programming note 11-262
 - register settings 11-262
 - extlwi 27-810
 - extlwi. 27-810
 - extrwi 27-810
 - extrwi. 27-810
 - extsb 27-725
 - extsb. 27-725
- F**
- features
 - ICU 4-135
 - FIFO 23-623
 - FIFO control register 23-615
 - FIFO operation
 - interrupt mode 23-623
 - polled mode 23-624
 - FIT 12-275
 - FIT (fixed interval timer)
 - interrupts, causes 11-266
 - interrupts, register settings 11-266
 - fixed interval timer 12-275
 - fixed interval timer. See FIT
- G**
- general interrupt handling registers, listed 11-251
 - GPIO0_IR 28-996
 - GPIO0_IRO 25-655
 - GPIO0_ODR 28-997
 - GPIO0_OR 28-998
 - GPIO0_TCR 28-999
 - GPR0-GPR31 28-897
 - GPRs (general purpose registers)
 - interrupt control instructions 10-132
 - guarded (G) storage attribute
 - controlled by SGR 6-178
 - preventing speculative accesses 10-118
 - virtual mode 6-166
- I**
- I storage attribute. See caching inhibited (I) storage attribute
 - IAC1-IAC4 28-894, 28-898
 - IAC1–IAC4 13-292
 - icbi 27-727
 - function 4-142
 - icbt 27-728
 - function 4-142
 - iccci 27-729

Preliminary User's Manual

- function 4-142
- ICCR 28-899
- ICDBDR 28-901
- ICDBDR (Instruction Cache Debug Data Register)
 - illustrated 4-147, 28-901
 - programming note 4-148
- icread 27-730
 - function 4-143
 - programming note 4-148
- ICU (instruction cache unit)
 - cachability control 4-138
 - coherency 4-139
 - features 4-135
 - instructions 4-142
 - organization 4-136
 - synchronization 4-139
- IIC 24-631
- IIC0_CLKDIV 28-1000
- IIC0_CNTL 28-1001
- IIC0_DIRECTCNTL 28-1002
- IIC0_EXTSTS 28-1003
- IIC0_HMADR 28-1005
- IIC0_HSADR 28-1006
- IIC0_INTRMSK 28-1007
- IIC0_LMADR 28-1008
- IIC0_LSADR 28-1009
- IIC0_MDBUF 28-1010
- IIC0_MDCNTL 28-1011
- IIC0_SDBUF 28-1012
- IIC0_STS 28-1013
- IIC0_XFRCNT 28-1014
- IIC0_XTCNTLSS 28-1015
- initialization
 - code example 9-212
 - of processor 9-210
 - requirements 9-211
- inslwi 27-808
- inslwi. 27-808
- insrwi 27-808
- insrwi. 27-808
- instruction
 - add 27-668
 - add. 27-668
 - addc 27-669
 - addc. 27-669
 - addco 27-669
 - addco. 27-669
 - adde 27-670
 - adde. 27-670
 - addeo 27-670
 - addeo. 27-670
 - addi 27-671
 - addic 27-672
 - addic. 27-673
 - addis 27-674
 - addme 27-675
 - addme. 27-675
 - addmeo 27-675
 - addmeo. 27-675
 - addo 27-668
 - addo. 27-668
 - addze 27-676
 - addze. 27-676
 - addzeo 27-676
 - addzeo. 27-676
 - and 27-677
 - and. 27-677
 - andc 27-678
 - andc. 27-678
 - andi 27-679
 - andis. 27-680
 - b 27-681
 - ba 27-681
 - bc 27-682
 - bca 27-682
 - bcctr 27-688
 - bcctrl 27-688
 - bcl 27-682
 - bcla 27-682
 - bclr 27-692
 - bclrl 27-692
 - bl 27-681
 - bla 27-681
 - cmp 27-696
 - cmpi 27-697
 - cmpl 27-698
 - cmpli 27-699
 - cntlzw 27-700
 - cntlzw. 27-700
 - crand 27-701
 - crandc 27-702
 - creqv 27-703
 - crnand 27-704
 - crnor 27-705
 - cror 27-706
 - crorc 27-707
 - crxor 27-708
 - dcbf 27-711
 - dcbi 27-712
 - dcbst 27-713
 - dcbt 27-714
 - dcbz 27-716
 - dccci 27-718
 - dcread 27-719

divw 27-721
divw. 27-721
divwo 27-721
divwo. 27-721
divwu 27-722
divwu. 27-722
divwuo 27-722
divwuo. 27-722
eieio 27-723
eqv 27-724
eqv. 27-724
extsb 27-725
extsb. 27-725
icbi 27-727
icbt 27-728
iccci 27-729
icread 27-730
isync 27-732
lbz 27-733
lbzu 27-734
lbzx 27-736
lha 27-737
lhau 27-738
lhax 27-740
lhrx 27-741
lhz 27-742
lhzu 27-743
lhzux 27-744
lhzx 27-745
lmw 27-746
lswi 27-747
lswx 27-749
lwarx 27-751
lwz 27-753
lwzu 27-754
lwzux 27-755
lwzx 27-756
macchw 27-757
macchws 27-758
macchwsu 27-759
macchwu 27-760
machhw 27-761
machhwsu 27-763
machhwu 27-764
maclhw 27-765
maclhws 27-766, 27-800
maclhwu 27-768
mcrf 27-769
mcrxr 27-770
mfcrr 27-771
mfdcr 27-772
mfmsr 27-773
mfspr 27-774
mtcrf 27-778
mtdcr 27-779
mtspr 27-781
mulchw 27-783
mulchwu 27-784
mulhhw 27-785
mulhhwu 27-786
mulhwu 27-788
mulhwu. 27-788
mullhw 27-789
mullhwu 27-790
mulli 27-791
mullw 27-792
mullw. 27-792
mullwo 27-792
mullwo. 27-792
nand 27-793
nand. 27-793
neg 27-794
neg. 27-794
nego 27-794
nego. 27-794
nmacchw 27-795
nmacchws 27-796
nmachhw 27-797
nmachhws 27-798
nmaclhw 27-799
nmaclhws 27-800
nor 27-801
nor. 27-801
or 27-802
or. 27-802
orc 27-803
orc. 27-803
ori 27-804
oris 27-805
rfci 27-806
rfi 27-807
rlwimi 27-808
rlwimi. 27-808
rlwinm 27-809
rlwinm. 27-809
rlwnm 27-812
rlwnm. 27-812
sc 27-813
slw 27-814
slw. 27-814
sraw 27-815
sraw. 27-815
srawi 27-816
srawi. 27-816

Preliminary User's Manual

- srw 27-817
- srw. 27-817
- stb 27-818
- stbu 27-819
- stbux 27-820
- stbx 27-821
- sth 27-822
- sthbrx 27-823
- sthu 27-824
- sthux 27-825
- sthx 27-826
- stmw 27-827
- stswi 27-828
- stswx 27-829
- stw 27-831
- stwbrx 27-832
- stwcx. 27-833
- stwu 27-835
- stwux 27-836
- stwx 27-837
- subf 27-838
- subf. 27-838
- subfc 27-839
- subfc. 27-839
- subfco 27-839
- subfco. 27-839
- subfe 27-840
- subfe. 27-840
- subfeo 27-840
- subfeo. 27-840
- subfic 27-841
- subfme 27-842
- subfme. 27-842
- subfmeo 27-842
- subfmeo. 27-842
- subfo 27-838
- subfo. 27-838
- subfze 27-843
- subfze. 27-843
- subfzeo 27-843
- subfzeo. 27-843
- sync 27-844
- tlbia 27-845
- tlbre 27-846
- tlbsx 27-848
- tlbsx. 27-848
- tlbsync 27-849
- tlbwe 27-850
- tw 27-852
- twi 27-855
- wrtee 27-858
- wrteei 27-859
- xor 27-860
- xori 27-861
- Instruction Cache Debug Data Register. See ICDB-DR
- instruction cache unit. See ICU
- instruction fields 30-1200
- instruction formats 27-664, 30-1199
 - diagrams 30-1201
- instruction forms 30-1199, 30-1201
- instruction queue
 - illustrated 10-115
 - role in processing instructions 10-114
- instruction set
 - brief summaries by category 10-127
 - for embedded processors 10-128
- instruction set portability 27-663
- instruction set summary
 - cache control 10-132
 - CR logical 10-131
- instruction storage interrupts
 - causes 11-261
 - register settings 11-261
- instruction timings 32-1251
 - branches and cr logicals 32-1251
 - general rules 32-1251
 - instruction cache misses 32-1255
 - loads and stores 32-1254
 - strings 32-1254
- instructions
 - alphabetical, including extended mnemonics 30-1159
 - arithmetic and logical 10-129, 31-1236
 - branch 10-131, 31-1241
 - byte-reverse, usefulness of 10-113
 - cache
 - DAC debug events 13-299
 - cache control 31-1244
 - cache control, alignment of 10-107
 - compare 10-130
 - comparison 31-1242
 - condition register logical 31-1240
 - CR logical 10-130
 - extended mnemonics 31-1213
 - format diagrams 30-1201
 - formats 30-1199
 - forms 30-1199, 30-1201
 - ICU controlling 4-142
 - interrupt control 10-132, 31-1245
 - opcodes 30-1192
 - privileged 31-1211
 - privileged, listed 10-123
 - processor management 10-133, 31-1247

- for reading DCRs 10-124
- for reading privileged SPRs 10-123
- rotate and shift 31-1243
- specific to PowerPC Embedded Controllers 31-1209
- specific to PowerPC embedded processors 31-1205
- storage reference 31-1232
- storage reference, alignment of 10-107
- storage reference, in core 10-129
- TLB management 10-133, 31-1245
- interrupt controller interface 7-59
- interrupt enable register
 - description 23-613
- interrupt identification register
 - description 23-614
- Interrupts 24-653
- interrupts
 - alignment 10-107
 - register settings 11-263
 - summary 11-263
 - behavior 11-245
 - critical input 11-257
 - data machine check 11-259
 - data storage 6-169, 11-259
 - register settings 11-260
 - debug, register settings 11-268
 - DTLB miss 6-170
 - DTLB, register settings 11-267
 - external
 - programming note 11-262
 - register settings 11-262
 - fetching past, speculatively 10-120
 - FIT, causes 11-266
 - FIT, register settings 11-266
 - handling priorities 11-247
 - handling priorities, illustrated 11-247
 - instruction storage 6-170
 - causes 11-261
 - register settings 11-261
 - ITLB miss 6-170
 - ITLB miss, registers 11-268
 - machine check, causes of 11-258
 - machine check—instruction
 - handling 11-258
 - register settings 11-259
 - PIT, register settings 11-265
 - program
 - causes 11-264
 - ESR usage 11-264
 - register settings 11-264
 - register settings during critical 11-258
 - system call, register settings 11-265
 - TLB miss, preventing 6-170
 - TLB-related 6-168
 - vector offsets, illustrated 11-250
 - WDT, causes 11-266
 - WDT, register settings 11-267
- isync 27-732
 - and ITLB 6-167
 - context synchronization, example 10-126
- ITLB (instruction translation lookaside buffer)
 - accesses 6-166
 - consistency 6-167
 - miss interrupts 6-170, 11-268
- L**
- lbz 27-733
- lbzu 27-734
- lbzx 27-736
- lha 27-737
- lhau 27-738
- lhax 27-740
- lhbrx 27-741
- lhz 27-742
- lhzu 27-743
- lhzux 27-744
- lhzx 27-745
- li 27-671
- line control register
 - description 23-617
- line status register 23-619
- Link Register. See LR
- lis 27-674
- little endian
 - alignment 10-107
 - byte ordering supported 10-110
 - mapping 10-110
 - storage regions
 - accessing data from 10-112
 - fetching instructions from 10-111
- lmw 27-746
- load strategies, controlled by DCU 4-141
- logical instructions
 - CR 10-130
 - overview 10-129
- LR 28-902
- LR (Link Register)
 - branch instructions 10-131
 - function 10-86
- lswi 27-747
- lswx 27-749
- lwarx 27-751
- lwz 27-753

Preliminary User's Manual

lwzu 27-754
 lwzux 27-755
 lwzx 27-756

M

macchw 27-757
 macchws 27-758
 macchwsu 27-759
 macchwu 27-760
 machhw 27-761
 machhwsu 27-763
 machhwu 27-764
 machine check interrupts
 causes 11-258
 machine check—instruction interrupts
 handling 11-258
 register settings 11-259
 maclhw 27-765
 maclhws 27-766, 27-800
 maclhwu 27-768
 MALO_CFG 28-1017
 MALO_ESR 28-1019
 MALO_IER 28-1021
 MALO_RCBS0 28-1022
 MALO_RXCARR 28-1023
 MALO_RXCASR 28-1024
 MALO_RXCTP0R 28-1025
 MALO_RXDEIR 28-1026
 MALO_RXEOBISR 28-1027
 MALO_TXCARR 28-1028
 MALO_TXCASR 28-1029
 MALO_TXCTP0R 28-1030
 MALO_TXCTP1R 28-1030
 MALO_TXDEIR 28-1031
 MALO_TXEOBISR 28-1032
 mapping
 big endian 10-109
 little endian 10-110
 structure, examples 10-109
 mcrf 27-769
 mcrxr 27-770
 memory interface
 bus attachment
 alternative 18-353
 external bus master 18-368
 SRAM
 burst mode 18-359
 device-paced transfers 18-362
 memory map
 address space usage 10-80
 memory mapping
 of hardware 10-121

memory-mapped input/output registers. See MMIO registers
 mfcrr 27-771
 mfdcr 27-772
 mfmsr 27-773
 mfspr 27-774
 mftb 27-777
 mftbu 27-777
 MMIO (memory-mapped input/output) registers
 directly accessed 10-101, 28-872
 indirectly accessed 10-105, 28-875
 MMU (memory management unit)
 data storage interrupts 6-169
 DTLB miss interrupts 6-170
 execute permissions 6-173
 general access protection 6-172
 instruction storage interrupts 6-170
 ITLB miss interrupts 6-170
 MSR and access protection 6-172
 recording page references and changes 6-171
 TLB management 6-170
 zone protection 6-173
 mnemonics, extended. See extended mnemonics
 modes
 real, storage attribute control 6-177
 mr 27-802
 mr. 27-802
 MSR 28-903
 MSR (Machine State Register)
 bits and exception handling 10-122
 contents after resets 9-199
 illustrated 11-251
 interrupt control instructions 10-132
 programming note 11-251
 mtrcr 27-778
 mtrcrf 27-778
 mtdcr 27-779
 mtspr 27-781
 mulchw 27-783
 mulchwu 27-784
 mulhhw 27-785
 mulhhwu 27-786
 mulhwu 27-788
 mulhwu. 27-788
 mullhw 27-789
 mullhwu 27-790
 mulli 27-791
 mullw 27-792
 mullw. 27-792
 mullwo 27-792
 mullwo. 27-792

N

nand 27-793
 nand. 27-793
 neg 27-794
 neg. 27-794
 nego 27-794
 nego. 27-794
 nmacchw 27-795
 nmacchws 27-796
 nmachhw 27-797
 nmachhws 27-798
 nmaclhw 27-799
 nmaclhws 27-800
 nop 27-804
 nor 27-801
 nor. 27-801
 not 27-801
 not. 27-801
 notation 5-47, 27-664, 30-1200
 notational conventions 5-47

O

OCM0_DSARC 28-1033
 OCM0_DSCNTL 28-1034
 OCM0_ISARC 28-1035
 OCM0_ISCNTL 28-1036
 OPBA0_CR 28-1037
 OPBA0_PR 28-1038
 opcodes 30-1192
 optimization
 coding guidelines 32-1249
 alignment 32-1250
 boolean variables 32-1249
 branch prediction 32-1250
 dependency upon CR 32-1250
 floating point emulation 32-1249
 or 27-802
 or. 27-802
 orc 27-803
 orc. 27-803
 ori 27-804
 oris 27-805

P

page identification fields, UTLB 6-163
 parallel-to-serial conversion 23-607
 PCI configuration registers
 offsets 10-105, 28-875
 PCIC0_BAR0 28-1039
 PCIC0_BIST 28-1040
 PCIC0_BRDGOPT1 28-1041
 PCIC0_BRDGOPT2 28-1042
 PCIC0_CACHELS 28-1043

PCIC0_CAP 28-1044
 PCIC0_CAPID 28-1045
 PCIC0_CFGADDR 28-1046
 PCIC0_CFGDATA 28-1047
 PCIC0_CLS 28-1048
 PCIC0_CMD 28-1049
 PCIC0_DATA 28-1051
 PCIC0_DEVID 28-1052
 PCIC0_ERREN 28-1053
 PCIC0_ERRSTS 28-1054
 PCIC0_HDTYPE 28-1055
 PCIC0_ICS 28-1056
 PCIC0_INTLN 28-1057
 PCIC0_INTPN 28-1058
 PCIC0_LATTIM 28-1059
 PCIC0_MAXLTNCY 28-1060
 PCIC0_MINGNT 28-1061
 PCIC0_NEXTIPTR 28-1062
 PCIC0_PLBBEAR 28-1063
 PCIC0_PLBBESR0 28-1064
 PCIC0_PMC 28-1067
 PCIC0_PMCSR 28-1068
 PCIC0_PMSCRR 28-1070
 PCIC0_PTM1BAR 28-1071
 PCIC0_PTM2BAR 28-1072
 PCIC0_REVID 28-1073
 PCIC0_SBSYSID 28-1074
 PCIC0_SBSYSVID 28-1075
 PCIC0_STATUS 28-1076
 PCIC0_VENDID 28-1078
 PCILO_PMM0LA 28-1079
 PCILO_PMM0MA 28-1080
 PCILO_PMM0PCIHA 28-1081
 PCILO_PMM0PCILA 28-1082
 PCILO_PMM1LA 28-1083
 PCILO_PMM1MA 28-1084
 PCILO_PMM1PCIHA 28-1085
 PCILO_PMM1PCILA 28-1086
 PCILO_PMM2LA 28-1087
 PCILO_PMM2MA 28-1088
 PCILO_PMM2PCIHA 28-1089
 PCILO_PMM2PCILA 28-1090
 PCILO_PTM1LA 28-1091
 PCILO_PTM1MS 28-1092
 PCILO_PTM2LA 28-1093
 PCILO_PTM2MS 28-1094
 PCIPCIC0_PLBBESR1 28-1066
 performance
 DCU
 improve with simultaneous caching 4-150
 limited by sequential caching 4-151
 overview 4-149

Preliminary User's Manual

- PID 28-904
 - PID (process ID)
 - illustrated 6-172
 - PIT 12-274, 28-905
 - PIT (programmable interval timer)
 - interrupts, register settings 11-265
 - PLB0_ACR 8-67, 28-1095
 - PLB0_BEAR 28-1096
 - PLB0_BESR 28-1097
 - POB0_BEAR 28-1099
 - POB0_BESR0 28-1100
 - POB0_BESR1 28-1102
 - portability, instruction set 27-663
 - pre-fetch
 - branches to CTR 10-119
 - branches to LR 10-119
 - buffers 10-114
 - past interrupts 10-120
 - primary opcodes 30-1192
 - privileged mode
 - defined 10-122
 - instructions, listed 10-123
 - privileged SPRs
 - instructions for reading 10-123
 - problem state. See user mode
 - process ID. See PID
 - processor
 - management instructions 10-133
 - program interrupts
 - causes 11-264
 - ESR usage 11-264
 - register settings 11-264
 - programmable interval timer 12-274
 - programming note
 - external or timer interrupts 11-262
 - instruction pipeline 4-148
 - MSR affected by instructions 11-251
 - RPN field 6-164
 - pseudocode 27-664
 - PVR 28-906
- R**
- real mode
 - storage attribute control 6-177
 - register description 23-611
 - registers
 - CCR0 28-878
 - CPC0_CR1 28-928
 - CPC0_ER 28-929
 - CPC0_FR 28-930
 - CPC0_JTAGID 28-931
 - CPC0_PLLMR 28-932
 - CPC0_PSR 28-934
 - CPC0_SR 28-936
 - CR 28-863, 28-880
 - CTR 17-332, 28-881
 - DAC1 13-293
 - DAC1–DAC2 13-293, 28-882
 - DBCR0 28-883, 28-885
 - DBSR 13-291, 28-887
 - DCCR 28-889
 - DCP0_ADDR0–DCP0_ADDR1 28-937
 - DCP0_CFG 28-938
 - DCP0_CFGADDR 28-939
 - DCP0_CFGDATA 28-940
 - DCP0_ESR 28-941
 - DCP0_ID 28-943
 - DCP0_ITOR0–DCP0_ITOR3 28-944
 - DCP0_MEMBEAR 28-945
 - DCP0_PLBBEAR 15-313, 28-946
 - DCP0_RAM0–DCP0_RAM3FF 28-947
 - DCP0_VER 28-948
 - DCR numbering 28-866
 - DCRs
 - indirectly accessed 10-99
 - DCWR 28-891
 - DEAR 28-893
 - DMA0_CR0–DMA0_CR3 20-508, 28-949
 - DMA0_CT0–DMA0_CT3 20-511, 28-951
 - DMA0_DA0–DMA0_DA3 20-511, 28-952
 - DMA0_POL 28-953
 - DMA0_SA0–DMA0_SA3 20-510
 - DMA0_SA0–DMA0_SA3 28-954
 - DMA0_SG0–DMA0_SG3 20-512
 - DMA0_SG0–DMA0_SG3 28-955
 - DMA0_SGC 20-512, 28-956
 - DMA0_SLP 28-957
 - DMA0_SR 20-507, 28-958
 - during debug exceptions 11-269
 - EBC0_BEAR 28-959
 - EBC0_BESR0 28-960
 - EBC0_BESR1 28-962
 - EBC0_BnAP 28-963
 - EBC0_BnCR 28-964
 - EBC0_CFG 28-965
 - EBC0_CFGADDR 28-967
 - EBC0_CFGDATA 28-968
 - EMAC0_GAHT1–EMAC0_GAHT4 28-969
 - EMAC0_IAHR 28-970
 - EMAC0_IAHT1–EMAC0_IAHT4 28-971
 - EMAC0_IALR 28-972
 - EMAC0_IPGVR 28-973
 - EMAC0_ISER 28-974
 - EMAC0_ISR 28-976

EMAC0_LSAH	28-979	MALO_TXCARR	28-1028
EMAC0_LSAL	28-980	MALO_TXCASR	28-1029
EMAC0_MR0	28-981, 28-982	MALO_TXCTP0R	28-1030
EMAC0_OCRX	28-984	MALO_TXCTP1R	28-1030
EMAC0_OCTX	28-985	MALO_TXDEIR	28-1031
EMAC0_PTR	28-986	MALO_TXEOBISR	28-1032
EMAC0_RMR	28-987	MMIO registers	
EMAC0_RWMMR	28-989	directly accessed	10-101, 28-872
EMAC0_STACR	28-990	indirectly accessed	10-105, 28-875
EMAC0_TMR0	28-991	MSR	28-863, 28-903
EMAC0_TMR1	28-992	OCM0_DSARC	28-1033
EMAC0_TRTR	28-993	OCM0_DSCNTL	28-1034
EMAC0_VTCI	28-994	OCM0_ISARC	28-1035
EMAC0_VTPID	28-995	OCM0_ISCNTL	28-1036
ESR	28-895	OPBA0_CR	28-1037
EVPR	28-896	OPBA0_PR	28-1038
GPIO0_IR	28-996	PCIC0_BAR0	28-1039
GPIO0_ODR	28-997	PCIC0_BIST	28-1040
GPIO0_OR	28-998	PCIC0_BRDGOPT1	28-1041
GPIO0_TCR	28-999	PCIC0_BRDGOPT2	28-1042
GPR	28-863	PCIC0_CACHELS	28-1043
GPR0-GPR31	28-897	PCIC0_CAP	28-1044
IAC1-IAC4	28-894, 28-898	PCIC0_CAPID	28-1045
IAC1-IAC4	13-292	PCIC0_CFGADDR	28-1046
ICCR	28-899	PCIC0_CFGDATA	28-1047
ICDBDR	28-901	PCIC0_CLS	28-1048
IIC0_CLKDIV	28-1000	PCIC0_CMD	28-1049
IIC0_CNTL	28-1001	PCIC0_DATA	28-1051
IIC0_DIRECTCNTL	28-1002	PCIC0_DEVID	28-1052
IIC0_EXTSTS	28-1003	PCIC0_ERREN	28-1053
IIC0_HMADR	28-1005	PCIC0_ERRSTS	28-1054
IIC0_HSADR	28-1006	PCIC0_HDTYPE	28-1055
IIC0_INTRMSK	28-1007	PCIC0_ICS	28-1056
IIC0_LMADR	28-1008	PCIC0_INTLN	28-1057
IIC0_LSADR	28-1009	PCIC0_INTPN	28-1058
IIC0_MDBUF	28-1010	PCIC0_LATTIM	28-1059
IIC0_MDCNTL	28-1011	PCIC0_MAXLTNCY	28-1060
IIC0_SDBUF	28-1012	PCIC0_MINGNT	28-1061
IIC0_STS	28-1013	PCIC0_NEXTIPTR	28-1062
IIC0_XFRcnt	28-1014	PCIC0_PLBBEAR	28-1063
IIC0_XTCNTLSS	28-1015	PCIC0_PLBBESR0	28-1064
interrupt handling	11-251	PCIC0_PMC	28-1067
LR	28-902	PCIC0_PMCSR	28-1068
MALO_CFG	28-1017	PCIC0_PMSCRR	28-1070
MALO_ESR	28-1019	PCIC0_PTM1BAR	28-1071
MALO_IER	28-1021	PCIC0_PTM2BAR	28-1072
MALO_RCBS0	28-1022	PCIC0_REVID	28-1073
MALO_RXCARR	28-1023	PCIC0_SBSYSID	28-1074
MALO_RXCASR	28-1024	PCIC0_SBSYSVID	28-1075
MALO_RXCTP0R	28-1025	PCIC0_STATUS	28-1076
MALO_RXDEIR	28-1026	PCIC0_VENDID	28-1078
MALO_RXEOBISR	28-1027	PCIL0_PMM0LA	28-1079

Preliminary User's Manual

PCILO_PMM0MA 28-1080
 PCILO_PMM0PCIHA 28-1081
 PCILO_PMM0PCILA 28-1082
 PCILO_PMM1LA 28-1083
 PCILO_PMM1MA 28-1084
 PCILO_PMM1PCIHA 28-1085
 PCILO_PMM1PCILA 28-1086
 PCILO_PMM2LA 28-1087
 PCILO_PMM2MA 28-1088
 PCILO_PMM2PCIHA 28-1089
 PCILO_PMM2PCILA 28-1090
 PCILO_PTM1LA 28-1091
 PCILO_PTM1MS 28-1092
 PCILO_PTM2LA 28-1093
 PCILO_PTM2MS 28-1094
 PCIPCIC0_PLBBESR1 28-1066
 PID 28-904
 PIT 12-274, 28-905
 PLB0_ACR 8-67, 28-1095
 PLB0_BEAR 28-1096
 PLB0_BESR 28-1097
 POB0_BEAR 28-1099
 POB0_BESR0 28-1100
 POB0_BESR1 28-1102
 PVR 28-906
 reserved 28-863
 reserved fields 28-863
 SDRAM0_BOCR-SDRAM0_B3CR 28-1103
 SDRAM0_BEAR 28-1104
 SDRAM0_BESR0 28-1105
 SDRAM0_BESR1 28-1107
 SDRAM0_CFG 28-1108
 SDRAM0_CFGADDR 28-1109
 SDRAM0_CFGDATA 28-1110
 SDRAM0_ECCCFG 28-1111
 SDRAM0_ECCEsr 28-1112
 SDRAM0_PMIT 28-1113
 SDRAM0_RTR 28-1114
 SDRAM0_STATUS 28-1115
 SDRAM0_TR 28-1116
 SGR 28-907
 SLER 28-909
 SPR numbering 28-863
 SPRG0-SPRG4 10-90
 SPRG0-SPRG7 28-911
 SPRs
 overview 10-83
 SRR0 28-912
 SRR1 28-913
 SRR2 28-914
 SRR3 28-915
 SUOR 28-916
 TBL 28-918
 TBU 28-919
 TCR 12-275, 12-276, 12-279, 28-920
 TSR 12-276, 12-278, 28-921
 UARTx_DLL 28-1118
 UARTx_DLM 28-1119
 UARTx_FCR 28-1120
 UARTx_IER 28-1121
 UARTx_IIR 28-1122
 UARTx_LCR 28-1123
 UARTx_LSR 28-1124
 UARTx_MCR 28-1126
 UARTx_MSR 28-1127
 UARTx_RBR 28-1128
 UARTx_SCR 28-1129
 UARTx_THR 28-1130
 UIC0_CR 28-1131
 UIC0_ER 28-1133
 UIC0_MSR 28-1135
 UIC0_PR 28-1138
 UIC0_SR 28-1140
 UIC0_TR 28-1143
 UIC0_VCR 28-1146
 UIC0_VR 28-1147
 USPRG0 10-90, 28-922
 XER 28-923
 ZPR 28-924
 reservation bit 27-751, 27-833
 reserved fields 28-863
 reserved registers 28-863
 resets
 effects on MSR 9-199
 effects on SPRs 9-200
 processor initialization 9-210
 processor state after 9-199
 rfc1 27-806
 rfi 27-807
 rlwimi 27-808
 rlwimi. 27-808
 rlwinm 27-809
 rlwinm. 27-809
 rlwnm 27-812
 rlwnm. 27-812
 rotlw 27-812
 rotlw. 27-812
 rotlwi 27-810
 rotlwi. 27-810
 rotrwi 27-810
 rotrwi. 27-810
 rxtended mnemonics
 bnectr 27-690

S

Save/Restore Registers 0-1. See SRR0-1

sc 27-813

scratchpad register 23-622

SDRAM controller

DCRs

indirect access 10-99, 10-100, 28-869, 28-870

offsets 10-99, 28-869

SDRAM0_B0CR-SDRAM0_B3CR 28-1103

SDRAM0_BEAR 28-1104

SDRAM0_BESR0 28-1105

SDRAM0_BESR1 28-1107

SDRAM0_CFG 28-1108

SDRAM0_CFGADDR 28-1109

SDRAM0_CFGDATA 28-1110

SDRAM0_ECCCFG 28-1111

SDRAM0_ECCEsr 28-1112

SDRAM0_PMIT 28-1113

SDRAM0_RTR 28-1114

SDRAM0_STATUS 28-1115

SDRAM0_TR 28-1116

secondary opcodes 30-1192

serial-interface characteristic 23-608

serial-to-parallel conversion 23-607

SGR 28-907

SGR (Storage Guarded Register)

controlling speculative accesses 10-119

shadow TLB. See DTLB

signals

EBC 18-352

SLER 28-909

slw 27-814

slw. 27-814

slwi 27-810

slwi. 27-810

Special Purpose Register General 0-7. See SPRG0-7

special purpose registers. See SPRs

speculative accesses

to CTR or LR 10-119

defined 10-118

down predicted path 10-119

fetching past interrupts 10-120

fetching past tw or twi 10-121

fetching past unconditional branches 10-121

preventing inappropriate 10-118-10-122

SPRG0-7 (Special Purpose Register General 0-7)

temporary storage to 10-90

SPRG0-SPRG4 10-90

SPRG0-SPRG7 28-911

SPRs (special purpose registers)

contents after resets 9-200

listed, with page references 10-84

overview 10-83

privileged, instructions for reading 10-123

srw 27-815

srw. 27-815

srwi 27-816

srwi. 27-816

SRR0 28-912

SRR0-1 (Save/Restore Registers 0-1)

illustrated 11-252

SRR1 28-913

SRR2 28-914

SRR3 28-915

srw 27-817

srw. 27-817

srwi 27-811

srwi. 27-811

stb 27-818

stbu 27-819

stbux 27-820

stbx 27-821

sth 27-822

sthbrx 27-823

sthu 27-824

sthux 27-825

sthx 27-826

stmw 27-827

storage attributes

caching inhibited (I)

real mode 6-178

virtual mode 6-165

endian (E)

and little endian 10-110

real mode 6-179

when controlled by TLB 6-166

guarded (G)

controlling speculative accesses 10-118

real mode 6-178

virtual mode 6-166

memory coherent (M)

not supported 6-166

real mode 6-177

TLB control of 6-165

user-defined (U0)

real mode 6-179

virtual mode 6-166

virtual mode 6-165

write-through (W)

real mode 6-178

Storage Guarded Register. See SGR

storage reference instructions 10-129

storage regions

Preliminary User's Manual

- big endian
 - alignment 10-107
 - byte-reverse instructions ??-10-113
- little endian
 - accessing data from 10-112
 - alignment 10-107
 - fetching instructions from 10-111
- storage synchronization 10-127
- string instructions
 - access protection 6-176
- structure mapping
 - examples 10-109
- stswi 27-828
- stswx 27-829
- stw 27-831
- stwbrx 27-832
- stwcx. 27-833
- stwu 27-835
- stwux 27-836
- stwx 27-837
- SUOR 28-916
- sub 27-838
- sub. 27-838
- subc 27-839
- subc. 27-839
- subco 27-839
- subco. 27-839
- subf 27-838
- subf. 27-838
- subfc 27-839
- subfc. 27-839
- subfco 27-839
- subfco. 27-839
- subfe 27-840
- subfe. 27-840
- subfeo 27-840
- subfeo. 27-840
- subfic 27-841
- subfme 27-842
- subfme. 27-842
- subfmeo 27-842
- subfmeo. 27-842
- subfo 27-838
- subfo. 27-838
- subfze 27-843
- subfze. 27-843
- subfzeo 27-843
- subfzeo. 27-843
- subi 27-671
- subic 27-672
- subic. 27-673
- subis 27-674

- subo 27-838
- subo. 27-838
- supervisor state. See privileged mode
- sync 27-844
- synchronization
 - context 10-124
 - execution, defined 10-126
 - ICU 4-139
 - references to PowerPC Architecture 10-124
 - storage 10-127
- system call interrupts
 - register settings 11-265

T

- TBL 28-918
- tblrehi 27-847
- tblrelo 27-847
- tblwehi 27-851
- tblwelo 27-851
- TBU 28-919
- TCR 12-279, 28-920
- TID (translation ID)
 - and MMU access protection
- time base 12-272
 - implementation 10-95
- timer interrupts
 - programming note 11-262
- timers
 - FIT 12-275
 - fixed interval timer 12-275
 - PIT 12-274
 - programmable interval timer 12-274
 - TCR 12-279
 - timer control register 12-279
 - timer status register 12-278
 - TSR 12-278
 - watchdog 12-276
- timings
 - instruction 32-1251
 - branches and cr logicals 32-1251
 - general rules 32-1251
 - instruction cache misses 32-1255
 - loads and stores 32-1254
 - strings 32-1254
- TLB (translation lookaside buffer)
 - access protection 6-172
 - execute permissions 6-173
 - interrupts 6-168
 - invalidate instruction 6-171
 - management instructions 10-133
 - preventing miss interrupts 6-170
 - read/write instructions 6-171

search instructions 6-171
 sync instruction 6-171
 zone protection 6-173
 See also ITLB;UTLB;DTLB
 tlbia 27-845
 and TLB management 6-171
 tlbre 27-846
 and TLB management 6-171
 tlbsx 27-848
 and TLB management 6-171
 tlbsx. 27-848
 and TLB management 6-171
 tlbsync 27-849
 and TLB management 6-171
 tlbwe 27-850
 and TLB management 6-171
 translation ID. See TID
 translation lookaside buffer. See TLB
 trap 27-853
 TSR 12-278, 28-921
 tw 27-852
 fetching past 10-121
 tweq 27-853
 tweqi 27-856
 twge 27-853
 twgei 27-856
 twgle 27-853
 twgt 27-853
 twgti 27-856
 twi 27-855
 fetching past 10-121
 twle 27-853
 twlei 27-856
 twlgei 27-856
 twlgt 27-853
 twlgti 27-856
 twlle 27-853
 twllei 27-856
 twllt 27-854
 twllti 27-856
 twlng 27-854
 twlngi 27-856
 twlnl 27-854
 twlnli 27-857
 twlt 27-854
 twlti 27-857
 twne 27-854
 twnei 27-857
 twng 27-854
 twngi 27-857
 twnl 27-854
 twnli 27-857

U

UART Reset and Sleep mode 23-625
 UARTx_DLL 28-1118
 UARTx_DLM 28-1119
 UARTx_FCR 28-1120
 UARTx_IER 28-1121
 UARTx_IIR 28-1122
 UARTx_LCR 28-1123
 UARTx_LSR 28-1124
 UARTx_MCR 28-1126
 UARTx_MSR 28-1127
 UARTx_RBR 28-1128
 UARTx_SCR 28-1129
 UARTx_THR 28-1130
 UIC0_CR 28-1131
 UIC0_ER 28-1133
 UIC0_MSR 28-1135
 UIC0_PR 28-1138
 UIC0_SR 28-1140
 UIC0_TR 28-1143
 UIC0_VCR 28-1146
 UIC0_VR 28-1147
 unconditional branches
 AA field 10-115
 speculative accesses 10-121
 unified TLB. See UTLB
 user mode
 defined 10-122
 user-defined (U0) storage attribute
 controlled by SU0R 6-179
 virtual mode 6-166
 USPRG0 10-90, 28-922
 UTLB (unified translation lookaside buffer)
 access control fields 6-165
 entry format, illustrated 6-163
 field categories 6-163
 functional overview 6-163
 page identification fields 6-163
 translation field 6-164

V

virtual mode
 and TLB control of storage attributes 6-165

W

watchdog timer 12-276
 WDT (watchdog timer)
 interrupts, causes 11-266
 interrupts, register settings 11-267
 write strategies
 used by DCU 4-140
 write-through (W) storage attribute
 controlled by DCWR 6-178

Preliminary User's Manual

wrtee 27-858
wrteei 27-859

X

XER 28-923
xor 27-860
xori 27-861

Z

Zone Protection Register. *See* ZPR
ZPR 28-924
ZPR (Zone Protection Register)
 illustrated 6-173