

24-Bit, 96 kHz Stereo DAC with Volume Control

Features

- Complete Stereo DAC System: Interpolation, D/A, Output Analog Filtering
- ATAPI Mixing
- 101 dB Dynamic Range
- 89 dBFS THD+N
- Low Clock Jitter Sensitivity
- +3 V to +5 V Power Supply
- Filtered Line Level Outputs
- On-Chip Digital De-emphasis for 32, 44.1, and 48 kHz
- Digital Volume Control with Soft Ramp
 - 94 dB Attenuation
 - 1 dB Step Size
 - Zero Crossing Click-Free Transitions
- 30 mW with 3 V supply

Description

The CS4341 is a complete stereo digital-to-analog system including digital interpolation, fourth-order delta-sigma digital-to-analog conversion, digital de-emphasis, volume control, channel mixing and analog filtering. The advantages of this architecture include: ideal differential linearity, no distortion mechanisms due to resistor matching errors, no linearity drift over time and temperature and a high tolerance to clock jitter.

The CS4341 accepts data at audio sample rates from 2 kHz to 100 kHz, consumes very little power and operates over a wide power supply range. These features are ideal for DVD, A/V receiver and set-top box systems.

ORDERING INFORMATION

| | |
|-----------|---------------------------|
| CS4341-KS | 16-pin SOIC, -10 to 70 °C |
| CDB4341 | Evaluation Board |

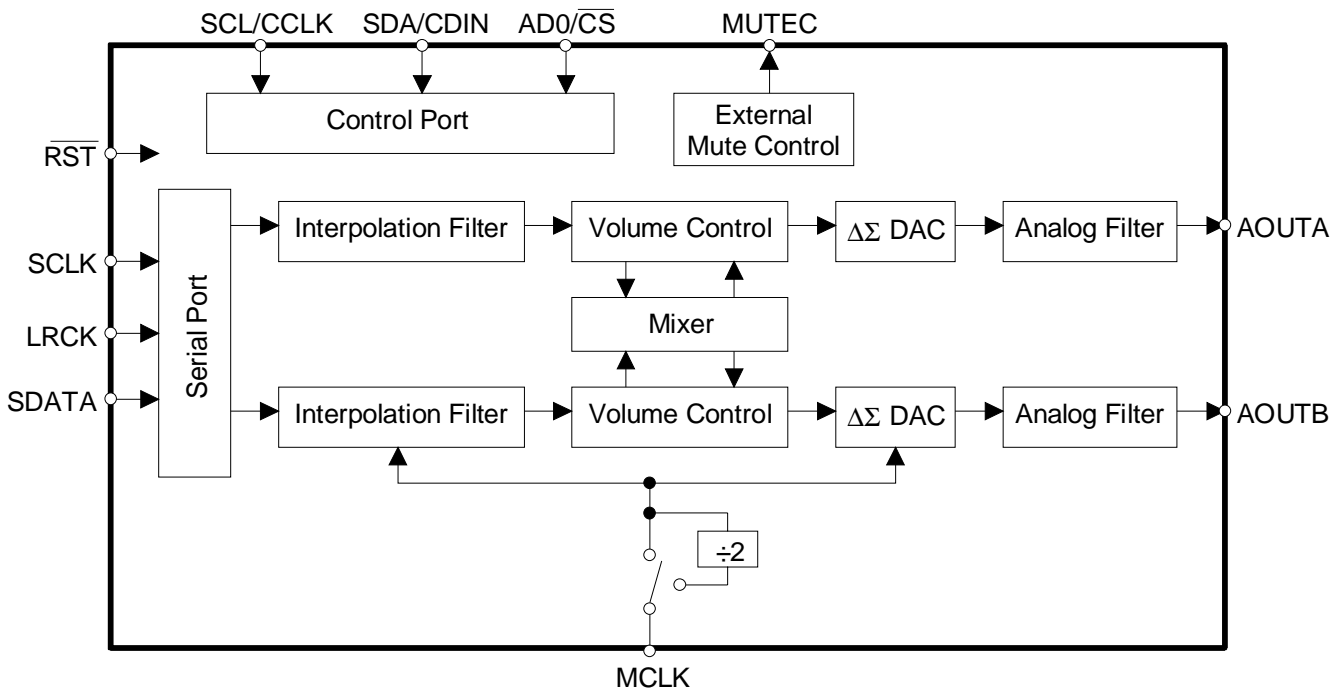

Preliminary Product Information

This document contains information for a new product. Cirrus Logic reserves the right to modify this product without notice.

TABLE OF CONTENTS

| | |
|--|-----------|
| 1. CHARACTERISTICS AND SPECIFICATIONS | 5 |
| ANALOG CHARACTERISTICS | 5 |
| POWER AND THERMAL CHARACTERISTICS..... | 7 |
| DIGITAL CHARACTERISTICS | 7 |
| ABSOLUTE MAXIMUM RATINGS | 7 |
| RECOMMENDED OPERATING CONDITIONS | 7 |
| SWITCHING CHARACTERISTICS | 8 |
| SWITCHING CHARACTERISTICS - CONTROL PORT..... | 10 |
| 2. TYPICAL CONNECTION DIAGRAM | 12 |
| 3. REGISTER QUICK REFERENCE | 13 |
| 3.1 MCLK Control (address 00h) | 13 |
| 3.2 Mode Control (address 01h) | 13 |
| 3.3 Volume and Mixing Control (address 02h)..... | 14 |
| 3.4 Channel A Volume Control (address 03h) | 14 |
| 3.5 Channel B Volume Control (address 04h) | 14 |
| 4. REGISTER BIT DESCRIPTION | 15 |
| 4.1 Master Clock Divide Enable | 15 |
| 4.2 Auto-Mute | 15 |
| 4.3 Digital Interface Format..... | 16 |
| 4.4 De-emphasis Control | 16 |
| 4.5 Power On/Off Quiescent Voltage Ramp | 17 |
| 4.6 Power Down..... | 17 |
| 4.7 Channel A Volume = Channel B Volume | 18 |
| 4.8 Soft Ramp or Zero Cross Enable..... | 18 |
| 4.9 ATAPI Channel Mixing and Muting | 19 |
| 4.10 Mute | 20 |
| 4.11 Volume Control | 21 |
| 5. PIN DESCRIPTION | 22 |
| Analog Power - VA..... | 22 |
| Analog Ground - AGND | 22 |

Contacting Cirrus Logic Support

For a complete listing of Direct Sales, Distributor, and Sales Representative contacts, visit the Cirrus Logic web site at:

<http://www.cirrus.com/corporate/contacts/>

¹°C is a registered trademark of Philips Semiconductors.

Preliminary product information describes products which are in production, but for which full characterization data is not yet available. Advance product information describes products which are in development and subject to development changes. Cirrus Logic, Inc. has made best efforts to ensure that the information contained in this document is accurate and reliable. However, the information is subject to change without notice and is provided "AS IS" without warranty of any kind (express or implied). No responsibility is assumed by Cirrus Logic, Inc. for the use of this information, nor for infringements of patents or other rights of third parties. This document is the property of Cirrus Logic, Inc. and implies no license under patents, copyrights, trademarks, or trade secrets. No part of this publication may be copied, reproduced, stored in a retrieval system, or transmitted, in any form or by any means (electronic, mechanical, photographic, or otherwise) without the prior written consent of Cirrus Logic, Inc. Items from any Cirrus Logic website or disk may be printed for use by the user. However, no part of the printout or electronic files may be copied, reproduced, stored in a retrieval system, or transmitted, in any form or by any means (electronic, mechanical, photographic, or otherwise) without the prior written consent of Cirrus Logic, Inc. Furthermore, no part of this publication may be used as a basis for manufacture or sale of any items without the prior written consent of Cirrus Logic, Inc. The names of products of Cirrus Logic, Inc. or other vendors and suppliers appearing in this document may be trademarks or service marks of their respective owners which may be registered in some jurisdictions. A list of Cirrus Logic, Inc. trademarks and service marks can be found at <http://www.cirrus.com>.

| | |
|--|-----------|
| Analog Output - AOUTA and AOUTB..... | 22 |
| Reference Ground - REF_GND..... | 22 |
| Positive Voltage Reference - FILT+..... | 22 |
| Quiescent Voltage - VQ..... | 22 |
| Master Clock - MCLK..... | 23 |
| Left/Right Clock - LRCK..... | 23 |
| Serial Audio Data - SDATA..... | 23 |
| Serial Clock - SCLK..... | 24 |
| Reset - RST..... | 24 |
| Serial Control Interface Clock - SCL/CCLK..... | 24 |
| Serial Control Data I/O - SDA/CDIN..... | 24 |
| Address Bit / Chip Select - AD0/ \overline{CS} | 24 |
| Mute Control - MUTEC..... | 24 |
| 6. APPLICATIONS | 25 |
| 6.1 Grounding and Power Supply Decoupling | 25 |
| 6.2 Oversampling Modes | 25 |
| 6.3 Recommended Power-up Sequence | 25 |
| 6.4 Use of the Power ON/OFF Quiescent Voltage Ramp | 25 |
| 7. CONTROL PORT INTERFACE | 26 |
| 7.1 SPI Mode | 26 |
| 7.2 I ² C Compatible Mode | 26 |
| 7.2 Memory Address Pointer (MAP)..... | 27 |
| 8. PARAMETER DEFINITIONS | 33 |
| Total Harmonic Distortion + Noise (THD+N) | 33 |
| Dynamic Range..... | 33 |
| Interchannel Isolation | 33 |
| Interchannel Gain Mismatch..... | 33 |
| Gain Error..... | 33 |
| Gain Drift | 33 |
| 9. REFERENCES | 33 |
| 10. PACKAGE DIMENSIONS | 34 |

LIST OF FIGURES

| | |
|---|----|
| Figure 1. External Serial Mode Input Timing | 9 |
| Figure 2. Internal Serial Mode Input Timing | 9 |
| Figure 3. Internal Serial Clock Generation | 9 |
| Figure 4. I ² C Control Port Timing | 10 |
| Figure 5. SPI Control Port Timing | 11 |
| Figure 6. Typical Connection Diagram | 12 |
| Figure 7. SPI Mode Control Port Formatting | 27 |
| Figure 8. I ² C Mode Control Port Formatting | 27 |
| Figure 9. Base-Rate Stopband Rejection | 28 |
| Figure 10. Base-Rate Transition Band | 28 |
| Figure 11. Base-Rate Transition Band (Detail) | 28 |
| Figure 12. Base-Rate Passband Ripple | 28 |
| Figure 13. High-Rate Stopband Rejection | 28 |
| Figure 14. High-Rate Transition Band | 28 |
| Figure 15. High-Rate Transition Band (Detail) | 29 |
| Figure 16. High-Rate Passband Ripple | 29 |
| Figure 17. Output Test Load | 29 |

| | |
|---|----|
| Figure 18. Maximum Loading | 29 |
| Figure 19. Power vs. Sample Rate (VA = 5V) | 29 |
| Figure 20. CS4341 Format 0 (I ² S) | 30 |
| Figure 21. CS4341 Format 1 (I ² S) | 30 |
| Figure 22. CS4341 Format 2 | 30 |
| Figure 23. CS4341 Format 3 | 31 |
| Figure 24. CS4341 Format 4 | 31 |
| Figure 25. CS4341 Format 5 | 31 |
| Figure 26. CS4341 Format 6 | 32 |
| Figure 27. De-Emphasis Curve | 32 |
| Figure 28. ATAPI Block Diagram | 32 |

LIST OF TABLES

| | |
|--|----|
| Table 1. Master Clock Divide Enable | 15 |
| Table 2. Auto-Mute Enable | 15 |
| Table 3. Digital Interface Formats | 16 |
| Table 4. De-emphasis Filter Configurations | 16 |
| Table 5. Power On/Off Ramp Enable | 17 |
| Table 6. Power Down Enable | 17 |
| Table 7. A=B Volume Control Enable | 18 |
| Table 8. Soft Ramp and Zero Cross Enable | 19 |
| Table 9. ATAPI Decode | 19 |
| Table 10. Mute Enable | 20 |
| Table 11. Digital Volume Settings | 21 |
| Table 12. Common Clock Frequencies | 23 |

1. CHARACTERISTICS AND SPECIFICATIONS

ANALOG CHARACTERISTICS

($T_A = 25\text{ }^\circ\text{C}$; Logic "1" = $V_A = 5\text{ V}$; Logic "0" = AGND;
 Full-Scale Output Sine Wave, 997 Hz; MCLK = 12.288 MHz; F_s for Base-rate Mode = 48 kHz, SCLK = 3.072 MHz,
 Measurement Bandwidth 10 Hz to 20 kHz, unless otherwise specified; F_s for High-Rate Mode = 96 kHz,
 SCLK = 6.144 MHz, Measurement Bandwidth 10 Hz to 40 kHz, unless otherwise specified. Test load $R_L = 10\text{ k}\Omega$,
 $C_L = 10\text{ pF}$ (see Figure 17)),

| Parameter | Symbol | Base-rate Mode | | | High-Rate Mode | | | Unit |
|--|--------|----------------|-----|-----|----------------|-----|-----|------------------|
| | | Min | Typ | Max | Min | Typ | Max | |
| Dynamic Performance for $V_A = 5\text{ V}$ | | | | | | | | |
| Specified Temperature Range | T_A | -10 | - | 70 | -10 | - | 70 | $^\circ\text{C}$ |
| Dynamic Range (Note 1) | | | | | | | | |
| 18 to 24-Bit | | | | | | | | |
| unweighted | | 92 | 97 | - | 91 | 96 | - | dB |
| A-Weighted | | 96 | 101 | - | 95 | 100 | - | dB |
| 16-Bit unweighted | | - | 95 | - | - | 94 | - | dB |
| A-Weighted | | - | 99 | - | - | 98 | - | dB |
| Total Harmonic Distortion + Noise (Note 1) | THD+N | | | | | | | |
| 18 to 24-Bit 0 dB | | - | -89 | -84 | - | -89 | -84 | dB |
| -20 dB | | - | -77 | -72 | - | -74 | -69 | dB |
| -60 dB | | - | -37 | -32 | - | -36 | -31 | dB |
| 16-Bit 0 dB | | - | -88 | - | - | -89 | - | dB |
| -20 dB | | - | -75 | - | - | -73 | - | dB |
| -60 dB | | - | -35 | - | - | -34 | - | dB |
| Interchannel Isolation (1 kHz) | | - | 100 | - | - | 100 | - | dB |
| Dynamic Performance for $V_A = 3\text{ V}$ | | | | | | | | |
| Specified Temperature Range | T_A | -10 | - | 70 | -10 | - | 70 | $^\circ\text{C}$ |
| Dynamic Range (Note 1) | | | | | | | | |
| 18 to 24-Bit | | | | | | | | |
| unweighted | | 99 | 94 | - | 97 | 92 | - | dB |
| A-Weighted | | 102 | 97 | - | 101 | 96 | - | dB |
| 16-Bit unweighted | | - | 93 | - | - | 91 | - | dB |
| A-Weighted | | - | 96 | - | - | 96 | - | dB |
| Total Harmonic Distortion + Noise (Note 1) | THD+N | | | | | | | |
| 18 to 24-Bit 0 dB | | - | -94 | -89 | - | -92 | -87 | dB |
| -20 dB | | - | -74 | -69 | - | -76 | -71 | dB |
| -60 dB | | - | -34 | -29 | - | -32 | -27 | dB |
| 16-Bit 0 dB | | - | -93 | - | - | -91 | - | dB |
| -20 dB | | - | -73 | - | - | -71 | - | dB |
| -60 dB | | - | -33 | - | - | -31 | - | dB |
| Interchannel Isolation (1 kHz) | | - | 100 | - | - | 100 | - | dB |

Notes: 1. One-half LSB of triangular PDF dither is added to data.

ANALOG CHARACTERISTICS (Continued)

| Parameters | Symbol | Min | Typ | Max | Units |
|-----------------------------|----------------|---------|--------|---------|-----------------|
| Analog Output | | | | | |
| Full Scale Output Voltage | | 0.63•VA | 0.7•VA | 0.77•VA | V _{pp} |
| Quiescent Voltage | V _Q | - | 0.5•VA | - | VDC |
| Interchannel Gain Mismatch | | - | 0.1 | - | dB |
| Gain Drift | | - | 100 | - | ppm/°C |
| AC-Load Resistance (Note 2) | R _L | 3 | - | - | kΩ |
| Load Capacitance (Note 2) | C _L | - | - | 100 | pF |

| Parameter | Symbol | Base-rate Mode | | | High-Rate Mode | | | Unit |
|---|--------|----------------|----------|------------|----------------|----------|-------|------|
| | | Min | Typ | Max | Min | Typ | Max | |
| Combined Digital and On-chip Analog Filter Response (Note 3) | | | | | | | | |
| Passband (Note 4) | | 0 | - | .4535 | - | - | - | Fs |
| to -0.05 dB corner | | - | - | - | 0 | - | .4621 | Fs |
| to -0.1 dB corner | | 0 | - | .4998 | 0 | - | .4982 | Fs |
| to -3 dB corner | | | | | | | | |
| Frequency Response 10 Hz to 20 kHz | | -.02 | - | +.08 | -0.06 | - | 0 | dB |
| StopBand | | .5465 | - | - | .577 | - | - | Fs |
| StopBand Attenuation (Note 5) | | 50 | - | - | 55 | - | - | dB |
| Group Delay | tgd | - | 9/Fs | - | - | 4/Fs | - | s |
| Passband Group Delay Deviation 0 - 40 kHz | | - | - | - | - | ±1.39/Fs | - | s |
| 0 - 20 kHz | | - | ±0.36/Fs | - | - | ±0.23/Fs | - | s |
| De-emphasis Error (Relative to 1 kHz) | | - | - | +.2/- .1 | (Note 6) | | | dB |
| Fs = 32 kHz | | - | - | +.05/- .14 | | | | dB |
| Fs = 44.1 kHz | | - | - | +0/- .22 | | | | dB |

- Notes:
- Refer to Figure 18.
 - Filter response is guaranteed by design.
 - Response is clock dependent and will scale with Fs. Note that the response plots (Figures 9-16) have been normalized to Fs and can be de-normalized by multiplying the X-axis scale by Fs.
 - For Base-Rate Mode, the Measurement Bandwidth is 0.5465 Fs to 3 Fs. For High-Rate Mode, the Measurement Bandwidth is 0.577 Fs to 1.4 Fs.
 - De-emphasis is not available in High-Rate Mode.

POWER AND THERMAL CHARACTERISTICS

| Parameters | | Symbol | Min | Typ | Max | Units |
|--------------------------------------|------------------------------|---------------|-----|------|-----|-------------------|
| Power Supplies | | | | | | |
| Power Supply Current VA = 5 V | normal operation | I_A | - | 15 | 17 | mA |
| | power-down state | I_A | - | 60 | - | μ A |
| Power Dissipation VA = 5 V | (Note 7) normal operation | | - | 75 | 85 | mW |
| | power-down | | - | 0.3 | - | mW |
| Power Supply Current VA = 3 V | normal operation | I_A | - | 10 | 14 | mA |
| | power-down state | I_A | - | 30 | - | μ A |
| Power Dissipation VA = 3 V | (Note 7) normal operation | | - | 30 | 42 | mW |
| | power-down | | - | 0.09 | - | mW |
| Package Thermal Resistance | | θ_{JA} | - | 110 | - | $^{\circ}$ C/Watt |
| Power Supply Rejection Ratio (1 kHz) | (Note 8) | PSRR | - | 60 | - | dB |
| | (60 Hz) | | - | 40 | - | dB |

Notes: 7. Refer to Figure 19.

8. Valid with the recommended capacitor values on FILT+ and V_Q as shown in Figure 1.

DIGITAL CHARACTERISTICS ($T_A = 25^{\circ}$ C; VA = 2.7V - 5.5V)

| Parameters | | Symbol | Min | Typ | Max | Units |
|-----------------------------|----------|----------|-----|-----|----------|---------|
| High-Level Input Voltage | VA = 5 V | V_{IH} | 2.0 | - | - | V |
| | VA = 3 V | | 2.0 | - | - | V |
| Low-Level Input Voltage | VA = 5 V | V_{IL} | - | - | 0.8 | V |
| | VA = 3 V | | - | - | 0.8 | V |
| Input Leakage Current | | I_{in} | - | - | \pm 10 | μ A |
| Input Capacitance | | | - | 8 | - | pF |
| Maximum MUTEC Drive Current | | | - | 3 | - | mA |

ABSOLUTE MAXIMUM RATINGS (AGND = 0V; all voltages with respect to ground.)

| Parameters | Symbol | Min | Max | Units |
|---|-----------|------|----------|--------------|
| DC Power Supply | VA | -0.3 | 6.0 | V |
| Input Current, Any Pin Except Supplies | I_{in} | - | \pm 10 | mA |
| Digital Input Voltage | V_{IND} | -0.3 | VA+0.4 | V |
| Ambient Operating Temperature (power applied) | T_A | -55 | 125 | $^{\circ}$ C |
| Storage Temperature | T_{stg} | -65 | 150 | $^{\circ}$ C |

WARNING: Operation at or beyond these limits may result in permanent damage to the device. Normal operation is not guaranteed at these extremes.

RECOMMENDED OPERATING CONDITIONS (AGND = 0V; all voltages with respect to ground.)

| Parameters | Symbol | Min | Typ | Max | Units |
|-----------------|--------|-----|-----|-----|-------|
| DC Power Supply | VA | 2.7 | 5.0 | 5.5 | V |

SWITCHING CHARACTERISTICS ($T_A = -10$ to 70°C ; $V_A = 2.7\text{V} - 5.5\text{V}$; Inputs: Logic 0 = 0V, Logic 1 = V_A , $C_L = 20\text{pF}$)

| Parameters | Symbol | Min | Typ | Max | Units |
|--|-------------------|---------------------------|-----------------------------|------|---------------|
| Input Sample Rate | F_s | 2 | - | 100 | kHz |
| MCLK Pulse Width High MCLK/LRCK = 512 | | 10 | - | 1000 | ns |
| MCLK Pulse Width Low MCLK/LRCK = 512 | | 10 | - | 1000 | ns |
| MCLK Pulse Width High MCLK / LRCK = 384 or 192 | | 21 | - | 1000 | ns |
| MCLK Pulse Width Low MCLK / LRCK = 384 or 192 | | 21 | - | 1000 | ns |
| MCLK Pulse Width High MCLK / LRCK = 256 or 128 | | 31 | - | 1000 | ns |
| MCLK Pulse Width Low MCLK / LRCK = 256 or 128 | | 31 | - | 1000 | ns |
| External SCLK Mode | | | | | |
| LRCK Duty Cycle (External SCLK only) | | 40 | 50 | 60 | % |
| SCLK Pulse Width Low | t_{sckl} | 20 | - | - | ns |
| SCLK Pulse Width High | t_{sckh} | 20 | - | - | ns |
| SCLK Period MCLK / LRCK = 512, 256 or 384 | t_{sckw} | $\frac{1}{(128)F_s}$ | - | - | ns |
| SCLK Period MCLK / LRCK = 128 or 192 | t_{sckw} | $\frac{1}{(64)F_s}$ | - | - | ns |
| SCLK rising to LRCK edge delay | t_{slrd} | 20 | - | - | ns |
| SCLK rising to LRCK edge setup time | t_{slrs} | 20 | - | - | ns |
| SDATA valid to SCLK rising setup time | t_{sdls} | 20 | - | - | ns |
| SCLK rising to SDATA hold time | t_{sdh} | 20 | - | - | ns |
| Internal SCLK Mode | | | | | |
| LRCK Duty Cycle (Internal SCLK only) (Note 9) | | - | 50 | - | % |
| SCLK Period (Note 10) | t_{sckw} | $\frac{1}{\text{SCLK}}$ | - | - | ns |
| SCLK rising to LRCK edge | t_{sckr} | - | $\frac{t_{\text{sckw}}}{2}$ | - | μs |
| SDATA valid to SCLK rising setup time | t_{sdls} | $\frac{1}{(512)F_s} + 10$ | - | - | ns |
| SCLK rising to SDATA hold time MCLK / LRCK = 512, 256 or 128 | t_{sdh} | $\frac{1}{(512)F_s} + 15$ | - | - | ns |
| SCLK rising to SDATA hold time MCLK / LRCK = 384 or 192 | t_{sdh} | $\frac{1}{(384)F_s} + 15$ | - | - | ns |

Notes: 9. In Internal SCLK Mode, the Duty Cycle must be 50% $\pm 1/2$ MCLK Period.

10. The SCLK / LRCK ratio may be either 32, 48, or 64. This ratio depends on part type and MCLK/LRCK ratio. (See Figures 20-26)

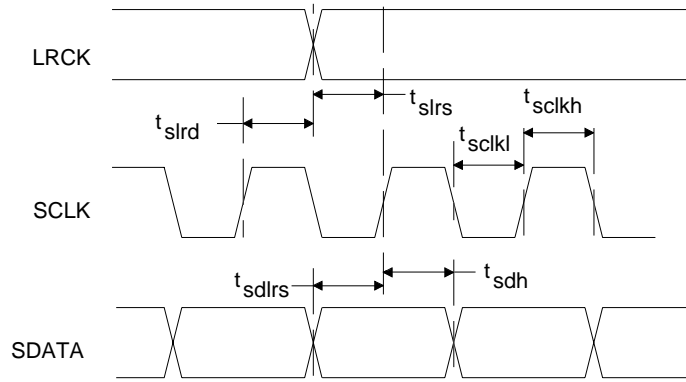

Figure 1. External Serial Mode Input Timing

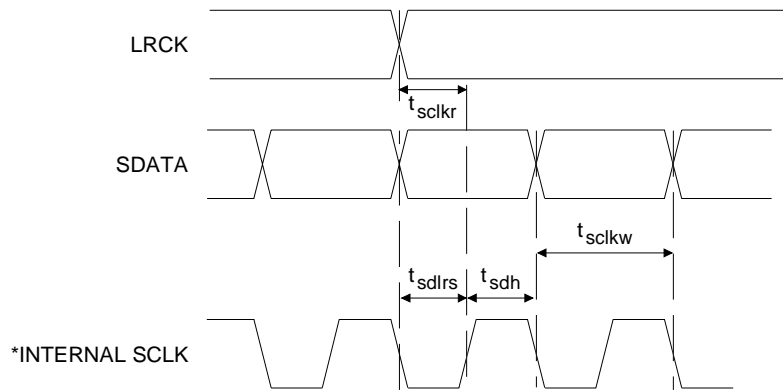

Figure 2. Internal Serial Mode Input Timing

*The SCLK pulses shown are internal to the CS4341.

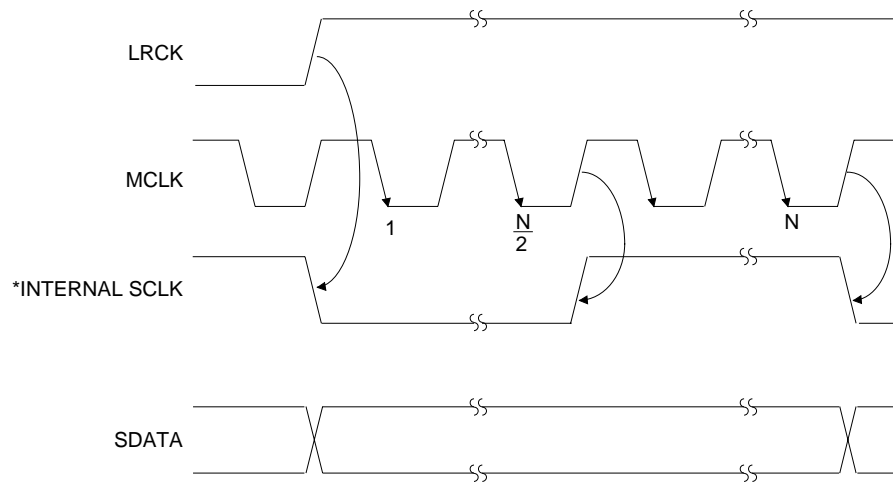

Figure 3. Internal Serial Clock Generation

* The SCLK pulses shown are internal to the CS4341.

N equals MCLK divided by SCLK

SWITCHING CHARACTERISTICS - CONTROL PORT

($T_A = 25\text{ }^\circ\text{C}$; $V_A = +5\text{ V } \pm 5\%$; Inputs: logic 0 = AGND, logic 1 = VA, $C_L = 30\text{ pF}$)

| Parameter | Symbol | Min | Max | Unit |
|--|------------|-----|-----|---------------|
| <i>I²C</i>[®] Compatible Mode | | | | |
| SCL Clock Frequency | f_{scl} | - | 100 | kHz |
| RST Rising Edge to Start | t_{irs} | 500 | - | ns |
| Bus Free Time Between Transmissions | t_{buf} | 4.7 | - | μs |
| Start Condition Hold Time (prior to first clock pulse) | t_{hdst} | 4.0 | - | μs |
| Clock Low time | t_{low} | 4.7 | - | μs |
| Clock High Time | t_{high} | 4.0 | - | μs |
| Setup Time for Repeated Start Condition | t_{sust} | 4.7 | - | μs |
| SDA Hold Time from SCL Falling (Note 11) | t_{hdd} | 0 | - | μs |
| SDA Setup time to SCL Rising | t_{sud} | 250 | - | ns |
| Rise Time of Both SDA and SCL Lines | t_r | - | 1 | μs |
| Fall Time of Both SDA and SCL Lines | t_f | - | 300 | ns |
| Setup Time for Stop Condition | t_{susp} | 4.7 | - | μs |

Notes: 11. Data must be held for sufficient time to bridge the 300 ns transition time of SCL.

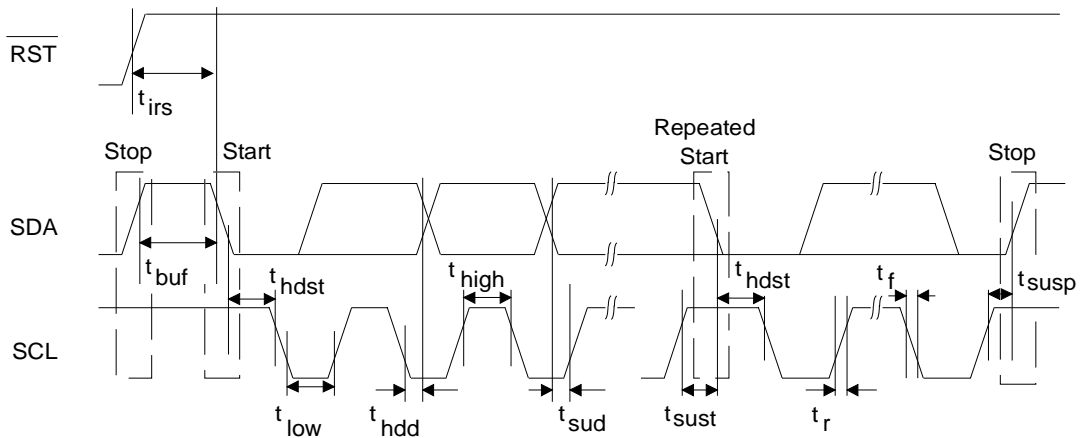

Figure 4. I²C Control Port Timing

SWITCHING CHARACTERISTICS - CONTROL PORT

($T_A = 25\text{ }^\circ\text{C}$; $V_A = +5\text{ V} \pm 5\%$; Inputs: logic 0 = AGND, logic 1 = VA, $C_L = 30\text{ pF}$)

| Parameter | Symbol | Min | Max | Unit |
|---|-------------------|-----|-----|---------------|
| SPI Mode | | | | |
| CCLK Clock Frequency | f_{sclk} | - | 6 | MHz |
| RST Rising Edge to CS Falling | t_{srs} | 500 | - | ns |
| CCLK Edge to CS Falling (Note 12) | t_{spi} | 500 | - | ns |
| CS High Time Between Transmissions | t_{csh} | 1.0 | - | μs |
| CS Falling to CCLK Edge | t_{css} | 20 | - | ns |
| CCLK Low Time | t_{scl} | 66 | - | ns |
| CCLK High Time | t_{sch} | 66 | - | ns |
| CDIN to CCLK Rising Setup Time | t_{dsu} | 40 | - | ns |
| CCLK Rising to DATA Hold Time (Note 13) | t_{dh} | 15 | - | ns |
| Rise Time of CCLK and CDIN (Note 14) | t_{r2} | - | 100 | ns |
| Fall Time of CCLK and CDIN (Note 14) | t_{f2} | - | 100 | ns |

Notes: 12. t_{spi} only needed before first falling edge of $\overline{\text{CS}}$ after $\overline{\text{RST}}$ rising edge. $t_{\text{spi}} = 0$ at all other times.

13. Data must be held for sufficient time to bridge the transition time of CCLK.

14. For $F_{\text{SCK}} < 1\text{ MHz}$

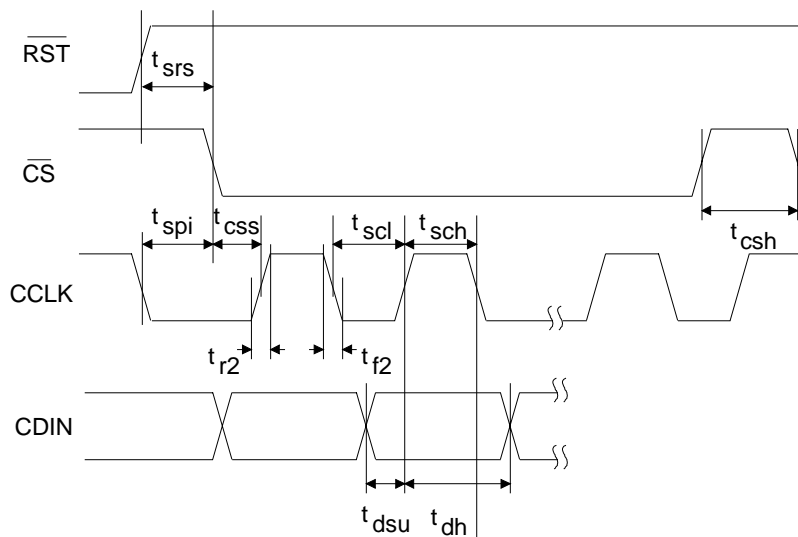

Figure 5. SPI Control Port Timing

2. TYPICAL CONNECTION DIAGRAM

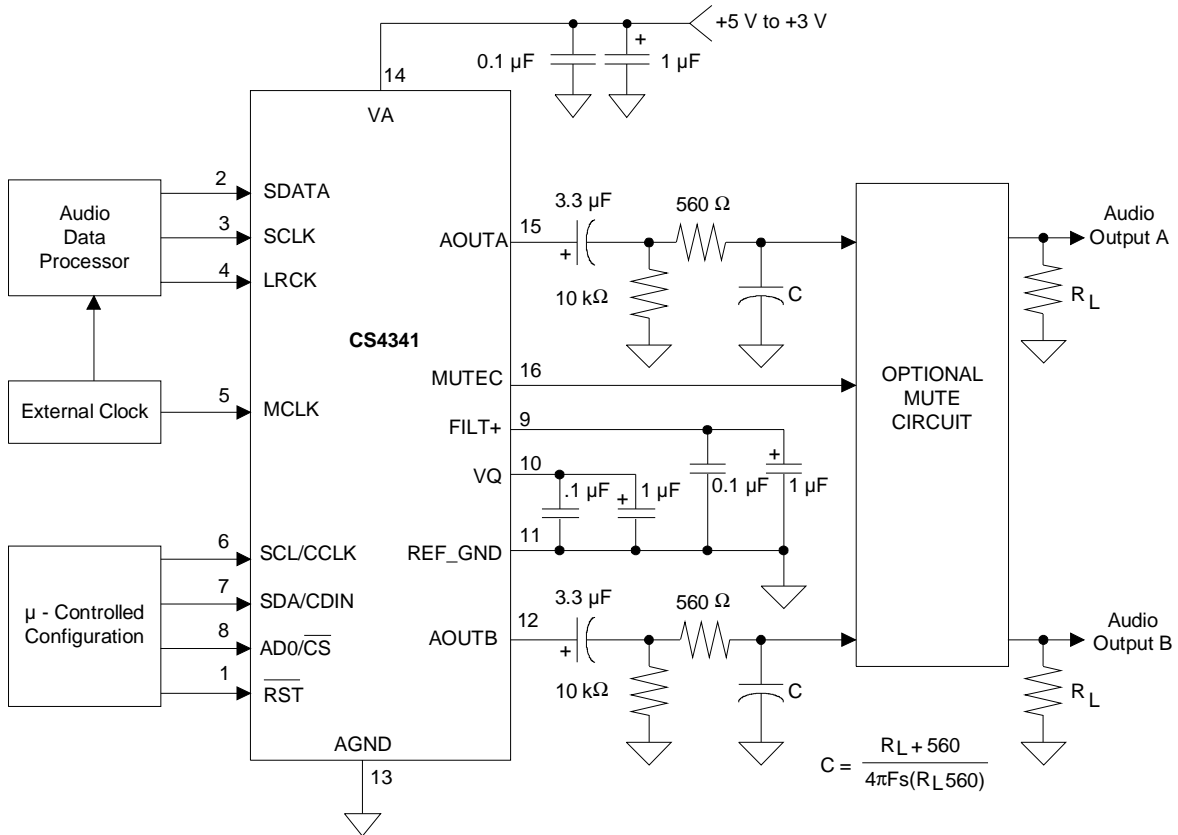

Figure 6. Typical Connection Diagram

3. REGISTER QUICK REFERENCE

** "default" ==> bit status after power-up-sequence or reset.

3.1 MCLK Control (address 00h)

| 7 | 6 | 5 | 4 | 3 | 2 | 1 | 0 |
|----------|----------|----------|----------|----------|----------|---------|----------|
| Reserved | Reserved | Reserved | Reserved | Reserved | Reserved | MCLKDIV | Reserved |
| 0 | 0 | 0 | 0 | 0 | 0 | 0 | 0 |

MCLKDIV (MCLK Divide-by-2 Enable)

Default = '0'.

0 - Disabled

1 - Enabled

3.2 Mode Control (address 01h)

| 7 | 6 | 5 | 4 | 3 | 2 | 1 | 0 |
|-------|------|------|------|------|------|-----|-----|
| AMUTE | DIF2 | DIF1 | DIF0 | DEM1 | DEM0 | POR | PDN |
| 1 | 0 | 0 | 0 | 0 | 0 | 1 | 1 |

AMUTE (Auto-mute)

Default = '1'.

0 - Disabled

1 - Enabled

DIF2, DIF1 and DIF0 (Digital Interface Format)

Default = '0'.

0 - Format 0, I²S, up to 24-bit data, 64 x Fs Internal SCLK

1 - Format 1, I²S, up to 24-bit data, 32 x Fs Internal SCLK

2 - Format 2, Left Justified, up to 24-bit data

3 - Format 3, Right Justified, 24-bit Data

4 - Format 4, Right Justified, 20-bit Data

5 - Format 5, Right Justified, 16-bit Data

6 - Format 6, Right Justified, 18-bit Data

7 - Identical to Format 1

DEM 1, DEM 0 (De-Emphasis Mode)

Default = '0'.

0 - Disabled

1 - 44.1 kHz De-Emphasis

2 - 48 kHz De-Emphasis

3 - 32 kHz De-Emphasis

POR (Power on/off Quiescent Voltage ramp)

Default = '1'.

0 - Disabled

1 - Enabled

PDN (Power-Down)

Default = '1'.

0 - Disabled

1 - Enabled

3.3 Volume and Mixing Control (address 02h)

| 7 | 6 | 5 | 4 | 3 | 2 | 1 | 0 |
|-------|------|------------|--------|--------|--------|--------|--------|
| A = B | Soft | Zero Cross | ATAPI4 | ATAPI3 | ATAPI2 | ATAPI1 | ATAPI0 |
| 0 | 1 | 0 | 0 | 1 | 0 | 0 | 1 |

A = B (Channel A Volume = Channel B Volume)

Default = '0'.

0 - AOUTA volume is determined by register 03h and AOUTB volume is determined by register 04h.

1 - AOUTA and AOUTB volumes are determined by register 03h and register 04h is ignored.

Soft & Zero Cross (Soft control and zero cross detection control)

Default = '10'.

| Soft | Zero Cross | Mode |
|------|------------|---|
| 0 | 0 | Changes take effect immediately |
| 0 | 1 | Changes take effect on zero crossings |
| 1 | 0 | Changes take effect with a soft ramp (default) |
| 1 | 1 | Changes take effect in 1/8 dB steps on each zero crossing |

ATAPI 0-4 (Channel mixing and muting)

(refer to Table 9)

Default = '01001', (Stereo)

AOUTA = Left Channel

AOUTB = Right Channel

3.4 Channel A Volume Control (address 03h)

3.5 Channel B Volume Control (address 04h)

| 7 | 6 | 5 | 4 | 3 | 2 | 1 | 0 |
|------|------|------|------|------|------|------|------|
| MUTE | VOL6 | VOL5 | VOL4 | VOL3 | VOL2 | VOL1 | VOL0 |
| 0 | 0 | 0 | 0 | 0 | 0 | 0 | 0 |

MUTE

Default = '0'

0 - Disabled

1 - Enabled

Volume

Default = '0'

(Refer to Table 11)

4. REGISTER BIT DESCRIPTION

4.1 MASTER CLOCK DIVIDE ENABLE

MCLK Control Register (address 00h)

| | | | | | | | |
|----------|----------|----------|----------|----------|----------|----------------|----------|
| 7 | 6 | 5 | 4 | 3 | 2 | 1 | 0 |
| Reserved | Reserved | Reserved | Reserved | Reserved | Reserved | MCLKDIV | Reserved |

Access:

R/W in I²C and write only in SPI.

Default:

0 - Disabled

Function:

The MCLKDIV bit enables a circuit which divides the externally applied MCLK signal by 2.

Note: This feature is present on revision C and newer devices. For backward compatibility with previous revision devices, this bit defaults to zero.

| MCLKDIV | MODE |
|---------|----------|
| 0 | Disabled |
| 1 | Enabled |

Table 1. Master Clock Divide Enable

4.2 AUTO-MUTE

Mode Control Register (address 01h)

| | | | | | | | |
|--------------|------|------|------|------|------|-----|-----|
| 7 | 6 | 5 | 4 | 3 | 2 | 1 | 0 |
| AMUTE | DIF2 | DIF1 | DIF0 | DEM1 | DEM0 | POR | PDN |

Access:

R/W in I²C and write only in SPI.

Default:

1 - Enabled

Function:

The Digital-to-Analog converter output will mute following the reception of 8192 consecutive audio samples of static 0 or -1. A single sample of non-zero data will release the mute. Detection and muting is done independently for each channel. The quiescent voltage on the output will be retained and the Mute Control pin will go active during the mute period. The muting function is effected, similar to volume control changes, by the Soft and Zero Cross bits in the Volume and Mixing Control register.

| AMUTE | MODE |
|-------|----------|
| 0 | Disabled |
| 1 | Enabled |

Table 2. Auto-Mute Enable

4.3 DIGITAL INTERFACE FORMAT

Mode Control Register (address 01h)

| | | | | | | | |
|-------|------|------|------|------|------|-----|-----|
| 7 | 6 | 5 | 4 | 3 | 2 | 1 | 0 |
| AMUTE | DIF2 | DIF1 | DIF0 | DEM1 | DEM0 | POR | PDN |

Access:

R/W in I²C and write only in SPI.

Default:

0 - Format 0 (I²S, up to 24-bit data, 64 x Fs Internal SCLK)

Function:

The required relationship between the Left/Right clock, serial clock and serial data is defined by the Digital Interface Format and the options are detailed in Figures 20-26.

| DIF2 | DIF1 | DIF0 | DESCRIPTION | FORMAT | FIGURE |
|------|------|------|--|--------|--------|
| 0 | 0 | 0 | I ² S, up to 24-bit data, 64 x Fs Internal SCLK | 0 | 20 |
| 0 | 0 | 1 | I ² S, up to 24-bit data, 32 x Fs Internal SCLK | 1 | 21 |
| 0 | 1 | 0 | Left Justified, up to 24-bit data | 2 | 22 |
| 0 | 1 | 1 | Right Justified, 24-bit Data | 3 | 23 |
| 1 | 0 | 0 | Right Justified, 20-bit Data | 4 | 24 |
| 1 | 0 | 1 | Right Justified, 16-bit Data | 5 | 25 |
| 1 | 1 | 0 | Right Justified, 18-bit Data | 6 | 26 |
| 1 | 1 | 1 | Identical to Format 1 | 7 | 20 |

Table 3. Digital Interface Formats

4.4 DE-EMPHASIS CONTROL

Mode Control Register (address 01h)

| | | | | | | | |
|-------|------|------|------|------|------|-----|-----|
| 7 | 6 | 5 | 4 | 3 | 2 | 1 | 0 |
| AMUTE | DIF2 | DIF1 | DIF0 | DEM1 | DEM0 | POR | PDN |

Access:

R/W in I²C and write only in SPI.

Default:

0 - Disabled

Function:

Implementation of the standard 15μs/50μs digital de-emphasis filter response, Figure 27, requires re-configuration of the digital filter to maintain the proper filter response for 32, 44.1 or 48 kHz sample rates. NOTE: De-emphasis is not available in High-Rate Mode.

| DEM1 | DEMO | DESCRIPTION |
|------|------|-------------|
| 0 | 0 | Disabled |
| 0 | 1 | 44.1kHz |
| 1 | 0 | 48kHz |
| 1 | 1 | 32kHz |

Table 4. De-emphasis Filter Configurations

4.5 POWER ON/OFF QUIESCENT VOLTAGE RAMP

Mode Control Register (address 01h)

| | | | | | | | |
|-------|------|------|------|------|------|-----|-----|
| 7 | 6 | 5 | 4 | 3 | 2 | 1 | 0 |
| AMUTE | DIF2 | DIF1 | DIF0 | DEM1 | DEM0 | POR | PDN |

Access:

R/W in I²C and write only in SPI.

Default:

1 - Enabled

Function:

The power On/Off Quiescent Voltage Ramp allows the quiescent voltage to slowly ramp to and from 0 volts to the quiescent voltage during power-on or power-off. Please refer to the applications section for details of implementing this feature.

| POR | MODE |
|-----|----------|
| 0 | Disabled |
| 1 | Enabled |

Table 5. Power On/Off Ramp Enable

4.6 POWER DOWN

Mode Control Register (address 01h)

| | | | | | | | |
|-------|------|------|------|------|------|-----|-----|
| 7 | 6 | 5 | 4 | 3 | 2 | 1 | 0 |
| AMUTE | DIF2 | DIF1 | DIF0 | DEM1 | DEM0 | POR | PDN |

Access:

R/W in I²C and write only in SPI.

Default:

1 - Enabled

Function:

The device will enter a low-power state whenever this function is activated. The power-down bit defaults to 'enabled' on power-up and must be disabled before normal operation will begin. The contents of the control registers are retained in this mode.

| PDN | MODE |
|-----|----------|
| 0 | Disabled |
| 1 | Enabled |

Table 6. Power Down Enable

4.7 CHANNEL A VOLUME = CHANNEL B VOLUME

Volume and Mixing Control Register (address 02h)

| | | | | | | | |
|-------|------|------------|--------|--------|--------|--------|--------|
| 7 | 6 | 5 | 4 | 3 | 2 | 1 | 0 |
| A = B | Soft | Zero Cross | ATAPI4 | ATAPI3 | ATAPI2 | ATAPI1 | ATAPI0 |

Access:

R/W in I²C and write only in SPI.

Default:

0 - Disabled

Function:

The AOUTA and AOUTB volume levels are independently controlled by the A and the B Channel Volume Control Bytes when this function is disabled. The volume on both AOUTA and AOUTB are determined by the A Channel Volume Control Byte and the B Channel Byte is ignored when this function is enabled.

| A = B | MODE |
|-------|----------|
| 0 | Disabled |
| 1 | Enabled |

Table 7. A=B Volume Control Enable

4.8 SOFT RAMP OR ZERO CROSS ENABLE

Volume and Mixing Control Register (address 02h)

| | | | | | | | |
|-------|------|------------|--------|--------|--------|--------|--------|
| 7 | 6 | 5 | 4 | 3 | 2 | 1 | 0 |
| A = B | Soft | Zero Cross | ATAPI4 | ATAPI3 | ATAPI2 | ATAPI1 | ATAPI0 |

Access:

R/W in I²C and write only in SPI.

Default:

10 - Soft Ramp enabled.

Function:

Soft Ramp Enable

Soft Ramp allows level changes, both muting and attenuation, to be implemented by incrementally ramping, in 1/8 dB steps, from the current level to the new level at a rate of 1dB per 8 left/right clock periods.

Zero Cross Enable

Zero Cross Enable dictates that signal level changes, either by attenuation changes or muting, will occur on a signal zero crossing to minimize audible artifacts. The requested level change will occur after a timeout period between 512 and 1024 sample periods (10.7 ms to 21.3 ms at 48 kHz sample rate) if the signal does not encounter a zero crossing. The zero cross function is independently monitored and implemented for each channel.

Soft Ramp and Zero Cross Enable

Soft Ramp and Zero Cross Enable dictates that signal level changes, either by attenuation changes or muting, will occur in 1/8 dB steps and be implemented on a signal zero crossing. The 1/8 dB level change will occur after a timeout period between 512 and 1024 sample periods (10.7 ms to 21.3 ms at 48 kHz sample rate) if the signal does not encounter a zero crossing. The zero cross function is independently monitored and implemented for each channel.

| SOFT | ZERO | Mode |
|------|------|----------------------------------|
| 0 | 0 | Changes to affect immediately |
| 0 | 1 | Zero Cross enabled |
| 1 | 0 | Soft Ramp enabled |
| 1 | 1 | Soft Ramp and Zero Cross enabled |

Table 8. Soft Ramp and Zero Cross Enable
4.9 ATAPI CHANNEL MIXING AND MUTING

Volume and Mixing Control Register (address 02h)

| 7 | 6 | 5 | 4 | 3 | 2 | 1 | 0 |
|-------|------|------------|--------|--------|--------|--------|--------|
| A = B | Soft | Zero Cross | ATAPI4 | ATAPI3 | ATAPI2 | ATAPI1 | ATAPI0 |

Access:

R/W in I²C and write only in SPI.

Default:

01001 - AOUTA=aL, AOUTB=bR (Stereo)

Function:

The CS4341 implements the channel mixing functions of the ATAPI CD-ROM specification. Refer to Table 9 and Figure 28 for additional information.

| ATAPI4 | ATAPI3 | ATAPI2 | ATAPI1 | ATAPI0 | AOUTA | AOUTB |
|--------|--------|--------|--------|--------|------------|------------|
| 0 | 0 | 0 | 0 | 0 | MUTE | MUTE |
| 0 | 0 | 0 | 0 | 1 | MUTE | bR |
| 0 | 0 | 0 | 1 | 0 | MUTE | bL |
| 0 | 0 | 0 | 1 | 1 | MUTE | b[(L+R)/2] |
| 0 | 0 | 1 | 0 | 0 | aR | MUTE |
| 0 | 0 | 1 | 0 | 1 | aR | bR |
| 0 | 0 | 1 | 1 | 0 | aR | bL |
| 0 | 0 | 1 | 1 | 1 | aR | b[(L+R)/2] |
| 0 | 1 | 0 | 0 | 0 | aL | MUTE |
| 0 | 1 | 0 | 0 | 1 | aL | bR |
| 0 | 1 | 0 | 1 | 0 | aL | bL |
| 0 | 1 | 0 | 1 | 1 | aL | b[(L+R)/2] |
| 0 | 1 | 1 | 0 | 0 | a[(L+R)/2] | MUTE |
| 0 | 1 | 1 | 0 | 1 | a[(L+R)/2] | bR |
| 0 | 1 | 1 | 1 | 0 | a[(L+R)/2] | bL |
| 0 | 1 | 1 | 1 | 1 | a[(L+R)/2] | b[(L+R)/2] |
| 1 | 0 | 0 | 0 | 0 | MUTE | MUTE |
| 1 | 0 | 0 | 0 | 1 | MUTE | bR |

Table 9. ATAPI Decode

| ATAPI4 | ATAPI3 | ATAPI2 | ATAPI1 | ATAPI0 | AOUTA | AOUTB |
|--------|--------|--------|--------|--------|-------------|-------------|
| 1 | 0 | 0 | 1 | 0 | MUTE | bL |
| 1 | 0 | 0 | 1 | 1 | MUTE | [(aL+bR)/2] |
| 1 | 0 | 1 | 0 | 0 | aR | MUTE |
| 1 | 0 | 1 | 0 | 1 | aR | bR |
| 1 | 0 | 1 | 1 | 0 | aR | bL |
| 1 | 0 | 1 | 1 | 1 | aR | [(bL+aR)/2] |
| 1 | 1 | 0 | 0 | 0 | aL | MUTE |
| 1 | 1 | 0 | 0 | 1 | aL | bR |
| 1 | 1 | 0 | 1 | 0 | aL | bL |
| 1 | 1 | 0 | 1 | 1 | aL | [(aL+bR)/2] |
| 1 | 1 | 1 | 0 | 0 | [(aL+bR)/2] | MUTE |
| 1 | 1 | 1 | 0 | 1 | [(aL+bR)/2] | bR |
| 1 | 1 | 1 | 1 | 0 | [(bL+aR)/2] | bL |
| 1 | 1 | 1 | 1 | 1 | [(aL+bR)/2] | [(aL+bR)/2] |

Table 9. ATAPI Decode (Continued)
4.10 MUTE

Channel A Volume Control Register (address 03h)

Channel B Volume Control Register (address 04h)

| | | | | | | | |
|------|------|------|------|------|------|------|------|
| 7 | 6 | 5 | 4 | 3 | 2 | 1 | 0 |
| MUTE | VOL6 | VOL5 | VOL4 | VOL3 | VOL2 | VOL1 | VOL0 |

Access:

R/W in I²C and write only in SPI.

Default:

0 - Disabled

Function:

The Digital-to-Analog converter output will mute when enabled. The quiescent voltage on the output will be retained. The muting function is effected, similar to attenuation changes, by the Soft and Zero Cross bits in the Volume and Mixing Control register. The MUTE will go active during the mute period if the Mute function is enabled for both channels.

| MUTE | MODE |
|------|----------|
| 0 | Disabled |
| 1 | Enabled |

Table 10. Mute Enable

4.11 VOLUME CONTROL

Channel A Volume Control Register (address 03h)

Channel B Volume Control Register (address 04h)

| | | | | | | | |
|----------|----------|----------|----------|----------|----------|----------|----------|
| 7 | 6 | 5 | 4 | 3 | 2 | 1 | 0 |
| MUTE | VOL6 | VOL5 | VOL4 | VOL3 | VOL2 | VOL1 | VOL0 |

Access:

R/W in I²C and write only in SPI.

Default:

0 - 0 dB (No attenuation)

Function:

The digital volume control allows the user to attenuate the signal in 1 dB increments from 0 to -90 dB. Volume settings are decoded as shown in Table 11. The volume changes are implemented as dictated by the Soft and Zero Cross bits in the Volume and Mixing Control register. All volume settings less than -94 dB are equivalent to enabling the Mute bit.

| Binary Code | Decimal Value | Volume Setting |
|--------------------|----------------------|-----------------------|
| 0000000 | 0 | 0 dB |
| 0010100 | 20 | -20 dB |
| 0101000 | 40 | -40 dB |
| 0111100 | 60 | -60 dB |
| 1011010 | 90 | -90 dB |

Table 11. Digital Volume Settings

5. PIN DESCRIPTION

| | | | | | |
|----------------------------|----------------------------|---|----|----------------|----------------------------|
| Reset | $\overline{\text{RST}}$ | 1 | 16 | MUTEC | Mute Control |
| Serial Data | SDATA | 2 | 15 | AOUTA | Analog Output A |
| Serial Clock | SCLK | 3 | 14 | VA | Analog Power |
| Left/Right Clock | LRCK | 4 | 13 | AGND | Analog Ground |
| Master Clock | MCLK | 5 | 12 | AOUTB | Analog Output B |
| SCL/CCLK | SCL/CCLK | 6 | 11 | REF_GND | Reference Ground |
| SDA/CDIN | SDA/CDIN | 7 | 10 | VQ | Quiescent Voltage |
| $\overline{\text{AD0/CS}}$ | $\overline{\text{AD0/CS}}$ | 8 | 9 | FILT+ | Positive Voltage Reference |

Analog Power - VA

Pin 14, Input

Function:

Analog power supply. Typically 3 to 5VDC.

Analog Ground - AGND

Pin 13, Input

Function:

Analog ground reference.

Analog Output - AOUTA and AOUTB

Pins 12 and 15, Output

Function:

The full scale analog output level is specified in the Analog Characteristics specifications table.

Reference Ground - REF_GND

Pin 11, Input

Function:

Ground reference for the internal sampling circuits. Must be connected to analog ground.

Positive Voltage Reference - FILT+

Pin 9, Output

Function:

Positive reference for internal sampling circuits. External capacitors are required from FILT+ to analog ground, as shown in Figure 6. The recommended values will typically provide 60 dB of PSRR at 1 kHz and 40 dB of PSRR at 60 Hz. FILT+ is not intended to supply external current. FILT+ has a typical source impedance of 250 k Ω and any current drawn from this pin will alter device performance.

Quiescent Voltage - VQ

Pin 10, Output

Function:

Filter connection for internal quiescent reference voltage, typically 50% of VA. Capacitors must be connected from V_Q to analog ground, as shown in Figure 6. V_Q is not intended to supply external current. V_Q has a typical source impedance of 250 k Ω and any current drawn from this pin will alter device performance.

Master Clock - MCLK
Pin 5, Input
Function:

The master clock frequency must be either 256x, 384x, 512x, 768x or 1024x the input sample rate in Base Rate Mode (BRM) and 128x, 192x, 256x or 384x the input sample rate in High Rate Mode (HRM). Note that some multiplication factors require setting the MCLKDIV bit in the MCLK Control Register. Table 12 illustrates several standard audio sample rates and the required master clock frequencies.

| Sample Rate (kHz) | MCLK (MHz) | | | | | | | | |
|-------------------|------------|---------|---------|---------|---------|---------|---------|---------|---------|
| | HRM | | | | BRM | | | | |
| | 128x | 192x | 256x* | 384x* | 256x | 384x | 512x | 768x* | 1024x* |
| 32 | 4.0960 | 6.1440 | 8.1920 | 12.2880 | 8.1920 | 12.2880 | 16.3840 | 24.5760 | 32.7680 |
| 44.1 | 5.6448 | 8.4672 | 11.2896 | 16.9344 | 11.2896 | 16.9344 | 22.5792 | 32.7680 | 45.1584 |
| 48 | 6.1440 | 9.2160 | 12.2880 | 18.4320 | 12.2880 | 18.4320 | 24.5760 | 36.8640 | 49.1520 |
| 64 | 8.1920 | 12.2880 | 16.3840 | 24.5760 | - | - | - | - | - |
| 88.2 | 11.2896 | 16.9344 | 22.5792 | 33.8688 | - | - | - | - | - |
| 96 | 12.2880 | 18.4320 | 24.5760 | 36.8640 | - | - | - | - | - |

* Requires MCLKDIV bit = 1 in MCLK Control Register (address 00h)

Table 12. Common Clock Frequencies

Left/Right Clock - LRCK
Pin 4, Input
Function:

The Left/Right clock determines which channel is currently being input on the serial audio data input, SDA-TA. The frequency of the Left/Right clock must be at the input sample rate. Audio samples in Left/Right sample pairs will be simultaneously output from the digital-to-analog converter whereas Right/Left pairs will exhibit a one sample period difference. The required relationship between the Left/Right clock, serial clock and serial data is defined by the Mode Control Byte and the options are detailed in Figures 20-26.

Serial Audio Data - SDATA
Pin 2, Input
Function:

Two's complement MSB-first serial data is input on this pin. The data is clocked into SDATA via the serial clock and the channel is determined by the Left/Right clock. The required relationship between the Left/Right clock, serial clock and serial data is defined by the Mode Control Byte and the options are detailed in Figures 20-26.

Serial Clock - SCLK*Pin 3, Input**Function:*

Clocks the individual bits of the serial data into the SDATA pin. The required relationship between the Left/Right clock, serial clock and serial data is defined by the Mode Control Byte and the options are detailed in Figures 20-26.

The CS4341 supports both internal and external serial clock generation modes. The Internal Serial Clock Mode eliminates possible clock interference from an external SCLK. Use of the Internal Serial Clock Mode is always preferred.

Internal Serial Clock Mode

In the Internal Serial Clock Mode, the serial clock is internally derived and synchronous with the master clock and left/right clock. The SCLK/LRCK frequency ratio is either 32, 48, or 64 depending upon data format, as shown in Figures 20-26. Operation in this mode is identical to operation with an external serial clock synchronized with LRCK.

External Serial Clock Mode

The CS4341 will enter the External Serial Clock Mode whenever 16 low to high transitions are detected on the SCLK pin during any phase of the LRCK period. The device will revert to Internal Serial Clock Mode if no low to high transitions are detected on the SCLK pin for 2 consecutive periods of LRCK.

Reset - $\overline{\text{RST}}$ *Pin 1, Input**Function:*

The device enters a low power mode and all internal registers are reset to the default settings, including the control port, when low. When high, the control port becomes operational and the PDN bit must be cleared before normal operation will occur. The control port can not be accessed when reset is low.

Serial Control Interface Clock - SCL/CCLK*Pin 6, Input**Function:*

Clocks the serial control data into or from SDA/CDIN.

Serial Control Data I/O - SDA/CDIN*Pin 7, Input/Output**Function:*

In I²C mode, SDA is a data I/O line. CDIN is the input data line for the control port interface in SPI mode.

Address Bit / Chip Select - $\overline{\text{AD0/CS}}$ *Pin 8, Input**Function:*

In I²C mode, AD0 is a chip address bit. $\overline{\text{CS}}$ is used to enable the control port interface in SPI mode. The device will enter the SPI mode at anytime a high to low transition is detected on this pin. Once the device has entered the SPI mode, it will remain until either the part is reset or undergoes a power-down cycle.

Mute Control - MUTE $\overline{\text{C}}$ *Pin 16, Output**Function:*

The Mute Control pin goes high during power-up initialization, reset, muting, master clock to left/right clock frequency ratio is incorrect or power-down. This pin is intended to be used as a control for an external mute circuit to prevent the clicks and pops that can occur in any single supply system. Use of Mute Control is not mandatory but recommended for designs requiring the absolute minimum in extraneous clicks and pops.

6. APPLICATIONS

6.1 Grounding and Power Supply Decoupling

As with any high resolution converter, the CS4341 requires careful attention to power supply and grounding arrangements to optimize performance. Figure 6 shows the recommended power arrangement with VA connected to a clean supply. Decoupling capacitors should be located as close to the device package as possible.

6.2 Oversampling Modes

The CS4341 operates in one of two oversampling modes based on the input sample rate and the state of the MCLKDIV bit in the MCLK Control Register. Base Rate Mode (BRM) supports input sample rates up to 50 kHz while High Rate Mode (HRM) supports input sample rates up to 100 kHz. When the MCLKDIV bit is cleared, the devices operate in BRM when MCLK/LRCK is 256, 384 or 512 and in HRM when MCLK/LRCK is 128 or 192. When the MCLKDIV bit is set, the devices operate in BRM when MCLK/LRCK is 512, 768 or 1024 and in HRM when MCLK/LRCK is 256 or 384.

6.3 Recommended Power-up Sequence

1. Hold $\overline{\text{RST}}$ low until the power supply, master, and left/right clocks are stable. In this state, the control port is reset to its default settings and V_Q will remain low.
2. Bring $\overline{\text{RST}}$ high. The device will remain in a low power state with V_Q low and the control port accessible. The desired register settings can be loaded while keeping the PDN bit set to 1.
3. Set the PDN bit to 0 which will initiate the power-up sequence, which requires approximately 50 μs when the POR bit is set to 0. If the POR bit is set to 1, see Section 6.4 for total power-up timing.

6.4 Use of the Power ON/OFF Quiescent Voltage Ramp

The CS4341 uses a novel technique to minimize the effects of output transients during power-up and power-down. This technique, when used with external DC-blocking capacitors in series with the audio outputs, minimizes the audio transients commonly produced by single-ended single-supply converters.

When the device is initially powered-up, the audio outputs, AOUTA and AOUTB, are clamped to AGND. Following a delay of approximately 1000 sample periods, each output begins to ramp toward the quiescent voltage. Approximately 10,000 left/right clock cycles later, the outputs reach V_Q and audio output begins. This gradual voltage ramping allows time for the external DC-blocking capacitor to charge to the quiescent voltage, minimizing the power-up transient.

To prevent transients at power-down, the device must first enter its power-down state. When this occurs, audio output ceases and the internal output buffers are disconnected from AOUTA and AOUTB. In their place, a soft-start current sink is substituted which allows the DC-blocking capacitors to slowly discharge. Once this charge is dissipated, the power to the device may be turned off and the system is ready for the next power-on.

To prevent an audio transient at the next power-on, it is necessary to ensure that the DC-blocking capacitors have fully discharged before turning off the power or exiting the power-down state. If not, a transient will occur when the audio outputs are initially clamped to AGND. The time that the device must remain in the power-down state is related to the value of the DC-blocking capacitance. For example, with a 3.3 μF capacitor, the minimum power-down time will be approximately 0.4 seconds.

Use of the Mute Control function is recommended for designs requiring the absolute minimum in extraneous clicks and pops. Also, use of the Mute

Control function can enable the system designer to achieve idle channel noise/signal-to-noise ratios which are only limited by the external mute circuit.

7. CONTROL PORT INTERFACE

The control port is used to load all the internal settings of the CS4341. The operation of the control port may be completely asynchronous to the audio sample rate. However, to avoid potential interference problems, the control port pins should remain static if no operation is required. *

The control port has 2 modes: SPI and I²C compatible, with the CS4341 operating as a slave device in both modes. If I²C operation is desired, AD0/ $\overline{\text{CS}}$ should be tied to VA or AGND. If the CS4341 ever detects a high to low transition on AD0/ $\overline{\text{CS}}$ after power-up, SPI mode will be selected. The control port registers are write-only in SPI mode.

7.1 SPI Mode

In SPI mode, $\overline{\text{CS}}$ is the CS4341 chip select signal, CCLK is the control port bit clock, CDIN is the input data line from the microcontroller and the chip address is 0010000. All signals are inputs and data is clocked in on the rising edge of CCLK.

Figure 7 shows the operation of the control port in SPI mode. To write to a register, bring $\overline{\text{CS}}$ low. The first 7 bits on CDIN form the chip address, and must be 0010000. The eighth bit is a read/write indicator (R/ $\overline{\text{W}}$), which must be low to write. The next 8 bits form the Memory Address Pointer (MAP), which is set to the address of the register that is to be updated. The next 8 bits are the data which will be placed into the register designated by the MAP.

The CS4341 has MAP auto increment capability, enabled by the INCR bit in the MAP register. If INCR is 0, then the MAP will stay constant for successive writes. If INCR is set to 1, then MAP will auto increment after each byte is written, allowing block reads or writes of successive registers.

7.2 I²C Compatible Mode

In I²C compatible mode, SDA is a bi-directional data line. Data is clocked into and out of the part by the clock, SCL, with the clock to data relationship as shown in Figure 8. There is no $\overline{\text{CS}}$ pin. Pin AD0 forms the partial chip address and should be tied to VA or AGND as required. The upper 6 bits of the 7-bit address field must be 001000. To communicate with the CS4341 the LSB of the chip address field, which is the first byte sent to the CS4341, should match the setting of the AD0 pin. The eighth bit of the address byte is the R/ $\overline{\text{W}}$ bit (high for a read, low for a write). If the operation is a write, the next byte is the Memory Address Pointer, MAP, which selects the register to be read or written. The MAP is then followed by the data to be written. If the operation is a read, then the contents of the register pointed to by the MAP will be output after the chip address.

The CS4341 has MAP auto increment capability, enabled by the INCR bit in the MAP register. If INCR is 0, then the MAP will stay constant for successive writes. If INCR is set to 1, then MAP will auto increment after each byte is written, allowing block reads or writes of successive registers.

For more information on I²C, please see “The I²C-Bus Specification: Version 2.0”, listed in the References section.

* The MCLK is required for both control port interfaces.

Schematic & Layout Review Service

**Confirm Optimum
Schematic & Layout
Before Building Your Board.**

**For Our Free Review Service
Call Applications Engineering.**

C a l l : (5 1 2) 4 4 5 - 7 2 2 2



Memory Address Pointer (MAP)

| 7 | 6 | 5 | 4 | 3 | 2 | 1 | 0 |
|------|----------|----------|----------|----------|------|------|------|
| INCR | Reserved | Reserved | Reserved | Reserved | MAP2 | MAP1 | MAP0 |
| 0 | 0 | 0 | 0 | 0 | 0 | 0 | 0 |

INCR (Auto MAP Increment Enable)
 Default = '0'.
 0 - Disabled
 1 - Enabled

MAP0-2 (Memory Address Pointer)
 Default = '000'.

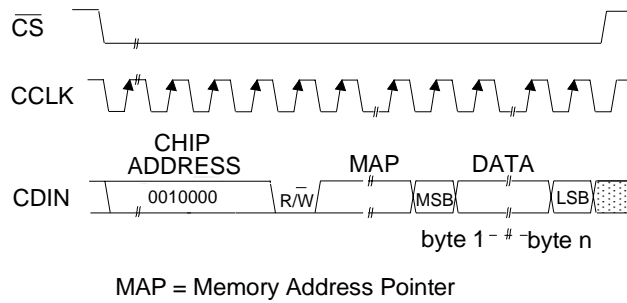
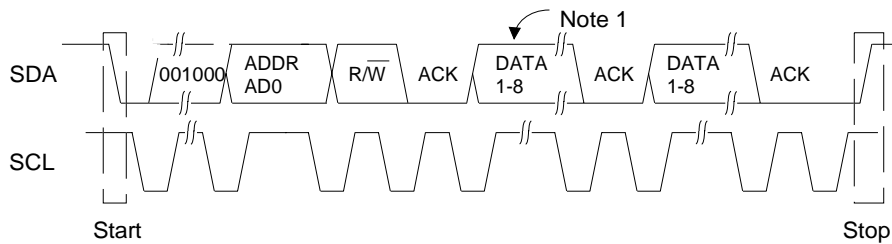

Figure 7. SPI Mode Control Port Formating



Note: If operation is a write, this byte contains the Memory Address Pointer, MAP.

Figure 8. I²C Mode Control Port Formating

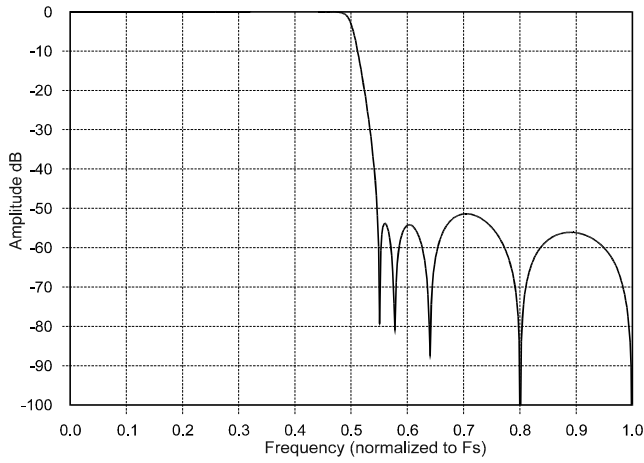

Figure 9. Base-Rate Stopband Rejection

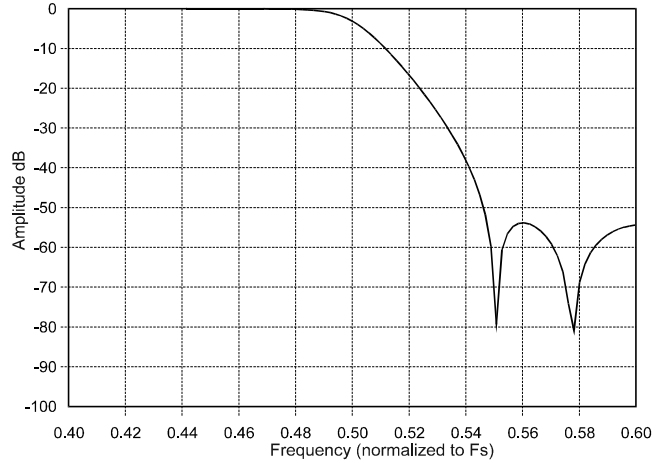

Figure 10. Base-Rate Transition Band

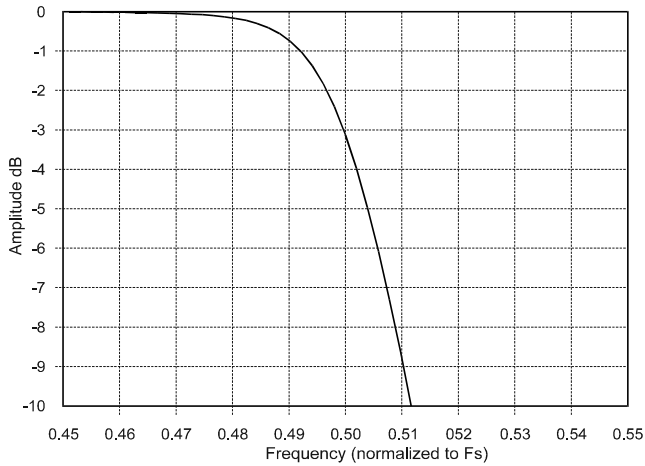

Figure 11. Base-Rate Transition Band (Detail)

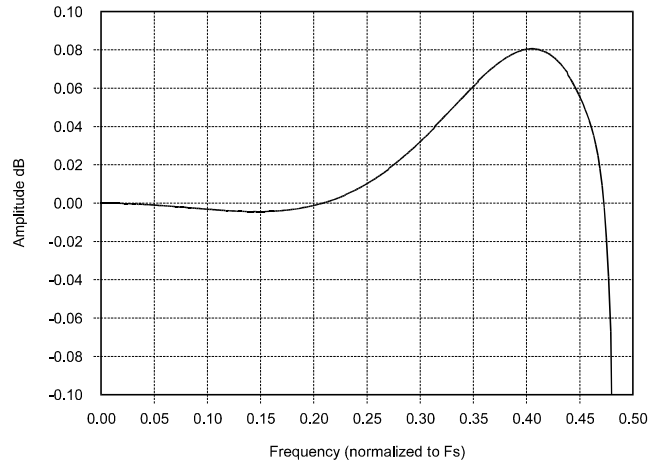

Figure 12. Base-Rate Passband Ripple

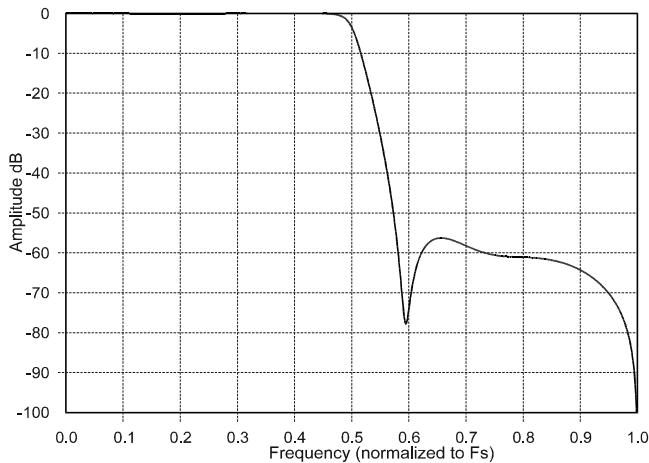

Figure 13. High-Rate Stopband Rejection

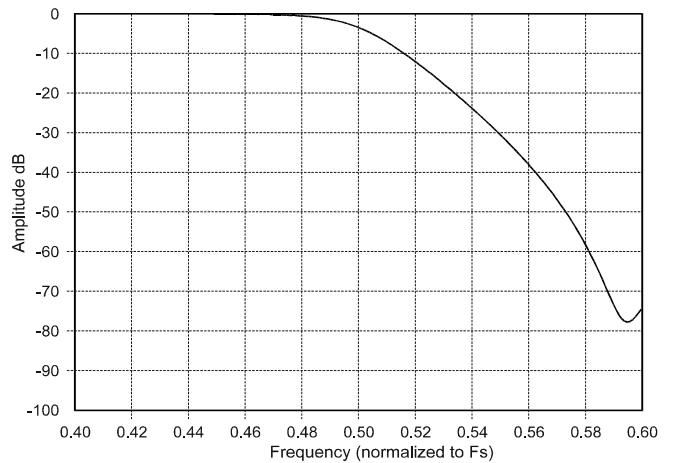

Figure 14. High-Rate Transition Band

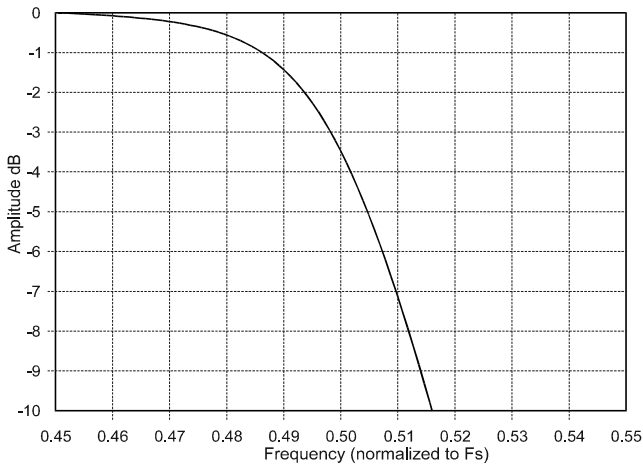

Figure 15. High-Rate Transition Band (Detail)

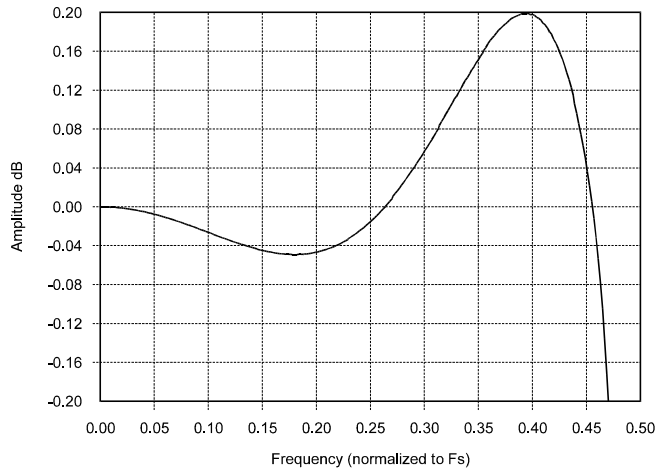

Figure 16. High-Rate Passband Ripple

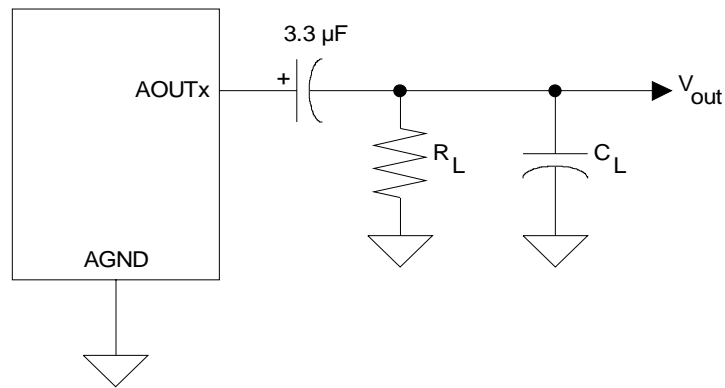

Figure 17. Output Test Load

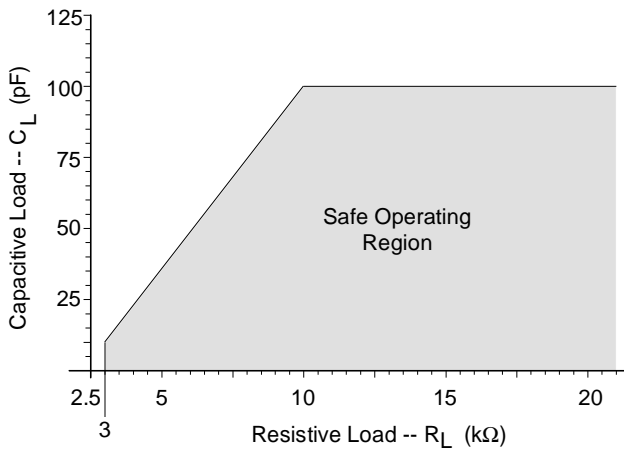

Figure 18. Maximum Loading

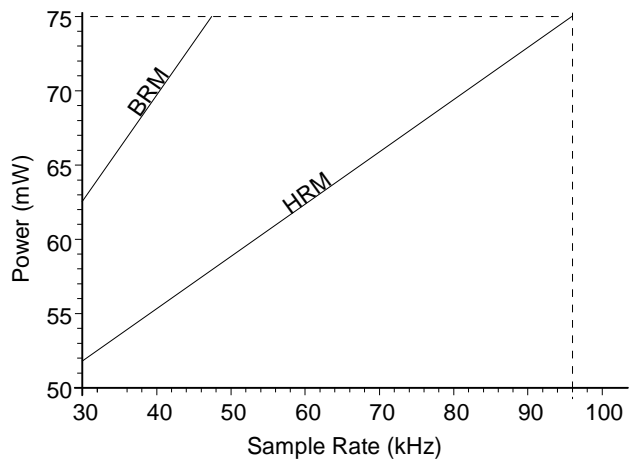
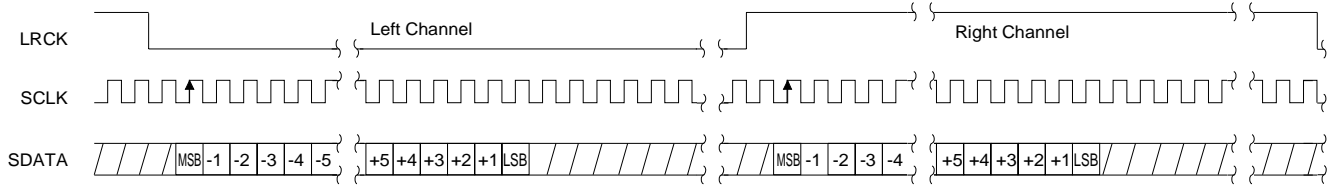
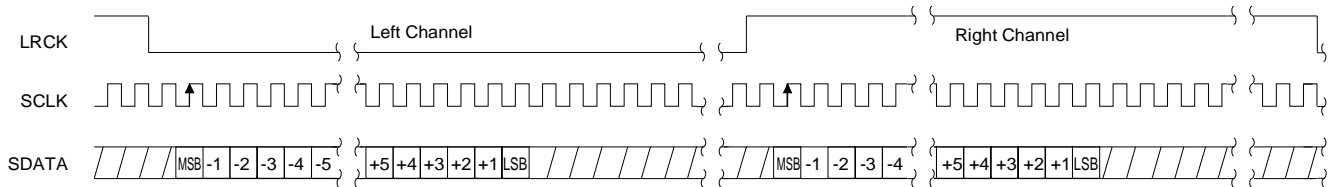

Figure 19. Power vs. Sample Rate ($V_A = 5V$)



| Internal SCLK Mode | External SCLK Mode |
|---|--|
| I ² S, Up to 24-Bit data and INT SCLK = 64 Fs if MCLK/LRCK = 512, 256 or 128 I ² S, Up to 24-Bit data and INT SCLK = 48 Fs if MCLK/LRCK = 384 or 192 | I ² S, up to 24-Bit Data Data Valid on Rising Edge of SCLK |

Figure 20. CS4341 Format 0 (I²S)

| Internal SCLK Mode | External SCLK Mode |
|---|--|
| I ² S, 16-Bit data and INT SCLK = 32 Fs if MCLK/LRCK = 512, 256 or 128 I ² S, Up to 24-Bit data and INT SCLK = 48 Fs if MCLK/LRCK = 384 or 192 | I ² S, up to 24-Bit Data Data Valid on Rising Edge of SCLK |

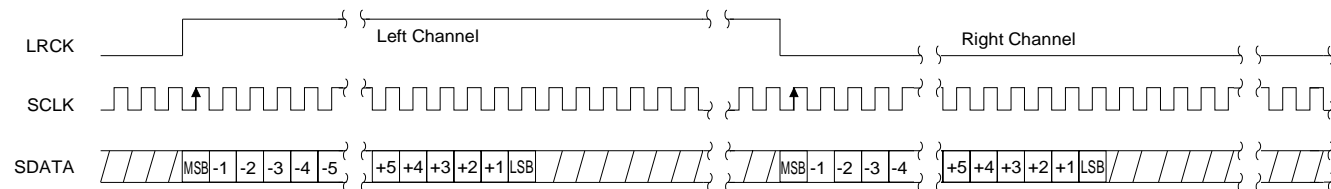
Figure 21. CS4341 Format 1 (I²S)

| Internal SCLK Mode | External SCLK Mode |
|--|--|
| Left Justified, up to 24-Bit Data INT SCLK = 64 Fs if MCLK/LRCK = 512, 256 or 128 INT SCLK = 48 Fs if MCLK/LRCK = 384 or 192 | Left Justified, up to 24-Bit Data Data Valid on Rising Edge of SCLK |

Figure 22. CS4341 Format 2

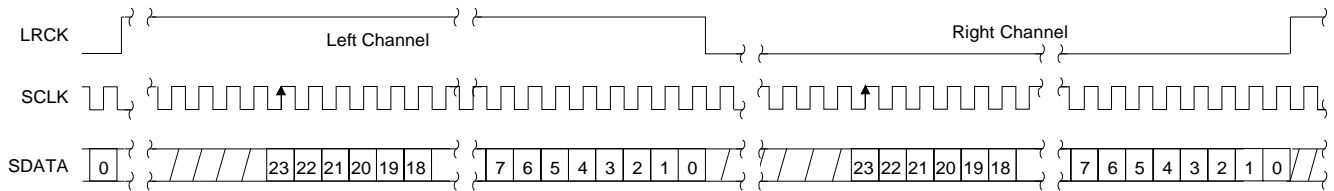

| Internal SCLK Mode | External SCLK Mode |
|--|--|
| Right Justified, 24-Bit Data MCLK/LRCK = 512, 256 or 128 INT SCLK = 48 Fs if MCLK/LRCK = 384 or 192 | Right Justified, 24-Bit Data Data Valid on Rising Edge of SCLK SCLK Must Have at Least 48 Cycles per LRCK Period |

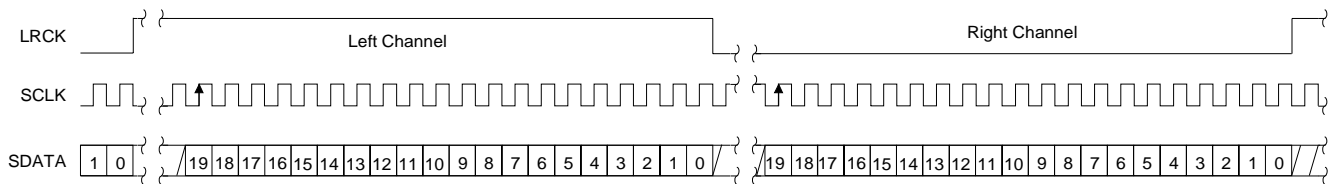
Figure 23. CS4341 Format 3

| Internal SCLK Mode | External SCLK Mode |
|--|--|
| Right Justified, 20-Bit Data MCLK/LRCK = 512, 256 or 128 INT SCLK = 48 Fs if MCLK/LRCK = 384 or 192 | Right Justified, 20-Bit Data Data Valid on Rising Edge of SCLK SCLK Must Have at Least 40 Cycles per LRCK Period |

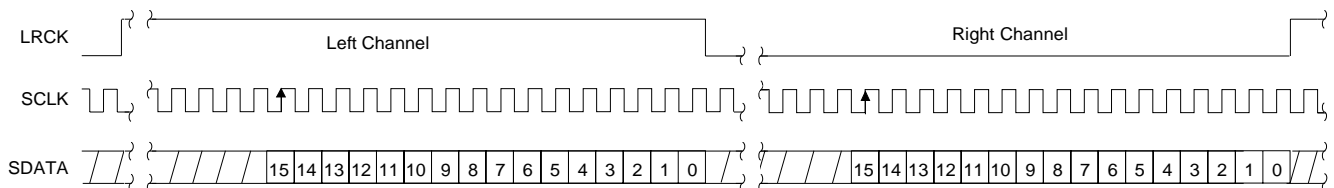
Figure 24. CS4341 Format 4

| Internal SCLK Mode | External SCLK Mode |
|--|--|
| Right Justified, 16-Bit Data MCLK/LRCK = 512, 256 or 128 INT SCLK = 48 Fs if MCLK/LRCK = 384 or 192 | Right Justified, 16-Bit Data Data Valid on Rising Edge of SCLK SCLK Must Have at Least 32 Cycles per LRCK Period |

Figure 25. CS4341 Format 5

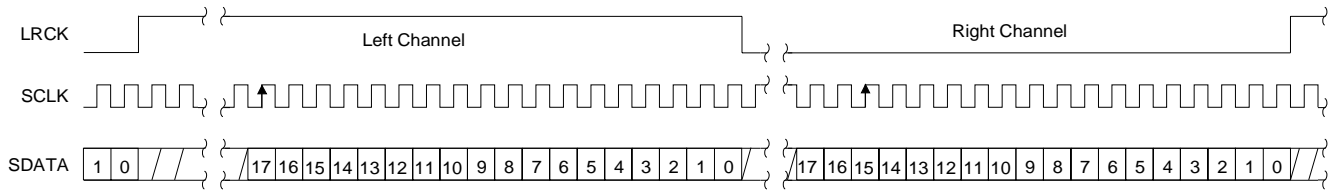

| Internal SCLK Mode | External SCLK Mode |
|---|--|
| Right Justified, 18-Bit Data MCLK/LRCK = 512, 256 or 128 SCLK = 64 Fs if SCLK = 48 Fs if MCLK/LRCK = 384 or 192 | Right Justified, 18-Bit Data Data Valid on Rising Edge of SCLK SCLK Must Have at Least 36 Cycles per LRCK Period |

Figure 26. CS4341 Format 6

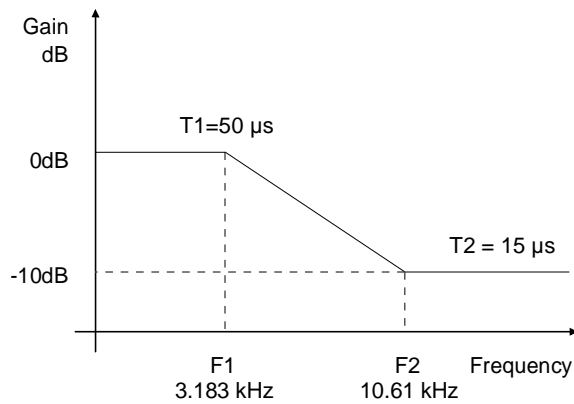

Figure 27. De-Emphasis Curve

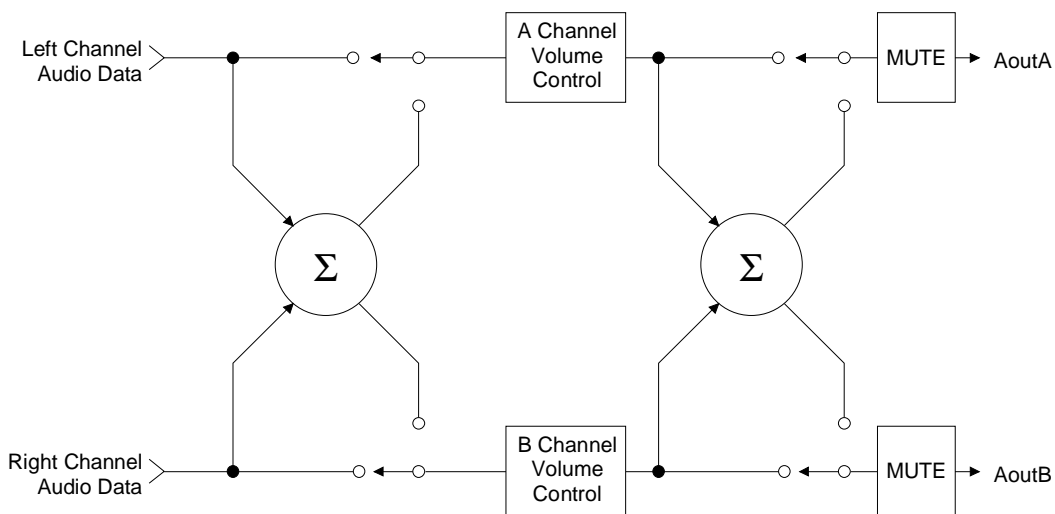

Figure 28. ATAPI Block Diagram

8. PARAMETER DEFINITIONS

Total Harmonic Distortion + Noise (THD+N)

The ratio of the rms value of the signal to the rms sum of all other spectral components over the specified bandwidth (typically 10Hz to 20kHz), including distortion components. Expressed in decibels.

Dynamic Range

The ratio of the full scale rms value of the signal to the rms sum of all other spectral components over the specified bandwidth. Dynamic range is a signal-to-noise measurement over the specified bandwidth made with a -60 dBFS signal. 60 dB is then added to the resulting measurement to refer the measurement to full scale. This technique ensures that the distortion components are below the noise level and do not affect the measurement. This measurement technique has been accepted by the Audio Engineering Society, AES17-1991, and the Electronic Industries Association of Japan, EIAJ CP-307.

Interchannel Isolation

A measure of crosstalk between the left and right channels. Measured for each channel at the converter's output with all zeros to the input under test and a full-scale signal applied to the other channel. Units in decibels.

Interchannel Gain Mismatch

The gain difference between left and right channels. Units in decibels.

Gain Error

The deviation from the nominal full scale analog output for a full scale digital input.

Gain Drift

The change in gain value with temperature. Units in ppm/°C.

9. REFERENCES

- 1) "How to Achieve Optimum Performance from Delta-Sigma A/D & D/A Converters" by Steven Harris. Paper presented at the 93rd Convention of the Audio Engineering Society, October 1992.
- 2) CDB4341 Evaluation Board Datasheet
- 3) "The I²C Bus Specification: Version 2.0" Philips Semiconductors, December 1998.
<http://www.semiconductors.philips.com>

10. PACKAGE DIMENSIONS

16L SOIC (150 MIL BODY) PACKAGE DRAWING

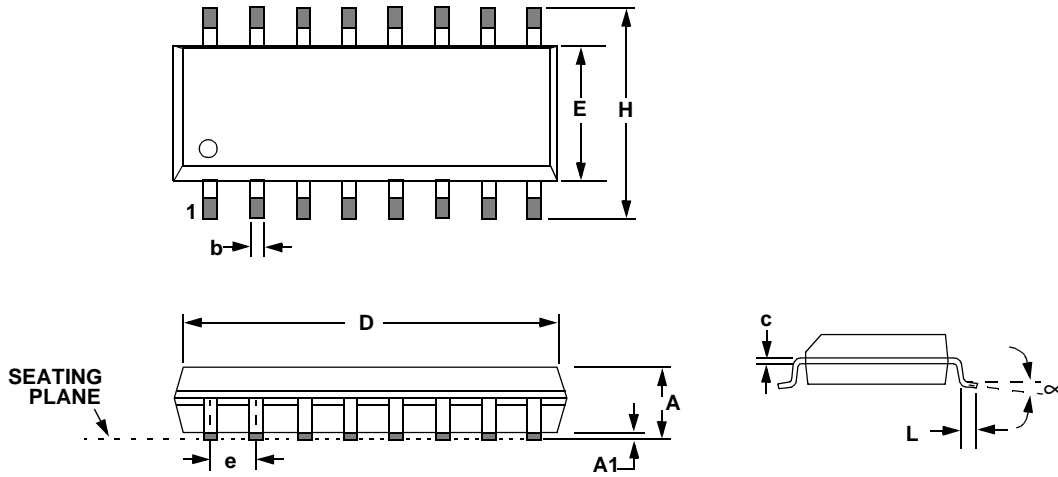

| DIM | INCHES | | MILLIMETERS | |
|-----|--------|-------|-------------|-------|
| | MIN | MAX | MIN | MAX |
| A | 0.053 | 0.069 | 1.35 | 1.75 |
| A1 | 0.004 | 0.010 | 0.10 | 0.25 |
| B | 0.013 | 0.020 | 0.33 | 0.51 |
| C | 0.007 | 0.010 | 0.19 | 0.25 |
| D | 0.386 | 0.394 | 9.80 | 10.00 |
| E | 0.150 | 0.157 | 3.80 | 4.00 |
| e | 0.040 | 0.060 | 1.02 | 1.52 |
| H | 0.228 | 0.244 | 5.80 | 6.20 |
| L | 0.016 | 0.050 | 0.40 | 1.27 |
| ∞ | 0° | 8° | 0° | 8° |

JEDEC # : MS-012

• **Notes** •

SMART
Analog™