

electronics

A McGraw-Hill Publication 75 Cents

TUNNEL DIODES

For nanosecond logic, p 72
(photo below)

NUCLEAR RADIATION

Designing for high dosage, p 51

ISOLATED PARAMP

Circulators not required, p 58

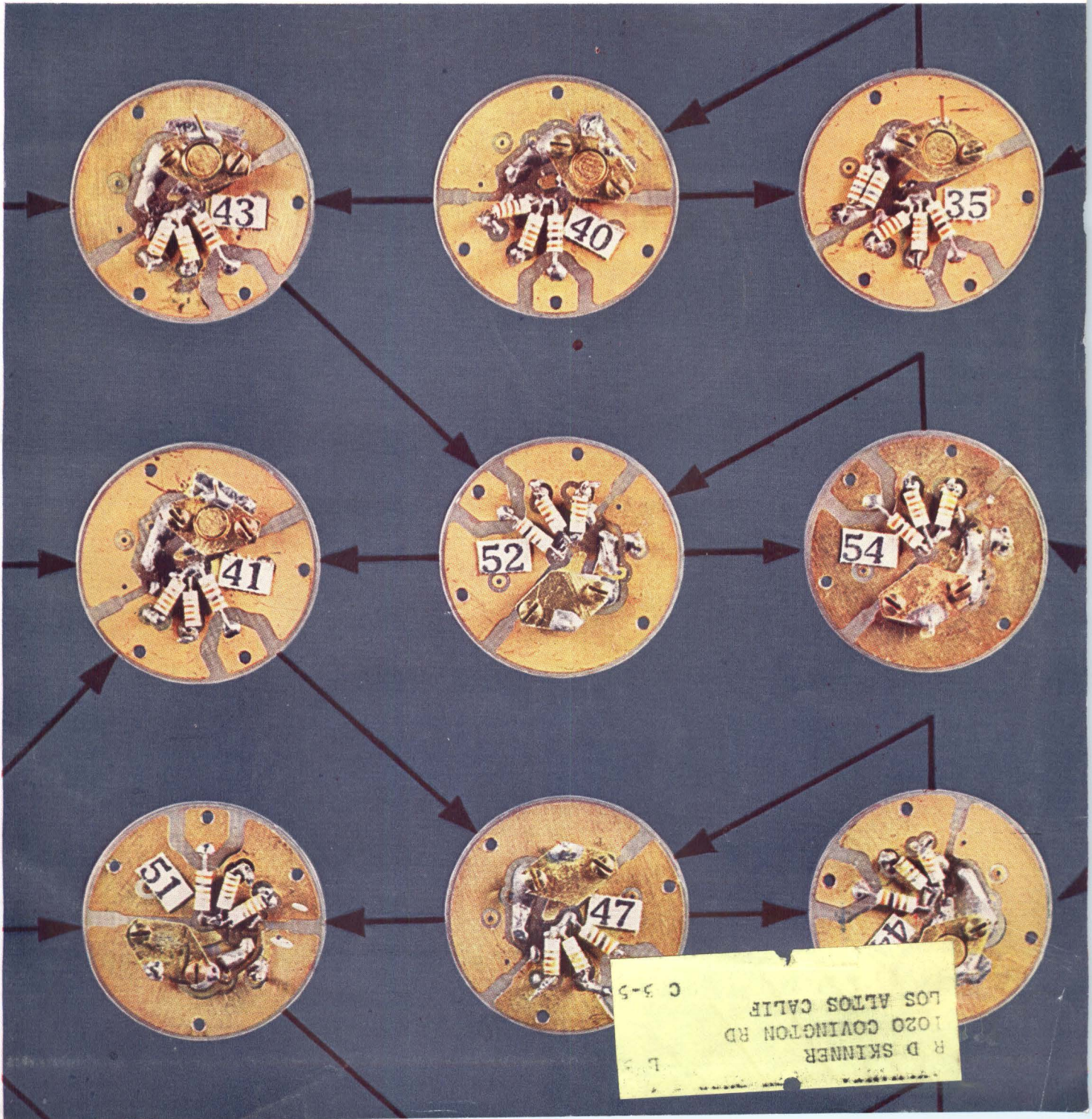

RAYTHEON

MAGNETICS OPERATION

MARCH

1962

S M T W T F S

1 2 3
 4 5 6 7 8 9 10
 11 12 13 14 15 16 17
 18 19 20 21 22 23 24
 25 26 27 28 29 30 31

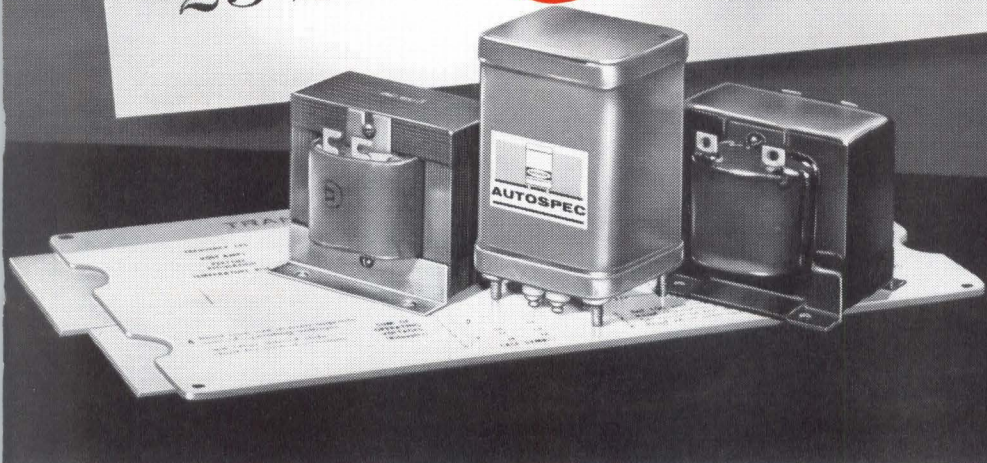

VITAL NEWS FOR ALL USERS OF TRANSFORMERS

AUTOSPEC from Raytheon...
 Transformers quoted in 3 days
 Delivered in 3 weeks

Raytheon announces the fastest, most efficient system yet devised for specifying, ordering and delivering power transformers and filter inductors to your requirements

From now on, every engineer can have at his fingertips a set of tools that will enable him to *automatically specify* the size of the transformer that exactly meets his electrical requirements. Mounting, terminal location and style are quickly and easily determined from convenient charts. The new Raytheon "AUTOSPEC" system delivers high quality "specials" in quantities from 1 to 15 within 3 weeks.

With AUTOSPEC, Raytheon has discarded

the classic trial-and-error approach to transformer design and has developed the first fully coordinated transformer data system for all required power, temperature rise, regulation and dimensional calculations.

A comprehensive brochure explains how you can employ AUTOSPEC to simplify your transformer design work and reduce component costs while cutting delivery time to the 2 to 3 weeks now associated with off-the-shelf items.

**HOW
 AUTOSPEC
 WORKS**



1. YOU DETERMINE SPECS,
 estimate size new easy way



2. QUOTE AND DRAWING
 confirms request in 3 days



3. PRODUCTION STARTS
 using new Raytheon technique

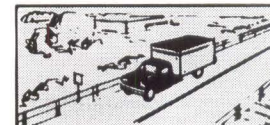

4. YOUR TRANSFORMERS
 are delivered within 3 weeks

**FREE
 SLIDE RULE**

**SEND COUPON
 ON PAGE 113** →

Unique transformer selector (shown in illustration above left) plus descriptive brochure and comprehensive technical manual will be sent by return mail on receipt of your coupon.

RAYTHEON

RAYTHEON COMPANY

MAGNETICS OPERATION

CIRCLE 251 ON READER SERVICE CARD

electronics

A McGraw-Hill Publication 75 Cents



W. W. MacDONALD, Editor

J. M. CARROLL, Managing Editor
 SENIOR EDITORS: Samuel Weber, George W. Sideris. SENIOR ASSOCIATE EDITORS: William E. Bushor, Michael F. Wolff. ASSOCIATE EDITORS: Michael F. Tomaino, Sylvester P. Carter, William P. O'Brien, John F. Mason, Thomas Emma, Sy Vogel, Leslie Solomon, M. M. Perugini, George J. Flynn, Laurence D. Shergalis. ASSISTANT EDITORS: Nilo Lindgren, Stanley Froud, Stephen B. Gray, Roy J. Bruun, George V. Novotny, Leon H. Dulberger. REGIONAL EDITORS: Harold C. Hood (Pacific Coast, Los Angeles), Thomas Maguire (New England, Boston), Cletus M. Wiley (Midwest, Chicago). ART DIRECTOR: Harry Phillips; Howard R. Berry. PRODUCTION EDITOR: John C. Wright, Jr. EDITORIAL ASSISTANTS: Gloria J. Meurer, Bernice Duffy, Lorraine Rossi, Virginia T. Bastian, Lynn Emery, Laura W. Smith, Bette H. Snyder, Rosemary Abbruzzese, Judy Haskins, Ann Mella. FOREIGN NEWS BUREAU: Director, John Wilhelm, Alyne Elias. LONDON—John Shinn, Derek Barlow, Nicholas Landon. Bonn—Peter Forbath, James Morrison, Silke McQueen. Paris—Robert Farrell, Arthur Erikson. Milan—Gene DiRaimondo. Mexico City—Bruce Bendow. Rio de Janeiro—Leslie Warren. Moscow—Stewart Ramsey. Tokyo—Richard Halloran, Charles Cohen, John Yamaguchi.

JAMES GIRDWOOD, Publisher

PUMPED TUNNEL DIODE-transistor logic processes data at 500-Mc rate in a circuit by GE. The transistor provides unidirectionality of information flow, the tunnel diode provides gain. *Since the transistor need not provide gain it may be operated close to its cutoff frequency. See p 72* COVER

SEMICONDUCTOR RADIATION DETECTORS Demonstrate Their Practicality. Sensitive to low-energy particles, these detectors are being used in space experiments and reactor diagnostics. *One estimate of next year's market: \$ $\frac{1}{2}$ million* 28

LANDING SYSTEMS for Manned Spacecraft. Approaches range from aircraft type radar beacons to on-board adaptive controls and combinations of pilot and ground control. *Maneuvering a powerless glider and overcoming communications blackouts are two of the major problems* 38

HIGHER FREQUENCY OPERATION Is One Goal of French Tube Manufacturers. Paris parts show also includes brushless variable transformer, electrostatic relay. *Missing from the show: implosion-proof tv picture tubes* 40

KERR CELL CAMERA Films in 5 Nsec. Six electronically-controlled shutters and film holders are arranged around central optics. *This permits framing rate of 100 million a second* 42

NUCLEAR RADIATION and How to Design Equipment to Live With It. The author considers high doses but low dose rate that may be encountered close to radioactive materials and tells how they affect metals, dielectrics and semiconductors. *The article supplements one we ran Feb. 10, 1961 dealing with transient, or nuclear weapon, radiation.* By P. Barratt 51

ISOLATED PARAMETRIC AMPLIFIER With Low Noise Figure. A big problem with parametric amplifiers is that they tend to be unstable. One way to cope with this instability is to use ferrite circulators to separate input and output. But circulators introduce losses. *This amplifier uses two varactors 90 degrees out of phase and a 3-db directional coupler to achieve isolation.* By L. D. Baldwin 58

BIONICS: Part IV—Applications and New Directions. The last article of a series deals in part with adaptive or learning networks that have been developed as analogies to biological systems. *One signal network consists of threads built up by passing current through ferrous sulfate solution. The paths, like memory associations, dissolve unless used.* By N. A. Lindgren 60

Contents continued

Published weekly, with Electronics Buyers' Guide and Reference issue, as part of the subscription, by McGraw-Hill Publishing Company, Inc. Founder: James H. McGraw (1860-1948).

Indexed Annually in Buyers' Guide and Reference issue.

Title ® registered U.S. Patent Office; © Copyright 1962 by McGraw-Hill Publishing Co., Inc. All rights reserved, including the right to reproduce the contents of this publication, in whole or in part.

Executive, editorial, circulation and advertising offices McGraw-Hill Building, 330 West 42nd Street, New York 36, N. Y. Telephone Longacre 4-3000. Teletype TWX N.Y. 1-1636. Cable McGrawhill, N. Y. PRINTED IN ALBANY, N. Y.; second class postage paid at Albany, N. Y.

OFFICERS OF THE PUBLICATIONS DIVISION: Nelson L. Bond, President; Shelton Fisher, Wallace F. Traendly, Senior Vice Presidents; John R. Callahan, Vice President and Editorial Director; Joseph H. Allen, Vice President and Director of Advertising Sales; A. R. Venezian, Vice President and Circulation Coordinator; Daniel F. Crowley, Vice President and Controller.

OFFICERS OF THE CORPORATION: Donald C. McGraw, President; Hugh J. Kelly, Harry L. Waddell, Executive Vice Presidents; L. Keith Goodrich, Executive Vice President and Treasurer; John J. Cooke, Vice President and Secretary.

Subscriptions are solicited only from those actively engaged in the field of the publication. Position and company connection must be indicated on orders. Subscription rates: United States and Possessions, \$6.00 one year; \$9.00 two years; \$12.00 three years. Canada, \$10.00 one year. All other countries \$20.00 one year. Single Copies, United States and Possessions and Canada 75¢. Single copies all other countries \$1.50.

THE PUBLISHER, UPON WRITTEN REQUEST FROM ANY SUBSCRIBER TO OUR NEW YORK OFFICE, AGREES TO REFUND THAT PART OF THE SUBSCRIPTION PRICE APPLYING TO COPIES NOT YET MAILED.

Subscribers: Please address all correspondence, change of address notices, subscription orders or complaints to Fulfillment Manager, Electronics, at above address. Change of address notices should provide old as well as new address, including postal zone number if any. If possible, attach address label from recent issue. Allow one month for change to become effective.

Postmaster: Please send Form 3579 to Fulfillment Manager, Electronics, 330 West 42nd Street, New York 36, New York.



Audited Paid Circulation

CONTENTS continued

VOLTAGE-CONTROLLED OSCILLATOR Uses Negative Feedback. It is used in an analog-to-digital converter that gives an output varying from 0 to 1,000 pulses per second as input varies from 0 to 10 mv. *Negative feedback loop includes two pulse counting discriminators with inputs from voltage-controlled oscillator and a stable reference oscillator.*
By N. W. Bell and V. Chiunti 64

COMPLEMENTARY COMPOUND EMITTER FOLLOWER. Compares the advantages and disadvantages of cascade and complementary compound emitter followers for applications where the current gain of a single emitter follower is insufficient. *Complementary circuit tends to limit power dissipation.*
By T. K. Hemingway 66

DEPARTMENTS

Crosstalk. <i>We've Just Not Been Trying</i>	3
Comment. <i>Cocktail Party Effect. Transmission-Line Charts</i>	4
Electronics Newsletter. <i>NASA Selects AT&T as Engineering Consultant for Manned Space Flight</i>	7
Washington Outlook. <i>Congress Supports Air Force on B-70, but Holds Up Nike Zeus Production Funds</i>	12
Meetings Ahead	44
Research and Development. <i>Tunnel Diode-Transistor Circuits Provide Fast Logic</i>	72
Components and Materials. <i>Potentiometer Senses Moving Light Source</i>	82
Production Techniques. <i>Rolled Joints Reduce Waveguide Costs</i>	88
New Products Design and Application. <i>Distributed-Constant R-f Module</i>	100
Literature of the Week	120
People and Plants. <i>Beau Electronics Opens New Plant</i>	122
Index to Advertisers	131

We've Just Not Been Trying

"DURING THE LAST FIVE YEARS . . . many new electronics firms have been started . . . almost none of which has failed. I believe something is wrong with a situation that perpetuates nearly every one."

The words are those of Finn J. Larsen, Army Assistant Secretary for Research and Development. They could be taken literally. Or they might have been chosen for their dramatic effect. At any rate, the electronics industry, by its very nature, requires a large number of companies. The sum total of their contributions, large and small, makes up the vast technological complex that is so vital to our scientific program, our national defense, our commercial expansion and our present way of life.

Where such a large number of companies is involved, obviously not all contribute at the same rate. But the intricate demands of today's technology often permits the smallest sub-subcontractor to play as vital a role as a major industry leader. Years ago a keen observer of the current scene gave us the words "For want of a nail, the shoe was lost . . ." and it is much like this in our field today.

Mr. Larsen's comments on the few failures in the field of electronics, however he meant them, put us in mind of the tv comedian who read to his audience a fictitious report to the effect that national traffic accidents during the week had been 28 percent below predictions. He followed this statistic with the statement "Some of you out there are just not trying!"

OLIVES AND COMPUTERS—How would you build a machine that could be taught by reward and punishment to do things better? Or even a machine that could modify its own actions in the light of what it had learned?

A computer could be rewarded by adding appropriate logic for a correct answer, so it gave a similar answer more speedily next time. For punishment, circuits that yielded wrong answers or didn't contribute to right ones could be pared away. Fit the computer with a robot armed with tools for adding or removing circuits—or with some electronic system that achieves the same result—and the reward-punishment process is automated.

But what if the nature of the problem changes? Suppose the computer is trained to recognize the letter

E. What does it do when presented with an *F*? It's likely the parts removed in the *E* recognition process are vital to *F* recognition. So they would have to be replaced and others removed as *F* is learned. This is hardly the best example of an automatic process.

In his concluding article on bionics this week, Assistant Editor Lindgren discusses some more reasonable approaches to apparatus that learns by reward and punishment. Their

basic simplicity helps these devices adapt themselves to a change of problem without drastic alterations.

One approach looks like a jar of olives. Except the olives are small metal spheres and the vinegar is acid that attacks the spheres and develops a non-conducting layer between their points of contact.

Electric pulses break down the insulating layers between spheres. Since the jar is fitted with electrodes through its wall, these pulses can be applied to any of the outer layer of balls and detected at other chosen locations. The apparatus is rewarded by bonus pulses that maintain a useful conducting path when the desired response is detected. If it delivers the wrong output, it is punished by allowing the insulation layers to reform.

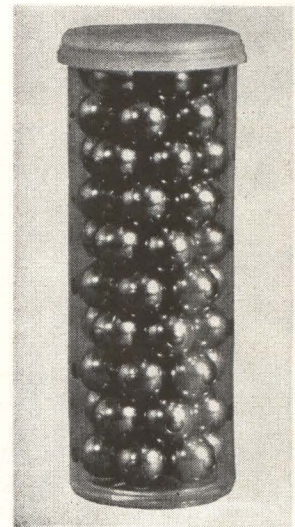

Coming In Our March 23 Issue

SYMBOGRAPHY. As promised a few months ago, we publish next week 500 graphical symbols and letter symbols for electronics diagrams. They will be arranged on one side of a 30 by 11½-inch foldout special section.

Another article tells how a tunnel diode working as an oscillator with a saturable reactor provides an excellent frequency-control device, by R. E. Morgan, of GE.

J. W. Martin and J. R. Cox, of Texas R&D Corp., in still another feature, describe uses of a solion tetrode in a chromatograph. An integrator using solion cells can drive a transistor, to operate control circuits.

Stainless Steel ATTENUATORS by WEINSCHEL

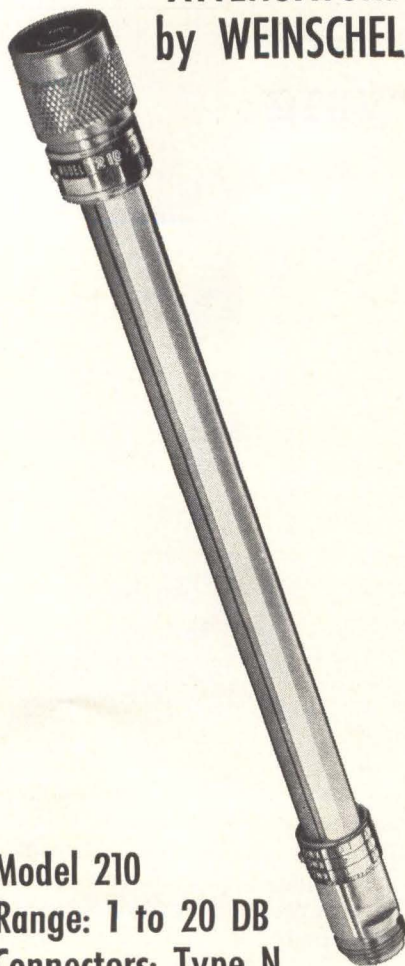

Model 210
Range: 1 to 20 DB
Connectors: Type N

The ruggedness and longer life of stainless steel connectors and metal parts make these attenuators exceptional—and only Weinschel makes them. The Model 210 has these additional

Exclusive Weinschel Features:

- Weinschel film resistors withstand shock and vibration and give maximum stability under peak pulse power and under extreme temperature and humidity cycling.
- Certificate of Calibration showing insertion loss test data with guaranteed accuracy explicitly stated.
- Critical dimension of inner contact depth held to ± 0.005 inches, exceeding all government specifications.

Write for Weinschel Engineering Bulletin

WEINSCHEL
ENGINEERING

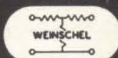

10503 METROPOLITAN AVENUE
KENSINGTON, MARYLAND
Tel.: 949-0141 (Area Code 301)
TWX: KENS 446
In California: 631 Wilshire Blvd.
Santa Monica
TWX: SMON 7185

COMMENT

The Cocktail Party Effect

I'm glad to see all this high-level dissertation on the cocktail party effect (*Crosstalk*, p 3, Feb. 16). I had observed this phenomenon for years—particularly in Washington and New York press parties—but had made no scientific analysis of it.

I had attempted to discuss my observation with other party attendees on various occasions, but at this point in the party the ambient noise level was too high for intelligent conversation. (It's hard to be profound while shouting.)

I finally concluded that my auricular system S/N somehow diminished directly in proportion to either party duration or alcoholic saturation. Thanks for helping clear up this disturbing conclusion. I'm leaving now to pick up some earplugs and go to a cocktail party.

HAL GETTINGS

Dynatronics, Inc.
Orlando, Florida

The *Crosstalk* discussed several cocktail party effects. One is the ability of a party attendee to screen out unwanted conversation and concentrate on the interesting talk, another is to decide from what direction a given sound comes. Combining these two effects, the party-goer can listen to a remote conversation when the nearer one becomes dull.

A third cocktail party effect is the gradually increasing noise level as speakers from several groups try to talk above the general din. The louder one person talks, the higher the others tend to raise their voices to combat him. The result is a cumulative increase in noise level until everybody is shouting to make himself heard.

Transmission-Line Charts

In reading the December 1, 1961, issue, I noticed the article Logarithmic Transmission-Line charts (p 48), by H. F. Mathis: In this article, the author introduces the same logarithmic charts that I have published, as early as 1955, in the

French periodical *L'Onde Electrique*.

R. GUILLIEN
Director

l'Ecole Nationale Supérieure
d'Electricite et de Mecanique
University of Nancy, France

Professor Mathis sent us a letter he received:

A few days ago my attention was drawn to an article entitled Logarithmic Transmission-Line Charts. I wish to refer to Fig. 2 (p 50), the Logarithmic $Z - \theta$ chart, which is basically similar to a chart published by the writer twenty-five years ago in the *Marconi Review*. It was still customary in those days to use hyps or nepers as units of attenuation, and the chart was plotted in those units. Between the chart published by you and the one by the writer there is a difference in origin of abscissae of 90 degrees or one-quarter wavelength.

I enclose copy of a paper written by three notable Marconi engineers: C. S. Franklin, N. M. Rust and B. J. Witt, on the design and setting up of the feeders and aerials of the world's first television station, at Alexandria Palace, London. It was my job to devise the chart in question to facilitate the feeder and aerial calculations in 1936 for the Alexandria Palace project, and the paper provides examples of its use in that project.

H. CAFFERATA

Marconi's Wireless

Telegraph Company, Ltd.
Chelmsford, Essex, England

Professor Mathis writes that he did not prepare a research paper but one intended to be a working tool, similar to others that had gone before, yet different in some details. He encloses a letter he wrote to Mr. Cafferata, which reads in part:

You may be interested in knowing that E. A. Kennelly published almost the same charts in 1914, in his very large book "Chart Atlas of Complex Hyperbolic Functions," which was published by the Harvard University Press. I did not know this until it was called to my attention by a friend.

H. F. MATHIS

The Ohio State University
Columbus, Ohio

LAMBDA

Convection Cooled Transistorized Regulated Power Supplies

AVAILABLE FROM STOCK

VISIT
LAMBDA
AT THE IRE SHOW
BOOTHS 2317-2319

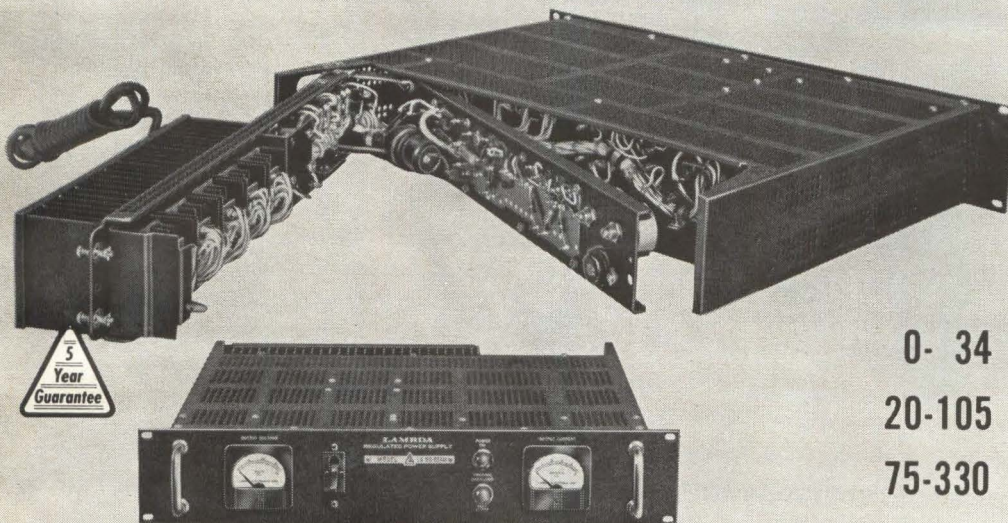

LA SERIES

0- 34 VDC 5, 10, 20 AMP
20-105 VDC 2, 4, 8 AMP
75-330 VDC 0.8, 1.5, 3 AMP

SPECIAL FEATURES

- Convection Cooled—No internal blowers or filters—maintenance free
- Ambient 50°C
- No Voltage Spikes or overshoot on "turn on, turn off," or power failure
- Guaranteed 5 years
- Remote programming over Vernier band
- Hermetically-sealed transformer designed to MIL-T-27A
- Easy Service Access
- Short Circuit Proof
- Constant Current Operation—Consult Factory

ALL MODELS 105-140 VAC INPUT

CONDENSED DATA—LA SERIES

DC OUTPUT (Regulated for line and load)

Model	Voltage Range (1)	Vernier Band (2)	Current Range (3)	Price (4)
LA 50-03B	0- 34 VDC	4 V	0- 5 AMP	\$ 395
LA100-03B	0- 34 VDC	4 V	0-10 AMP	510
LA200-03B	0- 34 VDC	4 V	0-20 AMP	795
LA 20-05B	20-105 VDC	10 V	0- 2 AMP	350
LA 40-05B	20-105 VDC	10 V	0- 4 AMP	495
LA 80-05B	20-105 VDC	10 V	0- 8 AMP	780
LA 8-08B	75-330 VDC	30 V	0- 0.8 AMP	395
LA 15-08B	75-330 VDC	30 V	0- 1.5 AMP	560
LA 30-08B	75-330 VDC	30 V	0- 3 AMP	860

Regulation (line) Less than 0.05 per cent or 8 millivolts (whichever is greater). For input variations from 105-140 VAC.

Regulation (load) Less than 0.10 per cent or 15 millivolts (whichever is greater). For load variations from 0 to full load.

Ripple and Noise Less than 1 millivolt rms with either terminal grounded.

Temperature

Coefficient Less than 0.025%/°C.

(1) The DC output voltage for each model is completely covered by four selector switches plus vernier band.

(2) Center of vernier band may be set at any of 16 points throughout voltage range.

(3) Current rating applies over entire voltage range.

(4) Prices are for unmetred models. For metred models add the suffix "M" and add \$30.00 to the price.

AC INPUT

105-140 VAC, 60 ± 0.3 cycle (5)

(5) This frequency band amply covers standard commercial power line tolerances in the United States and Canada. For operation over wider frequency band, consult factory.

Size

LA 50-03B, LA20-05B, LA 8-08B 3½" H x 19" W x 14¾" D
LA100-03B, LA40-05B, LA15-08B 7" H x 19" W x 14¾" D
LA200-03B, LA80-05B, LA30-08B 10½" H x 19" W x 16½" D

SEND FOR COMPLETE LAMBDA CATALOG.



LAMBDA ELECTRONICS CORP.

515 BROAD HOLLOW ROAD • HUNTINGTON, L. I., NEW YORK • 516 MYRTLE 4-4200

Western Regional Office: 230 North Lake Avenue, Pasadena, California • Phone: Code 213, MUrray 1-2544

New England Regional Office: 275 Boston Post Road, Marlboro, Massachusetts • Phone: Code 617, HUntley 5-7122

Middle Atlantic District Office: 515 Broad Hollow Road, Huntington, L. I., New York • Phone: Code 516, MYrtle 4-4200

CIRCLE 5 ON READER SERVICE CARD

Send for this
New Guide to
Microwave
Techniques and
Equipment!



Instruments, specs listed by
frequency band!
Typical bench setups pictured
Microwave techniques authoritatively
detailed



This new Microwave Catalog gives you a complete listing of Hewlett-Packard's full-range tested microwave instrumentation, together with helpful descriptions of various microwave measurement techniques. The information and the instrumentation are fully indexed, with instruments and equipment listed by frequency bands. Just find the frequency ranges in which you are interested . . . and you have basic specs on all

available equipment and instrumentation, together with a photograph of a setup incorporating the instruments.

Typical of the information in the catalog are discussions of swept frequency measuring techniques, methods for measuring SWR, and measurement of frequency, impedance, attenuation, power and noise figure.

HEWLETT-PACKARD COMPANY

Sales and service representatives in all principal United States areas; **Europe**, Hewlett-Packard S.A., Rue du Vieux Billard No. 1, Geneva; **Canada**, Hewlett-Packard (Canada) Ltd., 8270 Mayrand Street, Montreal.

Hewlett-Packard Co., 1501 Page Mill Rd., Dept. A, Palo Alto, California:

Please send new Microwave Catalog to:

Name _____
 Company _____ Mail Sta. _____
 Street _____
 City _____
 Zone _____ State _____

ELECTRONICS NEWSLETTER

NASA Selects AT&T as Engineering Consultant

WASHINGTON—NASA is negotiating with AT&T on a contract to provide system engineering support for manned space flight programs, including Mercury, Gemini and Apollo. The Bell System is to provide analysis and fact-finding support, but not hardware.

The arrangement is reminiscent of Air Force contracts for missile and space programs (p 22, Aug. 25, 1961). Air Force first used Space Technology Labs, a profit-seeking organization, and then Aerospace Corp., a nonprofit firm. STL's parent, Thompson Ramo-Wooldridge, was banned from selling hardware on STL project. Whether a similar ban will be placed on AT&T's Western Electric will be determined at the negotiation meeting, it was reported.

Dollar amount and duration are also to be negotiated. Duration will probably be one year, subject to renewal. NASA hopes to build up sufficient in-house capability to eventually dispense with this type of contract altogether. An estimated 200 AT&T personnel will be responsible to Joseph Shea, NASA deputy director for manned space flight systems.

Fast-Searching Cryogenic Memory Associates Data

CRYOGENIC associative memory circuit has been developed by General Electric's Heavy Military Electronics department and Research Laboratory. The device simultaneously compares all stored computer information, associating input data with any portion of related data in the memory. GE says it is the first operative circuit of its kind.

The memory circuit is composed of numerous lead and tin cryotrons, evaporated on a glass substrate. The circuit is kept in liquid helium, at a temperature of -452 F. Leads pass through the flask to room-temperature computing equipment.

GE says the memory's small size, high capacity and high speed should result in applications in military and commercial computers, includ-

ing air traffic control, missile detection and satellite monitoring and control.

The engineering model measures 3 by 6 by $\frac{1}{2}$ in., contains 81 cryotrons and stores three 3-bit words. Density can be raised to 16 21-bit words. GE estimates that a comparison time of 50 μ sec would be needed to locate the first association in a 300,000-bit memory.

West Ford Project Gets Go-Ahead for New Launch

BOSTON—Space Science Board is giving MIT Lincoln Laboratory approval for a second try at West Ford. A 40,000-mi-long orbiting belt of dipoles, 2,000-mi high, is to be used as reflector for intercontinental communications at 8 Gc.

The new payload has been extensively modified. The package launched Oct. 21, 1961, did not disperse its dipoles because the ejected package failed to spin, leaving the fibers clustered. Five or six clumps have been tracked for several months by Lincoln Lab's Millstone

Hill uhf radar equipment.

Besides mechanical redesign, a vhf beacon and telemetry have been added to indicate package position, spin and tumble rate, and dipole dispensing. To make room, the number of dipole fibers has been reduced from 350 million to 250 million, cutting weight to 50 lb.

Dipoles will be ejected on ground command only if the package goes into suitable orbit, to make sure dipoles have limited lifetime. During the wait for the second launch, high-capacity digital data transmission equipment has been tested with the moon as a substitute for the dipoles.

Commerce Department Sees Electronics Rise in 1962

WASHINGTON—Business and Defense Services Administration of the Department of Commerce sees 1962 as another growth year for electronics. More competition, however, will keep profits from rising at the same rate as factory value.

Here are the estimated increases: systems and equipment, \$7.2 billion, up seven percent; components, \$3.7 billion, up from \$3.54 billion; consumer electronics, \$1.9 billion, a gain of seven percent, with a rise of 50 to 100 percent anticipated for color tv.

Figures do not include R&D, business expenses and operating revenues. R&D may reach \$2.8 billion in 1962. Among the few declining segments are receiving

Court Upholds Pay Tv Broadcasts in Hartford

WASHINGTON—U. S. Court of Appeals last week upheld the FCC's authority to permit trial operation of pay tv systems. In dispute was the three-year license for RKO's Phonevision Co. in Hartford, Conn.

Connecticut Committee Against Pay Tv and a group of theatre chains said the FCC could not authorize a broadcasting system which requires payment of fees by the public. The court said Congress gave FCC power to experiment and develop communication facilities.

Phonevision plans to present 40 hours a week of programs over station WHCT, charge from 25¢ to \$3.50 a program. The system was developed by Zenith Radio Corp.

tubes, which are expected to drop \$10 million, to \$350 million. While semiconductor sales will rise \$30 million, to \$610 million, the profit increase will not be as large, BDSA says.

Ocean-Bottom Seismograph Detects Nuclear Blasts

DALLAS—Texas Instruments is reported to have developed a seismograph which will detect natural earth tremors and distant nuclear detonations when it is placed on the ocean floor at depths to 1,600 fathoms. The station is said to sense, gather and store seismic information automatically. Data is digitally recorded on magnetic tape for later recovery and interpretation. The system was developed as part of Project Vela Uniform.

Another Line of Large Computers on the Market

ANOTHER SERIES of computer systems, the 1800, was announced last week by Minneapolis-Honeywell's EDP division. One system is a central processor which performs more than 120,000 three-address operations a second and has a memory cycle of 2 μ sec. A floating-point arithmetic unit operates at nano-second speeds when used with the processor.

Developed for "very large business and scientific" uses, the two units combined sell for over \$1 million. The arithmetic unit makes extensive use of tunnel-diode circuits. Equipment utilizes features of the Honeywell 800 systems and will work with peripheral equipment in the 800 line.

Plan Computers That Read and Make Parts

ROCHESTER, MINN. — Development programs in numerical machine control and also in character reading systems are underway at IBM's General Products division here.

A new laboratory is working on ways to integrate numerically con-

trolled machines into moderately sized manufacturing operations. Aim is a data-processing system that will tie together parts design and manufacturing. Investigations will be made of mechanism synthesis by computer, parts selection and fitting and production techniques for selection and control of machines.

Object of the character recognition program is to develop equipment that is faster and more versatile than optical and magnetic readers now made by IBM. One aim is high-speed alphanumeric readers. Contextual reading, recognizing groups of letters and words, is one technique to be probed.

High-Accuracy Ranging System Contract Given

MOTOROLA'S Military Electronics division in Arizona has won the \$3 million contract for R&D on the Goddard Range and Range Rate Tracking System. Using carrier and side-tone modulation measurements, the system is to track near-space and cislunar probes with position accuracy of a few feet and velocity within fractions of a foot per second. Stations are to be transportable, to accommodate different satellite orbits. Development of ground and airborne equipment for NASA will take about a year.

Apollo Will Use Fuel Cells as Power Source

NORTH AMERICAN AVIATION is awarding two competitive contracts for development of fuel cells for Apollo spacecraft. One contract will go to Pratt & Whitney and the other to Tapco division of Thompson-Ramo-Wooldridge.

The cells, operating on oxygen and hydrogen are expected to provide a lightweight electrical power source, with potable water for the crew as a byproduct.

Ionics, Inc., of Cambridge, Mass., has teamed up with Tapco. Ionics has developed a unit reported to deliver 250 w at 28 v. It uses a stack of 40 internally-manifolded dual membrane cells.

In Brief . . .

ARMED SERVICES Electro-Standards Agency (ASESA) will move this summer from Fort Monmouth to the new Defense Electronics Supply Center, Dayton, Ohio.

JAPAN'S electronics exports to the U. S. in the first nine months of 1961 were \$78.4 million, up 24 percent over the 1960 period.

NASA launched its Orbiting Solar Observatory last week (p 8, March 2). The agency also announced it was establishing its Atlantic and Pacific Missile Ranges as independent field installations.

FORD MOTOR will include all-transistor ignition system as optional equipment on 1963 trucks.

BECKMAN INSTRUMENTS and Toshiba have formed a jointly-owned company, Beckman-Toshiba, in Tokyo. It will produce Beckman products in Japan.

DEFENSE DEPARTMENT patent policies were rapped by the Joint Congressional Economic Committee. It wants the Pentagon to follow AEC policies for greater public use of inventions.

BENDIX announces its computer division will specialize in engineering and scientific computers for military and other uses.

R&D CONTRACTS include \$200,000 to Electro Nuclear Systems in field of undersea warfare. Tasker Instruments will study analog-digital hybrid computer organization for Air Force.

ANTENNA contracts include \$700,000 to Rohr for two more missile range tracking antennas, and \$79,000 to Scientific-Atlanta for a tracking system for the Saturn booster.

MILITARY CONTRACTS include \$2.4 million to Fairchild Camera & Instrument, tv systems for Talos missiles; \$1 million to Kinetics Corp., switching devices for Titan; \$800,000 to Manson Labs, for uhf tactical communications for Navy.

NOW
AVAILABLE
WITH WELDABLE
LEADS

**RUGGED END-CAP
CONSTRUCTION FOR
LONG TERM STABILITY**

**EXCEPTIONAL RESISTANCE
TO MOISTURE
AND MECHANICAL
DAMAGE**

**SURPASS MIL-R-10509
PERFORMANCE
REQUIREMENTS**

AVAILABLE IN
REEL PACKING
FOR AUTOMATED
PWB INSERTION

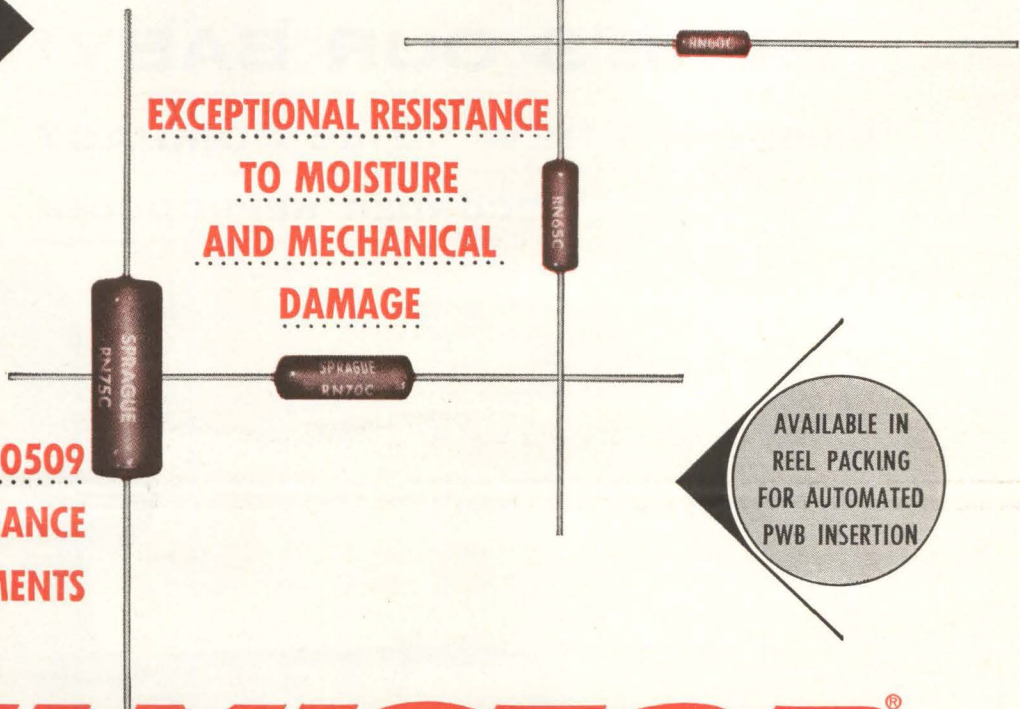

FILMISTOR[®]

METAL FILM RESISTORS

**OFFER 5 DISTINCT
TEMPERATURE
COEFFICIENTS TO
MEET ALL CIRCUIT
REQUIREMENTS**

Providing close accuracy, reliability and stability with low controlled temperature coefficients, these molded case metal-film resistors outperform precision wirewound and carbon film resistors. Prime characteristics include minimum inherent noise level, negligible voltage coefficient of resistance and excellent long-time stability under rated load as well as under severe conditions of humidity.

Close tracking of resistance values of 2 or more resistors over a wide temperature range is another key performance characteristic of molded-case Filmistor Metal Film Resistors. This is especially important where they are used to make highly accurate ratio dividers.

Filmistor Metal Film Resistors, in 1/8, 1/4, 1/2 and 1 watt ratings, surpass stringent performance requirements of MIL-R-10509D, Characteristics C and E. Write for Engineering Bulletin No. 7025 to: Technical Literature Section, Sprague Electric Co., 35 Marshall Street, North Adams, Mass.

*For application engineering assistance write:
Resistor Division, Sprague Electric Co., Nashua, New Hampshire.*

SPRAGUE COMPONENTS

RESISTORS
CAPACITORS
MAGNETIC COMPONENTS
TRANSISTORS

INTERFERENCE FILTERS
PULSE TRANSFORMERS
PIEZOELECTRIC CERAMICS
PULSE-FORMING NETWORKS

HIGH TEMPERATURE MAGNET WIRE
CERAMIC-BASE PRINTED NETWORKS
PACKAGED COMPONENT ASSEMBLIES
FUNCTIONAL DIGITAL CIRCUITS



'Sprague' and '®' are registered trademarks of the Sprague Electric Co.

HERE'S OUR BABY!
MINCOM'S NEW 1.2 mc COMPACT
RECORDER/REPRODUCER



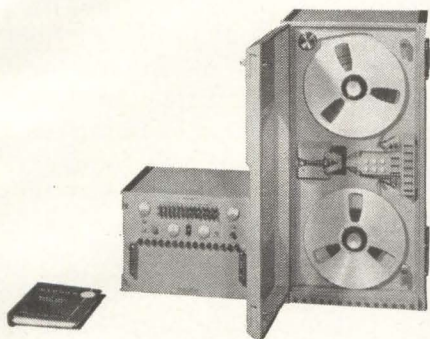

MINCOM'S NEW CMP-100 is the first mobile field recorder/reproducer with wideband and predetection performance. Like Mincom's standard-rack CM-100, the new **Series CMP** records up to 1.2 mc on seven tracks at 120 ips — with the positive accuracy possible only with longitudinal recording on fixed heads. Its two major components can be placed in an over/under configuration, side by side, or separated; it is easily fitted into many airborne, ship-board or van installations. The only transportable field system with six speeds, **CMP** is wired for full remote control and has two monitor playback channels.

Mincom Series G-100 — Now 600 kc at 120 ips

Bandwidth and speed are now increased in the **Series G-100**, a superb, all-purpose general instrumentation system with improved dynamic range. Performs both FM and analog testing, RF or closed-circuit data storage, with a Direct response of 300 cycles to 600 kc at 120 ips. FM response at 60 ips is dc to 20 kc (extended), dc to 10 kc (standard).

The **G-100** Recorder/Reproducer, with fourteen interchangeable analog or FM tracks in one standard rack, is reliable and simple, with plug-in card system record/reproduce modules and Mincom's exclusive DC tape transport.

Two Important Facts about Mincom Recorder/Reproducers

1. Indefinitely prolonged recording time is possible with Mincom systems. An **automatic** transfer, with a 30-second overlap, enables any pair of similar Mincom recorders to gather consecutive information for any desired period of time.
2. Mincom's method of longitudinal recording with stationary heads assures **reliable** response up to 1.2 megacycles. The mechanical precision of Mincom's fixed-head assemblies is an important factor in recording continuous, uninterrupted data, as well as in ease of operation and reduction of maintenance down time.



Write for details and complete specifications

Mincom Division **3M**
COMPANY

Los Angeles 25, California • Washington 4, D.C.

WASHINGTON OUTLOOK

CONGRESS SUPPORTS AIR FORCE ON B-70

A NEW POLITICAL RUMPUS is shaping up over the B-70 program. The House Armed Services Committee, in approving an aircraft, missiles and ships authorization bill for next year, added \$320 million to the administration's \$171 million B-70 budget. In unprecedented language, the committee "directed, ordered, mandated, and required" the use of the extra funds.

The present B-70 schedule calls for three stripped-down prototype models of the Mach 3 plane for flight testing. The House committee put in the extra funds to resume development of the bomb-nav, communications, and other electronic subsystems and to expand the program to six prototypes (including one fully-equipped weapon system model).

The committee, in effect, is supporting the Air Force in its fight against Defense Secretary McNamara on the B-70. McNamara showed no sign of changing his adamant stand against a B-70 stepup. He has already refused to spend the extra \$180 million voted by Congress for the B-70, is holding this year's level of spending to \$220 million. Odds are the Senate Armed Services Committee and the two appropriations committees will continue the pressure on McNamara.

Air Force has been unsuccessfully pushing for funds to reorient the program toward weapon system status, with eventual production of at least 35 operational-model aircraft. The plane has been redesignated the RS-70 (reconnaissance strike), would be crammed with missiles and reconnaissance apparatus and would no longer function as a conventional bomber with predetermined targets. Its mission would be to roam over enemy territory after an initial ICBM exchange, performing surveillance and selecting strategic targets.

NIKE ZEUS PRODUCTION HELD UP

ON ANOTHER CONTROVERSIAL defense project with considerable electronic implications—the Army's Nike Zeus anti-ICBM—the House Armed Services Committee supported McNamara's decision to withhold production.

Said the Committee: "These (terminal defense) systems would still not necessarily solve the problem of nuclear fallout from surface explosion outside the defended areas. There is a limit to the range of effectiveness of any terminal defense system." (The Army reported that a Nike Zeus launched at Kwajalein Island last week intercepted a simulated target missile.)

FAST ACTION ON SATELLITE SYSTEM?

COMMUNICATIONS SATELLITE CONTROVERSY continues, but Congress is now agreed on one point: it wants to settle the ownership issue this year. Senator Robert S. Kerr privately says he can send a bill to the Senate that will meet with administration approval. He wants to get a bill through the Senate in the next few weeks. The House must still hold hearings, so congressional agreement is likely to be a month or more away.

Predictions are that final legislation will bear the administration label, for political reasons, but with considerable alterations. The three bills now before Congress are the administration plan for public stock offerings, backed by the Department of Justice, but not FCC Chairman Newton N. Minow; Senator Estes Kefauver's proposal for government ownership, and Kerr's bill for ownership by domestic and international common carriers.

Big carriers like ITT and AT&T are backing Kerr, industry support is divided between the Kerr and administration plans. Opposition in Congress to the administration plan centers around the unwieldiness of the corporate structure it proposes. Participating communication companies, for example, would have limited control over decisions.

Meanwhile, the administration will meet Premier Khrushchev's recent bid for cooperation in space by offering the Soviets a share in a world-wide communications satellite system. This would not affect any U. S. ownership plan.

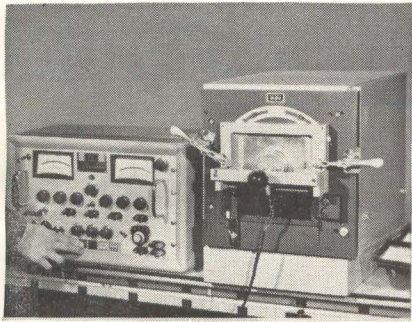
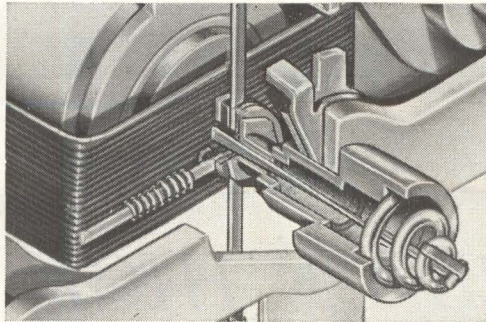
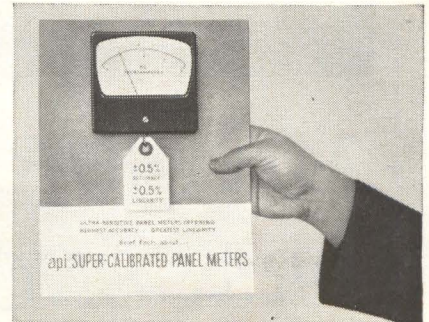

PHOTO-ELECTRONIC CALIBRATOR makes an individual scale to fit the exact response of each meter movement. There is no tracking error whatsoever.



TAUT-BAND MOVEMENT has no friction, no hysteresis . . . gives perfect repeatability. High-tensile band, low-mass suspension is non-destructible in normal use.



NEW BULLETIN 30 describes the various models of Super-Calibrated meters available and gives full specifications and prices. Request your copy.

FIRST SUPER-CALIBRATED TAUT-BAND METER SEE IT IN IRE BOOTH 3916-18

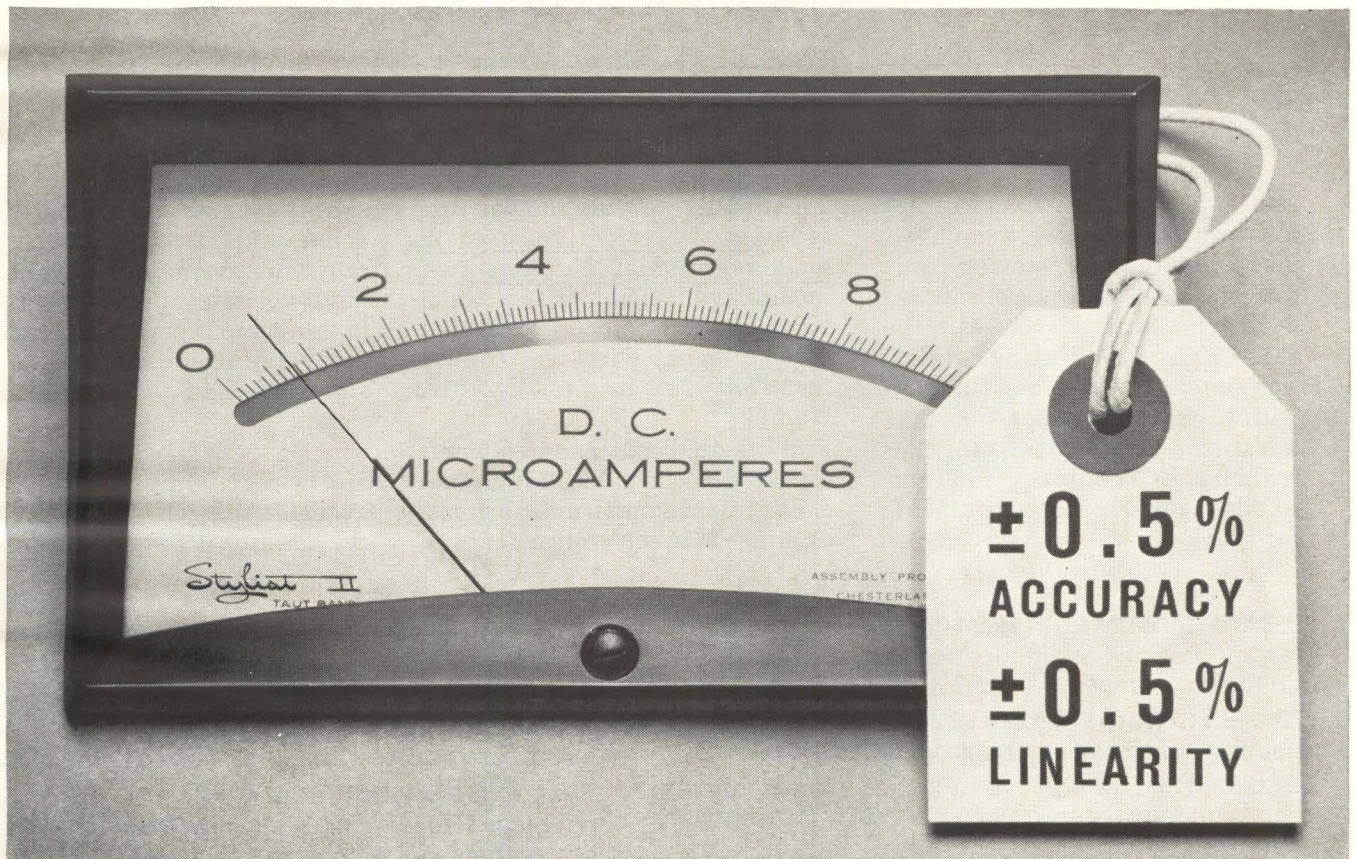

Full Scale Sensitivities to 2ua or 2mv

Someday, maybe, all meters will be super-calibrated. Until then you can get them only from API.

Super-Calibration permits you to upgrade present meter performance, but it also permits you to reduce costs if you are using more complicated instruments now for this level of performance.

Super-Calibrated meters have the inherent D'Arsonval stability plus the extreme ruggedness of taut-band design. They are interchangeable—between magnetic and non-magnetic panels—without calibration shift.

Write for Bulletin 30.



MEASURE VOLTAGE IN THE PRESENCE OF HIGH NOISE WITH NEW FLOATED AND GUARDED INTEGRATING DIGITAL VOLTMETER

You can easily and accurately measure voltage down to millivolt level, despite large common mode and spurious noise superimposed on the measured signal—with the DY-2401A Integrating Digital Voltmeter. You can use the DY-2401A on a lab bench—or take advantage of complete programmability, BCD outputs, and compatibility with other instruments for systems use.

This totally new instrument provides 140 db effective common mode rejection at all frequencies, including dc, enabling 10 volts of common mode pickup to appear on the signal with less than 1 microvolt error in the DY-2401A reading.

Fully floated and guarded input circuitry blocks induced ac ground currents, or common mode signals, existing between voltmeter and

signal source. Additionally, an active integration technique presents the average reading of the input voltage applied during a selected sample period, minimizing error due to noise unavoidably superimposed on the measured signal.

The DY-2401A is the most useful and versatile digital voltmeter available today. Here are some of the additional advantages you receive:

±300% OVERRANGING on the four most sensitive ranges provides additional accuracy and resolution on the commonly used 1-to-3 area.

ALL-ELECTRONIC CIRCUITRY assures maximum reliability, speed and noiseless operation.

BCD OUTPUT referenced to ground retains floating and guarded features when DY-2401A is used with output recorder.

±0.01% OR ±1 DIGIT STABILITY on the four highest ranges.

INTERNAL CALIBRATION SOURCE with ±0.01% per month stability.

10 CPS TO 300 KC frequency and frequency ratio measuring capability enables use as a solid state electronic counter with crystal-controlled time base.

FULL PROGRAMMABILITY with remote control lines referenced to chassis ground to allow system incorporation with complete retention of floating and guarding.

D Y M E C
A Division of Hewlett-Packard Company



Dept. E-3, 395 Page Mill Road, Palo Alto, California,
DAvenport 6-1755 (Area Code 415) TWX-117-U

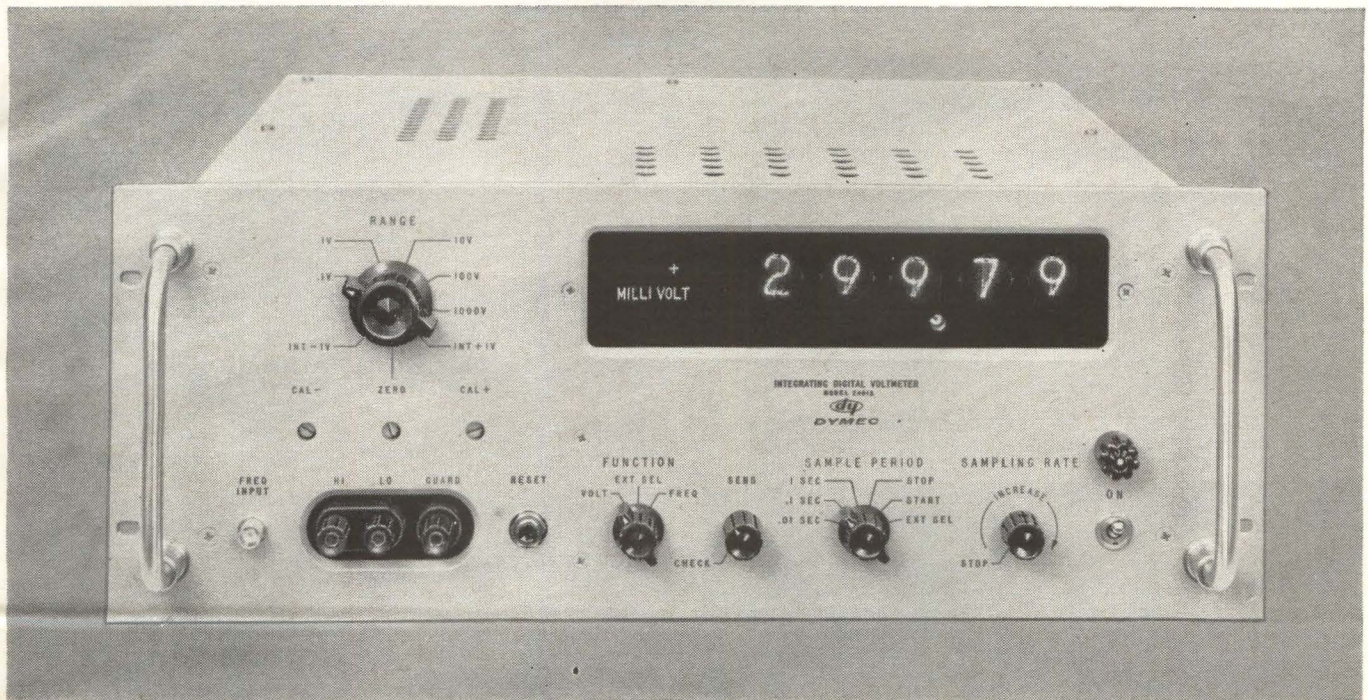

SPECIFICATIONS

2401A Digital Voltmeter

RANGE AND MEASUREMENT SPEED:

1-second sample period
99.999 mv, 999.99 mv, 9.9999 v, 99.999 v, 999.99 v

0.1-second sample period
100.00 mv, 1.0000 v, 10.000 v, 100.00 v, 1000.0 v

0.01-second sample period
0100.0 mv, 01.000 v, 010.00 v, 0100.0 v, 01000. v

± 300% overranging on four most sensitive ranges; overload circuit, at approx. 310% of range, automatically switches to 1000 v range.

DISPLAY:

5-digit Nixie readout. Polarity, decimal point, measurement units and overload condition indicated automatically.

COMMON MODE NOISE REJECTION:

Overall rejection, better than 140 db at all frequencies, 160 db at dc, provided by floated and guarded input circuitry with 1000 Ω in low side of measurement pair.

LINEARITY: ±0.005% of full scale or ±1 digit.

STABILITY: ±0.01% or ±1 digit on 4 highest ranges.

INTERNAL CALIBRATION:

Provides stability of ±0.01% per month.

INPUT IMPEDANCE:

Precision 1 megohm, 1 volt range and above; 100 K ohms, 0.1 volt range only.

RECORDER OUTPUT: BCD output referenced to ground.

SIZE: 6 $\frac{5}{8}$ " x 19" x 18 $\frac{3}{8}$ ", 48 lbs.

PRICE: \$3,950.00.

*See these New Instruments at
New York I.R.E., Booths 3015-3017*

FOR THE FIRST TIME—an AC/OHMS Converter which provides Floated and Guarded Broad-band AC Voltage and Rapid Resistance Measurements.



DY-2410A AC/Ohms Converter

Full programmability with remote control lines referenced to chassis ground to allow system incorporation with complete retention of floating and guarding.

For AC Measurements

50 CPS TO 100 KC MEASUREMENT RANGE with 110 db common mode rejection at 60 cycles when used with DY-2401A.

5 RANGES including high resolution 0.1 volt rms range.

300% OVERRANGING on the four most sensitive ranges provides additional accuracy and resolution in the commonly used 1-to-3 area.

For Resistance Measurements

6 RANGES from 100 ohms to 10 megohms with 300% overranging feature on all ranges.

UNIQUE DC GUARD makes possible fast resistance measurements by minimizing cable capacitance charging time.

PRICE: AC/Ohms (DY-2410A), \$2,250.00; AC only (DY-2410A-M1), \$1,850.00; ohms only (DY 2410A-M2), \$1,650.00.

Write today for data sheets on the DY-2401A and 2410A, which discuss instrument principles of operation, specifications and applications. Or better still, for a demonstration at your own bench, just call your Dymec/Hewlett-Packard representative.

We manufacture

Allen ELECTRONIC ORGANS.



Each year we produce, at an ever expanding rate, hundreds of thousands of reliable toroids for these instruments.

These inductors use Permalloy, Ferrite or Powdered Iron cores.

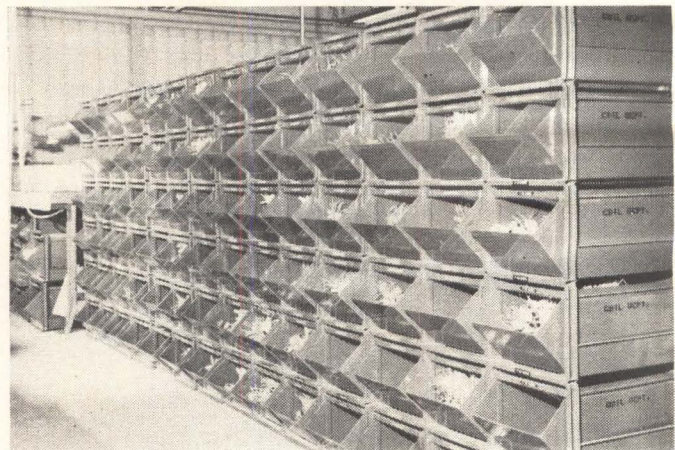
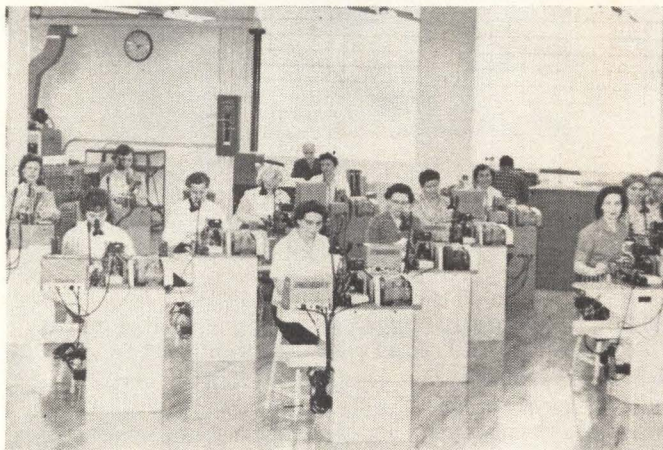
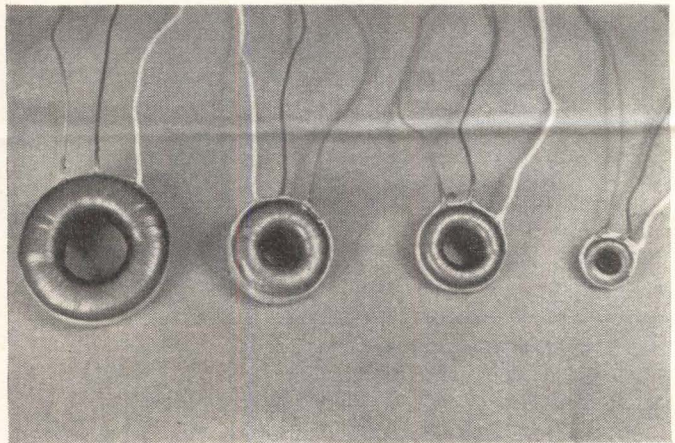
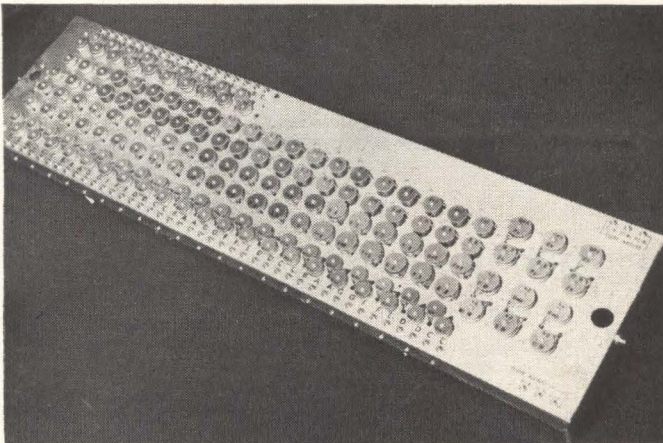

Our facility for producing these inductors represents one of the most modern and efficient toroidal production plants in the country.

Other component portions of Allen Organ manufacture have already been utilized by a multitude of electronic companies.

We believe that we are eminently qualified to supply these toroids at very competitive prices and, in many cases, for immediate shipment "out of stock".

For our own production we constantly maintain a stock of approximately 150 different sizes of toroidal inductors, covering an inductance range of 10 Mh. through 30 henries.

For quotations, please contact Dept. 2303

Allen ORGAN COMPANY

COMPONENTS DIVISION
macungie, pennsylvania

available now for the **ELECTRONICS INDUSTRY**

COMPLETE ELECTRON BEAM SYSTEMS

Applications:

- evaporation
- interconnection welding and joining
- epitaxial growth
- melting and zone refining
- surface conditioning
- encapsulation
- high temperature testing
- etching

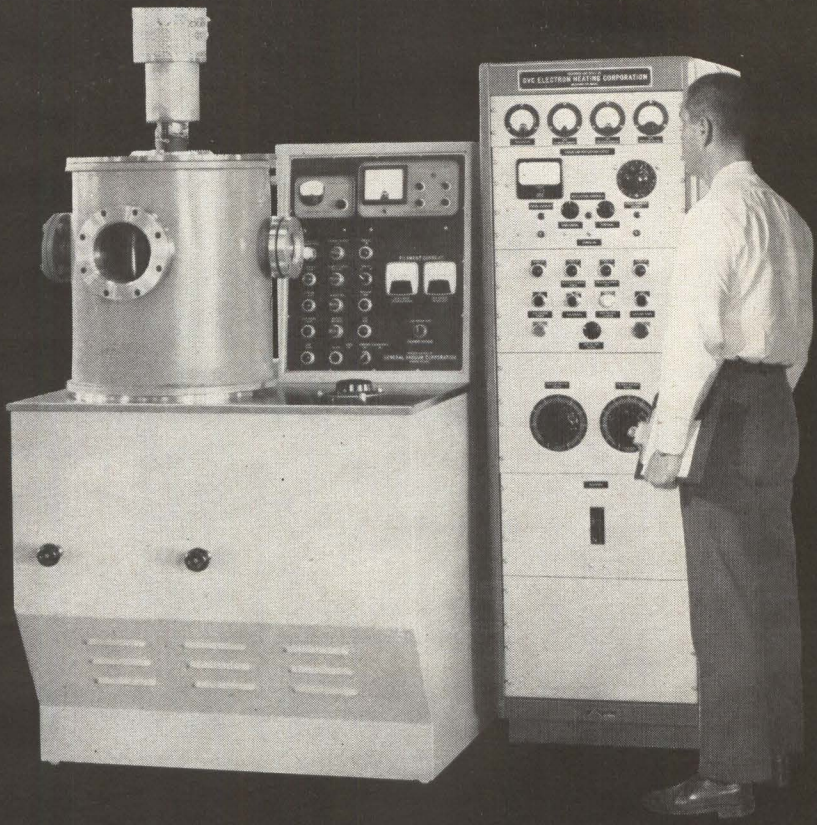

EHC — custom electron beam systems from standard modules

Equipment features — temperatures in excess of 7000°F • compact, modular construction • instantaneous automatic regulation of emission current • magnetic focus and deflection of beam • pulsed emission and focus • adjustable over-load current protection • no exposed high potential • system efficiency in excess of 90% • safe and easy operation • programmed operation

Headline news in electron beam systems and techniques is being made by Electron Heating Corporation. EHC has a unique application-engineering "task force" to work with you in problem-solving. Included in the "task force" are *process and application engineers* with an intimate knowledge of the field; *electronic design engineers* who have pioneered in the development of high power electron beam systems and controls; and *vacuum engineers* with an extremely broad background in all phases of vacuum technology. Important, also, is the feature that EHC Systems designs use **STANDARD PROVEN MODULES** (a variety of completely tested gun designs, power supplies, controls and vacuum systems with known characteristics). *Send for literature . . . or tell us about your requirements.*



ELECTRON HEATING CORPORATION

an affiliate of General Vacuum Corporation

80 Hicks Avenue

Medford 55, Massachusetts

proven electron beam systems for research, development and production

High Vacuum Systems and Equipment

- vacuum furnaces
- pumping systems
- altitude simulation
- ultra-high vacuum
- evaporators
- inert gas welding
- leak detection
- power supplies
- components
- custom designed systems

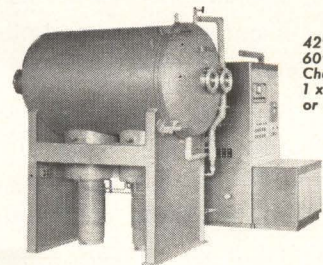

42" Dia. x 60" Long Chamber for 1×10^{-8} Torr or Lower

GVC GENERAL VACUUM CORPORATION
80 Hicks Avenue • Medford 55, Massachusetts

NOW... WESTINGHOUSE REFLEX KLYSTRONS



Now Westinghouse—with more than 30 years' experience in the microwave field—offers complete facilities for volume production of reflex klystrons. To assure you prompt service, more than 100,000 square feet of plant space is set aside for the manufacture of these and other microwave tubes.

Shown here are both cavity and waveguide tuned x-band tubes. Fixed-tuned, tuneable and trimmable types are also available. For application engineering assistance and quick-selector catalog, write to Westinghouse Electric Corp., Elmira, New York. **You can be sure . . . if it's Westinghouse.**

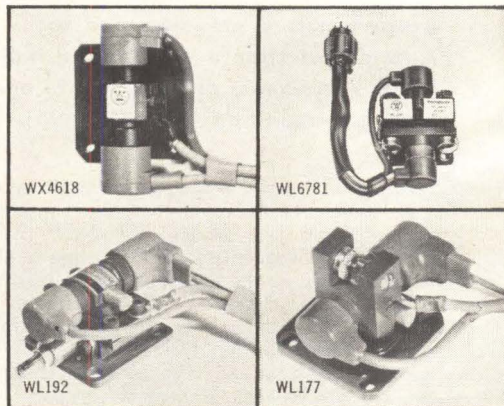

Westinghouse



PRINTED CIRCUIT

HIGH TEMPERATURE

RACK/PANEL

SUBMINIATURE

CANNON PLUGS WITH CRIMP SNAP-IN CONTACTS FOR EVERY REQUIREMENT

ENVIRONMENTAL

HIGH ALTITUDE

BUSINESS MACHINE

MIL-C-0026482A TYPE

MINIATURE

MIL-C-26500 TYPE

UMBILICAL

MIL-C-5015 TYPE

RF PLUGS

SEE
CANNON AT
IRE BOOTH
2727-2731

CRIMPING TOOLS

SEMI-AUTOMATIC



AUTOMATIC



HAND

IMAGINATIVE ENGINEERING For The Space Era

More than 20 years ago Cannon originated the crimp-type plug to fulfill the growing needs of the aviation industry. Since then, our research and development has kept pace with expanding technology, until today we provide plugs with crimp snap-in contacts for every application, every environment. A full range of crimp tools—hand, semi-automatic, automatic—gives you the utmost in flexibility. Whatever your requirements... whether standard solder pot versions or crimp snap-in contacts—consult your nearest Cannon sales office or distributor. For further information, write to:



CANNON ELECTRIC COMPANY, 3208 Humboldt Street, Los Angeles 31, California

Semiconductor Radiation Detectors

By HAROLD C. HOOD

Pacific Coast Editor

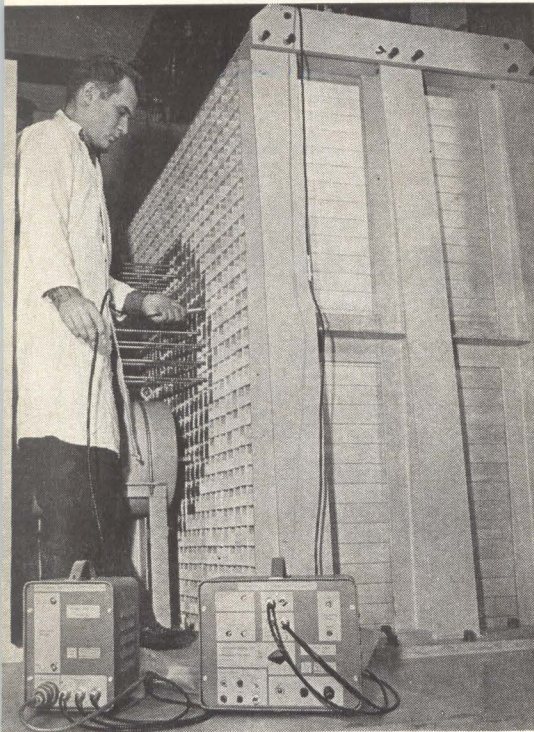

Atomics International uses neutron spectrometer in epithermal thorium reactor experiment

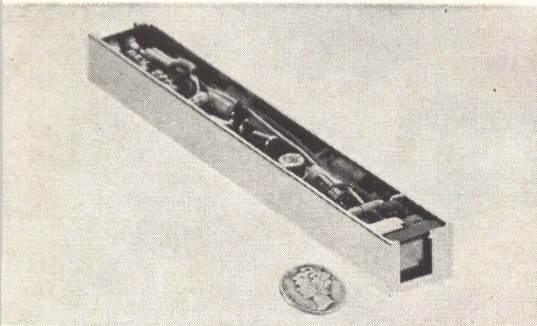

Semiconductor detector with miniature amplifier. These units may be stacked to form array



Detector can be inserted in body cavities as radioisotope tracer

LOS ANGELES—The nuclear semiconductor radiation detector is changing from a laboratory curiosity to a developmental manufactured device. One estimate of the potential market for semiconductor detectors next year is \$1 million.

So far, the usefulness of the detectors has been demonstrated in space measurements, probing oil well survey holes, determining neutron spectrums as a function of position in nuclear reactors, and in many industrial process control instruments.

Basic principle upon which the solid-state detector operates is illustrated. In a device developed by Solid State Radiation, Inc., phosphorus is diffused into high-resistivity *p*-type silicon. An *np* junction results somewhat less than one micron below the surface and a *p*-type depletion area extends for several hundreds of microns below. As ionizing radiation crosses this depletion region it gives up energy in the formation of electron-hole pairs. The internal electric field separates the electron-hole pairs and an external circuit pulse, the rise time of which is typically in the nanosecond range, results.

Stephen S. Friedland, SSR president, says the quantity of charge generated within a semiconductor detector from a given nuclear source is 10 times that generated within a gas detector. Formation

of an electron-ion pair in gas requires 32.5 electron volts while an electron-hole pair in a semiconductor detector results from 3.5 ev.

One-dimensional detector arrays have replaced photographic plates in space-borne beta-ray spectrometers. The instruments need not be recoverable, since data may be telemetered back to earth, and the spectrum is reported as a continuously changing function of vehicle height. Arrays of 10 elements each were flown aboard Discoverers 29 and 31. Spectrum range was 70 Kev to 1 Mev.

A proton spectrometer under development, using 16 side-by-side detectors for Van Allen belt measurements, will have a range from 10 Mev to approximately 200 Mev. Another, measuring up to 15 Mev, is orbiting in two Navy Transit satellites and reported to be sending back reliable data.

An epithermal neutron spectrometer, sandwiching a thin layer of Li^6 metal between two semiconductor detectors, shows considerable promise in the field of neutron and reactor physics, according to Friedland. One is being used in the Advanced Epithermal Thorium Reactor Program being sponsored by Southwest Atomic Energy Associates at Atomics International. The spectrometer measures the neutron energy spectrum directly with a linear output in the range of 0.5 to 15 Mev. Alpha and triton particles from the lithium-hydrogen reaction deposit energy in the two

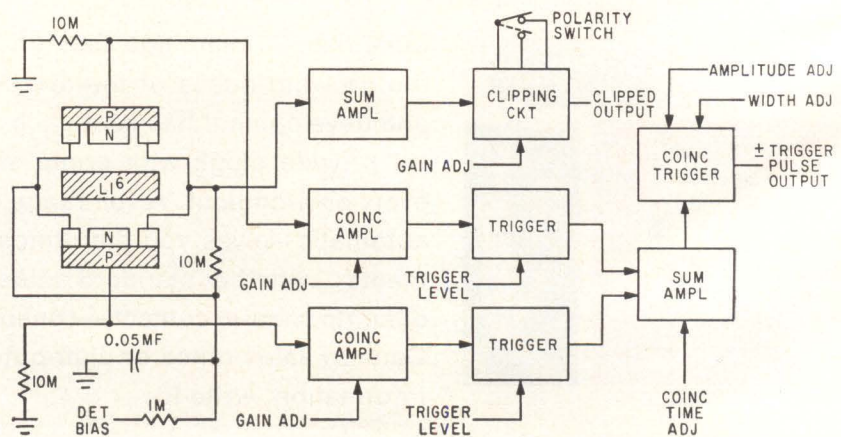

Simplified block diagram of epithermal neutron spectrometer

Demonstrate Their Practicality

detectors, the total shared energy is summed electronically and its amplitude is linearly related to incident neutron energy (see block diagram).

Other neutron detection devices use semiconductor detectors coated with suitable neutron-to-charge particle converter materials such as B^{10} , U^{235} , H, and Np^{239} .

Another two-dimensional array device developed at SSR is a beam profilometer of pulsed beams from large particle accelerators. Presentation of the beam during each burst of particles reportedly slashes many weeks from evaluation time. Another two-dimensional unit, using B^{10} -coated detectors is used to investigate flux density near a nuclear reactor and for nuclear reactor explosive diagnostics.

Three-dimensional arrays, the company says, may be feasible for cube-shaped cloud chambers. By feeding coordinates and pulse heights of triggered detectors into a computer, it may be possible to compute instantaneously the total energy and identify the particle. Under investigation is the possibility of substituting a continuous slab of semiconductor material in this application, to reduce the number of amplifiers and power supplies needed.

A spokesman for Jet Propulsion Laboratory is optimistic about space applications for both diffused junction and gold-silicon surface barrier types of semiconductor detectors. They are inherently small, rugged, fast and have low power requirements. Reliability expectations will be studied since anticipated uses call for lifetimes of three months to several years.

Size depends only on requirements for attaching leads to the two sides of detectors and for mounting. JPL expects several of the interplanetary Mariner and Voyager probes to fly SSR units and points out that semiconductor detectors have little competition in measuring many parameters important in space work, such as charged particles. However, crystals like sodium iodide and cesium

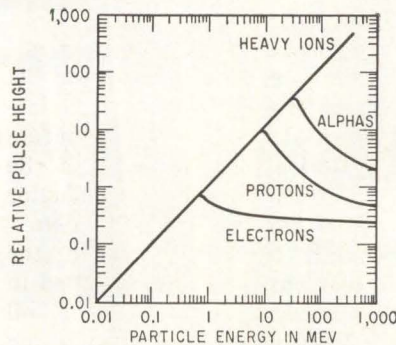

Range of linearity of pulse height vs energy for nuclear particles

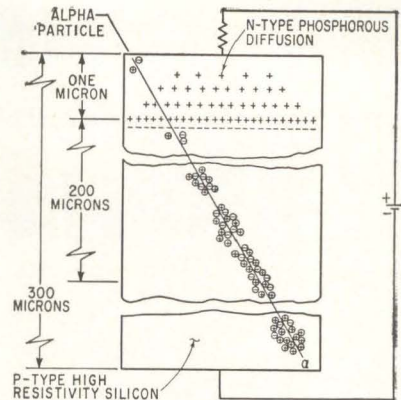

What ionizing radiation does when it enters solid-state detector

iodide, used with multiplier photo tubes, will remain the only practical devices for measuring gamma rays in near future, JPL says.

SSR adds that the future of the new detectors must be evaluated with cautious optimism. As yet, life characteristics of the device are unknown and some shelf deterioration has been reported. Some devices may exhibit excellent properties one day, be of questionable use the next and return to excellence the third day. A correlation of transistor production techniques with

those of semiconductor detectors is expected shortly to give detectors the reliability shown by transistors. Also under investigation is the effect of nuclear radiation damage on the detectors. After large doses, some fast neutron damage has been noticed.

Exposure to comparable gamma ray fields produces similar deterioration.

Other companies actively engaged in nuclear semiconductor detector development include Ortec, RCA of Canada, and Hughes.

Molecular Circuit Version of AN/ARC-63

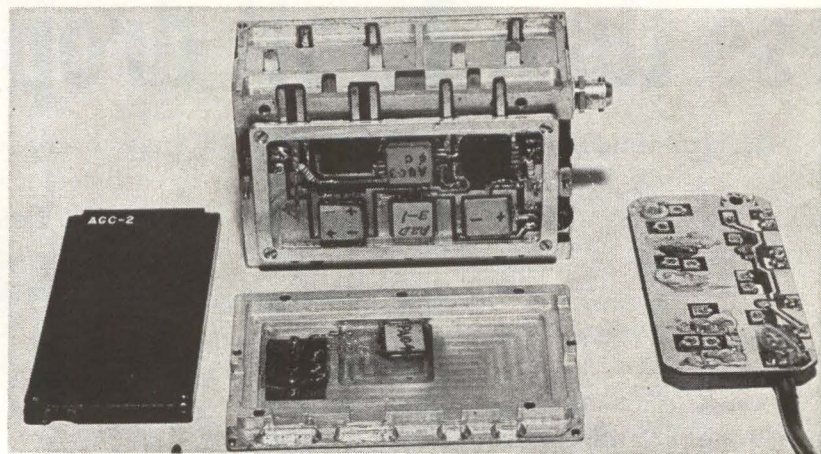

Westinghouse Electric and the Air Force this month showed a molecular circuit version of the AN/ARC-63 emergency communications receiver. It weighs ½-lb, compared to 5 lb for the conventional set. The number of parts was reduced from 219 to 82, including nine functional blocks (mixer-oscillator, three i-f and two a-f amplifiers, audio detector, differential and two-stage a-gc d-c amplifiers)

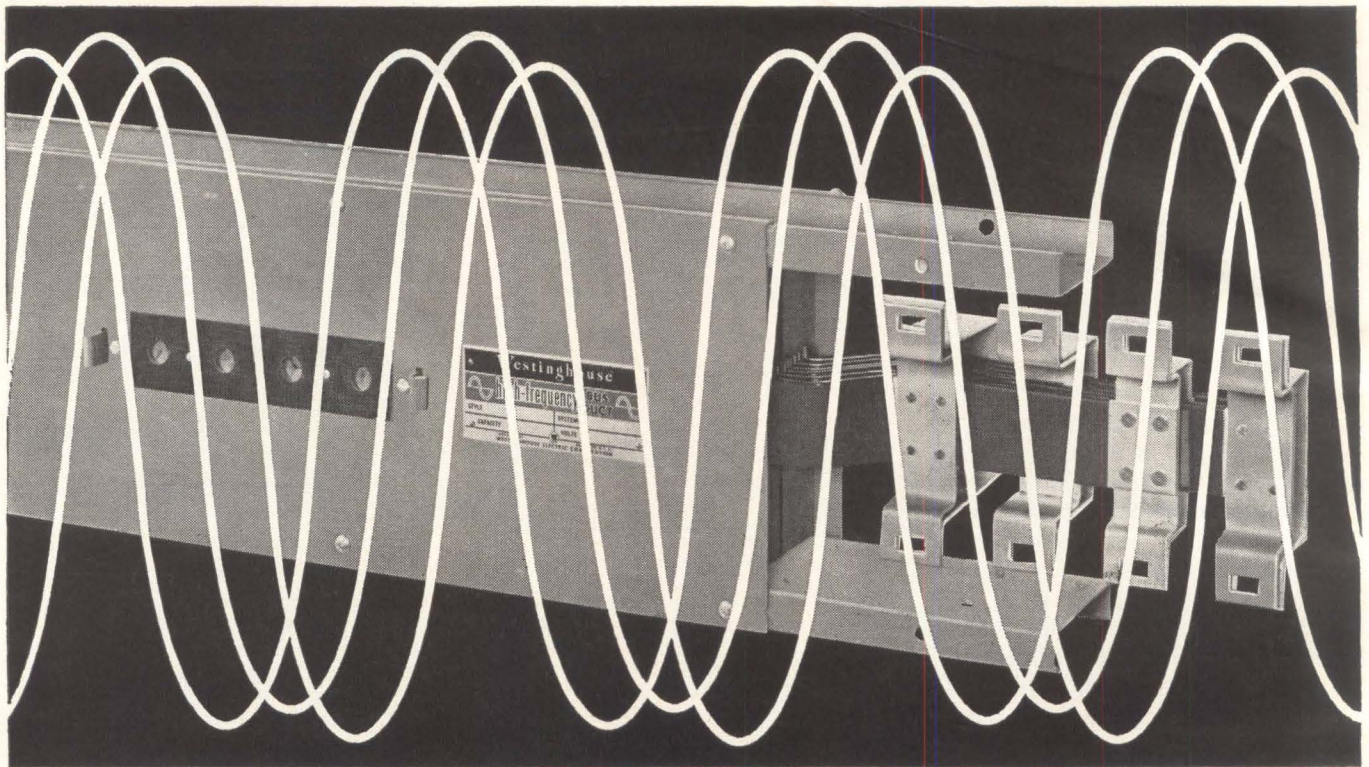

400-CYCLE BUS DUCT

less than 1 volt drop per 100 ft.

Here's the economical, efficient way to put high frequency exactly where you want it—at rock-bottom power loss. Westinghouse High Frequency Bus Duct is designed particularly for 400 to 20,000 cps systems, and distributes power over long runs more efficiently at 400 cycles than most systems do at 60 cycles. Gone are the expense, mess and big voltage drops of multi-run cable and conduit schemes. Gone is the need for special at-the-site power supplies.

Other advantages of Westinghouse High Frequency Duct: small size, light weight, power

taps every 30 inches over the entire duct length, easily relocated and easily installed.

High Frequency Bus Duct is available now . . . and only from Westinghouse. Call your local Westinghouse salesman or write Standard Control Division, Westinghouse Electric Corporation, Beaver, Pa. Ask for booklet B-7326. *You can be sure . . . if it's Westinghouse.*

Westinghouse 

Proved through 9,000,000 cycles



SUSPENSION TYPE METERS

- NO PIVOTS ▪ NO JEWELS
 - NO HAIR SPRINGS
- thus NO FRICTION

FACTS MAKE FEATURES

- 1 No pivots . . . no jewels . . . no hair springs . . . thus NO FRICTION.
- 2 Greater SENSITIVITY and REPEATABILITY
- 3 RUGGED and ACCURATE. Highly resistant to extreme shock. Accurate to 2% of full scale deflection (coming from line production at 1/2% maximum tolerance. Greater accuracy available on special order!) Famous Triplet patented Bar Ring Construction.

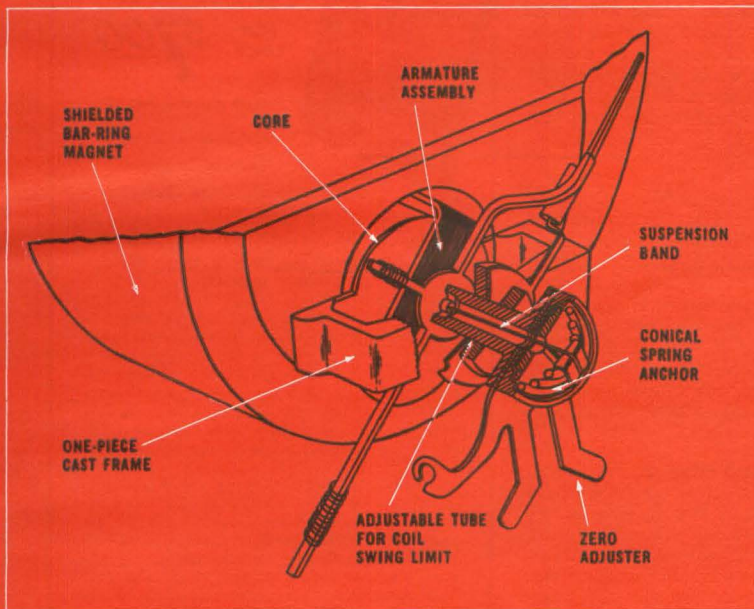

1 1/2 TIMES ACTUAL SIZE

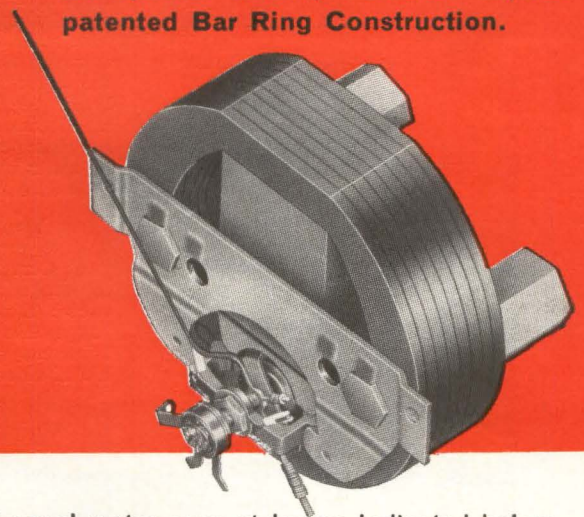

This improved new suspension type movement comes in standard panel meter case styles as indicated below. Meters can be used with almost negligible current drain. Especially applicable to transistor and similar circuits. Their high overload capacity prevents harm from surges many times normal full scale current. These instruments feature a short, very thin, narrow band kept tightly suspended on special spring terminals, which support the coil with its moving counter parts. The Triplet spring is conical in shape, the suspension wire being looped over and fastened to the top cone section. This allows freedom of action for the twisting suspension and added protection against severe shocks. As in all Triplet products, attention to detail makes for longer instrument life.

THE TRIPLET ELECTRICAL INSTRUMENT COMPANY, BLUFFTON, OHIO

8 CASE STYLES—11 MODELS—SIZES 2 1/2" THROUGH 8"



MANUFACTURERS OF PANEL AND PORTABLE INSTRUMENTS; ELECTRICAL AND ELECTRONIC TEST EQUIPMENT

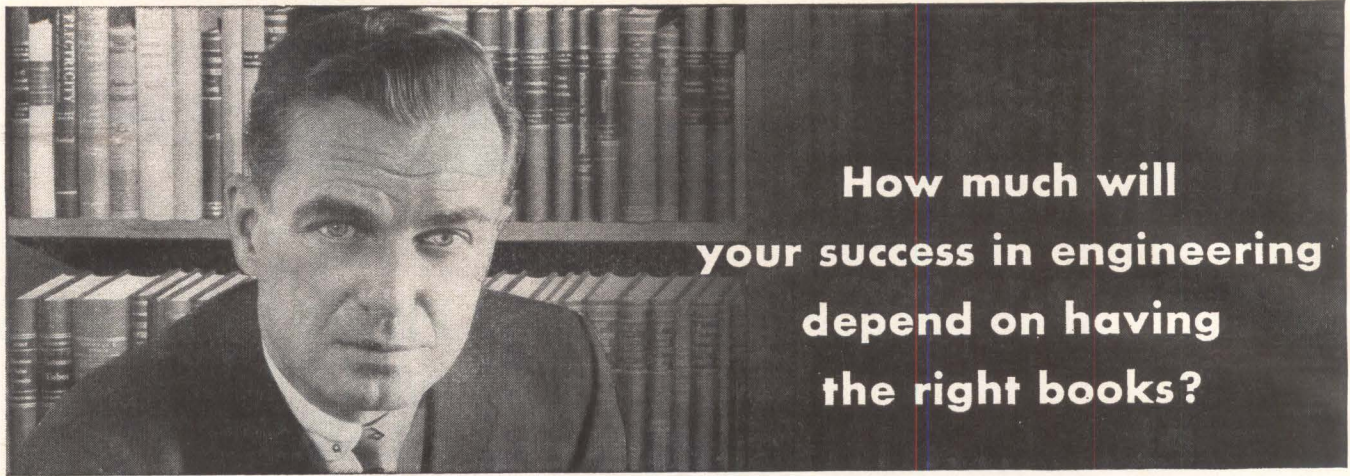

How much will
your success in engineering
depend on having
the right books?

The Electronics and Control Engineers' Book Club helps you keep ahead in your field . . . at a saving!

Start your membership with any of these selections:



Transistor Electronics by D. DeWitt and A. L. Ross-off. Full coverage from basic fundamentals to detailed mechanisms.

Publisher's Price, \$9.00
Club Price, \$7.65



Electronic Digital Computers by C. Smith. What they are, how they function, and their underlying principles.

Publisher's Price, \$12.00
Club Price, \$10.25



Control Engineers' Handbook by J. C. Truxal. A wealth of practical help on automatic feedback control systems.

Publisher's Price, \$22.50
Club Price, \$19.10



Mathematics for Electronics with Applications by H. M. Nodelman and F. W. Smith, Jr. Methods for solving practical problems.

Publisher's Price, \$7.00
Club Price, \$5.95



Epoxy Resins by H. Lee and K. Neville. Fully treats their modern applications and technology.

Publisher's Price, \$9.00
Club Price, \$7.65



How to Become a Professional Engineer by J. D. Constance. Authoritative guidance applicable in all states.

Publisher's Price, \$6.00
Club Price, \$5.10



Management for Engineers by R. C. Heimer. Practical know-how for the engineer-manager, covering every management area.

Publisher's Price, \$7.50
Club Price, \$6.40

Your engineering career owes a great deal to books. Why not take advantage of this convenient, economical way to have the best professional books available when you need them? THE ELECTRONICS AND CONTROL ENGINEERS' BOOK CLUB brings you the essential technical literature in your field. It also helps you overcome today's high cost of building a professional library by saving you an average of 15% from publisher's prices.

How the Club Operates. You regularly receive free of charge *The Electronics and Control Engineer's Book Bulletin*. This gives complete advance notice of the next main selection of the month, as well as many alternate selections. If you want the main selection you do nothing; the book will be mailed to you. If you want an alternate selection—or no book at all for that period—you can notify the Club by returning the convenient card enclosed with each *Bulletin*.

Saves You Time and Money. You agree only to the purchase of three books in a year. Certainly out of the large number of books in your field offered in any twelve months there are at least three you would buy anyway. By joining the Club you save both money and the trouble of searching.

Send No Money Now. Just check the book you want as your first selection on the coupon below. With it you will be sent *Electronic Designers' Handbook* for only one dollar. Take advantage of this offer and receive two books for less than the regular price of one!

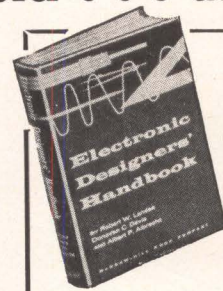

ACCEPT THIS
\$17.50 BOOK
FOR ONLY \$1.00

with membership in
The Electronics and
Control Engineers'
Book Club

ELECTRONIC DESIGNERS' HANDBOOK

By R. W. Landee, D. C. Davis,
and A. P. Albrecht

Provides fundamentals and data to help you in the design of all types of electronic equipment. A large number of the circuits used in many different applications are covered, together with theoretical and technical discussions and explanations, design examples to show application of theory, and graphical and tabular data needed in day-to-day design work.

Electronic Designers' Handbook is typical of the selections of THE ELECTRONICS AND CONTROL ENGINEERS' BOOK CLUB. All books are chosen by qualified editors and consultants. Their thoroughgoing understanding of the standards and values of the literature in your field guarantees the authoritativeness of the selections.

(NOTE: If you already own this volume, you may substitute any other book on this page as your DOLLAR book. Check two books below and you will receive the higher priced selection for only \$1.00.)

CLIP AND MAIL THIS COUPON TODAY

The Electronics and Control Engineers' Book Club, Dept. L-3-16
330 West 42nd Street, New York 36, N. Y.

Please enroll me as a member of The Electronics and Control Engineers' Book Club. You will bill me for my first selection indicated at right at the special club price and \$1 for *Electronic Designers' Handbook* (or alternate choice), plus few cents delivery costs. (The Club assumes this charge on prepaid orders.) Forthcoming selections will be described in advance and I may decline any book. I need take only 3 selections or alternates in 12 months of membership. (This offer good in U. S. only.)

PLEASE PRINT

Name

Address

City..... Zone..... State.....

Company

NO RISK GUARANTEE: If not completely satisfied, you may return your first shipment within 10 days and your membership will be canceled.

Send as my first selection: (If more than one book is checked we will send the higher priced selection as your \$1.00 book.)

- Transistor Electronics, \$7.65
- Electronics Digital Computers, \$10.25
- Control Engineers' Handbook \$19.10
- Mathematics for Electronics with Applications, \$5.95
- Epoxy Resins, \$7.65
- How to Become a Professional Engineer, \$5.10
- Management for Engineers, \$6.40

L-3-16

Introducing...

NEW Baird-Atomic MODEL OA-1 SCR TEST SET

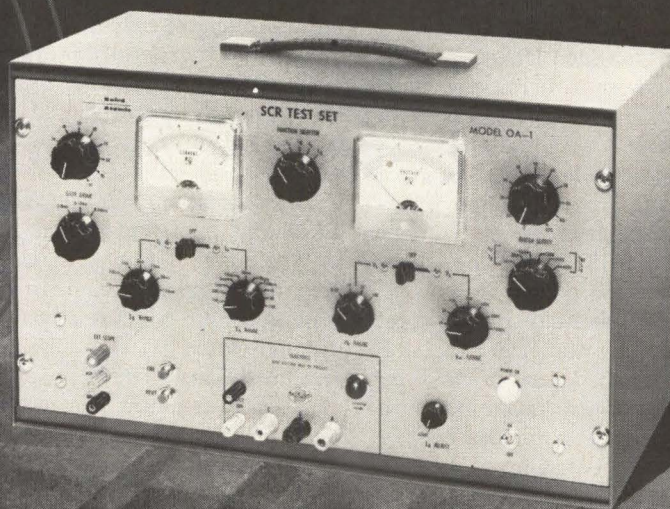

With the introduction of the new Model OA-1 Tester for Silicon Controlled Rectifiers, Baird-Atomic continues to offer the most complete line of transistor and semiconductor test equipment available. The Model OA-1 tests for:

V_{90} : Forward Breakover Voltage . . . also measures gate current to fire at any anode voltage . . . provision for connecting external gate bias . . . front panel current and voltage sensing jacks for graphic display of characteristics on external oscilloscope.

I_f : Forward Leakage Current

I_r : Reverse Leakage Current

V_f : Voltage drop from anode to cathode at forward current I_f ; also measures gate firing characteristics.

I_H : Holding Current

With this new Test Set, Silicon Controlled Rectifiers may be safely evaluated

under dynamic circuit conditions, since the power supplies of the Model OA-1 have built-in current limiting load resistors. And rear panel jacks are provided for connecting in additional resistance if required. The Model OA-1 features a high voltage power supply - up to 600V - and a high current supply - up to 10A - and provision is made for continuous control over all power supply ranges.

For the safety and convenience of the operator, an interlock jack is provided for controlling applications of high voltage to the front panel terminals. All components of the Model OA-1 SCR Test Set are conservatively rated for continuous operation at maximum specified currents. Call or write for detailed technical information.

Engineers and scientists: *Investigate challenging opportunities with Baird-Atomic. Write Industrial Relations Director. All qualified applicants will receive consideration for employment without regard to race, creed, color or national origin.*



BAIRD-ATOMIC, INC.

33 University Road · Cambridge 38, Mass.

ADVANCED OPTICS AND ELECTRONICS . . . SERVING SCIENCE

PROBLEMS AND PROPOSALS:

Manned Spacecraft Landing Systems

By ROY J. BRUUN

Assistant Editor

ONE OF THE KNOTTIEST problems now facing manned space system designers is how to bring the vehicle in safely through reentry to a controlled touchdown on land.

Several electronics companies are now designing landing systems. Approaches range from an instrument landing system incorporating available subsystems, proposed by GE, to an on-board adaptive control recommended by General Precision Labs. Raytheon leans toward an airborne guidance system with ground support equipment. Sperry takes a pilot-oriented approach.

The system under development at General Electric's Systems division would regulate the descent path from 500 miles out. The vehicle path would be controlled to dissipate the kinetic energy without overheating or overstressing the

vehicle. Landings can be made under automatic control, or the pilot can use a display and perform designated control responses.

GE says over 100 landings have been simulated with the system, on an analog computer, and that it is ready for application to specific vehicles.

Subsystems include the AN/TPQ-10 radar being produced for use by the Marine Corps in close-support bombing operations, a GE 225 computer and airborne beacon and decoder (Mod III G). The latter is similar to units developed as part of a radio command guidance system for launching ICBMs and boosters. Airborne weight is 28 lb.

System operation is outlined in the block diagram. Radar data enables the computer to compute position and velocity and generate satisfactory flight paths. Flight commands go to the vehicle over the radar link until the vehicle

comes in for a landing at its particular stalling speed. Accuracy is expected to be 1 to 2 fps.

GPL's report on its study program says that the complexity of landing a spacecraft may require an on-board adaptive control system. Adaptive systems respond instantly to operational conditions, not pilot or ground control. The adaptive system would back up ground-based regulator and servo-type systems.

An adaptive system, GPL feels, could cope with unpredictable operating variables. It could, for example, interrelate flight parameters to stall the vehicle the required few feet above the runway. Reasoning is that since vehicle, position and environmental parameters cannot be accurately foreseen, closed loop control is needed.

The regulator control system requires establishment of a reference trajectory and would act on deviations from that reference. The servo control system would control from existing position and conditions along a path estimated according to predicted future conditions. The adaptive backup system would make a "best estimate" of the effects of sudden changes in variables and controls.

Another argument in favor of including adaptive controls, GPL says, is the difficulty of maintaining air-ground communications through the ionized air that would sheath the reentering vehicle.

GPL stresses that the first consideration in manned vehicles is personnel safety. Provision should be made to monitor life-support equipment and operate emergency equipment. If retrorockets misfire, for example, the pilot should be able to transfer into an orbit transecting the fringes of the atmosphere.

Raytheon has been studying and planning instrumentation for a recovery control to be established at the Air Force Flight Test Center, Edwards AFB, Calif.

A company spokesman says that

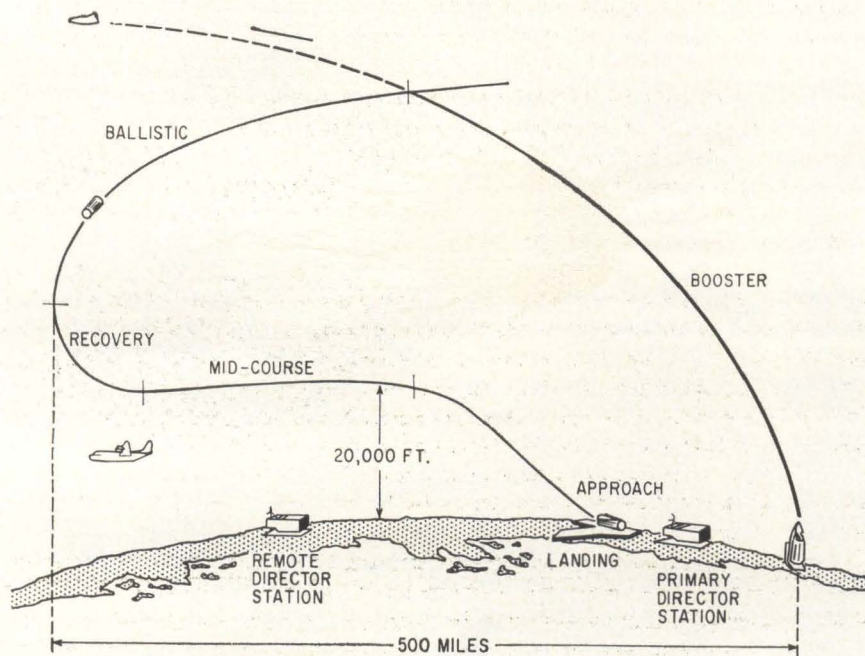

Sperry system may require two ground stations for optimum control

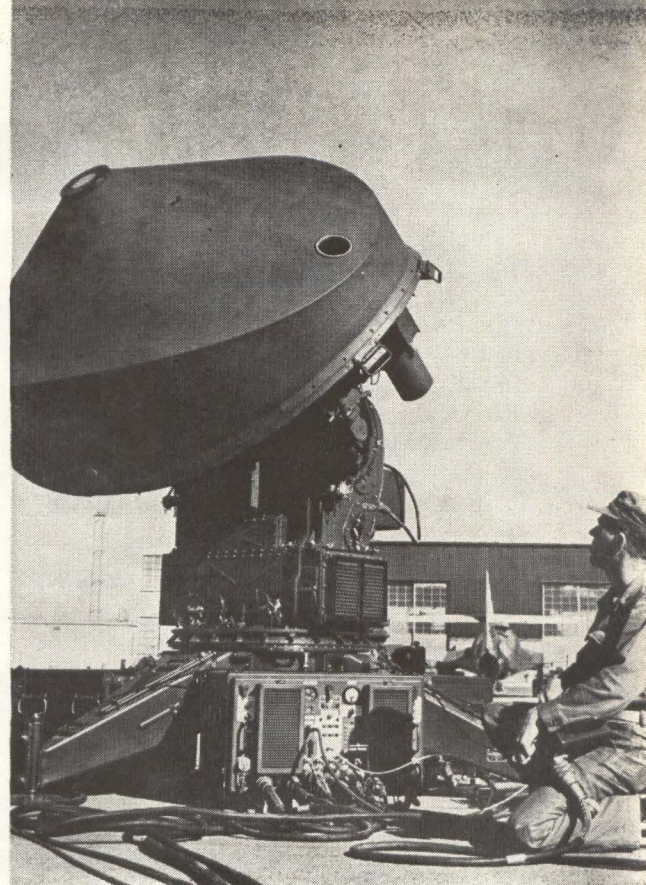
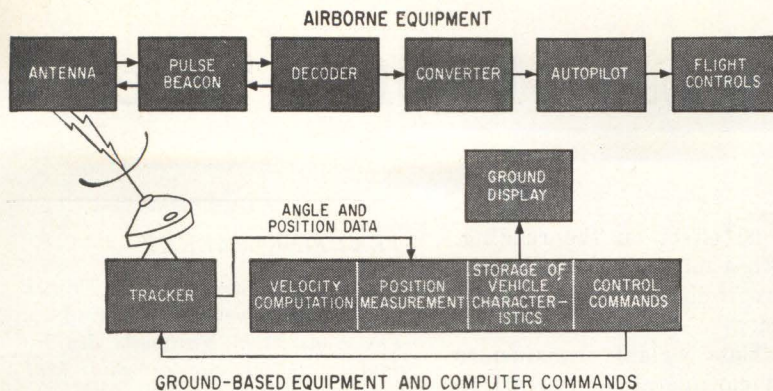

System proposed by GE (top left) would use available equipment like AN/TPQ-10 radar (above) originally designed for close-support air bombing. In Sperry system (left), pilots in air and on ground are given prime control roles

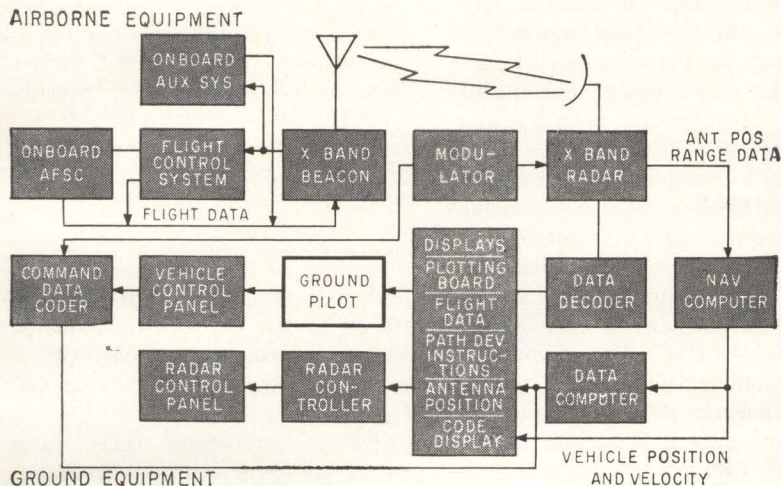

the weight penalty of maneuvering engines makes it likely that spacecraft will be gliders, creating severe terminal guidance problems. The trajectory of the approaching vehicle "may be viewed as a string whose slack may be oriented in many different ways" relative to the direct line between reentry and landing points.

The guidance system, he says, must enable the vehicle to fly a large number of "nominal trajectories which together encompass all the vehicle's maneuver potential."

Raytheon says the system could compute trajectories or select them from storage. However, real-time computation is difficult to achieve. Large, rapid-access storage would be required since it is uncertain whether taped data could be searched in time. Even if a trajectory is found quickly enough, the problem of controlling the vehicle remains. A glider's position and velocity cannot be forced to correspond to a trajectory.

Raytheon points out other guidance problems. Radar, the traditional ground-based instrument, gives only position and range rate

information. Errors are introduced when vector velocity is computed. While inertial guidance systems measure velocity accurately, their position information is not reliable during the terminal portions of a flight. Inhibition of communications by the reentry plasma sheath would depend on vehicle characteristics and communications frequencies.

Raytheon feels that reliability problems favor basing the system's principal components on the ground. But economics and versatility favor an entirely airborne system. With an airborne system, the vehicle could land at locations not equipped with ground-based equipment. The ultimate solution will probably be a combination of ground and airborne equipment, Raytheon says.

Further analysis of the problems and equipment requirements—particularly line-of-sight instrumentation, computers and terminal equipment—is needed, the company says.

Sperry Phoenix is developing a space vehicle landing system that consists of a control radar unit housed in a highway van and transmitter equipment located in the spacecraft to receive and transmit

coded radar signals. Called Man (Microwave - Aerospace - Navigation), it has been in development 1½ years. A company spokesman recently said that "it is possible that radar line-of-sight limitations will necessitate the use of an airborne-relay-mode of operation or the addition of an auxiliary ground station."

Sperry engineers see earth-based recovery systems for manned vehicles as primarily a pilot aid. To determine this, Sperry conducted extensive investigations of re-entry recovery and landing of unmanned glider vehicles. This study is reflected in the illustrated system in which a "ground pilot" assumes pilot functions. Ground pilot controls the "transition (re-entry) maneuver and navigation to a high key point." As the vehicle approaches flare-out and touchdown, phases during which time and computational factors become more critical, the automatic (computer-controlled) mode is used with the ground pilot monitoring the operation and overriding the control in the event of emergency (failure) conditions.

French Ready Implosion-Proof Tv Tubes

By ARTHUR ERIKSON
McGraw-Hill World News

PARIS—What wasn't displayed had industry insiders buzzing at the Fifth International Electronics Components Show held here recently.

Implosion-proof tv picture tubes were whisked off the stands of two manufacturers as the show opened. The official explanation: French safety regulations require a protective glass in front of picture tubes, so the new versions won't be released until this requirement is changed. But some informed showgoers felt the real reason was set makers' worries that news of an important tube development for next year's sets would keep hesitant prospective buyers out of the market for a while longer.

It's an open secret that SOVIREL, a company that supplies the glass for French-made picture tubes, is producing tubes with a fused steel coating that extends about four inches back from the face. The fused steel checks the spread of fissures should the glass crack. La Radiotechnique by mid-year will have on the market an implosion-proof tube, developed jointly with SOVIREL, with a tight polyester-glass sheath applied under pressure. The sheath extends about halfway back and there is a metal band around the edge behind the face.

Displays underlined a steady technological advance. CSF, for example, has an experimental O-type Carcinotron with 10-mw output at 0.7-mm wavelength. Thomson-Houston showed a high-power klystron with 25-Mw peak and 30-Kw average output over a frequency range of 2,700-3,100 Mc (with two tubes), up from 5-Mw peak and 10-Kw average last year.

French instrument makers are also climbing toward higher frequencies. Ribet-Desjardins, for one, displayed a sampling oscillograph with two identical channels having a passband of 0.5 nsec. Chauvin-Arnoux has a microvolt-ammeter, accurate to 3 percent, that can measure a-c currents to 1 amp at

frequencies to 1 Mc. D-c component has no effect on the reading, made with a microclip transformer so the circuit doesn't have to be disconnected.

A brushless variable transformer provoked considerable interest. In S.E.I.M.'s Variavolt, the lamination stack for the primary magnetic circuit is split along the line of zero flux and spring-loaded against a rotor carrying the secondary winding. This arrangement eliminates air gap between the primary and secondary, so losses are no more than in a fixed transformer. A nickel-stainless steel tube screens the secondary, which is completely isolated from the primary. Ratings run to 2 Kva. Output voltage varies steplessly from zero to 200, 300 or 500 volts, depending on the angle of the secondary winding.

S.T.A.R.E.C. showed a coaxial relay that switches within 10 ms either of two coaxial inputs to a

TEMPTING MARKET

PARIS—Sales curves for the French electronics industry are moving up. The Federation Nationale des Industries Electroniques said 1961 sales topped \$800 million, 21 percent over 1960. Components accounted for more than a third of the total. A market like that tempts manufacturers from other countries and the show reflected the temptation. A full third of the 600-odd exhibitors were non-French, West Germany led the outsiders with 67 exhibitors followed by the U. S. with 57

single output. The unit handles up to 3 kw at 100 percent, modulation, has vswr less than 1.05 over a frequency range from zero to 400 Mc.

CSF's electrostatic relay integrates low-level outputs from de-

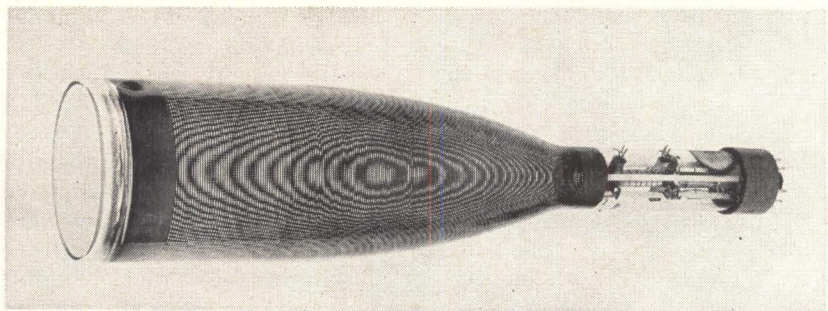

La Radiotechnique 1-Gc crt prototype. Helical post-acceleration gives sensitivity of 30 v/cm horizontal and 10 v/cm vertical

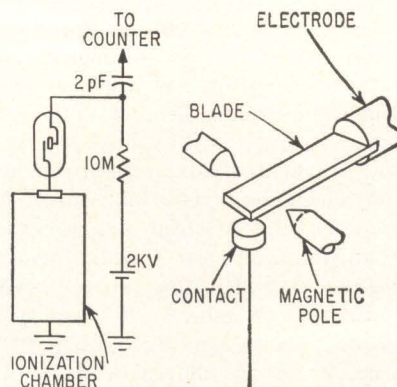

Charge buildup triggers movement of blade in CSF relay, integrating low-level outputs



S.E.I.M. brushless transformer varies output by changing angle of secondary winding

vices like ionization chambers or photoelectric cells. The outputs are stored on a collecting electrode fitted with a ferromagnetic blade restrained by two magnetic poles. When the charge built up on the blade equals the relay's sensitivity setting (10^{-10} coulomb or better), the electrostatic force between the blade and a contact just below its free end overcomes the magnetic force. The blade snaps against the contact and discharges, developing a pulse. Frequency of the pulses from the electrostatic relay represents the output of the device connected to the collecting electrode.

Digital Computer Will Run Red Lights in LA

LOS ANGELES is making a pilot installation this spring of a traffic control system run by a digital computer. In the initial installation, it will operate 26 lights along four miles of Sunset Boulevard and 10 lights on approach streets. Traffic flow data will be telephoned from automatic detectors to a Thompson Ramo Wooldridge RW-300 computer at City Hall.

West Germany May Join Private Satellite Net

BOSTON—It is likely that West Germany will build a ground station for Telstar, Bell Telephone Lab's communications satellite experiment (p 26, Feb. 16). The station would be in addition to one at Andover, Me., and those planned in England and France, John R. Pierce said at an MIT lecture.

Among other comments, Pierce expressed skepticism that the state-of-the-art is ready for the Army Advent Project to place a satellite in synchronous orbit. For communication satellite networks, he remarked, high-power, long-life equipment should be developed now, even before reliable boosters are ready. Among needs are masers not dependent on gas liquefaction and five-year attitude controls.

Pierce said that of satellites launched to date, only Vanguard I had anything like the lifetime needed. Telstar, he said, approaches the limits of today's art.

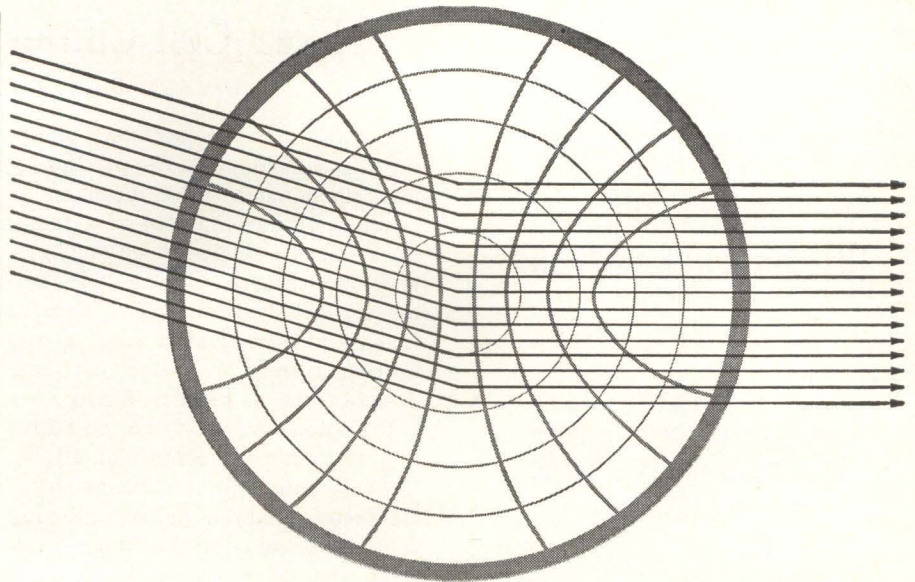

electronic alarm/control system insures CONTINUITY OF COMMUNICATIONS

A MARC alarm/control system, monitoring unattended microwave repeater terminals, can anticipate trouble, pinpoint its location, and initiate immediate corrective action. Among the typical alarm conditions which can be monitored are failure or degradation of RF performance, loss of signal, intruder and approach alarms, power failure, switchover to stand-by, carrier fault (major and minor), and tower light failure. Corrective action is initiated over the control channel.

Standard, off-the-shelf MARC systems are compatible with wire, radio, UHF, VHF, microwave, and carrier communications links, and may be installed without special modification to operate with all transmitters and receivers of conventional manufacture. Depending upon application requirements, MARC equipment is available for multiple-tone, TDM, and interrogation systems. "Order Wire" and other service channel functions are provided as required.

Modular, plug-in units are all-solid-state, and require virtually no maintenance. Power and space requirements are minimal; a typical repeater providing for 64 alarm functions occupies only $3\frac{1}{2}$ " of rack space, is powered readily from existing station voltages.

Write for current data sheets on standard MARC systems. Inquiries are invited on special systems.

MARC 3000 solid-state microwave and alarm equipment selected to monitor transcontinental microwave system.

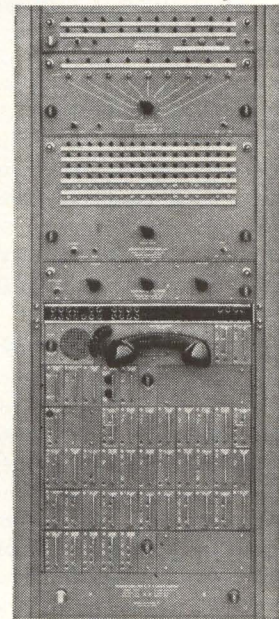

Typical master station used by Western Union on their MLD-4B Transcontinental Microwave System.



MOORE ASSOCIATES INC.

893 American Street • San Carlos, California

SPRAGUE®

MODEL 500

INTERFERENCE LOCATOR



This versatile instrument is a highly sensitive interference locator—with the widest frequency range of any standard available unit! Model 500 tunes across the entire standard and FM broadcast, shortwave, and VHF-TV spectrums from 550 kc. to 220 mc. in 6 bands.

It's a compact, portable, rugged, versatile instrument—engineered and designed for most efficient operation in practical field use. It features a transistorized power supply, meter indications proportional to carrier strength as well as sensitivity of 5 microvolts minimum for 5% meter deflection over entire tuning range.

For full details, send for brochure IL-106.

SPRAGUE ELECTRIC COMPANY
35 Marshall Street, North Adams, Mass.

SPRAGUE®
THE MARK OF RELIABILITY

Kerr Cell Camera Films in 5 Nsec

LOS ANGELES—Complete photographic records of high-speed physical phenomena have been made possible by development of a framing camera with Kerr cell shutters, reports Electro-Optical Instruments, of Pasadena. The camera takes six frames at a rate of 100 million frames a second with exposure times as brief as 5 nsec.

Collected by an f/3.5 objective lens with a focal length of 10 in., light is split into six beams by a six-faced, silvered prism, allowing separate images of the same event, from the same aspect, to be seen through the same set of optics.

The control system includes six channels of regenerative and passive trigger delays, modular pulse generators and pulse-forming networks, and series or parallel synchronous selectors.

Interframe time is continuously variable from 5 to 700 nsec. Framing rate is independent of exposure time and optical resolution. The latter two can be selected arbitrarily to accommodate the available light and the rate of the event.

The camera is intended for studies of explosive hydrodynamic phenomena, classical explosive propagation, exploding wires, and hypervelocity impact. The high energy densities of these phenomena allow self-luminous photography at very brief exposure times. For rapid evaluation, photos can be made on Polaroid film.

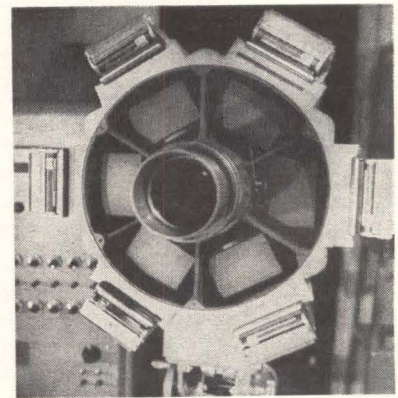

Six Kerr cell shutters and film holders surround central lens

Minnesota Sets Week Aside for Electronics

MINNESOTA last week celebrated its growth in electronics with exhibits in St. Paul and Minneapolis and the dedication of new graduate facilities at the University of Minnesota.

State officials now consider the industry a prime element in the state's economy. A spokesman for Gov. Elmer L. Anderson said new electronics plants reversed a downward trend in employment during 1959 and 1960.

In 1955, 26,135 Minnesotans were employed in electronics plants. By the end of 1961 there were 44,438 and another 1,500 jobs are anticipated in 1962. The number of companies increased from 89 in 1955 to 157 by 1962.

Growth of the industry has been aided by a gubernatorial committee set up by Orville Freeman, now U. S. Secretary of Agriculture (ELECTRONICS, p 30, June 17, 1960).

Development of suburban industrial parks is being pushed. Last year in the New Hope region, for example, the Twin Cities Science Industry Center saw new plants for National Connector, Miniature Instruments, Electro Nuclear Systems and Nedmac.

A regional research institute is in the final planning stages, under direction of W. G. Sheperd, chairman of the gubernatorial committee and head of the university's department of electrical engineering.

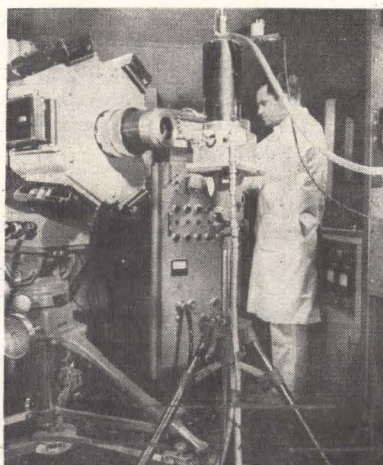

Camera set up to photograph exploding wire at 100 million frames a second

Au — Ni = RELIABILITY

AMP PRODUCT PERFORMANCE PROVES IT!

Gold over nickel plating . . . the standard AMP choice for printed circuit connector contacts! Not optional . . . but standard! And with good reason.

No haphazard choice dictated the metallic fraction that makes plating an important feature of the AMPin-cert* Printed Circuit Connector line. The decision to make gold over nickel standard plating came only after exhaustive tests involving a whole wide range of metals in various thicknesses and combinations.

Plating thicknesses, porosity, contact forces—all these were thoroughly tested. Exposure to heat, cold, corrosion and humidity . . . series after series of tests ran the gamut of extreme environmental conditions for every plating metal considered. Results, tabulated over a period of years, pointed to one fact—gold over nickel was vastly superior in every way.

These AMPin-cert Printed Circuit Connectors can be loaded to accommodate only those circuits actually

needed. There are no pre-loaded, unused contacts!

Crimp, snap-in type contacts are plated with .000030" gold over .000030" nickel (min.). There is no metal "creep". No debilitating oxide insulation buildup. Contact pressures are engineered to avoid excessive or quick plating wear. Consequently, AMPin-cert connectors last longer, give maximum performance and assured reliability.

Research findings on plating and facts on the AMP gold over nickel standard are available in reprints of papers published by AMP Research. Write for your copy today.



AMP

INCORPORATED
Harrisburg, Pennsylvania

AMP-LEAF* and AMP-BLADE* Connectors . . . are part of the AMPin-cert line which includes Pin and Socket, Printed Circuit, Coaxial, and General Duty types.

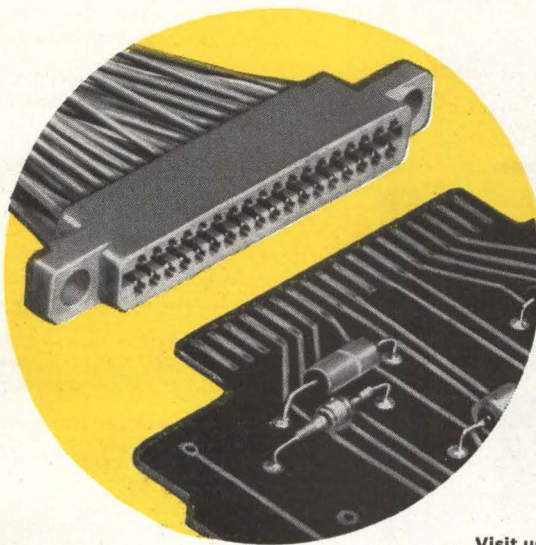

AMP-LEAF

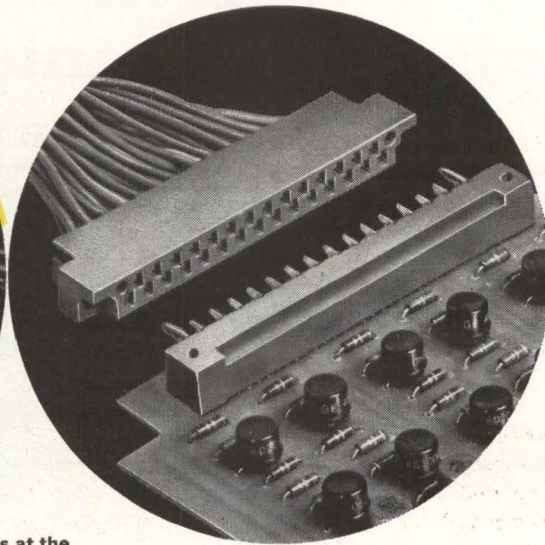

AMP-BLADE

Visit us at the
I.R.E. SHOW
Booths 2527-31
March 26-29

AMP products and engineering assistance are available through subsidiary companies in:
Australia • Canada • England • France • Holland • Italy • Japan • Mexico • West Germany

*Trademark of AMP Incorporated

In ten minutes . . . *literally* . . . you can design a complete, modern limit-test system, with TRI/LIM, our revolutionary, new modular system of limit instrumentation.

Seventeen engineering man-years went into the selection and design of TRI/LIM modules and circuitry. The result is a truly universal electronic limit-test system that can be programmed manually or digitally, measures 23 different electrical parameters, over a 10 million-to-1 range, with up to 4-digit resolution and compatible accuracy. Readout appears in simple go/no-go format, or as contact closures for sorting or marking. Printout accessories are easily accommodated.

A TRI/LIM system, quickly assembled to your specification from inexpensive mass-produced modules, does away with the patchwork look of home-built test instrumentation and — best of all — brings you the reliability characteristic of all trio/lab products.

You can get a single-limit TRI/LIM system for as little as \$500 — a fully programmable version for only \$650. The sky's the limit, of course — once you've caught the TRI/LIM fever.

Learn all about TRI/LIM from trio/lab's new "Handbook of Limit Instrumentation". It includes a definitive limit-of-error analysis; it's yours for the asking.

Design your next Limit-Instrumentation System in 10 minutes

...at IRE booth #3056

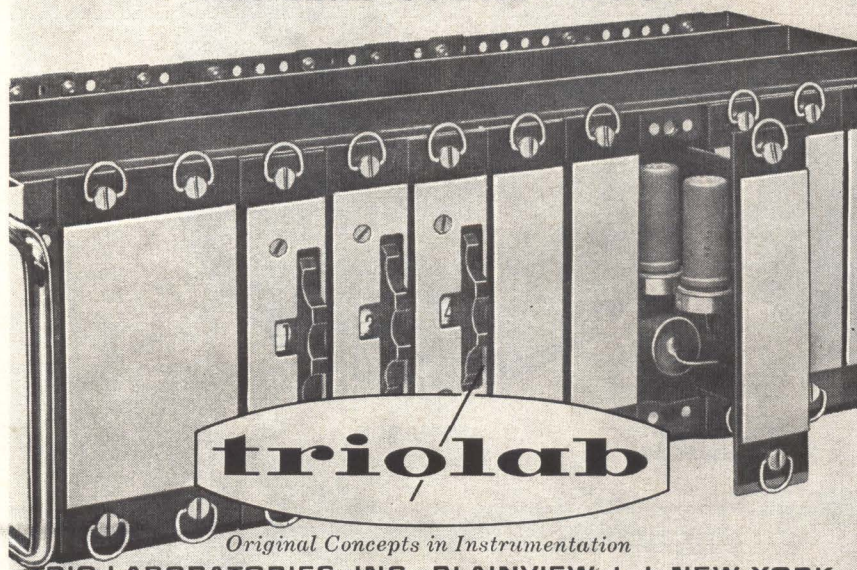

TRIO LABORATORIES, INC., PLAINVIEW, L. I. NEW YORK
OVERBROOK 1-0400, AREA CODE 516, TWX HKVL 1166

MEETINGS AHEAD

AUDIO ENGINEERING SPRING CONVENTION, AES; Ambassador Hotel, Los Angeles, Mar. 19-26.

IRE INTERNATIONAL CONVENTION, Coliseum & Waldorf Astoria Hotel, New York City, Mar. 26-29.

QUALITY CONTROL CLINIC, Rochester Society for Quality Control; University of Rochester, N.Y., Mar. 27.

ENGINEERING ASPECTS OF MAGNETO-HYDRODYNAMICS, AIEE, IAS, IRE, University of Rochester; University of Rochester, N.Y., Mar. 28-29.

QUALITY CONTROL ADMINISTRATIVE APPLICATIONS CONFERENCE, American Society for Quality Control; University of Montreal, Canada, Mar. 29-30

READ-ONLY DIGITAL COMPUTER MEMORIES DESIGN & APPLICATION DISCUSSION, Institution of Electrical Engineers (British); Savoy Pl., London, April 3.

ELECTRONIC & ELECTRICAL INDUSTRIAL-COMMERCIAL EQUIPMENT SHOW, Electrical Manufacturers Representatives Assoc. of Michigan; Artillery Armory, Detroit, April 4-6.

CHEMICAL & PETROLEUM INSTRUMENTATION SYMPOSIUM, Instrument Society of America; DuPont Country Club, Wilmington, Delaware, April 9-10.

NONDESTRUCTIVE TESTING CONVENTION, SNT; Pick-Carter Hotel, Cleveland, Ohio, April 9-13.

BUSINESS EQUIPMENT EXPOSITION, Business Equipment Manufacturers Association; McCormick Place, Chicago, April 9-13.

PLASMA SHEATH SYMPOSIUM, AF Cambridge Research Labs; New England Mutual Hall, Boston, April 10-12.

SOUTHWEST IRE CONFERENCE AND SHOW; Rich Hotel, Houston, Texas, April 11-13.

JOINT COMPUTER CONFERENCE, IRE-PGEC, AIEE, ACM; Fairmont Hotel, San Francisco, Calif., May 1-3.

HUMAN FACTORS IN ELECTRONICS, IRE-PGHFE; Lafayette Hotel, Long Beach, Calif., May 3-4.

ELECTRONIC COMPONENTS CONFERENCE, IRE-PGCP, AIEE, EIA; Marriott Twin Bridges Hotel, Washington, May 8-10.

AERO-SPACE INSTRUMENTATION SYMPOSIUM, Instrument Soc. of America; Marriott Motor Hotel, Washington, D. C., May 21-23.

ELECTRONICS PARTS DISTRIBUTORS SHOW, Electronic Industry Show Corp.; Conrad Hilton Hotel, Chicago, May 21-24.

NATIONAL AEROSPACE ELECTRONICS CONFERENCE, IRE-PGANE; Biltmore Hotel, Dayton, Ohio, May 22-24.

SELF-ORGANIZING INFORMATION SYSTEMS CONFERENCE, Office of Naval Research, Armour Research Foundation; Museum of Science, and Industry, Chicago, May 22-24.

THE FIRST CALIBRATED INFRARED SIGNAL GENERATOR!

MODEL 501 1 to 14 microns

Here, for the first time, is a standard calibrated Infrared Signal Generator that operates with the ease and efficiency you expect from standard electronic test equipment... eliminates the drawbacks of improvised set-ups. Developed with the cooperation of some of the country's leading infrared physicists, the Model 501 Generator provides advanced features found in no other single instrument.



FEATURES

- Wide Wave Length Range: 1-14 microns
- Calibrated Output Power
- Choice of Point Source or Collimated Beam Output
- Calibrated Step Attenuator
- Precision Servo Controlled Modulation
- Clean Spectral Profile
- Negligible Stray Light—Exclusive Prefiltering Monochromator
- Rapid Power Setting

APPLICATIONS

- System Sensitivity Measurements
- System Responsivity Measurements
- Detectivity Measurements
- Detector Responsivity Measurements
- Detector and System Frequency Response Measurements
- Jamming Susceptibility Measurements
- Resolution Measurements
- Standardization and Calibration
- Pattern Plotting

TELEWAVE LABORATORIES, INC.

43-20 34th St., Long Island City 1, N. Y.

We're interested in your needs. Tell us about them below—we'll rush complete information on the Model 501 and how it can help solve your problems.

Name _____

Title _____ Dept. _____

Company _____

Address _____

City _____ Zone _____ State _____

A B C D E F G
1 2 3 4 5 6 7 8 9 10 11 12

HOW THE MODEL 501 INFRARED SIGNAL GENERATOR WORKS

The instrument consists of a source, chopper, attenuator, monochromator and a power monitor.

The source produces a broadband radiated noise spectrum in the band of wavelengths from 1 to 14 microns, which is then filtered to produce the desired output signal.

Selection of desired wave length is accomplished by a monochromator (optical band-pass filter). The spectral profile of the output is governed by the entrance and exit apertures of the monochromator, which are cam-programmed to provide the bandwidth specified.

A choice of two specific output signals is provided: (a) a point source that radiates into a 5° cone; (b) a collimated beam one inch in diameter.

To distinguish output radiation from background radiation, the signal can be modulated by means of a chopper—a rotating shutter device located between the light source and the lens system focusing into monochromator.

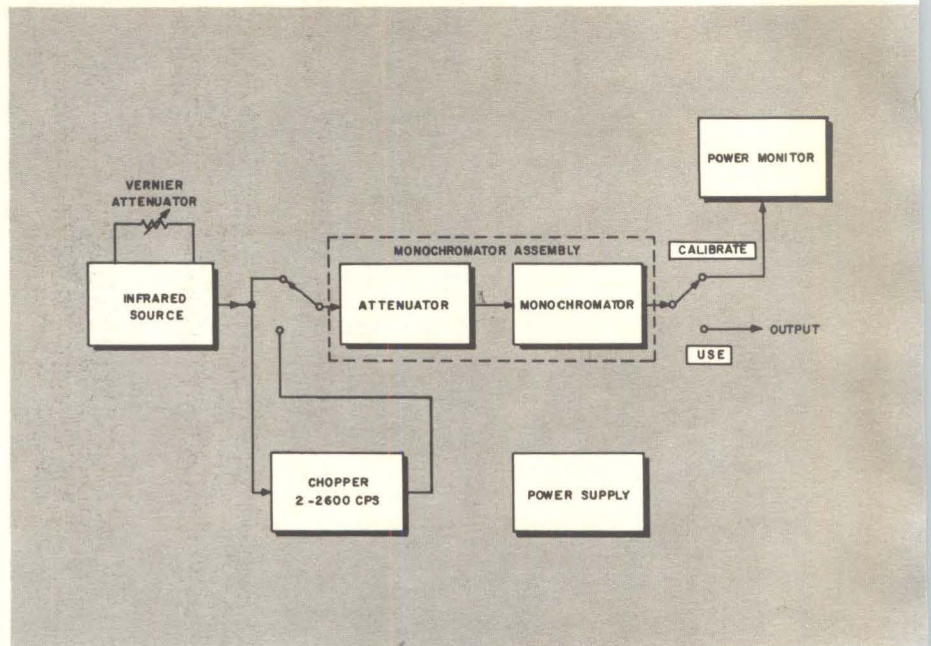

Power is monitored by means of a factory-adjusted thermistor bolometer and preamplifier, and a synchronous voltmeter.

Stepwise attenuation of the output signal is obtained by means of neutral attenuator grids placed within the monochromator.

SPECIFICATIONS

- Wave Length Range—1-14 microns
- Dial Calibration—0.2 microns
- Output Format—Switch selection of (a) Point Source 5.4° Cone of Radiation or (b) Collimated Beam 1-inch Diameter.
- Bandwidth—.35 micron Typical at 3 db points (at 5 microns)
- Power Output—1 microwatt Typical (at 5 microns)
- Power Output Accuracy—± 15%
- Step Attenuator—107:1 in seven 10:1 steps
- Step Attenuator Accuracy—± 10% per step
- Vernier Attenuator—100:1 in two 10:1 ranges
- Vernier Attenuator Accuracy—± 5%
- Modulation Frequency—2-2600 cps in 2 ranges
- Modulation Frequency Accuracy—± 2%
- Modulation Waveshape—100% square wave

Postage
Will be Paid
by
Addressee

No
Postage Stamp
Necessary
If Mailed in the
United States

BUSINESS REPLY CARD

First Class Permit No. 18, Long Island City 1, N. Y.

TELEWAVE LABORATORIES, INC.

43-20 34th ST., LONG ISLAND CITY 1, N. Y.

*This card will bring you
new information on
latest developments
in infrared generators*



**TELEWAVE
LABORATORIES
INC.**

43-20 34th St., Long Island City 1, N. Y.
EXeter 2-3288



Single-Place Gyrocopter by Bensen Aircraft Corp.

Get a close-up of growing manpower in VIRGINIA'S SHENANDOAH VALLEY

You're looking at the most valuable crop for new industry grown in Virginia's Shenandoah Valley. Here the farm tradition of big families is strong. Yet increasing farm mechanization is constantly freeing more and more of this growing rural manpower to fill new industrial jobs.

Add to that the small, independent farmer tradition of home-rooted conservatism and hard work. You'll see why you couldn't find a better place, or a pleasanter place to put the power of

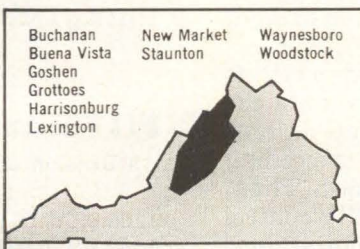

today's population explosion to work for you. Ask VEPCO for full economic facts about this famous Valley. . . its plant sites, hospitable communities and nearness to both materials and markets. Write, wire or phone.



VIRGINIA ELECTRIC and POWER COMPANY
Clark P. Spellman, Manager Area Development
Electric Bldg., Richmond 9, Virginia • Milton 9-1411
Serving the Top-of-the-South with 2,049,000 kilowatts
—due to reach 3,019,000 kilowatts by 1964.

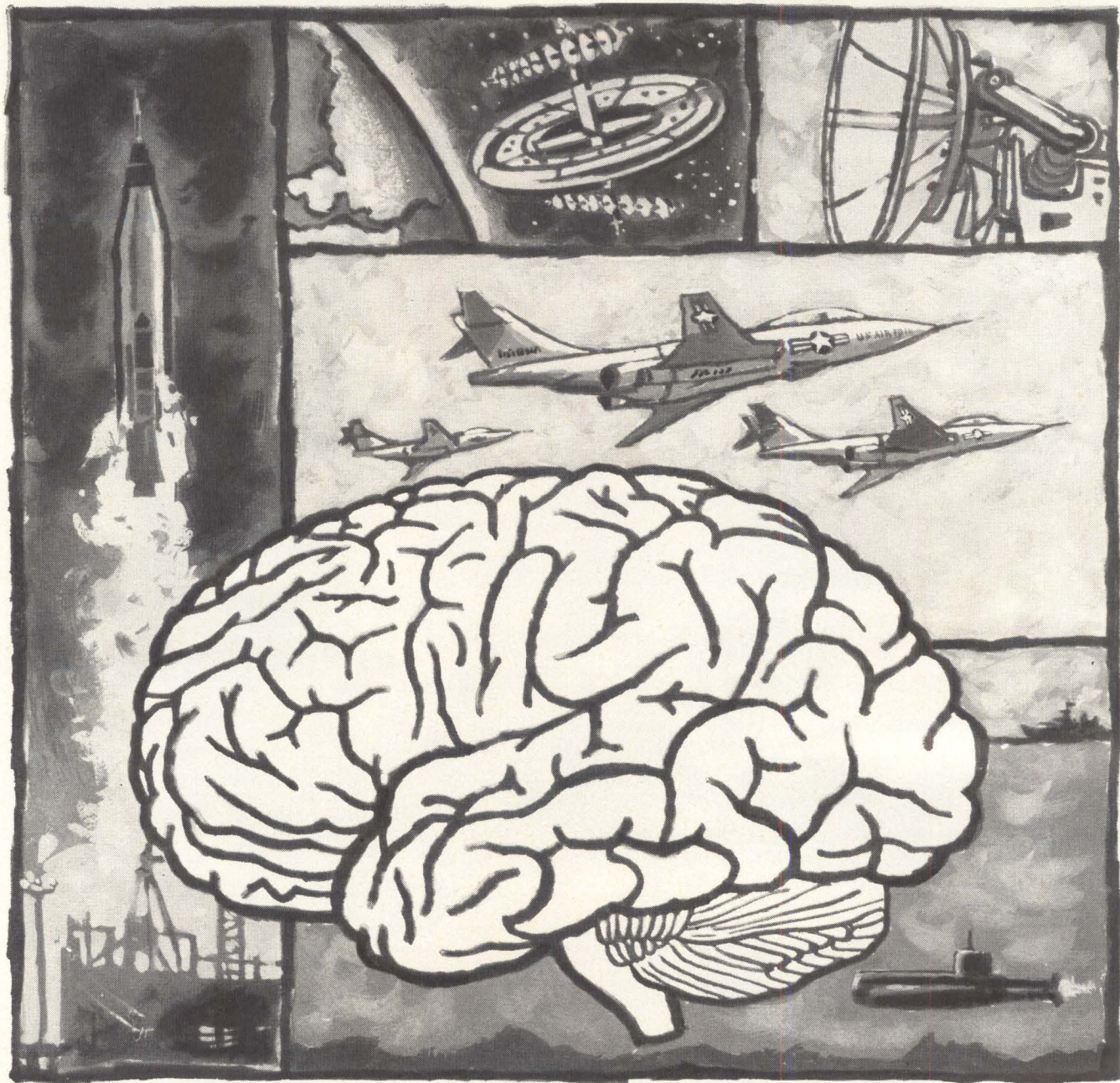

RELIABILITY IS A BRAINCHILD

It isn't inherent in the product itself; and it can't be tested into it either. Responsibility for reliability lies with policy and design. That's why Hitemp is recognized as the leading manufacturer of high temperature wire and cable.

Why Hitemp? First, reliability at Hitemp begins with company directives: Hitemp makes *only* the highest quality products. Second, Hitemp designs and engineers a margin of reliability exceeding customer and Mil specs into every foot. Then, Hitemp production, inspection and quality control procedures see to it that this margin is maintained

...from original concept to completed contract.

Wherever reliability of high temperature wire and cable, tubing and tape is mandatory, you'll find Hitemp specified!

HITEMP WIRES CO.

a Division of Simplex Wire & Cable Co.

1200 SHAMES DRIVE, WESTBURY, NEW YORK
1532 S. CALIFORNIA AVE., MONROVIA, CALIF.





NEW!

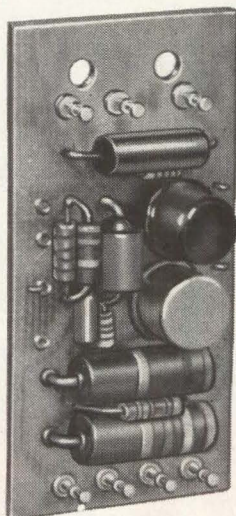

DC PULSE CIRCUIT

PRODUCES PRECISE POWER OUTPUT PULSE... AVAILABLE FROM .006 TO .5 SECONDS

This new circuit—when triggered by a SPDT switch or relay—produces a single pulse. The output pulse is independent of the "on" time of the input contacts and the d-c input voltage. With a current output of 300 milliamps up to 55 vdc, it can be used for pulsing relays, solenoids and

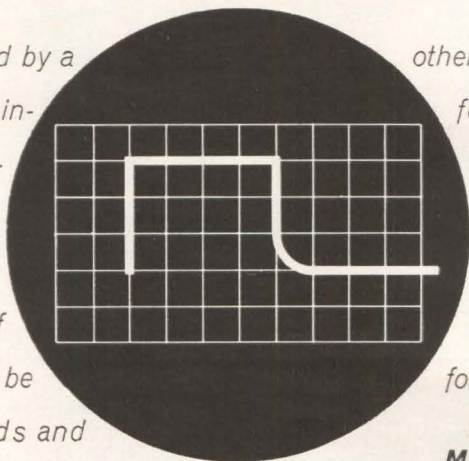

other electromagnetic devices, as well as for timing and sequencing applications. Get complete data on this and other MICRO SWITCH assemblies from our nearby branch office listed in the Yellow Pages...or write for Data Sheet 194.

**VISIT OUR EXHIBIT, IRE SHOW,
MARCH 26-29, BOOTHS 2206 and 2208.**

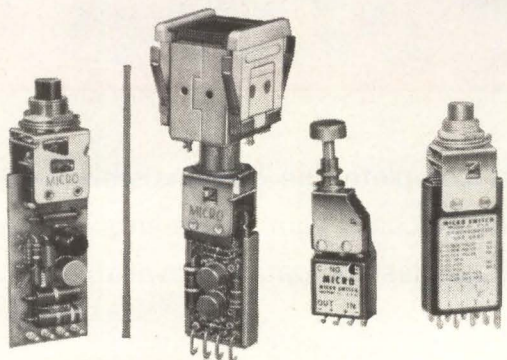

D-C Pulse Circuit is available assembled to a snap-action pushbutton switch.

Three additional lines of pulse circuits are available, with or without actuators.

MICRO SWITCH, FREEPORT, ILLINOIS

A Division of Honeywell

In Canada: Honeywell Controls, Limited, Toronto 17, Ontario



Honeywell

MICRO SWITCH Precision Switches



6 NEW PHILCO DEVELOPMENTS BROADEN THE DESIGNER'S HORIZONS



1 AMP. TUNNEL DIODE

For Tunnel Diode motors, power converters, and current surge limiters. TO-18 package. Tight peak current control.

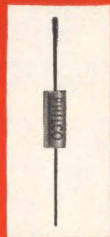

EPOXY-PACKAGED TUNNEL DIODE

New low cost, 5 ma high speed tunnel diode for logic and memory applications. Subminiature package mounts like a resistor.

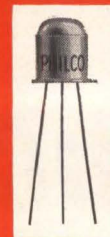

OPTICAL EPITAXIAL SILICON PLANAR TRANSISTOR

Responds to both electrical and light signals. High switching speed ($t_{ON} = 25$ nsec max.). High photosensitivity ($1 \mu\text{a}/\text{ftC}$).



2 Kmc MADT*

Amplifier, oscillator and mixer for UHF and microwave. Available in both TO-18 and coaxial packages.



400 mc POWER AMPLIFIERS AND OSCILLATORS

Guaranteed power outputs: 0.5 w at 160 mc (min. eff. 42%); 0.2 w at 240 mc (min. eff. 29%); 0.055 w at 400 mc (min. eff. 10%).



VIDEO AMPLIFIER TRANSISTORS

For driving CRT's and other high level ($V_{OUT} \geq 120$ V) wideband (to 5 mc) video requirements.

Philco complements its complete line of transistors with developments for new circuit possibilities. We welcome your comments and questions on these new Philco devices. Design samples and data are available now. Write Dept. E21662.

SEE THESE
NEW DEVICES AT THE
I.R.E. SHOW
BOOTHS 1302-1308

LANSDALE DIVISION
PHILCO
A SUBSIDIARY OF *Ford Motor Company*
LANSDALE, PENNSYLVANIA



*Micro Alloy Diffused-base Transistor

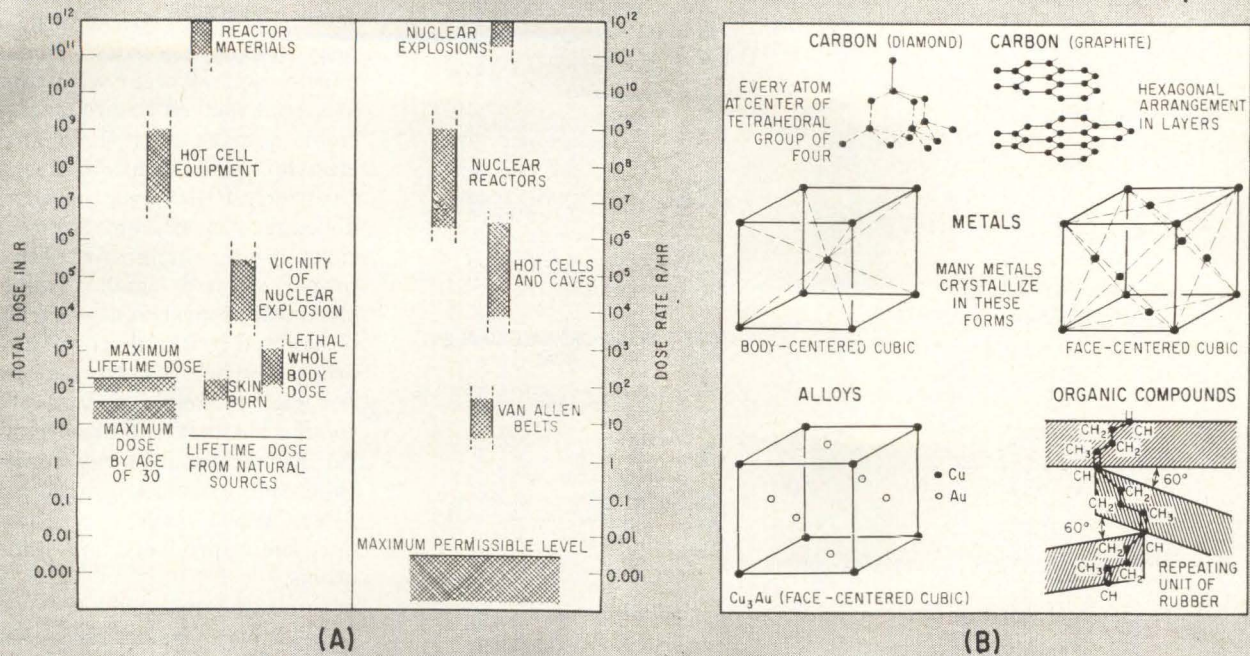

FIG. 1—Comparison of total doses and dose rates (A). Typical structures (B)

Designing Equipment for Nuclear Environments

How equipment and components are affected by radiation of high dosage, low dose rate and low rate of change of flux level radiation.

Damage is illustrated with simple models of the structure of matter

By P. BARRATT,*
Pye Ltd.,
Cambridge, England

A PREVIOUS ARTICLE in ELECTRONICS discussed the effects of transient radiation on electronic circuits.¹ Here, a different radiation environment, characterized by high doses but comparatively low dose rates and rates of change of flux levels is considered. Table I illustrates the differences between weapon ex-

plosion and reactor environments.

Electronic component behavior is only one aspect of the design problem; to it must be added: equipment activation; radiation heating; mode of equipment use and compatibility of the equipment with its environment, involving chemical and radiation properties.

Experimental data are still limited and theoretical predictions must frequently be qualitative rather than quantitative. For these reasons an approach is outlined which has proved valuable in this

type of work. The aim is practical, that of building up background knowledge to help resolve design problems when there are no guides.

The starting point is the expression of the structure of matter in terms of simple models, followed by the study of radiation damage in relation to the models. These aspects are sufficient for the determination of significant radiation types and the assessment of the relative suitabilities of available components of a given type. Published data, with their uncertain-

*Deceased, Feb. 11, 1962

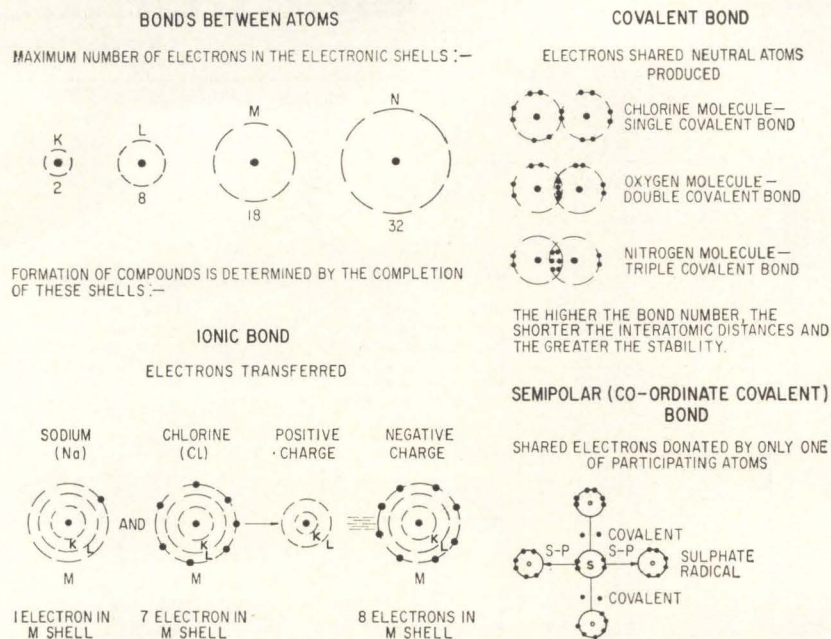

FIG. 2—Type of bond is important in studying radiation effects

ties as to the precise flux spectrum and irradiation temperature, need be used only to indicate the order of magnitude of significant doses or dose rates. In this work, too great reliance upon figures is inadvisable since the equipment is probably intended to work in an ill-defined environment. But, in some cases, radiation must be counted at least as important as such items as temperature and pressure.

Figure 1A shows the doses and dose rates encountered. Note that equipment within caves used for handling active material receives doses several decades greater than in the vicinity of a nuclear explosion. Television equipment used in shut-down reactors is regularly subjected to 10^6 R hr⁻¹ of gamma radiation and receives total doses well in excess of 10^9 R during its life. Gamma doses of 10^{10} R hr⁻¹ can occur in a working reactor.

There are a number of other situations in which moderate doses can be received, like near accelerators or active sources. These have been discussed already in more detail.²

The conditions requiring electronic parts and equipment to be exposed to radiation can be readily summarized. Humans can be exposed only to radiation levels which are low relative to those commonly used in nuclear technology, hence they cannot be used directly as a control or observing agent. This

results in a demand for remote observation, control and transmission.

Knowledge of the basic structures of materials is essential in interpreting and predicting radiation effects. The important features may lie in nuclear or electronic properties, lattice arrangements, chemical bonding and molecular orientation. Often, the detail in which a material must be considered depends on the property.

Mechanical and some physical properties can often be explained in qualitative terms without considering finer scale detail than the molecular. Physical properties such as electrical resistivity are related more to the electronic configurations.

Consistent with these simplifications, only four classes of materials (metals, inorganics, organics and semiconductors) need be distinguished. Figures 1B, and 2 illus-

TABLE I—COMPARISON OF ENVIRONMENTS

Radiation source	100-kiloton nuclear explosion	100-Mw power reactor
Equipment location	$\frac{1}{4}$ – $\frac{1}{2}$ mile from center	Max flux position in core
Gamma dose rate (R hr ⁻¹)	10^{12}	10^8
Neutron dose rate (cm ⁻² sec ⁻¹)	10^{18}	10^{13}
Duration of irradiation (sec)	10^{-6}	10^6
Total neutron dose (cm ⁻²)	10^{12}	10^{19}
Total gamma dose (R)	10^6	10^{12}

trate the following discussion.

Metals are represented as an assembly of ions with a large number of free electrons. Ionization effects, such as occur with gammas, are not expected to produce appreciable damage since the changes in electron concentration are relatively small. However, particles can dislodge atoms from lattice positions, giving changes in mechanical properties and small changes in electrical properties as electrons are obstructed by the disruption of the orderly lattice. There is a similarity with a simple picture of heat conduction, but radiation can give far higher local energy concentrations than occurs with thermal effects. When nuclear reactions occur their products are impurity atoms.

Inorganic materials are characterized by more marked chemical bonds than occur with metals. The electrovalent bond implies the presence of ions, and again there is comparative insensitivity to ionization. However, ionization sensitivity is greater than for metals.

Organic compounds are often complex assemblies of groups of atoms and are taken to include silicon-based as well as carbon-based materials. All types of radiation can cause considerable damage since ionization breaks the chemical bonds that determine the material properties. This sensitivity to radiation is in accord with the greater sensitivity to temperature increase that is found with the two previous groups. High melting point is frequently allied with resistance to radiation. Polymers—long chains of groups of atoms forming one, two or three-dimensional networks—are particularly important. Orientations and lengths of the chains are important in determining properties.

Semiconductors are only the borderland between metals and non-metals but their importance in electronics warrants specific treatment. The complexities of the semiconducting state are well known and radiation effects considered in detail are equally complex. Nevertheless, many effects can be explained using conventional ideas of charge carriers. The crucial point is the sensitivity of properties to small changes in charge carrier concentrations.

These four classes correspond to the classification of radiation damage effects and are convenient for grouping components of a given type. For example, capacitors may rely on organic or inorganic dielectrics.

Mention should be made of dislocations, a useful concept in considering solid-state behavior.^{3,4} They are imperfections in the structure and can give the material different properties to those it would have with a perfect lattice. They may represent weak points in the structure or sinks for other defects. This discussion cannot pretend to be even a survey of the useful models but, with the following section, it shows the value of a superficial approach to solid-state physics in the practical application of radiation damage concepts. Further information is available.^{5, 6, 7, 8}

Table II includes all types of radiation that may be encountered. The list can be reduced considerably; except in special cases, equipment containers or distance itself will remove all but neutrons and gammas. A possible exception lies in beta particles; viewing equipment may require the exposure of optical components to appreciable beta levels. Neutrons and gammas are most significant since the other particles show damage behavior similar to that of neutrons.

Before summarizing the most important mechanisms it is useful to define the threshold energies which radiation must possess to produce significant changes in material. There is considerable dependence on atomic weight but Table III, indicates the general situation.⁴ The values given assume that a lattice displacement requires an atom to be given 25 ev.

As the discussion of material structure indicates, the properties of matter depend either on how its constituent atoms are located spatially (the lattice) or how they are held together (bonding), or both. Radiation effects can be considered as displacement effects in which atoms are moved, with resulting disturbance of electrons, and ionization effects in which the atom remains in its lattice position but the local electron configuration is changed. Particulate radiation therefore produces both displacements and ionization while gammas

show predominantly ionizing action. Displacement effects can be further broken down into vacancies and replacement collisions. Vacancies are created when an atom leaves its lattice site and comes to rest in interstitial positions of unstable equilibrium. Neutron reactions produce new nuclides which are then impurity atoms. Replacement collisions occur when one displaced atom ejects another from its lattice site, which it then occupies since it has insufficient energy to leave. Figure 3 illustrates a number of the damage mechanisms.

These concepts agree with the observed types of damage. Effects range from permanent damage, which can only be partially annealed out, to temporary effects which disappear as soon as radiation is removed. Many materials show such limits of behavior, while others show both effects with widely varying relaxation times for partial recovery from the damage.

Figure 4A shows the characteristics symbolically, but the association of total dose effects with displacements and of rate effects with ionization is not generally valid.

Materials classification and radiation effects can now be brought together.

Metals are virtually insensitive to gamma radiation (apart from heating effects) and fast neutron doses of at least 10^{20} n/cm² are necessary before displacement effects produce significant changes in properties, such as resistivity and density, that are important from the electronic viewpoint. Magnetic properties may be affected by doses that are a decade lower.

Inorganic materials show more sensitivity; optical properties are affected by both neutrons and gammas in, for instance, glasses. Displacement effects lead to significant density changes for doses of 10^{18} . As a working rule for insulators, a dose of 10^{20} n/cm² leads to expan-

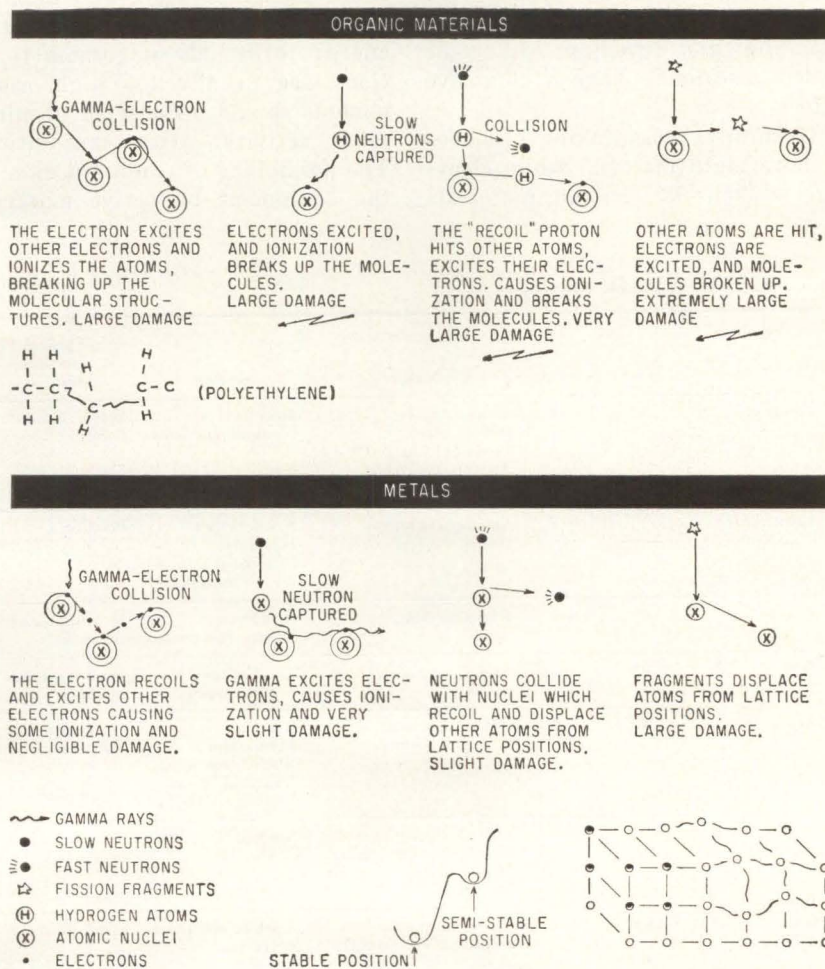

FIG. 3—Radiation damage mechanisms in organics and metals

sions of the order of 1 percent in insulating materials, and below this, expansion is linearly related to dose. Glasses may shatter for neutron doses in excess of about 10^{17} n/cm². Their optical transmission may be affected by gamma doses of only 10^7 R or neutron doses of 10^{14} — 10^{15} n/cm². Where comparison is appropriate, inorganic compounds are sensitive to doses a decade lower than those which are important with metals in the same application.

Organic materials may become effectively different materials for comparatively low doses. Changes in mechanical rather than electrical properties prevent their usage. The increase in conduction resulting from ionization can be considerable. Polymers are particularly susceptible. Figure 4B shows two of the important effects — cleavage and cross-linking — the breaking of chains and setting-up of bonds between chains. Processes such as this leave free radicals which enter into new chemical reactions. An important example is the evolution of gases within plastics, leading to clouding and swelling. In some cases gases may have a corrosive effect.

Generally, cross-linking produces a more rigid material while cleavage weakens it. Organic materials

differ in their susceptibilities and it must be emphasized that the many variations within a particular type prevent generalizing as to the behavior of individual examples. For instance, fillers may modify radiation resistance considerably. Silicones in general show behavior similar to carbon-based materials. A total neutron dose of 10^{18} n/cm² represents the limit for virtually all plastics and some are useless by 10^{14} — 10^{15} n/cm². The corresponding gamma doses are 10^5 — 10^6 R, as lower and upper limits.

Semiconductors are extremely sensitive. Silicon and germanium show considerable property changes by 10^{13} n/cm² or about 10^5 — 10^6 R of gamma. Again there are considerable variations from material to material and property to property, but the use of semiconductive materials in radiation fields should be avoided as far as possible.

With all four classes of material the degree of radiation damage depends not only upon the radiation but also upon previous history, irradiation temperature and impurities. With neutron fields, since the energy thresholds of gamma reactions are usually too high, components should be selected to minimize activity after irradiation. The possibility of contamination of the equipment by active material

affects design of the equipment casing only; it is desirable to contain the electronics fully to avoid compatibility problems.

Assessment of the relative merits of two materials from the neutron activation aspect is complicated by the types of active nuclides which are produced in the parent material, irradiation time and decay time. It is necessary to define the period for which the equipment will be irradiated because this determines the nearness of approach to saturation activity. Decay time is important since the active nuclides will decay at different rates. Figure 4C summarizes the general cases while Table IV lists the active nuclides formed by irradiation of some commonly used materials.

Frequently only one nuclide is important and the problem can then be stated simply. Time T_c is defined as the decay time at which samples of two materials that have received identical irradiations have equal activities. If handling is required before T_c has elapsed, one material is used, if later than T_c , the other.

Two simple expressions apply for short and long irradiation times.

If $t_{a,b}$ = half-lives of active nuclides in elements a and b , $A_{a,b}$ = atomic weights of parent nuclei, T_i = irradiation time and $\delta_{a,b}$ = activation-cross sections of parent

TABLE II — RADIATION

Name	Mass	Charge	Nature	Sources	Typical Shielding Materials	Ranges in Air (energy dependent)	Radiation Damage
Neutron	1	0	Basic particle; radioactive Fast neutrons $> 10^4$ e v Thermal neutrons < 0.025 e v	Reactors, Nuclear reactions	Water, concrete, boron	Up to 100's of feet	Lack of charge gives high penetration, hence distributed damage. Displacements and ionization
Electron (e) or Beta (β)	1 1837	-1	Basic particle; stable	Accelerators, Reactors, Nuclear reactions, Active materials	Plastics	Few feet	Easily stopped, damage is a surface effect
Proton (p)	1	+1	Basic particle; stable	Accelerators, Nuclear reactions	Most materials adequate	Inches or less	Charged, so easily stopped; displacements and ionization
Deuteron (d)	2	+1	Proton + neutron; stable	Accelerators, Nuclear reactions	Most materials adequate	Inches or less	"
Alpha (α)	4	+2	Helium nucleus; $2n + 2p$. Stable	Reactors, Accelerators, Nuclear reactions, "Natural" Radioactivity	Most materials adequate	Inches or less	"
Fission Product (F/P)	~95 or ~140	Variable	Remnants of atoms which have undergone fission, Maybe: Xe, Kr, Ba, Sr, Cs	Nuclear fission of, U, Pu, Th	Most materials adequate	Inches or less	"
Gamma (γ) X-rays.	Wave	0	Electromagnetic radiation, wavelengths of 10^{-7} — 10^{-11} cm	Nuclear reactions, Reactors, Accelerators, Active materials	Lead	Up to 100's of feet	Penetrating; distributed damage; ionization

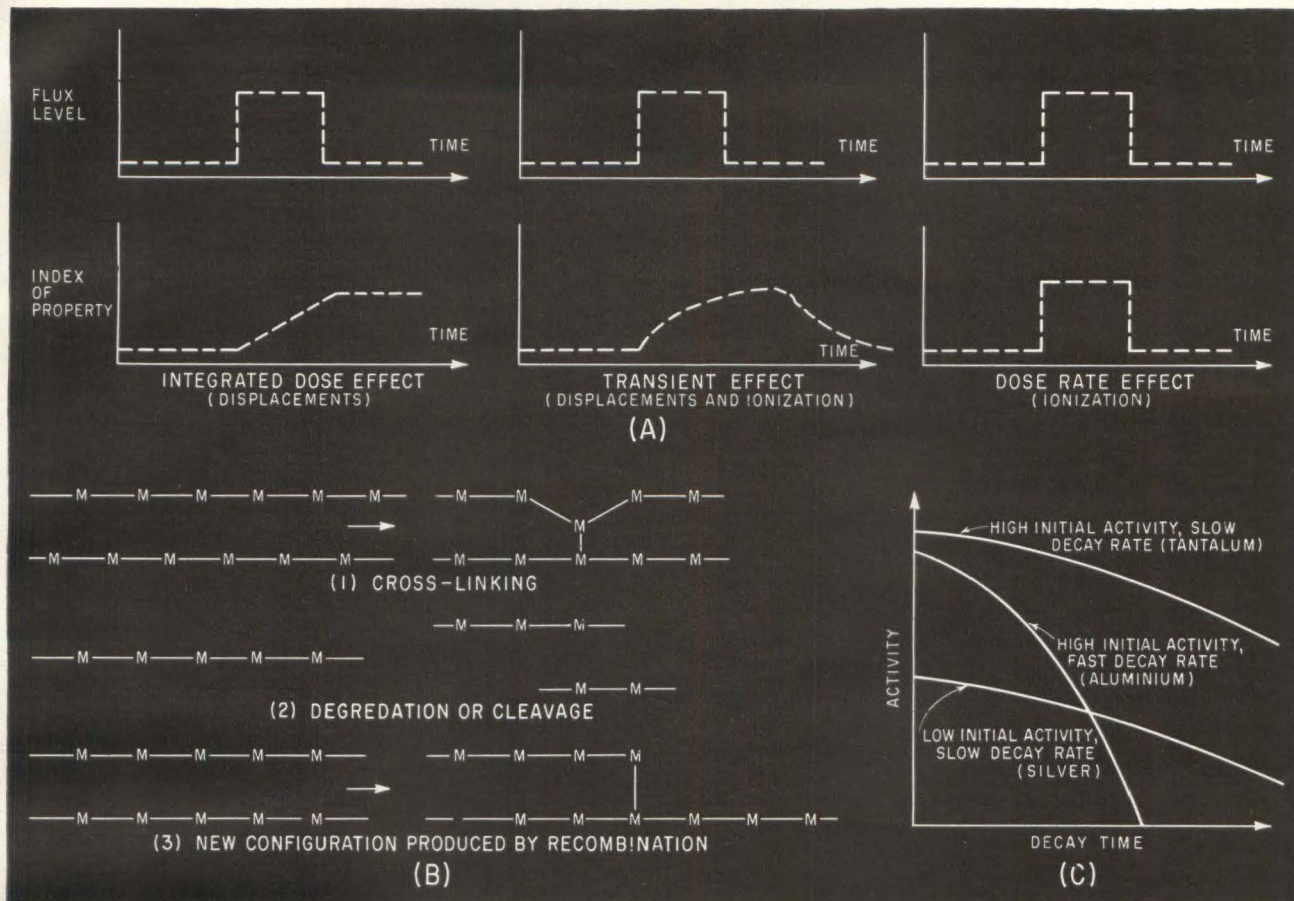

FIG. 4—Types of radiation (A). Radiation effects on polymers (B) and types of decay curves (C)

nuclei; then the decay time is

$$T_c \cong \frac{1.44 t_a t_b}{t_a - t_b} [\ln (A_a/\delta_a) - \ln (A_b/\delta_b)]$$

for $T_i \gg t_{a, b}$ and

$$T_c \cong \frac{1.44 t_a t_b}{t_a - t_b} [\ln (A_a/\delta_a) - \ln (A_b/\delta_b) + \ln (t_a/t_b)]$$

for $T_i \ll t_{a, b}$

These expressions apply to equal masses of the two elements; an equal volume basis yields different results.

Use of these limits can still give results of practical interest since they may not differ by a great amount. The general expression

TABLE III—THRESHOLD RADIATION IN EV TO PRODUCE DISPLACEMENTS

Radiation	Atomic Weight of Material Atoms		
	10	100	200
Neutron, Protons	76	638	1263
Alpha Particles	31	169	325
Fission Fragments of Atomic Weight 100	76	25	28
Gamma, Electrons	10^6	6.8×10^6	1.1×10^6

for T_c does not show any maxima or minima between the two limits, that is, T_c does not lie outside these limits for any intermediate irradiation time.

Comparison of equal masses of iron and aluminum gives T_c values of 57 m and 13.15 m for short and long irradiations; hence for immediate examination, iron is preferable; if a decay time of an hour or more is permissible then aluminum is the correct choice.

Correct selection can reduce component activities by factors of 10^0 or greater.

Energetic particles or photons are capable of giving considerable heating effects as they give up their energy. Except for a few elements with high thermal neutron absorption cross-sections, thermal neutrons (0.005–0.5 ev) produce negligible heating compared with fast neutrons (0.1–10 Mev) since the fluxes are usually comparable in thermal reactors—the only location in which neutron heating is likely to be important.

Thermal neutrons may, however, lead to activation and the subse-

quent emission of energetic particles, for example, 2.87 Mev betas from Al^{28} .

Gamma heating and fast neutron heating frequently have similar magnitudes and the effect is uniformly distributed throughout the material since both radiations are penetrating. Beta particles generally produce only surface heating.

In a reactor, gamma heating is usually due primarily to prompt fission and U^{235} capture gammas, hence the heating rate is proportional to the reactor power or flux level.

Published data^{9, 10, 11} agree with theoretical estimates in suggesting heating rates of the order of 0.5 watt gm^{-1} for gamma levels of 10^6 – 10^9 R/hr; taking 1 joule/gm deg C as a typical specific heat, this implies temperature rises of 30 deg C/min assuming no heat losses.

The heating problem can be minimized by: choice of material, provision of conduction paths to a heat sink such as a reactor coolant and designing for the anticipated temperature rises. The high thermal capacity gained by increasing the

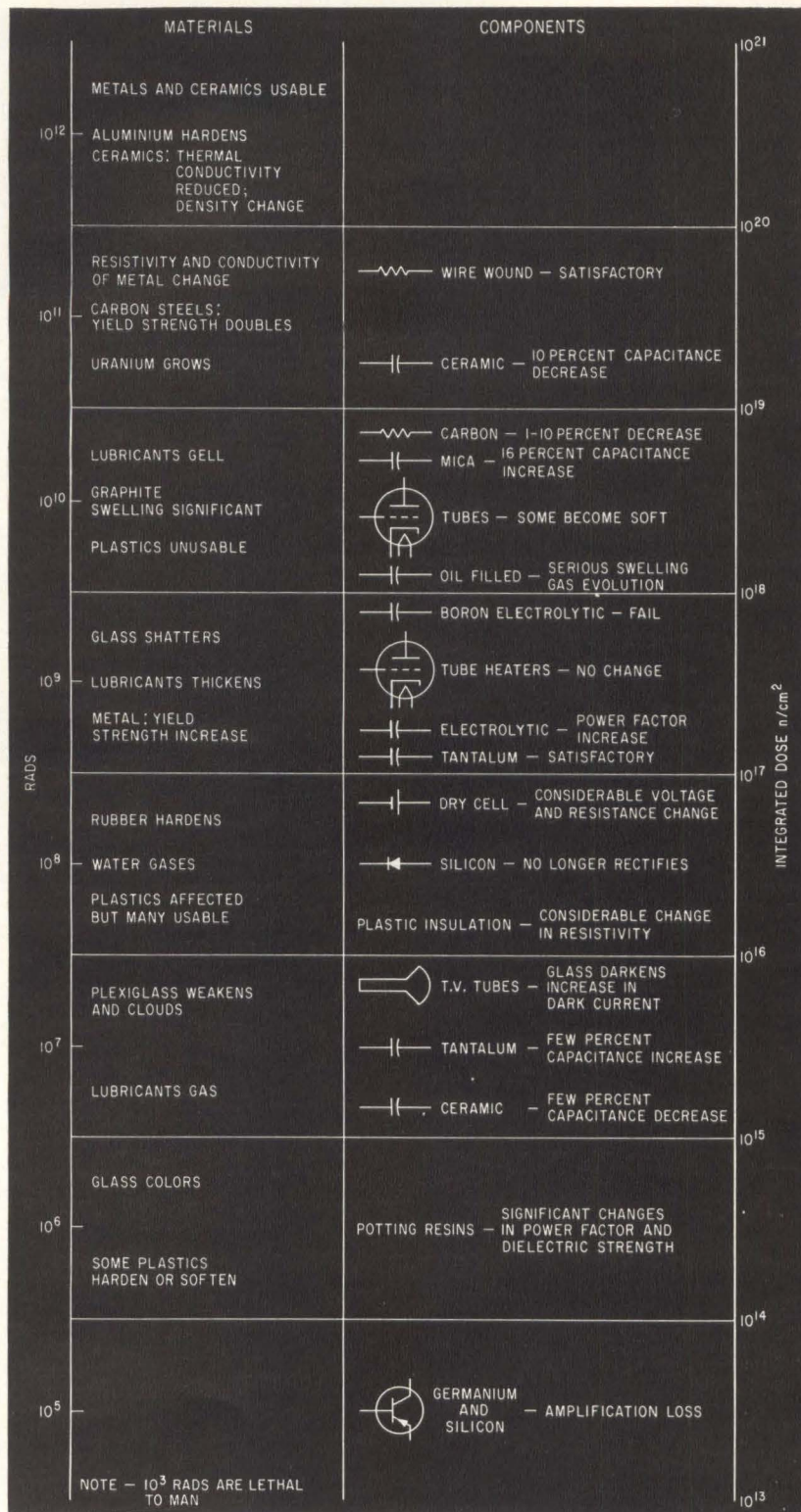

FIG. 5—Radiation damage to materials and electronic components

mass of material is no solution since the total heating rate is, to a first approximation, also proportional to mass. The provision of suitable sensing elements is desirable; thermistors are usable at fluxes of 10^{12} n/cm² sec and thermocouples are usually satisfactory.

Absorption mechanisms cannot

be described within the scope of this article, for further details references 4 and 12 could be consulted; the constants necessary for calculations are readily available.¹³ It is most important to obtain a good representation of the radiation energy spectrum before attempting predictions.

Summaries of experimental results and bibliographies have already been published.^{14, 15} These, with experience, form the basis of the summaries. Remember that pre- and postirradiation measurements will not necessarily indicate component performance under irradiation. Figure 5 relates electronic component damage to that of materials.

Some types of tubes may fail with neutron doses of about 10^{17} n/cm² but others are still satisfactory after doses in excess of 10^{18} n/cm². Envelope failure due to neutron damage is a common cause, particularly with boron-containing glasses. Gamma radiation colors the envelopes but is usually significant only in tubes such as thyratrons, multiplier phototubes, and vidicons which are ionization sensitive. Tubes may be used for neutron doses in excess of 10^{18} n/cm² and gamma doses of at least 10^{10} — 10^{11} R.

Ceramic, glass, and mica dielectric capacitors are, as would be expected, most satisfactory, typically showing capacitance decreases of a few percent for 10^{18} n/cm² or more. For the same dose, plastic dielectrics can show variations of 10-20 percent, and paper capacitors up to approximately 80 percent. Plastic dielectrics will be affected far more drastically by gammas than the inorganic dielectrics. Boron-containing electrolytics may fail with 10^{16} n/cm², and oil-filled capacitors are prone to gas evolution.

Tantalum electrolytics have good resistance (a capacitance maximum for 10^{15} — 10^{16} n/cm² was noted in one type) and are rather better than plastic dielectric capacitors. Effects on power factor are small but appreciable changes in leakage current have been measured. Generally, capacitors can be chosen to match the performance of the tube.

Resistances up to at least 10 megohms are insensitive to radiation damage. Observed resistance decreases may be due to ionization giving external conduction paths. Wire-wound and metal-film types will probably withstand at least 10^{19} n/cm² and have negligible sensitivity to large gamma doses. Possible weaknesses lie in the former and in the insulation. Typical re-

sistance changes are less than 1 percent for 10^{18} n/cm². Carbon composition resistors show resistance variations of from 1-10 percent for similar doses. As with all components, some resistors show unfortunate choice of materials or modes of construction and give considerably worse performance than the majority. Composition-type potentiometers appear to be more susceptible, with resistance changes of 10 to 30 percent for 10^{18} n/cm².

Neutron doses of 10^{14} n/cm² or less can seriously affect the electrical properties of germanium and silicon, while 2×10^6 R/hr¹ of gamma increases transistor noise levels by 25 db. Selenium withstands higher doses; it is an open question whether silicon or germanium is preferable. Individual diodes and transistors show better performances but tolerable dose levels must be set several orders of magnitude lower than for other components. The great sensitivity to gamma radiation is a considerable disadvantage.

Magnetic properties of materials are not seriously affected by doses of 10^{17} — 10^{18} n/cm² at least, hence many component types such as motors, relays, chokes and transformers must be judged in terms of their insulation. Leakage currents through plastics may change by a factor of 10^3 and mechanical breakdown can occur at neutron doses from 10^{14} n/cm² upwards, or about 10^7 — 10^8 R of gamma depending on the material. Quartz crystals irradiated to about 16^{18} n/cm² show frequency changes of less than 0.01 percent. Limit switches will generally be only as good as their housings. Dry cells show erratic behavior for neutron doses in the region of 10^{16} n/cm². Encapsulating materials may give almost order-of-magnitude changes in power factor, loss factor and dielectric strength, with smaller changes in dielectric constant at doses of 10^{14} n/cm².

There have been few attempts to irradiate and monitor working assemblies. Completely satisfactory performance has been found with units working at 1.2×10^{12} thermal n/cm² sec with 10^6 — 10^7 R/hr gamma, and to doses of 10^{18} thermal n/cm², 10^{15} f n/cm², + 10^6 R gamma.

In equipment design, the circuit

TABLE IV—ACTIVITIES OF MATERIALS AFTER IRRADIATION.

For 24 days irradiation at 10^{11} n cm ⁻² sec ⁻¹ of gm of parent material. Total dose of 2×10^{17} nvt			
Element	Active Nuclides	Half-life	Activity
Manganese	Mn ⁵⁶	2.6 hr	390 mc gm ⁻¹ (Saturated)
Tungsten	W ¹⁸⁷	2.4 hr	85 mc gm ⁻¹ (Saturated)
Copper	Cu ⁶⁴	12.8 hr	69 mc gm ⁻¹ (Saturated)
Tantalum	Ta ¹⁸²	111 d	23 mc gm ⁻¹
Aluminum	Al ²⁸	2.3 m	13 mc gm ⁻¹ (Saturated)
Cobalt	Co ⁶⁰	5.2 yr	8.5 "
Zinc	Zn ⁶⁹	51 m	4.6 " (Saturated)
	Zn ^{69m}	13.8 hr	0.46 " (Saturated)
	Zn ⁶⁵	245 d	0.37 "
Silver	Ag ^{110m}	270 d	1.15 "
Silicon	Si ³¹	2.62 hr	195 μc gm ⁻¹ (Saturated)
Iron	Fe ⁵⁹	45 d	24 μc gm ⁻¹
Oxygen	N ¹⁶	7.45 sec	1.42 " (Saturated)
	N ¹⁷	4.145 sec	0.35 " (Saturated)
	O ¹⁹	29.45 sec	4.39 " (Saturated)
	C ¹⁴	5568 yr	94.4 μc gm ⁻¹
Hydrogen	H ³	12.26 yr	226 "

used in the high flux regions should be minimal. It is far better to have elaborate external, accessible equipment if necessary. This may require a compromise with the policy of making the overall functioning of the equipment as insensitive as possible to variations in the performance of individual components.

Where material choices exist, the preference should be for those with low activation and radiation heating characteristics. Replacing organic materials by inorganic can increase life by $100 \times$, and $1,000 \times$ if metals can be used. In reactor work, the assembly should have a low overall neutron absorption cross-section. It is possible to design electronics that will serve as reliably as control rods. This is consistent with using as small quantities of material as possible to minimize total activity.

Structural members should be metal or ceramic, distance rather than insulators should be relied upon for insulation, and regard should be paid to the lower breakdown voltages between points at differing potentials.

It is essential to define the incident radiation as closely as possible and consider each component in detail in relation to the radiation. This involves the generally difficult task of establishing the true composition of materials used in the component.

There is a need to develop a general approach similar to that already suggested so that reasonable decisions can be made without too frequent recourse to expensive and time-consuming experiment. When experiments are necessary they should be fully instrumented so

that equipment behavior can be understood under irradiation conditions.

There is generally little to be said for shielding unless, for special reasons, weight and dimensions are relatively unrestricted.

It is hoped that this article has helped to put radiation into perspective as an environmental factor. With meticulous attention to detail, there is no reason why electronic equipment should not withstand for higher radiation doses than are usually required or regard as realistic.

The author thanks the directors of Pye Ltd. for permission to publish this paper and to record that this article represents work carried out by a team drawn from Pye TVT Ltd., Cathodeon Ltd., and Pye Ltd.

REFERENCES

- (1) J. W. Clark, et. al., What Designers Should Know About Transient Radiation. *ELECTRONICS*, p 62, Feb. 10, 1961.
- (2) P. Barratt, and L. M. Waters, The Applications of Closed-Circuit Television in the Nuclear Industry. *Jour Brit IRE*, 20, No. 3, p 225, Mar. 1960.
- (3) W. C. Dash, and A. G. Tweed, Observing Dislocations. *Scientific American*, 205, No. 4, p 107, Oct. 1961.
- (4) G. J. Dienes, and G. H. Vineyard, "Radiation Effects in Solids". Interscience Publishers, New York, N. Y., 1957.
- (5) A. H. Wilson, "The Theory of Metals". Cambridge University Press, 1953.
- (6) R. C. Evans, "Crystal Chemistry". Cambridge University Press, 1953.
- (7) J. Sasso, "Plastics Handbook for Product Engineers". McGraw-Hill, New York, N. Y.
- (8) W. Shockley, "Electrons and Holes in Semiconductors". Van Nostrand, New York, N. Y., 1950.
- (9) F. T. Binford, *Nucleonics*, 15, No. 3, p 93, Mar. 1957.
- (10) H. C. Claiborne, et. al., *Nucleonics*, 15, No. 10, p 114, Oct. 1957.
- (11) R. L. French, and J. B. Eggen, *Nucleonics*, 18, No. 3, p 117, Mar. 1960.
- (12) S. Glasstone, "Sourcebook of Atomic Energy". Van Nostrand, New York, N. Y., 1958.
- (13) O. R. Frisch, Ed., "The Nuclear Handbook". Newnes, London, 1958.
- (14) Radiation Effects Data Sheets, *Elec Mfg*, p 112, Feb. 1959.
- (15) P. Barratt, Radiation and Electronic Design, *Nuclear Eng*, p 251, June 1960.

Isolated Parametric Amplifier

Has Low Noise Figure

Input to this parametric amplifier is isolated from the output by using two time-varying reactances. Circulators are not needed, thereby reducing insertion loss and amplifier noise

By L. DAVID BALDWIN
Senior Research Staff Member,
Research Division,
General Dynamics/Electronics,
Rochester, N. Y.

ALTHOUGH PARAMETRIC amplifiers can perform as low-noise amplifiers in the microwave range, their instability limits their practical use. Amplifier circuits that show the greatest promise are regenerative; that is, small changes in source or load impedances or changes in pump power level cause large changes in gain or produce oscillations. Using circulators with the amplifiers reduces instabilities, but circulators are not available at all frequencies. Furthermore, circulators introduce an insertion loss, which adversely affects the amplifier noise figure, and their use often restricts the frequency range.

Some data has been obtained on parametric amplifiers that do not require ferrite circulators.¹ In a more advanced parametric amplifier circuit, the input is nearly isolated from the output. The use of two time-varying reactances pumped with a relative phase difference of 90 degrees, and two idler frequencies provides the nonreciprocal properties. The circuit constants can be adjusted so that the round-trip gain is less than unity, and oscillation is not possible for any combination of source and load impedances.

The isolated parametric amplifier is expected to have these advantages over the circulator amplifier:

- (1) Wide tunable bandwidth of the order of one octave.
- (2) Lower noise figure.
- (3) Stable operation at frequen-

cies where circulators are not available.

Figure 1 shows the isolated parametric amplifier. Two time-varying capacitances, with a relative phase difference of 90 degrees, couple the two signal resonant circuits to common idler resonant circuits. The idler circuits are tuned to the difference frequency, $\omega_L = \omega_p - \omega_s$, and to the sum frequency, $\omega_H = \omega_p + \omega_s$. A 3-db directional coupler provides a power split and a 90-degree phase shift at the signal frequency.

Power incident at port 1 of the 3-db coupler leaves ports 2 and 3. The phase at port 3 leads that at port 2 by 90 degrees. In the absence of parametric action, this power is almost totally reflected into ports 2 and 3 where it recombines and leaves port 4. However, because of the time-varying capacitances, idler currents are generated at frequencies ω_L and ω_H . The phasing reinforces the difference frequency cur-

rents from the two varactors and cancels the sum frequency currents in the idler resonant circuits.

Since power dissipation at the difference frequency causes regeneration at the signal frequency, amplification takes place at ports 2 and 3. The amplified power then recombines to leave port 4. Hence, there is a power gain between ports 1 and 4.

In the reverse direction, power incident at port 4 also splits and leaves ports 2 and 3, but the phase at port 2 leads that at port 3 by 90 degrees. The phasing causes reinforcement at the sum frequency and cancellation at the difference frequency. Since dissipation at the sum frequency requires an absorption of power at the signal frequency, there is a power loss at ports 2 and 3. Thus an attenuation is observed between ports 4 and 1.

A more quantitative analysis yields relationships for forward gain K_f , reverse gain K_r , and the

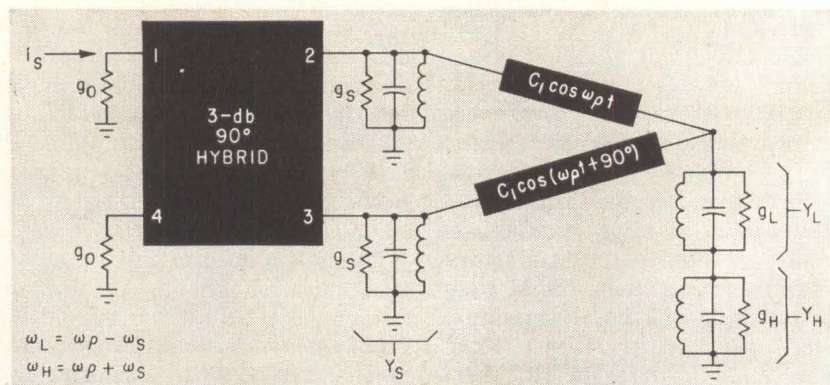

FIG. 1—Power gain in this parametric amplifier circuit is from ports 1 to 4. In the reverse direction, gain is less than unity

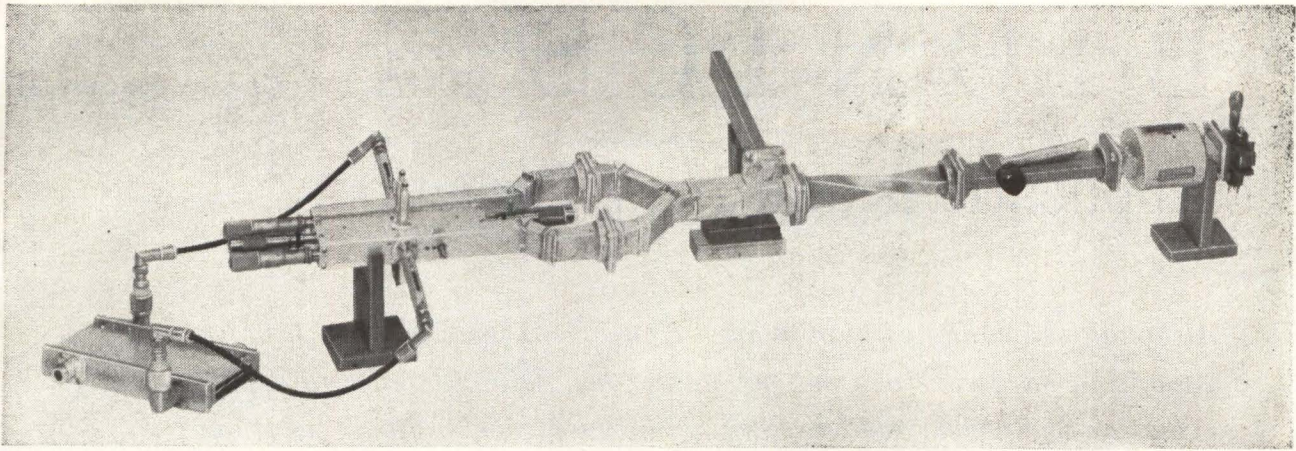

FIG. 2—Varactors are in the waveguide section in the center. The 9,000-Mc klystron is at the right

band-center equivalent noise temperature at high gain, T_{eo}

$$K_f = \left| \frac{Y_L^* (g_o - Y_s) + 2F_L}{Y_L^* (g_o + Y_s) - 2F_L} \right|^2 \quad (1)$$

$$K_r = \left| \frac{Y_H (g_o - Y_s) - 2F_H}{Y_H (g_o + Y_s) + 2F_H} \right|^2 \quad (2)$$

$$T_{eo} = \left[\frac{g_s}{g_o} + \frac{\omega_s}{\omega_L} \frac{(g_s + g_o)}{g_o} \right] \quad (3)$$

where

$$F_L = \frac{\omega_s \omega_L C_1^2}{4}$$

$$F_H = \frac{\omega_s \omega_H C_1^2}{4}$$

(F_L and F_H are symbols only, and are used to simplify Eqs. 1 and 2), g_s is the varactor loss at the signal frequency, g_o is the characteristic conductance of the 3-db coupler.

$$Y_i \approx g_i \left(1 + j 2Q_i \frac{\Delta \omega_i}{\omega_i} \right)$$

is the total admittance of the i -th resonant circuit, and Y_L^* is the complex conjugate of Y_L . The relationships are based on an ideal 3-db 90-degree directional coupler.

When Eq. 1 and 3 are compared with those obtained for an ideal-circulator amplifier, the results are identical. Therefore both amplifiers have the same gain, bandwidth, and equivalent noise temperature. However, since at many frequencies the 3-db coupler has much better bandwidth and insertion loss characteristics than the circulator, the isolated parametric amplifier can be expected to have a lower equivalent noise temperature and greater tunable bandwidth than the circulator circuit.

Equations 1 and 2 show that the reverse gain is nearly the inverse of the forward gain. Under the simplifying assumptions that $\omega_L \approx \omega_H$; $g_L \approx g_H$; and the varactor losses at the signal frequency, g_s , is much less than g_o , the round-trip gain, $K_f K_r$, is equal to unity. The term g_s adds attenuations in both directions.

If the loading at the idler frequencies is due entirely to varactor losses, then

$$g_L = \frac{\omega_L^2 C_o}{\omega_c}$$

$$g_H = \frac{\omega_H^2 C_o}{\omega_c}$$

where C_o is the mean varactor capacitance and ω_c is the angular cut-off frequency of the varactor. Under these conditions, if ω_H is greater than ω_L , the forward gain may exceed the reverse loss. If unconditional stability is required, slight additional loading to the difference frequency resonant circuit can be used to obtain a round-trip gain less than unity.

The experimental model of the isolated parametric amplifier, Fig. 2, can be tuned to operate in the frequency range of 700-900 Mc. A pump frequency of 9,000 Mc is used. The 3-db coupler for the signal circuit, shown at the left in Fig. 2, is connected to the signal circuit matching network by coaxial cables. The center conductors of the signal circuit matching networks pass through the pump circuit waveguides to the varactors located in the center waveguide. These conductors couple both signal and

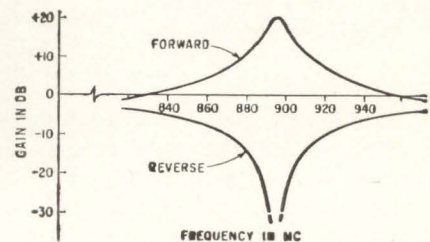

FIG. 3—Gain versus frequency of the amplifier at 895 Mc

pump power to the varactors.

The dual-resonant idler cavity is formed in the center waveguide between two adjustable shorting plungers. The two pairs of varactors used in a balancing arrangement minimize both the pump coupling across the idler cavity and the coupling of the idler power to the pump waveguide.

The output of the pump source, an X-13 klystron, passes through an isolator and a flap attenuator to a waveguide 3-db coupler. The coupler splits the pump power into two parts with the required 90-degree relative phase shift. A tuning screw and an adjustable plunger are used in each of the two pump waveguides to match the pump power to the varactors.

Figure 3 shows gain versus frequency characteristics for the amplifier adjusted for a 20-db forward gain at 895 Mc. The bandwidth is 10 Mc, and the reverse loss exceeds 30 db. The noise figure of the amplifier is 1.5 db.

REFERENCE

- (1) L. D. Baldwin, Nonreciprocal Parametric Amplifier Circuits, *Proc IRE*, 49, p 1075, June 1961.

BIONICS

PART IV (Last of a Series)

Applications and New Directions

Although the range of bionics investigations is wide and the promise great, the payoffs in hardware are not yet numerous. Directions being explored include evolutionary models and learning networks grown in liquid solution

By NILO LINDGREN
Assistant Editor

EVEN a superficial view of bionics projects and the interactions between the many disciplines reveals an impressive range of work. In one sense, there are no specialists in bionics. Investigators from any of the sciences may contribute. An embryologist studies the chronological evolution of electrical activity in the chick embryo, possibly useful in constructing models that function as input-output integrators.¹ A biologist studies the hydraulic and structural aspects of leaf shapes and leaf venation² and devises experiments to investigate the automatic control system of the fish.³ An electrical engineer, veterinarian and biostatistician develop probability models to describe the

characteristics of epidemics.⁴

In studies of the evolution of intelligence, H. J. Bremermann, a mathematician at the University of California, has developed the main evolutionary features in a theoretical model.⁵ He has used the model to compute the optimal rate of mutation such that the speed of evolution of a species towards a goal is maximal. The model shows the advantage of sexual reproduction in the development of needed new properties, in contrast to asexual reproduction which must rely on mutation alone to bring new properties into being. This theoretical model is adapted for simulation of evolution on an electronic computer. On a computer an evolution that has taken thousands of years could be simulated in hours. Bremermann suggests many applications for this model. Because man-made tools and techniques, as well as living systems, evolve and develop new properties, Bremermann suggests that the principle of evolution can be applied to the development of man-made artifacts. Work now in progress at U of C deals with the optimization of properties through evolutionary methods with sexual recombinations.⁶

One investigation of adaptive systems, Peripheral Access Lattice Structures, is being sponsored under an Air Force bionics contract. This work is being carried out by R. M. Stewart of the Space-General Corp. in California. His theoretical studies of structurally homogeneous adaptive logic nets has led to the design of two hypothetical machines, PAL-I and Mabiatic.⁷

Figure 1 shows a mockup of PAL-I. Each ball and each small disk on the larger disks is a NOR element, formed into an almost completely regular lattice structure, which is tapped at the periphery with three inputs and three outputs. Slight irregularities, having the characteristics of random crystal faults, are introduced into the structure so that it will operate properly.

Although this structure could be extended indefinitely, the model, which has a theoretical minimum of 24 switches, will produce any one of 2^{24} , or more than 16 million, different functions. By stimulus, response and punishment contacts, all on the periphery of the structure, any behavior out of the millions of possibilities can be established in about 50 trials. This conditioning procedure is functionally similar to the Artron developed by Melpar.⁸

The Mabiatic may be formed of a tremendous number of small metallic spheres immersed in acid, which will cause coatings to form on the spheres. The system will form a bonded lattice through which waves of polarization may propagate in a manner that may be similar to waves of nerve impulses in a living system.⁸ Platinum stimulus and response electrodes attached to a control circuit at the periphery of this lattice would selectively disturb the coated connections throughout this lattice to form the behavior patterns. Since the spheres can be extremely small, the logic potential and microminiaturization aspects are theoretically great.

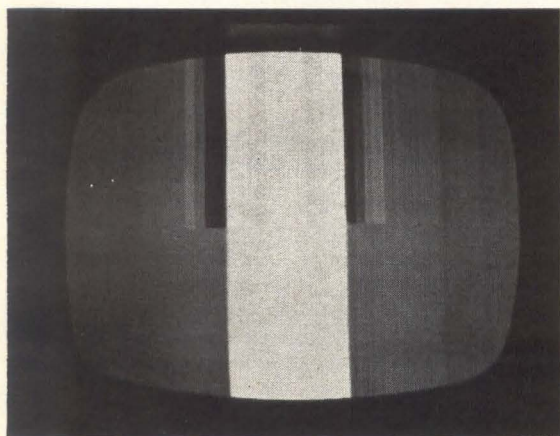

Television presentation of input (bottom) and output (top) of GE contrast device

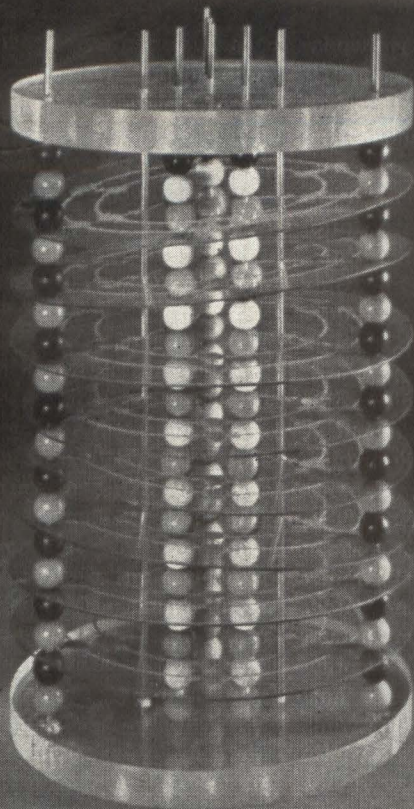

FIG. 1—Mock-up of an adaptive system called PAL-I consisting of 24 switches. By trial-and-error conditioning, this network can be made to converge quickly on any one of 16 million behavior patterns

Already in the hardware stage is the Artron developed by Melpar. The maze runner delivered to ASD in January is based on 10 component switches or decision elements. Each Artron component is a statistical switch, or binary logical gating device, with 16 possible states. These elements can be wired up completely at random initially; then this original statistical freedom is gradually conditioned or weighted towards performing an intended goal by reinforcing states that tend towards the goal and punishing the states that tend away from the goal. Each statistical switch contains a counter that serves as memory. If part of the Artron circuit is destroyed, or the goals change (that is, the maze is changed) the Artron relearns the new maze, or works towards the new goal.⁹ Application of an Artron-type learning network could conceivably be made in an unmanned vehicle which is moving into an unknown environment—for example, a space ship approaching a planet with an unknown atmosphere and gravitational effects.

Learning in such cases would need to be rapid, of course, or faciliatory, in the sense that the network might make fine corrections to a preprogrammed landing procedure.

Primarily, an Artron-type network could be used with equipment going into dangerous environments. It could be preconditioned on the ground to perform certain functions, to compensate for failures, and learn to deal with changes in environment. Melpar has been awarded another Air Force contract to study the feasibility of using Artron as a means of improving flight control reliability. A limitation with this type of network is its inability to deal adequately with noisy or rapidly changing (shifting) goals. An Air Force contract to study nonlinear problems, "Probability State Variable Devices", has gone to Adaptronics, Annandale, Va.

In England, Gordon Pask has been developing learning networks such as that in Fig. 2. The signal network consists of threads that build up out of a solution of ferrous

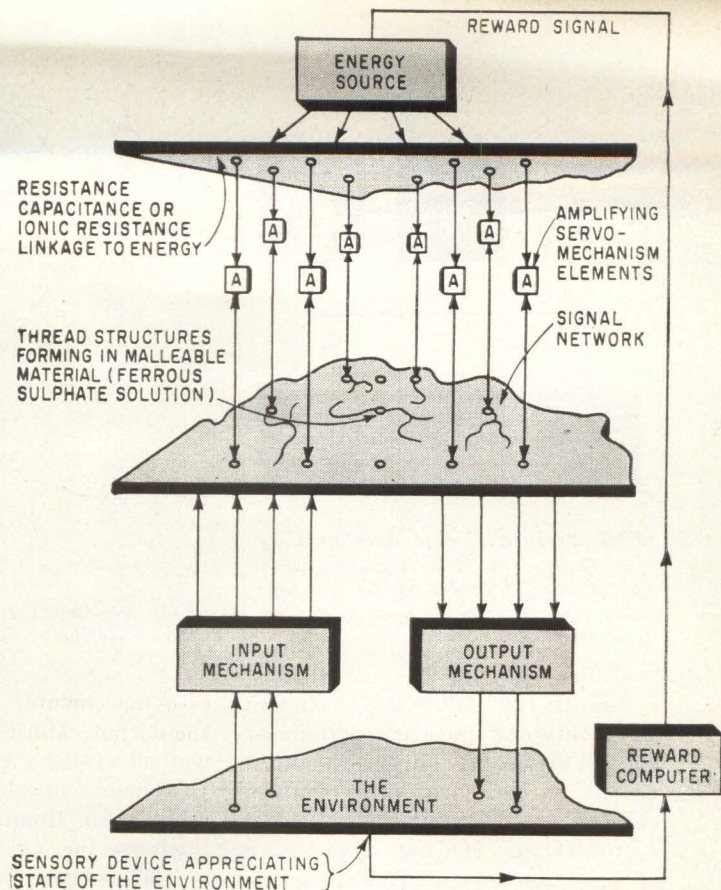

FIG. 2—In this learning network devised by G. Pask of Systems Research Ltd., England, a dynamic signal network of threads is formed in a ferrous sulphate solution. Thread distribution depends on reward signals

sulphate as a result of current passed through the solution by the amplifiers. The amplifier electrodes are either sources or sinks of d-c, and the low-resistance metallic threads develop from the sinks along lines of maximum current. These threads tend to dissolve due to local acidity, but remain dynamically stable as long as they pass sufficient current. The distribution of this signal network depends on the goals of the system. Rewards consist of giving more energy or current to the network distribution that performs or interacts with the environment in a desired stable fashion. Using this kind of adaptive network, Pask has made a magnetic receptor and an ear that can discriminate between two frequencies, one 50 cps, the other 100 cps. This ear consists of a gap in thread structure with fibrils that resonate at the excitation frequency.¹¹

Another ASD contract deals with Myoelectric Servo Control. It was awarded to Space Labs, Inc., in Van Nuys, California. This concerns the

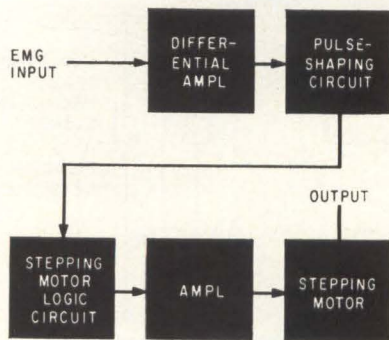

FIG. 3—In a system developed by Litton Systems, Inc., muscle action potentials generated by muscle tension are used in an open-loop control system

possibility of using body sensing and nontypical muscle reactions as control elements. This work might tie in with a projected contract called Tactual Perception of Visual Information. If, for example, a spaceman is oriented in a space-vehicle under high g , so that he is unable to use his arms or usual body motions to control his craft, or if he is unable to see his course, he could be fed orientation information to pressure-sensing nerves on the surface of his body. These nerves, though lacking the resolution of the other senses, such as the eyes or ears, nevertheless, might be trained to react characteristically to this input information. Thus, a diffuse sensation on a chest nerve might cause the space pilot to maneuver or tense his shoulder muscles just enough to control and guide his craft. Tensed muscles generate electrical potentials called muscle action potentials or electromyographic potentials, detectable with electrodes placed on the skin and can be converted or interpreted and used in a servo control. This is myoelectric servo control. Related but as yet uncontracted program of interest to the Air Force is a study and development of muscle substitutes.

At Litton Industries in California, considerable work has been done on an electromyographic (emg) open-loop control system.¹⁰ Muscle action potentials, whose spike repetition rate is proportional to muscle tension, activate a stepping motor. Each emg spike applied at the input, Fig. 3, results in a pre-

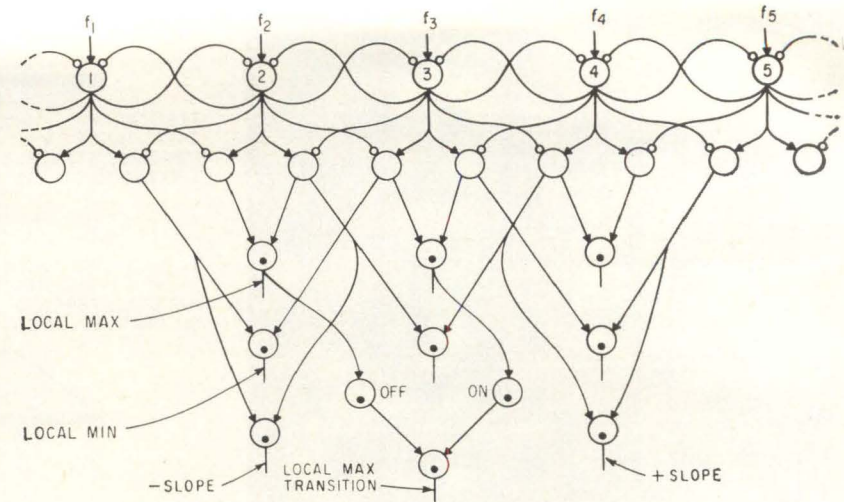

FIG. 4—Speech-processing network under development at RCA uses electronic artificial neurons. Each circle represents a neuron

cise incremental shaft rotation at the output. More sophisticated emg control systems are now under development in the Medical Electronics and Bionics dept. of Litton Systems, Inc.

EMG control systems could also be used for power amplification of natural movements, as for example in the U. S. Army's servo-soldier concept.

The development of the optical maser, or laser, makes it probable that as man enters space he will need to transmit information over the astronomical distances at optical frequencies. In one research program at Armour Research Foundation, it has been discovered that chloroplast, extracted from plants, has a narrow frequency acceptance, somewhere near ir. ARF has grown and harvested this chloroplast, deposited it on plates, and formed rudimentary ir detectors.¹² Such detectors might be made more sensitive; conceivably, a systematic search might reveal a spectrum of such narrow-band detectors in the near-optical region. Coupled with lasers, such devices could lead to a profitable exploitation of this frequency spectrum.

In yet another direction, ARF has worked with the olfactory sense, and is developing an artificial electrical nose that should be able to smell or recognize low concentrations of vapor in air.¹³

Other devices near the hardware stage are ear analogs. One of these, under ASD contract Research on Speech Processing through Cochlear Matching, has been designed

by the Sensory Systems group at the University of Arizona, headed by J. L. Stewart.¹⁴ Another bionics contract held by this university, in which the AF has a strong interest, is for an electronic simulation of the biological clock, a phenomenon exhibited by both plants and animals, that pace their functions in a cyclic fashion.¹⁵ Being considered, though not yet contracted, is another type of analog of the cochlea based on a nonuniform tapped, solid-state line. Possible recipient for this work is ITT, where much of the theoretical work has already been completed.

Another company involved in the development of a sophisticated speech processor based on neural networks is RCA. The network embodies many of the psychoacoustic phenomena known to operate in the human ear.¹⁶ The motion of the cochlea, the spiral receptor of the ear, is simulated by an RLC transmission line, which is a distributed low-pass structure. The outputs of these filters ($f_1, f_2 \dots f_n$ represent center frequencies) are fed into a neural network, Fig. 4, that pre-processes the frequency information.¹⁷ The first layer of electronic (transistor) neurons¹⁸ enhances small differences in signal amplitude in neighboring channels, the second layer selects the larger output of two neighboring neurons, and from this layer the local maxima, local minima, positive and negative slopes, and their local transitions are abstracted.

At GE's Advanced Electronics Center in Ithaca, N. Y., an elec-

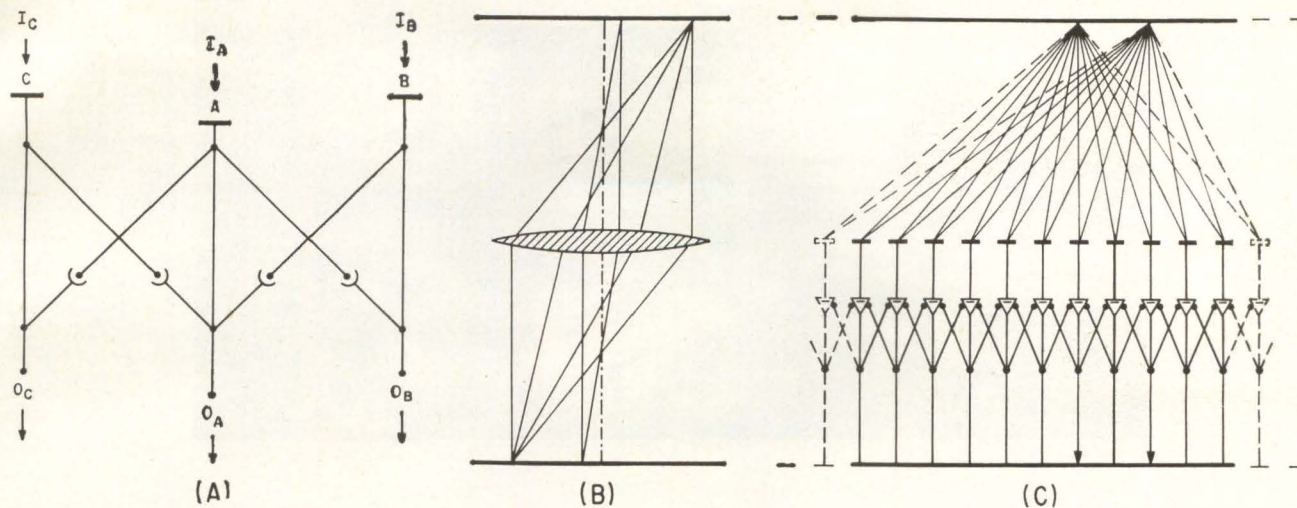

FIG. 5—Mutually inhibitory network is basis for contrast sharpener being developed by GE, Ithaca (A). Diagrams show how two point sources of light are imaged by a lens (B) and by a multifaceted eye in which neural inhibition compensates for diffraction and overlapping field effects (C)

tronic model of the eye of the limulus (horseshoe crab) relies on inhibitory interactions that have been found to exist in multi-faceted eyes. The device, which sharpens contrasts, could be used to accentuate edges in the pattern from an array of ir detectors, or to sharpen and refocus image edges and contours on a tv or radar system by operating on the video signal.¹⁰

The operation of a simplified mutually inhibitory network, Fig. 5A, is like that of an edge detector (Part III), in which neighboring receptors modify each other's outputs. In the model, receptor units *A*, *B*, *C*, which correspond to single facets (ommatidia) of the limulus eye, are connected so that *B* and *C* inhibit *A*, but *B* and *C* cannot inhibit each other. In its model, GE has used 10 summing amplifiers, the outputs of which are changed in magnitude and sign, and fed back

as inhibitory inputs to other amplifiers. Various weightings of inhibitory effects can be achieved by changing connections. So far, experiments have been conducted with a linear array of 10 units, but work is going on to develop a two-dimensional planar array of mutually inhibiting units. The photo shows how the edge of a band of light (bottom) has been sharpened (top).

Other studies of these inhibitory networks and of the resolving power of facet eyes have also been conducted by W. Reichardt in Germany. He has shown that lateral or mutual inhibition enables the multifaceted eye to portray perfectly the optical surroundings on the crosssection of the optic nerves.²⁰ This neural inhibition compensates for overlapping of visual fields and for diffraction effects. Figures 5B and 5C illustrate the difference between

image formation by a lens and image formation in the multifaceted eye by lateral inhibition. In Fig. 5C, only neighboring operational amplifiers are shown inhibiting one another; in the actual eye, the output of each amplifier is connected to the inputs of all other amplifiers.

Other work in the GE Bionics Engineering section includes the Visilog (visual analog), a device that calculates slant angles to a textured surface, which might be useful in a recognition machine for normalizing figures in the third dimension.²¹ Conceivably, the device could be used for landing unmanned vehicles upright on another planet. Another device is an adaptive filter that can learn to recognize repetitive signals buried in noise.²² The device could be used in recognizing characteristic ir outputs from missiles and in recognizing various kinds of bioelectric signals.²³

REFERENCES

- (1) J. J. Peters and C. J. Cusick, Bioelectric Patterns As Indicators of Behavioral Development in the Chick Embryo, 2nd Annual Bionics Symp., Ithaca, N. Y., Aug. 31, 1961.
- (2) H. C. Howland, Structural, Hydraulic and Economic Aspects of Leaf Venation and Shape, 2nd Annual Bionics Symp., Sept. 1, 1961.
- (3) H. C. Howland* and B. Howland, The Reaction of Blinded Goldfish to Rotation in a Centrifuge, (* State Univ. of N. Y., L. I. Center, Oyster Bay, N. Y.).
- (4) J. H. Whitlock, Bionics and Experimental Epidemiology, Dept. of Path. & Bact., Cornell Univ., 2nd Annual Bionics Symp., Aug. 30, 1961.
- (5) H. J. Bremermann, The Evolution of Intelligence: The Nervous System as a Model of Its Environment, Tech. Report No. 1, Dept. of Math., Univ. of Wash., July 1958; reissued, Dept. of Math. Univ. of Calif., March 1961.
- (6) Private communication from H. J. Bremermann, Vice Chairman, Dept. of Math., Univ. of Calif., Dec. 1961.
- (7) R. M. Stewart, Theory of Struc-

- turally Homogeneous Logic Nets, Space-General Corp., Glendale, Calif., Research Memo. 1, Aug. 25, 1961. Also, 2nd Annual Bionics Symp., Ithaca, N. Y., Aug. 1961.
- (8) R. M. Stewart, Structurally Homogeneous Adaptive Systems, Nat. Aerospace Elec. Conf. Presentation, 1961.
- (9) Lt. Anthony Bell, The Artron Model for Generalized Machine Learning, Wright Field, unpub. paper.
- (10) D. O. Ellis and F. Schneidermeyer, EMG Control System, Litton Pub. No. 1688; also presented at 4th Int. Conf. on Med. Elec., N. Y. C., July 1961.
- (11) G. Pask, The Natural History of Networks, in "Self-Organizing Systems", ed. by M. C. Yovits and S. Cameron, Pergamon Press, 1960. Also, private communication.
- (12) Conversation with George Jacobi, ARF, Chicago, Ill.
- (13) ARF Lays Groundwork for Synthetic Nose, *Chemical and Engineering News*, vol. 39, No. 14, p. 56, April 3, 1961.
- (14) W. F. Caldwell, E. Glaesser and J. L. Stewart, Design of an Analog Ear, Univ. of Ariz., given at 2nd Annual Bionics Symp., Ithaca, N. Y., 1961.
- (15) A. P. Sage and J. L. Melsa, Elec-

tronic Simulation of the Biological Clock, Dept. of E. E., Univ. of Ariz., given at 2nd Bionics Symp., 1961.

(16) F. L. Putzrath and T. B. Martin, Speech Recognition by Neural Networks, NEC, Oct. 1961.

(17) T. B. Martin, Analog Signal Processing by Neural Networks, NEC, Oct. 1961.

(18) E. P. McGrogan, Improved Transistor Neuron Models, NEC, Oct. 1961.

(19) D. Hildebrand, An Electronic Model of the Limulus Eye, GE Report No. R61ELC68, Sept. 1961.

(20) W. Reichardt, Neural Inhibition in Facet Eyes, to be publ. in *Proc 1st International Biophysics Congress*, Stockholm, 1961.

(21) W. Carel, et al., The Visilog: A Bionic Approach to Visual Space Perception and Orientation, NAEC, Dayton, Ohio, May 1961.

(22) F. L. Hiltz, The Adaptive Filter: A Bionic Approach to Recognition, NAEC, Dayton, Ohio, May 1961.

(23) W. O. Sydow and F. L. Hiltz, Biomedical Waveform Recognition, given at 3rd Annual GE Human Factors Symp., June 21, 1961.

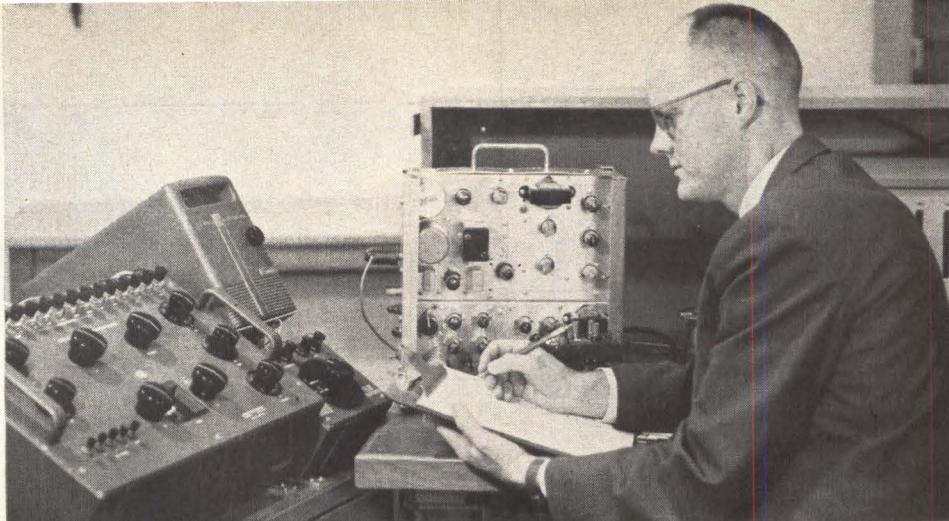

Author Bell measures linearity of voltage-controlled prototype model oscillator

Voltage-Controlled Oscillator Uses Negative Feedback

Specially designed pulse-counting discriminator circuit in feedback loop gives voltage-controlled oscillator adequate linearity for computing applications

By N. W. BELL
V. CHIUNTI
Bell & Howell Research Center,
Pasadena, Calif.

VOLTAGE-CONTROLLED oscillator using negative feedback to provide good linearity and stability can be used with a totalizing counter to integrate slowly varying signals. With an events-per-unit-time me-

ter, the oscillator can also be used as an analog-to-digital converter.

Oscillator output frequency varies between zero and 1 Kc as input voltage varies between zero and 10 mv. Linearity and stability are 0.1 percent at maximum frequency.

The voltage-controlled oscillator is conventional except that negative feedback has been added. With high loop gain, operating characteristics

depend only on the feedback element, which is a stable pulse-counting discriminator.

The feedback loop is shown in Fig. 1. With zero input feedback tends to make frequency equal to the frequency of the fixed 1.2 Kc oscillator. The difference frequency from the mixer is then zero.

With maximum input of 10 mv, the negative feedback circuit shifts oscillator frequency toward 2.2 Kc so that the sum of the input and feedback voltages to the d-c amplifier again approaches zero. The difference frequency from the mixer is 2.2 Kc - 1.2 Kc = 1 Kc. Zero drifts in the discriminators tend to cancel, and the 1.2-Kc fixed oscillator need not be stable. Linearity depends on linearity of discriminator number 1, and d-c amplifier bandwidth can be much narrower than system bandwidth.

Performance depends primarily on the discriminators, which should be stable, linear and have equal

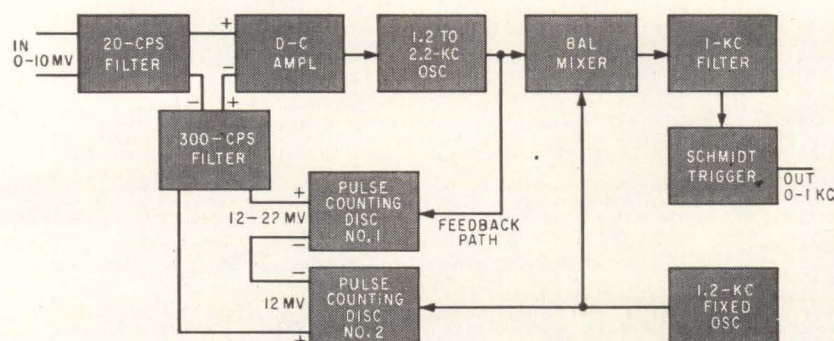

FIG. 1—With high loop gain, oscillator circuit performance depends on feedback discriminator

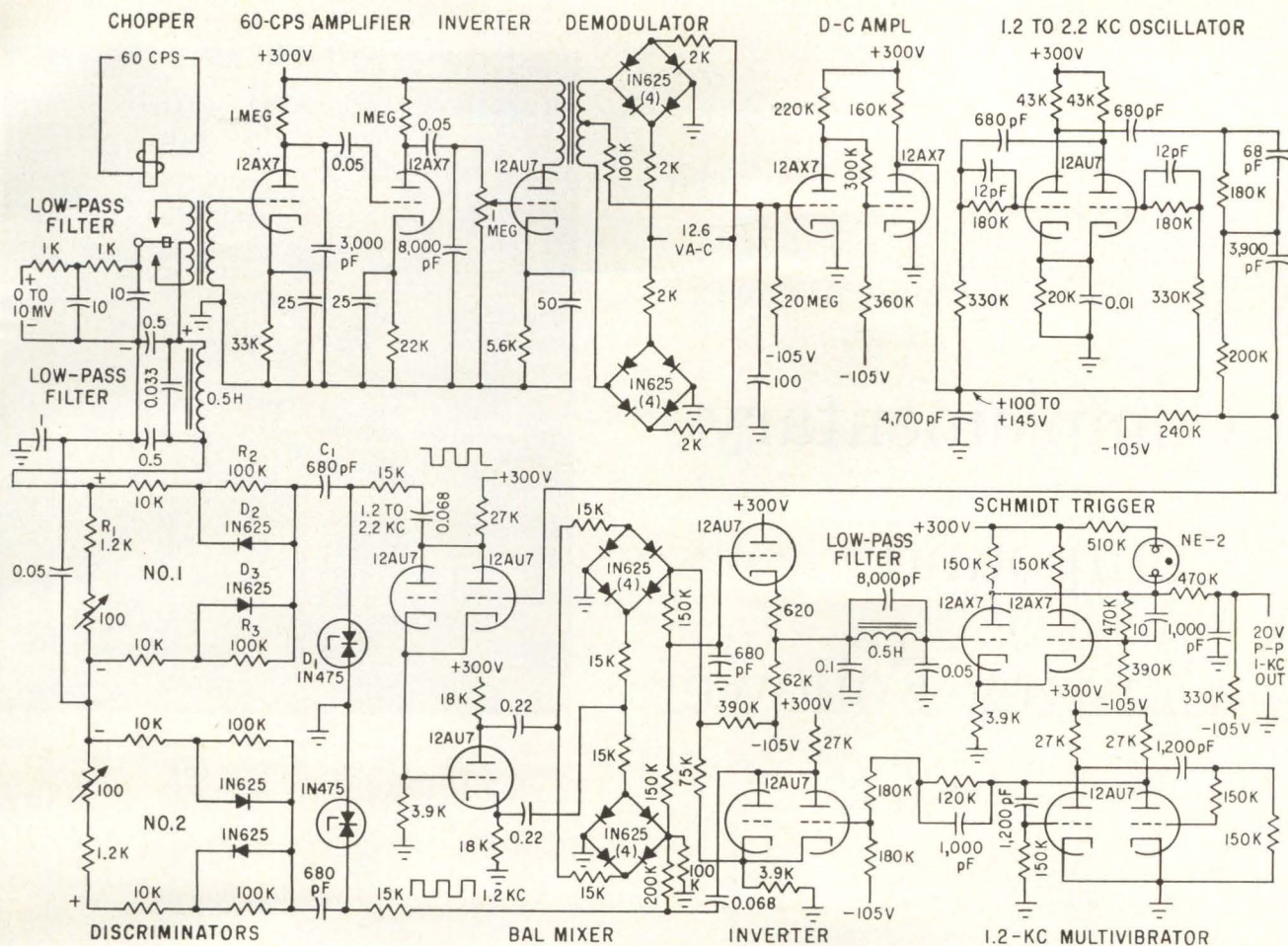

FIG. 2—Low-level voltage-controlled oscillator uses all conventional readily available components with no component selection or matching required

temperature characteristics. The pulse-counting discriminator in Fig. 2 provides linearity of better than 0.1 percent over an octave range. The input square wave is regulated by double-anode zener diode D_1 so that 5-percent variation in input amplitude produces less than 0.1-percent change in output.

Charging current for capacitor C_1 flows alternately through diodes D_2 and D_3 . Average charging current produces a voltage across R_1 and the 100-ohm potentiometer that is proportional to input frequency. The d-c output voltage is isolated from ground by capacitors. Charging capacitor C_1 must have low dielectric losses, and silvered mica was found to be satisfactory.

Resistors R_2 and R_3 improve linearity by removing the effects of varying diode resistance near the voltage origin of the diode curve. Temperature coefficient of the circuit depends primarily on regulating diode D_1 , and typical values are

about 0.025 percent per degree Fahrenheit. The two discriminators are packaged together in a small plug-in unit to cancel the zero shifts caused by temperature changes.

The input filter in Fig. 2 attenuates interference and noise near the 60-cps chopping frequency. The chopped d-c is amplified and then demodulated by a phase-sensitive demodulator. After additional d-c amplification, the signal is used to control frequency of an astable multivibrator, and the square-wave multivibrator output is amplified and fed back to discriminator number 1. Another astable multivibrator operating at 1.2 Kc provides input to the other discriminator. The negative discriminator terminals are connected together and the positive outputs provide the feedback voltage. The negative feedback loop is completed through a filter that removes ripple.

The difference in frequency between the outputs of the variable-

frequency and the 1.2-Kc multivibrators is produced in a balanced mixer using two diode rings. The diode rings act as shunt switches across the outputs of the phase inverter. Since one side of each switch is at ground potential and the phase-inverted signals are returned to ground, no isolation transformers are required.

The low-pass filter after the mixer removes high-frequency modulation products. A slicer circuit (Schmitt trigger) following the filter shapes output. Slicer hysteresis is made greater than filter p-p amplitude to avoid spurious outputs. Output is 20 v p-p, sufficient for most counters.

Discriminators 1 and 2 are adjusted for maximum and zero inputs, respectively. Loop gain is set for minimum response time by adjusting gain of the 60-cps amplifier. Response time is about 0.2 seconds. Calibration is maintained within 0.1 percent for several months.

Complementary Compound Emitter Follower

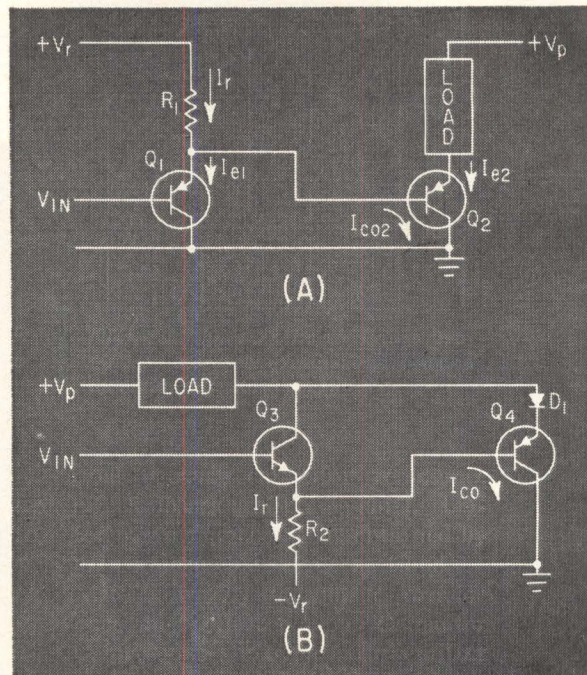

Ordinary compound emitter follower (A); new complementary emitter follower (B)

This circuit uses two complementary transistors to reduce power dissipation and increase power output at the lower frequencies

By T. K. HEMINGWAY and J. WILLIS* English Electric Aviation Ltd., Stevenage, Herts, England

IN APPLICATIONS where the current gain of a single emitter follower is inadequate, it is common practice to connect two transistors in cascade as shown at A in the figure. This is a convenient circuit for a class-A power output stage driving a reactive load where only a small phase shift between input and output voltages is permitted. The base current of power transistor Q_2 is provided from the emitter of Q_1 so the overall current gain is almost the product of the two grounded-emitter current gains. The circuit must be designed so that Q_1 remains conducting under the worst conditions.

Emitter current of Q_1 is given by $I_{e1} = I_r + I_{e2}/(\beta_2 + 1) - I_{co2}$ where the currents are as labeled in Fig.

1A. From this equation, if I_{co2} exceeds the sum of the other two currents, Q_1 will cutoff and lose control over Q_2 . This undesirable state can be avoided by choice of I_r .

The worst condition occurs when the Q_2 junction attains maximum temperature simultaneously with the input voltage reaching its maximum positive value. At this point I_{co} is maximum and I_{e1} is minimum, so I_r must be large enough to make I_{e1} positive in the equation.

Since I_r has its minimum value for maximum positive input voltage, choice of an adequate value under these conditions may result in a high normal standing current through R_1 and Q_1 resulting in large power dissipation in Q_1 unless V_r is large. Then the dissipation in R_1 will be high.

It may be preferable to use the complementary version shown at B.

The current drive to Q_4 base is now limited to the standing current I_r through resistor R_2 , so the minimum value of I_r must be made large enough to turn Q_4 fully ON under the worst conditions, that is with zero I_{co} and minimum beta in Q_4 . However, I_{co} in Q_4 will be drawn directly from the emitter of Q_3 , turning Q_3 harder ON so there is no danger of Q_3 cutting OFF at high temperatures. Further, Q_3 collector can now be returned to Q_4 emitter, with possibly the interpolation of diode D_1 or a resistor to establish a minimum V_{cb} of approximately 1 volt for Q_3 . The collector voltage of Q_3 thus has a low and nearly constant value, independent of input voltage, and dissipation can be small. This combination may use a silicon low-power device for Q_3 and a germanium power transistor for Q_4 .

* Now with Southern Instruments Ltd., London, England.

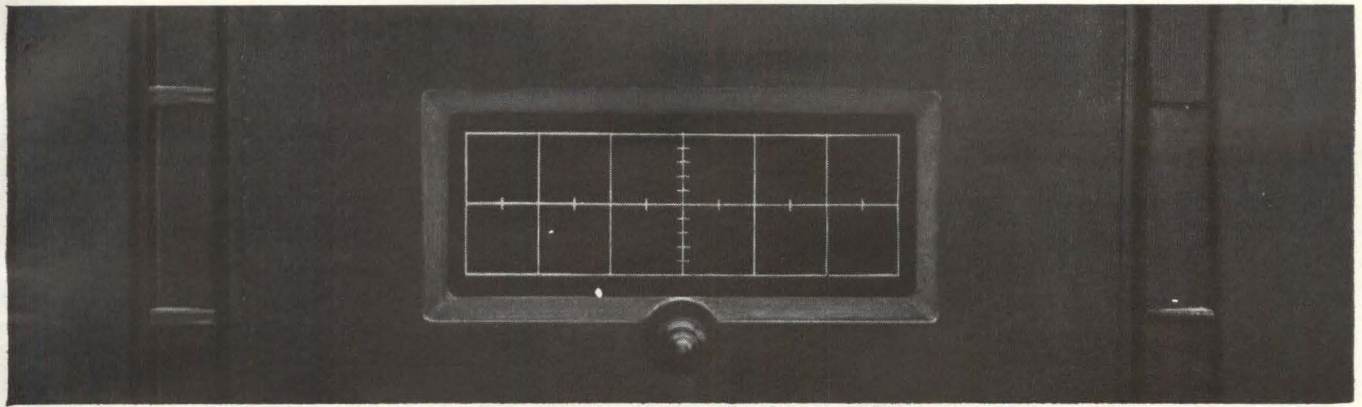

See anything?

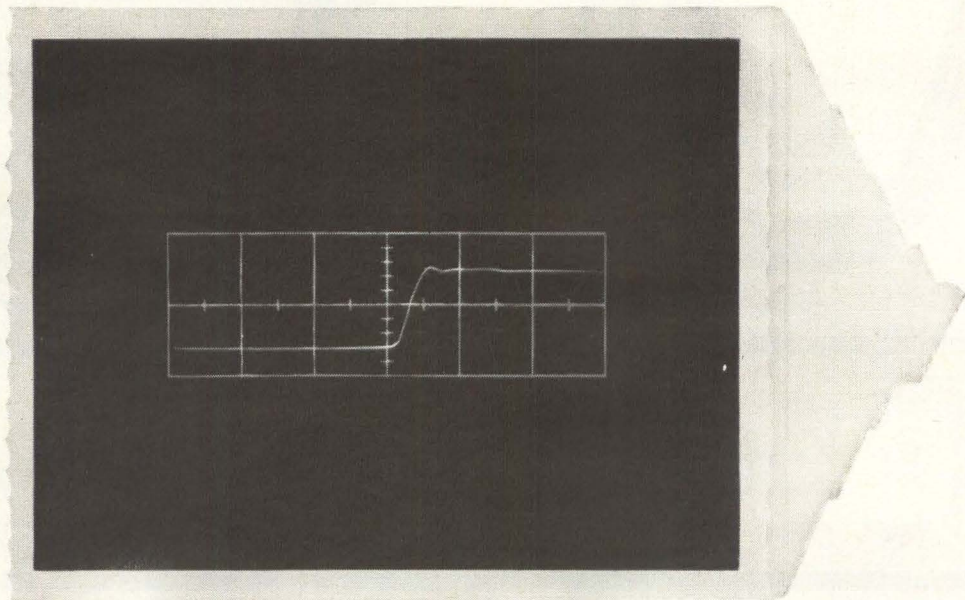

This new film did.

This new film saw something the eye couldn't: the rise time of a single pulse on a Tektronix 519 scope at a sweep rate of 2 nanoseconds/cm. The new film, Polaroid PolaScope Land Film, actually extends the usefulness of existing oscilloscopes by supplying "brightness" that the scope hasn't got!

The reason is that this PolaScope film has an ASA equivalent rating of 10,000, which means it can see things your eye cannot. It has about twice the writing rate of the Polaroid 3000-speed film, currently the standard for

high speed oscilloscope photography. (No other commercially available films come anywhere near the speed of PolaScope film.) And because it's made by Polaroid you get a finished usable print — see above — ten seconds after exposure.

PolaScope film will also give you better shots of slower pulses and stationary waveforms. So little light is required, camera aperture and scope intensity can be reduced considerably, and that's how to get really sharp oscilloscope pictures.

And wherever else light is at a premium — such as photomicrography and Kerr Cell photography — PolaScope film will make new applications possible, old applications more useful.

PolaScope Type 410 Film is packed 12 rolls to the carton. The price is actually lower than the Polaroid 3000-speed film. For the name of the industrial photographic dealer nearest you, write to Technical Sales Department, Polaroid Corporation, Cambridge 39, Massachusetts.

POLAROID®

New Polaroid Land 10,000-speed film for oscillography

WHAT'S YOUR TRANSFORMER PROBLEM?

Research in advanced applications? Optimizing performance/cost trade-off? Extreme reliability for military use? Audio, cathode ray, chokes, driver, filament, geofomers, toroids, hermetically sealed, instrumentation, pulse isolation, subminiature, micro-miniature, modulation, power, step-down, or transistor models? Triad solves thousands of transformer problems in all areas. Triad Transformer Corporation, 4055 Redwood Ave., Venice, Calif., or 305 N. Briant St., Huntington, Ind. Take the tough ones to Triad...and the easy ones too.

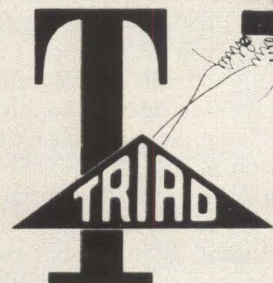
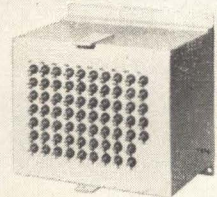
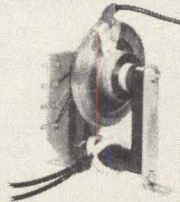
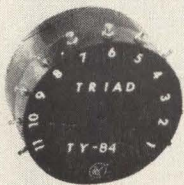

TRIAD TRANSFORMER CORP.
A DIVISION OF LITTON INDUSTRIES



New
AUTOGRAF
Model 680
Series
Recorders

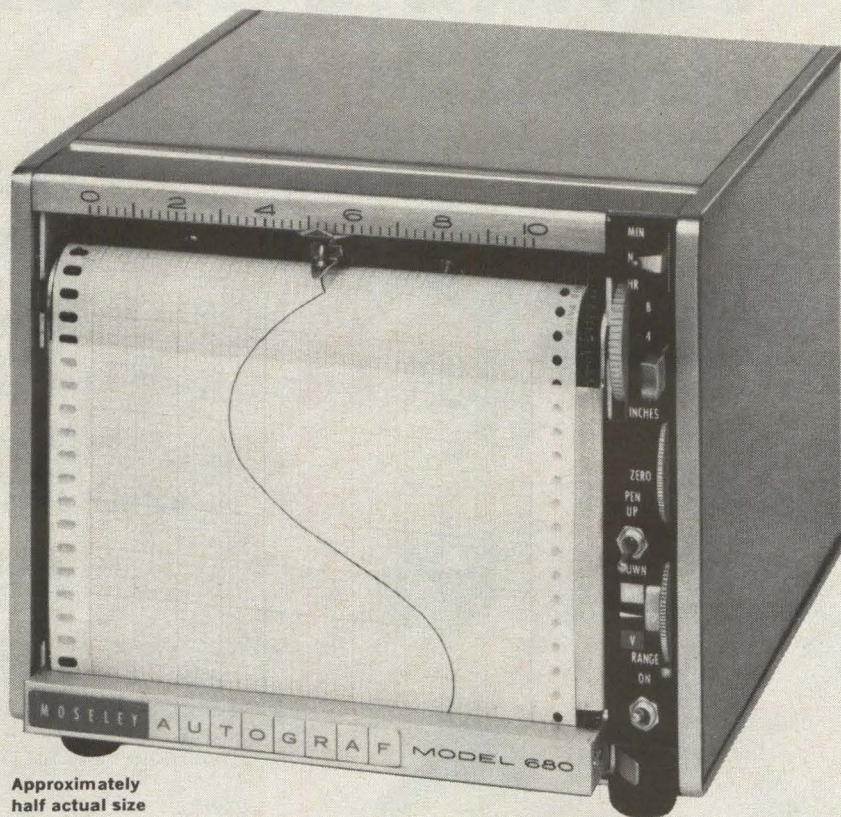

Approximately
half actual size

Moseley AUTOGRAF Model 680 Series Recorders have these features: One mv/inch to 20 v/inch in ten calibrated ranges • One millivolt full scale optional • Zener reference supply • Rack or table mounting; heavy industrial case optional • Instant change of 8 chart speeds • Chart tear-off, paper take-up roll • Convenient tilt surface for chart notation during recording • Ultra-compact, with revolutionary reduction in heat losses • High pen speed, $\frac{1}{2}$ sec. full scale • High accuracy, 0.2% full scale • Electric pen lift—remote control of pen • Operates up to 500 v off ground • All solid state circuitry • Output potentiometer, event marker, Hi-Lo limit switches optional • Thermocouple, milliammeter models available • Uses standard 6" paper 100' rolls • 5" recording space • Price, Model 680, \$750 • Single speed, single range Model 681, \$625 • Data subject to change without notice.

F. L. MOSELEY CO.

409 N. Fair Oaks Avenue • Pasadena, Calif.

The First Major Variable Resistor

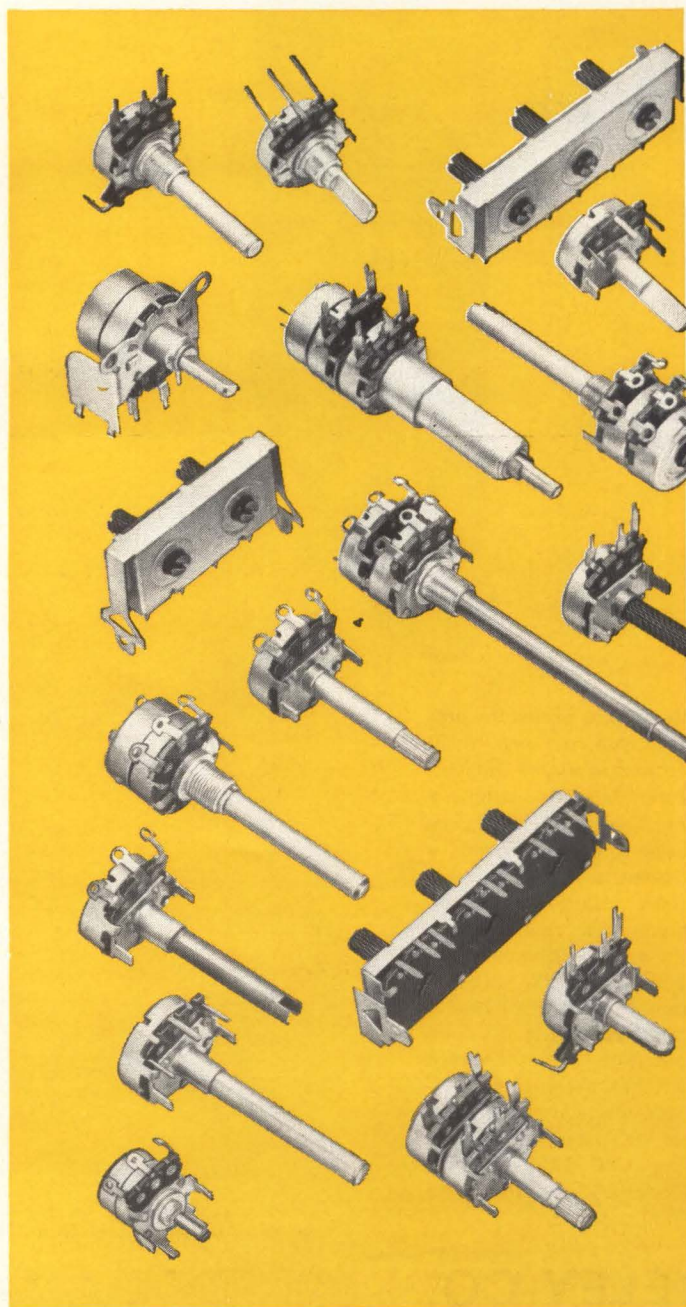

In load life, freedom from resistance change under mechanical wear and aging, Stackpole Controls with new STABILITE* Elements surpass any general purpose variable resistors produced since the early days of radio!

By achieving far greater variable resistor stability—at no increase in cost—the new Stackpole STABILITE elements provide greater circuit design freedom while assuring maximum dependability for the equipment in which they are used.

Available in all Stackpole Control

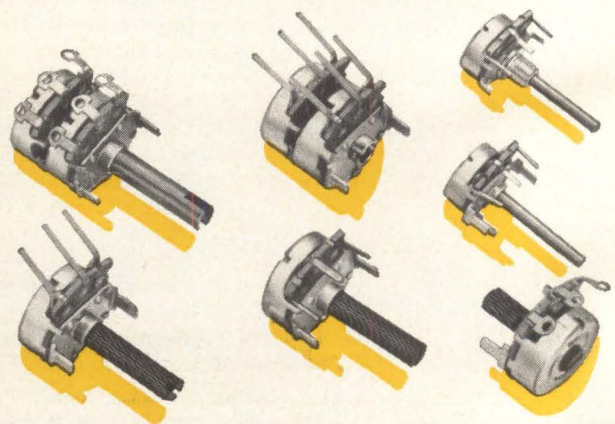

*Trademark, Stackpole Carbon Co.

Advance in STABILITY in Years

types, STABILITE elements handle higher loads with an absolute minimum of derating. And they maintain their tolerance through years of hard use!

STABILITE elements result from entirely new techniques in applying carbon dispersions to a specially-developed base material. The accompanying data tells its own story of truly remarkable performance under pertinent conditions of normal use.

For complete details and engineering samples, call your local Stackpole sales engineer or write on company letterhead to: Electronic Components Division, Stackpole Carbon Company, St. Marys, Pennsylvania.

STACKPOLE VARIABLE composition RESISTORS

Fixed Composition Resistors • Slide & Snap Switches • Ceramag®
Ferrite Cores • Fixed Composition Capacitors • Ceramagnet®
Ceramic Magnets • Electrical Contacts • Brushes for all Rotating
Electrical Equipment • Graphite Bearings, Seal Rings, Anodes
Hundreds of Related Carbon & Graphite Products



**Compare this performance
with any controls you've
ever used before!**

PERFORMANCE TEST

LOAD LIFE @ 25°C, 1000 hours

500 volts, dc. ¾ to 1 watt } depending
750 volts, dc. ½ watt, Min. } on value.

LOAD LIFE @ 70°C, 1000 hours

500 volts, dc. ½ to ¾ watt } depending
750 volts, dc. ½ watt, Min. } on value.

SHELF LIFE Unlimited

NOISE 3 to 8 millivolts, values
below 500,000 ohms.
8 to 12 millivolts, values
above 500,000 ohms.

Average Percent Resistance Change

ZERO LOAD @ 100°C for 1000 hours

±4%, values to 100k; ±2%, values above 100k.

VOLTAGE COEFFICIENT

Less than ±0.01% per volt. (±0.005% per volt, avg.)

TEMPERATURE CHARACTERISTIC

±3% from 20°C to 105°C

HUMIDITY: 95% RH @ 40°C for 240 hours

±4% to ±5%, values to 250k; ±6% to ±9%, values
above 250k.

MECHANICAL LIFE: 25,000 cycles . . . Less than ±4%

Control "Mechanics" Have Been Improved Too!

- New rear bearings assure wobble-free shaft operation.
- 70% less backlash on "ordinary" tandem controls. Zero backlash on tandems for stereo.
- Close-tracking or matched element controls available for stereo.
- Full line of switches for most types—rotary, push-push, pull-push.
- Built-in solder flux guards on switches of miniature, ⅝" diameter types.

Tunnel Diode-Transistor Provides Fast Logic

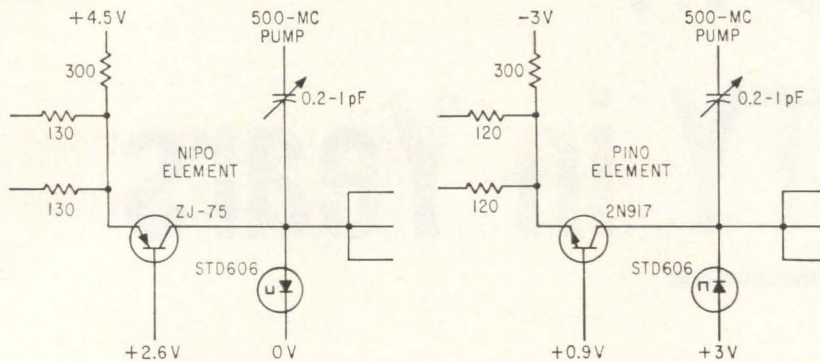

THE FRONT COVER. Uhf shift register uses pumped tunnel diode-transistor logic elements, which are made in negative input-positive output and positive input-negative output types

TUNNEL DIODE-TRANSISTOR logic with a 500-Mc bit rate can perform four logical functions in 2 nsec. As faster tunnel diodes and transistors become available, the 2-Gc logic rate can be increased. In addition, the system requires substantially fewer circuit modules.

The logic system, developed by General Electric, is said to take advantage of the high speed of tunnel diodes while providing practical working margins. It was described at the 1962 International Solid State Circuits Conference at the University of Pennsylvania in a paper by W. Peil and R. Marolf (ELECTRONICS, p 7, Feb. 16).

A switching margin of 30 percent is provided by the pumped tunnel diode-transistor logic. Because logical functions are performed sequentially rather than in parallel, only one-tenth the usual number of circuit modules are required. This reduction and the simple six-component module contribute to reliability.

High speed of the logic system can enable real-time radar signal processing to be performed digitally. In high-resolution radar, it could distinguish among multiple targets and calculate velocity in real time. The system is also expected to be useful in high-speed counting and coincidence detection involving real-time control.

Basis of the logic system is a newly developed germanium tunnel

diode. Commercially available as type STD606, it has typical switching speed of 50 nsec.

Speed of the system is attributed to the two-input NOR gate shown in the figure, which has a gain of 3 and consumes 50 mw. Because phase inversion occurs through the gate, positive input-negative output (PINO) and negative input-positive output elements are needed. The synchronous information signals are relocked at each logic gate by pumping the tunnel diode with a 500-Mc sine wave. A single phase pump source is common to all circuit modules.

Circuit Operation

With no input signal, the tunnel diode in the NIPO element switches once every positive half cycle of the pump signal from its bias point below the peak voltage into the high-impedance region. A negative input at one or both inputs prevents diode switching, providing a NOR gate. A PINO element is provided simply by using an *npn* transistor and inverting tunnel diode polarity. Since each type element switches on opposite half cycles of the pump signal, two levels of logic can be performed during a full pump cycle and logic can be performed at a 1-Gc rate. A third element, an inverting transformer, is used where one element feeds another of the same type. Combinations of the three elements permit any complex

logic to be performed.

Operating speed depends primarily on the tunnel diode, which provides gain and switching. The transistor provides isolation between input channels and unidirectional information flow. The isolation permits modules to be interconnected by matched microstrip transmission line, eliminating problems associated with reflections and permitting signal interconnections to be made over long distances. Line length is not critical because of the logic element relocking. To ensure the same pump signal phase to all modules, a standing wave is generated on the stripline. Because no gain is required of the transistor, it can be operated near its cutoff frequency.

With constant bias and pump voltages, input signal phase error of ± 60 degrees can be tolerated. Tolerances of components and of pump and bias voltages compare favorably with all-tunnel diode logic. A-c and d-c power supply tolerances of 20 to 25 percent are attributed to the 30 percent switching margin. Initial component variations are compensated by the variable capacitance in the pump feed.

To maintain the information in the system, the frequency band must extend from d-c to 500 Mc and a moderately controlled rolloff should exist to about 1.5 Gc.

A computer using the pumped tunnel diode-transistor logic system could be packaged in almost any form. Computers of 100,000 or more modules could be built without problems of heat dissipation.

Designing Transistor Phase-Shift Oscillators

By F. W. KEAR

The Lytle Corp., Albuquerque, N. M.

SINGLE-TRANSISTOR oscillator provides a sine-wave output using an R-C network to obtain phase shift and determine oscillator frequency. Adding a second transistor enables the oscillator to provide a square-

40
 FORTY
 XL
 40
 FORTY
 40
 REL

Founded in '22...Still first in '62

From that time back in the Twenties when REL achieved the first voice broadcast from a flying plane to the public (a Times Square crowd), our

"firsts" fill a bulging file. Our drawing boards promise even more for the next forty years. We're charting a course to keep REL the first name in telecommunications. That's why - when you have communications problems - you should turn to REL first!

Radio Engineering Laboratories - Inc

A subsidiary of Dynamics Corporation of America

Dept E • 29-01 Borden Ave • Long Island City 1, NY

A world leader today is REL's 75 kw tropospheric scatter amplifier, many of which are in use for defense communications.

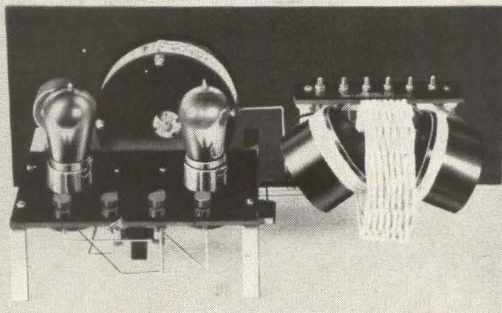

Now a collector's item, this REL regenerative receiver of 1923/24 had one stage of detection and one of audio amplification.

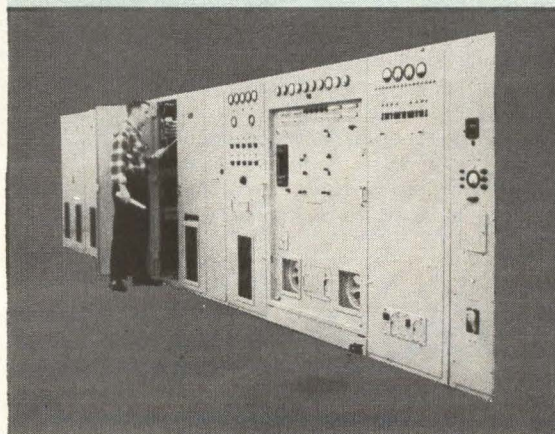

Visit REL at the IRE Show: main floor, booth 1301

Creative careers at REL await a few exceptional engineers. Address résumés to James Kelly, Personnel Director.

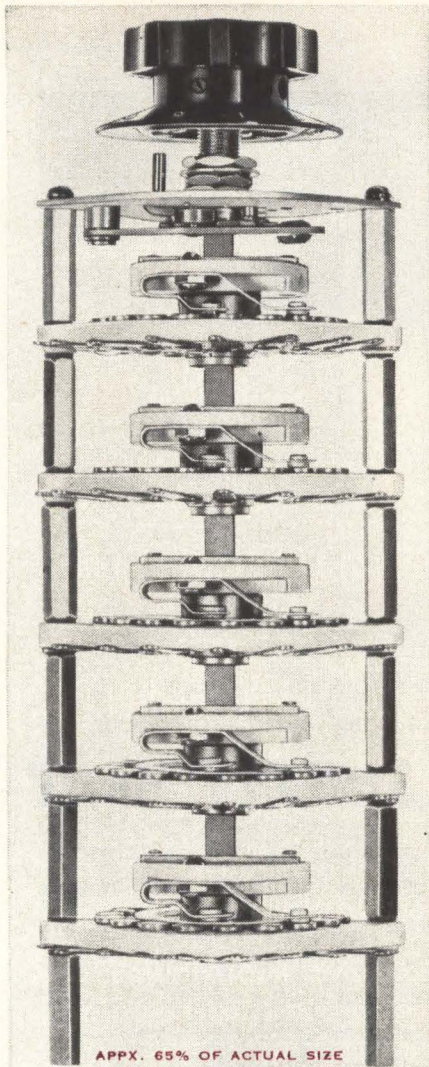

PRECISE • RUGGED • VERSATILE
12,000 SERIES SWITCH
FOR MAXIMUM ELECTRICAL & MECHANICAL PERFORMANCE

- Long-life construction ■ "Quality feel" positive detent action ■ Has superior contact resistance stability with \pm one milliohm variation for 20,000 operations under dry circuit conditions
- Has high insulation resistance (4,000 megohms) ■ 20°-30°-40°-60° indexing available ■ 1, 2, or 3 poles per deck ■ Wafers have up to 18 positions ■ Prototype quantities normally in stock ■ 1-2 weeks for production quantities ■ For complete specifications on this switch series, mark reader service card or request Shallcross L-32.

Shallcross ELECTRONICS
 MANUFACTURING CO. / SELMA, N. C.
 INSTRUMENTS • RESISTORS • SWITCHES • ATTENUATORS
 DELAY LINES

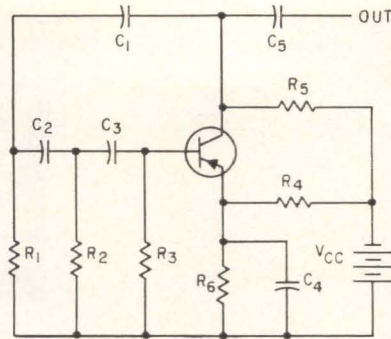

FIG. 1—Three-section R-C network provides required phase shift to obtain positive feedback

wave output simultaneously.

The typical phase-shift oscillator in Fig. 1 uses an *n*p*n*-transistor. In the common-emitter configuration, the signal is changed 180 degrees in phase between base and collector. The added 180-degree phase shift required to obtain positive feedback to the base is provided by C_1 through C_3 and R_1 through R_3 .

Current flow in the R-C circuit, which consists of resistance and capacitance in series, is determined by the series impedance of the components and the applied voltage, and it can be calculated using Ohm's law. Since reactance in an R-C network is capacitive, voltage lags current at a phase angle determined by the relative values of resistance and capacitance. Voltage drop across the resistance therefore leads applied voltage by this phase angle, and amplitude of the drop is determined by network current.

Obtaining Phase Shift

With a fixed capacitor, phase angle can be changed by varying resistance. As resistance approaches zero, phase angle between applied voltage and current can be varied up to 90 degrees. However, a phase shift network cannot have zero resistance since the only voltage across the capacitor would be applied voltage. With the minimum practical resistance in a phase-shift network, the phase angle will be slightly less than 90 degrees. At least three sections are required to produce the required 180 degrees phase shift to obtain positive feedback in the oscillator. Resistors should generally be chosen so that each section produces about 60 degrees phase shift. Power factor of the capacitor must also be consid-

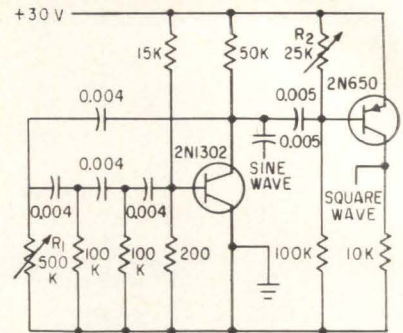

FIG. 2—Phase shift oscillator provides sine-wave and square-wave outputs simultaneously

ered because capacitor resistance affects losses and phase shift. Better performance can be obtained by using more than three sections.

Resistors R_3 , R_1 and R_5 provide base and collector bias. Capacitor C_1 provides a-c bypass for emitter resistor R_6 . Oscillations are initiated by any random noise, such as transistor noise or switch noise as power is applied.

Oscillator output is nearly sinusoidal and frequency is constant except for minor fluctuations caused by voltage and temperature changes. Phase is shifted 180 degrees at only one frequency. As either resistance or capacitance is varied, the frequency at which the correct phase shift occurs also changes. Since most applications of phase-shift oscillators require that frequency be variable, resistance in the phase-shift networks is usually made variable.

If a three-section phase-shift network is used, considerable gain is required from the transistor because of the losses incurred in the network. As the amount of phase shift required of each section is increased, losses in the section also increase because of the increased voltage drop through the resistor and the resistance of the capacitor. It is therefore desirable to use more sections with less phase shift required from each section.

The phase-shift oscillator in Fig. 2 can provide a variable sine-wave signal and a square-wave signal at the same time. Oscillator frequency is changed by R_1 and width of the square wave is varied by R_2 . Square-wave width is limited only by oscillator frequency. Four sections are used in the phase-shift circuit.

CLEANEST VACUUM

in 10^{-2} to 10^{-10} torr range

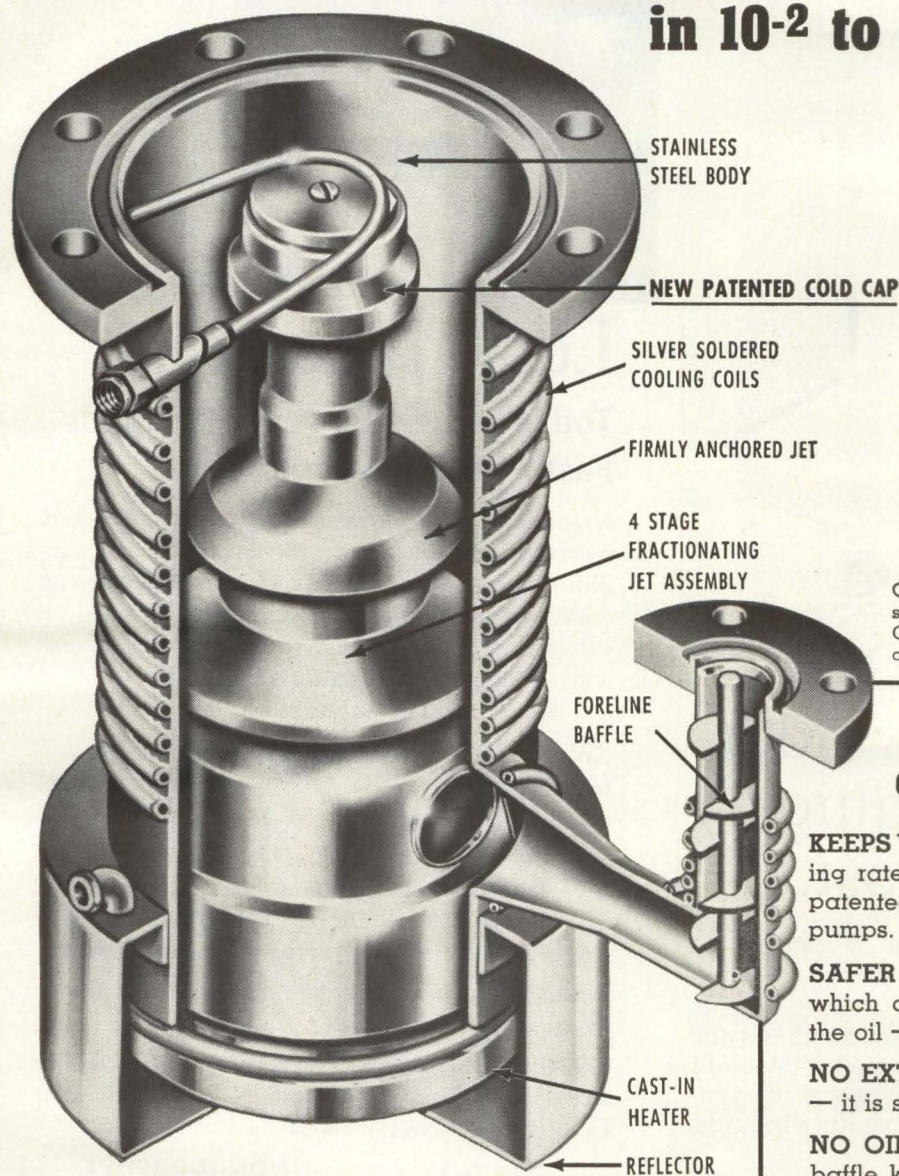

Other "HS Series" pumps to 32", peak speeds to 52,000 liters per second. Cold Cap standard on 10" pump, optional on 4" and 6" sizes.

THESE ADVANTAGES GIVE MORE DEPENDABILITY

KEEPS VACUUM CLEAN—backstreaming rate only $0.0005 \text{ mg/cm}^2/\text{min.}$, with patented cold cap on the 4" and 6" pumps.

SAFER OPERATION—no superheaters which operate above the flash point of the oil—no explosion risk.

NO EXTRA COST for all stainless body—it is standard equipment.

NO OIL LOSS—fluid retaining foreline baffle keeps oil in pump even if incorrectly air released.

QUICK HEAT UP AND COOL DOWN—cuts operating time and power cost.

NEW COLD CAP DESIGN cuts backstreaming 99%

Get speeds of 750, 1500 and 4200 liters per second with these new "HS Series" 4", 6" or 10" diffusion pumps. Each pump is shorter, more efficient, and attains higher speeds than all previous models. Smaller, lower-cost back-up pumps can be used because of high forepressure limits of new jet design.

Water temperature is not critical and, therefore, greater latitude of pumping oils is possible. These are the pumps to buy for the cleanest, fastest, low cost, most dependable vacuum system. Call or write for more details now on the new "HS Series" Diffusion Pumps.

Manufacturing Plants at Newton, Mass. and Palo Alto, Cal.



A Subsidiary of National Research Corp.

160 Charlemont Street, Dept. 4CC
Newton 61, Massachusetts

SEE THE NEW "HS SERIES" PUMPS AT THE IRE SHOW—BOOTHS 4425 — 4427

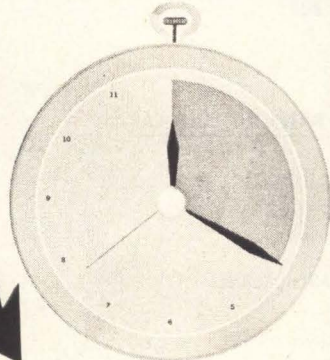
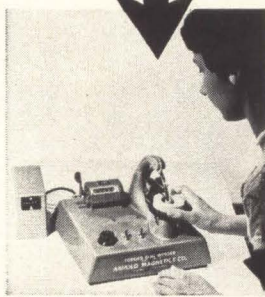
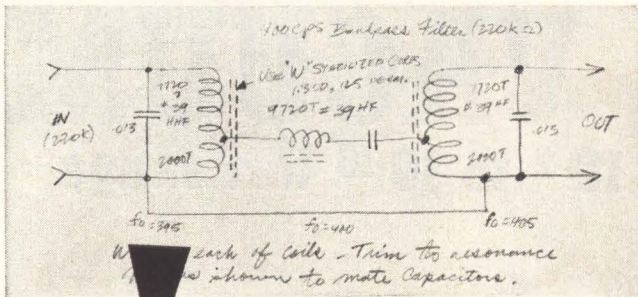

ARNOLD toroidal coil winder winds toroids quickly ... at low cost.

—from design to finished coils in 20 minutes

Now you can wind toroidal coils to meet specific requirements—one-of-a-kind, or production runs—right in your own plant. Low-cost Arnold winders are used throughout the world to produce bank, multi-layer and low-capacity windings, quickly and accurately.

Wide range—unit handles toroids from 0.18" finished ID to 4.0" finished OD... wire sizes from AWG 26 to 44... all types of wire, including teflon, ceramic, formvar and enamel.

Fast set-up for optimum flexibility—install the core, load the ring, and start winding in 45 seconds. Winding speeds up to 1500 turns/minute.

Price \$1200.00, complete with electronic counter, 3 sizes of winding rings, and all accessories.

Delivered from stock.

Write for complete literature on Model AMC-4 Winder.



ARNOLD MAGNETICS CORP.
6050 West Jefferson Blvd., Los Angeles 16, Calif.
Vermont 7-5313 • Upton 0-6284

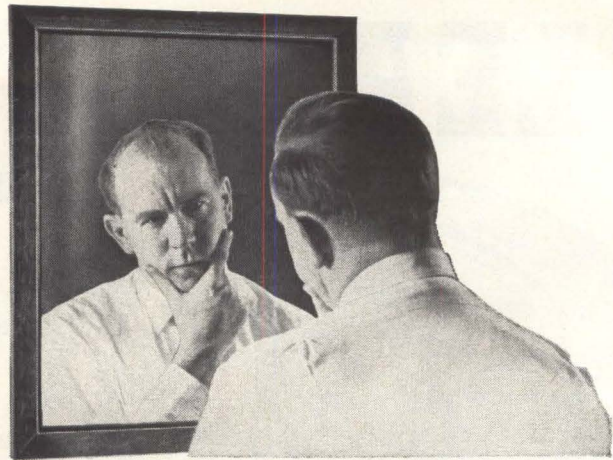

Let's face it...

Today's Pulse Circuitry Demands Fast Rise Time Components

High speed signal circuits as well as solid state power supply circuits can be improved and simplified by the use of SAGE non-inductively wound resistors. Such parts are currently supplied in values from 1 ohm through several thousand ohms. This valuable circuit feature can be provided on any SAGE or MIL wattage size.

No compromise is made with other superior performance features long associated with SAGE precision power resistors, such as:

- High temperature operation to 275°C...
- Temperature coefficient less than 20 ppm/°C
- Typical 1000 hour load life change less than .5%
- Fully insulated, 1000 volt rms test on axial lead units

Lower inductance of the order 30 to 1 is achieved by special SAGE winding technique.

EXAMPLE: Regular SA2W resistor (MIL RW59 size) 380 Ω reads approximately 3.5 u hy at 1 Mc. Comparable NSA2W 380 Ω unit reads .12 u hy.

Specify SAGE for your **NON-INDUCTIVE**
Power Resistor Requirements

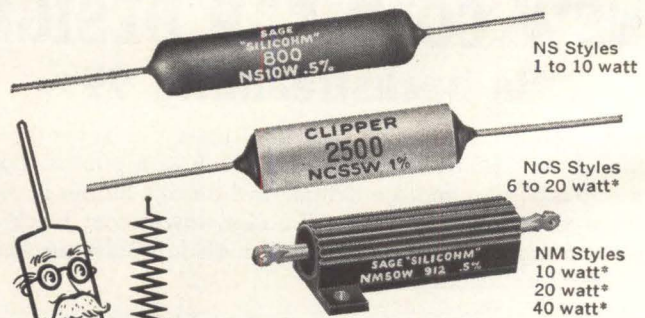

*Heat Sink mounted
Test samples available on request



SAGE ELECTRONICS CORP.
Country Club Road • East Rochester, N. Y.

CIRCLE 201 ON READER SERVICE CARD
electronics

Here is MEASURED RELIABILITY!

DUR-MICA CAPACITORS TYPE M2DM

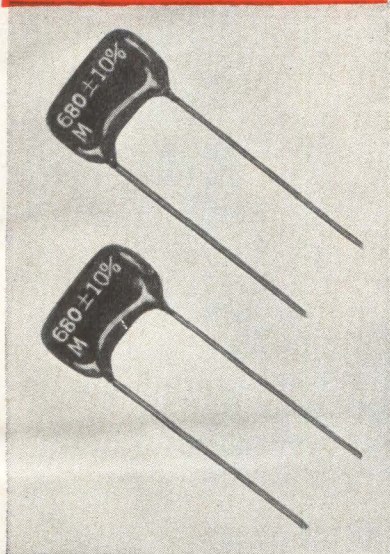

Ten thousand EL-MENCO high reliability dipped mica capacitors were put on life test at 85°C with 225% of the rated DC voltage applied—After 26,500,000 actual test unit-hours no failures of any type occurred.

The accumulated 26.5×10^6 test unit-hours without any failures can be used to calculate many different failure rates depending upon the confidence level desired. However, we shall explore the meaning of the results at a 90% confidence level.

Assuming no acceleration factor for either temperature or voltage, we have verified a failure rate of less than 0.01% per 1000 hours. (Actually, there is a temperature effect and it has been found that, with the DC voltage stress remaining constant, the life decreases approximately 50% for every 10°C rise in temperature. There is also a voltage effect such that, with the temperature stress remaining constant, the life is inversely proportional to the 8th power of the applied DC voltage.)

Assuming no temperature acceleration factor and assuming the voltage acceleration exponent is such as to yield an acceleration factor as low as 100, we have nevertheless verified a failure rate of less than 0.0001% per 1000 hours.

Assuming no temperature acceleration factor and assuming the voltage acceleration factor is on the order of 250 (test results are available to confirm this) we have accumulated sufficient unit-hours to verify a failure rate of less than 0.00004% per 1000 hours!

Note that all the above failure rates are calculated at a 90% confidence level!

Only 1 Failure in 14,336,000 Unit-Hours for 0.1 MFD Capacitors

Life tests have proved that El-Menco Mylar-Paper Dipped Capacitors — tested at 105°C with rated voltage applied — have yielded a failure rate of only 1 per 1,433,600 unit-hours for 1.0 MFD. Since the number of unit-hours of these capacitors is inversely proportional to the capacitance, 0.1 MFD El-Menco Mylar-Paper Dipped Capacitors will yield ONLY 1 FAILURE IN 14,336,000 UNIT-HOURS.

MYLAR-PAPER DIPPED CAPACITORS TYPE MPD

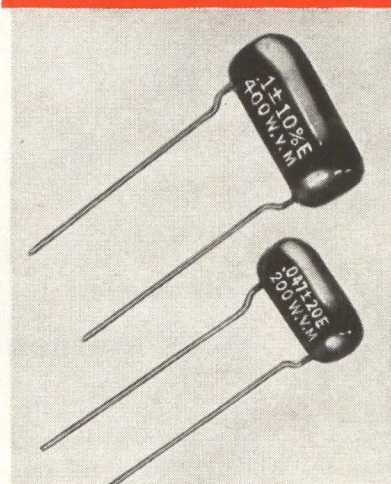

MINIMUM LIFE EXPECTANCY FOR 1.0 MFD** MYLAR-PAPER DIPPED CAPACITORS AS A FUNCTION OF VOLTAGE & TEMPERATURE

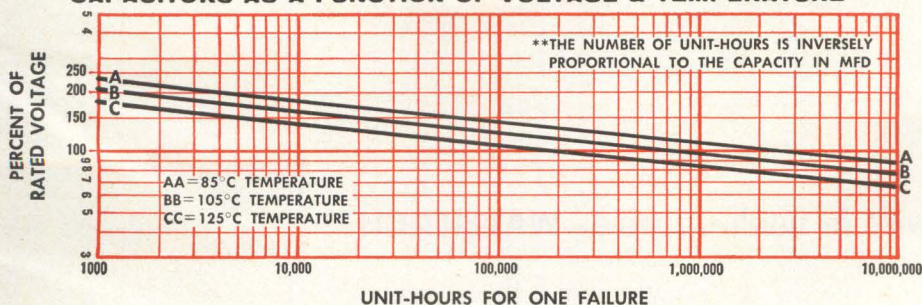

* Registered Trade Mark of DuPont Co.

Write for Reliability Study and technical brochures.

THE ELECTRO MOTIVE MFG. CO., INC. WILLIMANTIC, CONNECTICUT

MANUFACTURERS OF
El-Menco
Capacitors

*Dipped Mica • Molded Mica • Silvered Mica Films • Mica Trimmers & Padders
Mylar-Paper Dipped • Paper Dipped • Mylar Dipped • Tubular Paper*

ARCO ELECTRONICS, INC., Community Drive,
Great Neck, L. I., New York
Exclusive Supplier to Jobbers and Distributors
in the U. S. and Canada

West Coast Manufacturers Contact:
COLLINS & HYDE CO., 535 Middlefield Road,
Palo Alto, California
1250 E. Artesia Avenue, Long Beach, California

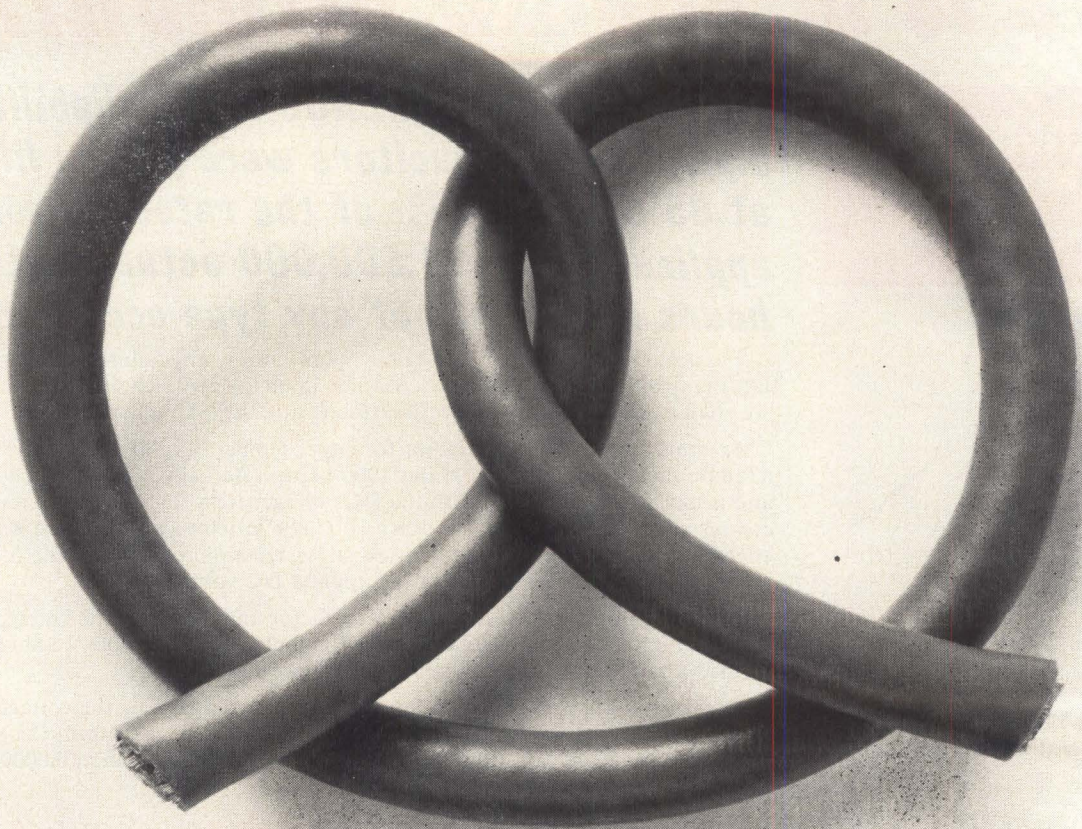

new twist in hook-up wire—WATERTIGHT!

WATERTIGHT Synkote® hook-up wire ends failures caused by moisture or other penetrations. It's 100% watertight through the strands, and flexible at extreme temperatures. Resistant to flame and abrasion. Available in a full range of sizes. Rigidly manufactured and tested to Mil-W-16878D-Type FFW and Mil-C-915A. Developed and engineered to meet today's exacting requirements for electric motors, transformers and coils, and tomorrow's new demands in missiles, aircraft, naval vessels, electrical and electronic equipment. Watertight Synkote® hook-up Wire—

PLASTOID

 CORPORATION
42-61 24TH STREET / LONG ISLAND CITY 1, N. Y. / ST 6-6200

1400

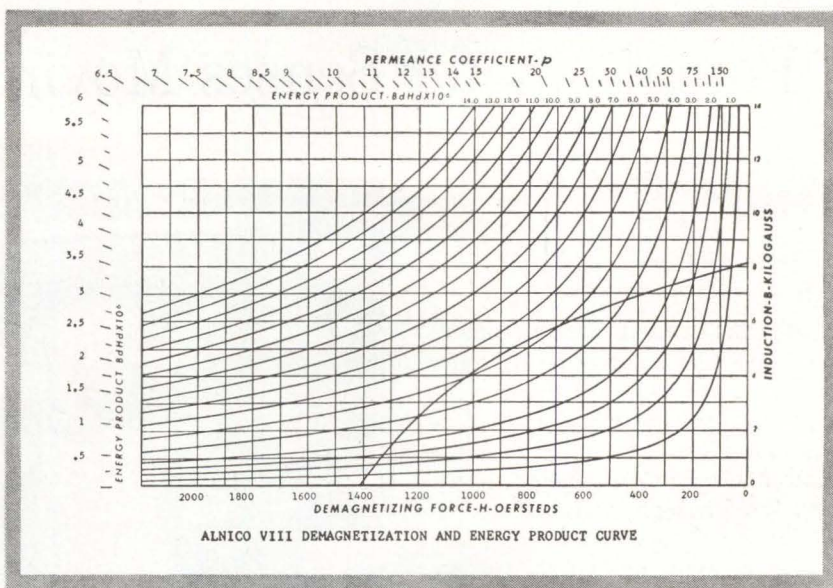

Alnico VIII offers you distinct advantages over any other permanent magnet material: It has the greatest coercive force of all the Alnicos — 1400 oersteds; its energy product approaches Alnico V and its temperature coefficient is remarkably low. For periodic focusing of traveling wave tubes, this unique combination of parameters results in high field strength, high gap flux density and completely eliminates the need for temperature compensation. ■ Also, the magnetic characteristics of Alnico VIII make it the logical choice for applications requiring short magnet length. ■ Indiana General engineers — backed by the largest, most experienced magnet production facility in the world — are specialists in tailoring Alnico VIII magnets to your requirements. **Wire or phone for application assistance or write today for technical bulletin #363 to Indiana General Magnet Division, Valparaiso, Indiana.**

Visit us at the IRE show — Booths 1310-1316

INDIANA GENERAL 

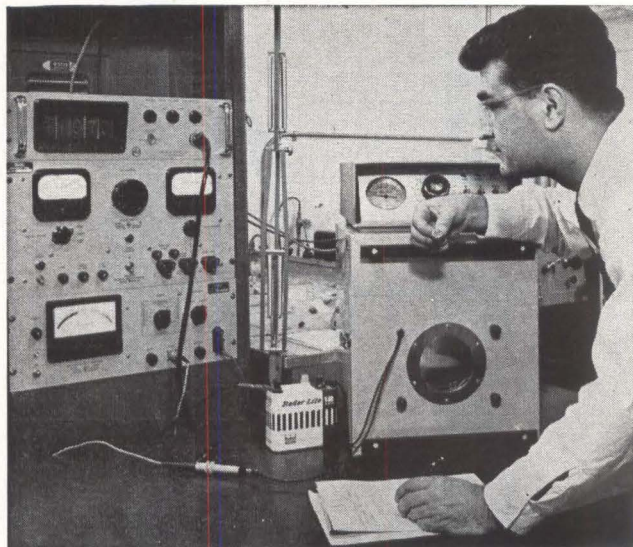

Light-actuated semiconductor analog of the mechanically operated potentiometer (left) is being tested for effects of temperature on voltage deviations by Guido Galli of Giannini Controls

Potentiometer Senses Moving Light Source

By CLAUD HAAKE
GUIDO GALLI
Giannini Controls Corp.,
Duarte, California

AN ELECTRO-OPTICAL potentiometer, now in production, uses a tiny light beam as its wiper arm. Primarily a position-measuring device, the unit functions exactly like an electromechanical potentiometer. However, the Photopot weighs less, is smaller, completely frictionless, has no contact wear, no inertia, and no hysteresis. The device has an infinite life, a very high sweep speed and no resonance frequency.

In the past year, the development of this light-actuated potentiometer has reached a stage of development where it is presently undergoing a severe testing program. Initial results indicate that the properties of the device will be most satisfactory.

The element of this device consists of a resistive film and an adjacent conducting strip which is separated from the resistive strip by a photoconductive crystal. The photoconductive material acts as an insulator when it is in the dark, and as a conductor when illuminated

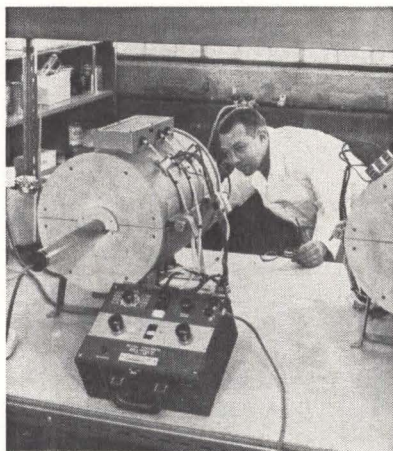

Mixed crystals for the photoconductive elements of the light-actuated potentiometer are carefully formed in a modified Frerichs type synthesis, shown above.

by the light beam. The device is independent of light intensity within wide limits.

One method of using the unit employs a non-movable shield that covers all but a narrow opening to the photoconductive crystal at a small distance from the crystal. When the light source moves, an angle is sensed.

A second method for operating

the device involves a light source, fixed with respect to the unit, and a movable shield with its slit. In this way, mechanical movement can be sensed and translated into voltage without friction.

Output of the device is a linear function of the light beam displacement on the crystal. However, functional output can be obtained for special applications.

Although its applications are numerous, the optical pot is best suited for direct light-position measurements. Angular displacements down to only tens of arc-seconds can be clearly resolved.

Sensitivity of the solid-state potentiometer is defined as the ratio of crystal resistance between conditions of light and dark. If CdSe is used as the photoconductor, typical sensitivity ratios of 10^6 at 1,000 microwatts per cm^2 of radiation between 7000 and 7400 Angstroms are observed.

The speed of response, is determined by either the rise or decay of the photoconduction process. The rise time is defined as the time measured from initial dark conditions to $1/e$ of the final light values. The decay time is defined as

REXOLITE® 1422

COPPER-CLAD DIELECTRIC WILL BOOST THE PERFORMANCE OF YOUR STRIP LINES

12 FACTS BACK THIS PROMISE

A TEN-SECOND
GLANCE AT THIS
CHART WILL SHOW
YOU HOW COPPER-
CLAD REXOLITE
1422 MEASURES
UP IN EVERY
RESPECT TO THE
IDEAL CRITERIA
FOR STRIP LINE
DIELECTRICS.

PROPERTY	IDEAL CRITERIA FOR STRIP LINES	REXOLITE 1422 PROPERTIES
Dissipation Factor	0.001 or less	0.0007
Dielectric Constant	Between 2 and 3 with ± 0.05 tolerance Must be homogeneous and isotropic	2.55 ± 0.01 Meets requirement
Thickness Variation	$\pm .002''$ to $\pm .004''$	Meets requirement
Coefficient of Thermal Expansion	As close to that of copper as possible	Slight warpage after processing, but with no adverse effects
Bond Strength	Must bond well to copper. 5# min; 8-10# average	Meets requirement
Solder Resistance	Withstand 440-450°F for 10 seconds	Meets requirement
Mechanical Strength	Rigid, with high mechanical strength	Meets requirement
Deformation	Must not permanently deform under loads up to 2000 psi at temperatures up to 200°C	Meets requirement
Processibility	Ability to be photo-etched by standard techniques. Easily machined (milled, ground, drilled, tapped) to close tolerances	Meets requirement
Radiation Resistance	Ability to withstand radiation with minimum change in operating characteristics	Meets requirement
Sheet Size	Large enough to provide for most required components.	Standard size sheets 10" x 10" in $\frac{1}{8}''$ to $\frac{1}{4}''$ Other sizes available on special order
Price	Economical—both in original price and processing cost.	Equal to or less than equivalent competitive materials

ANOTHER REXOLITE 1422 PLUS

Your strip line problems are welcomed by the broad dielectric engineering department at Brand-Rex. This team of specialists have worked cooperatively with design engineers from many of America's leading electronics firms to boost the performance of strip lines with Rexolite 1422.

Without obligation, you are invited to write for engineering help, samples and complete technical information about ... **REXOLITE 1422**

COPPER-CLAD DIELECTRIC



DIVISION OF
American ENKA Corporation

Dept. R, 38 Sudbury Road, Concord, Massachusetts
Phone: EMerson 9-9630

Vinyl, Teflon, Neoprene, Nylon, Polyethylene Wire and Cable —
Electrical Tubing and Sleeving — Turbo® Coaxial Cables

**THERE IS . . .
A DIFFERENCE**

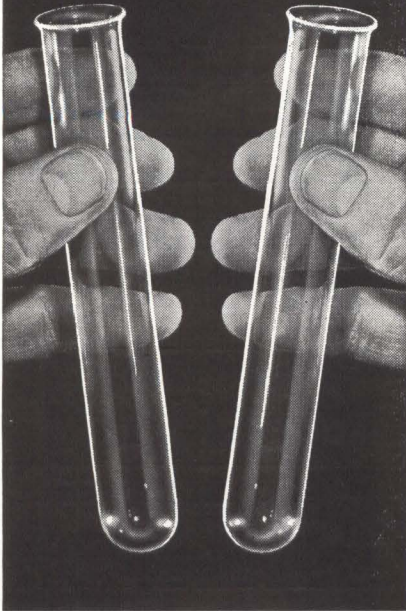

One test tube is made of glass, the other, Vitreosil pure fused quartz. Most glass deforms at low temperatures where Vitreosil will withstand continuous operation at temperatures up to 1100°C for extended periods of time. Unlike glass, Vitreosil can handle most common acid and corrosive materials in liquid or gaseous forms, even at high temperatures, with no reaction to the quartz.

VITREOSIL® PURE FUSED QUARTZ

For use in Production of Semi-Conductor Metals

VITREOSIL comes in beakers, crucibles, dishes, tubes, rods, and many other stock items in either clear or opaque. Transparent Vitreosil has excellent optical and electrical properties. Our know how enables us to hold close tolerances and quartz to metal seals are available. Special fabrication to your requirements.

SPECTROSIL®, the purest form of quartz, recommended where absolute purity is required in semi-conductor work. Spectrosil has unique optical and electrical properties and can be fabricated into standard shapes and special forms.

For more details see Chemical Engineering Catalog, Electronic Engineers Master or write for 32 page catalog and Spectrosil bulletin.



the time measured from initial light conditions to $(1 - 1/e)$ of the initial value. The measured rise and decay times for the average CdSe crystal are 0.001 and 0.005 seconds, respectively. However, the speed of response of the device itself is a complex matter and can best be expressed in terms of operating conditions. The scanning speed is only very loosely connected with crystal speeds. They have been measured to be as high as 7 meters/sec.

The breakdown voltage, measured between any terminal and the case is in excess of 500 volts rms. The insulation resistance, measured between any terminal and the case, is more than 1,000 megohms at 500 v d-c.

Resolution of the device is better than 0.0005-in. over an active length of about 0.5 in. This figure may be improved to yield a resolution of at least 0.00005 in.

Linearity is defined as the maximum deviation from the best-fitting straight line drawn between the 15 and 85 percent voltage points expressed as a percentage of the peak output voltage. Customarily, this is less than ± 1 percent. Deviations from linearity of less than 0.2 percent have been observed over a

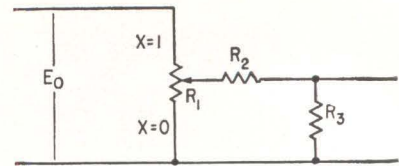

Basic circuit of photopot

range of 10 to 90 percent of full voltage.

Ultimate power dissipation of the device must be necessarily low to preserve the instrument-like qualities built in. Low power consumption would definitely be an asset in most applications.

Temperature dependence rests on the thermal sensitivity of the light-detecting crystal. Thus, temperature influences the output voltage and its linearity. However, if the load resistance in the output circuit is considerably larger than the impedance of the light path, the temperature range of operation is rather wide. Practical temperature limits, assuming not more than 1 percent variation from calibration, will include the range between -54 C and 71 C for a 1 megohm load. Photoconductive materials have been prepared which promise a higher temperature limit.

Evaluations of the deterioration

Rugged Crt For Outer Space

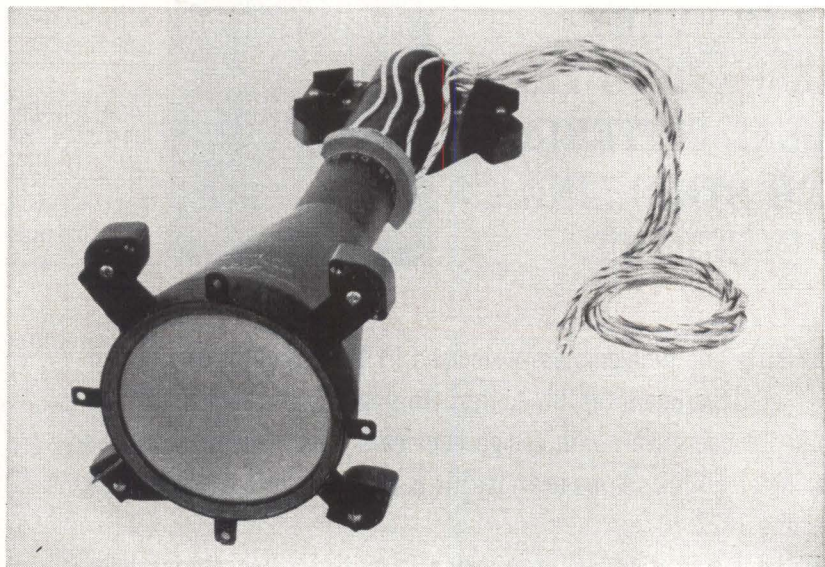

A cathode ray tube that can take the shock of thrust into outer space has been developed by the Electronic Tube and Instrument Division of General Atomics Corporation. The 5-inch single gun, tight tolerance tube can take vibration of 1,000 cycles per second at 0.10 in double amplitude, and impacts as high as 15 G with a time duration of 11 milliseconds, peak value occurring at about 5.5 milliseconds

of materials indicate that single crystals are far superior to sintered layer units. The superiority of single crystals have been further substantiated by applying conventional methods for protecting the crystals.

Among the most intriguing applications for the optically-activated potentiometer is the analog conversion of information. The device can translate a linear motion into a programmed non-linear output and vice versa. The data program to be followed is easily built into the optics.

Other applications suggested are stellar-body position indicator; blast detection system; pickoff for pressure transducer, accelerometer, gyro, torque-angle meter, or mercury manometer; and linear position sensor.

The light intensity from even a 20 KT bomb is adequate to operate the device at a considerable distance. It is not a seismic indicator and could not be fooled by an earthquake. A photometric device coupled with a Photopot could act as a remote station which could give information as to position and yield of a nuclear blast.

Glass Laser Operates In Near Infrared

A LASER using trivalent neodymium doped, barium crown glass, as the active material—rather than a gas or crystal as in previous lasers—has been operated.

Output is in near infrared 1.06 micron region, with a wavelength interval of some 30 angstroms. The glass material is in the form of clad rods, three inches long. Various diameters, including 0.012 inches were tried.

The new laser, developed at American Optical Co., Southbridge, Mass., has been operated with various flashtubes and provides pulsed output. With different levels of pumping power the wavelength interval is variable, from about 5 to 70 angstroms. It is believed that single lines in the output may prove to be as narrow as other lasers.

An advantage of using a glass laser material is the ease in which it can be formed into various shapes. This allows large surface areas for efficient cooling with a minimum of equipment.

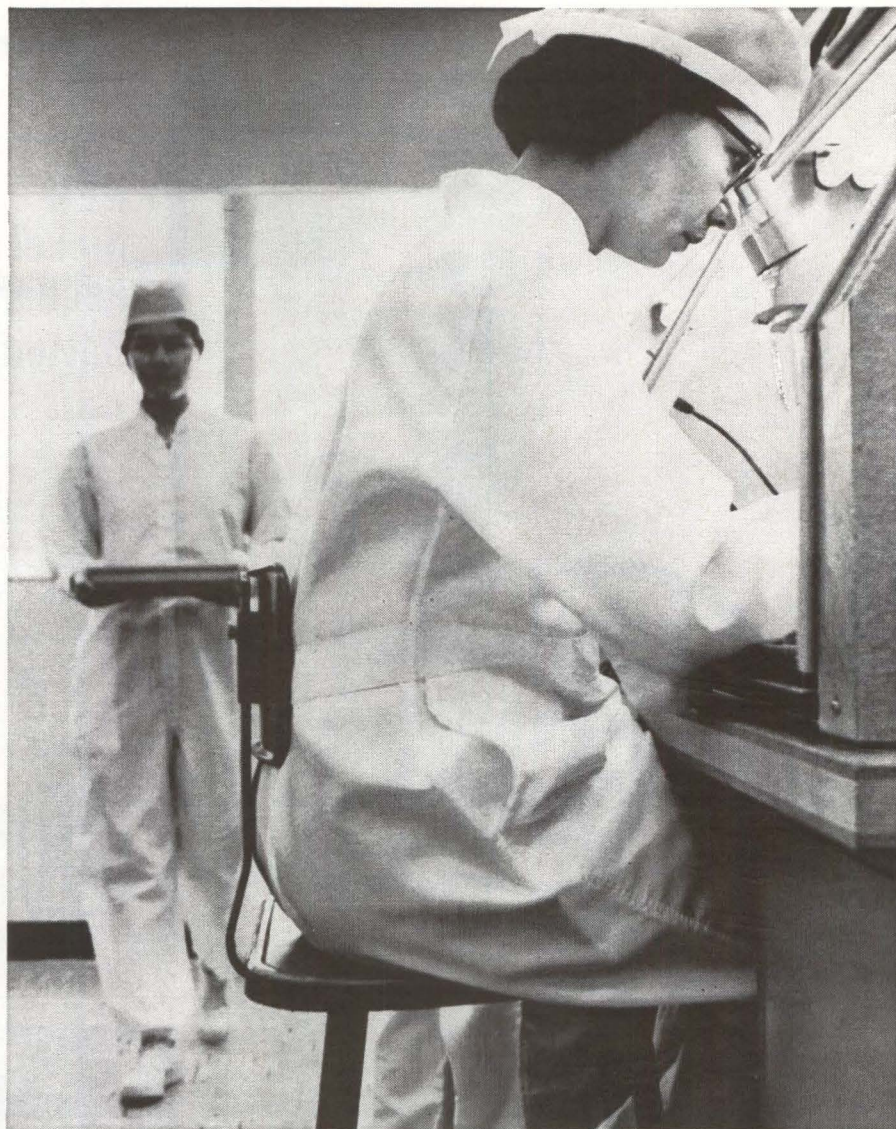

LINT-FREE!

Dependably lint-free uniforms with
DACRON® or NYLON
POLYESTER FIBER

Precision operations like those at The Barden Corp. require rigid lint-free quality standards. Uniforms of 100% "Dacron"* polyester fiber or 100% Du Pont Nylon dependably fulfill such quality-control requirements. Smooth-surfaced filament "Dacron" or filament Nylon do not generate lint! Even under the most exacting conditions of White Room cleanliness, "Dacron" and Nylon perform with outstanding lint-free efficiency.

Uniforms of "Dacron" or Nylon wear exceptionally well, stay fresh longer. And they can be successfully handled in commercial laundries. Doesn't the efficiency of your plant call for lint-free uniforms of Du Pont Nylon or "Dacron".

FOR SPECIAL ADVICE ON UNIFORMS, write: Uniform Counseling Service, E. I. du Pont de Nemours & Co. (Inc.), Textile Fibers Dept., Centre Road Bldg., Wilmington 98, Del.



Better Things for Better Living . . . through Chemistry

*"DACRON" IS DU PONT'S REGISTERED TRADEMARK FOR ITS POLYESTER FIBER. DU PONT MAKES FIBERS, NOT FABRIC OR UNIFORM



Fuse Blocks
for Internal
Mounting



Multiple
Pole Fuse
Extractor Post



Special
Application
Aircraft
Fuse Post



In addition to standard Littelfuse catalog items, hundreds of special application products are designed in accordance with customers specifications and manufactured to satisfy most stringent quality requirements. For your new application requirements we have a full staff of sales and development engineers ready to serve you. Simply write to Littelfuse, Des Plaines, Illinois or call us at Vanderbilt 4-1188.

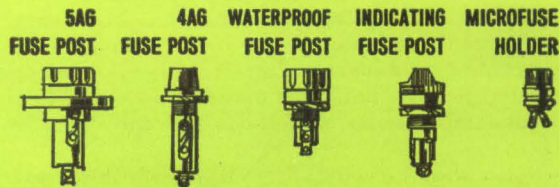

LITTELFUSE
Des Plaines, Illinois

When you need **POWER...**

choose **NICAD**[®]

**NEW
Nickel Cadmium
Rechargeable
Batteries**

SEALED CELLS

Hermetically sealed and rechargeable, Nicad batteries are small in size, require no maintenance, operate in any position. They make practical the battery operation of many types of equipment not previously suited to dry, mercury, or lead acid types.

VENTED CELLS

High surge power cells, in sintered or pocket plate types, are capable of sustained voltage at high discharge rates over a wide temperature range. They have extremely long life... little or no maintenance. For more of the POWER story, write

SEALED CELLS

VENTED CELLS



NICAD BATTERY DIVISION
GOULD-NATIONAL
BATTERIES, INC. E-1411 First National
Bank Bldg., St. Paul 1, Minn.

CIRCLE 202 ON READER SERVICE CARD

**L & R ULTRASONIC
CLEANING SOLUTIONS**



L & R #112
Waterless Ultrasonic
Instrument Cleaning
Solution (Ammoniated)



L & R #222
Waterless Ultrasonic
Instrument Cleaning
Solution (Ammonia-free)



**L & R
Hydro-Sonic**
Cleaning Solution
Concentrate

are specific!

We'll prove it! Send us small parts you find difficult to clean for test cleaning in our laboratory. We will do the job and return the cleaned parts to you, together with a recommendation for the right L & R cleaning solution which you can use in your ultrasonic cleaning equipment. For over 30 years L & R has been a world leader in precision cleaning for the watch and instrument fields. This experience is at your disposal. Or write for a copy of our latest catalog describing L & R's ultrasonic cleaning and rinsing solutions and ultrasonic cleaning equipment.

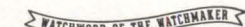

L & R MANUFACTURING COMPANY
577 Elm Street, Kearny, N. J. • Chicago 2, Ill. • Los Angeles 13, Calif.

CIRCLE 203 ON READER SERVICE CARD
CIRCLE 87 ON READER SERVICE CARD →

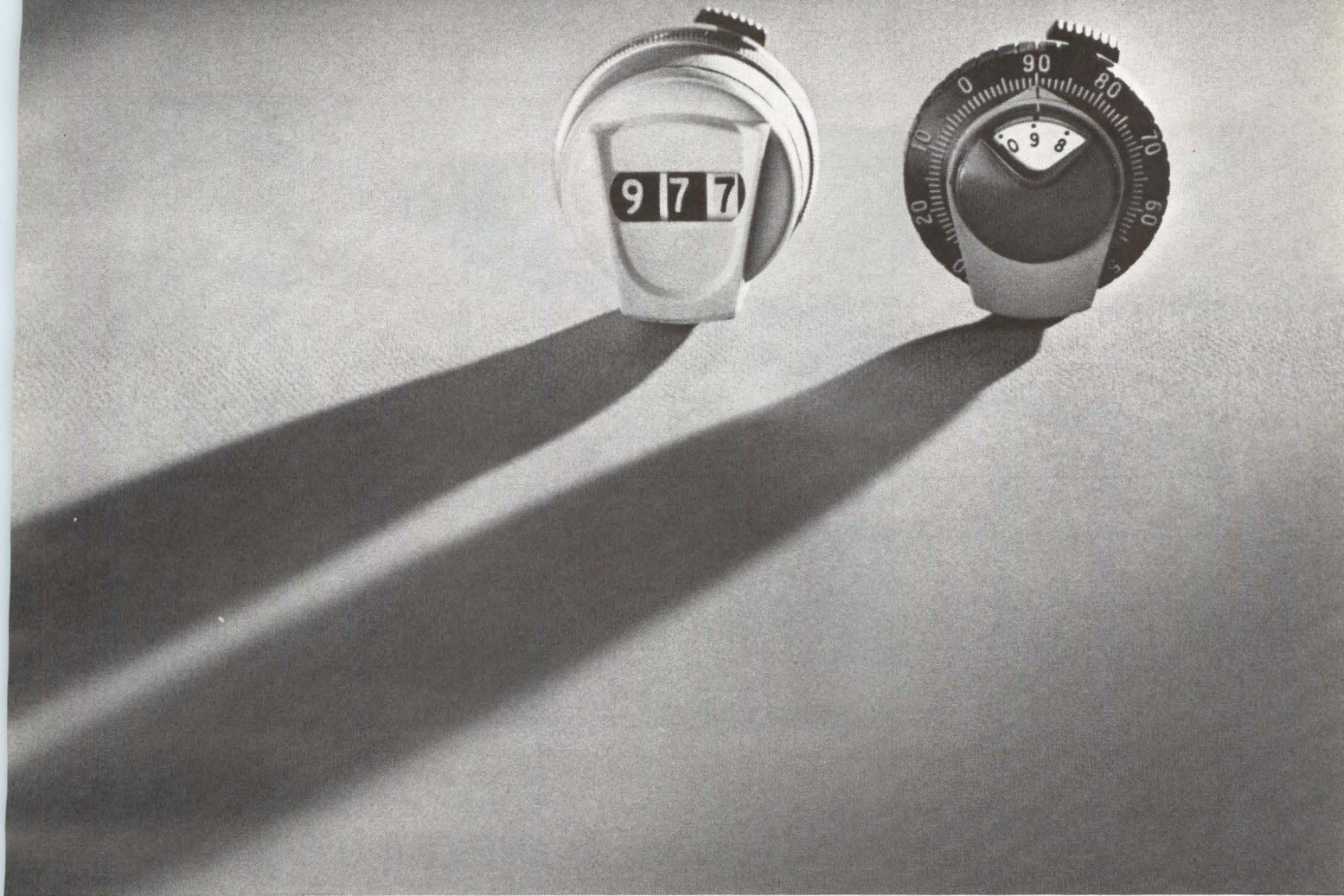

How do you prefer your Microdial®: Digital or Concentric Scale?

The Borg Microdial line (broadest in the industry) offers both types—two digital series, and three concentric scale series. Whichever type you like for potentiometer control, remember:

1. Each Borg Microdial features large numerals that are well contrasted to their backgrounds for squint-free readability. 2. Each can be equipped with positive braking to prevent accidental setting changes. 3. Indexing

accuracy is one part in a thousand, suitable to a potentiometer of .1% linearity, thus enabling you to get all the precision you pay for in a precision potentiometer. 4. Rugged design withstands rough handling and "panic" responses or setting changes. 5. Customization of counting wheels and gearing can give you practically any readout configuration you might require.

Most Microdial models come in a

variety of color combinations that contribute to appearance and permit coding for fast identification in panel groupings.

The Borg Microdial line is competitive too, as you can verify by contacting your nearby Borg technical representative or omnipresent Amphenol-Borg Industrial Distributor. Or, you can address specific inquiries to R. K. Johnson, Sales Manager:



BORG EQUIPMENT DIVISION

Amphenol-Borg Electronics Corporation,
Janesville, Wisconsin.



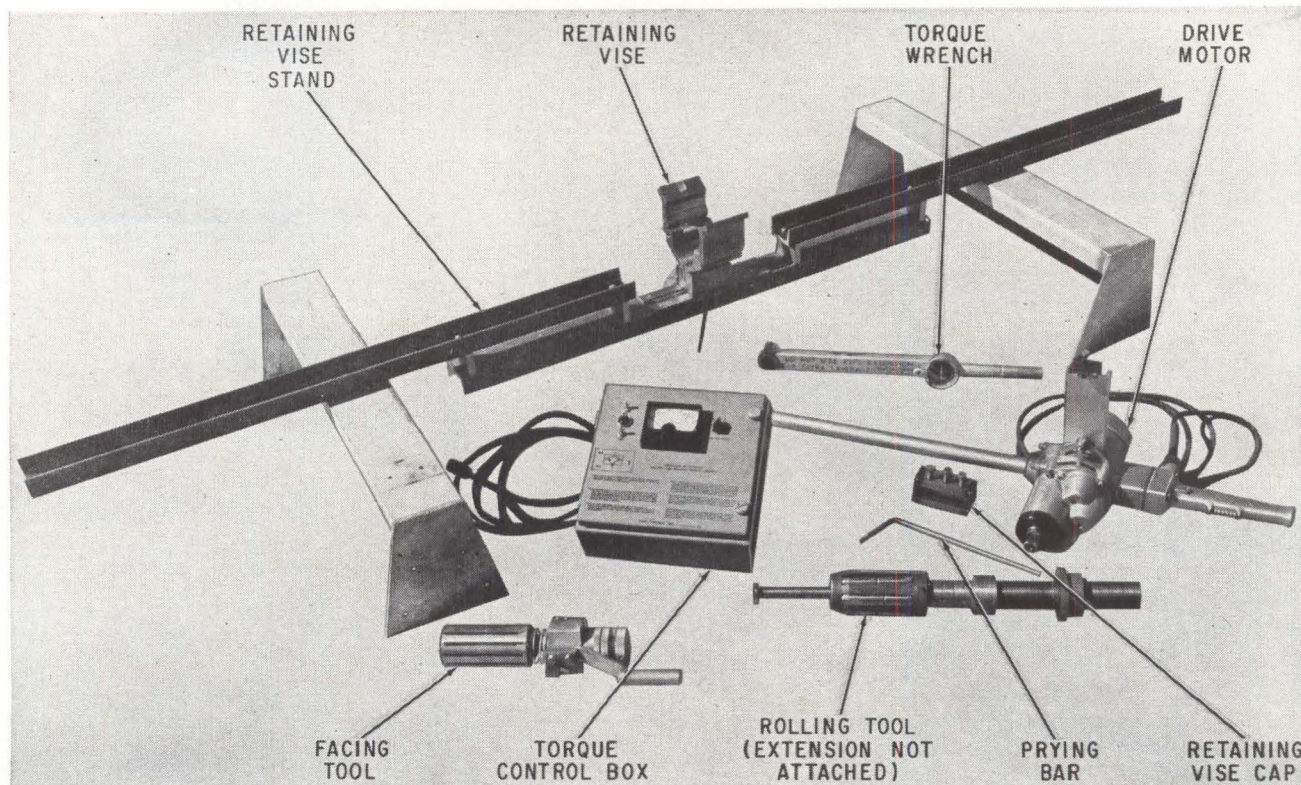

Equipment for making rolled joints in waveguide installation is relatively simple and inexpensive

Rolled Joints Reduce Waveguide Costs

By ROBERT A. ELMIGER*
Venetia, Pa.

WAVEGUIDE RUNS are the veins and arteries of the radio guidance and tracking system used to direct the Atlas ICBM to its target. Many of these waveguide runs are several thousand feet long and must be assembled in the field.

Flanged waveguide, whether rectangular or circular, must be pre-fabricated at the factory in various lengths. Special provisions must be made for shipment and storage to prevent denting or other damage to the waveguide, often at considerable expense. On the site, the sections are assembled by bolts or clamps with O rings for pressure seals at each joint.

Welded waveguide eliminates pre-fabricating sections. Waveguide material is shipped to the site, where welding is done by specially trained field service personnel. Rectangular waveguide is

welded manually; for circular waveguide, an automatic helium-arc welder was developed for field use. The depth of weld penetration, starting dwell time, and speed of torch are automatically controlled and adjustable.

The method being used presently is a mechanical connection, uses circular waveguide and is essentially a rolled joint. Sections of waveguide are butted together inside a stainless steel coupling sleeve. The joint is then rolled and expanded slightly from the inside by a special tool, and a strong, reliable leaktight joint, is formed by cold flow of waveguide metal into small ridges in the coupling. Tooling and procedures are similar to those in rolling tubes into boiler tube sheets. The pressure produced by rolling also helps align the butted sections of waveguide.

Raw waveguide, which is used in all methods, has dimensional tolerances that causes some mis-match. But mis-match is eliminated by the

rolling and each joint is essentially a smooth transition between sections. No special experience is required to operate the equipment, and personnel can be trained to use it in 10 to 15 minutes. The rolling tool was developed for General Electric by G. Wiedeke Co.; connections can be made for straight runs only, but this is the bulk of the installation.

First the sections to be joined are faced and deburred with a facing tool similar to that used for preparing waveguide for welding. The pieces are then butted in the center of a machined coupling and the tool, with a 20 foot adjustable extension, is inserted. The tool is then operated either manually or by motor until a pre-set torque is reached, at which time it is automatically stopped. The motor is then reversed and the tool withdrawn. Depending on the torque used, the material, and wall thickness of the coupling, it is sometimes necessary to use a restraining vise around the cou-

*Formerly with General Electric Co., Syracuse, N. Y.

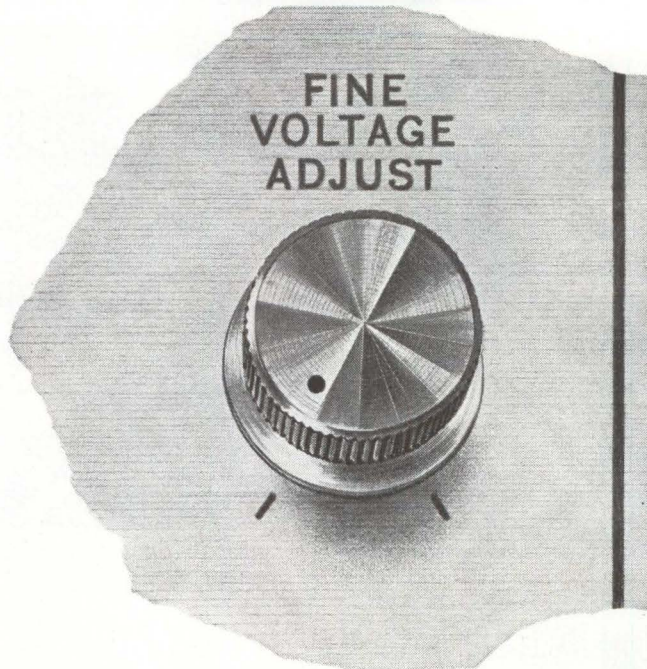

DETAIL FROM A WORK OF ART

A power supply control knob is a detail. We love details and give them the importance we feel is their due. For an electronic instrument, as well as a work of art, is the sum of all details. Technical details, electronic details, human factor details.

The fine voltage adjust control of our model 5015A is a case in point. We human-engineered this anodized aluminum knob for durability, appearance, torque/diameter ratio, panel protection against fingernail scratches, and just downright "feel." Nor did we stop here. We inspect every instrument we ship to make certain this "feel" is just right.

Turn this knob and you will find another detail:

smooth mechanical control translated into smooth electrical control. There is no need to twiddle to find the right voltage. You won't find parallax on the main voltage control. It has been eliminated by a unique mechanical linkage between the variable autotransformer and its tracking potentiometer.

You will also discover that the performance characteristics of this instrument far exceed our published ratings. That's because our specifications are based on performance at the end of five years of operation rather than at the time of shipment.

We think the model 5015A is a work of art. Won't you give our sales representative an opportunity to exhibit his artistic pride in a demonstration.

**POWER
DESIGNS**

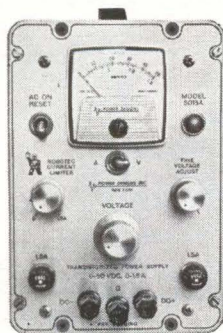

MODEL 5015A

See us at Booth 1516 IRE Show

POWER DESIGNS INC.

1700 Shames Drive, Westbury, L.I., N.Y.
EDgewood 3-6200, Area Code 516



NEED CABLE DATA?

Whatever your part in engineering and building electronic equipment, here's the NEW catalog that should be at your fingertips for CABLES! New Catalog No. 4C-61 gives complete charts on Royal RG and special application cables, physical and electrical characteristics, testing procedures, engineering tables (impedance, attenuation, etc.). Valuable information, too, on MIL-spec, signal, control and other multi-conductor cables.

WRITE for your copy — TODAY!

Royal Electric Corporation
301 Saratoga Avenue
Pawtucket, Rhode Island

In Canada: Royal Electric Company
(Quebec) Ltd.,
Pointe Claire, Quebec

ROYAL
ELECTRIC **INC.**
... an associate of

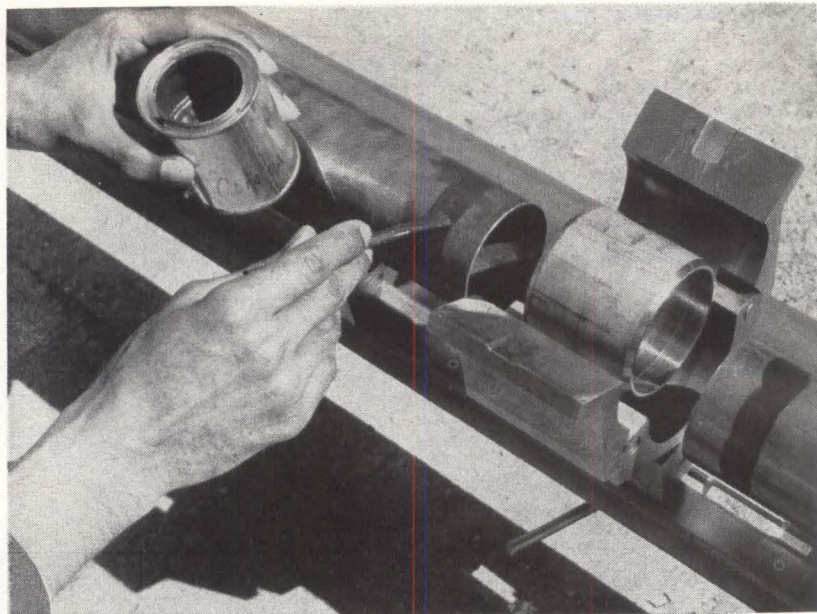

Sealing compound is applied to waveguide sections prior to assembly in grooved stainless steel coupling

pling to prevent excessive increase in diameter. The resulting joint is so smooth that the butting surfaces can hardly be seen. Upon completion of the run, a pressure drop test is made for leak tightness.

Circular waveguide is superior to rectangular in electrical loss characteristics and was used in these installations. The material is commercially hard drawn copper tubing; for welded waveguide, the copper must also be certified oxygen free. To compare physical strength, samples of each type of joint were pull-tested. At about 5,000 pounds pull on both flanged and welded samples, distortion began to occur at the annealed areas of the joints. Actual mechanical failure occurred at from 4,000 to 9,000 pounds for welded samples, and from about 8,000 to 10,000 pounds for flanged joints. Failures of rolled joints occurred between 14,000 and 18,000 pounds pull. These failures were in

the waveguide itself where it was gripped in the pull machine. Where the waveguide did not break, failure of the rolled joint was considered to occur when it slipped in the coupling. At this failure point the guide is still intact, with a slight separation between the butted surfaces in the coupling. Electrical tests have shown that several such joints in a run have only a slight effect on attenuation.

In bend tests, in which the free end of a run is lifted several feet, and in jump tests, in which a man jumps on a coupling at the center of a 12 foot section supported at the ends, rolled joints did not fail but welded and flanged joints did. Field tests on welded and rolled joints showed no pressure loss over several weeks when checked at 10 psi. Experience has shown that with flanged joints, considerable leakage occurs, especially when the coupling is exposed to low temperatures that affect the O rings. Electrical checks showed that each method met specifications. Data taken for the rolled waveguide gave an average attenuation that approached theoretical values.

In actual field installation practice some useful comparisons can be made. Flanged joints provide relatively simple assembly but a good pressure seal requires considerable work and checking. Flanged joints also can be easily replaced.

In automatic welding, external

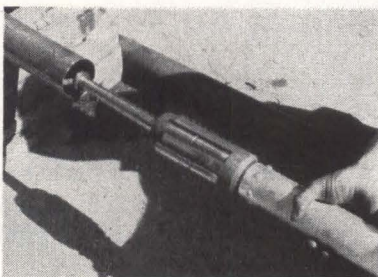

Rolling tool with extension is being inserted into waveguide section

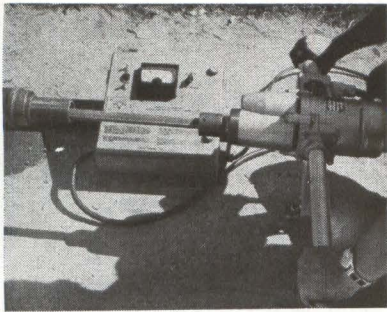

Drive motor with control box

conditions of temperature, wind, dust, and moisture have varying effect on the equipment. Prior to operation, test welds are required. After welding it is difficult to determine weld quality. In addition, only oxygen-free copper tubing, at extra cost, gives satisfactory results. To repair the run, a section is cut out and a new piece welded in. Installation equipment for rolled joints is basically simple and little difficulty is experienced in field assembly. Up to now, no joint has failed pressure test and consequently pressure testing has not been a problem. To repair the run, the affected section must be cut out. Special flanged sections are rolled on if the repair is in the middle of the run, and the remainder of the section is assembled in the normal manner. Test repairs have been made in $\frac{1}{2}$ hour.

Costs of field labor for each method of installation are comparable but overall costs of various installations differ widely. Material costs for welded and rolled installations are almost the same and the major cost difference is in the equipment required.

A complete welder costs approximately \$15,000; comparable rolling equipment can be obtained for about \$1,500. Figures comparing the rolling method with flanged guide show a saving of about \$2.00 per foot of installation for the rolling technique. Waveguide assembled using the rolled method also can be buried underground but flanged and welded joints do not have sufficient strength for the stresses caused by temperature cycles. By burying the waveguide in the ground instead of running it in a trench on rollers as is now done, an estimated \$5.00 per foot of run can be saved. Thus, both using rolling and burial, a substantial cost reduction is accomplished.



slash production costs with new automated coil winder ... fewer operators ... more coils per operator

Leesona No. 116 will wind 400 to 1,000 bobbin coils per hour... with one operator.

All the operator does, as the rotary table brings the winding heads to her, is load bobbin on arbor, clip start wire.

Automatically the No. 116 closes tailstock, tapes start lead, resets counter, starts winding, stops at ± 2 turns, waxes or tapes finish lead, indexes arbor, cuts wire, ejects and sorts.

It winds two or more different coils up to 3" diameter by $2\frac{3}{8}$ " long... simultaneously. Supports and winds from 100 lb. wire container, and stops when spool or container is empty. Six to twelve two-speed heads wind wire AWG 16 to 50 and finer.

No. 116 is designed by Robert Bachi. We build it to the customer's specifications.

For details call your nearest Leesona representative.



LEESONA CORPORATION
Warwick, Rhode Island

B.2.2

Offices: 5700 West Diversey Ave., Chicago, Ill. 1500 Walnut St., Phila. 2, Pa.
Sales Representative: A. R. Campman, Los Angeles, Calif.
Offices and demonstration rooms in Heywood, England; Paris, France; Frankfurt, Germany

now!

more features per dollar

in Panoramic's new, low cost spectrum analyzer

10 mc-43 kmc

New Model SPA-10 gives you reliable and versatile performance at a surprisingly low investment. Easy to use, too . . . human engineered for simple operation, component accessibility. Compare its features; see its performance at the IRE Show. We think you'll recognize SPA-10's embodiment of Panoramic's pioneering experience and pace-setting engineering capability.

Check these outstanding SPA-10 SPECIFICATIONS: 10 mc to 43,000 mc with one tuning head. Simple bandswitching through 8 bands. Dispersion continuously variable from extremely narrow band scans up to 80 mc for wide band. Accurate measurement of small frequency differences with self-contained frequency-marker oscillator, modulated by external source, generating precise side band markers. Three calibrated amplitude scales: linear, 40 db log, and power (square law). I-F bandwidth adjustable 1 kc to 80 kc. I-F attenuation adjustable 0-41 db in 1 db steps plus 20 db smooth attenuator. 0.01% accuracy frequency markers check entire SPA-10 tuning range to 43 kmc (optional).

Panoramic's New Model SPA-10 is a compact, easy-to-use instrument for reliable visual analysis of AM, FM and pulsed signals, oscillator stability, detection of parasites, harmonic output and other r-f and noise characteristics in Radar, Microwave and Communications devices.

A Panoramic engineer will be happy to discuss specific application to your project;

CALL COLLECT

PANORAMIC ELECTRONICS, INC.

530 South Fulton Avenue
Phone 914 OWens 9-4600
CABLE: Panoramic

Mt. Vernon, N. Y.
TWX: MT-V-NY 5229
Mt. Vernon, New York State

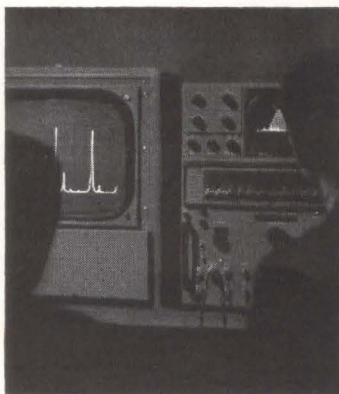

formerly
Panoramic Radio
Products, Inc.



see

SPA-10 "in action" at I.R.E. show booth 3301-3303

LINK

YOUR



WITH

REALITY

Whether you're designing a complex communication system, a new idea in computers, or a simple electronic device, you can depend on this kind of versatility to save you time and money.

- Knowledgeable recommendations relative to insulation materials and the ability to supply these materials.
- The capability to produce a wide range of constructions through diversified striping, braiding, shielding and cabling equipment.
- Brain power at your call to translate your preliminary designs or limiting parameters into functional wire and cable with the required performance and size characteristics.
- The ability to produce the product you need, military or commercial, and to meet all applicable U.L. or military specifications.

• Completely integrated facilities are nearby under one roof. This means production speed that meets delivery dates . . . scientific quality control to insure reliability . . . prices that are competitive.

Whether you require prototype quantities or millions of feet, call or write Brand-Rex.



division of
American Enka Corporation
31 Sudbury Road, Concord, Mass.
EMerson 9-9630

CIRCLE 204 ON READER SERVICE CARD

AVERAGE POWER OUTPUT AS A FUNCTION OF FREQUENCY FOR MICROWAVE TUBES. (MODIFIED FROM NERGAARD)

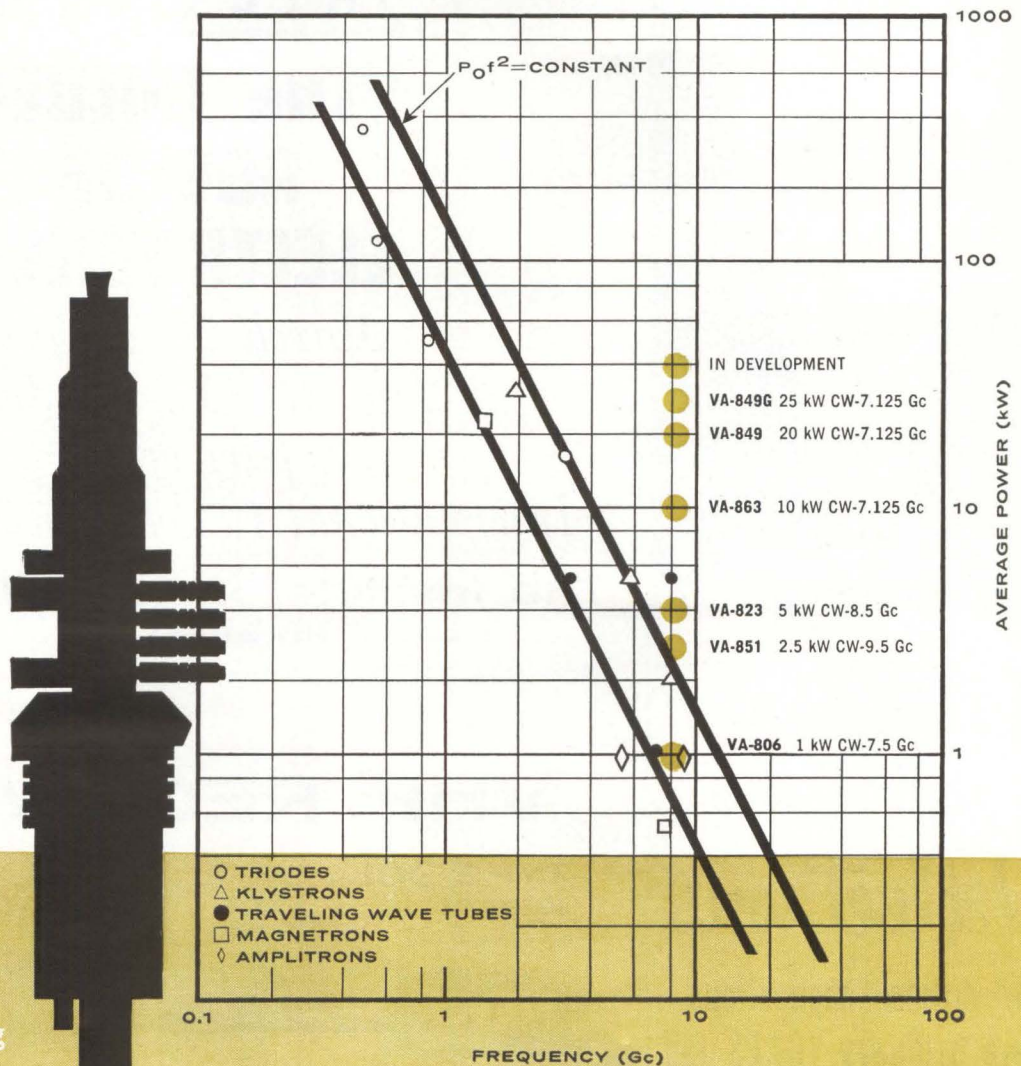

Power surveys by Nergaard,* plotting power output as a function of frequency

for tubes of varying powers, predicted that maximum wattage available in X-band would be less than 10 kW CW.

Varian research indicates this figure to be extremely conservative. Varian's recent introduction of the VA-849 amplifier klystron provided the industry with a tube capable of developing 20 kW CW power at 7.125-8.5 Gc. A modified VA-849 developed 51.5 kW power in the laboratory, and is now available as the VA-849G, conservatively rated at 25 kW CW. Varian accomplishments do not stop there. The company is now developing an X-band tube rated at a *minimum* of 50 kW CW.

If *your* microwave project calls for such out-ahead capability in power tube development, write Tube Division. *L. S. Nergaard, RCA Review, Dec., 1960



VARIAN associates
PALO ALTO 1, CALIFORNIA

DEFLECTRONS

BY CELCO FOR
PRECISION
DISPLAYS
SMALLEST
DEFLECTED
SPOTS

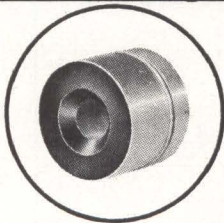

Deflectrons

for critical applications
where ordinary YOKES fail

REPEATABILITY to 0.1%!

SPOT GROWTH 1:1.3 max!

RECOVERY to 0.1%!

Just off the press "Linearity Notes"
by John M. Constantine — Request
your copy today.

Celco

Constantine Engineering
Laboratories Co.

Main Plant: MAHWAH, N. J. DAVis 7-1123
PACIFIC DIV.—UPLAND, CALIF. YUkon 2-0215
CENTRAL DIV.—LANESBORO, PA. ULYsses 3-3500

IRE SHOW



presenting

"THE GOLDEN AGE OF ELECTRONICS"

March 26-29, 1962

The New York Coliseum

... part of the

International Convention of the IRE

The Institute of Radio Engineers

1 East 79th Street • New York 21

Members \$1.00. Non-members \$3.00. Age limit: over 18

CIRCLE 205 ON READER SERVICE CARD

VHF RECEIVERS

TYPE 901
30-300 MC

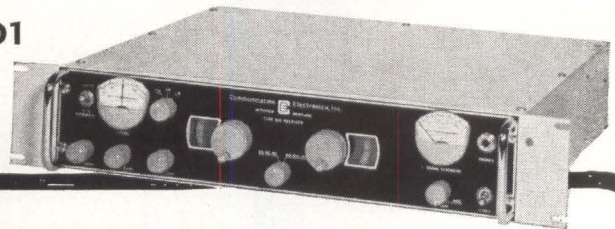

NEW!

From the house of RF Specialists . . . a completely new VHF receiver for AM, FM, CW reception is now available. Covering the frequency range of 30 to 300 mc, this precision receiving unit is compact (3 1/2" panel height) and employs solid state and vacuum devices.

Frequency range	30 to 300 mc (band 1: 30 to 60 mc) (band 2: 60 to 300 mc)
IF Bandwidths	300 kc and 20 kc
Sensitivity 300 kc bandwidth	AM-2 uv produces at least 14 db S/N for 50% modulation
Sensitivity 20 kc bandwidth	FM-4 uv produces at least 21 db S/N for 100 kc deviation at a 1 kc rate AM-2 uv produces at least 17 db S/N for 50% modulation FM-2 uv produces at least 20 db S/N for 7 kc deviation at 1 kc rate
Power input	115 volts, 50/60/400 cps
Power consumption	Less than 40 watts
Weight	18 lbs. (approximately)
Size	19" x 3 1/2" x 15 1/2"

FOR COMPLETE SPECIFICATIONS WRITE:

Communication  Electronics, Inc.
4900 HAMPDEN LANE BETHESDA, MARYLAND

CIRCLE 206 ON READER SERVICE CARD
electronics

BULLETIN:

SOLA ANNOUNCES A NEW CONCEPT
IN LINE VOLTAGE REGULATION IN
THE KVA RANGE . . .

- No moving parts, eliminating maintenance problems.
- Up to 10 times faster than mechanical regulators.
- Lower cost per KVA.

FOR THE FULL STORY ON THIS
COMPLETELY NEW CONCEPT IN
LINE VOLTAGE REGULATION
MAIL COUPON BELOW.



SOLA ELECTRIC CO.
1717 Busse Road
Elk Grove Village, Ill.
HEmpstead 9-2800
IN CANADA, Sola-Basic
Products Ltd., 377 Evans
Ave., Toronto 18, Ontario

SOLA ELECTRIC CO., Dept. D3,
1717 Busse Road
Elk Grove Village, Ill.

Send me all the facts on this new Sola line voltage regulator.

Name

Company

Title

Address

City State

**NEED
65-80 db
ISOLATION
BETWEEN
TRANSFORMER
WINDINGS?**

You do if your project involves very low signal levels. This was the case recently when a major transistor manufacturer specified EIC custom transformers with 65 db isolation between windings, from 60 cycles to 10 kc. (We can give you 80 db if required.) Insulation resistance specified (winding to winding and winding to case) was 300,000 megohms. Send us your complete specifications for prompt price and performance quotations.

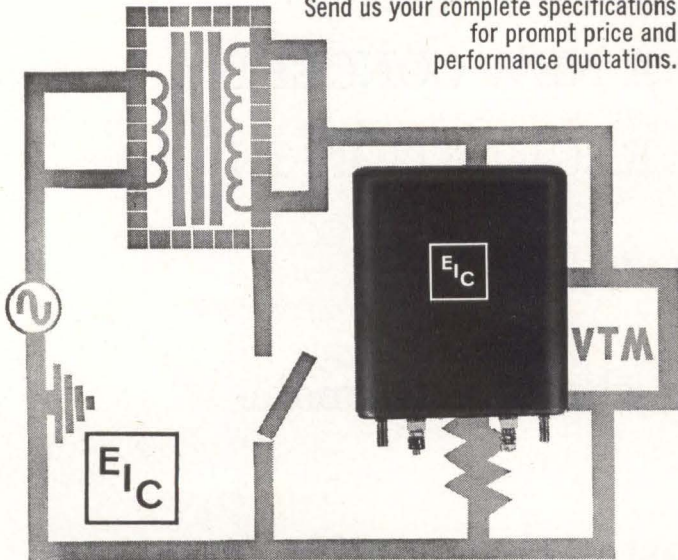

ELECTRODYNAMIC INSTRUMENT CORPORATION
Subsidiary of Reed Roller Bit Company
JA 6-3761 • 1841 Old Spanish Trail • Houston 25, Texas
CIRCLE 207 ON READER SERVICE CARD

**COSTS DOWN!
WIRE
FORMS
PRECISION UP!**

BY ARTWIRE

Art Wire's high speed, automatic machines and production economies mean BIG SAVINGS for you ... with guaranteed precision from the first to the millionth unit. Widest variety of wire components, made for today's automatic production lines, delivered on schedule to assure uninterrupted work flow.

Send a Sample or Blueprint for Estimates

ART WIRE AND STAMPING CO.

18 Boyden Place, Newark 2, N.J.

CIRCLE 208 ON READER SERVICE CARD

HAMLIN
electrical and
electronic
components

ACTUAL SIZE

ACTUAL SIZE

**MAGNETIC
REED SWITCHES**

Operate in any position — hermetically sealed — use in wet, dry, or "explosive" atmosphere. Not affected by high or low temps. Compact, rapid cycling, long life.

**GRAVITY SENSING
ELECTROLYTIC
POTENTIOMETER**

Excellent for gyroscope correction mechanisms. Not materially affected by vibrations. Keeps "hunting" to minimum. Compact — extremely accurate.

**MERCURY
SWITCHES**

Many design ideas. Super-sensitive — sealed against trouble. Select from huge variety of electrical and operating characteristics, contacts, lead and terminal arrangements. Custom designs upon request.

Specify HAMLIN

for systems to indicate or integrate functions of: RPM's thru circuits • TIME • MOTION • MEASUREMENT • TEMPERATURE • POSITION • SEQUENCE • FLOW • PRESSURE • LIQUID LEVEL

Specify HAMLIN

if you manufacture: TEMP. or FLOW CONTROLS • IND. PROCESS CONTROLS • ALARM DEVICES • GYROSCOPIC INSTRUMENTS • AUTOMATION • ATOMIC POWER REACTORS • RELAYS

SEND FOR BULLETIN

HAMLIN INC

DEPT. EL • LAKE and GROVE STREETS • LAKE MILLS, WISCONSIN

96 CIRCLE 96 ON READER SERVICE CARD



How to grow a beard...

Sit back and wait for your copy on that routing list. Okay if you like beards. Otherwise, look in this issue for the Reader Service Card. Fill in the "for subscriptions" section. Mail. Only 7½ cents a week.

electronics

A McGraw-Hill Publication, 330 West 42nd St., N. Y. 36

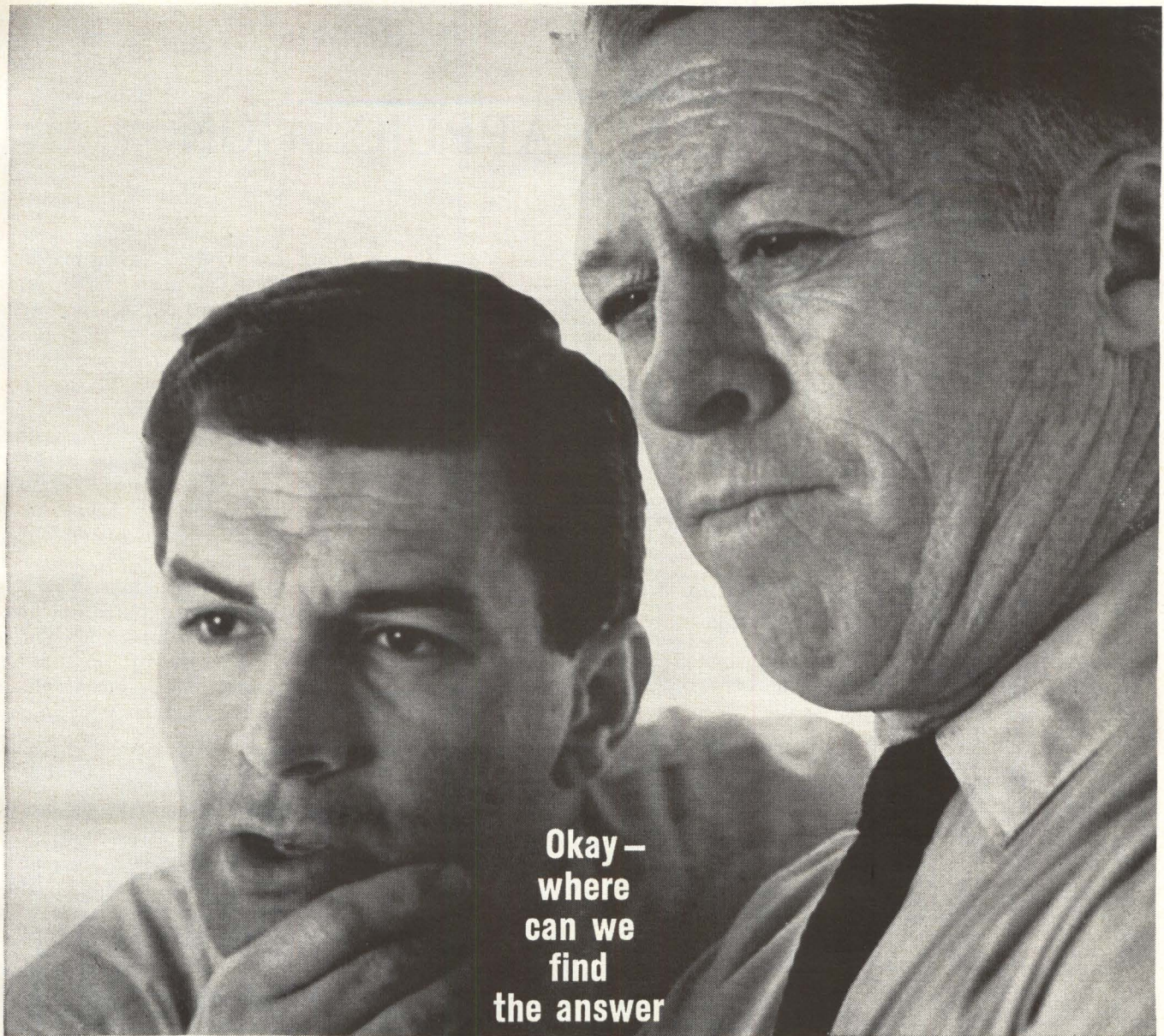

Okay —
where
can we
find
the answer

FAST!

If you find it increasingly difficult to get the up-to-date, expert information you need when you need it—here is important news from McGraw-Hill. A new professional encyclopedia has been developed that gives you latest available information in the scientific and engineering disciplines, and keeps you abreast of the whole spectrum of today's exploding technology.

Short-Cut to Basic Information on Every Aspect of Every Field: For help with everyday problems met in your work—as an instrument to help you bridge the gap between your specialty and other fields into which your work leads you—as a backstop and “refresher” in your own and related areas—there is no substitute for this new ready-reference tool in

encyclopedia-form. McGraw-Hill enlisted the support of 2,000 contributors, including Nobel Prize winners and leaders of research and industry, for this unprecedented and widely-acclaimed undertaking.

Mail Card for Free Brochure: If you feel pressured by the mountain of information facing the scientist and engineer today, the helpful brochure offered on the attached card is

“must” reading for you. It gives complete details of this extraordinary new method devised to answer your information needs. Simply mail the inquiry card today to receive your free copy. No obligation, of course.

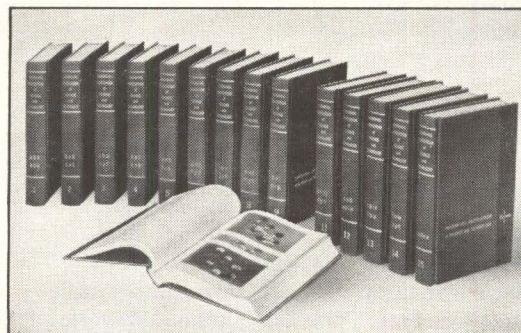

McGRAW-HILL BOOK COMPANY
331 West 41st Street, New York 36, New York

DESIGN AND APPLICATION

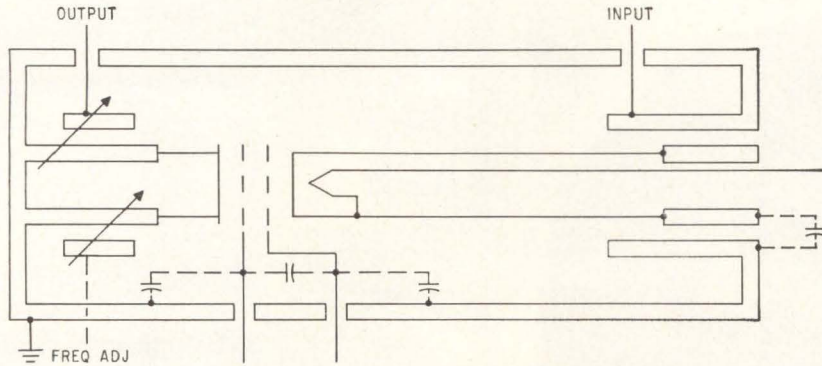

Distributed Constant R-F Module

150 WATTS IN 12 CUBIC INCHES

MICRODOT Inc., 220 Pasadena Avenue, South Pasadena, California, manufactures the Microdot power tetrode module averaging 12 cubic inches with power outputs up to 150 watts. The module features distributed-constant circuit components, weighs less than one pound

and covers frequencies from 215 to 1,000 Mc. Special circuit layout effects rapid heat transfer to mounting surface. They can be used as power amplifiers or, frequency multipliers and are available either grounded-grid or grounded cathode.

CIRCLE 301 ON READER SERVICE CARD

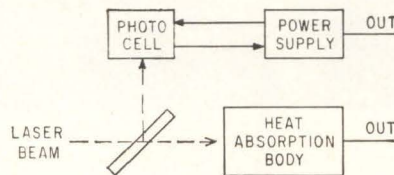

Laser Calorimeter

5-PERCENT ACCURACY

ANNOUNCED by Trion Instruments, Inc., 1200 North Main Street, Ann Arbor, Michigan, is the model M1-1 Calorimeter measuring total energy output as a black-body calorimeter and peak power with a photocell. The useful power range is 0.1 to 30 joules with the calorimeter and 0 to 20 Kw with the photocell. Accuracy is better than 5 percent and time resolution of the photocell is approximately 10^{-7} second. The nominal output is 10 μ v per joule calorimeter and 100 mv per kilowatt photocell, the input aperture is 0.75 inch and the input range of wavelengths is 0.3 to 3.0 microns. The unit was designed

to provide accurate pulsed laser output data and the low-level outputs may be read directly or recorded on strip charts.

CIRCLE 302 ON READER SERVICE CARD

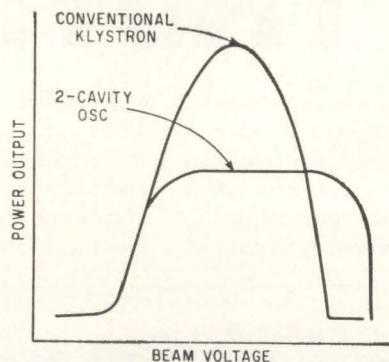

Two-Cavity Oscillator

PUMPS 10 AMPLIFIERS

OPERATING between 18 and 26.5 Gc, the new SOK family two-cavity oscillator made by Sperry Electronic Tube Division, Sperry Rand

Corp., Gainesville, Florida, provides from 200 to 600 mw of power with a flat-top output curve. This oscillator will pump 10 or more parametric amplifiers such as used in phased array radar systems. The tubes are metal-ceramic construction and use electrostatic focussing. Cooling is by forced air and the weight is less than 8 oz. The two-cavity oscillator has lower beam voltage, higher output power, higher efficiency and lower a-m and f-m noise than a reflex tube. There is no reflector element and spurious shock modulation and vibration is reduced. Because of the flat-top output, variations in beam voltage produce negligible variation in output power. In many cases, pump levers and afc circuits can be eliminated. The first member of the SOK family is the SOK-292 operating at 25 Gc, 600 mw output at beam voltage of 1,000 v, current of 35 ma, flat-top bandwidth (minimum) of 20 Mc and a modulation sensitivity (minimum) of 200 Kc per volt.

CIRCLE 303 ON READER SERVICE CARD

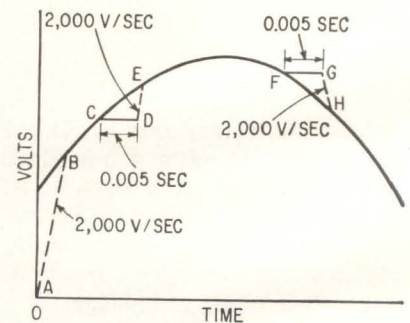

Digital Voltmeter

USES CLAMP AND HOLD

RECENTLY introduced by Non-Linear Systems Inc., P. O. Box 728, Del Mar, California is their NLS CH2 clamp and hold digital voltmeter that makes four digit measurements in ranges of $\pm 9.999/99.99/999.9$ v to an accuracy of

CIRCLE 101 ON READER SERVICE CARD →

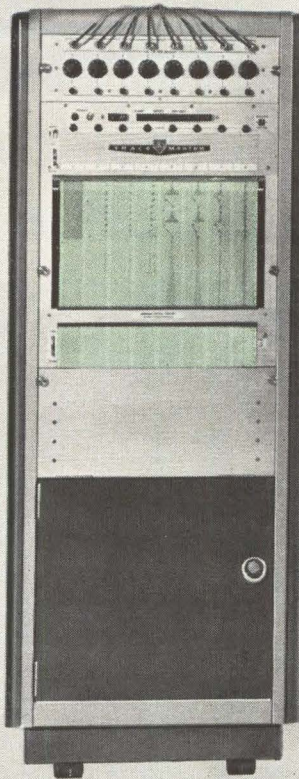
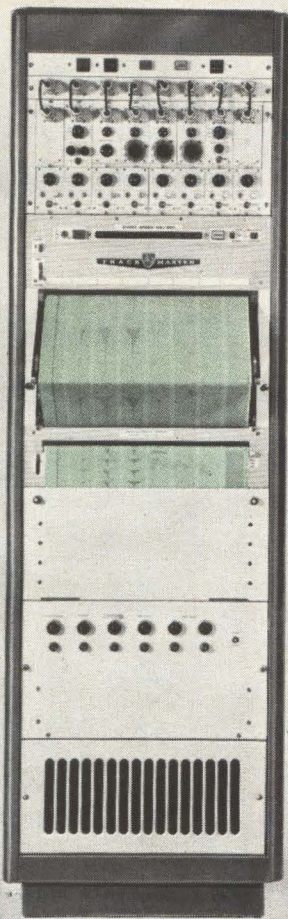

	SERIES 250 TRACEMASTER 8-channel, Rack Cabinet on casters	SERIES 260 TRACEMASTER 8-channel, Rack Cabinet on casters	SERIES 290 TRACEMASTER Model 291 Single-channel; Portable	SERIES 293 TRACEMASTER Model 293 3-channel; Portable
FREQUENCY RESPONSE	DC to 110 cps. $\pm 1\%$ at 40 mm. peak to peak. Down 3 db at 140 cps.	DC to 100 cps. $\pm 1\%$ at 40 mm. peak to peak. Down 3 db. at 125 cps.	DC to 90 cps. $\pm 5\%$ at 30 mm. peak to peak. Down 3 db at 125 cps.	DC to 90 cps. $\pm 5\%$ at 30 mm. peak to peak. Down 3 db at 125 cps.
BAND AMPLITUDE PRODUCT	5600 (i.e. 40 mm. x 140 cps.)	5000 (i.e. 40 mm. x 125 cps.)	3750 (i.e. 30 mm. x 125 cps.)	3750 (i.e. 30 mm. x 125 cps.)
SENSITIVITY RANGE	10 Microvolts to 100 v/cm	100 mv/cm to 20 v/cm	50 mv/cm to 50 v/cm	50 mv/cm to 50 v/cm
CHART SPEEDS	0.2 to 500 mm/sec.	1 to 250 mm/sec.	1 to 100 mm/sec.	1 to 100 mm/sec.
CHART CAPACITY	1000 ft. roll	1000 ft. roll	200 ft. roll	200 ft. roll
WEIGHT			18 lbs.	40 lbs.

NOW... a Tracemaster System to meet your recording problem!

AO Tracemaster presents three outstanding direct-writing recorder systems to help you acquire more meaningful low-frequency data.

Series "250"— Ideal for test installations requiring a multi-channel record of diverse signal inputs on a common time base.

Series "260"— Economical recording of simpler, medium sensitivity inputs requiring many identical channels.

Series "290"— Single-, 2- or 3-channel portable Tracemasters; ruggedness and performance reliability in a compact package for those on-the-spot recordings in the lab, field or plant.

... And they all feature the advanced Tracemaster Pen Motor and the exclusive direct-carbon-transfer writing method... assuring a clean, uniform, high-contrast, fine-line trace that is two to three times finer than any other direct-writing technique.

The important specifications above give only some of the many reasons why each system has established new standards of performance for direct-writing recorders in its class and price range. The complete story is yours for the asking... just write for the catalog!

**American  Optical
COMPANY**

INSTRUMENT DIVISION, BUFFALO 15, NEW YORK

*See a complete demonstration
at the IRE... AO Booth 3939.*

CIRCLE 101 ON READER SERVICE CARD

Honeywell Visicorder Oscillograph checks resolution of an event marker

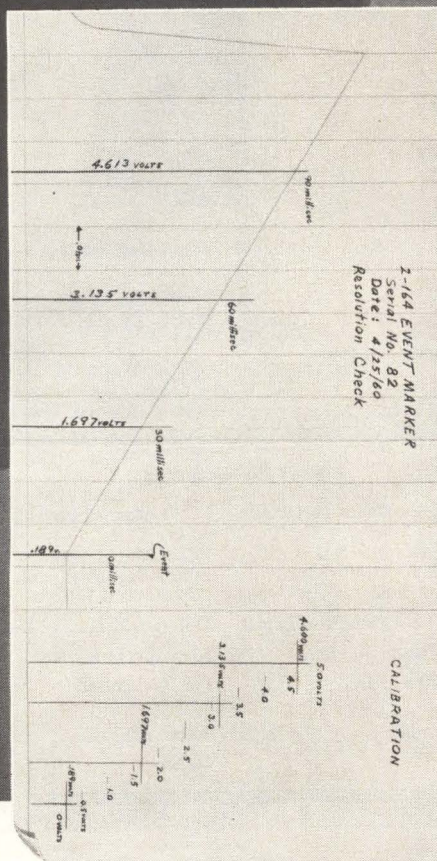

Electro Development Corporation, Seattle, Wash., uses a Model 1108 Honeywell Visicorder Oscillograph to prove the linearity and resolution of signal conditioner-event markers which they supply to the Boeing Company.

A missile telemetering system samples each channel only once every 30 milliseconds, but missile engineers want to know when some events occur to an accuracy of better than one millisecond.

The event marker (the small cube atop the Visicorder) produces a highly-linear ramp output that starts exactly when the marker is triggered by the event in question. This ramp continues for about 100 milliseconds . . . enough time so that the telemeter system can sample the ramp at least three times. A straight line drawn through these

points will accurately determine the occurrence of the event.

To check event marker linearity, the ramp is recorded at the very high record speed of 80"/sec. It's this high speed, the .01-second timing lines, the ease of operation, and the wide deflection capabilities of Honeywell galvanometers (approx. 7" in this application) that caused the Electro Development Corporation to select the Model 1108 Honeywell Visicorder.

Honeywell



First in Control



Dick Daniel, EDC Design Engineer, tests linearity of Model 2-164 event marker (small cube atop the Visicorder). Included in the rack at Daniel's right are a voltage calibrator, cathode follower, switching unit, trigger source and power 28V supply designed and built by EDC, and a Honeywell Model T6GA Galvanometer amplifier.

For more details about the Model 1108 (24 channels), the 1012 (36 channels) and other Honeywell Visicorders, write to Minneapolis-Honeywell, Heiland Division, 4800 E. Dry Creek Road, Denver 10, Colorado. Our DDD phone number is 303-794-4311.

CIRCLE 103 ON READER SERVICE CARD
March 16, 1962

± 0.01 percent ± 1 digit. When making single readings as an analog-to-digital converter, it has 0.01-percent accuracy, constant 10-megohm impedance, ± 0.001 v to ± 999.9 v range, 1 μ sec maximum read trigger lag and infinitely high measurement speed. The sketch shows the influence of slewing rate when digitizing a voltage waveform. At point A, the input is connected to the voltage source and the device slews at 2,000 v/sec. until it reaches B. It then tracks the waveform faithfully since the waveform rate is less than 2,000 v/sec. At point C, a read trigger is issued and within 1 μ sec (disconnect time), the unit disconnects from the waveform and measures the voltage at C in 5 ms. At point D, the unit again slews at 2,000 v/sec, until point E. It again tracks the waveform until point F where another read trigger is issued. The read triggers are initiated by the user.

CIRCLE 304 ON READER SERVICE CARD

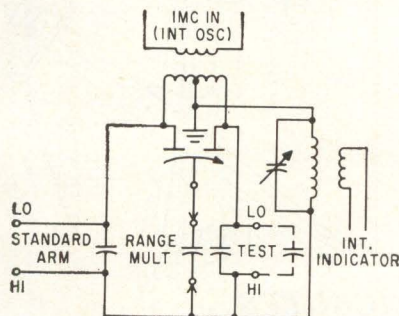

Capacitance Bridge

0.00002 PF RESOLUTION

RECENTLY announced by Boonton Electronics Corp., 738 Speedwell Avenue, Morris Plains, New Jersey is the 75B capacitance bridge having a capacitance range from 0.00002 to 1,000 pF and a conductance range, calibrated in both conductance and parallel resistance, covering 0.01 to 1,000 μ mhos and 1,000 ohms to 100 megohms. The unit also features a built-in d-c bias supply adjustable between 0 and -5 v and 0 to +125 v permitting measurements of component capacitance and conductance in the presence of d-c bias. Applications requiring use of bias include semiconductor junction capacitance and conductance, performance of voltage-variable capacitors and deter-

mination of voltage coefficient of capacitors. The circuit (shown in the sketch) is a modified Schering bridge. Coaxial connectors give access to both arms of the bridge allowing for differential measurements. Lowest range has 0.1 pF at full scale spread over 5,000 dial divisions. Bridge output transformer is tuned to 1 Mc to present lowest possible shunt loading of the output signal.

CIRCLE 305 ON READER SERVICE CARD

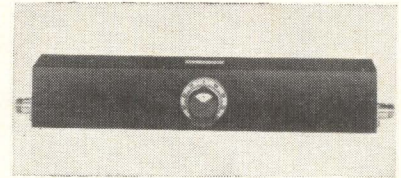

Coax Attenuators

TWO STANDARD VALUES

RLC ELECTRONICS, INC., 25 Martin Place, Port Chester, N. Y., offers variable coaxial attenuators with minimum insertion loss of zero db. Attenuation is essentially constant as a function of frequency with the required value selected by a linear dial movement. They are made in two standard values with direct reading settings in the AV-25 and linear settings in the AV-35. Units operate from 500 Mc to 11.0 Gc. Low vswr of 1.5 max is maintained by precision coaxial fabrication. Power rating, 2 w average; 2 Kw peak.

CIRCLE 306 ON READER SERVICE CARD

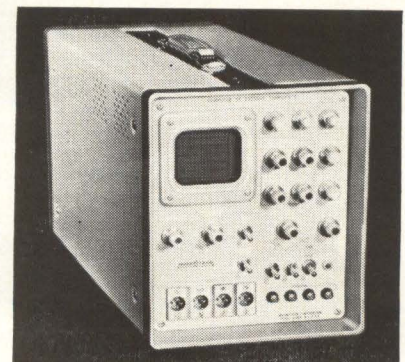

Digital Computer

MULTIPURPOSE

MNEMOTRON CORP., 45 S. Main St., Pearl River, N. Y. CAT400 is a portable, multipurpose digital computer for the study of biological and other variables. In addition to

HUNDREDS OF WIDTHS, DEPTHS AND HEIGHTS

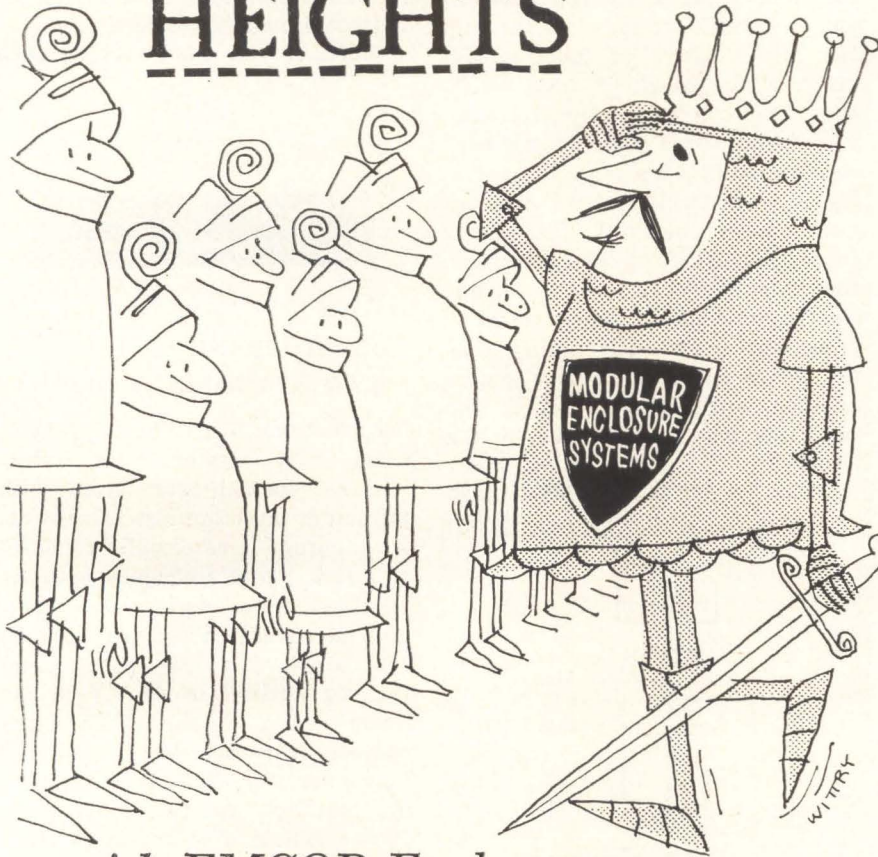

...with EMCOR Enclosures

Tailor-make a console, equipment bank or control center from the hundreds of standard enclosure widths, depths, and heights of the EMCOR Modular Enclosure System. Custom costly enclosure design time and modification is eliminated. Literally thousands of electrical, electronic or electro-mechanical equipment housing assemblies are available with EMCOR Standard Enclosures. With EMCOR, you get greater depth of line... the ultimate in flexibility and advanced design that defies obsolescence. Contact your local Ingersoll Products Sales Engineering Representative or write for full details.

A condensed version of Catalog 106 available at your request.

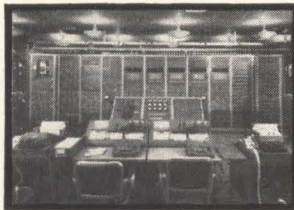
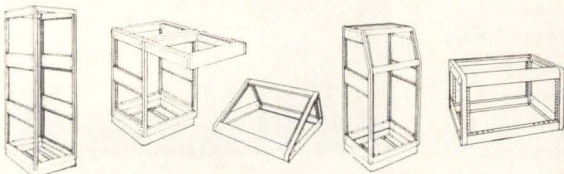

EMCOR - The Original Modular Enclosure System By
INGERSOLL PRODUCTS
Division of Borg-Warner Corporation
1000 W. 120th ST. • DEPT. 1242 • CHICAGO 43, ILL.

Most Ingersoll Products Sales Engineers also represent McLean Blowers for enclosures

averaging four different variables simultaneously, it serves a whole range of computing functions, such as: analog to digital conversion, recording fast wave forms, automatic plotting of digital data, statistical distribution of analog and events, and function generation.

CIRCLE 307 ON READER SERVICE CARD

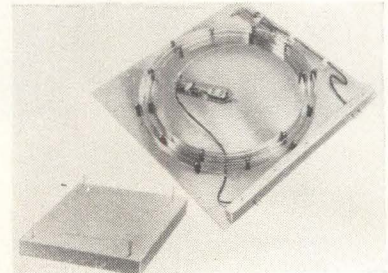

Delay Lines

MAGNETOSTRICTIVE

DELTIME INC., 608 Fayette Ave., Mamaroneck, N. Y. New magnetostrictive delay lines can be used as precise quantitative storage elements in memory systems. Units offer from 20 μ sec to 10 millisecc delay times, and 5 millisecc delay to 1 Mc with return-to-zero. They are housed in steel cases, providing protection against stray magnetic fields and ambient humidity, resulting in long-term stability. Advances in design and materials have reduced delay drift due to temperature changes.

CIRCLE 308 ON READER SERVICE CARD

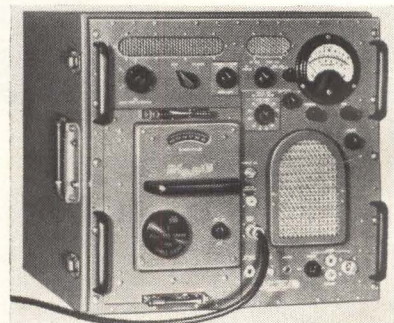

RFI Meter

EXTENDED RANGE

EMPIRE DEVICES, INC., Amsterdam, N. Y. Frequency range of noise and field intensity meter NF-112 has been extended to 15 Gc with the addition of new plug-in tuner model T-5/NF-112. The entire range from 1.0 to 15.0 Gc is now covered in a single instrument by means of

five plug-in tuning units, thus avoiding costly repetition of circuitry and components common to all frequency ranges. Tuning units can be interchanged in seconds.

CIRCLE 309 ON READER SERVICE CARD

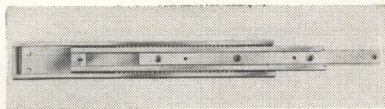

Slides

FOR MINIATURIZATION

GRANT PULLEY & HARDWARE CORP., High St., West Nyack, N. Y., offers a slide designed in keeping with trends toward miniaturizing and compressing equipment. The Micro-Slide features: $\frac{1}{16}$ in. side space, load capacity of 100 lb, continuous ball bearing action, quick-disconnect, full extension of supported unit.

CIRCLE 310 ON READER SERVICE CARD

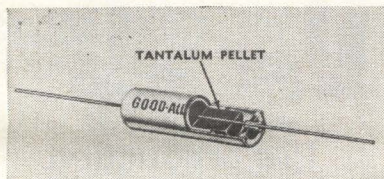

Tantalum Capacitor

SOLID, POLARIZED

GOOD-ALL ELECTRIC MFG. CO., Ogalala, Neb. Type 901 solid, polarized tantalum capacitor features superior leakage characteristic. Range: 0.0047 μ f to 0.330 μ f in 6, 10, 15, 20 and 35 v d-c. Case: 4 subminiature sizes per MIL-C-26655A.

CIRCLE 311 ON READER SERVICE CARD

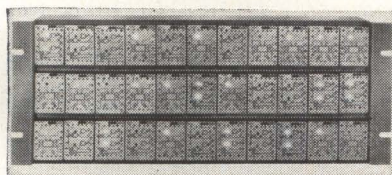

Logic Modules

PLUG-IN UNITS

HARMAN-KARDON, INC., Plainview, N. Y., announces Facilog digital logic modules designed for simple and economical systems interwiring. Each module is separately housed in a plug-in case, approximately 1 $\frac{1}{2}$ in. by 1 $\frac{3}{4}$ in. by 3 in. deep and contains up to 4 separate logical functions, depending upon the complex-

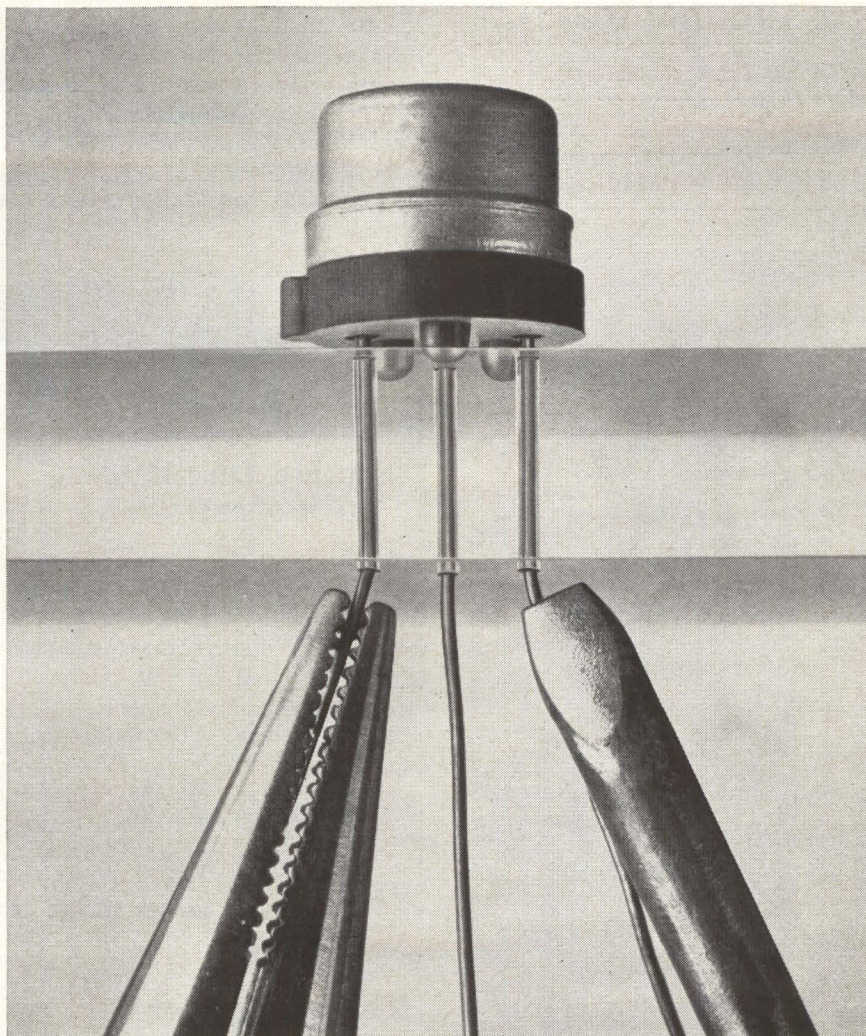

No Strain; no sweat

As any printed-circuit assembler knows, you've got to treat transistors with respect. Transipads do just that.

Transipads protect transistors from inadvertent abuse. They prevent lead strain and breakage. They provide a built-in air space to dissipate the heat of soldering. They allow easy removal of solder flux and permit unobstructed inspection of solder joints and fillets.

They produce a neater finished job, too, by providing uniform above-the-board spacing. And a more reliable assembly, as well. Transipad mountings anchor transistors so securely that even under conditions of shock and vibration, leads won't short together and cases won't short against p-c conductors or adjacent component leads.

What's more, you can realize all of these benefits for a remarkably modest cost—a matter of pennies in fact.

Fifty Transipad styles cover all of the most common TO case types. Included in the line-up are a number of converter styles that increase pin circles and widen lead spacing. All can be furnished in diallyl phthalate, alkyd, or nylon—with color coding, if you wish. Call or drop us a line for drawings and samples.



THE MILTON ROSS COMPANY

238 Jacksonville Road, Hatboro, Pa. • Phone: OSborne 2-0551
18045 Crenshaw Blvd., Torrance, Cal. • Phone: DAvis 3-7161

PROGRAM SWITCH

SEGMENTED CONTACTS

THAT CAN BE ALTERED FOR
SPECIFIC APPLICATIONS !!

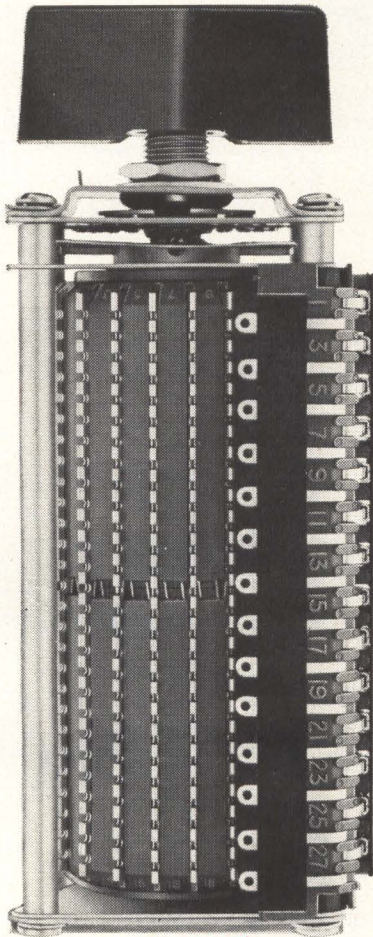

■ Provides compact method for combining up to 28 inputs or outputs with up to 24 different circuit configurations ■ Speeds up circuit grouping or testing in complex circuitry ■ Offers alterable programming without disassembly ■ Single-source test signals can be channeled to as many as 648 circuit combinations ■ For complete specifications on this switch series, mark reader service card or request Shallcross 111-S-DS.

Shallcross ELECTRONICS
MANUFACTURING CO./SELMA, N.C.
INSTRUMENTS • RESISTORS • SWITCHES • ATTENUATORS
DELAY LINES

ity of the circuit. Modules plug into a metal frame accommodating 33 modules. Frame may be mounted on a standard relay rack, 10 per 72 in. rack, accommodating up to 330 modules or a max of 1,320 circuits in a single rack.

CIRCLE 312 ON READER SERVICE CARD

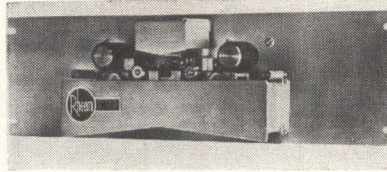

Punched Tape Reader HIGH SPEED

RHEEM MFG. CO., 5200 W. 104th St., Los Angeles, Calif. Model RR-1000 is nominally a 1,000 character per sec unit, and features completely transistorized circuits, photovoltaic sensing cells and rugged two speed motor drives. The unidirectional model is priced at \$1,450; bidirectional model, \$1,590. Standard model includes 2:1 speed ratio selectable with low level input, and 5, 7, and 8 level tape selection.

CIRCLE 313 ON READER SERVICE CARD

Sealed Connectors STAINLESS STEEL

HERMETIC SEAL CORP., Rosemead, Calif. Series SS nonmagnetic hermetically sealed connectors meet all applicable military specifications. They have leak rates in production as low as 1×10^{-8} cc/sec, with even tighter leak rates possible for special requirements.

CIRCLE 314 ON READER SERVICE CARD

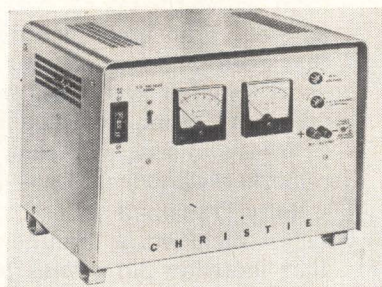

D-C Power Supply AND BATTERY CHARGER

CHRISTIE ELECTRIC CORP., 3410 W. 67th St., Los Angeles 43, Calif., introduces a line of wide-range d-c

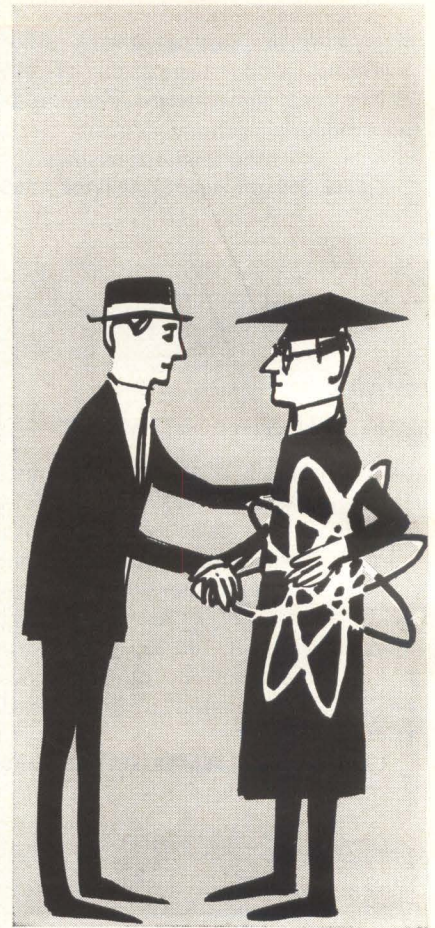

Pre-production Training of a Work Force at No Cost to You

This is a time-tested and proved-in-use plan in WESTern PENNSylvania by which employees will be trained in whatever skills are needed for YOUR particular operation at no cost to you. For details on labor and training . . . and for complete information on 100% financing of plant space at low, low interest rates . . . and WESTern PENNSylvania's favorable tax climate, wire or call collect or mail coupon below today.

WEST PENN POWER
an operating unit of ALLEGHENY POWER SYSTEM



Now available: Shell buildings at \$2.95 to \$3.25 a sq. ft. can be completed to your specs in 60-90 days. Or select from 200 other industrial properties.

WEST PENN POWER Phone: Temple 7-3000
Area Development Department (Area Code 412)
Greensburg, Pennsylvania

EL-2-5-3

Please send me data on: Pre-production Training
 Taxes 100% Industrial Plant Financing
 Industrial Properties

Name _____

Title _____

Company _____

Address _____

City _____ Zone _____

State _____ Phone _____

CIRCLE 209 ON READER SERVICE CARD
electronics

power supplies for laboratory, automatic battery charging or general purpose use. Six models offer a continuous voltage adjustment range of 1 to 145 v d-c and up to 50 amp. Standard a-c supply source required is 115 v, single phase, 60 cycle.

CIRCLE 315 ON READER SERVICE CARD

Packaged Circuits

CORNELL-DUBILIER ELECTRONICS, 50 Paris St., Newark, N. J. Line of low-cost digital computer packaged circuits has operating frequency range of d-c to 1 Mc with 0.2 μ sec rise and fall time.

CIRCLE 316 ON READER SERVICE CARD



Swept Oscillators

FLAT OUTPUT

ALFRED ELECTRONICS, 3176 Porter Drive, Palo Alto, Calif., offers a series of swept microwave oscillators featuring built-in levelers which hold power output constant to approximately ± 0.75 db over the entire frequency range and nominally to ± 0.1 over any 100 Mc interval. The 620 B sweepers offer a frequency range from 1 to 26 Gc.

CIRCLE 317 ON READER SERVICE CARD

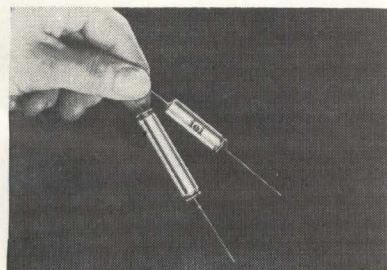

Capacitors

TANTALUM FOIL

INTERNATIONAL ELECTRONIC INDUSTRIES DIV., Standard Pressed Steel Co., Box 9036, Nashville, Tenn. New Super Series etched tantalum

March 18, 1962

IRE SHOW

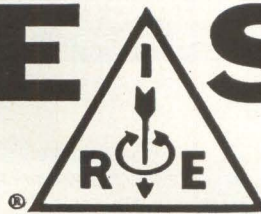

presenting

"THE GOLDEN AGE OF ELECTRONICS"

March 26-29, 1962

The New York Coliseum

... part of the

International Convention of the IRE

The Institute of Radio Engineers

1 East 79th Street • New York 21

Members \$1.00. Non-members \$3.00. Age limit: over 18

CIRCLE 210 ON READER SERVICE CARD

Complete Predetection Recording and Playback Capacity

with Utmost in Versatility

DEI

PREDETECTION

RECORD-PLAYBACK UNITS

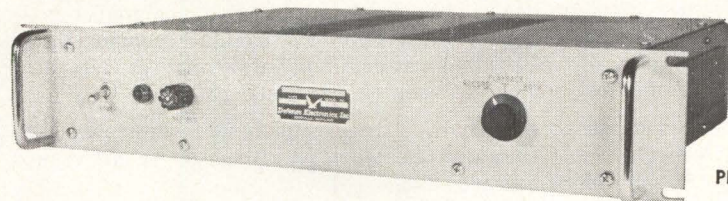

PPU-1

for TMR Series Telemetry Receivers

Size: 3½" X 19" X 14", designed for standard rack mounting

600 kc Video Carrier

600 kc data Bandwidth



For full information on the new DEI Predetection Record-Playback Units, Telemetry Equipments and Systems, write:

Defense Electronics, Inc.

Serving Government and Industry

WASHINGTON-ROCKVILLE INDUSTRIAL PARK
5455 RANDOLPH RD., ROCKVILLE, MARYLAND
TWX KENS 793 WHITEHALL 6-2600

CIRCLE 107 ON READER SERVICE CARD

107

DESIGNED AND PRODUCED BY
KEARFOTT SEMICONDUCTOR CORP.
 WEST NEWTON, MASS.

SHOWN TWICE ACTUAL SIZE

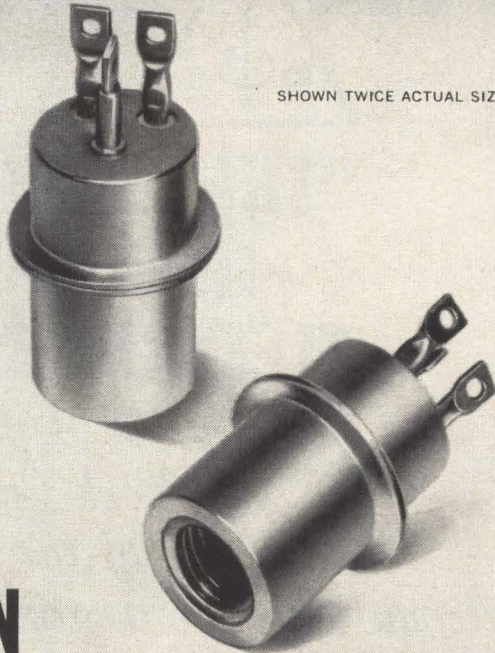

2N156
 2N158
 2N158A
 PNP
 GERMANIUM
 POWER
 TRANSISTORS

NOW IN WELDED TO-13 PACKAGE

**INCREASED RELIABILITY • IMPROVED PERFORMANCE
 REDUCED THERMAL RESISTANCE**

Kearfott now offers 2N156, 2N158 and 2N158A Germanium PNP Power Transistors in the TO-13 welded package in accordance with new EIA requirements. The new type is completely interchangeable with the original heavier and larger MM3 package. In addition, the new package reduces thermal resistance by more than 30%.

Electrically interchangeable with currently available units, Kearfott's design achieves greater reliability and improved performance. Welded closure and improved glass-to-metal header construction provide a positive hermetic seal to eliminate all possible contamination. Widely spaced, properly tinned terminals facilitate connections. Overall plating of case eliminates possibility of thermal or electrical discontinuities through corrosion of bare metal parts.

Performance has been improved through this new Kearfott design, it makes possible specially selected I_{CBO} ratings up to 200 volts and I_{CEO} ratings up to 100 volts.

The 2N156 and 2N158 series can also be provided in a TO-10 welded package with an improved glass-to-metal header and a "Flying-leads" option.

Write today for detailed data on these devices. Complete data is also available on Kearfott's 35-watt 2N538, 2N538A, 2N539, 2N539A, 2N540, 2N540A and 2N1261, 2N1262, 2N1263, 2N1501, 2N1502, 2N1202, 2N1203 Power Transistors.

For Technical Data and Prices Contact KEARFOTT DIVISION, GENERAL PRECISION, INC., Little Falls, New Jersey. Or Your Nearest Kearfott Sales Office.



GENERAL PRECISION

foil capacitors possesses twice the capacity values, case size for case size, of MIL-C-3965/2 units. They are designed to operate over a temperature range of -55°C to 85°C . Voltage range is from 15 through 150 wvdc. Capacitances range from $30\ \mu\text{f}$ to $1160\ \mu\text{f}$.

CIRCLE 318 ON READER SERVICE CARD

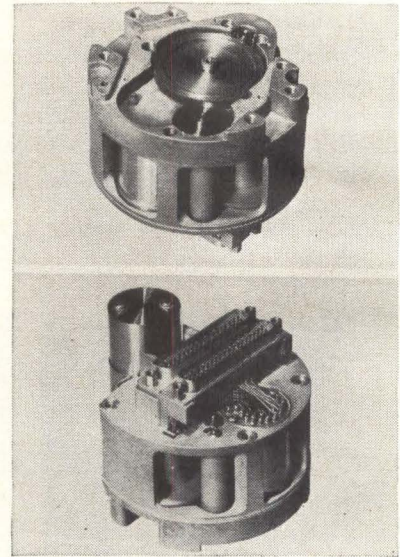

Tape Recorder

RUGGED UNIT

LEACH CORP., 18435 Susana Rd., Compton, Calif. Tape recorder features precision gear drive (photo above) and silicon rubber capstan (below) as mover for 75 ft of 1 mil Mylar tape. Temperature range (limitation is imposed by tape, not recorder) is -112°F (-80°C) and $+180^{\circ}\text{F}$ ($+82^{\circ}\text{C}$).

CIRCLE 319 ON READER SERVICE CARD

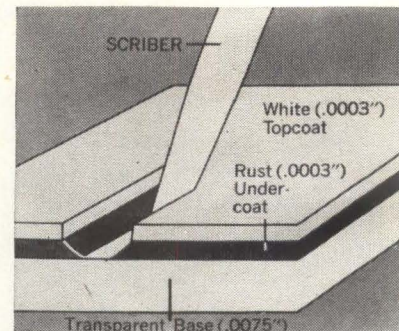

Scribe Coat Film

FOR P-C LAYOUTS

KEUFFEL & ESSER CO., Third and Adams St., Hoboken, N. J. New scribe coat film eliminates the necessity of using light tables in the scribing of printed circuit lay-

outs. It is a double coated film applied to a dimensionally stable base. The first is a rust colored film with high actinic holdback properties; the second is a white top coating for contrast and ease in doing linework.

CIRCLE 320 ON READER SERVICE CARD

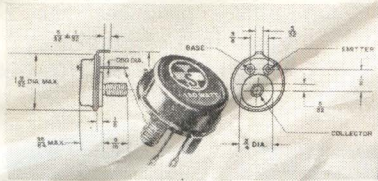

Transistors

HIGH POWER

SILICON TRANSISTOR CORP., Carle Place, N. Y., announces four diffused junction silicon transistors—*npn* high power devices suitable for applications in power converters, power supply regulators, relay replacements and controls, and d-c and servo amplifiers. They are 150 w, single-end stud types, featuring low leakage currents, high temperature stability, and low thermal resistance.

CIRCLE 321 ON READER SERVICE CARD

Frequency Standard

MELPAR, INC., Falls Church, Va. Miniature tuning fork frequency standard gives sine waves and square waves with crystal precision.

CIRCLE 322 ON READER SERVICE CARD



Data Recorder

BATTERY OPERATED

SONY CORP. OF AMERICA, 514 Broadway, New York 12, N. Y. Model PPW-22 spring powered two-chan-

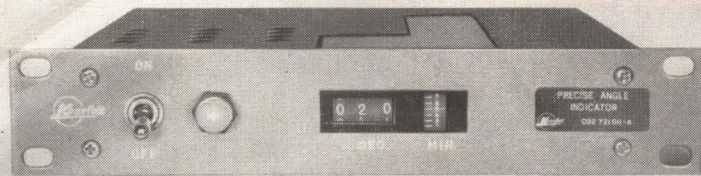

HIGH-ACCURACY PRECISE ANGLE INDICATOR

NEW KEARFOTT UNIT ACCURATE TO ± 6 MINUTES

The new CO 2721011 Precise Angle Indicator features an accuracy of ± 6 minutes. Latest addition to the Kearfott line of standard test equipment, the unit is designed to meet a wide range of applications. Typical Applications

- Indication of gyro angle of pitch, roll, or yaw and relaying of signal to any preselected impedance or voltage level.
- Indication of shaft position of remote synchro or resolver, and transmission of this information to any impedance or voltage level.
- Display of difference between two shafts when driven by transmitter and differential synchros.

In addition to high accuracy the instrument combines a number of other prominent advantages: it requires only a single power source; it has good sensitivity; it is designed for modular application; and it offers direct automatic read-out. The unit is of extremely compact construction and is built for maximal ease of maintenance.

The low-cost CO 2721011 Precise Angle Indicator is available with a single sensor, auxiliary dual-input sensor, or an auxiliary retransmitter. For additional information on this new test instrument, write for the brochure which describes its operation and capabilities in detail.

SPECIFICATIONS

Repeatability	± 1.2 min	Slewing Speed	7 sec/180°
Readability	0.5 min	Power (single source)	115 v, 1 ϕ , 400 cps
Input Power	30 va	Size	1 3/4 x 9 1/2 x 9 1/8 in.
Sensitivity	1.0 min	Weight	4 lbs.

Write for complete data



**KEARFOTT DIVISION
GENERAL PRECISION, INC.**

Little Falls, New Jersey

20 to 200 D.P.

Send your prints
for quotations

- SPURS
- HELICALS
- WORM AND WORM GEARS
- STRAIGHT BEVELS
- LEAD SCREWS
- RATCHETS
- CLUSTER GEARS
- RACKS
- INTERNALS
- ODD SHAPES

Quadrants and spindles with fine-pitch teeth are cut to close limits in our modern shop. Tell us your needs.

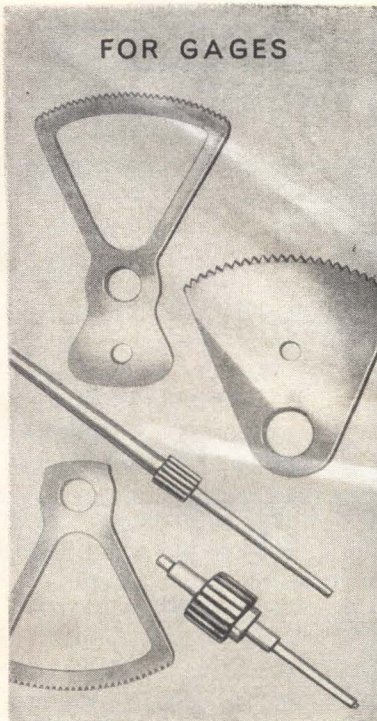

THE *Finest*  IN GEARS

Beaver Gear Works Inc.

1021 PARMELE STREET, ROCKFORD, ILLINOIS



CIRCLE 211 ON READER SERVICE CARD

IRE SHOW



presenting

"THE GOLDEN AGE OF ELECTRONICS"

March 26-29, 1962

The New York Coliseum

... part of the

International Convention of the IRE

The Institute of Radio Engineers

1 East 79th Street • New York 21

Members \$1.00. Non-members \$3.00. Age limit: over 18

110 CIRCLE 110 ON READER SERVICE CARD

nel analog data recorder/reproducer was designed primarily for acquisition of laboratory-quality data even under conditions of airborne, shipboard and vehicular uses. Complete unit (with battery case) weighs 60 lb and occupies less than 1.5 cu ft of space. It registers d-c to 100 cps data signals by means of pulse-width modulated recording, and reproduces the recorded signals into original form.

CIRCLE 323 ON READER SERVICE CARD

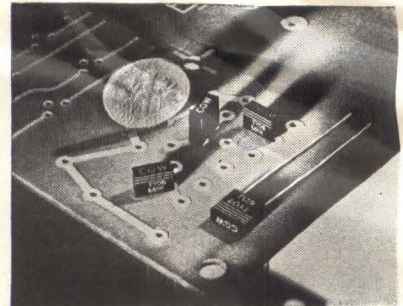

P-C Capacitors

GLASS DIELECTRIC

CORNING ELECTRONIC COMPONENTS, Bradford, Pa., has developed p-c glass dielectric capacitors that eliminate electrical shorts between components. They are equipped with radial leads, are encased in an insulating plastic shell. First units in the line are the TY-06 (1 to 560 pf) and the TY-07 (561 to 1,000 pf). Nominal dimensions of the TY-06 are 0.300 in. long, 0.115 in. wide, and 0.200 in. high. For the TY-07 they are the same except that height is 0.300 in. Operating temperatures are -55 to $+125$ C, with no derating, and dcwv is 300 v.

CIRCLE 324 ON READER SERVICE CARD

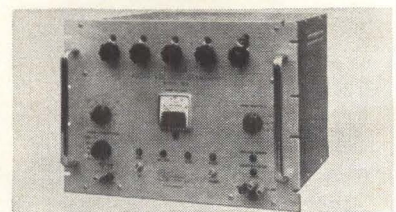

Audio Voltage Standard PRECISION UNIT

HOLT INSTRUMENT LABORATORIES, Oconto, Wisc. Model 323 provides fully variable voltage from 10 mv to 1,000 v at 5 internal frequencies up to 10 Kc. Using an external oscillator 20 Kc may be obtained at

electronics

any voltage setting. Unit will calibrate instruments at any load from 0 to 30 w through its full frequency and voltage range. Short term stability 0.01 percent; long term stability 0.03 percent per month.

CIRCLE 325 ON READER SERVICE CARD

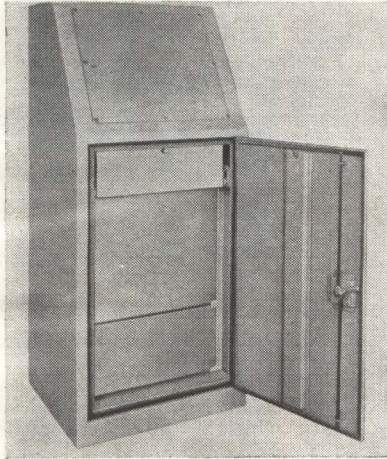

Shielded Console

MEETS MANY MIL SPECS

FALSTROM CO., 185 Falstrom Court, Passaic, N. J. Model C-100 is of heavy duty construction and is adaptable to a wide variety of uses. Panel mounting areas are provided inside both front and rear doors. A slide mounted utility driver is offered in either the front or rear. A slope front instrumentation panel, 17½ by 20 in., is provided in the front of the unit. Standard dimensions are: 58 in. high, 25 in. wide, and 23 in. deep.

CIRCLE 326 ON READER SERVICE CARD

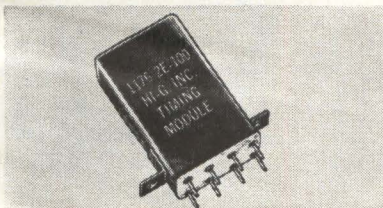

Timing Module

SOLID STATE

HI-G, INC., Bradley Field, Windsor Locks, Conn., offers a solid state timing module, single-pole construction, for d-c operation, with delays on "make" only of 1 millisecc to 30 sec or 1 millisecc to 20 sec, as required, with a tolerance of ±10 percent over the temperature range. Input voltage 18-31 v d-c; output

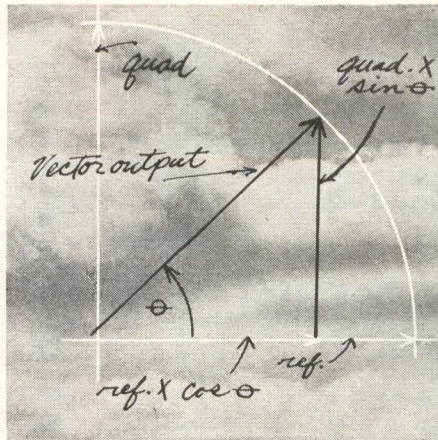

MODEL VPS-1

GERTSCH VARIABLE PHASE STANDARD

--permits shifting of phase between
2 self-generated voltages to any desired
angle, with accuracy better than $\pm .05^\circ$

Precise generation of voltage vectors. The Gertsch VPS-1 generates 2 signals differing in phase by any angle from 0° to 360° , as determined by front-panel controls. The reference signal has a fixed amplitude of 50V rms. The vector output, which may be displaced in phase, has a maximum amplitude of 50V rms, and can be attenuated in steps of 50 mv within a range of 0-50V rms.

Operation at any 3 frequencies within a range of 150-3000 cps is provided by a front panel selector switch. Fine adjust control permits varying the frequencies $\pm 5\%$ max.

Completely self-contained-unit requires no accessories for operation. Case or rack mounted. Send for literature VPS-1.

Gertsch

GERTSCH PRODUCTS, Inc.,

3211 South La Cienega Boulevard, Los Angeles 16, California / UPTon 0-2761 - VERmont 9-2201

Bristol choppers help U.S. Astronaut maneuver

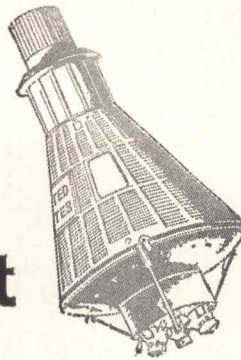

Friendship 7 spacecraft

Four Bristol Syncroverter* choppers formed a vital part of the infrared horizon sensors manufactured by Barnes Engineering Company, Stamford, Conn., and carried aloft in NASA's FRIENDSHIP 7 spacecraft by the first U. S. astronaut to orbit the earth.

The Bristol choppers function as sensitive phase detectors in the sensors as they establish a horizontal reference plane for the vehicle.

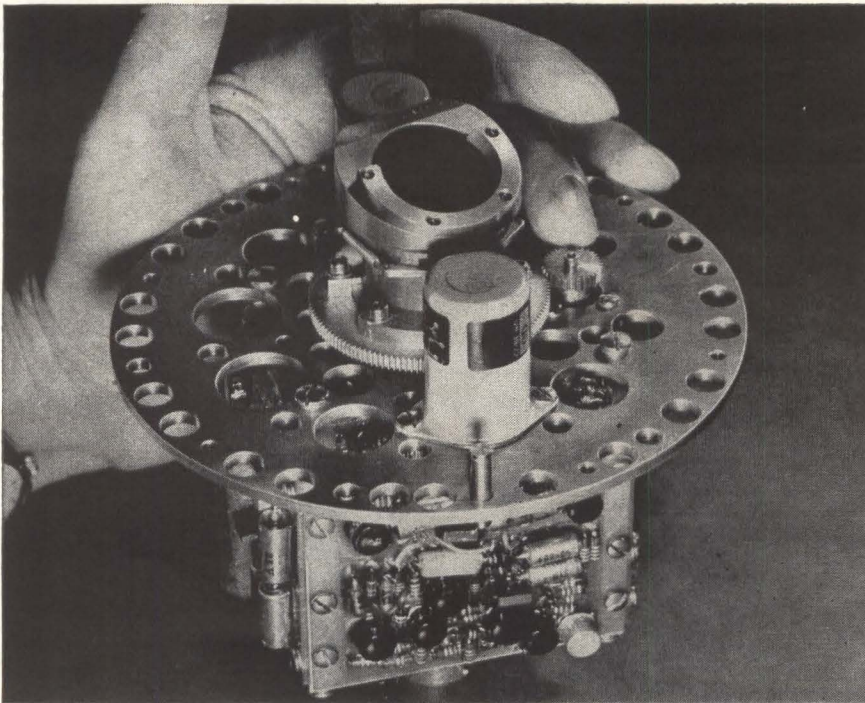

Infrared Horizon Sensor undergoes rigorous optical, mechanical, and electrical checks at Barnes Engineering Co. One Bristol chopper is located in foreground, in front of gear.

Bristol Syncroverter* choppers, noted for low noise, long life and high reliability, are finding a vital place in more and more missile guidance systems, as well as in analog computers, d-c amplifiers, and test equipment for industrial applications. More than 200 models available. Write for complete details.

**The Bristol Company, Aircraft Equipment Division,
150 Bristol Road, Waterbury 20, Conn.**

A Subsidiary of American Chain & Cable Company, Inc.

*T.M. Reg. U.S. Pat. Off. 2.22

BRISTOL...engineers for precision, builds for reliability



250 ma resistive or inductive on normally open. Temperature -65°C to $+125^{\circ}\text{C}$; vibration 20 g to 2,000 cps; shock 50 g for 11 ± 1 millise; life 1 million operations minimum.

CIRCLE 327 ON READER SERVICE CARD

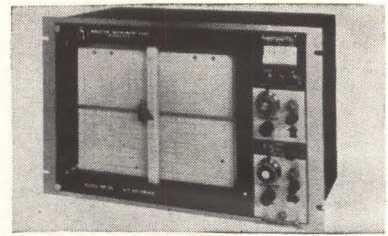

X-Y Recorder

BUILT-IN TIME BASE

HOUSTON INSTRUMENT CORP., P.O. Box 22234, Houston 27, Texas. Model HR-95T features high performance servos, interchangeable plug-in control modules, built-in time base on X axis and standard Zener reference supplies. Recorder utilizes conventional vacuum system for holding standard $8\frac{1}{2}$ in. by 11 in. graph paper to platen. New snap-in pen design utilizes standard recorder ink cartridges to eliminate ink filling problems. D-C accuracy is greater than 0.25 per cent full scale.

CIRCLE 328 ON READER SERVICE CARD

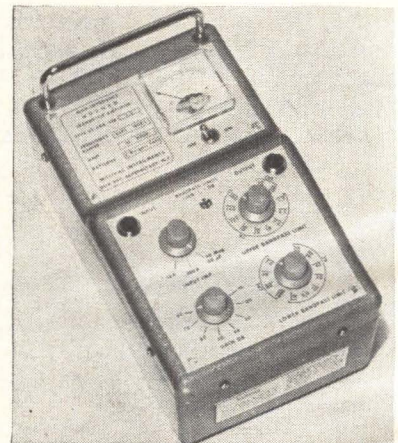

Low Noise Amplifier

TRANSISTORIZED

MILLIVAC INSTRUMENTS, INC., 1100 Altamont Ave., Schenectady, N. Y. New input configuration provides 50 meg, 50 pf input impedance in this battery-operated amplifier. Noise, with 50 meg input open or shorted, less than $3 \mu\text{v}$ with a band-pass of 10 Kc. Unit has other input impedances of 10,000 to 100,000

Acoustical Components of Superior Quality

JAPAN PIEZO supplies 80% of Japan's crystal product requirements.

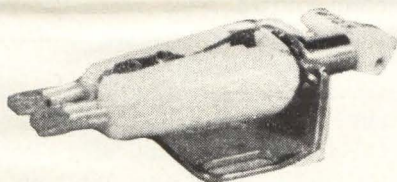
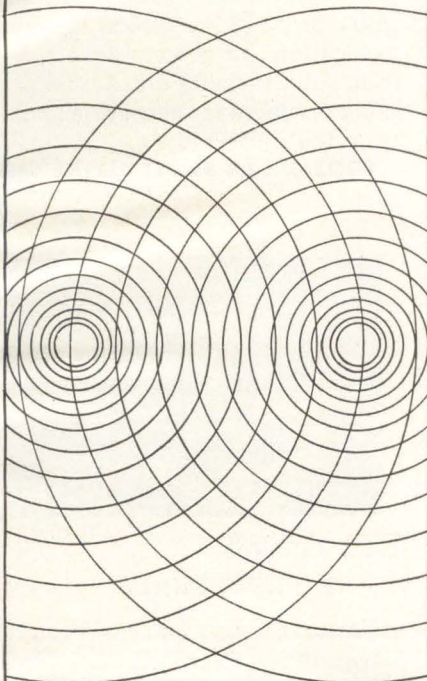

STEREO CARTRIDGE

Crystal — "PIEZO" Y-130
X'TAL STEREO CARTRIDGE

At 20°C, response: 50 to 10,000 c/s with a separation of 16.5 db. 0.6 V output at 50 mm/sec. Tracking force: 6 ± 1 gm. Compliance: 1.5×10^{-6} cm/dyne. Termination: $1M\Omega + 150$ pF.

Write for detailed catalog on our complete line of acoustical products including pickups, microphones, record players, phonograph motors and many associated products.



JAPAN PIEZO ELECTRIC CO., LTD.

Kami-renjaku, Mitaka, Tokyo, Japan

CIRCLE 212 ON READER SERVICE CARD

for use with lower source resistances. Upper and lower bandpass filters effectively reduce noise on unused band portions.

CIRCLE 329 ON READER SERVICE CARD

High-Energy Systems

YARDNEY ELECTRIC CORP., 40-50 Leonard St., New York 13, N. Y., announces high-energy electrochemical systems with a wide range of design possibilities—capacity ranging from 0.1 amp hr to 30,000 amp hr.

CIRCLE 330 ON READER SERVICE CARD

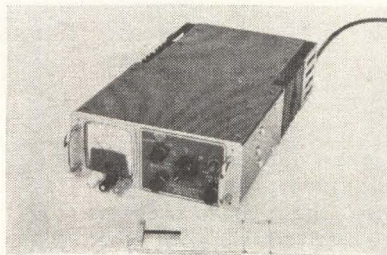

Power Supply PROGRAMMABLE

ELECTRONIC RESEARCH ASSOCIATES, INC., 67 Factory Place, Cedar Grove, N. J. Model TR60-2 occupies a panel height of $3\frac{1}{2}$ in. with a $\frac{1}{2}$ rack $8\frac{3}{4}$ in. panel length, yet provides highly regulated continuously adjustable output over the range 0-60 v d-c at 0-2 amp. Input is 105-125 v a-c, 60-1,000 cps; line or load regulation less than 0.005 percent, ripple less than $250 \mu\text{V}$; temperature coefficient less than 0.01 percent per deg C; transient response better than $50 \mu\text{sec}$.

CIRCLE 331 ON READER SERVICE CARD

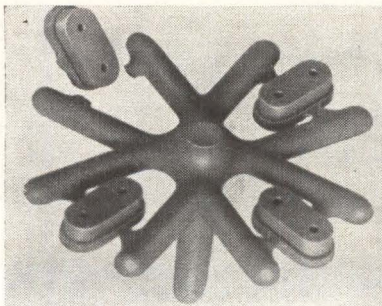

Alumina Ceramics INJECTION MOLDED

DIAMONITE PRODUCTS MFG. CO., Shreve, Ohio. Injection mold proc-

for improved MAGNETOSTRICTIVE FILTERS AND ARRAYS

it's **SPECTRAN**
ELECTRONICS

Nearly indestructible narrow-band-pass filters, centered from 20 kc/s to 425 kc/s, are available in bandwidths from 1 cps to 170 cps. Operable from well below -100°C to $+85^\circ\text{C}$, these filters have very low temperature coefficients, as low as $1 \text{ ppm}/^\circ\text{C}$ in certain ranges. In filter arrays, the differential temperature coefficient is substantially zero. Skirt slopes are 6 or 12 db per band-width octave.

Write for technical data sheets.

SPECTRAN
ELECTRONICS

146 Main Street
Maynard, Massachusetts

CIRCLE 213 ON READER SERVICE CARD

FREE TRANSFORMER SLIDE RULE SELECTOR



New convenient way
to determine trans-
former parameters.

SEE INSIDE FRONT COVER

RAYTHEON

RAYTHEON COMPANY

RAYTHEON COMPANY
Magnetics Operation
Waltham 54, Massachusetts
Gentlemen:

() Please send me my "AUTOSPEC"
transformer slide rule selector, des-
criptive brochure and technical man-
ual by return mail.

I am interested in this material:
() In connection with an immediate
project.
() For future reference.

NAME _____
TITLE _____
COMPANY _____
ADDRESS _____
CITY _____ STATE _____



**PROTECTION
IS NOT
COSTLY**

Airpax electro-magnetic circuit breakers add less than 0.5% to an equipment's base price while adding years of maintenance free, fail-safe performance. These circuit breakers have a versatility of application not available with other circuit protectors. They incorporate the protective features of fuses, thermal units and overload relays without their inherent disadvantages.



Series 500, Military Type
hermetically sealed, withstands 75 G shock

Series C-500, Industrial Type
positive protection at lowest cost

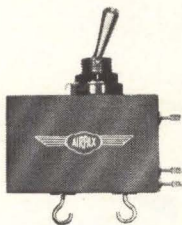

Series 500-R, Remote Indicating Type
auxiliary contacts for remote indication

Ratings from 50 MA to 15 amps

DC, 60 and 400 CPS types

No temperature derating

Instantaneous or delay types

Gang assemblies available

Series, shunt and relay circuit use

-55 C to +100 C temperature range

Trip free

CC33



CAMBRIDGE DIVISION • CAMBRIDGE, MARYLAND

ess enables the molding of parts from the same basic material usually used for powder pressing. This assures a high standard of quality, yet permits the manufacture of unusual designs that do not lend themselves to the normal powder pressing techniques. Illustrated on p 113 is a typical injection molded part in process as it comes from a multi-cavity die. Actual part being produced is shown disengaged from the sprue.

CIRCLE 332 ON READER SERVICE CARD

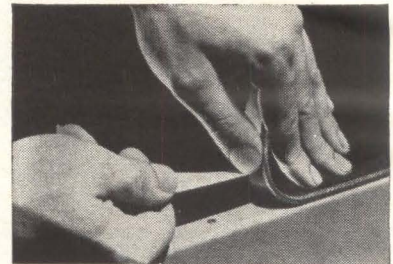

RFI Gasket AND FLUID SEAL

TECHNICAL WIRE PRODUCTS, INC., 129 Dermody St., Cranford, N. J. Teckstik is a strip of Monel or aluminum knitted wire mesh integral with a fluid seal of neoprene or silicone, which is backed by pressure-sensitive adhesive material. Resilient and conductive, Teckstik is effective for re-establishing electrical continuity at the joints in all types of rfi shields, while sealing them off from fluids.

CIRCLE 333 ON READER SERVICE CARD



Insulation Tester GOVERNORLESS

YOKOGAWA ELECTRIC WORKS, INC., 40 Worth St., New York 13, N. Y. Model L-5B is a 2 Kv/5000 megohm tester with no power source or carrying-cart required. In place of the mechanical control of rotation by the governor, the Zener character-

istics of silicon diodes is utilized. This makes reverse rotation possible, eliminates mechanical breakdown of governor and provides constant voltage. Ruggedized pivot-jeweled movement is sandwiched between silicon rubber beds. Entire moving part floats on neoprene shock absorbers. Price is \$245.

CIRCLE 334 ON READER SERVICE CARD

Gear Clamps

TECH-OHM ELECTRONICS, INC., 36-11 33rd St., Long Island City 6, N. Y., introduces a line of standard stock miniature precision single and two piece balanced gear clamps.

CIRCLE 335 ON READER SERVICE CARD

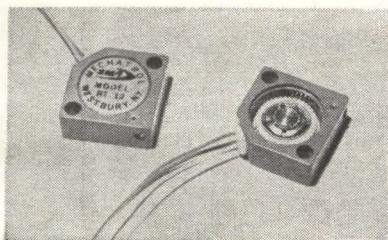

Potentiometers

PRECISION TRIMMERS

MECHATROL, a division of Servo mechanisms/Inc., 1200 Prospect Ave., Westbury, L. I., N. Y. For use in electrical circuits as a lead screw actuated two or three terminal variable resistance network, the new deposited metal film precision trimmer potentiometers feature a low temperature coefficient of resistance with infinite resolution available at competitive prices.

CIRCLE 336 ON READER SERVICE CARD

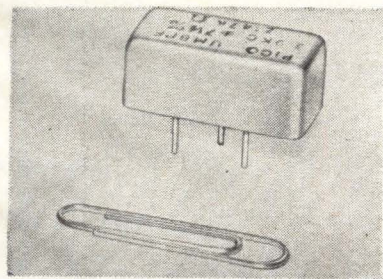

Telemetry Filter

ULTRAMINIATURE

POLYPHASE INSTRUMENT CO., East Fourth St., Bridgeport, Pa. All standard IRIG telemetry channels are covered by a new 1 1/8 in. by

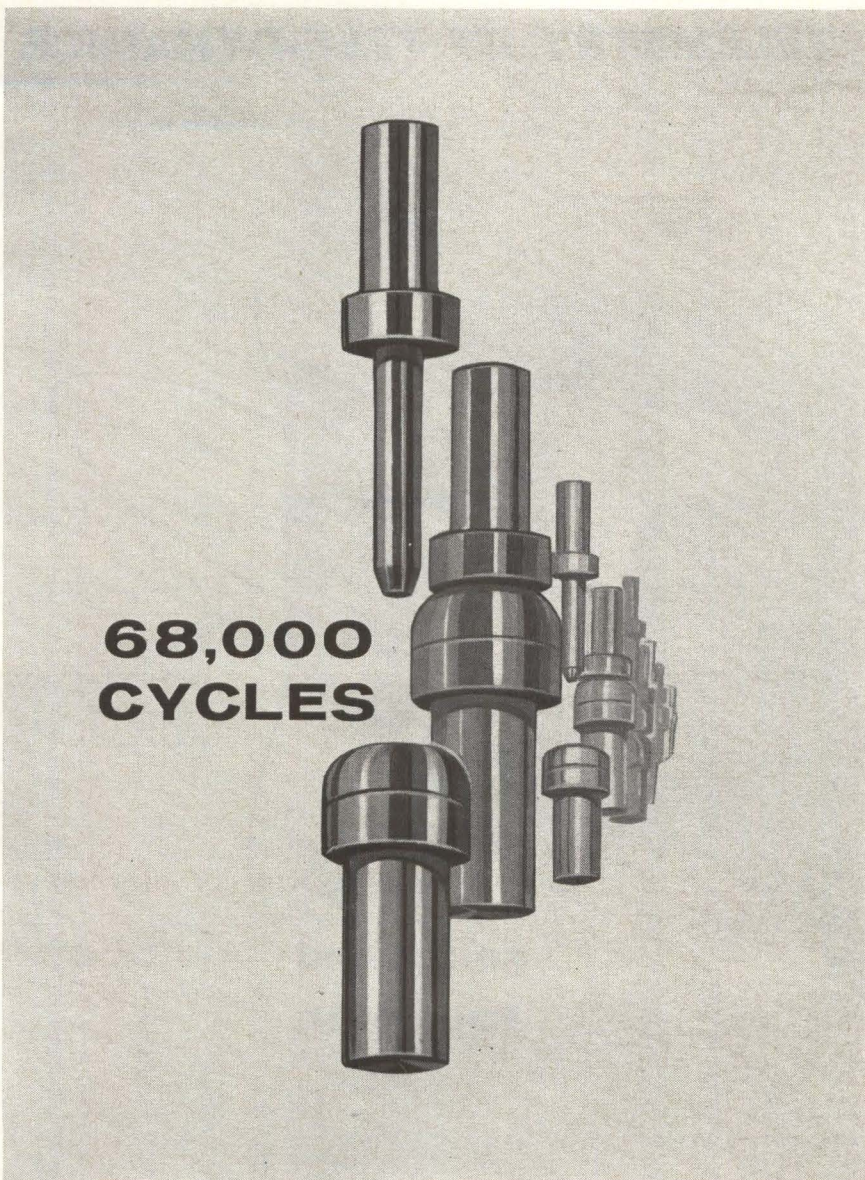

**68,000
CYCLES**

without change in contact resistance

That's the performance record of this new, solid-front .025" jack. And the unique construction of the caged beryllium copper spring in a housing with a blind hole permits dip soldering or encapsulation. What's more, after 68,000 cycles, there was no significant increase in contact resistance . . . and no physical deterioration.

In addition to this new jack, there are 35 other basic types of CAMBION Miniature Plugs and Jacks — and a wide choice of finishes and insulation, too — to meet your individual requirements for both conventional and printed circuits. They're carefully processed from the highest quality materials to meet all applicable MIL specifications. And like all CAMBION electronic components — the broad line includes more than 10,000 different items — they are unconditionally guaranteed in *any* quantity.

Wherever good contact is essential, insist on CAMBION plugs and jacks. For information on deliveries and prices, and a copy of PLUG AND JACK CATALOG No. 70, write to Cambridge Thermionic Corporation, 437 Concord Avenue, Cambridge 38, Massachusetts.

CAMBRIDGE THERMIONIC CORPORATION
GAMBION
The guaranteed electronic components



TELEMETRY BY TELE-DYNAMICS

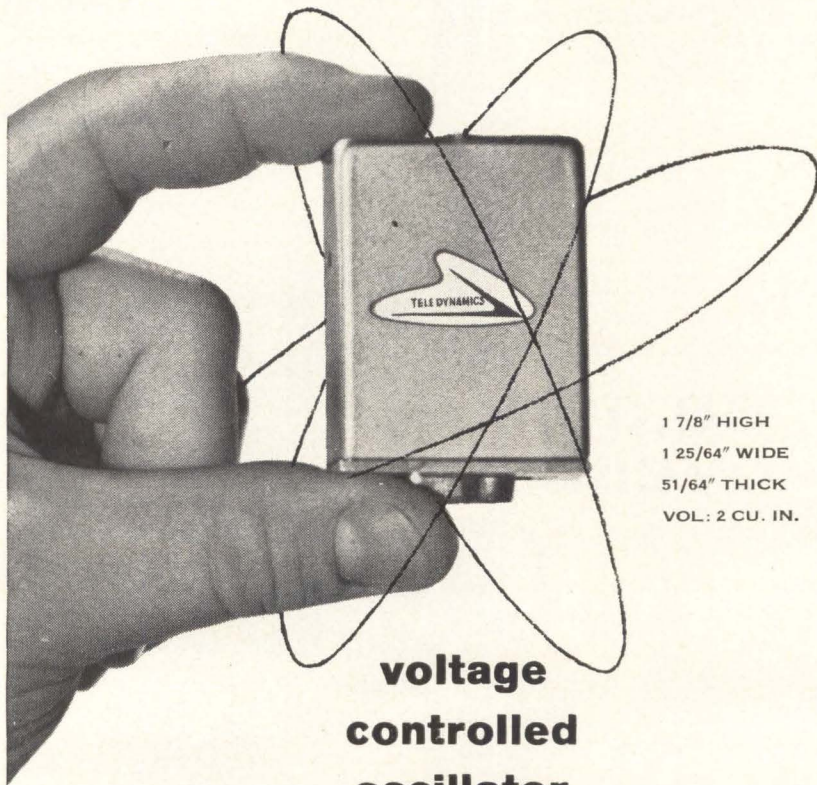

1 7/8" HIGH
1 25/64" WIDE
51/64" THICK
VOL: 2 CU. IN.

voltage controlled oscillator

Positive performance as proved by high customer acceptance characterizes Tele-Dynamics' 1270A voltage controlled oscillator. Exceptional electrical and environmental specifications, unique in off-the-shelf components at the right price, are representative of Tele-Dynamics' creative efforts in the complete telemetry field. Write for technical bulletins and a new capabilities brochure.

TECHNICAL CHARACTERISTICS

Input—0 to 5 volts or ± 2.5 volts
Linearity— $\pm 0.25\%$ BSL
Power Requirements—28 volts
at 9 ma max.
Distortion—1%
Amplitude Modulation—10%

ENVIRONMENTAL CHARACTERISTICS

Thermal Stability— -20°C to
 $+85^{\circ}\text{C}$ $\pm 1.5\%$ DBW
Altitude—Unlimited
Vibration—30G random
Acceleration—100G
Shock—100G

TELE-DYNAMICS

DIVISION

AMERICAN BOSCH ARMA CORPORATION

5000 Parkside Avenue, Philadelphia 31, Pa.

8670-Rev.

$\frac{1}{2}$ in. by $\frac{7}{16}$ in. electrical wave filter. It occupies 0.25 cu in., weighs 9.5 grams, and has p-c mounting. Model 75 B-F is a band pass filter for channels 3.9 Gc and up, and a low pass filter for channels 400 cps through 3 Kc. Impedance 47,000 ohms.

CIRCLE 337 ON READER SERVICE CARD

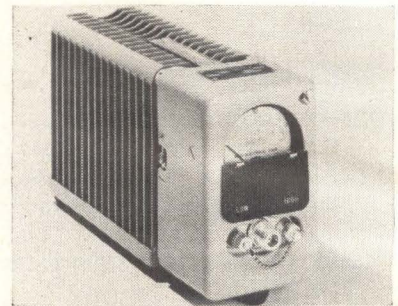

R-F Wattmeter PORTABLE UNIT

BIRD ELECTRONIC CORP., 30303 Aurora Rd., Cleveland 39, O. Model 6150 Termaline r-f wattmeter is a termination type absorption instrument having selectable dual power ranges of 0-30/0-150 w. Power values are read directly over the frequency range of 30-500 Mc. VSWR is 1.1 max. Input connector is female type N. Price, \$225.

CIRCLE 338 ON READER SERVICE CARD

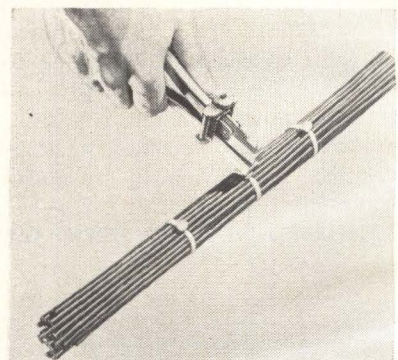

Cable Ties

SAVE TIME, LABOR

PANDUIT CORP., 17301 Ridgeland Ave., Tinley Park, Ill., introduces a new concept in permanent cable ties—the Sta-Strap. The line combines self-locking Nylon cable ties and clamps with a tensioning tool that automatically cuts off excess strap at a pre-set tension. The result is a big reduction in cabling time and labor with controlled, uniform tie tension.

CIRCLE 339 ON READER SERVICE CARD

Use the POLAROID® 10,000 SPEED Land Film

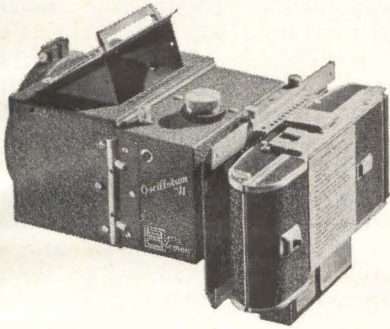

in the new BEATTIE-COLEMAN MARK II OSCILLOTRON

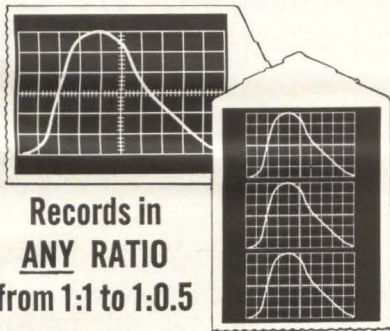

Here's the most versatile oscilloscope camera ever made. Especially designed for new 10,000 speed Polaroid Land Type 410 film that records pulses of extremely short duration. Prints in 10 secs. Easily change ratios from 1:1 to 1:0.5 without extra lenses. External focusing. Flat field lens. Electric shutter eliminates cable release. Direct viewing port or hood. Records up to 13 traces on one frame. Dark slide on Polaroid Land Camera back. Records written data on film. Fits any 5" scope. Attractively priced. Send for catalogs on all B-C Oscillotron models now.

"Polaroid"® by Polaroid Corporation



1004 N. OLIVE ST., ANAHEIM, CALIFORNIA
CIRCLE 213 ON READER SERVICE CARD
March 16, 1962

PRODUCT BRIEFS

ALUMINUM SOLDER corrosion resistant material. Scientific Products, Inc., 521 Marylyn Ave., State College, Pa. (340)

PHOTOCONDUCTOR CELLS cadmium sulphide. Sylvania Electric Products Inc., 730 Third Ave., New York 17, N. Y. (341)

CLUTCH DEVICES $\frac{3}{8}$ in. diameter. Fae Instrument Corp., 16 Norden Lane, Huntington, L. I., N. Y. (342)

X-BAND MAGNETRON low voltage. Avnet Instrument Corp., 70 State St., Westbury, N. Y. (343)

VOLTAGE REFERENCE 0.025 percent accurate. Electronic Development Corp., 423 W. Broadway, Boston 27, Mass. (344)

FREQUENCY STANDARD 4.999600 Kc. Reeves-Hoffman Division, Cherry and North St., Carlisle, Pa. (345)

DATA TRANSMISSION SYSTEM no multiplexing. Security Devices Laboratory, Rochester 21, N. Y. (346)

SENSITIVE MICROPHONE 0.025-1 cps. The Geotechnical Corp., 3401 Shiloh Road, Garland, Texas. (347)

TRANSISTORS hermetically sealed. Hermetic Seal Corp., Rosemead, Calif. (348)

MICROWAVE SWITCH vswr max 1.08:1. Waveguide, Inc., 851 W. 18th, Costa Mesa, Calif. (349)

RFI FILTER for airborne cameras. Astron Corp., 255 Grant Ave., East Newark, N. J. (350)

P-C PLUGS meet MIL C-21097. Cannon Electric Co., 3208 Humboldt St., Los Angeles 31, Calif. (351)

FOLLOWER INVERTER d-c to sine wave. Arnold Magnetics Corp., 6050 W. Jefferson Blvd., Los Angeles 16, Calif. (352)

INSTRUMENTATION POWER SUPPLY $1\frac{1}{2}$ in. cu. Vector Mfg. Co., Inc., Southampton, Pa. (353)

MINIATURIZED FILM RESISTOR metal oxide. Corning Electronic Components, Bradford, Pa. (354)

DELAY LINES ultrafast rise time. Ad-Yu Electronics Lab., Inc., 249 Terhune Ave., Passaic, N. J. (355)



1.

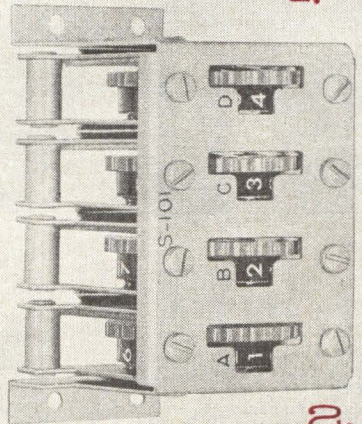

2.

APPX. 60% OF ACTUAL SIZE



3.

PRINTED CIRCUIT THUMBWHEEL SWITCH SOLVES UNIQUE OR COMPLEX SWITCHING PROBLEMS

Readily adaptable to wide range of custom applications in which printed board construction is required for unique or complex switching.

1. Compact modules for individual mounting.
2. Multiple decks may be integrally housed.
3. Typical binary printed wafer.

For complete specifications on this switch series, mark reader service card or request Shallcross 112-S-DS.

Shallcross ELECTRONICS
MANUFACTURING CO./SELMA, N.C.
INSTRUMENTS • RESISTORS • SWITCHES • ATTENUATORS
DELAY LINES

HOLE

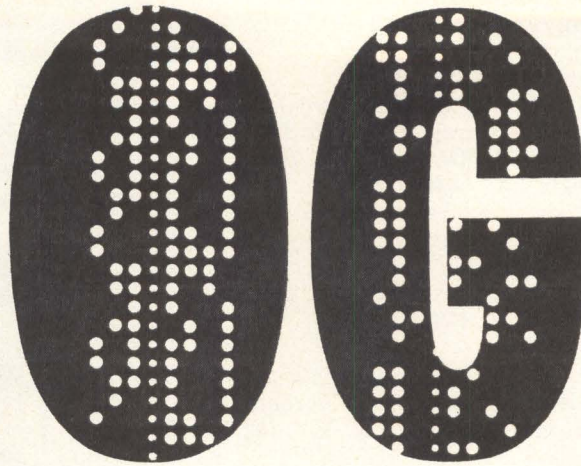
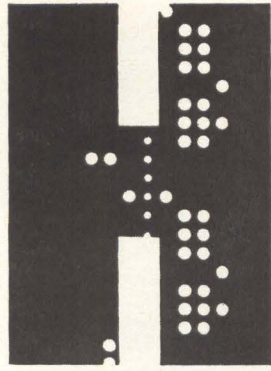

EECO PUNCHED-TAPE READERS DIGEST "BLOCKS" OF DATA FOR AUTOMATIC PROGRAMMING

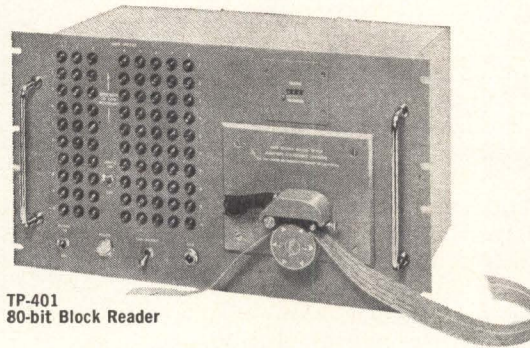

TP-401
80-bit Block Reader

Machine tool control and automatic checkout and tests are just two of many applications of EECO block readers, which offer complete test per block, identification of data function by position in block, elimination of data storage records and address decoding circuits. Straightforward programming by blocks. Standard units read 80, 96, 120, 160 bit blocks, in standard 19" rack mounting units or modular units. Takes 1", 8-level paper or mylar tape punched on 0.1" centers. Reader head designed for either forward or reverse reading. Most models are bi-directional. Write for data sheets.

MODEL	401	402	414	417	422	450*	452*	455*	460*	480	482
BITS PER FRAME	80	96	120	160	80	96	120	160	80		
LINES PER FRAME	10	12	15	20	10	12	15	20	10		
STEPS PER SECOND	6	5	4	3	6	5	4	3	6		
VERIFIER	✓	NO								✓	NO
CONTINUOUS AND REWIND SPEED (ips)	12	11	10	9¼	12	11	10	9¼	12		
FRAME LENGTH (inches)	1.0	1.2	1.5	2.0	1.0	1.2	1.5	2.0	1.0		
INPUT POWER	115 Vac 60 cps 150 watts.										
FORWARD AND REVERSE	FORWARD ONLY	✓									

*Modular unit



AUTOMATION DIVISION

Electronic Engineering Company of California

1601 E. Chestnut Avenue • Santa Ana, California • Kimberly 7-5501 • P.O. Box 58

Representative in Western Europe and Israel: Electronic Engineering S.A., C.P. 142, Fribourg, Switzerland

Literature of

FILTERS Kenyon Transformer Co., 1057 Summit Ave., Jersey City, N.J. Catalog F-621 fully describes the company's standard lines of telemetering, tone channel, and interstage filters. (356)

WIREWOUND RESISTORS Kelvin Electric Co., 5907 Noble Ave., Van Nuys, Calif. Catalog P-1 describes encapsulated precision resistors for p-c high density packaging. (357)

DIGITAL TRANSDUCERS Diginamics Corp., 2525 E. Franklin Ave., Minneapolis 6, Minn. An 8-page pamphlet of application notes is entitled "What? Why? How? Digital Transducers." (358)

TIMERS Logitek, Inc., 54 Rome St., Farmingdale, L. I., N. Y., offers a 4-page brochure on static time delays and time delay relay modules. (359)

D-C VOLTAGE REGULATORS Taber Instrument Corp., 107 Goundry St., North Tonawanda, N. Y., has available bulletin on miniature d-c voltage regulators. (360)

METALLIZED CERAMIC BASES Advanced Vacuum Products, Inc., 440 Fairfield Ave., Stamford, Conn., has issued a bulletin on high-temperature ceramic-to-metal bases for semiconductors. (361)

INSTRUMENTS & COMPONENTS Alford Mfg. Co., 299 Atlantic Ave., Boston 10, Mass. Catalog describes company's r-f instruments and coaxial components. (362)

PHYSIOLOGICAL STIMULATOR Theratron Corp., 1821 University Ave., St. Paul 4, Minn. Brochure illustrates and describes the Theratron physiological stimulator for nerve identification in surgery. (363)

CRYSTAL CAN RELAYS C. P. Clare & Co., 3101 Pratt Blvd., Chicago 45, Ill. Type F subminiature crystal can relay is described in a 12-page booklet. (364)

ENERGY DATA BOOK Yardney Electric Corp., 40-50 Leonard St., New York 13, N. Y., has available a special energy data book for design engineers. (365)

POWER TETRODES Calvert Electronics, Inc., 220 E. 23rd St., New York 10, N. Y., has available a

the Week

catalog containing data on two high frequency power tetrodes. (366)

WIREWOUND RESISTORS General Instrument Semiconductor Division, 96 Mill St., Woonsocket, R. I. Bulletin GR-40 describes and illustrates bobbinless precision wirewound resistors. (367)

INDICATOR TRIODE Tung-Sol Electric Inc., One Summer Ave., Newark 4, N.J., offers an information guide on the type 6977 indicator triode. (368)

ULTRASONIC MACHINING Raytheon Co., 225 Crescent St., Waltham 54, Mass., has published a brochure on ultrasonic machining. (369)

CORE MEMORY UNIT Ampex Computer Products Co., 9937 Jefferson Blvd., Culver City, Calif. Eight-page brochure describes the RQL core memory unit. (370)

RESISTORS Film Resistors Inc., 242 Ridgedale Ave., Morristown, N. J. Bulletin 12A covers a line of coaxial termination type carbon and metal film resistors. (371)

FERRITE BEAD CHOKES National Radio Co., Melrose 76, Mass. Data sheet CO-4 covers newly developed ferrite bead chokes. (372)

CLUTCHES AND BRAKES Vibrac Corp., 281 Billerica Rd., Chelmsford, Mass., offers a catalog on a line of magnetic dry particle clutches and brakes. (373)

TRANSMISSION LINE SYSTEMS Prodelin, Inc., Hightstown, N. J. Bulletin describes methods for pressurizing coaxial transmission line systems. (374)

SEALED CELLS Sonotone Corp., Elmsford, N. Y. Technical data catalog covers a line of miniature sintered-plate, nickel-cadmium sealed cells. (375)

HARMONIC GENERATORS PRD Electronics, Inc., 202 Tillary St., Brooklyn 1, N. Y. Technical data sheet discusses varactor harmonic generators. (376)

MOLDING COMPOUNDS Dow Corning Corp., Midland, Mich. A 4-page data sheet lists characteristics of 12 different silicone molding components. (377)



REALLY STACKED

In more ways than one. Stacked reels, a 3-stacked recording head, and an economy of size which would enable you to stack more than forty of these miniature tape recorders into a cubic foot of space. ■ Using less than 1 watt of power, the Precision Model PS-303M records an hour of voice frequency data on a single reel of tape. It operates quietly, weighs just a few ounces, incorporates an 8-transistor, 2-diode electronics circuit. ■ The space-saving reel design is the same used in PI instrumentation magnetic tape recorders. It is one of the many advanced features which enable all PI instruments to offer full-size performance in a fraction of the space. Write for our new short-form catalog for details.



PRECISION INSTRUMENT COMPANY
1011 Commercial Street • San Carlos • California
Phone LYtell 1-4441 • TWX: SCAR BEL 30
Representatives in principal cities throughout the world



CIRCLE 121 ON READER SERVICE CARD→

P. I. Invites inquiries from senior engineers seeking a challenging future.

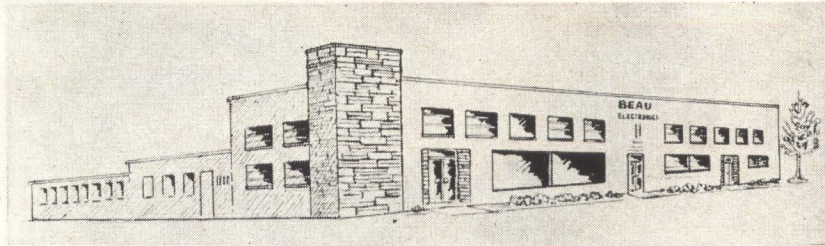

Beau Electronics Opens New Plant

BEAU ELECTRONICS, INC., of Waterbury, Conn., has occupied a new, two-story plant, tripling manufacturing facilities.

Sections of the first floor will be used for winding, grinding and varnishing operations, assembly of mass production items, precision testing and storage of finished and raw stock. Individual locations are designed to streamline production flow.

The second floor will contain air-conditioned offices for management, purchasing, sales, accounting and engineering.

Richard J. Beaulieu, president, said the new plant was needed to

meet a rapidly increasing sales backlog. The company, which started in 1958 with two employes, makes hysteresis motors, precision recorders, and instrument and data process controls.

R&D activities will also be expanded. Beau recently developed a tape deck transport designed to use its motors. Flutter at 7.5 ips is 0.07 percent, the company says. The motors have a rotor outside the stator. The motor ring acts as a permanent magnet and the poles shift as frequency varies. The company claims improved torque and stability, due to increased moment of inertia.

Granger Associates Promotes Phelps

JOHN M. PHELPS, Captain USN (Ret.) has been named vice president-operations of Granger Associates, Palo Alto, Calif., with overall responsibility for manufacturing, supply, quality assurance and field services.

Phelps joined the communications equipment firm last November as assistant to the president, John V. N. Granger.

Custom Components Elects Olerud

ROY A. OLERUD has been elected president of Custom Components, Inc., of Caldwell, N. J. Company supplies ferrite and powdered iron magnetic materials to the electronic and electrical industries.

Olerud, who formerly held ex-

ecutive positions with ITT Corp. and Allen B. DuMont Laboratories, replaces Harold I. Danziger, founder of the firm. Danziger will continue as chief executive officer, directing the growth and expansion activities of the corporation.



Kremer Moves Up At Sylvania

MERLE W. KREMER has been elected a senior vice president of Sylvania

Electric Products Inc., with responsibility for the company's Electronic Tube and Parts Divisions.

Kremer, who previously was a divisional vice president, is located at headquarters of the Electronic Tube Division in Emporium, Pa.

Potter Instrument Hires Landman

BERNARD S. LANDMAN has joined Potter Instrument Co., Inc., Plainview, L. I., N. Y., as project engineer for the systems department.

He comes to Potter from PRD Electronics, Inc., Brooklyn, N. Y.



Sprague Names Korli Inet Division Head

WILLIAM D. KORLI has been appointed vice president and general manager of Sprague Engineering Corp.'s newly acquired Inet Division in Compton, Calif.

Korli was formerly Pacific Division manager of Kurz & Root Co., Inc., Appleton, Wis.



Thompson Joins Microtech

MICROTECH, INC., Cheshire, Conn., announces the appointment of George Thompson as vice president and general manager of the com-

Problem for you:

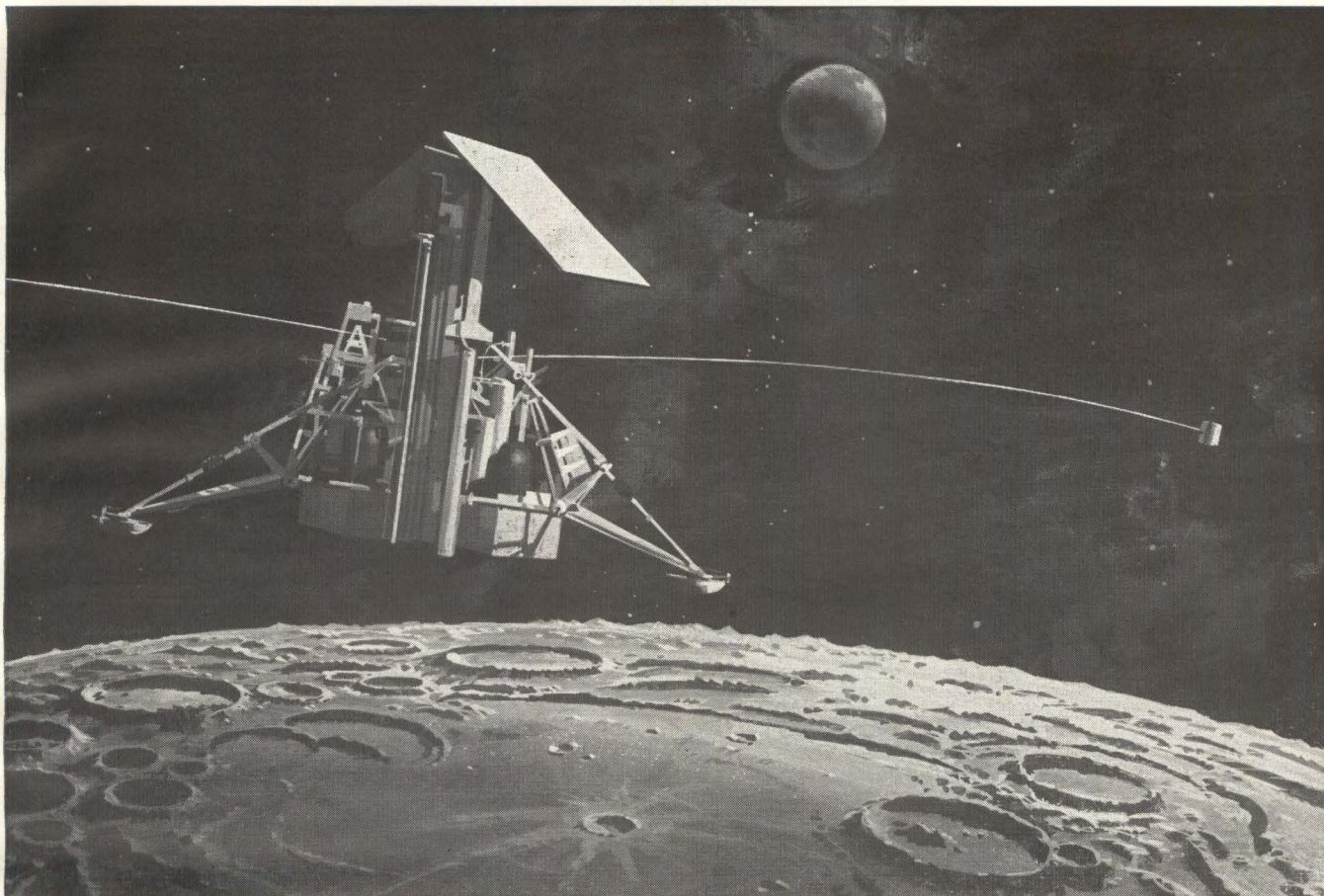

Soft land this vehicle on the moon

This spacecraft is SURVEYOR, one of the many important projects now under way at Hughes. It will "soft" land on the moon sometime in 1963. Its mission: to pierce and analyze the moon's surface; to transmit back to earth high quality television pictures; and to measure the moon's magnetic and radiation characteristics. To accomplish these demanding objectives, Project Surveyor requires the talents of many imaginative junior and senior engineers and physicists to augment its outstanding staff. A degree from an accredited university and U.S. citizenship are required. Experience in Aerospace Vehicles is preferred but not necessary. A few of the openings include:

CONTROLS ENGINEERS. Concerns airborne computers and other controls related areas for: missiles and space vehicles, satellites, radar tracking, control circuitry, control systems, control techniques, transistorized equalization networks and control servomechanisms.

CIRCUIT DESIGNERS. Involves analysis and synthesis of systems for: telemetering and command circuits for space vehicles, high efficiency power supplies for airborne and space electronic systems, space command, space television, guidance and control systems, and many others.

INFRARED SPECIALISTS. To perform systems analysis and preliminary design in infrared activities for satellite detection and identification, air-to-air missiles, AICBM, infrared range measurement, air-to-air detection search sets, optical systems, detection cryogenics and others.

SYSTEMS ANALYSTS. To consider such basic problems as: requirements of manned space flight; automatic target recognition requirements for unmanned satellites or high speed strike

reconnaissance systems; IR systems requirements for ballistic missile defense. Inquire today. Please airmail your resume to: **Mr. Robert A. Martin, Supervisor of Scientific Employment, Hughes Aerospace Divisions, 11940 W. Jefferson Blvd., Culver City 87, California.**

We promise a reply within one week.

creating a new world with electronics

HUGHES

HUGHES AIRCRAFT COMPANY
AEROSPACE DIVISIONS
An equal opportunity employer.

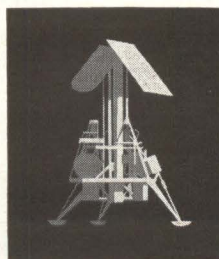

ANOTHER EXAMPLE OF RIXON'S SERVICE TO ITS CUSTOMERS

ADFAX ADAPTER DEVELOPED BY RIXON FOR SECURE FAX TRANSMISSION

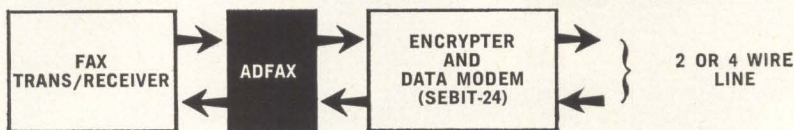

BEFORE

AFTER

The Problem:

Facsimile machines are used extensively by the various branches of government to make copies of documents for transmittal to other locations. Since a large segment of these documents are of a secret nature, security is of the utmost importance. Modern security systems employ digital transmission. Thus the problem was to convert the FAX signal to a synchronous digital data stream without destroying the usefulness of the transmitted picture.

The Solution:

By demodulating, slicing and time sampling the transmitter output, a two-level digital signal is produced. Either 1200 or 2400 bits per second may be used with the latter providing the maximum resolution. At the receiver, a carrier is modulated directly by the decoded digital signal and fed to the FAX machine in a normal manner. Thus black and white FAX transmission with resolution almost indistinguishable from the analog original is provided over secure data circuits by the ADFAX unit.

RIXON PROVES ITS CAPABILITIES ADAPT TO MEET ANY NEED

See our new digital data line at the IRE Show Booth 3034.







TELEPHONE: 622-2121 TWX: S-SPG 213

212 INDUSTRIAL PARKWAY - MONTGOMERY INDUSTRIAL PARK - SILVER SPRING, MARYLAND

CIRCLE 214 ON READER SERVICE CARD

Coto-Coils for Contact Capsules

TYPE	DC-V	Ohms	Nom. Watts	Nom. Amp/ Turns
S 	6	100	.40	250
	12	360		
	24	1400		
M 	6	50	.70	250
	12	175		
	24	820		
T 	6	100	.35	125
	12	400		
	24	1600		
	32	2800		
	48	4600		
U 	6	150	.24	125
	12	600		
	24	2500		

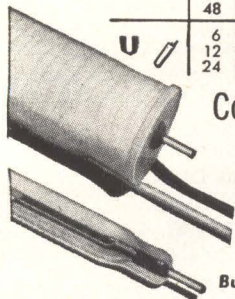

Coil Windings

WIRE SIZES

#6 to #56

CLASSES

A, B, F and H

Write for Bulletin and Prices

Since 1917 Coto-Coil has wound all types of coils for every application. Complete design and engineering service is available.

Coto-Coils COTO-COIL CO., INC.,
65 Pavilion Avenue
Providence 5, R. I.



How to grow a beard...

Sit back and wait for your copy on that routing list. Okay if you like beards. Otherwise, look in this issue for the Reader Service Card. Fill in the "for subscriptions" section. Mail. Only 7½ cents a week.

electronics

A McGraw-Hill Publication,
330 West 42nd St., N. Y. 36

pany. He will assume full charge of all operations of the firm, which is a subsidiary of Talley Industries, Inc., of Mesa, Ariz.

Thompson joins Microtech after more than ten years of service as manager of the Airtron Division of Litton Industries, in Linden, N. J.



Brayshaw Announces New Company

BRAYSHAW ELECTRONICS, INC., recently opened offices and plant at Olivia Street, McKees Rocks, Pa. The new corporation will manufacture selenium rectifiers, silicon rectifiers and other semiconductors and components.

President of the firm is Stanier E. Brayshaw who formerly was manager, semiconductor products R&D at Syntron Corp.



Dickson Electronics Appoints Jones

ROBERT L. JONES has been named production manager for Dickson Electronics Corp., Scottsdale, Ariz.

Dickson Electronics manufactures a line of Zener diodes, reference diodes, and high voltage rectifiers for the electronics industry.

Immediately prior to joining the company, Jones was production manager for silicon alloy and mesa

transistors at Hughes Semiconductor Division.

Wilson Assumes U. S. Sonics Post

U. S. SONICS CORP., Cambridge, Mass., recently named Robert D. Wilson to the new post of director of engineering.

Prior to this appointment, Wilson was manager of research and development administration for the Raytheon Co., and before this, was manager of the advanced development laboratory of the Raytheon Industrial Components division.

PEOPLE IN BRIEF

William T. Thomas leaves Princeton U. faculty to become director of R&D at Induction Heating Corp. **John Heavyside**, formerly with Fairchild Astrionics, appointed product development mgr. by North Atlantic Industries, Inc. **Henry L. Herold**, previously with Hughes Aircraft Co., named computer engineering mgr. for Scientific Data Systems, Inc. **Jan A. Narud**, from IBM Research Center, to Motorola Semiconductor Products as mgr. of circuits research. **Joseph M. Chirnitch**, ex-MB Electronics Co. and Lessells & Associates, takes post of product line mgr.-spectrum analyzers at Spectran Electronics Corp. **Albert Haselman** promoted to executive v-p of Prodelin, Inc. **Eugene C. Frost** moves up to director of quality and reliability assurance at Lockheed-California Co. **Lyle R. Groberg** advances to chief engineer, government products engineering, for Lenkurt Electric Co., Inc. **Ralph M. Wight**, v-p of Litton Industries, elected to board of directors of Magnasyn Corp. **John Layport**, formerly with Raytheon, named plant engineer for the Alberox Corp. **Bruno O. Weinschel**, head of Weinschel Engineering, named to the Public Advisory Committee on Air Force Calibration. **R. C. Chase**, v-p and g-m, Spectrol Electronics Corp., elected president of the Precision Potentiometer Manufacturers Association. **Kenneth C. Mathews**, ex-Sylvania Electric Products Co., now president of Mecanair, Inc.

Approaches laboratory standard precision under severe environmental conditions

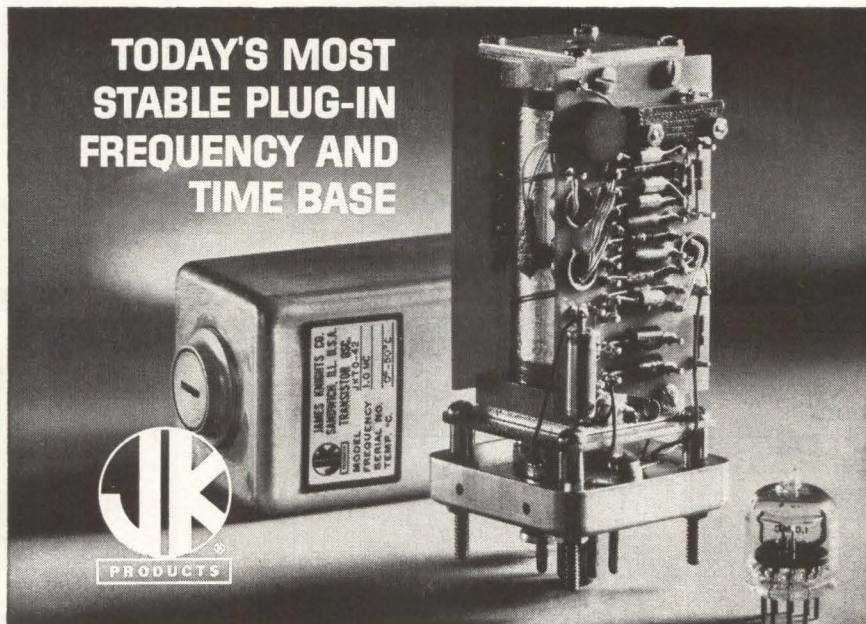

JKTO-43 TRANSISTORIZED FREQUENCY STANDARD

A rugged plug-in oscillator engineered for use in precision type equipment operating under severe environmental conditions. An AGC type, low constant crystal drive oscillator employing silicon transistors, precision glass-enclosed crystal having a "Q" in excess of one million, followed by a silicon transistor buffer output stage results in a high order of stability. A silicon zener diode is used to regulate the voltage supply to the oscillator and buffer. The crystal and oscillator are enclosed in a modern thermally balanced oven cavity where the average temperature can be held less than $\frac{1}{4}^{\circ}\text{C}$, over an ambient temperature range of minus 55°C to plus 80°C , by means of a high gain silicon transistor DC type proportional temperature controller oven circuit.

Special features include precision vernier trimmer capacitor located within the temperature controlled enclosure, accessible externally; output of 250 microwatts operating into a high or low impedance load at oscillator frequency with excellent short term stability.

Optional features include multiplication of oscillator frequency by two to eight or division by two to sixteen, voltage control of frequency by means of a varicap diode, and variation in power output where additional can be used.

SPECIFICATIONS

Stability: 5×10^{-6} /Day. *Frequency:* 1 mc to 5 mc normal range; 31.25 kc to 50 mc extended range. *Oven:* DC type proportional control. *Power:* 28 volt input. *Output:* 1.25 volts into 5 K ohm load. *Dimensions:* 2" x 2" x 4.5" seated height. Write for data sheet. **James Knights Company, Sandwich, Illinois.**

electronics

WEEKLY QUALIFICATION FORM FOR POSITIONS AVAILABLE

ATTENTION: ENGINEERS, SCIENTISTS, PHYSICISTS

This Qualification Form is designed to help you advance in the electronics industry. It is unique and compact. Designed with the assistance of professional personnel management, it isolates specific experience in electronics and deals only in essential background information.

The advertisers listed here are seeking professional experience. Fill in the Qualification Form below.

STRICTLY CONFIDENTIAL

Your Qualification form will be handled as "Strictly Confidential" by ELECTRONICS. Our processing system is such that your form will be forwarded within 24 hours to the proper executives in the companies you select. You will be contacted at your home by the interested companies.

WHAT TO DO

1. Review the positions in the advertisements.
2. Select those for which you qualify.
3. Notice the key numbers.
4. Circle the corresponding key number below the Qualification Form.
5. Fill out the form completely. *Please print clearly.*
6. Mail to: D. Hawksby, Classified Advertising Div., ELECTRONICS, Box 12, New York 36, N. Y. (No charge, of course).

COMPANY	SEE PAGE	KEY #
AC SPARK PLUG Electronics Div. of General Motors Corp. Milwaukee, Wisconsin	122°	1
ATOMIC PERSONNEL INC. Philadelphia, Pennsylvania	208°	2
BECKMAN INSTRUMENTS INC. Fullerton, California	212°	3
BRENTON EMPLOYMENT AGENCY Newark, New Jersey	208°	4
BUREAU OF SHIPS U. S. Navy Department Washington, D. C.	114°	5
COWIN ASSOCIATES Garden City, New York	207°	6
EITEL-McCULLOUGH INC. San Carlos, California	116*	7
ELECTRO-MECHANICAL RESEARCH INC. Sarasota, Florida	212°	8
ERIE ELECTRONICS DIV. Erie Resistor Corp. Erie, Pennsylvania	213°	9
ESQUIRE PERSONNEL SERVICE INC. Chicago, Illinois	208°	10
FAIRCHILD STRATOS Aircraft Missiles Div. Hagerstown, Maryland	198, 199°	11
GENERAL COMMUNICATION CO. Boston, Massachusetts	207°	12
GENERAL DYNAMICS / ASTRONAUTICS San Diego, California	79, 80	13
GENERAL DYNAMICS / ELECTRONICS A Div. of General Dynamics Corp. Rochester, New York	210°	14
GENERAL ELECTRIC CO. Communication Products Department Lynchburg, Virginia	128	15
GENERAL ELECTRIC CO. Defense Systems Department Syracuse, New York	127	16

CONTINUED ON PAGE 128

(cut here)

(cut here)

electronics WEEKLY QUALIFICATION FORM FOR POSITIONS AVAILABLE

Personal Background

NAME
HOME ADDRESS
CITY ZONE STATE
HOME TELEPHONE

Education

PROFESSIONAL DEGREE(S)
MAJOR(S)
UNIVERSITY
DATE(S)

FIELDS OF EXPERIENCE (Please Check)

3/16/62

- | | | |
|--|--|---------------------------------------|
| <input type="checkbox"/> Aerospace | <input type="checkbox"/> Fire Control | <input type="checkbox"/> Radar |
| <input type="checkbox"/> Antennas | <input type="checkbox"/> Human Factors | <input type="checkbox"/> Radio—TV |
| <input type="checkbox"/> ASW | <input type="checkbox"/> Infrared | <input type="checkbox"/> Simulators |
| <input type="checkbox"/> Circuits | <input type="checkbox"/> Instrumentation | <input type="checkbox"/> Solid State |
| <input type="checkbox"/> Communications | <input type="checkbox"/> Medicine | <input type="checkbox"/> Telemetry |
| <input type="checkbox"/> Components | <input type="checkbox"/> Microwave | <input type="checkbox"/> Transformers |
| <input type="checkbox"/> Computers | <input type="checkbox"/> Navigation | <input type="checkbox"/> Other |
| <input type="checkbox"/> ECM | <input type="checkbox"/> Operations Research | <input type="checkbox"/> |
| <input type="checkbox"/> Electron Tubes | <input type="checkbox"/> Optics | <input type="checkbox"/> |
| <input type="checkbox"/> Engineering Writing | <input type="checkbox"/> Packaging | <input type="checkbox"/> |

CATEGORY OF SPECIALIZATION

Please indicate number of months experience on proper lines.

	Technical Experience (Months)	Supervisory Experience (Months)
RESEARCH (pure, fundamental, basic)
RESEARCH (Applied)
SYSTEMS (New Concepts)
DEVELOPMENT (Model)
DESIGN (Product)
MANUFACTURING (Product)
FIELD (Service)
SALES (Proposals & Products)

CIRCLE KEY NUMBERS OF ABOVE COMPANIES' POSITIONS THAT INTEREST YOU

1 2 3 4 5 6 7 8 9 10 11 12 13 14 15 16 17 18 19 20 21 22 23 24 25
26 27 28 29 30 31 32 33 34 35 36 37 38 39 40 41

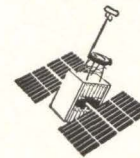

TO ENGINEERS AND SCIENTISTS
LOOKING FOR GREATEST PERSONAL
INVOLVEMENT IN MAJOR SYSTEMS FOR SPACE:

COMMON SENSE SAYS, "LOOK TO THE HEAVENS"... OR DOES IT?

All of the glamour that surrounds hardware in orbit often obscures one very meaningful fact. As much as 80% of a complete space system is, and remains, on the ground.

Here's another fact. Within General Electric, technical competence for the ground-based portion of space programs concentrates here in Syracuse, New York.

For instance, the highly reliable radio-inertial guidance system our engineers developed for ATLAS (now operational with the USAF) is the same system that has been used for booster guidance on 75% of America's space shots.

Another system, utilizing an entirely different set of engineering concepts, is MISTRAM*. Its current function is to introduce a revolutionary magnitude of precision into ICBM trajectory measurement. Important future ramifications lie in extending the system to global ranges, satellite tracking, space guidance and hypersonic traffic control.

Still other programs such as GESE (General Electric Electronic System Evaluator), the vast-scale Air Weapons Control System 412-L. Theoretical and Applied Space Physics, Radiation Effects Research, and many more, provide rugged exercises in technical ingenuity.

* MISTRAM's basic system concept involves a geometric arrangement of 5 ground radio receiving stations. Missile position, trajectory and velocities are continuously calculated with great accuracy from phase differences in a beacon signal received from the missile. Radar is used only to orient the radio receiving antennas in the general direction of the missile.

AN ADDED THOUGHT

This much diversity in one organization generates a uniquely flexible type of career environment. You can plot and re-plot your best avenue of advancement, without having to leave the company in order to do so.

IMMEDIATE OPPORTUNITIES IN THESE AREAS:

Communication Systems / Operations Analysis /
System Equipment Analysis / Weapons Integra-
tion / Applied Mathematics / Telecommunications
Systems Design / Programming Analysis / Engi-
neering Writing / Antenna & Microwave Compo-
nents / Equipment Evaluation / Information
Processing & Display Systems / Human Factors

For a prompt reply, mail us a copy of your resume (or an informal outline of your education and experience) in full confidence. Address to Mr. P. W. Christos, Div. 69-WK.

An Equal Opportunity Employer

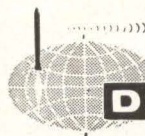

DSD DEFENSE SYSTEMS DEPARTMENT
A Department of the Defense Electronics Division

GENERAL ELECTRIC

Northern Lights Office Bldg., Syracuse, New York.

New, highly responsible opportunities created by vigorous growth of both military and commercial communication systems contracts —

COMMUNICATION SYSTEMS ENGINEERS

QUALIFICATIONS

— a minimum of 10 years' experience in the communications engineering field, 5 of which should have been directed toward communication systems involving microwave, telephone and teletype switching centers & data transmission.

OR

— a significant level of experience in design of complete, 2-way radio systems involving mobile and station packaging, and control by local and remote means.

ALSO IMMEDIATE OPENINGS FOR THE FOLLOWING:

- Antenna Design Engineers (UHF/VHF)
- Test Equipment Design Engineers (EE)
- Subsystem Design Engineers (EE)
- Transistor Circuit Design Engineers (EE)
- Transmitter Engineers (EE)
- Receiver Engineers (EE)
- Electromechanical Engineers (EE or ME)
- Component Evaluation Engineer (EE)

► Facility located 4 easy driving hours from Washington, D. C., in the beautiful, Blue Ridge area of Virginia. For a prompt review of your qualifications, write today in strict confidence to Mr. W. J. Kelly, Div. 69-WK

COMMUNICATION PRODUCTS DEPARTMENT
GENERAL ELECTRIC

Mountain View Road, Lynchburg, Va.
An Equal Opportunity Employer

EMPLOYMENT OPPORTUNITIES

The advertisements in this section include all employment opportunities — executive, management, technical, selling, office, skilled, manual, etc.

Look in the forward section of the magazine for additional Employment Opportunities advertising.

— RATES —

DISPLAYED: The advertising rate is \$40.17 per inch for all advertising appearing on other than a contract basis. Contract rates quoted on request.

An advertising inch is measured 7/8" vertically on a column—3 columns—30 inches to a page.

Subject to Agency Commission.

UNDISPLAYED: \$2.70 per line, minimum 3 lines. To figure advance payment count 5 average words as a line.

Box numbers—count as 1 line.

Discount of 10% if full payment is made in advance for 4 consecutive insertions.

Not subject to Agency Commission.

ADDRESS BOX NO. REPLIES TO: Box No.
Classified Adv. Div. of this publication.
Send to office nearest you.
NEW YORK 36: P. O. Box 12
CHICAGO 11: 645 N. Michigan Ave.
SAN FRANCISCO 11: 255 California St.

POSITION VACANT

Wanted: Experienced Electronic Control Engineer for automatic scale weighing applications. Must be fully versed in design and able to head up department. Good position for the right party. Our employees know of this ad. P-8422, Electronics.

SELLING OPPORTUNITY WANTED

Sales Engineers—New Group Engineers to represent equipment manufacturer. Territory—Texas, Kansas, Oklahoma, Missouri—retainer or commission. RA-8391, Electronics.

NEW INDUSTRY WANTED

Community Has Cash To Help locate industry in western Kentucky lake area. No gimmick! Plenty of water, labor, sites, gas, power. 100% plant financing. For more details call or write, West Hopkins Industries, Box 245, Dawson Springs, Ky.

ELECTRONIC DEVELOPMENT ENGINEERS

Immediate openings for EEs experienced in original semiconductor circuit and component design. Positions require problem definition, system design and prototype evaluation. Salary open.

Send resumes to Mr. J. E. McMahon,
UNION SWITCH & SIGNAL
Division of WABCO Pittsburgh 18, Pa.

EXPENSE PAID TRIP

... TO IRE SHOW
NEW YORK CITY, MAR. 26-29

SCOPE, Professional Placement Center, New England's most progressive agency specializing in the electronics industry, will prearrange client company all-expense sponsored trip and will schedule a number of selected interviews from its National roster of client companies to save you time.

Exceptional job opportunities are available in Research-Design-Development and Sales-Marketing-Application. Better your professional stature now... air mail resume in complete confidence—no obligation on your part. BS, MS and/or PhD degree required.

For full details write or call collect today: TWinbrook 9-8250.

Alan Glou.....Technical/Scientific
Sid Hopner.....Sales/Marketing
SCOPE
Professional Placement Center
1277 MAIN ST. WALTHAM, MASS.

electronics

WEEKLY QUALIFICATIONS FORM FOR POSITIONS AVAILABLE

(Continued from Page 126)

COMPANY	SEE PAGE	KEY #
GENERAL ELECTRIC CO. Light Military Electronics Department Utica, New York	130	17
HOLLNBERGER-BURCHELL ASSOCIATES West Islip, New York	208*	18
KOLLSMAN INSTRUMENT CORP. Sub. of Standard Kollsman Industries Inc. Elmhurst, New York	217*	19
LOCKHEED CALIFORNIA CO. A Div. of Lockheed Aircraft Corp. Burbank, California	136*	20
LOCKHEED-GEORGIA CO. A Div. of Lockheed Aircraft Corp. Atlanta, Georgia	120*	21
LOCKHEED MISSILES SPACE CO. A Div. of Lockheed Aircraft Corp. Sunnyvale, California	112*	22
MALLORY ELECTRONICS COMPANY Div. of P. R. Mallory & Co., Inc. Indianapolis, Indiana	208*	23
MCDONNELL AIRCRAFT St. Louis, Missouri	211*	24
MICROWAVE SERVICES INTERNATIONAL, INC. Denville, New Jersey	208*	25
MITRE CORPORATION Bedford, Massachusetts	181*	26
MOTOROLA, INC. Military Electronics Div. Western Center Scottsdale, Arizona	212*	27
NATIONAL AERONAUTICS & SPACE ADMINISTRATION Washington, D. C.	129	28
NATIONAL CASH REGISTER CO. Dayton, Ohio	215*	29
PAN AMERICAN WORLD AIRWAYS INC. Guided Missiles Range Div. Patrick AFB, Florida	202*	30
PHILCO WESTERN DEVELOPMENT LABS. Palo Alto, California	209*	31
REEVES INSTRUMENT CORP. Garden City, New York	214*	32
SANGAMO ELECTRIC CO. Springfield, Illinois	207*	33
SCOPE PROFESSIONAL PLACEMENT CENTER Waltham, Massachusetts	208*	34
SPACE TECHNOLOGY LABS., INC. A Sub. of Thompson Ramo Wooldridge Los Angeles, California	15*	35
SPEIDEL CORPORATION Industrial Division Warwick, Rhode Island	214*	36
SPERRY GYROSCOPE COMPANY Div. of Sperry Rand Corp. Great Neck, L. I., New York	212*	37
SPERRY MICROWAVE ELECTRONICS CO. Div. of Sperry Rand Corp. Clearwater, Florida	217*	38
STANFORD LINEAR ACCELERATOR CENTER Stanford University Stanford, California	102*	39
SYLVANIA MOUNTAIN VIEW OPERATIONS Mountain View, California	213*	40
UNION SWITCH & SIGNAL Div. of WABCO Pittsburgh, Pennsylvania	128	41

* These advertisements appeared in the 3/9/62 issue.

**You can be sure
to play an important part
in the exploration of space
...when you join NASA**

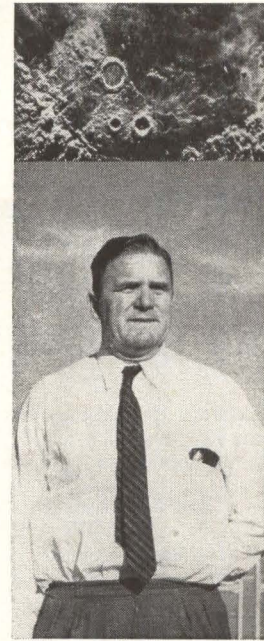

**A factual statement on career opportunities for scientists and engineers
from James E. Webb, head of NASA**

The exploration of space, for peaceful purposes and the benefit of all mankind, is the most challenging assignment ever given to the American scientific and engineering community.

To the men of NASA, the space program has many objectives: broad scale, rapid advancement of scientific knowledge of space, the moon and planets . . . the creation of a worldwide operational network of weather satellites . . . the establishment of a global satellite system of communications . . . prompt feedback of space technology into our economy . . . and many others. Technological advances through our space effort will bring total benefits exceeding those of any other undertaking in history.

The scientists and engineers who are directly involved in NASA's space program are faced with formidable research and development problems. NASA needs—and seeks—the best

creative scientific and engineering talent our nation has to offer.

We will provide the professional men who join NASA with the tools they need: a truly intellectual atmosphere, a framework for easy communication with colleagues in universities as well as government and industry laboratories, the most advanced equipment available, and the technical and clerical support to let you concentrate on the important aspects of your work.

Still, the greatest personal satisfaction may be found in the scope of the individual assignment and in the end product of the work—breaking out from the world we know into an entire new world and uncovering a flood of new benefits not only for ourselves, but for all mankind.

James E. Webb

To scientists and engineers in all disciplines, at all levels:

The dynamic expansion of NASA has created outstanding career positions and opportunities for rapid advancement. Career appointments are available in ten different locales: Washington, D. C.; Greenbelt, Maryland; Mountain View and Edwards, California; Hampton and Wallops Island, Virginia; Cleveland, Ohio; Huntsville,

Alabama; Cape Canaveral, Florida; and Houston, Texas.

Find out how you may contribute to the American space effort. You need send only one resume—it will be reproduced and distributed to all NASA facilities for evaluation.

*Write to: Director, Professional Staffing, NASA
Headquarters, Washington 25, D. C.*

AN EQUAL OPPORTUNITY EMPLOYER. POSITIONS ARE FILLED IN ACCORDANCE WITH AERO-SPACE TECHNOLOGY ANNOUNCEMENT 252B.

 **NATIONAL AERONAUTICS AND SPACE ADMINISTRATION**

ENGINEERS, EE:

Looking for more responsibility immediately... and a starting salary that reflects it?

General Electric's Light Military Electronics Department is seeking highly competent engineers to fill immediate technical leadership and consulting openings in the following program areas:

- | | |
|-------------------------------------|------------------------------------|
| Space Vehicle Guidance Systems | Command Guidance & Instrumentation |
| Missile & Satellite Computers | A.E.W. & Control |
| Microelectronics | Electronic Countermeasures |
| Space Detection & Surveillance | Space Communications & Telemetry |
| Navigation & Communication Systems | Undersea Warfare Systems |
| Silicon Crystal Circuit Development | Thin Films |
| | Automated Test Equipment |



LIGHT MILITARY ELECTRONICS DEPARTMENT

GENERAL ELECTRIC

THESE ARE SAMPLES OF THE IMMEDIATE OPENINGS:

- ▶ **TRANSISTOR CIRCUIT DESIGN**
...on computers utilized in airborne early warning system.
- ▶ **LEAD EE**
... to integrate logic and circuit design efforts on space vehicle guidance equipment.
- ▶ **CIRCUIT DEVELOPMENT AND APPLICATION ENGINEER**
... should be capable of doing work in the following areas: a) Paper design & synthesis of complex circuitry such as is found in airborne electronics; b) Analysis of complete systems to determine and design those portions capable of being micro-miniaturized; c) Advise and consult with product line electronic design engineers; d) Prepare proposals.
- ▶ **DATA PROCESSING CONSULTING ENGINEER**
... involves computer design, including logic and logic organization, basic computer circuit design, memory storage circuits and devices, overall computer systems synthesis. Also includes direct leadership of D/A projects for advance design techniques, consultation with design engineers on product line design problems, assistance in preparation of technical proposals, participation as panel member in design reviews, leadership of technical symposia in your design field.
- ▶ **SYSTEMS ANALYST**
... includes missile flight test and analysis regarding guidance systems and computation; orbital trajectory analyses; overall system, sub-system and error analysis.
- ▶ **COMMUNICATION ENGINEER**
... for design studies and analyses regarding command control systems for space applications.
- ▶ **SPACE NAVIGATION OR GUIDANCE ENGINEER**
... to conduct systems studies regarding integrating hardware, e.g., developing stellar, radio or inertial navigation or guidance systems to perform specific missile function.
- ▶ **STATISTICAL ANALYSIS ENGINEER**
... to perform analysis of statistical nature, e.g., correlation, error and probability of success analysis.

For a careful review of your qualifications, and a prompt reply, forward your resume today in strictest confidence. Address: Mr. R. Zukowski, Div. 69-WK., Light Military Electronics Dept., General Electric, French Road, Utica, New York.

An Equal Opportunity Employer

SEARCHLIGHT SECTION

(Classified Advertising)

BUSINESS OPPORTUNITIES

EQUIPMENT - USED or RESALE

DISPLAYED

RATES

UNDISPLAYED

The advertising is \$27.25 per inch for all advertising other than on a contract basis. AN ADVERTISING INCH is measured 7/8" vert. on a column, 3 cols.—30 inches—to a page. EQUIPMENT WANTED or FOR SALE ADVERTISEMENTS acceptable only in Displayed Style.

\$2.70 a line, minimum 3 lines. To figure advance payment count 5 average words as a line. BOX NUMBERS count as one line additional.

DISCOUNT of 10% if full payment is made in advance for four consecutive insertions.

Send NEW ADVERTISEMENTS or Inquiries to Classified Adv. Div. of Electronics, P. O. Box 12, N. Y. 36, N. Y.



MANUFACTURERS' REPRESENTATIVES

IN THE ELECTRONIC INDUSTRY

SAMUEL K. MACDONALD, INC.

manufacturers representatives over 25 years
1531 SPRUCE STREET, PHILA. 2, PA.

Territory:
Pennsylvania • New Jersey
Delaware • Maryland
Virginia • West Virginia
District of Columbia

Other Offices:
Pittsburgh
Baltimore
Washington, D.C.

LIFSCHULTZ FAST FREIGHT

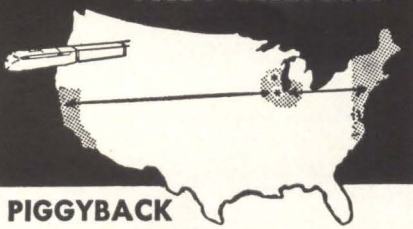

PIGGYBACK TO BOTH COASTS TRUCKLOAD RATES TO BOTH COASTS
•We welcome your inquiry.

PROMPT DAILY PICKUP and DELIVERY

FASTEST TO BOTH COASTS!

CIRCLE 460 ON READER SERVICE CARD

FOR RESEARCH—DEVELOPMENT & EXPERIMENTAL WORK

Over 10,000 different electronic parts: waveguide, radar components and parts, test sets, pulsers, antennas, pulse xmfrs, magnetrons, IF and pulse amplifiers, dynamotors, 400 cycle xmfrs, 584 ant. pedestals, etc.

PRICES AT A FRACTION OF ORIGINAL COST!
Visit or Phone—

COMMUNICATIONS EQUIP CO.

343 CANAL ST., N. Y. 13, N. Y.
(Formerly at 131 Liberty St.)
CHAS. ROSEN, WOrth 6-4045

CIRCLE 461 ON READER SERVICE CARD

Watch—the Searchlight Section for Equipment Opportunities

MFRS. REPS:

DID YOU KNOW THAT . . .

when you advertise in the electronics BUYERS' GUIDE we reprint your advertising and mail it to over 3,500 Sales Managers of electronic equipment manufacturing companies?

THIS IS COVERAGE BEYOND OUR BUYER'S GUIDE SUBSCRIBERS . . .

ADVERTISE IN THE 1962 EBG AND GET THIS EXTRA COVERAGE

INDEX TO ADVERTISERS



Audited Paid Circulation

• AMP Incorporated	43	• Power Designs, Inc.	89
• Airpax Electronics, Inc.	114	Precision Instrument Co.	121
• Allen Organ Co., Inc.	16		
• American Bosch Arma Corp.		• Radio Corporation of America... 4th Cover	
Tele-Dynamics Div.	118	Radio Engineering Laboratories, Inc.	73
• American Optical Co.	101	• Raytheon Company	2nd Cover, 113
• Arnold Magnetics Corp.	76	• Rixon Electronics, Inc.	124
• Art Wire & Stamping Co.	96	Ross Co., Milton.	105
Assembly Products, Inc.	13	Royal Electric Corp.	90
Baird-Atomic, Inc.	37	• Sage Electronics Corp.	76
Beattie-Coleman Inc.	119	Shallcross	74, 106, 119
Beaver Gear Works, Inc.	110	• Sola Electric Co.	95
• Bircher Corporation, The.	132	Spectran Electronics	113
• Borg-Equipment Division, Amphenol-Borg Electronics Corp.	87	Sprague Electric Co.	9, 42
Brand Rex Division American Enka Corp.	83, 92	Stackpole Carbon Co.	70, 71
Bristol Company, The.	112		
• Brush Instruments, Div. of Clevite Corp.	3rd Cover	Telewave Laboratories, Inc.	45, 46
		Texas Instruments Incorporated Transistor Products and Components Division	33, 34, 35, 36
Cambridge Thermionic Corp.	117	Thermal American Fused Quartz Co., Inc.	84
• Cannon Electric Co.	27	Triad Transformers Corp.	68
• Celco-Constantine Engineering Laboratories	94	• Trio Laboratories, Inc.	44
Communication Electronics, Inc.	94	Triplett Electrical Instrument Co.	31
• Constantine Engineering Laboratories	94		
• Coto-Coil Co., Inc.	124	Varian Associates	93
		Virginia Electric & Power Co.	47
Defense Electronics, Inc.	107		
duPont de Nemours & Co., Inc. E. I.	85	• Weinschel Engineering	4
Dymec, A Division of Hewlett Packard Co.	14, 15	West Penn Power	106
		Westinghouse Electric Corp.	26, 30
Electrodynamic Instrument Corporation	96		
• Electro Motive Mfg. Co., Inc.	77		
Electron Heating Corp.	25		
Electronic Engineering Co.	120		
General Dynamics/Astronautics	79, 80		
Gertsch Products, Inc.	111		
• Gould-National Batteries, Inc.	86		
• Hamlin, Inc.	96		
Helland Division, Minneapolis-Honeywell	102, 103		
• Hewlett-Packard Company	6, 17, 18, 19, 20, 21, 22, 23, 24		
• Hitemp Wires Inc.	48		
Hughes Aircraft Co., Aerospace Divisions	123		
• Indiana General Corp.	81		
• Ingersoll Products Division of Borg-Warner Corp.	104		
Institute of Radio Engineers	94, 107, 110		
• Japan Piezo Electric Co., Ltd.	113		
• Kearfott Div. General Precision Inc.	108, 109		
Kingsley Machines	131		
• Knights Company, James.	125		
L & R Mfg. Co.	86		
• Lambda Electronics Corp.	5		
Leosna Corp.	91		
Littlefuse, Inc.	86		
McGraw-Hill Book Co.	32, 97, 98, 99		
• Microswitch, Div. of Honeywell	49		
Minnesota Mining & Mfg. Co.	11		
Mincom Division	10, 11		
Moore Associates, Inc.	41		
• Moseley Co., F. L.	69		
NRC Equipment Co.	75		
• Panoramic Electronics, Inc.	92		
• Philco Corporation	50		
Plastoid Corp.	78		
Polaroid Corp.	67		

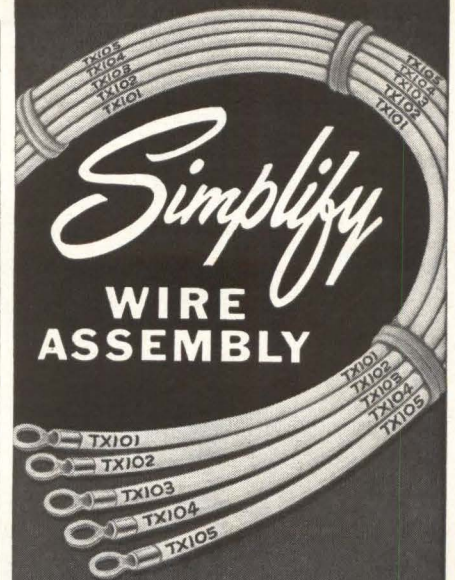

with a
KINGSLEY
Wire and Tube
Marking Machine

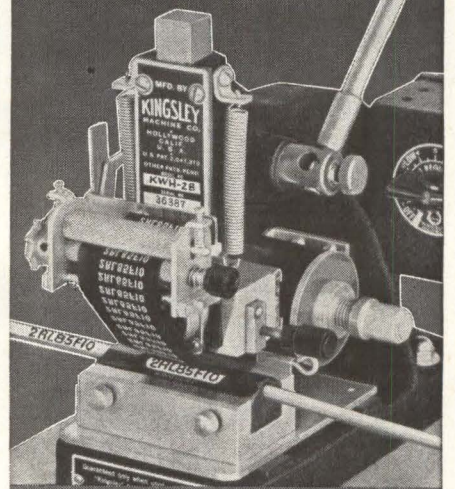

Now you can mark each wire or piece of plastic tubing with its own circuit number... quickly... economically, right in your own plant.

You reduce wire inventories because you need only one color of wire for as many circuits as necessary.

Simplify your assembly methods and speed production with the same machine that has proven so successful in the aircraft and missile field. Write for details.

KINGSLEY MACHINES
850 Cahuenga • Hollywood 38, Calif.

SEE US AT IRE BOOTH 4332

for maximum
reliability

SPECIFY BIRTCHER PCB-TAINERS®

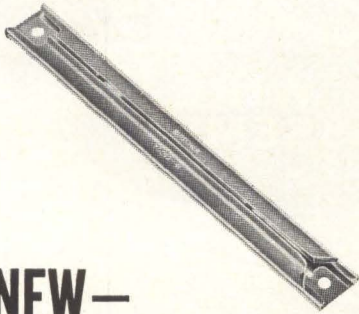

NEW— LOW COST SPRING CLIPS TO RETAIN PRINTED CIRCUIT BOARDS

PROVIDE EXCELLENT GROUND AND THERMAL PATHS

Birtcher PCB-Tainers simplify design and production, provide important cost savings. PCB-Tainers are tested to retain printed circuit boards under more than 30Gs, vibration up to 2000 cps. Material is beryllium copper for excellent electrical ground and thermal path. Standard lengths for 3/32-in. and 1/16-in. boards.

Available from
authorized distributors



Send for new technical
data sheet with
drawings, test report,
complete details.

THE BIRTCHER CORPORATION

INDUSTRIAL DIVISION

745 S. Monterey Pass Rd. • Monterey Park, Cal.

**TUBE/TRANSISTOR/COMPONENT
RETENTION AND COOLING DEVICES**

electronics



Audit Bureau
of Circulations



Associated Business
Publications

Audited Paid Circulation

JAMES T. HAUPTLI

Advertising Sales Manager

R. S. QUINT:
Assistant Publisher Buyers'
Guide and Business Manager
FRED STEWART:
Promotion Manager
B. ANELLO:
Market Services Manager

RICHARD J. TOMLINSON:
Production Manager
GEORGE E. POMEROY:
Classified Manager
HUGH J. QUINN:
Circulation Manager

ADVERTISING REPRESENTATIVES

NEW YORK (36):
Donald H. Miller, Henry M. Shaw,
George F. Werner
500 Fifth Avenue, OXFord 5-5959

BOSTON (16):
William S. Hodgkinson, Donald R. Furth
McGraw-Hill Building, Copley Square,
Congress 2-1160

PHILADELPHIA (3):
Warren H. Gardner, William J. Boyle
6 Penn Center Plaza, LOcust 8-4330

CHICAGO (11):
Harvey W. Wernecke, Robert M. Denmead
645 North Michigan Avenue, Mohawk 4-5800

CLEVELAND (13):
Paul T. Fegley
55 Public Square, Superior 1-7000

SAN FRANCISCO (11):
R. C. Alcorn
255 California Street, Douglas 2-4600

LOS ANGELES (17):
Peter S. Carberry, Ashley P. Hartman
1125 W. 6th St., Huntley 2-5450

DENVER (2):
J. W. Patten
Tower Bldg., 1700 Broadway,
Alpine 5-2981

ATLANTA (9):
Michael H. Miller, Robert C. Johnson
1375 Peachtree St. N.E., Trinity 5-0523

HOUSTON (25):
Joseph C. Page, Jr.
Prudential Bldg., Holcomb Blvd.,
Jackson 6-1281

DALLAS (1):
Frank Le Beau
The Vaughn Bldg., 1712 Commerce St.
Riverside 7-9721

LONDON W1:
Dennis McDonald
34 Dover St.

FRANKFURT/Main:
85 Westendstrasse

GENEVA:
Michael R. Zeynel
2 Place du Port

"Headquarters for Business Information"

McGraw-Hill Technical and Business Publications

American Machinist/Metal-
working Manufacturing
Aviation Week and Space
Technology
Business Week
Chemical Engineering
Chemical Week
Coal Age
Construction Methods and
Equipment
Construction Daily
Control Engineering
Electrical Construction
and Maintenance
Electrical Merchandising Week
Electrical Newsletter
Electrical West

Electrical Wholesaling
Electrical World
Electronics
Engineering Digest
Engineering and Mining Journal
E & MJ Metal and Mineral
Markets
Engineering News-Record
Factory
Fleet Owner
Industrial Distribution
National Petroleum News
Nucleonics
Nucleonics Week
Platt's Oilgram News
Platt's Oilgram Price Service
Power

Product Engineering
Purchasing Week
Science Week
Textile World

Overseas only:
Automobile International
(English, Spanish)
Ingenieria Internacional
(Spanish)
International Management
(English, Spanish)
Portuguese editions)
Metalworking Production
(Great Britain)

Available by subscription only — to qualified persons actively engaged in the field of the publication. For subscription rates and information describing the editorial coverage of any of the above publications, write to: Subscription Manager, Circulation Department, McGraw-Hill Publishing Company, 330 West 42nd Street, New York 36, N. Y.

COPYRIGHT 1961

BRUSH INSTRUMENTS

DIVISION OF CLEVITE CORPORATION

CLEVELAND, OHIO

**unmatched
peak in
penmanship...**

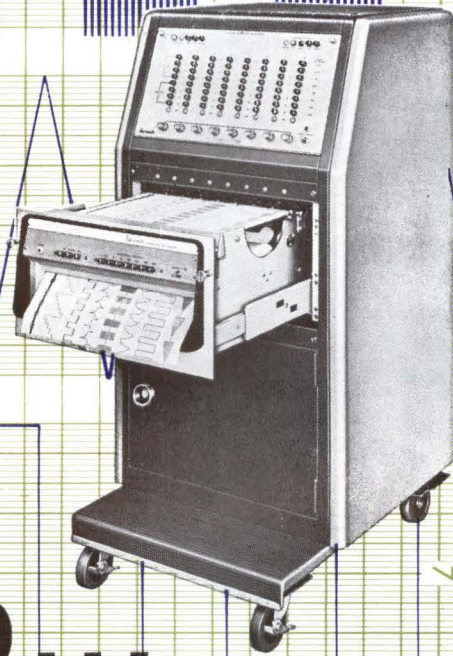

The totally new Brush Recorder Mark 200 made these incredibly crisp tracings. No other recorder in existence can match them. Note the line width. It never varies . . . regardless of writing velocity, regardless of chart speed. The writing mechanism is electrically signaled by the position-seeking "Metrisite" transducer . . . no parts to wear, infinite resolution, verifiable dynamic $\frac{1}{2}\%$ accuracy. Traces are permanent, high-contrast, reproducible . . . on low cost chart paper. The Mark 200 has but three standard controls . . . attenuator, pen position, chart speed. Such fidelity, simplicity and economy are possible with no other direct writing recorder. Write for details . . . they'll speak for themselves.

brush INSTRUMENTS

DIVISION OF

37TH AND PERKINS

CLEVITE
CORPORATION

CLEVELAND 14, OHIO

**NOW...
FROM RCA
NEW ECONOMIES
IN 200° C
SILICON POWER
TRANSISTORS**

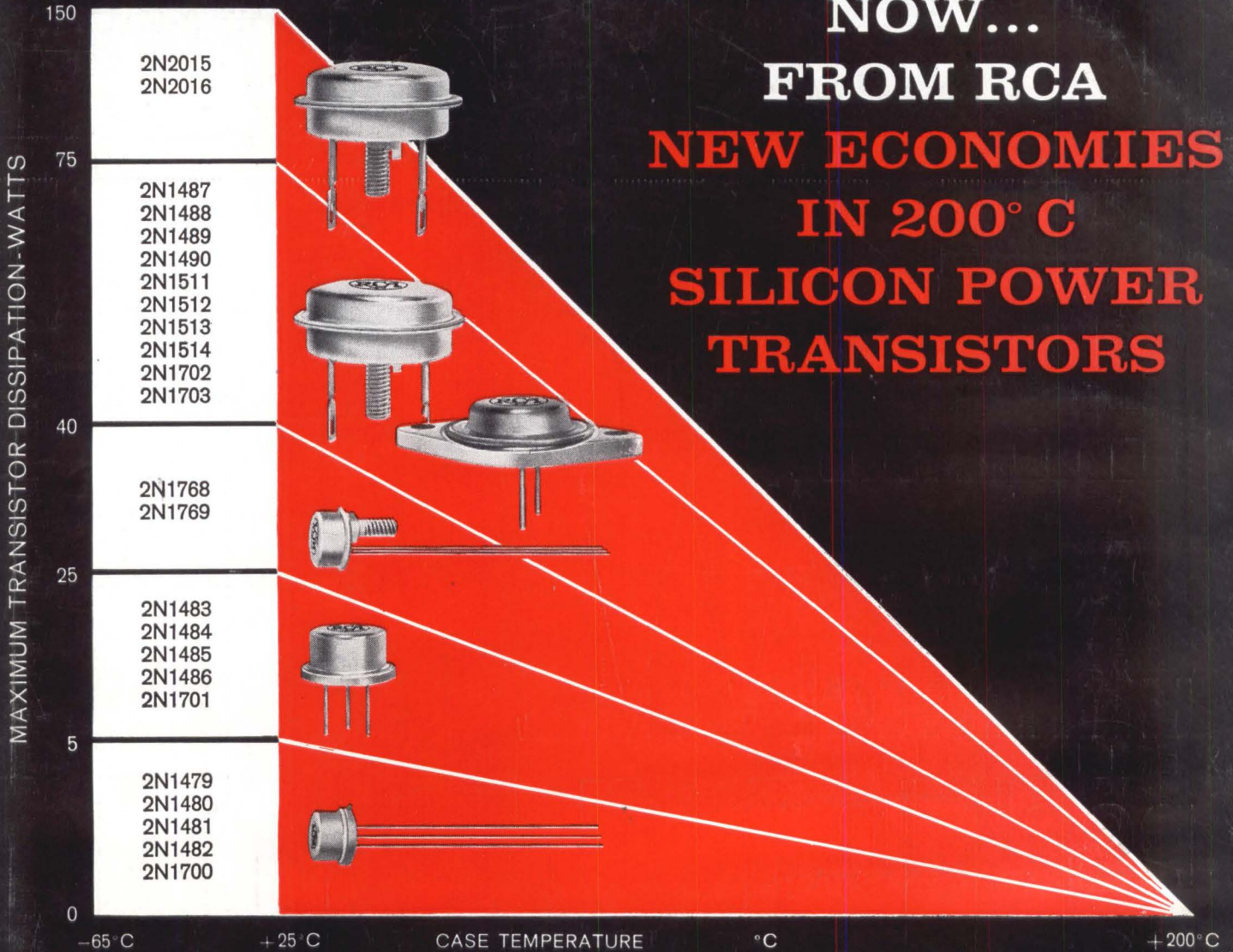

**Now Beta-Control Up To 10 Amperes...Extremely Low Saturation Resistance...
Power To 150 Watts At Prices Starting As Low As Comparable Germanium Power Types**

Check out the outstanding features of these 24 RCA N-P-N diffused-junction silicon power transistors, immediately available at low prices to meet your industrial and military applications requirements:

- Maximum operating temperature—up to 200°C.
- Maximum dissipation capability—up to 150 watts
- Very low thermal resistance—as low as 1.17°C/watt max.
- Very low saturation resistance—as low as 0.25-ohm max.
- High minimum beta
- Narrow Beta Spread

AVAILABLE THROUGH YOUR RCA DISTRIBUTOR

Call your RCA Field Representative today for complete sales and price information. For further technical information, write for RCA Technical Bulletins on these types. For detailed application information on the design of military and industrial equipment using RCA Silicon Power Transistors, send for new 28-page Application Guide on RCA Silicon Power Transistors—(Price: 50 cents per copy). Write to RCA Semiconductor and Materials Division, Commercial Engineering, Section C-19-NN-3, Somerville, N. J.



RCA FIELD OFFICES . . . EAST: Newark, N. J., 744 Broad St., HU 5-3900 • (Camden, N. J. area), Erlton, N. J., 605 Marlton Pike, HA 8-4802 • Syracuse, N. Y., 731 James St., Room 402, GR 4-5591 • Baltimore, Md., EN 9-1850 • **NORTHEAST:** Needham Heights 94, Mass., 64 "A" St., HI 4-7200 • **SOUTHEAST:** Orlando, Fla., 1520 Edgewater Drive, Suite #1, GA 4-4768 • **EAST CENTRAL:** Detroit 2, Mich., 714 New Center Bldg., TR 5-5600 • **CENTRAL:** Chicago, Ill., Suite 1154, Merchandise Mart Plaza, WH 4-2900 • Minneapolis, Minn., 5805 Excelsior Blvd., WE 9-0676 • **WEST:** Los Angeles 54, Calif., Box 54074, RA 3-8361 • (San Francisco area), Burlingame, Calif., 1838 El Camino Real, OX 7-1620 • **SOUTHWEST:** Dallas 7, Texas, 7905 Carpenter Freeway, FL 7-8167 • **GOV'T:** Dayton, Ohio, 224 N. Wilkinson St., BA 6-2366 • Washington, D. C., 1725 "K" St., N.W., FE 7-8500



The Most Trusted Name in Electronics
RADIO CORPORATION OF AMERICA

CIRCLE 200 ON READER SERVICE CARD