

electronics

INTEGRATED CIRCUITS

*Functional parts
aid design, p 72*

(Illustration below)

CRYOSAR DEVICES

*Promising computer
elements, p 39*

JUNCTION TRANSISTORS

*Chart classifies
modern types, p 46*

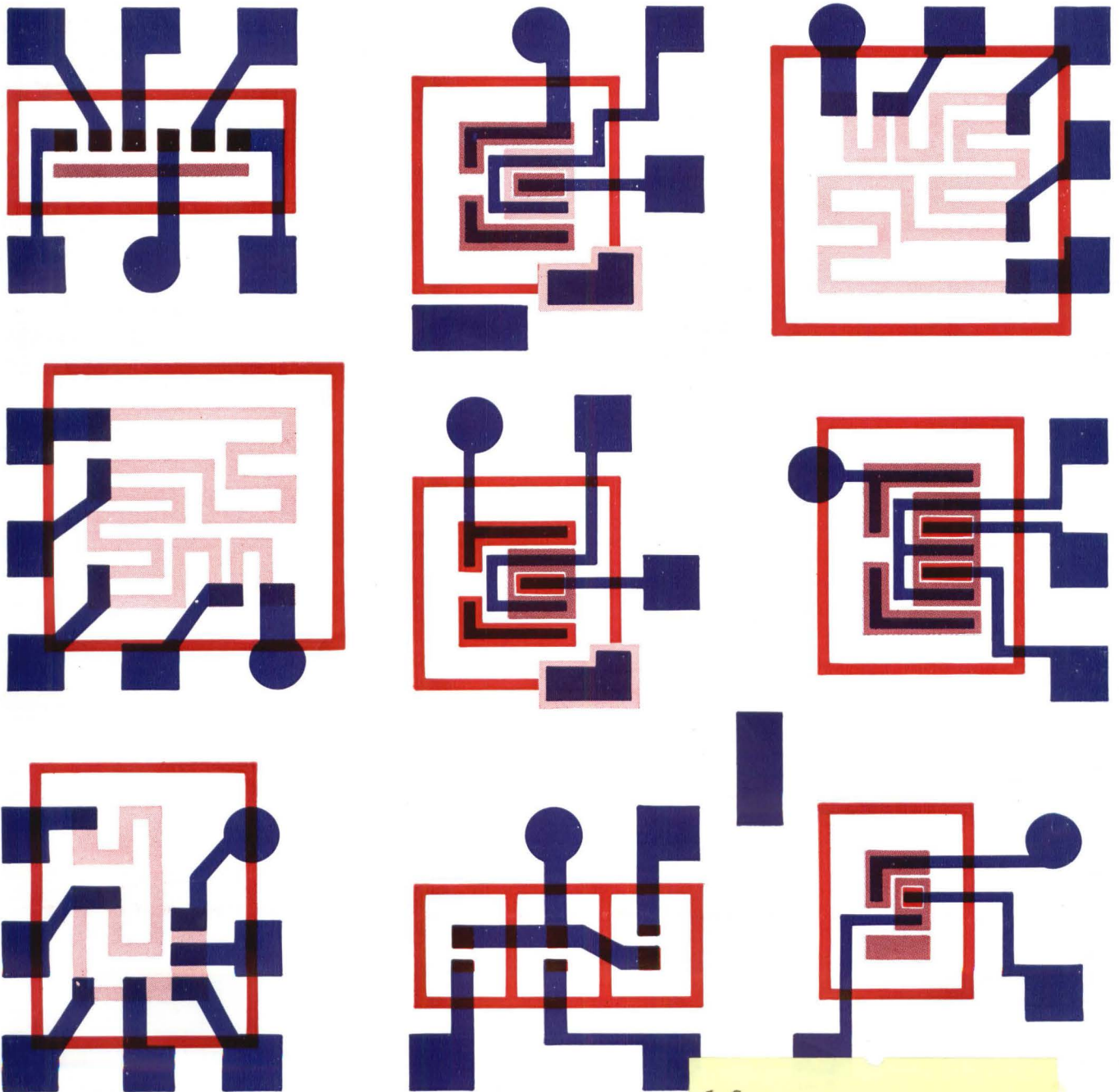

R D SKINNER
 1020 GOVINGTON RD
 LOS ALTOS CALIF
 C 3



FOR TOP RELIABILITY

MILITARY AND INDUSTRIAL

HERMETIC AUDIO AND POWER COMPONENTS... FROM STOCK

UTC stock hermetic units have been fully proved to MIL-T-27A, eliminating the costs and delays normally related to initial MIL-T-27A tests. These rugged, drawn case, units have safety factors far above MIL requirements, and are

ideal for high reliability industrial applications. Listed below are a few of over a thousand stock types available for every application. **Industrial ratings in bold.** Write For Latest Catalogs.

Typical Miniature Audios

RC-25 Case
61/64 x 1-13/32 x 1-9/16
1.5 oz.



| Type No | Application | MIL Type | Pri. Imp. Ohms | Sec. Imp. Ohms | Unbal. DC in Pri. MA | Response 2 db (Cyc.) | Max. level dbm |
|---------|--|-----------|------------------|----------------|----------------------|----------------------|----------------|
| H-1 | Mike, pickup. line to grid | TF4RX10YY | 50, 200CT, 500CT | 50,000 | 0 | 50-10,000 | + 5 |
| H-2 | Mike to grid | TF4RX11YY | 82 | 135,000 | 50 | 250-8,000 | +18 |
| H-5 | Single plate to P.P. grids | TF4RX15YY | 15,000 | 95,000 CT | 0 | 50-10,000 | + 5 |
| H-6 | Single plate to P.P. grids, DC in Pri. | TF4RX15YY | 15,000 | 95,000 split | 4 | 200-10,000 | +11 |
| H-7 | Single or P.P. plates to line | TF4RX13YY | 20,000 CT | 150/600 | 4 | 200-10,000 | +21 |
| H-8 | Mixing and matching | TF4RX16YY | 150/600 | 600 CT | 0 | 50-10,000 | + 8 |
| H-14 | Transistor Interstage | TF4RX13YY | 10K/2.5K, Split | 4K/1K split | 4 | 100-10,000 | +20 |
| H-15 | Transistor to line | TF4RX13YY | 1,500 CT | 500/125 split | 8 | 100-10,000 | +20 |

| Type No. | Application | MIL Type | Pri. Imp. Ohms | Sec. Imp. Ohms | Unbal. DC in Pri. MA | Response + 2 db (Cyc.) | Max. level dbm |
|----------|---|-----------|---|-----------------|----------------------|------------------------|----------------|
| H-20 | Single plate to 2 grids, can also be used for P.P. plates | TF4RX15YY | 15,000 split | 80,000 split | 0 | 30-20,000 | +12 |
| H-21 | Single plate to P.P. grids, DC in Pri. | TF4RX15YY | 15,000 | 80,000 split | 8 | 100-20,000 | +23 |
| H-22 | Single plate to multiple line | TF4RX13YY | 15,000 | 50/200, 125/500 | 8 | 50-20,000 | +23 |
| H-23 | P.P. plates to multiple line | TF4RX13YY | 30,000 split | 50/200, 125/500 | 8 BAL. | 30-20,000 | +19 |
| H-24 | Reactor | TF4RX20YY | 450 Hys.-0 DC, 250 Hys.-5 Ma. DC, 6000 ohms 65 Hys.-10 Ma. DC, 1500 ohms | | | | |
| H-25 | Mixing or transistors to line | TF4RX17YY | 500 CT | 500/125 split | 20 | 40-10,000 | +30 |



Typical Compact Audios

RC-50 Case
1-5/8 x 1-5/8 x 2-5/16
8 oz.

Typical Subminiature Audios

SM Case
1/2 x 11/16 x 29/32
.8 oz.



| Type No | Application | MIL Type | Pri. Imp. Ohms | Sec. Imp. Ohms | Unbal. DC in Pri. MA | Response + 2 db (Cyc.) | Max. level dbm |
|---------|-----------------------------|-----------|--|----------------|----------------------|------------------------|----------------|
| H-31 | Single plate to 1 grid, 3:1 | TF4RX15YY | 10,000 | 90,000 | 0 | 300-10,000 | +13 |
| H-32 | Single plate to line | TF4RX13YY | 10,000 | 200 | 3 | 300-10,000 | +13 |
| H-33 | Single plate to low imp. | TF4RX13YY | 30,000 | 50 | 1 | 300-10,000 | +15 |
| H-35 | Reactor | TF4RX20YY | 100 Henries-0 DC, 50 Henries-1 Ma. DC, 4,400 ohms. | | | | |
| H-36 | Transistor Interstage | TF4RX15YY | 25,000 (DCR800) | 1,000 (DCR110) | .5 | 300-10,000 | +10 |
| H-39 | Transistor Interstage | TF4RX13YY | 10,000 CT (DCR600) | 2,000 CT | 2 | 300-10,000 | +15 |
| H-40A | Transistor output | TF4RX17YY | 500 CT (DCR26) | 600 CT | 10 | 300-10,000 | +15 |

| Type No. | HV Sec. CT | DC MA* | Military Rating Fil. Secs. | DC MA* | Industrial Rating Fil. Secs. | Case |
|----------|------------|---------|----------------------------|---------|------------------------------|------|
| H-80 | 450 | 120 | 6.3V,2A. | 130 | 6.3V,2.5A. | FA |
| H-81 | 500/550 | 65/55 | 6.3V,3A-5V,2A | 75/65 | 6.3V,3A-5V,2A. | HA |
| H-82 | 540/600 | 110/65 | 6.3V,4A-5V,2A. | 180/100 | 6.3V,4A-5V,2A. | JB |
| H-84 | 700/750 | 170/110 | 6.3V,5A-6.3V,1A.,5V-3A. | 210/150 | 6.3V,6A-6.3V,1.5A-5V,4A. | KA |
| H-89 | 850/1050 | 320/280 | 6.3V,8A-6.3V,4A.,5V-6A. | 400/320 | 6.3V,8A-6.3V,4A.-3V,6A. | OA |



Typical Power Transformers

Pri: 115V 50/60 Cyc.
*Choke/Cond. inp.

| Type No. | Sec. Volts | Amps. | Test Volts | Case | Type No. | Sec. Volts | Amps. | Test Volts | Case |
|----------|------------|---------|------------|------|----------|------------|--------|------------|------|
| H-121 | 2.5 | 10(12) | 10 KV | JB | H-131 | 6.3 CT | 2(2.5) | 2500 | FB |
| H-122 | 2.5 | 20(26) | 10 KV | KB | H-132 | 6.3 CT | 6(7) | 2500 | JA |
| H-125 | 5 | 10(12) | 10 KV | KB | H-133 | 6.3 CT | 7(8) | 2500 | HB |
| H-130 | 6.3 CT | .6(.75) | 1500 | AJ | H-134 | 6.3 CT | 10(12) | 2500 | HA |

Typical Filament Transformers

Pri: 105/115/210/220V
except H-130 (115) and
H-131 (115/220) 50/60 Cyc.

Typical Filter Reactors

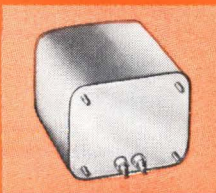

| Type No. | MIL Type | Ind. @ Hys. | MA DC | Ind. @ Hys. | MA DC | Ind. @ Hys. | MA DC | Ind. @ Hys. | MA DC | Res. Ohms | Max. DCV Ch. Input | Test V. RMS | Case |
|----------|-----------|-------------|-------|-------------|-------|-------------|-------|-------------|-------|-----------|--------------------|-------------|-------|
| H-71 | TF1RX04FB | 20 | 40 | 18.5 | 50 | 15.5 | 60 | 10 | 70 | 350 | 500 | 2500 | FB |
| H-73 | TF1RX04HB | 11 | 100 | 9.5 | 125 | 7.5 | 150 | 5.5 | 175 | 150 | 700 | 2500 | HB |
| H-75 | TF1RX04KB | 11 | 200 | 10 | 230 | 8.5 | 250 | 6.5 | 300 | 90 | 700 | 2500 | KB |
| H-77 | TF1RX04MB | 10 | 300 | 9 | 350 | 8 | 390 | 6.5 | 435 | 60 | 2000 | 5500 | MB |
| H-79 | TF1RX04YY | 7 | 800 | 6.5 | 900 | 6 | 1000 | 5.5 | 1250 | 20 | 3000 | 9000 | 7x7x8 |

And Special Units to
Your Specifications

UNITED TRANSFORMER CORPORATION

150 Varick Street, New York 13, N. Y.

PACIFIC MFG. DIVISION: 3630 EASTHAM DRIVE, CULVER CITY, CALIF.

EXPORT DIVISION: 13 EAST 40th STREET, NEW YORK 16, N. Y.

CABLES: "ARLAB"

CIRCLE 900 READERS SERVICE CARD

electronics

A McGraw-Hill Publication 75 Cents



W. W. MacDONALD, Editor

J. M. CARROLL, Managing Editor
SENIOR EDITORS: Samuel Weber, George W. Sideris. **SENIOR ASSOCIATE EDITOR:** Michael F. Wolff. **ASSOCIATE EDITORS:** Michael F. Tomaino, Sylvester P. Carter, William P. O'Brien, John F. Mason, Sy Vogel, Leslie Solomon, George J. Flynn, Laurence D. Shergalis. **ASSISTANT EDITORS:** Nilo Lindgren, Stanley Froud, Stephen B. Gray, Roy J. Bruun, George V. Novotny, Leon H. Dulberger. **REGIONAL EDITORS:** Harold C. Hood (Pacific Coast, Los Angeles), Thomas Maguire (New England, Boston), Cletus M. Wiley (Midwest, Chicago). **ART DIRECTOR:** Harry Phillips; Howard R. Berry. **PRODUCTION EDITOR:** John C. Wright, Jr. **EDITORIAL ASSISTANTS:** Gloria J. Meurer, Bernice Duffy, Lorraine Rossi, Virginia T. Bastian, Lynn Emery, Bette H. Snyder, Rosemary Abbruzzese, Ann Mella, Lorraine Werner. **FOREIGN NEWS BUREAU:** Director, John Wilhelm, Alyne Elias. **LONDON**—John Shinn, Derek Barlow, Nicholas Landon. **Bonn**—Peter Forbath, Silke McQueen. **Paris**—Robert Farrell, Arthur Erikson. **Milan**—Marc A. Messina. **Mexico City**—Bruce Bendow. **Rio de Janeiro**—Leslie Warren. **Moscow**—Stewart Ramsey. **Tokyo**—Richard Halloran, Charles Cohen, John Yamaguchi.

JAMES GIRDWOOD, Publisher

DIFFUSION MASKS used by Fairchild Semiconductor to make integrated-circuit components. *Devices help circuit designers plan and evaluate logic system breadboards. See p 72* COVER

ELECTROMAGNETIC COMPATIBILITY Analysis Center Begins Probe of Space Tracking RFI. Center is compiling data while tackling military interference problems. *Decisions reached by the center will heavily influence design, location and use of military electronics equipment* 20

TELSTAR'S TV PROGRAMS Underline American-European Cooperation. Here's how programs are converted, to satisfy differing tv standards, and transmitted over the Atlantic. *Launch of second satellite this fall will expand system* 26

NOBLE-GAS LASERS Provide More Optical Frequencies. Researchers demonstrate that 5 gases give 14 different frequencies at wavelengths between 1.5 and 2.2 microns. *Neon and helium mixture radiates coherent visible light* 28

SYNCHRONOUS SATELLITE Program Enters Second Phase. Development of full-size Syncom begins. *One of these could continuously relay voice and tv between the Americas, Europe and Africa* 30

CRYOSAR ELEMENTS Hold Promise for Tomorrow's Computers. A recent development in cryogenics, the Cryosar, operates by impact ionization of germanium at liquid helium temperatures. It may be used for storage cells, flip-flops and other computer building blocks. *Outstanding features are low cost, low power dissipation and simplicity of construction.*
 By L. M. Lambert and J. E. McAteer
 Aeronutronic Division of Ford Motor Co. 39

JUNCTION TRANSISTORS: A Guide to Modern Types. New chart classifies the many varieties according to method of fabrication. Grown, alloy, electrochemical, diffusion and epitaxial transistors are described. *Here is a clear and concise look at the basic differences in transistor configurations.*
 By R. L. Pritchard, Texas Instruments Inc. 46

OVERCOMING TURN-ON EFFECTS in Silicon Controlled Rectifiers. Limited turn-on speed of silicon controlled rectifiers causes problems in applications such as high-frequency inverters and pulse modulators. *Here are ways of avoiding unexpected triggering, high turn-on losses and possible device failure.*
 By N. Mapham, General Electric Co. 50

Published weekly, with Electronics Buyers' Guide and Reference issue as part of the subscription, by McGraw-Hill Publishing Company, Inc. Founder: James H. McGraw (1860-1948).

Title ® registered U.S. Patent Office; © copyright 1962 by McGraw-Hill Publishing Co., Inc. All rights reserved, including the right to reproduce the contents of this publication, in whole or in part.

Executive, editorial, circulation and advertising offices McGraw-Hill Building, 330 West 42nd Street, New York 36, N. Y. Telephone Longacre 4-3000. Teletype TWX N.Y. 1-1636. Cable McGrawhill, N. Y. PRINTED IN ALBANY, N. Y.; second class postage paid at Albany, N. Y.

OFFICERS OF THE PUBLICATIONS DIVISION: Nelson L. Bond, President; Shelton Fisher, Wallace F. Traendly, Senior Vice Presidents; John R. Callahan, Vice President and Editorial Director; Joseph H. Allen, Vice President and Director of Advertising Sales; A. R. Venezian, Vice President and Circulation Coordinator; Daniel F. Crowley, Vice President and Controller.

OFFICERS OF THE CORPORATION: Donald C. McGraw, President; Hugh J. Kelly, Harry L. Waddell, Executive Vice Presidents; L. Keith Goodrich, Executive Vice President and Treasurer; John J. Cooke, Vice President and Secretary.

Subscriptions are solicited only from those actively engaged in the field of the publication. Position and company connection must be indicated on orders. Subscription rates: United States and Possessions, \$6.00 one year, \$9.00 two years, \$12.00 three years. Canada, \$10.00 one year. All other countries \$20.00 one year. Single Copies, United States and Possessions and Canada 75¢. Single copies all other countries \$1.50.

THE PUBLISHER, UPON WRITTEN REQUEST FROM ANY SUBSCRIBER TO OUR NEW YORK OFFICE, AGREES TO REFUND THAT PART OF THE SUBSCRIPTION PRICE APPLYING TO COPIES NOT YET MAILED.

Subscribers: Please address change of address notices, subscription orders or complaints to Fulfillment Manager, Electronics, at above address. Change of address notices should provide old as well as new address, including postal zone number if any. If possible, attach address label from recent issue. Allow one month for change to become effective.

Postmaster: Please send Form 3579 to Fulfillment Manager, Electronics, 330 West 42nd Street, New York 36, New York.



Audited Paid Circulation

CONTENTS continued

NOVEL ZENER DIODE Array Forms High Speed Quantizer. Zener diodes provide simultaneous voltage comparison and stable voltage reference in an analog-to-digital converter while alleviating interaction problems inherent in conventional comparators. *Technique offers higher speed capability than is found in most other converters.*
By J. J. Kolarcik, Radio Corporation of America 52

SELECTING TV STANDARDS. Nomographs enable design engineers to get overall view of various combinations of bandwidth, resolution, scanning rates, aspect ratios and blanking interval. *This unusual design chart will be especially helpful to military and space tv designers.*
By J. W. Wipson 56

DEPARTMENTS

- Crosstalk. *The "Two Cultures" Controversy* 3
- Comment. *Powers of Number. Praise from a Student* 4
- Electronics Newsletter. *Niobium Makes Solid-Electrolyte Capacitor* 7
- Washington Outlook. *Army Wants 30,000 Planes, Navy Wants 518 New Ships* 12
- Meetings Ahead. *International Symposium on Quantum Electronics* 32
- Research and Development. *Thermoelectric Chamber Stabilizes P-C Boards. Gravity-Wave Generator* 64
- Components and Materials. *Evaluating Integrated-Circuit Performance* 72
- Production Techniques. *Making Bulbs for Double-Ended Tubes* 82
- New Products Design and Application. *Sweep Generator for Millimeter Frequencies* 88
- Literature of the Week 101
- People and Plants. *General Atronics Growth Continues* 102
- Index to Advertisers 109

The "Two Cultures" Controversy

IS WESTERN SOCIETY being split into two mutually antagonistic cultures, the traditional and the scientific? Is the gap between them becoming so wide it imperils our future?

A controversy over these questions began in England and is now gravitating to America. Because it focuses on challenges presented by the current scientific revolution, we consider it of particular interest to electronics engineers.

THE CONTROVERSY was triggered by a recent reply by British critic F. R. Leavis to a lecture given in 1959 by author-scientist C. P. Snow. Snow was shocked that no one in a literary group could describe the second law of thermodynamics, a question "which is about the scientific equivalent of 'Have you read a work of Shakespeare's?'" He went on to castigate literary people in general for being insufficiently aware of and in some ways opposed to the scientific revolution.

Scientists, Snow claims, struggle to improve man's social condition. This condition, he says, is that most humans are underfed and die before their time; it will, he thinks, be overcome by carrying out the scientific revolution, especially in the underdeveloped areas of the world. Scientists and engineers are called the people for this task, which Snow sees as the one way out through H-bomb war, over-population and the gap between rich and poor. Before they can be effectively utilized, however, it will be necessary to close the gap between the two cultures, he concludes.

THESE OPINIONS were attacked by Leavis because he was alarmed that Snow's "The Two Cultures and the Scientific Revolution" had become so influential as to be required reading in British schools. Leavis calls Snow "portentously ignorant" and feels that his thesis presents a challenge to be dealt with vigorously.

Leavis takes issue with Snow's description of the literary culture as well as with his idea of a world in which raising the standard of living is the almost exclusive aim. He questions Snow's emphasis of the world's overall social condition to the exclusion of the individual condition, and

calls for "something that is alien to either of Snow's two cultures," a third intelligence that is "strong in experience, and supremely human" to meet the challenges of the future arising out of the advance of science and technology.

This future, Leavis says, will be one of rapid changes, unprecedented tests and challenges, decisions and possible non-decisions, momentous and insidious in their consequences for mankind.

WE ARE KEENLY AWARE of the scientific revolution and of the importance of men who are in the forefront of it. Yet we disagree with much of Snow's story. We believe his picture of a society polarized into two antagonistic cultures to be exaggerated, and think that non-scientists are not as ignorant and opposed to science as Snow makes them out.

While concurring with Snow that Western technology should help underdeveloped nations to pass peacefully through their inevitable scientific revolution, we believe Leavis' warning that such concern is not enough to be a vital one. For the concern of man should not be solely with improving his physical standard of living. To suggest that we will be secure in a "scientific" future resulting from this concern is naive. Science and engineering will help us reach a better world, but only our humanity will enable us to realize it.

Coming In Our August 24 Issue

READING WRITING. Developers of reading equipment for data processing systems have made type and numeral readers practical and are going after handwriting readers. Next week, L. D. Harmon, of Bell Telephone Labs, describes a reader that identifies handwritten names of numerals. It makes logical decisions based on word appearance.

Other upcoming feature articles include a new approach to serial decoding, by R. M. Centner and J. R. Wilkinson, of Bendix Research Labs; a simplified curve tracer for displaying transistor beta, by J. V. McMillin, of Measurement Research Center; an r-f induction heater that simulates reentry, by B. E. Mathews and F. R. Sias, Jr., University of Florida, and a graphical method for designing digital circuits, by R. W. Hockenberger, of Avco.

ONLY H-K DIGITAL LOGIC

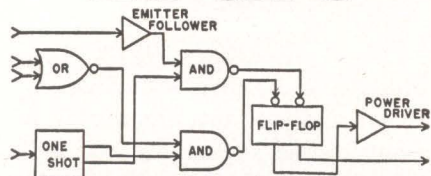

OFFERS THIS

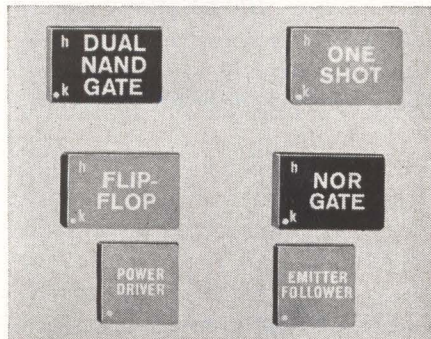

COMBINATION (and over 40,000 others)

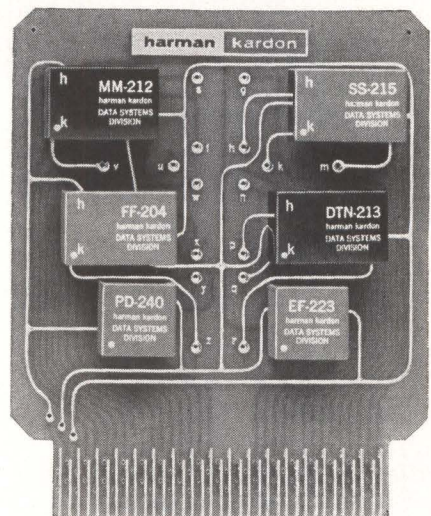

completely assembled
**FROM STOCK
COMPONENTS**
(at competitive prices)

3 COMPLETE AND COMPATIBLE
LOGIC MODULE SERIES
250KC • 125°C. • 5/10 MC

FREE! Send for complete details and...
FREE guide to Boolean Algebra!

Data Systems Division

harman kardon

Incorporated ■ Plainview, Long Island

COMMENT

Powers of Numbers

In the June 15 *Comment* (p 4) you rejected R. O. Whitaker's suggestion about his power-of-ten system on the grounds that it introduces severe printing problems.

May I point out that this same problem has been encountered in writing programs for digital computers. The solution to the problem has not only been found but is in widespread use. It is illustrated in the following table (using the example in Whitaker's letter):

| Prefix System | Power-of-Ten System | Digital Computer Notation |
|---------------|---------------------|---------------------------|
| 137 Tc | 137 (12) | 137. E+12 c |
| 64.8 nf | 64.8 (-9) | 64.8 E-9 f |
| 180 μohms | 180 (-6) | 180. E-6 ohms |

The letter E probably originated as an abbreviation for the word "exponent" (of ten multiplier). Note that the digital computer notation:

(1) Presents no print-setting problems. It can be (and regularly is) typed by *any* typist on conventional typewriters.

(2) Is already in widespread use by computer programmers.

(3) Is self-explanatory.

For further reference, you may check any of the numerous *Fortran* manuals distributed by I.B.M.

G. J. GALLAGHER

E. I. du Pont de Nemours &
Company
Wilmington, Delaware

Those parentheses in the power-of-ten portion of the table should really be circles around the numbers, in the Whitaker system. But, as reader Gallagher notes, circles around numbers involve printing problems.

A more recent letter from reader Whitaker, amending his original letter, ends with:

The one argument in favor of the prefixes is that it is easier to say "teracycles per second" than it is to say "times ten to the twelfth cycles per second." However, this advantage disappears if we use the word *up* to indicate positive powers of ten and the word *down* to indicate negative powers of ten. The fre-

quency in the example above would be spoken as "137 up 12." The capacitance would be spoken as "64.8 down 9."

An additional advantage of the exponent system over the prefix system is that order of magnitude of an expression may be more quickly obtained. In the case of the circle system, add the numbers in the circles. In the case of the prefix system, convert the prefixes, add up the characteristics of the numerical portions, and add the result to the converted prefixes.

R. O. WHITAKER

Rowco Engineering Company
Indianapolis, Indiana

Praise From a Student

At the moment, *ELECTRONICS* is the only electronics magazine I subscribe to. Before I ran across it in the library at Valparaiso University, I was continually frustrated by the rather immature and nonrigorous treatment of articles in the other well-known and popular magazines intended primarily for servicemen. Along with a few engineering journals, *ELECTRONICS* is the only publication which answers the needs of the serious student of electronics.

So I am glad that you have fulfilled your obligation to good scientific treatment of a scientific subject. And in particular I commend you for avoiding the characteristic dryness of some of the other journals, and for having a personality of your own which is inspiring instead of dully methodical.

It is true now that I am probably not the most valuable subscriber from the standpoint of your advertisers. But I shall probably still be reading *ELECTRONICS* when my time comes—so I hope you do not begrudge me the (most necessary) pleasure of your magazine now.

NORMAN R. DITTMAR
Petoskey, Michigan

In the interest of providing a wide variety of the latest information to this country's engineering students, who constitute one of the most valuable assets of the nation, we make a number of subscriptions available to senior engineering students.

predictable performance over wide ambient temperatures...

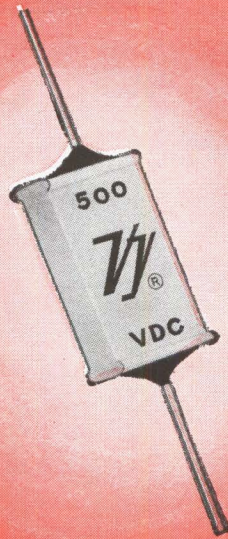

it's thermoproof!



solid state PORCELAIN CAPACITORS

- * low loss
 - * low noise
 - * greater stability
- * wide temperature range
 - * impervious to humidity

-55°C to +125°C operation
0.5 mmf to 6800 mmf
50 to 500 vdc
Conforms to MIL-C-11272B

© Vitramon, Inc. 1962

The monolithic, solid state construction of "VY" Capacitors give them a stability over a wide range of temperatures that is unique among components. When cycled between -55°C and 125°C, "VY" Capacitors exhibit essentially no capacitance drift (less than .05%) with no resultant physical damage or electrical change.

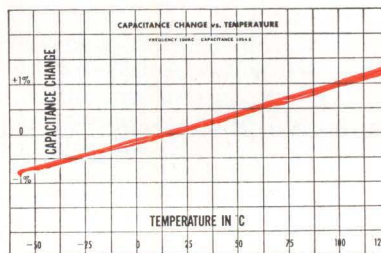

And performance is predictable! All "VY" Capacitors will retrace the curve, illustrated, within 5 ppm — an important factor in multi-stage circuits where capacitance must change in an identical manner in all stages, or where precise compensation is needed.

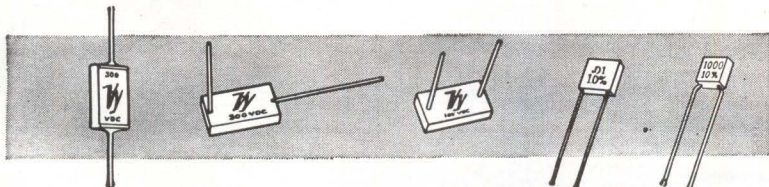

VITRAMON[®]

INCORPORATED

Box 544 • Bridgeport 1, Connecticut

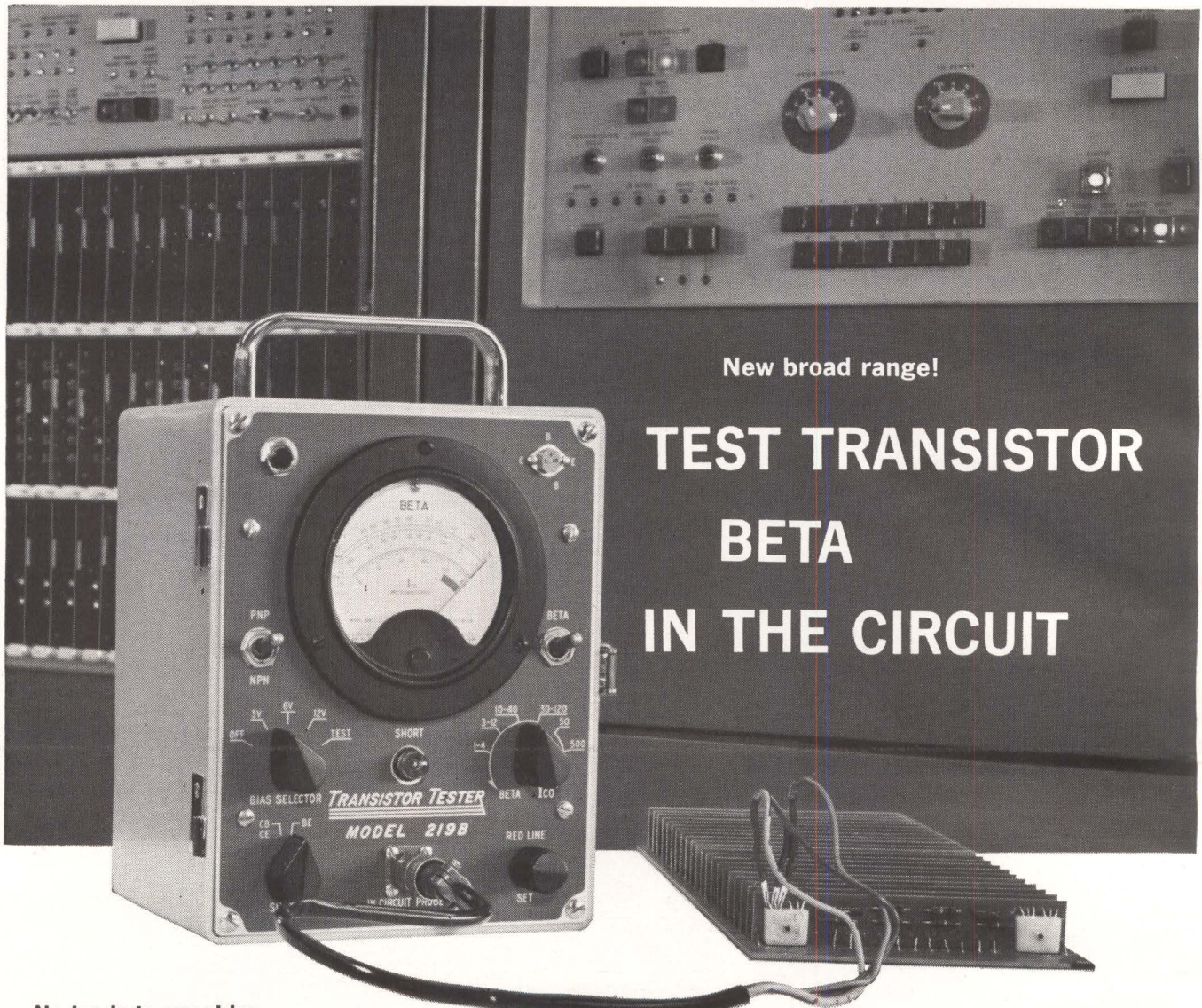

New broad range!

TEST TRANSISTOR BETA IN THE CIRCUIT

No leads to unsolder
Four overlapping Beta Ranges • High meter resolution
Direct reading with test circuit power off

SEE US AT WESCON

SPECIFICATIONS

- Test ranges**
 Beta 1-4, 3-12, 10-40, 30-120*
 I_{CO}: 0-50, 0-500 ua
- Accuracy**
 In circuit: ±20% for external loads over 500 ohms. Improved accuracy above 500 ohms, usable readings below 500 ohms.
 Out of circuit: ±10%
- Power:** Internal battery, mercury or zinc-carbon type, 600 hrs. av. life; output indicated on front-panel meter.
- Operating Temperature:** 32 to 149° F
- Size:** 9" high, 7⁵/₈" wide, 6¹/₂" deep, weight, 10¹/₄ lb., including batteries.
- Price:** \$275.00
 *Beta readings to 300 may be approximated.

New Sierra 219B 4-range Transistor Tester reads Beta directly in the circuit; also measures I_{CO}, Beta out of circuit.

Less downtime and less danger of damage to transistors under test with this new Sierra instrument—battery-operated, light weight, portable, easy to use.

Maintenance, quality control, incoming inspection and production testing are just a few of the applications where you save time and money by testing transistors, even complete assemblies, without unsoldering leads. Model 219B reads Beta in the circuit, 1 to 120. I_{CO} is measured on a straightforward basis; collector potentials of 3, 6 or 12 vdc may be selected. All controls are on the front panel . . . an instrument of convenience, speed, accuracy.

Write or phone today for information and demonstration.

PHILCO
 A SUBSIDIARY OF *Ford Motor Company*



SIERRA ELECTRONIC DIV.
 6919A BOHANNON DRIVE, MENLO PARK, CALIF.
 Phone, Area Code 415, 326-2060

ELECTRONICS NEWSLETTER

Niobium Capacitor Will Make Bow at WESCON

BOSTON—Solid niobium capacitor will be unveiled next week at WESCON by Sprague Electric Co. The solid-electrolyte capacitor has electrical characteristics and applications similar to tantalum. Two advantages cited by Sprague are:

First, niobium is more abundant and is available in domestic ores. The U. S. depends on Katanga, in the Congo for tantalum, so its use in the U. S. is controlled. Second, niobium prices may be lowered in the future, although first prices will be comparable to tantalum.

Sprague reports it worked three years on development of the solid niobium capacitor and has developed a process related to but substantially different from the tantalum process. Packages are identical to tantalum packages.

The company sees interest by the military, since niobium capacitors offer relief from the tight tantalum supply situation, and by industry too, since applications will be protected against the possibility of the government shutting off the supply of tantalum for nonmilitary uses.

NBS Establishes Three New Electronics Sections

CIRCUIT STANDARDS division at National Bureau of Standards' Boulder, Colorado, Laboratories, has created three new sections from units of the Electronic Calibration Center. The role of each of the new sections will be to continue to develop, maintain, and improve calibration services, instrumentation and measurement techniques. The new sections provide microwave calibration services, high-frequency calibration services and low-frequency calibration services.

Visible Light Lasers Go Onto Commercial Market

TWO COMPANIES have announced the commercial availability of c-w visible-light lasers, both helium-neon units with output in the 6,300 angstrom region. Both are priced at

\$7,500. One is being introduced at WESCON by Perkin-Elmer, who jointly developed it with Spectra-Physics, Inc., and the other is being introduced by Raytheon. The Raytheon unit has an estimated output of 15 μ w in a single mode, higher output in multimode operation.

Perkin-Elmer pointed out that feasibility had been reported by Bell Telephone Labs last month. Resonator design is similar to that shown last week by Bell Labs (see p 28). The exciter is a d-c-powered, 40-w, 40.68-Mc oscillator.

Field Measurements Detect Distant Nuclear Explosion

BOSTON—The recent high-altitude nuclear blast at Johnston Island was detected electromagnetically 6,000 miles away in Natick, Mass., by researchers from Space Sciences Inc. Arthur Winston, company

president, says the technique involves amplifying and recording below vlf, at frequencies of the order of 1 cps.

Nonpolarizable contacts 6 or 7 inches in diameter are imbedded in earth at five points in the Natick area, 100 feet to 1,000 feet apart. The electric field potential between two or more probes is amplified and fed into an x-y recorder which plots variations in potential against time. These marks of electric field measurements plotted against time yield a clear signature of the blast, says Winston, providing a picture of how ionospheric changes affect electric fields in the earth. The recordings are being analyzed for implications in nuclear test detection.

Japanese Form Guild For Computer Research

TOKYO—The Computer Technology Research Guild, an organization to correlate research on large computers in an attempt to compete with U. S. firms, was recently formed by Nippon Electric Co., Fuji Electric Communication Apparatus Mfg. Co. and Oki Electric Co.

Plans include development and manufacture within three years of a large, high-efficiency computer comparable to the IBM 7090. NEC will develop magnetic core equipment, Fuji the punch-card system and Oki the printer. The rest of the

One Way or Another, Hong Kong Gets Transistors

TOKYO—Reports reaching Japan say the Hong Kong government has refused the offer by the Ministry of International Trade and Industry to lift the ban on exports of transistors from Japan to Hong Kong. Exports were suspended since last May. Hong Kong has reportedly made arrangements to import transistors from West Germany and other European countries.

Neither the Japanese Foreign Office nor MITI received official reports from their consulates in Hong Kong. They were puzzled by the reports reaching the industry.

A spokesman for the Japan Machinery Export Association said however, "Whether the Hong Kong Government says yes or not, it does not make much difference so far as transistor exports to Hong Kong are concerned because stuffs are going anyway on business deals."

The Japan Electronics Parts Industry Association, with a membership of 120 firms, recently said a contract will be signed with one Hong Kong firm to export monthly 50,000 kits for six-transistor radios worth \$250,000. A spokesman for the association said similar deals will be signed with other Hong Kong companies

system will be developed jointly. Total development cost will be about \$2 million. The guild has received a \$241,666 government subsidy for fiscal 1962.

Navy Weighs Design for TFX Plane's Missiles

WASHINGTON—Navy has accepted the technical proposal of Hughes Aircraft for an air-to-air missile system that would be used on the Navy's version of the TFX tactical fighter plane (p 14, July 13, and p 14, Dec. 29, 1961). Hughes won in competition with Bendix, Grumman and Raytheon.

The Navy stressed that Hughes' selection does not commit it to final missile development. Says the Navy: "The major objectives will be to refine further the system proposal and to define the system characteristics in conjunction with the aircraft design studies."

The qualifications in Hughes' status reflect the extension of competition between Boeing and General Dynamics (with Grumman as a partner) for a Pentagon development contract for the plane itself.

Du Pont Enters Instrument Business With Analyzer

WILMINGTON, DEL.—An on-stream photometric analyzer of liquids, gases and some solids will be the first product of DuPont's Instrument Products division, established last January. To determine a materials' composition, the instrument measures the amount of visible or ultraviolet light of a specific wavelength that a sample absorbs. A similar principle is also used to measure the thickness of transparent and translucent films and coatings.

Army Command to Manage Electronic Activities

ARMY ELECTRONICS COMMAND, for the management of research, development, procurement and production of electronic material required by the Army, has been

officially established, announced Maj. Gen. S. S. Hoff, commander. The command, located at Ft. Monmouth, N. J., will also provide contact between the Army and industry. Operating budget is expected to vary between \$700 million and \$1 billion.

Electronics Command is one of five middle management commands, others being Missile, Weapons, Mobility and Munitions Commands.

Space Fuel Cell Contract Awarded By Air Force

SOLID-ELECTROLYTE fuel cell, able to operate at temperatures as high as 1,850 F, will be developed for the Air Force space program by Westinghouse Research Labs. The contract calls for modification of a previously developed experimental cell (p 27, June 8), to determine its feasibility for space use and for evaluation of the cell in comparison with other space power systems.

Electrolytes will be ceramic mixtures such as zirconium and calcium oxide. Electrodes will be metals such as platinum or nickel. Fuel will be hydrogen, fed to the negative electrode, and oxygen, fed to the positive electrode. Westinghouse says its experimental version has produced current densities of more than 100 amperes a square foot and that cells operated at low current density have operated longer than two months with no noticeable deterioration.

Industry Will Receive NASA Research Results

INDUSTRIAL APPLICATION advisory committee will coordinate NASA's efforts to transfer new scientific and technological knowledge from NASA's research and development to industry. The committee will recommend methods for identifying, retrieving, evaluating and disseminating innovations having a high industrial potential. Recommendations will be implemented through NASA's Office of Applications. E. P. Stevenson, who formerly held industrial positions, will head the committee.

In Brief . . .

MARINER II will be launched by NASA, no earlier than today, in the second attempt to reach Venus.

GENERAL ELECTRIC is entering the process instrumentation field. It estimates total annual market for equipment will grow from \$330 million now to \$700 million in 1970.

RADIO AND TV production during the first six months of 1962 was higher than in the first six months of 1961, reports EIA. Total tv output was 3,295,501 compared to 2,801,136 last year, and radio production was 9,264,445 compared to 7,537,290.

JAPANESE electronics output input increased 20 percent during 1961 to a total of \$1.4 billion, according to the U. S. Department of Commerce.

RAYTHEON reports that its Sparrow III missile, launched from an F4H fighter plane, downed a supersonic Regulus II missile. Raytheon quoted Navy as stating it was the first head-on interception of a ground-launched missile by an air-launched missile.

RADAR ALTIMETER with a range of zero to 5,000 feet is to be developed by Sperry Gyroscope for Air Force. Error below 40 feet is to be no more than 2 feet.

EIA ANNOUNCES that more than 60 microwave components manufacturers have agreed to participate in a statistical program for the industry.

CONTRACTS include \$1 million to Vitro Electronics, for 500 h-f communications sets; \$650,000 to Manson Labs, for r-f oscillators; \$469,000 to U. S. Science Corp. for aircraft instrument testers.

GENERAL ELECTRIC is developing a monitoring and telemetry system for a Snap 10-A, 500-w nuclear space power system being developed by Atomics International for AEC. Under another AEC contract, Martin Co. is to develop a conceptual design for another 500-w nuclear power system.

New from Sprague!

**GET THE FULL STORY AT
WESCON BOOTH 640**

2 x μ F

Get nearly twice the capacitance of older designs in Sprague's new high-gain etched-foil TANTALEX[®] Capacitors

IMPROVE FILTERING EFFICIENCY WITH NO SACRIFICE IN RELIABILITY, SIZE, OR WEIGHT!

HIGH CAPACITANCE Tubular Tantalex Capacitors with almost double the capacitance of standard etched-foil tantalum capacitors have been developed by the Sprague Electric Company to meet the needs of design engineers.

A new etching technique, the result of an intensive research program, gives considerably higher effective surface area to the capacitor electrodes *without sacrifice in reliability or in any of the electrical parameters* by which foil tantalum capacitors are usually judged.

Unlike other "high capacitance" foil tantalums, Sprague Tantalex Capacitors continue to maintain their rigid standards for shelf and service life under severe environmental conditions. Certain performance characteristics have actually been tightened. For example, allowable leakage current has now been halved, making the use of these capacitors possible in many new applications.

Etched-foil Tantalex Capacitors are available in two operating temperature ranges—polarized Type 112D and non-polarized Type 113D for -55 C to $+85\text{ C}$ operation, as well as polarized Type 122D and non-polarized Type 123D for -55 C to $+125\text{ C}$ operation.

The Foil-type Tantalex Capacitor Line also includes conventional low-gain etched-foil and plain-foil capacitors in both polarized and non-polarized construction, providing a foil tantalum capacitor for every application.



For complete technical data on 85 C capacitors, request Engineering Bulletin 3601B. For the full story on capacitors for 125 C operation, write for Engineering Bulletin 3602B. Address Technical Literature Section, Sprague Electric Company, 35 Marshall Street, North Adams, Massachusetts.

SPRAGUE COMPONENTS

CAPACITORS
TRANSISTORS
MAGNETIC COMPONENTS
RESISTORS
MICRO CIRCUITS

INTERFERENCE FILTERS
PULSE TRANSFORMERS
PIEZOELECTRIC CERAMICS
PULSE-FORMING NETWORKS
TOROIDAL INDUCTORS

HIGH TEMPERATURE MAGNET WIRE
CERAMIC-BASE PRINTED NETWORKS
PACKAGED COMPONENT ASSEMBLIES
FUNCTIONAL DIGITAL CIRCUITS
ELECTRIC WAVE FILTERS

SPRAGUE[®]
THE MARK OF RELIABILITY

'Sprague' and '®' are registered trademarks of the Sprague Electric Co.

45-402

August 17, 1962

CIRCLE 9 ON READER SERVICE CARD 9

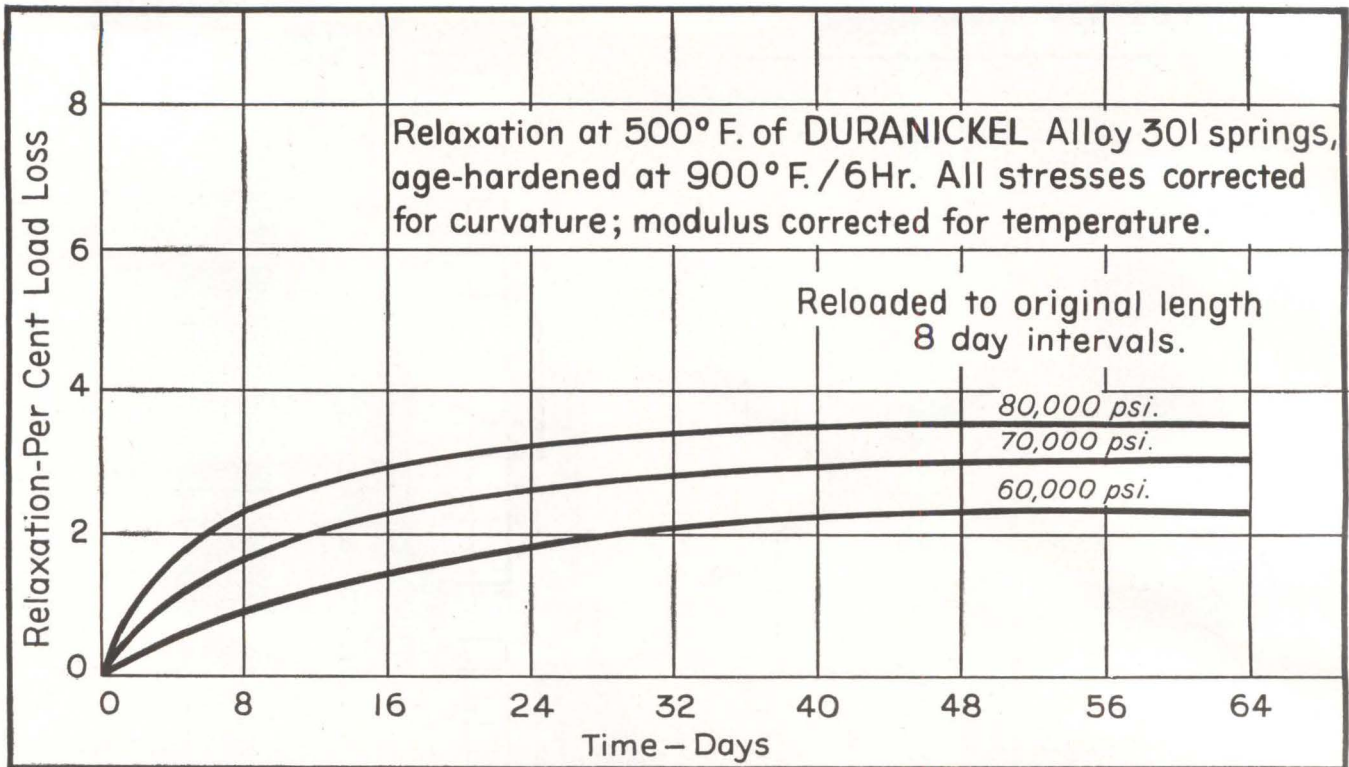

Nickel Alloy Springs last longer in Corrosive Environments and at High Temperatures

The physical constants of DURANICKEL Alloy 301 and PERMANICKEL Alloy 300

Kick out switches, relays, circuit breakers, solenoid valves, diaphragms and other spring type assemblies play a vital part in the efficiency of electrical equipment. If corrosion or high temperatures are important factors in the reliability and service life of your spring assembly, make sure they are made from a high nickel alloy for: (1) high strength stability; (2) resistance to relaxation at elevated temperatures; (3) oxidation resistance; (4) resistance to corrosive environments with good electrical properties.

INCONEL* Alloy X-750 is the outstanding choice for springs operating up to 1200° F because of its high strength stability, good oxidation and corrosion resistance, and resistance to relaxation.

DURANICKEL* Alloy 301 gives excellent service at temperatures up to 600° F. It is used for infrared bulb spring contacts, springs in sun lamps and spark plugs, electric toaster coils and numerous other applications requiring relaxation resistance at elevated temperatures.

| PHYSICAL CONSTANT | DURANICKEL Alloy 301 | PERMANICKEL Alloy 300 |
|--|-----------------------|-----------------------|
| SPECIFIC GRAVITY, GM/CM | 8.26 | 8.75 |
| DENSITY, LB./CU. IN. | 0.298 | 0.316 |
| THERMAL CONDUCTIVITY AT (32°-212°F.) BTU./SQ. FT./HR. °F./IN. | 128/137** | 400 |
| ELECTRICAL RESISTIVITY OHMS/CIR. MIL. FT. (68°F.) | 260** | 94.5** |
| MICROHMS/CM. (20°C.) | 43** | 15.7** |
| TEMP. COEF. OF RESISTIVITY PER°F. (68°-212°F.) | 0.0006 | 0.002 |
| PER°C. (20°-100°C.) | 0.001 | 0.0036 |
| MEAN COEF. OF THERMAL EXPAN. AT (77°-212°F.), IN./IN./°F. AT (25-100°C.) CM./CM./°C. | 0.0000072 0.000013 | 0.0000072 0.000013 |
| MAGNETIC TRANSFORMATION TEMP. F. (APPROX.) | 200** | 563** |

**Age-Hardened

Design Stress for age-hardened DURANICKEL Alloy 301 and PERMANICKEL Alloy 300 springs at elevated temperatures.

| Coiling Method | Maximum Shearing Stress for temperatures (°F.) indicated | |
|----------------|--|---------------|
| | Up to 400°F. | 550 to 600°F. |
| Cold | 70,000 psi | 60,000 psi |
| Hot | 70,000 psi | 60,000 psi |

Other nickel alloys recommended for electrical spring assemblies include — PERMANICKEL* Alloy 300 high electrical and thermal conductivity requirements, MONEL* Alloy 400 for

general applications requiring corrosion resistance in addition to toughness and strength up to temperatures of 450° F and INCONEL Alloy 600 for good strength, ductility, resistance to oxidation and good spring properties up to 750° F.

You can get the complete story on nickel alloy springs. Write for our technical bulletin T-35, "High Nickel Alloy Helican Springs." Our corrosion and high temperature engineers will be glad to help with any specific problem you have.

*Registered trademark

HUNTINGTON ALLOYS



HUNTINGTON ALLOY PRODUCTS DIVISION
The International Nickel Company, Inc.
Huntington 17, West Virginia

HOW TI 2N930/2N2411 GIVE YOU INPUT IMPEDANCES GREATER THAN ONE MEGOHM

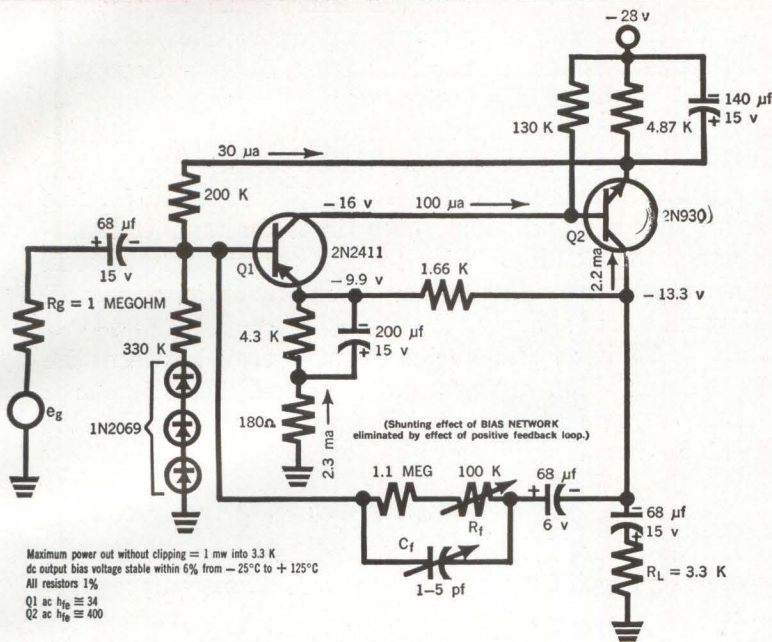

Maximum power out without clipping = 1 mw into 3.3 K
dc output bias voltage stable within 6% from -25°C to +125°C
All resistors 1%
Q1 ac $h_{fe} \approx 34$
Q2 ac $h_{fe} \approx 400$

TYPICAL CIRCUIT PERFORMANCE FEATURES WITH TI 2N930/2N2411

- Input Impedance > 1 megohm
- Wide Frequency Response = A_v 1 db Bandwidth 100 cps - 230 KC
R_g = 1 megohm
- Low Noise Voltage = 1.2 µv (rms), R_g = 0
- Stable Voltage Gain = 20 db ± .05 db from -25°C to +125°C
- Low Power Consumption = 65.5mw
- Small Loads Possible = down to 3.3 KΩ
- Power Gain = 46 db

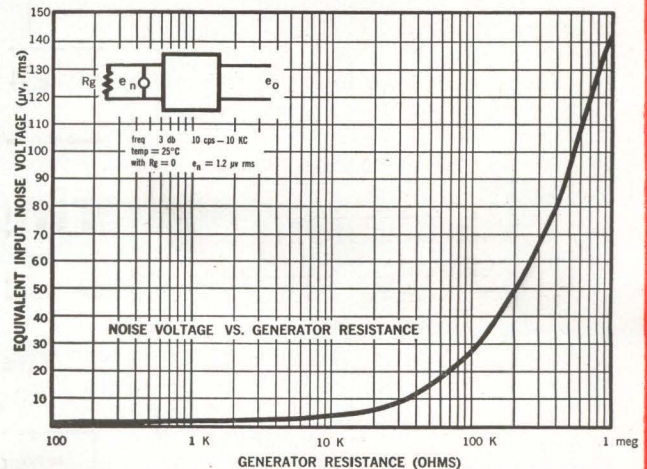
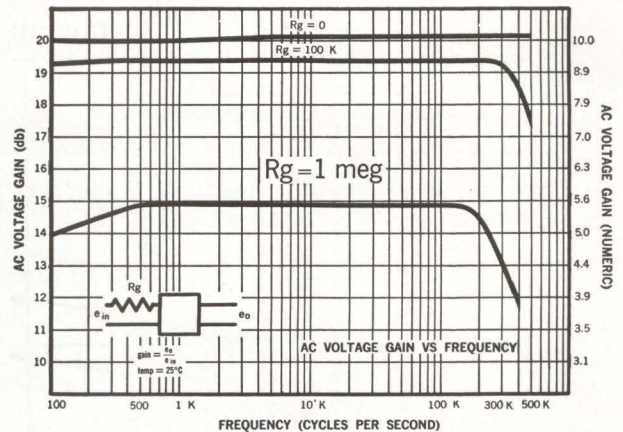

SIMPLIFY AMPLIFIER DESIGN WITH COMPLEMENTARY TI 2N930/2N2411 SILICON PLANAR TRANSISTORS

Now you can get input impedances greater than 1 megohm for your high impedance transducer applications using TI 2N930/2N2411. Complementary TI 2N930 (NPN)/2N2411 (PNP) transistors, both TO-18 case, also allow you single power supply design for direct coupling of low-level, high impedance sources. You get more stability, reliability and econ-

omy because you need fewer power supplies and fewer circuit elements. ■ For delivery when you need it on the TI 2N930 and 2N2411, call your TI Sales Office or Authorized TI Distributor!

| | TEST CONDITIONS | | LIMITS |
|-------------------|-----------------|---|-----------------|
| BV _{CEO} | 2N930 | I _C = 10 ma, I _B = 0 | 45 v min |
| | 2N2411 | I _C = -10 ma, I _B = 0 | -20 v min |
| I _{CES} | 2N930 | V _{CE} = 45 v, V _{BE} = 0 | 0.01 µa max |
| | 2N2411 | V _{CE} = -25 v, V _{BE} = 0 | -0.01 µa max |
| h _{FE} | 2N930 | V _{CE} = 5 v, I _C = 10 µa | 100 min-300 max |
| | 2N2411 | V _{CE} = -0.5 v, I _C = -50 µa | 10 min |
| h _{FE} | 2N930 | V _{CE} = 5 v, I _C = 10 ma | 600 max |
| | 2N2411 | V _{CE} = -0.5 v, I _C = -10 ma | 20 min-60 max |
| h _{re} | 2N930 | V _{CE} = 5 v, I _C = 500 µa, f = 30 mc | 1 min |
| | 2N2411 | V _{CE} = -10 v, I _C = -10 ma, f = 100 mc | 1.4 min |
| N.F. | 2N930 | V _{CE} = 5 v, I _C = 10 µa, R _g = 10 KΩ Noise Bandwidth 10 to 15 KC | 3 db max |
| | 2N2411 | V _{CE} = -0.5v, I _C = -50 µa, R _g = 10 KΩ Noise Bandwidth 10 to 15 KC | 2 db typ |

Other combinations are possible with 2N929/2N2412.

FOR DETAILED DESIGN INFORMATION CIRCLE READER REPLY CARD

TRANSISTOR
PRODUCTS
DIVISION



TEXAS INSTRUMENTS
INCORPORATED
13500 N. CENTRAL EXPRESSWAY
P. O. BOX 5012 • DALLAS 22, TEXAS

WASHINGTON OUTLOOK

ARMY WANTS ITS OWN 30,000-PLANE AIR FORCE

SUBSTANTIAL EXPANSION in Army aircraft procurement, now only \$218 million a year, is shaping up. An Army board of generals, headed by Lt. Gen. H. H. Howze, is studying new approaches to Army mobility on the battlefield, under instructions from Defense Secretary McNamara. The board proposes a massive stepup in procurement of diversified types of aircraft, ranging from radically new, small, air-cushion vehicles to large, four-engine turboprop transports.

The proposals reportedly call for 30,000 Army planes by 1970, five times what the Army now has and about three times the number tentatively authorized under the Pentagon's long-range operational plans. If the proposals are accepted, Army requirements for conventional ground transport vehicles would be cut sharply.

The Howze study is reviving the ancient controversy between the Army and Air Force over aviation roles and missions. The Air Force views the Army plan to expand its aircraft forces with considerable suspicion, considers it an invasion of its own bailiwick.

NAVY SEEKS \$25 BILLION IN NEW SHIPS

NAVY IS PUSHING PLANS for a substantial ship modernization program, against the backdrop of the administration's stress on preparation for limited war.

About 75 percent of the fleet was built during World War II. Navy wants at least 518 new vessels in the next seven years, double the present shipbuilding program. The cost, about \$25 billion, would be well over the Pentagon's present long-range plans for naval modernization.

The Navy has an ally in a House Armed Services Subcommittee. Headed by Rep. R. Mendel Rivers (D-S.C.), it is making an inquiry into what it calls a "warship gap" in U.S. defenses.

STRAW IN THE SATELLITE WIND: LOWER RATES FOR U. S.

NOTHING HAPPENED to the Communications Satellite Act during last week's hearings before the Senate Foreign Relations Committee. The committee sent the bill back to the Senate unchanged. The bill was sent to the committee in an effort to break the marathon debate begun by a group of 10 to 15 senators led by Estes Kefauver (D-Tenn.) and Wayne Morse (D-Ore.), who want government ownership of the system.

The only positive result of the week's delay in the showdown was the increased likelihood of reduced rates for government use of the satellite communications system. Support for this was voiced, although amendments putting it in writing were voted down in committee.

Top Administration officials supporting the bill, including Attorney General Robert F. Kennedy, Secretary of State Dean Rusk and FCC Chairman Newton Minow, did little to sway the dissident senators.

SARNOFF'S PROPOSAL DOES NOT STIR D. C.

WHILE THE ADMINISTRATION was lobbying hard for approval of the satellite monopoly, it was being urged by David Sarnoff, RCA chairman, to unify overseas communications policy and merge all American international carriers into a single company. The proposal, made in a speech before the American Bar Association, was not received by the administration with the warmth shown for the satellite communications plan. Similar proposals have been rejected previously. The best opinions in Washington are that no immediate action will be taken on the offer.

Trigger 2500 Volts at 1000 Amps



with Long-Life Raytheon CK1066 and CK1067

Looking for a miniature trigger tube which can reliably deliver over a million starts under extremely high hold-off voltage and pulse current? Consider the many advantages of Raytheon's CK1066 and CK1067. These reliable cold-cathode, gas-filled types require no heater voltage or standby power. And, because of their unique control grid construction, they offer positive control with low energy signal for high energy output.

If you are concerned with the design of turbine ignition systems, industrial control equipment, or other applications requiring a reliable arc-discharge trigger device, be sure to investigate the Raytheon CK1066 and CK1067.

RATINGS (ABSOLUTE VALUES) CK1066 AND CK1067

| | Min. | Max. |
|---|--------|---------|
| Anode hold-off voltage (Anode to grid, anode positive) | — | 2500 V |
| Anode operating voltage (Anode to cathode, anode positive) | 1000 V | 2800 V |
| Grid firing voltage (Grid to cathode, grid positive) | 300 V | 500 V |
| Grid current (peak reverse) | — | 5 ma |
| Peak anode current | 100 a | 1000 a |
| DC Anode current | — | 12 mAdc |
| Anode Input Power | — | 20 W |
| Bulb Temperature | -55 °F | +200 °F |
| Pulse Repetition Rate | — | 20 cps |

For complete technical data please write:

Raytheon Company, Industrial Components Division, 55 Chapel Street, Newton 58, Massachusetts

INDUSTRIAL COMPONENTS DIVISION

RAYTHEON

NEWTON 58, MASSACHUSETTS

CIRCLE 13 ON READER SERVICE CARD

NOW 1/2 μ SEC CAPABILITY IN RCA'S COMPLETE, INTEGRATED MEMORY PRODUCT LINE

RCA adds new ultra-high-speed, low-drive Microferrite Stacks to its full, integrated line of memory components.

New 0.5 μ sec Microferrite Word-Address Memory Stacks: RCA's new Microferrite Memory Stacks make possible complete read/write cycle times of less than 0.5 μ sec at driving currents no higher than 350 ma with at least 50 mv output. This revolutionary new stack, designed to meet Military Specifications, is a result of RCA's broad experience in producing thousands of memory planes and stacks in hundreds of configurations.

Versatile RCA Memory Planes and Stacks: In addition to the new Microferrite Word-Address Memory Stack, RCA's broad line includes: Wide temperature range stacks incorporating temperature stable, high-temperature ferrite cores...Temperature controlled stacks designed to meet MIL Specifications...Conventional memory stacks without temperature controls for applications requiring high quality at lowest possible price. All RCA planes and stacks are 100% dynamically tested to assure compliance with operating specifications. Planes are available in molded plastic, printed circuit and aluminum frames.

Wide-Margin Ferrite Cores — High-Speed Transfluxors: RCA offers one of the industry's most comprehensive lines of memory cores all designed with specified wide operating margins. One of the newest additions to the line is type 233 M1, a high-temperature core having an output variation less than 0.25 mv per $^{\circ}$ C over a 140 $^{\circ}$ C temperature range. RCA memory transfluxors are available with switching speeds as fast as 1.3 μ sec.

Field-Proved Complete Memory Systems: You can choose from a broad range of standard RCA types and custom designs to suit your needs. RCA is prepared to meet the tightest custom limits for voltage, current, temperature range and speed of operation to make each memory system compatible with your equipment.

Service: Today RCA Memory Products are in use in an ever widening range of commercial, industrial and military equipments...from high-speed printers, process controls, to military missile systems. Whatever your requirements, custom or RCA-standard, your local RCA Semiconductor and Materials Division field representative is prepared to provide a completely coordinated application service for all RCA Computer-Memory Products. Call him today. For specific technical information, write RCA Semiconductor and Materials Division, Commercial Engineering, Section FN8-3, Somerville, N. J.



Write today for information on RCA microferrite stacks and full line of Memory Products.



The Most Trusted Name in Electronics

RCA SEMICONDUCTOR & MATERIALS DIVISION FIELD OFFICES . . . EAST: Newark, N. J., 744 Broad St., HU 5-3900 • (Camden-Philadelphia Area) Erlton, N. J., 605 Marlton Pike, HA 8-4802 • Syracuse, N. Y., 731 James St., Rm. 402, GR 4-5591 • Baltimore, Md., EN 9-1850 • **NORTHEAST:** Needham Heights 94, Mass., 64 "A" St., HI 4-7200 • **SOUTHEAST:** Orlando, Fla., 1520 Edgewater Dr., Suite #1, GA 4-4768 • **EAST CENTRAL:** Detroit 2, Mich., 714 New Center Bldg., TR 5-5600 • **CENTRAL:** Chicago, Ill., Suite 1154, Merchandise Mart Plaza, WH 4-2900 • Indianapolis 5, Ind., 2132 East 52nd St., CL 1-1405 • Minneapolis 16, Minn., 5805 Excelsior Blvd., WE 9-0676 • Denver 11, Colorado, Continental Terrace Bldg., Suite 301, 2785 N. Speer Blvd., 477-1688 • **WEST:** Los Angeles 22, Calif., 6801 E. Washington Blvd., RA 3-8361 • (San Francisco Area) Burlingame, Calif., 1838 El Camino Real, OX 7-1620 • Seattle 4, Wash., 2250 First Ave. S., MA 2-8816 • **SOUTHWEST:** Dallas 7, Texas, 7905 Carpenter Freeway, ME 1-9720 • **GOVT:** Dayton, Ohio, 224 N. Wilkinson St., BA 6-2366 • Washington, D. C., 1725 "K" St., N.W., FE 7-8500 • **RCA INTERNATIONAL DIVISION,** 30 Rockefeller Plaza, New York 20, N. Y. Cable Address: RADIOINTER, N. Y.

VISIT THE RCA EXHIBIT AT WESCON—BOOTHS 1043-1050

for maximum
reliability

SPECIFY BIRTCHEER HEAT RADIATORS

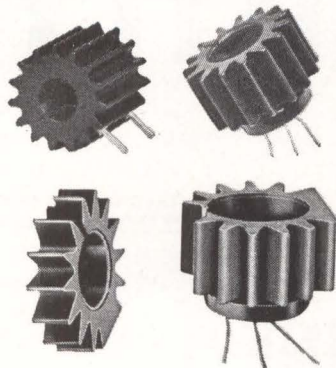

BOOST TRANSISTOR POWER OUTPUT UP TO 25%

With a 50% safety factor
...for pennies

Certified tests prove that you can increase transistor output by up to 25% with a 50% safety factor when you use Birtcher 3AL series aluminum heat radiators. Sizes IN STOCK for almost every TO package ... USN Equipment Approved Number AN/AAA-5, Air Corps 6172. For maximum transistor output with maximum reliability and *lowest cost* specify Birtcher Heat Radiators.

Available from authorized
distributors coast-to-coast



Write for catalog and
test reports on
world's largest line of
semiconductor cooling
and retention devices

THE BIRTCHEER CORPORATION

INDUSTRIAL DIVISION

745 S. Monterey Pass Road, Monterey Park, Calif.

TUBE/TRANSISTOR/COMPONENT
RETENTION AND COOLING DEVICES

16 CIRCLE 16 ON READER SERVICE CARD

ANOTHER EXAMPLE OF RIXON'S SERVICE TO ITS CUSTOMERS

THE DOUBLE D LINE

A SIMPLIFIED MECHANICAL DESIGN OF TERMINAL EQUIPMENT
FOR INCREASING RELIABILITY AND DECREASING COST



The Problem:

Many data communications systems today are either experimental forerunners of possible major systems of the future or part of an overall experimental program which may or may not be repeated. Because of the uncertainty about the future requirement for the hardware, it is not practical to develop special equipment for each application. This leaves us with the problem of constantly redesigning equipment to fit ever-changing requirements, or having to purchase superfluous equipment to meet the requirements. If a device is needed for development of various timing signals, to be compatible with existing equipment, then the logical answer would be to procure only a timing device — not a complete deck of equipment just to get a timing generator. There should be a solution to any requirement of this type—a solution which would provide complete functional units, each one performing one of the common functions in a data communications system. Incidentally, Rixon has the solution!

The Solution:

Rixon's solution is a new hardware approach based on simple, low-cost functional units with common mechanical features, which has eliminated the heretofore sacred mechanical design features. This naturally has resulted in a drastic reduction of manufacturing complexity, and an equally important improvement in reliability. Mechanical features, whose sole purpose was to provide quick access for mechanical service have now, through redesign, been eliminated—a cost-saving factor. Improved reliability is then achieved by eliminating potential mechanical failure points and by devoting more careful consideration to circuit and component design margins. Therefore, Rixon can furnish you with basic functional units which offer greater flexibility, increased reliability, and at lower cost.

RIXON ELECTRONICS, INC.

2121 INDUSTRIAL PARKWAY - MONTGOMERY INDUSTRIAL PARK SILVER SPRING MARYLAND
CIRCLE 200 ON READER SERVICE CARD

not a lab curiosity

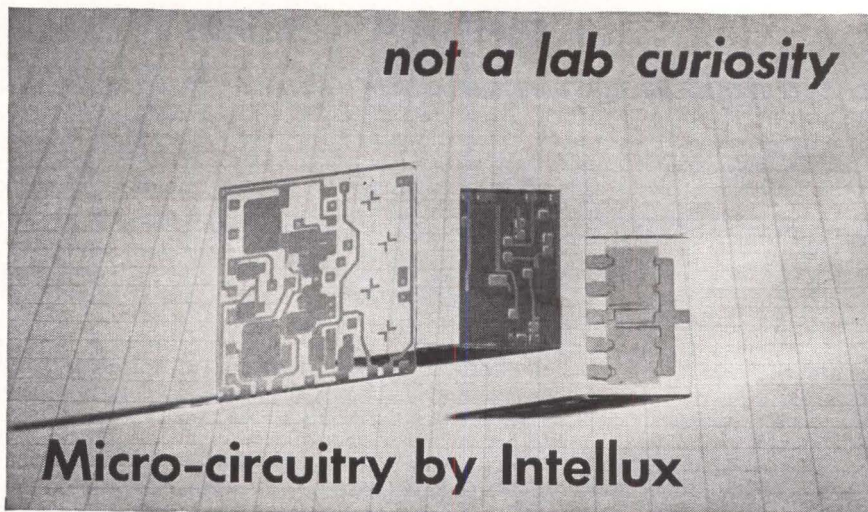

Micro-circuitry by Intellux

Available today — on a mass production basis . . . one or ten thousand. Passive element circuitry custom made to your schematic.

Resistors, capacitors, and inductors integrated, if necessary, on a special glass substrate. Typical component quality . . . resistors 1%, 50 ohms to 1 meg, TC better than 50 ppm.

The Intellux approach makes economic sense.

intellux
INCORPORATED

Write for
More Data

P.O. Box 929, Santa Barbara, Calif.

CIRCLE 201 ON READER SERVICE CARD

electronics

BELL LABORATORIES' NEW CONNECTOR STREAMLINES CABLE SPLICING

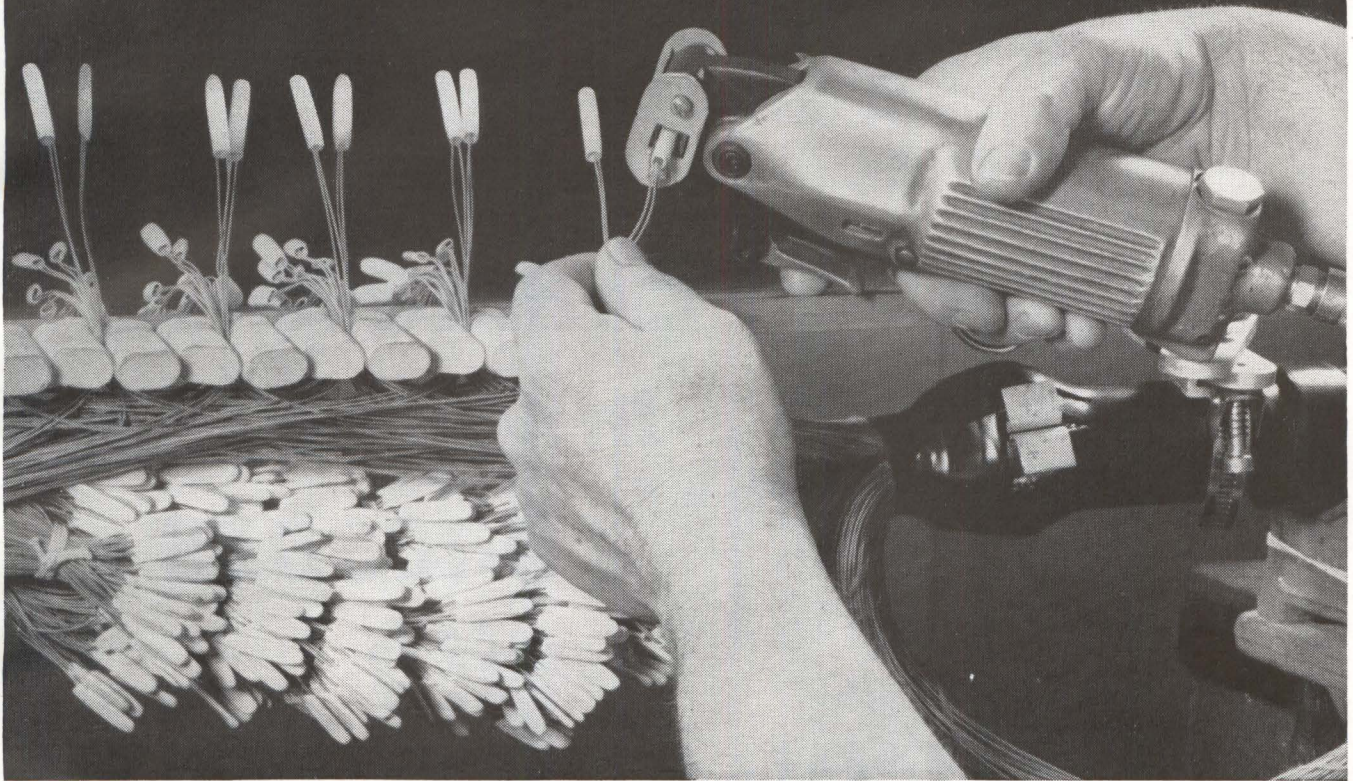

Telephone craftsman uses special pneumatic tool to flatten connector onto insulated wires. Metal tangs pierce insulation and produce a splice that is equivalent to a soldered joint.

Along the cable routes of the Bell System, wires are spliced at a rate of 250,000,000 a year. Conventionally, connections are made by "skinning" the insulation, twisting the bare wires together, and slipping on an insulating sleeve. Now, with a new connector initiated at Bell Telephone Laboratories, (diagram at lower right) splices can be made faster, yet are even more reliable.

The craftsman slips the two wire ends—with insulation intact—into the connector, then flattens the connector with a pneumatic tool. Springy phosphor bronze tangs inside the connector bite through the insulation to contact the copper wire. The stable, low-resistance splice established is maintained for many years, even under conditions of high humidity, corrosive atmospheres and vibration.

Ultrasensitive measuring techniques devised by our engineers demonstrate that the new connector provides the equivalent of a soldered connection,

even with voltages as low as 25 millionths of a volt.

Working with our manufacturing partners at Western Electric, our engineers developed this connector into a design capable of being mass-produced at low cost. It is being introduced in the Bell System.

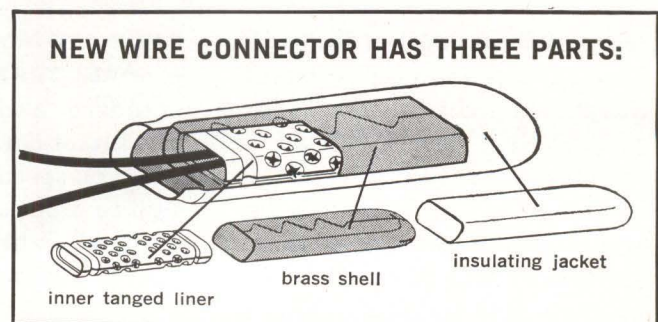

BELL TELEPHONE LABORATORIES

World center of communications research and development

Microwave, semiconductor and fast switching circuits with high density packaging, that heretofore have been thought impractical or impossible to build because of their bulk or complexity, can be successfully produced in TRI-PLATE Strip Transmission Line. □ In breadboarding, packaging and quantity production,

what the concept of strip transmission promised, TRI-PLATE techniques deliver — they've made the concept a practical reality! □ New circuit ideas — no matter how different or daring — are tested quickly, easily and economically with TRI-PLATE Strip Transmission Line Modules. They let you go from

paper schematics to functioning circuits in just minutes to evaluate new design concepts. □ A new approach to the design of a Dual Directional Coupler-Variable Phase Shifter, for example, was recently conceived by Bendix engineers. They needed a package that weighed only 8 ounces — and they needed it in just

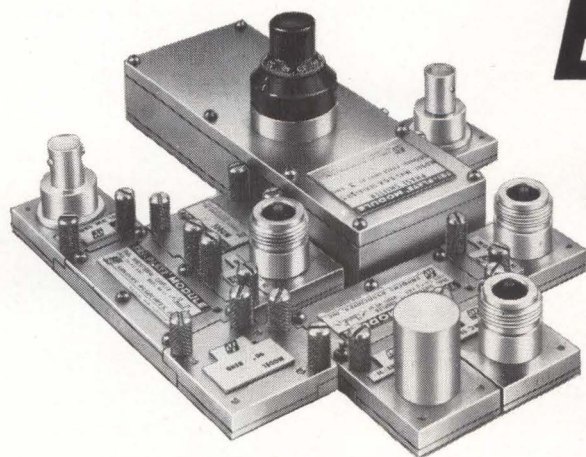

Evaluate new design concepts with Tri-Plate® modules

30 days! By breadboarding with TRI-PLATE Modules the circuit was proved practical, and Bendix gave Sanders the go-ahead to produce the design in quantity as Integrated TRI-PLATE Packages. □ Production models were delivered on schedule and weighed only 6 ounces! This is but one illustration of the new directions in electronics made possible by TRI-PLATE Products. □ There are more than 600

TRI-PLATE Modules — including over 150 TRI-PLATE Mounts for standard and advanced semiconductor devices — available to help you speed the time from design to production. And systems designed in Modules can be produced in quantity as Integrated TRI-PLATE Packages, with performance equal to or better than

the modular prototype, and with great savings in size and weight. □ For further information about TRI-PLATE Products — including specifications and prices — or for consultation regarding your specific requirements, write to Sanders Associates, Inc., Microwave Products Department, Nashua, New Hampshire.

® REG. T.M.; EXTENSIVE PATENT COVERAGE. SANDERS ASSOCIATES, INC.

CREATING NEW DIRECTIONS IN ELECTRONICS
SANDERS TRI-PLATE® STRIP TRANSMISSION LINE 



When the Egyptians referred to royalty in hieroglyphs, they surrounded the characters for these superior names with an oval frame called a cartouche. The hieroglyphs in this cartouche refer to Cleopatra.

In microwave technology, there are also superior names. Example: Varian Associates, who provide the highest power and efficiency available today in traveling wave tubes. Varian Wave Tubes represent the maximum extension of the art in several areas, namely:

MULTI-MEGAWATT, high efficiency, pulsed TWT's in S and C-bands.

MULTI-KILOWATT, high duty cycle, pulsed TWT's with PPM focusing.

HIGHEST FREQUENCY BWO's available with permanent magnet focusing.

CW TWT's for AIRBORNE ECM, lighter and more compact than previously available tubes.

Current programs, including 5 KW L-band TWT's for high performance phased array radars, and one watt BWO's to 75 gc, will maintain Varian's leadership in TWT technology. Varian is a superior name in TWT's, with an extensive line of available tube types. If you need superior TWT's, Varian has (or can design) the ideal tube for you. Contact Tube Division.



VARIAN associates

PALO ALTO 1, CALIFORNIA

Varian Subsidiaries: BOMAC LABORATORIES, INC. • S-F-D LABORATORIES, INC. • SEMICON ASSOCIATES, INC.
VARIAN ASSOCIATES OF CANADA, LTD. • SEMICON OF CALIFORNIA, INC. • VARIAN A. G. (SWITZERLAND)

CIRCLE 19 ON READER SERVICE CARD

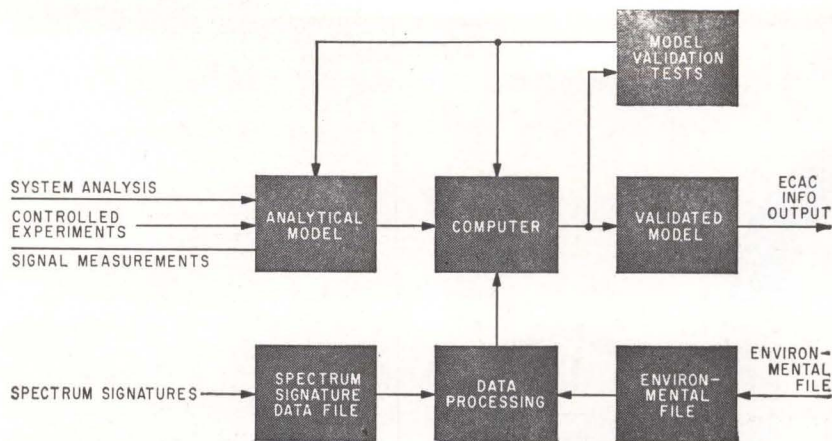

DATA FLOW in a typical radio interference problem solution worked on at Department of Defense's Electromagnetic Compatibility Analysis Center. Note the complexity of the input information

ECAC INFORMATION FLOW

DEPARTMENT OF DEFENSE *Electromagnetic Compatibility Program* involves flow of the following information to and from ECAC:

*spectrum signatures
environmental data
model validation tests
r-f measuring techniques
r-f measuring equipment
laboratory simulation
engineering standards
systems characteristics
tubes and components*

For earlier reports on the military's battle with rfi, see *ELECTRONICS*, p 24, June 2, 1961, and p 28, Nov. 24, 1961

Analysis Center Begins Probe

ECAC compiles data base while solving military rfi problems

By SY VOGEL
Associate Editor

ANNAPOLIS, MD.—Analysis of radio frequency interference (rfi) problems in a Space Detection and Tracking (Spadat) area will be undertaken by Department of Defense's Electromagnetic Analysis Center (ECAC). This new project involves analysis of factors involving Spadat radar, uhf radar, f-m telemetry, f-m radio relay, ground/air a-m voice radio, drone controls, missile-destruct links and television.

Work on specific projects is undertaken in addition to ECAC's prime mission of compiling and coordinating spectrum signatures and environmental data for a data base to be used in the military's overall battle against rfi.

PROJECTS—In addition to the Spadat project, ECAC will also analyze rfi in L-band radar in southern California, in the Montgomery, Ala., Air Defense Sector and in the Chesapeake Bay area.

Typical data of interest in the L-band radar rfi problem are signal densities, pulse amplitude distributions, operating and spurious fre-

quencies, pulse widths and separations. ECAC's prediction of receiver performance will include estimates of pulse-count outputs, ppi representations and Sage processor representations.

Study of the vhf-uhf interference problem in the Montgomery, Alabama, Air Defense Sector involves uhf radar, f-m telemetry, f-m radio relay and ground/air a-m voice radio. This area has thousands of emitters, many radiating c-w. The rfi problem in the Chesapeake Bay area involves several radio and communications systems.

DATA BASE—The data base will comprise the answers to any specific problems that ECAC works on, in addition to accumulated data. The accumulated data includes files of spectrum signatures of electronic equipments, describing performance characteristics, and an environmental file with information such as type of terrain near the equipment, site location, prf, hours on and off, atmosphere effects and antenna orientation.

ECAC now has data on about 65 equipments and expects to catalog about 200 additional equipments by July, 1963. Emphasis now is on getting data on equipments, particularly radar, that radiate at 100 Mc and up. Eventually, data on equipments operating below 100 Mc will be collected.

The environmental data file will eventually include hundreds of thousands of situations in the continental U. S., central Europe, striking-force operations and space operations. The enormous amount of data—perhaps 150 million 36-bit words will be needed for continental U. S. alone—is processed and reduced by the Census Bureau's Posdic system and stored on tape.

ECAC now uses a computer at the Armour Research Foundation. It will be replaced in November by a Univac 1107.

The data base being compiled will be used for many purposes. Results of analysis of specific problems will help the Department of Defense determine the value of such analysis, as well as solving problems.

Recommendations on operational problems could include equipment fixes (modifications made in the field), siting criteria, frequency assignments and allocations, and design requirements for new systems. Spectrum-signature restrictions may be imposed on new equipment going into an operational area.

ECAC will thus be able to use its files of data and analytical models and its predictions and analysis to tell operational commanders how to get the most out of their equipment when in a given rfi environment.

ECAC will also make information available to other organizations working on rfi problems, to aid in

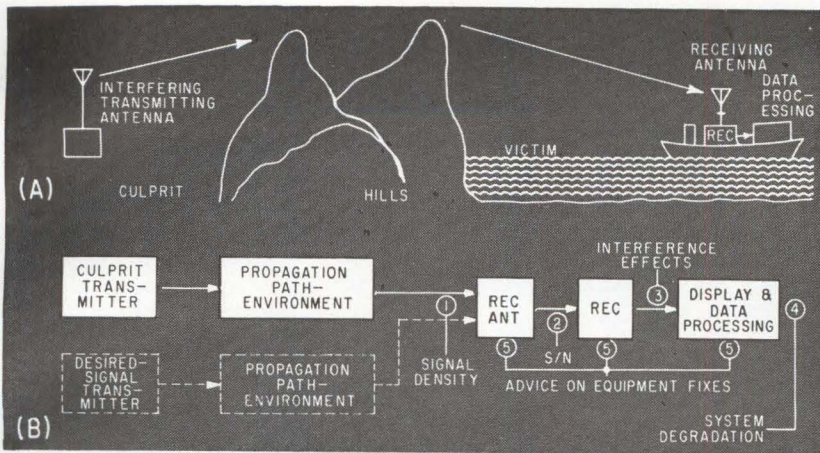

TYPICAL PROBLEM. *Transmitter hidden by coastal hills interferes with ship's radar (A). In analysis model (B) numbers indicate in ascending order of complexity the rfi problems to be solved*

of Space Tracking RFI

the design of rfi-resistant equipment and systems. Although ECAC is now working only on problems caused by unintentional rfi, the experience should be useful for solving jamming problems.

PROBLEM ANALYSIS—To analyze a particular rfi problem, ECAC will pump data derived from its files into an analytical rfi prediction model, as diagrammed.

After the computer runs through an analysis of an rfi problem, its predictions and analysis will be verified experimentally at one or more of the following test centers: Army Electronic Proving Ground, Ft. Huachuca, Ariz., Navy Air Navigation and Electronic Projects Station, Patuxent River, Md., and USAF Rome Air Development Center (RADC), Rome, N. Y.

Test results will be checked against the computer's analysis; if they do not coincide, the analytical model will be revised or/and additional input data obtained.

For example, suppose the captain of the ship shown in the drawing wants an estimate of the rfi his radar may encounter when cruising off a coastline.

The diagram represents the analytical model. The broken lines indicate the insertion of the desired-signal source in the model. The encircled numbers indicate types of information that ECAC

could give to the captain. For example, (1) is an estimate of the rfi signal density at the receiver antenna. The higher the number, the more complicated the problem. In addition to items (1) to (5), ECAC might also provide advice on siting criteria.

If it is determined that a change in frequency is necessary to cope with the situation shown in the drawing, and that this change would have to be outside the band of frequencies allocated to the task force including the ship off the coastline, ECAC might recommend assignment of another band.

MODELING TECHNIQUES—Perhaps ECAC's most difficult job is to develop analytical models that will produce accurate predictions of rfi and indicate suitable remedies. Generally, models will have to cope with multiple emitters that can cause interference.

One such difficult problem would be posed by the 20,000 emitters in a battle area—magnified by the problem of multiple propagation paths. A technique for reducing the number of possible interferers and simplifying the analysis problem uses probability distributions. Final answers or predictions to a given problem may be a statistical estimate. Such answers tell an operations officer the likelihood of interference in a given situation.

"Nothing is impossible to diligence and skill"

Samuel Johnson

These are the trademarks of some of our customers—each an important contributor to a dramatically growing industry. We at Potter pledge our diligence and skills to this growth through a constantly expanding program of research and development.

POTTER

**PTR/PTS-500
Perforated
Tape Reader
and Spooler
Combines...**

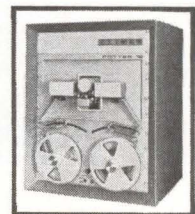

simplified design with increased versatility and reliability to offer the user a high-performance system at low cost.

The Model PTR-500 features the new **MONO BRAKE™**—a unique tape stopping device that eliminates tape bounce and buckling at the read station. Photoelectric sensing provides bi-directional read capabilities at standard tape speeds of 25 and 50 IPS. In addition, an optional gating and detector circuit provides end-of-tape sensing from a predetermined character in the tape.

Complete information on the PTR-500 Perforated Tape Reader and the PTS-500 Perforated Tape Spooler is available on request. Simply write...



EUROPE BOUND?
VISIT US AT Booth 28
IFIP Interdata Exhibition
in Munich, Germany
August 26 to September 2

POTTER INSTRUMENT CO., INC.
Sunnyside Boulevard • Plainview, New York

END RECTIFIER VOLTAGE TRANSIENT PROBLEMS WITH

CONTROLLED AVALANCHE



The revolutionary 12 amp ZJ218 Controlled Avalanche Rectifier protects itself and the rest of the circuit up to 3900 watts peak power dissipation in the reverse direction. You get new high reliability standards up to 1200 PRV, protection of other circuit components, simplified rectifier series operation in high voltage applications, continuous operation in avalanche breakdown region at high voltage, and built-in "zener" diode protection even well beyond 1200 volts.

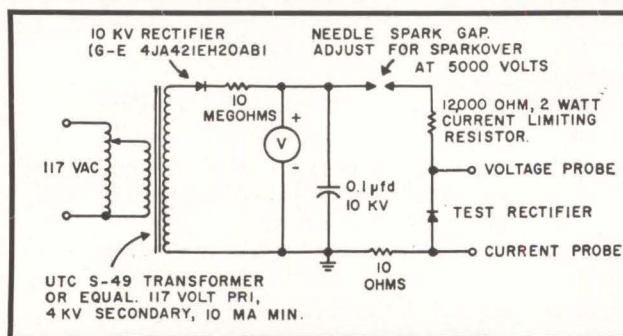

This reverse impulse test will prove how the Controlled Avalanche Rectifier withstands typical transient circuit voltages as high as 5000 volts, dissipates high levels of peak power in the reverse direction. Peak reverse power for rectifiers with avalanche voltages above 800 volts is over 250 watts in this circuit. (Connect a scope between the indicated voltage and current taps and ground to view impulse voltage and current.)

TEST IT YOURSELF . . . and prove beyond any doubt that your derating headaches are a thing of the past, that your transient voltage problems are solved more efficiently, more economically than ever before possible. The Reverse Impulse test circuit shown is all you need . . . along with the new G-E ZJ218 Controlled Avalanche Rectifier.

The ZJ218 Controlled Avalanche Rectifier is available in 600, 800, 1000 and 1200 PRV types. See your General Electric District Sales Manager and find out how to end your voltage transient problems with no derating. Or write Rectifier Components Department, Section 16H74, General Electric Company, Auburn, New York. In Canada: Canadian General Electric, 189 Dufferin Street, Toronto, Ontario. Export: International General Electric, 159 Madison Avenue, New York 16, New York.

GENERAL  ELECTRIC

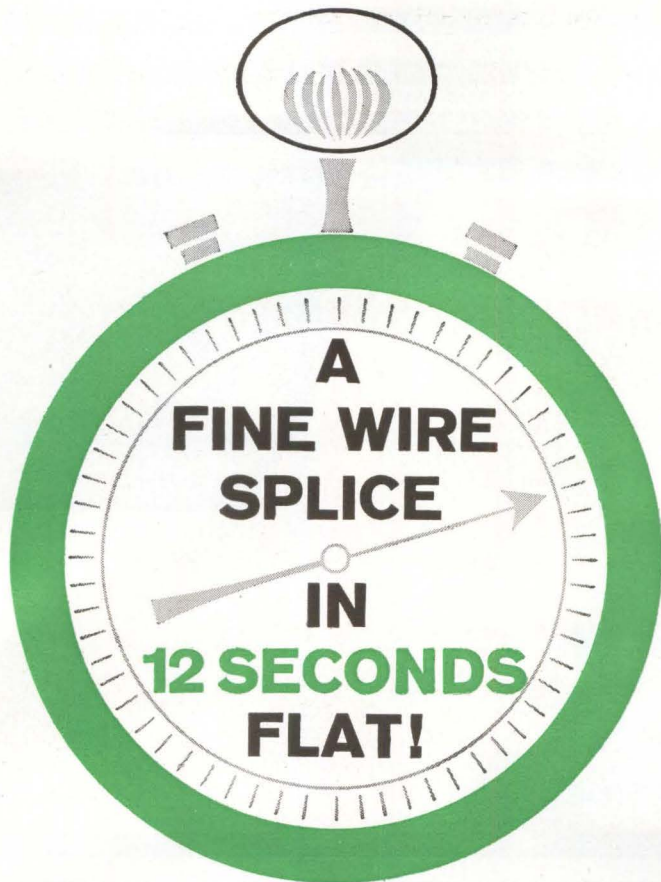

Visit us at the
WESCON Show
Booths 537-39, 625-26
August 21-24

and AMP makes it possible . . . without solder!

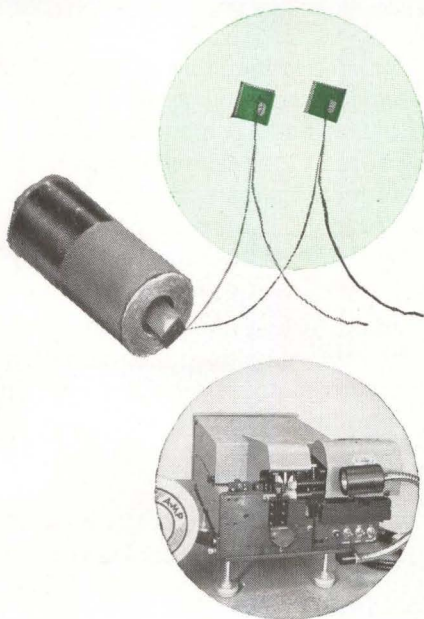

When you use solder to splice very fine magnet wire (34 to 44 gage or finer) to stranded lead wires, you usually end up doing a very slow burn. You get time-consuming stripping problems . . . unreliable wire damage or even wire breakage . . . cold solder joints . . . oxide contamination . . . high labor costs. And speed? Your best might be a splice a minute. The new AMP-FINE-Y-R Splice gets rid of these problems, and it does it fast—once every 12 seconds, 5 times a minute, 300 fine wire splices an hour—for all fine magnet wires from 34 to 44 gage or finer, and for all stranded lead wires 26 gage and finer.

The splice is mounted on Mylar* tape, which is fed into the crimping mechanism of a special air and electric AMP machine. Stripping wheels built into the machine quickly strip the fine wire insulation. An operator then places the stripped fine wire and stranded lead wire into the splice, actuates a foot pedal, and the splice is finished. Twelve seconds . . . one splice. No burning, no cold solder joints, no wire damage. No heat oxides form. And the Mylar insulates one side of the splice.

If you're designing transformers, relay coils, solenoids, inductors, feed coils, or any other product that involves fine wire splices, you need the AMP-FINE-Y-R splice.

Write to AMP today for complete specifications.

*Trademark of E. I. Du Pont Nemours & Co.

AMP
INCORPORATED
Harrisburg, Pennsylvania

AMP products and engineering assistance are available through
subsidiary companies in: Australia • Canada • England
France • Holland • Italy • Japan • Mexico • West Germany

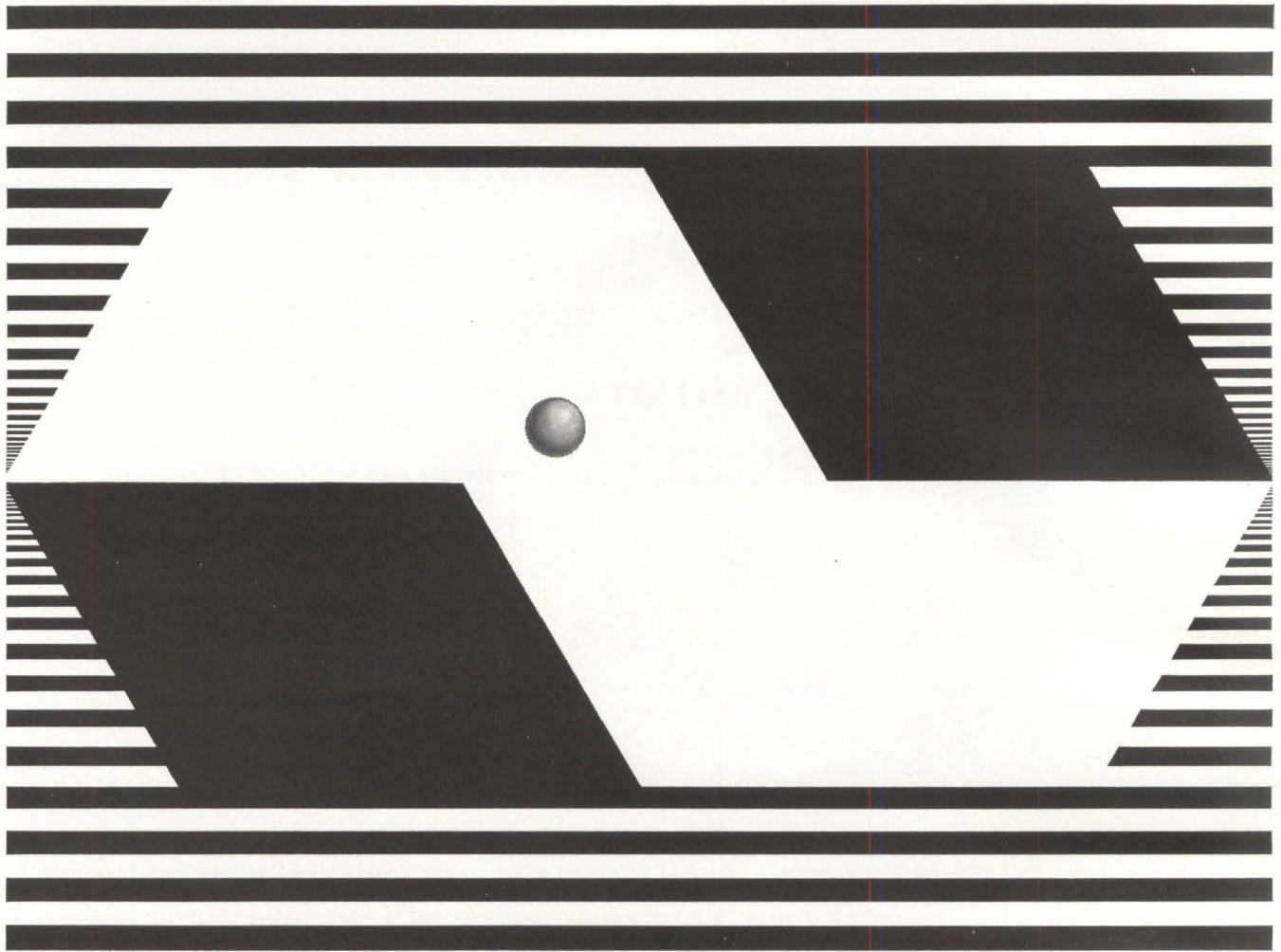

Explorers
in
the shape
of
things to come

An idea in the mind of man... that's where every achievement in the world begins. Peer into the minds of Lockheed Scientists and Engineers. There you see ideas in the making—ideas that some day will take on form and substance. Not all, of course. Some are too "far out." But, no matter how visionary, all ideas win serious attention.

As a result, this freedom of imagination has led to many distinguished accomplishments at Lockheed. And the future holds still more. For, among Lockheed's ever-expanding programs are: Spacecraft; Satellites; Man-in-Space Studies; Hypersonic Manned Aircraft; Advanced Helicopter Design; Sophisticated ASW and Ocean Systems.

Scientists and Engineers who thrive in an atmosphere of freedom; whose creative processes flourish through exchange of ideas; who relish exploring the unexplored—to such men we say: Lockheed has a place for you. For example: In Human Factors; Electronics Research; Thermodynamics; Guidance and Control; Stress; Servosystems; Reliability; Dynamics; Manufacturing Engineering; Astrophysics; Astrodynamics; Advanced Systems Planning; RF Equipment Engineering; Bioastronautics and Space Medicine; Weapons Effects; Aerophysics; Digital Communications; Antennas and Propagation Engineering; Tracking, Telemetry and Command Engineering; Communications Analysis. Send résumé to: Mr. E. W. Des Lauriers, Manager Professional Placement Staff, Dept. 1508, 2408 N. Hollywood Way, Burbank, California. An equal opportunity employer.

LOCKHEED
CALIFORNIA COMPANY
A DIVISION OF LOCKHEED AIRCRAFT CORPORATION

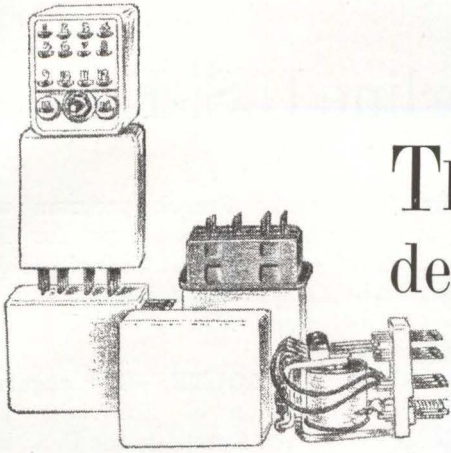

This new P&B a.c. relay deserves your critical appraisal

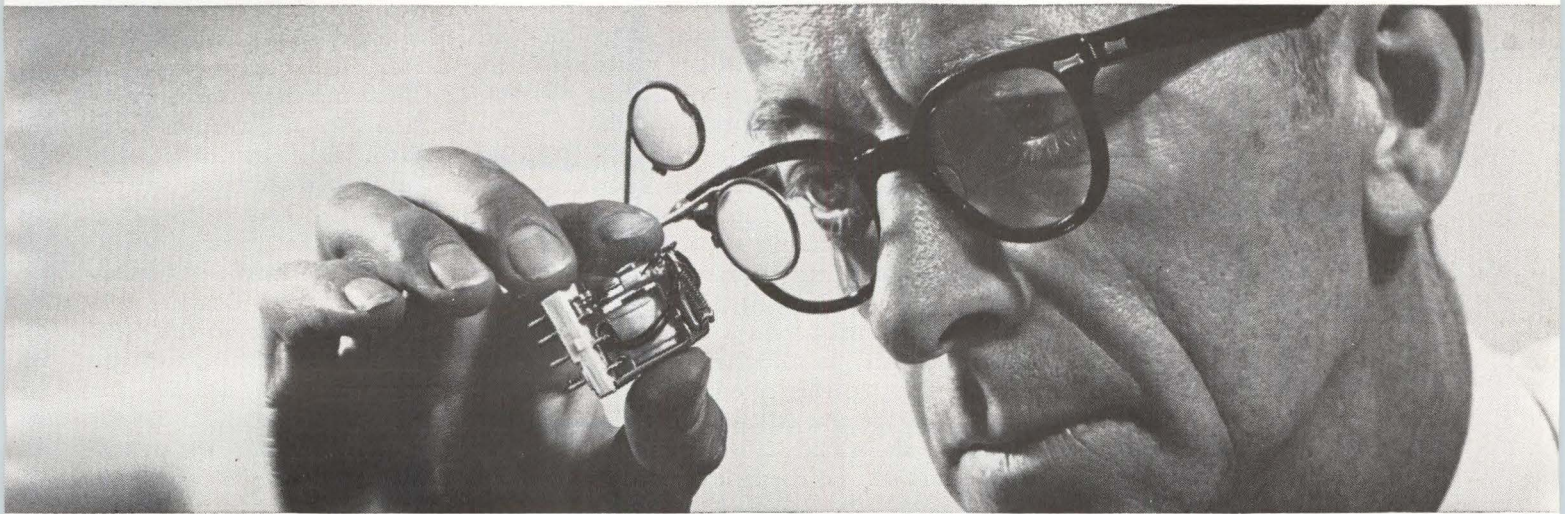

This remarkable new a.c. relay gives you these advantages:

SMALL SIZE. Only slightly larger than a cubic inch, yet has **MULTI-POLE CAPACITY.** Available in 4 form C or 2 form Z contact arrangements. Contacts are rated at 3 AMPS at 115 volts a.c., or 30 volts d.c. resistive. **LONG LIFE.** Engineered for millions of operations. **LOW POWER REQUIREMENTS.** Consumes only 1.2 volt-amps at nominal voltage. **SPECIFY P&B's KHP17A.**

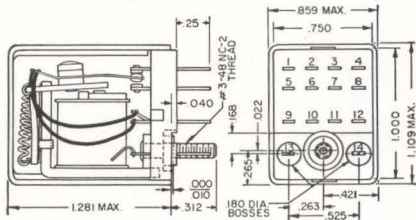

KHP Series, Dust Cover

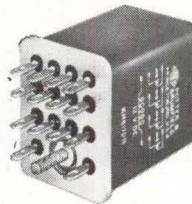

Available Hermetically Sealed
a.c. or d.c. Specify KHS Series

PROVEN DESIGN

Thousands of these relays designed for d.c. are successfully being used in such diverse applications as telephone carrier equipment, citizens band transceivers and business machines. If you use d.c., specify KHP17D. For a.c. applications, ask for KHP17A.

WRITE FOR DATA SHEET

P&B STANDARD RELAYS ARE AVAILABLE AT YOUR LOCAL ELECTRONIC PARTS DISTRIBUTOR



POTTER & BRUMFIELD

DIVISION OF AMERICAN MACHINE & FOUNDRY COMPANY • PRINCETON, INDIANA
IN CANADA: POTTER & BRUMFIELD, DIVISION OF AMF CANADA LIMITED, GUELPH, ONTARIO

CIRCLE 25 ON READER SERVICE CARD

Telstar's Tv Programs Underline U.S.-European

Launch of second satellite this fall will expand system

By PAUL CHERECWICH, JR.
 Editorial Staff
 LESLIE SOLOMON
 Associate Editor

NEW YORK—Expectations are that there will be two Telstar satellites in orbit this fall, broadening the scope of the first private satellite communications system. NASA will reportedly launch a second Bell Telephone Laboratories satellite for AT&T in October.

With the single Telstar now in orbit, transatlantic message and television transmissions can be carried out for only limited periods. The Andover, Me., ground station sees the satellite for at most 250 minutes a day, and the maximum mutual visibility with Europe is only 102 minutes a day.

Maximum duration of visibility comes only every 190 days. Telstar is on a comparatively high orbit (apogee is 3,501.8 miles and perigee is 593.35 miles), but the visibility periods vary due to the northward precession of the apogee.

The orbit is almost exactly the

one planned for the satellite. Telstar is expected to keep circling the earth for 200 years, but the electronic equipment on board will be shut off after two years. The equipment is functioning as planned (ELECTRONICS, p 7, Aug. 3), making the launch an all-around success.

Telstar has been used as a repeater for transmission of photofacsimile and high-speed data, for one-way and two-way telephone calls, and for black-and-white and color television, in addition to obtaining space environment data.

TELEVISION—Though Telstar is carrying out a number of scientific and engineering experiments, the one that has captured worldwide public—and political—interest is the transatlantic transmission of television broadcasts.

Engineering co-operation on both sides of the Atlantic is needed to get the signals to the satellite. Conversion and communications equipment of several kinds must be blended before Americans and Europeans can see each other's tv fare (see map and table).

Scan converters were not employed directly in the first programs from France and England. The

early French program was pre-converted on tape for American receivers. At Goonhilly Downs, the BBC uses a camera built to U.S. standards.

TV ROUTES—For regular transmission of Eurovision programs from Europe to the U.S., here's the procedure:

European tv pictures are transmitted to Eurovision's main switching center in Brussels, Belgium, at 625 lines and field frequency of 50 cps (625/50 is the western European standard). French pictures are scan converted from 819/50 to 625/50.

Pictures are then carried by coaxial cable to the English Channel, microwaved over the Channel, and sent by coaxial cable to the BBC center in London. There, they are scan converted to 405/50 for British consumption, and to 525/60 for the U.S. The 525/60 signals are sent by cable to Goonhilly Downs and by microwave to the nearby ground station for transmission to Telstar.

Telstar relays the television signals to Andover, Maine, at 525/60. The signals are carried by microwave to Portland, Me., and then

TRANSATLANTIC TRANSMISSION paths and conversion centers set up for American and Eurovision television

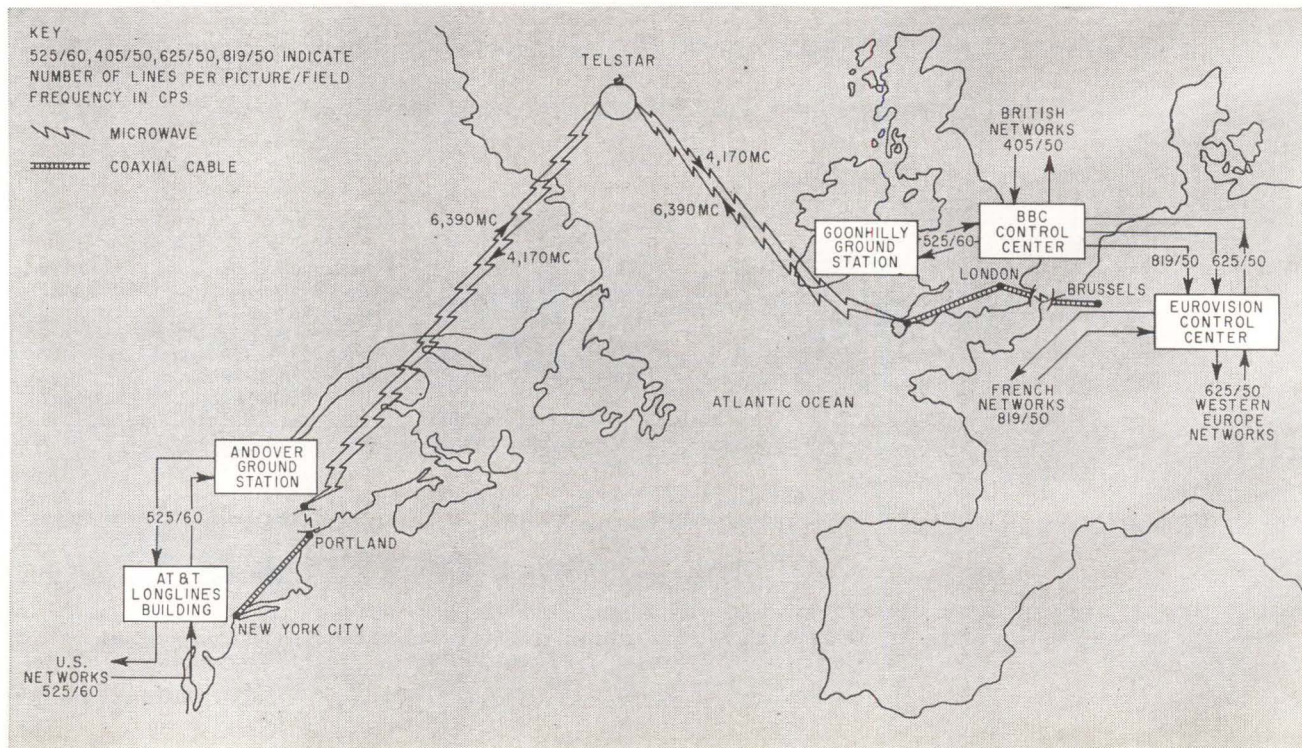

Cooperation

by coaxial cable to the AT&T long-lines building in New York City for network distribution.

Transmission from the U.S. to Europe follows the reverse procedure, with one exception. Scan conversion to French standards (819/50) is done in London, so no conversion is necessary at Brussels before transmission to France.

TRANSMISSION — The satellite receives signals—whether tv or other data—in a 50-Mc bandwidth around 6,390 Mc. Incoming signals are mixed with a crystal-controlled beat oscillator, producing 90-Mc signals (see diagram). They are amplified, mixed again to produce 4,170-Mc signals, then amplified 5,000 times by a traveling-wave tube (the only electron tube in the satellite—other active components are semiconductor devices) for transmission back to earth.

Leaving the satellite at $2\frac{1}{4}$ watts, signals are received on earth at 0.31×10^{-12} watt to 15×10^{-12} watt, depending on slant range distance.

The horn antenna at Andover, primary U.S. ground installation, has performed according to expectations. The absolute noise temperature is 51 K when the antenna is pointing near the horizon and is 32 K at zenith.

The effects of an f-m feedback circuit in the receiving system are particularly noticeable during tele-

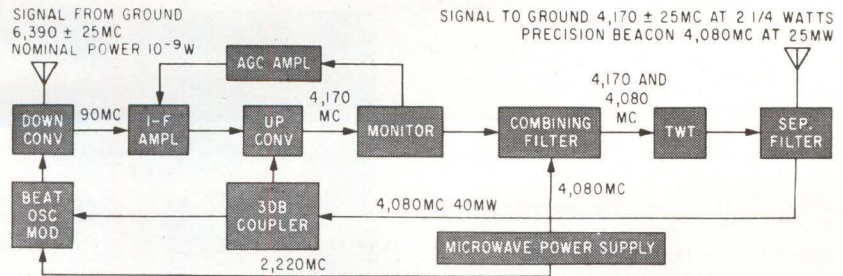

SATELLITE SYSTEM receives ground signals at 6,390 Mc, amplifies and converts them to 4,170 Mc, and also provides tracking signal

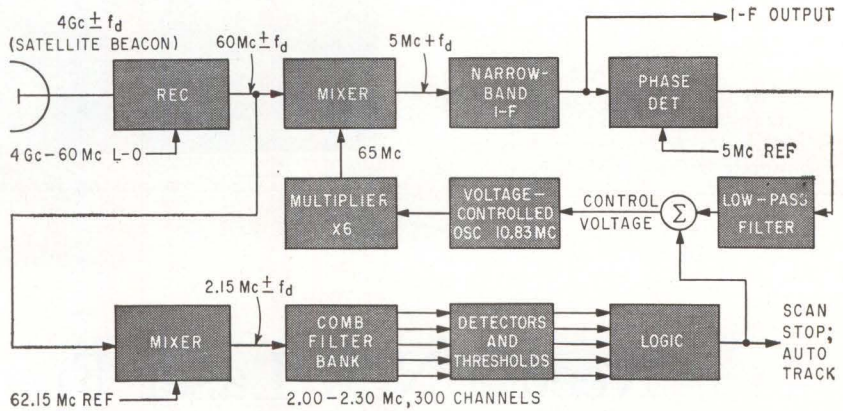

PRECISION TRACKING system at Andover, Me., uses comb filters to detect doppler shifts in satellite beacon signal

vision transmission and reception. The circuit acts as an automatic tuning device, rapidly tuning a narrow-band receiver to the exact frequency being transmitted at any instant, even though the signal varies over the bandwidth. The signal-to-noise ratio during television transmission is 43 db.

TRACKING—To let antennas track it, Telstar transmits a 4,080-Mc signal at 0.02 watt.

Tracking at Andover involves four steps: Orbital position is

predicted from data obtained on previous satellite passes. Course tracking by a vhf command tracking system narrows Telstar's position to 1 degree out of a 20-degree field of view. A precision tracking system further narrows the satellite's position to 0.02 degree. A method known as vernier autotrack then automatically tracks Telstar with the horn antenna, which has a 0.2 degree field of view.

A comb filter spectograph, developed by Itek, is used in the precision tracker (see diagram) to divide the broadcasting spectrum into 300 channels. A crystal filter in each channel is triggered whenever the satellite signal is encountered. A voltage-controlled crystal oscillator, receiving commands from the crystal filters, tunes the receiver in the precise frequency, thus accounting for doppler effects in the 4,080-Mc signal.

After the satellite has been acquired by tracking, radio commands turn on transmitting equipment. Telstar has not responded to command signals from some remote ground stations, such as the Holmdel, New Jersey, station. Project engineers feel this is due to distances involved and the susceptibility of the pulse signal to static.

WORLD TELEVISION TRANSMISSION STANDARDS

| Standards | Britain | Western Hemisphere | Western Europe | Eastern Europe | France |
|---|---------|--------------------|----------------|----------------|--------|
| No. of lines per picture | 405 | 525 | 625 | 625 | 819 |
| Video bandwidth (Mc) | 3 | 4 | 5 | 6 | 10.4 |
| Channel width (Mc) | 5 | 6 | 7 | 8 | 14 |
| Sound/video separation (Mc) | -3.5 | +4.5 | +5.5 | +6.5 | 11.15* |
| Sound carrier to edge of channel (Mc) | +0.25 | -0.25 | -0.25 | -0.25 | 0.1* |
| Interlace | 2:1 | 2:1 | 2:1 | 2:1 | 2:1 |
| Line frequency (Kc) | 10.125 | 15.750 | 15.625 | 15.625 | 20.475 |
| Field frequency (cps) | 50 | 60 | 50 | 50 | 50 |
| Picture frequency (cps) | 25 | 30 | 25 | 25 | 25 |
| Video modulation | + | - | - | - | + |
| Black level (%) | 30 | 75 | 75 | 75 | 25 |
| Audio modulation | a-m | f-m | f-m | f-m | a-m |

* French standards invert video and audio frequency in certain channels

LASER SEISMOGRAPHS

Possibility of accuracies to 1 part in 10^{11} with gaseous lasers is arousing interest in their use as highly accurate seismographs.

A seismograph using two lasers might work like this: one laser would be isolated from earth tremors while another would be anchored to the earth so that any deformation would change the separation between the laser mirrors. Since the exact laser frequency is a function of the distance between the mirrors, the change in distance could be measured by observing the change in beat frequency between the two lasers. In principle this measurement could be made to 1 part in 10^{11} if isolation and temperature control techniques were perfected



LASER TUBES containing the five noble gases are checked for alignment

Need a New Laser Frequency? Single Noble Gases Give 14 More

*If gases are mixed,
the number of frequency
possibilities is 20-plus*

By MICHAEL F. WOLFF
Senior Associate Editor

NEW YORK—Prospect of optical communications at a greater number of frequencies than was heretofore thought possible is offered by the recent discovery of several new gaseous optical masers (lasers) at Bell Telephone Laboratories.

Following hard on their report of laser action in neon-oxygen and argon-oxygen (ELECTRONICS, p 62, July 6), Bell scientists last week showed:

- A helium-neon laser that can emit a c-w beam of visible red light.
- Five single-noble-gas lasers that radiate c-w at a total of 14 different frequencies at wavelengths between 1.5 and 2.2 microns (see table).

HELIUM-NEON—The new helium-neon laser radiates at 6,328 angstroms, the highest coherent opti-

cal frequency yet reported. Its visibility is expected to make experimentation easier and also allow using more efficient photoemissive detectors and electro-optical modulators.

The device is also significant because it embodies construction techniques that have overcome some of the early doubts that the physical sensitivity of gaseous lasers might prevent using them in practical optical communication systems. It represents recent improvements in laser construction.

The original helium-neon laser (ELECTRONICS, p 31, Feb. 17, 1961) provided a coherent output in the near infrared. It used highly reflecting parallel mirrors that had to be aligned to a few seconds of arc in metal chambers at each end of the tube. The new laser is simplified and uses confocal mirrors outside the discharge. Mirrors need alignment only to a few minutes of arc. Tube terminations are merely glass windows and are inclined at the Brewster angle that minimizes reflection losses for radiation polarized in the plane of incidence, polarizing the emitted beam. The mir-

rors, now more accessible, are coated with dielectric layers designed for peak efficiency of reflectivity at about 6,350 angstroms.

Another difference is the use of a d-c discharge instead of r-f to impart energy to the helium. Metal electrodes were placed inside the glass cavity without impairing the gas efficiency, resulting in a more stable and uniform discharge and more efficient use of the input power, it was claimed.

The 3-milliwatt output beam has an angular divergence of $\frac{1}{2}$ minute of arc. (This means if it were projected at the moon through a 12-inch telescope it would cast a spot 1 mile in diameter.)

SINGLE-GAS LASERS — Recent experiments have borne out indications that coherent oscillation could be obtained with pure noble gases as the active medium (ELECTRONICS, p 7, Feb. 23). The studies were carried out in similar tubes but using a different excitation method—electron impact excitation.

In tubes filled with neon, argon, krypton or xenon, the free electrons in an r-f discharge impart their

GAS LASERS DEVELOPED AT BELL

| Gas | Frequency (10 ¹⁴ cps) | Wavelength (microns) |
|------------------------------|-------------------------------------|-------------------------|
| Helium-Neon | 2.683 | 1.114 |
| | 2.601 | 1.153 |
| | 2.586 | 1.16 |
| | 2.502 | 1.198 |
| | 2.485 | 1.207 |
| | 4.741 | 0.6328 (visible) |
| Neon-Oxygen, Argon-Oxygen | 3.551 | 0.8446 |
| Helium | 1.456 | 2.0603 |
| Neon | 1.423 | 2.1019 |
| Argon | 1.854 | 1.618 |
| | 1.771 | 1.694 |
| | 1.677 | 1.793 |
| | 1.455 | 2.0616 |
| Krypton | 1.775 | 1.690 |
| | 1.771 | 1.694 |
| | 1.681 | 1.784 |
| | 1.644 | 1.819 |
| | 1.561 | 1.921 |
| | 1.418 | 2.116 |
| | 1.371 | 2.189 |
| Xenon | 1.495 | 2.0261 |
| Cesium* | 0.4178 | 7.180 |

*Developed by T. R. G., Inc., Syosset, N. Y. Device operates at 488 deg. K

kinetic energy directly to the gas atoms. These atoms are thus excited to a higher energy level from which they fall and emit coherent radiation at a characteristic wavelength.

Because of differences in its electron configuration, pure helium acts differently. Laser action here is believed to be produced by excited helium atoms in an upper energy level transferring energy by collision with atoms in the ground state.

Three of the 14 coherent emission lines seen in the new lasers have never been observed in spontaneous emission. Electron impact is seen as a general technique that may lead to other coherent oscillations at other frequencies. Details of these studies are reported by C. K. N. Patel, W. R. Bennett, Jr., W. L. Faust and R. A. McFarlane in *Physical Review Letters*, Aug. 1.

Gaseous lasers are still less powerful than the solid-state lasers.

In some cases power output can be increased by increasing electron density. Power output of a xenon laser was raised from 5 mw to 10 mw by introducing helium into the xenon discharge.

DVST

Announcing
Machlett
Direct View
Storage
Tubes

ML-8130
ML-8139



Brightness:

Over 2000 foot lamberts — ML-8130
Over 1500 foot lamberts — ML-8139

Writing Speed — at full brightness:

Over one half million inches per second — ML-8130
Over 150,000 inches per second — ML-8139

Storage: Uniform Storage Characteristics

Resolution: To 80 written lines per inch at optimum brightness

Focus: — both tubes: Electrostatic

Deflection: ML-8130 — Electrostatic ML-8139 — Magnetic

USES

Airborne

Weather radar
Search Navigation
Terrain Avoidance

Shipboard

Sonar long-memory displays
Marine displays
Sonar devices displays

Ground

Slow-scan television
Storage instrumentation

Write today for complete data on these new Machlett Direct View Storage Tubes.



The Machlett Laboratories, Inc.



Springdale, Connecticut

An Affiliate of Raytheon Company

SPRAGUE PIEZO- ELECTRIC CERAMIC ELEMENTS

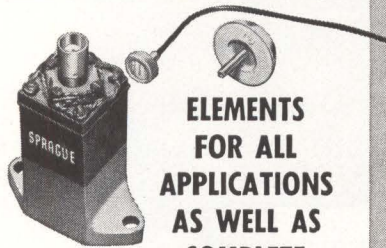

**ELEMENTS
FOR ALL
APPLICATIONS
AS WELL AS
COMPLETE**

**TRANSDUCER ASSEMBLIES
FOR MOST APPLICATIONS,
SUCH AS UNDERWATER
SOUND AND
VARIOUS ORDNANCE AND
MISSILE DEVICES.**



Sprague-developed mass production and quality-control techniques assure lowest possible cost consistent with utmost quality and reliability. Here too, complete fabrication facilities permit prompt production in a full, wide range of sizes and shapes.

Look to Sprague for today's most advanced ceramic elements—where continuing intensive research promises new material with many properties extended beyond present limits.



**YOUR INQUIRIES
ARE INVITED**

**WRITE FOR
LITERATURE**

SPRAGUE ELECTRIC COMPANY
35 Marshall Street, North Adams, Mass.

SPRAGUE®
THE MARK OF RELIABILITY

Design of Advanced Syncom Begins

HUGHES AIRCRAFT is now working on the advanced model of its Syncom communications satellite. The new version will probably carry four repeaters, each capable of continuously relaying up to 300 two-way telephone calls or one tv channel.

The company will first develop subsystems and an engineering structural model to determine the final design for a commercial system, under a development contract from NASA's Goddard Space Flight Center. After the development contract is completed, it would take about a year to get an advanced version ready for launching.

Three, small, experimental versions of Syncom are being built for launch early next year. These will provide only a single two-way voice channel. Engineering concepts for the control system, electronics and structure of these have been completed, Hughes said, and will be applied to the design of the larger version.

The satellite will be stabilized by spinning it at about 100 rpm. A 16-element phased array transmitting antenna will enable the satellite to transmit continuously to earth despite the spinning. A biconical horn antenna will be used for receiving

and whip antennas for telemetry and control.

Syncom is planned as a synchronous satellite. Orbiting at an altitude of 22,300 miles, it would appear stationary to earth stations. Stations would use fixed antennas rather than tracking systems.

One such satellite, parked over the Atlantic, would provide continuous 24-hour message and tv relay service among North and South America, Europe and Africa. Three satellites would blanket almost the entire earth.

New Symbols Adopted For Military Planes

MILITARY aircraft will be identified by a new, uniform designation system. The new designations are intended to clear up any confusion resulting from the use of dissimilar designations by the services for the same aircraft.

Classes of electronic equipment carried by the planes can be inferred from the designations.

The designation will be three letters, followed by a design number and letter to indicate model. The three letters will be, respectively, a status prefix symbol, a modified mission symbol and a basic mission or type symbol.

Status prefix symbols are: *G*, permanently grounded; *J*, special test, temporary; *N*, special test, permanent; *X*, experimental; *Y*, prototype; *Z*, planning. Operational aircraft will have no status prefix letter.

Modified mission symbols are: *A*, attack; *C*, cargo/transport; *D*, director; *E*, special electronic installation; *H*, search rescue; *K*, tanker; *L*, cold weather; *M*, missile carrier; *Q*, drone; *R*, reconnaissance; *S*, antisubmarine; *T*, trainer; *U*, utility; *V*, staff; *W*, weather.

Basic mission and type symbols are: *A*, attack; *B*, bomber; *C*, cargo/transport; *E*, special electronic installation; *F*, fighter; *H*, helicopter; *K*, tanker; *O*, observation; *P*, patrol; *S*, antisubmarine; *T*, trainer; *U*, utility; *V*, vtol and stol; *X*, research; *Z*, airship.

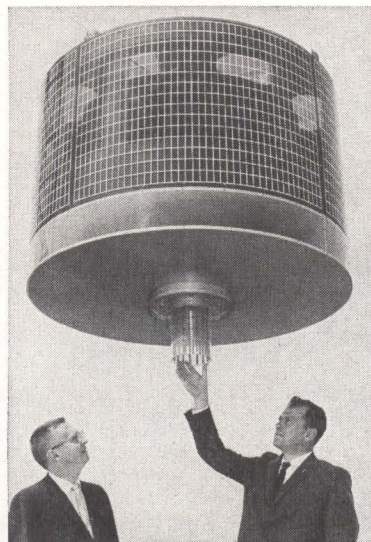

MOCKUP of advanced Syncom satellite. It will be 5 feet in diameter and weigh about 500 pounds

NEW G-E CERAMIC TUBES REDUCE MICROWAVE COMPONENT SIZE* UP TO 40 TIMES

Detailed value-analysis chart shows how size, cost and performance advantages can be yours. Clip coupon, or circle reader service number, for free copy.

In many UHF applications, up to 10 Ge (KMC), microminiature G-E ceramic tubes can replace TWT's, magnetrons, klystrons, and parametric amplifiers with no sacrifice in performance. G-E ceramic tubes are up to 40 times smaller and 20 times lighter than most UHF devices. Often, ceramic tubes can effect component cost reductions as high as \$1,400.

To determine the specific reductions G-E ceramic tubes can make in your equipment, check these 6 size- and weight-saving features:

1. Microminiature size and weight range:
Length: 0.315" to 2.75"
Diameter: 0.325" to 1.25"
Weight: 0.972 gram to 66.6 grams
2. High-gain, low-noise ceramic tubes eliminate components, require less complex circuitry. Useful to "C" and "X" band frequencies.
3. Ceramic tubes withstand strong spurious signals and switching transients; minimum protective circuits required.
4. Lower power requirements mean smaller, less elaborate power supplies.
5. High-temperature tolerance (400°C., max.) can eliminate cooling equipment.
6. Ceramic tubes are highly resistant to nuclear radiation; heavy shielding is eliminated. Ceramic planar structures tolerate high shock and vibration.

Most G-E ceramic tubes are on approved MIL-spec lists and are available "off-the-shelf" from your local General Electric Receiving Tube Sales Representative. Send today for your free value-analysis chart which lists all the size, cost and performance advantages that can be yours with G-E ceramic tubes.

Progress Is Our Most Important Product

GENERAL  ELECTRIC

G-E TIPS (Technical Information and Product Service)
General Electric Receiving Tube Dept.
Room 1730
Owensboro, Kentucky



Name _____ Title _____
Company _____
Address _____
City _____ Zone _____ State _____

*APPROXIMATE SIZE RANGE
OF COMPETITIVE DEVICES

ACTUAL SIZE



HOW CHEAP IS "CHEAP"?

"Why should we buy from you when we can get the 'same thing' from other suppliers at a lower price?"

In selecting a supplier of lacing tape (or any component), price and compliance with specifications are not the only criteria. But too often, manufacturers ignore the other factors involved and consequently lose money.

For example, in a \$15,000 piece of equipment there may be only 15 cents worth of Gudebrod lacing tape. It costs \$75 to work this tape. It may be possible to buy the same amount of tape from other suppliers for 2 or 3 cents less . . . it "will meet the specs" according to these suppliers. But one of our customers recently pointed out why he still specifies only Gudebrod lacing tape in such cases.

"We tried buying some cheaper tape that 'met the specs.' Within a few months our production was off by 50% . . . boy, did the production people really scream about that tape. And our labor costs doubled . . . our costing people really flipped!

"Another thing, why should we risk the possible loss of thousands of dollars when the original material cost difference is only a few cents. Once you put cheaper tape on and something goes wrong after the equipment is finished . . . you've had it. No, thank you! We learned our lesson! We buy Gudebrod lacing tape!"

Whether your firm uses one spool of lacing tape or thousands, there are four advantages in specifying Gudebrod for all your lacing requirements:

1. *Gudebrod lacing tape guarantees increased production!*
2. *Gudebrod lacing tape guarantees reduced labor costs!*
3. *Gudebrod lacing tape guarantees minimal maintenance after installation!*
4. *Gudebrod guarantees quality!* On every spool is a lot number and seal which guarantees that all Gudebrod lacing tape is produced under strict quality control. Our standards are more exacting than those required for compliance with Mil-T.

Our Technical Products Data Book explains in detail the complete line of Gudebrod lacing tapes for both civilian and military use. For your copy write to Mr. F. W. Krupp, Vice President, Electronics Division

GUDEBROD BROS. SILK CO., INC.

Electronics Division
225 West 34th Street
New York 1, New York

Executive Offices
12 South 12th Street
Philadelphia 7, Pa.

Visit us at the Wescon Show—Booth # 3506

MEETINGS AHEAD

WESTERN ELECTRONICS SHOW AND CONFERENCE, WEMA, IRE; Los Angeles, Calif., Aug. 21-24.

METALLURGY OF SEMICONDUCTORS CONFERENCE; American Institute of Mining, et al; Ben Franklin Hotel, Philadelphia, Pa., Aug. 27-29.

BALLISTIC MISSILE & SPACE TECHNOLOGY SYMPOSIUM, U.S. Air Force and Aerospace Corp.; Statler-Hilton Hotel, Los Angeles, August 27-29.

MAINTAINABILITY OF ELECTRONIC EQUIPMENT, EIA Engineering Dept. & Dept. of Defense; U. of Colorado, Boulder, Colo., Aug. 28-30.

INFORMATION PROCESSING, INTERNATIONAL CONFERENCE, IRE-PGEC, IFIPS, AIFPS; Munich, Germany, Aug. 29-Sept. 1.

INFORMATION ON THEORY INTERNATIONAL SYMPOSIUM, PGIT and Benelux Section of IRE; Free Univ. of Brussels, Belgium, Sept. 3-7.

ADVANCED TECHNOLOGY MANAGEMENT CONFERENCE, IRE-PGEM, AIEE, et al; Opera House on World's Fair Grounds, Seattle, Wash., Sept. 3-7.

DATA PROCESSING EXHIBIT, Assoc. for Computing Machinery; Onondaga County War Memorial, Syracuse, N. Y., Sept. 4-7.

PETROLEUM INDUSTRY CONFERENCE, AIEE and ISA; Carter Hotel, Cleveland, Ohio, Sept. 9-14.

ENGINEERING MANAGEMENT, IRE-PGEM, AIEE et al; Hotel Roosevelt, New Orleans, La., Sept. 13-14.

ENGINEERING WRITING AND SPEECH SYMPOSIUM, IRE-PGEWS; Mayflower Hotel, Wash., D. C., Sept. 13-14.

ELECTROCHEMICAL SOCIETY MEETING; Statler-Hilton Hotel, Boston, Mass., Sept. 16-20.

RECTIFIERS IN INDUSTRY MEETING, AIEE; Desher-Hilton Hotel, Columbus, Ohio, Sept. 18-19.

ORDNANCE ENVIRONMENTAL SYMPOSIUM (unclassified), R&D Div. of the Army Chief of Ordnance, Southwest Research Institute; El Tropicano Hotel, San Antonio, Texas, Sept. 18-20.

ADVANCE REPORT

QUANTUM ELECTRONICS INTERNATIONAL SYMPOSIUM, IRE, Société Française des Electroniciens et des Radioélectriciens, Office of Naval Research, et al; UNESCO House, Paris, France, Feb. 11-15, 1963. Oct. 1 is the deadline for final registration and for sending 3 copies of a summary to: The Third International Symposium on Quantum Electronics, 7 Rue de Madrid, Paris 8, France. Papers may be presented in either French or English. Topics include: masers; lasers; coherence; optical pumping; atomic clocks; applications to spectroscopy, magnetism and relativity. Emphasis will be on basic physical principles rather than engineering.



Type 661

SIMPLIFY YOUR PULSE-SAMPLING MEASUREMENTS

with this NEW
Tektronix
Dual-Trace
Oscilloscope

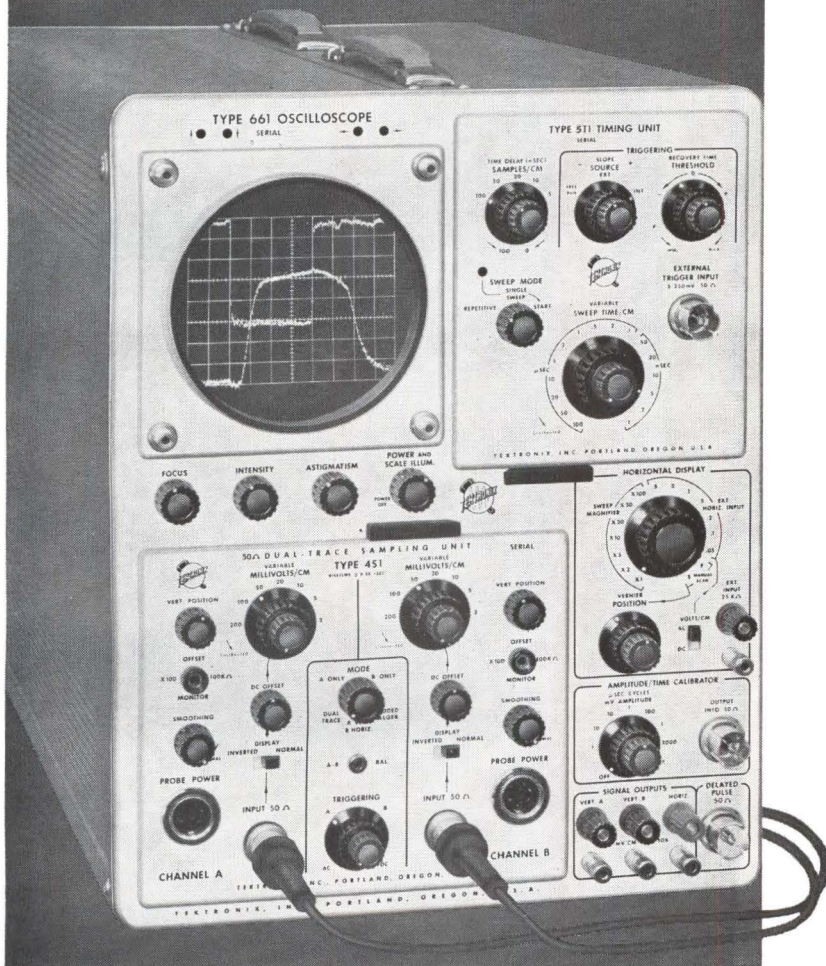

For a demonstration—please call your Tektronix Field Engineer.

Here's what you can do:

- ... Trigger internally—observe the leading edges of both A and B traces. Matched internal delay lines in both channels assure accurate time comparisons.
- ... Measure pulse risetimes with 0.35 nanosecond response in both channels. Time-measurement range extends to 1 millisecond.
- ... Display repetitive signals on 16 calibrated equivalent sweep rates from 1 nsec/cm to 100 μ sec/cm, accurate within 3%. Magnifier provides sweep expansion from 2 to 100 times . . . time per dot remains the same for digital readout.
- ... Change the probes' signal source without affecting the dot transient response.
- ... Reduce time jitter and amplitude noise, if needed, on the more sensitive vertical ranges and faster sweep rates by means of a smoothing control.
- ... Measure millivolt signals in the presence of a substantial dc component by means of a dc-offset voltage monitorable at the front panel.
- ... Calibrate with amplitude signals available from the front panel. Calibrate with timing signals traceable to National Bureau of Standards.
- ... Show lissajous patterns in addition to single and dual-trace displays and signals added algebraically.
- ... Drive X-Y plotters or similar readout accessories.
- ... Drive external equipment, with fast delayed-pulse output.
- ... Add plug-in units as they come along.

Here's how you do it:

- 1 Plug in the power cord and signal source,
- 2 Set the controls on the vertical and timing plug-in units,
- 3 Take the measurements.

In one compact laboratory oscilloscope you have a complete pulse sampling system with risetime of 0.35 nanosecond. Using the 50 Ω inputs, or the Tektronix passive probe or cathode-follower probe designed for use with the instrument, you can meet most of the general-purpose-measurement demands in repetitive-signal applications.

| | |
|---|--------|
| Type 661 Oscilloscope (without plug-ins) | \$1150 |
| Type 451 50 Ω Dual-Trace Sampling Unit | \$1430 |
| Type 571 Timing Unit | \$ 750 |
| Probes: | |
| Type P6026 Passive Probe | \$ 140 |
| Type P6032 Cathode-Follower Probe . . | \$ 160 |

U.S. Sales Prices, f.o.b. Beaverton, Oregon

Tektronix, Inc. P. O. BOX 500 • BEAVERTON, OREGON / Mitchell 4-0161 • TWX—BEAV 311 • Cable: TEKTRONIX

TEKTRONIX FIELD OFFICES: Albuquerque, N. Mex. • Atlanta, Ga. • Baltimore (Towson) Md. • Boston (Lexington) Mass. • Buffalo, N.Y. • Chicago (Park Ridge) Ill. • Cleveland, Ohio • Dallas, Texas • Dayton, Ohio • Denver, Colo. • Detroit (Lathrup Village) Mich. • Endicott (Endwell) N.Y. • Greensboro, N.C. • Houston, Texas • Indianapolis, Ind. • Kansas City (Mission) Kan. • Los Angeles, Calif. Area (Encino • Orange • Pasadena • West Los Angeles) • Minneapolis, Minn. • New York City Area (Albertson, L.I., N.Y. • Stamford, Conn. • Union, N.J.) • Orlando, Fla. • Philadelphia (Baia-Cynwyd) Pa. • Phoenix (Scottsdale) Ariz. • Pittsburgh (Monroeville) Pa. • Portland, Ore. • Poughkeepsie, N.Y. • San Diego, Calif. • San Francisco, Calif. Area (Lafayette • Palo Alto) • Seattle, Wash. • Syracuse, N.Y. • Washington, D.C. (Annandale, Va.).

TEKTRONIX CANADA LTD: Montreal, Quebec • Toronto (Willowdale) Ontario.

ENGINEERING REPRESENTATIVES: Kentron Hawaii Ltd., Honolulu, Hawaii. Tektronix is represented in twenty-five overseas countries by qualified engineering organizations. European and African countries, the countries of Lebanon and Turkey, please contact TEKTRONIX INTERNATIONAL A.G., Terrassenweg 1A, Zug, Switzerland, for the name of your local engineering representative. Other Overseas areas, please write or cable directly to Tektronix, Inc., International Marketing Department, P. O. Box 500, Beaverton, Oregon, U.S.A. Cable: TEKTRONIX.

CIRCLE 33 ON READER SERVICE CARD

CIRCLE 34 ON READER SERVICE CARD →

The Oak Approach

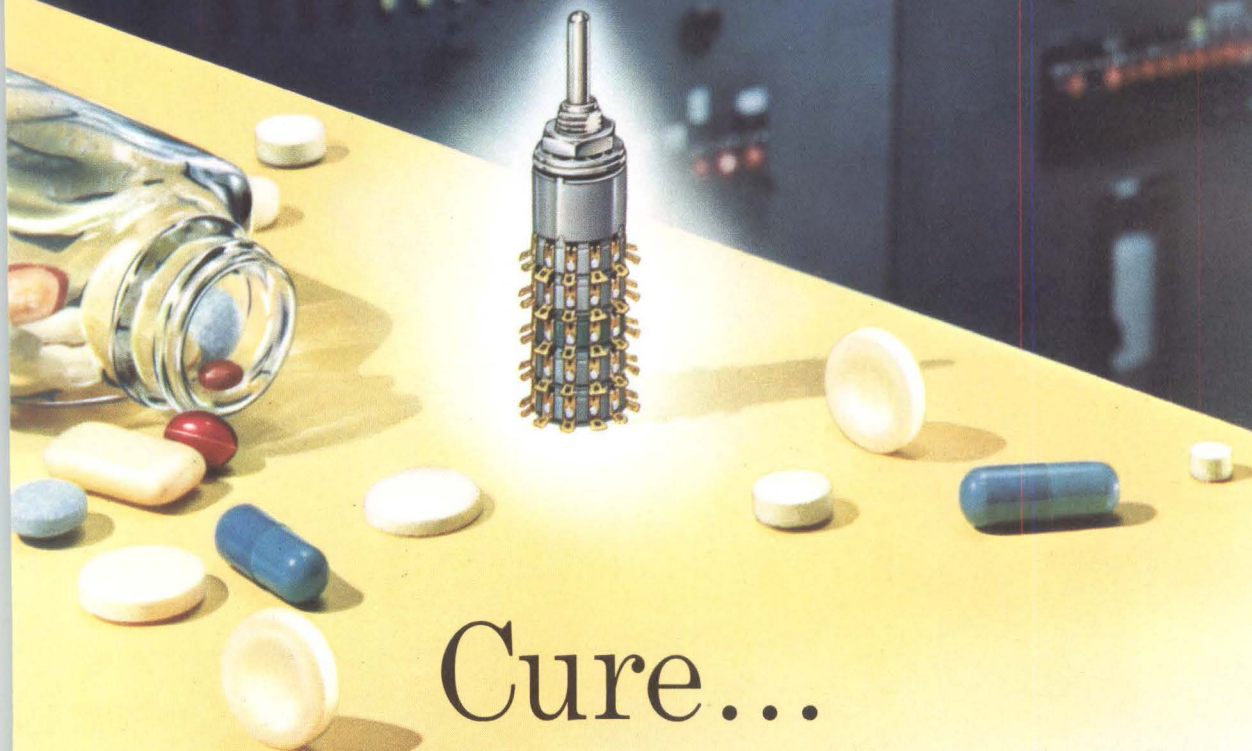

Cure... for space headaches

new ultracompact half-inch switch cuts space problems down to size!

It's become almost axiomatic in electronics that "thinking big" requires thinking *small*. And, of course, when circuit proportions shrink, the demand for smaller switches mounts correspondingly. Imagine how many tight places are presently crying for the advantages of this new *half-inch diameter, multisection rotary switch*: the *very first of its kind*, functionally equivalent to a regular-size rotary — physically smaller than your index finger!

Obviously rotary switches have "gone small" before; but this is far-and-away the first *multisection, 12-position* design able to match the versatility of its more sizable counterparts. Up to 5 sections per switch; 3 poles per section! And small

size doesn't imply delicateness. Half-inch Oak rotary switches shrug-off environmental extremes . . . withstand 50-hour salt spray; feature reliable double-wiping, self-cleaning contacts.

Even if your present requirements are apart from this sort of diminutive design, Oak application engineers still offer you a vital service. Their experience ranges through all sorts of switching problems involving function, environment, space and costs. And Oak capabilities also encompass production of precision subassemblies, made to your exact specifications.

For further information, contact your Oak representative. Or, feel free to phone us direct any time that we can be of help.

SWITCH SHOWN ACTUAL SIZE

Where creativity pays practical dividends

OAK rotary Power-Rated Switch — New compact design, with trim profile. Lowest-cost of all rotary power switches! Actually brings savings of one-third to one-half, compared to other alternatives. And the new Oak rotary Power-Rated Switch is just one current offspring of *New Product Engineering* — the department at Oak now given the full-time assignment of creating and improving product design. Rotary power switches can be had with one, two or three sections; provide up to 12 positions. UL listed for 125 vac, 6 amps; inductive rated at .75 PF; tested to 60,000 makes-and-breaks — or *ten times UL* requirements!

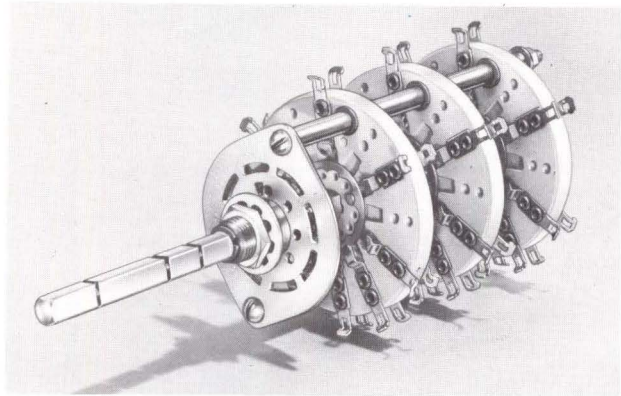

OAK space-saver slideswitch — 30% slimmer than prior designs, with seven fewer parts. Width savings so significant as to suggest literally hundreds of uses in equipment where space is at a premium! Economical too — you'll find this trim, new slideswitch *priced lower* than bulkier, ordinary models. Series-200 Oak slideswitches are obtainable in 11 different switching configurations. Rated 3 amps; available with or without UL listing. Double-wiping, self-cleaning contacts. Operation thoroughly tested, proven more reliable and longer-lasting than even its popular forebears.

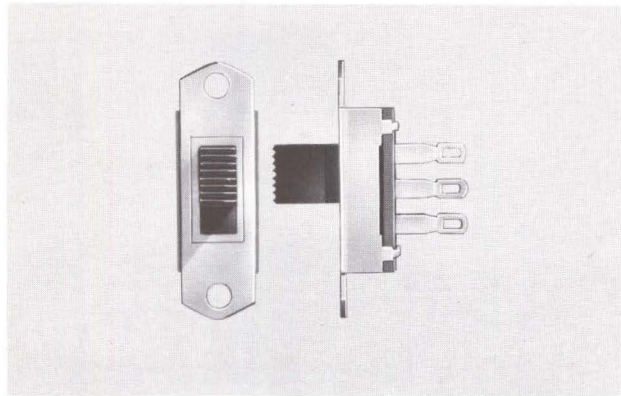

OAK also helps you save time! A new program now means distributors nation-wide will carry more than 130 types and sizes of Oak rotary switches, right on their shelves! You'll find superior replacements for many common makes; plus special configurations not available from stock *anywhere else*. Also component parts for assembling your own style of switch, from one to four sections, two to 23 positions. Quality is fully equivalent to our custom switch runs. Call collect for the name of your nearest Oak stock-switch distributor: Area code 815; 459-5000—request *Oak operator 10*.

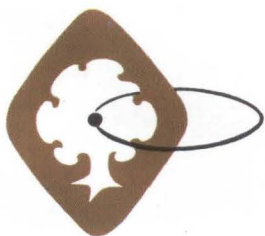
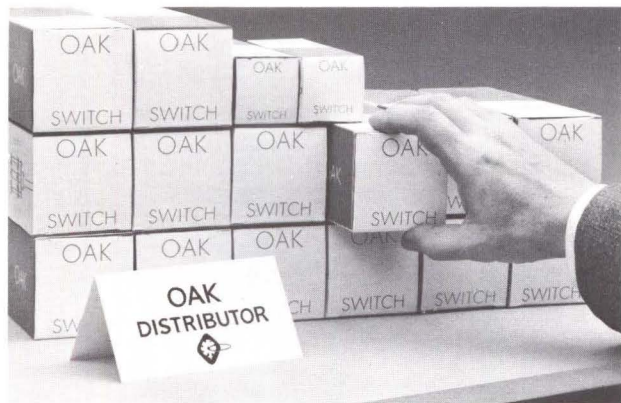

OAK MANUFACTURING CO.

CRYSTAL LAKE, ILLINOIS • Telephone: Area Code 815; 459-5000; TWX: CRYSLK 2350-U;
Plants in Crystal Lake, Illinois • Elkhorn, Wisconsin

Subsidiaries: OAK ELECTRONICS CORPORATION DELTA-f, INC. McCOY ELECTRONICS CO.
Culver City, Calif. Geneva, Ill. Mt. Holly Springs, Pa.

ROTARY AND PUSHBUTTON SWITCHES • TELEVISION TUNERS • VIBRATORS • APPLIANCE
AND VENDING CONTROLS • ROTARY SOLENOIDS • CHOPPERS • CONTROL ASSEMBLIES

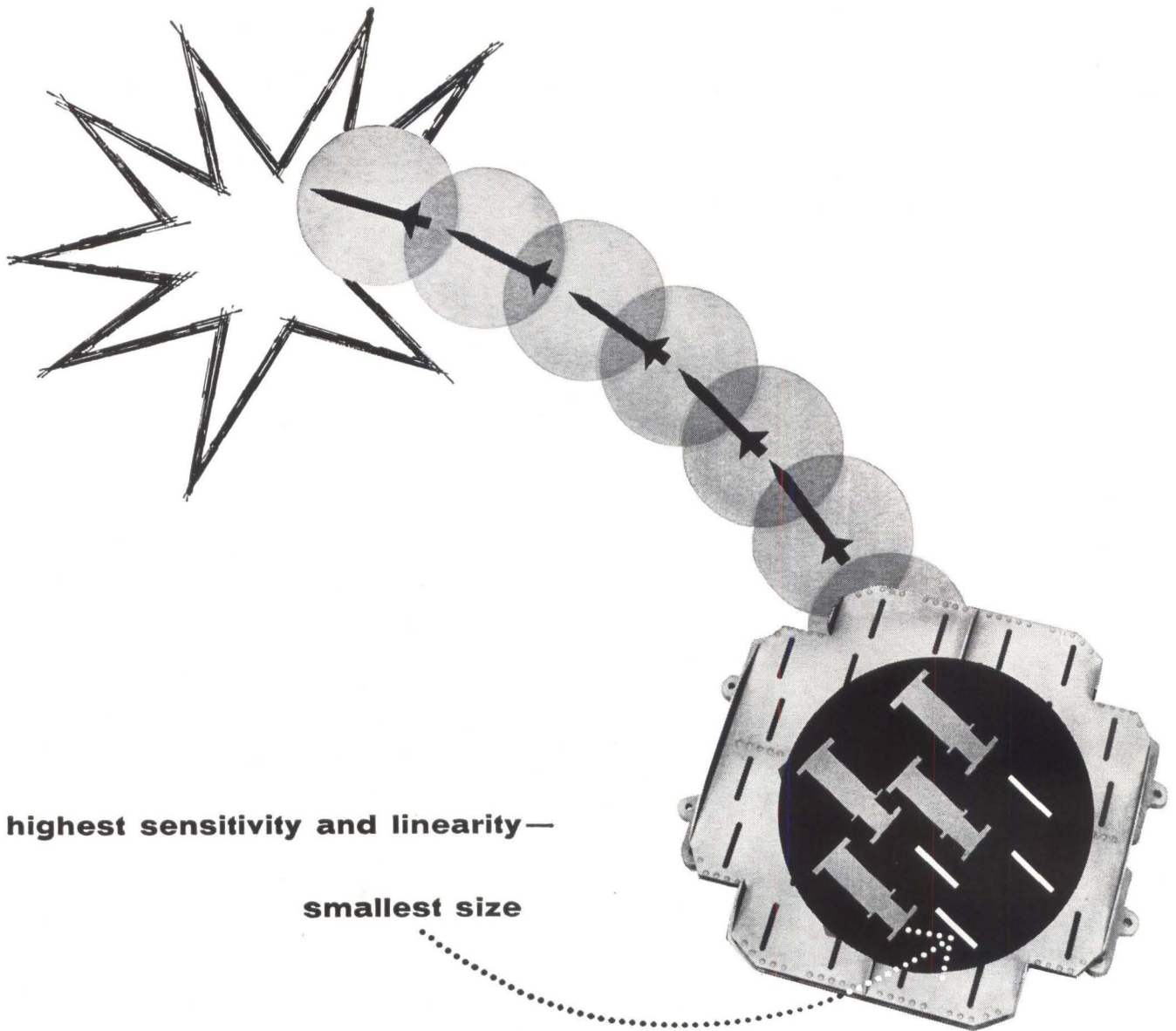

**highest sensitivity and linearity—
smallest size**

R-1 ferrite phase shifter used in scanning antenna.

That's why IGC microwave ferrite is the choice for new Rantec guidance antenna. Rantec Corporation selected our General Ceramics R-1 ferrite rods for the phase shifters of a production "flat plate" electronically conically scanned slot array. Reason: Sensitivity and linearity, together with extremely low insertion losses and uniform quality. These factors resulted in the smallest unit size with reproducible characteristics. ■ These "flat plate" antennae are applicable to aircraft, missile, satellite and ground applications. They replace the older parabolic types because of improved electrical performance, coupled with advantages in physical form factor and inherent reliability. ■ We make four basic microwave ferrite materials — R-1, R-4, R-5, and R-6. These are available in both custom and standard sizes and shapes and offer a wide range of saturation values. For complete specification data, write for Bulletin 29 to Indiana General Corporation, Electronics Division, Keasbey, New Jersey.

INDIANA GENERAL 



←CIRCLE 35 ON READER SERVICE CARD

CIRCLE 36 ON READER SERVICE CARD

You may not need capacitors as good as these

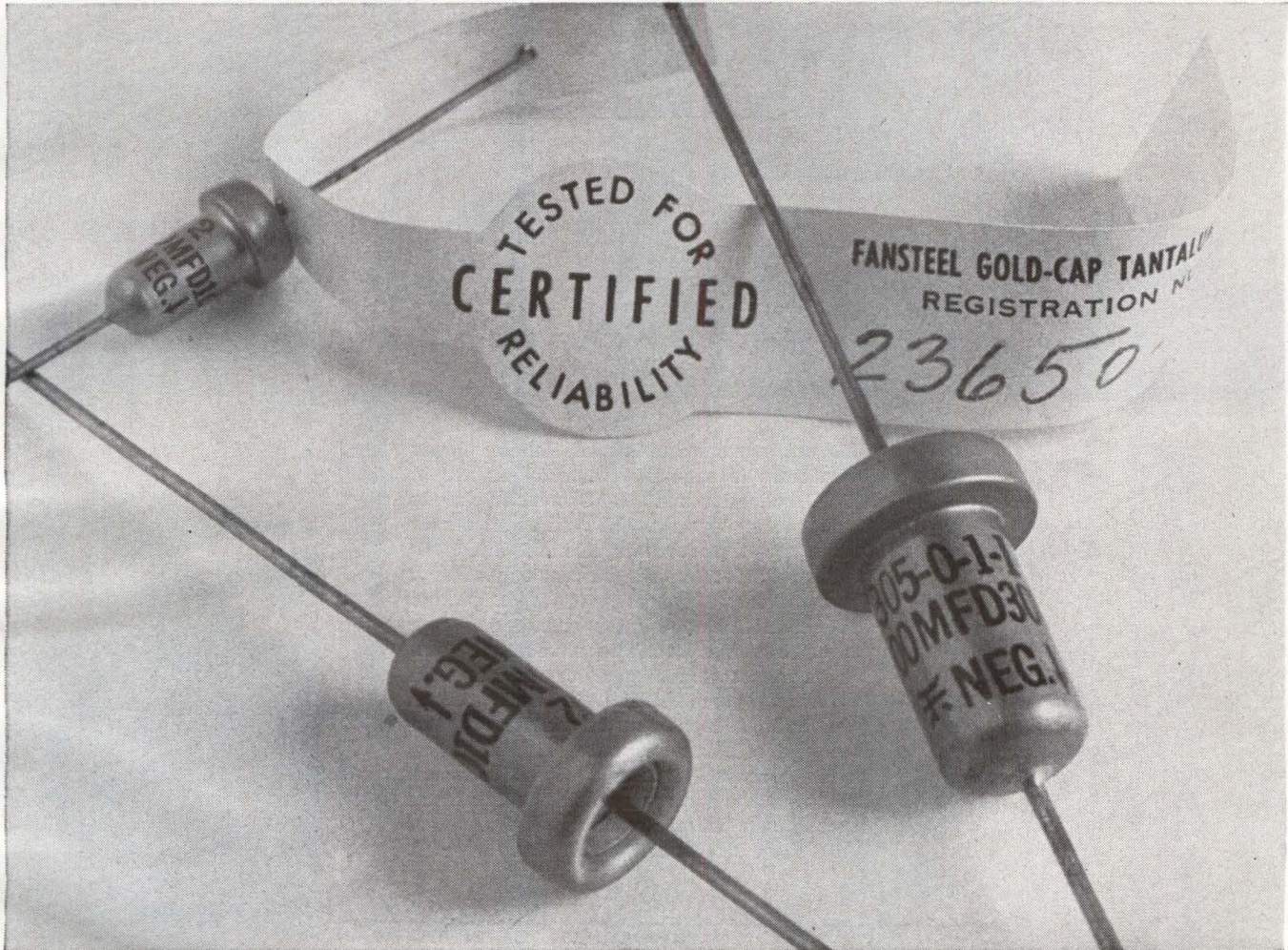

Fansteel GOLD-CAP® tantalum capacitors satisfy a very particular need for extremely high reliability. Your design may not justify their extra cost. If so, Fansteel makes and stocks twelve other types of tantalum capacitors that will surely fill the bill. Gold-Caps are produced under Fansteel Spec. No. 6CA-101 which exceeds the requirements of any Mil. Spec. The stability of each and every unit is tested at temperature extremes for Capacitance, D-C Leakage, E S R, and Impedance. Altogether, 7,891 readings, calculations, examinations, and comparisons are made for every 100 units by Fansteel's tough Reliability Center with the aid of modern computers. When a capacitor is given a GOLD-CAP tag, individually serialized, and provided with certified test results, it has *earned* it. No, we can't be positive that these are the best tantalum capacitors in the world, but

we have no reason to think that they aren't. Send for GOLD-CAP Spec. No. 6CA-101 and see what we mean. Rectifier-Capacitor Division, Fansteel Metallurgical Corporation, North Chicago, Ill.

This is what you get—certified test data, such as illustrated, is furnished with each and every GOLD-CAP capacitor. Further inspecting or testing is unnecessary.

| CAPACITOR NO. | TEST NO. | TEMP. °C | C | DF % | DC LKG. | % INITIAL C |
|---------------|----------|----------|------|------|---------|-------------|
| 23650-0012 | 1 | +25 | 54.0 | 4.8 | .80 | |
| 23650-0012 | 2 | -55 | 47.0 | 18.6 | .20 | 87.0 |
| 23650-0012 | 3 | +25 | 54.0 | 4.8 | .80 | 100.0 |
| 23650-0012 | 4 | +125 | 56.0 | 4.6 | 2.40 | 108.7 |
| 23650-0012 | 5 | +25 | 53.3 | 4.8 | .80 | 98.7 |

MORE POWER TRANSISTORS FROM BENDIX

90 NEW TYPES!

This newly expanded line of Bendix® Power Transistors is especially valuable for use in DC-DC converter and DC-AC inverter circuits and for switching up to 400 watts as drivers for relays, relay replacements, solenoids, magnetic clutches and other high current applications. Characteristics of typical types are listed in the table below. Included in the expanded line are power transistors which offer unusually flat beta curves for less amplifier distortion, increased current gain (up to 200 at 3 Adc), and increased power ratings. Each power transistor is 'Dynamically Tested,' an exclusive Bendix quality control process that tests each unit to assure uniformity and maximum reliability. For data on the complete line of Bendix Power Transistors and Power Rectifiers, write to Holmdel, N. J.



| Type Number | MAXIMUM RATINGS | | | CURRENT GAIN | |
|---------------|-------------------------|-----------------------|---------------------|-------------------|-----------------------|
| | V _{CES} Vdc | I _C Adc | P _C W | h _{FE} @ | I _C Adc |
| 2N297A* | 50 | 5 | 35 | 40-100 | 0.5 |
| 2N456A-8A | 40-80 | 7 | 50 | 30-90 | 5 |
| 2N637-8,A,B | 40-80 | 5 | 90 | 20-60 | 3 |
| 2N1011* | 80 | 5 | 35 | 30-75 | 3 |
| 2N1136,A,B | 40-80 | 5 | 90 | 50-100 | 3 |
| 2N1137,A,B | 40-80 | 5 | 90 | 75-150 | 3 |
| 2N1138,A,B | 40-80 | 5 | 90 | 100-200 | 3 |
| 2N1359-2N1365 | 40-100 | 3 | 90 | 35-150 | 1 |
| 2N1529-38,A | 30-90 | 5 | 90 | 20-70 | 3 |
| 2N1539-43,A | 30-90 | 5 | 90 | 50-100 | 3 |
| 2N1544-48,A | 30-90 | 5 | 90 | 75-150 | 3 |

*Also available per MIL-S-19500/36A & MIL-T-19500/67

Bendix Semiconductor Division



Main Office: South St., Holmdel, N. J.—Ph: SH 7-5400 • New England Office: 235 Bear Hill Rd., Waltham, Mass.—Ph: 899-0770 • Syracuse Office: 1054 James St., Syracuse, N. Y.—Ph: 474-7531 • Detroit Office: 12950 W. 8 Mile Rd., Detroit 37, Mich.—Ph: JO 6-1420 • Midwest Office: 1915 N. Harlem Ave., Chicago, Ill.—Ph: 637-6929 • Los Angeles Office: 117 E. Providencia Ave., Burbank, Calif.—Ph: VI 9-3961 • San Francisco Office: 128 El Camino Real, San Carlos, Calif.—Ph: LY 3-7845 • Canadian Affiliate: Computing Devices of Canada, Ltd., P.O. Box 508, Ottawa 4, Ont. • Export Office: Bendix International, 205 E. 42nd Street, New York, 17 N. Y. Stocking Distributors: Contact nearest sales office for name of local distributor.

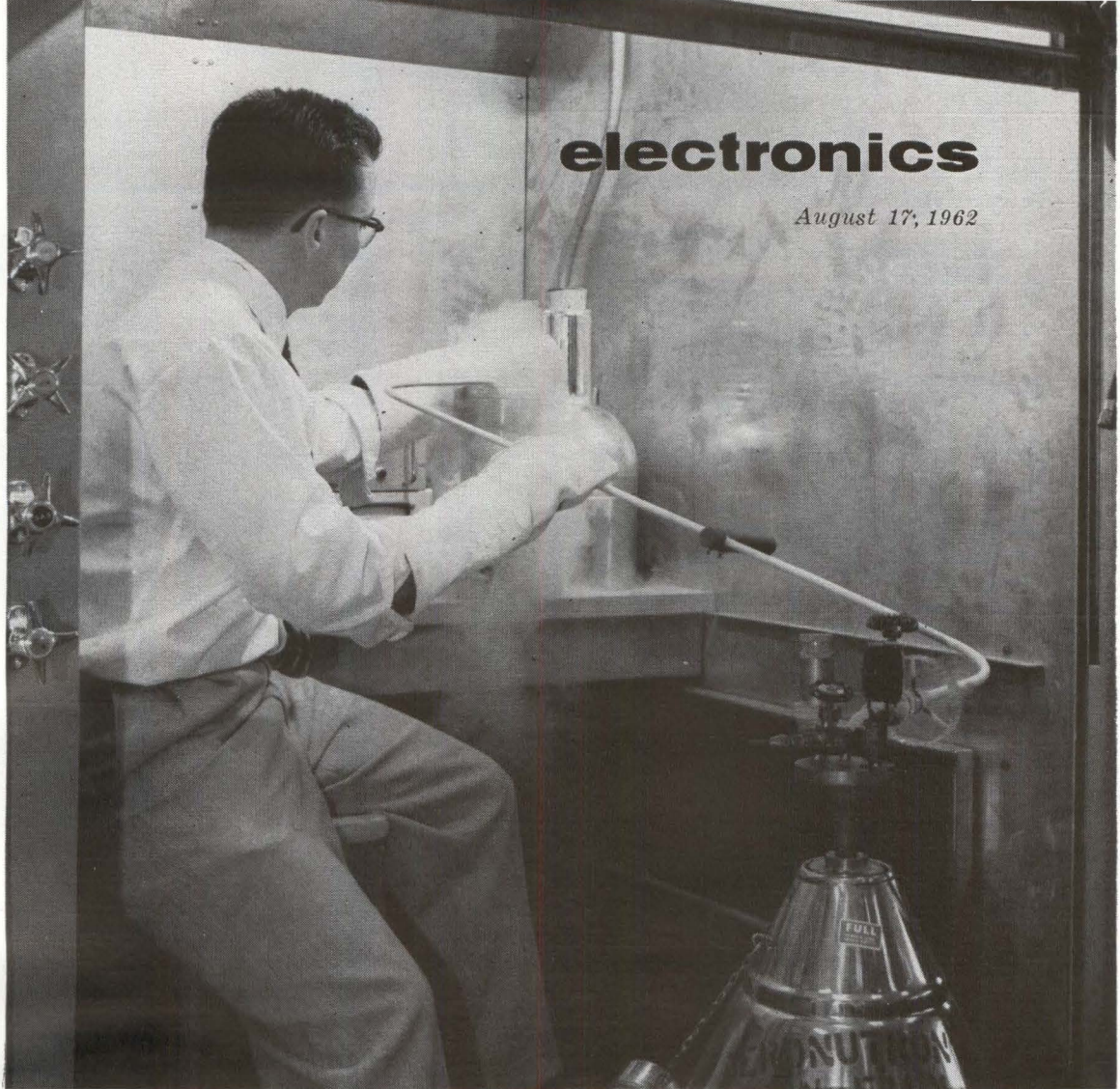

electronics

August 17, 1962

AUTHOR Lambert filling a nitrogen jacketed cryostat with nitrogen

The Cryosar: Promising Element For Tomorrow's Computers

A recent cryogenic development, the cryosar operates by the impact ionization of germanium at liquid helium temperatures. Its outstanding features are low element cost, low power dissipation and simplicity of construction

By L. M. LAMBERT and J. E. McATEER,
Research Laboratories,
Aeronutronic Division of Ford Motor Company,
Newport Beach, California

DATA PROCESSING is becoming more important as experimental knowledge of the physical world increases, as industrial and military facilities increase productivity and efficiency, and as the ever-expanding volume of the written word accumulates almost geometrically. To cope with these problems, increased effort has been expended toward systems that are faster, that are smaller in physical size, that have larger capacities and that have better input-output facilities. The cryosar has been investigated

PARAMETER DEFINITIONS

- V_p — Peak or breakdown voltage of the compensated cryosar
 V_s — Sustaining voltage or voltage after breakdown of the compensated cryosar
 I_p — Current at the peak or breakdown point of the compensated cryosar
 I_s — Sustaining current just after breakdown of the compensated cryosar
 V_b — Breakdown voltage of the uncompensated cryosar
 I_b — Current just after breakdown of the uncompensated cryosar
 V_a — Voltage between storage cryosar and selection cryosar of Fig. 2A
 V_c — Cryosar supply voltage in Fig. 2A
 V_{int} — Interrogation voltage. Applied in order to read out information stored in cryosar

GRAPHS of electric field versus current density in a typical uncompensated cryosar and compensated cryosar. N_A and N_D refer to number of acceptor or donor atoms, respectively—Fig. 1

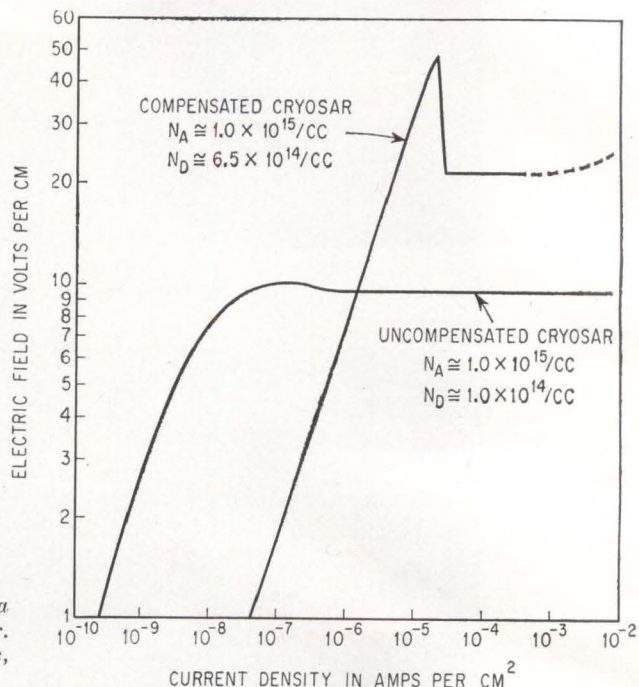

to evaluate its potential as a new device for faster, smaller, and larger-capacity digital systems.

Cryogenic systems of any type must compete with standard systems operating at essentially room temperature. To be practical, the cryogenic system must have something to offer that the standard systems does not. Present systems fail to provide:

(1) Adequate device characteristics to permit low-power (for example, one-microwatt) and high-speed (such as 100 Mc) operation, so that high-density packaging techniques can be fully utilized.

(2) Simple automatic or semi-automatic means of assembling high-component-count circuits. Even in principle, the solution to this problem is difficult to visualize because of the critical constructions involved in the various devices used.

(3) High enough reliability in the active devices; however, significant gains in this area are now being made through surface passivation techniques.

(4) Low enough cost in all phases so that it is economical to throw away faulty circuits or even subsystems.

(5) Means of engineering large systems, since high-component-count systems utilizing even moderately high-density packaging techniques and operating in the low megacycle region are difficult to assemble because of circuit noise cou-

pling and ground potential gradients.

It would be instructive to see whether the cryosar is able to make contributions to the solution of some of the present problems in these five areas. The categories may be examined in order for ease of comparison:

(1) The nature of the device phenomena often places bounds on the power capabilities of a device. By proper design, the breakdown current of the cryosar can be smaller than one microampere, with the corresponding sustaining voltage as low as a few tenths of a volt. One microwatt operating power is not a lower bound, but appears to be a reasonable value of power dissipation. The speed of switching at these low powers will probably be less than 100 Mc, but nevertheless should be in the megacycle region.

(2) Because of the simplicity of construction of the cryosar (essentially two contacts on a germanium wafer) important innovations in circuit assembly would be possible. The wafer itself could form the substrate for circuit construction. Multilayer interconnections may be possible using present evaporation technology.

(3) Since the impact ionization phenomenon used in the cryosar is a bulk phenomenon, the device is extremely reliable. Surface passivation and other precautions are not required, because surface proper-

ties are not that important.

(4) The cost of the unassembled cryosar device is essentially the cost of single-crystal germanium. It is difficult to visualize cheaper devices, since no individual yield problems are involved. In addition, if modern evaporation and masking techniques are employed, the cryosar circuitry would still be extremely cheap, and replacement would appear more feasible than repair of subsystems. The film deposition is noncritical; it is just a convenient way to put on ohmic contacts. If the films are thicker than about 3,000 Å, they are suitable for ohmic contacts. Unlike the cryotron, the films serve no function other than for contacts and therefore impurities, structure and other parameters have no meaning, whereas they are important to cryotron fabrication.

(5) It seems reasonable that if ground planes of lead (which is superconducting at liquid helium temperatures) are used in cryosar systems, perfect shielding and ideal ground planes can at last be realized.

In addition, since the cryosar is a majority carrier device, radiation damage should be less than with other existing semiconductor devices. For space exploration or high-radiation environment systems, this may well be an important factor.

Other cryogenic devices, such as the cryotron, also offer some

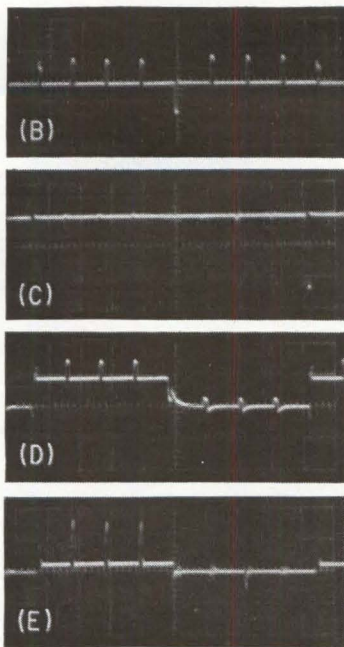
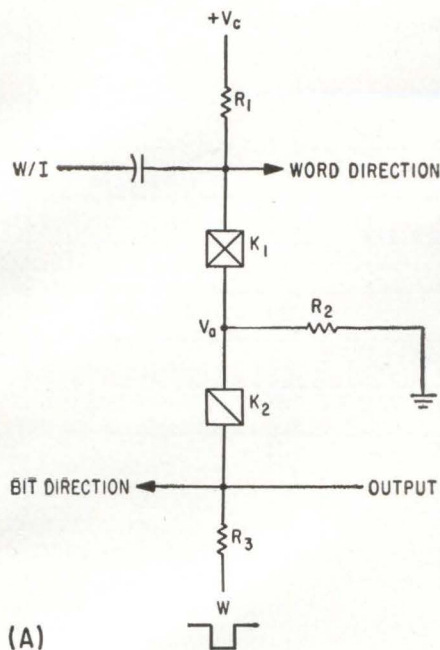

DOUBLE CRYOSAR storage cell (A) and its waveshapes at various points: W/I (B); W (C); $V(R_2)$ (D); output (E). Horizontal scale is $4 \mu\text{sec}$ per cm; vertical is 0.5 v per cm in (B) to (D), 0.1 v per cm in (E)—Fig. 2

advantages in these categories. However, the cryotron is critically dependent on temperature for its operation (typically $\pm 0.1 \text{ K}$). Since localized heating is inevitable in a practical digital system, this presents a grave problem and possibly a limitation in the speed of the device since the thermal conductivity of liquid helium is about that of air at room temperature. Temperature is not a critical control parameter with cryosars: $\pm 2 \text{ deg K}$ is satisfactory for most applications, for which operational temperature is about 4.2 deg K .

IMPACT IONIZATION — Impact ionization of germanium at liquid helium temperatures has been investigated as a physical phenomenon by many workers.¹⁻⁵ The negative resistance process and device possibilities were first investigated by Rediker and McWhorter⁶⁻⁸ who assigned to the device the name *cryosar*. *Cryo* pertains to the low-temperature environment involved in the device's operation. *Sar* is made up of the initial letters *s* for the switching, *a* for the avalanche, and *r* for the recombination processes. In short, the device switches ON by avalanche or ionization, and switches OFF by recombination of the free carriers. The avalanche process is an impact-ionization process whereby electrons, for example, in an *n*-type material, are accelerated to high enough energies

by the applied electric field so that when they collide with an un-ionized impurity atom, the impurity atom is then ionized, and its carrier is released to be accelerated and to ionize even more impurity atoms. The low-temperature environment of the cryosar is necessary to ensure that un-ionized impurity atoms exist in the semiconductor. The low temperature also permits the ionization to occur at lower electric fields because of the lower losses to the lattice. Electric fields of about a volt per centimeter are sufficient to ionize germanium at helium temperature. In a sense, the semiconductor crystal lattice at this temperature is a lossless waveguide for the propagating electron wave, except for the neutral and ionized impurity atoms and to a lesser extent, except for the dislocation and imperfections in the crystal lattice. This latter scattering mechanism has been estimated by Dexter and Seitz⁹ and is generally regarded as negligible in high-quality single crystals of silicon and germanium.

The impact ionization of single-crystal germanium containing a single-impurity type has been investigated by several workers since Hung and Glieman published their findings of low temperature anomalies in Hall coefficient and resistivities in 1950.^{10, 11} A typical plot of field-versus-log current is as shown² in Fig. 1. The sudden change in conductivity is due to the

generation of a large number of free carriers by impact ionization of un-ionized impurity atoms. The finite conductance prior to breakdown is of interest, and for moderate concentrations of a single impurity type (for example, donor or acceptor atoms less than 10^{16} atoms per cubic centimeter) it appears to be due, at least in part, to the mobility of thermally generated electrons or holes. The pre-breakdown mobility is governed by the scattering of the free carriers by the neutral and thermally ionized impurity atoms. (Intrinsic generation of carriers is of course completely negligible.) A formula for the mobility due to scattering by ionized impurity atoms has been proposed by Conwell and Weisskopf¹²⁻¹⁴ and appears to be approximated to a reasonable degree by considering only the Rutherford scattering due to the coulomb interaction of the carrier and the impurity center and also by considering the scattering potential caused by strains in the crystal lattice because of the presence of the charged impurity atom in a substitutional site. This latter scattering mechanism is essentially a discontinuity in the wave transmission properties of the periodic crystal structure.

Erginsoy¹⁵ has approximated the effect of the neutral impurity atom by analogy with the scattering of slow electrons by hydrogen atoms.

The cryosar of most interest, from the standpoint of device possibilities is the two-impurity or the heavily compensated cryosar. The presence of compensating impurity atoms cause the voltage-versus-log current characteristics to appear as shown in Fig. 1. The considerations concerning neutral and ionized impurity scattering are still valid in this case. However, the ionized impurities are now the entire population of compensation atoms, plus those majority atoms which gave up their electrons (for example, in *n*-type material) to the acceptors, plus those donors which

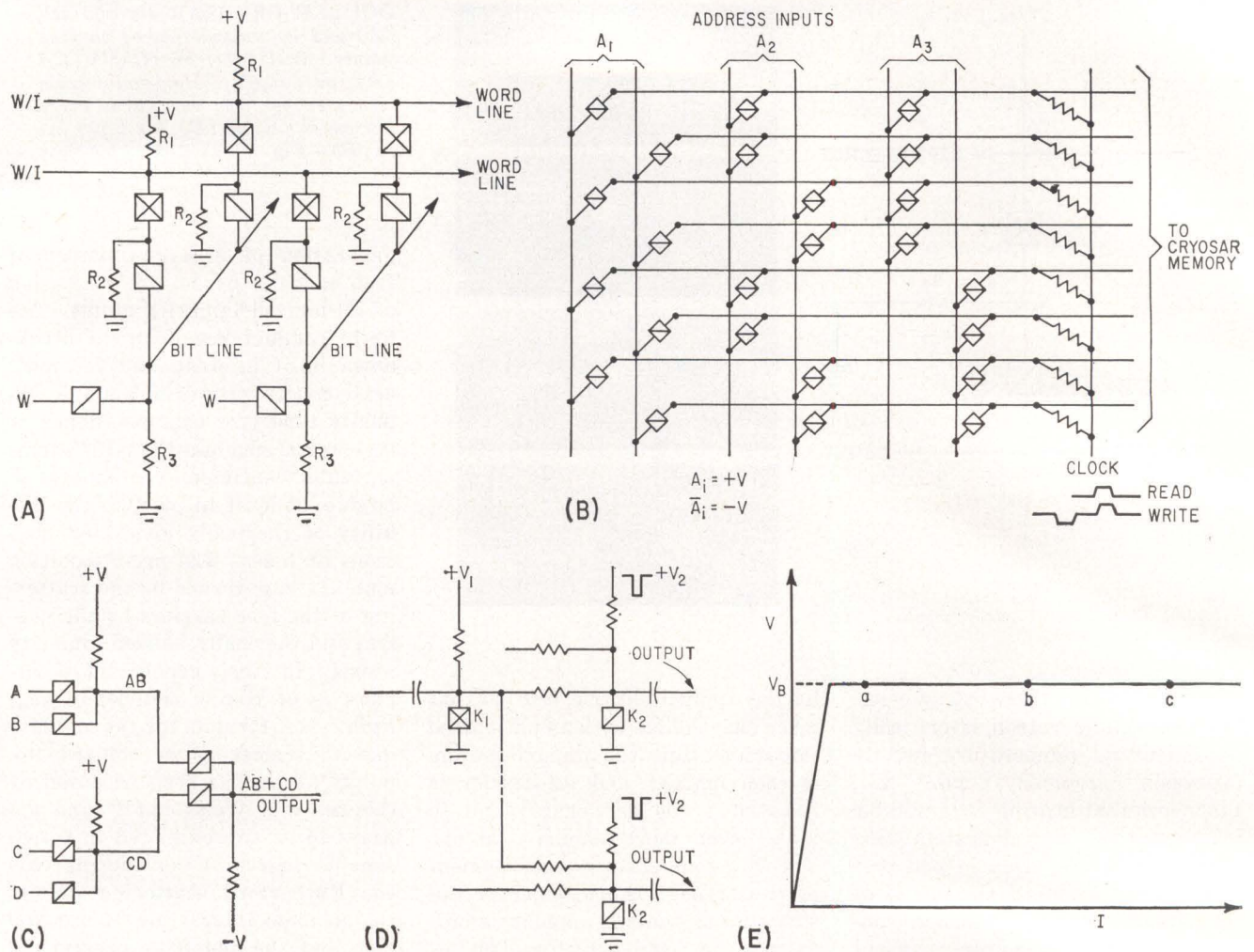

CRYOSAR CIRCUITS: memory (A); decoder (B); AND-OR gate (C); pulse-type logic (D). Graph of uncompensated cryosar operation for pulse-type logic circuit (E)—Fig. 3

provide thermally activated electrons for the conduction band. The remaining neutral-impurity atoms are those donor atoms which have not participated in either of the above donor-ionization processes. Because of the presence of the compensating atom, however, another pre-breakdown conduction process is in evidence. This conduction mechanism appears to be due to the finite probability of a carrier tunneling from an occupied or un-ionized impurity atom to an equivalent unoccupied or ionized impurity atom. This conduction process differs from the normal conduction process of thermally generated carriers in that it does not occur in the conduction or valence bands as is normal for n or p semiconductors, respectively. A compensating impurity is necessary to this phenomenon in order to empty the donor atom of its electron and thereby ionize it. The electron of the un-ionized donor then has a vacant site

to which it can tunnel. The probability of charge transfer within the impurity level increases rapidly with impurity concentration. At higher doping, concentrations greater than 10^{16} atoms per cubic centimeter in germanium, a different impurity conduction process occurs which does not require compensation. At very high impurity densities, the overlap of the wave functions of adjacent impurities is so strong that the carriers are no longer localized, and an impurity band is formed in which conduction can readily occur in a manner comparable to a metal. This second mechanism is not of present interest.

As the applied field is increased, the generation of carriers by impact ionization occurs; however, the breakdown field and the sustaining field no longer coincide in the heavily compensated case, the sustaining field being decidedly smaller. Such a situation can be recognized as

negative resistance. The origin of this negative resistance as suggested by McWhorter¹⁶ and investigated by Callaway and Cummings¹⁷ appears to be due to a loss mechanism analogous to scattering from an ionized hydrogen molecule, H_2^+ . Suppose, for example, that a pair of donor atoms in an n -type material are located adjacent to each other as well as in the vicinity of an acceptor impurity atom. Since the acceptor will certainly be ionized by capturing one of the two electrons associated with the two donor atoms, this leaves two donor atoms with one electron in addition to the newly ionized acceptor atom. Now if the donor atoms are properly spaced in their substantial lattice sites, the energy situation will be similar to that of an ionized hydrogen molecule, H_2^+ . This atomic configuration presents itself to conduction carriers as an additional inelastic scattering mechanism which absorbs energy, as do the

phonons, by being excited from the symmetric to antisymmetric state. The calculations of this loss mechanism agree favorably with experiment. It is necessary therefore that a larger electric field be provided to accelerate the conduction carrier to high enough energies to overcome this additional loss mechanism and to ionize the un-ionized impurity atoms by collision. Once the breakdown occurs, and therefore essentially all impurity atoms are ionized, the H_2^+ ion disappears and becomes just two ionized donor atoms. The field necessary to sustain this breakdown should be essentially the same as that required in an uncompensated material, where the proper consideration is given to the fact that the total number of ionized impurity scatterers is now the sum of the two impurity types.

CRYOSAR CIRCUITS—The very low operating currents and voltages of the cryosar element offer very intriguing possibilities for low power, large capacity storage systems.

Because the cryosar is a two-terminal device and has such a low resistance in the ON condition, the problem of coupling to the element on a system basis becomes quite severe. Johnston's¹⁸ approach to the solution of this problem was to fabricate a "compound" cryosar which essentially is a compensated and uncompensated cryosar in series. This gave rise to a two-terminal device having a double break and provided some isolation from element to element on a system basis.

Capacitive and electromagnetic coupling schemes were investigated and found unattractive for various reasons. The storage cell to be described, while somewhat similar to Johnston's, has several important differences.

The basic cell is shown in Fig. 2A. Component K_1 is a compensated cryosar while K_2 is an uncompensated cryosar. If the cell contains a one, K_1 is in the ON condition and K_2 is in the OFF, or high-impedance state. The ON current that flows through K_1 produces a voltage across R_2 which is slightly less than the breakdown voltage of K_2 . To read the information, a positive pulse is applied to the W/I (Write/Interrogate) terminal. Since K_1 is

in the ON condition, the voltage will appear across R_2 , causing K_2 to break down, and an output to appear across R_3 . The amplitude of the voltage is a function of the dynamic resistance of K_1 and K_2 and the bias point of K_2 with K_1 in the ON state. The signal which appears on the output is a positive pulse; therefore, all other K_2 cryosars in the bit direction have the voltage across them reduced if the cell is in the one state. If the other cells are in the zero state, the output is not large enough to break down K_2 ; therefore, all K_2 elements in the bit direction will remain in their high-impedance (several megohms) state, and good isolation is achieved.

In the zero state, K_1 is OFF and the interrogate pulse is insufficient to break it down, therefore no output will appear across R_3 .

Writing is accomplished by a two-pulse write cycle that consists of a negative pulse on the W/I line which clears all cells to zero. The ones are then written in by a positive pulse on the W/I line (equal to the interrogate pulse) and a negative pulse on the W line. The amplitude of the negative pulse is such that when it is in coincidence with the positive write pulse, both K_1 and K_2 are in their low-impedance state. When the pulses are removed, K_1 remains ON (low-impedance) while K_2 returns to its high-impedance (OFF) state.

Resistor R_1 is small enough so that the voltage drop across it is negligible though not small enough to unduly load the W/I driver.

Figures 2B through 2E show the waveshapes obtained with an experimental double-cryosar storage cell. The cryosars had the following characteristics: For K_1 , $V_p = 1.35$ v, $V_s = 0.6$ v, $I_p = 1.2$ μ a. For K_2 , $V_b = 0.52$ v, $I_b = 0.8$ μ a, and $R_{off} \approx 2$ megohms.

The cryosars were those used for obtaining characteristics and had large contact areas, and hence fairly large capacities; they do not represent the optimum design. From the waveshape it can be seen that with an interrogate signal of 350 mv that the ONE output is approximately 150 mv and the signal-to-noise ratio is about 5. Most of the noise is attributed to capacitive feedthrough and pickup in the lines into the helium bath. It should be possible to improve this ratio with smaller

contact size and good packaging techniques.

The storage cell described is, as mentioned, not optimum. The following design is based upon planar cryosars which appear to be obtainable and have the following characteristics:

For K_1 : $V_p = 0.3$ v, $V_s = 0.15$ v, $I_p < 0.5$ μ a, $I_s < 1$ μ a, and $R_{on} \approx 0$.

For K_2 : $V_b = 0.1$ v, $I_b < 0.1$ μ a, $R_{off} > 2$ megohms, and $R_{on} \approx 0$.

Should it prove unfeasible to use planar cryosars, then the bulk-type cryosar would be used. The only difference in the system would be that the voltages used would be higher. Therefore, more power would be consumed.

Using the above parameters and referring to Fig. 2A, assume $I_{on} = 2$ μ a. Let $V_a = 0.09$ v when K_1 is on. Therefore, $R_2 = V_a/I_{on} = 0.09$ v/2 μ a = 45,000 ohms.

If it is assumed that R_1 is small so that the voltage drop across it is negligible, then $V_c = V_a + V_s = 0.09 + 0.15 = 0.24$ v. Then the interrogate signal is given by $V_{int} \leq V_p - V_c = 0.06$ v. Let $V_{int} = 50$ mv.

If it is assumed that the output current through R_3 is to be limited to 2 μ a then $R_3 = V_{out}/I_{out}$.

The output voltage will be given by $V_{out} = V_{int} - \text{circuit losses}$, which in the idealized case is given by $V_{out} = V_{int} - (V_b - V_a)$, so that $V_{out} = 0.04$ v, and therefore, $R_3 = 20,000$ ohms.

Because both cryosars are in their high-impedance region when the cell is in the zero state, the noise signal will be determined by the capacity of the cryosars. If a S/N ratio of ten is desired, the capacitance allowable per element is found to be 0.05 Δt pf, where Δt is the rise time of the interrogate pulse in nanoseconds. Even for fast rise times it is easy to achieve capacities well below the allowable.

Figure 3A shows the connection in more detail. The cryosar on the W line serves as an isolator. The amplitude of the W pulse necessary for writing a one can easily be calculated and is found to be 0.21 v if the isolator cryosar has the same characteristics as the previous uncompensated cryosar.

It can be seen from Fig. 3A that uninterrogated storage cells on the bit line present a high impedance to the output signal on the bit line,

since the uncompensated cryosar is always in its high impedance state unless interrogated. However, any current which is caused to flow because of the capacitance of the element is in such a direction as to decrease the current through the compensated cryosar in the one (ON) state, and hence would tend to turn it OFF. This then is another restriction on the amount of capacitance an element may have. As mentioned previously, the ON current is taken as $2 \mu\text{a}$ while the sustaining current is assumed to be less than $1 \mu\text{a}$; therefore $C < 0.025 \Delta t \text{ pf}$, and as mentioned previously, this is not difficult to achieve.

The value of R_1 should be fairly low for the reasons mentioned previously. A reasonable value would be 50 ohms, so that the voltage drop would be negligible for a reasonable number of elements. When all cells common to a word line are in the one state, the impedance seen by the W/I driver during interrogate is

$$Z_{w/I} = R_1 \parallel \frac{R_2 \parallel R_3}{n}$$

where the vertical lines denote that the resistors are in parallel and n is the number of bits in the word. In the present case, if $n = 64$, $Z_{w/I} = 42 \text{ ohms}$. Thus, the W/I driver does not see a widely varying impedance.

The power consumption of the cell in the ON state is $0.48 \mu\text{w}$. If a fairly large system were built with a three-watt refrigerator, there would be considerable cooling power left for any circuits that might be put into the bath with the array.

It is worth noting that all the necessary pulse voltages are readily obtainable with tunnel diode cir-

cuitry. Tunnel diodes work quite well at liquid helium temperatures although no long-time storage data are available. It may be possible to construct a fairly large storage system where only a small number of connections to the outside environment are necessary.

CRYOSAR LOGIC—With the possibility of very small element capacities and extremely large OFF resistances, performing logic functions with fairly complex structures may be possible.

Johnston has described a decoder¹⁰ which could be used with the storage cell described previously. Figure 3B shows this decoder which is made up of uncompensated cryosars. If, for the sake of illustration, it is assumed that the uncompensated cryosars have a breakdown voltage of one volt and that the true state is denoted by an input of one volt, the operation is as follows:

During read, the normal of the address is applied to the decoder input lines and a positive clock signal is applied at the clock terminal as indicated. A positive pulse will then appear on the output of the true line. No output will appear on the other lines because of the clamping action of the cryosars which return to the false (negative input) input lines.

For writing into the memory, the complement of the address is applied to the decoder input lines and a negative clock pulse (clear operation) is applied to the clock input. A negative pulse will appear on the output that clears the word to zero. No negative pulse appears on the other lines because of the clamping action of the cryosars which return

to the positive inputs. The address is then returned to normal and followed by a positive clock pulse, and the decoder operates as for the read operation. This positive pulse on the word line in coincidence with the information signal (negative pulse) on the bit line selectively writes ones into the proper bit location.

The decoder described above is, of course, a logical AND gate. Used by itself, this gate has a level shift between input and output. It is possible to restore the original levels and perform an OR function by adding a second level of logic. This configuration is shown in Fig. 3C.

If it is assumed that the logic levels are +1 volt (true) and 0 volt (false) and the cryosars have a one-volt breakdown, then the output of the AND portion of the gate will be at +2 volts only if A and B are both at +1 volt. If either one or both of the inputs are at the lower voltage, then the output is at +1 volt. Thus, the first stage performs the logical function AB with the true output being represented by +2 volts. The output of the OR section will be +1 volt if either of the inputs are at +2 volts (true) so that a logical OR is performed. The configuration thus accomplishes the AND-OR function with the input and output levels corresponding.

Because of the low-loss nature of the elements in the ON state it may prove possible to perform many levels of logic before regeneration is necessary. Regeneration and inversion could possibly be accomplished with compensated cryosars or tuned diodes. The fan-in, fan-out capabilities should also be quite good because of the large resistances in the OFF state and small

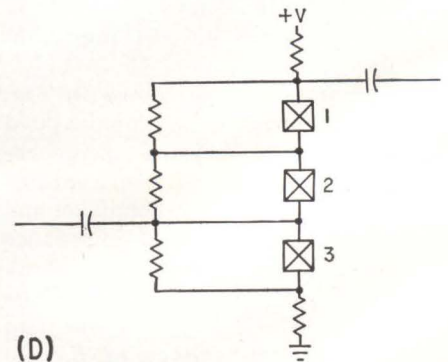
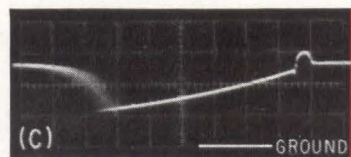
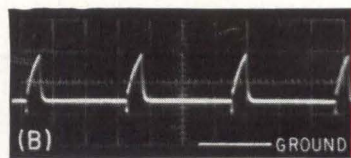
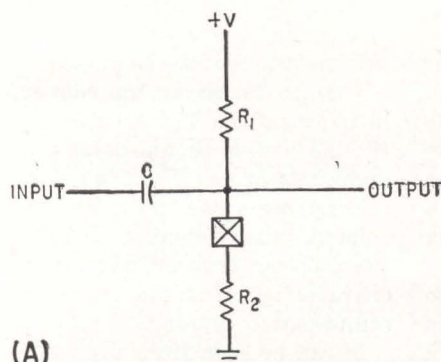

CRYOSAR PULSE GENERATOR (A); pulse generator waveshapes (B and C); another possible cryosar pulse generator (D). In waveforms, horizontal scale is $10 \mu\text{sec}$ per cm in (B) and $1 \mu\text{sec}$ in (C), vertical scale is 0.5 v per cm in both—Fig. 4

capacities of the elements.

Another possible logic configuration is shown in Fig. 3D. This is essentially a current summing type of logic. The uncompensated cryosar (K_2) is biased to point a of Fig. 3E and has a breakdown voltage equal to the sustaining voltage of the compensated cryosars (K_1) which provide the logical inputs. If all the K_1 cryosars inputs to one gate are in their low voltage state, then K_2 remains at point a . When the unit is clocked with a negative pulse, the current through K_2 is reduced and a negative pulse output produced. If any of the K_1 units are in their high voltage state, the K_2 unit has more current flowing through it and will be at point b for one input, point c for two inputs, etc. No output results when the negative clock is applied.

The output of this unit could turn off a K_1 cryosar of a succeeding stage, which had been turned on by a reset pulse, thus storing the information. This type of system would use a multiphase clock.

The fan-out capabilities of the K_1 unit are potentially excellent, being determined by the values of the voltage and resistors chosen for the circuit.

PULSE GENERATOR — Figure 4A shows a pulse generator circuit which has several different modes of operation, depending on the supply voltage. If the supply voltage is less than the cryosar peak voltage, a positive pulse triggers the device to the ON state and the output voltage remains at V_s providing

$$\frac{V - V_s}{R_1 + R_2} \geq I_s$$

where I_s is the sustaining current. The device may be returned to the high voltage state by a negative pulse at the input or by momentarily decreasing the supply voltage so that the current falls below I_s .

If the supply voltage is larger than V_p and

$$\frac{V - V_p}{R_1 + R_2} > I_p$$

where I_p is the peak current then the cryosar is on in the quiescent state. The application of a negative pulse at the input will turn the cryosar off and the output voltage will begin rising to $+V$ with a time constant essentially determined by

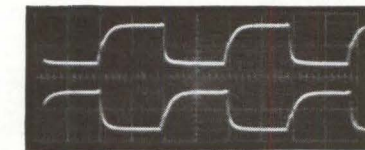
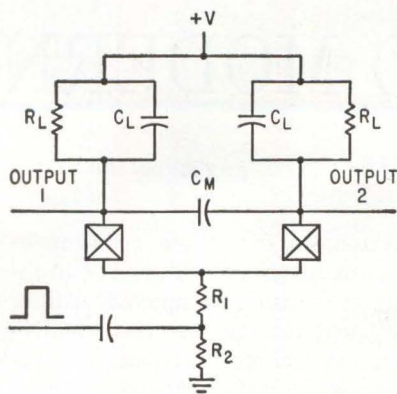

CRYOSAR T FLIP-FLOP and output waveforms. Horizontal scale is 10 μ sec per cm, vertical scale is 0.5 v per cm—Fig. 5

R_1 and C . When the voltage reaches V_p , the device will break down and return to the ON condition. Waveforms of a circuit operating in this mode are shown in Fig. 4B and 4C. The input was a negative pulse of about 150 mv amplitude and the circuit values were $R_1 = 1,600$ ohms, $R_2 = 100$ ohms, $C = 0.0047$ μ f, and $V = +2$ volts. Resistor R_2 is included in the circuit to prevent the signal source from being short circuited by the cryosar in its ON state.

This general type of circuit could be useful as a sense amplifier for the memory described and for storing of logical information. Its speed is primarily limited by the RC time constant as the voltage goes toward V_p (for the circuit tested). However, it should prove possible to make the circuit much faster than that presented.

Pulse generators capable of giving larger outputs, without increasing the inputs, should be possible using cryosars placed in series as shown in Fig. 4D. In this circuit each cryosar would have a voltage across it less than its peak voltage. The third cryosar is turned on by a positive pulse and goes to its low-voltage state, thus applying more voltage across the first two cryosars which are then turned on.

Figure 5 shows a cryosar flip-flop circuit together with the waveforms obtained at the two outputs.

The circuit works in the following manner.

The values of resistors are chosen so that in the quiescent state only one cryosar is in the ON condition. This is accomplished by assuring that if both cryosars attempt to be in the ON state, the sustaining current that must flow through each cryosar will result in a voltage drop across $R_1 + R_2$ and R_2 , so that the voltage across the cryosar must be less than the sustaining voltage and thus one must be in the OFF state.

The flip-flop is triggered by a positive pulse input which turns the ON cryosar off. The two capacitors, C_L , serves as "memory" by virtue of the different voltages which are across them, assuring that the cryosar which was off turns on and C_M aids in regeneration. The manner of triggering shown in Fig. 5 provides isolation between input and output.

The main disadvantage of this cryosar flip-flop circuit is that the design depends on an accurate knowledge of the value of sustaining current, I_s . At this time the sustaining current appears to be the least designable parameter of the cryosar and is sometimes even difficult to determine as it appears to vary over a given wafer.

This research has been sponsored in part by the Electronics Research Directorate of the Air Force Cambridge Research Laboratories, Air Force Office of Aerospace Research under Contract AF 19(604)-8458.

REFERENCES

- (1) F. J. Darnell and S. A. Friedberg, *Phys Rev*, **98**, p 1,860, 1955.
- (2) N. Sclar and E. Burstein, *J Phys Chem Solids*, **2**, p 1, 1957.
- (3) S. H. Koenig and G. R. Gunther-Mohr, *J Phys Chem Solids*, **2**, p 268, 1957.
- (4) G. Flnke and G. Lantz, *Fs. f. Naturforsch.*, **12(a)**, p 223, 1957.
- (5) S. H. Koenig, *Phys Rev*, **110**, p 986, 1958.
- (6) A. L. McWhorter, Semiconductor Dev. Conf.; Boulder, Colo., July 1957.
- (7) R. H. Rediker and A. L. McWhorter, Int. Conf. on Solid State Physics in Electr., and Telecomm, Brussels, Belgium, June 1958.
- (8) A. L. McWhorter and R. H. Rediker, *Proc IRE*, **47**, p 1,207, 1959.
- (9) D. H. Dexter and F. Seitz, *Phys Rev*, **86**, p 964, 1952.
- (10) C. S. Hung and J. R. Gliessman, *Phys Rev*, **79**, p 726, 1950.
- (11) C. S. Hung and J. R. Gliessman, *Phys Rev*, **96**, p 1,226, 1954.
- (12) E. Conwell and V. F. Weisskopf, *Phys Rev*, **77**, p 388, 1950.
- (13) H. Brooks, *Phys Rev*, **83**, p 879, 1951.
- (14) C. Herring (not published).
- (15) C. Erginsoy, *Phys Rev*, **79**, p 1,013, 1950.
- (16) A. L. McWhorter, MIT Lincoln Lab Rpt. 85G-0006.
- (17) J. Callaway and F. W. Cummings, *Phys Rev*, **126**, No. 1, 1962.
- (18) R. C. Johnston, MIT Lincoln Lab Rpt. 53G-0044.
- (19) R. C. Johnston, *NEREM Record*, Nov. 1960.

GUIDE TO MODERN JUNCTION

New classification of the many varieties of transistors according to the

JUNCTION TRANSISTORS, until recently, were made by one of two classical methods: the grown-junction, or the alloy-junction, technique. However, a number of new types of transistors made by the diffusion technique have become available, and more recently the epitaxial transistor has been introduced. This article classifies the various presently available transistors into five major categories and describes briefly their methods of fabrication.

The first junction transistors, in 1951, were of the grown-junction type.¹ This type comprises a rectangular bar, as shown in Fig. 1A, cut from a germanium crystal grown from a melt to which suitable impurities have been added. Emitter and collector contacts then are made to the base region, generally located approximately midway between the two ends. Shortly after the grown-junction technique, the alloy technique was developed,² in which small dots of indium were fused, or alloyed, into opposite sides of a germanium wafer of suitable conductivity, as illustrated in Fig. 1B. Emitter and collector contacts then are made to each of the dots, and the base contact is made to the wafer. Silicon transistors also can be made by each of these two techniques.

Attempts to reduce the dimensions of alloy transistors for high-frequency use subsequently led to the introduction of the electrochemical etching and plating technique, which led to the development of the surface-barrier transistor.³ The construction of this type of transistor is similar to that of the alloy transistor, except that depressions are etched into the wafer before the collector and emitter dots are added, and the latter are generally of much smaller size than in the conventional alloy transistor.

In each of these three classical methods of fabrication the three regions of the transistor—emitter, base and collector—generally are of uniform resistivity.

DIFFUSION TECHNIQUE—The introduction of solid-state diffusion techniques has provided an additional method, with a high degree of control, of making $p-n$ junctions and, hence, of fabricating transistors. Moreover, the use of diffusion techniques makes it possible to provide nonuniform emitter, base and collector regions so as to provide better transistor characteristics than are obtainable from the classical designs of uniform-resistivity regions.

Diffusion of impurities can take place from within the crystal,⁴ or

through the surface from an external source;^{5,6} the latter is termed gaseous diffusion. It is possible also to combine diffusion techniques with one of the classical techniques described above: for example, a nonuniform base region can be obtained by diffusion, while the emitter and collector junctions can be made by the alloy technique.⁷ Alternatively, one $p-n$ junction can be formed by diffusion while the other is formed by one of the classical techniques, or the entire transistor—that is, the two $p-n$ junctions—also can be formed by diffusion.

As a result of this flexibility, transistors made by diffusion may assume one of several different physical appearances. For example, some diffused transistors are indistinguishable in appearance from corresponding classical structures. On the other hand, some types of diffusion transistors are of the mesa construction, illustrated by Fig. 2A, in which the semiconductor wafer is etched down in steps so that the base and emitter regions appear as plateaus above the collector region. Both rectangular and circular cross sections have been employed, as illustrated by Fig. 2B and 2C, respectively.

EPITAXIAL TECHNIQUE—More recently, a new technique—that of epitaxial deposition—has been applied to commercial devices.⁸ In the epitaxial technique, a film of single-crystal semiconductor material is deposited on a single-crystal substrate. Most of the work on epitaxial films to date has consisted of depositing a layer of a semiconductor material on a substrate of the same material—that is, germanium on germanium or silicon on silicon. However, the deposited epitaxial film may be a different material from that of the substrate.

Thus far, the epitaxial technique has been used only to develop transistors in which a thin, high-resistivity collector region is deposited on a low-resistivity substrate of the same conductivity type⁹—that is, a thin p -type collector region is de-

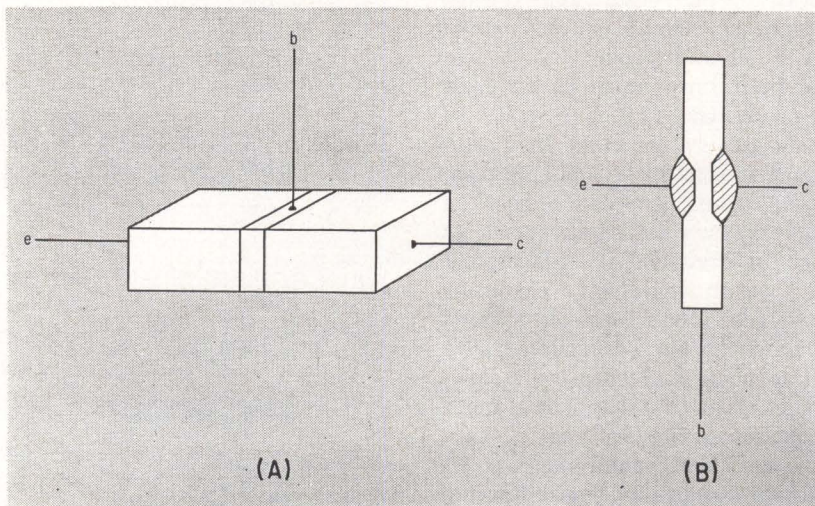

GROWN-JUNCTION type of transistor, (A); alloy-junction type, (B)
—Fig. 1

TRANSISTOR TYPES

By R. L. PRITCHARD
Texas Instruments Inc., Dallas, Texas

methods of fabrication

posited on a $p+$ substrate for germanium pnp transistors, or a thin n -type collector region is deposited on an $n+$ substrate for nnp silicon transistors. This leads to a family of transistors which will be termed here epitaxial-collector, known by a variety of names, such as diffused-base epitaxial mesa transistor. The chief advantage of this type is lower saturation resistance and lower collector storage time relative to a comparable, nonepitaxial device.

However, the epitaxial technique is considerably more general, and it is possible to deposit multiple layers of different conductivity type, that is, it is possible to form epitaxial junctions. For example, an n -type epitaxial collector can be deposited on an $n+$ substrate followed by a p -type epitaxial-base-layer deposition. The emitter region then may be made by conventional diffusion technique or by the alloying technique. This form of device (not yet commercially available) is termed here the epitaxial-base transistor. Finally, it should be possible to extend the epitaxial technique further to make a complete all-epitaxial transistor by epitaxially depositing collector, base, and emitter layers.

PLANAR TECHNIQUE — The planar technique, mentioned often in commercial literature, is an auxiliary technique for making junctions by standard diffusion techniques. Strictly speaking, the term planar refers to a device in which each of the junctions—emitter-base and collector-base in a transistor, as shown in Fig. 3—is brought to a common plane surface,¹⁰ as distinguished from the mesa structure in which one or more of the $p-n$ junctions are brought to the surface at the edge of a cylinder comprising the mesa, as shown in Fig. 2A. However, the real significance of the planar structure is not that it is planar, but that as a result of the technique of diffusion through an oxide mask used in making a planar structure, the junctions are formed beneath a pro-

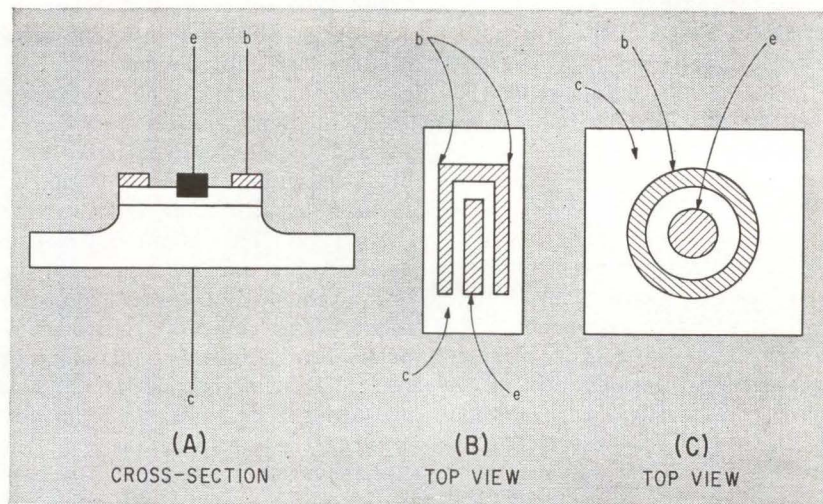

MESA TYPE construction for diffused-base or double-diffused transistors —Fig. 2

ductive oxide layer. Hence, many of the surface problems associated with other types of transistors having junctions exposed at the surface are avoided. As a result, this type of transistor has generally lower reverse currents and improved d-c current gain at low currents.

However, an equivalent structure could be fabricated in which the junctions were formed beneath a protective oxide coating but which were not actually planar.

CLASSIFICATION SCHEME — The transistor types are here classified according to five major categories—grown, alloy, electrochemical, diffusion, and epitaxial. The method of classification is somewhat arbitrary—for example, a grown-diffused transistor could be classified either as a grown transistor or as a diffused transistor. Accordingly, a cross-referencing scheme is necessary, provided here by the chart of Fig. 4, illustrating the interrelations among the various techniques in producing different types of transistor structures.

GROWN-JUNCTION TRANSISTORS—

(1) *Double-doped* transistor: the original grown-junction transistor, formed by growing a crystal and successively adding p - and n -type impurities to the melt during the course of growing the crystal.

(2) *Rate-grown* or *graded-junction* transistor: a variation of the *double-doped* type, in which n - and p -type impurities are added to the melt from which the crystal is grown. The growth rate then is varied in a periodic manner while the crystal is drawn from the melt. During one stage of the growth cycle, the crystal contains a predominance of p -type impurities, whereas during the other stage of the cycle n -type impurities dominate, resulting in a crystal from which nnp transistors can be cut.

(3) *Melt-back* transistor: a variation of the *rate-grown* transistor in which the rate growing is performed on a very small physical scale. This results in a lower thermal time constant for the crystal growing system, thinner base regions and, hence, higher-frequency transistors.

(4) *Melt-quench* transistor: similar to *melt-back* transistor.

(5) *Grown-diffused* transistor: a transistor made by combining diffusion techniques and the *double-doped* process. In this case, n - and p -type impurities are added simultaneously to the melt in the course of growing the crystal. Subsequently, the base region is formed by diffusion during the continued growth of the crystal.

(6) *Melt-back diffused* transistor: a transistor made by combining diffusion techniques and the *melt-back* process, analogous to the

combination of the grown and diffusion techniques described above leading to *grown-diffused* transistors. In this case, however, the impurities are added to the transistor bar by the *melt-back* process, and the base region subsequently is formed by diffusion by baking the transistor bar.

ALLOY-JUNCTION TRANSISTORS—

(1) *Alloy transistor* (previously known also as *fused transistor*): comprises a wafer of semiconductor material of *n*- or *p*-type conductivity with two dots containing *p*- or *n*-type impurities, respectively, fused or alloyed into the wafer on opposite sides of the wafer to provide emitter and base junctions, while the base region comprises the original semiconductor wafer.

(2) *Drift transistor*: (a) In scientific literature, a *drift transistor* refers to a type of transistor having a nonuniform, or graded, base region so that high-frequency response is improved relative to a similar uniform-base structure. (b) *Drift transistor, commercial*: A trade name for a *diffused-alloy transistor*.

(3) *Diffused-alloy transistor*: a transistor made by combining diffusion and alloy techniques. The semiconductor wafer is first subjected to a gaseous diffusion to produce the nonuniform base region, and then alloy junctions are formed in exactly the same manner as in a conventional *alloy transistor*. An intrinsic region transistor, for example a *pnip* unit, can be made by this technique by starting with a semiconductor wafer of essen-

tially intrinsic conductivity.

(4) *Alloy-diffused transistor*, or *post-alloy-diffused transistor*: another type of transistor made by combining diffusion and alloy techniques. The alloy dot material contains both *n*- and *p*-type impurities. Then the emitter-base junction is formed by the conventional alloy process, while the base region is formed by diffusion from within the crystal. This is the distinction between the diffused-alloy transistor and the post-alloy-diffusion technique. The collector region comprises the original semiconductor wafer. Alternatively, if the original wafer is of the same conductivity type as the base region, then the emitter-base junction and the base region can be formed as described above, while the collector junction can be formed as in a conventional *alloy transistor*. In this case, as in the case of the diffused-alloy transistor, an intrinsic region can be included between base and collector.

ELECTROCHEMICALLY ETCHED AND PLATED TRANSISTORS—

(1) *Surface-barrier transistor* (SBT): comprises a wafer of semiconductor material into which depressions have been etched on opposite sides of the wafer by electrochemical techniques. The emitter and collector base junctions, or metal-semiconductor contacts, are then formed by electroplating a suitable metal on the semiconductor in the depression areas on opposite sides of the wafer, while the original wafer constitutes the base region.

(2) *Micro-alloy transistor* (MAT): a variation of the *surface-barrier transistor* described above in which suitable *n*- or *p*-type impurities are first plated in the etched depressions and then alloyed into the *p*- or *n*-type semiconductor wafer.

(3) *Micro-alloy Diffused transistor* (MADT): a transistor made by incorporating diffusion techniques with the *micro-alloy transistor* construction described above. In this case, the semiconductor wafer is first subjected to gaseous diffusion to provide a nonuniform base region prior to the electrochemical plating process.

(4) *Electro-chemical Diffused*

Collector (ECDC) transistor: a transistor made by combining diffusion and electrochemical techniques. A nonuniform base region and the collector-base junction are obtained by gaseous diffusion into a semiconductor wafer that constitutes the collector region. Then the emitter-base junction is obtained by the electrochemical etch and plating technique, as in the MAT. The electrochemical technique also is used to place the collector contact close to the collector-base junction.

DIFFUSION TRANSISTORS—

(1) *Diffused-base transistor*: comprises another type of transistor made by combining diffusion and alloy techniques. In this case, a non-uniform base region and the collector-base junction are formed by gaseous diffusion into a semiconductor wafer that constitutes the collector region. Then the emitter-base junction is formed by a conventional alloy junction on the base side of the diffused wafer for example, by evaporation of a metallic stripe, while the remaining portion of the original wafer constitutes the collector region.

(2) *Diffused-emitter and base or double-diffused mesa transistor*: a semiconductor wafer which has been subjected to gaseous diffusion of both *n*- and *p*-type impurities to form two *p-n* junctions in the original semiconductor material. The active area of the transistor, that is, the area of the collector-base junction then is defined by etching away the undesired portions of the emitter and base regions to expose a mesa. An intrinsic-region transistor, such as *pnip*, also can be made by a variation of this process.

(3) *Triple-diffused transistor*: a variation of the double-diffused transistor in which the semiconductor wafer first is subjected to a deep diffusion to effectively lower the resistivity of the collector region—for example, to form an *nn+* structure for an *npn* transistor. The *nn+* wafer then is subjected to gaseous diffusion of both *p*- and *n*-type impurities to form emitter-base and collector-base junctions leading to an *npnn+* structure. Alternatively, this may be considered as an intrinsic-region transistor, such as *npin*, if the orig-

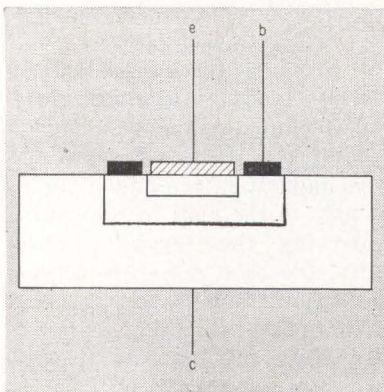

PLANAR type double diffused transistor—Fig. 3

inal semiconductor wafer has high resistivity.

(4) *Planar transistor*: comprises a semi-conductor wafer which has been subjected to gaseous diffusion of both *p*- and *n*-type impurities to form two *p-n* junctions in the original semiconductor material, as in the case of the diffused-emitter and base transistor. However, the active area of the device—that is, the area of the collector-base junction, is defined by oxide masking of the base diffusion, rather than by mesa etching (see Fig. 3).

EPITAXIAL TRANSISTORS—

(1) *Diffused-base epitaxial mesa transistor*: one of the epitaxial-collector transistor family. Made by combining diffusion, alloy and epitaxial techniques. First, a thin collector region is epitaxially deposited on a low-resistivity substrate. Then a nonuniform base region and the collector-base junction are formed by gaseous diffusion into the epitaxial collector region. The emitter-base junction is obtained from a conventional alloy junction on the base side of the diffused wafer.

(2) *Double-diffused epitaxial mesa transistor*: another of the epitaxial-collector transistor family. A thin collector region is epitaxially deposited on a low-resistivity substrate. Then base and emitter regions are formed as in the case of the ordinary double-diffused mesa transistor, and the collector-base junction area is defined by etching a mesa.

(3) *Planar epitaxial transistor*: another of the epitaxial-collector transistor family. A thin collector region is first epitaxially deposited on a low-resistivity substrate. Then base and emitter regions are formed as in the conventional planar transistor.

(4) *Epitaxial base transistor*: a transistor made by epitaxially depositing a base region of one conductivity type on a collector region of the opposite conductivity type. The emitter region then can be formed either by alloying or by diffusing, leading, respectively, to an *alloy-emitter epitaxial base transistor*, or a *diffused-emitter epitaxial base transistor*.

(5) *All-epitaxial transistor*. All three regions of the transistor are obtained by epitaxial deposition.

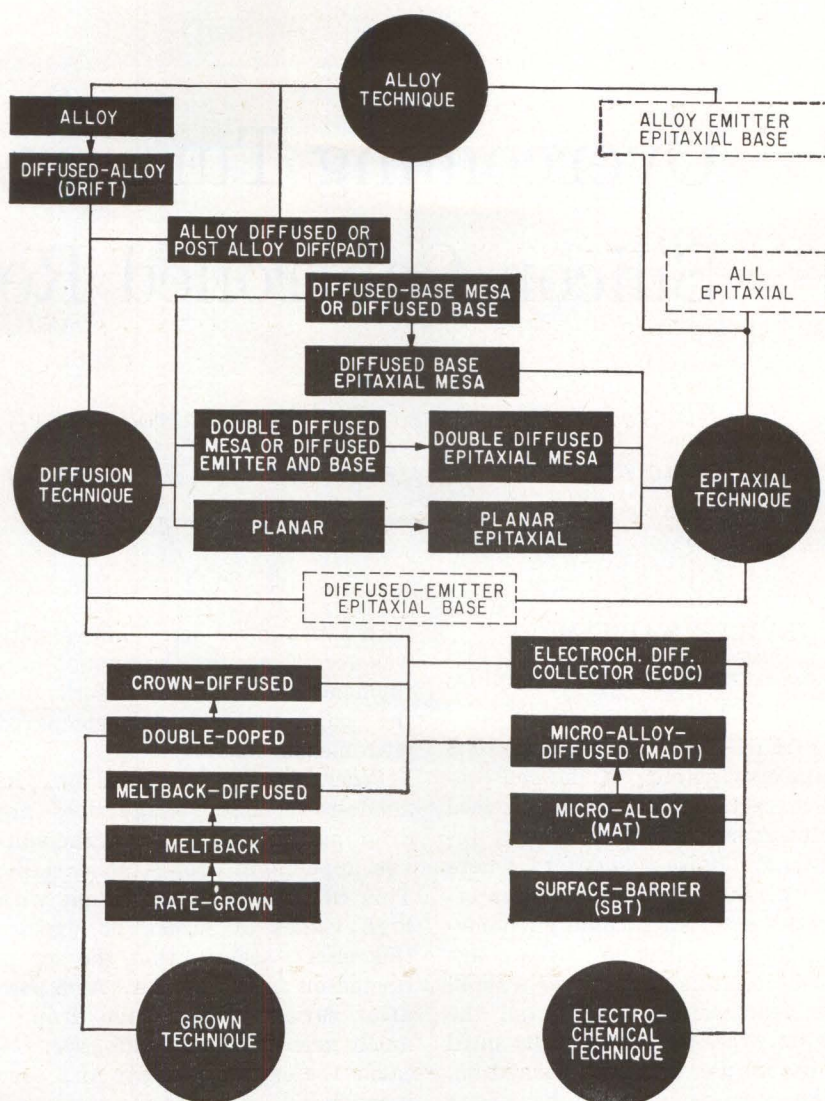

CHART classifies transistor types graphically as combinations of five basic techniques—Fig. 4

The material presented here obviously does not describe original work. A number of authors have categorized transistors in similar schemes. Several authors have also written excellent survey papers—e.g. R. N. Hall¹¹—describing methods of fabrication. The concept of the chart shown in Fig. 4 originated with H. L. Owens.

This article is based on material prepared for a book "Transistor Circuit Design" written by the engineering staff of Texas Instruments, Transistor Products Division, and shortly to be published by McGraw-Hill Book Co.

BIBLIOGRAPHY

1. W. Shockley, M. Sparks, G. K. Teal, "p-n Junction Transistors," *Phys. Rev.*, **83**, p 151, July 1951.
2. J. S. Saby, "Recent Developments in Transistors and Related Devices," *Tele-Tech.*, **10**, p 32, Dec 1951.

3. W. E. Bradley, "Part I-Principles of the Surface-Barrier Transistor," *Proc IRE*, **41**, p 1702, Dec 1953. J. W. Tiley and R. A. Williams, "Part II, Electrochemical Techniques for Fabrication of Surface-Barrier Transistors," *ibid.*, p 1706. J. B. Angell and F. P. Keiper, "Part III-Circuit Applications of Surface-Barrier Transistors," *ibid.*, p 1709.
4. J. R. A. Beale, "Alloy-Diffusion: A Process for Making Diffused-Base Junction Transistors," *Proc. Phys Soc.*, **70B**, p 1087, Nov 1957.
5. C. A. Lee, "A High-Frequency Diffused-Base Germanium Transistor," *Bell Sys Tech J.*, **35**, p 23, Jan 1956.
6. M. Tanenbaum and D. E. Thomas, "Diffused Emitter and Base Silicon Transistors," *Bell Sys Tech J.*, **35**, p 1, Jan 1956.
7. A. L. Kestenbaum and N. H. Ditrack, "Design, Construction, and High-Frequency Performance of Drift Transistors," *RCA Rev.*, **18**, p 12, March 1957.
8. M. J. O'Rourke, J. C. Marinace, R. L. Anderson, W. H. White, "Electrical Properties of Vapor-Grown Germanium Junctions," *IBM J Res and Dev.*, **4**, p 256, July 1960.
9. H. C. Theurer, J. J. Kleimack, H. H. Loar, and H. Christensen, "Epitaxial Diffused Transistors," *Proc IRE*, **48**, p 1642, Sept 1960.
10. J. A. Hoernl, "Planar Silicon Diodes and Transistors," Abstract only, *Trans IRE*, **ED-8**, p 178, April 1961.
11. R. N. Hall, "Fabrication Techniques for High-Frequency Transistors," *Fortschritte der Hochfrequenztechnik*, **4**, p 129, Akademische Verlagsgesellschaft m.b.H., Frankfurt am Main (1959) (In English).

Overcoming Turn-on Effects in Silicon Controlled Rectifiers

Limited turn-on speed of silicon controlled rectifiers causes problems in some applications. Here are ways of avoiding unexpected triggering, high turn-on losses and possible device failure

By NEVILLE MAPHAM
Rectifier Components Dept.,
General Electric Co., Auburn, N.Y.

UNPREDICTABLE EFFECTS during switching of silicon-controlled rectifiers have been noticed by designers of high-frequency inverters and pulse modulators, where high values of di/dt occur. Such effects are due to a turn-on phenomenon: the junctions of the scr are turned on, at first, only over a small area near the gate lead, and the turn-on process then spreads until whole junction has been turned on.

The turn-on velocity has been measured to a first approximation

with a two-gated scr. This velocity was used to predict the turn-on performance of two types of scr's, and the calculated results compared with measurements.

When the scr is turned on, the anode-to-cathode voltage does not drop immediately; instead, the voltage appears to drop exponentially. This effect is most prominent with high values of di/dt . To explain this effect, assume that the scr is turned on as in Fig. 1A. At 5 μsec after turn-on the voltage drop is much greater than at 25 μsec , because the current density at 5 μsec is much higher due to the restricted area. As the current density in-

creases, the voltage drop increases.

The high initial current density and high voltage drop generate considerable power within a small area, thus raising the temperature of the junctions. When this temperature exceeds 125 C there is a temporary falling off of the characteristics; this is especially noticeable in forward breakover voltage, turnoff time and dv/dt . In inverters, this effect appears as unexpected triggering of the scr's, resulting in both scr's being on simultaneously. If the heat becomes excessive it can permanently damage the scr's characteristics or destroy the device. Such scr failure shows as a small hole in the pellet from anode to cathode near the gate lead.

An unexpectedly high stud temperature also indicates turn-on losses due to slow spreading.

During the turn-on period, protection of the scr by fuses can be inadequate. Fuse ratings are based on the I^2t rating of the scr, derived from data taken with the whole junction turned on; the fuses, therefore, do not protect the scr against small-area heating.

MEASUREMENTS OF SPREAD

—To measure the velocity of turn-on spreading, several type-C80 235-ampere scr's were equipped with a second gate, placed diametrically opposite the normal gate. The normal gate was triggered with a short pulse, and the voltages across the two gates observed. It was assumed that when these two voltages become equal, the entire junction is

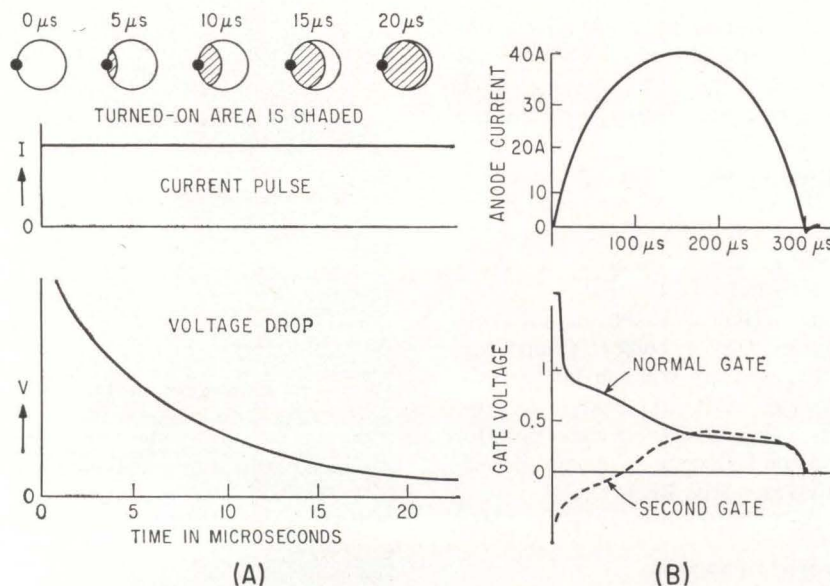

TURN-ON proceeds gradually along junction area, starting from gate lead point. Voltage drop decreases slowly, (A). Gate voltage response to a sinusoidal current pulse is plotted at (B)—Fig. 1

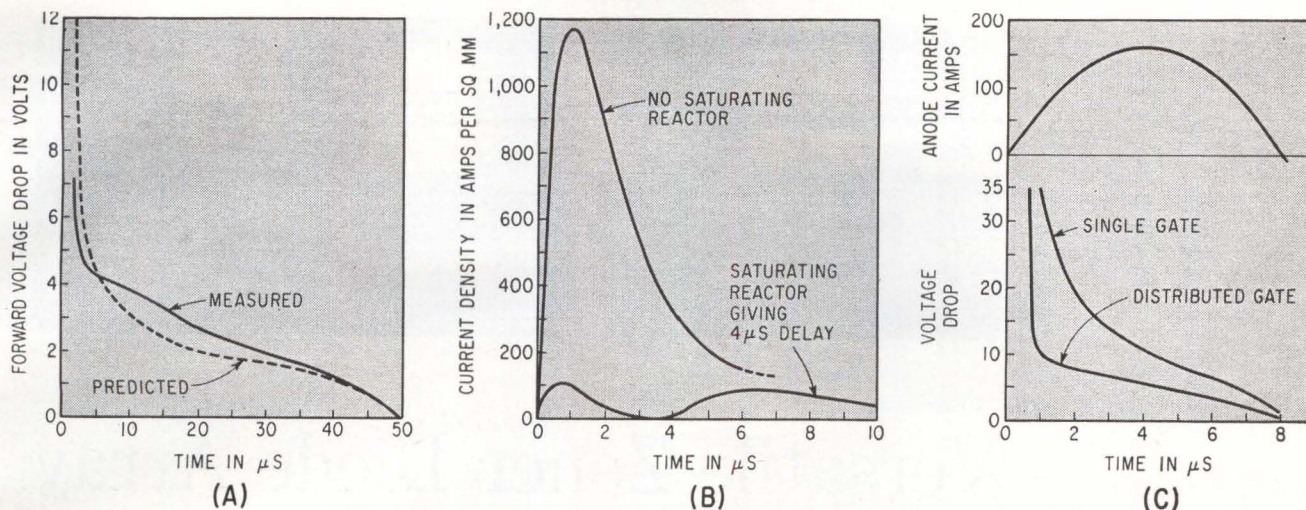

AGREEMENT between calculated and measured voltage drop curves is shown in (A). The effect of a series saturating reactor is seen in (B); improvement in turn-on with distributed gate is plotted in (C)—Fig. 2

turned on; the velocity of spreading would then be the distance between gates divided by time taken to equalize the voltages.

Figure 1B shows a typical oscillogram using a sine wave pulse. Velocity increases as the current waveform peak increases. The relationship between velocity and pulse peak value is a second-order effect. The velocity may be taken as 0.1 mm per μsec .

From physical measurements of the scr's junctions, it is possible to calculate the current density and voltage drop as turn-on propagates across the junction area. Using an assumed turn-on velocity, a turn-on curve can be calculated and then compared against a measured one. This has been done in Fig. 2A for a type-C35 25-ampere scr.

CORRECTIVE ACTION—Knowing that the spreading velocity is of the order of 0.1 mm per μsec , the designer can take corrective action. When the current rises rapidly, care must be taken to check for local heating. Local heating is liable to occur in any scr with a single gate lead when di/dt exceeds several amperes per μsec immediately after triggering. Knowing the junction diameter and the location of the gate lead, the current density at any time can be determined; at present the safe value for current density has not been established.

High local values of current density can be satisfactorily decreased by placing a saturating reactor in

series with the scr; this limits the current for several microseconds to a low value, until the reactor saturates. During the delay period the turned-on area has time to increase so that the current density is reasonably low when the bulk current flows.

Figure 2B shows a comparison of current density with and without a saturating reactor in a 110-ampere type-C50 scr; a 10-to-1 improvement is apparent. The reactor consisted of a 1-inch diameter core with a winding of a few turns.

Figure 3 shows the predicted and measured curves of voltage drop across a type-C50 scr carrying a 325-ampere sinusoidal pulse, 12

microseconds long; the delay period was 4 μsec with an 8-ampere current during the delay period. Divergence during the first 2 μsec is due to the inaccuracy of assuming that the gate is a point on the periphery; actually it is a small area near the periphery.

In practice, no significant improvement in the turn-on speed of a junction can be achieved by centrally locating the gate. However, a great improvement is achieved when a distributed gate is used.

Figure 2C shows measured voltage drop with a 160-ampere 8- μsec pulse and compares a single gate with a laboratory model of an scr having a distributed gate.

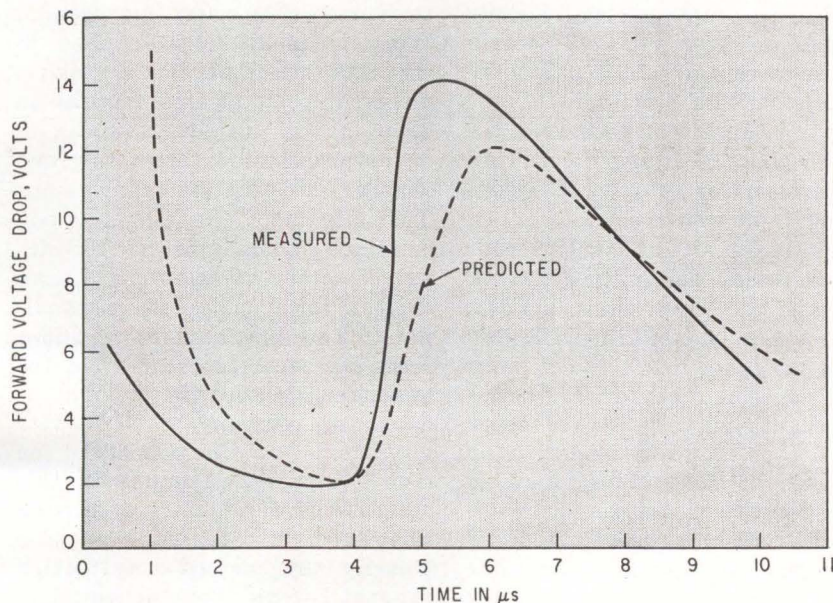

PREDICTED and measured curves agree for a 325-ampere sinusoidal pulse applied to type C-50 silicon controlled rectifier—Fig. 3

SOLID-STATE analog-to-digital converter uses zener diodes for quantizing—Fig. 1

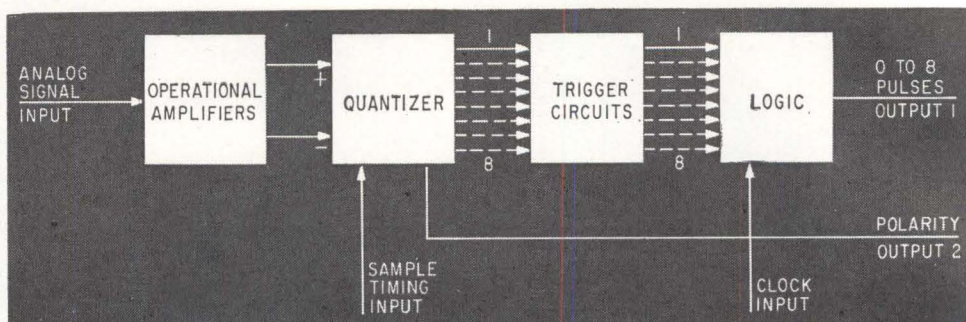

Versatile Zener Diode Array

Zener diodes provide simultaneous voltage comparison and stable voltage reference while alleviating interaction problems found in conventional comparators

By JOHN J. KOLARCIK

Surface Communications Labs, Radio Corporation of America, New York, N. Y.

AN ANALOG/DIGITAL converter, built to fulfill a particular signal processing requirement for an experimental character detection communication system, employs a simple conversion technique applicable in many other areas. Using solid-state components for active circuit elements, quantization or voltage selection of the signal sample is obtained through an array of zener diodes. The converter periodically samples an analog voltage to obtain a pulse stream of 0 to 8 pulses depending on the amplitude of the sampled voltage. The polarity of the quantized signal is also determined in the sampling process, thus producing rapid conversion.

The technique of simultaneous voltage comparison in the quantizer by an array of zener diodes appears to be a new one, offering a higher speed capability than found in most other converters because of the inherently faster response of zener diodes over standard diodes. The problems of interaction found in other converters using resistor-diode networks are greatly reduced by the zener diodes, which also offer stable voltage reference in each comparator.

Design principles are easily

adapted to other communication and telemetry applications.

OPERATION—In the first stage of the converter (Fig. 1), the signal is amplified to a level suitable for quantization. In this stage, it is also converted from a bipolar signal to two unipolar signals on two channels. In the second stage, the two unipolar channels are fed to their respective sampling circuits. With an input signal applied to the first stage of the converter, either unipolar channel obtains an output at any instant, resulting in an output obtained from only one sampler at each sampling time. The outputs of the sampling circuits are combined so that the signal of either sampler circuit can drive a linear pulse power amplifier. The linear pulse amplifier feeds the zener diode array of the quantizer, where the sample is quantized into any of 8 discrete quantum levels. The polarity of the signal is also determined in this stage, where a polarity sensing trigger circuit senses the pulse polarity by determining which channel has an input at sampling time. The polarity information is stored in a binary register.

In the third stage, the pulses from the fired zener diodes in the quantizer are fed to their respective pulse standardization circuit, which is a Schmitt trigger. Each pulse standardization circuit is connected to a precision trigger circuit. The time interval of each precision trigger circuit is made an integral multiple of the period of the clock frequency.

In the fourth stage, the precision trigger outputs are combined in logic circuits so that the output of the trigger corresponding to the longest time period, after a sampling, excludes all shorter periods. This exclusive period is mixed with clock pulses, using the logic circuits, to obtain a pulse stream of 0 to 8 pulses. The number of pulses obtained at the output is an indication of the magnitude of the signal input to the analog/digital converter. These pulses and the polarity information obtained in stage 2 provide sufficient information to be fed to digital data processing equipment.

ANALOG SIGNAL PROCESSING

—The analog signal is brought into the proper voltage amplitude range, 0 v to 8 v, by transistor operational amplifiers to facilitate processing by the quantizer, Fig. 2. The attenuator pad was used to set the gain of the amplifier system to the proper level to adjust for the various input signal levels used in test runs of the associated system. To allow using the quantizer for both the negative and positive voltage excursions of the analog signal,

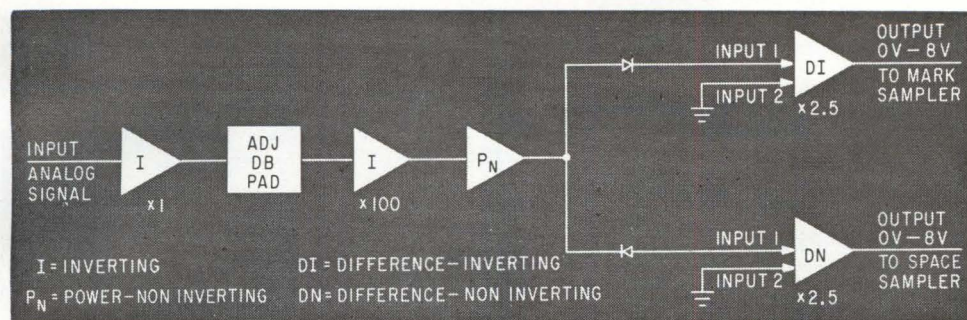

ANALOG SIGNAL processor splits bipolar signal into two unipolar signals—Fig. 2

Forms High-Speed Quantizer

diode rectifiers separate the bipolar input signal into two unipolar signal paths. The two unipolar signals feed two linear power amplifiers to provide the low impedance drive required by the sampling circuits. The linear amplifier connected to the space sampler output is arranged to obtain a noninverted output. Thus both the mark and the space channel outputs obtain a 0 v to -8 v output swing capability, enabling the use of a common quantizer for both channels.

SAMPLING CIRCUITS—The second stage of the converter consists of sampling circuits, a polarity determining circuit, quantizing circuits, and a voltage clamped linear power amplifier circuit (Fig. 3A). Two identical sampling circuits are used, each using an emitter follower circuit whose collector voltage is supplied by an additional emitter follower called a sampler driver. The sampler drivers are individually driven by gates which are connected to a one-shot delay trigger. The trigger has a pulse width of $50 \mu\text{sec}$ and is actuated by a synchronous timing pulse command from the system using the converter. Two outputs of the sampling circuits, M_1 and S_1 , determine amplitude of the signal sample, and two, M_2 and S_2 , determine the polarity of the sample. The former drive the pulse power driver from their respective mark and space channel inputs. The latter, also driven by the mark and space channel inputs, drive two Schmitt triggers. The sampler having the

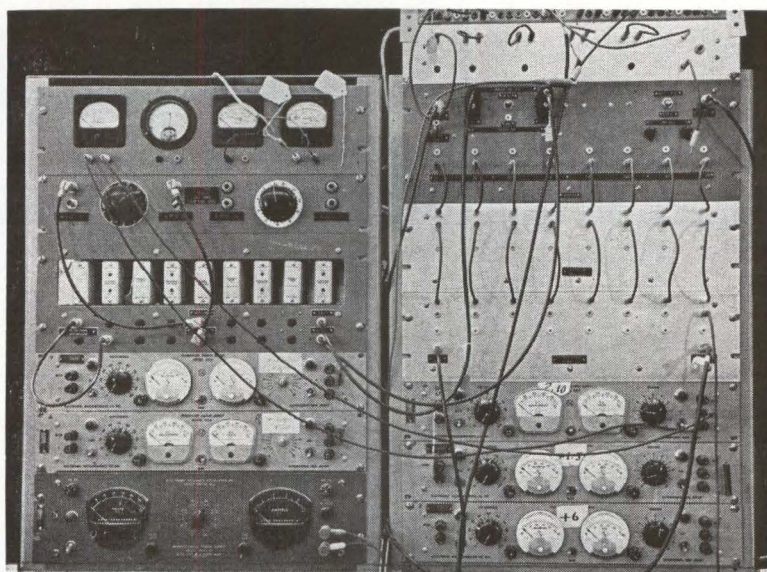

EXPERIMENTAL lab setup of analog/digital converter. Solid-state components will lead to more compact production model

larger input at the sampling time energizes the trigger of that channel. The Schmitt triggers connect to the alternate inputs of a polarity register bistable circuit to store the polarity data, during sampling intervals, for digital processing.

The two amplitude outputs M_1 and S_1 are combined to obtain a common drive to the linear pulse power driver. At the input of the power driver, the pulse signals are clamped to a 2-v d-c level to obtain a linear response from the quantizer circuits. The linear pulse power driver provides the low impedance, high current source required by the quantizing circuits.

QUANTIZATION—The quantization of the sample pulse signal

(Fig. 4) from the pulse power driver is performed in a zener diode array. The zener diodes provide the quantizer with stable reference voltages of low output impedance. The array consists of eight zener diodes having zener voltage breakdown from 2 v to 9 v in 1-v increments for the successive diodes. The 2-v zener diodes were used to accommodate the lowest quantum level since zener diodes of less than 2 v are not commercially available. The sample pulse signal amplitude input has a range of 0 v to -8 v. To obtain a linear response a d-c clamp of 2 v is required. This permits a -0.5 v input pulse level to fire the -2 v zener, quantum level 1, at -2.5 v. Quantum level 2 permits a -1.5 v

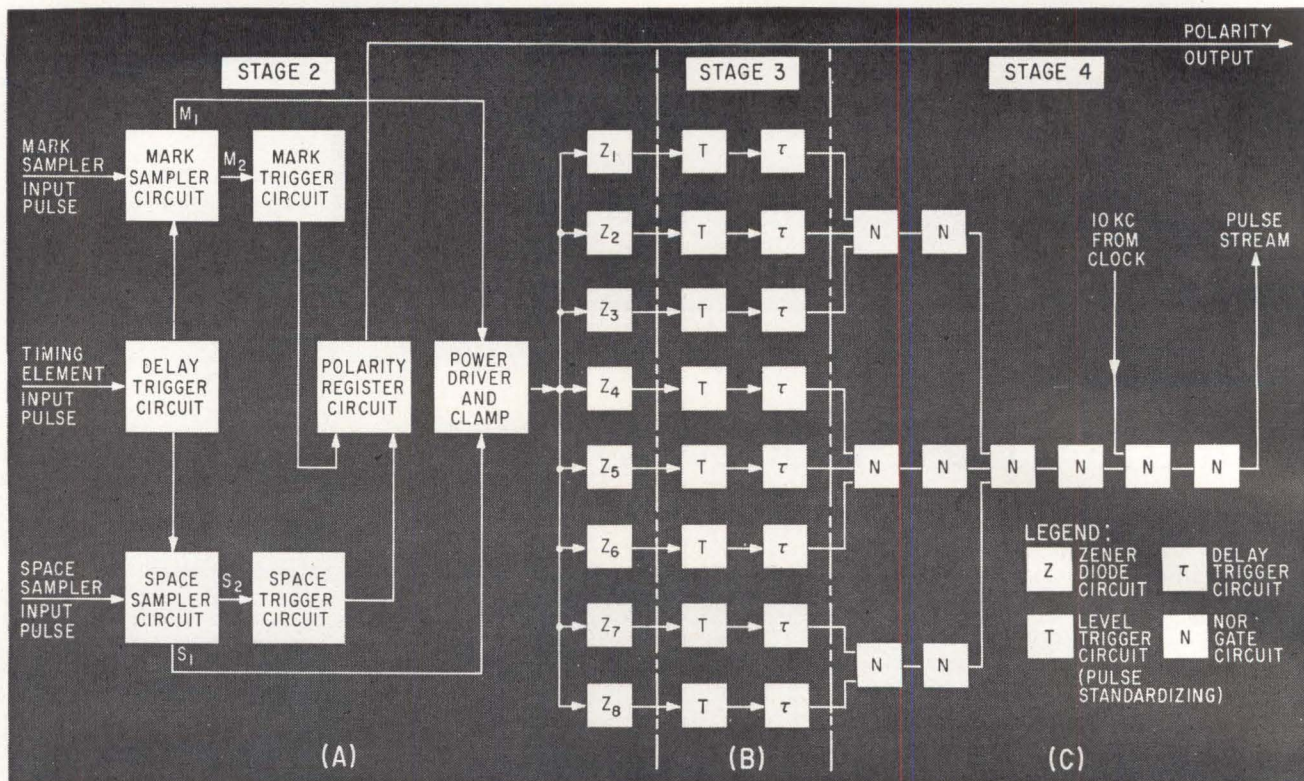

QUANTIZER (A) DETECTS signal polarity and stabilizes signal. Trigger circuits (B) select appropriate signals. Output NOR circuits (C) select signal of longest time period—Fig. 3

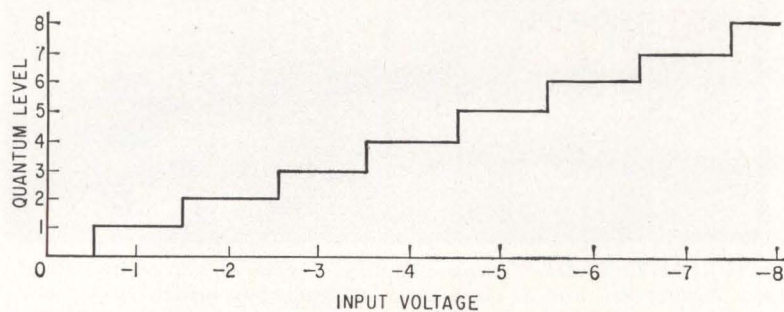

QUANTIZER input-output characteristics obtained from zener diode array—Fig. 4

level to fire the -3 volt zener at -3.5 v. The quantum levels 3 to 8 are similarly obtained where the highest quantum level, 8, permits a -7.5 v level to fire the -9 v zener at -9.5 v. The 0.5 v excess over the zener breakdown voltage allows a uniform voltage to be developed at each zener diode load resistor, providing uniform triggering voltage for the pulse standardizing trigger circuits.

TRIGGER CIRCUITS—The third stage comprises 8 pulse standardizing and 8 precision trigger circuits (Fig. 3B). Each of the zener diodes activates a pulse standardizing trigger circuit which, in turn, ac-

tivates its respective precision trigger circuit. The standardizing trigger circuits, which obtain their uniform standard voltage swing when triggered, provide a sufficient level to fire the precision trigger. Depending on the level of the sampled input signal, 0 to 8 precision triggers are fired at each sampling time. The pulse duration of each precision trigger is made an integral multiple of the pulse repetition period of the system clock.

OUTPUT LOGIC—Outputs of the precision triggers are combined in NOR logic circuits (Fig. 3C) so that the trigger corresponding to the longest time period, after a sam-

pling, excludes all shorter periods. This exclusive output signal is mixed with clock pulses, using the NOR logic circuits, to obtain a pulse stream of 0 to 8 pulses. The number of pulses obtained at the output is an indication of the magnitude of the signal input to the converter.

The pulse stream of 0 to 8 pulses together with the polarity signal provided the required information, in digital form, for the digital data processing equipment used. The converter operated successfully when tested for several weeks with an experimental character detection communication system.

Modification of the converter for other applications includes changing the number of quantum levels and selecting zener diodes to provide a specified nonlinear characteristic. The serial output presentation could be converted to a simultaneous coded or noncoded form.

Other applications include a method for digitization of voice and facsimile signals. Uses may be found in reduction of large stores of analog data to digital form, to more readily enable statistical evaluation.

TRIPPLET

ACTUAL SIZE

USES UNLIMITED:

- Field Engineers
- Application Engineers
- Electrical, Radio, TV,
and Appliance Servicemen
- Electrical Contractors
- Factory Maintenance Men
- Electronic Technicians
- Home Owners, Hobbyists



MODEL 310 complete VOLT-OHM- MILLIAMMETER



World's Largest Selling POCKET SIZE V-O-M

FEATURES:

- 1 Hand size and lightweight, but with the features of a full-size V-O-M.
- 2 20,000 ohms per volt DC; 5,000 AC.
- 3 EXCLUSIVE SINGLE SELECTOR SWITCH speeds circuit and range settings. The first miniature V-O-M with this exclusive feature for quick, fool-proof selection of all ranges.

SELF-SHIELDED Bar-Ring instrument; permits checking in strong magnetic fields • Fitting interchangeable test prod tip into top of tester makes it the common probe, thereby freeing one hand • UNBREAKABLE plastic meter window • BANANA-TYPE JACKS—positive connection and long life.

■ Price—only \$37.50; leather case \$3.20.

Available For Immediate Delivery From Your Triplet Distributor's Stock

THE TRIPPLET ELECTRICAL INSTRUMENT COMPANY, BLUFFTON, OHIO

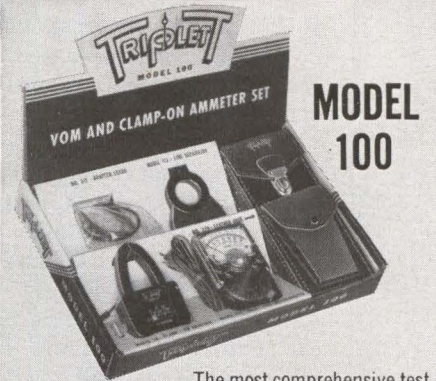

MODEL 100

The most comprehensive test set in the Triplet line is Model 100 V-O-M Clamp-On-Ammeter Kit, now available at distributors. The world's most versatile instrument—a complete accurate V-O-M plus a clamp-on-ammeter with which you can take measurements without stripping the wires. Handsome, triple-purpose carton holds and displays all the components: Model 310 miniaturized V-O-M, Model 10 Clamp-On-Ammeter, Model 101 Line Separator, No. 311 Extension leads, and a leather carrying case, which neatly accommodates all the components. Model 101 literally makes it possible to separate the two sides of the line when using Model 10. Extension leads permit use of Model 10 at a distance from the V-O-M. Complete Model 100 is only \$64.50



THE WORLD'S MOST COMPLETE LINE OF V-O-Ms. AVAILABLE FROM YOUR TRIPPLET DISTRIBUTOR'S STOCK

COPING WITH NEW PROBLEMS

Nomographs Select Tv Standards

Charts enable design engineers to get overall view of various combinations of bandwidth, resolution, scanning rates, aspect ratios and blanking interval

By J. WARREN WIPSON
Consultant,
Fullerton, California

WITH the increase of military television, ground-based and space-borne, a number of television system standards have come into use. While the conventional broadcast standard is most commonly used, the gamut runs from wide bandwidth high-resolution to narrow bandwidth slow-scan space systems.^{1, 2} Resolution for any particular application may range from 100 or 200 tv lines to well over 1,000 lines with corresponding video bandwidths spanning from a few Kc to over 20 Mc. With this wide choice, the job of specifying and evaluating tv systems can be overwhelming. With the charts in this article, the systems engineer can obtain an overall view of various combinations of bandwidth, resolution, scanning rates, aspect ratios and horizontal blanking intervals.

FORMULA INVOLVED—The nomographs were developed from

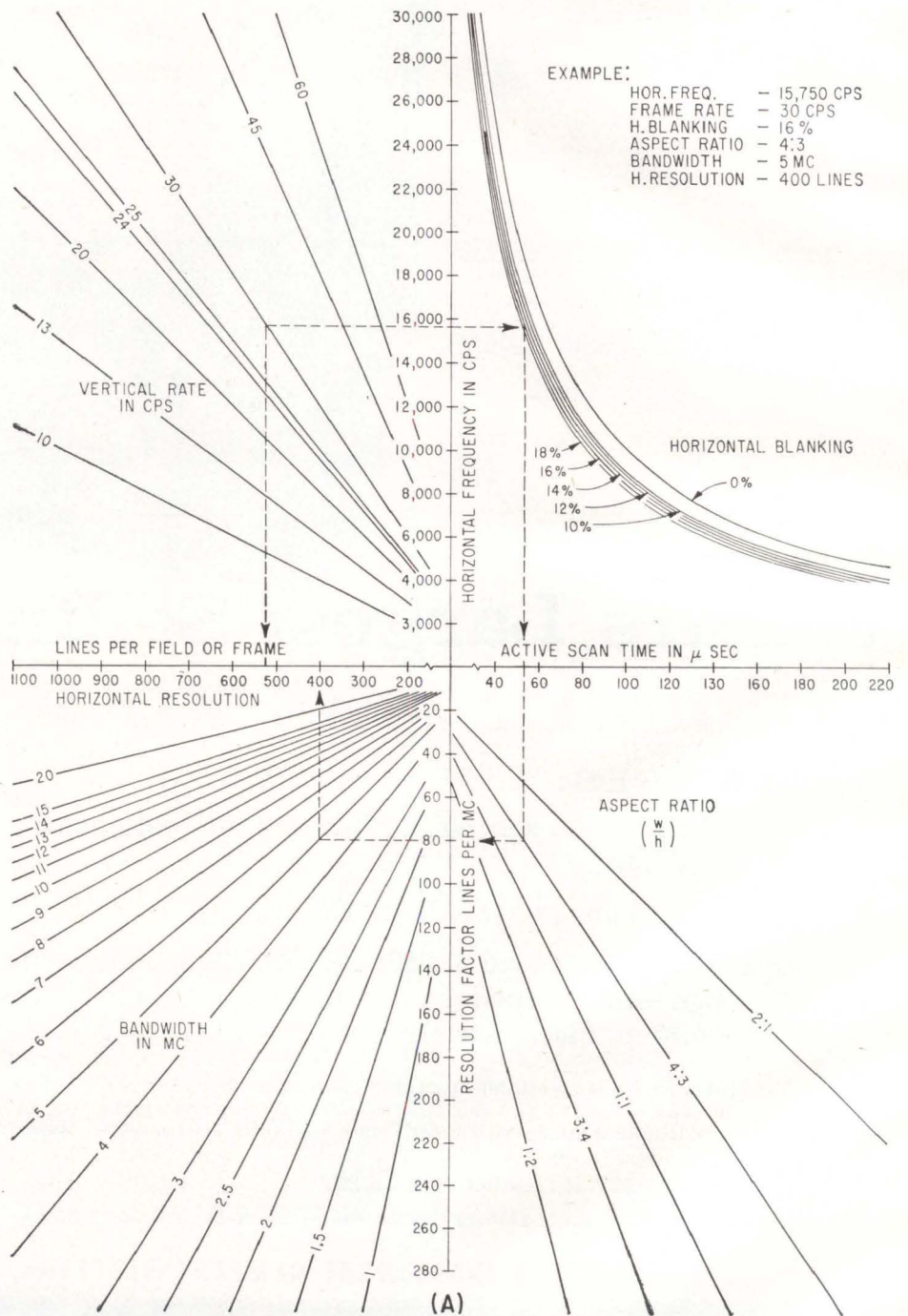



ELECTRONICS
PROGRESS IN SEMICONDUCTORS

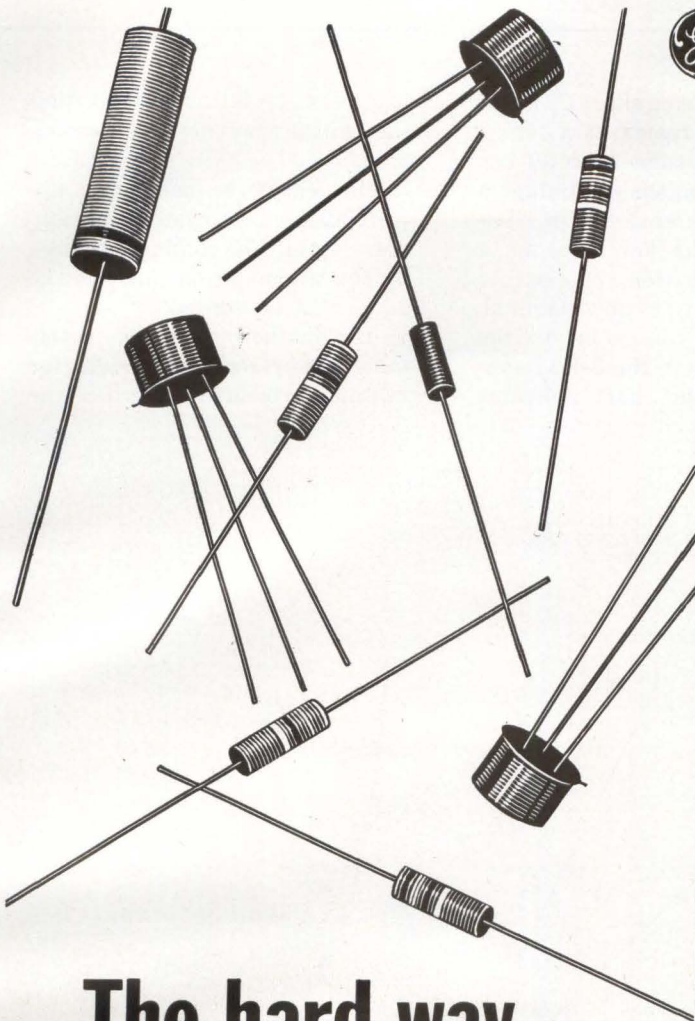

The hard way
(up to 9 unnecessary components)

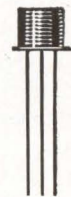

The unijunction
(one little transistor)

**REDUCE OVERALL CIRCUIT COST...SIMPLIFY CIRCUITRY...
IMPROVE STABILITY OVER A WIDE TEMPERATURE RANGE**

Consider the cost savings. Example: in a typical time delay circuit, one unijunction transistor can save you up to \$13.11 by replacing three silicon transistors, one diode, one capacitor and four resistors. Another example: in a typical voltage threshold detector, one unijunction can save you up to \$7.40 by replacing two silicon transistors, one capacitor and three resistors. Our Application Engineers can give you many more examples, all reflecting similar cost savings with improved stability in your timing circuits.

2N489 series. TO-5 case. Military and industrial applications (a military version is used on MINUTEMAN)

2N2417 series. TO-18 case. Essentially the same electrical characteristics as 2N489 in a smaller package

2N1617 series. TO-5 case. For general purpose industrial applications with economy and stability

5C28 series. TO-18 case. Radical new structure. High switching speed (typical $t_{on}=50$ nsec), low valley current (3 milliamps max.), low saturation voltage (2.2 volts max.)

For detailed Application Notes on the unijunction, on the new 5C28 series, and on unijunction temperature compensation, see your G-E District Sales Manager. Or write Section 16H136, Semiconductor Products Department, General Electric Company, Electronics Park, Syracuse, New York. In Canada: Canadian General Electric, 189 Dufferin St., Toronto, Ont. Export: International General Electric, 159 Madison Avenue, New York 16, N. Y.

AVAILABLE THROUGH YOUR G-E SEMICONDUCTOR DISTRIBUTOR

GENERAL  ELECTRIC

the formula $H_r = 2[(1 - B)/f_h]$ (BW/A) relating horizontal resolution to the scanning frequency, horizontal blanking time, video bandwidth and aspect ratio.³ Here H_r is the horizontal resolution in tv lines, B is the percent horizontal blanking, f_h is the scanning frequency in cps, BW is the bandwidth in cps, 2 is the number of changes per cycle (for black and white resolution lines) and A is the aspect ratio (w/h).

Assume that an f-m transmission link is to be used having an r-f bandwidth of ± 10 Kc with a 2:1 deviation ratio as calculated from the signal-path noise characteristic. Since only 5 Kc of video bandwidth is allowable, the designer must critically examine the subject of information to be transmitted. Surveillance of instruments and gages which indicate comparatively slowly may require fairly good resolution but yet the information rate or the number of pictures transmitted per second can be low. On the other hand, rapidly changing events may require moderate resolution (350 tv lines) at a more rapid framing rate ($\frac{1}{2}$ fps).⁴ The problem of arresting subject motion when using slow framing rates is a separate consideration⁵ that can be accommodated by electrical or mechanical shuttering⁶ when natural lighting is available or by strobe lighting the subject.

TYPICAL SOLUTIONS—Given the 5-Kc video bandwidth with a subject of cloud formations the designer may choose a frame rate of one picture every 10 seconds. Since the subject orientation and physical makeup may best fit a square format (1:1 aspect ratio), approximately equal horizontal and vertical resolution will be selected. Using the chart, a trial solution will be tested with the three previously determined parameters (bandwidth, frame rate and aspect ratio).

For instance, from chart C: select 300 lines per frame at a frame rate of 10 sec and read 30 cps horizontal frequency. Using a 10-percent blanking factor (admittedly on the low side) as a first approximation, proceed to the 1:1-aspect ratio diagonal. Moving from this point to the interception with the 5-Kc bandwidth trace, the chart indicates

300 lines resolution proving that the initial selection was reasonable.

The chart is useful to approximate the system parameters within the confines imposed by the transmission link and the subject to be viewed.

As another example, determine the system parameters for minimum bandwidth when the

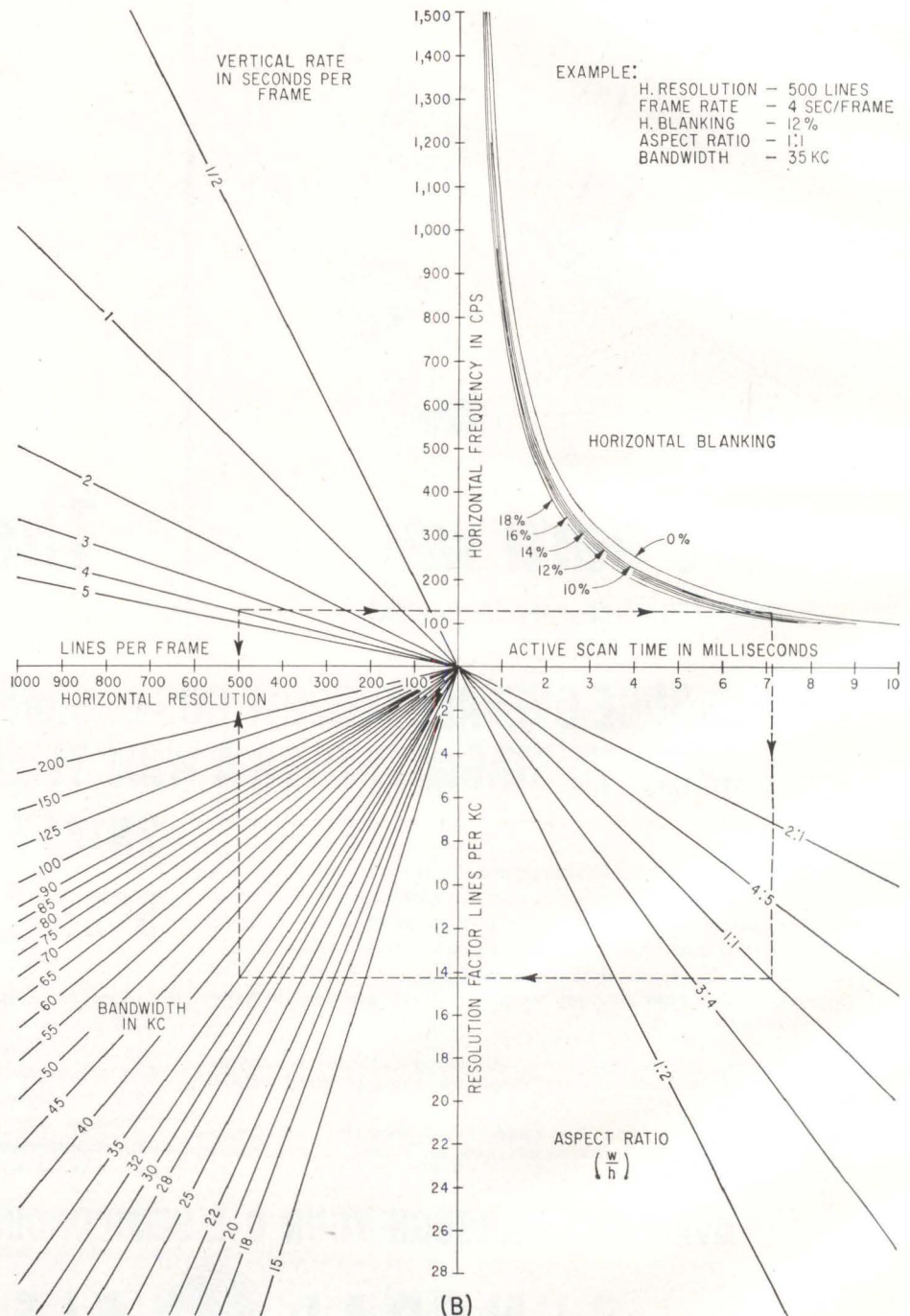

Q.

Who has the facts about looking things over from down under?

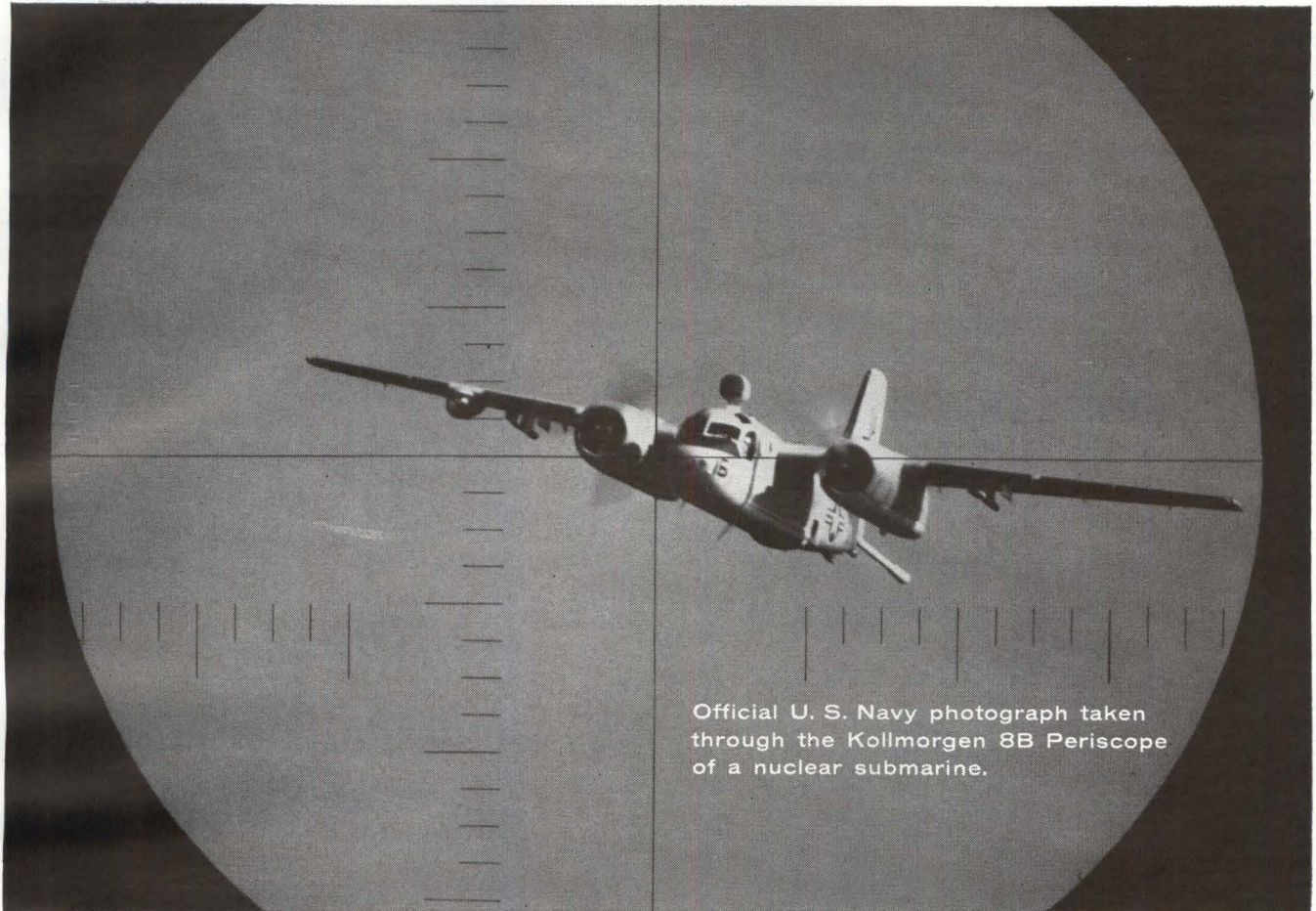

Official U. S. Navy photograph taken through the Kollmorgen 8B Periscope of a nuclear submarine.

A.

The Engineers who create Kollmorgen Periscopes

They'll tell you that the accompanying photograph was taken under difficult conditions. The obstacle? The water over a completely submerged submarine. The object? An S2F Tracker flying an ASW mission . . . so close that it was in the Kollmorgen 8B Periscope's field of view for just a fraction of a second. Only a precise combination of electro-mechanics and optics could track such a fleeting target with such definition.

You'll also learn that Kollmorgen periscopes serve as the "eyes" of virtually all

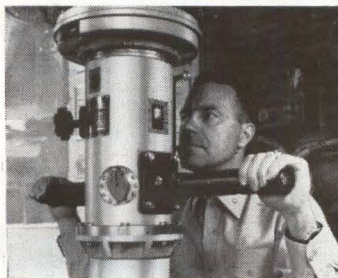

U. S. submarines . . . that Kollmorgen bunker-type periscopes monitor most missile testing and launching operations . . . that Kollmorgen hot-cell and underwater periscopes are on duty in almost every major nuclear installation in North America!

What is your question? If it is in the area of remote viewing, aligning, testing, inspecting, measuring or controlling, the answer may be among the growing number of optical/electronic/mechanical devices, instruments and systems engineered by Kollmorgen.

Write for literature describing the combined capabilities and facilities of Kollmorgen and its subsidiaries, Instrument Development Laboratories and Inland Motor Corporation.



KOLLMORGEN

may already have the answer to your next question in optics or electromechanics.

KOLLMORGEN CORPORATION • NORTHAMPTON, MASSACHUSETTS

desired horizontal resolution is 500 lines and the framing rate is 4 sec/frame. Inspection of chart B shows that the bandwidth will have to be greater than 15 Kc to have a vertical resolution of at least 200 lines. Assuming that the vertical resolution is to be close to that of the horizontal, the other conditions for minimum bandwidth are: aspect ratio should be a minimum (although usually not less than 1:1 unless the outline of the subject warrants); and blanking time should be a minimum. While this is governed by circuit design, practical percentages will fall in the same range regardless of the scan rate.

Using a minimum of 12-percent blanking (the circuit designer will probably want more), and an aspect ratio of 1:1, trial plots can be made starting from 500 lines resolution in an attempt to arrive at a desirable horizontal scanning frequency. For instance, for about 35-Kc bandwidth, read 125 cps horizontal and 500 lines per frame. For less bandwidth, a compromise might be made at the expense of vertical resolution. For 400 lines per frame and 100 cps horizontal, the bandwidth is about 28 Kc.

While this article touches superficially on the study of resolution, more comprehensive treatments are to be found in the many references⁷⁻¹⁰.

REFERENCES

(1) L. L. Pourcian and others, High-resolution Television System, *Journ SMPTE* 69, p 105, Feb., 1960.
 (2) C. D. La Fond, Ranger to Provide Real Moon Close Up, Missiles and Rockets, p 32, Jan. 29, 1962.
 (3) D. G. Fink, Television Engineering Handbook, McGraw-Hill Book Co., p 8, 1957.
 (4) TV to Monitor Centaur Liquid Hydrogen Effect, *Aviation Week*, 76, p 9, Feb. 26, 1962.
 (5) R. G. Neuhauser, Sensitivity and Motion Capturing Ability of TV Camera Tubes, *Journ SMPTE* 68, p 455, June, 1959.
 (6) Tiros Satellite and Associated Ground Equipment, *Astronautics*, 5:6, p 32, June, 1960.
 (7) O. H. Shade, Image Gradation, Graininess and Sharpness in Television and Motion Picture Systems, *Journ*

SMPTE p 131, Feb., 1952; p 181, March, 1952; p 97, Aug., 1953; p 593, Nov., 1955.
 (8) M. W. Baldwin, The Subjective Sharpness of Simulated Television Images, *Bell Sys. Tech. Journ*, 19, p 563, Oct., 1940.
 (9) A. Sandor, Effective Spot Size in Beam Scanning Tubes, *Journ SMPTE* 69, p 735, Oct., 1960.
 (10) H. J. Schlafly, Some Comparative Factors of Picture Resolution in Television and Film Industries, *Proc IRE*, 39:6, Jan., 1951.
 (11) IRE Standards on Video Techniques: Measurement of Resolution of Camera Systems, 1961, *Proc IRE*, March, 1961.

(12) Laurence White, Measuring Spot Size of High Resolution Cathode Ray Tubes, *Electronic Equipment Engineering*, Aug., 1959.
 (13) R. G. Neuhauser, Picture Characteristics of Image-Orthicon and Vidicon Camera Tubes, *Journ SMPTE* 70, p 696, Sept., 1961.
 (14) W. G. Gibson and A. C. Schroeder, Vertical Aperture Equalizer for Television, *Journ SMPTE* 69, p 395, June, 1960.
 (15) D. G. Fink, Television Engineering Handbook, p 2, McGraw-Hill, Book Co., 1957.
 (16) G. H. Cook, Performance of Television Camera Lenses, *Journ SMPTE* 69, p 406, June, 1960.

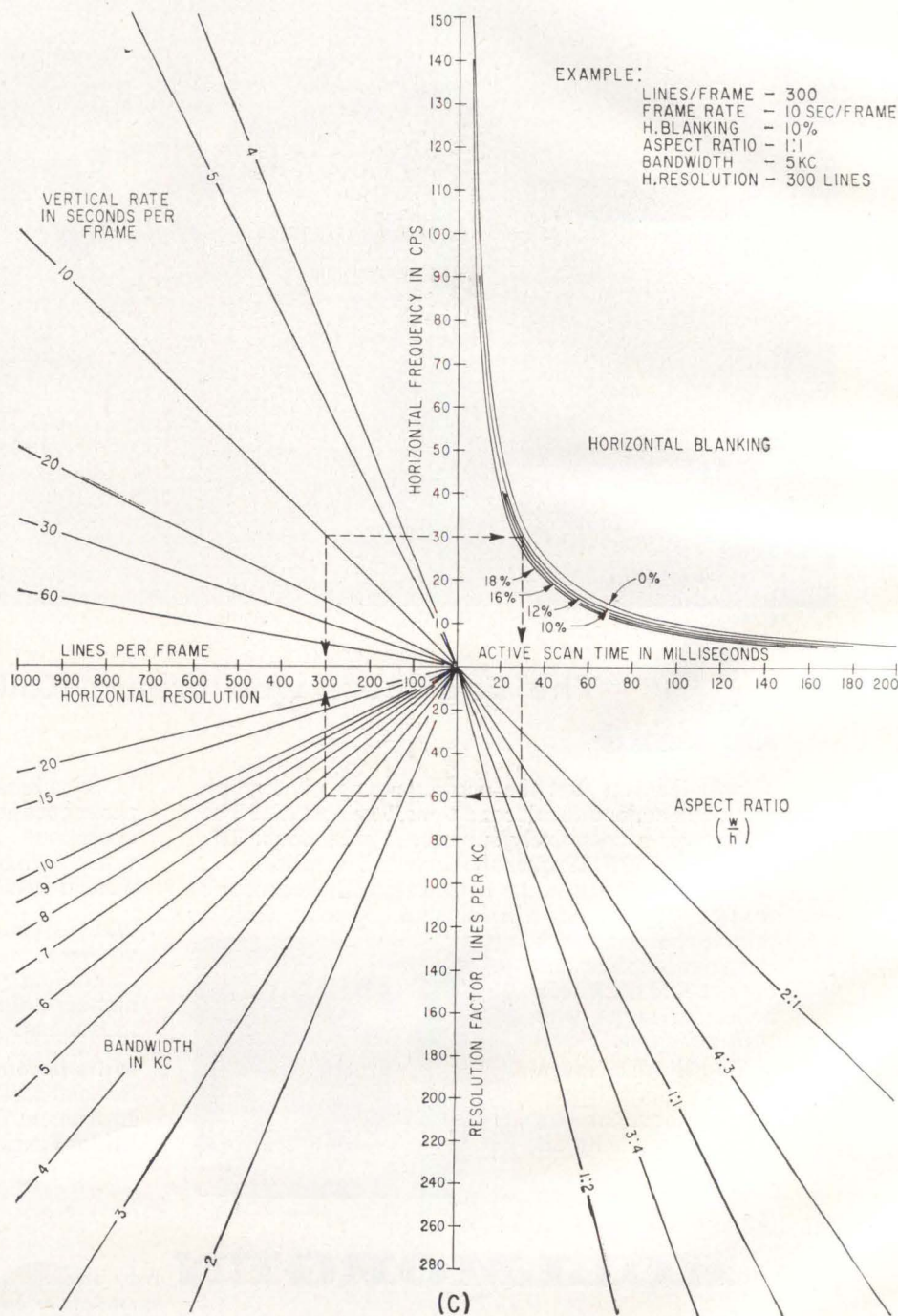



THREE GOOD THINGS TO KNOW ABOUT RAULAND

Scan Converter STORAGE TUBES

- Resolution Capability of 800 to 1000 TV lines
- Erase Capability of less than 2 seconds
- Extensive research and development facilities make tubes available to you in any combination of electrostatic or magnetic deflection

Two stock types are:

- (1) Magnetic deflection in and electrostatic deflection out
- (2) Magnetic deflection in and out

Many other combinations are possible—and available. Your inquiries are invited.



FLAT FACE DISPLAY TUBES

Rauland's flat face tubes (16", 22", 24") minimize parallax error. Resolution capability of 1000 TV lines at 100 foot-lamberts light output. Suit your specific requirements with any type of radar display tube in any size with any type phosphor or gun.

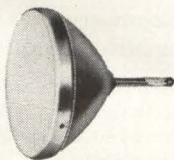

HIGH-RESOLUTION, HIGH-BRIGHTNESS TUBE

Round 21" high voltage CRT will resolve at least 1000 TV lines at 300-500 foot-lamberts light output. For displays under high ambient light conditions. Write or phone . . .

The RAULAND Corporation 4245 N. KNOX AVE. • CHICAGO 41, ILL. • MULBERRY 5-5000

CIRCLE 61 ON READER SERVICE CARD

A subsidiary of

ZENITH

Radio Corporation,
Chicago, Illinois

NEW Openings for EEs & MEs in Product Design and Development

Delco Radio's continuous search for new and improved electronic products provides challenging opportunities—in several areas—for capable engineers; specifically:

MOBILE COMMUNICATIONS (Automobile Radiotelephone) EQUIPMENT—

EEs—3-5 yrs. Exper—for design of and production assistance with 150 and 450 mc receiver transmitters; transistorization, packaging, duplex operation and dial mobile. Desire experience or interest in mobile communications equipment, private system or telephone link.

Project Engineers—work includes supervising type tests and FCC qualification testing of automotive radiotelephone equipment. Must audit designs for field reliability.

SUBMINIATURE MILITARY COMMUNICATIONS EQUIPMENT—

EE or ME—for assignment to development group designing all-transistor portable transmitters and receivers, operating in 2-100 mc range. FM—AM—FSK—CW—SSB modulation.

AUTOMOTIVE RADIO DESIGN AND DEVELOPMENT—

EE—to work with Senior Engineer on advanced development of auto radios and other entertainment devices, including FM-AM, miniaturized circuitry and components.

ME—for design of small electronic mechanisms, including FM-AM, Signal Seeking and push-button tuners, and components modules.

EE or ME—for packaging of auto radios and associated tuners, solenoids, etc. Required to make some engineering contacts with automobile manufacturers.

DIGITAL CIRCUITS AND SYSTEMS—includes card, module and digital systems design, and production liaison involving components and special purpose systems operating from 200 kc to 10 mc.

Project Engineer—to direct efforts of design engineers and technicians in designing

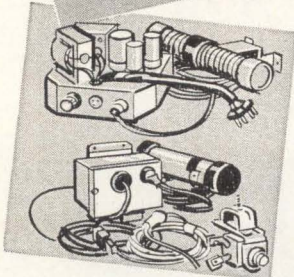
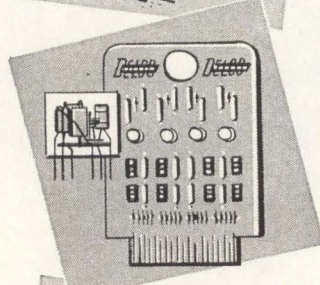

and releasing digital circuits for production. Supervisory experience highly desirable.

EEs—for design and development testing and packaging of transistorized digital switching circuits from 200 kc to 10 mc.

RELIABILITY ASSURANCE—

Project Engineer—to handle tests and evaluations of transistorized systems and components, both power and small signal type. Must evaluate results and associated statistical data. Also includes failure analysis work with suppliers and production.

EE—for design and development work on test equipment for semiconductors and special products, such as radiotelephone.

AUTOMOTIVE ELECTRONICS—non-entertainment automotive electronic development including radio control for Garage Door Operators; other transistor applications in automobile, usually involving electromechanical transducers—

ME—for advanced development work in electromechanical systems used in automotive field.

EE—for design and development of transistorized automobile equipment.

EE or ME—with electromechanical interests for development of electronic equipment for the automotive service market.

● If your interests and experience fall in the above areas and if you're looking for an opportunity to fully exercise your personal competence . . . among men of like talent . . . in unmatched facilities . . . then let's talk. Send your resume today to the attention of Mr. Carl Longshore, Supervisor Salaried Employment.

An equal opportunity employer



DELCO RADIO DIVISION OF GENERAL MOTORS
KOKOMO, INDIANA

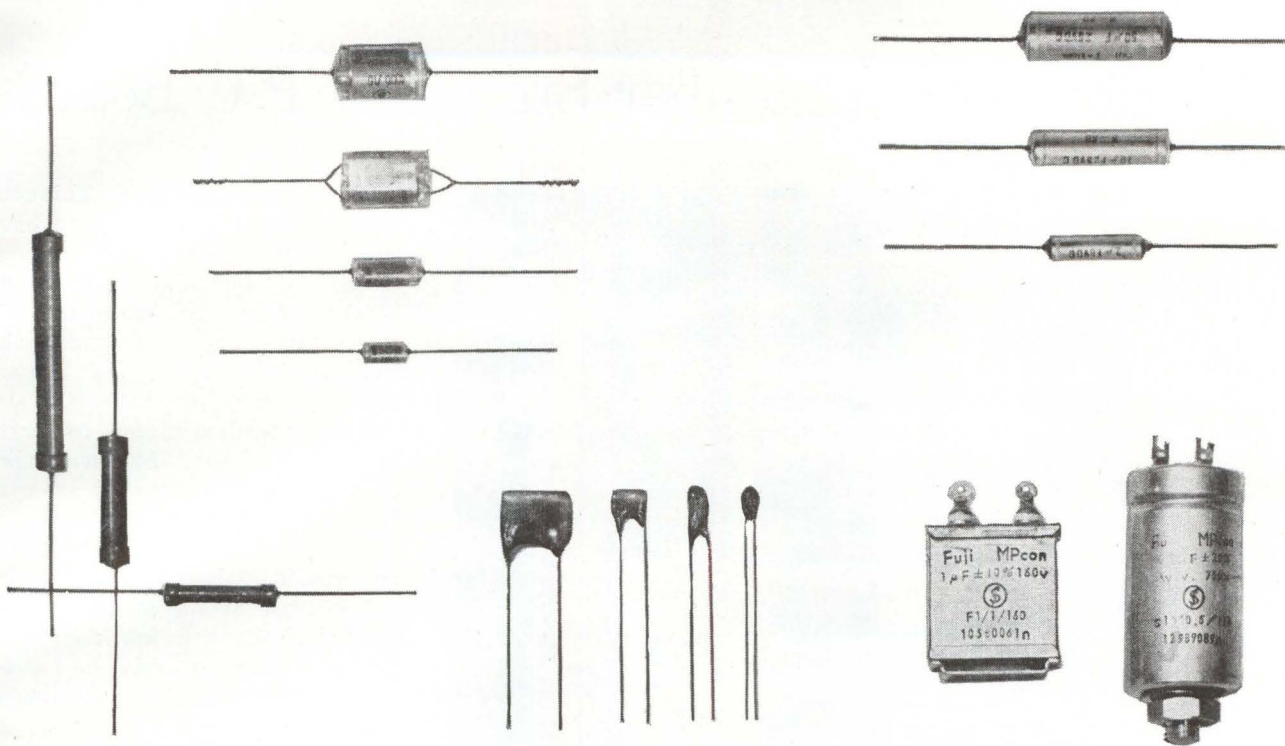

HOW TO BE SURE OF QUALITY IN ELECTRONIC COMPONENTS

One way to be sure of the quality of electronic components is to manufacture them yourself under rigid quality control for use in your own systems. This is exactly how Fuji Tsushinki started manufacturing electronic components. Fuji is one of Japan's leading manufacturers in the field of telecommunications, computers and automatic controls. For over 25 years Fuji has devoted a large part of its research and production to the development of better components for its own equipment and systems. Now these precise, reliable components are available to other

manufacturers who want top performance at economical prices. Fuji components include capacitors, resistors, semi-conductors, relays, switches, filters, oscillators and other specialized items. All Fuji components are rigidly quality controlled during manufacture and subjected to rigorous testing, to match the quality and reliability of the finest electronic systems. Before you make a major decision in components buying, check the quality and prices of our products. Detailed specifications and application data are available from our representatives shown below.

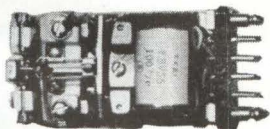

"Where the Future
is Today



FUJI TSUSHINKI SEIZO K. K.
(Fuji Communication Apparatus Mfg. Co., Ltd.)

Tokyo, Japan

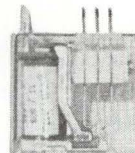
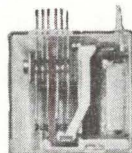
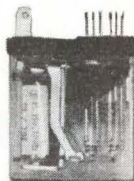

Represented by: * The Nissho American Corporation: New York 5, 80 Pine St., WH 3-7840. Chicago 8, 140 S. Dearborn St., CE 6-1950
* The Nissho Pacific Corporation: San Francisco 4, 120 Montgomery St., YU-2-7901. Los Angeles 14, 649 S. Olive St., MA 7-7691

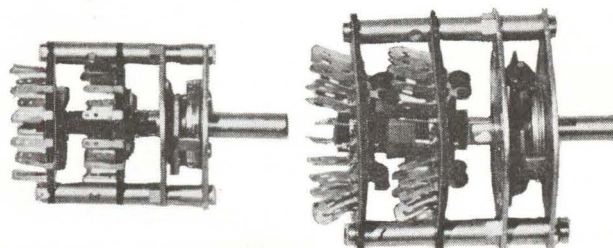
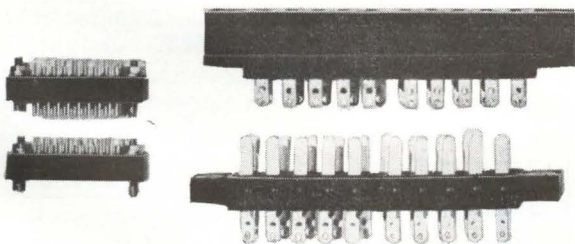

Thermoelectric Chamber Stabilizes P-C Boards

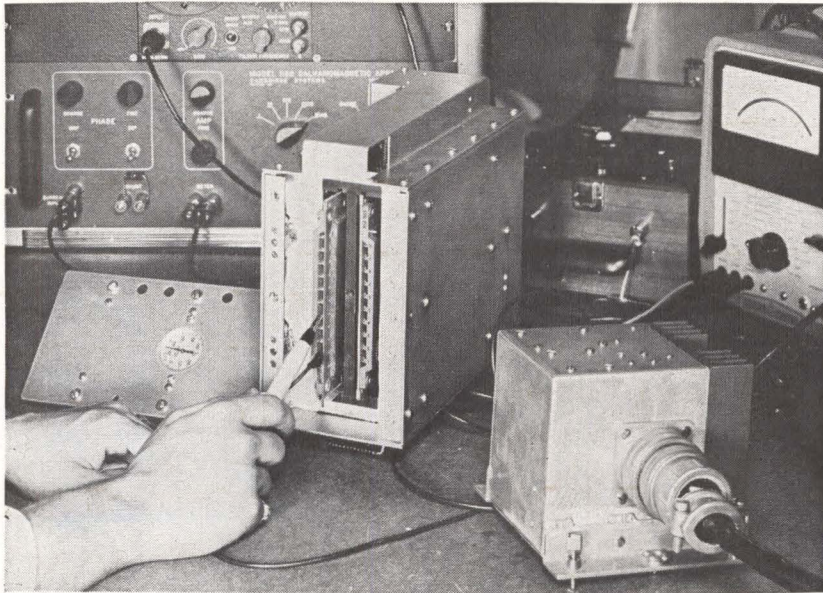

THERMOELECTRIC chamber with cover removed controls operating temperature of printed circuit boards

Thermal environments can now be controlled on a systems level

By DAVID J. BEAUBIEN, Pres.
Cambridge Systems Inc.
Newton, Mass.

THERMALLY STABLE environments can be provided for conventional printed-circuit boards by a recently developed thermoelectric chamber. Constant improvements in thermoelectric materials with accompanying price reductions have made more extensive use of thermoelectric devices feasible. Thermoelectric temperature control on a systems level is now considered practical if careful design practices are followed.

Designing temperature-stable circuits becomes increasingly difficult as other requirements are increased, so that even the most complex stabilizing techniques may not be sufficient to permit use of a circuit in a system. The thermal environment of circuits like oscillators, video-amplifier strips or timing circuits can often be stabilized

above ambient temperature, as is done by the crystal oven. However, this approach is not always desirable if the circuit must operate reliably for extended periods at the higher temperature or if abrupt changes in ambient temperature are anticipated.

Under conditions where circuit design or ovens are not adequate for dealing with temperature problems, thermoelectric modules can sometimes provide a solution. The thermoelectric chamber in the photograph was designed for such situations. It maintains temperature of conventional printed circuit boards at 25 ± 1 degree C with variations in ambient temperature from -55 to 55 degrees changing at a rate of 1 degree C per minute.

CHAMBER DESIGN—A key feature in the design is the aluminum I beam shown in Fig. 1, which provides a path of high thermal conductivity to the thermoelectric modules mounted at the ends of the beam. The printed circuit boards are encapsulated in epoxy resin, and the surfaces are finished to provide low thermal resistance between

the boards and the I beam. This configuration has been found to have low response time, since heat provided to or removed from the board is not limited by the usual air space. Heat removed from the chamber is dissipated by fins on the modules.

Ducts permit a stream of air to be circulated past the lower modules, through the fan at the rear of the chamber and across the fins of the upper modules as it is discharged. This thermal design makes efficient use of the pumping capabilities of the modules. Total temperature gradient along the I beam during maximum heat rejection is less than 1 degree C.

Selecting a thermoelectric module for a particular application is a primary factor in achieving a successful design. A wide variety of thermoelectric modules is available having figures of merit from 1.8×10^{-3} to 3.2×10^{-3} and operating currents from 1 to 40 amperes. Other characteristics that vary widely include mechanical strength, uniformity, intralment thermal insulation, and electrical insulation.

Generally, a thermoelectric element is chosen that provides the highest figure of merit consistent with cost. Power requirements must also be considered, since low-cost, high-current modules may use power inefficiently and require a bulky power supply. However, modules having higher impedance with small cross-sectional element area may not be uniform mechanically. If additional effort is required to mate them to flat heat sinks and chamber members, costs are increased. At the present state of development in the thermoelectric industry, it is desirable to work with the module manufacturer to obtain a compatible design. Off-the-shelf modules are seldom ideally suited to a particular application.

CONTROL CIRCUIT—The control system for the thermoelectric chamber is shown in Fig. 2. Deviations in temperature from 25 degrees C

NOW DESIGN HIGHEST FREQUENCY / LOWEST NOISE MICROWAVE CIRCUITS

with:

**REPLACEABLE
INTERCHANGEABLE
DEPENDABLE**

NEW TI GaAs PILL VARACTORS

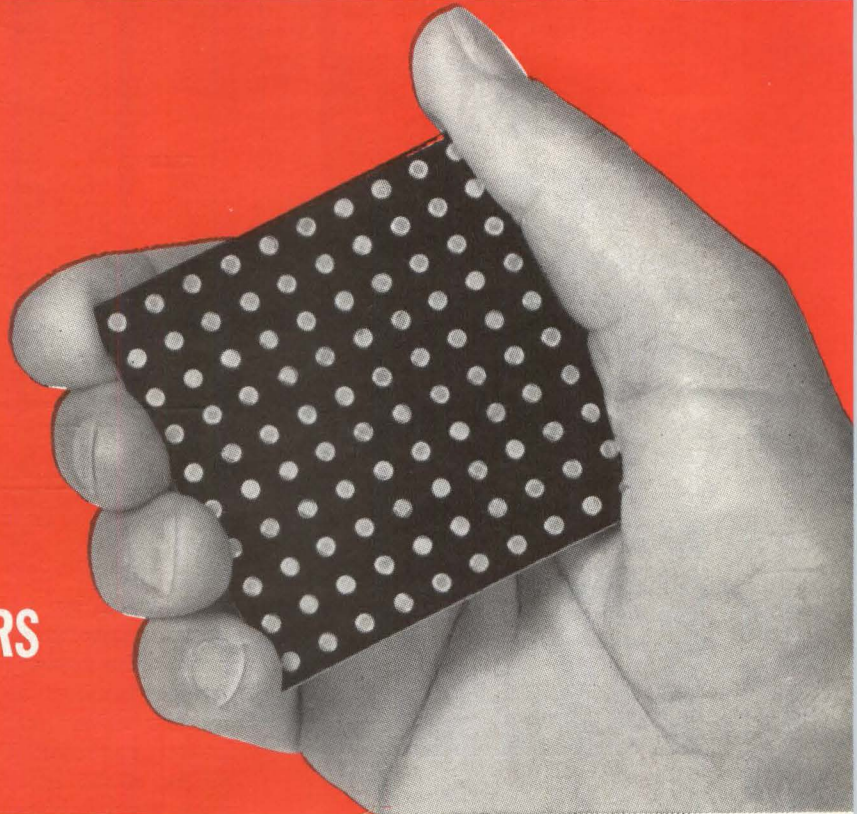

Now you can design microwave circuits for highest frequencies at lowest noise with the new GaAs Pill Varactor Diode from Texas Instruments. These new subminiature devices offer you minimum cutoff frequency of 90 Gc to 150 Gc at -2 volts with low junction capacitance — C_J @ 0 bias from 0.15 to 0.75 pf. Your production line requirements for identical plug-in units are met through tight control of junction and package characteristics. These features offer you the lowest package capacitance and inductance in industry today — backed up with TI varac-

tor manufacturing capacity to meet your tightest production schedules.

TI GaAs Pill Varactor Diodes are particularly applicable to:

- Low Noise Parametric Amplifiers • Harmonic Generators
- Microwave Switches • Sub-harmonic Oscillators • Phase Shifters • Parametric Limiters

TI also offers GaAs Varactor Diodes in the double-ended microwave cartridge.

electrical characteristics at 25°C ambient temperature (unless otherwise noted)

| parameter | test conditions | A-610 | | A-611 | | A-612 | | units |
|---|----------------------|-------|-----|-------|-----|-------|-----|-------|
| | | min | max | min | max | min | max | |
| BV_R Reverse Breakdown Voltage | $I_R = 10\mu a$ | 8 | | 8 | | 8 | | Volts |
| C_T Total Capacitance (See Notes 1, 2, 3) | $f = 1mc, V_R = 0$ | 0.45 | 1.0 | 0.45 | 1.0 | 0.45 | 1.0 | pf |
| Q Quality Factor (See Notes 4, and 5) | $f = 3Gc, V_R = -2V$ | 30 | | 40 | | 50 | | |

NOTES:

1. Case capacitance is typically 0.27 pf.
2. Varactor series resonance typically occurs at 14 Gc.
3. Selection can be made to customer C_T specification ± 0.05 pf.
4. Quality factor measurement method available on request.
5. Cutoff frequency is defined as the measurement frequency (3 Gc) times the quality factor.

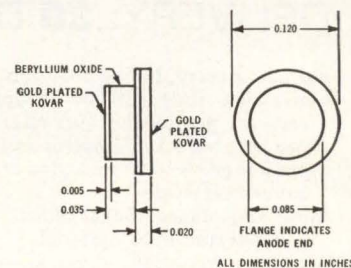

COMPONENTS DIVISION
CAPACITORS, DIODES,
RECTIFIERS, RESISTORS,
SEMICONDUCTOR NETWORKS,
SILICON CONTROLLED RECTIFIERS



TEXAS INSTRUMENTS

INCORPORATED

13500 N. CENTRAL EXPRESSWAY
P. O. BOX 5012 • DALLAS 22, TEXAS

19262

CIRCLE 65 ON READER SERVICE CARD

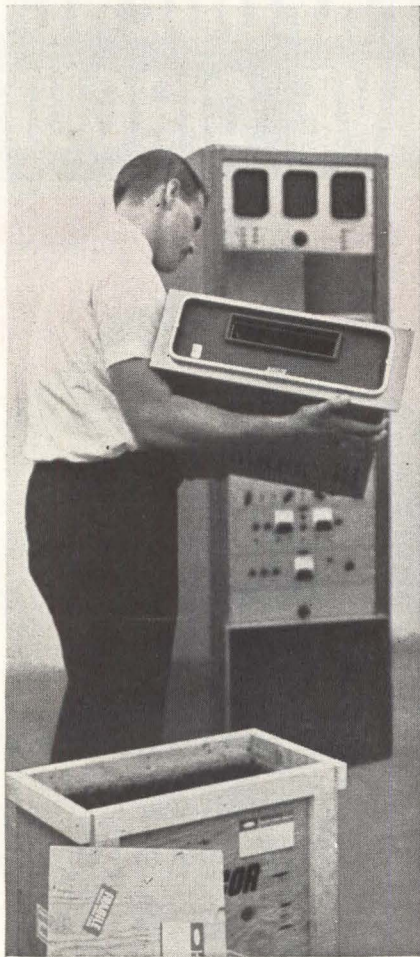

NOW READY:

ANALOG-TO-DIGITAL CONVERTER

NAVCOR MODEL 2201

LOW PRICE: **\$2935**

ACCURACY: **.05%** ABSOLUTE

DELIVERY: **30 DAYS**

Format: Binary, 10 bits plus sign.
 Conversion Rate: 10,000 complete conversions per second (9.1 microseconds per bit plus 9.1 microseconds.)
 Input Range: ± 10.23 volts; lower or higher ranges available.
 Input Impedance: 5,000 ohms; high impedance amplifier optional.

Other models start from \$2,775. Both Binary and Binary-Coded-Decimal formats are available. Options include Sample and Hold, Multiplexing, and Over-Range Indication. For more information, write to NAVIGATION COMPUTER CORPORATION, Valley Forge Industrial Park, Norristown, Pennsylvania.

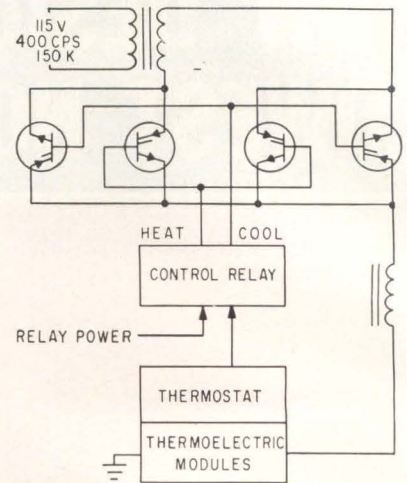
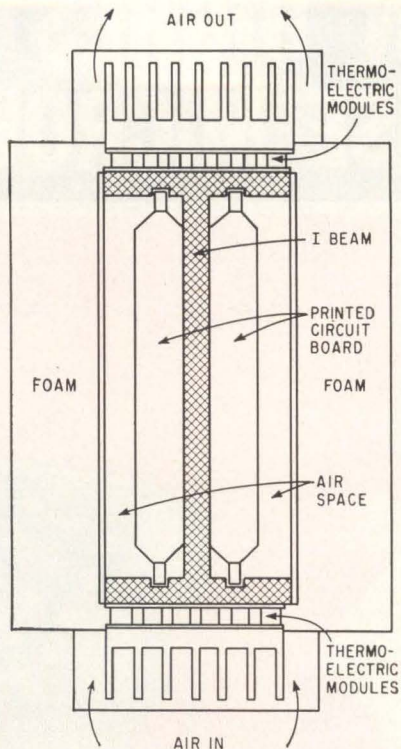

SILICON CONTROLLED rectifiers avoid problems of switching heavy thermoelectric currents with relay contacts—Fig. 2

HIGH THERMAL conductivity to thermoelectric modules is provided in chamber by aluminum I beam—Fig. 1

are sensed by a thermostat that operates a control relay. The relay selects the appropriate silicon controlled rectifier so that the same module either provides or removes heat as required. Using silicon rectifiers avoids the problem of using relay contacts to switch continually the relatively high d-c associated with thermoelectric devices.

Ripple in the d-c supplied to the thermoelectric module is reduced to less than 10 percent by a simple

series choke. Adding a capacitor to reduce ripple further does not significantly improve performance, but the addition of another component does reduce overall reliability.

The 5-inch cube in the photograph houses the complete power supply and control circuit. The unit shown was designed for use in a van or aircraft and requires 115-volt, 400-cps power of 150 watts. The entire chamber is built to meet military specifications.

Gravity-Wave Generator Is Being Built

THEORETICAL and experimental research is being carried out on the detection and generation of gravity waves. The existence of gravity waves has been predicted from the General Theory of Relativity proposed by Einstein in 1916. The oscillations in a gravitational field are analogous to electromagnetic waves in an electromagnetic field. The theory indicates that a gravitating mass such as a double star or spinning rod one meter long radiates about 10^{-30} ergs per second when rotated rapidly about a transverse axis.

The research is being conducted under grants from the Air Force Office of Scientific Research and the

National Science Foundation by Prof. J. Weber of the University of Maryland. He is building a detector to search for gravity waves from interstellar space. He is also constructing a generator and expects shortly to demonstrate that gravity waves can be produced and detected in the laboratory, according to a report in the AFOSR Research Review by Lt. Col. J. E. Duval, Nuclear Physics Div.

The detector is a $1\frac{1}{2}$ -ton aluminum cylinder housed in a vacuum chamber, which is expected to vibrate because of gravitational radiation incident on it. Displacements of the end faces of the cylinder are converted into electrical signals by

Transient Voltages... Cause and Cure

A transient voltage can be generated whenever a magnetic component is energized, or de-energized. The peak amplitude of the spike can be many times the normal steady state peak inverse voltage, and is dependent on the amount of magnetic energy stored in the circuit and the rate of change of the collapse of the resultant flux field.

The amount of magnetic energy stored in various circuit reactances can be approximated by $L \frac{i^2}{2}$, and this energy, when current is interrupted can produce a voltage equal to $L \frac{di}{dt}$. It is apparent, therefore, that under severe load or overload conditions, a high level transient voltage with substantial energy can be generated.

In actual applications, transients are generated mainly through interruption of current by switching, although circuit characteristics and phenomena can contribute to the problem. Full advantages to be gained from silicon rectifiers are available only if they are properly applied and protected. Silicon rectifiers have low inverse voltage capabilities and thermal capacity, so any overvoltage condition, even for a few microseconds, can destroy the junction. The circuits illustrated are typical of those where problems have been found.

In addition to the three most common causes, less obvious circuits and phenomena can generate transients. Among these are minority carrier recovery, switching magnetic amplifiers, lightning or random line conditions and motor regeneration.

The problem of computing C or RC filters is complicated because of the possibility of changing circuit operating parameters or causing oscillation.

Tarzian's recently developed line of "klipvolt" selenium transient voltage suppressors, therefore, offers a relatively low cost, simply applied method of positive protection. In many applications, a "klipvolt" suppressor will reduce overall circuit cost and increase reliability. The accompanying table covers the important design factors

of voltage and current that govern typical application of suppressors; however, special designs and ratings are available on request. There are two basic types of suppressors, the non-polarized for use primarily across AC components, and the polarized for use in DC load circuits. In some instances, however, it may be preferable to use non-polarized suppressors in output circuits for more positive clamping or non-interference with circuit timing or operation.

Switching in Primary—Transients are caused by interruption of "magnetic" current, or by energizing the primary and causing oscillation between inductance and distributed capacity.

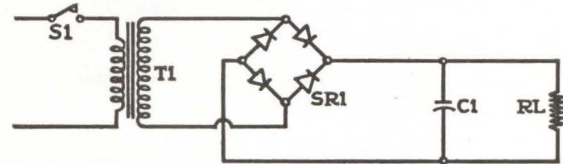

FIGURE 1

Switching Load—When the load is switched, the magnetic energy stored in the input circuit generates a voltage across the rectifiers and switch.

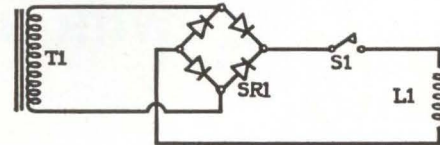

FIGURE 2

Magnetic Components on Common Line—Other magnetic components like motors, solenoids, relays or breakers can generate a transient peak when input is interrupted. The generated voltage will appear across the rectifier.

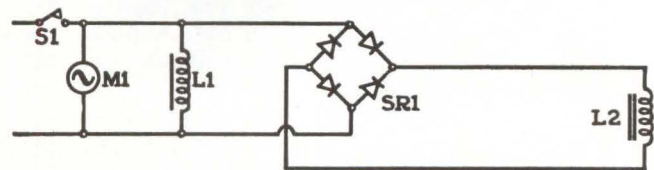
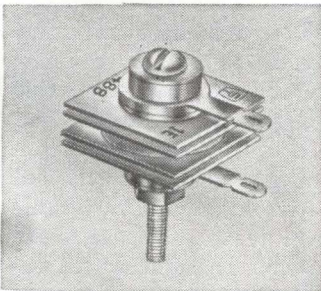

FIGURE 3

TYPICAL *klipvolt* SUPPRESSORS—SINGLE PHASE



| DC LOAD CURRENT | | 0-35 | 36-55 | 56-100 | 101-110 | 110-200 | 201-350 |
|-----------------|-----------|-------|--------|--------|---------|---------|---------|
| PIV | RMS VOLTS | AMPS | AMPS | AMPS | AMPS | AMPS | AMPS |
| 50 | 35 | S-487 | S-487A | S-487B | S-487A | S-487B | S-487C |
| 100 | 70 | S-488 | S-488A | S-488B | S-488A | S-488B | S-488C |
| 200 | 140 | S-490 | S-490A | S-490B | S-490A | S-490B | S-490C |
| 300 | 210 | S-492 | S-492A | S-492B | S-492A | S-492B | S-492C |
| 400 | 280 | S-493 | S-493A | S-493B | S-493A | S-493B | S-493C |
| 500 | 350 | S-494 | S-494A | S-494B | S-494A | S-494B | S-494C |
| 600 | 420 | S-495 | S-495A | S-495B | S-495A | S-495B | S-495C |

TYPICAL THREE PHASE SUPPRESSORS

| DC LOAD CURRENT | | 0-60a | | 61-115a | | 116-200a | | 201-450a | |
|-----------------|-----------|-------|-------|---------|--------|----------|--------|----------|--------|
| PIV | RMS VOLTS | H.W. | BR | H.W. | BR | H.W. | BR | H.W. | BR |
| 50 | 35 | S-539 | S-539 | S-539 | S-539A | S-539A | S-539B | S-539B | S-539C |
| 100 | 70 | S-540 | S-540 | S-540 | S-540A | S-540A | S-540B | S-540B | S-540C |
| 200 | 140 | S-542 | S-542 | S-542 | S-542A | S-542A | S-542B | S-542B | S-542C |
| 300 | 210 | S-544 | S-544 | S-544 | S-544A | S-544A | S-544B | S-544B | S-544C |

Note: All types without suffix letter use plates 1" square; with "A"—1¼", with "B"—1.6"; and with "C"—2" square. Length depends on voltage rating and varies from 1½" to 4¾".

Write for complete
"klipvolt" application information.



SARKES TARZIAN, INC.

World's Leading Manufacturers of TV and FM Tuners • Closed Circuit TV Systems • Broadcast Equipment • Air Trimmers • FM Radios • Magnetic Recording Tape • Semiconductor Devices
SEMICONDUCTOR DIVISION • BLOOMINGTON, INDIANA
In Canada: 700 Weston Rd., Toronto 9 • Export: Ad Auriema, Inc., New York

*I am the seeker incessant,
 Endless avenues I roam, ravelling
 Slender threads toward logical conclusions,
 Splintering the thrum of inaudibility
 To halt the hereafter with heartbeats,
 Combing the static deep for denizens
 Of stingered steel and polarized petards,
 Slicing through quake and classic crust
 To wrench the secrets of antiquity
 From the very bowels of earth, so man,
 Perhaps, can stir a step nearer heaven.
 To sing the song of truth and amplify
 Its message. My mission this, my task eternal—
 I am sound.*

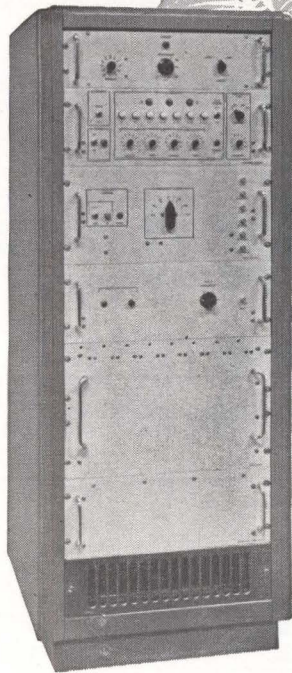

TO HALT THE HEREAFTER WITH HEARTBEATS

The very low frequency phenomena of heartbeats, like those of underwater sounds, speech, structural or geological shock and vibrations, no longer defy real time, high resolution analysis. Focussing broad scientific background and intensive research talents on the problem, General Applied Science Laboratories, Inc. has developed the SA-12 Spectrum Analyzer — capable of 1 second analysis time for 500 line resolution in frequency ranges from 0-250,000 cps.

A major component of GASL's MASSDAR (Modular Analysis, Speedup, Sampling and DATA Reduction) System, the SA-12 is compatible with GASL Probability Distribution Analyzer ND-501 and Spectral Density Analyzer DI-11.

Other outstanding characteristics include:

- Six scales (Frequency ranges in cps):

| | | |
|--------|--------|-----------|
| 0-5 | 0-250 | 0-5000 |
| 0-62.5 | 0-1000 | 0-250,000 |
- Analysis of both real and recorded inputs
- Analysis of periodic, random and transient data
- Simultaneous digital and analog output

SEND FOR ILLUSTRATED BROCHURE OR
 CALL TO MAKE ARRANGEMENTS FOR A DEMONSTRATION

Pathways to Progress from the Ageless Truths of Technology

GENERAL APPLIED SCIENCE LABORATORIES, INC.

Merrick and Stewart Avenues, Westbury, New York
 (516) EDgewood 3-6960

piezoelectric crystals. Relative displacements of the end faces of about 10^{-15} cm have been detected. Displacements of 10^{-16} cm are expected to be detectable when instrumentation has been completed. The search for gravity waves from space will be made in the kilocycle frequency range, and Prof. Weber predicts his equipment will detect gravitational flux with a power spectrum of about 10^{-4} ergs per square centimeter per second per cycle.

The generator is also an aluminum cylinder housed in a vacuum chamber and is 8 inches in diameter and 6 feet long. A driving force with a 1-ton amplitude causes the cylinder to vibrate at 1,650 cps. The force is applied by piezoelectric crystals fastened to the cylinder and stressed electrically to give the desired force.

The two cylinders are isolated from each other by being suspended in vacuum chambers that are mounted on insulators to isolate them from earth vibrations. Since acoustical and direct coupling are eliminated by this arrangement, interactions between the cylinders are expected to be through the gravitational field.

The interaction is postulated to be through the near part of the gravitational field, which is analogous to the coupling of two electrical circuits by induction rather than the radiation of an electromagnetic field. The gravitational radiation transmitted from the generator to the detector, corresponding to the electromagnetic radiation transmitted from a transmitting to a receiving antenna, is too weak to be detected. However, if the detector is sensitive to perturbations of the near field, it is expected to be sensitive to gravitational radiation from interstellar space, since this gravitational radiation is expected to be of greater intensity than that from the vibrating cylinder.

The possibility of harnessing gravity similarly to electromagnetism is not regarded as significant. However, the value of the investigation lies in the possibility of solving some of the problems associated with gravity. For example, new knowledge about the universe might be directly applicable to Air Force problems that are not presently even anticipated.



300°C NANOSECOND DIODE

THE INSIDE STORY OF UNIPLANAR* VS. MULTI-PART CONSTRUCTION

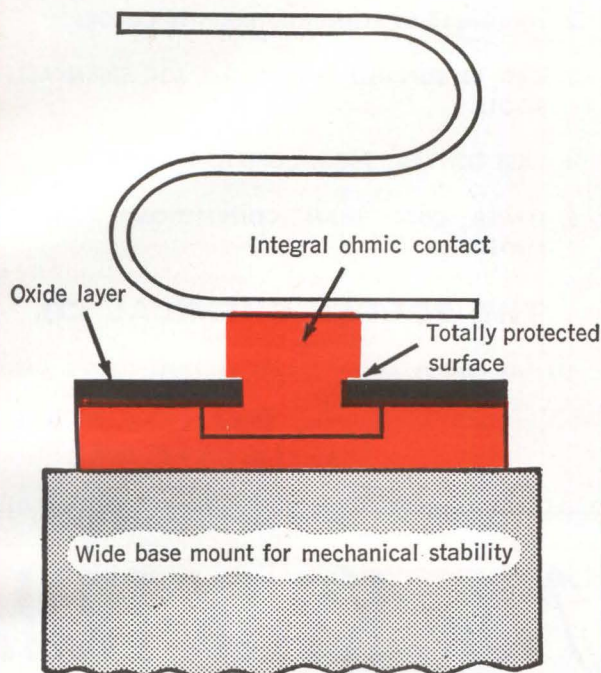

RAYTHEON/RHEEM UNIPLANAR* DIODE

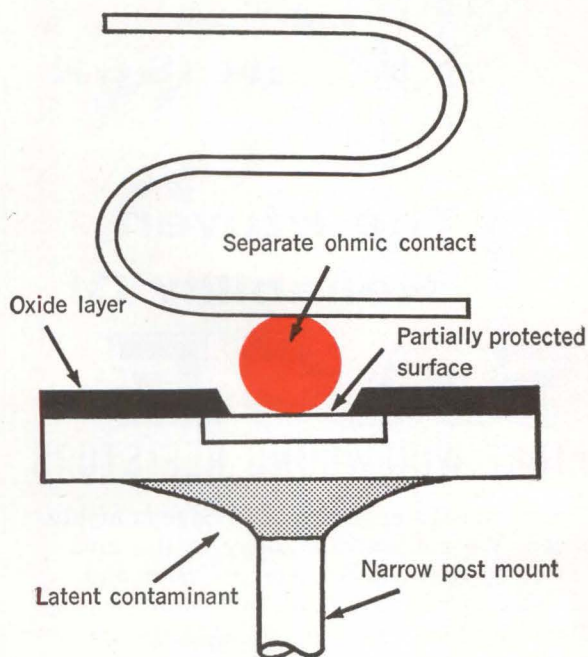

CONVENTIONAL PLANAR MULTI-PART DIODE

UNIPLANAR* construction boosts silicon diode reliability

Uniplanar* one-piece construction, produced at Raytheon/Mountain View (formerly Rheem Semiconductor), brings a major improvement to silicon planar diode reliability. This is demonstrated by a 300°C storage capability, unequalled shock and vibration resistance, and more uniform electrical characteristics.

The result of Raytheon/Rheem Uniplanar* construction is a one-piece unit that can't shake loose or become misaligned. The entire chip assembly, including ohmic contact, is formed by a single process. This technique permits positive

surface passivation of the entire junction area. A high level of uniformity is achieved, since ohmic contacts are chemically formed thousands at a time.

300°C storage is obtained because, for the first time, it is possible to exclude the latent contaminants introduced by multi-part assembly techniques.

Uniplanar* construction is available at no extra cost in such types as 1N914, 1N916, 1N3064, and 1N251. For further information, please contact the nearest Raytheon Field Office.

* Exclusive one-piece planar construction from Raytheon/Mountain View (formerly Rheem Semiconductor).



ACHIEVE

IN 1962

With The Proven Reliability Of

SAGE

MINIATURE WIREWOUND RESISTORS

Product design engineering at Sage is highly specialized. We concentrate solely in the area of bridging that gap between *precision* and *stability* on the one hand and *power rating* on the other.

Now, for flat card assembly as well as for other component cluster approaches to circuit squeezing, SAGE offers industry's smallest grouping of 1, 2, and 3 watt resistors.

| Actual Size | Style | Rated Watts at 25°C | Nominal, inches | | Range, Ohms |
|-------------|-------|---------------------|-----------------|----------|-------------|
| | | | Length | Diameter | |
| | S1W | 1 | .406 | .094 | .5—10,000 |
| | SA1W | 2 | .500 | .125 | .5—15,000 |
| | SA2W | 3 | .500 | .187 | .5—18,000 |

Performance features of MIL-R-26C are easily met. SA2W is in fact RW59, presently the smallest unit detailed in MIL-R-26C.

Sage Impervohm silicone resin provides moisture and voltage protection, and may be safely operated at temperatures to 350°C.

Above styles available in non-inductive windings, also with weldable leads on special order.

Test samples available on request



SAGE

SAGE ELECTRONICS CORP.
Country Club Road • East Rochester, N. Y.



NEW!
RESINITE®

SHRINK VINYL TUBING

1. AVAILABLE IN MIL-I-631-C, MIL-I-7444-B and AMS-3630-B SPECIFICATION TYPES.
2. AVAILABLE IN STANDARD RESINITE COLORS.
3. CAN BE SUPPLIED CUT TO SIZE FOR SHRINKABLE BOOTS.
4. FAST DELIVERY FROM COMPTON, CALIF.
5. LOWER COST THAN CONVENTIONAL SHRINK MATERIALS.

THE BORDEN CHEMICAL CO.
RESINITE DIVISION

BOX 4428 COMPTON, CALIF. 1 CLARK ST., NORTH ANDOVER, MASS.

THE BORDEN CHEMICAL COMPANY

CIRCLE 202 ON READER SERVICE CARD

Now, KWIK-TRIM

THE POTENTIOMETER WITH THE

VISUAL INDICATOR

IMPROVED RESOLUTION APPROX. 10% TO 25% OVER MANY COMPARABLE TYPES.

Designed for the ultimate in reliability and performance and to meet applicable military specifications for shock, temperature cycling, vibration, altitude, fungus, humidity, immersion, salt spray, sand and dust.



MULTIPLE ADJUSTMENT

A KWIK-TRIM one to one nominal adjustment . . . A vernier 45:1 ratio for precise setting . . . Shaft is journaled at each end with precision bearing fit . . . These precision features are your assurance for ease of setability and the stability of setting.



Please Write for ELECTRICAL, MECHANICAL AND ENVIRONMENTAL SPECIFICATION CATALOG.



General Scientific CORP.

A SUBSIDIARY OF SAN FERNANDO ELECTRIC MFG. CO.
1535 FIRST ST. SAN FERNANDO, CALIF.
EM 1-1193 . . . TWX S.F. CAL 9900

CIRCLE 203 ON READER SERVICE CARD

CIRCLE 71 ON READER SERVICE CARD →

*Mindpower and Manpower...
shaping the future in*

COMMUNICATIONS and ELECTRONIC SYSTEMS

ENGINEERS: Today the men at Motorola are developing resourceful solutions to the complex problems of America's most advanced communications and electronic systems. Creative mindpower is being applied to such vital areas as the Navy's sonobouy and oceanographic instrumentation programs...the Army's VHF single side band radio central system...the Air Force's UHF ground-air communications system...and NASA's cis-lunar and deep space tracking programs. Advanced studies are also being made in random access digital communications, digital-to-voice translation, high speed teleprinting, phased arrays and solid state circuitry. To participate in this challenging work, write today describing in detail your experience in the following areas:

Systems Design • analysis and synthesis of complete systems for operation in hydro-space, surface and aerospace environments. Human factors engineering and operations research.

Equipment Design • high performance solid state receivers, transmitters, frequency synthesizers and data handling equipment for radar and communications systems, oceanographic instrumentation systems and display complexes.

Familiarity with State-of-the-Art • statistical communications theory, advanced signal processing techniques, ultra-reliability through application of low-level redundancy, advanced structural and thermal designs for severe environments.

We are particularly interested in the programs on which this experience was obtained, and the extent of your technical responsibility. Address information to our Manager of Engineering at the location of your choice for immediate and confidential attention.

*An equal
opportunity
employer*



MOTOROLA

Military Electronics Division

CHICAGO 51, Illinois, 1450 North Cicero Avenue
SCOTTSDALE, Arizona, 8201 East McDowell Road
RIVERSIDE, California, 8330 Indiana Avenue

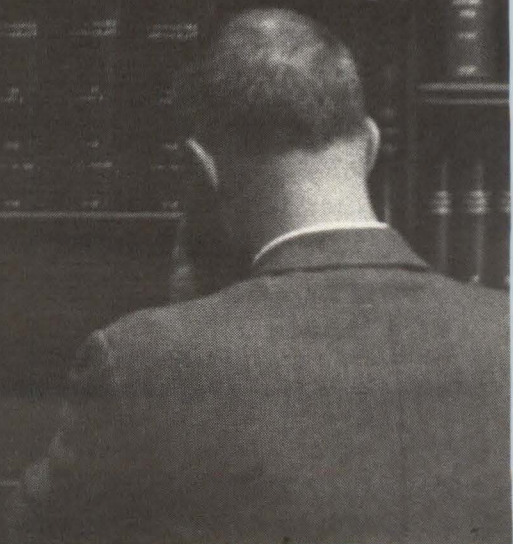

EVALUATING

Integrated-Circuit Performance

By PETER SCHINK, Fairchild Semiconductor, Mountain View, California

Plan functional circuits with available parts, save time and money

INTEGRATED circuits, or circuits existing in a single substrate, offer possibilities of remarkable increase in reliability at circuit cost approaching that of a single transistor.

Integrated-circuit parts are now available to facilitate breadboarding a custom circuit and determine its adequacy. Offered by Fairchild Semiconductor, these functional parts provide circuit designers with a degree of freedom in obtaining a custom-designed integrated circuit without undergoing unnecessary and expensive tooling costs.

Cover photograph shows integrated parts offered initially to custom designers. Two 15K resistors are shown top right and left center. A 6K resistor is shown at bottom left; two medium geometry transistors, top center and right center; a small geometry transistor, bottom right; a large geometry transistor, right center; a common anode diode array, bottom center; and a common cathode diode array, top left. These parts represent an initial offering to fill particular needs. Future parts will include field-effect transistors, large-valued resistors, and capacitors.

The objective will be to provide further versatility in using integrated circuits, to obtain electronic functions with the ultimate in reliability at minimal cost.

TYPICAL CHARACTERISTICS—A high speed *npn* switching transistor is available with these typical parameters: $LV_{CE0} = 10$ v, $C_{ob} = 5$ pf at $V_{CB} = 5$ v, $f_t = 400$ Mc at $I_C = 3$ ma, $V_{CE}(\text{sat}) = 0.25$ v at

$I_C = 3$ ma. and $\tau_s = 20$ nsec at $I_C = I_{B1} = I_{B2} = 10$ ma. The total power of a circuit incorporating this transistor should not exceed 500 mw.

The diffused *p*-type 6K resistor is available with taps at 100, 200, 500 ohms, 1K, 2K, and 6K. Resistor breakdown voltage = 20 v at 10 μ a, and temperature coefficient from +25 C to +125 C is +2,000 ppm per deg C.

Three high speed silicon diodes are available in the common-anode configuration, with these typical characteristics: $BV = 30$ v at 10 ma, $V_F = 0.8$ v at 3 ma, $C_o = 4.0$ pf at $V_R = 0$, and ΔV_F (voltage match between diodes) = 15 mv max. at 3.0 ma.

These integrated parts, packaged in standard TO-5 cans, provide a breadboard circuit with characteristics similar to those of the final single-substrate circuit. Each device encounters a *p*-type diffusion to isolate it from the substrate, and therefore has the inherent capacitances and leakage currents of the eventual device. Geometry of diffused areas of the elements remain constant when integrated into the circuit, so parameters will not vary between breadboard and final circuit. Temperature coefficients of resistors in an integrated circuit are taken into account by providing diffused resistors.

DESIGN ADVANTAGES—Reliability of integrated circuits is enhanced by the fact that both passive and active elements are in effect placed in the circuit, using proven, silicon planar transistor diffusion techniques. These elements are then connected into a circuit by evaporating interconnecting metal in a single step.

As in the case of transistors, integrated circuits are manufactured

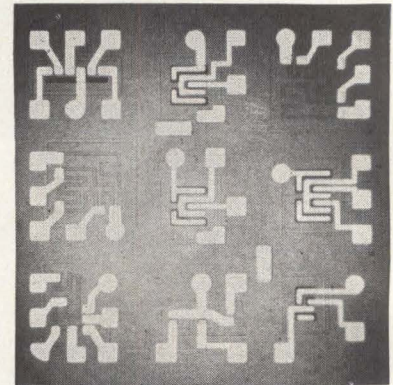

ASSORTMENT of integrated circuits, also shown on the cover, including resistors, transistors and diodes

in large numbers on silicon wafers which, following diffusions and evaporative metal interconnections, are scribed into individual circuits and packaged. The cost of circuits per wafer is inversely proportional to yield, and can approach transistor costs, because manufacturing techniques are similar to those used on transistors, and the number of circuits per wafer can approach the number of transistors per wafer.

As an additional cost factor, the circuit must meet necessary black-box conditions, regardless of the numerous device parameters required of a single transistor in the circuit. It therefore becomes meaningless to subject various transistors within the integrated circuit to individual parameter requirements which do not influence circuit operation. Circuit yields per wafer thus can be theoretically better than transistors per wafer.

DESIGN DRAWBACKS—An apparent, but possibly surmountable, drawback of integrated circuits is lack of flexibility in circuit configuration. Microelectronic approach doesn't adapt itself to last-minute circuit change, because of the relatively expensive and time-consuming art of making high resolution and accurately-registered masks for each diffusion step in the process. An answer to this problem is simply a thorough, exact worst-case design, using rules of design pertinent to integrated circuits.

To make a valid worst-case design, however, certain peculiarities of integrated circuits must be taken into account. To obtain elec-

FOR PRODUCTION ECONOMY

CONSIDER TUNG-SOL PRESS-FIT SILICON RECTIFIER ASSEMBLIES

For applications requiring 3 amps to 75 amps, Tung-Sol production techniques can deliver attractively economical, production-ready rectifier assemblies employing press-fit diodes. Availability of rectifiers in both polarities makes it possible to mount more than one diode on a single heat sink, resulting in assemblies that are the lightest weight available for any given power capacity. They lend themselves to compact designs, as the shortest dimension can be mounted in any of three planes. Minimal operating temperatures in the 1-15 amp range, plus surge ratings to 400 amps and PRV ratings to 600V assure maximum circuit protection.

Tung-Sol press-fit diodes have proved highly reliable in a wide variety of applications. They are hermetically sealed, with welded cases and ceramic-to-metal seals. All have protective finishes to withstand moisture and the corrosive conditions present in normal industrial environments.

For more information about Tung-Sol rectifier assemblies, or press-fit diodes for use with your own heat sinks, contact the Tung-Sol regional office nearest you, or write for Bulletin CT-17. Tung-Sol Electric Inc., Newark 4, New Jersey. TWX: NK193.

TYPICAL CONFIGURATIONS

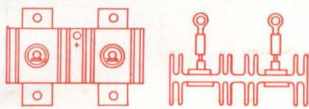

SINGLE PHASE CENTER TAP

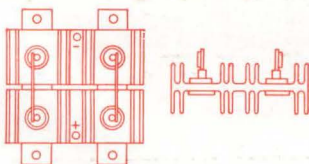

SINGLE PHASE BRIDGE

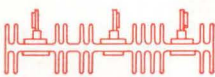
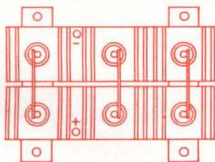

THREE PHASE BRIDGE

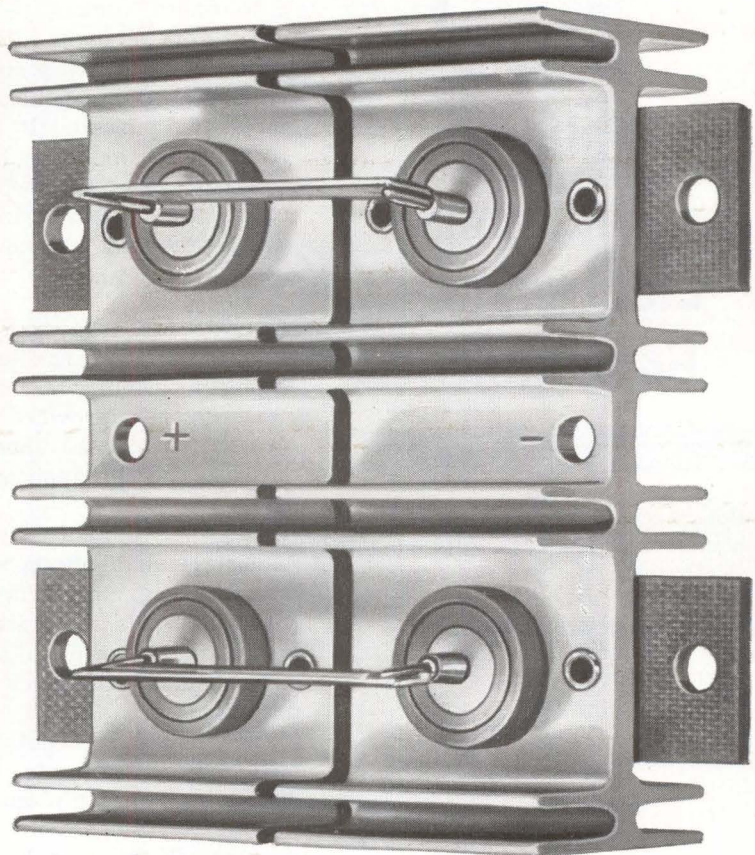

Sales Offices: Atlanta, Ga.; Columbus, Ohio; Culver City, Calif.; Dallas, Tex.; Denver, Colo.; Detroit, Mich.; Melrose Park, Ill.; Newark, N.J.; Seattle, Wash. CANADA: Montreal, Que.; Abbey Electronics, Toronto, Ont.; Prairie Pacific Distributors, Ltd., Edmonton, Alta.

 **TUNG-SOL[®]**

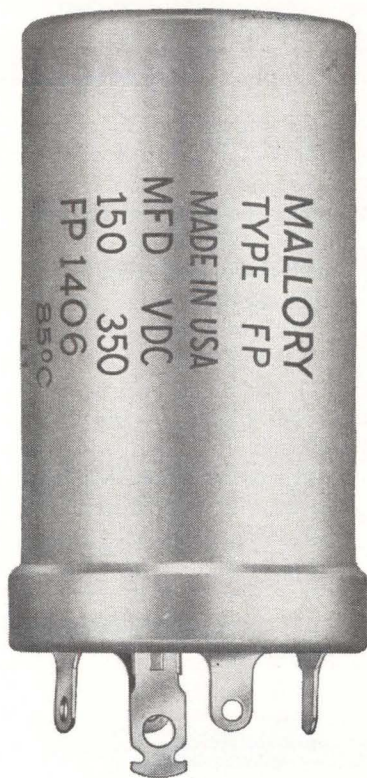

Mallory Aluminum Electrolytic Capacitors

For your products ranging from home instruments to military electronics, you can find any electrolytic capacitor you need in the Mallory line . . . unbeatable for quality, variety and performance. 85° ratings, MIL types, subminiatures, wax tubulars. Name it and you can get it . . . from stock at factory prices from Mallory Distributors. Write for latest catalog.

Distributor Division
P. O. Box 1558, Indianapolis 6, Indiana

P. R. MALLORY & CO. Inc.
MALLORY

trical isolation between adjacent active devices in the substrate, an isolation diffusion is required to form compartments of *n*-type or collector material in the substrate. The isolation diffusion is *p*-type, forming a wall around and a floor under the *n*-type starting material. By virtue of a back-biased *pn* junction, isolation between collector regions is obtained. Associated with the *p* isolation region is the parasitic junction capacitance and leakage current associated with a junction area of this size.

Diffused resistors are normally made during the *p*-type base diffusion of the transistors, and they have temperature coefficients of approximately +2,000 ppm/deg. C. Since a diffused resistor uses the bulk resistivity of a *p* region floating on *n* material, a distributed capacitance is associated with the resistor in an amount determined by the voltage gradient along the resistor.

These factors discourage worst-case design, unless they may be taken into account with a breadboard that accurately simulates operation as it would be in the final integrated circuit. It is obvious that a valid simulation of the leakages, temperature coefficients and capacitances would be difficult when using standard individual components.

USE OF KIT—This is the way the integrated parts enable manufacture of a custom integrated circuit:

Designer is provided with integrated parts, data sheets, circuit boards, and an application handbook.

Designer develops his circuits, using the data sheets and breadboards, designates parts of the circuits he wants integrated. Breadboard is returned to the maker, accompanied with black box parameters.

The maker lays out the masks necessary to make the circuit, and constructs test equipment to insure circuit performance within specifications. These are the expensive steps in the process which will be minimized by this approach.

Circuits are then diffused, packaged, and tested to specification as they come off the production line. Some of the design rules that have to be followed in using the inte-

grated units are described below:

A point-count system is used to determine area consumption of the final circuit. Each device is assigned a point-count value, and the total for the circuit should not exceed a prescribed figure. This correlates with the maximum possible amount of circuitry permitted per chip, before yield becomes markedly affected.

The isolation diffusion region should always be committed in the circuit. This reduces undesirable collector-to-collector capacitive coupling effects, and facilitates layout of the evaporative metal interconnections over the silicon dioxide on the top surface of the substrate.

Resistors designed into the circuit may be expected to vary ± 20 percent from the desired absolute value, but if absolute values can be discarded as a criterion, like resistors in the same substrate will be matched within ± 1 percent.

Noise Levels Measured For Various Resistors

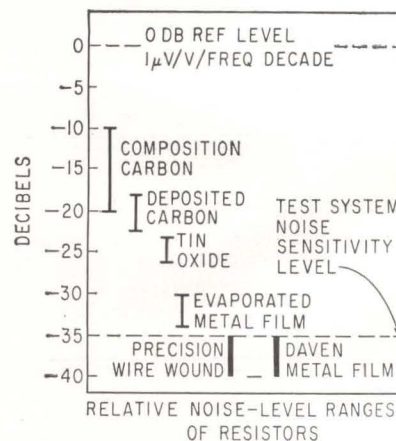

CURRENT NOISE levels for metal film resistors have been compared to precision wire wound resistors, as well as other types (see chart).

According to tests conducted against U. S. Bureau of Standards measurement criteria, the best measurement of current noise is in the area of -35 to -40 db. Below this point there is no observable difference between test set noise and resistor noise. It was at this level that Daven conducted tests on their own metal film resistors.

Current noise is measured in microvolts per volt per frequency decade. The measurement is in deci-

SERVOSCOPE® SERVO SYSTEM ANALYZER*:

the constant factor in servo system analysis

From missile design to industrial equipment, wherever servo systems must be tested and evaluated quickly, accurately, and dependably, the SERVOSCOPE® servo system analyzer is still the standard (shown: Model F . . . frequency range 0.005 — 100 cps).

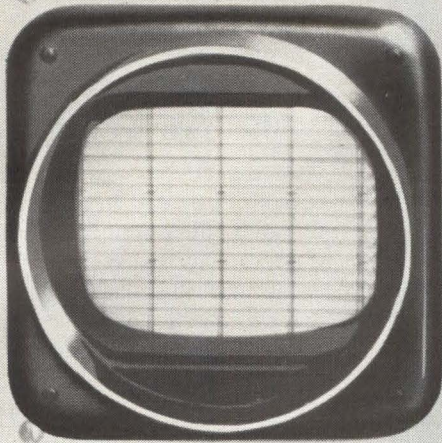

When Servo engineers introduced this remarkable self-calibrating "servo system analyzer" twelve years ago, industry was quick to recognize an important advance. Why? From the simplest to the most complex electronic, electrohydraulic, electromechanical, and electropneumatic servo system, SERVOSCOPE provided reliable answers in a hurry. Here, at last, was an accurate, useful standard — a well thought out, well designed test instrument made for servo engineers by servo engineers.

Today, twelve years, and thousands of instruments later, wherever you look you see SERVOSCOPE. To the engineer working with missiles, weapons systems, airborne gear, ground support equipment, instrumentation, navigation equipment, communications, computers, industrial feedback loops, controls . . . SERVOSCOPE is an accepted fact, an accepted part of the program. SERVOSCOPE is still the standard.

If your lab is still without a SERVOSCOPE, see what it can do . . . ask for a demonstration. Call the Servo office or representative in your area today. A free set of SERVOSCOPE WORKSHEETS or Servo conversion factors, as well as technical literature, will be sent you on request.

SERVO CORPORATION OF AMERICA
111 New South Road • Hicksville, L. I., N. Y. • WElls 8-9700



* A SERVOMATION® PRODUCT



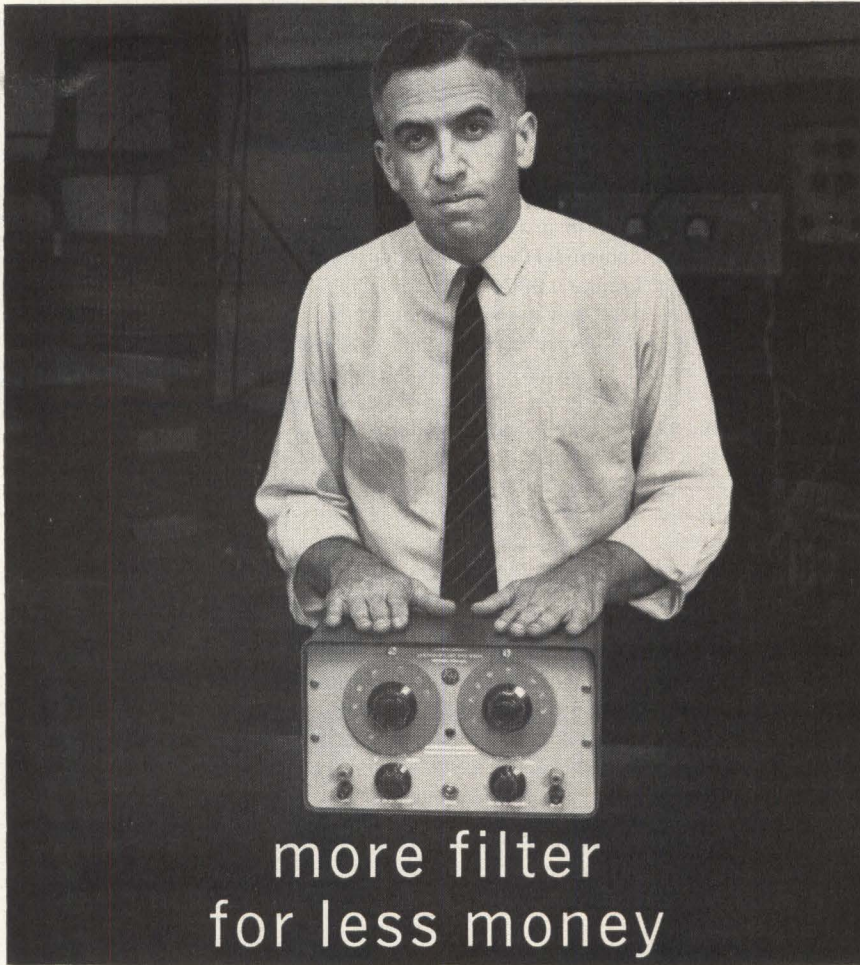

more filter
for less money

the Model 310-AB!

Look at all the features Krohn-Hite packs into one low-cost filter! Krohn-Hite's Model 310-AB variable band-pass filter covers the range from 20 cps to 200 kc. It features continuous independent adjustment of the high and low cut-off frequencies, so that the center frequency and band width are both adjustable.

Slope is 24 db per octave. Dials are direct-reading for quick and accurate measurement. Cut-off frequency accuracy is $\pm 10\%$, with $\pm 5\%$ available.

A big advantage of the Model 310-AB is its high input impedance. It can be bridged across sensitive circuits without disturbing them. Its low output impedance is another advantage, and the output doesn't require terminating in a specific load.

Low noise is another feature of the 310-AB. Its hum and noise spec is that of other much more expensive filters (less than 0.25 millivolt rms), allowing the filter to work at low signal levels.

How does Krohn-Hite put so many features into a \$350 filter? Easy — Krohn-Hite are filter *specialists* — the first to introduce many filtering techniques now in widespread use. So, for the most for the money, ask for a demonstration of the 310-AB. Check it out, and then check the price tag! Write for full specifications.



KROHN-HITE CORPORATION

580 Massachusetts Avenue • Cambridge 39, Mass.

Pioneering in Quality Electronic Instruments

bels with the zero decibel reference being one microvolt per volt per frequency decade as measured on an approved Quan-Tech Labs test set, Model 315.

Below the level of -35 to -40 db, at which the metal film resistors and precision wire wound types were charted, the application of voltage did not change the measurement. This is the lowest level of sensitivity of the approved test set.

Silicone Coat Protects Microwave Components

GENERAL PURPOSE protectant, developed to prevent tarnish of metals finds application in microwave guides, where surface corrosion of aluminum inhibits electrical characteristic of guide.

New silicone compound can be sprayed, wiped or dipped to any metal, UCAR 101 Silicone provides a thin coat having long-lasting finish. In the waveguide application, the uniformly thin film of silicone does not change critical dimensions.

Bond strength formed with a metal surface falls between a mechanical bond and a true chemical bond. Bonding mechanism is a form of chemisorption or hydrogen bonding. Union Carbide's coat is highly resistant to attack by oxides, sulphides or other gaseous materials that attack metal. Thermal stability is good. Short time tests have been performed on copper. Coating withstands 3 to 5 minutes on copper exposed to 1,200 deg F.

Lowering Temperature Of Induction Coil

CZECH RESEARCHERS claim that the temperature factor of an induction coil can be diminished by winding the coil on a supporting body with a low coefficient of expansion. Czech monthly *Slaboproudny Obzor* reports that further reduction is achieved with auxiliary compensation members. Coil can be divided into two parts connected outside of the supporting body with metal column. Both parts of such a coil are connected with a member from non-conducting material located inside the coil body. Invention was developed by Jaroslav Endrst and Vladimir Rehacek on their patent 99,209.

*a comprehensive guide to current
information on every branch of
Science and Technology*

*... a practical new way to bridge the gap between your
specialty and other fields into which your work leads you*

New from
**McGRAW-
HILL**

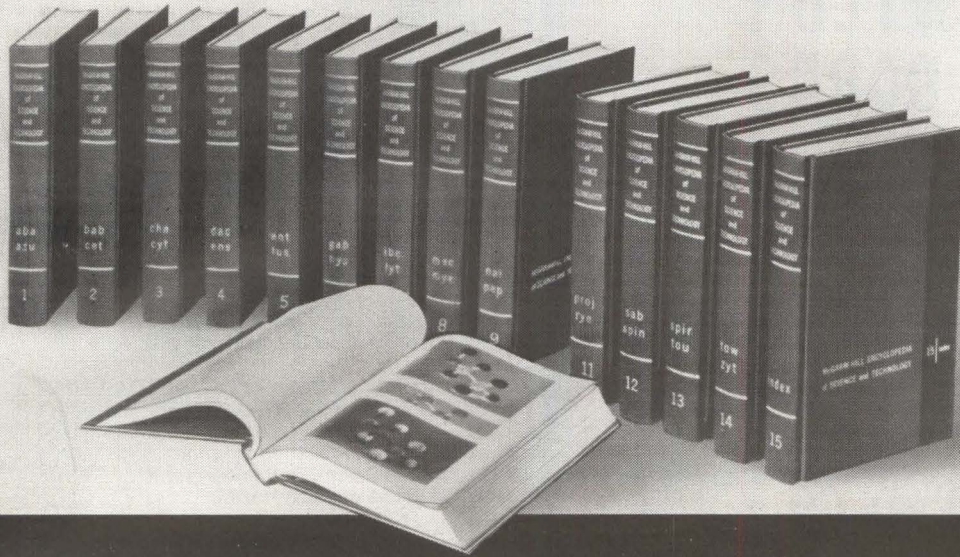

**If you find yourself among the
growing number of science and
engineering specialists unable
to keep up with the explosive
pace of developments today, you
will see a valuable solution at
the top of this page.**



X-TYPE NYLON LACING CORDS

Look to the Linen Thread Company for the most complete line and latest types of lacing tapes and cords for electronics—including X-Type Nylon Cords, which meet Specification Mil-T-713A, cost far less, give superior performance in indicated applications. Other Specification Lacing Cords, Tapes and Braids in Nylon, Linen, Teflon, Cotton, Dacron.

Est.
1784



Write for new illustrated catalog, "Lacing Cords and Tapes for Electronics."

THE LINEN THREAD CO.

(A Div. of Indian Head Mills, Inc.)

Dept. 16H BLUE MOUNTAIN, ALABAMA
CIRCLE 204 ON READER SERVICE CARD

Eisler

A NAME TO REMEMBER IN MACHINERY FOR ELECTRONICS

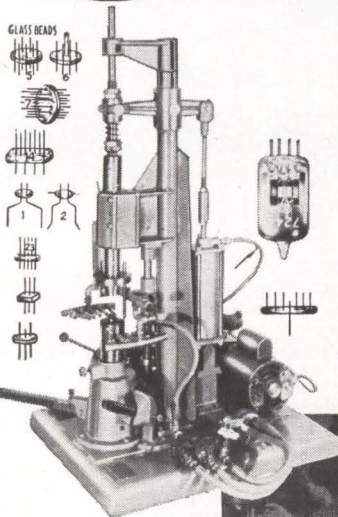

At left: No. 105-BST1 Single position Button Stem and Wafer making machine—Fully automatic. Designed for small production runs on special tube parts or for laboratory use. Produces button stems up to 1/4" diameter. Machine can be supplied with up to 24 positions.

Illustrated below: An Eisler precision Vertical Spot Welder designed exclusively for welding of electronic components. Available in sizes from 1/2 to 7 1/2 KVA.



Write us today for full particulars!

EISLER ENGINEERING CO., INC.

Charles Eisler Jr., President

751 So. 13th St., Newark 3, N.J.

80 CIRCLE 80 ON READER SERVICE CARD

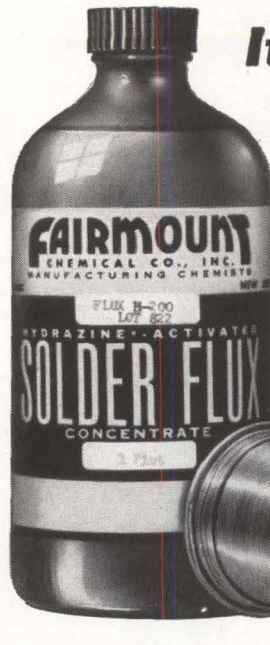

It stands alone

You can't buy HYDRAZINE-ACTIVATED FLUX* or Core Solder under any other brand name. Fairmount is the sole producer.

Hydrazine-Activated Flux and Core Solder offers an exclusive combination of advantages:

- High wetting properties for good "bite."
- Non-corrosive connections.
- Residues removed by heating or water rinse.
- No change on aging.

These performance characteristics were confirmed in a recent evaluation of leading fluxes used in the fields of printed wiring and etched circuitry.

No one flux is best for all purposes. TEST HYDRAZINE FLUX AND CORE SOLDER FOR YOURSELF. The liquid permits pre-fluxing, is useful for soft-soldering a wide range of copper and copper-based alloys. The core solder flows at an ideal rate, leaves a minimum of soldering residues. Write for samples of either, or technical literature.

*U.S. Patent No. 2,612,459 and others

Available only from Fairmount and its sales agents.

Fairmount
CHEMICAL CO., INC.
136 Liberty St., N. Y. 6, N. Y.

CIRCLE 205 ON READER SERVICE CARD

10MC FREQUENCY COUNTER/STANDARD

A NEW CONCEPT IN PRECISION MEASURING

The Model 14-20C 10MC Frequency Counter/Standard combines features of a precision counter and a high stability frequency standard into an advanced design unit.

- Simultaneous and independent use of both frequency standard and counter.
- Stability of 1×10^6 per day and 5×10^6 per week.
- Nine standard decade output frequency from 0.1cps. Gate time from 1 millisecond to 100 seconds.
- Counts any one of nine decade frequencies from 0.1cps to 10MC for period and time interval measurements.
- Self checks counting and gate circuits at any of these frequencies in all combinations of available gate times.
- Operates within -20° C to $+55^\circ$ C.
- Operates from an external 100KC or 1MC reference frequency.

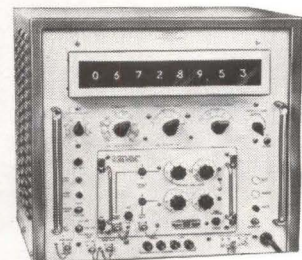

\$2,200

WESCON BOOTH #3245

NORTHEASTERN
ENGINEERING INCORPORATED
AFFILIATE OF ATLANTIC RESEARCH CORPORATION

DEPT. 4A MANCHESTER, NEW HAMPSHIRE

Employment Opportunities Open At All Levels

CIRCLE 206 ON READER SERVICE CARD

Countdown for moon shot: 1890

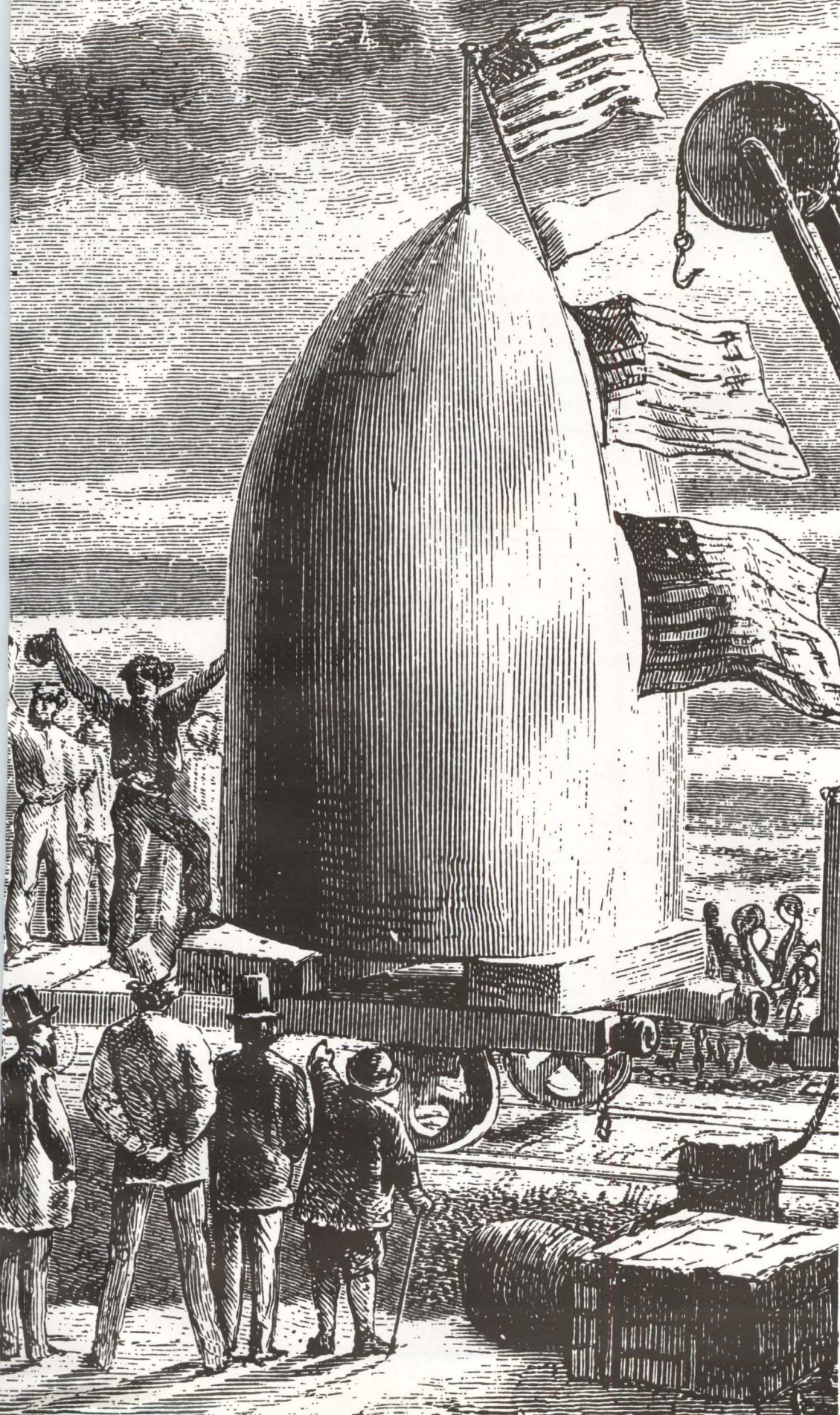

Finish the moon shot Jules Verne began 72 years ago!

Science fiction pioneer Jules Verne foresaw problems in hitting the moon. His fictional moonship missed its mark, after nearly colliding with a meteor.* Now, 72 years later, Hughes offers you the opportunity to be part of a real moon project.

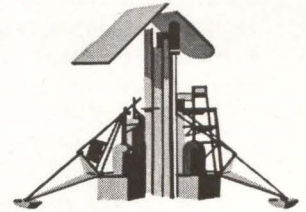

Help us soft-land the SURVEYOR on the moon with a package of delicate test instruments. Or work with us on other sophisticated projects: SYNCOM (synchronous-orbit communications satellite); VATE (versatile automatic test equipment; Anti-ballistic Missile Defense Systems (boost-intercept, mid-course, terminal) and many others. Positions are open for senior and junior control engineers, circuit designers, electronic weapon systems analysts, mechanical engineers and infrared specialists, with degrees from an accredited university.

Please airmail your resume today to:

Mr. Robert A. Martin
Head of Employment
Hughes Aerospace Divisions
11940 W. Jefferson Blvd.
Culver City 23, California

Creating a new world with ELECTRONICS

HUGHES

HUGHES AIRCRAFT COMPANY
AEROSPACE DIVISIONS
An equal opportunity employer.

*In Verne's 1890 novel, "From the Earth to the Moon," his spaceship, "Columbiad," was launched from Tampa, Florida—just 120 miles from Cape Canaveral! After missing the moon, the craft returned to earth at 115,200 miles an hour. It plunged into the sea, popped to the surface—and the three men inside were found "playing at dominoes."

Bettman Archive

Making Bulbs for Double-Ended Tubes

Electrode support buttons are precisely located in bulbs for storage tube

HIGH PRECISION is required in the glass bulbs used in new dual gun storage tubes. Especially critical are electrode support locations on the envelopes, since these determine the relation of collector and storage screens to the read and write guns. Physical specifications and seal contours for the envelopes are also stringent.

To solve the problems, engineers of Raytheon, the tube manufacturer,

and Corning Glass Works, the bulb manufacturer, first had to state the requirements in terms understood by personnel at both companies, since such stringent specs had not previously been required of production line bulbs. Then complementary methods were developed to locate the electrode support buttons during envelope manufacture and to position interior parts during tube manufacture.

The function of the finished CK-7702 tube is to store electronic signals for comparison and to create a bright display. A current use of

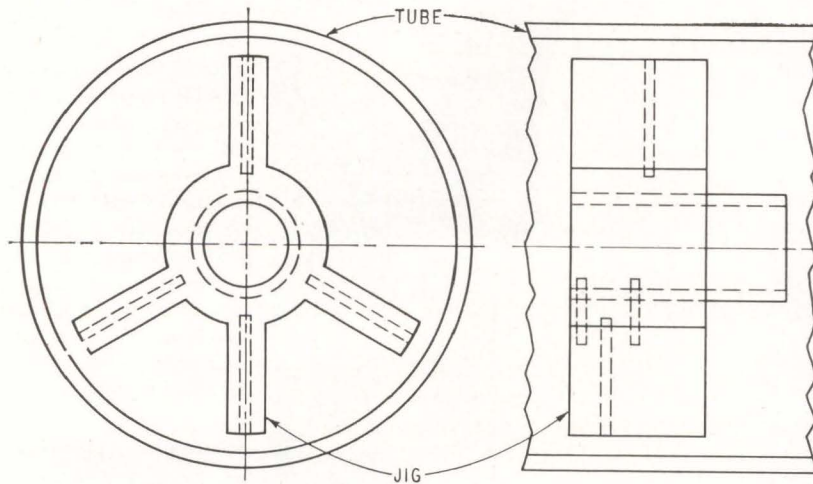

JIG WAS specially developed to locate buttons with high precision

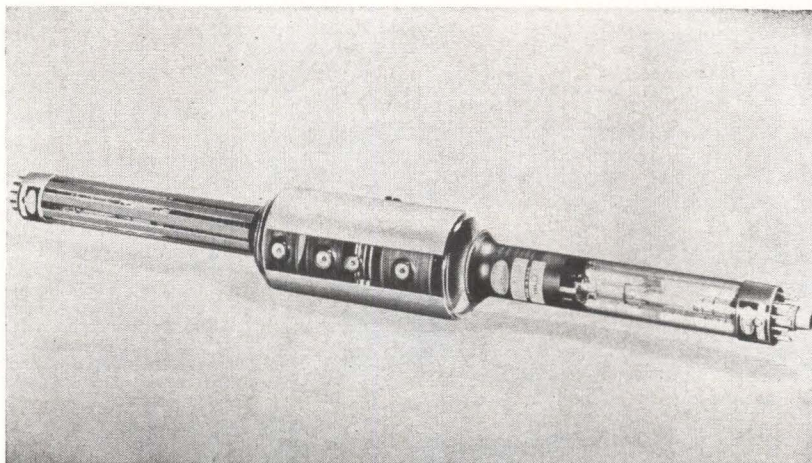

DUAL-GUN storage tube requires high precision in the location of electrode support buttons so that read and write guns are adequately aligned

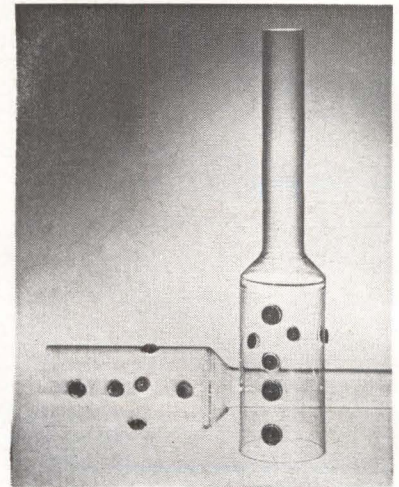

ON THE BULB standing vertically, the small button in the longitudinal alignment is the reference and the other three are anode contacts. The other three buttons are the precisely located screen assembly supports

the tube is in the U. S. Coast Guard's experimental RATAN (Radar and Television Aid to Navigation) system. The radar image of marine traffic and fixed objects is converted into a television image, and, since the signals are stored, moving objects leave trails on the tv screen. Display brightness is high enough for viewing in ordinary light.

BULB MANUFACTURE—First step in making the bulbs is to form the envelope bodies and flared necks from glass tubing. Next, using a special jig, one neck is sealed to the body, with a deviation in concentricity of no more than 0.020-inch of the center axes of both neck and body along their entire lengths.

A standard gauge is used to mark the body for the reference button, one of four buttons around the body of the bulb that will support the assembly of four collector and storage screens. The other anode button locations also are spotted longitudinally on the body at the same time with this gauge.

The special jig shown in the sketch is then used to fix the square-

AIRTRONICS

electronic products for the telephone industry...



Portable Test Hybrid
Simplifies cable acceptance tests and return loss measurements.



Far End Terminating Set
Provides precision network termination during cable testing.



Pulse Meter
Furnishes a convenient method of measuring dial speed and percent make.

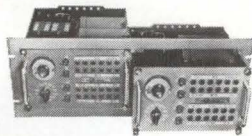

Program Equalizer
Corrects Attenuation Distortion easily, quickly. In use by many AM and FM Broadcast Stations.

PRECISION NETWORKS
WE 115 TYPE

•
BUILD OUT AND
TERMINATING SET

•
PROGRAM EQUALIZERS

•
TRANSMISSION
MEASURING SET

• FOR DETAILED SPECIFICATIONS AND PRICES, CONTACT YOUR NEAREST DISTRIBUTOR OR WRITE AIRTRONICS INTERNATIONAL CORPORATION — P.O. BOX 8429, FORT LAUDERDALE, FLORIDA.

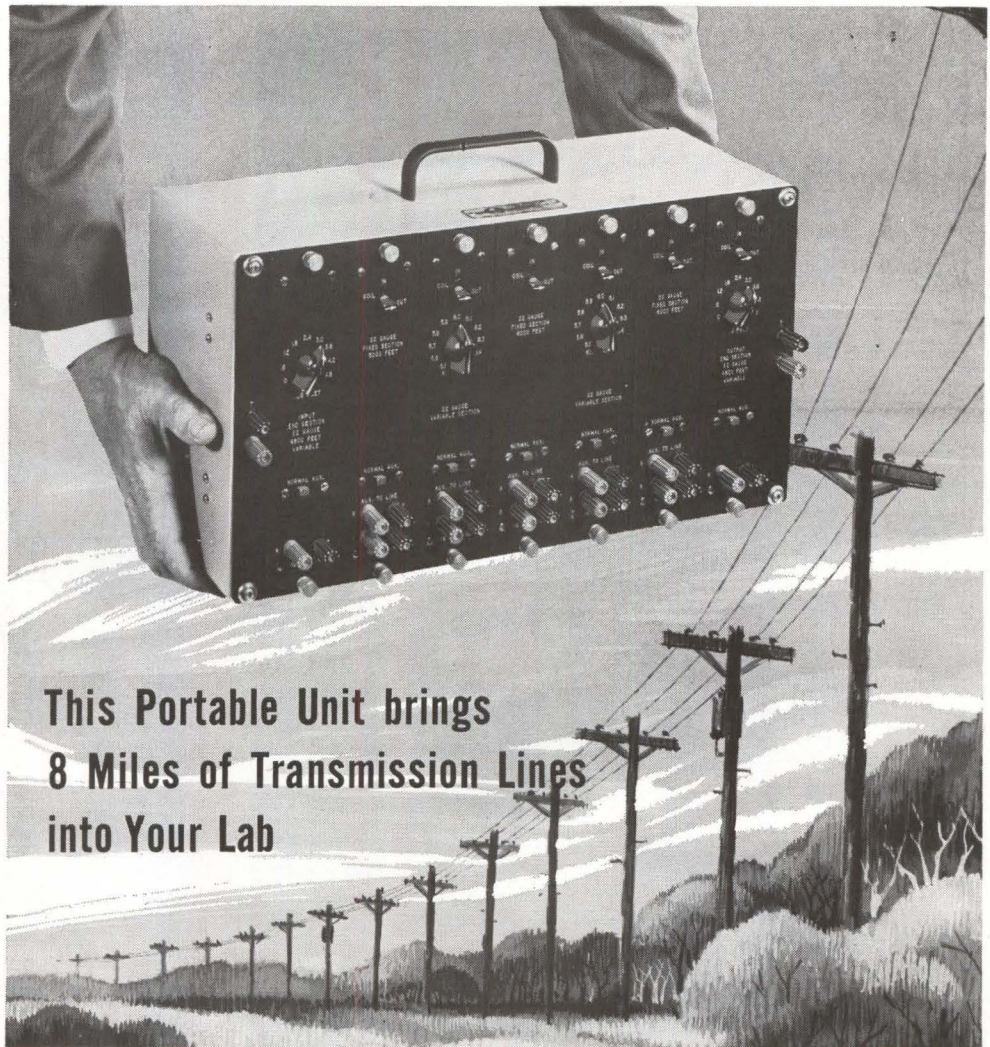

This Portable Unit brings
8 Miles of Transmission Lines
into Your Lab

Eliminates the Need for Leased Lines

Wherever you have a requirement for transmitting information, data, and intelligence this portable equipment will simulate transmission lines right in your lab.

The standard unit simulates 8 miles of transmission line, but it can be modified for any line length required. Plug-in modular construction. Seven plug-in modules each simulate 6,000 ft. of standard telephone cable with loading coil.

The Airtronics Artificial Line meets field engineering requirements. Some time-saving, money-saving laboratory uses are for testing data transmission (offers loaded or unloaded test facility); for testing amplifier operation over telephone lines (permits actual frequency response measurement to be observed over a simulated line); for checking system gain requirements for a pre-determined frequency range; for simulating complex values of AC impedance and DC resistance as incorporated in telemetry circuit transmission; for training purposes (used exclusively by every major telephone company).

The Airtronics Artificial Line is available in 19, 22, 24 and 26 gauge.

FOR FURTHER INFORMATION CONTACT:

AUTOMATIC SALES CORPORATION / A subsidiary of General Telephone & Electronics or Write direct...



6900 WEST ROAD 84
FORT LAUDERDALE, FLA.
TELEPHONE LU 3-4541

Acoustical Components of Superior Quality

JAPAN PIEZO supplies 80% of Japan's crystal product requirements.

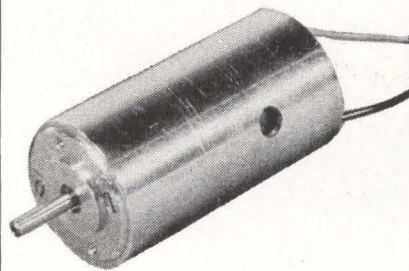
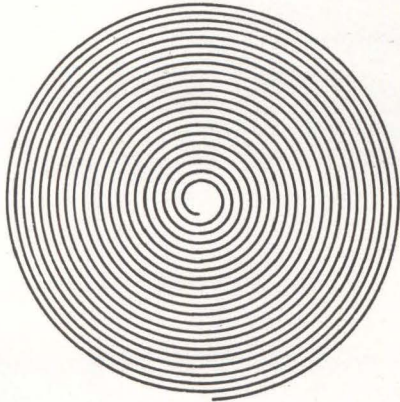

PHONOGRAPH MOTOR — DC

PM — 31-1

9V, 2,500RPM: No-load current, 35 mA; load current, 80 mA. Starting torque, 13 g-cm; load torque, 5 g-m. Size: 2.4 cm × 4.6 cm. Weight: 100 gm.

Write for detailed catalog on our complete line of acoustical products including pickups, cartridges, microphones, record players and many associated products.



JAPAN PIEZO ELECTRIC CO., LTD.

Kami-renjaku, Mitaka, Tokyo, Japan



STORAGE TUBE is used to convert radar information into tv display in marine navigation aid

ness and the radial and longitudinal position of the four buttons that will hold the screen assembly. The jig fits inside the bulb body.

A reference button is the first to be sealed. A hole is opened in the bulb body with a hand torch and the button is seated against the end of the reference arm of the jig. A pin is passed through the hole in

the button into the hole in the arm of the jig, holding it in place. While the glass is still soft, the button is with-drawn enough so that it is outside the inside diameter of the bulb body. Then the button is adjusted with a hand gage for correct distance from the center axis of the bulb and for proper tilt in relation to envelope wall.

After the seal is annealed, the pin is withdrawn and the jig is used for the other three screen buttons. After sealing, the center of the four-button system must be within 0.02-inch of the bulb axis.

Positioning of the remaining three anode buttons is not as critical and is done by eye at previously marked places.

TUBE MANUFACTURE—In tube manufacture, the screen assembly is also positioned by pins; the screen assembly is placed on pedestal, the bulb body is slipped over it, and the pins are inserted through the holes in the buttons into the holes in the assembly.

Tube manufacture is completed by installing the remainder of the

Tv Images of X-Ray Views

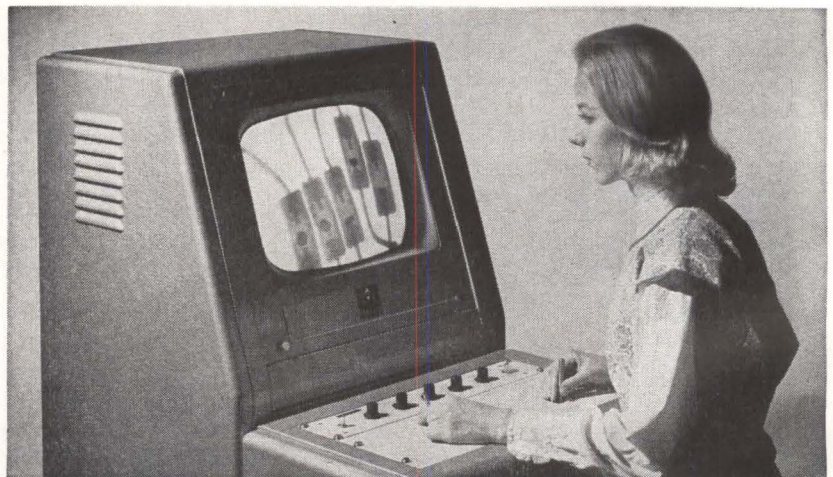

DIRECT tv viewing of x-ray views of various types of components has been made possible by recent development of high resolution tv cameras. Quality checks of small components are speeded and substantial economies are realized by eliminating x-ray film processing equipment, film stock and by reducing inspection time.

The television system, developed

by American Microwave and Television Corp., has high resolution due to the small spot size, 18 Mc video amplifier bandwidth and 945 scanning lines. Equivalent optical resolution would be 700 lines horizontal and 650 lines vertical.

Further work is going on to provide greater magnification within the $\frac{3}{8} \times \frac{1}{2}$ inch viewing rectangle of the x-ray pick-up tube.



THAT'S ABOUT THE SIZE OF IT

Slap 10,000 *pf* of stable capacitance in just .176 of a square inch of your circuit board with this new Corning TY capacitor. It's the TY09, the biggest of a small but stable bunch.

All our TY's give you ultrastable capacitive elements of fused glass and foil. The new case and potting compound eliminate inter-component, wire, or chassis short circuits.

You'll find TY's mount easily because we space the parallel leads uniformly on .100" grids and they're symmetrical with the case. Welding or soldering is easier, too, with the gold-flashed Dumet leads. We *weld* them to the conductive plates to give you greater strength.

Check this table for the TY sizes and ratings you need. All of them perform at 300 volts from -55°C . to $+125^{\circ}\text{C}$. with no derating.

| | Capacitance Range pf | | L $\pm .005''$ | W $\pm .010''$ | T $\pm .005''$ | S $\pm .020''$ | |
|------|----------------------|-------|----------------|----------------|----------------|----------------|--|
| | Min. | Max. | | | | | |
| TY06 | 1 | 560 | .300" | .200" | .115" | .200" | |
| TY07 | 560 | 1000 | .300" | .300" | .115" | .200" | |
| TY08 | 1001 | 2700 | .500" | .300" | .115" | .400" | |
| TY09 | 2701 | 10000 | .900" | .700" | .195" | .800" | |

Get more information fast from Corning Glass Works, 3901 Electronics Drive, Raleigh, North Carolina.

CORNING

Electronic Components

ONLY **ALPHA-TEMPIL** MEASURES SURFACE TEMPERATURE **ANYWHERE**

SIMPLY—
ACCURATELY—
QUICKLY—
POSITIVELY—
INEXPENSIVELY—

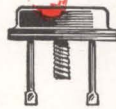

No Thermocouples
No Resistance Bulbs
No Thermometers
No Thermistors



±1% of Stated
Temperature

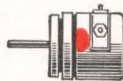

Responds In Less Than
1 Millisecond



Melting Action Is
Unmistakeable—
No Confusing Color
Interpretations
Will Not Revert

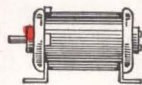

Costs Less Than 1 Cent
An Application

ALPHA-TEMPIL[®] products tell you instantly when any critical temperature is reached. Below rated temperature, the TEMPIL[®] mark is dull and chalky. When exact temperature is reached, the mark liquifies sharply and becomes glossily transparent... a change easy to recognize. Components throughout the entire circuit can be temperature-checked to ±1% of stated temperature without expensive and complex thermocouples. Complete temperature profiles of any component can be determined by using several different TEMPILSTIK[®] or TEMPILAQ[®] marks.

How it works:

TEMPILAQ[®]: Apply a thin dab to the surface to be heated. This will dry almost instantly to a dull mark, ready for use.

TEMPILSTIK[®]: For temperatures below 500°F, stroke a mark on the working surface before beginning the heating cycle. For higher temperatures, stroke the surface occasionally during heating.

Alpha Temperature Indicating Kits

- Ideal for laboratory, prototype, production use
- Packaged in handy durable metal storage case

| KIT NO. | RANGE |
|----------------|--------------------------------|
| TEMP-200 Temp. | 175°F (79°C) to 294°F (146°C) |
| TEMP-300 Temp. | 300°F (149°C) to 388°F (198°C) |
| TEMP-400 Temp. | 400°F (204°C) to 525°F (274°C) |

CONTENTS:

- 10 - ½ oz. bottles of TEMPILAQ[®] in systematically spaced temperature ranges.
- 20 sample TEMPILSTIKS[®] (pellet form) in the same systematically spaced temperature ranges as the TEMPILAQ[®].
- 2 - ½ oz. bottles of thinner for TEMPILAQ[®].

All Tempilaq[®] and Tempilstik[®] products are available from stock in more than 100 temperature ranges from 100°F (38°C) to 2500°F (1371°C).

Send for sample and catalog sheet describing full range of temperatures available.



ALPHA WIRE CORPORATION

Subsidiary of LORAL Electronics Corporation
200 Varick Street, New York 14, N.Y.
Pacific Division:
11844 Mississippi Ave., Los Angeles 25, Calif.



TEMPILAQ
\$2.00 per
2 oz. bottle



TEMPILSTIK
\$2.00 ea.



**ALPHA
TEMPERATURE
INDICATING KIT**
\$18.00 ea.

electronics, sealing the other neck to the body and evacuating the tube. The method for locating buttons and positioning the screens (patent pending by Raytheon) has permitted rapid production of the tubes.

APPLICATIONS — The storage tube has many application possibilities. Characteristics such as simultaneous write and read, variable automatic prime, fast erase, and magnetic deflection of both read and write beams make possible the design of advanced systems.

Resolution of 1,200 tv lines per diameter at 50 percent modulation is obtained through magnetic focus with dynamic correction. The tube meets requirements of FAA-R-1213b, and is designated for use in other military equipment specifications.

One advanced system that uses modified version of the tube is a radar bright display equipment, being developed for the Federal Aviation Agency. Principal elements of the transistorized equipment are a scan converter that accepts radar, beacon, map and range-ring video signals, stores these signals within the storage tube, then sends out the information in a form suitable for presentation on high-resolution television displays.

Hungarians Electroplating Powder Metal Parts

NOVEL METHOD of electroplating metal parts produced by powder metallurgy, pressed to size and sintered, combines vapor heat treatment and electroplating. Development was undertaken at General Machine Planning Institute of Budapest, Hungary.

An oxidizing process is substituted for the traditional treatment preceding electroplating, so that components produced by powder metallurgy are provided with an oxide coating. The oxide is then plated with a nickel film. The oxide layer seals the otherwise porous material, thereby preventing penetration of melted nickel which would otherwise produce internal corrosion.

Of interest to engineers and scientists

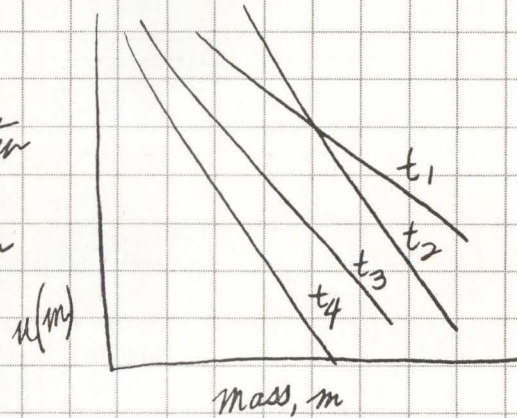
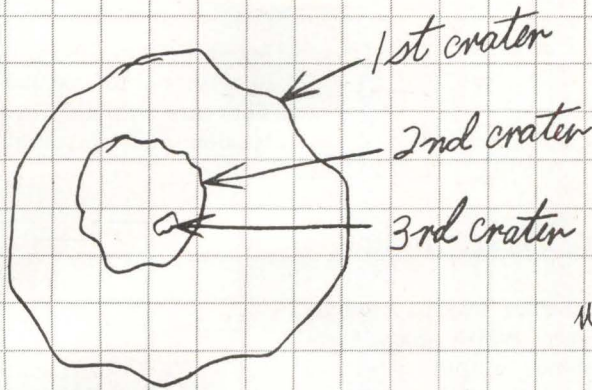

LUNAR SURFACE RESEARCH

...one of more than 500 R&D programs under way at Douglas

This Douglas study seeks to increase man's understanding of the character of the moon's surface and how it will react to space-exploring machines and men.

Theoretical investigations are being supplemented by experiments in the Douglas Space Physics Laboratory. Here the effects of high vacuum on simulated properties of the surface of the moon are being studied to deduce the best model for the lunar surface that satisfies existing data. Moon crater formation is also under study to determine whether volcanic processes are in action.

Of career interest to engineers and scientists

Douglas has entered into a period of greatly expanded activities in a number of programs (like the above) which relate to tomorrow's

technology. Outstanding positions are now open in a wide variety of fields.

We urge you to contact us regarding current openings if you have a background in any of the engineering or scientific areas related to missile and space systems or space exploration.

Send us your resume or fill out and mail the coupon. Within 15 days from the receipt of your letter, we will send you specific information on opportunities in *your* field at Douglas.



MISSILE & SPACE SYSTEMS DIVISION

An equal opportunity employer

Mr. F. V. Edmonds
Missile and Space Systems Division
Douglas Aircraft Company
3000 Ocean Park Boulevard
Santa Monica, California

F-7

Please send me full information on professional opportunities in my field at Douglas.

Name _____
Engineering or scientific field _____
Address _____
City _____ State _____

DESIGN AND APPLICATION

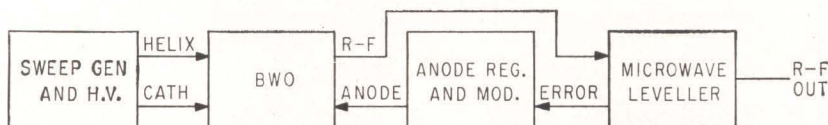

either a-c or d-c. Load ranges are between 0 to 10 and 0 to 200,000 lb with up to 500,000 lb optional. They are available in compression, tension and universal series. Na-

Sweep Generator For Millimeter Frequencies

BWO is swept between 26.5 and 40 Gc with 1-percent linearity

ANNOUNCED by Wave Particle Division of Paradynamics, Inc., Huntington Station, L. I., New York, is the model V850A swept signal source for K_a band. Typical power output is 10 mw between 26.5 and 40 Gc. The oscillator is a permanent magnet focused backward wave oscillator whose output changes linearly with time by the application of a time varying voltage to the helix. Shaper networks produce 1-percent frequency linearity over the band. Internal sawtooth sweeps between 0.1 and 100 cps are pro-

vided or external sweeps can be applied. Sweep width goes from single frequency output to entire range of instrument. Frequency is indicated within 1 percent on a front panel meter. Five presettable

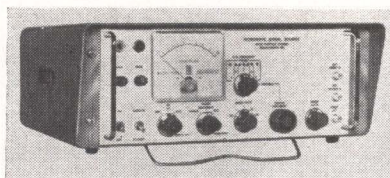

narrow-band swept frequencies are available. Residual f-m is held below 0.002 percent over entire instrument range.

CIRCLE 301, READER SERVICE CARD

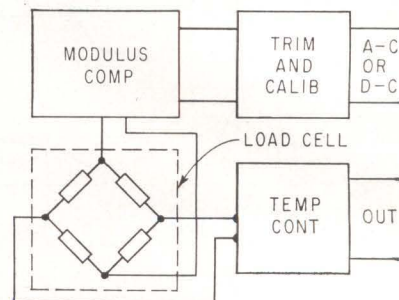

tural frequency is over 1 Kc and linearity is better than 1 percent with continuous resolution. Hysteresis is less than 0.08 percent rated load output and creep is less than 0.1 percent after 30 seconds. Overloads of 150 percent (300-percent optional) cause no change in zero or calibration. The cell uses the piezoresistive effect of a silicon element. A mechanical strain produces a change in electrical resistance of the element in a precision bridge circuit. Large and accurate voltage changes are developed and split resistors are used for internal temperature compensation. (303)

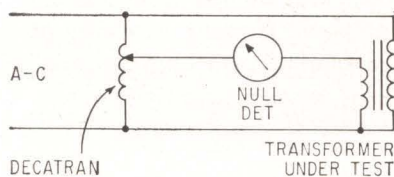

Precise Ratio Transformer Is Phase Reversible

RECENTLY announced by Magnetic Amplifiers Div., 632 Tinton Ave., N. Y. 55, New York, the Decatran ratio transformer is a compact panel component that is phase reversible, has better than 0.02-percent accuracy and a resolution of 1 part on 1,000. A multiposition switch produces preset ratios of 0.000 to 1.099 and 0-and 180-degree phase. Frequency range is 30 to 1,000 cps. Applications include a-c potentiometers, transformer checking, servos, instrument calibration and potentiometer testing. Struc-

turally, it consists of a single toroidal core upon which an input (primary winding) and three tapped output (secondary) windings are placed. The secondary windings are arranged so as to be selectively added together to yield a three decade output. Selection is by a three decade thumbwheel switch, with a fourth switch section for changing the phase of the input. The sketch shows a typical application. (302)

Solid State Load Cell Uses Piezoelectric Effect

MANUFACTURED by Semtran Instruments Inc., Rt 73 Industrial Center, Maple Shade, New Jersey, the model 3200 load cells feature an output of 100 mv per volt input at 75 F with outputs of 1 v at rated load with 10 v input and up to 30 v optional input. Excitation can be

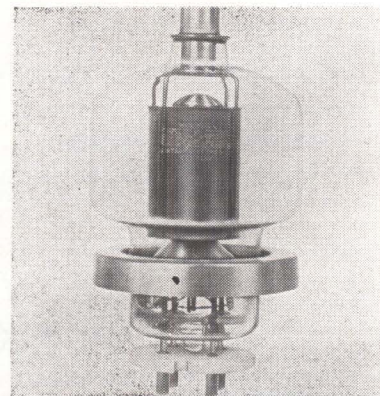

High-Vacuum Tetrode Features Reliability

UNITED ELECTRONICS CO., 42 Spring St., Newark 4, N. J. The 4PR60B



VIBRATION NEWS

MB ELECTRONICS • A DIVISION OF **TEXTRON ELECTRONICS, INC.**
Representatives in principal cities throughout the world

MB Hydraulic Shakers cut vibration-testing costs for large payloads

Vibration or shock testing of very large payloads—such as missile sections, or complete missiles—usually requires extremely high forces at moderate velocities and frequencies. It is not unusual for force levels to be in the order of 100,000 lbs.

In this force range, MB's electro-hydraulic shakers may cost as low as 1/5th the price of comparable electro-dynamic units. What's more the electro-hydraulic shaker is much smaller and more compact. For example, a hydraulic actuator with a 100,000 lb. force rating is only 18" square by 13" high!

MB's hydraulic shakers complement our line of electro-dynamic exciters and extend the limits of vibration, shock and fatigue testing. The electro-dynamic exciter fills the need for testing at high frequencies and relatively low forces and amplitudes, whereas hydraulic shakers are most advantageous for tests requiring ex-

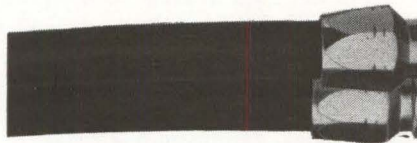

View of typical MB hydraulic actuator with a force rating of 100,000 lbs. Measures only 18" x 18" x 13".

tremely high vibratory forces and long strokes in the low to intermediate frequency range.

Some applications for hydraulic shakers:

- fatigue testing of heavy structures and members
- brute force testing of large, high pressure pipe, massive weldments

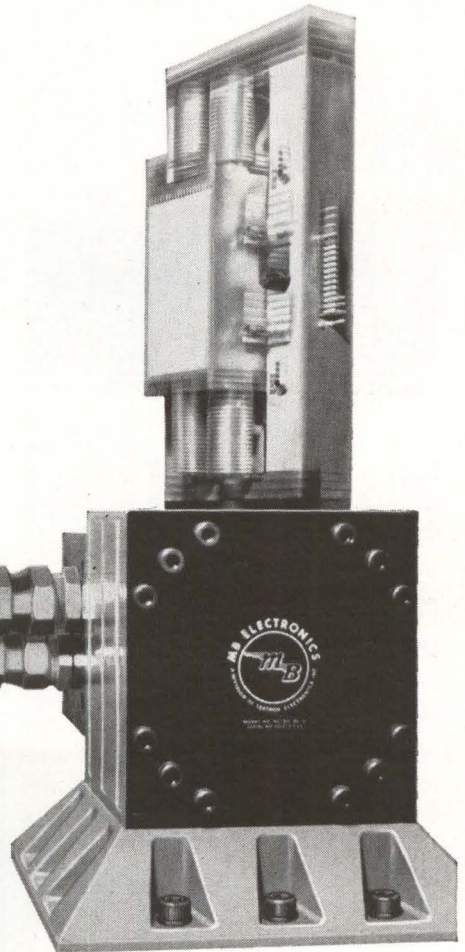

- vibrating heavy mass loads directly-supported on the shaker
- simulating transportation specifications
- applying static and dynamic loads simultaneously
- pulse testing and combined tests in environmental chambers
- simulating vibratory loading transmitted through more than one support

An MB hydraulic shaker system can add extensively to your testing capabilities; available in 27 standard models with forces of 1,000 to 100,000 lbs. and strokes to 18". These shaker systems can also be custom designed to meet your specific requirements.

For detailed information write to MB Electronics; 781 Whalley Ave., New Haven 8, Conn.

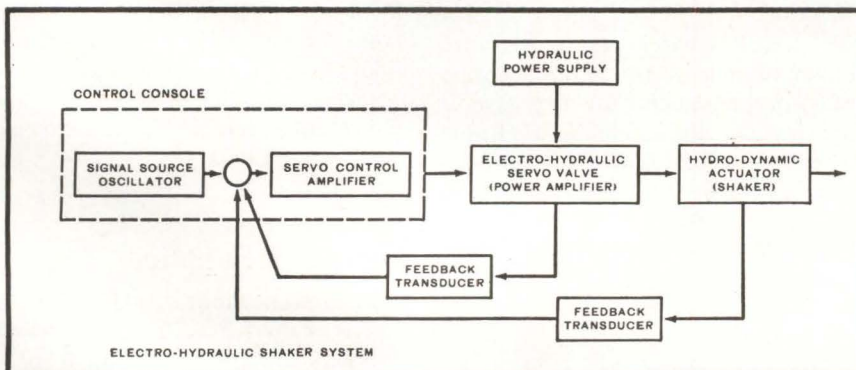

Principle of operation—input signals are fed to electronic servo amplifier, where they are combined with feedback signals from hydraulic shaker. After amplification, this signal is supplied to the electro-hydraulic servo valve which converts electrical variations into fluid flow variations which in turn are reproduced by the hydraulic power stage of the valve. Actuator velocity is proportional to oil flow and varies according to electric input signal.

No. 1 OF A SERIES . . .

The Difference Between Digital Voltmeters:

Franklin Electronics Makes Every Kind of Digital Voltmeter

HERE IS THE



Model 650 . . . 0.0001 to 1200.0 V DC . . . \$1850

MODEL 650

CIRCUIT: All-electronic.

METHOD: Voltage-to-time conversion,
electronic ramp.

The all-electronic voltage-to-time conversion, ramp-type digital voltmeter (such as the Franklin Model 650 shown here) is preferred where (1) higher speed readings are desired; (2) the measured voltage may be unstable or noisy and; (3) printer operation is desired.

The Model 650, in addition to the inherent qualities of ramp-type digital voltmeters, has other important features too . . . a practically infinite input impedance . . . automatic polarity indication . . . optional automatic range switching . . . internal calibration cell . . . and a host of other advantages fully described in DATA SHEET 2027.



AT WESCON BOOTH 2154

DIGITAL VOLTMETERS OF EVERY KIND

is intended for use in pulse-modulator circuitry. It has a pulse power output in the range of 300 Kw with 1 Kw of pulse driving power. Features for reliability include very high peak emission, high grid and screen dissipation capability.

CIRCLE 304, READER SERVICE CARD

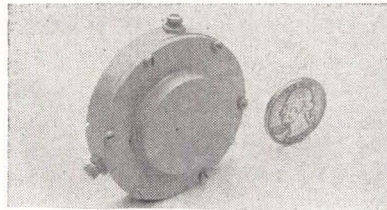

Coax Circulators Rated 10 W Average Power

CASCADE RESEARCH, a div. of Lewis and Kaufman Electronics Corp., 5245 San Fernando Road West, Los Angeles 39, Calif., announces a line of subminiature coaxial circulators and isolators in all frequency ranges from 500 to 11,000 Mc. A typical unit pictured operates from 2,200 to 2,500 Mc and provides isolation of at least 20 db; insertion loss, 0.3 db; power 10 w average, 5 Kw peak; vswr, 1.20; operates from -20 C to +75 C. (305)

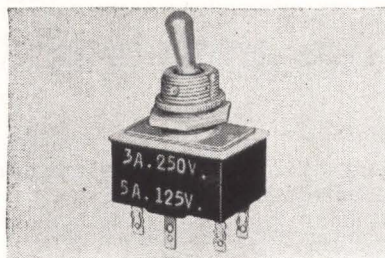

Toggle Switch Designed for Dry Circuits

CUTLER-HAMMER, 315 N. 12th St., Milwaukee 1, Wisc., offers an a-c, d-c toggle switch equipped with silver or gold flash current contact carrying members for dry circuit and low energy applications. Rated 3 amp at 250 v and 5 amp at 125 v, a-c, d-c, the device has 0.110-in. tab type quick connect terminals which are also suitable for use as solder lugs. (306)

Ferrite Circulators

MOTOROLA, INC., P.O. Box 5409, Phoenix, Ariz., has available a wide

range of compact, 3- and 4-port ferrite circulators covering the frequencies from uhf to 9.6 Gc. (307)

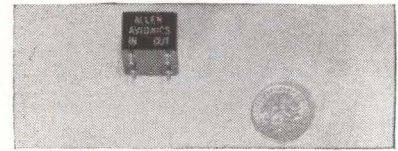

Modular Delay Line Suited for P-C Boards

ALLEN AVIONICS, INC., 255 E. Second St., Mineola, L. I., N. Y. Series A measures $\frac{3}{8}$ in. by $\frac{3}{8}$ in. by 0.450 in. high and is a complete delay line in itself. Delays range from 0.1 to 1 μ sec with a time delay to rise time ratio of better than 3. By combining units this ratio can be increased to about 70 with time delays up to 250 μ sec. Completely encapsulated, modules have a temperature coefficient of 50 ppm per deg C. Normal dcwv is 300. Quantity price is \$6.75 each. (308)



Decade Counter Operates to 1 Mc

ROBOTOMICS, INC., 4624 E. Garfield St., Phoenix 8, Ariz. Model F1702D operates to 1 Mc and features plug-in transistors and plug-in display lamps. Miniature contact springs are gold plated, bifurcated, with four separate contact points for max reliability. Display is bright 1 in. in-plane display with optional decimal point, or optional + and - sign. Decade operates from a single +12 v supply at less than 2 w. Modular boards can be quickly interchanged to provide minimum down time and fast field servicing. (309)

Filament Supplies

ALFRED ELECTRONICS, 3176 Porter Drive, Palo Alto, Calif. Four new filament supplies providing 0 to 15 v at 0 to 5 amp are designed for fail-safe operation to prevent accidental heater damage of micro-

wave tubes. Voltage and current are metered. (310)

Running Time Meter

INDUSTRIAL TIMER CORP., Highway 287, Parsippany, N. J. Series C-8 compact and rugged d-c running time meter provides digital read-out of operating time from 1/10th of an hour to 9999.9 hours. (311)

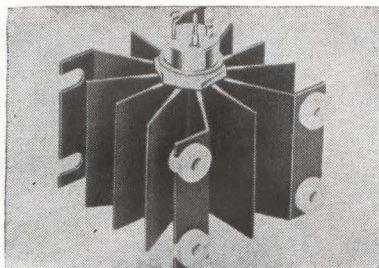

Semiconductor Cooler Uses Teflon Washers

WAKEFIELD ENGINEERING, INC., Wakefield, Mass. Radial fin semiconductor cooler for rectifier or stud mounting transistor applications is adaptable to stack arrangements. Uses standard Teflon insulating washers. Accommodates press fitted and stud mounted (up to 1/8 in. hex case) rectifiers and transistors. Semiconductor mounting surface and one foot is not anodized. (312)

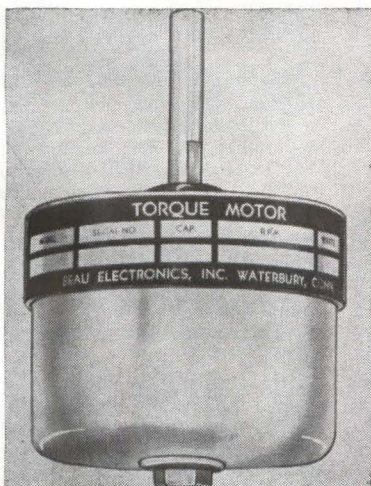

Small Torque Motor Offers Constant Tension

BEAU ELECTRONICS, INC., Waterbury, Conn., announces a small torque motor, designed to operate at a constant tension without vibration, shimmy, and cogging, and producing a uniform pull on tapes,

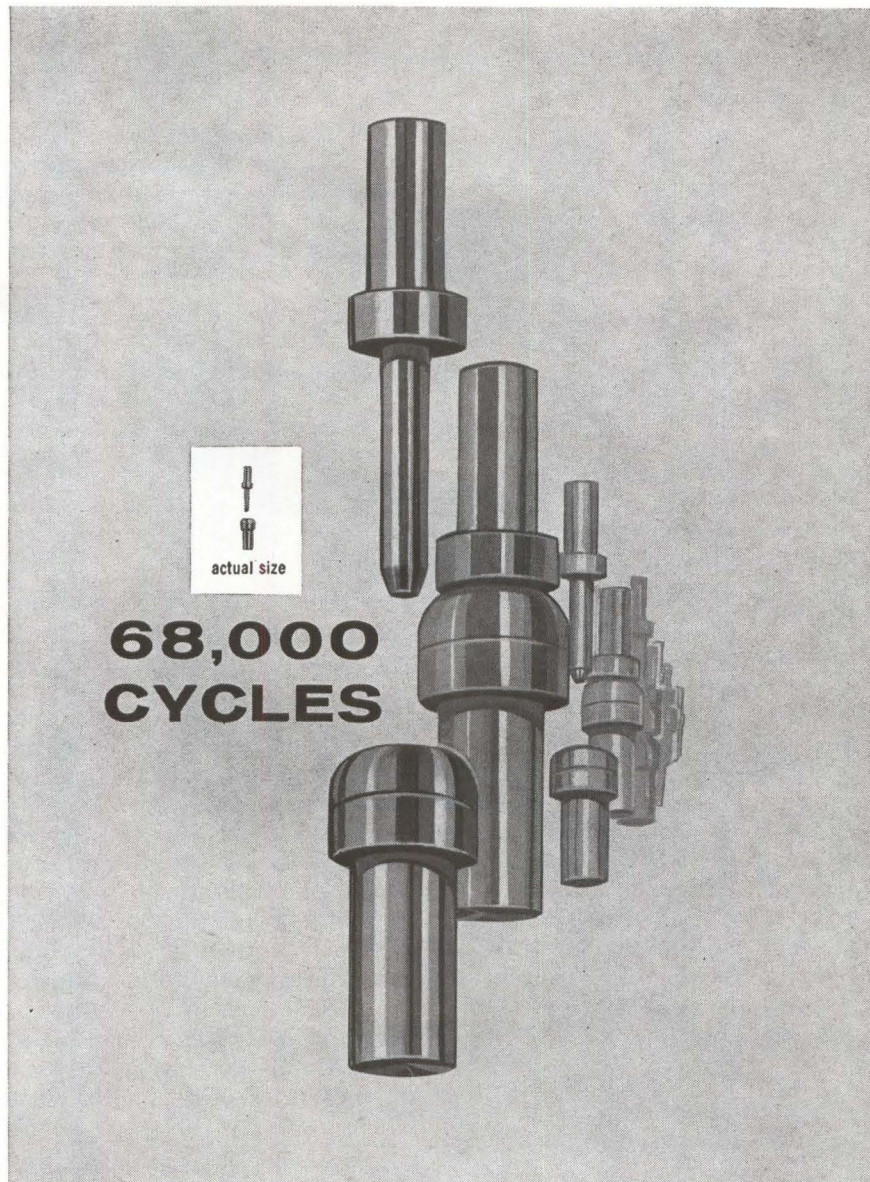

**68,000
CYCLES**

without change in contact resistance

That's the performance record of this new, solid-front .025" jack. And the unique construction of the caged beryllium copper spring in a housing with a blind hole permits dip soldering or encapsulation. What's more, after 68,000 cycles, there was no significant increase in contact resistance . . . and no physical deterioration.

In addition to this new jack, there are 35 other basic types of CAMBION Miniature Plugs and Jacks — and a wide choice of finishes and insulation, too — to meet your individual requirements for both conventional and printed circuits. They're carefully processed from the highest quality materials to meet all applicable MIL specifications. And like all CAMBION electronic components — the broad line includes more than 10,000 different items — they are unconditionally guaranteed in any quantity.

Wherever good contact is essential, insist on CAMBION plugs and jacks. For information on deliveries and prices, and a copy of PLUG AND JACK CATALOG No. 70, write to Cambridge Thermionic Corporation, 437 Concord Avenue, Cambridge 38, Massachusetts.



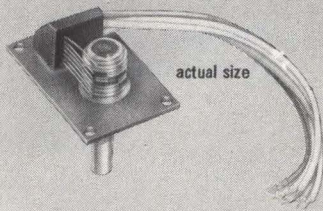

Gamewell made this special completely from scratch.

Every part of this rotary switch was newly designed by Your Engineered Specials service to meet a customer's special requirements. The unit provides bi-directional operation at 160 rpm max. It is rated at 28 VDC, 60 ma ... has high vibration and shock resistance ... and -55° to +150°C. temperature range. Although this design called for only six poles and 11 switching segments, many more could have been provided.

Gamewell's YES service has developed answers to hundreds of special "pot" problems. Interested? Write for the full story.

***your
engineered
Specials service**

yes



THE GAMEWELL COMPANY, ELECTRONICS DIVISION, 1619 CHESTNUT STREET, NEWTON UPPER FALLS 64, MASS. A SUBSIDIARY OF E. W. BLISS COMPANY.

threads, fine wire, film, or yarn. With an efficiency factor of 2.1 w per oz-in., the type 4001 offers 12 oz-in. of torque with a power input of 25 w max. The six-pole unit has an overall diameter of 3 in. and operates within a temperature range of from -65 to ±165 F.

CIRCLE 313, READER SERVICE CARD

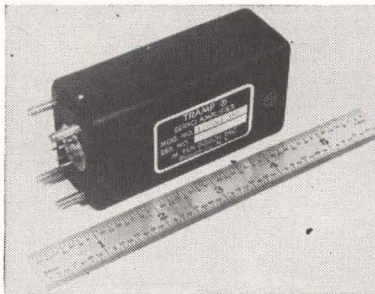

Servo Amplifier Features Reliability

M. TEN BOSCH, INC., Pleasantville, N. Y., has developed a 400-cycle servo amplifier capable of yielding 6 w over a temperature range of -55 to +125 C. The transistorized, hermetically sealed unit has a wide range of applications where reliability is required. Power gain at 2 w output with a 20 Kw input impedance is 2400. Phase shift is adjusted internally to 0 deg. A supply voltage of 28 v d-c at 350 ma is required. For orders of 10 to 99 unit price of the model 1800-4700 is \$272. (314)

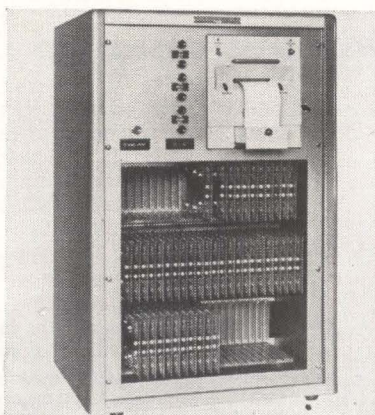

Operations Recorder Needs No Decoding

ROCHESTER INSTRUMENT SYSTEMS, INC., 275 N. Union St., Rochester 5, N. Y. Model RA-150 direct reading Recording Annunciator is designed to maintain a continuous surveillance of a number of stations and automatically print out alarms

actual size



Accurate time totalizing meter

Hermetically sealed 21 jewel watch movement and spring coupled D.C. (20-35 v) torque motor gives accuracy within 1% even under most critical operating conditions. Determine reliability, prevent failures, and facilitate maintenance procedures of aircraft or missile electronic equipment and systems. 1,000 and 10,000 hour readings. Parabam's sub-miniature meter meets all requirements of MIL-M-26550.

PARABAM
DIVISION OF HF HOUSTON FEARLESS CORPORATION
12822 Yukon Avenue, Hawthorne, Calif./OSborne 9-3393

CIRCLE 207 ON READER SERVICE CARD

- **SCAN CONVERSION**
- **FLICKERLESS DISPLAY STORE**
- **VIDEO STORAGE**

RECORDING STORAGE TUBE SYSTEMS

Single-gun, dual-gun, multi-tube systems to convert scan for radar, sonar, television, and to perform analog processing, data analysis, contract or expand time scale, auto correlation.

- **SLOWED TELEVISION TRANSMISSION**

by telephone line or other narrow-band systems.

- **IMAGE ENGINEERING**

OPTICAL CHART READERS, FLYING SPOT SCANNERS, LOW-LIGHT-LEVEL CAMERAS, and IMAGE RECTIFICATION. Automatic inspection and recognition of size, shape, color, and texture.



Write or call for complete information:

IMAGE INSTRUMENTS, Inc.
2300 Washington Street
Newton 62, Massachusetts
617 Woodward 9-8440

along with the time in the exact sequence and in a dependable, permanent record. The RA-150 basically consists of four units: an encoder; a storage and converter unit; a control unit; and a digital printer. Depending on options, a 100-point RA-150 is priced at about \$5,000. (315)



Sweeping Oscillator Gives Rapid Alignment

KAY ELECTRIC CO., 14 Maple Ave., Pine Brook, N. J. The Rada-Sweep BX-300, a sweeping oscillator designed for rapid precise alignment of aircraft Nav/Com equipment, incorporates a fixed band sweep and markers with one knob control and 11 center frequencies plus one spare. It also features 28 pulse-type crystal control markers which are accurate to ± 0.05 percent. It has a 70 ohm output impedance with 0.5 v rms, r-f output at 70 ohms flat to ± 0.5 db over widest sweep width. (316)



Magnetic Amplifiers Provide High Stability

MILITARY & COMPUTER ELECTRONICS CORP., 900 N.E. 13th St., Ft. Lauderdale, Fla. Series 20 Ultamag magnetic amplifiers deliver 2 v across 10,000 ohms with only 1×10^{-5} w control, a power gain of 46 db with stability in the order of 1 percent. Temperatures (operating)

August 17, 1962

**MR. ENGINEER:
10 YEARS
MAGNETIC
RELIABILITY
CAN BE
ECONOMICAL!**



MACE solid state magnetic frequency detectors and "P" series SCR firing magnetic amplifiers offer more reliability at a much lower cost than any other types on the market. Lack of field failures or "wear outs" have established minimum life at 10 years. Features include maximum resistance to shock, vibration, moisture — and excellent resistance to radiation.

MAGNETIC FREQUENCY DETECTORS

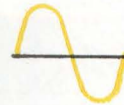

Filtered & Unfiltered
Better than 1% accuracy!
50 cps to 50 KC!
1% Linearity!
High Stability!

Provides economical and reliable method of converting frequency to proportional current. Provides 1 ma of DC output for full scale frequency with 1 mw of usable output available from units. Series 110, 150 used to drive meter or other devices where rectified, unfiltered output is required. Series 210, 250 incorporates internal inductor to reduce nonlinearity produced by filtering the output. Series 310 is internally filtered and used to drive transistors, etc. Operating temperature ranges from -55° to $+100^{\circ}$ C.

Series 110 — \$18.50*
Series 150 — \$26.50
Series 210 — \$22.00
Series 250 — \$30.00
Series 310 — \$26.50

"P" SERIES SCR FIRING MAGNETIC AMPLIFIER



Guaranteed to control any SCR!
Self regulating!
As low as 1 ma sensitivity!
Better than 2% stability!
Controls SCR output linearity!

Available in industrial or military configuration, 115 v or 230v, 60 or 400 cps.

\$69.50 each*

*Unit cost to 5 units!



m/a/c/e

MILITARY AND COMPUTER ELECTRONICS, INC.

900 N.E. 13th St. • Ft. Lauderdale, Fla. • JA 3-1438

WESCON BOOTH 3016

CIRCLE 93 ON READER SERVICE CARD

93

FINEST FAMILY OF MINIATURE ACCELEROMETERS

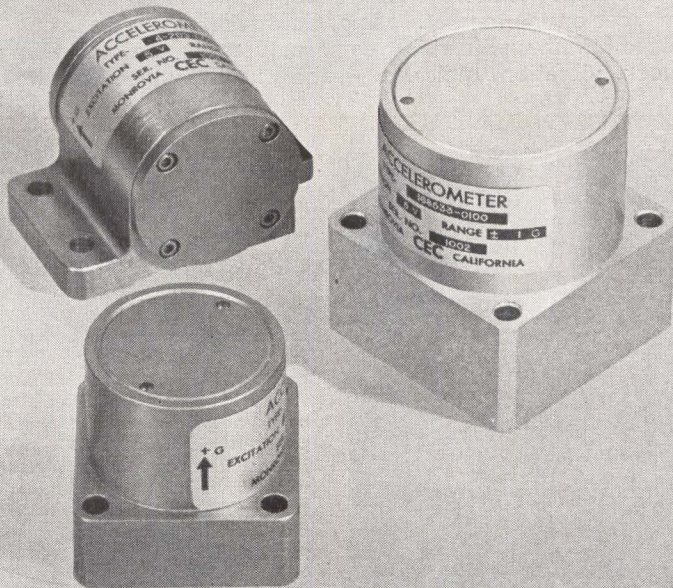

This family of versatile accelerometers offers standard models for virtually any acceleration-measurement requirement...in 10 standard ranges from $\pm 1g$ to $\pm 500g$. For tri-axis measurement, see opposite page. Outstanding features include: small size, light weight, precision construction for long life and superior performance. You

can depend on the calibration figures that accompany each instrument. More than 15 major checks are used to prove performance. All CEC accelerometers are compatible with a wide range of associated CEC instrumentation. For complete specifications, write for CEC Bulletin 4202-X21, or call your CEC sales and service office.

CEC

Transducer Division

CONSOLIDATED ELECTRODYNAMICS
PASADENA, CALIFORNIA • A SUBSIDIARY OF BELL & HOWELL

are $+10\text{ F}$ to 130 F , (storage) from -60 F to 180 F . Units can withstand 1,000 percent overload and can be operated into a dead short without damage. They are practically invulnerable to shock, vibration, moisture—and have excellent resistance to radiation.

CIRCLE 317, READER SERVICE CARD

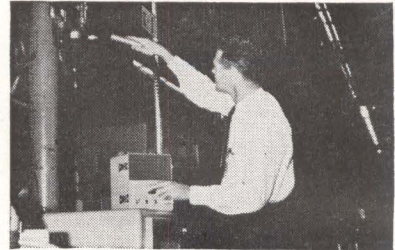

Leak & Friction Detector Aids Quality Control

DELCON CORP., 943 Industrial Road, Palo Alto, Calif., announces an instrument for inspecting fabricated pressure and vacuum vessels or systems by instantaneously detecting ultrasonic sound energy from leaks as minute as 0.003 in. in diameter. The transistorized Ultrasonic Translator is operable for one year on three mercury cells. (318)

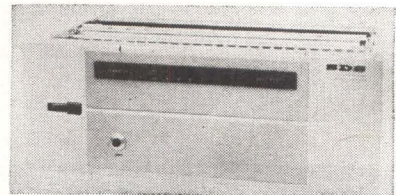

High Speed Multiplexers Operate to 100 C

SCIENTIFIC DATA SYSTEMS, INC., 1542 Fifteenth St., Santa Monica, Calif. The MU-series analog switches are designed for data gathering and other switching applications. They settle to 0.01 percent in less than $15\ \mu\text{sec}$, and have over-all accuracies of 0.015 percent. Control facilities permit channels to be selected either at random or sequentially. Price for a typical 64-channel solid state system is \$5,300 including control registers. (319)

Coax Crystal Mixers

MICROLAB, Livingston, N. J. The XR series of lightweight, coaxial crystal mixers cover the 225 to 600 Mc region in seven overlapping

ranges, are fixed tuned, and require no r-f adjustment. (320)

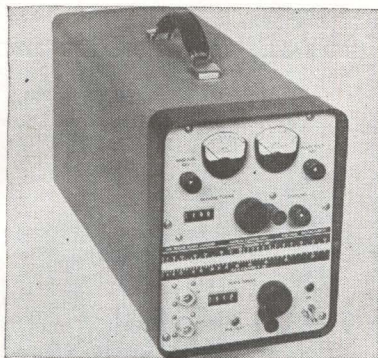

Triode Power Amplifier Tunes 350 to 2,000 Mc

ANTRON CORP., 17 Felton St., Waltham 54, Mass. Model 125 increases the power level of uhf and L band signal generators and low power oscillators, and may be used as a frequency multiplier as well. Up to 17 db of gain and up to 3 w of output power are available over most of the tuning range. An output coupling control permits gain and bandwidth to be adjusted. (321)

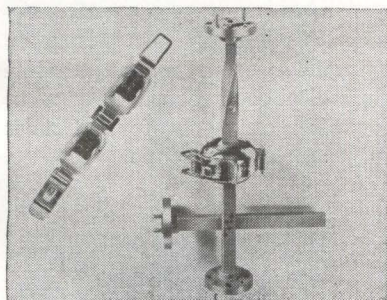

Microwave Clamps Come in Sizes W, A, B

DEMORNAY-BONARDI CORP., 780 So. Arroyo Parkway, Pasadena, Calif. Clamps permit rapid assembly and disassembly of waveguide instruments and components without the time consuming inconvenience of assembly with screws. Perfect alignment of the flanges and strong mechanical connection is assured. Currently the clamps are available in DeMornay-Bonardi sizes W, A, and B. This covers the frequency range of 50 to 140 Gc. (322)

Polyester Resin

DUREZ PLASTICS DIVISION, Hooker Chemical Corp., North Tonawanda,

FIRST MINIATURE TRI-AXIS ACCELEROMETER

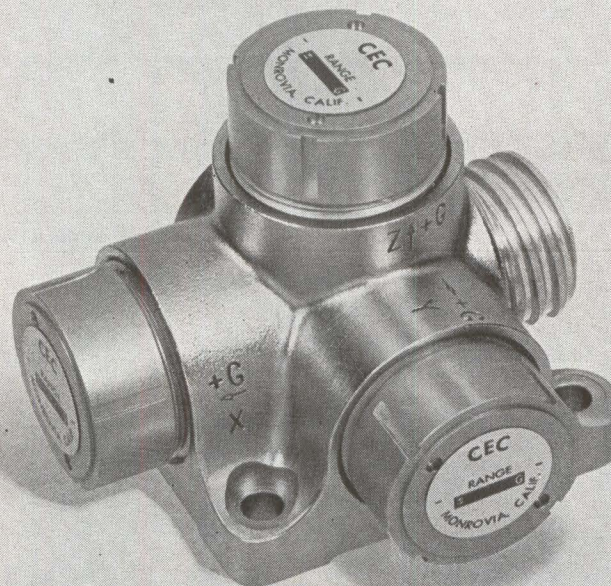

A new instrument, CEC's Type 4-204 Tri-Axis Strain Gage Accelerometer is the smallest and lightest of its type — measures three axes of acceleration on a single mounting surface. Range of each axis ($\pm 5g$ to $\pm 500g$) is factory selectable. Provision is made inside the transducer case for electrical temperature compensation. Perform-

ance characteristics are outstanding. Cross axis response: less than $0.01g/g$. Linearity and hysteresis combined: not more than $\pm 0.75\%$. Operable temperature range: $-70^{\circ}F$ to $+300^{\circ}F$. For complete data, call your nearest CEC sales and service office or write for Bulletin CEC 4204-X1. *When you think of transducers, think of CEC.*

CEC

Transducer Division

CONSOLIDATED ELECTRODYNAMICS
PASADENA, CALIFORNIA • A SUBSIDIARY OF BELL & HOWELL

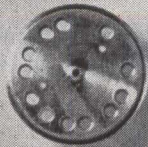

Only one way to clean it. Ultrasonically.

Complete cleanliness is a must in the production of precision gyroscope parts. A grain of dust, a microscopic fiber, even a fingerprint could spoil its performance.

Manufacturers of these tiny components and assemblies have found only ultrasonic cleaning can do the job properly . . . and high-powered Westinghouse ultrasonic equipment does the job best.

Solid state ultrasonic generators are trouble-free. All-metal Magnapak transducers cannot be overdriven, and deliver more cleaning power per watt than any others.

Westinghouse offers standard equipments in tank sizes from 1½ to 600 gallons, and powers up to 25,000 watts, or cleaning installations engineered to your production problem.

For more information or a demonstration, contact Westinghouse Industrial Electronics Division, 2519 Wilkens Avenue, Baltimore 3, Md. You can be sure . . . if it's Westinghouse.

Westinghouse



Ultrasonics

CIRCLE 209 ON READER SERVICE CARD

For Production

Line Testing...

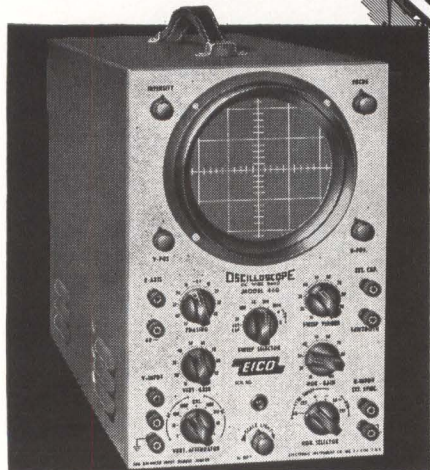

EICO SCOPES

give you:

- professional performance
- reliability
- ruggedness
- versatility

...at moderate cost

EICO's high quality standards and low initial cost add up to true economy: EICO units outperform scopes selling for two or three times EICO's prices.

With kits, the initial cost is even lower. And the experience each operator gains in building his own, increases his efficiency, and enables him to keep his scope in better condition, with less "down" time.

| | prices | | freq. resp. (sinusoidal) | | sensitivity (rms) | |
|-------------------------|---------|----------|--------------------------|----------------------|-------------------|-------------|
| | kit | wired | vert. | horiz. | vert. | horiz. |
| 5" Push-Pull Scope #427 | \$69.95 | \$109.95 | DC-500 KC/FLAT | 2 CPS TO 450 KC/FLAT | 10mv P-P/cm | 0.5V P-P/cm |
| 5" DC-4.5 MC Scope #460 | 79.95 | 129.95 | DC-4.5 mc/flat | 1 cps to 400 kc flat | 25 mv/in | 0.6 V/in |



See the 41 additional EICO test instruments helpful for your lab and production work. Write for free Catalog & name of neighborhood Distributor.

3300 NORTHERN BOULEVARD, Dept. 8B, L. I. C., 1, N. Y.

SEE EICO AT WESCON BOOTH 3035

N. Y., announces Hetron 218, a rigid general-purpose polyester resin with improved impact and craze resistance plus a high degree of fire retardance.

CIRCLE 323, READER SERVICE CARD



Monitor Scope Displays ECG, EEG

MEDTRONIC, INC., 3055 Highway 8, Minneapolis 18, Minn. Using a wide variety of plug-in adapters, conventional ECG, EEG, and fetal ECG are easily displayed on the monitor scope. Adapters allow inputs to be connected to the unit either directly, through the a-c power lines, or by means of wireless radio telemetry. An output on the monitor scope makes possible the simultaneous recording on a direct writer, any waveform that is monitored by the scope. (324)



Coax Relay Operates From -55 to +85 C

GENERAL COMMUNICATIONS CO., 677 Beacon St., Boston 15, Mass. Two-position r-f switch model 2TNCW-55-A has a life expectancy of one million cycles. Frequency range is 0 to 5 Gc. Vswr is 1.2:1 max up to 4 Gc. Crosstalk is—40 db max up

add 5% in the West

to 3.5 Gc. Standard connectors are type TNC and BNC. Typical shock and vibration specifications are 100 g for 11 millisecc and 10 g per MIL-STD-202. (325)

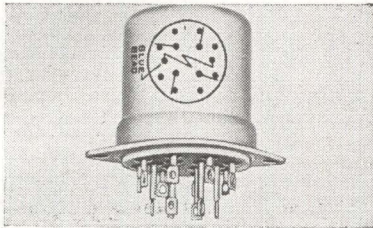

Subminiature Relay Withstands 50 G Shock

STRUTHERS-DUNN, INC., Pitman, N. J. Measuring $1\frac{1}{8}$ in. in diameter by $1\frac{3}{8}$ in. above mounting surface, type FC-410 handles 10 amp loads at either 28 v d-c or 115 v a-c. It has a rotary armature and four Form C (4 pdt) contacts designed for a minimum of 100,000 operations under rated loads and over an ambient temperature range of -65 to 125 C. Meets MIL-R-5757D specs. Withstands 50 g shock and 20 g vibration to 2,000 cps. (326)



S-Band Attenuator Saves Panel Space

ANTENNA AND RADOME RESEARCH ASSOCIATES, 27 Bond St., Westbury, N. Y. Continuously variable attenuator is designed for front panel control installations. Connectors are mounted on the rear of its $3\frac{1}{2}$ in. diameter to reduce panel space. Frequency range is 4.0-4.5 Gc; attenuation range, 0-50 db min; max vswr, 1.5; max insertion loss, 0.5 db; power, 10 w average and 5 Kw peak. (327)

Event Recorder

TECHNI-RITE ELECTRONICS, INC., 65 Centerville Road, Warwick, R. I. The TR-120 rack mounting inkless event recorder will monitor up to 20 on-off events simultaneously on a single heat sensitive chart. (385)

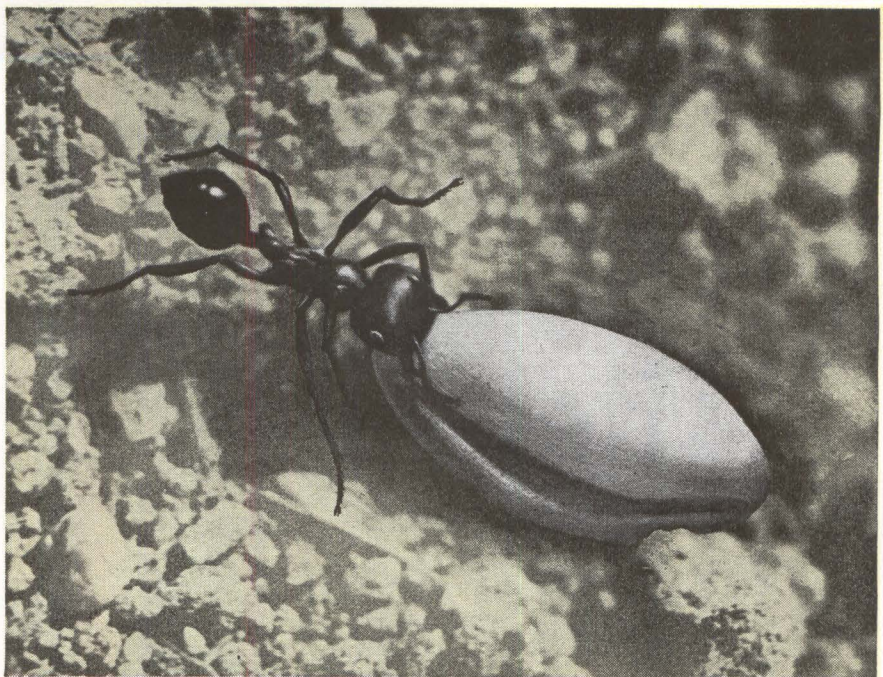

U.S. Dept. of Agriculture photo

ENORMOUS CAPACITY IN A LITTLE PACKAGE

Size for size — Dearborn's MP series capacitors have almost *twice as much capacitance* as similar existing types. Up to 170% more capacitance is offered without increasing volume or sacrifice of desirable electrical characteristics. Very low RF impedance is assured!

Typical is a 100VDC unit measuring only .125" in diameter and .5" long, packed with a capacitance of .01 mfd!

Once a desire — now a reality! Dearborn capacitors offer the design engineer maximum capacitance in a microminiature case, made possible through a recent Dearborn breakthrough.

Delivery? From stock to 10 days, of course!

For comprehensive information request 100VDC Addendum Sheets to Engineering Data DC-15A (metal case) or CS-15A (plastic encased style).

Dearborn

ELECTRONIC
LABORATORIES INC.

P. O. Box 3431 • Orlando, Florida • Area Code 305 838-3011

MCA 983

WESCON BOOTH 2144

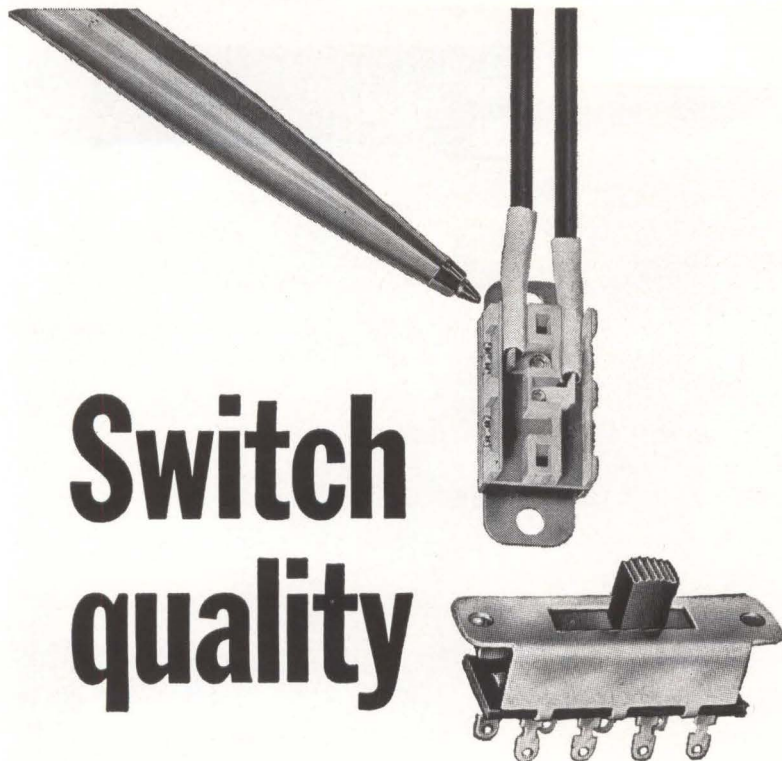

Switch quality

...YOU CAN FEEL in the smooth yet positive movement usually associated only with costly switches—indicative of a mechanical action that permits 10 ampere U.L.I. ratings in even the smallest Stackpole slide switches.

...YOU CAN SEE in the molded nylon bases and built-in terminal barriers of quick-connect terminal types . . . in the nickel plated cases and colorful triggers . . . in space-saving opportunities even for complex circuit switching.

...YOU CAN PROFIT FROM in terms of modern product styling, greater product dependability, faster production. Best of all Stackpole slide switch prices start at only \$0.039. Over 15 basic types cover every circuit and rating need.



Learn more! Write for new Bulletin 78-101 on the world's largest slide switch line to:

Electro-Mechanical Products Div., Stackpole Carbon Company, Johnsonburg, Pennsylvania.

STACKPOLE

BRUSHES FOR ALL ROTATING ELECTRICAL EQUIPMENT • CERAMAGNET® CERAMIC PERMANENT MAGNETS • ELECTRICAL CONTACTS • FIXED & VARIABLE COMPOSITION RESISTORS • SNAP & SLIDE SWITCHES • FERRITE CORES • GRAPHITE BEARINGS & SEAL RINGS • GRAPHITE HEATING ELEMENTS & ELECTRODES • HUNDREDS OF RELATED CARBON & GRAPHITE PRODUCTS

PRODUCT BRIEFS

MINIATURE GEARHEADS and speed reducers. Available in all Bureau of Ordnance sizes from 5 to 18. Siamco, Div. of Tech-Ohm Electronics, Inc., 36-11 33rd St., Long Island City, N. Y. (328)

AUTOMATIC D-C DIGITAL VOLTMETER for use with analog computers for pot setting and readout. Auto Data, 943 Turquoise, San Diego, Calif. (329)

HIGH SPEED MEMORY uses terminal switching technique. It operates through clear/write and read/restore cycles in better than 1.5 μ sec. Indiana General Corp., Electronics Div., Keasbey, N. J. (330)

SIZE 15 STEPPER MOTOR is mechanically detented. It provides an analog output from a digital input. Kearfott Division, General Precision, Inc., 1150 McBride Ave., Little Falls, N. J. (331)

POWER RHEOSTAT is vitreous enameled, wire wound. Standard units available in 22 resistance values from 1 to 2,500 ohms. Tru-Ohm Products, 3426 W. Diversey Ave., Chicago 47, Ill. (332)

UPPER SIDEBAND FILTER in compact size. It is designed for use in ssb military communications equipment. Systems Inc., 2400 Diversified Way, Orlando, Fla. (333)

FREQUENCY STANDARD is completely transistorized. Unit has a mean-time-between-failure rate of better than 10,000 hr. FXR, 33 E. Franklin St., Danbury, Conn. (334)

SOLID STATE CHOPPER for microvolt p-c use. Unit uses photosensitive light actuated element. James Electronics Inc., 4050 N. Rockwell St., Chicago, Ill. (335)

NEUTRON BEAM MONITOR, parallel geometry. It has a background count of less than 1 count per hr. Amperex Electronic Corp., Duffy Ave., Hicksville, N. Y. (336)

D-A CONVERTER has an accuracy of ± 0.03 percent of full scale. It operates at clock rates up to 200 Kc. Navigation Computer Corp., Valley Forge Industrial Park, Norristown, Pa. (337)

SUBCARRIER OSCILLATOR SYSTEM for telemetry or f-m magnetic tape recording. It offers flexibility in selection of operating modes. Vidar Corp., 2296 Mora Drive, Mountain View, Calif. (338)

DIGITAL VOLTMETER is reed relay type. It has 3 automatically selected ranges up to ± 999.99 v. Non-Linear Systems, Inc., Del Mar, Calif. (339)

PHOTO LAYOUT KITS for producing printed circuit artwork. Two types are available. Keil Engineering Products, Inc., 6833 Manchester, St. Louis 10, Mo. (340)

CRYSTAL OSCILLATOR is voltage controlled. Unit generates 4 mw at 75

Mc with ± 50 Kc deviation. Itek Electro-Products Co., 75 Cambridge Parkway, Cambridge, Mass. (341)

PRINTED CIRCUIT BOARD for curved applications. It is made of laminated, flame-resistant epoxy glass. RG Circuits Co., 15216 Mansel Ave., Lawndale, Calif. (342)

PLASTIC SLEEVES for wire identification and insulation. Furnished in 10 sizes, No. 16 through $\frac{3}{8}$ in. diameter. W. M. Brady Co., 727 Glendale Ave., Milwaukee 9, Wisc. (343)

PNP GERMANIUM POWER TRANSISTORS in 5 and 15 amp styles. All are stabilized at 125 C for 100 hr. Clevite Transistor, 200 Smith St., Waltham 54, Mass. (344)

D-C/D-C STATIC INVERTERS, power klystrons, magnetrons and crt's. Miniature unit weighs 26 oz. Abbott Transistor Laboratories, Inc., 3055 Buckingham Road, Los Angeles 16, Calif. (345)

RECTILINEAR INK PEN can be adapted to most recorders. Max excursion possible using the device is 5 cm. Invengineering, Inc., P. O. Box 360, Belmar, N. J. (346)

R-F ATTENUATOR with 50 ohms impedance. It can be set to any value from 1 to 102 db in 1 db increments. Telonic Industries, Inc., 60 North First St., Beech Grove, Ind. (347)

P-C BOARDS made of high alumina ceramic. They are available in a wide range of sizes and thicknesses. Centralab, 900 E. Keefe Ave., Milwaukee 1, Wisc. (348)

WAVEGUIDE WATER LOAD handles 50 Kw peak, 25 Kw average. Frequency range is 7.1 to 8.6 Gc. Airtron, a division of Litton Industries, 200 East Hanover Ave., Morris Plains, N. J. (349)

CERAMIC PERMANENT MAGNET molded to customer specifications. Material has high coercive force. Allen-Bradley Co., 102-H West Greenfield Ave., Milwaukee 4, Wisc. (350)

KLYSTRON TUBE MOUNTING BOXES for the millimeter bands. A rugged waveguide clamping bracket is provided. TRG, Inc., 400 Border St., East Boston, Mass. (351)

REFLEX KLYSTRON OSCILLATOR delivers 80 mw min power output. Tube operates at 23-24.5 Gc. Sperry Electronic Tube Division, Sperry Rand Corp., Gainesville, Fla. (352)

GENERATOR triggers delayed shutters. Time delay per channel is 1-10,000 μ sec, continuously adjustable. Abtronics, Inc., 64 South P St., Livermore, Calif. (353)

SHIELDED WIRE TERMINATOR is 1,000 percent faster than manual method. It meets MIL standards. Sorensen Industrial Electronic Co., Route 10, Dover, N. J. (354)

SOLID STATE A-D CONVERTERS feature high speed. Units have accuracies to ± 0.01 percent. Scientific Data Systems, Inc., 1542 Fifteenth St., Santa Monica, Calif. (355)



TRANSISTOR CHOPPERS

(Series 7000)

that
have a noise level
of only 35 uv into 10K at 400 CPS
and
can be driven from DC thru 5KC
with
no drive transformer required
yet
provide complete isolation
between drive and signal circuits.

TYPE 7005 SPDT RATINGS

Signal Input Voltage ± 15 V DC or peak
Signal Current 1 ma maximum
Drive Frequency 0 to 5 KC
Drive Voltage 6 to 10 V RMS sq. wave

SPECIFICATIONS (AT 25° C)

| PARAMETER | CONDITIONS | TYPICAL | MAX. |
|--------------------------------------|--|---------------|---------------|
| Turn On Time | 0 to 1KC 1.5V DC input sig. 10K load 50 KC bandwidth | 10 μ sec. | 20 μ sec. |
| Turn Off Time | as above | 20 μ sec. | 30 μ sec. |
| Linearity | 6V DC drive 10K load 50 KC bandwidth | .5% | 1.5% |
| On Resistance | 10K load 10 mv to 15V DC input sig. 6V DC drive | 50 ohms | |
| Off Resistance | No drive voltage 10K load 0.1V DC input sig. | 1000 meg. | |
| Drive Input Imp. | 6V DC input to drive | 1200 ohms | |
| Noise | 6V 400 CPS sq. wv. drive 10K load on pins 3, 4, & 5 20 CPS to 1.5KC bandwidth | 35 uv RMS | 70 uv RMS |
| Offset (between pins 3-4 and 3-5) | 6V 400 CPS sq. wv. drive 100 ohms input 10K ohms output 20 CPS to 1.5KC bandwidth | 50 uv RMS | 70 uv RMS |

Volume is only
1 cubic inch.

CC34

PHONE
228-4600



TWX CAMB
MD 545-U

CAMBRIDGE DIVISION INCORPORATED CAMBRIDGE, MARYLAND

KEARFOTT



Kearfott MN-60

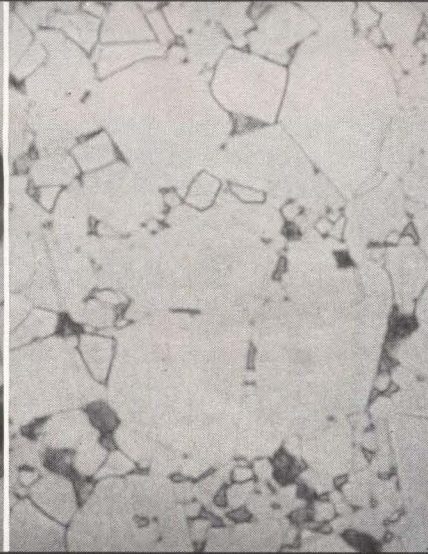

Brand X Ferrite

Both Micrographs Taken at 1067X Magnification

FERRITE APPROACHES SINGLE-CRYSTAL STRUCTURE UNIFORMITY, DENSITY GIVE HIGH PERMEABILITY

Kearfott's MN-60 Ferrite is specially formulated for optimum performance in recording heads and other applications. Uniform crystal structure, sharp crystal boundaries, and careful control of voids produce its excellent characteristics. Initial minimum permeability is 5000, with an average of 6000 in production quantities. It is easily machined into small difficult shapes with typical tolerances of 0.0001 inch. Surfaces are finished by machining to 16 microinches and by lapping to 8 microinches.

OTHER FEATURES OF MN-60

| | |
|--------------------------------|-------------------------------|
| Negligible Eddy Current Losses | Low-Core Loss Characteristics |
| High DC Resistivity | Low Electrical Losses |
| High Curie Temperature | Highest Uniform Quality |

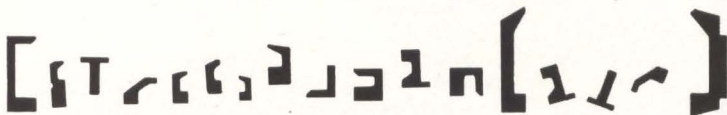

Typical Kearfott head configurations (actual size).

TYPICAL CHARACTERISTICS OF MN-60

| | |
|--|------------------------|
| Initial Permeability (at 21°C, 800 cps) | 5000 minimum |
| Maximum Permeability Range (at 3000 gauss) | 9000-10,000 gauss |
| Flux Density (B _{max}) (at 2 oersteds) | 4800 gauss |
| Loss Factors (at 10 kc) | 3 x 10 ⁻⁶ |
| (at 50 kc) | 4.5 x 10 ⁻⁶ |
| (at 200 kc) | 45 x 10 ⁻⁶ |
| Curie Temperature | 190°C |
| DC Resistivity | 300 ohm-cm |

For complete data write Kearfott Division, General Precision, Inc., Little Falls, New Jersey.



GENERAL PRECISION

Literature of the Week

TRANSISTORIZED POWER SUPPLIES Acopian Technical Co., 927 Spruce St., Easton, Pa. Three bulletins cover 45 plug-in-power supplies. (356)

SERVO REPEATER Datex Corp., 1307 S. Myrtle Ave., Monrovia, Calif. Spec sheet A/24 describes the SR-115 two-speed servo repeater. (357)

DELAY LINES Ad-Yu Electronics Lab., Inc., 249 Terhune Ave., Passaic, N. J. Single-page bulletin describes type T10 series ultra-fast rise time delay lines. (358)

P-C BOARD ETCHING FMC Corp., 161 E. 42nd St., New York 17, N. Y. Bulletin 119 contains information useful in setting up continuous etching of p-c boards. (359)

TRANSISTOR TYPES General Electric Co., Syracuse, N. Y., has published a 16-page transistor interchangeability brochure. (360)

MEASURING INSTRUMENTS Sensitive Research Instrument Corp., 310 Main St., New Rochelle, N. Y. Vol. 29 No. 6 of a house organ covers a 10-in. vernier d-c Poly-ranger and a fluxmeter calibrator. (361)

QUARTZ CRYSTAL OSCILLATORS Bulova Watch Co., Inc., 40-10 61st St., Woodside 77, N. Y. Catalog sheet describes high-precision oscillators in the 8 Kc to 100 Mc range. (362)

FREQUENCY CONVERTER Lincoln Instrument Co., Inc., Box 1194, Santa Ana, Calif. Bulletin 20323 discusses a multiple channel frequency converter for flow control systems. (363)

PANEL METER Helipot Division of Beckman Instruments, Inc., 2500 Harbor Blvd., Fullerton, Calif., has published a data sheet on Style 32 (3 1/2 in. square) panel meter. (364)

SERVO ASSEMBLIES Kearfott Division, General Precision, Inc., Little Falls, N. J. A catalog sheet describes a line of miniature integrated servo assemblies. (365)

RELAY CIRCUITS Automatic Electric Co., 400 North Wolf Road, Northlake, Ill., has published "Relay Magic", a 40-page booklet that contains 31 time-tested circuits. (366)

IR INSTRUMENTATION Barnes Engineering Co., 30 Commerce Rd., Stamford, Conn. Bulletin 14-003 is a collection of articles describing the infrared instrumentation used in weather satellites. (367)

PARTICLE-MONITOR RECORDER Royco Instruments Inc., 440 Olive St., Palo Alto, Calif. Leaflet 120-262 covers a digital-printing auxiliary for airborne- or liquidborne-particle monitor application. (368)

MAGIC TEE Microwave Development Laboratories, Inc., 15 Strathmore Road, Natick Industrial Centre, Natick, Mass. Data sheet illustrates

and describes the WR187 magic tee for 5.4-5.9 Gc. (369)

CRT MAGNETIC SHIELDS Magnetic Shield Division Perfection Mica Co., 1322 No. Elston Ave., Chicago 22, Ill. Data sheet 160 deals with sophisticated design crt Netic and Co-Netic magnetic shields. (370)

ALL PURPOSE RELAY Artisan Electronics Corp., 171 Ridgedale Ave., Morristown, N. J., offers a bulletin describing the model RH all purpose economy relay. (371)

TAPE READER AND SPOOLER Potter Instrument Co., Inc., 151 Sunnyside Blvd., Plainview, N. Y., offers a brochure on the PTR-500 perforated tape reader and PTS-500 perforated tape spooler. (372)

ULTRASENSITIVE TRANSDUCERS Sensonics, Inc., 3831 Plyers Mill Road, Kensington, Md. A series of ultrasensitive, noise-free Bariducers are illustrated and described in a four-page bulletin. A price list is available. (373)

ROTATING COMPONENTS Daystrom, Inc., Transicoil Div., Worcester, Pa., has available a 20-page condensed catalog dealing with a line of rotating components. (374)

C-C TV MONITORS Cohu Electronics, Inc., Kin Tel Div., 5725 Kearny Villa Rd., San Diego 12, Calif. Data sheet 6-256 describes 12 c-c tv monitors from 14 in. to 21 in. (375)

POWER SUPPLIES Electronic Research Associates, Inc., 67 Factory Place, Cedar Grove, N. J. Short form cat. No. 120B covers over 400 types of transistorized power supplies. (376)

POTENTIOMETRIC VOLTMETER Smith-Florence, Inc., Overlake Industrial Park, Redmond, Wash. A catalog sheet covers the model 951, a 0.01 percent standard potentiometric voltmeter. (377)

ELECTRONIC PRINTER Hull Instruments, 726 Mission St., So. Pasadena, Calif. A 6-page brochure describes an ultra high speed printer which, through the use of fiber optics, is capable of printing 6,000 characters per sec. (378)

D-C AMPLIFIER Neff Instrument Corp., 1088 E. Hamilton Rd., Duarte, Calif. A 4-page brochure describes type 106 multipurpose broadband solid-state single ended d-c amplifier. (379)

COMPACT DIGITAL ENCODER Gulton Industries, Inc., 212 Durham Ave., Metuchen, N. J., has issued an illustrated bulletin on the digital encoder for converting analog voltages to digital information in adverse environments. (380)

FUEL CELL ELECTRODES Yardney Electric Corp., 40-50 Leonard St., New York 13, N. Y., has available a paper describing the development and use of a new concept in fuel cell electrode design. (381)

STAMPED METAL PRODUCTS F. G. Clover Co., Inc., 160 Franklin Ave., Rockaway, N. J. A 4-page brochure illustrates, metal cable straps, bands, tags. Prices included. (382)

BALLANTINE SENSITIVE ELECTRONIC VTVM

model
300-G

Price: \$315

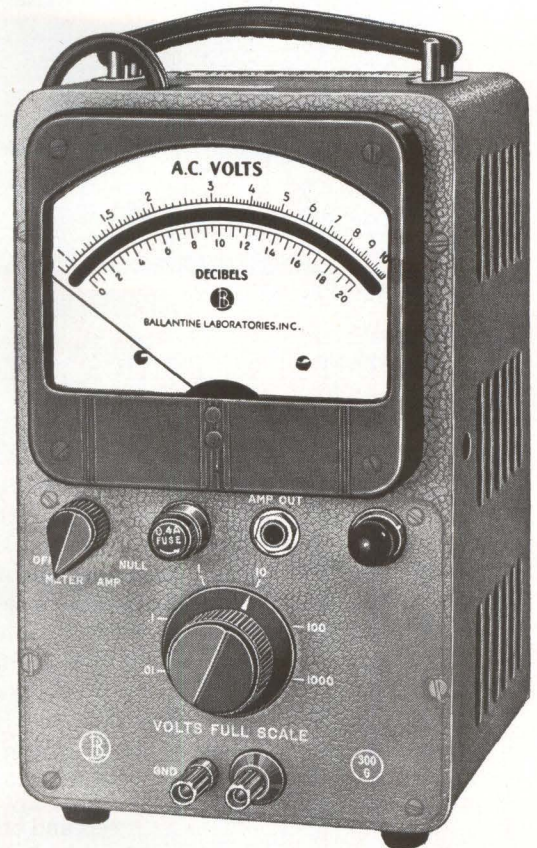

GIVES
YOU
1%

ACCURACY
OVER ENTIRE METER SCALE

1 mV-250 V, 20 cps-20 kc

Ballantine's hand-calibrated logarithmic voltage scale makes it possible to read voltages to the same high accuracy at the bottom as at the top of the scale. You use the full 5 inches of mirror-backed scale. This instrument incorporates the best of the features developed in 25 years experience designing and building laboratory-quality vtvm's. Conservative operation of long life instrument tubes and high multiple path feedback over the frequency range result in a unit which is insensitive to tube deterioration or tube changes. There is less than 1/2% change in indicated voltage for a change in power supply voltage of 115 ±10%.

Every Model 300G is given a 50-hour "aging" at full power line voltage during a period of several days prior to its calibration. After calibration, each instrument is "aged" again for 3 to 4 hours and then cross-checked by a second operator at a second test console before final acceptance. This is not an occasional test but applies to every Ballantine instrument. Of course components such as indicating meters receive extensive testing prior to assembly into a vtvm.

You can be assured of more than 3000 hours use within specifications, without servicing or recalibration. The 300G is an excellent instrument for use as a reference standard in any electronics laboratory.

Frequency Range: 10 cps to 250 kc
Accuracy in % of reading anywhere on the scale: 1%, 1 mV to 250 V, 20 cps to 20 kc; 2%, 1 mV to 1000 V, 10 cps to 250 kc
Available in 19 inch relay rack version as Model 300G-S/2 at \$320



Write for brochure



BALLANTINE LABORATORIES INC.

Boonton, New Jersey

CHECK WITH BALLANTINE FIRST FOR LABORATORY AC VACUUM TUBE VOLTMETERS, REGARDLESS OF YOUR REQUIREMENTS FOR AMPLITUDE, FREQUENCY, OR WAVEFORM. WE HAVE A LARGE LINE, WITH ADDITIONS EACH YEAR. ALSO AC/DC AND DC/AC INVERTERS, CALIBRATORS, CALIBRATED WIDE BAND AF AMPLIFIER, DIRECT-READING CAPACITANCE METER, OTHER ACCESSORIES.

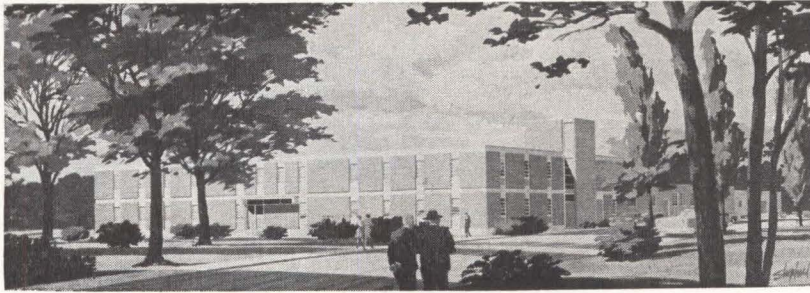

General Atronics' Growth Continues

AS PART of a long-range expansion plan, General Atronics Corporation soon will break ground for a 29,000-square-foot addition to its main building in Wyndmoor, Pa. The building presently houses the firm's corporate offices and its Electronic Tube, Instrument and Products divisions.

David E. Sunstein, president, said additional office space and research and development laboratory facilities will be included in the brick two-story and basement annex which will adjoin the front of the building.

The new wing will give the firm 55,000 square feet at Wyndmoor. Its Military Electronics division is located in West Conshohocken in a new 9,000 square-foot air-conditioned building in the Industrial Center. Current expansion also included the opening of a new re-

search and development center at Arlington, Mass., on August 1, according to Sunstein.

Malcolm M. Hubbard, of M. M. Hubbard Associates, and formerly president of Hermes Electronics and vice president of Itek Corporation, will manage the new facility for General Atronics.

Hubbard, who helped organize the MIT Lincoln Laboratory for the Department of Defense and became its assistant director under Albert G. Hill, said present plans for the Arlington plant call for specialization in theoretical studies for the communication field and signal handling for radar.

He will coordinate his R&D activities, Hubbard said, with the firm's West Conshohocken division and work closely with Hill, professor of physics at MIT and a director of General Atronics Corp.

Fink Named IEEE General Manager



PRESIDENTS of two major engineering societies, slated for merger early next year, have announced the appointment of Donald G. Fink as general manager of the newly formed Institute of Electrical and Electronic Engineers (IEEE). Fink is now director of the Philco Scientific Laboratory and will remain in that post until his successor is appointed.

Warren H. Chase, head of the AIEE, and Patrick E. Haggerty, president of the IRE, stated that Fink was the unanimous choice of

a 14-man Merger Committee appointed by the Boards of the two societies.

As general manager, Fink will be the chief staff officer responsible for the day-to-day operation of the world's largest engineering society, with an estimated membership of 160,000. Among his responsibilities will be the supervision of the publication of technical periodicals which, for AIEE and IRE, now total forty.

Fink has combined notable careers in technical publishing, government service and industrial research. After graduation from MIT and a year on its research staff, he joined the editorial staff of ELECTRONICS in 1934 and became its chief editor in 1946.

During and after World War II, while on leave of absence from his editorial duties, he served as advisor and consultant to various branches of the government.

In 1952 he joined Philco, where he is now director of the Philco Scientific Laboratory.

Fink has been a Fellow of the IRE since 1947 and of the AIEE since 1951.

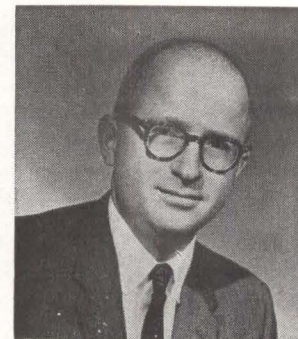

Rakonitz Joins E-H Research Labs

GEORGE RAKONITZ has joined E-H Research Laboratories, Inc., Oakland, Calif., test instruments manufacturer, as manager of microwave products.

Rakonitz was formerly vice president in charge of sales and engineering at Coopertronix, Palo Alto.

George Sauer Forms Rep Organization

GEORGE SAUER, formerly manager of the components department, Electronics division, Curtiss-Wright

DYNAMICS INSTRUMENTATION AMPLIFIERS

—designed for
system flexibility
and highest quality
operation—where *the*
ultimate in perform-
ance is essential

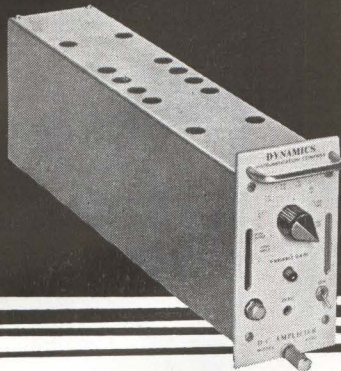

Model 6050—differential dc amplifier. Designed specifically to meet the system engineer's requirements, unit incorporates the following features:

Wide bandwidth: DC to 10 kc.

Dual outputs (simultaneous): $\pm 10v$ at 100 ma and $\pm 10v$ at 10 ma.

High common-mode rejection with 1000-ohm input line unbalance: Withstands 117 VAC common mode voltage between input and output ground.

Isolation: Input and output are completely isolated from each other—from rack cabinet, and power line. **Small size:** 2 $\frac{7}{8}$ " W x 5 $\frac{1}{4}$ " H x 16 $\frac{1}{2}$ " D.

Dynamics manufactures many types of instrumentation amplifiers—guarded, insulated, and isolated. Write for literature on the Model 6050, or the entire line.

DYNAMICS INSTRUMENTATION COMPANY

583 Monterey Pass Road, Monterey Park, Calif.
Phone: CUMberland 3-7773

CIRCLE 210 ON READER SERVICE CARD

LOW COST HIGH PERFORMANCE SPECTRUM ANALYZER

10 mc - 43 kmc

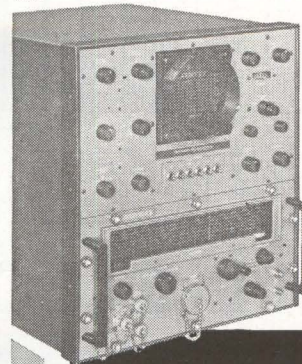

WITH
**ONE
TUNING
HEAD**

PANORAMIC MODEL SPA-10

Model SPA-10 provides sensitive broad-band spectrum analysis through Ka band in a single, low cost, compact unit. With such outstanding features as high sensitivity, wide dispersion range, and adjustable selectivity the easy to use SPA-10 complements Panoramic's unmatched array of widely accepted exceptionally reliable RF and microwave analyzers. Many SPA-10 modular sections are derived from the highly regarded, ultra sensitive model SPA-4a.

CHECK THESE FEATURES

High sensitivity (see table below). • Dispersion adjustable to 80 mc. • Selectivity adjustable 1-80 kc. • Calibrated dispersion marker with modulation provision to measure narrow band dispersions accurately. • Bright, easily read 5" CRT display with calibrated linear, 40 db log and power amplitude scales. • Single knob tuning control with illuminated slide rule scale, accurate within $\pm 1\%$ or $\pm 1mc$ whichever is greater. • Crystal controlled $\pm 0.01\%$ markers (optional) check signal frequency calibrations over entire SPA-10 range. • Single tuning head includes coaxial and waveguide input mixers, plus noise-free non-contacting klystron cavity shorts. • Adjustable smoothing filter simplifies noise analysis.

| FREQUENCY | MIN. DISCERNIBLE LEVEL |
|------------------|------------------------|
| 10 — 680 MC | -95* to -105 dbm |
| 360 — 2360 MC | -85* to -95 dbm |
| 2.20 — 6.04 KMC | -90* to -100 dbm |
| 4.64 — 12.24 KMC | -80* to -95 dbm |
| 12.0 — 18.0 KMC | -70* to -85 dbm |
| 18.0 — 26.5 KMC | -60 dbm (nominal) |
| 26.5 — 43.0 KMC | -50 dbm (nominal) |

*Guaranteed minimum sensitivity throughout bands.

For detailed information on models SPA-10 as well as SPA-4a, write—wire—phone



530 South Fulton Ave. • Mt. Vernon, N. Y. (914) OWens 9-4600. • TWX-MT-V-NY-5229
Cables: Panoramic, Mt. Vernon, N. Y. State

Be sure to see us at WESCON:
Booth # 3354-5.

CIRCLE 103 ON READER SERVICE CARD 103

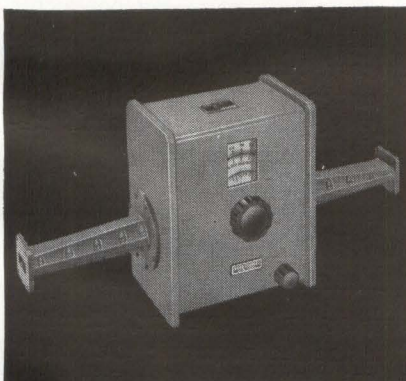

DIRECT-READING PHASE SHIFTER

Model X1646A is a direct-reading versatile instrument offering full 360° of phase shift over the entire waveguide frequency range. Constant insertion loss (2db max.) is combined with an accuracy of 2° from 8.0 to 10.0 Gc/s and 3° from 10.1 to 12.4 Gc/s to assure outstanding performance. Useful for power levels up to 10 watts. Features includes full RF shielding and a mechanical locking device to allow zero dial adjustment. Reset-ability is .25°.

Model X1646A Available from stock **\$382⁵⁰**



BUDD-STANLEY CO.
175 Eileen Way, Syosset, Long Island, N. Y.
NEW 1962 CATALOG AVAILABLE UPON REQUEST

CIRCLE 211 ON READER SERVICE CARD
August 17, 1962

Specify

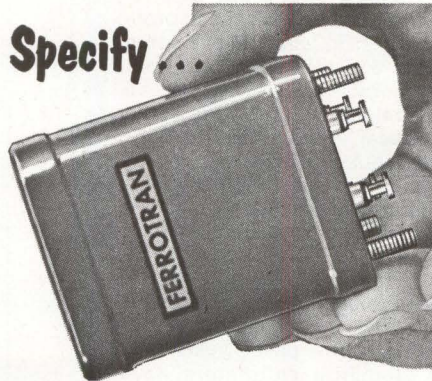

POWERTRAN DUAL OUTPUT D.C. POWER SUPPLIES

Smallest Available! Short-Circuit Protected!
Two independent D. C. output voltages: not grounded to case; supply two positive or two negative voltages; or a positive and a negative voltage.
Input 115 volts, 60 to 2000 cycles; tubeless 10,000 hour guaranteed life; temperature: -40° C. to 85° C.
GB Case—2 $\frac{3}{4}$ " X 2 $\frac{3}{8}$ " X 2 $\frac{3}{4}$ ".

| Model | D.C. Voltage | D.C. Current | % Reg. | % Ripple | Price |
|-------|--------------|--------------|--------|----------|-------|
| MA7 | 7, 7 V. | 60 ma. | 1.5 | .3 | \$55 |
| MA10 | 10, 10 V. | 60 ma. | 1.5 | .15 | 55 |
| MA12 | 12, 12 V. | 60 ma. | 1.5 | .15 | 55 |
| MA15 | 15, 15 V. | 50 ma. | 1.5 | .30 | 55 |
| MA20 | 20, 20 V. | 50 ma. | 1.5 | .40 | 60 |
| MA24 | 24, 24 V. | 40 ma. | 2.0 | .40 | 60 |
| MA28 | 28, 28 V. | 40 ma. | 2.0 | .40 | 60 |
| MA515 | 5, 15 V. | 50 ma. | 1.5 | .30 | 60 |
| MA712 | 7, 12 V. | 50 ma. | 1.5 | .25 | 60 |
| MA122 | 12, 24 V. | 40 ma. | 1.5 | .40 | 65 |

Intermediate voltage values or combinations available at no extra cost. FOR COMPLETE LINE SEE EEM, Pg. 625.

FERROTRAN ELECTRONICS CO.
693 BROADWAY • N. Y. 12, N. Y. • AL 4-5810

CIRCLE 212 ON READER SERVICE CARD

WORLD LEADER IN THIRD GENERATION ALL-ELECTRONIC DIGITAL VOLTMETERS

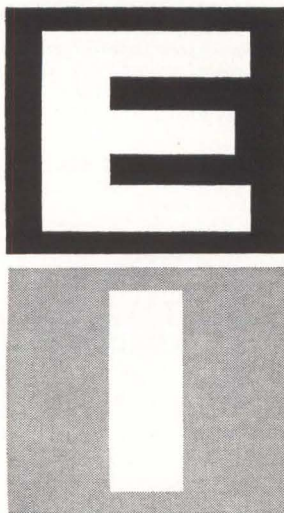

As engineers know, first designs of any transistorized equipment can be tricky . . . uncertain. In the case of digital voltmeters, EI met these problems back in 1957 when we pioneered solid state D. V. M's. By 1959, our second-generation instruments had increased reliability, fewer parts, and better "specs." Today's THIRD-GENERATION, ALL-ELECTRONIC series have even fewer parts, simplified circuitry, improved packaging, and a lower price. Display is quicker than the human eye. Precision and accuracy are unmatched. Available models measure any or all electrical parameters and contain all provisions for systems use. In the past 8 years, over 10,000 EI digital voltmeters have been shipped! There is no short cut to this kind of experience. We invite you to set your standards to EI.



Electro Instruments, Inc.
8611 BALBOA AVENUE, SAN DIEGO 12, CALIFORNIA

For complete information, see us at WESCON Booth 2021-2022, call the EI office nearest you, or write direct.

Corp., now has his own manufacturers' representatives organization covering Metropolitan New York and Northern New Jersey for components and clean room specialties. The firm is called J. George Sauer Associates and is situated in Saddle Brook, N. J.



William Happ Takes New Post

WILLIAM W. HAPP, formerly with Lockheed Missiles and Space Co., has joined American Micro Devices, Inc., Phoenix, Ariz., as research director.

In his new position, Happ will head a seven-scientist team in a research program aimed at discovering new processes of semiconductor technology with concentration on integrated circuitry. He will also be active in preparation of the firm's proposals for research contracts.

B.R. Eichbaum Joins Philco Corporation

BARLANE R. EICHBAUM, formerly with the Aeronutronic division of the Ford Motor Co., has joined the staff of the Philco Scientific Laboratory at Blue Bell, Pa., Donald G. Fink, laboratory director, has announced.

As his first assignment Eichbaum will undertake responsibility for planning Philco's program in computer research, and in that connection he will be chairman of the Memory Task Force of the Scientific Laboratory, Fink said.

ITT Kellogg Plant To Be Expanded

ALCORN COUNTY, Miss., voters recently approved a \$200,000 bond election which, added to \$303,000

remaining from last year's bond issue, will be used to finance a 60,000 sq ft addition to the Kellogg International Telephone and Telegraph Company of Chicago subsidiary plant there.

The estimated \$509,000 expansion to the recently completed \$947,000 Corinth plant will bring total plant space to 142,000 sq ft and will add about 200 more employees, according to W. G. Cregeen, plant manager.

PEOPLE IN BRIEF

Ellis Friedman leaves Travler Radio Corp. to join The Magnavox Co. as a corporate v-p and coordinator of manufacturing. **Haldon A. Leedy**, director of the Armour Research Foundation, elected to the board of directors of Stewart-Warner Corp. DIT-MCO, Inc., advances three div. mgr's to v-p's: **William C. Comer**, **Fred N. Epperon**, and **Price D. Wickersham**. **James F. Towler** promoted to chief engineer for Regency Electronics, Inc. **Barry R. Norman**, ex-Pacific Semiconductors, Inc., appointed reliability mgr. for Wyle Laboratories' West Coast Testing div. **Bernard N. Riskin**, formerly with Applied Data Research, now project engineer at National Computer Analysts, Inc. **Harlan W. Frerking**, previously with Sperry Electronic Tube div., appointed mgr. of engineering for Microwave Electronics Corp. **Thomas B. Smith**, from Allied Research Associates, Inc., to Space Sciences, Inc., as head of the Electronics dept. **Walter Varner**, ex-General Dynamics/Astronautics, named applications programming project director at Computer Sciences Corp. **Joseph A. Nevin** moves up at Frequency Engineering Laboratories to project mgr. for the AN/WLR-1 countermeasures program. **Harold T. Adkins**, formerly with Curtiss-Wright Corp., appointed chief of new product development at Sigma Instruments, Inc. **Herbert Schaeffer**, previously with IMC Magnetics, and **Vincent Tria**, ex-Shepherd Electronics, appointed plant superintendents, Magnetics div. and Mechanical div., respectively, at March Dynamics.

SPACE ERA ELECTRONICS

are
"HOMING
IN"
to
**Atlanta's
DE KALB!**



An exciting new Electronics-Scientific Center is taking root in Greater Atlanta's DeKalb County.

Here, just 15 minutes from downtown Atlanta, such leaders in space age electronics as

**LITON INDUSTRIES • THETA ELECTRONICS • SCIENTIFIC ATLANTA
• ELECTRONIC WIRE & CONNECTORS, INC. •
ARMOUR CHEMICAL — ELECTRONICS LABORATORY**

are establishing a new base of operations. These companies were represented in and are making increasingly valuable contributions to every space try.

Among their reasons for choosing DeKalb are these:

1. Proximity of Emory University and Georgia Tech with their famous electronics training and research programs and equipment
2. Communications, transportation facilities
3. Room for company to grow, unusual living advantages for personnel.

OTHER INDUSTRIES, TOO,

are choosing DeKalb — now more than 300 new ones — among them such leaders as GENERAL MOTORS, RIEGEL PAPER, GENERAL ELECTRIC, KRAFT FOODS.

INVESTIGATE DE KALB!

Send TODAY for new color brochure and also for Electronics Study prepared by Georgia Tech.

| | |
|---|---|
| <input type="checkbox"/> INQUIRIES CONFIDENTIAL | <input type="checkbox"/> COLOR BROCHURE |
| | <input type="checkbox"/> GA. TECH ELECTRONICS STUDY |
| <p>Write, Wire or Phone F. WM. BROOME, Industrial Manager DeKalb Industrial Committee of 100 P. O. Drawer 759, Atlanta 22, Ga. Telephone 378-3691</p> <p>OR</p> <p>C. O. EMMERICH, Chairman DeKalb County Commission Decatur, Ga., Telephone 373-5731</p> | |
| <p>Name _____</p> <p>Title _____</p> <p>Company _____</p> <p>Address _____</p> <p>City & State _____</p> | |

electronics

WEEKLY QUALIFICATION FORM FOR POSITIONS AVAILABLE

ATTENTION: ENGINEERS, SCIENTISTS, PHYSICISTS

This Qualification Form is designed to help you advance in the electronics industry. It is unique and compact. Designed with the assistance of professional personnel management, it isolates specific experience in electronics and deals only in essential background information.

The advertisers listed here are seeking professional experience. Fill in the Qualification Form below.

STRICTLY CONFIDENTIAL

Your Qualification form will be handled as "Strictly Confidential" by ELECTRONICS. Our processing system is such that your form will be forwarded within 24 hours to the proper executives in the companies you select. You will be contacted at your home by the interested companies.

WHAT TO DO

1. Review the positions in the advertisements.
2. Select those for which you qualify.
3. Notice the key numbers.
4. Circle the corresponding key number below the Qualification Form.
5. Fill out the form completely. *Please print clearly.*
6. Mail to: D. Hawksby, Classified Advertising Div., ELECTRONICS, Box 12, New York 36, N. Y. (No charge, of course).

| COMPANY | SEE PAGE | KEY # |
|---|----------|-------|
| AF SC-AFLC Joint Professional Placement Office New York, New York | 193* | 1 |
| ANTENNA SYSTEMS INC. Hingham, Massachusetts | 192* | 2 |
| ATOMIC PERSONNEL INC. Philadelphia, Pennsylvania | 190* | 3 |
| AVCO RESEARCH AND ADVANCED DEVELOPMENT A Division of Avco Corporation Wilmington, Massachusetts | 194* | 4 |
| THE BENDIX CORPORATION Kansas City Division Kansas City, Missouri | 196* | 5 |
| DELCO RADIO Div. of General Motors Corp. Kokomo, Indiana | 62 | 6 |
| DOUGLAS AIRCRAFT CO. Missile and Space Systems Division Santa Monica, California | 96* | 7 |
| ESQUIRE PERSONNEL SERVICE INC. Chicago, Illinois | 190* | 8 |
| HOUSTON INSTRUMENT CORPORATION Bellaire, Texas | 108 | 9 |
| JET PROPULSION LABORATORY Pasadena, California | 108 | 10 |
| LOCKHEED CALIFORNIA CO. Burbank, California | 24 | 11 |
| LOCKHEED MISSILES & SPACE CO. Div. of Lockheed Aircraft Corp. Sunnyvale, California | 110* | 12 |
| McDONNELL St. Louis, Mo. | 192* | 13 |
| MICROWAVE SERVICES INTERNATIONAL INC. Denville, New Jersey | 190* | 14 |

Continued on page 108

(cut here)

electronics WEEKLY QUALIFICATION FORM FOR POSITIONS AVAILABLE

(cut here)

(Please type or print clearly. Necessary for reproduction.)

Personal Background

NAME

HOME ADDRESS

CITY ZONE STATE

HOME TELEPHONE

Education

PROFESSIONAL DEGREE(S)

MAJOR(S)

UNIVERSITY

DATE(S)

FIELDS OF EXPERIENCE (Please Check)

81762

- | | | |
|--|--|---------------------------------------|
| <input type="checkbox"/> Aerospace | <input type="checkbox"/> Fire Control | <input type="checkbox"/> Radar |
| <input type="checkbox"/> Antennas | <input type="checkbox"/> Human Factors | <input type="checkbox"/> Radio—TV |
| <input type="checkbox"/> ASW | <input type="checkbox"/> Infrared | <input type="checkbox"/> Simulators |
| <input type="checkbox"/> Circuits | <input type="checkbox"/> Instrumentation | <input type="checkbox"/> Solid State |
| <input type="checkbox"/> Communications | <input type="checkbox"/> Medicine | <input type="checkbox"/> Telemetry |
| <input type="checkbox"/> Components | <input type="checkbox"/> Microwave | <input type="checkbox"/> Transformers |
| <input type="checkbox"/> Computers | <input type="checkbox"/> Navigation | <input type="checkbox"/> Other |
| <input type="checkbox"/> ECM | <input type="checkbox"/> Operations Research | <input type="checkbox"/> |
| <input type="checkbox"/> Electron Tubes | <input type="checkbox"/> Optics | <input type="checkbox"/> |
| <input type="checkbox"/> Engineering Writing | <input type="checkbox"/> Packaging | <input type="checkbox"/> |

CATEGORY OF SPECIALIZATION

Please indicate number of months experience on proper lines.

| | Technical Experience (Months) | Supervisory Experience (Months) |
|-------------------------------------|-------------------------------|---------------------------------|
| RESEARCH (pure, fundamental, basic) | | |
| RESEARCH (Applied) | | |
| SYSTEMS (New Concepts) | | |
| DEVELOPMENT (Model) | | |
| DESIGN (Product) | | |
| MANUFACTURING (Product) | | |
| FIELD (Service) | | |
| SALES (Proposals & Products) | | |

CIRCLE KEY NUMBERS OF ABOVE COMPANIES' POSITIONS THAT INTEREST YOU

1 2 3 4 5 6 7 8 9 10 11 12 13 14 15 16 17 18 19 20 21 22 23 24 25

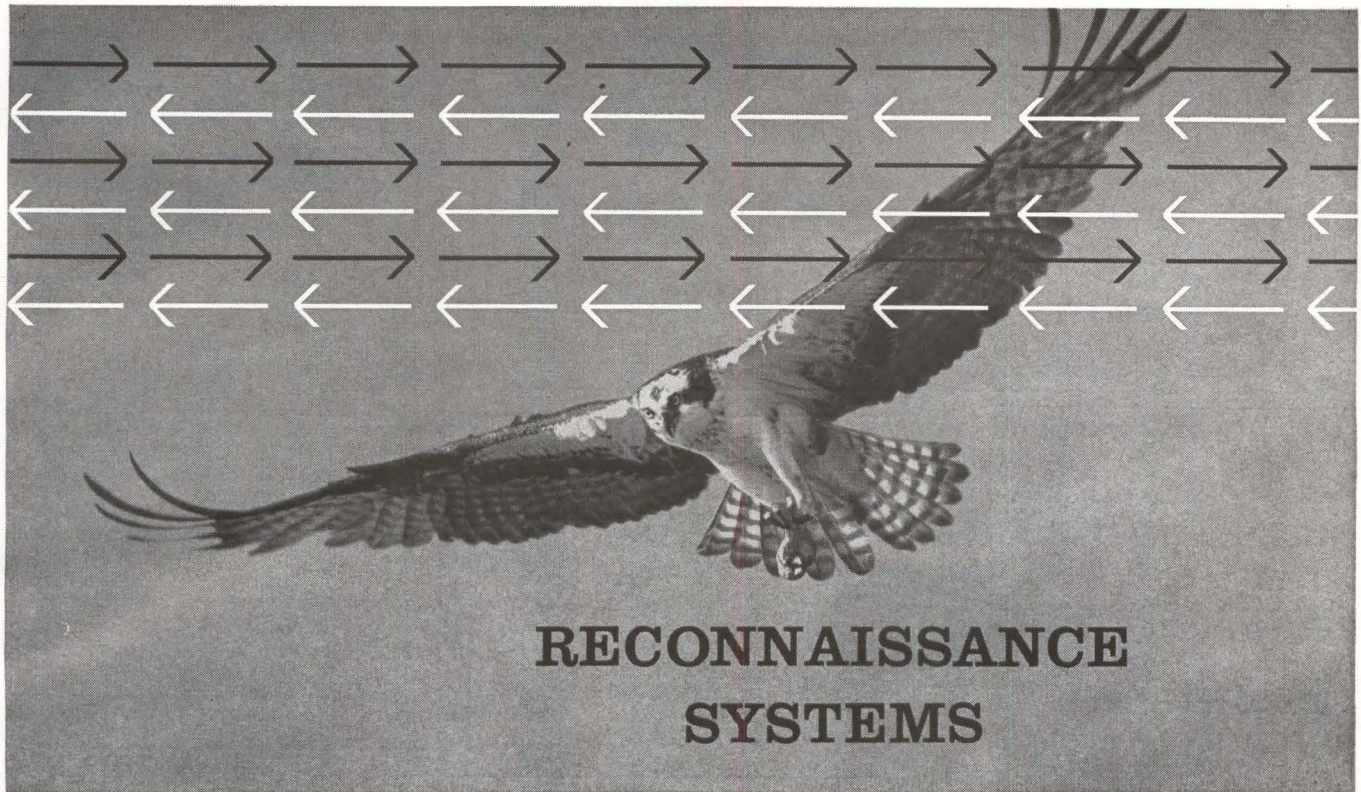

**Stimulating career opportunities for Reconnaissance Systems Engineers
at Sylvania on the San Francisco Peninsula**

SYLVANIA ELECTRONIC SYSTEMS—WEST

offers a broad spectrum of challenging problems involved in Reconnaissance Systems Engineering including: Feasibility Studies, Operational Analysis, System Synthesis and Performance Analysis, Application and Development of Advanced Techniques, Specification of Constituent Subsystems, Human Factors Engineering and Operations Research. Typical areas in which openings currently exist include the following:

DATA ANALYSIS and SIGNAL PROCESSING. Carry out studies, the objectives of which are the design of new, or the refinement of existing data collection systems. Studies range from the analysis required to develop and define operating requirements compatible with economic and state-of-the-art considerations, through systems conceptual design in block diagram form and including specification of hardware design approach.

STATISTICAL ANALYSIS. Perform various statistical analyses at various levels of sophistication, set up mathematical models of stochastic processes. Fields of particular interest include experimental design, theory of queues, theory of mixtures, allocation of resources, search theory, and general operations research.

INTERCEPT AND DETECTION. Direct or perform reconnaissance systems operational and technical requirements studies; electronic signal environment studies; synthesis of electronic intercept systems from conception to hardware specification and system block diagram; analysis of system performance and of data related to telemetry, communications, radar and others. Direct or prepare reports and proposals and maintain technical contact with customer representatives.

ANTENNA AND PROPAGATION. Perform analyses of electromagnetic propagation aspects of reconnaissance and other systems; analyze direction finding problems and develop direction finding techniques; determine antenna requirements and configuration during synthesis of reconnaissance systems. Activities include report writing, and customer contacts.

These openings exist at all experience levels. Advanced degrees in EE, physics, or mathematics desirable.



Complete information may be obtained by writing, in confidence to

Roger Harlan

SYLVANIA ELECTRONIC SYSTEMS • WEST

P. O. Box 188 • Mountain View, California

An Equal Opportunity Employer



EMPLOYMENT OPPORTUNITIES

The Advertisements in this section include all employment opportunities—executive, management, technical, selling, office, skilled, manual, etc. Look in the forward section of the magazine for additional Employment Opportunities advertising.

Positions Vacant Civil Service Opportunities Employment Agencies
Positions Wanted Selling Opportunities Wanted Employment Services
Part Time Work Selling Opportunities Offered Labor Bureaus

DISPLAYED

The advertising rate is \$40.17 per inch for all advertising appearing in other than a contract basis. Contract rates quoted on request.

An advertising inch is measured $\frac{3}{4}$ " vertically on a column—3 columns—30 inches to a page.

Subject to Agency Commission.

RATES

\$2.70 per line, minimum 3 lines. To figure advance payment count 5 average words as a line.

Box Numbers—counts as 1 line.

Discount of 10% if full payment is made in advance for 4 consecutive insertions.

Not subject to Agency Commission.

UNDISPLAYED

Send **NEW ADS** to **CLASSIFIED ADV. DIV.** of **ELECTRONICS**, P.O. Box 12, N. Y. 36, N. Y.

jpl needs

SPACECRAFT DATA ANALYSIS DIRECTOR

To direct team of specialists in the in-flight analysis of spacecraft engineering data and command control of lunar and interplanetary spacecraft. Leadership ability and experience in missile or spacecraft systems; BS or MS in Physics, Engineering or Math.

Send complete resume to
PERSONNEL DEPT.

JET PROPULSION LABORATORY

CALIFORNIA INSTITUTE OF TECHNOLOGY
4814 OAK GROVE DR. • PASADENA, CALIF.

"An equal opportunity employer"

Electronic Instrument Technicians The Oak Ridge National Laboratory Operated by UNION CARBIDE NUCLEAR COMPANY

at
Oak Ridge, Tennessee
Has openings for

Highly skilled electronic instrument technicians to work with electronic engineers in the development, installation and maintenance of electronic systems. Digital data handling, transistorized pulse height analyzers, analog and digital computer systems are only a few examples.

Minimum high school education, with additional training in electronics and at least three years' experience in installation and maintenance of complex electronic systems. Entrance rate \$3.10 per hour; \$3.16 per hour after six months. Reasonable interview and relocation expenses paid by Company.

Excellent Working Conditions
and

Employee Benefit Plans
An Equal Opportunity Employer

Send detailed resume to:

Central Employment Office
UNION CARBIDE NUCLEAR COMPANY
Post Office Box M Oak Ridge, Tennessee

ELECTRONIC CIRCUIT DESIGNERS

Excellent opportunity in New Products Department of rapidly growing company making recorders and laboratory test instruments. Requirements are a degree in electrical engineering from a leading college or university and three or more years experience in instrument circuit design employing both vacuum tubes and transistors. All development work would be on proprietary instruments.

Write in confidence to:

Technical Director
HOUSTON INSTRUMENT CORPORATION
4950-4951 Terminal Avenue
Bellaire 101, Texas.

electronics

WEEKLY QUALIFICATIONS FORM FOR POSITIONS AVAILABLE

(Continued from page 106)

| | | |
|--|------|----|
| NATIONAL AERONAUTICS AND SPACE ADMINISTRATION Washington, D. C. | 191* | 15 |
| NORTHROP CORP. Norair Beverly Hills, California | 149* | 16 |
| NORTHROP CORP. Norair Hawthorne, California | 151* | 17 |
| PHILCO WESTERN DEVELOPMENT LABS. Palo Alto, California | 195* | 18 |
| REPUBLIC AVIATION CORPORATION Farmingdale Long Island, New York | 194* | 19 |
| SPACE AND INFORMATION SYSTEMS a division of North American Aviation Inc., Los Angeles, California | 196* | 20 |
| SPACE TECHNOLOGY LABORATORIES INC. Sub. of Thompson Ramo Wooldridge Inc. Redondo Beach, California | 11* | 21 |
| SYLVANIA ELECTRONIC SYSTEMS- WEST Mountain View, California | 107 | 22 |
| UNION CARBIDE NUCLEAR CO Oak Ridge, Tennessee | 108 | 23 |
| VAPOR CORPORATION Chicago 48, Illinois | 192* | 24 |

* These advertisements appeared in the 8/10/62 issue.

SEARCHLIGHT SECTION

(Classified Advertising)

BUSINESS OPPORTUNITIES

EQUIPMENT - USED or RESALE

DISPLAYED RATE

The advertising rate is \$27.25 per inch for all advertising appearing on other than a contract basis. Contract rates quoted on request. AN ADVERTISING INCH is measured $\frac{3}{4}$ inch vertically on one column, 3 columns—30 inches—to a page. EQUIPMENT WANTED or FOR SALE ADVERTISEMENTS acceptable only in Displayed Style.

UNDISPLAYED RATE

\$2.70 a line, minimum 3 lines. To figure advance payment count 5 average words as a line.

PROPOSALS, \$2.70 a line an insertion. BOX NUMBERS count as one line additional in undisplayed ads.

DISCOUNT OF 10% if full payment is made in advance for four consecutive insertions of undisplayed ads (not including proposals).

FOR RESEARCH — DEVELOPMENT & EXPERIMENTAL WORK

Over 10,000 different electronic parts: waveguide, radar components and parts, test sets, pulsers, antennas, pulse xmtrs, magnetrons, IF and pulse amplifiers, dynamotors, 400 cycle xmtrs, 584 ant. pedestals, etc.

PRICES AT A FRACTION OF ORIGINAL COST!
COMMUNICATIONS EQUIP CO.

343 CANAL ST., N. Y. 13, N.Y. WO 6-4045

CHAS. ROSEN (Formerly at 131 Liberty St.)

CIRCLE 950 ON READER SERVICE CARD

OVER 2,000,000

RELAYS IN STOCK!

Send for Catalog 55

Universal RELAY CORP.

42 WHITE ST., N. Y. 13, N. Y. • WAlker 5-6900

CIRCLE 951 ON READER SERVICE CARD

Your Best Source of Supply for—

HIGH PURITY METALS SEMICONDUCTORS

GROMA METAL CORP.

50 Broad St., New York 4, N. Y.

Plant, Houston, Pa.

CIRCLE 952 ON READER SERVICE CARD

*Your Inquiries to
Advertisers Will
Have Special Value . . .*

—for you—the advertiser—and the publisher, if you mention this publication. Advertisers value highly this evidence of the publication you read. Satisfied advertisers enable the publisher to secure more advertisers and—more advertisers mean more information on more products or better service—more value—to YOU.

INDEX TO ADVERTISERS



Audited Paid Circulation

| | | | |
|---|---------|---|--------|
| • AMP Incorporated | 23 | • Oak Mfg. Co. | 34, 35 |
| Airpax Electronics, Inc. | 99 | • Panoramic Electronics Inc. | 103 |
| Airtronics International Corp..... | 83 | Parabam, Div. of Houston Fearless Corp. | 92 |
| • Alpha Wire Corp. | 86 | • Potter Instrument Co., Inc. | 21 |
| American Machine & Foundry Co. | 25 | Potter and Brumfield Div. American Machine & Foundry Co. | 25 |
| • Ballantine Laboratories, Inc. | 101 | • Radio Corporation of America 15, 4th Cover | |
| Bell Telephone Laboratories..... | 17 | Rauland Corp., The..... | 61 |
| Bendix Corporation Semiconductor Division | 38 | • Raytheon Company | 13, 69 |
| Birtcher Corporation, The..... | 16 | • Rixon Electronics, Inc. | 16 |
| Borden Chemical Co., The..... | 70 | • Sage Electronics Corp. | 70 |
| • Budd-Stanley Co. | 103 | Sanders Associates, Inc..... | 18 |
| Cambridge Thermionic Corp..... | 91 | Sarkes Tarzian Inc..... | 67 |
| Consolidated Electrodynamics Corp. 94, | 95 | • Servo Corporation of America | 75 |
| • Corning Electronic Components | 85 | • Sierra Electronic Corp. | 6 |
| • Cosmic Condenser Co. | 110 | Speer Carbon Co. | 14 |
| • Dearborn Electronic Laboratories Inc. 97 | | Sprague Electric Co. | 9, 30 |
| De Kalb Industrial Committee..... | 105 | Stackpole Carbon Co..... | 98 |
| Deleo Radio | 62 | Tektronix, Inc. | 33 |
| Douglas Aircraft Co. | 87 | Texas Instruments Incorporated Components Division | 65 |
| Dynamics Instrumentation Co..... | 103 | Texas Instruments Incorporated Transistor Products Division | 11 |
| • Eisler Engineering Co., Inc. | 80 | Triplett Electrical Instrument Co..... | 55 |
| Electro Instruments Inc. | 104 | • Tung-Sol Electric, Inc. | 73 |
| • Electronic Instrument Co., Inc. (EICO) 96 | | • United Transformer Corp. 2nd Cover | |
| • Fairchild Semiconductor Corp. 3rd Cover | | Varian Associates | 19 |
| Fairmount Chemical Co., Inc. | 80 | • Vitramon, Inc. | 5 |
| Fansteel Metallurgical Corp..... | 37 | Westinghouse Electric Corp. Industrial Electronics Div..... | 96 |
| Ferrotran Electronics Co. | 103 | | |
| Franklin Electronics Inc. | 90 | | |
| • Fuji Tsushinki Seizo K.K. | 63 | | |
| Gamewell Co., The | 92 | | |
| • General Applied Science Laboratories, Inc. | 68 | | |
| General Electric Co. Receiving Tube Dept..... | 31 | | |
| Rectifier Components Dept..... | 22 | | |
| Semiconductor Products Dept..... | 57 | | |
| General Scientific Corp..... | 70 | | |
| Gudebrod Bros. Silk Co., Inc..... | 32 | | |
| Harman Kardon Inc..... | 4 | | |
| Hughes Aircraft Co. Aerospace Divisions | 81 | | |
| • Image Instruments, Inc. | 92 | | |
| • Indiana General Corp. | 36 | | |
| Intellux Inc. | 16 | | |
| International Nickel Co., Inc., The Huntington Alloy Prod. Div..... | 10 | | |
| Invac Corp. | 109 | | |
| • Japan Piezo Electric Co., Ltd. | 84 | | |
| Kearfott Div. General Precision Inc... 100 | | | |
| • Kollmorgen Corp. | 59 | | |
| Krohn-Hite Corp. | 76 | | |
| Linen Thread Co., The..... | 80 | | |
| Lockheed Calif. Co. | 24 | | |
| • M B Electronics, A Division of Textron Electronics, Inc. | 89 | | |
| • Mace Inc. | 93 | | |
| Machlett Laboratories, Inc., The..... | 29 | | |
| Mallory and Co., Inc., P. R..... | 74 | | |
| McGraw-Hill Book Co. | 77, 78, | | |
| Motorola Military Electronics Div..... | 71 | | |
| • Navigation Computer Corp. (NAVCOR) 66 | | | |
| • Northeastern Engineering, Inc. | 80 | | |

CLASSIFIED ADVERTISING

F. J. Eberle, Business Mgr.

EMPLOYMENT OPPORTUNITIES 107-108

EQUIPMENT
(Used or Surplus New)
For Sale

INDEX TO CLASSIFIED ADVERTISERS

| | |
|---|-----|
| • Communications Equipment Co. | 108 |
| Groma Metal Corporation..... | 108 |
| Houston Instrument Corporation..... | 108 |
| Jet Propulsion Laboratory..... | 108 |
| Sylvania Electronics Systems • West.. | 107 |
| Union Carbide Nuclear Co..... | 108 |
| • Universal Relay Corp. | 108 |

• See advertisement in the July 25, 1962 issue of Electronics Buyers' Guide for complete line of products or services.

This Index and our Reader Service Numbers are published as a service. Every precaution is taken to make them accurate, but electronics assumes no responsibilities for errors or omissions.

Specialists in... PERIPHERAL DATA PROCESSING systems, equipment, and components

DATA LOGGERS



MODEL TR-200
TYPEWRITER-TRANSMITTER/RECEIVER

Using IBM's new Selectric (golf-ball) Typewriter with printing speed of 15 characters/sec., featuring INVAC Corporation's photoelectric techniques. Special clock attachment for data logging available.

PAPER TAPE PUNCHES & READERS

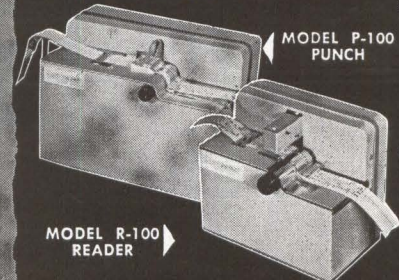

MODEL R-100
READER

20 characters per sec, solenoid actuated, extremely compact.

PHOTOELECTRIC ENCODED KEYBOARDS



MODEL PK-144
KEYBOARD

Features: photoelectric design, no metallic switches or contacts. Encoding matrices are eliminated.

Technical bulletins available
on request . . .

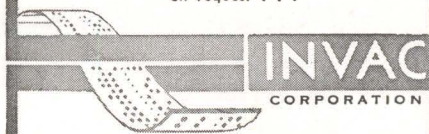

26 FOX ROAD, WALTHAM 54, MASS.



**ELECTROLYTIC
AND
PAPER TUBULAR
CONDENSERS**

"35 YEARS OF PROVEN
DEPENDABILITY"

COSMIC CONDENSER CO.
853 WHITTIER STREET, BRONX, N. Y.
LUdlow 9-3360
CIRCLE 110 ON READER SERVICE CARD

NIMS

**NATIONWIDE IMPROVED
MAIL SERVICE PROGRAM**

**For Better Service
Your Post Office
Suggests**

**That You Mail Early
In The Day!**

electronics



Audit Bureau
of Circulations

Associated Business
Publications

Audited Paid Circulation

JAMES T. HAUPTLI

Advertising Sales Manager

R. S. QUINT:
Assistant Publisher Buyers'
Guide and Business Manager
FRED STEWART:
Promotion Manager
B. ANELLO:
Market Services Manager

RICHARD J. TOMLINSON:
Production Manager
GEORGE E. POMEROY:
Classified Manager
HUGH J. QUINN:
Circulation Manager

ADVERTISING REPRESENTATIVES

ATLANTA (9):
Michael H. Miller, Robert C. Johnson
1375 Peachtree St. N.E., Trinity 5-0523
(area code 404)

BOSTON (16):
William S. Hodgkinson, Donald R. Furth
McGraw-Hill Building, Copley Square,
Congress 2-1160 (area code 617)

CHICAGO (11):
Harvey W. Wernecke, Robert M. Denmead
645 North Michigan Avenue, Mohawk 4-5800
(area code 312)

CLEVELAND (13):
Paul T. Fegley
55 Public Square, Superior 1-7000
(area code 216)

DALLAS (1):
Frank Le Beau
The Vaughn Bldg., 1712 Commerce St.
Riverside 7-9721 (area code 214)

DENVER (2):
J. W. Patten
Tower Bldg., 1700 Broadway,
Alpine 5-2981 (area code 303)

HOUSTON (25):
Joseph C. Page, Jr.
Prudential Bldg., Halcombe Blvd.,
Riverside 8-1280 (area code 713)

LOS ANGELES (17):
Peter S. Carberry, Ashley P. Hartman
1125 W. 6th St., Huntley 2-5450
(area code 213)

NEW YORK (36):
Donald H. Miller, Henry M. Shaw,
George F. Werner
500 Fifth Avenue, LO-4-3000
(area code 212)

PHILADELPHIA (3):
Warren H. Gardner, William J. Boyle
6 Penn Center Plaza, LOcust 8-4330
(area code 215)

SAN FRANCISCO (11):
R. C. Alcorn
255 California Street, Douglas 2-4600
(area code 415)

LONDON W1:
Edwin S. Murphy Jr.
34 Dover St.

FRANKFURT/Main:
Matthée Herfurth
85 Westendstrasse

GENEVA:
Michael R. Zeynel
2 Place du Port

"Headquarters for Business Information"

McGraw-Hill Technical and Business Publications

American Machinist/Metal-
working Manufacturing
Aviation Week and Space
Technology
Business Week
Chemical Engineering
Chemical Week
Coal Age
Construction Methods and
Equipment
Construction Daily
Control Engineering
Electrical Construction
and Maintenance
Electrical Merchandising Week
Electrical Newsletter
Electrical West

Electrical Wholesaling
Electrical World
Electronics
Engineering Digest
Engineering and Mining Journal
E & M Metal and Mineral
Markets
Engineering News-Record
Factory
Fleet Owner
Industrial Distribution
National Petroleum News
Nucleonics
Nucleonics Week
Platt's Oilgram News
Platt's Oilgram Price Service
Power

Product Engineering
Purchasing Week
Science Week
Textile World

Overseas only:
Automobile International
(English, Spanish)
Ingenieria Internacional
Construccion (Spanish)
International Management
(English, Spanish)
Portuguese editions
Metalworking Production
(Great Britain)

Available by subscription only — to qualified persons actively engaged in the field of the publication. For subscription rates and information describing the editorial coverage of any of the above publications, write to: Subscription Manager, Circulation Department, McGraw-Hill Publishing Company, 330 West 42nd Street, New York 36, N. Y.

2N996

SILICON PLANAR EPITAXIAL PNP for

HIGH SPEED, HIGH CURRENT LOGIC

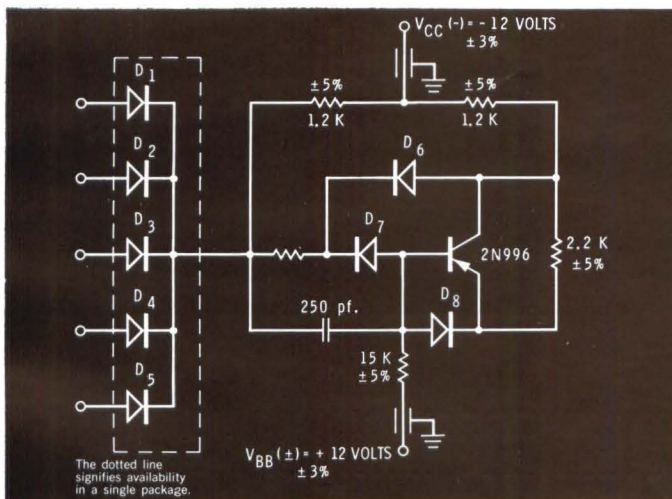

FAN OUT MAXIMUM = 5; TYPICAL PROPAGATION DELAY = 15 nSec.
D₁ through D₈ : All FD6002.

- 60 mA High Current Operation
- 15 nSec Typical Propagation Delay
- 200° C Maximum Junction Temperature
- Direct Replacement for Many Germanium Transistors

The advantages of the Silicon Planar construction are now available in a wide variety of direct replacements for germanium. In addition, the diode gate now is available in a single package TO-5 type can (special product FSP-463) for miniaturized packaging.

FD-6002*
V_F @ I_F = 100 mA 1 V Max.
I_R @ V_R = 25 V 100 mμA Max.
t_{rr} @ I_F = I_R recover to 10% of I_F for all I_F from 10 mA to 200 mA 4 nSec Max.

2N996*
BV_{CEO} @ I_C = 10 μA 15.0 V Min.
h_{fe} @ f = 100 mc, I_C = 10 mA 2.3 typical
V_{CE(sat)} @ I_C = 60 mA, I_B = 2 mA 0.3 V Max.

* OFF-THE-SHELF FROM DISTRIBUTORS

WESCON BOOTHS
2129-2131

FAIRCHILD
SEMICONDUCTOR

545 WHISMAN ROAD, MOUNTAIN VIEW, CALIF. • YORKSHIRE 8-8161 • TWX: MN VW CAL 853
A DIVISION OF FAIRCHILD CAMERA AND INSTRUMENT CORPORATION

CIRCLE 901 READERS SERVICE CARD

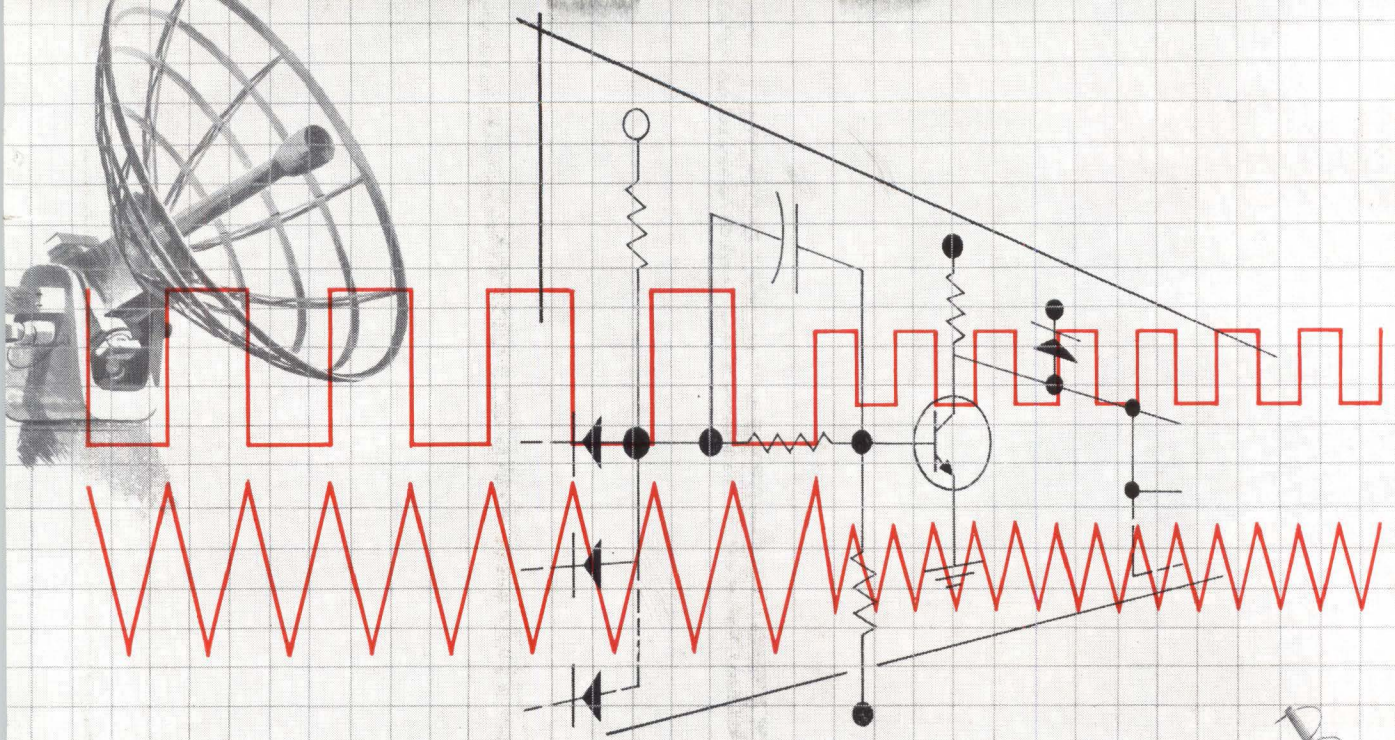

A New Electronically Tunable Oscillator

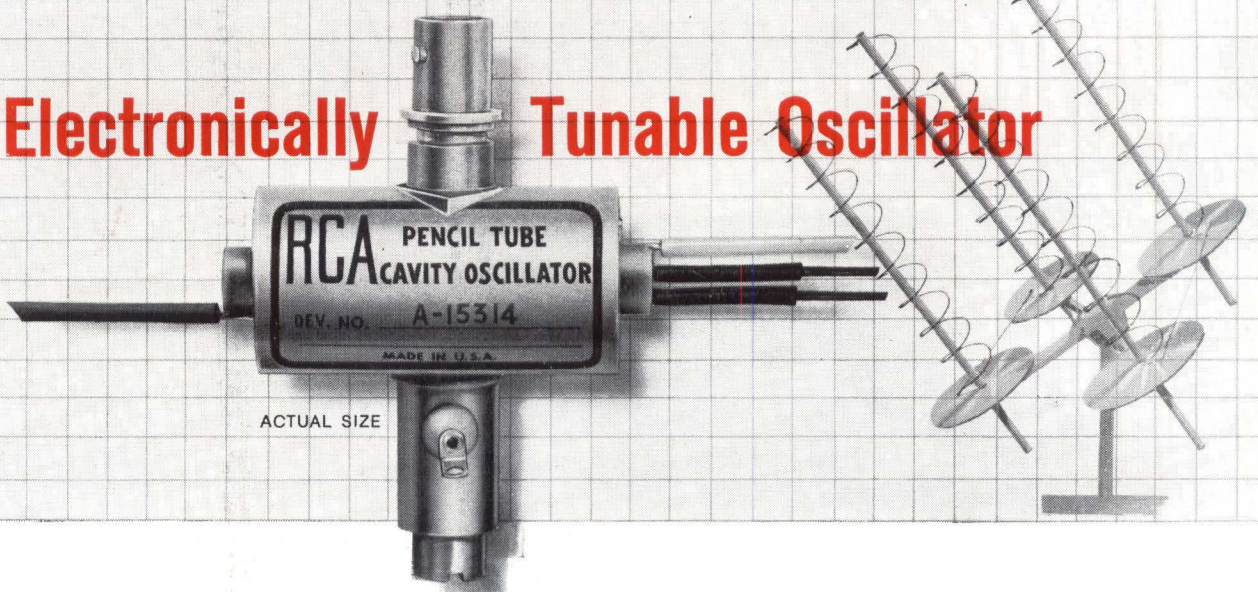

RCA L and S BAND VARACTOR-TUNED INTEGRAL-CAVITY "PACKAGED" MICROWAVE DEVICES MORE VERSATILE AND EFFICIENT THAN KLYSTRONS

RCA's new varactor-tuned integral-cavity pencil tube, A15314, operating at 1880 Mc, makes possible electronic frequency control in applications such as radar beacons, proximity devices, area surveillance equipment and telemetering devices, as well as in local oscillators and signal sources.

The cavity can be mechanically tuned between 1865 Mc and 1895 Mc and electronically tuned ± 10 Mc from any preset frequency within this range. Tuning sensitivity is approximately 1 Mc/volt. Power output over the tuning range is 200 mw minimum.

The integral packaging of the varactor with the cavity makes possible either electronic frequency control or frequency-modulated output. As such, the device has many advantages over klystrons including: better frequency stability in an FM system under conditions of varying heater and plate voltages and ambient temperature changes. Further advantages are lower input power, higher efficiency, longer life, and lower cost.

For additional information see chart at right. Detailed specifications and application information are available by writing: Manager, Microwave Marketing, RCA Electron Tube Division, Harrison, N. J.

General Data—RCA-A15314

| Electrical | | |
|--|--------------|-------|
| Heater Voltage | 6.0 \pm 5% | volts |
| Heater Current | 160 | ma |
| Maximum DC Plate Voltage | 150 | volts |
| Maximum DC Plate Current | 35 | ma |
| Minimum Varactor Voltage | 0 | volts |
| Typical Operation—Frequency Modulated Oscillator | | |
| DC Plate Voltage | 125 | volts |
| DC Plate Current | 35 | ma |
| Varactor Bias | -10 | volts |
| Peak-to-Peak Modulating Voltage | 20 | volts |
| Center Frequency | 1880 | Mc |
| Peak Frequency Modulation | ± 10 | Mc |
| Minimum Power Output | 200 | mw |

INDUSTRIAL TUBE PRODUCTS FIELD OFFICES—OEM Sales:
 Newark 2, N. J., 744 Broad St., HU 5-3900 • Chicago 54, Ill., Suite 1154, Merchandise Mart Plaza, WH 4-2900 • Los Angeles 22, Calif., 6801 E. Washington Blvd., RA 3-8361 • Burlingame, Calif., 1838 El Camino Real, OX 7-1620 • **Government Liaison:** Harrison, N. J., 415 South Fifth St., HU 5-3900 • Dayton 2, Ohio, 224 N. Wilkinson St., BA 6-2366 • Washington 7, D. C., 1725 "K" St., N.W., FE 7-8500 • **International Sales:** RCA International Div., Clark, N. J., FU 1-1000

