

electronics

ORGANIC DIODE MEMORY New advance in data storage

(photo below)

BEAM PLASMA AMPLIFIERS

Promise high power in millimeter waves

CONTROLLING RFI IN WEAPONS

Avoids problems in solid-state controls

RATIO COMPUTER

Combines Hall effect with electro-optics

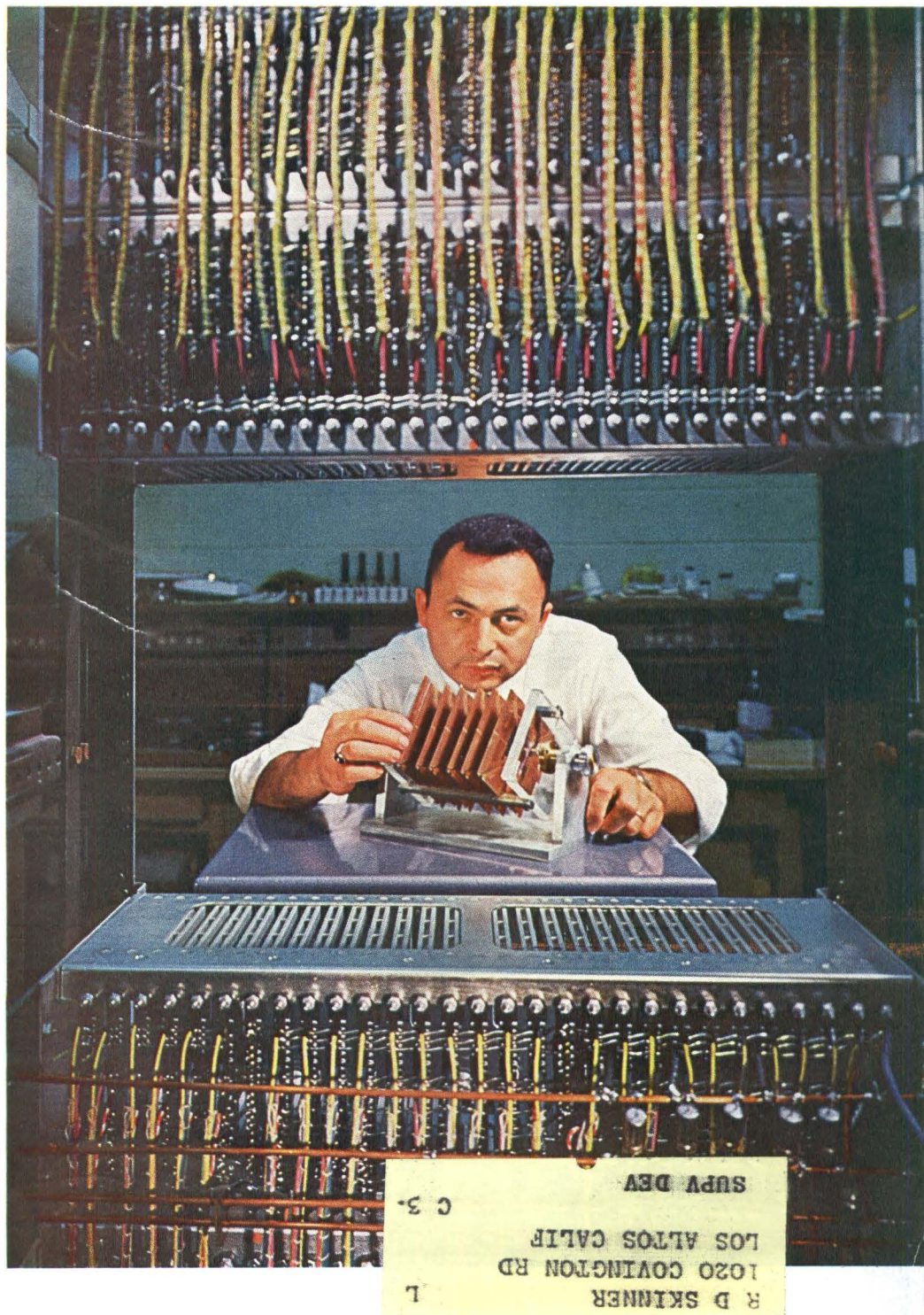



HI-FI

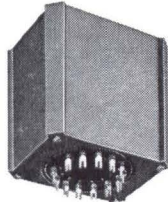

Transistor output; matches any PP transistor to 4, 8, 16 Ω speaker. Primary 48, 36, 12 Ω C.T.; 20 \sim to 20 KC; 40 watts.

MINIATURE MIL TYPE

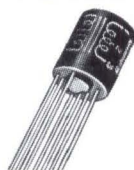

Metal case hermetically sealed to MIL-T-27B. Gold Dumet leads spaced on 0.1 radius, for printed circuit application.

CHOPPER

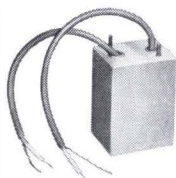

Magnetic shielded plus electrostatic shield for voltage isolation of 2×10^4 . Primary 200K C.T. to within 0.1%. Secondary 50K.

HIGH POWERED AUDIO



Low distortion 2.5 KW output transformer, PP 450 TH's 18,500 ohms C.T. to 24/6 ohms, 20 KV hipot. 520 lbs.

CATHODE FOLLOWER OUTPUT



Provides equal voltages to 5 loads. Primary inductance maintained to 5% with 20% change in DC unbalance and 30% change in AC voltages.

"SPECIAL" CUSTOM BUILT AUDIO TRANSFORMERS TO YOUR SPECIFICATIONS

HI-FREQUENCY CARRIER TO MIL-T-27B



Electrostatically shielded, humbucking, +30 dbm level. Within .5 db 250 cycles to 110 KC. 600/135: 600 centertapped to .1% tolerance.

HYBRID TRANSFORMER

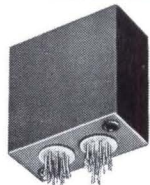

Two transformers each 600 Ω primary. 40K Ω C.T. secondary 250 cycles to 5 KC within 1/4 db. 40 db isolation over band.

MICROMODULE



Life tested per micromodule specs.: no failures. 10K Ω C.T. to 10K Ω , 100 mw from 400 \sim to 20KC.

Exceptional quality and reliability is provided in all UTC designs. Over 30 years of engineering knowledge and experience substantiated by extensive field performance assure the highest quality and most reliable components in the industry. Complete environmental testing facilities are incorporated to prove out new designs. Full analysis and evaluation of materials are conducted in UTC's Material and Chemical Laboratories. Rigid quality control measures coordinated with exhaustive statistical findings and latest production procedures results in the industry's highest degree of reliability. Range covered in Audio Transformers is from 0.1 cycles to 400 MC . . . microwatts to 50 KW.

SUBMINIATURE MOLDED TRANSFORMER

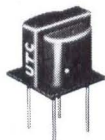

Grade 3 with printed circuit leads for transistor application. 150 Ω to 150 Ω at 10 dbm level. Size 1/2 x 1/2 x 1/2"; weight 5 grams.

BOLOMETER TRANSFORMER

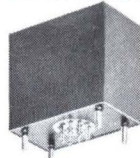

Primary 10 ohms, secondary 530K ohms, 230:1 ratio, response from 1/2 cycle to 25 cycles. 120 db magnetic shielding, plus full electrostatic shielding.

ULTRA-MINIATURE



Electrostatically & magnetically shielded output transformer 3/16 D. x 1/4" H. Pri. 15K CT. Sec. 8K CT; max. level 50 mw; audio range response. To MIL-T-27B, grade 4.

MILITARY AND COMMERCIAL TYPES FOR EVERY PHASE OF THE ELECTRONICS ART

- POWER TRANSFORMERS
- AUDIO TRANSFORMERS
- INDUCTORS
- PULSE TRANSFORMERS
- ELECTRIC WAVE FILTERS
- LUMPED CONSTANT DELAY LINES
- HIGH Q COILS
- MAGNETIC AMPLIFIERS
- SATURABLE REACTORS
- REFERENCE UNITS

Write for catalog of over 1,200 UTC HIGH RELIABILITY STOCK ITEMS IMMEDIATELY AVAILABLE from your local distributor.



UNITED TRANSFORMER CORP.

150 VARICK STREET, NEW YORK 13, N. Y.

PACIFIC MFG. DIVISION: 3630 EASTHAM DRIVE, CULVER CITY, CALIF.
EXPORT DIVISION: 13 EAST 40th STREET, NEW YORK 16, N. Y. CABLE: "ARLAB"

CIRCLE 900 ON READER SERVICE CARD

W. W. MacDONALD, Editor
Telephone Area Code 212 (971-2645)

J. M. CARROLL, Managing Editor (2293)

SENIOR EDITORS

Samuel Weber (2371)
George W. Sideris (3444)

SENIOR ASSOCIATE EDITORS

Michael F. Wolff (2600)
John F. Mason (2666)

ASSOCIATE EDITORS

Michael F. Tomaino (2071)
William P. O'Brien (2297)
George J. Flynn (2188)
George V. Novotny (3151)
Leon H. Dulberger (3446)
Alexander A. McKenzie (2685)

ASSISTANT EDITORS

Stephen B. Gray (2245)
Barry A. Briskman (2306)
Dan Smith (2467)
Joel A. Strasser (2127)

REGIONAL EDITORS

Harold C. Hood,
1125 W. 6th St., Los Angeles 90017, Calif.
(213-482-5450)
Laurence D. Shergalis,
John Hancock Bldg., 255 California St.,
San Francisco 94111, Calif. (415-362-4600)
Thomas Maguire
McGraw-Hill Bldg., 607 Boylston St.,
Boston 02116, Mass. (617-262-1160)
Cletus M. Wiley,
Blair Bldg., 645 N. Michigan Ave.,
Chicago 60611, Ill. (312-664-5800)

ART DIRECTOR

Howard R. Berry (2430)

ASSISTANT ART DIRECTOR

John C. Wright, Jr. (3430)

EDITORIAL ASSISTANTS

Lorraine Rossi, Virginia T. Bastian,
Lynn Emery, Ann Mella, Lorraine Werner,
Alice M. O'Brien, Sharon Parks,
Claire Benell, Kay Fontana

FOREIGN NEWS BUREAU

DIRECTOR, John Wilhelm, (2532);

Lawrence Mihlon (2997), Aylene Elias
(2998)

LONDON—John Shinn, Derek Barlow,
Nicholas Landon, 34 Dover St., London
W.1, England

BONN—Bruce Bendow, Richard Mikton,
Silke McQueen, Mittelstrasse 39, Bad
Godesberg, Germany

BRUSSELS—27 Rue Ducarle, Brussels,
Belgium

PARIS—Robert Farrell, Arthur Erikson,
17 Ave. Matignon, 3rd Fl., Paris 8,
France

MILAN—Marc A. Messina, Via Manzoni
No. 12, Milan, Italy

MEXICO CITY—Wesley Perry, Jr.,
Lafragua 4-314, Mexico 1 D.F. Mexico

RIO DE JANEIRO—Leslie Warren, Rua
Mexico 3-S/1507 1509, Rio de Janeiro,
Brazil

MOSCOW—Stewart Ramsey,
Kutuzovsky Prospekt 19, Apt. 28-29,
Moscow, USSR

TOKYO—Richard Halloran, Charles Cohen,
John Yamaguchi, Toranomon Sangyo
Bldg., 1 Kotohiracho Shiba, Minato-Ku,
Tokyo, Japan

CIRCULATION MANAGER

Hugh J. Quinn (2310)

C. C. RANDOLPH, Publisher (2016)

electronics

A MCGRAW-HILL WEEKLY 75 CENTS

ASSOCIATIVE MEMORY. Matrix of organic thin-film diodes made by vacuum evaporation of copper phthalocyanine on metal may prove economic for large-scale associative memories. RCA Labs has already built an experimental unit on 4×4 cards. *This is one of many significant advances in computer memory technology.* See p 35

COVER

CONDUCTIVE MEMORY. Erasable thin-film memory looks promising for new kinds of displays and may provide meshless storage tubes, too. *Other new components reported last week: a high-sensitivity, high-resolution vidicon, gallium-arsenide devices for microwave generation and for high infrared output*

10

SYNCOM TIME DELAY. To facilitate Syncom's use for voice communications, a proposed standard for time delay should be relaxed, says the project director. *We used Syncom to interview him last week, and the delay didn't bother us*

11

UNJAMMABLE COMMUNICATIONS? Dipole belts in orbit have shown their value for strategic military communications, according to West Ford's director. *He urges operational use, says the belts won't interfere with astronomy*

26

WHAT'S NEW IN COMPUTER MEMORIES? Memory incompatibility has been one of the stumbling blocks on the road to an all-microelectronic computer. Several recent developments seem to point the way toward eventual realization of high speed, large capacity, small size and low cost. *They include laminated ferrites, thin films, cryoelectric devices and organic diodes.*

By M. F. Wolff 35

BEAM PLASMA AMPLIFIER: NEW MILLIMETER WAVE DEVICE. To tap the potential of the millimeter wave spectrum, new devices capable of generating substantial power at these frequencies will be required. Most promising is a device in which an electron beam passes through a plasma, exciting oscillations. *Power gain of 40 db at 38 Gc has been reported.*

By G. A. Swartz, RCA Labs 40

CAN RFI CONTROL PREVENT WEAPONS FAILURES? Radio frequency interference can impair the reliability of weapons by premature actuation of the explosive mechanism. It behooves weapons system designers to know the r-f properties of solid-state components used in d-c control circuits. *Proper use of a pnpn switch, for instance, dictates specific precautions.*

By R. J. Sanford, USNOL 43

Published weekly, with Electronics Buyers' Guide as part of the subscription, by McGraw-Hill Publishing Company, Inc. Founder: James H. McGraw (1860-1948).

Title ® registered U.S. Patent Office; © copyright 1963 by McGraw-Hill Publishing Co., Inc. All rights reserved, including the right to reproduce the contents of this publication, in whole or in part.

Executive, editorial, circulation and advertising offices: McGraw-Hill Building, 330 West 42nd Street, New York, N. Y., 10036. Telephone Area Code 212 971-3333. Teletype TWX N. Y. 212-640-4646. Cable McGrawhill, N. Y. PRINTED IN ALBANY, N. Y.; second class postage paid at Albany, N. Y.

OFFICERS OF THE PUBLICATIONS DIVISION: Shelton Fisher, President; Vice Presidents: Joseph H. Allen, Operations; John R. Callahan, Editorial; Ervin E. DeGraff, Circulation; Donald C. McGraw, Jr., Advertising Sales; Angelo R. Venezian, Marketing.

OFFICERS OF THE CORPORATION: Donald C. McGraw, President; Hugh J. Kelly, Harry L. Waddell, L. Keith Goodrich, Executive Vice Presidents; John L. McGraw, Treasurer; John J. Cooke, Vice President and Secretary.

Subscriptions are solicited only from those actively engaged in the field of the publication. Position and company connection must be indicated on orders. Subscription rates: United States and Possessions and Canada, \$6.00 one year, \$9.00 two years, \$12.00 three years. All other countries \$20.00 one year. Single copies, United States and Possessions and Canada 75¢. Single copies all other countries \$1.50.

THE PUBLISHER, UPON WRITTEN REQUEST TO OUR NEW YORK OFFICE FROM ANY SUBSCRIBER, AGREES TO REFUND THAT PART OF THE SUBSCRIPTION PRICE APPLYING TO COPIES NOT YET MAILED.

Subscribers: Please send change of address notices, subscription orders or complaints to Fulfillment Manager, Electronics, at the address below. Change of address notices should provide old as well as new address, including postal zone number if any. If possible, attach address label from recent issue. Allow one month for change to become effective.

Postmaster: Please send Form 3579 to Fulfillment Manager, Electronics, P. O. Box 430, Hightstown, New Jersey, 08520.



Audited Paid Circulation

Contents continued

ANALOG RATIO COMPUTER USES HALL MULTIPLIER.

Hall effect devices can be quite useful in analog computing functions. A unique ratio computer, consisting of an InSb plate in combination with an electro-optic transducer has been devised. *Optics provides high input-output isolation.*

By H. H. Wieder, USNOL 46

USING VARACTORS TO EXTEND FREQUENCY CONTROL RANGE.

Most afc circuits in transistorized receivers perform well only within narrow limits when using reactance-type control of the local oscillator. An unusual varactor circuit provides an 11-Mc afc band with only 1 volt input. *The technique yields improved performance with fewer components.*

By T. P. Prouty, Consultant 48

TRACKING GEMINI.

Installation of the latest ground-support equipment began this week at Carnarvon, Australia. *When completed, the station will be the first able to handle both Gemini flights and orbiting scientific observatories*

54

OCEANOGRAPHY.

Understanding and exploiting the oceans will require so much materials and equipment development that space programs may be reduced to secondary importance. *That's what an admiral told the National Electronics Conference last week*

56

DEPARTMENTS

Crosstalk. Slowdown in Space?	5
Comment. Instruction Manuals. Transistor Symbols	6
Electronics Newsletter	17
Meetings Ahead. National Relay Conference	18
Washington This Week. Administration Considers "Early Warning System" to Alert Industry to Procurement Shifts	20
Research and Development. Designing Zero-Drift D-C Differential Amplifiers	66
Components and Materials. New Package for Micro-transistor	75
Production Techniques. Versatile Winder Reduces Cost	80
New Products. Counter Makes Practical Measurements	87
Literature of the Week	97
People and Plants. ITT Plans New Plant	100
Index to Advertisers	107

**New Cast Mica Capacitors
Provide Major Change in
High Power Mica Design**

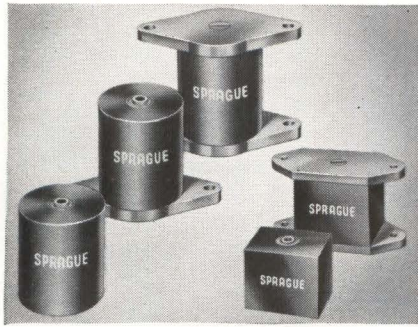

The first major change in high power transmitter-type Mica capacitors in over 25 years has resulted in a modern, miniaturized mica capacitor with liberal new design possibilities.

Designed and developed by the Sprague Electric Mica Capacitors are approximately 30% smaller in size and weight than old-fashioned, bulky, potted assemblies.

Encapsulated in high-temperature epoxy resin by a patented process, these unique capacitors will operate at temperatures to 125 C without derating—greatly in excess of the 70 C or 85 C limits of conventional capacitors. This exclusive construction also provides superior thermal conductivity—far better than with porcelain—enabling these capacitors to carry higher r-f currents.

Unlike older units with fragile insulating housings, Sprague Cast Mica Capacitors are rugged. Their tough epoxy resin encapsulation, with improved hermetic seals, eliminates use of potting waxes which tend to melt and cause damage to electron tubes and other components.

Sprague Cast Mica Capacitors, designed not only to meet but exceed MIL Specifications, are made in both the familiar cylindrical as well as a new rectangular shape, with female threaded terminals on opposite ends.

Although smaller in size than conventional capacitors, Cast Micas can be procured—for interchangeability—with one or two aluminum plates having the same center-to-center mounting holes as standard types. Where space is critical, they may also be mounted or stacked without plates by means of dual-ended headless screws.

For application engineering assistance write to Mica Capacitor Section, Field Engineering Dept. For complete technical data write for Engineering Bulletins 1230 and 1240 to Technical Literature Service, Sprague Electric Co., 35 Marshall St., North Adams, Massachusetts.

45C-142-63

CIRCLE 200 ON READER SERVICE CARD
electronics November 8, 1963



**HYREL® IF Filters, developed and qualified
for use on the Minuteman Program,
are NOW available for YOUR projects!**

For the lowest failure rate which the present state of the art permits, plan and build with today's most reliable EMI filters . . . Sprague HYREL IF Filters. Data thus far accumulated indicates a failure rate of .012%/1000 hours. Calculated failure rates are based on more than 25,000,000 unit-hours of life test on basic filter elements.

HYREL IF Filters are designed and manufactured by the same high reliability techniques which gained acceptance and validation for Sprague's famous HYREL capacitor lines.

Application engineering assistance is available to you from strategically located Sprague Filter Development Centers in North Adams, Mass., Vandalia, Ohio, and Los Angeles, Calif.

For further information on Sprague HYREL IF Filters, write to Technical Literature Service, Sprague Electric Company, 35 Marshall Street, North Adams, Massachusetts.

SPRAGUE EMI PRODUCTS AND SERVICES

INTERFERENCE FILTERS AND CAPACITORS
WAVE AND TELEMETRY FILTERS
EMI SYSTEMS ENGINEERING
EMI TEST FACILITIES
COMPONENT ENVIRONMENTAL TEST FACILITIES

45F-131-63 E1



CIRCLE 3 ON READER SERVICE CARD 3

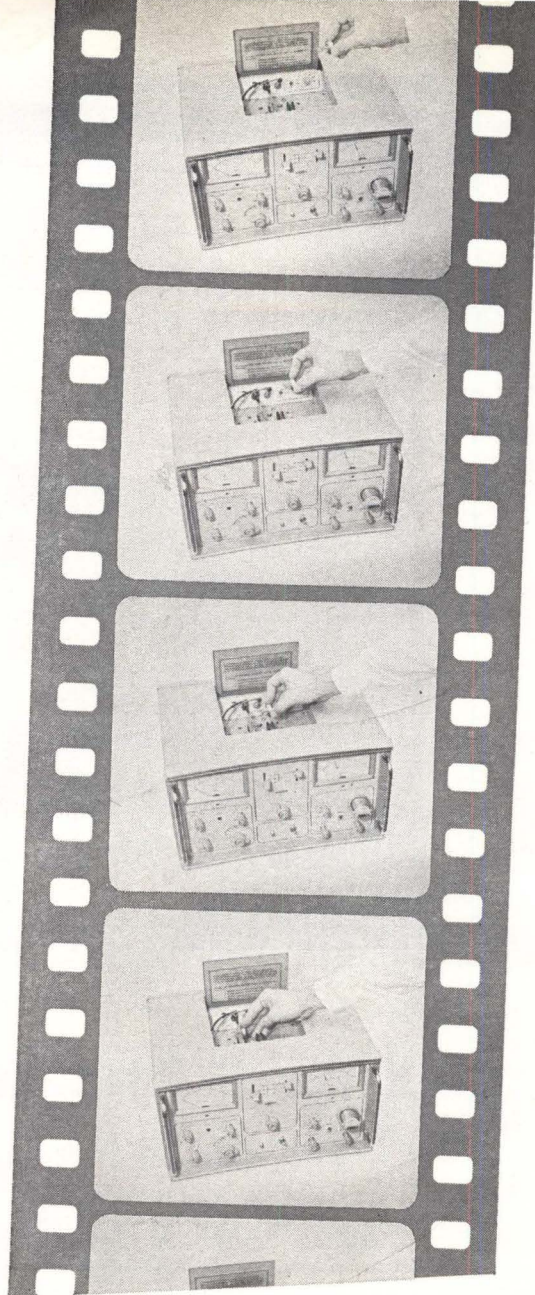

Screen Test

Here's how you screen out a 4F transistor before it can abort a rocket, or bug the operation of a big computer. You preview its performance in a Sierra Model 500A Power Transistor Tester.

Mounting your transistor, rectifier, diode, SCR or zener diode in 500A's unique Heat-Sink Well sets the stage for the test. Then you feed it a bridge mix of live circuit conditions: Power levels to 300 v. Peak currents to 50 amps.

Now you really turn on the heat. 500A's precision Heat-Sink Temperature Control lets you test transistor parameters at settings of Ambient, 40°C, 50°C, 60°C, 70°C, and 80°C.

At this stage, 500A has stripped your transistor of

all its secrets. You read it like an open script. Transistor Beta (0-50, 0-500) shows up on a digital dial. Accurate front-panel Voltmeter and I_C Meter displays reveal saturation resistance, leakage current, and collector breakdown voltage. With this handsome profile of data at hand, there's little chance of passing along bad transistors or throwing out the good ones.

Program notes on the Model 500A Power Transistor Tester can be found in the product bulletin, available from the address below. Or, you can arrange for a sneak preview of the instrument itself through your nearest Sierra sales representative.

SIERRA ELECTRONIC DIV.
OF
PHILCO
A SUBSIDIARY OF *Ford Motor Company*

Sierra Electronic Division/ 3875 Bohannon Drive/Menlo Park, California

Slowdown in Space?

IN OUR CROSSTALK of July 26 we expressed the fear that mounting opposition to Project Apollo would force a slowdown. Recent events are in the process of bearing this out.

One ingredient in the trend toward a slowdown was created by the Administration's proposal in September for a joint U. S.-Soviet moon expedition. The confusion following this announcement has provided an ideal opportunity for long-time opponents to wield their axes.

One result has been a budget-cutter's field day. NASA originally requested \$5.7 billion for fiscal 1964 and the House finally voted \$5.1 billion. Even more substantial cuts have been proposed which, fortunately, have so far been defeated. But if the present aura of confusion and misinformation about the goals and possible benefits of Project Apollo is not dispelled, the program is headed for more trouble. There could be a stretchout past the original 1970 target date. According to NASA Administrator James E. Webb, such a delay would, among other things, add an additional \$2-to-\$3 billion to the program's cost.

Senator Fulbright's recent attack on the Apollo program is an example of the determined opposition space agency officials face. In a speech, just before the Senate Appropriations Committee was to consider the space budget, he called for cutting the budget and using the resulting funds for education and employment, saying that "it is not at all clear the Russians are trying to beat us to the moon."

Such a proposal beclouds the issue. Why can education and employment needs be met only with funds taken from the space budget? This is obviously not the only available source of money, and to offer a choice between the two areas of endeavor serves only to confuse the public.

Moreover, we should not allow our program to fluctuate according to daily readings of Soviet intentions. Premier Khrushchev's recent statement that at present they do not plan cosmonaut flights to the moon could have been made to get us to slow down our effort. (It was only two weeks earlier that Soviet Ambassador Anatoli Dobrynin flatly announced the Soviet Union had embarked on a program to land men on the moon by 1970.)

And even if the moon is not the next Soviet objective, we doubt very much that the overall Soviet space effort is being relaxed. Khrushchev's announcement may be only a restatement of the sequence of space goals. In one sense, the Soviets may not be racing the U. S. to put a man on the moon . . . their next goal might be to put a manned laboratory in orbit around the earth. The Soviets have often proposed such a station as the first step in a journey to the moon. After this stage is achieved, Khrushchev could easily announce intentions to continue to the moon.

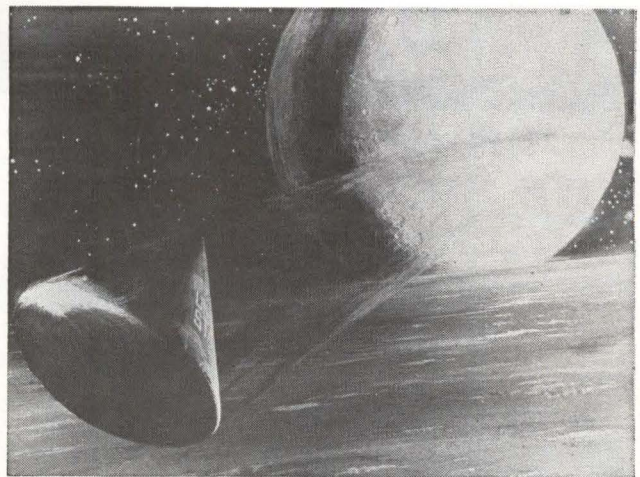

The technological advances necessary to build a manned orbital space station are, in many cases, the same as those needed in the Gemini and Apollo programs: rendezvous, docking, astronaut transfer in space.

[These capabilities, which we do not now have, are presumably the goal of the maneuverable spacecraft the Soviets launched last week.]

The space program is no less vital today than it was in May 1961 when the President, in what might go down in history as one of his more important speeches, called the program necessary for our prestige and security.

We believe a maximum space effort is important to our national interests and security, just as the conquest of new environments in the past has always proven to be. In fact the only valid objection we can see to the program would be if it is in some way conducted at the expense of a military space program. While this fear has been expressed by several congressmen there is certainly no reason why a military program must be so sacrificed.

The recent DOD-NASA agreement to cooperate in developing a manned orbital space station seems to be a step forward in a good direction. Proof will come, of course, if and when the agreement is implemented.

The U. S. has a long, expensive record of taking action and then cancelling it or slowing down. Will the same thing happen here? Must we wait for some Pearl Harbor in space before we realize its importance to us?

The pace of history is quickening. In the days past there was always time to catch up, to pick up the discarded ideas of the Billy Mitchells. Can we be so confident about the future? We have publicly accepted the Soviet challenge. Will our slackening be, in the words of Senator Clinton Anderson, branded as another example of a great nation which has passed its prime and is too effete to endure even nominal belt tightening in order to remain the lead nation in the free world?

now
available
for
immediate
delivery:

JERROLD RF SWEEP EQUIPMENT ...the industry's finest!



**Model 900B
Super Sweep Generator**

Wide plus narrow band in one versatile instrument. Handles all IF, VHF, UHF sweep requirements. Sweep widths from 10kc to 400mc. Frequency range from 500kc to 1,200mc. Built-in crystal-controlled harmonic markers, dc or ac scope preamplifier, precision attenuator. **\$1,980.00**



**Model LA-5100
rf Log Amplifier**

Accurate within ± 1 db over 80db dynamic range. Frequency range 500kc to 100mc. Lets you make exact measurements of attenuation in networks, filters, amplifiers with dynamic ranges down to 85 db. Total rf response displayed in precise log ratio on standard dc-coupled scope. **\$795.00**

Model 900A Wide-Band Sweeper

Sweep widths from 100kc to 400mc. Frequency range from 500kc to 1,200mc. **\$1,260.00**

Model 707 Ultra-Flat Sweeper

Flatness of ± 0.05 db in highest single octave. Plug-in oscillator heads. **\$840.00**

All for immediate delivery. Prices f.o.b. Philadelphia. Write for complete technical data on these and other Jerrold rf test instruments.

JERROLD
ELECTRONICS

Industrial Products
Division,
Philadelphia 32, Pa.

A subsidiary of THE JERROLD CORPORATION

COMMENT

INSTRUCTION MANUALS

We agree wholeheartedly with your man in Japan (*Crosstalk*, p 5, Oct. 18) that good manuals can mean the life or death of a purchase order when selling against competitive brands.

Yet look how few manufacturers regard their instruction manuals as being as much a part of their product as the actual hardware is!

One of the basic troubles is that management tends to look upon an industrial writer as some inferior breed, as a sort of engineer who didn't quite make it. So they are loath to set up a communications department staffed by these halfway-engineers.

The result is that what writing gets done is done by an engineer who can be persuaded, or bullied, into spending a couple of hours now and then cranking out words. And I imagine that your editors are pretty well aware that engineers are not among the world's best writers.

There are available, of course, highly competent writers who can understand, and write about, even the most abstruse topics. But they look for, and get, salaries comparable with top engineering ones. And unfortunately, it's not too easy to tell a good writer from a poor one, without first having the poor writer wreck the communications program . . .

MICHAEL PERRY

Industrial Communications Associates
New York, New York

TRANSISTORS AND TUBES: SYMBOLS AND CIRCLES

Commenting on the correspondence on Transistor Symbols (p 6, Sept. 6, Sept. 13, Sept. 27, Oct. 4):

Graphical symbols for electron tubes are drawn with a circular envelope symbol and, as an obvious sequel, crystal detector diodes and transistors have been so drawn in the U. S. However, the American practice in the power field was to show semiconductor rectifiers without an enclosure.

This raised questions as to proper practices for a combined standard for graphical symbols for electronics, power and communications (ASA Y 32.2). At a standardizing committee meeting at this time, the point was brought out that the circle had become more generalized than that of an enclosure, and by then had become a stage symbol; that is, it represented potential amplification, mixing, X-ray generation, etc. As such it helps in circuit tracing, and there is no reason to distinguish between electron tubes and semiconductor devices. (A television receiver schematic without any device envelope symbols would be explicit but hard to analyze.) However, the American Standard properly reflects the practice in the power field of drawing semiconductor rectifiers without the enclosure symbol.

Incidentally, any concept that the circle (or the later elongated or partial outlines) is necessary to indicate the vacuum or gas is probably now only historical. The American Standard recognizes that some continue to detail the "gas dot" and others omit it for gas tubes as being subject to various and possibly wrong interpretations in accordance with the background of the individual.

ALAN C. ROCKWOOD

Newton, Massachusetts

• In the latest issue of Y32.2, American Standard on Graphical Symbols for Electrical and Electronic Diagrams, Item 35 says in part that the general envelope symbol identifies the envelope or enclosure regardless of evacuation or pressure. When used with electron-tube component symbols, the general envelope symbol indicates a vacuum enclosure unless otherwise specified. Furthermore, Item 73.10B indicates that in semiconductors the envelope symbol may be omitted if no confusion would arise or if none of the elements is connected to the envelope.

Under these circumstances, it would seem that the circle is indeed an envelope symbol rather than a recognition symbol for active devices. This view is borne out by the fact that passive devices such as semiconductor diodes, Hall generators, certain relays and explosive squibs, also use the envelope symbol.

NANOSECOND SWITCHING

Regretfully, I notice the inadvertent omission of the acknowledgment section of the paper entitled, "A Key to Nanosecond Switching: Combining Tunnel and Charge-Storage Diodes" (p 42, Oct. 18).

I wish to point out that a considerable amount of circuit design and test was done by T. M. LoCasale and J. E. Stone. With their effort, the concept and the circuit described in the above article were reduced to practice.

PAUL CHOW

Univac Division of Sperry Rand Corporation
Blue Bell, Pennsylvania

Performance advantages of a better broadband instrumentation tape

— in pre-detection, pulse code modulation, and other critical high-frequency instrumentation recording applications.

The shortest wavelengths in broadband recording are less than five times those of visible light. To magnetically record and reproduce such wavelengths requires a tape surface smoothness approaching that of an optical surface.

Memorex Type 62 Broadband Tapes look smooth to the eye, but what is more important, they look smooth even to the electron microscope — competitive products do not. They are twice as smooth as the best competitive tape, and this near-perfect surface is produced unerringly over the miles of tape on each roll.

Electron microphotographs of surfaces of Memorex tape and competitive product at the same magnification (6000x).



MEMOREX TAPE

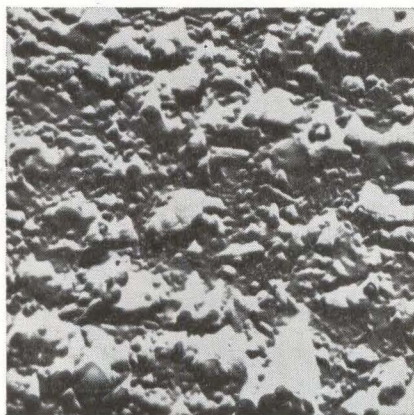

LEADING COMPETITIVE TAPE

Users of Memorex Type 62 Broadband Tapes receive important performance advantages, including:

as much as 6 db more response at the highest frequency — the result of the ultra-smooth surface;

as much as 3 db greater undistorted output — the result of a coating more densely packed with well-oriented particles of oxide;

more than 3 db higher signal-to-noise ratio — the result of extreme uniformity of distribution of particles within the coating;

no measurable increase in dropouts, even after 100 plays — the result of scrupulous cleanliness and care in manufacturing and the use of a durable, electrically conductive coating which will not shed oxide.

These improvements in performance were measured on a Mincom CM 100. Still greater improvements can be expected when using recorders with more extended bandwidth.

electronics November 8, 1963

Memorex broadband tapes offer you a wider choice of coating thickness to suit your recording application:

62J (370 μ inch coating) — for high output

62K (270 μ inch coating) — a new intermediate coating thickness

62L (170 μ inch coating) — the thinnest coating offered to date, giving you 25% more playing time per roll.

Digital or pulse recording applications — The smooth, thin coatings of Type 62 Broadband Tapes will provide the higher resolution and greater pulse packing densities required by advanced recording systems.

Memorex manufactures precision magnetic tapes for instrumentation and computer use, including Type 22 Computer Tape (tested and certified at 800 and 556 bpi), Type 33 Instrumentation Tape, Type 42 High Resolution Tape, and Type 62 Broadband Tape. To obtain complete technical data sheets, write to Memorex Corporation:

1182 Shulman Avenue / Santa Clara, Calif.

Important New Report for all Instrumentation Tape Users

MEMOREX Monograph #2, titled "Head Wear Considerations in Magnetic Tape Recording," available free on request. Write MEMOREX at address above.

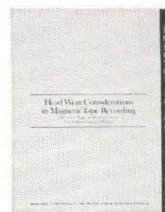

**MEMOREX
CORPORATION**
PRECISION MAGNETIC TAPE

CIRCLE 7 ON READER SERVICE CARD

7

WHAT'RE YOU DOING TOMORROW?...NEXT

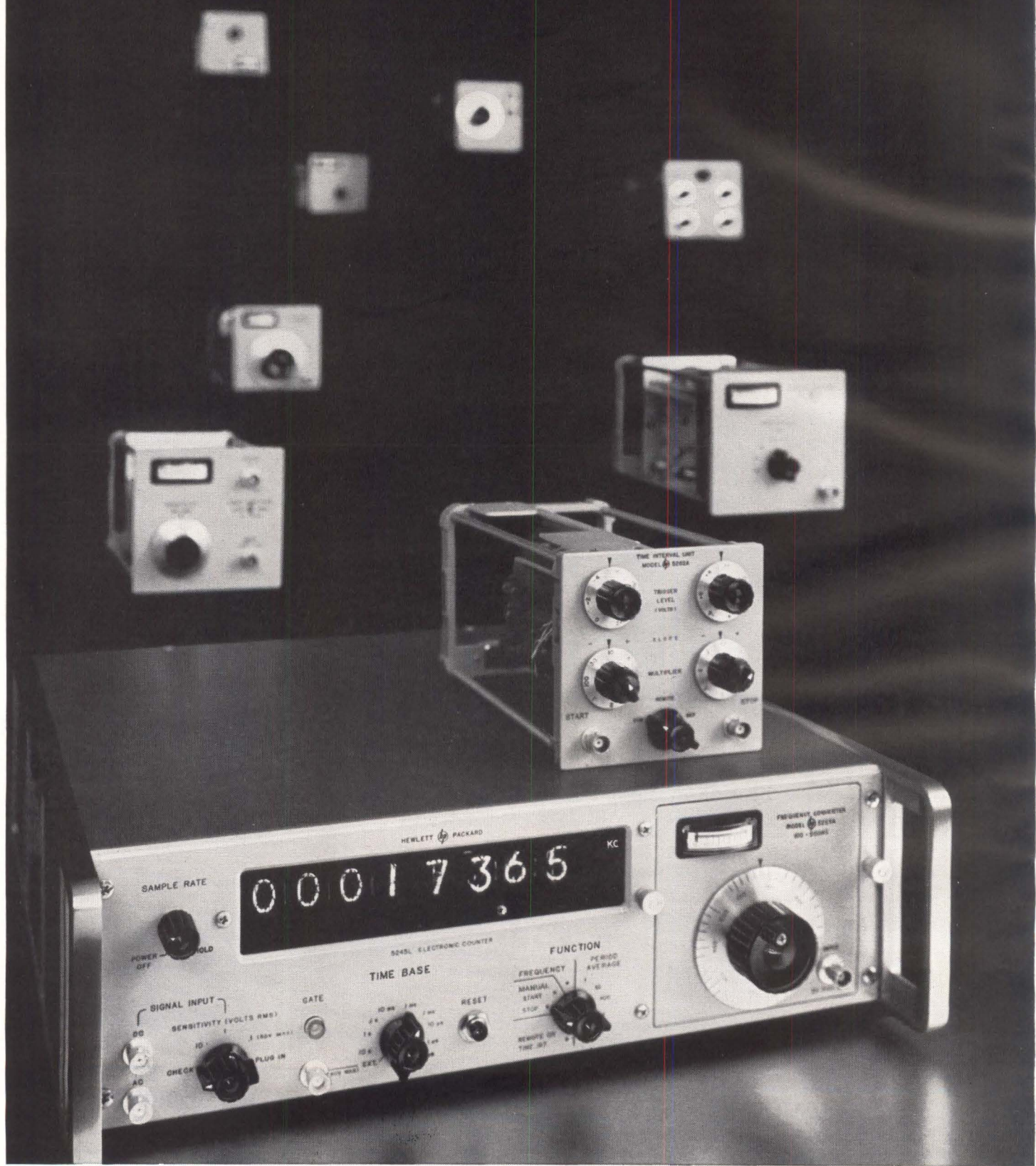

WEEK?....A YEAR FROM TODAY?....1965?....1970

Make a date with the hp 5245L Universal Electronic Counter...it'll be working for you, whatever your measuring requirement!

MANY PLUG-INS AVAILABLE NOW
MORE TO COME

Measure to 500 mc today, to 2500 mc tomorrow with the versatile hp 5245L and today's widest array of precision counter plug-ins.

The solid state 5245L Counter and its plug-in units let you custom-design the instrument to your specific measuring need by adding plug-ins when, but not until you need them. As your requirements change, you can easily and economically change the 5245L to meet them.

The 5245L measures frequency, period, multiple period average, ratio and multiples of ratio. The basic counter, without plug-ins, offers a maximum counting rate of 50 mc with 8-digit resolution. With just one plug-in you can measure from 50 to 512 mc.

Other plug-ins include a video amplifier which increases the 5245L sensitivity to 1 mv rms and a time interval unit which enables the counter to measure time interval from 1 μ sec to 10^8 sec. More plug-ins, including one to extend the capability to 2500 mc, are in final development. All retain the basic accuracy of the counter.

SPECIFICATIONS

FREQUENCY MEASUREMENTS

Range: 0 to 50 mc
Gate time: 1 μ sec to 10 sec in decade steps
Accuracy: ± 1 count \pm time base accuracy
Reads in: kc or mc, with positioned decimal

SCALING

Range: 0 to 50 mc
Factor: by decades up to 10^9

PERIOD AVERAGE MEASUREMENTS

Range: single period, 0 to 1 mc; multiple period, 0 to 300 kc
Periods averaged: 1 period to 10^5 periods in decade steps
Accuracy: ± 1 count \pm time base accuracy \pm trigger error
Frequency counted: single period, 10^7 to 1 cps in decade steps; multiple period, 10^7 to $\frac{1}{10}$ the number of periods averaged, cps in decade steps
Reads in: sec, msec, μ sec with positioned decimal

RATIO MEASUREMENTS

Displays: (f_1/f_2) times period multiplier
Range: f_1 , 0 to 50 mc; f_2 , 0 to 1 mc in single period, 0 to 300 kc in multiple period; periods averaged 1 to 10^5 in decade steps
Accuracy: ± 1 count of $f_1 \pm$ trigger error of f_2

TIME BASE

Frequency (internal): 1 mc
Stability: aging rate: less than ± 3 parts in 10^9 per day; as a function of temperature, less than ± 2 parts in $10^{10}/^\circ\text{C}$, -20°C to $+55^\circ\text{C}$; as a function of line voltage, less than ± 5 parts in 10^{10} for $\pm 10\%$ change in line voltage
short term: less than ± 5 parts in 10^{10} p-p with measurement averaging time of 1 sec under constant environmental and line voltage conditions

With still more plug-ins on the way, the 5245L will never lose its usefulness . . . in fact will become more useful as your measuring task becomes more demanding and you add plug-ins to the one basic counter.

Beyond this built-in flexibility, the 5245L offers these unparalleled advantages . . . yours to match against any comparable instrument:

- Direct counting to 50 mc
- Time base stability better than 3 parts in 10^9 /day
- Display storage for continuous readout
- Sample rate, independent of gate time, adjustable 0.2 to 5 sec
- Readout in close-spaced rectangular Nixie tubes
- Four-line BCD output for systems, recorder use
- Remote programming capability
- Plug-in circuit construction for easy maintenance
- Compact, stackable cabinet only $5\frac{1}{4}$ " high

The specifications tell the story briefly. Check them out for a partial indication of the superior performance offered by the 5245L. Then call your Hewlett-Packard field sales office for a demonstration on your bench.

Start using the 5245L today . . . and you'll be using it for a long time to come.

GENERAL

Registration: 8 digits in-line with Nixie tubes
Sample rate: 0.2 sec to 5 sec, independent of gate time
Operating temperature: -20°C to $+65^\circ\text{C}$
Output: 4-line BCD
Remote operation: all functions programmable from front panel controls except "sample rate" and sensitivity, may be programmed remotely
Size: $19" \times 5\frac{1}{4}" \times 18\frac{3}{8}"$ deep
Price: \$3250

PLUS THESE PLUG-INS AVAILABLE NOW:

- hp 5253B Frequency Converter: extends range of 5245L to 512 mc, \$500
- hp 5261A Video Amplifier: increases sensitivity of 5245L to 1 mv rms, 10 cps to 50 mc, \$325
- hp 5262A Time Interval Unit: converts 5245L to time interval counter with a resolution of 0.1 μ sec, \$300

Data subject to change without notice. Prices f.o.b. factory.

**HEWLETT
PACKARD
COMPANY**



1501 Page Mill Rd., Palo Alto, Calif., (415) 326-7000. Sales and service representatives in principal areas. Europe, Hewlett-Packard S.A., 54 Route des Acacias, Geneva, Switzerland; Canada, Hewlett-Packard (Canada) Ltd., 8270 Mayrand St., Montreal, Que.

8623



SEC VIDICON operates in bright light or in near-dark

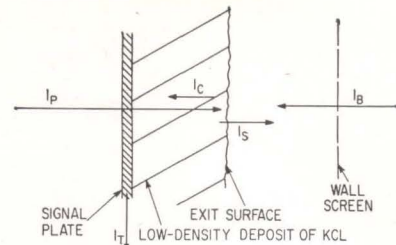
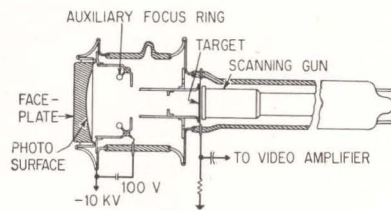

TARGET operation for SEC vidicon is shown schematically

CROSS SECTION of SEC vidicon. Developers say resolution is inherently high

Conductive Memory Points to New

Erasable thin-film memory may take mesh out of storage tube

By **MICHAEL F. WOLFF**
Senior Associate Editor

WASHINGTON — New types of storage and display devices may result from phenomenon reported at the IEEE Electron Devices Meeting last week by N. H. Lehrer and R. D. Ketchpel, of Hughes Research Labs. They described an erasable thin-film conductive memory that makes use of a reversible sustained electron bombardment-induced conductivity (SEBIC) effect in cadmium-sulfide films.

The structure consists of two metal electrodes between which is a CdS dielectric layer and a barrier layer of doped CdS. Exposure to light or electron beams reduces barrier height, increasing conductivity by 2 to 4 orders of magnitude. The conductivity remains for as long as 30 minutes after the beam is removed, but can be erased when the electric field that has been applied between the two opposing faces of the dielectric film is momentarily reversed. The film is then restored to its preexcited value in milliseconds.

A high-energy electron beam can increase conductivity in microseconds; resolution, apparently limited by film thickness, might be thousands of lines per inch.

Meshless Storage Tube—One possible application of this ability to store a two-dimensional conductivity pattern by beam scanning is a high-resolution, meshless storage tube. This would use an electro-luminescent (EL) layer adjacent to the SEBIC layer; SEBIC layer is covered by a thin metal electrode facing the electron gun and the EL layer is covered with a transparent electrode adjacent to the faceplate. The impedance of the layers are chosen so that in the unstored condition the maximum voltage is across the SEBIC layer and the EL layer is dark. In scanning, the electron gun's grid is modulated according to the information to be displayed and stored. Where the beam strikes the SEBIC material, the EL layer will light and store the pattern.

To realize this application, as well as others such as high-sensitivity camera tubes, scan converter tubes and computer storage devices, high-resolution readout techniques must be developed. Hughes is now working on these.

SEC Vidicon—Details of Westinghouse Electric's new tv-camera tube, the secondary electron conduction vidicon (*ELECTRONICS*, p 17, Nov. 1) were described by G. W. Goetze and A. H. Boerio. The tube (see illustrations) uses an SEC target that has an aluminum layer covered with a low-density layer of potassium chloride. The target is polarized by applying a position voltage on the aluminum layer and stabilizing the

KCl at ground potentials.

Electrons in the 10-kev-range penetrate the aluminum electrode and dissipate a large fraction of their initial energy within the KCl, where they create conduction electrons and free secondary electrons. A fraction of the free electrons are collected by the wall screen; some flow through the porous layer to the backplate.

Because the SEC target uses free electrons for multiplication and charge storage, the conduction due to electrons in the conduction band is avoided and it is possible to obtain a high speed of response. Since the image amplification occurs entirely within the thin membrane, it is an inherently high-resolution process. It was claimed that 1,000 tv lines per inch were resolved by an experimental tube.

Microwave Devices—New data on direct generation of microwaves in bulk semiconductors (*ELECTRONICS*, p 24, June 21) were reported by J. B. Gunn, of IBM's Watson Research Center. Oscillations as high as 6.5 Gc have been observed in gallium arsenide when pulsed electric fields are applied through ohmic contacts. A similar effect has been observed in indium phosphide.

By improving heat dissipation in the gallium-arsenide device, the duty cycle has been raised from 0.02 percent to 14 percent, so Gunn is hopeful of achieving c-w operation. Peak powers of 3.75 watts at 800 Mc, average powers of 3 mw at 1.2 Gc, pulse lengths of 5 microseconds and

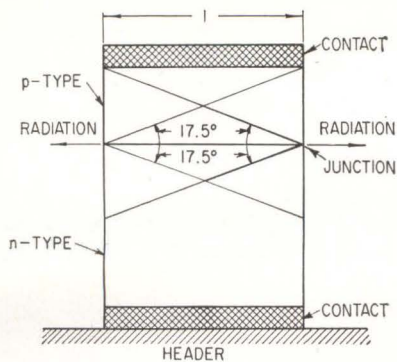

(A)

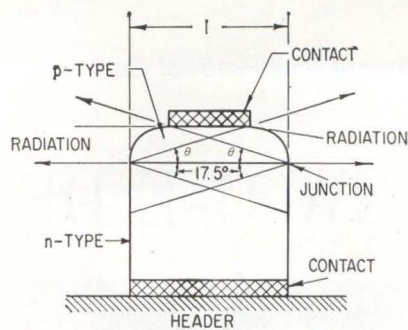

(B)

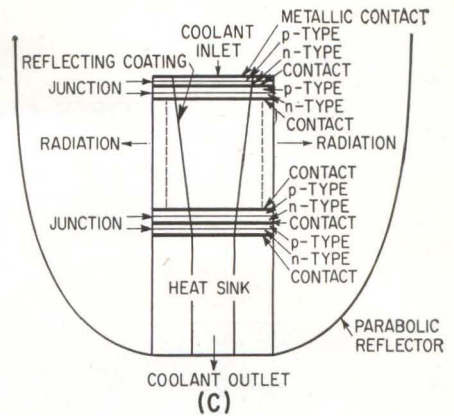

(C)

NEW CONFIGURATIONS for gallium-arsenide diodes: edge-emission design (A) for d-c or high average pulse power; spherical shaping (B) to multiply efficiency; series stacking (C) for high peak power

Displays

efficiencies of 1.9 percent have been obtained.

The device has been used with a tuned cavity in a superregenerative receiver; power gain exceeded 1,000 with $\frac{1}{2}$ -mw input at 1,200 Mc. If it goes c-w, most likely application seems to be as local oscillator for microwave receivers.

New geometries for raising power output of gallium-arsenide infrared diodes were reported by R. B. Liebert, B. V. Keshavan, M. F. Lamorte and L. J. West, of RCA. By using emission from the periphery rather than just the *p* and *n* regions, pulse-power outputs can go over 1 kw with total semiconductor area less than 20 sq cm. Average output can exceed 10 w. The resulting diodes compete with tungsten lamps in efficiency and power output, it

was reported. Similar things have been done with laser diodes.

Some configurations are illustrated above. Emission from the entire periphery of a single junction is suitable for d-c or high average power under pulse conditions. Edge emission, plus spherical shaping can increase efficiency 20 to 40 times over ordinary diodes, it was reported. By stacking in series, configurations suitable for high peak powers may be obtained.

Syncom's Time Delay: No Great Problem

By **JOEL STRASSEF**
Assistant Editor

NEW YORK—In an interview conducted last week via the Syncom II communications satellite, Russ Burke, NASA's project director for Syncom, told *ELECTRONICS* that a proposed international standard for time delay in one-way h-f propagation would probably have to be broadened to permit synchronous-satellite voice communications.

Burke was referring to a proposal pending before the International Consultative Committee on Telegraphy and Telephony (CCITT).

Document G.114, proposed at the CCITT Study Group XVI meeting in Geneva June 24 to 28, would impose a maximum time delay of 0.150 sec, and permit a delay of 0.325 sec for a "poorer circuit."

The experiment in which *ELECTRONICS* participated last week carried a conversation over a 50,000-mile range. The delay encountered was 0.3 sec (*ELECTRONICS*, p 17, Nov. 1). But it was observed during the interview that the time delay, while noticeable, did not in any way impede the conversation. Only when we performed a countdown test with Burke did a delay and the resulting echo become apparent. There was one echo suppressor in the circuit.

The experimental call was initiated by Burke in his office at NASA headquarters in Washington, then carried by four-wire ground line to the SYNARC transmitting station near Goddard Space Flight Center in Greenbelt, Md. Signals were beamed at 7,360 Mc from Goddard to Syncom II in orbit 22,300 miles over Brazil. Syncom retransmitted the call at 1,815 Mc to the SYNCLKH station at Lakehurst, N. J.

The signals then traveled by ground line back to Goddard and from there by regular telephone line to *ELECTRONICS*' editorial offices.

Delay Adds Up—One of the most significant problems facing synchronous satellites now is a way to cope with the time delay caused by the satellite's distance from the earth (*ELECTRONICS*, p 18, Aug. 9).

On one 22,300-mile bounce, or 25,000 miles at the edge of the satellite's range, the delay for the 50,000-mile roundtrip is 0.3 sec.

However, if two satellites were required to reach a point halfway around the earth, the one-way delay would be 0.6 sec. In short, a person asking a question would have to wait a full 1.2 sec for his reply to reach him from a point opposite on the globe. This does not include natural pauses in conversation and delays from connecting ground lines.



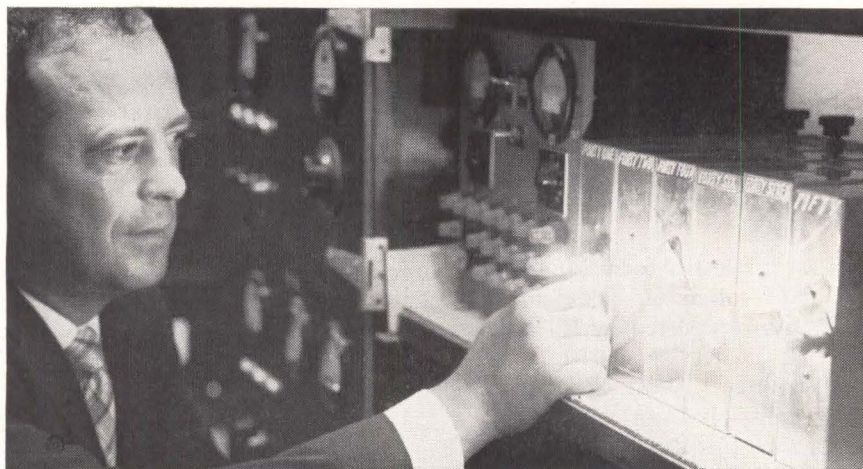

TIPS (Technical and Product Service)

5 NEW G-E DEVELOPMENTS

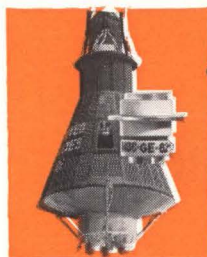

Torture tests show why G-E ceramic tubes flew with Mercury



 Even a 1,200% overload doesn't faze this pea-sized powerhouse. Ever since last February, the people in one of our labs have been trying to torture to death a batch of type 7486 ceramic tubes—like those used in Mercury capsules. But these rugged 7486's keep right on delivering 4 full watts of 485-megacycle CW output.

Actually, the maximum operational *rating* for the 7486 is only 150 plate volts, 8 milliamperes plate current, and 2 milliamperes grid current. However, month after month the 7486's under test have taken a *continuous* 350 volts, 20 ma. plate and 8 ma. grid current. And one tough little specimen is still going strong after 68 days of 50 ma. plate and 20 ma. grid current.

Like all G-E ceramic tubes, the 7486 also assures superior resistance to shock, high temperatures, and nuclear radiation. It can take steady-state radiation above 10^{11} roentgens and 10^{19} NVT.

The Y1223—a tiny developmental triode that delivers over 40 watts at 400 megacycles.

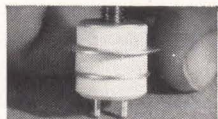

All this out of a one-half cubic inch tube! In lab tests, one Y1223 was driven to deliver 58 watts at 400 mc. before the anode rod in a coaxial amplifier turned blue with heat and forced a power drop-off. It's a good bet that Y1223's and other ceramic tubes will find many missile and defense applications. (Perhaps in one of *your* upcoming new designs.)

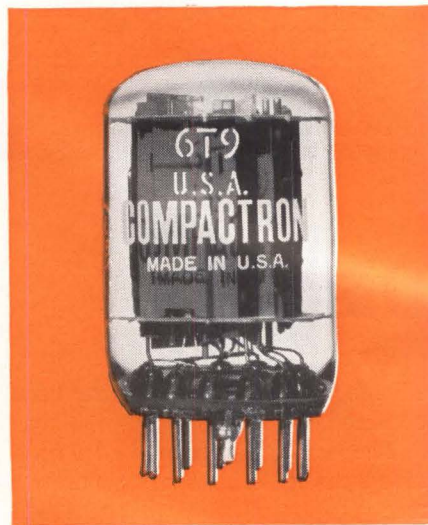

This new 6T9 triode-pentode compactron packs more audio output in a lot less space

 The 6T9 is a welcome new member of the growing compactron family. Their rapidly increasing uses are sure to include lots of jobs for this new audio preamplifier and power output compactron.

The pentode section of the 6T9 is rated at 12 watts plate dissipation. A relatively large cathode in the pentode contributes to easy driving—about 8 volts peak signal (compared with 12 volts needed by the 6AQ5) readily obtainable from the triode section. The triode features an amplification factor of 90 and transconductance of 3,000 microhms.

This one compactron, standing barely two inches above its 12-pin socket, offers the designer a 5-watt drive/power output combination. He can use it for all the audio applications ever found for the 6AQ5 plus 12AX7 duo . . . and then some. For example, how about a lightweight (but heavy-duty!) single-tube phonograph? We are quite sure that you can think of plenty of jobs for the versatile 6T9—and, of course, they'll all involve less wiring, less labor cost, more compact design, and above all—*better performance.*

CIRCLE 201 ON READER SERVICE CARD
November 8, 1963 electronics

PUT NEW "ACCENT ON VALUE"



New ICAS and CCS ratings for transmitting compactrons raise the 175-megacycle performance level for communications equipment

 Additional ratings for compactron types 7984 and 8156 beam pentodes have now been established—for their expanded application in both mobile and fixed station transmitters. Operated at 175-megacycle UHF, here's what a 7984 will deliver:

ICAS (Intermittent Commercial and Amateur Service)—32 watts

CCS (Continuous Commercial Service)—26 watts

IMS (Intermittent Mobile Service)—46 watts

What a boost in performance over the old standby type 6146! At 175 mc., the 7984 delivers 28% more power with far less drive. Not only that. By eliminating the top cap and the composition base, the 7984 compactron saves $\frac{3}{4}$ " in seated height and gets rid of a chronic mobile communication trouble spot—the long, loose platelead. Mechanically rugged, yet lighter in weight than the 6146, the compactron is less susceptible to shock and vibration.

The compactron design, with 12 pins, also makes possible multiple plate, cathode and screen connections at the socket. This eases the work of the equipment designer in orienting tube sockets in the most efficient locations.

CIRCLE 202 ON READER SERVICE CARD

electronics November 8, 1963

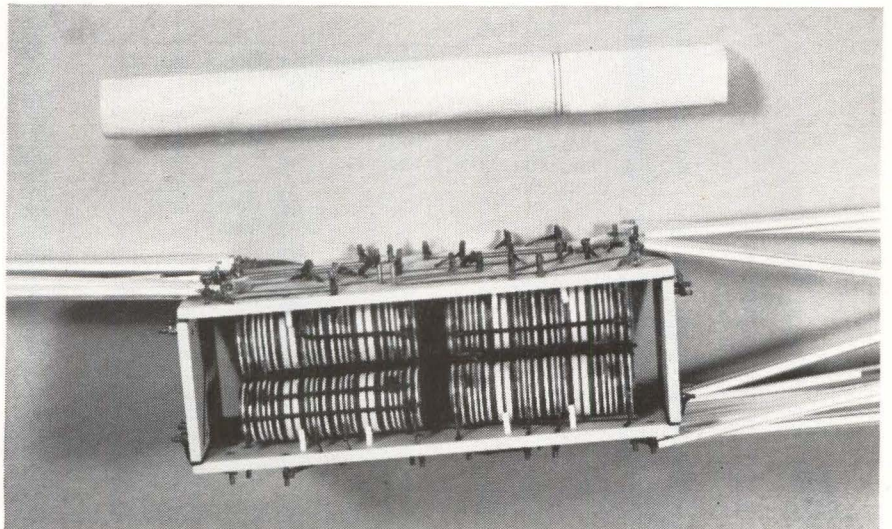

G.E.'s "hard" TIMM 3-bit parallel adder uses new packaging technique

 A new high-density packaging technique has enabled G.E. to build a rugged 3-bit parallel adder . . . "hardened" against high-intensity radiation. This development, using G.E.'s TIMM (*thermionic integrated micro module*) circuitry, provides a 3.6 cubic inch package that weighs a mere 2.18 ounces—yet contains 15 NORS and 1 OR in eight compact modules.

The adder's components total 107 triodes, diodes and resistors

. . . all designed to operate flawlessly at 580°C. with one simple, low-voltage power source. Required primary power is only 15 ma. at 16 VDC—and the package performs well even when the supply is varied between 12 and 19 volts.

This developmental computer component was built at the G-E Tube Department's advanced development laboratory. It's another good example of the Company's continuing, intensive effort to achieve extremely compact, high temperature and radiation-tolerant modules for missiles, space vehicles, reactor installations, and other highly sophisticated systems.

Progress Is Our Most Important Product

GENERAL  ELECTRIC

For more information: Write G-E Tube Dept., Technical Information and Product Service (TIPS), Room 7018C, Owensboro, Kentucky. Please specify product(s).

CIRCLE 13 ON READER SERVICE CARD 13



OZALID NEWSLETTER

NEW IDEAS TO HELP YOU WITH ENGINEERING REPRODUCTION AND DRAWING

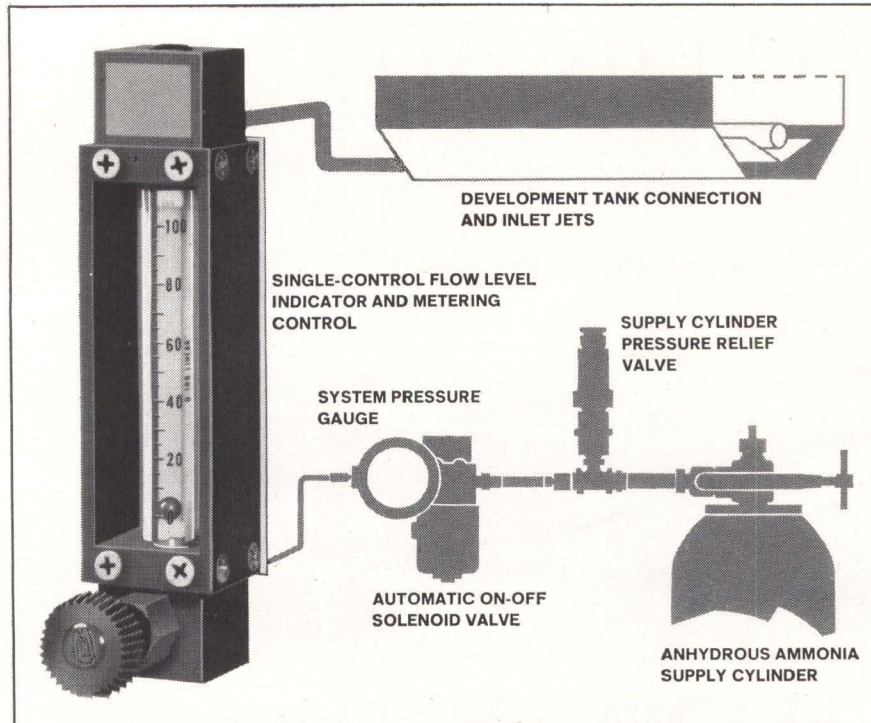

This Ozalid Anhydrous Ammonia System is readily adaptable to practically all diazo machines. Conversion is accomplished quickly and easily using detailed instructions contained in each kit.

The Ozalid Anhydrous Ammonia System gives you full control with only one control! Saves up to 50% in ammonia costs alone!

An Ozalid Anhydrous Ammonia System brings the convenience and economy of pressurized ammonia gas development to your dry developing diazo white printer. And it's all in one, easy-to-install conversion kit.

It's amazingly simple to operate, too. One control does it all! Automatically meters the exact quantity of ammonia necessary to produce clean, sparkling, fully-developed prints. You get outstanding results with all dry diazo materials...from fastest speed to lowest.

And economy? On most machines a single 150-lb. tank of ammonia

lasts from two months to six months. In fact, the usual savings in ammonia costs alone run up to 50%. There are other important savings to be gained also. For example, metal tank parts, evaporator trays and other essential components last far longer. This results in even more savings by reducing down time and maintenance costs.

Another important point. The Ozalid Anhydrous Ammonia System cuts machine warm-up time in half; it's always ready to take on those rush jobs.

Sounds too good to be true doesn't it? But many companies can tes-

tify, it is true. And the cost is low! Bring the convenience and economy of improved pressurized gas development to your diazo machine. Why do without it any longer? Contact your GAF Ozalid Representative for full details. Or write: General Aniline & Film Corp., Ozalid Sales Dept., Binghamton, New York.

Now, photos without photography... in seconds!

Ozalid 101 CTF is a new film that can produce high quality duplicates of photographic negatives and transparencies without camera... without chemicals... without darkroom! A positive printing, diazo sensitized continuous tone film, Ozalid 101 CTF makes duplicates, dry and ready for use in seconds... by the same method that prints of drawings, forms, etc., are made on Ozalid diazo machines. It produces negative from negative, positive from positive, even black and white copies of color transparencies. Ask your GAF Ozalid Representative for a free sample and see the advantages and economy it can offer you.

New 111 V double coated black projecto-viewfoil...

Prints up to 75% faster than similar foils. Saves you time and money on production runs. Blackest of blacks, this new viewfoil is closer to absolute opacity than any foil ever available for transparency use. Exclusive rice paper separator sheets don't have to be removed from foils for processing, provide greater protection from scratching and easier handling... without decreasing image quality. Ask your GAF Ozalid Representative for a free sample or write: General Aniline & Film Corporation, Dept. H2, Binghamton, New York.



OZALID

REPRO PRODUCTS OF GENERAL ANILINE & FILM CORPORATION
BINGHAMTON, NEW YORK

See us at the VCC Show, Booths, 325, 327, 329, 331, 424, 426, 428, 430



Testing Integrated Circuits? reduce test time and cost

With TI's new Integrated Circuit Tester, the 659A, you can make 36 d-c or logic function tests on integral circuit packages in less than 2 seconds. Two-terminal (Kelvin) connections are made to 14 active leads. You can stack two units—operate them in series—for a 72 test sequence. You can program the 659A easily using printed circuit boards for bias conditions, tim-

ing, limits, and sorting logic. Integral circuit packages, no matter their size or shape, mount on device holders which plug into the test socket. To operate, simply press the start button. Four solid-state power supplies provide test bias voltages. Internal logic determines classification to 15 categories for use with a companion sorter. Failures are indicated on front

panel lights. The 659A is compact, yet designed for ease of maintenance. Test points are accessible on the front panel, printed circuit boards are easily removable . . . and the basic unit is priced at \$16,500 f.o.b. plant. Let a TI representative show you the advantages of 659A integrated circuit testing.

Write for complete information.

INDUSTRIAL
PRODUCTS
GROUP



TEXAS INSTRUMENTS

INCORPORATED

P. O. BOX 66027 HOUSTON 6, TEXAS

609



Advances the State-of-the-Art in Angle Measurement

DIGISEC Optical Encoders Achieve Accuracies of 1 Arc-Second, Peak ...and Better

Natural Codes, Continuous Outputs
Without Code Conversion, Gears, Brushes, or Reference Rotor



UNIT SHOWN: Optical Unit 5" x 2.50"; Translator, 6.5" x 17" x 6" deep; wt. 15 lbs.; Total Power 30 Watts.

Typical DIGISECs* provide 19-digit resolution and accuracy in a 5-inch diameter case (illustrated above with transistorized translator and display unit), 18-digits in a 3½-inch case, and 20-digits in a 10-inch case. □ Parallel, on-the-fly, direct digital readout in any natural code including binary and decimal. □

Incremental readout for system simplification or precision tachometer applications. □ Analog outputs also available for high precision servos—equivalent to 32,768 pole resolver (19-digit model). □ Low inertia, non-contacting encoder disc, low friction bearings. □ Simple associated circuitry — high reliability.

For more information write or call, Technical Services Manager, Adcon Division, Dept. 57.

*Patents Pending



WAYNE-GEORGE CORPORATION

322 NEEDHAM STREET, NEWTON 64, MASSACHUSETTS (617) 969-7300

CIRCLE 16 ON READER SERVICE CARD

Laser Beams Do Kill Cancer

SAN FRANCISCO—Year-long experiments at Tufts-New England Medical Center in Boston have shown that laser beams are effective killers of cancerous tissue transplanted in hamsters (p 7, July 19). In extensive tests with two types of human and one type of animal cancer, the healthy tissue surrounding the tumors suffered no permanent damage, according to Dr. Paul E. McGuff. Dr. McGuff, who initiated the studies, spoke here last week before the American College of Surgeons.

The transplanted human cancers were malignant melanoma, which arises in the skin and glands, and thyroidal carcinoma. The animal tumor was fibrosarcoma, found in connective tissue and bone. The lasers used in the experiments were various Raytheon-developed, pulsed, ruby devices ranging in output from $\frac{1}{2}$ joule to 360 joules. Exposure time ranged from $\frac{1}{4}$ to 3 msec.

Of 18 tumors of malignant melanoma that were treated, 13 disappeared completely 15 to 29 days after exposure to the laser beams. Of 14 thyroidal carcinomas treated, 13 disappeared completely in 5 to 29 days. The 14th animal died from causes not connected with the treatment. With the 6 hamsters carrying

the fibrosarcoma transplants, there was a 60 to 80 percent destruction of the tumors in 20 to 50 days.

SST Electronic Needs— Standard Items Largely OK

WASHINGTON—With a few obvious exceptions such as the automatic pilot (p 7, June 14), electronic equipment required by the supersonic passenger plane is not expected to be substantially different from that developed for subsonic jets. This was the consensus emerging from a discussion among aircraft and equipment manufacturers and airline and government representatives. The Airlines Electronic Engineering Committee sponsored the meeting

Syncom III Will Ride On Improved Thor-Delta

WASHINGTON — Thrust-augmented Thor-Delta (TAD) booster that was added to NASA's launch vehicle program last week will lift Syncom III into a preferred, equatorial synchronous orbit, probably over the Pacific Ocean, during the second

quarter of 1964. Capable of producing a 20 to 30-percent increase in thrust over the current Thor-Delta, TAD will also be used for future Biosatellites and Orbiting Solar Observatories (OSO).

NASA Will Monitor Jupiter R-F Signals

GREENBELT, MD.—Yale University has been awarded a \$83,785 contract to design and develop a 24-hour radio monitoring network for the mysterious low-frequency signals sporadically emitted from Jupiter. Goddard Space Flight Center made the award. The signals, first reported in 1955, have been observed throughout the range from 10 to 50 Mc. Data collected at 16.5 light on their mechanism and the planet's magnetosphere.

Solid-State Radar Gives Digital Range, Speed Data

BALTIMORE—An all-solid-state cooperative radar system for both manned and unmanned space missions has been built at Westinghouse's Aerospace division. Compact and lightweight, it operates at X band and has a range of 500 miles. Called Prador (Pulsed Ranging Doppler Radar), it employs an interrogator and a transponder. The system derives range and velocity in digital form. Range accuracy is 0.5 percent or 3 feet, and velocity accuracy is 1 percent or 1 foot per second, whichever is greater.

Range is determined by tracking the pulse recurrence frequency. Pulsing in both the interrogator and transponder is controlled by identical range-track circuits. Range error is derived by comparing the center of the received pulse with the center of the range gate. When the range error is nulled, both the interrogator and transponder transmit at the same pulse-recurrence

Spy Case the First of Its Kind

WASHINGTON—John W. Butenko, the electronics engineer arrested and charged with espionage last week in New Jersey, is the first employee of a private corporation to be accused of passing his firm's top secret information to the Russians. FBI agents had to go all the way back to the famed case of Ethel and Julius Rosenberg, executed for espionage, to find a case involving civilians not employed by the government.

Butenko was employed by the International Electric Corp. of Paramus, N. J., as control administrator; he was in charge of maintaining a master schedule for the ITT subsidiary's work on the worldwide command and control network being developed for SAC. He has been a member of the IRE, and subsequently the IEEE, since 1949

frequency, and the pulse-recurrence frequency is matched to range.

In a cooperative mode, the system can be used for two-way communications; without the transponder, it acts as an altimeter.

Low-Cost ILS Prototype Planned for Summer Test

FAA SHOULD have a prototype low-cost ILS ready for testing next summer, judging from contracts awarded three firms. ITT will build marker and glide slope equipment, Airborne Instrument and Scanwell the localizer. ITT said that by modular design and prefabrication, low-traffic airstrips will get an ILS comparable in quality but costing one third what systems cost now, \$276,000. It will be solid-state and have no standby transmitter—modular design minimizes the need for it, ITT said. Power output will be 15 or 20 w, compared to 200 w for conventional systems.

Soviets Clean Castings Electrohydraulically

UNDERWATER spark discharge is being used at the Leningrad Machine Tool Plant to clean the surfaces of castings weighing anywhere from a few ounces to several tons. The inventor, L. A. Yutkin, claims that pressures up to 28,000 atmospheres together with ultra-sound and shockwave created during spark discharge in water accomplish the cleaning. Compared with the former methods, electrohydraulic cleaning requires 50 times less energy and 15 times less water while increasing productivity threefold, it was said.

Formaldehyde Maser Operates at 4 mm

SOVIET scientists A. F. Krupnov and V. A. Skvortsov have achieved maser generation at 72,838 Mc using transitions in the formaldehyde

molecule. Frequency stability is enhanced by absence of fine structure. Described in *Radiofizika*, 6, No. 3, 1963, p 513, as an instrument built along the lines of a scaled-down ammonia maser with a TM_{010} cavity and crystal-stabilized klystron as radiation source, measured output power is in the order of 10^{-11} watt.

Wide-Band Amplifier Uses Varactors for UHF

WIDE-BAND phase-shift amplifier, developed by the University of Michigan's David K. Adams, achieves a 3-db noise level at 200 Mc using existing varactors—and could do better, he said, with newer ones. More stable and tending to stay accurately tuned, the device employs double sideband mixer circuits to operate from d-c to microwave frequencies. His two-stage component, in the first stage, achieves 6-db gain for a given bandwidth—but in the overall system, reaches 14 db with a 100 Mc bandwidth. One prime application would be in radio astronomy, Adams says, where environmental conditions would have no adverse effects.

MEETINGS AHEAD

RADIO FALL MEETING, IEEE, EIA; Hotel Manger, Rochester, N. Y., Nov. 11-13.

FALL JOINT COMPUTER CONFERENCE, AFIPS, IEEE, ACM; Las Vegas Convention Center, Las Vegas, Nev., Nov. 12-14.

MAGNETISM-MAGNETIC MATERIALS ANNUAL CONFERENCE, AIP, IEEE-PTGMITT; Chalfonte-Haddon Hall, Atlantic City, N. J., Nov. 12-15.

EASTERN ANALYTICAL SYMPOSIUM-INSTRUMENT EXHIBIT, Society for Applied Spectroscopy, American Microchemical Society; Statler Hilton Hotel, New York, N.Y., Nov. 13-15.

MEASURE TESTING-CONTROL AUTOMATION INTERNATIONAL EXHIBITION, MESUCORA; Palais de la Defense, Paris, France, Nov. 14-21.

DIGITAL COMPUTER EQUIPMENT USERS SOCIETY MEETING, DECUS, Lawrence Radiation Laboratory; Livermore, Calif., Nov. 18-19.

ENGINEERING IN MEDICINE AND BIOLOGY ANNUAL CONFERENCE, IEEE, ISA; Lord Baltimore Hotel, Baltimore, Md., Nov. 18-20.

ULTRASONICS ENGINEERING SYMPOSIUM, IEEE-PTGUE; Marriott Motor Hotel, Washington, D. C., Dec. 4-6.

VEHICULAR COMMUNICATIONS NATIONAL CONFERENCE, IEEE-PTGVC; Adolphus Hotel, Dallas, Texas, Dec. 5-6.

FALL URSI MEETING, IEEE Seattle Section, URSI, Boeing Scientific Research Laboratories; University of Washington, Seattle, Wash., Dec. 9-12.

FIRST MICROELECTRONICS CONFERENCE, EIA; Irvine Auditorium, University of Pennsylvania, Philadelphia, Penn., Dec. 10-11.

NON-LINEAR PROCESSES IN THE IONOSPHERE MEETING, NBS; Central Radio Propagation Laboratory, Boulder, Colo., Dec. 16-17.

AMERICAN ASSOCIATION FOR THE ADVANCEMENT OF SCIENCE MEETING, AAAS; Cleveland, Ohio, Dec. 26-30.

ADVANCE REPORT

NATIONAL RELAY CONFERENCE, NARM, Oklahoma State University; Student Union Building, Oklahoma State University, Stillwater, Okla., April 28-30, 1964; November is month to submit 200-word abstracts to Prof. Daniel D. Lingelbach, Oklahoma State University, School of Electrical Engineering, Stillwater, Okla. 74075. Topics include all facets of electromagnetic relays, plus developments in solid state relays. Screening committee will notify acceptance by Dec. 15. Final draft deadline is Feb. 15, 1964.

Vital Band Freed For Radio Astronomy

GENEVA—The hydrogen-line band (1,400-1,427 Mc) has been reserved for the exclusive use of radio astronomers by working committees at the ITU space communications conference (p 19, Oct. 4). A formal vote must still be taken, but informed sources say this first decision is of "vital importance." The same allocation was made in 1959 but Soviet bloc countries then reserved the right to use the frequencies for fixed and mobile services; they have now agreed not to.

Radio telescopes tuned around 1,420 Mc can detect the presence of 21-cm hydrogen radiation, which occurs at the same frequency throughout space. Doppler measurements of hydrogen movement aid in mapping the galaxy.

High-Field Si Triode Has Single Junction

WASHINGTON—New type of field-effect triode was reported at the IEEE Electron Devices Meeting last week. H. C. Nathanson, J. R. Szedon and N. A. Jordan, of Westinghouse Research Labs, described a single-junction planar silicon triode they call the high-field triode.

Device consists of a degenerate *p*-region diffused onto a high-resistivity *n*-type substrate; a gate electrode is insulated from the junction by a conventional oxide. When the junction is reverse biased and an electric field applied to the gate, electrons are pulled to the surface and current flows by a mechanism tentatively thought to be tunneling. Above several volts across the diode, the current saturates sharply, yielding a pentode-like characteristic with typical output resistances greater than 2 megohms. Typical open circuit voltage gain is greater than 200.

Sensors Monitor Patients In Experimental Hospital

MONTGOMERY, ALA.—An experimental hospital opened here last week. The prefabricated, circular, 24-bed Atomedic Hospital structure, like a sister facility planned for the New York World's Fair next spring, uses electronic monitors to measure parameters picked up by sensors worn by patients, closed-circuit tv in four rooms reserved for intensive care, and Data Phones to transmit information both inside the hospital and to larger facilities nearby. A computer will be installed next month to store data and supply access to patient administrative records.

Plant Expenditures Going Up Next Year

U. S. BUSINESS now plans to invest \$40.7 billion, or 4 percent more, in new plants and equipment in 1964 than it did in 1963, according to the McGraw-Hill annual fall survey. It would be a record dollar volume if carried out as now planned and would be even larger if this preliminary survey follows the patterns of

Space Maneuvers

POLYOT I, Russia's maneuverable satellite, ceased transmitting early this week after achieving its "final orbit" last Saturday. Launched last Friday, the unmanned spacecraft, changed orbital altitude and direction on command from the ground, the Russians said

others made in the fall. These have underestimated what actually happened by an average of about 3 percent over the past eight years.

The communications industry plans a high level of capital investment in 1964 and 1965 in line with its steady growth pattern. So does the electrical machinery industry, including electronics, which now plans to put \$740 million, or 1 percent more, in capital expenditures in 1964.

Apollo Debate Rolls On —So Does Test Program

WHILE WASHINGTON debates whether we should or should not have a moon program, space engineers are methodically moving ahead with it. Preparations were readied last week for testing the escape system of the Apollo spacecraft at the White Sands Proving Grounds in New Mexico. The escape system is designed to eject the command module in which the astronauts will be riding if trouble should develop. Once blown clear, the module will parachute back to ground. Over the next year or so, the escape system will be tested on both boiler plate and production models of Apollo. Malfunctions will be simulated on the launch pad and in flight up to around 60,000 ft. Five flight tests using the Little Joe rocket are presently planned.

IN BRIEF

FREE-WORLD electronics production, worth \$22 billion two years ago, should hit \$47 billion by 1970, predicts William E. Roberts, Ampex president. He sees upsurges in materials science, microcircuits, cryogenics, bionics, quantum-mechanics technology and related electro-optical devices, solar cells, thermoelectricity and magnetohydrodynamics.

DEFENSE SECY. McNamara last week ordered the Navy to power its next aircraft carrier by conventional means. The Joint Congressional Committee on Atomic Energy, now holding closed hearings on the advisability of building a nuclear surface fleet, is expected to give him a fight on this.

ARMY, NAVY and Air Force post-contract administration will be consolidated next spring on a test basis in the Philadelphia area. If the plan improves contract supervision, other regional headquarters will be set up.

NASA has decided to drop four early Apollo flights to go over to the more advanced Saturn 1B. These tests will be made with all three modules—command, service and LEM—instead of the command module by itself as had been previously planned.

ARMY has given Philco \$19-million follow-on contract for R&D on the Shillelagh missile.

NIPPON Electric will help Pakistan build 500,000 transistorized radios in the next five years.

20,000 computer installations, 5,000 more than now, will be operating by 1965, predicts Univac's Louis T. Rader. Computer R&D is a \$150-million-a-year item, he said.

FCC IS INVITING comments on its proposal to revise the table of uhf-tv assignments, adding 400 new ones and raising the number of educational slots from 230 to 600.

ITU SPACE conferees in Geneva chatted with Washington and New York last week via Syncom II (see related story on p 11).

CAPEHART will assemble hi-fi consoles for Matsushita, for U.S. sales only.

ELECTRONIC Associates Inc. has bought Pacific Data Systems Inc.

Cushions Sought For Impacts of Defense Shifts

Gathering steam are several moves to prepare industry for major shifts and cuts in federal spending. Top officials are giving more and more thought to cushioning the impact on industries, like electronics, heavily dependent on defense work.

One big puzzler is just where defense dollars go and how they influence the economy. After subcontracting, the impact is diffused and effects often unknown. This is one question Senator Joseph Clark (D-Pa.) will be tackling this month in four weeks of hearings by his subcommittee on Manpower and Employment. He also wants to figure out how to minimize hardships. This is also the aim of a bill to be introduced soon by Senator George McGovern (D-S.D.). It would set up a national economic conversion commission to help vulnerable industries plan for change.

In the Pentagon, McNamara is establishing an "early warning system" aimed at alerting firms and communities in advance of injurious changes. The possibilities of this are limited by the secrecy of many changes. Consultations are likely to be used rather than formal announcements that might cause panic.

FCC May Move Airborne Tv To Microwave

If FCC shifts airborne educational tv frequency to the 2,500 to 2,690-Mc band, demand for economical microwave equipment would increase. The shift is being considered because of the outstanding success of the Midwest Program for Airborne Television Instruction which serves 1,125 schools in six states. MPATI now wants six uhf stations instead of two. FCC is worried that airborne etv would, on a nationwide basis, eat up the lower-range uhf channels. FCC already faces a shortage of uhf assignments for school and commercial use in populous areas.

The drawback FCC sees in forcing airborne educational tv into microwave is the possible added cost to schools using the service. Before it decides MPATI's appeal, FCC wants to find out if a six-channel airborne tv facility is technically feasible, if the 2,500 to 2,690-Mc band can be used, and how uhf and microwave operational costs compare. FCC experts don't think the differences would be great. If they are correct, FCC is very likely to make the shift.

Medical Devices Face Regulation

Food & Drug Administration is pushing legislation to regulate the medical devices industry. A bill, by Rep. Oren Harris (D-Ark.), is pending before his House Commerce Committee. It would empower FDA to require manufacturers of devices—from electric toothbrushes to radiation-therapy machines—to prove the devices are both safe and effective, as advertised or labeled, before they can be sold for diagnostic or therapeutic purposes. The proposed law, some form of which is likely to be approved, is designed to discourage quacks as well as to regulate and set standards for equipment, materials and devices. FDA estimates medical equipment sales at \$2 billion a year.

Overseas Cable Dispute: Who Gets the Voice?

Loss of Revenue from lucrative international record communications is the basis of objections by ITT, Western Union International and Press Wireless to AT&T proposal that FCC allow it to lease both voice and nonvoice circuits in transatlantic cables. In its objection, ITT's subsidiary, American Cable & Radio, asks part ownership—rather than leasing—of all AT&T coaxial undersea cables. It further proposes to finance and install another cable. RCA, which has gained a part-ownership arrangement with AT&T in a future Pacific cable, has filed comments asking for competitive rates or indefeasible rights so it can compete for transatlantic service. Western Union International would also like part-ownership. FCC officials expect a long and complicated fight.

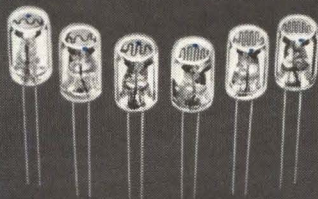

6 small, rugged additions to the Sylvania photocell family

Only $\frac{1}{4}$ inch in diameter, these new T-2 photocells may be the answer to a design problem you have right now. They range in 2-foot-candle resistance from 40,000 ohms to 1500, with voltage ratings from 300 volts to 50.

Like their more familiar T-4 counterparts, these cells are tough. They're built to meet military requirements for shock and vibration resistance, and to operate at altitudes up to 80,000 feet. Further, they are hermetically sealed (not just "virtually" sealed) in a glass envelope that has a Blue Dot inside. This



NEW PHOTOCONDUCTOR KIT—
Contains three T-4 photocells, one Sigma AC/DC relay, 22,000-ohm 1-watt resistor, photocell mounting bracket, and circuit booklet showing 19 different control and measuring applications. Available from Sylvania Electronic Distributors.

is double protection from moisture. If any should happen to get inside through serious mishandling after a unit leaves us, the dot turns pink and replacement can be made before any damage is done.

Where are Sylvania photoconductors being used? In such diverse types of equipment as clothes dryers and electric organs, furnace shut-offs and streetlight controls. If photoconductors can be useful to you, contact your Sylvania sales engineer or write to Electronic Tube Division, Sylvania Electric Products Inc., Box 87, Buffalo, N. Y. 14209.

SYLVANIA

SUBSIDIARY OF
GENERAL TELEPHONE & ELECTRONICS



THE TRULY ENLIGHTENED ENGINEER AVOIDS ANY THOUGHT OF SELF-INTEREST WHEN CONTEMPLATING A NEW JOB.



WHETHER ONE CAN SKIN-DIVE IN THE PACIFIC AND SKI IN THE CALIFORNIA MOUNTAINS COULDN'T MATTER LESS



MAYBE WHIZZING AROUND IN AN X.K.E.; OR RAISING ONE'S OWN CYMBIDIUMS WOULD TEMPT MY FRIENDS. I REJECT IT.

EVEN THE CHANCE TO RUB MINDS WITH THE KEENER CHAPS AROUND UCLA, USC OR CALTECH LEFT ME STRANGELY UNMOVED.



PERSONAL CONSIDERATIONS COULD NEVER HAVE PERSUADED ME* TO WORK FOR HUGHES BUT THE TOW PROGRAM NEEDED ME... THAT DID IT.

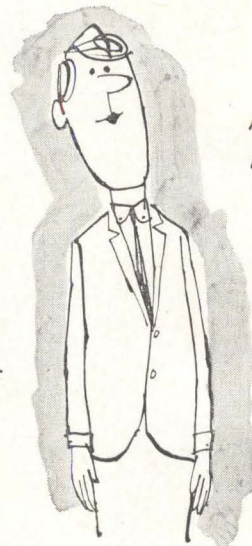

MAYBE I AM HAPPY AT HUGHES, BUT COULD I CONTRIBUTE MORE IF I WERE MISERABLE?

Hughes is hiring! Numerous opportunities now exist on a variety of advanced projects and studies. For example: **F-111B PHOENIX** Guided Missile System, **TOW** Anti-Tank Missile, **SURVEYOR** Lunar Spacecraft, **SYNCOM** Communications Satellite, **ARPAT**, Advanced **POLARIS** Guidance, **VATE** Versatile Automatic Test Equipment, Hard Point Defense Systems and others. Positions are open for experienced specialists with accredited degrees and U. S. citizenship.

CONTROLS ENGINEERS. Concerns airborne computers and other controls related areas for: missiles and space vehicles, satellites, radar tracking, control circuitry, control systems, control techniques, transistorized equalization networks and control servomechanisms.

CIRCUIT DESIGNERS. Involves analysis and synthesis of systems for: telemetering and command circuits for space vehicles, high efficiency power supplies for airborne and space electronic systems, space command, space television, guidance and control systems, and many others.

INFRARED SPECIALISTS. To perform systems analysis and preliminary design in infrared activities for satellite detection and identification, air-to-air missiles AICBM, infrared range measurement, air-to-air detection search sets, optical systems, detection cryogenics and others.

SYSTEMS ANALYSTS. To consider such basic problems as: requirements of manned space flight; automatic target recognition requirements for unmanned satellites or high speed strike reconnaissance systems; IR systems requirements for ballistic missile defense.

Please airmail your resume to:

Mr. Robert A. Martin
Head of Employment
Hughes Aerospace Divisions
11940 W. Jefferson Blvd.
Culver City 43, California

Creating a new world with electronics

HUGHES

HUGHES AIRCRAFT COMPANY
AEROSPACE DIVISIONS

An equal opportunity employer.

Report from

**BELL
LABORATORIES**

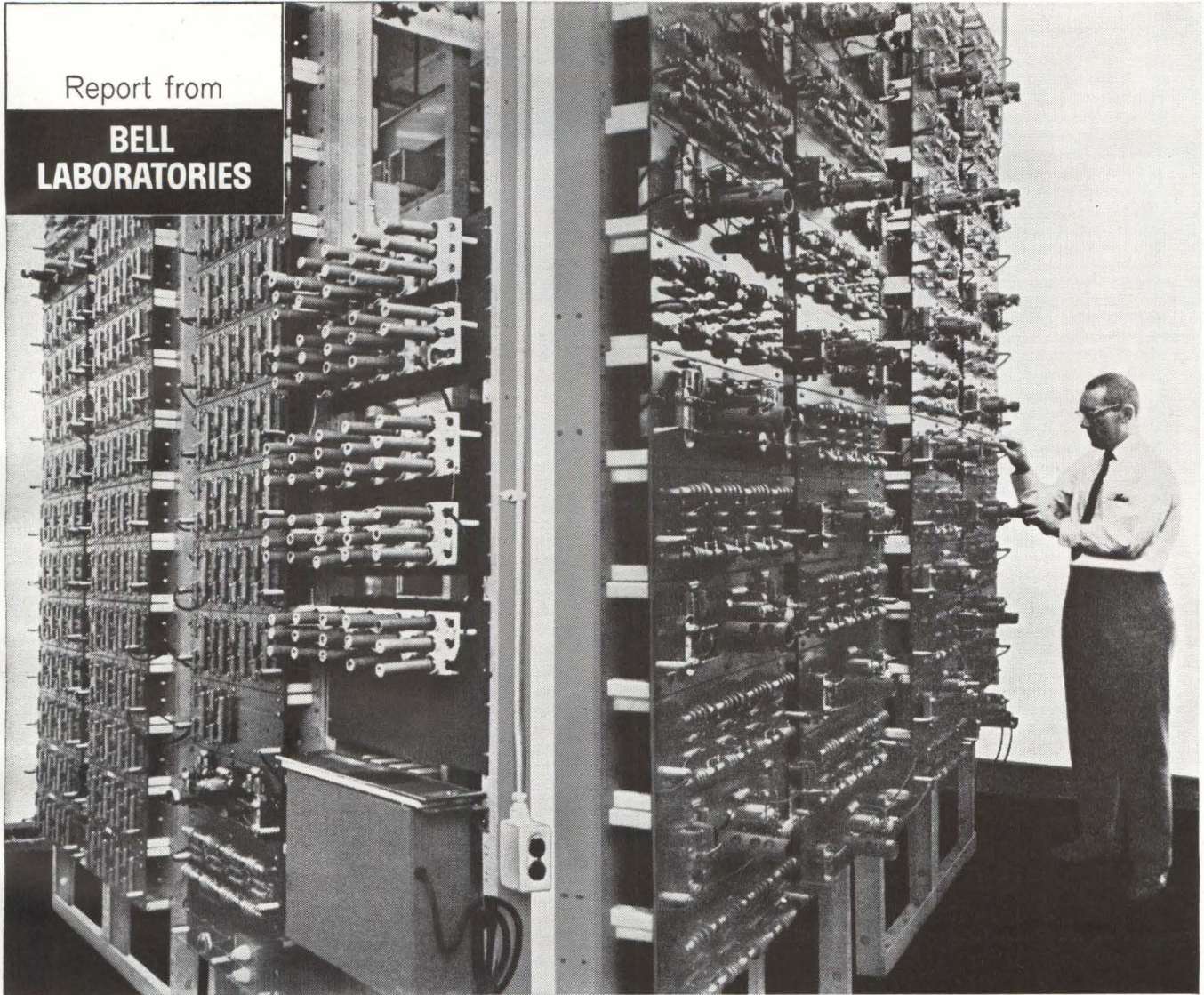

Engineer A. H. Evans measures the effect of voltage surges on Bell Laboratories' simulated undersea telephone cable. Simulating 180 amplifiers and 181 cable sections, with a total length of 3600 miles, the arrangement includes over 1100 electrical components. Photo merges two sides of the simulated cable so that both can be viewed at once.

THE UNDERSEA "CABLE" THAT NEVER GOES TO SEA

In undersea cable systems, electric power for the amplifiers is transmitted along the cable itself. To make this possible, precisely engineered circuits and devices must be designed into the system for protecting electron tubes and other components from sudden voltage surges which may result from accidental damage to the cable.

In systems such as these, the computation of the effects of such surges to establish the needed design parameters is extremely complex. Here, as in many other areas of our work, a solution to the problem has been found through electrical simulation.

Full-scale simulation is achieved by means of networks of electrical components. For the new 128-channel cable scheduled for transatlantic service this year, a network (above) was built to simulate the power path of a 3600-mile cable with its 180 amplifiers.

With the aid of this simulator, engineers can study the effects of voltage surges, the operation of electron tube protectors, and the performance of the power supply in the various contingencies that may occur in active service.

This study of unknown factors by means of electrical simulation is an example of how engineers at Bell Laboratories work to assure the performance and reliability of new communications systems before they are committed to service.



Bell Telephone Laboratories

World center of communications research and development



AT ERIE

TECHNOLOGICAL PRODUCTS...

AT ERIE TECHNOLOGICAL PRODUCTS...

AT ERIE TECHNOLOGICAL PRODUCTS...

AT ERIE

TECHNOLOGICAL PRODUCTS...

AT ERIE TECHNOLOGICAL PRODUCTS...

AT ERIE

TECHNOLOGICAL PRODUCTS...

AT ERIE

TECHNOLOGICAL PRODUCTS...

AT ERIE TECHNOLOGICAL PRODUCTS...

AT ERIE TECHNOLOGICAL PRODUCTS...

AT ERIE

TECHNOLOGICAL

PRODUCTS...

research inversely proportional to part size

As the size of the things we work on at Erie Technological Products has grown smaller and smaller . . .

The size of the talents and the group we have available to work on them has grown larger and larger . . .

Continuing enlargement of research facilities . . . additions of outstanding, dedicated specialists to our research staff . . . increased involvement by both research staff and engineering people in research projects . . . continuing emphasis by Production on improving established quality standards . . . all these are evidence of today's thinking at Erie Technological Products, Inc. . . . where Research, Production, and Quality Assurance are combined in highest reliability products for electronics.

May we tell you more . . . in an across-the-desk discussion?



Interior of a special high-vacuum unit showing a special developed fixture used in coating thin-film substrates.

WHERE IMAGINATION CREATES VALUE IN ELECTRONICS

ERIE

TECHNOLOGICAL

PRODUCTS, INC.



formerly Erie Resistor Corporation

644 West 12th Street
Erie, Pennsylvania

CIRCLE 25 ON READER SERVICE CARD

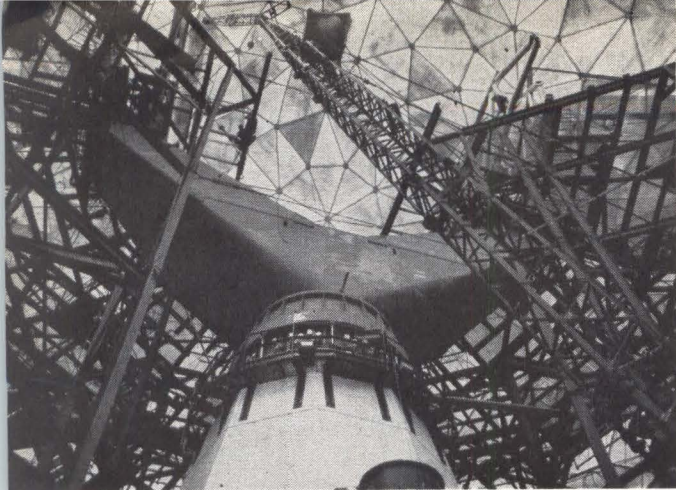

LATEST PHOTO of Haystack antenna being constructed under radome. In an operational orbital scatter system, this facility could provide many voice channels

WORK AND REWARD

Basic concept for orbital scatter was first proposed by Walter E. Morrow, Jr., and Harold Meyer, formerly with Thompson Ramo Wooldridge. It grew out of the 1958 Barnstable Study, named for the Cape Cod community where scientists and the military met to discuss the need for highly reliable, invulnerable, long-range, strategic communications.

Last week, MIT president Julius A. Stratton presented Morrow with an Award for Outstanding Achievement—a citation for his part in the West Ford project and a prize of \$2,500. Morrow, the project's manager since 1958, is leader of the Space Techniques and Equipment Group at MIT

Orbital-Scatter Concept Proves Out

Project manager urges operational use for unjammable communications

By **THOMAS MAGUIRE**
Regional Editor, Boston

WALTHAM, MASS.—Twin operational belts of orbiting, disposable tin-alloy dipoles could provide one-hop communications of strategic military importance without interfering with radio or optical astronomy, according to the manager of Project West Ford.

Walter E. Morrow, Jr., of MIT Lincoln Laboratory, pointed out to an IEEE gathering two weeks ago that the decision on future launches will be a government policy matter. But the feasibility of orbital scatter communications has been established, and interference factors are virtually nil, he said.

"We were constrained by the political environment to put the experimental belt in a specialized orbit," Morrow said, referring to protests of astronomers and the resultant decision to use a predicted-lifetime orbit.

Solar radiation pressure plus the second harmonic of the earth's gravitational field are gradually causing the belt to drop into the atmosphere. Morrow said computer calculations indicate a lifetime of 2 to 4 years for the experimental belt. Estimates last summer

set it at less than 3 years (ELECTRONICS, p 12, July 5, 1963).

Operational Requirements — At present, Morrow said, the belt can be used 6 hours a day by the West Ford terminals. Above 50 deg north latitude, continuous observation would be possible.

Morrow said a 4,000-mile altitude would be desirable for operational belts—twice as high as the experimental belt. One orbiting ring of microwave scatterers in a polar orbit and the other in equatorial orbit would give worldwide coverage for long-range, unjammable strategic communications. Coverage would be continuous; no handover would be necessary.

The system would have very high invulnerability, he added. "An enemy could burn a hole in the belt 40 to 50 km wide—but the differential motions of the dipoles would fill it in." Bandwidth would be high, he said, and many users could share the belt. Antenna tracking rates would be slow, only a few degrees per day over polar areas.

Interference Low — Most of the "dire predictions" about interference of the belt with astronomical observations were "irrational and emotional," Morrow said.

Radio astronomers, he said, have not found a single reflection from the belt at any other frequency, despite predictions about "signals filling the sky."

"Other things are reflecting signals," he added. "The moon, Echo balloons, and 500 or so objects that are hurtling around up there—and there will be more and more satellites as time goes on." Only possible relief for the radio astronomers, he said, is to obtain cleared frequencies.

To further guard against any possible interference with optical astronomy, Morrow said, the dipoles can be coated to reduce reflectivity.

He thinks that the West Ford payload of microwave scatterers could be increased by one, maybe two orders of magnitude before it seriously interferes with other scientific work. An increase in the number of dipoles in the belt, plus a pair of Haystack antennas (ELECTRONICS, p 49, Nov. 9, 1962) would permit many voice channels.

Disposable Dipoles — Disposable dipoles, under development at Lincoln Laboratory and National Research Corp., are made from a tin-alloy powder of 5-micron grains. It is possible, Morrow said, to add a chemical "fuse" to break up the dipoles after a set time and solar radiation pressure would "sweep them out of the sky." The orbit could be chosen strictly for its communications desirability.

The "fuse", Morrow said, could be set for a 2½-year period, for example. At the 2-year mark, a replacement belt could be sent up and be ready in plenty of time. In this

way, belts, half-belts and unused belts would not add to the clutter in space.

Technical Advances—Support was given under West Ford to such developments as sequential coding and to equipment development. X-band masers, power tubes, other components and techniques are byproducts of the program.

“Now the military is going into X-band,” said Morrow. “But before West Ford, there was general scepticism about this region for communications.”

Morrow said that the transmitter at the Camp Parks, Pleasanton, Calif., terminal uses 40-kw klystrons, and that they are getting ready to install a 100-kw klystron. At the East coast terminus, at Millstone Hill in Westford, Mass., 20-kw klystrons are used. The X-band waveguide system for West Ford was “a very fussy job,” but he said it showed that X-band waveguides can carry hundreds of watts without burning up.

The propagation path is far from clean, he said. Multipath and doppler smear pose the toughest problems. He described the doppler smear as “not a unique shift, but a broad frequency smear,” and said it now amounts to 1.5 to 1.6 kc. It is difficult to build a multipath correction system, so “incoherent” techniques similar to radiometric methods were developed. Experiments leading to improvements in data transmission included multi-frequency keying and sequential coding (ELECTRONICS, p 20, April 13, and p 20, June 21, 1963).

ARECIBO, TOO

So powerful is the new Arecibo Ionosphere Observatory that it will probably be able to detect by radar techniques the West Ford dipoles, even though AIO operates at L band and the dipoles are resonant to X-band signals. AIO's nominal frequency is 430 Mc, average power is 150 kw and peak power $2\frac{1}{2}$ Mw. Primary missions of the $18\frac{1}{2}$ -acre radar telescope system, dedicated last Friday in Puerto Rico (p 17, Nov. 1) are planetary and ionospheric studies

UNIQUE MACHLETT DP-30 FOR... SWITCH TUBE OR PULSE AMPLIFIER

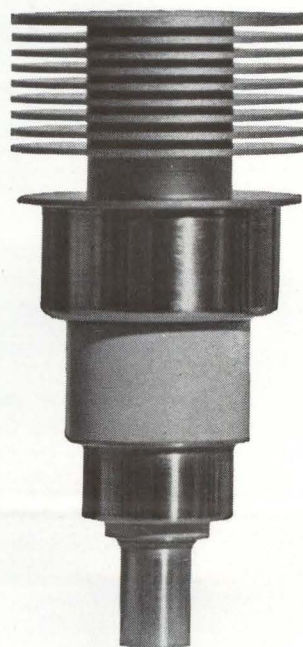

as switch tube:
30kw switch
at 0.0033 d

OR

as pulse amplifier:
20kw peak pulse
at 1Gc

The unique DP-30 planar triode does double duty as an rf pulse amplifier (or oscillator), or modulator/switch tube. Typical performance as an rf amplifier: 20kw peak pulse power at 1Gc, 0.001 d. Typical performance as a switch tube: 5a x 6kv for 30kw switch power at 0.0033d. ■ For data write: The Machlett Laboratories, Inc., Springdale, Connecticut. An affiliate of Raytheon Company.

MACHLETT

ELECTRON TUBE SPECIALIST

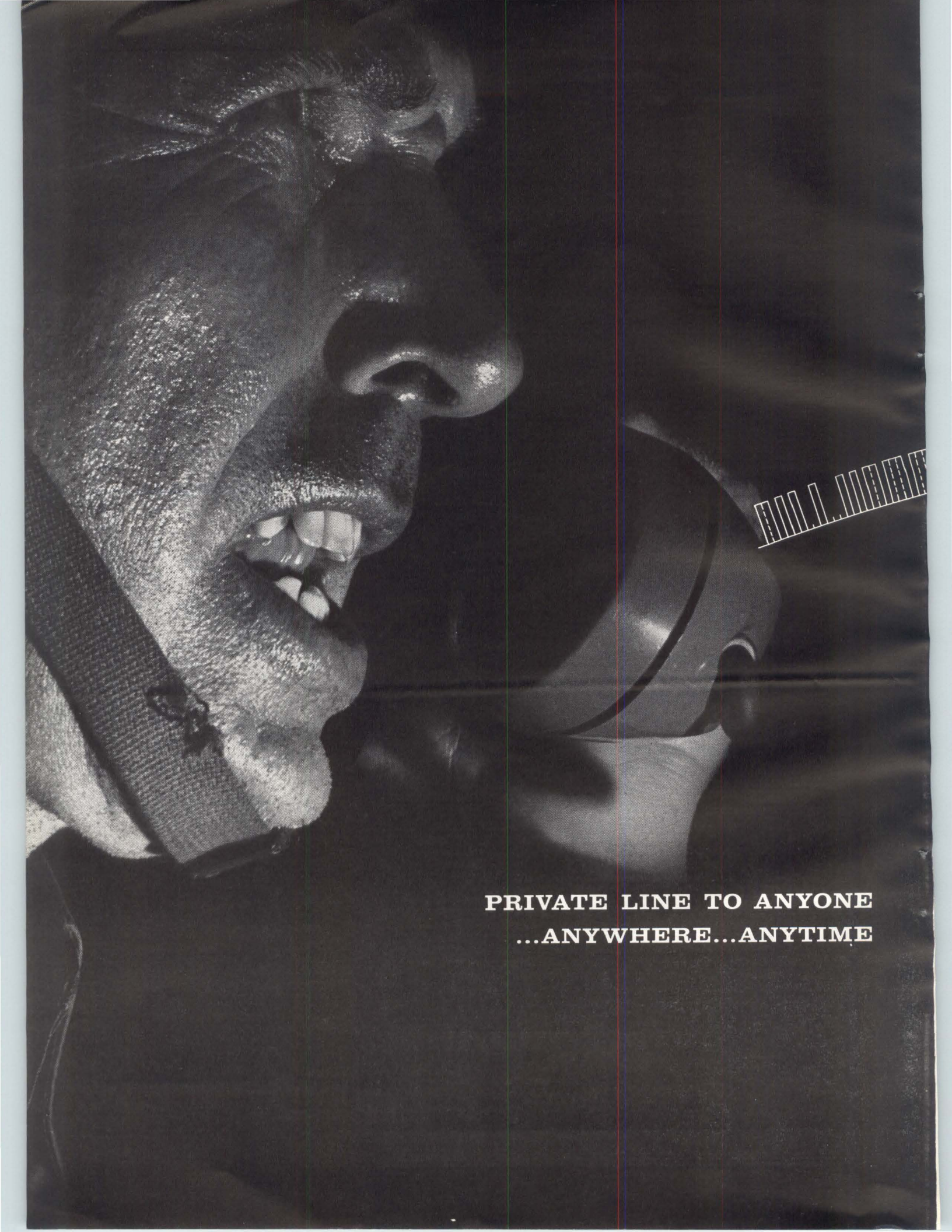

**PRIVATE LINE TO ANYONE
...ANYWHERE...ANYTIME**

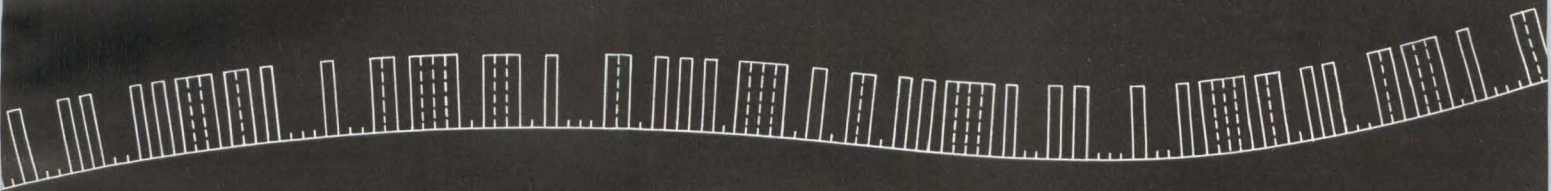

MOTOROLA'S RADEM* concepts, being applied to the most important recent advance in military communication systems...will carry many high-priority radio messages simultaneously in a single wideband frequency channel; maintain private-line direct dialing without central exchanges or fixed nets; do this without interference between concurrent messages transmitted from different locations within the system; and perform these tasks with designs that lend themselves to the application of advanced, integrated electronic circuitry. (M) RADEM is one of the many major military and space electronic programs in progress at Motorola. Scientists and engineers interested in joining the men who are making basic contributions to both research and applications in advanced electronics write today describing your background and experience in:

Systems Design • operational and functional systems analysis, economic analysis, optimum time-bandwidth utilization, digital, voice and data communications, secure communications.

Advanced Equipment Design • solid state receivers, transmitters and repeaters, digital modems, digital data processing and display units, voice processing and reproduction equipment.

Familiarity with State-of-the-Art • statistical theory of communications, spread-spectrum techniques, coding theory, integrated circuit applications, digital logic design, solid state RF circuit techniques, auto correlation and cross correlation techniques.

We are particularly interested in programs on which your experience was obtained and the extent of your technical responsibility. Please address this information to our Manager of Engineering at the location of your choice for immediate and confidential attention.

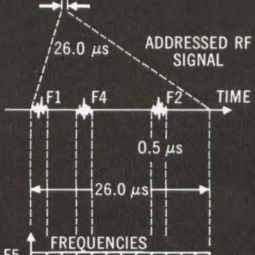
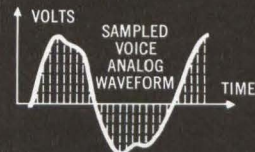

*RADEM (Random Access Delta Modulation) principle diagramed above is the result of 5 years of independent Motorola research.

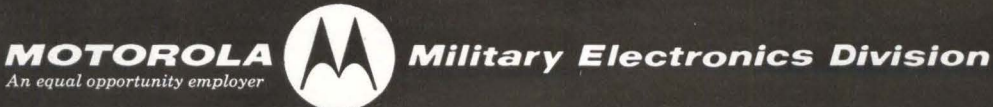

CHICAGO 51, Illinois, 1450 North Cicero Avenue / SCOTTSDALE, Arizona, 8201 East McDowell Road

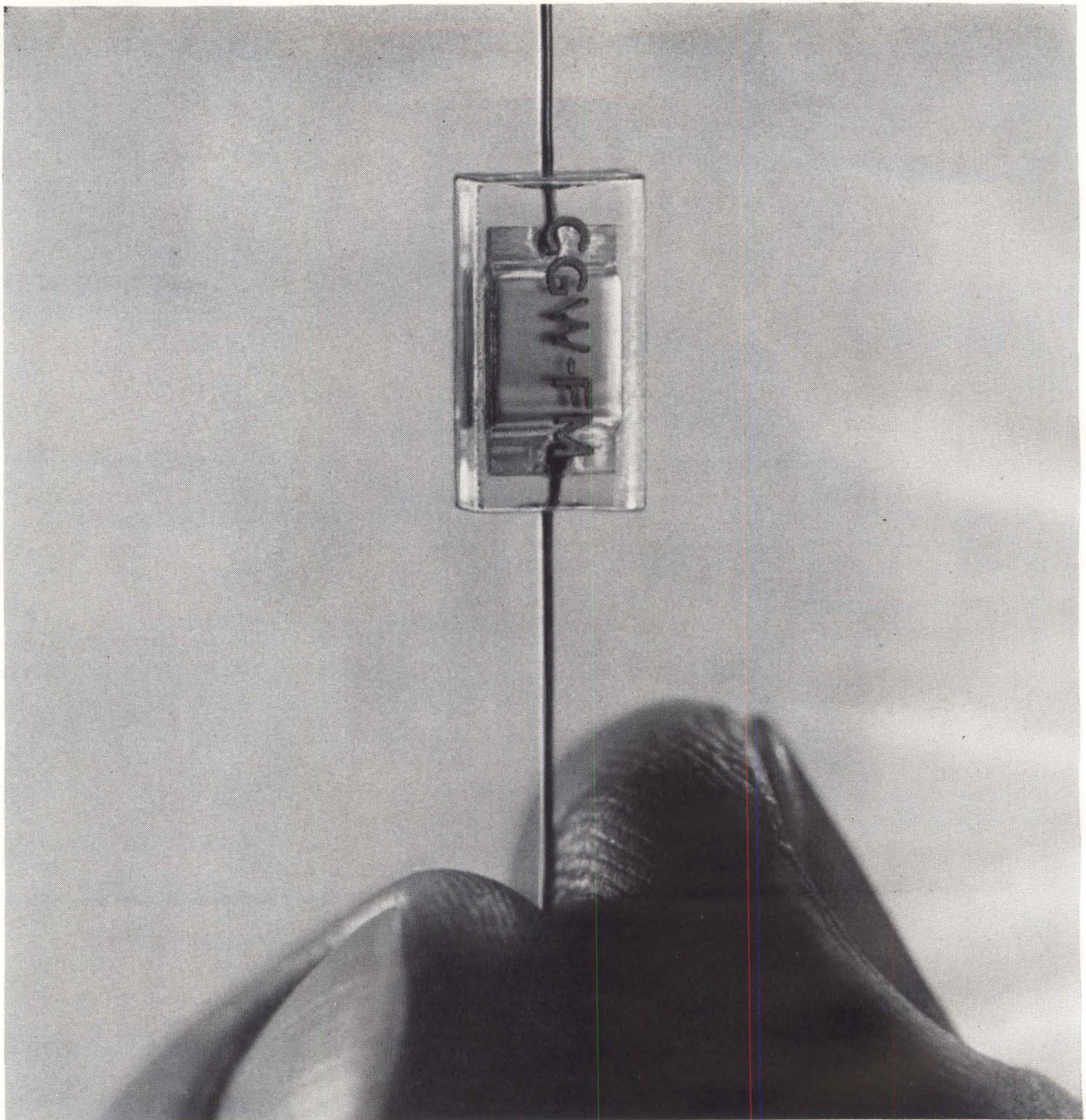

SECOND BEST?

That's the Corning CYFM capacitor. It's topped only by the Corning CYFR—the first one that completed the Autonetics/Minuteman high reliability program.

We learned how to make the CYFM while working to improve reliability. It's electrically and environmentally interchangeable with the CYFR. The major difference is price, and that's because we use refined processes on the CYFR for applications requiring guaranteed failure rates and reliability.

All in all, the CYFM is a positively

sealed capacitor for complete environment-proof performance (it goes far beyond MIL-C-11272B), and it sells for less.

Developmental testing of the CYFM went 6,000,000 test hours, and included load life, boiling salt, salt spray, fluxes, and solvents.

You can get its reliable capacitive element of foil and ribbon glass, frozen inside glass with hermetic seals at the leads, in four types. The CYFM10 gives pf values from 0.5 to 300; CYFM15, 220 to 1200; CYFM20, 560 to 5100; CYFM30, 3600 to 10000.

But, when you must have the ultimate in *guaranteed* reliability to your specifications, specify the CYFR. It's available in the same sizes and capacitance range. The CYFR is second to none.

For complete information, write for data sheets.

CORNING ELECTRONICS

A DIVISION OF CORNING GLASS WORKS
3901 ELECTRONICS DR., RALEIGH, N. C.

small
change



FOUR-LAYER INTEGRATED CIRCUIT AND LOGIC MODULE CARRIER

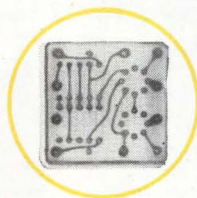

Small change? Yes—but it guarantees big performance. This little board is one sample of our leadership in the field of precision multilayer circuitry. It costs just about what you see here. Why not send us **your** requirements?

CINCH-GRAFIK

DIVISION OF UNITED-CARR FASTENER CORPORATION



200 South Turnbull Canyon Road, City of Industry (Los Angeles), California • Phone (Area Code 213) 333-1201
Offices in 22 Principal Cities throughout United States, Canada, England and Australia listed under Cinch Mfg. Co.
or United-Carr Fastener Corporation • Cinch • Ucinite • Monadnock Mills • Howard B. Jones • Palnut

WHAT MAKES AN INSTRUMENTATION CABLE FAIL?

It can pass inspection perfectly one minute and fail miserably the next. Simply manufacturing it to spec isn't good enough. Insurance against failure must be built into the cable at every step from diagram to installation.

Where can it go wrong? At almost any point not adequately safeguarded. Here are four of the most common trouble spots:

- (1) Incompatible Plasticizers
- (2) Filler Material
- (3) Component lay-factors
- (4) Shielding

INCOMPATIBLE PLASTICIZERS A unique form of chemical warfare within cable materials has fouled more than one missile program. Plasticizer materials have to be added to compounds to obtain the required flexibility. These additives are seldom compatible with each other. Incompatible plasticizers used in systems in contact with each other without control may attack each other with disastrous effects. (As a prime example, additives in low temperature neoprene jackets are not always compatible with the insulating materials.)

Manufacturers can control plasticizer migration problems by selecting proper materials and by using suitable barriers between components. Many specifications make the use of barrier material optional and a manufacturer whose only concern is price will leave it out.

Rome-Alcoa, as a result of its wide experience with materials, always uses barriers where migration could be a problem.

FILLER MATERIALS When spurious signals arrive at your display, recording or control panel, the fault could be in the improper selection of filler material. Compatibility between insulations and filler materials is of prime importance.

In the case of some plastics or rubbers, the material's "memory" can cause it to shrink disproportionately, creating undue stresses internally in the cable. This can cause kinking of the insulated conductors; electrical failures follow.

Only experience can tell a cable manufacturer how to compensate for "memory" and how to control compatibility in filler materials. Experience in areas such as this has given Rome-Alcoa its remarkable record of instrumentation cable reliability.

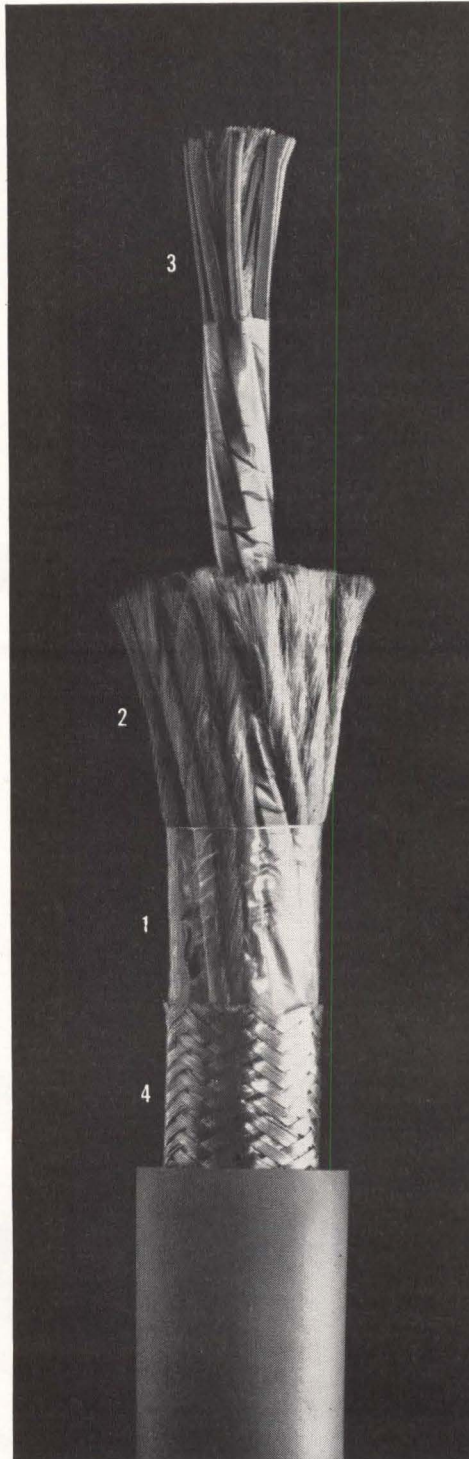

COMPONENT LAY-FACTORS Conductor kinking can also be a result of mistakes in the twisting of component conductors. Inconsistent tensions and improper sequence of lay-up can create uneven tensions in the assembled conductors.

In such cases, individual conductors may actually push through their insulations, causing electrical failures.

Obviously, these mistakes should be avoided during cabling. At this stage in cable construction careful, experienced workmanship can provide safeguards against possible trouble later on. Such careful craftsmanship sometimes costs a little more, but it can make the difference between success and failure.

SHIELDING Constructed of many ends of fine strands, shielding braids are prone to having broken and loose ends. These can break through insulations and short out component conductors. Improperly treated, they are the most common cause of shielding failures.

It's cheaper to let such loose ends remain in the braid—but it can also be disastrous. Experience on thousands of such shieldings has taught Rome-Alcoa the exact tensions which must be maintained, as well as methods of protecting and treating loose ends.

HOW TO AVOID FAILURES No manufacturer can promise you 100% reliability at every development stage. But it's only logical that the one way to be sure of maximum reliability is to have your cable planned and manufactured by a company with depth of experience and a record of reliability in the field.

Rome-Alcoa is, frankly, one of the few companies that qualify. We've been designing and constructing these cables since their first conception—long enough to know what can cause a cable failure, and how to avoid it. If you're planning to design or install instrumentation cable soon, call us.

As a starter, send for our 24-page booklet titled "Instrumentation Cables, Cable Assemblies and Hook-up Wires." In it, we describe instrumentation cable constructions, production, military specifications and our qualifications. For your copy, write Rome Cable Division of Alcoa, Dept. 27-113, Rome, N.Y.



New Bourns 10-Turn Servo-Mount Potentiometers: Smaller Cases, Up to 39% Higher Resistances!

The many advanced design concepts introduced by Bourns miniature precision potentiometers in the past two years are now available in two brand-new servo-mount units. The new Models 3550 and 3750 deliver 25 to 39% more total resistance in smaller-than-conventional packages because their thin-wall plastic cases make room for a 20%-longer resistance element.

There's more—the new units also provide better linearity and finer resolution. Their shafts are supported by precision ball-bearings and the rotors are virtually backlash-free. In addition, new case materials make possible a maximum operating temperature 20° higher than that of competitive units now available.

Both the Model 3550 and 3750 incorporate the Bourns exclusive SILVERWELD® multi-wire termination. Both are also subjected to 100% inspection and the rigorous double-check of the

Bourns Reliability Assurance Program. All the advanced features of these two new potentiometers strengthen our statement: Don't MIL-SPECulate—SPECify Bourns!

Write today for complete technical data.

	MODEL 3550	MODEL 3750
Size:	7/8" x 1 1/2"	1/2" x 1 3/8"
Standard Resistances:	100Ω to 200K	100Ω to 100K
Resolution:	0.06 to 0.008%	0.09 to 0.02%
Independent Linearity:	±0.20% Std.	±0.25% Std.
Power Rating at 70°C:	2.5 Watts	1.0 Watt
Operating Temp. Range:	-65° to +125°C	-65° to +125°C
Meets Steady-State Humidity Requirements:	Yes	Yes



UNITS SHOWN 1/2 ACTUAL SIZE

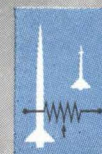
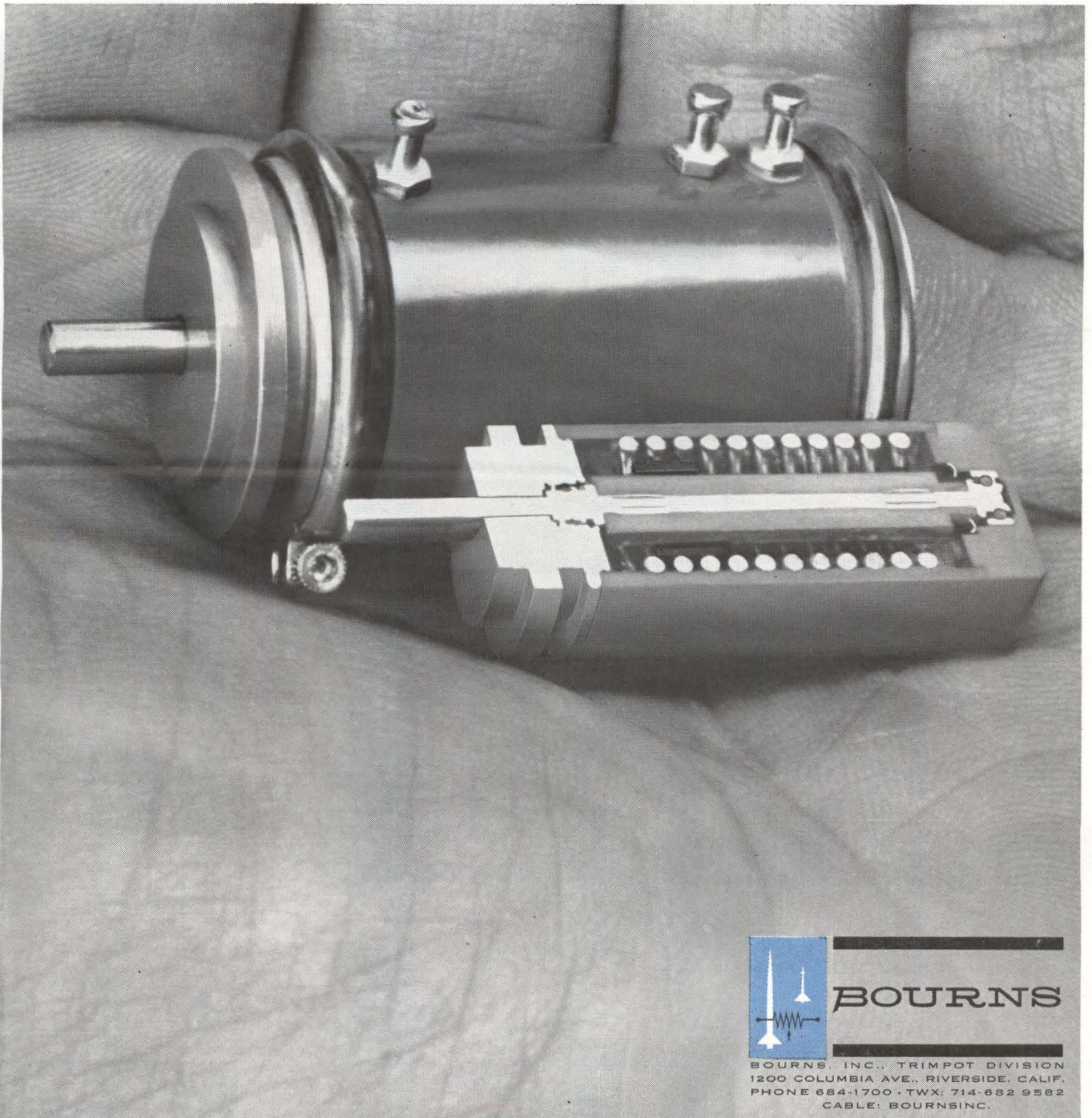

BOURNS

BOURNS, INC., TRIMPOT DIVISION
1200 COLUMBIA AVE., RIVERSIDE, CALIF.
PHONE 684-1700 • TWX: 714-682 9582
CABLE: BOURNSINC.

MANUFACTURER: TRIMPOT® & PRECISION POTENTIOMETERS, RELAYS; TRANSDUCERS FOR PRESSURE, POSITION, ACCELERATION. PLANTS: RIVERSIDE, CALIFORNIA; AMES, IOWA; TORONTO, CANADA

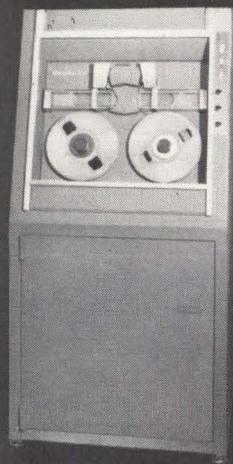

the **MT-24**

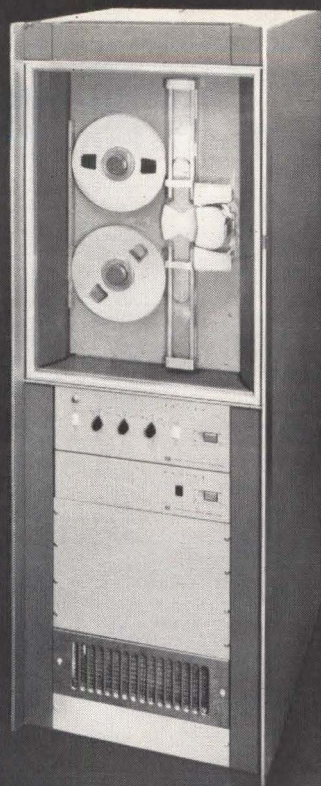

the **MT-36**

and now...the **MT-75**

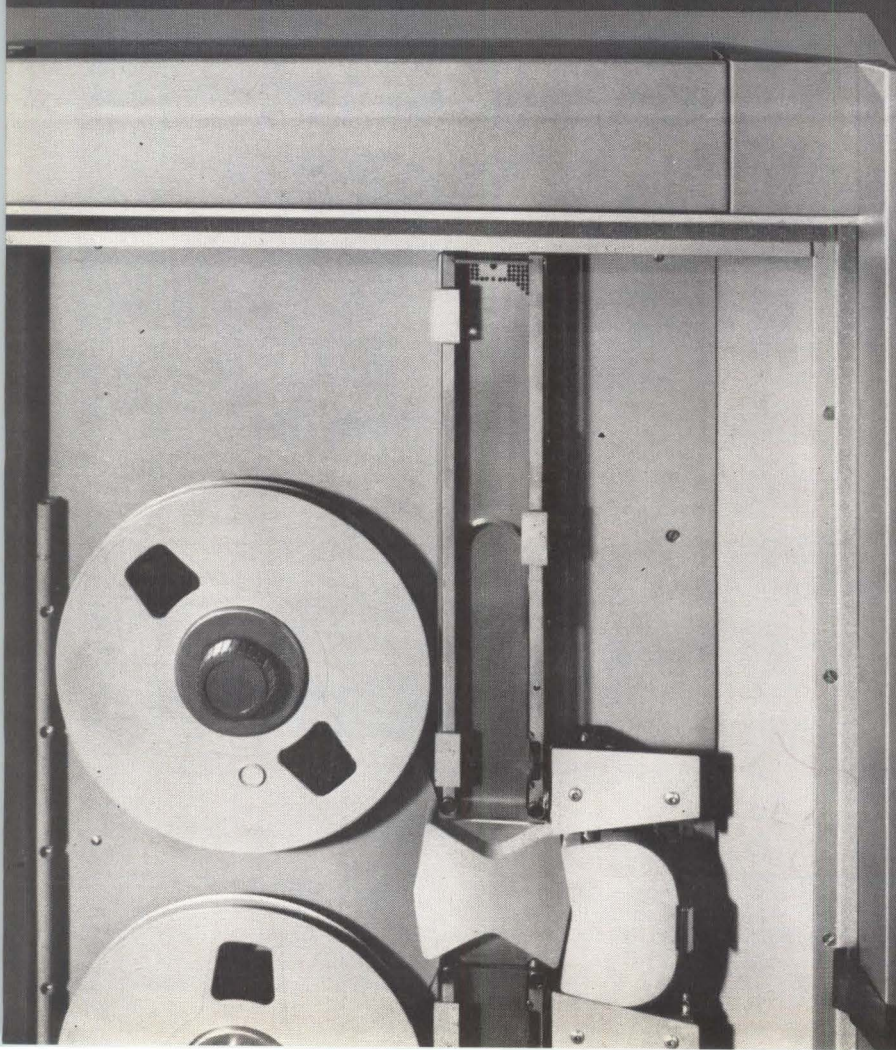

Small cost . . . **BIG PERFORMANCE**

Now, with the introduction of the new MT-75, Potter offers a complete family of high-performance, vacuum-column magnetic tape transports, featuring packing densities to

800 b.p.i.

These new Potter transports, the MT-24, the MT-36, and the MT-75, have been thoroughly value-engineered for the highest possible reliability at minimum cost. They cover a tape speed range of 1 to 75 ips; provide data transfer rates to 60kc. All are IBM-compatible. Here are the facts:

MT-24: 1-36 ips — data transfer to 28.8kc, 200 commands per sec.

MT-36: 1-50 ips — data transfer to 40kc, 200 commands per sec.

and the NEW MT-75: 1-75 ips — data transfer to 60kc, 200 commands per sec.

Interested? Complete data is available on these, as well as many other Potter models for speeds to 150 ips and packing densities to 1200 b.p.i. For information on the broadest line of digital transports available anywhere, just write to Sales Manager.

POTTER
INSTRUMENT CO., INC.
151 Sunnyside Boulevard, Plainview, New York



T.M.

CIRCLE 34 ON READER SERVICE CARD

ORGANIC-DIODE associative memory shown on the front cover is assembled by Hans Schnitzler, of RCA Labs. Blue square (see inset) is evaporated phthalocyanine film that extends between the diodes' common cathode electrode (obscured) and the gold anode electrodes arrayed around the periphery. Each anode connects to two etched copper wires that fan out to the card edge

By **MICHAEL F. WOLFF**
Senior Associate Editor

WHAT'S NEW IN

COMPUTER MEMORIES

Laminated ferrites, cryoelectric memory with cavity sensing, new thin-film techniques, and organic diode arrays point the way toward computer memories compatible with microelectronics

NEW DEVELOPMENTS in computer memories indicate that progress is being made toward the goal of an all-microelectronic digital computer. This will be evident at next week's Fall Joint Computer Conference in Las Vegas, where several speakers will report improvements in fabricating computer memories compatible with integrated circuits. Lack of this capability has been one of the stumbling blocks toward the microelectronic commercial computer that is of

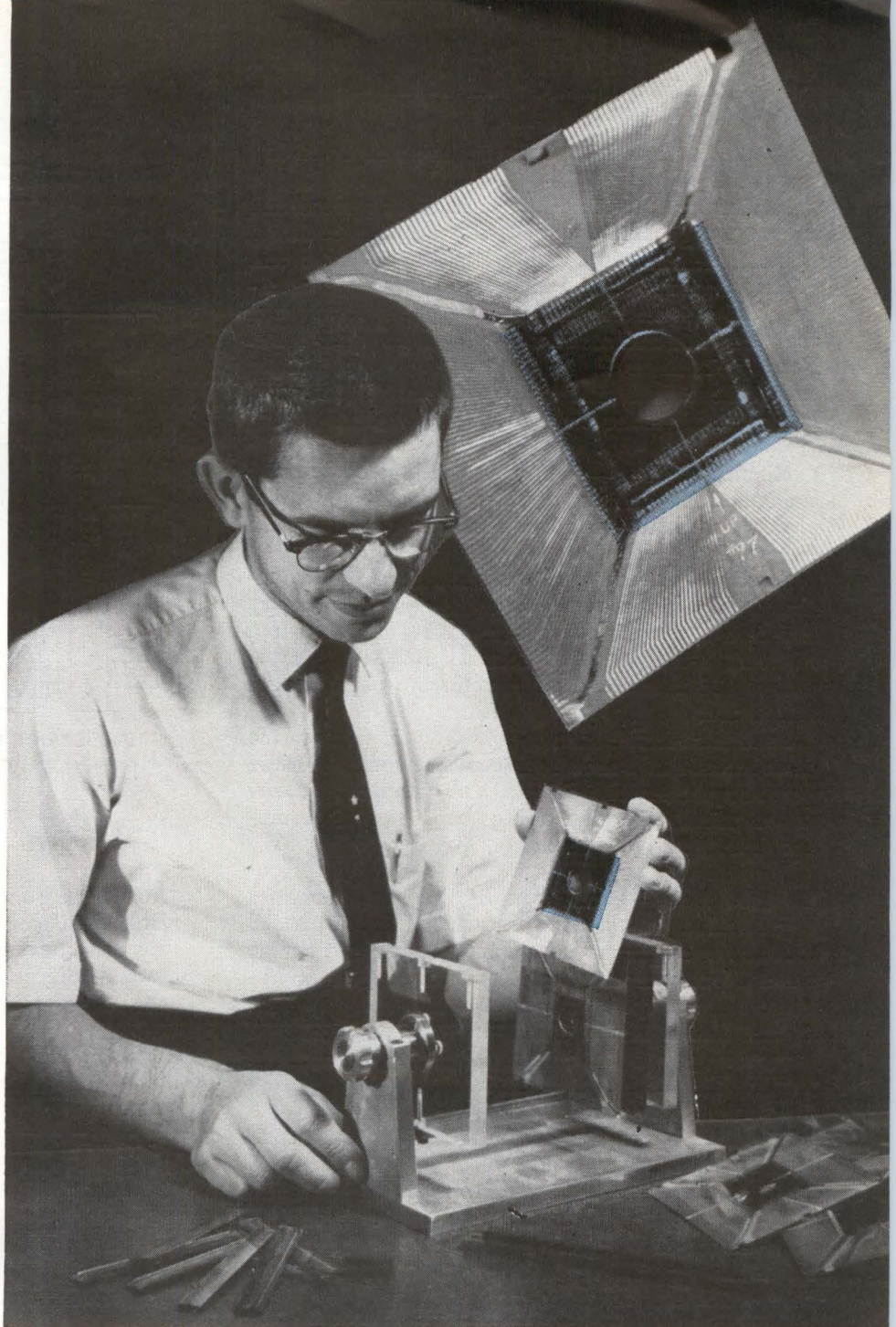

great interest to industry because of its expected low cost and high speed.

Memory research is aimed at increasing speed and capacity, a goal that can be met only by reducing memory element size, and for which magnetic and superconductive techniques are receiving major attention. In magnetics, comparable speeds have been achieved with microferrites and thin magnetic films. Next week, however, RCA will reveal a technique they believe will make ferrite memories cheaper, faster and of greater capacity than thin films.

Laminated Ferrites—The new technique employs lamination of ferrites, a simple batch fabrication process for making a monolithic sheet of ferrite with embedded conductors.¹

Feasibility of the low-cost method has been demonstrated with an experimental random-access memory less than a ¼-inch square that stores 128 bits in a 16-word, 8-bits-per word format. Read-write cycle time is 100 nsec and read currents are on the order of 350 ma.

Laminated-ferrite memories with cycle times in the microsecond range are also under development. These would require less associated electronics and operating power, might have total storage capacities of 10 million to 100 million bits.

How Its Done—Fabrication of the new memories begins with a glass substrate on which a set of parallel conductive stripes is silk-screened with a metallic paste. Next, a ferrite slurry incorporating an appropriate binder is spread evenly over the substrate where it dries into a flexible sheet that can be peeled off intact along with the conductive stripes underneath. Two such sheets are prepared plus a third or "spacer" sheet which has no conductors.

The next step is to stack all three sheets in a sandwich arrangement with the spacer in the center and the embedded conductors in the outer sheets facing each other at right angles across the spacer. The effect is that of a buried grid (see photo) whose horizontal and vertical lines are separated by a thin ferrite sheet which acts as an electrical insulator.

Finally, the stack is laminated under moderate pressures and temperatures, and sintered. Access to the conductors in the stack is obtained through tiny holes punched in the ferrite sheets before they are laminated. Overall thickness of the laminate is approximately 5 mils and the conductor spacing is 10 mils.

Integrated Circuits—In a typical core memory, one-half the cost lies in the associated electronics. Combining laminated arrays with integrated circuits is expected to result in substantial cost-per-bit reduction over the present state of the art and make random-access ferrite memories with capacities in excess of 10^7 bits economical.

Experimental memory arrays have been operated at 1 Mc where the 1-mv sense outputs and drive currents of less than 50 ma are compatible with silicon integrated circuits. RCA is starting work on 1-Mc drive and sense circuits for which bipolar or metal-

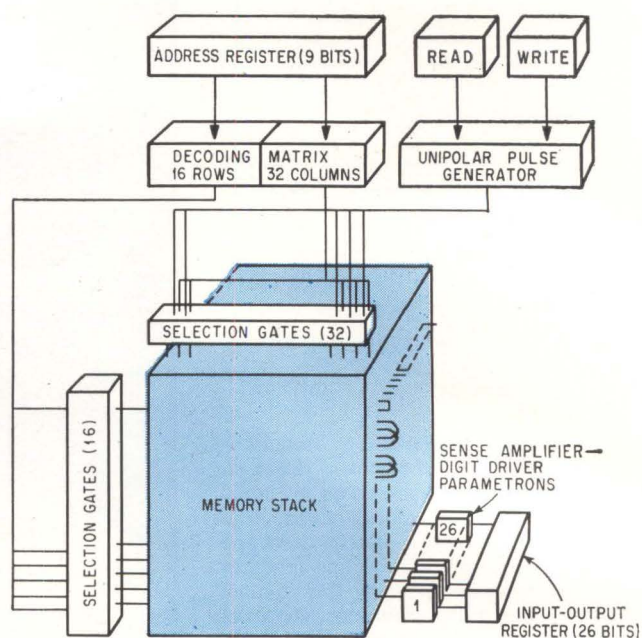

PHASE-SCRIPT memory uses cylindrical thin-film parametrons for both digit driver and sense amplifier functions—Fig. 1

oxide-semiconductor transistors will be used, depending upon ease of fabrication. Successful application of these devices, which will require both new circuits and modification of present devices, could conceivably be followed by use of deposited thin film transistors.

Thin Films—New technique developed at National Cash Register is expected to reduce costs of thin-film memories for practical parametron computing systems.² Method employs a thin magnetic film as a phase-script memory element in what appears to be one of the first applications of thin films to moderate speed, low-cost memories.

In the phase-script memory, so called because "0" and "1" are stored in terms of the phase of an a-c signal, the memory input and output signals are ideally suited for parametrons (phase-locked subharmonic oscillators). The new technique employs a simple cylindrical thin-film parametron to provide both digit driver and sense amplifier functions, thus considerably reducing the cost and enhancing reliability of the memory, according to NCR. Also, by using the film in a rotational switching mode rather than creep, significant speed advantages are obtained—roughly an order of magnitude beyond ferrite phase-script memories.

A 512-word (26 bits per word) ndro memory has been designed and is shown in Fig. 1. The memory stack consists of planes of encapsulated solenoids with the plated-wire digit lines inserted into the solenoid apertures and connected end-to-end in an appropriate noise-cancelling arrangement. Basic memory cycle is 5 μsec to be compatible with the 200-kc data rate of the parametrons. Diode logic is used to decode the addresses which are developed by parametron flip-flop registers driving phase-to-d-c converters.

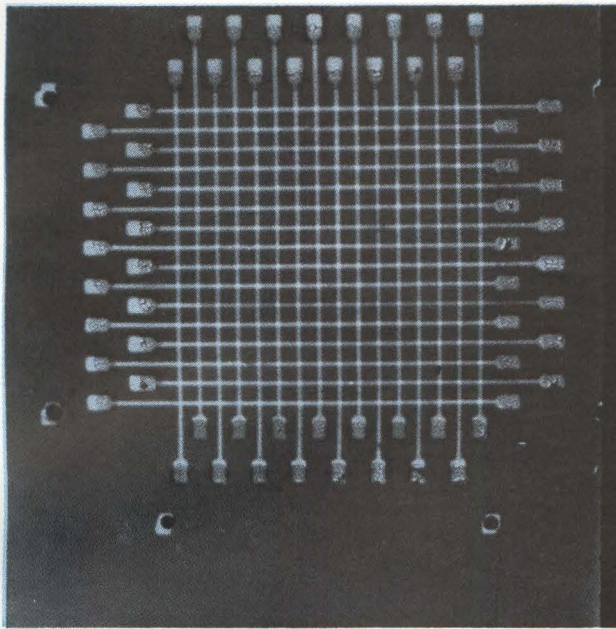

MAGNIFIED X-RAY photo of laminated ferrite memory array shows embedded conductors

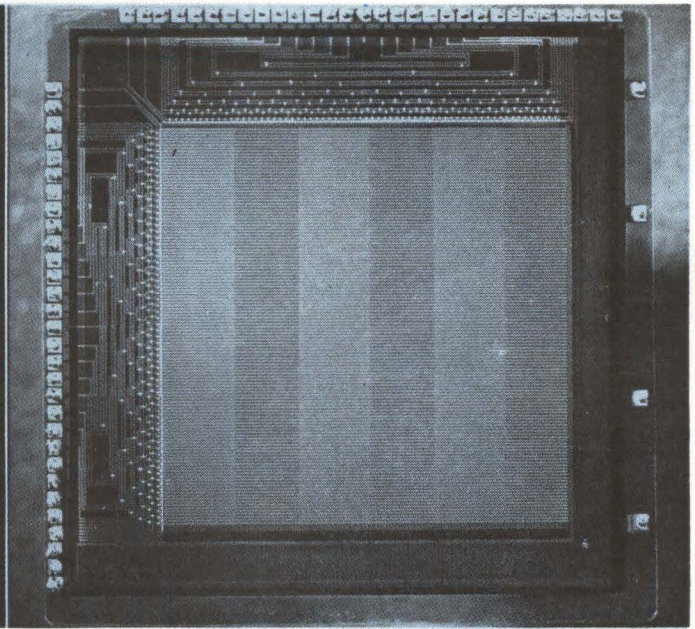

16,384-BIT CRYOELECTRIC memory with cavity sense and cryotron address matrices

The digit parametrons are cylindrical thin-film parametrons pumped at 20 Mc and operated so as to produce approximately 100 ma peak-to-peak digit current in the line. The digit parametron also operates as a sense amplifier and is part of a three-parametron chain which forms the input-output register.

Cryoelectric Memories—While magnetic techniques look promising for high speed, random access memories with capacities around 10^7 bits, superconductivity may be the answer for large-capacity memories of the order of 10^9 bits. First practical step toward this goal was the operation of a 16,384-bit superconductive memory plane at RCA Labs (ELECTRONICS, p 8, June 28). The two-inch-square plane is composed of several thin-film layers including a superconducting thin film, two grids of lead drive lines and a zig-zag lead sense line.

The sense line is one of the limiting features of the plane. In addition to being difficult to fabricate it becomes prohibitively long with increasing memory size. This causes an appreciable delay between the onset of the read currents and the ensuing sense output pulse. Next week, however, RCA will report on a cavity sense structure which overcomes these disadvantages and is considered to offer the potential for large high-speed memories not heretofore possible.³ Work is supported in part by Rome Air Development Center.

Cavity Sensing—The continuous sheet memory with the cavity sense structure consists of a storage plane, sense plane and "X" and "Y" drive lines (see Fig. 2). The latter are orthogonal to, and insulated from, one another and are insulated from the memory plane. The sense plane and memory plane films are elec-

trically connected along one edge and together with the ground plane comprise the cavity.

If the drive currents are polarized such that their magnetic fields constructively add to that of the stored currents, the resultant magnetic field at the region of memory plane beneath the intersection where the drive currents coincide will be sufficient to destroy the superconducting state of this region; as a consequence, a flux change occurs within the cavity beneath the intersection. The time-varying magnetic and electric fields give rise to a sense pulse indicating the presence of a stored "1". Absence of a pulse indicates a "0" was stored.

Performance—Good signal-to-disturb ratios are inherent in this memory and ratios of 20:1 have been observed. A 128×128 -bit memory with cavity sense and cryotron addressing matrices has been fabricated by multilayer vacuum deposition on a 2×2 -inch substrate (see photo). The plane has been operated with full selection on one cryotron selection tree. Drive currents of about 125 ma were used to interrogate the memory cells with an overall selection tolerance of approximately 20 percent. Sense voltages of 3 mv were observed at 3.6 deg K.

Initial operation has been at a cycle time of 1 μ sec but higher speed is anticipated by improvements in the selection tree.

Large-capacity planes are considered possible because of the absence of disturbing pulses when a cell is half selected. Drive lines are now fabricated on 10-mil centers but it is felt these can be reduced to 3 mils, making practical a $1,024 \times 1,024$ -bit plane. RCA believes that the crossover point where a superconductive memory would be more economical than a magnetic memory occurs when the memory com-

CRYOELECTRIC MEMORY plane exploded view shows decoding assembly and cavity sense structure—Fig. 2

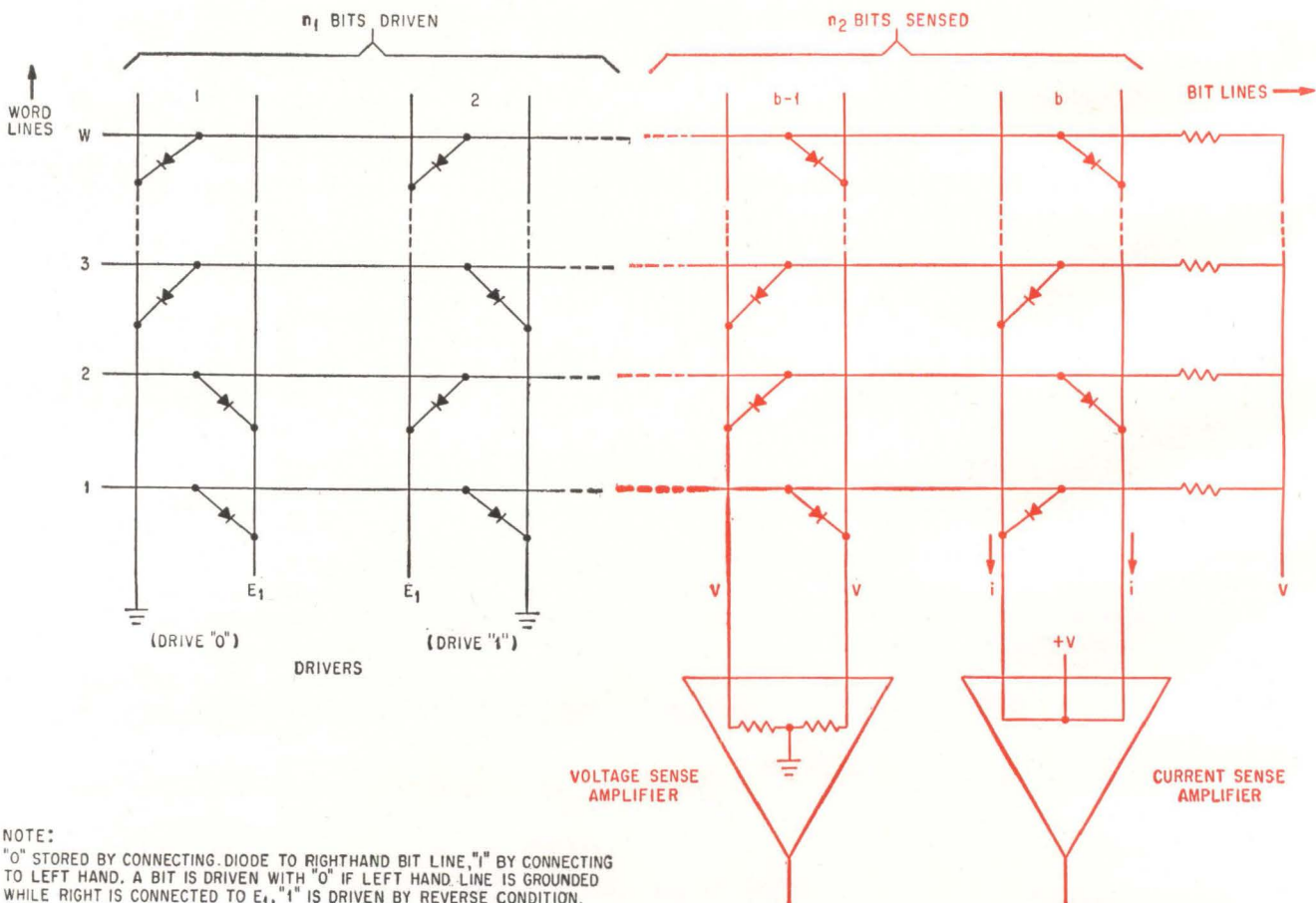
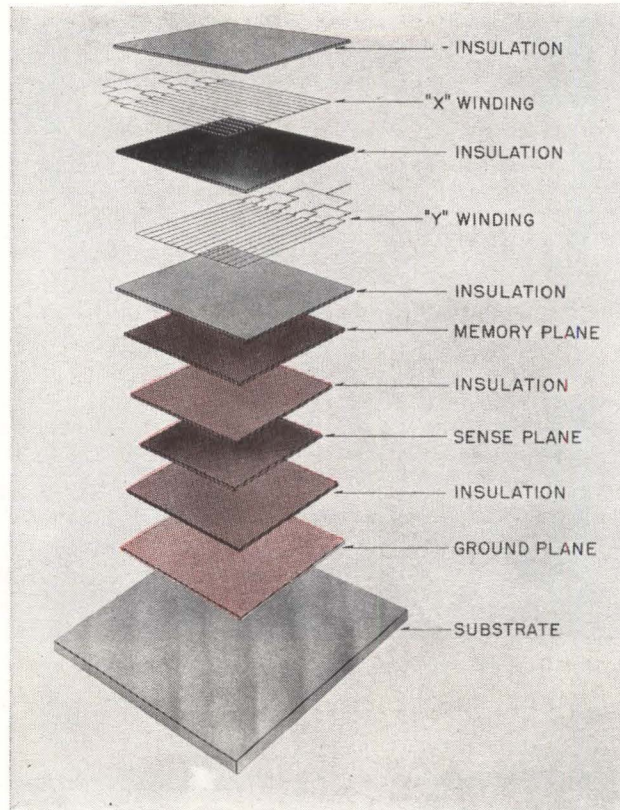

DIODE ARRAY is composed of w word lines and b pairs of bit lines, thus storing w words each b bits long. Sense amplifiers may be either voltage or current amplifiers—Fig. 3

prises more than a few million bits:

Associative Memories—The still-embryonic field of content addressable, or associative, memories will come under scrutiny in two papers. An experimental associative memory has been built at RCA Labs using 4×4 -inch plastic cards incorporating interconnected arrays of evaporated organic diodes.⁴ The memory is capable of searching stacks of punched-cards in parallel and reading out stored information electronically without making it necessary to remove the cards from the stacks.

The number of words in the memory is determined by the number of cards in the file, and the number of bits per word by the number of diodes on each card. At present, cards can accommodate one word consisting of up to 128 bits. Each diode in the memory has two independent anode connections to the bit lines, and a common cathode to which it is connected through all the word lines (see Fig. 3). All cards are interconnected electrically along their edges.

To write binary information into this memory, one of the anode connections to a diode is broken, ideally with a hole-punch. Depending on which anode connection this is, a "1" or a "0" is stored.

To interrogate the memory, it is necessary only to send in pulses which correspond to a portion of the stored pattern on one or more of the bit line pairs. Wherever there is a card that meets this criterion, its other bit lines become electrically active and transmit the associated remainder of the stored pattern in the form of positive and negative pulses which are sensed outside the memory.

Thus, if a name and address are stored in binary form on a card, the computer need only be told all or part of the name to learn the address associated with it. Such an arrangement can also be used as a reversible encoder-decoder since it is possible to drive the bits on the right side of Fig. 3 and sense those on the left.

Another important feature of the memory is its ability to retrieve in sequence all words which in general would match a given interrogation. Exactly $2m-1$ memory cycles are required to retrieve m words, regardless of the number of words in the memory or the number of bits per word.

Organic Diodes—A large diode matrix serving as a fixed, associative memory is considered economically feasible only if sizeable arrays of diodes can be batch-fabricated at low cost. For this reason, and because the resulting diodes can be put on flexible substrates, RCA is investigating vacuum evaporation of the organic semiconductor copper phthalocyanine. This compound is a dye and serves as the middle layer of a three-layer diode sandwich whose outer layers are metal anode and cathode electrodes. While still far from being a reproducible, practical thin-film diode, such devices have been used on 10-bit cards to verify that the memory interrogation scheme works. Typical diodes with an area of 3.5 sq mm have rectification ratios of approximately 10^5 , capacitance of 50 to 100 pf, and a voltage drop of about 1.5 v at a forward current of 2 ma.

Future plans call for further research to determine if practical diode arrays can be fabricated in this manner, and also if an economical scheme can be developed for interconnecting the individual cards.

300 Nsec Search—Thin-film search memory that can do a complete search in 300 nsec has been built at Univac division of Sperry Rand.⁵ The memory elements, termed "bicores," consist of two superimposed thin magnetic films. A cobalt-iron film serves as a non-destructive memory element while a low-coercivity nickel-iron film serves as the sensing element.

Speed of a search, or associative, memory with "bicores" is limited to a large extent by the transistor circuits and the packaging that is used. Emphasis in designing the new memory was on obtaining high speed. The memory is considered to have the potential to do a complete search in 100 nsec; that is, it could compare one million incoming data words with all the stored key words in 0.1 second.

Rope Memories—Design of a 256-word rope memory that can store up to four 16-bit words per core will be described by Peter Kuttner, of Burroughs.⁶ Cycle time is 8 μ sec, serial or parallel readout is possible.

Rope memories are nondestructive readout, permanent storage memories. Information patterns are generated by threading a sense line through a core if a "1" is to be stored and bypassing the core if a "0" is to be stored.

In his paper, Kuttner will compare the rope memory with three other types of permanent storage memory—capacitive, electromagnetic coupling, and permanent magnetic twistor. These three have several factors in common including the following: each storage element stores one bit, outputs are on the order of a few millivolts, some batch fabrication techniques are possible, and they are organized in a linear select mode. Cycle times are 200 nsec, 1 μ sec and 5 μ sec, respectively.

Rope memories have the advantage of being able to perform logic, and, also, no decoding circuits are required to select a core. Because of this, 30- to 50-percent fewer components can result, says Kuttner. Storage density is between 500 and 800 bits per cubic inch, outputs are on the order of 100 to 200 mv.

Two types of storage elements can be used in rope memories: bobbin cores and ferrites. While 6 μ sec is considered the best cycle time obtainable with bobbin cores without overdriving, Kuttner feels that 2-4 μ sec is attainable by using linear ferrites in novel geometries.

REFERENCES

- All papers to be presented at Fall Joint Computer Conference, Las Vegas, Nov. 12-14, 1963.
- (1) R. Shabbender, C. Wentworth, K. Li, S. Hotchkiss, and J. Rajchman, Laminated Ferrite Memory.
 - (2) B. A. Kaufman and Eduardo Ulzurrun, A New Technique for Using Thin Magnetic Films as a Phase Script Memory Element.
 - (3) L. L. Burns, D. A. Christiansen, and R. A. Gange, A Large Capacity Cryoelectric Memory with Cavity Sensing.
 - (4) M. H. Lewin, H. R. Beelitz, and J. A. Rajchman, Fixed, Associative Memory Using Evaporated Organic Diode Arrays.
 - (5) C. A. Rowland and W. O. Berge, A 300 Nanosecond Search Memory.
 - (6) Peter Kuttner, The Rope Memory: A Permanent Storage Device.

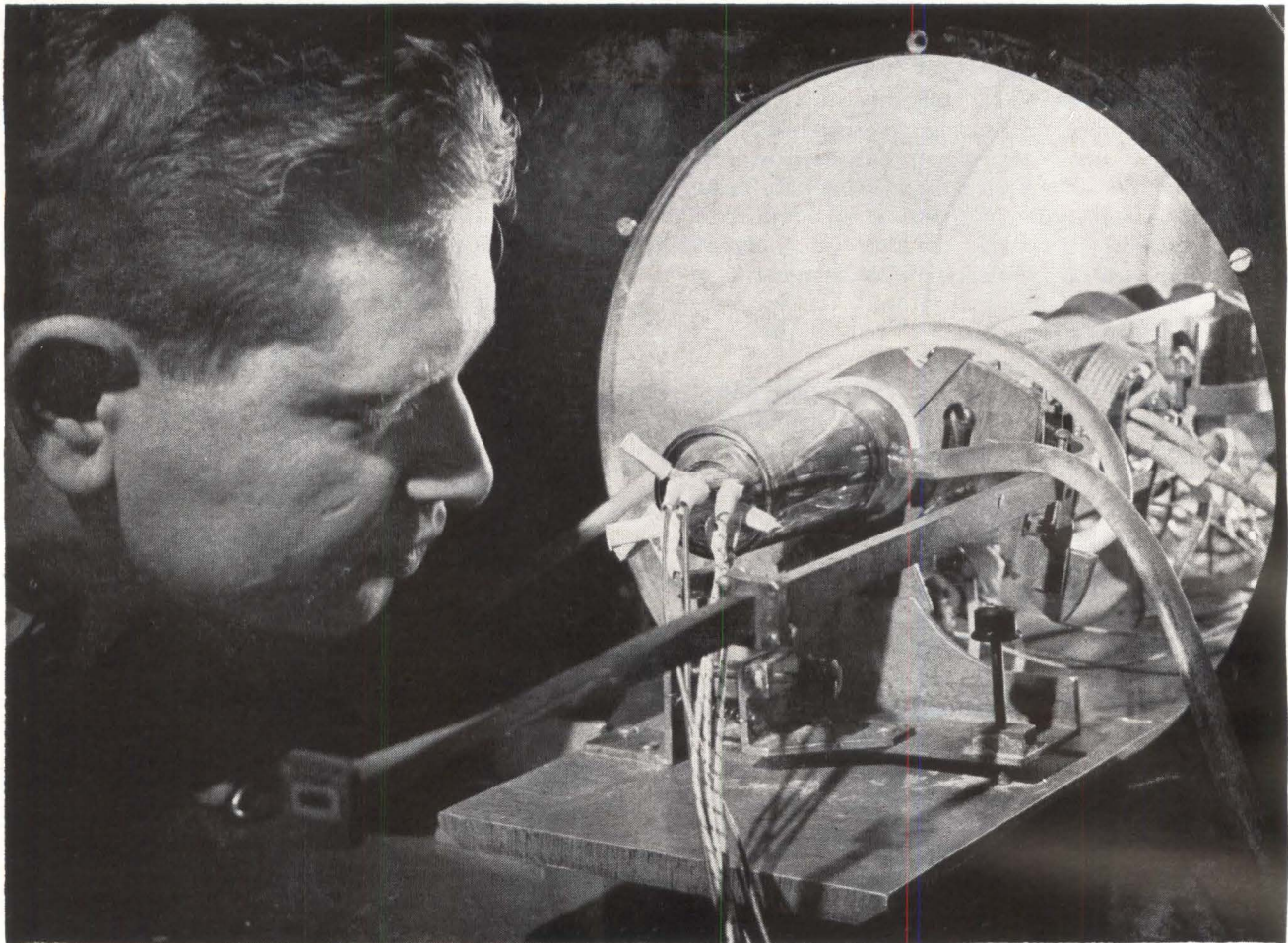

EXPERIMENTAL beam-plasma tube is amplifying 23 Gc signal for 8 db overall gain as author looks on. Flexible hoses supply cooling water

New Millimeter Wave Device—

High-current-density electron-beam is directed into cesium plasma in newest amplifying technique for millimeter and submillimeter waves. When perfected—which may take several years—beam-plasma amplifiers could supply tens of watts at up to 100,000 Gc

By **GEORGE A. SWARTZ**, RCA Laboratories, Princeton, New Jersey

MILLIMETER and submillimeter waves are the only part of the electromagnetic spectrum below-visible light still relatively unconquered by existing technology. Although devices for generating coherent electromagnetic radiation at up to 600 Gc (0.5 mm) are available¹, the cost of such devices is high and the power available is low.

Important limitations on existing

millimeter-wave generators are the extremely close mechanical tolerances that must be maintained in the minute structures necessary and the limited power they can handle. The curve in Fig. 1A (constructed by L. S. Nergaard of RCA Laboratories) shows power output as a function of frequency for existing and future devices.² The region under the solid lines represents

existing technology; the region inside the triangle represents the possible future role of plasma devices in generating millimeter and submillimeter waves.

Oscillations—Excitation of plasma oscillations by a high-velocity electron beam traversing a plasma was predicted by Bohm and Gross in 1949.³ Plasma oscillation frequency

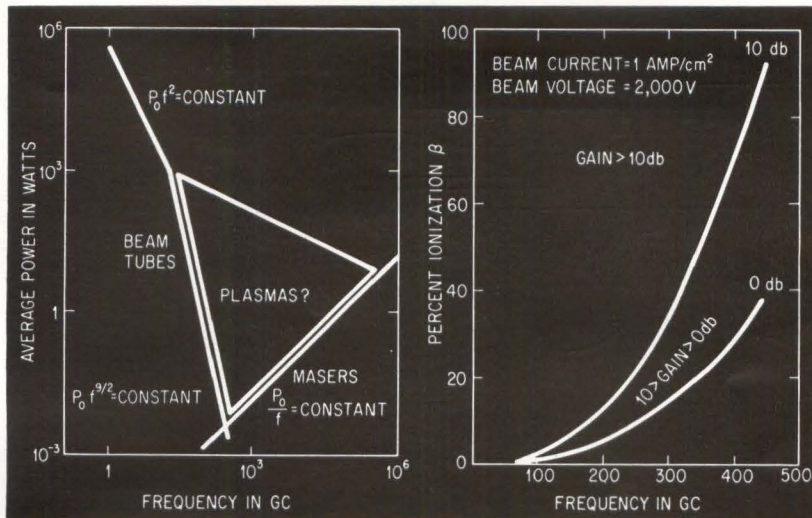

ELECTRON-BEAM plasma devices may operate in the triangular area of the power-frequency plane (A). Calculated curves for plasma amplifier gain (B) as a function of frequency and percent of plasma ionization—Fig. 1

MILLIMETER AND SHORTER WAVES

A big gap in the electromagnetic spectrum runs from about 100 Gc out to laser frequencies, a bandwidth of about a million Gc. This is the region of millimeter and submillimeter waves. Waveguides and cavity resonators shrink to the vanishing point for these wavelengths and any component with wires is likely to have too much self-inductance and capacitance to be tolerated. Radical new circuits and techniques are therefore required before this region can be used.

The beam-plasma amplifier is one such radical technique. If these devices can be developed as successfully as now seems probable, the big gap is likely to be substantially lessened

BEAM-PLASMA AMPLIFIER

ω_p is related to the plasma density n by

$$\omega_p^2 = n e^2 / \epsilon_0 m$$

where e is the charge on an electron, m the mass of an electron and ϵ_0 is the permittivity of free space. Plasma oscillations, through their associated electric fields, create a space-charge wave on the beam, which in turn generates larger amplitude coherent plasma oscillations. Thermal noise in the plasma is responsible for the initial low-amplitude plasma oscillations. If a low-amplitude space-charge wave is impressed on the beam before the beam enters the plasma, the plasma oscillates at the frequency of the impressed wave. Maximum system gain occurs when space-charge frequency ω is equal to ω_p .

While the beam-plasma system is potentially unstable, the instability is convective, which means that the wave or perturbation on the beam increases with the distance the beam travels through the plasma. The gain mechanism in the system is analogous to that in a traveling-wave tube in which the helix is replaced by a plasma. In contrast to the twt tube—in which the beam velocity is in synchronism with the phase velocity of a wave on the helix—the beam in a beam-plasma device can travel at any velocity that is much greater than the thermal velocity of the plasma electrons.

Amplification—The beam-plasma amplifier, which utilizes the penetration of a plasma by an electron

beam, has certain advantages with respect to a twt tube in which a beam passes near a slow-wave structure. In a beam-plasma device the high-frequency field does not tend to diminish toward the center of the beam as in a beam-helix device. Penetration of the entire beam by the plasma oscillation field results in a higher gain per space-charge wavelength and permits a larger beam diameter, hence more power output. However, the beam-plasma amplifier has an important limitation which results from beam electrons colliding with the ions and neutral atoms of the plasma. This mechanism dissipates power in the beam and creates noise in the output.

Beam dissipation by particle colli-

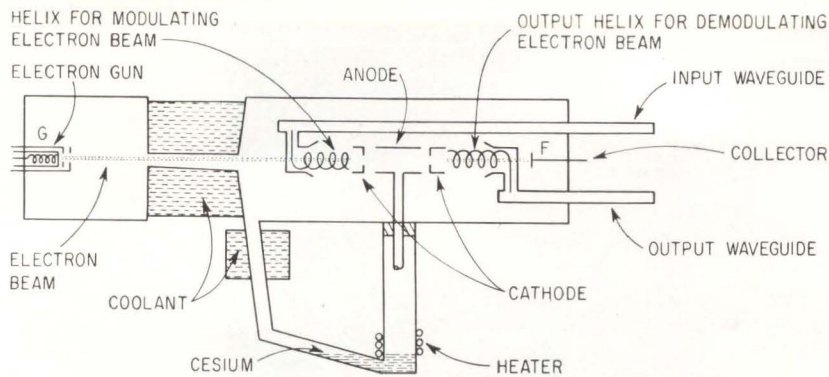

PULSATING electron beam at 1,400 volts is sent through cesium plasma to produce 40 db gain at 23 Gc (1.3 cm), but losses in helices and elsewhere cut net gain to 8 db—Fig. 2

sion places a limit on the useful plasma density and thus the frequency at which gain will occur. The criterion is that the gain per wavelength caused by the beam-plasma interaction must be greater than the loss per wavelength caused by electron collision; mathematically,

$$\kappa l > 1,$$

where κ is the gain constant in nepers per cm and l is the mean free path (in centimeters) of the beam electrons. κ is fixed by such parameters as electron-beam diameter, velocity and density, plasma electron collision frequency, and the operating frequency. Length l is determined by such parameters as electron-beam velocity, collision cross-section of the gas used for the plasma, and total particle density in the plasma.

Consider a large diameter 2,000-volt electron beam passing through a cesium plasma. Since ion density is fixed by the operating frequency, the maximum permissible density of neutral particles allowing a net gain can be calculated. Plotted in Fig. 1B are the minimum percent ionization for both 10-db gain and 0-db gain as a function of operating

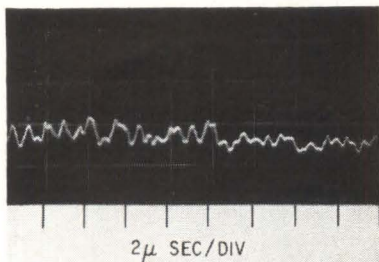

POWER OUTPUT (not signal waveform) of 23-Gc beam-plasma amplifier fluctuates at about 1 Mc—Fig. 3

frequencies, where percent ionization is the ratio of ion density to the sum of ion and neutral density.

For the case shown in Fig. 1B, ionization must be greater than 30 percent for reasonable gain at 300 Gc. This minimum ionization may be reduced by increasing beam velocity and density. However, inhomogeneities in the plasma and the use of smaller beam diameters to prevent high-order modes of the space-charge wave increases the minimum percent ionization. Thus about 30 percent ionization will have to be achieved in a usable beam-plasma amplifier operating at 300 Gc.

Realization—In 1958 Boyd, Field, and Gould⁴ experimentally verified the Bohm and Gross theory. In their experiments they passed an electron beam through an input helix, a mercury plasma and an output helix. Microwave power at 2 Gc was coupled to the electron beam by the input helix. Density of the mercury plasma was varied continuously and at a critical value the power from the output helix increased sharply. Beam-plasma amplifiers subsequently constructed were of similar design.^{5, 6, 7} Chernov and Bernashevski have observed 30 to 40-db power gain at frequencies up to 38 Gc in a mercury plasma,⁸ which is the highest reported frequency achieved by such a device.

A 23-Gc beam-plasma amplifier⁹ recently tested is shown in the photograph; a schematic is shown in Fig. 2. A 1,400 volt electron beam was sent through a cesium plasma and interaction over a 3-cm length of plasma produced a 40-db power gain, but losses in the input

and output helices and windows cut the net power gain to 8 db. One-megacycle density instabilities were present in the plasma and these instabilities were reflected in the detected output signal, as shown in Fig. 3. The cesium Penning arc that provided the plasma may be capable of producing the highly ionized dense plasmas required to generate millimeter waves.

To achieve reasonable efficiencies and power from extremely high frequency amplifiers requires beam current densities of 500 to 2,000 amp per cm², which have already been produced by highly convergent electron guns¹.

Two major difficulties must be surmounted before millimeter wave generation is practical with a beam-plasma device. First, a mechanism must be developed for coupling millimeter-wave power to the device without resorting to mechanical structures such as a helix or cavity. Second, a stable plasma with a density of 10¹⁴ to 10¹⁵ ions per cm³ and ionization of 5 to 50 percent must be produced. The higher the density, the higher the percent ionization required.

The cesium Penning arc may resolve the latter difficulty. Coupling may be solved through the use of such phenomena as the propagation of surface waves on a plasma column or of waves in a magneto-plasma. Once the major difficulties are overcome, which may happen within the next few years, the way will be open for the development of a new class of devices for generating coherent electromagnetic radiation.

REFERENCES

- (1) G. Convert, Y. Ta, and P. Moutou, *Proc International Congress on Microwave Tubes*, Scheveningen, Holland, Sept. 1962, To be Published.
- (2) L. S. Nergaard, Private Communication.
- (3) D. Bohm and E. Gross, *Phys Rev* 75 p 1851, 1949.
- (4) G. D. Boyd, L. M. Field, and R. W. Gould, *Phys Rev* 109 p 1393, 1958.
- (5) M. A. Allen and G. S. Kino, *Phys Rev., Letters*, 6 p 163, 1961.
- (6) E. V. Bogdanov, V. J. Kislov, and Z. S. Chernov, *Proc Symposium on Millimeter Waves 1954*, p 57, Polytechnic Press of the Polytechnic Institute of Brooklyn, N. Y., 1960.
- (7) P. Chorney, *Proc of Conference on Wave Interaction and Dynamic Non-Linear Phenomena in Plasmas*, Feb. 1963, Penn State U., To be Published.
- (8) Z. S. Chernov, and G. A. Bernashevski, *Proc of Symposium on Electromagnetics and Fluid Dynamics of Gaseous Plasma 1961*, p 31, Polytechnic Press of the Polytechnic Institute of Brooklyn, N. Y., 1962.
- (9) G. A. Swartz and L. S. Napoli, *Proc of Conference on Wave Interaction and Dynamic Non-Linear Phenomena in Plasmas*, Feb. 1963, Penn State U., To be Published.

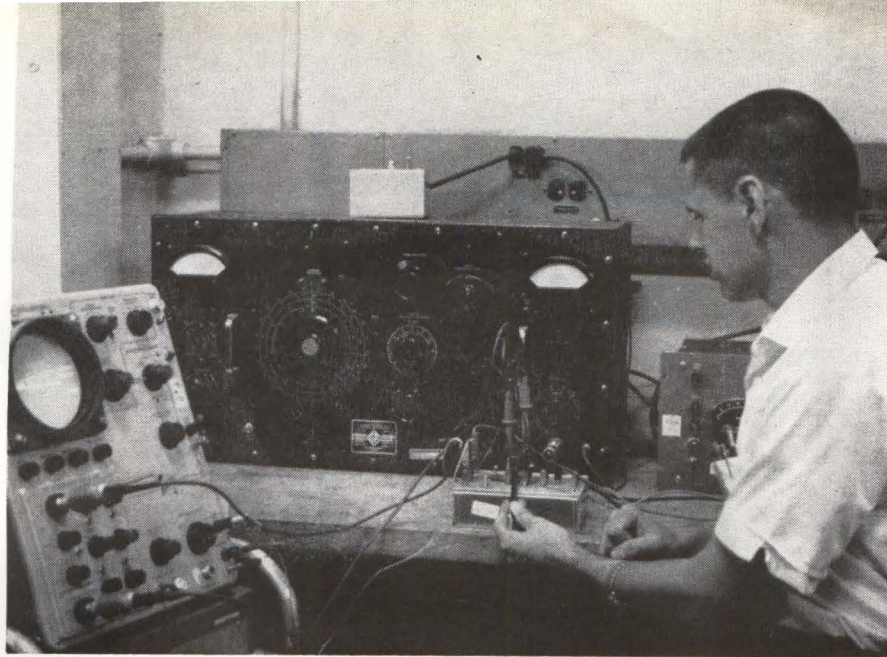

AUTHOR makes measurements of the r-f sensitivity of semiconductor devices

Can RFI Control Prevent WEAPONS FAILURES?

Today's modern weapons often include electronic circuits. Where solid-state components are used, radio-frequency interference can impair or destroy reliable operation

By **RICHARD J. SANFORD**

Advanced Engineering Div., U. S. Naval Ordnance Laboratory, White Oak, Md.

EFFECTS of electromagnetic radiation on weapons circuits has been considered only in the last few years, after it was discovered that the unrestricted use of a number of our operational weapons in the vicinity of operating transmitting antennas impaired both the reliability and the safety of the weapons.

Failures resulted from the premature actuation of an electro-explosive device, or EED (squib). In this device, an electric current passing through a bridge wire heats it to a temperature that initiates a small explosive charge. This small charge then performs some useful task, such as opening or closing switch

contacts, igniting a rocket motor, or detonating a warhead. Since the EED responds to the heating effect of an electric current, it is just as sensitive to stray radio frequency energy as it is to the direct current with which it is usually fired. For this reason, considerable effort is being expended to provide r-f protection for EED's and to design weapons using a minimum of r-f-sensitive components.

Switch—The explosive switch is one EED for which a number of replacements are available. The electro-mechanical relay is insensitive to r-f signals because

SIGNALS WITH A REAL BANG

In addition to being efficient under ideal circumstances, switches for use in weapons circuits must be reliable in the adverse environments in which weapons operate. Aside from mechanical, thermal and chemical considerations, solid-state devices must also withstand RFI. If they fail to do so, a tiny radio signal could impair or destroy their operation

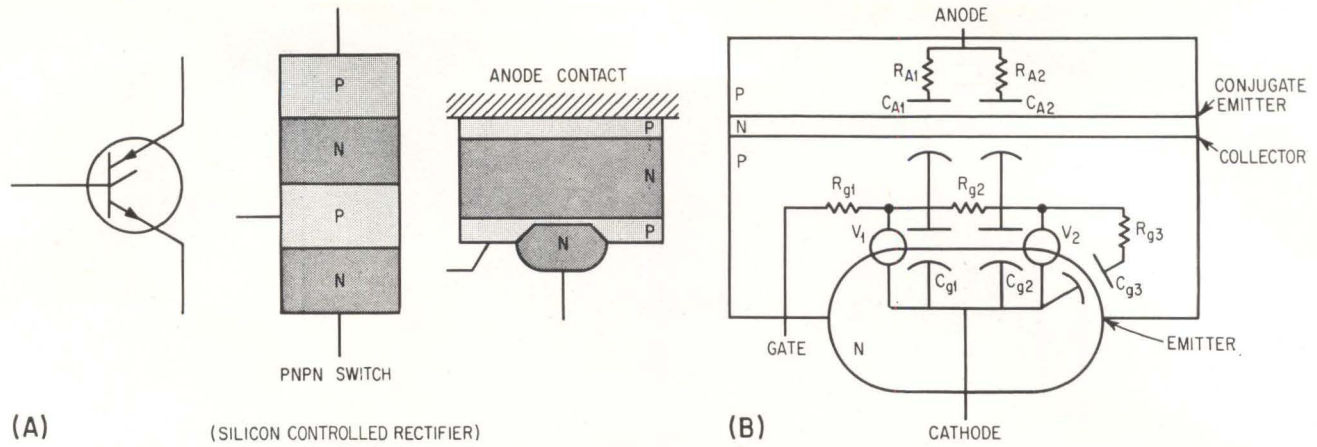

(A) EMITTER or cathode junction, collector junction and conjugate emitter or anode junction of a pnpn switch (A), and r-f equivalent circuit of an unfired controlled rectifier (B)—Fig 1

of its slow response and high inductance. The transistor, where applicable, is smaller and more rugged than the relay, and although it is not particularly insensitive to r-f, its properties are well enough known to electrical engineers, for r-f-protected switching circuits to be devised. The *pnpn* switch provides most of the advantages of the transistor but is more efficient as a switch and can be latched to remain in the closed position after the input signal has been removed. Since it is normally used in d-c circuits, its r-f properties are not widely understood.

The controlled rectifier, also known as the controlled switch or *pnpn* switch, is a semiconductor device that closes an electrical connection between anode and cathode when a suitable electrical signal is applied between gate and cathode. This connection remains closed as long as a current flows through it, whether the gate signal remains or not.

The heart of a silicon controlled rectifier is a single crystal of pure silicon consisting of four alternating layers of *p*- and *n*-type material, which form

three interacting *p-n* junctions. These are the emitter or cathode junction, the collector junction, and the conjugate emitter or anode junction as shown in Fig. 1A. The lower two junctions form in effect, a high gain *nnp* transistor, and the upper two junctions form a low gain *pnp* transistor, both transistors using the same collector. The α of each transistor increases with collector current at low currents. Since the transistors are connected for positive feedback, the device switches on when the collector current rises to such a value that the sum of the α 's exceeds unity. A forward voltage of about 0.5 volt must be placed across the emitter junction to raise the collector current to this value, and so any signal, d-c or r-f, that can raise the gate voltage to this level can fire the switch.

Radio Frequencies—The r-f properties of an unfired *pnpn* switch can be explained by means of the equivalent circuit of Fig. 1B. C_{g1} , C_{g2} , and C_{g3} represent the distributed emitter capacitance of the switch, while V_1 and V_2 illustrate the fact that the switch fires when the emitter is forward biased by about 0.5 volt. R_{g1} is the resistance between the gate contact and the closest part of the emitter. The resistance in the gate *p* region (R_{g2}) is from one side of the cathode to the other. This may be comparable to R_{g1} in some cases; but if the cathode extends across the entire width of the gate region, R_{g2} may sometimes reach several thousand ohms. The resistance between various parts of the emitter and the collector varies with the distance between them as shown by R_{g3} . The distributed anode capacitance, which is the capacitance of the collector and conjugate emitter in series is represented by C_{A1} and C_{A2} . The distributed anode resistance is represented by R_{A1} and R_{A2} .

A controlled rectifier has some inherent protection against r-f signals introduced at its gate lead. The capacitance C_{g1} of its emitter junction combines with the resistance R_{g1} around the gate contact to form a simple RC filter that attenuates the r-f. The action of this filter decreases the sensitivity of the switch as the frequency of the gate signal is increased.

Regions—When the r-f voltage is applied between

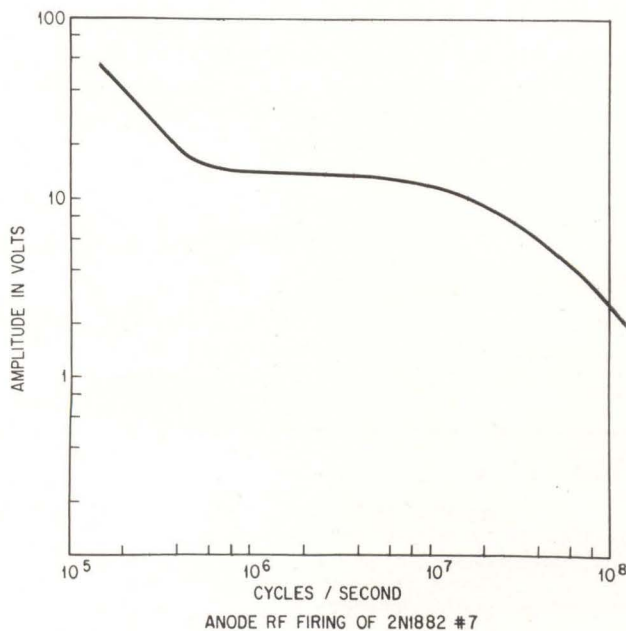

ANODE radio-frequency firing of a 2N1882 rectifier—Fig. 2

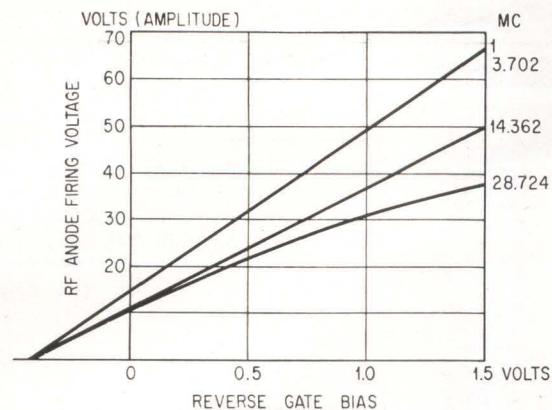

(A) ANODE PROTECTION BY GATE BIAS

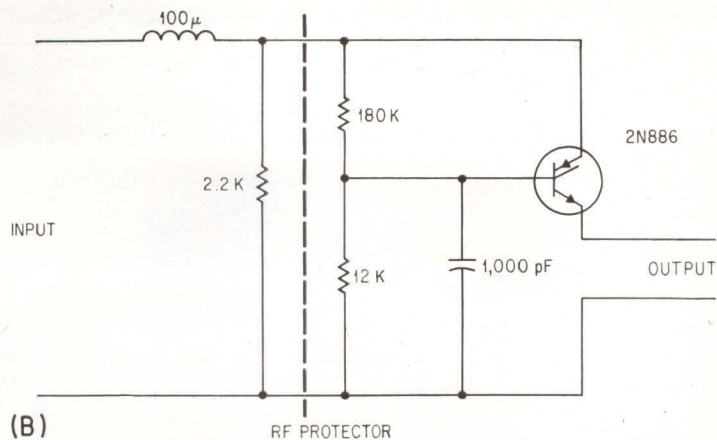

(B) RF PROTECTOR

GATE-bias protection of anode (A), and circuit that provides r-f protection (B)—Fig. 3

anode and cathode, it is divided between the reactance of the anode capacitance and the impedance across the emitter junction. Examination of the curve of Fig. 2A shows three regions to be explained. At low frequencies, the sensitivity of the switch is proportional to the frequency. In this region, the emitter impedance appears to be dominated by the bias resistor connected between gate and cathode. Resistors R_{g1} and R_{g2} also affect the impedance in the same manner. Over a range of higher frequencies, the anode voltage to fire the switch is independent of frequency. This begins to occur at that frequency at which the capacitive reactance of the emitter becomes comparable to the resistance across the emitter. Above this frequency, the impedance becomes predominantly capacitive, and a constant fraction of the applied anode voltage should be found across the voltage sensitive emitter. At still higher frequencies, it is found that the r-f anode voltage that the switch can withstand is again reduced. Then those parts of the emitter junction that are farthest from the collector are protected by the additional collector—emitter resistance R_{g3} ; and as the frequency is increased, a progressively smaller area of the emitter junction is effective in providing emitter capacitance. This decrease in emitter capacitance with increasing frequency is reflected in the highest frequency segment of the curve in Fig. 2B.

Protection—The voltage divider model of the *pnpn* switch suggests two methods of protection against r-f which inadvertently reaches the anode. One method is to apply a reverse bias to the gate, so that a larger voltage swing must be produced at the emitter if the r-f is to fire the switch. This method is effective at all frequencies tested as shown in Fig. 3A. A simpler method is to place a capacitor between gate and cathode. This capacitor acts as a low impedance shunt path to reduce the voltage across the emitter. The gate capacitor provides effective anode protection at the lower radio frequencies, but the gate resistances R_{g1} and R_{g2} reduce the effect of external gate-cathode shunt paths at the higher frequencies.

One possible application of the silicon controlled rectifier is as a low pass filter to protect the bridge wire of an electro-explosive device from low fre-

quency radio signals. At low radio frequencies such as 150 kc, conventional LC filters tend either to be physically bulky or to have prohibitively high series resistances. The circuit of Fig. 3B was designed to protect bridge wire devices against 32 volt rms signals between 100 kc and 30 Mc. The low-frequency protection is provided entirely by the circuitry to the right of the broken line. The gate capacitor enables the controlled switch anode to withstand 32-volt rms signals up to about 3 Mc. The gate is isolated from the r-f input by an RC filter. The circuits to the left of the line form a rudimentary filter to provide protection at higher frequencies. Its effectiveness is limited by the shunt capacitance of the particular choke used. A more appropriate conventional filter can extend the protection to much higher frequencies.

Fig 4 shows the model switch protector with an explosive switch and a copper shield. The model, which uses only conventional components, is built into a Lucite cube 0.5-inch on a side. At the bottom the protector, switch and shield are shown assembled.

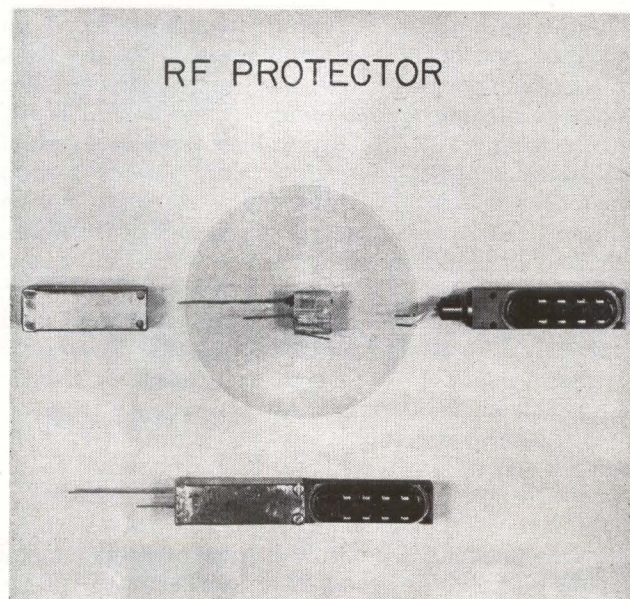

MODEL switch protector with explosive switch and copper shield—Fig. 4

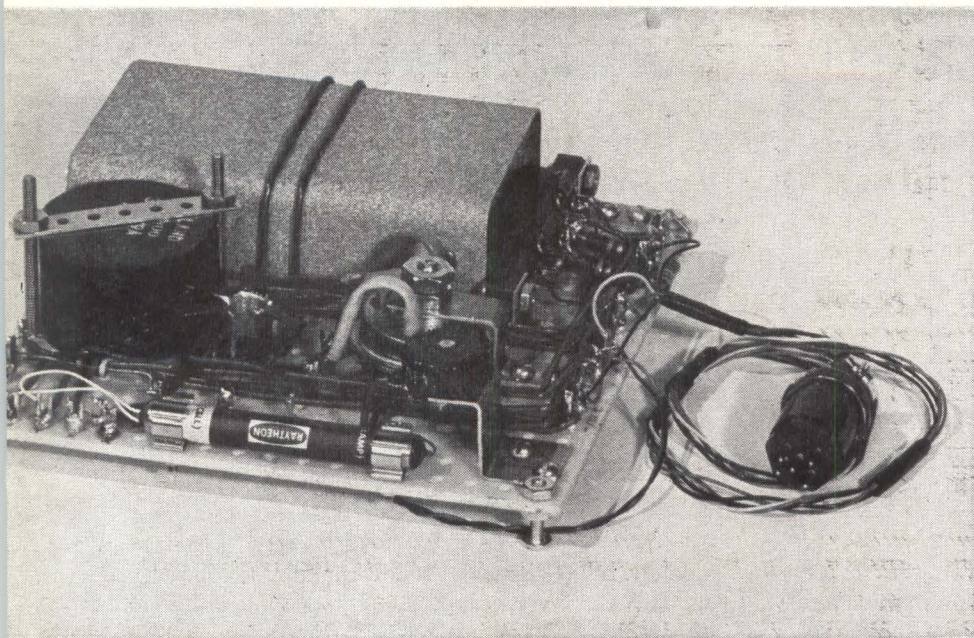

ASSEMBLED ratio computer uses Burr-Brown model 130D differential amplifier (rear), Raytheon model CK-1112 electro-optic transducer clip mounted at front, ferrite-core enclosure for InAs Hall plate (left center) and 2N174 Hall current driver transistor at opposite edge.

HALL-EFFECT REMINDER

Analog multipliers based on the Hall effect depend upon the electromagnetic interaction between a longitudinal current i_h in a semiconductor plate¹ and an effective orthogonal magnetic field.² A transverse Hall potential v_h is generated in the plate that is placed in a gap of an electromagnetic core of which the field strength is controlled by magnetizing current i_c . The Hall voltage is directly proportional to the product of i_c and i_h , or $v_h = k i_c i_h$. Coefficient k depends upon permeability and geometry of the magnet, density of charge carriers and their mobility within the semiconductor.

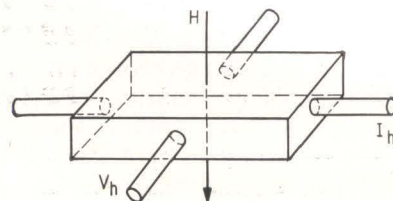

Analog Ratio Computer Uses

Necessary isolation circuits permit use of Hall effect with other devices

HALL GENERATORS used as multipliers may be employed to perform a variety of additional analog computing functions³. A ratio computer based on the Hall effect in vacuum-deposited, micron-thick films of indium antimonide has been described⁴. The large v_h of film devices is an advantage in reducing design complexity. Relatively high input and output impedances of such Hall generators provide a good match to auxiliary circuits. However, films have a higher intrinsic noise level across their Hall electrodes than similar bulk crystalline devices, especially at low i_h and i_c driving levels.

The construction of a ratio computer employing a commercially available indium arsenide Hall plate is shown in Fig. 1. The larger dash-enclosed rectangle (X) contains the multiplier. Its Hall voltage output is applied to input terminal a of the differential amplifier A , whose other terminal b , is connected to an arbitrary input voltage v_i . The amplified difference ($v_i - v_h$) is applied to the 2N652 grounded-emitter power amplifier and controls the light intensity emitted by the lamp I . The effective value of the photoresistor R is a function of the light incident upon it.

The smaller dash-enclosed rectangle (Y) thus con-

stitutes an electro-optic transducer. The photoresistor incorporated into the 2N174 grounded-emitter power amplifier stage determines the amplitude of the drive current i_h applied to the Hall generator. The purpose of the electro-optic transducer and of the circuit associated with it, is to provide a feedback loop around the differential amplifier and to maintain a high degree of isolation between the input and output circuits of the Hall multiplier.

Circuit Operation—Let a current i_c be applied to the solenoid of the multiplier and let a potential v_i be applied to input b of the differential amplifier A . The output signal drives the base of the 2N652 into conduction causing a current to flow through lamp I . The light output of the latter brings about a decrease in R thus decreasing the bias on the 2N174 power transistor. A current i_h now flows into the Hall plate and a potential v_h is generated across the Hall plate. The process continues until the feedback loop is in balance and $v_h = v_i$.

Provided the misalignment potential of the Hall plate is negligible and the differential amplifier is balanced, the Hall current will then be proportional to

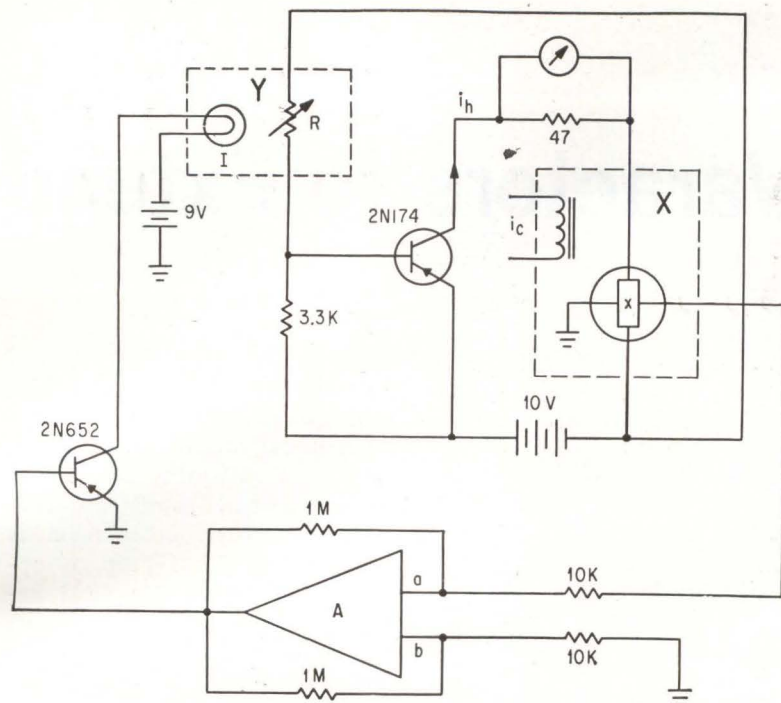

ANALOG ratio computer with Hall-effect multiplier (X), electro-optic transducer (Y) comprising lamp I and photoresistor R. Differential amplifier A controls Hall current by feedback loop around it—Fig. 1

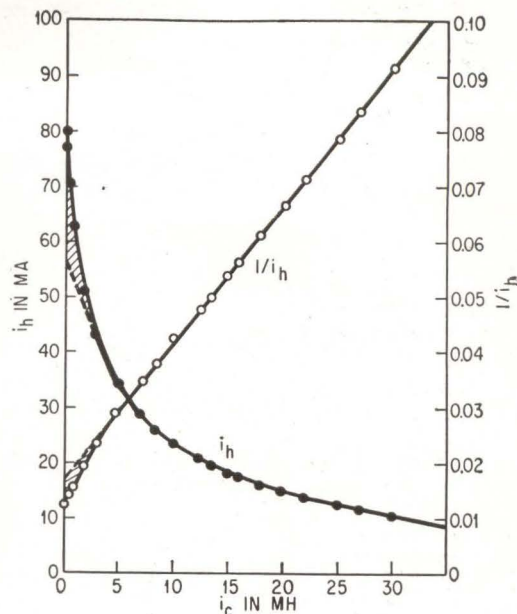

HYPERBOLA shows dependence of Hall current i_h on magnetizing current i_c for constant input potential $v_i = 50$ mv. Reciprocal of i_h is a linear function of i_c except at values less than 5 ma. Shaded area is hysteresis region owing to transducer—Fig. 2

Hall Multiplier

By H. H. WIEDER, U. S. Naval Ordnance Laboratory, Corona, California

the ratio of v_i to i_c

$$i_h = v_i / k i_c \quad (1)$$

Equation 1 is that of an equilateral hyperbola with asymptotes at $i_c = 0$ and $i_h = 0$. In practice, a misalignment potential in the Hall plate, a residual magnetization in the core or a finite unbalance in the differential amplifier may cause a signal to appear at the input for $i_c = 0$. This shifts the asymptote of i_c to the left or to the right of the coordinate axes and therefore to values of i_h that are finite at $i_c = 0$. It also reduces the accuracy of the divider⁴.

A photograph shows the assembled ratio computer exclusive of power supply. Its behavior and performance are illustrated in Fig. 2, which shows that for v_i fixed at 50 mv, the reciprocal Hall current is proportional to i_c in accordance with Eq. 1. The proportionality is maintained to within 2 percent for $5 \text{ ma} \leq i_c \leq 35 \text{ ma}$. The shaded part of the curve is the region in which the misalignment potential of the Hall plate, the differential amplifier unbalance and hysteresis of the electro-optic transducer render the operation of the device marginal. Results similar to those shown in Fig. 2 were obtained for $1 \text{ mv} \leq v_i \leq$

100 mv. The dynamic range of v_i is evidently limited by the peak permissible i_h and the linear operational region of the differential amplifier.

The stability of the ratio computer appears to be primarily a function of the drift in the differential amplifier and of the electro-optic transducer. Conceivably, improvements in both of these devices, as well as the introduction of a circuitual method for automatic balance of the misalignment potential between the Hall electrodes, would improve the performance of the ratio computer by a considerable margin. The simplicity, large dynamic range of operation and fair precision are the primary advantages of this ratio computer.

REFERENCES

- (1) H. H. Wieder, Hall Effect Stroboscope and Noise Discriminator, Rev. Sci. Instr., 33, p. 64, 1962.
- (2) E. H. Putley, "The Hall Effect and Related Phenomena", Butterworth and Co., London, 1960.
- (3) W. A. Scanga, A. R. Hilbinger and C. M. Barrack, Hall-Effect Multipliers, ELECTRONICS 33, July 15, 1960.
- (4) H. H. Wieder, Analog Division Based on the Hall Effect, Rev. Sci. Instr., 34, p. 422, 1963.

Using Varactors to Extend

Oscillator's collector resistor provides d-c amplification of afc input, giving varactor broadened voltage swing. Resulting frequency sensitivity is over 5.5 Mc/volt

By THOMAS P. PROUTY, Consulting Engineer, Newport Beach, California

FIND THE SIGNAL

Most transistor automatic-frequency-control systems are fine if the incoming signal stays within two or three percent of its nominal value—beyond this, they often can't product enough local-oscillator variation to track satisfactorily.

But there's a solution. This varactor technique develops an 11-Mc afc band in a 40-Mc local oscillator with only 1 volt afc input. What's more only one transistor is needed

AUTOMATIC frequency control (afc) circuits for vacuum-tube receivers have traditionally used reactance tube control of the local oscillator. Transistor receivers have also been designed using this technique, but several other methods are available. When properly applied, these circuits can yield improved performance with fewer components.

The basic oscillator used in this discussion is shown in the circuit of Fig. 1A. Although tuned circuit data is not given, performance data for the various afc circuits has been taken in the vicinity of 40Mc. Intentional circuit capacitance is kept at a minimum consistent with alignability.

The basic oscillator is extremely tolerant of component variations and displays a frequency shift of less than 500kc when the supply voltage

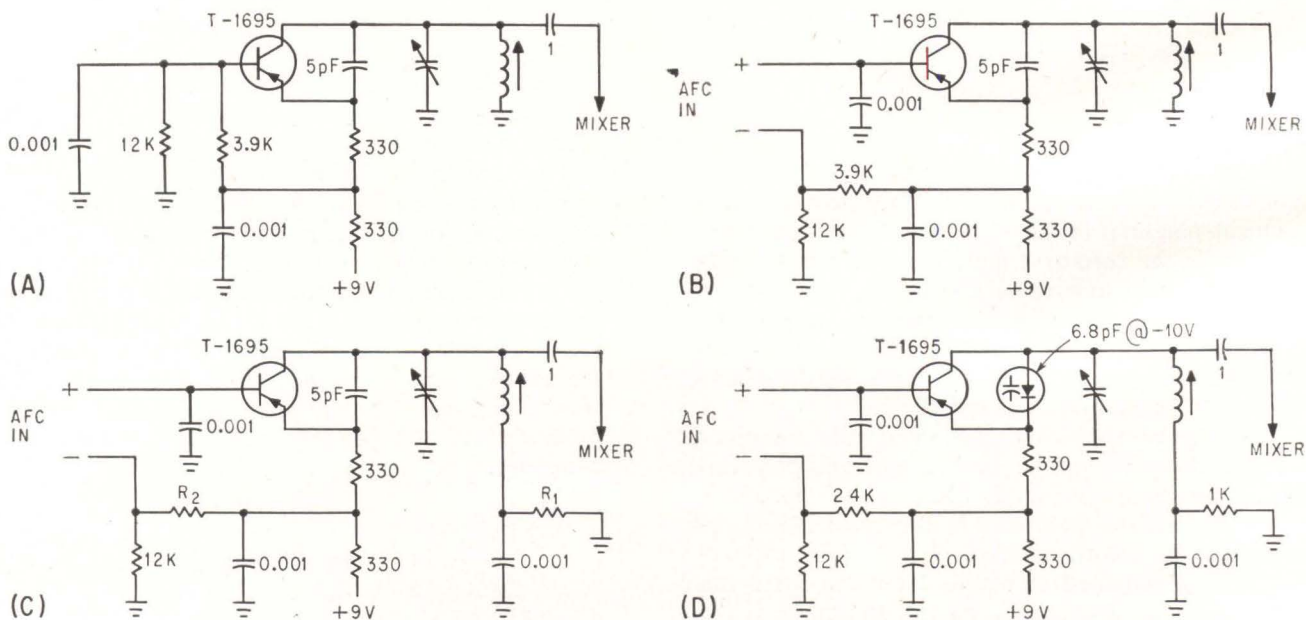

LOCAL OSCILLATOR (A) is designed for high stability, giving 200-kc frequency variation at 40 Mc for supply voltage change of 6 to 12 volts. Simplest afc circuit (B) provides 1.5 Mc/volt sensitivity using emitter current control; improved circuit (C) uses collector voltage control for 2.5 Mc/volt sensitivity; final circuit combines both techniques with varactor control to produce 5.8 Mc/volt sensitivity and dynamic range of 11 Mc—Fig. 1

Frequency-Control Range

is changed from 6 to 12 volts.

Emitter Current Control—The simplest form of afc is shown schematically in Fig. 1B. An error signal, usually derived from a discriminator circuit, is applied in series with the base bias network. The sensitivity of this circuit is typically about 1.0 to 1.5 Mc/volt. The performance for the values shown is given in Fig. 2 and is a nearly-straight voltage-frequency characteristic and an exceptionally flat output amplitude over the frequency range.

Collector Voltage Control—If a resistor is added in series with the collector supply, the collector voltage will vary with afc input voltage. Such a circuit, Fig. 1C, has increased sensitivity of up to 2.5 Mc/volt with a 1,000 load resistor, as

shown in Fig. 2. It is important in this circuit for the bias network to be accurately adjusted otherwise oscillator "drop-out" or control phase reversal is likely to occur. Figure 2 shows that as the sensitivity is increased the output voltage becomes more variable and the usable range of operation diminishes.

Varactor Control—Variable capacitance diode afc circuits are quite common in receivers but use more components than the foregoing circuits. They also suffer from much lower sensitivity and from increased loading of the oscillator owing to losses in the diode and in its biasing network.

An unusual exception is shown in Fig. 1D. A resistor in the collector supply allows the transistor to function as a d-c amplifier between

afc input and the variable capacitance diode. The diode also functions as a feedback capacitor whose value increases as its Q drops—hence, as loading on the oscillator increases so does the feedback. This connection also provides greater sensitivity by adding the input signal in series with the d-c amplifier output signal, at least as far as the diode is concerned.

Circuit performance is described in Fig. 2. Since this circuit combines both emitter current and collector voltage control with the variable capacitance diode, a large tuning range and high sensitivity is to be expected. Actual sensitivity is 5.8 Mc/volt; the total electronic tuning range is over 11 Mc. The wide range and relatively flat output suggest the use of this circuit in sweep generators and panoramic receivers.

PLOTTING characteristics of three afc circuits on same graph allows easy comparison of performance—Fig. 2

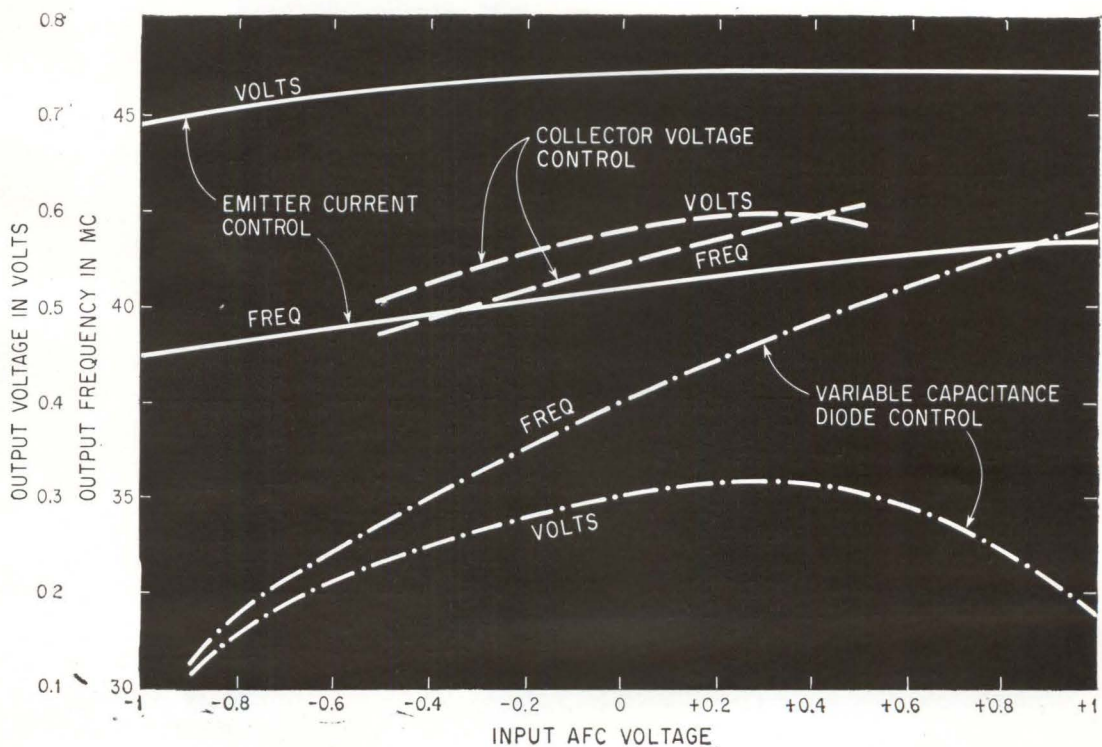

100

11 LBS.

GE3963-2
NIGHT LIGHT
GENERAL ELECTRIC



Instantly recognize shelf stock from package labels which tell all product facts — and picture the product as well. Using blank roll stock, economically print complete label in exact quantities. Change part or all of imprint in seconds.



Save costs of expensive decals, change date codes or other data in seconds. Direct printing with Markem cylindrical object printer, specialty inks and quick-change type saves label or decal purchase and application costs, permits quick changes in part or all of imprint.

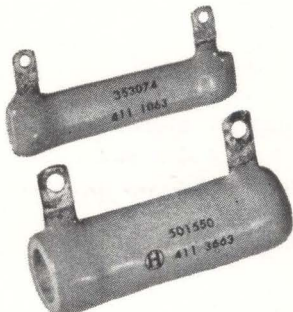

Production print irregular, concave surfaces at high speed, reduce labor costs of hand stamping or using manually-operated machine. Markem 200A offset Unitized. Printing Head prints up to 1800 pieces/hour, gives uniformly high quality prints, handles a range of sizes.

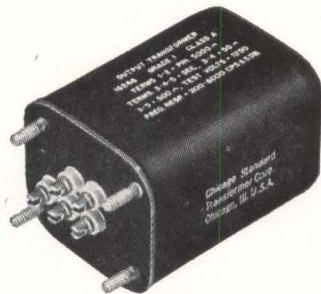

Direct-print complete identification on one or more surfaces, including all values, ratings, connection data, name and trademark — with greater speed, durability and economy than possible with hand stamping, labeling, nameplates, etc. Direct prints can't fall off, stay clean and readable for product's life.

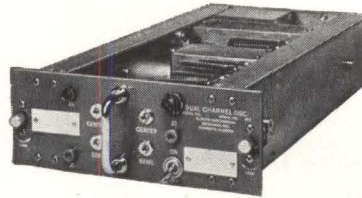

Prevent "outside source" delays, special production scheduling by using flexible, high-production in-plant Markem identification. Meet military specifications for durability and readability, print fixed and variable data simultaneously.

The best product identification usually costs the least

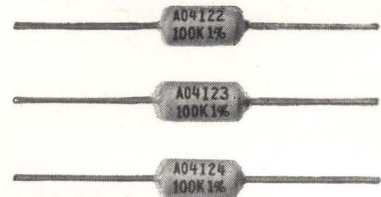

Sequentially number components and save \$50 per 1000 units. Printing the number, trademark, type number, value and date code by special Markem offset process saves label purchase, inventory, obsolescence and application costs. Change imprint, reset numbering unit in seconds. No wiping between imprints, no voiding numbers if component isn't printed.

Using proven Markem production identification techniques on your products and packages — as typified in the actual examples shown — reduces labor costs . . . prevents costly mistakes in sorting, shipping and use of the product . . . encourages reordering exact replacements made by you . . . helps establish future purchases by repeatedly registering your name with the customer.

And Markem machines, type and inks assure clean, durable and complete prints on the *surfaces, shapes* and

materials you must mark. Whether your identification involves MIL-spec inks, micro-miniature imprints, consecutive numbering, pilot or production runs, in-line or separate operation — Markem can tailor the right equipment and method to meet your needs and save you money. Ask your Markem Technical Representative to supply detailed recommendations — or write Electrical Industries Division, Markem Machine Co., Keene 5, New Hampshire.

Free 12-page Catalog shows numerous electrical/electronic applications of Markem equipment. Write for your copy.

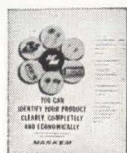

WINNER OF THE PRESIDENTS' **E** FOR-EXPORT AWARD

MARKEM

TECHNICAL ASSISTANCE AND INDUSTRY-PROVEN EQUIPMENT
WORLDWIDE . . . TO HELP YOUR PRODUCT SPEAK FOR ITSELF

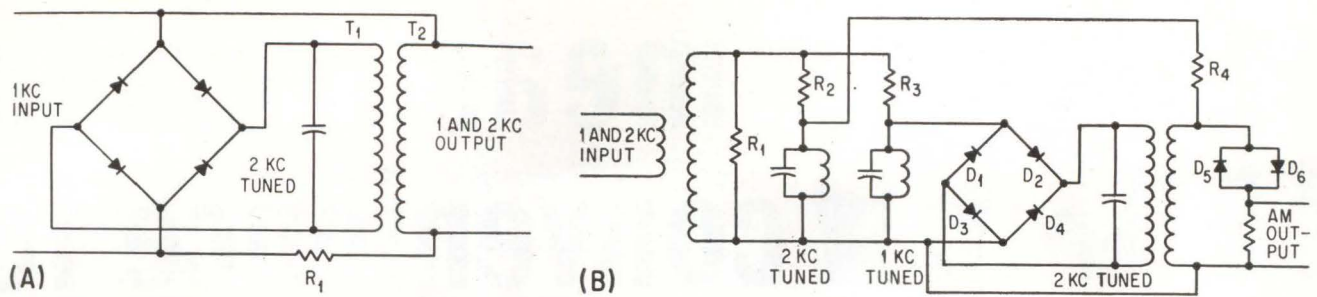

(A) SIMPLE transmitter (A) and receiver (B) circuits feature high accuracy

Low-Cost Circuit Measures Frequency Translation

Technique measures frequency translation distortion (FTD) from 1/20 to 50 cps in single-sideband data transmission circuits

By **S. E. WATFORD**, Chief,
Transmission Engineering, Communications Div.,
White Sands Missile Range, New Mexico

DIGITAL DATA transmission traffic is increasing. Transmission parameters are becoming more stringent, with the emphasis on minimizing all distortion factors. Distortion measurement techniques must keep pace with transmission refinements.

Frequency translation is one type of transmission distortion affecting single-sideband transmitting and multiplexing equipment. In ssb, the carrier frequency and one sideband are suppressed, prior to intelligence transmission, to conserve bandwidth, with a frequency equal to the original carrier restored at the receiver. Any difference between original and restored carrier frequencies is frequency translation distortion (FTD).

Generally, FTD is negligible in voice transmissions (translations of 20 to 30-cps can be tolerated). But in digital data transmission, FTD becomes troublesome. Commercial data modem equipment requires the intelligence be transmitted with a FTD of less than 5-cps. Many ssb systems have pilot tone systems or some other technique to insure minimizing of FTD. Older systems, and many low-cost multiplexing systems are not similarly equipped. They depend on manual-adjustment and local-oscillator stability to minimize FTD, and are definitely affected by FTD.

Frequency translation is often considered difficult to measure. One solution, with a high degree of accuracy, is a simple measurement technique. Mathematically, if two frequencies, for example, F and $2F$, are simultaneously transmitted over a circuit subject to FTD, they arrive as $F + \Delta f$ and $2F + \Delta f$. These two frequencies are separated at the receiver, and the $F + \Delta f$ frequency doubled ($2F + 2\Delta f$). Subtracting the $2F + \Delta f$ from the $2F + 2\Delta f$ fre-

quency results in output Δf , precisely equal to the frequency translation distortion.

Circuits—Actual hardware for FTD measurement is uncomplicated. Signal source is two passive networks with an audio signal generator set at 1-kc; an oscilloscope is the detector. Networks are illustrated.

The transmitter (A) consists of a bridge rectifier with output into a 2-kc tuned circuit (passive frequency doubler). The 1-kc signal is also fed to T_2 through dropping resistor R_1 , producing a complex waveform (1-kc and 2-kc signals combined). The F and $2F$ transmitted frequencies are produced.

The receiver circuit (B) uses a step-up transformer to provide an input voltage level sufficient for detection. The transformer secondary terminates in resistor R_1 , giving an approximate terminating impedance to the circuit under test. Two tuned circuits, bridged across the secondary, separate the 1-kc + Δf and 2-kc + Δf frequencies. The 1-kc + Δf frequency is applied to the bridge rectifier (D_1 — D_4), with output into the 2-kc tuned circuit (doubler delivers 2-kc + $2\Delta f$). The 2-kc + Δf frequency is applied through dropping resistor R_4 to the transformer secondary. The diode detector (D_5 — D_6) receives both frequencies and develops an a-m envelope: $(2\text{-kc} + 2\Delta f) - (2\text{-kc} + \Delta f) = \Delta f$. Envelope period is measured on an oscilloscope to determine amount of FTD.

Actual hardware used can be sophisticated: substitute a small transistor fixed-oscillator for the audio oscillator; or, replace the diode detector with a balanced modulator and low-pass filter producing a sinewave equal to Δf . The latter can be accurately measured on an electronic counter.

The measurement technique described has been evaluated in various circuits subject to FTD. There was no apparent difficulty in measuring FTD from less than 1/20-cps to an excess of 50-cps.

With these circuits, routine monitoring of ssb facilities can hold FTD to a minimum. Also, facilities not normally considered for transmission of digital data can now be used; and field time for system alignment of ssb multiplex equipment will be reduced.

new measurement convenience for high-sensitivity, wide-band dual-trace applications—

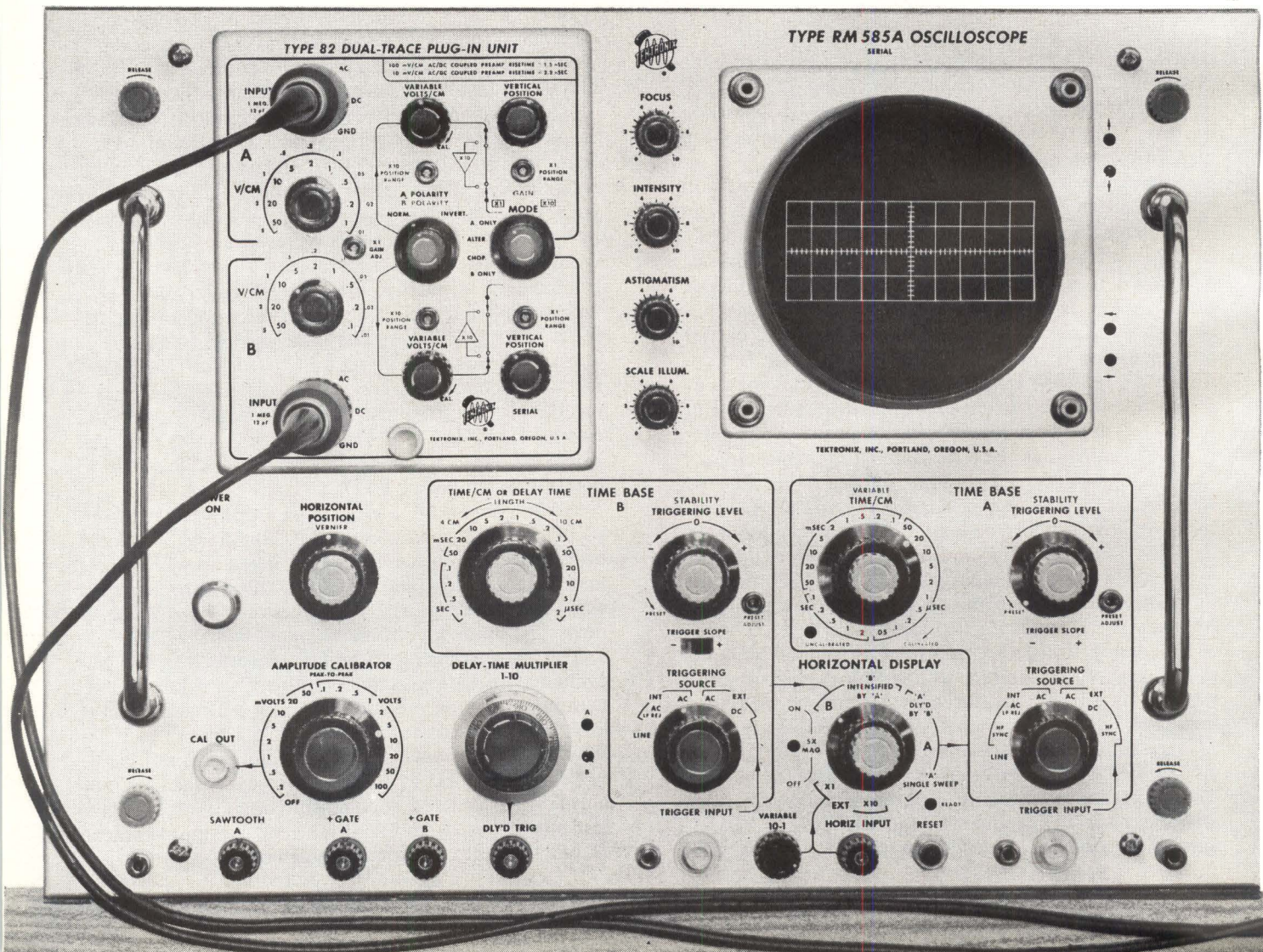

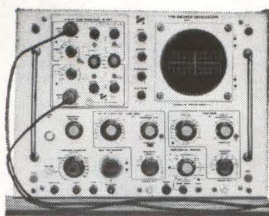

*Tektronix Type 580A series...
..... high-speed oscilloscopes
with general-purpose utility*

- **DUAL-TRACE OPERATION** with 4 operating modes and independent controls for each channel—for individual attenuation, positioning, inversion, and ac or dc coupling as desired.
- **PASSBAND** typically DC-TO-85 MC (3-db down) at 100 mv/cm (12-db down at 150 Mc), and typically DC-TO-80 MC (3-db down) at 10 mv/cm.
- **CALIBRATED SENSITIVITY** in 9 steps from 100 mv/cm to 50 v/cm, and in *10X Amplifier Mode*, from 10 mv/cm to 5 v/cm, variable between steps.
- **INTERNAL AND EXTERNAL TRIGGERING** to 150 Mc.
- **SWEEP RANGE** from 10 nsec/cm to 2 sec/cm.
- **SINGLE-SWEEP PHOTOGRAPHY** at 10 nsec/cm.
- **BRIGHT, HIGH-RESOLUTION DISPLAY** with small spot size.
- **CONVENTIONAL PASSIVE PROBES** for convenience.

PLUS

- **COMPATIBILITY WITH 17 LETTER-SERIES PLUG-INS** to permit differential, multi-trace, sampling, other laboratory applications—when used with Type 81 adapter.

Supplied small size passive probes provide high input impedance characteristics. Probes increase input R to 10 megohms and decrease input C to approximately 7 pf.

Risetime (of supplied probe, plug-in unit, oscilloscope) at over-all sensitivity of 100 mv/cm is approximately 4½ nsec.

Type RM585A Oscilloscope, illus. \$1825
Size—14" high, 19" wide, 22¼" deep.
Weight—81 pounds, approx.

Type 585A Oscilloscope \$1725
Size—16¾" high, 13¾" wide, 23¾" deep.
Weight—74 pounds, approx.

Types RM585A and 585A have 2 modes of calibrated sweep delay—either triggered or conventional—ranging from 1 µsec to 10 seconds.

Type 581A Oscilloscope \$1425
No sweep-delay capabilities . . . but other features similar to Type 585A.

PLUG-IN UNITS

Type 82 Dual Trace Unit \$ 650
(includes 2 passive probes)

Type 86 Single-Trace Unit \$ 350
(includes 1 passive probe . . . has single channel operation.)

ADAPTER Enhances Versatility
The Type 81 Adapter allows insertion of 17 Tektronix letter-series plug-ins. Bandwidth (up to 30 Mc) and Sensitivity depend upon plug-in used.

Type 81 Plug-In Adapter \$ 135

Oscilloscope Prices without plug-in units.

U.S. Sales Prices f.o.b. Beaverton, Oregon

PLEASE CALL YOUR TEKTRONIX FIELD ENGINEER OR DISTRIBUTOR.

Tektronix, Inc. / P. O. BOX 500 • BEAVERTON, OREGON 97005 / Phone (Area Code 503) Mitchell 4-0161 • Telex: 036-691 • TWX: 503-291-6805 • Cable: TEKTRONIX • OVERSEAS DISTRIBUTORS IN 27 COUNTRIES

Tektronix Field Offices: in principal cities in the United States. Consult Telephone Directory • Tektronix Limited, Guernsey, Channel Islands
Tektronix Canada Ltd.: Montreal, Quebec • Toronto (Willowdale), Ontario • Tektronix Australia Pty. Limited, Sydney, New South Wales

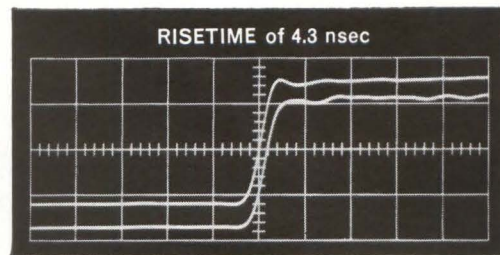

Dual-trace display of input and output pulses of a transistor amplifier at 10 nsec/cm—with lower trace delayed 1 nsec by amplifier under observation. Type 585A/82 combination can display time coincidence between input channels with no measurable difference at 10 nsec/cm.

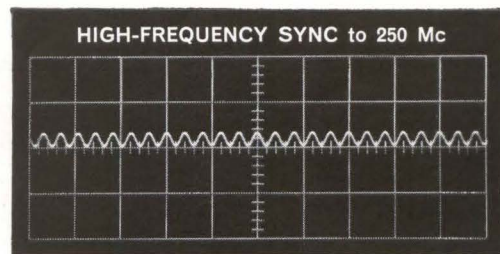

Display of a 250 Mc Sine Wave at 10 nsec/cm, using the H. F. Sync Mode. In this mode, the Type 585A/82 combination can display steady signals from 5 Mc to 250 Mc, with a fraction of a cm of displayed amplitude.

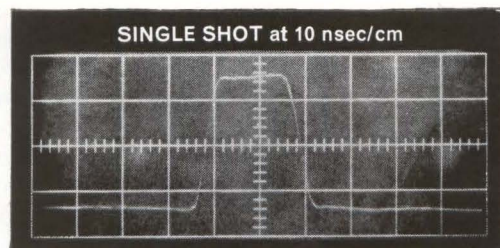

Display of a fast transient at 10 nsec/cm, using single-sweep operation and the Tektronix C-19 Camera. Single-sweep feature of the Type 585A/82 combination facilitates photographic recording of most one-shot phenomena.

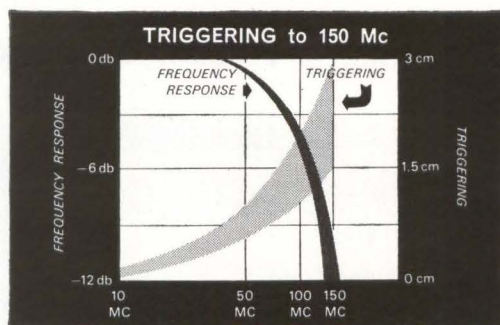

Typical frequency response and internal triggering characteristics of Type 585A/82 combination—showing minimum number of cm necessary for triggering.

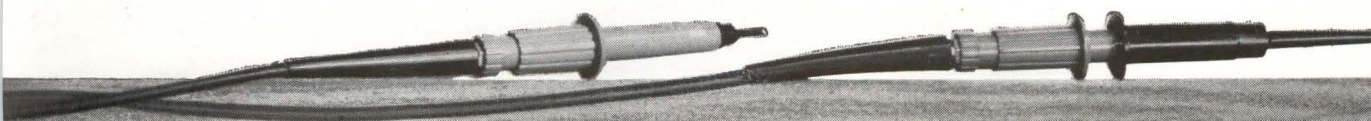

NASA's Newest Trackers Go to Australia

This week, work began on station to handle Gemini and observatory flights

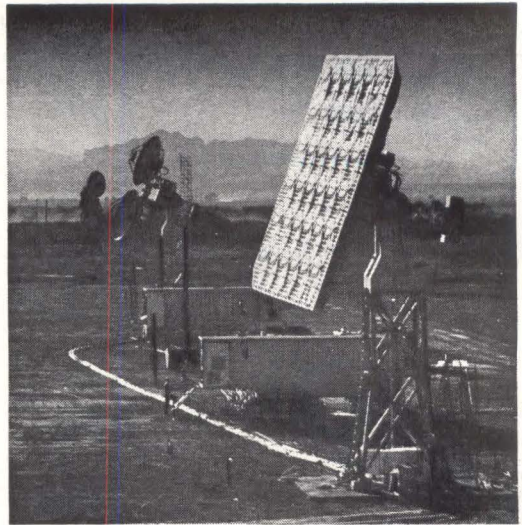

RANGE AND RANGE RATE SYSTEM uses vhf beacon to find spacecraft, then shifts to narrow-beam S-band system for precision tracking. Vhf antenna in foreground, a 28-foot array of cavity-backed slots, has a beamwidth of 16 deg. S-band parabolas have beamwidth of 2.5 deg

GREENBELT, MD.—Installation of 15 tons of NASA's latest tracking gear began this week at Carnarvon, Australia. By next May, the site will become the first tracking station able to handle both manned Gemini and unmanned observatory spacecraft.

Equipment will include the Goddard Range and Range Rate tracking system, the FPQ-6 tracking radar, two pcm telemetry systems, the Gemini digital command system and a telemetry system for orbiting observatories.

Carnarvon, 60 miles north of

Perth, is directly opposite Cape Canaveral on the earth. Most spacecraft pass over it on their first orbit. NASA and Australia's Weapons Research Establishment will jointly operate the station when it becomes operational.

Range and Range Rate—Built for Goddard Space Flight Center by Motorola, this sidetone ranging system attains a range (distance) resolution of ± 15 meters and range rate (radial velocity) resolution of 0.1 m/sec.

In operation, the vhf antenna

scans the area where a satellite is expected and automatically locks onto the Minitrack satellite beacon. The S-band antenna is slaved to the vhf antenna. When the vhf antenna acquires the spacecraft, the S-band (2,270 Mc) carrier frequency unspools the satellite's S-band transponder, which responds at 1,705 Mc.

The S-band antenna then locks onto the satellite, transmits range tones, and tracks automatically. Now free of the vhf system, it extracts range from range-tone round-trip time, range rate from doppler shift, and angular data to pinpoint the satellite's position.

Range and range rate may also be obtained at vhf with a vhf transponder in the spacecraft.

The vhf antenna operates as a phase monopulse tracking antenna. One of two 14-foot S-band parabolic antennas transmits, the other receives using amplitude monopulse tracking.

Vhf and S-band systems radiate 10 kw; 1 kw may be used for close tracking to avoid transponder saturation. The S-band satellite transponder radiates 1 w, and the vhf 4 w. To permit tracking from three stations, the S-band transponder has three channels. Transmission range is 32,000 km.

Tracking Radar—Until the FPQ-6 is installed, an MPS-26 radar will

Dyna Soar's Tracker Is Checked Out

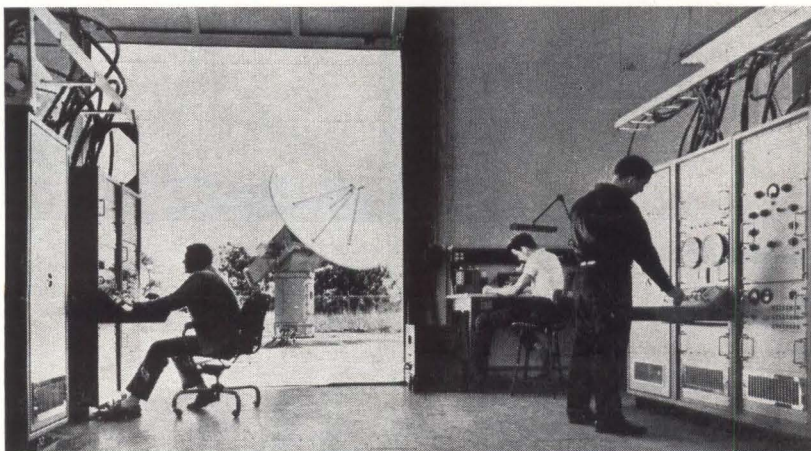

DEVELOPMENTAL MODELS of the solid-state ground antenna tracking system for the X-20 manned orbital glider have been delivered and accepted, it was reported last week by Radiation Inc., subcontractor to RCA. System also provides gain needed for air-ground communications and data transfer (for system details, see ELECTRONICS, p 24, June 22, 1962)

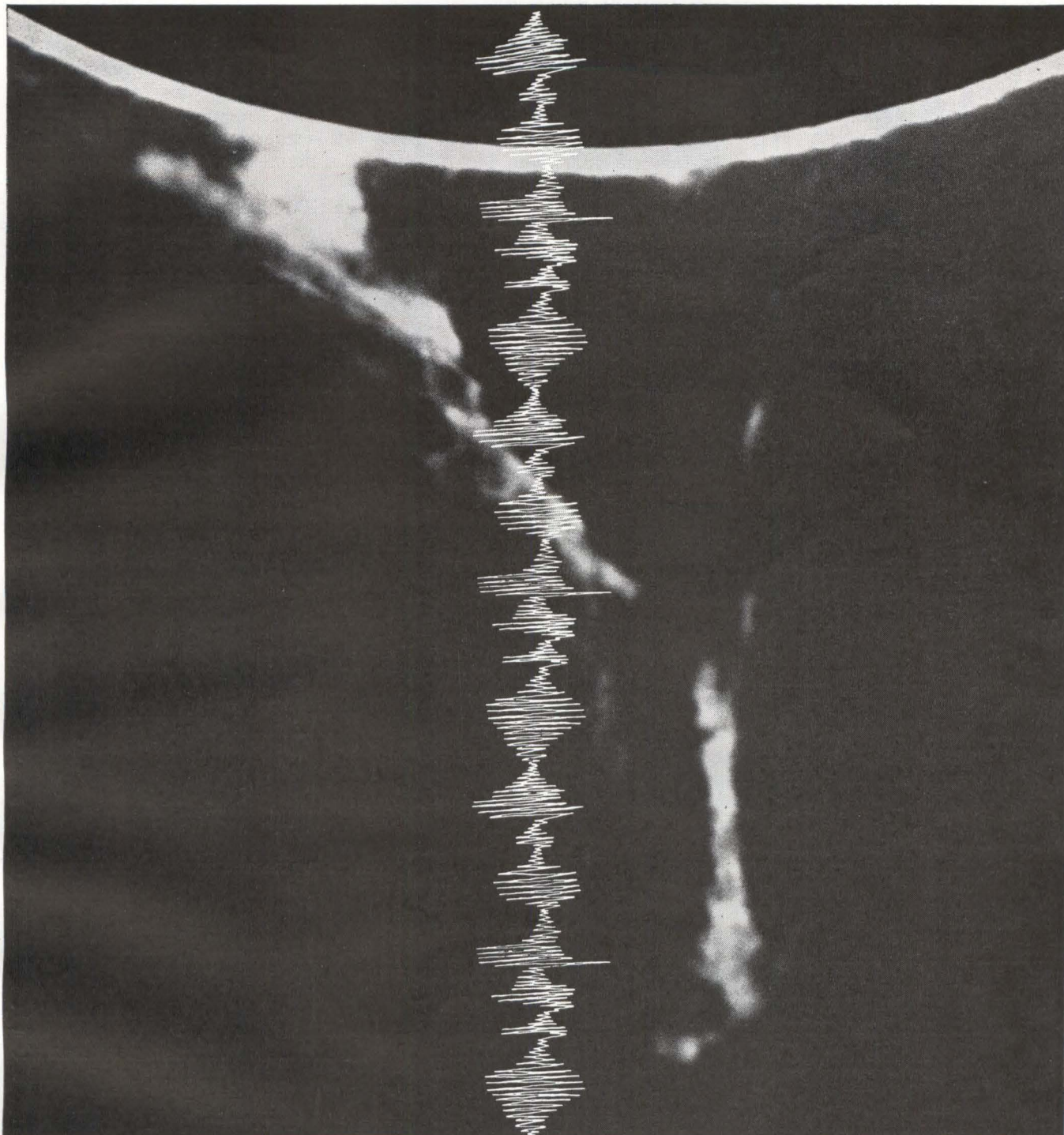

Who gathers sun storm data on one recorder, replays it exactly on 8 others?

AMPEX

Here's something new under the sun; nine different recorders with identical electronics and heads. For the first time, you can record a missile shot at Canaveral and play it back exactly on a different recorder at Seattle, Santa Monica, Huntsville, or Woomera. There's no longer a need for duplicity of recorders to insure precise reproduction. And it's no longer necessary to bring field recorders back to the lab for playback. Another advantage of the new Ampex family: the electronics are interchangeable. This cuts down on the amount of spare parts you need. Electronics can be shuttled around where they are needed and not remain idle in

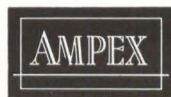
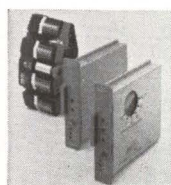

an unused recorder. The new Ampex family includes the FR-1200, the FR-1300, the FL-300, the FR-100 C, the DAS-100, and the modernized FR-1100, FR-100 A, FR-100 B, and FL-200. Each offers superb performance and outstanding reliability, with frequency response to 300 KC Direct, to 20 KC FM and PBM. Each is designed for versatility in the lab or in the field. Now, all are truly compatible. For additional information on this Ampex family write to the only company providing recorders, tape and core memory devices for every application: Ampex Corporation, Redwood City, California. Sales and service engineers throughout the world.

New from Sprague!

GERMANIUM P-N-P 2N2962



**Extends High-Efficiency
ECDC® Transistor
Performance to
VHF POWER RANGE**

- High Voltage—40 Volts
- High f_T —800 mc (typ.)
- Isolated Mounting Stud offers Design Freedom

TYPE	V _{CEs}	P _G @ 160 mc	P _O @ 160 mc
2N2962	40 V	6 db	.5 W
2N2963	40 V	5 db	.5 W
2N2964	30 V	6 db	.5 W
2N2965	30 V	5 db	.5 W



For application engineering assistance, write to Transistor Division, Sprague Electric Co., Concord, N. H. For technical data, write for Engineering Bulletins 30,452 and 30,454 to Technical Literature Service, Sprague Electric Co., 35 Marshall St., North Adams, Mass.



45T-165-63

be used to search for and track spacecraft. The FPQ-6 monopulse radar, built by RCA, can make nonambiguous range measurements to 32,000 nautical miles (for system details, see *ELECTRONICS*, p 26, Dec. 15, 1961). The first of these radars are going into the Atlantic Missile Range (p 26, June 14, 1963).

Telemetry and Command — Two pulse-code-modulation telemetry systems built by ElectroMechanical Research, Inc., will be used during Gemini flights—one for the Gemini capsule, another for the Agena stage. They operate with a wide variety of formats, bit rates and word lengths. The format and distribution of data are selected by patchboards.

Data will be transmitted to Gemini and Agena with a digital command system (dcs) built by Radiation, Inc. After parity checks are made on inputs, valid words are stored in a 40 × 512-bit core memory. After the memory is loaded with command words, data may either be displayed or transmitted.

Dcs can transmit the entire mem-

ory contents sequentially, a group of manually selected words or single words stored in the input-output buffer. Dcs will also transmit clock and velocimeter non-command words. An emergency override will transmit any of 64 priority words in the memory.

EGO Telemetry—For observatory spacecraft, particularly the Eccentric (orbit) Geophysical Observatory, the EGO telemetry system will be used.

For monopulse tracking, it has a 136-Mc four-array Yagi antenna receiver. Remote controls select vertical, horizontal, or circular antenna polarization. A servosystem provides for autotracking.

Slaved to this antenna is one for a 400-Mc dual telemetry receiving system. In one system, pcm signals of different polarization go to separate receivers. Signals are combined in a diversity combiner tracking filter. Data is recorded or extracted for real-time display. The second telemetry system is similar except that signals are f-m.

The EGO system also includes a 123-Mc command transmitter.

Next Frontier the Oceans?

By CLETUS M. WILEY
Regional Editor, Chicago

CHICAGO—Potential economic and technical benefits of ocean engineering may eventually reduce space programs to secondary importance, Rear Admiral E. C. Stephen told a National Electronics Conference session last Tuesday.

Opening up seven-tenths of the world for exploration, oceanography offers strong market challenges to everyone, declared Stephen, chief of the Navy's deep submergence systems review group.

Default of leadership—in exploiting new sources of diamonds, fuels and a wealth of new materials and resources—to other nations, could result in far greater shocks than Sputnik, he said.

Proposing a "marriage with the space program—funded by a joint checking account," the admiral's list of compatible fallouts from the space program included position fixers, remote manipulators, minia-

ture components, digital telemetry and power plants from chemical and atomic fuel cells.

Stephen's group is researching new materials, causes and cures for corrosion and higher-resolution sonar devices, in addition to reviewing service rescue capabilities—from space capsules to submarines.

Oceanography offers peacetime

Computer Runs Papermill

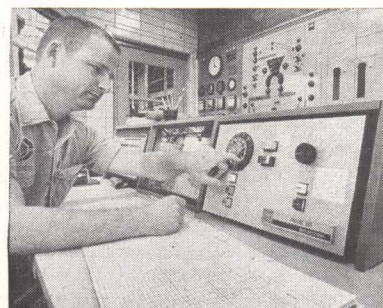

ON-LINE controller for Gulf States Paper plant is Westinghouse Prodac 580 computer. It runs 350-ton-a-day pulp digester

Motorola MIDA* Miniature Diode Assemblies

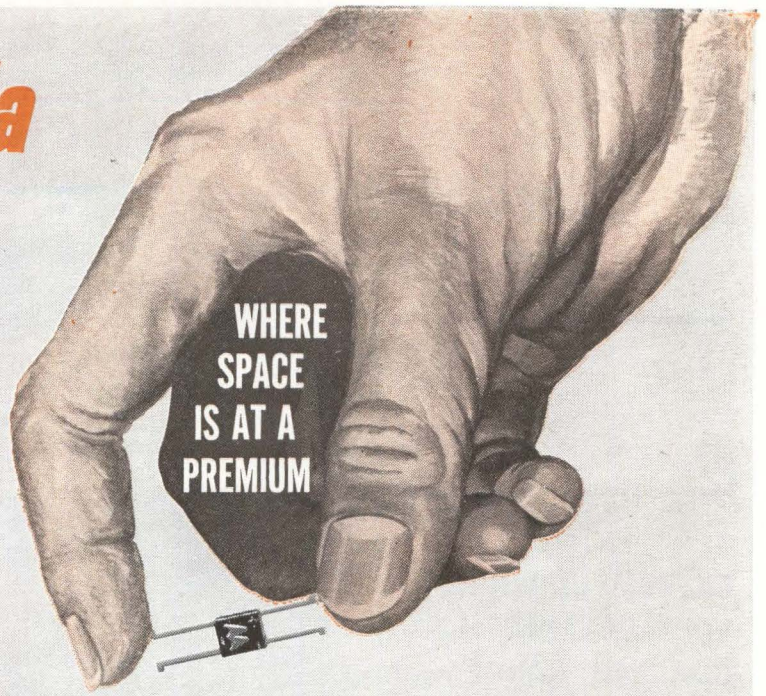

IN SHAVERS, METERS, UNIVERSAL MOTORS, ETC.

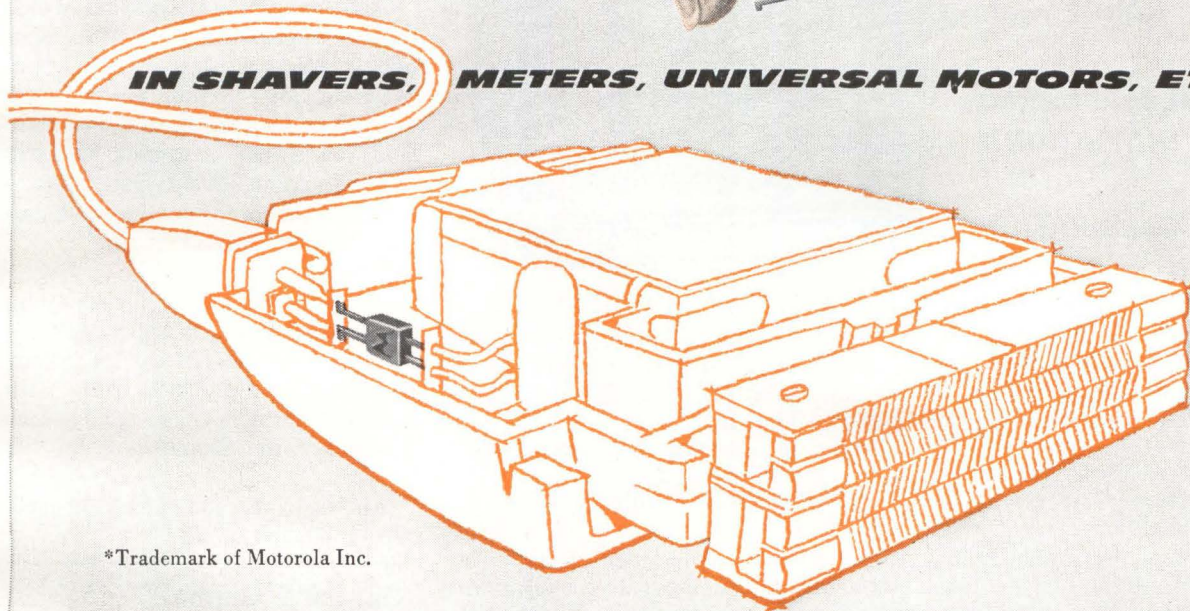

*Trademark of Motorola Inc.

Here is a radically new series of low-cost bridge circuits, center taps, and voltage doublers now available in a single, compact and rugged molded package . . . with the highest output-current/size ratio available! Motorola MIDA miniature diode assemblies measure only about 1/12th the size of a postage stamp . . . yet are rated at *one full amp!*

MIDA assemblies are designed to improve operations of universal motors similar to those used in electric shavers and food mixers. The increased voltage from the rectified AC extends motor power and speed range and, because of their extremely small size, MIDA assemblies can easily be mounted inside the motor case. Application in meters, instruments, and appliances requiring DC power are all *naturals* for MIDA assemblies, too.

MIDA assemblies are available in three basic

single-phase rectifier circuits: 1-amp full-wave bridge (MDA920 series); .5-amp single-phase center tap (MDA 930 series); and two 1-amp single-phase center taps, common anode (MDA940 and MDA950 series).

A new Motorola-developed accelerated oxide growth technique of surface passivating used for individual diodes assures rugged, long-range stability for MIDA circuits. Units have successfully passed such stringent MIL-STD-750 tests as temperature cycling, thermal shock, moisture resistance, salt atmosphere, surge current, shock, vibration, frequency, and lead fatigue.

Write for complete details about Motorola's MIDA miniature diode assemblies to: Technical Information Center, Motorola Semiconductor Products Inc., Box 955, Phoenix, Arizona, 85001.



MOTOROLA Semiconductor Products Inc.

BOX 955 • PHOENIX, ARIZONA 85001 • A SUBSIDIARY OF MOTOROLA INC.

103-70

WORKHORSE



Downtime's nemesis, rugged and reliable as a purebred workhorse — that's Mincom. Common denominator of dependability in all four basic Mincom Recorder/Reproducers is the exclusive Mincom DC Top Plate. Here's a tape transport built with beautiful simplicity: Only 12 moving parts with four easy adjustments, full dynamic braking, instant six-speed pushbutton control, seven or fourteen tracks — plus tape speed accuracy within $\pm 0.005\%$ using Mincom's Cyclelock®. Whether your specifications call for wideband predetection at 1.5 mc, or a comfortable 120 kc at 60 ips, there's a reliable Mincom workhorse to meet your facility's needs. Write today for details.

Mincom Division **3M**
COMPANY

2049 South Barrington Avenue, Los Angeles 25
425 13th Street N.W., Washington 4, D.C.



This Tiger flies to SCHPLNDBSCP B

If you want to ship to SCHPLNDBSCP B, however, you won't find it on the map. That's short for some of the major points we serve: San Francisco, Chicago, Hartford, Philadelphia, Los Angeles, New York, Detroit, Boston, Seattle, Cleveland, Portland, and Binghamton. In fact, you can get Tigers' overnight freight service to

most of the major markets in the country.

In addition, Skyroad, Tigers' combination air-truck service takes you into almost 2000 cities. That's why you're better off shipping with Flying Tigers. We can deliver the goods. After all, we're the nation's largest and most experienced all-cargo airline.

first in airfreight with airfreight first **FLYING TIGER LINE**



lector would help predict when and where fish could be expected, how many and what type. Remote push-buttons could close stoppers on vertical arrays of a dozen bottles to sample phosphates, nitrates and other nutrients. Lowerable capsules could assemble a vertical picture of temperature, salinity and other factors affecting fishing environments thousands of meters deep.

A high speed, maneuverable research submarine would permit passive gear to track and listen to schools of fish, to gain a better understanding and prediction of their habits and behavior, Austin added.

Graphite Masks Cut Thin-Film Expense

CHICAGO—Graphite masks, cut by a numerically controlled machine, can reduce costs and improve processing on a thin-film circuit production line, the Naval Avionics Facility (NAFI), of Indianapolis, reported at the National Electronics Conference last week.

The masks can be prepared for less than \$20. Staff engineer David Zimmerman told *ELECTRONICS* that a graphite mask can be used for up to 250 depositions.

Mask preparation begins with an automatic data-recording and storage system that determines X and Y coordinates relative to reference layout drawings. A general-purpose digital computer programs numerical control tapes for the mask-drilling machine.

A tool with a 30-degree point cuts an inverted conical groove on the underside of the mask. Plunge depth control of the tool holds line with as close as 0.01 inch in 0.05-inch graphite membrane blanks. The shape of the groove provides a shadowless path for vapor film depositions on their way to glass substrates.

Aluminum is vacuum deposited 1,000 Å thick on the top surface of the mask, to protect the thin edge of the machined grooves and to prevent graphite contamination of the substrates.

NAFI has a semiautomated pilot plant for in-line deposition. The line,



LAPP STAND-OFF INSULATORS

...in all these standard sizes to save you time and money

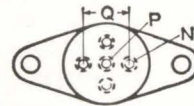
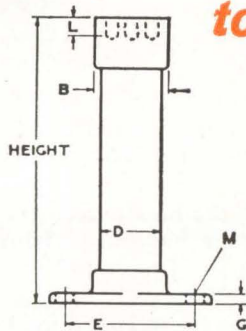

Other tapped hole sizes or arrangements available on special order.

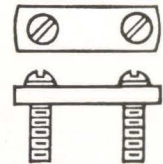

ORDER KEEPER SEPARATELY

STAND-OFF INSULATOR DIMENSIONS IN INCHES

(STOCK HEIGHTS LISTED BELOW)

Cat-log No.	Material	Cantilever Strength inch-pound	Height in inches	B	D	E	G	L	M	N	P	Q
14761 24229	Porcelain Steatite	375 450	4-6-8	1 3/8	1	2 1/4	3/8	3/2	3/2	1/4-20	1/4-20	3/8
14760 24114	Porcelain Steatite	600 700	4-6-8-10	1 3/8	1 1/4	2 3/8	3/2	3/8	3/2	1/4-20	1/4-20	1 1/8
22408 41775	Porcelain Steatite	1200 1400	6-8-10-12	1 7/8	1 1/2	2 7/8	1/4	7/16	3/2	1/4-20	1/4-20	1 3/8
13981 24110	Porcelain Steatite	1800 2100	6-8-10-12	2 1/4	1 3/4	3 3/4	1/4	5/8	1 1/2	3/8-18	3/8-16	1 1/4
42588	Porcelain	4000	6-8-10-12	3 3/8	2 1/2	5	3/8	1/2	1 1/2	3/8-18	3/8-16	2



Insulators shown are standard. Similar insulators available with caps or bases on both ends.

WRITE for Bulletin 301-R.
Lapp Insulator Co., Inc.,
211 Sumner Street, LeRoy, N. Y.

GUDEBROD CABLE-LACER SPEEDS AND IMPROVES WIRE HARNESS TYING—

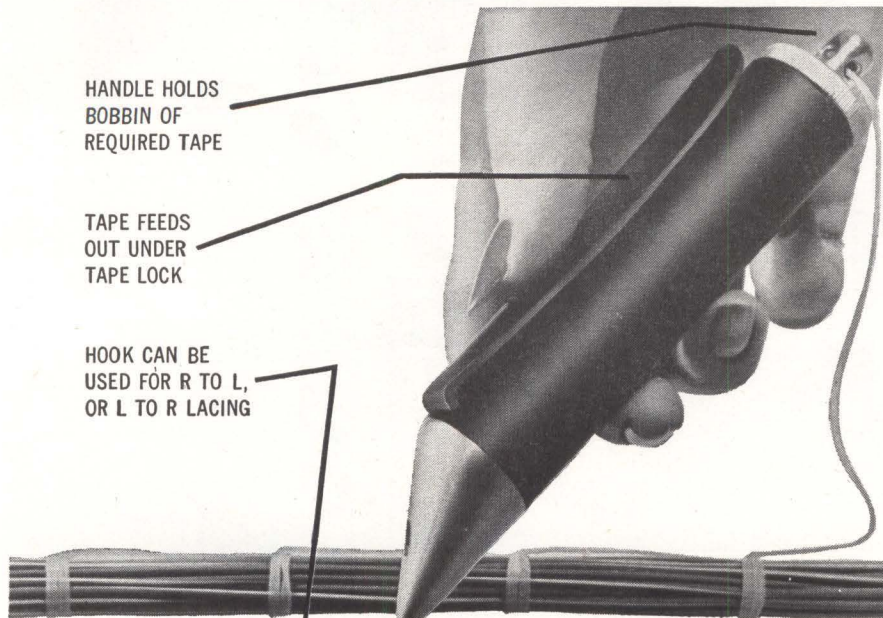

HANDLE HOLDS
BOBBIN OF
REQUIRED TAPE

TAPE FEEDS
OUT UNDER
TAPE LOCK

HOOK CAN BE
USED FOR R TO L,
OR L TO R LACING

**GUDEBROD
FLAT BRAIDED
LACING
TAPES FOR
EVERY NEED**

Specify Gudebrod Lacing Tapes for all your requirements. They meet or exceed all MIL-T specifications and commercial requirements. They will help increase your production because Gudebrod carefully tests, measures, and maintains close tolerances for slip resistance, fray resistance, breaking strength, wax content, fungistatic effectiveness. Standard, burn proof, high temperature tapes available in regular spools or in bobbins for the Cable-Lacer.

The Gudebrod Cable-Lacer is the first production tool specifically designed to speed, ease and improve the lacing of wire harnesses.

A bobbin of tape in the handle feeds tape as needed making the handling of long sections unnecessary. The number of splices are reduced too.

The hook (which can be arranged for left to right, or right to left hand lacing) facilitates the passing of the tape over or under the wiring.

The tape lock provides a firm hold on the tape augmenting the hand pull for up to 30% tighter knots. Hand contact in knot tying is eliminated.

The ease of handling the tape, the speeding of the knot tying, the elimination of hazard to hands are all appreciated by the harness section worker. Efficiency improvements of 20% and more have been proven. The Gudebrod line of lacing tapes is available in bobbins for use in the Cable-Lacer.

Gain these advantages for your harness tying operation—improved worker conditions—increased production—higher quality harness. For complete information get in touch with the Electronic Division.

GUDEBROD BROS. SILK CO., INC.

FOUNDED IN 1870

Electronics Division



12 SOUTH 12TH STREET, PHILADELPHIA 7, PENNSYLVANIA

developed jointly with IBM, can turn out 480 square inches of four-layer integrated thin-film circuits in 8 hours.

Atomic Battery Aims At 10-Year Shelf Life

SAN FRANCISCO—A \$260,000 contract for further development of a long-life, high-voltage nuclear battery has been awarded Eitel-McCullough by Sandia Corp.

The battery draws its energy from the continuous radiation derived from the decomposition of radioactive krypton-85 gas. The gas has a half-life of 10 years, giving it a 10-year shelf-life for possible storage. The battery weighs 1½ ounces.

The device consists of a small bulb of a high-resistance glass, 0.006-in. thick and containing 1.7 cubic centimeters of 5-percent krypton-85 gas, at 90 psi. The bulb is plated with nickel for mechanical support. The tube is coated with a conductive layer of carbon or some other light element. Beta particles (electrons) generated by decomposition of the gas penetrate the bulb and are captured in the coating, since high-resistance glass prevents their reentering the bulb.

A charge is then rapidly built up in the exterior coating. The charge is taken off by lead wires and used to charge or maintain a charge on a very-low-leakage capacitor.

When new, the battery can produce 1,000 picoamperes; in 10 years, half that. Output is almost constant regardless of load. The drop is about 10 percent at 3 kv and the battery can operate up to 5 kv.

CMC 7 in, E 13 B out

PARIS—The Council of the Swedish Bank Association has recommended that its members adopt the Bull CMC 7 magnetic check character (ELECTRONICS, p 28, Aug. 2). The recommendation makes the CMC 7 for all practical purposes the standard for Europe. Bank associations of 11 other European countries adopted the Bull character at a meeting in Paris last February. At that time, Sweden was the only country in favor of the American E 13 B character

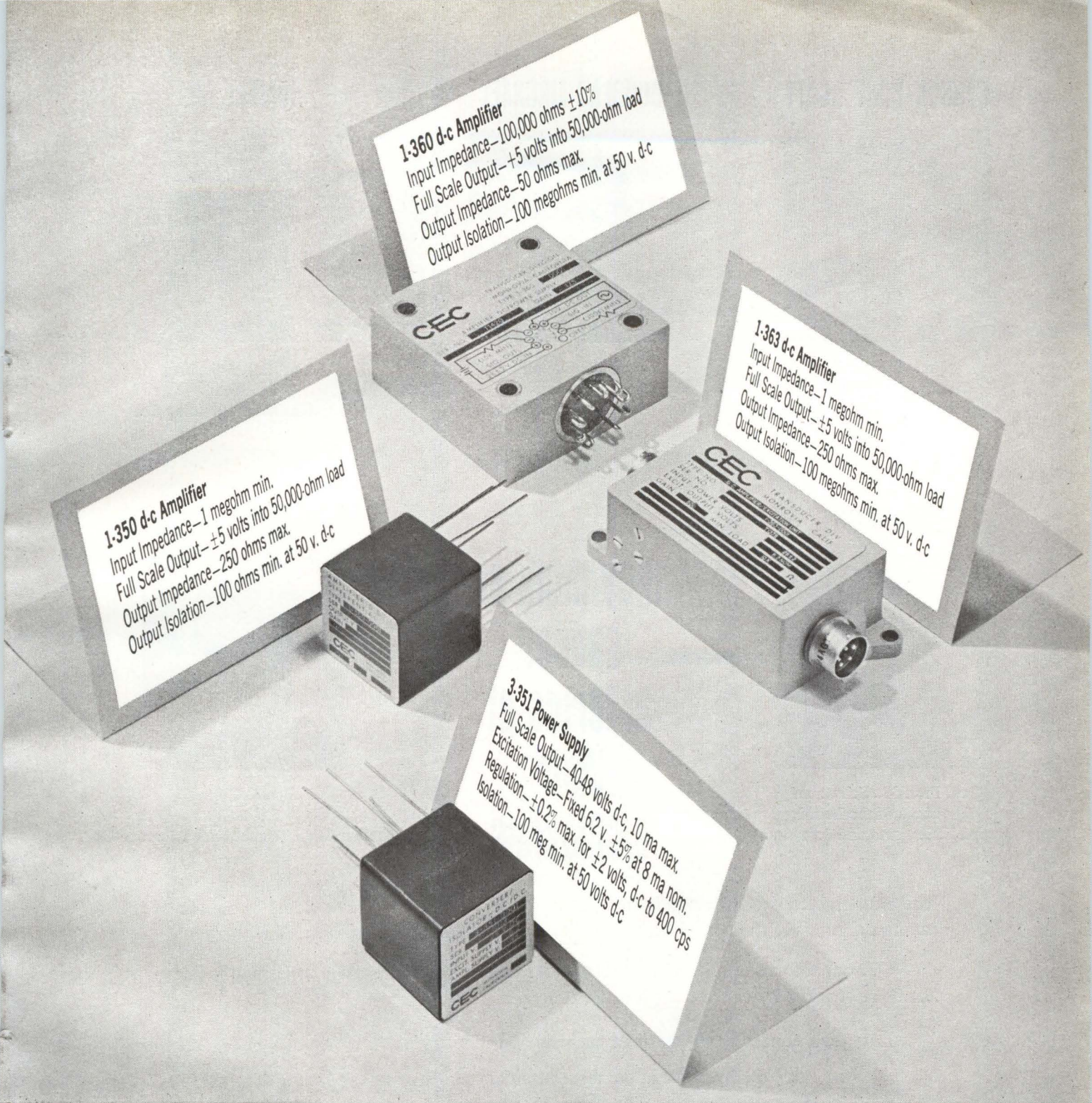

New miniature d-c amplifiers

With superior performance already proven

CEC's new miniature differential d-c amplifiers have a unique feature: a design philosophy and manufacturing technique already tested and proven in CEC's high output transducers used in major aerospace programs. As a result, combined characteristics of the new amplifiers are superior to those of any others available today—especially under extreme acceleration, vibration, and shock. You get outstanding stability, low output and high input imped-

ance, wideband frequency response, superior linearity and hysteresis effects, excellent isolation and common mode rejection, and CEC's built-in reliability.

All are small size, direct-coupled true differential amplifiers designed to amplify low level signals...in general radio telemetry equipment or airborne tape systems.

Four units are available: one (the 1-350) is the amplifier only, another (the 3-351) is a d-c excitation supply. Two amplifiers

(the 1-363 & 1-360) are single packages; each with a d-c to d-c converter, isolator, and excitation supply. Some specifications are shown above. For further information, call or write for Bulletins in CEC Kit 3445-X1.

CEC
 Transducer Division

CONSOLIDATED ELECTRODYNAMICS

A Subsidiary of Bell & Howell • Pasadena, Calif. 91109

CIRCLE 63 ON READER SERVICE CARD

CARSON PIRIE SCOTT



John T. Pirie, Jr.
Chairman of the Board
Carson Pirie Scott & Co.

DOUGLAS AIRCRAFT



Donald W. Douglas, Jr.
President
Douglas Aircraft Co.

HUMBLE OIL



Carl E. Reistle, Jr.
President
Humble Oil and Refining Co.

SEAGRAMS



Gen. Frank R. Schwengel
Chairman of the Board
Joseph E. Seagram and Sons, Inc.

**they think of
cancer
in terms of
their
employees**

SOUTHERN BELL TEL & TEL



Ben S. Gilmer
President
Southern Bell Telephone & Telegraph Co.

These far-sighted executives and hundreds of others have opened their doors to the life-saving programs of the American Cancer Society. Here are their reasons:

One out of four Americans... be they on the board of directors or on the assembly line ... will be stricken by cancer, at present estimates.

Last year, cancer cost American business and industry...

25,000 lives lost in the most experienced
age group of employees: 45-54

300,000 workers off the job

\$200,000,000 in lost man-hours

These are some of the reasons why it is good business to fight cancer. You can fight it with a free cancer education program for your employees, that pays off in lives saved.

Link your company with the hundreds of others who think of cancer in terms of their employees. The American Cancer Society Unit in your community is ready to help you.

AMERICAN CANCER SOCIETY

(This space contributed by the publisher as a public service.)





Shielded Power Supply Cables—Rubber



Plastic Microphone Cables

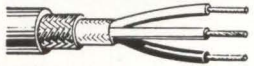

Shielded Interconnecting Cables



Duplex Connector Extension Cords



Low Impedance Lines

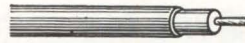

Cathode Ray Tube Lead



Miniaturized Cables

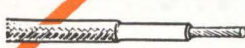

Grid Wires

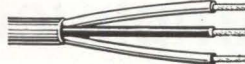

Unpaired Intercom Cables

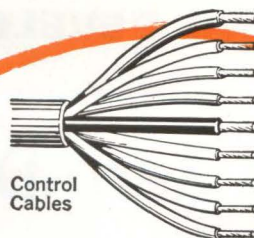

Control Cables



Audio Cables

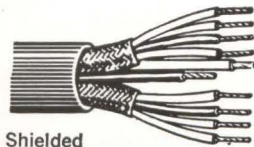

Shielded Control Cables



Coiled Test Prod Wire



RC/U Cables

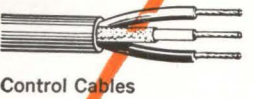

Control Cables



Miniature Audio Cables



2-Conductor Power Cords



Miniature Microphone Cables



Magnet Wire



Automation Cable

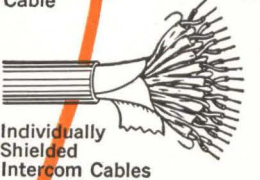

Individually Shielded Intercom Cables

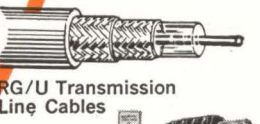

RG/U Transmission Line Cables



3-Conductor Power Cords



Rubber Microphone Cables



Hook-Up Wires



Duplex Primary Wires



Multiple Pair Cables



Strain Gauge Cables

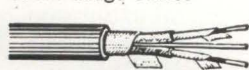

Broadcast Audio Cables



TV Eye Camera Cable



Call System Cables



PA System Cables



Sound & Alarm System Cables

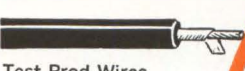

Test Prod Wires



2 & 3 Conductor Extension Cords

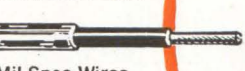

Mil-Spec Wires

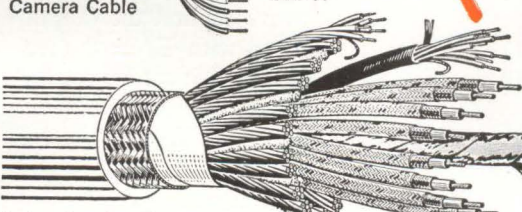

Color, Studio, Closed Circuit Camera Cables



75-Ohm Video Cable



Portable Cordage



Coiled Cords



Industrial Intercom Wires

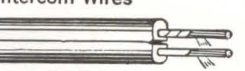

Lamp Cordage

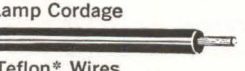

Teflon* Wires
*Du Pont trademark



2-Conductor Power Cords



Miniature Microphone Cables



Shielding & Bonding Cable



Special Sound Cables

Mr. Design Engineer... **BELDEN** Has It

Every electronic and electrical wire you need—from the finest drawn magnet wire to the most complex multi-conductor cable.

There is a Belden wire or cable in every insulation and shielding to meet your design and application requirements. Here is just part of this complete line. Available from stock.

Belden

WIREMAKER FOR INDUSTRY
SINCE 1902 — CHICAGO

One Wire Source for
Everything Electronic
and Electrical

- electronic wire • magnet wire • lead wire • power supply cords
- cord sets • portable cordage

8-4-1

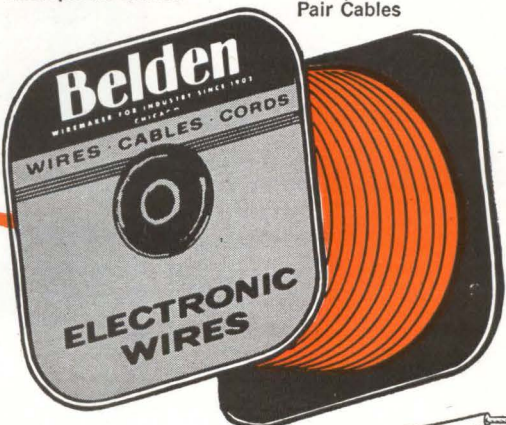

Designing Zero-Drift D-C Differential Amplifiers

By WILLIAM E. EARLE, Research Department, The Foxboro Company, Foxboro, Mass.

Thermal drift can be eliminated even with unselected transistors

SEVERAL recent analyses of thermal zero drift in transistor d-c differential amplifiers have pointed out various sources of this drift; however, usually they have made unnecessary complicating assumptions, and have taken into account too few of the transistor character-

istics to be of real value in designing low-drift amplifiers. As a result, 100-percent temperature testing is still required to select suitable low-drift transistor pairs.

An investigation into the relationship between thermal zero drift and transistor parameters has resulted in the discovery of a linear relationship between the input thermal zero drift and the initial base-emitter voltage difference. Further study showed that this relationship can be derived from conventional junction transistor theory.

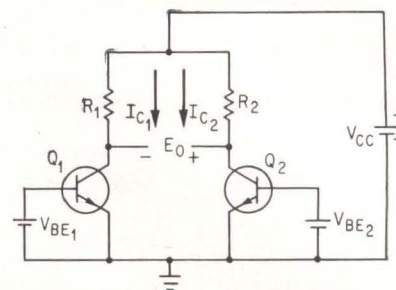

DIFFERENTIAL amplifier achieves low thermal drift by balancing with $V_{BE1} = V_{BE2}$ —Fig. 1

Starting point for a derivation of the thermal zero drift equation for a d-c differential amplifier is an equation that relates collector current to temperature and base-emitter voltage. Using commercially available silicon transistors operating at low collector currents, this equation is

$$I_c = A T^m e^{\frac{q}{KT}} (V_{BE}-1.106) \quad (1)$$

where A = a constant (varies widely from transistor to transistor), m = 1.25 (may vary somewhat from transistor to transistor), q = electron charge, K = Boltzmann's constant, T = temperature in deg K, and V_{BE} = base-emitter voltage.

This simple relationship can be derived from the general expression for collector current¹ by making certain reasonable assumptions, and inserting the known values for the various coefficients.^{2, 3, 4}

Drift Equation—An expression for differential-input thermal drift may be derived provided that the output remain balanced with $E_o = 0$ (see Fig. 1). Using Eq. 1, it can be shown that the input thermal drift between temperatures T_1 and T_2 is

$$\Delta V_{BE T_1, T_2} = (V_{BE1} - V_{BE2})_{T=T_2} - (V_{BE1} - V_{BE2})_{T=T_1} \quad (2)$$

$$\Delta V_{BE T_1, T_2} = T_2 \frac{K}{q} (m_1 - m_2) \ln \left(\frac{T_1}{T_2} \right)$$

$$+ \frac{T_2 - T_1}{T_1} (V_{BE1} - V_{BE2})_{T=T_1}$$

If transistor Q_1 and Q_2 have equal m values, as is always approximately

NBS Sets New Physical Constants

GENERAL PHYSICAL CONSTANTS RECOMMENDED BY NAS-NRC				Adopted by NBS ¹			
Constant	Symbol	Value	Est.* error limit	Unit			
				Système Intern. (MKSA)		Centimeter-gram-second (CGS)	
Speed of light in vacuum	c	2.997925	3	$\times 10^8$	$m s^{-1}$	$\times 10^{10}$	$cm s^{-1}$
Elementary charge	e	1.60210	7	10^{-19}	C	10^{-20}	$cm^{1/2}g^{1/2}s^{-1}\ddagger$
		4.80298	20			10^{-10}	$cm^{3/2}g^{1/2}s^{-1}\ddagger$
Avogadro constant	N_A	6.02252	28	10^{23}	mol^{-1}	10^{23}	mol^{-1}
Electron rest mass	m_e	9.1091	4	10^{-31}	kg	10^{-28}	g
Proton rest mass	m_p	1.67252	8	10^{-27}	kg	10^{-24}	g
Faraday constant	F	9.64870	16	10^4	C mol ⁻¹	10^3	$cm^{1/2}g^{1/2}mol^{-1}\ddagger$
Planck constant	h	6.6256	5	10^{-34}	J s	10^{-27}	erg s
Fine structure constant	α	7.29720	10	10^{-3}		10^{-3}	
Charge to mass ratio for electron	e/m_e	1.758796	19	10^{11}	C kg ⁻¹	10^7	$cm^{1/2}g^{-1/2}$
		5.27274	6			10^{17}	$cm^{3/2}g^{-1/2}$
Rydberg constant	R_∞	1.0973731	3	10^7	m ⁻¹	10^5	cm ⁻¹
Gyromagnetic ratio of proton	γ	2.67519	2	10^8	rad s ⁻¹ T ⁻¹	10^4	rad s ⁻¹ C ⁻¹
(Uncorrected for diamagnetism, H ₂ O)	γ'	2.67512	2	10^8	rad s ⁻¹ T ⁻¹	10^4	rad s ⁻¹ C ⁻¹
Bohr magneton	μ_B	9.2732	6	10^{-24}	J T ⁻¹	10^{-21}	erg C ⁻¹
Gas constant	R	8.3143	12	10^0	J ^o K ⁻¹ mol ⁻¹	10^7	erg ^o K ⁻¹ mol ⁻¹
Boltzmann constant	k	1.38054	18	10^{-23}	J ^o K ⁻¹	10^{-16}	erg ^o K ⁻¹
First radiation constant ($2\pi hc^2$)	c_1	3.7405	3	10^{-8}	W m ²	10^{-5}	erg cm ² s ⁻¹
Second radiation constant	c_2	1.43879	19	10^{-2}	m ² K	10^9	cm ² K
Stephan-Boltzmann constant	σ	5.6697	29	10^{-8}	W m ⁻² K ⁻⁴	10^{-5}	erg cm ⁻² s ⁻¹ K ⁻⁴
Gravitational constant	G	6.670	15	10^{-11}	N m ² kg ⁻²	10^{-8}	dyn cm ² g ⁻²

*Based on 3 std. dev., applies to last digits in preceding col. †Electromagnetic syst. ‡Electrostatic syst. 1 Reprinted from NBS Technical News Bulletin, Oct. 1963.

CONSISTENT set of values for physical constants has been adopted by the National Bureau of Standards for all NBS publications, replacing several alternative sets of "best values". Partial table is shown above, full set is published in October NBS Technical News Bulletin. Abbreviated set is also available from NBS on wallet-size plastic cards



Polaroid circular polarizers do it better.

They kill glare and reflections, no hands, and improve contrast for daylight viewing. And by combining them with linear polarizers, you can control image intensity or color (variable red for dark-adapted eyes at night, for instance). For information on complete custom designed filter systems, write: Polaroid Corporation, Polarizer Division, Department E-11, 119 Windsor Street, Cambridge 39, Mass. In Great Britain: Polarizers (United Kingdom) Ltd., 26 Stamford Street, London S.E. 1, England. In Europe: Polaroid GmbH, Holzhausenstrasse 30, Frankfurt/Main, Germany.

"POLAROID"®

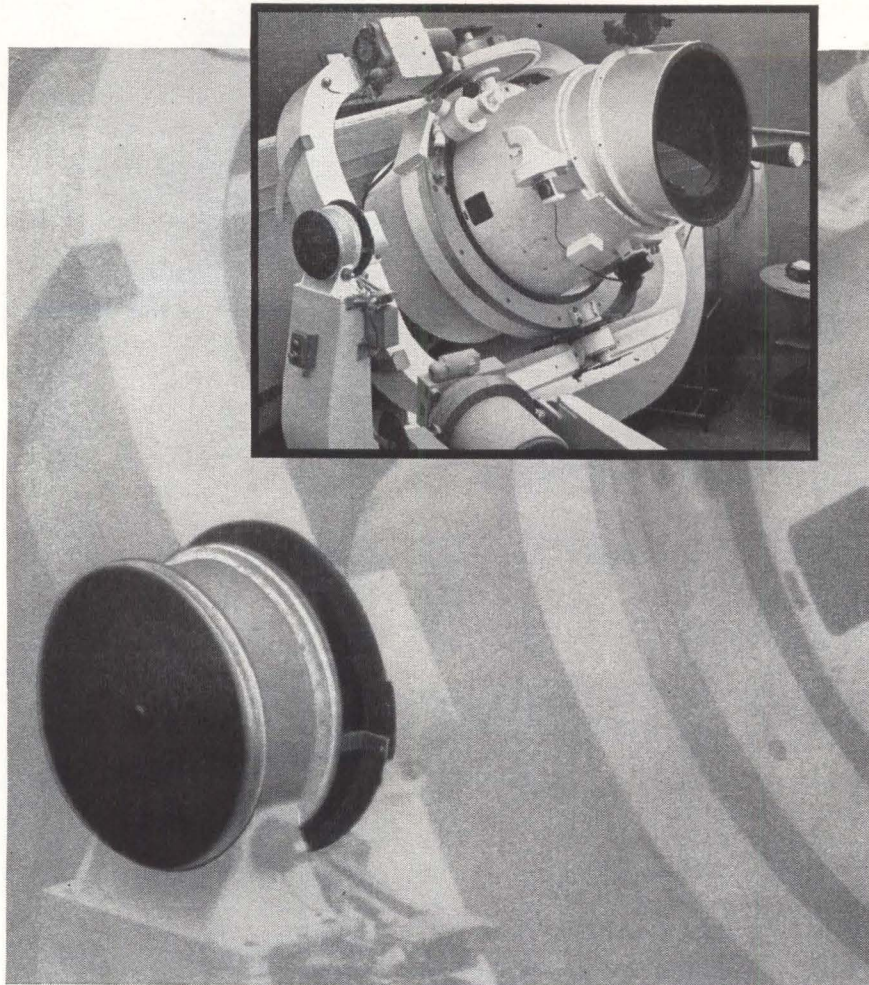

Photo-courtesy of Lincoln Laboratory, Lexington, Mass.

Inland Gearless Torquers help keep re-entry spectrograph on target!

Project PRESS on Roi-Namur Island in Kwajalein Atoll . . . under the scientific direction of M.I.T. Lincoln Laboratory . . . employs this spectrograph to investigate the physical effects associated with the flight of ballistic missiles from mid-course through re-entry, for the Advanced Research Projects Agency.

Two Inland Gearless Torquers, directed by computer command, position both azimuth and elevation of the spectrograph at velocity rates up to 10°/sec and acceleration rates of 2°/sec². Tracking error of position is less than 1 minute of arc in 0.1 second. Smooth positioning prevents smearing of spectral images on the film.

Fast, smooth, high-resolution response to signals is a major reason why Inland Gearless Torquers win so many missile and space-vehicle assignments. The superior performance of these direct-drive d-c torque motors comes from torque-to-inertia ratios 10 times higher than equivalent gear-train servo motors.

What's your problem? If you're currently planning a servo system calling for output torques between 20-ounce-inches and 3000 or more pound-feet, compare Inland Gearless Torquers with any alternative. Write to Inland Motor Corporation; Radford, Virginia for all the facts today.



true, the first term of Eq. 2 vanishes and

$$\Delta V_{BE1, T_2} = \frac{T_2 - T_1}{T_1} (V_{BE1} - V_{BE2})_{T=T_1} \quad (3)$$

$$\text{or } \left. \frac{\Delta V_{BE}}{\Delta T} \right|_{T_1, T_2} = \frac{(V_{BE1} - V_{BE2})_{T=T_1}}{T_1} \quad (4)$$

Equation 4 shows that a differential amplifier can be made to have zero input thermal drift, by setting $V_{BE1} = V_{BE2}$ and then balancing the collector circuit so that $E_o = 0$.

Excellent experimental verification of Eq. 4 comes from two sets of input thermal drift measurements, made on 22 pairs of unselected transistors.

The first set of measurements consisted of noting the input thermal drifts under the common operating condition of equal collector currents, which, in general, means unequal base-emitter voltages. The observed drifts in terms of initial base-emitter voltage differences, when plotted, showed a general correspondence to the straight-line plot of the theoretical drift from Eq. 4.

For the second set of measurements, the input thermal drifts were measured under the suggested operating condition of equal base-emitter voltages, and hence generally un-

Wide-Angle IR Detector Developed for 100 C

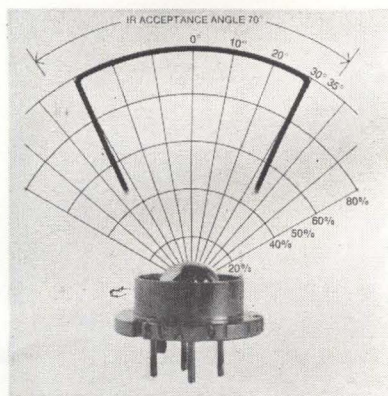

DESIGNED for high-accuracy detection of minute temperature variations, new Servotherm infrared detector with an angle of acceptance of 70 degrees has been developed by Servo Corporation of America, Hicksville, N. Y. It may be coated to peak at any wavelength between 9 and 15 microns, uses a germanium immersed window type detector housed in stainless steel flanged capsule, has withstood test temperatures over 100 deg C

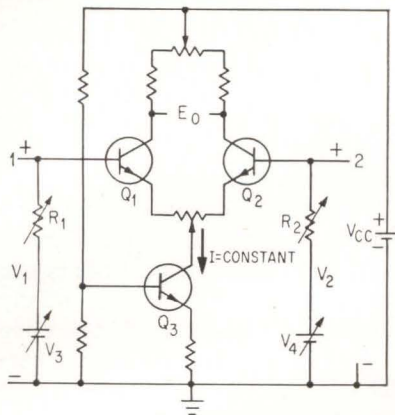

DIFFERENTIAL base current flowing between the input terminals can be eliminated over a range of temperatures by providing suitable paths for base current—Fig. 2

equal collector currents. Equation 4 indicates that there should be no input drifts for this mode of operation. Measurements showed this to be essentially true, the largest drift being $8.1 \mu\text{V}/\text{deg C}$ and the average drift being $2.4 \mu\text{V}/\text{deg C}$. There was no connection between the magnitude of the β 's and the input thermal drift, or between the degree of β match and the drift. Only 2 of the 22 transistor pairs tested were of the two-in-a-can, adjacent-chip construction, proving that adjacent-chip transistors are not essential in building low drift amplifiers.

The fact that input drifts were not identically zero for the measurements made with equal base-emitter voltages, indicates unequal values of m (see Eq. 2) or the presence of other small-order effects. These small remaining drifts can be corrected by introducing an input thermal drift equal and opposite to the observed drift. This is done by introducing a calculable (see Eq. 4) initial base-emitter voltage, using a low-resistance emitter balancing potentiometer.

Base Current Offset—Up to this point, zero differential input source resistance has been assumed. The presence of a finite source resistance means that the flow of differential base current will generate a differential input voltage, or offset, indistinguishable from an actual differential input signal.

In general, this offset will be non-zero and a function of temperature. However, with certain currently available transistors, the operating

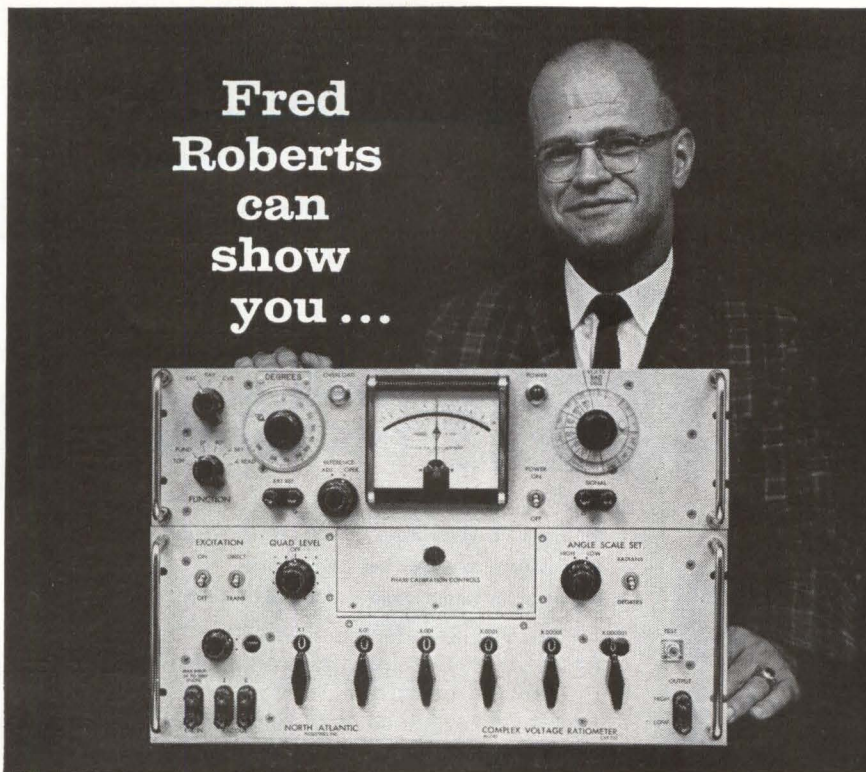

Director of Marketing, North Atlantic Industries

how to measure ac ratios regardless of quadrature

North Atlantic's **Complex Voltage Ratiometer** is a completely integrated test set for measuring grounded 3 terminal networks. By providing self-calibrated quadrature injection, the Model CVR-551 permits calibrated meter readings of phase angle up to 30° or 300 milliradians full scale, and, in addition, provides direct readings of in-phase and quadrature voltages. As an added feature, the integral Phase Angle Voltmeter* and AC Ratio Box can be used independently. Abridged specifications follow:

In-Phase Ratio Range, R_I000000 to ± 1.111110 with full accuracy
Phase Angle Range, α	± 1.0 to ± 300 milliradians ± 0.1 to $\pm 30^\circ$ (in 6 calibrated ranges)
Frequency	Any specified frequency, 50 cps to 3KC
Input Ratio Error, R_I	$\pm (.001 + \frac{.0001}{R_I} + \delta \tan \alpha)$ % of reading
Phase Angle Error, α	$\pm .0003$ radians or $\pm .017^\circ$ (low ranges) $\pm 3\%$ full scale (high ranges)
Phase Angle Voltmeter* (independently used)	$\pm 2\%$ full scale 1 millivolt to 300 volts (in 12 calibrated ranges)
A.C. Ratio Box (independently used)	1 ppm terminal linearity .35f (300 volts max)

North Atlantic's CVR* line includes 2 and 3 frequency models. All models available with optional 10 ppm Ratio Box control of quadrature injection.

Send for data sheet or contact your local North Atlantic sales representative now for complete information.

*Trademarks



NORTH ATLANTIC industries, inc.
TERMINAL DRIVE, PLAINVIEW, I. I., NEW YORK • Overbrook 1-8600

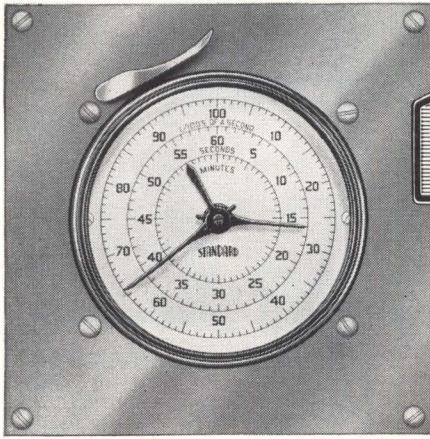

THE ONE TIMER WITH ALL THE FEATURES

- Portable, Panel or Wall Mounting
- Scale Divisions from 1/1000 sec. to 1/5 sec.
- Totalize from .360 sec. to 60 min.
- Accuracy range from $\pm .0002$ to $\pm .1$ sec.

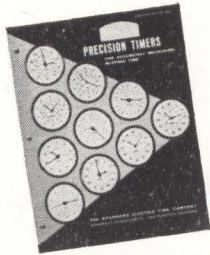

Since 1932 Standard Electric Time Company has been developing and manufacturing units for the precise measurement of elapsed time. Accuracy, rugged construction and long life are Standard features.

For full details request free 20 page catalog No. 257.

THE STANDARD ELECTRIC TIME COMPANY

89 LOGAN STREET • SPRINGFIELD, MASSACHUSETTS

CIRCLE 203 ON READER SERVICE CARD

FREDDY

by RUPE



What you need, Freddy, in order to screen out those unwanted signals, is a **REEVES-HOFFMAN CRYSTAL FILTER** (or maybe in your case just the container would be good enough). Like Freddy, perhaps you have a need for a good filter system. If so, why not get the facts now about Reeves-Hoffman crystal filters, available in frequency ranges from audio to 30 mc to meet commercial or military specifications. Are we coming through loud and clear? Then write for bulletin QCF.

REEVES-HOFFMAN
CARLISLE, PENNSYLVANIA
DIVISION OF DYNAMICS CORPORATION OF AMERICA

PRODUCERS OF PRECISION
FREQUENCY CONTROL DEVICES...
crystals • crystal-controlled
frequency sources, standards,
filters • component ovens.

base currents can be extremely small, meaning that the offset generated by the correspondingly small differential base current may be negligible, even with a relatively high source resistance.

If the offset is still unacceptably large in spite of using low current transistors, then it is possible to use a more complex circuit that entirely eliminates the offset by preventing the flow of any differential base current through the input source. Figure 2 is an example of this type of circuit. Transistor Q_3 acts solely as a current source, drawing a known constant current from the emitters of Q_1 and Q_2 .

For the circuit of Fig. 2 it is possible to adjust R_1 , R_2 , V_3 and V_4 , so that the differential input current between terminals 1 and 2 can be set equal to zero, and made to have a zero temperature coefficient. Assuming that $\beta_1, \beta_2 \gg 1$, the zero temperature coefficient of differential input current will occur when:

$$\frac{V_4 - V_A}{V_3 - V_A} = \frac{\text{temperature coefficient of } \beta_1}{\text{temperature coefficient of } \beta_2}$$

where $V_A = V_1 = V_2$ (with terminals 1 and 2 floating). Resistors R_1 and R_2 may be adjusted to give any value of V_A , which will not result in Q_1 and Q_2 being in cutoff or saturation.

Since V_A is a chosen value (even though arbitrarily chosen), the circuit of Fig. 2 does not have good common mode rejection, meaning that either the differential input source or the amplifier power supply should be floating. In the particular situation where there is negligible differential source resistance, the flow of base current through the source can be neglected and the circuit will have good common-mode rejection.

The author thanks Robert A. Brodeur for building the test fixtures and performing measurements.

BIBLIOGRAPHY

- (1) W. Shockley, 'The Theory of p-n Junctions in Semiconductors and p-n Junction Transistors,' *Bell Sys. Tech. J.*, 23, p 435, July 1949.
- (2) E. M. Conwell, 'Properties of Silicon and Germanium,' *Proc IRE*, 46, p 1281, June 1958.
- (3) H. Kressel, H. S. Veloric, A. Blicher, 'Design Considerations for Double-Diffused Silicon Switching Transistors,' *ECA*
- (4) G. Bemski, 'Recombination Properties of Gold in Silicon,' *Phys. Rev.* 111, p 1515, Sept 15, 1958.

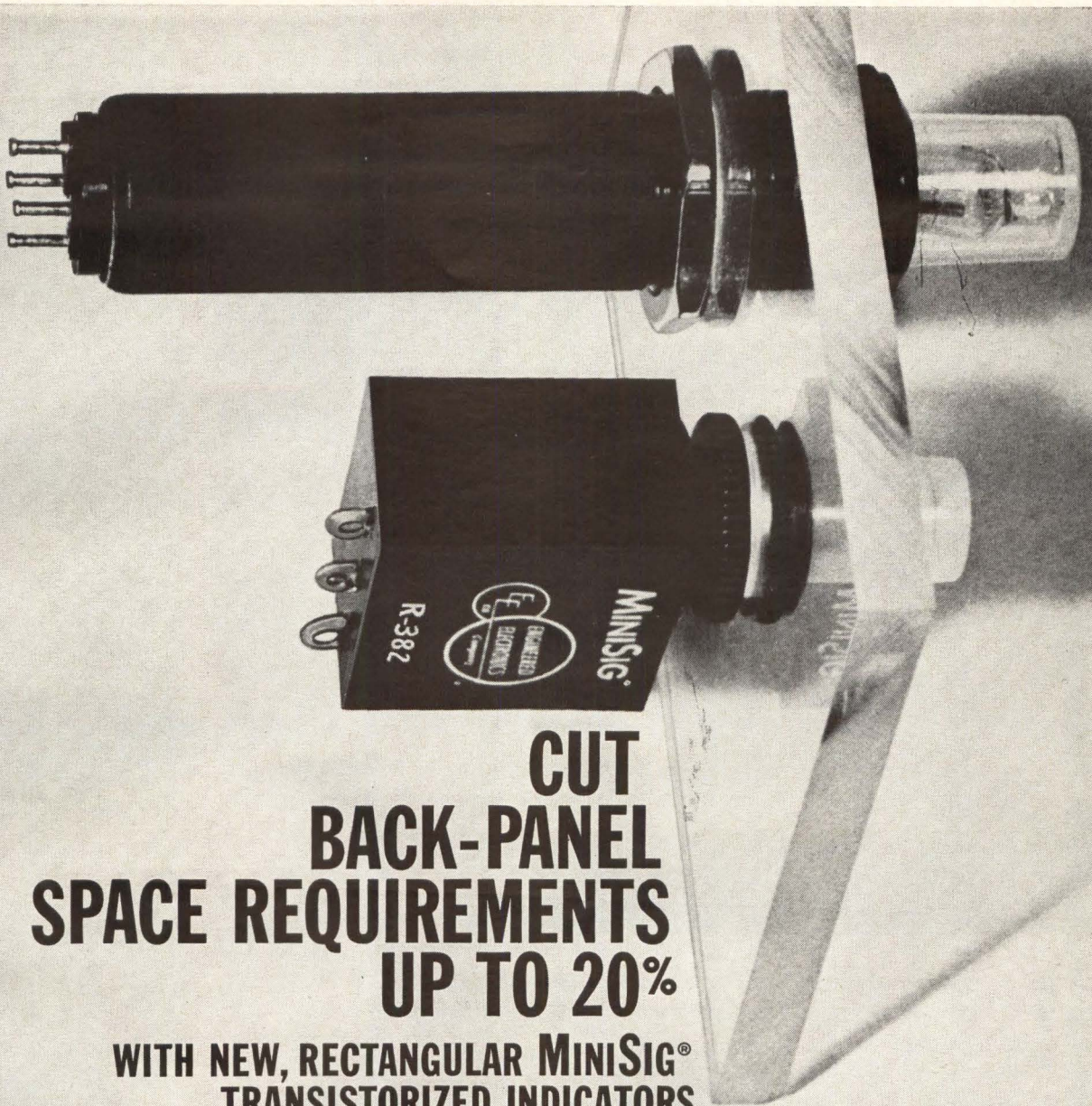

CUT BACK-PANEL SPACE REQUIREMENTS UP TO 20%

WITH NEW, RECTANGULAR MINISIG® TRANSISTORIZED INDICATORS

Here's the new shape of indicator miniaturization. In these tiny MINISIG models, the typical 2" extension behind the panel shrinks to about $\frac{3}{4}$ "; at the same time, overall volume is reduced by as much as one-fifth.

Performance, however, is king-size. These are high-gain devices with built-in transistor driver-amplifiers and low-voltage incandescent lamps. They operate directly and brightly from low-voltage signals, yet are a light load on the signal source. Lamp currents stay inside the indicator housing, out of your sensitive logic circuits.

If your needs are highly specialized, chances are EECo's design staff can find a fast, economical answer — an answer backed by the MINISIG record of reliability in hundreds of major systems.

THREE MODELS AVAILABLE

Model R-382: -11V, off; -3V, on.

Model R-481: 0V, off; -6V, on. Features keep-alive current to extend bulb life.

Model R-381: 0V, off; +6V, on.

Back-panel dimensions: $\frac{3}{4}$ " x $\frac{3}{4}$ " x $\frac{1}{2}$ "

Lens colors available: red, green, amber, white.

EECo offers you a full line of MINISIG indicators. Choose from neon, filament and thyratron types. Many have adjustable operating characteristics, and will accommodate a broad range of input signal conditions.



Competitive prices, fast delivery. Write today for technical data.

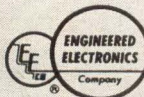

ENGINEERED ELECTRONICS Company

1441 East Chestnut Avenue, Santa Ana, California
Telephone: 547-5651 Cable Address: ENGELEX

New FILM-THIN Copper-clad Laminates for space-saver or multi- layer printed circuits



Synthane copper-clad laminates are now being produced with a base laminate of only .0035" and up—with 1 or 2 oz. cladding available on one or both sides. A pre-impregnated glass cloth with epoxy resin filler is also available for bonding multi-layer circuits. These new materials are produced under clean room conditions. Property values are comparable to military specs for the same materials in standard thicknesses. Write for folder of Synthane metal-clad laminates.

SYNTHANE
CORPORATION **S** OAKS, PENNA.

Glendale 2-2211 (Area Code 215) TWX 215-666-0589
Synthane-Pacific, 518 W. Garfield Ave., Glendale 4, Calif. TWX GLDL 4417U

Synthane Corporation, 36 River Rd., Oaks, Pa.
Gentlemen:
Please send me Synthane metal-clad laminates folder.

Name _____

Address _____

City _____ Zone _____ State _____

SYNCHRON[®]
MOTORS

INTEGRITY
in
Name—Product—Policy

HANSEN MANUFACTURING CO., INC., Princeton, Indiana
SINCE 1907

17...

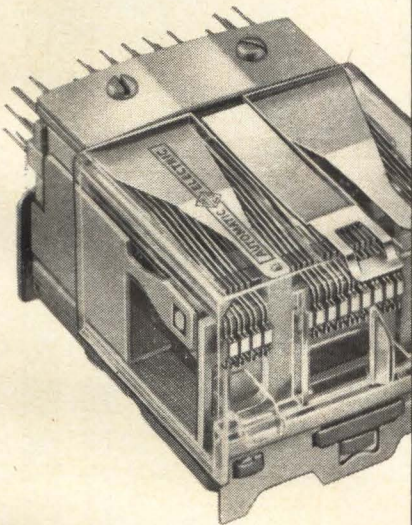

34...

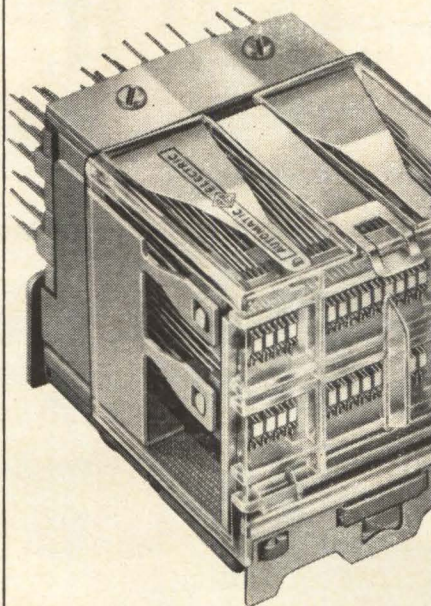

51...shift
in one fast play

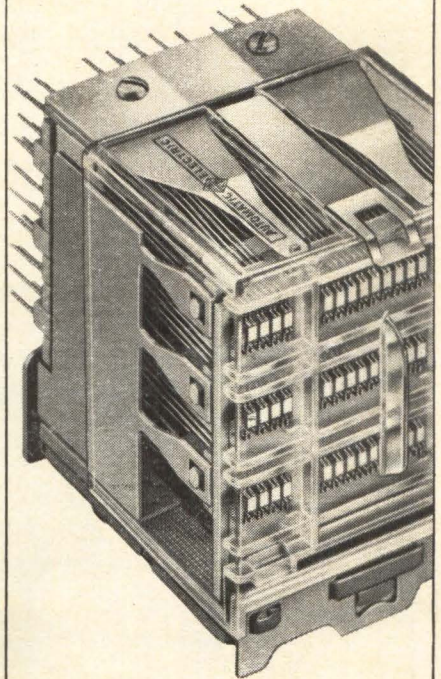

Assuring the simultaneous transfer of circuits in a multiple-relay group is one of the trickier problems faced by electrical and electronic engineers. AE's happy solution is the WQA Relay—the first industrial-control component specifically designed for uniform transfer of up to 51 circuits.

The modular construction of the WQA permits one, two or three rows of contact forms, each with a capacity for 17 circuit transfers. Unique, compact design saves valuable

mounting space, replacing 4 or more "general-purpose" relays. Remarkably sensitive, even the largest pile-up requires less than 6 watts input. Continuing tests show a life expectancy of over 800 million operations without readjustment.

For full information, ask for Circular 1957-B. Write the Director, Control Equipment Sales, Automatic Electric, Northlake, Illinois.

AUTOMATIC ELECTRIC

Subsidiary of

GENERAL TELEPHONE & ELECTRONICS



What's in it for you?

Just this. This Leach Balanced Armature Relay withstands 2000 foot lbs. of shock loading and 30 G's to 2000 cps vibration to meet Mil-S-901B for equipment-mounted components. How? First, the standard relay has a dynamically balanced armature that provides equalization of the mass to stabilize the contact structure. Next, exclusive buffer blades are added to provide additional stability to the stationary contacts. Finally, the internal mechanism is tied down tight to the enclosure.

But shock and vibration resistance may not be your main aim. Maybe you're looking for minimum voltage spike generation, or radiation resistance, or extended life at maximum rated current, or other special features. This Leach Balanced Armature Relay or one like it will end your search. So stop looking. Start asking Leach for the answers.

LEACH

 CORPORATION

RELAY DIVISION: 5915 Avalon Blvd. • Los Angeles 3, California • Export: Leach International S. A.

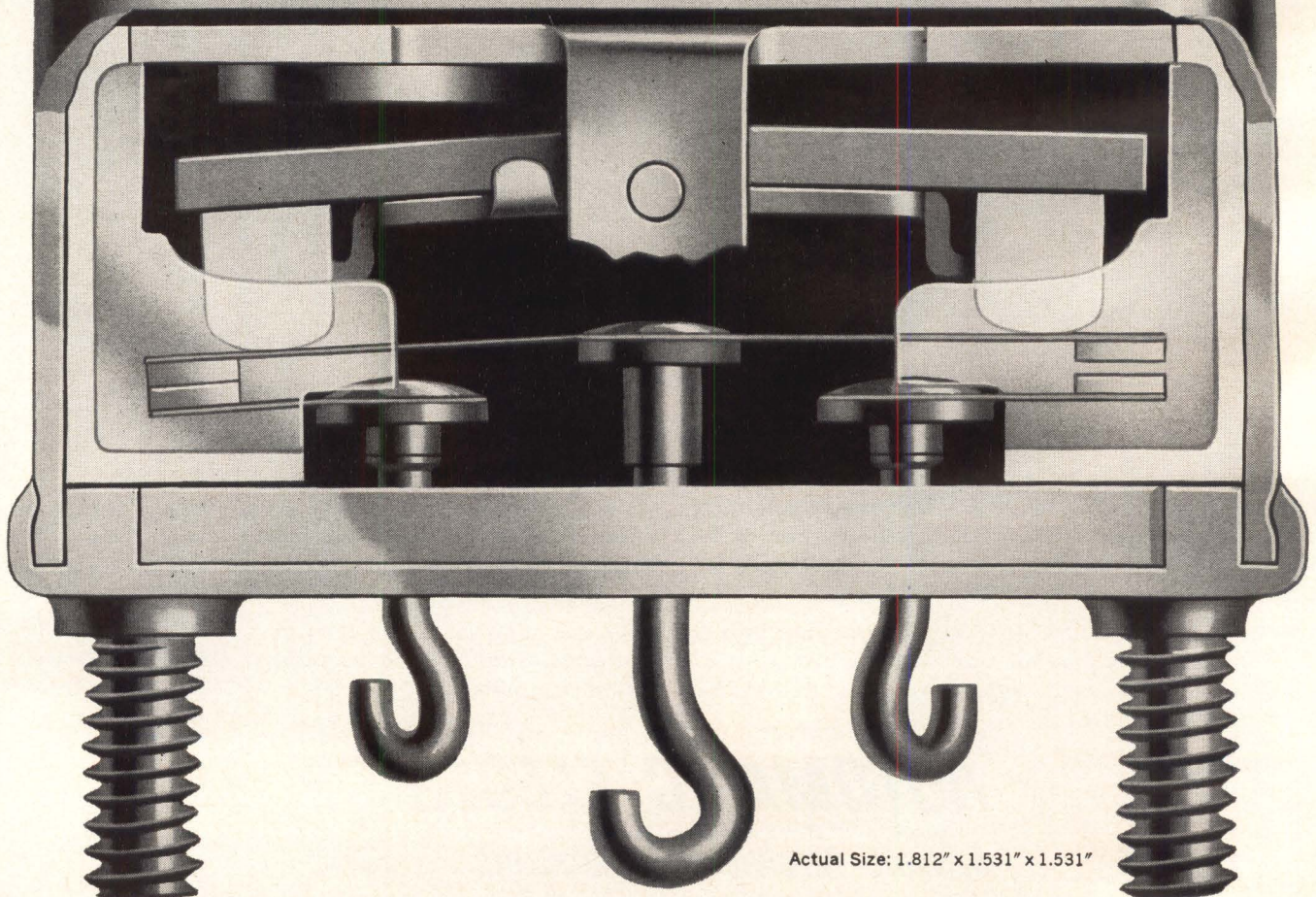

Actual Size: 1.812" x 1.531" x 1.531"

New Package for Microtransistor

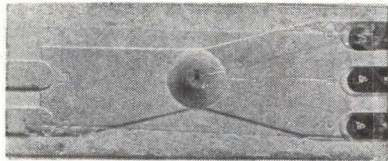

◀ TAB transistor packaged for shipment. Use of Mylar makes testing up to 150°C in package possible

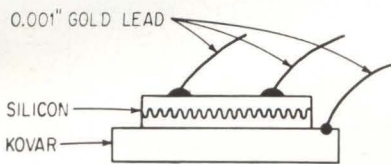

CROSS SECTION of silicon tab transistor. Normally, Kovar is used as collector connection; extra lead is attached for convenience in tab transistor applications

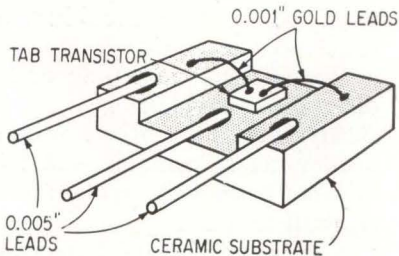

CERAMIC substrate of the microtransistor. Gray surface is evaporated gold to which are welded—or soldered—0.005" diameter leads. Entire device will be coated with epoxy

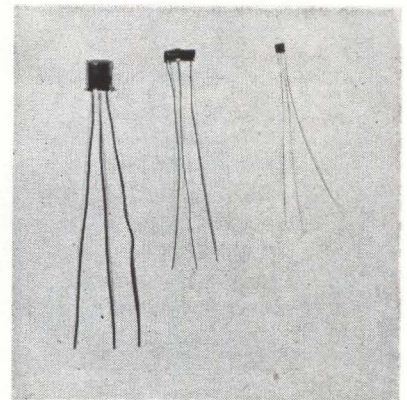

STANDARD TO-18 package is many times the size of ceramic microtransistor. Device in center is first production unit; device on right is latest package design

Rugged device is only slightly larger than tab transistor it replaces

NEW PACKAGING scheme developed by National Semiconductor Corp. has resulted in a ceramic microtransistor only slightly larger than a tab transistor, and almost as rugged as the conventional type, originally designed with medical electronics in mind, the ceramic microtransistors are also being used in an aerospace application.

OEM production line employees are not used to working with 0.001" gold leads; the leads are too fine to be soldered or welded. Even though gold has a high melting point, the wire melts as soon as a soldering iron is brought near. Loss figures for the tab transistors were extremely high, almost too high to make the tab transistor economically feasible. Manufacturers started looking for something better.

For one customer, NSC started attaching leads to a ceramic substrate, mounting a tab transistor on the substrate, and covering the pack-

age with epoxy. The new devices were still small, but they virtually eliminated handling problems. This version although satisfactory required further refinement.

NSC started looking for a better way. First the ceramic substrate was examined. Instead of a flat piece of ceramic with three areas of gold film, a smaller piece of ceramic

was made with a channel in the center. Gold was evaporated onto the upper surfaces and the face of the channel. Leads were then attached to these surfaces. The tab transistor was attached to the center channel, and emitter and collector leads were attached to the raised end pieces. Finally, the substrate was covered with an epoxy.

Couplers Kill Reflected RFI

Used as harmonic pads, they protect high-power microwave transmitters

CHICAGO—Experiments at Stanford Research Institute indicate that waveguide directional couplers make ideal harmonic pads. Also, they might be used as high-frequency attenuators in combination with leaky-wave filters to reduce radio

frequency interference from microwave systems.

At the ninth Electromagnetic Compatibility Conference two weeks ago, L. Young, of Stanford, reported that sidewall couplers offer a simple means of harmonic padding and extend absorptive attenuation well beyond the first few harmonics.

Harmonic Pads—Pads are used between rejection filters and high-power transmitters to protect the transmitting tube from reflected har-

Lepel

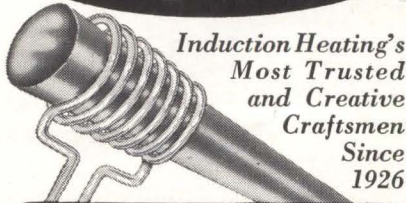

Induction Heating's
Most Trusted
and Creative
Craftsmen
Since
1926

HIGH FREQUENCY INDUCTION HEATING UNITS

- for
- BRAZING • SOLDERING
 - HEAT TREATING
 - BOMBARDING
 - MELTING
 - ZONE REFINING
 - CRYSTAL GROWING
 - PLASMA TORCH

ELECTRONIC TUBE GENERATORS

Kilocycle Frequency Units
Megacycle Frequency Units
Dual Frequency Units

and

- SPARK GAP CONVERTERS



LEPEL ACCESSORY EQUIPMENT

Work Tables • Automatic Turntables •
Roto Heating and Quenching Units •
Water Recirculating Systems • Remote
Control Operating Units • Change-Over
Switches • Bell Jar Fixtures • Zone
Refining, Crystal Growing and Plasma
Torch Equipment.

FREE APPLICATION ENGINEERING
SERVICE—Our engineers will process
your work samples and submit
recommendations.

WRITE FOR LEPEL CATALOG

Lepel HIGH FREQUENCY
LABORATORIES, INC.

55th ST. & 37th AVE., WOODSIDE 77, N. Y. C.
CHICAGO OFFICE: 6246 WEST NORTH AVENUE

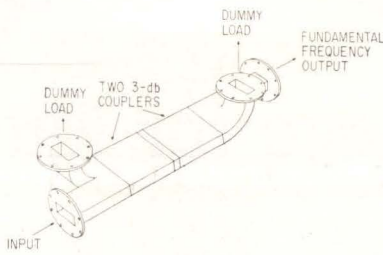

ZERO-DB COUPLER used as harmonic pad is made by cascading two 3-db short-slot side-wall couplers (left). At right is combination of leaky-wave filters and directional coupler, suggested for absorbing wide range of harmonic frequencies

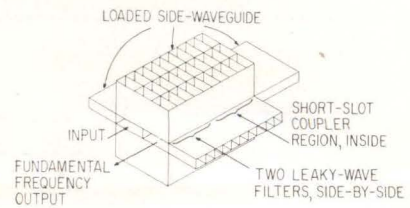

monic power and to avoid harmonic resonances in the line.

Young found that 0-db or 3-db directional couplers give a low, steady attenuation over a wide frequency range, including perhaps 10 or more harmonics. With two 3-db sidewall couplers cascaded to form a 0-db coupler, as illustrated, average reflection was generally between -10 db and -20 db around X band.

Of the various types of couplers available, he said, best results are attained with short-slot sidewall couplers, with 3-db couplers slightly better than 0-db couplers.

The couplers attenuate by absorption rather than reflection. High attenuation is left to more compact rejection filters such as multicavity bandpass filters or waffle-iron low-pass filters.

Performance of the couplers as harmonic pads, Young said, improves as frequency rises, unlike leaky-wave filters which perform better at the lower harmonic frequencies. Because of this, Young suggested, the couplers and leaky-wave filters might be combined as shown to attenuate well beyond the fourth or fifth harmonic. Two leaky-wave filters are connected by a 3-db coupler which sprouts side waveguides in all available directions.

S-Band Radar Filter—A filter that can suppress all significant spurious power at microwave frequencies from high-power radar was described by J. P. Rooney, of GE, and F. P. Ventolieri, of Air Force's Rome Air Material Area. The filter was designed for the AN/FPS-6, an S-band radar with a peak power of 5 Mw. The transmitting tube is a magnetron. The spurious outputs include some close to the fundamental operating band, as well as harmonics.

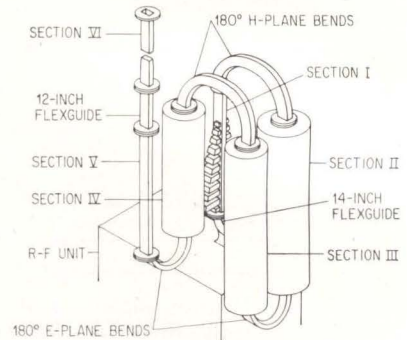

SIX SECTION filter absorbs all significant spurious radiation from FPS-6 radar

The filter (see illustration) consists of 6 sections: 1) a low-pass reactive filter providing high attenuation from 3.1 to 3.8 Gc; 2) a low-pass leaky-wall filter with high attenuation from 3.7 to 6.5 Gc; 3) low-pass leaky-wall filter to attenuate the third harmonic; 4) same type of filter for second harmonic; 5) 36-inch waveguide spacer, and 6) reduced-width-waveguide high-pass filter to provide high attenuation below 2.6 Gc.

Five months of operation and tests, Rooney said, show that the filter permits interference-free operation of the FPS-6 in almost any r-f environment. Attenuation measured more than 60 db from d-c to 2.55 Gc and from 3.15 to 10 Gc. The design goal for the passband was 2.7 to 2.9 Gc.

Pure Molybdenum Can Now Be Cold Worked

RESISTIVITY ratios of 10,000 and greater are presently being measured on 1/8-in. diam. molybdenum crystals



ACTUAL SIZE

SIMPLE WAY to buff the rough out of switching



Here's the simple, inexpensive way to eliminate switch contact interference in fast-responding electronic circuits—in electronic test equipment, digital equipment, numeric machine tool controls, etc. It not only saves costly custom circuit development time, it saves space and is easy to wire-in.

This "buffer" device is an electronic circuit which can be mounted on a standard mechanical switch. Triggered by the switch, it provides the quick, interference-free contact required by systems involving high-speed electronic circuits that operate in less than a millisecond. This simple device can also be used independently as a flip-flop. Four circuits are available: positive output for resistive loads of 100 to 500 ohms; 500 ohms or greater; and negative output for those loads.

Send for Data Sheet 177 or see the Yellow Pages for the nearest MICRO SWITCH Branch Office.



PUSHBUTTON
ACTUATOR



ILLUMINATED
ACTUATOR



MICRO SWITCH

FREEPORT, ILLINOIS

A DIVISION OF HONEYWELL

IN CANADA: HONEYWELL CONTROLS LIMITED, TORONTO 17, ONTARIO

HONEYWELL INTERNATIONAL—SALES AND SERVICE OFFICES IN ALL PRINCIPAL CITIES OF THE WORLD. MANUFACTURING IN UNITED STATES, UNITED KINGDOM, CANADA, NETHERLANDS, GERMANY, FRANCE, JAPAN.

Hughes New Display Instruments...receive low frequency data—store it—display it in half-tone images—at big savings in transmission costs (low frequency lines may be used in place of microwave channels or coaxial cables).

MODEL 203 TONO-CORDER* DISPLAY INSTRUMENT The Model 203 is used in a variety of data processing, instrumentation and control systems applications where it is desirable to display half-tone images or graphical data from a low speed processor or communications channel. Unit is portable and utilizes a 5-inch storage tube. Input signals are analog voltages, to the X and Y deflection amplifiers and a Z axis intensity modulating signal. Five or more grey shades. Writing speed—30,000 inches per second and faster. Erase time—350 milliseconds. Storage time—3 to 5 minutes.

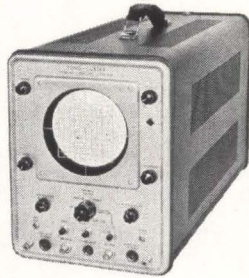

MODEL 210 TONO-CORDER* DISPLAY INSTRUMENT. The 210 is a rack mounted integral display unit utilizing a 10-inch storage tube providing greater viewing surface and high resolution. This instrument provides five or more grey shades with writing speeds of 10,000 inches per second and faster. Storage time is 3 to 5 minutes and data can be erased in less than 800 milliseconds. The Model 210 can also be used at high data rates. In this case the data link is needed for only short periodic intervals to up date the display and may be time shared with other equipment to perform other functions.

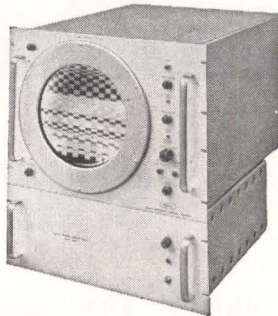

MODEL 401 SLOW SCAN TV MONITOR Another first by Hughes, this unit utilizes a 5-inch storage tube and was designed for use with slow scan television systems and provides both adjustable scan time and lines per frame. Resolves 600 black and white TV lines per useful tube diameter. Displays up to 6 grey scales. Offers four display modes and a complete complement of controls and input, output connectors. Compatible and easily integrated with most slow scan systems.



For full information on the above instruments, write, wire or call HUGHES INSTRUMENTS, 2020 Oceanside Boulevard, Oceanside, California. For export information write Hughes International, Culver City, California.

*Trademark, Hughes Aircraft Co.

HUGHES
HUGHES AIRCRAFT COMPANY
HUGHES INSTRUMENTS
OCEANSIDE, CALIF.

subsequent to triple-pass zone refining. Electron beam refined molybdenum is melted in a dynamic vacuum of 10^{-6} torr. The material is essentially gas free, making it ideal for vapor-deposition applications.

Super-pure molybdenum will find immediate application in electronics where the purity of the foil and wire in semiconductor devices at elevated temperatures is important.

Materials Research Corporation, Orangeburg, New York, offers single or triple pass electron beam zone refined single crystal rods, foils down to 0.003-in. thickness, and specially prepared alloys and powders. Single crystals with 100 and 110 orientations are available in various diameters, with orientations to 2 degrees.

Previously, molybdenum had to be hot-worked with concomitant contamination of carbon. Important aspect of the MRC processing is that the refined rod may now be plastically deformed into foil and wire. Company estimates that total interstitial content of the new molybdenum is less than 7 parts per million.

Rectangular Capacitors

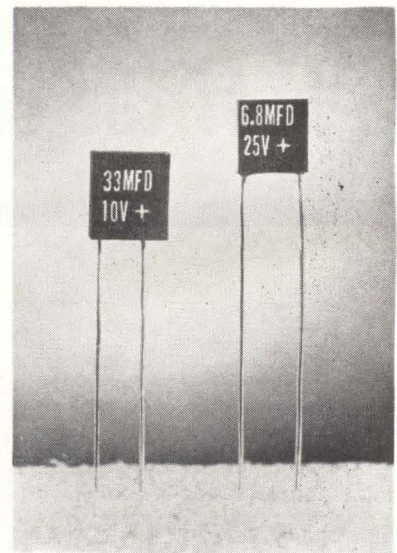

TYPE LTS CAPACITORS by Tansitor are useful for printed circuit applications because of their rectangular shape and plug-in type leads. They have a dry electrolyte and are epoxy encapsulated. Ratings range from 6 to 35 volts dc, and from 3.9 to 68 microfarad.

HIGH GAIN I.F. PENTODES

When improved i.f. performance is required, the first choice of television designers is the EF183, EF184 combination.

In i.f. amplifier circuits the frame-grid construction of these two tubes gives outstanding advantages of reduced microphonics, uniformity, better controlled characteristics and high gain—twice the slope of conventional tubes.

Both tubes are available with 6.3V, 0.45A or 0.6A heater ratings.

CHARACTERISTICS

EF183

gm	14	12.5	10.6	mA/V
E _b	170	200	230	V
E _{c2}	90	90	90	V
I _b	14	12	10.5	mA
E _{cl}	-1.8	-2.0	-2.1	V

EF184

gm	15.6	15	mA/V
E _b	170	200	V
E _{c2}	170	200	V
I _b	10	10	mA
E _{cl}	-2.0	-2.5	V

EF183

6EH7

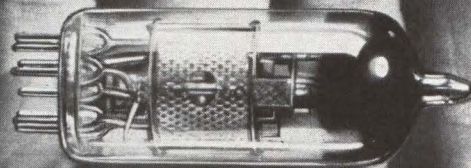

VARIABLE MU R.F. PENTODE

EF184

6EJ7

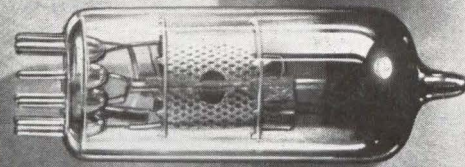

R. F. PENTODE

Full details on the Mullard range of tubes for television, stereo and high-fidelity available from:

INTERNATIONAL ELECTRONICS CORPORATION,
81 SPRING STREET, NEW YORK 12, N.Y. 
Worth 6-0790

Mullard
ELECTRONIC TUBES

MULLARD OVERSEAS LTD., LONDON, ENGLAND

*Mullard is the trade mark of Mullard Limited

Versatile Winder Reduces Costs

Fast, pitch-programmed, potentiometer-coil winder is self correcting

WIRE FEED RATES and tension are controlled by servos and strain-gage sensors in a new wire-winding machine designed for high-speed production of precision wire-wound potentiometer coils. Among other features not generally found on conventional coil winders is a photoelectric curve tracer used for programming windings.

The machine—developed by Solatron Enterprises, of Los Angeles—provides linear windings on magnet-wire mandrel material. It can also operate as a continuous-function winder or a self-compensating linear, or function, winder. The machine can produce varnished, baked, and helix coils at a rate of 5,000 turns per minute with a 2-mil pitch, or 10 inches of finished coil per minute. At reduced speeds 0.45-mil resistance wires can also be used.

The machine is capable of operating in four separate modes: high speed, continuous, linear mode; high-speed, pitch programmed, function mode, self-correcting linear mode; and self-correcting, function-winding mode. The machine gives improved accuracy with reduced costs through higher yields, according to a company spokesman.

A roller-type applicator can apply

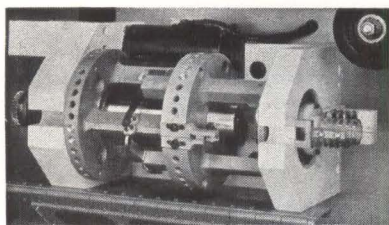

WINDING ENCLOSURE includes a mounted commercial spool of precision resistance wire that is concentric to the mandrel

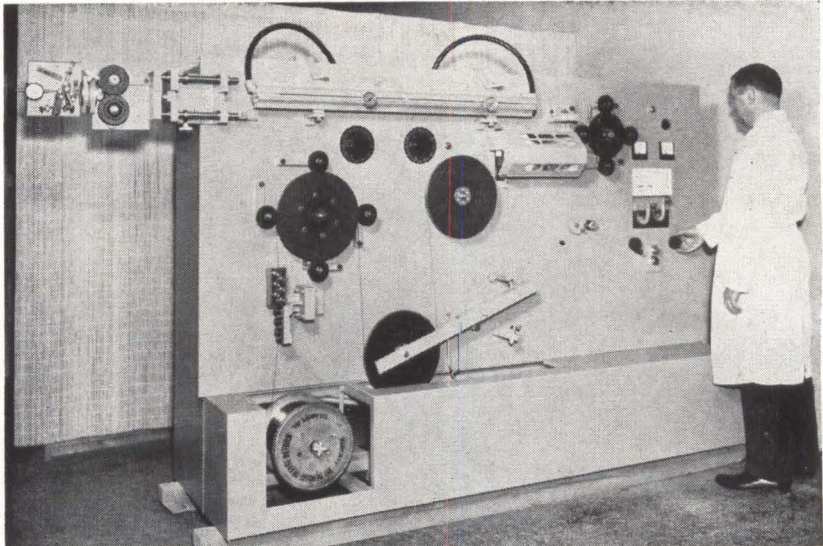

POTENTIOMETER-COIL winding machine designed for continuous high volume production of quality potentiometer windings

a variety of varnishes to the wound mandrel. Adjustable viscosity of the varnish permits application of a narrow stripe to complete envelopment. A radiant heat oven with adjustable temperature control cures the varnish.

Programmer—The program is controlled by a photoelectric follower that traces an ink line plotted on an endless belt of rectangular graph paper. A potentiometer connected to the pitch-program differential is driven by a servo. The motion of the arm of the potentiometer will follow the curve seen by the photoelectric follower.

Resistance-wire pulley contacts are built into the winding head, and an extremely precise constant current source is attached, through slip rings, to one of the pulley contacts. After the start of the winding is grounded through a clip lead, a voltage is measured at the point of wrap by the second resistance-wire pulley. This voltage, exactly proportional to the resistance of the winding, is compared to a master voltage generated by a very precise linear potentiometer geared directly to the

metering wheel. Any difference is used to correct the winding pitch. Total resistance of the winding produced can be preset and is controlled to an accuracy of ± 0.05 percent and is repeatable within the linearity tolerance.

Self-Correcting — Combining the function programming with the self-correcting circuit enables production of resistance-controlled, function windings. This feature is especially useful for winding functions with large slope ratios.

Several resistance wires can be spliced to make one winding without affecting accuracy. Thus multiple-wire high-slope windings are wound to the same tolerances as single wires, Solatron reports.

Glass Diode Assembled And Tested Automatically

DIODE assembly machine, manufactured by Transistor Automation Corp., automatically assembles and tests glass diodes. Beaded lead as-

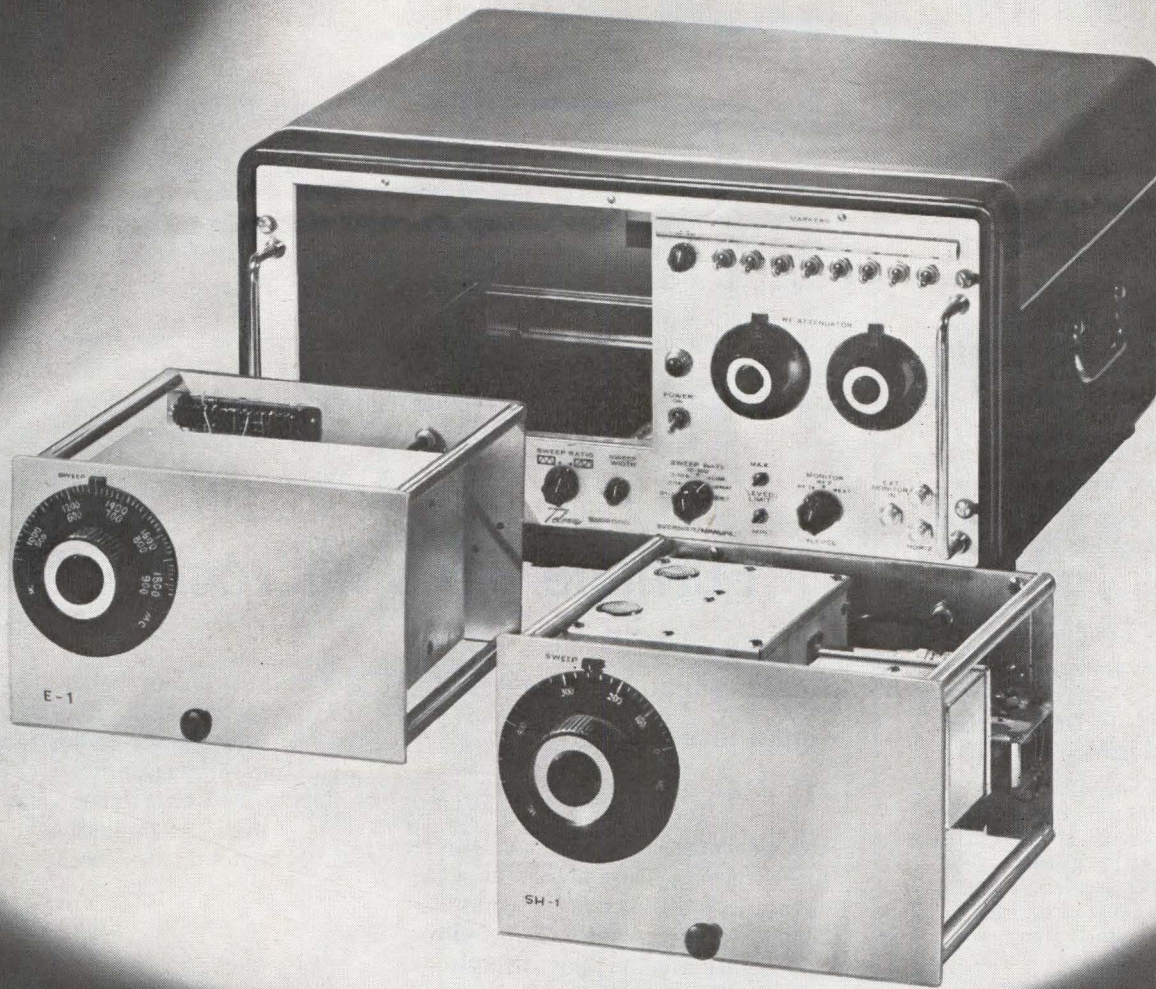

640,000,000 cycles-free!

The engineer who has determined the profitability of using sweep generator techniques now has another 22 pleasant discoveries awaiting him. That's the precise number of oscillator heads that conveniently plug into Telonic's SM-2000 Sweep Generator.

The trio shown above, for example, consists of an SM-2000 with just two of these heads, an SH-1 and an E-1. Together they cover a frequency range of 500 Kc to 1840 mc, **over 600 mc further than any comparable instrument and at several hundred dollars less cost.** Add to this the flexibility of being able to utilize any of 20 other oscillators and you have an instrument that obsoletes anything available for precise frequency generation and response testing.

General Specifications

Display linearity.....Better than 1.2:1
 Source VSWR.....Below 1.3:1
 Vernier attenuation.....0 to 10 db
 Horizontal sweep.....Approx. 15 volts
 Zero base line.....Oscillator off during return sweep
 Frequency markers.....Birdy-By-Pass

Sweep rate.....Line frequency, 50-60 cps
 Frequency range*

SH-1 oscillator head (variable marker optional).....500 Kc to 460 mc
 E-1 oscillator head (variable marker optional).....460 mc to 1840 mc

Prices

SM-2000695.00
 SH-1400.00
 E-1750.00

*There are 22 different plug-in heads available for the SM-2000 covering audio to 3000 mc in various frequency ranges and sweep widths. Prices range from 300.00 to 995.00. Complete catalog on request.



INDUSTRIES, INC.

60 NORTH FIRST AVENUE
 BEECH GROVE, INDIANA
 PHONE STATE 7-7241 AREA CODE 317

TWX 317-635 4748

Representatives in

Baltimore, Boston, Chicago, Cleveland, Dallas, Dayton, Denver, Huntsville,
 Indianapolis, Los Angeles, New York City, Orlando, Philadelphia, San Francisco,
 Seattle, St. Louis, Syracuse and principal cities throughout the world.

❖ SWEEP GENERATORS

❖ RF ATTENUATORS

❖ CW OSCILLATORS

❖ COAXIAL SWITCHES

OPPORTUNITIES IN MELPAR'S RAPIDLY EXPANDING ELECTRONICS DIVISION

Melpar's Electronics Division has an immediate need for Engineers to fill these important positions:

MICROWAVE RECEIVER DESIGN

Specific problems include parametric amplifiers, varactor techniques, microwave filters, ultra-stable programmable oscillators, and dual and triple channel balanced receivers for monopulse and guard antenna gating.

DATA PROCESSING SYSTEMS DESIGN

Perform the logic design of digital equipment to process real time flight data. Problems include specifying necessary digital/analog interface equipment and the design of computer systems for a variety of applications.

COMPUTER PROGRAMMING

Generate programs for fixed point real time computers to be used with special purpose digital and analog equipment.

COMMUNICATIONS

Perform design studies of terminal equipments for time frequency dodging, matched filters, adaptive highly reliable communications throughout the electromagnetic spectrum. Techniques of interest include spread spectrum circuitry, error detection and correction coding, and privacy and security circuitry.

For Further Details,
write in confidence to:

John A. Haverfield

Manager—Professional Placement

MELPAR INC.

(A Subsidiary of Westinghouse
Air Brake Co.)

3436 ARLINGTON BLVD.
FALLS CHURCH, VA.

(A Suburb of Washington, D.C.)

an equal opportunity employer

semblies and first seal crystals are loaded into the machine heads. The machine automatically advances the whisker until it touches the crystal, then it advances it an additional 0.0002 to 0.005 inches. The additional advance can be predetermined to an accuracy of ± 0.0001 inch. Electrical pulses bond the whisker to the crystal, and a heat cycle is started to form a glass-to-glass seal. After cooling, the diode is automatically given an electrical test and then deposited in either the "good" or "reject" bin.

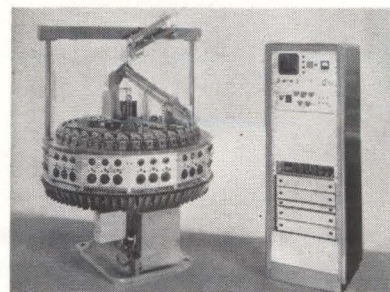

The machine is capable of processing 3,000 units per hour, the company says.

Furnace Fires Microcircuits

Furnace features automatic temperature control and adjustable rate of travel

CONVEYOR-TYPE Trent silver-firing furnace with automatic temperature control is being used at National Resistronics for firing silver and gold-platinum alloy dispersions on aluminum-oxide and barium-titanate substrates. The substrates are used in microcircuit manufacturing.

Small wafers are normally loaded on 6X6-inch ceramic tiles that are manually placed on the conveyor belt and manually unloaded as they emerge from the furnace. Speed of travel through the furnace can be varied from one to four feet per minute by the control panel. Maximum firing temperature is 1,400 to 1,500 F and firing time is approximately 45 minutes.

The furnace is subdivided into six sections: loading, preheat, heating, holding, cooling, and unloading. The preheat, heating, and holding zones are separately heated and temperatures are automatically controlled. Insulation is provided by combination layers of insulating brick and slab insulation. The working space is muffled to diffuse radiant heat—resulting in closer temperature control. There are heating elements on all four walls of the working chamber. The conveyor belt is 6 inches wide

and constructed of balanced-weave 0.310 stainless steel. It is powered by a 1/3-horsepower motor through a variable-ratio gearbox.

Operating experience has indicated that it is preferable to constantly maintain the furnace at op-

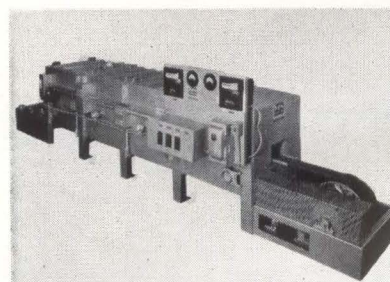

SILVER-FIRING furnace used by National Resistronics in making microcircuit substrates

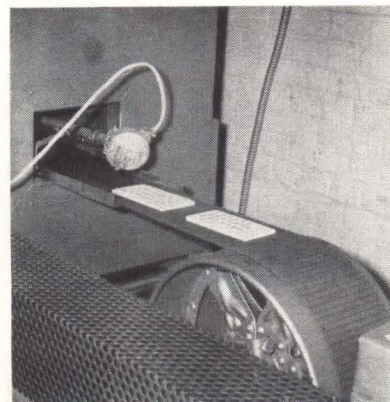

TWO TILES carrying microcircuit wafers emerged from the furnace

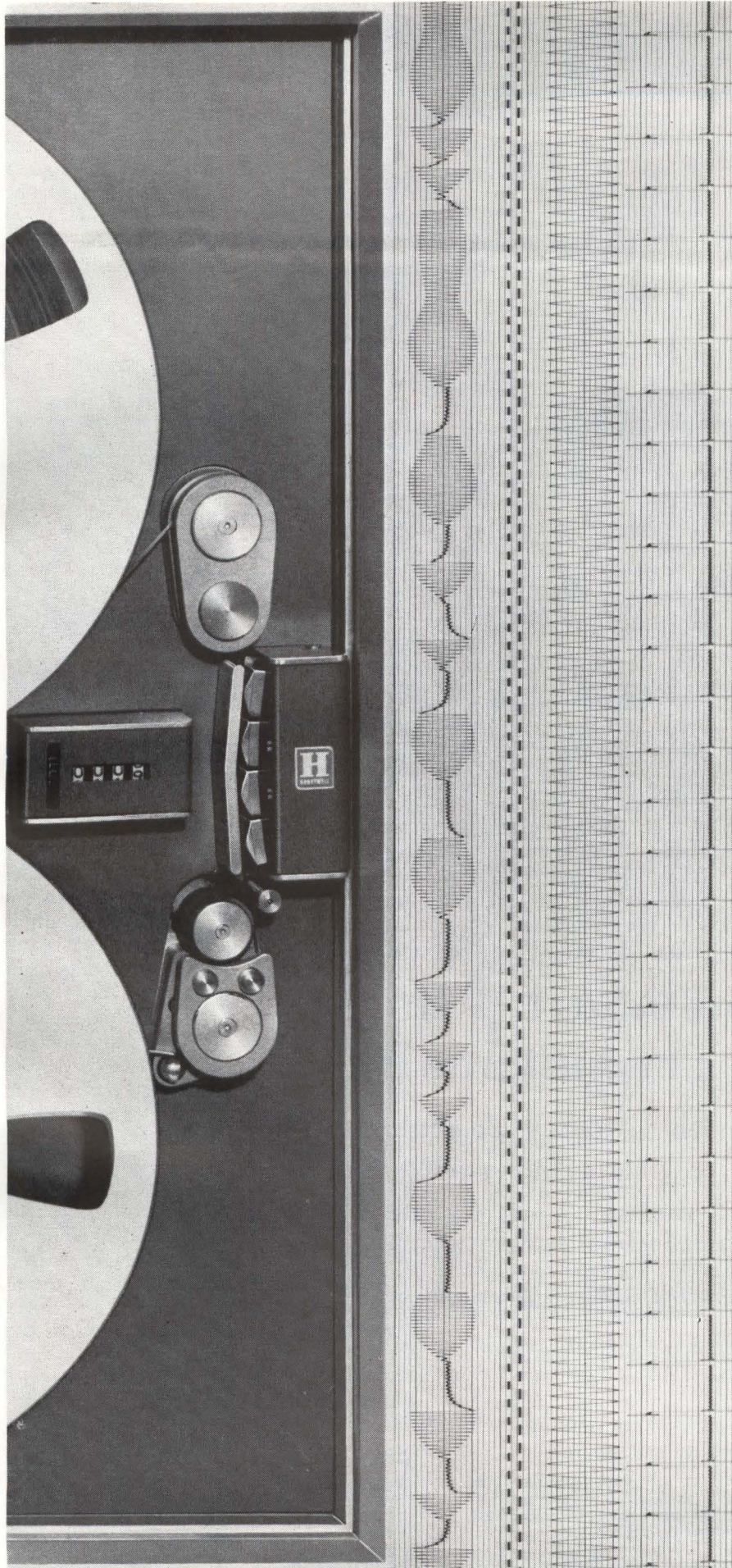

NOW and/or LATER

To get the most out of analog data, you should be able to see it now or see it later, use it now or use it later.

The ideal combination of recording instruments for making the most of your analog data is a Honeywell tape recorder, such as the compact Honeywell 8100 portable instrumentation recorder/reproducer, used with the Honeywell Visicorder Oscillograph.

For immediate readout, the Visicorder gives you an instantaneous record of 1 to 36 channels of data from DC to 5000 cycles per second. A variety of paper speeds from .1 to 160 inches per second gives you the trace resolution you need. Five models of the Visicorder are available.

At the same time, you can record up to eight channels (plus voice and compensation) of data up to 10,000 cycles on the 8100 portable. Later on, you can play selected portions of your data into the Visicorder. Four tape speeds (1 7/8, 3 3/4, 15, and 30 ips) give you record and playback versatility for whatever frequency you're recording.

In the Honeywell 8100, several head and tape configurations are available (including IRIG). All models have a built-in calibration panel, automatic switching of center frequencies, and a new, improved tape drive that cuts flutter to a minimum and eliminates tape breakage. A built-in monitor scope and voice channel are optional. In addition, Honeywell manufactures complete laboratory tape systems with capacities of up to 60 channels on 2-inch tape.

For complete information about the Honeywell 8100, the Visicorder Oscillograph, and other recording equipment, contact your nearest Honeywell office, or write: Honeywell, Denver Division, Denver 10, Colo. Or call us direct at 303:794-4311. In Canada, contact Honeywell Controls, Ltd., Toronto 17, Ontario.

DATA HANDLING SYSTEMS

Honeywell

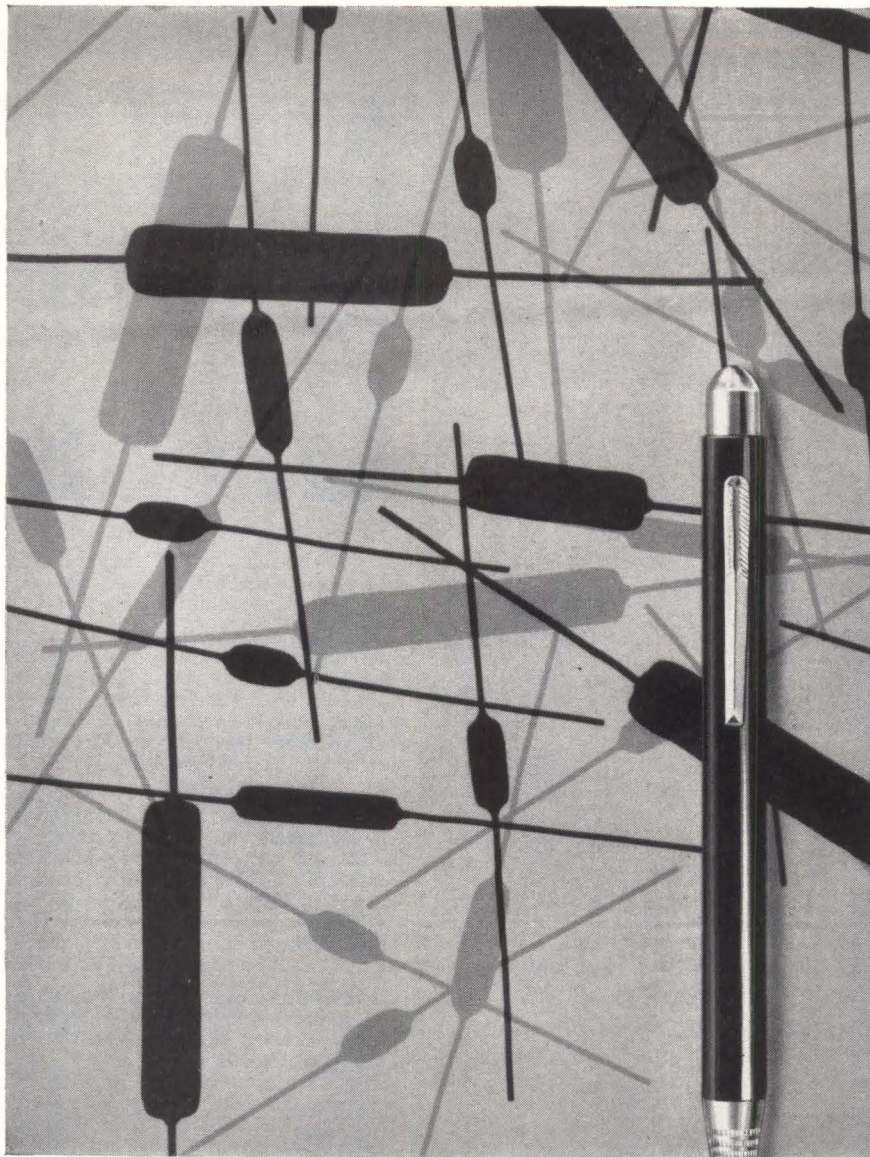

What do you want in space-saving resistors?

- low TC close accuracies 1000 V dielectric
 wide resistance ranges extremely high stability

You'll find all of these characteristics in Ward Leonard S-Coat (Silicone Coated) precision resistors. Ward Leonard offers eight standard types from 1 to 12.5 watts, in a wide range of resistance values.

S-Coat miniature resistors exceed MIL-R-26C requirements for characteristics G or V.

S-Coat wirewounds round out the comprehensive Ward Leonard line of axial lead resistors, power and precision. Write for Bulletin 45A, or evaluation samples.

Ward Leonard Electric Co., 30 South Street, Mount Vernon, N. Y.
 (In Canada: Ward Leonard of Canada, Ltd., Toronto.)



WARD LEONARD
ELECTRIC CO. MOUNT VERNON
 NEW YORK
 RESISTORS • RHEOSTATS • RELAYS • CONTROLS • DIMMERS

erating temperatures to avoid thermal shock to the muffle caused by periodic shutdowns. When starting up the furnace, however, temperature is increased in 200-deg steps, with half-hour periods between steps.

Vapor-Spray System Coats Circuit Boards



AN IMPROVED method of spraying photo-resist coatings—utilizing the Chemtronic vapor spray system—makes it possible to spray an even coating without pinholing, air entrapment, or oil and water contamination, according to the manufacturer.

The method is reported especially useful for etching and chemically milling printed-circuit boards. Since the coating is sprayed at nozzle pressure as low as 2 psi, material savings are said to be achieved through reduced bounceback and overspray.

The Chemtronic System—developed by the Zicon Corporation—is a self-contained spraying device which uses a vapor both for atomizing and as a transport medium. Coating thickness can be rigidly controlled, and—since compressed air is not used—temperature and humidity have no effect on the process, Zicon says.

The system may also be used for applying a conformal coating of two-part epoxy, urethane, or any other material, unreduced and without de-airing, to printed-circuit boards and other electronic components.

AEROCOM PRESENTS VHF AM TRANSMITTERS and RECEIVERS

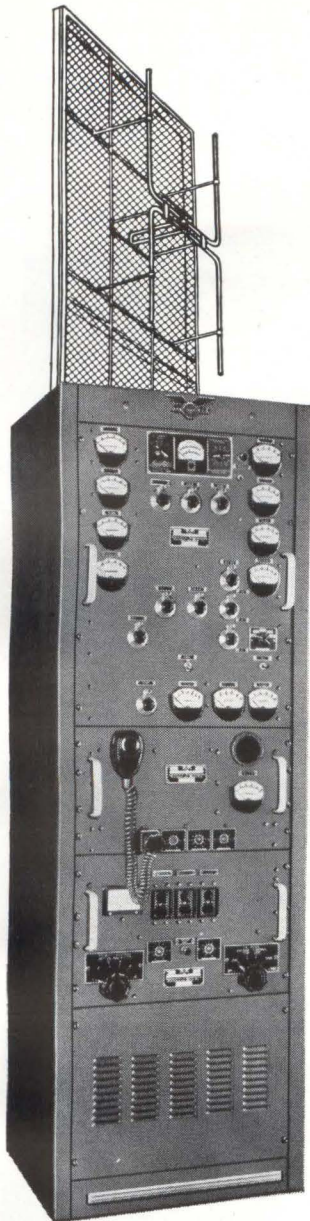

AEROCOM communications equipment is designed with both performance and reliability in mind, and is produced by experienced personnel using high-quality materials. The following features are found in all three transmitters: Single crystal controlled frequency (plus an additional frequency $\frac{1}{2}\%$ away from main frequency); stability $\pm .003\%$ or $\pm .001\%$ over temperature range of 0°C to $+55^{\circ}\text{C}$, any humidity up to 95%; audio system incorporates high level plate modulation, with compression; forced ventilation with air filter is employed. Welded steel cabinets.

◀ **Model 10V1-A**—1000 Watts output—Successfully being used in Troposcatter service for communications with aircraft beyond the optical horizon. Frequency range 118-153 mc. Can be completely remote controlled by using AEROCOM's remote control equipment. All tuning from front panel by means of dials. Power requirements 210-250 V 50/60 cycles, single phase.

Model VH-200—200 Watts output in range 118-132 mc. Excellent for both point-to-point and ground-to-air communications. Press-to-talk and audio input may be remoted using single pair of telephone lines. Power requirements 105-120V 50/60 cycles. Also available for use above 132 mc; output drops gradually to 150 watts at 165 mc.

Model VH-50—50 Watts output. Frequency range 118-153 mc. Outstanding low power transmitter for ground-to-air service. With remote control provisions; main power control with front panel switch. Convection cooling for press-to-talk service—otherwise forced air cooling. Power requirements 115/230 V 50/60 cycles.

▶ **Model 85 VHF Receiver.** A high performance, low noise, single channel crystal controlled, single conversion VHF receiver. Stability normally $\pm .001\%$ (with oven crystal $\pm .0005\%$) over temperature range 0°C to $+55^{\circ}\text{C}$. Sensitivity $\frac{1}{2}$ microvolt or better for 1 watt output with 6 db signal to noise ratio. Standard selectivity bandwidth 30 kc; other widths available. Spurious response down 90 db. Frequency range 118-154 mc. Power requirements either 115 V or 230 V 50/60 cycles. Made for standard rack panel mounting.



As in all AEROCOM products, the quality and workmanship of this VHF equipment is of the highest. All components are conservatively rated. Replacements parts are always available for all AEROCOM equipment.

*Complete
technical data available
on request*



FCC Type Accepted
for Aviation Service

3090 S. W. 37th Avenue — Miami 33, Florida

In "check out" system similar to this, EI engineers first developed the input filter now standard on all EI voltmeters.

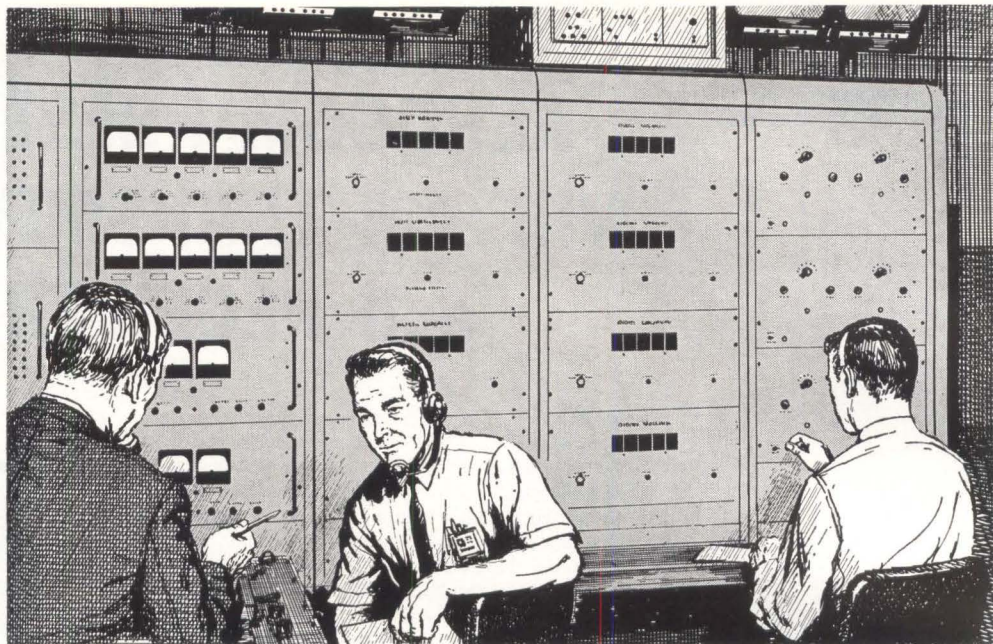

Classic Jobs of Measurement

Performed by Electro Instruments

THE EI VIEWPOINT

by Dr. Walter East
President, Electro Instruments, Inc.

Almost never, in actual practice, is a purely stable source of voltage encountered in measuring DC voltages. Minor variations go undetected if measurement is done with an instrument employing a mechanical needle movement, because of the friction involved in the



Dr. East

Two Types of Interference

Besides variations inherent in a voltage source, a secondary set of variations can come about with the introduction of a magnetic field, either natural or man-made. We know these variations as normal mode and common mode interference voltages, with unwanted normal

Filtered EI Voltmeter Ends Threat to Aircraft Program

What is today a standard feature of Electro Instruments' voltmeters was first developed to meet the emergency needs of a major aircraft designer*. In actually flight testing a new type aircraft, it had been planned to telemeter information gathered by transducers placed throughout the ship to a ground-located monitoring station. Equipment of latter included several EI digital voltmeters.

Threat of Costly Delay

Despite satisfactory preliminary tests, actual engine run-up produced unwanted normal mode voltages so great that accurate voltmeter readings were impossible. Trouble was traced to electrical wiring within the aircraft. Re-

mode voltages being called "ripple." It was over two years ago that Electro Instruments took the forward step that other digital voltmeter manufacturers still have to make. Recognizing that, in 95% of cases, unwanted variations in DC voltage measurements result from normal mode voltages rather than common mode voltages, we incorporated an input filter in every model voltmeter in our extensive line.

An interesting story about "ripple" appears above. It's another actual instance in which we fulfilled our promise: "You name it, we'll find a way to measure it!"

wiring would mean a 30-day program delay, and a loss of \$100,000.

At this point, EI engineers suggested filtering out the undesirable noise at the input to the voltmeters, and letting major portions of all transmitted information be channeled through them. The suggestion was adopted, and a satisfactory filter developed within days. This first successful use of a "ripple" filter led to its being made an integral part of future Electro Instruments' voltmeter models. *Name on request.

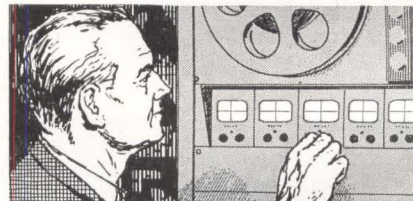

Oscilloscope Raises Level of Confidence in Tape Recordings

The mere presence of recorded electronic impulses on tape does not necessarily constitute usable information. Operational tests of aircraft, missiles, spacecraft, etc., rely on tape recordings for depth analysis of performance. Mechanical needle movement metering provides only quantitative observation. Use of monitor oscilloscopes provides qualitative presentation as well, increases confidence level of tape recorded information.



Electro Instruments, Inc.
8611 Balboa Avenue, San Diego 12, California

EI SALES, SAN DIEGO, CALIF. • ELECTRO INTERNATIONAL, INC., ANNAPOLIS, MD. • TRANSFORMER ENGINEERS, SAN GABRIEL, CALIF.

Counter Makes Practical Measurements

Unit reads transducer
Outputs directly

ELECTRONIC counter is capable of making direct measurements of practical quantities such as kilograms per hour, gallons per second, and revolutions per minute when used with an appropriate transducer.

Model 5214L has an extra set

of decades for controlling gate-open time that are presettable at either the front panel or remotely to any integer from 1 to 100,000. This feature makes it possible to measure normalized ratio, time (period) or rate (frequency). The resulting display of practical units eliminates a great deal of laborious calculation. All data displayed on the five digital display tubes is also available from

a binary-coded decimal output for recording or systems applications.

In addition to special features afforded by the use of adjustable decades, the device can totalize like most universal counters. Basic counting rate is 2 cps to 300 kc. Price: \$1,475. Hewlett-Packard Company, 1501 Page Mill Rd., Palo Alto, Calif.

CIRCLE 301, READER SERVICE CARD

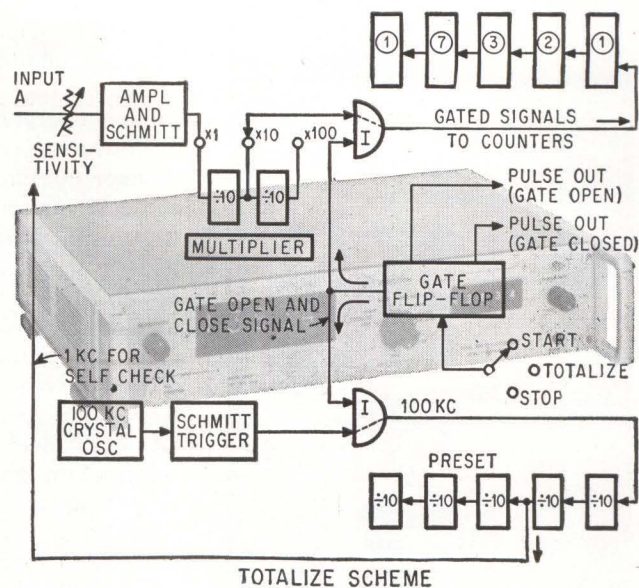

Klystron Uses Electrostatic Focusing

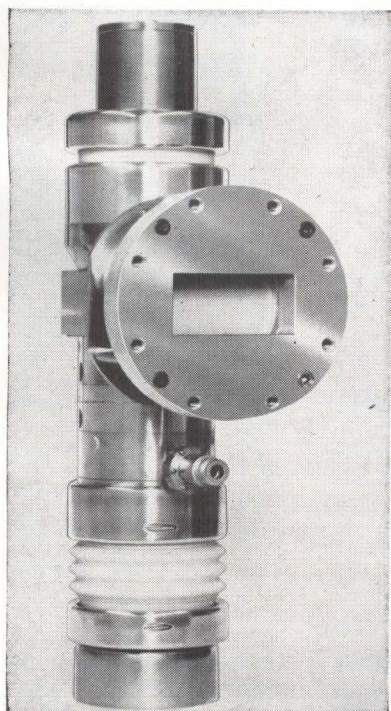

METAL - CERAMIC klystron model L 3668H weighs only 25 pounds and is rated at 50 kw peak and 5 kw average between 2.7 Gc and 2.9 Gc. Maximum efficiency is 48 percent with saturation gain of 35 db.

The magnetic field used in conventional klystrons has been replaced by electrostatic fields generated by non-intercepting lens electrodes, operating at cathode potential. Since the radio-frequency gaps are ungridded, high values of average power, gain and efficiency are achieved.

Applications include mobile, airborne, space tracking and communications systems. The tube is only 17-inches long and is one eighth the size and weight of more standard devices according to the manufacturer. Litton Industries, Electron Tube Div., 960 Industrial Rd., San Carlos, Calif. (302)

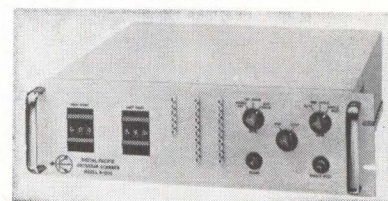

Crossbar Scanner Speeds Programming

MODEL R-1100 crossbar scanner has plug-in modular construction that allows data capacity to be expanded with requirements. Unit is a multiple-position, variable-pole, solid-state device that provides complete program flexibility, random access and ideal switching with over 100×10^6 operations per circuit. The instrument offers nearly unlimited capacity and may be expanded in a matter of minutes to handle as many as 600 channels with single or 60-wire output.

Scanner programming may be either random or sequential with excellent low-level switching char-

*in this neat
package . . .*

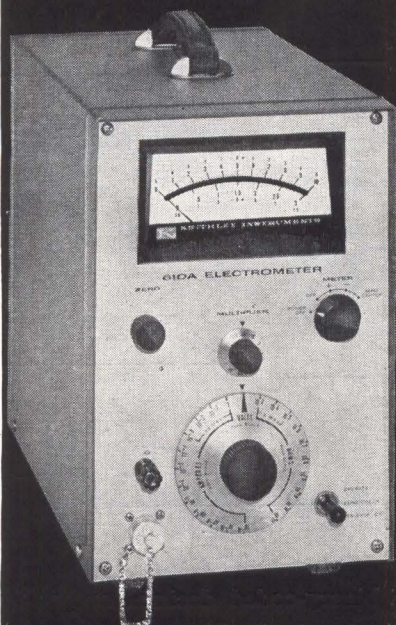

*a complete
dc laboratory*

The Keithley 610A Electrometer has 64 dc ranges . . . all you need to investigate in-circuit measurements with no loading, semi-conductor parameters, capacitor characteristics, photo-electric devices, piezo-electrics, properties of insulators and outputs of ion chambers. The 610A is line-operated and comes in bench or rack models. Brief specifications:

- **9 voltage ranges** from 0.01 to 100 volts fs with 2% accuracy on all ranges
- **input impedance** selectable in decade steps from 1 ohm to 10^{14} ohms
- **28 current ranges** from 3 amperes to 10^{-13} ampere fs
- **27 resistance ranges** from 10 to 10^{14} ohms fs with provision for guarding
- **constant current source** from 1 milliampere to 10^{-12} ampere in decade steps
- **gains to 1000** as a preamplifier, dc to 500 cps bandwidth, 10 volt and 1 milliampere outputs
- **price** \$565

Other ELECTROMETERS

Model 620,	31 ranges, bat.-operated,	\$280
Model 621,	37 ranges, line-operated,	\$390
Model 600A,	54 ranges, bat.-operated,	\$395
Model 603,	50 kc bandwidth amplifier,	\$750

Send for latest catalog



**KEITHLEY
INSTRUMENTS**

12415 Euclid Avenue • Cleveland 6, Ohio

acteristic. Signal switching is accomplished with reed relays and contact material of the switch is gold utilizing the twin-cantilever offset reed principle. Contact resistance is 100 milliohms or less, with switching life of over one-hundred million operations.

Power may be removed from the scanner to eliminate down time due to accidental erasing or power failure during critical test periods. If a data channel is damaged, it can be repaired in 3 to 5 minutes and all matrices, logic and command cards are readily interchangeable.

Remote readout is provided along with binary coded decimal, random access, channel identification, printer information and external drive of sine or square wave. Digital Pacific Electronics Corp., 5258 Anna St., San Diego, Calif.

CIRCLE 303, READER SERVICE CARD

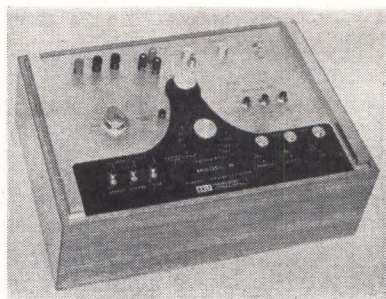

**Transfer Standard
Covers Broad Range**

THERMAL transfer standard, model 6, provides complete thermocouple protection against overload, broad frequency (5 cps to 1 Mc) and voltage range (0.5 to 1,000 v), extremely low a-c/d-c difference and d-c reversal error. It is designed particularly for high accuracy a-c measurement and portability. Price is \$750. Holt Instrument Laboratories, Oconto, Wisc. (304)

**New Polymer Offers
High Heat Resistance**

RESPONDING to the expanding requirements for thermoplastics with higher heat resistance, Cylolac X-27 has been added to a growing line of ABS polymers. Heat deflection temperatures have been raised to 225 F (107C) at 264 psi (18.5 kg/cm²) ASTM loadings while hold-

Cornered

by
**PW Assembly
Problems?**



DYNASERT®

Discover how **DYNASERT®** automatic inserting equipment can open new ways to profit for you. This is modern, automated component insertion. Even if your production is as little as a few hundred insertions a week, Dynasert delivers a multitude of advantages. It's high-speed: up to ten times faster than costly hand methods. It delivers uniformly high product quality. It automatically feeds, cuts, and bends leads, inserts and clinches all types of axial lead components. Requires little operator training. Changes made from one board or component type in seconds. Money saved in direct labor costs and production time can pay for a Dynasert installation in less than a year. Get complete facts. Write for a free copy of: Dynasert — Production Equipment for Electronics. Dynasert Dept. 3, United Shoe Machinery Corp., Boston, Massachusetts.



United Shoe Machinery
BOSTON, MASSACHUSETTS

CIRCLE 205 ON READER SERVICE CARD
November 8, 1963 electronics

MORE THAN 100 KLEIN PLIERS

SPECIALLY DESIGNED FOR THE ELECTRONIC FIELD

Special skills are important in the wiring of today's sophisticated assemblies for electronic and telemetry systems. Klein has developed special pliers to assist in solving difficult assembly problems.

- For instance, there is a plier with a blade as hard as a file for cutting nickel ribbon wire (No. D230-4C).
- For instance, there is an oblique cutter, specially designed for printed circuits . . . it cuts and crimps the end to hold wire in place for soldering. (D 052-C).
- For instance, there is a needle nose plier with the tip bent to facilitate reaching into confined spaces. D 338-5½ C.

In all, there are over 100 different styles and sizes of pliers available from stock. Klein will be glad to discuss with you the development of a special tool to solve a particular problem you may be facing.

ASK YOUR SUPPLIER



The Klein Plier Catalog illustrating and describing the complete Klein line of pliers is available on request.

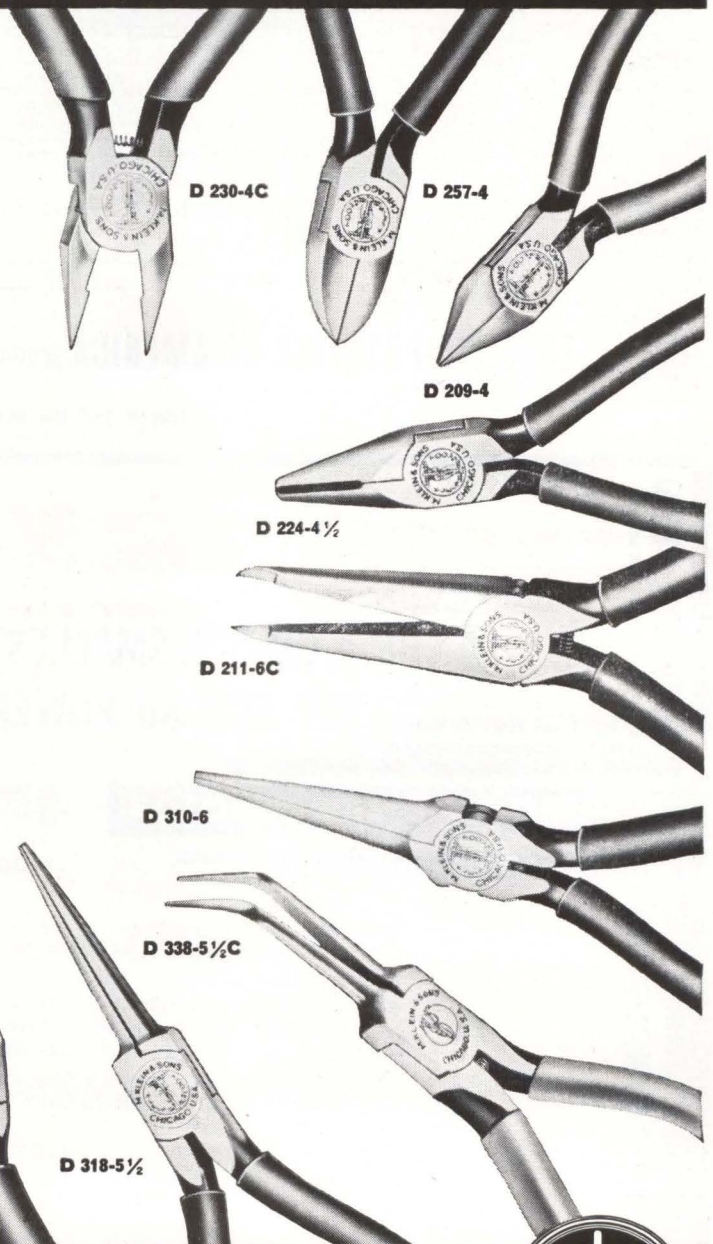

Mathias **KLEIN** & Sons
 Established 1857 Chicago, Ill., U.S.A.

INCORPORATED
 7200 McCORMICK ROAD, CHICAGO 45, ILL.



NEW 40 MC PULSE GENERATORS

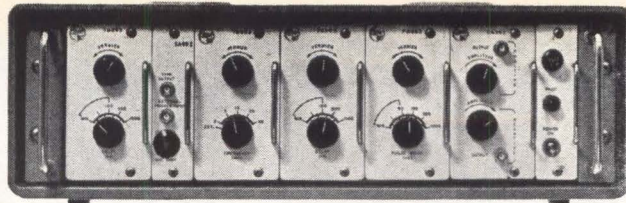

Feature Modular Expandability, Rise / Fall to 5 ns

The new SERVOPULSE® 9000 Series offers general-purpose pulse generators conveniently modularized to provide special capabilities. Among their outstanding features are very high clock rates, rise times to 5 ns and expandability which defies obsolescence. They deliver clean, sharp waveforms, and permit multi-pulse functions. Several Modules are available for each function of time delay, pulse width, frequency, and amplification. The units are packaged for either rack-mount or benchwork, with integral power supply. A wide spectrum of special functions is possible at prices you would expect for standard generators. Detailed information on request.

	MODEL 9350	MODEL 9450	MODEL 9455	MODEL 9550
Frequency Range	.2 cps - 5 kc	100 cps - 2 mc	100 cps - 10 mc	2 mc - 40 mc
Delay	.1 ms - 1 sec.	0 - 1 millisec.	0 - 1 microsec.	0 - 1 microsec.
Pulse Width	.1 ms - 1 sec.	.1 μ s - 1 ms.	25 ns - 1 μ s	25 ns - 1 μ s*
Simultaneous Pos & Neg Outputs	10V open circuit 7V into 93 ohms	10V open circuit 7V into 93 ohms	10V open circuit 7V into 93 ohms	10V open circuit 7V into 93 ohms
Rise & Fall Time	Under 5 nanosec.	Under 5 nanosec.	Under 5 nanosec.	Under 5 nanosec.
Max Duty Cycle At Full Amplitude	70%	70% - 40% at 2 mc	90%	90% - 60% at 40 mc
One Shot/Sync & External Trigger	Yes	Yes	Yes	Yes
Price	\$660.00	\$835.00	\$975.00	\$1,390.00

FLAT TOP FOR ALL INSTRUMENTS LESS THAN $\pm 2\%$ AT MAX. PULSE WIDTH.

* 15 ns at 40 mc



SERVO CORPORATION OF AMERICA SERVOPULSE® PRODUCTS
111 New South Road • Hicksville, L. I., New York • WAtte R-9700

CIRCLE 206 ON READER SERVICE CARD

ing good dimensional stability. Cycolac X-27 is highly corrosion resistant, offers excellent electrical properties, is produced in a wide range of high-gloss colors and has good impact resistance. It can be laminated, textured, painted, bonded, vacuum-metallized and chrome plated. Included among its many uses are bases for printed circuiting. Injection molding and extrusion of X-27 is similar to that of other Cycolac polymers, with the exception that higher process temperatures normally are required. Marbon Chemical Division, Borg-Warner Corp., Washington, W. Va. CIRCLE 305, READER SERVICE CARD

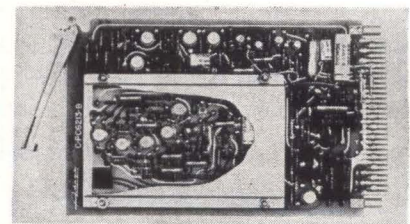

Sample and Hold Amplifier Has Rapid Response Time

MODEL SA-3 sample and hold amplifier has response time of less than 10 μ sec to reach 0.01% of final value for a full-scale input-step change, an aperture of only 100 nsec and a 100 μ sec recovery from overloads as high as 1,000% of full scale.

Unit is designed to follow rapidly-moving waveforms and then, on digital command, to hold the sampled value accurately for long periods. Fast overload recovery is accomplished by a feedback clamp incorporated in the amplifier.

Applications of the SA 3 include simultaneous sampling of multiple analog inputs, and storing of intermediate solutions between iterations in analog computer operations. Price: \$450. Adage, Inc., 292 Main St., Cambridge 42, Mass. (306)

Pushbutton Switches Offer 6 Lamp Displays

LIGHTED pushbutton switches have been designed for a missile fire control system. They have six lamp displays, 4 pdt circuitry and plug-in

HERE IS THE WORLD'S SMALLEST MOTOR YET IT'S SO POWERFUL . . .

MITSUMI MICRO MOTOR



MODEL MI-100

Less than 20mm in diameter, the new Mitsumi Micromotor provides a startling efficiency of over 50%, the barrier which miniature motors are not allowed to pass.

A novel construction principle helped to make this accomplishment possible. The form is more simplified by setting all the terminals at one position. Because the entire mechanism is given full protection against irregular revolution and above all, electrical noise is entirely eliminated, you may call this the most perfect micromotor yet devised. Please write for complete information on Mitsumi Micromotor, and we will send you specifications and data.



MITSUMI PARTS
MITSUMI ELECTRIC CO., LTD.
TOKYO • OSAKA • NEW YORK

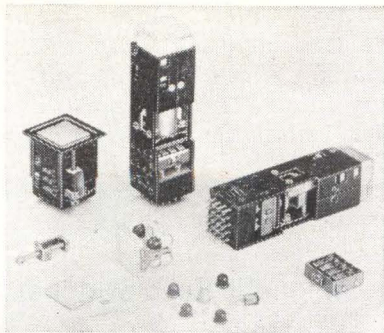

terminals. Filters and flange base T1 $\frac{3}{4}$ lamps may be changed from front of panel without special tools and without actuating switches. Units measure 4.2 long. Subpanel units mount on 1.2-in. centers and panel-mounting units include bezel mount on 1.6 by 1.7-in. centers. Units are rated 2.5 amp inductive or 5 amp resistive 28 v d-c/115 a-c for a life of 25,000 cycles. Environmental specifications include vibration 10 g, shock 50 g, temperature -65F to 160 F, humidity, salt spray. Haydon Switch Inc., 536 Leonard St., Waterbury 20, Conn. CIRCLE 307, READER SERVICE CARD

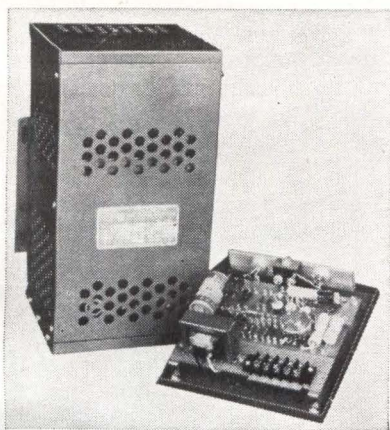

Voltage Regulator With Solid-State Design

COMPACT 1-kva voltage regulator is designed for use as an OEM component where size and weight are critical. It features both fast and close-tolerance regulation. Regulation is ± 0.25 percent for ± 10 percent variations in line and load when operated at its rated output setting. When adjusted to other than rated output, ± 1 percent regulation is held. Response is approximately 0.1 sec for voltage to return to regulation envelope and stay there. Regulator is of solid-state design; the

WIDE RANGE VACUUM MEASUREMENT



NEW GAUGE SYSTEM measures pressures from 2.5 to 2×10^{-10} torr

NRC's new model 763/553 Vacuum Gauge System combines a UHV Ionization and two Thermocouple gauges with a matched control to measure a wide range of pressures with exceptional repeatability and reliability.

Gauge Features . . . ■ Two-filament design — easily interchanged
 ■ Increased sensitivity and accuracy at low pressures ■ Rugged grid withstands long periods of outgassing ■ Platinum coating shields elements from electrostatic charges for increased sensitivity and accuracy at low pressures

Control Features . . . ■ Over-pressure protector to shut off ion gauge if pressure exceeds 150% of full scale ■ Clear cut zero set for accuracy and repeatability of readings ■ Zero drift practically non-existent
 ■ Choice of controls — with (model 763) or without (model 753) thermocouple gauges in both console and rack mounted design

For more information on the gauge system or any individual part, send for data sheet G-1.



NRC EQUIPMENT CORPORATION
 A Subsidiary of National Research Corporation
 160 Charlemont Street
 Newton 61, Massachusetts
 Area Code 617 DEcatur 2-5800

MANUFACTURING PLANTS IN NEWTON, MASSACHUSETTS AND PALO ALTO, CALIFORNIA

MODEL JKTO-60: designed for use where minimum power consumption is mandatory. In 1.0 to 5.0 mc range, it features a proportional controlled oven combined with a dewar flask offering extremely low oven power consumption with a very close non-cycling temperature control. Requires only .75 watt max. at -30°C . Daily aging stability is 1×10^{-8} or better after initial aging. "Varicap" voltage control, optional.

**exceptional
low power consumption
reduces power-loss
to an absolute minimum**

For additional technical data, WRITE:



PRODUCTS
THE JAMES KNIGHTS COMPANY
SANDWICH, ILLINOIS

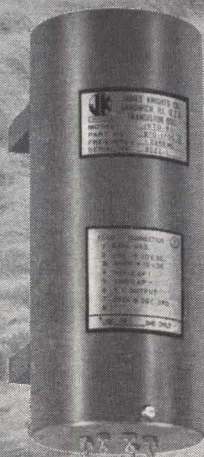

**JKTO-60
ULTRA-STABLE
TRANSISTORIZED
OSCILLATOR**

CIRCLE 207 ON READER SERVICE CARD

REMOTE DATA RETRIEVERS, EVENT AND DATA RECORDERS

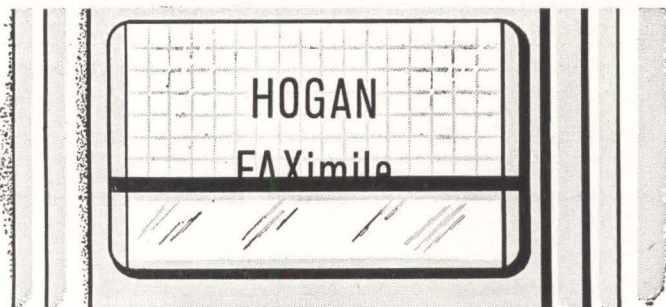

**THE ANSWER TO
YOUR RECORDING PROBLEMS...**

Whatever your recording problem may be—HOGAN FAXimile recorders are available, or can be designed, to fill your requirements. As many as 2000 simultaneously recording styli—up to 100 styli to the inch for high-speed facsimile—chart widths to 30" and feed rates to 50" per second.

HOGAN specializes in electrolytic techniques for event, spectrum analysis, oscillograph and facsimile recording, frequency time analysis, computer printout, automatic high speed plotting and special purpose binary and gray scale recording applications.

"Use Hogan design ability!"

HOGAN FAXimile Corporation • 635 Greenwich St., New York 14, N. Y.
A SUBSIDIARY OF TELAUTOGRAPH CORPORATION

CIRCLE 94 ON READER SERVICE CARD

electronic control unit is mounted on the end panel for ease of removal. With no moving parts it is rugged and free of maintenance. Sola Electric Co., 1717 Busse Road, Elk Grove Village, Ill.

CIRCLE 308, READER SERVICE CARD

Magnetic Reed Switches Are Mercury-Wetted

MODELS HWDT-1 and HWDT-2 mercury-wetted, magnetically actuated double throw reed switches are designed to be used with a polarizing magnet. The HWDT-1 has a break-before-make contact arrangement; the HWDT-2 has make-before-break contacts. Both are the same basic size as existing dry reed switches and are interchangeable in existing coil designs. They are extremely sensitive and quiet in operation. When biased normally closed, they will operate as low as 35AT, or 20AT when biased as polarized bi-stable units. Life expectancy is over 100×10^6 operations, with speeds of over 180 cps. Contact ratings are 50 w, d-c resistive, up to 400 v or 2 amp max. They are priced as low as \$2.20 each in quantities of 50,000. Hamlin, Inc., Lake & Grove Streets, Lake Mills, Wisc. (309)

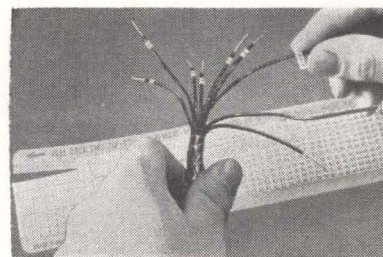

Small Wire Markers Meet MIL Specs

SELF-STICKING B-400 wire markers for small electronic wires combine positive readout and permanent adhesion to any type of wire or insulation. The $\frac{1}{2}$ in. long markers are designed for wires, cables and harnesses up to 0.150 in. o-d in electronic equipment and assemblies. They withstand 30 days immersion in No. 10 oil at 65 C with no change in legibility or adhesion. They resist temperatures to 150 C indefinitely; up to 200 C with little

November 8, 1963 electronics

change in background color. W. H. Brady Co., 726 W. Glendale Ave., Milwaukee, Wisc. (310)

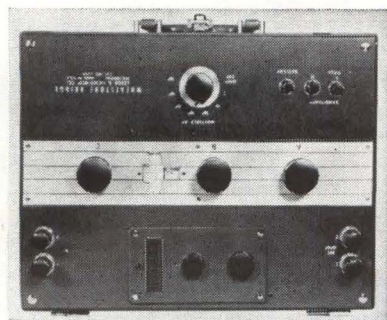

Wheatstone Bridge Has Laboratory Accuracy

PRECISION d-c Wheatstone bridge offers convenient, on-the-spot measurement of resistance in research, design and quality control applications, with laboratory accuracy. With a range span of 1 ohm to 11.01 megohms in seven ranges, and a limit of error of ± 0.05 percent or better, it features sensitivities of better than 0.05 percent for measurements up to 1 megohm. Two pairs of binding posts are provided for connections to: (1) the unknown resistance, and (2) an external null detector, if greater sensitivity is required. Bridge measures $14\frac{1}{2}$ in. by $11\frac{1}{2}$ in. by $7\frac{1}{2}$ in. and weighs 21 lb. Leeds & Northrup Co., 4901 Stenton Ave., Philadelphia, Pa. (311)

Silicon Rectifiers Now 1-Ampere Rated

THREE types of 1-ampere rated flangeless silicon rectifiers designed to meet MIL-S-19500/155A (USN) are in production. Type USN1N-3189 is rated at 200 v peak reverse voltage; the 3190, at 400 v prv; and the 3191, at 600 v prv. All units provide a d-c output current of 1 amp at 100 C, and 0.5 amp at 150 C. They are capable of with-

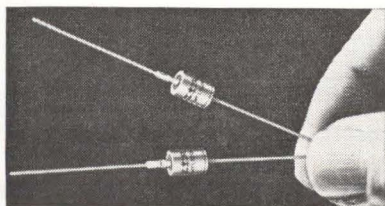

These ALITE[®] POWER TUBE CERAMICS

Not only
LOOK ALIKE

They are
IDENTICAL

- **Physically**
- **Electrically**

Envelopes . . . spacers . . . windows . . . insulators — whatever your requirements for high alumina ceramic power tube components, you can rely on Alite for exact duplication of properties, part after part, order after order.

This repeatability is assured by Alite's rigid Quality Control procedures. For example, accompanying each group of parts through production is a card on which is kept a record of material lot code numbers, process times and temperatures, etc. In-process and final inspections are detailed and thorough.

As a result, Alite high alumina ceramics are perfectly homogeneous. Dimensional tolerances are strictly held. Several Alite formulations, with differing Al_2O_3 content, are available which meet or exceed the specifications of our most demanding customers.

Alite parts can be supplied unmetallized, metallized, or as vacuum-tight ceramic-to-metal sub-assemblies.

* * * *

Let us review your specific requirements — without obligation: send us prints and other pertinent data. Or, write for free bulletins giving complete information about Alite.

ALITE
DIVISION

U. S. STONEWARE

BOX 119 ORRVILLE, O. 44667

5-J

CIRCLE 95 ON READER SERVICE CARD

HELP YOUR POST OFFICE TO SERVE YOU BETTER

BY

MAILING EARLY IN THE DAY

NATIONWIDE IMPROVED MAIL SERVICE PROGRAM

CHESTER

MULTI-CONDUCTOR CABLES

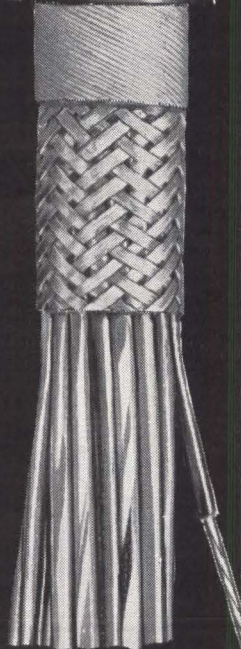

Custom constructions to meet your exact requirements. Any combination of conductors, Plastico[®] insulations, shields, jackets, color coding, etc. Send for brochure, today!

CHESTER CABLE CORP.
CHESTER, NEW YORK
a subsidiary of
TENNESSEE CORPORATION



96 CIRCLE 96 ON READER SERVICE CARD

standing high current surges, and have a peak non-recurrent surge current rating of 30 amp over 1 cycle at full load of 1 amp at 100 C. All devices are packaged in the DO-13 flangeless package, and weigh approximately 3 grams each. International Rectifier Corp., 233 Kansas St., El Segundo, Calif. CIRCLE 312, READER SERVICE CARD

Alphanumeric Display Available in 6 Colors

MODEL D2019 can display all letters A through Z, numbers 0 through 9, and other characters. It features 16 segment in-plane display with bright 1 1/4 in. high characters, and 100,000-hr incandescent lamps. Visibility



exceeds 30 ft under bright ambient lighting conditions. Standard lamps are 5 v at 60 ma; optional lamps are 28 v at 24 ma, or 3 v at 20 ma. Dimensions: 1 3/8 in. wide by 3 1/8 in. high by 1 in. deep. Displays are available on single unit panels, or on common panels with up to 12 displays per panel. Colors available are red, gray, amber, blue, green, and clear. Robotomics Enterprises, Inc., 4504 North 16th St., Phoenix, Ariz. (313)

BESIDES THE WIDEST LINE OF DIFFERENTIAL VOLTMETERS WHAT ELSE DOES FLUKE MAKE?

POWER SUPPLIES FREQUENCY EQUIPMENT, PRECISION MEASUREMENT INSTRUMENTS

For CATALOG DIGEST: Write JOHN FLUKE MFG. CO., INC., Box 7428, Seattle, Wash. 98133



CIRCLE 208 ON READER SERVICE CARD



TYPE ANY SYMBOL perfectly in 4 seconds

If you use symbols you need TYPIT[®] - and a standard typewriter. 1000 stock symbols from α to ω , + any custom symbol you want. TYPIT[®] is the simplest, fastest, cleanest -- best way and it's easy as Π ! Write today for free catalog.

TYPIT[®] manufactured by mechanical enterprises, inc. 3127-E Colvin Street, Alexandria, Va.

Gentlemen:
Send: Catalog Representative
Name _____ Title _____
Company _____
Address _____
City _____ Zone _____ State _____

CIRCLE 209 ON READER SERVICE CARD

How high is your goal?

Ours are out of sight—in the labyrinth of space. But your opportunities are a tangible reality, here and now at North American's Space and Information Systems Division. Many senior engineering and scientific positions are available in the following area:

COMMUNICATIONS ENGINEERING

- To conduct research and development programs in the RFI field, with heavy experience in electronic systems in the 100-10,000 MC range.
- Design of special instrumentation antennas, and communications components and their installation, including installation stress analysis.
- Design and operation of receiving systems including the phase-lock principle.
- Design and operation of aircraft and/or spacecraft electronic systems with emphasis in radar systems.
- Theoretical analysis and study in the field of communications, microwave systems, and measurement techniques.
- Advanced technical studies associated with antennas, propagation, and application of microwave frequencies to aerospace vehicles.

Interested? Please contact:

Mr. P. L. MONTAG
ENGINEERING AND SCIENTIFIC
EMPLOYMENT
12214 LAKEWOOD BLVD.
DOWNEY, CALIFORNIA

All qualified applicants will receive consideration for employment without regard to race, creed, color, or national origin.

**SPACE AND INFORMATION
SYSTEMS DIVISION**
NORTH AMERICAN AVIATION



LITERATURE OF THE WEEK

GERMANIUM THERMOMETER Texas Instruments Inc., 3609 Buffalo Speedway, Houston 6, Texas. Bulletin C163 covers a series of germanium thermometer probes available for use at 1.5 to 40 K range. (360)

SYNCHROS Vernitron Corp., 52 Gazza Blvd., Farmingdale, N. Y. Bulletin CS/TS-4-8-1 gives complete specifications on the company's size 8 Thru-Bore synchros. (361)

TOROID WINDER Electro Devices, Inc., 75 Adams St., Newton, Mass. A 4-page bulletin on the model D-7 production toroid winder describes its features and specifications and shows typical cores wound. (362)

TELEMETRY GROUND STATION Defense Electronics, Inc., 5455 Randolph Rd., Rockville, Md., has published a bulletin on the model TPRS-5 universal telemetry ground station. (363)

DIGITAL MODULES Cambridge Thermionic Corp., 445 Concord Ave., Cambridge, Mass. 02138. A 52-page catalog contains circuit diagrams and operating characteristics on the company's complete line of Cambion 12-pin digital logic modules. (364)

COMPONENT PLATING Cohan-Epner, Inc., 142 W. 14th St., New York 11, N. Y. Brochure describes the company's facility and capability in plating components for the aerospace and electronics industry. (365)

CRT DISPLAYS Beta Instrument Corp., 377 Elliot St., Newton 64, Mass., offers a 4-page brochure to aid the prospective user of a cathode-ray-tube display in defining and specifying a system best suited for his application. (366)

COMPONENT SELECTOR Cornell-Dubilier Electronics, 50 Paris St., Newark 1, N. J. The 144-page Component Selector, an engineering aid, covers capacitors, rfi filters and testing devices, wave lines, relays, vibrators, power supplies and test instruments. (367)

DESOLDERING/RESOLDERING IRON Enterprise Development Corp., 1102 E. 52nd St., Indianapolis, Ind. 46205. A desoldering iron that speeds electronic circuit repairs is described in bulletin E-63. (368)

SHIELDED ROOMS Magnetic Shield Division Perfection Mica Co., 1322 N. Elston Ave., Chicago, Ill., 60622. A 40-page performance data compilation describes shielding complete rooms using Co-Netic and Netic magnetic shielding alloys. (369)

RFI DATA INSERT Electro International, Inc., Box 391, Annapolis, Md., has made available a 24-page data sheet insert covering the equipments making up its m analysis system. (370)

DESK-TOP COMPUTERS Electronic Associates, Inc., Long Branch, N. J. 07740. Two all-transistor desk-top analog

COAXIAL CABLES

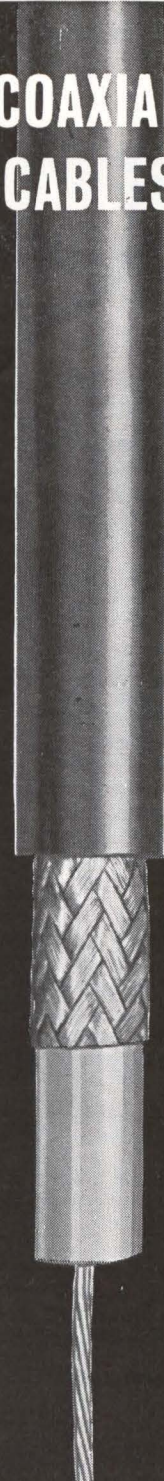

Accepted by industry as the quality line of Coaxial cables.

Conform to Military Specifications including MIL-C-17C—or your own special requirements.

Send for complete Coaxial Cable catalog.

**CHESTER
CABLE CORP.**
CHESTER, NEW YORK
a subsidiary of
TENNESSEE CORPORATION

CHESTER



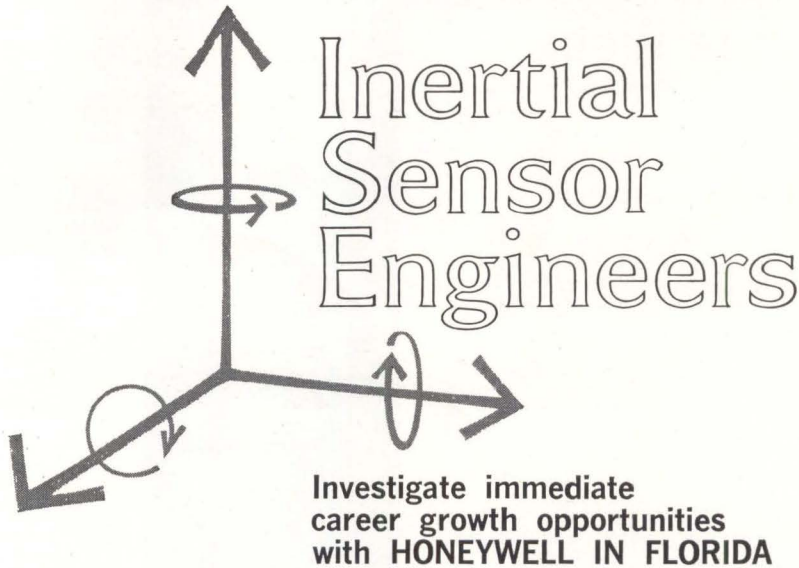

Inertial Sensor Engineers

Investigate immediate career growth opportunities with HONEYWELL IN FLORIDA

Current in-house contracts at our Florida West Coast Aerospace Guidance/Navigation Center call for more top professionals to assist in solving the systems problems of the '70's. Assignments in a wide variety of disciplines and at every level of experience are now open. Among them:

INERTIAL SENSOR DESIGN AND ANALYSIS

Inertial Sensor Engineer (Senior) — BSEE, ME or Physics. Five years minimum experience in application, specification, test procedures and/or design and development of precision gyros and accelerometers for inertial navigation and guidance systems. Ability to analyze effect of gyro and accelerometer performance on system; plan test programs and interpret data to identify error sensitivity with respect to a variety of disturbance inputs (vibration, thermal gradients, magnetic fields, etc.); recommend design modifications necessary to obtain improved performance. Experience on gyros with gas-lubricated spin motors desirable. Should be capable of liaison with all levels of personnel in other departments associated with design, production, procurement, and use of inertial sensors.

INERTIAL SENSOR/INERTIAL COMPONENT

Design Engineer — BSME/EE. Three or more years experience in development and testing of gyros/accelerometers. Familiarity with electronic instrumentation techniques (including pulse circuits) and servo-mechanism practice. Knowledge of electromagnetic components, i.e., gyro torquers, pickoffs, etc.

Design Engineer — BSME. Three or more years experience in design of floated gyros/accelerometers for guidance applications. Familiarity with gyroscopic principals and applicable design analysis techniques. Able to design and conduct investigations pointed toward improving performance and producibility from a production standpoint. Knowledge of gas-bearing lubrication techniques desirable.

Many other immediate opportunities exist in associated disciplines so if you're "guidance oriented" we urge you to contact us at once.

QUALIFIED APPLICANTS ARE INVITED TO VISIT our facilities, meet our people and discover for themselves the many added advantages of working and living here on Florida's Suncoast. Simply send a brief note describing your education, experience and specific job interest to R. L. Keese, Honeywell, 13350 U. S. Highway 19, St. Petersburg, Florida. We promise a prompt, confidential reply.

Honeywell

An Equal Opportunity Employer



To investigate professional openings in other Honeywell facilities, send resume to F. F. Laing, Honeywell, Minneapolis 8, Minn.

HONEYWELL ENGINEERS ARE DOING THINGS IN FLORIDA

computers featuring high-speed, low-cost problem solving capabilities are described in bulletin AC62025.

CIRCLE 371, READER SERVICE CARD

STABISTORS Transitron Electronic Corp., 168 Albion St., Wakefield, Mass. A booklet contains 12 uses for silicon and germanium stabistors. (372)

SILICON RECTIFIERS National Transistor, 500 Broadway, Lawrence, Mass., has issued a new 4-page silicon rectifier reference chart. (373)

MAGNETIC ALLOY Westinghouse Materials Mfg. Division, Blairsville, Pa. Bulletin 52-163 (9-12) describes Hiperco 50, a soft magnetic alloy for high flux levels. (374)

H-F RADIO TRANSMISSION Lenkurt Electric Co., Inc., San Carlos, Calif. Vol. 12 No. 8 of *The Demodulator* contains a review of the nature of h-f transmission and some techniques for improving its quality and reliability. (375)

CABLE JACKS & PLUGS Sealectro Corp., 139 Hoyt St., Mamaroneck, N.Y. New ConheX subminiature cable jacks and plugs designed for use with semi-rigid coaxial cable are described in a data sheet. (376)

INJECTION LASERS Electro-Nuclear Laboratories, Inc., 2443 Leghorn St., Mountain View, Calif. Two-color brochure describes a comprehensive source of injection diode sources for both laser and sub-laser operations. (377)

VIDEO VTVM Ballantine Laboratories, Boonton, N. J. Technical bulletin illustrates and describes model 311 sensitive linear video voltmeter. (378)

MERCURY-WETTED RELAYS Babcock Relays, a division of Babcock Electronics Corp., 3501 Harbor Blvd., Costa Mesa, Calif. Bulletin BW-6301 introduces a new line of mercury-wetted contact relays. (379)

TERMINALS Angler Industries Inc., 97 Chestnut St., Newark 5, N. J., has available a new catalog on a line of Tef-Lok Teflon-insulated terminals for miniature and subminiature electronic assemblies. (380)

THERMISTORS Victory Engineering Corp., 122-48 Springfield Ave., Springfield, N. J. Handbook V1133 gives complete information on thermistors, their characteristics and circuitry. (381)

SILICON POWER TRANSISTORS Silicon Transistor Corp., Carle Place, N. Y., offers a specification sheet for STC 1080 series npn, 75-w silicon power transistors. (382)

REED RELAYS Wheaton Industries, Inc., 422 Interstate Road, Addison, Ill. A two-page bulletin features new modular type reed relays. (383)

D-C POWER SUPPLIES Stancor Electronics, Inc., 3501 Addison St., Chicago, Ill. 60618, has released a brochure on a new line of regulated d-c power supplies for fixed output voltage applications. (384)

PRODUCT
NEWS from EPL

NEW... hi-voltage regulated DC Power Supply under \$400.



ELECTRO
RB-500 \$395.00

Compare Value

Brand	Volts	Current	Regulation (Combined line & load)	Price
K	0-325	0-200 MA	0.02%	\$495.00
S	0-500	0-200 MA	2.0%	400.00
Electro RB-500	0-500	0-250 MA	0.03%	395.00

Compare Features

High Voltage Output: 0-500 VDC. 0-250 MA
Precise Regulation: 0.03% or .015V, whichever is greater, for combined line (105-125V) and load (no-load to full-load) variations.
Ripple: 5MV, RMS maximum.
Bias Output: 0-150 VDC.
Filament Outputs: Two separate 6.3V at 5A outputs for 6.3V at 10A or 12.6V at 5A.
Primary and Secondary Protection.
2% D' Arsonval Meters: Dual scale . . . 0-500V/0-150V. 0-250 MA
Separate AC, DC Switches.
Continuous Output Voltage Adjustment: Regulation maintained well below 3V output setting.
 Wherever precisely regulated DC power is a must, the EPL RB-500 fills the bill economically. Engineered and built for heavy-duty production testing; electronic circuitry development and design in industry, laboratories and schools.

Write for Literature & Name of Your Electro Distributor!



3200

ELECTRO PRODUCTS LABORATORIES

6125-F Howard, Chicago 48 (Niles), Ill.
Phone: 647-6125

Canada: Atlas Radio Corp., Toronto

Since 1936—Pioneers in DC Power Supplies

CIRCLE 210 ON READER SERVICE CARD

electronics November 8, 1963

Specialist



IN WIRE & CABLE CONSTRUCTIONS

Wiring problems can't always be answered by standard materials, even from the broad range of wire products available today. Markel's capacity for engineering high temperature wire and cable constructions to meet particular needs has grown steadily with the demand. The toughest requirements in temperature, corrosive atmospheres, flexing, corona effect, etc., can be solved—with long range economy and reliability — by specially designed products from our FLEXLEAD Division.

Teflon, Silicone Rubber, Fiberglass, Nylon

Any combinations of insulations, shielding, fillers, liners, and jacket materials—for temperatures from -90° to 260° C—with single, twisted pair, or multiple conductors. May we help you solve your wiring problems?

Norristown, Pa. L. FRANK MARKEL & SONS

FLEXLEAD

**HIGH
TEMPERATURE
WIRE AND
CABLE**

Get more facts. Write or call for a
FLEXLEAD Wire and Cable Selector

CIRCLE 99 ON READER SERVICE CARD

99

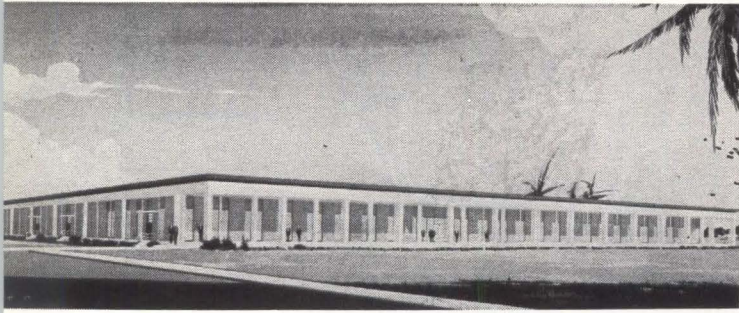

ITT Plans New Plant

PLANS TO CONSTRUCT a \$3-million plant in West Palm Beach, Fla., to manufacture integrated circuits and other semiconductor devices under the management of ITT Semi-Conductors, Inc., have been announced by ITT Corporation.

Ground breaking is expected later this month, and the building is scheduled for completion in February 1964.

Announcement of the project was made by vice president John J. Graham, ITT's area general manager—North America, who said that the new 135,000-square foot structure will employ eventually about 500 persons.

Allen J. Dusault, president of ITT Semi-Conductors, Inc., said that in addition to integrated circuits, the plant will be engaged in the development of other types of micro-circuits and new products in specially designed laboratories.

ITT has 161,000 employees in 49 countries located in its 150 factories, laboratories and service units, and a dozen telephone and telegraph operating companies.

The present National Transistor facility in Lawrence, Mass., will continue operating as a unit of ITT Semi-Conductors, Inc.



Radiation Realigns Management

RADIATION INCORPORATED has announced a realignment of its management. Harold E. O'Kelley (picture) has been named vice president, operations, of Radiation-Melbourne, the principal operating division of the Florida electronics firm. He succeeds Eric J. Isbister who has been assigned to the post of vice president and assistant to the executive vice president.

Prior to his new assignment, O'Kelley was director of the Surface Systems Engineering division of Radiation-Melbourne.

A. W. Sissom was appointed to fill O'Kelley's previous post as director of the Surface Systems Engineering division. He was formerly director of the company's Advanced Communications division.

General Radio Appoints Soderman

ROBERT A. SODERMAN has been appointed engineering manager of General Radio Company's new plant in Bolton, Mass., scheduled to open early in 1964.

Soderman has been with General Radio since 1945, most recently as administrative engineer and leader of the Impedance Group.



Hunter Elected Hycon President

THE BOARD of directors of Hycon Mfg. Co., Monrovia, Calif., has announced the election of Kenneth E. Hunter as president and chief executive officer. He had been executive vice president of the company.

Hycon develops and manufactures aerial reconnaissance systems and electronic missile test equipment.

EOS Promotes Stephens

CHARLES W. STEPHENS has been named manager of the newly formed Optics division at Electro-Optical Systems, Inc., Pasadena, Calif. He was formerly associate manager of

NRC Announces Plant Expansion

COMPLETION of a \$250,000 plant expansion program has been announced by NRC Equipment Corp., Newton, Mass., a subsidiary of National Research Corp. This boosts NRC's vacuum manufacturing facilities there by 30 percent, to 80,000 square feet.

The new 18,500-square-foot building will be used for assembly, test, supplies, shipping and receiving. Equipment manufactured in Newton includes high vacuum systems and components such as space simulation chambers, electron beam welders, arc furnaces, thin film coat-ers, diffusion pumps, valves and gages.

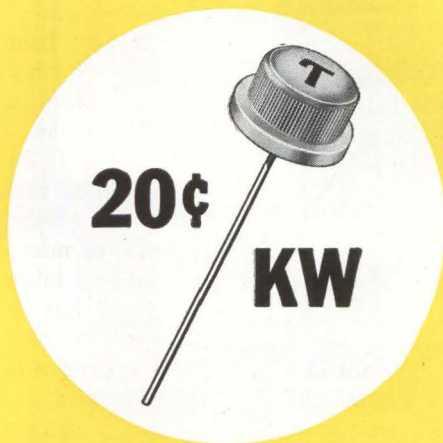

Our family of industrial silicon rectifiers delivers unsurpassed performance at economical prices.

In a 600 volt, 3-phase bridge, the rectifier cost is only 20c for every KW delivered. The savings in other power supply systems are equally impressive.

Rugged and reliable, these hermetically sealed devices offer high surge current capability. De-

signed for all industrial power supply applications in the 10 to 75 ampere range, many types are available in both the new press-fit and standard stud-mounted packages.

Transitron has a long history of leadership in the design and mass production of rectifiers. Since introducing the first commercial rectifiers in 1955, we have pioneered in the development of these devices for space, military and industrial use.

Where can you use the industrial silicon rectifier?

Originally designed for automotive alternator systems, it is being used in a steadily growing range of industrial power supply sys-

tems. Some typical applications are: battery chargers, alternators, electroplating, cathodic protection systems, signaling devices, marine electrical systems, motor drive and motor control systems, relay panel equipment.

Whatever commercial application you are considering, Transitron can deliver — immediately and in volume — the silicon rectifier that will do the job economically. Your Transitron Distributor has a complete stock on his shelf right now. Our engineers stand ready to help you with any design problem you may have. For further product and design information, write for Transitron's Industrial Rectifier Bulletin, Transitron, Wakefield, Mass.

PIV (Volts)	15A Types	18A Types	20A Types	25A Types
50	1N3208	1N3491	TR322	1N3659
100	1N3209	1N3492	TR323	1N3660
200	1N3210	1N3493	TR324	1N3661
300	1N3211	1N3494	TR325	1N3662
400	1N3212	1N3495	TR326	1N3663
500	1N3213	—	—	1N3664
600	1N3214	—	—	1N3665

All types available in reverse polarity.

order your Industrial Silicon Rectifiers from

Transitron T

electronic corporation
wakefield, melrose, boston, mass.

SALES OFFICES IN PRINCIPAL CITIES THROUGHOUT THE U. S. A. AND EUROPE • CABLE ADDRESS TRELCO

specify the new circuit breakers
by Mechanical Products, Inc.

AVNET

contact The Avnet System
for best service & on-time delivery

the line includes breakers with
both standard commercial and
Mil Spec part nos. Mechanical
Products' circuit breakers meet
requirements of MIL C-5809
and MIL C-7079.

for MP circuit breakers

MECHANICAL PRODUCTS

call your Local Avnet Headquarters

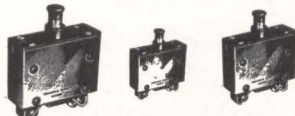

Westbury, L. I.; Chicago; Phoenix;
Burlington, Mass.; Syracuse, N. Y.;

LOCAL

Salt Lake City; Bellevue, Wash.;
San Diego, L. A., Sunnyvale, Cal.

CIRCLE 211 ON READER SERVICE CARD

CONTINUOUS VARIABLE FILTERS

Center frequency continuously
adjustable over 6 to 1 range.

High Input Impedance. Over 40 db attenuation for harmonics and noise. Matched pair available.

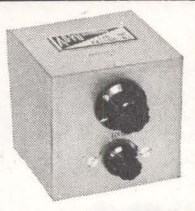

TYPE A103

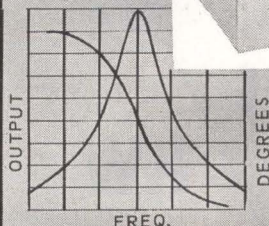

Attenuation Characteristics: 3 db points at 6%, 10 db points at 10%, 20 db points at 30% off center frequency.

Phase Characteristics: Phase shift is zero at center frequency, 45° at 3 db points, 75° at 10 db points.

GROUP 1 - 1.5 to 1 Range: Center at 50, 60, 80 cps up to 12 kc.

GROUP 2 - 2 to 1 Range: Center at 50, 90, 150 cps up to 40 kc.

GROUP 3 - 3 to 1 Range: Center at 50, 60, 200 cps up to 30 kc.

GROUP 4 - 6 to 1 Range: Center at 50, 100, 200 cps up to 12 kc.

AD-YU ELECTRONICS INC.

249 TERHUNE AVE., PASSAIC, N. J.

CIRCLE 212 ON READER SERVICE CARD

the EOS Advanced Power Systems division.

Stephens will be responsible for all activities of the division and will report directly to the office of technical director and manager of operations under John M. Teem, corporate vice president and technical director.



**Hughes Aircraft
Names Field**

LESTER M. FIELD has been appointed to the new position of vice president-research of Hughes Aircraft Co., Culver City, Calif.

Field, who until his new appointment was a vice president in the company's components group, will be in charge of planning, coordination and guidance of Hughes research activities for the company's three operating groups and the research facility at Malibu, Calif.



**Applied Technology
Elects Grigsby**

WILLIAM E. AYER, president of Applied Technology, Inc., Palo Alto, Calif., has announced the election of John L. Grigsby to the position of vice president-engineering.

Grigsby has held the position of chief engineer since joining the company in January 1960.

TO ORDER REPRINTS

Fill in, cut out coupon below

insert in envelope and mail to:

electronics Reprint Dept.

330 W. 42nd Street, New York, N. Y. 10036

REPRINT ORDER FORM

For Listings of Reprints Available Turn To Reader Service Card

(To help expedite mailing of your reprints please send cash, check or money order with your order.)

For Reprints of the latest Special Report:

Materials for Space Age Electronics

Send me.....Reprints of Key No. **R-42** at 50¢ each.

For Reprints of previous **Special Reports** or **Feature Articles** fill in below:

Send me.....Reprints of Key No.(s).....@.....¢ each.

(For prices, see Reader Service Card.)

*For orders of **Bulk Reprints** of other editorial articles in this issue or past issues:

Send me.....Reprints of page No.(s).....of issue date.....

of article entitled.....

*Minimum bulk order 100 copies. You will be advised of costs by return mail.

Name

Number of Street

City, Zone No., State

Breslin Assumes Vice Presidency

GENERAL RF FITTINGS, INC., Boston, Mass., and Port Salerno, Fla., announces the promotion of J. David Breslin from sales manager to vice president-marketing.

In his new capacity, Breslin will be responsible for overall marketing and general sales of the company's line of TNC, TM and GM precision coaxial connectors.

PEOPLE IN BRIEF

Philip Levine leaves Empire Devices to head up design and development of bolometers and related components for Filmohm Corp. **Se Puan Yu**, formerly with GE, appointed a senior scientist of Litton Industries' Electron Tube div. research lab. Univac promotes **Cecil M. Shuler** to v-p, Central region. **Charles A. Bogenrief**, v-p of Robertshaw Controls Co., named g-m of its Acro div. **James J. Sullivan**, ex-Bogart Mfg. Corp., now director of mfg. at Paradyamics, Inc. **William M. Pease**, former president of Aracon Laboratories, appointed director of special projects for Raytheon's Space and Information Systems div. **Stephen D. Moxley, Jr.**, advances to engineering mgr. of Avco Electronics' Huntsville facility. **Otto Riss** moves up to operations mgr. of the Bendix Products Aerospace div. **Allen Chop**, from Lockheed Missiles and Space Co. to Eitel-McCullough, Inc., as mgr., quality control, of the power grid div. **Carroll F. Augustine**, previously with Microwave Devices, named an engineering section head at Weinschel Engineering. **Clifford E. Berry** leaves Consolidated Electrodynamics Corp. to become mgr. of advanced development of Vacuum-Electronics Corp. **Fred D. Kochendorfer**, formerly with NASA, appointed mgr. of advanced systems and programs for Philco's WDL div. **Andrew J. Unetic**, ex-Bourns, Inc., now exec v-p of Kinetics Corp. **Max Sanders**, previously with Controls Co. of America, named quality control mgr. for Sola Electric Co. **John F. Williams** moves up to asst. to the v-p and group exec of IBM Corp.

• SCAN CONVERSION • FLICKERLESS DISPLAY STORE • VIDEO STORAGE

RECORDING STORAGE TUBE SYSTEMS

Single-gun, dual-gun, multi-tube systems to convert scan for radar, sonar, television, and to perform analog processing, data analysis, contract or expand time scale, auto correlation.

• SLOWED TELEVISION TRANSMISSION

by telephone line or other narrow-band systems.

• IMAGE ENGINEERING

OPTICAL CHART READERS, FLYING SPOT SCANNERS, LOW-LIGHT-LEVEL CAMERAS, and IMAGE RECTIFICATION. Automatic inspection and recognition of size, shape, color, and texture.



Write or call for complete information:



INSTRUMENTS, Inc.

2300 Washington Street
Newton 62, Massachusetts
617 WOODWARD 9-8440

CIRCLE 213 ON READER SERVICE CARD

specify the new U.S. Sencor Products

AVNET

contact Avnet for best service

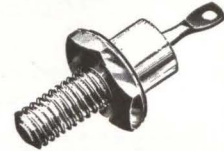

on-time delivery of

SEMCOR

diodes and capacitors

5 watt miniature Zener Diodes, high voltage temperature compensated Reference Elements, non-polar solid and hermetically sealed wet Tantalum Capacitors, 400MW Glass Zeners Mil Types USN 1N 962BM -USN 1N 984BM

call your local Avnet Headquarters

AVNET

The Avnet System, coast to coast

CIRCLE 214 ON READER SERVICE CARD

INDICATOR LIGHTS for your miniaturization program must be of high reliability. To assure this, we offer such vital features as: Watertight construction; resistance to vibration and corrosion; high-heat plastic, or glass, lenses; rugged brass terminals; anti-rotation (locked) construction; phenolic insulation of Mil. Spec. grade; 7 lens colors, etc.

SUB-MINIATURES

by **DIALCO**

For NEON or INCANDESCENT LAMPS



The T-2 Neon Lamp is available in two types: NE-2D (MS25252) for 105-125 V AC-DC; and the High Brightness type NE-2J (not MS) for 110-125 V AC only. In DIALCO units the current-limiting resistor is built-in (U.S. Pat. No. 2, 421,321).



Typical assemblies shown here: No. 137-8836-931 with built-in resistor (conforms to MS25237); No. 181-8836-931 (water-tight) with built-in resistor.

The T-1 1/4 Incandescent Lamps are available in voltages ranging from 1.3 to 28 V. Typical assemblies shown here: No. 162-8430-931 (conforms to MS25256) . . . No. 134-3830-375-9 (with rotatable readout lens); and No. 174-8430W-131 (water-tight, with dimmer cap).

Samples on Request—at Once—No Charge

For complete data, request Catalogs on Sub-Min. Indicator Lights

Foremost Manufacturer of Pilot Lights

DIALIGHT CORPORATION
60 Stewart Ave., Brooklyn 37, N.Y. • (212) HYacinth 7-7600

Units Mount in 15/32" Clearance Hole



No. 137-8836-931

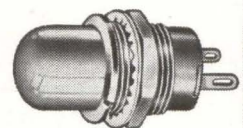

No. 162-8430-931

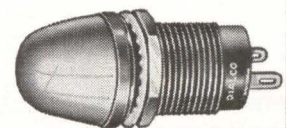

No. 181-8836-931

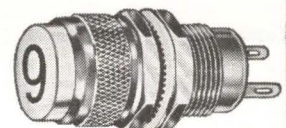

No. 134-3830-375-9

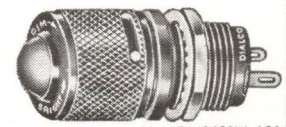

No. 174-8430W-131

(Units shown approx. actual size)

electronics

WEEKLY QUALIFICATION FORM FOR POSITIONS AVAILABLE

ATTENTION: ENGINEERS, SCIENTISTS, PHYSICISTS

This Qualification Form is designed to help you advance in the electronics industry. It is unique and compact. Designed with the assistance of professional personnel management, it isolates specific experience in electronics and deals only in essential background information.

The advertisers listed here are seeking professional experience. Fill in the Qualification Form below.

STRICTLY CONFIDENTIAL

Your Qualification form will be handled as "Strictly Confidential" by ELECTRONICS. Our processing system is such that your form will be forwarded within 24 hours to the proper executives in the companies you select. You will be contacted at your home by the interested companies.

WHAT TO DO

1. Review the positions in the advertisements.
2. Select those for which you qualify.
3. Notice the key numbers.
4. Circle the corresponding key number below the Qualification Form.
5. Fill out the form completely. Please print clearly.
6. Mail to: Classified Advertising Div., ELECTRONICS, Box 12, New York, N. Y. 10036. (No charge, of course).

COMPANY	SEE PAGE	KEY #
ATOMIC PERSONNEL INC. Philadelphia, Pa.	58*	1
BAUSCH & LOMB INC. Rochester, N. Y.	105	2
HONEYWELL St. Petersburg, Fla.	98	3
JET PROPULSION LABORATORY Pasadena, Calif.	59*	4
MELPAR, INC. Sub. of Westinghouse Air Brake Co. Falls Church, Virginia	82	5
PAN AMERICAN WORLD AIRWAYS INC. Guided Missiles Range Div. Patrick AFB, Fla.	105	6
SCM CORPORATION Data Processing Systems Div. Oakland, Calif.	58*	7
SPACE & INFORMATION SYSTEMS DIV. North American Aviation Inc. Downey, Calif.	97	8

* These advertisements appeared in the Nov. 1st issue.

(cut here)

electronics WEEKLY QUALIFICATION FORM FOR POSITIONS AVAILABLE

(cut here)

(Please type or print clearly. Necessary for reproduction.)

Personal Background

NAME

HOME ADDRESS

CITY ZONE STATE

HOME TELEPHONE

Education

PROFESSIONAL DEGREE(S)

MAJOR(S)

UNIVERSITY

DATE(S)

FIELDS OF EXPERIENCE (Please Check)

11863

- | | | |
|--|--|---------------------------------------|
| <input type="checkbox"/> Aerospace | <input type="checkbox"/> Fire Control | <input type="checkbox"/> Radar |
| <input type="checkbox"/> Antennas | <input type="checkbox"/> Human Factors | <input type="checkbox"/> Radio—TV |
| <input type="checkbox"/> ASW | <input type="checkbox"/> Infrared | <input type="checkbox"/> Simulators |
| <input type="checkbox"/> Circuits | <input type="checkbox"/> Instrumentation | <input type="checkbox"/> Solid State |
| <input type="checkbox"/> Communications | <input type="checkbox"/> Medicine | <input type="checkbox"/> Telemetry |
| <input type="checkbox"/> Components | <input type="checkbox"/> Microwave | <input type="checkbox"/> Transformers |
| <input type="checkbox"/> Computers | <input type="checkbox"/> Navigation | <input type="checkbox"/> Other |
| <input type="checkbox"/> ECM | <input type="checkbox"/> Operations Research | <input type="checkbox"/> |
| <input type="checkbox"/> Electron Tubes | <input type="checkbox"/> Optics | <input type="checkbox"/> |
| <input type="checkbox"/> Engineering Writing | <input type="checkbox"/> Packaging | <input type="checkbox"/> |

CATEGORY OF SPECIALIZATION

Please indicate number of months experience on proper lines.

	Technical Experience (Months)	Supervisory Experience (Months)
RESEARCH (pure, fundamental, basic)
RESEARCH (Applied)
SYSTEMS (New Concepts)
DEVELOPMENT (Model)
DESIGN (Product)
MANUFACTURING (Product)
FIELD (Service)
SALES (Proposals & Products)

CIRCLE KEY NUMBERS OF ABOVE COMPANIES' POSITIONS THAT INTEREST YOU

1 2 3 4 5 6 7 8 9 10 11 12 13 14 15

AUTOTRACK ANTENNA MOUNT

TYPE SCR 584, MP 61B

360 degree azimuth, 210 degree elevation sweep with better than 1 mil. accuracy. Missile velocity acceleration and slewing rates. Amplidyne and servo control. Will handle up to 20 ft. dish. Supplied complete with control chassis. In stock—immediate delivery. Used world over by NASA, ABMA, USAF.

AIRBORNE AUTOTRACK X-Y MOUNT

Gimbal mount, compl. w/all servos & drives for full sweep. \$475.

**SCR 584 RADARS AUTOMATIC TRACKING
3 CM & 10 CM**

Our 584s in like new condition, ready to go, and in stock for immediate delivery. Ideal for telemetry research and development, missile tracking, satellite tracking, balloon tracking, weather forecasting, anti-aircraft defense tactical air support. Used on Atlantic Missile Range, Pacific Missile Range, N.A.S.A. Wallops Island, A.B.M.A. Desc. MIT Rad. Lab. Compl. inst. bk. available \$25.00 ea. Series, Vol. 1, pps. 207-210, 228, 284-286.

PULSE MODULATORS

MIT MODEL 9 PULSER

1 MEGAWATT—HARD TUBE

Output 25 kv 40 amp. Duty cycle, .002. Pulse lengths .25 to 2 microsec. Also .5 to 5 microsec. and .1 to .5 msec. Uses 6C21. Input 115v 60 cycle AC. Mfr. GE. Complete with driver and high voltage power supply. Ref: MIT Rad. Lab. Series Vol. 5 pps. 152-160.

500KW THYRATRON PULSER

Output 22kv at 28 amp. Rep. rates: 2.25 microsec. 300 pps, 1.75 msec 550 pps, .4 msec 2500 pps. Uses 5C22 hydrogen thyatron. Complete with driver and high voltage power supply. Input 115v 60 cy AC.

2 MEGAWATT PULSER

Output 30 kv at 70 amp. Duty cycle .001. Rep rates: 1 microsec 600 pps, 1 or 2 msec 300 pps. Uses 5948 hydrogen thyatron. Input 120/208 VAC 60 cycle. Mfr. GE. Complete with high voltage power supply.

15KW PULSER—DRIVER

Biased multivibrator type pulse generator using 3E29. Output 3kv at 5 amp. Pulse widths .5 to 5 microsec. easily ad. to .1 to .5 msec. Input 115v 60 cy AC. \$475. Ref: MIT Rad. Lab. Series Vol. 5 pps. 157.

MIT MODEL 3 PULSER

Output: 144 kv (12 kv at 12 amp.) Duty ratio: .001 max. Pulse duration: .51 and 2 microsec. Input: 115 v 400 to 2000 cps and 24 vdc. \$325 ea. Full desc. Vol. 5 MIT Rad. Lab. series pg. 140.

MICROWAVE SYSTEMS

300 TO 2400MC RF PKG.

300 to 2400MC CW. Tuneable. Transmitter 10 to 30 Watts. Output. As new \$475.

X BAND DOPPLER SYSTEM

AN/APN-102 G.P.L. ANT/RCYR/XMTR PKG. 4 Beam Pulsed Janus Planar Array—New \$1600.

AN/TPS-ID RADAR

500 kw 1220-1359 mcs. 160 nautical mile search range P.P.I. and A Scopes. MTI. thyatron mod. 5J26 magnetron. Complete system.

10 CM. WEATHER RADAR SYSTEM

Raytheon, 275 KW output S Band. Rotating yoke P.P.I. Weather Band. 4, 20 and 80 mile range. 360 degree azimuth scan. Supplied brand new complete with instruction books and installation drawings. Price \$975 complete.

AN/APS-15B 3 CM RADAR

Airborne radar. 40 kw output using 725A magnetron. Model 3 pulser. 30-in. parabola stabilized antenna. PPI scope. Complete system. \$1200 each. New.

10KW 3 CM. X BAND RADAR

Complete RF head including transmitter, receiver, modulator. Uses 2J42 magnetron. Fully described in MIT Rad. Lab. Series Vol. 1, pps 616-625 and Vol. II, pps. 171-185 \$375. Complete System. \$750.

AN/APS-27 X BAND RADAR

Complete 100 kw output airborne system with AMTI, 5C22 thyr. mod, 4J52 magnetron, PPI, 360 deg az sweep, 60 deg. elev. sweep, gyro stabilizer, hi-gain revr. Complete with all plugs and cables \$2800.

M-33 AUTO-TRACK RADAR SYSTEM

X band with plotting board, automatic range tracking, etc. Complete in 2 van complex incl. 1 megawatt acquisition radar.

AN/APS-45 HEIGHT FINDER

Airborne system, 40,000 ft. altitude display on PPI & RHI. 4375 mcs. 400kw output using QK-172 megatron, 5622 thyatron.

L BAND RF PKG.

20 KW peak 890 to 1040 MC. Pulse width .7 to 1.2 microsec. Rep rate 150 to 420 pps. Input 115 vac. Incl. Receiver \$1200.

200MC RF PKG

175 to 225 mc. Output: 200 to 225 kw. 5 microsec 60 pps. Input: 115v 60 cycle AC. \$750.

AN/UKR-5A TELEMETRY SET

Mfr. Raymond Rosen Eng'g Co. 215-235 mc receiving terminal with recorders. \$2400.00



Radio-Research Instrument Co.
550 5th Ave. New York 36, N.Y.
Tel. JUdson 6-4691

CIRCLE 956 ON READER SERVICE CARD

Advertisement

Unique Relay Catalog Now Available

NEW YORK, N. Y. Nov., 1963. Universal Relay Corp., 42 White St., New York 13, N. Y. announces the publication of their latest 32 page catalog. Universal's normal inventory includes over 2,000,000 relays in approximately 30,000 types. In most cases stock is sufficient to give immediate delivery of production quantities. This catalog is not just a listing of items available "on order" but it is an indication of in-stock items (either as complete units or as ready-to-assemble components). Average shipment is made within 48 hours. Where coils and frames require assembly, or relays require special testing or adjustment, shipments are made within one week to ten days.

Universal is completely equipped to assemble, adjust and thoroughly test any type of relay. A personal interest is taken in every order. This interest is maintained as the order is processed and continues even after the customer receives the merchandise, until he makes sure that it satisfies his needs. All merchandise is guaranteed, subject to customers' inspection and approval and may be returned within 30 days for replacement or credit. Catalog E-763 may be obtained by writing directly to:

UNIVERSAL RELAY CORP.

42 White St., New York 13, N. Y.
Telephone 212 WA 5-6900

CIRCLE 957 ON READER SERVICE CARD

FREE Catalog
OF THE WORLD'S FINEST
ELECTRONIC GOV'T
SURPLUS BARGAINS



HUNDREDS OF TOP QUALITY ITEMS — Receivers, Transmitters, Microphones, Inverters, Power Supplies, Meters, Phones, Antennas, Indicators, Filters, Transformers, Amplifiers, Headsets, Converters, Control Boxes, Dynamotors, Test Equipment, Motors, Blowers, Cable, Keys, Chokes, Handsets, Switches, etc., etc. Send for Free Catalog—Dept. B-3

FAIR RADIO SALES
2133 ELIDA RD. • Box 1105 • LIMA, OHIO

CIRCLE 958 ON READER SERVICE CARD

BC-221 FREQUENCY METER—"Depot Reconditioned" mechanically & electronically by the Signal Corps, with new tubes and recalibrated & new calibration book. New manual & accessories. Only a few at . . . \$99.50
BC-221 FREQUENCY METER—with crystal and original calibration book. Excellent. \$69.50
TS-175 FREQUENCY METER—85 to 1,000MC with crystal and original calibration book. Modulation. Excellent condition. \$149.50
STANDARD LAB RECEIVER APR-4Y AM & FM w/3 tuning units 38-1000MC. . . \$199.50
w/4 tuning units 38-2000MC (checked out). \$314.50
TS-148/UP SPECTRUM ANALYSER "X" band. 8470-9630MC. Lab checked out. . . \$149.50
ARC-3 RECEIVER 100-156MC 8 channel. NEW. . . \$29.95
TS-13/AP "X" BAND SIGNAL GENERATOR & power meter 9305-9445MC. New with accessories. . . \$29.95

Write for Bulletin #39—Loads of bargains
R. W. ELECTRONICS INC.
2430 S. Michigan Ave. Chicago, Ill. 60616
CALumet 5-1281

CIRCLE 959 ON READER SERVICE CARD

OPTICAL BENCHES
\$13. to \$13,000. New Catalog

THE Ealing CORP.

2250 Massachusetts Avenue, Cambridge, Mass., 02140

CIRCLE 960 ON READER SERVICE CARD

MICROWAVE ANTENNAS

Parabolic, 6 foot dia., Andrews, Spun Aluminum. 1700-2400 MCs Complete with mounting bracket, Di-pole, de-icers, etc. Unused—Crated—Cheap. One Hundred Available.

SIERRA-WESTERN ELECTRIC

1401 Middle Harbor Road
Oakland, Cal. Tel. 832-3527

CIRCLE 961 ON READER SERVICE CARD

ELECTRON TUBES

KLYSTRONS • ATR & TR • MAGNETRONS
SUBMINIATURES • C.R.T. • T.W.T. • 5000-6000 SERIES

• SEND FOR NEW CATALOG A2 •

A & A ELECTRONICS CORP.
1063 PERRY ANNEX
WHITTIER, CALIF.
AN 92865 OR 943-2829

CIRCLE 962 ON READER SERVICE CARD

POTTING APPLICATORS
MANUAL AND DISPOSABLE

6cc 12cc 30cc
FOR POTTING, ENCAPSULATING, AND SEALING OF MINIATURE COMPONENTS
PHILIP FISHMAN CO.
7 CAMERON ST., WELLESLEY 81, MASS.



CIRCLE 963 ON READER SERVICE CARD

Color DIAL TELEPHONES \$10.95

Factory rebuilt Western Electric in white, beige, ivory, pink, green, or blue. If 4 prong plug is required add \$2.00. Fully guaranteed. Write for free list. All shipments FOB.



SURPLUS SAVING CENTER
Waymart Dept. E-11863 Penna.

CIRCLE 964 ON READER SERVICE CARD

WRITE FOR NEW KEYSTONE free catalog

We are the leading producers of BATTERY HOLDERS, TERMINALS, TERMINAL BOARDS & ELECTRONIC HARDWARE.

KEYSTONE ELECTRONICS CORP. 49 BLEECKER ST. NEW YORK 12, N. Y.

CIRCLE 965 ON READER SERVICE CARD

SMALL AD but BIG STOCK

of choice test equipment and surplus electronics

Higher Quality—Lower Costs
Get our advice on your problem

ENGINEERING ASSOCIATES

434 Patterson Road — Dayton 19, Ohio

CIRCLE 966 ON READER SERVICE CARD

TUBES & COMPONENT FREE...CATALOG BARRY ELECTRONICS

512 BROADWAY 212-WALKER 5-7000
NEW YORK 12, N.Y. TWX-571-0484

CIRCLE 967 ON READER SERVICE CARD

SPECIAL

2C43 Tubes. New, in orig. cartons. Less than 1/2 orig. cost. \$9.75 ea.

Write on your letterhead for price list of other tubes at similar savings.

ELECTRO SALES CO.

1608 Milwaukee Ave., Chicago 47 BR. 8-8080

CIRCLE 968 ON READER SERVICE CARD

Sold!

"Please discontinue our ad in 'Searchlight' as we have sold the equipment through this advertising."

Can "Searchlight Serve You?"

INDEX TO ADVERTISERS

• Ad-Yu Electronics Inc.	102	• Lapp Insulator Co., Inc.	61	• United Transformer Corp. 2nd cover	
Aerocom	85	Leach Corporation	74	Ward Leonard Electric Co.	84
Alcoa		Lepel High Frequency Laboratories, Inc.	76	Wayne-George Corp.	16
Rome Cable Div.	32	Machlett Laboratories, The	27		
Ampex Corporation	55	• Markel & Sons, L. Frank	99		
Automatic Electric	73	Markem Machine Co.	50		
• Avnet Electronics Corp.	102, 103	Mechanical Enterprises Inc.	96		
• Ballantine Laboratories, Inc.	58	Melpar Inc.	82		
• Belden Manufacturing Co.	65	Memorex Corp.	7		
Bell Telephone Laboratories	23	• Microswitch			
• Bourns Inc.	33	Division of Honeywell	77		
• Chester Cable Corp.	96, 97	Mincom Division			
Cinch-Graphik	31	Minnesota Mining & Mfg. Co.	59		
Consolidated Electroynamics Corp.	63	Mitsumi Electric Co., Ltd.	90		
Corning Electronics		Motorola Military Electronics Div.	28, 29		
A Div. of Corning Glass Works	30	Motorola Semiconductor Products Inc.	57		
Dialight Corporation	103	• Mullard Ltd.	79		
• Electro Instruments Inc.	86	• NRC Equipment Co.	93		
Electro Products Laboratories	99	• North Atlantic Industries, Inc.	69		
Engineered Electronics Co.	71	Ozalid A Div. of General Aniline & Film Corp.	14		
• Erie Technological Products, Inc.	24, 25	Polaroid Corp.	67		
Fairchild Semiconductor Corp.	108	Potter Instrument Co., Inc.	34		
3rd cover		Radio Corporation of America	4th cover		
Fluke Mfg. Co., Inc., John	96	• Reeves Hoffman Div. of Dynamics Corp. of America	70		
Flying Tiger Line	60	Servo Corporation of America	90		
General Electric Co.		Siera Electronic Div. of Philco	4		
Tube Dept.	12, 13	Space & Information Systems Div. of North American Aviation	97		
Gudebrod Bros. Silk Co., Inc.	62	Sprague Electric Co.	3, 56		
Hansen Mfg. Co., Inc.	72	Standard Electric Time Co., The	70		
• Hewlett-Packard Company	8, 9	Sylvania Electric Products, Inc. Electronic Tube Div.	21		
Hogan Faximile Corp.	94	• Synthane Corp.	72		
Honeywell	98	• Tektronix, Inc.	52, 53		
Denver Division	83	• Telonic Industries, Inc.	81		
Hughes Aircraft Co.		Texas Instruments Incorporated	15		
Aerospace Divisions	22	Industrial Products Group	101		
Hughes Aircraft Co.		Transitron Electronic Corp.			
Hughes Instruments Div.	78	• United Shoe Machinery Corp.	88		
Image Instruments Inc.	103	U. S. Stoneware	95		
• Inland Motor Corp.					
Sub. of Kollmorgen	68				
Jerrold Electronics Corp.	6				
• Keithley Instruments, Inc.	88				
• Klein & Sons, Mathias	89				
• Knights Company, James	94				

CLASSIFIED ADVERTISING

F. J. Eberle, Business Mgr. (2557)	
EMPLOYMENT OPPORTUNITIES	105
EQUIPMENT	
(Used or Surplus New)	
For Sale	105-106
WANTED	105

CLASSIFIED ADVERTISERS INDEX

• A & A Electronics Corp.	106
• Barry Electronics	106
Bausch and Lomb Inc.	105
Binswanger Corporation	105
Ealing Corporation	106
Electro Sales Co.	106
• Fair Radio Sales	106
Fishman Co., Philip	106
Keystone Electronics Corp.	106
Lifschultz Fast Freight	105
Olson Electronics, Inc.	105
Pan American Guided Missiles Range Div.	105
Plishner, P. J.	105
R. W. Electronics, Inc	106
• Radio Research Instrument Co.	106
Sierra Research Corp.	105
Sierra Western Electric	106
Surplus Saving Center	106
• Universal Relay Corp.	106

• See advertisement in the July 25, 1963 issue of electronics Buyers' Guide for complete line of products or services.

This Index and our Reader Service Numbers are published as a service. Every precaution is taken to make them accurate, but electronics assumes no responsibilities for errors or omissions.

electronics



Audit Bureau of Circulation



Associated Business Publications

AUDITED PAID CIRCULATION

JAMES T. HAUPTLI (2210)
Advertising Sales Manager

HENRY M. SHAW (3485)
Market Research Manager

DAVID M. TEMPEST (3139)
Promotion Manager

electronics Buyers' Guide

R. S. QUINT (2335)
General Manager

RICHARD J. TOMLINSON (3191)
Business Manager

THEODORE R. GEIPEL (2044)
Production Manager

NEW YORK TELEPHONE: Dial Direct:
971 plus number in parenthesis,
Area Code 212

ADVERTISING REPRESENTATIVES

ATLANTA, GA. 30309
Michael H. Miller, Robert C. Johnson
1375 Peachtree St. N.E.
Trinity 5-0523 (area code 404)

BOSTON, MASS. 02116
William S. Hodgkinson
McGraw-Hill Building, Copley Square,
Congress 2-1160 (area code 617)

CHICAGO, ILL. 60611
Harvey W. Wernecke,
Robert M. Denmead
645 North Michigan Avenue,
Mohawk 4-5800 (area code 312)

CLEVELAND, OHIO 44113
Paul T. Fegley
55 Public Square, Superior 1-7000
(area code 216)

DALLAS, TEXAS 75201
Frank Le Beau
The Vaughn Bldg.,
1712 Commerce St.
Riverside 7-9721 (area code 214)

DENVER, COLO. 80202
John W. Patten
Tower Bldg., 1700 Broadway,
Alpine 5-2981 (area code 303)

HOUSTON, TEXAS 77025
Kenneth George
Prudential Bldg., Halcombe Blvd.,
Riverside 8-1280 (area code 713)

LOS ANGELES, CALIF. 90017
Ashley P. Hartman, John G. Zisch,
1125 W. 6th St., Huntley 2-5450
(area code 213)

NEW YORK, N. Y. 10036
Donald H. Miller (212) 971 3615
George F. Werner (212) 971 3617
Donald R. Furth (212) 971 3616
500 Fifth Avenue

PHILADELPHIA, PA. 19103
Warren H. Gardner, William J. Boyle
6 Penn Center Plaza,
LOcust 8-4330 (area code 215)

SAN FRANCISCO, CALIF. 94111
Richard C. Alcorn
255 California Street,
Douglas 2-4600 (area code 415)

LONDON W1:
Edwin S. Murphy Jr.
34 Dover St.

FRANKFURT/Main:
Mathee Herfurth
85 Westendstrasse

GENEVA:
Michael R. Zeynel
2 Place du Port

TOKYO:
George Olcott,
1, Kotohiracho, Shiba, Minato-ku

SILICON PLANAR EPITAXIAL MICROLOGIC OFF THE SHELF

INTEGRATED LOGIC BUILDING BLOCKS AVAILABLE FROM DISTRIBUTORS

The improved and expanded family of Fairchild Epitaxial Micrologic products is now available for immediate delivery from distributor stocks or in volume quantities from the factory. A complete family of silicon Planar NOR logic building blocks, Epitaxial Micrologic has all necessary transistors and resistors diffused into a single chip of silicon by the Planar process and interconnected with metal over oxide. The new epitaxial construction gives these elements superior performance in speed, noise immunity and logic level separation. Typical propagation delay for the basic NOR circuit using the entire family is 12 nanoseconds. Available in JEDEC TO-5 and TO-47 type packages. For complete information on all nine Fairchild Epitaxial Micrologic elements, send for our 20-page data brochure, which includes specifications for the FACT reliability program.

FAIRCHILD
SEMICONDUCTOR

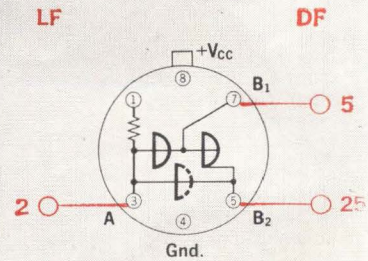
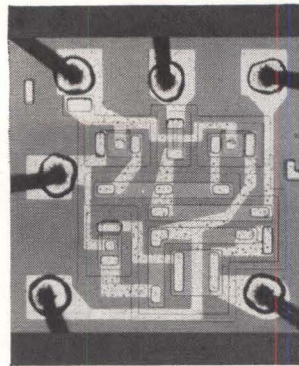

900 BUFFER

A low impedance inverting driver circuit.

POWER DISSIPATION (25°C)

	TYPICAL
INPUT HIGH	16 mW
INPUT LOW	45 mW

POSITIVE AND
NEGATIVE LOGIC: $B_1, B_2 = \bar{A}$

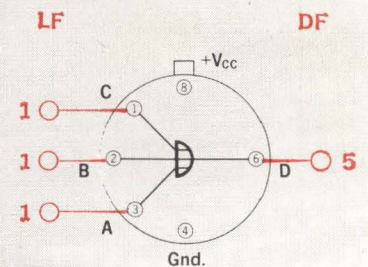
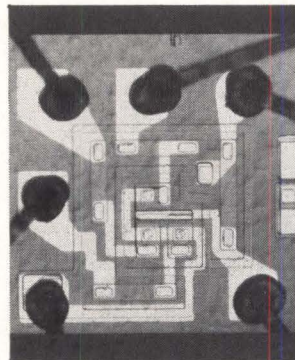

903 THREE-INPUT GATE

A three-input NAND/NOR circuit.

POWER DISSIPATION (25°C)

	TYPICAL
INPUT HIGH	19 mW
INPUT LOW	5 mW

POSITIVE LOGIC: $D = \overline{A + B + C}$
 $= \bar{A} \bar{B} \bar{C}$

NEGATIVE LOGIC: $D = \bar{A} \bar{B} \bar{C}$
 $= \bar{A} + \bar{B} + \bar{C}$

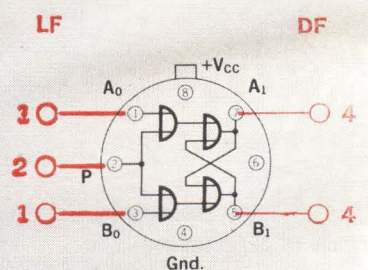
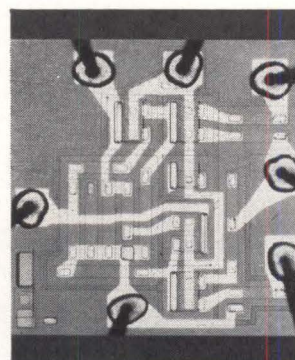

906 HALF-SHIFT REGISTER

A gated input storage element without inverter
(reduces power dissipation).

POWER DISSIPATION (25°C)

TYPICAL	36 mW
---------	-------

POSITIVE LOGIC: $A_1 = \bar{B}_1 (A_0 + P)$
 $B_1 = \bar{A}_1 (B_0 + P)$

NEGATIVE LOGIC: $A_1 = \bar{B}_1 + A_0 P$
 $B_1 = \bar{A}_1 + B_0 P$

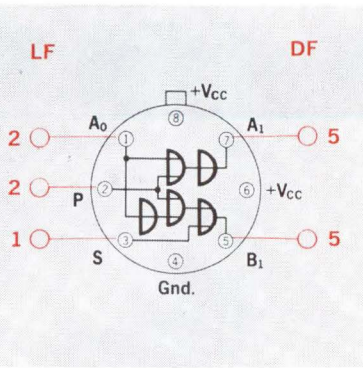
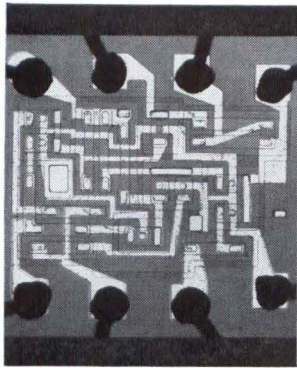

901 COUNTER ADAPTER

Provides gated, non-inverted complementary outputs from a single-valued input.

POWER DISSIPATION (25°C)
TYPICAL
55 mW

POSITIVE LOGIC: $A_1 = A_0 + P$
 $B_1 = (\bar{A}_0 + P) \bar{S}$
NEGATIVE LOGIC: $A_1 = A_0 \cdot P$
 $B_1 = \bar{A}_0 \cdot P + \bar{S}$

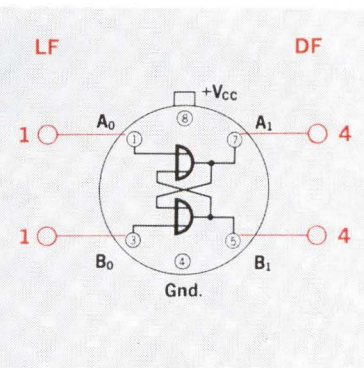
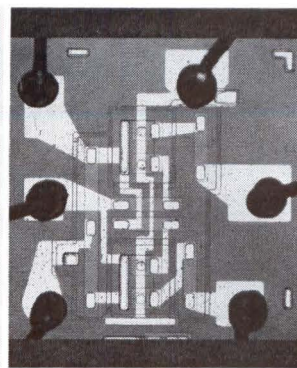

902 FLIP-FLOP

A bistable flip-flop storage unit.

POWER DISSIPATION (25°C)
TYPICAL
22 mW

POSITIVE LOGIC: $A = \bar{A}_0 \bar{B}_1$
 $B = \bar{B}_0 \bar{A}_1$
NEGATIVE LOGIC: $A = \bar{A}_0 + \bar{B}_1$
 $B = \bar{B}_0 + \bar{A}_1$

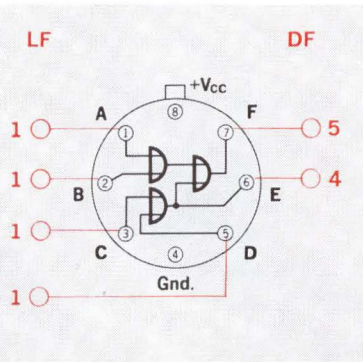
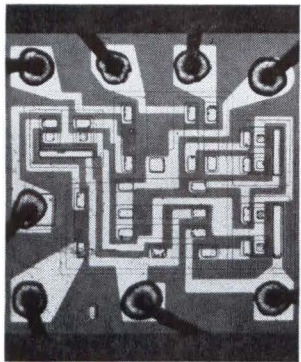

904 HALF ADDER

A two-level AND/OR gate suited for use as a complete half-adder, an exclusive OR gate or any similar logic function.

POWER DISSIPATION (25°C)
TYPICAL
45 mW

POSITIVE LOGIC: $E = \bar{C} + \bar{D}$
 $F = (A+B)(C+D)$
NEGATIVE LOGIC: $E = \bar{C} \bar{D}$
 $F = A \cdot B + C \cdot D$
IF $C = \bar{A}$
and $D = \bar{B}$
 $E = AB$
 $F = A\bar{B} + \bar{A}B$
 $E = A + B$
 $F = AB + \bar{C}\bar{D}$

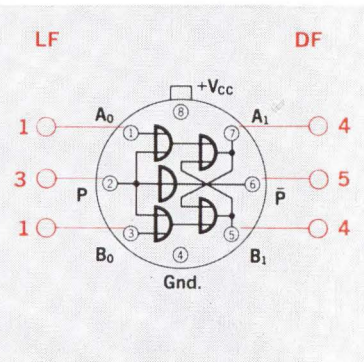
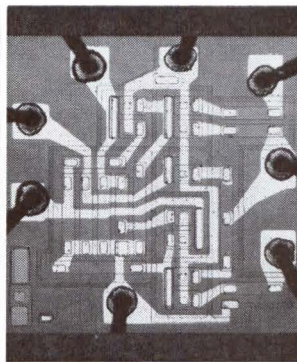

905 HALF-SHIFT REGISTER

A gated input storage element with inverter.

POWER DISSIPATION (25°C)
TYPICAL
53 mW

POSITIVE LOGIC: $A = \bar{B} (A_0 + P)$
 $B = \bar{A} (B_0 + P)$
NEGATIVE LOGIC: $A = \bar{B} + A_0 \cdot P$
 $B = \bar{A} + B_0 \cdot P$

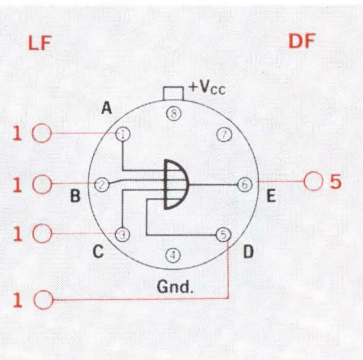
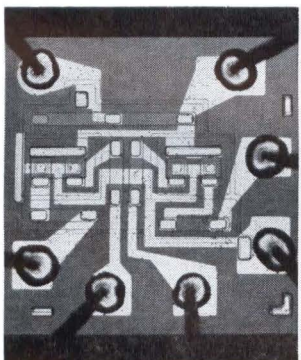

907 FOUR-INPUT GATE

A four-input NAND/NOR circuit.

POWER DISSIPATION (25°C)
TYPICAL
INPUTS HIGH 19 mW
INPUTS LOW 5 mW

POSITIVE LOGIC: $E = \overline{A+B+C+D}$
 $= \bar{A} \bar{B} \bar{C} \bar{D}$
NEGATIVE LOGIC: $E = \bar{A} \bar{B} \bar{C} \bar{D}$
 $= \bar{A} + \bar{B} + \bar{C} + \bar{D}$

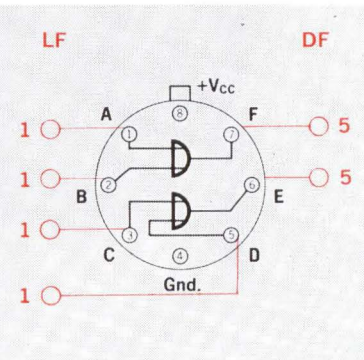
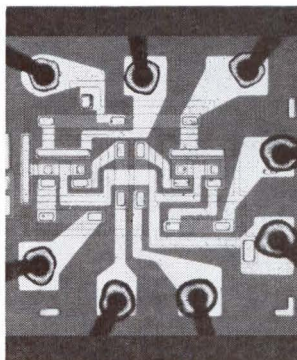

914 DUAL TWO-INPUT GATE

Dual NAND/NOR gates capable of forming a flip-flop, noninverting gate, or gate plus inverter.

POWER DISSIPATION (25°C)
TYPICAL
INPUTS HIGH 38 mW
INPUTS LOW 10 mW

POSITIVE LOGIC: $F = \overline{A+B} = \bar{A} \bar{B}$
 $E = \overline{C+D} = \bar{C} \bar{D}$
NEGATIVE LOGIC: $F = \bar{A} \bar{B} = \bar{A} + \bar{B}$
 $E = \bar{C} \bar{D} = \bar{C} + \bar{D}$

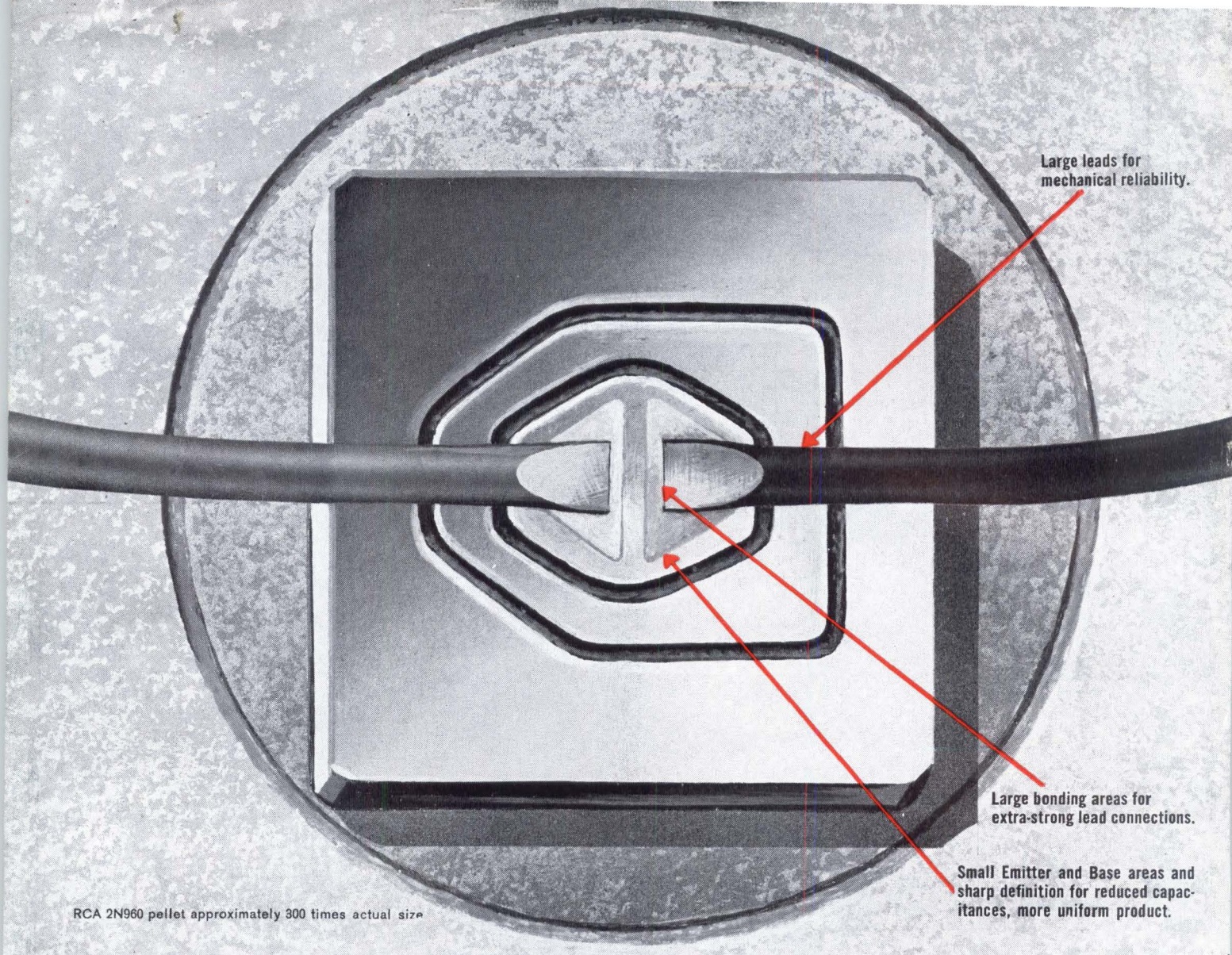

RCA 2N960 pellet approximately 300 times actual size

RCA TRAPEZOID MESA BRINGS NEW RUGGEDNESS TO 2N960 SERIES

RCA develops a new geometry and a new Germanium PNP Epitaxial Mesa Technology for new ruggedness, higher speed and greater unit-to-unit uniformity.

New RCA TRAPEZOID MESAS 2N960-2N967 answer industry's demand for fast and reliable switches. The unique construction developed by RCA increases over-all mechanical and electrical reliability and incorporates all of these design improvements:



TO-18 Package

- Minimum emitter and base area to reduce capacitances
- Minimum distance between base contact and emitter junction to reduce base resistance
- Maximum target bonding area for greater lead size and strength.

All these new design and processing improvements mean improved reliability and better performance. Typical T_{ON}

values for RCA's 2N960 are 25 nsec (2N960 max. is 50 nsec). For additional information on the new RCA TRAPEZOID MESA family, call your RCA Representative today. Or write: Commercial Engineering, Section CN-11, RCA Electronic Components and Devices, Harrison, N. J.

Available through your RCA Distributor

For a complementary ultra-high-speed NPN type...specify RCA 2N955A

The outstanding features of this 1000-Mc Germanium Epitaxial Mesa Switching Transistor include:

- 6 nsec stage delay in DTL logic circuits...7 nsec stage delay in RCTL circuits...under "worst-case" conditions and with a fan-out of three
- Low stored charge in saturation...45 pC typical
- High dc beta over a broad range of collector currents.



The Most Trusted Name in Electronics

CIRCLE 902 ON READER SERVICE CARD