

# electronics®

## NEW ERA IN ASTRONOMY

Big dish in Puerto Rico will have progeny

## PULSE LASER POWER SUPPLIES

How to avoid damaging parts

## UNITY-GAIN BUFFERS

Feedback scheme achieves precision

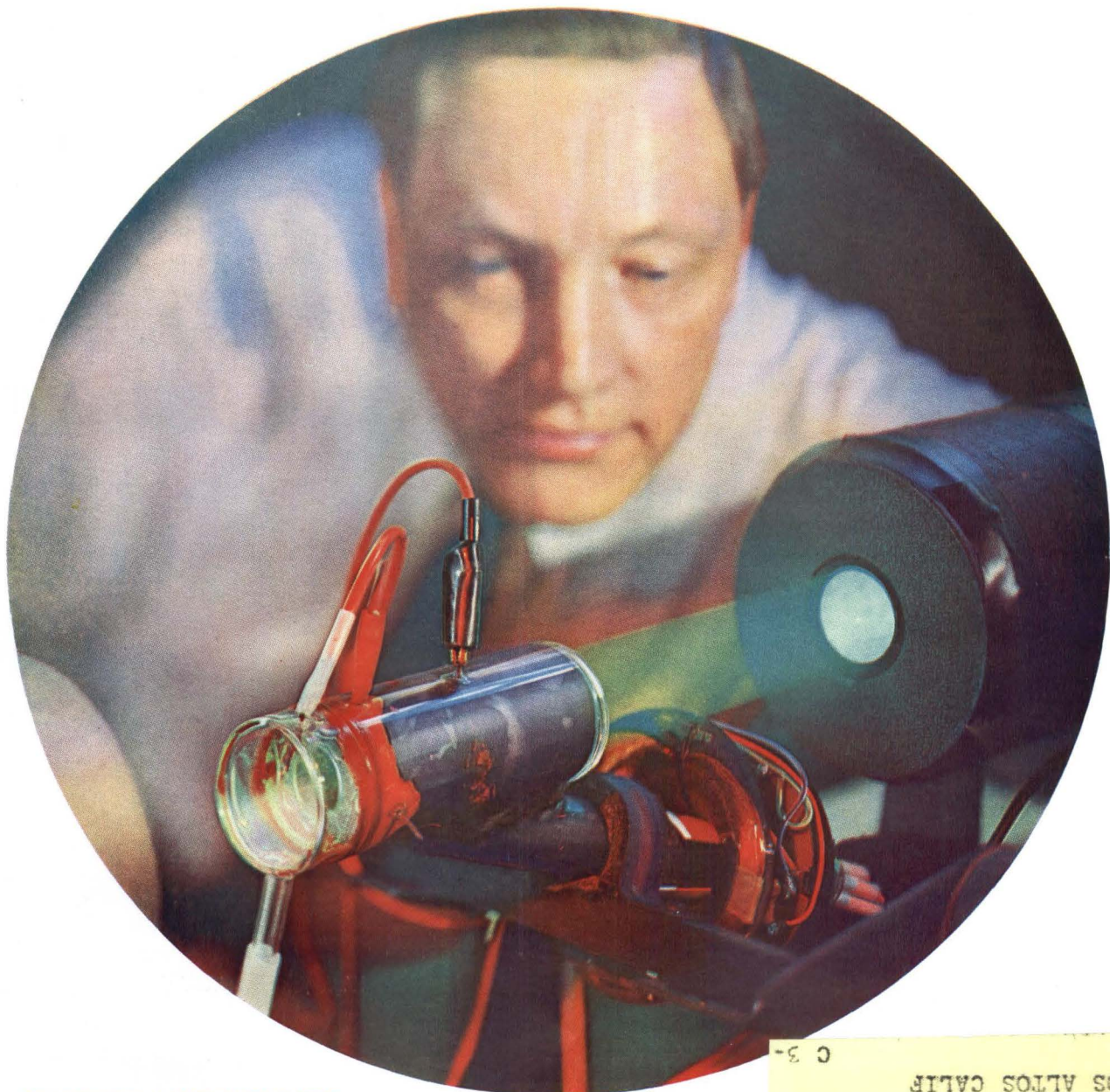

SOLID-STATE LIGHT MODULATOR uses electron gun to trace image on birefringent KDP crystal

R D SKINNER  
 1020 GOVINGTON RD  
 LOS ALTOS CALIF  
 C 3- L

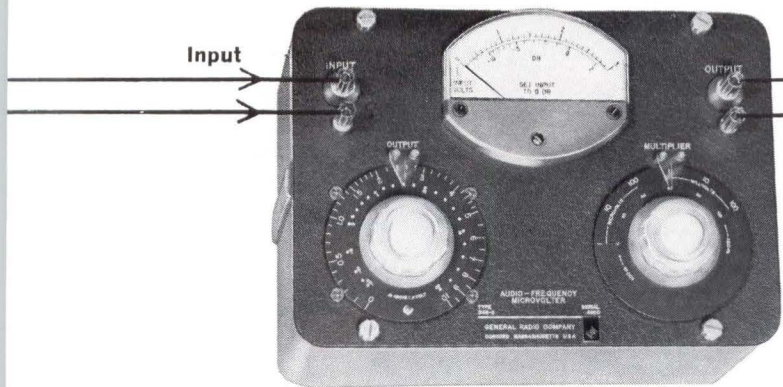

**SELECT: Accurately  
Known Voltages  
From 0.5 $\mu$ v to 1.0 volts**

with Type 546-C  
Audio-Frequency  
Microvolter. . . \$180 in U.S.A.

A passive instrument, the Microvolter attenuates audio-oscillator outputs to produce accurately known voltages. Its excellent frequency characteristics preserve the purity of waveform, and its panel meter allows constant monitoring of voltage level.

The wide range of the Microvolter and its ability to provide accurately known, extremely small voltages, makes it ideal for determining the emf generated by microphones, pickups, and other transducers. As commonly used, the 546-C provides a known voltage equal to that produced by the transducer as measured on an external amplifier-indicator (usually a simple, uncalibrated meter).

In addition, this instrument has found wide acceptance for the measurement of gain and loss in such things as amplifiers, transformers, networks, and lines.

**Output-Voltage Range:** From 0.5 microvolt to 1.0 volt open circuit, when the input voltage is set to the standardized reference value (2.2v). Basic accuracy is  $\pm 3\%$  into open circuit.

**Output Impedance:** Approximately 600 ohms. No correction of the output voltage is necessary for load impedances of the order of 100,000 ohms and greater.

**Input Impedance:** Approximately 600 ohms, substantially independent of output setting on all but the highest multiplier position.

**Input Requirements:** About 2.2 volts across 600 ohms, or approximately 8 milliwatts.

**Dimensions:** Width 10, height 7 $\frac{1}{4}$ , depth 6 $\frac{1}{4}$  inches over-all.

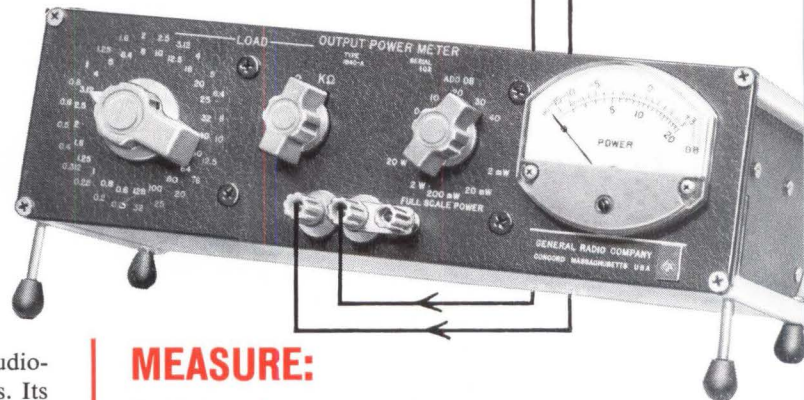
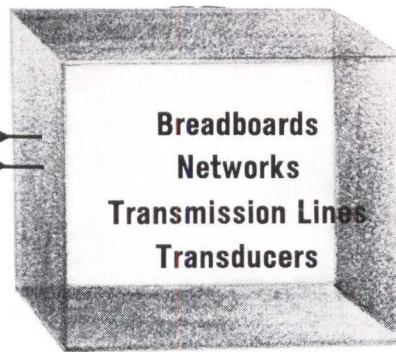

**MEASURE:  
Output Power and Impedance  
0.1mw-20 watts; 0.6 $\Omega$  to 32K $\Omega$**

with Type 1840-A Output Power Meter  
\$210 in U.S.A.

This is a passive instrument for the measurement of output power levels and impedances of audio-frequency equipment. The Type 1840-A presents a constant load to the device under test. Power is indicated directly on a meter-face in both watts and decibels/re 1mw. The impedance value appears at that dial setting which yields the maximum power reading (impedance values are arranged in 48 quasi-logarithmic steps).

Its wide power range and quasi-rms meter make the Type 1840-A an ideal instrument for the measurement of power output of amplifiers, transformers, transducers, networks, and low-frequency lines.

**Power Range:** 0.1 milliwatt to 20 watts. Auxiliary db scale reads from -15 to +43 db re 1 milliwatt. Basic accuracy is  $\pm 1$  db from 30c to 10 kc: does not exceed  $\pm 1.5$  db at 20c and 20 kc.

**Impedance Range:** 0.6 ohm to 32 kilohms in two ranges; 48 individual impedance settings spaced approximately  $\sqrt[3]{2}$  apart.

**Waveform Error:** True rms indicated despite as much as 20% second and third harmonics present in the input signal.

**Dimensions:** Width 12, height 4, depth 8 inches over-all. Panel adaptor sets available for 19-inch relay rack mounting (panel height 3 $\frac{1}{2}$  inches).

GR Manufactures a complete line of  
Audio and Sound Measuring Equipment

Write for complete information

**GENERAL RADIO COMPANY**

WEST CONCORD, MASSACHUSETTS

IN CANADA: Toronto 247-2171, Montreal (Mt. Royal) 737-3673  
IN EUROPE: General Radio Overseas, Zurich, Switzerland

NEW YORK, N. Y., 964-2722  
(Ridgefield, N. J.) 943-3140

CHICAGO  
(Oak Park) 848-9400

PHILADELPHIA, 424-7419  
(Abington) 887-8486

WASHINGTON, D.C.  
(Rockville, Md.) 946-1600

SYRACUSE  
454-9323

DALLAS  
FL 7-4031

SAN FRANCISCO  
(Los Altos) 948-8233

LOS ANGELES  
469-6201

ORLANDO, FLA.  
425-4671

CLEVELAND  
886-0150

CIRCLE 900 ON READER SERVICE CARD

**W. W. MacDONALD, Editor**  
Telephone Area Code 212 (971-2645)

**J. M. CARROLL, Managing Editor (2293)**

**SENIOR EDITORS**

Samuel Weber (2371)  
George W. Sideris (3444)

**SENIOR ASSOCIATE EDITORS**

Michael F. Wolff (2600)  
John F. Mason (2666)

**ASSOCIATE EDITORS**

Michael F. Tomaino (2071)  
William P. O'Brien (2297)  
George J. Flynn (2188)  
George V. Novotny (3151)  
Leon H. Dulberger (3446)  
Alexander A. McKenzie (2685)

**ASSISTANT EDITORS**

Stephen B. Gray (2245)  
Barry A. Briskman (2306)  
Dan Smith (2467)  
Joel A. Strasser (2127)  
Vincent S. Acunto (2592)  
C. R. Whetstone (3495)  
Eric Valentine (2710)  
Louis S. Gomolak (2472)  
G. G. Tirellis (2187)

**REGIONAL EDITORS**

Harold C. Hood,  
1125 W. 6th St., Los Angeles 90017, Calif.  
(213-482-5450)  
Laurence D. Shergalis,  
John Hancock Bldg., 255 California St.,  
San Francisco 94111, Calif. (415-362-4600)  
Thomas Maguire  
McGraw-Hill Bldg., 607 Boylston St.,  
Boston 02116, Mass. (617-262-1160)  
Cletus M. Wiley,  
Blair Bldg., 645 N. Michigan Ave.,  
Chicago 60611, Ill. (312-664-5800)

**ART DIRECTOR**

Howard R. Berry (2430)

**ASSISTANT ART DIRECTOR**

John C. Wright, Jr. (3430)

**EDITORIAL ASSISTANTS**

Lorraine Rossi, Virginia T. Bastian,  
Lynn Emery, Ann Mella, Lorraine Werner,  
Alice M. O'Brien, Sharon Parks,  
Claire Benell, Kay Fontana,  
Sandra A. Le Mond, Mary Jo Jadin

**FOREIGN NEWS BUREAU**

**DIRECTOR**, John Wilhelm, (2532);  
Lawrence Mihlon (2997), Alyne Elias  
(2998)  
**LONDON**—John Shinn, Derek Barlow,  
Nicholas Landon, 34 Dover St., London  
W.1, England  
**BONN**—Bruce Bendow, Richard Mikton,  
Silke McQueen, Mittelstrasse 39, Bad  
Godesberg, Germany  
**BRUSSELS**—27 Rue Ducarle, Brussels,  
Belgium  
**PARIS**—Robert Farrell, Arthur Erikson,  
17 Ave. Matignon, 3rd Fl., Paris 8,  
France  
**MILAN**—Marc A. Messina, Via Manzoni  
No. 12, Milan, Italy  
**MEXICO CITY**—Wesley Perry, Jr.,  
Lafagua 4-314, Mexico 1 D.F. Mexico  
**RIO DE JANEIRO**—Leslie Warren, Rua  
Mexico 3-S/1507 1509, Rio de Janeiro,  
Brazil  
**MOSCOW**—Stewart Ramsey,  
Kutuzovsky Prospekt 19, Apt. 28-29,  
Moscow, USSR  
**TOKYO**—Richard Halloran, Charles Cohen,  
John Yamaguchi, Toranomon Sangyo  
Bldg., 1 Kotohiracho Shiba, Minato-Ku,  
Tokyo, Japan

**CIRCULATION MANAGER**

Hugh J. Quinn (2310)

**C. C. RANDOLPH, Publisher (2016)**

# electronics

A MCGRAW-HILL WEEKLY 75 CENTS

**ELECTRON GUN CONTROLS LIGHT.** This solid-state light modulator by Motorola consists of a birefringent KDP crystal in a vacuum chamber. Electron gun produces a magnetically deflected beam that traces out an image on the crystal and thus controls light from projection lamp. *Resolution of 100 lines per inch is achieved in projecting crt or tv displays. See p 58* COVER

**SPACE STATION.** When Defense Secretary McNamara cancelled the Dyna-Soar program last week and substituted the Manned Orbiting Laboratory, it created an upheaval in Air Force space planning and contracting. *This week's report sorts out what will be required for the MOL* 10

**MILITARY COMPUTERS.** New breed of computers will probably result from Air Force Project Forecast. Object is to let commanders work problems directly with computers. *Key to concept is low-cost logic and memories, to make computer time cheaper* 24

**WORLD'S LARGEST ANTENNA.** One-thousand-foot dish carved out of a Puerto Rican mountainside exemplifies the demands of science and the military for longer-range radio and radar astronomy. In its active mode, two klystrons originally developed for BMEWS put out 2.5 megawatts peak. *Next may come a multiplate antenna with 5,000 flat plates each 20 by 20 feet arranged around a 1,000-ft tower.* By T. Maguire 29

**LASER POWER SUPPLIES.** The capacitor bank of an optically pumped laser must be charged at a gradually increasing voltage to avoid a high initial load on the a-c power lines. A constant-current network is often used at the input to the rectifier transformer. But its output voltage must be limited at periods of zero load to avoid damage to components. *This circuit accomplishes the required voltage limiting automatically and without distortion.* By S. J. Grabowski, General Electric 33

**UNITY-GAIN BUFFER AMPLIFIER.** Isolation amplifiers used in a-c control systems must have a gain of precisely unity and zero phase shift. Most of these buffers depend upon use of precision components. This one depends on feedback. *Essentially, it is a two-stage transistor amplifier in which a common-base stage is followed by an emitter follower.* By D. K. Phillips, Operations Research Inc. 36

**GATED PULSES SELECT FREQUENCIES.** This circuit uses digital techniques to distinguish between different frequencies. Leading edges of input signals trigger a precision multivibrator and coincidence of pulses provides frequency discrimination. *Heart of the system is a magnetic monostable multivibrator with low drift and good thermal characteristics.* By J. H. Firestone, General Time 38

Contents continued

Published weekly, with Electronics Buyers' Guide as part of the subscription, by McGraw-Hill Publishing Company, Inc. Founder: James H. McGraw (1860-1948).

Title ® registered U.S. Patent Office; © copyright 1963 by McGraw-Hill Publishing Co., Inc. All rights reserved, including the right to reproduce the contents of this publication, in whole or in part.

Executive, editorial, circulation and advertising offices: McGraw-Hill Building, 330 West 42nd Street, New York, N. Y., 10036. Telephone Area Code 212 971-3333. Teletype TWX N. Y. 212-640-4646. Cable McGrawhill, N. Y. PRINTED IN ALBANY, N. Y.; second class postage paid at Albany, N. Y.

OFFICERS OF THE PUBLICATIONS DIVISION: Shelton Fisher, President; Vice Presidents: Joseph H. Allen, Operations; John R. Callahan, Editorial; Ervin E. DeGraff, Circulation; Donald C. McGraw, Jr., Advertising Sales; Angelo R. Venezian, Marketing.

OFFICERS OF THE CORPORATION: Donald C. McGraw, President; Hugh J. Kelly, Harry L. Waddell, L. Keith Goodrich, Executive Vice Presidents; John L. McGraw, Treasurer; John J. Cooke, Vice President and Secretary.

Subscriptions are solicited only from those actively engaged in the field of the publication. Position and company connection must be indicated on orders. Subscription rates: United States and Possessions and Canada, \$6.00 one year, \$9.00 two years, \$12.00 three years. All other countries \$20.00 one year. Single copies, United States and Possessions and Canada 75¢. Single copies all other countries \$1.50.

THE PUBLISHER, UPON WRITTEN REQUEST TO OUR NEW YORK OFFICE FROM ANY SUBSCRIBER, AGREES TO REFUND THAT PART OF THE SUBSCRIPTION PRICE APPLYING TO COPIES NOT YET MAILED.

Subscribers: Please send change of address notices, subscription orders or complaints to Fulfillment Manager, Electronics, at the address below. Change of address notices should provide old as well as new address, including postal zone number if any. If possible, attach address label from recent issue. Allow one month for change to become effective.

Postmaster: Please send Form 3579 to Fulfillment Manager, Electronics, P. O. Box 430, Hightstown, New Jersey, 08520.



Audited Paid Circulation

Contents continued

**COMMUNICATIONS RANGE NOMOGRAPH.** Simplifies the solution of the communications range equation. *Any single term of the equation can be found if the remaining terms are known.* By M. W. Shores, General Dynamics/Pomona 41

**MULTIFONT READER.** New entry in the estimated \$1-billion-a-year market for document readers is a system that can read three pages or seven file cards a second. It's done with a flying-spot scanner and a logic system. *Commercial system reads three type styles, others read nine and eight type styles* 49

**SOLID-STATE POWER DRIVE.** Servo power drive for gun mounts and antennas is one-quarter the size of an amplidyne system. *Key subsystem uses silicon controlled rectifiers* 51

**AIR-GROUND DATA LINKS.** A standard that would facilitate the proposed mechanization of routine air-traffic-control communications is nearly ready. *Meanwhile, Air Force is looking to more digital data links as alternatives to voice communications* 54

DEPARTMENTS

**Crosstalk.** Standard Standards 5

**Comment.** VSWR Chart 6

**Electronics Newsletter** 17

**Meetings Ahead.** Global Communications International Symposium 18

**Washington This Week.** Tax break or Loans Proposed as Stimulants for Commercial R&D 20

**Research and Development.** Crystal Modulates Light Beams 58

**Components and Materials.** Silicon Rectifier Controls Power in Either Direction 63

**Production Techniques.** PERT Aids Small Projects, Too 66

**New Products.** Tape Stores Computer Queries 71

**Literature of the Week** 75

**People and Plants.** ITT Expands in West 76

**Index to Advertisers** 80

**Now from Sprague!**

# SEPT<sup>®</sup>

## SILICON PLANAR EPITAXIAL TRANSISTORS 2N2217 thru 2N2222

TO-5 (P <sub>D</sub> =.8W) TO-18 (P <sub>D</sub> =.5W)	2N2217 2N2220	2N2218 2N2221	2N2219 2N2222
BV <sub>CBO</sub>	60 V (min.)	60 V (min.)	60 V (min.)
I <sub>CBO</sub> @ 50V	10nA(max.)	10nA(max.)	10nA(max.)
h <sub>FE</sub> @ I <sub>C</sub> =150 mA	20-60	40-120	100-300
V <sub>CE</sub> (SAT) @ I <sub>C</sub> =150 mA	.4 V (max.)	.4 V (max.)	.4 V (max.)
C <sub>ob</sub> @ 10 V	8 pF	8 pF	8 pF
f <sub>T</sub> @ V <sub>CE</sub> = 20 V I <sub>C</sub> = 20 mA	400mc(typ.)	400mc(typ.)	400mc(typ.)

Sprague N-P-N SEPT<sup>®</sup> Transistors are designed for optimum emitter perimeter-to-area ratio, providing outstanding gain uniformity from 0.1 mA to 500 mA and f<sub>T</sub> (typ.) of 400 mc. Sprague epitaxial techniques guarantee high BV<sub>CEO</sub> (30V) and low V<sub>CE</sub> (SAT) (.24 V @ 150 mA).

**SEPT<sup>®</sup> TRANSISTORS FILL A WIDE RANGE OF APPLICATIONS AS SWITCHES, CORE DRIVERS, AND AMPLIFIERS!**

For application engineering assistance, write to Transistor Division, Sprague Electric Co., Concord, N. H. For technical data, write for Engineering Bulletins 32,000, 32,005 and 32,010A to Technical Literature Service, Sprague Electric Co., 35 Marshall St., North Adams, Mass.

### SPRAGUE COMPONENTS

TRANSISTORS  
CAPACITORS  
RESISTORS  
MICROCIRCUITS  
INTERFERENCE FILTERS

PULSE TRANSFORMERS  
PIEZOELECTRIC CERAMICS  
PULSE-FORMING NETWORKS  
TOROIDAL INDUCTORS  
ELECTRIC WAVE FILTERS

CERAMIC-BASE PRINTED NETWORKS  
PACKAGED COMPONENT ASSEMBLIES  
BOBBIN and TAPE WOUND MAGNETIC CORES  
SILICON RECTIFIER GATE CONTROLS  
FUNCTIONAL DIGITAL CIRCUITS

**SPRAGUE<sup>®</sup>**  
THE MARK OF RELIABILITY

'Sprague' and '®' are registered trademarks of the Sprague Electric Co

**LOW  
PRICE  
LUXURY  
MODEL**

**Measure**

- Frequency to 20 or 50 mc
- Period to 1 mc
- Multiple Period Average to  $10^5$  periods
- Ratio

***Two new  
Electronic Counters from  
Hewlett-Packard***

These new instruments offer high counting rates, high sensitivity, all the recognized hp quality performance features. By eliminating plug-in capability for applications where complete versatility is not needed,

Hewlett-Packard provides you with the features of "luxury" instruments at the lowest possible cost. Here's what you get in the hp 5242L (maximum counting rate of 20 mc) and the hp 5244L (counting rate to 50 mc):

- Stable time base with drift less than  $\pm 2$  parts in  $10^7$  per month
- 100 mv rms sensitivity
- High sampling rate (0.1 sec to 5 seconds, variable), independent of gate time
- Seven-digit readout, rectangular Nixies, display storage for continuous display
- BCD output for digital recorders, systems use
- Self check in all functions
- Operate  $-20^\circ$  to  $+65^\circ$
- Solid state, plug-in module construction, compact, bench and rack model in one

*All this for only \$2225 (5242L) or \$2450 (5244L)*

Have your Hewlett-Packard field engineer demonstrate the model that will best serve your application. Where plug-in versatility is needed, ask him to show you models 5243L and 5245L. They provide more measurement capabilities than any other counter available today.

*Data subject to change without notice. Prices f.o.b. factory.*

**HEWLETT  
PACKARD  
COMPANY**



8863

1501 Page Mill Road, Palo Alto, Calif. 94304, (415) 326-7000. Sales and service in all principal areas. Europe, Hewlett-Packard S.A., 54 Route des Acacias, Geneva, Switzerland; Canada, Hewlett-Packard (Canada) Ltd., 8270 Mayrand St., Montreal, Que.



# Standard STANDARDS

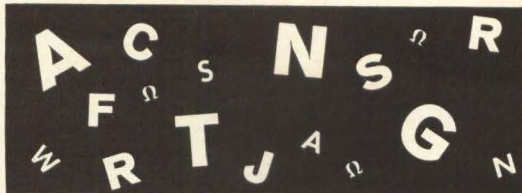

**THIS MONTH** the IEEE Symbols Committee will approve and forward to the Standards Committee a proposed standard on symbols for units. In due time this proposed standard will probably be adopted by the institute and perhaps by the American Standards Association as an American standard.

If adopted, the standard will go a long way towards facilitating communications between electronics engineers in the U.S. and in the rest of the world and between electronics engineers and physicists even here in the U.S.

Basically, it would bring our letter symbols for units into agreement with the latest work of the International Organization for Standardization and the International Electrotechnical Commission. The symbols used by physicists already agree substantially with this international work.

The major change would be the required use of upper-case letters for symbols for units derived from proper names: A for ampere, C for coulomb, Ci for curie, B for bel, F for farad, Gal for gal, H for henry, Hz for hertz, J for joule, Np for neper, N for newton,  $\Omega$  (upper-case Greek omega) for ohm, R for roentgen, S for siemens, T for tesla, V for volt, W for watt and Wb for weber.

The gal (named in honor of Galileo) or  $\text{cm/s}^2$ , siemens or reciprocal ohm, hertz or cycle/s and tesla or  $\text{Wb/m}^2$  may seem strange to some American engineers but are widely used throughout the rest of the world.

The new standard would do away with some strange practices in the U. S. For example, our engineers speak of the "kilocycle" although the only definition of the kilocycle ever adopted was "a community vehicle for ten centipedes". This was passed, jokingly, by the former IRE Standards Committee. The FCC and the State Department have already standardized on the symbol kc/s; soon the National Bureau of Standards and NASA will adopt the kHz (and of course all the permutations of metric prefixes).

Gone would be the Bev that leaves some readers in doubt as to whether a thousand-million or a million-million electron volts is meant. The new unit would be the GeV (gigaelectronvolt).

Other changes too would help bring American engineering standards up to date with those of the rest of the world: use of the (unified) atomic mass unit, use of the joule instead of the calorie whenever possible, abandonment of the term centigrade for the Celsius temperature scale, use of the candela instead of the candle (and  $\text{cd/m}^2$  for the lambert), use of teslas and amperes instead of gauss and gilberts whenever possible, use of the weber instead of the maxwell, use of the term micrometer instead of micron, use of  $\text{A/m}^2$  instead of the oersted, and avoidance of the pint, quart and gallon for liquid measure (because of different U. S. and UK meanings). The symbol r/min would be preferred over the familiar rpm.

No human being likes to see his lifetime habits suddenly deprecated and, indeed, it may be some time before international symbols are universally adopted in this country, but the proposed standard will go a long way towards making it easier to communicate internationally in this truly international art and towards enabling U.S. manufacturers to compete more effectively for world markets.

## EXCEPTIONALLY STABLE WAVEFORMS

EVEN AT 5,000 MC,  
TRACES ARE UNMARRED  
BY DOT-SPLATTER

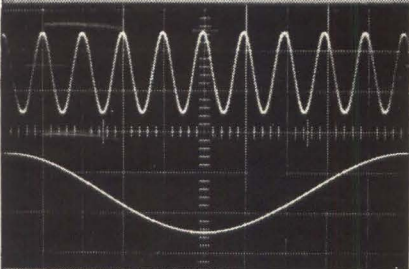

Unique triggering stability of Analab Type 701 plug-in demonstrated by display of 5,000-mc sine wave. Bottom trace shows same waveform expanded 10:1 (a double exposure).

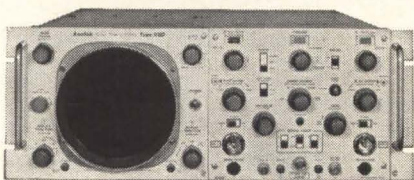

Analab Type 1120R/701 sampling oscilloscope (rack mounting). Also available as portable scope.

ONLY WITH

# Analab

## SAMPLING OSCILLOSCOPES

using the completely transistorized  
TYPE 701 sampling and sweep plug-in

Now, with the new Analab scope system, you can obtain signal-repetition rates to 5,000 mc and over, without external pre-trigger signals, countdown generators, or delay lines. Waveforms can be plotted with slaved x-y recorder, or stored indefinitely on the Analab storage scope (type 1220/701). The most undistorted deflection, brightest displays obtainable on any high-frequency oscilloscope.

### Type 701 plug-in features:

- Built-in trigger circuits with one-knob control...triggers directly from the signal.
- Built-in sweep circuits, sweep ranges from 10 picoseconds/cm to 2 microseconds/cm.
- Built-in direct-coupled dual-channel amplifiers, nominal risetime 350 picoseconds.

Write or phone for complete technical data and demonstration.

**Analab Instrument  
Corporation**

Cedar Grove, N. J. • (201) 239-6500

## COMMENT

### TRANSISTOR-RADIO JAMMER

It disturbs me to see a letter from somebody who had devised electronic jammers to blank out transistor radios (p 6, Nov. 22) and from a reader who approved of this (p 6, Nov. 29).

On the one hand, I know that it can be most annoying to be forced to listen to another person's choice of what in most of these cases can only loosely be described as music.

But, on the other hand, there are enough jamming signals floating around unintentionally right now, without having to add to them deliberately. For instance, f-m radios are prohibited from being operated on airlines because the i-f is too close to some navigation bands.

Instead of adding to the extraneous signals in the air, let's do what we can to reduce them.

S. BARRAT

Ithaca, New York

### DISGUISED ELECTRONICS

One of your readers, G. Barbara (p 6, Dec. 6) seems to be quite shaken up over radios that look like bottles of scotch, and radios that are actually small bars. He overlooks the fact that the makers of these disguised items have found that there is a limit to the number of ways they can package a transistor radio and make it look new and different while still looking like a radio. And there are always people who will buy something because it looks different, people who would buy a radio only because it resembled a waffle or a carrot.

Radios are not the only consumer electronics items that have the same old circuit repackaged ever so often to look as though they were hot out of the R&D lab. Even the specs can be juggled around a little to make the item look like new.

And as for predicting that this trend may produce "oscilloscopes that look like wastebaskets," that wouldn't be too bad as long as the cleaning men don't try to dump out the insides.

R. BOWLBY

South Gate, California

### VSWR CHART

In our article Easy-To-Use Chart for VSWR (p 38, Nov. 22), one sentence reads: The standard method of determining vswr,  $\rho$ , is to measure the impedance at the input of the line, ( $R_p$ ), normalize by the characteristic (surge) impedance of the line, ( $R_0$ ), and solve for vswr.

The statement written is not the equivalent of our: The standard method of determining the vswr is to measure the impedance at the input of the line, normalize by the characteristic (surge) impedance of the line, and solve for vswr by formula or by plotting the normalized value on . . . .

The statement as it appeared is incorrect in that  $R_p$  is not the impedance of the line, but is the reciprocal of the real part of the admittance (see the Fig.).

In the formula, the first two  $p$ 's in the denominator should be  $\rho$ 's, and the square-root sign should extend across the entire expression to the right of the  $\pm$  sign in the denominator.

G. H. HAGN  
B. M. SIFFORD

Communication Laboratory  
Stanford Research Institute  
Menlo Park, California

### WIRES CUT CRYSTALS

In reviewing the article, Wires Cut Crystals Accurately, in the Nov. 1 issue of ELECTRONICS (p 46), I noticed an error in the dimensional tolerance of 0.005 inch; it should read 0.0005 inch. And the upper right photo is upside down.

As an additional comment, we have found since submitting the article that domestic wire, properly selected, is equal to European tungsten wire in this application.

E. H. LEDERER

Semiconductor Products Department  
General Electric Company  
Syracuse, New York



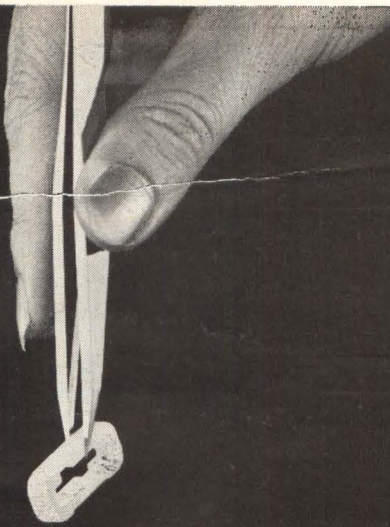

What good is a getter?

*Babcock uses them to increase relay reliability.*

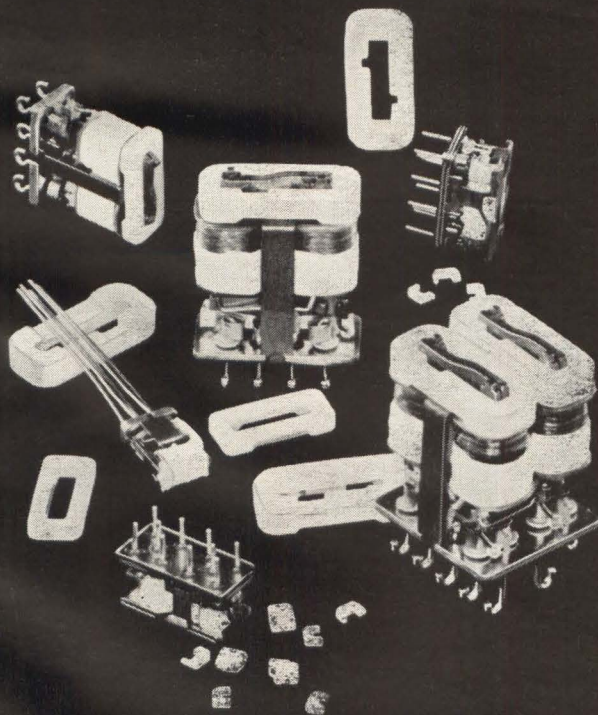

**Exclusive Babcock Design Feature Provides Lower Contact Resistance & Longer Relay Life**

Contact contamination from vaporization is one of the major causes of erratic performance and eventual failure of hermetically sealed relays. After extensive investigation Babcock Relays, in conjunction with Corning Glass Works, has developed an activated getter from Corning's Vycor brand porous glass. During operation, the activated getters prevent relay contacts from being fouled by contaminants emitted at elevated temperatures. Babcock has subjected relays using Vycor getters to hundreds of thousands of operations at loads varying in excess of 200G's for 11 milliseconds and vibration at 35G's, 3-5,000 cps. It has been determined that up to 99% of organic contaminants remaining after production degassing are adsorbed by the dessicant. Conclusive life testing at 125°C has proven that contact erosion and contamination accumulation on all vital areas within hermetically sealed relays has been substantially reduced. Consistently lower contact resistance is also exhibited due to the reduction in contamination.

The end result provides Babcock relays with increased performance and efficiency, higher temperature application, and longer, more reliable life.

Babcock reliability rated relays featuring Vycor getters include:



**BR-5**—Transistor-sized dry circuit to one amp



**BR-13**—Microminiature, all-welded for dry circuit to 3 amp



**BR-17**—Half-size magnetic latching for dry circuit to 2 amp operation. Also available as non-latching model.

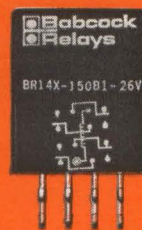

**BR-14**—Subminiature 4 PDT available in 10, 7.5 and 5 amp



**BR-19**—Subminiature all-welded 10 amp relay. BR-20 magnetic latching version also available.

Send for complete catalog.

**BABCOCK  
RELAYS**

A DIVISION OF BABCOCK ELECTRONICS CORPORATION  
3501 HARBOR BLVD., COSTA MESA, CALIF. • 546-2711

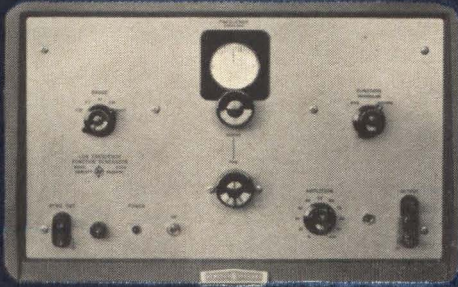

202A

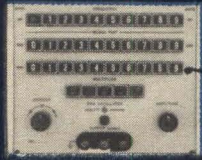

241A



211A

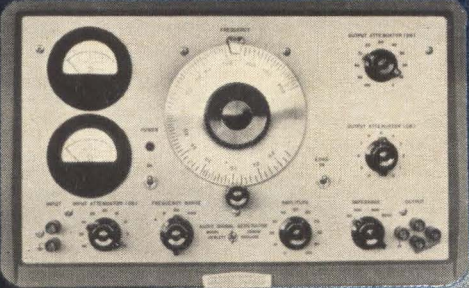

205AG



204B

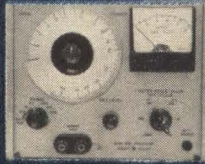

208A



206A

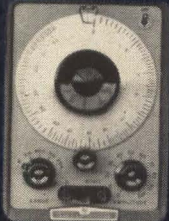

200CD

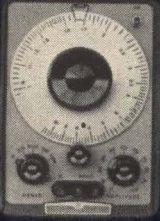

202C

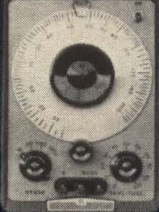

200AB



201C

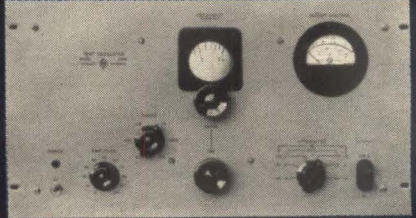

650A

# In Tune

## Accurate test signals for every application, 0.008 cps to 10 mc

In this group of accurate, easy-to-use oscillators from Hewlett-Packard, one is just right for your test measurements. The resistance-capacitance oscillator, pioneered by Hewlett-Packard, offers simple operation, high frequency stability, wide frequency range, with low distortion, excellent frequency response and high amplitude stability. Controls are few and easy to use. The oscillators provide depend-

able output without tedious resetting or adjustment. Each is designed to make your test work faster, easier and more economical.

8838

# HEWLETT PACKARD COMPANY



1501 Page Mill Road, Palo Alto, Calif. 94304, (415) 326-7000. Sales and service in all principal areas. Europe, Hewlett-Packard S.A., 54 Route des Acacias, Geneva, Switzerland; Canada, Hewlett-Packard (Canada) Ltd., 8270 Mayrand St., Montreal, Que.

Model	Frequency Range	Description, Features	Output	Price
200AB Audio Oscillator	20 cps to 40 kc, 4 ranges	Ideal for amplifier testing, modulating signal generators, testing transmitter modulator response; balanced output	1 watt (24.5 v/600 ohms)	\$165*
200CD Wide Range Oscillator	5 cps to 600 kc, 5 ranges	Subsonic to radio frequencies, useful for testing servo and vibration systems, medical and geophysical equipment, audio amplifiers, video frequency circuits; low distortion independent of load	160 mw (10 v/600 ohms)	\$195*
201C Audio Oscillator	20 cps to 20 kc, 3 ranges	High power, designed for testing amplifiers, speakers, crossover nets; 40 db attenuator in 10 db steps	3 watts (42.5 v/600 ohms)	\$250*
202A Low Frequency Function Generator	0.008 to 1200 cps, 5 ranges	Source of continually variable, transient-free sine, square, triangular waves for electrically simulating mechanical, physical, medical phenomena; $\pm 1\%$ stability	28 mw (30 v p-p/4000 ohms)	\$550**
202C Low Frequency Oscillator	1 cps to 100 kc, 5 ranges	Ideal for subsonic, audio, ultrasonic applications such as vibration, electro-cardiograph, electro-encephalograph; <0.5% distortion and <0.1% hum; recovery time <5 sec at 1 cps output	160 mw (10 v/600 ohms)	\$300*
204B Solid State Portable Oscillator	5 cps to 560 kc, 5 ranges	Solid state, portable, battery or optional ac operation; output fully floating, will drive balanced and unbalanced loads referenced above or below ground; highly stable; distortion <1%	10 mw (2.5 v/600 ohms)	\$315***
205AG Audio Signal Generator	20 cps to 20 kc, 3 ranges	A single instrument for making high power audio tests, gain and frequency response measurements; two VM's measure input and output of device under test	5 watts adjustable/50, 200, 600, 5000 ohms	\$600**
206A Low Distortion Audio Signal Generator	20 cps to 20 kc, 3 ranges	Distortion <0.1%; ideal for testing FM broadcasting units, high fidelity audio systems; metered output, variable in 0.1, 1, and 10 db steps to 111 db	+15 dbm/50, 150, 200 ohms	\$900**
208A 208A-DB Portable Test Oscillators	5 cps to 560 kc, 5 ranges	Excellent frequency response and stability; output monitored by VM with 2% accuracy into 600 ohms; 208A is calibrated in volts; 208A-DB is calibrated in db; solid state; operates from rechargeable batteries and ac line	10 mw (+10 dbm) (2.5 v/600 ohms)	\$525 \$535
211A Square Wave Generator	1 cps to 1 mc	Provides square waves for audio, video testing, 20 nsec rise time; full amplitude variation on each of 2 outputs	3.5 v/75 ohms 27 v/600 ohms	\$350
241A Pushbutton Oscillator	10 cps to 1 mc	Pushbutton selection of frequency for repetitive, production testing; excellent resetability, stability	10 mw (2.5 v/600 ohms)	\$425
650A Test Oscillator	10 cps to 10 mc, 6 ranges	Ideal for measurements in audio, supersonic, video, rf ranges; metered output flat within 1 db; distortion <1%, 20 cps to 100 kc; less than 2%, 100 kc to 1 mc; approx. 5% at 10 mc; 50 db attenuator, 10 db steps	15 mw (3 v/600 ohms)	\$550**

\*Cabinet models; rack mount models \$5 additional. \*\*Cabinet models; rack mount models \$15 less. \*\*\*AC operation optional, \$25 extra.

Data subject to change without notice. Prices f.o.b. factory.

# Manned Space Station:

Orbiting lab will save \$100 million. Here's what it will accomplish

**WASHINGTON** — Cancellation of the Air Force's Dynasoar program last week is causing an immediate drop in military space procurement. Less than \$100 million will be spent over the next 18 months on the manned orbiting laboratory (MOL) that replaced Dynasoar, for which additional funding in the same period would have been twice this amount.

Approximately \$400-million was expected to have been already spent by the time the program was finally closed out early this week, according to Defense Secretary McNamara. Ultimately, it would have cost about \$1 billion to get the first Dynasoar into space by 1968.

In spite of the decision to cancel Dynasoar, a number of supporting programs will remain intact. Asset, a program to flight-test a variety of aircraft configurations on reentry, will be greatly expanded. The second unmanned Asset vehicle was delivered to Cape Kennedy two weeks ago. RCA's communications and tracking system for Dynasoar will continue since it has application to Gemini and Apollo. And, the Aerospace Plane, a Dynasoar follow on, that was to scoop air out of the atmosphere to mix with hydrogen fuel is seen as a possible ferry vehicle to support future space stations.

**Missions** — Manned orbiting space stations have potential applications as general reconnaissance spacecraft. Future versions housing up to 24 men could be used to observe enemy troop movements and military installations and to monitor nuclear detonations. Huge space command stations as well as manned-interceptor operating bases are expected to be off-shoots of the MOL program. Missile-detection

stations capable of analyzing fuel content of the engine exhaust plumes of enemy ballistic missiles could be an important warning system for our national defenses.

Official pronouncements on the station's mission were limited to predicting tests of navigational aids and meteorological sensors, and other classified activities. It's expected that, in addition, research will be directed toward communications satellites, blackout problems, free-space antenna measurements, radio propagation, and sensors: including radar, infrared, ultraviolet, television and photographic. A jam-proof communications satellite planned for launch from a station would be a 1,000-ft diameter reflective balloon. Lasers are expected to be tested both as communications devices and as weapons, since an orbiting space station would be an ideal stable platform (ELECTRONICS, Sept. 13, p 42).

Research at or near the space station would include tests of rendezvous, docking, transfer and of life support systems, and studies of extravehicular modes; hard, clear vacuum and weightlessness. Man-machine interactions as well as man's ability to perform, adapt, tolerate and make repairs in the space environment will be studied from the beginning.

**First Station** — DOD expects to launch the first MOL during the latter part of 1967, or early 1968. The 25-ft-long by 10-ft-diam station will mate with a modified Gemini capsule (Gemini-X) and be compatible with Martin-Marietta's Titan III. The station will house 2 to 6 men. It will be a pressurized cylinder with artificial gravity created by spin-rotation. Plans are to launch it into a near-earth orbit of between 100 and 350 miles for about 30 days.

Astronauts, seated in Gemini-X during launch, will move into the laboratory following injection into orbit. On completion of their mis-

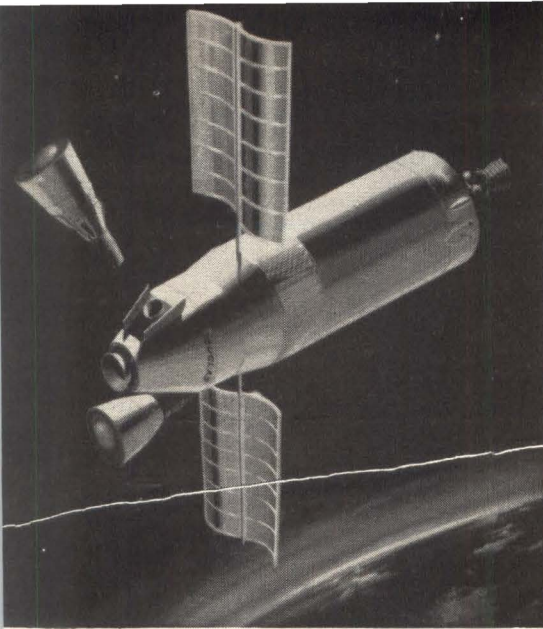

CYLINDRICAL SPACE STATION designed for rendezvous with Gemini capsules was proposed by Douglas

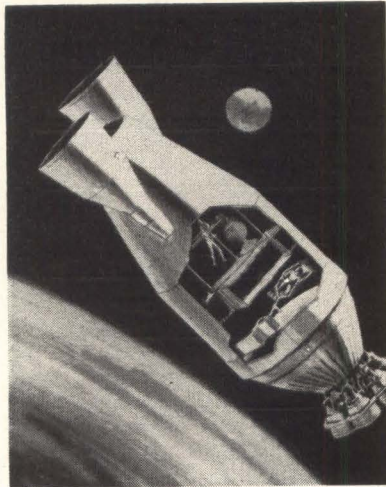

GEMINI CAPSULES attached to station conceived by Douglas. Cutaway shows whirling centrifuge couch that creates artificial gravity

SPACE COMMAND STATION by Lockheed would use nuclear power to support 12 men as the station orbits synchronously

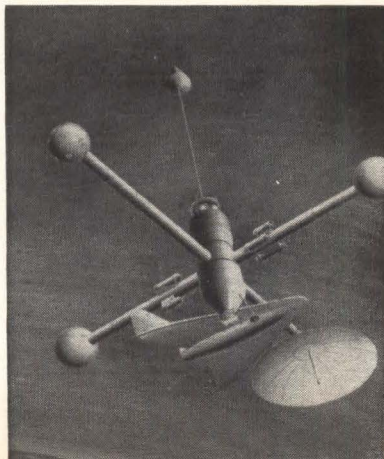

# Its Future

By JOEL A. STRASSER  
Assistant Editor

SETH PAYNE  
McGraw-Hill World News

sion, the astronauts will return to the Gemini capsule, detach it from MOL and return to earth.

If man's utility in space is demonstrated satisfactorily and longer missions are necessary, MOL will rendezvous with a second Gemini-X capsule to permit relief crews to replace the original crews in the laboratory. MOL will make use of existing NASA control facilities including the Gemini tracking network.

**Power Source**—Nuclear power will probably be used for MOL, according to an Air Force source. Since station power requirements are about 1 kw per man, and since 2 to 6 men will be required for the early missions, a nuclear power source that provides 1 to 6 kw will be necessary.

Any of four types of SNAP nuclear systems will meet these criteria, according to Frank K. Pittman, AEC's director of reactor development. Included in these are two hydride-type reactors, one with thermoelectric and one with a mercury-rankine cycle (SNAP-2). *Atomics International* developed these for AEC. *Martin Co.*'s radioisotope generators with either a brayton or a stirling cycle might also be used. Shielding isn't required for all these radioisotope generators, as it is for all hydride-type reactors. Since any decision would be based on weight considerations, NASA would probably recommend a radioisotope generator. But, all the SNAP units meet the necessary power requirements.

**Contracts**—Study contracts to define the new program will be awarded in the next few weeks. Air Force already has proposals from industry. Douglas, Martin, Lockheed, Boeing, North American and Grumman are among those that made study presentations to the Air Force some months ago. In addition, all of NASA's space station studies sponsored by the Manned Spacecraft Center at Houston and

Langley Research Center are being made available to Air Force. This includes results of a \$1 million space-station study contract let to Douglas Aircraft by NASA as recently as December 2.

The Douglas study consists of refining the NASA concept of an orbiting laboratory—a cylindrical, six-man spacecraft capable of being launched with a Saturn vehicle, and using a centrifuge to provide intermittent artificial gravity. The study, to be completed in 6 to 9 months, will also examine the feasibility of launching both ferry and supply spacecraft on a single vehicle.

Other concepts that NASA has been investigating include extensions of the Apollo spacecraft concept to house 3 men for 100 days to a year, and large stations housing 24 men for 1 to 5 years. In the large stations, one type uses rotation to achieve artificial gravity, another is a zero-gravity station.

In addition to space station studies, other NASA technology that will be transferred to the Air Force includes Gemini capsules as required and accumulated experience from the Project Mercury man-in-space and the Titan II launch vehicle programs.

---

## Range System Relays Best Signal

**AUTOMATIC** techniques to aid space vehicle tracking are included in Motorola's Remote Data Acquisition and Transmission System designed for the Edwards AFB test range. Signals are compared and only the best one received by a data acquisition unit is transmitted to Edwards; other DAU's along the 345-mile range ignore it. Additionally, the stations are automatically activated as the on-signal, originating at range terminus, is passed down the line from one station to the next.

This way the new system lets several Edwards control centers receive, record, and display test data from vehicles in flight. It also provides continuous two-way UHF communications between them. The overall system includes the data acquisition units linked by a chain of microwave relay-repeaters. It uses a tone coding method for on-off and position switching and a similar code system for monitoring all data but analog. Handling that are voltage-controlled oscillators.

---

UNMANNED data acquisition and relay unit is one of several strung over the 345-mile Air Force and NASA test range



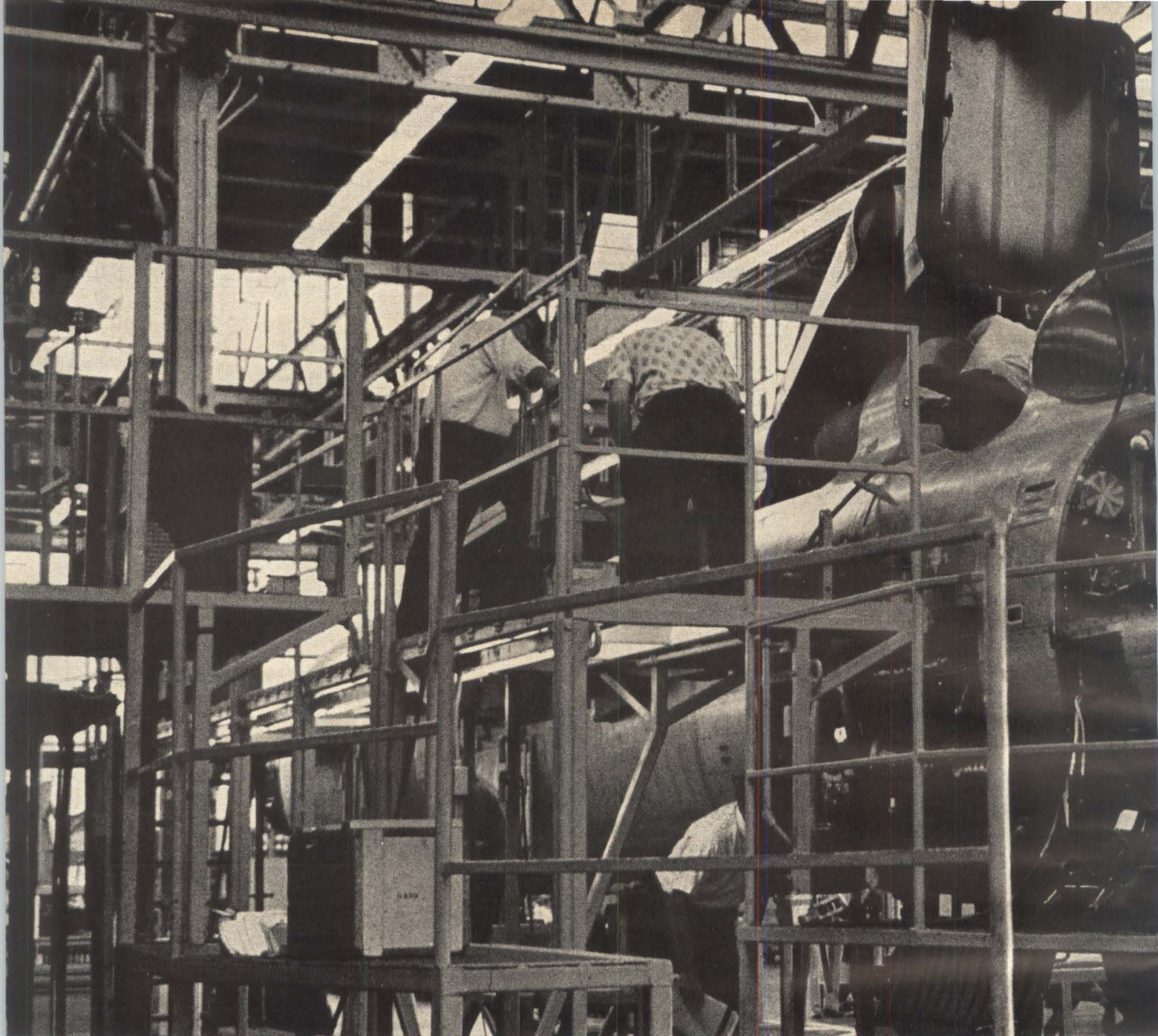

## How much in money? months? manpower? PERT COST

---

IBM's new PERT COST program brings the dimensions of cost and manpower to the already proven U.S. Navy's PERT program. Now you can plan, monitor and control the many factors in big, complex jobs.

Before you start a project, PERT COST provides a disciplined, comprehensive plan of action—that covers all three elements—to meet your project objectives.

As you progress, PERT COST provides up-to-the-minute progress reports on all areas of the job. You know what's on schedule, what's behind. The program pinpoints trouble spots for immediate action.

PERT COST handles projects of up to 75,000 separate activities, with subnet divisions of up to 750 subactivities each. The elements of all jobs—from your own plant and from outside subcontractors—are merged, level-by-level, into the overall PERT COST network. Whether you're building a missile or developing a market, PERT COST makes project management easier for you. Ask your IBM representative.

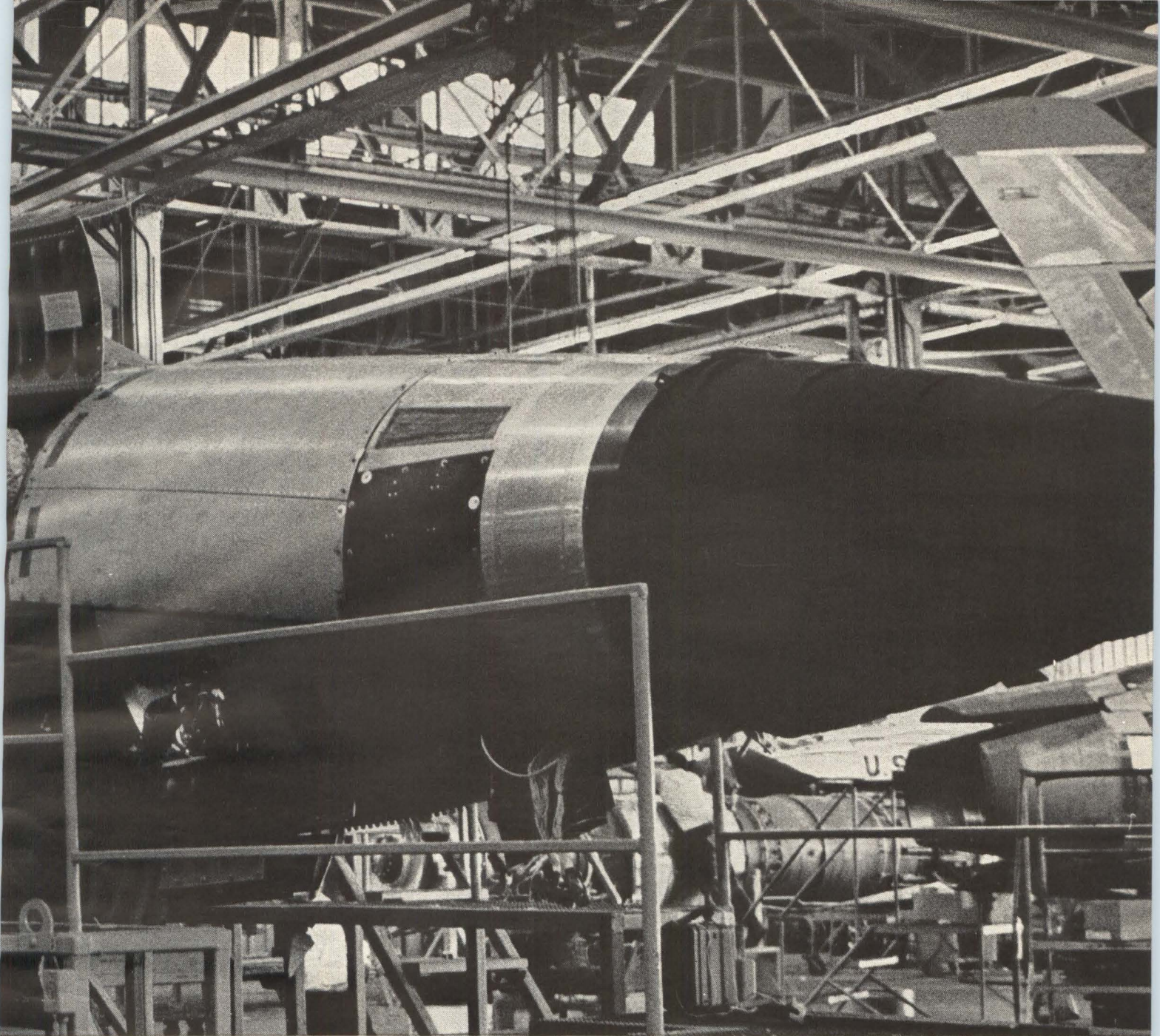

has the answers.



IBM 7090 and 7094 Data Processing Systems can be programmed to use PERT COST techniques. Systems produce regular management reports, in a form you can use, for every level of management involved. Reports show progress to date, immediate forecast and estimate for completion as planned.

**IBM**<sup>®</sup>  
DATA PROCESSING

CIRCLE 13 ON READER SERVICE CARD

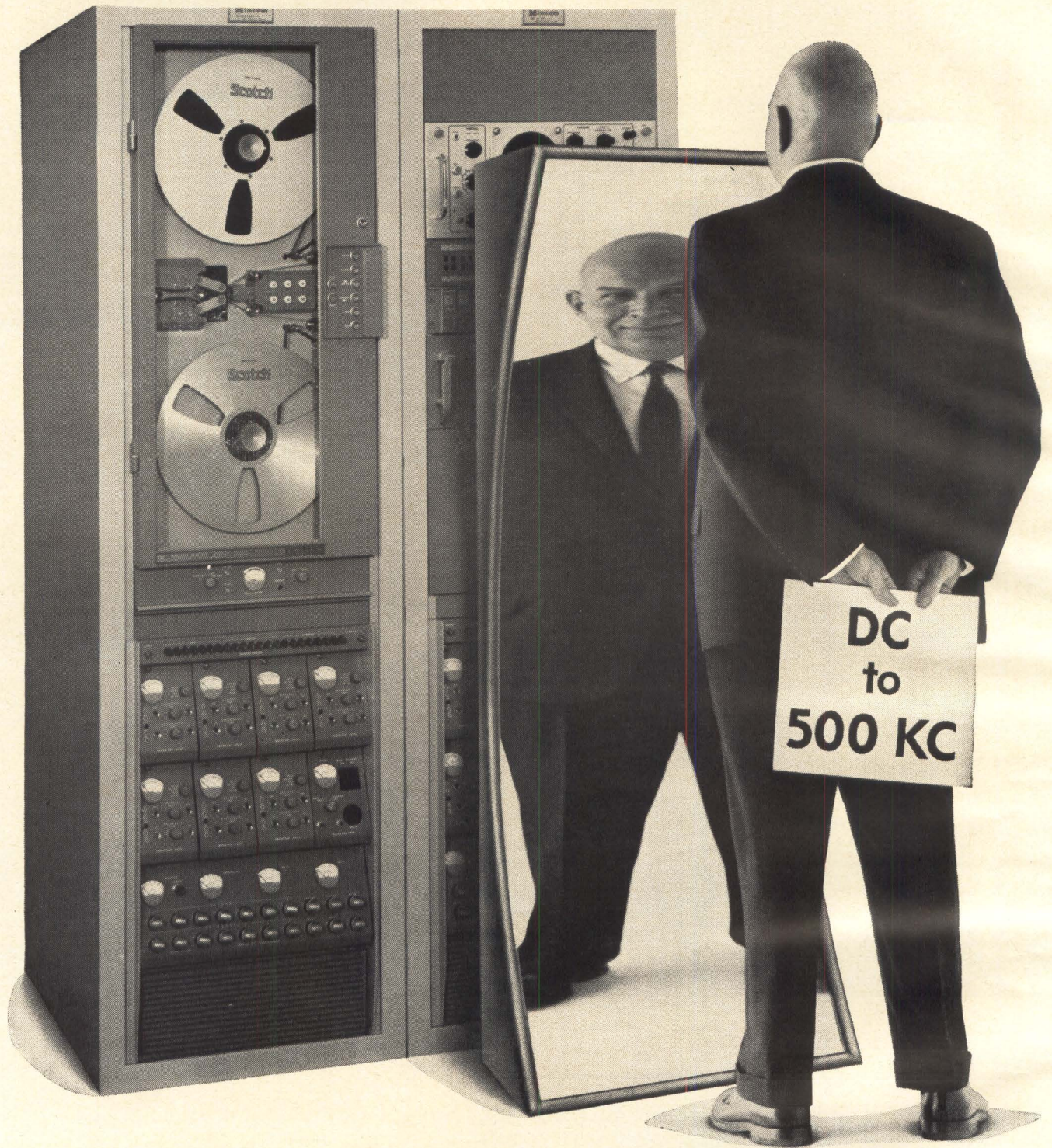

**WIDEBAND FM** recording, using 1.5-megacycle analog techniques to attain an improved frequency response of DC-500 kc, is Mincom's latest telemetry development. Heart of the new system is the standard **Mincom 1.5-mc CM-114 Recorder/Reproducer**. The extended FM responses enable telemetry facilities to record simultaneously the most complex narrow-band and wideband signals in PCM, PCM/FM, PDM, and FM/FM modulation. More advantages: Extended low frequency response, excellent linearity, seven or fourteen recording tracks, versatility without modification, greater dynamic range, dropout reduction virtually to zero. Write today for details and complete specifications.

**Mincom Division** **3M**  
COMPANY

2049 South Barrington Avenue, Los Angeles 25  
425 13th Street N. W., Washington 4, D. C.



FOR COUNTING  
SUBTRACTING  
ADDING  
FREQUENCY DIVIDING  
KEYING  
TIMING  
COMPUTING  
SCALING  
PROGRAMMING  
CODING  
MODULATING  
MATRIXING  
INDEXING  
MULTIPLEXING  
READING OUT



## Sylvania counter tubes: simplest, most economical way to do many jobs

Versatile is the word for Sylvania counter tubes—look at the many jobs they can do, with very little associated circuitry.

Put bezels with numbers on a bank of Type 8035 counter tubes, for example, and you can read the output of a high-speed computer directly. Or you can use counter tubes to drive a conventional lighted read-out display, and eliminate a great deal of circuitry you would need with any other kind of driver.

Sylvania counter tubes are dependable—we've instituted special tests and manufacturing refinements and controls to keep you from receiving any units that skip or stick. Another plus is a stronger header construction in all types, with leads spaced around a circular wafer rather than crowded into a conventional straight-line flat pressed stem. With plenty of room between leads, the breakdown voltage is higher—all Sylvania counter tubes can

withstand more than 200 volts between electrodes (excluding anodes).

Take another look at Sylvania counter tubes as a simple, economical, dependable way to do many jobs. For the helpful Sylvania Counter Tube Handbook, containing more than 50 design circuits, some transistorized, contact your Sylvania sales engineer. Or write to Electronic Tube Division, Sylvania Electric Products Inc., Box 87, Buffalo, N. Y. 14209.

# SYLVANIA

SUBSIDIARY OF  
**GENERAL TELEPHONE & ELECTRONICS**



NEW CAPABILITIES IN: ELECTRONIC TUBES • SEMICONDUCTORS • MICROWAVE DEVICES • SPECIAL COMPONENTS • DISPLAY DEVICES



## If you've never driven a car with front-wheel drive, try the one that won at Monte Carlo.

The classic Monte Carlo Rally is a tortuous 2500-mile performance test crammed with icy alpine curves, hairpin corners, and hair-raising speed trials. Last January, a front-wheel drive SAAB took first place over-all—for the second year in a row. And of the top ten cars, seven others had front-wheel drive, too. Significant.

SAAB's front-wheel drive applies full engine\* torque directly to the front wheels. No wasted power, superefficient. You get better balance and flatter cornering because SAAB has a near-perfect center of gravity (few cars do). You get amazing traction wherever you go. And some owners get up to 60,000 miles on a set of tires. With the transmission up front, SAAB has a roomy interior and a flat floor: no driveshaft; no driveshaft hump. More room for you.

SAAB's front-wheel drive makes sense in or out of competition, on icy roads, in snow . . . anywhere you go. So does SAAB's new brake system (dual independent master cylinders with hydraulic lines that diagonally connect front and rear wheels). Try a 1964 front-wheel drive SAAB at your nearest SAAB dealer soon. Only \$1895, P.O.E.

\*Engine, transmission and differential warranted for 2 years or 24,000 miles.

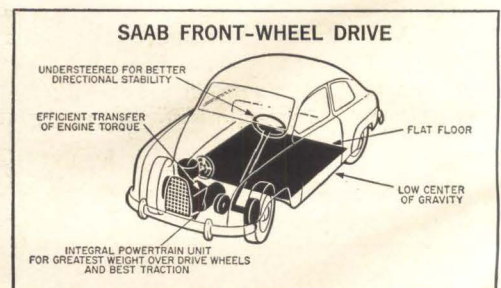

Shopping imports? Write for full descriptive literature on SAAB. SAAB Overseas, Inc., Department 412, 405 Park Ave., New York, N.Y.

**SAAB** STURDY • STYLISH • SWEDISH  
New York • New Haven • Denver • Jacksonville

# ComSat Corporation Gets a Break

WASHINGTON — Communications Satellite Corp. prospects received a lift last week when AT&T made clear it will not use cables to compete with the proposed satellite system. AT&T will use satellite circuits to Europe and South America if they are available at a reasonable cost by 1967-68, AT&T executive vice president James E. Dingman said in a letter to Leo D. Welch, board chairman of ComSat. AT&T's plans for new cables will complement ComSat, Dingman wrote. AT&T's backing is expected to raise investor interest in ComSat, whose initial stock offering is due next spring.

## X-Rays Measure

### Thin-Film Thickness

OBSERVATION made during x-ray interference studies is the basis for a new method of determining the thickness of extremely thin films, according to Professor Nathan Wainfan of Brooklyn Polytechnic. The phenomenon manifests itself as a structure in the scattered radiation accompanying the specularly reflected x-ray beam, Wainfan said last week at a meeting of federal research officials in the school. It is attributed to an interference between the components of scattered radiation originating at two surfaces of the thin film. The interference structure has been used to determine the thickness of vacuum-deposited films ranging in thickness from 250 Å to 1,000 Å. The results were consistent with those obtained by other techniques, Wainfan said.

## Artemis Completed— Probing Long-Range ASW

PROJECT ARTEMIS is now ready to go, says Columbia University (p 26, Jan. 13, 1961). Columbia's Hudson Labs has completed installation of the huge deep-sea acoustic re-

## The Situation in Rome

WASHINGTON—Department of Defense's decision to relocate, by June, 1967, the supply mission of Rome Air Materiel Area will not affect other electronics activities at Griffiss Air Force Base, N. Y., Air Force says.

Air Force says that procurement of off-the-shelf equipment for the Logistics Command will be moved to other—as yet unspecified—depots, but that procurement connected with research and development for the Systems Command will not be affected.

Nor is there to be any effect on Rome Air Development Center. RADC is responsible for much of the Air Force's ground equipment development, including radar and command and control systems. In fiscal 1963, RADC let over \$91 million in R&D contracts and also does in-house work.

Rome AMA is one of 33 facilities that DOD plans to close or curtail. A number of Army depots with some electronic supply and maintenance functions are on the list. DOD says their closing reflects better inventory control

ceiver complex, including high-gain receivers mounted in a mid-ocean tower 30 miles from Bermuda, a 17,000-ton tanker modified so it can raise and lower a five-story-high sound generator into the sea, and a shore lab in Bermuda containing advanced signal processing systems to analyze the data. Artemis is expected to provide much information on the behavior of sound in the ocean and the feasibility of submarine detection at great distances.

## Navy Gets Moving On Project Omega

PROJECT OMEGA, which the Navy has been thinking about since the early 1940's, may finally be moving into high gear. ITT said last week it has received a contract to develop solid-state shipboard receivers for the long-range navigation program. Northrop says it has developed the transmitting antenna and receiver for Omega. Omega will use a network of six to eight high-powered transmitters operating at 10.2 and 13.6 kc. Their signals will cover

the globe with an intersecting hyperbolic grid against which the position of a ship can be checked with an accuracy of one to two miles. Omega, while not as accurate as the existing Loren C and Transit satellite systems, will be much cheaper, according to Northrop.

## Computer Tallies Bowling Scores

SUNNYVALE, CALIF.—A fully automatic bowling scorekeeper was introduced here last week by Doban Labs. The electronic system keeps track of strikes, spares and fouls and switches to a tenth-frame mode automatically.

The system goes into operation when the ball hits a sensing switch at the end of its travel. After a specified delay, four strobe lights are actuated in sequence, each covering a zone of the pin deck. Light reflected from the pins is picked up by a bank of photocells and transmitted as serialized pulses to the computer. Lights and photo-

cells are arranged so that pins can be counted only once. Pulses are level clipped to differentiate between pins and reflections. Should a foul occur, a foul signal inhibits the count, and a foul marker is printed.

Computer-logic circuitry is all solid-state and consists primarily of flip-flops. The miniature computer itself is a subtraction device, counting the number of pulses from the photoelectric sensing unit and subtracting from ten. Should the bowler score a strike, no score is printed; the count of 10 is held in the memory until two more balls are rolled. The systems lease for about \$50 a month.

## Japanese Develop Another Chromatron-Type Tv Tube

TOKYO—Toshiba says it has developed a Chromatron-type color-tv tube, apparently to dispel fears Sony may steal the market with a low-priced Chromatron-type set.

Observers say it is unlikely Toshiba is now planning to manufacture a set of its own. Ten-inch and smaller Chromatron tubes are simple to make, according to Toshiba, but the larger sizes are extremely difficult. Larger sizes would be needed, however, because the potential market for color here is thought to be in the 16 and 19-inch sizes. Sony last spring said it would introduce a Chromatron set before the end of the year, but so far has not made public its progress.

## Wayside Unit Automates Rapid-Transit Trains

WAYSIDE control system developed by Westinghouse will provide almost any degree of automation desired for rapid-transit trains, the company says. According to Westinghouse, the system regulates train speed, starts and stops the trains, opens and closes doors, announces trains, and performs all supplementary func-

tions needed for safety and service. A control center containing an on-line, stored-program digital computer feeds instructions to the wayside stations, and gets feedback information in return. Solid-state data handling system maintains communications with other parts of the transit line.

## Taking Stock

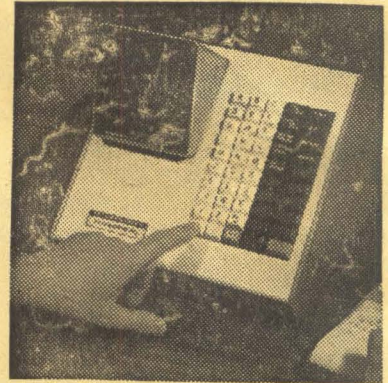

TELEREGISTER has introduced a stock quotation system, Telequote III, that displays market data on a crt screen when a stock symbol is entered and the function key punched. Data is kept current by a central computer

## MEETINGS AHEAD

AMERICAN ASSOCIATION FOR THE ADVANCEMENT OF SCIENCE MEETING, AAAS; Cleveland, Ohio, Dec. 26-30.

RELIABILITY-QUALITY CONTROL NATIONAL SYMPOSIUM, IEEE, ASQC, ASME, EIA; Statler Hilton Hotel, Washington, D. C., Jan. 7-9.

CHARGE TRANSFER COMPLEX SYMPOSIUM, USAF Scientific Research Labs; Denver, Colo., Jan. 19-24.

ANTENNA RESEARCH APPLICATIONS FORUM, Midwest Electronics Research Center; University of Illinois, Urbana, Ill., Jan. 27-30.

MANAGEMENT CONFERENCE, ERA; New Orleans, La., Jan. 28-31.

ANNUAL MEETING-SEMINAR, Precision Potentiometer Manufacturers' Association, Hollywood Beach Hotel, Hollywood, Fla., Jan. 29-31.

INSTRUMENTATION SYMPOSIUM, ISA North Central Area; New Sheraton-Ritz Hotel, Minneapolis, Minn., Jan. 30-31.

MILITARY ELECTRONICS WINTER CONVENTION, IEEE-PTGMIL; Ambassador Hotel, Los Angeles, Calif., Feb. 5-7.

ELECTRONIC COMPONENTS INTERNATIONAL EXHIBITION, FNIE, SDSA; Paris Exhibition Park, Paris, France, Feb. 7-12.

PHYSICAL METALLURGY OF SUPERCONDUCTORS MEETING, AIMMPE Metallurgical Society; Hotel Astor, New York, N. Y., Feb. 18.

INTERNATIONAL SOLID STATE CIRCUITS CONFERENCE, IEEE, University of Pennsylvania; Sheraton Hotel and University of Pennsylvania, Philadelphia, Pa., Feb. 19-21.

NUMERICAL CONTROL PRESIDENTS' CONFERENCE, Numerical Control Society; Hotel Plaza, New York, N. Y., Feb. 20-21.

SCINTILLATION-SEMICONDUCTOR COUNTER SYMPOSIUM, IEEE, AEC, NBS; Hotel Shoreham, Washington, D. C., Feb. 26-28.

### ADVANCE REPORT

GLOBAL COMMUNICATIONS INTERNATIONAL SYMPOSIUM, IEEE, University of Pennsylvania; University and Sheraton Hotel, Philadelphia, Pa., June 2-4, 1964; Feb. 28 is deadline for submitting 35-word abstract and 300 to 500-word summary to Richard Guenther, Globecom VI Program Chairman, RCA Communications Systems Division (Bldg. 1-3-1), Camden, N. J. 08102. Some suggested topics are terrestrial radio transmission, deep space and military satellite communications, data transmission systems, industrial communication and control, military command control systems, cable transmission, economic factors in systems design, switching systems, input-output technology.

## Companies Take Aim At Car Radio Field

MOTOROLA is introducing a combination f-m/a-m car radio in hopes of capturing part of a rapidly expanding market. The radio has an "Acoustinator" circuit, designed to minimize cross modulation on the f-m band. Motorola estimates that f-m/a-m car radio sales increased more than 166 percent in 1963 and anticipates a gain of more than 42 percent in 1964. Moreover, it says the dollar sale on f-m/a-m combination car radios is almost three times greater than for a-m units.

Philco will make car radios this spring for the first time since 1960. The fully transistorized a-m units will be sold to the parent Ford Motor Co. and other interested manufacturers. Ford will use them in 25 percent of its 1965-model, radio-equipped vehicles a Motorola spokesman said.

## IN BRIEF

### MOL Slow Getting Off Ground

WASHINGTON—Red tape is slowing the start of the Air Force's Manned Orbiting Laboratory program (p 17, Dec. 13), but procedures should be worked out by early next year and a new round of contractor proposals begun. One goal will be to make as few changes in the Gemini space capsule as possible. A key factor will be to strip weight to accommodate the added weight of the space station.

Ten teams, consisting of 28 companies, had submitted proposals when the program was still a low-priority study project. AF had this month planned to award several four-month contracts for about \$1 million each, but this has been halted until a general approach to MOL can be worked out (see p 10 for related story).

### Secret Navy Satellite Is Gravity Stabilized

WASHINGTON — Navy secretly launched another gravity-gradient satellite Dec. 5. It uses the two-axis dumbbell configuration (p 16, Aug. 23) developed by Applied Physics Laboratory of Johns Hopkins University. The satellite, part of the Transit Research and Attitude Control (TRAAC) program, was launched into a circular orbit with an apogee of 601 miles and a perigee of 585 miles. The satellite uses a long beryllium-copper boom to stabilize it in an earth-oriented attitude. To damp boom oscillations, a weight is attached to the end of the boom with a spring. The weight moves up and down on the spring like a yo-yo until oscillations end. The system is similar to those launched June 15 and Sept. 24.

### Magnetic Gage Measures Hardness of Moving Steel

MAGNETIC GAGE that determines the hardness of rapidly moving steel has been developed by Assembly Products, Inc., the firm says. The gage operates on the principle that the harder a piece of steel, the easier it retains magnetism. The pickup assembly of the gage consists of three heads. As a strip of steel moves along, the first head erases any stray

magnetism, the second magnetizes spots on the steel and the third reads the induced magnetism.

### Britain Will Try Pay Tv Next Year

LONDON—Britain is to have large-scale experiments in pay-as-you-watch tv beginning next year. The Postmaster General said last week he is offering licenses to five groups to conduct three-year experimental services. Participants include Rank and other film interests, commercial tv contractors, newspapers and Rothschilds Merchant Bank. Program plans include new motion pictures, stage plays, opera and sport and educational fare.

### Ultrasonic Tests Sought For Filament-Wound Units

DOUGLAS AIRCRAFT is developing ultrasonic techniques and standards for detecting production defects in filament-wound structures, such as rocket nozzles and solid-fuel motor cases. The program includes acoustical properties measurement of test materials with built-in flaws that affect the strength and reliability of the structures. Work is being carried out under a \$39,590 contract from the Air Force Systems Command.

**LASER EXPERIMENT** connected with the S-66 ionospheric beacon satellite has been given high priority by NASA. Launch, previously scheduled for a Scout rocket, has been reset for a Thor-Delta booster.

**AIR FORCE** has given Philco a \$1-million contract to improve techniques for penetrating enemy ICBM defense systems.

**GENERAL TELEPHONE** has installed a teletypewriter system at the University of Missouri Medical Center that transmits laboratory test data to nurses, stations throughout the hospital.

**ELECTRONICS** trade mission sponsored by the Dept. of Commerce will tour Great Britain May 9 through June 5, 1964. London, Birmingham, Manchester and Glasgow are on the itinerary.

**NASA** has cancelled five scheduled Ranger spacecraft to save \$90 million in the program of unmanned exploration of the moon. It will place more reliance on the remaining four Rangers.

**ARMY** has given General Dynamics a \$10,620,000 contract for continued R&D on the Mauler air-defense missile. This brings 1963 Mauler awards to \$58,963,639.

**INTERNAL REVENUE** Service says university professors can deduct research expenses, including travel, that are incurred without expectation of profit apart from salary.

**IBM COMPUTER** will score the ninth Olympic Winter Games next month at Innsbruck, Austria. Scores will be keyed on IBM 1050 typewriter-like terminals at each of the six event sites and transmitted over phone lines to a 1401 computer at Innsbruck University.

**WORK HAS BEGUN** on a \$500,000 expansion of the U. S.-Mexican space tracking station in Guaymas, Sonora, on Mexico's northwest coast, in preparation for Gemini and Apollo flights.

**GE WILL DEMONSTRATE** controlled nuclear fusion at the New York World's Fair. Evidence of the reaction will be shown on large oscilloscope screens, and electronic digital-counters will record the number of neutrons released from the deuterium.

**LEAR SIEGLER** will build 50 more automatic-landing systems for French Caravelle jetliners.

## **ComSat Call for System Designs Goes Out Soon**

**Industry proposals** for the engineering design of the first commercial satellite system will be requested soon by the Communications Satellite Corp. Wide latitude will be permitted in proposals. However, the corporation will spell out performance of a hypothetical ground station to keep the plans uniform. Companies may propose satellites for medium-altitude or synchronous orbits, or a combination of both.

CSC puts system channel capacity in the "several hundred" range. Design life must be three years, and the company selected may have to guarantee this lifetime. Prototypes must be ready to test launch by 1966 with the system ready to operate in 1967. Only U.S. companies will be solicited for proposals. They will be given about six weeks to work them up. Then, six-month studies will be awarded to more than one company for parallel studies. Following this, a system will be selected, and development and production contracts awarded.

## **Tax Break or Loans Proposed As Stimulants for Commercial R&D**

**Defense Secretary McNamara's** latest economy moves are comparatively minor portents of bigger spending reductions to come. The next defense budget will be only a few hundred million dollars off this year's \$51 billion, but the next five years will be a different story.

How to cushion the long-term effect is a major concern. A new study by Stanford Research Institute suggests the government increase the private demand for R&D, since so much of R&D is concentrated in defense industries. Stanford proposes private R&D be stimulated through tax credits, loans or loan guarantees, or even a government-industry cost-sharing program with the government eventually being reimbursed. This would provide an alternative to direct government backing of civilian R&D or product planning.

The Institute's analysis, prepared for the Senate Manpower Subcommittee, views the outlook for defense-firm conversion to civilian pursuits somewhat more darkly than the Defense Department. The Pentagon has said that the hard core of military spending—that part which has no civilian utility—accounts for only 2 percent of the gross national product and that the problem of defense cutbacks has been exaggerated. But the Institute emphasizes that in electronics, shipbuilding, missile and aircraft production, conversion problems are major because defense work represents from one-half to all of their output.

## **Cost-Reduction Guidelines Drawn**

**A guideline paper** to help defense contractors dovetail their cost-reduction programs with the Pentagon's programs is being drafted at the Defense Department. The paper will go to the top 100 contractors and major industry associations. It will outline the minimum steps the department feels contractors should take to have an effective cost-reduction program, and will establish a method for contractors to report their accomplishments.

## **Who Buys the Subsystems?**

**Pentagon is being pushed** to require that the armed services furnish major equipment to defense contractors whenever feasible. The suggestion comes out of the Comptroller General's investigation of procurement of radar and loran equipment, tape recorders and interrogating systems bought by Grumman Aircraft Engineering Corp. under an Air Force contract. The Comptroller General says the Air Force failed to give Grumman pertinent information on its own buying experience, and that as a result, Grumman bought at prices 61 percent higher than the services normally pay.

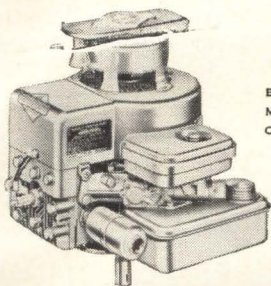

BRIGGS & STRATTON ENGINE  
MODEL #80906, VERTICAL  
CRANKSHAFT, 3 HP ENGINE.

**Here is another new application  
where an Allen-Bradley ceramic  
magnet is benefiting  
the customer**

■ In their new ignition system, Briggs & Stratton has succeeded in obtaining longer coil life, as well as longer life for spark plugs and breaker points. A major departure in this new design was the use of a ceramic permanent magnet in place of the metallic magnet previously used in the magneto.

This new design placed strict physical limitations on the magnet by its restricted space within the die cast aluminum flywheel. The special characteristics of Allen-Bradley MO5B ceramic magnets enabled them to meet all the requirements for size, magnetic strength, coercive force, and temperature coefficient.

You owe it to yourself to investigate Allen-Bradley's line of quality ceramic permanent magnets—it's almost certain Allen-Bradley can supply a standard ceramic magnet formulation even though you may have a special application. For more detailed information, please write: Allen-Bradley Co., 110 W. Greenfield Ave., Milwaukee, Wis. 53204. In Canada: Allen-Bradley Canada Ltd., Galt, Ontario.

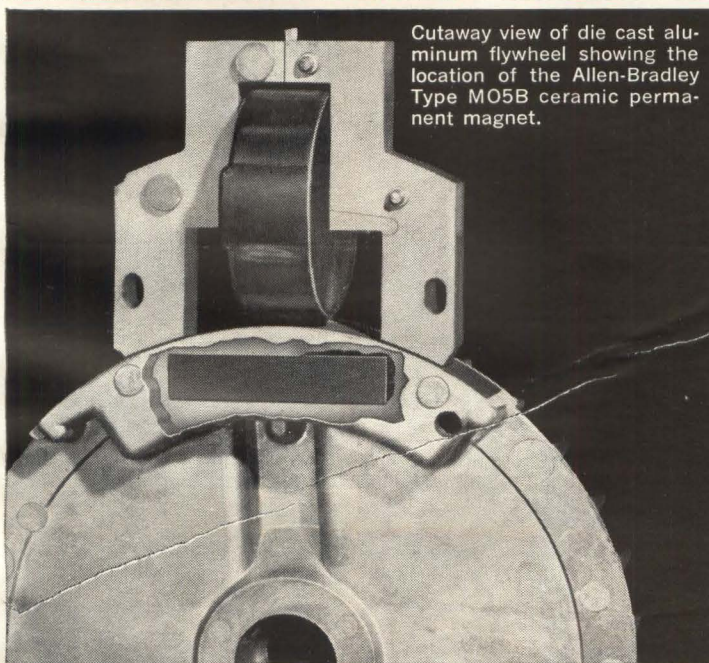

Cutaway view of die cast aluminum flywheel showing the location of the Allen-Bradley Type MO5B ceramic permanent magnet.

Allen-Bradley Type MO5B magnet used in Briggs & Stratton engine.

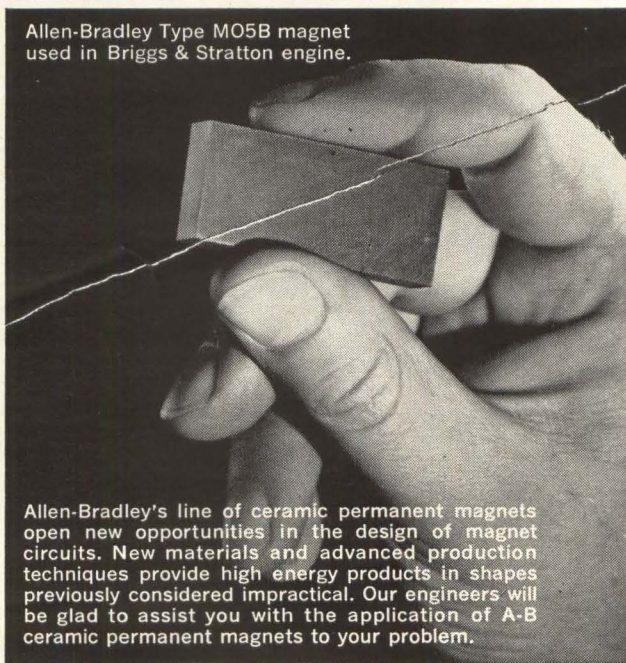

Allen-Bradley's line of ceramic permanent magnets open new opportunities in the design of magnet circuits. New materials and advanced production techniques provide high energy products in shapes previously considered impractical. Our engineers will be glad to assist you with the application of A-B ceramic permanent magnets to your problem.



**ALLEN - BRADLEY**  
QUALITY ELECTRONIC COMPONENTS

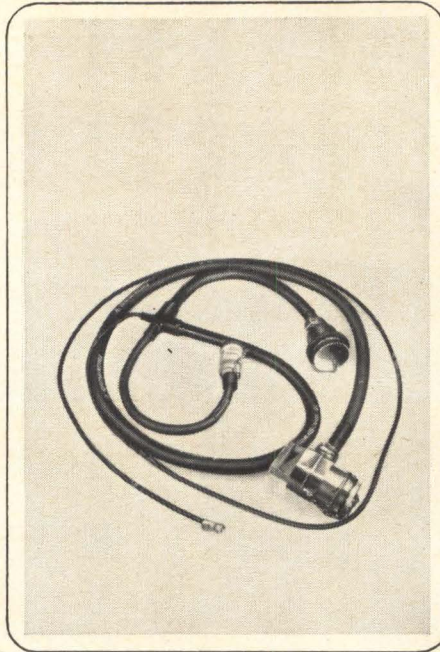
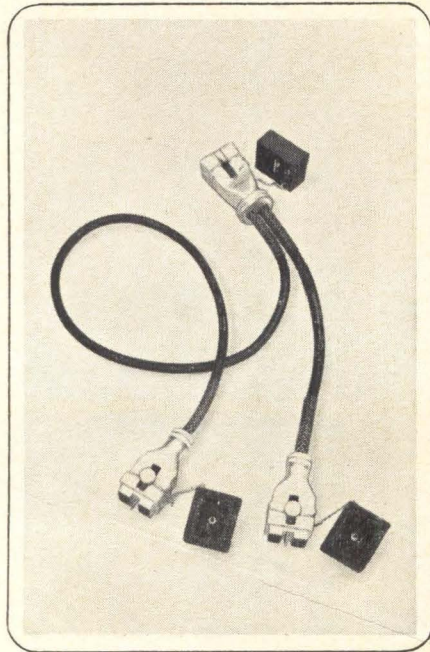
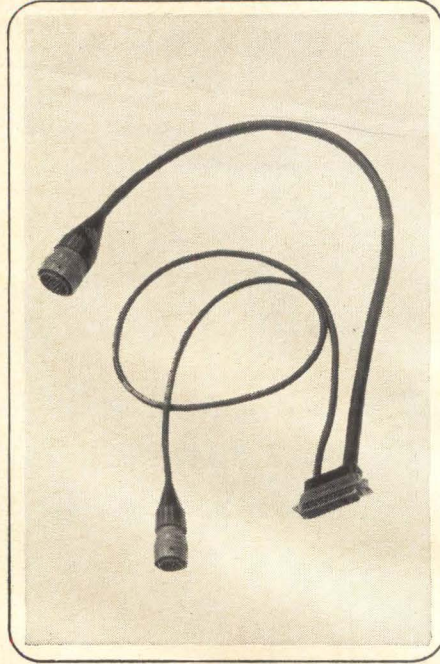
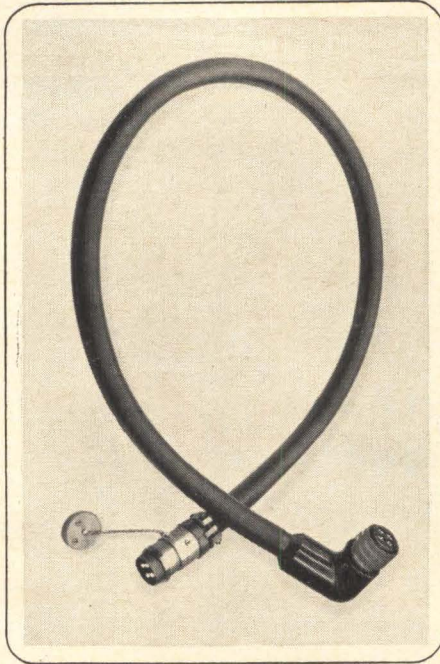
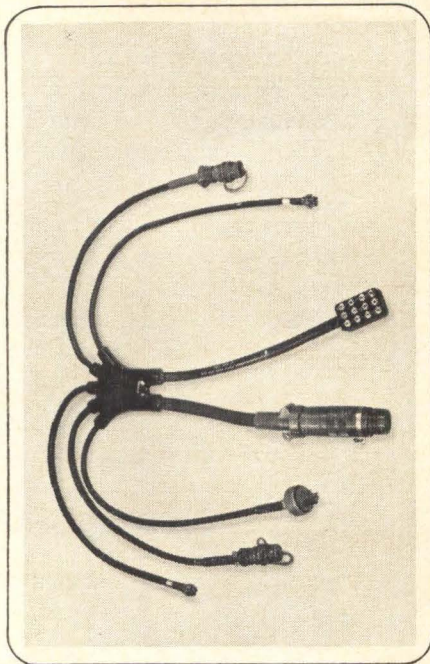

**Now  
let us  
solve  
your  
cable  
problem  
!**

You'll probably never need any of these five cables.

But somebody did. And the same versatility and reliability-control which fit these special cables to special needs are now available to solve your cable problems.

These are products of Rome's Special Products Facility, where unique cable constructions are everyday products.

Cables like these can't afford to fail—there often isn't a second chance. So Rome insures reliability with a quality control program second to none. It tests each cable construction continuously throughout construction and inspection.

The program has been so successful that we recently won the first aerospace reliability contract ever awarded to a cable manufacturer. Its goal is to prevent cable assembly malfunctions in the Minuteman missile.

Other cable constructions from Rome's Special Products Facility have proved themselves reliable on such projects as Hound Dog, Atlas, Mercury, and Sergeant.

Our Special Products Facility brochure explains how you can fit Rome's unique experience, skills and equipment to your specific problems. Just send the coupon.



Special Products Facility  
Rome Cable Division of Alcoa  
2937 South Tanager Avenue  
Los Angeles 22, California

Please send my copy of your brochure describing how I can benefit from Rome's Special Products Facility.

NAME \_\_\_\_\_

COMPANY \_\_\_\_\_

ADDRESS \_\_\_\_\_

CITY \_\_\_\_\_ ZONE \_\_\_\_\_ STATE \_\_\_\_\_



*Thiokol Panelyte Copper-Clad Sheet meets the rigid demands of sophisticated circuitry in atomic radiation detection equipment*

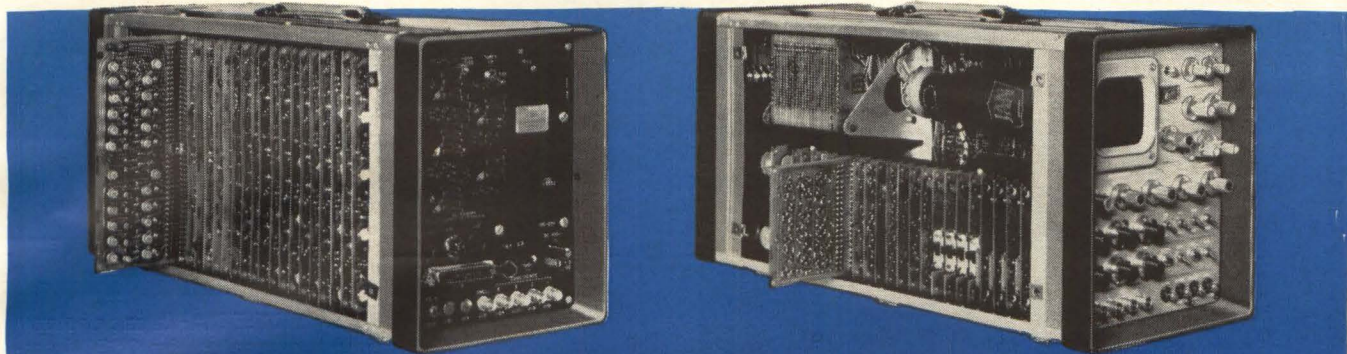

TMC ANALYZER  
using Panelyte  
Printed Circuit Card

DETECTS,  
MEASURES,  
IDENTIFIES  
Radioactive  
Material

One of the highly intricate new tools now available to scientists and engineers to evaluate radiation is the multi-channel pulse height analyzer produced by Technical Measurements Corporation, of North Haven, Connecticut. For the many complex electronic circuits built into this instrument—as shown in the cutaway photos above—TMC uses Thiokol Panelyte copper-clad plastic sheet, only.

Panelyte copper-clad circuit boards combine the high electrical and physical properties needed in this demanding application. A glass epoxy G-10 Thiokol Panelyte Grade 1615, combining high insulation resistance and mechanical strength, was selected exclusively for this specialized application. High strength and solder resistance are specified by TMC Engineering and are provided by this superior grade.

Panelyte copper-clad and other electrical grades of sheet stock meet NEMA and government specifications. For full,

information, write to Panelyte. Or see the Product Design Section of Sweet's Catalog. For rapid delivery, call the nearest Panelyte office or distributor.



LAMINATED SHEET, ROD, TUBE, HIGH PRESSURE MOLDINGS AND FABRICATED PARTS

THIOKOL CHEMICAL CORPORATION

Panelyte Industrial Division N. Enterprise Ave., Trenton 4, N. J.

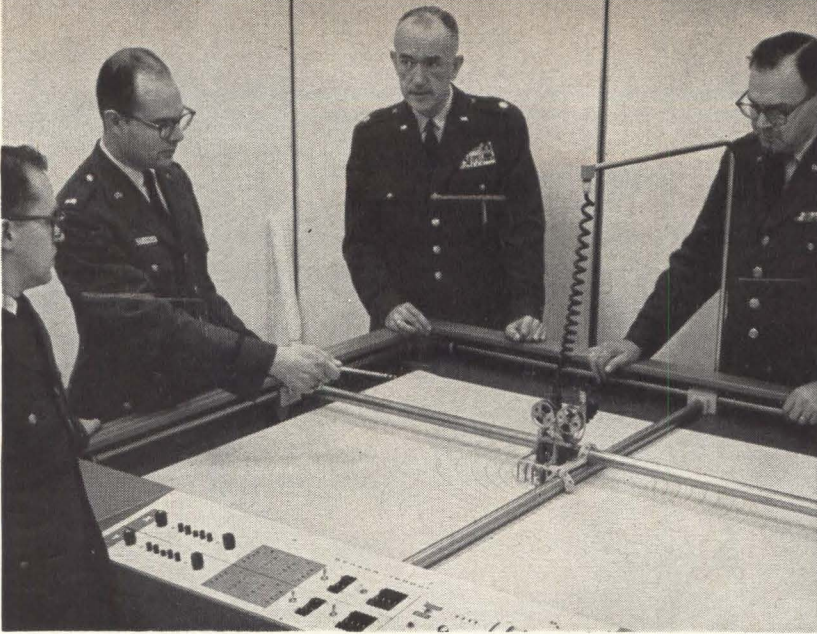

PLOTTER tied into 7030 gives target and trajectory data pictorially

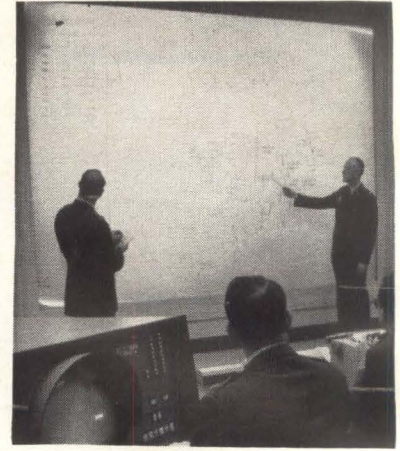

NORAD BATTLE MAP is one of many displays generated by 7030 computer at Air Force Systems Design Laboratory

## New Breed of Computer Sought

AF Project Forecast stresses easy access; key is lower bit cost

By **THOMAS MAGUIRE**  
Regional Editor, Boston

**BOSTON**—Project Forecast, the study to determine Air Force computer needs over the next decade, will force-feed computer technology. The likely result is new class of computers, with significant impact on information processing in general.

Project Forecast recommendations in 13 technical categories are now being submitted to top USAF and DOD levels. Near-future goals for computers include greater speed, capacity and flexibility—but most of all, direct accessibility to commanders without middlemen programmers.

**Key Is Low Cost**—Cheaper computer power will be one of the keys to achieving this “approachability”, according to Frederick C. Frick, of MIT Lincoln Laboratory, who headed the panel of data-processing and display experts in Project Forecast.

Frick sees computer power “several orders of magnitude cheaper

per bit” within five years. This, he said, will permit optimizing user time instead of machine time. Problem-oriented languages will be developed to replace procedures-oriented languages.

Frick thinks cheaper machine time will be a “natural fallout” of integrated circuits and advances in memory technology. With cheaper logic and memory power, computer programs can let military commanders—or scientists—work directly with the computer, using the language of the job itself and specifying matrices instead of detailed procedures.

This is not new, Frick points out, but it is expensive in machine time.

Frick made his comments following the dedication December 3 of the Systems Design Laboratory (SDL) at Hanscom Field, Bedford, Mass. (**ELECTRONICS**, p 29, March 22; p 19, Dec. 6).

**C & C Speed Boost**—This \$10-million lab was built by the AF Electronic Systems Division to “improve the breed” of computer-based command and control systems. The military is pressing for accelerated development of data-processing hardware and software.

Gen. Bernard A. Schriever, head of Air Force Systems Command, emphasized the future weapons and delivery systems “must be capable

of response in a matter of seconds rather than minutes—and in many cases a matter of milliseconds. But responses of this speed strain the state of the art in computer technology, and it appears very likely that new design concepts and radical changes in computer organization will be required.”

**User-Oriented Systems**—Maj. Gen. C. H. Terhune, Jr., commander of ESD and a manager of Project Forecast, said one of SDL’s first jobs will be work on techniques to permit military commanders to talk directly to machines, through user-oriented languages.

Gen. Terhune, told the Fall Joint Computer Conference last month “nothing short of absolute rethinking of computer design, programming and operation could give the Air Force the kind of computer capability it needs . . . the large staffs of programmers must be bypassed, giving the user direct and immediate control over the mode of his computer operation. This can be done only by giving the user a new class of computer systems.”

**Access by Telephone**—MIT meanwhile, in an ARPA-Office of Naval Research project, is tackling the problem of providing easy access to computers “physically and intellectually.” The beginnings of a sys-

tem are operating under Project MAC, an acronym for both Multiple-Access Computer and Machine-Aided Cognition.

About 40 teletypewriters are installed around MIT labs and offices, and each can dial their programs and problems into two 7094's through telephone lines. The time-sharing technique under development would, says Prof. Robert M. Fano, "turn the computer into a public utility," putting computer power simultaneously at the service of many people, when and as wanted.

The Army, too, is pushing for new computers, for tactical operations. The CCIS-70 studies seek to plan the types of computers which will be needed by 1970 (ELECTRONICS, p 32, April 12). And USAERDL has funded a 12-months study to forecast the state of the art in digital computers in the period 1970-85 (p 8, Aug. 16).

## Cores in Chambers Report Nuclear Events Directly

LEMONT, ILL. — Toroidal cores placed in spark chambers enable the chambers to report nuclear events directly, as computer-oriented digits, Richard Miller, of the University of Chicago, told an Argonne Accelerator Users Group meeting this month.

Three-dimensional wiring solves the location-ambiguity problem and adapts spark chambers to automatic information reporting, he said.

Wired spark chambers require considerably less energy than optical event-reporting systems, Miller said. Digital information may be transferred directly to computers, without the necessity of encoding or decoding. Readouts are available 0.1 microsecond following a spark, may also be stored for later computer processing. System should be capable of recording 2 or 3 spark tracks within the same gap, he said.

University of Chicago has wired core memory spark chambers to link its Fermi cyclotron to its Maniac III computer. Fast-scan circuits, to be delivered this month, will be used in experiments over the next 3-4 months.

## Unique production techniques assure reliable ML-6696/6697... 50kw service

**RF SEAL-IN** techniques, used by Machlett since 1949, make possible closely spaced electrodes for low drive. Oxide-free closure of tube envelope maintains interior cleanliness essential to high vacuum. (Below)

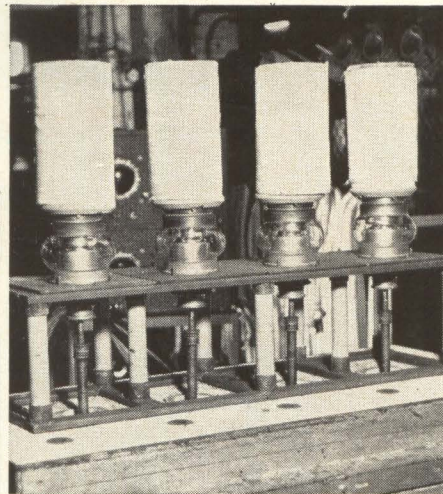
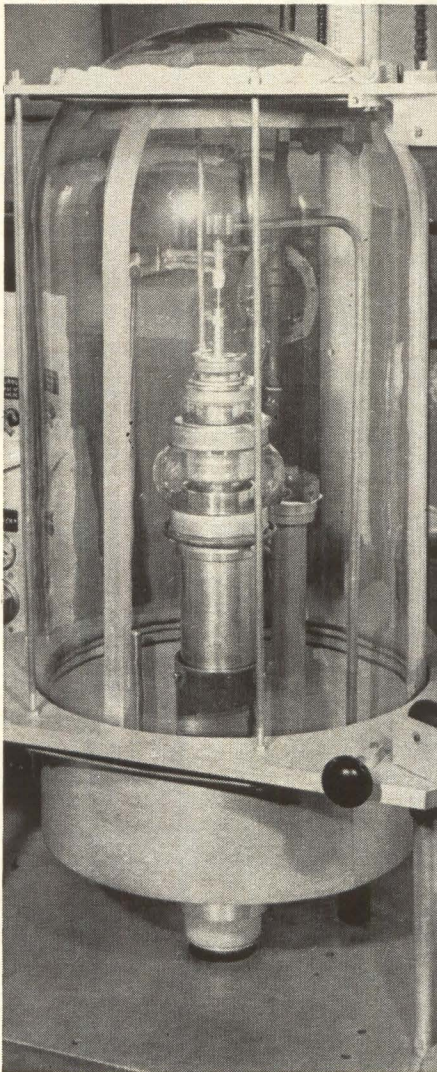

**SPECIAL JACKETS** are used for thorough anode outgassing during exhaust of ML-6697 (F.A.C.). Other unusual methods have been developed for oven baking, anode heating, grid outgassing, and cold cathode desparking.

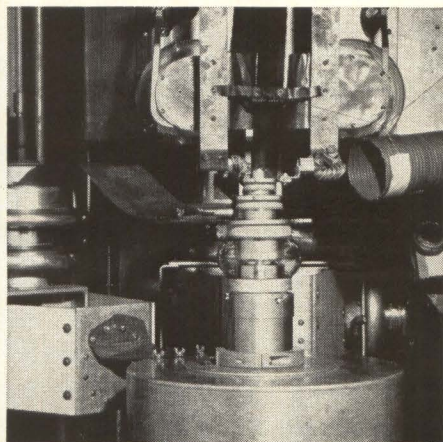

**UNIQUE 1.2 MW TEST SET** is used for high-power rf amplifier test of water-cooled ML-6696. Tests are programmed from remote control console.

For complete dependability in power tubes, depend on Machlett experience in design and production. For more information on Machlett ML-6696, ML-6697 and other large power tubes, write The Machlett Laboratories, Inc., Springdale, Connecticut. An affiliate of Raytheon Company.

**MACHLETT**  
ELECTRON TUBE SPECIALIST



**1 MC to 300 MC  
WIDE-SWEEPING  
SWEEPING OSCILLATOR**

**KAY**  
*Multi-Sweep*  
**159-A**

**ALL SOLID STATE**

- **300 mc to less than 1.0 mc in single sweep**

The Multi-Sweep Model Video 300 is a wide range video-vhf sweeping oscillator which provides a full 300 mc of swept-frequency output by all-electronic frequency modulating techniques. It provides a linear swept frequency output, AGC'd for constant output over the frequency band. The Multi-Sweep Model Video 300 includes provision for the insertion of external oscillators to generate variable birdie-bypass type markers on all frequencies. A calibrated frequency dial permits the use of the unit as an IF-VHF oscillator with continuously variable center frequency and sweep width.

- **All electronic**

**Sweep Frequency Range**

The Model 300 is a wide-sweeping swept frequency oscillator with high and undistorted output, essentially free of spurious signals. Over the entire sweeping range, it generates a 0.5 volt (rms into load) output which is held constant to within  $\pm 0.25$  db by a fast-acting automatic gain control circuit. The RF output is monitored by a calibrated panel meter.

- **All solid state**

**Sweep Rate**

The repetition rate of the sweep may be locked to the nominal line frequency or varied around this frequency for hum checks. A manually-controlled swept output provides a means of varying c-w signal in sync with the oscilloscope display. The manual control covers the same frequency range to which the Model 300 is set for electronic sweeping.

- **0.5 volt rms into load AGC'd to  $\pm 0.25$  db**

**Advanced Design**

The Multi-Sweep Model 300 employs recently developed techniques in providing a compact and versatile instrument. All elements, including the frequency modulated source and its means of modulation use recently developed solid state circuits. Careful isolation and buffered outputs provide for excellent waveshapes and clean, reliable outputs.

- **Built-in detector**

**SPECIFICATIONS**

**Frequency Range:** Continuously variable 1 mc to 300 mc.

**Markers:** Provision for birdie-bypass markers derived from external oscillators. Separate level control and output.

**Sweep Width:** Linear, continuously variable 200 kc to 300 mc. CW operation.

**Attenuators:** Switched 20,20,20,10,6,3 db plus variable 6 db.

**Sweep Rate:** Variable around line frequency, locks to line. Manual control.

**Power Supply:** Input approx. 20 watts, 117 volts ( $\pm 10\%$ ), 50-60 cps ac, regulated.

- **Stable narrow sweeps**

**RF Output:** 0.5 volt rms into nominal 50 ohms (70 ohms on request); flat to within  $\pm 0.25$  db over widest sweep — metered.

**Dimensions:** 6 $\frac{3}{4}$ " x 15 $\frac{1}{2}$ " x 13 $\frac{1}{2}$ ".

**Weight:** 24 lbs.

**Price:** \$795.00 f.o.b. factory.

**KAY ELECTRIC COMPANY**

Dept. E-12 Maple Avenue, Pine Brook, Morris County, New Jersey Capital 6-4000

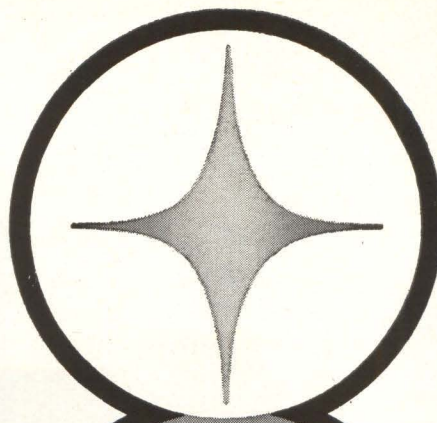
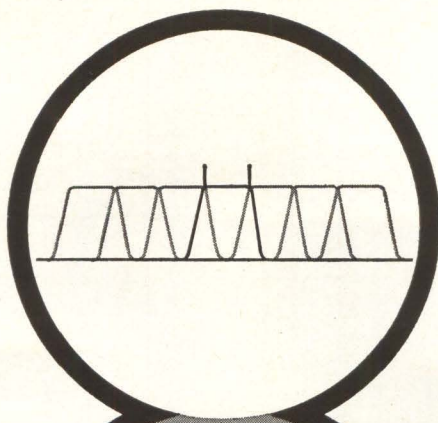
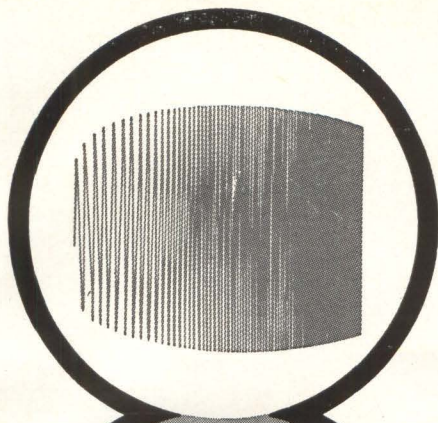

Sweep: Frequency Response of Headsets — e.g., 300 cps to 3,000 cps on a 5 cps sweep



Sweep: TV Receivers — e.g., 170 to 220 mc at a 60 cps "Line" Rate

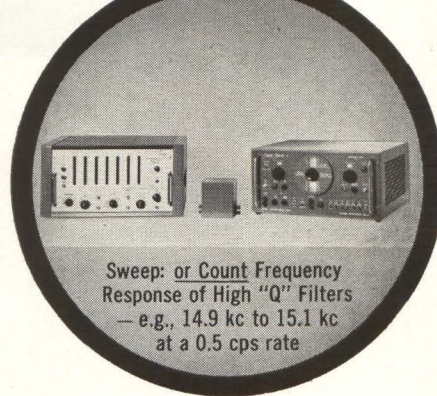

Sweep: or Count Frequency Response of High "Q" Filters — e.g., 14.9 kc to 15.1 kc at a 0.5 cps rate

## Complete VERSATILITY... Audio, Video, VHF

### KAY *Ligna-Sweep* SKV® All-Electronic SWEEPING OSCILLATOR 935 - B



50 CPS TO 220 MC IN 12 BANDS • WIDE RANGE OF SWEEP WIDTHS  
VARIABLE REP RATES • MANUAL AND AUTOMATIC OPERATION

- Single wide-sweep video displays from 10 mc down to 1 kc.
- Linear and logarithmic sweeps of 0.2 cps to 30 cps; or sweep locked to line frequency.
- Audio Sweep of 50 cps to 20,000 cps.
- 8 fixed, narrow-band video frequency sweeps for repetitive operations.
- Fundamental frequency 10 mc to 220 mc (widths to 30 mc plus).
- High-level output of 1 V rms into 70 ohms. AGC'd to  $\pm 0.5$  db over widest sweep.
- Manually-operated control for varying oscillator frequency.
- Fixed pulse-type markers or variable marker provision.

Price: \$1295.00 F.O.B., Factory

The wide frequency range, extensive choice of sweep widths and repetition rates make the Kay *Ligna-Sweep* SKV a most useful sweeping oscillator.

For high frequency work, the unit provides 9 sweep bands, operating at fundamental frequencies for wide, stable sweeps from 10 to 220 mc. At the low end of the spectrum, an audio frequency sweep from 50 to 20,000 cps is provided. High order stability permits frequency sweeps to as low as 50 cps.

For checking high-Q circuits and low-frequency response characteristics, either log or linear sweeps at variable rep rates down to 0.2 cps are available. This wide choice of sweep rates (continuous to 30 cycles, and fixed line lock) makes it easy to select that highest rep rate which gives both an accurate response display and easiest, brightest viewing on the scope screen. With the manual frequency control, the trace on the scope screen may be held and examined in detail, (counted precisely, measured on a VTVM) at any frequency point on the scope display.



Check Video Bandpass — e.g., 1 kc to 10 mc at 1 cps rate

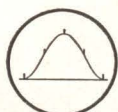

Check Radar IF's — e.g., 25 to 35 mc at 30 cps



Check Audio Bandpass — e.g., 50 cps to 20 kc at 1 cps Log Sweep

Write for Complete Catalog Information

## KAY ELECTRIC COMPANY

Dept. E-12 Maple Avenue, Pine Brook, Morris County, New Jersey Capital 6-4000



# Recording Advantages

you get *only from Sanborn*

Sanborn *inkless, heated stylus* recording on matching Permapaper® charts will give you a clear, permanent record of the signals *you want to record*—under *your conditions of use*. Every one of the performance characteristics listed below have been available from Sanborn for the last five years—and thousands of channels in use today are the best evidence that this is a *proven, practical* and *positive* means of recording. Here are the advantages it can give you in actual practice:

- **1/4 division LINEARITY** ( $\frac{1}{2}\%$  of 50 div. chart)
- **2.5 ms RISE TIME** (10 div. deflection, 10% to 90%)
- **4 cycles/mm RESOLUTION** even at small amplitudes
- **NO DOWN TIME** for filling reservoirs, priming, unclogging styli . . . no ink on your hands or clothes
- **TRUE RECTILINEAR WRITING** without linkages
- **NO PARALLAX ERROR** or “NEGATIVE” TIME . . . all styli contact chart along a fixed, common knife edge
- **NO LOSS OF WRITING AT HIGH OR LOW TEMPERATURES** . . . no pressurized, temperature-sensitive writing medium container
- **RELIABLE, SIMPLE, FIELD-PROVEN ELECTRONICS** use heavy current feedback without electromechanical transducers in the feedback loop

Call your H-P Field Engineering Office now for complete specifications and expert application help on your recording requirements.

## SANBORN COMPANY

INDUSTRIAL DIVISION  
WALTHAM, MASS. 02154

*A Subsidiary of Hewlett-Packard Company*

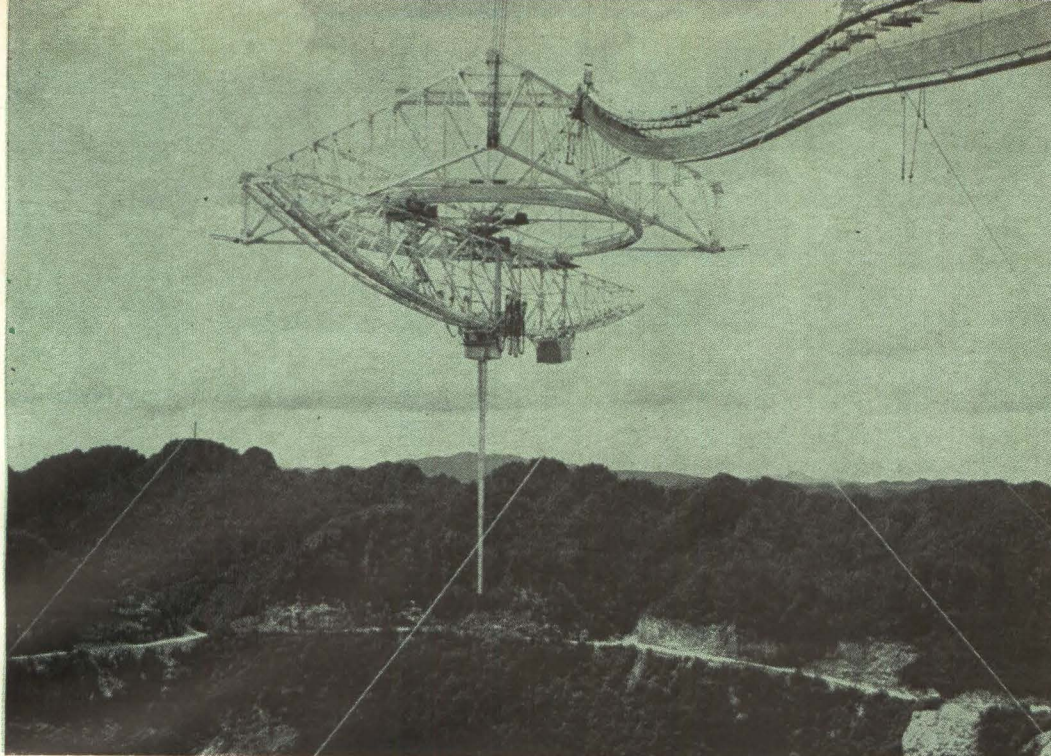

LINE FEED hangs vertically from carriage house (center). Taper and spacings of openings in the line feed determine the direction and intensity of energy fed to the reflector (on ground below). Phase and amplitude are corrected electronically. Second carriage house provides balance and second feed. Catwalk (upper right) carries transmission-line waveguide from operations building

# ARECIBO

## NEW ERA IN RADIO ASTRONOMY

By THOMAS MAGUIRE, Regional Editor, Boston

**LEAPFROGGING** demands of science and the military for megawatt transmitters, antenna apertures measured in acres and low-noise receiver systems are exemplified in the new Arecibo Ionospheric Observatory (AIO) in Puerto Rico (p 20, Jan. 27, 1961; p 18, May 17, 1963; p 17, Nov. 1).

The \$9 million AIO, built with Advanced Research Projects Agency (ARPA) funds and managed by Cornell University, has the world's largest antenna, a 1,000-foot dish of an aperture dictated by the task of capturing back-scattered energy from electrons. Its

operating frequency, 430 Mc, is influenced by the availability of high-power klystrons developed originally for BMEWS.

The AIO, built under the technical direction of Philipp Blacksmith of Air Force Cambridge Research Laboratories, is now undergoing specification tests. Its research schedule will be determined by a DOD-appointed committee under R. N. Bracewell of Stanford University.

**More Power**—In terms of previously developed radio and radar astronomy telescopes, the 1,000-foot-wide spherical reflector, a galvanized steel mesh with a surface area of 18.5 acres, extends man's probing power and listening power hundreds and thousands of times. Compared to the 250-foot reflector at Jodrell Bank, England, the Arecibo facility is 16 times more sensitive in the radio astronomy mode and has 256 times the radar power.

Astronomers say the Arecibo facility will be capable of picking up radio signals from sources as far as 10 to 12 billion light years away—double the listening range of Jodrell Bank.

According to Thomas Gold of Cornell, Arecibo is

---

### PLAN SECOND WAVELENGTH

Ionospheric and planetary probes by the world's most powerful radio astronomy instrument will be further enhanced by a two-wavelength capability for simultaneous echoes. To give the AIO a 40-Mc capability—possibly within the next 6 months—four two-element Yagis will be attached to the 430-Mc line feed about 35 feet down from the carriage house. The new feed will comprise a combination of a phased array and a Yagi, with four drive elements each having its own parasitic director

10,000 times more powerful than the installation at Millstone Hill, Mass. in 1958 when it bounced a radar signal off Venus. "That means that the echo we get back from Venus should be 40,000 times more powerful than those we got back from Venus with the Millstone Hill Facilities—so there should be no trouble recognizing the signal and no need for extensive signal processing."

The AIO will be used for research in three principal areas: ionospheric measurements, radar astronomy and radio astronomy. Ionospheric research was the principal reason for construction of the observatory. It was proposed by William E. Gordon of Cornell, an originator of the theory of electron scattering cross-section and now director of the AIO.

**Partial Return**—An estimated  $10^{-19}$ , or one trillionth part of the energy directed at individual electrons in the ionosphere is scattered back to the 1,000-foot collecting dish. From data about the motion of the particles, information can be obtained on electron temperature and density.

ARPA officials point out that the structure and processes in the ionosphere are important to the military because of the effects of the ionosphere on weather, communications and detection. The AIO may be helpful in detection of ballistic missiles, but scientists say the missile would have to come fairly close to the limited 40-degree scan area of the beam.

In the radar astronomy mode, it is believed that the AIO will be able to reach out some 500 million miles, perhaps to Jupiter. Limitations will be set by the time of transit of a radar signal as well as by loss of power through divergence of the beam.

In the radio astronomy mode, the AIO could reach to the limits of the universe. The AIO staff will try to listen to the sun, but they think that most of the energy at 430 Mc is absorbed in the solar corona.

Working in the radar astronomy mode, it should be possible to get valuable information about the moon including its surface. It is hoped that, with sophisticated data processing, a separation of signals to about 2 to 3 miles will be achieved. This will also mean improved accuracy in calculating the lunar orbit.

**Exotic Sources**—In radio astronomy, the AIO will be listening to radio sources 10 to 12 billion light years away. Also, as a radio astronomy facility, it may help to identify some of the powerful radio sources identified optically in recent years.

Transmitter power of the AIO is 2.5 megawatts peak and 150 kw average. Pulse lengths can be varied from 2  $\mu$ sec to 10 milliseconds and prf from 1 to 1,000. The transmitter, shown in Fig. 1, is capable of producing 2.5 megawatt peak power at a maximum duty cycle of 6 percent. It can be easily reconnected for c-w output with a capability of 100 kw.

**Frequencies**—The signal source is an ultrastable oscillator that produces 1 Mc. A multiplier furnishes four 20-mw outputs at 1, 30, 400 and 430 Mc. The 430 Mc signal is fed to a 3-watt amplifier where any modulation desired at the output can be introduced.

The intermediate amplifier uses an Eimac klystron,

## AFTER ARECIBO

Top echelons of the Department of Defense have before them a proposal for funding a larger antenna of even greater sensitivity than the AIO. This is the multiplate antenna, proposed by Air Force Cambridge Research Laboratories (p 42, Sept. 7, 1962).

Such a multiplate antenna comprises some 5,000 flat plates, each 20  $\times$  20 feet, arranged in four elliptical areas around a central tower. The 1,000-foot tower requires a feed platform maintained in position by guy cables and also a servomechanism. This quadri-ellipse configuration could provide a maximum aperture distance of 2,500 feet in two planes with an aperture area equivalent to a 1,600-foot dish. Each plate is adjustable in height and orientation to redirect energy from an arbitrary direction to the focus in proper phase. A computer determines proper tilt angle and center height of each plate, with a 10-second maximum time for repositioning all plates.

Soviet radio astronomers have proposed a similar antenna

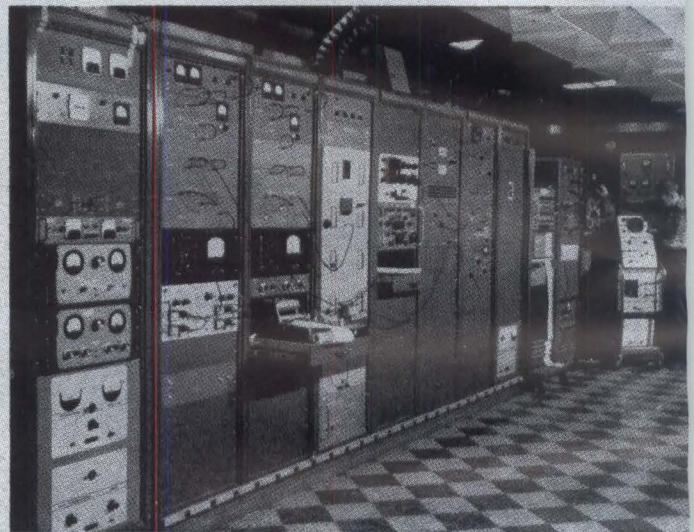

RECEIVER room, containing i-f section and some data processing equipment, is connected by 1,400 feet of coaxial cable to receiver front end located in antenna house

coupled to the final stage through two lines containing attenuators and a phase shifter. The final stage uses two Varian klystrons, each rated for 1.25 Mw peak and 75 kw average power.

Accessory equipment for the r-f section of the transmitter consists of a frequency divider chain that drives the pulse repetition rate generator that in turn feeds the adjustable pulse delay units. The signal then passes to the gate system that switches the 3-watt amplifier modulator on and off to produce square pulses.

The 81-Mc r-f link is triggered by a gate from the pulse delay unit. The link provides high-voltage isolation from ground level. The mod-anode modulator switches the final klystron beam current on before the r-f pulse is applied and off after the r-f pulse is stopped.



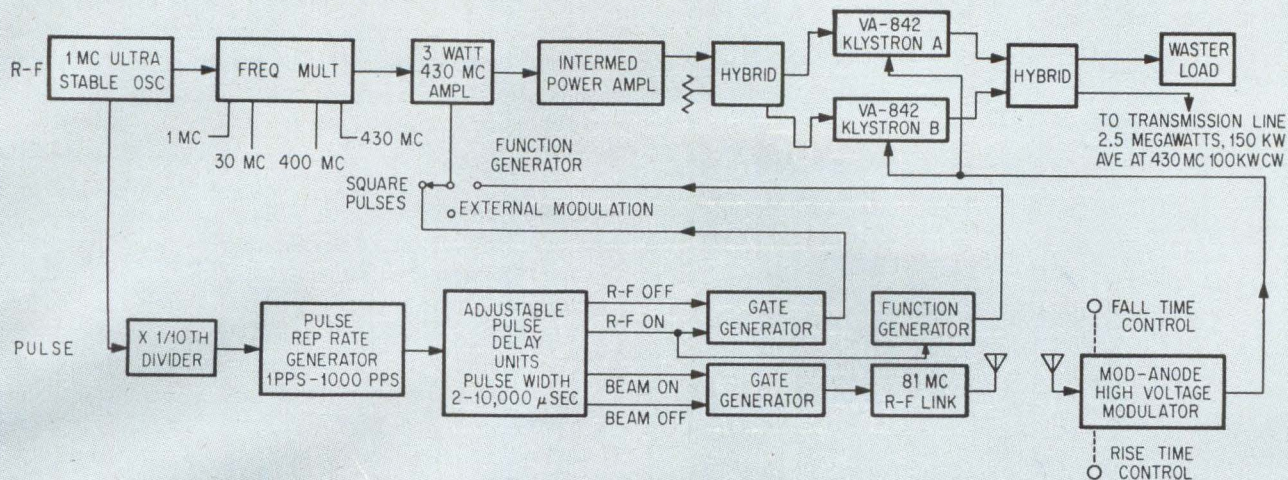

VERSATILITY built into transmitter permits megawatt pulse output or a 100-kw c-w signal using the same tubes—Fig. 1

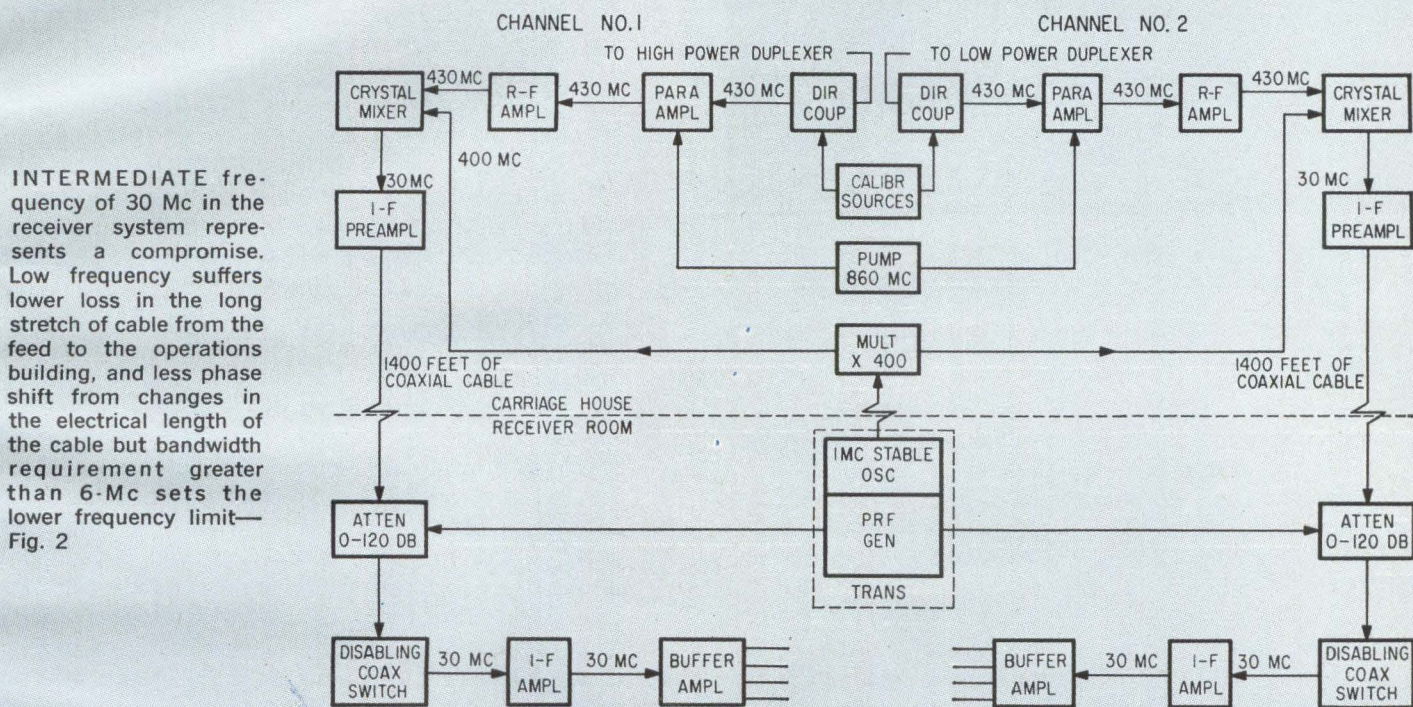

INTERMEDIATE frequency of 30 Mc in the receiver system represents a compromise. Low frequency suffers lower loss in the long stretch of cable from the feed to the operations building, and less phase shift from changes in the electrical length of the cable but bandwidth requirement greater than 6-Mc sets the lower frequency limit—Fig. 2

**R-F Feed**—The transmission system was designed to deliver 5 megawatts peak and 300 kw average power to the feed above the huge dish from the 430 Mc transmitter located in the operations building. The entire system is designed around WR 2100 waveguide and waveguide components. The feed (p 46, July 7, 1961) corrects for aberrations of spherical optics, using techniques conceived at AFCRL. About half the 1,400 feet of waveguide is rigidly supported and half is supported from a flexible, cable-hung catwalk. The expansion and contraction of rigidly supported sections is accommodated by sliding clamps and articulators; devices that allow motion in three dimensions without electrical degradation. The flexibly mounted run on the catwalk is allowed to bend through the insertion of eight properly spaced flexible sections of waveguide.

The receiver r-f section includes the receiving equipment in the carriage house below the platform and the main amplifiers in the receiver room as shown in Fig. 2. The equipment in the carriage house includes two separate channels, each of which has a directional coupler, Adler electron-beam type parametric amplifier, low-noise r-f amplifier, crystal mixer, and i-f preamplifier. Noise calibration sources, the pump for the parametric amplifier and a chain multiplier to supply the reference signal for the crystal mixers—all these are common to both channels.

The front-end equipment is connected to the main amplifiers in the receiver room through two coaxial cables 1,400 feet long. The received signal is fed to the parametric amplifier through the directional coupler, which is followed by a low-noise r-f amplifier. The signal is translated from 430 Mc to 30 Mc

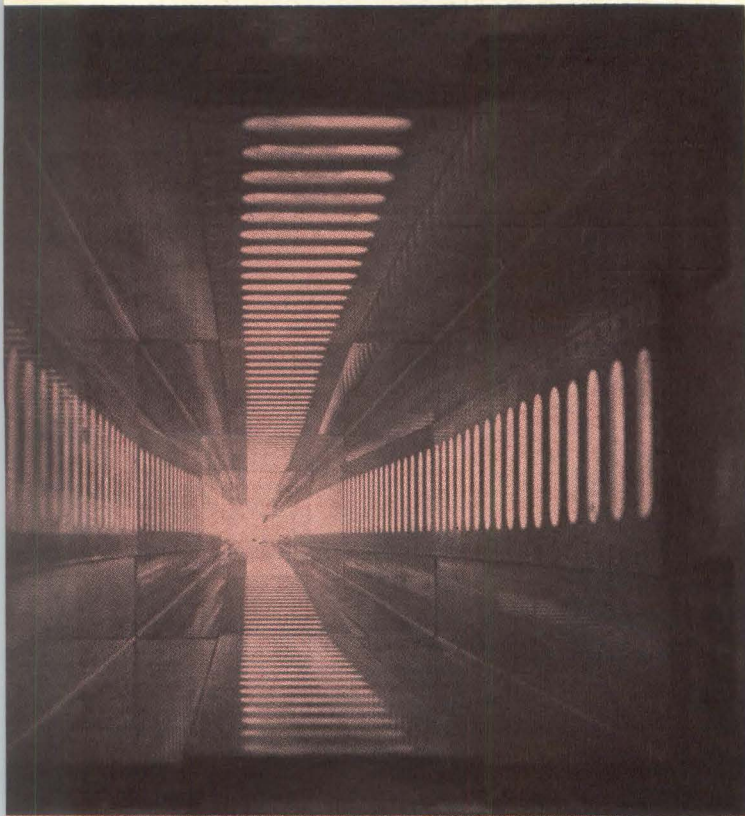

WAVEGUIDE antenna feed is 96 ft long with below-resonant, series, transverse slots spaced about 0.2 wavelength apart. Normally operated with circular polarization, the feed can also use linear polarization resulting from in-phase excitation of corresponding orthogonal slots

in a crystal mixer. The 400 Mc reference signal for the mixer is obtained from a multiplier chain derived from 10 Mc, which is locked to the 1 Mc standard source. The output of the mixer is fed to the i-f preamplifier before it is sent through the long coaxial cable to the receiver room.

**Filtering**—In the main receiver section, the 30 Mc signal is fed to the main amplifier through an adjustable attenuator. The main i-f has a gain adjustment for a fine change in output level. The amplified signal is then fed to the buffer amplifiers that provide each receiver channel with four identical outputs isolated from each other. Any output of the buffer amplifier

is connected to the proper filter in the filter bank to limit the receiver bandwidth. The signal from the filter is fed to a phase-sensitive detector or base-band mixer. The output of this mixer is fed to a square law detector and from there it is sent to the data processing section.

As outlined in Fig. 3, the data processing includes a master timing system, a bank of range gates and output samplers, a comb-filter spectrum analyzer, an a-to-d converter, control circuits and output display and recording facilities. A Control Data Corp. 160-A computer in the adjacent room is used for processing data.

For electron density measurements the incoming signal, after being filtered and detected, is fed into a bank of 100 consecutive range gates. A square-law detector is used so that output voltage values will be proportional to the power received by the antenna. The timing of the range-gate system is controlled by counters driven by the 1 Mc station frequency standard. The delay between the transmitted pulse and the opening of the first range gate is adjustable in one microsecond steps from 0 to 10 milliseconds. The width of the gates is also adjustable from 2  $\mu$ sec to 10 msec. Passive r-c integrator circuits are used in the range gates with time constants of 0.01, 0.1 and 1.0 second available. The input gates and output sampler gates are low-leakage transistors driven by transistor shift registers, one controlled by the radar timing circuits and the other by the output display or recording device. In addition to the 100 sampled range outputs, provision is made for recording continuously, on a multichannel strip chart recorder, any six selected range intervals.

**Spectrum Check**—A separate channel connected to the output of one of the buffer amplifiers is used for spectrum measurements. The signal is translated down to 455 kc, gated in range and fed into a bank of one hundred filters, each with a bandwidth of 100 cps. These filters can be placed adjacent to each other to produce a 10 kc total bandwidth or can be spaced to provide comb filters of 20, 50 or 100 kc width. The filter outputs are detected and applied to r-c integrators with a time constant of one second. The outputs of these integrators are sampled with high-speed relays and the data are then displayed or recorded.

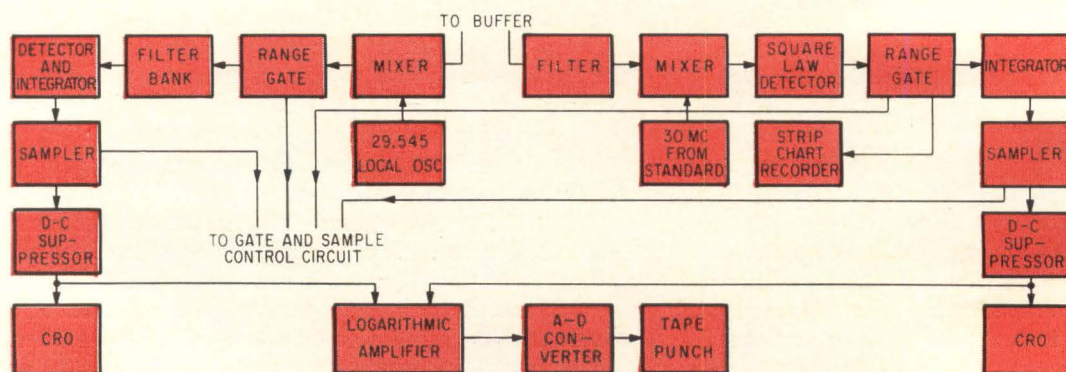

DATA-PROCESSING section of receiver described in text gives quick-look, strip-chart and tape-punch outputs—Fig. 3

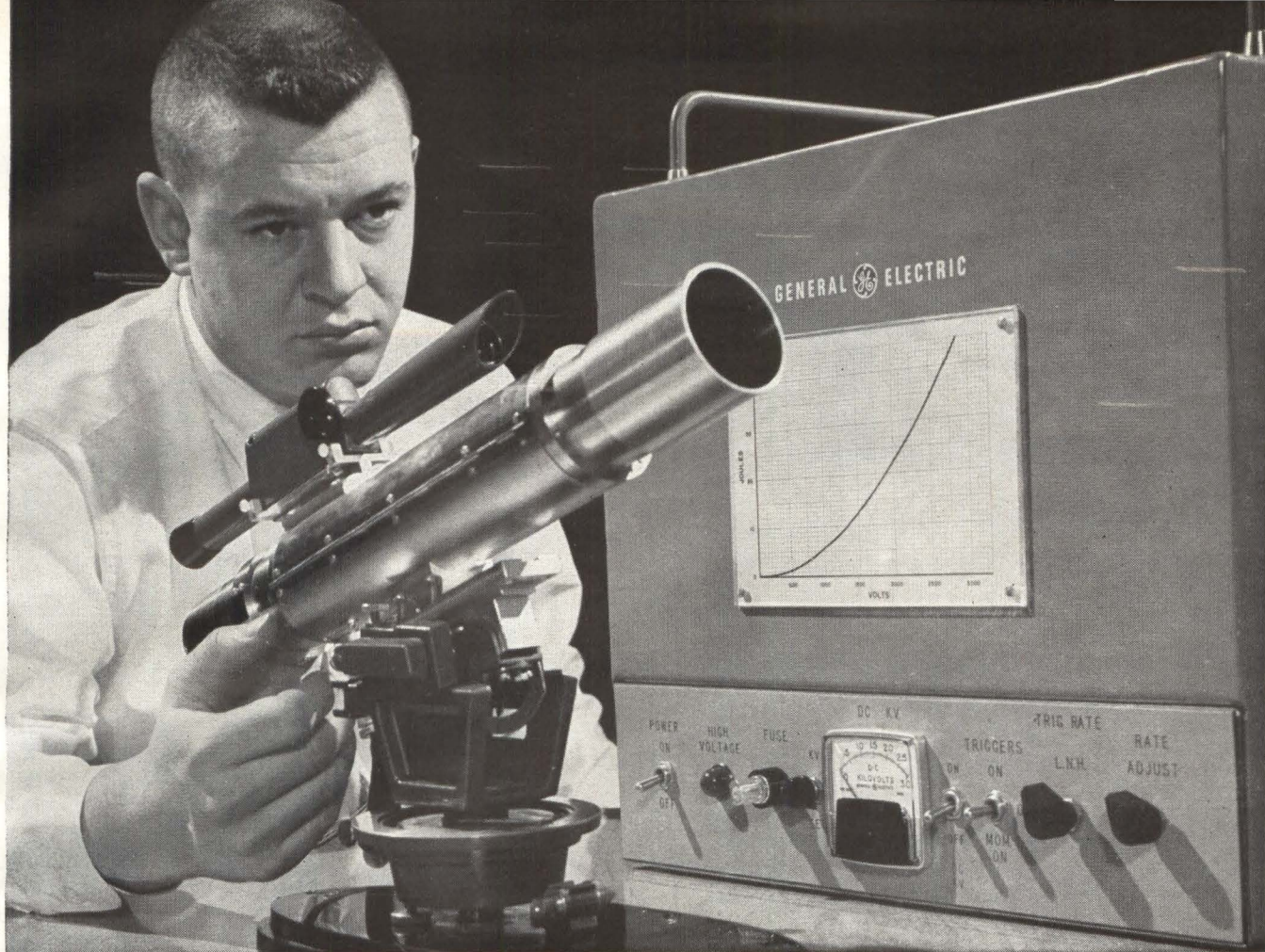

LASER equipment test conducted by W. R. Mallory of G. E. Electronics Lab

# Pulse Power Supply Design for Laser Pumping

Practical circuit design that specifies a minimum of equipment combines constant-current capacitor charging with limiting of output voltage

By S. J. GRABOWSKI, Heavy Military Electronics Dept., General Electric Co., Syracuse, N. Y.

**CONSTANT-CURRENT** networks used with varying loads require a means of limiting or regulating the output voltage of the network. Since output current from the network is constant, determined by design values of the inductors and capacitors making up the network, output volt-

age will vary with the effective load. This means that if the load on the constant current network is of a form comprising separate blocks of power (as in pumping a laser) voltage across the output terminals of the network will increase during zero-load periods. Under these con-

ditions, iron-core reactors in the network will saturate or some of the network components will be destroyed by high voltage.

For the laser application considered here, a constant-current network on the input side of the rectifier transformer was chosen to

## RAPID CHARGING PROBLEM

Large blocks of energy triggered to discharge rapidly through high-intensity lamps (as in pumping lasers) require high-voltage capacitor charging. At high repetition rates, manual and motor-control limiting of peak line currents is impossible. Electronic limiting includes use of phase-shift rectifiers in which the charging current controls the on phase of the rectifiers; or a constant-current network controls the input of a rectifier-type d-c supply. In the first case, wave-shape distortion and necessary grid-control gas tubes are a disadvantage. If constant-current networks are used with varying loads, output voltage must be limited. This article tells how the latter method has been applied

control charging current because the network itself does not add harmonics to the a-c power source. Distortion can occur from the clamping circuits used to limit the output voltage of the constant-current network, but this can be reduced in several ways. A variable transformer can be used on the input side of the network to vary the network output voltage and current since the output current of a constant-current network is proportional to its input voltage. Alternatively, the clamping circuits used to limit the output voltage from the network can be designed not to limit prior to a complete loss of load on the network.

**Total System**—The three top units of Fig. 1 make up the power supply that produces direct voltage for the pulse-forming network consisting of coils and capacitors in the modulator.

System operation starts with impulses formed in the trigger generator, amplified and used to trigger a high-power ceramic hydrogen thyratron tube in the modulator to initiate a pulse of energy for the flash lamp.

Repetition rate is controlled from the trigger generator. The voltage to which the pulse-forming network capacitors charge is adjustable at the load-control circuit.

The d-c power supply comprises a constant-current network, load control with limit and step-up transformer with silicon rectifiers.

The circuit diagram for the constant-current network and design equations are shown in Fig. 2. Equation (3) shows that the output current  $I$  is independent of output voltage  $E$  and output impedance  $Z$

since these quantities do not appear in the equation.

It is significant that network output current  $I$  is constant only for the case where  $Z_1$  and  $Z_2$  have no resistive components because a resistive component in either impedance is positive and therefore  $Z_1 + Z_2$  will not be equal to zero.

**Limiting Voltage**—The load control unit with maximum voltage limit is shown in Fig. 3. Two silicon controlled rectifiers in a back-to-back arrangement are used to take up the current that is not required by the energy storage capacitors in the modulator when the system is not operating at rated load. In operation, the amount of current flow through these rectifiers is controlled by adjustment of variable resistor  $R_1$ .

This resistor is part of a firing circuit for which voltage is supplied by the output of a single-phase bridge rectifier circuit formed by rectifiers  $D_7$  to  $D_{11}$  and regulated by zener diode  $D_9$ .

The time required to charge capacitor  $C_1$  to a voltage that will make unijunction transistor  $Q_1$  con-

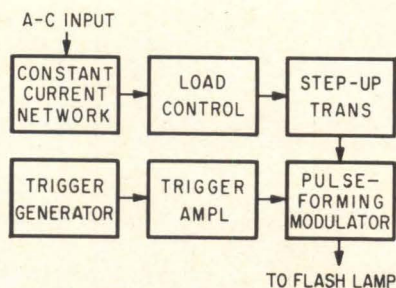

BASIC power supply system comprises power supply proper (above) and trigger circuits that operate pulse modulator (below)—Fig. 1

duct and discharge the capacitor is controlled by resistor  $R_1$ . Rapid discharge of the  $C_1$  through  $Q_1$  results in a voltage pulse being passed by pulse transformer  $T_1$  to fire the two silicon controlled rectifiers  $Q_2$  and  $Q_3$ .

If for any set division of load current between these rectifiers and the modulator, the modulator load current is lost, voltage will rise to a limit set by zener diode  $D_{12}$ , which then conducts to make  $Q_2$  and  $Q_3$  take up the current not being taken by the modulator load.

The voltage step-up rectifier transformer with silicon single-phase bridge rectifier stacks is conventional for the required voltage and current to the modulator.

**Pulse Former**—The pulse forming modulator shown in Fig. 4 is a line type with a five-section pulse-forming network consisting of the network coil  $L_2$  and the capacitor bank  $C_3$  producing a pulse 30  $\mu$  sec long.

The switch tube in the modulator is a high power ceramic hydrogen thyratron to insure reliable triggering at high temperature and high repetition rates. Rectifier  $D_1$  is used to provide a charging path for the pulse forming network capacitors.

In series with the flash lamp is a high-voltage secondary of a saturating core trigger transformer  $T_1$ . This transformer allows the flash lamp to be triggered with a short high-voltage spike superimposed on the leading edge of the main pulse. The spike is generated by the discharge of  $C_2$  through the modulator switch tube when this tube is triggered. Coil  $L_1$  and capacitor  $C_1$  form a filter to insure that the high-voltage trigger spike does not get back to the d-c power supply components that are not rated to stand this high voltage spike.

The trigger generator and trigger amplifier are of conventional design with trigger generator a transistor silicon rectifier type.

## REFERENCES

- (1) W. R. Mallory and Dr. K. F. Tittel, High repetition rate pulsed lasers, Paper presented at Brooklyn Polytechnic Institute Optical Maser Symposium.
- (2) "Silicon Controlled Rectifier Manual," 2nd ed., General Electric Co.
- (3) S. J. Grabowski, Monocyclic constant current networks, Internal General Electric Technical Information Publication.
- (4) Glasoe and Lebacqz, "Pulse Generators" MIT Radiation Laboratory Series, 5, McGraw-Hill Book Co.

**CONSTANT-CURRENT** network showing practical values of component parts and basic design information—Fig. 2

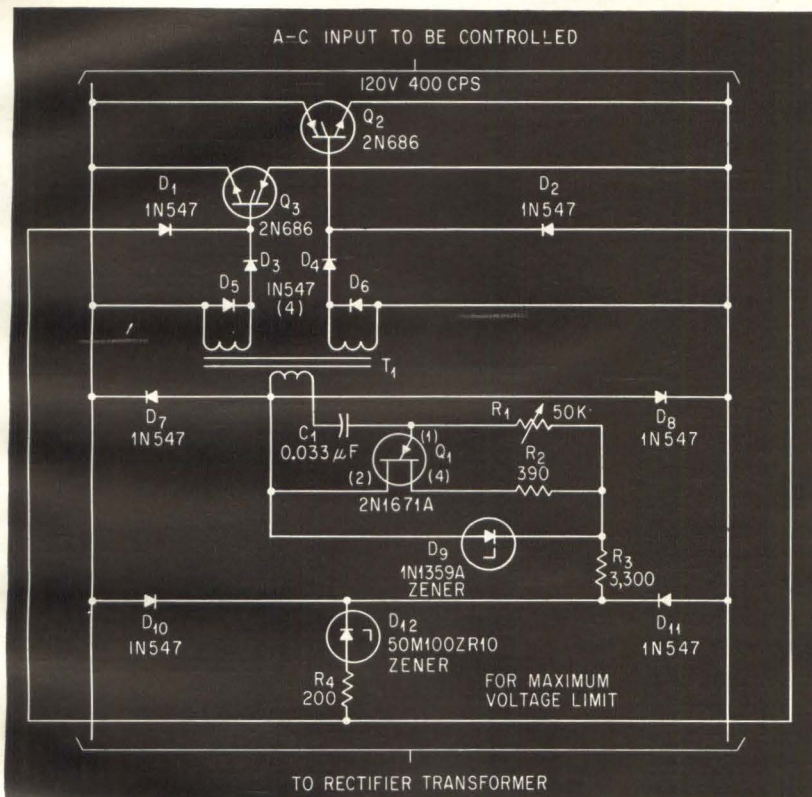
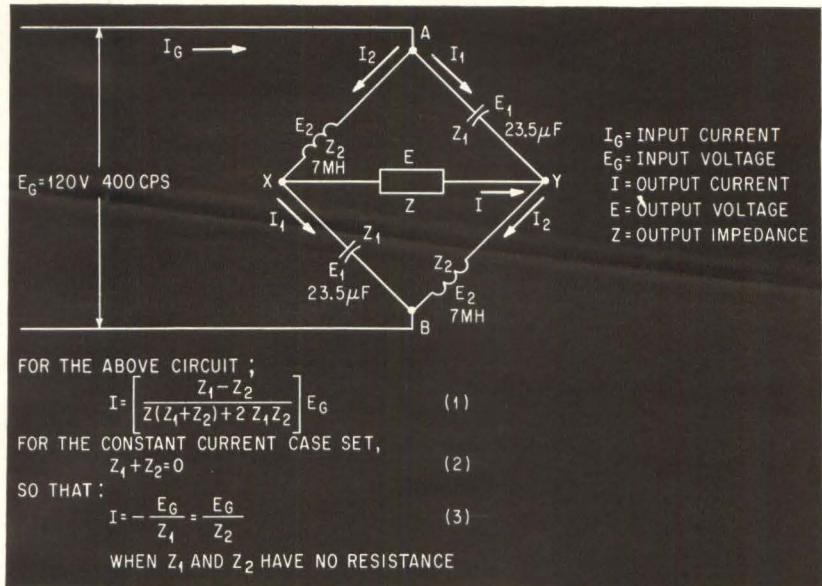

**LOAD-CONTROL** circuit with voltage limiting. The pulse transformer has unity ratio and is good for 2 μsec—Fig. 3

**PULSE-FORMING** modulator that operates laser-pumping flash lamp. Rectifier  $D_1$  is made up of seven rectifiers bypassed by parallel 390,000-ohm resistor and 0.001-μf capacitor—Fig. 4

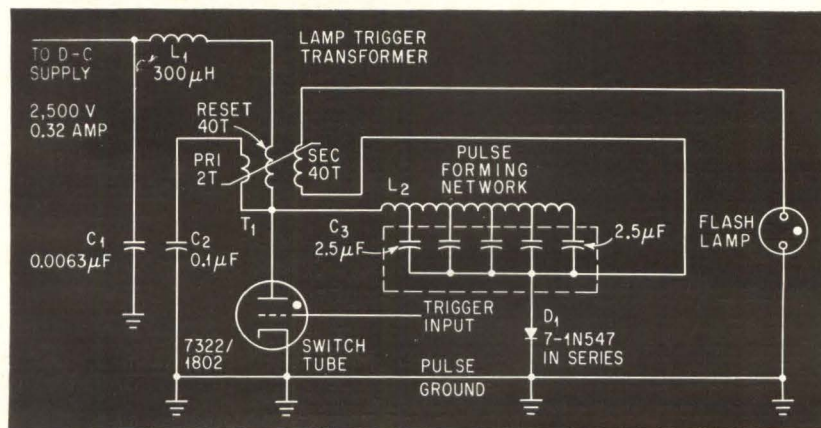

# Unity-Gain Buffer Acquires

In conventional form, a unity-gain amplifier requires precision resistors or transformers to determine gain. Here is a highly stable transistor circuit that eliminates precision parts and acquires unity gain inherently from feedback

**ALTERNATING CURRENT** systems often require precision gain, constant phase shift and buffer amplifiers to isolate sensing components like resolvers from their loads. Precision gain is needed to preserve the scale factor, while phase shift must remain constant so that the a-c error voltage of the servo is not swamped by quadrature voltage.

Conventionally, these devices are operational amplifiers with three or more stages employing feedback. Precision resistors or transformers are used to determine the gain. Moreover, stable performance over the operating environment is not easily achieved in feedback amplifiers, and in most cases, several compensating R-C filters must be installed to achieve a suitable stability margin.

This simple, two-stage amplifier has a precise and positive gain of unity without phase reversal, and high input impedance, low output impedance and negligible phase shift. Precision components are not required because unity gain is acquired inherently by the feedback. Since there are only two stages, nearly any configuration of the circuit will have adequate stability margins without compensation. If a gain other than unity is desired, it can be achieved by changing the turns ratio of one or more of the magnetic components such as the transformer in the servo loop, since the amplifier isolates the load from the component.

**Operation**—The circuit is shown in Fig. 1. The first stage operates in the common-base mode, with the distinction that the output voltage  $e_o$  is used as the point of equivalent a-c ground. The collector supply, the base and the emitter resistor all have a-c shorts to  $e_o$  rather than to ground. The input voltage to the first stage (emitter to base) is then  $e_i - e_o$ . The second stage is an emitter follower with its load resistor grounded. Its input voltage is the output of the 1st stage plus its own output voltage. An a-c equivalent representation of the circuit appears in Fig. 2A.

The input and output of each stage may be written from inspection of the diagram in Fig. 2A. The gain can be derived from the expression for the output of the second stage

$$A_2 [(e_i - e_o)] = e_o \quad (1)$$

$$A = e_o/e_i = A_2 A_1/1 + A_2 A_1 - A_2 \quad (2)$$

where  $A_1$  = voltage gain of the 1st stage and  $A_2$  = voltage gain of the second stage.

The second stage is an emitter follower with gain near unity. The gain of the common-base 1st stage furnishes all the loop gain. With typical values of  $A_1 = 35$  and  $A_2 = 0.94$ , the total gain is 0.99818. With variations (due to components and environment) of  $A_1 = 20$  to 60 and  $A_2 = 0.92$  to 0.96, the total gain has a nominal value of 0.997488 with a variation of  $\pm 0.001818$  or  $\pm 0.1823$  percent. For accuracy, this nominal value of gain would be used in computing the scale factor in a servo loop rather than exactly unity.

**Impedances**—The output impedance  $Z_o$ , may be derived by redrawing the block diagram with the input grounded as shown in Fig. 2B, and defining  $R_o$  as the open-loop output impedance, or as the output impedance if there were no feedback. From inspection of the schematic

$$1/R_o = 1/R_{k2} + 1/R_{k1} + 1/h_{ie1} + 1/h_{ib2} + R_c/h_{fe2} \quad (3)$$

where:  $h_{ie1}$  = a-c impedance from base to emitter of first stage,  $h_{ib2}$  = a-c impedance from emitter to base of second stage, and  $h_{fe2}$  = a-c current gain of the second stage.

$$\text{From inspection of Fig. 2B, } e'_o = A_2 (e_o - e_o A_1) \quad (4)$$

$$Z_o = e_o/i_o = e_o/(e_o - e'_o)/R_o = R_o e_o/e_o (1 - A_2 (1 - A_1)) \quad (5)$$

$$Z_o = R_o/1 - A_2 + A_1 A_2 \cong R_o/A_1 A_2 \quad (6)$$

From Eq. 3,  $R_o$  can be no larger than  $h_{ie1}$ , and Eq. 6 indicates that the output impedance  $Z_o$  is  $R_o$  reduced by the product of the gains of each stage. A low output impedance may therefore be realized.

Input impedance  $Z_i$ , may be derived directly from the schematic. Note that the load on the collector of the first stage is  $h_{ic2}$ , the a-c impedance from base to emitter of the second stage. The input current is

$$i_i = (e_i - e_o) (1/R_{k1} + 1/h_{ib1} + 1/r_c + h_{ie2}) \quad (7)$$

where  $h_{ib1}$  = a-c impedance from emitter to base of

# Precision by Feedback

By DAVID K. PHILLIPS, Operations Research Inc., Santa Monica, Calif.

the first stage and  $r_c$  = collector resistance of  $Q_1$ .

Dividing Eq. 7 by  $e_i$

$$i_i/e_i = 1/Z_i = (1-A) (1/R_{k1} + 1/h_{ie1} + 1/r_c + h_{ie2}) \quad (8)$$

Typically:

$$\begin{aligned} h_{ie1} &\ll R_{k1} \\ h_{ie1} &\ll r_c + h_{ie2} \end{aligned}$$

Therefore:

$$Z_i \cong h_{ie1}/1 - A \quad (9)$$

Since  $A$  is near unity, the input impedance is equal to  $h_{ie1}$ , increased by a large factor.

Note that  $R$  and  $C_s$  in Fig. 1 are not required since the actual a-c load on the collector  $Q_1$  is  $h_{ie2}$ , rather than  $R_c$ ;  $R$  and  $C_s$  were included to make clear the idea of a complete common-base stage tied to  $e_o$  rather than to ground. With the absence of  $R$  and  $C_s$ , and the replacement of  $C_c$  with a zener diode, the circuit becomes simple and might be manufactured on a single silicon wafer.

## CIRCUIT VALUES

The basic feedback scheme for unity gain was originally derived from a vacuum-tube circuit. From this original idea, the author designed and built the transistor circuit shown in the schematic. The values for this circuit were

$$\begin{aligned} R &= 100,000 \text{ ohms} & R_{b1} &= 240,000 \text{ ohms} & C_b &= 0.01 \mu\text{f} \\ R_c &= 500,000 \text{ ohms} & R_{b2} &= 125,000 \text{ ohms} & C_s &= 0.01 \mu\text{f} \\ R_{k1} &= 20,000 \text{ ohms} & R_{k2} &= 5,000 \text{ ohms} & E &= 30 \text{ volts} \end{aligned}$$

The transistors used by the author were 2N336's.

While preparing this manuscript for *Electronics*, Phillips took the time to perform another analysis on his circuit and suggests that the following component values would be optimum

$$\begin{aligned} R &= 0 & R_{b1} &= 750,000 \text{ ohms} & C_b &= 0.01 \mu\text{f} \\ R_c &= 50,000 \text{ ohms} & R_{b2} &= 50,000 \text{ ohms} & C_s &= \text{open circuit} \\ R_{k1} &= 10,000 \text{ ohms} & R_{k2} &= 1,000 \text{ ohms} & E &= 30 \text{ volts} \end{aligned}$$

The original transistors should be replaced with improved units now available such as the 2N2219 or 2N2222 devices intended for use with the optimized values

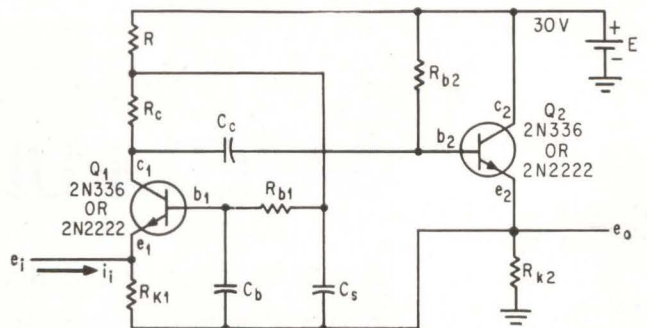

SIMPLE circuit originally designed by the author requires only two transistors—Fig. 1

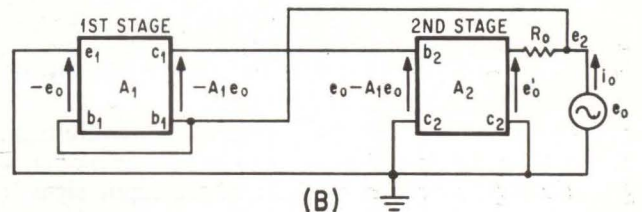
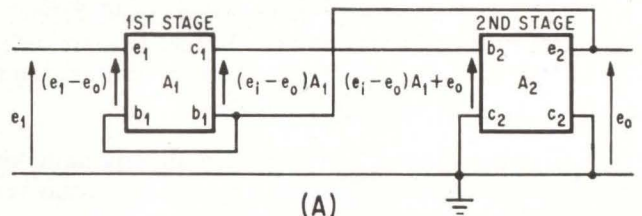

EQUIVALENT a-c representation of the amplifiers first stage (A), and modified version with grounded input circuit (B)—Fig. 2

## ADVANTAGES OVER PAST TUNING DEVICES

- Discriminates between large numbers of channels of information over a relatively small well-defined bandwidth.
- Does not require tuned elements but operates as a high-Q device even at low frequencies.
- Responds only to a signal sustained for a pre-determined period to provide outputs from integrating circuits.
- Has rapid response time and discriminates against noise and spurious signals.
- Responds to any selected harmonic or group of harmonics.
- Circuit is economical in design and may be constructed with digital modules.
- Power drain is low

By J. H. FIRESTONE

General Time Corp., Stamford, Conn.

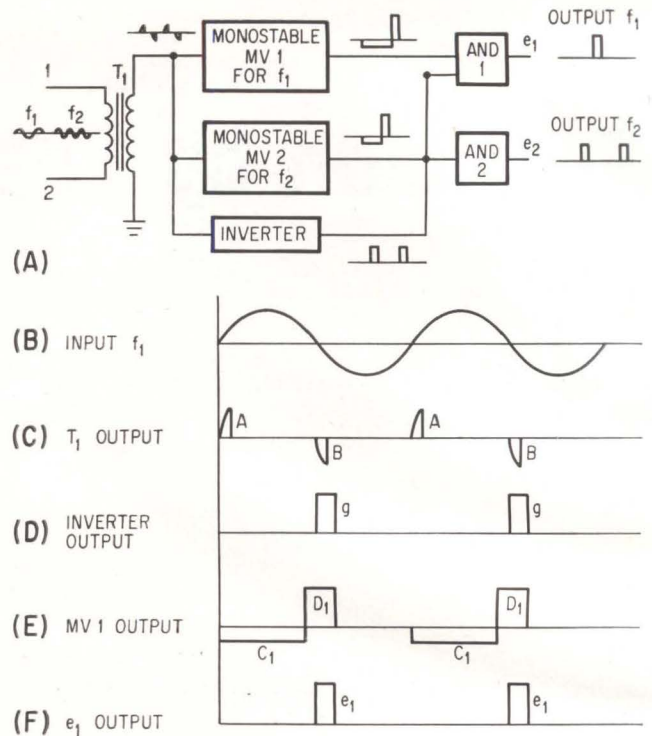

FREQUENCY discriminator in basic form (A); discriminator pulses (B through F)—Fig. 1

# GATED PULSES YIELD SELECTED

Discriminator senses leading edges of input signals, such as sine or square waves, to establish reference points and derive variable pulses, which can be precisely gated to provide outputs at selected frequencies

**THIS VERSATILE** frequency discriminating circuit is useful for such applications as channel selection in radio and television, telemetering, multichannel control systems in which each channel is represented by a discrete frequency, and other devices requiring tuning to different frequencies.

**Circuits**—Figure 1A illustrates an especially simple digital frequency-discriminating circuit. In this version the signal input, for example of frequency  $f_1$  or  $f_2$ , is applied across input terminals 1 and 2 to the primary of a saturable stepup transformer  $T_1$ . The operation of the transformer is illustrated in Fig. 1C for the sinewave input  $f_1$  of Fig. 1B. Preferably this triggering transformer has a high turns ratio so that the peak voltage of the secondary output is relatively high.

These pulses  $A$  and  $B$  can be further amplified and shaped as precise markers of the input signal's half period points. If pulse  $A$  triggers a precision monostable multivibrator as in Figure 1E, pulse  $B$  will coincide with pulse  $D_1$  if it appears at the right place in the right time as shown. This coincidence is frequency discrimination.

This peaking transformer output may be applied

directly to monostable multivibrator 1 and 2 and to the inverter. The inverter opens AND gates 1 and 2. Monostables 1 and 2 provide the second inputs to the AND gates. The presence of an input frequency  $f_1$  or  $f_2$  at terminals 1 and 2 is indicated by an output at  $e_1$  or  $e_2$ .

The basic frequency discriminator without additional circuits also detects higher harmonics. A low-pass filter designed with cutoff below the second harmonic of the frequency to be detected can be advantageously used on the input.

Details of the Fig. 1A circuit are shown in Fig. 2. Monostable multivibrator 2 and AND 2 are omitted.

The heart of the discriminator is the monostable circuit. This may be any type of one-shot delay multivibrator that receives an input pulse, waits for a pre-determined delay period and thereafter delivers a single output pulse of predetermined duration. The Mu-chron magnetic monostable multivibrator, which has excellent thermal and long life stability, is available in miniature module form from General Time.

In Fig. 2, a signal may first be filtered through a low-pass device (not shown) if it is desired to eliminate harmonics. (Advanced system designs include



DIODES: 1N 658

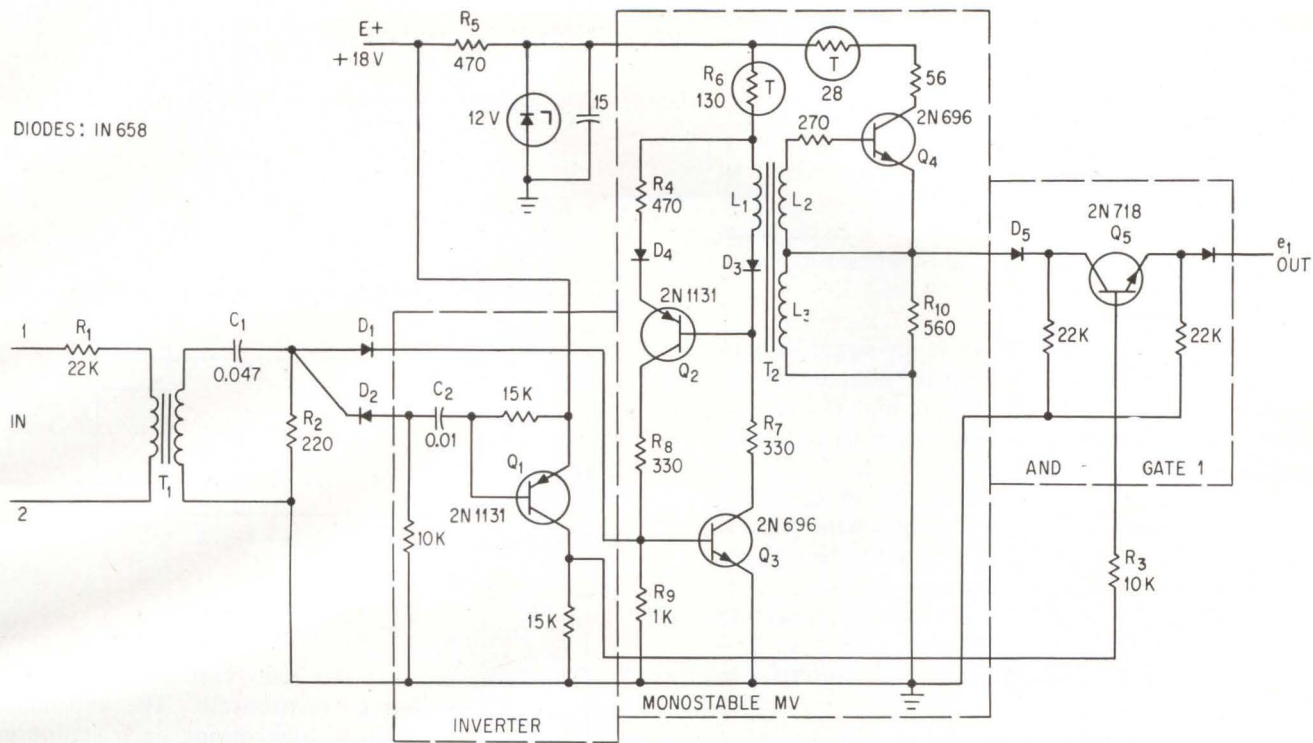

DISCRIMINATOR circuit, showing one each of the two multivibrators and gates—Fig. 2

## FREQUENCY OUTPUTS

additional digital circuits to eliminate low pass filters. These systems are capable of detecting any selected harmonic or group of harmonics.) Then the signal voltage is applied across inputs 1 and 2 and through limiting resistor  $R_1$  to the primary of  $T_1$ . As the input voltage alternates, the secondary winding applies an output voltage to combination  $C_1$  and  $R_2$  which differentiates this voltage.

A negative spike B (Fig. 1C) coupled through  $C_1$  is also passed through diode  $D_2$  and through  $C_2$  of an amplifying, shaping and inverting circuit. The resulting amplified and inverted (positive) spike  $g$  (Fig. 1D) is transmitted through  $R_3$  to enable  $Q_5$  (AND 1).

**Multivibrator**—When a positive spike  $A$  (Fig. 1C) is coupled through  $C_1$ , this is transmitted through  $D_1$  to monostable 1. The positive input renders  $Q_3$  conductive. As a result, saturating current is drawn from  $E+$  through limiting resistors  $R_5$ ,  $R_6$  and coil  $L_1$ , wound on core  $T_2$ , formed of commercial square hysteresis loop material. The saturating current path is completed through  $D_3$ ,  $R_7$ , and conducting  $Q_3$ .

At this time, until the core  $T_2$  has been saturated,  $L_1$  presents a high impedance to the saturating current and a considerable voltage drop is developed across  $L_1$ . This voltage drives the base of stage  $Q_2$  negative with respect to its emitter and thus causes  $Q_2$  to begin conducting also. The latter stage then draws currents that flow through  $R_8$  and  $R_9$  to ground. The voltage

drop across  $R_9$  causes the base of  $Q_3$  to be driven positive, which latches the stage  $Q_3$  and hence stage  $Q_2$  also in a conducting condition for the duration of the saturating current drawn through  $L_1$ . In addition, the saturating current induces a voltage in coil  $L_2$  of a tapped winding also wound on  $T_2$  and connected across the base and emitter of  $Q_4$ . This induced voltage in  $L_2$  is of a polarity to keep  $Q_4$  cut off. Similarly an induced voltage appears across  $L_3$ . This is pulse  $C_1$  in Fig. 1E, which represents the set or fixed delay period of monostable 1. Diode  $D_5$  prevents this voltage from affecting stage  $Q_5$ .

When the core of  $T_2$  is driven past saturation, the impedance of  $L_1$  is lowered and the resulting drop in the emitter-base voltage of  $Q_2$  shuts it off. This withdraws the latching bias from the base of  $Q_3$  and the latter shuts off also. At this instant the return of the core flux to its residual saturation level induces in  $L_2$  a voltage of such polarity that the base of  $Q_4$  is driven positive relative to its emitter. Transistor  $Q_4$  now begins the reset phase as it conducts resetting current through  $L_3$  of the tapped winding on core  $T_2$  and then to ground. Resistor  $R_{10}$  is a high impedance shunted across  $L_3$  to prevent the development of excessive peak voltages when  $T_2$  saturates. During conduction of the reset current, a voltage is induced in winding  $L_1$ , which reverse-biases  $Q_2$  to deprive  $Q_3$  of any driving current during the entire reset stage. The voltage induced in  $L_2$ , however, serves to keep

reset transistor  $Q_4$  conductive until core  $T_2$  is resaturated in the original direction. Reset voltage  $D_1$  appears across winding  $L_3$  and is shown in Fig. 1E.

Now pulse  $D_1$  appears at the collector of stage  $Q_5$ . In the event that the AND gate is enabled by pulse  $g$ , then pulse  $D_1$  is passed through  $Q_5$  to output  $e_1$  (Fig. 1F).

Additional circuits in monostable 1 include state-of-the-art voltage regulation and temperature compensation techniques.

**Design Formulas**—In Fig. 3, an input signal varying in frequency from  $f_{w1}$  to  $f_{w2}$  is to be detected by the discriminator. Pulses  $A$ ,  $g_{w2}$ ,  $g_{w1}$ ,  $C$  and  $D$  are generated by the discriminator with fixed pulse widths now to be determined.

As the frequency increases from  $f_{w1}$  to  $f_{w2}$ , pulse  $g$  moves from right to left and coincides with pulse  $D$  to provide an output at AND 1 (see Fig. 1F). Thus coincidence occurs from  $t_{w1}/2$  to  $t_{w2}/2$  and  $t_{w1}/2 = T/2 + \Delta T/2$ ,  $t_{w1} = T + \Delta T$ , thus low-frequency cutoff  $f_{w1} = 1/(T + \Delta T)$ . Also,  $t_{w2}/2 = T/2 - T_g$ ,  $t_{w2} = T - 2T_g$ , thus high-frequency cutoff  $f_{w2} = 1/(T - 2T_g)$ .

Bandwidth  $f_{w2} - f_{w1} = \Delta f_{w1-2}$

$$\Delta f_{w1-2} = \frac{1}{T-2T_g} - \frac{1}{T+\Delta T} = \frac{\Delta T + 2T_g}{(T-2T_g)(T+\Delta T)}$$

$$\Delta f_{w1-2} = \frac{\Delta T + 2T_g}{(T-2T_g)(T+\Delta T)}$$

Mid-frequency ( $f_{w0}$ )

$$f_{w0} = \frac{f_{w2} - f_{w1}}{2} + f_{w1} = \frac{f_{w2}}{2} + \frac{f_{w1}}{2}$$

$$= \frac{1}{2} \left( \frac{1}{T-2T_g} + \frac{1}{T+\Delta T} \right) = \frac{T + \Delta T/2 - T_g}{(T-2T_g)(T+\Delta T)}$$

$$f_{w0} = \frac{T + \Delta T/2 - T_g}{(T-2T_g)(T+\Delta T)}$$

In most cases the pulse widths of  $A$  and  $g$  are much smaller than those of  $D$  or  $C$ . And so with  $T \gg T_g \ll \Delta T/2$

$$f_{w2} \approx 1/T$$

$$\Delta f_{w1-2} \approx \frac{1}{T} - \frac{1}{T+\Delta T} = \frac{\Delta T}{T(T+\Delta T)} = \frac{1}{T(1+\Delta T)}$$

$$f_{w0} \approx \frac{T + \Delta T/2}{T(T+\Delta T)} \approx \frac{1}{T + \Delta T/2} \quad (1)$$

**Monostable Design**—The monostable output, set pulse  $C$  and reset pulse  $D$ , must be equal in volt-second area or  $V_c T/2 = V_d \Delta T/2$ , and for square loop material (neglecting losses),  $V_c T/2 = 2N_3 \phi_m$  or

$$T = \frac{L_1 N_3 \phi_m}{V_c} \quad (2)$$

where  $N_3$  = number of turns of output coil  $L_3$ ,  $\phi_m$  = peak value of saturation flux of core  $T_2$ ,  $V_c$  = voltage of output set pulse  $C$  across  $L_3$ , and  $V_d$  = voltage of output reset pulse  $D$  across  $L_3$ , also,  $V_d \Delta T/2 = 2N_3 \phi_m$ .

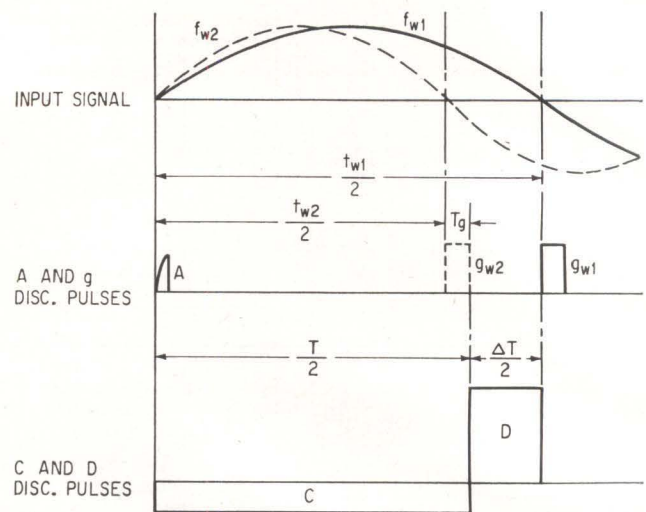

DETAILS of several Fig. 1 pulses—Fig. 3

$$\frac{\Delta T}{2} = \frac{2N_3 \phi_m}{V_d} \quad (3)$$

The saturating set and reset currents flow mainly in the coils  $L_1$  and  $L_3$  respectively. The impedance of the coils is relatively high during each saturating phase so that practically the full zener voltage  $V_z$  appears across each coil.

During the set phase  $V_{L1} \approx V_z - V_{D3} - V_{ce \text{ sat. } Q_3} \approx V_z - 1$ . Also,  $V_{L1} = (V_c N_1)/N_3$ . During the reset phase,  $V_{L3} \approx V_z - 1 = V_D$ , so that

$$V_c \approx \frac{N_3}{N_1} (V_z - 1) \quad (4)$$

$$V_D \approx V_z - 1 \quad (5)$$

Combining Eq. 1, 2, 3, 4 and 5,

$$f_{w0} \approx \frac{1}{T + \frac{\Delta T}{2}} = \frac{1}{\frac{4N_3 \phi_m}{V_c} + \frac{2N_3 \phi_m}{V_D}} = \frac{1}{\frac{4N_3 \phi_m N_1}{(V_z - 1) N_3} + \frac{2N_3 \phi_m}{(V_z - 1)}} = \frac{V_z - 1}{2\phi_m (2N_1 + N_3)}$$

The design of the monostable reduces to a proper choice of zener voltage, saturation flux and turns of coils  $L_1$  and  $L_3$ . The turns of coil  $L_2$  should be such that it causes saturation of  $Q_4$  without loading  $L_3$ . Of course,  $Q_2$  and  $Q_3$  must be driven to saturation during their conduction phases.

The equation for bandwidth reduces to

$$\Delta f_{w1-2} \approx \frac{V_z - 1}{4\phi_m N_1 (1 + N_1/N_2)}$$

The design of the peaking transformer, inverter and gate depends largely on input signal strength and frequency. In general, additional circuits may be needed to generate pulses  $A$ ,  $B$  and  $G$  so that  $T_g \ll \Delta T/2$ .

Output circuits could consist of fast integrating or switching networks, depending on ultimate receiver response time and sensitivity.

## REFERENCES

- (1) A. Meyerhoff, "Digital Applications of Magnetic Devices", p 333, John Wiley & Sons, 1960.
- (2) Texas Instruments, "Transistor Circuit Design"—"Blocking Oscillators", p 427, McGraw-Hill, 1963.
- (3) M. Ingenito, "Magnetically Coupled Multivibrators", ELECTRONICS, p 43, March 1963.

# Communications Range Nomograph

Will solve for any single term in the communications range equation shown in the panel providing the other factors are known

By MARVIN W. SHORES, General Dynamics/Pomona, Pomona, Calif.

**THE NOMOGRAPH** illustrated can simplify the solution of the well-known communications range equation (panel). Any single term of this equation may be derived if the remaining terms are known. The nomograph is made up of six frames, intermeshed to shorten the length of the graph with minimum compression of the scales. Each frame consists of three verticals and each vertical represents a term of the equation shown in the panel or a product of two or more terms, or constants. The third vertical in each frame is common to a vertical in the next frame as shown.

**Operation**—The rules in operating the nomograph are: (1) Perform each step within a frame by drawing a straight line through the two known points; (2) The intersection point of the straight line and the

third vertical is common to the next adjacent frame. From this point a straight line is drawn within the adjacent frame to the known value on the second vertical; (3) The intersection on the third vertical of the adjacent frame provides a take-off point for the next frame. This progression is continued until the value of the unknown in the final frame is intersected. As an example, select  $P_T = 10^3$  watts,  $G_T = 25$  db,  $G_R = 27$  db,  $F = 5,000$  Mc and  $P_R = -110$  dbm.

Now, to find the maximum range,  $R$ , first place a straight line between  $P_T$  and  $G_T$ . The intersection on the  $P_T G_T$  vertical is 55 dbw. Secondly, place a straight line across the next adjacent frame from the  $P_T G_T$  product of 55 dbw to 27 db on the  $G_R$  scale. The intersect point on the third vertical provides an origin point for the next adjacent frame.

Thirdly, place a straight line from this origin point across the next adjacent frame to  $5 \times 10^3$  Mc on the  $F$  scale. The intersection of the line and third vertical in this frame provides the origin point for the next adjacent frame, and finally, a straight line across this frame to  $-110$  dbm on the  $P_R$  vertical provides the solution:  $R = 1.9 \times 10^9$  feet. The minimum detectable signal  $P_R$  corresponds to a signal-to-noise ratio that satisfies the requirements of the system. For example, a minimum ratio of 3 db for the preceding example defines the maximum noise power, within the system bandpass, as  $-113$  dbm. By drawing a straight line from this level on the  $P_R$  vertical through the value of the system noise figure (NF), an intercept point on the  $KT B$  vertical is obtained. This point is common to the next frame. Drawing a straight line through this point and the anticipated system temperature yields a value of system bandpass.

Effective system temperature is the effective accumulated noise temperature derived from the antenna noise temperature and the effective accumulated noise temperature of the receiver and the loss elements inherent to the signal path between the antenna and the receiver. The antenna noise temperature varies somewhat depending on the pointing attitude relative to noise sources such as galactic, sun, earth and absorption. As present day receiver systems become further refined to function with relatively small transmitter powers at excessive ranges through outer space, a greater emphasis will be placed upon reducing effective system temperature.

With the introduction of parametric and maser amplifiers, significant

## SOLVING FOR COMMUNICATIONS RANGE

The communications range between a given transmitter and receiver may conventionally be found by solving the communications range equation

$$R = \left( \frac{P_T G_T G_R \lambda^2}{KT B \overline{NF} 16 \pi^2} \right)^{1/2}$$

In this equation,  $R$  = the distance between transmitting and receiving antennas;  $P_T$  = Power delivered to the transmitting antenna driven element;  $G_T$  = Effective gain of the transmitting antenna;  $G_R$  = effective gain of the receiving antenna;  $\lambda$  = wavelength of the operating frequency;  $K$  = Boltzman's constant;  $T$  = Absolute temperature in degrees K;  $B$  = effective bandwidth of the receiver system and  $\overline{NF}$  = effective noise figure of the system.

This equation may be modified to

$$R = \left( \frac{P_T G_T G_R 984^2}{P_R 16 \pi^2 f^2} \right)^{1/2}$$

where  $984/f(\text{Mc})$  = wavelength ( $\lambda$ ) in feet at the operating frequency, and  $P_R = KT B \cdot \overline{NF}$ .

The product of  $KT B \cdot \overline{NF}$  describes the total level of thermal noise power present in the system. The nomograph shown in this article arbitrarily designates this power level as the minimum detectable signal power,  $P_R$ . In practice, however, the signal-to-noise ratio must be sufficiently greater than unity to insure that reliable intelligence can be detected by the system at maximum range.



# New Value Package

You can use the Type 561A Oscilloscope—with Type 3A1 Dual-Trace Amplifier Unit and Type 3B3 Time-Base Unit—for a wide range of DC-to-10 MC laboratory applications.

You can observe no-parallax displays and sharp trace photography. For the new crt has an internal graticule with controllable edge lighting.

You can display single or dual-trace presentations or algebraic addition.

You have 10 mv/cm sensitivity with .035  $\mu$ sec risetime.

You have highly adaptable time-base features including:

1. Calibrated sweep range—from 0.1  $\mu$ sec/cm to 1 sec/cm for normal and delayed-sweep presentations.
2. Calibrated sweep delay—for setting and measuring precise delay intervals: from 0.5 microsecond to 10 seconds.
3. Single-sweep control — for simplifying waveform photography of normal-sweep presentations.
4. Flexible triggering facilities—with triggered operation extending to beyond 10 megacycles.

Also, you can use any of 12 other amplifier and time-base units for differential, multi-trace, sampling, other applications, including matched X-Y displays using the same type amplifier units in both channels.

Type 561A Oscilloscope . . . . . \$470

Type 3A1 Dual-Trace Amplifier Unit . . . . \$410

Type 3B3 Time Base Unit . . . . . \$525

Rack-Mount Model also available.

Occupies only 7 inches of standard rack height.

Type RM561A. . . . . \$525

Oscilloscope prices without plug-in units.

U.S. Sales Prices, f.o.b. Beaverton, Oregon

# Sweep Delay and Dual-Trace Plug-in Units

with the Tektronix Type 561A Oscilloscope

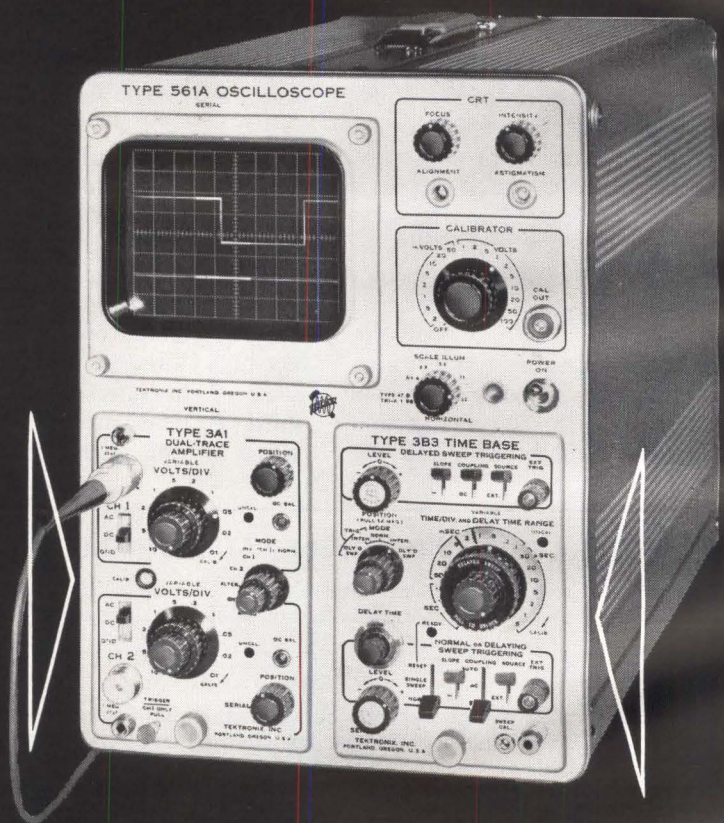

For a demonstration, please call your Tektronix Field Engineer

**Tektronix, Inc.** / P. O. BOX 500 • BEAVERTON, OREGON 97005 / Phone (Area Code 503) Mitchell 4-0161 • Telex: 036-691 • TWX: 503-291-6805 • Cable: TEKTRONIX • OVERSEAS DISTRIBUTORS IN 27 COUNTRIES

**Tektronix Field Offices:** in principal cities in the United States. Consult Telephone Directory • **Tektronix Limited,** Guernsey, Channel Islands  
**Tektronix Canada Ltd.:** Montreal, Quebec • Toronto (Willowdale), Ontario • **Tektronix Australia Pty. Limited,** Sydney, New South Wales

sensitivity gains due to the reduction of total effective temperature have become highly feasible. Parametric or maser amplifiers have effective

temperatures that are relatively insignificant compared to the total equivalent temperature contributions from the antenna, spillover,

absorption, line losses, etc. For this reason, the nomograph provides a wide range of effective system-noise temperatures.

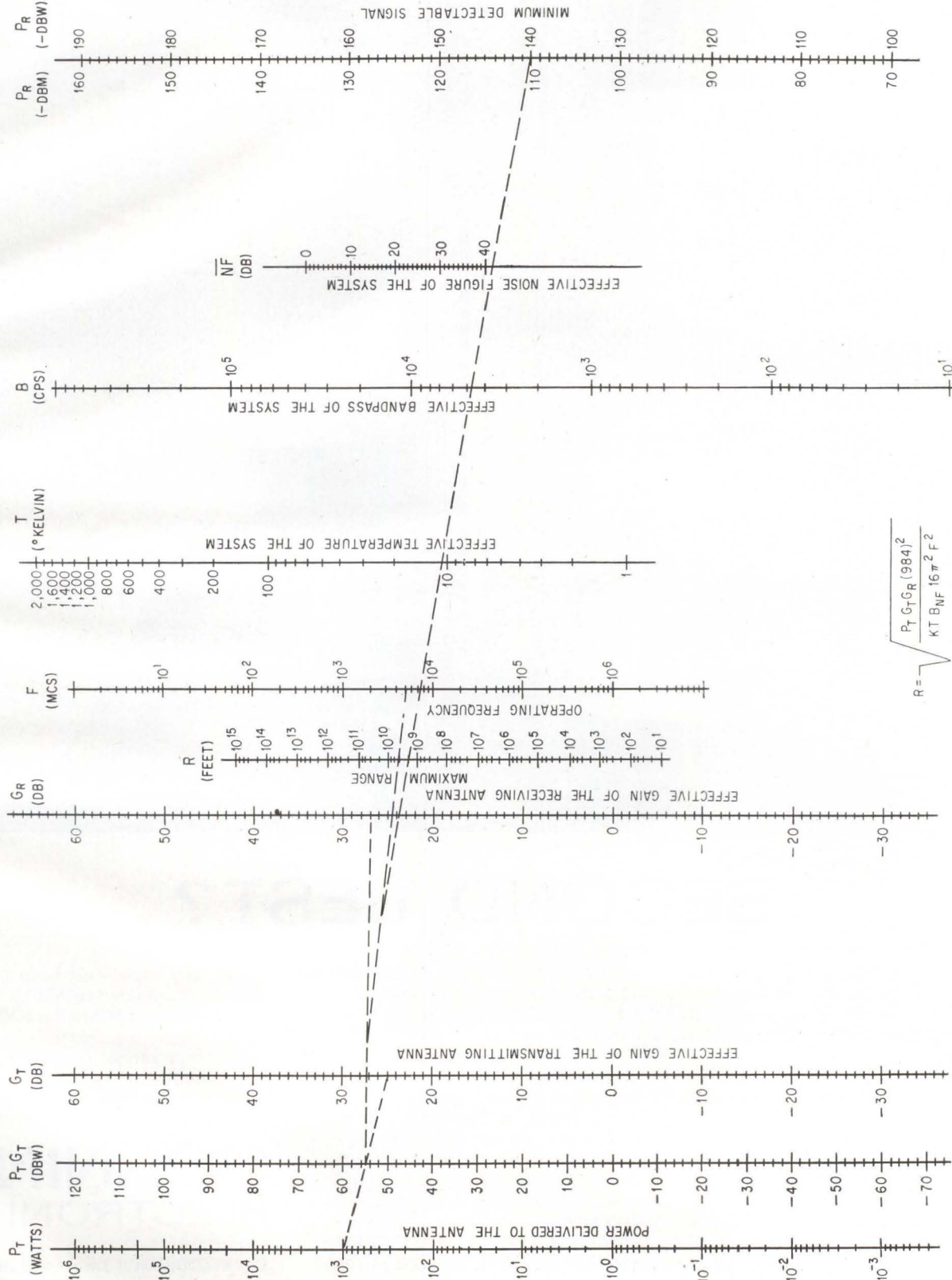

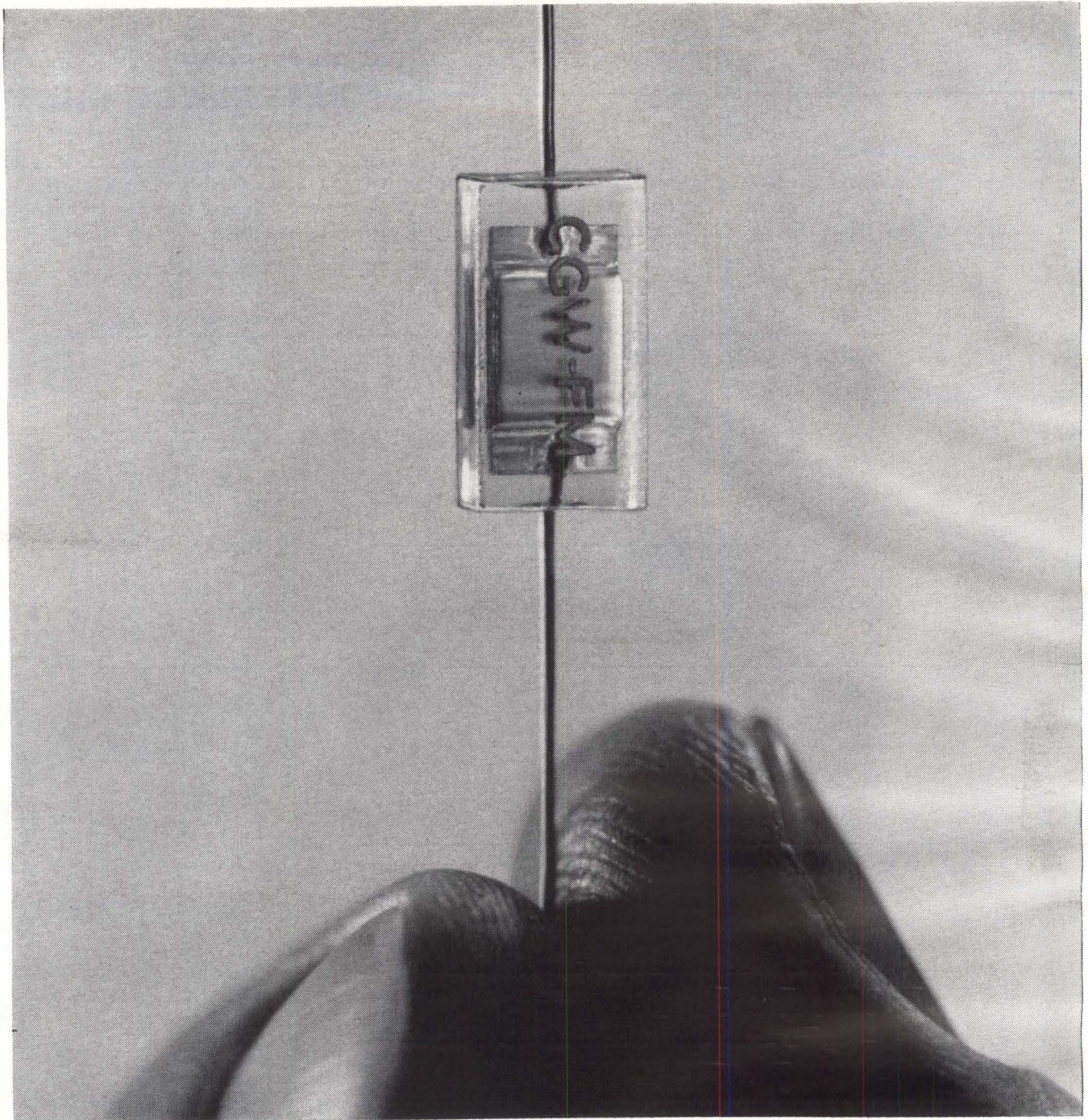

## SECOND BEST?

That's the Corning CYFM capacitor. It's topped only by the Corning CYFR—the first one that completed the Autonetics/Minuteman high reliability program.

We learned how to make the CYFM while working to improve reliability. It's electrically and environmentally interchangeable with the CYFR. The major difference is price, and that's because we use refined processes on the CYFR for applications requiring guaranteed failure rates and reliability.

All in all, the CYFM is a positively

sealed capacitor for complete environment-proof performance (it goes far beyond MIL-C-11272B), and it sells for less.

Developmental testing of the CYFM went 6,000,000 test hours, and included load life, boiling salt, salt spray, fluxes, and solvents.

You can get its reliable capacitive element of foil and ribbon glass, frozen inside glass with hermetic seals at the leads, in four types. The CYFM10 gives pf values from 0.5 to 300; CYFM15, 220 to 1200; CYFM20, 560 to 5100; CYFM30, 3600 to 10000.

But, when you must have the ultimate in *guaranteed* reliability to your specifications, specify the CYFR. It's available in the same sizes and capacitance range. The CYFR is second to none.

For complete information, write for data sheets.

# CORNING ELECTRONICS

A DIVISION OF CORNING GLASS WORKS  
3901 ELECTRONICS DR., RALEIGH, N. C.



Type 230-A

# 10 to 500 MC POWER AMPLIFIER

— for Low-Level Applications

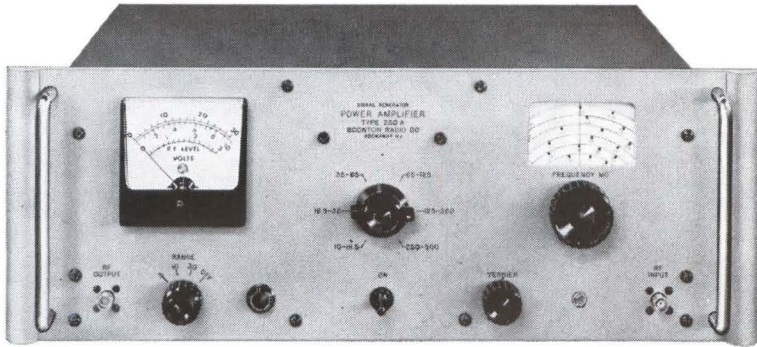

The BRC Power Amplifier Type 230-A is the ideal RF amplifier for low-level applications exhibiting a typical noise figure of 6 to 8 db. Three tuned, cascaded stages of grounded-grid amplification provide up to 30 db gain and a maximum power output of 5 watts. Typical applications include:

**RECEIVER PRE-SELECTOR** — The Type 230-A, when used as a pre-selector with conventional communications receivers, will readily provide fractional microvolt sensitivities.

**TUNED SELECTIVE FILTER** — BRC 230-A provides a convenient means for the selective amplification of RF signals in the 10 to 500 Mc. range with excellent rejection of undesired frequencies.

**HARMONIC AMPLIFIER** — The new power amplifier may be used to amplify desired harmonics in the output of signal generators and frequency synthesizers thereby extending their useful range.

**FREQUENCY COUNTER PRE-AMPLIFIER** — Type 230-A as a pre-amplifier for conventional frequency counters, such as the *hp* 524/525, will provide a 15 to 30 times improvement in input sensitivity. Remote, off-the-air frequency measurements of FM broadcast and communication transmitters may be readily performed.

**RF MILLIVOLTMETER PRE-AMPLIFIER** — When used as a pre-amplifier for RF millivoltmeters, such as the *hp* 411, the 230-A will provide 15 to 30 times improvement in sensitivity.

## BOONTON RADIO COMPANY

A Division of Hewlett-Packard Company



GREEN POND ROAD, ROCKAWAY, NEW JERSEY

Tel. 627-6400 (Area Code 201) TWX: 201-627-3912 Cable Address: Boonraco

**RF RANGE:** 10 to 500 Mc.

**BAND RANGES:** 10-18.5 Mc. 65-125 Mc.  
18.5-35 Mc. 125-250 Mc.  
35-65 Mc. 250-500 Mc.

**RF GAIN:** 30 db (10-125 Mc.)  
27 db (125-250 Mc.)  
24 db (250-500 Mc.)

**RF BANDWIDTH:** >700 Kc. \*(10-150 Mc.)  
>1.4 Mc. \*(150-500 Mc.)

\*Frequency interval between points 3db down from max. response

**RF OUTPUT:**

**RANGE:** Up to 15 volts\*

\*Across external 50 ohm load

**IMPEDANCE:** 50 ohms.

**CALIBRATION:**

0.2 to 3 volts f.s.;

increments of approx. 5%.

1.0 to 10 volts f.s.;

increments of approx. 5%.

2.0 to 30 volts f.s.;

increments of approx. 5%.

**ACCURACY:** ±1.0 db of f.s. (10-250 Mc.).

±1.5 db of f.s. (250-500 Mc.).

**LEAKAGE:** Effective shielding is greater than 40 db.

**RF INPUT:**

**LEVEL:** <0.316 volts\* (10-125 Mc.)

<0.446 volts\* (125-250 Mc.)

<0.630 volts\* (250-500 Mc.)

\*For 10 volt output into 50 ohms

**IMPEDANCE:** 50 ohms

**AM RANGE:** Reproduces modulation of driving source 0-100% up to 5 volt max. carrier output

**AM DISTORTION:** <10% added to distortion of driving source

**FM RANGE:** Reproduces modulation of driving source except as limited by the RF bandwidth

**FM DISTORTION:** Negligible distortion added to distortion of driving source for deviations and modulation frequencies <150 Kc.

**INCIDENTAL AM:** <10% added to modulation of driving source at 150 Kc. deviation

**MOUNTING:** Cabinet for bench use; by removal of extruded strips suitable for 19" rack mounting

**POWER REQUIREMENTS:**

105-125/210-250 volts,

50-60 cps, 150 watts

Price: \$1200.00 F.O.B. Rockaway, N. J.

# Who says all females are alike?

All females are supposed to be unpredictable, unreliable, and hard to handle.

Here's one that isn't. It's the "better half" of Amphenol's new Ultra-Mate\* connector.

## GO/NO-GO RELIABILITY

The Ultra-Mate connector is more than predictable. You can bet your life on it—which is exactly what astronauts do each time they soar away from the launch pad. Ultra-Mate will mate *only* if every pin fits snugly into every socket. No mis-connection intermittencies.

## EASY TO HANDLE, TOO

Ultra-Mate gets its go/no-go reliability from the female half's hard faced, closed entry receptacle. Ultra-Mate is the only truly environmental, space age connector that combines a hard dielectric with *front* servicing. Any stubby-fingered technician can assemble or disassemble an Ultra-Mate connector in mere seconds.

How did we do it?

Take a close look at the female Ultra-Mate. You'll see 55 funnel-shaped openings, one for each contact. These hard-dielectric entryways guide contact-pins smoothly into their sockets. Like Figure 1 at the right. If pins are bent out of line, the connector halves just won't mate.

Now, look a little closer. See those tiny slots fanning out of each entryway? These are the secret of Ultra-Mate's front release system.

Only the standard removal tool will fit into these slots. No wrong-size contacts. No oversize test prods. Ultra-Mate is idiot-proof. And it's fast. Contact positions are clearly marked in front of the dielectric.

## MIL-C-26500 PERFORMANCE

For the first time, an environmental connector combines tamper-proof safety and service features with MIL-C-26500 performance. Ultra-Mate also meets the requirements of MIL-C-38300, a recently issued Air Force specification that retains the rigid environmental and temperature standards of MIL-C-26500, but specifies either a hard closed-entry or soft dielectric. It also employs, as does MIL-C-26500, front removal of contacts and incorporates new reliability requirements never included in connector specifications to date.

Here's what you get with a fully pressurized Ultra-Mate connector:

1. Operates continuously, with current load, at 200°C ambient.

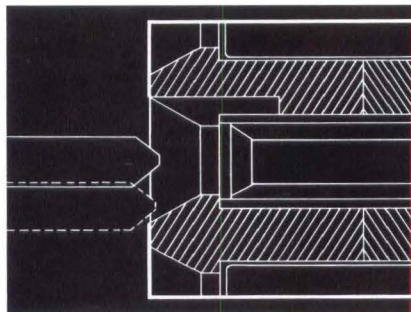
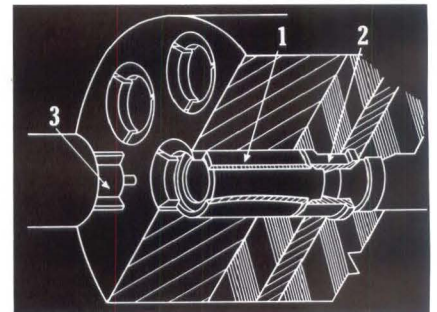

**Figure 1.** Slight misalignment is self-corrected by the beveled entry of the Ultra-Mate connector. Badly bent pins will prevent mating until they are replaced.

2. Undamaged by 50 g's shock.
3. Withstands thermal shock, 5 cycles between -55°C and +260°C.
4. Carries 1,500 volts RMS submerged in salt water while pressure is alternated between sea level and 75,000-ft. altitude equivalents.
5. Handles 1,000 volts RMS at altitudes up to 110,000 feet.
6. Insulation resistance exceeds 5,000 megohms.
7. Unaffected by exposure to hydraulic fluid, lubricating oil, ozone, and moisture.

## ULTRA-MATE AVAILABILITY

You can specify Ultra-Mate connectors now in all basic sizes referenced in MIL-C-26500. Bayonet or threaded couplings. Any Amphenol Sales Engineer can give you the complete specs and engineering data. Or, write to: Dick Hall, Vice-President, Marketing, Amphenol, 1830 S. 54th Avenue, Chicago 50, Illinois.



**Figure 2.** Standard removal tool depresses activation sleeve (1) which spreads tangs of retention clip (2) apart. Tool (3) never directly touches clip.

\*Ultra-Mate is a Trademark of Amphenol-Borg Electronics Corporation



A DIVISION OF AMPHENOL-BORG ELECTRONICS CORPORATION



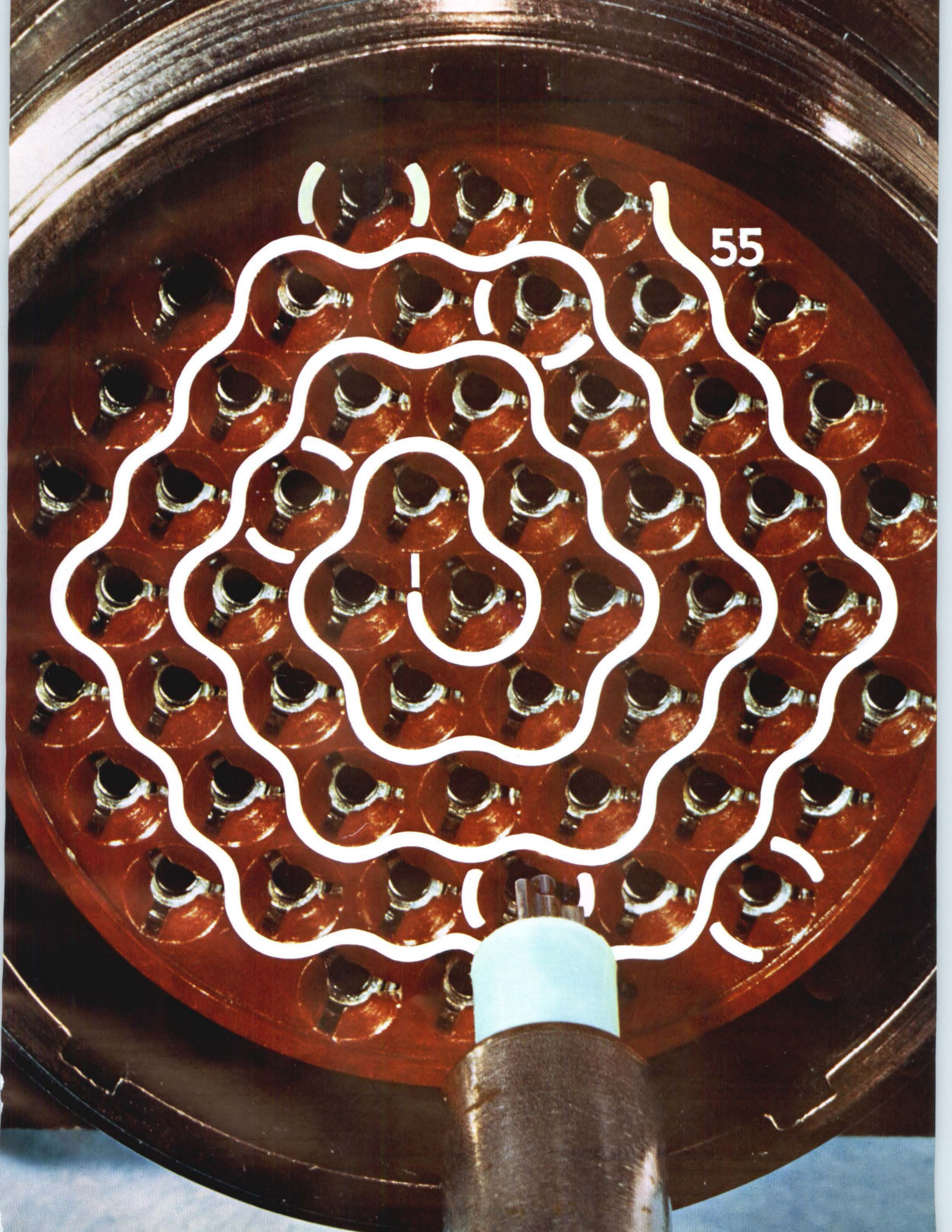

55

TELEMETRY DOWN TO EARTH!

# THE HONEYWELL VISICORDER MEASURES STRAIN ON A ROTATING SCRUBBER MILL

\* \* \* \* \*

Telemetry is usually thought of as signal transmission across tremendous voids. Allis-Chalmers uses the Honeywell Visicorder oscillograph to bring telemetry down to earth.

At the Allis-Chalmers processing machinery department in Milwaukee, design engineers wanted to measure grinding mill stresses while the huge machines process metal ore, taconite, cement, and other materials. Large, costly slip rings and dismantling of the machinery had to be avoided, and if possible, all tests were to be made under actual operating conditions in the user's plant.

The problem was neatly solved with a telemetry system built around a Honeywell 906 Visicorder oscillograph and a Honeywell Bridge Balance Unit. With this system, stresses on the shell of the mill, torque on the shaft, and strain on the entire mill can be measured with the mill in operation, and with a minimum of inconvenience to the customer.

Strain gages are placed on the mill at points where stresses are to be measured. Multiplexed data from the gages are broadcast by an FM transmitter attached to the rotating mill, and are picked up by an FM receiving unit. The multiplexed signal is 'sorted out' by audio filters and discriminators, and sub-frequencies and frequency variations are changed to a varying DC voltage.

The Honeywell Visicorder was selected to record the data because Allis-Chalmers engineers wanted to measure even the slightest variation at high frequencies (in this case, as high as 1800 cps), and to measure and record all three data channels simultaneously. In addition, the immediately-readable record produced by the Visicorder gave the engineers an on-the-spot reading of stress variations as well as a permanent record for later use.

There is a Honeywell Visicorder to fit your test requirements. Six models offer frequency response from DC to 5000 cps, with paper speeds from .1 inch per hour to 160 inches per second. For complete specifications on all Visicorder oscillographs, call your nearest Honeywell Industrial Products Group office, or write: Honeywell, Denver Division, Denver 10, Colorado, where our number is: 303-794-4311. In Canada, contact Honeywell Controls, Ltd., Toronto 17.

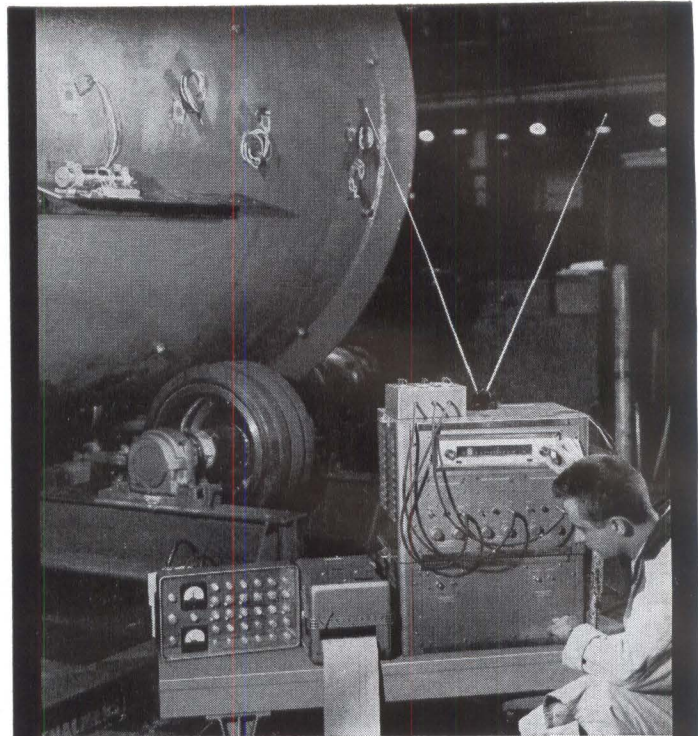

The Honeywell Model 906 Visicorder oscillograph and Honeywell Bridge Balance Unit used in a telemetry system for measuring stresses on a rotary scrubber mill manufactured by Allis-Chalmers, Milwaukee.

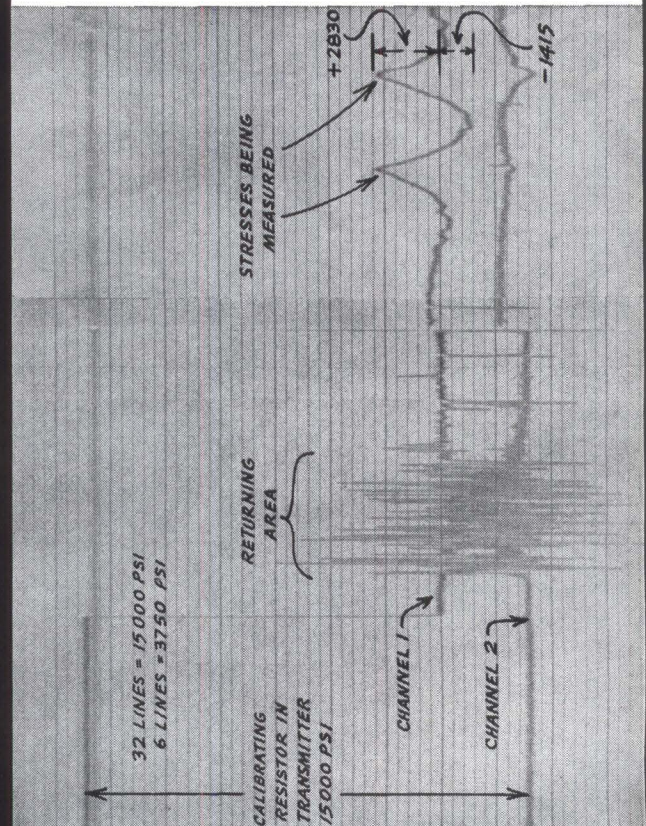

This Visicorder record of telemetered scrubber mill stress data is shown one-half actual size. Records of this type enable A-C to make necessary changes in their formulae for stresses on mill shells and heads.

DATA HANDLING SYSTEMS

# Honeywell

HONEYWELL INTERNATIONAL Sales and Service offices in all principal cities of the world. Manufacturing in United States, United Kingdom, Canada, Netherlands, Germany, France, Japan.

# System Reads Three Type Fonts

Can read three documents  
a second, tape the data  
and print business forms

By JOHN M. CARROLL  
Managing Editor

**BLUE BELL, PA.** — A new contender for an estimated \$1-billion future annual market for print readers entered the lists here last week as Philco, a subsidiary of Ford Motor Co., introduced its multifont paper reader.

The system demonstrated can read alphanumeric characters in three common typewriter fonts at the rate of 2,000 characters per second. It accepts 8½ in. by 14 in. sheets at the rate of three per second or 3-by-5 cards at seven per second. Its output is on magnetic tape in binary-coded decimal code at 90 to 100 inches per second. Punched paper tape and card outputs are also available. On magnetic tape, the output is packed to 190 to 500 characters per inch.

A repertory of 35 instructions provides choice of format for reading and printing business forms. The output is compatible with all known digital data-processing systems. Triple scanning of selected characters can provide an additional accuracy check. A related print reader developed for the U. S. Post Office for reading Zip code numbers, city and state on envelopes has demonstrated an error rate of less than ⅓ of one percent.

The commercial print reader will sell for \$575,000 and lease for \$15,000 a month on a one-shift

basis. Philco quotes nine-month delivery.

**How It Works** — Incoming documents remain stationary as they are scanned by a special flying-spot scanner (fss), whose crt is a joint Philco (gun)-Westinghouse (phosphor) development. The scanner stops the document feed by locking onto the leading edge of the document.

In the locating mode, the fss scans the whole page until it locates the first character. Then it scans one character at a time. It then dissects each character into 680 bits (34 × 20 matrix). The video output from the fss is a train of 680 pulses of varying amplitude.

The second unit of the system, the video processor, first finds the bottom of the line of print then ascertains character height. Next the video signal is passed through two cascaded differential amplifiers to sharpen character outlines and reject fill-ins or unintentional smudges.

The pulse-amplitude modulated wavetrain next goes to the cross correlator where each pulse in the wavetrain is cycled through a shift register where it is compared with the corresponding information from each of 110 multifeature extraction masks or patterns. Values of resistance set decision levels for the grey scale of the patterns. A match is determined on a statistical basis. The cross correlator makes the decision as to which character is being scanned or a decision to reject the character (as in the case of strikeovers or interlineations), in which case a question mark may be printed out.

These decisions are stored in a

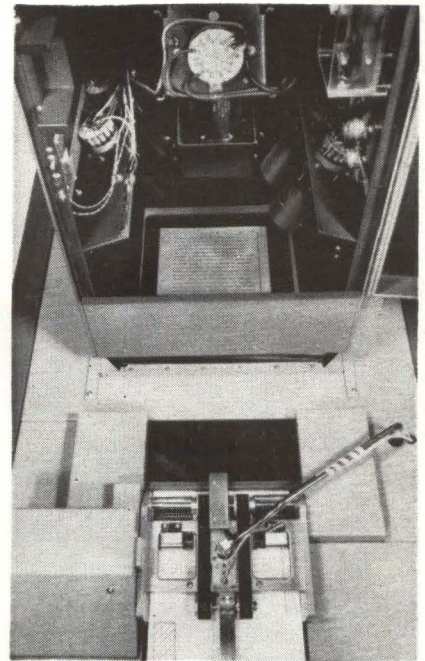

VACUUM-ASSISTED mechanical equipment smooths out document and positions it under special flying-spot scanner (above)

4,000-character memory that may be expanded in 2,000-character increments. Finally, a code converter generates a unique computer code signal for each different character.

Logic circuits are of the transistor-diode (TDL) type working in the AND, OR mode.

**Related Work** — This print reader is a commercial version of a system designed for the U. S. Post Office. A developmental model delivered two years ago could read nine fonts of type and handle business envelopes in sizes up to 8 by 11 inches. Three reader systems are under contract with the third to be delivered in July, 1965.

Philco is building a print reader for Rome Air Development Center to handle Air Force intelligence data. Part of an information storage and retrieval system for the 425-L project, it will have to read material typewritten on 3-by-5 cards. It will have to recognize eight styles of type including teleprinter type, forty special characters including some Greek letters and mathematical symbols, subscripts, superscripts and manually underlined material. Output will be on punched paper tape at 300 characters per second. Delivery is scheduled for spring 1964.

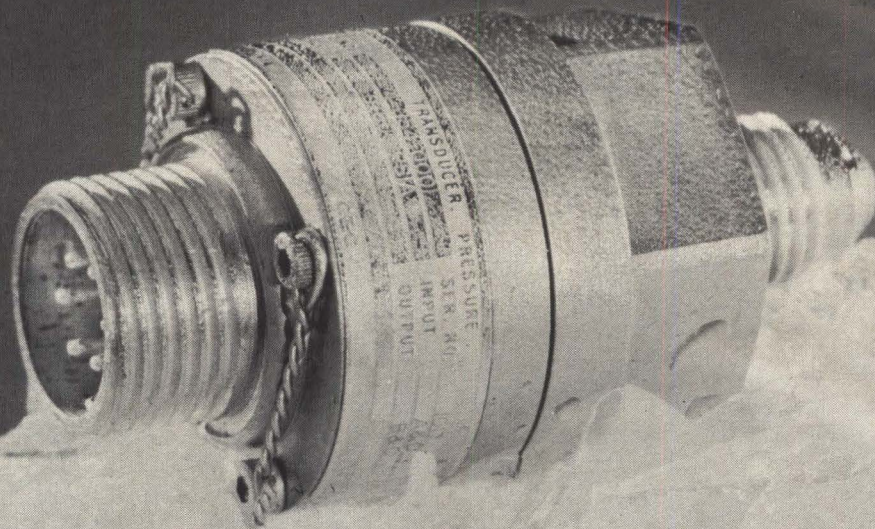

## 1.130" by 2.25" by 5 Oz. by $-459^{\circ}\text{F.}$ to $+300^{\circ}\text{F.}$

That's the 4-354 Cryogenic Pressure Transducer from CEC

Now in use by major aerospace contractors, the 4-354 Pressure Transducer is a new addition to the extensive line of CEC transducers. The 4-354 Pressure Transducer was designed to operate in ranges of  $-459^{\circ}\text{F.}$  to  $+300^{\circ}\text{F.}$  Its compensated temperature range is  $-320^{\circ}\text{F.}$  to  $+250^{\circ}\text{F.}$  It will accurately measure gage and absolute pressures of fluids in ranges of 0-100 psi to 0-5000

psi. The 4-354 produces a 20 mv. output compatible with millivoltmeters, oscillographs, galvanometers, oscilloscopes, amplifiers, and other equipment. A special stress isolation design prevents erroneous outputs caused by mechanically induced distortion or vibration. It will remain accurate under extreme acceleration, vibration, and shock. It is 2.25 inches high and has a

diameter of 1.130 inches. Weight is 5 oz. Combined linearity and hysteresis is 0.5% of full range output.

Call or write for Bulletin CEC 4354-X6.

**CEC**  
Transducer Division

**CONSOLIDATED ELECTRODYNAMICS**  
A Subsidiary of Bell & Howell • Pasadena, Calif. 91109

CIRCLE 50 ON READER SERVICE CARD

MORE THAN  
**1000**  
DELIVERED

CEC's high output  
pressure transducer



The CEC 4-390 is a high output, unbonded strain gage pressure transducer with integral, solid state power supply and amplifier, providing a 5 volt DC output signal. It measures absolute and gage pressures of fluids and gases in ranges from 0-100 through 0-5000 psi.

The 4-390 is a standard item, being produced in quantity. Major aerospace contractors have proven this instrument capable of maintaining superior performance characteristics in extreme acceleration, vibration and shock environments.

This transducer is the result of CEC's many years of instrumentation experience. Call or write for Bulletin CEC 4390-X12.

**CEC**  
Transducer Division

**CONSOLIDATED ELECTRODYNAMICS**  
A Subsidiary of Bell & Howell • Pasadena, Calif. 91109  
CIRCLE 51 ON READER SERVICE CARD  
electronics December 20, 1963

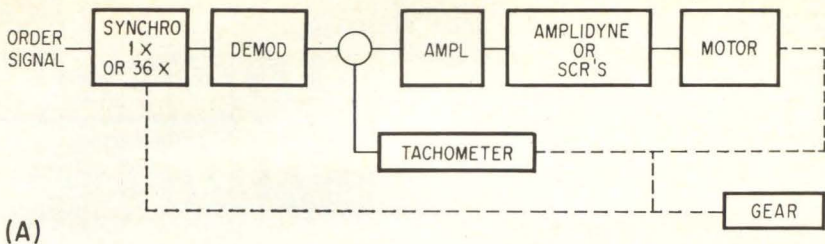

(A)

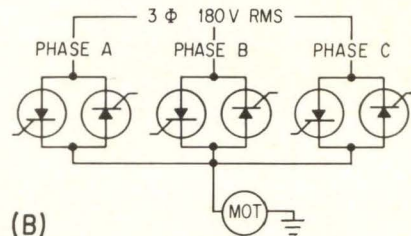

(B)

POWER DRIVE system for gun mount (A). Basic power circuit (B) uses three opposing pairs of silicon controlled rectifiers

## SCR's To Drive Guns

Solid-state servo power drive is one-quarter the size of amplidyne system

**PITTSFIELD, MASS.**—Solid-state power drive that can be used instead of amplidynes in servo drives for antennas, optical trackers, gun mounts and gun directors, is under development here by General Electric's Ordnance dept. Power range is from less than 1 to over 100.

GE and Bureau of Naval Weapons are now negotiating a study contract for a prototype of a 5-inch, 54-caliber gun mount drive.

Because the drive uses silicon controlled rectifiers (scr's) and transistors, not rotating machinery, it is a quarter the size and a third the weight of the equivalent amplidyne system, according to George H. Bissell, of GE. Weight would be 800 lb and volume 7.7 cu. ft.

The new system is competitive in price with amplidynes and is expected to become more economical, GE says. Response is faster because of elimination of a mechanical time constant. The system is quiet, easy to install and maintain.

Disadvantages are that the fly-wheel effect, which stores mechanical energy for surges, is lost. Also, the solid-state drive requires a larger gear motor because the heat-to-torque ratio is not as good as with an amplidyne. But GE feels advantages outweigh disadvantages.

**Lab Model**—The lab-tested solid-state system is capable of 45 kw peak power, 4-cycle bandwidth, and less than 3 min of error during a 9-sec  $\pm 15$ -deg roll (for other comparisons, see table).

The system consists of servo and power amplifiers. To energize the power amplifier, a-c power is applied directly to the scr's and their firing angle controlled with unijunction transistor circuits. Filtering and lock-out circuits prevent accidents.

**Power Amplifier**—Six power scr's, six scr pulse amplifiers, six unijunction-transistor firing circuits, lock-out circuits and a power transformer comprise the amplifier subsystem.

The firing circuits convert d-c error signal voltage to properly phased trigger pulses. The output of the pulse amplifier output then triggers the power scr's. These in

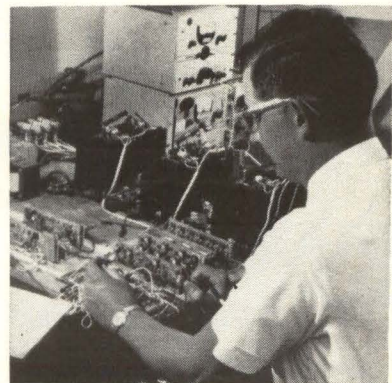

BREADBOARD model of solid-state drive

NOW YOU  
CAN GET . . .

**CUSTOMIZED  
FEATURES**

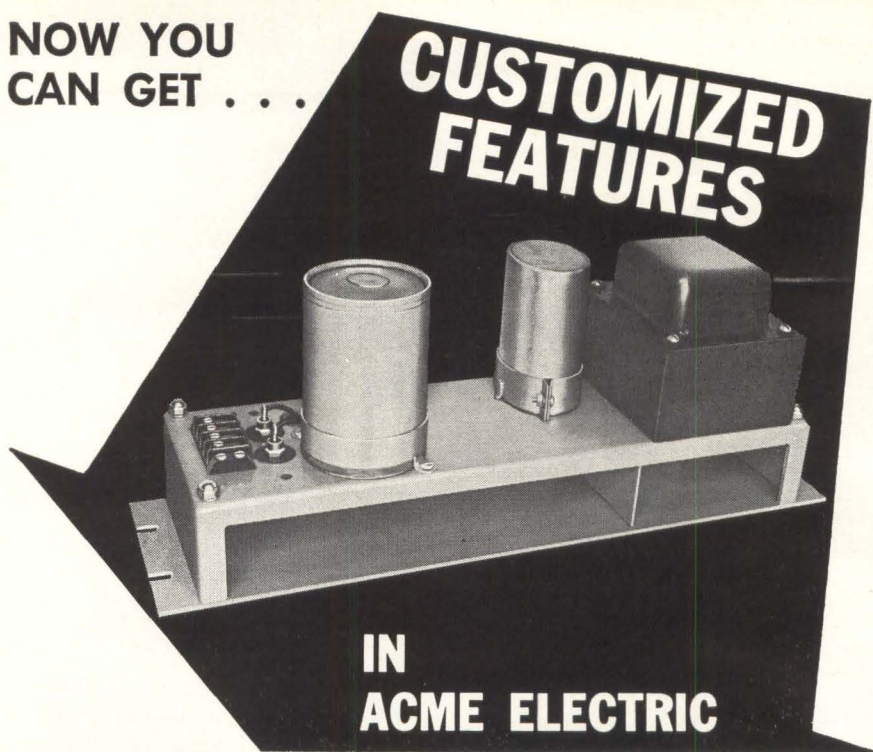

**IN  
ACME ELECTRIC**

# STANDARD POWER SUPPLIES

Why be satisfied with the performance limitations of ordinary power supplies when Acme Electric makes a **standard regulated power supply** with operating features usually obtainable only in specially designed units? This line of Acme Electric power supplies originated as custom designed models, then were simplified and standardized.

## RELIABILITY EVALUATION PROVED BY DESIGN SIMPLICITY

- Continuous duty, constant voltage transformer
- resonant capacitor with adequate bleeder to discharge after turn-off,
- computer grade, electrolytic filter,
- silicon rectifiers,
- practical positioning of terminal board provides input and output connections in one place,
- heavy gauge, relay rack panel with components spaced for maximum free air circulation,
- negligible thermal drift
- losses and instability of tubes eliminated,
- zero to full load recovery time, 0.1 second,
- practically instantaneous recovery under input voltage fluctuation,
- current limiting protection,
- ripple voltage RMS less than 1%,
- efficiency 80% or better,
- standard rack models in ratings from 50 watts to 2400 watts, 24 to 250 volts dc.
- Write for catalog 174.

**Acme**  **Electric**

**Engineers and Builders of...**

3112 WATER STREET, CUBA, NEW YORK  
In Canada: Acme Electric Corp. Ltd.  
50 Northline Rd., Toronto, Ont.

SAA 3722-3038

REGULATED POWER SUPPLIES  
STATIC POWER RECTIFIERS  
VOLTAGE STABILIZERS  
VOLTAGE REGULATORS

### OPERATIONAL COMPARISONS\*

	Amplidyne	Solid-State
Gain at 1/9 cps	240	400
Gain at 1/4.5 cps	60	60
L-f time constant	0.05-	0.0035
	0.013 sec	sec
Velocity constant	200	400
Efficiency	70%	90%
	(rated load)	(all loads)
Predicted weight (2-axis system)	2,200 lb	800 lb

\* System developed for 3-inch 50-caliber train drive

turn prevent application of a-c power to the d-c drive motor.

When an scr is triggered, power is sent to the motor. When the a-c voltage reverses and current attempts to flow in the opposite direction, the scr turns off. The amount of power delivered to the motor is varied by changing the phasing of the trigger pulse to the scr. Three scr's permit current flow in one direction; the other three allow flow in the opposite direction. Lock-out circuits prevent opposite scr's from firing simultaneously.

**Servo Amplifier**—A tachometer provides inner-loop velocity feed-back while 1X and 36X synchros provide outer loop position feedback. A transformerless demodulator converts the 60-cps synchro error signal to a d-c voltage. Demodulator and tachometer outputs are combined and amplified in a d-c amplifier which then drives the firing circuits. Proper switching between the 1- and 36-speed signals is accomplished with a synchronizing circuit.

### Bookmaker Gambles On

#### Microelectronics—Loses

CHICAGO—Microelectronics helped a bookie take horse race bets here, police reported last week. A wire soldered to a dime in his left trouser pocket, led to a plastic case on his belt; another led to the case from his right pocket. Radio signal from an accomplice triggered a device in the case. It gave the suspect a slight shock when he was holding both dimes and alerted him to plug in ear-phones for race results.

# From 6 volts to 100 volts— get Mallory quality in all solid tantalum capacitors

Available ratings  
for Mallory type  
TAS solid  
tantalum capacitors

With the addition of new 75 and 100 volt ratings, the Mallory TAS line of solid tantalum capacitors now gives you a complete range of ratings . . . including all standard MIL ratings. The new 75 volt units come in values from 0.47 to 3.3 mfd. The 100

volt series ranges from .47 to 2.7 mfd. Temperature rating is  $-80^{\circ}\text{C}$  to  $+125^{\circ}\text{C}$ . Both are in two case sizes: MIL size A, .125" dia. by .250"; and size B, .175" dia. by .438". Tinned nickel leads are standard; untinned or Dumet leads on special order.

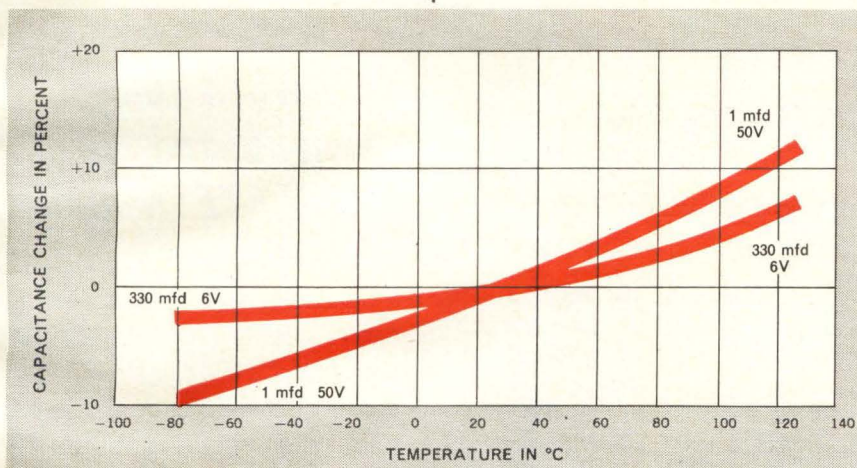

Typical temperature stability curve for type TAS; other ratings show comparable performance.

Proved by over 14 million piece-hours of reliability testing, with only 4 catastrophic failures in all this period, Mallory TAS capacitors are made with the consistently high quality that comes from over 12 years of experience in tantalum capacitor manufacturing. Many ratings are

available on immediate delivery. All are designed and tested to meet or exceed requirements of MIL-C-26655A and MIL-C-26655/2C. For a copy of our new Bulletin 4-40J, write to Mallory Capacitor Company, Indianapolis 6, Indiana, a division of P. R. Mallory & Co. Inc.

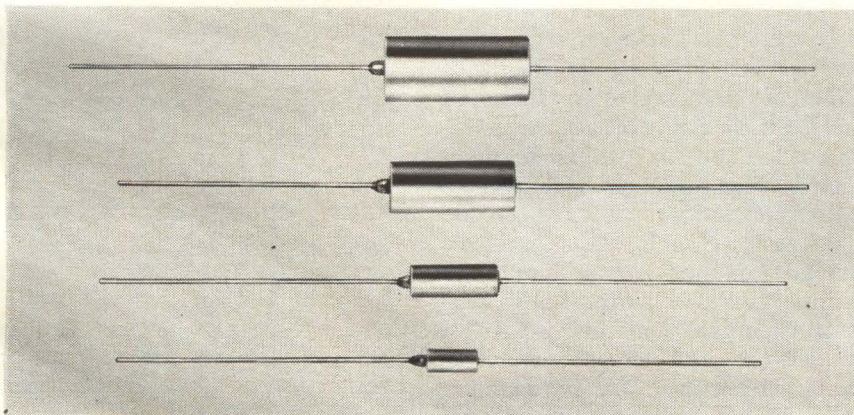

WET SLUG, FOIL AND SOLID TANTALUM CAPACITORS

VOLTAGE	MAXIMUM MFD.	MINIMUM MFD.
100	2.7	.47
75	3.3	.47
50	22	.47
35	47	.0047
20	100	.0047
15	150	.0047
10	220	.0047
6	330	.0047

P. R. MALLORY & CO. Inc.  
**MALLORY**

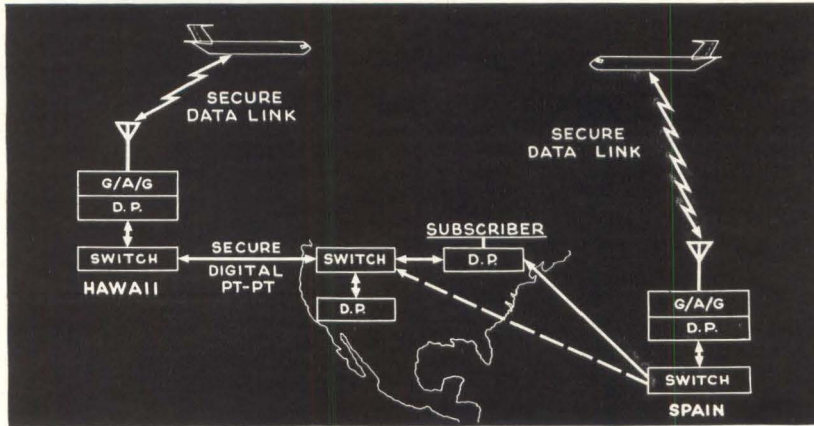

THIS AIRBORNE equipment is needed to provide for receipt of canned messages, their display, and technical acknowledgment to the ground environment. Electronic unit weighs 13 pounds, costs \$3,500. Display weighs 7 pounds, costs \$2,000

## AIRLINES MAY ADOPT Digital Communications

Standard will soon be proposed for civil and military systems

**WASHINGTON**—Radio Technical Commission for Aeronautics (RTCA) is now ready to propose a standard that will allow the airlines to proceed with an air/ground digital communication system, if and when FAA provides for such a system.

Although FAA's plans for improving the national system (ELECTRONICS, p 91, Jan. 4) call for continued use of voice communication through 1975, interest in the digital data-link is not dead, Frank C. White, of the Air Transport Association of America, told the 1963 Fall Meeting of the RTCA this month. FAA does have a program using both outside contractors and in-house capability.

Meanwhile, the Air Force—much further along than FAA in data-link—has reached a point at which improvements in voice techniques show diminishing returns and a digital system is the only alternative, Lt. Col. R. E. Winters, of Hanscom Field, Mass., said. An ideal system would provide for a completely automated, secure, high-speed system of communication from aircraft to

any ground user and/or to other aircraft.

**Airline Data-Link** — Objectives of the program are to determine requirements and the proper time period for incorporating data-link into the national system, define operational and functional requirements, and initiate hardware development to evaluate and advance new techniques.

While the use of primary and secondary radar for data acquisition is progressing well, voice communications are needed for call up and acknowledgment, ATC clearances and requests for changes in clearances, and advisory communications.

One FAA experiment involves a device that takes the hourly weather teletypewriter messages and converts them to voice messages to eliminate the repetitive chore of having a specialist broadcast the information on the vhf omnidirectional range voice channel.

A fair case already exists, White said, for providing a ground/air digital communications circuit to airline aircraft on operational control channels. This need will be weighed against the cost and the result will either be the introduction of a digital communications system or some delay.

Major cause for delay, White

## HOW MUCH DOES A BAD GUESS COST...

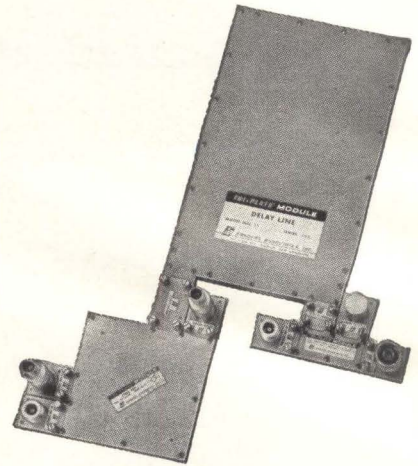

when you  
breadboard with  
**TRI-PLATE® modules?**

Nothing. Because TRI-PLATE modules are used again and again to test functioning circuits. Let's say you design an L-band mixer delay line circuit. You connect the corresponding TRI-PLATE modules (in 5 or 10 minutes) and apply power. But the circuit needs modification. Have you lost \$645, the total cost of the modules shown?

No . . . even after you prove the design all you've spent is time. Ultimately you've saved time and money by debugging the circuit rapidly. Then you go to final product design in a TRI-PLATE Strip Transmission Line package. Discover the advantages of strip transmission line — write Sanders Associates, Inc., Microwave Products Dept., Nashua, New Hampshire.



CREATING NEW DIRECTIONS IN ELECTRONICS

**SANDERS**

TRI-PLATE STRIP TRANSMISSION LINE

©Reg. T.M. Extensive Patent Coverage, Sanders Associates, Inc.

**CIRCLE 54 ON READER SERVICE CARD**

December 20, 1963 electronics



A TRI-PLATE® solid state package is smaller, lighter and less costly than an equivalent waveguide assembly. Much more reliable, too. Our 10 times harmonic multiplier, used as an LO source in a mixer circuit, converts an RF signal of 2205 MC to an IF frequency of 60 MC. This is a completely passive device and contains only one varactor and 2 mixer diodes. Spurious signals in the LO source are down -30 db. □ We use TRI-PLATE



techniques in designing and mass producing custom microwave products that consistently outperform coax and waveguide. Also, we supply standard TRI-PLATE modules to people who want to breadboard prototype systems, or prove out circuit ideas. TRI-PLATE techniques are for people designing for tomorrow. □ Write for further information to Sanders Associates, Inc., Microwave Products Department, Nashua, N.H.

## Why tinker with a KLYSTRON?

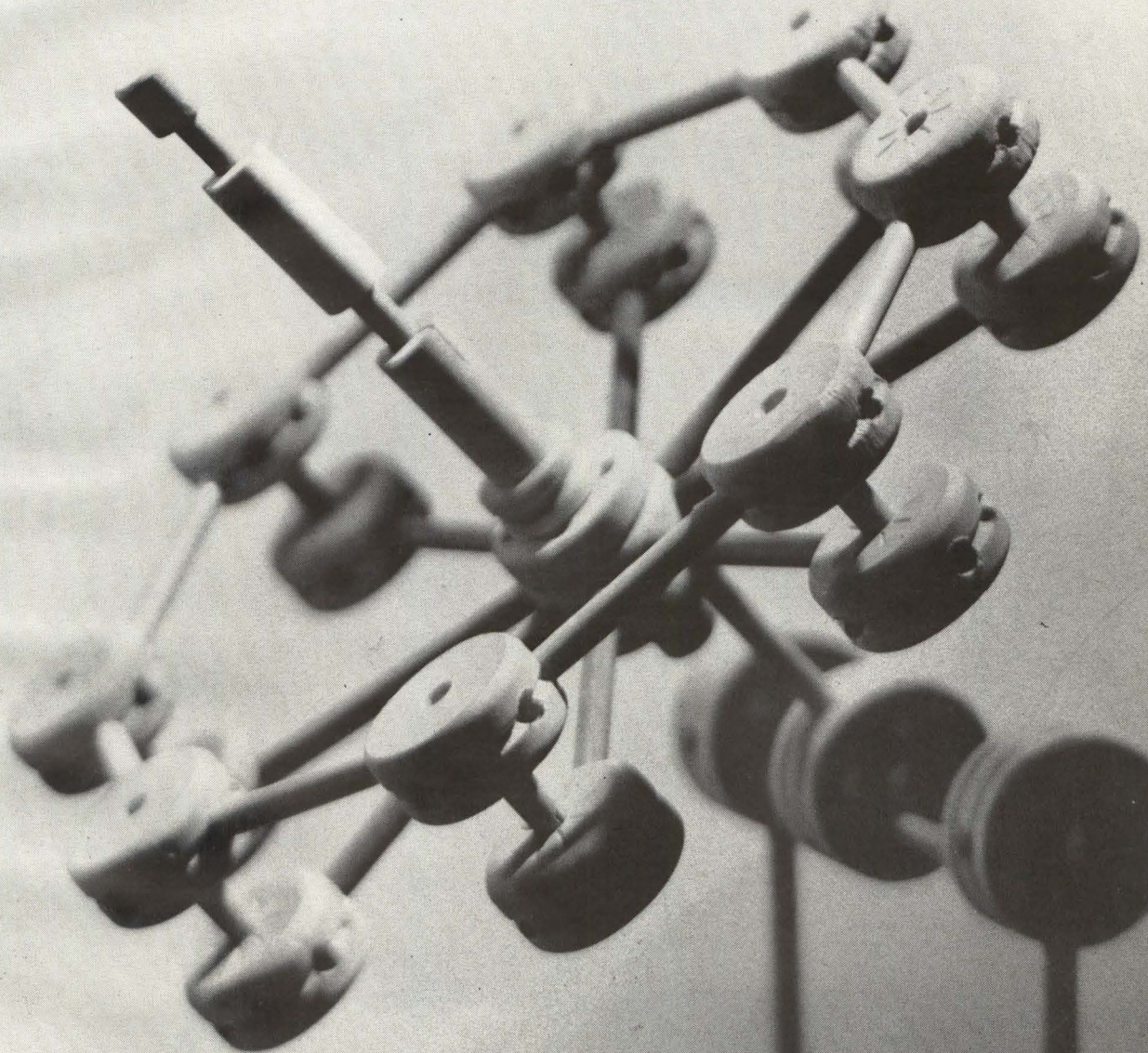

©Reg. T.M., Extensive Patent Coverage. Sanders Associates, Inc.

CREATING NEW DIRECTIONS IN ELECTRONICS · SANDERS TRI-PLATE STRIP TRANSMISSION LINE



# NOW-ONLY 3 RFI METERS

COVER 20 cycles to 15,000 megacycles



**NF-315** 20 CPS - 15 KC



**NF-105** 14 KC-1000 MC

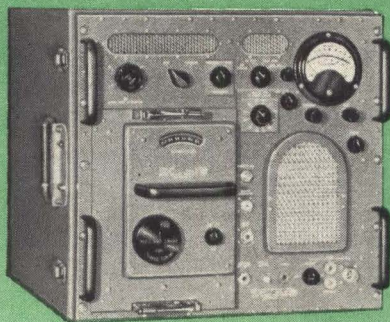

**NF-112** 1000 - 15,000 MC

With the addition of Model NF-315 to the already popular and proven Models NF-105 and NF-112, Empire consolidates its position of leadership in the field of RFI instrumentation.

Now, with three basic instruments you can handle all RFI testing requirements, both military and commercial.

**ECONOMICAL:** You need only three instruments, instead of the six or more required with competitive makes. And, throughout the ranges of the NF-105 and NF-112, you can select plug-in tuning units for only the ranges you need.

**COMPACT:** Empire's plug-in tuning unit design avoids bulky and costly circuit repetition. Valuable lab space is conserved and units are easily transportable for field assignments.

**EASY TO USE:** Uniformity of design philosophy among all three instruments results in simplest possible operating procedures and minimizes operator training.

**DEPENDABLE:** Conservative design, extensive use of solid-state components, and rugged mechanical construction result in longest possible service-free life.

#### **TECHNICALLY SUPERIOR:**

- ★ Better accuracy is assured by stable built-in calibrators for all models.
- ★ Greater stability is assured by well-regulated voltages and extensive use of feedback circuitry.
- ★ Unexcelled shielding effectiveness permits accurate readings despite high ambient electromagnetic levels.
- ★ All three instruments are provided with remote antennas, for maximum operating flexibility.
- ★ Provision for X-Y plotting is designed into all three instruments.

Write for latest catalog 634



**EMPIRE DEVICES**

Manufactured by

THE SINGER COMPANY • METRICS DIVISION  
915 PEMBROKE ST., BRIDGEPORT, CONN., PHONE (203) 366-3201

ELECTRONIC INSTRUMENTATION • MICROWAVE COMPONENTS

said, has been the lack of a system standard. RTCA is now ready to propose a standard that will permit both civil and military agencies to develop compatible data communications systems that will serve the unique requirements of each user.

**Air Force Data-Link**—During the past year, USAF has installed digital

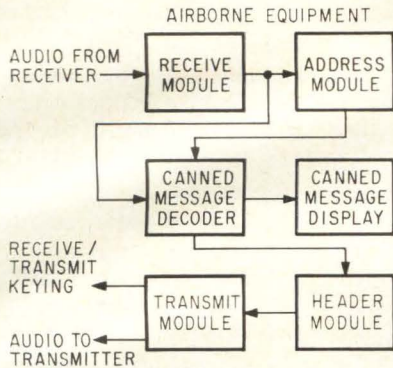

USAF says an ideal system would provide for a completely automated, secure, high speed system of communication from any aircraft to any ground user or to other aircraft

ground/air communication system on a limited basis. The W-47 meteorological system is almost operational and an air to ground teletypewriter system is about to be put in.

A big step forward was taken, Winters said, in the area of standardization with adoption of the ASCII code by the RTCA. "It is hoped that in the near future this code will be nationally and internationally adopted," he added.

A future possibility for getting around the propagation problems inherent in long-range h-f transmission, is via a uhf satellite transponder system.

## Two-Computer System Guides Data Retrieval

**PARAMUS**—Computer-based information-retrieval system assists the 150 engineers at ITT Communication Systems here, providing access to more than 8,000 engineering reports. The system grew out of a \$5-million Air Force study of information requirements and processing techniques in world-wide communications.

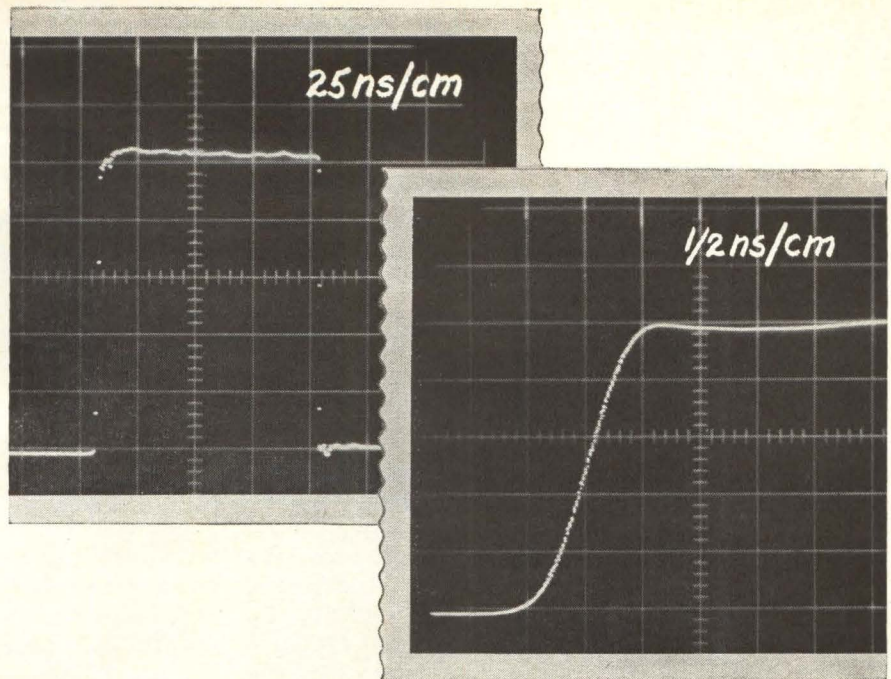

## Proof! 1 amp avalanching in less than 1 nanosecond at 1 megacycle with TI's 7101 Pulse Generator

High amplitude, high rep rate, fast rise/fall times are features of TI's Model 7101 Avalanche Pulse Generator. Voltage amplitude is variable to  $\pm 50$  volts into 50 ohms, rise/fall times are less than one nanosecond, repetition frequency is variable from 100 cycles to one megacycle. Ideal for advanced applications such as thin-film work, the 7101 furnishes selectable width pulses by means of plug-in modules from 5 to 100 nanoseconds or by external charge lines. Delay with respect to sync pulse is variable from 40 to 400 nanoseconds. Like all TI pulse generators, the Model 7101 is compact, lightweight and portable, extremely convenient to use. Circuitry is all solid-state. Write for complete information.

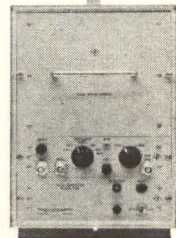

INDUSTRIAL  
PRODUCTS  
GROUP



**TEXAS INSTRUMENTS**  
INCORPORATED  
P. O. BOX 66027 HOUSTON 6, TEXAS

SENSING • RECORDING • TESTING • DIGITIZING INSTRUMENTS  
THE INSTRUMENTS OF TEXAS INSTRUMENTS

601  
CIRCLE 57 ON READER SERVICE CARD

## NIMS

NATIONWIDE IMPROVED MAIL SERVICE PROGRAM

For Better Service  
Your Post Office  
Suggests

That You Mail Early In The Day!

# Solid Crystal Modulates Light Beams

Projection display device  
is based on birefringent  
KDP crystal element

By **EVERT LINDBERG**  
Motorola, Inc.  
Military Electronics Division,  
Chicago, Ill.

**WORKING MODEL** of a solid-state light modulator for image projection has been built at Motorola's Military Electronics Division (see cover). The system is one in which the electron gun does not supply the light output, but serves only as a control element. The brightness of the display depends only on the light source. Virtually any light source can be used; experimental models have used mercury-arc lamps and incandescent projection lamps, but compatibility between the display technique and the rapidly expanding laser field is readily apparent.

The modulator uses a transparent, birefringent KDP ( $\text{KH}_2\text{PO}_4$ ) crystal, placed at the image plane of the projector, in an evacuated chamber, see Fig. 1. An electron gun placed off-axis in a separate vacuum chamber scans the crystal with a modulated electron beam, thus producing the image which is then projected.

A solid-state light modulator has several apparent advantages over other projection systems. There are no moving parts; the operation is compatible with electronic inputs; storage is inherent in the required crt development, and controllable persistence or selective erasure is possible through the secondary emissive characteristics of the modulating element. Response and resolution appear to be better than with conventional crt displays.

**Optical axis effect**—The optical axis effect in uniaxial crystals has been

known since the 17th century. When a beam of ordinary light passes through certain crystals, each ray splits into two components, with different planes of polarization. On leaving the crystal, these components recombine into rays with a phase shift in polarization. Kerr, in 1876, showed that the optic axis in a uniaxial crystal can be shifted in the direction of the electrostatic lines of force by applying a voltage normal to the optic axis.

To be useful as a light-modulating element, a Z-cut crystal is necessary.

(A Z-cut crystal has its principal faces perpendicular to the optic axis). Though normally uniaxial, the crystal becomes biaxial when a voltage is impressed across the two principal faces. Plane-polarized light entering the crystal is broken into two perpendicularly polarized rays. One of these, the ordinary ray, travels at a constant speed. The other, called the extraordinary ray, varies its velocity as a function of the applied voltage. When the two rays recombine after traversing the crystal thickness, the resulting ray

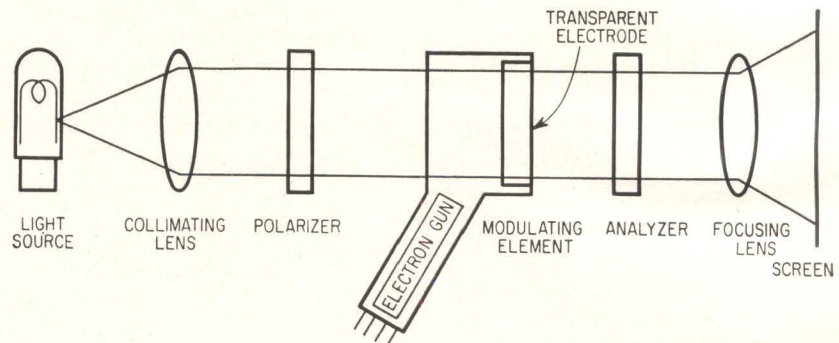

LIGHT PATH through electro-optic light modulator, shown on the cover. Modulating element is between polarizer and analyzer, and is scanned by electron gun at bottom—Fig. 1

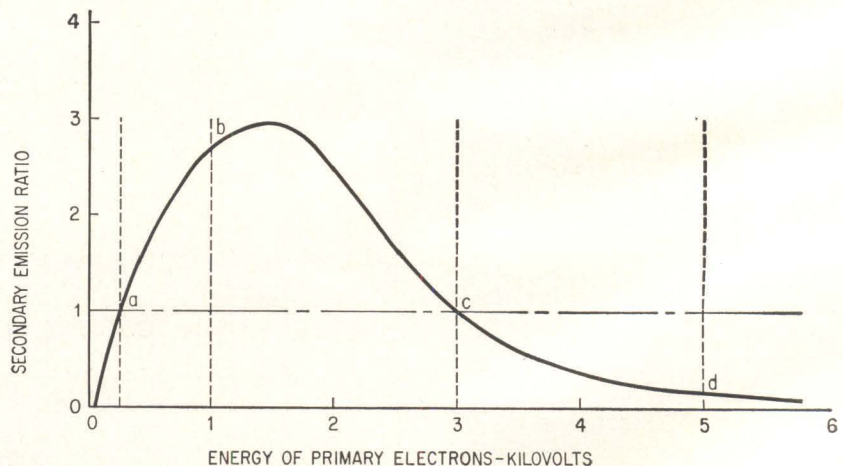

SECONDARY emission characteristics of modulating crystal material determine persistence characteristics. Charge on crystal can be erased by high-energy electrons, which decrease secondary emission ratio below unity—Fig. 2

## Kodak reports on:

sweat in glass... film for a nervous audience... a nice fluidized bed

### To make a laser, use a laser

As of this writing, alas, very few routine uses for lasers exist. As far as the eye can see, the present market is nearly all R&D. In this business, unlike some others we are in, product uniformity is hardly worth millions per annum. R&D customers have no objections if a KODAK Laser Rod shipped this week is quite a bit better than one shipped six weeks ago.

We don't make KODAK Laser Rods with the same tooling philosophy we use for KODAK INSTAMATIC Cameras. Each rod is individually handcrafted. This suggests tradition. There is a tradition of optical craftsmanship, and we even have it; but we do not go so far as to claim we have men who were taught how to fashion laser rods by their grandfathers. A six-month-old tradition in the laser craft is pretty hoary.

KODAK Laser Glass has acquired a much envied reputation in the last six months for optical quality. Optical quality is worth having in a laser rod, not so much for feelings of serenity it may induce in the owner as for minimizing beam divergence and internal losses. It is bought with chemical and glass-working sweat and in turn buys very low threshold in small rods and very high efficiency in big ones. Up to the time this ad

was written, we had made them as long as 30 inches and had obtained efficiencies as high as 2¼%. Without sly tricks, we calculate efficiency as simply the energy in the capacitor bank,  $\frac{1}{2}CV^2$ , divided into what the calorimeter measures.

One item of special tooling we have found most valuable for maintaining optical quality in long rods and in more ingenious configurations that customers have devised. This gadget Grandpa never had in his optical shop. It is a helium-neon gas laser. Here, then, is one of the still very rare routine, day-in, day-out uses of a laser.\* Day in and day out the handcraftsmen keep trotting over to it to use with or without Twyman-Green plates as a light source of fantastically long coherence length for interferometrically establishing optical parallelism of the two ends of a KODAK Glass Laser Rod. If the ends happen to be separated by a million or so wavelengths, it is no more trouble to see what touching-up is still needed than it ever was to check the Newton's ring pattern on an aerial photo-lens component through a test glass.

*Correspondence on this subject is conducted by Apparatus and Optical Division, Eastman Kodak Company, Rochester, N. Y.*

\*And not even our own type!

### How to load an oscillograph for grand occasions

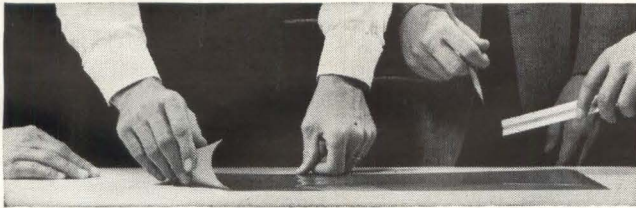

Some of the photographic film you see around these days is only .0025" thick. See how flat it lies.

It turns out that this thin film is handy under certain conditions for recording galvo traces instead of pictures. Normally, of course, our paper serves this purpose. Imagine, however, a 40-trace recording that represents some big shoot. Each of

those black lines may trace some individual breadwinner's hopes, fears, plans, and ambitions. He would be a pretty jittery boy by the time he sweated out his turn for a look at the record. Therefore copies are made before anybody snags on to the original, perhaps as many copies as there are traces.

Quality and speed of copying dictate film as the oscillographs' diet instead of paper on these grand occasions. The thinner the film, the longer the run before time out for a refill. The name of the film is KODAK LINAGRAPH Recording Film (ESTAR Thin Base). The original record can be annotated by pen or pencil on either side, but there is no abrasive to wear the guiding surfaces in the instruments.

*Arrangements to get this film out where it will do the most good are made through Eastman Kodak Company, Photorecording Methods Division, Rochester, N. Y.*

### Thermoplastic flour

The number of people who know about the fluidized-bed method of coating with plastics is as nothing compared with the number who have never heard of it. If hitherto in the second group, you are hereby switched. To what purpose is for you to determine.

TENITE Butyrate 522G looks like flour, except that in addition to white it can come in any hue you choose. Put some in a double-bottomed container. Make the upper bottom a tight-fitting porous plate of sintered glass or metal, or make it solid and minutely perforated. Pump air into the space between the bottoms. If the pore size and the air pressure are right, seething will commence. "Seethe" hardly belongs in the engineering vocabulary, but it conveys the idea. No dust cloud rises, but the level of the powder does rise. It takes on a ghostly look—a pseudo-liquid, a pseudo-solid, prodigious to behold.

All objects sink in it. If the object is hot enough (480° - 570°F), the powder particles hitting it melt to form a coating. Unless the object is very thin or for other reasons loses surface temperature quickly, the coating thickens steadily.

Have some curves:

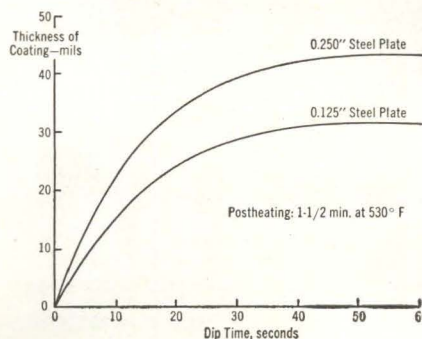

The postheating melts the surface layer and polishes it. Dielectric strength of a .020" coating runs around 16,000 volts.

*Note that thick coatings can be made, as compared with lacquers. Note that all openings are entered and all cavity interiors coated. Note where to send for Technical Report TR-12: Eastman Chemical Products, Inc., Kingsport, Tenn. (Subsidiary of Eastman Kodak Company). Note that though this organization equally prides itself as a marketer of organic solvents, it flinches not at bringing this technique to the attention of the technological public.*

**This is another advertisement where Eastman Kodak Company probes at random for mutual interests and occasionally a little revenue from those whose work has something to do with science**

# NEW

**VERSATILITY IN  
LIGHT  
MEASUREMENT**

## lite-mike

measures:

MEASUREMENT	MONOCHROMATIC SPECTRUM		CHROMATIC SPECTRUM
	LASER	GALLIUM ARSENIDE	
WAVESHAPE Rise time Fall Time Duration Amplitude	Yes	Yes	Yes
Average Power (watts)	Yes	Yes	*
Energy (joules)	Yes	Yes	*

\*Can be calculated within spectral response capabilities.

RESPONSE RANGE	
ANGSTROMS	MICRONS
1.13 $\mu$	0.35 $\mu$
NEAR IR 10 $\mu$	NEAR UV 3,000
9,000	0.9
8,000	0.8
7,000	0.7
6,000	0.6
5,000	0.5
VISIBLE	0.4
4,000	0.3



Compact (10" high) and lightweight, the EG&G LITE-MIKE has built-in controls for sensitivity and balancing of ambient light. Head is swivel-mounted for ease of alignment with source.



AUTHOR shown adjusting experimental model of crystal modulator

has undergone a polarity rotation dependent on the applied voltage.

If the crystal is placed between two polarizing filters whose polarizing axes are 90 deg apart, and collimated light is directed through the combination, the light output from the analyzer is a function of the voltage applied across the crystal. If a charge pattern can be placed on the crystal, a corresponding light pattern will be transmitted.

# NEW

**SD-100 SILICON  
PHOTODIODE** offers this  
*unique combination of advantages*

- (1) **FAST RESPONSE** / Rise time:  $4 \times 10^{-9}$  sec. @ 90v  
Fall time:  $15 \times 10^{-9}$  sec. @ 90v
- (2) **WIDE SPECTRUM** 0.35 to 1.13 microns (10% points)
- (3) **HIGH SENSITIVITY** 0.25 microamps per microwatt
- (4) **LOW NOISE**  $1 \times 10^{-12}$  watts  $\cdot$  (cps) $^{-1/2}$
- (5) **WIDE DYNAMIC RANGE** 0.1 amp to approx.  $10^{-8}$  amp

Applications: receiving equipment for lasers and injection laser systems; measurements on modulator and pulsed light sources; measurements of light intensity and wave forms, detection of color changes.

For full information on LITE-MIKES and SD-100 photodiodes, contact: Marketing Dept., EG&G, 176 Brookline Ave., Boston 15, Mass.



**EDGERTON, GERMESHAUSEN & GRIER, INC.**

1007

BOSTON • LAS VEGAS • SANTA BARBARA

**CRT Construction**—For charging the crystal surface with an electron beam, moderately high potentials are needed. Field development by a cathode-ray beam derives from the fact that the potential of a bombarded insulator depends on the secondary emission ratio of its surface. This ratio may be greater or less than 1, depending on the electron energy, as shown in Fig. 2.

Assuming this curve applies for mica, and assuming that the transparent electrode and second anode of the CRT envelope in Fig. 1 are held at potential  $d$ , 5,000 volts above the cathode of the electron gun, a beam scanning the surface produces less secondary electrons than there are primary electrons arriving and the surface is charged in a negative direction, producing a field across the crystal. In this case, the highest field which may be developed corresponds to the charging of the surface to the limiting potential  $c$ , in which case the electrons bombarding the mica surface produce more secondary electrons than the number of primary electrons arriving, and the surface would then be charged in the opposite direction

toward  $c$ , producing a field in a reverse direction to that previously considered. Since the energy range from  $a$  to  $c$  is about 3,000 volts, the potential difference developed across the crystal is limited to this value if the surface is charged positively.

If it is not convenient to use leakage to discharge the fields produced by scanning, electrons may be used for discharging the surface as well as for charging it. This discharge can be accomplished by a spray of electrons from the charging gun at a later time, or from a second gun. Advantage is taken of the change in direction of charging of the surface with change in electron energy.

**Present Development**—Main drawback in working models built to date is the need for continuous pumping, caused by outgassing of the crystal produced when high-velocity electrons strike it. Mathematical analysis shows that resolutions of 500 lines per inch can be expected. Contrast is a function of the aperture angle of the crystal; contrast ratios of 100 to 1 can be achieved, for example, with a 1/8-inch ADP crystal and a light beam collimated to within 5 deg. One of the inherent defects of this type of device is its comparatively narrow angular field of view. Since an unstressed crystal is uniaxial, zero retardation occurs only for light parallel to the optic axis. For light inclined to this axis, the retardation is finite and linearly polarized light becomes sufficiently elliptical to allow a small amount to pass through the analyzer. Since the aperture angle is inversely proportional to the thickness of the crystal, one approach to widening the angle is to use as thin a crystal as practical. Since the angular field is limited by the natural birefringence of the crystal, another approach to widening it is to use a retardation plate whose retardation in each direction is opposite to that of the modulating crystal and whose retardation axes coincide with those of the modulator crystal. A third approach to widening the angular field is to use a 90-deg rotator between a pair of matched modulating crystals so that a component of light vibrating parallel to the fast axis of one crystal would be rotated so that it is vibrating parallel to the slow axis in the second crystal. The resulting retardation is then zero.

**Fred  
Roberts  
can  
show  
you ...**

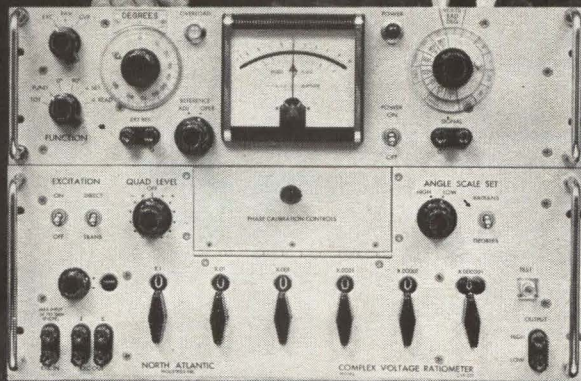

Director of Marketing, North Atlantic Industries

## how to measure ac ratios regardless of quadrature

North Atlantic's **Complex Voltage Ratiometer** is a completely integrated test set for measuring grounded 3 terminal networks. By providing self-calibrated quadrature injection, the Model CVR-551 permits calibrated meter readings of phase angle up to 30° or 300 milliradians full scale, and, in addition, provides direct readings of in-phase and quadrature voltages. As an added feature, the integral **Phase Angle Voltmeter\*** and **AC Ratio Box** can be used independently. Abridged specifications follow:

<b>In-Phase Ratio Range, <math>R_I</math></b> .....	.000000 to $\pm 1.111110$ with full accuracy
<b>Phase Angle Range, <math>\alpha</math></b> .....	$\pm 1.0$ to $\pm 300$ milliradians $\pm 0.1$ to $\pm 30^\circ$ (in 6 calibrated ranges)
<b>Frequency</b> .....	Any specified frequency, 50 cps to 3K
<b>Input Ratio Error, <math>R_I</math></b> .....	$\pm (.001 + \frac{.0001}{R_I} + \delta \tan \alpha)$ % of reading
<b>Phase Angle Error, <math>\alpha</math></b> .....	$\pm .0003$ radians or $\pm .017^\circ$ (low ranges) $\pm 3\%$ full scale (high ranges)
<b>Phase Angle Voltmeter* (independently used)</b> .....	$\pm 2\%$ full scale 1 millivolt to 300 volts (in 12 calibrated ranges)
<b>A.C. Ratio Box (independently used)</b> .....	1 ppm terminal linearity .35f (300 volts max)

North Atlantic's CVR\* line includes 2 and 3 frequency models. All models available with optional 10 ppm Ratio Box control of quadrature injection.

Send for data sheet or contact your local North Atlantic sales representative now for complete information.

\*Trademarks



**NORTH ATLANTIC industries, inc.**  
TERMINAL DRIVE, PLAINVIEW, I. I., NEW YORK • OVerbrook 1-8600

# **LEVIN HIGH PRECISION CABINET MOUNTED INSTRUMENT LATHES**

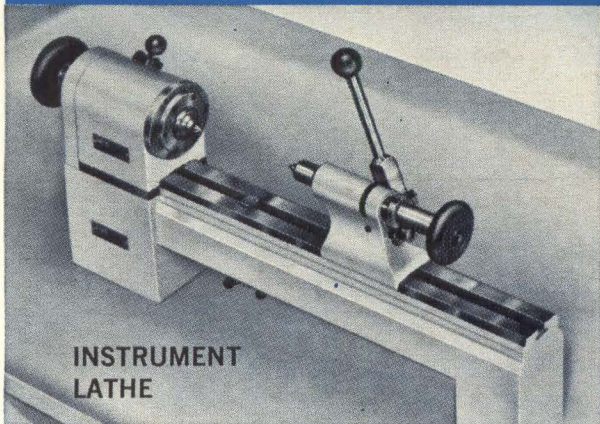

**INSTRUMENT  
LATHE**

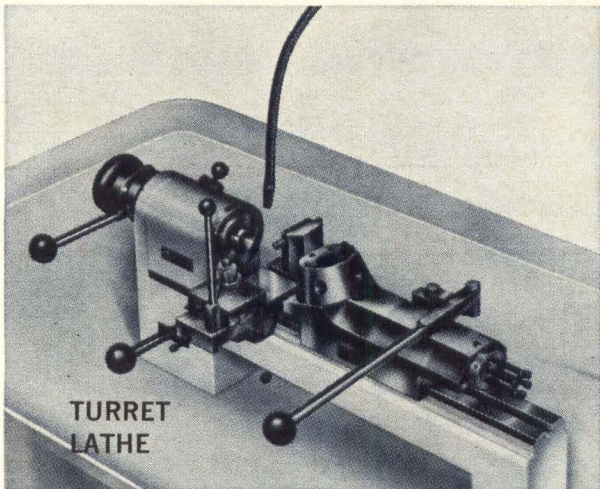

**TURRET  
LATHE**

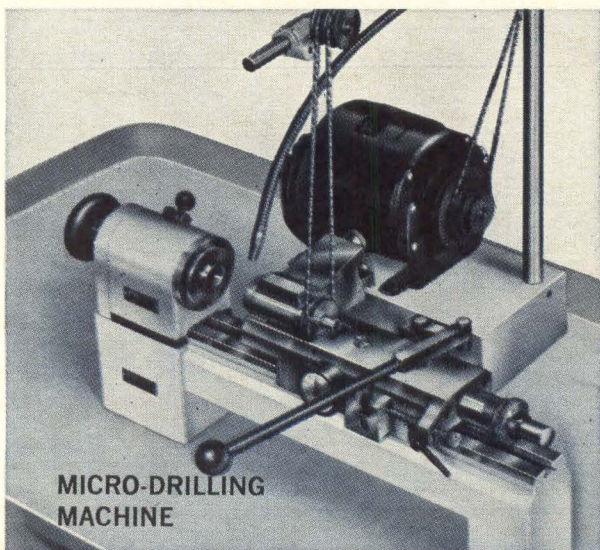

**MICRO-DRILLING  
MACHINE**

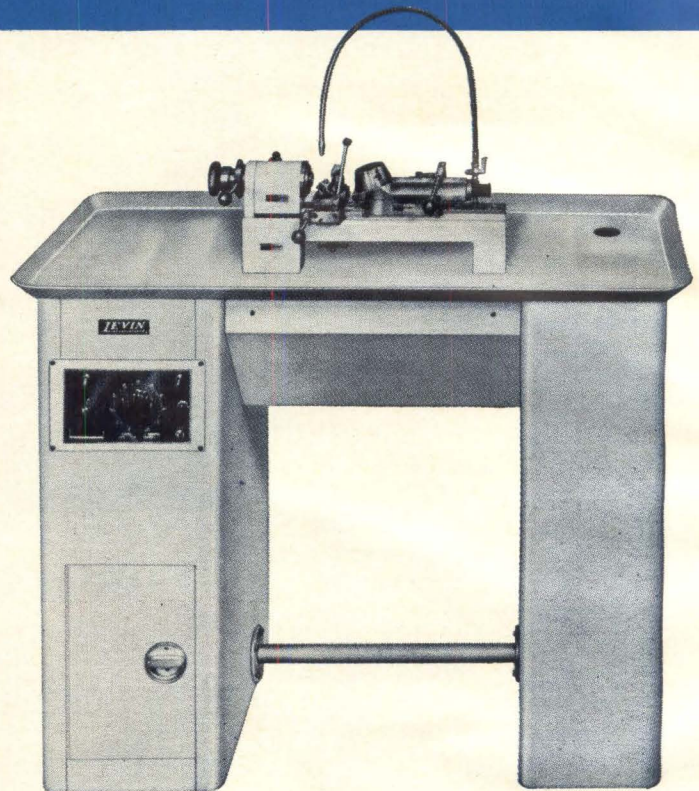

*LEVIN* now offers a complete line of Instrument Lathes mounted on a welded steel cabinet. These machines have the advantages of greater rigidity, higher spindle speeds, increased operator efficiency due to cabinet design, multi-vee belt drive, and for the first time, operating and alignment tolerances heretofore available only on specially built lathes.

Your *LEVIN* dealer or the factory will be glad to furnish complete details. These machines are on display in dealer showrooms in New York and Los Angeles. Send for complete catalog.

# **LEVIN®**

**LOUIS LEVIN & SON, INC., 3573 HAYDEN AVENUE  
CULVER CITY, CALIFORNIA**

**DEALERS:**

**RUSSELL-HOLBROOK & HENDERSON, INC.**

**NEW YORK and LOS ANGELES**

**INDUSTRIAL TOOL & SUPPLY COMPANY — SAN JOSE**

**MARSHALL TOOL & SUPPLY CORPORATION — LOS ANGELES**

**ROYAL-TSCHANTRE — BALTIMORE**



# Silicon Rectifier Controls Power in Either Direction

Structure shows how device works for a-c static or phase-control switching

By J. LUSCHER  
H. C. VOORRIPS  
B. ZEGA  
Battelle Memorial Inst.,  
Geneva, Switzerland

**SEMICONDUCTOR** junctions having backward-rectifier characteristics permit the construction of a controlled bidirectional power switch. The device is especially suited for a-c static or phase-controlled switching functions, or in applications where otherwise two silicon-controlled rectifiers are used in an antiparallel configuration.

The device, Fig. 1, has an  $n\pi n$  structure with a central region of high resistivity  $p$ -type silicon terminated on both sides by alloyed degenerate  $p$ -type layers.

The impurity distribution in the  $n$ -type regions is closely controlled. Junctions  $J_1$  and  $J_2$  exhibit backward-rectifier characteristics.

If the device is polarized so that the current flows in the direction  $P_1-P_2$ , junction  $J_2$  can be considered as an ohmic contact to the  $N_2$  zone of a conventional four-layer structure  $P_1N_1\pi N_2$ . If the polarization is reversed, the junction  $J_1$  represents an ohmic contact to the  $N_1$ -zone of a  $P_2N_2\pi N_1$  structure. A current-voltage characteristic shown in Fig. 2 results from such a structure. In both directions of current flow there is a forward blocking branch with a forward breakover voltage.

To control the switching of the device into the *on* state, it is provided with contacts on the  $n$ -layers. These are driven with respect to

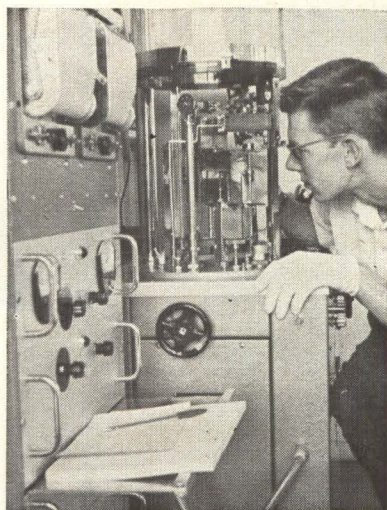

ALUMINUM-boron films for the bidirectional switch are prepared by vacuum deposition

the  $P^+$ -zone, working as an emitter, by negative voltage pulses.

**Light Switch**—Analogous to the conventional four-layer switch, the device can be switched on by light. As the illuminated device presents a very low resistance to d-c as well as to an a-c current, it is considered a real light-controlled switch.

In addition to the advantage of a device controllable in both directions, and so replacing two con-

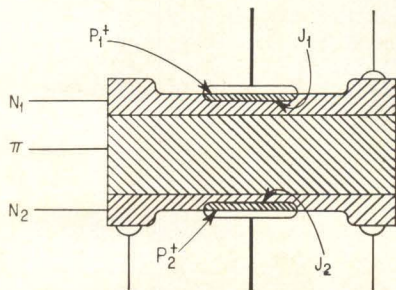

BASIC structure of the bidirectional switch. Backward rectifier characteristics are obtained by precise control of the  $n$ -regions, Fig. 1

ventional four-layer structures, the problem of controlled avalanche (only recently overcome) has been solved in a straightforward manner. The width of the  $\pi$  zone and its impurity concentration have been chosen so that the forward breakover voltage is determined by the punch-through of the space charge region in this zone. The punch-through mechanism, avoids inherent danger of destruction of the device by localized avalanche phenomena.

**Preparation**—The working principle of the device requires that the junctions  $J_1$  and  $J_2$  represent low resistances under reverse bias, as the voltage drop across the reverse-biased junction adds to the voltage drop corresponding to that of the conventional four-layer structure. However, for each current direction, one of the  $P^+$ -layers works as an emitter, and its efficiency must be sufficiently high to obtain a low gate current. To satisfy these requirements, it is necessary that the impurity concentration of the  $n$ -regions at the junctions  $J_1$  and  $J_2$  be 2 to  $3 \times 10^{19} \text{ cm}^{-3}$ . With a higher impurity concentration, a tunnel junction would result with too low an emitter efficiency.

With a lower impurity concentra-

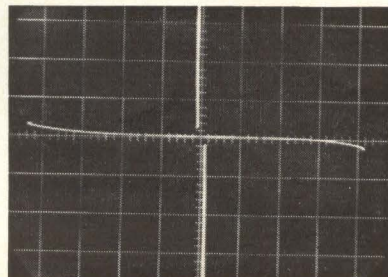

GATES of device are driven to switch at 40 volts instead of breakover of 300 volts. Scale: horizontal, 10-v/cm; vertical 20 mA/cm, Fig. 2

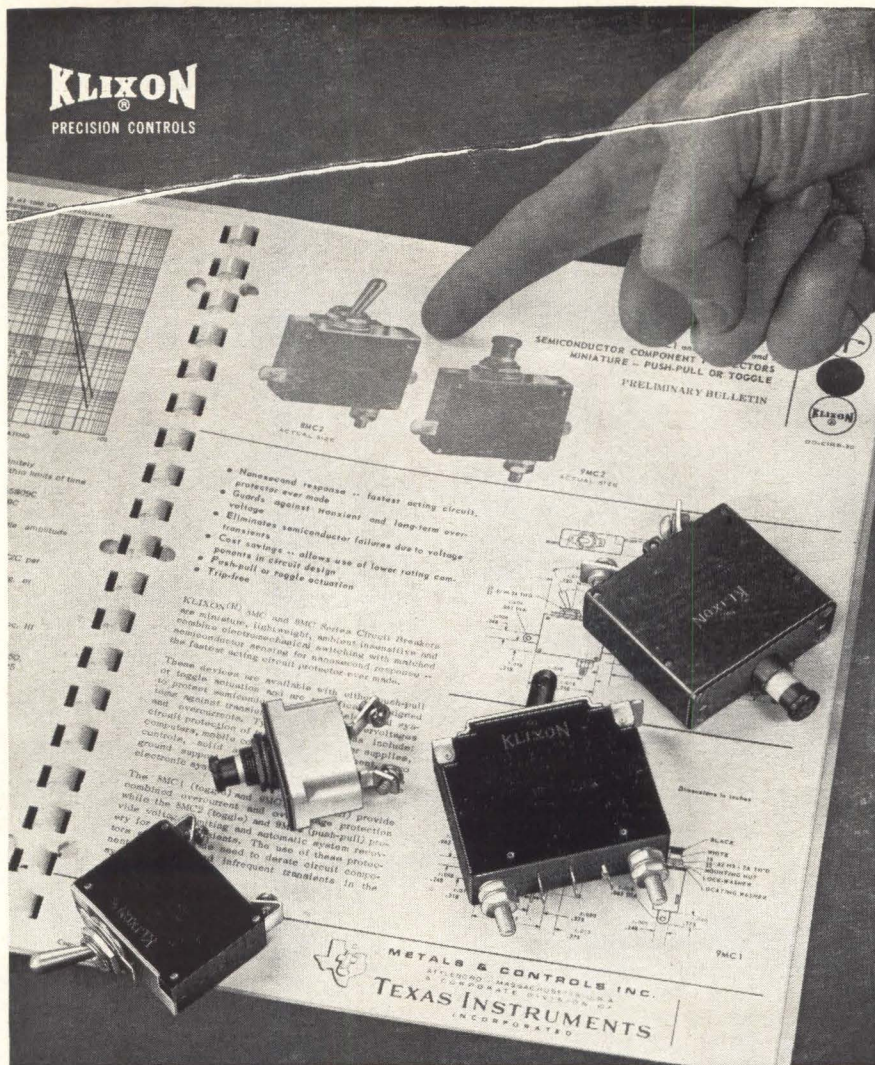

## Circuit breaker selection made easier!

New fact file describes distinctive advantages of all four types of KLIXON circuit breakers

For the first time, you can get all the data you need to evaluate thermal, thermal-magnetic, magnetic and magnetic-electronic types of circuit breakers . . . in one convenient package.

Only TI makes all four . . . and favors no particular type. So, you get unbiased help in selecting the type that best protects your circuits and/or systems from faults due to overcurrent or overvoltage.

Compare! Our SP-40 fact file shows that New KLIXON Magnetic-Electronic Circuit Breakers, with nanosecond response, are the fastest acting devices ever made for protecting transistorized equipment circuitry against transient and prolonged overloads.

You'll also find that New KLIXON Magnetic Circuit Breakers combine trip-free protection, fast response time and more design options than comparable units. As for KLIXON Thermal and Thermal-Magnetic Circuit Breakers, you'll see that their high rupture capacity and resistance to shock and vibration have no equals for protecting wire and cable in airborne applications.

Write today for our new SP-40 fact file . . . the quickest, easiest means of selecting the right circuit breaker from all four types.



**METALS & CONTROLS INC.**  
5012 FOREST ST., ATTLEBORO, MASS.  
A CORPORATE DIVISION OF  
**TEXAS INSTRUMENTS**  
INCORPORATED

tion, on the other hand, the barrier width would be too large to obtain a significant tunneling effect in the reverse direction. The junctions would no more have a backward-rectifier characteristic, and a high voltage drop across the device in the on state would result.

The following methods were applied to obtain the necessary impurity distribution for satisfying the above requirements. The  $n$ -doped layers of the basic  $n$ - $\pi$ - $n$ -structure, obtained by a conventional diffusion, are submitted to a controlled electrolytic etching. In this process, use is made of the fact that the sensitivity of the dissolution rate to illumination increases rapidly on approaching the limit between degenerate and nondegenerate material. Both electrolytically-etched surfaces are then coated with an aluminum-boron film, obtained by simultaneous evaporation of the two components in vacuum<sup>1</sup> (photo). Regrown  $P^+$ -layers are subsequently formed by alloying these films into the  $n$ -type layers. Ohmic contacts for controlling the device are thereby produced simultaneously on the degenerate parts of the  $n$ -type layers.

**Characteristics**—By choosing different doping levels at the emitter-junctions and different resistivities and widths of the  $\pi$ -layer, a large variety of characteristics may be ob-

## NEC Transistor has 1/8-Inch Diameter

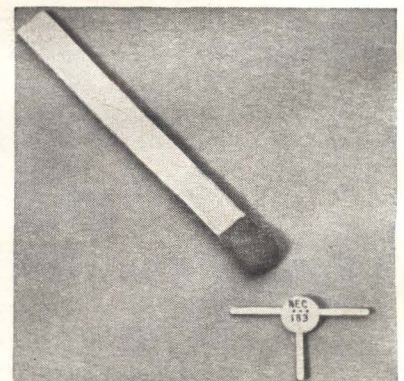

MICRODISC Silicon planar transistors by Nippon Electric Company Ltd are expected to find wide acceptance for module and automated circuit applications. The devices are expected to cost from 35 to 50 cents in lots of 1,000

tained with the described structure. A typical medium power device has a breakover voltage of 300 V and a maximum current rating of 8 A.

The maximum gate current to fire is 20 mA, the voltage drop in the two conducting modes is 1 v at 50 mA, increasing to 1.5 v at maximum current rating. Higher turn-on gains than about 300 can be achieved if a larger voltage drop is admissible (2 volts at 100 A/cm<sup>2</sup>).

The work referred to was sponsored by the Compagnie Generale d'Electricite (France), whom the authors wish to thank for permission to publish this communication.

#### REFERENCE

(1) Ch. Dufour, B. Zega, Obtention par évaporation sous vide de couches de composition prédéterminée par contrôle de débit de chaque source, *Le Vide* (France), No. 104, March-April 1963, p. 180.

### Boron Phosphide Crystal Growth Now Seen Possible

BEDFORD, MASS.—Discovery of a new compound may lead to growth of single-crystal boron phosphide, which has not been grown by conventional techniques. The high energy gap of boron phosphide suggests it may have heat-resistant, and possibly radiation-resistant, properties now found only in diamond semiconductors.

At Air Force Cambridge Research Labs, A. F. Armington and Capt. R. F. Mitchell have succeeded in synthesizing boron phosphide hexaiodide, a product of research in 111-V compounds. Decomposition of group-111 and group-V iodides may provide another approach to crystal growth. AFCRL will soon award an industry contract for attempted growth from the powdered thermal decomposition product.

### Ion Exchange Yields Pure Selenium

VIENNA—Selenium, 99.999 per cent pure, is being produced in Hungary by ion exchange. A solution of crude selenium in nitric acid is passed through a column of cation and anion exchangers. Selenium is washed out from the anion exchanger by a 2N solution of sodium hydroxide. It is then precipitated by sulphur dioxide, according to report from Budapest.

For precise temperature testing from  $-300^{\circ}\text{F}$  to  $+525^{\circ}\text{F}$

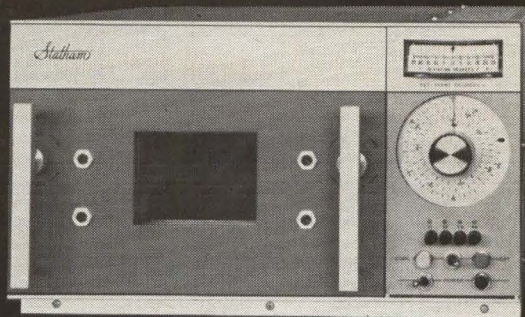

### STATHAM MODELS SD6 AND SD3 ARE 700 CU. IN. CAPACITY CHAMBERS FEATURING $\pm 1/4^{\circ}\text{F}$ CONTROL ACCURACY

Designed for precise temperature testing of electronic components, Statham Models SD6 and SD3 chambers feature true proportional control of heater power by all solid-state circuitry. The design advances in these chambers eliminate the conventional heater power relay and cycling about the control point.

Model SD6 has a range of  $-100^{\circ}\text{F}$  to  $+525^{\circ}\text{F}$ . For high performance and convenience, liquid CO<sub>2</sub> is used for cooling. Developed especially for low temperature requirements, Model SD3 operates from  $-300^{\circ}\text{F}$  to  $+400^{\circ}\text{F}$  and utilizes liquid nitrogen for cooling.

#### CONVENIENT TEMPERATURE CONTROL

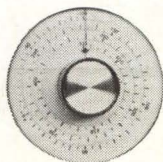

#### 24 Inch Dial Control

Models SD6 and SD3 feature 24 lineal inches of calibrated set-point scale. Temperature readout is obtained by a deviation meter calibrated in one-degree increments. This expanded scale approach provides a level of accuracy and readability not attainable in conventional chambers.

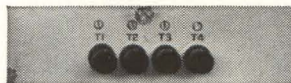

#### Optional Push-Button Control

Frequently repeated temperature settings can be made faster and more accurately with Statham's *push-button* temperature selection control. The buttons, which may be set at any desired temperature, provide precise repeatability.

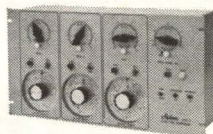

#### Cycle Time Controller

Statham cycle time controllers permit programming the chambers in any required sequence of hot-ambient-cold-ambient, etc.



Statham Instruments, Inc.  
Environmental Products Division  
2221 Statham Blvd., Oxnard, Calif.  
HUnter 6-1080 (Area Code 805)

# PERT Aids Small Projects, Too

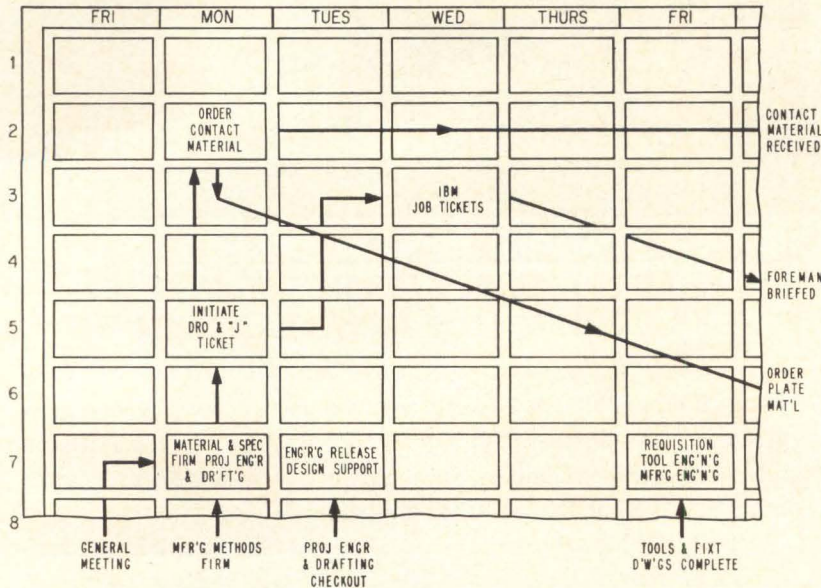

PERT DIAGRAM is a timetable of events that allows dovetailing without confusion. Partial view of actual chart used shows detail of operations

Permits faster decisions, increasing efficiency with smoother operation

**SINCE 1958**, PERT (program evaluation review technique) has been functioning well for large endeavors such as the Polaris missile program. It is generally conceded that to realize PERT's major advantages a project should be large—but does it work for small projects?

Recently, Elco Corporation, Willow Grove, Pa., applied PERT to a small but complex order and reports that results were extremely favorable. Smoothness in the flow of production as well as a high degree of efficiency convinced management that this technique is an answer to production planning and control problems. The long line of time-consuming adjustments required by special runs together with their necessary disruption to other routine operations, are reduced to a minimum. This order of 6,000 special connectors, required designing, manufacturing and shipping within 5 weeks. The products, connectors, were similar in design to those currently in production by the company but required some retooling. Also, the tight time requirement caused a shifting of existing work in several departments.

**Procedure** — The first step was a meeting for detailed evaluation where all operations from drafting to shipping were studied. A realistic time assumption was made for each operation. The events were laid out on paper as a series of squares and the action required as connecting arrows in accordance with a time table for work that had to be performed. Three time estimates were made—optimistic, normal and pessimistic—and used in a formula to calculate a statistical expected time

## PERT Math Easier With New Rule

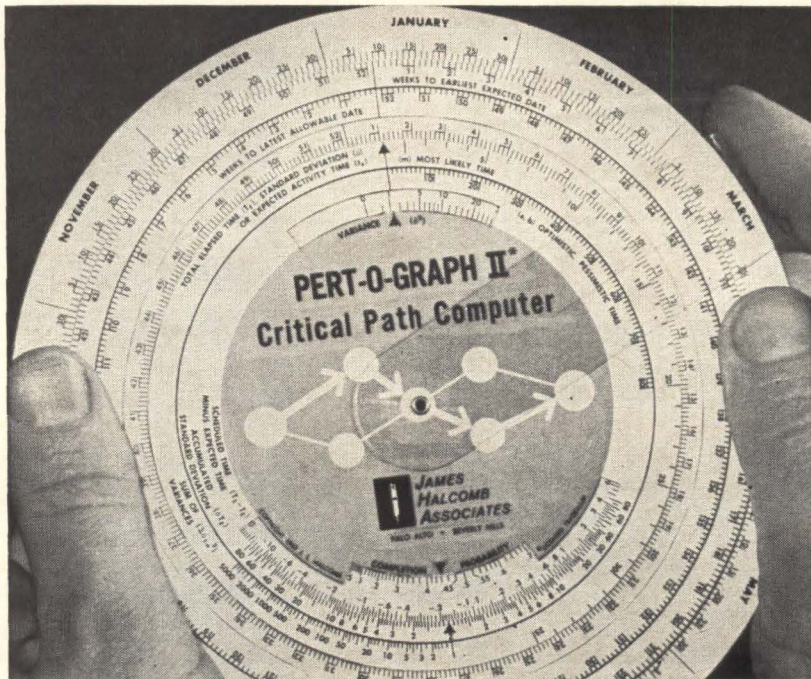

NEW EDITION of Pert-O-Graph eliminates need for electronic computer in solving Pert problems. First edition solved only statistical expected time problems but this modified version can solve all basic PERT computations. This plastic circular slide rule was designed and is available from James Halcomb Associates, Palo Alto, Calif.

Report from

**BELL  
LABORATORIES**

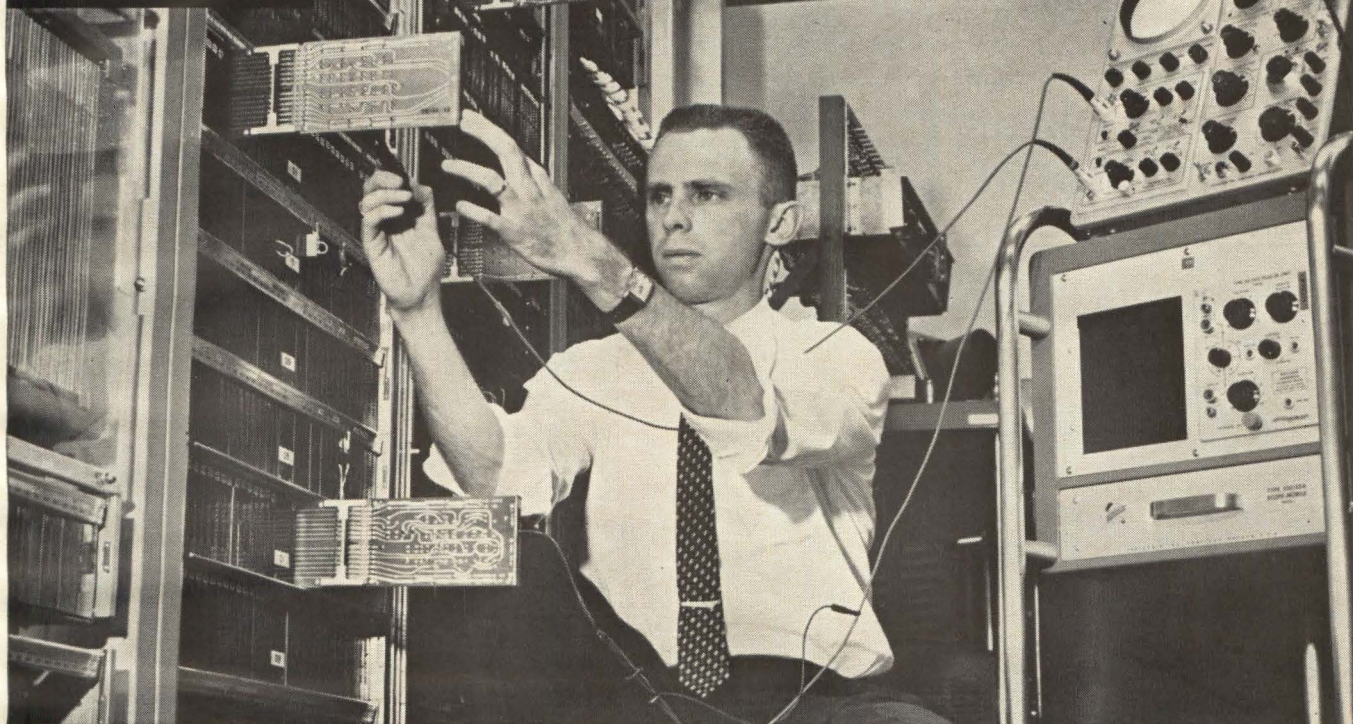

Bell Laboratories' E. G. Hughes tests printed circuit boards in experimental central office control equipment for 101-Electronic Switching System. The system automatically detects trouble, switching out a defective unit and switching in a duplicate unit so service is not interrupted.

## High-Speed Switching System Provides New Telephone Services for Business

A new electronic switching system designed to meet the special needs of business customers has been developed at Bell Telephone Laboratories. This system provides many new telephone services such as a way for reaching a seven- or ten-digit number by dialing only three digits, setting up conference calls by dialing other customers into the conversation, and automatically transferring incoming calls from your phone to another by predialing special codes.

A notable feature of the new system is a high-speed control unit. Operating from a telephone switching center, the unit scans—thousands of times per second—all the telephone connections in dozens of business offices that may be located many miles apart. It spends only two-thousandths of a second in

each office, but in that time it determines what has to be done and arranges for the necessary actions.

Another feature of the new system is the high-capacity memory. From this, the control unit can draw, in eight-millionths of a second, such specific instructions as how to handle a certain call.

The new switching system operates compatibly with existing electromechanical switching systems in the Bell System. Such Bell Laboratories inventions as the transistor are indispensable to its compactness and the high reliability of its operation. The system was developed for use by businesses as a private branch exchange, and a model has been installed by Western Electric for trial by two New Brunswick, New Jersey, companies.



**BELL TELEPHONE LABORATORIES**

World center of communications research and development

# Trapped by

## PW Assembly Cost Factors?

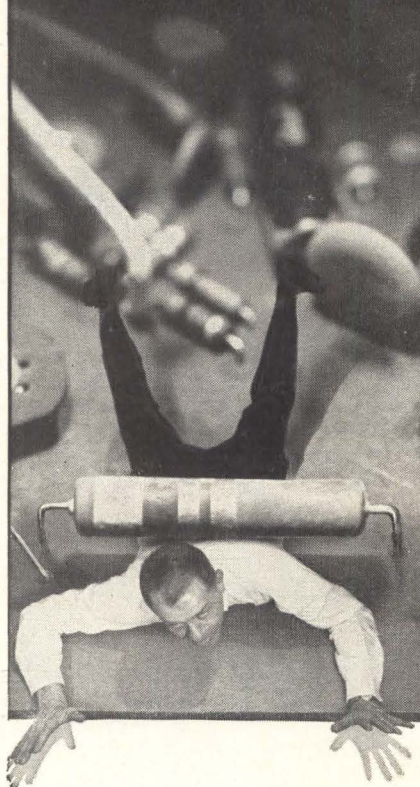

Then **DYNASERT**<sup>®</sup> component inserting machine may be your way out. This is automated, high-speed inserting at its best: up to 10 times faster than costly hand methods. And savings add up and up: users find that their savings in direct labor costs and production time easily pay for a Dynasert installation in less than a year. Dynasert delivers product uniformity. Greater efficiency. Superior quality. It automatically feeds, cuts and bends leads, inserts and clinches all types of axial lead components. Virtually no operator training required. Changes made from one board or component type in seconds. Interested? Send for a free copy of: Dynasert — Production Equipment for Electronics. Dynasert Dept., United Shoe Machinery Corporation, Boston, Massachusetts.



**United Shoe Machinery**  
BOSTON, MASSACHUSETTS

(ELECTRONICS, p 30, Nov. 17, 1961). With this graphical display of the operations, the PERT diagram, it was now possible to search for expedient shortcuts in schedule or locations where lost time could be easily regained. Some custom tailoring of the operations was made to fit the required schedule and this modified PERT diagram was distributed to all departments concerned. A meeting of the department leaders held for discussion resulted in some fine adjustments to the chart. It was then given a broad distribution to concerned personnel.

**Application** — In applying PERT, operations ordinarily performed in sequence were started simultaneously. These operations were drawings, purchasing, routing orders and production tooling. As the preliminary work progressed, many inevitable problems ensued but were solved by the right man at the right time resulting in many economies. When the project was ready for the production floor, a minimum number of assemblies were needed for the final check of tools and procedures. Production was accelerated with increased personnel until the order was complete.

A final meeting of department leaders revealed that the course had been closely followed with minimum interference to other routine manufacturing processes.

### Soldering Iron Holder For One or Two Workers

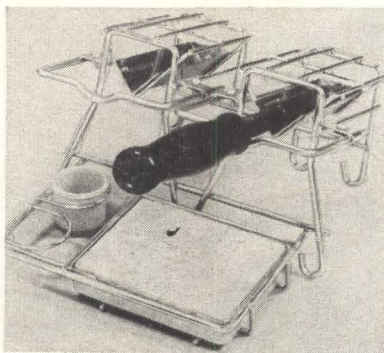

**SOLDERING IRON** holder by Titchener & Co., Binghamton, N. Y., provides a convenient soldering station with room for two irons, wiping sponge, and cleaning and flux containers. The device can be used for two workers or for soldering irons with different tips. It will not tip easily or transmit heat

## OPPORTUNITIES IN MELPAR'S RAPIDLY EXPANDING ELECTRONICS DIVISION

Melpar's Electronics Division has an immediate need for Engineers to fill these important positions:

### MICROWAVE RECEIVER DESIGN

Specific problems include parametric amplifiers, varactor techniques, microwave filters, ultra-stable programmable oscillators, and dual and triple channel balanced receivers for monopulse and guard antenna gating.

### DATA PROCESSING SYSTEMS DESIGN

Perform the logic design of digital equipment to process real time flight data. Problems include specifying necessary digital/analog interface equipment and the design of computer systems for a variety of applications.

### COMPUTER PROGRAMMING

Generate programs for fixed point real time computers to be used with special purpose digital and analog equipment.

### COMMUNICATIONS

Perform design studies of terminal equipments for time frequency dodging, matched filters, adaptive highly reliable communications throughout the electromagnetic spectrum. Techniques of interest include spread spectrum circuitry, error detection and correction coding, and privacy and security circuitry.

For Further Details,  
write in confidence to:

**John A. Haverfield**

Manager—Professional Placement

**MELPAR**  **INC.**

(A Subsidiary of Westinghouse  
Air Brake Co.)

**3436 ARLINGTON BLVD.  
FALLS CHURCH, VA.**

(A Suburb of Washington, D.C.)

*an equal opportunity employer*

## Aluminum Plates Easily After Sodium Zincate Dip

RARE-METAL plating of aluminum poses problems. The property of aluminum to combine readily with most atmospheres even while being processed has made its plating difficult. Conventional plating methods may result in inconsistent quality and difficulty in passing environmental tests required by government agencies.

A new process for plating rare metals on aluminum is announced by Cohan-Epner, Inc., of New York City. The company has installed a new facility for plating aluminum and uses 17 different stations with no backtracking for each work piece before the first electrodeposit.

Key to the process is a dip of sodium zincate that prepares the surface of the aluminum for a basic coat of copper. Careful control of the plating is performed continually by accurately measuring its thickness. A Micro-Derm back-scatter beta-ray thickness gauge is used for this purpose. (This instrument uses a direct-reading meter to display the reflected beta rays after counting with a Geiger counting tube. The amount of reflected rays is a function of the thickness of the plating.) Variation in plating thickness signals a changing condition in the process and rapid adjustments assure consistent control and minimal waste.



## Table Centers Work To $\pm 0.0001$ Inch



ROTARY CENTERING table developed by Sheffield—a Bendix subsidiary—automatically centers a workpiece to within  $\pm 0.0001$  inch of the table's vertical axis. The rotary table is  $19\frac{1}{2}$  inches in diameter and is capable of supporting up to 100 pounds

## Gas Laser product spectrum

The label you see on the lasers above is the one that's best known among all commercial CW gas lasers in use today. What keeps the Spectra-Physics label in the forefront is the integrity and experience in back of it, and the quality which has gained acceptance for Spectra-Physics lasers throughout the scientific disciplines.

One of the five current production models of helium-neon lasers will likely fit your needs, whether for systems and instrument use, classroom demonstration, or advanced laboratory research. The newest, a Spectra-Physics invention,\* is the Model 116, the first instrument capable of providing reliable high-gain operation over a wide range of wavelengths.

**Full one-year warranty**—When you purchase any Spectra-Physics laser, you can look forward to a high order of reliability in its operation, backed by a strong 1-year warranty which even includes the plasma tube.

- 1 Model 112 laser.....\$8200
- 2 Model 116 laser.....\$13,250
- 3 Model 115 laser.....\$4650
- 4 Model 130 laser.....\$1525
- 5 Model 131 laser.....\$1950
- 6 Model 401 Power Meter.....\$355
- 7 Model 200 Exciter (for Models 112, 115)
- 8 Model 250 Exciter (for Model 116)
- 9 Model 251 Exciter (for Model 131)
- 10 Model 302 Precision Adjusting Base
- 11 Model 301 Precision Adjusting Base

May we send you data sheets and add your name to the mailing list for Spectra-Physics Laser Technical Bulletins? Address us at 1255 Terra Bella Avenue, Mountain View 3, California (or call collect—(415) 961-2550).

\*PATENT PENDING

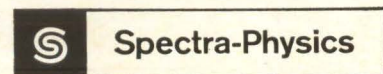

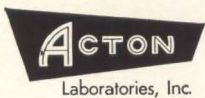

# Precision Phase and Voltage Instruments

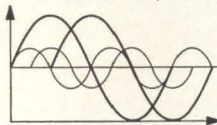

For precision laboratory and production uses in component checkout and servo analysis.

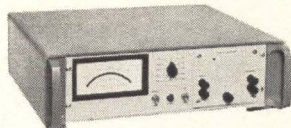

## AUTOMATIC READOUT IN DEGREES PRECISION PHASE METER 329-A

- Readings from 0°-360° in 30° span scales.
- ±1.0° absolute accuracy in range from 30 cps to 50 kc.
- Useful in 5 cps to 300 kc range.
- Standard signal input: 100 mv to 150 volts, extendable from 1 mv to 1,000 volts.
- Plug-in modules for phase shifting capability and other functions.
- FULLY TRANSISTORIZED.

## DIRECT READING OF COMPLEX VOLTAGES PRECISION PHASE/VOLTMETER 360-A



- Measures total, fundamental, quadrature and in-phase inputs.
- High common mode and harmonic rejection. Operates at up to four frequencies within 50 cps to 20 kc range.
- Scale provides direct phase angle reading, accurate to ±1° 0°-360°, absolute.
- Voltage measurements, ±2% in 20 cps to 20 kc frequency range.
- Signal inputs from 1 mv to 300 volts.



## DIRECT DIGITAL READOUT PRECISION PHASE/VOLTMETER 330-A

- Direct four-digit reading from 0°-360°, with 0.1° sensitivity and resolution.
- Reads 0 to 999.9 volts.
- Provides analog output, 0 to -3.60 volts.
- Absolute accuracy, ±0.5°, in frequency range from 30 cps to 40 kc; special to ±0.2°. ±1°, in frequency range of 20 cps to 100 kc.
- 0.2 to 200 volts signal input.
- Fully transistorized, except for high impedance input.

The Acton Laboratories group of precision phase and voltage measuring instruments is engineered with built-in foresight against obsolescence.

Many "plug-in" modules are available to extend operating versatility, provide other useful readouts, and where required, to match the equipment to unusual inputs or applications.

Complete Technical Data on Request

© 1963



A Subsidiary of  
Bowmar Instrument Corp.  
533 Main Street  
Acton, Massachusetts

Laboratories, Inc.

PRECISION ANGLE POSITIONING DEVICES • PRECISION ELECTRONIC INSTRUMENTATION • PRECISION ROTOFLEX TELEMETRY COMMUTATORS • INDEPENDENT ENVIRONMENTAL TESTING

70 CIRCLE 70 ON READER SERVICE CARD



## HAMLIN magnetic reed SWITCHES

the largest selection ever offered...

The use of magnetic reed switches has been increasing by leaps and bounds, and Hamlin engineers have set the pace with the greatest selection. All standard varieties, of course, plus...

- DRM-001 High Voltages (up to 5000 v)
- DRG-DTH Double Throw (Form C)
- DRR-5 Heavy Duty (up to 50 v amp.)
- DRS-5 Heavy Thrust (in-rush to 15 amp.)
- HRC-1 No-Bounce (Mercury wetted)

and many more designed for special requirements... YOUR specifications. Send for literature.

SEE IT! HEAR IT!



FREE CARD  
with magnet and switch

# HAMLIN INC

Dept. EL • LAKE AND GROVE STREETS • LAKE MILLS, WISCONSIN  
CIRCLE 201 ON READER SERVICE CARD



## THE NEW SUPER WEE-DUCTOR

An ultra reliable MOLDED SHIELDED r.f. subminiature inductor—available in inductances from 0.1 μH to 100,000 μH in 73 values.

The SUPER WEE-DUCTOR is shielded for minimum coupling in high density packaging and has extremely low dc resistance. Only 0.410" long and 0.157" in diameter, the SUPER WEE-DUCTOR meets all the requirements of MIL-C-15305B (Amendment #1), Grade 1, Class B, including moisture and immersion resistance and operation from -55°C to +125°C.

For complete engineering data, write Dept. WL-15, or phone 201-464-9300. All values available from stock.

## NYTRONICS, INC.

550 Springfield Ave., Berkeley Heights, N.J.  
Design Leaders

STANDARD components to meet CUSTOM requirements

CIRCLE 202 ON READER SERVICE CARD  
December 20, 1963 electronics



# Tape Stores Computer Queries

Device stores up to 14 decimal digits on each tape line

**MODEL SD 145** is a high reliability, low-speed, magnetic-tape unit designed for use as a low-cost digital-computer data entry and query device. Unit is semiautomatic and will automatically insert small quantities of prestored information into a computer that might otherwise be manually typed in. Advantages of the SD 145 include improved data-entry accuracy, increased entry speed, possible reduction of software requirements and small size. The device is a self-contained unit that is integrated both physically and electrically in one housing.

In its presently intended mode of operation, the SD 145 stores up to 14 decimal digits across each line of a 3-inch wide Mylar-base magnetic tape. Standard tape lengths available permit either 400, 650 or 950 lines of digital information to be stored in each interchangeable tape cartridge with the present density of 3 lines per inch. Typed or handwritten descriptors associated with the prestored digital data can

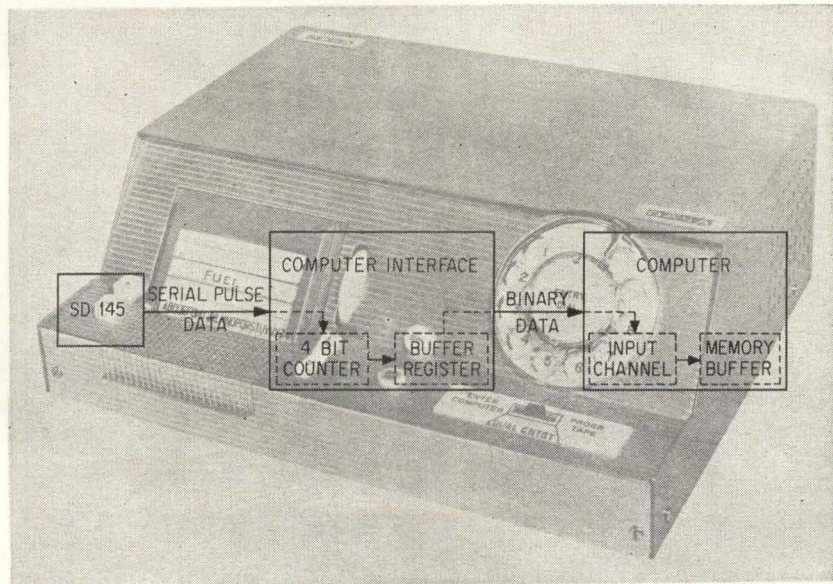

be written on the front of the tape. Rapid access to a particular position on the tape memory is accomplished by an electric motor-drive mechanism that rapidly positions the tape until the desired descriptor appears.

The unit uses a solid-state power supply and programs with a modified telephone dial mounted in a small box containing a solid-state pulse circuit.

The magnetic tape-to-computer buffer converts the unitary-coded data stored on the tape to a data

format appropriate to the computer. Design details for the serial-to-parallel conversion may vary somewhat with characteristics (e.g. word size) of the particular computer being used. A counter converts the unitary-coded octal numbers into binary-coded numbers, while a buffer-register stores successive octal digits before they are read into the computer memory. Dasa Company, Inc., 235 Bear Hill Rd., Waltham 54, Mass.

CIRCLE 301, READER SERVICE CARD

## System Measures VSWR Continuously

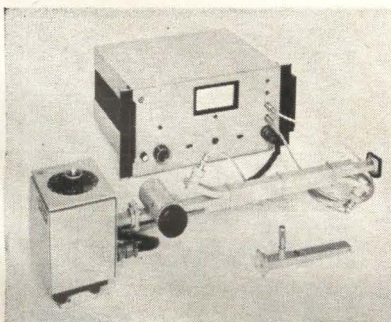

**Measuring** system model 305 provides continuous measurements of vswr vs. frequency between 8.5 Gc and 9.6 Gc as normally supplied. Units can also be supplied for other frequency ranges. Overall system accuracy is better than 2 percent.

Model 305 contains a klystron oscillator that is mounted in a protective housing along with a blower and repeller-tracking potentiometers.

The oscillator features automatic repeller tracking that permits single-knob frequency control. No adjustments are required after initial factory alignment. The system electronics consists principally of a ratio meter and klystron power supply.

In addition to performing conventional point-by-point vswr measurements, this system has re-

measure  
true  
rms  
to  
50  
mc

**NEW  
Wideband  
Voltmeter**

- 20 cps to 10 megacycles  $\pm 1\%$
- 18 cps to 20 megacycles  $\pm 3\%$
- 15 cps to 50 megacycles  $\pm 5\%$
- 100 microvolt to 300 volt range
- crest factor, 6 at full scale
- crest factor, 60 at tenth scale
- 1 megohm, 20 pf input impedance
- ac amplifier output—100 mv, rms
- ac amplifier response—6 nsec
- dc output—100 millivolts

Model 121 True rms Wideband Voltmeter . . . . . \$870  
Model 1201 Cathode Follower Probe . . . . . \$120

Send for Engineering Note describing the Model 121

ALSO AVAILABLE  
Model 120 Peak Reading Voltmeter-Amplifier . . . . . \$775



**KEITHLEY  
INSTRUMENTS**

12415 Euclid Avenue • Cleveland 6, Ohio

order output jacks that permit vswr vs. frequency to be plotted directly on a conventional X-Y recorder or oscilloscope. Moreover, the model 305 is an excellent signal source with a nominal power output of 20 mw either 1,000 cps square-wave modulated or c-w. California Technical Industries, Div. of Textron, Inc., 1421 Old Country Rd., Belmont, Calif.

CIRCLE 302, READER SERVICE CARD

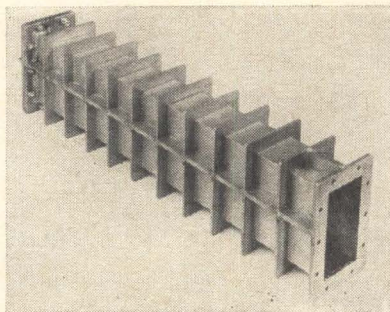

**Waveguide Load  
Rated at 2,000 W Average**

MODEL D1486 is constructed in RG-69/U waveguide (6.66 in. by 3.41 in.) and is rated at an average power of 2,000 w in the frequency range 1.2 to 1.7 Gc. No external cooling is required. It is pressurized to 25 psig. Price is \$475. Radar Design Corp., Pickard Drive, Syracuse 11, N.Y. (303)

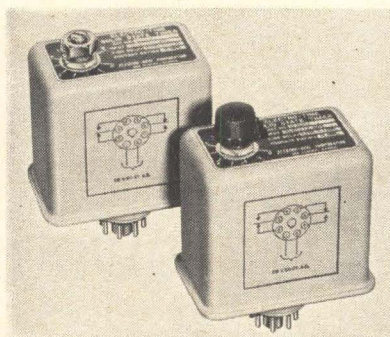

**Industrial Timers Are  
Solid-State Units**

A NEW CONCEPT in solid state interval timers is now available in two forms. The first is a cumulative timer in which an interval up to 5 minutes may be preset to time flow of material; however an interruption in this flow, up to 15 minutes, may take place without changing the ac-

the versatile, NEW  
**ELECTROPUNCH**  
can increase your  
light assembly  
production as  
much as 100%

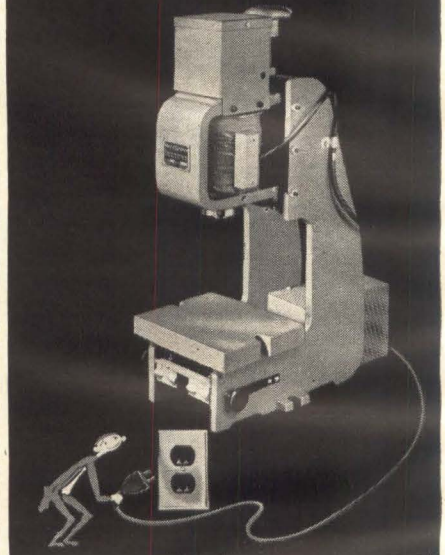

**BLACK &  
WEBSTER**  
INC.  
570 PLEASANT STREET,  
WATERTOWN 72, MASS.

Gentlemen:

Please send me information about the Black & Webster Electropunch (Model C) for light punching, heavy duty swaging, staking and riveting which:

1. delivers up to 75 blows per minute
2. has precisely controllable impact up to 10,000 lbs.
3. never needs air lines
4. doesn't require skilled labor
5. sets up easier and quicker
6. cuts costs, time, and labor
7. is bench mounted

NAME \_\_\_\_\_  
COMPANY \_\_\_\_\_  
STREET \_\_\_\_\_  
CITY \_\_\_\_\_ ZONE \_\_\_\_\_ STATE \_\_\_\_\_  
DEPT. E \_\_\_\_\_

CIRCLE 203 ON READER SERVICE CARD

December 20, 1963 electronics

accumulated time in the timer. In effect this timer adds the time increments of actual flow until the preset time has elapsed. The second and similar device is a monitor that will time-out when there is an interruption in a continuous flow, or signal, exceeding the preset time interval, but will not time-out if the flow is resumed before the allotted time. Time intervals have repeat accuracy within  $\pm 1$  percent of preset time. Electro-Seal Corp., 938 North Ave., Des Plaines, Ill. (304)

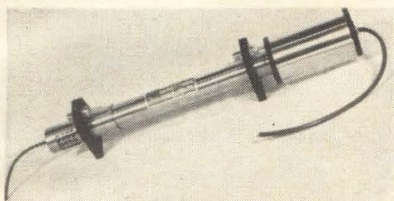

**High-Power TWT  
Has Low Noise**

TRAVELING-WAVE TUBE model HA-100B is a ppm-focused, 1-watt device that provides a minimum small-signal gain of 35 db with minimum saturation power output of 1 watt between 2.0 Gc and 4.0 Gc. Unit exhibits a maximum noise figure of 13 db.

Low noise figure coupled with high power output results in a wide range of linear operation that reduces the effects of inter- and cross modulation when multisignal reception is experienced. The twt has a linear dynamic range of approximately 90 db/Mc, and is compact. Air flow of 5 cfm at 1/2-inch of water is required for cooling. Huggins Laboratories, Inc., 999 East Arques Ave., Sunnyvale, California. (305)

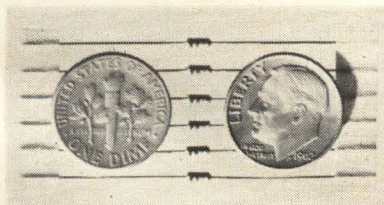

**Tiny Resistor  
Rated 0.1 W at 70 C**

TYPE RKL10, 0.1-w resistor, with a length of 0.134 in. and a diameter of

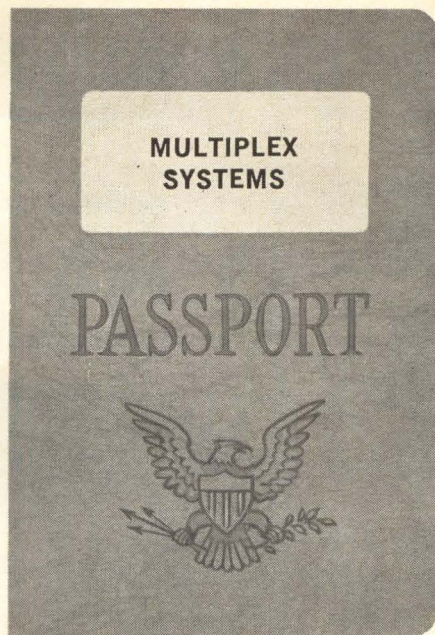
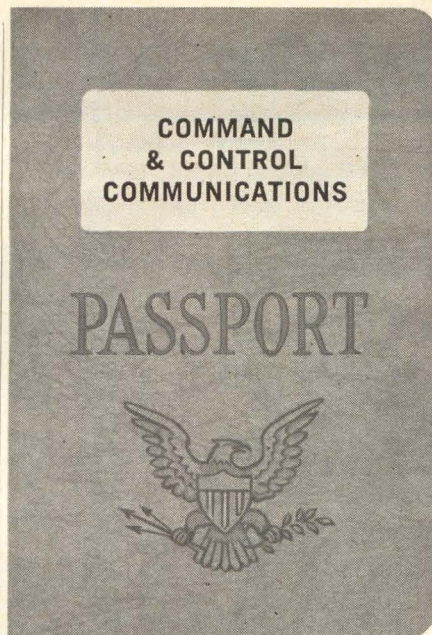

## Pick your passport to Florida

Staff expansion is now under way at Electronic Communications, Inc. Experienced communications engineers are being offered unusual opportunities for professional growth and personal satisfaction with the recognized industry leader in command and control communication systems.

ECI engineers are working on stimulating research, development, and product engineering programs in multiplex systems, miniaturized transmitters and receivers, command and control systems, and in advanced communications areas. Work ranges from VLF to X band, and includes both military and space systems.

ECI engineers are living in the satisfying surroundings of St. Petersburg, Florida — one of America's best-known cities for year around recreation and relaxation. Cultural and educational opportunities are abundant too.

Send your resume today to Director of Professional Placement, Electronic Communications, Inc., Box 12248, St. Petersburg, Florida. (An equal opportunity employer.)



**ELECTRONIC COMMUNICATIONS, INC.**  
St. Petersburg, Florida

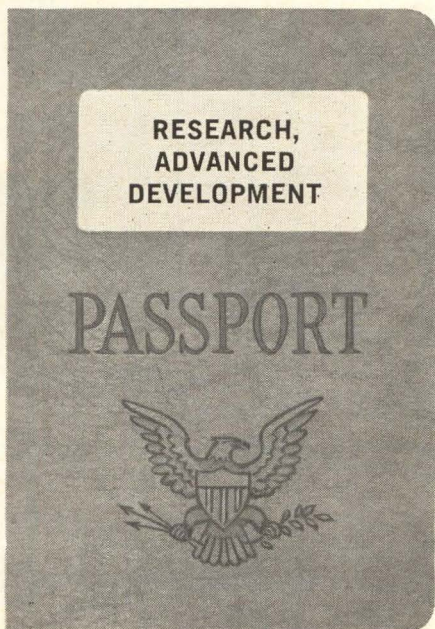

specify the new Sperry Products  
contact Avnet for best service

# AVNET

on-time delivery of the latest  
Sperry Semiconductors

including NPN and PNP silicon  
planar & PNP silicon alloy transistors (many types QPL approved),  
silicon planar differential & darlington amplifiers, dual emitter  
differential choppers

many other Sperry products are  
available immediately from Avnet

# SPERRY

call your local Avnet Headquarters  
The Avnet System, coast to coast

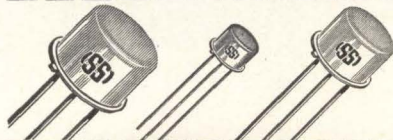

Westbury, L. I.; Chicago; Phoenix;  
Burlington, Mass.; Syracuse, N. Y.;

# LOCAL

Salt Lake City; Bellevue, Wash.;  
San Diego, L. A., Sunnyvale, Cal.

CIRCLE 204 ON READER SERVICE CARD

## Magnetic Reed

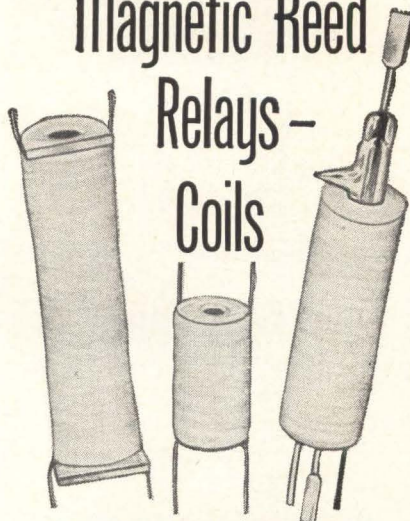

Basic and special REED RELAYS and/or COILS  
for high reliability and sophisticated switching.

- Operating Inputs: low as 1mA. and 15mW.
- Standard Coil Voltages: 6, 12, 24, 32, 48V in stock for immediate delivery.
- Special Voltage or Resistance, multiple windings for flip flop, memory and crosspoint selection applications — to customer specifications.
- New Type SP Coils: for high voltage vacuum-type reeds, 1 1/4" lg.
- Standard Coil Termination: 3" flexible leads. Also available with solid copper leads, printed circuit pins and rigid lugs — silver plated or tinned.
- Relay Contacts in Form A, B, C and latching.

# Coto-Coil

Write for Prices  
**COMPANY, INC.**  
65 Pavilion Ave.  
Providence, R. I. 02905

0.055 in., is available from 10 ohms to 220,000 ohms at 5 percent and 10 percent tolerances. The leads have low thermal conductivity to minimize soldering effects, they are soldered to cavities at the ends of the substrate so dispensing with the usual end cap, eliminating a source of noise and providing a longer resistance path in the space available. The electrical specifications substantially meet MIL R 105090. The resistor is manufactured by Siegert in West Germany, and is available from British Radio Electronics Ltd., 1742 Wisconsin Ave., N. W., Washington 7, D. C.

CIRCLE 306, READER SERVICE CARD

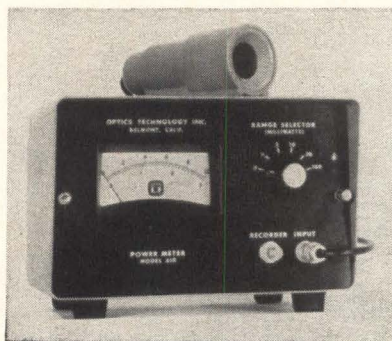

## Instrument Measures Laser Power Output

SELF CONTAINED power meter measures the output of continuous lasers and other light sources in the visible and near infrared ranges. Unit includes a sensitive broadband detector and a meter calibrated in milliwatts. It has 6 dynamic ranges that permit measurement of signals between 0.03 and 1,000 mw. Signal levels can be continuously recorded through attachment of a high-impedance, ten-millivolt, strip-chart recorder.

The detector head has a large aperture for simplified alignment and the detector itself is recessed to minimize ambient-light effects. A magnet located within the head permits convenient mounting in a wide variety of locations. To assure optimum accuracy, each unit is individually calibrated and all circuit components are selected for long-term stability.

Called model 610, the device has a spectral range of 4,000 to 11,000 Å and an input aperture of 1 inch. Price is \$295. Optics Technology, Inc., Belmont, Calif. (307)

IN A GREAT  
MANY APPLI-  
CATIONS, A  
**FLUKE**  
DIFFERENTIAL  
VOLTMETER

- DOES THE WORK  
OF A DIGITAL  
VOLTMETER  
COSTING SEVERAL  
TIMES AS MUCH

For CATALOG DIGEST: Write  
JOHN FLUKE MFG. CO., INC.,  
Box 7428, Seattle, Wash. 98133

CIRCLE 205 ON READER SERVICE CARD

## J V E VACUUM COATER

Advanced technique  
& many years'  
experience!!

JVE's Bell Jar  
Coater is vital for  
all the electronics  
makers!

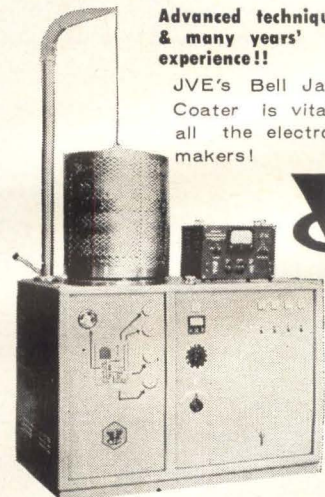

### TYPE EH-6 •

- Ultimate Pressure:  $1 \times 10^{-6}$  Torr
- Glass Bell Jar: 400 mm dia. x 400 mm
- Pumping System: Diffusion pump using liq-N<sub>2</sub> trap

\* For further please write to:

**JAPAN VACUUM ENGINEERING CO., LTD.**  
No. 5, 1-chome, Ginza-nishi, Chuo-ku, Tokyo, Japan  
• Cable Address: "VACTEC" Tokyo

CIRCLE 206 ON READER SERVICE CARD

December 20, 1963 electronics

# SPECIFY TELEPHONE TYPE COMPONENTS

BY  
**Stromberg-Carlson**

Thoroughly proved in telephone switching operations, Stromberg-Carlson components bring a new high in quality and reliability to many industrial applications.

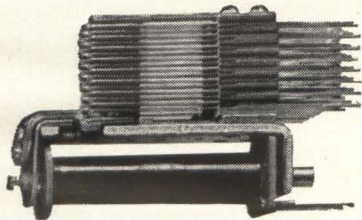

**RELAYS** Types A, B, BB, C and E. All standard spring combinations are available. Send for our Bulletin T-5000R3.

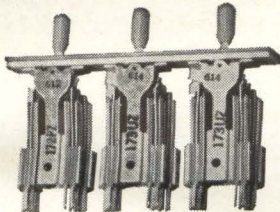

**KEYS** Broad selection of push-button, cam and twist types. Send for Bulletin T-5002R2.



**HANDSETS** High-efficiency models; standard or with switch assemblies. Send for Bulletin T-5017R.

Plus all other telephone switchboard components. For technical data on the full Stromberg-Carlson line, write to Industrial Sales Department.

**STROMBERG-CARLSON**  
A DIVISION OF GENERAL DYNAMICS  
114 CARLSON ROAD • ROCHESTER 3, N. Y.

CIRCLE 207 ON READER SERVICE CARD

electronics December 20, 1963

## LITERATURE OF THE WEEK

**ELECTRONIC MEASURING INSTRUMENTS** Waveforms, Inc., 333 Sixth Ave., New York City, N. Y., 10014. A 32-page brochure-catalog describes electronic measuring instruments and the theory behind their performance. (360)

**PCM TELEMETRY GROUND STATION** Monitor Systems, Inc., Fort Washington, Pa. Technical bulletin 1011 gives complete information on model 1011 universal pcm telemetry ground station. (361)

**ACCELEROMETER/AMPLIFIER** Kistler Instrument Corp., 8989 Sheridan Drive, Clarence, N. Y., 14031. Bulletin S-132663 describes a high level quartz piezoelectric accelerometer/amplifier package. (362)

**F-M TELEMETRY TRANSMITTER** Radiation Inc., Melbourne, Fla. Bulletin B109 describes an all solid-state f-m telemetry transmitter for operation in the 216-260 Mc telemetry band. (363)

**PERFORATED TAPE READER** Data-stor Division of Cook Electric Co., Skokie, Ill. Spec-Release DSD-SR22 describes model 52 perforated tape reader. (364)

**IMPREGNATING & CASTING SYSTEMS** Hysol Corp., Olean, N. Y. Bulletin E-317 covers C23 Unfilled and C24 Filled—heat curing, flexible impregnating and casting systems. (365)

**BALLISTIC THERMOPILE** TRG Inc., Route 110, Melville, N. Y., 11749. Data sheet contains specifications and applications of a ballistic thermopile for measuring laser outputs. (366)

**NYLON FASTENERS** Product Components Corp., 15 Washington Ave., Hastings-on-Hudson 2, N. Y. Catalog and price schedule describes a broad line of molded nylon fasteners. (367)

**PICOAMMETER** Keithley Instruments, Inc., 12415 Euclid Ave., Cleveland 6, O. Two-page engineering note covers the model 409 high-stability picoammeter. (368)

**ENVIRONMENTAL PARTS** Tenney Engineering, Inc., 1090 Springfield Road, Union, N.J., has published a comprehensive, illustrated catalog of the most frequently ordered environmental equipment replacement parts. (369)

**AIR MOVEMENT** Howard Industries Inc., 1760 State St., Racine, Wis. Brochure describes the model 8010 Cyclom fan and illustrates eight other air-movement units. (370)

**MICA CAPACITORS** Sangamo Electric Co., Springfield, Ill. 62705, has published a 20-page bulletin covering a complete line of transmitting type mica capacitors. (371)

**TAPE RECORDER HEAD** Michigan Magnetics, Inc., Vermontville, Mich. A technical catalog page describes the 3K17 tape recorder head designed for microminiaturization. (372)

specify the new circuit breakers  
by Mechanical Products, Inc.

# AVNET

contact The Avnet System  
for best service & on-time delivery

the line includes breakers with  
both standard commercial and  
Mil Spec part nos. Mechanical  
Products' circuit breakers meet  
requirements of MIL C-5809  
and MIL C-7079.

for MP circuit breakers

# MECHANICAL PRODUCTS

call your Local Avnet Headquarters

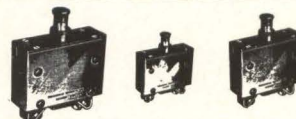

Westbury, L. I.; Chicago; Phoenix;  
Burlington, Mass.; Syracuse, N. Y.;

# LOCAL

Salt Lake City; Bellevue, Wash.;  
San Diego, L. A., Sunnyvale, Cal.

CIRCLE 208 ON READER SERVICE CARD

## OPTICAL BENCHES AND ACCESSORIES



**SECOND  
HARMONIC  
GENERATOR  
CONVERTS  
RED LASER  
LIGHT TO  
BLUE.**

COVER PICTURE  
FROM ELECTRONICS  
MAY 10, 1963

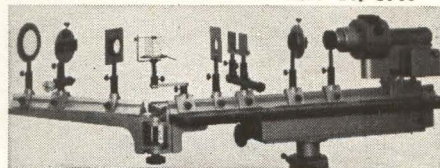

STRAIGHTNESS TO 0.1 mm

All the rails and carriages are standardized and interchangeable with parts made by other manufacturers.

WRITE FOR CAT. 81F

**KLINGER SCIENTIFIC  
APPARATUS**  
83-45 Parsons Blvd., Jamaica 32, N. Y.  
Tel: 212 OLYmpia 7-0335

CIRCLE 75 ON READER SERVICE CARD

75



## ITT Expands in West

**CONTINUING** its expansion into California, ITT last week dedicated a \$1-million Federal Laboratories facility in San Fernando. Located on a 10-acre site and employing 250 people, the 75,000-sq-ft laboratory is the manufacturer of tacan and vortac air-navigation equipment, loran long-range navigation equipment, missile guidance and launching systems, and electronic countermeasures, radar and sonar training equipment.

Federal Laboratories is part of an expanding ITT operation in California which will result in a plant investment of \$42 million and an employment of 10,000 persons by 1964, according to John J. Graham, ITT vice president/area general manager—North America. The International Telephone and Telegraph Corporation's association with the state, which goes back 50 years to the time Lee de Forest perfected the vacuum tube for the Federal Telegraph Co. of Palo Alto, has increased in recent years with the acquisition of Jennings Radio Manufacturing Corp. of San Jose and Salinas, General Controls of Glendale, and Cannon Electric Co. of Los Angeles. Also, agreement has been announced to purchase Gilfillan Corp. of Los Angeles, a manufacturer of ground-controlled-approach radar landing systems.

Space age problems will be emphasized at the new facility. Specific projects underway include the study of infrared radiation from stars and missiles, the development of the "crystal ball" gyroscope for high outer space and earth accuracy, and the design and study of machines with human intelligence characteristics capable of identifying individuals, vehicles or aircraft by the sounds they emit.



### Silicon Transistor Promotes Hildebrand

G. A. HILDEBRAND has been appointed vice president in charge of marketing for Silicon Transistor Corporation, Carle Place, N. Y. He

was advanced to this newly created position after serving with the company as director of marketing since May of this year.

Hildebrand was formerly with RCA in numerous marketing capacities.

### Sternberg Accepts EOS Position

SIDNEY STERNBERG has joined the staff of Electro-Optical Systems, Inc., Pasadena, Calif., as vice president and general manager.

Before joining EOS, Sternberg was chief engineer of the Astro-Electronics division of RCA, Prince-

ton, N. J., where he was responsible for the operation of the entire engineering department encompassing a staff of about 1,300.



### FXR Gets New Vice President

D. SCOTT BOWMAN has been appointed to the post of vice president, marketing, for FXR, Danbury, Conn.

FXR manufactures radio-frequency connectors, cables and switches; microwave components, test equipment and systems.

Before assuming marketing responsibilities at FXR, Bowman served on the corporate staff as director of marketing.



### Vitro Electronics Elevates Setterholm

VERNON M. SETTERHOLM has been named president of Vitro Electronics, a division of Vitro Corporation of America. Vitro Electronics is headquartered in Silver Spring, Md.

Setterholm has served in executive and technical capacities with Vitro since December 1947. Most

# HOW TO USE YOUR ELECTRONICS BUYERS' GUIDE

## Page Number References

For your convenience, advertisers in the **ELECTRONICS BUYERS' GUIDE** have the page numbers of their advertisements listed adjacent to their listings in the Product Listings (yellow paper) section of the book. Refer to these advertisements for full specifications on products. Keep your **ELECTRONICS BUYERS' GUIDE** at your work area at all times.

**ELECTRONICS BUYERS' GUIDE**  
A MCGRAW-HILL PUBLICATION

## TO ORDER REPRINTS

Fill in, cut out coupon below  
insert in envelope and mail to:

**electronics** Reprint Dept.  
330 W. 42nd Street, New York, N. Y. 10036

## REPRINT ORDER FORM

(To help expedite mailing of your reprints please send cash, check or money order with your order.)

For Listing of Reprints Available see the Reader Service Card.

For Reprints of the latest Special Report:  
What's New in Semiconductors

Send me.....Reprints of Key No. **R-45** 1-10, copies 75¢ ea.  
10-24, 60¢ ea. 25 or more 50¢ ea.

For Reprints of previous **Special Reports** or **Feature Articles** fill in below:

Send me.....Reprints of Key No.(s).....@.....¢ each.  
(For prices, see Reader Service Card.)

\*For orders of **Bulk Reprints** of other editorial articles in this issue or past issues:

Send me....Reprints of page No.(s)....of issue date....

of article entitled.....

\*Minimum bulk order 100 copies. You will be advised of costs by return mail.

Name .....

Number of Street .....

City, Zone No., State.....

# New Trygon Modular DC Supplies!

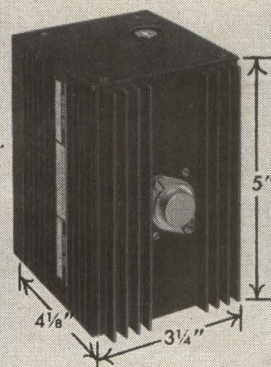

## Plug them in anywhere— then forget them!

This is literally true. You merely select the proper Trygon module and then mount it wherever you like, in any position — horizontally or vertically. All solid state components are silicon, and a generous heat sink is built-in—which means you can operate in ambients up to 71°C with no problems. The built-in current limited short circuit protection automatically resets when the fault is removed — so again, you don't have to worry where you place a Trygon module in a system.

Remote sensing? Provision is built-in. Remote programming, too. And premium components plus derated circuits yield MTBF figures in excess of 30,000 hours. (Yet, if service is ever required, all components are readily accessible.) For additional flexibility, input/output connections are available with either terminal strips, solder lugs or octal sockets.

Check the table below for the models you need. For prompt delivery, contact your local Trygon rep. Or, write for complete specifications and catalog, to: Dept. E-10.

## ELECTRICAL SPECIFICATIONS

Regulation: 0.02% load, 0.01% line  
Ripple: 0.5 mv RMS max.  
Recovery Time: Less than 25 microseconds  
Remote Programming: Provided on all units over output range

MODEL	VOLTS	AMPS	PRICE
PS20-400	0-20	0-0.4	\$140
PS32-250	0-32	0-0.250	\$140
PS50-150	0-50	0-0.150	\$155
PS3-1.5F	2.5-3.5	0-1.5	\$130
PS6-1F	4-8	0-1	\$120
PS12-900F	10-14	0-0.9	\$115
PS18-800F	16-20	0-0.8	\$120
PS24-700F	22-26	0-0.7	\$120
PS28-600F	26-30	0-0.6	\$120
PS48-400F	46-50	0-0.4	\$130

NOTE: All models designated "F" are also available with reduced current output at lower prices.

# TRYGON

**ELECTRONICS, INC.**  
111 Pleasant Ave. Roosevelt, L. I., N. Y.  
(516) FR 8-2800 TWX (516) 868-7508



# VOLTAGE/CURRENT REFERENCE .001% STABILITY / .01% ACCURACY

- electronic chopper-stabilized amplifier
- temperature controlled and stabilized zener reference
- complete short circuit protection
- extremely low ripple and noise
- completely solid state
- price: \$1800.00
- voltage mode: 0 to 100 V at 200 ma max.
- current mode: 0 to 100 ma at 100 V max.
- 3 full-scale ranges of 1, 10, and 100 volts/ma
- digital output selector, 5-decade resolution
- .0001% line and load regulation

**PAR PRINCETON APPLIED RESEARCH CORPORATION**

Box 565 / Princeton, N. J. / Tel: 799-1222, area code 609

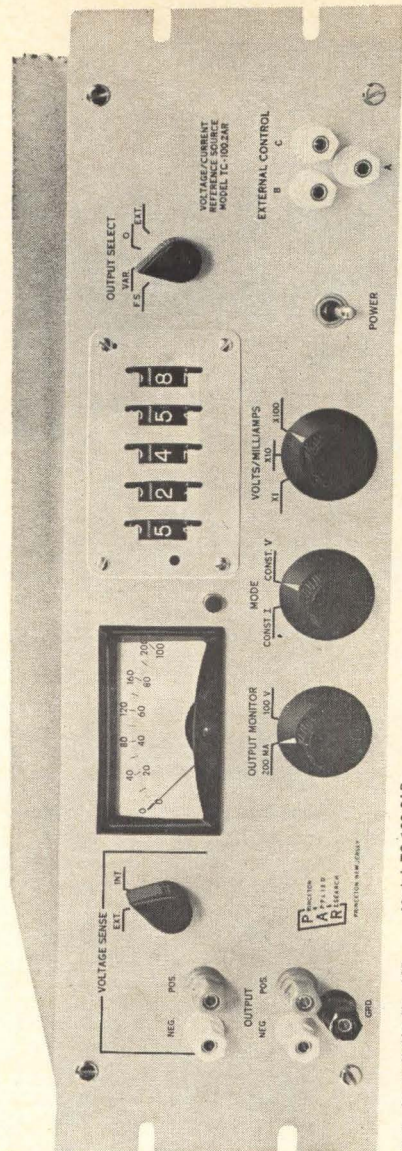

Write for Bulletin No. 105 Model TC-100.2AR

recently, he was vice president of Vitro Electronics, responsible for manufacturing and operations.

Vitro Electronics supplies custom telemetry, surveillance and communications electronic equipment to all military services.

## PEOPLE IN BRIEF

**Matthew N. Cinelli** leaves Westinghouse Electric to join Philco as mgr. of its Consumer Products div. electronics plant. **Robert M. Bergslien** moves up to g-m of Lumen Electronics, being replaced as chief engineer by **Robert Rosencranz**, former senior engineer. **Fred O. Weirich** promoted to director of engineering at Belden Mfg. Co. **Charles E. Hodgkins** raised to product mgr. and engineering coordinator for Vitramon, Inc. **Jack T. Miller**, ex-ITT Federal Laboratories, named mgr. of operations for Thomas Electronics, Inc. **Thomas V. Parke**, previously with Beckman Instruments, Inc., appointed coordinator R&D-electronics of Schlumberger Limited. **R. Burton Power**, from Tung-Sol Electric, Inc. to Hazeltine Corp. as asst. to the president. **James B. Plunkett** advances to product mgr.-atomic instruments at Baird-Atomic, Inc. **John A. Clark**, formerly with Pratt & Whitney Aircraft Co., now director of engineering at Wincharger Corp. Westinghouse Semiconductor div. ups **Adalbert N. Knopp** to advisory engineer, Trinistor design and development section. **Roger B. Neighborgall**, ex-General Precision, Inc., named asst. v-p of the General Instrument Corp. Defense and Engineering Products Group. **D. C. McKenzie**, previously with Texas Instruments, appointed a senior engineer at Signetics Corp. **Edward C. Bertolet** of Behlman-Invar Electronics Corp. and **S. H. Bellue** of Packard Bell Electronics Corp. elected chairman of the board and chairman of the exec committee, respectively, of Wescon.

# Primo

## MICROPHONES

A complete line of microphone cartridges and units for the OE market

Types :

- \* Uni-Directional
- \* Magnetic
- \* Velocity
- \* Crystal
- \* Dynamic
- \* Condenser
- \* etc.

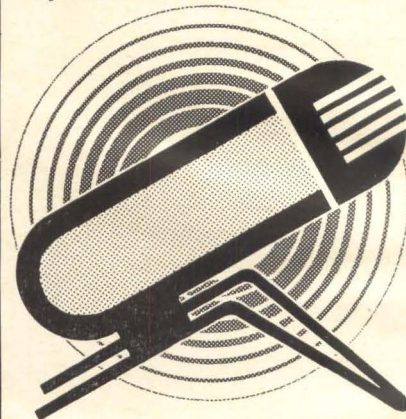

For catalog write to :

**PRIMO CO., LTD.**

2043 MURE, MITAKASHI,  
TOKYO, JAPAN

CIRCLE 209 ON READER SERVICE CARD

### FASTENERS FROM

**DIE CAST ZINC ALLOY**

- Wing Nuts
- Cap Nuts
- Thumb Nuts
- Thumb & Wing Screws

**MOLDED NYLON & DELRIN**

- Screws
- Hex Nuts
- Washers
- Screw Insulators

**ZINC ALLOY**

## WING NUTS

washer base

high wing

senior series

low wing

**widest range of types, thread & blank sizes FROM STOCK**

GRC's WING NUT types include senior, junior and economy series — exclusive washer base, high, low, extra low, capped and round wing styles. Patented recessed wings, smooth-acting washer-like bosses simplify assembly, improve appearance. Available in thread and blank sizes from #4 thru 1/2".

GRC's exclusive methods — die casting zinc alloy or molding Nylon and Delrin fasteners in one high speed automatic operation — assure high quality at lowest possible cost.

Write, wire, phone TODAY for SAMPLES, prices, your copy of GRC's NEW INDUSTRIAL FASTENER CATALOG

**GRIES REPRODUCER CORP.**  
World's Foremost Producers of Small Die Castings  
151 Beechwood Ave. • New Rochelle, N. Y.  
Phone: (914) NEW Rochelle 3-8600

CIRCLE 210 ON READER SERVICE CARD  
December 20, 1963 electronics



# HOW TO USE YOUR ELECTRONICS BUYERS' GUIDE

## Advertising Product Sections

Advertisements in the ELECTRONICS BUYERS' GUIDE are grouped together according to the kind of product advertised. All Power Supply advertisements, for example, will be found in the same section of the book. Thus it is made convenient for you to "shop" through the specifications presented to you by advertisers, without having to flip pages back and forth constantly. Keep your ELECTRONICS BUYERS' GUIDE close to your work area at all times.

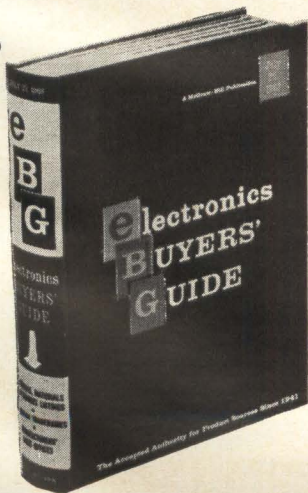

## SEARCHLIGHT SECTION

(Classified Advertising)

BUSINESS OPPORTUNITIES  
EQUIPMENT - USED or RESALE

### DISPLAYED RATE

The advertising rate is \$27.25 per inch for all advertising appearing on other than a contract basis. Contract rates quoted on request. AN ADVERTISING INCH is measured 7/8 inch vertically on one column, 3 columns—30 inches—to a page. EQUIPMENT WANTED or FOR SALE ADVERTISEMENTS acceptable only in Displayed Style.

### UNDISPLAYED RATE

\$2.70 a line, minimum 3 lines. To figure advance payment count 5 average words as a line. PROPOSALS, \$2.70 a line an insertion.

BOX NUMBERS count as one line additional in undisplayed ads.

DISCOUNT OF 10% if full payment is made in advance for four consecutive insertions of undisplayed ads (not including proposals).

THIS 2K25 Klystron Mount. PRD type W/  
WEEK var att. & full-shielding. \$45.00 ea.

RADAR AUTO-TRACK & TELEMETRY ANTENNA PEDESTALS  
3 & 10 CM. SCR 584 AUTOTRACK RADARS. M-33 RADAR  
TPS-1D SEARCH. APS-45 TPS-10D HT. FINDERS. WK RADARS.  
FPN-3200A. APS-10 APS-15B APS-27 (AMTI) SEARCH. ■  
APN-102 DOPPLER. DOZENS MORE. CARCINOTRONS. PFN'S.  
25.5-1-2-3-6 MEGAWATT PULSE MODULATORS. CAVITIES.  
PULSE TRANSFORMERS. IF STRIPS. WAVEGUIDE. BENDS  
200 MG. 1 KMC. 3 KMC. 6 KMC. 9 KMC. 24 KMC. RF PKGS.

RADIO RESEARCH INSTRUMENT CO.  
550 5TH AVE., NEW YORK 36, N.Y. JU 6-4691

CIRCLE 955 ON READER SERVICE CARD

## OPTICAL BENCHES

\$13. to \$13,000. New Catalog

THE Ealing CORP.

2250 Massachusetts Avenue, Cambridge, Mass., 02140

CIRCLE 956 ON READER SERVICE CARD

## EMPLOYMENT

for all employment advertising including Positions Vacant or Wanted and Selling Opportunities Offered or Wanted.

## SEARCHLIGHT

A national medium for Surplus New or Used Equipment and other Business Opportunities

## PROFESSIONAL SERVICES

A dignified method for Specialized skills and services.

Benefit yourself

by using these sections

Most useful to the advertiser

Most useful to the reader

## EMPLOYMENT OPPORTUNITIES



The advertisements in this section include all employment opportunities—executive, management technical, selling, office, skilled manual, etc.

Look in the forward section of the magazine for additional Employment Opportunities advertising.

### — RATES —

**DISPLAYED:** The advertising rate is \$40.17 per inch for all advertising appearing on other than a contract basis. Contract rates quoted on request.

An advertising inch is measured 7/8" vertically on a column—3 columns—30 inches to a page.

Subject to Agency Commission.

**UNDISPLAYED:** \$2.70 per line, minimum 3 lines. To figure advance payment count 5 average words as a line.

Box numbers—count as 1 line.

Discount of 10% if full payment is made in advance for 4 consecutive insertions. Not subject to Agency Commission.

## ALBUQUERQUE DIVISION

## ACF INDUSTRIES INCORPORATED

A Prime Contractor for the  
Atomic Energy Commission

Now is the time for you to advance  
into the exciting and limitless

### NUCLEAR PROPULSION FIELD

We have openings for:

### ELECTRICAL/ELECTRONIC ENGINEERS

to participate in the development and testing associated with nuclear propulsion and other programs in the nuclear field. Experience level required varies, ranging from three years upward. Some are supervisory positions.

BSEE degree and U. S. citizenship required

Albuquerque, a city of 260,000, provides an attractive working environment with excellent schools, two universities (we have a liberal educational benefits plan for those who wish to continue their studies), numerous churches, a complete range of cultural and recreational activities and a sunny, dry, healthful climate that remains pleasant and mild winter and summer.

General Supervisor,  
Professional Recruiting  
Albuquerque Division,  
ACF Industries, Incorporated  
P. O. Box 1666,  
Albuquerque, New Mexico

ALL APPLICANTS WILL RECEIVE CONSIDERATION FOR EMPLOYMENT WITHOUT REGARD TO RACE, CREED, COLOR, OR NATIONAL ORIGIN.

### POSITION VACANT

Electronic and Electro/Mechanical Technicians, designers, checkers, draftsmen and detailers—Work for leading firm of licensed professional Engineers. Write to United Engineers, 150 Causeway Street, Boston 14, Mass.

### EMPLOYMENT SERVICES

Resumes and application letters that make employers want you. Composed, printed by Executive Resumes, Dept. F, Executive Suite, 744 Broad St., Newark, N. J.

# INDEX TO ADVERTISERS

• Acme Electric Corp. . . . .	52	Japan Vacuum Engineering Co. Ltd. . . . .	74	• Tektronix Inc. . . . .	42
• Acton Laboratories, Inc. . . . .	70			Texas Instruments Incorporated Industrial Products Group . . . . .	57
Alcoa, Rome Cable Div. . . . .	22			• Texas Instrument Incorporated Metals & Controls Division . . . . .	64
Allen Bradley Co. . . . .	21			Thiokol Chemical Corp. . . . .	23
• Amphenol, a Div. of Amphenol-Borg Electronics Corp. . . . .	46, 47	Kay Electric Co. . . . .	26, 27	• Trygon Electronics Inc. . . . .	77
Analab Instrument Corp. . . . .	6	• Keithley Instruments, Inc. . . . .	72		
Avnet Electronics Corp. . . . .	74, 75	Klinger Scientific Apparatus . . . . .	75		
Babcock Relays, Inc. . . . .	7	Levin and Son, Inc., Louis. . . . .	62	• United Shoe Machinery Corp. . . . .	68
Bell Telephone Laboratories . . . . .	67				
Black & Webster, Inc. . . . .	72				
Boonton Radio Corp. . . . .	45				
Brush Instruments, Div. of Clevite Corp. . . . .	3rd cover				
Consolidated Electrodynamics Corp. . . . .	50, 51	Machlett Laboratories Inc., The Mallory and Co., Inc., P. R. . . . .	25, 53		
Corning Electronics, Div. of Corning Glass Works . . . . .	44	Melpar Inc. . . . .	68		
Coto-Coil Co., Inc. . . . .	74	Minnesota Mining & Mfg. Co. Mincom Division . . . . .	14		
Eastman Kodak Co. . . . .	59	• North Atlantic Industries, Inc. . . . .	61		
Edgerton, Germeshausen & Grier . . . . .	60	Nytronics Inc. . . . .	70		
Electronic Communications Inc. . . . .	73				
• Empire Devices . . . . .	56	Primo Co., Ltd. . . . .	78		
		Princeton Applied Research Corp. . . . .	78		
Fluke Mfg. Co., Inc., John . . . . .	74	Radio Corporation of America . . . . .	4th cover		
General Radio Co. . . . .	2nd cover				
Gries Reproducer Corp. . . . .	78				
Hamlin, Inc. . . . .	70	Saab Motors Inc. . . . .	16		
• Hewlett-Packard Co. . . . .	4, 8, 9	• Sanborn Co. . . . .	28		
Honeywell, Denver Div. . . . .	48	Sanders Associates, Inc. . . . .	54, 55		
		Spectra Physics . . . . .	69		
		Sprague Electric Co. . . . .	3		
		Statham Instruments, Inc. . . . .	65		
		Stromberg-Carlson a Div. of General Dynamics Corp. . . . .	75		
		Sylvania Electric Products Inc. Electron Tube Div. . . . .	15		
IBM, Data Processing . . . . .	12, 13				

**CLASSIFIED ADVERTISING**  
**F. J. Eberle, Business Mgr. (2557)**

**EMPLOYMENT OPPORTUNITIES . . . . . 79**

**EQUIPMENT**  
 (Used or Surplus New)  
 For Sale . . . . . 79

**CLASSIFIED ADVERTISERS INDEX**

ACF Industries . . . . . 79  
 Ealing Corporation . . . . . 79  
 • Radio Research Instrument Co. 79

• See advertisement in the July 25, 1963 issue of electronics Buyers' Guide for complete line of products or services.

This Index and our Reader Service Numbers are published as a service. Every precaution is taken to make them accurate, but **electronics** assumes no responsibilities for errors or omissions.

## electronics



AUDITED PAID CIRCULATION



Associated Business Publications

**JAMES T. HAUPTLI (2210)**  
 Advertising Sales Manager

**HENRY M. SHAW (3485)**  
 Market Research Manager

**DAVID M. TEMPEST (3139)**  
 Promotion Manager

**electronics Buyers' Guide**

**R. S. QUINT (2335)**  
 General Manager

**RICHARD J. TOMLINSON (3191)**  
 Business Manager

**THEODORE R. GEIPEL (2044)**  
 Production Manager

**NEW YORK TELEPHONE:** Dial Direct: 971 plus number in parenthesis, Area Code 212

## ADVERTISING REPRESENTATIVES

**ATLANTA, GA. 30309**  
 Michael H. Miller, Robert C. Johnson  
 1375 Peachtree St. N.E.,  
 Trinity 5-0523 (area code 404)

**BOSTON, MASS. 02116**  
 William S. Hodgkinson  
 McGraw-Hill Building, Copley Square,  
 Congress 2-1160 (area code 617)

**CHICAGO, ILL. 60611**  
 Harvey W. Wernecke,  
 Robert M. Denmead  
 645 North Michigan Avenue,  
 Mohawk 4-5800 (area code 312)

**CLEVELAND, OHIO 44113**  
 Paul T. Fegley  
 55 Public Square, Superior 1-7000  
 (area code 216)

**DALLAS, TEXAS 75201**  
 Frank Le Beau  
 The Vaughn Bldg.,  
 1712 Commerce St.  
 Riverside 7-9721 (area code 214)

**DENVER, COLO. 80202**  
 John W. Patten  
 Tower Bldg., 1700 Broadway,  
 Alpine 5-2981 (area code 303)

**HOUSTON, TEXAS 77025**  
 Kenneth George  
 Prudential Bldg., Halcombe Blvd.,  
 Riverside 8-1280 (area code 713)

**LOS ANGELES, CALIF. 90017**  
 Ashley P. Hartman, John G. Zisch,  
 1125 W. 6th St., Huntley 2-5450  
 (area code 213)

**NEW YORK, N. Y. 10036**  
 Donald H. Miller (212) 971 3615  
 George F. Werner (212) 971 3617  
 Donald R. Furth (212) 971 3616  
 500 Fifth Avenue

**PHILADELPHIA, PA. 19103**  
 Warren H. Gardner, William J. Boyle  
 6 Penn Center Plaza,  
 LOcust 8-4330 (area code 215)

**SAN FRANCISCO, CALIF. 94111**  
 Richard C. Alcorn  
 255 California Street,  
 Douglas 2-4600 (area code 415)

**LONDON W1:**  
 Edwin S. Murphy Jr.  
 34 Dover St.

**FRANKFURT/Main:**  
 Matthee Herfurth  
 85 Westendstrasse

**GENEVA:**  
 Michael R. Zeynel  
 2 Place du Port

**TOKYO:**  
 George Olcott,  
 1, Kotohiracho, Shiba, Minato-ku

Signal on  
conventional channel  
width

40mm

Identical signal  
on Mark 280 channel width

80mm

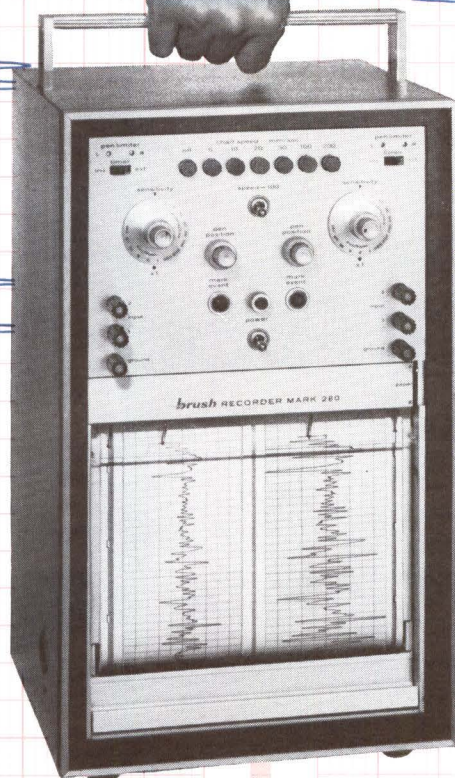

# New! Brush records 35 cps full scale on 80mm

The new portable **Mark 280** doubles resolution of traces without sacrificing frequency response! And . . . you get instantaneous rectilinear ink records of unparalleled accuracy and clarity. Forced fluid writing presents traces, at frequencies to 35 cps full scale, on low cost chart paper. Dual channels each have 10 divisions in an 80 mm width, with trace width constant at one-tenth of a chart division. So now, you can easily detect minute signal variations and take *full* advantage of a 1/2% system accuracy. Matched solid-state amplifiers provide a sensitivity of 0.5 millivolts/div. Operating controls include attenuator, pen position, variable gain and 12 push-button chart speeds. No other recorder can match the total capability of the Mark 280. Write for details.

**brush** INSTRUMENTS

DIVISION OF CLEVITE 37TH AND PERKINS, CLEVELAND 14, OHIO

CIRCLE 901 ON READER SERVICE CARD

# NOW SWITCH WITH **RCA** SILICON CONTROLLED RECTIFIERS

Here are 16 solid reasons why

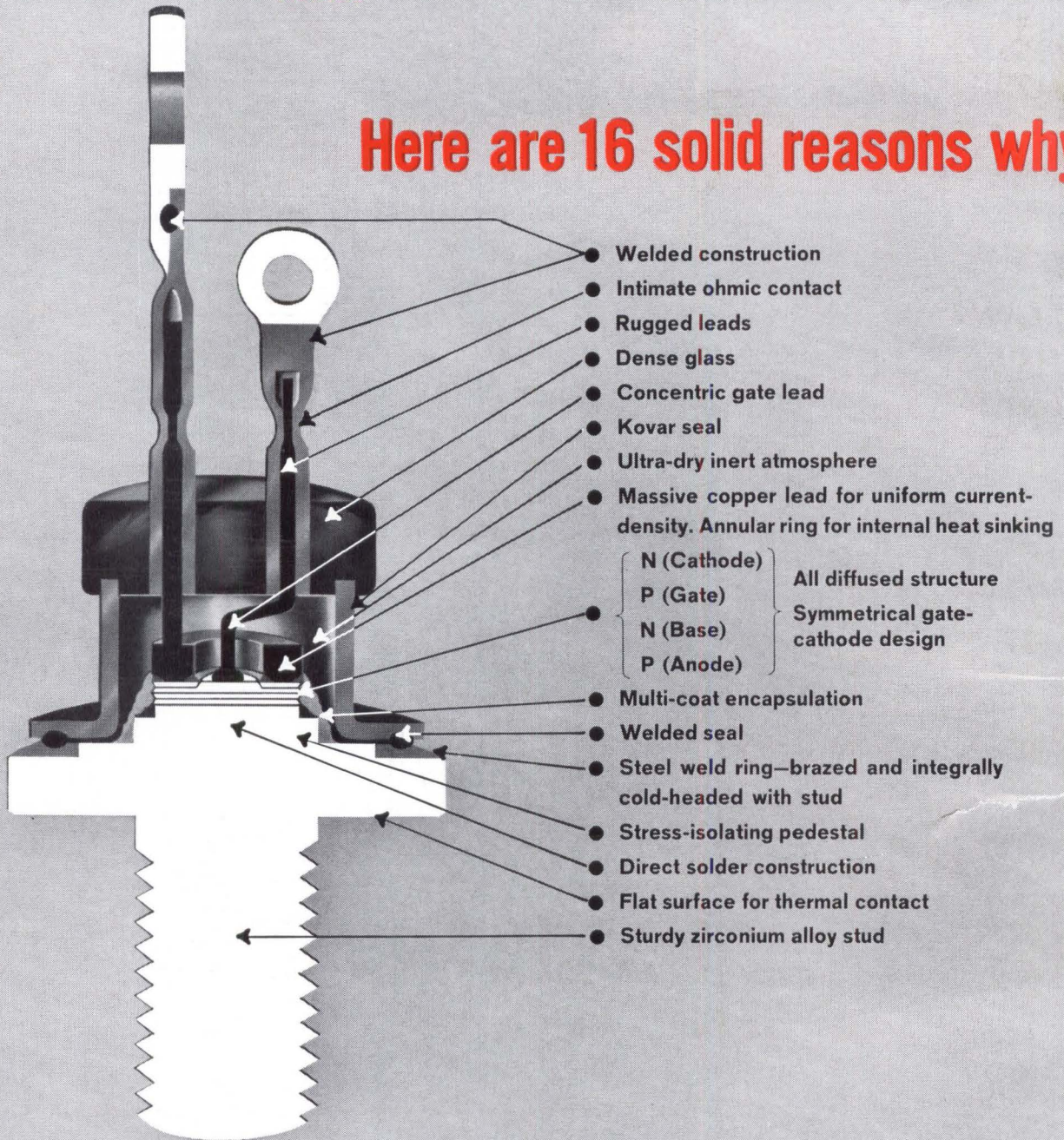

- Welded construction
  - Intimate ohmic contact
  - Rugged leads
  - Dense glass
  - Concentric gate lead
  - Kovar seal
  - Ultra-dry inert atmosphere
  - Massive copper lead for uniform current-density. Annular ring for internal heat sinking
  - N (Cathode)
  - P (Gate)
  - N (Base)
  - P (Anode)
  - Multi-coat encapsulation
  - Welded seal
  - Steel weld ring—brazed and integrally cold-headed with stud
  - Stress-isolating pedestal
  - Direct solder construction
  - Flat surface for thermal contact
  - Sturdy zirconium alloy stud
- } All diffused structure  
} Symmetrical gate-cathode design

Check the outstanding construction and operating features of RCA's two new families of silicon controlled rectifiers...RCA 2N681 to 2N689 and RCA 2N1842A to 2N1850A...all-diffused, SCR's for power control and electrical switching applications in industrial apparatus and military equipment.

FORWARD CURRENT	BLOCKING VOLTAGE									
25 Amp (RMS) 16 Amp (Avg) @ 65°C	25	50	100	150	200	250	300	400	500	
	2N681	2N682	2N683	2N684	2N685	2N686	2N687	2N688	2N689	
16 Amp (RMS) 10 Amp (Avg) @ 80°C	2N1842A	2N1843A	2N1844A	2N1845A	2N1846A	2N1847A	2N1848A	2N1849A	2N1850A	

These RCA Silicon Controlled Rectifiers are designed for use in your circuits at their full ratings—full current at peak reverse and peak forward blocking voltage. And RCA brings you all these big operating advantages: • Application tested for 100% safety margin on surge current • Very low thermal resistance • Forward voltage drop measured at high current (100 Amps for 2N681 family) • Installation torque capability = 50 inch-lbs • Tight control of firing characteristics • Long term operating stability • 100% aging at maximum ratings and 100% dynamic testing.

Call your RCA Representative today for complete details on these rugged new RCA SCR's . . . or write: Commercial Engineering, Section 1-N-12, RCA Electronic Components and Devices, Harrison, N. J.

Write today for your free copy of this new RCA Application Note, SMA-16 . . . "Circuit Factor Charts For Use In Applications With RCA Silicon Controlled Rectifiers"

AVAILABLE THROUGH YOUR RCA DISTRIBUTOR



The Most Trusted Name in Electronics

CIRCLE 902 ON READER SERVICE CARD