

Electronics®

Characteristics of thin-film transistors: page 53

East-West electronic spying: page 74

All-channel tv's impact on design: page 90

April 20, 1964

75 cents

A McGraw-Hill Publication

Below: new permanent optical memory for computer, page 64

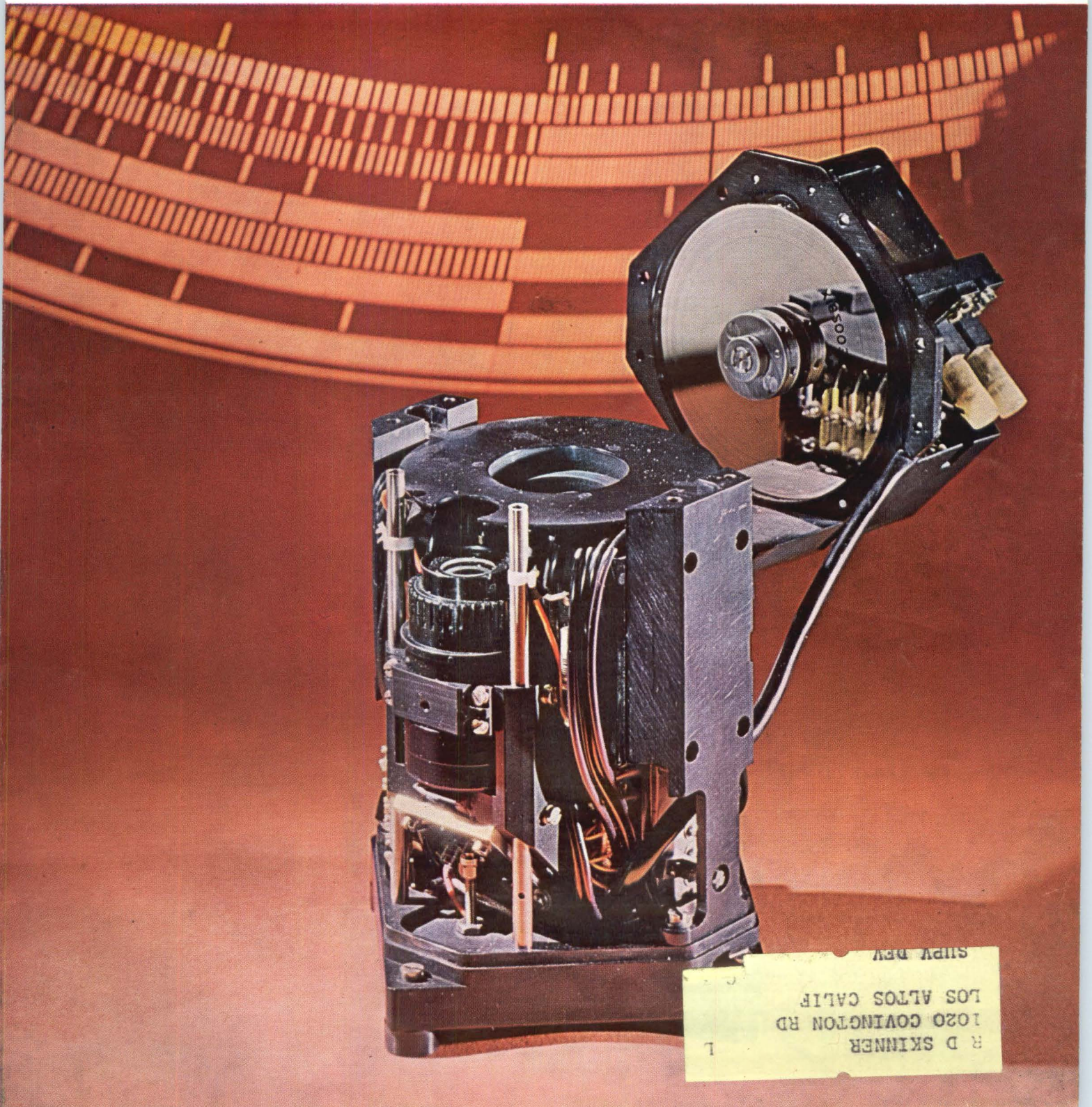

FOR MEASUREMENTS OF

Inductance

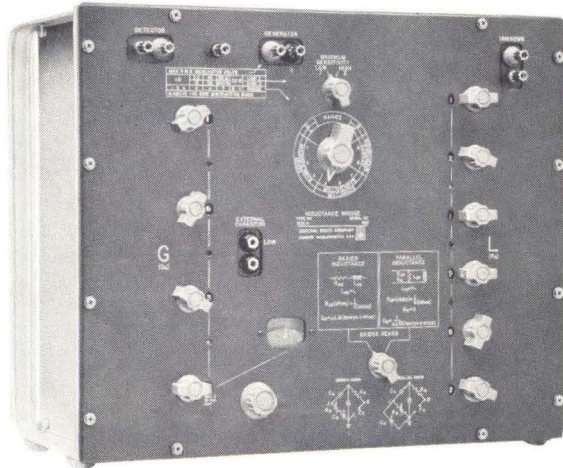

Type 1632-A Inductance Bridge . . . \$950

The ideal bridge for rapid, precise L and G measurements, and for calibration of inductance standards

It has a wide range, 0.0001 μ h to 1111 h, with 0.1% direct-reading accuracy and six-figure resolution. Contains easy, fool-proof readout with in-line decade readings and indicated decimal points. Measures series or parallel inductance; circuits and instructions are engraved on its panel. Designed for use at 1 kc and lower, but usable to 10 kc. External generator and null detector required.

Type 1633-A Incremental-Inductance Bridge . . . \$1050

An invaluable tool for measuring magnetic properties of silicon steel, magnetic alloys, ferrites, chokes, transformers, and filters

Accurately and conveniently measures inductance under different conditions of dc and ac excitation. These incremental inductance measurements can be made while the inductor is operating in the circuit. Accuracy of $\pm 1\%$ for L; $\pm 2\%$ for R and Q. Has wide impedance ranges: L — 0.1 μ h to 1000 h; R — 10 m Ω to 1 M Ω . Indicates Q or R of inductor directly at any of nine frequencies between 50 c and 15.75 kc. Accepts applied signal of up to 1250 v (ac or dc) at 7 amps; up to 50 amps with Type 1633-P1 Range-Extension Unit (\$125).

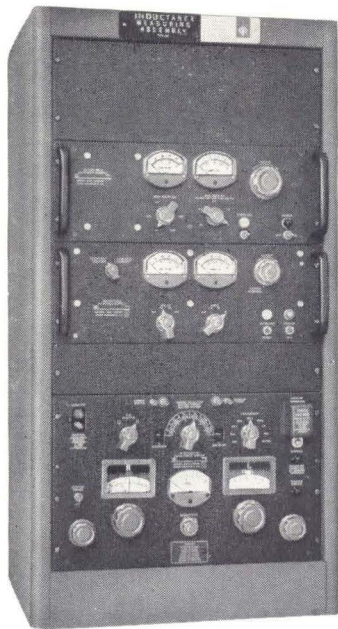

COMPLETE SYSTEMS

. . . for measuring the inductance and loss of coils with ferromagnetic cores at high dc and ac excitation levels. Each assembly includes a bridge, two 200-voltampere power supplies, rack, and interconnecting cables.

Type 1630-AL Inductance-Measuring Assembly . . . \$2660

For 60-cycle measurements

Contains: Type 1633-A Incremental-Inductance Bridge
Type 1265-A Adjustable DC Power Supply
Type 1266-A Adjustable AC Power Supply

Type 1630-AV Inductance-Measuring Assembly . . . \$3450

For measurements at 9 frequencies from 50 c to 15.75 kc

Contains: Type 1633-A Incremental-Inductance Bridge
Type 1265-A Adjustable DC Power Supply
Type 1308-A Audio Oscillator and Power Amplifier

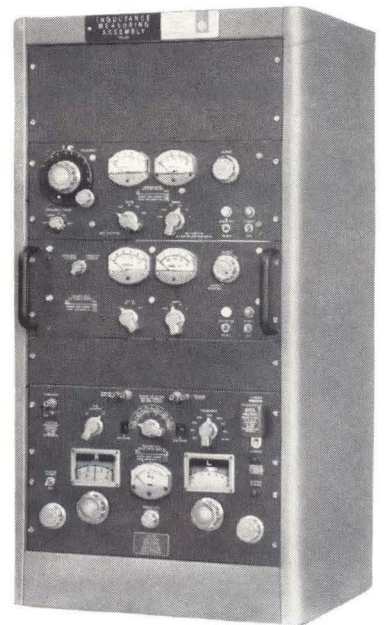

Write for complete information on any of these instruments

GENERAL RADIO COMPANY

WEST CONCORD, MASSACHUSETTS

IN CANADA: Toronto 247-2171, Montreal (Mt. Royal) 737-3673
IN EUROPE: General Radio Overseas, Zurich, Switzerland

NEW YORK, N. Y., 964-2722
(Ridgefield, N. J.) 943-3140

CHICAGO
(Oak Park) 848-9400

PHILADELPHIA, 424-7419
(Abington) 887-8486

WASHINGTON, D.C.
(Rockville, Md.) 946-1600

SYRACUSE
454-9323

DALLAS
FL 7-4031

SAN FRANCISCO
(Los Altos) 948-8233

LOS ANGELES
469-6201

ORLANDO, FLA.
425-4671

CLEVELAND
886-0150

Circle 900 on reader service card

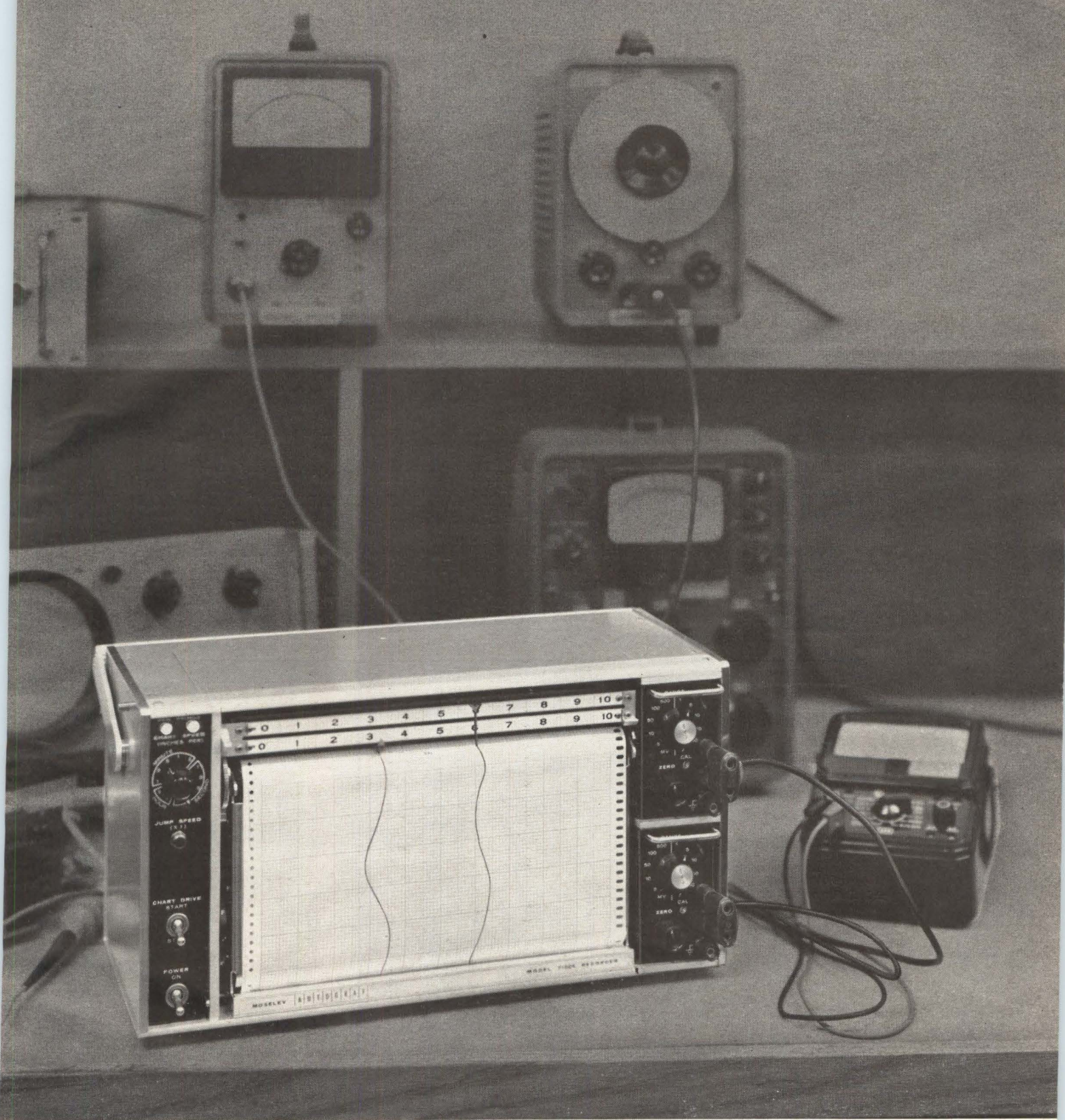

1 MEG INPUT IMPEDANCE
 INSTANT CHART-SPEED CHANGE
 EASY-LOADING MAGAZINE
 TOTAL MEASURING VERSATILITY

MOSELEY 
 an affiliate of Hewlett-Packard

New MOSELEY 7100A (two-pen) and 7101A (single-pen) 10" Strip Chart Recorders provide high impedance at null on all ranges, shift chart speeds in milliseconds with an exclusive 12-speed changer (10:1 remotely-controlled jump speeds optional) and make life easier with an exclusive modular loading system for 120' chart rolls. Circuitry is rugged, compact, solid state, cool running; offers better than 0.2% accuracy and 120 db DC common mode rejection. Half-second balance time, 10 calibrated input ranges, level continuously variable from 5 mv to 100 v (1 mv optional). Ample power to drive retransmitting pots, event markers, limit or alarm switches. Model 7100A, \$1800; Model 7101A, \$1390. Try on your bench or in your rack; call your Moseley/Hewlett-Packard field engineer. F. L. MOSELEY CO., 409 N. Fair Oaks Avenue, Pasadena, California.

9099R

Circle 1 on reader service card

Put one to
work for you

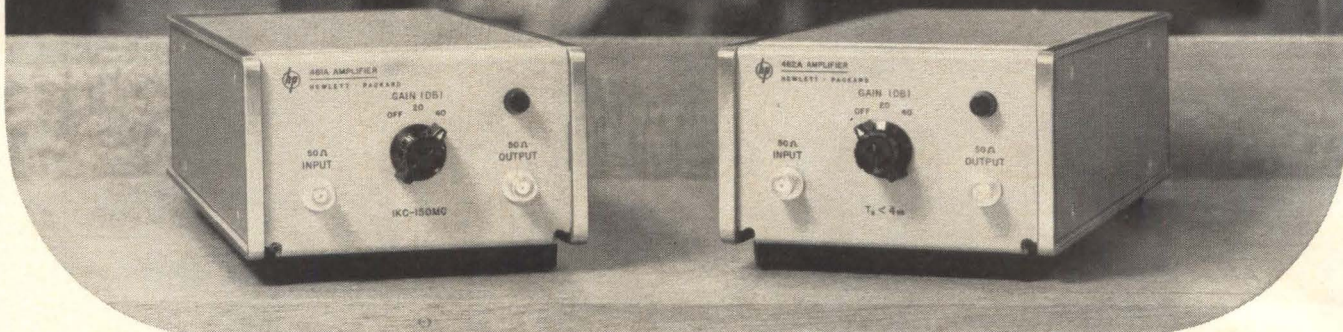

Two new amplifiers from Hewlett-Packard Whether you're interested in amplifying pulses or other signals from audio to vhf, one of these new amplifiers from Hewlett-Packard will suit your purpose. The 461A is a general purpose amplifier with an essentially flat frequency response from 1 kc to 150 mc; the 462A is a pulse amplifier with less than 4 nanosecond rise and fall times. Both amplifiers have 20 and 40 db gain, are completely solid state and have exceptional stability. Check the specs; then call your nearest hp field sales office for a demonstration.

Specifications

461A

Frequency Range:
1 kc to 150 mc

Frequency Response:
 ± 1 db from 500 kc reference

Gain at 500 kc:
20 or 40 db ± 0.5 db selected by front panel switch

Input Impedance:
Nominal 50 ohms

Output:
 $\frac{1}{2}$ v rms into 50 ohm resistive load

Noise:
Less than 40 μ v referred to input

Distortion:
Less than 5% at maximum output and rated load

Price:
\$325

Data subject to change without notice.
Prices f.o.b. factory.

An extra measure of quality

5008

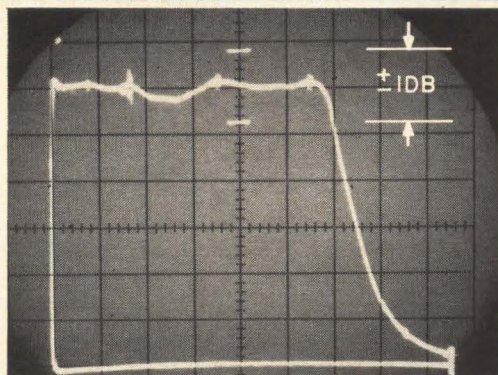

461A Frequency response curve: markers at 50, 100, 150 and 200 mc; 40 db gain.

462A a) Input pulse (5 mv p-p); b) Output pulse (500 mv p-p) 40 db gain; sweep speed 5 ns/cm

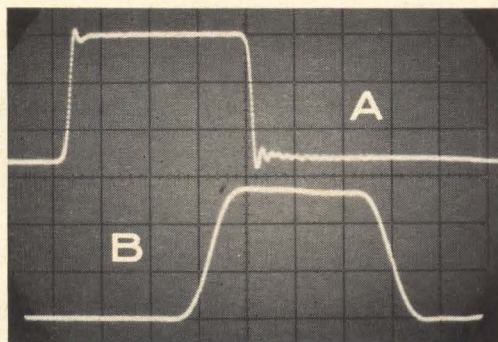

462A

Pulse Response:
Rise and fall times for both leading and trailing edges, less than 4 ns; overshoot less than 5%

Pulse Overload Recovery:
Less than 1 μ sec for 10 times overload

Pulse Duration:
30 μ sec for 10% droop

Noise:
Less than 40 μ v referred to input

Input Impedance:
Nominal 50 ohms

Gain:
20 or 40 db selected by front panel switch

Output:
1 v p-p into 50 ohm resistive load

Price:
\$325

GENERAL

Size:
3-14/32" x 5-1/8" x 11"

Weight:
4 lbs.

Power Supply:
115 or 230 v $\pm 10\%$, 50 to 1000 cycles

**HEWLETT
PACKARD
COMPANY**



1501 Page Mill Rd., Palo Alto, California 94304, (415) 326-7000. Sales and service in all principal areas. Europe, Hewlett-Packard S.A., 54 Route des Acacias, Geneva, Switzerland; Canada, Hewlett-Packard (Canada) Ltd., 8270 Mayrand St., Montreal, Quebec.

Electronics

Page 4	Readers comment
8	People
12	Meetings ahead
15	Editorial
17	Electronics newsletter
43	Washington newsletter
115	New products
136	New literature
139	New books
141	Technical abstracts

In this issue

Microelectronics	53
Components	61
Computers	64
Circuit design	72
Military electronics	74
Industrial electronics	82
Consumer electronics	90

Electronics review

Page 27	Another step closer	30	TVing the olympics
27	Big brother	30	Why Ranger failed
28	End of "Roger"	30	Gas laser radar
28	Saltwater tropo	32	Night vision aided
29	Babel on wheels	34	Squeeze on lemons
29	Low-cost power booster	34	Magnetic mysteries

Probing the news

101	IBM burns its bridges
103	How IBM builds Microcircuits
104	Should we sell to the Russians?

Technical articles

I. Design

Thin-film transistors fill a gap	53
Operating characteristics of the new insulated-gate transistor for linear and digital circuits on a single substrate Harold Borkan, Radio Corp. of America	
Boost for electronic tuning: part 2	61
Method for detecting tracking errors when variable-voltage diodes are used in multiple tuning L.A. Weldon and R.L. Kopski, Philco Corp.	
Permanent optical memories for compact systems	64
New memory is an ideal way to manipulate large amounts of fixed data quickly and economically. (cover). Fred P. De Negri, Bendix Corp.	
Designer's casebook	72
Switching high voltage with cold cathode tubes; improving peak voltmeter response; combined feedback stabilizes an amplifier	

II. Applications

The silent war: electronic spying	74
Electromagnetic reconnaissance is a guarantee against sneak attack, and is vital for arms control John M. Carroll, Managing Editor	
Take two tons of flour . . .	82
Electronic control in a bakery caused more than technical problems. But it keeps cookie quality and taste consistent Louis S. Gomolak, Industrial Electronics Editor	
Low-cost transistors revamp uhf tuner design	90
Bonanza in solid-state devices as the government requires all-channel television receivers Leon H. Dulberger, Staff Writer	

Electronics

Editor: Lewis H. Young

Managing editor: John M. Carroll

Senior editors

Technical: Samuel Weber

News: George Sideris

Senior associate editors: Michael F. Wolff, John F. Mason

Department editors

Advanced technology: George V. Novotny

Communications: Alexander A. McKenzie

Components: Michael F. Tomaino

Computers: Stephen B. Gray

Consumer electronics: V. S. Acunto

Industrial electronics: Louis S. Gomolak

Instrumentation: George J. Flynn

Manufacturing: C.R. Whetstone

Military electronics: John F. Mason

New products: William P. O'Brien

Solid state: Michael F. Wolff, G.G. Tirellis

Space electronics: Joel A. Strasser

Staff writers: Leon H. Dulberger, Peggy Jackson

Regional editors

Boston: Thomas Maguire, editor; Alice M. Moyer

Chicago: Cletus M. Wiley, editor; Virginia T. Bastian

Los Angeles: Harold C. Hood, editor; Linda Hamner

San Francisco: Laurence D. Shergalis, editor; Mary Jo Jadin

Copy editors

Howard Rausch, Sally Powell

Illustration

Art director: Howard R. Berry

Assistant art director: John C. Wright, Jr.

Editorial production: Ann Mella, Sandra A. LeMond

Editorial secretaries: Claire Benell, Lynn Emery, Kay Fontana, Sharon

Parks, Lorraine Rossi, Barbara Schubert, Lorraine Werner

McGraw-Hill news service

Director: John Wilhelm; **Atlanta:** Fran Ridgeway; **Chicago:** Bruce Cross;

Cleveland: Arthur Zimmerman; **Dallas:** Marvin Reid;

Detroit: Donald MacDonald; **Los Angeles:** Kemp Anderson, Michael Murphy,

Ron Lovell; **San Francisco:** Margaret Ralston, Ed. Addeo;

Seattle: Ray Bloomberg; **Washington:** George Bryant Jr., Glen Bayless,

Charles Gardner

McGraw-Hill world news service

Bonn: Richard Mikton; **Brussels:** Arthur Erikson; **London:** Derek Barlow;

Mexico City: Wesley Perry; **Milan:** Bruce Bendow;

Moscow: Donald Winston; **Paris:** Dan Smith;

Rio de Janeiro: Leslie Warren; **Tokyo:** Richard Halloran, Charles Cohen

Circulation manager: Hugh Quinn

Reprints: T.M. Egan

Publisher: C.C. Randolph

Electronics: April 20, 1964, Vol. 37, No. 14

Printed in Albany, N.Y. Second class postage paid at Albany, N.Y.

Subscriptions are solicited only from those actively engaged in the field of the publication. Position and company connection must be indicated on orders. Subscription prices: United States and Possessions and Canada, \$6.00 one year, \$9.00 two years, \$12.00 three years. All other countries \$20.00 one year. Single copies, United States and Possessions and Canada 75¢. Single copies all other countries \$1.50.

Published every other Monday by McGraw-Hill Inc. 330 West 42nd Street, New York, N.Y. 10036. Founder: James H. McGraw, 1860-1948.

Subscribers: The Publisher, upon written request to our New York office from any subscriber, agrees to refund that part of the subscription price applying to copies not yet mailed. Please send change of address notices, subscription orders or complaints to Fulfillment Manager, Electronics, at the address below. Change of address notices should provide old as well as new address, including postal zone number if any. If possible, attach address label from recent issue. Allow one month for change to become effective.

Postmaster: Please send Form 3579 to Fulfillment Manager, Electronics, P.O. Box 430, Hightstown, New Jersey 08520

Readers Comment

Dictatorship

Your Feb. 28 Crosstalk item [p. 5] on DOD was well stated. The entire defense of the U. S. should not be under one man's dictatorship—regardless of his competence.

Paul C. Sheretz
San Diego, Calif.

Amen

I should like to add a resounding "Amen" to B. F. Miessner's comments in the March 13 issue [p. 6].

H.B. Tilton
Tucson, Arizona

Radar beeps

I was pleased to see on p. 17 in the Feb. 28 issue that you have taken the wraps off a big problem—perhaps a lot bigger than your box-statement suggests.

The question of basic policy implied by the Air Force use of super-power radar near large cities may be just as horrendous as those raised by you concerning DOD on page 5 of the same issue—and, indeed, are very closely related.

The rumors in Pittsburgh differ from your newsletter. The Federal Communications Commission at Buffalo is said to be much concerned about the Air Force radar interference and is not inclined to class 100 megawatts blanketing a city as equivalent to a ham radio next door. But where the military is in control what can they do?

There is nothing secret about the radar parameters. The beam shape can be estimated from the time-duration of the beep and by inspecting the dish and feed from a couple of miles. But why bother—anyone can drive to within 300 feet of the open antenna. From a couple of miles at a suitable elevation one can estimate the power and wavelength with Lecher wires. The max range one gets by matching the beep with the living-room piano, and the pulse width is visible on the family tv by expanding the horizontal sweep.

There are a lot of questions that an engineer would want to ask.

New from Sprague!

For extreme size reduction and unusual capacitance stability . . .

COMPARE!

The tubular polycarbonate film capacitor and the rectangular oil-impregnated paper capacitor are both rated 10 μ F, 100 VAC, 400 cy.

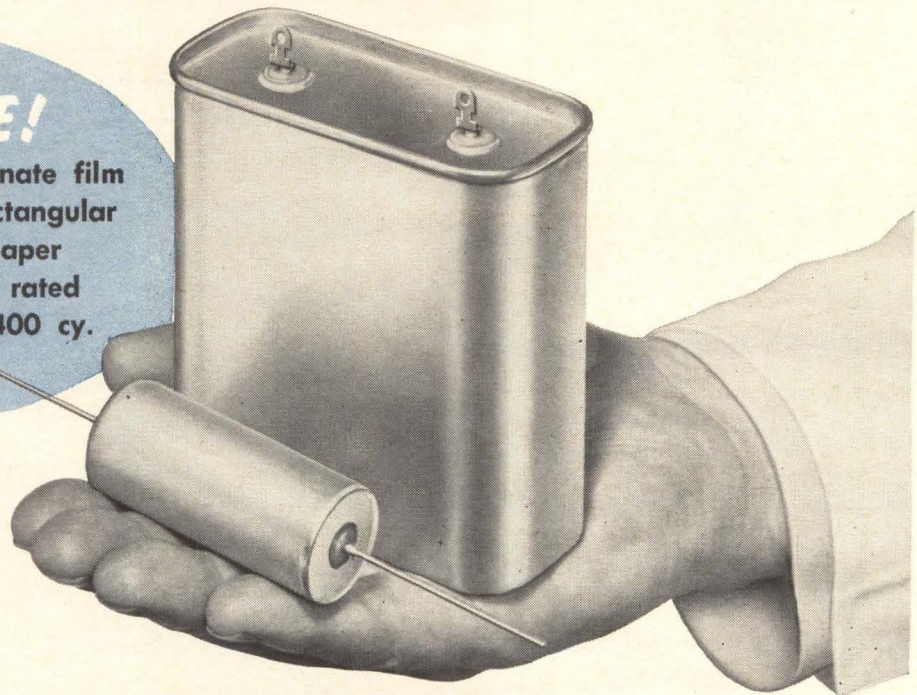

FILMITE® 'K' POLYCARBONATE FILM CAPACITORS

- New Filmite 'K' Polycarbonate Film Capacitors are more than 13 times smaller than paper capacitors of equivalent capacitance value and voltage rating!
- Polycarbonate film dielectric provides exceptionally high capacitance stability over the entire temperature range, due to inherently low coefficient of expansion of polycarbonate film and a dielectric constant which is nearly independent of temperature.
- Filmite 'K' Capacitors exhibit almost no capacitance change with temperature—dramatically better than polyester-film types, they even surpass polystyrene capacitors.
- Low dissipation factor (high Q) makes these capacitors extremely desirable where high current capabilities are required, as in SCR commutating capacitor applications.
- Low dielectric absorption (considerably lower than that of many other commonly-used film dielectrics) over a broad frequency/temperature spectrum makes Filmite 'K' Capacitors ideal for timing and integrating.

- Extremely high insulation resistance, especially at higher temperatures. Superior to many other commonly-used film dielectrics.
- Close capacitance tolerances—available to $\pm 0.25\%$!
- Filmite 'K' Capacitors are excellent for critical applications including tuned circuits, analog and digital computers, precision timing and integrating circuits because of the unusual properties of the polycarbonate film dielectric.

Type 260P Filmite 'K' Capacitors are metallized, utilizing non-inductive construction. They feature special self-healing characteristics, in the rare event of capacitor dielectric breakdown. Designed for operation at full rated voltage over the temperature range of -55 C to $+105\text{ C}$, these metal-clad capacitors are hermetically-sealed and are available with both standard and weldable wire leads or solder tabs in a variety of mounting styles.

Types 237P and 238P Filmite 'K' Capacitors are of high-purity foil construction, and are hermetically sealed in metal cases. Operating temp. range, -55 C to $+125\text{ C}$.

For complete technical data on Type 260P and on Type 237P and 238P Capacitors, write for Engineering Bulletins 2705 and 2700, respectively, to Technical Literature Service, Sprague Electric Company, 35 Marshall Street, North Adams, Massachusetts.

SPRAGUE COMPONENTS

CAPACITORS
TRANSISTORS
RESISTORS
MICROCIRCUITS
INTERFERENCE FILTERS
45C-4110

PULSE TRANSFORMERS
PIEZOELECTRIC CERAMICS
PULSE-FORMING NETWORKS
TOROIDAL INDUCTORS
ELECTRIC WAVE FILTERS

CERAMIC-BASE PRINTED NETWORKS
PACKAGED COMPONENT ASSEMBLIES
BOBBIN and TAPE WOUND MAGNETIC CORES
SILICON RECTIFIER GATE CONTROLS
FUNCTIONAL DIGITAL CIRCUITS

SPRAGUE®
THE MARK OF RELIABILITY

'Sprague' and 'Q' are registered trademarks of the Sprague Electric Co.

The Original **Bullet-Nose Capacitor!**

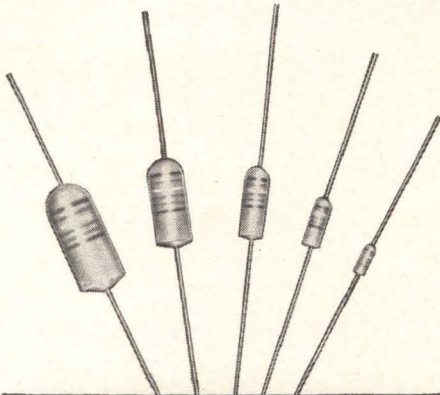

Sprague Fully-Molded Solid Tantalex® Capacitors in Five Case Sizes!

PERFORMANCE CHARACTERISTICS COM- PARABLE TO CONVENTIONAL METAL- CLAD UNITS FROM OTHER SOURCES

Type 154D Tantalex Capacitors were developed by Sprague to help designers of digital computing equipment and other industrial electronic devices reduce their costs. They are particularly practicable for applications which demand good electrical characteristics without necessarily requiring the superior moisture resistance of metal-cased units.

Type 154D Capacitors are available in a complete range of ratings and case sizes, including two tiny sizes for high-density "cordwood" packaging. Because of the uniformity of their molded cases, these bullet-shaped capacitors are ideally suited for machine installation on printed wiring boards.

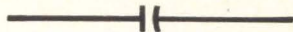

For complete technical data, write for Engineering Bulletin 3530A to the Technical Literature Service, Sprague Electric Co., 35 Marshall St., North Adams, Massachusetts.

45C-104-64



*Sprague' and '®' are registered trademarks of the Sprague Electric Co.

Why are they using this long wavelength which is extremely difficult to shield against (as compared to microwaves) and which went out of radar use at the beginning of World War II? Probable answers: to reduce rain response, to avoid radial blind speeds, and to obtain high coherent power for moving target indication. But these are lazy reasons. There must be many other ways of solving these engineering problems.

Why locate these sets next to big cities? Ostensibly, to control Nike missiles without video relaying. Probable real reason: this military net is being sold as a civilian air-traffic control system!! When you take a close look at the military arguments, the future civilian use will be given as an excuse. But when you point out that this method of traffic control was obsolescent at the end of World War II, you will be told of the military need. The evident hope of the military is to get so much money tied up that it will be too late to blow the whistle.

Do we really have to pay this kind of price for protection against sub-sonic bombers? It is one thing to jazz up the economy and allay the neurotic anxiety of the populace by building up a Maginot line named Distant Early Warning. It is something else to use taxpayers money to tie up the technological future of this country in little knots.

I could be wrong, but my guess is that these decisions were made by military and civilian bureaucrats whose technological learning stopped at the end of World War II and who have been busy building a personal empire ever since.

One reason why I think so: I visited the Pittsburgh radar set-up. Everything I saw was World War II vintage. This is a new installation costing over \$20 million. Rooms filled with racks of smoking-hot vacuum tubes! Video displays that were inadequate for heavy traffic when designed at Massachusetts Institute of Technology in 1944. If a computer manufacturer tried to sell this stuff, he would be laughed into bankruptcy. . . .

Why is the Air Force getting away with this in Pittsburgh? The answer: Pittsburgh is a hilly town and less than five percent of the population is being hit—a feature

well known in the siting of long-wave radar. I predict that when they set up such a search radar near a flat city so that 50 percent of the people are annoyed, the military will be hoist on their own petard—at the taxpayer's expense. . . .

(Name Withheld)

More recently, Name Withheld told us that the situation is much worse than the fact that the Russians have 800 low-speed bombers; he believes it involves the "nth country problem." Right now, n equals four, because four countries possess atomic weapons capabilities. In the future, "some small nth country might hijack an ordinary commercial airliner and drop an atomic bomb where it pleases." The military would then have to be able to protect against "a devil of a problem," by identifying the airliner in a hurry and shooting it down. In this situation, our reader adds, Nike missile sites near cities do make sense.

Abbreviations

Regarding your request for an abbreviation for optoelectronic technology [Jan. 24, p. 5], how about Optron or Optech? Or Optronology? Or Opticology?

Mrs. Thomas W. Newmyer
Greensburg, Pa.

Alignment

There were some errors in my article (Aligning Saturn missile's guidance system) in the Feb. 21 issue [p 26]:

Page 26, column 1, third paragraph, line 3 should read "a five-sided prism."

Page 26, column 2, first paragraph, line 11 should read "lens," not lense.

Same column, eighth line from bottom, chopping frequency is 266 cps.

Page 27, fourth line from end, first prism response is 0.7 to 1.35 microns.

Fig. 2, R₆ should be a variable resistor, and the 5,760-ohm resistor should be connected to -28 volts.

Walter S. Zukowsky
Perkin-Elmer Corp.
Norwalk, Conn.



Every contact here (and most others*)...

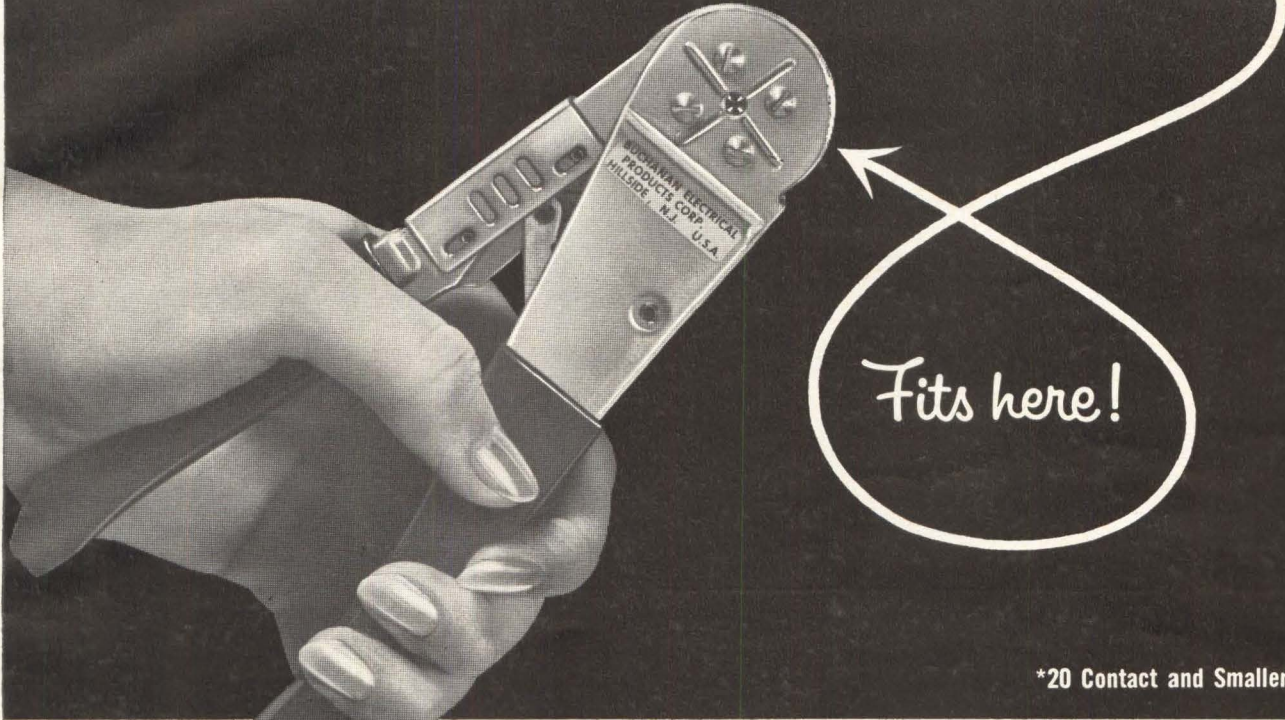

Fits here!

*20 Contact and Smaller

New miniature cycle-controlled crimping tool!

6 $\frac{3}{4}$ " from end to end. 10 ounces, total weight. Open handle span, 4". These are the facts behind this unique new Buchanan® miniature cycle-controlled crimping tool . . . that crimps miniature removable pin and socket contacts in a multitude of sizes and designs.

Now crimp in confined areas. Now crimp with much less fatigue. (Low hand pressure makes it ideal for female operators.) Now get all the operating advantages of the Buchanan MS-3191-A crimping tool — in half the size!

And what features: one tool and inexpensive

positioners can crimp almost any contact . . . #20 or smaller, in wire sizes #20 through #30. There are no operator adjustments. By selecting the proper positioner, you program the tool to provide the correct crimp depth, crimp location and point of ratchet release . . . under-crimping or over-crimping are virtually impossible. The four-indent crimp provides the most uniform displacement of wire and contact material over a wide range of contact and wire sizes.

Get all the facts on this exciting new miniature cycle-controlled crimping tool by Buchanan.

Write today for complete crimping library and the new catalog

BUCHANAN
ELECTRICAL PRODUCTS CORPORATION

216-420 Route #22

HILLSIDE, NEW JERSEY

a subsidiary of Elastic Stop Nut Corporation of America

[SAME RATINGS...1/3 SIZE†]

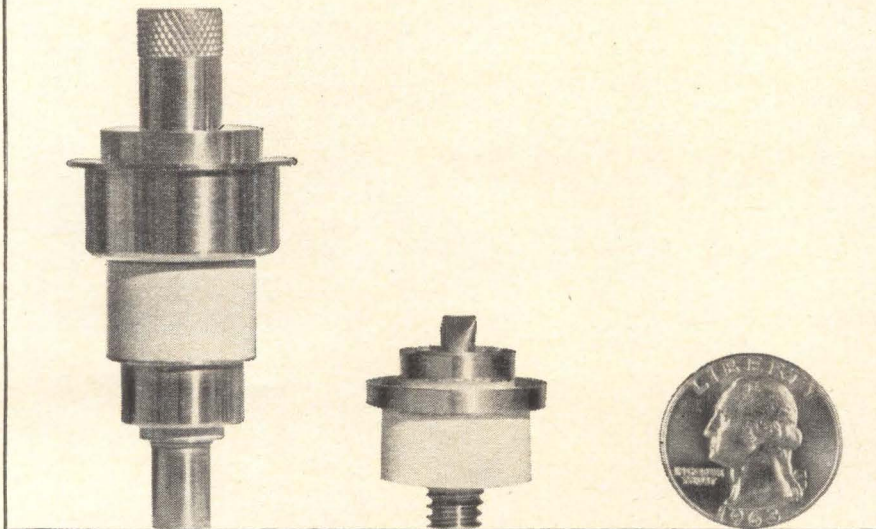

Machlett's new Miniature Planar Triodes have all the characteristics which have brought outstanding acceptance to its present planar triode line. For information write: The Machlett Laboratories, Inc., Springdale, Connecticut. An affiliate of Raytheon Company.

TABLE OF COMPARISON

<u>New</u>	<u>Conventional</u>	<u>Application</u>
		For either conventional or miniaturized planar triodes
ML-8534* (Heat Sink)	ML-7698	Plate or Grid-Pulsed (3500v 5.0a) (2500v 5.0a)
ML-8535* (Radiator)	ML-7211	CW to over 100 watts
ML-8536* (Heat Sink)	ML-7815	Plate or Grid-Pulsed (3500v 3.0a) (2500v 3.0a)
ML-8537* (Radiator)	ML-7855	Plate or Grid-Pulsed (3500v 3.0a) (2500v 3.0a) CW to 100 watts
ML-8538** (Heat Sink)		Switch Tube (30kw, 0.0033d) or Pulse Amplifier (20kw pulse at 1Gc)
ML-8539** (Radiator)	ML-8533 (DP-30)	Switch Tube (30kw, 0.0033d) or Pulse Amplifier (20kw pulse at 1Gc)

†Excluding seal-off tip. Actual in-cavity spacing for ML 8534 or ML 8536 is only 0.720" max.; threaded heat sink screws flush into cavity, minimizing sink requirements.

*Machlett Frequency Stable anode and Phormat cathode.
**Phormat cathode.



People

William H. C. Higgins, executive director of Bell Telephone Laboratories Electronic Switching Division, will be the top executive of the company's proposed mammoth Communications Development Center near Chicago [Electronics, April 6,



1964, p. 17]. Higgins, who is 56 this month, joined American Telephone and Telegraph Co. right after graduation from Purdue University in 1929 and went to the Bell Laboratories technical staff in 1934. His first jobs were with development of ship-to-shore and ground-to-air radio telephone equipment. He was later concerned with the development of radar, missile and communications systems, including the Nike-Ajax guided missile system, the Distant Early Warning Line and the command guidance system for the Titan intercontinental ballistic missile.

Jonas M. Shapiro, 48-year-old vice president and technical adviser of Hallicrafters Co., has been named president of Manson Laboratories, Inc., Hallicrafters' military communications subsidiary. Shapiro got his electrical engineering degree from the City



College of New York, after attending night classes for 10 years while holding daytime electronics jobs. He joined Manson in 1953. Before that, he held communications positions with Link Radio Co., the U. S. Army Signal Corps and the California Division of Highways. He developed a radio frequency synthesizer for the Bureau of Ships and was instrumental in the production engineering of subminiature transceivers for the Signal Corps. He holds six patents and has 12 patents pending.

BREADBOARD

with this solid state operational amplifier

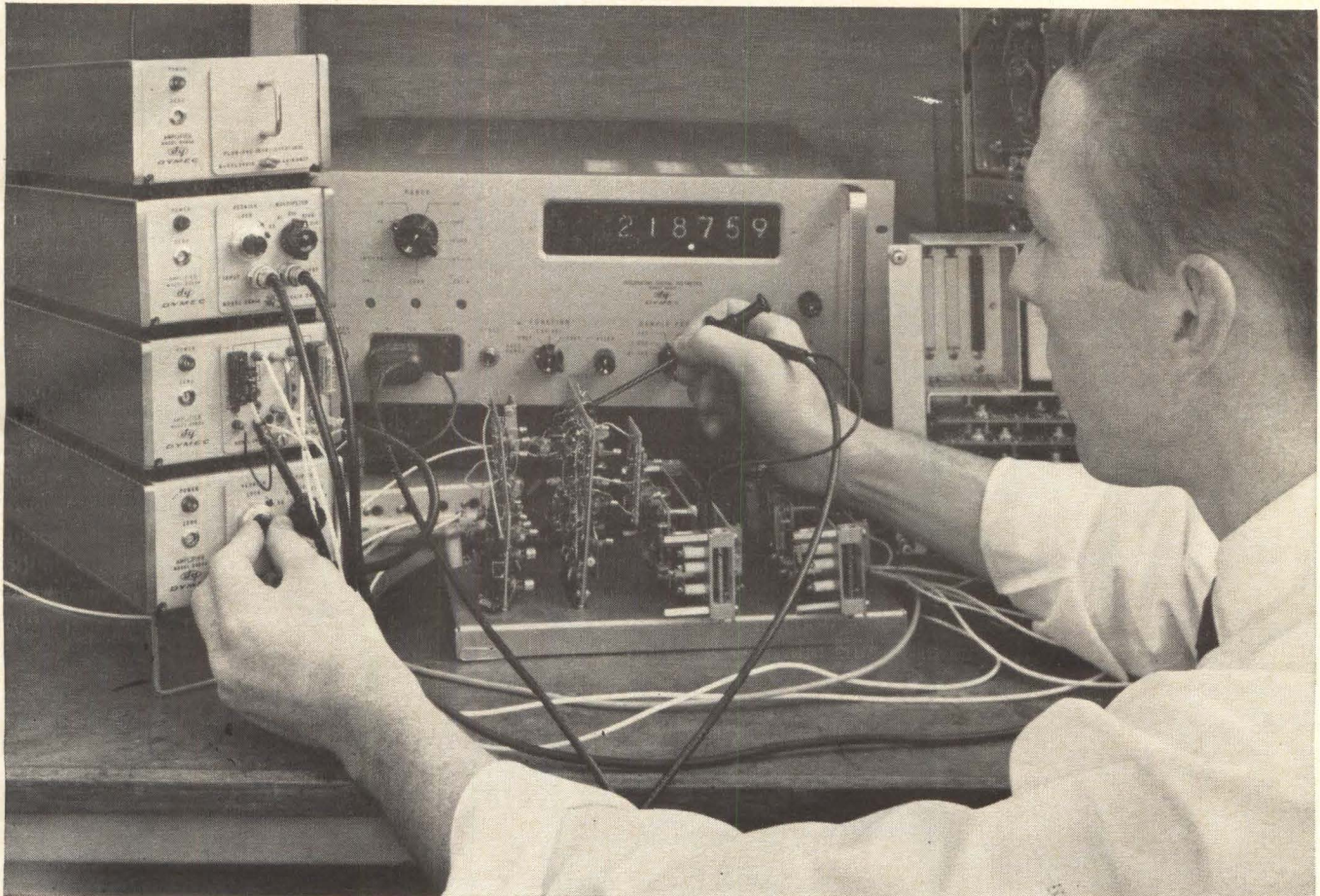

Use the DY-2460A as an active element of your newly designed circuits...
AMPLIFIER ■ SUMMER ■ HIGH IMPEDANCE ISOLATOR ■ INTEGRATOR ■ INVERTER

Check out new design concepts and ideas in a hurry with the DY-2460A DC Amplifier as a circuit element. This wideband, solid state instrument is ready-made for a wide variety of circuit applications which will save you time and effort.

The low-cost DY-2460A is designed for general purpose use. Amplitude and phase response are properly controlled beyond unity gain to permit a variety of feedback networks. A self-contained power supply in each instrument provides highest isolation when operating a group of amplifiers at different potentials. A non-synchronous photoconductive chopper eliminates all effects of ac pickup.

Plug-in design of the 2460A increases its versatility. A patch unit plug-in brings input, output, summing point and feedback circuit to the front panel; other plug-ins

provide switchable gains in steps from 1 through 1000, vernier adjustment through 11,000, and a high-accuracy plus-one configuration with greater than 10^{10} ohms input resistance.

The 2460A will supply an output of ± 10 v peak at 10 ma. Zero drift is less than $1\mu\text{v}$ per week, noise less than $4\mu\text{v}$ peak to peak.

Ask your Dymec/Hewlett-Packard field engineer for all the details on how the DY-2460A can make your breadboarding easier.

Price: DY-2460A Amplifier, \$395. DY-2461A-M1 Data Systems Plug-in, \$85; DY-2461A-M2 Bench-use Plug-in, \$125; DY-2461A-M3 Patch Unit Plug-in, \$75; DY-2461A-M4 Plus-one Gain Plug-in, \$35.

Data subject to change without notice. Prices f.o.b. factory.

DYMEC
A DIVISION OF HEWLETT-PACKARD COMPANY
DEPT. D316, 395 PAGE MILL ROAD, PALO ALTO, CALIF. • PHONE (415) 326-1755 TWX 415-492-9363



MALLORY

P. R. MALLORY & CO. INC., INDIANAPOLIS 6, INDIANA

Wound Anode Mercury Batteries have high energy at low temperatures

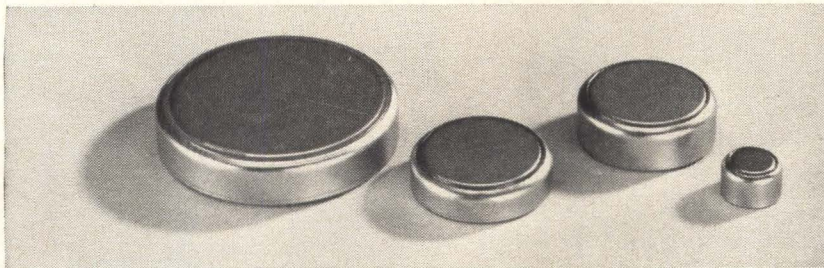

When temperatures drop to around 32°F, most dry batteries just don't put out the milliamperes the way they do at 70°F. And at 0°F, they practically give up.

Not so with our wound anode series of Mallory Mercury Batteries. As the chart shows, this construction of the famous mercury system pioneered by Mallory has 12 times as much capacity at 32°F as our standard (pressed anode) mercury cell . . . 6 times as much at +15°F. The wound anode cell at 32°F has 94% of its 68°F capacity . . . 46% at +15°F . . . and still has 10% capacity left at -4°F. And this is all the more remarkable when you consider that the Mallory mercury system has nearly four times the energy per pound of conventional Leclanché batteries.

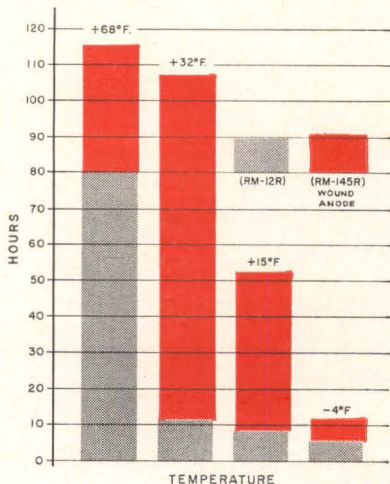

We make the wound anode mercury system in four different cell sizes, with nominal capacities from 400 to 13,000 milliamperes hours. Voltage is 1.35 volts per cell. We can either help you select a standard model or engineer a custom-designed power pack for your particular circuitry, space and capacity requirements.

CIRCLE 240 ON READER-SERVICE CARD

New Backing for Semiconductors

Looking for a backing plate for high power semiconductor devices? Then you've probably puzzled over getting a material that has good conductivity and a coefficient of expansion that matches silicon or germanium.

Our Elkonite® materials and other powder metal compositions of refractory constituents could be just what you need. By varying composition, we can tailor their coefficient of expansion to match closely with the semiconductor material. Their thermal conductivity is good, and they have excellent mechanical properties. And we can supply them as discs pressed and sintered to accurate dimensions . . . no more need to worry about close-tolerance cutting from bar stock.

CIRCLE 242 ON READER-SERVICE CARD

Need stability from -55° to +125°C? Try this new aluminum electrolytic

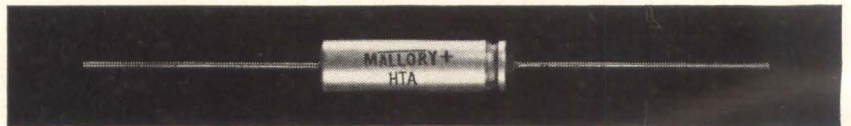

You can get broad-temperature stability and reliability in a new kind of capacitor we have developed . . . the Mallory Type HTA. This is an aluminum electrolytic that has plenty of life and stability at temperatures up to 125°C. And even at -55°C it retains about 85% of its original capacitance. That's temperature performance approaching tantalum . . . at aluminum prices!

The HTA comes in ratings of 8 to 300 mfd, 60 to 3 volts. Case diameter is 3/8"; case length, 1 3/16" to 1 5/8".

CIRCLE 241 ON READER-SERVICE CARD

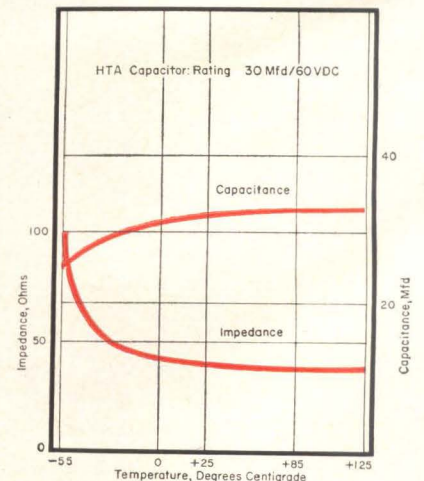

DESIGNER'S FILE

Radiation-proof tantalum capacitors

The new XTG line of Mallory wet slug tantalum capacitors is designed to resist the effects of radiation. A group of sample capacitors recently passed a series of radiation exposure tests in the Ground Test Reactor of Lockheed Missiles and Space Company, Sunnyvale, California.

Capacitors were subjected to both gamma ray and neutron bombardment at 75°F. During 6744 minutes of reactor build-up time, the following dosage levels were reached:

Fast neutron bombardment: 6.579×10^{13} neutrons/cm², at energy level greater than 0.1 Mev.

Gamma radiation: 79.56×10^6 gamma rad. (C) from carbon source.

Capacitance, dissipation factor and DC leakage were measured for each capacitor at 120, 400 and 800 cps, both before and at the end of the dosage period. No detrimental changes in electrical characteristics occurred.

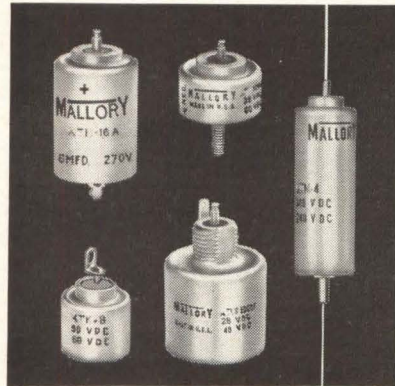

The XTG line uses special materials and construction to achieve radiation resistance. Temperature range is -55°C to $+85^{\circ}\text{C}$. The line includes the same capacitance and voltage ratings as standard MIL-type Mallory wet slug tantalum capacitors, in all MIL terminal configurations.

CIRCLE 243 ON READER SERVICE CARD

High-precision cutting of "difficult" materials

How would you cut the molybdenum wave guide aperture shown here to highly accurate dimensions?

An excellent answer is EDM—

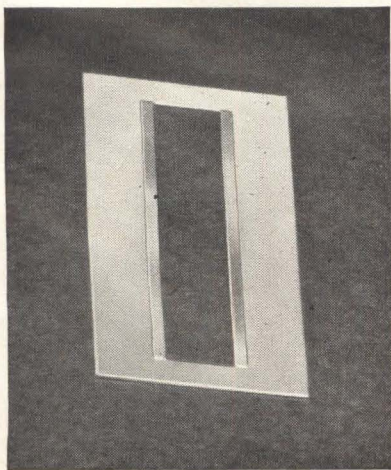

CIRCLE 244 ON READER SERVICE CARD

electrical discharge machining. And where you need to maintain exceptionally close tolerances and accurate reproduction of complex contours, the electrode material to use is Elkonite® 10W3. On the part shown here, for instance, an Elkonite 10W3 electrode made it possible to hold slot width tolerances of 0.0001".

Any time you have a forming job that's difficult enough to warrant electrical discharge machining, it pays to consider Elkonite electrodes. Their ability to machine sharp corners and intricate contours in fine detail . . . their far longer service on the EDM machine . . . their ability to cut to extreme tolerances . . . will speed your production and reduce total machining costs.

Mallory Film Resistors stay stable in high humidity

A recent series of humidity exposure tests demonstrate the ability of Mallory Type MOL metal oxide film resistors to hold stable values of resistance when subjected to extreme moisture.

The tests were run on a group of 33,000-ohm, 3-watt MOL resistors with nominal 10% tolerance. First, the resistors were exposed to 95% relative humidity at 40°C for 100 hours at no load. Result: average change in resistance was +0.37% . . . maximum change was +0.51%.

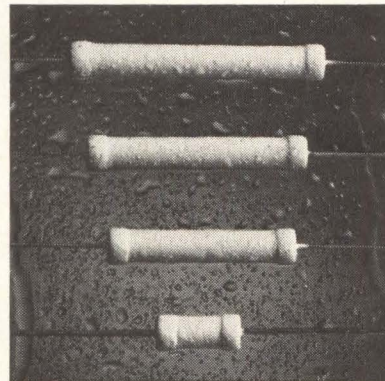

Next, the resistors were held for 1000 hours in this same atmosphere, with full rated wattage applied. Result: average change in resistance was in the band from -0.7% to $+0.62\%$; maximum changes were -1.2% and $+1.6\%$.

Through all this high humidity test Mallory MOL resistors remained at resistance values well within their stated tolerances. On long-term load life tests—10,000 hours—they show equally fine stability, with resistance holding within 1% of initial values.

The MOL series comes in 2, 3, 4, 5 and 7 watt ratings, with resistance values ranging from 30 ohms minimum on the 2 watt to a maximum of 125K ohms for the 7 watt unit. Standard tolerance is 10%; other tolerances can be supplied.

CIRCLE 245 ON READER SERVICE CARD

NOW...

**THE FAMOUS
JERROLD
900-B
SWEEP SIGNAL
GENERATOR**



**OFFERS CENTER
FREQUENCIES FROM
500 kc to 2,000 mc
without plug-ins**

The versatile Jerrold Model 900-B Sweep Signal Generator now extends its useful frequency range all the way up to 2,000 mc, with sweep widths ranging from 10 kc to 800 mc. A diode frequency doubler, priced at only \$150, increases the usefulness of the 900-B without the need for plug-ins.

Frequency Doubler Specifications

Input Frequency ... 500-1000 mc
Output Frequency ... 1000-2000 mc
Conversion loss at
1 volt RMS less than 12 db
Output component, other
than harmonic
of input 20 db or more below
Maximum Input 1 volt RMS
Connectors 50 ohm, BNC

The diode frequency doubler can also be used with the economical Jerrold 900-A Sweep Generator.

Model 900-B \$1,980
Model 900-A \$1,260
Frequency Doubler \$ 150

Write for complete technical data,
Jerrold Electronics Corporation, 15th
& Lehigh Ave., Philadelphia 32, Pa.



A subsidiary of THE JERROLD CORPORATION

Meetings

Spring Joint Computer Conference, American Federation of Information Processing Societies; Sheraton-Park Hotel, Washington, D.C., April 21-23.

Southwestern IEEE Show, Southwestern IEEE; Dallas Memorial Auditorium, Dallas, Texas, April 22-24.

Photographic Science and Engineering International Conference, Society of Photographic Scientists & Engineers; Hotel Americana, New York, N.Y., April 27-May 1.

Magnetic Inductance Core Conference, Magnetic Powder Core Association of the Metal Powder Industries Federation; Chicago, Illinois, April 28.

Annual National Relay Conference, NARM, Oklahoma State University, Okla. State Univ., Stillwater, Okla., April 28-30.

Region 6 Annual Conference, IEEE; Hotel Utah Motor Lodge Convention Center, Salt Lake City, Utah, April 29-May 1.

Frequency Control Annual Symposium, U. S. Army Electronics Research & Development Labs.; Shelburne Hotel, Atlantic City, N.J., May 4-6.

IEEE Packaging Industry Subcommittee Technical Conference, IEEE; Nassau Inn, Princeton, N.J., May 4-6.

ISA Biomedical Sciences Instrumentation National Symposium, ISA; University of New Mexico, Albuquerque, New Mexico, May 4-6.

EIA Workshop on Maintainability, EIA; Sheraton-Jefferson Hotel, St. Louis, Mo., May 5-7.

Electronic Components Conference, EIA, IEEE; The Marriott Twin Bridges Motor Hotel, Wash., D.C., May 5-7.

Aerospace Electronics Annual Conference, PTG-ANE, Dayton Section of IEEE; Biltmore Hotel, Dayton, Ohio, May 11-13.

Electronic Parts Distributors Show, Electronic Industry Show Corp.; Conrad Hilton Hotel, Chicago, May 18-20.

PTG-MITT International Symposium, IEEE; International Hotel, J.F.K. International Airport, New York, N.Y., May 19-21.

Organic Solid State Annual Symposium, Franklin Institute Labs; Philadelphia, Pa., May 25.

Tenth Annual Radar Symposium, Army, Navy, Air Force, University of Michigan Inst. of Science and Technology; Fort Monmouth, N.J., May 26-28.

Analysis Instrumentation Symposium, ISA; Sheraton Palace Hotel, San Francisco, Calif., June 1-3.

Electromagnetic Windows Symposium, The Antenna Lab., Dept. of Electrical Engineering, Ohio State Univ., in conjunction with US Air Force; Ohio State Univ., Columbus, Ohio, June 2-3.

Telemetry National Conference, AIAA; Biltmore Hotel, Los Angeles, Calif., June 2-4.

Call for papers

Northeast Electronics Research and Engineering Meeting (NEREM), New England Section of IEEE, Northeast Electronics Research and Engineering; Commonwealth Armory and the Somerset Hotel, Boston, Mass., November 4-6. June 30 is deadline for submitting 600-1000 word summary in triplicate, plus 35-40 word abstract containing author(s) name(s), affiliation(s), business and home address, and telephone contact(s) to James E. Storer, Boston Section, IEEE, 313 Washington Street, Newton 58, Mass. Papers invited for presentation should describe significant original advancements in research and development.

Automotive Electrical & Electronic Engineering Conference, Southeastern Michigan Section and PTG-IECI of IEEE, University of Michigan, Michigan State University, Wayne State University and University of Detroit; McGregor Memorial Center of Wayne State University, Detroit, Michigan, September 22-23. Deadline is July 15 for submitting a 500-1000 word abstract indicating length of time required for presentation, to E. A. Hanyasz, Chairman of the Papers Committee General Motors Research Labs., G. M. Tech. Center, Warren, Michigan. Topics covering effective development of automotive transportation, both in vehicles and highways, requiring extensive developments in electrical and electronic equipment and devices will be considered.

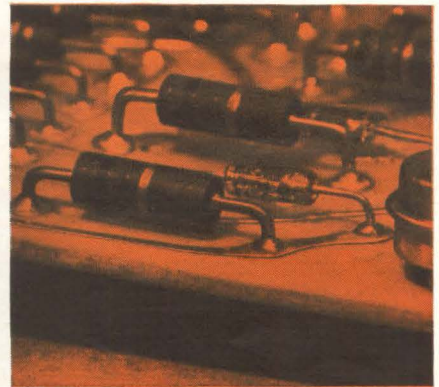
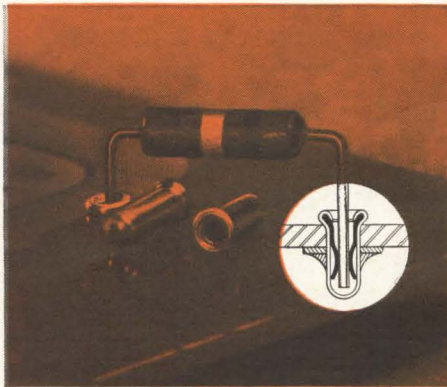
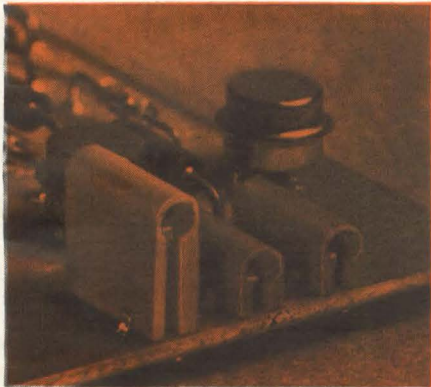
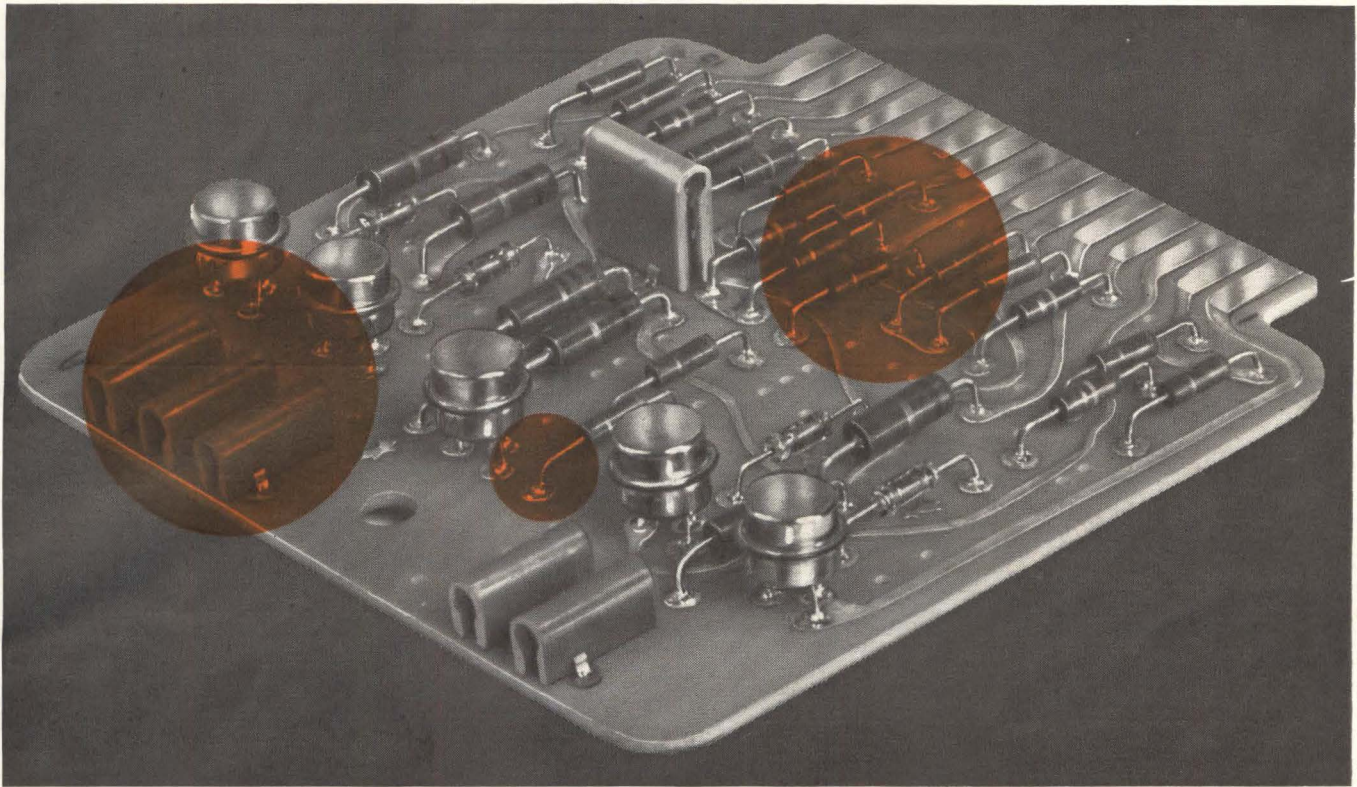

Some spots can be changed!

Take, for instance, mounting components for testing. That's one spot. The others? Testing circuits, and readying components on the board for soldering. They *all* can be changed for the better with our printed circuit board accessories.

Our Reusable Component Receptacle permits hand insertion of components to be tested. No need to solder them. That means, no damaged boards or components. Plus:

- single hole size—.089"—accepts jack
- jack accepts component leads ranging from .018" to .040" diameter
- up to 100 insertions without loss of retention

The Test Probe Receptacle offers:

- testing without removing board from connector
- tall version for clearance anywhere on board
- probing from front or rear
- "V" shaped legs promote capillary action during soldering
- all versions use standard .052" hole size
AMP standard gold over nickel plating

Our CIRCUITIP★ terminals offer a common denominator for all component leads regardless of type or stock size. Once formulated, the same solder schedule holds true for all components. In addition, you get:

- positive retention of components prior to soldering
- uniform solder fillets
- elimination of plated-through or eyeletted holes
- automatic trimming and bending of leads
- high speed application for lowest applied cost

There are many more good reasons why it pays to change these spots in your printed circuit boards and they're available on request. Send for them today.

★Trademark of AMP INCORPORATED



AMP products and engineering assistance are available through subsidiary companies in: Australia • Canada • England • France • Holland • Italy • Japan • Mexico • West Germany

Who needs whom?

Editorial

On page 104, we probe a complex subject: Should American firms trade with the Soviet Union and its satellites?

The question is particularly timely for electronic companies. Faced with a decline in military business, many firms would like to find new outlets for their products and capabilities. The Eastern Bloc looks like a natural.

Certainly the Russians would be delighted to have a chance to buy American electronic components, instruments, subassemblies and systems. We asked Don Winston, the McGraw-Hill bureau chief in Moscow, to explore the subject with the Soviet counterpart of a chamber of commerce.

Its position: "We want to trade with you. Actually we want to trade with anyone who is willing to make honorable deals. Our shopping list is vast and our credit is good. We know about competition and how to bargain. So you are invited to sit down with us. However, if you don't want to bargain because you feel your precious security is involved, we will not dry up and blow away because of it. We will trade with other capitalist nations who will then receive the business your firms have lost."

That the Russians already do a considerable business with some of the United States' allies is certainly true. And a lot of United States firms chafe under the restrictions the State Department imposes on such trade while European companies chalk up the sales.

But the problem is not as simple as it may seem. More than dollars are involved. If the U. S. were to obtain markets for its electronics companies at the risk of the country's security, it would be a bad bargain indeed.

Although our relations with the Russians are relatively cordial today, history shows they could well freeze again tomorrow. Communist doctrine still preaches that any means is worth the end when dealing with capitalist countries. History has shown that Soviet methods include deceit, fraud, treaty abrogation and downright lies.

Electronic equipment poses more of a dilemma than most other products. Apparently there is no such thing as nonmilitary electronics in the Soviet Union. The Soviets are believed to put 90% of their electronics output into military and space programs. The remaining 10% falls far short, in volume and technology, of satisfying the country's hunger for industrial electronics.

What the Soviets would like, of course, is a chance to buy U. S. industrial electronics to expand and modernize Russian industry. Such purchases would take the pressure off the Soviet production machine.

How much electronic gear, and of what type, should be sold to Russia? Most company officials are willing to let the State Department make the decision. And certainly the department should.

Most executives are realistic enough, and patriotic enough, to let government experts set the policy. But they have a right to expect that decision to be based on a comprehensive study of all the relevant factors, and not influenced by emotional, political or special-interest pressures.

The Administration should begin such a study now.

12 'ABC' POWER SUPPLIES

FLEXIBILITY • HIGH QUALITY • LOW COST

**CHECK
KEPCO**



GROUP

from 0-2V/1A to
0-2500V/2ma

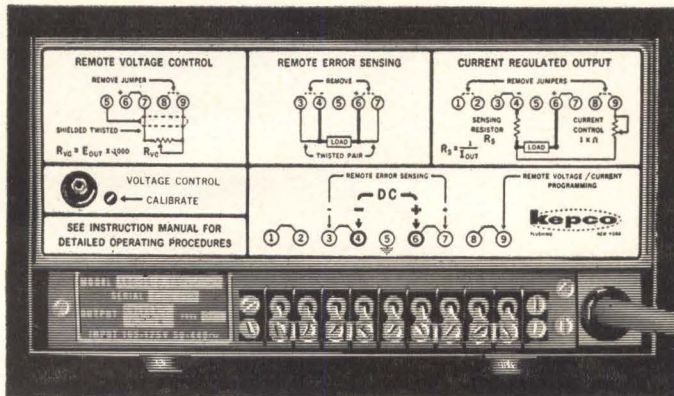
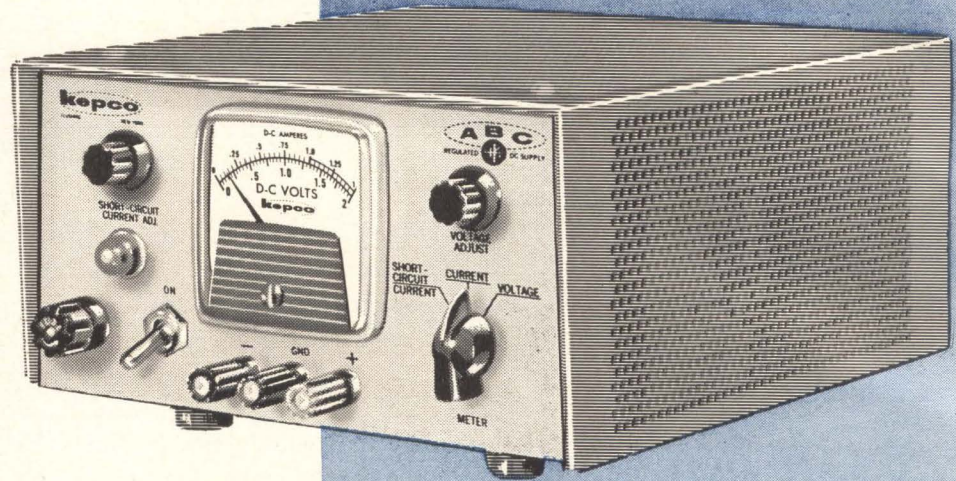

VOLTAGE/CURRENT REGULATED

Connections provide for:

- REMOTE PROGRAMMING OF VOLTAGE OR CURRENT BY RESISTANCE OR VOLTAGE
- REMOTE ERROR SENSING
- PARALLEL AND SERIES CONNECTION

**PROMPT DELIVERY
MOST MODELS FROM STOCK**

0.05% REGULATION and STABILITY

ALL-TRANSISTOR MODELS

DC OUTPUT VOLTS	DC OUTPUT AMPS	RIPPLE RMS MV	PRICE	*METERED MODEL
0-2	0-1	0.25	\$ 179.00	ABC 2-1M
0-7.5	0-2	0.25	159.00	ABC 7.5-2M
0-10	0-0.75	0.25	119.00	ABC 10-0.75M
0-15	0-1	0.25	159.00	ABC 15-1M
0-18	0-0.5	0.25	119.00	ABC 18-0.5M
0-30	0-0.3	0.25	119.00	ABC 30-0.3M
0-40	0-0.5	0.25	159.00	ABC 40-0.5M

HYBRID MODELS

0-200	0-0.1	0.5	199.00	ABC 200M
0-425	0-0.05	0.5	199.00	ABC 425M
0-1000	0-0.02	1.0	274.00	ABC 1000M
0-1500	0-0.005	1.0	274.00	ABC 1500M
0-2500	0-0.002	1.0	334.00	ABC 2500M

INPUT REQUIREMENTS: 105-125V AC, 50-440 cycles.

All-Transistor Circuit is illustrated below. The Hybrid Circuit is a unique design which achieves high efficiency and reliability through the use of Transistorized Reference and Amplifiers combined with a Vacuum Tube series pass element for reliable high voltage operation.

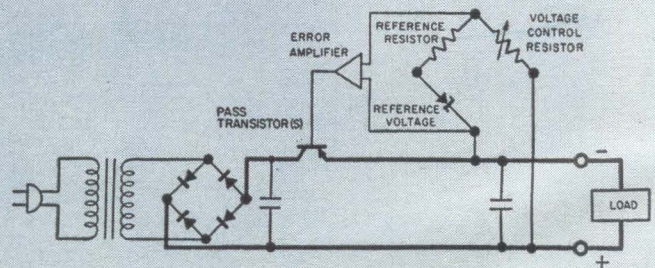

All models are designed for continuous operation without de-rating under all specified line, load and temperature conditions.

* UNITS are available without volt/amp meter; delete suffix "M" from model number and deduct \$20.00 from price (ABC 2500M, ABC 1500M, ABC 1000M voltmeter only; deduct \$15.00).

RACK MOUNTING ADAPTER (5-1/4" H x 19" W):

Model RA-4: for mounting 2 units\$15.00
Model RA-5: for single unit\$15.00



For complete specifications on more than 230 standard model Power Supplies, send for NEW Catalog B-631.

131-38 SANFORD AVENUE • FLUSHING 52, N.Y., U.S.A. • Phone (212) IN 1-7000 • TWX# (212) 539-6623 • Cable Address: KEPCOPOWER, NEW YORK

Electronics Newsletter

April 20, 1964

Early warning of earthquakes

The earthquake that rocked Alaska on Good Friday also inspired a \$1 million program of earthquake diagnosis and prediction. The Coast and Geodetic Survey wants lasers, monitors, electronic clocks and other electronic equipment for a pilot program to see if enough can be learned about pre-earthquake signals to set up an early warning system. The agency has been using optical tiltmeters and other equipment in a low-budget program of quake analysis, but now it plans an all-out effort—if funds are made available.

Paired lasers would be aimed at sensors across a known geodetic fault, for constant monitoring of distances across the fault. Tiny changes in distance may signal oncoming disturbances, and lasers are ideal for precise measurement of distance. Geophysicists of the Geodetic Survey are also planning to plant sensitive geophones to monitor sounds in the earth before, during and after a quake. A chain of such readings might discover a pattern of warning signals before a quake and could set the stage for a worldwide system of deep-placed geophones.

The agency is also establishing a \$6 million worldwide network of about 125 seismic stations for routine monitoring of earthquakes. Almost 100 of these stations are already established. The network is expected to cost \$1 million a year to operate.

Phase shift to "rotate" radar

An inertialess scanning system for antennas that could provide 360° radar views is being developed in England. It is based on a method of modulating the frequency of the incoming signal with a varying phase shift so that the static antenna array acts like a rotating antenna. D.E.N. Davies of Birmingham University, who worked out the modulation system, feels it will be possible to scan within the time between pulses and to obtain continuously bright radar display. Scan rotational frequencies will be in the order of several hundred kilocycles and possibly up to a megacycle. At present, Davies is working at radio frequencies of about 400 Mc, but this is more for convenience (since all antenna dimensions are in small scale) than because of operational requirements.

Little missile market grows

While the market for long-range strategic missiles and their components is declining, the Army and Navy are pushing ahead with work on new short-range tactical missiles.

The Army has ordered into production the shoulder-fired, bazooka-like Redeye. The 30-pound missile is designed for battlefield use against low-flying planes. The smallest of the U. S. guided missiles, it uses an infrared system to home in on the heat of an attacking airplane's engine. A \$13-million contract went to the General Dynamics Corp. at Pomona, Calif. Redeye will be used by the Marine Corps as well as the Army.

The Army has also selected two contractor teams to conduct competitive component development programs for the Army Air Defense System for the 1970's (AADS-70's). One team is headed by Hughes Aircraft Co. and the other by the Radio Corp. of America.

AADS-70 will be a mobile battlefield system, designed to knock down short-range tactical ballistic missiles, air and submarine-launched missiles and aircraft. It would replace the Nike-Hercules and Hawk missiles now

Electronics Newsletter

used and could also complement the Nike-X antimissile missile, if Nike-X is ever put into use. Army will not identify components to be studied under the present contracts, but they probably include advanced guidance and radar.

The Navy, meanwhile, has received proposals from 12 company teams for an Advanced Surface Missile System. This missile would be a follow-on, in the 1970's, to the Terrier, Tartar and Talos surface-to-air missiles. The missile that had been under development, Typhon, was cancelled because of technical problems, rising costs and complexity. Navy hopes to award feasibility contracts to as many as four prime contractors by July. Program definition study awards would be made six months later. A single contractor would be picked for a design study by the beginning of 1966.

Admiral deciding on color tubes

The Admiral Corp. is reported to be nearly ready to announce that it will manufacture its own color-tv tubes. At the company's annual meeting this month, Ross Siragusa, board chairman, said that "we will come to a decision about making our own color tubes in a few weeks, and we may be in production within two years." But the industry believes that Admiral will be in production a lot sooner than that.

Meanwhile Admiral, like the rest of the television industry, is set to sell only all-channel tv sets in interstate commerce after April 30. The company gave the Federal Communications Commission some worries a few months ago when a vhf-only set appeared in its 1965 tv line. The FCC is now confident of a smooth transition from very-high frequency to all-channel tv receivers.

New contender in home-taped tv

A world race for the home television tape-recorder market was declared this month when the Fairchild Camera and Instrument Corp. demonstrated a recorder it expects to sell for \$500. In December, a British recorder called Telcame, backed financially by Cinerama, Inc., was shown in this country. But enthusiasm for Telcan was dampened by picture instability. There are also reports that the Sony Corp., of Japan, is developing a home recorder.

The Fairchild recorder may reach the retail stores in 18 months, as a factory-built-in accessory to tv sets. With a portable tv camera—this should cost about \$150, Fairchild says—a family could tape its own tv movies.

Fairchild's prototype was designed by Wayne Johnson, director of research at the Winston Research Corp., a subsidiary in Los Angeles. It was Johnson who sparked development of a broadcast tv-tape machine for Bing Crosby Enterprises, in the 1950's.

Demonstrated picture quality was good, even though Johnson used an inexpensive tape transport and narrow bandwidth. He said that wow and flutter are eliminated electronically, but didn't disclose how, and that "information theory enhancement" provides acceptable resolution in a bandwidth of 2.25 megacycles. Audio, video and synchronization signals are combined through a recording head. On playback through a second head, the signals are separated again and fed to appropriate points in the tv set. An 11-inch spool of 1/2-mil tape, four-track and a quarter-inch wide, plays for an hour.

LOOK WHAT'S NEW

at *cppe*

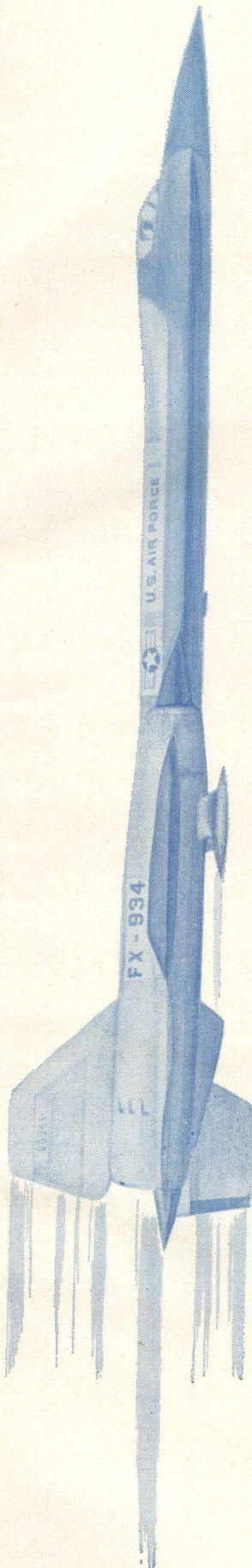

NEW!

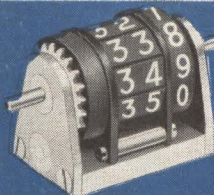

**Miniature
5/32" numeral
ANGLE
COUNTERS**

Utilizing the new Clifton Precision stacked element display breakthrough, these counters are less than 1/2 the size and 1/3 the weight of presently available 5/32" numeral counters.

NEW!



**Synchro
Length
Motor Rate
Tachometers**

These full drag cup units enable you, when it is especially desirable, to dispense with long, heavy motor tachs. Torque/Inertia Ratio is 90,000 rad/sec² and Output Voltage 3v/1000 rpm.

NEW!

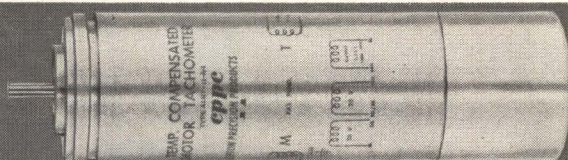

Temp. Compensated Motor Tachometers

Tightly compensated from -55°C to +125°C, these integrating motor tachs have a scale factor of 2.75v/1000 rpm. and signal to null ratio of 400. All contained in a 3.125" length.

NEW!



**AUTOMATIC
CARRIER
LANDING
INDICATOR**

This discrete message indicator provides visual display of 6 pre-selected words (check-off, ACL ready, wave-off, etc.) which indicate to pilot his landing approach condition. Designed and manufactured by Clifton.

NEW!



**Size 8
BuWeps
Synchros**

These are the latest addition to our already wide line of BuWeps synchros. Available as Control Transmitters, Control Transformers and Differential Transmitters.

CLIFTON PRECISION PRODUCTS

Division of Litton Precision Products, Inc.

Clifton Heights, Pa.

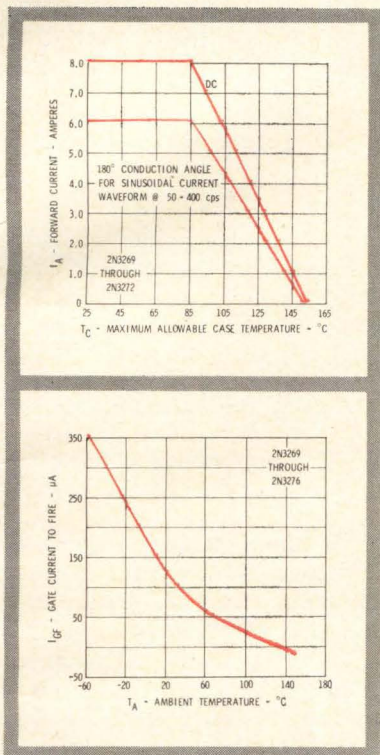

**NEW! PLANAR SCR
WITH HIGH CURRENT:
8 AMPS CONTINUOUS**

**2N3272 ALSO FEATURES
200 μ A GATE SENSITIVITY**



- **8 amps continuous forward current to +85°C**
- **I_{GF} (gate sensitivity) – 200μA max**
- **Low forward and reverse leakage – 200nA max @ 25°C./400V; 200μA max @ 150°C./400V**
- **High breakdown voltage – 400V**
- **Operation to 150°C. with no voltage derating**

The new 2N3272 leads off a brand new Fairchild line of Planar SCR's featuring high current, high power capabilities as well as high gate sensitivity. The table below illustrates eight new types designed primarily for military service. Typical applications include capacitive discharge or line type modulators, deflection circuits, inverters, pre-regulation for power supplies, phase control circuits, time delay circuits, squib firing circuits. For further information, write for data sheets and application notes.

			
TYPE	FORWARD BLOCKING VOLTAGE	TYPE	FORWARD BLOCKING VOLTAGE
2N3269	100V	2N3273	100V
2N3270	200V	2N3274	200V
2N3271	300V	2N3275	300V
2N3272	400V	2N3276	400V

7/16" Hexagonal Stud
 Gate P_d—0.5W
 Average forward current—6.0 amps
 Continuous forward current—8.0 amps

JEDEC TO-5
 Gate P_d—0.1W
 Average forward current—1.7 amps
 Continuous forward current—2.2 amps

AVAILABLE DIRECTLY FROM DISTRIBUTOR STOCKS

FAIRCHILD
SEMICONDUCTOR

LOGIC...

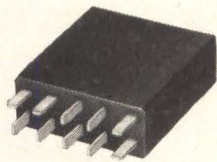

*New line of digital modules
offers flexibility, economy
and high packaging density*

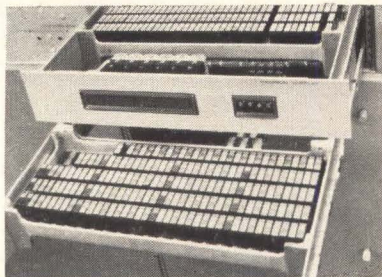

horizontal drawer mounting

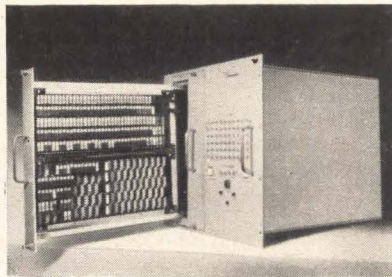

vertical drawer mounting

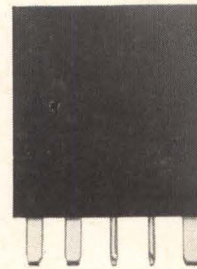

actual size

Radiation Incorporated now provides the most versatile and reliable line of logic modules available today. Superior electrical design and unusual stability have been proved through use in a wide range of digital applications. Calculated mean time before failure indicates a significant breakthrough in high reliability design. For example: based on extensive tests, MTBF for Radiation's low-speed NOR Module is in excess of 2,940,000 hours!

FLEXIBILITY . . .

Two sets of fully compatible resistor-transistor logic circuitry are available. One operates at bit rates up to 200 kc, the other at rates up to 1 Mc. More than a dozen standard modules are available from stock. Types include: 4-input NOR; Counter Shift Register; Power Inverter; Emitter Follower; Complementary Driver; Differential; and Filter (Decoupler).

ECONOMY . . .

Radiation Logic Modules provide unusual economy of use. Each module represents a fraction of the entire digital system, and is designed for easy interrogation. Replacement or circuit changes is achieved by simply plugging in another unit. Downtime is greatly reduced, and bench work is completely eliminated!

PACKAGING DENSITY . . .

Construction consists of welded circuitry molded in epoxy, and mounted with high-density module connectors on cast aluminum frames. The resulting positive-contact module measures only 0.4x1x1.1 inches, with a 1/4-inch pin protrusion. This configuration permits packaging densities of 113 to 137 modules per inch of panel space in standard racks. In addition, the units may be mounted in any manner—vertical or horizontal drawer, removable or fixed.

Write or phone for technical information on these unique logic modules. Radiation offers the services of its experienced engineering staff in the application of logic modules. We will also be glad to help solve your unique data problems. Radiation Incorporated, Products Division, Dept. EL-04, Melbourne, Florida. Telephone: (305) 723-1511.

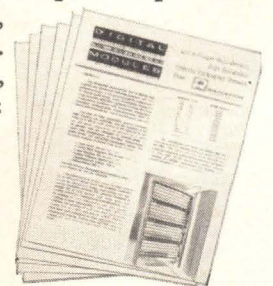

RADIATION
INCORPORATED

this one latches

Babcock makes two different half-size can relays

this one doesn't

Designed for low profile mounting, Babcock's new half-size crystal can relays are available for latching (BR-17) and non latching (BR-16) application. Both types feature exceptionally high sensitivity and durability. Remarkably efficient coil operation requires only 175 mw pull-in power to switch any load from dry circuit to 2 amps. Predicted failure rate on the BR-16 and BR-17 is less than 0.1% in 10,000 operations with a 90% confidence factor.

These exclusive Babcock high reliability features are the reasons why:

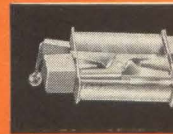

High-flux armature action. Balanced armature is located inside coil along path of maximum flux concentration. High density of magnetic force lines in core allows armature movement with minimum field excitation.



Heat sink / magnetic flux conductor. Coil cover of high permeability alloy lowers heat generation through improved magnetic circuit efficiency, while functioning in dual capacity as heat conductor-radiator.

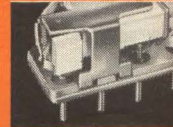

Activated Vycor getter. Exclusive to Babcock, this porous glass getter prevents contact contamination by adsorbing outgassed organic substances, following production degassing at 200°C under less than 5 microns vacuum.



Welded-header construction. Automatic sealing process gives stronger header-case bond and prevents solder flux contamination. Leakage rate is less than 10^{-9} c.c. per sec. by mass spectrometer.



Self-wiping, gold-plated contacts. Contacts of AgMgNi alloy with specially-designed configuration assure miss-free performance under load and minimize low level contact resistance.

The BR-16 is available in SPDT and DPDT versions, the BR-17 as DPDT only. Various mounting arrangements and either plug-in or solder hook terminals can be supplied as standard. Send for complete details.

BABCOCK RELAYS

A DIVISION OF BABCOCK ELECTRONICS CORPORATION
3501 HARBOR BLVD., COSTA MESA, CALIF. • 546-2711



News Briefs



Room temperature curing Sylgard® 185 resin, companion product to Sylgard 184 resin, provides added heat conductance for circuit "hot spots" and opaqueness where transparency is not desired. A black, solventless silicone resin, it cures to form a tough, flexible embedment that assures environmental protection and cushioning for electronic components. Sylgard 185 resin cures in deep sections in 24 hours at room temperature . . . or in 15 minutes at 150 C.

CIRCLE 290 ON READER SERVICE CARD



Dip, brush or spray Dow Corning® 630 protective coating. This solution of silicone polymers air dries to a flexible, wax-like film that is highly water repellent. The excellent surface resistivity of the clear protective coating makes it ideal for the protection of printed circuit assemblies and components operating under heat and humidity conditions. High volume and surface resistivity are maintained even after prolonged exposure to harsh environmental conditions.

CIRCLE 291 ON READER SERVICE CARD

Now... a room-temperature-curing transparent packaging material, that's easy to use, easy to repair

Transparent and tough . . . firm and flexible . . . new room-temperature-curing Sylgard® 184 resin cures without applied or exothermic heat. It can be used to package and protect the most heat-sensitive components.

Sylgard 184 resin is a virtually colorless, solventless silicone material designed for the potting, filling, embedding and encapsulating of electronic circuits. Applied as a low viscosity fluid, Sylgard 184 resin flows easily around the most intricate parts. It cures, even in deep sections, in 24 hours at room temperature . . . or in 15 minutes at 150 C.

When cured, Sylgard 184 resin has a resilient, penetration resistant surface. To repair or replace defective components, the resin can be cut away and new resin poured in place and cured to re-form the embedment.

Sylgard 184 resin cushions and protects components from mechanical shock — can be twisted and bent . . . withstands elongation of nearly 100 percent. Its tensile strength ranges from 800 to 1000 psi, and it has a long service life at operating temperatures of -65 to 200 C.

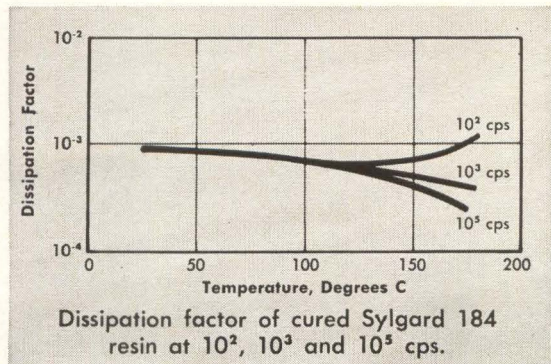

CIRCLE 289 ON READER SERVICE CARD

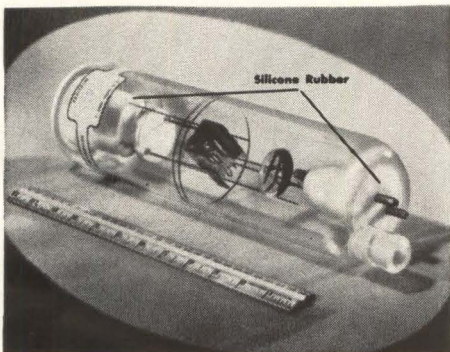

Seal, bond, insulate in one operation with Silastic® RTV silicone rubber. The Flash-X Ray tube shown utilizes it to insulate against high voltage at one end and to provide flexible support between glass and power cable at the other.

Its adhesive quality and the typical silicone properties of moisture resistance and heat stability make it suitable for use in a wide variety of applications.

CIRCLE 292 ON READER SERVICE CARD

We'll be pleased to forward full information on these and other materials that aid reliability and performance. Just write Dept. 3904, Electronic Products Division, Dow Corning, Midland, Michigan.

Dow Corning

first major breakthrough in trimmer design in 10 years!

MIDGI-TRIM

Trademark

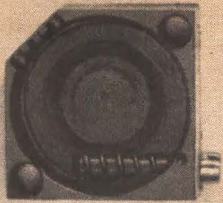

Non-conductive case
Non-conductive
adjusting screw
with metal cap

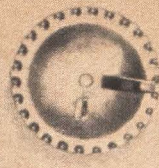

Cog Wheel

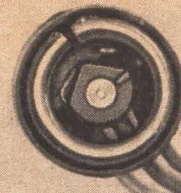

Non-conductive base

LOOK AT THE FACTS ABOUT THIS REVOLUTIONARY NEW TRIMMING POTENTIOMETER

PATENT APPLIED FOR

Here's the secret of Conelco's Midgi-Trim — unitized design that eliminates five parts common to conventional trimmers. Conelco's revolutionary cog wheel delivers six-fold reliability — integrating the mechanical actuator . . . electrical wiper . . . slip ring . . . spring preload . . . slip clutch action . . . and positive rotating stop into one composite unit.

Midgi-Trim is the most reliable $\frac{3}{8}$ " square trimmer you can buy . . . easily meets and greatly exceeds the requirements of MIL-R-27208A.

- Perfectly sealed to completely withstand humidity.
- Dielectric strength: 1,000 V AC min.
- Insulation resistance: a full 1000 megohms min.
- Never-Fail clutch and cog wheel drive mechanism.
- Non-conductive case and adjusting screw with metal cap.
- Conventional 2-hole mounting.
- Evaluation samples available immediately! Phone your local Conelco Components stocking representative today or write for specifications and data file 2504-1.

CONELCO COMPONENTS

465 WEST FIFTH STREET, SAN BERNARDINO, CALIFORNIA 92401

Medical electronics

Another step closer

Lasers have been used, successfully, to kill certain types of skin cancer cells, but only in hopelessly ill patients.

Three patients, who subsequently died, volunteered for the laser treatment of malignant melanoma at the Pasadena (Calif.) Tumor Institute, where Dr. James T. Helsper has been conducting related cancer research on rabbits. In each of the three cases, the localized effect of the laser treatment was not sufficient to halt the cancer spread. But Helsper, who believes the experiments were the first in which humans were treated, is optimistic.

Research on the effects of laser energy on pigmented and non-pigmented cells in rabbits had disclosed that pigmented cells were completely destroyed by a single exposure to 25 joules per square centimeter, whereas similar non-pigmented cells were able to stand repeated firings without showing signs of tissue destruction or alteration.

Like the rabbits. The results with the three patients were exactly like the results with rabbits. The laser energy from a single firing killed the pigmented cancerous cells whereas the non-pigmented cells were resistant to at least 20 firings. "The big gimmick here is seeing the biological effect on the pigmented tissue," says Helsper. "From preliminary work in tissue culture, it appears that laser energy may have a biological effect over and above that of the physical energy imposed on cells."

Bigger laser. Helsper isn't sure what is next. He says that the laser firings helped only when small areas were treated. When larger areas were treated, there was no effect. Some thought is being given to trying a more powerful laser, but

he has no definite plans. "We've been told that we need a more potent laser," he says. "Some say our use of this one is like taking a BB gun to a battleship."

The laser was donated to the Institute by the manufacturer, Hughes Aircraft Co.'s Electronics division. It is a pulsed ruby laser of relatively low energy, extended from a minimum of one to a maximum of two joules. Peak watt output is approximately 20,000 watts and power output is approximately 8 megawatts per square centimeter. Most firings were confined to a target of $\frac{1}{4}$ square millimeter. Pulses averaged about one millisecond.

The lens system used had a focal distance of about 1.8 centimeters from the lens. Doctors devised a small nylon cone which could be sterilized and placed over the lens system. The focal spot centered at the end of the cone permitted placement of tissue at the exact focal distance from the lens.

Consumer electronics

Big brother

The biggest crowd-stealer at the National Association of Broadcasters Show in Chicago was a mobile television snooper developed by the

Tanner Engineering Co. of Wilmington, Calif.

Using methods smacking of military electronic reconnaissance, inventor James Tanner's little black truck drives through neighborhoods and records how many sets are tuned to what television channels.

Tanner's equipment does four jobs: receives station-broadcast tv signals on all channels, receives the weak signal radiated by every tv set's horizontal oscillator, compares horizontal synchronizing signals, and scores one count for a channel every time its signal coincides with the home-broadcast signal.

Three antennas. Two halo antennas, mounted on the roof of the truck, pick up a station's tv signals on all vhf and uhf channels. Radiation from receiving sets is received by an antenna on the hood. This antenna rotates about twice every three seconds, scanning both sides of the street in a corkscrew pattern 600 feet in diameter.

Broadcast and set signals go to a gating unit that scans each broadcast channel sequentially for 1/40 second.

While the gate is open, signals received from sets in homes are compared with the broadcast channel signal. If there is coincidence for four synchronizing cycles, a count of one is recorded for the channel being gated.

It is impossible to count the same



Truck cruises along residential street, picking up tv signals and recording the viewing choices of the residents.

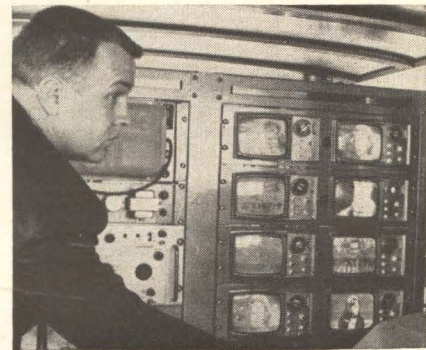

set twice, according to Tanner. To pass through the gating system, the two signals being compared have to be in phase. This can occur at only one point on the ground along the path of the snooper vehicle, Tanner says.

Tanner does not claim that his system counts every set within range. He says that out of 200 operating sets, only 100 to 150 may be counted. By picking up color-burst signals, he adds, the system can tell whether a color receiver is tuned to a color program.

Automatic counters. The prototype uses miniature receivers, made by the Sony Corp., to display all broadcasting channels and to generate the needed horizontal synchronizing signals. It has banks of electromechanical counters to tally the stations tuned in. An engineer operates the equipment while the truck is driven through the streets.

Future vehicles will have receivers that supply only the horizontal synchronizing signals and tape-record the coincidences. This system will only need to be turned on and off, a job that can be done by a relatively unskilled driver.

Broadcasters expressed curiosity and admiration about how the truck works. Comparing Tanner's method with usual rating techniques, the owner of a station in the South said, "I'd rather trust transistors than somebody's diary."

Communications

End of "Roger"

Complete automation of all communications between ground and aircraft is in the offing, following establishment of technical standards for digital techniques by the Radio Technical Commission for Aeronautics. Civil aircraft probably won't be affected for several years because of the high cost of installing new ground and air equipment, but the automation is just right for the supersonic transport.

One system. Digital systems are already being used by the military to control weapons-carrying aircraft

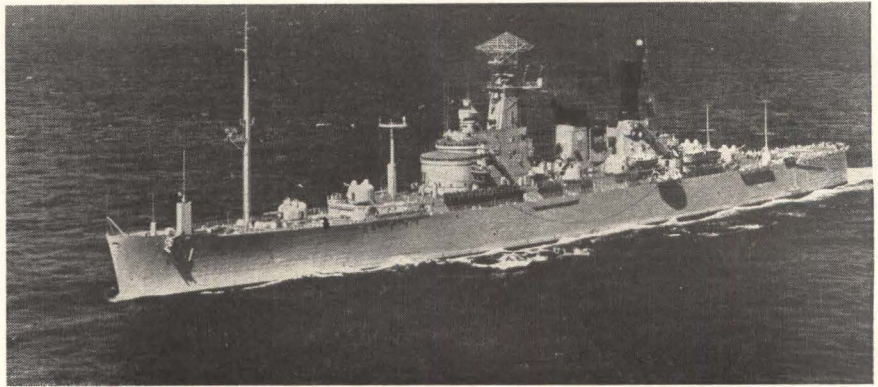

USS Northampton is the first ship to be equipped with tropospheric scatter communications equipment.

and to provide greater speed and security for special-purpose aeronautical military communications. A powerful boost was given to the establishment of a single system when the Department of Defense agreed not to authorize any additional special-purpose digital communications. Future air-ground networks must work into the common-user system and also have provisions for future air traffic control. Implicit in the Defense Department's decision is a willingness to withdraw its previous strong support of Fieldata, the 64-character alphanumeric code used by most military digital systems.

Automation will almost completely eliminate oral communication by the pilot. Only in emergencies will voice communications override the normal data channel.

In the aircraft, output signals from automatic sensor devices like altimeters, temperature indicators and even fuel gauges can be converted to digital codes and sent automatically to the ground. From the ground, information fed into a computer both automatically from the air and by human traffic controllers on the ground can be triggered for transmission back to the aircraft. Instead of oral instructions, the pilot will receive standard canned messages from electromechanical devices or a printout similar to a teletypewriter message. Almost all of the normal air-ground traffic will be in record or display form, contributing to over-all safety. If necessary, the messages can be sent in cipher.

Standard code. The system will be based on the newly adopted American Standard Code for Information Interchange—X3.4-1963. Additional technical agreement provides for synchronization for both bits (individual on or off pulses) and characters (a minimum of seven bits). The use of standard code and label characters will permit sending canned or original messages either to a single receiver or several.

Saltwater tropo

Tropospheric scatter communications have finally gone to sea. The technique of bouncing radio waves off the troposphere to provide long-range multichannel communications at high frequencies has been used extensively on land. Now the first ship-to-shore troposcatter equipment has been installed aboard the USS Northampton, a CC-1 tactical command ship that is an integral part of the National Military Command System.

Engineers at Radio Engineering Laboratories, Inc. who supplied the equipment, are reluctant to discuss the range of fade-free reception, but admit it may be "hundreds of miles." Land stations in the Distant Early Warning Line operate over an average distance of 200 miles and a new installation to link Thule, Greenland, with the Line will span 591 miles. It seems likely, though, in view of the lower power and smaller antennas aboard ship, the Northampton's range is well under 500 miles.

Solid-state

Low-cost power booster

In solid-state electronics, the closest thing to a vacuum tube is the insulated-gate field-effect transistor. At least four major companies are working to perfect the device, sometimes called the metal-oxide-semiconductor transistor.

Engineering samples already are being offered by TRW Semiconductors Co., a division of Thompson Ramo Wooldridge Inc., the Norden division of the United Aircraft Corp., and the Radio Corp. of America. The semiconductor division of the Fairchild Camera & Instrument Corp. plans to offer samples this summer.

The insulated-gate field-effect transistor is simpler, and therefore potentially cheaper than an ordinary transistor. It consists of a silicon substrate with metal source and drain contacts, plus an insulated-gate electrode.

The big problem. The companies are seeking to get the problem of surface instability sufficiently controlled to go into full-scale production of the transistors. It is quite possible that the solution to this problem is not too far off.

Reports of excellent high-frequency characteristics point to its use as a general-purpose low-power device up to uhf. Present field-effect transistors appear limited to 10-20 megacycles. The transistor can handle signals of several volts and is inherently low in cross modulation distortion.

RCA has been letting customers sample the (TA 2330) transistor for about a year. This unit is useful up to 100 megacycles. RCA is also trying to develop versions for higher frequencies, and has produced a laboratory device that operates as an oscillator up to a gigacycle.

TRW speculates that the device could be the linear power amplifier of the future. The company plans to offer 300-milliwatt units initially and sees no problem in getting to one watt and, eventually, beyond. It has operated oscillators

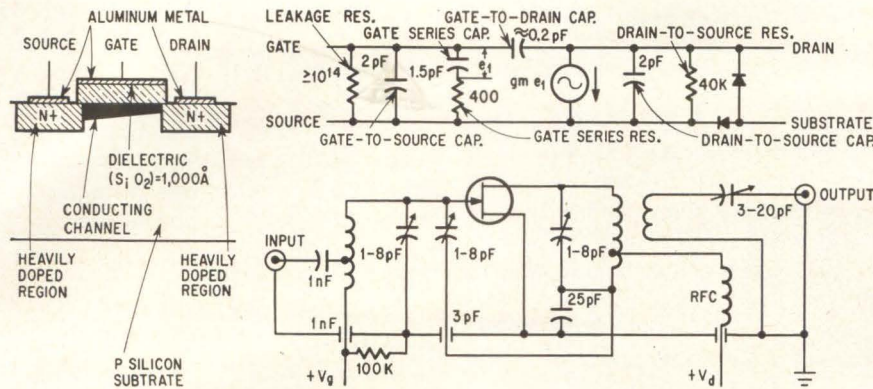

Construction of TRW's insulated-gate field-effect transistor (left) and its equivalent circuit. At right, it's used in a 100-megacycle amplifier.

Babel on wheels

The Electronic Industries Association's monumental analysis of Federal Communications Commission license data for most of the radio transmitters used in vehicles will be completed before the first of May. It was started nearly eight months ago and covers some 1.9 million authorized stations, mostly in cars and trucks but with more than a sprinkling of fixed base stations. While not every license is in active use, a short listen to the bedlam on any of the police, taxi or other band receivers indicates intolerable crowding.

The FCC hasn't been much help mainly because it can not create new radio channels. Rapid growth of the land-mobile radio services has tended to outpace the economics, if not the engineering skills, of band-splitting—like making three channels exist where only two were used before.

Crowded air. Since overcrowding is often a geographical phenomenon (some Los Angeles channels have as many as 25 different occupants) the EIA study showing just how many transmitters, on what frequency and in what area they are, should help FCC do some sophisticated reshuffling. In fact, the agency sent three staff members to Los Angeles in late March for four days to delve into a typically bad situation.

EIA's statistical task has been complicated by the way FCC keeps its records. For example, some 200,000 mobile station authorizations

cannot be immediately identified geographically; they go through the computer twice before the authorizations can be pro-rated to proper areas.

Another group, the National Association of Manufacturers, feels that unused channel assignments should not lie idle. Its communications committee has proposed a pilot test employing television channels 14 and 15, unused in the Los Angeles area. The proposal is comparable with those of EIA, American Automobile Association and Automobile Club of Southern California. If FCC approves, the radio space in the two tv channels (between 470 and 482 Mc) could theoretically accommodate almost 250 more mobile-radio channels to ease the city's overcrowded radio space.

New study. The Commission recently withheld action on the NAM proposal and slapped down another (sponsored in part by EIA) that would have reallocated frequencies between 25 and 890 Mc. However, FCC requested another study by EIA and the Joint Technical Advisory Committee, the group comprising representatives from industry and members of the Institute of Electrical and Electronics Engineers, to see if mobile radio channels can be fitted into television bands 2 through 13 (54 to 72, 75 to 88 and 170 to 216 Mc). Commissioner Kenneth A. Cox and chief engineer James E. Barr were appointed to head up this advisory committee for the Land Mobile Service.

at 500 megacycles and obtained a 20-decibel power gain at 105 megacycles with the grounded source amplifier shown. Noise was less than 4 decibels. The high performance was made possible by the reduction of parasitics through construction to tolerances of 0.1 mil.

Norden is interested in the device for microelectronics applications, such as linear amplifiers, that will benefit from its high input impedance (10^{14} to 10^{15} ohms). Norden believes it has licked the stability problem, and is selling samples for breadboarding purposes.

The high-input impedance has aroused considerable interest among instrument companies. Both HP Associates and Tektronix, Inc., are researching the device and Crystalonics, Inc., feels it would be forced to build one should the high-frequency characteristics prove out.

Space electronics

Televising the Olympics

The Japan Broadcasting Corp. thinks it has a solution to the problem of transmitting television coverage of the Olympic Games from Tokyo to the United States [Electronics, April 6, 1964, p. 30].

The company plans to offer \$3 million toward the cost of launching a satellite, Relay III. The rest of the \$8 million cost would be paid by the U. S. National Aeronautics and Space Agency.

Japan, a country interested in business generally and in electronics specifically, has a big promotional stake in televising the Olympics in October. It would be especially beneficial if she could also claim a role in creating a space satellite.

If the Japanese were to advertise on American network tv in prime time, it would cost from \$200,000 to \$265,000 an hour. Two weeks of Olympic coverage would give the country some \$5 million in advertising value.

Why Ranger failed

No one was home April 3, the day the Senate's Committee on Aeronautical and Space Sciences released the National Aeronautics and Space Administration report on what went wrong with Ranger 6 and how Ranger 7 was being corrected. NASA's Ranger project engineers were "at a meeting," and nobody answered the phone in the Ranger project office at the Radio Corp. of America.

The report summed up the opinion of the five-man NASA committee investigating the failure of Ranger 6 last February 2 to send close-up tv pictures of the lunar surface back to earth.

The committee issued five stinging indictments against Jet Propulsion Laboratory of the California Institute of Technology, the project manager, and its subcontractor, Radio Corp of America, builders of the tv camera systems. These were:

- "The two video systems were more complex than required" and some components common to both tv system were not completely independent.

- "Possibilities of failure were increased as a result of practices employed in the design and construction of the spacecraft." Cited were parts of the circuitry that were vulnerable to short circuits.

- The directional antenna had never been tested together with the high-power, 60-watt tv system.

- Complete preflight testing was not done for the 12 days before launch for fear of damage.

- Pre-flight ground testing "may have obscured potentially dangerous situations which could have enhanced accidental triggering of critical control circuits."

Corrective measures. NASA plans to launch Ranger 7 in late June after the spacecraft is redesigned so that the command turn-on functions of the two camera systems are separated. Originally, NASA wanted to scrap the entire tv subsystem and replace it with two newly-designed, completely independent camera chains, but this would have taken 12 to 18 months.

Cause unknown. The NASA re-

view board said that "the most likely but not conclusively proven explanation for the failure was an unscheduled turn-on" of both the tv and channel 8 telemetry simultaneously two minutes after launch. If the tv was turned on before it entered space vacuum, arcing and corona discharge would have destroyed both tv systems.

Scapegoat? Jet Propulsion Laboratory can't defend itself. As a NASA contractor it must offer "no comment." But friends of JPL point out that NASA's own Office of Space Sciences and Applications had approved the system development and test procedures for Ranger 6 and that NASA's scheduling of four Ranger tv shots was a tacit admission of the complexity of the job. Some JPL supporters even feel that NASA is maneuvering to oust California Institute of Technology from its administrative position and take over the lab. And there is the inevitable speculation that NASA, looking for a scapegoat, pounced on JPL.

Advanced technology

Gas laser radar

A missile-ranging laser radar, probably one of the first practical applications of the continuous-wave gas laser, is nearing hardware form at the Perkin-Elmer Corp. in Norwalk, Conn.

Called Optical Direction and Ranging, the system is intended to provide highly precise real-time measurements of speed, altitude and range of missiles immediately after they have been launched. It can be adapted to perform other functions such as long-range missile tracking and rocket-sled measurements.

Perkin-Elmer developed the radar under a \$250,000 development contract from the Rome Air Development Center and is hoping for a contract to install an operational system at Cape Kennedy.

The laser system uses a 100-milliwatt visible red beam at 6,238 angstroms. The continuous beam is

FLUKE

offers the most complete line of differential voltmeters on the market

Features common to all models are infinite input resistance at null; in-line readout with automatic lighted decimal; front panel DC polarity switch; standard cell reference (zener diode optional); taut band suspension meter and flow-soldered glass epoxy printed circuit boards.



Choose the degree of accuracy that meets your need...

Models	801B		825A		821A		803B		803D		823A	
	DC	AC	DC	AC	DC	AC	DC	AC	DC	AC	DC	AC
DC ACCURACY ±% of input voltage	0.05%		0.02%		0.01%		0.05%	0.2%	0.02%	0.1%	0.01%	0.1%
AC ACCURACY ±% of input voltage												
INPUT RANGE	0-500V		0-500V		0-500V		0-500V		0-500V		0-500V	
FREQUENCY RANGE		20 cps-10 kc		5 cps-100 kc		5 cps-100 kc	
MAXIMUM FULL SCALE SENSITIVITY	10 mv		1 mv		1 mv		10 mv DC 1 mv AC		1 mv		1 mv	
MAXIMUM METER RESOLUTION	50 uv		5 uv		5 uv		50 uv DC 5 uv AC		5 uv		5 uv	
REFERENCE	Std. cell (zener diode optional)		Std. cell (zener diode optional)		Standard cell		Std. cell (zener diode optional)		Std. cell (zener diode optional)		Standard cell	
PRICE Cabinet model	\$485.00		\$590.00		\$795.00		\$875.00		\$1,100.00		\$1,300.00	
Rack model	\$505.00		\$610.00		\$815.00		\$895.00		\$1,120.00		\$1,320.00	

Prices and data subject to change without notice. Prices f.o.b. factory.

MILITARIZED — DC DIFF. VOLTMETER

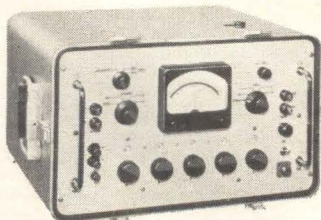

MODEL 8011A
PRICE: \$1745.00
Complete technical data on all FLUKE voltmeters available upon request.

PARTIAL 8011A SPECIFICATIONS

ACCURACY: ±0.05% of input from 0.1 to 500V
±0.1% of input or 0.5 mv, whichever is greater, below 0.1V
NULL RANGES: ±10, ±1, ±0.1, ±0.01V
INPUT IMPEDANCE: Infinite at null from 0 to 500V
MAXIMUM METER RESOLUTION: 50 uv
REFERENCE: Temperature controlled Zener diode

John Fluke Mfg.
Co., Inc., Box 7428
Seattle 33, Wash.

FLUKE

INSTRUMENTS

PR 6-1171 TWX 206-879-1864 TLX 852 Cable: FLUKE

Circle 31 on reader service card

modulated at 100 megacycles and diverges at 4.5 arc seconds toward the moving missile, giving a wider field of view. A 2.5-inch specially designed retro-mirror, mounted on the upper portion of the missile's first stage, reflects the beam back to the radar's receiving optics and photomultiplier. The return signal data, together with signals from two auxiliary angular readout systems, can be simultaneously recorded. This information allows computer reconstruction of the missile's trajectory to measure missile positions, velocity and acceleration for purposes of range safety, impact prediction and control.

Accuracy. The outstanding feature is accuracy: ± 0.06 feet on measurement of distance from the instrument to the missile; ± 0.92 second of arc on elevation and azimuth readings; and ± 0.01 feet per second² in acceleration measurements. The altitude range is zero to 60,000 feet.

The high accuracy is made possible by the use of a continuous-wave laser. Unlike pulse-type laser radars, which have only moderate precision but long operating ranges, the gas laser is better adapted to continuous measurement with high resolution at moderate ranges. Pulsed lasers do not permit the same accuracy because the shape of their pulses has not been sufficiently defined, while the rise shape of the 1/20-nanosecond pulses with which the continuous-wave laser light beam is modulated permits precise time measurement.

Because the gas-laser beam can locate targets already within its reasonably wide angle of view, it can achieve second-of-arc accuracies without comparably precise mechanical tracking equipment. To achieve similar accuracy with a one-centimeter microwave doppler radar requires a 1,600-ft antenna.

Competition. Closest competition with the Perkin-Elmer system so far was announced by two Hallcrafters Co. engineers at the IEEE International Convention in March. The Hallcrafters experimental system intended for measuring target velocity in space, uses noncoherent light, also r-f modulated.



Army weapons sight using cascaded image-intensifier tubes will be in the hands of troops next year. It intensifies low-level light 80,000 times.

Military electronics

Night vision improves

American soldiers standing guard on the uneasy truce line in Korea, at the frontiers of a divided Germany or stationed in a host of other international trouble spots may soon see more clearly and safely in the dark.

The trend in Army night vision equipment is towards passive devices making use of low-level natural light and away from active devices such as the sniperscope that requires use of a powerful artificial light and infrared filter to illuminate the target—and also risks giving away our own positions.

The new passive devices make use of image-intensifier tubes as did the active devices before them. But now several tubes are combined to intensify light from stars, moon or skyglow by 80,000 times or more. An improved weapons sight using the passive equipment will soon be in the hands of troops. Soon to follow are binoculars, night viewers and telescopes. The image-intensifier tubes can be teamed up with vidicons or image orthicons for remote television viewing of a tactical situation.

Cascaded intensity. An image intensifier consists of a glass mem-

brane coated on the inside with a silver oxide-caesium film containing several special additive materials. When struck by light photons the film emits electrons into the evacuated tube. A simple ring-and-disk system of electron optics having an applied potential of 10 to 15 kilovolts focuses the electrons on a green-white phosphor screen. The output of one image intensifier forms the input to the next in a cascaded stack. Optical lenses are used at the input and output of the stack and a stack can subtend a field of view from 3° to 26°.

No electronic amplification is necessary except where the image intensifier feeds a vidicon or other television tube. The only electronic equipment usually required is a multivibrator-type d-c/d-c converter used to raise the output of a mercury wafer battery to the kilovolt level. The converter is now all solid state and use of microcircuits is under consideration. The image intensifiers can be used both for low-level visible light (in which case an S20 photoemissive surface is preferred) and for the near infrared—0.8 to 1.5 microns—(where an S1 photoemitter would be used).

Future devices. Still newer devices are under development for the far infrared—from 9 to 12 microns—where practically every living thing radiates energy. Here the target would be scanned with a single-point receiver utilizing a photoconductive substance such as lead telluride, lead sulphide, indium antimonide, germanium or antimony-germanium as an infrared-to-electrical transducer. The present approach is to use a mechanical raster scan. Later devices may use a mosaic of transducer elements or employ electronic scanning. Of course this equipment cannot provide direct viewing and electronic amplification is essential.

Active-device night vision equipment is currently out of favor in research and development. However, recent developments in that area reduced the weight of the sniperscope from 22 to 11 pounds and produced a dual-purpose infrared-visible light tank search light. A three-watt gallium arsenide infra-

New Ink Rectilinear Recorder for analog computer or telemetry write-out

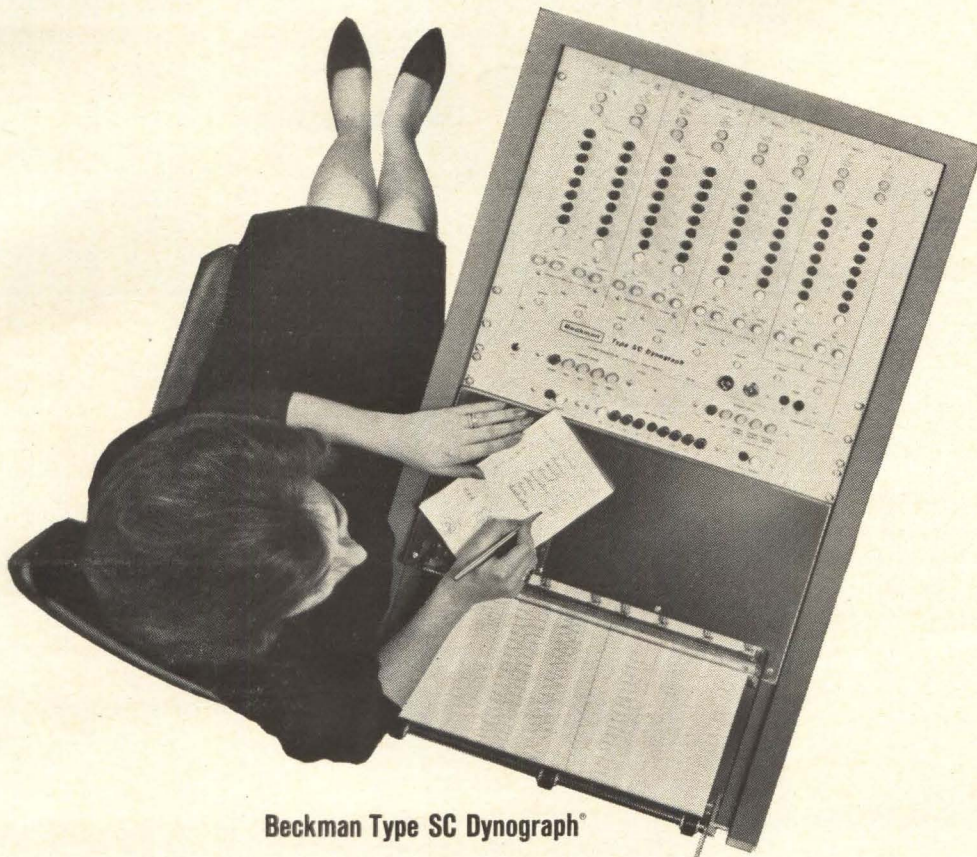

Beckman Type SC Dynograph®

All the desirability of the Dynograph ink-rectilinear recorder, in a design for complete compatibility with analog computers

Famous Locked-In Accuracy at the tracing! Servo system constantly compares pen tip and input signal for maximum accuracy and linearity.

Reliable Solid-State Circuitry eliminates drift, component aging. No warm-up time; low total power consumption (230 w. max., for 8 channels).

- Channels: 8 analog plus event marker (standard)
- Width: 40 mm (50 divisions) /channel
- Sensitivity Range: 2.5-250 volts full scale
- Input Impedance: 1 megohm, single-ended or differential
- Linearity: $\pm 0.25\%$
- Frequency Response: DC-150 cps
- Zero Suppression: 3 times full scale
- Computer Controls: "Operate," "Hold," "Reset"
- Polarity Reversal: for each channel
- Local-remote Controls: "Chart Speed," "Event Marker"
- Centralized Push Button Controls: "Sensitivity," "Paper Speed," "Calibrate," "Polarity," "Local-Remote"
- Pressurized inking system
- Paper Capacity: 1,000 ft. high gloss maximum contrast
- Paper Take-up: Reel standard, optional take-up assembly available
- Paper Drive: Zero weave, 8 or 16 speeds
- Calibration: Operate, zero, calibrate, attenuator
- Overload Indicator: each channel
- Timing Marker: one/sec or remote; second marker optional

Write, or see your local Offner Representative,
for Bulletin O64-1039 on the Type SC Dynograph®

Beckman®

INSTRUMENTS, INC.

OFFNER DIVISION

SCHILLER PARK, ILLINOIS • 60176

INTERNATIONAL SUBSIDIARIES: GENEVA, SWITZERLAND; MUNICH, GERMANY; GLENROTHES, SCOTLAND; PARIS, FRANCE; TOKYO, JAPAN; CAPE TOWN, SOUTH AFRICA

red light source has also been developed. Lasers look promising as infrared light sources since they would permit faster scanning of the target.

Center of the Army's night vision effort is the Engineer Research and Development Laboratories, Ft. Belvoir, Va.

Industrial electronics

Squeeze on lemons

Catching lemons on the assembly line is a constant goal of auto makers. Now the Chrysler Corp. plans to use computers for quality control on all of its 1965 models.

The move will cost \$2.4 million a year in leasing charges, according to Fred M. Glassford, a Chrysler vice president, but that comes to only about \$1 a car. He says that IBM 1710 systems are already in use at the Dodge assembly plant in Mantramk, Mich., near Detroit, and at the Los Angeles plant where Plymouths, Valiants and Dodges are assembled.

How it works. At the newest installation—the Plymouth assembly plant in Detroit—the assembly line is broken down into seven major sections from body-weld to final water test. Each of the seven is subdivided into production, inspection and repair. Inspection report forms in the assembly sections are coded into three-digit numbers from 000 to 999 with each number representing an auto part.

If an inspector in the final line section notices that section personnel must tighten the inside handle of the right front door, he circles the proper code number on the form. When the vehicle and the form arrive at the data collection station at the end of the assembly section, the operator removes the form, places it in an appropriate slot and key-punches the code number. The data speeds to the computer and out through a teletypewriter in the office of the departmental superintendent, who can quickly note trends.

The system includes a PM In-

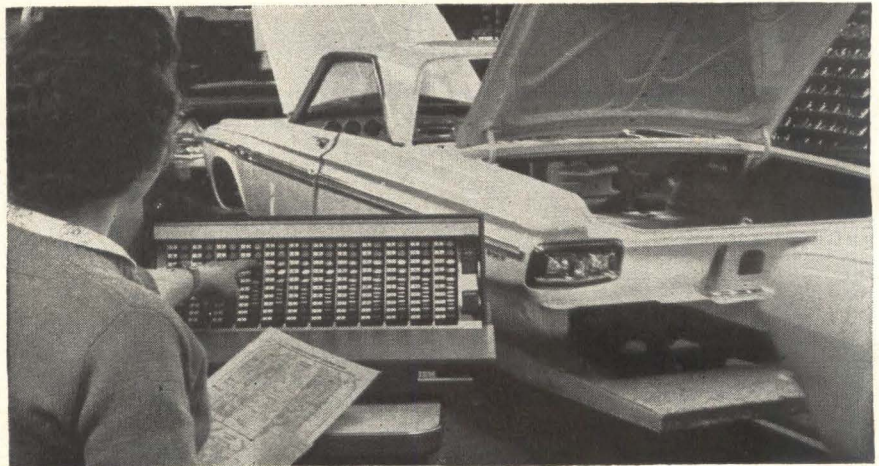

In goes another report, maybe a loose bolt.

terface, developed by the Performance Measurements Co. of Detroit., which transmits computer data instantly to teletypewriters in the plant. This is said to eliminate complex cabling and to permit the computer to put out information at 10,000 characters a second.

Future applications of the system will include measuring performance capability of the car on the assembly line—or “closing the loop.”

Instrumentation

Magnetic mysteries

The Russell Varian Castle Rock Observatory, to be built on a crest of the Santa Cruz mountains overlooking Saratoga, will be California's first geomagnetic observatory. It will be operated by the U. S. Coast and Geodetic Survey.

The land on which the observatory will be located is owned by the Varian Foundation, a nonprofit organization set up under the will of Russell Varian, who, with his brother Sigurd, invented the klystron and established Varian Associates, Palo Alto, Calif. Varian Associates will construct buildings and provide access roads and utilities. After construction, the company will transfer title to the foundation which will make the facility available to the Survey.

Only four geomagnetic survey stations are now located in the con-

tinental United States. They are at Fredericksburg, Va., Dallas, Texas, Boulder, Colo., and Tuscon, Ariz. The Varian Observatory will link an otherwise complete chain. Two other U. S. observatories are located in Hawaii and Alaska.

The new observatory will pioneer in the application of new instruments to geomagnetic research.

Magnetosphere. Interest and activity in magnetic field measurements has increased with space exploration activity.

There have been several theories attempting to explain magnetism around the earth. Latest is that there is a movement of currents through the earth's center. According to the theory, the earth's magnetism may even reverse, and in fact, some theorists claim that it has reversed several times in the past million years. However, some prominent physicists, while agreeing that currents passing through the earth cause the magnetic fields, do not go along with the reversal-of-field theory.

Isolation from outside electrical and magnetic disturbances was the prime consideration in choosing the location of the observatory. A bonus feature is that the observatory will be located very nearly on top of the San Andreas earthquake fault. To date there is no proof of correlation between earthquake activity and magnetic variations but scientists hope to gather some meaningful data on both of these disturbances.

COMPLETELY
GNU

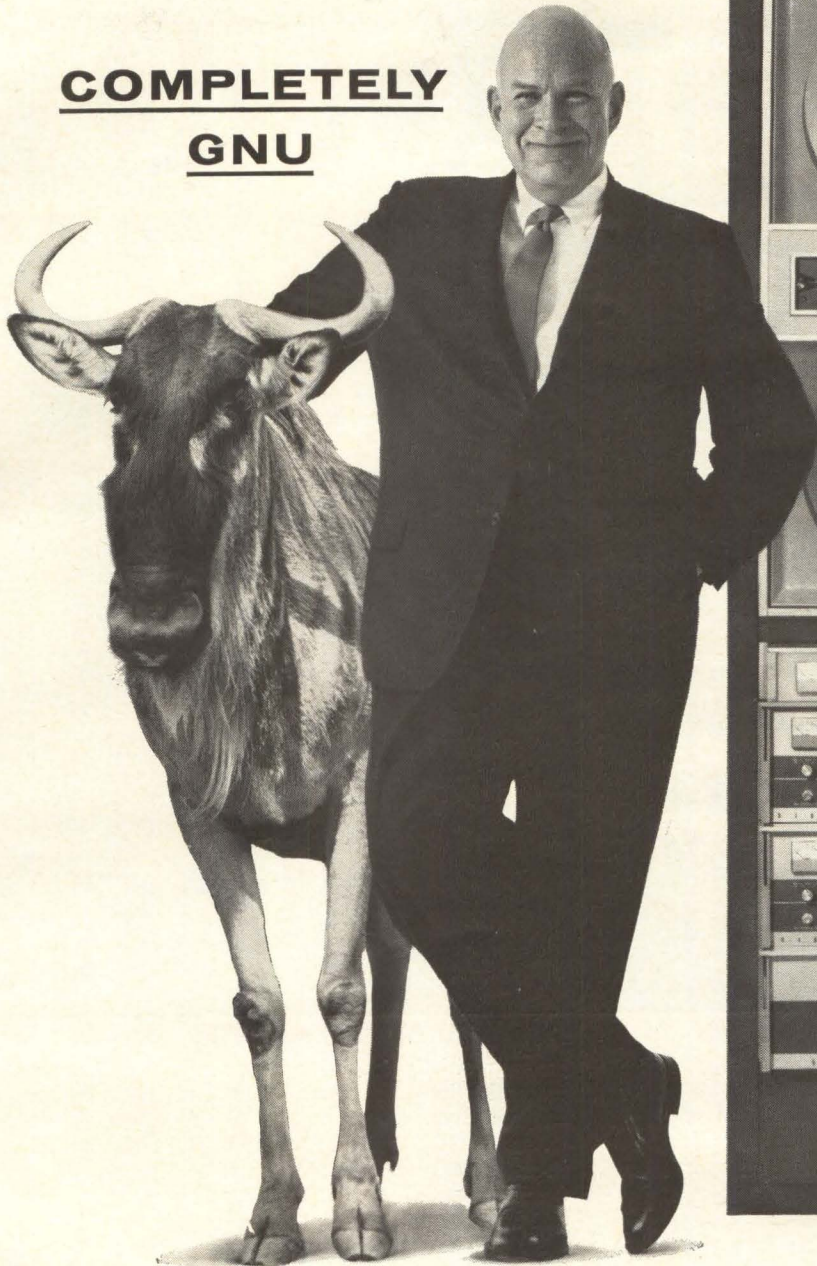

MINCOM'S NEW TIDAX 1.5-mc RECORDER/REPRODUCER

The new TIDAX is a head-on approach to your problems in telemetry and general instrumentation. This high-performance Recorder/Reproducer provides a full fourteen 1.5-mc tracks in one rack — with fully automatic equalization at all speeds. Wideband FM (DC to 500 kc) is available without modification. Signal-to-noise ratio (RMS/RMS) is 25 db at all speeds. TIDAX telemetry capabilities include simultaneous post- and pre-detection recording in PCM, PCM/FM, PAM/FM, PACM and FM-type carrier systems. Mincom's exclusive DC Top Plate is rugged, simple and reliable — full dynamic braking, instant push-button speed control, tape change from 1/2" to 1" in less than ten minutes. Write today for details and complete specifications.

Mincom Division **3M**
COMPANY

300 South Lewis Road, Camarillo, California • 320 Shaw Road, South San Francisco, California • 529 Pennsylvania Building, 425 13th Street, N. W., Washington, D. C. • 135 West 50th Street, New York, New York • Post Office Box 272, Fairborn, Ohio • 1230 Orange Avenue, Winter Park, Florida • 2121 Santa Anna Avenue, Dallas, Texas • Eltron Engineering Sales, Inc., 246 Walnut Street, Newtonville, Massachusetts

10,000,000 torturous test hours later...

*A Wire Wound Resistor Failure Rate of
0.02%/1,000 Hours,
on Full Power at 125° C!*

The figures above are revolutionary in the technology of wire wound resistors. For this is a failure rate achieved under accelerated environmental conditions...with a failure being defined as any change in resistance in excess of $\pm 0.5\%$ on 1% tolerance units and 0.2% on .01% tolerance units when operated under full power at 125°C.

This is the fourth consecutive High Reliability Report by Daven in which a lowering of the failure rate has been achieved...and the progress continues!

Daven's High Reliability Resistor Program proceeds under a rigorously strict 100% testing program. Every resistor in this program is continuously tested, from the time the raw materials arrive at the plant through the multiple life tests that are conducted at full power for thousands of hours. Each test and production procedure is carefully documented. Resistors are vibration tested under power; have five temperature cycles; and are burned in for 100 hours at 125°C under full power. An IBM punched card facility collects, analyzes and tabulates data on every phase of the program. The confidence level for this program has been assumed to be 60%.

The Daven High Reliability Resistor Program provides production quantities of "documented reliability" units. This

program strictly identifies part number, performance and production lot with traceability back to individual operations and operators.

As a result, Daven wire wound resistors now participate in virtually every major missile high reliability program, including Syncom, Apollo, Gemini, Saturn, Minuteman, Polaris, Titan and many others.

Daven high reliability wire wounds are available in the following specifications:

Daven Type	Dia. (Inches)	Length	Max. Watts	Max. Volts	Max. Res. .001" Dia. Wire	Lead AWG
HR1282	.125	.312	.05	100	16K	#22
HR1258	.250	.30	.125	100	127K	#22
HR1250	.250	.50	.15	200	226	#20
HR1195	.250	.75	.25	300	511	#20
HR1257	.312	.812	.50	300	750K	#20
HR1252	.375	1.0	.75	600	1.5 Meg.	#20
HR1172	.500	1.0	1.0	600	2.0 Meg.	#20

For complete details on these resistors, and the High Reliability Program, write to Daven today!

DAVEN 
LIVINGSTON, NEW JERSEY

(201) WYman 2-4300 • TWX 201 992-7356 • Cable: DAVEN LIVINGSTON N J

familiar faces from the world's broadest line of indicating relays

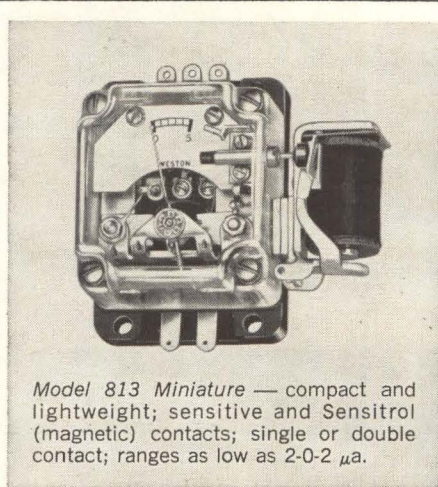

Model 813 Miniature — compact and lightweight; sensitive and Sensitrol (magnetic) contacts; single or double contact; ranges as low as 2-0-2 μ a.



Model 1092 Sensitrol—low cost; all purpose; magnetically shielded; wide range adjustability; ideal for use in engineering breadboard circuits.



Model 705 Sensitrol—highly sensitive; surface or flush mounted; single or double, fixed or adjustable contact; ranges as low as 0.5-0-0.5 μ a.



Model 723 Sensitrol—sealed; shielded; internal reset; solder terminals; single or double magnetic contact; ranges as low as 1-0-1 μ a.

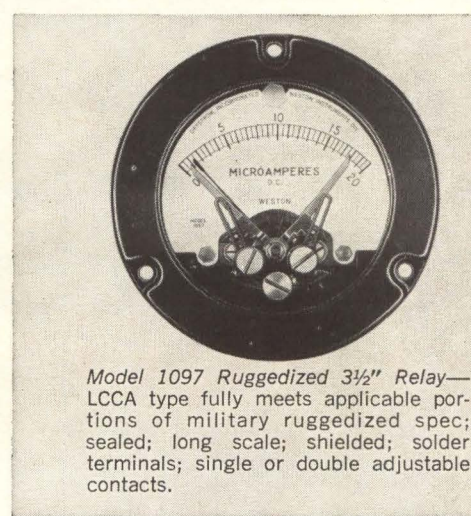

Model 1097 Ruggedized 3 1/2" Relay—LCCA type fully meets applicable portions of military ruggedized spec; sealed; long scale; shielded; solder terminals; single or double adjustable contacts.

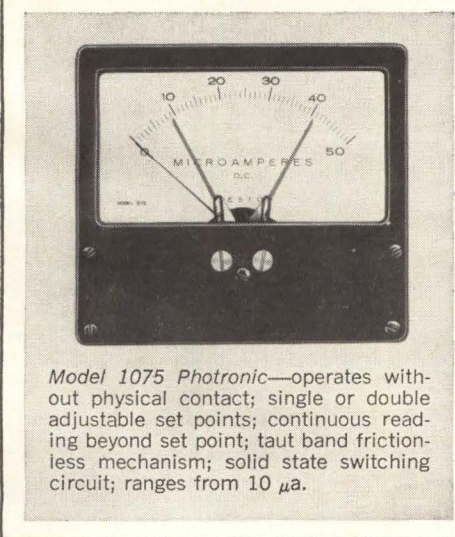

Model 1075 Photronic—operates without physical contact; single or double adjustable set points; continuous reading beyond set point; taut band frictionless mechanism; solid state switching circuit; ranges from 10 μ a.

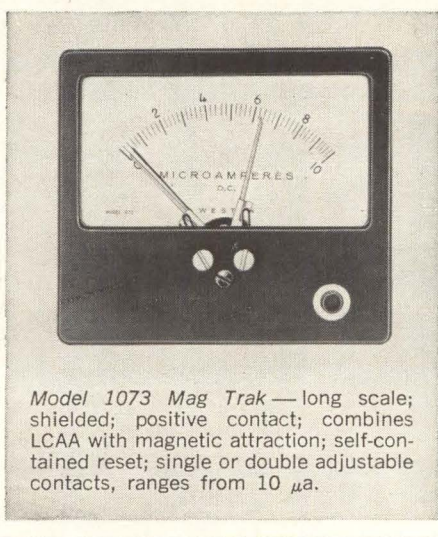

Model 1073 Mag Trak—long scale; shielded; positive contact; combines LCAA with magnetic attraction; self-contained reset; single or double adjustable contacts, ranges from 10 μ a.

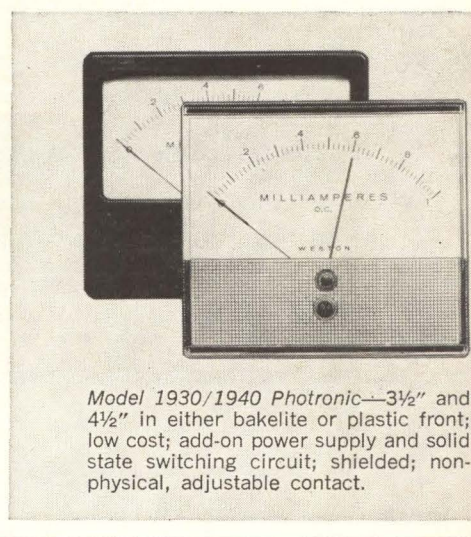

Model 1930/1940 Photronic—3 1/2" and 4 1/2" in either bakelite or plastic front; low cost; add-on power supply and solid state switching circuit; shielded; non-physical, adjustable contact.

world's standard in measurement and display
 **WESTON**
 INSTRUMENTS & ELECTRONICS

614 Frelinghuysen Ave.,
 Newark 14, New Jersey
 Division of
 Daystrom, Incorporated



Type 230-A

10 to 500 MC POWER AMPLIFIER

— for Low-Level Applications

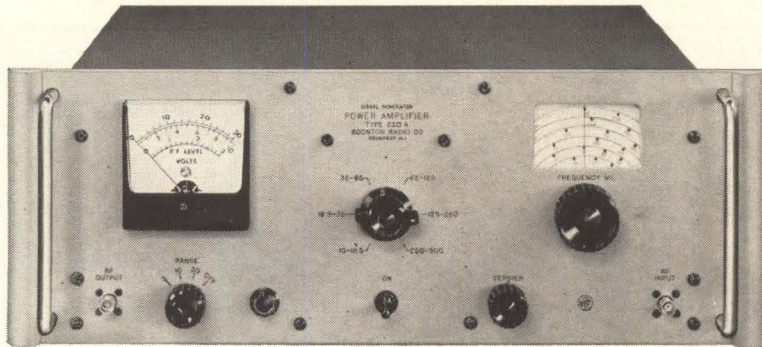

The BRC Power Amplifier Type 230-A is the ideal RF amplifier for low-level applications exhibiting a typical noise figure of 6 to 8 db. Three tuned, cascaded stages of grounded-grid amplification provide up to 30 db gain and a maximum power output of 5 watts. Typical applications include:

RECEIVER PRE-SELECTOR — The Type 230-A, when used as a pre-selector with conventional communications receivers, will readily provide fractional microvolt sensitivities.

TUNED SELECTIVE FILTER — BRC 230-A provides a convenient means for the selective amplification of RF signals in the 10 to 500 Mc. range with excellent rejection of undesired frequencies.

HARMONIC AMPLIFIER — The new power amplifier may be used to amplify desired harmonics in the output of signal generators and frequency synthesizers thereby extending their useful range.

FREQUENCY COUNTER PRE-AMPLIFIER — Type 230-A as a pre-amplifier for conventional frequency counters, such as the **hp** 524/525, will provide a 15 to 30 times improvement in input sensitivity. Remote, off-the-air frequency measurements of FM broadcast and communication transmitters may be readily performed.

RF MILLIVOLTMETER PRE-AMPLIFIER — When used as a pre-amplifier for RF millivoltmeters, such as the **hp** 411, the 230-A will provide 15 to 30 times improvement in sensitivity.

BOONTON RADIO COMPANY

A Division of Hewlett-Packard Company



GREEN POND ROAD, ROCKAWAY, NEW JERSEY

Tel. 627-6400 (Area Code 201) TWX: 201-627-3912 Cable Address: Boonraco

RF RANGE: 10 to 500 Mc.
BAND RANGES: 10-18.5 Mc. 65-125 Mc.
18.5-35 Mc. 125-250 Mc.
35-65 Mc. 250-500 Mc.

RF GAIN: 30 db (10-125 Mc.)
27 db (125-250 Mc.)
24 db (250-500 Mc.)

RF BANDWIDTH: >700 Kc.* (10-150 Mc.)
>1.4 Mc.* (150-500 Mc.)

*Frequency interval between points 3db down from max. response

RF OUTPUT:

RANGE: Up to 15 volts*

*Across external 50 ohm load
IMPEDANCE: 50 ohms.

CALIBRATION:

0.2 to 3 volts f.s.;
increments of approx. 5%.

1.0 to 10 volts f.s.;

increments of approx. 5%.

2.0 to 30 volts f.s.;

increments of approx. 5%.

ACCURACY: ±1.0 db of f.s. (10-250 Mc.).

±1.5 db of f.s. (250-500 Mc.).

LEAKAGE: Effective shielding is greater than 40 db.

RF INPUT:

LEVEL: ≤0.316 volts* (10-125 Mc.)

≤0.446 volts* (125-250 Mc.)

≤0.630 volts* (250-500 Mc.)

*For 10 volt output into 50 ohms

IMPEDANCE: 50 ohms

AM RANGE: Reproduces modulation of driving source 0-100% up to 5 volt max. carrier output

AM DISTORTION: <10% added to distortion of driving source

FM RANGE: Reproduces modulation of driving source except as limited by the RF bandwidth

FM DISTORTION: Negligible distortion added to distortion of driving source for deviations and modulation frequencies <150 Kc.

INCIDENTAL AM: <10% added to modulation of driving source at 150 Kc. deviation

MOUNTING: Cabinet for bench use; by removal of extruded strips suitable for 19" rack mounting

POWER REQUIREMENTS:
105-125/210-250 volts,
50-60 cps, 150 watts

Price: \$1200.00 F.O.B. Rockaway, N. J.

New Termination Design now gives you wide choice of lead materials...

in famous **VY**[®] axial-radial porcelain capacitors

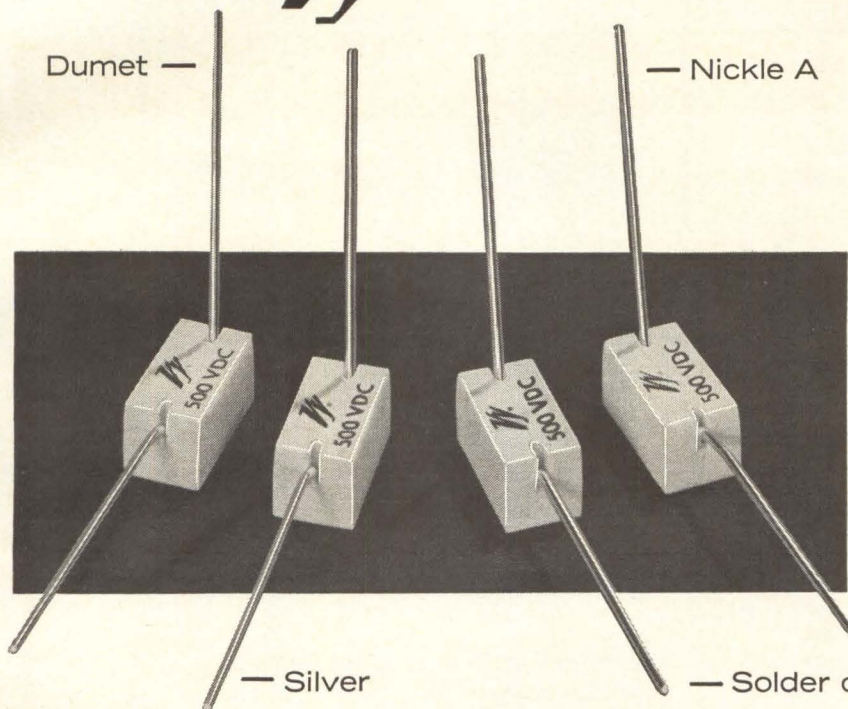

- * Conforms with MIL-C-11272
- * 0.5 to 5600 pf
- * -55° C to 125° C operation
- * 300 and 500 vdc

Supplied with:
Solder coated copper
Dumet
Nickle A
Silver

■ Now you can order these famous high reliability components with leads that are compatible with your connection requirements. New termination design guarantees positive contact and strengthens bond of leads to capacitor body. Axial-radial configuration saves board space, and gives greater flexibility to circuit wiring. Available with zero temperature coefficient as well as standard +105 ppm/°C... offers the exceptional electrical and physical characteristics inherent in all "VY" Capacitors. Write for data sheet containing complete specifications.

©Vitramon, Inc. 1964

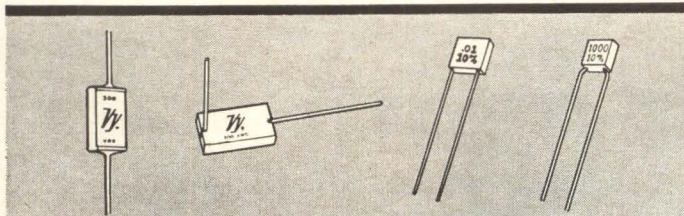

Vitramon
INCORPORATED

BOX 544 • BRIDGEPORT 1,
CONNECTICUT, U.S.A.

In United Kingdom contact:
Vitramon Laboratories
Limited
45 Holloway Lane
Harmondsworth, Middlesex
England

KLEIN PLIERS *Speed up electronic wiring*

When the crystal set was a seven-day wonder, Klein long nose pliers were used to adjust the cat's whisker. Through the era of B and C battery sets, Klein kept pace by providing pliers specially adapted for electronic wiring.

Today, more than 100 different styles and sizes of Klein pliers are available to provide the exact tools needed for any job. Klein engineers have developed a special plier for wiring printed circuits; a high hardness

plier for cutting nickel ribbon wire; a transverse end cutting plier for cutting closely in confined spaces; extremely small pliers for wiring midget assemblies—and many others.

Klein has also developed special pliers to do special jobs requested by electronic manufacturers.

For better work done more quickly and at lower cost, be sure the pliers you use are exactly suited to the job . . . made by Klein, of course, "Since 1857."

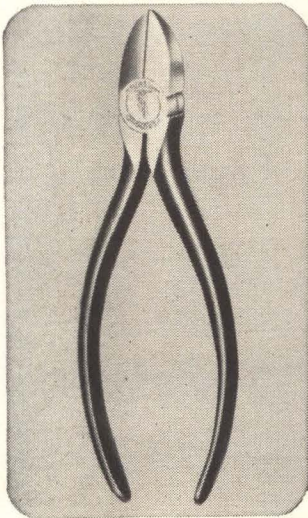

202-5C Oblique Cutting Plier with narrow nose. Available with coil spring. 5½-, and 6-in. sizes.

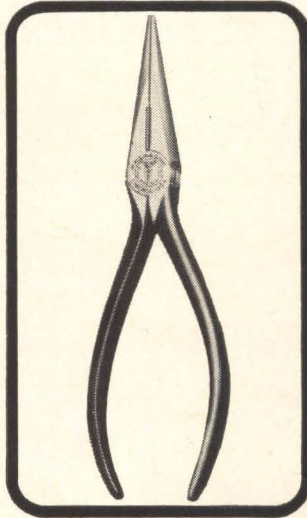

203-5C Long Nose Side Cutting Plier. Available in 5½-, 6½- and 7-in. sizes. Supplied with coil spring.

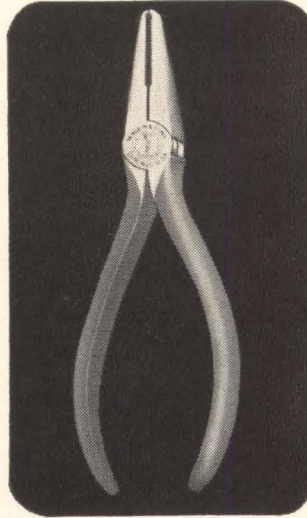

204-6C Transverse End Cutting Plier, 6-in. long. Supplied with coil spring to hold jaws open.

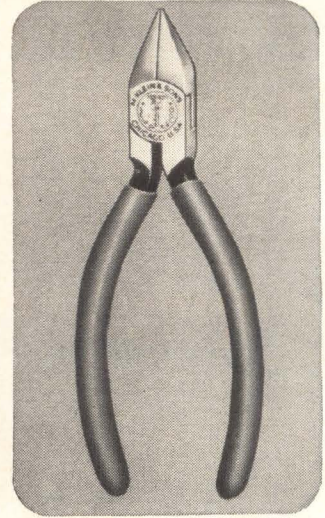

D209-5C Lightweight, Pointed Nose, Flush Cutting Plier. Supplied with coil spring to hold jaws open.

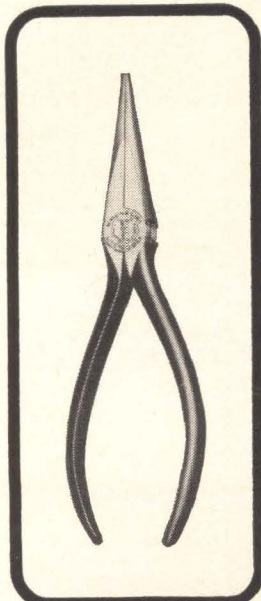

301-5C Long Nose Plier. Available in 5½-, 6½- and 7-in. lengths. Coil spring.

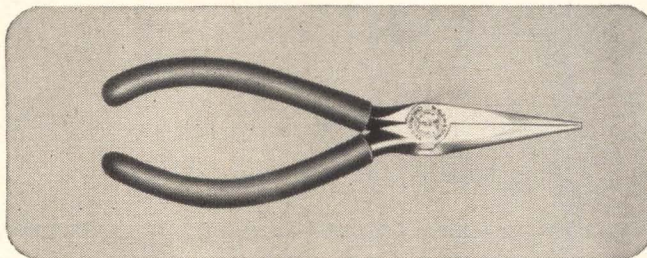

D307-5½C Slim Long Nose Plier for reaching into confined spaces. Yellow plastisol handles. Supplied with coil spring to hold jaws open.

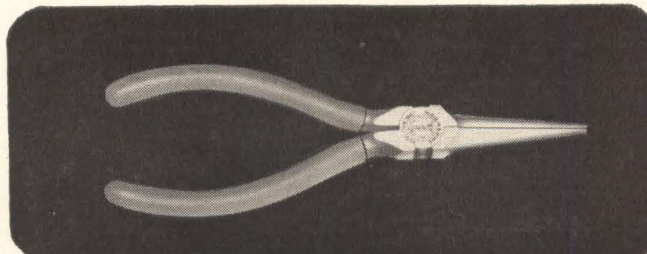

D310-6C Slim Long Nose Plier. Handles are yellow plastisol covered. Supplied with coil spring to keep jaws open.

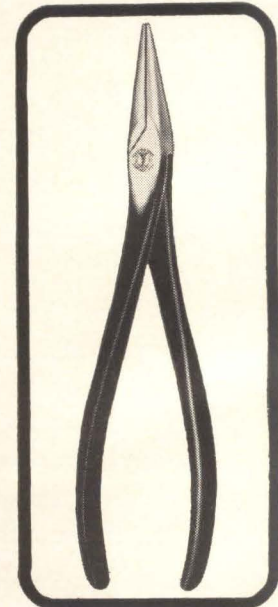

314-8 8-in. Long Nose Plier. Jaws have knurl.



Mathias KLEIN & Sons
Established 1857 **Chicago, Ill., U.S.A.**

INCORPORATED

7200 McCORMICK ROAD, CHICAGO 45, ILL.

See Your Distributor

Foreign Distributor: ITT Export Corporation, New York

*looks
good,
doesn't
it?*

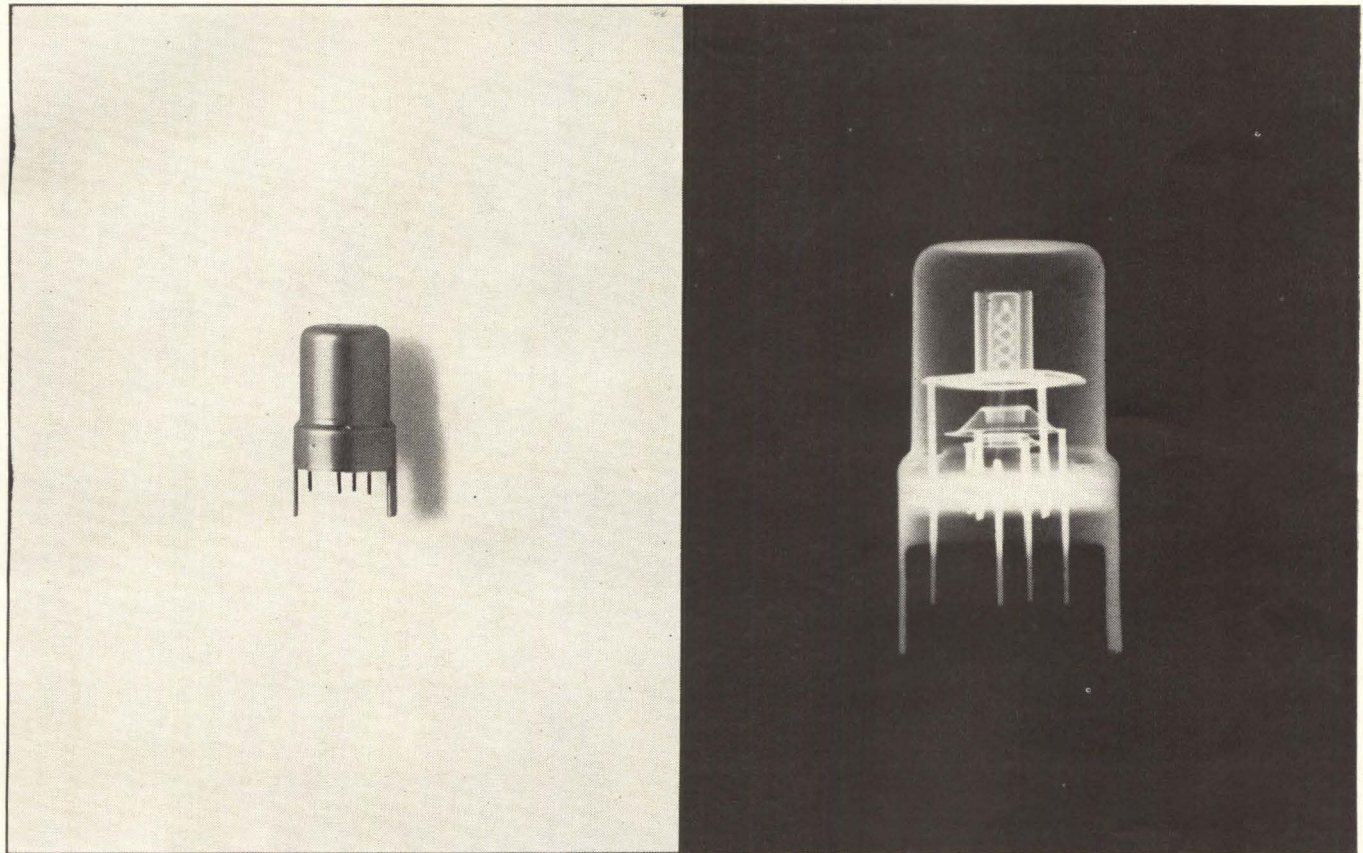

*...and you're sure it is when you
look at it the "AnSCO Way"!*

Often a tiny defect can escape most methods of detection. That's why so many companies depend on AnSCO Industrial X-ray films to make the final check on their components.

No method of non-destructive inspection shows up tiny imperfections (especially in tiny components) more clearly or quickly than a radiograph on AnSCO Superay® "H-D" X-ray film.

This Class I film is especially designed for high definition radiography. Its ultrafine grain and high contrast provide the ultimate in image quality. Although used primarily with low voltage tech-

niques, Superay "H-D" maintains its high definition characteristics and image quality throughout the full KvP range.

Make your final checks on components the "AnSCO Way"... it's the sure way. Ask your AnSCO X-ray Products Representative for full details about AnSCO Industrial X-ray films and chemicals. He's always at your service.

gaf AnSCO
X-RAY PRODUCTS
GENERAL ANILINE & FILM CORPORATION
BINGHAMTON, NEW YORK

NEW LAMBDA MODULAR-SUBRACK

All Silicon, 0-20 and 0-40 VDC, Power Supplies Offer Highest Performance AT LOWEST PRICES

RACK MOUNTED—
¼ and ½ rack models
can be mounted
in unique Lambda
rack adapters

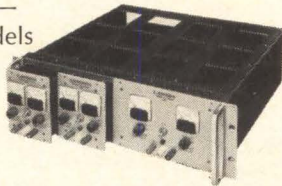

CHASSIS MOUNTED—
Flush chassis
mounting as
component
supply

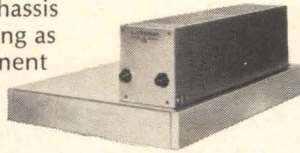

BENCH USE—
Compact, minimum
bench width, with
protective feet

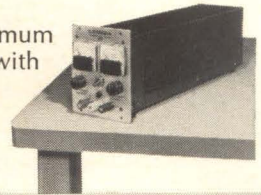

TEMPERATURE COEFFICIENT .015%/°C

LH SERIES
¼ AND ½ RACK MODELS
TO SERVE ALL YOUR NEEDS

REMOTELY
PROGRAMMABLE AND
CONTINUOUSLY VARIABLE

PERFORMANCE—
GUARANTEED FOR 5 YEARS

MEETS RFI SPECIFICATIONS—
MIL-I-26600, Class 3

WIDE VOLTAGE
AND FREQUENCY RANGE—
105-135 VAC, 45-480 cps

CONVECTION-COOLED—
no blowers, no external heat sinks

SERIES/PARALLEL OPERATION
and ± output to a common reference

REGULATION—Line or Load—
.015% or 1 MV whichever is greater

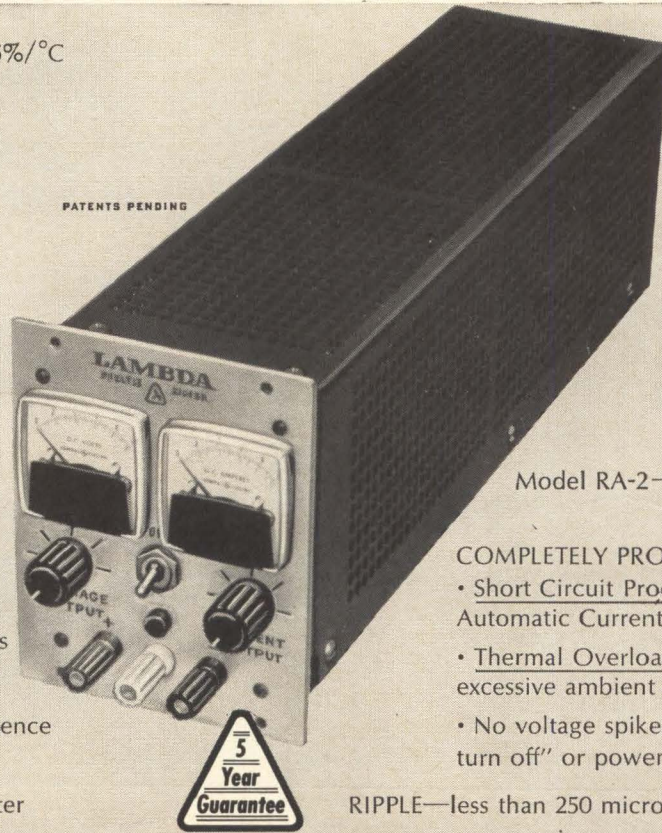

RACK ADAPTERS

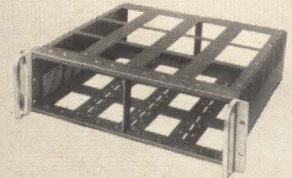

Model RA-1—for ruggedized mounting and use with chassis slides. Features front panel insertion Price \$60.00

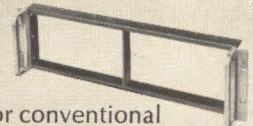

Model RA-2— for conventional rack mounting. Price \$25.00

COMPLETELY PROTECTED

- Short Circuit Proof—Continuously Adjustable Automatic Current Limiting
- Thermal Overload Protection against excessive ambient temperatures
- No voltage spikes due to "turn on, turn off" or power failure.

RIPPLE—less than 250 microvolts rms and 1 millivolt P-P

CONDENSED TENTATIVE DATA

DC OUTPUT—VOLTAGE REGULATED FOR LINE AND LOAD

MODEL	VOLTAGE RANGE	CURRENT RANGE AT AMBIENT OF: (1)				SIZE			CHASSIS (2) MOUNTING	PRICES	
		30°C	50°C	60°C	71°C	H	W	D		NON-METERED	METERED (3)
LH 121	0-20V	0-2.5A	0-2.0A	0-1.7A	0-1.5A	5 1/16"	4 1/16"	15 1/16"	\$154	\$159	\$184
LH 122	0-20V	0-4.5A	0-3.5A	0-3.0A	0-2.5A	5 1/16"	8 3/8"	15 1/16"	\$220	\$225	\$250
LH 124	0-40V	0-1.25A	0-1.1A	0-1.0A	0-0.75A	5 3/16"	4 1/16"	15 1/16"	\$149	\$154	\$179
LH 125	0-40V	0-2.5A	0-2.1A	0-1.8A	0-1.5A	5 1/16"	8 3/8"	15 1/16"	\$229	\$234	\$259

(1) Current rating applies over entire voltage range

(2) Non-metered models with flush panel (add suffix S to model number)
LH 121-S and 124-S: 4-5/16" × 3-13/16" × 15-5/16"
LH 122-S and 125-S: 4-5/16" × 8" × 15-7/16"

(3) Metered models with front panel controls (add suffix FM to model number)

SEND FOR COMPLETE LAMBDA CATALOG.



LAMBDA ELECTRONICS CORP.

515 BROAD HOLLOW ROAD • MELVILLE, L. I., NEW YORK • 516 MYRTLE 4-4200

SALES OFFICES AND REPRESENTATIVES CONVENIENTLY LOCATED IN MAJOR CITIES

Circle 42 on reader service card

Washington Newsletter

April 20, 1964

Checking on the snoopers

Books that whip up public interest are favorite starting points for Congressional investigations. Rachel Carson's "Silent Spring" is now bringing tighter control of the use of pesticides. **Investigators for the House and Senate were hoping for the same kind of reaction to two recent books on electronic snooping, but so far, they are disappointed.**

Thus far Vance Packard's "Naked Society" and Myron Brenton's "Privacy Invaders" haven't sparked enough interest to support the sort of broad inquiry into the use of electronic listening devices the Senate Constitutional Rights Subcommittee made a decade ago.

However, hopes for a broad look at the issue haven't been abandoned. Attention is now focused on a scholarly study being made with Carnegie Corp. funds by Alan F. Westin, an associate professor of public law at Columbia University, for the New York City Bar Association. Westin will hold a symposium in Tuxedo, N. Y., next month, and publish a report later.

He intends to cover the utility of laser beams for eavesdropping, closed-circuit concealed television surveillance, microminiature radio transmitters, lie detectors used without a subject's awareness, subliminal and subaudial message projection, brainwave analysis, and the increased pace of computer processing of information on millions of private individuals. **He will focus on the laws—or lack of them—affecting these developments, and thus will provide fodder for legislators.**

The House Government Operations Committee is currently involved in a critical investigation of government agency use of telephone listening gadgets and lie detectors. It is already satisfied that polygraphy use has gone far beyond national security requirements, and is used in routine personnel work.

Soviet asks to join US satellite setup

The latest bid to participate in the Communication Satellite Corp. system comes from the Soviet Union. Soviet and corporation officials have picked a time and place for hard negotiations: June 15 at Geneva.

The meeting early this month of European countries seeking to participate in the satellite system will be followed by another in May. No firm agreements have been reached, but there has been some progress, corporation officials say.

Meanwhile, the Federal Communications Commission is processing requests from about 210 private companies to buy corporation stock. Stock sales—which were to have been this month—are not expected before May. One reason for the delay is an impending decision by the military to buy services in the commercial system. **This would mean an annual fee of \$25 million or more for the company.**

Within the next week or so, contractors for the basic satellite system are scheduled to be selected. Two or more companies will conduct six-month studies before a system is selected.

Proprietary data rules changing

The Defense Department may soon revise the Armed Services Procurement regulations governing acquisition of technical data from military contractors. **The changes would let the military be more selective in the data it seeks, while still preserving the government's right to any informa-**

Washington Newsletter

tion needed for subsequent competitive procurement. Decisions on data needed will be made early in the contract negotiations. **The concept of proprietary data is expected to be dropped.**

Under present regulations for research and development contracts, if an item is developed wholly at government expense, the contractor must supply all data necessary for reproduction of the item, including proprietary data (manufacturing and other secrets), with unlimited rights. However, in supply contracts the policy is to acquire only data needed for operation and maintenance, plus sufficient descriptive data to permit subsequent procurement from the same source or an adequate substitute from others.

No change is contemplated in the regulations on data developed wholly at government expense. But for both R&D and supply contracts where items are developed at private expense, the distinction between proprietary data (the definition of which has long caused government-industry controversy) and data otherwise readily available to the government would be abolished. Instead, **the government would spell out in the initial contract the data it feels entitled to** and would define the specific purposes for which it is to be used. But the government would not call for the data unless it actually needs it. Prime contractors, in turn, would require their subcontractors to follow the same rules. At present, data wanted by the government is sometimes difficult to get because subcontractors refuse to turn it over to prime contractors.

Conversion aid spelled out

A newly adopted Armed Services Procurement Regulation makes it clear that the Defense Department will help pay for the cost of diversification planning by military contractors facing a substantial loss of defense business. **This aid has been available for some time, but some contractors apparently didn't know it.** The new regulation says plainly that the government can defray the cost of long-range planning for adjusting to the loss or reduction of defense business. The cost may be allocated as an indirect cost under a military contract. The government aid extends only to planning—not to research, development and engineering costs leading to new products for sale to the general public. **And the Defense Department will participate only to the extent that the contractor's business is military in nature.**

Spectrum space referee

James D. O'Connell, who headed the Army Signal Corps from 1951 to 1959, has been given a new White House post. He will be special assistant to the President for telecommunications and director of telecommunications management. **His office will coordinate government communications requirements,** much as the Defense Communications Agency does now for the Pentagon. O'Connell is an assistant director of the Office of Emergency Planning, and has been an electronics consultant to a number of firms. **One of the controversial issues he will face is whether the government preempts more spectrum space than it actually needs while civilian needs are rising.**

Offer to Soviets

NASA may offer to join the Soviets in experiments with Relay I, an active communications satellite. Previous joint tests were with the passive balloon satellite, Echo II.

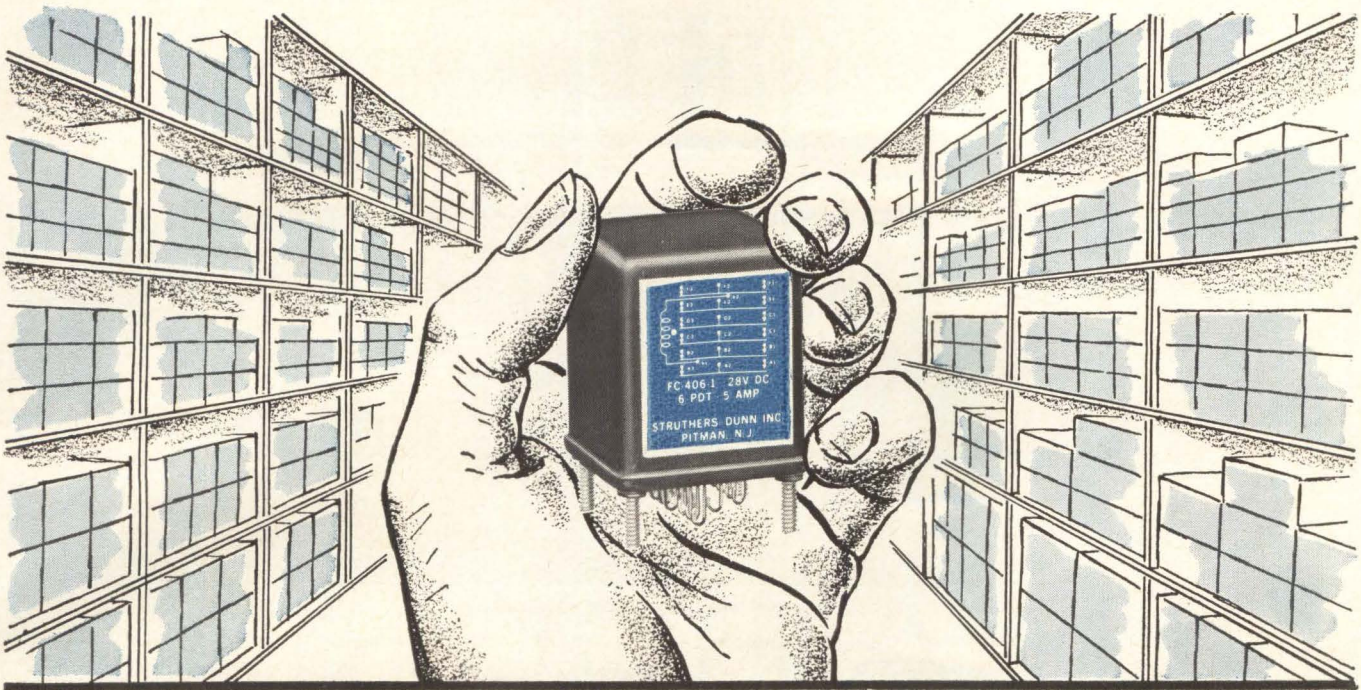

IN STOCK at Your Distributor's

Dunco 4 & 6 pole
balanced armature
Air Frame Relays
...to MIL-R-6106C

No waiting.

Your Struthers-Dunn stocking distributor has a complete stock of these Dunco Air Frame Relays.

The FC-400 — a 10-ampere, 4-pole double throw relay.

And the FC-406 — a 5-ampere, 6-pole double throw relay.

He has them both in 28 volt d-c, or 115 volt 400 cycle a-c models. And with plug-in or hook-type solder terminals.

For long life and exceptional reliability, we manufacture with non-gassing materials, clean often as assembly progresses, then hermetically seal each relay before it's permitted to leave the white room.

Standard models — to MS-25269-A1 and -D1; MS-25271-A1 and -D1; MS-25327-A1 and -D1; and MS-25329-A1 and -D1 — are available now.

For relays, see your distributor. For specifications and name of your nearest distributor, write Struthers-Dunn, Inc., Pitman, New Jersey.

STRUTHERS-DUNN, Inc.

PIONEERS IN SPACE AGE RELAY RELIABILITY

Member, National Association of Relay Manufacturers



SALES ENGINEERING OFFICES IN: Atlanta • Boston • Buffalo • Charlotte • Cincinnati • Cleveland • Dallas • Dayton • Encino • Englewood • Houston • Kansas City • Las Vegas • Memphis • Newark • New York • Orlando • Pittsburgh • St. Louis • Salt Lake City • San Antonio • San Diego • San Mateo • Scottsdale • Seattle • Southfield • Wichita • Wilmette. **Canadian Licensee:** Renfrew Electric Co., Ltd., Toronto. **Export Department:** 1505 Race St., Philadelphia 2, Pa., U.S.A.

Fairchild Controls' Industrial Potentiometers Can Save You 20%

FAIRCON

FAIRCHILD'S NEW LINE GUARANTEES HIGHEST QUALITY AND CUTS THE HIGH COST OF POTENTIOMETERS

Faced with the problem of high cost for high performance? The FAIRCON line offers a new high level of precision for industry—bridging the gap between low quality commercial grades and ultra

sophisticated MIL spec potentiometers.

Top Performance Plus Substantial Savings Too

Check the FAIRCON LIN-Chart below. The white band in the chart indi-

cates the standard high linearity available in the FAIRCON F200 two-inch, single-turn potentiometer. If your requirements fall within this broad range, you can save UP TO 20% over the complete MIL spec unit you may now be using. Similar savings (and precision) are available throughout the entire FAIRCON line of single-turn and multi-turn potentiometers.

You save money with Fairchild GUARANTEED quality and performance—and with quality potentiometers especially engineered and manufactured for large volume industrial applications. Whatever your control problems... computing... instrumentation... process control... communications... involving potentiometers, send us your requirements, blueprints and specifications for prompt appraisal and quotations. FAIRCON for quality... *at a price commensurate with overall system cost.*

LIN-CHART FOR FAIRCON F200 POTENTIOMETER

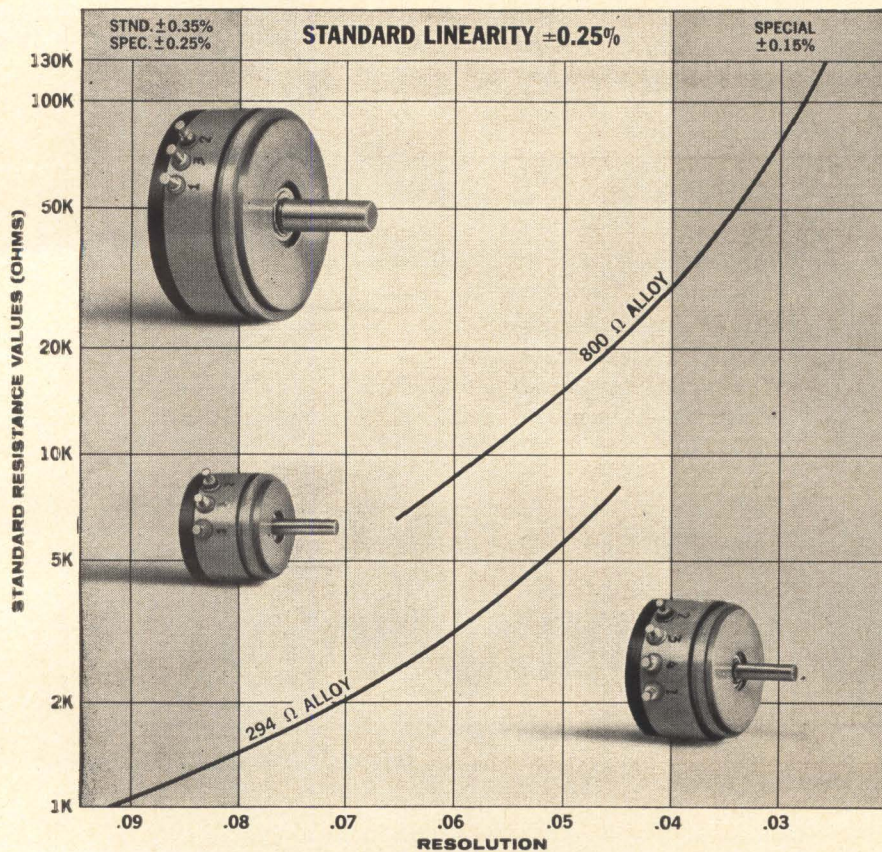

Chart and specifications for complete FAIRCON line available on request.

Similar Savings on Trimmers

You can save with volume requirements for industrial trimmers too. Check Fairchild Controls' prices on new FAIRCON trimmers.

FAIRCHILD

CONTROLS

A DIVISION OF FAIRCHILD CAMERA AND INSTRUMENT CORPORATION

225 PARK AVENUE, HICKSVILLE, L.I., NEW YORK
 TELEPHONE: (516) WE 8-5600. TWX: 516 433-9146
 CABLE: FAIRCON-HICKSVILLE, NEW YORK, U.S.A.

ASTRODATA

MORE THAN 1,000 STANDARD ADC'S FROM A LIBRARY OF 13 BASIC CARDS

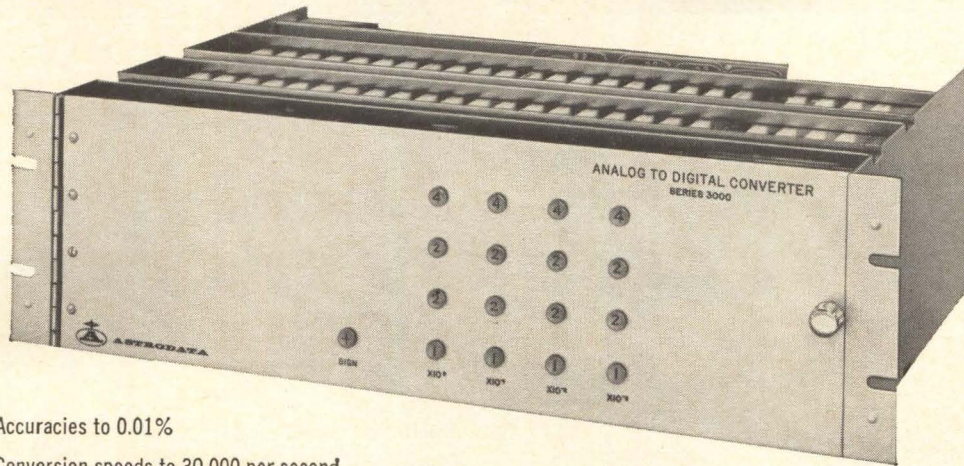

- Accuracies to 0.01%
- Conversion speeds to 30,000 per second

Astrodata low cost Series 3000 Analog-to-Digital Converters meet the requirements of virtually all data acquisition systems with 1088 standard production models. From these you can select the full scale range . . . speed . . . accuracy . . . sample-and-hold . . . resolution . . . output format best suited to your specific system.

Designed for easy integration into existing or new

data acquisition systems, standard features include individually buffered data output lines . . . adjustable output logic levels (clamped) . . . wiring installed for future addition of input amplifier or sample-and-hold circuits . . . front panel readout of data (including polarity) . . . and isothermal environment of converter network and reference voltage diode to assure maximum accuracy over wide temperature range.

Series 3000 ADC's ideal for use with time-multiplexed input data

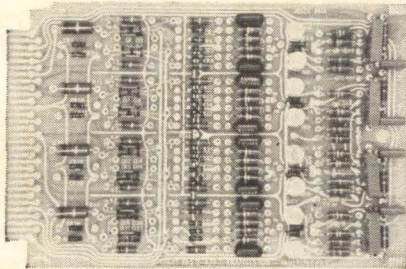

HIGH LEVEL MULTIPLEXERS

Model 155-83 low cost, high-level-input multiplexer module has been developed for high speed analog switching applications.

Inputs per card	6 one-wire or 4 two-wire
Input Voltage	± 5 volts
Switching Time	$< 5 \mu\text{sec}$
Crosstalk	$\pm 0.01\%$
Input Impedance	1000 megohms/number of switches in multiplexer group

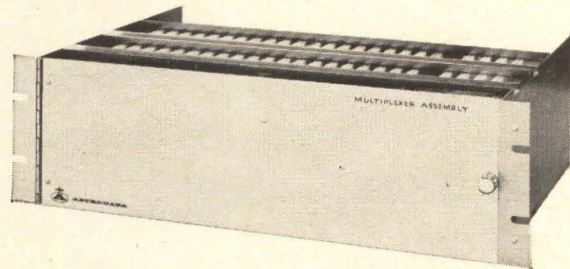

MULTIPLEXER ASSEMBLIES

Series 950 multiplexer assemblies consist of cards, shown at left, for single ended channels in multiples of 6 or differential channels in multiples of 4. Power supply and output buffer amplifier are included. Channel identification data can be furnished in binary or BCD form. The multiplexer channels can be addressed directly by computers or advanced sequentially to meet the requirements of specific systems applications.

17

Contact your nearest Astrodata representative today for a demonstration or write for technical literature giving complete specifications.



ASTRODATA INC.
240 E. Palais Road • Anaheim, California

SOME INSIDE FACTS ABOUT BALANCED ARMATURE RELAYS

High environmental relays of the same type look much alike, and have essentially the same components. It is how well the design integrates the components, and how well they

are manufactured, assembled and tested, that assure extra life and efficiency. Consider Leach's Series 9224, a 10 amp, 4PDT balanced armature relay:



Magnetic coil assembly

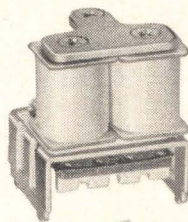

Efficient magnetic coil construction insures positive make. Coils are tested individually, not by sampling.

Balanced armature



Balanced armature assembly withstands high shock and vibration. Armature is special alphetized magnetic iron for maximum fatigue resistance.

Contact assembly

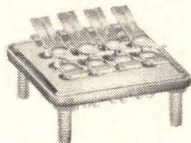

Special alloy contacts with maximum contact pressure and overtravel give extended life at maximum rated current.

Single actuating mechanism

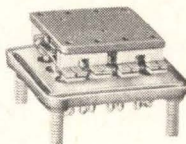

Single actuating mechanism of inorganic material, plus bifurcated contacts, provide reliable contact switching under minimum current as well as rated load conditions.

Arc suppression barriers

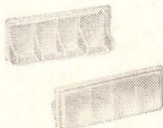

Inorganic arc suppression barriers permit 3-phase load ratings.

Header assembly



High quality glass seals minimize leakage and dielectric breakdown under extreme environments.

Advanced cleaning techniques and "white room" sealing assure contaminant-free construction.

Leach offers the most extensive line of high environmental balanced armature, crystal can and other standard types of relays. Leach also will design and produce custom relays with special capabilities to meet your most stringent applications. For prices on standard units, or to discuss custom orders, phone or write:

LEACH
CORPORATION
RELAY DIVISION
5915 Avalon Blvd., Los Angeles 3, Calif.
Export: Leach International S.A.

YOU ASKED FOR IT!

PRACTICAL SOLUTIONS TO RF PROBLEMS

A news bulletin for the exchange of views and information covering every aspect of RF Power Measurement, including stories on novel and exotic uses. Here you can ask questions, offer solutions, and suggest topics for discussion. There is nothing like it anywhere. A free subscription to "Watt's New From Bird" is yours for the asking.

NOW TELL US WHERE TO SEND IT

watt's new from BIRD

published and copyrighted 1964 by the bird electronic corporation
vol 1 no X

cleveland (solon), ohio 44139

A reader writes, "Can a scope be connected across a Termaline Wattmeter to observe modulation?" Answer - Yes, if it is audio AM. "WNFB #2 answered my waveform problem."

IS A LOAD A DUMMY? Most users think of a load as a resistor at the end of a line and that is that. We thought we might expand on this a little. ----- If the line dimensions around the resistor (Fig. 3) were chosen as $R/\sqrt{5}$ (e.g. $50/\sqrt{5} = 22$ ohms), the real part of the impedance remained at 50 ohms for frequencies about 2-1/2 times higher than before, but a capacitive reactance appeared from the start. This was corrected by a short series inductance and the 12" resistor

proper profile of the shell is a curve to which the length of the tangent to the axis is a constant, in other words a tractrix.



BIRD ELECTRONIC CORPORATION

CLEVELAND (SOLON) OHIO 44139
30303 AURORA RD., Phone 216-248-1200

Quality Instruments for RF Power Measurement



Termaline® Wattmeters



Hi-Power Attenuators



Coax RF Filters



Thru-line® Wattmeters

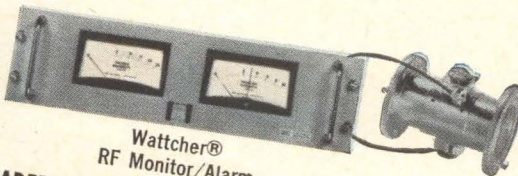

Wattcher® RF Monitor/Alarm

CIRCLE 230 ON READER SERVICE CARD

9 out of 10 RESISTOR DELIVERIES MADE FROM STOCK...

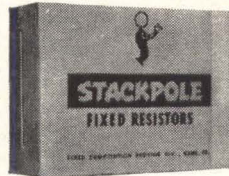

...and that 10th one goes the next day!

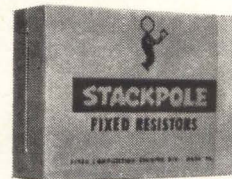

Big inventories of $\frac{1}{4}$, $\frac{1}{2}$, 1 and 2 watt fixed composition resistors permit Stackpole to fill orders fast—make same day shipments nine times out of ten. Production lines in America's biggest tv, radio, phonograph and industrial plants roll without a hitch. That's one side of Stackpole dependability in resistors.

On the other side—**never a catastrophic failure in service.** These rugged resistors exceed all military and industrial requirements; defy erratic resistance changes in severe environments.

Run your own test. Challenge us on "same day" shipments. Better yet, from your standpoint, test these failure-proof resistors in your own lab. For complete specs (or to place an order) write or phone Electronic Components Division, Stackpole Carbon Company, Kane, Pa. Phone 814-837-7000. TWX 814-826-4808.



STACKPOLE
Electronic Components Division

FORMICA® is our trademark for various products, including our brand of industrial plastics.



FORMICA®
FR-200

• **Flame retardant** • **High strength** • **No premium price**

FORMICA FR-200 paper-phenolic laminate . . . for flame retardant printed circuitry. NEMA grade FR-2. Meets properties of MIL-P-3115C. Burn time: 4 sec. (ASTM D635-65 test modified to show burn time after 1st ignition.) High flexural strength (flatwise average value: 21,500 psi lengthwise, 17,500 psi crosswise.) Excellent insulation resistance. High solder blister resistance . . . in excess of 15 sec. at 500°F. Good solvent resistance: 10 min. in trichloroethylene. Can be punched cold up to and including 1/16", warm (140° to 180°F) up to and including 3/32". Available copper clad or unclad. And you pay no more for FORMICA FR-200 than you would for a top-quality XXXP grade.

WRITE FOR DATA ON:

- Electrical /electronic grades
- Copper clad laminates
- Mechanical grades
- Engraving stock

FORMICA CORPORATION
DEPARTMENT I-421, CINCINNATI 32, OHIO
subsidiary of 

FORMICA®
industrial plastics

See The Formica World's Fair House at New York for the newest and best in carefree contemporary living.

On exhibit at Spring Joint
Computer Conference, April 21-23

New from Potter...

TRANSPORTS "matched" to the performance of your computer

You're looking at the business end of a Potter MT-36, one of a family of 3 new digital magnetic tape transports now available for prompt delivery to value-conscious buyers.

Compact . . . reliable, each of these new vacuum-column tape memory systems was designed to serve a specific data range. You don't have to pay for performance you can't use. All of these new units look alike, operate alike, are designed alike — with most parts interchangeable. You can get the benefits of standardization, yet still have choice of performance and price.

PACKING DENSITIES TO 800 bpi



MT-24

1-36ips —
data transfer
to 28.8kc

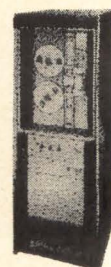

MT-36

1-50ips —
data transfer
to 40kc

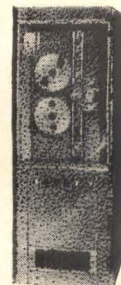

MT-75

1-75ips —
data transfer
to 60kc

IBM or other computer formats

Interested? Call Potter today (516) OV 1-3200

POTTER



INSTRUMENT CO., INC.
151 Sunnyside Boulevard, Plainview, New York

Circle 52 on reader service card

Depositing active and passive thin-film elements on one chip

A thin-film transistor offers hope of removing the last obstacle to a long-time goal in microcircuitry

By Harold Borkan

RCA Laboratories, Princeton, N.J.

Thin-film transistors offer hope of clearing the last obstacle to attaining a long-time goal of microelectronics. They could allow all-thin-film circuits containing both active and passive components to be deposited on a single substrate in large volume and at low cost. One device being studied is the insulated-gate thin-film transistor (TFT).

Although the device is still in the laboratory stage of development, the life and stability observed in many of the versions have been encouraging. TFTs have operated many months after fabrication, and continuously for many weeks. They have been used experimentally in digital as well as linear circuits, and will eventually provide the circuit designer with the building blocks for integrating many different kinds of circuits.

Development is far enough along so that it is possible to relate electrical characteristics to physical parameters, describe operating characteristics and indicate circuits where the TFT may be particularly useful.

Many advantages

The TFT is well suited as the active element in a completely integrated circuit. It is small, has the desirable electrical characteristics of high input impedance, high transconductance and large gain-bandwidth product, and can be deposited upon an insulating substrate.

Thin-film resistors and capacitors can also be formed easily on the same substrate, with the important advantage that their electrical characteristics are similar to their conventional-component counterparts. In contrast, passive components that are prepared on semiconducting or other noninsulating substrates are not usually equivalent to conventional ones. Diffused resistors have lower tolerances and the capacitors have smaller values

because of present limitations in semiconductor technology.

The TFT is a field-effect transistor that consists of a metal gate electrode separated by a thin insulating film from a semiconductor layer that is usually cadmium sulfide. Construction details are given in the panel on p. 54. Current flows through a channel in the semiconductor between two electrodes called the source and drain. Conductivity of this channel is controlled by the voltage applied to the insulated gate.

TFTs can also be used as diodes by connecting the gate and drain. Besides being entirely compatible with passive components, the triodes and diodes can be interconnected into large arrays of complicated circuits, possibly through automated deposition techniques. Thus the TFT should be of great interest to circuit designers.

Operating characteristics

The TFT is characterized by a plot of drain current as a function of drain voltage with the gate voltage as a parameter. Typical drain characteristics are shown in the oscillograms on p. 56 and, like those for conventional field-effect transistors, can be seen to resemble the characteristics of a pentode vacuum tube.

Due to the presence of the insulating layer, the TFT gate may be biased either positively or negatively with respect to the source without drawing appreciable gate current. At zero gate voltage, no appreciable current flows between source and drain. But when the gate voltage is made positive, this small current is enhanced by several orders of magnitude because a conducting channel is formed in the cadmium sulfide just under the insulator. In some units this current may be less than one microampere and increase to 5- or 10-milliam-

peres with positive bias, limited only by the power-handling capability of the TFT.

This type is called an enhancement TFT. The oscillogram on top is that of an enhancement TFT where the gate voltage required for onset of drain current (V_0) is about one volt. Only negligible current flows for gate voltage less than +1 volt.

The other kind of TFT operation, called the depletion mode, is similar to the mode of operation in a conventional field-effect transistor having a p-n junction at the gate. A depletion TFT has sizable drain current flowing at zero gate bias because of an initial built-in conductivity in the semiconductor. This drain current may be depleted by applying negative gate voltage or enhanced by positive gate voltage. The characteristics on the bottom

oscillogram are of a depletion unit with V_0 of about -1 volt and about 1 milliampere drain current flowing at zero gate bias.

Both types desirable

It is especially desirable to have both enhancement and depletion TFTs. Enhancement units are useful for direct-coupled applications since the quiescent d-c voltage of the output of one stage can match the quiescent voltage of the input to the succeeding stage. Depletion-type units are useful for input stages, detector stages and other applications where zero gate bias operation is desirable.

The TFTs whose oscillograms are shown are typical. Both units have transconductances (g_m) of about 4,000 micromhos and have similar character-

Insulated-gate TFT: how it's made, how it works

The insulated-gate thin-film transistor (TFT) is one of a variety of devices being examined by researchers looking for an active component for thin-film integrated circuits.

The devices under study fall into two categories—thin-film versions of conventional bipolar transistors, where both electrons and holes enter into the conduction process, and so-called majority-carrier devices where conduction is primarily by means of either hole or electron movement through the material.

Majority-carrier devices include the TFT and metal-base triodes. In the latter, "hot" carriers having relatively high energies are injected in either of two ways: by emission over a potential barrier that exists at a metal-semiconductor junction, or by tunneling through an extremely thin insulating layer.

All these devices are beset by fabrication problems of varying degrees, but the TFT appears to be furthest ahead in development.

Field effect

The TFT is a field-effect transistor. An early form of the field-effect transistor was described by Julius E. Lilienfeld in 1933.¹ In this device the conductivity between two electrodes was modulated by the potential applied to a third electrode—close to, yet insulated from, a semiconductor layer.

In 1952 Shockley described a "unipolar" field-effect transistor² in which the control electrode, the gate, consisted of a reverse-biased p-n junction in a semiconductor substrate. Many such field-effect transistors are now available commercially.

The insulated-gate field-effect transistor was first reported by P. K. Weimer,^{3,4} and its characteristics were described by Borkan and Weimer.^{5,6} The TFT is deposited upon an insulating substrate, usually glass, and is made entirely by evaporation techniques. Cadmium sulfide is usually used for the semiconductor substrate, but thin films of cadmium selenide have also been successful.⁷⁻⁹

S.R. Hofstein and F.P. Heiman¹⁰ have described another insulated-gate field-effect transistor. This device is formed in the surface of a single crystal of silicon. Although some of its physical mechanisms are similar to those in the TFT, differences in the nature of the semiconductor and structure produce some differences in characteristics and their utilization.

Construction technique

Two forms of TFTs that differ in evaporation sequence and electrode materials are shown at the left. The TFT on top shows a staggered-electrode arrangement, with the source and drain on the opposite side of the semiconductor from the gate electrode. The one on the bottom is the more recent coplanar-electrode structure¹¹ where all three electrodes are on the same side of the semiconductor.

In both structures the semiconductor consists of an evaporated layer of a substrate such as polycrystalline n-type cadmium sulfide less than one micron thick. The two insulator materials used most frequently are silicon monoxide and calcium fluoride. The insulator is quite thin, usually less than 0.1 micron. The gate electrode is deposited through a mask and centered over the source-drain gap. Gold or aluminum is satisfactory for the gate material in either structure.

The source and drain electrodes must make low-impedance, or ohmic, contacts to the cadmium sulfide. Evaporated gold underlying the sulfide and evaporated aluminum overlying the sulfide have been found to be satisfactory for these contacts.

In the typical experimental units the electrodes are 100 mils long. The source and drain electrodes are separated by a gap of 0.4 mil or 10 microns. The thickness of the layers have been exaggerated in the figure; the gap width is about 20 times the thickness of the sulfide.

To obtain the required high-resistivity semiconductor, the sulfide is deposited on a heated substrate and later baked in air. The sulfide is deposited in one vacuum system; and all the other fine-pattern evaporation takes place in another system equipped for precision-masking.

The staggered structure requires a reregistration of the pattern with the masks after the sulfide is deposited. The coplanar structure is easier to fabricate because it does

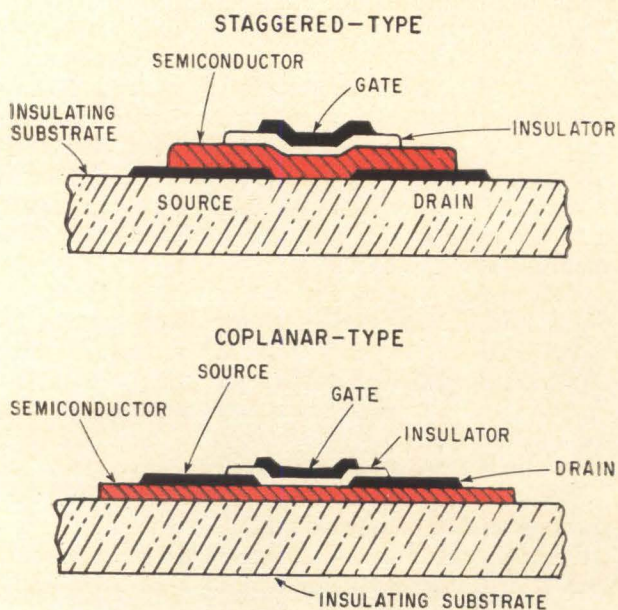

istics except for the value of V_o . TFTs have been made with transconductances as high as 25,000 micromhos, comparable to the best vacuum tube. (Currently available field-effect transistors generally have transconductances under 3,000 micromhos.) As shown in the panel, g_m is a function of drift mobility, capacitance, source-drain spacing and drain current. Once the device is fabricated, g_m can be varied only by changing drain current through variations in gate voltage within the power handling capability of the structure.

The dynamic output resistance, r_d , of each of these units is about 40,000 ohms and the voltage amplification factor, μ , is about 160. The drain characteristics intersect at the origin with negligible voltage offset, indicating that the source and

drain contacts are ohmic.

The gate current is very small in both depletion and enhancement TFTs because the gate electrode is insulated from the semiconductor. Typical d-c input resistance is high, usually greater than 10 megohms. The maximum safe drain voltage of the experimental TFTs is about 10 volts and maximum power dissipation is about 20 milliwatts.

Equivalent circuit

The small-signal equivalent circuit of a TFT is shown in (A) on p. 57. The gate, drain and source electrodes are represented as the nodal points G, D and S. The impedances between gate-source and gate-drain electrodes are represented by parallel R-C circuits. The magnitude of these impedances is

not require the realignment procedure and the additional vacuum pumpdown. Another advantage of the coplanar structure is that the heat treatment needed to produce the high resistivity sulfide may be applied without damage to underlying electrodes.

Theoretical analysis

An analysis of the TFT has been made, which predicts the drain characteristic solely from the effect of the electric field produced by the potentials applied to the electrodes.⁹ In this analysis it is assumed that the semiconductor layer is thin and homogeneous, and that the source and drain make ohmic contacts to the semiconductor. Only majority carriers are assumed to exist in the semiconductor and it is assumed that their mobility is constant. The drain current, I_d , as a function of gate voltage and drain voltage, V_g and V_d , relative to the source is

$$I_d = \frac{\mu C_g}{L^2} \left[(V_g - V_o) V_d - \frac{V_d^2}{2} \right] \quad (1)$$

where μ is the drift mobility in units of $\text{cm}^2/\text{volt-sec}$, C_g is the capacitance across the insulator layer in farads, L is the length of gap between the source and drain electrodes in centimeters and V_o is the gate voltage required for the onset of drain current.

Equation 1 is a method of calculating the drain characteristics, I_d and V_d , from the physical device parameters for positive drain voltages up to the knee of the I_d - V_d characteristic. Shockley⁹ has shown that an "extrapolated pinch-off point" region occurs above the knee where the drain current is constant, independent of V_d . The normalized drain characteristics predicted by Eq. 1 are shown, where the parameter $(V_g - V_o)$ is the effective gate bias.

As will be shown transconductance (g_m) and the TFT operating points can be obtained from these curves. The area plotted is divided into two regions by the dashed curve, 2, representing the locus of the knees of all the characteristics. In region 1, at low drain voltages well below the onset of current saturation, the output conductivity, G_d , is linear with $(V_g - V_o)$:

$$G_d = (\mu C_g / L^2) (V_g - V_o)$$

The drain voltage at the knee, line 2, is equal to $(V_g - V_o)$. In the high-drain-voltage, current-saturation region, 3, there is a square-law dependence of drain current on $(V_g - V_o)$:

$$I_d = (\mu C_g / 2L^2) (V_g - V_o)^2$$

A consequence of this is that the transconductance, g_m , is proportional to the square root of the drain current:

$$g_m = \frac{1}{L} \sqrt{2\mu C_g I_d}$$

With this square-law dependence, the TFT might become

an excellent r-f detector. Voltage V_o represents the gate voltage required for the onset of drain current. If surface states or traps (regions that can capture and immobilize electrons) are present in the semiconductor V_o is positive and TFT is of the enhancement-type. If V_o is negative, the unit has an initial source-drain conductivity at zero gate bias and is termed a depletion TFT.

A figure of merit that characterizes the high-frequency performance of a three-terminal active device is the gain-bandwidth product (GBW). For the TFT it can be shown

$$GBW \approx g_m / 2\pi C_g \quad (2)$$

The analysis predicts

$$GBW = \mu (V_g - V_o) / 2\pi L^2 \quad (3)$$

Equations 2 and 3 relate the electrical characteristics, transconductance and capacitance, with the physical parameters: mobility, L and V_o . The equations show that gain-bandwidth product can be increased by finding higher-mobility semiconductors and by decreasing the source-drain gap, L . However, the drain current will be limited by the power handling capability of the TFT. Present 100-mil-long TFTs are capable of dissipating approximately 10 to 20 milliwatts, giving GBW up to 25 megacycles.

Experimental measurements of TFT drain characteristics show excellent agreement with the analytically predicted parameters G_d , I_d and g_m . This is convincing evidence that the primary operating mechanism in the TFT is the conductivity modulation of the semiconductor channel by field effect.

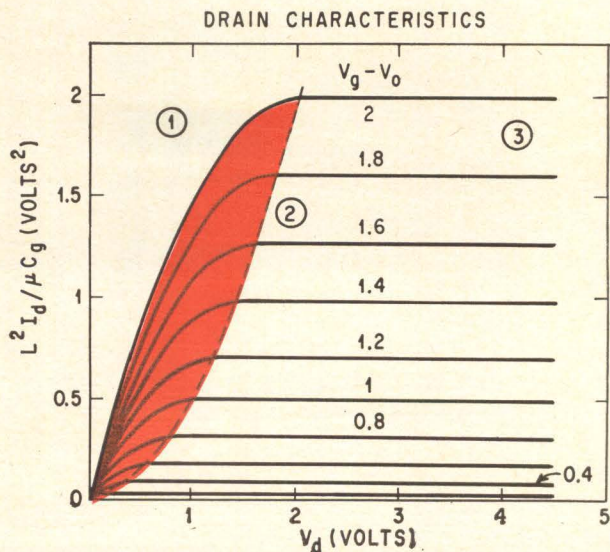

dependent upon the d-c operating point and also upon the frequency. The output circuit consists of the dynamic output resistance, r_d , driven by a current generator, $g_m e_{gs}$. Drain-source capacitance is small and can be neglected.

The impedances between the elements in a TFT have been measured by several different techniques with consistent results. The total gate capacitance, C_g , as measured between the gate and both the source and drain electrodes is shown in (B). The data were obtained from a staggered TFT (see panel) but the variations and magnitudes are typical of coplanar units.

Capacitance C_g is plotted as a function of gate-to-source voltage with drain-to-source voltage as a parameter. The transfer characteristic at the bottom of (B) shows that the unit is of the depletion type.

Approximately one milliampere of drain current

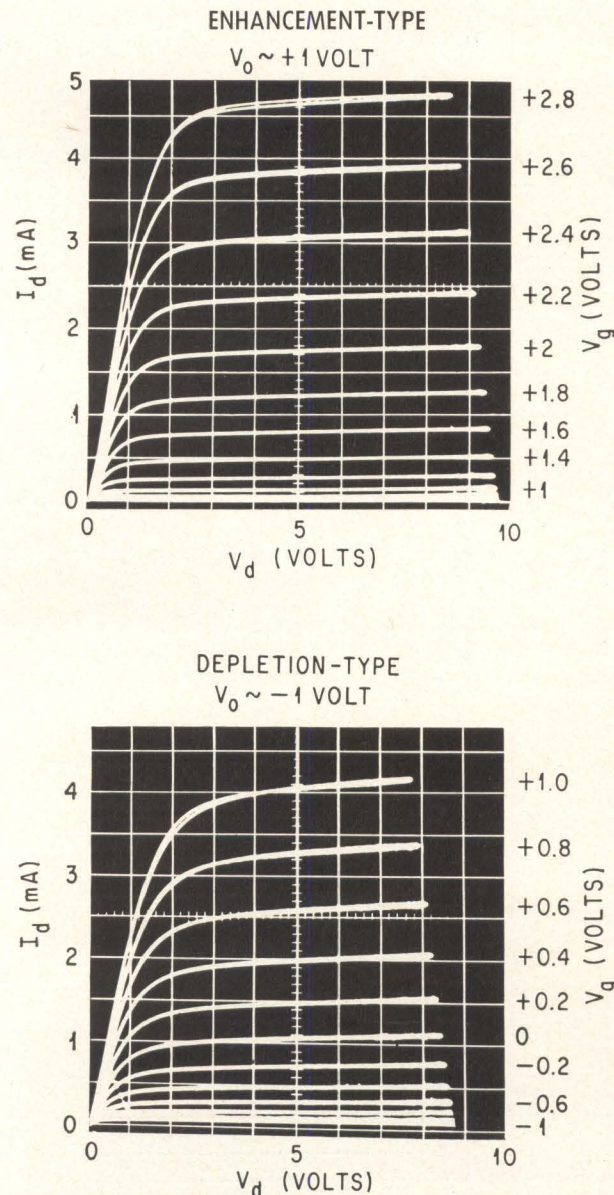

Oscillographs of drain characteristics are shown for an enhancement TFT and a depletion TFT.

flows during the zero-bias condition. With zero drain volts applied, the capacitance increases and tends to level off as the gate voltage increases in the positive direction. This shows that the width of the space-charge region in the semiconductor adjacent to the insulator is being reduced as the gate voltage is increased. The asymptotic value of capacitance approaches the capacitance across the insulator layer.

Gate capacitance

At the higher drain voltages, it is found that the total gate capacitance increases, reaches a maximum, and then decreases with gate voltage. This has been observed in both enhancement and depletion TFTs, the peak in capacitance being shifted toward positive gate biases for the enhancement units. The capacitance data presented were taken at 100 kilocycles using a Boonton Electronics capacitance bridge. Other measurements, taken at frequencies between 2 kc and 200 kc, have shown similar results except that the measured capacitance decreases slightly at the higher frequencies. The percentage change in capacitance is quite small (roughly 20%). However, as described below, the important point about capacitance is that most of it exists in the gate-source circuit.

Three-terminal capacitance measurements have been made to determine the isolated capacitances and shunt resistances that exist between the three terminals of the TFT. The results of such measurements are shown in (C) p 57 where the black curves correspond to zero drain voltage and the colored curves are for five volts applied to the drain.

The total gate capacitance, C_g , is separated into two components: C_{gs} , the capacitance between gate and source, and C_{gd} , the capacitance between gate and drain. It can be seen that C_{gs} can be 25 picofarads, which is comparable to commercially available field-effect transistors having transconductances of about 1,000 micromhos.

With both source and drain electrodes grounded, the total gate capacitance divides about equally between the gate-source and the gate-drain regions. However, at drain voltage in the saturation region, the major portion of gate capacitance exists in the gate-source circuit, and only a relatively small amount is in the gate-drain circuit. It is fortunate that C_{gd} is relatively small since it is magnified by feedback in TFT amplifier circuits, as described later. If C_{gd} were large to begin with, it would be very difficult to use TFTs in cascaded wideband amplifiers.

The shunt resistances from the gate to the source electrode and to the drain electrode also vary with operating voltages. At zero drain voltage, the gate-drain and gate-source resistances are about equal and are not sensitive to gate voltage. But the gate-drain resistance increases and the gate-source resistance decreases as the drain voltage is increased. It has been found that these shunt resistances, measured at 100 kilocycles, are usually greater than about one megohm. In the operating range the gate

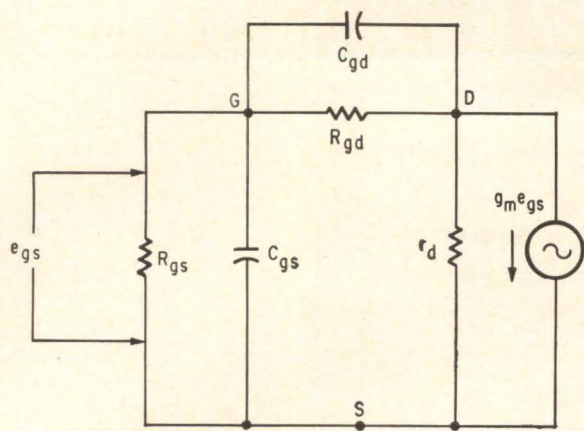

A

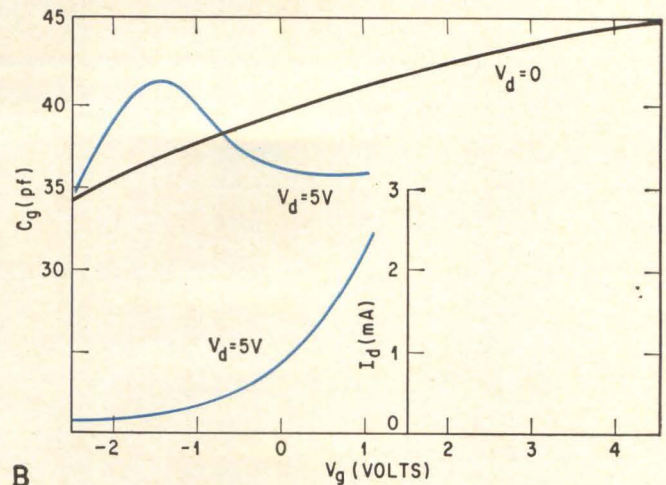

B

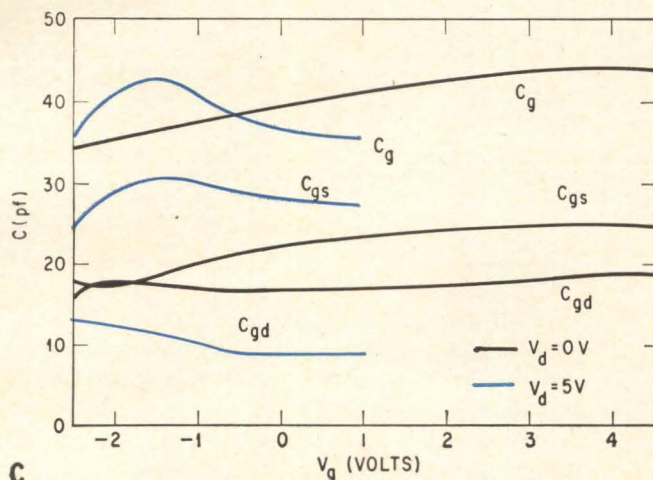

C

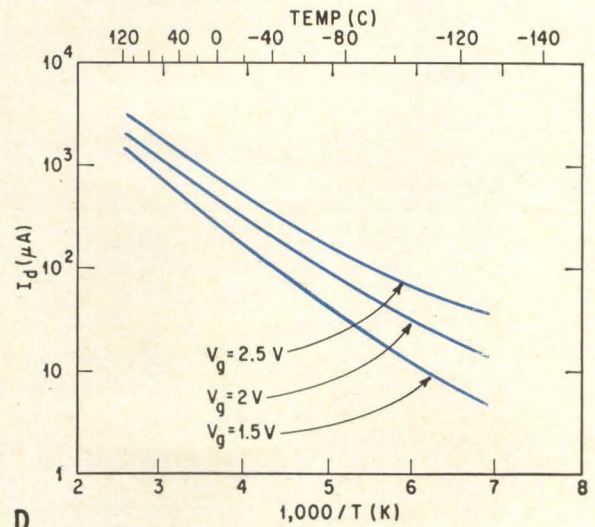

D

Small-signal TFT has an equivalent circuit (A). Total gate capacitances and transfer characteristics of a staggered-electrode depletion TFT (B). The total gate capacitance, C_g , is distributed between gate-source, C_{gs} , and gate-drain, C_{gd} , regions (C). Temperature dependence of drain current (D).

is effectively tied to the source through a lower impedance than to the drain, even though the structure is symmetrical.

The measured capacitances and transconductances of experimental TFTs have indicated gain-bandwidth products of up to about 25 megacycles, which is sufficient for many wideband amplifier applications. Some TFTs with a gain of two have operated at 60 megacycles.

The temperature dependence of an experimental TFT is evident from (D). This shows the drain current plotted as a function of the reciprocal of the absolute temperature for a constant drain potential of four volts and various gate voltages. The drain current decreases to about 1/100 of its original value when the temperature is decreased from $+120^\circ$ to -130° centigrade.

TFT amplifier circuits

An understanding of the electrical characteristics of the thin-film transistor allows this use in designing both conventional and integrated circuits. The design of a single-stage linear amplifier is appropriate for beginning a discussion of circuit design.

As might be expected, a TFT amplifier can be made with either the source, gate or drain grounded. As shown in the table on p. 58, the grounded-source TFT has high input impedance and is capable of voltage gain. The grounded-gate TFT has low impedance and it, too, is capable of voltage gain. The grounded-drain or source-follower amplifier has high input impedance, low output impedance and gain less than unity.

The measured performance on a typical TFT grounded-source amplifier is shown on p. 59 where voltage gain of a low-pass and several band-pass amplifiers are plotted as functions of frequency. The low-pass amplifier produced a voltage gain of 8.5 from d-c up to 2.6 megacycles, and thereafter fell at six decibels per octave. The measured gain-bandwidth product is 22 megacycles.

These measurements were made using a low-impedance signal source while the output was loaded with additional capacitance simulating a subsequent TFT. Of course, in using three-terminal active devices, one may exchange gain for bandwidth if the inherent voltage amplification factor is not exceeded. For the characteristics of the three

	TFT AMPLIFIER	R_{IN}	C_{IN}	VOLTAGE GAIN: A	R_{OUT}
GROUND SOURCE		HIGH	$C_{gs} + (1-A)C_{gd}$	$\frac{-\mu R_L}{r_d + R_L}$	$R_L \parallel r_d$
GROUND GATE		$\frac{r_d + R_L}{1 + \mu}$	C_{gs}	$\frac{(1 + \mu)R_L}{r_d + R_L}$	$R_L \parallel r_d$
GROUND DRAIN		HIGH	$C_{gd} + (1-A)C_{gs}$	$\frac{\mu R_L}{r_d + (1 + \mu)R_L}$	$R_L \parallel \frac{r_d}{1 + \mu}$

Impedance and gain characteristics are for the three amplifier connections of a TFT. μ , g_m and r_d are the TFT amplification factor, transconductance and dynamic output resistance, respectively.

bandpass amplifiers that are shown, the output circuits were resonant at 25, 36, and 60 megacycles. At 60 megacycles the gain was 2.5 and the measured gain-bandwidth product was 17 megacycles.

A photomicrograph of an integrated all-evaporated three-stage amplifier shows the TFTs spaced two mils apart and directly coupled together¹². The input, output, ground and drain-supply voltage connecting points, as well as the three load resistors, are shown in the photo on p. 59.

This circuit performed as a cascaded three-stage amplifier having a voltage gain of nearly 100. While this is a simple example of a TFT integrated circuit, much more sophisticated integrated circuits have since been built. For example, a completely integrated thin-film scan generator has been built (see photo) that has more than 100 TFTs in an area of 0.15 square inch^{13, 14}.

The author



Harold Borkan received a degree in electrical engineering from Rutgers University in 1950 and at that time joined the technical staff of RCA Laboratories at Princeton, N.J. He did graduate work at Rutgers on a part-time basis and received the MS degree in Electrical Engineering in 1954. Since 1952 he has been engaged in research on television

camera tubes and associated circuits. He is more recently concerned with the measurement, analysis and utilization of developmental thin-film semiconductor devices. Mr. Borkan is a Senior Member of the Institute of Electrical and Electronics Engineers, a member of Eta Kappa Nu and the recipient of two RCA Achievement Awards.

Cascading

In the design of cascaded TFT amplifiers, the gate-drain capacitance restricts the bandwidth even though the capacitance is smaller than the gate-source capacitance. This feedback capacitance is usually about 10 picofarads, but appears to be magnified at the input of a grounded-source amplifier due to the Miller effect, in which an impedance between input and output appears as a reduced impedance at the input. The gain-bandwidth product that was described earlier is an optimum figure that is applied to TFTs unburdened by the Miller capacitance term, $(1-A)C_{gd}$ (see table). Cascaded grounded-source stages yield much poorer over-all performance than is expected from the individual gain-bandwidth products.

Some solutions

Many solutions to this Miller-effect problem are possible but most have severe limitations. The grounded-gate amplifier, for example, is capable of voltage gain but cannot be cascaded without introducing a poor impedance match that cuts the voltage gain. This situation may be improved by alternating source-follower and grounded-gate stages, a solution adequate for lumped-parameter circuits but very difficult to integrate. Another solution that suffers from the same difficulty is the cascode connection—a grounded-source amplifier driving a grounded-gate stage.

The most promising solution is to use a source-follower amplifier, direct-coupled to a grounded-source stage as shown in (A) on p. 60. The input capacitance is very low, approximately equal to C_{gd} , since degeneration reduces the effect of C_{gs} . At

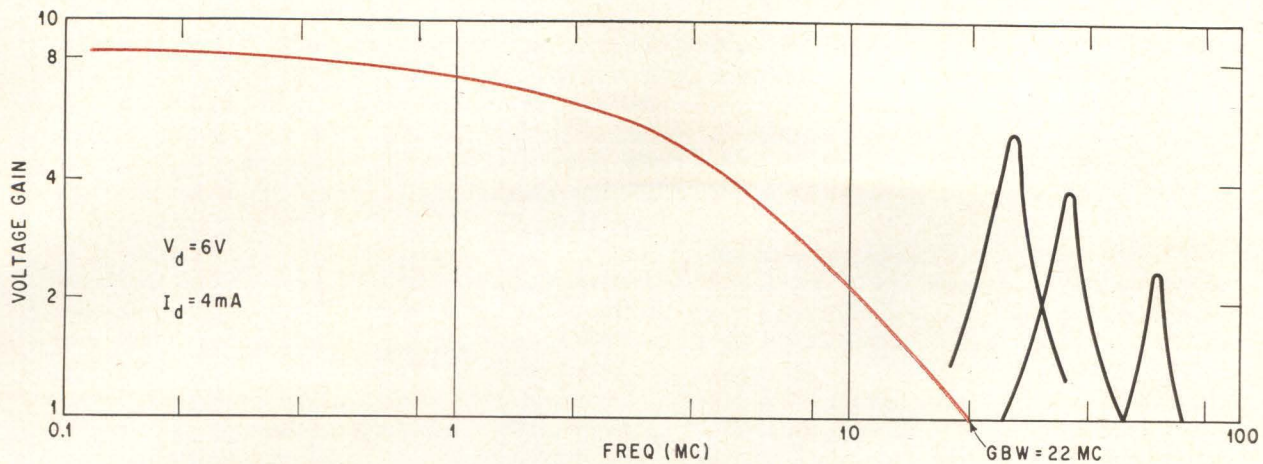

Gain vs. frequency data are for a low-pass amplifier (in color) and three band-pass amplifiers.

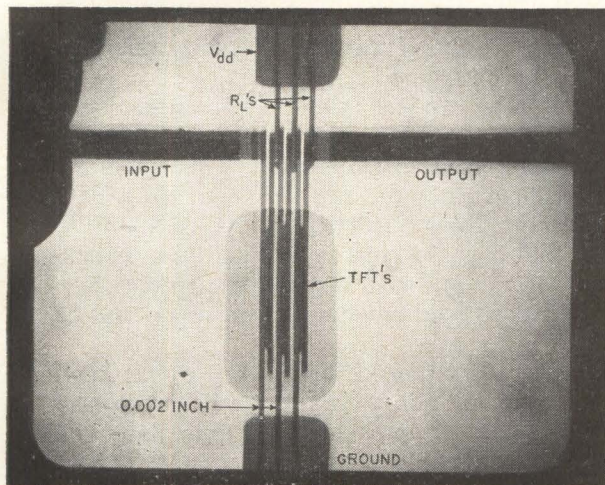

Cascaded three stage direct-coupled amplifier.

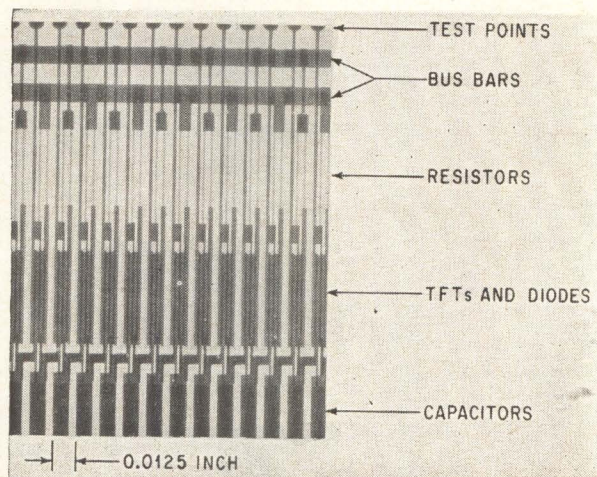

Enlarged portion of thin-film scan generator.

the output of the source follower, the large Miller capacitance of the gain stage is driven by the low output impedance of the source follower and, therefore, does not restrict the bandwidth. The output capacitance of this combination is low.

An essential feature of cascaded direct-coupled amplifiers is that the quiescent d-c voltage be the same at the output as at the input of each stage. Otherwise the d-c operating point would progress out of the useful operating range of the drain characteristics.

In the circuit illustrated, the drain supply voltage is 3V volts, with 2V volts existing across the TFT and V volts across the resistor. The TFTs required are enhancement types with bias of V volts on their gates. With this configuration the input and output are both at 2V volts. It is difficult to match input and output voltages with the arrangements mentioned earlier.

A layout for the integrated circuit of each amplifier stage is also shown in (A). The input and output electrodes are in line and the circuit may be cascaded simply by adding on to the array. Only two bus-bars, one for ground and the other for the drain supply voltage, are needed in this arrangement. The resistors can be made of evaporated Nichrome and are aligned with the length of the

TFTs to conserve space.

It is possible to fabricate this composite circuit in an area 10 mils by 100 mils, corresponding to a density of 1,000 stages per square inch. The composite electrical characteristics of this stage are much better than those of the individual TFTs. The resultant gain-bandwidth product approximates the optimum figure derived in Eq. 2 of the panel. This composite amplifier stage can also be considered for a building block in switching applications where high speed is important.

Bistable multivibrator

The simple bistable multivibrator (B) on p. 60 uses direct-coupled enhancement TFTs. Only two resistors, two TFTs and the triggering circuit are needed. The graph at the right has been obtained from an actual TFT drain characteristic load line. Voltage V_1 , the output voltage of TFT-1 (and also the input voltage of TFT-2), is plotted against voltage V_2 , the output of TFT-2 (and also the input of TFT-1).

Since the input voltage of one TFT is the output of the other, the only possible operating points are the three intersections of these curves. The criteria for circuit stability are that the voltage gain of the TFTs be less than unity at the two outer points and

greater than unity at the center. The two outer points represent the cutoff and full-on conditions, while the central point is the mid-range of the drain characteristic. These stability criteria are easily satisfied with TFTs.

Switching

The TFT is useful in switching applications, since negligible power is consumed in the off state and only moderate power (about a milliwatt) in the on state. The switching waveforms observed for a typical TFT show two 2-milliampere drain-current transitions: X-X is a transition from low to high drain current while Y-Y is the reverse, from high to low drain current. The transient of opposite polarity that is observed on the waveform represents direct feedthrough of signal via the gate-drain capacitance. These results were obtained using a pulsed source having 50 ohms impedance.

TFTs are ideally suited for switching circuits in digital computers; in fact, computer applications offer probably the greatest potential use for TFTs.

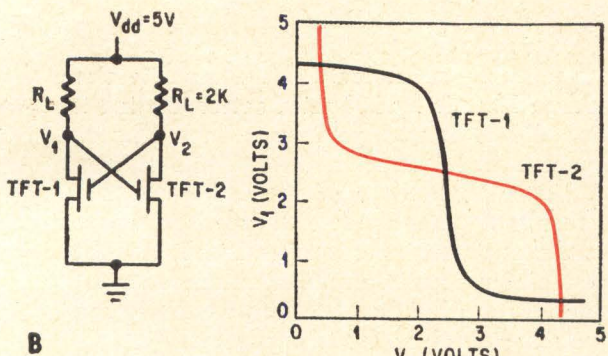
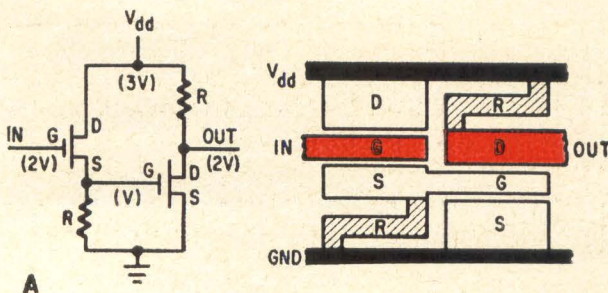

Direct-coupled composite amplifier stage consists of a source follower driving a grounded-source stage (A). The layout of the integrated pattern is at right. The possible operating points of multivibrator (B) are indicated by the intersections of the two load lines.

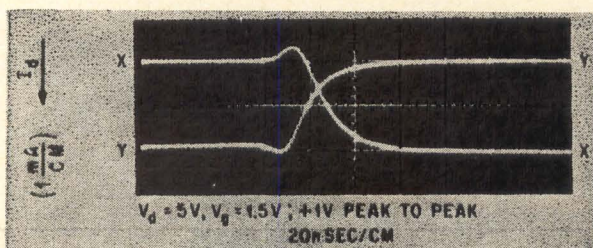

Typical drain current transitions occur in about 30 nsec.

This is because complete logic systems of AND gates, OR gates and inverter circuits can be fabricated in large arrays easily and economically. The circuit design would be the same as for conventional logic circuits—the main point to remember is that parallel logic, where all drains are connected together and all sources are connected together, is a better choice with TFTs than the series system where the drain of each TFT is connected to the source of the next. The reason is that when a TFT is conducting, its source-drain voltage drop is about one volt. In parallel logic these voltages do not add as they do with series logic.

Shift registers can be assembled by directly coupling multivibrators of the type described previously. The necessary triggering would be accomplished with conventional techniques.

The thin-film transistor can be made to function as a diode by connecting the gate and drain electrodes. The best diode characteristics occur when V_g equals zero. An example of a circuit employing diode and triode TFTs is provided by the scan generator referred to previously. This generator, which demonstrates the possibility of using TFTs in X-Y addressing circuits, has 30 clock-driven stages that transfer binary inputs in a manner similar to a shift register. Each stage consists of two TFTs two load resistors and a diode and capacitor.

The research reported in this article was sponsored by the Air Force Cambridge Research Laboratories, Office of Aerospace Research, under contract number AF19 (628)-1617 and RCA Laboratories, Princeton, N. J.

The author thanks H. Johnson, P.K. Weimer, W.S. Homa, V.L. Frantz, H.P. Lambert and R.G. Pugliesi.

References

- J.E. Lilienfeld, "Device for Controlling Electric Current," U.S. Patent 1,900,018, March 7, 1933.
- W. Shockley, "A Unipolar 'Field-Effect' Transistor," Proc IRE, Vol 40, p 1,365, Nov. 1952.
- P.K. Weimer, "An Evaporated Thin Film Triode," presented at Solid State Device Research Conference, Stanford University, California, June 1961.
- P.K. Weimer, "The TFT—A New Thin-Film Transistor," Proc IRE, Vol 50, p 1,462, June 1962.
- H. Borkan and P.K. Weimer, "Characteristics of the Insulated-Gate Thin-Film Transistor," Northeast Electronics Research and Engineering Meeting, IRE NEREM Record, Nov. 1962.
- H. Borkan and P.K. Weimer, "An Analysis of the Characteristics of Insulated-Gate Thin-Film Transistors," RCA Review, Vol 24, p 153, June 1963.
- F.V. Shallcross, "Cadmium Selenide Thin-Film Transistors," Proc IEEE, Vol 51, p 851, May 1963.
- F.V. Shallcross, "Evaluation of Cadmium Selenide Films for Use in Thin-Film Transistors," RCA Review, Vol 24, p 676, Dec. 1963.
- H.L. Wilson and W.A. Gutierrez, "Cadmium Selenide Thin-Film Field Effect Transistors," presented at the Electrochemical Society Meeting, Pittsburgh, Pa., April 1963.
- S.R. Hofstein and F.P. Heiman, "The Silicon Insulated-Gate Field-Effect Transistor," Proc IEEE, Vol 51, p 1,160, Sept. 1963.
- P.K. Weimer, F.V. Shallcross, and H. Borkan, "Coplanar-Electrode Insulated-Gate Thin-Film Transistors," RCA Review, Vol 24, p 661, Dec. 1963.
- P.K. Weimer, "Evaporated Circuits Incorporating Thin-Film Transistors," Presented at the International Solid-State Circuits Conference, Philadelphia, Pennsylvania, February 1962.
- P.K. Weimer, H. Borkan, L. Meray-Horvath, and F.V. Shallcross, "An Integrated Thin-Film Image Scanner," presented at the International Solid State Circuits Conference, Philadelphia, Pa., Feb. 20, 1964.
- M.F. Wolff, Thin-Film Transistors Form Scanning Generator, Electronics, Feb. 21, 1964.

Boost for electronic tuning: part 2

More details on how to use voltage-variable capacitors are given, and a method for detecting tracking errors that crop up in multiple tuning applications

By L.A. Weldon and R.L. Kopski

Philco Corp., Lansdale, Pa.

Why more voltage-variable capacitors than ever are now being put to work to tune communications circuits, and how they do this, was explained in detail in part 1 of this article (Electronics, April 6, 1964, p 49).

Circuit designers are taking a fresh look at cost comparisons, especially for high-quality equipment. Voltage-variable capacitance diodes eliminate the need for mechanical linkages in tuning applications, and systems using them can be tuned faster and more accurately than with a mechanical tuner. In multiple tuning, voltage-variable capacitors allow improved circuit layout.

The diodes can electronically tune two or more circuits to the same frequency, hold the circuits in phase, and multiply frequency with good efficiency at relatively high power levels. Resonant circuits may be tracked or tuned to maintain a constant frequency difference by adjustment of shunt capacitance and adjustment of inductance. Adjustment of a small variable voltage source in series opposition to the bias control voltage provides three-point

tracking technique and reduces tracking error.

The diagram on this page shows how to obtain tracking voltage from temperature compensating (TC) diodes. The TC diodes are forward biased from a constant-current source of about 100 microamperes (R_1 and the bias supply). The total voltage drop across TC_2 and R_2 should be about 0.75 volt. The drop across TC_1 and the tracking potentiometer should be variable from 0.5 volt to 1 volt.

Capacitance tracking

There are various applications—such as in RC filters and capacitance bridge circuits—where the diode capacitance, rather than the frequency of a tuned circuit, must be tracked; diagram A on p. 63 shows a method for two-point tracking of diode capacitances. A proportional difference in bias voltage approximately compensates differences in K and V_0 between diodes. Shunt capacitors compensate for variations in n , as in frequency tracking. Constant K cannot be exactly compensated by this method because of the presence of V_0 as part of the effective bias for each diode; therefore, the tracking characteristics by this method will differ somewhat from the method shown in circuit B, p. 63.

Series opposing voltages, similar to those described with three-point frequency tracking, may be used to compensate V_0 , thereby giving three-point capacitance tracking that is equivalent to three-point frequency tracking.

The major disadvantage of the capacitance tracking methods described is the possible reduction in effective capacitance range of the system. A diode with higher capacitance than other diodes in the system requires a higher proportional tracking voltage; this diode will limit the system range by reaching the limit of its maximum operating voltage before the other diodes do.

In most applications, the circuit designer is concerned with the frequency tracking error that will

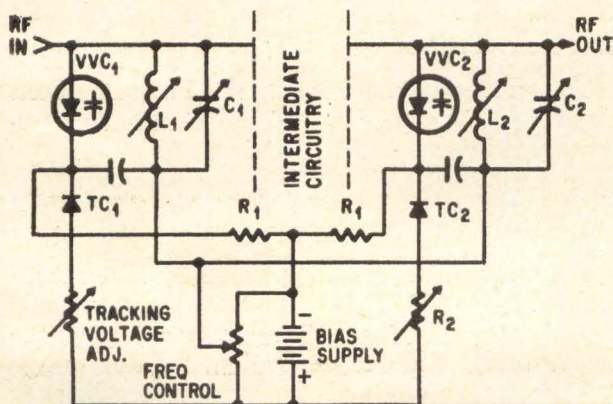

Tracking voltage is derived from temperature-compensating diodes.

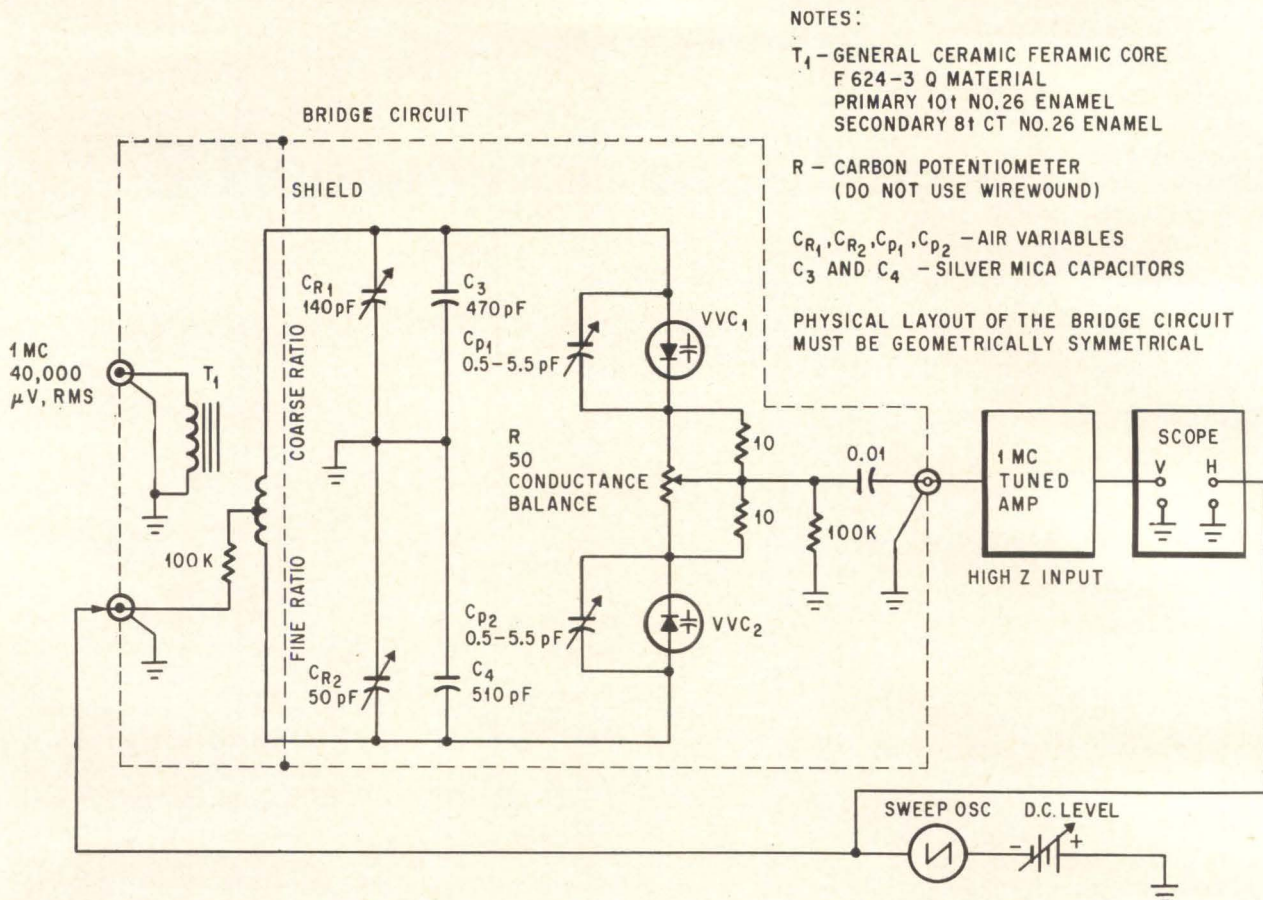

Test set-up for measuring capacitance tracking.

result from using a randomly selected set of diodes. However, from the viewpoint of measurement and specification of diode tracking characteristics, it is more desirable to deal with capacitance rather than frequency, since capacitance is a characteristic of the diode itself. A capacitance tracking specification will generally be useful for circuit design regardless of the circuit application.

To make use of the specified or measured capacitance-tracking characteristics in design evaluation, a relationship between percent frequency-tracking error, D_f , and percent capacitance-tracking error, D_c , must be established. Combining expressions for D_f and D_c ,

$$D_f = \frac{40,000 - 200 \sqrt{200^2 - D_c^2}}{D_c} \quad (4)$$

The expression appears cumbersome at first glance. However, some arithmetic will show that for values of D_c less than 10%, the percentage frequency-tracking error (D_f) is, for all practical purposes, equal to one-half the percentage capacitance-tracking error (D_c). This is a convenient relationship for translating specified and measured performance of a voltage-variable capacitance into circuit performance.

Measurement of tracking error

Capacitance tracking of a voltage-variable ca-

pacitance can be measured in test setup above. This capacitance bridge circuit has an output signal voltage proportional to the capacitance unbalance. The signal is preamplified and applied to the vertical input of an oscilloscope. The sweep voltage applied to the horizontal input of the oscilloscope also provides simultaneous slow variation of the bias on the diode. The resultant scope display on p 63 is a picture of diode capacitance-tracking as a function of bias voltage. One-point tracking is shown at the left, two-point tracking at the right. Vertical scale is one cm p/p equals 0.1 percent capacitance difference. Horizontal scale is one cm equals 10 volts.

Test set calibration

The test set up above is calibrated by using fixed capacitors of known nominal capacitance and percentage difference, calculated from

$$\frac{2(A - B)}{A + B} \times 100$$

The calibration is accomplished by first substituting fixed capacitors for the two voltage-variable capacitors (VVC₁ and VVC₂) and adjusting the coarse bridge ratio capacitor C_{R1}, the fine bridge ratio capacitor C_{R2} and the conductance balance resistor R to achieve a null balance.

Next, the two fixed capacitors are interchanged

and the resultant output is measured by the vertical deflection on the oscilloscope. Capacitors C_{R1} and C_{R2} are readjusted to halve this deflection. The fixed capacitors are then removed and the terminal capacitance is balanced by adjusting C_{P1} and C_{P2} to obtain a null indication. The input signal may be increased to obtain an exact null.

The first and second steps are repeated until the interchanging of the fixed capacitors results in equal bridge output and their removal gives zero output.

The oscilloscope graticule is calibrated as follows: Pairs of fixed capacitors, having nominal capacitances covering the range of values exhibited by the voltage-variable capacitors and having convenient percentage differences, such as 0.5%, 1% and 1.5%, are measured in the test setup. The vertical deflection exhibited by a capacitor pair is marked on the graticule at a point along the scope's horizontal axis (bias voltage) where the voltage-variable capacitor would exhibit nominal capacitance. The result is a field of "tracking-error percentage" lines. The shape of these lines is a function of the capacitance range of the voltage-variable capacitor and of the loading of the bridge circuit by the tuned amplifier.

Testing the diodes

Now two voltage-variable capacitances are inserted into the bridge where the fixed capacitors used to be, and the sweep voltage applied. Capacitors C_{R1} , C_{R2} and R are then adjusted for null condition at some bias voltage. This is one-point tracking, usually best achieved at the midpoint of the bias-voltage range.

Two-point tracking can be best achieved by performing the above procedure at about 1.5 times the low-bias voltage endpoint and then adjusting C_{P1} and C_{P2} for null condition at about 0.6 times the high-bias voltage endpoint.

In either one-point or two-point tracking, the bridge-signal level must be low enough to prevent affecting the capacitances at low-bias voltage values. This is checked by interchanging the capacitances, readjusting for null, and noting whether the display obtained is identical to that obtained previously. A 20-cps linear-sweep generator, with output adjustable to 100 volts, in series with an adjustable 100-volt d-c bias supply, has been found to work well as a source of sweep voltage.

Since the bridge-ratio capacitors C_{R1} and C_{R2} effectively modify the proportionality constant K of the voltage-variable capacitances, this is equivalent to varying the inductance in the tracking method shown in diagram B. Also, the bridge capacitors C_{P1} and C_{P2} are equivalent to the trimmer capacitors C_1 and C_2 of B, so that the capacitance-tracking characteristics measured in the test circuit on p. 62 will be identical to the frequency tracking characteristics obtained in L and C circuit B—remembering, of course, that the capacitance error measured will be twice as great as the frequency error under the same conditions.

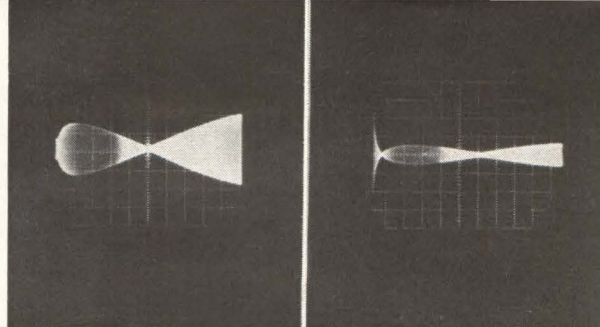

Typical one and two-point tracking displays.

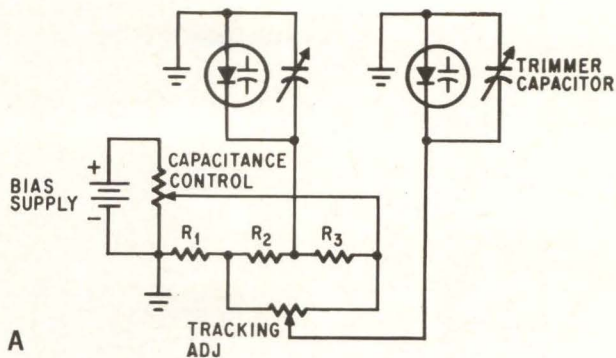

A
Two-point tracking of diode capacitance.

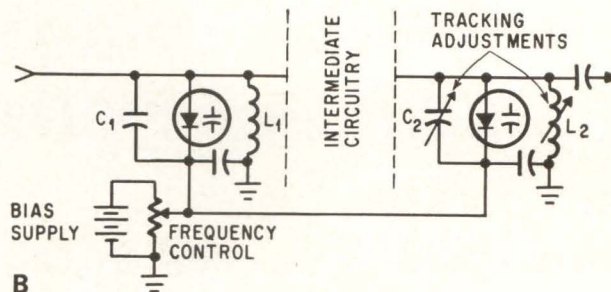

B
Conventional two-point tracking uses L and C adjustment.

The authors



Lawrence A. Weldon joined the Philco Corp. in 1960 as an applications engineer. He is currently applications supervisor for communications circuits and is responsible for evaluation of semiconductor devices intended for communications applications. He is a 1959 graduate of Drexel Institute of Technology in Philadelphia.



Robert L. Kopski received his B.S.E.E. in 1963 from Lehigh University. He joined the Philco Corp. in 1961. He worked in the transistor application department on switching and communication circuit design, transistor evaluation and the evaluation of voltage-variable capacitor tracking error. He is currently working in the circuit engineering department of the company's special products operation, and is responsible for the design of microwave solid-state switch drivers.

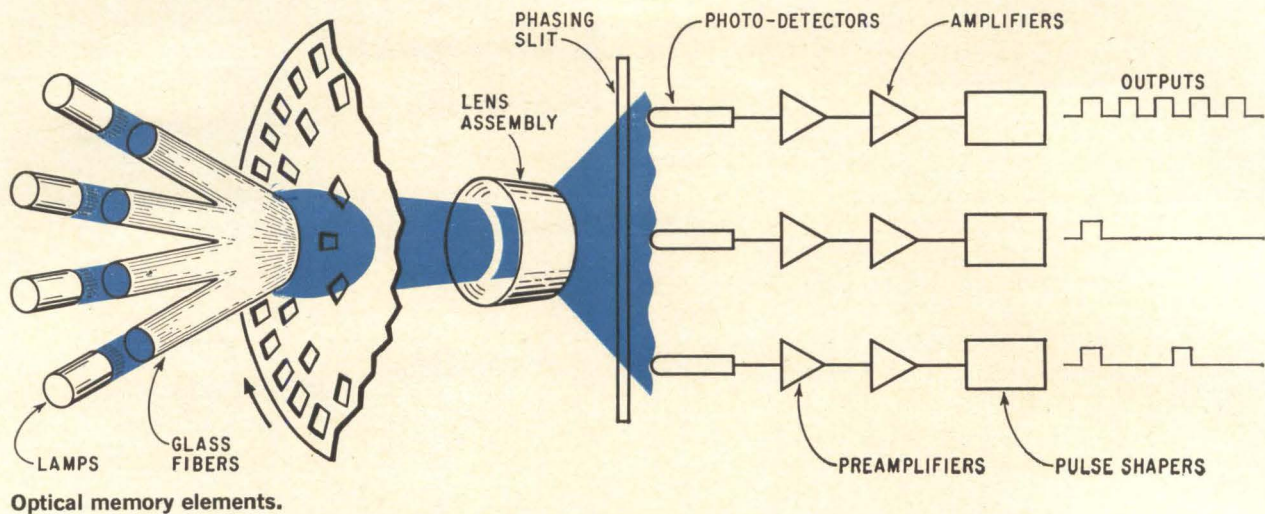

Computers

Permanent optical memories for compact systems

Manipulating large amounts of fixed data quickly, they're especially valuable for table look-up and other tasks in systems using only small amounts of temporary storage

By Fred P. DeNegri

Bendix Corp., Eclipse-Pioneer division, Teterboro, N.J.

Optical memory offers an ideal way to store and retrieve permanent data simply, compactly and economically.

Optical storage permits a capacity of several million bits, average access times of fractions of a millisecond, and bit-transmission speeds in the megacycle range. The resulting devices are especially suitable for table look-up, program storage, function generation, nomographic electronic computation,¹ and operational digital applications.

With optical techniques, permanently stored data remains in its recorded state indefinitely. It cannot be affected by such forces as temperature extremes, power failures, power transients or radioactivity.

Another advantage is that optically stored data

is retrieved by nondestructive readout. And when more than one light source is used, with derated lamps and random fiber-optic mixing, the optical reader's reliability is increased well above that of other components in the system.

These characteristics make optical storage especially useful in such airborne applications as in navigational computers, autopilots, monitoring systems, air-data computers, fire-control computers and display systems. Ground-based applications are in digital simulators, special-purpose computers for machine-tool or process control, monitoring systems, and as input devices for general-purpose digital computers.

The disk-type optical memory was designed for

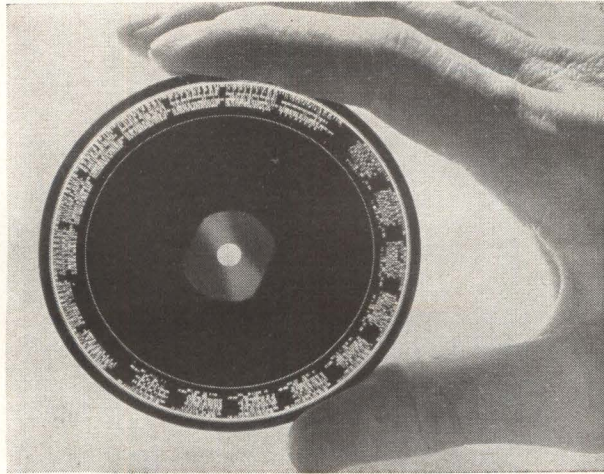

Data disk.

storing permanent data for an airborne digital multi-engine monitoring system [Electronics, Jan. 11, 1963, p. 38].

Previously, a flight engineer would monitor the performance of the plane's engines by using flight manuals containing tables of characteristics, and give the pilot the optimum control settings for a specific airspeed and altitude. In the monitoring system, the tables are on the disk of the optical memory, the table look-up is done electronically, the data is transformed on a digital computer and the information is presented to the pilot by lights or markers on his instruments.

Specifications for the memory device in this multiplexing system could not be filled by existing techniques. Optical techniques were then being developed and their feasibility for the system's specifications was apparent. The problem, briefly, was to store 22,528 RZ (return to zero after each write pulse) bits in $3\frac{1}{2}$ by $3\frac{1}{2}$ by $6\frac{1}{2}$ inches, to be delivered as eight-volt pulses at a bit rate of 409.6 kilocycles with an average access time of 2.5 milliseconds.

Ingredients of memory

The basic elements of a typical optical memory are: 1. a means of recording or writing permanent data, 2. a permanently stored data structure, 3. a means of illuminating the data structure, 4. a means of reading the stored data, and 5. a means of moving the stored data past the reading point.

To these can be added other features such as: 1. ease of completely changing the stored data, 2. redundant illumination in case of lamp failure, 3. capability for permanently synchronizing the multiple data channels with each other, and 4. self-contained electronics for pulse shaping.

The relationship among these elements is shown on opposite page. For a typical reader channel, the source of illumination starts the data-flow cycle by providing enough light for a usable signal amplitude. This light is then modulated by a rotating

track of windows etched in an opaque metallic film on a glass disk. The disk data pattern is then magnified, to simplify mechanical adjustments at the reading point during assembly, and is screened by a phasing slit.

In A below, d is the window width (in radians) and ω is the angular velocity of the data track. The width of the phasing slit, e in B, is also measured in radians, and must be less than the width of the window. The phasing slit, which is a single slit extending over all of the data tracks, is shown as a dashed line in the over-all figure. C shows the resulting forcing function that is presented to the photo-detector. A forcing function, which can be expressed as an equation or a diagram, represents an incoming signal over which a system has no control and is forced to follow.

The photo-detector attempts to follow the forcing function but, due to limitations such as its frequency cutoff point, produces a distorted waveform as in D. The typical detector has a turnoff time somewhat longer than its turn-on time. This characteristic is attributed to the excess carrier current that has been set in motion by light striking the photosensitive junction.² This residual current cannot immediately cease flowing. The detector output is then differentiated, as shown in E, and is now ready for pulse manipulation, which involves amplification and shaping.

Success development of the optical memory was predicated on the design of a basic reader channel capable of useful response frequencies beyond 500 kilocycles. Also, because of space limitations, a photo-detector of the miniature solid-state type was favored.

At the start of development, the frequency limits

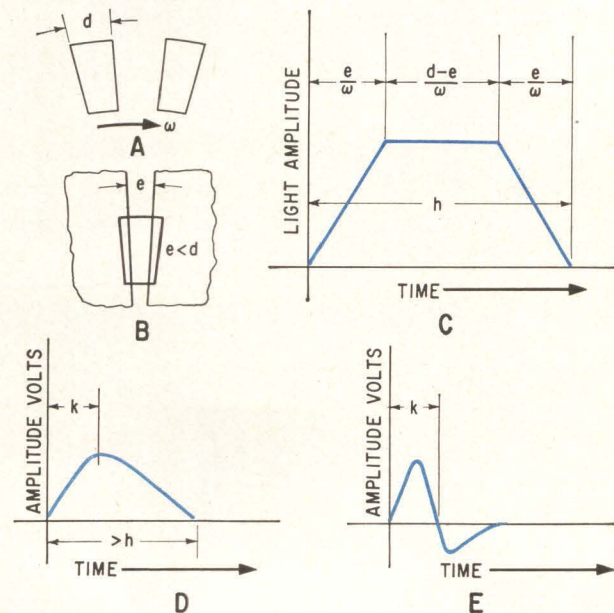

Forcing function generation: magnified window (A); phasing slit (B); light-forcing function (C). Detector output: photo-junction output (D) and differentiated waveform (E).

of commercially available photodiodes were rated by their manufacturers at about 50 kilocycles—adequate for the applications for which they were designed, such as reading punched paper tapes or similar perforated media, but only potentially useful in optical memory readers.

Improvements in the relationships between such photodiodes and other elements of the basic reader channel, such as light intensity, bit geometry, lens magnification, circuit design and slit widths, made it possible to read optically up to 500 kilocycles. Later advances in detector technology, such as using exposed transistor junctions, made it possible to read optically beyond a million cycles.

However, the resulting reader channel has practical limitations due to other sources of possible error, such as the geometry of the recorded data, mechanical eccentricities and run-outs, optical distortions, and environmental distortions due to temperature, shock and vibration. Before working tolerances can be assigned to these sources of error, a total tolerable phase error must be determined. To do this, two possible modes of readout can be considered: RZ (return to zero) and NRZ (non-return to zero), as shown in A below.

Phase errors will be considered at the output interface where logical pulse handling begins. By assuming practical pulse-width ratios, the figure shows that maximum phase errors for both RZ and NRZ must be less than $\pm \frac{1}{4}$ of the RZ clock pitch, P. For RZ (B), this means that the pulse,

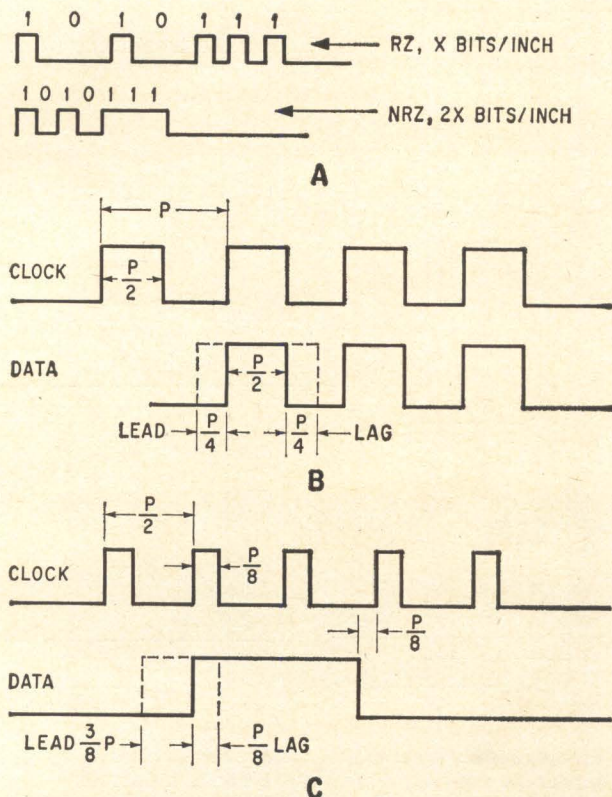

Recording comparisons: data formats (A); tolerable pulse phase error for RZ (B) and NRZ (C) modes.

whose width is $P/2$, can lead or lag by half of its width, or $P/4$, before interfering with the correct reading of an adjacent pulse; the total allowable drift is twice $P/4$, or $P/2$.

In NRZ recording (C), twice as much data can be recorded per inch, as shown in A, so the NRZ clock pitch, as compared with the RZ clock pitch, is $P/2$. If the clock-pulse width is $P/8$, then the maximum allowable drift is $\frac{3}{8}P$ leading and $P/8$ lagging, before impinging on an adjacent pulse slot; the total allowable drift is $\frac{3}{8}P$ plus $P/8$, or $P/2$, as before. This total error can be assigned as follows: environmental and other sources, 50%; reader channel bandwidth distortions, 25%; and mechanical, optical and geometric errors, 25%.

Capabilities

This memory, in conjunction with an input-output console, is capable of serial or parallel output of nine-digit data. The encoded format is serial unitary weighted. Each pulse has a value of one, and such functions as X , $\sin X$, $1 - \cos X$, $\sin^2 X$, $\ln(X + 1)$, $1/X$, $\sqrt{X + \frac{1}{4}} - \frac{1}{2}$, $2X/\pi$, X^2 and \sqrt{X} can be read out at the nominal design frequency of 409.6 kilocycles as RZ pulse trains. The resolution of each function over its assigned range is one part in 2,048, which is also the number of clock pulses per disk revolution. The 11th channel contains a single reference pulse that starts the data-retrieval cycle; this pulse indicates when to begin reading data.

A motor speed of 12,000 revolutions a minute provides this memory with an average access time of 2.5 milliseconds. The memory unit consumes about 10 watts of power and has been qualified for airborne operation from -54° to 71° C. Its total weight, including all pulse-shaping electronics, is 3.5 pounds; it occupies 80 cubic inches.

The data disk from this memory [p. 65] is a photo-etched copy of an original master disk, which is used to make many such copies. Its three-inch diameter is capable of storing up to 22 channels of data with 4,096 bits per channel, or a total of 90,112 bits. Its nickel-on-glass construction allows the disk to be handled without fear of data contamination from such sources as fingerprints and solvents.

The lens system that magnifies the data structure is a conventional 10-millimeter camera lens providing $5\times$ magnification. Its function is to preserve the track-to-track alignment built into the data structure by the dividing engine used to make it, and to allow the correct track pitch as seen at the detector station. A prism bends the optical image by 90° to accommodate the memory envelope restrictions. After the lens system is properly focused, no further adjustments are required.

Four prefocused incandescent lamps provide the necessary illumination. The light is distributed with about 800 glass fibers, divided into four equal groups, and randomly distributed over one output area; in effect, the light is channeled by four fingers of fibers into a single cylinder of light.

The resulting output beam of light is thus com-

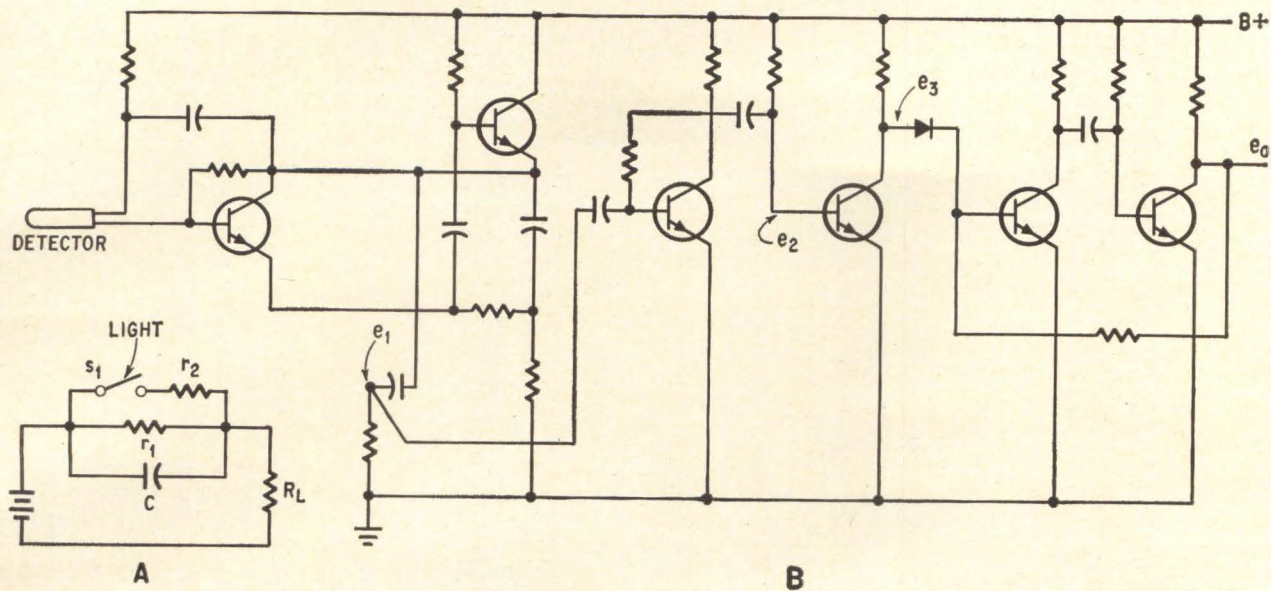

Photo junction equivalent circuit (A); typical reader electronics (B).

posed of hundreds of conically diverging beams that overlap as the distance from the output interface increases. This overlapping helps absorb a lamp failure without adverse effect on the memory. Each lamp has a statistical life of 6,000 hours, based on 20% failures, at 2.5 volts.

Photo-detectors

Two basic types of detectors are used for optical readout. The first is a dual photodiode that functions excellently for frequencies below 500 kilocycles. Because of its frequency limitation, however, it requires a relatively complex circuit.

The second type of detector is actually an exposed transistor junction packaged into a standard diode configuration. This junction is intrinsically much faster than the diode junction and also requires a less complex preamplifier circuit. This type of detector is capable of frequencies exceeding one megacycle. A representative circuit for the photo-detector is shown in A above. The modulating light impinging on the junction, is represented by switch S_1 , whose closed state corresponds to light "on" and whose open state corresponds to light "off." The r_1 represents the dark resistance of the junction; r_2 in combination with r_1 represents the irradiated junction resistance and C represents the intrinsic capacitance as seen across the junction. The previously mentioned distortion of the forcing function is evident here in the relative magnitudes of the time constants for both the "off" state and the "on" state. Where $t_{off} > t_{on}$,

$$t_{off} = \left[\frac{r_1 R_L}{r_1 + R_L} \right] C; \quad t_{on} = \left[\frac{\left(\frac{r_1 r_2}{r_1 + r_2} \right) R_L}{\left(\frac{r_1 r_2}{r_1 + r_2} \right) + R_L} \right] C$$

A typical reader electronic channel, shown in B above, possesses the following waveforms: e_1 , the

preamplifier output, differentiated waveform, 50 millivolts peak to peak, at 500 kilocycles; e_2 , class A amplifier output, 1.5 volts peak to peak; e_3 , class B amplifier output, six-volt amplitude, and e_0 , multivibrator output, +8 volts amplitude, < 0.1-microsecond rise and decay, one-microsecond pulse width.

The e_0 output pulse can be driven directly into a 1000-ohm gating load for further pulse manipulation. The photo below shows actual outputs on a cathode-ray tube display.

Since the photojunction frequency response is inversely proportional to the phasing slit width, and its amplitude response is directly affected by the same slit width, a compromised working width is established at about 75% of a singular magnified window.

The single output is then improved as much as possible by first focusing the lens system for peak signal amplitude and elimination of optical cross-talk. This requires monitoring of the cathode-ray

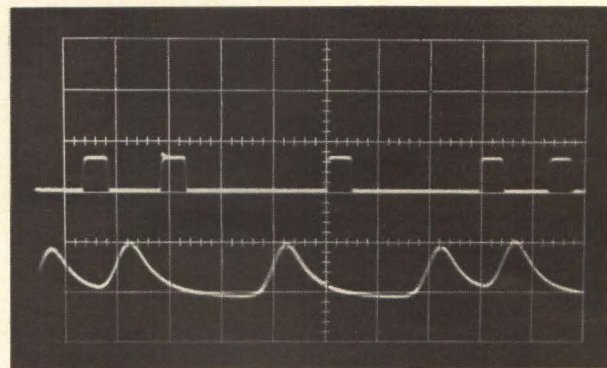

Typical output waveforms at 650 Kilocycles, RZ readout: pulse shaper (top), with 10 volts per centimeter; preamplifier (bottom), with 1 microsecond per centimeter and 50 millivolts per centimeter.

tube during assembly and calibration, since the detector peaks in the infrared region where human perception is inadequate.

Woven into the focusing adjustment is a separate reader adjustment, which is being monitored during assembly. Both adjustments are performed until peak output results. The remaining detectors are then adjusted to peak while observed in a cathode-ray tube. At this point the two extreme channels (innermost and outputmost tracks) are monitored simultaneously and the phasing slit, which is a single slit common to all tracks, is adjusted so that all data tracks are phased synchronously.

Final phasing is performed while the shaped pulse outputs are being monitored. At this time, final individual reader adjustments and slit adjustments are performed and all hardware is secured. Dimensional tolerances and mechanical adjustment locks assure that no optical cross-talk will occur when the memory is being interrogated.

Recording modes

Assuming identical limitations for all contributing errors, for both RZ and NRZ, on p. 66 shows that when the tolerable pulse phase errors are ap-

plied to NRZ data, pulse trains are possible that double bit rates and double capacities. The additional price for using NRZ, however, shows itself as increased complexity and hardware in the associated readout electronics.

For optical RZ data readout, the bit rate and bit frequency are equal. This means that the useful bandwidth of the reader channel for nonlinear data pulses is limited by pulse distortions exceeding $\pm 1/4$ of the pulse pitch, as in B on p. 66.

For optical NRZ data readout, the bit rate is twice the bit frequency. The bandwidth requirements of an NRZ nonlinear data channel are half as severe as in a comparable RZ data channel. This is evident in A on p. 66, where a series of NRZ ones are not required to change state. The result is that the highest frequency encountered on a data channel is only one-half the clock frequency. Therefore, using the same reader channel bandwidth, it is possible to read a double bit rate when using NRZ, providing a double clock frequency is made available, such as by recording a double clock, or by doubling electronic frequency after clock readout. The double clock rate can be read out from the memory because clock pulses are spaced linearly, and are therefore not subject

Optical memory applications

The optical memory, in conjunction with the minimal associated circuits indicated on page 71, is capable of the following uses:

1. Read-out of serial weighted pulse trains
 - a Single disk, or drum revolution
 1. Functions with positive slopes
 2. Functions with negative slopes
 3. Intermixed functions
 4. Two-dimensional nomograms
 5. Functions with scale factors
 6. Functions without scale factors
 7. Families of curves
 - b Multiple disk, or drum, revolutions
 1. Multi-valued functions
 2. Two or more term addition
 3. Two or more term subtraction
 4. Two or more factor multiplication by logarithms
 5. Two or more element division by logarithms
 6. Combinations of one thru five
2. Read-out of serial binary data
 - a All forms of binary codes such as natural binary and binary coded decimal
 - b All types of functions, tables, programs, etc.
3. Read-out of parallel binary data
 - a All forms of binary codes
 - b All types of functions, tables, programs, etc.
4. Miscellaneous
 - a Interrogation and readout for a serial weighted pulse encoded memory can be performed in any practical number base system, or, in any combination of bases, providing the input-output registers are properly connected with the necessary feedback loops.
 - b Conversion from any practical number base to any other base can be accomplished with the clock and reference tracks of the memory in conjunction with suitably wired external registers. An example of intermixed functions is as follows: Assume an optical memory, possessing serial unitary weighted pulse functions encoded in the RZ format, in

conjunction with presettable up-down counting registers. If the memory contains M functions such as f_1, f_2, \dots, f_m , than a family of additional functions can be generated by using any function, f_i , to operate the index (or clock) register, and any function, f_j , to operate (or accumulate in) the output register. The result is a family of functions: $N_{y,i} = A \pm f_j [f_i^{-1}(N_x)]$, where A = output register preset value, N_y = number of accumulated output pulses, and N_x = clock position, whose maximum value is determined by the limiting range of the two selected functions. \pm indicates the up or down counting mode.

Optical memory specifications

1. MTBF: For the basic memory channel consisting of lamps, fibers, motors, optics, detector, pre-amp and pulse shaper: up to 18,000 hours.
2. Cost per bit (including pulse shapers): 10 cents per bit for low capacities (up to 50,000 bits); 5 cents per bit for medium capacities (up to 250,000 bits); one cent per bit for high capacities, (up to 10 megabits). Actual costs would be a function of the number of readout channels.
3. Capacities: Disk configuration up to one megabit; drum configuration up to 10 megabits.
4. Typical volumetric bit densities (with pulse shaping):

For low capacities:	560 bits per cubic inch
For medium capacities:	1,000 bits per cubic inch
For high capacities:	5,000 bits per cubic inch.
5. Bit rates: RZ, 800 kc
NRZ, 1.6 Mc.
6. Average access times: As low as 0.625 msec for drums.
As low as 1.25 msec for disks.
7. Mechanical vibration: MIL-E-5272C Procedure XIII.
8. Temperature Range: -54° to $+71^\circ$ C.
9. Thermal Shock: MIL-E-5272C Procedure I.
10. Power consumption: As low as 10 microwatts per bit for high capacities.
11. Bits per track: up to 16,384.
12. Number of tracks: up to 620 for 10-megabit memory.
13. Disk sizes: up to 8 inches O.D., depending on access time.

to the bandwidth distortions of nonlinear pulse trains, which are pulse trains that do not have pulses in every pulse position. This would be almost any pulse train that is not a train of clock pulses.

Using RZ or NRZ recording, it is possible to encode and retrieve data from the memory in either parallel or serial fashion. The serial data may be coded in binary or as weighted pulse trains, both of which would possess random track access.

To differentiate between these two serial modes, it should be noted that a serial binary train of pulses contains pulses of different weights as determined by the selected code. Their relative position in time determines the weight of each pulse, such as in the series 1, 2, 4, 8, 16, 32. In contrast, a weighted pulse train contains pulses of different weights arranged in groups of identical weights, such as 11122222244. . . . These pulses are counted, or accumulated—rather than being shifted into the output register—by switching them into the appropriate weighted state of the output-counting register.

Assignment of parallel or serial words to corresponding clock positions is identical to the programming schemes used with general-purpose

Drum sizes: up to 8 inches O.D., depending on access time.

14. Disk or drum change time: less than 10 minutes.

Solving nomographs with an optical memory

A potentially important application for an optical memory is in storing nomographic data for solving engineering problems. In effect, combining the speed of electronics with the simplicity of graphic techniques permits rapid solution of complex problems such as ordinary or partial differential equations

An example illustrates how the technique works: Assume that a point has been selected on curve U and another on curve V, and that a straight line has been drawn through the two points. Where does the line cross curve W?

The angle formed by the straight line and the horizontal axis is the same at all three points of intersection. If the angles are equal, then their tangents are also equal. Therefore, $(U_y - V_y)/(U_x - V_x) = (W_y - V_y)/(W_x - V_x)$. Or, the difference between the Y coordinates of the intersection points on curves U and V, divided by the difference in their X coordinates, is equal to the difference between the Y coordinates of the intersection points on curves W and V, divided by the difference in their X coordinates.

Given the coordinates of the points on curves U and V, a computer can easily find a pair of coordinates for the points on the W curve that will satisfy this linear relationship.

The values of U and V and of their X and Y coordinates, together with a clock track, can be placed on an optical memory as columns of bits, and scanned by photoelectric cells as the memory is moved past them. At any instant the cumulative count of the bits in a given column is taken as the value of that variable in the column at that instant. Knowing the values of U and V, the count can be stopped when the prearranged known value reaches this cumulative count. At this moment the U_x and U_y values are known through their simultaneous cumulative counts.

In a second pass, values of W coordinates are tried out

Front cover

The cover photograph shows a disk optical memory, with the cover open for changing the disk, an enlarged portion of which is in the background.

In less than 10 minutes the memory can be opened, the disk changed and the memory restored to operation. A fixed mechanical gauge sets the disk into its correct optical plane. No trimming adjustments are required.



computer memories. Although these schemes are readily adaptable to the optical memory, they do not permit maximum use of the memory as a basic system component. The serial weighted-pulse encoding scheme permits the generation of incremental functions, of functions attained by intermixing of pulse trains, elementary computation by pulse accumulation, and the storage and retrieval of multi-dimensional nomograms. The storage of nomograms permit faster solution rates when solv-

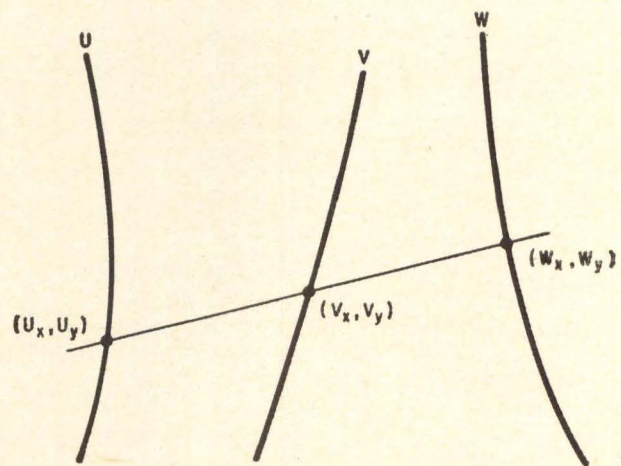

in the linear relationship, using the known U and V coordinate values; there will come an instant when they satisfy the relation. By stopping the W count at that instant, the cumulative W-count is the value of W that satisfies the relation for the specified U and V values.

Among the more complex nomographs that can be stored and solved with this technique are those for ordinary differential equations, or systems of these, is much more difficult but technique shows promise.

A simple nomographic-electronic computer called Noel is in an advanced stage of development at Massachusetts Institute of Technology, where its operation approaches 1,000 solutions a second. Note that this is 1,000 solutions, not computations, per second. The memory used in Noel was built at MIT. Also being investigated is the use of delay lines for temporarily storing the nomographic bit pattern, which would minimize mechanical wear of the permanent optical memory.

Most of the above information is taken from reference 3

ing equations and other relationships and also results in simpler and less costly hardware.³

The optical memory is ideally suited for the serial weighted-pulse encoded formats because of its high bit rates, low access and high packing density. Indications are that dimensional reduction incurred in the generating of nomograms will play a significant role in the simplification and cost reduction of special-purpose digital systems.^{4, 5}

Function encoding

Since parallel and serial binary encoding systems are well known in the computer field, no specific example will be given. However, since the weighted-pulse concept is relatively new, a brief example will show how a specific function can be encoded.⁶ In this sample, each pulse is assigned a value of one, resulting in a unitary-valued pulse train.

To encode and store a function (such as $y = f(x)$), it must lie in the first quadrant of an X,Y coordinate system. In addition, it must pass through the origin at its lower range limit and possess a positive slope of less than one in magnitude. Functions that do not possess these characteristics may be transformed prior to encoding.

The same X,Y coordinate system is graphically represented on the storage surface. Here, the clock channel set, of windows represents the X axis, any function channel the Y axis, and the singular reference mark defines the origin.

The function $Y = \sin X$ satisfies the above requirements. The range to be encoded will be assumed as 0 to $\pi/2$, which will be divided into 2,048 increments. This number also represents the quantity of clock pulses assigned to this range.

The value of one pulse, ΔX , then, equals $\pi/2$ divided by 2,048, or $1/1,304$. The clock position, N_x , corresponding to any value of X, equals X divided by ΔX . Similarly, the number of function pulses, N_y , corresponding to N_x , equals y divided by Δy . However, $\Delta X = \Delta Y$ by the nature of the stored pattern geometry. Therefore, $N_y = y$ divided by Δx . Substituting in the original equation delivers the quantizing equation:

$$\begin{aligned}y &= \sin X \\N_y \Delta X &= \sin (N_x \Delta X) \\N_y &= (1/\Delta X) \sin (N_x \Delta X) \\N_y &= 1304 \sin (N_x/1304)\end{aligned}$$

The author



Fred DeNegri received his mechanical engineering degree and his MS in computer engineering from Stevens Institute of Technology in Hoboken, N.J. Since 1948 he has been involved in the development of analog, digital and hybrid instrumentation systems and associated components. His more recent work has been in the development of optical memory and

high-resolution electrostatic shaft-encoding systems for airborne use. He holds patents in these fields.

This equation is solved for every value of N_x from 1 to 2,048, and each solution is rounded off to its nearest integral value. If the resulting answer differs from the preceding solution by one, etch a window in that clock location for the function. If the answer does not differ by one from the preceding solution, do not etch a window, and proceed to the next clock position, etc. Such a process is readily programmed for quantizing on a general-purpose digital computer. The output format from the computer can be a punched paper tape or typed sheets, either of which will serve to program the encoding engine.

Retrieval of data

Data may be retrieved from the memory in several ways, depending on the encoded data format. The minimal associated equipment required to operate the memory for any mode is shown in the figure on the opposite page.

A typical interrogation cycle for the memory would be as follows:

1. The output register is set into its proper configuration—that is, parallel input or serial input, as a shifting or counting register.

2. The output register is preset to zero or some other value and its up or down counting mode selected.

3. The proper function, or functions, are selected for entry into the output register. The same is done with the index register.

4. The desired clock position is placed into the index register.

5. The REF control switch is closed and the first reference pulse from the memory “sets” the control flip-flop, which in turn open the AND gates. Pulse trains will then flow simultaneously into the index and output registers. Upon the occurrence of the zero state of the index register, the flip-flop is reset and all pulse flows cease. The output register will then contain the desired answer.

The optical memory disk or drum can be provided with magnetic read-write capability for scratch-pad use. Magnetic recording is performed on the edge of the disk or on the surface of the drum-supporting flange. Read-write bit rates are lower than optical bit rates, and are further lowered when data disk or drum interchangeability is involved.

Many system applications are required to manipulate a large proportion of fixed or permanent data using a small amount of temporary storage. One example would be an aircraft performing routine reconnaissance. The pattern is predetermined, so the coordinates for the turns can be stored permanently for each search area. Corrections are needed to compensate for effects of wind, altitude and other variables. These corrections could be made by a flight computer or a flight engineer working continuously with the permanent stored data.

Nomographic computation, combined with high-bit-rate, high-capacity optical memories, can pro-

vide faster solutions of special-purpose tasks, and require less hardware.

Fabrication and test

The lamp and fiber assembly first requires the selection of lamps whose area of maximum intensity can be centered on the axis of a supporting sleeve which, in turn, is cemented to the lamp. This assures accurate aiming at the fiber inlets. The fiber assembly requires a fixture into which each fiber is placed individually to achieve the desired random output distribution. The input and output interfaces are then ground and polished.

The data disk is perhaps the most involved sub-assembly, since it requires a reliable means of converting the original data to the desired window structure. The fabrication cycle is begun by placing a sensitized glass blank into a special camera. This camera is designed to index the blank in predetermined steps, such as 1/2048 or 1/4096. Facing the camera is a set of shutters, each capable of admitting or blocking a "bit" of light intended for the sensitized blank. Each shutter correspond to a radial word on the data disk. Hence at each indexed position a complete word is exposed. This assures pulse phase alignment after the light-forcing function is transformed into the electronic time domain. At this stage, also, the permanent clock "lead" is impressed on the disk.

Input to the shutters, to establish the desired word, is provided by an automatic punched-paper-tape reading system equipped with manual override and feedback monitoring. The entire operation is a closed-loop, self-monitoring cycle that reads words from the paper tape, sets the shutters, monitors their position, flashes the exposing light, indexes the sensitized blank and repeats the cycle.

Engine-positioning accuracies limit the resolution of data to be encoded. Since each radial word placed on a disk is self-synchronous on readout, the location of each word is not as critical as it would be if the disk were to be used as a positioning reference. Hence, an engine accuracy of ± 30 seconds of arc is adequate to encode a 4,096-word, 22-track disk.

For higher track capacities on both disks and drums using multiple station readout, the engine positioning accuracy must be controlled more stringently. The engine used in this case is positioned by a closed-loop, incremental digital system using a 16-digit Gray code photoelectric encoder as the feedback element. This engine is capable of encoding 16,384 bits per track for both disk and drums.

The completed and phased memory is tested by having the memory generate a punched tape of its own contents. This tape is then automatically compared with the original programming tape, and corrections are made as necessary.

Disk or drum?

The permanently stored data structure on the disk consists of concentric circles of windows

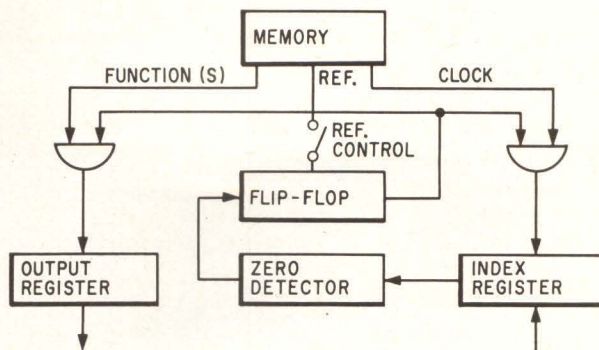

Minimal associated circuits required for optical memory applications.

etched in a thin metallic film bonded to a stable glass base. A vacuum-deposited nickel film, several millionths of an inch thick, has been found to have the best over-all characteristics. The combination of metallic film on glass requires a photo-etching process that causes a loss of line density. However, the ability to fabricate many data disks from a single master reduces disk cost considerably. For high line densities a drum surface is preferred to a disk, with each data drum a separate generated master rather than a photographic copy.

In a drum, line density is not lost, due to the transfer process used with disks. The higher cost of making a drum is compensated for by the increase in storage capacity of the data surface.

Other considerations are involved in selecting either a disk or a drum. These include access time and encoding format.

For low access times, a drum is preferred. For a given amount of data, its smaller diameter is able to tolerate higher speeds. When the desired encoding is in the serial-weighted pulse family (for instance, 11122222244...), such as is used for nomogram storage, the disk may be preferred because its increasing track diameters permit storage of increasing number of bits per track.

Dust particles are no problem, as the data surface is continually in motion and the resulting forced airstream across the surface is enough to "sweep" the disk clean. Also, the entire instrument is hermetically sealed, when specifications permit.

References

1. Douglas P. Adams, Countable-Bit, Nomographic Electronic Computation, Princeton University, Department of Graphics and Engineering Drawing, Technical Seminar Series, Report No. 5. Feb. 11, 1963.
2. A. G. Jordan and A. G. Milnes, Photoeffect on Diffused P-N junctions with Integral Field Gradients, IRE Trans, Oct. 1960.
3. Douglas P. Adams, Nomographic-Electronic Computation, a New Graphics for Tomorrow's Problems, Department of Mechanical Engineering, Massachusetts Institute of Technology, Dec. 16, 1963.
4. Douglas P. Adams, Countable-Bit Nomographic Electronic Computation—NOEL, Workshop on Computer Organization, Edited by Alan A. Barnum and Morris A. Knapp, Spartan Books, Inc., 1963.
5. Douglas P. Adams, Computer in a Shoebox, Machine Design, Sept. 14, 1961.
6. Bendix Corporation, Eclipse-Pioneer Division, Data conversion for Optical Memory Storage, Report No. 7441-63-EI. April, 1963.

Designer's casebook

Designer's casebook is a regular feature in Electronics. Readers are invited to submit novel circuit ideas, packaging schemes, or other unusual solutions to design problems. Descriptions should be short. We'll pay \$50 for each item published.

Cold-cathode gas tubes switch high voltage fast

By Robert E. Daniels and Arthur D. Cook

Argonne National Laboratory, Argonne, Ill.

In equipment designed to be carried aloft in a balloon, a reliable, high-voltage switching device having a short delay time and a very fast rise time was required to operate an array of spark chambers. A spark chamber is an instrument used by physicists interested in high-energy phenomena to observe the path of an ionizing particle passing through the chamber.

The average rate anticipated in the experiment was two pulses per second, and a recovery time of 0.15 seconds had to be available after each pulse so that the recording cameras might be advanced. As in all airborne equipment, weight, size and electrical efficiency were important design considerations.

The methods regularly used to switch high voltage were considered for this application, including spark gaps, thyratrons and hard tubes. The device finally selected was a cold cathode krytron gas tube (krypton), type KN2 or KN6, made by Edgerton,

Germeshausen and Grier, Inc. The physical size, ruggedness and cold-cathode operation of these tubes make them ideal for airborne equipment. The trigger voltage and trigger current requirements are within the range of transistor trigger circuits, and the tubes are easily shielded for operation in high magnetic fields.

The anode hold-off voltage rating for the krytrons is lower than that required to be switched in this application, and an arrangement for stacking tubes that employed a resistive divider to equalize the voltage drops was developed to allow higher voltages to be switched. When switching 10 kilovolts with this stacking circuit, experimental observations indicate that firing delays of 0.2 microsecond are obtained by increasing the trigger voltage from 300 to 500 volts.

The complete pulser, trigger and driver is shown below. Transistors Q_1 , Q_2 and Q_3 form a line driver, allowing this part of the circuit to be located remotely. Cable lengths of 10 feet between the driver and trigger circuits cause no deterioration in performance. The operation of the driver is similar to the action of a thyatron in that a negative pulse input to Q_1 causes transistors Q_2 and Q_3 to go into a regenerative mode, and to rapidly discharge capacitor C_4 into the base-emitter junction of Q_4 and Q_5 . This turns on Q_4 and Q_5 , discharging C_5 into transformer T_1 , which drives the pulser.

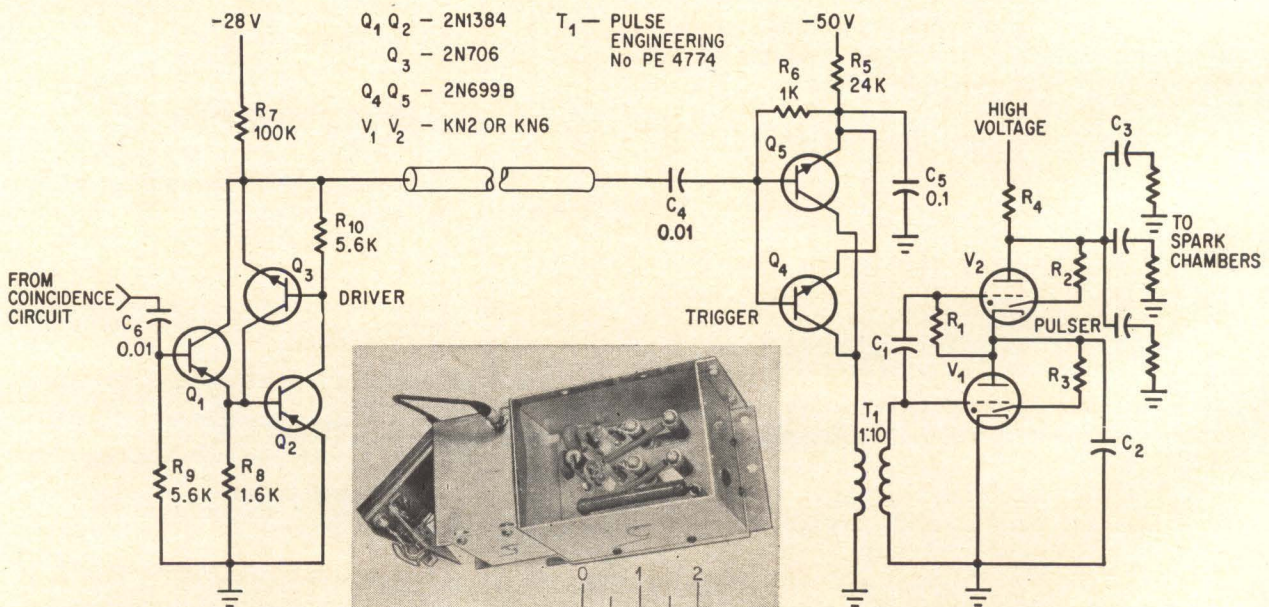

High-voltage pulser. Inset shows construction of trigger circuit attached to the side of the spark-chamber pulser. One side of the aluminum box for pulser circuit is made of Rexolite upon which are mounted the pulser components.

Both the line driver and trigger circuits obtain their pulse power from capacitors. This allows the power supply to be isolated by large resistors and prevents it from being shorted in case of circuit failure. The krytrons V_1 and V_2 are stacked in series with charging resistor R_4 . Resistors R_2 and R_3 provide the keep-alive current to the tubes and serve to divide the high voltage equally across them.

The over-all delay in this pulser (0.35 μsec) oc-

curs in the rise time of T_1 (approximately 0.2 μsec) and the firing delay of krytrons (about 0.15 μsec). Life tests on the krytrons in this application indicate an average life of 165,000 operations. The pulser and trigger circuits have been tested in magnetic fields as high as 2.5 kilogauss with the use of magnetic shields.

This work was performed under the auspices of the Atomic Energy Commission.

Amplifier improves peak voltmeter response

By Masami Uno

Faculty of Engineering, Shizuoka University, Hamamatsu City, Japan

The conventional method for measuring the peak value of a pulse is to charge a low-leakage capacitor C , through a cathode follower and a diode, with the pulse to be measured. The voltage across C is then read with a vacuum-tube voltmeter.

For this method to operate successfully, the charging time constant of the circuit must be small enough so that C is completely charged to the peak pulse value before the pulse begins to fall. On the other hand, the discharging time constant of the capacitor should be large enough so that the charge is maintained long enough for the measurement.

In general, the voltage across C is related to the input voltage by the equation $e_c = e_i [1 - \exp(-t/\tau)]$. If the charging time constant is made small, e_c will approach e_i rapidly, allowing C to charge to the peak value of even very narrow pulses. However, the discharge time constant formed by C , its own leakage resistance and the in-

put of the vtm also becomes small, and the measurement time becomes too short. If C is made large to increase the measurement time, C will not charge to the peak pulse voltage.

In the new circuit shown above, an amplifier V_2 is added to the conventional peak voltmeter. The voltage across C is applied as negative feedback to one input of the amplifier, and the pulse to be measured is applied to the other. Assuming that the delay in the amplifier is negligible and that the gain A of the amplifier is much greater than unity, the equation for the capacitor voltage e_c now becomes $e_c = e_i [1 - \exp(-tA/\tau)]$. This indicates that negative feedback has reduced the charging time constant to τ/A . It becomes possible to measure the peak value of a pulse with a width narrower by a factor of $1/A$ than is possible by the conventional method with the same value of C . Furthermore, if C is made A times larger, the available measurement time becomes A times longer without affecting the minimum width of the measured pulse.

In the circuit shown, the gain of the second stage of V_2 is about 10. Voltage across the charging capacitor C is fed back to V_2 through cathode followers V_5 and V_1 . Readout is accomplished by a 0-1 milliammeter (connected) through cathode-follower V_5 and differential cathode follower V_6 .

The author thanks Z. Abe of the General Research Laboratory of Hitachi, Ltd.

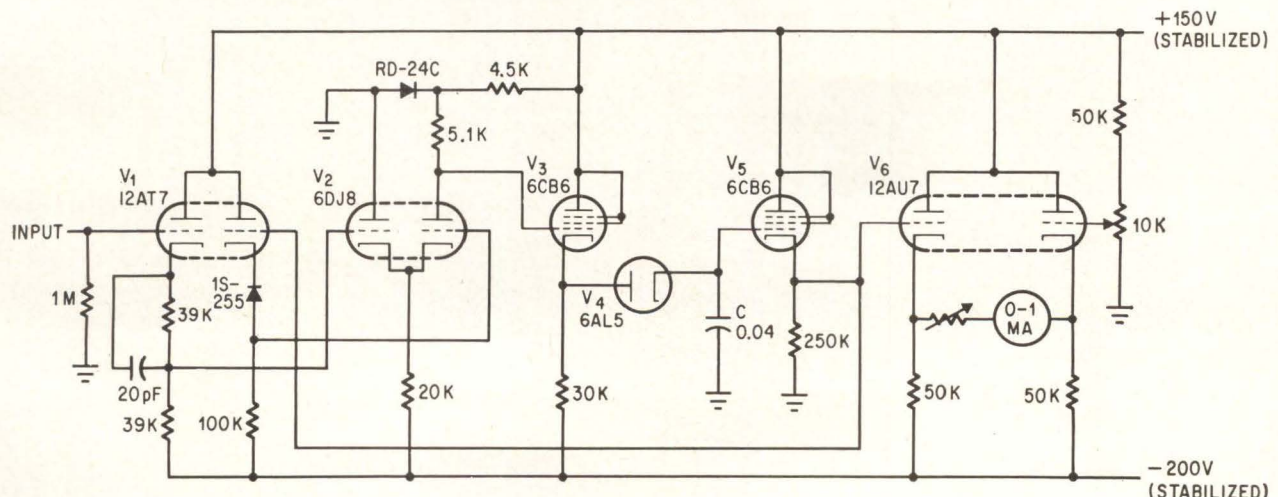

This peak voltmeter was tested with a 12.5-volt sawtooth whose base was varied from 15 to 700 microseconds. Response fell off only 3% at low end, whereas conventional voltmeter response falls to about half. Good linearity is obtained up to 40 volts.

The silent war: electronic spying

Electromagnetic reconnaissance is one of the best guarantees against a sneak attack on the U. S. or one of her allies. It's also vital for effective arms control

By John M. Carroll

Managing Editor

Governments don't like to talk about electronic spying—they seldom even acknowledge that it exists. But exist it does, and every time a plane is shot down along the Iron Curtain there's a chance it was engaged in gathering information electronically.

Since 1950, a total of 26 United States planes have been forced down or shot down along these frontiers, and 108 airmen have lost their lives or their freedom.

Major powers conduct electromagnetic reconnaissance, or ferreting, to keep track of a potential enemy's new electronic systems and his deployment of men and materiel. This information is essential in guiding electronics research and development, establishing logistic requirements for perimeter defense, and planning to evade, destroy or jam an enemy's electronic defenses.

Some disarmament experts also see electronic data-gathering as a tool for keeping the peace.

Clues from the news

Electronic intelligence, or the suspicion of it, popped into the news several times recently.

First a North American T-39B Sabreliner with three Air Force officers aboard was shot down over East Germany. This type of jet trainer has been equipped for special radar training missions, but its use specifically for electronic intelligence has never been disclosed.

Next, a Douglas RB-66 Destroyer, a plane often used for electromagnetic reconnaissance, was lost in the same general area. Later there was an announcement that Martin RB-57 Canberras had been used for high-altitude overflights of the Chinese mainland. And then there was President Johnson's disclosure of the existence of the A-11, a high-flying supersonic twin-jet capable of replacing the U-2 for overflights, even of the Soviet heartland.

There are also reports that electronic-intelligence versions of the Samos photographic reconnaissance satellite have been launched in polar orbits.

Soviet restraint

Undoubtedly the Soviet Union also gathers electronic intelligence. A few years ago there were rumors that a Russian electronic reconnaissance plane had crashed off northern Canada.

Why do so few Soviet ferrets become casualties?

One reason may be superior restraint by Soviet crews. U. S. forces characteristically operate with everything turned on that can make a radio wave. For that reason, flights 100 miles off shore can be highly productive of electronic intelligence.

But the Soviets typically hold back their electronic transmissions until the last minute, and it may require actual intrusion of their air space to intercept the electronic Orders of Battle—such as tracking radar, fighter-director radar, ground-air missile command signals and ground-air and air-air communications.

Active and passive measures

Electronic countermeasures, of which electromagnetic reconnaissance is only a part, divide neatly into two parts: passive measures, or reconnaissance, and active measures, or jamming.

Jamming attempts to prevent the enemy from using his electronic equipment by either saturating it with noise (barrage jamming) or by deceiving it with intentionally misleading signals (beacons, repeaters, inverse amplifier, gate stealers and track breakers).

Reconnaissance merely establishes the location and electromagnetic characteristics, or "signature" of enemy transmitters.

Electromagnetic reconnaissance plays a major role in strategic and tactical countermeasures.



Action in the North Pacific. Two Soviet Badger reconnaissance bombers that flew over the attack carrier Kitty Hawk (CVA-63) are escorted away by a Navy F-4 Phantom II (not shown) and an F-8 Crusader. The twin-jet Badger is used by both the Soviet Navy and Air Force. Its official name is the Tupolev TU-16. It has a 3,975-mile range.

Electronic spying mission

Every Wednesday at 0700, N. N. Petrov, Captain Third Rank of Naval Aviation, takes off in his twin-jet Tupolev TU-16. He circles the pine-barrens of the Kamchatka Peninsula as he climbs to 13,000 meters, then comes about to a course of 045, true.

Only an observer who has seen a dozen enlisted men climb into the midsection of the bomber would know there is something different about this plane. It is a ferret, one of dozens of Soviet, British and American aircraft that regularly patrol the frontier that separates East from West, playing the serious and dangerous game of electromagnetic reconnaissance.

An hour after takeoff Pavel Ivanov, the senior radio mechanic, comes in on the public-address system to announce an intercept. Ivanov is covering L band from his console. He recognizes the five-times-a-minute beep of AN/FPS-24 search radar.

Minutes later, the radio mechanic at the X-band receiving position picks up the high-pitched squeal of tracking radar. It is time to turn now and follow a dog-legged northward course that will take the big plane east of Gambell on St. Lawrence Island and on toward the polar ice pack.

Hours later, the plane will return with a dozen reels

of magnetic videotape and log books bulging with intercept reports of U. S. radars, ionospheric sounders and vhf communications signals, all to be sent to the Signal Intelligence Service in Moscow.

The incident is fictitious, but such events happen daily. Not only off Alaska but on both sides of the Iron Curtain—along the borders of East Germany and Czechoslovakia, the coasts of the Adriatic and Black Seas, the jungles of Southeast Asia, the shoreline of Communist China and the white beaches of Cuba.

Soviet ferreting seldom breaks into the news the way U. S. ferreting does—that is, by having one of their ferrets shot down. The main reason U. S. guns hold their fire when Soviet planes intrude is that many Polish and Czech defectors have escaped in military aircraft.

But there have been at least 90 Soviet intrusions into West Germany during the last two years. Soviet planes have flown over the U. S. Pacific Fleet several times, and regularly patrolled waters off Alaska. On one occasion, two planes flew over parts of Alaska itself.

Soviet trawlers off the U. S. coasts carry an undue amount of electronic equipment for just fishing. There is also a fairly general presumption that the Soviets have launched spy satellites in orbits over the U. S.

In strategic ferreting the object is to locate and identify potentially hostile transmitters including radar, communications, missile guidance and navigational aids. These are purely passive electronic countermeasures. In tactical ferreting, on the other hand, the object is to determine what electronic weapons are being used by an enemy and to determine what countermeasures to employ.

In tactical reconnaissance analysis of data must be carried out while flying over the target area. In strategic uses, analysis may take place in a laboratory many miles from the interception site.

Technically the objectives are the same: capture the signal, determine its frequency, type of modulation (including pulse repetition frequency, pulse width and switching mode, if any), antenna characteristics (including beam width and pattern, rate of rotation, switching mode and polarization), and bearing.

A major controversy in strategic electronic reconnaissance revolves around techniques of signal analysis. Ever since wideband videotape recorders came into being, there has been a tendency to cap-

ture all signals indiscriminately and to rely on analysis officers to identify the individual signals and correlate them with positional information. But as the number of potentially hostile radars has multiplied and frequency control has improved, it has become all but impossible to sort out the signals. As a result, many tapes recorded at great risk have been, as far as their actual strategic value is concerned, just so much junk.

Thus there is a movement these days to do more analysis in flight of even strategic information, and planes like the Lockheed RC-130 Hercules have become flying laboratories.

Receiving enemy signals

The first objective electromagnetic research is to receive or intercept enemy signals. There are two approaches to this problem. The first is to scan throughout the frequency band of interest using a relatively narrow-band microwave receiver. The second approach is to use a wide-open receiver that responds to all signals within the band.

In fighter aircraft, ferret receivers are usually

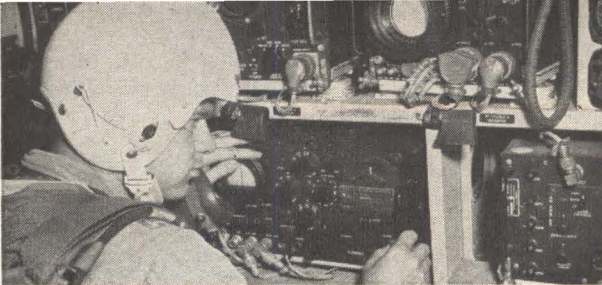

Raven position No. 1 of an RB-66C. The Electronics Warfare Officer is searching for radar signals with an Apr-14 intercept receiver. Next to it is an APR-8B panoramic intercept adapter. Top row of equipment consists of another APR-8B, an ALA-5 pulse analyzer, an ALA-6 direction finder and an aircraft instrument panel. Most of this gear is of late World War II vintage.

New uses for old gear

Operational weapons are frequently a generation behind the best materiel available. World War I was fought with Krag rifles and borrowed Lee-Enfields even though the Springfield was officially adopted in 1903.

So it is with electromagnetic reconnaissance gear. The workhorse of the tactical Air Command is the RB-66. This plane is slated to be replaced by the mach-2 RF-46 but will be around for a long time.

Right now the RB-66 uses the APR-9 as its receiver for electronic intelligence. This equipment came out in 1945. Although some APR-9's have traveling-wave tube front ends, the operational units use a plain old tuned cavity. However, the APR-9's are being replaced with APD-4's.

The four is a semiautomatic system utilizing wide-open frequency-discriminating receivers. It records everything on 35-millimeter film for later processing and analysis. Each wide-open frequency discriminator receiver covers a certain channel. The receivers do not have search-and-lock-on capability because their function is just to listen in, not to defend the aircraft or provide an electronic countermeasures. The system may also be used for radar direction-finding.

One of the largest ferret systems in use is called the ASD-1. It is flown in RC-135 jet tankers of the Strategic Air Command. It was built by the Air Force's Aeronautical Systems division and has both manned and automatic positions. It is much too big for either the Tactical Air Command or the Navy.

Operational reconnaissance gear lags badly behind the equipment now in research and development. The USD-7 exists only in prototype. YIG-TWT-YIG receivers have been manufactured in only limited quantities. Practically speaking, the U. S. has made little progress in this field since 1945.

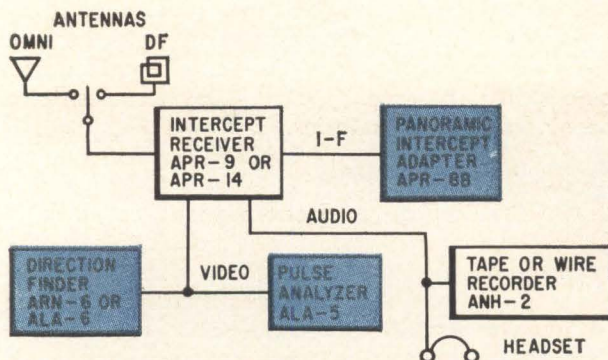

Electromagnetic reconnaissance equipment like that used aboard RB-66 bombers of the Tactical Air Command.



Raven position No. 2—there are four. The officer is correcting the altimeter reading on his instrument-panel repeater. The repeater panel, sandwiched neatly between two ALA-6's contains a compass, air-speed indicator, altimeter, cabin-pressure indicator, clock and latitude-longitude indicator. Bottom row contains another APR-14 and APR-8B. Top row holds three ANH-2 wire recorders, the AIC-10 interphone control panel, and an emergency oxygen bottle. Newer gear performs the annotation function automatically.

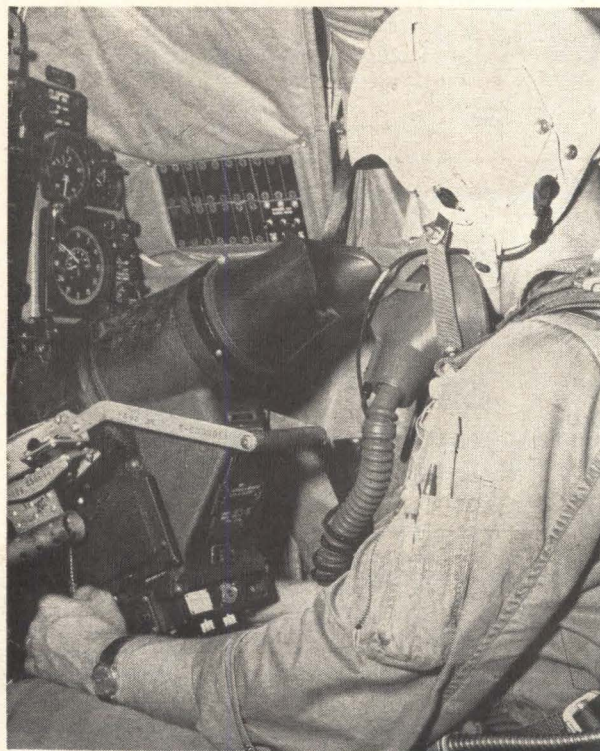

Navigator—also on the EMR team. This navigational radar scope helps establish the position of the Air Force RB-66C Destroyer in the air. Above the scope is an N-1 aircraft compass and above the compass are a dial and a clock.

channelized because such receivers can be made small and light. On large bombers, search and lock-on receivers are used. They sweep a band, locate an intercept and lock on.

Until now, most lock-on schemes were analog in nature. They simply located a signal above a certain threshold and used a servo system to tune to

it. Newer systems are being digitized—often with microelectronic circuits—and can be programmed to lock only onto signals possessing certain predetermined characteristics.

Lock-on capability is important in both strategic and tactical reconnaissance. In the tactical situation the electronic warfare officer must identify

Clues to electronic reconnaissance activity: U.S. planes shot down since 1950

Date	Type plane	No. planes	Result	Where	Comments
4/8/50	PB4Y-2 Privateer (USN)	1	shot down	Baltic Sea	10 lost; patrol/recon plane
6/8/51	F-80 (USAF)	2	forced down	Nuernberg-Fulda area of Germany, landed in Czechoslovakia	planes returned
11/6/51	P2V Neptune (USN)	1	disappeared	near Siberia	10 lost; weather recon
11/19/51	C-47 (USAF)	1	forced down	Hungary	4 returned
6/13/52	RB-29 (USAF)	1	disappeared	Sea of Japan off Hokkaido, left Yokota AB	13 dead; classified recon flight
7/31/52	Mariner PBM (USN)	1	damaged	Yellow Sea	2 killed; 2 injured; patrol/recon plane
10/7/52	RB-29 (USAF)	1	disappeared	Japanese territory	8 lost; routine recon flight
10/8/52	C-47 (USAF)	1	attacked	Koennern, near Berlin	medical evacuation
1/18/53	P2V-5 Neptune (USN)	1	ditched	off Swatow in the Formosa Straits	6 missing, 2 alive
3/10/53	F-84 (USAF)	2	one plane shot down	near Czech border	pilot saved
3/15/53	RB-50 (USAF)	1	attacked	100 mi northeast of Petropavlovsk, Siberia	no damage, recon flight
7/29/53	RB-50 (USAF)	1	shot down	off Russian coast	15 lost; recon flight
1/27/54	RB-45 (USAF) F-86 (USAF)	1 16	attacked (escorts)	Yellow Sea	recon flight; 8 Migs attacked; 1 shot down
3/12/54	AD Skyraiders (USN)	2	attacked	from USS Randolph; near Czech. border
7/25/54	AD Skyraiders (USN)	2	attacked	from USS Philippine Sea, South China Sea	shot down 2 La-7's
9/4/54	P2V Neptune (USN)	1	shot down	near Siberia	1 dead, 9 survivors; patrol/recon plane
11/7/54	B-29 (USAF)	1	shot down	North Hokkaido, Japan	10 survived, 1 died; photo-mapping recon flight
2/5/55	RB-45 (USAF) F-86 (USAF)	1 12	attacked (escorts)	Yellow Sea	recon flight; 2 Mig 15's shot down
2/9/55	AD Skyraider (USN)	1	shot down	near Tachen Islands	no casualties
5/10/55	F-86 (USAF)	8	attacked	coast of N. Korea	2 Migs shot down; 1 possibly
6/22/55	P2V Neptune (USN)	1	crash landed	St. Lawrence Island, from NAS Kodiak	3 of 11 injured
8/18/55	T-6 (USAF)	1	shot down	near N. Korea	1 killed, 1 injured
8/22/56	P4M Mercator (USN)	1	shot down	near Wenchow in Communist China	16 died; recon flight
1/12/57	Navy plane (USN)	1	attacked by AA fire	Formosa Straits	slight damage
3/6/58	F-86 (USAF)	1	shot down	bet. N. & S. Korea	local training flight
6/27/58	C-118 (USAF)	1	shot down	Soviet Armenia	9 released
9/2/58	C-130 (USAF)	1	shot down	Soviet Armenia	17 died
11/17/58	RB-47 (USAF)	1	attacked	Baltic Sea	recon flight
11/17/58	RB-47 (USAF)	1	attacked	Sea of Japan	recon flight
6/16/59	P4M Mercator (USN)	1	attacked	Sea of Japan, 85 mi. east of Wonsan, Korea	1 injured; infrared recon flight
5/11/60	U-2 (CIA)	1	shot down	USSR, from Adana, Turkey	recon flight, pilot released
7/1/60	RB-47 (USAF)	1	shot down	Barents Sea	4 missing, 2 released
2/14/62	C-124 (USAF)	1	buzzed	Berlin Air Corridor
10/27/62	U-2 (USAF)	1	shot down	near Cuba	1 dead; photo recon
5/17/63	H-23 helicopters (USA)	2	forced down	N. Korea	checking markers
1/28/64	T-39B Sabreliner (USAF)	1	shot down	Germany	3 dead; radar training
3/10/64	RB-66 Destroyer (USAF)	1	shot down	Germany	3 released; navigation training

dangerous signals such as tracking radar, and go about jamming them. In the strategic situation, the operator of the electronics equipment frequently wants a longer look at an interesting target to log it properly in his report.

During World War II and the Korean conflict, receivers such as the RDO, SPR-2 and APR-4 operated in the scanning mode, using tuning motors to drive butterfly tank circuits. But the tuning process was slow, spectral coverage was limited and poor selectivity of the tuning circuits led to many spurious responses.

Wide-open receivers

These early intercept receivers had little advantage over a wide-open receiver. A wide-open microwave receiver consists of an antenna, crystal detector and video amplifier (A). It may be possible to pick up signals 50 decibels below one milliwatt with such a receiver. A modern example of a wide-open receiver is the tail-end radar detector.

In addition to having relatively low sensitivity, the wide-open receiver gives no indication of the frequency of the intercepted signal. It is necessary to record the receiver output on magnetic tape, together with some baseband reference signal. Later an analysis officer must laboriously scan short random samples of the tape, using a variable narrow-band filter and recorder to isolate each frequency component on the tape—and Heaven help him if there is any intermodulation present!

The wide-open frequency discriminator (B), called the wideband high intercept probability receiver, is sometimes referred to as WOFD or WHIP. This discriminator adds an indication of frequency to the wide-open receiver.

A signal is introduced into the wide-open receiver and split into two branches. Each branch includes a tuned circuit. In one branch the tuned circuit is responsive to the low end of the frequency band being measured, while in the other branch the tuned circuit is responsive to the high end. The outputs of the two branches go to different sets of deflection plates of a cathode-ray oscilloscope, and the angle between the two oscilloscope traces may be interpreted in frequency. This arrangement may be used to indicate phase instead of frequency. When used with two directional antennas, it can indicate the direction of the enemy transmitter.

Tuned front ends

The invention of the traveling-wave tube changed the concept of receiver design. This tube could cover with uniform response an octave of bandwidth. Furthermore, portable video recorders could capture the output of these receivers on magnetic tape.

However, the problems of analysis set a limit on how much of this tape could be processed while the information was still meaningful. Nevertheless, the wide-open receiver and videotape recorder proved useful on missions such as the U-2 flights.

By adding a broadband traveling-wave tube to

a wide-open receiver (B), it may be possible to get 20 to 25 decibels of gain. Frequency discrimination can be achieved by placing a traveling-wave tube amplifier ahead of an APR-9 receiver that is mechanically swept from 1.0 to 10.5 gigacycles. These receivers were designed at Stanford University, and prototypes were built at the Airborne Instruments Laboratory division of Cutler-Hammer, Inc., Production models were made by Collins Radio.

Then came the invention of the yttrium iron-garnet (YIG) tuner. Here a polished sphere of yttrium iron garnet is placed inside a magnetic solenoid within a waveguide. Passing current through the solenoid permits varying the frequency of the YIG tuner over an octave bandwidth—roughly 25% above and below center frequency. YIG tuners are available to tune in decade increments from 200 to 18,000 megacycles. Their insertion losses vary from five to eight decibels.

A typical microwave tuned radio-frequency receiver using input and output YIG tuners with a wideband traveling-wave tube between them (C) can tune over an octave in frequency at a scanning rate of 100 cycles per second. Such a receiver is useful in working with modern spectrum analyzers.

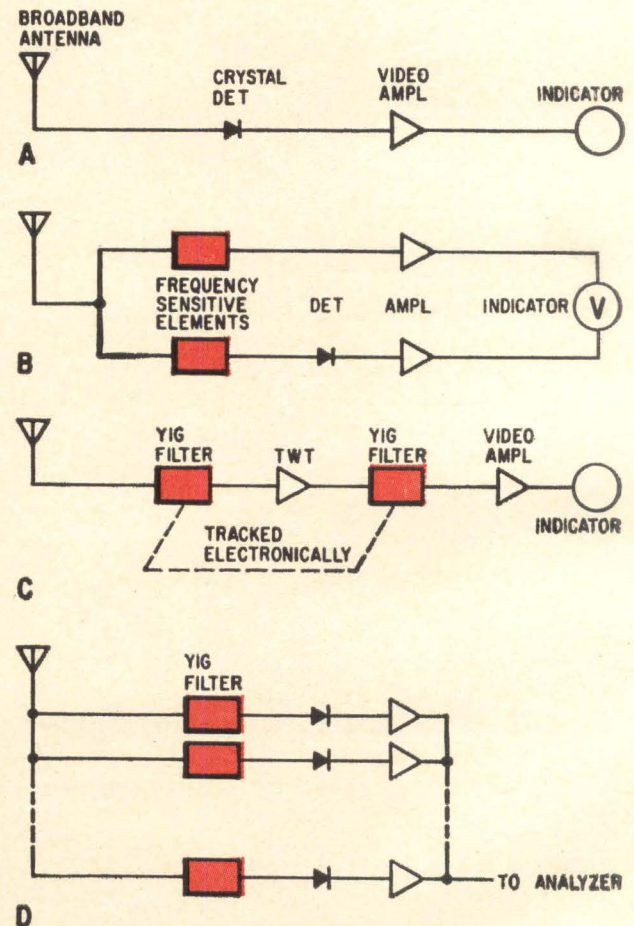

Types of intercept receivers: the wide-open receiver (A), the wide-open frequency-discriminator receiver (B), a tuned-radio-frequency receiver using Yig tuners and a traveling-wave tube (C), and the latest multiple-channel receiver (D).

Electronic reconnaissance: state of the art

Equipment

	Status		Prototype	Limited Production	Limited Use	Operational
	Proposed	Experimental				
Receivers						
Mechanically-tuned (APR-9)						Operational
Mechanically-tuned, twt front end					Limited Use	
Electrically-tuned, twt front end				Limited Production		
Multiple-channel			Prototype			
Multiple-channel, tunnel diode front end		Experimental				
Paramp front end		Experimental				
Maser front end	Proposed					
Infrared receivers	Proposed					
Recorders						
Audio wire						Operational
Audio tape						Operational
Video magnetic tape					Limited Use	
Video thermoplastic tape	Proposed					
Camera, manual						Operational
Camera, automatic	Proposed				Limited Use	
Camera, annotated	Proposed					
Analyzers						
Analog meter						Operational
Graphic, amplitude vs time						Operational
Amplitude vs frequency, panoramic adapter (if)						Operational
Amplitude vs frequency, spectrum analyzer (octave)					Limited Use	
Frequency vs time		Experimental				
Integrated display	Proposed					
Direction finders						
Loop type						Operational
Goniometer type					Limited Use	
Polarization indicating		Experimental				

Multiple-channel receiver

The latest in electronic reconnaissance receivers is the multiple-channel system USD-7, a prototype of which was recently completed (D). It is to be manufactured by the Airborne Instruments Laboratory. The receiver increases the frequency intercept capability of reconnaissance equipment to the Ku band from its present X-band capability.

The USD-7 is being miniaturized; it will use only solid-state, and perhaps some microelectronic, components. The receiver covers the entire band of interest using a series of detectors and YIG filters. It can be made to work with an array of directional antennas for direction-finding.

A major problem in the development of multiple-channel receivers was interaction between channels. This required an "ambiguity eliminator" to discriminate between desired signals and spurious responses, and design work on YIG filters.

Developmental reconnaissance receivers have been built using tunnel diodes, parametric amplifiers and even masers. But the more the sensitivity of a receiver is increased, the more difficult become the problems of shielding the receiving installation.

Traveling-wave tubes cannot be swept in frequency, but they do afford an octave or so of bandwidth. Furthermore, it is possible to design a tube

to function simultaneously as both an amplifier and mixer. But the tubes do generate spurious signals, and it is hard to make each identical to every other. This is especially bad in direction-finder applications in which two receivers are mounted in pods on opposite wingtips of an aircraft.

Also, operation of traveling-wave tubes always involves a trade-off between noise and gain. For example, a tube with a noise figure of three to six decibels will be saturated by a signal five decibels below one milliwatt, while a tube with a noise figure of 8 to 10 decibels will be saturated by a signal as low as 13 decibels below one milliwatt. This means that if you can tolerate the extra noise you can get twice the radar range.

Some engineers believe that the best electronic reconnaissance system may turn out to be an infrared detector that can pick out a hot radar antenna even when the antenna is not transmitting. Of course, use of infrared receivers would require ferrets to work even closer to the transmitter, with all attendant risks.

Signal analysis

During World War II, operators used pulse analyzers to determine the characteristics of radar intercepts. These instruments used bucket-capacitor

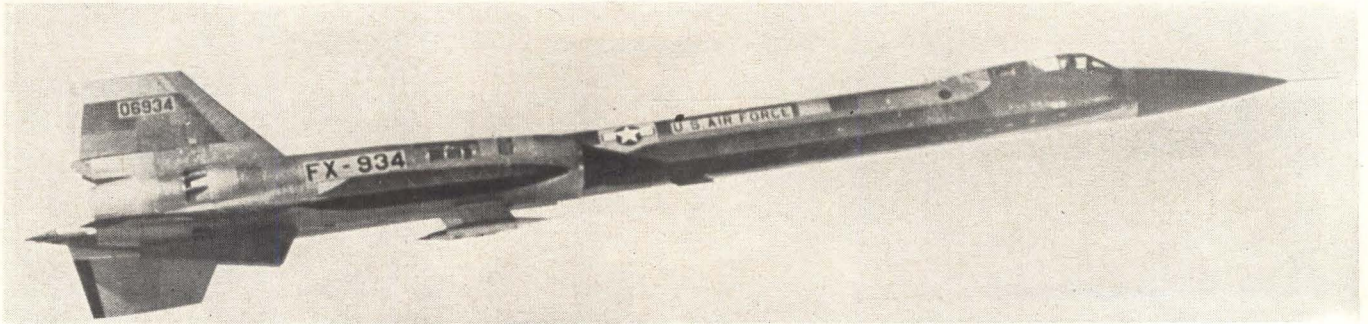

Latest ferrets:

Electronic reconnaissance planes

Lockheed A-11 is a 2,000-mph aircraft with a service ceiling of 70,000 feet. It is designed to carry a heavy load of electronic and photo-reconnaissance equipment. Its range is reported to exceed 4,000 miles.

circuits and analog-type panel meters to measure and display pulse width and repetition rate.

In addition, panoramic intercept adaptors were used to display a frequency spectrum equal to the intercept receiver's intermediate-frequency and centered upon the frequency to which the receiver was tuned. Wire recorders, and later tape, were used to capture signals for later analysis.

With the advent of videotape recording it be-

came possible to record signal bandwidths that greatly exceeded the limitation of one kilocycle per inch per second that restricted the range of conventional tape recorders.

An example of a tape recorder that could be used in electronic reconnaissance is the Ampex VRX-1006. This single-channel wide-band recorder has a four-megacycle frequency response and can record up to 90 minutes. It uses two-inch tape on either 12½- or 14-inch reels. Its peak time-displacement error is plus or minus 20 nanoseconds and it can begin recording data two seconds after observation begins.

Doing it with pictures

After World War II, graphic displays have been found to be more informative than the analog meter presentation. For example, a four-gun cathode-ray oscilloscope triggered by the intercepted pulse (or operating with an astable sweep generator) can provide a display of time vs. amplitude (A). Such a display clearly illustrates the lobe pattern of a radar beam as the beam rotates past the receiving antenna, and is useful in analyzing pulse-time multiplexed signals. The calibrated horizontal sweep ranges of the four guns extend from 0.1 microsecond per centimeter to one second per centimeter.

Also, the current waveform applied to the YIG filter of an electronically tuned intercept receiver may be slaved to the horizontal sweep of a cathode-ray oscilloscope to provide a frequency-vs.-amplitude display of the whole frequency band of interest. Such a display is not affected by the receiver intermediate-frequency bandpass characteristics, as is the conventional panoramic adapter display (B).

The excellent bandpass characteristics of modern intercept receivers and spectrum analyzers permit displaying the intermediate frequency of the intercepted signal directly on the scope face of the spectrum analyzer. In this way, unique spectral signatures of individual items of hostile equipment can be obtained and identified. The technique permits following closely the redeployment of electronic material. The operator can even tell when the enemy changes his magnetrons!

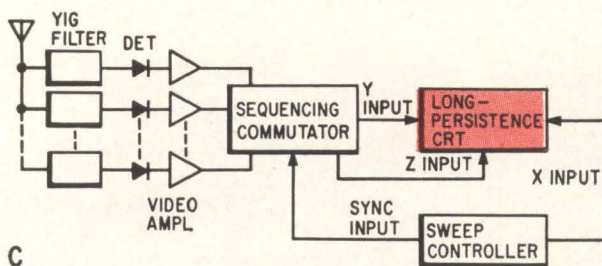
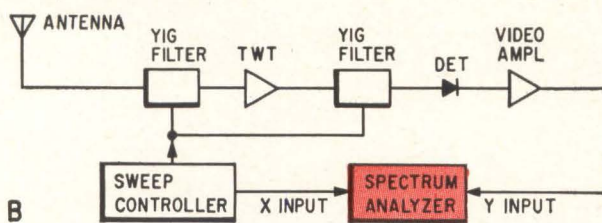
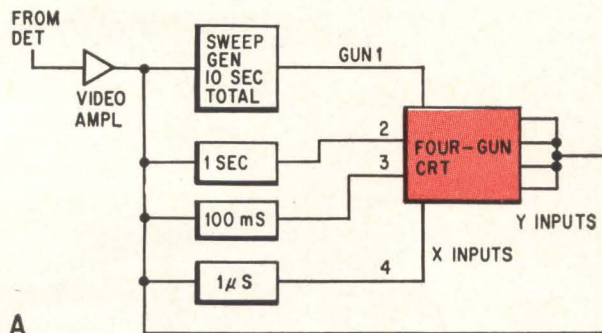

Analysis equipment: amplitude vs. time display using 4-gun cathode-ray tube (A), spectrum analyzer giving an amplitude vs. frequency display of an octave or more (B), and frequency vs. time display.

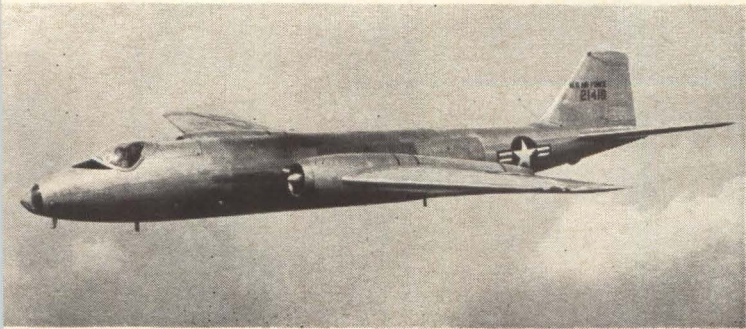

Martin RB-57D Night Intruder is a U. S. Air Force version of the English Electric Canberra. Basic aircraft is a single-place twin jet; the version used in overflights of Red China is a larger airplane.



McDonnell RF-4C Phantom II will become a major electronic reconnaissance plane for the Air Force. Its top speed exceeds 1,400 miles an hour. Later on, the Navy will probably go to the Grumman EA-6A Intruder.

The outputs of a multiple-channel receiver can be applied to video filters with slightly overlapping response characteristics to provide a time-vs.-frequency display (C). This display can, in turn, be intensity-modulated to add amplitude information. Such a three-dimensional intercept display can be very useful.

Graphical intercept outputs are photographed to provide a permanent record for later analysis. A back-printing fiber-optic display device can be employed to continuously annotate the intercept record with positional information derived from the aircraft's latitude-longitude computer. Modern cathode-ray tubes permit simultaneous photography of the scope display and viewing by the intercept operator.

Director finding

The final chore of the operator is to get a DF fix on the hostile transmitter. Formerly, two antennas were used for reconnaissance, both housed in a radome beneath the ferret plane. One was a discone for omni-directional reception. The other consisted of two microwave-horn antennas back to back, one polarized vertically, the other horizontally. The antenna rotated in synchronism with a PPI oscilloscope trace to present a twin-leaf pattern pointing at signal maximum.

This was unsatisfactory because of the effects of the radome on the aircraft's aerodynamic configuration and because of the time required to get a bearing. Furthermore, the oscilloscope presentation of a signal maximum is never as precisely defined as the visual presentation of a signal minimum or null indication.

Modern systems use flush-mounted broadband antennas located in different parts of the plane. Polarity of the receiving antenna system can be switched easily and quickly from horizontal to vertical to circular. Use of log periodic antennas permits covering a 10-to-1 bandwidth while a goniometer presentation provides an instantaneous display fixing on the signal null. The speed of modern ferret aircraft, as well as provisions for automatic positional annotation, permit a lone plane to triangulate hostile stations quickly.

Integrated reconnaissance

A trend in ferreting will be an integrated servo system combining aerial photography, electromagnetic reconnaissance, infrared and ultraviolet devices.

One such system was the Little Snooper, a Boeing C-45 outfitted with aerial cameras by Chicago Aerial Industries, Inc., electronic reconnaissance gear by Ling-Temco-Vought, Inc., videotape recorders by the Ampex Corp., infrared surveillance equipment by HRB-Singer, Inc., and a General Electric low-light-level television camera. The aircraft flew in May, 1963.

And the future

Even if general disarmament were agreed to by the major nations of the world, either the signers of such a treaty or some supernational agency would have to carry on ferreting operations to guard against violations of the treaty. In fact, the U. S. Arms Control and Disarmament Agency is vitally interested in such reconnaissance.

Peace can flourish only when nations are secure in the knowledge that no sneak attack is imminent, and electronic reconnaissance can help to grant that assurance. Yet every ferret flight risks not only the lives of the airmen involved but the peace of the world.

However, there may be a better way. A day may come when U. S. ferret planes with light blue noses, wing tips and tail surfaces will patrol one side of the East-West border with Russian pilots at the controls and Russian navigators plotting the course, while similarly equipped Bears and Badgers with Americans in command patrol the Eastern side of the frontier. And Irish, Swedish and Burmese operations analysis officers may probe the logbooks and scan the magnetic tapes, looking for—but hopefully never finding—evidence of treaty violations.

The author thanks John F. Mason, Senior Associate Editor, and Laurence D. Shergalis, Regional Editor, San Francisco, and Herbert Cheshire, McGraw-Hill World News, Washington, for their help in gathering material for this article.

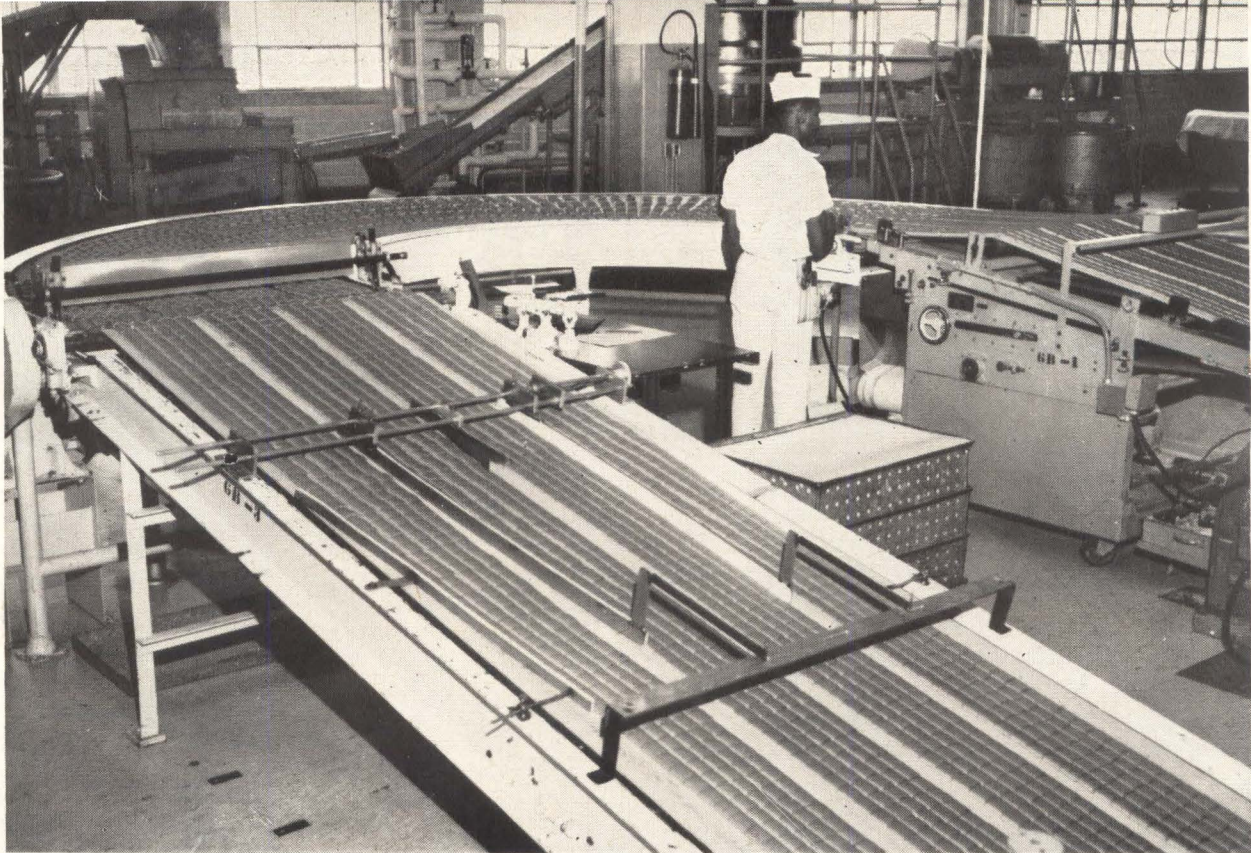

Stacked end to end, these Fig Newton cakes would reach from New York to Philadelphia. More than one million pounds are baked daily, using a process computer to direct batching of the ingredients.

Industrial electronics

Take two tons of flour . . .

Nabisco's batching system, the first in the baking industry to be controlled by a computer, keeps cookie quality and taste consistent

By Louis S. Gomolak
Industrial Electronics Editor

Every day the world's biggest biscuit baker, the National Biscuit Co., turns out nearly 400 miles of Premium Saltine crackers, using a digital computer to control batching. Batching is a process which brings together, in correct sequence, the near-ton of ingredients required for each batch. (Although computer-controlled batching is widely used in the cement and petroleum industries, its use in baking is new.

In early 1962 when Nabisco received bids for a control system for a new addition to its Chicago

bakery, one stood out like a chocolate cookie in a bag of marshmallows. Instead of quoting on an analog system, the Systems Design division of the Foxboro Company, Foxboro, Mass., proposed digital computer control.

Computers are new in the highly competitive food processing industry, which is governed by taste whims and impulse buying. Nabisco plunks down over three-and-a-half million dollars a year for research on the cookie and cracker with the new taste, the different appeal.

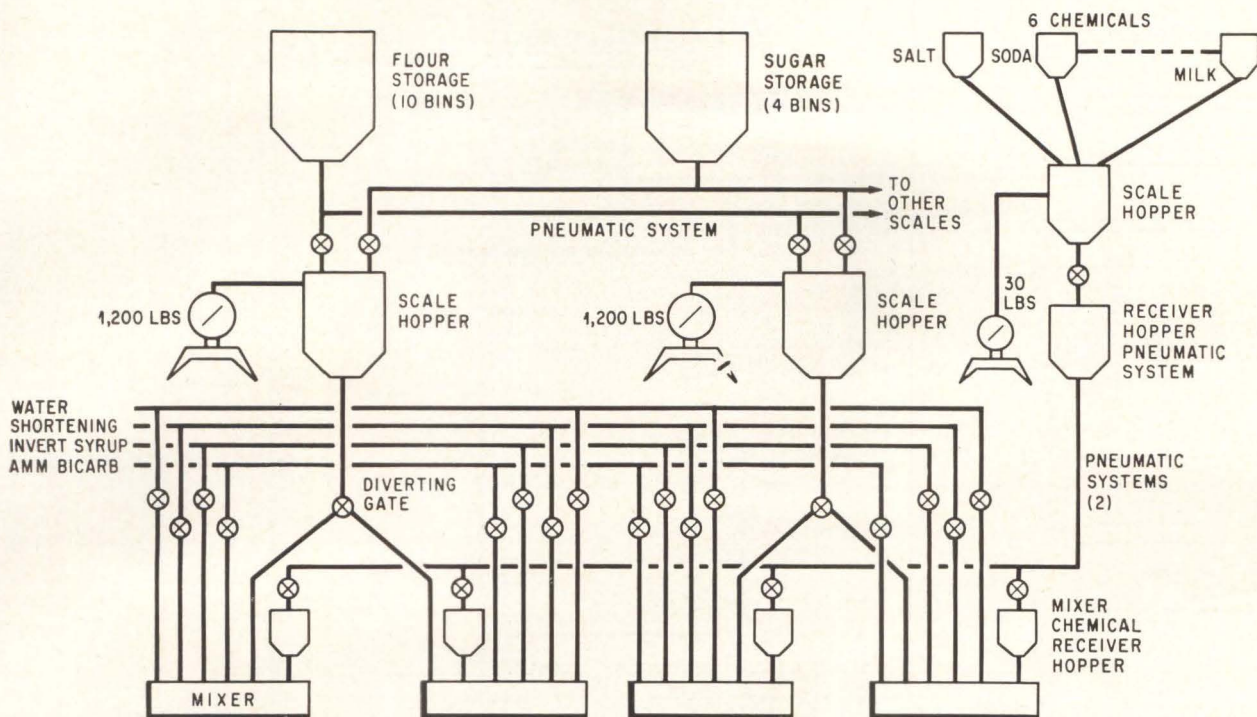

Tons of ingredients are delivered from the storage bins to the scale-hoppers, weighed, and then dumped by gravity flow into mixing machines. All pneumatic systems are computer controlled.

The black specter haunting every baker is that today's cookie may not taste like yesterday's. Taste variation can kill a line faster than my three-year old can gulp down an Oreo. Nabisco sees computer-controlled batching as a giant step toward uniform quality—identical taste in each variety of the 17 million cookies and crackers coming out of the ovens daily.

The process computer also controls batching of all the ingredients used to bake over a million and a half pounds of Fig Newtons—enough to stretch from New York to Philadelphia, if no one nibbles—every sixteen working hours. Ingredient delivery is computer-controlled, too, in the daily production of 70 thousand pounds of Oreo cream sandwiches, 55 thousand pounds of Ritz crackers, and a veritable mountain of Cheeze Nips, Triangle Thins and snack varieties.

A Saltine, as an example, goes through five major processing steps before it can be shipped: batching the dry and liquid ingredients; mixing; shaping the dough; baking and packaging. Nabisco's computer system, at the present time, controls the batching process—a sticky web of timings and sequences demanding strict quality control.

Flour flows

The constant in baking is the recipe. To achieve consistent results—the housewife in a closet-sized kitchen or the master baker in a mile-long facility must follow a recipe for amount of ingredient, sequence of batching, mixing and baking time.

There are twenty dry and chemical ingredient storage bins at the Chicago bakery. These hold tons of three types of flour, granulated sugar, 4X (confectioners) sugar, and chemicals such as milk powder, salt, soda and the like. These main bins are filled by the carload, pneumatically. They are not under computer control.

The process computer enters the picture by selecting, metering and controlling the weight of large quantities of ingredients, a thousand pounds or more at a time—at an accuracy of one pound in twelve-hundred—delivering them from the bins to scale-hoppers, 1,200 pound capacity receptacles containing a weight-scale. As shown in the diagram above, dry ingredients are conveyed pneumatically, but while the scale-hoppers are common to each bin, they can be fed from only one bin, one ingredient at a time. This allows accurate weight control and, in case of a valve failure, prevents ruining a number of batching processes by massive over-delivery of an ingredient.

Probably the toughest systems design problem was sequencing—operating the nine dry and liquid ingredient delivery systems to a 0.1% accuracy. There is a total of 16 steps for just one system actuation. These include actuating and getting feedback signals from valves, motors, blowers, electro-pneumatic and electrical mechanical devices.

The normal sequence is to weigh an ingredient, compare its value to one stored in the computer memory, then discharge it from the fourth floor

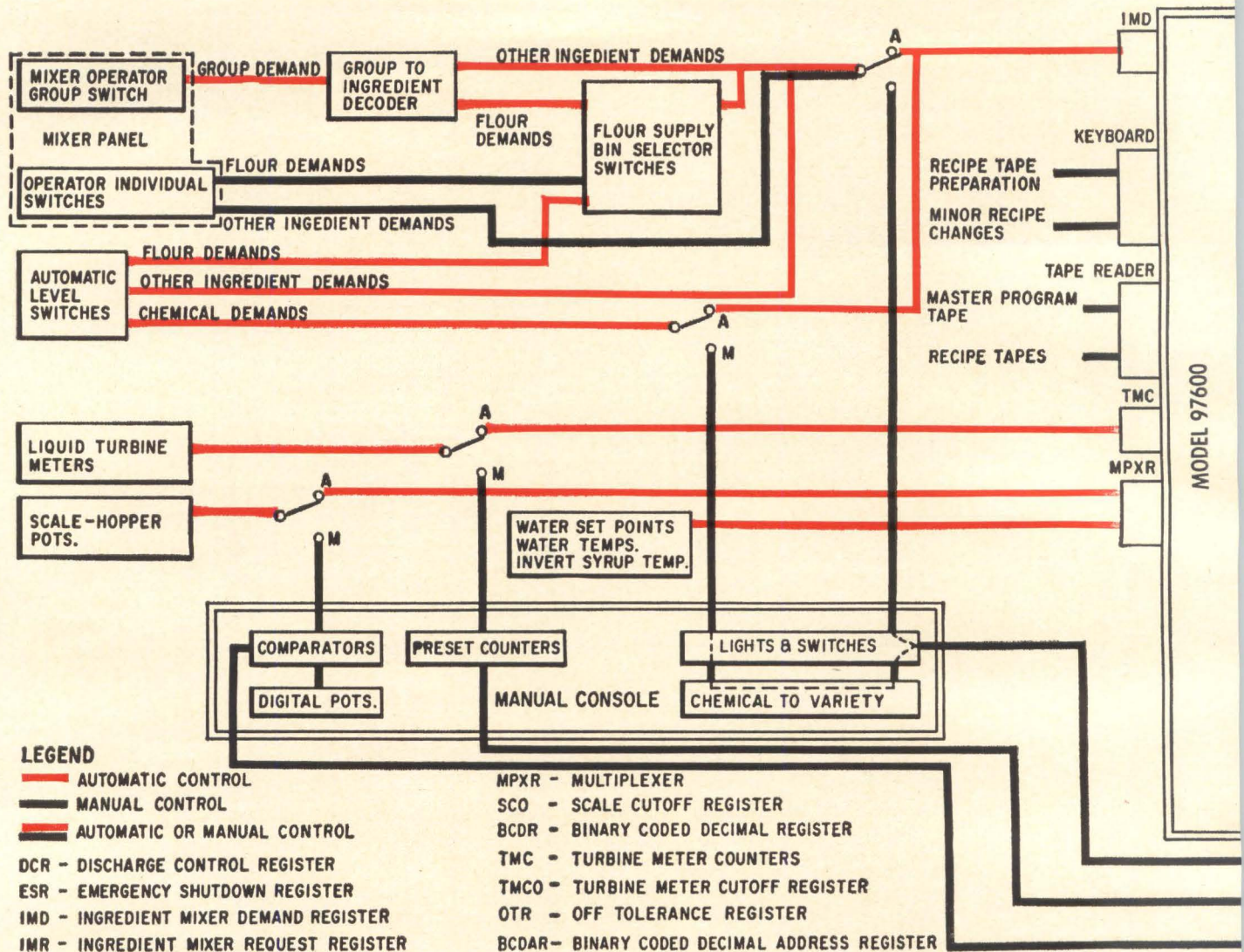

LEGEND

- AUTOMATIC CONTROL
- MANUAL CONTROL
- AUTOMATIC OR MANUAL CONTROL

- DCR - DISCHARGE CONTROL REGISTER
- ESR - EMERGENCY SHUTDOWN REGISTER
- IMD - INGREDIENT MIXER DEMAND REGISTER
- IMR - INGREDIENT MIXER REQUEST REGISTER

- MPXR - MULTIPLEXER
- SCO - SCALE CUTOFF REGISTER
- BCDR - BINARY CODED DECIMAL REGISTER
- TMC - TURBINE METER COUNTERS
- TMCO - TURBINE METER CUTOFF REGISTER
- OTR - OFF TOLERANCE REGISTER
- BCDAR - BINARY CODED DECIMAL ADDRESS REGISTER

Automatic delivery begins when a mixer-operator selects a switch position for ingredient group signals. These are decoded into specific ingredient

demands and treated by the computer on either a chronological or priority basis. Demands are satisfied by output signals to ingredient-selecting

bin, using gravity flow, into a third floor mixing machine. While only one ingredient can be delivered to one scale-hopper at a time, two types of flour and two types of sugar, can be, and are, moved simultaneously, to four different scale-hoppers. As the computer sees demands for the various dry ingredients, it starts and stops the four systems, and delivers the required ingredient to one of seven scale-hoppers which are fed by each system.

The chemicals have a system of their own because they are weighed in small quantities—as bakeries go—of up to 30 pounds, versus 1,200 pounds for the flours or sugars. The chemicals are also delivered as a sub-batch to the individual mixer chemical receiver hopper, located just above each mixing machine.

The liquids used—water, shortening, invert syrup (a viscous sweetener) and ammonia bicarbonate—are each delivered directly from their source to the mixing machines. They can be delivered to a mixer one at a time or three or four

simultaneously; the sequence of mixing might call for, say, water to be mixed with flour, then add shortening and ammonia bicarbonate, mix, add granulated sugar, mix and so on.

Nabisco does not want to rely completely on computer control yet, so mixing time is still under control of the mixer operator. Although the semi-automatic portion of the control system has been in use since May of 1963, and the computer system has been on-line since January 1, 1964, Nabisco feels the system is still experimental. If it works to their expectations, there are thoughts of extending computer control to include mixing time, the multi-temperature 300-foot long ovens, and possibly even to packaging.

The all-knowing computer

The Ingredient Metering Control System includes both computer- and operator-actuated networks as illustrated in the diagram at the top of this page. There is no manual back-up system; the operator-initiated process and the computer

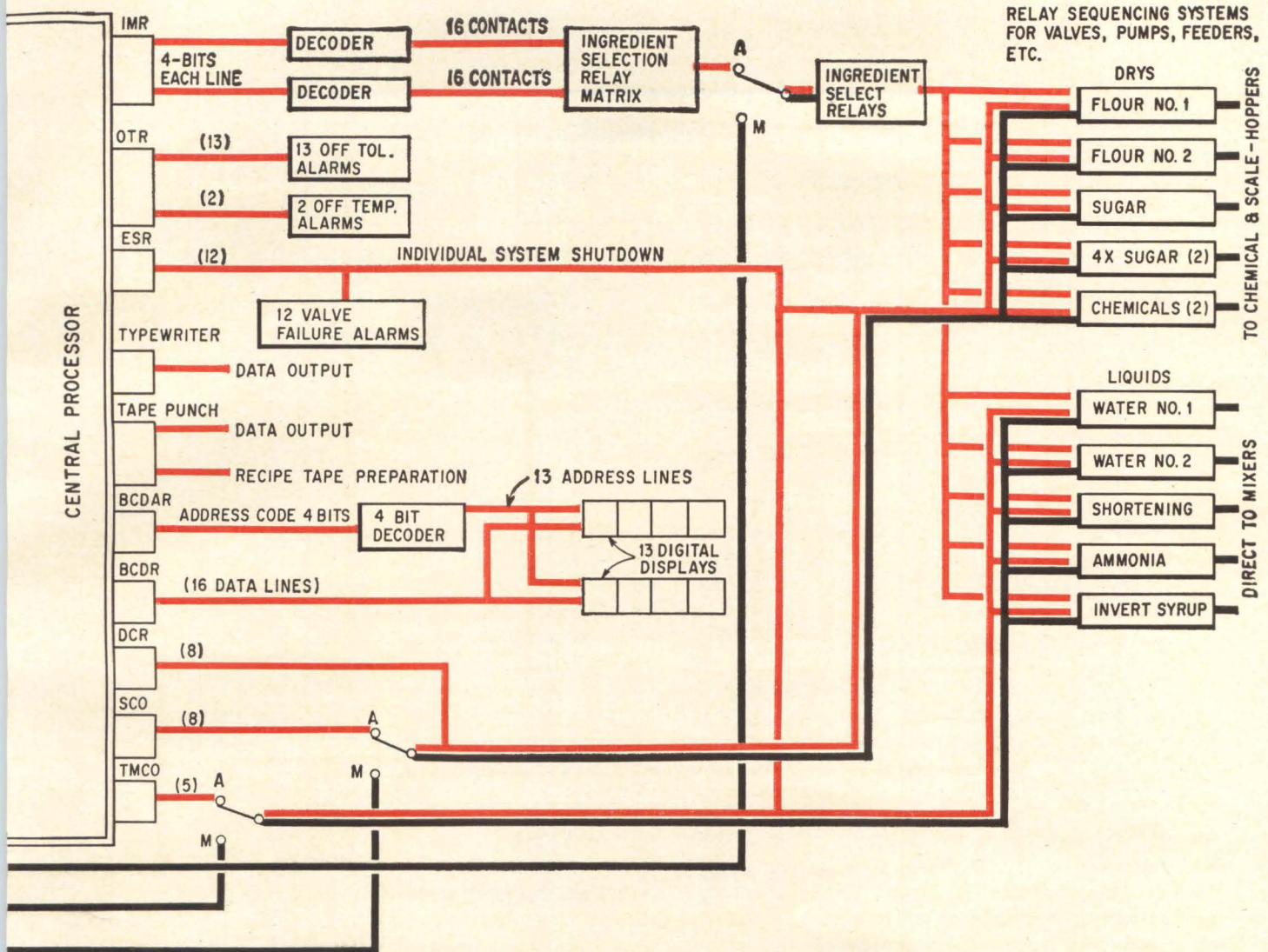

relays. The computer continuously monitors the dry or liquid ingredients, shutting the systems down when the correct weight has been delivered,

and dumping the dry ingredients into the mixing machines. The liquids go directly into the mixers, channeled from their sources by the computer.

system use the same bank of ingredient select relays.

The computer is Foxboro's model 97600 Central Processor, which is an integral unit of its 97000 Digital Industrial Process Control System. The Central Processor is functionally equivalent to Digital Equipment Corp.'s PDP-4. The 97600 was custom designed by Digital to specs drawn up by Foxboro's Digital Systems division at Natick, Mass.

By the ton

Mixer ingredient control divides into three major operations—dry ingredients, chemicals, and liquids.

Mixing a batch of cookie or cracker dough means blending almost a ton of various dry and liquid ingredients for specified periods—sixteen different times a day. Early each morning, the mixer superintendent programs pinboards, located at the back of each mixer-operator control panel. The panels are attached to each of the eleven giant mixing machines. On the face of the panel is a selector

switch marked group one, two, three and four, plus a reset position. Each group number specifies certain ingredients, both dry and liquid. For example, group one could be flour and water, group two shortening and granulated sugar, etc. The four groups represent the sequence of various ingredients into the mixing process; totaled they are the recipe for, say, Saltine crackers.

As the bell for work rings, each mixer-operator starts a batching sequence by turning the selector switch to group one. The outputs of the pinboard energize relays. A contact of the relay supplies the specific ingredient demand signals to the computer. These demands go, in the case of flour, to the Flour Supply Bin and Pneumatic System Selector Switches which further decode the flour signal to select a specific bin for use that day. The other group-one ingredient demand, for water, goes directly to the Ingredient Mixer Demand register. All demands are processed on either a chronological or priority basis by the computer, being determined by both the master and recipe programs

stored in a 4,000 word, 8-microsecond cycle, 18-bits per word memory. The master program calls for the 88 ingredient-demand input channels to be scanned once every ten seconds; the weight measurement channels are scanned once every four seconds during a measurement sequence.

The computer stores these demands and satisfies them (as soon as all previous demands for a specific ingredient system have been cleared from the output registers) by sending coded signals through the Ingredient Mixer Request register.

The output of this register is an eight-bit binary signal, which is divided and sent to two four-bit reed-relay decoders. Relay logic is used throughout the system, except for the computer which is solid-state. Relays were used principally because of the high price of high-power-rated semiconductors. The output of each four-bit decoder is sixteen discrete signals (using all possible combinations of four-bits). These signals are applied to the horizontal and vertical lines of a 16 x 16 matrix called the Ingredient Selection Relay Matrix which selects one of up to 256 ingredient-mixer combinations.

Working with the Ingredient Mixer Request register is a single-bit register, not shown in the control diagram, called the GO flip-flop. This register powers the relay decoder contacts, after a delay of five to ten milliseconds. The delay allows the contacts to settle down after the relays are energized. These relays handle all ingredient selection for the eleven mixers; false signals could select ingredients for one mixer through contacts that had been set for another mixer. After the delay, power is applied to the decoder contacts via the GO flip-flop, by the computer. This actuates the desired relay in a bank of latching-type Ingredient Select Relays which provide power to start up the required pneumatic delivery system.

The pneumatic system moves, say, flour from a storage bin to a scale-hopper. On the mixer-operator's control panel a green "In Operation" light is illuminated. The computer monitors the weight once every four seconds if all pneumatic systems are in operation—more often if system load de-

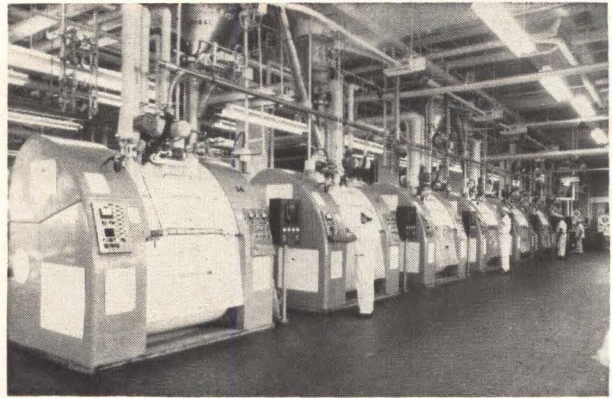

Batches of ingredients, weighing a ton, are mixed in eleven giant mixing machines, pictured here. Just above each is a chemical receiver-hopper for salt, soda or milk-powder.

creases to one or two systems. It compares the signal (zero-to-ten volt range) from a potentiometer on the scale to a weight value stored in its memory. When the scale-hopper potentiometer signal, which comes through a multiplexer, reaches a pre-programmed value, the computer sends out an inlet valve-closing signal through the Scale Cutoff register. By the time the valve actually closes, the exact amount of flour, plus or minus a pound will have been delivered to the scale-hopper. After thirty-seconds delay during which the flour particles suspended in air settle out, the computer again takes a look at the in-scale weight, compares it to the in-memory value and displays the actual weight on a binary-coded-decimal input digital display on the control room panel. If the flour weight in the scale-hopper is within the stored value, the computer sends a scale discharge signal through the discharge register automatically discharging the flour into the mixing machine.

The over-weight problem

Before an Ingredient Select Relay is energized, the computer checks the scale-hopper for an off-tare condition—any unaccounted for weight. This might be ingredients left from a previous load or, as has happened, of monkey-wrenches left by workmen after a repair job. If the scale is off-tare, the value is printed out and also displayed on a digital readout. A supervisor, after having cleared up the trouble, pushes a Scale Advance button, ordering the computer to override the off-tare signal and energize the ingredient select relay.

If the scale-hopper inlet valve does not close within a stored time delay, a feedback signal is routed to the computer. The signal activates the Inlet Valve Failure Alarm through the emergency shutdown register. The appropriate pneumatic system is shut down and this information is printed out for the panel operator. The operator, having notified maintenance, then resets the off-tolerance register via the Advance button and clears the emergency shutdown register via an entry to the

Recollections of a process engineer

■ The case of the white avalanche

To discover exactly how much the pneumatic systems, under computer control, were delivering, Nabisco conducted pre-start-up tests of different types of scale-hoppers. A huge cart called a dough trough was rolled under one scale-hopper. The hood of this scale-hopper fitted tightly over the top of the dough trough and it was impossible to tell what, if anything, was going into the cart. Once, somebody forgot that 1,200 pounds of flour were already in the trough and commanded the computer to deliver another 1,200 pounds of flour. It did. When the trough was rolled away, a fine white avalanche roared down. It was like trying to fit ten pounds of jello into a six-ounce glass.

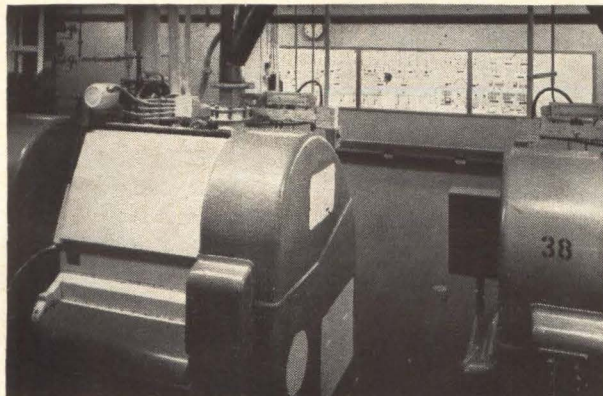

White-room precautions are taken to keep ever-present dust out of control panel and computer rooms. This is the forty-foot control room panel, as viewed from between two mixing machines.

computer on the teletypewriter.

Add ten pounds of salt

The chemicals are controlled in the same manner as the flour ingredients. The differences in chemical selection and delivery are that chemicals are delivered as a sub-batch to the chemical mixer receiver hopper, and that the computer gets only a demand for chemicals for, as an example, mixer number one.

Stored in the computer, when the recipe punched tapes are run at the beginning of the day, are the various types of chemicals and combinations of types for each mixing machine. The chemicals—salt, soda, milk powder, meal, and others—are weighed (and compared to memory value) one at a time and discharged by computer signal into the large pneumatic system receiver-hopper. When all ingredients for mixer number-one are in this receiver-hopper, a computer generated signal activates the pneumatic system, sending the sub-batch to the mixer chemical-receiver hopper. At the specified time in the recipe mixing sequence the mixer operator presses a Chemicals Discharge button on the mixer control panel, dumping the chemical sub-batch into the mixer.

In the chemical delivery system the computer controls vibratory feeders which carry the chemicals from their individual supply bins to the pneumatic system receiver scale-hopper. Thus, there is no need for an inlet valve failure check as in the flour and sugar systems. There are both off-tolerance and off-weight sequences. The mixer operator can accept the off-tolerance or off-weight condition by later reappportioning the other ingredients. This is done by going into the memory through the teletypewriter keyboard and changing the ingredient values for this particular batch—the same is true for flour and sugar.

Liquid systems

The liquids—water, shortening, ammonia bicarbonate and invert syrup—are piped directly

from storage, or city water lines to the mixing machines, at specified times in the recipe mixing procedure.

In each of the five liquid systems, two for water because of the large amounts used, there is a turbine meter. This is a device with a propeller located in the pipe. As the liquid sweeps by the propeller turns. Using magnetic pick-up, the turbine meter sends a series of pulses—16 equal a tenth-of-a-pound—directly into the computer Turbine Meter Counter.

When the pulses total the cutoff weight stored in memory, the computer generates a shutdown signal through the Turbine Meter Cutoff register closing the inlet valve. After a delay the computer checks back to see that the valve has closed. Then the computer compares the actual metered liquid weight with the desired weight stored in memory. The actual weight is always displayed at the end of each metering cycle on a digital display on the control room panel.

The liquid shortening and ammonia bicarbonate systems are straightforward operations; the water and invert syrup systems are not.

In the invert system, the amount of weight delivered per unit volume depends upon temperature. When temperature rises, syrup viscosity increases. Stored in the computer memory is an invert correction table. The computer monitors the invert temperature, using resistance bulbs, about once every second and, using the table, corrects the weight for the number of pulses coming from the turbine meter.

In the water system the story is more complicated. Every recipe specifies one of three water temperatures—some cookies need hot water, some ice cold, others normal tap water. When the computer receives a demand for water, it selects one of three set point water temperature generators located on the control room panel. (There is about a three or four percent difference in water weight over a temperature range of 35° to 180° F.)

The computer selects the right set point and starts the water flowing, continuously comparing

■ The case of the cavitating chemicals

One of the pre-start-up problems involved measuring the chemicals in the high production hoppers. The measurement devices are merely level switches. When covered with material, a torque is developed to hold the level switch contact open. However, this rotating switch (a paddle-wheel type of device) causes cavitation with some types of chemicals. When this happens, the paddle encounters no torque and causes the switch contact to close (as it does on low-level when the level of material drops below the paddle).

When cavitation occurred in the mixer chemical receiver hopper, a new chemical demand signal was sent to the computer. Since the computer can't detect between a genuine low-level signal and one caused by cavitation, it supplied a second batch of chemicals.

The solution was to add new circuitry which allows only one chemical demand signal per batch to be created.

the actual water temperature to the set point. Until water temperature and set point coincide, all water goes to drain.

The water is handled by two three-way valves, under control of an analog temperature controller attached to a resistance bulb near the valves.

There is about one-hundred and fifty feet of piping from the three-way valves to the mixer inlet valves. By the time water travels this far it can change temperature. This could be disastrous in a tightly specified recipe. To avert wastage of batch, there is, near the mixer inlet valves, an interlock analog temperature controller. Signals from resistance bulbs come to the controller from the mixer-inlet valve area and also from the three-way valve area.

The computer activates the three-way valves but does not begin counting turbine meter pulses right away. The computer first monitors the temperature at the three-way valves and also the action of the interlock controller. When the temperature is right at the three-way valves, the computer sends a signal to close the drain valve. This signal will not take effect until the interlock controller also signals the valve that the temperature is the same throughout the system. The computer then closes the drain valve, opens the mixer-inlet valve and counts turbine meter pulses.

If the actual metered weight is out-of-tolerance when compared to the memory value, an off-weight

alarm is actuated. The off-weight is typed out and the computer blocks further use of that particular water system. Pushing the liquid system Advance button on the control room panel will reset all registers and release the system for new demands.

If the mixer inlet valve does not close, after the computer checks back, an inlet valve failure alarm is sounded, the system is shut down, and the condition is printed out. The panel room operator must then push the Advance button and clear the emergency register via a keyboard entry.

When all ingredient groups have been loaded into the mixer at their proper time, each ingredient in its proper sequence, the operator switches the group selector to reset. This tells the computer the batch is completed. Batch data can now be printed out if desired.

Right now Nabisco has almost more data than cookies. The company is now examining the data to find out if it can optimize the control process.

Nabisco is presently installing another pair of the giant mixing machines to feed a new three-hundred-foot-long oven. Batching process control is more complicated than either Nabisco or Foxboro anticipated; as has been the case with every process newly placed under computer control. Nabisco is studying ways to optimize control and gain memory space.

If they can't, they say the memory system may have to be expanded to accommodate increased control functions.

■ The case of the dusty contacts

Dust is a real problem in a bakery. Sugar dust, flour dust, chemical dust, dust dust and more dust. In the pulverizer room where Nabisco refines granulated sugar to make its own 4X confectioners' sugar, the dust is so fine that drawing even the smallest arc would produce a sizable explosion. Electrical equipment, motors, etc. must be explosion-proof.

The potentiometers, switches, relays and other kinds of equipment are so-called dust-proof but, because they require periodic adjustment, they are not hermetically sealed. The flour, sugar, and other kinds of dust build up into some extremely effective insulation.

During the initial phases of system start-up, the computer occasionally failed to cutoff the feeding operation to a scale at its cutoff value. Upon investigation it became apparent that not enough current was drawn by the measuring system to break down the dust film formed on the potentiometer winding. (Good systems design requires low currents through voltage devices such as potentiometers if high accuracy is to be maintained.)

The solution was to use a capacitor between the wiper and one end of the scale potentiometer. The capacitor was the energy source for a reversing current during scale discharge. This current reversal broke down the film formed on the potentiometer.

Since many field logic conditions must be fed back into the computer and since all computer inputs are low-voltage d-c, the most straightforward scheme would be to use low-voltage d-c on the field relay contacts. However, to counteract the dust problem, 110v a-c is used for these contacts, with buffer-relays supplying the low-voltage d-c feedback into the computer.

No hands

There is one more system which is connected to the process computer. At the present time, Nabisco is running a number of high production mixing machines. When the scale-hoppers for these mixers signal the computer that ingredient level is low, the computer searches its memory for ingredient type and delivery sequence, then activates the right pneumatic system, on a priority basis. The high production mixers must be satisfied before any non-priority system demands are met. It is more important to keep high production going than to fill the demands for those products made in batches.

The computer also controls the liquids and chemicals for a continuous Oreo cookie system. These demands are automatically generated by level switches. These ingredients are supplied on a batch basis to large hoppers which furnish a continuous supply to the Oreo system. When the new batch has been delivered, the bakery management can, if desired, have a print out of that particular batch, or any batch for that matter.

Almost no hands

If for some reason the computer is not functioning, system operation is initiated by an operator in the control room. Under semi-automatic control the mixer-operator still uses the selector switch to initiate the batching process. When the group

ingredient signals are decoded by the pinboard relays, the individual dry ingredient demand signals come into the control room panel and light various ingredient lights. The panel operator pushes an ingredient Start button which energizes the same Ingredient Select Relay equipment that a computer signal would have actuated.

For the desired weight of the dry ingredients the operator adjusts a manual potentiometer, with digital readout. Then the pneumatic system automatically delivers the ingredient to the mixer specified and when the desired value is reached a comparator amplifier on the panel sends a systems shutdown signal to the pneumatic system. The operator can then take a look at a vacuum-tube voltmeter calibrated in pounds—zero to 1,200—and if the weight is within specification push a scale discharge button.

For liquids, the panel operator adjusts the pre-set knobs on the system's Veeder-Root counters for the desired liquid weight. When the pre-set and turbine meter counts reach coincidence, the counter generates a shutdown signal.

For the chemicals, the operator must go through two steps. He sets up manual potentiometers for the different chemicals and switches a selector to the specific mixing machine. Next he watches the indicators and when they light up for the various chemicals, he pushes a Chemical Start button. When the last chemical of the chemical sub-batch is in the pneumatic system receiver hopper, the pneumatic system will automatically deliver the sub-batch in the manner already described.

One option the mixer-operator has, during either computer or semi-automatic control, is that of demanding any dry ingredient in advance. By turning a mixer-panel hold-discharge switch to hold, and then switching the selector to the next group, the operator commands the computer to deliver the ingredient whose demand is first recognized, and weigh it. But the automatic discharge signal is blocked by the mixer-operator's hold. When switched to discharge, the scale-hopper will dump into the mixer. This is one way in which the operator can have ingredients waiting, until a mixing operation is completed. It is also the way the operators schedule their coffee and smoke breaks.

For some time to come

Many problems have yet to be ironed out before complete bakery computerization becomes a reality. Nabisco's installation is now running, on-line, throughout two 8-hour shifts per day. Over a sixteen-hour period the control system produces, with uniform quality from a batching standpoint, millions of cookies and crackers daily. While there are other bakery computer systems—see box at right—Nabisco's computer-controlled batching is the first major advance in the baking industry toward absolute quality control by computer direction.

The author thanks Ralph Guimond, Bob Benson, and Wendell Young, of Foxboro and George Quinn and John Gude of Nabisco, for their assistance.

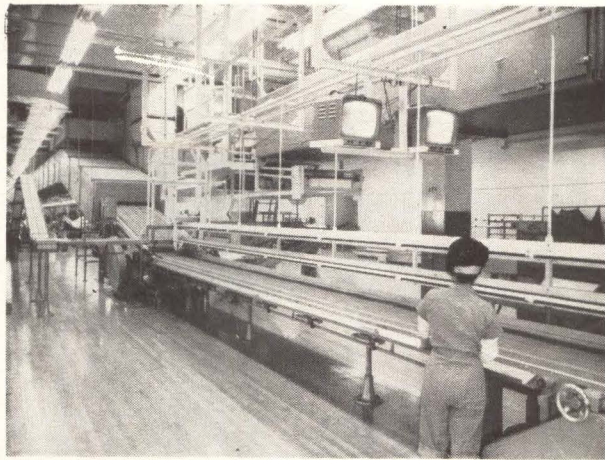

Cooling tunnels, at left, have closed-circuit tv cameras strategically placed throughout. Operator watches potential trouble areas during cooling of cookies.

Computers in bakeries

There soon will be three computers in the baking industry. Nabisco's has been operating on-line since January 1. A GE-225 data processor calculating formulation, including nutritional values and farm purchasing prices, has been in operation since late '63 for recipes at Pillsbury Company's Minneapolis bakery.

The third will be the system now being installed in the Kitchens of Sara Lee. According to E.E. Kuphal, Director of Facilities Planning for the bakery, the Honeywell 610 computer will be delivered sometime this month and on-line operation of the mixing and batching sequences should start in late July at the earliest. Closed-loop control of the 150-foot-long ovens will begin after sufficient data has been logged to determine exactly how to control the eight different temperature zones. Warehousing freezer operations should begin this month.

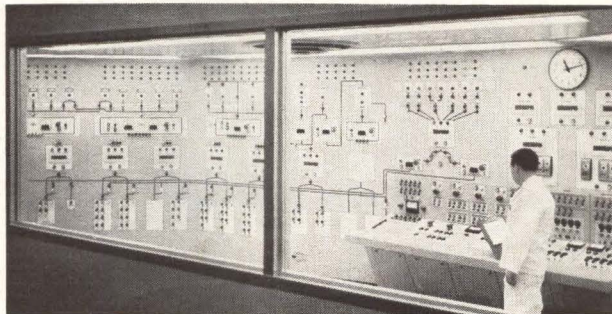

Checking the daily baking schedule during the period last year when Nabisco used only the semi-automatic control system. Although the processes may be actuated from the panel, delivery of the ingredients is still automatic.

Low-cost oscillator transistors revamp uhf tuner design

Government mandate for all-channel television receivers steps up uhf tuner design. Engineers are replacing vacuum tubes with transistor-diode circuits

By Leon H. Dulberger

Staff Writer

The television industry's need for reliable, efficient, low-cost ultrahigh-frequency tuners has revised tuner design. The hot, costly vacuum tube is being replaced by the cool, inexpensive transistor. Semi-conductor diodes have already overtaken the vacuum tube as mixer elements.

Over \$50 million will be spent on uhf tuners this year as television receiver manufacturers comply with the government's requirement that all new sets be equipped, by April 30, for both uhf and vhf reception.

There are nearly 60 million tv receivers in this country but less than ten percent of them can get uhf broadcasts. About 120 uhf television transmitting stations were in operation at the beginning of this year. In the 470 to 890 megacycle range used for ultrahigh-frequency transmission there are 70 channels. The use of these high frequencies and the large number of channels required, as well as price considerations, has led to new tuner designs.

The design of vhf tuners has become routine; tuning circuits are formed by multiturn coils, fixed capacitors and adjustable metal core coils—using lumped parameters. By comparison, tuned coaxial lines a fraction of a wavelength long, stray capacitance and tiny variable capacitors or stamped inductance rings may be used at uhf—combining lumped and distributed parameter techniques.

Manufacturers are faced with the problem of deciding whether the public will insist on detent tuning—the familiar click-stop arrangement in vhf tuners. Two major methods are being used now by uhf tuner manufacturers; capacitance tuning with continuous geared devices, and inductance tuning with mechanical detenting. The large number of channels on the uhf band makes station selection

difficult and detent tuning is seen as a probable solution.

The most important problem is that of providing effective and reliable uhf tuner performance at economical prices. The customer is being asked to buy uhf capability in his all-channel receiver, though broadcasting service of interest to him may not yet exist in his area. A new receiver will cost about \$20 more than the straight vhf receiver.

Transistor vs. vacuum tube

Design engineers at most of the uhf tuner manufacturing companies have turned to the transistor. They say that it is more reliable than the vacuum tube. This is important from a product marketing point of view.

Perhaps an even more cogent reason for the increased use of the transistor is its lower cost. A transistor sells for less than a first-rate tube. Manufacturers of black and white tv sets are having to scramble for nickels and it's easy to understand why the transistor became everyone's first choice when its priced dropped to 70 cents, undercutting the nuvistor vacuum tube which sells for \$1.05. A tube requires other components; a socket for the tube runs about five to ten cents, including labor. Transistors don't require sockets, are soldered directly into the circuit. The heater circuit for a vacuum tube demands a feedthrough capacitor at the cost of about five cents with labor, plus a heater choke for another five cents, roughly.

Another requirement of vacuum tubes, which makes them less popular with designers, is the need to specify one of two filament types—in the case of nuvistors, a 6DV4 or a 3 DV4—depending on whether the uhf tuner will be used with a trans-

former-powered receiver, or a line-powered, series heater string receiver. With a transistor no filament power is required.

Several transistor types are available including the silicon planar epitaxial SE3002, by Fairchild Semiconductor, the first firm to break the price barrier and bring the devices into competitive stance with vacuum tubes. The semiconductor division of Sylvania Electronic Products, Inc. is also producing an oscillator transistor that tuner builders report is available in limited quantities. Texas Instruments Inc. makes a germanium transistor which is a pnp type, but by reversing only the collector supply wiring of the tuner, it may readily be used. The company guarantees a junction temperature rating of 125° C that is compatible with uhf tuner design.

Another problem arising from the use of vacuum tubes in uhf tuners is the frequency drift of sensitive components caused by heat generated by the tube's filament. A transistor produces no heat.

Capacitance tuning most prevalent

The majority of the half a dozen major uhf tuner manufacturers are producing variable-capacitance tuners. The technique calls for a three-gang capacitor with each section tuning a coaxial line. Representative of the capacitance-tuned designs is the uhf tuner built by the F. W. Sickles division of General Instrument Corp. It uses a diode mixer, and a transistor oscillator, the latter being a silicon planar epitaxial type.

An antenna coupling loop transfers r-f energy into the quarter-wavelength, capacitively tuned, coaxial line. A small amount of the energy is then magnetically coupled to the mixer through an iris, also called a coupling window, cut into the coaxial wall. The mixer compartment consists of another capacitively tuned coaxial line, electrically a quarter-wavelength long, but physically much shorter. The desired quarter-wave electrical length is achieved by allowing for stray capacitances, and controlling the inductance per unit wavelength by adjusting the wire (or line) diameter of the coax, in different models.

To adjust tracking of the r-f section over the entire band, the plates of the variable capacitor in the r-f section are bent to allow it to track with the oscillator, as a step during calibration of the tuner. Metal tab capacitors are used to trim the r-f response of the tuning capacitor. This is done essentially to control reception of channel 83, at the high end of the uhf band.

The mixer element is a point contact diode chosen for efficient heterodyning action at the operating frequencies. In the Sickles tuner it is a silicon type 1N82A. This diode exhibits a low conversion loss resulting in minimum over-all system noise figure. Poor conversion efficiency causes snow in the received picture, though there is little effect on the sound channel. The diodes are manufactured and selected for low noise, and obtained both from General Instrument's own semiconductor division

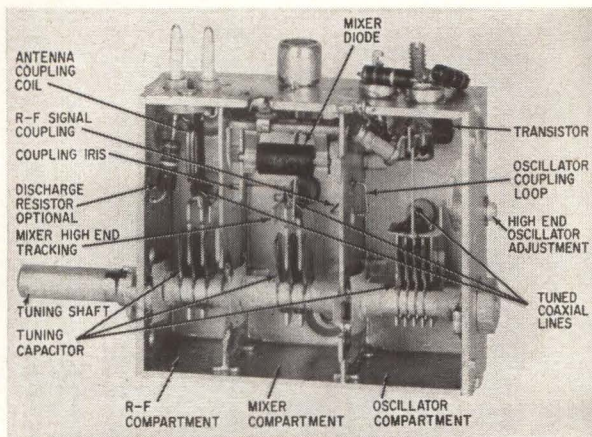

Compact transistor uhf tuner by the Sickles Division of General Instrument Corp. uses capacitance tuning to select stations. Coaxial lines form tuned circuits.

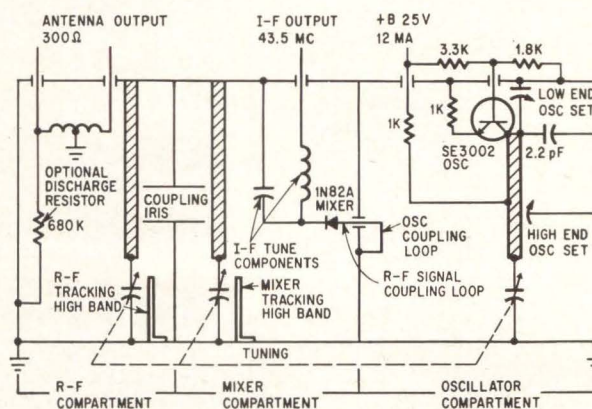

A silicon, point-contact diode mixer and a silicon planar epitaxial transistor oscillator are used in this uhf tuner developed by the Sickles Division.

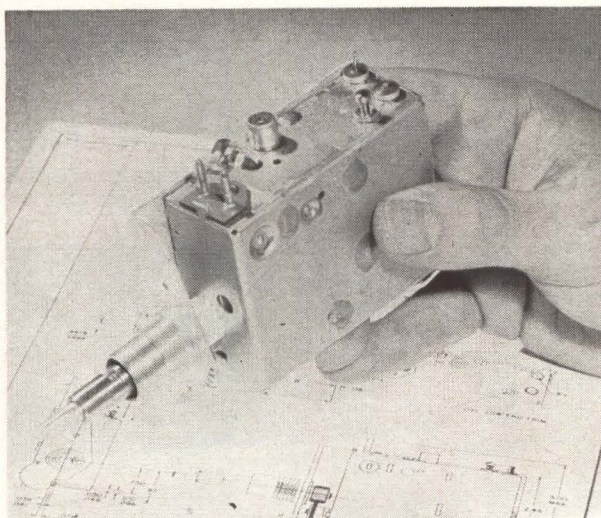

To get channel selection and fine tuning with a single knob, Standard Kollsman Industries, Inc. designed their tuner with a two-speed planetary drive in conjunction with a coaxial shaft. The outer shaft carries the channel indicator dial, and the inner shaft, keyed to the outer by a pin-in-slot, provides station selection and fine tuning.

and from the Semiconductor division of Sylvania Electric Products, Inc., a unit of General Telephone and Electronics.

The oscillator compartment is made up of a half-wave long capacitively tuned coaxial line. The selection of a half-wavelength permits end feeding of the coaxial line by the oscillator transistor. A combination of voltage and current feed is used. Both high and low-frequency trimmers set the ends of the tuning spectrum in the oscillator circuit. The oscillator circuit might be considered as a modified Colpitts circuit, with tapped capacitance feedback, though some inductive feedback exists. The coaxial nature of the circuit physically places the components inside the tuned circuit. The two capacitors for oscillator feedback consist of the internal capacitance of the transistor, and the combination of the trimmer and compensating capacitors.

The compensating capacitor has a coefficient opposite to the inherent temperature coefficients of the transistor and other hardware such as the coaxial line, ganged capacitor and trimmer.

The oscillator transistor used is Fairchild Semiconductor's type SE3002. It exhibits good oscillator action and has adequate power to drive the mixer diode. The collector load may be either a choke or resistor, with the resistor most often used.

Coupling from the oscillator to the mixer compartment is by a pickup loop in the oscillator compartment. The loop wire passes through the wall of the oscillator-mixer common wall, and then becomes an r-f pickup loop which couples to the mixer diode, located in the mixer compartment. The diode feeds the resulting i-f signal to the i-f tuned circuit components, tuned to 43.5 Mc center frequency. The i-f output is fed into the channel 1 position of the vhf tuner in the tv receiver with which it is designed to operate. By agreement within the industry, channel 1 is connected so that both the r-f amplifier tube, and the mixer tube in the vhf tuner may be used to provide an i-f gain of roughly 40 db, measured at the 43.5-Mc center frequency.

Final values of the inductance and capacitance in the i-f circuit of the uhf tuner are chosen to give

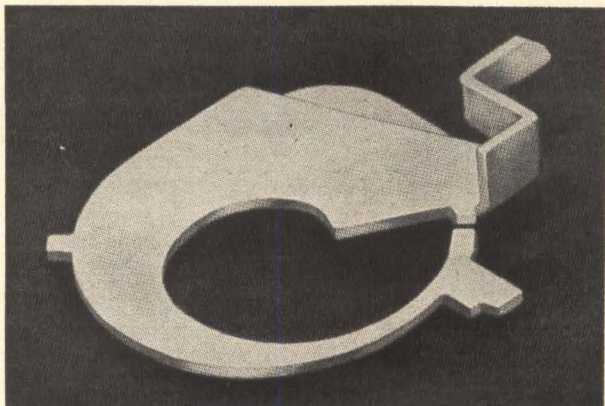

Inductive element in Oak Manufacturing Co.'s uhf tuner.

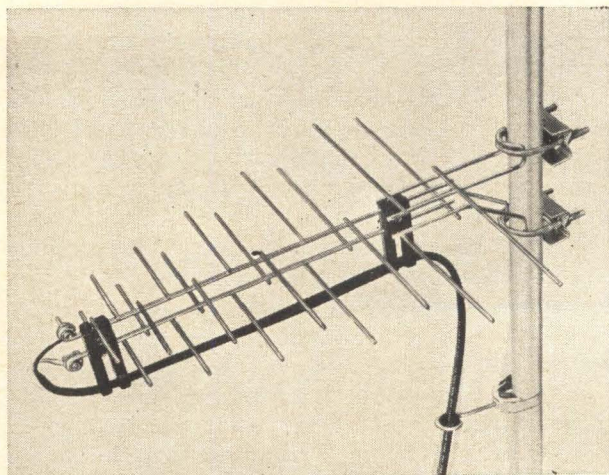

Log periodic uhf receiving antenna by Blonder-Tongue Laboratories, Inc. provides high gain, broadband, pickup.

maximum over-all receiver performance with the particular vhf tuner used, and the connecting cable employed with it.

Integral tuner

According to Alfred Sfredo, Jr., chief engineer, tv tuners, for the Sickles Division of General Instrument Corp., building an integral uhf-vhf tuner presents problems which place realization of such a design at least a year away. One reason is the price differential between transistor and vacuum tubes. When transistors and tubes for vhf are priced equally, one barrier will be overcome.

A more pressing reason for building vhf and uhf tuners in separate mechanical packages is that uhf uses transmission line type tuning, and vhf uses lumped constant tuning. The integration of the two tuning methods will certainly compromise the performance of a tuner in one of the spectrums, or possibly both. Actually, some form of mechanical or electrical switching would be needed, and even then performance would be compromised. Sfredo doesn't believe that the industry wants to settle for a compromise, but he notes that every tuner house is trying to solve the problem.

Inductive tuning permits detenting

Most industry experts remember that tv set buyers insisted on click-stop tuning, rejecting continuously tuned, front ends for vhf though only 12 channels were involved. Uhf covers 70 channels which are generally harder to tune. At uhf a form of "memory tuning" has evolved for receivers, providing a mechanical means of setting stations without repeated fine tuning. Detent tuning requires linearity of dial coverage. This is readily achieved with inductance tuned, frequency determining circuits.

The Oak Manufacturing Co. has developed an inductance tuned uhf tuner which uses a transistor oscillator and diode mixer. The company points out that all its new uhf tuners are transistor operated. Oak uses an inductive element, or ring,

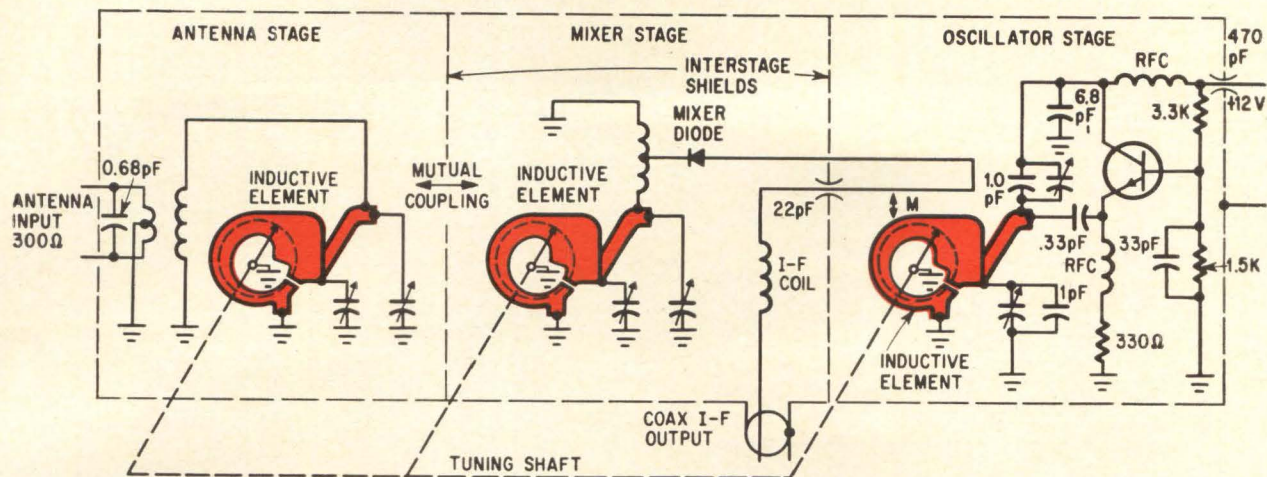

Inductive tuning used in Oak Manufacturing Co.'s tuner permits detented design. Precious metals coat the inductive elements to control surface conductivity and achieve wear resistance.

made of steel for rigidity. It is a flat metallic stamping in the form of a circle, with an electrical gap. To control the electrical surface conductivity, and the wear and life-determining characteristics, the inductive elements are coated with precious metals including gold and silver. The wiper element is formed in a "U" shaped cross-section made of silver.

One inductance element is used in each of the uhf tuner stages, including the antenna, mixer and oscillator. The inductive tuning format used by Oak permits a 270° active dial spread, which gives roughly a 4° detent channel stop-width. An advantage claimed for inductive tuning is that only one element need be stamped out for each stage. With a variable capacitor, several must be stamped and then assembled and careful attention to radial and axial tolerances, both mechanical and electrical, must be provided.

As to potential contact trouble using inductive tuning, it should be remembered that wiper contacts are used on variable capacitors as well as inductive tuning systems. The velocity rate, a prime cause of wear, is lower on variable capacitors. Oak has tested the inductive uhf tuning system and found its wear resistance far exceeds anticipated consumer use. Additionally, the system remains free of wiper noise. The Oak tuner permits rotation in either direction and can be provided to continuously pass through 360°.

Edward D. Chalmers, vice president Engineering at Oak, points out that development of an inexpensive uhf amplifier transistor would permit a better distribution of gain in all tuner designs. Right now, the industry has to achieve all the gain at i-f frequencies which can lead to operating instabilities. R-f transistors must be priced at under \$1.00 for tuner use.

Antenna developments pace uhf

Development of high performance receiving antennas for uhf operation is getting increased attention. One manufacturer produces a small loop an-

tenna built right into the receiver and this works reasonably well. But antenna manufacturers have found that high gain antennas are required in many cases at uhf frequencies, even in cities. The problem in cities is elimination of ghosts and the solution is often achieved by the better directivity afforded by a high gain antenna.

The outdoor bow tie antenna has long been popular for uhf use. It is actually a form of dipole that is a section of a broad-band conical antenna. A conical antenna may be thought of as two ice cream cones set end to end. For uhf, flat pieces of aluminum are used to form the bow ties which approximate sections of the conical, and a flat wire grid sheet is used as a reflector, which helps to boost gain at some frequencies. Also popular is the corner reflector antenna and the parabolic antenna, two high efficiency designs for uhf reception.

A wideband, high-gain antenna with great promise at uhf frequencies, is the log periodic, so-called because the spacing and length of its elements are periodically related on a logarithmic basis. It can be thought of as a section of transmission line, along which several stubs have been placed, whose relationship to each other in terms of length and separation is the same as that used in the calibration of a slide rule (as on the C scale).

The log periodic antenna operates like a traveling Yagi. One may think of the stub arrangement as moving up and down the transmission line progressively with frequency. Thus, the only elements active for a particular uhf channel are the ones that are resonant at that channel frequency.

The Blonder-Tongue Laboratories, Inc. have built a log periodic antenna designed for uhf receiver use, engineered to achieve the maximum gain possible with the log periodic principle, at minimum cost. In Blonder-Tongue's design usually no less than five of the log periodic elements are active for reception of any one channel. A simplified but essentially accurate explanation of this antenna's operation during reception of a single channel in the uhf band is that one stub acts as

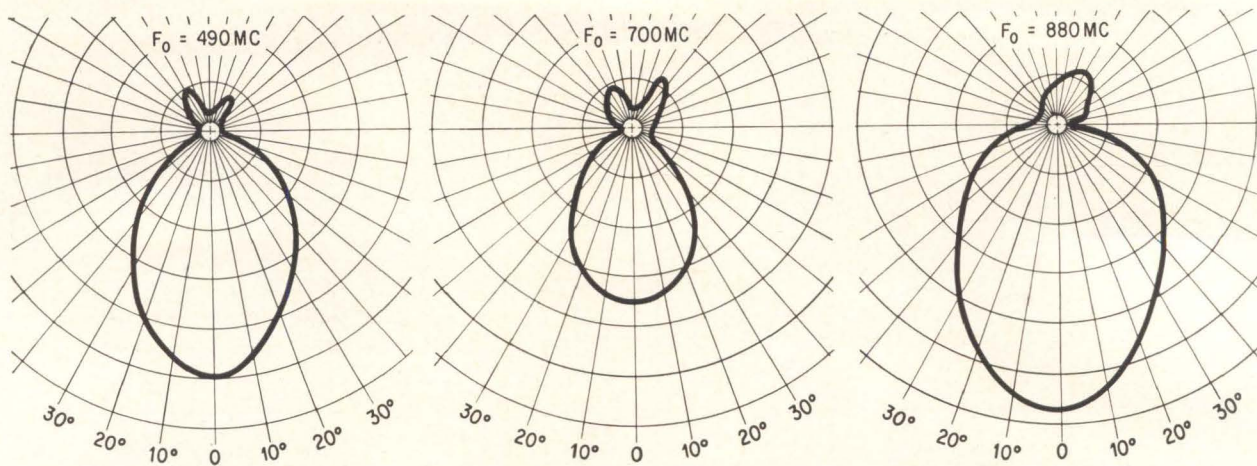

Horizontal receiving pattern of uhf log periodic antenna built by Blonder-Tongue Laboratories, Inc. The gain over a tuned dipole is 9.2 db at 490 Mc and 10.5 db at 880 Mc. Front-to-back reception ratio is at least 20 db.

the equivalent of a driven element in a Yagi, while two of the shorter ones in front act as directors and two of the rear elements act as reflectors. The elements in front and in back of the element that tunes to the channel being received, may alternately be thought of as intercepting elements, or cells, adding energy to the signal picked up by the main element.

The receiving pattern of the Blonder-Tongue antenna is characterized by the cleanliness of the broadband and high gain response in the desired forward lobe, over the frequency range of 470 Mc to 890 Mc. Careful spacing of the transmission line is observed in design to raise the antenna impedance and achieve the closest possible match to a 300 ohm television tuner input.

The firm choose an all-welded steel design, with a heavy zinc coating to maintain antenna efficiency. Heavy connector terminals are employed to avoid signal loss due to skin resistance at uhf frequencies.

Future uhf tuner components

The mixer diode is considered to be one of the most troublesome components in the entire tuner, and subject to what one chief tuner engineer describes as "black magic". Unbonded point contact diodes are generally used. They are susceptible to physical as well as electrical shock. The latter may be caused by static electricity discharge, or by electrically leaky soldering irons which inject a voltage into the diode during the wiring steps.

Therefore, research is now being carried out on back-diodes, a variation of the tunnel diode, for mixer service. To date, however, both performance and price do not allow its use in uhf tuners.

Thin film techniques are under study for uhf tuners but for economic reasons use of thin film is impractical now and may be for several years to come. One television receiver engineer observes that since picture tubes now take up considerable space, the advantages of thin film circuits in reducing tuner size may not be a practical goal.

Use of a transistor to replace the mixer diode for future uhf tuner designs is also being considered. The autodyne system of local oscillator-conversion circuitry, where a single transistor is used simultaneously as the oscillator and mixer is also under consideration. But this system is subject to signal overloading and other troubles. Based on the experience of European vacuum tube autodyne circuit makers the system seems to hold little promise.

Continuing experiments with airborne uhf television transmission, may be important. One theory holds that six tv transmitting planes constantly in flight over the country could provide complete coverage at uhf frequencies. The possibility of using satellites like the Syncom or other systems for commercial uhf transmission has been advanced. However, higher power transmitters would be required than are presently available in satellites. An alternate to higher transmitter power might be high gain receiving antennas, though experts hold that practical designs of moderate size could not be readily achieved.

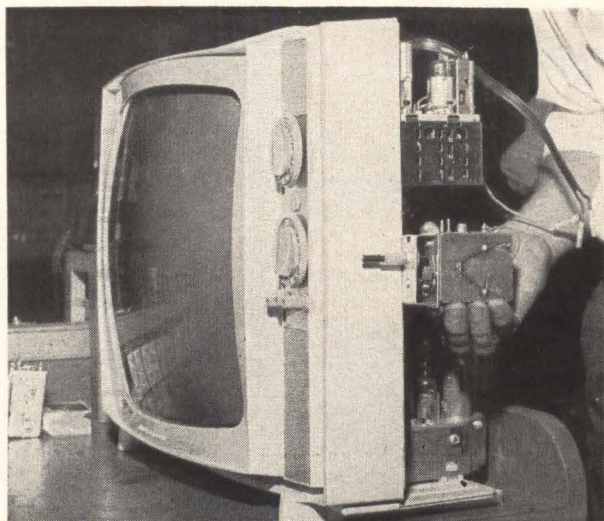

Uhf tuner by Sickles Division of General Instrument Corp. is held by technician. Vhf tuner is mounted on tv receiver. The combination provides coverage from channels 2 through 83, comprising an all-channel receiver.

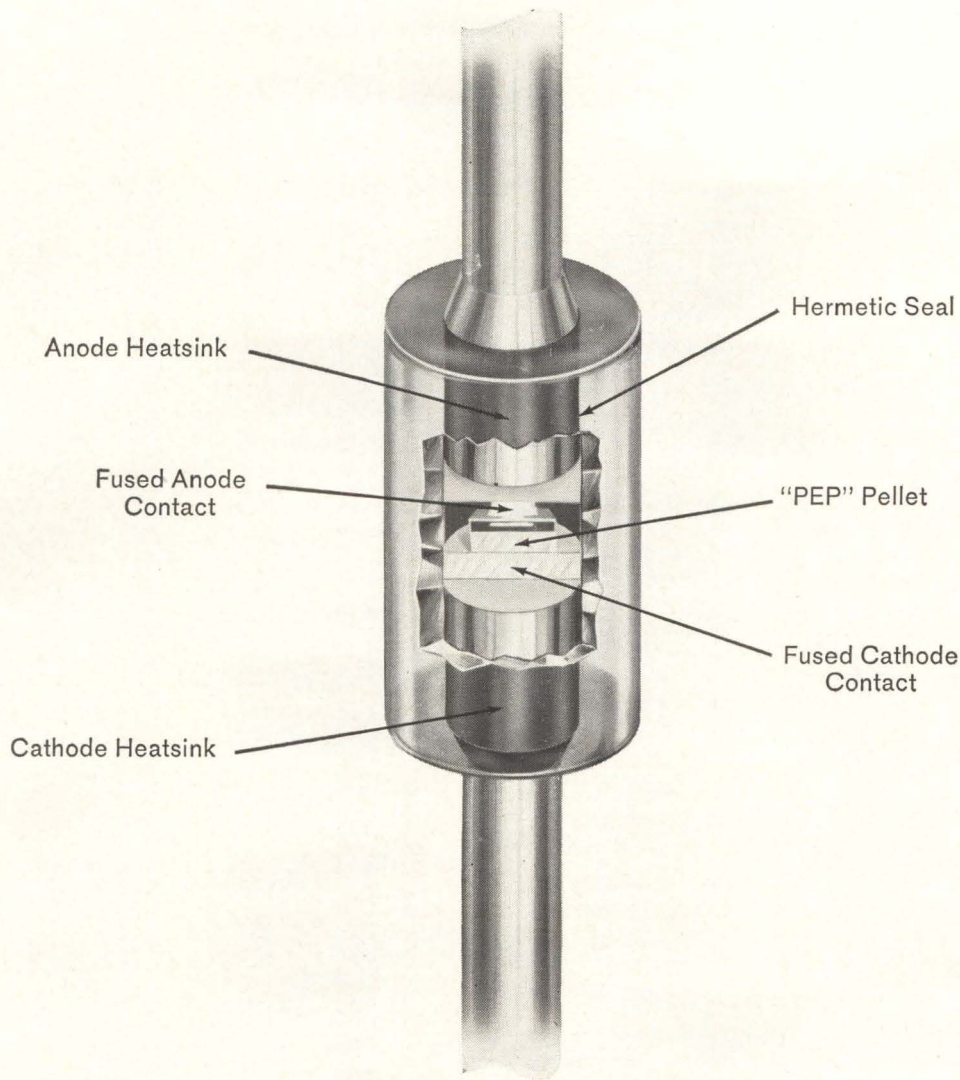

smaller than most...as rugged as they come...and inherently more reliable!

The new General Electric **Double Heatsink Diode** features a simplified design that eliminates the "S" strap, offers fused anode and cathode contacts, and provides increased power dissipation in less unit volume. Process stabilization at 300°C assures outstanding parameter stability. This combination of design and process control, coupled with the advantages of the DHD Planar Epitaxial Passivated pellet, offers outstanding electrical performance and device reliability.

To learn more about the performance and economic advantages the **Double Heatsink Diode** can offer your designs, see your Semiconductor Products District Sales Manager, or write Semiconductor Products Department, Section 16D160, General Electric Company, Electronics Park, Syracuse, New York. In Canada: Canadian General Electric, 189 Dufferin Street, Toronto, Ontario. Export: International General Electric, 159 Madison Avenue, New York 16, New York.

Comparison of General Electric "PEP" Diode Pellets

	1N4151-54	1N4148-49	SD-300	1N4150	SD-400	SD-800	
Breakdown Voltage BV @ 5 μ a	35-75	100	40		40	40	volts
Leakage Current I_R @ 30 volts, 25°C	50	50	0.1 @ 10V	50	50	50	nano-amps (max)
Capacitance C @ 0 volts C @ -10 volts	2-4	2-4	3	2.5	6	30 15	pico-farads pico-farads
Recovery Time t_{rr} ($I_R = I_F = 10$ ma, recovery to 1 ma)	4	5	100	4	10	20	nano-seconds
Conductance typical I_F @ $V_F = 1$ volt, 25°C	100	150	100	250	400	800	ma

Available through your G-E semiconductor distributor



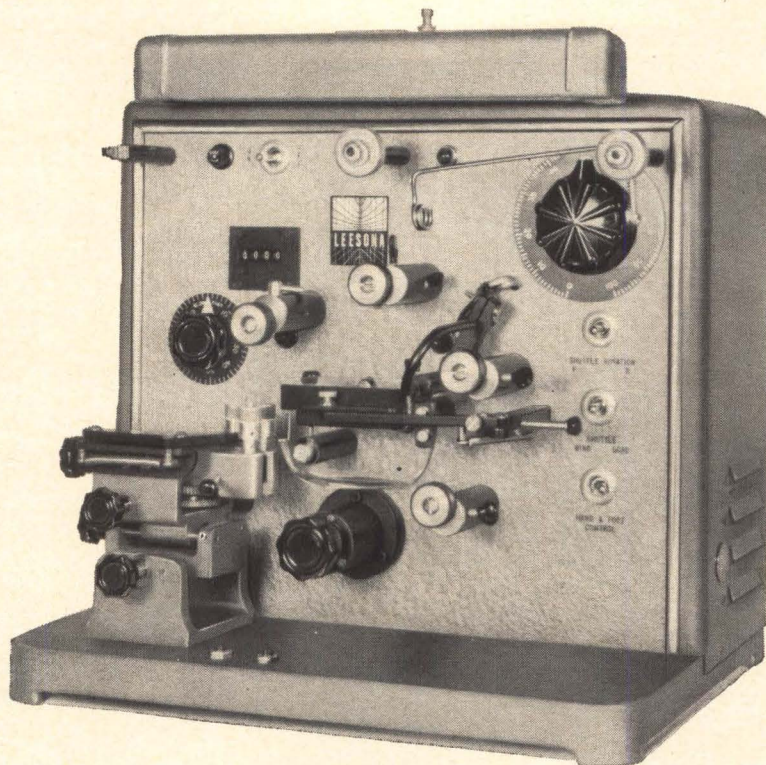

New from Leeson®...

Toroidal Coil Winding Equipment

engineered for greater economy...versatility...reliability!

Auxiliary Units For Toroidal Winders

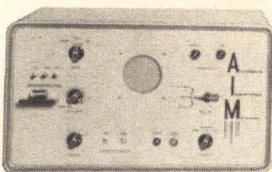

**AUTOMATIC INDUCTANCE
MATCHING COMPARATOR**
for closer tolerance

Inductance range:
500 Microhenries to
50 Henries.

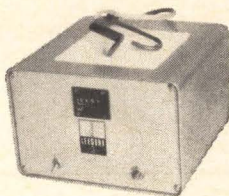

**PHOTOELECTRIC TURNS
COUNTER**
for positive turns control

- winds heavy wires on small toroids, due to unique shuttle design and external drive. Virtually eliminates hand winding.
- large 6" shuttle diameter provides: (1) greater wire capacity; (2) faster production in Mag. Amp. work; (3) virtual elimination of splicing.
- loading, winding, and removing or installing cores can be quickly accomplished without removing the specially designed shuttles or sliders.
- speed and ease of set-up make the Leeson TO-133 Toroidal Winder, the ideal equipment for large-scale production plants as well as model work shops.
- top quality materials—and top quality production standards—insure maximum reliability and minimum maintenance requirements.
- finished core size: O.D. 2½", I.D. .055", Height 2".
- wire sizes: AWG 22 to AWG 50.

For detailed specifications write LEESONA CORP., Warwick, R.I.



23B.4.10

SOCKET-BY-SOCKET SECOND-SOURCE STRENGTH

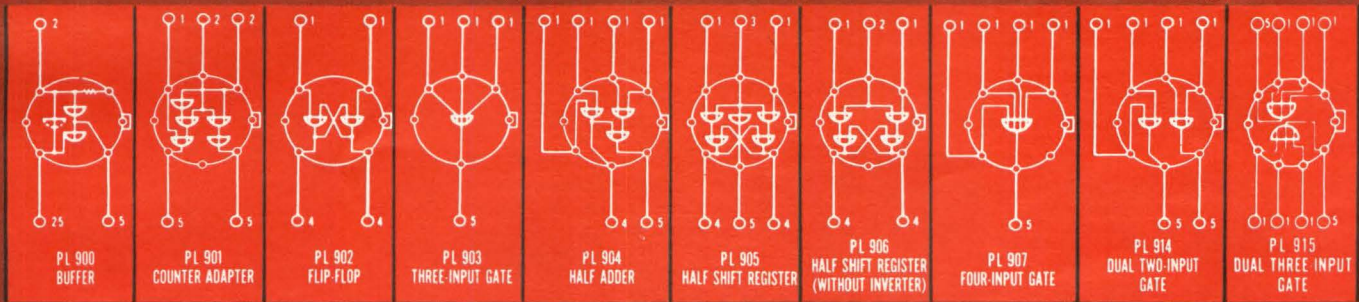

Philco brings bona fide two-source strength to microelectronics with the industry's only family of socket-by-socket interchangeable circuits.

Now, for the first time, designers have the opportunity to utilize a complete family of compatible, integrated logic building blocks—off-the-shelf—with the assurance of two-source availability. These ten Micrologic circuits, with more to come, provide the flexibility required to convert almost any logic system, operating at speeds up to 2 megacycles, to microelectronic circuitry. They are particularly important to designers of systems for operation in military equipment environments because of their interchangeability and compatibility on a worst-case basis. ■ Each Micrologic circuit is manufactured, using the Planar Epitaxial Process, under

a cross-licensing agreement with Fairchild Camera and Instrument Corporation. Each circuit is made with identical masks and process steps and is identical to and interchangeable with Fairchild Micrologic. Each is available off-the-shelf from Philco and a nationwide network of Philco franchised distributors. ■ Additional families of low-power Micrologic circuits and other silicon integrated circuits will soon be available. ■ When you consider microelectronic circuitry, be sure of availability, compatibility and interchangeability. Specify Philco Micrologic—the industry's only bona fide two-source circuits. For information, write Department E42064.



MICROELECTRONICS OPERATION

PHILCO

A SUBSIDIARY OF *Ford Motor Company*

LANSDALE DIVISION, LANSDALE, PA.
In Canada: Don Mills Road, Don Mills Ontario, Canada

Circle 97 on reader service card

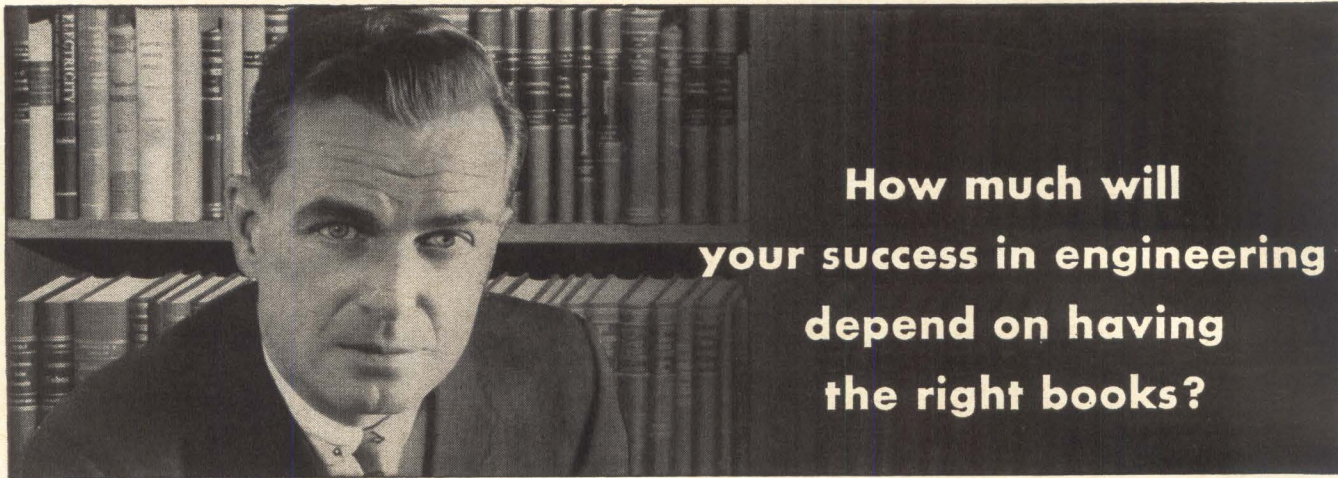

How much will
your success in engineering
depend on having
the right books?

The Electronics and Control Engineers' Book Club helps you keep ahead in your field . . . at a savings

Start your membership with any of these selections:



Electronic Switching, Timing, and Pulse Circuits by J. M. Pettit. Provides a practical understanding of operation of complex circuits.

Publisher's Price, \$8.50
Club Price, \$7.25



Information Transmission, Modulation, and Noise by M. Schwartz. A unified approach to communication systems.

Publisher's Price, \$12.50
Club Price, \$10.65



Mathematics for Electronics with Applications by H. M. Nodelman and F. W. Smith, Jr. Methods for solving practical problems.

Publisher's Price, \$7.00
Club Price, \$5.95



Digital Computer and Control Engineering by R. S. Ledley. Full coverage from basic electronic design to advanced programming techniques.

Publisher's Price, \$14.50
Club Price, \$12.35

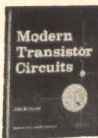

Modern Transistor Circuits by J. Carroll. Presents almost 200 modern transistor circuits in 101 separate articles.

Publisher's Price, \$10.00
Club Price, \$8.50



Magnetic Recording Techniques by W. E. Stewart. Full description of magnetic recording methods and devices.

Publisher's Price, \$10.00
Club Price, \$8.50



Wave Generation and Shaping by L. Strauss. Essential features and techniques of practical wave-generating and shaping circuits.

Publisher's Price, \$12.50
Club Price, \$10.65

Your engineering career owes a great deal to books. Why not take advantage of this convenient, economical way to have the best professional books available when you need them? THE ELECTRONICS AND CONTROL ENGINEERS' BOOK CLUB brings you the essential technical literature in your field. It also helps you overcome today's high cost of building a professional library by saving you an average of 15% from publisher's prices.

How the Club Operates. You regularly receive free of charge *The Electronics and Control Engineers' Book Bulletin*. This gives complete advance notice of the next selection-of-the-month, as well as many alternate selections. If you want the main selection you do nothing; the book will be mailed to you. If you want an alternate selection—or no book at all—you can notify the Club by returning the convenient card enclosed with each *Bulletin*.

Saves You Time and Money. You agree only to the purchase of three books in a year. Certainly out of the large number of books in your field offered in any twelve months there are at least three you would buy anyway. By joining the Club you save both money and the trouble of searching.

Send No Money Now. Just check the book you want as your first selection on the coupon below. With it you will be sent *Transistor Circuit Design* for only one dollar. Take advantage of this offer and receive two books for less than the regular price of one. (If coupon is detached, write to The Electronics and Control Engineers' Book Club, Dept. L-4-20, 330 W. 42nd St., New York, N. Y. 10036.



ACCEPT THIS
\$15.00 BOOK

FOR ONLY \$1.00

with membership in
The Electronics and
Control Engineers'
Book Club

TRANSISTOR CIRCUIT DESIGN

Prepared by the Engineering Staff
of Texas Instruments Incorporated

Here's a practical reference that can ease your transistor circuit design work. It brings you a wealth of data and facts prepared by the engineering staff of Texas Instruments, Inc. Reflecting the combined knowledge and experience of 32 expert circuit design engineers, this book makes conveniently available the actual design procedures and circuits most often requested from Texas Instruments.

Transistor Circuit Design is typical of the selections of THE ELECTRONICS AND CONTROL ENGINEERS' BOOK CLUB. All books are chosen by qualified editors and consultants. Their thoroughgoing understanding of the standards and values of the literature in your field guarantees the authoritativeness of the selections.

(NOTE: If you already own this volume, you may substitute any other book on this page as your DOLLAR book. Check two books below and you will receive the higher priced selection for only \$1.00.)

CLIP AND MAIL THIS COUPON TODAY

The Electronics and Control Engineers' Book Club, Dept. L-4-20
330 West 42nd Street, New York, N. Y. 10036

Please enroll me as a member of The Electronics and Control Engineers' Book Club. You will bill me for my first selection indicated at right at the special club price and \$1 for *Transistor Circuit Design* (or alternate choice), plus local tax, and a few additional cents for delivery costs. (The Club assumes this charge on prepaid orders.) Forthcoming selections will be described in advance and I may decline any book. I need take only 3 selections or alternates in 12 months of membership. (This offer good in U. S. only.)

PLEASE PRINT

Name

Address

City..... State..... Zip Code.....

Company

NO RISK GUARANTEE:

If not completely satisfied, you may return your first shipment within 10 days and your membership will be canceled. L-4-20

Send as my first selection: (If more than one book is checked we will send the higher priced selection as your \$1.00 book.)

Electronic Switching, Timing, and Pulse Circuits, \$7.25

Information Transmission, Modulation, and Noise, \$10.65

Mathematics for Electronics with Applications, \$5.95

Digital Computer and Control Engineering, \$12.35

Modern Transistor Circuits, \$8.50

Magnetic Recording Techniques, \$8.50

Wave Generation and Shaping, \$10.65

ITT P-29 KLYSTRON POWER SUPPLY with F-2904 millimeter klystron in place. \$1,500, without tube.

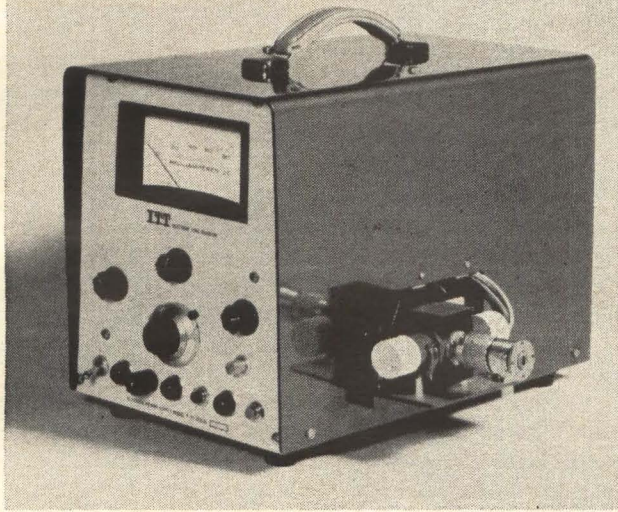

ITT F-2900 KLYSTRON with CR-80 transition delivers up to 1.5 watts. \$1,950.

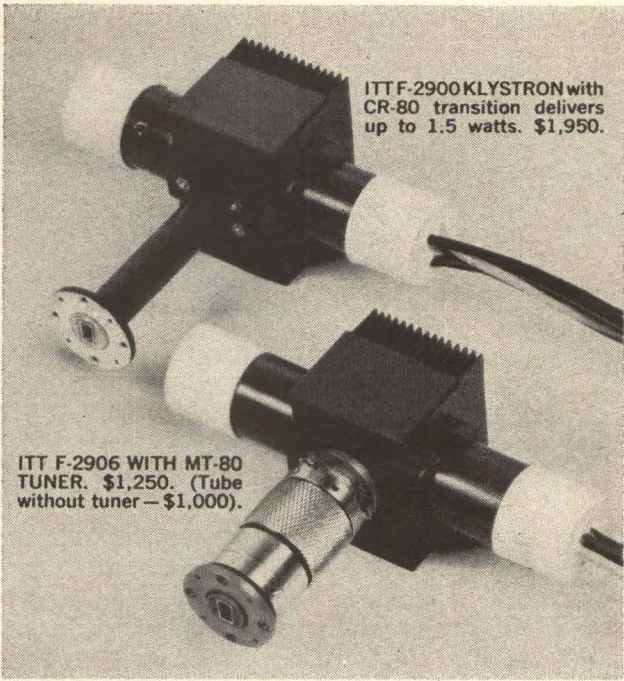

ITT F-2906 WITH MT-80 TUNER. \$1,250. (Tube without tuner—\$1,000).

THE ITT MILLIMETER WAVE FAMILY

Tube type	Frequency*	Power**	Typical Operation				Refl. V.	Heater V.	Heater Amps
			Beam Volts	Beam mA	Focus V.				
F-2900	33-38 Gc.	1 watt	2000	.40	-50	-600	6.3	1.2	
F-2904	28-33 Gc.	1 watt	2000	.40	-50	-600	6.3	1.2	
F-2905	33-38 Gc.	500 mW	2000	.40	-50	-600	6.3	1.2	
F-2906	28-33 Gc.	500 mW	2000	.40	-50	-600	6.3	1.2	

*Center frequency preset within this range per customer request. 0.1% electronic tuning, 2% mechanical tuning with MT-80.
 **F-2900 and F-2904 supplied with 1.5 watt output at fixed frequency on special order.

Four-tube 8-millimeter family from ITT!

Now, for the first time, ITT introduces a "family of tubes" design concept at millimeter wave frequencies. Included in this new family are four klystrons plus a compatible bench-type power supply. Tubes operate in the 8-millimeter region covering frequencies from 28-38 Gc. Output powers range from .5 to an unmatched 1.5 watts. All four tubes are similar in electrical and mechan-

ical design for complete interchangeability over the entire frequency range. Mechanical tuner matches all tubes as does the power supply (see above illustrations). Liquid cooling is also available if desired.

Write for additional data and tell us about your millimeter application.

4-millimeter family coming soon!



ELECTRON TUBE DIVISION

CLIFTON, NEW JERSEY

INTERNATIONAL TELEPHONE AND TELEGRAPH CORPORATION

ES Product of the month: 400 CPS FREQUENCY CONVERTER

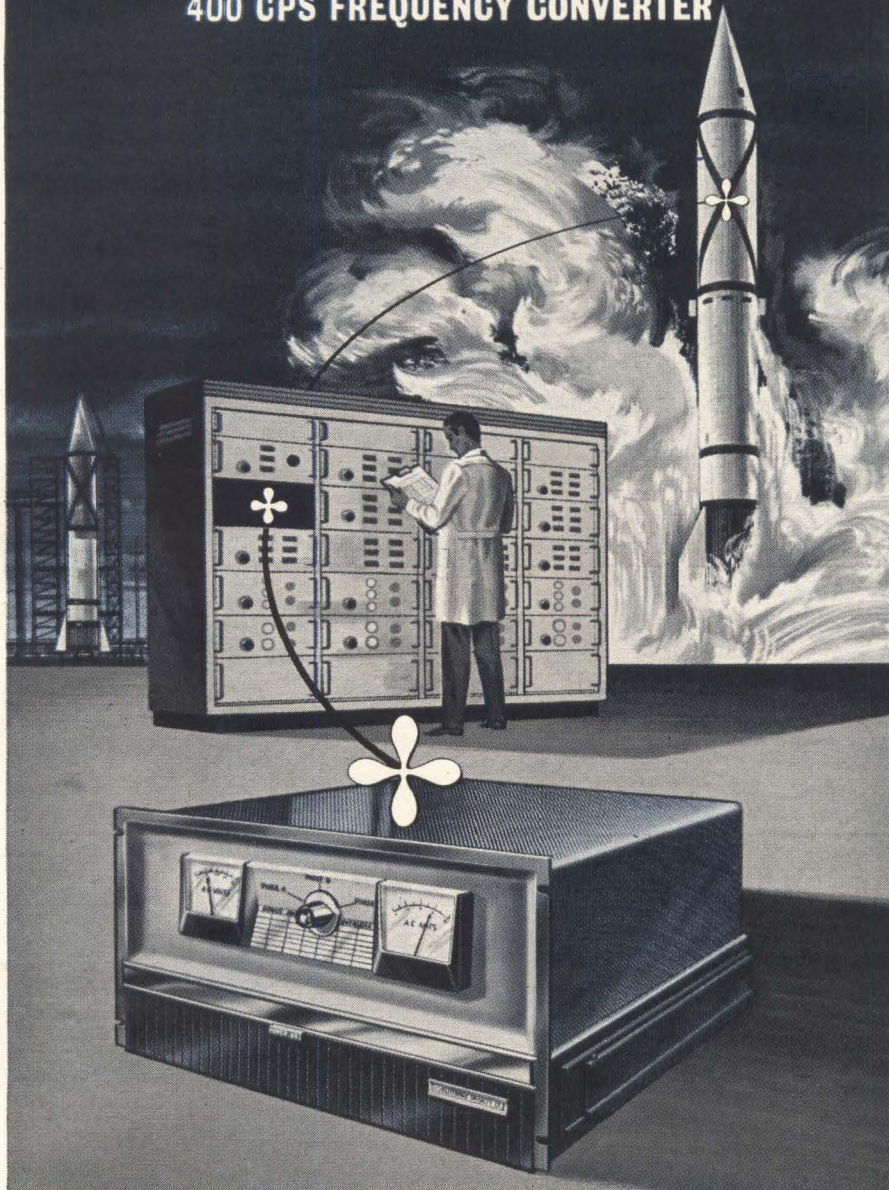

Electronic Specialty's extensive engineering experience in the power conversion field has led to a major development in the state-of-the-art. A unique, small, lightweight, solid state, 60 to 400 cps frequency converter is now entering production. The 80 pound unit, in portable laboratory or standard 19 inch rack configuration, was designed for testing military aircraft and missile electrical systems. A low acoustical noise factor makes it ideally suited for military Mobile Training Units. The new unit offers substantial reductions in cost, weight, size, and maintenance.

This reliable frequency converter has the following outstanding specifications. Size: 19" w x 10½" h x 21" d. Weight: 80 lbs. **INPUT:** Voltage, 115/200 VAC ± 10%, 3 phase wye or delta; Frequency, 50 cps or 60 cps. **OUTPUT:** Voltage, 115/200 VAC, 3 phase, 4 wire; Frequency 400 cps ± 1%; Voltage regulation, ± 2 VAC, L-N; Phase displacement angle, 120° ± 5°; Load, 0-3 KVA (0-1 KVA per phase); Load P. F., .85 lead to .75 lag; Temperature, 0°F to +125°F operating. The unit is uncritical to load balance and has a total harmonic distortion of 5% maximum.

FOR COMPLETE INFORMATION WRITE TO WILLIAM MARCY, DIRECTOR OF MARKETING, ADDRESS BELOW.

ES is a diversified, dynamic, multi-divisional organization serving defense and industry over a broad range of vital areas with advanced systems, sub-systems, and state-of-the-art components. Major contributions are currently being made in the following:

ELECTRONIC AND ELECTROMECHANICAL CONTROLS:

gyroscopes, relays, static switching devices, sensors, flashers, regulators, converters, rotary and linear actuators, motors, generators, weapon and camera controls, electromechanical assemblies for aerospace applications.

COMMUNICATIONS:

antennas, flexible and rigid waveguides, coaxial switches, diplexers, power dividers, filters, radio telescopes, solar furnaces, matching networks, antenna drive motors and controls.

POWER:

precise power systems, dynamotors, computer power sources, motor - generators, actuators, starter generators, power conversion systems, transmission towers for public utilities.

SPACE CONDITIONING:

electronically programmed environmental controls and systems for industrial, commercial, and military applications.

SYSTEMS:

Systems Laboratories conduct research, development and study programs in reconnaissance, electronic countermeasures, interferometer phased array systems, and total energy packages; integrating divisional components, sub-systems, and specialized technical skills.

For information concerning the corporate systems capability, product line, or research and development programs, write to the Director of Marketing, address below.



ELECTRONIC SPECIALTY CO.

5121 SAN FERNANDO ROAD, LOS ANGELES, CALIFORNIA 90039

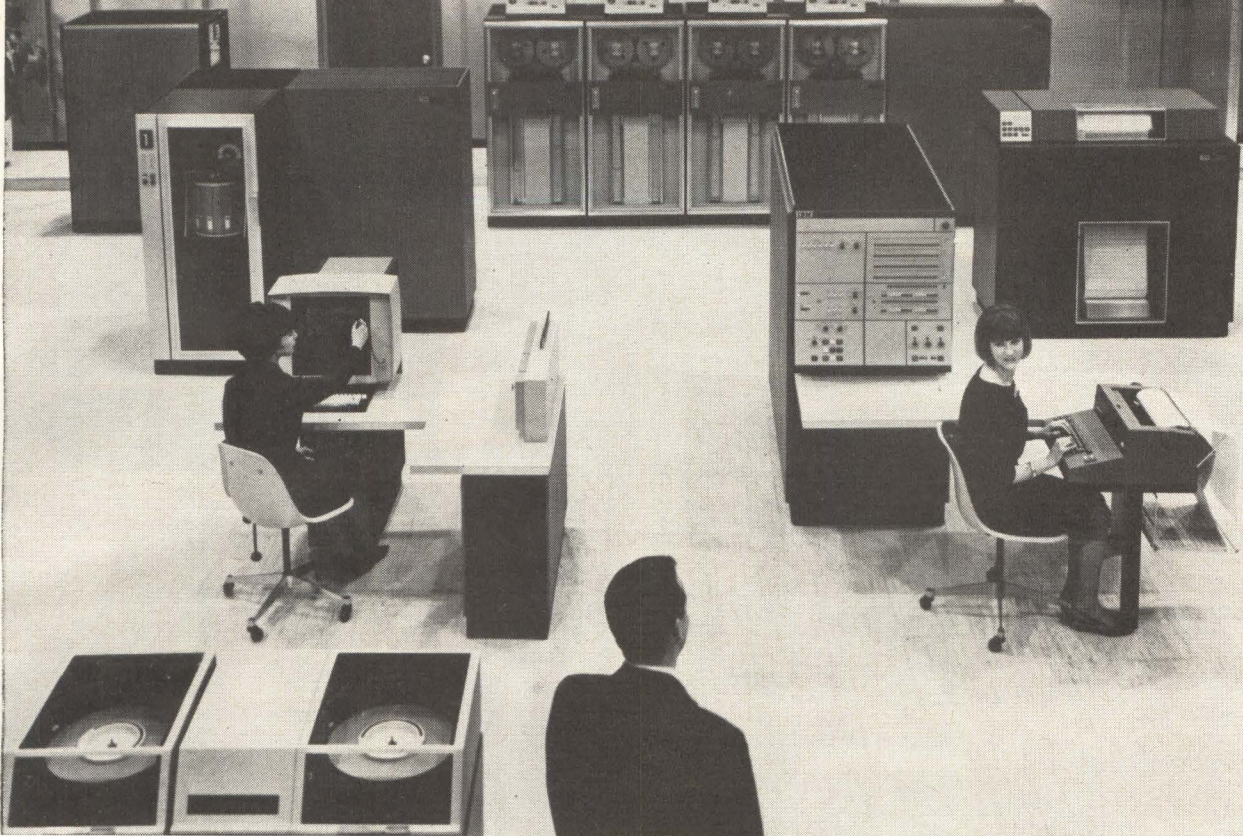

Giant IBM system/360 occupies one third the floor area of former computers of the same power.

Computers

IBM burns its bridges

System/360 spans all segments of the market. It's compatible, modular, and built with microelectronics. IBM has made its own commercial computers obsolete

By Lewis H. Young

Editor

Thomas J. Watson Jr., chairman of International Business Machines Corp., faced a closed-circuit television audience of 100,000 businessmen in mid-April. "This is the most important product announcement we have ever made," he told them.

The company had gone to extraordinary lengths to introduce its new IBM system/360. And engineers could understand why. With a single new system, IBM had made every one of its commercial

computers obsolete.

First with microelectronics. Enthusiastically, Watson called the new system a new generation of computing machines. The same system is available in machines that are as small as the current IBM 1400 series or bigger than the IBM 7000 series machines. All—big or small—can use the same programs. And a user can increase the power or capability of his installation by adding modules of memory and logic.

It is the first commercial computer equipment to be built with microelectronic components. The tiny devices make logic circuits faster and cheaper.

The same system can be used to solve scientific problems or process paperwork in commercial data applications. In fact, the same computer can do both jobs equally well. Warren C. Hume, president of IBM's Data Processing division, predicted: "The system/360 will allow a company to integrate all its computer functions in a single machine."

Faster and cheaper. IBM claims its new system will mean faster, less expensive and smaller computers. Comparing a small system/360 to an equivalent IBM 1401 computer, one company executive said, "It is four times faster than the 1401 even though its cost will be about the same." The machine is equivalent to a 1410 computer and will cost far less.

Another executive, Bob O. Evans, vice president, Development Data Systems division, compared a large



Passive elements are screened on ceramic wafers and baked.

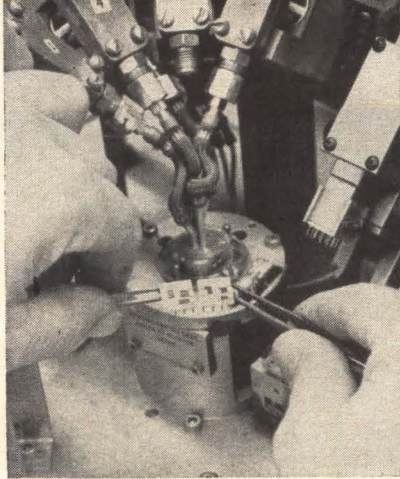

Thin copper pins for connections are inserted automatically.

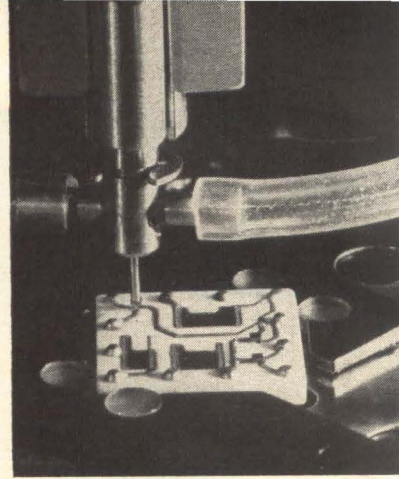

Semiconductor devices, the size of a grain of salt, are positioned

system/360 machine to the Stretch computer. Te said, "The new machine will be 50% faster than Stretch and will occupy only 30% as much floor area."

I. New computer organization

When IBM announced the system/360, it unveiled 350 separate items. They included six different models, from the smallest, model 30 through models 40, 50, 60 and 62 to the biggest, model 70; also 19 different memories and 44 input and output devices, 26 brand new.

Development of the central processors and peripheral equipment was carried out in IBM laboratories around the world. The control memory, for example, was designed at the company's Hursley, England, facility, along with the model 30 central processor. IBM's Italian facility designed paper tape equipment.

Compatible and modular. Although each model has its own

unique logic structure, every machine has the same general-purpose organization. The biggest innovation is the addition of many general registers and floating point registers (see figure below) to work with the arithmetic units. With such an organization, even the smallest sized computer can run input and output operations (up to 248 different devices) while it is performing arithmetic or data processing operations.

The three-part arithmetic unit allows the computer to perform arithmetic, data processing and communication control operations.

Memories in levels. A hierarchy of memories stores data. Fast transistorized memories perform local storage; core memories are available at two speeds; giant core memories, one-seventh the size of conventional core memory units, have capacities of up to 8 million characters, all directly addressable; and magnetic strip memory cells

can store up to 400 million characters.

The giant core memories allow the system to store programs for many jobs and to run the computer nonstop on different problems.

Because the machine has such capabilities, supervisory programs are required to run it. Even the smallest unit has a microprogram to direct data flow. It is a "read only" capacitive memory, made by etching a pattern of copper on an epoxy glass plate.

Tinier cores. IBM's fastest core memory, with a one-microsec cycle time, uses smaller cores—0.013 inch inner diameter and 0.021 inch outer diameter instead of 0.019 inch inner and 0.030 inch outer diameters.

Cycle time is further reduced by the use of microelectronic circuitry that runs the logic portion of the memory system. IBM was able to locate its core modules around the smaller circuitry, cutting the length of circuit paths and shortening cycle times even more.

Automation of core memory production will reduce the cost of these units sharply. IBM estimates per-bit costs in large memories will be only one tenth the cost of former memories.

II. Shrinking logic

IBM's microcircuit building block is an unsophisticated circuit compared to the integrated circuits of many military applications. But it is practical for commercial manufacture. The company calls it "solid logic technique."

The company chose this method because it thought production yields would be far higher than those of integrated monolithic cir-

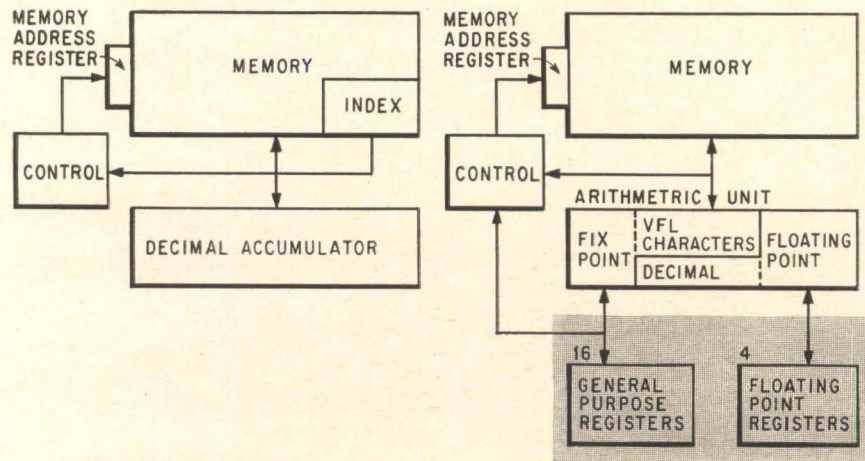

Architecture of new computer system shows the big innovation: the addition of a three-part arithmetic unit connected to general and floating point registers, compared to a former IBM computer.

circuits. So far the gamble has paid off. Yields have averaged between 50% and 60% though they have dropped as low as 20% on bad production days.

Something old. Circuit design was carried out just as if conventional discrete components were to be used. In fact, circuit diagrams of the new modules are quite similar to those drawn for IBM's earlier computers. The approach: tried and tested diode transistor logic.

When IBM decided to design a microelectronic system, designers suggested 400 to 500 digital circuits. Engineers modified them to 35 basic designs—including such circuits as and-or inverters, inverting drivers, exclusive-or blocks, and indicator drivers to light bulbs—which could build any equipment in the system/360.

The limited number of circuits helps make the system look attractive economically. IBM has shrunk the cost per wafer by reducing the

types of modules and increasing the volume of each type.

Even though full-scale production has not yet started, the economics look so good Andrew H. Eschenfelder, general manager, Components division, says, "We can build a basic digital module so it will cost no more than a transistor."

Nanosecond switching. Another attractive feature of IBM's new microcircuit design is its ultra high speed operation. Classified according to speed, there are three families of circuits: one group operates at speeds of 5 to 6 nanoseconds (billionths of a second), another at 15 to 30 nanoseconds and a third at 300 nanoseconds.

Eliminating the long wiring normally found in most computers is partially responsible for the faster operation. But not completely. The semiconductors and resistors of IBM's solid logic technique are held to closer tolerances so design-

ers get the exact electrical characteristic they want.

At very high speeds, IBM gets additional speed by holding transistors out of saturation with a feedback circuit. In addition, the production technique turns out semiconductor devices with junctions equivalent to junctions in the best grade of transistors.

Impact on components. Ever since microelectronic circuits were first built, component suppliers have wondered how far a systems builder might go with them. IBM has supplied an answer a lot of companies won't like. It has gone all the way back to the raw materials.

Although IBM will use its solid logic technique only for computer logic units in arithmetic units and control units at the start, its future plans seem clear. Peripheral equipment will be redesigned soon.

IBM is shrinking rapidly as a customer for discrete components.

How IBM makes microcircuits

To fabricate its computers, IBM developed a microelectronic technique it is calling Solid Logic. The end products are hybrid circuits: passive elements silk-screened on a ceramic wafer and active elements—transistors and diodes—made separately and soldered to the wafer.

IBM chose an established circuit design, diode transistor logic, because it appeared flexible, economical and suited to automatic production. The extensive use of diodes keeps costs down since diodes are cheaper than transistors.

Each silicon diode chip, the size of a grain of salt, contains two diodes with a common anode connection. The transistor, the same size silicon chip, is a single sided device. All electrodes are on the same side for automatic connection.

Active elements. IBM goes back to the basic material to start its active elements. It grows its own silicon crystals and slices them into wafers. In four etching and vacuum diffusion steps, the emitter, collector and base are laid down and junctions built. Photographic tech-

niques lay out 1,100 transistors on each wafer.

Then the half dollar of silicon is coated (or passivated) with a 60-millionths-of-an-inch layer of glass. Over connection points, three to a device, a hole is etched through the glass with acid and lined with chrome-copper alloy and lead.

Gold plated copper pellets are shaken over the wafer until they drop into the etched holes. Heating the wafer melts the lead linings in the holes, soldering the pellets to the silicon chip. The pellets become electrical and mechanical contacts.

The wafer is then cut into individual devices. Each device is tested automatically for 28 electrical characteristics, and transistors are graded into types. IBM is building two classes of transistor and two types of diode.

Passive elements. The ceramic substrate is about $\frac{5}{8}$ inch square, with 12 tiny holes positioned around its edge. Wiring patterns and resistors are silk screened on it, an old and established technique.

The resistor material is really a semiconductor: palladium oxide

and silver in a glass binder. Resistor shapes are maintained close to squares because long thin shapes would slow down the speed of operating circuits.

After the resistors are baked onto the ceramic, the square wafer is dipped in solder to make connections to the resistors. Copper pins are then fed into the 12 peripheral holes and swaged into place.

Specially designed equipment then automatically measures the resistance and trims it by sand blasting to within one percent of specified value, at a rate of one per second.

Finally, the semiconductor devices are placed automatically on the ceramic wafer, pellet side down. The wafer is then encapsulated in plastic.

IBM currently has 100,000 square feet of floor space at its Fishkill plant devoted to building its solid logic technique units. By the fall of 1965, when production of the system/360 computers reaches a peak, the company will have one million square feet of production space for the circuits.

reliability achievement **99.9999**
 reliability requirement **99.997**

.0029

**ON THE
 MATTER OF
 SURPLUS
 RELIABILITY**

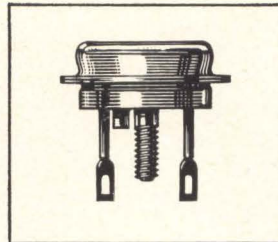

For its participation in the Minuteman program, Delco Radio contracted to produce a high power germanium transistor that was reliable to .003%/1,000 hours.

Twenty months and 54 million transistor test hours later, the failure rate objective was achieved. Ahead of time. The device was being supplied in production quantities.

Delco continued its investigation of the failure modes. High stress tests—pulse life, helium bomb, thermal shock, high-intensity vibration—were intensified. Tons of computerized data accelerated the test program.

Television monitors probed the growth of base material. A new process; surface passivation and ambient control,

was developed to stabilize crystal environment.

Currently this power transistor and its family have a failure rate of .0001%/1,000 hours. Also, the device tests favorably at temperatures of 135-150° C.

What we have learned from our experience on Minuteman has been applied to all our semiconductor devices. Car radio transistors, for instance. 3 million a year. And silicon rectifiers, 150,000 daily.

Come to the high volume people for high confidence level reliability.

DELCO RADIO 
 DIVISION OF GENERAL MOTORS, KOKOMO, INDIANA

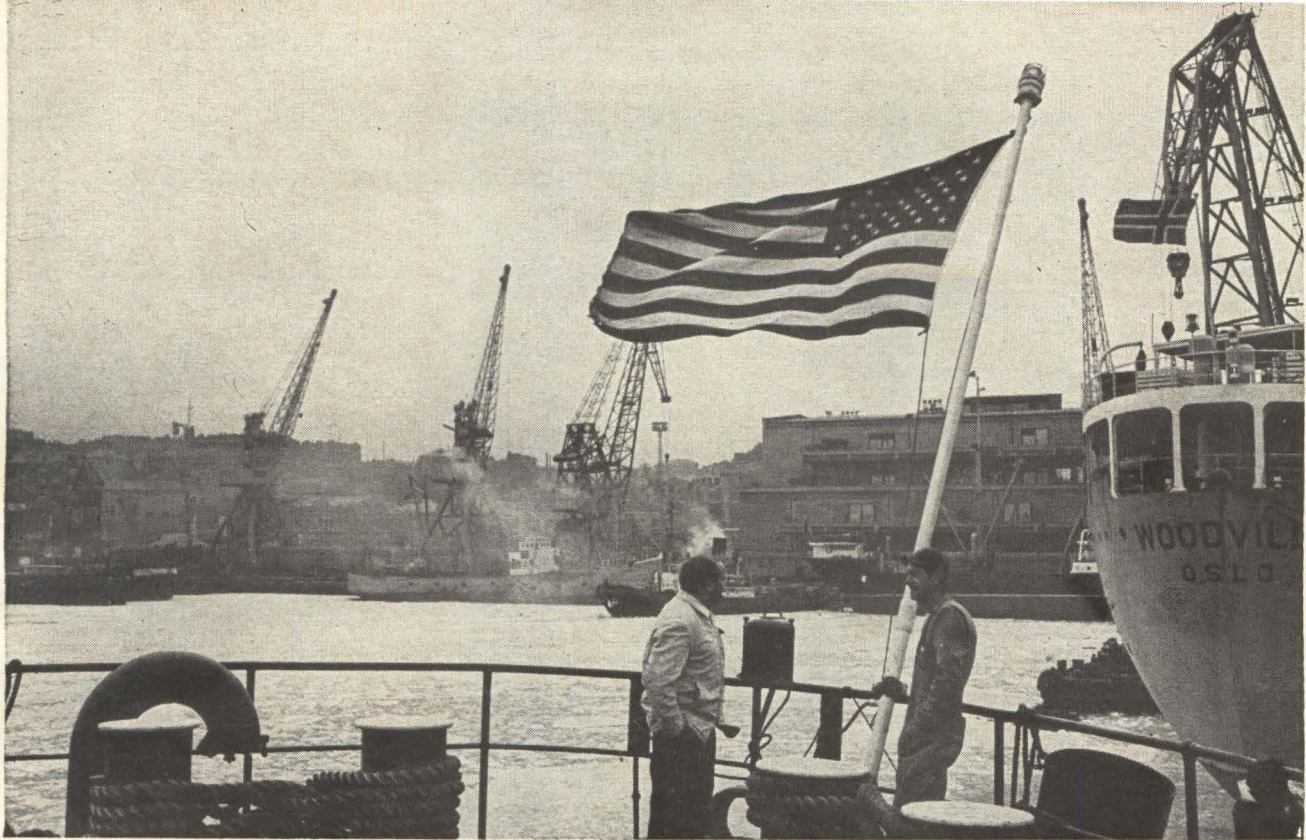

Russia's Black Sea port, Odessa, sees rare sight, the American flag. It flies from stern of the Washington Trader, one of the ships unloading U.S. wheat last month. Quarter-billion-dollar wheat deal with Russia set the stage for the current debate on U.S.-Soviet trade.

Industrial Electronics

Should we sell to the Russians?

Communist countries want to buy electronic equipment. They're already getting it from our allies. Should the U. S. relax its export ban?

On the wall of a Commerce Department office in Washington is a chart depicting the rise and fall of applications from American companies for licenses to export products to the Communist bloc.

"That," says a department official pointing to a steep rise in 1959, "is Camp David," where President Eisenhower and Premier Khrushchev reached agreements that eased international tensions.

Then skipping a few years of ups

and downs on the chart, he comes to an almost perpendicular plunge. "That is the Bay of Pigs," the unsuccessful invasion of Cuba in 1961.

United States trade with the Soviet Union, and the attitude of business to that trade, reflects the headlines. The headlines now speak of relaxing tensions. The urge to do business with the Communists is on the rise again. As a result, the U.S. is beginning its first major reevaluation of East-West trade policy since the cold war began.

Whether the U. S. should, like its allies, reduce restrictions on sales of electronic and other technical

products to the Communist bloc poses such a tangle of strategic, psychological, financial and political questions that the problem will probably not be resolved until after the fall elections.

The Johnson Administration has implied that it would accept some relaxation of restrictions. But before it makes any drastic changes it wants a mandate from Congress.

U. S. restrictions. U. S. law prohibits exports that substantially contribute to the Soviet-bloc economy. This definition stretches wider than our allies' bans on selling militarily useful equipment.

The U. S. permits some electronic sales to the Red bloc, but these total only about \$1 million a year. The U. S. bans all sales to Communist China and other Asian Communist countries, but other Western nations do business with Peking.

The embargo list. The U. S. and 14 other Western nations prohibit sales of military and space equipment to Communist countries. The embargo list, kept up to date by a coordinating committee, includes

An Electronic's staff report, compiled from dispatches by Electronics regional editors and McGraw-Hill World News Bureaus in the U.S., Moscow, London, Paris, Tokyo and Bonn.

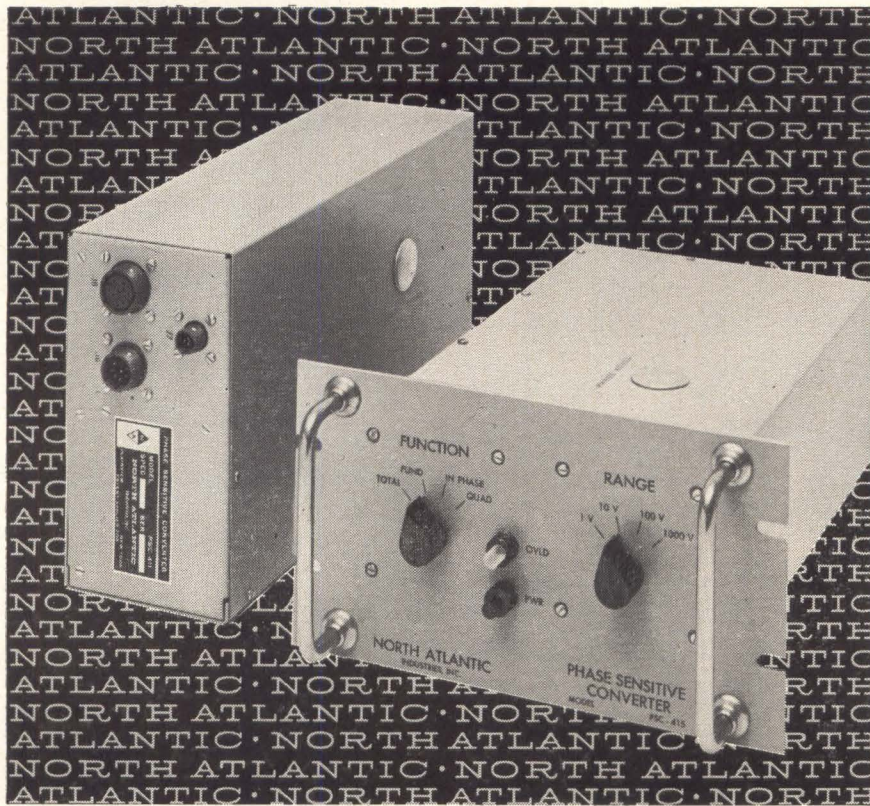

how to measure in-phase and quadrature with 0.1% accuracy—in milliseconds

Previously unobtainable accuracy and millisecond response are only two of the reasons why NAI's Phase Sensitive AC-to-DC Converters meet the most critical requirements in computer, recording, automatic test and digital display systems.

Unlike conventional converters, these all solid state modules measure **not only total signal—but quadrature, in-phase and fundamental components as well.** DC output is proportional to selected input component, yet unaffected by harmonics. A wide range of manual and relay-actuated models permits selection and programming of function, range and frequency to suit test or system requirements.

Specifications of relay-programmed models PSC-410 and -411, and manually switched models PSC-415 and -416 are given in the table.

Voltage Range	PSC-410, PSC-415 PSC-411, PSC-416	1 volt to 300 volts f.s., 4 ranges 10 millivolts to 300 volts f.s., 6 ranges
Functions		Total, Fundamental, In-Phase Quadrature
Frequency Range		
Total mode & response*		60 cps to 10kc 0.5 sec. 350 cps to 10kc 0.1 sec.
Phase Sensitive		Single frequency from 60 cps to 2kc.
Input Impedance		1 megohm
Output		-10 to +10 vdc into 10k load
Linearity		0.1% f.s. (10 mv dc)

*dependent upon output filter

The North Atlantic man in your area can quickly show you how the PSC models simplify automatic AC measurements. Call today for his name and request Bulletins.



NORTH ATLANTIC industries, inc.
TERMINAL DRIVE, PLAINVIEW, L. I., NEW YORK • Overbrook 1-8600

practically all electronic equipment relevant to the production or use of military and space systems.

In 1958, much industrial electronic equipment was removed from the list. In 1962, the latest revision, several items, including electron-beam welders, were added and some of the transistors were removed.

U.S. restrictions, however, are more stringent than those of some European countries. Besides the coordinating panel's list, the Commerce Department has a "positive list" of products that cannot be exported without licenses. It includes practically every type of electronic equipment, components and materials worth selling, even radio and tv. This is what most of the argument is about. License applications are carefully screened and frequently refused.

To sell or not to sell?

There is no clear-cut consensus in the electronics industry on the wisdom of trading with the East.

"We believe in peace through trade," says Michel Bergerac, director of overseas operations, ITT Cannon Electric, Inc., a subsidiary of the International Telephone & Telegraph Corp., but "with the East it's a very complicated matter.

"As long as we don't sell products of an advanced state-of-the-art nature, there is no reason not to sell," he continues. "There are no bad moral connotations as long as the goods sold aren't strategic.

"A real objection is in the placement of sampling orders where the company is buying just one or two of a product in order to copy it. In this case, we charge a higher price."

A contrary view comes from Ray Gilmer vice president of marketing for Varo, Inc., in Garland, Tex. "I say let's don't sell them anything. I definitely oppose any trade with Communist countries," he declares. Varo is not trading with the Red bloc and doesn't intend to.

"Morally wrong." Adds the president of another Southwest firm: "It is ethically and morally wrong to trade with Communist nations . . . Regardless of how some attempt to justify such trade, we think there is more than dollars involved here."

Other companies, with a stake in the European market, are

The Hughes/NASA Syncom stands still at 6875 mph to talk to a billion people.



CIRCUIT DESIGNERS... is your appointment in space with Hughes?

Today, Hughes is one of the nation's most active aerospace/electronics firms. Projects include: F-111B PHOENIX Guided Missile System, TOW Anti-Tank Missile, SURVEYOR Lunar Spacecraft, SYNCOM, VATE, ARPAT, POLARIS, Hard Point Defense and others. This vigor will assist the qualified engineers and scientists towards more and better opportunities for both professional and personal growth.

Many immediate openings exist. The engineers selected for these positions will be assigned to the following design tasks: the development of high power airborne radar transmitters, the design of which involves use

of the most advanced components; the design of low noise radar receivers using parametric amplifiers; solid state masers and other advanced microwave components; radar data processing circuit design, including range and speed trackers, crystal filter circuitry and a variety of display circuits; high efficiency power supplies for airborne and space electronic systems; telemetering and command circuits for space vehicles, timing, control and display circuits for the Hughes COLIDAR (Coherent Light Detection and Ranging).

If you are interested and believe that you can contribute, make your appointment today.

For immediate consideration, please airmail your resume to:

Mr. Robert A. Martin
Head of Employment
Hughes Aerospace Divisions
11940 W. Jefferson Blvd.
Culver City 43, California

Creating a new world with electronics

HUGHES

HUGHES AIRCRAFT COMPANY

AEROSPACE DIVISIONS

An equal opportunity employer.

U. S. CITIZENSHIP REQUIRED

... "Why not let us compete?" ...

ranked by the advantage their competitors gain through sales to the Soviet bloc.

B. A. Olerich, general manager of the international division of the Ampex Corp., thinks it "certainly does not represent anything constructive if U.S. firms are barred from selling behind the Iron Curtain when other Western countries are free to sell."

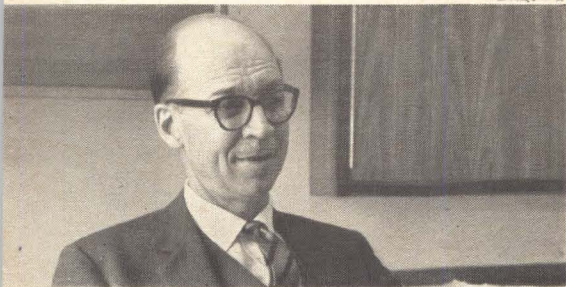

B.A. Olerich, Ampex Corp.: Restrictions on exports "certainly does not represent anything constructive. . . when other countries are free to sell."

"Why not let us compete," asks another Ampex official, "and have Russia pay for her equipment with dollars, contributing to our economy?"

Scope is criticized. U. S. trade restrictions "go far beyond the objective of keeping military equipment out of (Russian) hands," says James H. Binger, president of Honeywell Inc.

"The U. S. should broaden the list of items we can trade," he maintains. "We're not going to starve them out and we're not making it tough on them by keeping our products out. If they don't get these items from us, they will get them somewhere else."

"I know the French are selling (nuclear analyzers) to Russia," complains the sales manager of a Chicago company. "The French have even sold instruments they learned to make while working under license agreements from U. S. manufacturers. I am sure the British are selling nuclear instruments to Russia. Why shouldn't we have a piece of this business?" He says his com-

pany could sell 5% to 10% of its output to the Soviets. "If we had some super-secret technique of making these instruments, maybe there would be some excuse for dragging our feet," he argues.

Gertsch Products, Inc., in Los Angeles, doesn't trade with the Eastern bloc, but says it would if the United States Government okayed it.

"I know other countries do it, but we do not," says Elmer Gertsch, president. "I have an inquiry now on my desk from Yugoslavia about the newest state-of-the-art equipment, but we won't answer it."

London wants more

The British government is developing a favorable climate for expanded East-West trade except in strategic products. Moreover, it wants the strategic list revised to take into account communist scientific achievements. It is foolish, the British insist, to embargo equipment the Russians are now producing.

only **4** basic materials... **1** ...mylar*..

...a new capacitor construction concept to give high performance and low cost. Filmatic® by Paktron

Britain's economy depends on overseas sales. In addition the government believes that trade will ease tensions and raise the standards of living in the East.

"A fat man is less likely to become a Communist than a thin one," says Prime Minister Home.

Just a few million. United Kingdom exports of electrical machinery total about \$200 million a year. Of this, Russia in 1962 and 1963 took \$4.5 million and \$4.2 million, or only 2%. Telecommunications exports to the Soviets rose from \$153,000 in 1962 to \$750,000 last year. Exports of scientific electrical instruments to Russia are around \$2 million a year.

Major British exports to the East are civil radars, marine communications, direction finders, broadcast gear, plus some computers.

Most makers of electronic instruments here see more business coming in large plant contracts. Instrumentation and controls comprise as much as 10% of a chemical plant's cost. At least five such contracts are being negotiated with the Rus-

sians, Czechs and Communist Chinese, including a \$111 million synthetic fiber plant for the Soviet Union.

The Soviets have just contracted for a \$6-million plant to assemble cathode-ray tubes.

Trade with China. About \$600,000 worth of scientific instruments including photographic and optical goods, was sold to Communist China in 1963. But there are signs that trade is expanding.

The Chinese need analytical instruments. This month, more than \$1.5 million worth of British scientific equipment was shown in Peking. The items displayed had been on a Chinese shopping list. The Chinese are expected to buy most of them at the end of the show.

In November there will be another British industrial exhibition in Peking. It will include telecommunications and electronic equipment and scientific instruments.

French say "oui". France, too, has relatively few restrictions except for strategic electronic equipment. But trade is hardly booming.



Ray Gilmer, of Varo, Inc.: "I say let's don't sell them anything." He's just returned from a trip that included Saigon (above) and Berlin, and doesn't think coexistence is possible.

In 1962 France exported \$1,738,367 worth of electronics gear to Rumania, \$1,584,489 to Russia and only minor amounts to other Soviet satellites. For Rumania and Russia, the big categories were radio and television transmitters.

2
...foil...

3
...leads...

4
...impregnant

This unique combination provides a rugged self-case, high lead strength, excellent moisture resistance, improved life, high volumetric efficiency . . . all at a considerable savings in cost.

Available in three case sizes.

Range:	.001 mfd. through .5 mfd.
Voltage:	50-100-200-400-600 WVDC
Tolerance:	± 10% & ± 20%

*DuPont

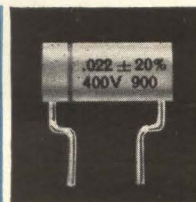

ACTUAL SIZE

Filmatic®
Capacitors
with
RIPPLEWELD™



PAKTRON

DIVISION ILLINOIS TOOL WORKS INC.
1321 LESLIE AVENUE • ALEXANDRIA, VIRGINIA

Acme  **Electric**

---KNOWS HOW TO

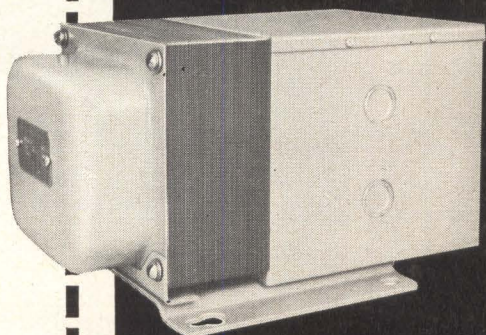

MAKE LINE VOLTAGE BEHAVE!

With an Acme Electric Voltage Stabilizer connected to the supply circuit, output voltage becomes precisely constant regardless of line voltage fluctuation or changes in the load.

Voltage regulation is practically instantaneous with response to either undervoltage or overvoltage variation occurring in approximately 25 milliseconds. Stabilization is held within 1% over a range of 15% line voltage variation.

Improved circuitry provides a high degree of wave-form fidelity. Protected automatically against overload or short circuit by its current limiting design. Sturdily constructed, no moving parts, practically no maintenance.

A STANDARD DESIGN FOR EVERY APPLICATION



Dependable, approved designs are available in ratings from 15 VA to 5 KVA. Secondary voltage outputs of 6.3; 120; 240; 480 volts.

SAA-3740-3055

Acme  **Electric**

Engineers and Builders of...

314 WATER STREET, CUBA, NEW YORK
In Canada: Acme Electric Corp. Ltd.
50 Northline Rd., Toronto, Ont.

REGULATED POWER SUPPLIES
STATIC POWER RECTIFIERS
VOLTAGE STABILIZERS
VOLTAGE REGULATORS

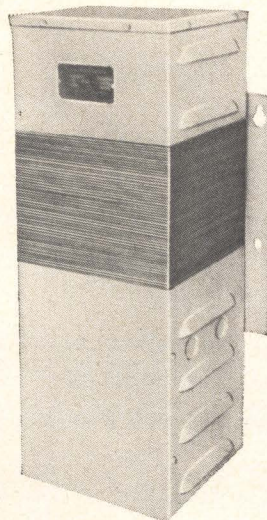

... Computers for the Red Chinese? ...

and receivers, various kinds of measuring instruments and cathode-ray tubes.

Nonetheless, Paris seems to want French industry to maintain a warm relationship with the Russians. This is why French companies participate in Russian trade shows.

Recently established diplomatic relations with Communist China have not yet resulted in any substantial trade in electronic equipment. In September, the French will exhibit measuring equipment in Peking.

Japan is doing business

Japan has trade agreements with Russia, and unofficially promotes private trade with Red China. Japan is a converter nation with few raw materials. China has the raw materials, but little manufacturing.

Red China wants large digital computers, which could be used to develop nuclear weapons, power resources, oil refining and other industry. One rumor is that the Mitsubishi Electric Co. may produce the Gamma 60 computer for sale to China. Mitsubishi has a tie-in with Compagnie des Machines Bull, which makes the computer in France.

A group promoting Chinese-Japanese trade listed as other needs radio communications and broadcast equipment as well as other wireless equipment, including radar, loran and navigation aids. Test equipment is also needed, but much of it is on the embargo list.

Trouble in Taiwan

Nationalist China—a big Japanese customer—is unhappy about the trade with Peking. There have been serious repercussions in Taiwan over last September's agreement to sell China a chemical fiber plant. About 4% of the plant's \$20 million cost is for control and measurement apparatus. Though the plant has not yet been shipped, there is talk of a second sale.

Under private agreements, Japanese shows were held last year in Peking and Shanghai. This year the Chinese will display their prod-

ucts in Tokyo and Osaka. China doesn't want to sell; it wants to show the technical level that Japanese equipment should surpass for sale to China.

During 1963, Japan exported more electronic equipment to Red China than to Russia: about \$1,004,000 compared with \$637,000. Best sellers were industrial controls and measuring equipment.

This year, Japan will sell Russia about \$9 million worth of electronic products directly, plus the controls for fertilizer and chemical plants that Russia is expected to buy. Before long, Japan expects to be able to export numerically controlled metalworking tools too. Japan is a convenient source of products needed in Siberia.

View from the Kremlin

The Western electronics equipment that Russia most wants is advanced instrumentation and control systems.

The Soviets are striving for a 225% increase in their chemical industry, and will need from the West somewhere between \$1 billion to \$10 billion in plant equipment. Instrumentation will be a considerable portion of that.

They will also buy refineries, complete with controls, and will probably want computers for new power stations and high-voltage transmission networks.

The Soviets could also turn to the West for automatic production lines. Installation of 400 such lines was planned for last year, but only about half were completed. Western observers believe the Soviets are weak in sensors and servo-mechanisms, though their computing capability is good.

Because components are largely swallowed up in military electronics—more than 90% of Russia's electronics industry is engaged in military and space programs—components trade will probably never extend beyond spare parts and modules for imported control systems. Nor will consumer electronics be a substantial market for many years. Russia won't spend its gold reserves for tv sets.

Figures on foreign electronics trade are difficult to get. Practically all of Russia's electronics purchases ride piggyback on larger items and don't always show up in

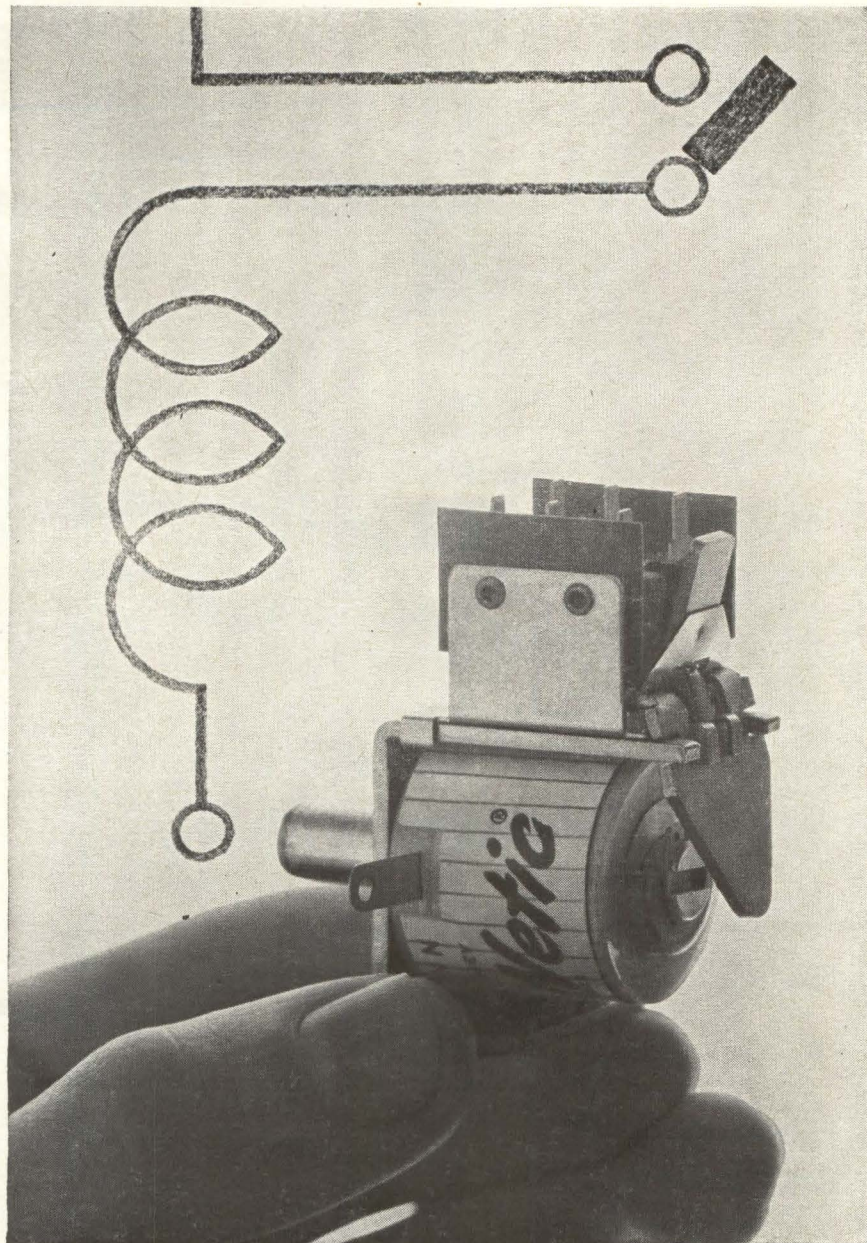

WHY USE TWO IF ONE WILL DO?

The Heinemann Type B Time-Delay Relay can double as its own load relay. It's got a continuous-duty coil. Once actuated, it can remain locked-in indefinitely. This, combined with DPDT snap-action switching at up to 5 amps, can obviate the need for a separate slave relay in many applications.

Yours might be one of them. Here's a quick rundown of the Type B's specs:

Standard Timings: 1/4, 1/2, 1, 2, 3, 4, 5, 8, 10, 15, 20, 30, 45, 60, 90, 120 seconds.

Contact Capacity: 5 amperes at 125V or 250V AC; 5 amperes at 30V DC, resistive; 3 amperes at 30V DC, inductive.

Coil Voltages: 60 cycles AC: 6, 12, 24, 48, 110, 115, 120, 208, 220, 230, 240 volts; DC: 4, 6, 12, 24, 28, 48, 64, 110, 120 volts. (Others available.)

For more detailed specifications on the Type B (and on all the other time-delay relays in the Heinemann line), write for Bulletin 5005.



HEINEMANN
ELECTRIC COMPANY
2600 Brunswick Pike, Trenton 2, N. J.

SA 2578

BURNPROOF LACING TAPE AT NO ADDITIONAL COST —FROM GUDEBROD

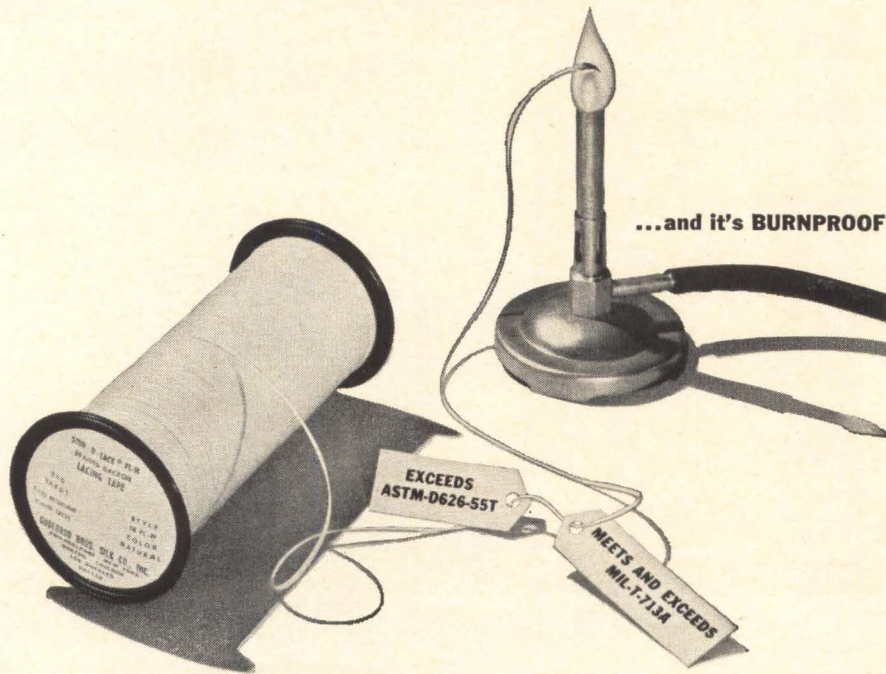

THE CABLE-LACER
increases worker efficiency by 25%

The first production tool available to ease, speed and improve the wire tying operation—producing tighter knots and more uniform harness.

Handle holds bobbin of cable lace, feeds as needed. Easily refilled. Eliminates handling long sections of tape, reduces splicing. Get your Production Department to investigate.

The specification of non-combustible materials in electronic equipment has, until now, required the use of special, higher priced lacings for harness tying. Through extensive work in their R&D Department, Gudebrod is producing two new burnproof lacing tapes—both available at no additional cost!

The first of their kind, these new tapes are made of Dacron* fibers and are flat braided for excellent handling and knotting qualities. In addition to meeting or exceeding all requirements for MIL-T-713A, the burnproofing exceeds ASTM-D626-55T.

Two types are being produced—Stur-D-Lace FLH, impregnated with a flame-proof fungistatic synthetic rubber finish, and Stur-D-Lace-R impregnated with a flameproof fungistatic vinyl finish. Both are essentially stable at —100° to 350°F. Neither will burn, but they will melt when a hot flame is applied. Each type is available in seven different strengths. Gudebrod Technical Product Bulletin #6 gives details.

The introduction of burnproof lacing tapes at standard prices represents another advancement in cable lacing practice by Gudebrod. The Gudebrod line of lacing tapes covers the entire range of wire harness tying requirements for both military and commercial equipment. Send for the Data Book on Gudebrod Tapes.

*"Dacron" is Du Pont trade name for its polyester fiber.

... East strives to catch up ...

the trade figures. For instance, when England sold the Soviets a textile mill recently, the controls weren't listed under electronics.

But there is no doubt that trade is up sharply. For instance, between 1961 and 1962 (the last year for which figures are available in Moscow), instrument imports rose from about \$45 million to nearly \$60 million. Most of the instruments were bought from Soviet-bloc countries. England and West Germany together sold some \$4 million worth to Russia during the Cuban crisis year of 1962, while U. S. sales were less than \$250,000 in 1961 and about \$90,000 in 1962.

Within the Soviet bloc

The annual Leipzig Fair in East Germany, with exhibits from all over Eastern Europe, is a good indicator of technical developments and policies within the Soviet bloc.

At the 1964 show last month, it was clear that efforts to catch up are being made.

While Russia still supplies most military requirements, other Communist countries are planning to push development of such equipment as solid-state devices, microelectronics gear and lasers.

Most bloc members, like Russia, are stressing chemical-industry and automation buildups, forcing a re-vamping of economic planning. After years of downgrading the electronics industry in favor of heavy machinery and other durables planners find they can't build modern industry without electronics.

Hardest push in Germany. Of all the bloc nations, East Germany is giving electronics the most attention. Communist Party boss Walter Ulbricht has ordered that all industries rely on electronic data processing by 1970 to save manpower. He is giving top priority to solid-state devices and microelectronics—still in the laboratories in East Germany—and he wants automated production for use in computers and communications.

Plans are to introduce micro-modules into computers by 1965 and to transistorize telephone and radio systems by 1966. In 1965, the

GUDEBROD BROS. SILK CO., INC.
FOUNDED IN 1870



Electronics Division
12 SOUTH 12TH STREET, PHILADELPHIA 7, PENNSYLVANIA

state-owned VEB Electromat, in Dresden, is to have an automatic line able to produce a million transistors a year. A similar line is being prepared for Czechoslovakia. In 18 months, the state plant in Hermsdorf is supposed to produce 500 micromodules an hour. A plant in Frankfurt with 2,500 employees, is exporting power transistors to other bloc nations.

Look-alikes. That East Germany is copying American equipment was obvious from a couple of electronic equipments on display at the fair, one a comparator and another a recorder. Prices were competitive too.

East Germany is well along in lasers and has displayed several models. It expects to export about 100 next year. Neodymium-doped glass, ruby crystal and gas-type lasers for research, welding and other industrial applications are made. About 100 East German engineers are now developing lasers.

East German exports of electronics spurted 180% between 1962 and 1963. But exports are tied to political strategy. Communications equipment, for example, is exported to Africa and Asia and is also bought from Western Europe.

Poorer Cousins. Poland and Hungary are advancing rapidly in fields such as lasers and building-block electronic elements. The Czechs appear to be making strides in computers. Bulgaria and Rumania are still the poor cousins in electronics technology.

Want more details?

Exports to Communist countries are regulated under two primary laws: the Battle Act (Mutual Defense Assistance Control Act of 1951), for the strategic embargo list, and the Export Control Act of 1949, for the "positive list."

The Government Printing Office, Washington, D.C. 20402, sells reports on these acts, with the texts, actions taken to enforce the acts, lists of embargoed or to-be-licensed products, and statistics on East-West trade. Recommended are:

Export Control, 66th Quarterly Report, by the Secretary of Commerce, 1964. Price: 20 cents.

The 1958 Revision of East-West Trade Controls, the State Department report on the Battle Act. Price: 25 cents.

The Battle Act Report 1963, a Department of State Publication 7406. Price: 30 cents.

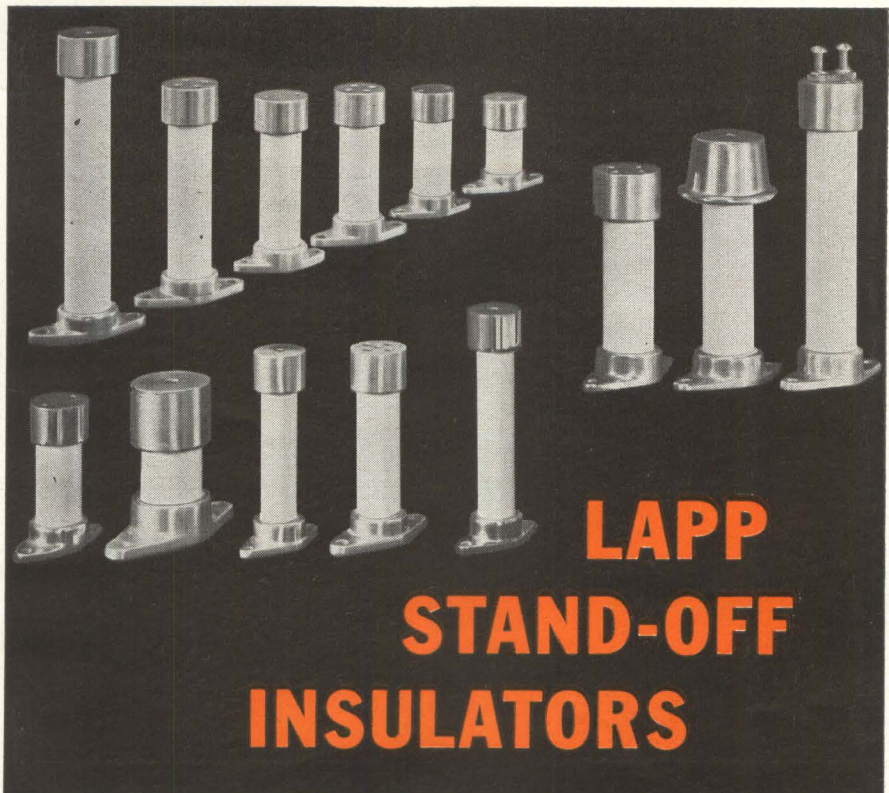

LAPP STAND-OFF INSULATORS

*...in all these standard sizes
to save you time
and money*

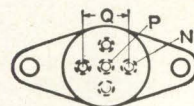
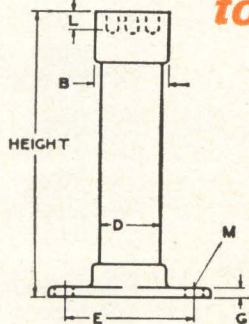

Other tapped hole sizes or arrangements available on special order.

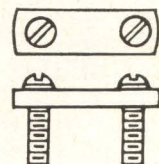

ORDER
KEEPER
SEPARATELY

STAND-OFF INSULATOR DIMENSIONS IN INCHES

(STOCK HEIGHTS LISTED BELOW)

Cat-log No.	Material	Cantilever Strength inch-pound	Height in inches	B	D	E	G	L	M	N	P	Q
14761 24229	Porcelain Steatite	375 } 450 }	4-6-8	1 3/8	1	2 1/4	3/16	3/32	3/32	1/4-20	1/4-20	3/16
14760 24114	Porcelain Steatite	600 } 700 }	4-6-8-10	1 5/8	1 1/4	2 5/8	7/32	3/8	3/32	1/4-20	1/4-20	1 3/16
22408 41775	Porcelain Steatite	1200 } 1400 }	6-8-10-12	1 7/8	1 1/2	2 7/8	1/4	7/16	3/32	1/4-20	1/4-20	1 3/8
13981 24110	Porcelain Steatite	1800 } 2100 }	6-8-10-12	2 1/4	1 3/4	3 3/4	1/4	5/16	1 3/32	5/16-18	3/8-16	1 1/4
42588	Porcelain	4000	6-8-10-12	3 1/8	2 1/2	5	3/8	1/2	1 3/32	5/16-18	3/8-16	2

Lapp

Insulators shown are standard. Similar insulators available with caps or bases on both ends.

WRITE for Bulletin 301-R.
Lapp Insulator Co., Inc.,
217 Sumner Street, LeRoy, N. Y.

Here's the First Planar Stud-Mounted Silicon Controlled Rectifier



... and 5 things you should know about it:

1. Low leakage, as low as $10\mu\text{a}$ @ 25°C

2. Reliability and lot uniformity for greater design margin

3. New process provides self-bias, assures greater stability at high temperature

4. Priced competitive with non-planar versions

5. Immediate availability including the following new types:

LOW LEAKAGE TCR 50 SERIES

Features: Maximum DC forward and reverse current @ rated voltage (Is, Ir) of $10\mu\text{a}$ @ 25°C and $250\mu\text{a}$ @ 125°C . Maximum forward voltage @ 25°C (VF) of 1.3 volts @ 3A.

Type	Minimum forward and reverse breakover voltage
TCR 50	50
TCR 51	100
TCR 53	200
TCR 56	400

COMMERCIAL TCR 70 SERIES

Features: Maximum DC forward and reverse leakage current @ rated voltage (Is, Ir) of $50\mu\text{a}$ @ 25°C and 1.0ma @ 125°C . Maximum forward voltage @ 25°C (VF) of 1.75A @ 3A.

Type	Minimum forward and reverse breakover voltage
TCR 70	50
TCR 71	100
TCR 73	200
TCR 76	400

TURN-OFF TRANSWITCH TCR

80 SERIES Features: Maximum forward and reverse leakage current @ rated voltage of $10\mu\text{a}$ @ 25°C and $250\mu\text{a}$ @ 125°C . Minimum turn-off beta of 10 @ 2.0 amps Ic.

Type	Minimum forward and reverse breakover voltage
TCR 80	50
TCR 81	100
TCR 83	200
TCR 86	400

STANDARD SERIES

All of Transistron's standard $\frac{1}{16}$ " stud mounted SCR devices are manufactured by planar process. Typical series are:

- 2N1600-1604
- 2N1770-1777
- 2N1770A-1777A
- TCR 3
- TCR 13
- TCR 23
- TCR 505
- TCR 43

All available in volume immediately

Available through your authorized Transistron Distributor

**Planar
SCRs
in other
packages,
too!**

Immediately available in volume.

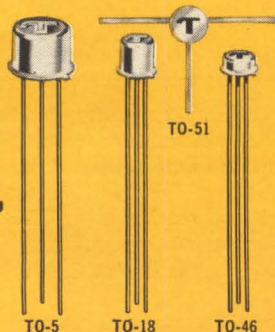

**FREE:
SCR
bulletin
file**



Gives you complete specifications and details on the broadest line of planar silicon controlled rectifiers available today. A must for your files. Write today: SCR FILE Transistron, Wakefield, Mass.

Transistron

electronic corporation
wakefield, melrose, boston, mass.

SALES SERVICES IN PRINCIPAL CITIES THROUGHOUT THE U.S.A. AND EUROPE • CABLE ADDRESS: TRELCO

Analog multiplier develops 2.8-v output

New design idea uses thin-film magneto-resistors.

Multipliers have applications in power measurement, control systems and computers

Conventional bridge-type analog multipliers use servo-controlled potentiometers to unbalance the bridge. A new solid-state device uses thin-film flux-sensitive resistors, called magneto-resistors, as variable bridge arms, shown in the accompanying schematic diagram. The bridge is then unbalanced by applying a magnetic field to the magneto-resistors.

Two 1,000-ohm thin-film magneto-resistors are mounted in 0.006-inch-wide air gaps in the multiplier's magnetic core. An input, applied to the coil wound on the multiplier's core, produces push-pull resistance swings and unbalances the bridge.

Besides measuring power, the multipliers are used in control systems and analog computers, where they provide such functions as division and square-rooting, as well as multiplying and squaring. Other uses for the multiplying action are in wide-range wattmeters, modulators, mixers, choppers, discrimi-



nators, detectors and spectrum analyzers for audio frequencies.

The magneto-resistance multiplier has several advantages over Hall-effect multipliers. They include higher output voltage, lower drive current, wider temperature range, smaller size and automatic cancellation of induced "noise" voltages. Narrow air gaps permitted by the use of thin-film magneto-resistors also minimize magnetizing current.

Maximum dissipation in the magneto-resistance elements is 0.3 watt, permitting 24-volt maximum input. Drive current for full output is then only 12 milliamperes. Outputs exceeding 2.8 volts can be achieved in short-duty-cycle applications where higher input voltages may be applied to the bridge terminals. The resistance and inductance of each half of the multiplier's split coil are 90 ohms and one henry, respectively. Coil input frequencies cover d-c to 1,000 cycles per second; the magneto-resistance bridge, being a resistive load, may be operated from d-c to one megacycle.

The series 3000 MistoR multiplier weighs six ounces and fits into a can $1\frac{1}{8}$ inches high by $1\frac{1}{8}$ inches square. Without the can it can be fitted into the case of a conventional moving-coil meter, converting the meter into a wattmeter, root-mean-square voltmeter or rms current meter for use in the audio range.

The price for single quantities is \$98.50; delivery is in six to eight weeks.

American Aerospace Controls, Inc., 123 Milbar Blvd., Farmingdale, L. I. Circle 301 reader service card

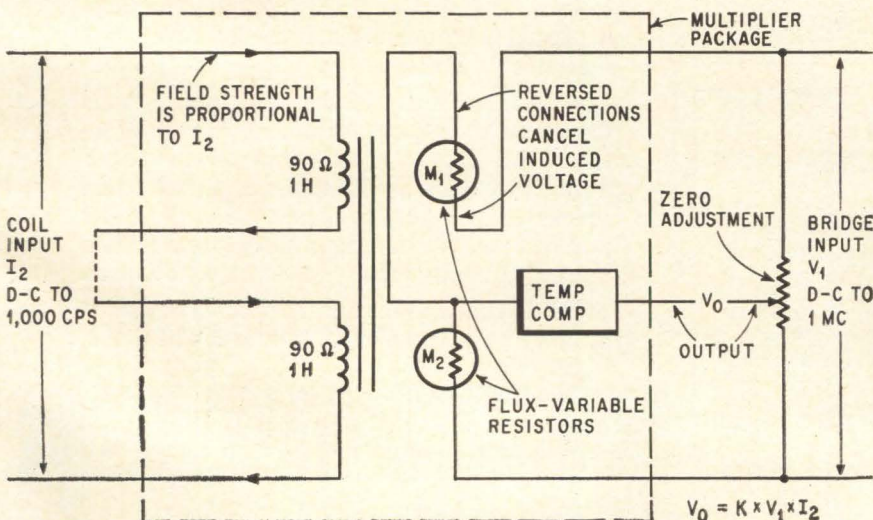

Magnetic circuit is arranged so that coil input I_2 produces differential (push-pull) changes in M_1 and M_2 resistance

Zener diodes in micro size

Micro-size zener diodes exhibit reliable temperature compensation characteristics up to ± 0.001 percent of the zener voltage, in an effective range of 6.2 v to 18 v. Dynamic impedances are kept low (25 to 100 ohms), with critically close tolerances of $\pm 1\%$. The devices meet or exceed all requirements of MIL-S-19500C and specifications of more sophisticated reliability program. Physical sizes start at 0.150 in. by 0.050 in. with lead configurations to suit special requirements. Prices start at \$12 per unit in 100-lot quantities.

MicroSemiconductor Corp., 11250 Playa Court, Culver City, Calif. [302]



Scientific-Atlanta, Inc.

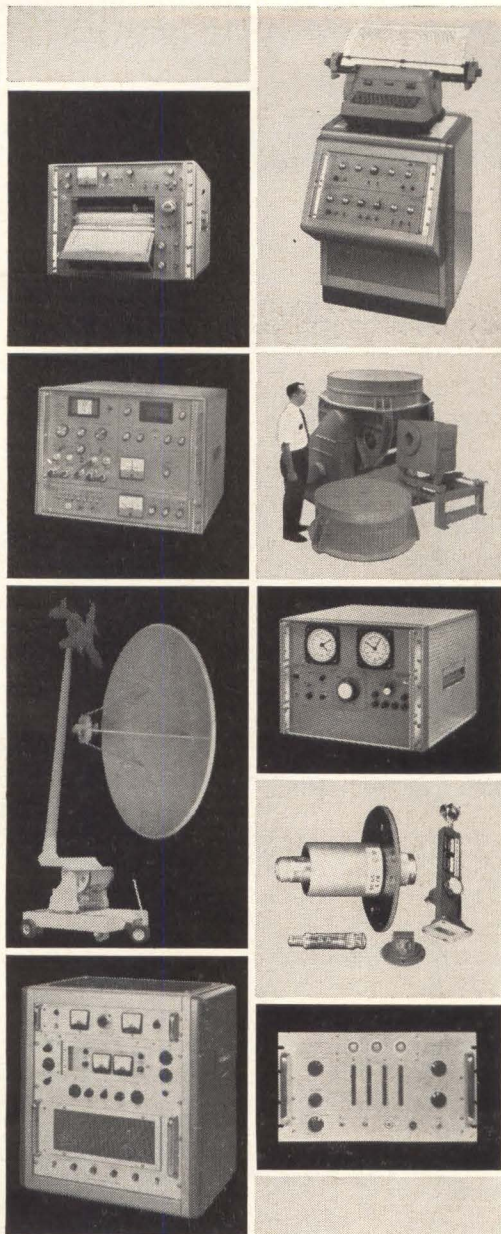

From Soup to Nuts!

Scientific-Atlanta's Antenna Range Systems

ANTENNA PATTERN RECORDERS Rectangular and Polar
 ■ RADIATION DISTRIBUTION PRINTER Three-Dimensional Numerical Patterns in Angular Grid Form ■ WIDE RANGE RECEIVER The World's Most Advanced ■ ANTENNA POSITIONERS Antennas to 30 Feet Diameter ■ MODEL TOWERS Ten Models Available ■ POSITIONER CONTROLS AND INDICATORS Complete Line for all Applications
 ■ SIGNAL SOURCES Remotely Tunable ■ COAXIAL COMPONENTS For Any Requirement ■ PATTERN RANGE ANTENNAS Also, Horns, Feeds, and Reflectors ■ ANTENNA PATTERN INTEGRATOR Automatic, Two-and Three-Dimensional ■ Anything you need, off-the-shelf or special design, reasonable prices, highest specifications, proved in world-wide service. Write today to:
 ■ Scientific-Atlanta, Inc., P. O. Box 13654, Atlanta, Georgia 30324 Phone: 404-938-2930 TWX: 404-938-1322

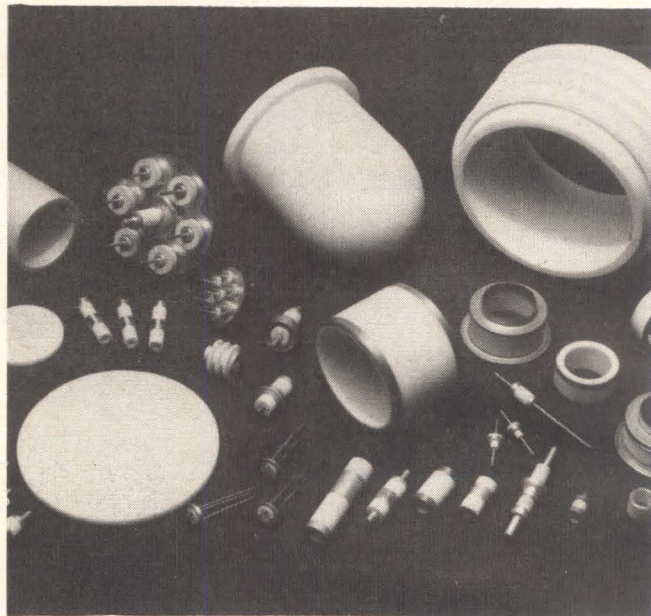

C.G.E.C. Pure sintered oxides Vacuum-tight ceramic-metal assemblies

In the field of pure sintered oxides produced by C.G.E.C. two ceramics are specially adapted to electronic applications :

Alucer 97 and Berycer

ALUCER 97

97 % pure alumina sintered at high temperature, specially well adapted to refractory metallizing for ceramic-metal seals.

BERYCER

pure beryllia (BeO content higher than 99,9 %) sintered at high temperature. Berycer provides a very good thermal conductivity and a great electrical resistivity.

Both oxides are vacuum-tight, non porous (therefore immediately degassed), very refractory. They have a high mechanical strength, a good resistance to thermal shocks, low losses under high frequency, good dielectric properties. They can be machined to accurate dimensions and offer an excellent surface finish.

C.G.E.C. can produce components in Alucer 97 or Berycer, according to your specifications.

COMPAGNIE GENERALE D'ELECTRO CERAMIQUE

**P.O. Box 113 TARBES (H.P.) FRANCE
TEL: 93-32-91 TARBES**

New Components and Hardware

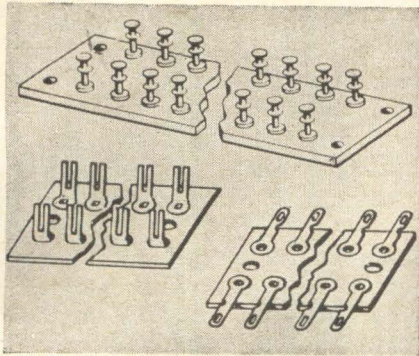

Terminal boards eliminate tooling

Standardized terminal boards cut production costs by eliminating the tooling and set-up charges usually applied to nonstandardized boards. Boards are available in a variety of the most popular terminals spaced $\frac{1}{4}$ inch, $\frac{7}{32}$ inch and $\frac{3}{8}$ inch apart. Insulation and materials conform to MIL specs. Terminals are securely riveted and hot tinned finished, providing easy solderability and a shelf life described by the manufacturer as indefinite. Keystone Electronics Corp., 49 Bleeker St., New York, N.Y. [311]

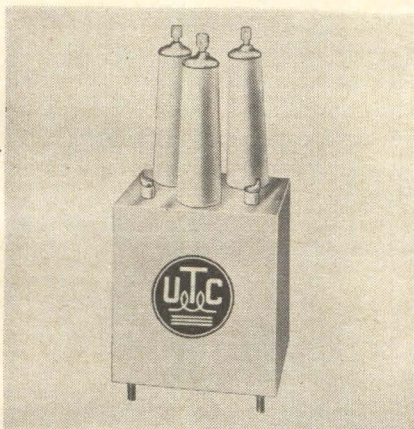

Driver transformer is compact and light

A transistor driver transformer, engineered for compactness and high voltage capabilities, is suitable for driving high impedance loads such as oscillator tubes 15,000 v d-c above ground. It is manufactured and guaranteed to MIL-T-27B,

grade 4, class R, life X. Input is 24 v and output 480 v, peak-to-peak triangular wave. Maximum size is $2\frac{3}{4}$ by $2\frac{3}{4}$ by $2\frac{1}{8}$ in. high. Ceramic seal terminals $\frac{2}{8}$ in. high are placed opposite mountings. United Transformer Corp., 150 Varick St., New York 13, N.Y. [312]

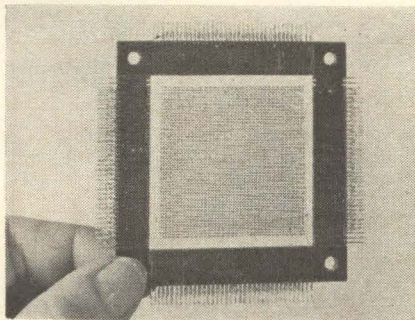

Ferrite cores enhance high-speed memories

New ferrite core planes and stacks make possible 1- μ sec cycle times for coincident current memory systems. The units feature 20-mil diameter cores with 180-nsec switching times and are available in various bit and winding configurations. Tentative electrical specifications for the planes and stacks include a read and write drive current requirement of 750 ma, which produces an output of 35 mv average. The zero output voltage is 7 mv average. These parameters are measured with a driving pulse rise time of 50 nsec and a 450-nsec pulse width. Core dimensions are 20 mil o-d and 13 mil i-d. Ferroxcube Corp. of America, Saugerties, N.Y. [313]

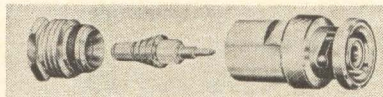

Wedge-lock connector pressurized to 50 psi

An all-purpose captive-contact wedge-lock cable clamping type connector has been developed. Fully weather-proofed and pressurized to 50 psi for cables with

you won't believe this

Our RF Millivoltmeter has the widest range and greatest sensitivity of any instrument of its kind. We told you you wouldn't believe this! If you'll look at illustration [a] you will see our instrument, the PEL 626, or [b] the rack mounted version.

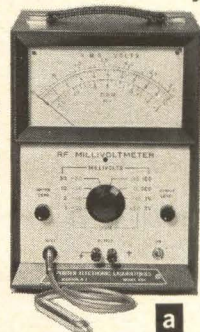

But, these pictures don't prove a thing. Read on!



If you'll look into illustration [c] you'll find our PEL 626 brochure which gives you all the facts and figures on our remarkable instrument. And if that isn't enough, send for [d] our Test Reports. These you can believe. Send for your copy today.

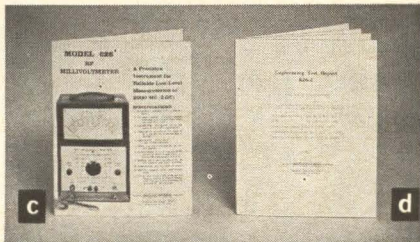

PORTER
ELECTRONIC LABORATORIES
BOONTON, NEW JERSEY
Instruments that advance the art

NEW! HIGH SENSITIVITY

GENERAL PURPOSE 247A

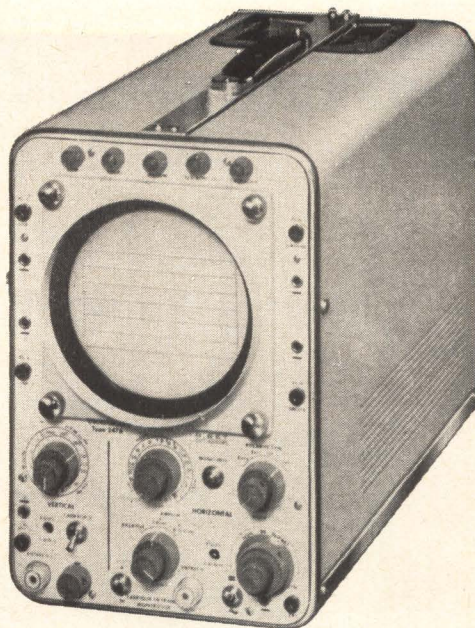

The type 247-A oscilloscope fully qualifies as a universal instrument because its performances and the size (13 cm (5") dia.) of its C.R. Tube authorize accurate measurements and tests in all fields of low-frequency instrumentation. Also, because of its simplicity of operation, the 247-A is ideally suited for practical laboratory work of an educational nature.

TECHNICAL SPECIFICATIONS

Vertical amplifier

1 channel; Frequency range: DC to 1 Mc/s (-3 dB)
Sensitivity: 50 mV/cm

AC: 10 c/s sinewave or 50 c/s square-wave to 100 Kc/s (-3 dB)
Sensitivity: 5 mV/cm

Calibrated attenuator: step-adjustable from 5 mV to 20 V/cm
in 12 positions
Sequence: 1 - 2 - 5 - 10 etc...

Attenuator vernier ratio 1/3
Constant input impedance: 1 M Ω 47 pF

Sweep

Free-running - triggered - single sweep
Duration: 1 s/cm to 0.5 μ s/cm in 20 calibrated positions
Vernier: 1:3 ratio -
x 5 magnification expanding
sweep durations from 3 s/cm to 0.1 μ s/cm

Sync

5 positions: single-sweep, HF, LF, TV-line, TV-frame
Polarity: + or - internal or external
selection of triggering level

Horizontal Amplifier

Frequency range: 0 to 500 Kc/s (-3 dB)

Sensitivity: 1 V/cm or 10 V/cm (switch-selected)
Vernier: 0 to 1
Constant input impedance: 1 M Ω and 47 pF

Cathode-ray Tube

5 ADP 2 or equivalent type
Screen: 13 cm (5") dia.
deflection factors:
X: 30 V/cm (approx.)
Y: 20 V/cm (approx.)

Direct drive of H and V plates
Acceleration voltage: 3 Kv

MECHANICAL FEATURES

Light-alloy chassis, readily-detachable panel for easy access to circuits.

1) Tube complement

9/ECF80 - 2 NM2L or equivalent types

2) Power supply

105 - 115 - 127 - 220 - 240 V - 50 or 60 c/s

3) Dimensions

Width: 20,5 cm - (8")
Depth: 38,5 cm - (15")
Height: 31 cm - (12")
Weight: 14 kg - (30 lbs)

OTHER INSTRUMENTS

Oscilloscopes

204 A - High speed and fast rise oscilloscope
241 A - 242 A - 243 A, Multi-function osc. with
plug-in preamplifiers.
255 B - Portable oscilloscope
245 A - High performance portable oscilloscope
246 A - High sensitivity low-frequency oscilloscope
248 A - Maintenance oscilloscope.

Sweep frequency Generators

411 A - Laboratory sweep frequency generator
410 B - TV - FM sweep frequency generator
476 A - Radio sweep frequency generator

Signal Generators

405 A - Low frequency RC signal gen. (30 c/s-300 Kc/s)

428 A - HF constant amplitude signal generator
(100 Kc/s-30 Mc/s)
458 - Pulse generator (5 c/s - 50 Kc/s).

TV pattern generators

465 C - Portable electronic pattern generator
464 A - Test - pattern generator

Regulated power supplies

117 A - Transistorised regulated power supply
114 A - Regulated power supply

Cameras

1000 A - oscilloscope camera with Polaroid
1001 B - oscilloscope recorder

New Components

unperforated jackets, the ease with which its three components (nut assembly, contact-wedge assembly, body assembly) may be put together cuts assembly time by more than 50 percent. No special tools are required. Shorting inside the connector is eliminated as no combining or trimming of braid is required. There is no indentation of cable dielectric, resulting in low vswr.

Automatic Metal Products Corp., 323 Berry St., Brooklyn 11, N.Y. [314]

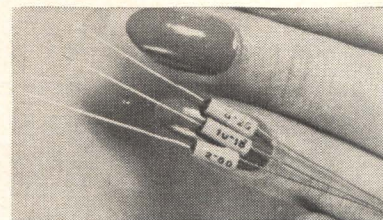

Electrolytic capacitor features low leakage

Ultraminiature electrolytic capacitor type TTC features excellent electrical characteristics, low leakage, low equivalent series resistance, and high reliability—all packaged in a microminiature case. It has an operating temperature range of -30° C to +65° C. Capacitance tolerance is -10 percent to +100 percent of rated capacitance. The low-cost capacitors are also subjected to extensive life and shelf tests.

Aerovox Corp., 740 Belleville Ave., New Bedford, Mass. [315]

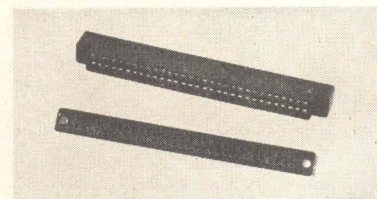

P-C connectors have bellows contacts

Three printed-circuit connectors—22, 31 and 41 contact configurations having beryllium copper bellows contacts with two taper pin receptacles per contact—have been an-

INTER-PLANS

RIBET-DESJARDINS

MEASURE & CONTROL DEPARTMENT, 13-17, rue Périer MONTROUGE / PARIS TEL : ALESIA 24-40
CANADIAN BRANCH : RIBET-DESJARDINS (CANADA) Room 114, 5757 Decelles Avenue - MONTREAL.

nounced. The bellows contact principle results in low card insertion and extraction forces.

Viking Industries, Inc., 21343 Roscoe Blvd., Canoga Park, Calif. 91304. [316]

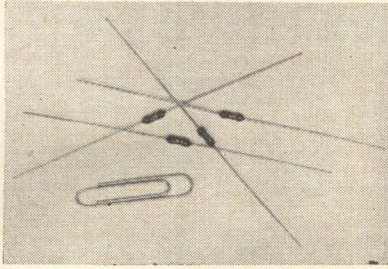

Metal film resistors rated 1/4 watt at 100 C

Miniature metal film resistor, the RE-1/4, rated 1/4 w at 100 C with weldable or solderable leads is constructed with expansion fitted cap and lead assemblies. Conformal coating withstands severe mechanical and environmental stress. Resistances from 10 ohms to 200,000 ohms in tolerances from ±0.1 percent to ±5 percent (±1 percent standard), and temperature coefficients of ±100 ppm/deg C (C-1), ±50 ppm/deg C (C-2), or ±25 ppm/deg C (C-3) are available. American Components, Inc., 8th Ave. and Harry St., Conshohocken, Pa. [317]

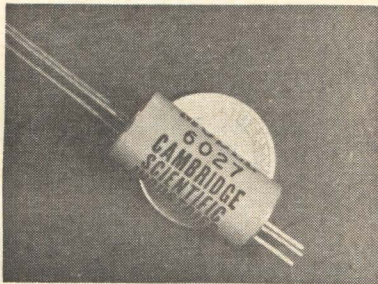

Midget chopper weighs 12 grams

Tiny but tough electromechanical chopper is ideal for printed circuits. Specifications are: size, 0.4 in. in diameter, 0.8 in. long; weight, 12 grams; noise, less than 1μv into 100,000-ohm load; vibration, 10 g to 2,000 cps. It has all welded construction. No solder flux eliminates contact contamination, assuring at least 5,000 hours of operation. Cambridge Scientific Industries, Inc., 527 Poplar St., Cambridge, Md. [318]

Vacuum-melted alloys for glass hermetic seals



RODAR[®]
NIRON[®] 52
NIROMET[®] 46

Specified Industry-wide for

PERMANENTLY-BONDED VACUUM-TIGHT SEALS!

Thermal Expansion

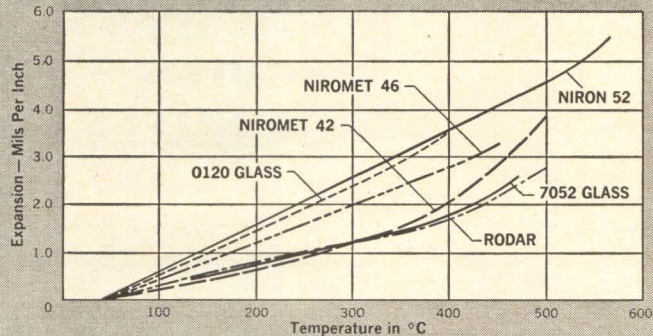

RODAR[®]

NOMINAL ANALYSIS: 29% Nickel, 17% Cobalt, 0.3% Manganese, Balance—Iron

Rodar matches the expansivity of thermal shock resistant glasses, such as Corning 7052 and 7040. Rodar produces a permanent vacuum-tight seal with simple oxidation procedure, and resists attack by mercury. Available in bar, rod, wire, and strip to customers' specifications.

Temperature Range	Average Thermal Expansion °cm/cm/°Cx10 ⁻⁷	COEFFICIENT OF LINEAR EXPANSION *As determined from cooling curves, after annealing in hydrogen for one hour at 900° C. and for 15 minutes at 1100° C.
30° To 200°C.	43.3 To 53.0	
30 300	44.1 51.7	
30 400	45.4 50.8	
30 450	50.3 53.7	
30 500	57.1 62.1	

NIRON[®] 52

NOMINAL ANALYSIS: 51% Nickel, Balance—Iron
For glass-to-metal seals with Corning #0120 glass.

NIROMET[®] 46

NOMINAL ANALYSIS: 46% Nickel, Balance—Iron
For vitreous enameled resistor terminal leads.

NIROMET[®] 42

NOMINAL ANALYSIS: 42% Nickel, Balance—Iron
For glass-to-metal seals with GE #1075 glass.

CERAMVAR

NOMINAL ANALYSIS: 27% Nickel, 25% Cobalt, Balance—Iron
For high alumina ceramic-to-metal seals.

Call or write for Sealing Alloy Bulletin

WILBUR B. DRIVER CO.
NEWARK 4, NEW JERSEY, U.S.A.

IN CANADA: Canadian Wilbur B. Driver Company, Ltd.
50 Ronson Drive, Rexdale (Toronto)

Precision Electrical, Electronic, Mechanical and Chemical Alloys for All Requirements

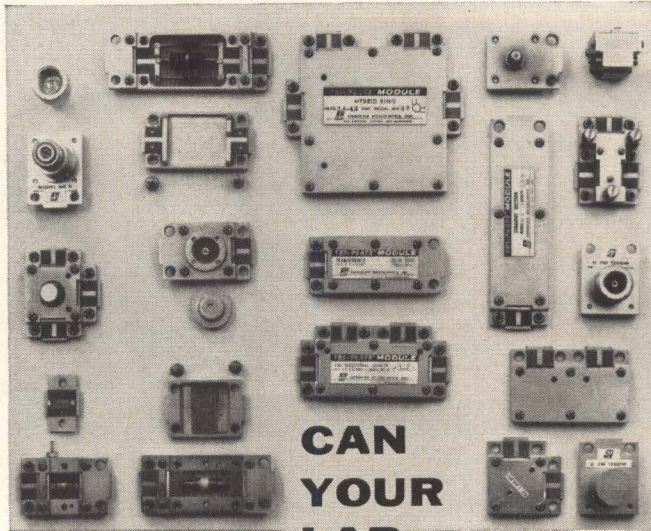

**CAN
YOUR
LAB
BREADBOARD
MICROWAVE
CIRCUITS
IN MINUTES?**

It can with TRI-PLATE® modules. TRI-PLATE modules offer you the fastest, most economical technique for testing and proving strip transmission line microwave circuits. In minutes you can assemble the TRI-PLATE modules that correspond to your schematic, lock in signal paths by tightening integral connectors, apply power and test the authentic circuit . . . in high-performance strip transmission line.

Another important reason why these versatile modules belong in your microwave lab — you can re-assemble TRI-PLATE modules just as quickly and easily for evaluating alternative designs . . . they're re-usable indefinitely in countless configurations. Electrical characteristics are consistently superior because TRI-PLATE modules are high quality components in module form — their integral connectors minimize losses and (unlike coax connectors) introduce negligible VSWR. Modules for almost every function are available in kits for S, L and C bands.

Also, when you execute your designs in TRI-PLATE modules, you have the added assurance that your final production package — fully integrated in strip transmission line — will be even more compact, lightweight and efficient, with a form factor superior to any other microwave medium. Write for catalog and design data to Sanders Associates, Inc., Microwave Products Dept., Nashua, New Hampshire.

© Reg. T.M., Sanders Associates, Inc. Extensive Patent Coverage.

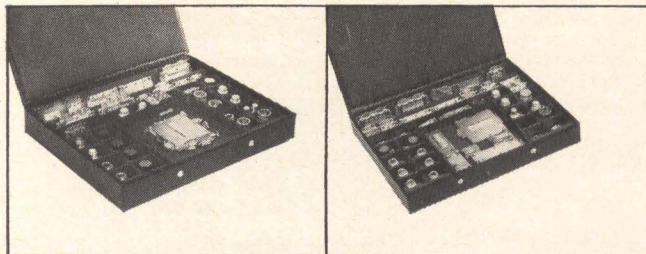

CREATING NEW DIRECTIONS IN ELECTRONICS 
SANDERS TRI-PLATE STRIP TRANSMISSION LINE

120 Circle 120 on reader service card

**FOR OFHC
COPPER COMPONENTS**

Call  **JANNEY**

Call **JANNEY** for Forgings,
Extrusions, High Energy Rate Forming

Benefit from JANNEY's extensive experience in forming OFHC* Copper and other high conductivity alloys for electronic applications. We offer:

1. Engineering know-how in this field
2. Flexibility of operation
3. Comprehensive quality controls
4. Machining facilities
5. Capacities: primarily parts weighing between 2 and 6 pounds each and billet sizes ranging between 2½" and 5" in diameter.

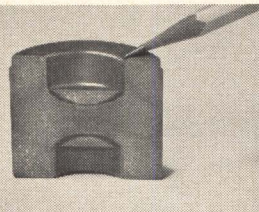

**OFHC COPPER
ELECTRONIC COMPONENT**
(HER Formed for smoother finish, better parts, less metal loss, simpler tooling)

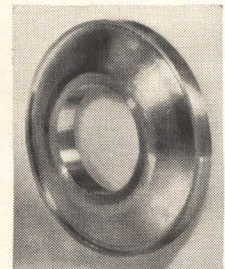

OFHC COPPER
(Ring Forging, Rough Machined)

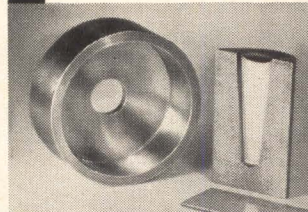

OFHC COPPER
Components for Electronic Applications



OFHC COPPER
A housing that has been backward extruded and machined. Note solid end.

*Challenge us with your problem.
Write, wire or phone.*

JANNEY CYLINDER COMPANY

7401 STATE ROAD, PHILADELPHIA 36, PA.
Phone: (215) MAYfair 4-6600

*Reg. Amer. Mtl. Clímax, Inc.

Circle 204 on reader service card

New Instruments

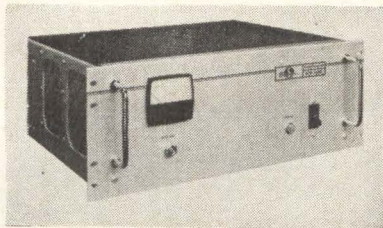

Scr regulators have low distortion

High-efficiency a-c regulators that are about half the size and weight of comparable units are announced. The ACR series silicon-controlled-rectifier a-c regulators, offered in 500, 1000, 2000, 3000, and 5000 VA models, are designed for controlling rms voltage to a variety of loads requiring precision regulation, low distortion, and fast response time. Units can be programmed and sensed remotely. Regulation is ± 0.1 percent rms. Time constant is 30 millisecond. Distortion is less than 3 percent. Series operates at up to 95-percent efficiency. Temperature coefficient for all models is 0.015 percent per deg C. Prices start at \$290.

Sorensen, a unit of Raytheon Co., Richards Ave., South Norwalk, Conn. [351]

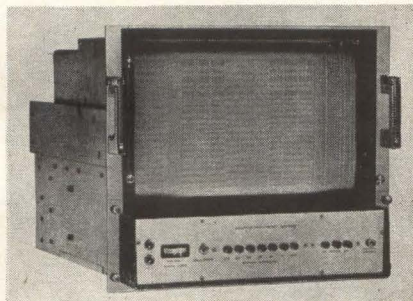

Operations monitor records multiple events

A new 150-channel operations monitor has been developed for recording on-off, go/no-go or other two-state operations in order of occurrence, duration and time relationship. Model 14 3615 00 can record on all 150 channels simultaneously with time accuracies of 1.25 millisecond. Resolution of pulses as short as 2.5 millisecond is easily

achieved. The sequence recording system contains a pulse power supply and an interchangeable switching logic by which a variety of inputs can be accommodated. The entire unit is packaged in a shielded, mounted enclosure which meets MIL-I-26600, Class I specifications for rfi emanation.

Brush Instruments, division of Clevite Corp., 37th and Perkins, Cleveland 14, Ohio [352]

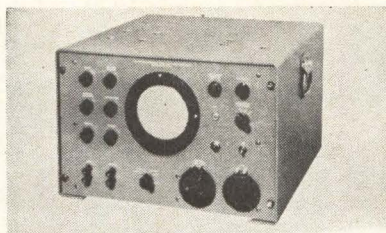

Ultrasonic phasemeter serves as standard

An ultrasonic primary phase standard/meter, model 718-B, measures phase shift to ± 0.1 deg absolute, by comparing its precision internal reference with a signal return from a component under test. The instrument also generates two voltages having a previously adjustable phase relationship which may be used to calibrate phase meters. Phase shift is read in a continuous range of 0 to 360 deg on two precision calibrated dials, one coarse and the other of which reads through a range of $+3$ deg to -3 deg with widely spaced 0.1-deg calibrations.

Acton Laboratories, Inc., 533 Main St., Acton, Mass. [353]

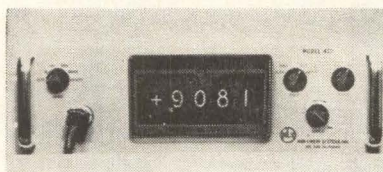

Digital voltmeters offer high sensitivity

Low-cost, 4-digit, all-electronic digital voltmeters, series 4300, are announced. Available in 18 models,

10¹⁵ OHMS RANGE

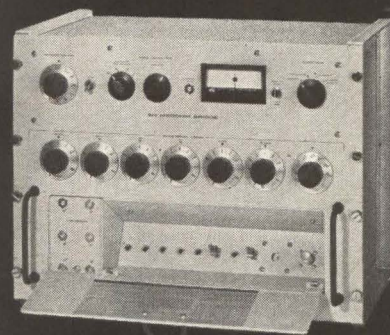

.05% ACCURACY

KEITHLEY MODEL 515 guarded Wheatstone Bridge offers a range of 10^5 to 10^{15} ohms and accuracy from .05% to 1%. Direct-reading, it is ideal for the verification of high-megohm resistors and for measurements of resistor voltage coefficients and leakage and insulation resistances.

The instrument has an extremely stable electrometer null detector, supplies its own bridge potentials up to 10 volts and contains a shielded measuring compartment.

An external power supply provision allows use of Keithley Models 240 or 241 Regulated High Voltage DC Supplies for bridge potentials up to 1000 volts. External shielded measurements to 200° C. can be made by using a triaxial cable accessory. Semi-automatic calibration is an added convenience feature.

MEGOHM BRIDGE \$2150

Accessories

MODEL 5152
Remote Test Chamber \$90

MODEL 5153
60" Triaxial Cable \$25

*Send for catalog
giving full details*



**KEITHLEY
INSTRUMENTS**

12415 Euclid Avenue • Cleveland 6, Ohio

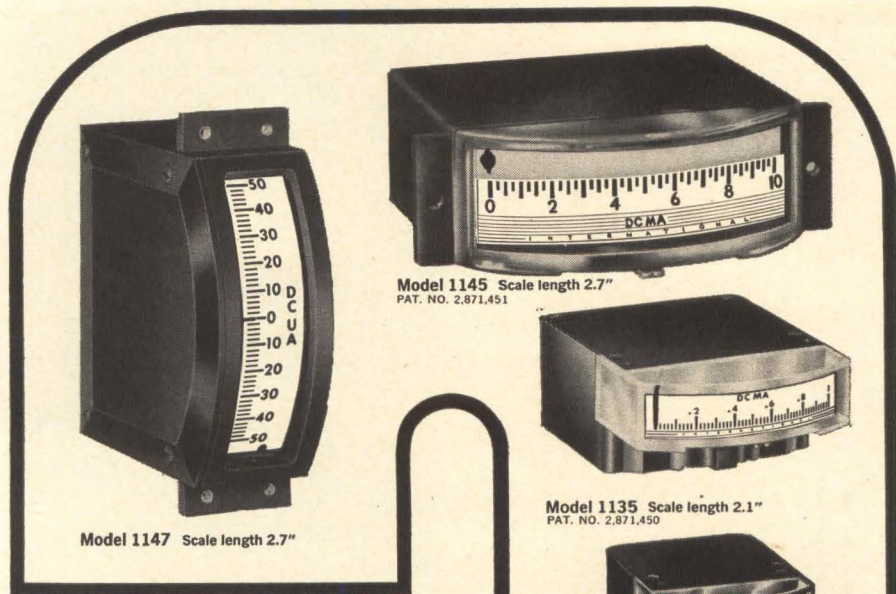

Model 1147 Scale length 2.7"

Model 1145 Scale length 2.7"
PAT. NO. 2,871,451

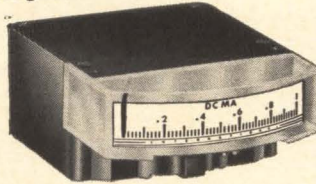

Model 1135 Scale length 2.1"
PAT. NO. 2,871,450



Model 1120 Scale length 1.2"



Model 2120
Scale length 1.3"

who makes the broadest line of EDGEWISE METERS?

We do.

International pioneered the concept of Edgewise Panel Meters in 1947 and today offers you more models of top-quality, realistically priced Edgewise Meters than any other company.

Engineers know us as the one best source for standards and specials in a wide variety of ranges and with all these high-performance features:

- Bi-level scale that minimizes parallax.
- External, easily accessible zero adjust.
- Meet applicable portions of ASA Specification C39.1.

- Specially designed clear plastic front for maximum illumination of scale — reduces shadow and glare.
 - Zero at left, center or right, according to your needs.
 - May be used as null indicator.
 - Internal illumination on some models.
 - Some models meet applicable portions of MIL-M-10304B.
 - Conveniently located modification and service centers.
- FOR ENGINEERING DATA SHEETS . . . and for your special requirements on Edgewise Meters, Panel Meters and Electronic Control Products . . . phone, wire or write our sales department.

**international
instruments inc.**

88 Marsh Hill Road, Orange, Connecticut, Cable: "INTERINST"

Member of NEMA
Electrical Indicating Instrument Section

New Instruments

they offer high common mode rejection (60 db at 60 cps), 1000-v ground isolation, and 100 μ v sensitivity. They feature automatic, manual or programed range selection, and automatic polarity changing. Ranges of the series 4300 are $\pm 0.9999/9.999/99.99/999.9$ v d-c. Maximum speed is two readings/sec plus 0.5 sec for automatic ranging. Accuracy is \pm (0.05 percent of reading +1 digit). Prices range from \$875 to \$1,235.

Non-Linear Systems, Inc., P.O. Box 728, DelMar, Calif. [354]

Synthesizer-exciter has digital readout

Type 263 synthesizer-exciter has a 1-w maximum output and a continuously variable frequency range of 100 kc to 30 Mc. A resolution of ± 0.05 cps at any frequency, digital readout, a-m and f-m modulation facilities and a built-in 1-Mc frequency standard accurate to 5 parts in 10^9 are featured.

Rohde & Schwarz, 111 Lexington Ave., Passaic, N.J. [355]



Digital meters read voltage and frequency

Series 990 digital instruments are designed to offer an extra measure of versatility and reliability for industrial usage. Providing the choice of both frequency and d-c voltage measurements in one instrument, the four models of series 990 make full use of electronic techniques and dispense with electromechanical switching. Measurement ranges extend from zero to 750 v d-c and from 2 cps to 1 Mc for frequency measurements. Provisions are also included for directly driving a digital printer. Priced from \$1,095.

Electro Instruments, Inc., 8611 Balboa Ave., San Diego 12, Calif. [356]

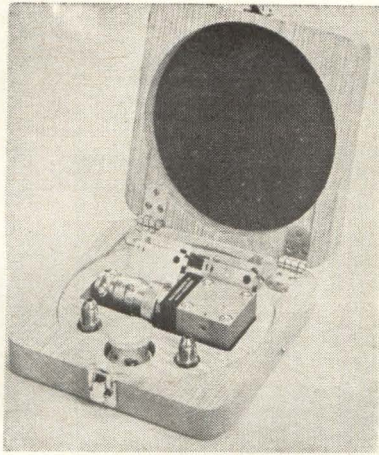

Pressure transducer kit offers high accuracy

On the market is a pressure transducer kit that offers accuracy of 1 percent of reading from 1 to 500 psi, differential or gage. Intended for general test laboratory use, the model KP15 kit includes a P15 pressure transducer rated at 2000 psi maximum line pressure, five bi-directional interchangeable diaphragms with ranges of ± 1 , ± 5 , ± 25 , ± 100 and ± 500 psi, wrenches and accessory fittings.

Pace Engineering Co., 13035 Saticoy St., North Hollywood, Calif. [357]



Voltage standard has modular design

Model 146AG5 a-c absolute voltage standard has an output voltage range of 0 to 511.110 v rms and a resolution of 1 mv with six full switching decades. Standard output frequencies are 50, 60, 400, 800, 1000, 2400, and 4800 cps; absolute accuracy is 0.035 percent. The all-transistor unit is modular, uses convection cooling only. Input power is 105 to 125 or 210 or 250 v, 47 to 440 cps, 200 w.

Rotek Instrument Corp., 11 Galen St., Watertown, Mass. [358]

Watch DEI

SOLID STATE SIGNAL SOURCES and TEST TRANSMITTERS...

- LOW RF LEAKAGE
- STABLE FREQUENCY
- VERY LOW PHASE JITTER

136 mc Band

400 mc Band

1700 mc Band

BORESIGHTING RECEIVER TESTING



BST Series . . . 136, 400, 1700 mc Bands. Control Panel & Attenuator Optional.

Designed for continuous unattended service with local or remote control panel. Weatherproof enclosure. Choice of 3 frequencies with stable RF output level. Internal AM modulator. For more information request Bulletin BST.



CSG Series . . . 136-138 mc in 1kc steps, 400-406 mc in 1kc steps, 1700-1710 mc in 10kc steps.

Adjustable output level - 20 to -160dbm. PM and AM modulation capability within ± 1 db from dc to 150kc. Operates from 115V 50-400 cps or from external battery. For more information request Bulletin CSG.



TTG-1 Phase Modulated Signal Generator. Single Fixed Frequency 370 to 410 mc.

Adjustable output level - 13 to -140dbm. PM modulation capability 5 cps to 200kc. Plug in CR-74/U crystal allows frequency change with simple retuning procedure. For more information request Bulletin TTG-1.



CTT-1 Test Transmitter. Single Fixed Frequency 136 to 138 mc.

Adjustable output level 0 to -130dbm. PM and AM modulation capability within ± 1 db from dc to 100kc. Voltage controlled Vernier tuning over ± 20 kc. Weatherproof housing. For more information request Bulletin CTT-1.

PIONEER IN AEROSPACE TELEMETRY EQUIPMENT AND SYSTEMS



DEI
RESEARCH
DEVELOPMENT
MANUFACTURING

Defense Electronics, Inc.

ROCKVILLE, MARYLAND

PHONE (301) 946-2600 TWX 301-949-6788
SHERMAN OAKS, CALIFORNIA PHONE (213) 873-4322

Librascope magnetic encoders



have a

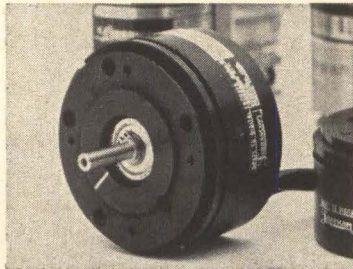

service life of



1 billion cycles

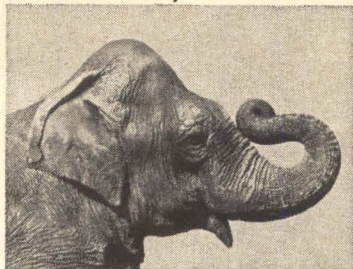

From Librascope, magnetic non-contact encoders that perform for 1 year at 2,000 rpm without failing. Plus 232 other mil-spec. encoders with the widest choice of codes, capacities, and sizes available. **Write today for your Magnetic Encoder Brochure.**

LIBRASCOPE GROUP.

**GENERAL
PRECISION**

COMMERCIAL COMPUTER DIVISION
808 WESTERN AVENUE • GLENDALE 1, CALIF.

G3-10384

New Semiconductors

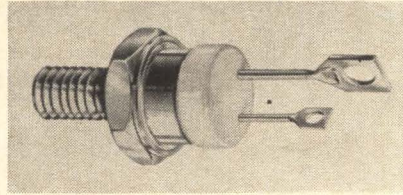

All-diffused scr's feature reliability

Series 2N681 through 2N689 silicon-controlled rectifiers in the TO-48 packages are designed for regulated power supplies, power inverters and motor-control circuit-design requirements. The all-diffused units feature rigid post-and-clip construction with the posts that connect the terminals to the pellet anchored at both ends. This produces an element of reliability and mechanical capability said to be unequalled in the scr field. The devices have a positive temperature coefficient for the forward break-over voltage (V_{bo}) characteristic, with the minimum V_{bo} guaranteed at $T_c = -55^\circ\text{C}$.

Silicon Transistor Corp., Carle Place, N.Y. [331]

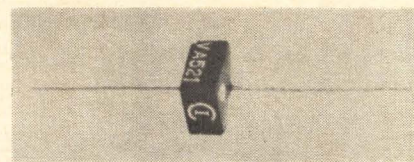

Capacitor diodes have high Q

Silicon high capacitance Varactron diodes feature an all-epitaxial construction with an abrupt junction design to permit maximum change in capacitive reactance. Working voltage is 100 v d-c with low reverse current leakage specified. The diode has a minimum Q of 200 at -8 v and 25 Mc with a series resistance of 0.125 ohm max. Capacitance values of the VA-520 series is 250 pf at -8 v (330 pf at -4 v). The diodes find important applications as circuit tuning elements for amplifier, oscillators, automatic frequency control loops, frequency

tracking filters, remote control tuning, frequency connectors and modulators, and self-balancing bridge circuits.

Crystalonics, Inc., 147 Sherman Ct., Cambridge 40, Mass. [332]

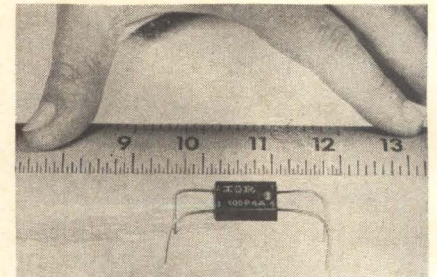

Rectifier assembly replaces four diodes

A series of extremely compact silicon rectifier assemblies with large output capabilities is being produced to replace bulky circuitry made up of individual semiconductor devices. The new assemblies will perform the functions that formerly required four individual diodes. Designated the 10B series, the assemblies are single-phase, full wave bridge rectifiers rated from 200 to 1,000 v peak reverse voltage. Output is up to 1.8 amp average dc and transient capability is from 350 to 1,250 v. Other circuit configurations are available in this miniaturized rectifier line including the center tap, doubler, tripler and quadrupler circuits. Price is \$2.50 to \$4.50.

International Rectifier Corp., 233 Kansas St., El Segundo, Calif. [333]

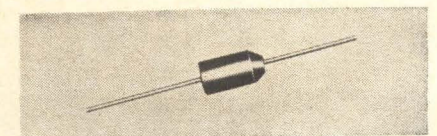

Axial rectifiers deliver 2 amp d-c

Miniature axial rectifiers provide an average d-c output up to 2 amperes half-wave at voltages ranging from 15 to 1,200 piv. The 2A series of insulated body silicon rectifiers op-

erate at full rated current up to 50 C and withstand an 8-millisecond 200-ampere surge. They have a maximum reverse current of $25 \mu\text{a}$ at rated voltage, a maximum d-c forward drop of 1.2 v at rated current, and meet all environmental specs of MIL-S-19500 C.

Solitron Devices, Inc., 500 Livingston St., Norwood, N.J. [334]

Silicon rectifier rated at 1,500 v

A top-hat, axial-lead silicon rectifier rated at 1,500 v, 1 amp is announced. The single-junction 1N4374 offers space savings, improved circuit efficiency, and increased reliability for applications such as high-voltage radar power supplies, h-v cathode-tube circuits, and microwave power supplies. In addition to a working peak reverse voltage rating of 1,500 v, it features a high surge current capability of 15 amperes (one cycle at 50 C), a low forward voltage drop of 1.5 v at $I_F = 500 \text{ ma}$, and a leakage current of only $300 \mu\text{a}$ at 1,500 v and 150 C. Price is \$5.36 (100 to 999 quantities).

Texas Instruments, Inc., 13500 North Central Expressway, Dallas, Tex. [335]

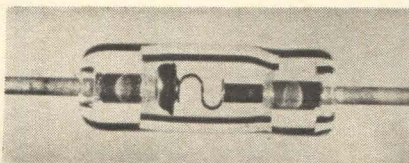

Four-layer diodes encased in glass

Silicon four-layer subminiature glass diodes are two-terminal devices that exhibit many of the characteristics of the more complex multiterminal devices. In the ON state the device has a dynamic resistance of less than 2 ohms and a voltage drop of approximately 1 v; in the OFF condition it has a forward leakage of less than $5 \mu\text{a}$. Switching is accomplished by varying the voltage across the device. Switching time is in the fractional microsecond region. Dissipation is 150 mw.

National Transistor, 500 Broadway, Lawrence, Mass. [336]

Trouble-free Performance

RMC DISCAPS

TEMPERATURE COMPENSATING

TYPE C

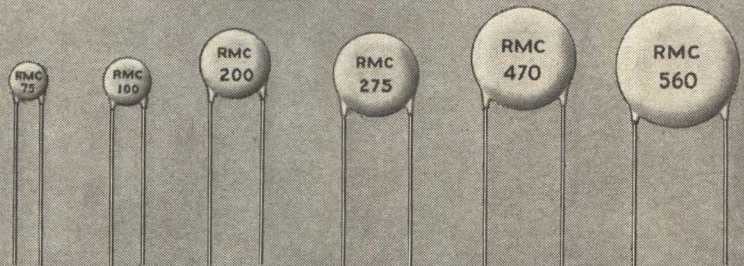

TC	.290	.400	.570	.660	.790	.890
P-100	1- 5 MMF	6- 10 MMF	11- 20 MMF	—	—	—
NPO	1-15	16- 33	34- 69	70- 85 MMF	86-115 MMF	116-175 MMF
N- 33	1-15	16- 33	34- 69	70- 85	86-115	116-175
N- 75	2-15	16- 33	34- 69	70- 95	96-130	131-190
N- 150	2-15	16- 36	37- 67	68- 95	96-130	131-230
N- 220	2-15	16- 36	37- 75	76-100	101-160	161-230
N- 330	2-20	21- 51	52- 75	76-115	116-190	191-270
N- 470	2-20	21- 51	52- 80	81-120	121-200	201-275
N- 750	2-32	33- 75	76-155	156-220	221-300	301-470
N-1500	10-74	75-140	141-220	221-399	400-550	551-800
N-2200	20-75	76-150	151-299	300-450	451-680	681-900

Temperature Coefficients up to N5200 Available on Special Order

Disc sizes under $\frac{1}{2}$ " diameter have lead spacing of .250. Discs $\frac{1}{2}$ " diameter and over have .375 spacing.

RMC Type C DISCAPS meet or exceed all specifications of the EIA standard RS-198. Rated at 1000 working volts, Type C DISCAPS provide a higher safety factor than other paper or mica capacitors.

Constant production checks assure that all specifications and temperature characteristics are met. Another phase of complete quality control consists of 100% testing of capacities.

Throughout the years leading manufacturers have relied on RMC for quality of product and maintenance of delivery schedules. Write on your company letterhead for additional information on DISCAPS.

SPECIFICATIONS

POWER FACTOR: Over 10 MMF less than .1% at 1 megacycle. Under 10 MMF less than .2% at 1 megacycle

WORKING VOLTAGE: 1000 V.D.C.

TEST VOLTAGE (FLASH): 2000 V.D.C.

LIFE TEST: 1500 volts for 1000 hrs. at $85^\circ\text{C} \pm 3^\circ\text{C}$

CODING: Capacity, tolerance and TC stamped on disc

INSULATION: Durez phenolic—vacuum waxed

INITIAL LEAKAGE RESISTANCE: Guaranteed higher than 7500 meg-ohms

AFTER HUMIDITY LEAKAGE RESISTANCE: Guaranteed higher than 1000 megohms

LEADS: No. 22 tinned copper (.026 dia.)

TOLERANCES: $\pm 5\%$ $\pm 10\%$ $\pm 20\%$

DISCAP
CERAMIC
CAPACITORS

RMC

RADIO MATERIALS COMPANY

A DIVISION OF P. R. MALLORY & CO., INC.

GENERAL OFFICE: 4242 W. Bryn Mawr Ave., Chicago 46, Ill.

Two RMC Plants Devoted Exclusively to Ceramic Capacitors

FACTORIES AT CHICAGO, ILL. AND ATTICA, IND.

RMS ASSOCIATES

COMPUTER CONTROLLED DISPLAYS

Economical, reliable, large screen computer controlled displays for simulation, command and control, trouble shooting, machine aided design . . .

- **FULLY TRANSISTORIZED**
(except for CRT)
- **FAST**
 - ... High Speed Display plots more than 65,000 random points/sec
 - ... Standard Speed Display plots more than 16,000 random points/sec
- **VERSATILE OPTIONS**
 - ... CURVILINE® Character writing, vector writing, light pen, buffer, keyboard and many others.
- **COMPUTER INTERFACES**
 - ... Presently being supplied for CDC 160A, DDP 24, IBM 7094, UNIVAC 1107, SDS 930, PB 250, others available.
- **LARGE SCREEN** (21" Rectangular)

... and MORE!

WRITE FOR
COMPLETE
DETAILS!

... from \$11,840



RMS ASSOCIATES, INC.

... data processing & display products

102 E. Sandford Blvd., Mt. Vernon, N.Y. 10550
914 OWens 9-5515

SEE OUR DISPLAY AT BOOTH #2, WASH., D.C.
SPRING JOINT COMPUTER CONFERENCE!

Don't let the price tag fool you!

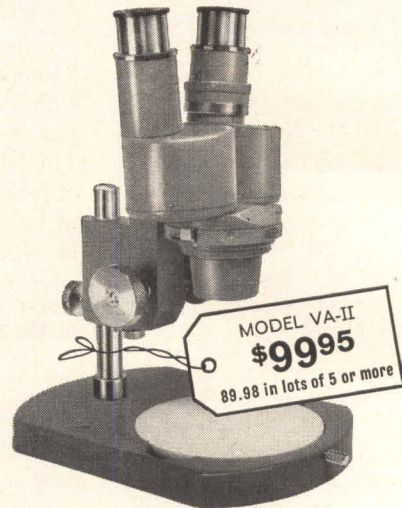

This is a genuine, full-quality Elgeet-Olympus STEREO microscope

Distortion-free optics, brilliant imagery. Ideal for quality control, inspection and assembly of miniature parts and circuits. Magnification: 8X to 40X. A complete range of coated achromatic optics is available. For details, write Elgeet Optical Co., Inc., 303 Child Street, Rochester, New York 14611.

Circle 205 on reader service card

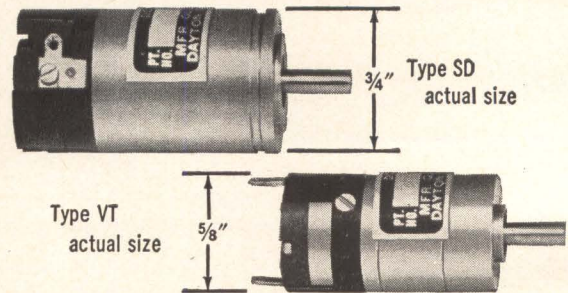

2 BRAND NEW D.C. MOTORS

yes, smaller!

We believe the new Globe SD and VT motors are the smallest and lightest permanent magnet precision d.c. motors available. Typical continuous duty output for these motors is 0.3 oz. in. and 0.25 oz. in. at 10,000 rpm. respectively. A variety of windings is offered to produce the characteristics required. Standard windings for 27 v.d.c. produce no-load speeds from 5,000 to 22,000 rpm; 3 to 50 volts standard, higher voltages available. Special units can include speed governors, gearheads, brakes, and radio noise filters. Unusual efficiency and output torque are obtained with high reliability, designed to meet MIL specs. Write for Bulletin VTD to Globe Industries, Inc., 1784 Stanley Avenue, Dayton 4, Ohio.

GLOBE

GLOBE
INDUSTRIES,
INC.

New Subassemblies and Systems

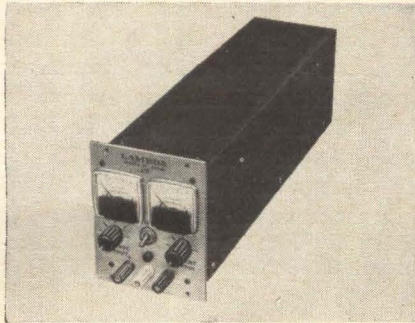

Power supplies are silicon regulated

All-silicon, regulated, continuously variable power supplies have voltages up to 40 v d-c and currents up to 4 amps. The LH series is available in 1/4 rack and 1/2 rack sizes. They feature uniform temperature coefficients from 0 to 50 C. Integrated silicon circuit maintains 0.015%/deg C temperature coefficient for any incremental change over the operating temperature range of the supply. Units are completely protected against short circuit and electrical overload and excessive ambient temperature. Line regulation is 0.015% or 1 mv, whichever is greater, for a-c input of 105-135 v a-c. Load regulation is 0.015% or 1 mv, whichever is greater, for no load to full load. Lambda Electronics Corp., 515 Broad Hollow Road, Melville, L.I. [371]

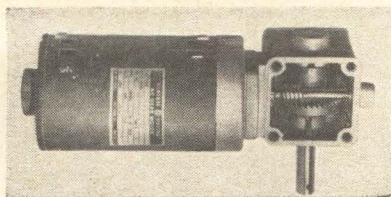

Small gear motors for automated systems

A complete line of small gear motors is capable of being used in an extremely wide variety of applications in numerically controlled machines and automated systems. Designated Mina-Gear, the right-angle design gear motor with the Spiroid face-type gearing is available in models ranging from 1/100

to 1/2 h-p with output speeds from 15 to 350 rpm. Reduction ratios are available from 10:1 up to 102:1. Gear housing will combine with eight different motor frames, is available with a built-in clutch, and can be built as a separate reducer. The line comes in virtually all motor types: a-c, d-c and a-c/d-c. General Electric Co., Schenectady 5, N.Y. [372]

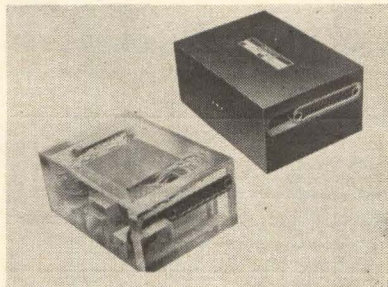

Foam-potted package contains 100 dry reeds

One hundred dry reeds are incorporated into a single package for a new missile ground control computer. A new method of encapsulation, involving polyurethane foam, affords lighter weight and repairability not possible with solid potting materials. All 100 reeds operate from a single coil with 5-milli-sec response at nominal coil voltage. Outside dimensions are approximately 4 1/2 by 6 1/4 by 2 3/4 in. Wintronics Div./Michigan Magnetics, Inc., 1132 S. Prairie Ave., Hawthorne, Calif. [373]

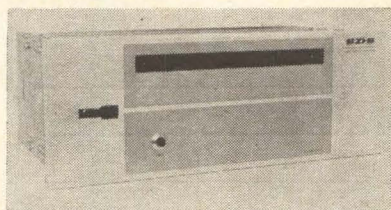

A/d converters rated to 30,000 bits/sec

Series AD 20 analog-to-digital converters have conversion rates up to 30,000 bits per sec, with accuracies up to ±0.01%. The all-silicon converters have an operating

GLASS ENCLOSED

AMPERITE

Thermostatic DELAY RELAYS

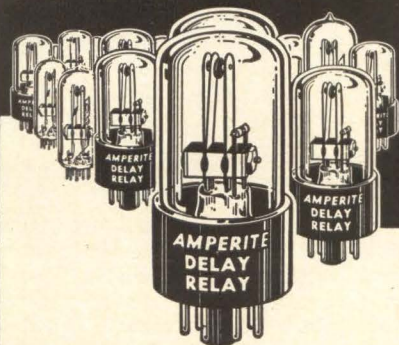

Offer true hermetic sealing
-assure maximum stability and life!

Delays: 2 to 180 seconds . . . Actuated by a heater, they operate on A.C., D.C., or Pulsating Current . . . Being hermetically sealed, they are not affected by altitude, moisture, or climate changes . . . SPST only—normally open or normally closed . . . Compensated for ambient temperature changes from -55° to +80° C . . . Heaters consume approximately 2 W. and may be operated continuously . . . The units are rugged, explosion-proof, long-lived, and—inexpensive!

TYPES: Standard Radio Octal, and 9-Pin Miniature.
List Price, \$4.00

PROBLEM? Send for Bulletin No. TR-81

AMPERITE

BALLAST REGULATORS

Hermetically sealed, they are not affected by changes in altitude, ambient temperature (-50° to +70° C.), or humidity . . . Rugged, light, compact, most inexpensive.

List Price, \$3.00

Write for 4-page Technical
Bulletin No. AB-51

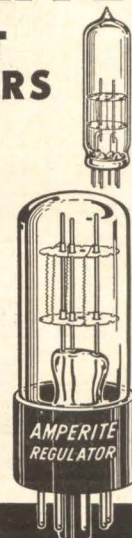
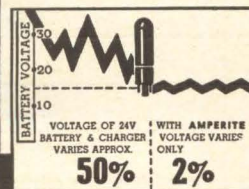

AMPERITE

600 PALISADE AVE., UNION CITY, N.J.

Telephone: 201 UNion 4-9503

In Canada: Atlas Radio Corp., Ltd.,
50 Wingold Ave., Toronto 10

DYNAMICS TEST INSTRUMENTS

—compact tape recorder monitor provides
simultaneous voltage metering of 13 data channels

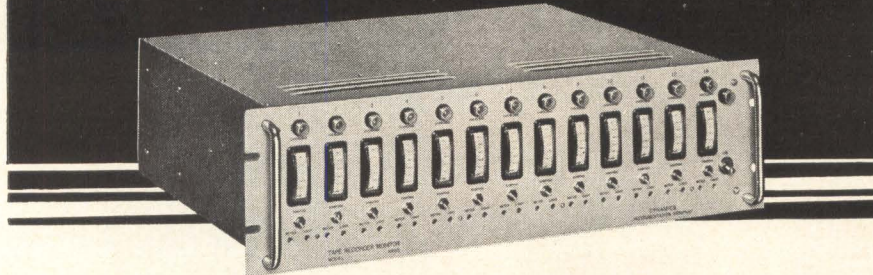

Model 4995 combines 13 ac voltmeters into a package only 5 1/4" high x 19" wide x 16" deep. Each meter reads 1 volt rms full scale. Peak rms signals in excess of 1 volt energize neon lamps—visually indicating an overscale condition. Isolated from power ground. All signal commons are tied together but floated from cabinet ground. Double-shielded transformers assure maximum isolation from the power line.

Input voltage range: 0-1 volt rms.
Frequency range: 1.7 cps to 30 kc.
Metering: 0-1 volt rms full scale indication.
Overload neon indicators: Illuminate on peak of rms signals in excess of 1.0 volt rms.

Write for literature on Model 4995, or the complete line of Dynamics test instruments and signal conditioning equipment.

DYNAMICS INSTRUMENTATION COMPANY
583 Monterey Pass Rd., Monterey Park, Calif. • Phone: CU 3-7773

Circle 207 on reader service card

COMINCO

HIGH PURITY METALS
AVAILABLE FORMS

clip and save

Product	ALUMINUM	ANTIMONY	ARSENIC	BISMUTH	CADMIUM	GOLD	INDIUM	LEAD	SILVER	TIN	ZINC
BARS	✓	✓	✓	✓	✓	✓	✓	✓	✓	✓	✓
SHEETS	✓				✓	✓	✓	✓	✓	✓	✓
WIRE	✓				✓		✓	✓		✓	✓
POWDER		✓	✓	✓	✓	✓	✓	✓	✓	✓	✓
SHOT		✓		✓	✓	✓	✓	✓	✓	✓	✓
ROD	✓			✓	✓		✓	✓	✓	✓	✓
RIBBON							✓	✓			
PRE-FORMS	✓				✓	✓	✓	✓	✓	✓	✓
SALTS					✓		✓				

COMINCO PRODUCTS, INC.

electronic materials division

933 West Third Avenue, Spokane 4, Washington
Phone Area Code 509 RI 7-7103 • TWX 509 328-1207

3602

New Subassemblies

temperature range from 0° C to 100° C. Transformer coupling from control and output signals minimizes grounding problems. Four models are available with binary or BCD output. Price for model AD 20-14, 13 binary bits plus sign, 13,300 conversions per sec, is \$3,700. Scientific Data Systems, 1649 Seventeenth St., Santa Monica, Calif. [374]

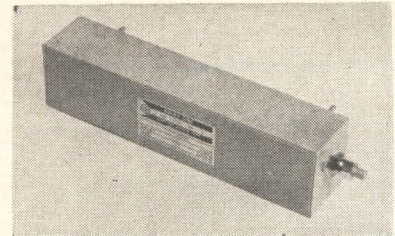

Delay line provides high resolution

Variable delay line for use as a phase shifter in the frequency range from 50 cps to 200 kc has been developed. The V649 has a delay range of 0 to 10 μ sec which is continuously adjustable by 10 turns of a 1/4-in. control shaft, providing a resolution of 5 nsec or 0.2 deg phase shift at 100 kc. Delay linearity with frequency is constant within 1 percent over the frequency range. Vswr is within 2 db up to 150 kc and within 3 db up to 200 kc. Temperature coefficient of delay is 25 parts per million and impedance is 100 ohms. Unit is ideal for use as a phase shifter for c-w signals; however, it can delay pulse information, when so used it has a rise time 1.8 μ sec; ripple is 5% and attenuation is 5.5 db.

Computer Devices Corp., 6 W. 18th St., Huntington Station, N.Y. [375]

Pumping modules produce high vacuum

High-vacuum pumping modules, the SB series, are available in 4, 6 and 10-in. sizes. They can be quickly mounted on chambers used for research and testing in metallurgy, materials, electronics, and space simulation. Each module consists of a diffusion pump, slide

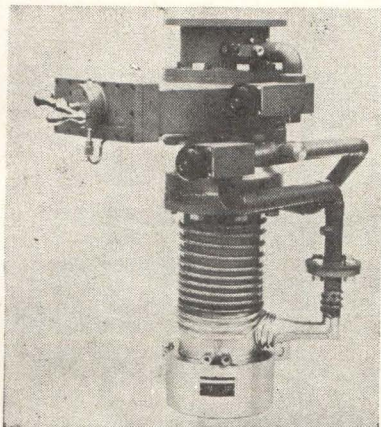

valve, baffle and manifold assembly. Net pumping speeds are 300 liters per sec for the 4-in., 600 liters per sec for the 6-in. and 1,500 liters per sec for the 10-in. units. Ultimate pressure capability is in the 10^{-8} torr range with guaranteed performance in the 10^{-7} torr range. NRC Equipment Corp., 160 Charlemont St., Newton 61, Mass. [376]

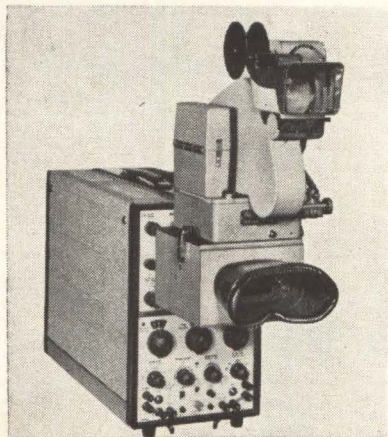

Pulse advance magazine for crt cameras

Model 3800P pulse advance Rautomatic magazine for film-processing oscilloscope camera systems, records data, processes film, and views results in 85 seconds. Its integrated design enables the user to convert the pulse type unit to a continuous film system by means of a new gear train conversion kit—model 3804. Model 3800P will completely develop and affix the film. It operates at a max speed of 12 frames per minute so that it is easily adjustable for $\frac{3}{4}$ in. or $1\frac{1}{2}$ -in. frame. Price is \$2,200. Analab Instrument Corp., 30 Canfield Road, Cedar Grove, N. J. [377]

NO OTHER SOLID STATE SWITCH can match this



in performance ... reliability ... and size / from ... 

HERE'S WHY:

✓ ITS PERFORMANCE

Frequency	5.4 to 5.9 Gc
Insertion loss	1 db
Isolation	45 db
VSWR	1.4
Switching speed	5 nanoseconds
RF Power	2 Watts average

✓ ITS RELIABILITY

Temperature: Operating	-54°C to 110°C
Storage	-85°C to 160°C
Vibration: 20 G's	10 to 2000 cycles
10 G's	2000 to 5000 cycles
Shock: 100 G's	

✓ ITS SIZE

2" x $\frac{1}{2}$ " x $\frac{1}{2}$ " ... occupies $\frac{1}{2}$ cu. in. ... weighs only 2.3 ounces

This switch can be used in virtually any application requiring a high performance C-Band Switch, military or commercial.

■ AEL has the most complete line of off-the-shelf solid state switches available today.

■ **IMPORTANT:** We also can provide you with solid state switches incorporating virtually any characteristics you desire. WE INVITE your inquiry for custom designs.

AEL HAS SOLID STATE SWITCHES TO MEET ALL THESE REQUIREMENTS

FREQUENCY RANGE
from 1 mc to over 35 Gc

BROAD BANDWIDTH
10-1000 mc in one switch
200-8200 mc in one switch

HIGH POWER
to 20 KW peak, 50 watts average

HIGH SPEED
as fast as 0.2 nanoseconds

LOW INSERTION LOSS
down to 0.1 db

HIGH ISOLATION
to 150 db

MULTIPLE THROWS
as many as 32 throws

RELIABILITY
to meet missile requirements

COAX, WAVEGUIDE and STRIPLINE



American Electronic Laboratories, Inc.
1309 RICHARDSON ROAD, COLMAR, PA. • suburban Phila. • Phone: (215) 822-2929
Engineers: Investigate the rewarding opportunities at AEL

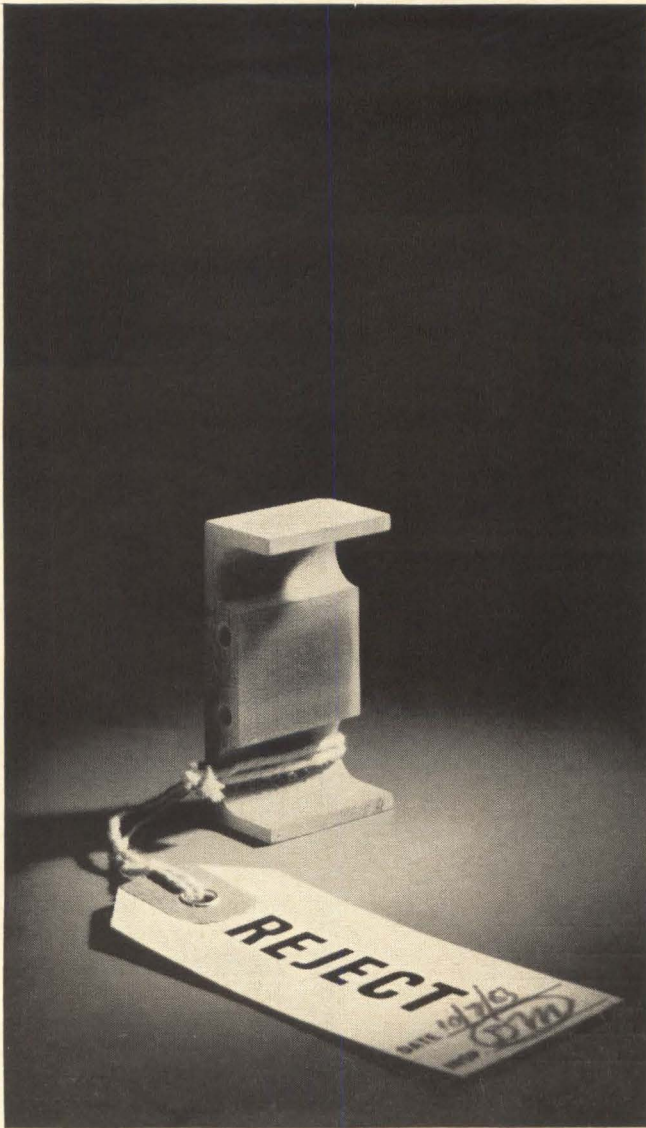

Your responsibility?

One advantage of buying laminated plastic fabricated parts from us is that mistakes in machining are ours.

You pay for what you order. Material spoiled is our headache.

Rejects can happen. Even in our fabricating shop, probably the largest of its kind in U.S. and with 35 years of working with laminated plastics, they can happen. We keep them down through strict quality control. We keep them down because correct cutting speeds, feeds, clearances, sharp tools, knowledge of the laminates (which we make) and proper construction of dies, jigs and fixtures are second nature. If you want to save trouble and money, order laminated plastics parts direct from Synthane. Send for a copy of our new booklet—"Laminated Plastics Parts . . . Make or Buy?" Synthane Corporation, 36 River Rd., Oaks, Pa.

You furnish the print . . . we'll furnish the part

SYNTHANE

CORPORATION **S** OAKS, PENNA.

Synthane-Pacific, 518 Garfield Avenue, Glendale 4, California



HOW TO USE CATALOG 700

FOR ALL IT'S WORTH!

CHECK LISTS SIMPLIFY COMPONENT SELECTION

Helpful hints at the beginning of each major product section — list factors to consider when selecting solder terminals, terminal boards, insulated terminals, coil forms, chokes, capacitors, connectors, hardware. Just one of the many features to assist you in fully utilizing this comprehensive catalog of more than 15,000 *guaranteed* CAMBION® electronic components. Contact your Authorized CAMBION Distributors for local availability. Write for particular samples, sales engineering or additional free copies of full-line Catalog 700. Cambridge Thermionic Corporation, 204 Concord Avenue, Cambridge, Massachusetts 02138.

CAMBION®

Standardize on CAMBION...The Guaranteed Electronic Components]

Circle 208 on reader service card

MINITAN

CORDWOOD

CONSTRUCTION

Solid Tantalum Capacitors

CASE	ACTUAL SIZE	MFD	WVDC	DIA.	LGTH.
Y		.001 to 2.2	20 to 2	.070	.125
P		.047 to 4.7	35 to 2	.070	.160
B		.33 to 15.	35 to 2	.075	.190
A		.68 to 22.	35 to 2	.100	.225
G		3.3 to 47.	20 to 3	.150	.250

Maximum capacitance — minimum case size. Available with axial or radial leads. Over 120 standard Cordwood ratings in production. On-time delivery of prototype or production quantities assured. Quality proven in hundreds of thousands of units.

"See our broad line of miniature solid tantalum capacitors at the NEP/CON Show—Booth 79.



COMPONENTS, INC.

SMITH STREET, BIDDEFORD, MAINE
AREA CODE 207-284-5956

New Microwave

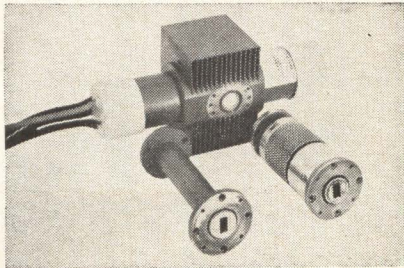

Small and rugged reflex klystrons

Type F-2900 millimeter-wavelength reflex klystrons cover the 28-to-38-Gc range; they are fixed-tuned and deliver a minimum of 1 watt power output at the design frequency specified by the user. A 2% tuning range is available when the MT-80 mechanical tuner is acquired as an optional accessory. The electronic tuning range is 0.1%. The small size and rugged construction of these tubes make them suitable as test equipment primary signal sources, receiver local oscillators, parametric amplifier pumps, and low-power transmitters.

International Telephone and Telegraph Corp., 320 Park Ave., N.Y.C., N.Y. [391]

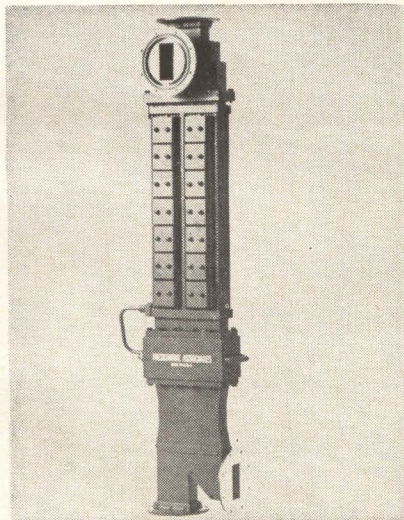

S-band duplexer achieves low losses

A compact circuit utilizing ferrite and gas tube technology to provide efficient duplexing at 6 Mw peak,

30 kw average in S band has been developed. The new circuit provides transmitter and receiver isolation with minimum losses and fast recovery time. The gas tube elements are replaceable in the field. The MA-3234 package is well-suited for the ultra-high powers being generated at S-band, and also in systems employing parametric amplifiers in the receiver. When used with low-loss, long-life gas-tube parametric amplifier protectors, the device offers complete duplexer reliability. Receiver isolation is 20 db at all times regardless of the antenna mismatch. Transmittal losses of 0.5 db and receiver losses of 0.2 db have been achieved over a 10% bandwidth.

Microwave Associates, Inc., Northwest Industrial Park, Burlington, Mass. [392]

Two-cavity oscillator operates at 13.3 Gc

Designed for doppler radar applications, the X1111 two-cavity oscillator operates at 13.3 Gc with a minimum output of 2 w. Its inherent amplitude stability and high-power output make it ideal for parametric amplifier pumping applications. Unit also has excellent temperature stability, low noise characteristics, and is built for use in severe environmental conditions. Eitel-McCullough, Inc., 301 Industrial Way, San Carlos, Calif. [393]

Flexible waveguides are pressure-tight

Flexible waveguides with elliptical cross section for the 4.4- to 8.6-Gc range are produced in long continuous lengths. Construction is high-conductivity copper, corrugated

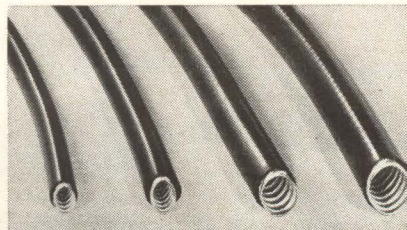

Telrex



The Choice of the Discriminating Communication Engineer . . . the Man who Never Settles for Anything Less than THE-VERY-BEST!

telrex "BEAMED-POWER" ANTENNAS and ANTENNA SYSTEMS

Provide optimum performance and reliability per element, per dollar. Antennas from 500 Kc to 1500 Mc. Free PL88 condensed data and pricing catalog, describes military and commercial antennas, systems, accessories, Towers, Masts, Rotators, "Baluns" and transmission line data.



Asbury Park 41, New Jersey, U.S.A.
Circle 210 on reader service card

HEATH SERVO PEN RECORDER... TYPICAL VALUE IN A NEW RESEARCH AND TEACHING LAB INSTRUMENTATION SERIES!



FEATURES AND PERFORMANCE WORTH FIVE TIMES ITS LOW PRICE!

Unbeatable value! True potentiometric input. Five adjustable ranges: 10, 25, 50, 100 & 250 mv plus plug-in 5-pin connectors for special ranges. Rapid chart advance; pen lift; paper tear-off guide; optional motor speeds; 10" chart; 1 sec. response. Factory assembled & tested. Write for details on entire Malmstadt-Enke Lab series!

Assembled EUW-20A . . . 20 lbs. . . . \$19 mo. . . . \$195.00



HEATH COMPANY 67-4-1
Benton Harbor, Michigan 49023

Please send free folder on Lab Series Equipment.

Please send Free Heathkit catalog.

Name _____ (please print)

Address _____

City _____ Zone _____ State _____

EK-138

THERMOCOUPLE AMPLIFIER



MODEL 190

for

- RECORDER PREAMPLIFIERS
- OVEN CONTROLS
- GLASS FURNACES
- BEARING MONITORS
- METER PREAMPLIFIERS
- DC SHUNT AMPLIFIER

A new concept in solid-state DC amplifiers; no tubes, no transistors, no choppers. Typical gains 4000, $\pm 5 \mu\text{v}$ null stability; ten-year life. Price only \$84.00; quantity discounts, immediate delivery.

Request Technical Bulletin No. 19



acromag
INCORPORATED

15360 TELEGRAPH RD.

DETROIT 39, MICH.

TELETYPE:
313-

538-4536

Phone: 538-4242, Area Code 313

Circle 211 on reader service card

SUBJECT: *More New Shielded Coil Forms*

USE: *RF Coils, Chokes, Filters, Transformers*

FREQ: *To 200 MC.*

SOURCE: *Micrometals*

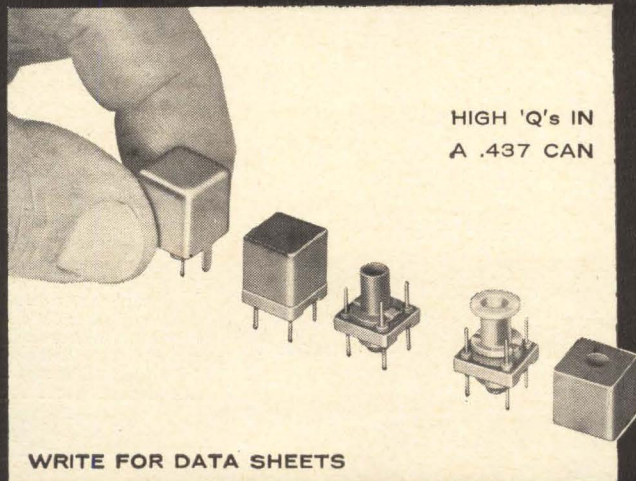

WRITE FOR DATA SHEETS

MICROMETALS

72 E. MONTECITO AVE., SIERRA MADRE, CALIFORNIA
213-MUrray 1-9025

New Microwave

and covered with a polyethylene jacket. The waveguides are pressure-tight and feature performance comparable with rigid rectangular systems. They simplify site layout and reduce installation costs for fixed or transportable systems. A selection of end fittings is available to adapt elliptical waveguide to standard rectangular waveguide flanges.

Andrew Corp., P.O. Box 807, Chicago, Ill. 60642. [394]

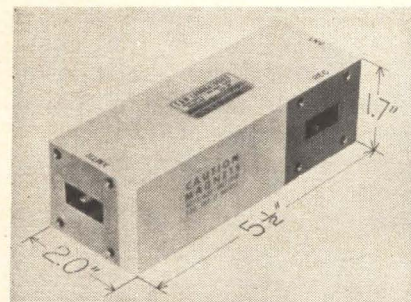

Compact duplexers operate in X band

Model X201LTI duplexer provides 60 db minimum isolation from antenna to receiver over the range of 8.5 to 9.6 Gc, has an 0.25 db max insertion loss from antenna to receiver and a max vswr of the transmitter port of 1.10. Unit measures 1.625 in. by 2.0 in. by 5.5 in. and weighs less than 2 lb.

E&M Laboratories, 7419 Greenbush Ave., N. Hollywood, Calif. [395]

Traveling-wave tube designed for 1.7 to 2.3 Gc

Type 7642 traveling-wave tube incorporates periodic-permanent-magnet focusing. It delivers 18 watts c-w power output in the 1.7 to 2.3-Gc communications band. This twt may be used as a driver tube for ground-based satellite telemetry transmitters and for tv studio-to-transmitter links. Variants of the 7642 are available for operation in the new 2.5 to 2.69-Gc educational tv band.

Radio Corporation of America, Harrison, N. J. [396]

New Production Equipment

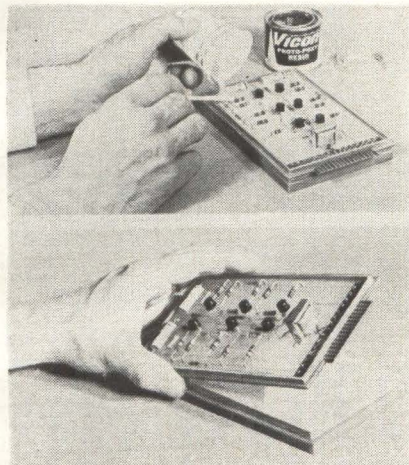

Compact kit provides easy-to-build circuits

A new method of preparing prototype breadboard circuits for lab testing or for limited production circuitry has been developed. Called Proto Boards, the units are available in kit form and consist of (1) a silicon rubber base, soft to receive wire ends of components, impervious to solder, gridded for easy layout; (2) a plastic frame with either side or end (or no connectors) connectors which fit over the base after preliminary circuit is assembled; (3) a Proto-Poxy kit consisting of catalyst and resin in separate cans, a mixing paper cup and wooden stir rods; (4) Proto-Sketch sheets in pad form for preliminary layout of the circuit on gridded paper. The ease with which circuits are built with so few components is the significant design breakthrough. By eliminating the hundreds of tiny hardware parts, Proto Boards offer not only speed but labor saving costs. The Vicon Instrument Co., 1353 Mesita Rd., Colorado Springs, Colo. [421]

Bonder mounts multiple components

A new precision machine rapidly bonds up to six different semiconductor components to headers or substrates under steady state conditions. The assembly equipment features six individual component

trays; a single, thermostatically controlled heat column; a lazy-susan arrangement that speeds selection and transfer of components to the substrate; a high-accuracy micropositioner/optical train for natural, tension-free "feel" to component positioning; a dual gas system, one for tinning, one for bonding; a variable amplitude oscillator that imparts a horizontal scrubbing motion to the tool during bonding to speed eutectic formation. It is claimed that improved reliability of devices manufactured with this machine is assured because of the uniformity of control of all bonding conditions.

Kulicke and Soffa Mfg. Co., 135 Commerce Drive, Fort Washington, Pa. [422]

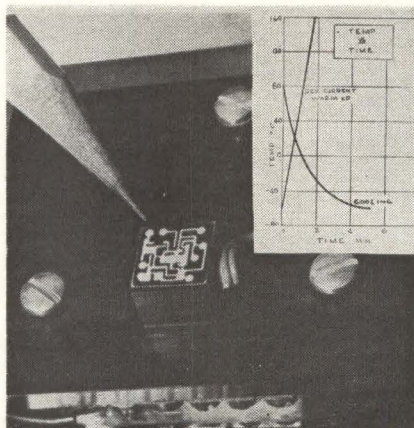

Thermal test block checks microcircuits

A new thermal test block for microcircuits is cooled and heated thermoelectrically. It can be adapted to small transistors, crystals and resistors. Unit will pull down to -70°F in less than 5 minutes, -80°F under slight vacuum-Bell Jar. By reversing polarity the unit heats to 225°F in less than 2 minutes. Block requires water cooling. Fin-fan cooling is available. Dimensions are $3\frac{1}{2}$ by $3\frac{1}{2}$ by 1 in., insulated. Model 600 can be used for thermal-life cycling, circuit parameter measurement as a function of temperature, and to check temperature coefficient of resistance. Frigtronics, Inc., 525 Broad St., Bridgeport, Conn. 06604. [423]

Voltage/Current Reference Sources WITH .001% STABILITY

ALL MODELS FEATURE:

Voltage mode

8-hour stability: 0.001%
line and load regulation: 0.0001%
output impedance: $10\ \mu\text{ohms}$

Current mode

8-hour stability: 0.002%
line regulation: $100\ \text{m}\mu\text{a}$
load regulation: 0.005%

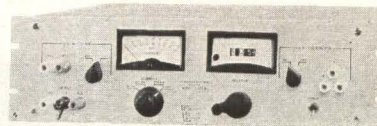

Model TC 602R

Output: 0 to 60V at 2 amps
Absolute Accuracy: 0.1% of full scale
Ripple and Noise: $50\ \mu\text{volts rms}$
Adaptable to constant current operation with external resistors.
Price: \$1185.00

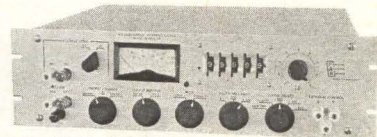

Model TC 100.2BR

Output: 0 to 100V at 200 ma; 0 to 100 ma at 100V
Absolute Accuracy: 0.01% voltage, 0.02% current
Output Selection: 3 ranges 1, 10, 100V/ma full scale
Resolution: $100\ \text{m}\mu\text{a}$ voltage, $100\ \mu\mu\text{a}$ current
Price: \$2050.00

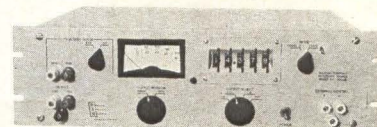

Model TC 100.2R

Output: 0 to 100V at 200 ma; 0 to 100 ma at 100V
Resolution: 1 mv; $1\ \mu\text{a}$
Absolute Accuracy: 0.01% of full scale voltage, 0.02% of full scale current
Price: \$1350.00

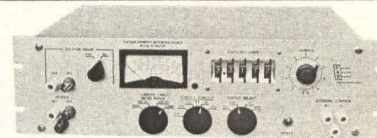

Model TC 602CR

Output: 0 to 60V at 2 amps; 0 to 2 amps at 60V
Resolution: $1\ \mu\text{V}$ voltage, $10\ \text{m}\mu\text{a}$ current
Output Selection: 2 ranges voltage, 3 ranges current
Ripple and Noise: $50\ \mu\text{V rms}$
Price: \$1450.00



Write for Bulletin No. 112D to:

PRINCETON APPLIED RESEARCH CORP.
Box 565, Princeton, New Jersey
Tel: 799-1222, area code 609

SPECTRUM ANALYSER FOR SSB

3 mc to 30 mc
6 cps selectivity

\$4,900

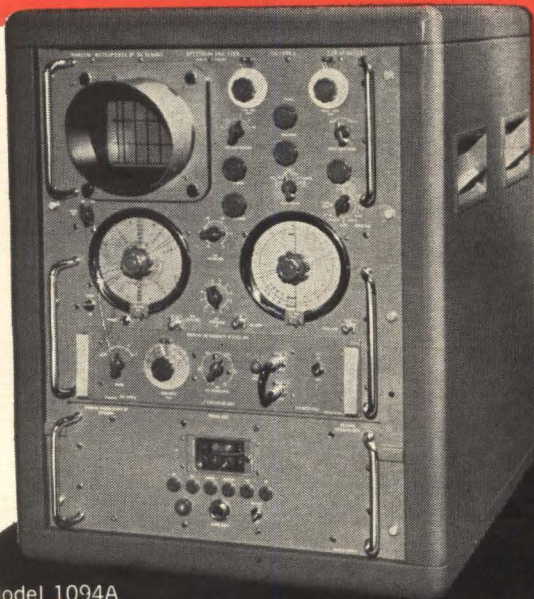

Model 1094A

- L.F. extension unit for 100 cps to 3 Mc.
- Sweep width variable 0 to 30 kc.
- 60db dynamic range.
- Selectivity 6 cps, 30 cps and 150 cps.
- Internal hum and intermodulation below 60db.
- Pre-selection ahead of mixers.
- Triple conversion with xtal band-pass filters.

Write
for detailed
catalog sheet.

MARCONI INSTRUMENTS

DIVISION OF ENGLISH ELECTRIC CORPORATION
111 CEDAR LANE • ENGLEWOOD, NEW JERSEY
Main Plant: St. Albans, England

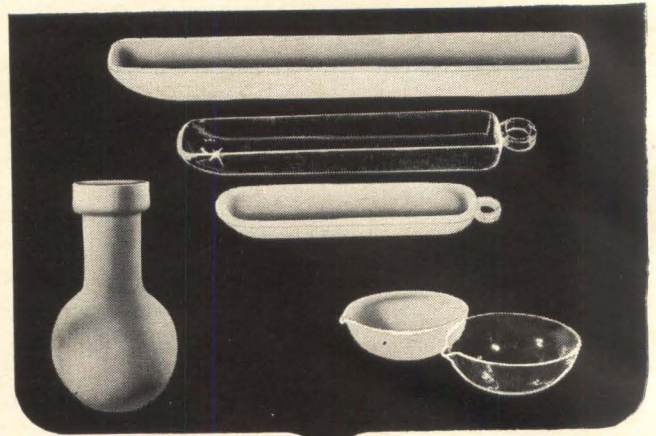

"VITREOSIL"® is the word for VITREOUS-SILICA (PURE FUSED QUARTZ)

No other material has the unusual properties of VITREOSIL pure fused quartz. It takes temperatures up to 1100°C, is unaffected by thermal shock, resists most acids, has excellent light transmission and electrical and heat insulation characteristics. Write for more details.

23



THERMAL AMERICAN FUSED QUARTZ CO.

RT. 202 & CHANGE BRIDGE RD. MONTVILLE, NEW JERSEY

Circle 212 on reader service card

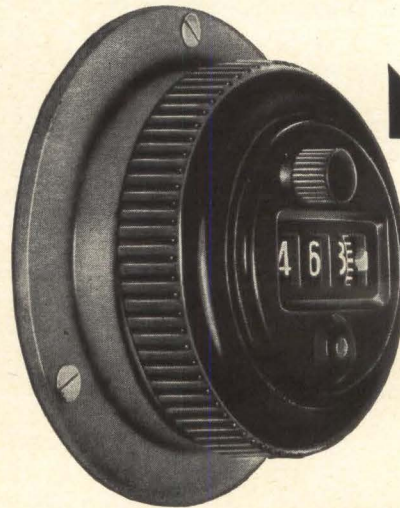

With or
without
locking
device

Counting knob Zivy Z 1003



for mounting on precision
multiturn-potentiometers,
controls of precision instruments,
for machine tools, etc.
read to $\frac{1}{500}$ of a turn
estimate $\frac{1}{1000}$ th
Z 1003 A = On-Panel Mounting
Z 1003 E = Flush Mounting, with flange

Write to:
V. G. Herman
49 West 96th Street
New York 25, N. Y.
Phone:
Riverside 9-3369

New Materials

Metal strip makes cryogenic magnets

Cryotape, a material for making superconducting magnets, is composed of a niobium-tin core encased in a niobium sheath. It may be wound, unwound, and then re-wound without damage to the material. It is $\frac{5}{8}$ in. wide and $2\frac{1}{2}$ mil thick, available in continuous lengths up to 1,000 ft. Cryotape is guaranteed to carry a minimum of 250 amp at zero field; 100 amp at 70 kilogauss field. It has been pulsed to 1 million gauss. Price is \$3 per ft in quantities in excess of 1,000 ft; \$4 per ft, less than 1,000 ft. Minimum order is \$250.

Materials Research Corp., Orangeburg, N.Y. 10962. [411]

Epoxy resin retards flame

Dolphon CW-1070 is a flame retardant Class H epoxy supplied in a one-package, semi-solid form. Designed for use at elevated temperature (180 C), it has been developed for casting, potting and impregnating electrical equipment operating at high temperatures. CW-1070 meets all the requirements of MIL-T-27A, Grades T&U, provides superior high temperature resistance, excellent electrical properties, good mechanical strength, low shrinkage, and extreme flexibility. At 70° F, it has a pot life of at least six months.

John C. Dolph Co., Monmouth Junction, N.J. [412]

Chemical stripper removes wire coatings

Developed to aid electronic assembly work, a new chemical stripper, designated NY-OFF485, represents a one-step system for the removal of various nylon coatings from wire. Nylon-coated wire ends can be dipped in NY-OFF485 to easily wipe away unwanted coating prior to soldering or welding. Wire can be prepared rapidly without fear

of damage to the base metal. The material packaged in ready-to-use form, sells for \$5 a pint and \$8 a quart.

Chemclean Corp., 128-07 Eighteenth Ave., College Point 56, N.Y. [413]

Silver tapes supply conductivity

Conductive silver transfer tapes introduce a new way to produce conductive lands, connections, or circuits on different substrates. This new dry process replaces the present wet application of silver paints and eliminates disadvantages such as irregular thickness, smearing, overflow of the silver layer and waste of expensive silver material. Conductive leads in any pattern or shape can be placed with great accuracy on a desired surface without the necessity of masking the surface not to be coated. The tapes, supplied in rolls, are available in any thickness value (generally between 0.0005 and 0.005 in.) and in any requested width up to $\frac{1}{2}$ to 8 in.)

Vitta Corp., 382 Danbury Park, Wilton, Conn. [414]

Molding compound for semiconductors

A thermosetting material, type 305 silicone molding compound, provides maximum electrical and environmental protection for diodes, transistors and power rectifiers. Semiconductor devices encapsulated in the transfer molding compound operate at a temperature range of -65° to 275° C for a minimum of 10,000 hours. The high flow material permits a high-speed molding cycle and low molding pressures of 150 to 1,000 psi. Even at 200° C, the material shows a dissipation factor of only 0.006 or less at a frequency of 10^5 cps, a low value compared with conventional molding compounds. Also, the compound protects device functions from severe mechanical shock, vibration and high g forces.

Dow Corning Corp., Midland, Michigan. [415]



How high is your goal?

Ours are out of sight—in the labyrinth of space. But your opportunities are a tangible reality, here and now, at North American's Space and Information Systems Division.

COMMUNICATIONS ENGINEERS

The purpose of the ground operational support systems unit is to study the interfaces and to insure compatibility between the lunar spacecraft and ground systems. Work will include GOSS interface specification, compatibility testing, reflectivity study, and signal strength study. These are senior research positions requiring a BSEE degree (advanced preferred) with several years communications and radar systems engineering experience.

The data systems unit will manage all the data handling equipment and part of the data acquisition equipment of the lunar spacecraft. MSEE and experience with PCM telemetry equipment, TV or premodulation equipment and recording devices are required.

The R.F. electronics group is responsible for all R.F. equipment aboard the lunar spacecraft. Work will involve analysis of space communication systems. BSEE with several years communications experience required.

Interested? Please contact:

MR. P. D. GODAN
ENGINEERING AND SCIENTIFIC
EMPLOYMENT
12214 LAKEWOOD BLVD.
DOWNEY, CALIFORNIA

All qualified applicants will receive consideration for employment without regard to race, creed, color, or national origin.

SPACE AND INFORMATION
SYSTEMS DIVISION
NORTH AMERICAN AVIATION



LITTLE CHOPPER



BIG PERFORMER

Where component space is limited—Bristol's Subminiature Chopper offers:

- 0.1 cu. in. size
- complete shielding
- radiation resistance
- airborne environmental ratings
- lowest noise level

Write for detailed spec sheet. **The Bristol Company**, Aircraft Division, 152 Bristol Road, Waterbury, Conn. 06720.

A subsidiary of American Chain & Cable Company, Inc. 4.7

BRISTOL . . . engineers for precision, builds for reliability



New Literature

Converters and multiplexers Texas Instruments Inc., 3609 Buffalo Speedway, Houston, Texas, has announced a 12-page catalog on the series 8000 analog-to-digital converters and multiplexers.

Circle 451 reader service card

Components Cambridge Thermionic Corp., Cambridge, Mass. 02138, offers a completely revised full-time engineering design catalog of its more than 15,000 types of guaranteed Cambion electronic components. [452]

Precision instruments Rohde & Schwarz Sales Co., Inc., 111 Lexington Ave., Passaic, N. J. Catalog describes a precision capacitance meter, inductance meter and limit bridge. [453]

Pin and socket connectors AMP Inc., Harrisburg, Pa. offers a 48-page catalog on the complete line of AMP-Incert series M crimp, snap-in type pin and socket connectors. [454]

Stepping drum programmer Tenor Co., 13460 W. Silver Spring Drive, Butler, Wisc. Bulletin 0164 illustrates and describes a stepping drum programmer that provides a basic method for controlling load circuits in an interlocked predetermined sequence. [455]

Insulating products 3M Co., 2501 Hudson Road, St. Paul, Minn. 55119, offers a brochure containing data and samples of nine of its Class F insulating products. [456]

Scope accessories Tektronix, Inc., P.O. Box 500, Beaverton, Oregon 97005, has prepared a 36-page booklet covering a family of accessories now available for oscilloscopes. Request copies on business letterhead.

Fluid amplifiers Electronic Devices Dept., Corning Glass Works, Bradford, Pa. Bulletin describes fluid amplifier applications, the usefulness and properties of photosensitive glass in making the devices, design and fabrication techniques, and details of several operating devices. [457]

Adjustable stop switches Daven Division of McGraw-Edison Co., Livingston, N. J. A 4-page brochure provides complete specifications and prices on 87 adjustable stop switches that now replace 2,001 standard types. [458]

Precision potentiometers Helipot Div. of Beckman Instruments, Inc., 2500 Harbor Blvd., Fullerton, Calif., has published data sheet 63560 for models 6103, 6213, and 6603 single-turn rotary cermet precision pots. [459]

Magnetic tape transport Digital Equipment Corp., 146 Main St., Maynard, Mass. Bulletin describes tape transport type 570, an electro-pneumatic device that is compatible with IBM 7291-VI format and has a maximum transfer rate of 62,000 six-bit characters per second. [460]

Communications technology Comtek Inc., 435 Main St., Woburn, Mass. Brochure discusses the company interest in, and facilities for undertaking development of a wide variety of electronic and electromechanical devices oriented to microwave concepts and indigenous to the field of communications technology. [461]

Semiconductor testing Semiconductor Specialists, Inc., 5700 W. North Ave., Chicago, Ill. 60639. Bulletin covers the transistor, capacitor, diode, Zener reliability testing and encapsulation services being offered. [462]

Miniature trimmer CTS Corp., 1142 W. Beardsley Ave., Elkhart, Ind. Data sheet 1201 covers the series 201 low-cost miniature knob-operated carbon trimmer variable resistor with wide resistance range. [463]

Telemetry ground station Defense Electronics, Inc., Rockville, Md. Bulletin UPTS-1 describes a self-sufficient telemetry ground station for reception and recording of satellite signals in the 398 to 402-Mc range. [464]

Voltage-current calibrators Computer Test Corp., Route 38 Longwood Ave., Cherry Hill, N.J. Bulletin No. 63-1 presents data on models 1082/1085 voltage-current calibrators, instruments for amplitude analysis of a-c, pulse, or d-c signals from 1 mv to 200 v. [465]

R-f coaxial connectors General RF Fittings, Inc., 702 Beacon St., Boston, Mass. 02115, has issued an 8-page catalog describing series GM micro-miniature r-f coaxial connectors. [466]

Telemetry filters Kenyon Transformer Co., Inc., 1057 Summit Ave., Jersey City 7, N.J., has published an engineering monograph entitled "Optimizing Subminiature Subcarrier Telemetry Filters." [467]

Electronic components National Tel-Tronics Corp., 52 St. Casimir Ave., Yonkers, N.Y. Data contained in a 44 page catalog of electronic component parts are designed for use as a ready reference in purchasing and engineering. [468]

Facilities brochure Intellux Inc., 30 S. Salsipuedes St., Santa Barbara, Calif. Brochure illustrates and describes the company's products and facilities in the areas of: thin-film circuitry; flush, inlaid and multilayer printed circuitry; and electronic components. [469]

Color-coded lever switch The Capitol Machine and Switch Co., 36 Balmforth Ave., Danbury, Conn. Single-page bulletin describes and illustrates the HLL 3-position lever switch with color coded positions. [470]

Semiconductor test equipment Fairchild Semiconductor Instrumentation, 844 Charleston Road, Palo Alto, Calif. A brochure describes eight high-speed, high-volume testers designed to serve both semiconductor users and manufacturers. [471]

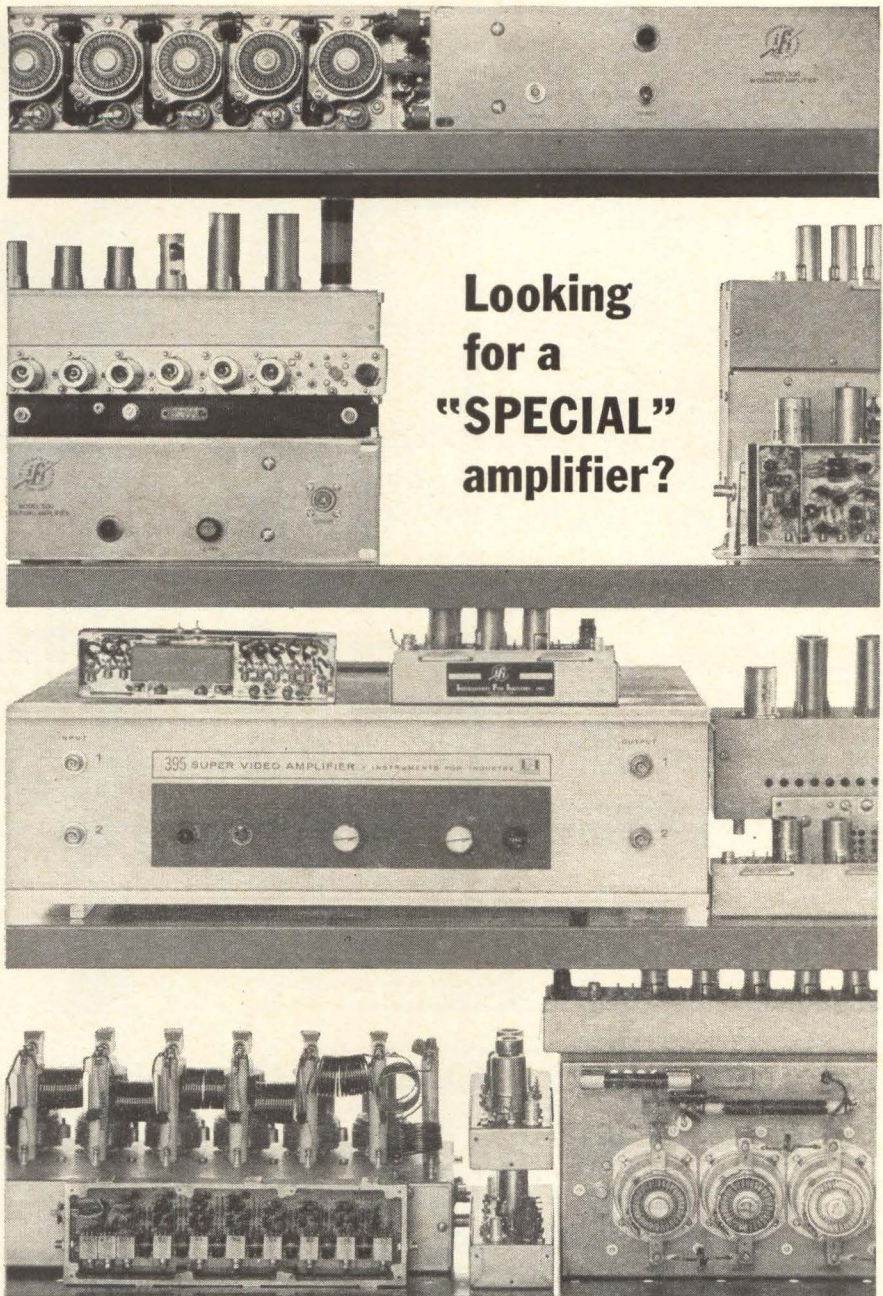

Looking
for a
"SPECIAL"
amplifier?

CHANCES ARE WE'VE BUILT IT

Nobody builds **more** amplifiers, or **more types** of amplifiers: IF, RF, Broadband, High Power, Video, Low Noise, Nuvistor, Transistorized. Distributed, VHF, UHF . . . you name it.

It will pay you to check with IFI, **headquarters** for amplifiers, RF, ECM, ECCM, training and automatic checkout systems.

Ask for latest spec bulletins, or better yet, 'phone our Customer Service Engineer: OV 1-7100 (Code 516).



INSTRUMENTS FOR INDUSTRY, INC.

101 NEW SOUTH ROAD,
HICKSVILLE, L.I., N.Y.

NEW!
Complete Engineering and Specification Catalog



free catalog
STANDARDIZED COMPONENTS

KEYSTONE

Write for Catalog

TERMINALS

PRE-PUNCHED BOARDS

BATTERY HOLDERS

TERMINAL BOARDS



KEYSTONE ELECTRONICS CORP. • 49 BLEECKER ST., NEW YORK 12, N.Y. • GRamercy 5-4600

Circle 214 on reader service card

IN FLORIDA

your most strategic location is

PLANT CITY

SEND FOR INDUSTRIAL SURVEY

HERE'S WHY

LOCATION AND TRANSPORTATION — Located just outside the higher cost metropolitan Tampa-St. Petersburg areas, Plant City is served by Florida's two principal railroads and by numerous truck lines. Only minutes away from the Port of Tampa and Tampa International Airport.

LABOR . . . AVAILABLE LOCALLY — A ready supply of local production workers, male and female, already proven quickly adaptable in learning specialized skills.

LIVING . . . AN ESTABLISHED COMMUNITY — Industry is welcome in this busy, progressive 70-year-old city with educational, civic and cultural advantages.

LAND . . . NEW, CITY OWNED INDUSTRIAL PARK — 350 acre, municipally-owned Industrial Park, engineered for all types of industry. Has adjoining airport and spurs of Atlantic Coastline and Seaboard railroads. Utilities include natural gas. Many other excellent locations, small or large acreage, nearby.

PLANT CITY INDUSTRIAL DEVELOPMENT COMMITTEE
Dick Prewitt, General Manager • P. O. Box 1509 - J15, Plant City, Florida

CITY MOST CONVENIENT TO ALL FLORIDA

138 Circle 138 on reader service card



SPILL PROOF STORAGE BATTERIES

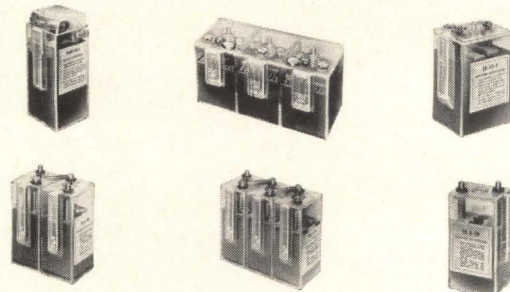

These special, Electrolyte Retaining Batteries, are designed for applications requiring a compact source of dependable power. They offer the portability of dry cells but provide the stable voltage, current producing capabilities, reliability and economy of lead-acid storage batteries. Pricing is favorable for mass-market applications. **Spill-Proof** — This feature is attained through top construction of the cells and by use of separators which retain 80% of the electrolyte. Volume of free electrolyte is relatively small, when compared with that of the conventional storage battery. **All-Position Operation** — Retention of electrolyte in the separators permits operation in any position with minimum loss in output and little change in center of gravity. **Charge Indicator** — Built-in, ball-type specific gravity indicators show full charge and when to recharge. **Construction** — Transparent plastic containers and covers make possible permanent, leak-proof seals and rugged, light-weight construction. **Versatile** — A wide range of stock batteries and cells is available. This is extended by factory assembly of stock units into multiple cell batteries to meet voltage and space requirements. Many types are produced and certified under Military Specifications.

For complete information write:

Wisco manufactures over 200 Charge Retaining and conventional lead-acid battery types.



WISCO

DIVISION

The Electric Storage Battery Co. 

1222 — 18th Street, Racine, Wis. 53403

Circle 216 on reader service card

New Books

Pulse Circuits

Basic Pulse Circuits, by Richard Blitzer, McGraw-Hill Book Co., New York, 436 p, \$11.75.

This book has two noteworthy features: it gives both vacuum-tube and transistor circuits for almost every type of pulse circuit covered, and describes the operation of both in minute detail.

Although written for the technician who wants to upgrade himself, the book is a useful reference for an engineer unfamiliar with pulse circuits, or who needs occasional brushing up.

The topics covered are mostly those included in the senior term of the electronic technician course taught at RCA Institutes, where the author has been an instructor for the past 16 years: networks, pulse amplifiers, linear and non-linear waveshaping, multivibrators, time-base oscillators and generators, binary and octal systems and electronic counters, gates, pulse-circuit applications, and transient analysis.

Stephen B. Gray

Lasers

Masers and lasers: How they work, what they do, by M. Brotherton, McGraw-Hill Book Company, New York, 1964, 207 p, \$8.50.

An addition to the small but growing number of books on lasers, Dr. Brotherton's volume is written for the nonspecialist. It explains the basic principles of masers and lasers, gives the necessary technical background in nontechnical language, and tells the story of how these devices were discovered, developed and built, and what they may be used for.

The book develops the concept of energy levels and level transitions, then goes on to show how the first maser was built and why it could not have been built any other way. Successive chapters describe the next development—the ruby laser, the semiconductor junction laser, and finally the real and projected applications, with stress on communications.

This is not a book for the physicist, but it will give the engineer

who is working in a more conventional field the necessary perspective for understanding and evaluating new laser and maser developments. The technical executive can derive from it the basic knowledge he will need when lasers and laser applications become commercial items. To the reader who has no professional interest whatsoever in lasers or in masers, Dr. Brotherton's well written book will tell a fascinating story of one of our time's most amazing inventions.

George V. Novotny

Space electronics

Appointment In The Sky: The Story of Project Gemini, by Sol Levine, with foreword by President Lyndon B. Johnson, Walker and Company, New York, 1964, 214 p, \$5.

Although basically not a technical work, Sol Levine's book is useful in placing the U. S. and Soviet space programs in perspective. Billed as "the story of Project Gemini," the book does more to describe the motivation and mission profiles of the Mercury, Gemini and Apollo programs with pertinent details on the Vostok series added. The book is a result of the efforts of Martin Company's deputy technical director for Gemini to interpret the manned space program for the general public. While the purpose is to be commended, one cannot help but notice the large number of Martin Co. mentions throughout the book.

For the engineer who follows U. S. and Soviet developments, the author does quote Drew Pearson in giving names of three Soviet cosmonauts said to have perished in the early Soviet space efforts. He cites the cases of Cosmonauts Alexis Ledovsky and Terenty Shiberno who, in separate flights in 1957, were reportedly sent 200 miles into space and never recovered. In January, 1959, Andrei Mitkov's launch vehicle reportedly blew up on the launch pad 20 seconds after lift-off. It wasn't until April, 1961 that the Russians succeeding in sending Yuri Gagarin into orbit and recovering him.

The U. S. has had its moments,

THE SENSATION OF WESCON '63



... hundreds sold since

TR-104 Solid State Telemetry Receiving System from Astro Communication Laboratory

We've been struggling to keep up with demand for the TR-104 ever since its wildly-successful introduction at WESCON last summer.

And no wonder. This VHF/UHF telemetry receiver is one exciting package, combining versatility, highest quality components and construction, and a large helping of design ingenuity.

Our people have prepared eight pages of specs about it—your copy will be on its way just as soon as we hear from you. In the meantime, ponder these features:

- Completely solid state for reliability and high MTBF.
- All-modular construction.
- Covers 55-2300 mc range with 8 plug-in RF heads.
- Ten IF bandwidths (10 kc to 3.3 mc).
- Four IF bandwidth amplifiers and matching demodulators may be installed at one time; bandwidths switchable from front panel.
- Crystal VFO; VFO/AFC controlled front ends.
- Four meters (tuning, signal strength, video output, deviation).
- Crisp, human-engineered styling; all operating controls on front panel; inputs and outputs on rear panel.
- Requires only 35 watts of power... may be battery-operated in field.

Ask us about other new telemetry and surveillance receivers designed and produced by Astro Communication Laboratory. Write, wire or phone:

ASTRO COMMUNICATION LABORATORY

DIVISION OF AERO GEO ASTRO CORP.
801 Gaither Road
Gaithersburg, Maryland
Phone: 301-948-5210 • TWX 703-354-0334
"RF Equipment for the Systems Engineer"

Technical Abstracts

Alphanumeric display

The Matricon, an Alpha-Numeric Target Cathode Ray Symbol Tube,* R. Winfield, Sperry Gyroscope Co., Great Neck, L.I.

The Matricon is an electrical-output cathode-ray tube for generating alphanumeric symbol signals for television-type presentation in which they are combined with video-intensity modulation signals for simultaneous display.

Symbols are generated in the Matricon by an alphanumeric matrix target that controls the incident electron beam from an electrostatic electron gun to a signal-collector element. The metallic elements comprising the target are individually controlled and selected for each symbol, permitting digital techniques for symbol selection. The entire target is used for each display and thus there is no magnification of beam position error between tube and display.

The resulting signals can be accurately timed and automatically controlled by standard computer techniques. They also have wide bandwidths for compatibility with nonstandard, high-resolution television displays.

Scan conversion

Scan Conversion as Applied to Manual Multichannel Tracking, John Cole and Ray Winfield, Sperry Gyroscope Co., Great Neck, L.I.

This paper describes a system that allows a single operator to keep several radar target displays continuously updated.

Each tracking channel has its own cathode-ray storage-tube scan converter to store the new scan information. The stored information is fed sequentially from each scan converter to a common television monitor displaying the radar return picture; each channel is fed in upon completion of data entry from the previous channel.

The system uses a one-gun magnetic storage tube with electrical output to minimize read-write registration errors, and has enough storage-time capacity to retain the written information even for the

slowest practical antenna-scan periods. Old information is automatically erased when an operator enters the target-position error, which is done by a joy-stick-controlled target-hook marker.

Among the system's advantages are the nonfading, high-brightness, constant-intensity video and automatic target sequencing on a single display, leading to less operator fatigue and more efficient operation.

Presented at the Third National Symposium of the Society for Information Display, Feb. 24-28, San Diego, Calif.

Particle counter

Junction counters produced by ion implantation doping, F.W. Martin, W.J. King, S. Harrison, Ion Physics Corp., Burlington, Mass.

A solid-state silicon radiation counter has been developed for detecting and analyzing low-energy charged particles. Although nuclear spectroscopists have a choice of three other counters (diffused-junction, lithium-drift and surface barrier) for special purposes, the new counter covers the main characteristics of the three others and serves as a multipurpose device.

Implanting impurity-doping ions near the surface of a semiconductor offers a means of permanently creating a surface region of a given type of conductivity. This technique has been used to insert acceptor ions in a silicon lattice and to produce a surface region in a junction counter similar to that in a thin-diffused counter.

However, the concentration of acceptors as a function of depth below the surface can be altered from the usual profile obtained by diffusion. Dead layers can be thinner than in most diffused counters. The surface region may be regarded as one intermediate between that in a surface-barrier and a diffused-junction counter, in which the charge responsible for the formation of a junction has been implanted so close to the surface that many characteristics of a barrier are retained, but conduction in a direction parallel to the surface is by holes and electrons in a

New Mayflower Air-Ride vans give softest, safest ride for any move



Sensitive, High-Value Commodities—Ride 86% softer! Mayflower Air-Ride vans are running coast-to-coast. Available upon request, planned ahead, at no extra cost.

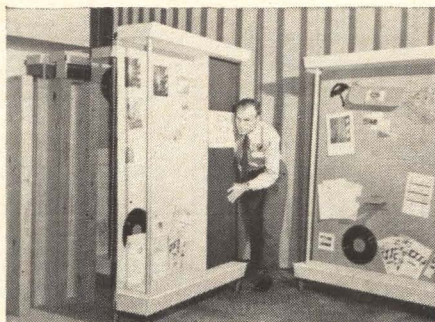

Exhibits—Mayflower assures on-time delivery, eliminates rough riding and handling. Crating seldom required. Most displays can have Air-Ride vans for point-to-point or exhibit tours.



Household Goods—Trained movers and exclusive agents help key people you transfer. No Mayflower vans have tailgates. Everything rides safely locked inside, out of the weather.



IMPORTANT: Mayflower has more Air-Ride vans than all other movers combined. Call Mayflower's agent for help. He's in the phone book Yellow Pages in over 2700 localities. AERO MAYFLOWER TRANSIT CO., INC. • INDIANAPOLIS
America's Most Recommended Mover

ENGRAVE EVERYTHING FROM 6 FT. PANELS TO TINY NAMEPLATES

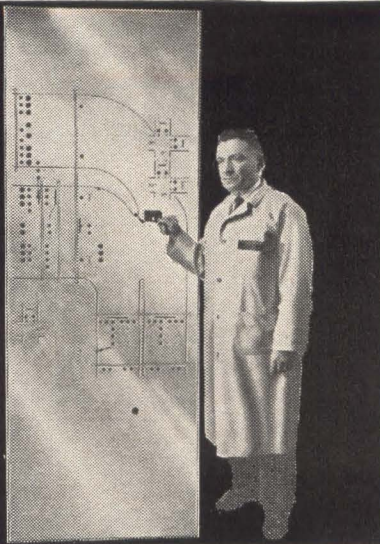

**Tracer-guided arm guides the worker—
makes everyone a skilled engraver.**

Convenient—It's right in the plant when and where you need it.

Accurate—Positive depth of cut with automatic depth regulator. 15 accurate ratios.

Speedy—Self-centering work holder cuts set-up time in half.

Ask for complete, illustrated catalog EE-14

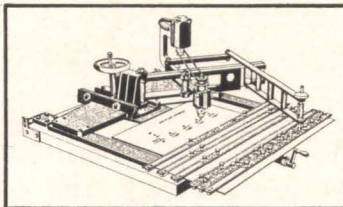

new hermes engraving machine corp.

154 WEST 14th ST., NEW YORK 11, N. Y. Chicago, Atlanta, Dallas, Los Angeles, Montreal

It stands alone



Hydrazine-Activated Flux* and Core Solder offers an exclusive combination of advantages:

- High wetting properties for good "bite."
- Non-corrosive connections.
- Residues removed by heating or water rinse.
- No change on aging.

No one flux is best for all purposes. TEST HYDRAZINE FLUX AND CORE SOLDER FOR YOURSELF. The liquid permits pre-fluxing, is useful for soft-soldering a wide range of copper and copper-based alloys. The core solder flows at an ideal rate, leaves a minimum of soldering residues. Write for samples of either, or technical literature.

Available only from Fairmount and its sales agents. *U.S. Patent No. 2,612,459 and others

Fairmount
CHEMICAL CO., INC.
136 Liberty St., N. Y. 6, N. Y.

NEW

Packed with more important data than ever before...

the 1964-65 issue of **Electronics Buyers' Guide.**

Four great major sections: Product Listings; Product Advertising; Index of Electronics Manufacturers; Government, Other Agencies and Technical Services.

USED

Week in, week out, EBG is the industry's standard catalog-directory... a necessary working tool for the men who buy and the men who sell components, equipment, systems, materials and services.

Electronics Buyers' Guide
A McGraw-Hill Publication
330 West 42nd Street,
New York, N.Y. 10036

p-region below the surface oxide layer.

Using the implantation technique, large-area (122 mm²) counters have been produced in 10,000 ohm-cm of silicon with resolutions as good as 50,000 electron volts at 40-volt bias. Dead layers and resolution of these counters are better than in typical diffused-junctions counters, and the resolution of these counters is better than typical barrier counters of the same size.

Present designs cannot compete with lithium-drift devices in depletion depth, but are useful for high-resolution spectroscopy.

Presented at ninth scintillation and semiconductor counter symposium sponsored by the IEEE, AEC and NBS, Feb. 26, 1964, Washington, D. C.

Decimal memory

Polycrystalline Ferroelectric Multiremanence Memory Elements,* C.E. Land, G.W. Smith and I.D. McKinney, Sandia Laboratory, Albuquerque, New Mexico.

A new computer memory element stores data directly in decimal form. Memory devices used in nearly all modern computers now store information in binary form, using devices with only two stable states, such as magnetic cores. Thus, they can remember only two digits. In contrast, the new element can be made to have ten or stable states, thus allowing a computer using this memory to make its calculations directly in the more convenient decimal system.

The new memory element is made possible by the development of a technique for hot pressing piezo-electric ceramics. Several types of elements have been constructed using lead-zirconate-titanate ceramic materials. Information is stored in the element by applying a fixed number of voltage pulses of sufficient magnitude and duration to change the effective polarization of the material in small increments. The resulting stable polarization state may be detected by measuring the small-signal response of the element. One simple method of doing this is to switch the element into the tuned circuit of an oscillator. The resulting oscillator frequency corresponds to the information state of the element.

In addition to having many levels

of storage capacity, the new element is said to have three other important characteristics; the data can be read out nondestructively, little energy is required to switch from one state to another and little time is required to switch from one state to another.

In addition to computer applications, the new element is claimed to have important potential for use in f-m discriminators, tunable filters, voltage variable coupling transducers, ceramic transformers and stress or strain sensors.

Sealing components

New Composite Materials for Packaging Semiconductor Devices,*
A.M. Huntress, Texas Instrument Incorporated, Attleboro, Mass.

Advances made in materials for packaging semiconductor devices are described. One new composite material for sealing metal-to-glass in the manufacture of eyelets and headers allows transistors to operate at three times the normal power level with no increase in junction temperature. The material consists of a layer of copper, clad on both sides with F-15 Alloy (iron-nickel-cobalt). Addition of the copper layer increases thermal conductivity to roughly 15 times that of solid F-15 Alloy, does not detract from basic requirements for a glass sealing material.

Another new material is a composite foil for weldable printed circuits. This weldable foil has high peel strength between the foil and epoxy-filled fiberglass substrate. In addition, with the composite material, the weld nugget is confined to the upper layers of the foil and helps prevent damage to the substrate. The three-layer foil has a thin top layer of nickel, an intermediate layer of steel and a thin bottom layer of aluminum. Each material has a specific function. The nickel provides a weldable surface, and has a low electrical resistivity which helps keep the welding current confined to the upper layer of the foil. It also alloys easily with conventional lead materials. The steel layer provides a thermal barrier. The aluminum layer provides high bond strength to an epoxy glass substrate. This particular setup is intended primarily for integrated circuits which have flat,



*...when your order for foil
and sheet comes to us*

If you need Aluminum Brazing Foil, we can help you. We have 713 and 718 brazing alloys in stock, ready and waiting to help you solve your brazing problem.

Fast shipment on orders is another service we are proud of—twenty-four hours after receipt of your order is standard shipping practice with us.

We can slit to your specifications—that is a specialty of ours. We can sheet foil—that is another specialty of ours.

Call or write and let our specialists serve you.

Check and return to us for our price schedule ALC 286-5.



American Lamotite Corporation

2914 EAST 81st ST. • CLEVELAND, OHIO 44104 • AREA CODE 216, PHONE 271-1000

Circle 143 on reader service card

To order reprints: Fill in, cut out coupon below, insert in envelope and mail to: **Electronics Reprint Dept.,
330 W. 42nd Street, New York, N.Y. 10036**

Reprint order form

For listing of reprints available see the Reader Service Card.

Modern Electronic Packaging

Send me reprints of Key no. R-48 at 50¢ each.

For reprints of previous special reports fill in below:

Send me reprints of Key No.(s) @ ¢ each.
(For prices, see Reader Service Card)

Name

Number of street

City, State, Zip code



*If circuit problems got you beat
And connector specs are hard to meet
Don't cry or cuss or rant or rage,
Just grab the phone and call for . . .*

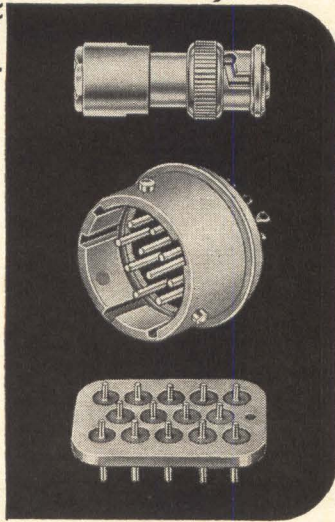

DAGE

Skilled DAGE engineers are ready at all times to help you solve unusual problems in the highly specialized field of

RF CONNECTORS and Hermetic Glass Seals

For your everyday needs, DAGE can ship from stock within 24 hours. DAGE reliability is known throughout the world.

Write for Catalog and Prices

DAGE • FIRST in Ideas • FIRST in Quality • FIRST in Service
ELECTRIC COMPANY, INC.
 FRANKLIN, INDIANA • PHONE 317/736-6136

Circle 215 on reader service card

HAVE YOU CONSIDERED USING PHOTOCELLS?

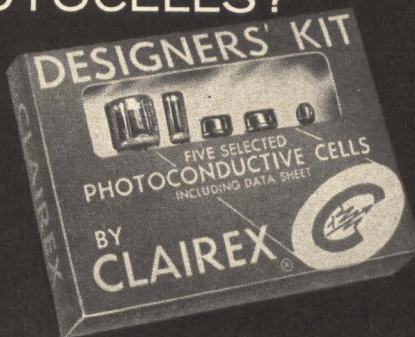

WE'VE JUST MADE IT EASY FOR YOU . . .

New! — from Clairex — a selection of photoconductive cells, varying in sensitivity, spectral response, speed and size to suit most applications, and including the CL505, CL603A, CL704L, CL707 and CL902 — in convenient kit form complete with technical data — only \$10.00.

Free On Request —
 Designers' Kit Information
 plus New 1964 Edition
 16 page Designers' Manual

CLAIREX

"The LIGHT Touch in Automation and Control"

8 West 30 Street, New York, N. Y. 10001, 212 MU 4-0940

gold-plated F-15 Alloy leads.

Frame parts of F-15 Alloy contain a stripe of aluminum metallurgically-bonded on each side, for integrated circuit packages. This composite material suggests the possibility of bonding the leads directly to the semiconductor device. The lead frame parts are turned out in continuous lengths. They are separated to serve as the integral connection from the semiconductor device to the external circuit in flat packaged circuits. Tips of the leads are clad in aluminum.

Sampling system

Simple Submicrosecond Transient Sampling Techniques,* D.N. Bray and H.J. Jensen, Sandia Corp., Livermore Laboratory, Livermore, Calif.

This technique is useful where the event to be observed occurs only once, or where reduction to a form for digital computer processing is required.

This sampling system is built about a transmission line that has 30 memory units, each consisting of 120 tunnel diodes in series, attached at intervals along the line. The unknown signal is applied and propagates down the line, where it is detected at one of the early memory units and a trigger pulse is generated or is supplied externally. The trigger pulse, which must have more amplitude than the maximum of the unknown signal, is applied at the opposite end of the line just before the unknown signal arrives and propagates in a direction opposite to the input. The memory stores the maximum negative potential seen during propagation of the two pulses. Thus, the peak value sensed is the amplitude of the trigger pulse minus the amplitude of the unknown pulse at the memory gate when the trigger pulse arrives, and the voltage recorded is the complement of the input.

The technique allows the reconstruction of an unknown pulse up to about one microsecond along from a series of samples taken as often as every 10 nanoseconds, with sample apertures of about 2 to 15 nanoseconds.

* Paper presented at International Convention of the IEEE, held in New York City, March 23-26, 1964.

EMPLOYMENT OPPORTUNITIES



The advertisements in this section include all employment opportunities — executive, management, technical, selling, office, skilled, manual, etc.

Look in the forward section of the magazine for additional Employment Opportunities advertising.

— RATES —

DISPLAYED: The advertising rate is \$52.00 per inch for all advertising appearing on other than a contract basis. Contract rates quoted on request.

An advertising inch is measured 7/8" vertically on a column—3 columns—30 inches to a page.

Subject to Agency Commission.

UNDISPLAYED: \$2.70 per line, minimum 3 lines. To figure advance payment count 5 average words as a line.

Box numbers—count as 1 line.

Discount of 10% if full payment is made in advance for 4 consecutive insertions.

Not subject to Agency Commission.

New York • Los Angeles • St. Louis • Minneapolis • Atlanta

EE-MATH

**CONFIDENTIAL
SELECTIVE
FEE-PAID
ALL DEGREES**

SEND RESUME TO:



**AEROSPACE
PLACEMENT CORPORATION**
P.O. Box 2125 Philadelphia, Pa. 19103



E. E.'s
for FEE-PAID Positions
WRITE US FIRST!
Use our confidential application for professional, individualized service . . . a complete national technical employment agency.
ATOMIC PERSONNEL, INC.
Suite 1207L, 1518 Walnut St., Phila. 2, Pa.

EMPLOYMENT OPPORTUNITIES:

for all employment advertising including Positions Vacant or Wanted and Selling Opportunities Offered or Wanted.

SEARCHLIGHT SECTION:

A national medium for Surplus New or Used Equipment and other Business Opportunities.

PROFESSIONAL SERVICES:

A dignified method for Specialized consultant skills and services.

**BENEFIT YOURSELF BY
ADVERTISING IN THESE
SECTIONS**

For Rates and Information Write:

Electronics

Classified Advertising Div.,
P.O. Box 12, New York, 10036

Employment

Electronics

Opportunities

**QUALIFICATION FORM
FOR POSITIONS AVAILABLE**

ATTENTION: Engineers, Scientists, Physicists

This Qualification Form is designed to help you advance in the electronics industry. It is unique and compact. Designed with the assistance of professional personnel management, it isolates specific experience in electronics and deals only in essential background information.

The advertisers listed here are seeking professional experience. Fill in the Qualification Form below.

Strictly Confidential

Your Qualification Form will be handled as "Strictly Confidential" by Electronics. Our processing system is such that your form will be forwarded within 24 hours to the proper executives in the companies you select. You will be contacted at your home by the interested companies.

What To Do

1. Review the positions in the advertisements.
2. Select those for which you qualify.
3. Notice the key numbers.
4. Circle the corresponding key number below the Qualification Form.
5. Fill out the form completely. Please print clearly.
6. Mail to: Classified Advertising Div., Electronics, Box 12, New York, N. Y. 10036.

COMPANY	SEE PAGE	KEY #
AEROSPACE PLACEMENT CORP. Phila., Pa.	145	1
ASSEMBLY PRODUCTS, INC. Chesterland, Ohio	150*	2
ATOMIC PERSONNEL, INC. Phila., Pa.	145	3
GUIDED MISSILE RANGE Div. of Pan American World Airways, Inc. Patrick AFB, Fla.	150*	4
IBM CORP. Owego, New York	147	5
MOTOROLA, INC. Scottsdale, Arizona	146	6
NATIONAL CASH REGISTER CO. Hawthorne, Calif.	149*	7
SPACE & INFORMATION SYSTEMS DIV. North American Aviation, Inc. Downey, Calif.	135	8

* These Advertisements appeared in the April 6, issue.

(cut here) (cut here)

Electronics Qualification Form For Positions Available

(Please type or print clearly. Necessary for reproduction.)

Personal Background

Name
Home Address
City Zone State
Home Telephone

Education

Professional Degree(s)
Major(s)
University
Date(s)

Fields of Experience (Please Check)

42064

- | | | |
|--|--|---------------------------------------|
| <input type="checkbox"/> Aerospace | <input type="checkbox"/> Fire Control | <input type="checkbox"/> Radar |
| <input type="checkbox"/> Antennas | <input type="checkbox"/> Human Factors | <input type="checkbox"/> Radio—TV |
| <input type="checkbox"/> ASW | <input type="checkbox"/> Infrared | <input type="checkbox"/> Simulators |
| <input type="checkbox"/> Circuits | <input type="checkbox"/> Instrumentation | <input type="checkbox"/> Solid State |
| <input type="checkbox"/> Communications | <input type="checkbox"/> Medicine | <input type="checkbox"/> Telemetry |
| <input type="checkbox"/> Components | <input type="checkbox"/> Microwave | <input type="checkbox"/> Transformers |
| <input type="checkbox"/> Computers | <input type="checkbox"/> Navigation | <input type="checkbox"/> Other |
| <input type="checkbox"/> ECM | <input type="checkbox"/> Operations Research | <input type="checkbox"/> |
| <input type="checkbox"/> Electron Tubes | <input type="checkbox"/> Optics | <input type="checkbox"/> |
| <input type="checkbox"/> Engineering Writing | <input type="checkbox"/> Packaging | <input type="checkbox"/> |

Category of Specialization

Please indicate number of months experience on proper lines.

	Technical Experience (Months)	Supervisory Experience (Months)
Research (pure, fundamental, basic)
Research (Applied)
Systems (New Concepts)
Development (Model)
Design (Product)
Manufacturing (Product)
Field (Service)
Sales (Proposals & Products)

Circle Key Numbers of Above Companies' Positions That Interest You

- 1 2 3 4 5 6 7 8 9 10 11 12 13 14 15

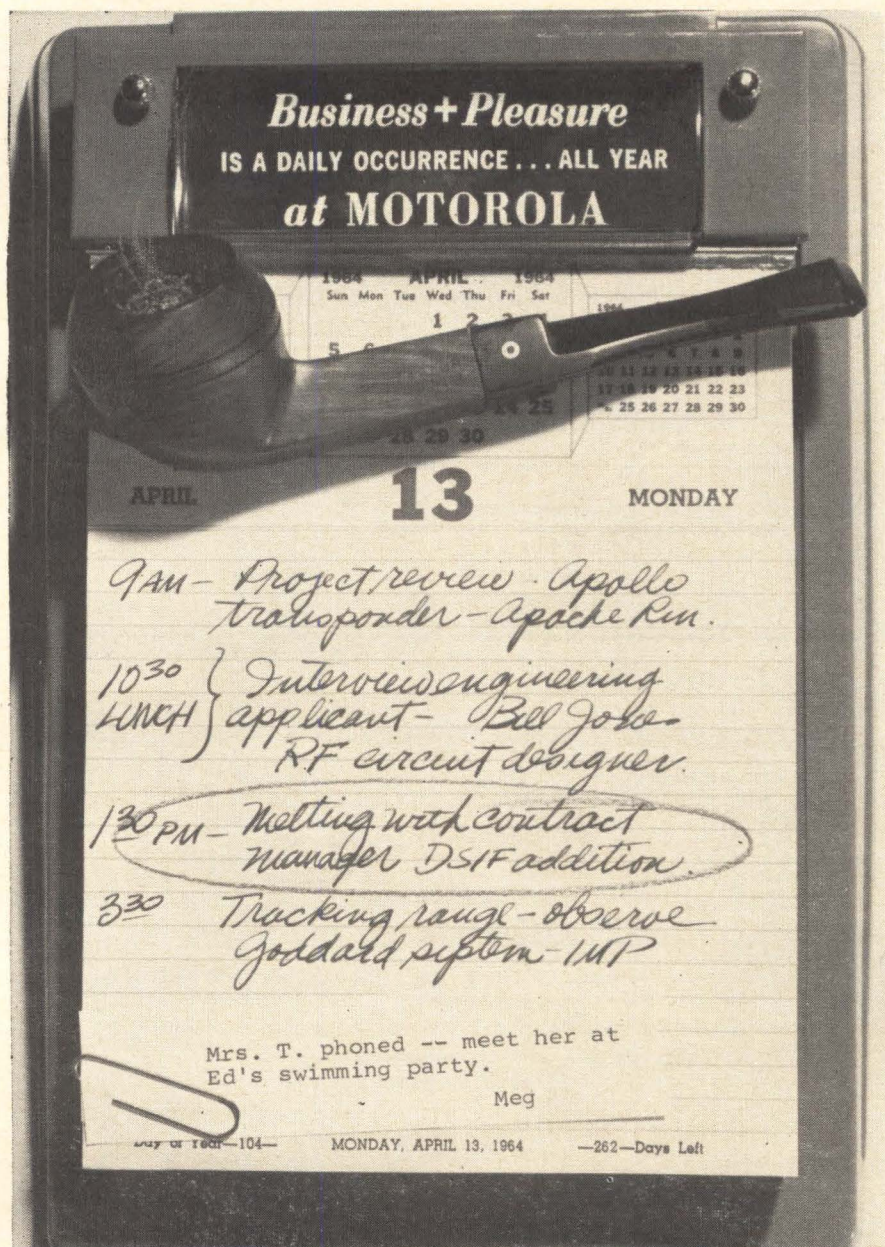

A CALENDAR JAM-PACKED WITH OPPORTUNITY for career fulfillment in aerospace electronics can be yours at Motorola in Phoenix. There's exciting, pace-setting work to be done on Gemini, Apollo and other equally advanced projects — interspersed with wonderful fun-in-the-sun weekends the year 'round, that add a zestful new dimension to living. Check these opportunities:

- | | | |
|---------------------------------|--|-------------------------|
| Antennas & Propagation | Reliability Analysis | Guidance & Navigation |
| Solid State R. F. | Parts Reliability | Command & Control |
| Microwave Techniques | Reliability Program Coordination | Space Communications |
| Missile & Space Instrumentation | Data Acquisition, Processing & Display | Signal Processing |
| Operational Support Equipment | CW Transponders | ECM, CCM & Surveillance |
| Integrated Circuitry | Radar and Radar Transponders | Tracking & Telemetry |

Contact Phil Nienstedt, Manager of Recruitment, Department 654



Military Electronics Division • Western Center • P.O. Box 1417, Scottsdale, Arizona
MOTOROLA ALSO OFFERS OPPORTUNITIES AT CHICAGO, ILLINOIS — AN EQUAL OPPORTUNITY EMPLOYER

SEARCHLIGHT SECTION

(Classified Advertising)
BUSINESS EQUIPMENT
— USED OR RESALE
OPPORTUNITIES

STEPPING SIGMA HERMETICALLY
SWITCHES KURMAN SEALED
SENSITROLS WARD LEONARD
STRUTHERS M. AUTOMATIC
DUNN ELECTRIC
ROTARY RACHET LEACH
ALLIED CLARE
LEDEX EVENS
CLARE NOLD
LEACH RANCE
MINIA ALLIED
SIGMA CRAFT
NORTH LEDEX
ELECTRIC KEYING
DORMEYER PHILLIPS
TELEPHONE CONTROLS
TYPE AMPERITE
KURMAN PRODUCTION WESTERN
STEVENS QUANTITIES ELECTRIC
ARNOLD MOST MAKES CUTLER
IN STOCK HAMMER
CONTACT Send for GENERAL
MERCURY Latest ELECTRIC
SOLENOIDS Catalog GUARDIAN
ADVANCE E CONTACTORS
ALLEN BRADLEY PRICE ELECTRIC
POTTER SQUARE D WESTON
BRUMFIELD MINIATURE AIRCRAFT

LARGEST STOCK OF RELAYS IN THE WORLD

Universal RELAY CORP.

42 WHITE ST. NEW YORK 13, N. Y. WALKER 5-6900

CIRCLE 961 ON READER SERVICE CARD

TEST EQUIPMENT

Germ. Transistor Asby, Eq. Lab. Xtal Grow, Auto. GE and SIL Diode and Trans. Test Eq.

FS-4122, Electronics
255 California St., San Francisco, Calif.
94111

CIRCLE 962 ON READER SERVICE CARD

TOP BRAND ELECTRON TUBES • WE BUY AND SELL

- ★ EXCESS INVENTORIES
- ★ TERMINATION CONTRACTS
- TERRIFIC SAVINGS!

Send for FREE Buyers' Guide

METROPOLITAN SUPPLY CORP.
443 PARK AVE SOUTH • NEW YORK 16, N. Y.
212-MU 6-2834 • TWX 212-867-5888

CIRCLE 963 ON READER SERVICE CARD

RADAR AUTO-TRACK & TELEMETRY ANTENNA PEDESTALS
3 & 10 CM. SCR 584 AUTOTRACK RADARS. M-33 RADAR
TPS-1D SEARCH. APS-45 TPS-10D HT. FINDERS. WX RADARS.
FPN-32GA. APS-10 APS-15B APS-27 (AMTI) SEARCH. ■
APN-102 DOPPLER. DOZENS MORE. CARCINOTRONS. PPN'S.
.25-.5-1-2-3-6 MEGAWATT PULSE MODULATORS. CAVITIES.
PULSE TRANSFORMERS. IF STRIPS. WAVEGUIDE. BENDS
200 MC. 1 KMC. 3 KMC. 6 KMC. 9 KMC. 24 KMC. RF PKGS.

RADIO RESEARCH INSTRUMENT CO.
550 5TH AVE., NEW YORK 36, N. Y. JU 6-4691

CIRCLE 964 ON READER SERVICE CARD

WRITE FOR NEW **KEYSTONE**
free catalog

**BATTERY HOLDERS, TERMINALS,
TERMINAL BOARDS & HARDWARE**

KEYSTONE ELECTRONICS CORP.
49 BLEECKER ST., NEW YORK 12, N. Y.

CIRCLE 968 ON READER SERVICE CARD

Electronics | April 20, 1964

KAY ELECTRIC Sweep Generator
Model 110 A Mega Sweep..... 275.00

KEY ELECTRIC Marka Sweep
Model Video 50..... 275.00

KAY ELECTRIC Kile Sweep
Model 134 B..... 275.00

NARDA Impedance Meter
Model V-127 "V"-Band..... 295.00

BOONTON RADIO CORP.
Transistor Test Set Model 275-A..... 350.00

De MORNEY-BORNARDI
Precision Attenuator DBB-410..... 150.00

HEWLETT PACKARD Power Supply
Model 715 A..... 125.00

VARIAN CORP. Graphic Recorder Model G-10,
Dual Range 1 MV and 10 MV..... 195.00

E-H RESEARCH LABS. Millimicrosecond Pulse
Generator, Model 120 B..... 350.00

BIRD Wattmeter TS-118 A 20 to 1400 MCS
20 to 500 Watts..... 250.00

NARDA-ALOE Ultrasonic Cleaning Machine,
Model 1501-A, 300 Watts, 40 KC, 5 Gal.
Tank 350.00

WATERMAN Pocketscope Model S-15 A Twin
Tube Dual Tracer..... 150.00

HEWLETT PACKARD Directional
Couplers, Model G 752 D..... 100.00

HEWLETT PACKARD Shorting
Switch, Model X 930-A..... 60.00

COMPUTER MEASUREMENTS CORP.
Digital Printer, Model 400 C..... 275.00

CONSOLIDATED ELECTRODYNAMICS CORP.
Autovac Vacuum Gauge, Type 3294 B.... 250.00

All material in excellent condition. All prices
F.O.B., San Francisco, Cal., subject to prior sale.
Send for Listing and Flyers.

Marty's Mart

1236 Market St., San Francisco 3, California
Phone: UNDERhill 3-1215

POTTING APPLICATORS
MANUAL AND DISPOSABLE
6cc 12cc 30cc
FOR POTTING, ENCAPSULATING, AND
SEALING OF MINIATURE COMPONENTS
PHILIP FISHMAN CO.
7 CAMERON ST., WELLESLEY 81, MASS.



CIRCLE 966 ON READER SERVICE CARD

Antique

TELEPHONES

As is complete, decorative purpose
\$17.50. Working order, inter-comm.
\$19.50 Ext. on dial \$24.50, talking
circuit only. Write for complete list.
All shipments FOB, Simpson, Pa.
TELEPHONE ENGINEERING CO.
Dept. 42064, Simpson, Pa.

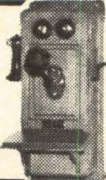

CIRCLE 967 ON READER SERVICE CARD

TUBES & COMPONENT
FREE...CATALOG
BARRY ELECTRONICS

512 BROADWAY 212-WALKer 5-7000
NEW YORK 12, N.Y. TWX-571-0484

CIRCLE 968 ON READER SERVICE CARD

BUSINESS OPPORTUNITY

Engineer or Company with Marketable Prod-
ucts or ideas wanted. We can offer interest
or merger in old established business. Box
391, 1501 Broadway, N. Y.

Somebody—Somewhere

needs your idle equipment! Reach that
buyer quickly and economically thru the

"SEARCHLIGHT SECTION"

The meeting place of
Used Equipment Buyers and Sellers

**SENIOR STAFF EXPANSION:
SCIENTISTS AND ENGINEERS**

room for
achievement
at **IBM**®

Projects: Opportunities at all technical staff levels to work with a group which, during 1963, participated in aerospace projects and studies connected with lunar logistics vehicles, computer concepts, micrometeoroid-measurement capsules, MODS, global-range missiles, MORL, SSGS, GEMINI and other large-scale space-vehicle guidance systems.

Opportunities: Expansion of the senior staff at the IBM Space Guidance Center* in Owego, N. Y., and of groups at Huntsville, Ala., and Los Angeles requires people skilled in the advanced technologies implicit in these R & D areas:

Creative Mathematics

Operations research and analysis
Space navigation (trajectory and orbital analyses)
Systems synthesis

Advanced Systems Design

Manned space flight
Inertial guidance
Reconnaissance data acquisition and processing
Flight control systems
Communications systems

Advanced Equipment Design

Electronic sensors (radar processors)
Optical sensors
Advanced aerospace computers:
• Organization
• Design automation
• Logic design
• Thin film circuits
• Input/Output devices
• Integrated circuits (semiconductor physics)

Qualifications: A scientific or engineering degree in any one of a broad range of disciplines, with related experience in one or more of the areas listed above.

IBM is an Equal Opportunity Employer.

Please write, outlining your qualifications and interests, to:
R. R. Hayden, Manager of Employment, IBM Space Guidance Center, Dept. 554R3, Owego, N. Y. 13827.

*The Space Guidance Center was built on a 700-acre site in 1957 to contain IBM's burgeoning defense and space efforts. Current projects include: TITAN II and III, SATURN I and V, GEMINI and MOL.



■ A M P Inc. 13 Garceau, Hargave & McCullough, Inc.	■ Instruments For Industry, Inc. 137 Duncan-Brooks, Inc.
■ Acme Electric Corp. 110 Scheel Adv. Agency	■ International Instruments, Inc. 122 Cook, Smith & Colwell, Inc.
■ Acromag Incorporated 132 Tri-Art Associates	■ Janney Cylinder Co. 120 John B. Ferguson Jr., Adv.
■ Aero Mayflower Transit Co. Inc. 141 Caldwell, Larkin & Sidener-Van Riper Inc.	■ Jerrold Corp. 12 Irving Gould Adv. Inc.
■ American Electronic Laboratories, Inc. 129 Benn Associates	■ Keithley Instruments Inc. 121 Bayless-Kerr Company
■ American Lamotite Corp. 143 Amperite Co.	■ Kepeco Inc. 16 Weiss Advertising
■ H.J. Gold Co. 127	■ Keystone Electronics Corp. 138 Sound Advertising
■ AnSCO, A Div. of	■ Klein & Sons, Mathias 40 The Buchen Co.
■ General Aniline & Film Corp. 41 Lennen & Newell Inc.	■ Lambda Electronics Corp. 42 Michel Cather, Inc.
■ Astro Communication Laboratory 139 S.G. Stackig, Inc.	■ Lapp Insulator Co., Inc. 113 Wolf Associates, Inc.
■ Astrodata Inc. 47 Bonfield Associates, Inc.	■ Leach Corp. 48 Hixson & Jorgensen, Inc.
■ Babcock Relays 23 Jay Chiat and Associates	■ Leesona Corp. 96 Chirurg & Cairns, Inc.
■ Beckman Instruments Inc., Offner Div. 33 Erwin Wasey, Ruthrauff & Ryan Inc.	■ Machlett Laboratories Inc., The 8 Fuller & Smith & Ross Inc.
■ Bird Electronics Corp. 49 John Willett Adv.	■ Mallory & Co. Inc., P.R. 10, 11 The Aitkin-Kynett Co.
■ Boonton Radio Company 38 George Homer Martin Associates	■ Marconi Instruments 134 Armand Richards Adv. Agency
■ Bristol Co., The 136 Chirurg & Cairns, Inc.	■ McGraw-Hill Book Co. Inc. 98 Micrometals
■ Brush Instruments, Div. of	■ Printing Advertising Promotion 132
■ Clevite Corp. 3rd Cover	■ Minnesota Mining & Mfg. Co.,
■ Carr Liggett Adv., Inc.	■ Mincon Div. 35
■ Buchanan Electrical Products Corp. 7 Keyes, Martin & Company	■ Reach, McClintock & Co. Inc.
■ Cambridge Thermionic Corp. 130 Chirurg & Cairns, Inc.	■ Monroe, Div. of Litton Industries 140 West, Weir & Bartel Inc.
■ Clairex Corp. 144 S. Paul Sims Co.	■ Moseley, F.L. 1 L.C. Cole Company Inc.
■ Clifton Precision Products 19 Ivey Adv. Inc.	■ New Hermes Engraving Machine Corp. 142 Doner-Harrison, Inc.
■ Cominco Products Inc. 128 McKim Adv. Limited	■ North Atlantic Industries, Inc. 106 Dunwoodie Associates Inc.
■ Compagnie Generale D'Electro	■ Paktron, Div. Illinois Tool Works 108, 109 Inc.
■ Ceramique 116 Termonet Technique	■ Raymond E. Finn & Associates
■ Components Inc. 130 Creative Adv. Agency	■ Philco, A Sub., of Ford Motor Co. 97 Maxwell Associates, Inc.
■ Conelco Components 26 Getz and Sandborg Inc.	■ Plant City 138 Clayton and Mohler Adv.
■ Dage Electric Co., Inc. 144 La Grange & Garrison Inc.	■ Porter Electronic Laboratories 117 Conti Adv. Agency, Inc.
■ Daven Div. of McGraw Edison 36 Keyes, Martin & Co.	■ Potter Instrument Co. Inc. 52 Larcom Randall Adv. Inc.
■ Defense Electronics Inc. 123 Compton Jones Associates	■ Princeton Applied Research Corp. 133 Mort Barish Associates
■ Delco Radio 104 Campbell-Ewald Company	■ RMS Associates, Inc. 126 Harrison, Finch & Kline, Inc.
■ Dow Corning Corp. 24, 25 Church and Guisewite Adv., Inc.	■ Radiation Inc. 22 G.M. Basford Company
■ Driver Co., Wilbur B. 119 George Homer Martin Associates	■ Radio Corporation of America 4th Cover Al Paul Lefton Co.
■ Dymec Div. of Hewlett Packard Co. 9 L.C. Cole Company Inc.	■ Radio Materials Co.,
■ Dynamics Instrumentation Co. 128 Balsam Advertising, Inc.	■ Div. of P. R. Mallory Co. 125 Rosenbloom, Elias & Associates
■ Electronic Specialty Co. 100 Grant Adv., Inc.	■ Ribet Desjardins 118 Inter-Plans
■ Elgeet Optical Co., Inc. 126 Hutchins Adv. Co., Inc.	■ Sanders Associates 120 Chirurg & Cairns, Inc.
■ Fairchild Controls 46 Dunwoodie Associates Inc.	■ Scientific-Atlanta 116 Coinmark
■ Fairchild Semiconductor 20, 21 Johnson & Lewis Inc.	■ Sierra Electronics, Div. of Philco 14 Hal Lawrence, Inc.
■ Fairmount Chemical Co. 142 G.M. Basford Co.	■ Space & Information Systems Div. of
■ Fluke Mfg. Co., Inc., John 31 Pollock & Loth, Inc.	■ North American Aviation 135 Batten, Barton, Durstine & Osborn Inc.
■ Formica Corp. 51 Perry-Brown Inc.	■ Sprague Electric Co. 5, 6 The Harry P. Bridge Co.
■ General Electric Co.,	■ Stackpole Carbon Co. 50 Meek and Thomas, Inc.
■ Semiconductor Products Dept. 95 Ross Roy Inc.	■ Struthers-Dunn, Inc. 45 The Harry P. Bridge Co.
■ General Precision, Librascope Div. 124 Weekley and Valenti, Inc.	■ Synthane Corp. 130 Arndt, Preston, Chapin, Lamb & Keen Inc.
■ General Radio Co. 2nd Cover K.E. Morang Co.	■ Telrex Laboratories 131 George Homer Martin Associates
■ Globe Industries Inc. 126 Odiorne Industrial Adv. Inc.	■ Thermal American Fused Quartz Co. 134 Inc.
■ Gudebrod Bros. Silk Co. Inc. 112 Lee Ramsdell & Co. Inc.	■ Kniep Associates
■ Heath Company 131 Advance Advertising Service Inc.	■ Transitron Electronic Corp. 114 The Bresnick Co. Inc.
■ Heinemann Electric Co. 111 Thomas R. Sundheim Inc.	■ Vitramon, Inc. 39 Ted Sommers, Inc.
■ Hewlett Packard Co. 2 L.C. Cole Company Inc.	■ Weston Instruments & Electronics 37 G.M. Basford Co.
■ Hughes Aircraft Company 107 Foote, Cone & Belding	■ Wiseco Div.
■ ITT Electron Tube Division 99 West Weir & Bartel Inc.	■ Electric Storage Battery Co. 138 E.L. Speer Adv., Agency
	■ Zivy & Co., N. 134 Gerhard Rechsteiner

■ For more information on complete product line see advertisement in the latest Electronics Buyers' Guide

Advertising sales staff

James T. Hauptli: [212] 971-2210
Advertising sales manager

Atlanta, Ga. 30309: Gus H. Krimsier, Michael H. Miller, 1375 Peachtree St. N.E., [404] TR 5-0523

Boston, Mass. 02116: William S. Hodgkinson, McGraw-Hill Building, Copley Square, [617] CO 2-1160

Chicago, Ill. 60611: Robert M. Denmead, Daniel E. Shea, Jr., 645 North Michigan Avenue, [312] MO 4-5800

Cleveland, Ohio 44113: Paul T. Fegley, 55 Public Square, [216] SU 1-7000

Dallas, Texas 75201: Frank Le Beau, The Vaughn Building, 1712 Commerce Street, [214] RI 7-9721

Denver, Colo. 80202: John W. Patten, David M. Watson, Tower Bldg., 1700 Broadway, [303] AL 5-2981

Houston, Texas 77025: Kenneth George, Prudential Bldg., Halcombe Blvd., [713] RI 8-1280

Los Angeles, Calif. 90017: Ashley P. Hartman, John G. Zisch, 1125 W. 6th St., [213] HU 2-5450

New York, N.Y. 10036: Donald R. Furth [212] 971-3616
Donald H. Miller [212] 971-3615
George F. Werner [212] 971-3617
500 Fifth Avenue

Philadelphia, Pa. 19103: William J. Boyle, Warren H. Gardner, 6 Penn Center Plaza, [215] LO 8-6161

San Francisco, Calif. 94111: Richard C. Alcorn, 255 California Street, [415] DO 2-4600

London W1: Edwin S. Murphy Jr., 34 Dover Street

Frankfurt/Main: Matthee Herfurth, 85 Westendstrasse Phone: 77 26 65 and 77 30 59

Geneva: Michael R. Zeynel, 2 Place du Port 244275

Paris VIII: Denis Jacob, 17 Avenue Matignon ALMA-0452

Tokyo: Shigeo Chiba, 1, Kotohiracho, Shiba, Minato-ku (502) 0656

Osaka: Kazutaka Miura, 163, Umegae-cho, Kita-ku [362] 8771

Nagoya: International Media Representatives, Yamagishi Bldg., 13,2-Chome, Oike-cho Naga-ku

R.S. Quint: [212] 971-2335
General manager
Electronics Buyers' Guide
David M. Tempest: [212] 971-3139
Promotion manager
Henry M. Shaw: [212] 971-3485
Market research manager
Richard J. Tomlinson: [212] 971-3191
Business manager
Theodore R. Geipel: [212] 971-2044
Production manager

Classified advertising

F.J. Eberle, [212] 971-2557
Business Manager

Employment Opportunities 145-147
Business Opportunities 147
Equipment
(Used or Surplus New)
For Sale 145-147

Classified advertisers index

Aerospace Placement Corp.	145
Atomic Personnel, Inc.	145
■ Barry Electronics	147
■ Fishman, Co., Philip	147
■ IBM	147
■ Marty's Mart	147
■ Metropolitan Supply Corp.	146
■ Motorola Inc.	146
■ Radio Research Instrument Co.	146
■ Telephone Engineering Co.	147
■ Universal Relay Corp.	146
FS 4122	146

Executive, editorial, circulation and advertising offices: McGraw-Hill Building, 330 West 42nd Street, New York, N.Y., 10036. Telephone Area Code 212-971-3333. Teletype TWX N.Y. 212-640-4646. Cable McGrawhill, N.Y. Offices of the Publications Division: Shelton Fisher, President; Vice Presidents: Joseph H. Allen, Operations; John R. Callahan, Editorial; Ervin E. DeGraff, Circulation; Donald C. McGraw, Jr., Advertising Sales; Angelo R. Venezzian, Marketing. Officers of the Corporation: Donald C. McGraw, President; Hugh J. Kelly, Harry L. Waddell, L. Keith Goodrich, Executive Vice Presidents; John L. McGraw, Treasurer; John J. Cooke, Vice President and Secretary. Title R registered U.S. Patent Office; © copyright 1964 by McGraw-Hill, Inc. All rights reserved, including the right to reproduce the contents of this publication, in whole or in part.

MTBF, 4321 hrs.
CL = 99.5% !!

Over 1000 MARK 200's
in use
7,500 channels

17 users
100 Systems
137,861 Operating hours
 $\frac{137,861}{19} = 7255$ hrs. MTBF

Here's reliability you can pin down 7255 hours MTBF... FIELD PROVED!

This documented figure, from 137,861 operating hours of field experience, is accepted by the Apollo PACE Program. This is a *Mean Time Between Failure* almost double the reliability requirement specified for this type of instrumentation by the Program. 7,255 hours MTBF is the equivalent of operation at peak performance for 181 weeks at 40 hours per week . . . or 3½ years! This field-proven reliability and unmatched precision and clarity of trace is inherent in all Mark 200's . . . whether for MIL or commercial applications. Write for complete story.



Reliability is one of the reasons why 130 MARK 200's are being installed in TEL 4 at Cape Kennedy and Down Range Stations. Shown is a bank of 38 ready for shipment.

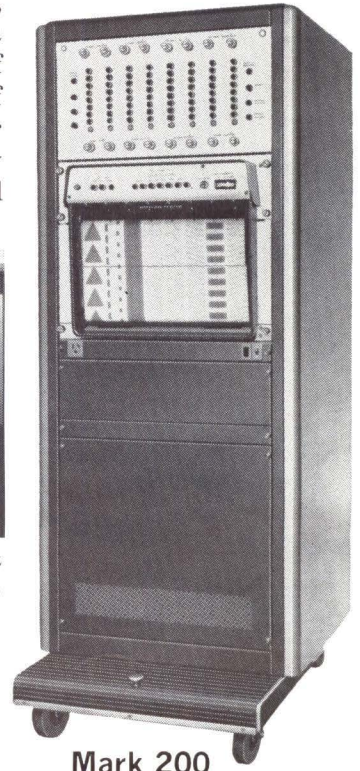

Mark 200

brush INSTRUMENTS
DIVISION OF CLEVITE 37TH AND PERKINS, CLEVELAND 14, OHIO

Circle 901 on reader service card

Now...The First Low-Cost Controlled Rectifier Specifically Rated for 110-Volt Line Operation

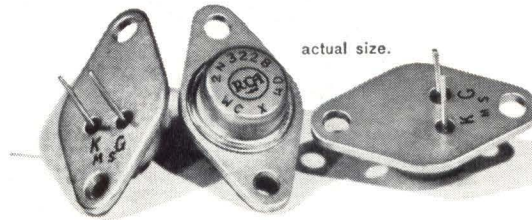

actual size.

RCA BRINGS MASS-PRODUCTION ECONOMIES TO NEW SCR 2N3228



ADD THE NEW SELLING POWER OF SILICON CONTROLLED RECTIFIERS TO YOUR PRODUCT DESIGN

Whether your design has application in small, hand-held appliances or in commercial and industrial power controls, the new RCA 2N3228 offers the big advantages of the Silicon Controlled Rectifier—at true mass-production economies.

This all-diffused PNP unit is the first SCR specifically designed and rated for line operation and at the price you've been waiting for. It is conservatively rated at 330 V transient PRV, 5 amp (I_{FRMS})—average current of 3.2 amp (I_{FAV})—at 50°C case.

RCA-2N3228 is ruggedly constructed in the compact diamond package. It can be bolted directly to the chassis for heat sinking, or it can be mounted on printed circuit boards.

Why not prove to yourself that you can get both economy and performance in this new SCR. Evaluate its characteristics in that design you've been holding for 1966—get it to market in '64! You'll find that the 2N3228 is conservatively rated for your 110V application in switching, speed control, heating control, lighting control. You'll discover that the RCA 2N3228 is in fact the industry's best value.

For information, call your nearest RCA Field Office, or order from your RCA Distributor. For technical data, write: Commercial Engineering, Section I-N-4-2, RCA Electronic Components & Devices, Harrison, N. J.

Available from your RCA Distributor

MAXIMUM RATINGS—RCA-2N3228	
Forward Current @ $T_c = 50^\circ\text{C}$ Av. DC Current (I_{FAV})* RMS value (I_{FRMS})	3.2 amperes 5.0 amperes
Transient Peak Reverse Voltage (non-repetitive) V_{RM} (non-rep)	330 Volts
Peak Reverse Voltage (repetitive) V_{RM} (rep)	200 Volts
Peak Forward Blocking Voltage (repetitive) V_{FBOM} (rep)	200 Volts

*at 180° conduction angle, with heat sink

RCA FIELD OFFICES—EAST: 32 Green St., Newark 2, N. J., 485-3900 • 731 James St., Room 402, Syracuse 3, N. Y., GR 4-5591 • 605 Marlton Pike, Haddonfield, N. J. (08034), HA 8-4802 • Greater Baltimore Area, 1725 "K" St., N.W., Washington 6, D.C., FE 7-8500 • NORTHEAST: 64 "A" St., Needham Heights 94, Mass., HI 4-7200 • SOUTHEAST: 200 East Marks St., Orlando, Fla., 425-5563 • CENTRAL: Suite 1154, Merchandise Mart Plaza, Chicago 54, Ill., 527-2900 • 2132 East 52nd St., Indianapolis 5, Ind., CL 1-1405 • 5805 Excelsior Blvd., Minneapolis 15, Minn., WE 9-0676 • 714 New Center Bldg., Detroit 2, Mich., TR 5-5600 • WEST: 6801 E. Washington Blvd., Los Angeles 22, Calif., RA 3-8361 • 1838 El Camino Real, Burlingame, Calif., OX 7-1620 • 2250 First Ave., South, Seattle 4, Wash., MA 2-6816 • GOVERNMENT: 224 N. Wilkinson St., Dayton 2, Ohio, BA 6-2366 • 1725 "K" Street, N.W., Washington 6, D.C., FE 7-8500 • RCA INTERNATIONAL DIVISION, 30 Rockefeller Plaza, New York 20, N. Y. • Cable Address: RADIOINTER, N. Y.



The Most Trusted Name in Electronics

Circle 902 on reader service card