

Electronics®

Improving integrated electronics reliability: page 56

Designing with the state variable: page 63

Annual European market report: page 79

December 26, 1966

75 cents

A McGraw-Hill Publication

Below: Despite crises, electronics is on the rise in Europe, page 83



European markets 1967

R D SKINNER
1020 GOVINGTON RD
LOS ALTOS CALIF 94022
C 3-

Completely Automatic CAPACITANCE BRIDGE



*Just Insert a Capacitor...
and Read the Answer*

Direct Reading ... C and D (or G) indicated with decimal point and correct unit of measurement.

Fast ... measuring rates up to 2 per second ... works with scanner-type inputs.

Accurate ... $\pm 0.1\%$ of reading for C and G; $1\% \pm 0.001$ of reading for D.

Stable ... a true bridge whose accuracy depends only on passive standards and fixed transformer ratios and is independent of generator voltage variations and phase-sensitive-detector errors. Three-terminal configuration permits accurate remote measurements.

BCD Output ... BCD (1-2-4-2 code) for data processing and recording.

Wide Range

Frequency	120c/s	400c/s	1kc/s
Capacitance	0.0001 μ F to 1000 μ F 4 ranges	0.01pF to 100 μ F 7 ranges	0.01pF to 100 μ F 7 ranges
Conductance	1 μ S to 1S 4 ranges	0.1nS to 1S 7 ranges	0.1nS to 1S 7 ranges

Dissipation Factor: 0.0001 to 1.0 in one range

Automatic Capacitance Bridge Assembly Type 1680-A ... \$4975 in U.S.A.

If you think a 1680 Automatic Capacitance Bridge can save you time and money and improve accuracy, why not write or call us for a demonstration?



RCA Aerospace Systems Division, Burlington, Massachusetts, has responded to the Department of Defense's challenge to industry to attain new levels of product quality by instituting a company-wide Zero Defects program. For example, in their Purchased Materials Inspection Department, new test equipment has been installed to upgrade measurement techniques and accuracy. A GR Type 1680 Automatic Capacitance Bridge and Type 1137 Data Printer are now used for incoming inspection of capacitors, whereas a manually balanced bridge was previously used. Capacitance measurements were not only tedious and time-consuming, but were also subject to a considerable amount of human error. With the installation of the Type 1680 Automatic Bridge, a thirty-percent saving in time has been realized; accuracy has been increased ten times; and data is automatically and permanently recorded.

BOSTON • NEW YORK • CHICAGO • PHILADELPHIA • WASHINGTON, D.C.
SYRACUSE • DALLAS • SAN FRANCISCO • LOS ANGELES • ORLANDO
CLEVELAND • TORONTO • MONTREAL
GENERAL RADIO COMPANY (Overseas), ZURICH, SWITZERLAND
GENERAL RADIO COMPANY (U.K.) Ltd., BOURNE END, ENGLAND

GENERAL RADIO
WEST CONCORD, MASSACHUSETTS

Circle 900 on reader service card

VALUE

BIG:
11" x 17"
X-Y RECORDER

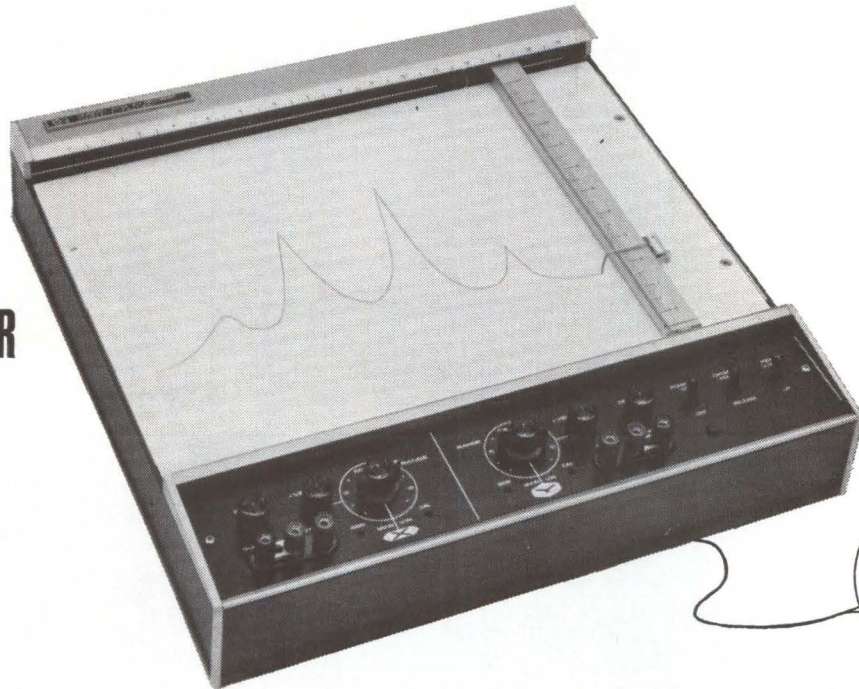

SMALL:

\$1195

Now in a bigger chart size—a value-priced Moseley X-Y recorder offering solid-state reliability and the same performance you get from the Model 7035A 8½" x 11" X-Y Recorder (\$895).

The Moseley 7005A lets you record on an 11" x 17" chart for increased resolution. Five calibrated ranges each axis, 1 m V/in. to 10 V/in. High input impedance, floating and guarded input, 0.2% accuracy at full scale. Adjustable zero set each axis. Autogrip care-free electric paper hold-down. Electric pen lift. Bench and rack mount model in one. Metric Model 7005AM is also available.

You get all these features for your recording applications for just \$1195. For complete information just call your

Hewlett-Packard field engineer or write Hewlett-Packard, Palo Alto, California 94304, Tel. (415) 326-7000; Europe: 54 Route des Acacias, Geneva.

BRIEF SPECIFICATIONS

Input Ranges: 7005A 1, 10, 100 mV/in.; 1, 10 V/in.
7005AM 0.4, 4, 40, 400 mV/cm; 4 V/cm

Input Resistance: Potentiometric—1 mV/in. range; 100K—10 mV/in.;
1 Megohm—0.1, 1, 10 V/in.

Accuracy: ± 0.2% at full scale; linearity: ± 0.1% of full scale;
dead band: ± 0.1% of full scale.

Model 17108A External Time Base provides 5 sweep speeds either axis 0.5 to 50 sec/in. (\$175).

**HEWLETT
PACKARD**  **MOSELEY
DIVISION**

Precision Frequency Comparison with the hp 8405A Vector Voltmeter

The Hewlett-Packard 8405A Vector Voltmeter can make many measurements that were formerly difficult or even impossible, and frequency comparison is just one of the many applications filled by this versatile tool.

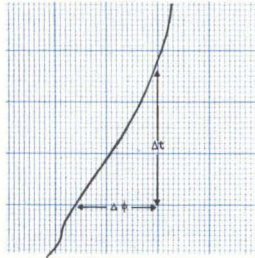

Using the 8405A, you can make frequency comparisons to $1/10^3$ of typical standard frequencies of 1 MHz and above... and it takes only minutes. Older methods took up to a day's time to make similar comparisons with the same resolution. With the 8405A the Channels A and B inputs of the instrument are simply connected to the outputs of the frequency sources to be compared. The phase is compared and indicated on the phasemeter of the instrument. Phase change, and its direction can be recorded by the use of a strip-chart recorder; the frequency difference in proportional parts then can be easily calculated.

Free Application Data

An application note on frequency comparison techniques is now available—write today for your copy of Application Note #77-2, "Precision Frequency Comparison": Hewlett-Packard, 1501 Page Mill Road, Palo Alto, California 94304, Tel. (415) 326-7000; Europe: 54 Route des Acacias, Geneva.

Check the specifications of this new, wideband, 2-channel rf millivoltmeter-phasemeter and match them against your application.

Major Specifications, hp 8405A Vector Voltmeter

Frequency Range is 1 to 1000 MHz in 21 overlapping octave bands; automatic tuning within each band.

Voltage Range for Channel A (synchronizing channel), 300 μ v to 1 v rms (5-500 MHz), 500 μ v to 1 v rms (500-1000 MHz), 1.5 mv to 1 v rms (1-5 MHz).

Voltage Range for Channel B (input to Channel A required), 100 μ v to 1 v rms, full scale. Full-scale meter ranges from 100 μ v to 1 v in 10 db steps. Both channels can be extended to 10 v rms with 10214A 10:1 Divider.

Phase Range of 360° indicated on zero-center meter with end-scale ranges of $\pm 180^\circ$, $\pm 60^\circ$, $\pm 18^\circ$, $\pm 6^\circ$. Phase meter OFFSET of $\pm 180^\circ$ in 10° steps permits use of $\pm 6^\circ$ range for 0.1° phase resolution at any phase angle.

Price: \$2500.

**A NEW
TIME-SAVING
TECHNIQUE**



HEWLETT **hp** PACKARD
An extra measure of quality

News Features

Probing the News

- 111 IC's heed Bell System's busy signal
- 114 An uncommon market
- 116 New wave of gear for boatmen

Electronics Review

- 35 **Consumer electronics:** Stimulating diode
- 36 **Advanced technology:** Power of positive thinking
- 36 **Military electronics:** Shrike out
- 37 **Communications:** Predicting the path
- 38 **Instrumentation:** Crash program; Rapid read
- 40 **Avionics:** Adapting to change
- 40 **Space electronics:** Critical observation; Three in orbit; The human touch
- 44 **Integrated electronics:** On key
- 44 **For the record**

Electronics Abroad

- 167 **Japan:** Readers' corner; Added competition
- 168 **Great Britain:** Light touch; Ready for orbit; Radar birdwatcher
- 169 **Sweden:** To market
- 169 **France:** African campaign
- 170 **United Arab Republic:** Comings and goings
- 170 **Australia:** New market
- 170 **Around the world**

Departments

- 4 Readers Comment
- 8 People
- 14 Meetings
- 16 Meetings Preview
- 23 Editorial
- 25 Electronics Newsletter
- 49 Washington Newsletter
- 125 New Products
- 126 New Products Index
- 150 New Books
- 152 Technical Abstracts
- 154 New Literature
- 165 Newsletter from Abroad

Technical Articles

- Integrated electronics** 56 **Integrated circuits in action: part 3**
Getting your money's worth
Though users pay for reliability, they may not be getting it because of poor reliability-assurance techniques or blatant misuse
Carl Moskowitz, Instrumentation editor

- Design theory** 63 **Analyzing networks with state variables**
A new technique solves the differential equations that describes the dynamic behavior of a linear system by arranging them in a form easily solved by electronic computation
Louis dePian, George Washington University

- Circuit design** 72 **Designer's casebook**
 - Zener diode controls variable phase shifter
 - Emitter follower enhances oscillator's frequency variation
 - Neon tube staircase generator performs two jobs

- Marketing** 79 **1967 European markets report (cover)**
A statistical analysis of electronics markets in 10 countries

- 83 **The climb continues**
Electronics' reporters fanned out across Europe to document the industry's projected growth
 - 84 West Germany
 - 87 France
 - 90 United Kingdom
 - 94 Italy
 - 96 The Netherlands
 - 97 Belgium
 - 99 Sweden
 - 100 Switzerland
 - 101 Spain
 - 102 Denmark
 - 103 Portugal
 - 103 Austria
 - 104 Soviet Union

- Annual index** 157 **Technical articles 1966**
A listing of technical articles and authors published in Electronics in 1966

Electronics

Editor-in-Chief: Lewis H. Young

Senior editors

Design: Samuel Weber

Application: George Sideris

News: Kemp Anderson Jr.

Assistant to the editor: Sally Powell

Senior associate editors: John F. Mason, Donald Christiansen, Robert Henkel, Joseph Mittleman

Department editors

Avionics: W.J. Evezia

Communications: Leonard Weller

Computers: Wallace B. Riley

Design theory: Joseph Mittleman

Electronics abroad: Arthur Erikson

Electronics review: Stanley Zarowin

Industrial electronics: Alfred Rosenblatt

Instrumentation: Carl Moskowitz

Military electronics: John F. Mason

New products: William P. O'Brien

Special projects: Donald Christiansen

Staff writers: Jan Rahm, William Olcott

Regional Bureaus

Domestic

Boston: Thomas Maguire, manager; Robin Carlson

Los Angeles: William B. Wallace, manager; June Ranill

San Francisco: Walter Barney, manager; Mary Jo Jadin

Washington: Robert W. Henkel, manager; William D. Hickman, John Rhea, correspondents; Patricia C. Hoehling

Foreign

Bonn: John Gosch

Tokyo: Charles Cohen

Copy editors

David Goller, Albert Tannenbaum, James Chang

Graphic design

Art director: Saul Sussman

Assistant art directors: Ann Mella, Valerie S. Betz

Production editor: Arthur C. Miller

Editorial secretaries: Marlene Angrist, Claire Benell, Lynn Emery, Lorraine Fabry, Kay Fontana, Patricia Gardner, Lorraine Longo

McGraw-Hill News Service

Director: John Wilhelm; **Atlanta:** Fran Ridgway; **Chicago:** James Rubenstein;

Cleveland: Arthur Zimmerman; **Dallas:** Marvin Reid;

Detroit: N. Hunter; **Houston:** Ron Lovell; **Los Angeles:** Michael Murphy, Gerald Parkinson

San Francisco: Margaret Drossel

Seattle: Ray Bloomberg; **Washington:** Arthur L. Moore, Charles Gardner, Herbert W. Cheshire, Seth Payne, Warren Burkett

McGraw-Hill World News Service

Bonn: John Johnsrud; **London:** John Shinn;

Mexico City: Bruce Cross; **Milan:** Ronald Taggiasco;

Moscow: Howard Rausch; **Paris:** Peter Kilborn;

Rio de Janeiro: Wes Perry; **Tokyo:** Marvin Petal

Reprints: Susan Nugent

Publisher: Gordon Jones

Electronics: December 26, 1966, Vol. 39, No. 26

Published every other Monday by McGraw-Hill, Inc. Founder: James H. McGraw 1860-1958.

Printed at 99 North Broadway, Albany, N.Y. 12207; second class postage paid at Albany, N.Y.

Executive, editorial, circulation and advertising addresses: McGraw-Hill Building, 330 W. 42nd Street, New York, N.Y. 10036. Telephone (212) 971-3333. Teletype TWX N.Y. 212-640-4646. Cable address: MCGRAWHILL N.Y.

Subscriptions are solicited only from those actively engaged in the field of the publication. Position and company connection must be indicated on orders. Subscription prices: United States and possessions and Canada, \$8.00 one year, \$12.00 two years, \$16.00 three years; all other countries, \$25.00 one year. Single copies: United States and possessions and Canada, \$1.00; all other countries, \$1.75.

Officers of McGraw-Hill Publications: Joseph H. Allen, President; Bayard E. Sawyer, Executive Vice President; Vice Presidents: J. Elton Tuohig, Operations; John R. Callahan, Editorial; Donald C. McGraw, Jr., Marketing; John M. Holden, Marketing Services; Huber M. Gemmill, Circulation; Angelo R. Venezian, Production; Robert M. Wilhelm, Controller.

Officers of the Corporation: Donald C. McGraw, Chairman of the Board; Shelton Fisher, President; L. Keith Goodrich, Hugh J. Kelly and Robert E. Slaughter, Executive Vice Presidents; John J. Cooke, Vice President and Secretary; John L. McGraw, Treasurer.

Title © registered in U.S. Patent Office: © Copyright 1966 by McGraw-Hill, Inc. All rights reserved. The contents of this publication may not be reproduced either in whole or in part without the consent of copyright owner.

Subscribers: The publisher, upon written request to our New York office from any subscriber, agrees to refund that part of the subscription price applying to copies not yet mailed.

Please send change of address notices or complaints to Fulfillment Manager; subscription orders to Circulation Manager, Electronics at address below. Change of address notices should provide old as well as new address, including postal zip code number. If possible, attach address label from recent issue. Allow one month for change to become effective.

Postmaster: Please send form 3579 to Fulfillment Manager, Electronics, P.O. Box 430, Hightstown, New Jersey 08520

Readers Comment

From bad to worse?

To the Editor:

If a new elapsed time and time identification procedure is to be introduced [Nov. 14, p. 43] at least make it a consistent system. The first day—New Year's—is day "0" because zero full days have passed in that year. With this start, a number can be assigned to each period of time from the beginning of the year and it will be correct.

Things are bad enough in measurement with the English and metric systems—let's not start another illogical system.

John M. Graham

Graham & Associates
Glendale, Ariz.

More on the milliday

To the Editor:

We proposed a base-10 time system about September, 1962, although this proposal was never published. We were working on thermal conductivity at that time and all units worked nicely until we got to the time parameter involved. We thought then that a decimal system of time would be in order.

We built a clock, mostly as a curiosity, using some of the terminology—notably the milliday—used by Frank Cilino [Nov. 14, p. 43]. I must admit that we hadn't thought of the possible application of this system to computers.

James R. Moss

Research associate
Coors Porcelain Co.
Golden, Colo.

Tripped on tariff

To the Editor:













Your article headed "it's a dilemma for some Britons" [Nov. 14, p. 337] intimates that starting this month [November] British component manufacturers will shelter behind a tariff barrier of 30%.

I must point out to you that this statement is quite incorrect in fact and, of course, has a very important bearing on the comment which follows.

The position is that currently

All from Sprague!

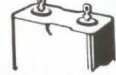
TWELVE OF OUR MOST POPULAR METALLIZED CAPACITOR TYPES

SPRAGUE TYPE	Case And Configuration	Dielectric	Temperature Range	Military Equivalent	Engineering Bulletin
 680P	hermetically-sealed metal-clad tubular	metallized Metfilm* 'A'	-55 C, +85 C	no specification	2650
 431P	film-wrapped axial-lead tubular	metallized Metfilm* 'E' (polyester film)	-55 C, +85 C	no specification	2445
 155P, 156P	molded phenolic axial-lead tubular	metallized paper	-40 C, +85 C	no specification	2030
 218P	hermetically-sealed metal-clad tubular	metallized Metfilm* 'E' (polyester film)	-55 C, +105 C	CH08, CH09 Characteristic R	2450A
 260P	hermetically-sealed metal-clad tubular	metallized Metfilm* 'K' (polycarbonate film)	-55 C, +105 C	no specification	2705
 121P	hermetically-sealed metal-clad tubular	metallized paper	-55 C, +125 C	no specification	2210C
 118P	hermetically-sealed metal-clad tubular	metallized Difilm® (polyester film and paper)	-55 C, +125 C	CH08, CH09 Characteristic N	2211D
 143P	hermetically-sealed metal-clad "bathtub" case	metallized paper	-55 C, +125 C	no specification	2220A
 144P	hermetically-sealed metal-clad "bathtub" case	metallized Difilm® (polyester film and paper)	-55 C, +125 C	CH53, CH54, CH55 Characteristic N	2221A
 284P	hermetically-sealed metal-clad rectangular case	metallized paper	-55 C, +105 C	no specification	2222
 283P	hermetically-sealed metal-clad rectangular case	metallized Difilm® (polyester film and paper)	-55 C, +125 C	CH72 Characteristic N	2223
 282P (energy storage)	drawn metal case, ceramic pillar terminals	metallized paper	0 C, +40 C	no specification	2148A

For additional information, write Technical Literature Service, Sprague Electric Company, 35 Marshall St., North Adams, Massachusetts 01247, indicating the engineering bulletins in which you are interested.

*Trademark

SPRAGUE COMPONENTS

CAPACITORS
TRANSISTORS
RESISTORS
INTEGRATED CIRCUITS
THIN-FILM MICROCIRCUITS
49C-1105

PULSE TRANSFORMERS
INTERFERENCE FILTERS
PULSE-FORMING NETWORKS
TOROIDAL INDUCTORS
ELECTRIC WAVE FILTERS

CERAMIC-BASE PRINTED NETWORKS
PACKAGED COMPONENT ASSEMBLIES
BOBBIN and TAPE WOUND MAGNETIC CORES
SILICON RECTIFIER GATE CONTROLS
FUNCTIONAL DIGITAL CIRCUITS



*Sprague and ® are registered trademarks of the Sprague Electric Co.



**IBM SYSTEM/360...
a high-performance,
high-reliability**

**computer...uses flat flexible cable
interconnections of TEFLON® FEP FILM**

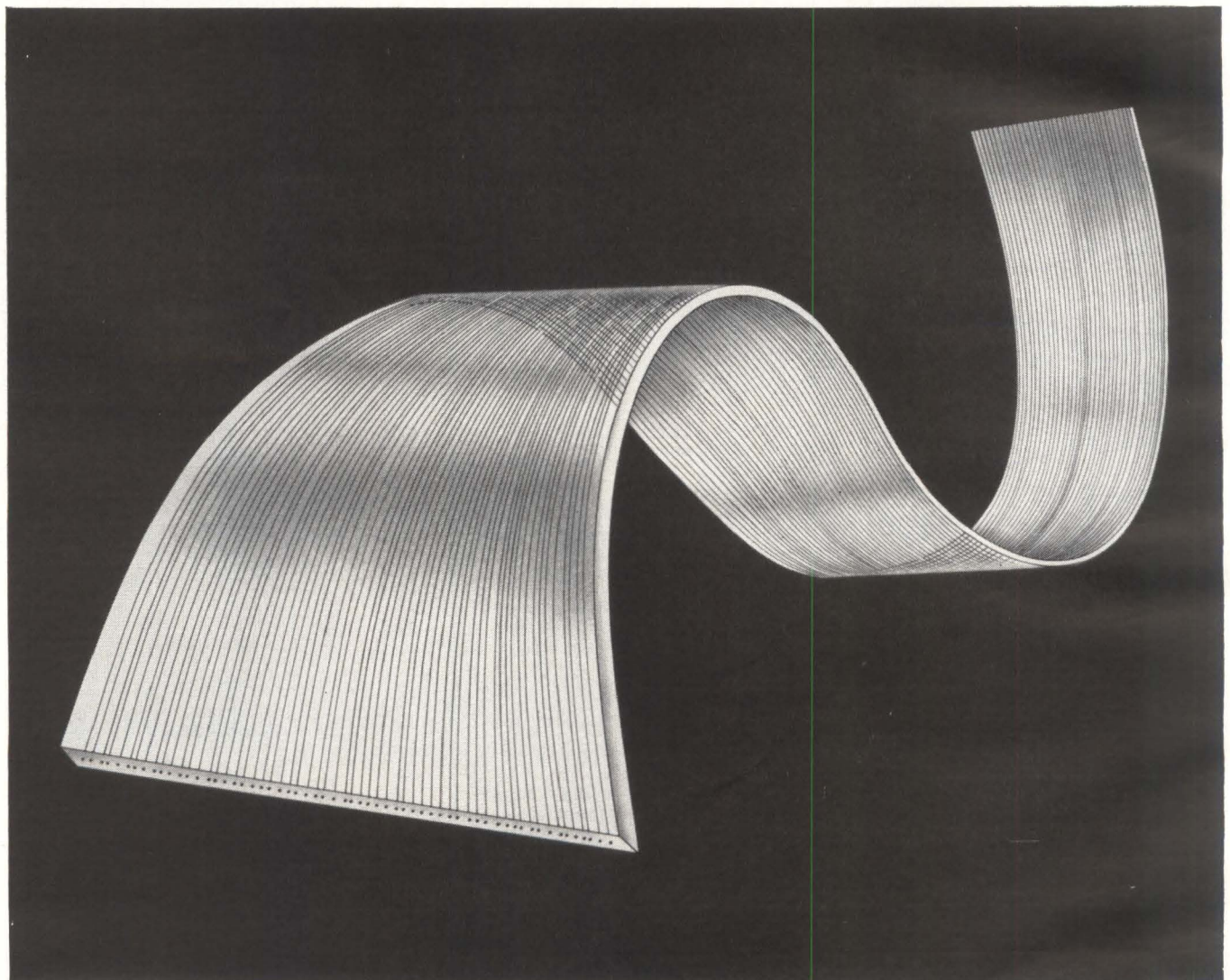

The IBM SYSTEM/360 is a versatile, flexible data-processing system able to handle a broad range of applications. It offers a wide choice of central processors, files, printers, terminals, and input and output units. In developing this system, IBM designers put special emphasis on ease and reliability of interconnections. They chose the flat flexible cable concept, with up to 60 conductors per cable, in preference to conventional cables that take more space.

And to insure the reliable performance of the flat flexible cable, they chose insulation of non-flammable Du Pont TEFLON* FEP fluorocarbon film—an easy-to-work-with, transparent dielectric film with all the electrical properties,

environmental resistance and unsurpassed reliability of Du Pont TEFLON resins.

If you or your designers are considering flat flexible cable for your products, be sure to evaluate TEFLON FEP FILM for the insulation: the surest way to realize the full advantages of reliability, convenience and performance in this type of wiring. For complete information, write: Du Pont Company, Room 4774, Wilmington, Delaware 19898.

*Du Pont's registered trademark.

TEFLON® FEP FILM
A new dimension in TEFLON



there is a 20% import duty on semiconductor devices and integrated circuits imported into this country plus the temporary import surcharge of 10%. The latter will be discontinued at the end of November, 1966, however, when the temporary import surcharges cease and the duty will then revert to the basic 20%.

W.R. West

Secretary
Electronic Valve & Semiconductor
Manufacturers' Association
London

■ Both our reporter and the British government official who gave him the 30% figure lapsed on the 10% surcharge, now extinct. The dilemma over ic's, though, hasn't been laid to rest.

Greater expectations

To the Editor:

What brought me out of my chair when reading "The other side of the recruiting coin" by Alex Martens [Oct. 31, p. 100] was the sentence: "At that time we were naive enough to judge a man's potential . . . without seriously attempting to explore the engineer's technical ability or motivation."

How can the head of a research and development department say his company used to judge a man by his education, training and experience and imply that it has now put away all those foolish measurements?

How does that company judge a man? By interviews to determine technical competence and a test at the sophomore or junior level of college which represents actual problems routinely encountered by

the personnel of the company. Can this mean that the company's personnel routinely performs work that is only at the sophomore and junior college level? But the employee is expected to correctly complete only 50% of the quiz. Can you deduce that only 50% accuracy is expected on these low-level tasks?

I can't believe that Martens is for real, but if he is, my respect for the design engineer with a degree drops a couple of decibels. Considering what is expected of non-degreed types working for that indifferent giant, the United States Civil Service, it just doesn't add up.

When I have a job opening, I go through many of the recruiting steps that your article spelled out. However, there is a difference. I have to find someone who is extremely knowledgeable in the basics of electronics, pneumatics, mechanical, electrical, explosives, supply systems and procedures, with instructional ability. What's more, he has to be able to get along professionally and socially with generals and with privates.

Additionally, he has to have knowledge of a surface-to-air missile system, preferably the Hawk. And his starting salary for long hours under adverse conditions (ask about our Vietnam program) is \$10,927.

Ray Dobbs

Hdqtrs. Battery
6th Battalion, 61st Artillery

■ Reader Dobbs has long and varied experience in the Air Force, industry and, finally, in civil service. He is presently in Germany providing technical assistance to the U.S. Army on the Hawk missile weapons system.

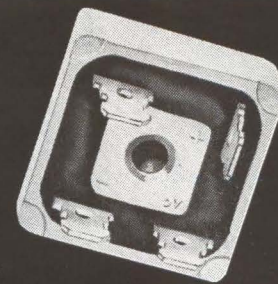

"ALPAC" A NEW CONCEPT!

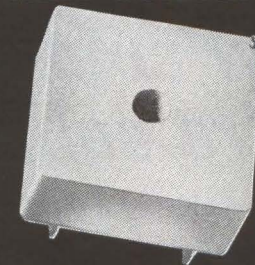

high current integrated rectifier circuits

"ALPAC" bridge rectifier circuits offer:

ALUMINUM CASE — A new power bridge rectifier circuit designed in a functional aluminum case.

HIGH CURRENT — Up to 25 amps average rectified current available from PIV ratings of 50 to 600 volts.

SMALL SIZE — Case size is 1.125"x1.125" x.406" max.

TERMINALS INSULATED FROM CASE — Unique 3-way-universal-terminals allow maximum installation flexibility.

"ALPAC" is specifically designed to simplify packaging and minimizing production costs. Economically priced to replace multiple stud rectifier usage, "ALPAC" reduces space requirements by one third with improved reliability.

Internally, "ALPAC" utilizes the Semtech high performance rectifiers, welded together for mechanical strength. The device is rated at a maximum thermal resistance of 1.5°C/Watt.

Technical bulletins describing the "ALPAC" high current Bridge Rectifiers, Doublers, and Center Taps are available.

SEMTECH CORPORATION

WESTERN OFFICE: 652 Mitchell Road, Newbury Park, California
(805) 498-2111 (213) 628-5392/TWX 805-499-7137
Central: 140 No. La Grange Road, La Grange, Ill. (312) 352-3227
Eastern: 71 West 23rd St. N.Y., (212) 989-7550/TWX 212-640-5060
European Sales: Bourns AG, Alpenstrasse 1,
6301 Zug, Switzerland (042) 4 82 72/73

SUBSCRIPTION SERVICE

Please include an Electronics Magazine address label to insure prompt service whenever you write us about your subscription.

Mail to: Fulfillment Manager
Electronics
P.O. Box 430
Hightstown, N.J. 08520

To subscribe mail this form with your payment and check new subscription renew my present subscription

Subscription rates: in the U.S.: 1 year, \$6; two years, \$9; three years, \$12. Subscription rates for foreign countries available on request

CHANGE OF ADDRESS

ATTACH
LABEL
HERE

If you are moving, please let us know five weeks before changing your address. Place magazine address label here, print your new address below.

name

address

city

state

zip code

How come we're selling a competitor's product?

Very simple — we've joined Burnell's well known sophisticated design technology and its production facilities to our own to form a single superb organization for the manufacture of filters unsurpassed for performance and reliability. This represents a giant step forward in our continuing development program aimed at eliminating all limitations on filter specifications and volume production. As a result, Burnell-Nytronics can now make on-time deliveries of filters produced to the most exacting requirements, regardless of bandwidth or shape. Regardless of quantity.

Among the advanced classifications of filters being supplied our customers are: Linear phase band pass filters with arithmetic symmetry; matched filters such as pulse compression networks; subminiature thermally stable filters; zero phase shift harmonic suppression networks; constant resistance tapped delay lines; time domain waveform shaping filters; and shape factors of 1.002 to 1.

Send for literature describing our standard and custom products, and facilities.



10 Pelham Parkway, Pelham, New York 10803 ■ (914) 738-5000 ■ TWX: 914-235-3809

People

As the new president of the Dictaphone Corp., **Walter W. Finke** (rhymes with Pinky) will lead the office equipment company into new product areas. Heavily instilled with the computer fervor in his former position as president of Honeywell, Inc.'s Electronic Data Processing division, Finke is enthusiastic about applying the systems approach to office equipment. He made it clear last week that he'll not put Dictaphone into the general-purpose electronic data processing systems business, but he will add peripheral devices for data processing to the company's product line.



Walter W. Finke

Such a move would be a logical one for the company which has been showing signs of corporate restlessness in the past few years, diversifying into facsimile transmission, classroom teaching devices and even a service to provide temporary office employees. Under Finke, the company will have a growing interest in the communications aspect of office systems.

Finke has been credited with pushing Honeywell into the computer business 11 years ago. It's been said that Finke's optimism wasn't shared by others in Honeywell's executive suite because then, more than now, the field was dominated by the International Business Machines Corp.

Finke, a fifty-nine-year-old lawyer, started with Honeywell's Ordnance division in 1950, later becoming the assistant to the president of the parent company. In 1955, the Raytheon Co. and Honeywell formed a joint computer venture, called the Datamatic Corp., which Finke headed. In 1957, Honeywell bought out Raytheon's 40% share and today claims it is second in the industry.

Although he is taking over as president and chief executive officer at Dictaphone, Finke will retain his seat on Honeywell's board.

Finke is a graduate of the Uni-

RESOLVER/SYNCHRO DIGITAL CONVERSION

A very short course for engineers who are concerned with converting resolver or synchro data to digits and vice versa.

Engineers working in digital computer input/output interface systems for tactical airborne equipment, aircraft and space vehicle simulation, antenna positioning or programming, and similar systems are increasingly involved in solving the digital/analog interface problem for resolver and synchro data. Accomplishing this task becomes quite simple by taking advantage of North Atlantic's family of high accuracy resolver/synchro converters. Through the use of solid-state switching and precision transformer techniques, these converters provide single-speed accuracy and resolution from 10 to 17 bits, along with solid-state reliability and calibration-free operation.

Resolver/Synchro-To-Digital Conversion

One typical North Atlantic resolver/synchro interface is the Automatic Angle Position Indicator (Figure 1), which converts angular data from both 400Hz resolvers and synchros to digits.

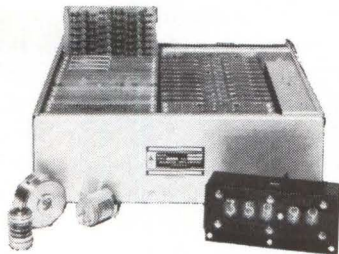

Figure 1. Model 5450 Automatic Angle Position Indicator converts resolver and synchro angles to digital form.

This device uses all solid-state plug-in cards and trigonometric transformer elements (no motors, gears or relays), and operates at all line-to-line voltages from 9 to 115 volts. It can be supplied in a wide range of configurations for specific system requirements, for example, signal frequencies 60Hz to 10KHz, binary or BCD outputs, .001° resolution with 10 arc second

accuracy, and multi-speed and/or multiplexed inputs. Its five-digit Nixie readout can be integral or remote.

The unit illustrated has an accuracy of .01°, and two basic modes of operation. They are read-on command (rapid acquisition) and tracking (least significant bit update). Prices start at \$5900.

Digital-To-Resolver/Synchro Conversion

North Atlantic's all solid-state digital-to-resolver/synchro converters (Figure 2) accept digital input data at computer speeds in either binary angle or binary sine/cosine form and convert to either resolver or synchro data. Their high accuracy and resolution (up to 17 bits) and freedom from switching transients meets an important requirement in space-mission simulation and antenna positioning systems for smooth servo performance at low rates of data change. All models are usually supplied with input storage registers.

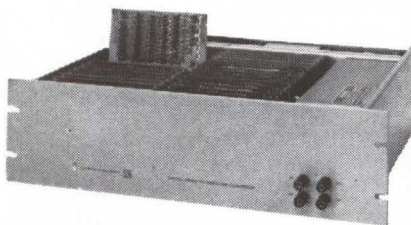

Figure 2. Series 536 Digital-To-Resolver Converters translate binary digital angle to four-wire resolver data.

Depending on the combination of features specified, prices are in the \$4500. to \$6000. range.

Modular D-R/S Converters For High-Density Systems

The plug-in converters pictured in Figure 3 were developed by North Atlantic specifically for airborne systems and for aircraft simulation systems requiring high-den-

sity multi-channel operation. The modules illustrated provide 11-bit digital-to-synchro conversion and are capable of driving up to four torque receivers. As with other North Atlantic resolver/synchro interfaces, conversion is achieved through solid-state switching and trigonometric transformers, so there are none of the stability or calibration problems associated with conventional resistor-chain/amplifier type converters. Prices, in production quantities, run about \$1100. per set. In prototype quantities about \$1500. a set.

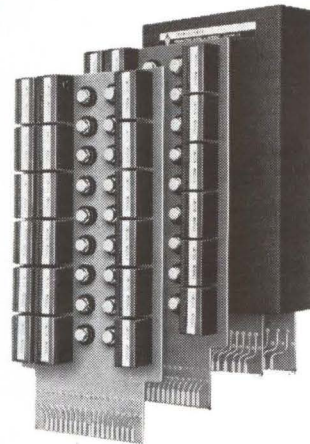
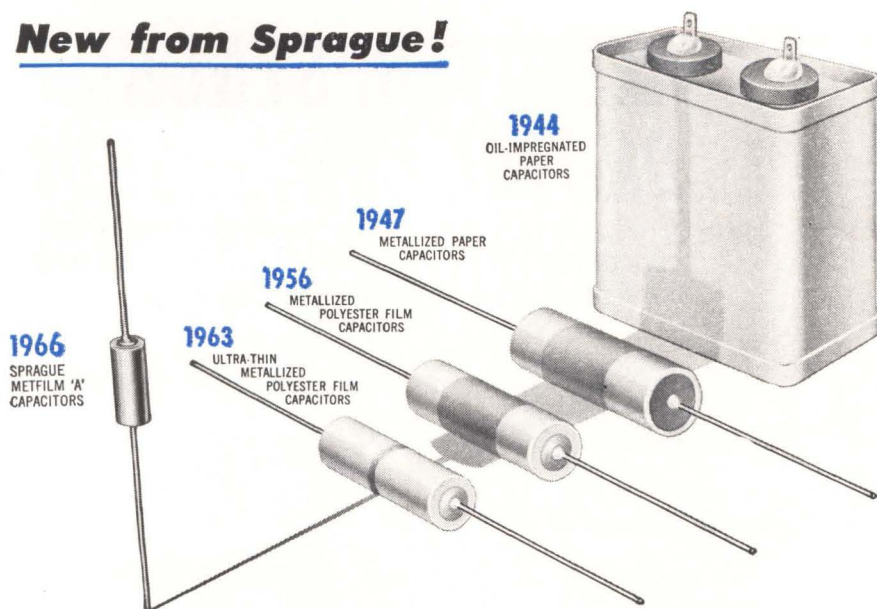

Figure 3. Series 537 D/S Converter Modules can drive multiple torque receivers from 11-bit digital data.

If you would like to take advantage of North Atlantic's state-of-art experience in resolver/synchro computer interface, we would be pleased to show you how these converters can meet your particular requirements. Or if you prefer, we will arrange a comprehensive technical seminar for your project group, without cost, in your own plant. Simply write: North Atlantic Industries, Inc., 200 Terminal Drive, Plainview, N. Y. 11803. TWX 510-221-1879. / Phone 516-681-8600.

New from Sprague!



METFILM* 'A' CAPACITORS ... dramatically smaller in size, yet more reliable than military-grade capacitors of the past!

Just a few years ago, the only 10 μ F capacitor considered dependable enough for military applications was Type CP70 (to JAN-C-25), and was a block-busting 3 $\frac{3}{4}$ " wide x 1 $\frac{3}{4}$ " thick x 4" high. Today, you can get a military-quality 10 μ F tubular capacitor measuring only $\frac{1}{2}$ " in diameter x 1 $\frac{1}{4}$ " long. And it's more reliable than any capacitor of the past!

Sprague Type 680P Metfilm 'A' Metallized Capacitors meet all environmental requirements of MIL-C-18312, yet they occupy only one third the volume of conventional metallized film capacitors of equivalent capacitance and voltage rating. Employing a new thin organic film dielectric system, Type 680P capacitors use a dual film totalling only 0.00008" thick, as compared to conventional polyester-film capacitors with a single film measuring 0.00015".

Another distinct advantage of the Metfilm 'A' dielectric system is minimum degradation of electrical properties during life.

Hermetically sealed in corrosion-resistant metal cases, capacitor sections are effectively of non-inductive construction, resulting in capacitors with performance characteristics superior to those of comparably-sized capacitors.

Type 680P Metfilm 'A' Capacitors are available with capacitance values to 10 μ F in both 50 and 100 volt ratings.



For complete technical data, write for Engineering Bulletin 2650 to Technical Literature Service, Sprague Electric Company, 35 Marshall Street, North Adams, Massachusetts 01247.

*Trademark

SPRAGUE COMPONENTS

CAPACITORS	PACKAGED COMPONENT ASSEMBLIES
TRANSISTORS	FUNCTIONAL DIGITAL CIRCUITS
RESISTORS	MAGNETIC COMPONENTS
THIN-FILM MICROCIRCUITS	PULSE TRANSFORMERS
INTEGRATED CIRCUITS	CERAMIC-BASE PRINTED NETWORKS
INTERFERENCE FILTERS	PULSE-FORMING NETWORKS

45C-6111R1



*Sprague and ® are registered trademarks of the Sprague Electric Co.

People

versity of Minnesota. He practiced law, taught and served in several Government posts before joining Honeywell.

Although Varian Associates won't release figures, it's known that the Quantum Electronic Devices and Recorder divisions are two of the company's weakest groups and account for a very small share of the company's sales. In an effort to revitalize the divisions, Varian has turned to **Louis Malter**, 59, who has experience in rejuvenating weak divisions. Malter, a Varian group vice president, has been named head of both units.



Louis Malter

Malter, who started with the company in 1958, possesses these credentials:

- He set up the company's highly competent Central Research Laboratories, where Varian developed the Vallon vacuum pump.
- And he convinced Varian to enter the vacuum products and systems field, and became manager of the unit producing that equipment in 1959. Varian calls the division the most profitable one of its kind in the business.

The route. Malter says he will try to guide the divisions to success by following his old formula—develop new products. "Conceptually, the measurements group (which includes the two divisions) will be looked upon as the home of divisions starting up," he says.

The Quantum Electronics division makes time standards and rubidium standards equipment and atomic hydrogen masers; the Recorder division produces magnetometers and graphic recorders.

Malter holds a master's degree in physics from Cornell University.

Before coming to Varian, Malter worked for the Radio Corp. of America, mostly in microwave tube development.

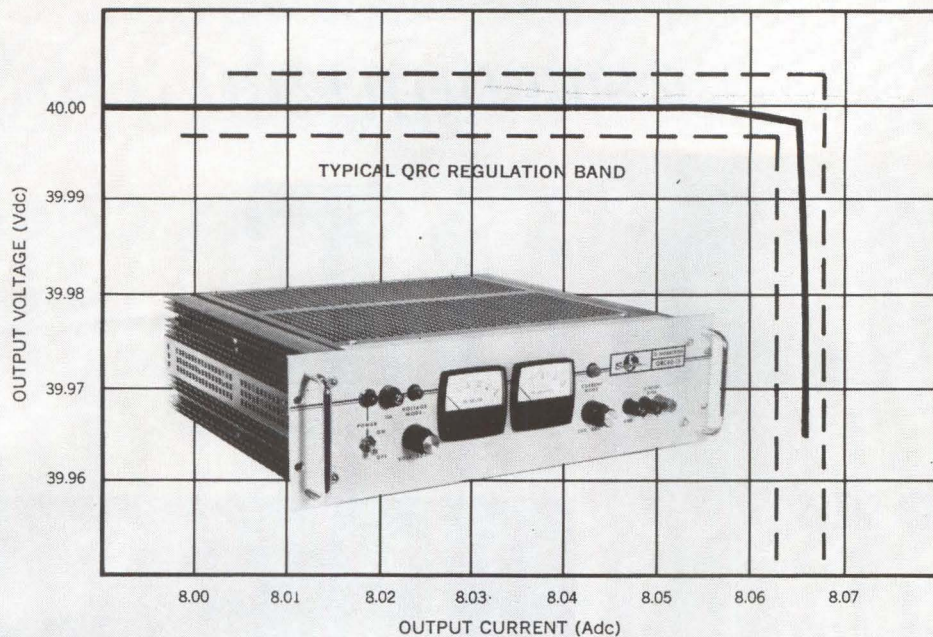

Automatic crossover between constant voltage and constant current modes

Sorensen QRC Power Supplies offer $\pm .005\%$ regulation

The Sorensen QRC series—wide range, transistorized power supplies—provide constant voltage/constant current regulation so sharp the units operate without ever leaving the specified regulation band. Voltage regulation is $\pm .005\%$ for line and load combined. The QRC's are provided with front panel dial set adjustment of voltage and current limits, as well as voltage/current mode indicator lights. Other design features include: Low ripple . . . 1 mV rms • No turn-on/turn-off overshoots • Remote sensing and

programming • Series/parallel operation • Input voltage 105-125 or 201-239 Vac, 50-400 c/s • Temperature capability to 71°C • RFI spec meets MIL-I-26600 and MIL-I-6181D. All Sorensen power supplies conform to proposed NEMA standards. For QRC details, or other standard/custom power supplies, AC line regulators or frequency changers, contact your local Sorensen rep, or write: Raytheon Company, Sorensen Operation, Richards Ave., Norwalk, Connecticut 06856 Tel: 203-838-6571.

ELECTRICAL & MECHANICAL SPECIFICATIONS

MODEL NUMBER	OUTPUT VOLTAGE RANGE (Vdc)	CURRENT OUTPUT RANGE (Adc)	VOLTAGE REGULATION (LINE & LOAD COMBINED)	RIPPLE VOLTAGE (rms)	CURRENT REGULATION	RIPPLE CURRENT (rms)	RACK HEIGHT (INCHES)	PRICE
QRC20-08A	0-20	0-8	$\pm .005\%$ or ± 1 mv	1 mv	$\pm .05\%$ or ± 4 ma	1 ma	3½	\$410.00
QRC20-15A	0-20	0-15	$\pm .005\%$ or ± 1 mv	1 mv	$\pm .05\%$ or ± 8 ma	2 ma	5¼	525.00
QRC20-30A	0-20	0-30	$\pm .005\%$ or ± 1 mv	1 mv	$\pm .05\%$ or ± 16 ma	4 ma	7	700.00
QRC40-4A	0-40	0-4	$\pm .005\%$ or ± 1 mv	1 mv	$\pm .05\%$ or ± 3 ma	1 ma	5 †	315.00
QRC40-8A	0-40	0-8	$\pm .005\%$ or ± 1 mv	1 mv	$\pm .05\%$ or ± 4 ma	1 ma	3½	450.00
QRC40-15A	0-40	0-15	$\pm .005\%$ or ± 1 mv	1 mv	$\pm .05\%$ or ± 8 ma	2 ma	5¼	575.00
QRC40-30A	0-40	0-30	$\pm .005\%$ or ± 1 mv	1 mv	$\pm .05\%$ or ± 16 ma	4 ma	7	775.00

†Half rack

RAYTHEON

FOR FOREIGN SALES AND PRICES consult nearest facility. CONTINENTAL EUROPE: Sorensen-Ard-ag AG, 8045 Zurich, Switzerland, Binzstrasse 18. FRANCE: Sorensen-France, 25 A Rue du Chablais, 74 Annemasse; GERMANY: Sorensen G.m.b.H., 6 Frankfurt am Main, Wilhelm-Leuschnerstrasse 93, UNITED KINGDOM: Cossor Instruments Ltd., The Pinacles, Elizabeth Way, Harlow Essex, England. ALL OTHER FOREIGN SALES: Raytheon Company, International Sales and Services, Lexington, Massachusetts 02173, U.S.A.

From the recognized leader in
CLARE offers

Two SIZES

Three PACKAGE CONFIGURATIONS

Four DIFFERENT SWITCHES

Five COMPLETE LINES



- A. Clared Open-coil Relays for pcb (CRT, CRTN)
- B. Clared Metal-enclosed Modules for pcb (CRM)
- C. Clared Relays (plug-in or solder type) for wired assemblies (CRA, CRB)
- D. MicroClared Epoxy-molded Modules for pcb (MRME)
- E. MicroClared Open-coil Relays for pcb (MRMC)

CLAREED RELAY CHARACTERISTICS

	GENERAL PURPOSE	HIGH VOLTAGE	MERCURY-WETTED	MICROCLAREED
Contact Arrangements Enclosed Modules (up to 3 spaces) Open Coil Modules (up to 12 spaces) Round Cans (up to 12 spaces)	Forms A, B, C A, B, C A, B, C	Forms A, B, C A, B, C A, B, C	Forms A, B A, B A, B	Up to 5 form A Up to 5 form A
Contact Rating Switched Load Carry Load	15 va max., non-inductive 1 amp max., 250 v max. 5 amps max., not switched	15 va max., non-inductive 1 amp max., 250 v max. 5 amps max., not switched	50 va max., non-inductive 3 amps max., 500 v max. 5 amps max., not switched	10 va max., non-inductive .750 amp max., 200 v max. 2 amps max., not switched
Life Expectancy High Level Load Low Level	20 x 10 ⁶ operations .500 amp, 28 v 100 x 10 ⁶ operations	20 x 10 ⁶ operations .500 amp, 28 v 100 x 10 ⁶ operations	100 x 10 ⁶ operations 3 amps, 16.5 v 1 x 10 ⁹ operations	10 x 10 ⁶ operations .125 amp, 28 v 100 x 10 ⁶ operations
Stand-Off Voltage	500 v rms	1500 v rms, Standard 5000 v peak, Special*	1000 v rms, Standard 3000 v peak, Special*	250 v rms
Operate Time** (nominal coil power, including bounce)		As low as .6 ms		As low as .5 ms
Must Operate Sensitivity		As low as 80 mw		As low as 60 mw

*AVAILABLE WITH SPECIAL ASSEMBLIES **DEPENDING ON NUMBER OF CONTACTS

sealed-contact reed relays—

Maximum Choice in

REED RELAYS

Your application determines the Clareed® Relay you use...with the versatile Clareed and MicroClareed lines!

These high-reliability, long-life reed relays offer you the inherent maintenance-free reliability of contacts sealed in glass... switching speeds in the low millisecond range...a variety of operate power and contact loads...plus your choice of en-

closed pcb modules, open-coil pcb relays, or round cans for wired assemblies.

Clareed and MicroClareed® Relays are Clare-built from start to finish...with automated, superclean production assuring you Clare quality and Clare reliability. All are 100% tested for dielectric strength, operating characteristics, contact resistance, and seal integrity.

Choose the relay characteristics you need. Clare will help you specify for long life and utmost economy in operation.

For complete information, ask your Clare sales engineer, circle the Reader service number below, or write

Group 12N4
C. P. CLARE & CO.
3101 Pratt Blvd.
Chicago, Illinois 60645

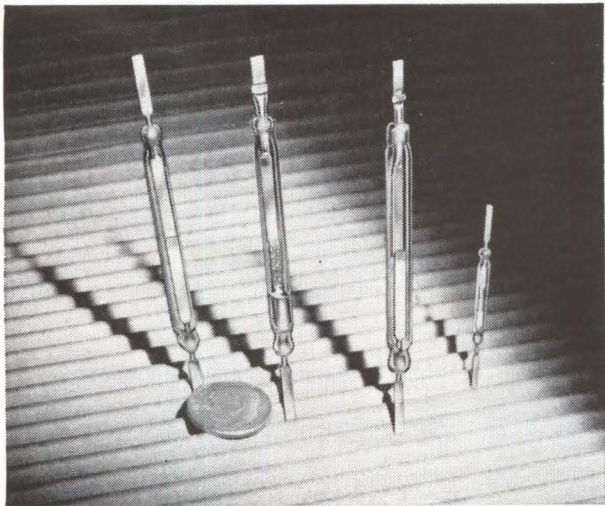

Left to right: General Purpose, Mercury-Wetted, High Voltage, MicroClareed



relays and related control components

ERRORS make us angry!

that's why we
manufacture
variable
attenuators
with error of less
than 0.05 db*

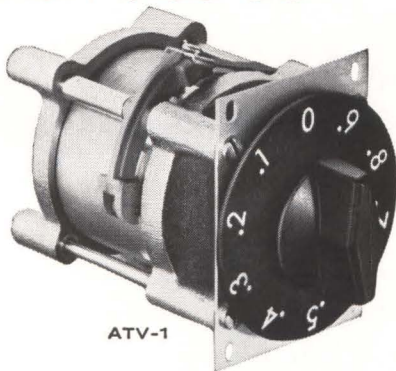

ATV-1

Think attenuators... say the words "Precision Performance"... and you must conclude Jerrold ATV-Series Turret Attenuators. Small, compact, they cost far less than you might expect.

Jerrold attenuators set the pace with intrinsic quality like coin-silver contacts for maximum conductivity, finest-quality deposited carbon disc and rod pad resistors for extreme accuracy, and positive spring-loaded detent mechanism for faultless resolution—in fact all the electrical features of "pull-and-turn" attenuators at one third the cost!

Model ATV-1,* 0-0.9 db in 0.1 db steps
(Fixed Attenuation 3 db), Accuracy ± 0.05 db at
max. attenuation. **\$275.00**

Model ATV-9, 0-9 db in 1 db steps,
Accuracy ± 0.1 db at max. attenuation. **\$250.00**

Model ATV-50, 0-50 db in 10 db steps,
Accuracy ± 0.5 db at max. attenuation. **\$195.00**

Group this with 50 ohm impedance, VSWR of 1.06:1 at 1000 MHz (1.1:1 at 1200 MHz), low insertion loss .1 db maximum, and you come up with THE BEST BUY IN THE INDUSTRY! If you're operating DC to 1200 MHz... send for complete specs today.



MEASUREMENT AND
TEST INSTRUMENTATION

JERROLD ELECTRONICS CORPORATION
Government and Industrial Division
Philadelphia, Pa. 19105

Meetings

Electrical and Electronic Measurement and Test Instrument Conference, IEEE; Talisman Motor Inn, Ottawa, Canada, Jan. 9-11.

Symposium on Reliability, American Society for Quality Control, IEEE; Sheraton-Park Hotel, Washington, Jan. 10-12.

Computer-Aided Circuit Design Conference, Engineering Institutes; University of Wisconsin, Madison, Wis., Jan. 16-18.*

Computer Aid For Reliability Analysis of Electronics Conference, Engineering Institutes; University of Wisconsin, Madison, Wis., Jan. 19-20.*

Symposium on Computers and Communications, IEEE; Miramar Hotel, Santa Monica, Calif., Jan. 19.

American Society for Quality Control Meeting, American Society for Quality Control; California State Polytechnic College, Kellogg Campus, Pomona, Calif., Jan. 21.

Midwest Welding Conference, Illinois Institute of Technology Research Institute; Illinois Institute of Technology, Chicago, Jan. 24-25.

Ultrasonic Manufacturers Association Technical Symposium and Meeting, Ultrasonic Manufacturers Association; New York, Jan. 25.

Conference on Color Television Broadcasting, Society of Motion Picture and Television Engineers; Park Shelton Hotel, Detroit, Jan. 27-28.

Power Meeting, IEEE; Statler Hilton Hotel, New York, Jan. 29-Feb. 3.

Symposium on Nondestructive Testing of Welds, Illinois Institute of Technology Research Institute; Illinois Institute of Technology, Chicago, Jan. 30-Feb. 2.

American Society for Testing and Materials Meeting, American Society for Testing and Materials; Statler Hilton Hotel, Detroit, Mich., Feb. 5-10.

Winter Convention on Aerospace & Electronic Systems, IEEE; International Hotel, Los Angeles, Feb. 7-9.

Electronic Packaging Conference, Society of Automotive Engineers; Roosevelt Hotel, New York, Feb. 14-16.

International Solid State Circuits Conference, IEEE; University of Pennsylvania, Sheraton Hotel, Philadelphia, Feb. 15-17.

Airborne Photo-Optical Instrumentation Seminar, Society of Photo-Optical Instrumentation Engineers; Ramada Inn, Cocoa Beach, Fla., Feb. 20-21.

National Air Meeting on Collision Avoidance, Institute of Navigation; Dayton, Ohio, Feb. 23-24.

Particle Accelerator Conference—Accelerator Engineering and Technology, IEEE; Shoreham Hotel, Washington, March 1-3.

International Symposium on Residual Gases in Electron Tubes and Sorption-Desorption Phenomena in High Vacuum, Italian Society of Physics; Rome, March 14-17.

International Convention, IEEE; New York Hilton Hotel and Coliseum, March 20-24.

Symposium on Modern Optics, Polytechnic Institute of Brooklyn; Waldorf-Astoria Hotel, New York, March 22-24.

Photovoltaic Specialists Conference, IEEE; Sheraton Cape Colony Inn, Cocoa Beach, Fla., March 28-30.

Call for papers

Conference on the Systems Impact of Large Scale Integrated Electronics, IEEE; Los Angeles, July, 1967. Jan. 15 is deadline for submitting abstracts to Harold Petersen, the Rand Corp. 1700 Main Street, Santa Monica, Calif. 90406.

Technical Conference, Society of Motion Picture and Television Engineers; New York Hilton, New York, April 16-21. Jan. 16 is deadline for submission of papers 101st Conference, SMPTE Headquarters, 9 East 41st St., New York, N.Y. 10017.

International Microwave Symposium, IEEE; Boston, Mass., May 8-11, 1967. Feb. 1 is deadline for submitting 200-word abstracts to T. Saad, chairman, technical program committee, Sage Laboratories, Huron Drive, Natick, Mass.

* Meeting preview on page 16

AC metrology will never be the same after the Fluke 931A, the first true rms differential voltmeter. Measure the precise rms value of virtually any waveform within 0.05% from 30 Hz to 50 KHz. Overall frequency response is 10 Hz to 1 MHz. Range is 0.01 to 1100 volts. Ten to one crest factor accounts for effects caused by voltage spikes and pulse trains. Comes with or without probe. Both line or combination line/rechargeable battery powered versions are offered. Base price is \$895.

The new Fluke Model 931A True RMS Differential Voltmeter yields accurate rms measurements of any waveform which previously could be made only by ac to dc comparison with a thermal transfer standard. Other features include high input impedance, in-line digital readout (lighted decimal), solid state design, and linear recorder output.

The null meter indicates percent deviation from the dialed voltage.

Ten percent overranging minimizes range changing.

Battery operation gives ideal isolation from ground loops.

Model 931A meets MIL-SPEC shock and vibration requirements.

For complete information, please call your Fluke Sales Engineer or write.



FLUKE • Box 7428, Seattle, Washington 98133 • Phone: (206) 776-1171 • TWX: (910) 449-2850

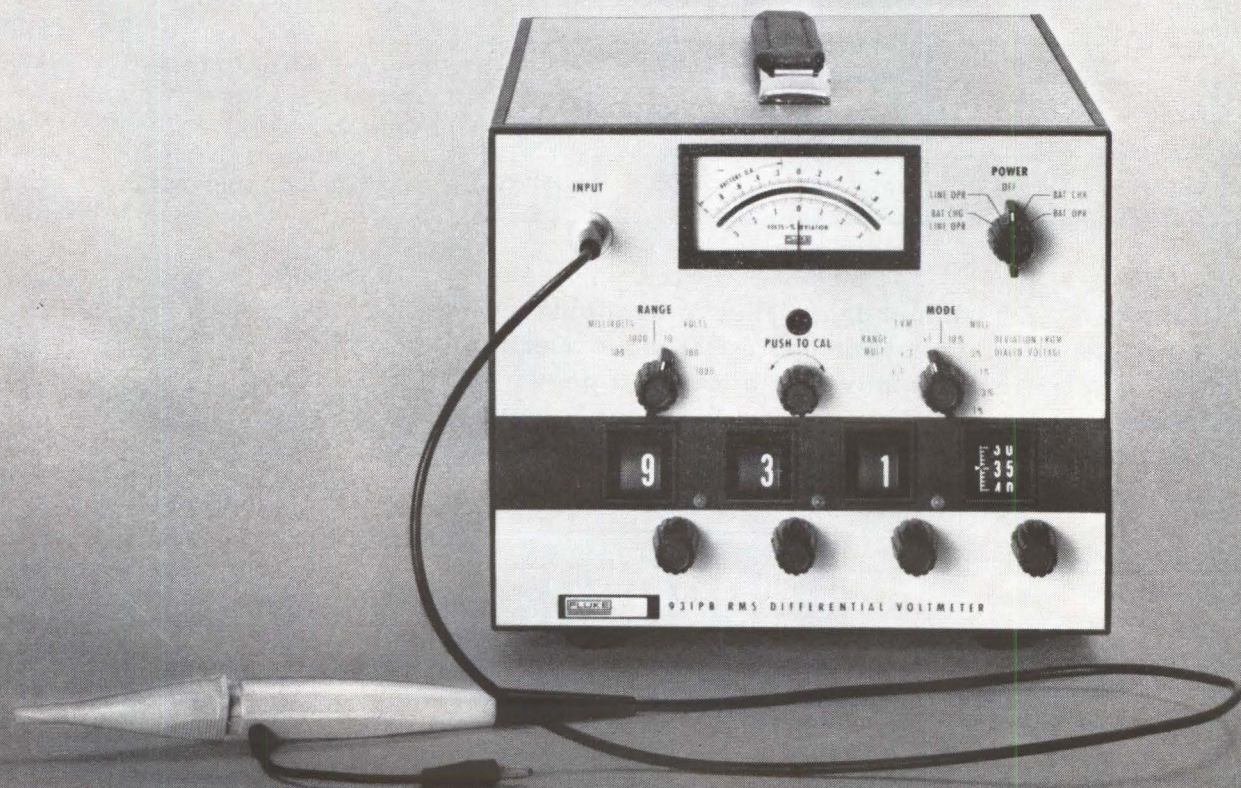

0.5 db



This is the typical wideband noise figure of Sprague Types 2N4383 and 2N4384 high-gain, low-level NPN silicon epitaxial planar transistors. Maximum NF is 2.0 db, one db lower than the type that has been the industry's most popular high-gain, low-level transistor.

Sprague Electric also offers Types 2N4385 and 2N4386, with noise figures of 1.0 db typ., 3.0 db max.

Characteristic	Conditions	2N4383 (TO-5 Case)	2N4384 (TO-18 Case)	2N4385 (TO-5 Case)	2N4386 (TO-18 Case)
BV_{CBO}	$I_C = 10 \mu A$	40V min.	40V min.	40V min.	40V min.
BV_{CEO}	$I_C = 10 mA$	30V min.	30V min.	30V min.	30V min.
I_{CBO}	$V_{CB} = 30V$	10nA max.	10nA max.	10nA max.	10nA max.
I_{EBO}	$V_{EB} = 5V$	10nA max.	10nA max.	—	—
h_{FE}	$V_{CE} = 5V, I_C = 1 \mu A$	60 min.	60 min.	—	—
h_{FE}	$V_{CE} = 5V, I_C = 10 \mu A$	100 min.	100 min.	40 min.	40 min.
h_{FE}	$V_{CE} = 5V, I_C = 1 mA$	120 min.	120 min.	100 min.	100 min.
NF	$V_{CE} = 5V, I_C = 10 \mu A, r_g = 10K\Omega,$ Bandwidth = 10 Hz to 15.7 kHz	2db max.	2db max.	3db max.	3db max.

Evaluate these devices without delay. They're available **now** in production quantities. Call your nearest Sprague Electric district office or sales representative for prices and delivery. Or, write Marketing Dept., Semiconductor Division, Sprague Electric Company, Concord, N.H. 03302.

SPRAGUE COMPONENTS

TRANSISTORS	PACKAGED COMPONENT ASSEMBLIES
CAPACITORS	FUNCTIONAL DIGITAL CIRCUITS
RESISTORS	MAGNETIC COMPONENTS
INTEGRATED CIRCUITS	PULSE TRANSFORMERS
THIN-FILM MICROCIRCUITS	CERAMIC-BASE PRINTED NETWORKS
INTERFERENCE FILTERS	PULSE-FORMING NETWORKS

499-6162



Sprague and *®* are registered trademarks of the Sprague Electric Co.

Meeting preview

Help from the computer

Last May the University of Wisconsin sponsored the first important technical session on computer-aided design. Now, less than a year later, the school is holding its second meeting on the subject. Between Jan. 16 and 18 the meeting will be devoted to computer-aided circuit design; on Jan. 19 and 20 the program will turn to computer aid for reliability analysis.

Try it out. The first day of the circuit design meeting will be devoted to a workshop on ECAP, or electronic circuit analysis program. Those attending will be invited to apply the program to some basic circuit problems on d-c and a-c.

The next two days of the meeting will feature formal technical papers and discussions, with emphasis on the techniques of circuit modeling, the implementation of circuit analysis, time sharing in design analysis and tolerance and transient analysis. Among the featured speakers will be Gerald Herskowitz, an associate professor at Stevens Institute of Technology, who will talk on computer modeling and integrated circuit design; Allan F. Malmberg, a researcher at Los Alamos Scientific Laboratory, who will present a paper on nonlinear analysis, and Arnold Spitalny, chief of computation at the Norden division of the United Aircraft Corp., who will outline his work on computer-aided ic design.

In addition, discussions will be conducted on such transient circuit analysis programs as Predict and Sceptre.

Data bank. The program devoted to reliability analysis will feature Chauncey W. Watt, a branch chief at the Electronics Research Center of the National Aeronautics and Space Administration. Watt has been a strong supporter of a plan to establish a reliability data bank to serve as a center for gathering, assessing and distributing information on integrated circuit reliability.

One speaker, Nathan O. Sokal, will present a paper on circuit design by the NET 1 program. Sokal is one of the first men in this field to set up a consulting company.

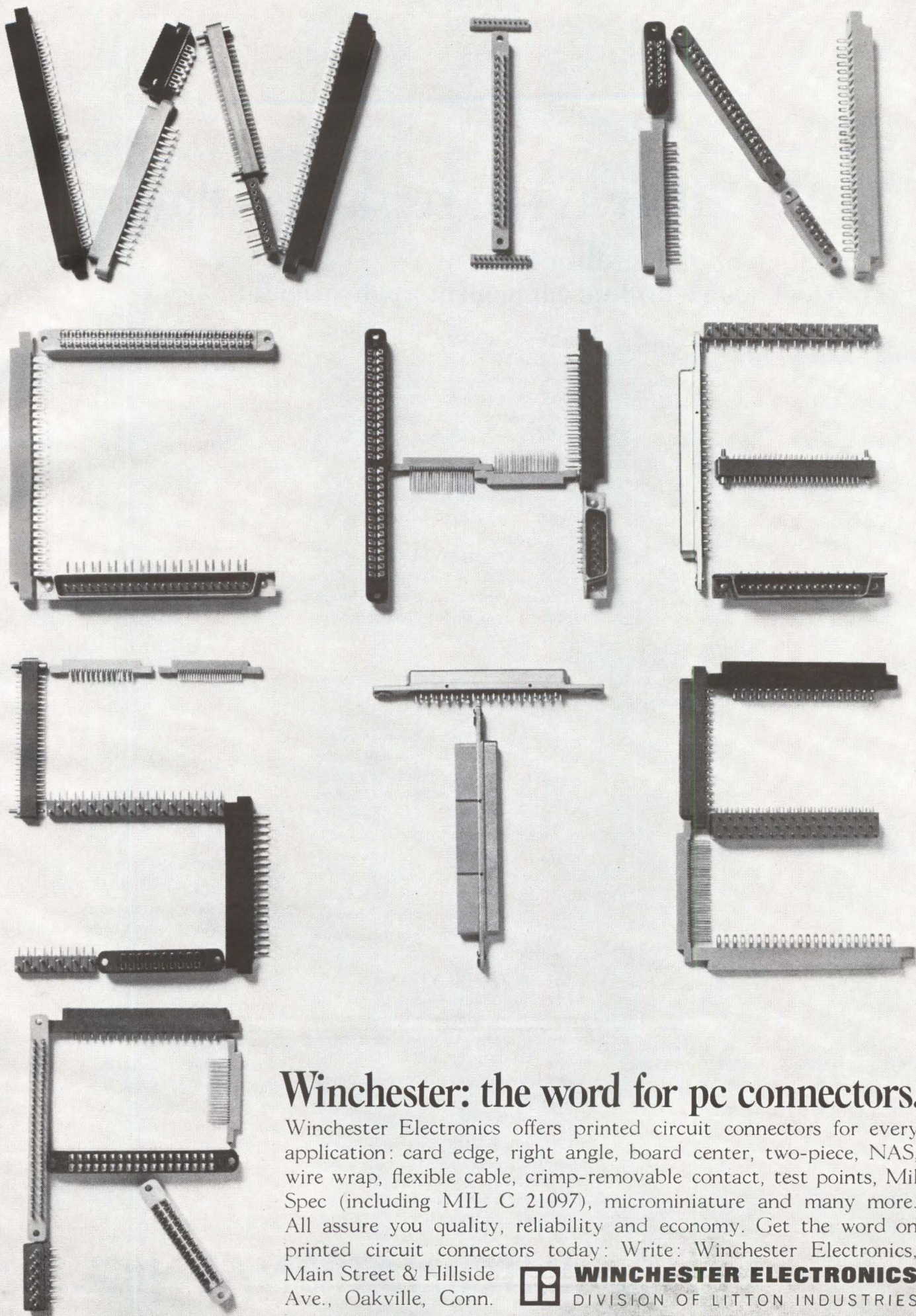

Winchester: the word for pc connectors.

Winchester Electronics offers printed circuit connectors for every application: card edge, right angle, board center, two-piece, NAS, wire wrap, flexible cable, crimp-removable contact, test points, Mil Spec (including MIL C 21097), microminiature and many more. All assure you quality, reliability and economy. Get the word on printed circuit connectors today: Write: Winchester Electronics, Main Street & Hillside Ave., Oakville, Conn.



WINCHESTER ELECTRONICS

DIVISION OF LITTON INDUSTRIES



Nickel Silver...The Versatile Alloy

A new look at nickel silver for electrical and electronic component applications.

The nickel silver alloys share a number of outstanding characteristics. These include high strength and toughness, good resistance to stress relaxation, superior corrosion and tarnish resistance, good workability and joinability, high elastic modulus and excellent spring properties. In addition, they offer considerable economic advantages. And, in many applications, their "silver" appearance proves highly desirable.

Nickel silvers have long been known to metallurgists as versatile alloys. They are copper-base alloys containing zinc and usually between 12% and 18% nickel. As economic conditions and materials have changed, engineers and designers have taken a fresh look at the nickel silvers. And they are finding that the nickel silvers offer both superior performance and economy in a wide variety of applications such as electrical connectors, contacts and springs.

MECHANICAL PROPERTIES

There are many nickel silver alloys. You can select one composition for high strength and superior spring properties. Select another—that will work-harden at a low rate—for forming and deep drawing. Or you can easily obtain a combination of qualities in other standard compositions.

Typical mechanical properties of four of the most widely used nickel silver alloys—CA 770, 766, 752 and 735—are shown in the accompanying chart.

STRENGTH THROUGH COLD WORKING

Nickel silvers attain their strength through cold working. Exceptional strengths can be obtained with tensile strengths and yield strengths both exceeding 100,000 psi, depending upon the amount of cold work. The degree of cold work is generally expressed in temper designations.

HIGH MODULUS OF ELASTICITY

The modulus of elasticity in tension of nickel silver alloys is higher than that of many copper-base metals. The modulus increases with the amount of nickel in the alloy. Values of 18,500,000 to 21,500,000 psi are available to insure greater structural rigidity and permit simpler, more rugged designs.

SUPERIOR CORROSION RESISTANCE

Nickel silver alloys resist tarnishing and corrosion. This means that in many electrical components you can often eliminate the need for costly protective coatings.

These alloys have excellent resistance to normal and saline waters. An interesting example of this is found in the nickel silver buckles, buttons and knife handles recovered in excellent condition from Civil War blockade runners sunk off the coast of North Carolina. The food industry has used nickel silver for many years where resistance to fatty acids is important. And manufacturers commonly use nickel silver for drafting instruments, eyeglass hardware and other products that come into frequent contact with the corrosive salts of human skin.

EASE OF FABRICATION

Nickel silver alloys lend themselves to just about any conventional fabrication technique. They're easily machined, drawn, stamped or formed. And they can be joined by any of the conventional techniques... resistance welded, brazed, soldered or mechanically joined.

AVAILABLE FORMS

The nickel silver alloys are available in a variety of convenient forms, including sheet and strip, round and flat wire, rods and bars.

SOME TYPICAL APPLICATIONS

TV tuner contacts. Among the reasons for selecting nickel silver for this application, the manufacturer has cited: low tarnishing rates, extended life, electrical contact improvement and consistency in forming and maintaining spring contact. Wear characteristics have proven excellent, with a subsequent reduction in service calls.

Electrical connectors. The economy, strength and tarnish resistance of nickel silver make it an ideal material for electrical connectors. For example, nickel silver is being used for a line of electrical connectors rated at 9 amperes. Insertion and withdrawal forces were consistent over thousands of cycles. The ease of working nickel silver permits the use of conventional dies; and its anti-galling characteristics help prolong die life, which in turn aids in maintaining dimensional tolerances. Added economy was realized through the elimination of the need for further protective coatings. Wires can easily be joined to the nickel silver connector by soldering, welding or mechanical crimping.

Printed circuit connectors. Use of a nickel silver alloy by a computer manufacturer eliminated the need for costly protective plating of the parts. Resistance to corrosion and tarnishing are outstanding characteristics of nickel silvers.

SEND FOR MORE INFORMATION

International Nickel recently published a paper covering many of the technical aspects of this material. It's called "Engineering Properties of Wrought Nickel Silvers." We'll be happy to send you a copy. Just write The International Nickel Company, Inc., 67 Wall Street, New York, New York 10005.

INTERNATIONAL NICKEL

MECHANICAL PROPERTIES OF FOUR TYPICAL NICKEL SILVER ALLOYS

CA 770 Nickel Silver						
Nominal Composition: 55 Cu, 18 Ni, 27 Zn Strip .020-.025 in. thick						
Temper	Tensile Strength, psi		Yield Strength, psi 0.5% ext. under load		Elongation per cent, 2 in.	
	Grain Size		Grain Size		Grain Size	
	.030mm	.005mm	.030mm	.005mm	.030mm	.005mm
Annealed	62,000	77,000	28,000	45,000	35	31
Half Hard	85,000	102,000	76,000	84,000	12	6
Hard	100,000	112,000	85,000	86,000	3	2
Extra Hard	108,000	—	86,000	—	2.5	—
Spring	114,000	122,000	85,000	—	1	1

Application: Most widely used nickel silver alloy for mechanical and current-carrying springs, connectors, clips, receptacles and contacts.

CA 766 Nickel Silver						
Nominal Composition: 56.5 Cu, 12 Ni, 31.5 Zn Strip .020 in. thick						
Temper	Tensile Strength, psi		Yield Strength, psi 0.5% ext. under load		Elongation per cent, 2 in.	
	Grain Size		Grain Size		Grain Size	
	.035mm	.005mm	.035mm	.005mm	.035mm	.005mm
Annealed	60,000	72,400	—	42,100	59	43
Half Hard	82,500	94,100	71,000	76,200	16	5
Hard	100,000	106,400	—	79,100	3	1.5
Extra Hard	108,000	—	—	—	2.5	1
Spring	114,000	118,700	—	78,000	1.8	1

Application: Used widely for current-carrying springs, connectors, receptacles and terminals.

CA 752 Nickel Silver			
Nominal Composition: 65 Cu, 18 Ni, 17 Zn Strip .040 in. thick—0.035mm grain size			
Temper	Tensile Strength, psi	Yield Strength, psi 0.5% ext. under load	Elongation per cent, 2 in.
Annealed	58,000	25,000	40
Half Hard	75,000	62,000	8
Hard	84,000	74,000	3
Extra Hard	89,000	83,000	1

Application: A general purpose alloy for springs, bellows, spun or drawn parts.

CA 735 Nickel Silver						
Nominal Composition: 72 Cu, 18 Ni, 10 Zn Strip .040 thick						
Temper	Tensile Strength, psi		Yield Strength, psi 0.5% ext. under load		Elongation per cent, 2 in.	
	Grain Size		Grain Size		Grain Size	
	.035mm	.005mm	.035mm	.005mm	.035mm	.005mm
Annealed	54,000	64,700	26,000	40,400	43	26
Half Hard	69,000	80,600	57,000	76,900	9	5
Hard	78,500	90,100	72,000	85,500	4	3
Extra Hard	85,000	93,400	81,000	87,000	3	3

Application: Used widely for severe deep drawing applications such as diode cans, connector shells and severely formed springs.



ERROR CORRECTOR

With a stylus like this — originally a chicken bone — the Romans kept records and wrote messages on a “codex,” a wooden tablet coated with black beeswax. The rounded knobs on the “eraser” end were used to smooth over errors and prepare the surface for correction. With Codex today, transmission errors in communications can be “smoothed over” and corrected in one operation. Using a new convolutional forward-acting code, Codex error correcting

equipments are fitted to the type of system they serve; code strength and style are varied to match the error patterns of such diverse channels as telephone plant, HF radio, troposcatter and undersea cable. They assure *enough* protective power for any given system, without wasteful and unnecessary complexity. If your data or message system still uses an electronic “chicken bone” to cope with transmission errors, phone, write or Telex Codex.

CODEX
CORPORATION

• 222 ARSENAL STREET, WATERTOWN, MASSACHUSETTS •
ZIP CODE 02172 • (617) 926-3000 • TELEX 094-6332 •

A whole litter of them, in fact. In the form of technical bulletins covering the most complete line of ferrite materials and shapes in the world. Included are core sizes and shapes not available as standard from any other manufacturer and ferrite materials made only by Indiana General.

Take flyback transformers, for example. In color-TV our 05 ferrite is the leading core material because of its high-voltage per-

formance. Where ferrites for filters are concerned, our TC-7 combines extremely high "Q" and low loss with the most linear temperature coefficient of inductance found anywhere.

In all, we list 11 ferrite materials in 315 standard shapes and sizes including: cup cores; toroids; transformer C cores; rods and strips; E, I, U, and C cores; the international series of cup cores, and cross cores.

Whether you are designing circuits or purchasing components, you can have our Ferramic® Materials Bulletins Nos. 100 thru 105 on your desk. Write Mr. K. S. Talbot, Manager of Sales, Indiana General Corporation, Electronics Division/Ferrites, Keasbey, New Jersey.

INDIANA GENERAL 

COPYRIGHT 1966, INDIANA GENERAL CORPORATION.

We're ready to let the cat out on our 315 standard ferrite core shapes and 11 different materials.



How can you tell when you're ready for on-site gas supply?

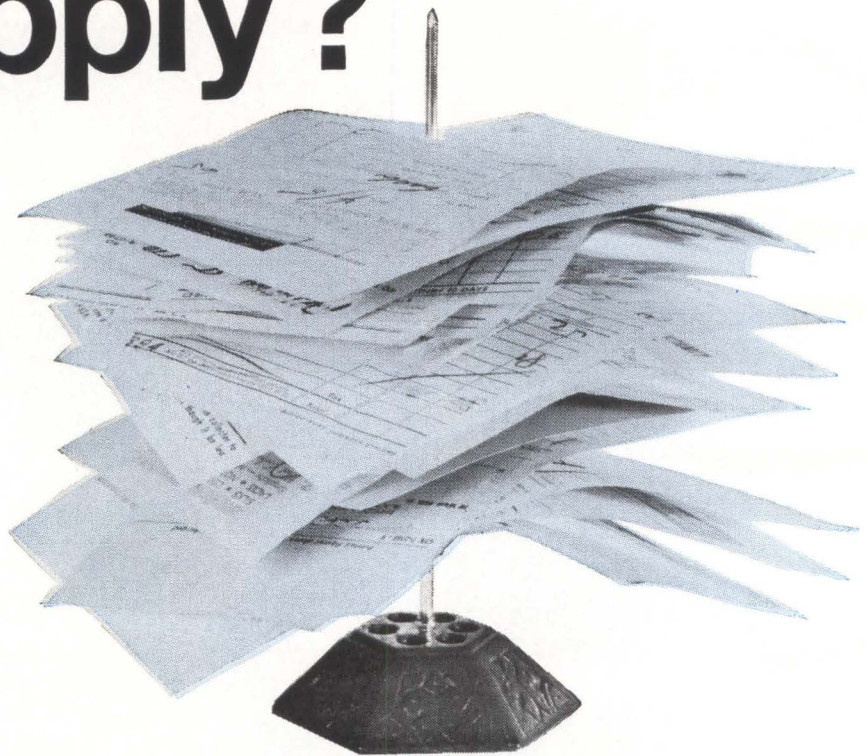

First let us review your recent industrial gas bills.

Next determine your monthly gas requirements.

Then take a good look at your own present on-site generator — or at the distance separating you from the gas-producing facility serving you now. Finally, ask yourself: "How much could I save by being supplied from a modern on-site plant?"

Air Products supplies industrial gases in any quantities you wish — from cylinders to tank cars. Frequently, however, we find we can save our customers money by pipeline supply from a plant built on or near their premises.

This on-site concept—pioneered by Air Products—is recognized around the world as an efficient and reliable means of supplying tonnage oxygen, nitrogen, argon, hydrogen, annealing, and other industrial gases.

If you suspect there may be a better way of meeting your industrial gas needs than the one you're now using, let us explore the economics of on-site supply with you. Write or phone today. Air Products and Chemicals, Inc., Industrial Gas Division, Allentown, Pennsylvania. Phone (215) 395-4911.



Air Products and Chemicals
INC.

ALLENTOWN, PENNSYLVANIA

Editorial

The \$10 billion bobble

This year will be one that most electronics concerns will look back upon with fond memory and even reverence. For almost all of them it has been the best year on record, with sales topping even the most optimistic forecasts.

Earlier this month, the White House quietly released an announcement that almost entirely explained the unexpected dimensions of this boom. The Pentagon, it seems, made a tiny mistake in estimating its Vietnam war costs. Instead of the \$8 billion to \$10 billion outlay projected a year ago, the Defense Department has spent \$20 billion in 1966.

As we've noted all year, a larger percentage of these expenditures has gone for tactical electronic equipment such as communications gear, navigation and control systems for aircraft and helicopters, and infantry fire controls, than for strategic weapons, and suppliers and component makers have reaped a bonanza. The flood of money into other industries like clothing, food, motor vehicles and construction has caused a boom from which other sectors of the electronics industry benefited. Sales of color tv sets, tape recorders and stereo equipment were limited by production rather than by demand.

Still, no matter how beneficial the Pentagon's \$10 billion bobble was for the electronics industry in 1966, there is something fundamentally wrong with it. For one thing, of course, the industry and everyone else, will have to pay for it sometime next year or the year after. Most people are already paying for it in higher prices, the result of all this overheating of the economy.

But even more important is the question concerning the kind of procedure that would allow the Defense Department to make a 100% error in projecting its spending—particularly this Defense Department. In the six years since Robert S. McNamara took over the reins, the American public has been fed a daily diet of press releases describing the efficiency of the Pentagon. Computer techniques and cost effectiveness, we are told, have changed the department from a morass of duplication to an object of efficiency, an agency so efficient, in fact, that other cabinet officers have been urged to model their departments' operations on the Pentagon's.

McNamara has answered reporters' questions about procurement and costs with computer-like rapidity, pouring out a numbing blizzard of figures.

The blizzard raged last September when he reported on cost effectiveness in the most recent year, but a lot more people were becoming suspicious of his figures. A Congressional subcommittee probing earlier cost figures found them to be filled with nonsensical assumptions. The \$10 billion mistake made for 1966 should make all of McNamara's figures suspect. And it lays to rest, once and for all, McNamara's insistent claim of infallibility.

Another turning point

Political change is sweeping Western Europe and the new look will have a marked effect on electronics technology and companies. Europe is at another turning point. For the first time since the end of World War II, the fear of invasion by, or war with, the Soviet Union is not the one compelling force in determining the foreign and economic policies of such countries as the United Kingdom, West Germany, Italy and France. With abatement of this fear, the leaders of these nations are increasingly turning their attention to domestic economic problems and the touchy matter of national prestige. Nationalism, always smoldering close to the surface, is about to flame throughout Europe.

Fueling the fire will be a concentrated effort to improve national technologies, and thus improve national economies. Almost all these countries are dissatisfied with their current technological progress, most particularly their progress in electronics, computers and space exploration. Although the lag in application of technology—the crux of the dissatisfaction—is not a new problem, only this year has it been publicly acknowledged by the statesmen of Europe. And in 1967 they plan to do something about it.

For electronics companies, the political and economic shocks that hit Europe in 1966—crisis in Britain and recessions in West Germany, Belgium, the Netherlands and Sweden—will have both a depressing and a stimulating effect. Sales of consumer products next year will slip in almost every country in Western Europe; sales of communications equipment and industrial electronics will rise sharply. Over-all, the gains will more than offset the declines, and consumption of electronic products in Europe should rise 8.5% in 1967 to \$6.19 billion [see page 79].

U.S. concerns will face their toughest sledding in Europe in years. European nations, proud of their cultural heritage and past glories, fear that they are sliding into second-class positions in a Western world dominated by the U.S. Many will take out these fears on American electronics firms, tangible representatives of this power shift.



A high-power signal generator

Wavering signals may cut the ice in certain Alpine applications. But there's no place for them in the r-f test and measurement laboratory. There you'll want rock-steady signals from a stable source of r-f power — the kind of performance you'd get with a Sierra Series 470A High-Power Signal Generator.

The four Sierra 470A's deliver signals at selectable frequencies through 2.5 GHz with ultra-reliable all-solid-state circuits. (Exception: The final output tube, a standard type, that can be changed in 30 seconds.) Power outputs range from around 70 watts at 400 MHz to 15 watts at 2.5 GHz. You can monitor power output plus grid and cathode currents on direct-reading front-panel meters. All units incorporate automatic no-load, underload protection. Prices are lower than you might expect at \$2,495 (for coverage of 200–500 MHz or 470–1000 MHz), \$2,775 (1000–1800 MHz), and \$3,300 (1800–2500 MHz).

One call to Sierra will produce an echoing avalanche of relevant data and information. Or write Sierra/Philco, 3885 Bohannon Drive, Menlo Park, California 94025.

Circle 24 on reader service card

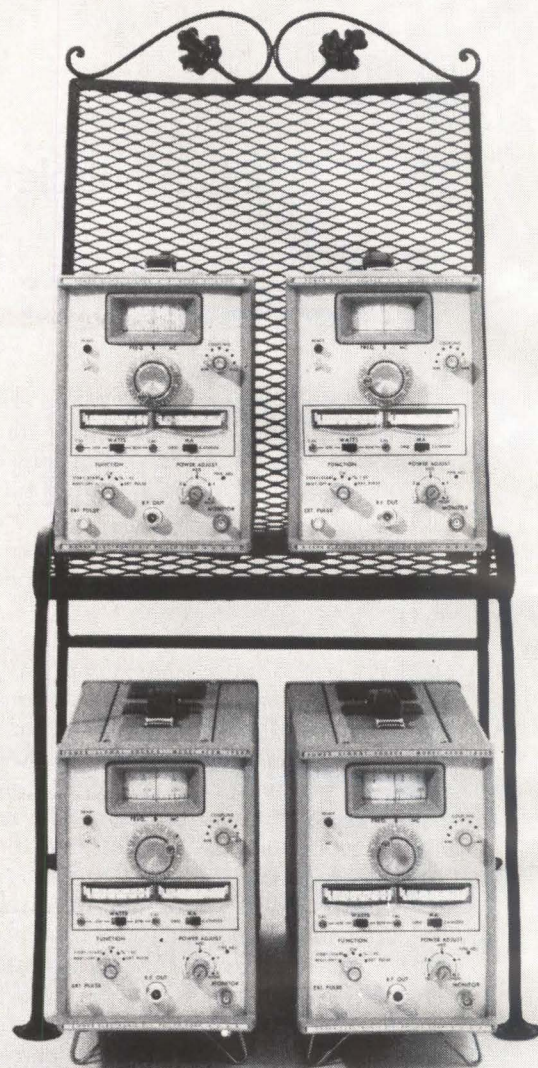

...Four others from Sierra



PHILCO-FORD CORPORATION
Sierra Electronic Operation
Menlo Park, California • 94025



TIME PROVEN COMPONENTS

ADC wasn't in business when sundials were in vogue, but for the past thirty years we've been supplying components for the electronics industry that match the sundial for consistently reliable performance.



REAL TIME RELIABILITY

Real time reliability at ADC is a state of mind—a constant yardstick held up to measure each component manufactured. While the applications for our transformers, filters and communication components may change, the continuous challenge to produce products that offer the utmost in performance and reliability never does. □ We are proud to be associated with an industry that has, through technology, changed the face of the globe. Years ago, ADC delivered the industry's most reliable components. Today, that same tireless attention to detail has made ADC PRODUCTS a manufacturer of the world's most reliable electronic products. □ We recognize this as a never-ending challenge to produce the finest components for the world's greatest globe changers—our customers. We're proud that our components have found their way into space capsules, airliners, communication networks, submarines and just about every sophisticated electronic device made. □ Thirty years of real time reliability has made us even more aware of our responsibility as a respected leader and supplier of communications components.

ADC PRODUCTS 6405 CAMBRIDGE ST. ■ MINNEAPOLIS, MINN. 55426

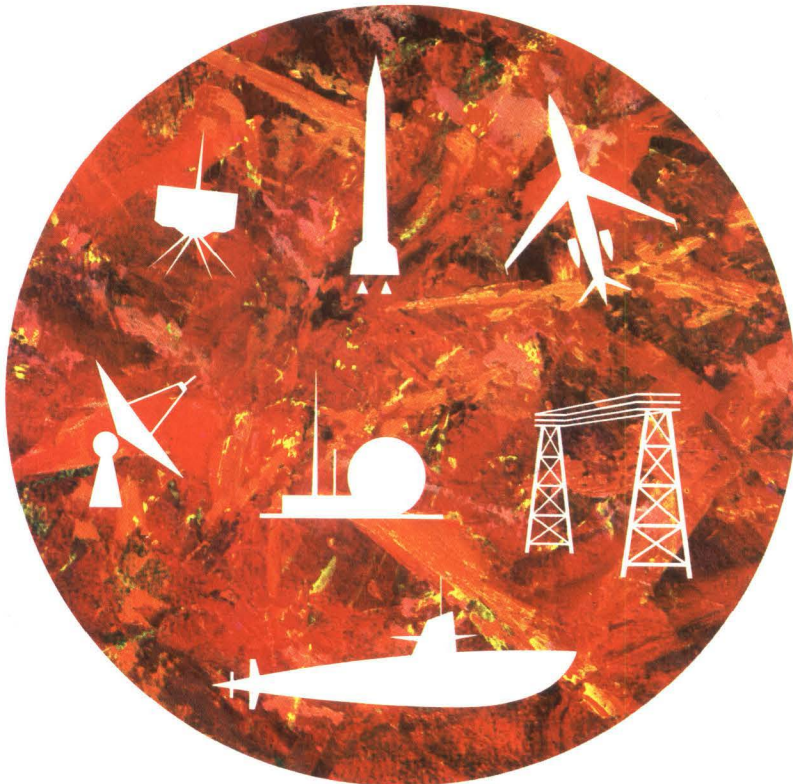
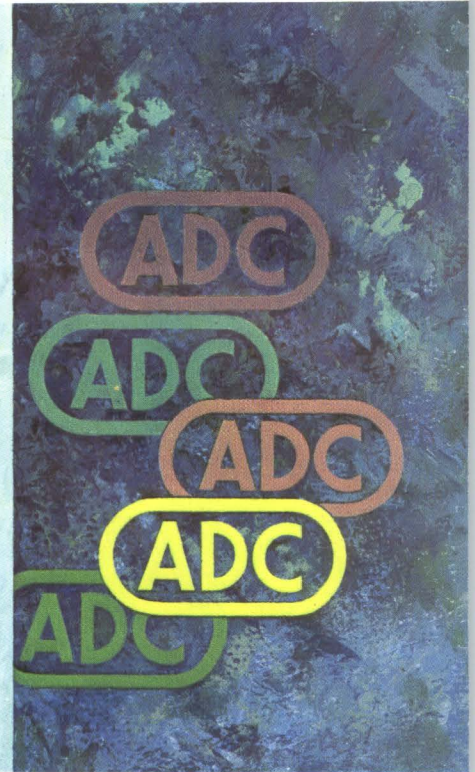



**If you are thinking of something new
and important in data-recording by photography,
you ought to have lunch in this place**

This is a dining room in the largest plant on earth devoted to photography. A majority of the Kodak men you see here are engineers whose entire professional careers are devoted to making photographic systems work supremely well.

Let us assume you are an engineer whose specialty does not happen to be photography and photographic systems, and let us assume you have a photographic problem or a photographic scheme (whichever you choose to consider it). It is quite possible that in this picture is the very guy who is best prepared in all the world to advise you to forget it and think of something else.

On the other hand, since he gets paid to make

photography successful, he has much stronger motivation to figure out with you what next step to take and what you have to decide.

But Kodak is a huge organization. How do you find him? How do you get in touch with him?

Actually there is nothing to *that* problem. We have a department whose major assignment has always been to learn enough about your case to get you together with the right party. You address that department as **Special Applications, Eastman Kodak Company, Rochester, N. Y. 14650.** Most contacts start by phone: (716)-325-2000, Ext. 5129.

Kodak

It's time we let you know

Monsanto has been working

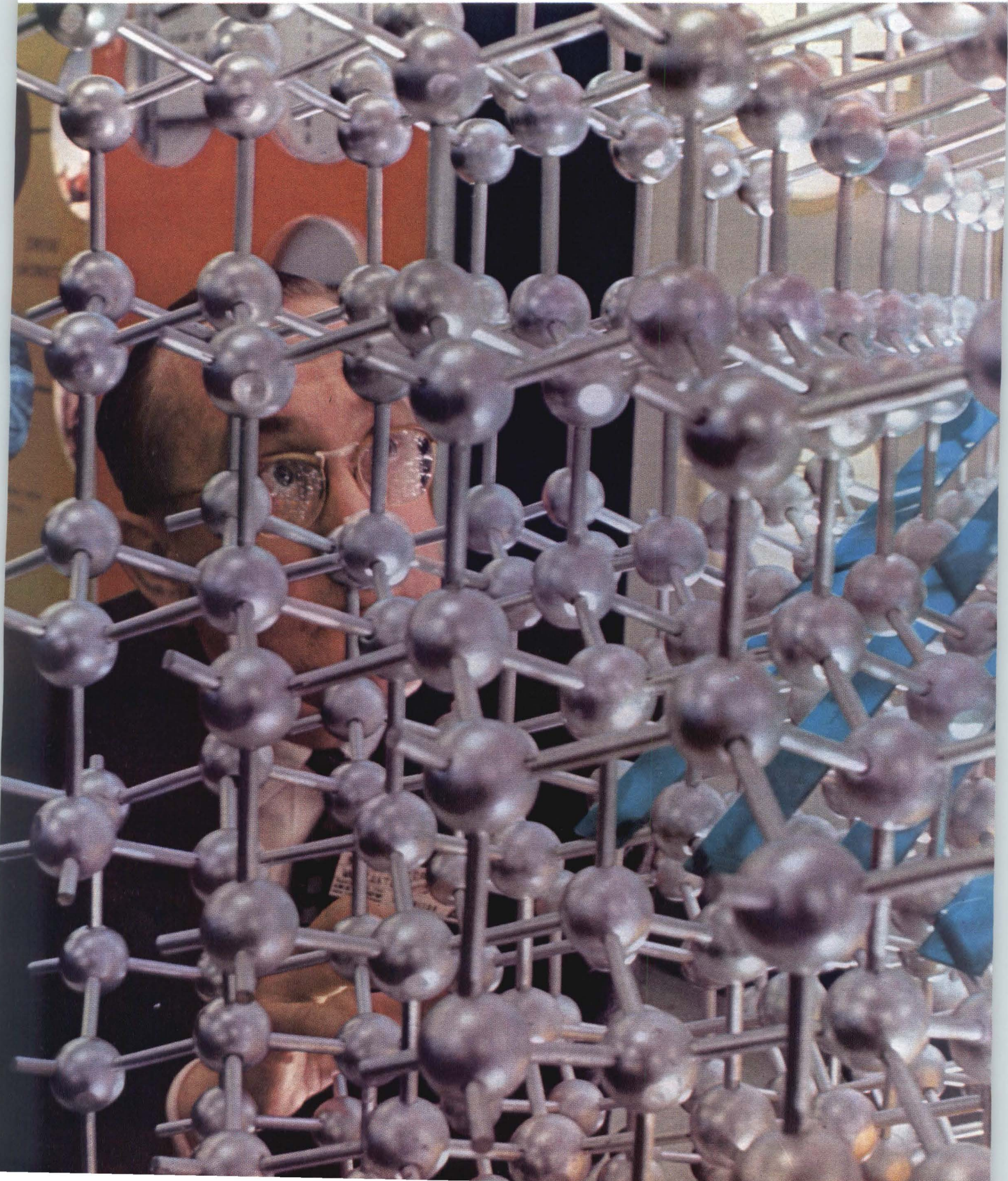

with you for years

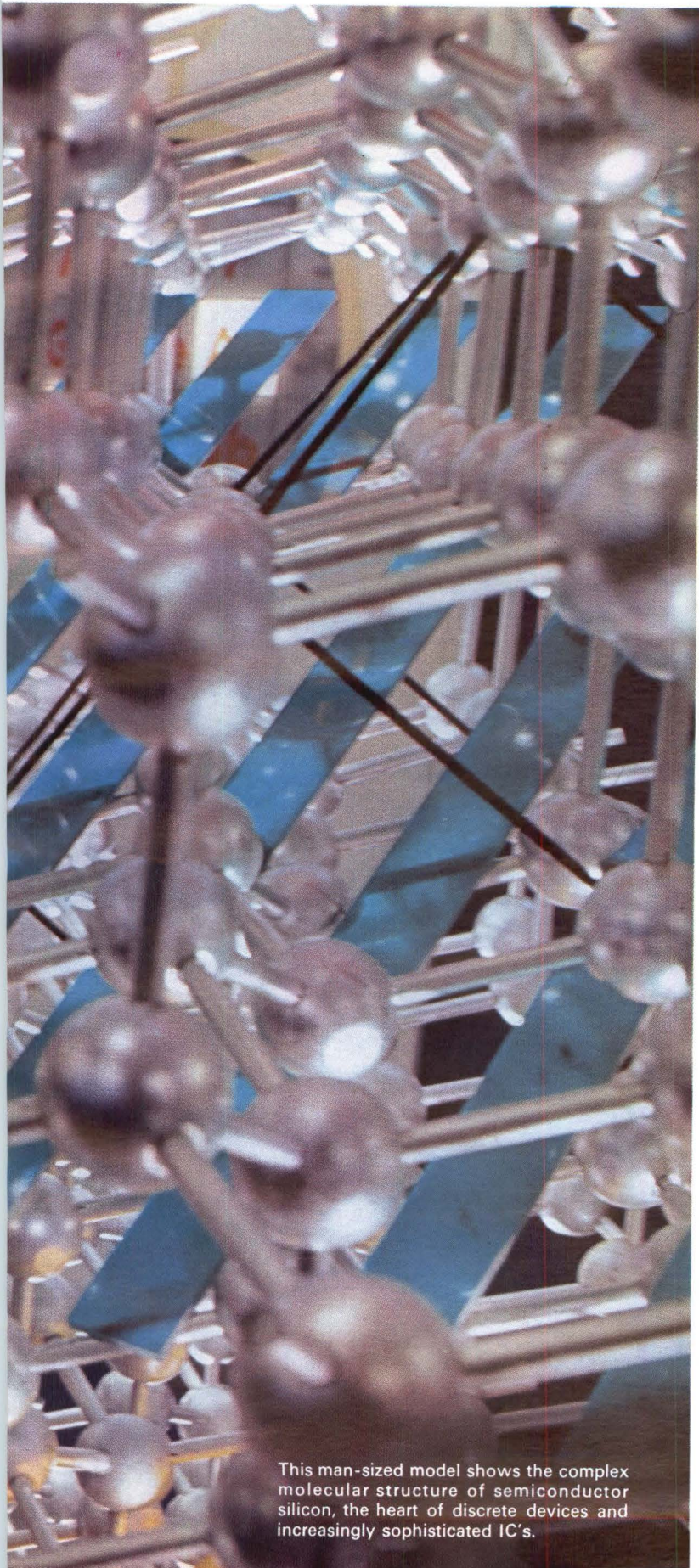

This man-sized model shows the complex molecular structure of semiconductor silicon, the heart of discrete devices and increasingly sophisticated IC's.

One of every three transistors and IC's in your plant, for example, is made with silicon from Monsanto—the largest supplier of sophisticated silicon materials to the electronics industry for almost a decade.



MONSANTO COUNTER/TIMER 1010

You've been a Monsanto "customer" right along, in a manner of speaking, but there's no reason why you should have known. You don't see our name, although we make more basic silicon and GaAs materials than anyone. Monsanto's presence shows up only in the end product's high quality.

From now on, you'll see our name with increasing frequency on the growing Monsanto line of counter-timers, pulse generators, and digital voltmeters. These new state-of-the-art instruments—precisely accurate, applications-oriented, and highly reliable—are designed for you by Monsanto engineers whose knowledge of precise test and measurement shows in the elevated performance characteristics of every design. Each instrument symbolizes a continuing Monsanto tradition: use of fundamental research disciplines to develop sophisticated products of extraordinary value and technical merit.

There's much more to tell you and show you about these new and unusual instruments. Call your nearest Monsanto Field Engineering Representative and ask for a demonstration. Or write to Monsanto, Electronics Technical Center, 620 Passaic Avenue, West Caldwell, New Jersey 07006. Or telephone: (201) 228-3800, Ext. 34.

Monsanto
ELECTRONIC
INSTRUMENTS

Circle 31 on reader service card

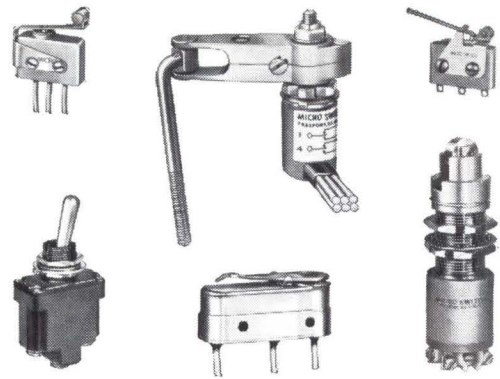

MICRO SWITCH offers the world's largest selection of sealed switches.

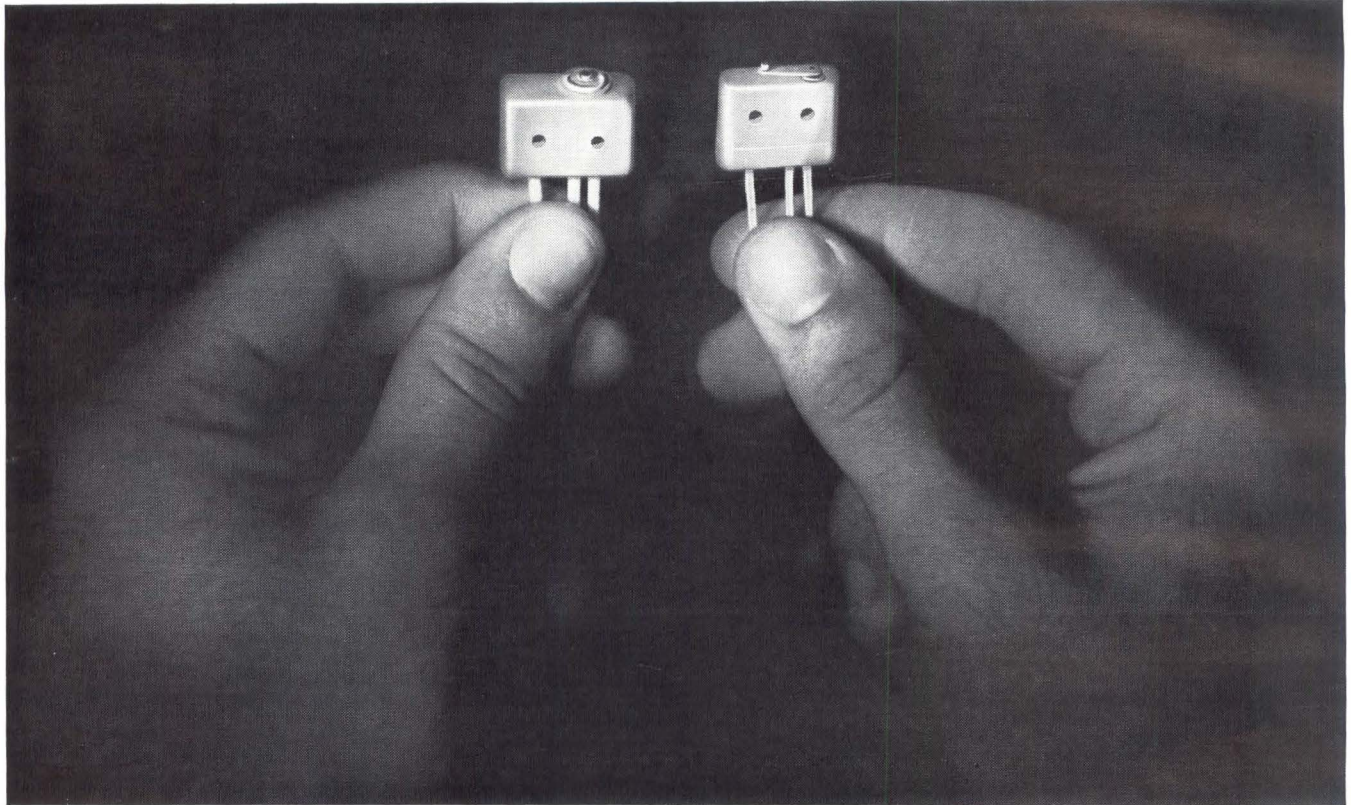

**Which switch
is sealed
well enough
for your needs?**

The term "sealed" and the many methods used to seal switches often mean different things to different people. At MICRO SWITCH the technique of sealing precision switches is a fine art, involving thirty years of experience in solving hostile environmental problems. We classify sealed switches according to their design, construction, materials and performance.

For example, the two switches shown above appear similar. But they are different. The switch on the left is "Environment-Proof." It provides excellent protection against changes in atmospheric pressure, moisture and corrosive vapors. The one on the right is a "Hermetically Sealed" switch. It uses the most complete seal construction possible (metal-to-metal fusion at actuator, mounting tubes and cover, plus glass bead seal at terminals). This means extra assurance of protection for an unlimited period.

We have many hundreds of sealed precision switch types. For experienced help in selecting the exact design you need, call a Branch Office. Or, write for new Catalog 52.

MICRO SWITCH

FREEPORT, ILLINOIS 61032

A DIVISION OF HONEYWELL

HONEYWELL INTERNATIONAL—Sales and service offices in all principal cities of the world. Manufacturing in United States, United Kingdom, Canada, Netherlands, Germany, France, Japan.

Adlake Mercury Displacement Relays —Application Data

Operates Under a Wide Range of Temperature Conditions

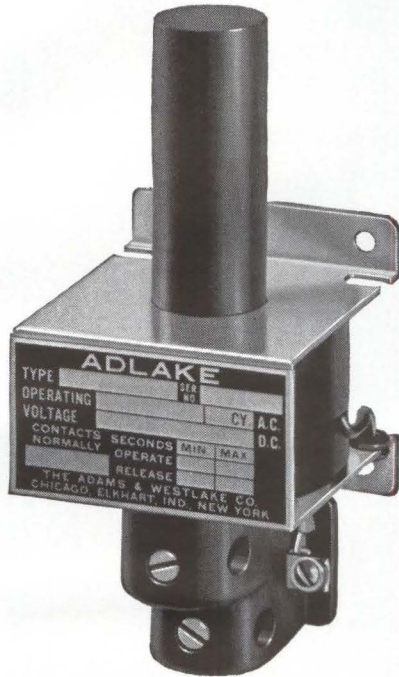

Varying ambient temperatures have little or no effect on Adlake Mercury Displacement Time Delay relays. From the graphic illustrations, ambient temperatures up to 200° F or down to -37.8° F (freezing point of mercury), the change in timing is less than 10%.

Adlake relays have been subjected to temperatures well below -37.8° F for extended periods. Upon raising the temperature to a point above the freezing point of mercury, the relay will again become operative. The relay will not suffer any damage as a result of the extended exposure to low temperature. This portrays the ruggedness of Adlake Relays due to their simplicity of design.

Mercury Displacement Relays — Temperature vs. Time Delay

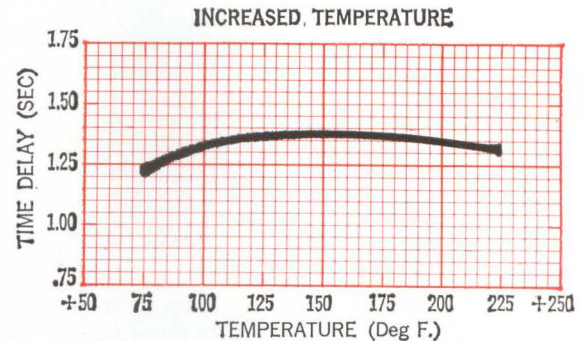

Effect of increased temperature on time delay characteristics. Curve is typical for a normally open, slow-make relay having nominal time delay of 1.25 seconds.

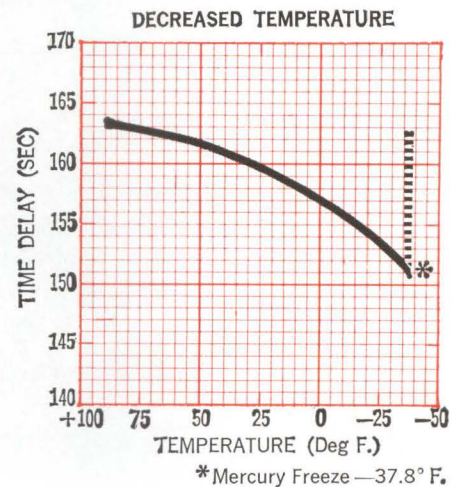

Effect of decreased temperature on time delay characteristics. Curve is typical for a normally open, slow make relay having nominal delay of 160 sec.

Backed by sound research and disciplined engineering, Adlake applies the industry's broadest line of mercury displacement and mercury wetted relays to the creative solution of design circuit problems. However unique or special your application, Adlake can assist you in

developing it. For prompt, personal and knowledgeable attention to your relay needs, contact the one source that is the complete source in the mercury relay field. Contact Adlake today for catalog and further information.



THE ADAMS & WESTLAKE COMPANY

Dept. 2126, Elkhart, Indiana, U.S.A. 46514 • (AC 219) 264-1141

TRANSPORTATION EQUIPMENT • ARCHITECTURAL PRODUCTS • MERCURY RELAYS • DOORS AND ENTRANCES • CONTRACT MANUFACTURING

The closer you get to a Bendix Pancake connector, the more innovations you see.

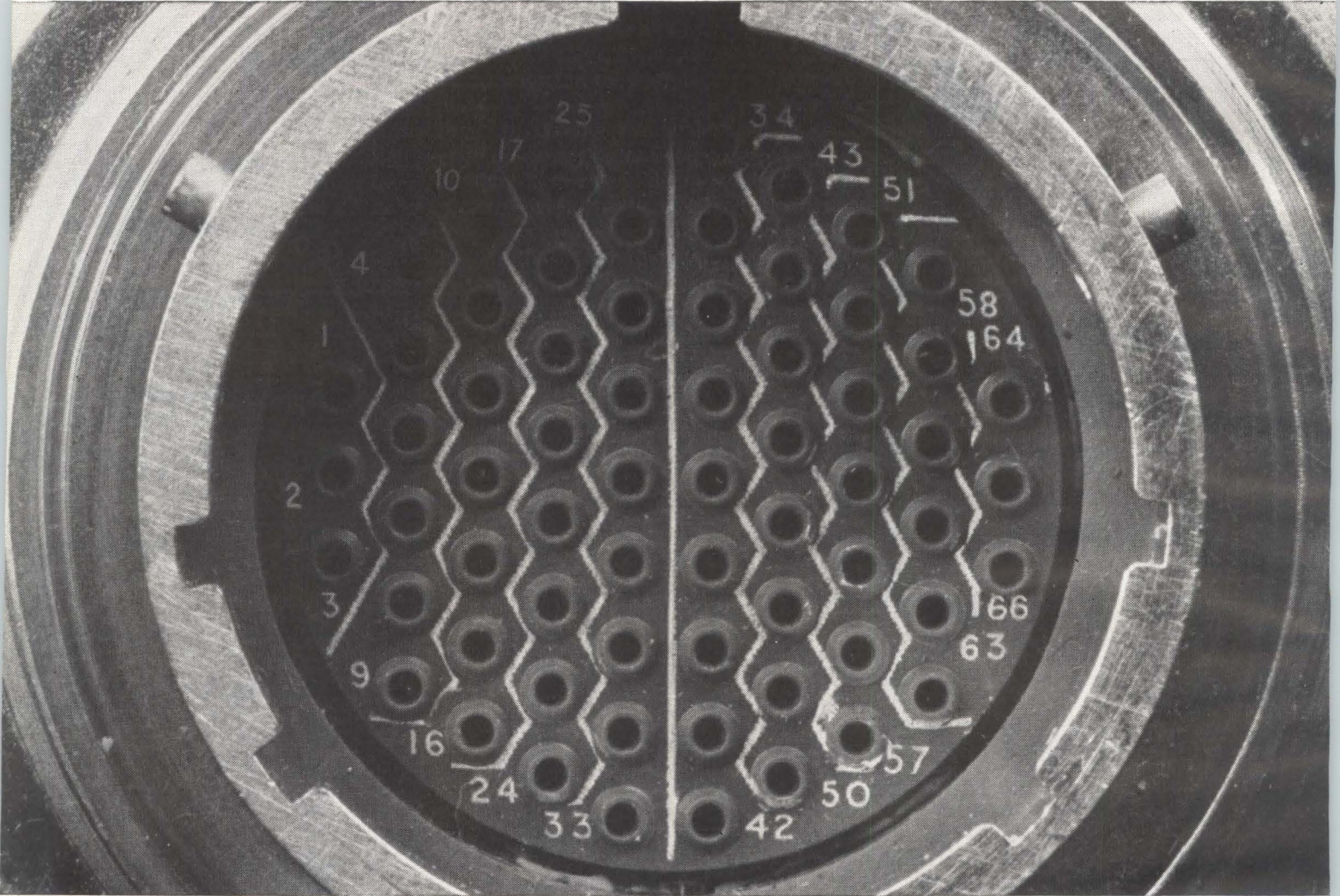

You're looking at room for up to 66 contact pins in our Size 18 Double Density model, for example. Look further and you'll see Bendix® JT Pancake™ connectors cut weight up to 60%, length up to 50%, making them the lightest, smallest miniature cylindricals available.

You'll see nine major connector improvements, too. Included are greater

resistance to pin contact splay and bending. Design simplicity. Increased reliability. A wide, wide temperature range (cryogenic to 392°F). Hard face socket inserts to prevent pin contact dielectric piercing. Alternate keying to eliminate cross plugging. Better sealing. Improved contact identification, too.

What about design versatility?

Choose from crimp, solder, grommetted, potted and hermetic versions. Eight shell types and nine shell sizes — 8 through 24; 34 insert patterns; 16-, 20-, 22- and 24-contact sizes that will accept a wire range of 16 through 28 gage.

Like to look even further into Bendix JT Pancake connectors? Just write us in Sidney, New York.

Electronics Review

Volume 39
Number 26

Consumer electronics

Stimulating diode

In the fall of 1963 Tyco Laboratories, Inc., of Waltham, Mass., announced that it had achieved laser action from silicon carbide (SiC) diodes. The claim was vigorously challenged and the question has never been fully resolved. Shortly thereafter, the Norton Co., a producer of abrasives and a principal supplier of SiC to the semiconductor industry, acquired a license from Tyco for the "laser" process but Norton engineers never achieved laser action. However, the intensity of the light emission; (the strong spikes of electroluminescence that are sometimes mistaken for coherent emission) gave Norton researchers a better idea: use the material at room temperature to produce sound tracks on home movies.

Rising stock. When Norton announced earlier this month that it had found a potentially profitable application for the relatively inexpensive material, the reaction in Wall Street was swift; in one day Norton's stock rose \$13 to \$42. It has since held at about that level.

Commercial use of the SiC in cameras, however, will not be as immediate as some investors thought, since there is no volume production and the development diodes cost \$100 each.

Study of the needle-thin beam of cold light led to a decision which "was a matter of cold arithmetic," says Robert A. Stauffer, Norton vice president for research. "We abandoned the search for a SiC laser and concentrated on a method of producing the diodes repeatedly and inexpensively," he explains.

Different steps. Norton is not saying what that method is, except to indicate that the trick is in the combination of crystal growing, doping and junction fabrica-

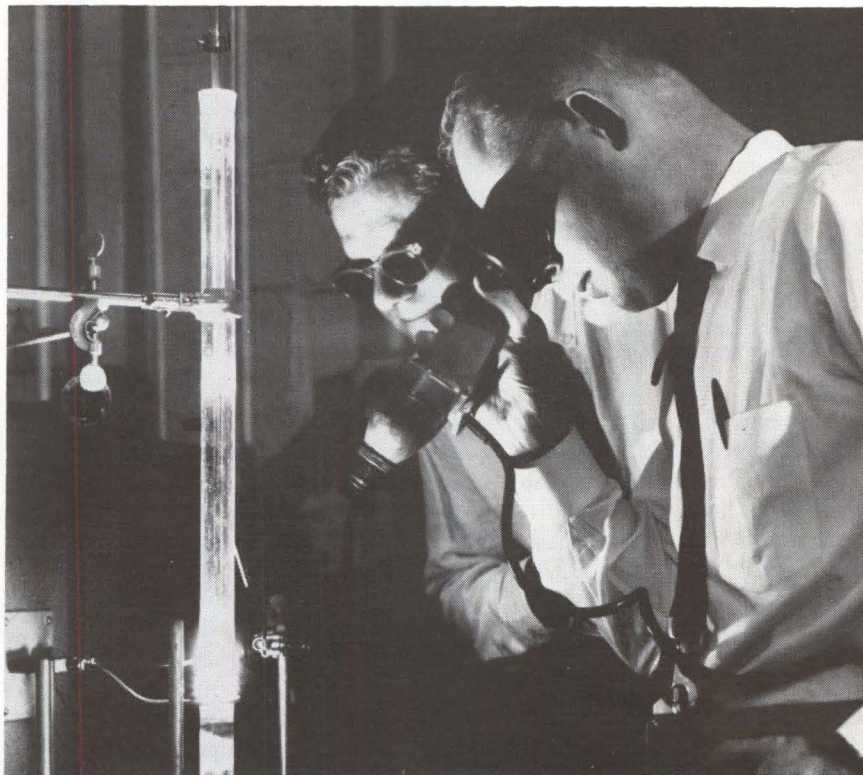

Norton scientists examine brilliant flash produced by new silicon carbide electroluminescent diodes.

tion, and that "every step along the way is different from the principal methods of semiconductor device manufacture."

Tyco was using a traveling-solvent process for crystal growth when it announced continuous room-temperature laser action.

The Norton diodes emit in the yellow part of the visible spectrum, at about 5,700 angstroms, and film is quite sensitive to this wavelength. Diodes which peak at 4,560 angstroms, in the blue-green, can also be produced. Stauffer says these might be even better, might give a little faster response, "but we haven't tamed that type yet."

So far Stauffer reports the yellow diodes have been used to put sound tracks on 16-millimeter film only. "We just tore the standard sound system out and installed the diode recording system," he says. Fre-

quency response was about 6,000 hertz, roughly comparable to a professional film soundtrack. Norton engineers made more than 100 color and black-and-white sound films with the process, which requires no lenses or optics. Only a microphone and solid state amplifier are needed in addition to the diode; it would take up one-tenth the space required by conventional recording techniques. In home movie systems, the diode method would replace magnetic stripes on film, which require special projector equipment. In the professional field, the method could replace elaborate systems of lamps, mirrors and lenses.

Amateur market. The technique has not been tried with 8-mm systems, which dominate the amateur market. This would require a camera designed for sound, and the 8-mm manufacturers have not yet

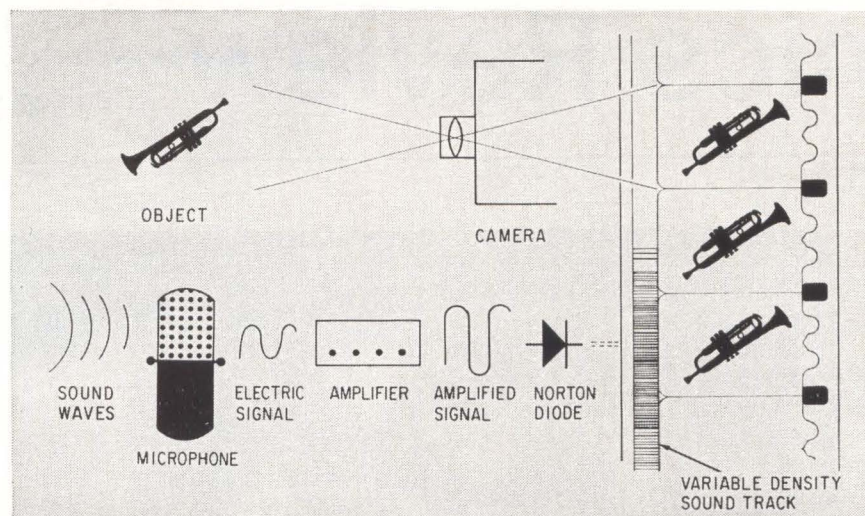

Sound can be recorded on film using optical techniques. Norton's new diode translates sound signals into light signals.

gone into this part of the market.

Norton plans to manufacture and sell the diodes and also offer non-exclusive licenses for sound recorders and other patented uses of the light emitters, says K. Lloyd Martin, general manager of the research division. In mass production all the components needed by a camera maker to add sound to home movies would cost only \$25, the company says.

Norton will also develop diodes for optical readout of encoders in data processing systems, for other computer applications, for signal lamps in instruments and for film-marking devices in mapping applications.

Advanced technology

Power of positive thinking

One of the major annoyances for students of extrasensory perception (ESP), according to one research group, is that the best subjects, in time, lose their ability.

Russell Targ, a physicist who believes in ESP and its allied arts, and is one of the developers of the f-m and supermode laser, [Electronics, Sept. 20, 1965, p. 101] feels that the typical card-guessing tests are self-defeating. Targ, a researcher at Sylvania Electric Products, Inc.'s Mountain View, Calif.,

laboratories, maintains that the conventional tests delay rewarding the subject until after a long series of guesses. Immediate reward, or reinforcement, is fundamental to operant conditioning.

For enhancement. In an effort to help, Targ has turned to the field he knows best, electronics, and has devised a system that tests psychokinesis (the ability to move an object by willpower, or as some ESP supporters explain it, by the brain's electromagnetic energy). Targ, however, isn't trying to prove ESP's existence. His aim is to enhance a subject's ability to exercise it.

Targ's system is essentially an electron beam tube, which drives a train of slow-moving electrons at a double collector. One part of the collector is ring-shaped, the other is a plate behind the hole in the ring. Each collector is led to ground through a resistor, and a galvanometer is connected across the two resistors. If an equal number of electrons hits each collector, there will be no potential between the resistors, and the galvanometer will read zero, a condition which can be brought about through magnetic focusing of the beam. An imbalance of electrons on either collector will cause more current to flow through its resistor and will deflect the galvanometer.

There are a number of ways to cause such an imbalance, the simplest being to bring a magnet close

to the tube. Targ, however, wishes to deflect it by sheer willpower.

Apart from his laser research work at Sylvania, Targ is president of Parapsychology Research Group, Inc., a not-for-profit organization that conducts ESP research. Working with him is Charles T. Tart, an assistant professor of psychology at the University of California.

A subject working with Targ's electron tube system receives an immediate reward when he alters the beam's direction, since the galvanometer's movements are recorded on a strip chart and the subject can see the squiggles immediately if the beam moves.

Random choice. Targ is also working with a form of electronic card-guessing, in which a box, with four colored buttons, generates random numbers. The device, designed by David B. Hurt, an engineer at the Fairchild Camera & Instrument Corp., reinforces by punishment as well as by reward. The object is for the subject to guess which of the four buttons will light up.

At the heart of the box is a 1-megahertz multivibrator built with Fairchild's micrologic integrated circuits.

Targ claims "encouraging" results from his devices. He says one subject tried to move the electron beam in ever-increasing spirals; the strip chart rewarded him with squiggles.

"I'm reluctant to offer any hypothesis for the operation of psychokinesis. Speculation without repeatable data is where people get into trouble," he says.

In any case, Targ is much more interested in the idea of teaching ESP than in setting up experiments to prove its existence. "My whole effort will stand or fall on the idea of immediate reinforcement."

Military electronics

Shrike out

The Shrike faces retirement. Pentagon officials agree that the two-year-old air-to-ground missile has

outlived its usefulness. Within a year, the Air Force and the Navy will replace it with the Standard-ARM (antiradiation missile), which will have a better guidance system.

Named a prime contractor for the new missile this month was the Pomona division of the General Dynamics Corp. The initial order, for \$3.4 million, is expected to eventually swell to more than \$200 million. Subcontractors for the guidance subsystems are the International Business Machines Corp. and Maxson Electronics Corp. There are reports that the Bendix Corp. may receive a sub-contract, too.

Narrow view. Pilots flying over North Vietnam have had trouble hitting enemy radar installations with the Shrike. Not only do the planes have to veer off flight paths to aim the missile toward the target, but the enemy has learned to switch his radar on and off to "spook," or divert, the incoming missile.

The Standard-ARM is an adaptation of the Navy's ship-launched Standard missile, a weapon guided by its mother ship's radar. Under this system, shipboard radar blankets the area of the target with signals and the missile's sensors pick up reflected signals to home in [Electronics, Dec. 27, 1965, p. 112]. Like the Shrike, the new Standard-ARM will rely entirely on enemy radar signals for aiming.

For security reasons the Defense Department will say little about the specifications for the new missile's guidance, which is called TIAS, for target identification acquisition system. But it is known that the system will have four-quadrant targeting, meaning that it will be able to home in on a target from any angle; in contrast, the Shrike was limited to a 90° sweep.

Memory, too. Unlike the Shrike's guidance, the Standard-ARM's system will have a memory unit that will enable it to lock onto a target as soon as the aircraft carrying it is illuminated by the enemy's radar. Further, the new weapon won't need to follow a continuous signal to stay on course.

In awarding the contract, the Pentagon is specifying that the missile's design be flexible enough to accommodate improvements during its production run. Although military officials won't say what improvements will be pushed, it's obvious that an effort will be made to include electronic counter-measures and counter-countermeasures.

Communications

Predicting the path

The choice of the best frequency for high-frequency communications

is made by operators skilled in interpreting data on the condition of the ionosphere, which changes with exasperating irregularity [Electronics, Oct. 3, p. 45]. Ionospheric sounders, which step through 160 frequencies between 2 and 32 megahertz, can indicate which frequencies are propagating best at a given moment; but the operator uses his own experience to evaluate what changes are likely as he transmits. He is helped in this calculation by long-term frequency predictions. Granger Associates of Palo Alto, Calif., is prepared to provide additional assistance in the form of a computerized path predictor.

Ten-channel model. Granger built such a computer system more than a year ago, but the one it will deliver to the Navy Electronic Laboratory at San Diego, Calif., next month can handle 10 channels, in contrast to the single-channel capability of the first machine. In the new machine soundings are taken every 10 minutes and information is printed out on four lines:

- A digital evaluation of the quality of each usable frequency.
- An indication of the lowest and highest possible frequencies, plus the current frequency and the best alternate frequency.
- A notation of the time, the current operating frequency, how long it will be useful and with probability of useful operation 20 minutes ahead.
- A notation of the date, the alternate frequency (with instructions to change if the present frequency is about to become useless), and the probability of the alternate's operating 20 minutes hence.

Inputs to the computer, a Digital Equipment Corp. PDP-8, are ionograms from the sounder and an interference date. At each sounder scan, at intervals of about 10 minutes, the computer stops all other input-output operations, accepts a video signal from the sounder through an analog-to-digital converter and samples the data and stores it. It takes 50 milliseconds to sample each sounder frequency: 1 msec for a synchronizing pulse, 5 msec to listen to noise, 10 msec to sample two frequency pulses and the rest of the period for com-

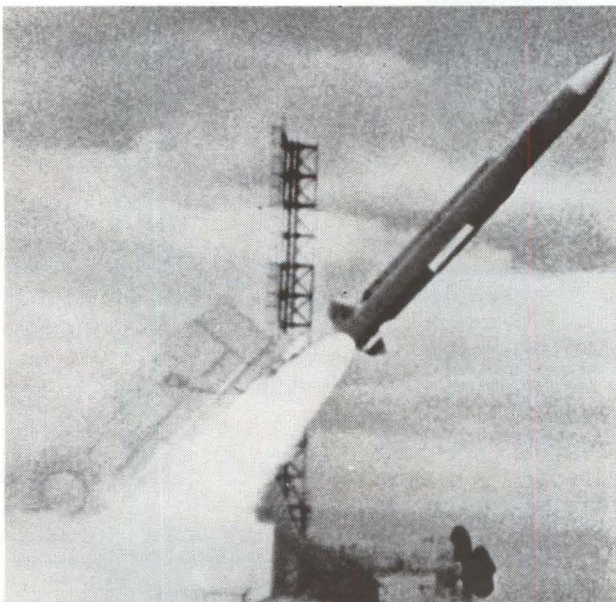

Early version of the Standard missile fired from a ship. The weapon is being upgraded with a new guidance system, which will enable it to home in on a target from any angle; the Shrike had only a 90° sweep. The General Dynamics Corp. has been named prime contractor for the new missile.

puting the predictions.

Builds its library. The ionogram provides amplitude and multipath distortion as a function of frequency. Interference data gives the noise level. From these inputs, the computer calculates the best frequency and two alternates. Since the computer builds its own library, storing up to 10 days of sounder data, it does not need the long-term predictions.

Basically, the Granger contribution was in marrying its sounder to the PDP-8 and in writing the program. The original system, the 9077 path predictor, was introduced in the fall of 1965, but it did not have the channel capacity required for the Defense Communications Agency's common user radio transmission system program. Additional memory permitted the expansion to 10 circuits with 160 possible frequency assignments in each circuit.

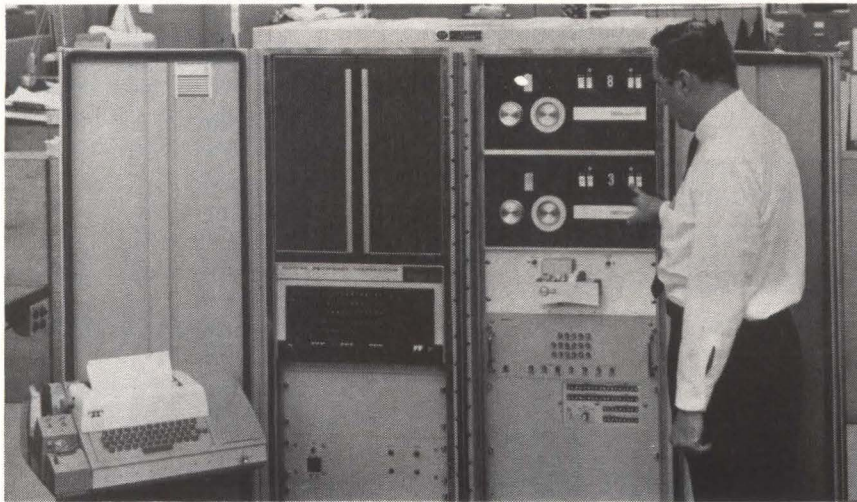

Granger Associates computerized path predictor for operations of high-frequency communication gear.

Instrumentation

Crash program

Telemetry systems have survived some rugged tests: they've been sunk in the ocean, blasted off in rockets and fired out of cannons, and have then been retrieved for use again.

What next?

They'll be slammed into walls and flipped over at speeds up to

85 miles per hour to test how well cars can withstand crashes.

At the Ford Motor Co.'s proving ground in Dearborn, Mich., five or six new cars carrying specially designed telemetry gear will be destroyed each week in experimental accidents involving car-and-car and car-and-barrier crashes plus roll-overs and drops.

Write-off. Present electronics systems for gathering car-crash data are made as inexpensively as possible because in most cases the gear doesn't survive the test. So, instead of bothering to convert the analog data collected from sensors into digital data directly in the car, the engineers have simply fed the analog signals through an umbilical cord to an accompanying car. There the information has been recorded on tape and later converted into digital data for computer assessment. This translation and assessment process can take as

Wright Corp., uses a pulse-code modulated transmitter mounted in the test car's trunk. Both the transmitter and the sensors are built into shock-insulated packages that reduce the force of a crash to levels that the test equipment can tolerate. The packages are built to protect the transmitter and sensors from the impact of head-on crashes at up to 85 mph.

Analog signals in this system are converted into digital signals and fed from a remote receiver directly into a computer for assessment. The computer then calculates the attenuation of the signals and multiplies them back to their original levels to measure crash results. Ford engineers estimate that this entire operation will take about 10 minutes.

Rapid read

At least twice a year telephone servicemen must make frequency adjustments at remote microwave stations. With conventional scaling and heterodyne counters, the job may take hours. The Computer Measurements Co. has designed a counter for the Bell System that will make the servicemen's task easier and faster.

The counter reads frequencies from 10 hertz to 135 megahertz directly. The crystal-controlled unit reaches its minimum frequency stability of one part in a million per year only one hour after it is plugged in. Counters with this stability generally require 24 to 48 hours to stabilize—much too long for a man who has to get a system back on the air or correct some frequency problem.

Cliff-hanger. A few weeks before the company was to deliver 17 units to Bell for evaluation, it found a Motorola, Inc., crystal that filled the bill. "It was a real cliff-hanger," says Nyal McMullin, the company's marketing manager, "until we came across a new crystal just out of the development stage."

The natural quartz crystal oscillator is a 3-Mhz unit whose output is counted down by CMC's circuitry to produce the accurate 1-second gating pulse required to

long as three days.

Now Ford, working with its Philco-Ford Corp. subsidiary, has developed a system that can be removed from a car after a test crash and used again. The new gear also does away with the cumbersome umbilical cord and shortens test-analysis times.

Built to last. The system, developed in cooperation with Scientific Controls of El Paso, Texas, and Barry Controls of Watertown, Mass., a division of the Barry

this is the electronic keyboard!

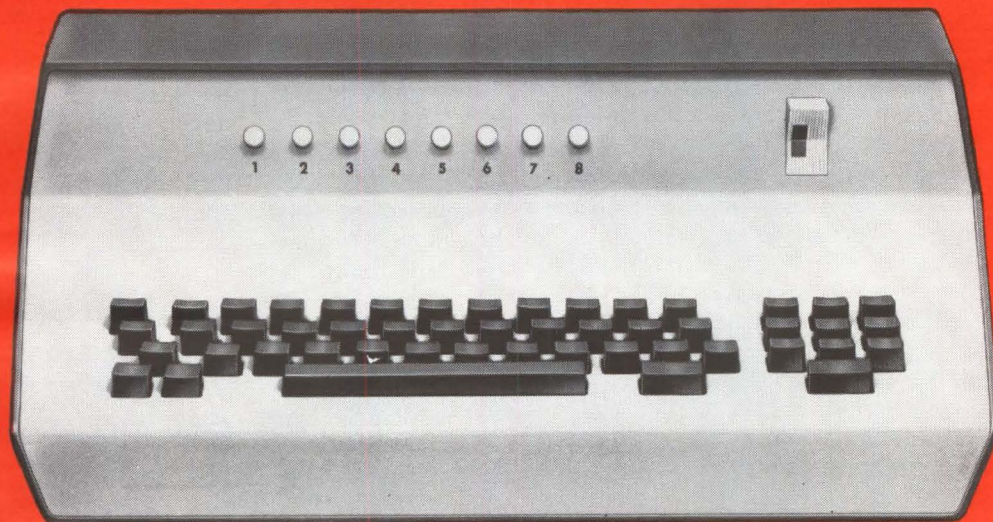

NAVIGATION COMPUTER CORPORATION

Dept. EL-212
Norristown, Pennsylvania • 215/666-6531

DISTRICT OFFICES
Seabrook, Maryland • 301/577-2010
Garden Grove, California • 714/839-0232

NAVCOR[®]

Valley Forge Industrial Park
Norristown, Pennsylvania

LOOKS GREAT! Now send me all the
details on the NAVCOR 1050 Electronic Keyboard
and how it can be customized to fit my requirements.

Name _____

Title _____

Company _____

Address _____

City _____

State _____ Zip _____

Dept. EL-212



measure frequency. The crystal and compensating circuits are quickly heated and then the temperature is kept constant by an oven, says Kenneth Backman, product manager at Motorola's Communications division.

Designed to operate with the Bell Systems TD-3 microwave link equipment, the counter will be part of a test set used for periodic maintenance and repair at radio repeater installations.

Bell looked at scaling and heterodyne counters but found them wanting. Scaling counters, which lack a high-frequency capability, scale down the frequency and build it up again to get a reading. While the frequency samples are being taken, the signal must remain present and unchanging—a condition not always realized.

Flip-flops. With heterodyne models, the operator must constantly turn dials to change operating range and mentally add the dial position figure to the frequency on the counter display to arrive at the actual frequency.

Bell will use the counter to check the 135-Mhz submultiple of the beat oscillator in a receiver and a 40-Mhz shift oscillator that change frequencies between the received and transmitted signals.

To operate at high frequencies the company uses a high-speed counting stage at the input. This is a ring-type counter with nonsaturated transistors that permit flip-flops to switch faster. Some units have measured frequencies as high as 200 Mhz.

Other manufacturers make direct-reading counters that operate close to the frequency range of CMC's 135-Mhz unit. The electronics instrument department of the Inorganic division of the Monsanto Co. makes a 100-Mhz unit and has operated counters up to 180 Mhz.

Avionics

Adapting to change

When designers were developing plans for the F-111, they realized

that such a high-performance plane required some kind of adaptive control system. At the speeds envisioned for the aircraft, a pilot couldn't react quickly enough to compensate for deflections from course caused by air pockets, for example.

Now the Air Force is considering using such an adaptive device in all its high-performance planes. The first such add-on system to be examined by the military has been developed by the Autonetics division of North American Aviation, Inc. The unit will soon be installed in an F-101B test-bed at the flight dynamics laboratory at Wright-Patterson Air Force Base for 14 months of trials.

Earlier systems. Present high-speed planes have control systems to aid the pilot, but none are adaptive. Generally, these devices simply preprogram a change in the gain in the craft's control system in relation to its altitude, speed and load. Such systems aren't fast enough or flexible enough to meet the needs of supersonic flight.

The Autonetics adaptive system is similar in many respects to the F-111's, which was developed by the General Electric Co. Essentially, both adjust a plane's controls by monitoring the craft's responses to control changes. They achieve this adaptive control in slightly different ways, however.

In the Autonetics design, a special-purpose computer adjusts the ratio between the pilot's mechanical inputs and the deflective forces exerted on the plane's control surfaces—wings, rudder and stabilizer. According to P.P. Shipley, the system's manager, the new unit would be able to maintain uniform flight dynamics over a wide range of speeds and altitude (in higher, thinner air, controls react slower than in lower air). At least three inputs are required to stabilize the craft; these signals record yaw and pitch, the rate of attitude changes, and linear acceleration or angle of attack.

Front-end feedback. Another part of the system, called Trisafe, is the electronic link between the pilot's mechanical inputs and the craft's control surface actuators. A triply

redundant system, it affords some of the advantages of majority logic but isn't as complex. Trisafe works on the principle of individual front-end feedback from a common circuit summing the outputs of three parallel amplifiers. Because the feedback amplifiers' outputs are 180° out of phase with the inputs, the feedback tends to inhibit the input, and, as a result, the amplifiers' output. The amplifiers are, therefore, self-limiting devices.

Should an amplifier become saturated due to a hard-over maneuver, its output would be so high it would inhibit the other two; thus, the total power dumped into the common output circuit wouldn't exceed an established limit.

GE's system for the F-111 assures stability through a technique called median signal selection, under which the control gain is reduced if the plane's response to a control motion is too great, or increased if the response is too slight.

Space electronics

Critical observation

The failure of the Orbiting Astronomical Observatory last April will mean changes in the electronics of many observatory-class satellites. Part of a report just released by the National Aeronautics and Space Administration demands tighter reliability and quality requirements on all space hardware. The report also calls for changes in the management organization at the Goddard Space Flight Center, Greenbelt, Md., which handles observatory-class satellites. In addition, NASA inspectors will be placed in contractors' plants and hardware will undergo tougher tests under simulated space conditions.

NASA aimed most of its criticism at the Orbiting Astronomical Observatory but also indicated it was dissatisfied with the other observatory-class satellites and the Nimbus weather satellite.

Changes demanded. Specifically, the report outlines five changes in

SPEER COMPONENT COMMENTS

How to get more satisfaction from your metal film resistors— without switching brands

It's easy. Just ask your supplier to incorporate his resistors into packaged networks or assemblies.

With pre-assembled networks, you can obtain packaging densities far greater than those obtainable with individual metal film resistors. In fact, volume savings of up to 80% can be achieved.

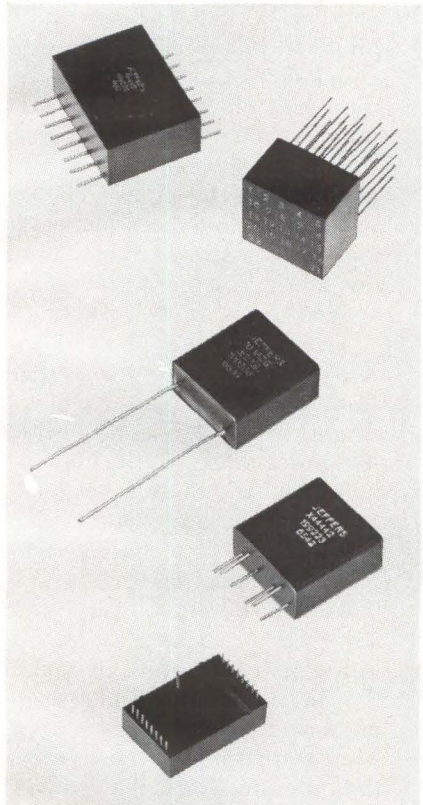

Pre-assembled and tested discrete resistor networks also offer reliability levels many magnitudes higher than those achievable with individual assemblies.

Another important advantage of networks is that manufacturing and performance cost factors can, in most cases, be surprisingly reduced.

As we noted above, these advantages (and others) will accrue no

matter what brand of metal film resistor you happen to be using. On the other hand, we would be remiss not to remind you that our Jeffers Electronics Division's JXP resistor has a definite edge over every other brand. Which means that networks incorporating this "white room" precision resistive element can really give you something extra in the way of increased satisfaction.

We therefore suggest that you don't just investigate metal film resistors networks, but that you investigate our JXP precision networks specifically. Mail us the coupon—and discover just how satisfying resistor satisfaction can be.

Please try to ignore the surplus performance that components sometimes deliver

You probably read the editorial on this subject that one of the industry magazines published not long ago. Nevertheless, the message is worth repeating:

A component designed to meet one set of specifications may also test out to more rigid specifications. And engineers have been known to cut costs by designing such a component into equipment for which it wasn't intended.

The only trouble is—they're putting themselves out on a limb (not to mention their supplier). Subsequent lots of the component may very well turn out to perform much closer to the claimed specifications—for a variety of reasons.

Speer components are among those that sometimes deliver this surplus performance. (The operative word here is "sometimes," incidentally. There are also areas in which our components always outperform their specifications. But that's another story—one we'll get into in a future issue.)

Your continued cooperation in this matter of under-specifying is much appreciated. We suspect that it's a little chilly out there on that limb.

Typical Error #8 in the testing of inductors

We're referring specifically to the testing procedures for measuring inductance and Q, as outlined in MIL-C-15305.

We heartily recommend these procedures for all commercial, industrial and military users of inductors (even users of our superb Jeffers inductors). But, as our headline suggests, there are more than a couple of commonly made test errors to watch out for.

There are eight.

Error #8, for example, consists of extreme variations in test area environment. Solution? Make sure that your measurements are made at room ambient temperature, relative humidity and pressure.

In future issues, we'll cover the other seven errors and indicate how to avoid them also.

So watch this space.



SPEER® Speer Carbon Co.

Speer Carbon Co. is a Division of
Air Reduction Company, Inc.
JEFFERS ELECTRONICS DIVISION
DuBois, Pennsylvania 15801

Rush complete information on your metal film resistor networks.

Name _____

Title _____

Company _____

Street _____

City _____ State _____ Zip _____

electronics for future orbiting astronomical observatories. These modifications would affect batteries, the problem of high-voltage arcing, stabilization, telemetry and electromagnetic interference. Generally, NASA recommends more redundancy at the subsystem level.

The agency noted that 41 of 42 small scientific satellites placed into orbit since Goddard was established in 1959 were considered successful, but only five of the eight observatory-class spacecraft worked as expected.

Three in orbit

The Federal Communications Commission is considering three major plans to put satellites to work in a domestic communications system. The plans, submitted this month, call for an initial system to be in operation by late 1969 and rapid expansion over the next 10 years.

Two of the plans were submitted by organizations already in the communications field—the Communications Satellite Corp. and the American Telephone & Telegraph Corp.; the third was offered by the Ford Foundation, which wants a separate television distribution system with heavy emphasis on educational tv. Both Comsat and AT&T propose large, flexible systems that could accommodate the technical goals of the Ford Foundation's plan. However, Ford wants the profits from the satellite system to underwrite educational tv; Comsat and AT&T think educational tv should look elsewhere for revenue.

Comsat thinks its ownership of the satellite portion of such a system is unchallengeable. It ducks the issue of who should own the ground stations though it leaves little doubt it wants a cut of the profits. AT&T is willing to concede to Comsat the satellite ownership, but states that the common carriers using the system should own the ground stations.

One-way calls. The major difference between Comsat's and AT&T's plans, however, is largely in how the system would be used. AT&T would split telephone calls so that one conversation goes via satellite, the other half by conventional com-

munications links. Comsat's plan calls for telephone calls to go both directions by satellites, though its system could accommodate AT&T's plan. The difference is in the type of ground facilities built.

AT&T would start with a two-satellite system having a basic capacity of 9,600 two-way voice-grade circuits that could be divided between tv use and voice and record traffic. This would be increased by 1980 to 83,000 voice circuits, 27 tv channels and a reserve of 61 tv channels for occasional use. To achieve this capacity, AT&T would use huge tube-shaped satellites with highly directional antennas, pulse-code modulation (pcm) for voice circuits and both pcm and frequency modulation for tv, operating in the 4- 18- and 30-gigahertz frequency bands.

Look alike. Comsat's plan would start with approximately 42,000 voice-grade circuits and increase to more than 100,000 by 1980. Technically, the satellite would be much like those envisioned at AT&T, though working in the 10-GHz frequency. Comsat would pepper the nation with far more ground stations than AT&T. Comsat's initial four-satellite system—spaced over the time zones—would service 130 ground stations, mixed between tv and voice-grade communications. Each year, more stations would be added until well over 200 would be operating by 1980.

Both the Comsat and AT&T system would cost slightly over \$100 million each initially. AT&T estimated its system would cost about \$339 million by 1980, compared with \$538 million to build a comparable ground system.

Comments on the various plans must be filed with the FCC by Feb. 1. A commission decision is expected by late spring and it appears certain that some type of system will be in operation by 1970.

The human touch

Despite all the things man has accomplished in space, he has remained little more than a passenger from liftoff to orbit. If something

goes wrong during this period, all the astronaut can do is push the abort button. But there is a growing feeling in the National Aeronautics and Space Administration that the pilot should be given the reins. Man, after all, has proved he can perform in space as well as his electronics—and usually more reliably.

Next summer, tests will begin with the X-15 rocket research plane to see how well the Apollo astronauts can perform if something goes wrong with the Saturn 5 launch vehicle. The \$1.5-million program is a joint effort of NASA's Marshall Space Flight Center, Huntsville, Ala., which is responsible for the Saturn launch vehicles, and the Ames Research Center, Mountain View, Calif., which performs aeronautical research.

Off the ground. The Air Force and NASA have been studying pilot-controlled takeoffs for years in simulators. Emergency conditions during liftoff were duplicated and pilots evaluated the performance of potential control systems in overcoming the crisis. The emergencies included engine failures and maladjustments and failure of the rate gyroscope in the guidance system.

Ten flights are planned in the X-15 to validate the simulator studies. The flights, from NASA's Flight Research Center, Edwards Air Force Base, Calif., will determine whether display systems can sense deviations from planned flight trajectories in time for the pilot to take action.

Backup by man. NASA officials say there is no lack of confidence in the instrument unit that controls the Saturn launch vehicles or the guidance and control system in the Apollo spacecraft. The purpose of the program, under the direction of the agency's Electronics and Control division, is to learn if men can back up these systems—and at minimum cost. NASA thinks they can.

Project officials say accelerometers can be installed in the booster to sense deviations from the planned course. This information can be transmitted to the display and the astronaut could then cor-

RCA LOW-COST OP AMPS GO HIGH VOLTAGE

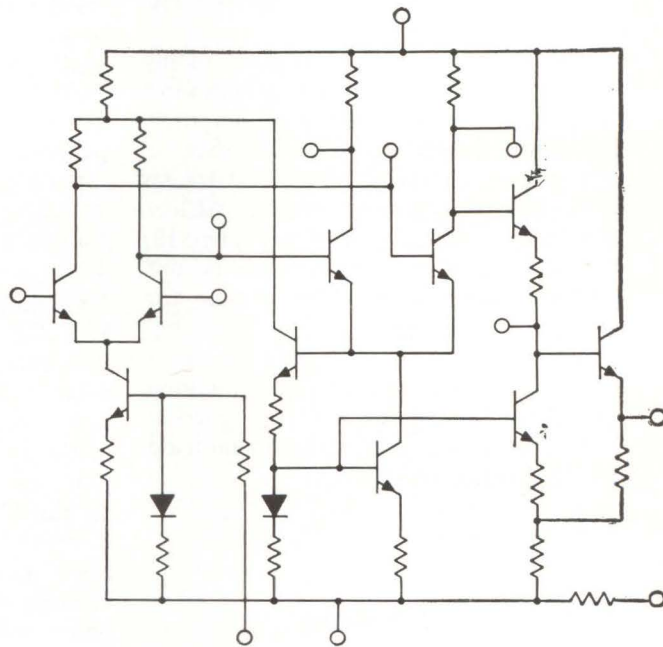

- 70dB typ open-loop voltage gain
- 320 kHz typ bandwidth at -3dB point
- 103dB typ common-mode rejection ratio
- 92 ohms typ output impedance
- 14 volts typ output voltage swing
- $\pm 3V$ to $\pm 12V$ supply
- $-55^{\circ}C$ to $+125^{\circ}C$ operation

The industry's biggest performance/dollar values
in monolithic linear integrated circuits

New CA3015 12-lead TO-5 style...\$7.50 (1000+)

New CA3016 14-lead Flat Pack...\$8.50 (1000+)

FOR MORE INFORMATION, check your RCA Distributor for his prices on CA3015 and CA3016, or contact your nearest RCA representative. For Technical Bulletin and Application Note, write Commercial Engineering, Section ICN 26-4, RCA Electronic Components and Devices, Harrison, N.J. 07029.

Look into RCA's growing linear line

CA3000	CA3001	CA3002	CA3004 CA3005 CA3006	CA3007	CA3008 CA3010	CA3011 CA3012	CA3013 CA3014
DC Ampl	Video Ampl	IF Ampl	RF Ampl	AF Ampl	Opr Ampl	Wide- Band Ampl	Wideband Ampl Discrim- inators

AVAILABLE THROUGH YOUR RCA DISTRIBUTOR



THE MOST TRUSTED NAME IN ELECTRONICS

Circle 43 on reader service card

rect the vehicle's attitude. The pilot's commands would be relayed to the instrument unit's control computer, which controls the engine actuators.

Extra memory. Another modification would be a reprogramming of the craft's guidance computer. This could be circumvented if NASA goes ahead with plans for an auxiliary memory system. [Electronics, Oct. 31, p. 26 and Dec. 12, p. 54]. But this memory is not expected to be ready in time for the moon flight.

While project officials are pessimistic about getting their manned control system on the current Apollo, they believe it can be used in future boosters.

Integrated circuits

On key

Integrated circuits have found their way into amateur radio equipment. Palomar Engineers of Escondido, Calif., is building a Morse keyer that costs \$67.50, compared with about \$95 for keyers with transistors or tubes.

The keyer operates on a 4½-volt battery, compared with 45 volts for transistor models. Each keyer has six IC's and dual two-input gates that also act as binary counters. The device forms dots, dashes and spaces at speeds from five to 50 words per minute. Its speed control is a blocking oscillator circuit composed of a capacitor and variable resistor.

The key is a single-pole, double-throw switch. When the key is moved, the blocking oscillator puts out a string of pulses. Two binary counters count these pulses. One counter produces dots when the key moves in one direction; the counters work together to produce dashes when the key moves the other way.

The counter output drives a single-pole, single-throw d-c relay, which allows the keyer to feed into tube transmitters of several hundred volts with either negative or positive keying.

For the record

▪ **Growth.** Honeywell, Inc., plans to increase by 50% the size of its computer engineering and research center in Waltham, Mass. Ground will be broken next spring for a 106,000-square-foot addition. The enlarged quarters will consolidate the Electronic Data Processing division's engineering and programming organizations.

▪ **Computer contract.** The Lockheed-Georgia Co. has awarded a \$3-million contract to the Nortronics division of the Northrop Corp. for 67 computers to be used in the malfunction analysis detection and recording system (Madar) on the C-5A transport. Lockheed-Georgia is a division of the Lockheed Aircraft Corp. A Lockheed-Georgia spokesman says one computer will handle navigation and another will control the Madar system. He adds that there will be some interface between the two computers with both performing some peripheral tasks.

▪ **To catch a thief.** Muirhead Instruments, Inc., of Mountainside, N.J., has won an estimated \$250,000 lease contract to provide 100 facsimile machines for transmitting fingerprints. New York State picked Muirhead over the Westrex division of Litton Industries, Inc. Facsimile resolution is 200 lines per inch. Installation of the machines began on Dec. 20 and will eventually cover the entire state.

▪ **Hook up.** A group headed by Richard Lehman, a professor at Franklin and Marshall College in Lancaster, Pa., is planning a computer center to serve some 50 small colleges in the Middle Atlantic states. It plans to start installing hardware in late 1969 or early 1970 at the Eastern Pennsylvania Information Center in Lancaster. At first eight or 10 schools will tie into a relatively small processor at the center, and as more colleges show interest additional terminals will be built and a larger processor set up at Franklin and Marshall.

▪ **Better late than . . .** The ground systems group of the Hughes Aircraft Co. is a year behind schedule on delivery of 10 high-power trans-

mitters for a Voice of America broadcasting complex to be based in the Philippines. Even though Hughes is late, it's still early because the site itself will not be ready for the transmitters until early 1968. One transmitter is ready for shipment but nine others won't be finished until March.

▪ **Automatic voting.** The Filper Corp. of San Ramon, Calif., has introduced an electronic vote processing machine. The system, called Garox, records votes directly from the voters by electronically reading paper ballots.

▪ **New generation.** The Air Force has awarded Astrosystems International, Inc., a development contract aimed at the direct conversion of heat energy into electric power at practical levels of voltage and current. Astrosystems will design, construct and operate a laboratory model of a power generator using electrokinetic phenomena (EKP) in plasma. EKP power generation could produce useful amounts of electrical power in space or other environments where weight and volume are limiting factors. The generator design is based on a closed-cycle system that uses cesium vapor superheated to temperatures as high as 2,000° C.

▪ **Hood link.** A coast-to-coast communications network will link the vast crime files of the Federal Bureau of Investigation to 15 police departments across the nation. The network will permit computer storage and transmission of information about stolen property and wanted criminals.

▪ **Radar award.** The Air Force has awarded the Philco-Ford Corp.'s Aeronutronic division a \$1,650,000 contract for development of a coherent data-processing radar system. The forward-scanning system will identify and locate navigational checkpoints.

▪ **Flight test.** The Ryan Aeronautical Co. has shipped to White Sands, N.M., a flight test model of the radar system that will guide Apollo astronauts to a soft landing on the moon. The system will undergo six months of testing. Preliminary flight tests were performed in San Diego, Calif., aboard a NASA helicopter.

AMELCO FET

'Diff Amps' combine high input impedance with minimum tracking error!

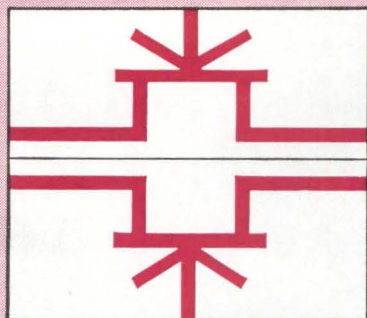

Until now, poor tracking was the price of high input impedance when using field effect transistors. No longer! Now Amelco's 2N3921 matched FET Differential Amplifier is providing tracking better than $10\mu\text{V}/^\circ\text{C}$ and input offset of less than 5mV. Best yet, the price for this outstanding performance is surprisingly low. And, if your requirements allow less stringent temperature characteristics, the 2N3922 with $25\mu\text{V}/^\circ\text{C}$ tracking is even less expensive.

GUARANTEED VALUES 2N3921

TRACKING = $10\mu\text{V}/^\circ\text{C}$
 OFFSET = 5mV
 LEAKAGE = 0.25 nA
 TRANSCONDUCTANCE = 1500 μmhos
 NOISE FIGURE = 2.0 db

Prices	1 - 99	100 - 999
2N3921	\$26.50	\$17.67
2N3922	\$18.50	\$12.33

AMELCO SEMICONDUCTOR

DIVISION OF TELEDYNE, INC. • 1300 TERRA BELLA AVENUE • MOUNTAIN VIEW, CALIFORNIA • Mail Address: P. O. Box 1030, Mountain View, California • Phone: (415) 968-9241 / TWX: (415) 969-9112 / Telex: 34-8416 • REGIONAL OFFICES: Southwest — Suite 213, 8621 Bellanca Ave., Los Angeles, California 90045, (213) 678-3146 • Northwest—1300 Terra Bella Ave., Mountain View, California, (415) 968-9241 • East—P. O. Box 2091, Paterson, New Jersey 07509, (201) 696-4747; P. O. Box 366, Kimberton, Pennsylvania 19442, (215) 885-1755 • Northeast—805 High Street, Westwood, Massachusetts, (617) 326-6600; 60 Broad Hollow Rd., Melville, L. I., N. Y. 11749, (516) 692-4070 • Southeast—711 Magnolia Avenue, Orlando Florida, (305) 423-5833 • Midwest—650 West Algonquin Road, Des Plaines, Illinois, (312) 439-3250; 3020 Woodlark Lane, St. Paul, Minnesota, (612) 646-1161 • Canada—Deskin Sales, Montreal, Quebec, (514) 384-1420.

1961

1962

1963

1964



1965



1966



6 YEARS
NO MISSION FAILURE

ECI's AN/ARC-89(V) communication system for SAC Airborne Command Post has been operating continuously since February 1961. New ECI miniaturized system assures an even greater dependability as established in recent USAF tests.

**Delegate
your
communication
system
dependability
problem
to us.**

If we haven't already solved it, we will. That goes for your size/weight, compatibility and message integrity problems too.



ELECTRONIC COMMUNICATIONS, INC.
ST. PETERSBURG DIVISION

To investigate career opportunities in communications, call or write Mr. Chuck Kelly, Professional Placement Office, Electronic Communications Inc., P.O. Box 12248, St. Petersburg, Florida 33733. Telephone (813) 347-1121. (Equal opportunity employer, M & F.)

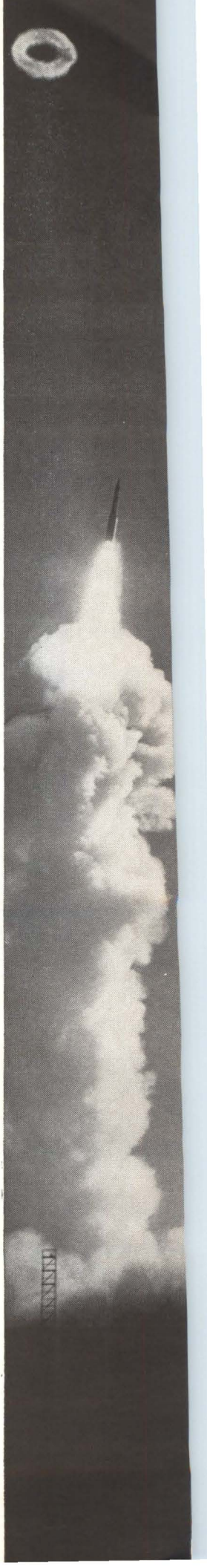



MAKE US PROVE IT. Expanded production capabilities enable us to ship orders for 1,000 parts and up within 2 weeks. This includes all 57 catalog models: Military (RT-10, 11, 12) Commercial and General Purpose in rectilinear and square styles.

For faster trimmer delivery phone 402-564-3131

WRITE FOR CATALOG B

DALE

DALE ELECTRONICS, INC.

1300 28th Avenue, Columbus, Nebraska
In Canada: Dale Electronics, Canada, Ltd.

Washington Newsletter

December 26, 1966

Air Force probes reports of graft in space awards

The Air Force Systems Command is looking into alleged improprieties in connection with the awarding of contracts by its Space Systems division for the space-ground link subsystem. Top systems command officials confirmed that they "are investigating an allegation that gratuities were accepted by an individual." They declined to discuss the matter further until their investigation is completed because it would be "prejudicial to the individual involved."

The space-ground program would consolidate the various tracking, telemetry and command functions required by Air Force satellites and spacecraft into a single integrated-circuit system. The system, operating on S band, would replace the various pieces of equipment used in current programs. Competitive negotiations on at least one of the program's three packages aren't expected to be completed until February—considerably behind schedule.

Bidding for integration, installation and check-out are said to be the Philco-Ford Corp., TRW, Inc., and the General Dynamics Corp. General Dynamics and Philco are reportedly in the running for the ground-station award, and Radiation, Inc., and General Dynamics' Dynatronics division for the pulse code modulation (pcm) telemetry contract.

Spy satellite program awarded to TRW, Aerojet

A contract for an expanded spy satellite program has been awarded to the TRW Systems group of TRW, Inc. Aerojet General Corp., a subsidiary of General Tire & Rubber Co., will build the sensor package for the craft. The project, called Program 266, is a follow-on to Midas—a polar-orbit satellite intended to detect ballistic-missile launchings with infrared sensors—that never got out of the research and development stage, although the last two shots were said to have been successful. A second-generation satellite was considered necessary in order to take advantage of significant advances in spacecraft orbit life and reliability, as well as improvements in sensors. Program 266 reportedly will have sensor capability beyond infrared.

The Air Force, which identified Program 266 only as an "unmanned space technology program," said R&D funding will total \$104.5 million, with \$54.5 million going to Aerojet and \$50 million to TRW. The Air Force will try to telescope the program—from research and development to operation—into three years, qualifying it as an operational program during the R&D phase. TRW won the competition for the satellite award over Lockheed Aircraft Corp., the Midas contractor. Aerojet also built the infrared package for Midas.

House to study 'neglected' arms projects

Mendel Rivers (D., S.C.), chairman of the House Armed Services Committee and a frequent opponent of Pentagon policies, plans to set up special subcommittees to investigate military programs that some Congressmen feel have been neglected by the Pentagon. At least two such programs—antisubmarine warfare and nuclear-ship construction—are good candidates for more funds in next year's budget, Washington sources say. The panels will also take a look at avionics for tactical aircraft, advanced manned bombers, missile defense systems, and military manned space flight.

Washington Newsletter

'Hindsight' finds military's labs match industry's

A continuing Pentagon study finds the current productivity of military in-house laboratories comparable to that of private facilities. The first interim report on "Project Hindsight," a 30-month-old review of 20 major weapons systems, also concludes that the Defense Department has realized a big payoff from its investment in research over the past 20 years, and that scientific programs directed toward a goal set by Pentagon managers make greater contributions than do efforts left to the discretion of scientists.

Eros satellite costs are growing

The bill for the Interior Department's earth resources observation satellite project (Eros) is getting larger. Original plans called for a small spacecraft resembling the 300-pound Tiros weather satellite [Electronics, Oct. 3, p. 52], but the department's Geological Survey now is thinking seriously of a 1,000-pound-plus craft with a heavier sensor and electronic payload. The Interior Department is seeking help from other agencies, particularly from the Agriculture Department, to finance the project's costs, which are certain to run above the initial \$20 million estimate. The timetable calls for the first Eros to fly some time in 1969.

Heir apparent at Defense agency

There is no evidence that Defense Secretary Robert S. McNamara is thinking of quitting his post—he begins his seventh year at the Pentagon in January—but it does appear that more of his tasks are being turned over to Cyrus R. Vance, deputy Defense Secretary and the man considered by many to be the heir apparent. For example, the Vance signature has been turning up on an increasing number of defense documents in recent weeks.

Budget squeeze may slow work on AEC accelerator

The budget squeeze stemming from rising Vietnam war costs is expected to slow initial design work on the Atomic Energy Commission's planned 200-billion-electron-volt proton accelerator. The AEC has selected Weston, Ill., near Chicago, as the site for the accelerator facility, and Rep. Melvin Price (D., Ill.) is attempting to rally support for fiscal 1968 authorization of \$10 million to begin the design work. Washington observers, however, think Price, chairman of the research, development and radiation subcommittee of the Joint Committee on Atomic Energy, may have to settle for \$3 to \$4 million. Ultimate cost of the 200-bev unit has been put at \$348 million, with as much as \$87 million going for electronic hardware.

Addenda

Interest in systems management continues to grow. The Senate Science and Technology subcommittee will hold hearings Jan. 24 through 27 to discuss with aerospace and electronic companies possible application of systems engineering to solve national social and economic problems. . . . A calibration service for oscilloscopes will soon be started by the National Bureau of Standards. Initial measurements will be from 5 to 100 volts at a risetime of 10 nanoseconds, and from 100 to 1,000 volts at 30 nanoseconds . . . A single office has been established under Defense Department Comptroller Robert N. Anthony to try to reduce, standardize and simplify the 800 reporting demands that can currently be imposed on contractors.

What's new about Mallory CGS Computer Grade Capacitors?



Proved higher ripple ratings... established by tests of many hundreds of capacitors. *Four times* as high for same case size, *twice* as high for same CV values. ESR specs are lower, too.

More capacitance . . . twice as much per case size as we could formerly offer. Maximum: 280,000 mfd at

3 WVDC, or 1800 mfd at 450 WVDC in the 3" by 5 $\frac{7}{8}$ " case.

880 standard ratings, at 65°C ambient. Write for new Bulletin 4-80. Mallory Capacitor Company, a division of P. R. Mallory & Co. Inc., Indianapolis, Indiana 46206.

50th
ANNIVERSARY

MALLORY

Tektronix Type 453 oscilloscope has

- 50 MHz Performance
- Dual Trace ● Delayed Sweep
- Easy-to-Use Triggering



and-----it's designed to be carried!

Pick it up and be convinced. The Type 453 weighs 28½ pounds and is built to go when and where you go.

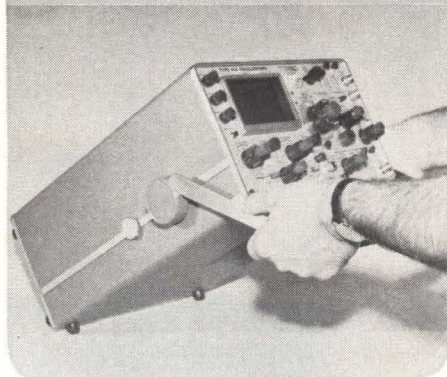

Don't worry about damaging the front panel and knobs—they're protected by a cover that also carries the accessories.

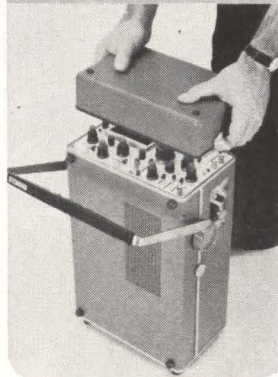

Take the Type 453 through tight places easily . . . the vertical carrying position increases portability.



Take it anywhere. The rain/dust cover is a standard accessory and carries the complete manual and optional viewing hood.



The Type 453 is a portable instrument with rugged environmental capabilities plus the built-in high performance normally found only in multiple plug-in instruments.

The vertical amplifier provides dual trace, DC to 50 MHz bandwidth with 7 ns risetime from 20 mV/div to 10 V/div. (DC to 40 MHz, 8.75 ns T_r at 5 mV/div.) The two included Type P6010 miniature 10X probes maintain system bandwidth and risetime performance at the probe tip—DC-50 MHz, 7 ns—with an increase in deflection factors of 10X. You can also make 5 mV/div X-Y and 1 mV/div single trace measurements.

The Type 453 trigger system takes the guesswork out of triggering. Pushing all the lever switches up provides a sweep and the most often used trigger logic. The sweep triggered light gives the operator a positive indication of a triggered sweep and the automatic triggering provides greater usability.

You can operate the delayed sweep with ease. Lever con-

trol to the right and HORIZ DISPLAY switch to A INTEN DURING B gives delayed sweep operation. Setting the B TIME/DIV and the DELAY-TIME MULTIPLIER to meet your requirements and switching to DELAYED SWEEP allows $\pm 1.5\%$ delay measurements to be made.

The Type 453 is a continuation of the Tektronix commitment to quality workmanship. Its design and layout make it easy to maintain and calibrate. Transistors plug in and are easily removed for out-of-circuit testing. An accurate time ($\pm 0.5\%$) and amplitude ($\pm 1\%$) calibrator permits quick field calibration.

The front panel protection cover carries all the accessories with the complete manual carried in the rain and dust cover. The Type C-30 Camera and a viewing hood that fits in the rain cover also are available.

Type 453 (complete with probes and accessories)	...	\$2050.00
Type C-30 Camera	\$ 350.00
Collapsible Viewing Hood	\$ 7.50

U.S. Sales Prices, FOB Beaverton, Oregon

Tektronix, Inc.



For complete information, contact your nearby Tektronix field engineer or write:
Tektronix, Inc., P.O. Box 500, Beaverton, Oregon 97005

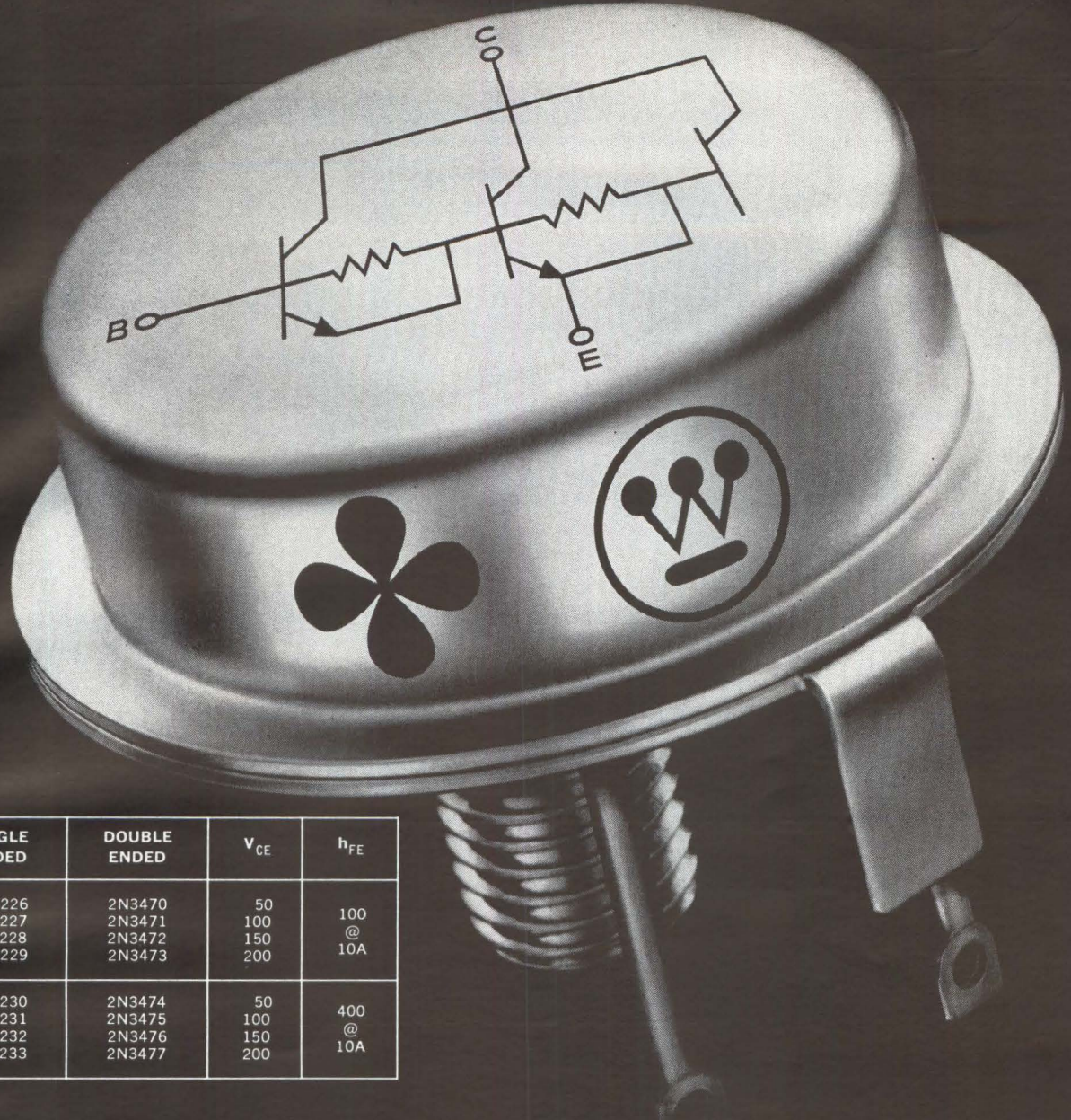

SINGLE ENDED	DOUBLE ENDED	V_{CE}	h_{FE}
2N2226	2N3470	50	100 @ 10A
2N2227	2N3471	100	
2N2228	2N3472	150	
2N2229	2N3473	200	
2N2230	2N3474	50	400 @ 10A
2N2231	2N3475	100	
2N2232	2N3476	150	
2N2233	2N3477	200	

Inside story of the new look in series regulators

Westinghouse power integrated amplifiers eliminate a complete driver stage. Save space, improve reliability, cut costs with Westinghouse power integrated amplifiers. Types 2N2233 and 2N3477 provide exceptionally high gain at high power levels— $h_{FE} = 400$ at 10 amps, I_C , $V_{CE} = 200$ volts and $P_D = 150$ watts. Single and double

ended packages provide complete design flexibility. Check these exclusive features:

- Hard soldered junctions eliminate thermal fatigue.
- Large emitter-base area puts an end to secondary breakdown.
- True monolithic construction stops runaway leakage.

And, of course, reliability is assured by the exclusive Westinghouse Lifetime Semiconductor Guarantee. ♣ For full information call your Westinghouse salesman or distributor, or write to the Westinghouse Semiconductor Division, Youngwood, Penn. 15697.

You can be sure if it's Westinghouse



SC-2079



Westinghouse warrants to the original purchaser that it will correct any defect or defects in workmanship, by repair or replacement f.o.b. factory, for any silicon power semiconductor bearing this symbol ♣ during the life of the equipment in which it is originally installed, provided said device is used within manufacturer's published ratings and applied in accordance with good engineering practice. This warranty shall constitute a fulfillment of all Westinghouse liabilities in respect to said products. This warranty is in lieu of all other warranties expressed or implied. Westinghouse shall not be liable for any consequential damages.

Circle 53 on reader service card

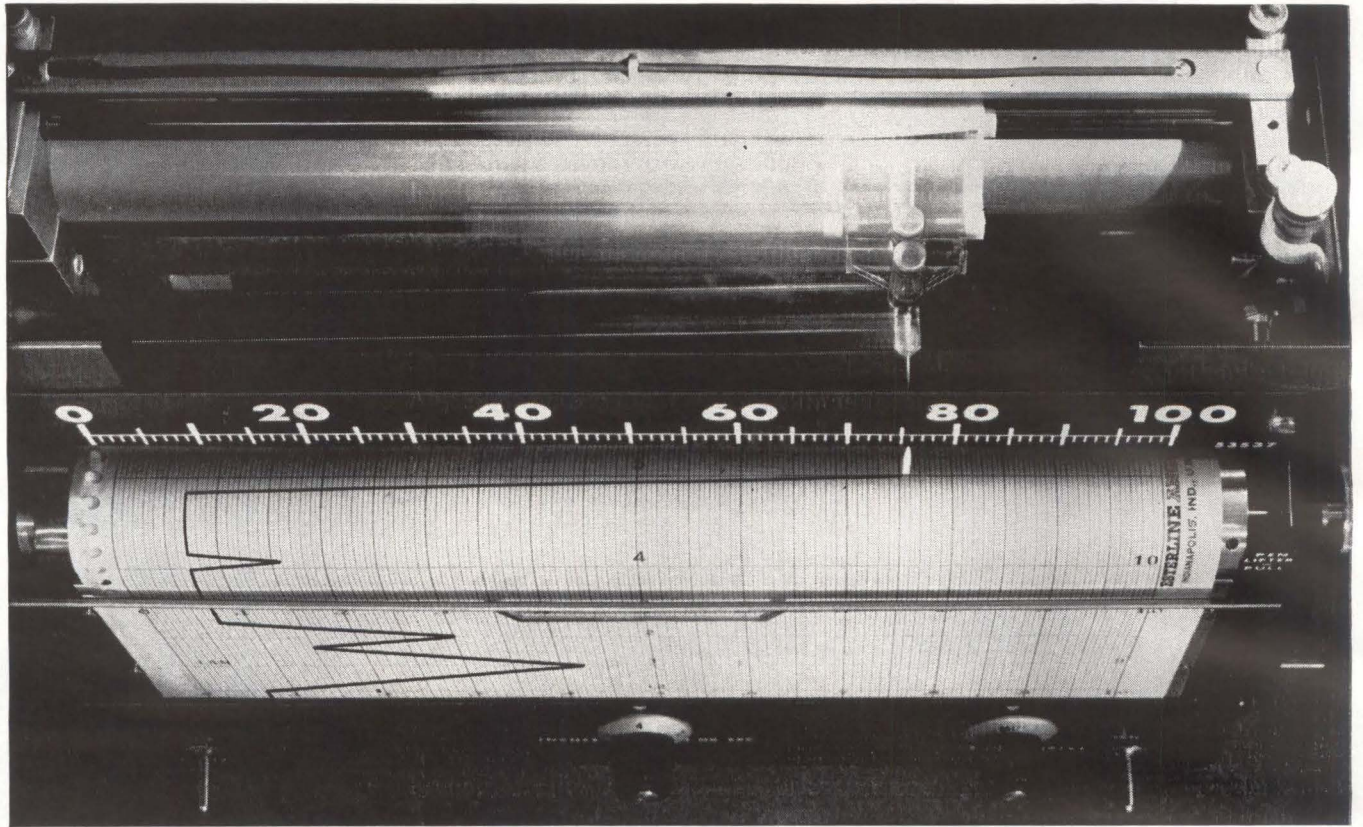

Only the pen moves. No pulleys. No drive cords. No gears.

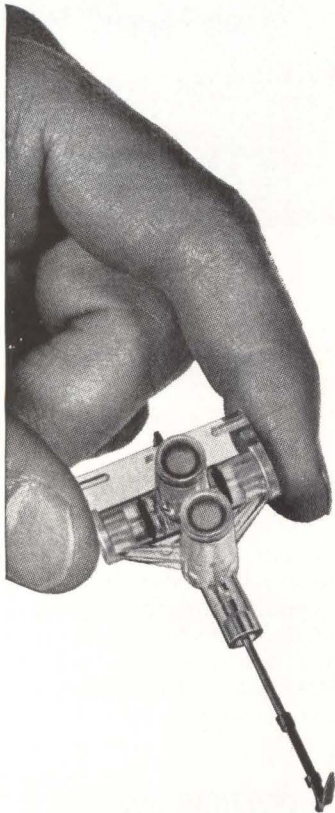

An inertial what?

An inertial ink pump for our 2/10 second response Speed Servo® Recorder

It uses the inertia of a small stainless steel ball to pump ink as needed.

It writes a legible record at speeds above 100" per second (2/10 second response over 10" span). Yet it doesn't bleed at the slowest speeds. We call it Speed Line Writing.

And for this new Speed Servo®, Speed Line Writing is required. Its servo motor has only one moving part. No gears, pulleys or drive cords.

Want more features? Take off balance input impedance of 500,000 ohms. Accuracy is $\pm 0.4\%$ of span for any range.

This recorder meets all specifications to 50,000 ohms source impedance and maintains rated accuracy to 100,000 ohms.

The Speed Servo's® feedback potentiometer is made of conductive plastic and has effectively

infinite resolution. It lasts thousands of hours longer than any wire-wound potentiometer.

Need Adjustable Zero Adjustable Span (AZAS)? This Speed Servo® option has zero elevation and suppression continuously adjustable from 0 to 100 MV for any span setting. Span is continuously adjustable from 1 to 100 MV.

You can choose from 15, 10 or 5 speed automatic chart drives. Dial speeds from $\frac{1}{2}$ " per hour to 8" per second.

■ Learn more about this exciting breakthrough in servo recording. Write for our Series "E" Catalog.

Esterline Angus Instrument Company, Inc.
Box 24000E • Indianapolis, Indiana 46224

Excellence in
instrumentation for
over 60 years



ESTERLINE ANGUS

Technical Articles

IC's in action, part 3
Getting your money's worth
page 56

Integrated circuits and high reliability seem so inseparable that reports of failures of equipment due to IC's are hard to believe. The facts are that even though users are paying for reliability they may waste it through improper reliability-assurance techniques and occasionally through blatant misuse. Because current demand outstrips supply, manufacturers are reluctant to prove the reliability of their circuits, putting the onus on users.

Analyzing networks with
state variables
page 63

As networks become more complex, the conventional mesh and node techniques taught in engineering schools produce equations that are difficult if not impossible to solve. A new technique, called the state variable, allows the engineer to write equations based on the energy-storing elements of a circuit. It simplifies the differential equations that describe the dynamic behavior of a linear system and arranges them in a form easily solved by electronic computation.

1967 European Markets
page 79



Electronics magazine's annual market survey of Europe predicts that consumption will rise 8.5%, to \$6.19 billion, though Europe is in for some political and economic crises. Reporters for the magazine fanned out over Europe to question industry experts, politicians and government economists who told them what electronics firms can expect. In general, consumer product sales are in for a sharp drop; industrial, military and communications sales will climb sharply. For the cover, art director Saul Sussman imposed a map of Europe on the curves that show rising electronics markets.

Coming
January 9

- Annual U.S. market report
- Computer-aided design, part 4
- Details of the Apollo computer

Integrated circuits in action: part 3

Getting your money's worth

Users of integrated circuits pay for high reliability, but may waste it through poor reliability-assurance techniques and occasionally, through blatant misuse

By Carl Moskowitz

Instrumentation editor

Integrated electronics and the concept of high reliability seem so inseparably linked that one finds reports of faulty IC's—or, worse yet, equipment failures due to IC's—hard to believe. Yet the truth is that while integrated circuits may have inherent reliability advantages, IC equipment isn't necessarily superior. In fact, a Defense Department spokesman says the application of IC's may result in an equipment that is less reliable than its equivalent built with discrete solid state components.

Stock excuses given for failing to achieve the equipment reliability that ought to be possible with IC's are mismanagement of IC fabrication or poor quality control, as well as misapplication of the IC's.

To these, Ernest Wood, deputy assistant director of defense research and engineering in the Pentagon, adds another. The techniques for connecting IC's into systems—welding, soldering or using special connectors—are still to be perfected, he says, and aren't as reliable as those used in connecting conventional solid state assemblies. Improvements in this area may require new technology, he adds.

There's ample evidence that poor reliability-assurance procedures by IC suppliers have caused failures at the user's incoming inspection, or in his outgoing equipment. They have occurred even in devices intended for programs demanding ultra-high reliability.

At Rome Air Development Center in New York, Joseph B. Brauer, chief of the solid state applications section, reports that some IC's slated for an air defense system were "dead on arrival." The shipments included devices with lids on backwards and pins reversed, according to Brauer, devices that could not pass even a basic static check [Electronics, Oct. 17, p. 86]. Brauer, like most of his

associates, concludes that the problem to be tackled first is that of quality at the customer's incoming inspection. Once those failures representing carelessness or poor quality control and those representing misuse (apparently few in number) by the customer are eliminated, the rest of the devices should indeed exhibit the inherent high reliability of which they are capable.

Top priority

Since today's first order of business is weeding out the weak sisters, vendors and enlightened users are working together to find out why IC's fail and then make corrections to cut down the likelihood of repeats.

Such big users as the Autonetics division of North American Aviation, Inc., Raytheon Co., the Aerospace division of Westinghouse Electric Corp., and such agencies as the National Aeronautics and Space Administration and RADC have set up complex failure analysis facilities.

NASA has injected a walloping \$400,000 in its Electronics Research Center at Cambridge, Mass., to set up a laboratory for investigating IC and component failure modes and mechanisms.

Scrutiny of failed IC's usually reveals flaws for which the device manufacturer is accountable. Occasionally, failures due to poor equipment design or misuse of the end equipment are uncovered. One reason that user-induced failures are rare could be that most equipment in which IC's have so far been used is for the most part carefully designed. As prices drop and IC's are used in a broader range of equipment, the picture could change.

The vast amounts of time and money invested in failure analysis are expected to pay off in pinpoint-

ing failure mechanisms so that device manufacturers can correct their fabrication methods. Secondly, the failure analysis programs are expected to identify those failure modes that can be accelerated, so that screening techniques can cull them before they get into equipment.

Ultimate programs

On the bright side, there's ample evidence that integrated circuits can currently provide equipment reliability that just a few years ago was believed unattainable. The Minuteman and Apollo programs, for example, have yielded estimated ic failure rates of 0.0007% and 0.0028% per thousand hours, respectively.

This level of reliability has not been achieved at low cost. Even users who anticipate riding on the coattails of the high reliability programs cannot do so for nothing. Invariably they will have to perform, or pay for, burn-in—typically of 168 hours duration—of every ic they use.

A danger, notes RADC's Brauer, is that users buying unscreened, off-the-shelf ic's drawn from the same family as those being shipped to ultrahigh-reliability programs, will be tempted to extrapolate the reliability of the high reliability units to the unscreened units. It can't be done, he warns. The reason is that the unscreened ic's contain two different device populations—only one of which is representative of the inherent reliability of the device type. The other group are those weak devices that will fall by the wayside during an infant mortality or debugging phase.

Admittedly, some benefits do accrue to these users from the high-reliability programs. Refinements in design and processing resulting from the discovery of new failure mechanisms improve the generic devices to which they are applied.

Complex tests

Making the ic user's life more complicated are the added problems in testing ic's. Gone are the relatively simple incoming inspection tests used with discrete components. The complete integrated circuit must be functionally tested, and more complex procedures are needed to validate the performance specifications.

In developing failure rates, it may turn out to be impossible to relate a rate only to a generic ic type; it may have to be tied to individual manufacturers as well. Further, while good data is a must in developing failure rate information, NASA holds that the vast amount of data already generated is poorly used. The space agency is considering establishing a technical data bank that would include vendor survey information with test data for typical ic's of every manufacturer. According to C.W. Watt, chief of the components standards branch of the space agency's Electronics Research Center, such a data bank would speed procurement of reliable parts and possibly, "if the manufacturer is qualified," could reduce the user's incoming inspection "to a 100% screening of a few

TYPICAL SCREEN & BURN-IN MATERIAL FLOW

1006921			
QUANTITY		DATE	
SERIAL NO.			
ID NO.		DIFF CODES	
VENDOR		A.O.	
TEST	SAMPLE	REJECTS	DATE
SEPARATE INTO DIFFUSION LOTS			
VISUAL	100%		
BEND & PULL	5 Pcs.		
VENDOR SURVEILLANCE	5 Pcs.		
MARKING	100%		
ELECTRICAL TEST (1)	100%		
THERMAL SHOCK TEST	100%		
HELIUM LEAK TEST	100%		
NITROGEN BOMB TEST	100%		
GROSS LEAK TEST	100%		
168 HOUR HI TEMP. STORAGE	100%		
CENTRIFUGE (Y1 AXIS) TEST	100%		
CONTINUITY TEST	100%		
CENTRIFUGE (Y2 AXIS) TEST	100%		
ELECTRICAL TEST (2)	100%		
72 HR. REVERSE BIAS	200 Pcs.		
PROPAGATION DELAY TEST	200 Pcs.		
SHOCK & VIBRATION	77Pcs.		
H _{FE} (BETA) TEST			
168 HR. OPERATING	100%		
ELECTRICAL TEST (3)	100%		
FINAL VISUAL	100%		
COLOR CODE	100%		

Note: 477 PIECES AT BACK BIAS. PROPAGATION DELAY & SHOCK & VIBRATION MUST BE A SAMPLE FROM EACH DIFFUSION LOT. 2% FROM EACH DIFFUSION LOT.

Screen and burn-in procedures for IC's for the Apollo program. The entire lot of about 4,000 devices is subjected to all except destructive tests. Any failure for which a reason cannot be found is cause for rejecting the entire lot. Otherwise, the rejection or acceptance of a lot depends on the kind and number of failures.

characteristics, or even to a sample basis."

Users are more likely to buy standard ic's than to order custom devices. "There are two reasons for this preference," explains Jack Gifford, group supervisor of the Boeing Co.'s electrical parts activity. "First, there is apt to be more than one vendor for standard devices, and, second, more proof of reliability is available."

Custom circuits are usually specified only when no available circuit can do the required job and volume requirements justify the cost.

A separate problem associated with the use of special circuits, according to H.T. Go, a quality assurance expert, is the difference in quality between the samples manufacturers submit for evaluation and their production units. This, says Go, complicates the task of setting up valid reliability tests for such items. More often than not, he adds, the contract price has to be renegotiated in these cases or the specifications waived. This problem underscores the disadvantage of buying a custom circuit from one source. Late delivery of parts is damaging, but when a company's only source has to be shut off because it is delivering bad parts,

the result can be chaotic. Go's comments reflect his experiences with the Aerospace division of Westinghouse Electric Corp. He is now director of quality and reliability engineering for Fairchild-Hiller Corp.

Once a device is selected, a testing program must be developed to screen both out-of-spec units and potential failures. The complexity of ic's makes it uneconomical to test every parameter of every device, and herein lies one of the major benefits of a good failure analysis program: it can help zero in on those screening tests that will accurately and economically detect both faults and potential failures.

A good example, if a highly sophisticated one, of selective screening by a high-volume user, is the Apollo program's parts-reliability procedure for ic's used in the guidance and navigation computers. Blending screen and burn-in tests with failure analysis, it has resulted in a frequency of field failures lower than that achieved with 100% testing alone.

Saving money

The low-volume user, however, sometimes accepts a manufacturer's final test data in lieu of doing his own testing. "This can be dangerous," says Go. "We have received devices from vendors that couldn't possibly work. For example, some I've seen had no wiring between the chip and the header pins." Many customers electrically test ic's on a sample basis, while others test them all before assembling them into equipment. Westinghouse's Aerospace division switches from a sampling plan to 100% testing on the basis of the percentage of failures for a given type.

The cost of screening is very high and most testing procedures reflect this. Boeing, according to Gifford, prefers to pick one parameter for 100% testing and sample the rest.

Some users don't test the devices until after they are assembled in the equipment for which they were purchased. For example, some computer makers check ic's by functionally testing the computer they are used in.

Environmental testing on receipt is normally done on a limited basis and usually only for military contracts. But some users, after repeated failures during systems temperature tests, have found it necessary to set up some kind of temperature trials for all incoming ic's. Most often, a device is qualified once environmentally and is rechecked periodically.

Further assurances

As in the case of most semiconductor devices, the bulk of ic failures are discovered during initial screening; however, some failure modes take time to develop. Examples of such time-dependent modes would be hot spots stemming from faulty diffusion and thin spots in intraconnections that fail under shock or load.

Such failure modes point to a need to test devices

as they will eventually be used and at temperatures other than normal ambient—a procedure called burn-in. Burn-in is necessary when maintenance of assembled equipment is difficult, costly or impossible.

For example, Raytheon performs a 100% screen and burn-in of all critical parts for the Apollo computer, with the devices operated as an 8-volt ring oscillator. Failure mechanisms discovered determine whether a lot is acceptable. It is not possible to rework any parts, but lots can be re-screened. In the Raytheon program, page 57, there are three functional electrical tests plus such environmental trials as baking, centrifuge and vibration. Just before the final electrical test, the units are burned-in for 168 hours. Testing after burn-in reveals the effectiveness of a manufacturer's screening.

Apollo case history

In the Apollo program, each lot of ic's is subjected to the sequence of tests shown in the chart on page 57. Catastrophic failures are removed as they occur and are earmarked for failure analysis, along with failures in the electrical tests at the end of the sequence. The entire lot of circuits is stored until the results of failure analysis are available.

The Apollo screen and burn-in procedure was designed to detect failure modes that would occur as a device operated under normal conditions. The electrical parameter tests also ensure that the end item, in this case the guidance computer, will work properly.

The criteria for acceptance of any given lot now includes qualitative as well as quantitative data. The qualitative information—the cause of the failure—is important because some failure modes—for example, surface instability and interconnection corrosion—when detected are known to be present in the entire production lot. The causes of such modes originate in the production process and their detection results in rejection of the whole lot, even

Failure data of IC's in Apollo computer

Number of single NOR gates	Percentage	Operating hours (x10 ³)	Failures	Failure rate* (λ)
	failures at screen and burn-in			
23,000	0.75	42,600	6	0.011
53,000	0.25	178,400	0	0.004

Computer	Operating hours (x10 ³)	Field failures	Failure rate* (λ)
Block I (single NOR gate)	70	6	0.002
Block II (dual NOR gate)	10	0	0.0014 (per gate) 0.0028 (per package)

$$*\lambda = \frac{\% \text{ Failures}}{10^3 \text{ operating hours}} \quad (\text{at } 50\% \text{ confidence level})$$

if only one device fails. The entire lot will also be rejected if the cause of the failure cannot be found.

Conversely, lots with such failures as those caused by openings due to nicks in the bond wire or cracked chips can be rescreened using stress tests which trigger or identify these failures.

The Apollo approach has proved successful and less costly than the program managers anticipated. In the table, the data for the single NOR gate used in the Apollo guidance and navigation computer not only shows the failure rates for this unit but a relationship between the number of field failures and the number of failures occurring at screen and burn-in. The field failures involve lots that exhibited many failures during the initial screening process. This suggests that the field failures could be reduced even further if the rejection criteria were tightened.

New problems

Life testing of IC's will probably become obsolete, at least in the case of high-reliability programs. The time and cost involved in life testing to verify a failure rate of 0.00001% per thousand hours—the sort of rate a manned Mars mission may require — would be astronomical.

Most of us wouldn't live long enough to see the completion of the life tests necessary to prove the required reliability of most present-day equipment if the tests were operated at rated conditions. Fortunately, this apparent case of things worsening as they get better may not be as serious as it seems. What the equipment designer really needs is a generic failure rate representative of various classes of integrated circuits to project the estimated reliability of his designs at their inception and as they progress. Chances are that for IC equipment, it will be a paper projection from start to finish. In days of lower reliability, when failures were encountered along the way (at the breadboard stage or in prototype equipment, for example), data on the actual failures could be factored into the system reliability calculations.

Accelerating failure modes

It may not be economical for some users to perform a burn-in, but some method of weeding out time-dependent failures is desirable. Several accelerated test techniques are used including step stress, the operation of devices for a specified period at 25° and 125° Centigrade, and high temperature storage.

Step stress, the most common method, accelerates time-dependent failure modes by increasing stress levels in discrete steps until a large percentage of the test sample fails in a short period of time. The process in essence achieves a time compression, and meaningful results are available after the devices are evaluated to determine whether or not the failures would have occurred at lower stress levels or normal operating conditions.

Such tests are usually restricted to thermal and electrical stress, but can also include mechanical



IC's for the Apollo program are operated in Raytheon's burn-in rack for 168 hours. The devices are subjected to power and input signal stresses that simulate actual use as they perform in an 8-volt ring oscillator.

stress. In one method, operating devices are subjected to increasingly higher ambient temperatures; in another, the IC's are kept at a constant ambient and the power dissipation within them is increased. Test conditions sometimes specify simultaneous increases in temperatures and power dissipation until failure occurs.

Several high-stress tests have provided clues to potential failure mechanisms of IC's, according to A. Tamburrino, the principal investigator of IC reliability at RADC. Tamburrino does not advocate the universal use of these tests but feels they should be considered and used according to a program's reliability goals.

"For example," says Tamburrino, "it is possible to determine the quality of oxide layers by measuring the leakage currents when an IC is reverse biased at an elevated temperature. The test is limited only by how much voltage the circuit can take before being damaged.

"Even design weaknesses can be discovered with high-stress tests," he continues. "One way is to operate the device under conditions that are nothing like it will see under actual use." Such a test was used by Tamburrino to evaluate a diode-transistor logic circuit. The DTL, which normally switches between two states at low power levels, was biased to an intermediate level. The device was then in a condition permitting it to dissipate high power. Tamburrino says that 1,000 milliwatts were dissipated in a 100-milliwatt surface for almost 300 hours at 150°C. The circuit was adjudged very reliable and Tamburrino says he never had one

How and why integrated circuits fail

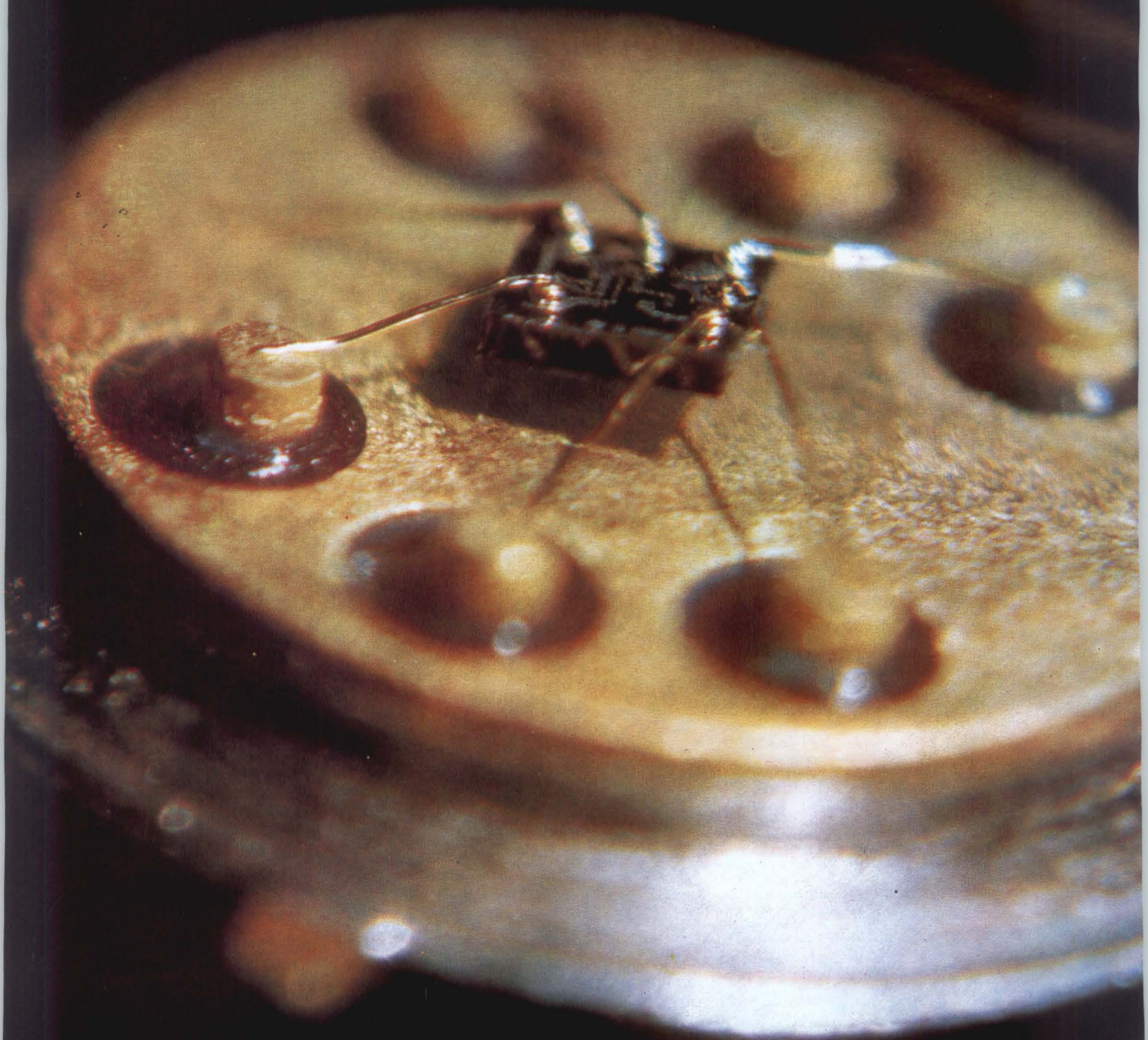

Poor bonding of the device to header can cause thermal runaway. This picture and those on the opposite page were made at Raytheon Co.'s Space and Information Systems division.

A burn-out. To assess lead current capacity, burn-outs in aluminum intraconnections may be induced by subjecting the device to excessive current or voltage.

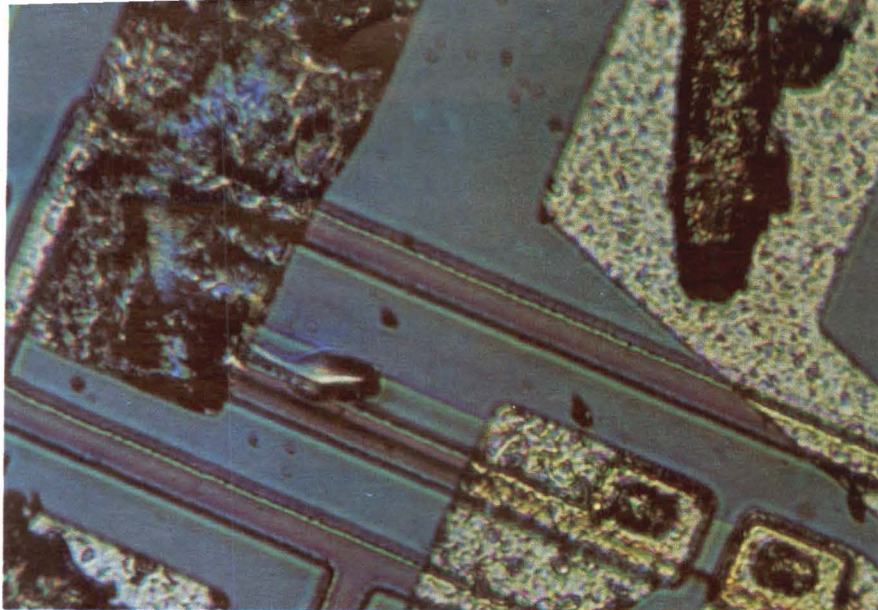

Cracks in the silicon chip can cause overheating and may eventually create open or short circuits. Cracks are usually the result of mishandling or poor processing and normally are found when the wafer is visually inspected.

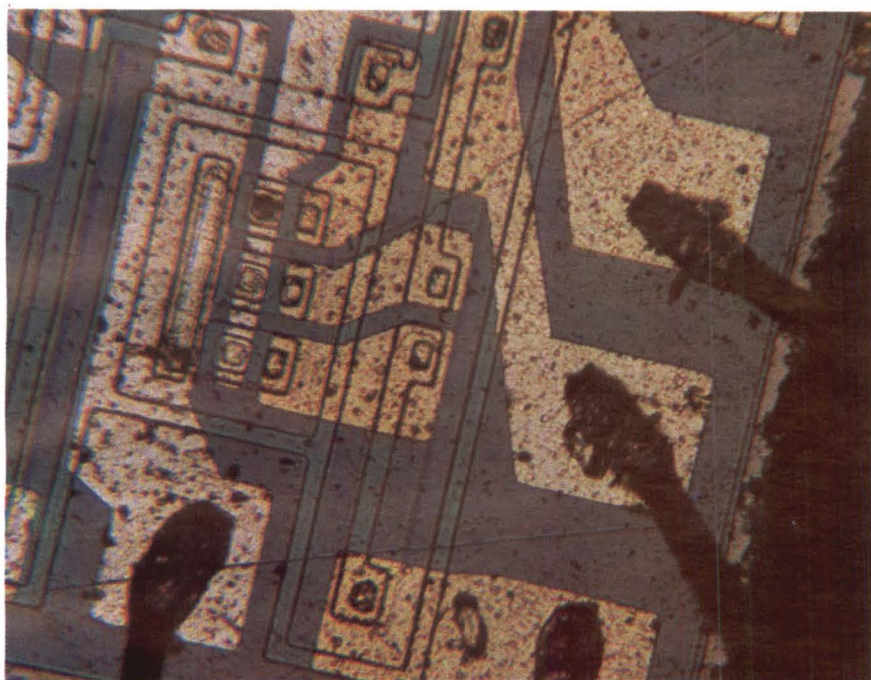

Corrosion surrounding the gold balls can cause electrical leakage as well as weak or open bonds in an integrated circuit. The culprits are contaminants and other residues left on the device surface.

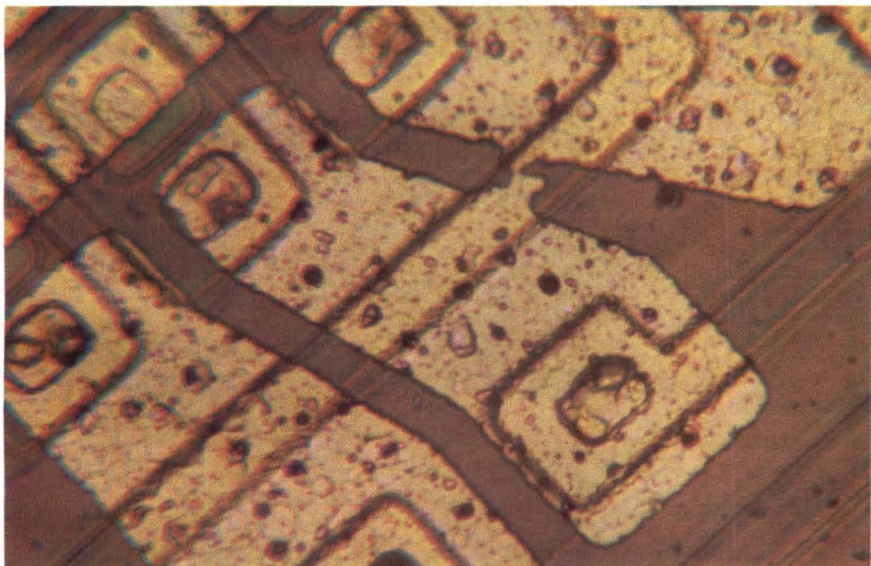
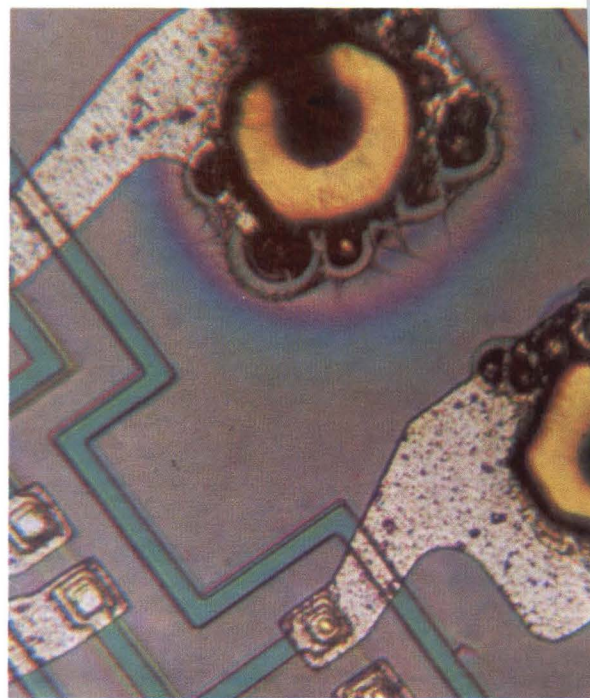

Short circuit between adjacent aluminum intraconnections is the result of a faulty mask that permitted the conducting path to be deposited.

fail incoming tests. However, one-third of the DTL's failed under the stressed conditions. The early results of failure analysis hint that inversion of the input diodes and output transistors caused the failures and may have been due to a process flaw.

Stress testing is not foolproof, the experts advise. Sometimes the circuits pass the tests but their performance is degraded. This was the experience of one aerospace company that used thermal stress to screen incoming IC's but found that circuits that passed didn't operate properly when assembled into systems.

Another problem with thermal stress is that a failure mechanism that occurs at 125°C may veil failure modes that take place at lower temperatures. Extrapolating the failure rate experienced at high temperatures to the lower temperature may, therefore, lead to erroneous conclusions.

Test equipment

The equipment for detecting IC failures or deteriorating IC parameters can be separated into two basic categories — static and dynamic — and two subgroups — manual and automatic.

Static testers test d-c characteristics only and are probably the least expensive. However, many users find that static tests don't really indicate how a device will operate under dynamic conditions, and are turning to dynamic a-c tests to simulate operating conditions. Commercial dynamic testers are usually relatively expensive.

Often the variety of IC types used in a system doesn't permit efficient use of complex automated testing equipment, and users may decide to develop their own gear for their particular need. A tester recently developed at RADC automatically scans all the d-c parameters for up to 90 IC's and records the data on punched tape. The tester prints out data in tabular form, marking any overloads or out-of-tolerance parameters.

Examples of large, flexible commercial IC testers are Fairchild Camera & Instrument Corp's series 8000 array test system and Texas Instruments Incorporated's model 553 dynamic system.

New test equipment is also being evaluated for use in uncovering failure mechanisms prior to device failure. One method being tried by Raytheon is an infrared troubleshooting test set. Devices operating in a subassembly are tested to detect abnormal thermal patterns.

The system compares the infrared pattern of devices being scanned with the profiles of up to 128 failure modes for that assembly stored within the test system's memory. The assembly under test is scanned within 45 seconds and the profile is entered into the system's core memory to be compared — a 55-second process — with the recorded failure profiles. These failure profiles are sequentially numbered, and the comparison operation selects only the one most similar to the circuit's own profile and displays the number. The test operator then consults a chart to see what parts are associated with the failure mode.

Raytheon has already put the infrared test system to work on a production line of printed circuit cards. The results have been favorable and the company is now experimenting with the tester as a trouble shooter for assemblies made with IC's. "An obvious advantage of the tester," declares R. Vanzetti, Raytheon's manager of infrared techniques and systems, "is its ability to reduce field failures by showing up overstressed modules in the system."

Infrared testing for IC's is also being considered by the Air Force. In a recent request for quotation, Wright-Patterson Air Force Base specified a transparent-to-infrared potting compound for IC modules to exploit these testers.

Useful junk pile

In high-reliability programs, the failures are more "important" than acceptable units since the failure mechanisms determine whether an entire lot being evaluated can be used. In the Apollo program, for example, an entire lot of 5,000 NOR gates would be rejected if only two units were found to have open interconnections resulting from corrosion.

However, "finding bad units is not the answer to reliability. In fact, neither is finding the fault," says John Gaffney, manager of Raytheon's failure analysis laboratory. "Most important is taking the corrective action to make certain the fault never happens again."

Failure analysis techniques include microprobing, microscopy and spectroscopy. Newer techniques and instruments such as infrared mapping and electron beam scanning microscopes are being tried, but their widespread application will have to wait until their usefulness can be demonstrated.

A problem area here is the lack of historical data for each device. Another difficulty, Gaffney notes, is that "no one knows how IC's age on a storage shelf." The Defense Department confirms the existence of this problem, and the Pentagon's Wood warns that "the Government could suffer heavy losses unless a means for measuring the effects of shelf and transit life is developed before a large inventory of equipment and replacement modules is accepted and placed into the logistics pipeline."

Many users blame some of the problems of IC failure on a lack of standardization among device manufacturers. One user, an instrument maker, asserts that IC's would be more widely used in instruments if the terminology, test methods and conditions and characteristics specified by IC makers were standardized. Standardization could also encourage multiple sources and promote long-term availability of devices.

Another difficulty is that because demand currently outstrips supply in this industry, the burden of proving reliability has been pushed onto the shoulders of the user and not on those of the IC manufacturer. Go of Fairchild states that the user has paid for reliability and should get it. Most users are opposed to the current "test, test and more test" philosophy, he adds.

Analyzing networks with state variables

A new technique for solving the differential equations that describe the dynamic behavior of a linear system arranges them in a form easily fed into an analog computer

By Louis dePian

George Washington University, Washington

For circuit analysis, most engineers still rely on the conventional mesh and node techniques taught at engineering schools. These methods work even though they sometimes produce complex n^{th} -order differential equations that defy easy solution. To analyze many new complex designs in a reasonable amount of time, the engineer wants an assurance of simpler equations. For that there is a new mathematical tool called the state variable.

The state variable is a quantity that describes the energy stored in a system, hence, the state of the system. When the system is an electrical network, the variables are usually the currents through the inductors and the voltages across the capacitors of the network. This choice allows the engineer to describe the dynamic behavior of a network with n first-order differential equations rather than one n^{th} -order differential equation. Thus, if a network is usually described by a second-order differential equation, the state-variable method describes this network with two first-order differential equations. These first-order equations are written in terms of the chosen state variables and any input voltage or current sources.

The author



Since receiving his doctorate in 1952 from the Carnegie Institute of Technology, Louis dePian has been teaching electrical engineering. Presently he is at George Washington University. His contributions to network theory include a textbook, "Active Linear Network Theory." He is also a consultant to private research companies near Washington, D.C.

First-order equations give the state-variable technique its strongest advantages: they are ideally suited to solution by either analog or digital computer. In an analog computer only one integrating network is required for each equation. Furthermore, state techniques need not be restricted to systems that are described only by differential equations; they may also be used to analyze and design sequential machines, switching networks and sampled data systems. Indeed, the present trend in system theory is toward intensified study of time-domain models through the notion of state.

The advantages of the state variable method are best seen by comparing the approach to analyzing a circuit with that of conventional analysis.

Example 1: Conventional versus state variable

In the conventional method, Kirchoff's voltage law, when applied to the loops of the network, at top of page 64, yields the following equations:

$$e_i = R_i i + \frac{1}{C} \int i_1 dt - \frac{1}{C} \int i dt \quad (1)$$

$$0 = R_o i + L \frac{di}{dt} + \frac{1}{C} \int i dt - \frac{1}{C} \int i_1 dt \quad (2)$$

The output is

$$e_o = R_o i \quad (3)$$

The conventional method requires that i and i_1 be eliminated from equations 1 and 3 so that the output e_o becomes the only unknown in the equation. To accomplish this, equations 1 and 2 have to be differentiated to eliminate the integrals and the result manipulated by substitution to remove i and i_1 .

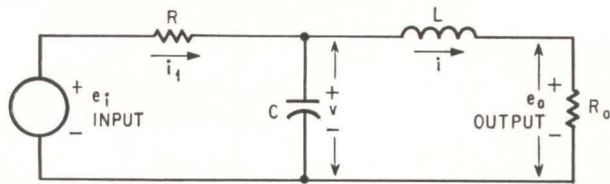

Current i through the inductor, and voltage v across the capacitor are chosen as the state variables. First-order differential equations are then written to express the dynamic behavior of the network in terms of i and v .

Hence,

$$\frac{d^2 e_o}{dt^2} + \left(\frac{R_o}{L} + \frac{1}{RC} \right) \frac{de_o}{dt} + \frac{1}{LC} \left(1 + \frac{R_o}{R} \right) e_o = \frac{1}{LC} \frac{R_o}{R} e_i \quad (4)$$

In the state-variable method, the selected state variables are the current i through inductor L and the voltage v across capacitor C since these terms are directly related to the storage energy elements in the network. To write the state-variable equations, the voltage across the inductor, $L(di/dt)$, and the current through the capacitor, $C(dv/dt)$, are expressed in terms of the state variables and the input. Thus,

$$L \frac{di}{dt} = v - R_o i \quad (5)$$

$$C \frac{dv}{dt} = \frac{1}{R} e_i - \frac{1}{R} v - i \quad (6)$$

or after rearranging,

$$\frac{di}{dt} = -\frac{R_o}{L} i + \frac{1}{L} v + 0 e_i \quad (7)$$

$$\frac{dv}{dt} = -\frac{1}{C} i - \frac{1}{RC} v + \frac{1}{RC} e_i \quad (8)$$

Only the first derivatives of the state variables appear. In matrix notation these equations may be rewritten as

$$\begin{bmatrix} \frac{di}{dt} \\ \frac{dv}{dt} \end{bmatrix} = \begin{bmatrix} -\frac{R_o}{L} & \frac{1}{L} \\ -\frac{1}{C} & -\frac{1}{RC} \end{bmatrix} \begin{bmatrix} i \\ v \end{bmatrix} + \begin{bmatrix} 0 \\ \frac{1}{RC} \end{bmatrix} e_i \quad (9)$$

The output may now be expressed directly in terms of the state variable and the input. In this case, it is simply

$$e_o = R_o i \quad (10)$$

In the conventional method the designer must solve equation 4, a second-order differential equa-

tion. In the state-variable method two first-order differential equations, 7 and 8, are solved for i and v , and the output is given directly by equation 10. When the equations have been brought into the form of equations 7 and 8 or simply equation 9, they are said to be in the normal form.

Establishing a general procedure

The preceding example was a simple one, so the network equations written in the normal form are relatively uncomplicated while, the equations for state-variable analysis are rather complex.

In the general case, however, the opposite is true. In fact, it is in the general form that the equations of the state variable method lend themselves so well to electronic computation. The network has k inductors, $n-k$ capacitors (total number of inductors and capacitors equals n , the order of the network), and m inputs. The state variables are the currents i_1, i_2, \dots, i_k through the inductors and the voltages $v_{k+1}, v_{k+2}, \dots, v_n$.

First step. Take the voltage V_j (j varies from 1 to k) across each inductor, express it as $L_j(di_j/dt)$, and equate it to the sum of the associated voltages according to Kirchhoff's voltage law. These voltages are of three categories: (a) voltages across capacitors expressed in terms of state variables v_i ; in general there are as many such terms as there are capacitors, so these can be expressed as the sum of all capacitor voltages,

$$\sum_{i=k+1}^n E_{ji} v_i$$

where E_{ji} are dimensionless coefficients; (b) voltages across resistors in terms of state-variable currents through inductors; in general there are as many such terms as there are inductors, so these can be expressed as the sum of all resistor voltages,

$$\sum_{i=1}^k R_{ji} i_i$$

where R_{ji} has dimensions of resistance and is expressed in terms of the resistances of the circuit; (c) input voltages and currents x_i ; in general there are as many such terms as there are inputs, so these can be expressed as the sum of all inputs,

$$\sum_{i=1}^m F_{ji} x_i$$

where F_{ji} is dimensionless if the input x_i is a voltage or has dimensions of resistance if the input x_i is a current. Thus, the total voltage across each inductor is

$$V_j = L_j \frac{di_j}{dt} = \sum_{i=k+1}^n E_{ji} v_i + \sum_{i=1}^k R_{ji} i_i + \sum_{i=1}^m F_{ji} x_i \quad (11)$$

$$j = 1, 2, \dots, k$$

Second step. Take the current i_j (j varies from $k+1$ to $k+n-k=n$) through each capacitor, express it as $C_j(dv_j/dt)$, and equate it to the sum

of the associated currents according to Kirchhoff's current law. These currents are also of three varieties: (a) currents through inductors expressed in terms of state variables i_j . There are as many such terms as there are inductors, so these may be expressed as the sum of all inductor currents,

$$\sum_{i=1}^k H_{ji} i_i$$

where H_{ji} are dimensionless coefficients; (b) currents through conductors in terms of state-variable voltages across capacitors. There are as many such terms as there are capacitors, so these may be expressed as the sum of all currents through conductors,

$$\sum_{i=k+1}^n G_{ji} v_i$$

where G_{ji} has dimensions of conductance and is expressed in terms of the resistances of the circuit; (c) input voltages and currents x_i . There are as many such terms as there are inputs, so these may be expressed as the sum of all inputs,

$$\sum_{i=1}^m K_{ji} x_i$$

where K_{ji} is dimensionless if the input x_i is a current, or has dimensions of conductance if the input x_i is a voltage. Thus,

$$i_j = C_j \frac{dv_j}{dt} = \sum_{i=1}^k H_{ji} i_i + \sum_{i=k+1}^n G_{ji} v_i + \sum_{i=1}^m K_{ji} x_i \quad (12)$$

$$j = k + 1, k + 2, \dots, n.$$

The normal form is obtained by dividing equation 11 by L_j , equation 12 by C_j and rearranging

$$\begin{aligned} \frac{di_1}{dt} &= \frac{R_{1,k}}{L_1} i_1 + \dots + \frac{R_{1,k}}{L_1} i_k + \frac{E_{1,k+1}}{L_1} v_{k+1} + \dots \\ &+ \frac{E_{1,n}}{L_1} v_n + \frac{F_{1,1}}{L_1} x_1 + \dots + \frac{F_{1,m}}{L_1} x_m \\ \frac{di_k}{dt} &= \frac{R_{k,1}}{L_k} i_1 + \dots + \frac{R_{k,k}}{L_k} i_k + \frac{E_{k,k+1}}{L_k} v_{k+1} + \dots \\ &+ \frac{E_{k,n}}{L_k} v_n + \frac{F_{k,1}}{L_k} x_1 + \dots + \frac{F_{k,m}}{L_k} x_m \\ \frac{dv_{k+1}}{dt} &= \frac{H_{k+1,1}}{C_{k+1}} i_1 + \dots + \frac{H_{k+1,k}}{C_{k+1}} i_k + \frac{G_{k+1,k+1}}{C_{k+1}} v_{k+1} + \dots \\ &+ \frac{G_{k+1,n}}{C_{k+1}} v_n + \frac{K_{k+1,1}}{C_{k+1}} x_1 + \dots + \frac{K_{k+1,m}}{C_{k+1}} x_m \\ \frac{dv_n}{dt} &= \frac{H_{n,1}}{C_n} i_1 + \dots + \frac{H_{n,k}}{C_n} i_k + \frac{G_{n,k+1}}{C_n} v_{k+1} + \dots \\ &+ \frac{G_{n,n}}{C_n} v_n + \frac{K_{n,1}}{C_n} x_1 + \dots + \frac{K_{n,m}}{C_n} x_m \quad (13) \end{aligned}$$

with matrix notation, these equations condense to

$$\begin{bmatrix} \frac{di_1}{dt} \\ \vdots \\ \frac{di_k}{dt} \\ \vdots \\ \frac{dv_{k+1}}{dt} \\ \vdots \\ \frac{dv_n}{dt} \end{bmatrix} = \begin{bmatrix} \left[\frac{R_{ji}}{L_j} \right] & \left[\frac{E_{ji}}{L_j} \right] \\ \vdots & \vdots \\ \left[\frac{H_{ji}}{C_j} \right] & \left[\frac{G_{ji}}{C_j} \right] \end{bmatrix} \begin{bmatrix} i_j \\ \vdots \\ i_k \\ \vdots \\ v_{k+1} \\ \vdots \\ v_n \end{bmatrix} + \begin{bmatrix} \left[\frac{F_{ji}}{L_j} \right] \\ \vdots \\ \left[\frac{K_{ji}}{C_j} \right] \end{bmatrix} \begin{bmatrix} x_1 \\ \vdots \\ x_m \end{bmatrix} \quad (14)$$

where

$$\left[\frac{R_{ji}}{L_j} \right] \text{ is a } k \times k \text{ matrix,}$$

$$\left[\frac{E_{ji}}{L_j} \right] \text{ is a } k \times (n - k) \text{ matrix,}$$

$$\left[\frac{H_{ji}}{C_j} \right] \text{ is a } (k - n) \times k \text{ matrix,}$$

$$\left[\frac{G_{ji}}{C_j} \right] \text{ is a } (n - k) \times (n - k) \text{ matrix,}$$

$$\left[\frac{E_{ji}}{L_j} \right] \text{ is a } k \times m \text{ matrix,}$$

$$\left[\frac{K_{ji}}{C_j} \right] \text{ is a } (n - k) \times m \text{ matrix}$$

A more compact form may be obtained with the following definitions:

$$q_j(t) = \begin{cases} i_j(t) & j = 1, 2, \dots, k \\ v_j(t) & j = k+1, k+2, \dots, n \end{cases} \quad (15)$$

$$[q(t)] = \begin{bmatrix} q_1(t) \\ \vdots \\ q_n(t) \end{bmatrix} \quad (16)$$

$[q(t)]$ is called the state vector.

$$[A] = \begin{bmatrix} \frac{R_{ji}}{L_j} & \frac{E_{ji}}{L_j} \\ \vdots & \vdots \\ \frac{H_{ji}}{C_j} & \frac{G_{ji}}{C_j} \end{bmatrix} \quad (17)$$

$$[B] = \begin{bmatrix} \frac{F_{ji}}{L_j} \\ \vdots \\ \frac{K_{ji}}{C_j} \end{bmatrix} \quad (18)$$

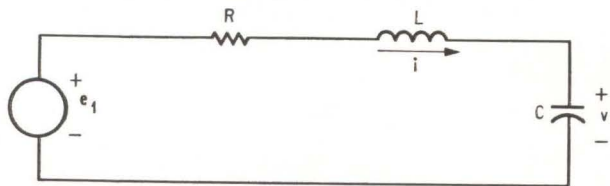

Single-loop RLC network is analyzed by the state-variable technique with i , the current through the inductor and v , the voltage across the capacitor.

$$[x(t)] = \begin{bmatrix} x_1(t) \\ \vdots \\ x_m(t) \end{bmatrix} \quad (19)$$

The normal form is then:

$$\frac{d[q(t)]}{dt} = [A][q(t)] + [B][x(t)] \quad (20)$$

A direct solution can be obtained by integrating each $dq(t)/dt$ once, since every $dq(t)/dt$ term in equation 20 represents the first derivative of each state variable $[q(t)]$. Sets of equations of this type are ideally suited to analog computation and it is the form that we want to obtain. The right-hand side of equation 20 represents the sum of a matrix $[A]$ multiplied by a matrix $[q(t)]$, which contains a column of state variables, and a matrix $[B]$ multiplied by $[x(t)]$, which contains a column of input functions. In the previous example, the equivalent of these matrices were

$$q_1(t) = i(t), \quad q_2(t) = v(t) \quad (21)$$

$$[q(t)] = \begin{bmatrix} q_1(t) \\ q_2(t) \end{bmatrix} \quad (22)$$

$$[A] = \begin{bmatrix} -\frac{R_o}{L} & \frac{1}{L} \\ -\frac{1}{C} & -\frac{1}{RC} \end{bmatrix} \quad (23)$$

$$[B] = \begin{bmatrix} 0 \\ \frac{1}{RC} \end{bmatrix} \quad (24)$$

$$[x(t)] = e_1(t) \quad (25)$$

So far only the normal form equations are set up. No attempt has been made to solve them. The general form of the solution is described later.

Although the method may seem complicated at first, it is really a straightforward procedure developed from routine steps. In fact, these steps can be easily programmed into a digital computer. And here lies one of the advantages of the state-variable method: its form is such that the digital computer can readily set up the equations. Actually, the computer becomes necessary only when the number of elements, loops and nodes of the

circuit is large and when alternate designs of a network must be considered. In simple cases, like the previous example, either method is convenient and the choice depends on personal preference.

Example 2 is offered to further illustrate the general procedure for setting up the state variable equations (7,8).

Example 2: Series RLC network

Problem: express the dynamic behavior of the network shown at left in terms of its state variables.

First. Choose the state variables. As in example 1 the current through the inductor, i , and the voltage across the capacitor, v , are chosen.

Second. Form a first-order differential equation for each state variable (di/dt and dv/dt) in terms of v and the input voltage e_1 .

$$\frac{di}{dt} = -\frac{R}{L}i - \frac{1}{L}v + \frac{1}{L}e_1$$

and,

$$\frac{dv}{dt} = \frac{1}{C}i$$

Third. Write the normal form matrix equation. Hence,

$$\begin{bmatrix} \frac{di}{dt} \\ \frac{dv}{dt} \end{bmatrix} = \underbrace{\begin{bmatrix} -\frac{R}{L} & \frac{1}{L} \\ \frac{1}{C} & 0 \end{bmatrix}}_{[A]} \begin{bmatrix} i \\ v \end{bmatrix} + \underbrace{\begin{bmatrix} \frac{1}{L} \\ 0 \end{bmatrix}}_{[B]} e_1$$

Choosing the state variables

So far only the inductor currents and capacitor voltages were chosen as the state variables. This choice was arbitrary. Other voltages and currents as well as their derivatives can also be designated state variables. The reason for this initial choice was that these particular variables directly describe the energy stored in the network. If i_j is the current through inductor L_j , then the energy stored in this inductor is $\frac{1}{2} L_j i_j^2$. Similarly if v_j is the voltage across capacitor C_j , the energy stored in this capacitor is $\frac{1}{2} C_j v_j^2$. In fact, the total stored energy in the general network described by equations 11 and 12 is

$$W = \frac{1}{2} \sum_{j=1}^k L_j i_j^2 + \frac{1}{2} \sum_{j=k+1}^n C_j v_j^2 \quad (26)$$

In example 1, the state variables were i , v and the total stored energy was

$$W = \frac{1}{2} Li^2 + \frac{1}{2} Cv^2 \quad (27)$$

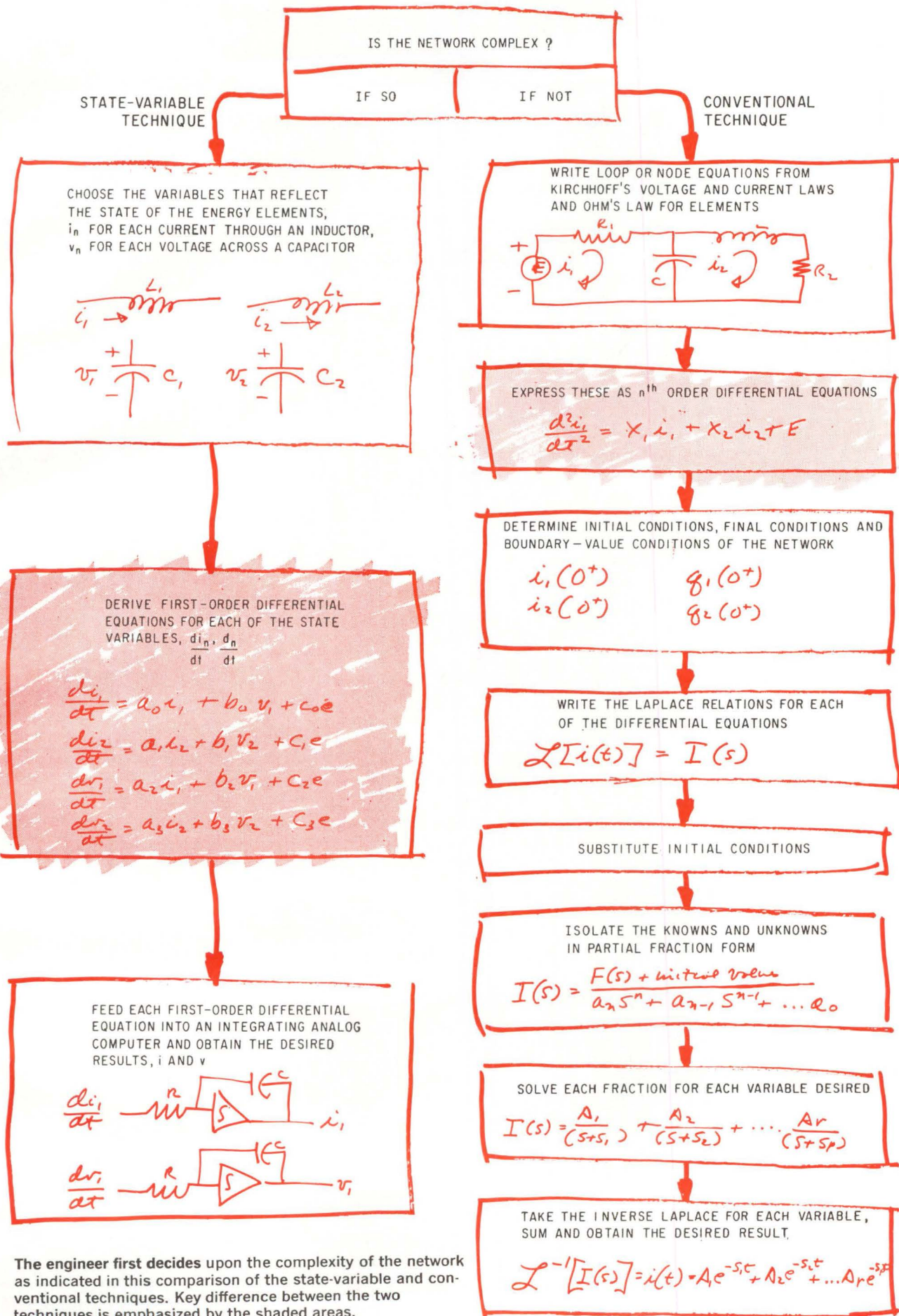

The engineer first decides upon the complexity of the network as indicated in this comparison of the state-variable and conventional techniques. Key difference between the two techniques is emphasized by the shaded areas.

Another reason why these particular variables are chosen as the state variables is that usually the initial conditions necessary to obtain a solution of the differential equations are given in terms of inductor currents and capacitor voltage or charge. However, the derivative of a state variable can also be defined as a new state variable. In example 1, we could have chosen as the state variables i , and di/dt , rather than i and v , since v can be expressed as a function of these and the input.

$$v = L \left(\frac{di}{dt} \right) + R_o i \quad (28)$$

In fact, the output and its derivatives (as many derivatives as necessary to have the proper number of total variables) may be used as state variables. In example one, we could have chosen e_o and de_o/dt as the state variables since the original state variables can be expressed linearly in terms of these. (Here we are not showing the general method by which these linear relationships can be found, but simply that they exist.) Let

$$q_1 = e_o, \quad q_2 = de_o/dt \quad (29)$$

It is not difficult to show that

$$i = \frac{1}{R_o} q_1 \quad (30); \quad v = q_1 + \frac{L}{R_o} q_2 \quad (31)$$

Combining these equations with 7 and 8 (the normal form in terms of state variables i, v) yields the normal form in terms of the new state variables q_1, q_2 :

$$\frac{dq_1}{dt} = 0q_1 + q_2 + 0e_1 \quad (32)$$

$$\frac{dq_2}{dt} = -\frac{1}{LC} \left(1 + \frac{R_o}{R} \right) q_1 - \left(\frac{R_o}{L} + \frac{1}{RC} \right) q_2 + \frac{R_o}{RLC} e_1 \quad (33)$$

Converting to normal form

It is always possible, given an n^{th} -order differential equation of the network in the conventional form, to find a set of n equations in the normal form. To show this, consider differential equation 4. Define as the state variables, the variable of the differential equation $q_1 = e_o$ and its derivative $q_2 = de_o/dt$. This immediately results in

$$\frac{dq_1}{dt} = q_2 \quad (34)$$

Substituting these variables in equation 33 yields:

$$\frac{d^2 e_o}{dt^2} + \left(\frac{R_o}{L} + \frac{1}{RC} \right) q_2 +$$

$$\frac{1}{LC} \left(1 + \frac{R_o}{R} \right) q_1 = \frac{1}{LC} \frac{R_o}{R} e_1$$

and, noting that $d^2 e_o/dt^2 = dq_2/dt$ yields

$$\frac{dq_2}{dt} = -\frac{1}{LC} \left(1 + \frac{R_o}{R} \right) q_1 - \left(\frac{R_o}{L} + \frac{1}{RC} \right) q_2 + \frac{1}{LC} \frac{R_o}{R} e_1 \quad (35)$$

(compare with equation 33).

In terms of the state variables q_1 and q_2 the matrix normal form of equation 20 is now expressed as,

$$[A] = \begin{bmatrix} 0 & \mathbf{1} \\ -\frac{1}{LC} \left(1 + \frac{R_o}{R} \right) & -\left(\frac{R_o}{L} + \frac{1}{RC} \right) \end{bmatrix} \quad (36)$$

$$[B] = \begin{bmatrix} 0 \\ \frac{R_o}{RLC} \end{bmatrix} \quad (37)$$

This procedure connects the conventional form of one differential equation to a normal form involving the output and its derivatives as state variables. It is also possible to go from one set of state variables to another. Although these operations are rather simple, they become more complicated for more elaborate networks. There are, however, direct techniques (amenable to digital computer programming) for performing these operations in the normal form. The manual difficulties involved in these operations are matrix manipulations, such as matrix inversions. These are routine calculations for digital computers.

Another advantage of the state-variable approach is that it adapts very easily to analog computer applications. The equations once in normal form

$$\frac{dq_1}{dt} = A_{11}q_1 + \cdots + A_{1n}q_n + B_{11}x_1 + \cdots + B_{1m}x_m \quad (38)$$

$$\frac{dq_n}{dt} = A_{n1}q_1 + \cdots + A_{nn}q_n + B_{n1}x_1 + \cdots + B_{nm}x_m$$

may be written, after integration, as

$$\begin{aligned} q_1 &= A_{11} \int q_1 dt + \cdots + A_{1n} \int q_n dt \\ &\quad + B_{11} \int x_1 dt + \cdots + B_{1m} \int x_m dt \\ &\vdots \\ q_n &= A_{n1} \int q_1 dt + \cdots + A_{nn} \int q_n dt \\ &\quad + B_{n1} \int x_1 dt + \cdots + B_{nm} \int x_m dt \end{aligned} \quad (39)$$

These are in the exact form of the operations that

the analog computer performs: summation, integration and multiplication by a constant.

Solving the equations

So far only aspects of how the differential equations are established in normal form have been presented. Now it is possible to establish the general procedure for their solution. The solution can be performed either in the time domain or in the frequency domain, with Laplace or other operational transforms.

The normal form is given by equation 20 where $q(t)$ is a vector (state vector) defining the n state variables as in equation 16, and $x(t)$ is the input vector defining the m inputs as in equation 19. The matrix $[A]$ is an $n \times n$ matrix and $[B]$ an $n \times m$ matrix containing element constants of the network.

For p outputs, the solution includes $y_1(t)$, $y_2(t)$, \dots , $y_p(t)$, defined as an output vector

$$[y(t)] = \begin{bmatrix} y_1(t) \\ y_2(t) \\ \vdots \\ y_p(t) \end{bmatrix} \quad (40)$$

The outputs can be expressed linearly and directly, without involving derivatives, in terms of the state variables and the inputs:

$$\begin{aligned} y_1(t) &= C_{11}q_1(t) + \dots + C_{1n}q_n(t) \\ &\quad + D_{11}x_1(t) + \dots + D_{1m}x_m(t) \\ &\vdots \\ y_p(t) &= C_{p1}q_1(t) + \dots + C_{pn}q_n(t) \\ &\quad + D_{p1}x_1(t) + \dots + D_{pm}x_m(t) \end{aligned} \quad (41)$$

or in a matrix notation as,

$$[y(t)] = [C] [q(t)] + [D] [x(t)] \quad (42)$$

where $[C]$ is a $p \times n$ matrix and $[D]$ a $p \times m$ matrix containing constant elements. In example 1, there was one output e_o ($p = 1$), one input e_1 ($m = 1$) and two state variables i , v ($n = 2$). Note from equation 10 that

$$[C] = [R_o \ 0] \quad [D] = 0 \quad (43)$$

If, for example, the designer also desired to know the current i_1 and considered it as an output (thus e_o and i_1 are the outputs, $p = 2$), he could write $e_1 = Ri_1 + v$. With equation 10, this yields the following output equations:

$$\begin{aligned} e_o &= R_o i + 0v + 0e_1 \\ i_1 &= 0i - \frac{1}{R} v + \frac{1}{R} e_1 \end{aligned} \quad (44)$$

and, therefore,

$$[C] = \begin{bmatrix} R_o & 0 \\ 0 & -\frac{1}{R} \end{bmatrix} \quad [D] = \begin{bmatrix} 0 \\ \frac{1}{R} \end{bmatrix} \quad (45)$$

The object of the general solution is to find $q(t)$

from equation 20 and substitute it in equation 12 for the solution.

Here, the proof is not presented, only results are shown. The solution for $q(t)$ in the time domain takes the form

$$[q(t)] = \epsilon^{[A]t} [q(0)] + \int_0^t \epsilon^{[A](t-\tau)} [B] [x(\tau)] d\tau \quad (46)$$

where $[q(0)]$ is the state vector defining the initial conditions of $[q(t)]$; $[A]$ and $[B]$ are the constant matrices in equation 20 and

$$\epsilon^{[A]t} = [I] + [A]t + [A]^2 \frac{t^2}{2!} + [A]^3 \frac{t^3}{3!} + \dots \quad (47)$$

usually written as

$$[\phi(t)] = \epsilon^{[A]t} \quad (48)$$

is known as the fundamental matrix. $[I]$ is the identity matrix whose elements are all unity. The matrix $[A]^2 = [A] [A]$, $[A]^3 = [A] [A] [A]$ etc. In equation 46, $[B]$ cannot be removed from the integral, even though it is a constant, since in matrix multiplication, the order cannot be changed.

This solution now may be applied to example 1 with the following numerical values:

$$\begin{aligned} L &= \frac{1}{2} & C &= \frac{1}{2} & R &= 1 & R_o &= \frac{7}{2} \\ q_1 &= i & q_2 &= v \\ i(0) &= 0 & v(0) &= 1 \\ e_1(t) &= u(t) \text{ (unit step)} \end{aligned} \quad (49)$$

Equations 23 and 24 yield:

$$[A] = \begin{bmatrix} -7 & 2 \\ -2 & -2 \end{bmatrix} \quad (50)$$

$$[B] = \begin{bmatrix} 0 \\ 2 \end{bmatrix} \quad (51)$$

Therefore, by matrix algebra

$$[A]^2 = \begin{bmatrix} 45 & -18 \\ 18 & 0 \end{bmatrix} \quad (52)$$

$$\epsilon^{[A]t} = \begin{bmatrix} 1-7t+18.5t^2-\dots & 0+2t-9t^2+\dots \\ 0-2t+9t^2-\dots & 1-2t+0t^2-\dots \end{bmatrix} \quad (53)$$

Equation 53 is rewritten as,

$$\epsilon^{[A]t} = \begin{bmatrix} -\frac{1}{3}\epsilon^{-3t} + \frac{4}{3}\epsilon^{-6t} & \frac{2}{3}\epsilon^{-3t} - \frac{2}{3}\epsilon^{-6t} \\ -\frac{2}{3}\epsilon^{-3t} + \frac{2}{3}\epsilon^{-6t} & \frac{4}{3}\epsilon^{-3t} - \frac{1}{3}\epsilon^{-6t} \end{bmatrix} \quad (54)$$

For calculations carried out by a digital computer, the form of equation 53 rather than 54 is required. Substituting these results into the solution given by equation 16 results in,

$$i = \frac{2}{3}\epsilon^{-3t} - \frac{2}{3}\epsilon^{-6t} + 2 \int_0^t \left(\frac{2}{3}\epsilon^{-3(t-\tau)} - \frac{2}{3}\epsilon^{-6(t-\tau)} \right) d\tau$$

$$v = \frac{4}{3} \epsilon^{-3t} - \frac{1}{3} \epsilon^{-6t} + 2 \int_0^t \left(\frac{4}{3} \epsilon^{-3(t-\tau)} - \frac{1}{3} \epsilon^{-6(t-\tau)} \right) d\tau$$

and after the evaluation of the integrals,

$$i = \frac{2}{9} \left(\epsilon^{-3t} - 2\epsilon^{-6t} + 1 \right)$$

$$v = \frac{1}{9} \left(4\epsilon^{-3t} - 2\epsilon^{-6t} + 7 \right) \quad (55)$$

Finally, the output e_o is obtained from equation 10,

$$e_o = \frac{7}{2} i$$

or

$$e_o = \frac{7}{9} \left(\epsilon^{-3t} - 2\epsilon^{-6t} + 2 \right) \quad (56)$$

This solution is in the time domain. An analogous solution may be obtained in the complex frequency domain (Laplace transform). If a capital notation is adopted to denote Laplace transforms, then equation 46 gives

$$[Q(s)] = [\Phi(s)] [q(0)] + [\Phi(s)] [B] [X(s)] \quad (57)$$

where $[\Phi(s)]$ is the Laplace transform of $[\phi(t)]$ as given in equation 48. It is equal to

$$[\Phi(s)] = \{s[I] - [A]\}^{-1} \quad (58)$$

where the -1 denotes the inverse matrix, and is known as the characteristic frequency matrix of the network. In terms of the numerical example,

$$[X(s)] = \mathcal{L} u(t) = \frac{1}{s} \quad (59)$$

and

$$\{s[I] - [A]\}^{-1} = \left\{ \begin{bmatrix} s & 0 \\ 0 & s \end{bmatrix} - \begin{bmatrix} -7 & 2 \\ -2 & -2 \end{bmatrix} \right\}^{-1}$$

$$= \begin{bmatrix} s+7 & -2 \\ 2 & s+2 \end{bmatrix}^{-1} = \frac{\begin{bmatrix} s+2 & 2 \\ -2 & s+7 \end{bmatrix}}{5^2 + 9s + 18}$$

or

$$[\Phi(s)] = \begin{bmatrix} \frac{s+2}{(s+3)(s+6)} & \frac{2}{(s+3)(s+6)} \\ -\frac{2}{(s+3)(s+6)} & \frac{s+7}{(s+3)(s+6)} \end{bmatrix} \quad (60)$$

Substituting these results in equation 58 results in

$$I(s) = \frac{2}{(s+3)(s+6)} + \frac{4}{s(s+3)(s+6)}$$

$$V(s) = \frac{s+7}{(s+3)(s+6)} + \frac{2(s+7)}{(s+3)(s+6)}$$

or

$$I(s) = \frac{2}{9} \left(\frac{1}{s+3} - \frac{2}{s+6} + \frac{1}{s} \right)$$

$$V(s) = \frac{1}{9} \left(\frac{4}{s+3} - \frac{2}{s+6} + \frac{7}{s} \right) \quad (61)$$

which are indeed the Laplace transforms of equation 55. The output is then expressed as,

$$E_o(s) = \frac{7}{2} I(s)$$

or

$$E(s) = \frac{7}{9} \left(\frac{1}{s+3} - \frac{2}{s+6} + \frac{1}{s} \right) \quad (62)$$

Designer's decision

Because it is so new the state-variable technique has still not found its niche in engineering. Potential users are still comparing it to other methods such as mesh, node, topology, Laplace, etc., that have so far dominated the field. Whether or not it is here to stay will depend on the applications the designer finds for it, whether it can do things better and whether it provides a better insight into the problems to be solved.

The state-variable approach has two main advantages—it blends nicely with analog computer calculations and its successive steps are easily programed for digital computers—become really powerful when the network under investigation is complex. For simple problems, like the ones discussed here, it is much more convenient to apply the conventional method. Nobody in his right mind would solve these problems with the state variable method. The application of the state-variable technique is best suited for cases where computer assistance, digital or analog, is available.

In the conventional method, the designer has to find the roots of an algebraic equation (the characteristic equation) of degree equal to the order of the network. If this equation is higher than quadratic a computer may be necessary. The argument then may be that if a computer is put to this task, the problem may as well be solved through the state-variable method. The argument is debatable. In the last analysis it is the designer who, knowing all methods and the computing assistance available to him, will decide the best method suited for his needs. Even with conventional analysis, it is sometimes advantageous to have the normal-form equations available, in terms of currents through inductors and voltages across capacitors. This affords better insight of the problem than with only the single differential equation of the conventional method.

Bibliography

- L.A. Zadeh and C.A. Desoer, "Linear System Theory," McGraw-Hill Book Co., 1963.
 R.J. Schwarz and B. Friedland, "Linear Systems," McGraw-Hill Book Co., 1965.
 F.F. Ku and J.F. Kaiser, "System Analysis by Digital Computer," John Wiley and Sons, Inc., 1966.

New Honeywell Model 85 Digital Multimeter* makes $\pm .005\%$ measurements in 10 ms! With one encoding!

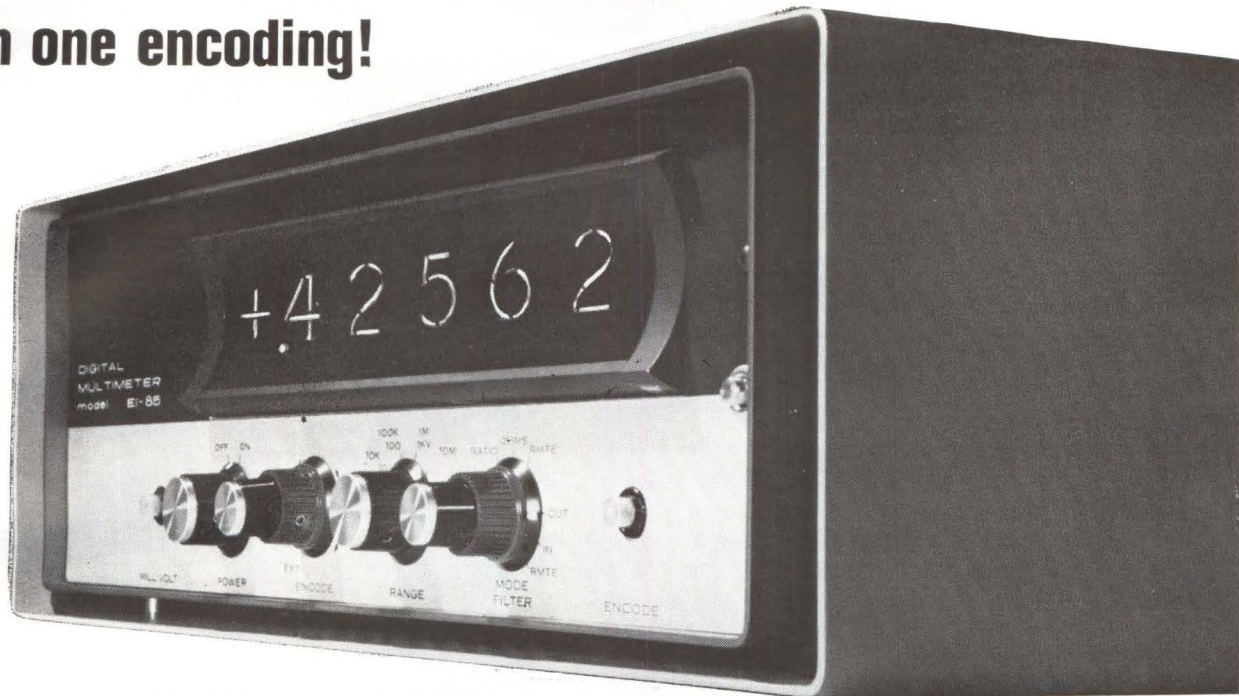

(and you don't have to take a second reading!)

Accurate, full 5 digit measurements are now possible in 10 msec with the Honeywell 85's successive approximation logic.

Why the "one encoding"? Because unlike other high speed instruments which are allowed to encode before their input circuitry settles to full accuracy, the 85 contains a sensing circuit which acknowledges settling of its high impedance input section to $\pm .001\%$ of final value before allowing its logic circuitry to encode. All within 10 msec! Repeat encodings are not necessary to obtain that "last digit of accuracy" with this high speed Honeywell DVM. This assures you consistent repetitive readings.

Noise Rejection - Not forgetting the effect of noise, the 85's guarded differential input and active Bessel filter provide 160 db of CMR and 60 db NMR at 60 Hz while maintaining a constant high input impedance of greater than 1,000

megohms to 10 volts F.S. This means, of course, no loss of accuracy due to noise or source loading during encoding!

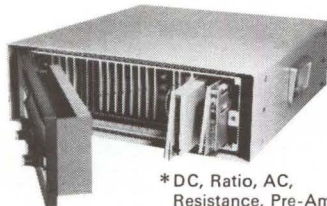

*DC, Ratio, AC, Resistance, Pre-Amplifier

Whether your need is for accurate high speed measurements of dynamic fast changing signals, high speed system operation (100 readings/second) or a versatile accurate multimeter for general purpose use, the 85 fills the bill!

Other Features - Complete multimeter capability utilizing plug-in card accessories • DC and Ratio comprise the basic instrument • 10μ volts basic resolution without pre-amplifier (1 volt F.S.)

- Differential guarded input on *all* modes of operation
- Autorange and polarity in *all* modes
- Storage in readout prevents "blinking"
- Storage in electrical outputs allows time-sharing operation
- Isolated BCD and 10-line decimal outputs and remote control are standard
- AC converter - 5 digit 10μ volt resolution, 10 Hz to 100 KHz
- Resistance converter - .01 ohms to 10 megohms
- Pre-amplifier - for 1 microvolt resolution.

Priced from \$5,150.00.

Complete 85 High Speed System - Complete line of Honeywell system modules for signal conditioning, scanning, comparison, timing, automatic programming, and peripheral outputs such as computer compatible paper or magnetic tape can be easily added to your 85. Contact your Honeywell Sales Office or send coupon.

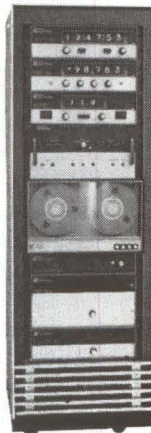

Honeywell • Mail Station 433 12A
Test Instruments Division
Denver, Colorado 80217

Please send literature on the 85 Digital Multimeter.

Name _____
Company _____
Address _____
City _____
State _____ Zip _____

DATA HANDLING SYSTEMS
Honeywell

Designer's casebook

Designer's casebook is a regular feature in Electronics. Readers are invited to submit novel circuit ideas, packaging schemes, or other unusual solutions to design problems. Descriptions should be short. We'll pay \$50 for each item published.

Zener diode controls variable phase shifter

By Theodore T. Kalal

Institute for Enzyme Research
University of Wisconsin, Madison

A zener diode in a phase-shifting circuit provides convenient control of the phase angle of low-frequency signals. Shifts as large as 70° can be made without distorting the signal's waveshape. Operating as a voltage variable resistor, the zener diode gives the circuit a phase shift sensitivity of 15° per volt. The diode's resistance is varied by changing the setting of potentiometer R_2 and the output amplitude is kept constant over the range of phase shift by varying R_1 .

As a variable phase reference, the circuit can control a large number of servomechanisms. In a wideband military receiver, for example, the troublesome mechanical linkages that gang-tune the intermediate-frequency strips could be replaced by positioning servos for each knob, referenced to a single phase shifter. The receiver would then be tuned by varying the phase angle of the reference voltage.

The circuit's simplicity and low cost make it attractive for such consumer applications as a-c motor speed controls in mixers, blenders and drills. Motor speed may be regulated by a lagging phase shifter that would control the firing point of a silicon controlled rectifier; the scr's cut-in point determines motor speed by limiting the amplitude of the voltage that reaches the motor.

Because the phase shifter is voltage variable, it may serve as the correction circuit in the feedback loop of an automatic phase-control system.

The circuit operates like an ordinary phase shifter except that a transistor replaces the transformer. The transistor performs conventional transformer functions, isolating the input from the output and placing identical signals of opposite polarity at the terminals of its secondary. In the schematic, transistor Q_1 is flanked by matched 1-kilohm resistors so the signals across them are equal (within 2%), but are opposite in polarity.

Capacitor C_1 and zener diode D_1 split the signal

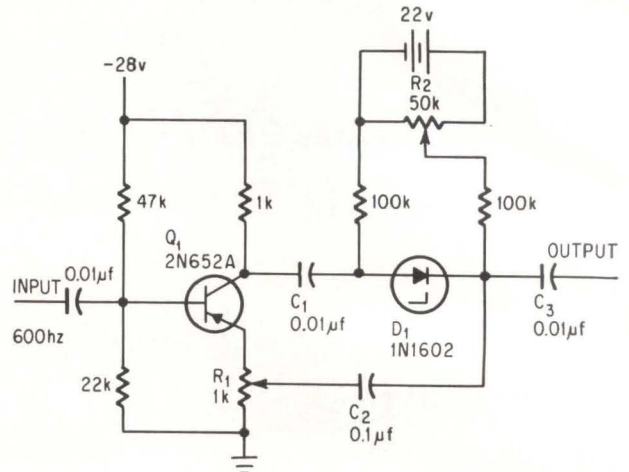

Collector signals are split into quadrature components by capacitor C_1 and zener diode D_1 . The phase of the output signal is determined by the relative magnitudes of the two quadrature components, as adjusted by zener diode.

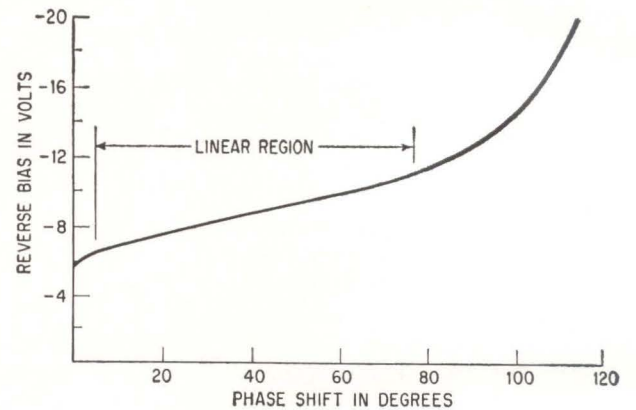

Resistance of zener diode D_1 remains linear during nearly 80° of phase shift. The slope of the linear portion indicates that phase-shift selectively is 15° per volt.

voltage at the collector into quadrature components. When the impedance of D_1 equals that of C_1 , the output signal phase leads that of the collector by 45° . As the resistance of D_1 gets smaller, a larger portion of the output voltage appears across C_1 ; this further increases the angle by which the output leads the collector signal phase. When the resistance of the zener approaches zero, the lead angle approaches 90° . The graph directly above shows this effect—an increase in the reverse bias on the zener increases the phase shift. The nonlinearity

above 70° or 75° of shift is caused by the residual resistance in the zener; at this point the resistance cannot be further reduced by increasing the reverse bias voltage, thus proportional voltage division becomes impossible.

As the resistance of the zener becomes very large, however, capacitor C₁'s contribution to the output voltage becomes negligible; hence the output voltage is virtually in phase with the collector voltage. The capacitance of C₂ is very large compared with C₁ so its effect on the phase of the output voltage may be neglected. Capacitor C₃ couples.

There is a five-to-one reduction in output ampli-

tude as the phase shift is varied from minimum to maximum; this effect can be largely overcome by adjusting potentiometer R₁ to increase the resistance between the emitter of Q₁ and the wiper of R₁. Properly adjusted, the output amplitude variation is less than 1.2 to 1 over the entire phase-shift range.

Distortion of the output may be caused by a signal whose amplitude is so large that it drives the zener diode into its forward conducting region. If the signal remains within the zener region, however, distortion is more than 50 decibels below the signal level.

Emitter follower enhances oscillator's frequency variation

By Gordon Silverman

Rockefeller University, New York

An emitter follower, added to a phase-shift oscillator to provide a low impedance for coupling to other circuits, produces an unexpected performance bonus. With the addition of the emitter follower, the oscillator's output frequency increases by a factor of $\sqrt{2}$ over that of an unmodified oscillator. Thus, for a given output frequency, a smaller value of capacitance may be applied. Furthermore, the modified oscillator exhibits greater frequency sensitivity with changes in R than the unmodified circuit.

One application for the oscillator is a psychological testing device that measures the subject's ability to follow a moving target—in this case a light source. The oscillator's frequency is propor-

tional to the intensity of illumination falling on the light-sensitive resistor, R₅. For other applications, a potentiometer can replace R₅ to produce a simple variable frequency source. With a current-sensitive resistor as an external bias supply, the circuit could operate as a remotely controlled oscillator.

The network consisting of capacitors C₁ to C₃, resistors R₂ to R₆ and the input impedance of transistor Q₁ produces the 180° phase shift necessary for oscillation. In a conventional phase-shift oscillator, Q₂ is omitted and the feedback network is connected directly to Q₁'s collector. The unmodified circuit, Q₁ is a current source and the frequency of oscillation is expressed as

$$f = \frac{1}{2\pi RC\sqrt{6}} \quad (1)$$

where R and C are the resistance and capacitance in the phase shift network. The added emitter follower drives the phase shift network from a voltage source instead of a current source. The frequency at which the base current into Q₁ is 180° out of phase with the emitter voltage of Q₂ is

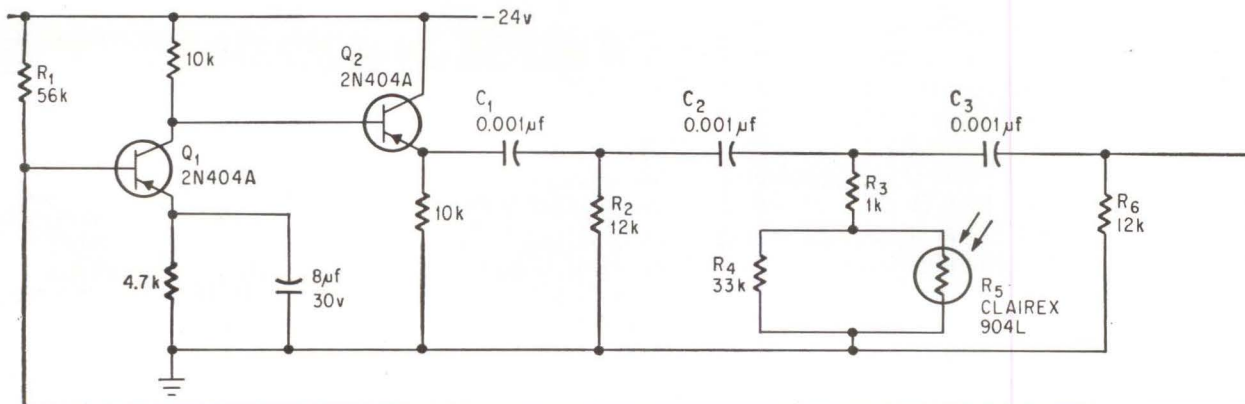

Variable frequency, phase-shift oscillator is controlled by light-sensitive resistor R₅. Emitter follower Q₂ makes circuit more sensitive to resistance changes than a conventional phase-shift oscillator.

now given by

$$f = \frac{1}{2\pi C\sqrt{3R'R_2}} \quad (2)$$

$$R' = R_3 + \frac{R_4R_5}{R_4 + R_5}; C = C_1 = C_2 = C_3$$

This equation assumes that Q_1 has zero input impedance and the emitter follower has zero source impedance. Equation 2 is plotted in the graph together with experimental values; the wide divergence between experimental and theoretical curves at lower resistance values is caused by the assumptions that were made. If the input impedance of Q_1 is included in the calculations the frequency of oscillation is given by

$$f = \frac{1}{2\pi C\sqrt{3R'R_2 + (R' + 2R_2)h_{ie}}}$$

where $h_{ie} = Q_1$'s input impedance.

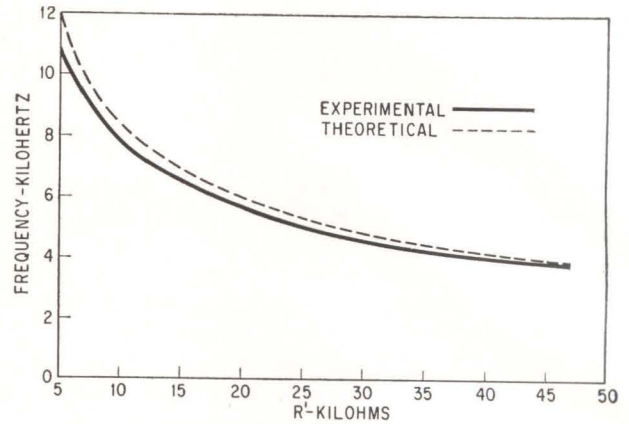

Frequency variation is plotted as a function of R' , the resistance of the shunt leg which is a combination of R_3 , R_4 and R_5 . Discrepancy between experimental and theoretical curves results from assuming zero input impedance for Q_1 .

Neon tube staircase generator performs two jobs

By A.B. Cistola

IBM Space Guidance Center, Owego, N.Y.

The dual functions of frequency and voltage division can be performed by the circuit shown at the right with much fewer components than are normally required for either. In one mode, the circuit acts as a staircase generator to divide the input voltage into equal steps. In the second mode, it performs as a frequency divider and separates out odd-numbered pulses in an input train. This effectively eliminates the need for decoding logic usually associated with binary systems.

The mode of operation is determined by the range of the input voltage, as shown in the chart.

By varying 10-turn potentiometer R_1 , a square-wave input voltage with variable amplitude is supplied to the series resonant L_1C_1 combination. Inductor L_1 should have a high Q since the voltage that is developed across L_1 must be high enough to fire the neon tube. The combination of R_2 and C_2 forms an integrator.

With a square-wave voltage of about 54 volts applied to resonant circuit L_1C_1 , the voltage developed across L_1 is sufficient to cause current pulses to flow through R_2 due to the firing of the neon tube. Capacitor C_2 then accumulates a charge that opposes input voltages of one polarity, preventing firing of the neon tube, but aids input

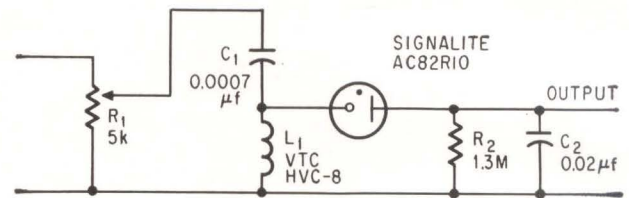

Square-wave voltage, developed across L_1C_1 , breaks down neon tube and provides current to resistor R_2 , charging capacitor C_2 until accumulated charge breaks down the tube in the opposite direction.

voltages of the opposite polarity, producing breakdown.

If breakdown is assumed to occur on the positive pulses, then no current flows through the tube on the negative pulses, as shown in the first scope recording. For every positive pulse an additional charge accumulates on C_2 until the voltage across C_2 in series with the negative voltage across L_1 is enough to cause a discharge through the tube in the opposite direction. When this takes place all subsequent negative input pulses will reduce the accumulated positive charge on C_2 to zero and then begin to build up in the negative direction until C_2 again discharges through the tube; and the cycle begins again. This is shown by the center waveshapes.

The number of step levels in a staircase cycle is adjusted with the potentiometer in small increments, as displayed on the chart. As the input voltage is reduced, various staircases are generated with increasing step levels and peak-to-peak amplitudes. A point is reached, however, where further reduction of input voltage does not cause tube

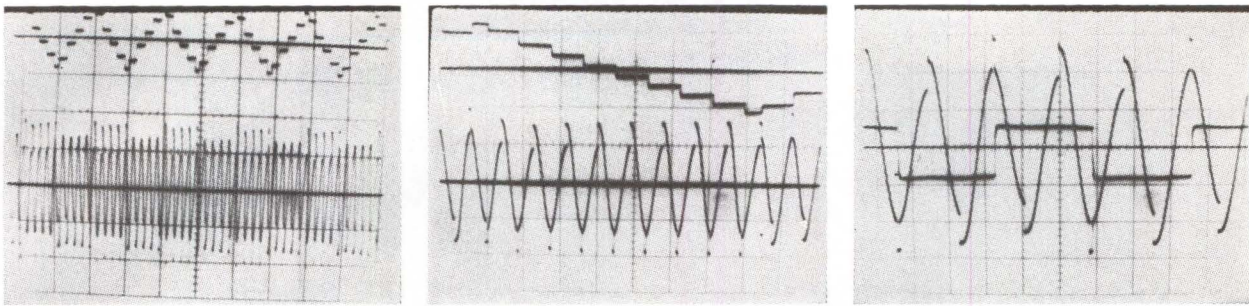

No current flows through the tube when negative pulses are applied at the input, shown at the left. When positive pulses are applied, charge accumulated on C_2 eventually discharges through a zero level and builds up in reverse polarity, center. The step levels are changed by reducing the input voltage. However, beyond a certain point, further reduction prevents tube current from flowing. At this point the circuit behaves as a frequency divider.

current to flow on every positive or negative going cycle. This is the voltage at which the circuit starts operating in the frequency-divider mode.

When the input voltage across L_1 and C_1 is about 40 volts, then the voltage across L_1 requires several cycles to build up to firing level. The LC circuit acts as a heavy load immediately upon application of the input signal and requires some time to build up, as shown in the third recording. After approximately $1\frac{1}{2}$ input cycles, the voltage across L_1 is sufficient to fire the tube. A charge of about 1 volt then develops across C_2 due to current flow through R_2 . When the tube discharges, the voltage across L_1 is reduced below the maintaining level of the tube. After the next $1\frac{1}{2}$ cycles the tube fires in the opposite direction. Effectively a 3 to 1 division of the

input-square wave is developed across C_2 . Frequency division by fives, sevens or nines can be obtained by reducing the input voltage to R_1 .

To insure proper operation a neon tube with a large difference between its breakdown and maintaining voltages is required. It should be checked on a curve tracer for cleanliness of the breakdown curve and should have as close a tolerance as possible on breakdown and maintaining voltage levels in both directions, otherwise there will be a slight unbalance between positive and negative step levels. A tube that meets these requirements is the AC82R10, manufactured by Signalite, Inc. Breakdown voltage is 100 ± 3 volts, and the maintaining voltage is 82 ± 1 volts. The tube has no negative resistance from 0.5 to 10 milliamperes.

CIRCUIT FUNCTION	INPUT VOLTS (P-P)	OUTPUT WAVE SHAPE	OUTPUT AMPLITUDE (P-P VOLTS)	REMARKS
FREQUENCY DIVIDER	32	[Square wave]	1.0	7's COUNT
	36	[Square wave]	1.0	5's COUNT
	40	[Square wave]	1.0	3's COUNT
INPUT SQUARE WAVE		[Square wave]		
STAIRCASE GENERATOR	44	[Staircase wave]	13	10 STEPS @ 1.3v EACH
	50	[Staircase wave]	10	6 STEPS @ 1.6v EACH
	54	[Staircase wave]	6	3 STEPS @ 2v EACH

Changing the range of the input voltage establishes function as a frequency divider or a staircase-voltage generator. Staircases with four, five, seven, eight and nine step levels can be generated at intermediate input voltage settings.

NEW DEUTSCH SYSTEM OBSOLETES

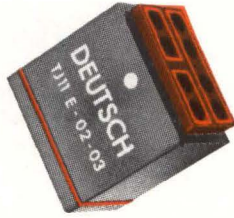



THE TERMINAL JUNCTION

A new system for point to point wire connection and integration

This newest, most flexible system releases today's engineer from the limitations usually associated with interconnection. One wire or thousands of wires may be connected by this simple, reliable method that:

- Replaces terminal strips and binding posts
- Does away with contact damage
- Eliminates splices and solder
- Uses standard crimp tools
- Uses **one** fail-safe, expendable assembly tool
- Uses **one** fool-proof assembly procedure
- Is self-locking
- Is modular
- Saves weight and space
- Connects and disconnects instantly
- Protects connections without potting
- Meets or exceeds MIL-C-26482 where applicable, and exceeds most user specifications

The Terminal Junction system is the ultimate in simplicity.

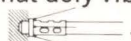
- The wire termination is ruggedized so that it can't bend, break, bind or gall .
- Crimping the terminal to any wire is done with standard tools, and provides strong, reliable termination . When inserted in the modular block, the terminations are interconnected instantly in a variety of hook-up patterns .
- The low-resistance connections are secured by self-locking retainers that defy vibration, shock and high pulling loads .

System build-up, breadboarding and all processes where one must patch, bus, splice or feedthru can be vastly simplified with this flexible, "people oriented" system. Its simplicity, combined with total reliability, makes possible immediate conversion without special training of assembly personnel... and, with the move to Terminal Junctions come the benefits of efficiency and upgraded connections.

The following columns describe how you can save time, space and circuits. Read on... let your own ingenuity dictate how you can benefit by using this revolutionary system.



TIME SAVER

The Terminal Junction system eliminates wasted time and motion in all phases of equipment design, breadboard, prototype, assembly, checkout and maintenance.



Quick, reliable crimp termination of wires with standard tools.

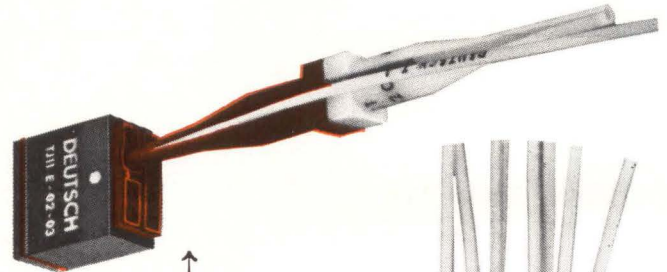

Instant connection (or disconnection) requires one, fail-safe, expendable tool which is small enough to be stored with wire harnesses.

One Terminal Junction module, with eight wires that have been connected in a fraction of the time required by other methods. 

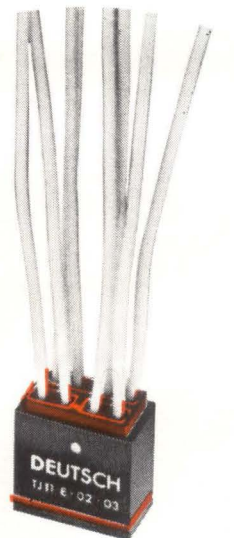

*Terminal Junction modules shown are model TJ11E-02** which connect wire sizes AWG 20 through AWG 24.

EXISTING CONNECTION METHODS



SPACE SAVER

Terminal Junctions occupy a fraction of the space formerly needed for an equal connection capacity. And, there is no limit to the number of modules and multi-module assemblies that may be used to form high density interconnection panels and systems.

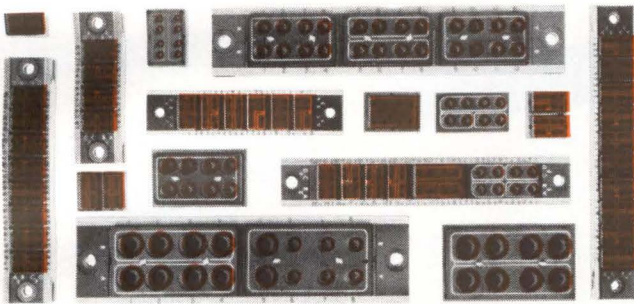

Typical module and multi-module assemblies for space-saving connection and integration. Standard units shown will handle wire sizes AWG 24 through AWG 4. White lines on each module outline points of common connection.

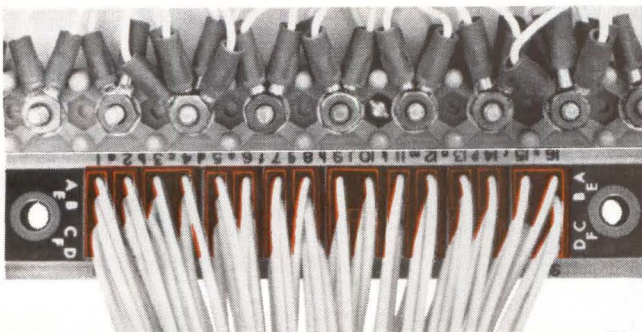

Sixty four size AWG 20 wires perfectly connected and fully protected in a fraction of the space previously needed. Compare the amount of space saved in this case... the terminal strip handles only 28 wires, and affords them no protection.



Use Feedthru Terminal Junctions for all through-connection applications; use them as high density, lightweight, fully environmental connectors; or, use multi-module assemblies for patchboard and through-panel applications.



The **JIFFY JUNCTION**® is a fully environmental single conductor connector. Use it as a replacement for splices or any one-wire connection problem.



CIRCUIT SAVER

Circuit and equipment failures due to the breakdown of exposed or poorly protected junctions and splices are eliminated by Terminal Junctions. All connections in each module are protected from mechanical damage by solid dielectric material; shorting caused by moisture and contaminants is prevented by resilient silicone rubber sealing glands at each wire entry point; the positive locking retention system resists shock, vibration and high pulling loads to assure perfect continuity in each circuit. Dielectric separation between circuits exceeds military specifications, and because the tool used for connection and disconnection is of dielectric material the shorting possibility normally associated with checkout and maintenance is reduced to a minimum.

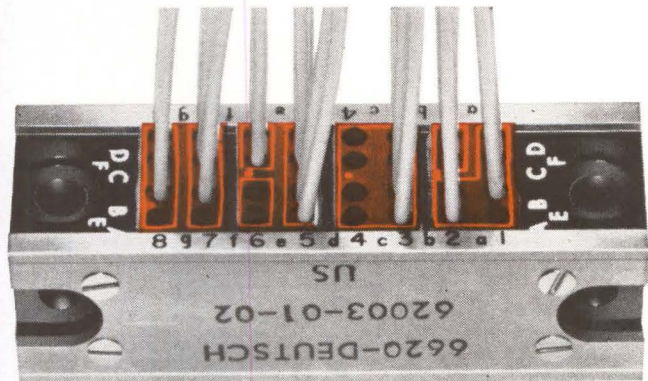

Actual size modules are shown in a multi-module assembly; typical busing layouts are included (white lines outline common connection points). Those entry points not occupied by wires are sealed by plugs to assure complete environmental immunity.

The Terminal Junction is the newest member of the performance proven Rear Release Family of Deutsch connectors and interconnection devices. Using **one** type of crimp tooling, **one** assembly procedure, and **one** fail-safe insertion/removal tool, any interconnection system may be upgraded to modern levels of efficiency and reliability. For more information about Terminal Junctions contact your local Deutschman, or write today; ask for Data File TJ-3.

DEUTSCH

ELECTRONIC COMPONENTS DIVISION • Municipal Airport • Banning, California

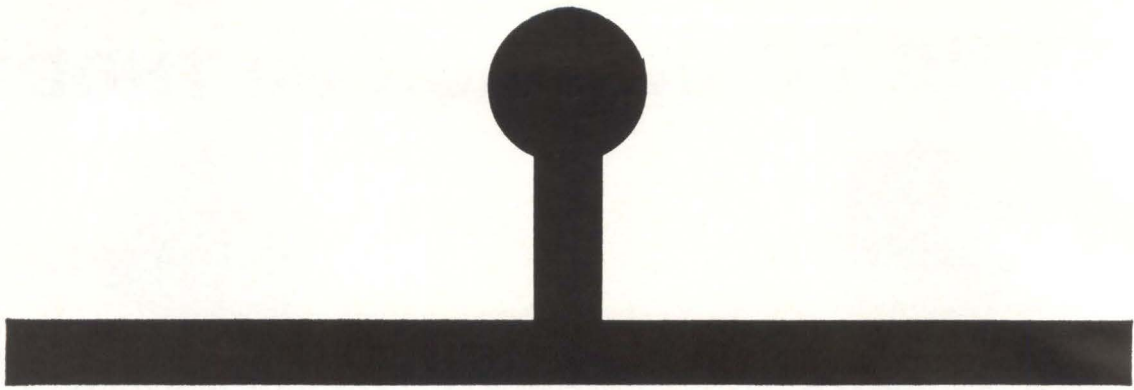

from .5 to 10,000 μ f
nothing's as reliable
as the CYFR

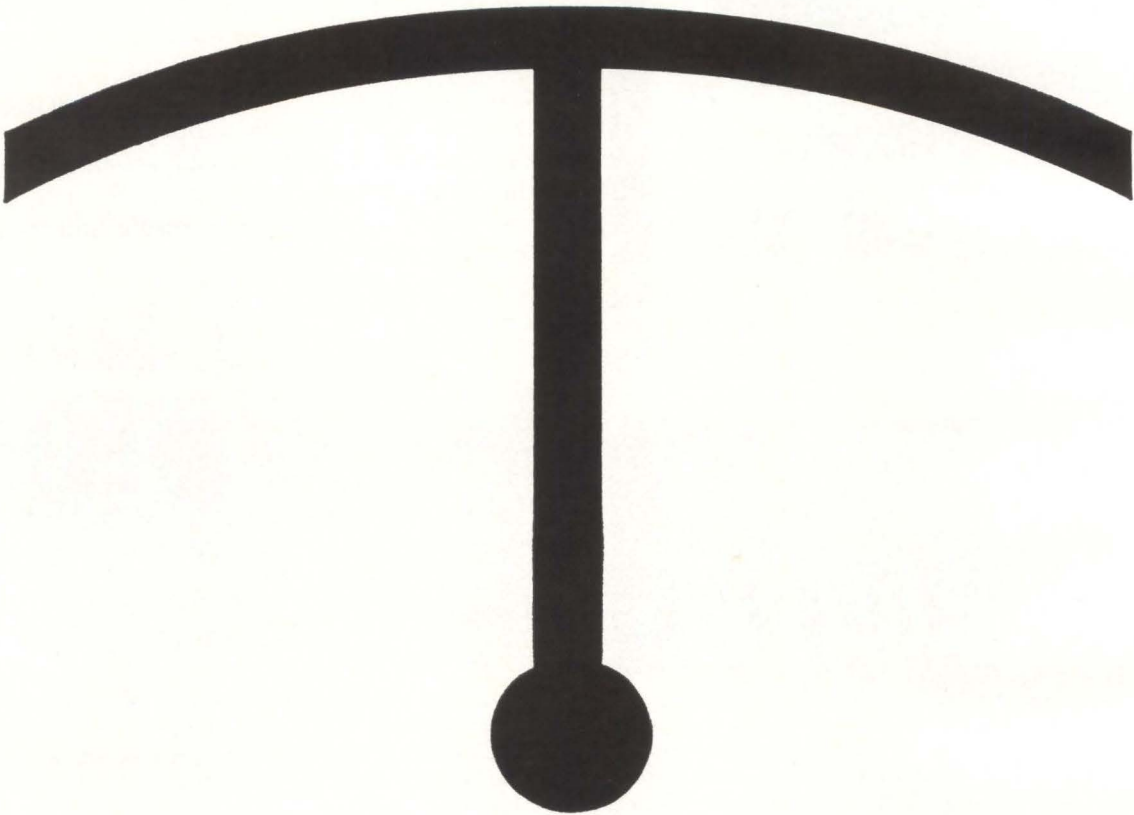

Ask the men who designed the Surveyor, built the Minuteman, wired the Gemini, are testing the Apollo.

During the CORNING® CYFR Capacitor building process, we keep a constant eye on reliability and reproducibility with more than 200 continuous lot acceptance tests. Every CYFR meets or exceeds our J-950 and J-951 specs, which in turn exceed MIL-C-11272B.

All this documented reliability is yours, together with the precise *stability* that only a glass dielectric can manage.

After 2000 hours at 125°C with full voltage applied, capacitance change in a CYFR is less than 0.5% or 0.5 μ f; the dissipation factor is less than 0.0015 and insulation resistance is greater than 10¹¹ ohms.

Why ever risk an entire system on capacitors that can't give you the assurance of Corning dielectric stability? For complete CYFR Capacitor data in our new CORNING® Glass Capacitor Guide, send to Corning Glass Works, 3913 Electronics Drive., Raleigh, N. C.

CORNING
ELECTRONICS

European electronics markets 1967

The outlook for Western Europe's electronics markets is 8.5% more business next year despite an over-all economic slowdown.

By the editors of Electronics



Process controls and systems	35.0	10.2	88.2	38.0	34.0	31.0	20.1	94.0	110.0	160.3
Welding equipment	0.7	0.1	3.4	1.5	1.0	0.5	0.5	4.3	6.5	18.5
Other production and control equipment	7.5	1.0	28.0	10.0	5.0	3.8	3.0	33.0	50.0	141.3
TEST AND MEASURING INSTRUMENTS, total	38.4	8.3	106.8	49.8	51.4	37.5	12.3	102.3	125.2	532.0
Amplifiers, laboratory type	0.4	0.1	2.2	0.4	0.8	0.3	0.1	1.5	2.9	8.7
Calibrators and standards	2.0	0.4	4.0	2.5	3.8	2.0	0.7	3.4	5.4	24.2
Components testers	2.2	0.5	5.0	2.5	3.2	2.2	0.4	3.9	6.0	25.9
Counters	3.0	0.3	4.0	2.7	1.9	2.5	0.8	5.2	3.7	24.1
Electronic voltmeters and ammeters	3.0	0.5	7.6	3.3	2.7	1.3	0.5	5.1	10.0	34.0
Microwave test and measuring instruments	4.5	2.4	10.0	4.5	7.5	6.0	1.4	8.4	13.5	58.2
Oscillators	1.8	0.2	4.5	1.5	1.7	1.3	0.4	4.0	5.2	20.6
Oscilloscopes	6.0	1.5	22.0	9.0	8.2	7.0	2.1	20.2	20.0	96.0
Power supplies, laboratory type	4.0	0.6	10.0	4.5	4.8	3.3	1.0	8.0	9.5	45.7
Recorders	3.5	1.0	10.0	6.0	7.0	3.2	1.4	10.5	12.2	54.8
Signal generators	2.5	0.3	5.5	4.0	3.3	2.5	0.9	6.1	7.5	32.6
Spectrum analyzers	0.5	0.2	2.0	0.9	1.5	0.4	0.1	2.0	4.3	11.9
Other test and measuring instruments	5.0	0.3	20.0	8.0	5.0	5.5	2.5	24.0	25.0	95.3
TOTAL CONSUMPTION, assembled equipment	294.0	110.7	1,332.3	644.0	315.7	281.2	212.7	1,307.3	1,696.3	6,194.2
COMPONENTS, in millions of dollars‡										
Antennas	2.0	1.9	18.0	5.3	2.8	4.4	3.5	16.0	36.4	90.3
Cabinets and racks	3.4	0.5	17.3	7.0	4.5	3.0	1.0	17.8	21.6	76.1
Capacitors, fixed and variable	6.0	2.8	47.5	12.3	7.4	8.0	5.0	58.7	77.0	224.7
Coils (including intermediate-frequency)	1.0	0.3	13.6	4.2	2.2	1.3	0.6	15.4	19.5	58.1
Connectors	3.0	1.4	26.5	8.0	4.3	3.0	3.0	33.3	30.0	112.5
Crystals and crystal filters	0.6	0.6	3.0	1.3	1.1	0.8	0.9	8.3	2.3	18.9
Delay lines	0.8	0.2	1.5	0.6	1.0	0.7	0.2	2.4	3.4	10.8
Diodes	2.4	2.0	27.0	5.9	5.0	5.5	4.0	30.1	26.8	108.7
Electronics hardware	4.4	1.0	19.8	8.0	5.2	4.0	1.3	19.2	24.7	87.6
Ferrite devices	1.5	0.5	3.5	1.9	2.1	1.2	1.1	16.7	6.4	34.9
Filters and networks (except crystal)	0.7	0.3	5.5	1.5	1.0	1.0	0.6	7.3	6.5	24.4
Integrated circuits (including film hybrids)	0.4	0.2	5.0	0.5	0.5	0.8	0.4	7.4	5.0	20.2
Loudspeakers	2.5	0.5	8.7	2.0	5.5	1.0	0.5	8.8	10.0	39.5
Magnetic tape	2.0	1.2	8.4	3.0	2.2	2.5	2.0	8.4	9.3	39.0
Potentiometers	1.1	1.2	10.4	3.5	2.4	2.3	1.1	12.3	16.8	51.1
Power supplies (OEM type)	2.5	1.5	12.5	7.5	6.6	3.2	2.2	9.1	14.5	59.6
Printed circuits	3.0	1.4	10.5	2.0	1.6	3.5	1.5	11.0	13.5	48.0
Relays	4.0	2.9	33.0	11.5	6.0	6.7	3.6	28.2	17.0	112.9
Resistors, fixed	3.8	0.9	23.0	8.8	4.2	2.0	1.5	21.5	22.2	87.9
Servos and synchros	1.0	0.2	6.4	1.5	2.7	1.3	0.7	4.7	7.4	25.9
Subassemblies	9.0	1.5	43.0	18.0	12.0	5.1	0.6	40.5	48.0	177.7
Switches, manual	1.3	1.1	11.5	2.0	1.3	2.5	1.4	17.2	16.7	55.0
Transducers	1.7	0.7	12.5	3.5	2.0	2.4	1.5	12.3	16.3	52.9
Transformers and chokes	7.5	4.4	23.2	10.0	9.8	8.5	5.6	25.5	43.1	137.6
Transistors	3.5	3.5	53.0	13.2	6.0	7.0	5.0	65.7	54.1	211.0
Tubes, all	13.5	2.0	71.1	32.3	43.0	9.5	2.6	87.0	73.0	334.0
Wire and cable (for electronics)	4.6	2.3	20.3	9.5	6.3	6.0	4.0	26.0	33.0	112.0
Other components	8.5	2.0	15.5	10.0	6.0	6.0	2.4	12.0	25.0	87.4
TOTAL CONSUMPTION, components	95.7	39.0	551.2	194.8	154.7	103.2	57.8	622.8	679.5	2,498.7

‡Includes components used to produce equipment both consumed domestically and exported.

*Less than \$0.075 million.

Electronics December 26, 1966

©Copyright 1966, Electronics® a McGraw-Hill Publication

European electronics markets—1967

	Belgium-Luxembourg	Denmark	France	Italy	Netherlands	Sweden	Switzerland	United Kingdom	West Germany	Total
ASSEMBLED EQUIPMENT, in millions of dollars										
CONSUMER PRODUCTS, total	46.8	32.2	364.1	257.0	46.3	55.5	55.3	323.4	462.2	1,642.8
Phonographs and radio combinations	6.4	2.0	27.8	20.5	5.4	5.2	8.8	33.0	34.7	143.8
Radios	8.8	6.5	54.5	36.0	8.2	7.8	8.7	53.5	130.0	314.0
Tape recorders (for home use)	1.6	4.2	11.8	6.5	2.2	5.0	2.3	11.9	17.5	63.0
Television sets	25.0	18.0	250.0	187.0	26.0	34.0	33.0	200.0	255.0	1,028.0
Other consumer products	5.0	1.5	20.0	7.0	4.5	3.5	2.5	25.0	25.0	94.0
MEDICAL EQUIPMENT, total	9.6	3.2	26.6	5.8	8.3	7.5	5.5	31.6	46.8	144.9
Analytical laboratory equipment, electronic	2.2	0.6	4.5	0.5	1.3	1.5	1.2	5.4	9.2	26.4
Diathermy (short wave) equipment	0.3	*	1.5	0.3	0.4	0.1	0.1	1.6	2.5	6.8
Electrocardiographs and electroencephalographs	0.6	0.1	2.3	0.5	0.6	0.3	0.3	2.5	2.5	9.7
Hearing aids	1.5	0.5	4.6	2.5	1.2	1.3	1.0	5.9	7.3	25.8
X-ray equipment, medical	2.5	1.0	8.5	0.5	2.3	2.3	1.7	10.2	16.3	45.3
Other medical electronic equipment	2.5	1.0	5.2	1.5	2.5	2.0	1.2	6.0	9.0	30.9
COMMUNICATIONS, total	67.2	22.4	347.6	108.8	72.8	63.9	59.2	357.9	453.0	1,552.8
Broadcast equipment	5.0	3.8	30.5	12.0	5.2	10.0	7.4	17.0	17.5	108.4
Closed circuit television	0.7	0.1	3.9	2.0	0.6	0.4	0.3	4.8	6.8	19.6
Intercoms and sound systems	3.2	1.9	23.4	6.6	5.0	3.9	3.0	24.9	52.0	123.9
Land mobile	4.0	1.5	25.8	9.0	4.5	5.5	1.0	30.6	54.5	136.4
Microwave relay systems	3.8	0.8	25.5	10.0	4.0	3.1	0.7	33.8	22.0	103.7
Navigational equipment, air and marine	30.0	9.5	135.0	45.0	35.0	31.0	40.0	140.0	185.5	651.0
Radar	3.0	2.0	48.5	16.5	6.0	3.3	2.5	58.0	73.0	212.8
Telemetry	2.5	0.8	30.0	2.2	0.5	1.7	1.7	21.8	9.7	70.9
Other communications equipment	15.0	2.0	25.0	5.5	12.0	5.0	2.6	27.0	32.0	126.1
COMPUTERS AND RELATED EQUIPMENT, total										
(not including process control systems)	43.1	20.3	257.5	127.0	50.1	42.3	34.2	256.1	291.1	1,121.7
Analog and hybrid computers	4.1	1.0	22.5	6.5	3.3	1.9	1.5	23.5	12.5	76.8
Converters: analog-digital, digital-analog	2.4	0.8	16.0	5.0	2.3	1.8	1.3	15.0	18.6	63.2
Digital computers	25.3	16.0	165.0	82.0	30.5	29.0	26.0	155.0	177.0	705.8
Memories	3.0	0.9	18.7	10.0	4.0	2.6	1.9	21.2	19.0	81.3
Readers and readout devices	2.3	0.6	10.3	3.5	2.5	2.0	1.0	11.4	24.0	57.6
Other computer-related equipment	6.0	1.0	25.0	20.0	7.5	5.0	2.5	30.0	40.0	137.0
NUCLEAR INSTRUMENTS AND EQUIPMENT, total	9.0	2.5	22.1	9.3	10.7	7.0	7.0	14.7	21.1	103.4
Accelerators	1.0	0.4	4.5	1.8	2.2	0.9	1.6	2.8	4.0	19.2
Analyzers	1.7	0.5	3.7	1.5	1.2	1.5	1.1	2.2	3.1	16.5
Radiation monitoring equipment	1.8	0.4	3.8	1.7	2.0	1.3	1.0	2.2	4.2	18.4
Reactor controls	1.5	0.3	3.2	1.0	2.3	1.2	1.3	2.8	3.5	17.1
Semiconductor and other detectors	1.0	0.2	1.4	0.8	1.0	0.3	0.4	0.7	1.3	7.1
Other nuclear instruments and equipment	2.0	0.7	5.5	2.5	2.0	1.8	1.6	4.0	5.0	25.1
INDUSTRIAL EQUIPMENT, total	79.9	21.8	207.6	86.3	76.1	67.5	39.2	221.3	296.9	1,096.6
Dictating machines	1.0	0.1	4.0	1.8	1.0	0.7	0.6	5.5	7.0	21.7
Industrial X-ray equipment	1.5	0.3	4.6	1.9	2.0	1.6	0.9	6.2	10.5	29.5
Infrared equipment	3.6	0.9	12.9	4.9	3.4	3.0	1.8	10.5	25.4	66.4
Machine tool controls	8.2	3.9	25.0	11.3	9.5	10.0	3.5	29.0	33.0	133.4
Motor controls	8.5	2.0	14.0	5.5	8.0	5.8	3.7	14.7	25.8	88.0
Photoelectric devices	2.6	0.3	2.0	0.9	1.2	1.0	0.3	3.6	6.0	17.9
Power supplies (for production and control equipment)	11.3	3.0	25.5	10.5	11.0	10.1	4.8	20.5	22.7	119.4

ELECTRONICS EQUIPMENT CONSUMPTION

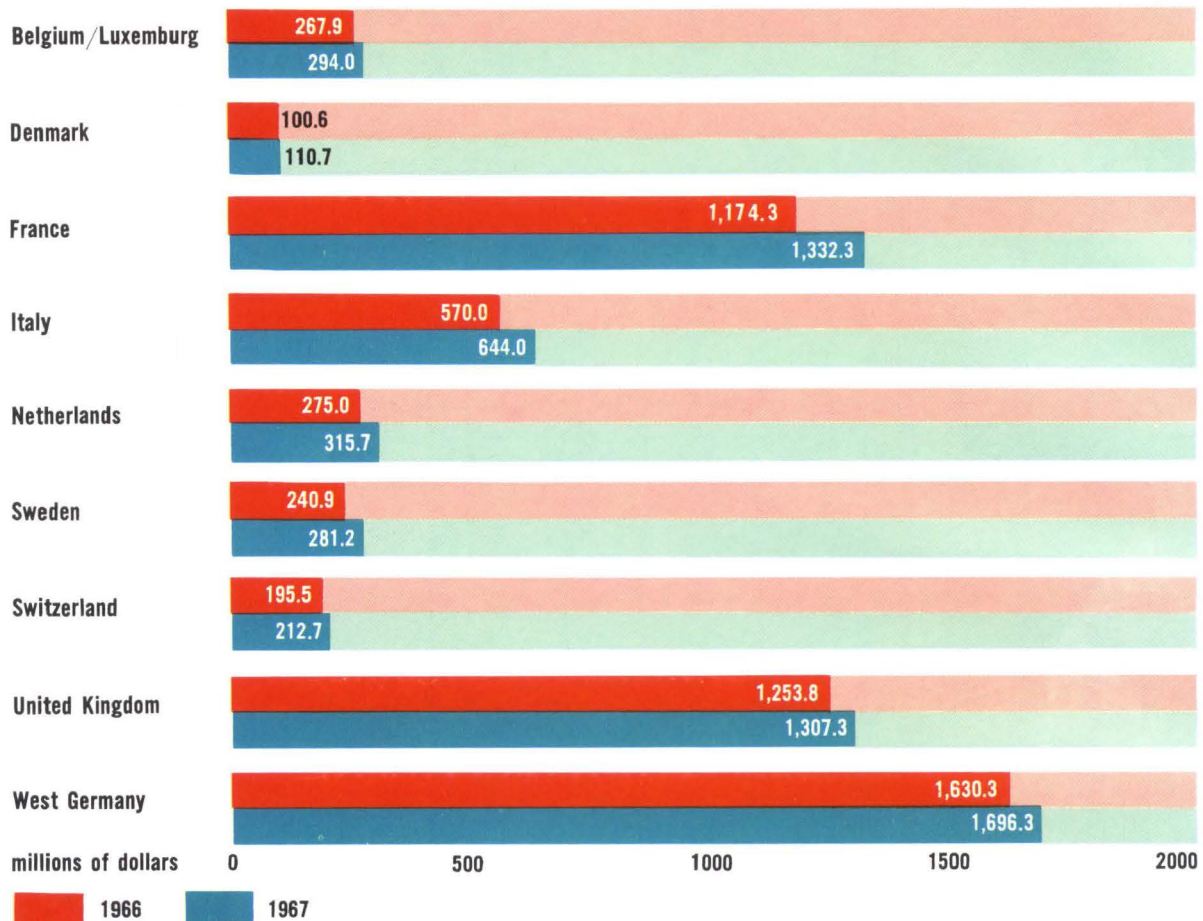

SMALLER EUROPEAN ELECTRONICS MARKETS

	Austria	Finland	Greece	Ireland	Norway	Portugal	Spain	Yugoslavia	Total
Consumer products	27	22	8	6	18	9	75	24	189
Medical equipment	4	3	1	2	2	1	5	3	21
Communications equipment	20	15	8	5	16	7	29	18	118
Computers and related equipment	23	19	6	4	22	8	20	22	124
Nuclear instruments and equipment	3	1	*	*	2	*	3	2	11
Production, control and other industrial equipment	23	17	5	4	14	4	30	20	117
Test and measuring instruments	7	5	2	2	4	2	16	6	44
Assembled equipment, total	107	82	30	23	78	31	178	95	624
Components, total†	21	30	6	5	32	5	75	20	194

†Includes components used both to produce equipment consumed domestically and exported

*Less than \$0.75 million

Note: The statistical base for these forecasts is not as broad as for those of the markets shown on the main chart.

The forecasts in this market report are consensuses of market estimates obtained from more than 150 industry associations, government agencies, banks, diplomatic missions and companies. Milton Drake, director of research, gathered the statistics. Reports on market trends came from Electronics magazine correspondents in Bonn, London, Paris, Milan, Brussels, Stockholm, Zurich, Madrid, Copenhagen, Vienna and Lisbon.

Western Europe's economic growth will taper off in 1967. Tv sales will stagnate but the over-all electronics market will rise 8.5%.

Here's why:

- Industrial control equipment sales will spurt
- Computer sales will continue to climb
- Components will show faster growth

European electronics markets: 1967

The climb continues

Electronics forecasts the 1967 market for electronics equipment at \$6.19 billion, up 8.5% over 1966, despite the slowdown in sight for Western Europe's economy

Although the growth of Western Europe's leading economies will slow next year, electronic-equipment markets will expand sharply.

For the 10 countries surveyed in detail, Electronics magazine forecasts an over-all 1967 market for electronics gear of \$6.19 billion, up 8.5% from an estimated \$5.7 billion this year. The increase doesn't quite match the estimated 8.7% gain made this year over 1965; the slight slowing is generally ascribed to the stagnation of European consumer-electronics markets.

However, the very factors that point to a poor year for consumer-product sales indicate sharp increases in sales of industrial control equipment and computers, as most European governments next year will seek to brake consumer spending and accelerate plant investment in an effort to pick up the pace of their economies.

France and Italy excepted, the Common Market's outlook is anything but rosy. West Germany, the leading industrial country in the six-nation bloc, posted only a 2.8% gain in gross

national product this year and can't expect to do much better in 1967. The economic pace will slow in both Belgium and the Netherlands next year, and over-all Common Market expansion is expected to only about match the 4.5% registered this year.

All the members of the seven-nation European Free Trade Association will be affected by the recession in store for Britain, the dominant member, over the next few months. Britain's gross national product is expected to grow by only 1% in 1967. What's more, the recession will slow British electronics business growth so much that France next year will take Britain's place as the second largest European market behind West Germany.

This total consumer-electronics market in the 10 countries surveyed will fall next year to \$1.64 billion, with most of the decline stemming from a drop in tv-set sales. Markets for black-and-white sets are approaching saturation and color tv won't provide a boost until 1968. Radio and tape-recorder volume will rise in 1967, however.

Efforts to prod lagging econ-

Contents:

84	West Germany
87	France
90	United Kingdom
94	Italy
96	The Netherlands
97	Belgium
98	Sweden
100	Switzerland
101	Spain
102	Denmark
103	Portugal
103	Austria
104	Soviet Union

omies will send sales of industrial control equipment soaring in Western Europe next year. Electronics magazine predicts total sales in this field of \$1.1 billion next year, a stunning 27% climb on the heels of this year's estimated 20% jump. A tight labor supply and rising costs on the Continent have manufacturers rushing to automate, while in Britain the Wilson government is waging a campaign to upgrade antiquated industrial facilities.

These same conditions will make for a strong computer market of about \$1.12 billion up 13% from 1966's estimated \$990 million.

Sales of communications equipment will gain at a slower rate than this, as Western European governments, usually big customers, fight to pare their spending. Electronics magazine forecasts a 1967 communications-gear market of 1.55 billion, up 8% from 1966. However, starting in 1968 or 1969 electronic telephone exchanges will begin replacing conventional crossbar equipment on a mass scale, and this will open a big market.

Military markets are generally uncertain, though

France will continue to make heavy defense outlays. Because of the Labor government's defense cutbacks, British military-electronics concerns are turning increasingly to exports. Sweden will move ahead with its program for the Viggen supersonic jet fighter and work will start on the \$300 million air-defense ground-environment network (Nadge) of the North Atlantic Treaty Organization.

West Germany remains the top electronics consumer in Western Europe, with a forecast 1967 market of \$1.7 billion. France, whose economy slowed two years ago but is going strong now, will take the number two spot with a 1967 market of \$1.33 billion. Britain will slip to third place with a projected market of \$1.30 billion.

Forecasts made last year for 1966 included components in total consumption. This year, components figures have been kept separate as there is some duplication: the components go into equipment sold domestically and exported. Had the components been included, Britain would have retained second place in the 1967 rankings.

West Germany set for 4% rise as controls and computers offset consumer lull



Like a Volkswagen negotiating the Bavarian Alps, the West German economy figures to stay in low gear for a while. Even though the coalition government of Chancellor Kurt Georg Kiesinger hopes to speed up the economy soon, economists say the slowdown that set in last year will last well into 1967.

But while the economy labors like a small car going uphill, the electronics industry will perform more like a Mercedes. Electronics magazine's forecast puts the 1967 market at \$1.696 billion, a gain of nearly 4% from the estimated \$1.630 billion of this year.

To be sure, the economic problems confronting Chancellor Kiesinger affect electronics markets. To wipe out the \$1 billion budget deficit now in sight for 1967—under German law the budget must balance—the new government presumably will boost taxes on consumer goods, bad news for television and radio set makers.

And the new government certainly won't restore the 15% budget cut already slated for the Federal Post Office, Germany's largest single user of non-military communications equipment.

Then, too, German military-electronics companies are in for a buffeting in their home market. West Germany is committed to spend just over \$1 billion on United States military hardware before June 30 under its agreement to offset part of the cost of maintaining U.S. troops in Germany.

German avionics companies are especially concerned about possible cutbacks in military projects.

But the setbacks in these sectors will be more than offset by gains in others. Spurred by a labor-short economy, the market for industrial equipment will show solid growth. Sales of components also will move up sharply, 11%. The German space electronics market, though still small, will be among the leaders in growth.

Upward with industry

West Germany first turned to foreign workers—the Gastarbeiter—to keep the output of her factories apace with growing prosperity. Now, industry is turning increasingly to electronics to step up productivity.

As a result, the market for production equipment and computers will increase next year to \$587 million, a gain of 8% from last year, according to the Electronics magazine forecast. The number of computer installations alone will rise slightly more than 20%. Although large enterprises will continue to be the major computer users, experts say that smaller ones will account for the biggest percentage gain in installations next year. Lower rental prices and improved service are encouraging small-sized companies. There are about 2,600 digital computers in Germany, more than in any other European country.

Actually, the growth in the number of computer

installations dropped off this year from the 1965 increase of 32%. But the statistics belie the true market conditions. The reason for the apparent letup, experts say, is that deliveries and installations take longer as systems become more complex. "It used to take from 12 to 14 months to fill a computer order; now customers have to wait up to 16 months," an industry official says.

The International Business Machines Corp., with an approximate 68% share of the computers installed in Germany, will continue to lead the data processing parade next year. But its competitors are trying hard to cut down IBM's lead. Siemens AG, Germany's largest electronics concern, is making a particularly strong bid for a bigger share of the market. Some 1,800 Siemens engineers and scientists are now working in computer development. Production facilities in Munich have been enlarged and sales organizations established abroad. There are now three Siemens-owned computer centers, each equipped with the company's 4004 system, operating in West European countries; and several more are being planned.

These efforts have borne fruit. More than 240 Siemens data processing systems have been ordered or installed to date, including some 100 third-generation 4004 systems, the company's version of the Spectra 70 computer developed by the Radio Corp. of America.

In terms of systems ordered, Siemens placed third behind IBM and Bull-General Electric this year, up a notch from last year's standing. In dollar value of orders, Siemens ranked second.

Traffic and mass-transit control is turning into a promising market for data processing systems and other electronic gear. To solve their mounting traffic problems several major cities are planning to install, or already have in use, computerized systems to control vehicle flow in downtown areas.

In West Berlin, for instance, a Siemens vsr 16,000 computer controls traffic-light timing at 10 intersections. A second such computer has already been installed to extend control to 27 additional

intersections. In Munich, where a system covering 10 intersections has been operating since February, work is under way to extend traffic-light control to a total of 160 intersections. An Arch 1000 computer, a product of Britain's Elliott-Automation Ltd., is the heart of the Munich system. Another Elliott computer, a 4120 model, will be added to the system soon. Hamburg, too, has turned to electronics to speed traffic flow. And next year, Aachen may follow suit.

As for mass-transit control, Hamburg's subway system has started trials of automatic train control on a 3.6-mile-stretch of track. If the trials are successful, all trains in the system will be electronically controlled by the end of 1967. The work is being done by Siemens and Allgemeine Elektrizitats Gesellschaft, each of which has an initial contract for about \$85,000.

Another important lift for the industry will come from numerical controls for machine tools. Some 250 machines are expected to be sold in 1967, a 25% increase from 1966. The market should continue strong over the next few years since nc was slow in getting off the ground in Germany and started to catch on solidly only two years ago. About 20% of the German nc machine-tool market is covered by imports, mainly from the U.S. Also doing well in nc in Germany is Italy's Ing. C. Olivetti & Co. S.p.A.

Consumer cool-off

The lull in growth of the West German economy points to a poor year ahead for consumer electronics. Electronics magazine's market forecast for 1967 is \$462.2 million, slightly off from this year's figure.

Even though television-receiver sales have leveled off, set makers haven't turned pessimistic. Their market still is mainly in first sets, rather than replacements. Of the 20 million West German households, only about two-thirds have tv sets. As a result, the industry figures it will sell nearly 2 million sets next year, 1.2 million of them first sets. A first-set market, of course, isn't nearly as sensitive to consumer whim as a replacement market.

Further buoying the industry's long-term outlook is the impending advent of color tv. Germans will first see it starting next Aug. 25 at the West Berlin radio show. But color won't be a major factor in the 1967 consumer market. Says Hermann Moessner, general director of the equipment division of Telefunken AG, "It'll take about four years before color-set sales reach 25% of the total television market."

Germany's Central Association for the Electro-technical Industry predicts that from 50,000 to 100,000 color sets will be sold next year. Sales are expected to inch up to about 150,000 sets in 1968.

There are two reasons underlying this estimate. One is the initial high price of sets; the other is limited color programming. A 23-inch table model will cost about two and a half times more than a

West German electronics markets (millions of dollars)

	1966	1967
Electronics industry, total	1,630.3	1,696.3
Consumer products	472.9	462.2
Medical equipment	50.5	46.8
Communications	422.0	453.0
Computers and related equipment	282.5	291.9
Nuclear instruments and equipment	20.8	21.1
Production, control and other equipment	260.2	296.9
Test and measuring equipment	121.4	125.2
Components	612.4	679.5

black-and-white receiver of the same size, or from \$500 to \$625. Coupled with that, only eight hours of colorcasts a week—four hours on each of Germany's two major networks—are scheduled in the beginning. "Not many people will buy a set just to watch an hour's worth of color a day," says Guenther Huecking, head of the association's radio and television section.

All of West Germany's dozen or so makers of black-and-white receivers plan to enter the color market. How long the four or five smallest manufacturers can hang on, however, is an open question. There's talk of a cooperative effort in chassis production among the four smallest companies, whose total output is less than 100,000 sets a year.

Electronics magazine's survey predicts that the radio market will be about the same size in 1967 as this year—around \$165 million. Because of near-saturation conditions—about 90% of households have at least one radio set—next year's market will be largely in replacements, extra sets, portables and so-called universal sets that can be used in cars. Because low-cost Japanese transistor sets have captured a sizable share of the market for small sets, German producers are gravitating toward higher-priced sets offering automatic tuning, waveband spreading and similar features.

As for home tape recorders, sales are expected to rise about 10% to \$17.5 million in the year ahead. Grundig Werke GmbH this year introduced a tape recorder with a monolithic circuit; this represents the first use of an integrated circuit in a consumer product in West Germany.

Queasy over communications

One sector that has German companies worried for the short term is communications equipment. The market forecast shows a respectable climb of 6.5% in 1967 to \$453 million. But in some king-pin segments, much of the business will go to foreign concerns. The West German government, for instance, is committed to buying large amounts of military gear—including electronics—from abroad and particularly the United States. And German airline operators continue to show a marked preference for proven U.S. or British avionics equipment.

To make matters worse, the Federal Post Office has had its 1967 budget for communications, including telephone equipment, cut by 15%. The market forecast for microwave relay systems, as a result, shows a drop to \$22 million in 1967, from this year's \$23.3 million. This hurts German producers in an important domestic market they have almost exclusively to themselves. To recoup, communications-equipment makers are intensifying their efforts in export markets.

The cutback in Post Office spending points to a stretchout in the changeover from electromechanical telephone exchanges to electronic ones. Currently, three experimental semielectronic telephone exchanges are in service in West Germany. They operate on space division multiplex and are de-



German Federal Post Office will have 100-mile Telefunken-built microwave link between West Germany and West Berlin in full operation by mid-1967. But cutback in Post Office budget for communications will depress microwave market next year.

signed to handle up to 10,000 subscribers. A fourth exchange, a 400-subscriber unit, will be installed next year near Stuttgart by Telefunken AG. The Post Office plans one day to shift to large exchanges—20,000 to 30,000 subscribers—with centralized electronic accounting, fast dialing and automatic fault detection. But orders for these are a long way off.

Pulse-code modulation, too, is in its beginnings in the German telephone system. Trials will start early next year of short-distance, point-to-point transmissions. If the trials are successful, the Post Office may put some pcm systems into use on a regular basis, but not in time to give German communications-equipment makers a lift in 1967.

Nor is there short-term succor in sight from space communications. A second satellite ground station is planned for the facility at Raisting in Bavaria. But the new station, with a 90-foot-diameter antenna, isn't scheduled to start operating until 1969, when it will be used with the International Telecommunications Satellite Consortium's Intelsat-3 global system.

Even further off is the advent of laser telephony. The Communications Research Institute at Darmstadt has been experimenting with laser transmission at distances up to 10 miles to find the best method of modulating laser beams and to check the effect of atmospheric disturbances on transmissions at different wavelengths. But the institute predicts it will be 1980 before laser transmission links are used in the public telephone system.

Bonn's budget problems also have West German avionics producers on edge. More paring of government spending seems inevitable and some likely victims are the experimental vertical-takeoff-and-landing (VTOL) supersonic fighter known as the VJ

101-X2, the Dornier Do-31 VTOL military jet transport and the VC 400 turbo-prop VTOL transport. Says an executive of one German avionics company: "The best we can hope for is that the market remains steady. There's no chance for it to go up."

For avionics makers, however, there are a few bright spots for the long term. Late this year, the U.S. and West German governments decided to go ahead with preliminary engineering studies on an advanced vertical short takeoff and landing (AVS) fighter. The plane will be developed by the Republic Aviation division of the Fairchild Hiller Corp. and by Entwicklungering Sud, jointly owned by Boelkow/Siebel AG and Messerschmitt.

With a good chance for a \$500 million contract for a dozen development aircraft to follow late in 1967, avionics makers now have something substantial to look forward to for 1968. A leading contender for the AVS navigation-landing system is one developed by Teldix GmbH, a joint venture of Telefunken and the Bendix Corp. [Electronics, May 30, p. 216].

Still another project with long-term promise is the VAK-191 VTOL fighter, which Germany and Italy are developing together. The plane could one day be tapped to succeed the Luftwaffe's Fiat G.91, but it will be 1970 at least before the plane goes into production.

Electronics companies can count, too, on a small but growing space market as West Germany seeks a modest place in this field. This year, government space spending soared 66% to \$60 million. Plans for 1967 aren't yet set, but the upward trend should continue. There's talk in government circles of spending some \$450 million over the next few

years; space outlays should be spared from drastic cuts. About 30% of space funds are earmarked for electronics and all of West Germany's major electronics companies are in on the action.

Leap for components

West German component makers will have a burgeoning market next year. The forecast is for a rise from this year's \$612.4 million to \$697.5 million.

Semiconductors will pace the components market, with about half of them going into consumer electronics products. Television-set makers, for example, are expected to gobble up \$20 million of semiconductors.

The trend toward the use of plastic-encapsulated transistors in consumer products is gaining momentum. Charles M. Clough, marketing manager in Germany for Texas Instruments Incorporated, predicts that plastic transistors will gain the lead from conventional, metal-enclosed types within two years, and adds that by 1968 their share of the consumer-products market for semiconductor devices should be around 85%. They are also expected to make broad inroads in the automobile field and in household appliances, where they'll be used in timing and temperature-control devices.

The industrial electronics market is expected to consume about \$30 million of semiconductor devices next year and the military electronics market \$8 million. Integrated-circuit sales will spurt; the consensus forecast for 1967 is a \$5 million market, but some IC makers expect a level of \$8 million, a 10-fold increase from 1966. Most of the circuits come from U.S. producers' European subsidiaries.

De Gaulle government bolsters French outlook with boost in spending for arms and space



President de Gaulle's drive for national grandeur will keep France's electronics industry flourishing in 1967. Ever-increasing government spending for space projects, arms, computers and telecommunications will bolster the French market, as will relaxation of the government's rigid price-stabilization policy.

Electronics magazine's forecast is for a market next year of \$1.332 billion, up 13% from this year. France still trails West Germany and Britain as a total market—components included—but of the Big Three in West European electronics, France figures to show the most growth next year.

With such a year in the offing, one would expect an air of satisfaction throughout the industry. Instead, there's an undercurrent of apprehension,

especially among French component producers. They're concerned about the influx of U.S. companies that have set up semiconductor plants. Radio and television set makers are baffled by the consumer electronics market, which expanded this year when everyone expected it to sag. Many observers still aren't sure which way the receiver market will move next year.

Up with space

All apprehensions disappear, however, when you turn to space electronics. Government spending for national and joint space programs in 1967 should run close to \$100 million, and electronics companies stand to pick up about half this business.

France next year will phase out her Hammaguir

French electronics markets
(millions of dollars)

	1966	1967
Electronics industry, total	1,174.3	1,332.3
Consumer products	357.8	364.1
Medical equipment	22.3	26.6
Communications	298.0	347.6
Computers and related equipment	232.0	257.5
Nuclear instruments and equipment	20.4	22.1
Production, control and other equipment	147.1	207.6
Test and measuring equipment	96.7	106.8
Components	458.9	551.2

launching site in the Algerian Sahara and start installing electronics equipment at Kourou, French Guiana—the new French Cape Kennedy. The \$70-million Kourou facility is scheduled to go into operation in 1969.

Before they pull out of Hammaguir, though, the French next February will launch the last two "D" series satellites with French-made Diamant rockets. The two satellites will differ little from their predecessors, but will carry some new hardware: spin-stabilization equipment and an array of 144 reflectors for laser tracking. Like this year's D-1-A satellite, the two 1967 spacecraft will carry transmitters stabilized in frequency to within 10^{-9} for doppler tracking; the transmitters, though, will run continuously instead of on command as before.

For these shots, the French space agency plans to use three laser tracking stations. Compagnie Générale d'Electricité (CGE) has already installed one station at St.-Michel-de-Provence in southern France, and two others are being installed at Athens and at Hammaguir. The lasers have a peak power of 50 megawatts and produce a highly homogeneous infrared beam at a rate of 20 pulses a minute. Ranging tests with U.S. satellites have found the St. Michel laser accurate within five feet. CGE has developed a tracking laser that operates in the green range with a peak power of 300 megawatts, but so far the government hasn't decided to buy it for the satellite-tracking stations.

Prime contractor for the two 1967 satellites is the government's Bretigny Space Center, and the major subcontractor is Engins Matra s.a. CSF-Compagnie Générale de Télégraphie Sans Fil is supplying the onboard transmitters, Sud Aviation the reflector arrays and Société Anonyme de Télécommunications (SAT) the satellites' silicon solar cells.

The two final Hammaguir shots will be followed by a lull in French launchings. Then, in 1968, a French satellite will be launched with a U.S. booster to collect data from 500 to 1,000 weather balloons sent up over the South Pacific and Indian Oceans.

French companies will be kept busy in the meantime on international projects. Further, to insure that space communications won't become a monopoly of the U.S. and the Soviet Union if the joint European projects go awry, the French government has development studies under way on two national communications satellites.

The French space electronics industry is heavily involved in all the satellites so far scheduled by the European Space Research Organization, including ESRO II and ESRO I that will be launched with U.S. Scout boosters next March and September respectively.

Prime contractor for the first payload is Britain's Hawker Siddeley Dynamics, but France's Engins Matra is the primary subcontractor. The French are more closely tied to ESRO I, which despite its designation will be the second ESRO satellite. Laboratoire Central de Télécommunications (LCT) is prime contractor for ESRO I, SAT is supplying its solar generators, and Intertechnique s.a. will provide the onboard pcm coding equipment.

Finally, France is participating in preparing the payloads for the International Telecommunications Satellite Consortium, which de Gaulle doesn't particularly like because it's owned 58% by the U.S. French companies have subcontracts for two Intel-sat payloads; LCT will provide the decoder for the telecommand system and SAT the satellite solar cells.

Mushrooming military market

As it has in recent years, de Gaulle's aim to free France of military dependence on the U.S. will give a boost to the French electronics market. Military spending for 1967 will rise 6.8% to \$4.7 billion, and about 30% of France's military outlays finds its way into the coffers of electronics companies. Expenditures on de Gaulle's "force de frappe," his controversial nuclear striking force, will slip from \$1.2 billion this year to \$1.1 billion in 1967. Little of the cut, though, will be felt in the electronics sector. The spending reduction largely reflects the completion of an enriched-uranium plant to supply the makings for nuclear warheads.

Most of the increase in the 1967 military budget will be siphoned off by the French navy and the air force, both big electronics consumers. The navy's budget includes \$15.4 million for new equipment, much of it radar and telecommunications gear. The air force will get a dozen new Mirage IV strategic bombers next year, most likely equipped with CSF's "Cobra" low-altitude radar. Also, early in 1967 the air force will choose either the Mirage F-2 or the F-3 as its new-generation bomber; both are highly sophisticated electronically.

As for international military projects, Compagnie Française Thomson Houston-Hotchkiss Brandt stands to gain from Nadge, NATO's \$300 million Europe-wide early-warning network being built by a consortium headed by the Hughes Aircraft Co. Thomson-Houston, a member of the consortium, will provide five "Palmier" three-dimensional radar

systems. The first units will be delivered in 1968, and the entire Nadge network should be installed in four or five years.

Communications on rise

Electronics magazine's survey points to an 18% surge in the communications sector next year to about \$347.6 million.

Most of the increase will stem from stepped-up spending by the de Gaulle government for military electronics, including navigational aids, radar and the like. A whopping increase is in store for the post office's telecommunications budget, but the electronics industry can't get excited about it because most of the \$385 million slated outlay is earmarked for the addition of 272,000 phones to the French telephone system.

However, the post office is also planning to switch to computer control at some new exchanges and is continuing the program of research in electronic switching at its Lannion center in Brittany. Companies participating in this research are Le Matériel Téléphonique and Compagnie Générale de Constructions Téléphoniques, both International Telephone and Telegraph Corp. subsidiaries, plus Compagnie Industrielle des Télécommunications and Société Française des Téléphones Ericsson.

The government's broadcasting organization, Office de Radiodiffusion-Télévision Française (ORTF) next year will complete installation of its second television network, a 625-line system that currently covers more than half of France. It will buy some 100 microwave links for the network, with Thomson-Houston and csf continuing as prime suppliers. In preparation for color broadcasts, which will start next September on the second channel, ORTF will be setting up 12 new studios. Thomson-Houston's electronics group vice president, J.E. Guignonis, estimates his company's share of the studio-equipment purchases alone at close to \$2 million.

Computers keep climbing

U.S. companies—notably the International Business Machines Corp. and Bull-General Electric—dominate the fast-growing French computer market. The Electronics magazine forecast puts this market next year at \$257.5 million, up from \$232 million.

Some French industry insiders expect even greater gains. Maurice Ponte, president of csf, expects a 30% rise in industry volume, and Maurice Ruby, an economist for the French electronics industry's trade association, predicts "soaring" computer sales to banks and insurance companies. Ruby also sees sharp gains in sales of process control systems to chemical, petroleum and metallurgical concerns. The survey puts the 1967 market for process control systems at \$38 million—slightly more than double this year's figure.

IBM and Bull-GE will once again have the business-computers market practically to themselves, but stronger French competition looms in the field of scientific and industrial machines.

At the behest of the de Gaulle government, two

major French computer makers this year merged to form the so-called "Société S." The new concern brings together Compagnie Européenne d'Automatisme Electronique (CAE) and Société d'Electronique et d'Automatisme (SEA), whose parent companies are csf, Compagnie Générale d'Electricité and the Schneider industrial group. Under de Gaulle's Plan-Calcul, the data-processing counterpart of the force de frappe, Société S and a similar new company making peripheral equipment will get \$130 million in government aid to develop a third-generation French computer for scientific and industrial use.

Until this computer is ready for the market in late 1968 or early 1969, Société S will rely mainly on the Sigma 7 computer, built under license from Scientific Data Systems Inc., to widen its share of the market; CAE and SEA have a current combined share of close to 15%. Pierre Edrom, development director for the merged companies, expects a 1967 sales gain of 40% for Société S. He says government orders with the company will increase somewhat, and he's hoping for even faster growth in the private sector. Société S expects its government sales to account for 65% to 68% of its total business next year, against 70% to 75% of the merged concerns combined 1966 volume.

Uneasy about semiconductors

The components market should surge to \$551.2 million in 1967 from the \$458.9 million of this year, according to the survey. But though over-all prospects are glittering, French semiconductor makers are fretting about their long-term future in integrated circuits. Five U.S. companies—all with eyes on the potentially lucrative market for integrated circuits—will have semiconductor plants operating

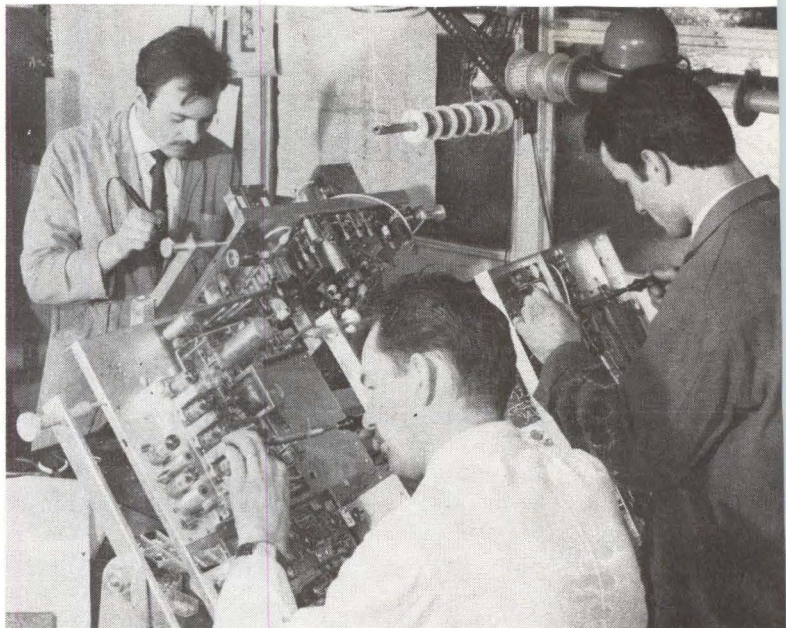

French receiver makers have started pilot runs on Secam color sets. Colorcasts will start next fall but market won't amount to much before 1968.

or about to open in France before the end of 1967.

Just what French components makers are up against is reflected in the purchasing plans of Société S: Edrom expects the concern to buy only 45% of its active components from French-controlled companies next year. Prospects are that the plight of French semiconductor makers will worsen as electronics concerns increasingly shift to ic's.

The U.S. companies with semiconductor affiliates in France are Texas Instruments Incorporated, the Fairchild Camera & Instruments Corp., the International Telephone and Telegraph Corp., Motorola, Inc. and the Transitron Electronic Corp.

These concerns represent rough competition for five native components producers, three of them tied to foreign companies. All-French are the Société Industrielle de Liaisons Electriques (Silec) and Compagnie Générale des Semiconducteurs (Cosem), a cse subsidiary. Sovcor Electronique s.a. is French controlled, but the Corning Glass Works holds a substantial minority interest in it. La Radiotechnique s.a. is controlled by Philips Gloeilampenfabrieken nv of the Netherlands, and Société Européenne des Semiconducteurs (Sesco) is a joint venture of Thomson-Houston and the General Electric Co., though both act French.

Sovcor will be the first French company to have a go at volume output of ic's. The company plans to start producing a line of transistor-transistor-logic and diode-transistor-logic circuits early next year. The four other components companies seem convinced that they can't, at this time, corner enough of the ic market to justify volume production of the devices. Most of the ic's now turned out by French producers are for military equipment, a market the de Gaulle government limits, to the extent that it can, to French concerns.

Cooperative efforts appear to offer one way out of the French companies' dilemma. Cosem and

Silec already have moved in that direction with an agreement to cooperate on ic research and production, a move pointing to common production facilities and possibly to an outright merger. Cosem will also collaborate with Sesco on ic research, but in this case at the insistence of the government, which is backing the R&D effort. Finally, Cosem's parent company cse has joined with Grundig GmbH in a program to develop ic's for consumer products.

Consumer electronics: maverick market?

Sales of television sets in France this year zigged after a lot of people thought they would zag. As a result, many in the industry are hesitant to forecast the 1967 consumer electronics market. The consensus forecast puts the level at \$364.1 million, up slightly from last year.

The industry's wait-and-see attitude stems from a sharp and sudden upturn in television and radio sales late last summer, a gain touched off by government cancellation of a sales tax on tv sets. This move came just before the annual August vacation exodus, and the biggest sales gainers were portable tv sets and car radios. The spurt offset a poor first half and turned what had started as a dismal year into a fairly good one.

One observer, Ruby of the industry's trade association, believes the fall surge provided the tv-receiver market with enough momentum to lift sales about 10% in 1967. However, a spurt triggered in part by the demise of a sales tax could be a one-shot boost and not the beginning of a trend. Then there's another imponderable—the advent of color broadcasts next September. It might check the sales of black-and-white receivers, and no one expects color sets to be much of a market factor until 1968. Electronics magazine's forecast shows the 1967 tv market holding at this year's level and radio sales advancing slightly.

Automation at home, avionics abroad help U.K. electronics as economy drags



Government planners in Whitehall and the economic pundits of Fleet Street see a grim year ahead for the British economy. But there are exceptions and electronics is among them.

The pundits are convinced Britain is in for a recession in early 1967, the after-effect of the stiff dose of deflationary medicine Prime Minister Harold Wilson prescribed last summer to cure the ailing pound sterling. An upturn of sorts seems likely during the second half; but the planners and pundits nonetheless say the economy will grow no more than 1% during 1967.

One of the few comforts in Britain's bleak situation is the outlook for the electronics industry. Despite the over-all stagnation of the economy, the Electronics magazine forecast for the British market predicts a 3.5% climb next year to \$1.3 billion—the result of the shift in national direction and purpose.

What's more, British electronics producers have a good year in sight for exports, especially of military hardware and satellite ground stations. As a result, the industry should gobble up \$622.8 million of components during 1967, 11.4% more than this year. True, the consumer electronics market will

suffer a setback, but 1967 should be the best year the electronics industry has yet had.

There's no element of paradox in this forecast. Although deflation means the economy as a whole must mark time for several months, what's good for the pound sterling will mean a pretty penny for the electronics industry. To bolster Britain's payments position, the Wilson government has mounted a drive aimed at modernizing the country's antiquated industrial plant so that British products can better compete in the world's export markets. "Britain's new role is industrial excellence," says Anthony Wedgwood Benn, who as Minister of Technology spearheads the drive.

This new goal for Britain points to stepped-up spending for automation equipment and for computers, which now look to be the 1967 growth leaders in electronics. To be sure, the government has tightened up the money market as part of its deflation package, and total plant investment may fall as much as 6% next year. But the impact on the market for automation equipment will, at worst, be slight. The government still offers attractive incentives for investment in new plant and machinery in key industries; the investments most often include automation equipment.

Another lift for electronics in a year when the economy generally will languish will come from a shift to electronic telephone exchanges; the first orders are due next year. Despite a cutback in defense spending, the outlook for British avionics producers has lost little luster because exports should make 1967 a banner year. And—no surprise—the market for integrated circuits will expand sharply.

Computers coming up

In contrast to the chill winds of recession that will cool Britain's economy, balmy trade winds are forecast for the computer market during 1967 and for that matter through the end of decade. Gains of about 20% a year in the number of computer installations are predicted through the early 1970's. Some 600 new machines went into service this year and the installation of 720 more is predicted for 1967. By 1970, about 5,000 computers valued at a total of \$1.12 billion should be operating in Britain.

The 1967 market—outright sales and rental income—is estimated by Electronics magazine at \$256.1 million, up from \$234 million this year.

Almost anywhere else in the world, the lion's share of the computer market would go to the International Business Machines Corp. But not in Britain. There, International Computers and Tabulators Ltd. and IBM each have about 40% of the market now, and no substantial change in the situation is in sight for next year. The third-ranking company in the market, English Electric-Leo-Marconi (EELM), should see its share of the market climb from 7.5% to 10% next year.

The relatively poor showing of IBM in the United Kingdom (in most European countries, IBM dominates the computer market) is partly the result of

the Wilson government's continuing effort to develop a strong domestic computer industry. To develop its 1900 series, which so far has matched IBM's 360 in the British market, ICR got a \$15 million government loan. And the government is going ahead with a five-year plan to set up a nationwide computer network for research that will include \$50 million of hardware—mostly British.

Government agencies, too, are throwing most of their computer business to British companies. ICR has on its order books a pair of 1906 computers for the state-owned British Railways. The Post Office will acquire five EELM System 4/70 machines in the period from 1968 through 1970 to automate postal savings and checking accounts, and it has an option on four more System 4/70's. IBM, however, last summer pocketed one of the largest data processing orders ever placed in Britain—the first phase of a \$63.28 million system for the British Overseas Air-

British electronics markets
(millions of dollars)

	1966	1967
Electronics industry, total	1,253.8	1,307.3
Consumer products	379.8	323.4
Medical equipment	28.7	31.6
Communications	349.9	357.9
Computers and related equipment	219.0	256.1
Nuclear instruments and equipment	14.6	14.7
Production, control and other equipment	168.6	221.3
Test and measuring equipment	93.2	102.3
Components	558.7	622.8

craft Corp. BOAC by 1980 plans to have 100 centers around the world tied into three third-generation on-line computers to handle seat reservations, flight routing, crew control, stock control, administration and the like.

Along with straight data processing, process control applications will help swell the computer market. About 100 of the 1,200 computers operating in Britain are used for process control, and the number is expected to climb to 350 by 1970. With the petrochemical industry, particularly, turning to direct digital control, and with automation the keynote of processing industries generally, the market for process control equipment is forecast at \$94 million next year, a gain of better than 20%. Sales of numerical controls for machine tools are expected to double—to \$29 million—after a sparkling performance in 1966. Ferranti Ltd. and Elliott-Automation Ltd. are the kingpin British companies in automation.

IC upsurge

It follows that the market for integrated circuits will soar along with computers, themselves the

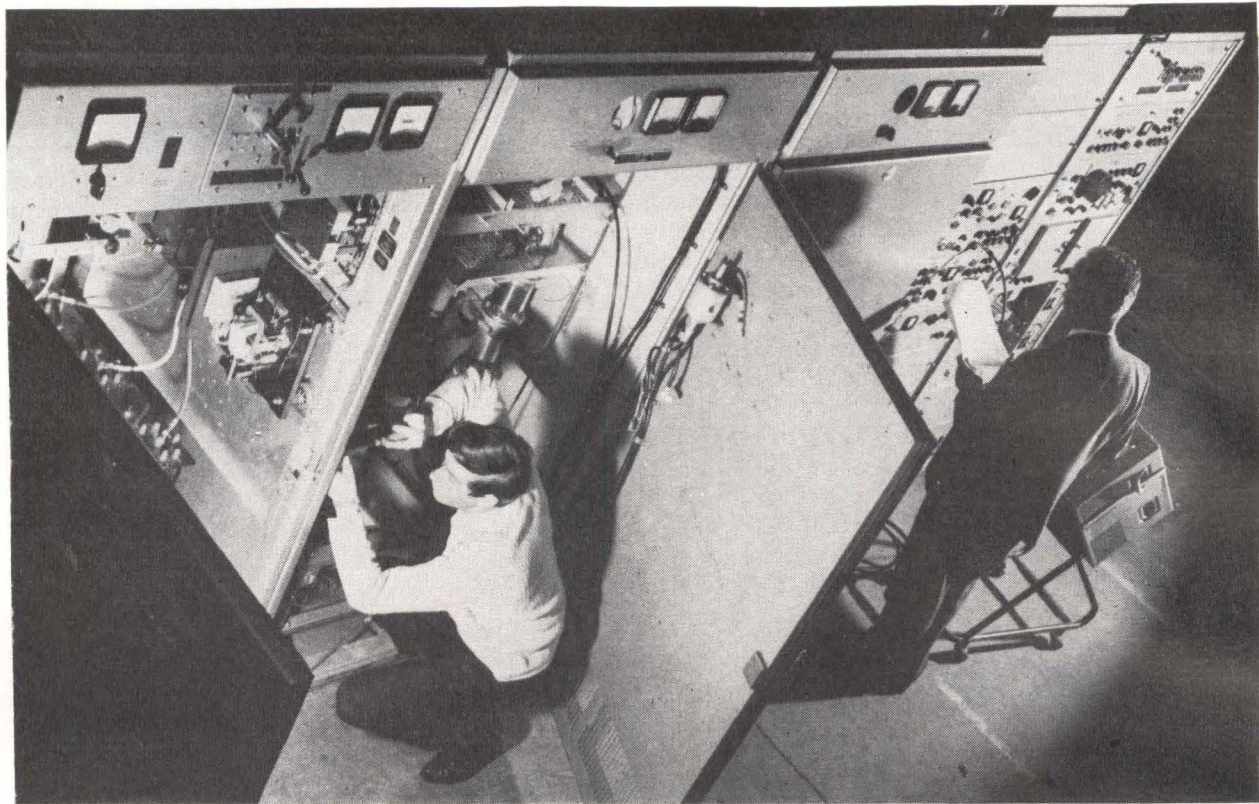

British communications equipment makers see a good year ahead, both at home and abroad. This Marconi uhf television transmitter, destined for Denmark, will start test broadcasting in color next year from a Copenhagen suburb.

major market for ic's. From \$2.8 million this year, the ic market—still in its beginnings, really—will more than double to \$7.4 million next year, Electronics magazine's market survey indicates. Both producers and users expect ic prices to be competitive with those for discrete components within two years. By 1970, then, the British ic market should hit a level somewhere between \$35 million and \$50 million.

Five major British companies are eyeing this burgeoning market. So are such giant foreign concerns as Texas Instruments Incorporated, Motorola Inc., Fairchild Camera & Instrument Corp., Philips Gloeilampenfabrieken NV and the International Telephone & Telegraph Corp.; all have affiliates in Britain either producing ic's or preparing to.

Among British companies, the Marconi Co. and Ferranti are the leading producers. Each, though, is its own best customer, with the bulk of output earmarked for in-house computer production. Also in the ic picture are Elliott-Automation, The Plessey Co. and Associated Electrical Industries Ltd. (AEI).

With so many companies scrambling for ic business there are bound to be casualties. Says a Marconi executive: "There is going to be shakeout of microelectronics producers in the country beginning in the middle of next year. Foreign producers will be affected as well."

Telecommunications climbing

A pair of young and fast-growing sectors—electronic telephone exchanges and satellite ground stations—will help carry the British market for com-

munications equipment to \$357.9 million in 1967, a gain of \$8 million.

The upcoming year will see the first 50 or so orders placed by the Post Office for TXE 2 electronics exchanges. This is just the first batch of electronic exchanges the Post Office has in mind. From now on, only electronic equipment will be ordered for exchanges having up to 3,000 lines.

Research in telecommunications points to even more electronics in telephone and telex systems in the future. Standard Telecommunications Laboratories, a subsidiary of IRT, has shown that several hundred thousand telephone conversations can be transmitted with laser light along a glass filament about twice the diameter of a human hair. The Post Office itself has a research program underway in fiberoptic transmission and also is experimenting with circular waveguides that one day may replace cables for long-distance transmissions.

The Post Office, too, presumably will help boost the market for satellite communications ground stations, a sector that has telecommunications-equipment makers excited. Under consideration are 90-foot antennas for the Goonhilly Downs station.

However, British companies expect the bulk of their ground-station business to come from abroad. The industry estimates that some 50 countries will buy about 80 stations during the coming five years and the U.K.'s share could easily be half of these.

Marconi, working with Cable and Wireless Ltd., has the best foothold in the ground-station business. The company already has built four stations—all with antennas in the 40-foot category. One station

was for the Ascension Island tracking facility for the Apollo communications support satellite; the other three were for the Anglo-American Initial Defense Communications Satellite Project. For the business in sight over the next few years, though, Marconi will have strong compatriot competitors. AEL, Plessey and the General Electric Co. (a British company not affiliated with its American namesake) have formed a consortium called World Satellite Terminals Ltd., while Standard Telephone and Cables Co., an RTT unit, has teamed up with Vickers Ltd. to bid on satellite ground stations.

Although it certainly can't match the ground-stations market in magnitude, closed-circuit television may turn out to be a sleeper in Britain. Marconi alone sold about \$3 million of CCTV hardware last year and expects a much larger 1967 market. Much of the lift in CCTV sales, surprisingly, is coming from the Independent Television Authority's educational programs, now viewed in some 15,000 schools throughout the U.K. Watching these programs has whetted the appetites of school authorities for CCTV setups of their own.

Avionics aplenty

Britain's new restrained defense posture surprisingly hasn't brought a slump to the country's avionics industry. Much of the new lean look in the Labor government's defense budget stems from a switch to buying military aircraft from the United States rather than developing them at high cost in Britain [Electronics, March 7, p. 299]. The electronics gear for these planes, though, will mainly be British. With plenty of military and civil business in sight, 1967 should be a banner year for avionics.

Some \$42 million or more of British electronics hardware is earmarked for the approximately 200 F-4 Phantom fighters ordered by Britain from the McDonnell Aircraft Corp. And the 66 Lockheed C-130 Hercules transports ordered for the Royal Air Force will carry considerable U.K. electronics.

Then, too, avionics equipment makers are picking up some fallout from the defunct TSR-2 program, which was dropped in 1965 when projected costs started to get out of hand. Since then, the government has decided to buy 50 F-111 fighter-bombers from the U.S., and much of the cost will be offset by U.S. purchases of British hardware. The first order has gone to Elliott-Automation, which this fall won a contract to develop the "head-up" system for the U.S. Navy's Integrated Light Attack Avionics System [Electronics, Sept. 5, p. 199]. Elliott had worked on a similar head-up system for the TSR-2.

Another TSR-2 system that has found a ready market is a sophisticated reconnaissance installation that incorporates cameras, side-looking radar and infrared line-scan equipment. EMI Electronics Ltd., its developer, has adapted the system for the RAF's Phantoms; the German Luftwaffe also may buy the EMI "recce" pod.

Three major air defense systems ordered during 1966 will keep British electronics companies busy

during the next few years. A giant Saudi Arabian air defense network will bring \$280 million of business to the British Aircraft Corp., AEL, Marconi and other U.K. companies. The Australian "Hubcap" system has Plessey as prime contractor, and the \$300 million-plus Nadge project means at least \$30 million of electronics work for Marconi, the British member of the six-company consortium, led by the Hughes Aircraft Co., that is undertaking the project. Marconi says it will negotiate nine contracts for Nadge during 1967. The system is expected to take four or five years to complete.

The Anglo-French aerospace alliance, now five years old, also could provide an increasing amount of work during 1967 and beyond for U.K. avionics. Two supersonic-aircraft development programs—the Concorde transport and the Jaguar trainer/fighter—are already well along. Two other possible joint projects—a variable-wing fighter and an airbus transport—will also depend heavily on U.K. electronics, as Britain leads France in avionics. The Anglo-French Martel air-to-ground missile, for instance, uses a tv aiming system developed by Marconi; a French version is radar-guided.

In the civil field, British avionics are increasingly finding a place in airliners, particularly for navigation. BOAC plans to evaluate a self-contained navigation system on long jet flights next year. The system ties together Elliott-Automation's new inertial navigator and such existing navigation aids as doppler radar and loran position-fixing gear. Other BOAC flight tests slated next year will evaluate Decca Navigator Co.'s Dectra system, a long-range hyperbolic radio-navigation aid, and miniature integrated-circuit digital computers that can handle many calculations usually made by a human navigator. BOAC will have its entire fleet of Boeing 707 jets fitted out with Marconi doppler navigation systems by next summer.

The upcoming year looks good, too, for ground avionics producers. Marconi has an order for a \$3.36 million air traffic control system scheduled to go operational at London Airport in 1969. Marconi will also install, with Compagnie Française Thomson-Houston, secondary radar at the Brussels National Airport for Eurocontrol, a seven-nation air traffic control body. The two companies will install a similar system at Shannon Airport in 1968.

Standard Telephone and Cables already has picked up \$1.2 million of orders for an instrument landing system it announced only last fall, and it is negotiating with other likely customers. Along with a strong market at home and in Western Europe, such British avionics producers as stc, Plessey, Decca, A.C. Cossor Ltd. and Pye Telecommunications Ltd. are finding an increasing market in the Soviet bloc.

Waiting for color

The sickly pallor that currently tinges the British consumer electronics market can't change to a rosy hue until color television catches on. And as color broadcasts won't start in Britain until late next year,

1967 looks bleak for set producers.

British consumer electronics volume next year is expected to drop 10% from 1966 to \$323.4 million, with sales of black-and-white tv sets accounting for most of the decline. With 13.5 million such sets in service, the market is largely a lackluster one of replacements.

Set makers, though, are convinced color tv will bring a turnabout in the situation. The industry trade association predicts that about 50,000 color sets will be sold during the first 12 months following the introduction of color programs late next year on the BBC's second network. Within five years, the association expects a million color sets to be in service in Britain.

These expectations could turn out to be over-

optimistic should Britain's economy take longer than expected to regain its health. As part of its deflation package, the government has tightened up on consumer credit. Further muddying the outlook for color is Britain's double standard in tv. Although the government has stated that color programs will be broadcast on BBC-2, which uses a 625-line standard, the Independent Television Authority is lobbying hard for color on a 405-line standard, too. Both BBC's first network and the ITV stations use the 405-line standard for their black-and-white programs.

A double standard for color would make the receivers about \$85 more expensive than sets with a single color standard. They will cost something like \$725 to \$850 during the first two years of color broadcasting.

Controls, computers to pace surge in Italy



Paradoxically, the recession that battered the Italian economy in 1964 and 1965 indirectly strengthened the Italian electronics industry. And now that the economy is on the rise again, the industry looks stronger than ever.

Hard hit at home by the recession, Italian electronics manufacturers turned to exports, taking their lead from the subsidiaries of American companies set up in the country mainly to produce for export markets. For 1967, then, the industry has its new-found markets abroad and the prospects of a rising home market. The Electronics magazine forecast is \$644 million, up \$74 million over this year's estimated market.

The gains in the domestic market will be enjoyed by most segments of the industry. Industrial equipment will pace the rise. Here the forecast is for a market of \$86.3 million, about 28% more than in 1966. Computer sales, too, figure to move up sharply. But only a moderate gain is forecast in consumer electronics and the market for communications equipment is in for a downturn.

The one shadow on the forecasts is how the economy will be affected by the recent floods, the worst to hit the country since the 14th century. Even before the floods had ended, some economists had estimated the bill for rebuilding in the devastated areas would run higher than \$3 billion. The government, an important electronics customer, and industry as well, will have to recast their spending plans; it's too early to tell exactly what effect the revised plans will have on the electronics industry generally, but they might well bolster the industrial equipment and communications markets.

Up with industry

No matter what the effect of the rebuilding effort, the market for industrial equipment seems

poised for a surge in 1967. A case in point is numerical controls for machine tools. Two years ago only a handful of nc systems were sold; the 1967 market is expected to run about \$11.3 million. Although the recession of 1964 cut investments in new plant equipment, it "allowed businesses to shop around and see what was available in the market," says Joseph Elbling, manager of the nc division of Ing. C. Olivetti & Co., S.p.A. "Now they are ready to buy and are insisting on the very latest technology." This view is echoed by many of the industrial electronics equipment makers.

Olivetti will begin production runs on two nc models in its Ivrea plant next year. It has already sold next year's planned output of 150 machines and expects to produce 250 to 300 in 1968. Of those already sold, 45 will go to West Germany, where a sharp increase in the nc market to several thousand annually is in prospect over the next few

Italian electronics markets
(millions of dollars)

	1966	1967
Electronics industry, total	570.0	644.0
Consumer products	231.0	257.0
Medical equipment	9.1	5.8
Communications	113.0	108.8
Computers and related equipment	94.8	127.0
Nuclear instruments and equipment	10.4	9.3
Production, control and other equipment	67.4	86.3
Test and measuring equipment	44.3	49.8
Components	176.7	194.8

years. Olivetti seeks a big share of that market, and in fact, may produce NC machine tools in Germany in the future.

Another significant area of growth for 1967 is computers and related equipment, a market that will reach an estimated \$127 million in sales as opposed to the \$94.8 million projected for 1966. One estimate says that industry has used only 15% to 18% of market potential for industrial processing and data transmission. Honeywell S.p.A., a relative newcomer to Italy, is aggressively pursuing the industrial processing and control potential of Italian industry.

Olivetti is turning its research and development in the direction of peripheral equipment for data processing centers. Olivetti-GE, S.p.A., owned 25% by Olivetti and 75% by the General Electric Co., is developing data processing and industrial control systems in its new Systems Information division and plans to draw heavily on research developed by the General Electric Co. in the United States and adapt it to European needs. Olivetti-GE, only two years old, has delivered the government's largest computer installation—the Elea 9003 for the Ministry of the Treasury.

International Business Machines Italia has just opened a \$16 million plant near Milan for the production of its system 360, Model 20. Antonio Cacciavillani, IBM Italia's sales manager, expects big future growth in data transmission and data handling systems for the military. He says, "Budgets are going up for this, and there are more NATO infrastructure programs in Italy." In the area of data transmission, the airline Alitalia will have an instant reservation system in operation in the beginning of 1967.

Components gaining and changing

The 1967 Electronics' survey predicts a \$194.8 million market for components—\$20 million above the 1966 estimate. The nature of the component market is changing along with its increased sales. Italy is using more and more solid-state circuitry and investing heavily in research and production facilities for solid state. Selina, an affiliate of Raytheon Co., is by its own estimate spending 8% to 10% of its total operating budget on research. Texas Instruments Italia has just opened a new plant in the South of Italy. Società Generale Semiconduttori Fairchild, a Fairchild Camera & Instrument Corp. affiliate, is completing two new plants near Milan and plans to inaugurate an international facility for both applied and basic research in one of these plants in 1967.

Solid state circuitry is finding application in some consumer products. S.p.A. Geloso, the country's largest manufacturer of tape recorders, has gone completely to solid state as has big phonograph manufacturer Lesa Costruzioni Elettromeccaniche S.p.A. Italy is the world's third largest manufacturer of washing machines and refrigerators and sgs Fairchild, for one, is developing solid state applications for the timers and temperature

control devices used in European household appliances.

Electronics magazine's forecast estimates a half-million dollar market for integrated circuits for 1967, but IC's should gain in importance. Giuseppe Fontana, market development manager at sgs Fairchild, claims that many manufacturers are incorporating integrated circuits into their latest prototypes.

Consumer electronics will show moderate gains, according to Electronics magazine's survey, and should total \$257 million. Television sales will feel the effect of the government's decision not to begin color television broadcasting until 1970. Industrialists would like to have the move to color sooner,

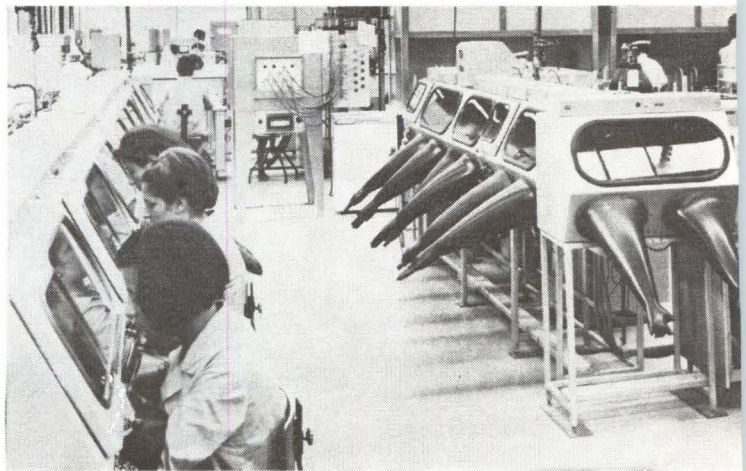

U.S. companies like the General Instrument Corp. are stepping up component production in Italy.

but the government's desire for self-imposed austerity to contend with the flood problems will probably ensure 1970 as the year for color. Mario Malerba, General Manager of FIAR—Fabbrica Italiana Apparecchi Radio, a General Electric affiliate—says, "The replacement market is decreasing because customers are waiting for color television. Our biggest market is made up of families buying their first tv set and we must drop the price to reach their economic level."

Communications a question

Communications sales, according to Electronics magazine's estimate, will show a small decrease in 1967 of about \$5 million. The floods may change this outlook. Rebuilding will include communications.

Part of the explanation for the drop forecast by the survey is the shortage of funds for the Ministry of Post and Telegraph's interurban network. One area that shows long-term promise, however, is mobile communications. Italian Railways, for example, has budgeted \$536 million for the next 10 years to modernize its system with closed circuit tv, automatic switching and line-control telecommunications networks.

Philips 'very cautious' about 1967 outlook



If the Dutch market were all that Philips Gloeilampenfabrieken nv had to worry about, the company's top brass would be as carefree as the crowds of Sunday skaters on Amsterdam's frozen canals. Electronics magazine's survey projects a 1967 market in the Netherlands of \$315.7 million, a gain of nearly 14% from 1966.

But Holland is just one of many markets for the Eindhoven-based electronics giant, and Philips describes its attitude towards over-all 1967 prospects as "very cautious." Television sets and components along with other consumer electronics and electric appliances account for two-thirds of Philips' worldwide business, and the growth of markets for these products is slowing, especially in Europe.

Philips expects rising sales of industrial equipment, computers, communications gear and instruments to offset some of the slowdown in its consumer electronics volume. Although Philips declines to make a specific 1967 sales forecast, its cautious position suggests expectations of a slighter gain than the 8% increase, to \$2.3 billion, posted this year.

Counting on color

Philips sees color television as the key to an upturn in consumer markets after 1967. The company is poised for a fast takeoff when color broadcasts get under way late next year in Holland and in such major markets as France, Britain and West Germany. For the past year it has been producing color sets commercially—on a small scale—for export to Canada, where U.S. color programs can be picked up.

Philips has a strong position in the studio-equipment area of color tv. Its Plumbicon tv

camera tube has already made inroads in the U.S., and a growing market has been found for Plumbicon-equipped cameras in medical and industrial tv. The company this year opened a new facility at Eindhoven to produce these tubes.

However, it's in the color-receiver field that Philips looks for a big boost in future sales volume. "After 1967 we expect a sharp rise in color tv sales in Europe—certainly by 1969," says F.C. Romeijn, deputy manager of Philips' central development bureau. "By 1970, the total European market should be well over 1 million sets a year."

Apart from the projected color tv boom Philips sees fast growth in the late 1960's for some other consumer electronics products. Sales of tape recorders, particularly, are expected to outpace the 8% average annual growth rate that Philips predicts for the over-all European consumer electronics market through 1975. The concern also has high hopes for the Philicorda electronic organ it introduced two years ago.

In radio, Philips doesn't expect much change in dollar volume. Unit sales are rising, but the market shift to smaller sets continues to offset this increase. Philips is pushing for more economic radio-receiver production, largely by concentrating manufacturing operations and automating plants. "The future of radio," says Romeijn, "is in the gradual improvement of quality and in cost reductions."

Computers spurt

Although it hasn't by any means written off the consumer electronics market, Philips is turning its attention increasingly to such nonconsumer sectors as automation equipment, communications equipment and computers.

The company's latest forecasts for European markets, which account for 75% of its sales, show why. J.F.C. Lamet, new manager of the commercial planning department at Eindhoven, predicts a 16% average annual rise in West European sales of non-consumer electronics equipment during the 1966-1975 period. This quickening of the pace from the 10% to 12% annual gains registered from 1960 to 1965 came this year, Lamet observes. By contrast, expansion in the consumer sector is forecast at only 8% annually for the 10 years through 1975.

Sales of computers in Western Europe are expected to increase at a 24% annual rate, and Philips intends to stake out a place in this market. The company plans to produce by 1968 or 1969 a line of business computers, backed up with peripheral equipment and software, ranging up to large machines. At the outset, Philips' machines might not clash head on with the larger IBM 360

Dutch electronics markets
(millions of dollars)

	1966	1967
Electronics industry, total	275.0	315.7
Consumer products	46.0	46.3
Medical equipment	6.0	8.3
Communications	65.0	72.8
Computers and related equipment	43.0	50.1
Nuclear instruments and equipment	8.0	10.7
Production, control and other equipment	61.0	76.1
Test and measuring equipment	46.0	51.4
Components	152.0	154.7

models of the International Business Machines Corp. But, says Romeijn, "you can't think of computers only in small sizes."

This year, Philips gained complete control of Electrologica nv, a small Dutch computer company in which Philips had earlier acquired a 40% holding, primarily to gain experience in the non-industrial computer field. Philips also has begun to build a marketing staff for its own computer division, originally set up three years ago.

Industrial market on rise

With steel producers continuing their modernization drive, and new oil refineries and chemical plants springing up throughout Europe, Philips sees a strong 1967 market for industrial electronics equipment. Furthermore, one of the company's French subsidiaries has developed a computer control system tailored to the needs of public utilities. A gain in sales of radar control systems for harbors and waterways is also expected.

In the longer term, the company sees a "very important" market in the offing for medical equipment combining X-ray, tv and tape-recording gear. Philips already uses its Plumbicon tube for X-ray pickup and has developed a video recorder for X-ray use.

In the area of electronic telephone switching, Philips will begin field trials early next year with a completely transistorized 1,000-line exchange at Utrecht, and later in 1967 will install another 1,000-line exchange at Aarhus, Denmark. Both systems will be experimental and will be installed alongside existing crossbar exchanges.

While Philips is working hard to develop a patent position in electronic exchanges, its executives don't foresee a dramatic shift to electronic switching. Technology, they explain, is moving so

fast that state-run telephone agencies are reluctant to invest in present-generation systems because the advent of integrated circuits threatens to soon make these systems obsolete.

Looking ahead

In laser research, Philips is concentrating on small, continuous-wave types, which it feels have the best commercial prospects. The concern this year moved a laser soldering gun from the research lab to the development lab; marketing of the device is being considered, but Philips has doubts about the cost of such a move and the market.

Philips doesn't expect the commercial use of lasers in telecommunications "for another two or three years." Researchers have made "fun" transmissions from one lab tower to another, but at this point the communications industry doesn't see a need for the wide band provided by laser transmission.

Regarding integrated circuits, Philips doesn't expect any sensational gain next year in their use in European consumer electronics. The company brought out a hearing aid with a linear circuit this year, but plans no further commercial use of consumer ic's until color tv comes along. Because of the large number of components in color sets, Philips' engineers see possibilities for ic's in this field, but at present they are using the devices only in computers, professional equipment and military and space gear.

At this stage, Romeijn notes, ic's are still expensive. "If you stuck one block of ic's into a tv set, it would give service people headaches," he adds. Also Philips feels the ic, as a component, changes the relationship between supplier and customer. "You have to do some of the designing for him," Romeijn says.

Belgians banking on controls



The Belgian electronics industry is banking on industrial markets and new technology to pull it through the certain slump in store next year for consumer and military markets.

By recent European growth standards, this has been a recession year for Belgium, and the 1967 outlook is for more of the same with only slight expansion in the economy anticipated at best. To be sure, the electronics market will outpace the over-all economy. Electronics magazine's forecast puts the market next year at \$294 million, up about 5% from an estimated \$281 million in 1966. This doesn't look too bad at first glance, but as Belgian electronics concerns ponder next year's outlook they must wistfully recall the 15% annual spurts of the early 1960s.

At that time, the television-set market was

mushrooming and the industry had a share of the North Atlantic Treaty Organization's F-104 Starfighter and Hawk missile programs. Military contracts have dwindled since then, and the tv market, now stagnant, may well decline next year. The prediction of growth in the over-all electronics market next year primarily reflects prospects for strong sales of industrial equipment and, to a lesser extent, computers.

Two of the three major Belgian electronics companies, Manufacture Belge de Lampes et de Matériel Electronique (MBLE) and Ateliers de Construction Electriques de Charleroi (ACEC), will get a boost from this expanding industrial-equipment market. The third, the Bell Telephone Mfg. Co. (BTM), sticks mainly to telephones and communications equipment. BTM, a subsidiary of the Inter-

Belgian electronics markets

(millions of dollars)

	1966	1967
Electronics industry, total	267.9	294.0
Consumer products	43.9	46.8
Medical equipment	8.7	9.6
Communications	68.6	67.2
Computers and related equipment	37.9	43.1
Nuclear instruments and equipment	6.7	9.0
Production, control and other equipment	65.2	79.9
Test and measuring equipment	36.9	38.4
Components	90.6	95.7

national Telephone and Telegraph Corp., next year can count on increased outlays for conventional telephone equipment by the state-run phone system, and the company is moving ahead with development of electronic exchanges.

Concern over consumer markets

Tv sales, the dominant factor in European consumer electronics markets, have the industry apprehensive; ACEC, BTM and MBLÉ all make television sets. Electronics magazine's survey predicts 1967 tv volume of \$25 million, the same level as this year. But some industry officials expect 1967 to mark the start of a steady decline from this year's total of 190,000 sets to a level of around 150,000 sets by 1969. Along with a tightening of consumer credit, the market is being depressed by the ballyhoo over color tv. The feeling is that many Belgian consumers are going to put off tv-set purchases until the advent of color.

For set producers, this will be quite a wait. The state-owned Belgian broadcasting network won't begin color broadcasts until 1970. Some color sets should be sold in 1968, as Belgians will be able to pick up color programs from France and West Germany beginning next fall, but marketing men



With Belgian military market in doldrums, MBLÉ is trying to sell NATO a reconnaissance drone.

don't expect the impact of color tv until 1970.

The market for components is expected to run the same course. Says Jacques LaGrange, MBLÉ's managing director: "Components will boom again after we get into the color boom—after 1970."

Uncertain military market

Uncertainty marks the outlook for the military electronics field. The industry was counting on a lift from the \$300 million NATO air-defense ground-environment project (Nadge), but no Belgian company is a member of the consortium, headed by the Hughes Aircraft Co., that won the contract. However, the Hughes consortium has still to negotiate individual contracts with each NATO country, and the Belgium government, which is investing \$12 million in Nadge, may yet be able to steer some subcontracts to Belgian companies.

Adding to the uncertainty is a major review of future military requirements now being undertaken by the Belgian defense ministry. The review has brought a pause in contract decisions, leaving several big equipment orders hanging fire.

One is a contract for 300 tanks, an order that would bring substantial work to Belgian electronics companies. Also awaiting a go-ahead is the planned purchase of 120 jet fighters to replace Belgium's aging F-84's. Decisions on these contracts almost certainly won't be made in time to bolster the 1967 military electronics market.

Meanwhile, MBLÉ is trying to sell a reconnaissance drone to NATO and is looking for export customers for a paratroop transceiver it has developed.

ACEC, MBLÉ and BTM all participate in Belgium's share of the international space programs of the European Launcher Development Organization and the European Space Research Organization.

Eyes on controls

LaGrange of MBLÉ feels that future hopes must rest on control-equipment sales, and Electronics magazine's survey bears him out. The 1967 market for production and control equipment is forecast at \$79.9 million, up a heady 22% from the estimate for this year.

Both MBLÉ and ACEC are developing new industrial electronics hardware. MBLÉ, a specialist in textile-industry gear, has perfected a system that controls the length of synthetic fibers in spinning mills. The company has begun to crack the U.S. market with a thermoluminescent radiation detector, and also has an instrumentation order for the natural-gas pipeline network being expanded throughout neighboring Holland.

ACEC has a strong position in process controls. Late this year, the company started to produce a new control computer, and it already as a backlog of orders for a Caravelle jetliner flight simulator, a catalyst control setup for an oxygen plant, two power-plant systems and a cement-plant system.

ACEC next year will deliver a tide-logging system for the Scheldt estuary to help Antwerp pilots get tankers into the new 100,000-ton lock there.

Boom continues for controls in Sweden



A lean year is ahead for the Swedish economy and the electronics industry expects to feel the pinch. There is general agreement that the industry's growth pace will slow, but no one is sure how severe the slowdown will be.

Prime Minister Tage Erlander has remarked that 1967 "won't be a dance on a bed of roses" for the country's economy. The warning applies to consumer electronics, but the downturn in this sector will be more than offset by a rise in sales of industrial equipment. And although the government may tighten its purse strings, there'll be a substantial military market next year.

Over-all, Electronics magazine's survey projects a total market of \$281.2 million next year, indicating a solid increase of \$32 million from 1966, but a slower rate of gain than this year's estimated 14%.

Accelerating automation

Pacing the 1967 Swedish electronics market will be industrial equipment, sales of which are expected to climb 28% to \$67.5 million. Much of the underlying strength in this area stems from the very conditions that point to a difficult year for the economy as a whole.

To brake inflation, the Erlander government has tightened up on credit. But a priority has been placed on industrial investment as part of a drive to stem rising manufacturing costs and keep Swedish products competitive in world markets. As a result, demand for process control hardware will continue its sharp expansion in 1967; Swedish plants are expected to acquire some \$31 million of new systems in the year. The effort to step up productivity also brightens the 1967 outlook for data processing sales.

Components climb

The components market is forecast at \$103.2 million, up about 10% from \$94.1 million in 1966. Integrated circuits will start to catch on strongly, and a projected 1967 market of \$800,000 will place Sweden behind only Britain, West Germany and France among West European ic consumers.

Stephen Finta, marketing manager of Ingenjorsfirman Nordisk Elektronik AB, which represents a score of U.S. companies, predicts a "tremendous increase" in the use of ic's next year. Frank Hammar, managing director of a Swedish IRT affiliate, Standard Radio and Telefon AB, says integrated circuits are employed in all of the company's re-designed military and air-traffic control equipment. And AB Gylling & Co., primarily a manufacturer of intercom equipment but also a printed-circuit producer, reports an increasing interest in thin-film circuits.

Finta expects a gain in sales of linear as well as digital circuits, and he's optimistic about prospects for field effect transistors. "People are getting used to them and are designing for them," he notes. Finta also sees a good market developing next year for silicon controlled rectifiers for consumer products.

Military moves

For military-electronics manufacturers, the big event in 1967 will be the first flight early in the year of the Saab 37-Viggen, Sweden's next generation supersonic interceptor-reconnaissance plane. It's estimated that some 600 of the planes will be built through the mid-1970's at a cost of close to \$2 billion. Between 25% and 30% of this outlay will go for electronics gear, and every major electronics producer in Sweden is slated to get a piece of the action. Deliveries of the Viggen—"thunderbolt" in Swedish—will begin in 1970, and production contracts are expected next year or 1968.

There's a good chance the government will pare military expenditures next year, but stretch-outs of orders rather than direct cuts seem in the offing. The Swedish air force alone expects to buy about \$500 million of electronics equipment over the next seven years. According to one air force study, this electronics spending will include some \$6 million a year for airborne radio equipment; \$5 million for radio links, multiplex equipment and carrier telephone equipment; \$8 million for ground radar; \$12 million for data-handling equipment; \$3 million for autopilots and missile guidance systems; \$4 million for test equipment; and \$5 million for ground installation equipment.

The air force estimates that about 25% of the

Swedish electronics markets

(millions of dollars)

	1966	1967
Electronics industry, total	240.9	281.2
Consumer products	50.5	55.5
Medical equipment	6.8	7.5
Communications	57.4	63.9
Computers and related equipment	35.8	42.3
Nuclear instruments and equipment	4.9	7.0
Production, control and other equipment	52.9	67.5
Test and measuring equipment	32.6	37.5
Components	94.1	103.2

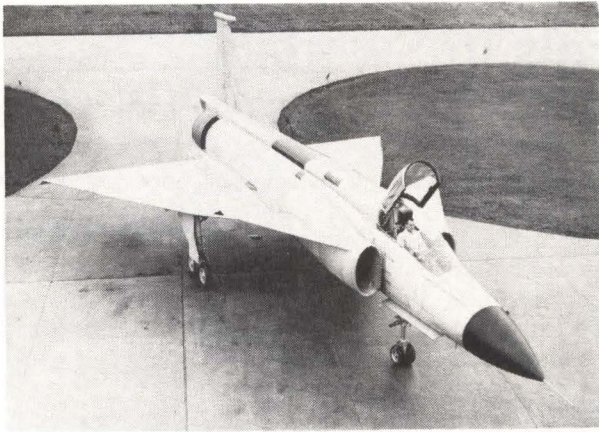

Future mainstay for Swedish military-electronics producers is the Saab 37-Viggen, Sweden's next generation supersonic interceptor-reconnaissance aircraft. Its initial flight will come early this year.

finished equipment, but between 50% and 60% of the components, will be bought from foreign sources. The Swedish air force is under no obligation to buy domestically, a fact that has helped open the Swedish market to foreign electronics makers.

Hans Lindgren, head of the electronics department of the Swedish Air Board, indicates that dop-

pler radar to detect low-flying planes is a high-priority item. The board is also following laser developments. It has ordered its first laser ceilometer from Allmann Svenska Elektriska Aktiebolaget and has an option on 10 more.

Consumer comedown

Consumer electronics producers don't expect to wax fat during the lean year ahead for the Swedish economy. Electronics magazine's survey indicates a \$5 million rise in the market to \$55.5 million this year, but there's little optimism among entertainment-set makers. They were counting on the advent of color and a second television network in 1968 to spur sales. Late this year, however, the government proposed 1970 as the introduction year, and the industry expects 1967 tv-set sales to about match the 200,000-unit level of 1966.

Two leading Swedish tv producers this fall joined forces to improve their manufacturing efficiency. Under the arrangement, Svenska AB Gasaccumulator (AGA) and Svenska AB Philips, a subsidiary of Holland's Philips Gloeilampenfabriek NV, will concentrate their set production at Philips' plant. Although AGA will continue to sell sets under its own name, the move leaves the country with just two set producers—Philips and Luxor AB, a Swedish independent.

Better times ahead with Swiss IC watch



Two of Switzerland's best-known institutions, the watch industry and the dense railway network that laces the Alps, will provide added impetus to the country's expanding electronics market next year.

The forecast is for sales of \$212.7 million, a gain of 8% from 1966. Industrial equipment should show the strongest growth, along with computers. Consumer electronics sales, on the other hand, are expected to edge downward.

Watch out

For the flourishing watch industry, 1967 should be a landmark year. Next spring—at long last—the prototype of the first Swiss electronic wristwatch should be ready. The Horological Electronics Center in Neuchâtel, an industry research arm, has been working on the device for three years.

The advent of the electronic wristwatch portends a change in the Swiss electronics industry. In relation to the quantity of electronics equipment consumed in the country, Switzerland is a small market for components. The 1967 forecast for components consumption is \$57.8 million but production of the electronic wristwatch figures to push this level up significantly during the next few years. Philips Gloeilampenfabriek NV of the

Netherlands, a nimble giant when it comes to moving into growth markets, has already appeared on the scene. Philips, together with the dominant company in the Swiss watch industry and four other Swiss concerns, this year formed a company called Fabrication des Semiconducteurs S.A. to produce integrated circuits for the electronic watch.

Swiss electronics markets
(millions of dollars)

	1966	1967
Electronics industry, total	195.5	212.7
Consumer products	56.5	55.3
Medical equipment	5.2	5.5
Communications	56.9	59.2
Computers and related equipment	27.9	34.2
Nuclear instruments and equipment	6.0	7.0
Production, control and other equipment	31.2	39.2
Test and measuring equipment	11.8	12.3
Components	53.3	57.8

The new unit will also turn out components for timing instruments the Swiss watch industry is developing for spacecraft.

Labor shortage

Industrial electronics sales should rise 25% next year to \$39.1 million. A prime factor here is Switzerland's labor shortage, now more acute than ever because of the limitations placed on the entry of foreign workers. The shortage, along with inflationary pressure, has forced Swiss industry to automate production plants.

The labor shortage is also accelerating a switch to automatic controls for the Swiss railroad network. Train-control equipment, in fact, is becoming something of a Swiss electronics specialty. Société Anonyme des Ateliers de Sécheron already has installed acceleration and braking controls in 200-odd trolleybuses and trains in Switzerland and France, while Brown, Boverie & Cie., Switzerland's best-known electrical-electronics company, has developed an electronic control system currently undergoing trials on a commuter line in northeastern Switzerland.

Another promising Swiss market is nuclear instrumentation. A \$1 million rise next year to \$7 million is forecast for this market, but there's much more to come. Projects planned or under way will give the country nuclear generating capacity of more than 2,000 megawatts by 1975, and all the plants will be packed with instrumentation.

Communications upswing

In communications, Albiswerk AG of Zurich has already installed the country's first semielectronic telephone exchange center at Bienne. No mass shift to electronic telephone exchanges is in sight, however, though Hasler AG and Standard Telephone and Radio AG, a subsidiary of the International Telephone and Telegraph Corp., are also working on electronic switching systems.

The over-all 1967 market for communications equipment is put at \$59.2 million, up \$2.8 million from 1966, with most of this business destined to go to suppliers of air navigation equipment. The Swiss air force is buying 57 Mirage III fighter planes from France, but the planes will be equipped with the American Tacan tactical air navigation system. And Swissair next year will take delivery of 11 jetliners from the Douglas Aircraft Co.

Consumer plateau

The 1967 consumer electronics market is expected to slip about 2% from this year's strong \$55.3 million. However, the long-term outlook is good. A government communications specialist predicts that the number of television sets in service in Switzerland, a nation of 5.8 million population, will climb to 1,750,000 by 1975 from the present 720,000.

Switzerland won't begin color tv broadcasting until 1970, but the market will get an early lift in 1968, when both France and West Germany will offer color programs that Swiss viewers can pick up.

Tv sets, computers spark Spain's spurt

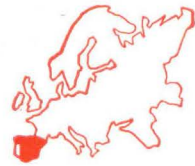

Change has become the order of the day in Spain. The long-standing dictatorship of Francisco Franco appears to be softening. Late this year, Franco offered his countrymen a new constitution and a measure of personal liberty. The regime, which once shut out foreign businessmen, foreign capital and foreign technology, has lowered the barriers. As a result, the economy and the electronics industry are surging upward. In the words of one Spanish television manufacturer, "After an excellent start in 1966, Spain should emerge in 1967 as one of Western Europe's fastest growing electronics markets."

Electronics magazine's survey projects a 1967 Spanish market of \$178 million; Spanish government economists put the figure much higher. There's general agreement, however, that the market is expanding sharply, especially in the fields of consumer electronics, communications and computers. Military requirements, too, are on the rise, and an added push is coming from Spain's infant space program.

Television is strong

Television saw its first big year in 1964, chalking up sales of 475,000 sets. This year the market reached almost 650,000 sets, and nearly 700,000 should be sold next year. "We have the fastest growth rate in Europe, and our market is only 30% to 35% saturated," says an economist at General Electric Española, summing up the outlook for the television industry. GE Española is a joint venture of the General Electric Co., Compagnie Française Thomson Houston-Hotchkiss Brandt and private Spanish investors.

Adding to the enthusiasm of set makers is the prospect of color tv by 1968. The government is committed to start color broadcasting then, though it has yet to decide what system it will use. The French Secam system (for sequential and memory) seems to have the edge over PAL (for phase-alternation-line), the West German system. Next year, France will send a team of Secam experts to Spain to advise the government-run broadcasting network on color.

Some 45 receiver manufacturers are competing for the tv market, but the lion's share of the business is split among three companies. Philips Iberica, almost entirely owned by Philips Gloeilampenfabrieken NV of the Netherlands, is the industry leader with sales of 140,000 sets in Spain this year. GE Española ranks second with 1966 tv sales of about 65,000 sets, and Iberia S.A., a wholly Spanish venture with licensing ties to the Philco-Ford

Corp., a subsidiary of the Ford Motor Co. is third.

Government: the big customer

Communications-equipment makers have in store a market estimated at \$29 million, much of it new hardware for the state-owned telephone and telegraph networks.

Spain's over-all military budget is a secret, but informed guessers put it at about \$100 million. Regarding electronics expenditures, it's known that Spain is ordering equipment for a second Hawk missile battalion; the first is already in place at Algeciras, across the bay from Gibraltar. Spain will also receive some 40 Northrop F-5 aircraft next year.

Other 1967 government outlays include \$10 million for a space program aimed at launching a satellite by 1972. Spain is involved in the global ground-station network of the United States National Aeronautics and Space Administration and has just concluded a pact with France for a joint tracking station in the Canary Islands. The government hopes to steer between 20% and 25% of the work on the latter project to Spanish electronics companies. The station will be integrated into the French "Diane" tracking network.

Computers on rise

The newest growth element in the market is data processing, expanding at a rate of about 33% a year. The consensus forecast for this sector is \$20 million in 1967, but government sources say it may go as high as \$30 million or more. The International Business Machines Corp. has more than half the Spanish market, and the Univac division of the Sperry Rand Corp., the National Cash Register Co. and Bull-General Electric share the remainder.

Danes look East for export growth

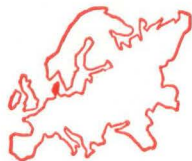

With a banner year behind it, the Danish electronics industry is aiming its efforts at export sales—particularly to Communist countries—rather than its own nearly saturated domestic market. Danish concerns expect their growth in 1967 to follow the pattern of 1966, when none reported a production increase of less than 15% and most rang up gains ranging between 20% and 25%.

The domestic market is forecast at \$110.7 million, with consumer products accounting for nearly a third of that, or \$32.2 million. Other major segments are expected to be communications equip-

ment at \$22.4 million; industrial electronic equipment, \$21.8 million; and computers, \$20.3 million. Sales of electronic components, which aren't included in the over-all market total, are expected to reach \$39 million.

All told, the Danish market will rise about 10% in each of these sectors in 1967. The most noteworthy new equipment items slated to appear on the scene in 1967 are an information-retrieval system for the Danish Technical University's scientific library and an electronic switching system for northern Jutland's telephone company. The information system, which will be operated through a Danish computer service organization known as DataCentralen, is due to be operative in January 1968. The electronic exchange—from Philips Gloeilampenfabriek n.v. of the Netherlands—may be installed by late 1967, but a more likely date is 1968.

The electronics industry is now one of Denmark's prime foreign-currency earners. Most companies estimate export sales at anywhere from 80% to 98% of production—mostly to the U.S., Britain, and Western Europe, but increasingly to Eastern Europe, primarily Poland, Hungary and Czechoslovakia, where lack of U.S. competition is a major plus factor. Danish companies have established what they call "Eastern sales teams" that are working with the Danish government to penetrate Communist markets through Denmark's foreign exhibitions program.

Under this program, the Danish government helps to subsidize or underwrite the cost of exhibiting Danish products at most foreign trade fairs. This subsidy is usually limited to paying shipping charges on merchandise and providing information on the market through consular services, plus arranging for local translations of sales material. Individual companies pay the cost of staffing their exhibit and their sales teams. The instruments marketed in the East are not covered by the North Atlantic Treaty Organization's embargo on strategic goods.

One cloud hanging over the otherwise bright export horizon is the question of whether Denmark will desert its current trading partners for a place in the European Economic Community, or "Common Market." Denmark now belongs to the European Free Trade Association (EFTA) along with the other Scandinavian countries, Austria, Portugal, Switzerland and Denmark's best customer, Britain. However, Danish Premier Jens Otto Krag has repeatedly stated that the Danish government is considering applying for EEC membership even if its trading partners can't join that bloc.

From the electronics industry's point of view, this could mean a substantial drop in the British market. The United Kingdom maintains a fairly high tariff wall, an advantage Danish companies, as EFTA concerns, enjoy over U.S. competitors. Danish electronics executives, while favoring EEC membership for their country, understandably want to hold out until Britain can join, too.

Portugal becoming base for exporters



Portugal's export mix, long limited to cork, wine and canned sardines, is beginning to reflect a fast-growing electronics-equipment industry.

Semiconductors, single-sideband communications gear and television receivers already turn up in export statistics, and the figures for such products are climbing. Electronics exports next year are expected to reach \$20 million, double the 1966 level.

Underlying the change in Portugal's image as an exporter is the country's largely untapped labor market. About half the size of Indiana but with twice the population, Portugal remains basically an agricultural nation with a surplus of workers—a magnet for export-minded electronics producers.

Portugal is still a long way from achieving the affluence of northern Europe, however, and as an electronics market it leads only Greece in Europe. The 1967 Portugese market is projected at \$31 million, with some \$9 million coming from consumer electronics, \$8 million from computer sales and rentals, and \$7 million from sales of communications equipment.

A pioneer in Portugese electronics and one of the country's fastest growing industrial concerns is Standard Eléctrica SARL, an affiliate of the International Telephone and Telegraph Corp. Standard Eléctrica's volume last year totaled about \$5.5 million. It currently has a 30% share of the domestic tv-receiver market and gets about 40% of the country's military electronics orders.

Standard Eléctrica expects its uptrend to continue in 1967. The company has a new factory near Lisbon that next year will start turning out transistors and diodes along with wound components. It is also completing negotiations with the government on a two-year contract to expand radio communications in Portugal's sprawling, troubled West African colony of Angola.

Much of Standard Eléctrica's success can be traced to its managing director, 46-year-old Antonio de Carvalho Fernandes.

"Electronics in Portugal is on its way to becoming one of the country's major export industries," Fernandes says. "Standard Eléctrica is already exporting electronic subassemblies and single-sideband radio communications equipment on a large scale. The export of semiconductor components is becoming a multimillion-dollar business with excellent prospects for the years to come."

Along with Standard Eléctrica, subsidiaries of Philips Gloeilampenfabrieken NV of the Netherlands and Grundig GmbH of West Germany are strong contributors to the rise in Portugal's elec-

tronics exports. Grundig this year opened a plant in northern Portugal that currently turns out 500 transistor radios a day using components imported from Germany. Grundig plans to assemble tv sets valued at \$7.5 million a year at the plant, 95% of them for export. Philips Portuguesa SARL is expected to step up its output of radio sets for export from the current annual level of 200,000.

Portugal still has to import many of the components for the hardware it exports, plus nearly all of its technology. However, both partially and fully transistorized commercial transceivers are being developed by Portuguese engineers.

Austrian exports have 'sound' ring



Famed for exporting waltzes and the music of great composers, it seems only natural that Austria's electronics exports should emphasize sound: tape recorders, hearing-aids, speakers and microphones.

Philips Gloeilampfabrieken NV's Austrian subsidiary, Philips GmbH, is currently producing 500,000 tape recorders a year, of which more than 90% are for export. Viktor Stuzzi Radiowerk, the nation's second largest tape-recorder manufacturer, is planning to offset any possible decline in exports by introducing new magnetic tape devices. It will soon market a language teaching unit, a sound system to divert a patient's attention from the pain of the dentist's drilling and a tape machine to be used in treating speech defects.

Two Vienna-based concerns, Akustiche und Kinogeraete GmbH and Viennatone, anticipate increased export sales in 1967. Akustiche produces microphones and exports 84% of its output, while Viennatone, a leading manufacturer of hearing-aids, currently exports 94% of its products.

However, the domestic electronics market is growing. Electronics magazine's survey puts 1967 sales in Austria at \$107 million, up from an estimated \$99 million this year. Consumer-products volume will account for about \$27 million of next year's projected total.

The survey anticipates a \$23 million computer market next year. The use of Austria as a base for leasing computers to Soviet-bloc nations seems to have become an established practice. Half of the Sperry Rand Corp. Univacs that are leased in Austria appear in Czechoslovakia or Hungary.

Communications sales will amount to about \$20 million, according to Electronics magazine's forecast. The Austrian government is currently hampered by lack of funds and is unable to finance expansion and improvement of the nation's communications network.

Russia looks better as outlet for U.S. gear



American electronics concerns seeking a share of the Soviet market can expect a boost in the coming year from a combination of three factors: the current efforts by the two governments to ease trade restrictions, Russia's need for more industrial automation equipment and miniaturized gear to upgrade its own technology, and the Russian public's growing demand for more consumer goods.

President Johnson already has eased curbs on East-bound shipments of such electronic products as airborne navigation equipment, radio and television sets and components, instruments, numerical control systems, digital-to-analog converters, storing and switching devices for computer thin-film memories, ground and marine radar gear, and equipment for manufacturing semiconductors.

If the political atmosphere seems bright, the economic portents are even more favorable. United States exports to Russia in 1967 seem certain to climb back near the 1964 total of \$162.5 million from the 1965 trough—approximately equaled this year—of \$64.7 million.

Replace the abacuses

One reason is the computer boom. To manage the world's biggest controlled economy the Russians desperately need computers to replace the abacuses still used for 90% of the country's economic calculations. By 1970 the Soviets plan to spend about \$4 billion for computers, peripheral equipment and programs, putting such spending at only the 1965 U.S. level, but doubling their own 1965 computer outlay. Soviet specialists concede that their computer industry can't build all the equipment needed.

Russia's second major need is miniaturized equipment. During a recent trade show a West European technician complained: "You daren't leave a printed circuit card in the open; at least a dozen have disappeared from our display. I wish we'd brought a lot of old circuit cards to give away, but I wish they'd stop swiping the ones here. We need them."

Fritz Schrepf, technical director of Univac Services AG in Zurich, is convinced Soviet semiconductors must be "pretty unreliable" because "they don't believe we have so little trouble with ours." Another recent Western exhibitor in Moscow says the Russians were surprised at the number of connections on a single printed-circuit card—50. "They say they have only about 12," he adds.

All of this provides a healthy atmosphere for Western companies seeking to sell manufacturing licenses or equipment to make semiconductors and integrated circuits.

The third—and potentially biggest—factor in Russian receptivity to electronic imports is the Soviets' new stress on consumer products. The current five-year plan proposes to increase the

consumer's share of the economy faster than ever before—but not as fast as heavy industry is expanded. Consumer sales are slated to rise an average of 6.9% a year through 1970, compared with an average annual gain of 5.6% over the past five years. Production of household appliances and goods is to increase about 12% a year.

This year, Soviet companies turned out 2.1 million black-and-white sets, a 28% increase from the like 1965 period, and this gain pace is expected to continue through 1967. Russian output of radios and phonographs totaled 2.6 million units in the 1966 first half, up 4% from a year earlier.

Despite these sunny prospects and the fact that U.S. companies enjoy technologies one to 10 years ahead of the Russians, men who are already selling the Soviet market warn that there are plenty of pitfalls. "Anybody who thinks he's going to come over here and do business as he would in Paris or Bonn is in for a rude awakening," says Romaine Fielding, a specialist in Soviet trade who has been representing the National Cash Register Co. in Moscow since July.

Fielding, whose dozen trips to Moscow since 1958 qualify him as a Los Angeles-Moscow commuter, offers several tips for American businessmen who want to do business in Russia:

- Have a specific end-user in mind.
- Raise your asking price. "The Russians never pay the asking price," he explains, "so anybody should start on that assumption."
- Study the government's present order of priorities. For example, the Russians are less interested in consumer end-products than in licenses and equipment for their manufacture.
- Bring lots of literature giving detailed description of your products. "In the U.S. you're dealing with a more experienced purchaser," Fielding comments. "He knows what he wants. He has read lots of literature on what's available. Here you have to explain everything—starting with 'This is a computer.'"
- Show your product in use, not sitting on a shelf. Many Russian purchasing officials have had little experience with electronic equipment and have only a vague idea of how it works. That's why at its most recent Moscow exhibit Olivetti-CE displayed its automation and mechanization equipment as complete systems actually controlling production, calculating payrolls and inventories and keeping bank records.

The Russians were so impressed with Olivetti's approach that they bought most of the equipment on display for \$1 million.

Reprints of this report are available at \$1 each.

© copyright 1966, Electronics ® A McGraw-Hill Publication

**If you were impressed by
our powerful 500-MW laser,**

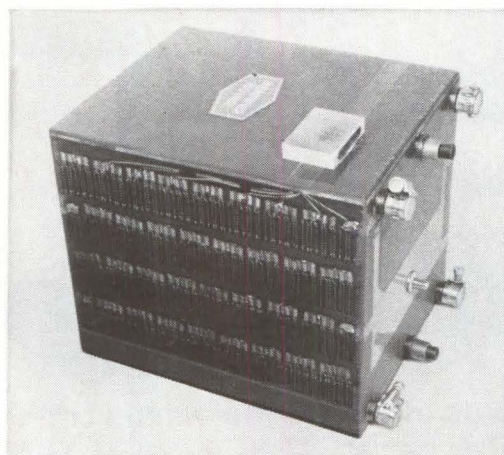

**now take a look at our
quiet new fuel cell.**

We developed it for the Army. It's so quiet you can't hear it 100 feet away. Yet it will provide 28 VDC for more than 1000 hours without major repair or replacement. And, complete with cell stack, blower, pump, starter and voltage regulator, it weighs only 30 pounds.

We don't know why portability and silence were needed for this fuel cell. But we think we know why we were asked to make it. It's because we're known for leadership throughout the expanding world of electronics.



For instance, we also make the world's most powerful laser (500-MW), and a tiny ½-watt CW unit. And the largest line of U.S.-made single crystals and crystal products. And a sophisticated line of solid state devices. And the country's first family of solid tantalum and foil-film capacitors.

For specific data on fuel cells – or lasers or any of our electronics field products – write Union Carbide Corporation, Electronics Division, 270 Park Avenue, New York, New York 10017.

4 outstanding operational amplifiers from NEXUS

4 useful design benefits for YOU

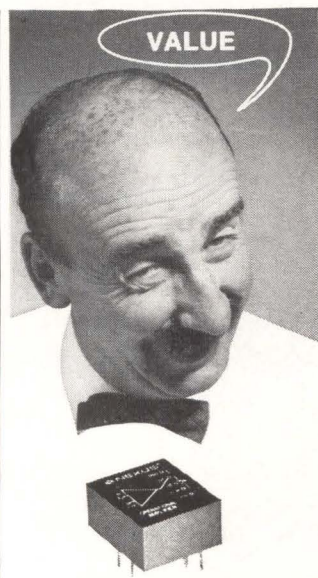

THE NEXUS SQ-10a

The versatile SQ-10a — priced at *only \$17* in quantities of 1-9 — offers absolutely the highest performance per dollar in the industry.

You should consider the SQ-10a, or its low-profile brother, the SF-10a (only .375" tall), as a potential means of both improving your system performance and saving money.

TYPICAL PERFORMANCE

Open loop gain @ dc.....100,000
 Output.....±11V @ 5mA
 Differential input impedance.....0.3 megohm
 Voltage stability (ΔE_{os}).....±5 μ V/°C
 Warm-up drift.....±100 μ V
 f_t2.0MHz
 Z_{cm}30 megohms

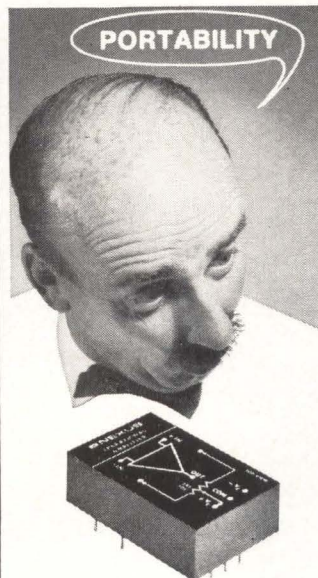

THE NEXUS 2LV-1

Developed specifically for use in a wide range of remote and portable battery-powered electronic equipment, this unit combines high reliability, excellent performance, and economical low-power operation. It operates on a supply voltage of ±2.7V; has a standby power drain of only 4 mW. Using all-silicon semiconductors it has an operating temperature range of -25° to +85°C.

TYPICAL PERFORMANCE

Supply voltage.....±2.7 Volts (nom.)
 Supply current (quiescent).....±900 μ A
 Output ($R_L = 1K @ 1Hz$).....±1.5V @ 1.5 mA
 Input offset current.....±1.5 nA
 $\Delta E_{os}/\Delta T$ (-25°C to +85°C).....±5 μ V/°C
 Differential input impedance.....0.2 megohms
 Common mode input impedance (@1 Hz).....25 megohms
 Size.....2.02" x 1.14" x 0.62"

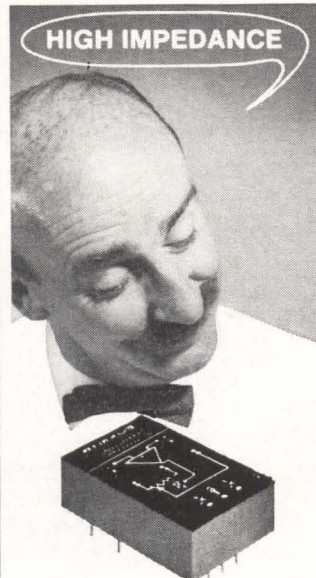

THE NEXUS LFT-1

This low cost FET operational amplifier offers a happy combination of extremely high input impedance (well over 1000 megohms), low input leakage current (<100 picoamps at 25°C), and a very favorable price (\$85, 1-9). It is ideally suited to applications requiring extremely low error currents, such as integrators, sample and hold circuits, and electrometer circuits.

TYPICAL PERFORMANCE

Differential input $Z @ dc$10¹⁰ ohms
 Input leakage current.....0.1 nA (max.)
 Open loop gain @ dc ($R_{LL} = 10K$).....50 k
 f_t1 MHz
 Output.....±10V @ ±2 ma (min.)
 $\Delta E_{os}/\Delta T$ (-25°C to +85°C).....10 μ V/°C

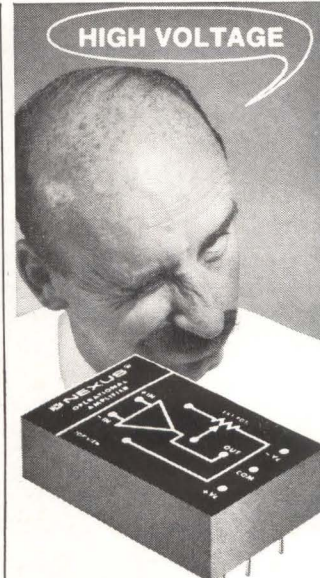

THE NEXUS MLF-100

Another FET input device, this Nexus op amp offers an output range of ±100V @ ±10 ma. It features long-term short-circuit protection for both inputs and output. Input impedance is on the order of 1000 megohms, with associated low, low input error currents.

TYPICAL PERFORMANCE

Output voltage range.....±100V @ ±10 mA
 Differential input impedance.....10⁹ ohms
 $I_{os} @ 25^\circ C$0.5 nA
 DC Gain @ 25°C.....200 K
 f_t1 MHz
 Z_{cm}10⁸ ohms
 Operating temp. range -25°C to +85°C

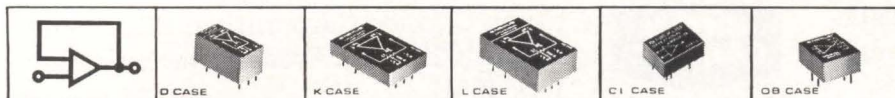

NEXUS

RESEARCH LABORATORY, INC.
 480 NEPONSET STREET, CANTON, MASS. 02021
 TEL: (617) 828-9000 TWX (617) 828-1022

Prices F.O.B. Canton, Massachusetts. Prices slightly higher outside North America.



Look to Johnson for all your component needs

CONNECTORS

SUB-MINIATURE INSULATED TYPES — Designed for printed circuit applications. Operating voltages to 1500 volts RMS . . . 5 amperes current carrying capacity . . . contact resistance less than 2 milliohms. Capacitance between two adjacent jacks less than one pf at 1 Mc. 10 colors available. Test-Point Strip/Handle — rapid-mounting polyamide body contains 12 test points each rated at 5 amps., maximum current capacity. Operating voltage 1500 volts RMS at sea level, 350 volts RMS at 50,000 feet. Contact resistance less than 2 milliohms.

STANDARD INSULATED CONNECTORS — A complete line of connectors molded of tough, low-loss, shock-proof polyamide in 10

colors meeting Fed. Std. 595. Tip, Banana and Dual Banana Plugs; Tip and Banana Jacks; Metal-Clad Tip Jack, Military; Jack and Sleeve; Binding Posts.

RIB-LOC TERMINALS — A new line of miniature, one-piece, insulated terminals with a unique serrated conical design, which resists loosening and turning. Provides an inexpensive approach to convenient press-in type terminals. Six colors conforming to Federal Color Standard No. 595. Terminal styles include single and double turret feed-thrus and stand-offs, .040" dia. tip plug and mating jack for .040 plug.

CAPACITORS

MACHINED PLATE TRIMMER AND TUNER TYPES — U, UA, UB, U-LC, V, AND W — Available in both printed circuit and chassis mounting types. U types available in differential and butterfly printed circuit mounting types in addition to single section types. V and W capacitors available in single section type only. Maximum capacities of up to 54 pf. Tuners consist of a machined plate trimmer and high Q air wound silver plated inductor, in resonant frequencies of 100 to 750 Mc.

SOLDER PLATE TYPES — Type M: Capacity values to 30 pf. Voltage ratings to 1250 volts peak. Available in single section, differential and butterfly types.

Type S: Capacity values to 100 pf. Voltage ratings to 3000 volts peak. Available in single section, differential and butterfly types.

Type K: Capacity values to 150 pf. Voltage ratings to 3800 volts peak. Available only in single section types. May be furnished in production quantities in full compliance to MIL-C-92A.

Type R: Capacity values to 340 pf. Voltage ratings to 4400 volts peak. Available only in single section type.

Type L: Capacity values to 200 pf. Voltage ratings to 3500 volts peak. Available in single section differential, butterfly and dual section types.

SPACER TYPES — Type C: Capacity values to 1500 pf. Voltage ratings to 13,000 volts peak. Available in single section and dual section types.

Type D: Capacity values to 1700 pf. Voltage ratings to 9000 volts peak. Available in single section and dual section types.

STAKED PLATE TYPES — Type E: Capacity values to 1000 pf. Voltage ratings to 4500 volts peak. Available in single section and dual section types.

Type F: Capacity values to 400 pf. Voltage ratings to 3000 volts peak. Available in single section and dual section types.

TUBE SOCKETS, INSULATORS, PILOT LIGHTS AND HARDWARE

ULTRA HIGH FREQUENCY SOCKETS — Continuous heat resistance to 500°F. with low loss, glass filled silicone base and heat treated beryllium copper contacts. Low inductance screen bypass capacitor available for VHF and UHF operation.

KEL-F SERIES — Molded of low dielectric loss-factor Kel-F plastic — designed for use with a wide selection of high power transmitting tubes.

STEATITE WAFER TYPES — Available in 4, 5, 6, 7, and 8-pin standard socket types, as well as Super Jumbo 4-pin types. Also giant 5 pin, and 7 pin Septar and VHF Septar Sockets.

SPECIAL PURPOSE TYPES — Includes sockets for special purpose tubes.

Note: For detailed specifications, request Socket Standardization Booklet 536 on your company letterhead.

INSULATORS — Low loss, high-voltage breakdown in either steatite or porcelain. Complete line includes Thru-panel Bushings and Insulators, Antenna Strain and Feeder Types, Cone and Stand-off Insulators, Lead-in Bushings and Feed-Thru Bowl Assemblies.

PILOT LIGHTS — Over 47 separate assemblies. Continuous indication neon types, models for high and low voltage incandescent bulbs, standard or wide angle glass, and lucite jewels. Specials, including types meeting military specifications, also available in production quantities.

PANEL BEARINGS — For use on 1/4" shafts and panels up to 3/8" thick. **CRYSTAL SOCKETS** — For low capacity, high voltage and high temperature operation. Glazed steatite, Grade L-423 or better. **DC-200 impregnated. RF CHOKES** — High quality construction. For 1.7 to 30 Mc range.

Johnson also offers a complete line of heavy-duty RF components for broadcast transmitting, RF heating, antenna phasing and other commercial applications.

Equipment in this line includes fixed and variable inductors, antenna phase sampling loops, isolation filter inductors, feed-thru bowl insulators, static drain chokes, RF contactors, and heavy duty make-before-break switches.



E. F. JOHNSON COMPANY
W A S E C A , M I N N E S O T A 5 6 0 9 3



Johnson brings you a long line of connectors

No matter what kind of application, Johnson's long line of jacks and plugs will supply your design needs. Whether it's military or commercial, whether it's sub-miniature or standard, there's a rugged polyamide insulated or un-insulated connector for your job. Johnson has a full line of tip and banana plugs, tip jack and sleeve assemblies, metal-clad and rapid mount tip jacks, dual banana plugs and the unique, patented Johnson binding post in three sizes. Insulated connectors color coded to federal color standards. Voltage breakdown ratings up to 11,000.



Get complete information on JOHNSON'S full line of connectors. Write today on company letterhead for free, detailed Johnson components catalog.

E. F. JOHNSON COMPANY
WASECA, MINNESOTA 56093

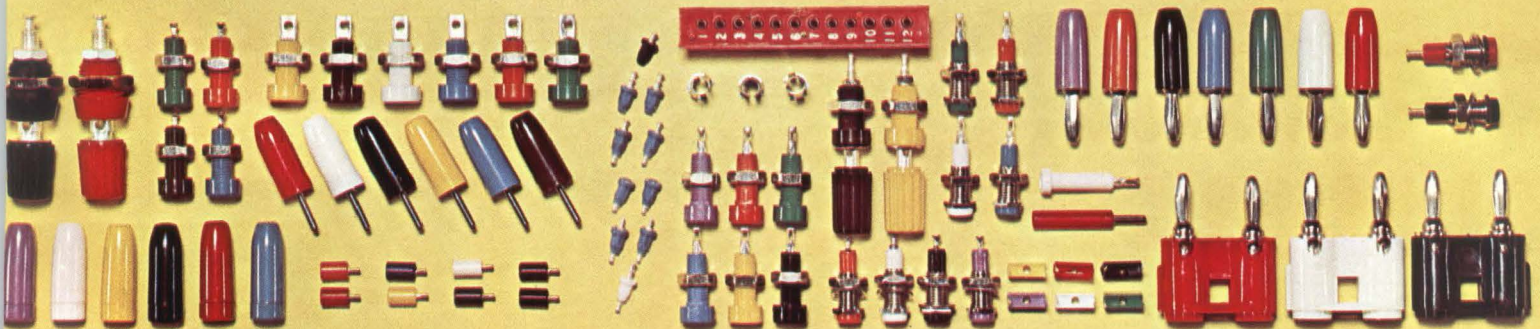

HERE'S A CONNECTOR FOR YOUR PROJECT, CONSTRUCTED OF TOUGH, LOW LOSS POLYAMIDE FOR RELIABLE PERFORMANCE UNDER ADVERSE CONDITIONS. TURN PAGE FOR DETAILS.

New PAR Lock-In Amplifier Measures Signals in the Presence of Noise by Crosscorrelation



Transistorized Lock-In Amplifier — Model HR-8

The PAR Model HR-8 Lock-In Amplifier represents a significant advance in signal processing equipment for experimentalists who must measure low-level signal intensities in the presence of noise. It employs the theoretically optimum technique for signal recovery, and can be incorporated into a large class of experiments in which the signal of interest is, or can be made periodic, and in which a reference voltage related in frequency and phase to the signal can be obtained. The Model HR-8 first amplifies and bandlimits the input signal and then crosscorrelates it with the reference signal, suitably phase shifted and shaped. The crosscorrelation of input and reference signals yields a DC output voltage proportional to the signal of interest, while the crosscorrelation of the reference and noise results in no net DC voltage. The system can also be described as a continuously integrating, highly sensitive, phase conscious voltmeter, the response of which is "locked" to that particular frequency and phase at which the signal information has been made to appear.

Technical Features:

Frequency Range: 1.5 cps to 150 KC continuously tunable in 5 ranges.

Time Constants: 11 values in 1-3 sequence extending from 0.001 to 100 seconds. Single or double section RC filtering.

Pre-Amplifiers: Interchangeable low-noise pre-amplifiers, operable either within the HR-8 or remotely, are used.

Type A: Differential 10 megohm input.

Type B: Low impedance transformer input for low source impedances.

Sensitivity: 21 calibrated full scale ranges in 1-2-5 sequence.

With Type A Pre-Amplifier: 100 nanovolts to 500 millivolts rms.

With Type B Pre-Amplifier: 1 nanovolt to 5 millivolts rms.

Output: ± 10 volts full scale, single-ended with respect to ground. Will drive galvanometric and servo recorders.

Frequency Selective Amplifiers: Notch network in negative feedback loop used in both signal and reference channel tuned amplifiers. Reference channel Q of 10. Signal channel Q adjustable from 5 to 25 with calibrated dial (no gain change with Q adjustment).

Phase Adjustment: Calibrated 360° phase shifter, providing continuous rotation as well as a four position quadrant switch which shifts phase in 90° increments.

Price: \$2,250 with either Type A or Type B Pre-Amplifier.

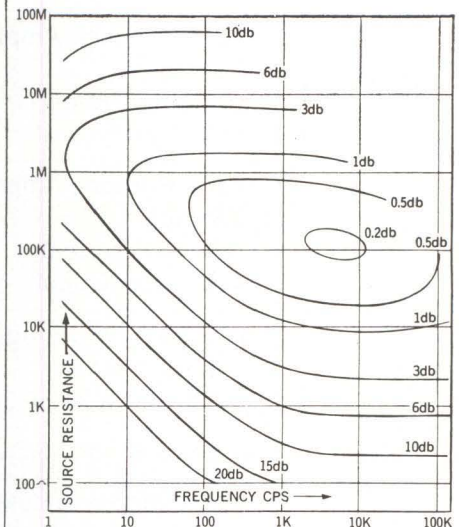

Contours of constant noise figure for a typical PAR Type A preamplifier plotted to show dependence on frequency and source resistance at 300° K. Amplifier operated single-ended.

Write for bulletin No. 120 on the HR-8 or ask for information on PAR's complete line of Lock-In Amplifiers and accessories.



If you have to choose either better NPN's or lower prices, choose both.

Fairchild NPN silicon transistors

Number	Application	h_{FE} @ I_C	V_{CE0} (Min.)	f_t MHz (Min.)	C_{OB} (Max.)	Price (1000-9999)
2N3563	UHF Amplifier/oscillator	20-200 8mA	12V	600	1.7pF	\$0.35
2N3564	Class-C RF Amplifier	20 15mA	15V	400	3.5pF	.40
2N3565	High gain, low noise amp.	150 1mA	25V	40	4.0pF	.28
2N3568	High voltage, high current amplifier and switch	40-120 150mA	60V	60	20.0pF	.32
2N3641	General Purpose Amplifier and Switch $t_{on} = 14\text{nsec}$ typical $t_{off} = 80\text{nsec}$ typical	40-120 150mA	30V	250	8.0pF	.41
2N3642	General Purpose Amplifier and Switch $t_{on} = 14\text{nsec}$ typical $t_{off} = 80\text{nsec}$ typical	40-120 150mA	45V	250	8.0pF	.45
2N3643	General Purpose Amplifier and Switch $t_{on} = 14\text{nsec}$ typical $t_{off} = 80\text{nsec}$ typical	100-300 150mA	30V	250	8.0pF	.43
2N3646	High Speed Saturated Switch $t_{on} = 18\text{nsec}$ max. $t_{off} = 28\text{nsec}$ max. @ 300mA	30-120 30mA	15V	350	5.0pF	.36
2N3690	Low noise RF-IF AGC Amp.	30 4mA	40V	400	1.6pF	.70
2N3694	High Frequency Amplifier	100-400 10mA	45V	200	3.5pF	.37
2N4275	High Speed, Saturated Switch $t_{on} = 12\text{nsec}$ max. $t_{off} = 12\text{nsec}$ max. @ 10mA	35-120 10mA	15V	400	4.0pF	.30
SE5020	Low Noise, RF-IF AGC Amplifier	20-200 4mA	20V	375	0.5pF (C_{re})	1.35*
SE6002	High Gain Amplifier	150-600 10mA	30V	40	25.0pF	.41*
SE7010	High Voltage, Video Amp.	30-300 25mA	150V	40	3.5pF	2.00*
SE8010	High Voltage Amplifier	40-150 100mA	60V	300	9.0pF	1.05*

(an * indicates 100-999 prices)



Probing the News

Integrated circuits

IC's heed Bell System's busy signal

Matchmaking has produced silicon-tantalum integrated circuits with a great future in every area of telephone communications

The Bell System is betting that integrated circuits will be key elements in the reliable, high-performance equipment it needs for the future. The initial trickle in what promises to be a flood of applications includes a tone generator for phone handsets, logic circuits for digital transmission systems, amplifiers for microwave relay networks and gear for electronic switching.

Several thousand tone generator circuits will be made next year at the Western Electric Co.'s Allentown, Pa. works. They will be installed in Touch-Tone Trimline telephones which have pushbuttons instead of a dial. Western Electric is the manufacturing arm of the Bell System. The ic's already slated for other equipment are, as a Bell man puts it: "in various stages of dress and undress, undergoing field trials that will determine their systems use." Several are in pilot production.

The mass debut of ic's in phone equipment was delayed by Bell's need for ultradependability in components. The go-ahead came when engineers at Bell Laboratories, Inc., a subsidiary of the American Telephone & Telegraph Co., succeeded in packaging two complementary materials—silicon and tantalum—to produce long-lived ic's.

A batch process, which combines beam-lead technology and a silicon nitride seal, makes it possible to encapsulate silicon devices—ic's or discrete transistors [Electronics, Nov. 14, 1966, p. 45]. Thousands of

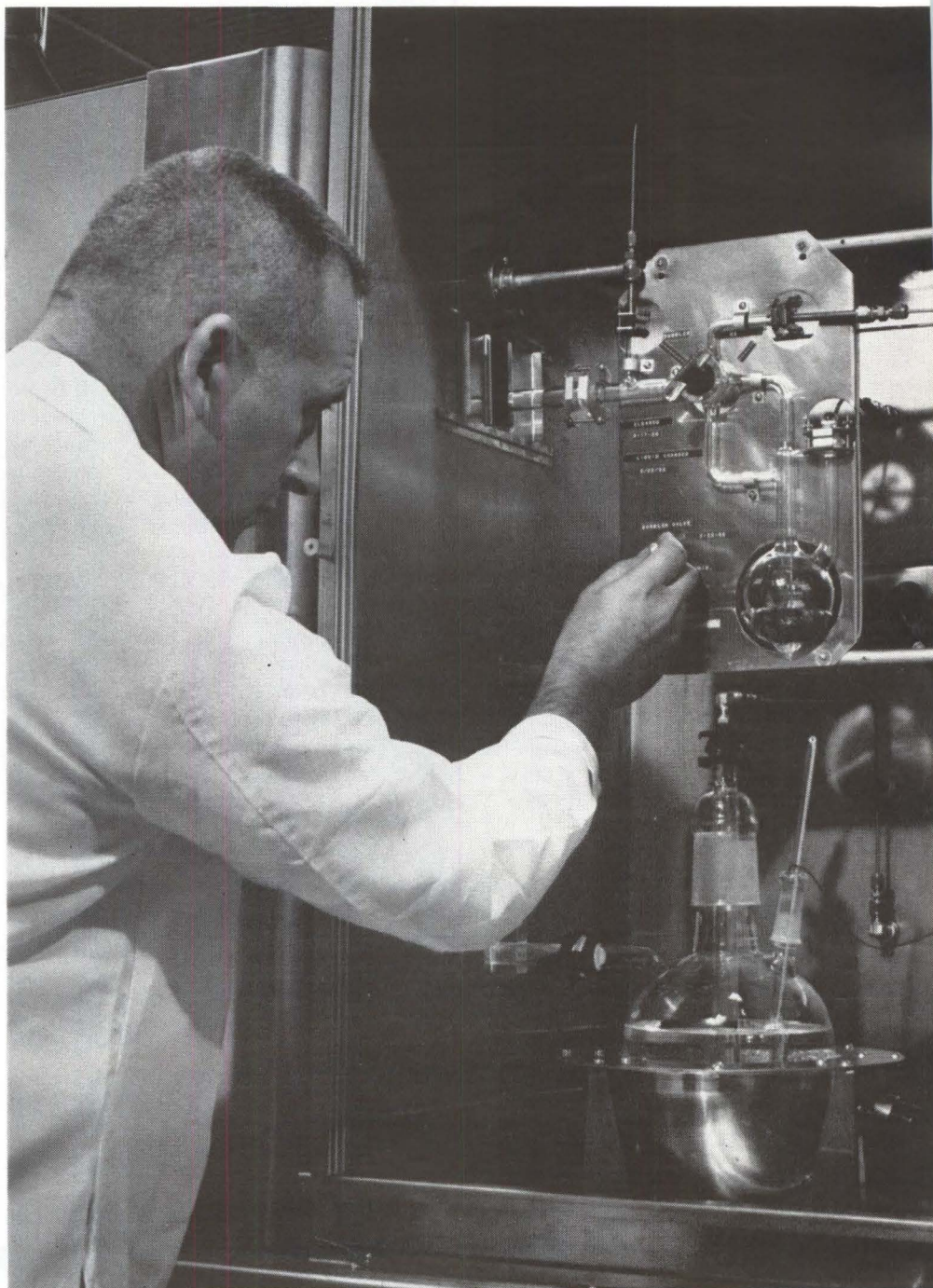

Bell System scientist checks reactive elements used to produce resistors and transistor bases on the silicon slice.

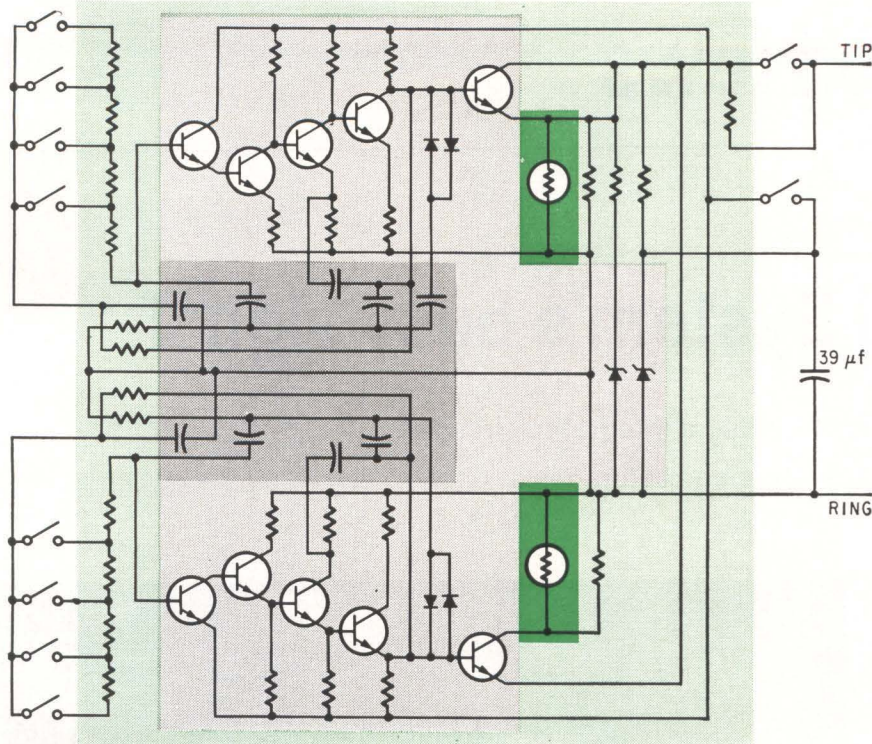

Tone generator for the Bell System's new phone has 26 components in a silicon chip 1/16-inch square.

devices, still on a single silicon slice, are sealed at one time. The process eliminates the need for costly airtight cans and provides a protective barrier against sodium and other injurious metallic ions. Devices sealed with the new method have already exhibited longer life under accelerated aging tests than comparable hermetically sealed assemblies.

Another big advantage of the beam-lead silicon IC is that it can be readily bonded to Bell's mass produced tantalum thin film substrates. Silicon is used for the active devices and tantalum offers precise, stable resistive and capacitive values. Both are essential to Bell's circuit requirements.

I. The right tone

The tone generator—significantly smaller, lighter and more reliable than its conventional inductor-capacitor predecessor—can be tuned after assembly.

The technology of the new unit is indebted to an old idea: an oscillator without inductors. The device has two switchable resistor-capacitor oscillators which generate a series of tones in prescribed pairs—one pair for each "dialed" digit. There is a total of seven tones, which are split four-three between the two oscillators.

The feedback loop in each amplifier of the assembly includes a notch, or twin-T, filter to control the oscillating frequency. The pair of tones is coupled to a telephone line by buffer amplifier stages in the silicon IC. The pressing of a digit button selects the corresponding frequency pair by switching a single resistor in each twin-T network. Tone frequencies can be switched with negligible effect on output level.

Tantalum thin film resistors and capacitors on separate substrates are connected by gold-tape leads to form the passive network that controls calling frequencies. The 26 active components are in a single silicon chip about 1/16-inch square. The complete tone generator assembly measures 1/2-inch by about 3/4-inch.

Since it is costly to make capacitors with tolerances smaller than $\pm 5\%$, the frequency-controlling resistors are designed 5% below the required nominal value. Although the tone frequency of the untrimmed oscillator can be as much as 10% above the desirable level, Bell Labs ingeniously adjusts the frequency downward by "trimming" resistance.

Trimming. When a tantalum film is given a positive charge with respect to another electrode and both

are immersed in an electrolyte, an electron current flows in the external circuit and ions flow in the electrolyte. The reaction at the anode changes tantalum into tantalum pentoxide by an amount that is directly proportional to the charge between the two electrodes. The voltage required to maintain a prescribed constant current is proportional to the total charge that has passed. Both the film thickness and the cell voltage are thus proportional to the total charge. This voltage dependence can be used to control dielectric film thickness precisely.

The thickness of the metal is reduced uniformly and replaced by the insulator tantalum oxide. Resistance values can be monitored during the trimming process, which is stopped when the proper level has been reached. Engineers at Western Electric's Allentown facility have automated the whole operation.

Busy line. In tuning the circuit, the notch's transmission attenuation is first measured by feeding the output of an oscillator into the twin network and adjusting the frequency until the network output is 180° out of phase with its input. The attenuation is measured again and high or low values are compensated by adjusting resistance in the circuit.

At this point, the beam-lead semiconductor chip is bonded to the substrate, and the two oscillators are tuned separately. Each is tuned by measuring only one input frequency, calculating its ratio to the design value and then increasing all resistors by that ratio. If the desired frequency is 941 hertz and the measured frequency 988 hz, each of the resistors is raised 5%. The remaining frequencies are attained by adjustment of the resistances associated with the other tones in inverse proportion to each design tone.

II. Digital system IC's

While the tone generator for handsets is the first application of IC's in operating telephone equipment, it represents only the tip of the iceberg. Digital data transmission systems, which send voice, data and television in a stream of digital pulses, are an intriguing possibility. Recently The Bell Labora-

tories Record, a company publication, discussed a variety of applications for the new circuit and the Bell system is being reengineered to take advantage of ic's.

Bell Labs is currently developing ic's for the T2, a medium speed system which uses pulse code modulation. Though many T2 components—transformers, inductors and large capacitors—cannot be miniaturized, ic's will cut costs. The logic portions of the T2 channel bank, which samples and codes analog signals into digital pulses, use ic's as does the multiplex unit, which combines channel groups into a 6.3-megabit pulse stream for cable transmission. Temperature matching is less difficult with thin film resistors since the ratios of values on a substrate remain essentially constant regardless of changes in environment. Thus, for such precision applications as pcm coders and decoders, thin film components are more accurate and cheaper than conventional resistors.

Two ic's, designed around combinations of the same logic gate, are used to gate, shift and store pulses in the T2 system. One consists of a pair of gates fabricated on a 45-by 45-mil silicon chip. The other assembly has six gates interconnected as a flip-flop on a 62-by 62-mil silicon chip. Upcoming versions will incorporate the latest beam-lead silicon nitride combinations.

Formed on only seven electrically isolated semiconductor areas, the dual logic gate contains 12 resistors, 22 diodes, and 6 transistors. Comparatively cheap and flexible, it will be used extensively by Bell.

Work is under way on additional types of ic's, including versions suitable for digital repeaters. The size of repeaters can be critical since they are often installed in manholes where there's not much extra space. And Bell is considering designs that would use more semiconductor circuits, thereby eliminating components that cannot be integrated.

Answering service. The most complex ic that Bell has developed is a reversible binary counter circuit for an as yet unnamed vestigial sideband data set still in the works. This system is, in effect, an answering service for computers. Units are typically installed at the terminals of data processing equipment to

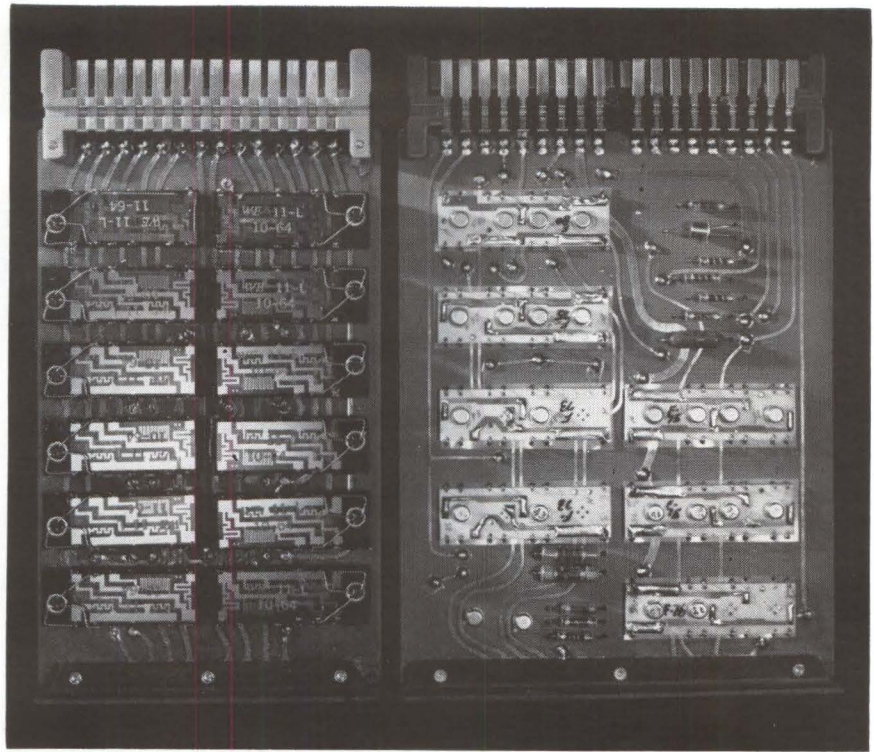

Circuit pack on the left, used in Bell's ESS, has 22 TRL gates plus other circuitry; it replaces the unit on right which contains only 12 gates.

convert digital data into analog signals for transmission over telephone lines. At the receiving end, a data set converts the analog signals back into digital pulses that can be fed into data processing equipment, printed out or put on punch cards.

The reversible counter, integrated on one chip 1.2 mil on a side, counts to 8,191 in 13 stages.

The basic building block used in Bell's first operational electronic switching system is the transistor resistor logic (TRL) gate. Complex logic functions are built up by interconnecting combinations of these gates, using hybrid thin film techniques on ceramic substrates. Since certain circuit combinations occur so frequently in the No. 101 ESS, it makes sense to build several gates along with their interconnections on a single substrate as a complete function. So far, there are 26 functional combinations, or codes, of logic gates in the No. 101 ESS devices. Engineers are now wrestling with the problem of getting the most mileage from the silicon ic techniques at their disposal.

The electronic switching system outperforms conventional electromechanical gear. In a complete configuration, customer switching units are connected by trunk lines and data links to a central control processor. Time-division switching of

transmission paths at each switching unit permits the system to be shared economically by from 200 to 3,000 telephone subscribers.

At microwave frequencies, which extend from about 1 to 30 gigahertz, the performance of conventional circuits is limited by such parasitics as stray capacitance and lead inductance. Bell Labs engineers believe ic's offer a solution to these problems. They have begun with two preamplifier circuits. One three-stage unit operating from 3.5 to 4.5 GHz is being evaluated for Bell's TD-2 radio relay system. The other, for the 1- to 2-GHz range is a five-stage assembly that might be used in military phased array receivers.

Both microwave ic's have a relatively large substrate for thick and thin film passive elements. The active components are interconnected at noncritical circuit points. The amplifiers are still using encapsulated transistors but beam-lead devices will probably replace them.

The union of active silicon with passive tantalum is already a great success—electronically, metallurgically and geometrically. In the years ahead, more and more transmission, switching, power and station equipment will incorporate ic's. The stakes are high but so is the eventual payoff.

An uncommon market

In West Germany, a young consultant has built a thriving brokerage business in second-hand electronic data processing systems

By John Gosch

Electronics Bonn Bureau

As more powerful new computers are sold, increasing numbers of older systems, many of which have been in service no more than two or three years, are again going on the market. Early this year, an enterprising young West German computer consultant named Peter Lohse noticed there were no middlemen to move these still useful machines to European customers. He stepped quickly into the breach and now owns—with two associates and the German-Atlantic Telegraph Co.—Computer GmbH, the Continent's first used-computer sales company.

Business has boomed since the fledgling venture set up shop near Dusseldorf last March. Lohse, who is the firm's business manager, reports that 10-month volume on the 100 systems the company handled topped \$125,000. He expects revenues of \$500,000 by the end of the first full year and perhaps \$1.25 million by the end of the second.

Computer GmbH's market includes research institutions and small- or medium-sized firms that can't afford the going rates for new machines. Other prospects include companies that either want to enlarge their present systems or have tasks for which sophisticated equipment would be overqualified.

Computer GmbH buys, reconditions and sells used computers for its own account. Its other principal interest is in brokerage. The company periodically queries computer manufacturers on the status of their trade-in inventories and checks this information against its file of prospects. When a match is uncovered, Computer GmbH acts as go-between. It provides an identical service for systems owners interested in selling.

Computer GmbH will arrange

time payment plans for purchasers. For this and other services, the company collects a commission of 10% to 20% of the sales price. This cost is generally shared by the buyer and seller.

Stock in trade. Lohse claims he can lay his hands on just about any kind of computer a customer might want. The firm's list of about 30 available systems includes equipment from the International Business Machines Corp., the Univac division of the Sperry Rand Corp., Machines Bull; and Control Data Corp. About 75% of the supply on hand is IBM gear.

Depending on their age and condition, the cost of second-hand systems can be anywhere from 10% to 50% of the original list price. Some used systems that are still, or have until recently been, in production are priced at less than 50% of their original value.

Computer GmbH is reluctant to get into the leasing business. "If we were to rent, we'd get into trouble with the manufacturers," Lohse

says. "It's vital that we stay on friendly terms since we need their support." After some lengthy negotiations, computer makers have agreed to service and guarantee whichever of their systems Lohse sells. They also supply software, handbooks, parts and training.

Branching out. Computer GmbH has fanned out all over West Germany and is planning to expand into Switzerland and Austria. Next on the agenda is Eastern Europe. Lohse is already negotiating equipment sales in East Germany, Czechoslovakia, Hungary, Rumania, Yugoslavia and the Soviet Union. The first transactions are expected within a few months. Lohse believes that eventually about one-quarter of the firm's business will be with the Eastern bloc. He is, however, walking softly past the problem of embargos and other trade restrictions in this area.

Buying, selling and brokerage are not the whole of the Computer GmbH story. The firm operates a computer service bureau to advise clients as far afield as Japan about systems applications and selection. In addition, it publishes a newsletter which comments on various aspects of worldwide computer markets.

Lohse, now 37, is something of a Teutonic Diebold. A graduate engineer, he got his start in the data processing field with IBM in 1957 when the company began production in West Germany. In 1961, Lohse moved on to the German subsidiary of Britain's International Computers and Tabulators Ltd. where he was a key marketing executive. Lohse felt secure enough to strike out on his own in 1963 and set up the service bureau that is still an important part of Computer GmbH.



Peter Lohse, business manager of Computer GmbH.

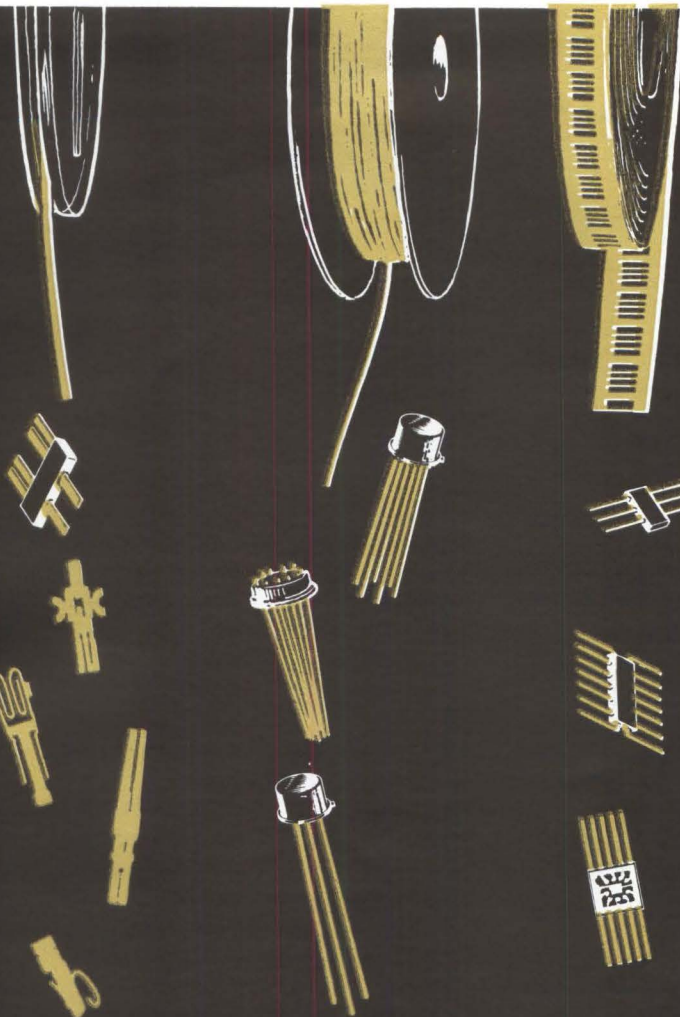

Many parts can be plated better, faster,
and more economically with
**BURTON'S NEW CONTINUOUS
PRECIOUS METAL PLATING PROCESS**

Burton's new CONTINUOUS precious metal plating process normally reduces cost of precious metal substantially by putting the plating only where you want it. In addition, some parts can be plated and manufactured ready for your use (see inset)!

If you use precious metal plated parts of any kind this outstanding advancement in plating techniques may save you time

and money while greatly improving quality. Why not find out about it? We'd be glad to send you complete information.

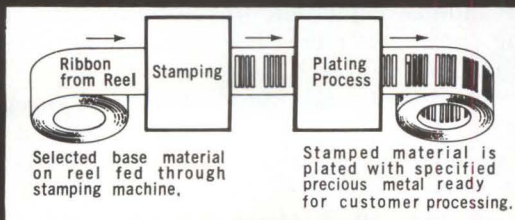

BURTON RESEARCH LABORATORIES, INC.
11240 PLAYA / CULVER CITY, CALIFORNIA / (213) 391-6325
A Division of Burton Silver Plating Company

New wave of gear for boatmen

More companies will unveil very high frequency, single sideband and radar sets for small craft at National Boat Show in New York

By William Olcott

Staff writer

A modest boom is shaping up in three areas for electronics concerns serving the pleasure-boat market. The National Boat Show, which opens in New York City Jan. 11, will feature a raft of new entries in vhf-fm radio-telephones, small radar, and long-range communications equipment using single sideband techniques.

At present the electronics market for pleasure craft amounts to \$25 million a year and it's growing at an annual rate of 18% to 20%—far faster than the current 6% to 7% annual increase in pleasure-boat sales—according to Walter P. Rhea, chairman of the instruments and electronics division of the National Association of Engine and Boat Manufacturers, Inc.

Rhea estimates that radio-telephones represent 60% of the marine electronics market for small craft. The balance is accounted for by depth sounders, radio direction finders, radar, loran and gas-fume detectors.

The number of seagoing radio-telephones has spurted during the past decade. By July 1956, the Federal Communications Commission had issued 50,952 radio-telephone licenses; by September 1966, the total had jumped to 134,504. The FCC data includes both commercial as well as pleasure boats, but the figures do suggest the speed at which this sector of the marine market is expanding.

I. The crowded sea

Unfortunately, the very popularity of radio-telephones has caused increasing congestion in the 2- and 3-megahertz bands. Boatmen complain of having to wait as long as two hours to place their calls.

Attempting to unsnarl this traffic

jam, the FCC made the 18-channel very high frequency, frequency-modulated band available to pleasure boaters on Oct. 1, 1962. The equipment involved appeared to be a natural for pleasure craft. Free of static and crosstalk, vhf requires no ground plate under the hull and can use a small antenna. Its range, though short, was deemed sufficient for boats cruising within 30 miles of shore.

The FCC's interest wasn't wholly disinterested. A general switch to vhf would reduce long-range interference and give the agency a wider frequency spectrum to work with. But despite Government encouragement, boatmen continued to ignore vhf.

However, in 1965 the trend to vhf picked up some needed steam. The Coast Guard provided an added incentive by setting up a distress frequency in the higher band. As a further inducement, the Environmental Science Services Administration of the Commerce Department offered continuous weather information on 162.5 Mhz. It plans to build 15 weather stations in addition to the one already operating in New York City. Facilities in Boston and Washington, D.C., are expected to be on the air by Jan. 1 and another eight will be broadcasting next summer. The network of stations will eventually cover the East, Gulf and West Coasts.

Lack of an adequate number of marine operators has slowed the acceptance of vhf. In a classic bureaucratic impasse, the FCC wouldn't license vhf operators without proof of demand, and the boating public wouldn't buy equipment until the agency provided for more operators. Now, however, this pic-

ture is changing. By mid-1965, there were 45 vhf marine operators. The total increased to 55 during 1966 and will probably hit 83 by the end of 1967.

No action. There was, says one manufacturer, more interest in than sales of vhf radio-telephones during 1966, but there are indications that this will no longer be the case. At last year's boat show only two companies—Kaar Electronics Corp. and Konigsberg Electronics, Inc.—displayed vhf sets. They will be joined at the upcoming show by five more companies: Ray Jefferson, Inc.; Simpson Electronics; Pearce-Simpson, Inc.; Sonar Radio Corp., and Raytheon Co.

Rhea has a word of assurance for mariners who fear vhf will render their a-m equipment obsolete. "The limited range of vhf indicates it is not a panacea for all spectrum problems," he says. Pleasure boatmen who want long-range communications won't have to run out and replace their conventional a-m equipment.

II. One way to go

This is where single sideband comes in. It greatly enhances long-range communications capacity, and owners of large pleasure craft—50 feet and up—are now investigating the potential of this interesting technique. Commercial vessels have, of course, long used ssb gear.

Although an a-m radio wave on an oscilloscope appears to be a single line, it actually has three parts—a central carrier generated at a specific frequency and two sidebands. When the carrier is modulated, the two sidebands bear identical intelligence. But with ssb techniques, the central carrier and one redundant sideband are filtered

**DO YOU
HAVE A
PARTICULAR
TORQUE
MOTOR
REQUIREMENT?**

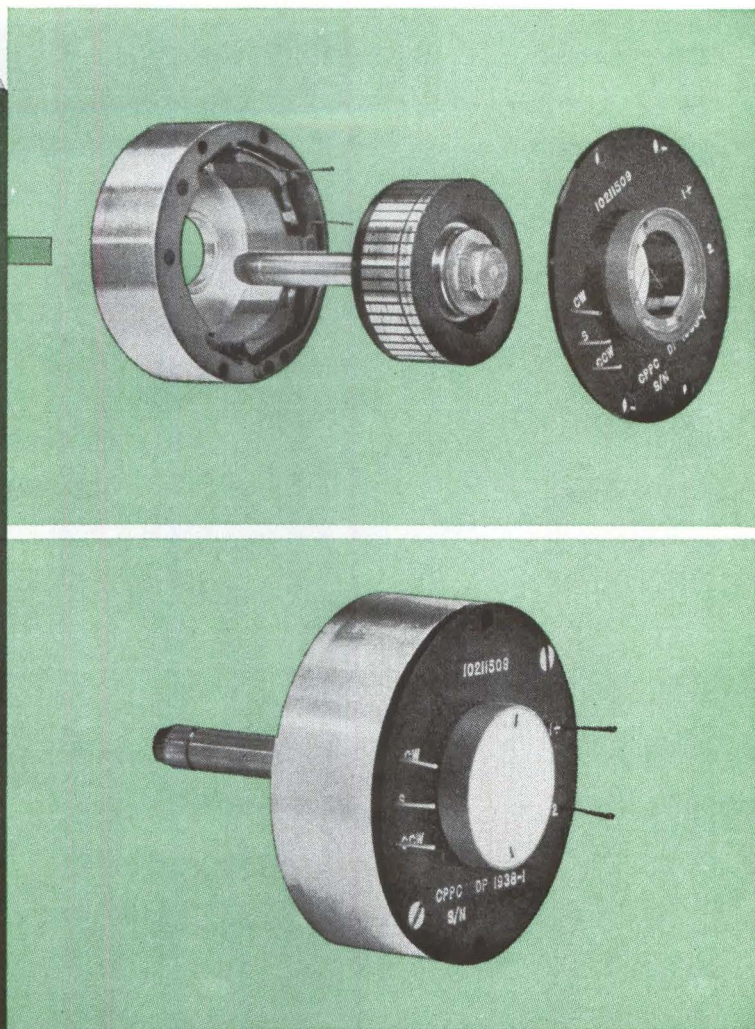

Infantryman with Redeye in launcher.



Infrared sensor locks on target. Miniature computer directs steering fins to guide Redeye.

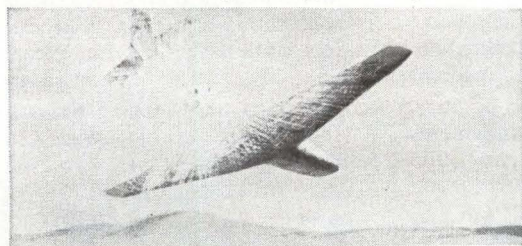

Redeye, traveling at supersonic speed, finds its target.

***Clifton designed this Torque
Motor-Potentiometer especially
for Redeye***

Clifton's deep experience with the "pancake" configuration gained from our leadership in gyro pickoff synchros and resolvers qualifies us to solve special problems in the torquer field.

A good example of our competence is this custom designed torque motor-potentiometer combination designed especially for Redeye. The torque generated meets the full demands of the missile spec. The packaging of the pot on the back shows the advantage of using a vendor who can supply imaginative design and a wide range of capabilities.

Call Clifton for your special needs in torquers. Area 215 MA 2-1000.



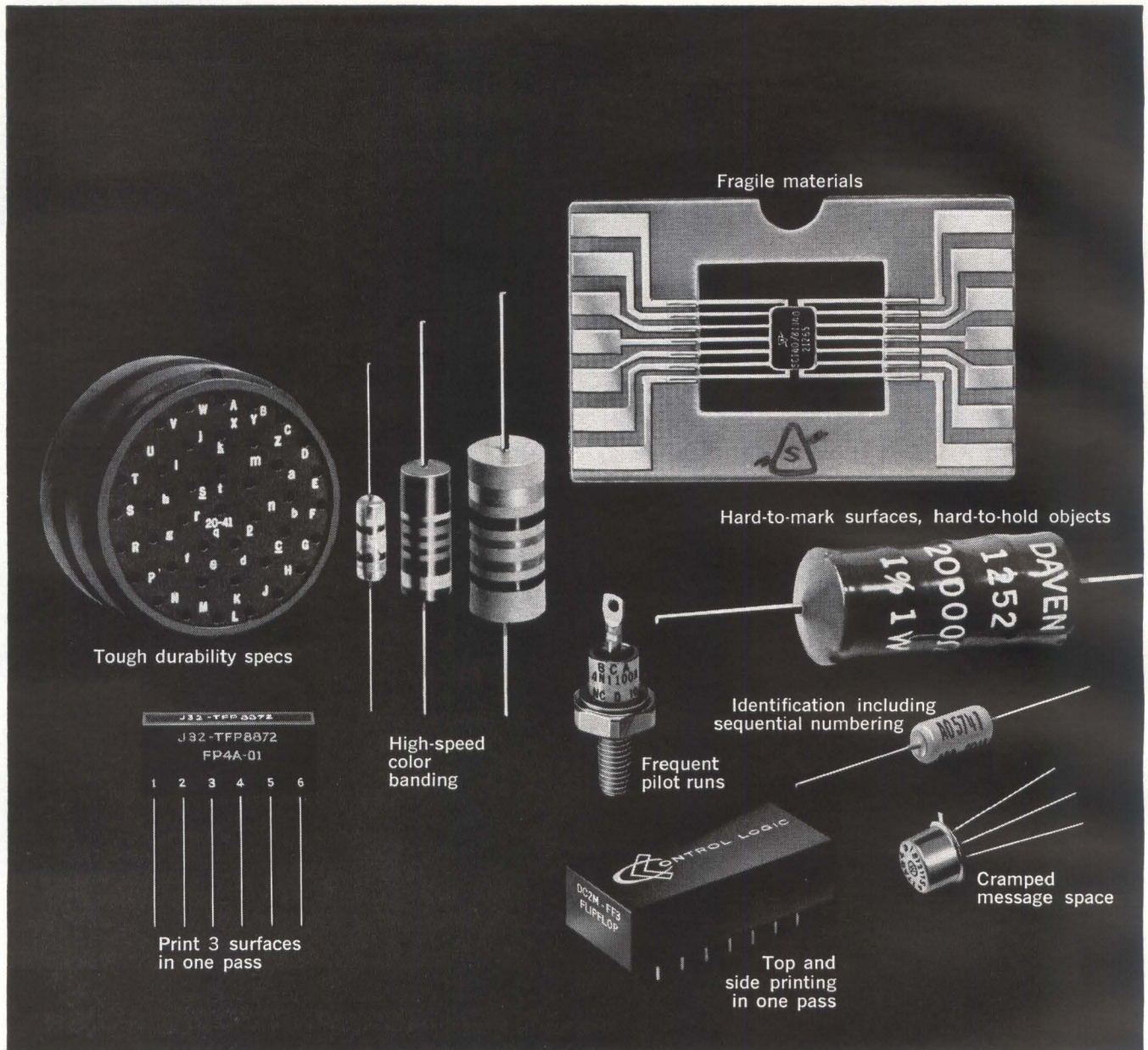

What marking job can we help you do better?

These are only a few of hundreds of marking jobs you can do more efficiently and more economically with Markem machines. So why waste time improvising and experimenting?

Call in a Markem man and get acquainted with today's broadest line of marking equipment. New high-speed color banding machines — some capable of putting three tiny bands on a miniature diode. Machines that combine sequential numbering with identification. Type so small you can print 14 characters plus trademark in an 0.125" diameter area. Quick-change type for short or pilot runs. New techniques combining special ink with flash-curing to help you meet severe durability specs. A production-speed imprinter so gentle you can safely mark flat pack ceramic components. And many other machines, specialty inks and printing elements. Right now our research engineers and chemists are working on even better ways to mark components. We'd like to be working with you. Markem Machine Company, 305 Congress St., Keene, N.H.

MARKEM[®]
HELPING YOUR PRODUCT SPEAK FOR ITSELF

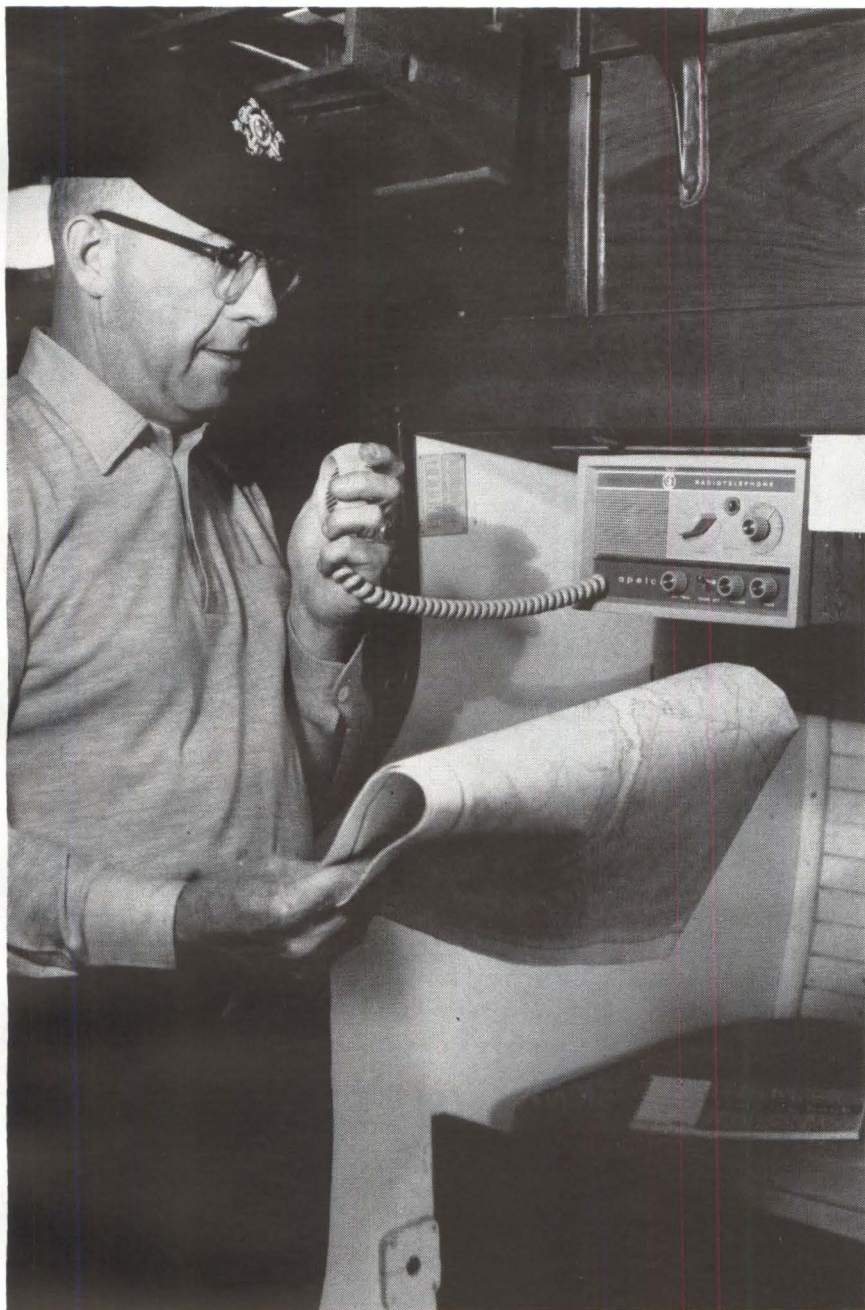

Single sideband radio-telephones are catching on in the marine electronics market. The Apelco Co., which made this unit, is one of four firms that will display ssb equipment at the upcoming National Boat Show in New York City.

out and messages are transmitted on the remaining sideband. As only one-quarter as much power is required to send a signal with this method, the same amount of power required for a full a-m band will send an ssb message four times as far with greater clarity. In addition, the signal requires far less frequency space.

Big money. Despite technical advantages, there are price drawbacks. An ssb radio-telephone costs \$2,000 to \$3,000, while a vhf set retails for about \$600 and an a-m model for \$200 to \$300. But as the consumer demand for better

long-range marine communications equipment increases, the cost of ssb gear should come down.

The FCC has lent a hand in this area as well as in the vhf field. The commission has ruled that as of Jan. 1, 1974, all marine radio-telephones operating above 4 Mhz must switch to ssb transmission. This won't affect the majority of pleasure boatmen, whose equipment operates in the 2- and 3-Mhz bands, but an FCC spokesman says the Government is considering a shift of all radio-telephones in the 2- and 3-Mhz bands to ssb. He says the United States is expected

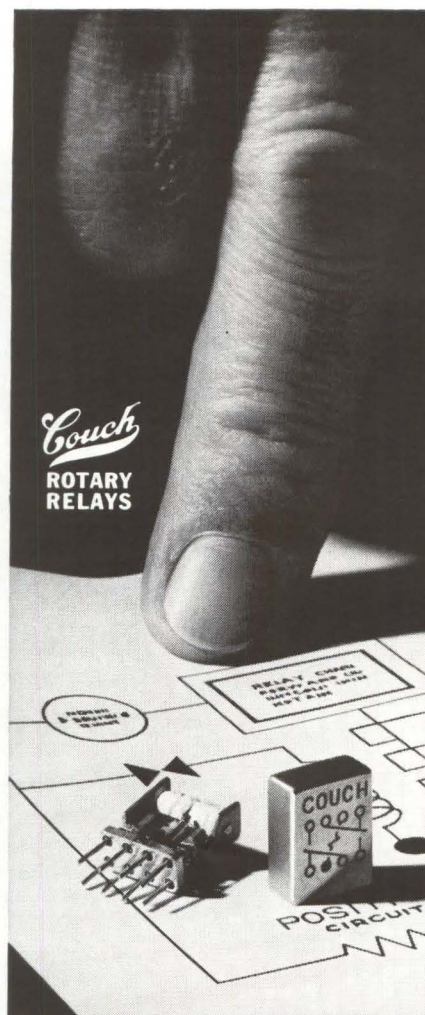

Cramped for space?

Use Couch 1/7-size Relays

Space/weight problem? The new Couch 2X 1/7-size crystal can relay gives you tremendous savings in space and weight. 0.1" grid — plus many outstanding specs — *all in micro-miniature*. Thoroughly field-proven in electronics and space applications.

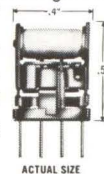

	2X (DPDT)	1X (SPDT)
Size	0.2" x 0.4" x 0.5"	same
Contacts	0.5 amp @ 30 VDC	same
Coil Operating Power	100 mw 150 mw	70 mw 100 mw
Coil Resistance	60 to 4000 ohms	125 to 4000 ohms
Temperature	-65°C to 125°C	same
Vibration	20 G	same
Shock	75 G	same

Broad choice of terminals, coil resistances, mounting styles. Write for detailed data sheets.

RUGGED ROTARY RELAYS  Dynamically and Statically Balanced

COUCH ORDNANCE INC.

3 Arlington St., North Quincy, Mass. 02171, Area Code 617, CYpress 8-4147 • A subsidiary of S. H. COUCH COMPANY, INC.



Quik/Sert SOCKETS

from BARNES...

THE MOST ADVANCED LINE OF SOCKETS FOR SEMICONDUCTOR AND OTHER MINIATURE DEVICES

- for production, test, aging, and breadboarding applications
- for flat pack and multi-lead TO-5 packaged I.C. s, transistors, relays and other miniature components
- for mounting on P.C. boards, chassis, breadboards, or use with mating base connectors
- for hard wiring, dip soldering, wire wrap, welding, tab or pin base mounting, compression fitting, or saddle mounting
- flat pack carriers and contactors, flip-top sockets for flat packs, module test connectors, and breadboard test connectors

Choose from over 3,000 standard sizes, configurations and materials. And Barnes can quickly produce custom sockets to meet any requirement. Call or write for complete technical data.

barnes
DEVELOPMENT COMPANY

LANSDOWNE PA 19050 ■ (215) MA 2-1525

to present a preliminary proposal to this effect at the World Administrative Radio Conference for Maritime-Mobile Services next October.

The show on the road. At the last boat show, only RF Communications, Inc., offered an FCC-approved ssb radio-telephone. This time, however, three more companies—Kaar, Raytheon and Apelco Co.—will show ssb wares. All four units can pick up a-m and compatible a-m signals.

Rhea predicts that the ssb market will expand as boatmen become more conscious of the need for safety items in both communications and navigation. Another observer agrees: "The market consists, for the most part, of inexperienced sailors—Sunday skippers with purchasing power—who can buy the electronics devices to make them expert."

III. Radar for small craft

The availability of small radar units for pleasure boats represents a step in this direction. Decca Radar, Inc., and Kaar will both introduce such equipment at the upcoming show. Other companies—the Bendix Corp. and Raytheon, for example—have offered small units in the past, but Rhea notes that their gear used vacuum tubes and drew more than 450 watts from a boat's power supply.

Decca's small transistorized radar, which sells for \$2,600, draws only 165 watts and has a range from 25 yards to 15 miles. The design of its antenna assembly, which incorporates scanner, gearbox and transceiver, eliminates the need for waveguide or coaxial cable lines to below-deck units. The antenna rotates at 36 revolutions per minute and puts a clear picture on the 6-inch display scope. The frequency of the 3-kilowatt transmitter is 9.440 gigahertz in the X band.

Kaar's radar is priced at \$2,850 and has a range from 35 yards to 16 miles. Completely transistorized except for the thyratron and magnetron, it contains a transceiver, antenna and 10-inch display scope. The frequency of the 6-kilowatt transmitter is 9.375 Ghz in the X band, and the power drain at 12 volts is only 156 watts because transistors are used instead of a rotary converter.

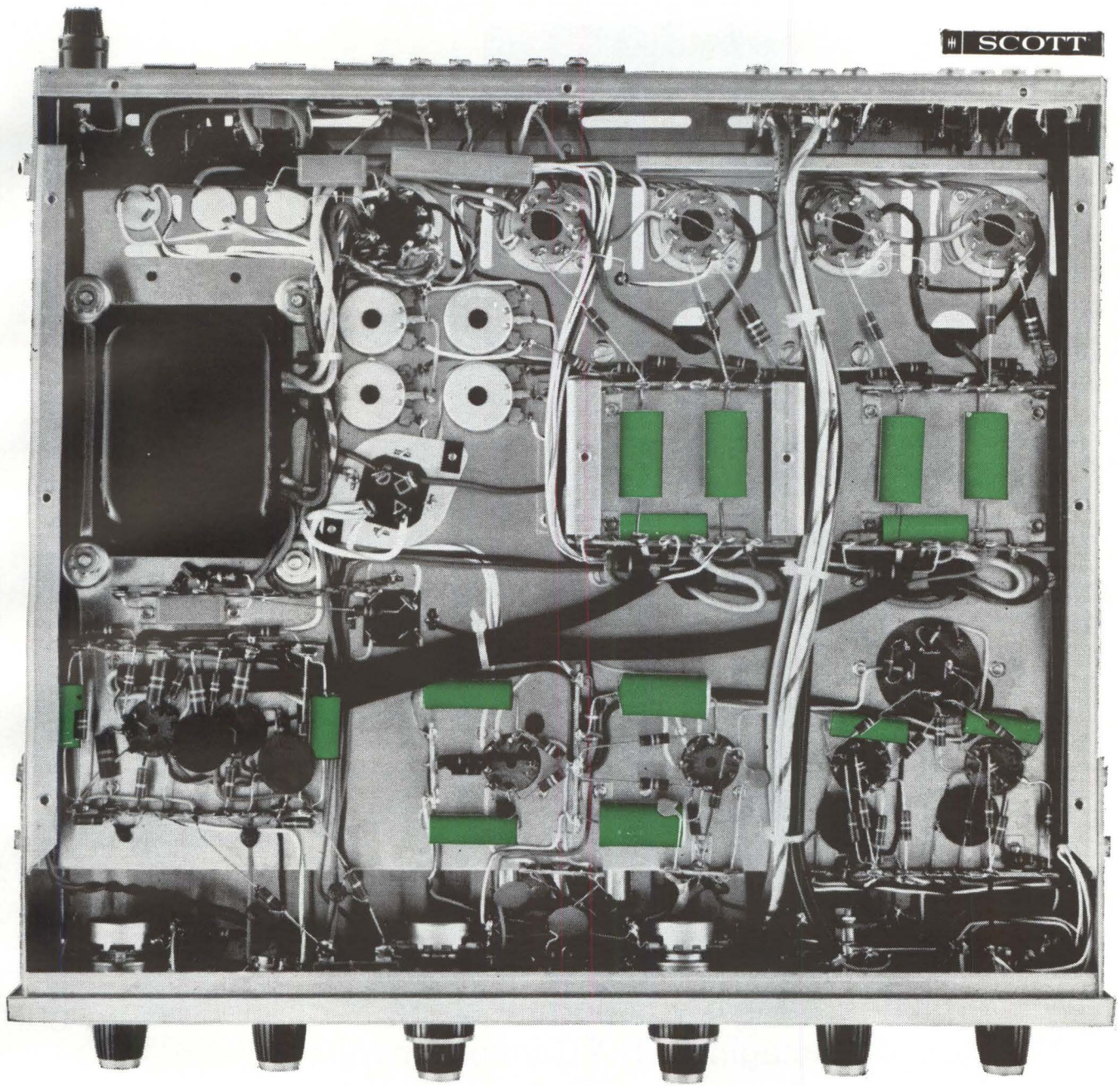

Capacitor reliability? Take Scott's word for it: MYLAR®

H. H. Scott manufactures some of the world's most widely used stereo amplifiers. They are recommended by many leading independent testing organizations. Because this kind of reputation depends on capacitor reliability, engineers at Scott use capacitors of MYLAR* exclusively for audio circuits from .047 to .47 microfarads:

"We don't have to worry about performance with capacitors of MYLAR in our components and consoles," says Chief Engineer Dan von Recklinghausen. "We use capacitors of MYLAR because of their low leakage, extremely long life, excellent capacitance stability and ability to withstand the wide temperature and humidity

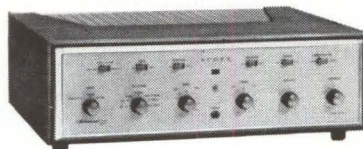

ranges encountered in high-power hi-fi amplifiers." MYLAR also offers high dielectric strength in thin gauges, so capacitors can be made smaller, leaving space for more circuitry. And, in many cases, capacitors of MYLAR cost less than paper.

Scott components and consoles are known for excellence in quality, performance and reliability. So are capacitors of MYLAR. For complete information write DuPont Co., Room 3370A, Wilmington, Delaware 19898. (In Canada, write DuPont of Canada Ltd., P.O. Box 660, Montreal 3, Quebec.)



*DUPONT'S REGISTERED TRADEMARK FOR ITS POLYESTER FILM.

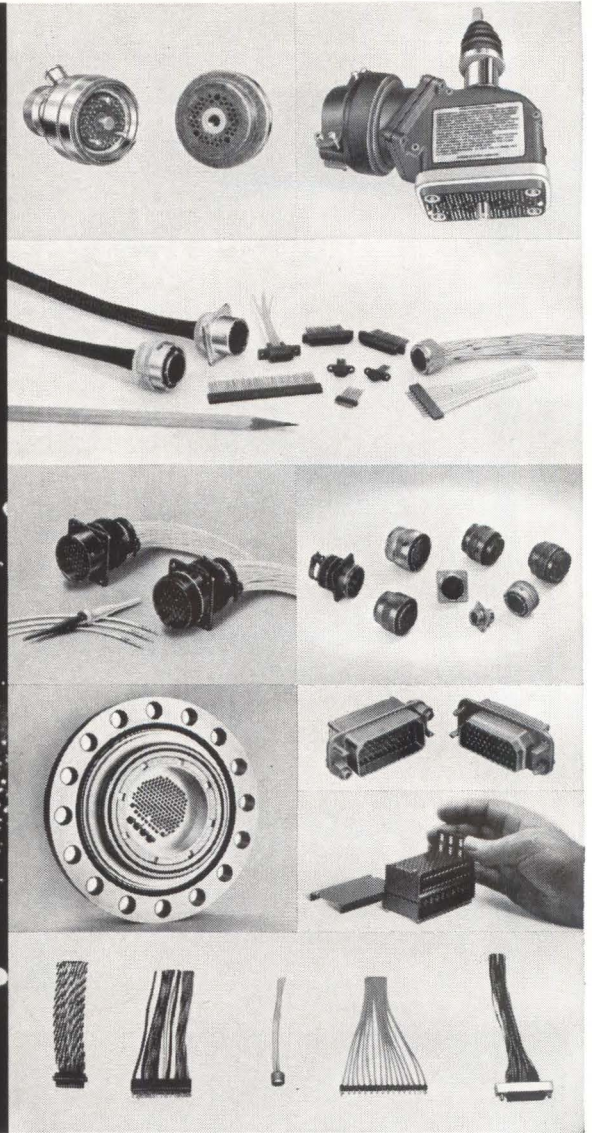

We've pioneered every important stage in connector design. What you can imagine...ITT Cannon provides.

Imaginative engineering that's unmatched in the industry distinguishes ITT Cannon connectors as the standard for reliability in space vehicles, ground support equipment, or any application where highly engineered connectors are paramount requirements.

Backed by a rigorous reliability program, including identification and traceability when required, ITT Cannon offers the widest selection of connectors available

— for every application and environment — microminiature, subminiature, miniature, and standard to solve every conceivable connector problem such as hermetic sealing, heat, radiation, shock, vibration, non-outgassing.

ITT Cannon is also the foremost supplier of special, highly engineered connectors for missiles and space vehicles, including breakaway-umbilicals, interstage disconnects, harnesses,

and associated equipment. If you have a special requirement, contact ITT Cannon, the world's most experienced and imaginative manufacturer of electrical connectors.

Write for our "Connector Selection Guide." ITT Cannon Electric, 3208 Humboldt Street, Los Angeles, California 90031. A division of International Telephone and Telegraph



CANNON ITT

No other RF transistors can offer this performance at these prices!

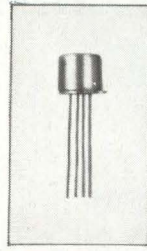

ACTUAL SIZE

RCA Type	2N4259	2N3933	2N3932	2N3478
Min. Power Gain @ 450 MHz	11.5 dB	—	—	—
Max. NF @ 450 MHz	5 dB	—	—	—
Min. Power Gain @ 200 MHz	—	14 dB	11.5 dB	11.5 dB
Max. NF @ 200 MHz	—	4.0 dB	4.5 dB	4.5 dB
NF @ 60 MHz	—	3 dB max.	2.5 dB typ.	2.5 dB typ.
Max. C_{cb}	0.55 pF	0.55 pF	0.55 pF	0.70 pF
h_{FE}	60-250	60-200	40-150	25-150
Min. BV_{CEO}	30	30	20	15
P_T @ 25°C Ambient	200 mW	200 mW	200 mW	200 mW
Price*	\$1.60	\$1.40	\$1.25	\$1.15

*In quantities of 1,000 and up.

RCA covers the communications spectrum from 27 MHz to 500 MHz. Every type available for immediate delivery in production quantities. These silicon epitaxial planar transistors for VHF and UHF communications are packaged in hermetically sealed 4-lead metal cases. Check the noise figure and the power gain... then check the price! You get top performance, top value, and immediate

delivery in production quantities—a unique combination that no other commercially-available RF transistor can offer! For complete information, pricing, and delivery, call your RCA Field Representative. For technical data sheet, write: RCA Commercial Engineering, Section EN12-4, Harrison, N. J. 07029.

SEE YOUR RCA DISTRIBUTOR FOR HIS PRICE AND DELIVERY

RCA ELECTRONIC COMPONENTS AND DEVICES



The Most Trusted Name in Electronics

Circle 123 on reader service card

INTERLOCKING CIRCUIT PROTECTION EASY MADE ~~POSSIBLE~~ WITH AIRPAX SERIES 50 APL CIRCUIT PROTECTORS



APL 3
SHUNT TYPE

AN EXAMPLE: In interlocking circuit protection, the problem is to interrupt power to one circuit when the current in another circuit exceeds its rated limit. The solution is easy with Airpax Series 50 APL circuit protectors. These electromagnetic time-delay protectors are assembled in a variety of connections. Several protectors can be ganged mechanically so that when one trips it opens the others. For example, equipments A and B operate jointly; if either fails, the other should be shut down. Each draws a different load; each has different inrush and transient overload characteristics. The solution is easy: select two different Airpax Series 50 APL protectors, each matched to the equipment it protects. If shut-down alarm is needed, choose one protector with separate contacts for remote indication. Mechanically gang the protectors, and there you have it. The table below shows stock combinations ready for your order.



APL 11
TWO POLE PROTECTOR

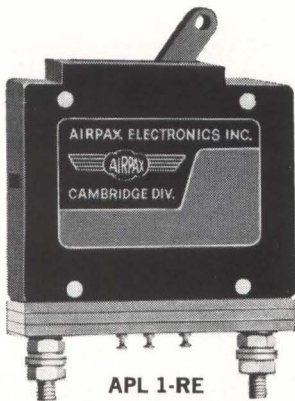

APL 1-RE
SERIES WITH REMOTE

TYPICAL DATA

Power	Delay	Typical Trip Time (Seconds) At 150% of Rated Current
Dc	50	0.02
	51	0.77
	52	12
60 Cps	60	0.04
	61	1.22
	62	14
400 Cps	40	0.03
	41	1.34
	42	19
	43	168

Types	Circuits	Standard Ratings (Amperes)
APL 1	1 Pole, Series	0.050
APL 3	1 Pole, Shunt	0.100
APL 11	2 Poles, Both Series	0.250
APL 13	2 Poles, 1 Series, 1 Shunt	0.50
APL 111	3 Poles, All Series	0.75
APL 113	3 Poles, 2 Series, 1 Shunt	1.00
APL 4	1 Pole, Relay	2.5
APL 1-R	1 Pole, Series, with Remote	5.0
APL 14	2 Poles, 1 Series, 1 Relay	7.5
APL 11-R	2 Poles, Both Series, 1 Remote	10.0
APL 114	3 Poles, 2 Series, 1 Relay	15
APL 111-R	3 Poles, All Series, with 1 Relay	20
		25
		30
		50

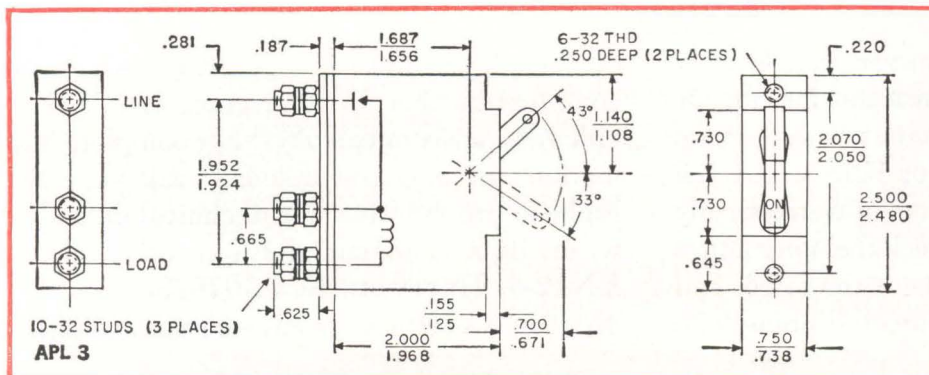

MORE DATA

We've a lot more data: delay curves, coil impedances, and several typical protector applications. Ask for Bulletin 16E-5R.

AIRPAX ELECTRONICS incorporated CAMBRIDGE DIVISION • CAMBRIDGE, MD. 21613
PHONE (301) 228-4600, TWX (301) 228-3558

Conductive rubber puts pressure on strain gauge

Durable pressure-sensitive elastomer can be used in low-cost transducers to drive meters or relays directly

A low-cost, pressure-sensing material that will compete with conventional strain gauges and may have considerable impact on the transducer market is now being sold by Scientific Advances, Inc., a subsidiary of the Battelle Memorial Institute.

The material can be used as a low-modulus, high elongation strain gauge or in transducers to measure pressure, weight and deflection wherever a reading within $\pm 5\%$ is accurate enough. It can also be used as a reliable, low-cost potentiometer element. The company sees applications in feedback controls for heating systems, industrial pumps and grain elevators, as well as for pressure sensors in refrigerators and automobiles.

The sensing material, called Conductomer, is a highly flexible elastomer substrate that is loaded with conductive material. The company declines to name the loading material except to say that it includes carbon and a metal. Conductomer's total resistivity decreases under compression as more conductive material comes in contact with it-

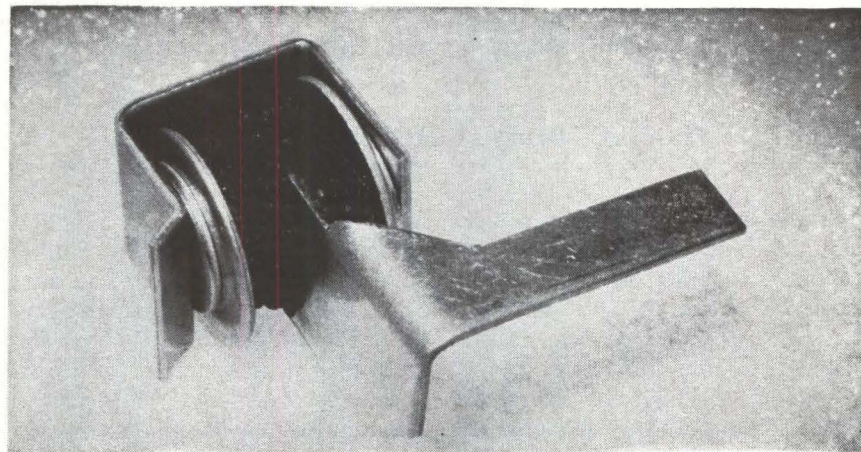

self, and returns to its original value when stress is removed.

As shown in the graph for a sample with an initial resistance of 15 kilohms, the change in resistivity is large. This allows Conductomer transducers to have outputs large enough to drive meters, relays or recorders directly. Unlike previous flexible conductors, the company says, the Conductomer does not exhibit fatigue. The curve remains linear within $\pm 5\%$, including hysteresis, even after 1 million cycles

of being compressed to 63% of its original length and brought back to full relaxation. Conductomer can be compressed greater than 63%, but it is not recommended since physical breakdown of the material starts at that point.

Conductomer is manufactured in pieces $\frac{1}{4}$ inch in diameter and $\frac{1}{4}$ in. long. By varying the amount of conductive elements loaded into the elastomer, tailored units with initial resistances as low as 10 ohms and as high as 50 kilohms and any desired degree of nonlinearity can be obtained.

In extremely large quantities, 500,000 or more, the projected price for each unit is about 75 cents, with the possibility of even lower prices in the future. For 100,000 units, prices will range from \$1.50 to \$5, depending on specifications.

Conductomer elements are being incorporated by the company into pressure transducers with lifetimes of more than 1,000,000 cycles. Diaphragms or Bourdon tubes serve as the basic gas, fluid or vapor pressure sensors and Conductomer elements replace the wirewound potentiometers normally used to translate the motion of the sensor into electrical output.

Transducers using Conductomer will be included in an instrument

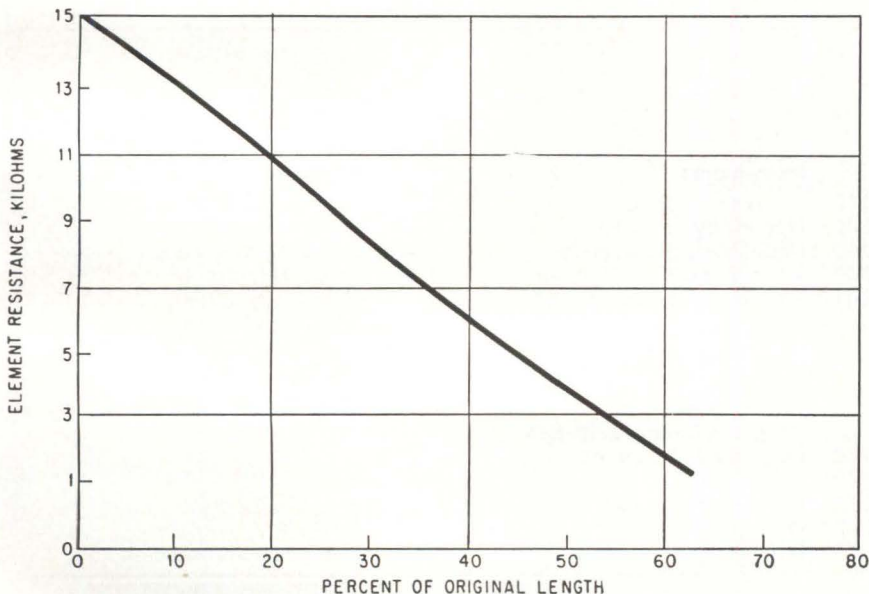

New Products

system the company is planning to market shortly. The instrument will include a meter, step-down transformer and rectifier. It will have a frequency response of 3 to 5 hertz, accurate to within 2% to 5% of full scale, including linearity, hysteresis and repeatability. As the temperature rises, the instrument's output increases by 0.2% full scale

for each degree F. The price of the instrument will be less than \$100—about \$50 in lots of several hundred. The company reports that comparable conventional instruments sell for \$220.

Sensor Technology and Instrument Division, Scientific Advances, Inc., 1400 Holly Ave., Columbus, Ohio 43212
Circle 349 on reader service card

Telemetry receiver obeys computer

Complete automation of receiver tuning and switching in complex telemetry systems is offered by Defense Electronics, Inc. through two solid state receivers controlled by a digital computer.

By use of a 10-bit control word, any of 216 operating modes can be selected, each mode corresponding to a different combination of channel frequency, intermediate-frequency bandwidth and post-detection bandwidth.

The receiver was designed for a ground checkout system for the telemetry in the Saturn rocket, under a contract with the Marshall Space Flight Center in Huntsville, Ala. Custom versions of the receiver are available.

Two models are being offered; type CR-101 operating at 215 to 260 megahertz, and type CR-102 operating at 2,200 to 2,300 Mhz for S-band systems. Both receivers are

for frequency- or phase-modulated signals, and are of the double superheterodyne types. The first i-f of the CR-101 is 60 Mhz and that of the CR-102 is 160 Mhz. The second i-f of both units is 10 Mhz.

The receiver may be operated remotely over a dataphone link, or locally through commands initiated by punched cards or punched paper tape. Through an associated digital interface unit, the computer can select any of the operating modes without any manual intervention. The interface unit is tailored to mate with specific computers or control sources.

Average switching time between modes is less than a millisecond, according to Harley Peter, project engineer in the receiver design department, but he says that switching between widely separated signal levels may require as much as 50 milliseconds, which is the worst-

case recovery time of the unit's automatic gain control.

The unit may be operated in 192 operating receiver modes. These correspond to any combination of 16 radio-frequency channels, four i-f bandwidths (200, 300, 500 and 750 khz) and three postdetection bandwidths ranging from 5 hz at the low end to either 100, 200 or 300 khz.

In a playback mode 24 variations are possible. Predetection signals sorted on tape are fed into the receiver. The playback unit converts the 10-Mhz i-f signal to a 600-khz signal required in predetection recording. Alternatively, the unit reconverts the 600 khz signal back to 10 Mhz for detection.

All input and output connections are located on the rear apron of the receiver. Predetection and post-detection video outputs are provided.

Specifications

Receiver type	CR-101	CR-102
Tuning range	215-260 Mhz	2200-2300 Mhz
Noise figure	7 db max	11 db max
Intermediate frequency		
1 st i-f	60 Mhz	160 Mhz
2 nd i-f	10 Mhz	10 Mhz
Image rejection	60 db min	60 db min
I-F rejection	80 db min	80 db min
Video amplifier		
Rated output	4 volts peak to peak	
Maximum output	10 volts peak to peak	
Load	75 ohms	
Approximate cost	\$7,500	On request
Delivery	90 days	
Defense Electronics, Inc. Rockville, Md. [350]		

New products in this issue

- 125 Conductive elastomer
- 126 Telemetry receiver

Components

- 128 An H of a tuning fork
- 130 Flexible corrugated cable
- 132 Pot has digital readout
- 134 Coaxial connectors

Semiconductors

- 136 Touch tuners for tv sets
- 136 Power transistors
- 138 Silicon diode
- 139 Plastic-packaged FET's

Instruments

- 140 Lab pulse modulator
- 140 Plug-in test modules
- 140 Broad-band phase shifter
- 140 X-Y oscilloscope
- 141 Strip chart recorders

Subassemblies

- 142 Choppers for any amplifier
- 142 Plug-in serial memory
- 142 D-c amplifier
- 142 A-c line conditioner
- 142 Power supply
- 143 Differential amplifier

Microwave

- 144 Multisection filter
- 144 Variable attenuators
- 144 Compact water loads
- 145 Ferrite isolators

Production equipment

- 146 Bubble the dirt away
- 146 Electroplating unit

Materials

- 148 Ceramic for transducers

TRW Metallized Capacitors



...stand tall

Type X601PE Metallized Mylars typify TRW's stature in advanced metallized dielectrics.

They're smaller and lighter... *metallized!* Tough and rugged...

epoxy sealed! Ideal for printed circuits...*save space!*

TRW offers many additional styles and dielectrics for demanding Military and Instrument needs.

Product information is available from TRW Capacitor Division, TRW INC., Box 1000, Ogallala, Nebraska. Phone (308) 284-3611. TWX: 910-620-0321.

TRW

Bulova can supply the crystal you need



to match your specs!

Many years of supplying crystal control units for the most advanced military and space programs enable Bulova to offer a full line encompassing virtually the entire frequency spectrum—2 kc to 125 Mc for oscillator and filter applications. We can supply every type of packaging—including koldweld and glass sealed. Our military crystals meet latest MIL-C-3098D specifications. All reasons why you should make Bulova your single source of supply.

HIGH PRECISION GLASS SEALED CRYSTALS 1 Mc to 125Mc. Available in vacuum sealed, glass enclosures of the HC-26/U and HC-27/U type.

Example: Precision SSB Crystals

Frequency: 1 Mc to 5 Mc
Holder: HC-27/U
Tolerance: $\pm .0025\%$ from -55°C to $+90^{\circ}\text{C}$, or to specification
Aging: 3×10^{-8} per week after one week stabilization at 75°C

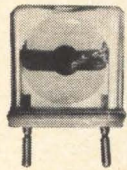

KOLDWELD SEALED CRYSTALS—low aging, high reliability, 1 Mc to 125 Mc. Now available in TO-5, HC-6/U and HC-18/U type cans sealed by the koldweld process to eliminate effects of heat and to reduce contamination.

Example: TO-5

Frequency: 15 Mc to 125 Mc
Tolerance: $\pm .0025\%$ from -55°C to $+105^{\circ}\text{C}$, or to specification
Aging: 1×10^{-7} per week after one week stabilization at 75°C



Write or call for specifications on Bulova's complete line of crystals. Address: Dept. E-17.

BULOVA
FREQUENCY CONTROL PRODUCTS

ELECTRONICS DIVISION OF BULOVA WATCH COMPANY, INC.

61-20 WOODSIDE AVENUE WOODSIDE, N.Y. 11377, (212) DE 5-6000

New Components and Hardware

An H of a tuning fork

Tuning forks, the classical resonators, are being challenged by an H-shaped device that can perform a tuning fork's tricks—plus a few new gyrations. Besides, says Hugh Baker, president of HB Engineering Corp., his Twintron is half the size and about one-quarter the price of a good tuning fork. And Baker adds, that the Twintron won't start resonating because of shock, vibration or acceleration.

Unlike a tuning fork, the mass and spring properties are separated in the Twintron and it is symmetrical, Baker explains. Q's can go as high as 8,000. Mild steel is usually used in its construction but other materials can be used, to obtain temperature stability as high as one part per million per degree Centigrade.

The vertical members of the device supply the mass and the crossbar web does the flexing. The masses rotate about the pivots, which are supported on foam rubber. The masses rotate about the pivots, which are supported on foam rubber. The web is usually flexed by a piezoelectric ceramic wafer attached to one side of the web. The wafer stretches or contracts with each half cycle of the input signal, which can range from microvolts up to 50 volts. For electrical output,

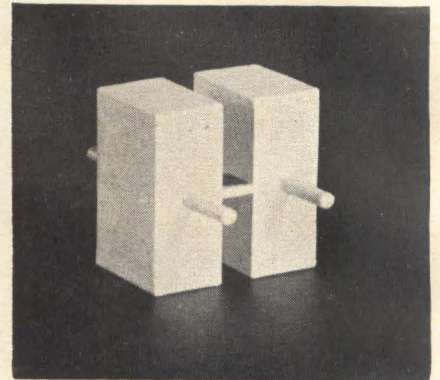

a second wafer is bonded to the other side of the web. The output frequency depends upon the dimensions, as in tuning forks. Center frequencies can be adjusted 1% electrically or 10% mechanically with movable inserts.

The device can also be driven by electromagnetic coils placed near or between the vertical members.

The Twintron is primarily a frequency source or a selection or rejection filter. Frequencies can range from less than 1 hertz to 20 kilohertz. If more than one wafer is placed on the web, multiple inputs and outputs are provided that allow the resonator to encode. Outputs can be in phase or 180° out of phase. Baker expects applications

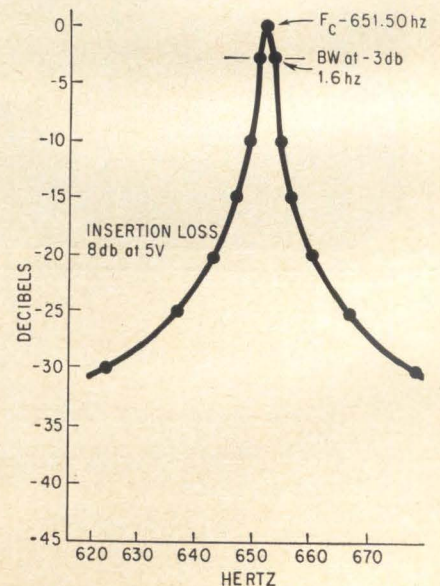
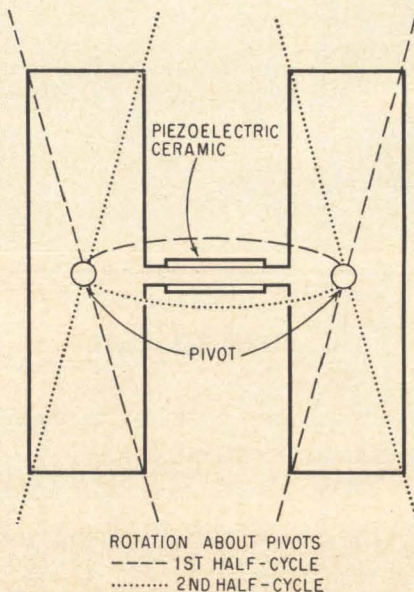

Masses rotate at a frequency determined by size when crossbar is flexed. Characteristics of a typical Twintron resonator are shown by the curve.

Did you ever wish someone
would combine the
best cleaning features
of fluorocarbon solvents
and water detergents?

Someone did!
It's called FREON® T-WD 602.

FREON T-WD 602 solvent* is a clear, stable dispersion of water in FREON® TF that combines the cleaning power of water detergents with the unique properties of FREON fluorocarbon solvents. It cleans organic and inorganic soils at the same time...and cleans better than water detergents alone.

Here's why:

Lower surface tension—Water has a surface tension of 72 dynes per centimeter. With a detergent, this drops to approximately 30. But FREON T-WD 602 has a surface tension of only 19.5 dynes! It easily penetrates even the most microscopic pores and crevices to dissolve and wash away contaminants that water and detergents can never reach...and its high density floats particulate matter away.

Quick drying—A system using FREON T-WD 602 speeds up production. Parts come out clean, dry and ready to handle. No extra drying procedures are needed.

Leaves no residue—Parts cleaned in FREON T-WD 602 followed by a FREON TF vapor rinse dry without leaving any residue.

Can be re-used—You can renew the FREON T-WD 602 bath just by letting it settle, skimming off soils and replacing with an equal volume of water.

FREON T-WD 602 is ideal for cleaning complex assemblies where a com-

bination of organic and inorganic soils exists. It is one of a group of "tailored" solvents for special cleaning problems based on FREON TF. For more information, mail the coupon.

*Process and composition patents applied for.



BETTER THINGS FOR BETTER LIVING
...THROUGH CHEMISTRY



Du Pont Co., Room 4345
Wilmington, Delaware 19898

Please send complete information on
 FREON T-WD 602; the other FREON
"tailored" solvents. I am interested in
cleaning _____

Name _____ Title _____

Company _____

Address _____

City _____ State _____ Zip _____

In Europe, mail to: Du Pont de Nemours International S.A.,
"Freon" Prod. Div., 81 route de l'Aire, Geneva, Switzerland

IMMEDIATELY AVAILABLE OFF-THE-SHELF

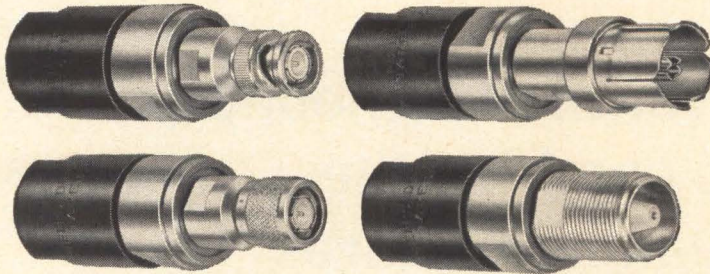

A new series of connectors for semi-rigid coax.

This new design incorporates a captivated collet holding mechanism providing positive holding capability with best possible electrical contact when installed. VSWR is low and the maintenance of cable pressures up to 30 psi are guaranteed when properly installed.

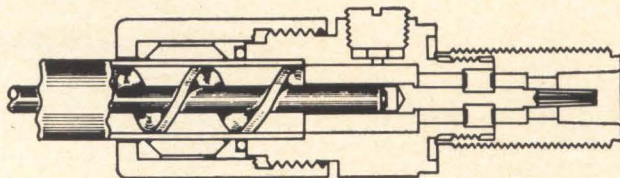

IN ALL SIZES. IN ALL INTERFACES.

From 1/4" to 7/8" in types N, HN, UHF, C, BNC, TNC, GR, and splice.

PLUS these important features

- A 1/8" NPT threaded gas port is provided for the attachment of pressure lines or gages and a conventional "O" ring gasket gas and moisture seal. A special epoxy barrier around the plug-in base prevents electrolysis.

Can we tell you more? Write for Bulletin SF, Issue 2

PHELPS DODGE ELECTRONIC PRODUCTS
NORTH HAVEN, CONNECTICUT



New Components

in comb filters, controls and data transmission. The device was originally developed so that a utility company could obtain meter readings over telephone lines.

In some cases, the device can be used as a transformer, Baker says. Fitted with plates, it becomes a capacitor chopper or modulator; or, the mechanical motion can chop or modulate a light beam or drive a clock.

One unit to be sold soon is a 60-hertz rejection filter with a Q of 200 and insertion loss of less than 3 decibels. Its price will be \$5. It will measure 2x1 1/2x1 inch. Prices for other units will range up to \$25, which will buy a 5,000-Q unit for any frequency up to 20 khz.

HB Engineering Corp., 1101 Ripley St., Silver Spring, Md. 20910 [351]

Flexible, strong corrugated cable

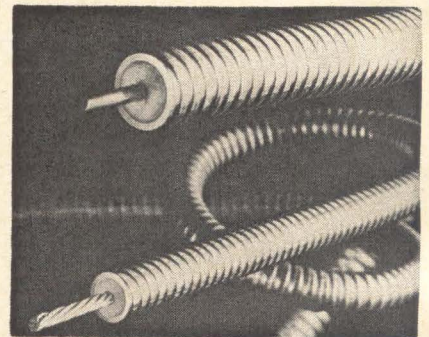

A seamless, corrugated coaxial cable with a metal jacket that is reported to be 50% more flexible than the solid-jacket type, is suited for aircraft, CATV, and broadcast industries, and a wide variety of other applications. Coro-Flex cable is available in both 0.500-in. and 0.325-in. outside diameters.

Because of its seamless configuration, the cable is completely moisture-proof. Compression tests indicate that it is 30% stronger than noncorrugated solid-jacketed cable because the impact stress is spread evenly over a wider area instead of causing a sharp bend or kink.

The 0.500-in. o-d Coro-Flex is electrically similar to the company's CATV cable which also offers

NEW LOWER PRICES

NEW TEST DATA FOR CTS INDESTRUCTIBLE CERMET SEMI-PRECISION RESISTOR NETWORKS

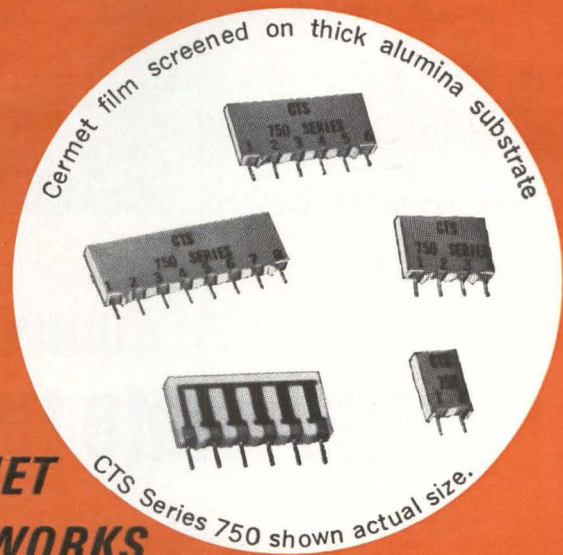

Series 750	2-Pin (1 Resistor)	4-Pin (3 Resistors)	6-Pin (5 Resistors)	8-Pin (7 Resistors)
Total Module Load	0.5 Watts	1.0 Watts	1.5 Watts	2.0 Watts
Approx. 10,000 cost	20¢ \$0.22 ea.	21¢ \$0.24 ea.	23¢ \$0.26 ea.	29¢ \$0.31 ea.
Approx. 100,000 cost	18¢ \$0.20 ea.	19¢ \$0.22 ea.	21¢ \$0.24 ea.	26¢ \$0.29 ea.

The data speaks for itself. Examine and judge its value for your application:

Extreme Stability and Reliability
High Power Capability: (Up to 1 watt per resistor)

- Space saving—a single module replaces up to 7 discrete resistors.
- Available in an infinite number of circuit combinations.
- Custom-built to your exact requirement.
- Ideally suited for cost-saving automatic handling.
- Cover coating unaffected by solvents.

STANDARD MODULE SPECIFICATIONS FOR ALL SIZES	
Resistance Range	50 Ω to 100K Ω
Resistive Tolerance	±5.0%
TC	±300 ppm/°C
Load Life: 0.1 W per resistor at 70°C, 1000 hrs. (Over 4,000,000 resistor hours)	±0.40% Δ R max. ±0.20% Δ R av.
Moisture Resistance: .1 rated wattage at 70°C, 90-98% humidity, 1000 hrs.	±0.50% Δ R max. ±0.20% Δ R av.
Insulation Resistance: measured wet after moisture resistance test, 200 VDC	500 meg. Ω
Thermal Shock: 5 cycles, -63°C to +125°C, no load	±0.10% Δ R max. ±0.03% Δ R av.
Short Time Overload: 2.5 times rated voltage, 5 sec.	±0.25% Δ R max. ±0.05% Δ R av.
Low Temperature Exposure: -63°C, 4 hrs.	±0.10% Δ R max. ±0.04% Δ R av.
Terminal Strength: 5 lb. tensile & compression, 30 sec.	±0.10% Δ R max. ±0.03% Δ R av.
Effect of Soldering: 63/37 solder, 246°C, 2 sec.	±0.10% Δ R max. ±0.05% Δ R av.



founded 1896 Request Cermet Catalog

CTS
OF BERNE, INC.
BERNE, INDIANA

SUBSIDIARY OF
CTS CORPORATION • ELKHART, INDIANA

Extra cost options	
Resistance Range	10 to 49 Ω, 101K to 1 meg. Ω
Resistive Tolerance	±0.5%, 1%, 2.5%
TC	±150 ppm/°C



current controls solid-state tuning



VARI-L "MITE" SERIES CURRENT-CONTROLLED INDUCTORS.

20 MODELS FOR FREQUENCIES FROM 2 KHz to 300 MHz.

Vari-L's are circuit-proven since before the transistor . . . for reliability in AFC, remote tuning, sweep-TV alignment, speech-bandwidth compression, airborne radar, missile checkout, and scores of other "no-nonsense" applications from hydrospace to aerospace.

The "MITE" Series, less than 1/10 the volume of the older models, equal or excel them in most respects. At the right are two circuits for interesting uses of the "Mites".

Send us your specs for our recommendation of a Vari-L model or circuit. We are co-operative in sampling for genuine production applications.

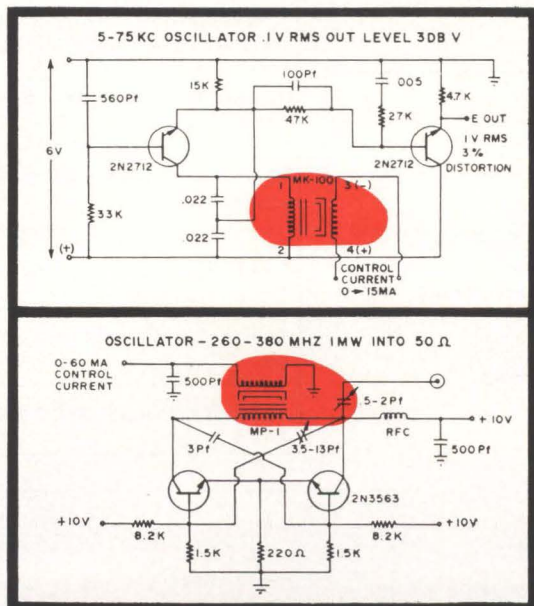

VARI-L CO INC / 207 Greenwich Ave. / Stamford, Conn. / 06904 / Phone 203-323-2176

New Components

low attenuation and high shielding. It is equal in performance to solid-jacket. Velocity of propagation is 80% and nominal impedance is 75 ohms. It can be terminated with standard type F connectors.

Coro-Flex of 0.325-in. o-d is electrically similar to RG87A/U type solid-jacketed coaxial cable, which offers lower attenuation and less stray signal pick-up. Its electrical characteristics are equal to solid-jacket. Velocity of propagation is 69.5% and nominal impedance is 50 ohms. It can be terminated with standard type N connectors.

Available dielectrics for Coro-Flex include Teflon, polyethylene and Polyfoam.

Amphenol Cable division, Amphenol Corp., 6235 South Harlem, Chicago, Ill. [352]

Digital readouts from precision pot

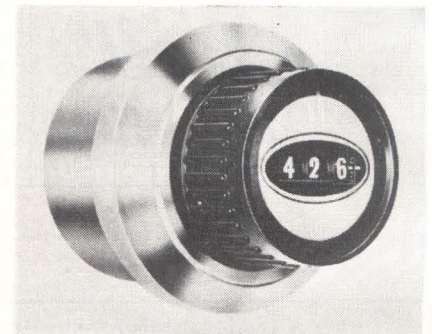

A precision potentiometer designated model 3650 Knobpot, with integrated digital readout, knob and potentiometer, requires less front panel space than most dials alone with essentially no rear space. It has a readability of 1 part in 10,000, a dial accuracy within 0.1% and a repeatability of reading within 0.05% voltage ratio.

Standard specifications include a resistance range of 100 to 100,000 ohms; resistance tolerance, $\pm 3\%$; power rating 2.5 w at 25° C, zero w at 85° C; operating temperature range, -25° to +85° C; vibration, MIL-R-12934, 10 g; shock, MIL-R-12934, 50 g; humidity, MIL-STD 202 Method 103.

Price is \$26.46 each in 1-to-4-

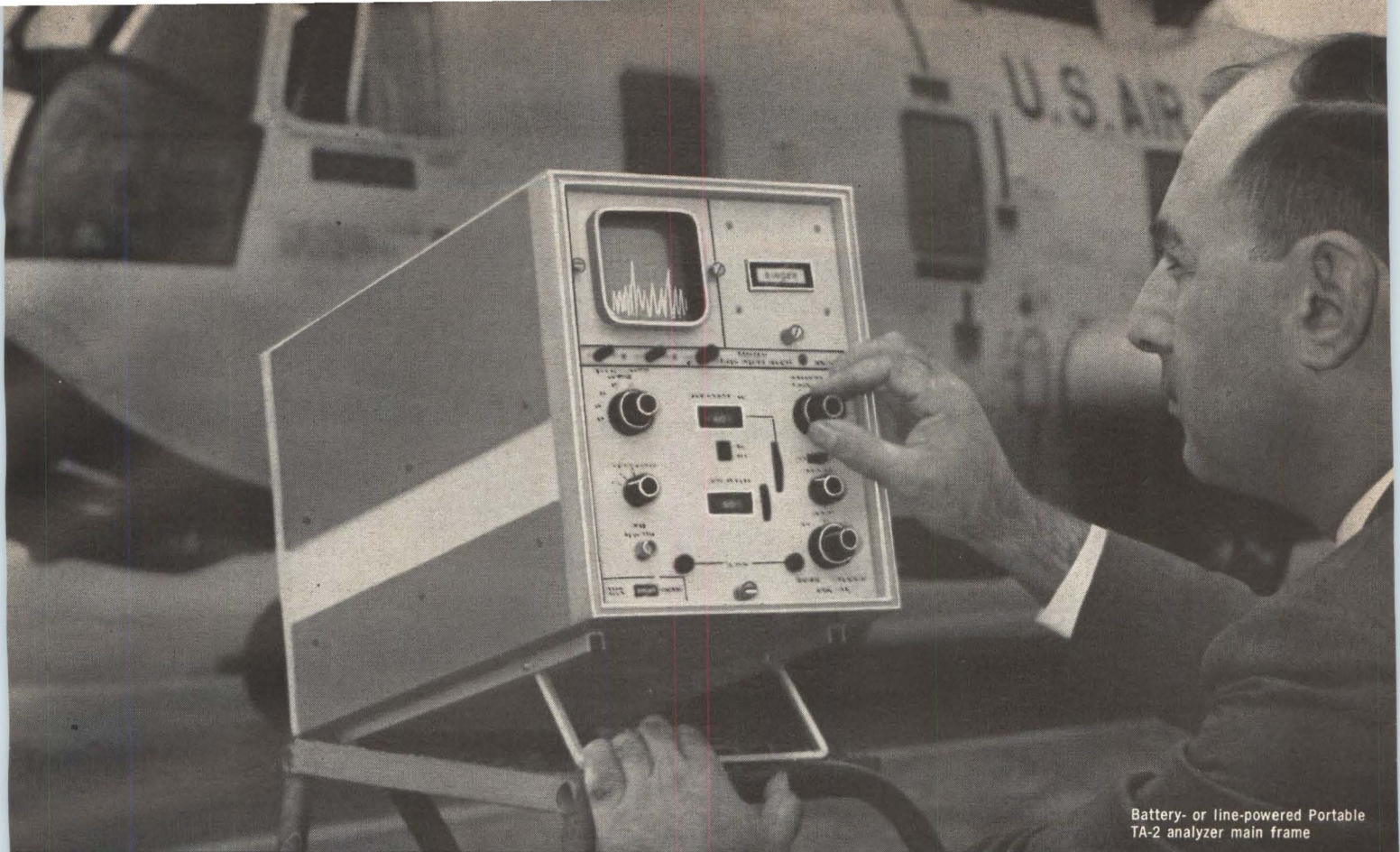

Battery- or line-powered Portable TA-2 analyzer main frame

THE STANDARDS

Panoramic* UNIVERSAL SPECTRUM ANALYZERS 20 cps to 27.5 Mc

Portable TA-2 and Rack or Bench Mount RTA-5 with 4 Solid State Interchangeable Modules



Rack- or bench-mount RTA-5 Analyzer main frame

Make precise, rapid swept band analyses anywhere! Check out and pinpoint troubles in communications signals, sound, vibration, noise and RFI.

The standard—feature-by-feature AC/DC or internal battery operation Bright, easily read calibrated spectrum displays Digital frequency readout of scanned band Calibrated linear and 40 db log level scales Built-in Xtal markers for self-checking Simplified — few controls, many preset for optimum results.

4 solid state plug-in modules feature digital center frequency and sweep width controls "Quick-look" overall analysis and highly resolved narrow scans are quickly set up Advanced design provides excellent dynamic range, sensitivity, resolution and sweep repeatability.

Choice of analyzer main frames for all modules Compact RTA-5 main frame is only 19" wide, 7" high, and 18½" deep — ideal for space saving, rack- or bench-mounting Portable, solid-state TA-2 weighs only 40 pounds, complete with module and internal rechargeable battery pack — also operates from almost any AC or DC source.

Modules For TA-2 & RTA-5 Main Frames	OFF SHELF DELIVERY			NEW
	AR-1 (Sonic)	AL-2 (log-scan sonic)	UR-3 (Ultrasonic)	VR-4 (Video)
Frequency Range	20-35,000 cps	20-35,000 cps	100 cps-700 kc	1 kc-27.5 mc
Sweep Widths	0.2, 1, 5, 20 kc	0.2, 1, 5, 20 kc; 25-25,000 cps log	adjust. to 0-400 kc	adjust. to 0-5 mc
Resolution	Automatic optimum to 25 cps		adjust. to 100 cps	adjust. to 200 cps
Residual distortion	All unwanted products at least 60 db down			-50 db
Sensitivity	30 μv full scale deflection			
Marker Spacing	0.02% Accuracy-Fundamentals shown-Harmonics Usable			
	2.5 kc	2.5 kc	25 kc	25 kc, 500 kc, 100 Mc

Write for brochure, or contact your local Singer Instrumentation representative



*A Trademark of THE SINGER COMPANY

EMPIRE • GERTSCH • PANORAMIC • SENSITIVE RESEARCH

SINGER
INSTRUMENTATION

THE SINGER COMPANY, METRICS DIVISION • 915 Pembroke St., Bridgeport, Conn. 06608, U. S. A. • PHONE (203) 366-3201

How can you get 24 outputs
from one antenna?

Use the unique MRC 24-channel
solid state multicoupler



■ This new solid state multicoupler from MRC has established five "firsts" in multicoupler design.

■ FIRST 24-channel solid state multicoupler to meet the requirements of MIL-E-4158C.

■ FIRST solid state multicoupler with 24 channels from one pre-amp to have intermodulation distortion products down by more than 60 dB.

■ FIRST 24-channel solid state multicoupler to meet the requirements of

MIL-STD-826 for radio frequency interference.

■ FIRST 24-channel solid state multicoupler to have less than 2 degrees phase shift between channels.

■ FIRST 24-channel solid state multicoupler to have better than $\pm .5$ dB tracking between channels.

■ Other benefits include built-in fault isolation (average time for repairs less than 30 minutes), 30,000 hour MTBF and convenient modular construction.

■ For complete specifications, write CONDUCTRON-MRC Division, 2311 Green Road, Box 614, Ann Arbor, Michigan 48107. Ask for bulletin 11D.



CONDUCTRON - MRC Division

ANN ARBOR, MICHIGAN



Circle 134 on reader service card

ELECTRICAL / ELECTRONIC
ENGINEERS
DESIGN · ANALYSIS · TEST

BSEE, plus appropriate experience in any of the following areas:

- Communications
- Computer Software
- AGE Systems
- Field Engineering
- Circuits/Systems
- Electro-optics
- Microwaves
- Power Systems
- Propulsion
- Instrumentation
- Guidance & Controls
- Batteries

For complete information, write Mr. R. C. Bird-sall, Professional Employment Manager, P.O. Box 504, Sunnyvale, California. An equal opportunity employer.

LOCKHEED
MISSILES & SPACE COMPANY
A GROUP DIVISION OF LOCKHEED AIRCRAFT CORPORATION

New Components

piece quantities; delivery, stock to 3 weeks.

Bourns, Inc., Trimpot division, 1200 Columbia Ave., Riverside, Calif., 92507. [353]

Coaxial connectors meet MIL-C-39012

Miniature r-f coaxial connectors have been developed for 50-ohm termination. The NCM3200 series will initially include eight types: 4 cable connectors, 3 feed-through connectors, and 1 circuit-board connector. The connectors have a common interface mating with other connector types such as OSM, BRM, and SRM. The units meet the specifications of MIL-C-39012.

The NCM series is designed to maintain a vswr of 1.3 to 1 or less to 10 Ghz when it is used with Plaxial cable, a low-loss flexible cable available from the manufacturer. The mating plug and jack of the NCM series may be used with other similar plugs or jacks and maintain good individual performance. No compensation has been designed into either the plugs or jacks to require their use as a pair.

The insertion loss is less than 0.15 db when tested to MIL-C-39012. R-f leakage protection is -90 db between 2 and 3 Ghz. The voltage rating of the connectors is 500 v a-c at 70,000 ft, and at that voltage, the minimum insulation resistance is 1,000 megohms.

The connector design is a captured contact Teflon insulator with a clamping mechanism. The captured contact maintains low vswr with cable strain and expansion. The female contact is gold plated brass to assure good contact durability and r-f performance. Connector shells are offered in either brass or stainless steel, for optimum strength at lowest possible cost.

The closely specified dielectric constant of the Teflon insulator and the tightly held machining tolerances on the piece parts result in an impedance tolerance of ± 2 ohms on these 50-ohm impedance connectors.

Cinch-Nu Line division of United-Carr Inc., 1015 Sixth St., Minneapolis, Minn., 55404. [354]

Quick cure for power control headaches

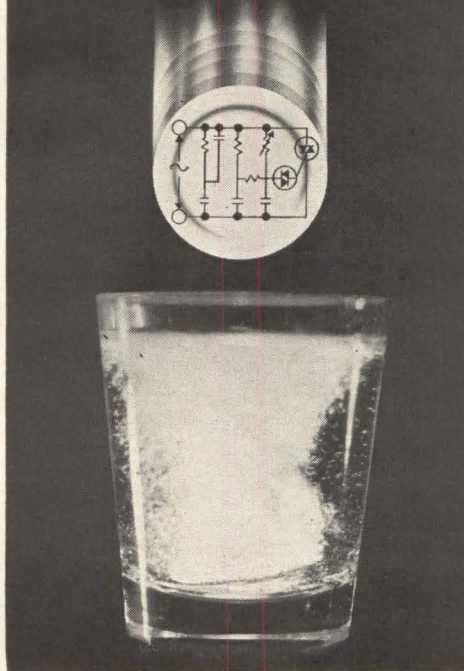

Low-cost G-E standard Triac circuit modules

■ Why suffer the pains of designing and building your own power control circuits? General Electric supplies S-100 series Triac power control modules, ready-made for a variety of applications.

Use them for speed control of a-c series motors and some types of induction motors, incandescent lamp dimming, heat control, or static AC power switching.

Designed for maximum flexibility, each G-E power control module is two inches wide, one inch high, and three inches long—complete with an insulated aluminum heatsink that can be grounded. Make your selection from the family of seven different standard modules available from General Electric. They're attractively

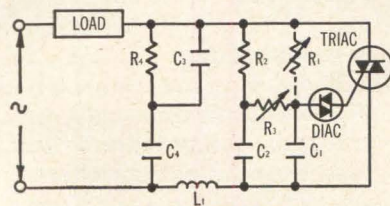

Typical circuit for extended range variable voltage control.

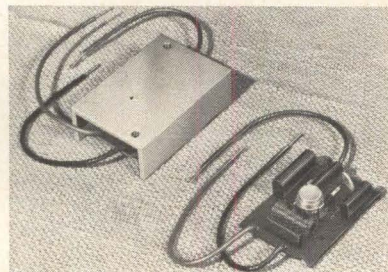

This 6 amp, 115 volt standard extended range variable AC voltage control circuit module with RFI suppression costs just \$5.85 in lots of 100.

priced—as low as \$3.80 in lots of 100.

When standard modules just won't do, come to G.E. for a special prescription. Special modules are already being built for many high-volume customers in data processing, appliances, reprographics, and communications. They're all part of G.E.'s total electronic capability.

Get more information on General Electric standard or custom power control modules from your authorized G-E distributor or G-E engineer/salesman. Or write to Section 220-35, General Electric Company, Schenectady, New York. In Canada: Canadian General Electric, 189 Dufferin Street, Toronto, Ont. Export: Electronic Components Sales, IGE Export Division, 159 Madison Ave., New York, N.Y.

SEMICONDUCTOR PRODUCTS DEPARTMENT

GENERAL  ELECTRIC

Handsome new
VECTOR
Fixed-Panel
PATCHBOARDS
available off-the-shelf!

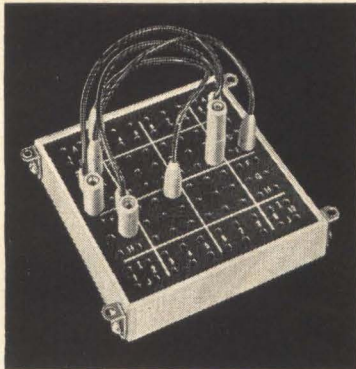

Lowest cost of any reliable patchboards... 10 cents or less per contact!

■ **7 Standard sizes**—10 to 300 receptacles; may be ganged or stacked for additional capacity.

■ **Quick delivery**—Wide range of standard sizes in stock at all times.

■ **New design**—Vector's new extruded aluminum frame gives the unit greater strength and a handsome custom look. Damage-proof entry insures reliability of beryllium copper gold-plated contacts. Standard panels are black phenolic with white alpha-numeric lettering, front and back.

■ **More contacts for your money**—Vector patchboards give far greater connection capability at much lower costs than X-Y type boards. In Vector patchboards, each contact is independent and can be connected to any other contact, providing maximum flexibility at lowest possible costs.

■ **Wide application**—Vector patchboards are used for programming machines, test set-ups, as instrument patchers, or as add-on accessories to give automatic machines greater flexibility.

■ **Specials**—Vector can provide custom units up to 15" x 36", and with special finishes, colors and printing, at moderate extra cost.

■ **Pre-programmed boards** also available. 204, 300, 450, 600 and 1200 contacts.

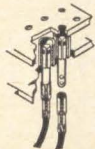

■ **Solderless slip-on contacts** speed backboard wiring by eliminating soldering. Leads may also be wire wrapped or soldered. Full line of stackable, multiple, and single color coded cords available.

For full information contact:

Vector 

ELECTRONIC COMPANY, INC.
1100 Flower Street, Glendale, California

New Semiconductors

Touch tuners for tv sets

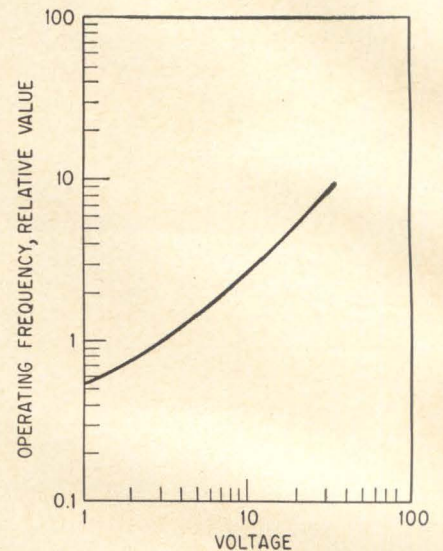
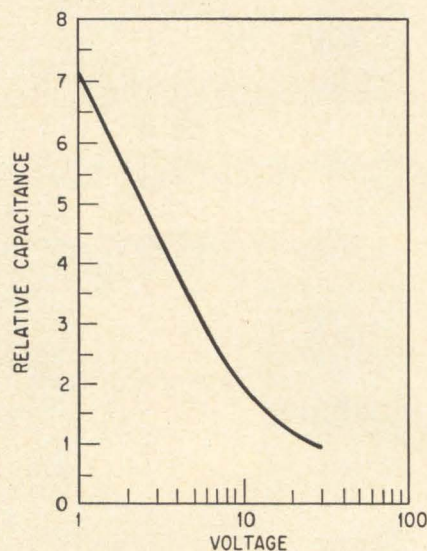

Variable-capacitance diodes automatically fine-tune two brands of German television receivers whenever the channel is changed. Soon, the devices will be available here.

The diodes, made by Intermetall, a German subsidiary of the International Telephone and Telegraph Corp., will be imported. ITT Semiconductors, an American subsidiary, expects to begin marketing them here in January. ITT is evaluating the devices and discussing applications such as pushbutton and remote tuning with American tv manufacturers.

The device can completely eliminate mechanical linkages, ITT says, and make the tv tuner so compact that it can be put anywhere in the set.

ITT says Intermetall has made more than a million of the diodes this year and that they are used in the Grundig and Nordmende brands of tv sets. Sales in Europe will be close to 10 million diodes in 1967, the company predicts.

The diodes will be sold in matched sets. Intermetall makes two types: BA141, in sets of three or four, which covers the very high frequency range; and BA142, in sets of two or three, for the ultra high frequency range. Both are silicon planar devices.

The tuning characteristic—change in capacitance with applied

d-c bias—is almost linear. This permits the diodes to lock onto the received picture signal.

The capacitance curve is normalized to the capacitance at 25 volts, while the relative frequency curve is normalized to 3 volts bias. At this bias the frequency of the BA141 is more than 20 gigahertz.

Specifications

	BA141	BA142
Junction capacitance at 3 v	12 pf	9.2 pf
at 25 v	2.2-3.2 pf	
Tracking accuracy	±3%	±2%
Tuning ratio (useful capacitance ratio)	4.25	3.5
Series resistance at 3 v	0.5 ohm	1.0 ohm
Q figure at 47 Mhz	>300	>600
at 170 Mhz	>80	>50
Cut-off frequency at 1Q	>20 Ghz	>10 Ghz
Series resonance frequency at 25 v	>1.45 Ghz	
Series inductance with 1.5 mm lead length	4 nh	
Breakdown voltage	>30 v	
Maximum operating voltage	28 v	
Leakage current	<5 μ amps	

ITT Semiconductors, International Telephone and Telegraph Corp., 3301 Electronics Way, West Palm Beach, Fla. 33402 [361]

Power transistors take less space

Space-saving flat packs house the manufacturer's 20-amp and 30-amp families of silicon power transis-



For those who think big—about availability, that is. Babcock's 1/6-size Model BR10 with unique universal contacts gives you "nonstop" load performance dry circuit to 1 amp. in the same unit. Now, you can order *one* relay to meet all your high-density circuit-board requirements—at no cost premium. And you'll find that this subminiature unit has everything... MIL-R-5757 conformance, unitized construction, solder-sealed or welded versions, standard circuit-board grid pattern, and a wide choice of terminal and mounting styles. Get more information about

the BR10, and the complete Babcock line of relays, all with universal contacts. Write Babcock Relays, Division of Babcock Electronics Corp., 3501 Harbor Blvd., Costa Mesa, Calif.; (714) 540-1234.



SPECIFICATIONS

SIZE: .405" h. x .500" l. x .230" w.	PULL-IN POWER: Low as 80 mw.
WEIGHT: Approx. 0.15 oz.	LIFE: To 150,000 operations
CONTACT ARRANGEMENT: DPDT	TEMP. RANGE: -65° C + 125° C

Babcock model **BR10** 1/6-size relays



**dry circuit
to 1 amp
universal
contacts**

4-6 WEEKS DELIVERY



in Production Quantities or Prototypes

Netic & Co-Netic Magnetic Shields

Fabricated to your exact specifications in any size or configuration. Two typical applications shown. 2-3 weeks delivery on special order.

Permanently effective Netic and Co-Netic are the recognized world standard for dependable shielding. About 80% of all magnetic shield designs in use originated here. Netic and Co-Netic are insensitive to ordinary shock, have minimal retentivity, never require periodic annealing. Total quality is controlled during manufacture. Design assistance gladly given.



Photomultiplier & CRT Shields

MAGNETIC SHIELD DIVISION

Perfection Mica Company

1322 N. ELSTON AVENUE, CHICAGO, ILLINOIS 60622

ORIGINATORS OF PERMANENTLY EFFECTIVE NETIC CO-NETIC MAGNETIC SHIELDING

Circle 180 on reader service card

Primo

NEW! DYNAMIC TYPE MICROPHONE UD-842

Provided with

- ★ Tone Controller
- ★ Wind Screen
- ★ Shock Absorber
- ★ Switch

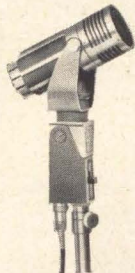

SPECIFICATIONS

- Cartridge: DM-35
- Frequency Response: 100~10,000 %
- Impedance: 50k Ω , 600 Ω (Dual Impedance)
- Sensitivity: -51dB (50 k Ω), -71dB (600 Ω)
- Dimensions: 48 ϕ x 120mm x 177mm

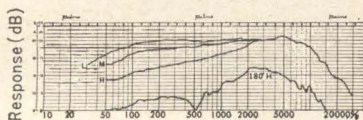

For catalog write to

PRIMO COMPANY LTD.

2043 Mure, Mitakashi, Tokyo, Japan
Tel. 0422-43-3121
Cable: "Primo Musashino Mitaka"
Telex: 0-22716 PRIMO TOK

Reprint order form

Send to: Electronics Reprint Dept.
330 West 42nd Street
New York, N. Y. 10036

For listing of reprints available see the reader service card.

To help expedite mailing of your reprints please send cash, check or money order with your order.

For reprints of the latest special report:

Communications Satellites Part I

Send me . . . reprints of key no R-89 at 75¢ each.

For reprints of previous special reports fill in below:

Send me . . . reprints of key no.(s) . . . at . . . ¢ each.

For prices see the reader service card.

Name

Number & Street

City, State

Zip code

New Semiconductors

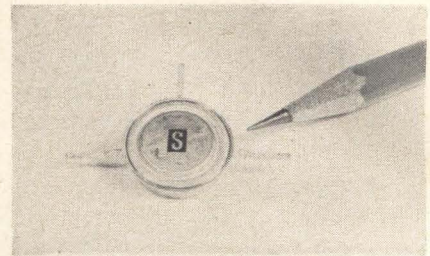

tors. The packages have a body diameter of less than 0.70 in., and a height of less than 0.20 in. The reduction in size was obtained without compromising any of the electrical parameters of the family.

The SDT 8100 series may be specified to the electrical characteristics of the 2N3597-2N3599; the MHT 8002-03, 8012-13, 8015-16, 8045, 8070-71; and the MHT8301-8304.

Although these transistors will handle high power along with current, their primary application is for use on circuit boards as high current switches. The devices may fill the bill for a variety of space applications where small size and light weight are dominant factors. Solitron Devices, Inc., 1177 Blue Heron Blvd., Riviera Beach, Fla. [362]

Silicon diode offers high speed switching

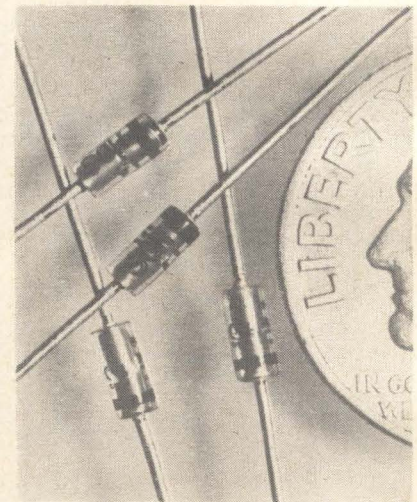

A whiskerless diode, called a W-O-W (without whiskers), provides high mechanical strength and long-term stability in critical circuits, the company says. In addition, electrical characteristics are

maintained under high temperature reverse bias conditions.

The subminiature, silicon planar epitaxial diode is a high conductance type designed for high speed switching and core driver applications. Specifications include low junction capability of 2 picofarads. The hermetically sealed package is a dual stud, fused glass-to-metal design.

A typical device, the type HDS11, is priced at 37 cents each in quantities of 1,000. Off-the-shelf delivery is offered.

Hughes Semiconductor Devices, a division of Hughes Aircraft Co., 500 Superior Ave., Newport Beach, Calif. [363]

Plastic-package FET's are low in cost



Low priced plastic FET's may reach the consumer and industrial markets in operational amplifiers, input stages to audio amplifiers, and other products where the high impedance input of such devices offers considerable advantage. They are priced at 50 cents each in quantities of 1,000 and up.

Types MPF103, 104 and 105 are n-channel, junction devices. Major characteristics include: typical forward transfer admittance ranging from 3,000 to 4,500 μmhos ; maximum gate-source cutoff voltage, ranging from -6 to -8 v d-c; zero-gate-voltage drain current, ranging from 1 to 5 to 4 to 16 ma d-c; minimum gate-source breakdown voltage, -25 v d-c; maximum input capacitance, 7 pf; maximum output admittance, 50 μmhos ; and maximum reverse transfer capacitance, 3 pf.

Motorola Semiconductor Products Inc., Box 955, Phoenix, Ariz., 85001. [364]



WHO KNOWS?



How to make the lowest priced, airline quality, L-Band blade antenna?

How to design flush mounted VOR/LOC antennas of minimum size and maximum performance?

How to design lightning protection into VHF blade antennas?

How to manufacture the L-Band annular slot antennas with the best maintenance record?

Airline people know that D&M antennas offer superior performance under all the environmental and operating conditions of modern flight. Whether your antenna requirement is for commercial, military or private aircraft, missiles or satellites, you can be sure ...

... D&M KNOWS!

Have you had antenna engineering experience at a high level? Would you like to apply it to problems of immediate practical value, like improving flight safety? Call or write the Chief Engineer at either our new Long Island plant or at Chatsworth (San Fernando Valley), California.

dorne and margolin

INCORPORATED

WEST COAST
9730 Cozycroft Avenue
Chatsworth, California 91311

EAST COAST
2950 Veterans Memorial Hwy.
Bohemia, New York 11716



20 Years of Leadership in Aircraft and Missile Antennas

New Instruments

Lab pulse modulator produces 9 kilowatts

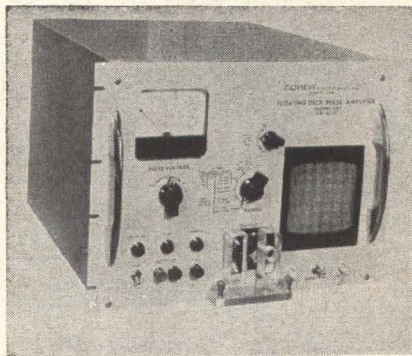

A general-purpose laboratory pulse modulator provides high-voltage pulse power with excellent wave-shape characteristics, according to the manufacturer. Model 604 is compatible with any standard laboratory pulse generator that has at least a 10-v output.

The 604 is triggered by the pulse generator and delivers precise pulses at powers up to 9 kw. The standard unit provides 1,500 v at 6 amps, but it is available with voltage and current combinations up to 10 kv and 100 amps at 9 kw. Pulse widths are continuously variable from 50 nsec to d-c, and repetition rate from a single shot to 1 Mhz. A floating deck design permits the unit to provide either positive or negative polarity.

The unit has application in laboratories for driving a large variety of microwave tubes, as the grid pulser for high-power hard-tube modulators, for triggering thyatrons, testing solid-state components, thin film sputtering experiments—wherever high-power pulses are needed.

The output pulse width and repetition rate have all the flexibility of the engineer's own pulse generator. In addition, the user is able to vary the rise time from 25 to 100 nsec. The output voltage swing is read on a 4½-in. meter panel, and a capacitance divider output is provided to allow scope viewing of the pulse.

Complete safety features for the equipment load and personnel are provided. The output may be

floated on either d-c or a-c voltages up to 5 kv, while the instrument case and controls remain at ground potential.

Price of the 604 is \$3,390; delivery, within 30 to 60 days. Cober Electronics, Inc., 7 Gleason Ave., Stamford, Conn., 06902. [371]

Plug-in modules reduce costs and downtime

A line of 20-Mhz test modules has been developed that, according to the manufacturer, will cut the cost of magnetic and digital test equipment and substantially reduce the need for special-purpose, fixed-package test hardware. The solid state test modules are for memory testing, telemetry timing and circuit evaluation.

The modules, series 2000, are packaged in building-block form to provide high performance signal parameters for bench testing and systems applications. Functions of the various modules can be combined for a wide variety of timing controls (trigger, sync, delay and width) and pulse controls (rise time, fall time and amplitude). The manufacturer says the modules will allow engineers to specify only the hardware required for a custom system and as requirements change, the system can be expanded and modified with additional plug-in modules. Ease of modular replacement also keeps downtime at a minimum.

The series includes a trigger module, a timing module, positive and negative current driver modules and two enclosures, one with and one without power. All modules measure 5x2¾x10 in. Both front and rear logic connections provide added wiring versatility. The modules also feature open and

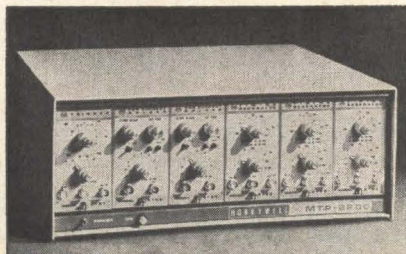

short-circuit protection with an operating temperature range from 0° to 50°C.

Honeywell, Computer Control division, Old Connecticut Path, Framingham, Mass. [372]

Phase shifter covers broad band



A phase shifter has been developed with an operating frequency range from 20 hz to 20 khz. The phase shift is continuously variable from 0 to 360° with direct meter reading in degrees of output phase shift. Accuracy of the instrument is 0.5° over the specified frequency range and over a dynamic range from 300 mv to 3 v. Input resistance is 1 megohm.

Model 329-B with C plug-in and 19-in. panel mounting is priced at \$840. Cabinet models are available as extra cost options. Delivery is within 30 days.

Acton Laboratories, Inc., 531 Main St., Acton, Mass. [373]

X-Y scope provides precise measurements

Related functions can be measured with extreme precision over a broad bandwidth by the S52 x-y oscilloscope. The unit features a 5-in., flat-faced tube with a variety of phosphors available as options. It contains identical vertical and horizontal amplifiers that have been matched so that measurements can be made with a phase error of less than 1% over the bandwidth of d-c to 2 Mhz.

The S52 may also be used as a conventional general purpose oscilloscope. A front-panel control permits the horizontal amplifier to be switched out of the circuit and the time base to be switched in. The time base is a miller type giving excellent linearity. Eighteen calibrated sweep speeds are provided

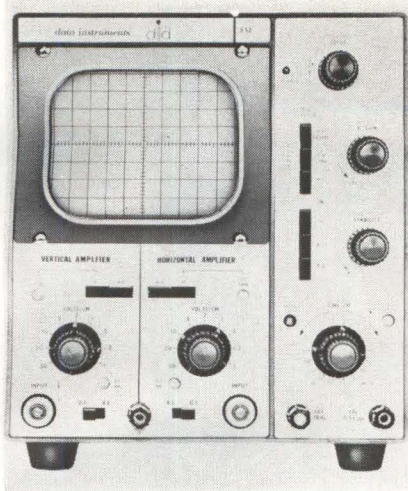

from 1 μ sec/cm to 0.5 sec/cm. The frequency range is d-c to 3 Mhz and the maximum sensitivity is 10 mv/cm.

The unit measures 15 in. x 9½ in. x 8½ in. and weighs 24 lbs. Price is \$575.

Data Instruments, 7300 Crescent Blvd., Pennsauken, N.J., 08110. [374]

Reliable, versatile strip chart recorders

A series of 10-inch strip chart recorders is announced for laboratory and process control instrumentation that, according to the manufacturer, offers very good operating convenience combined with high reliability and wide versatility. Functional, attractive bench-top styling is featured in both single and dual channel models of the series G-2000. Special versions include filter networks required for optimum performance in gas chromatography, spectrometry, radiation detection and so forth.

Sensitivity is 0.1% of the 10-inch span; accuracy, 0.25% or better; and pen response, 0.5 second full scale. Standard chart drive systems afford instant selection of up to four different chart speeds with eight speeds available optionally. Solid state and electronically-regulated reference circuits insure reliable operation and long life.

Several accessories and options are available. Price of the single-channel unit is \$995; the dual-channel unit, \$1,445. Delivery of first production instruments is scheduled for January, 1967. Varian Associates, 611 Hansen Way, Palo Alto, Calif., 94303. [375]

MICROCIRCUIT MODULES

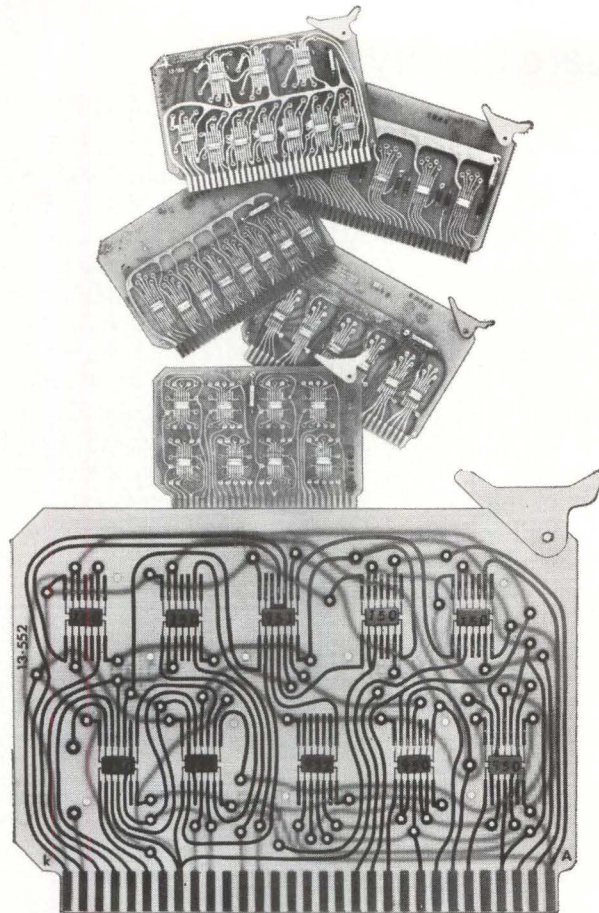

HIGHEST DENSITY

...and simplified Gating Rules Reduce Costs

The ADC 13-Series features unique function grouping, simplified gating rules and a 62 pin connector which permits the highest density per board. This means more functions per board — fewer boards required — less wiring — less noise problems — less cost. The 13-Series offers the most economical logic implementation as well as field proven performance. ■ The ADC 13-Series further expands (more than 30 new modules) the most complete line of logic modules available. ■ The 100 kc

- 10 Series, with germanium semi-conductors, is simple, economical and reliable. The 1 mc 11-Series using silicon semiconductors, is ideal for high performance applications and the 11G-Series meets all applicable MIL/NASA specifications. ADC offers free logic implementation service for competitive evaluation and application assistance.

■ Write for new short form catalog and obtain a free logic design handbook.

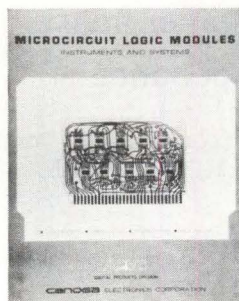

canoga ELECTRONICS CORPORATION

ADC DIGITAL PRODUCTS DIVISION

20131 Sunburst St., Chatsworth, Calif. 91311, Tel. (213) 341-3010, Twx (910) 494-1214

Choppers for any amplifier

Special-purpose or economy grade differential amplifiers can be converted into high-performance operational amplifiers with a stabilizer-amplifier unit from Computer Dynamics Inc. The module contains field effect transistors, making it a solid state version of the chopper stabilizer.

The chopper holds offset voltage and drift of the operational amplifier to approximately the stabilizer values given in the table. With the stabilizer, amplifier input voltages and feedback resistances can be made higher for greater output accuracy.

For example, the offset voltage drift of an economy off-the-shelf differential amplifier is about 20 microvolts per degree centigrade, says the company. Adding the chopper stabilizer and a few external trimming components reduces the drift to 0.5 μV . Current drift will also drop, from about 2 nanoamperes to about 0.2 picoamperes. In addition, the stabilizer-

amplifier raises the amplifier gain from about 2,000 to 3 million.

Designed into the unit are wide-band output and chopper-bypass filters. It's claimed that these will match the stabilizer-amplifier's frequency response to most types of differential amplifiers and prevent noise and oscillations in the assembly. However, the module is fitted with leads to the internal filter capacitors, so that the user can add capacitance externally if that is necessary for a closer match.

Specifications

Model	10M3
D-c gain	500 to 1,000
Input voltage offset	± 50 microvolts max
Input current offset drift	0.1 picoampere/ $^{\circ}\text{C}$ typical
Input current offset	± 20 picoamperes
Input voltage offset drift	0.2 microvolt/ $^{\circ}\text{C}$ typical
Input impedance	1 megohm
Chopper noise	(100 hz) 10 microvolts p-p typical
Output	± 0.5 v
Power requirements	± 15 to 18 vdc
Operating temperature	-55°C to $+85^{\circ}\text{C}$
Price (1 to 9)	\$105
Computer Dynamics Inc., 179 Water St., Torrington, Conn. 06790 [381]	

Plug-in serial memory for commercial uses

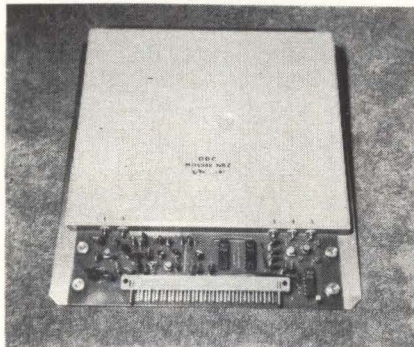

Low-cost serial memories have been introduced for commercial applications. The MD series employs integrated circuits for both the input gating and outputs, and stores up to 10,000 bits at 2 Mhz.

This plug-in memory module mounts in a standard 8-in. card

slot with $\frac{3}{4}$ -in. spacing. Both the delay line and p-c card mount on an aluminum plate $\frac{1}{16}$ in. thick which utilizes card guides in the same manner as a p-c card.

Delay Devices Corp., 24 Florida St., Farmingdale, L.I., N.Y., 11735. [382]

D-c amplifier boasts high impedance

A signal conditioning amplifier called the Accudata 120 has an input impedance of over 10 megohms. Temperature drift is below 5 $\mu\text{V}/^{\circ}\text{C}$ and noise below 2 μV d-c to 10 khz.

Front panel controls include a switch to select one of two gain ranges, 10 to 100 or 100 to 1000; a four-position rotary switch to vary amplification gain in fixed calibrated steps; and a continuously

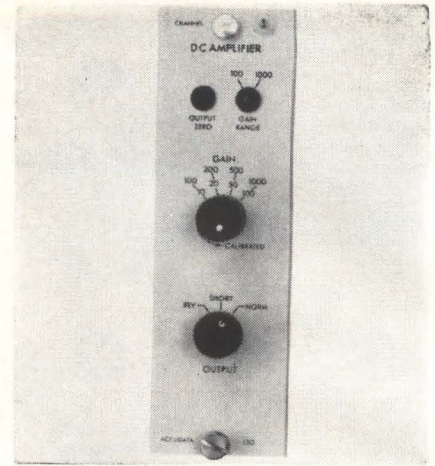

variable vernier control to increase amplification gain to the next higher calibrated position.

The Accudata 120 has an auxiliary 44-v d-c output at 50 ma to supply power to the Accudata 105-3 strain-gauge control, frequently used with such amplifiers. The manufacturer says this combination provides an individual power supply with each strain gauge channel.

Honeywell Inc., Test Instruments division, 4800 East Dry Creek Road, Denver, Colo., 80217. [383]

A-c line conditioner has fast response

Series 5000 a-c line conditioner completely isolates sensitive electronic equipment from all forms of power line disturbance. With response times of less than 50 μsec , input/output isolation of 100 db, maximum output distortion of 0.25% and regulation of $\pm 0.05\%$, these conditioners provide 5 kilovolt-amperes of transient-free, precisely regulated a-c power.

Design is all-silicon solid state, to instrumentation quality standards. Models are available to operate at 47 to 53, 57 to 63 and 380 to 420 hz, and 115 v, 230 v, and 440 v power.

Elgar Corp., 8046 Engineer Road, San Diego, Calif. [384]

Power supply energizes gas-filled lamps

Users of high intensity lamps can now standardize on a single power supply capable of energizing a wide variety of continuous arc, gas-filled



lamps. Model 352 power supply is claimed to be the only commercially available unit that will operate all xenon, xenon-mercury, xenon-neon, and mercury lamps over a range of 75 to 200 watts, and at a cost comparable with fixed single lamp supplies.

Conservative solid state design provides line regulation of $\frac{1}{2}\%$, load regulation of 1%, with less than 1% ripple, plus short circuit protection. These specifications assure maximum lamp life and freedom from arc wandering.

Model 352 is compactly packaged for standard rack mounting with an optional cabinet housing available, as illustrated. Special packaging configurations are available to OEM's for systems integration.

Electro Powerpacs, Inc., 253 Norfolk St., Cambridge, Mass., 02139. [385]

Differential amplifier features low noise

A low-cost, d-c differential amplifier that uses all-silicon planar transistors is designed for single or multiple use in instrumentation systems, industrial controls, biomedical research, geophysical instruments and general purpose laboratory use.

Features of the model 1755 include noise less than 1 microvolt rms below 1 khz and less than 5 μ v rms wideband; 1 megohm input impedance; less than 1 ohm output impedance; drift, less than 10 μ v per $^{\circ}$ C; output ± 100 ma at 10 v; adjustable gain, 50 to 500 or 200 to 2,000; adjustable null; common mode rejection ratio, 90 db; frequency response, d-c to 10 khz; recovery from overload, less than 1 msec; linearity, 0.05%; operating temperature range, -10° to $+75^{\circ}$ C.

California Electronic Mfg. Co., Inc., P.O. Box 555, Alamo, Calif., 94507. [386]

DO YOU MAKE THESE FIVE COMMON MISTAKES IN EVALUATING CAREER GROWTH OPPORTUNITIES?

1. Do you consider only the largest companies in your particular field? Size of opportunity is not necessarily proportional to size of company. Many medium size companies, such as ECI, offer faster achievement of professional recognition and personal satisfaction than do the "industry giants."

2. Do you fail to consider breadth of product/customer base? It's difficult to achieve career stability in a company that is closely tied to a narrow range of products and technologies and which sells them to a limited number of customers. You'll do better at ECI, where major projects in VHF/UHF communications, multiplex, space instrumentation, microelectronics, systems integration and advanced communications techniques are in progress simultaneously. ECI's broad customer base includes Army, Navy, Air Force, Marine Corps, NASA and foreign governments.

3. Do you consider joining a company which has insufficient R&D programs? Lack of aggressive R&D could mean future trouble for the company... and you. ECI has a wide range of Company and customer-funded development programs, particularly in the promising fields of microelectronics, telemetry, space instrumentation and digital switching systems.

4. Are you overly impressed with "boom" growth conditions? Growth that's too fast can point to future instability. Look for a record like ECI's, where years of stable, predictable growth demonstrate management's ability for both sound planning and successful execution.

5. Do you settle for less-than-optimum living conditions in the name of opportunity? You needn't! In addition to all the foregoing advantages, a career at ECI will let you and your family enjoy life to the fullest in St. Petersburg, Florida. This segment of Florida's Gulf Coast offers an unequalled combination of sunshine, beaches, golf, boating, and fishing plus cultural, educational and professional engineering opportunity.

RF ENGINEERS SYSTEMS INTEGRATION ENGINEERS DIGITAL SWITCHING ENGINEERS

Make a new career evaluation today! Investigate the immediate and attractive opportunities at ECI by sending your resume, in confidence, to K. S. Nipper, Director of Professional Placement, Electronic Communications, Inc., Box 12248E, St. Petersburg, Florida 33733. (An equal opportunity employer.)



St. Petersburg Division
Electronic Communications, Inc.

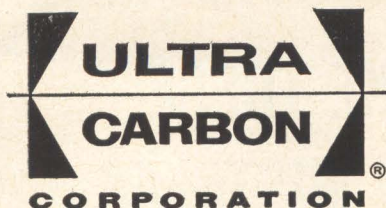

The shape of tomorrow, today

For more than 20 years, Ultra Carbon consistently has provided industry with advanced graphite technology. "F" purity graphite for the AEC . . . semiconductor crystal crucibles, boats, headers and fixtures made from *Ultra purity* graphite—these are typical of our past contributions to the electronic industries.

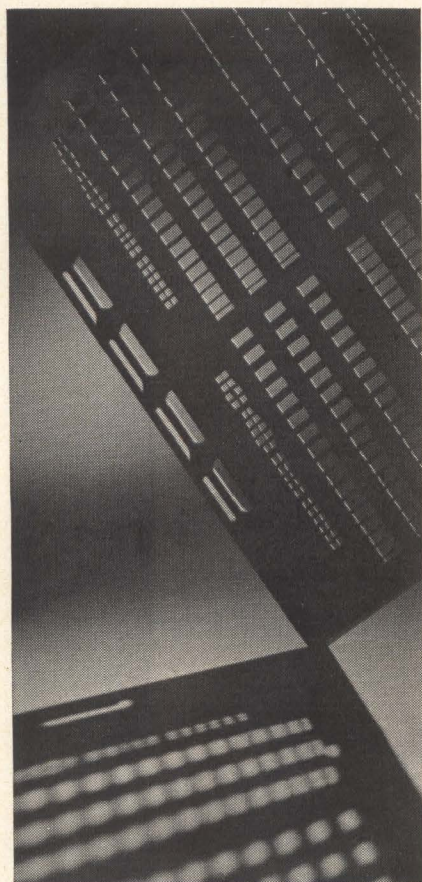

ULTRA/GRAPHITE masks, for processing thin film deposition circuits, are precisely machined. Write for information to Ultra Carbon Corporation, Box 747, Bay City, Mich. 48709.

New Microwave

Multisection filter is gang tuned

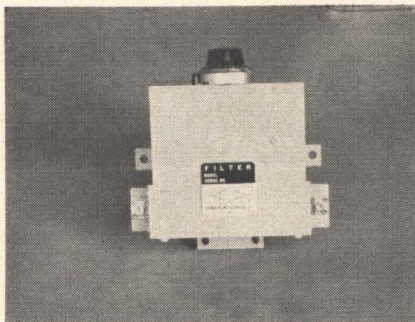

A 3-section bandpass filter that is gang tuned from 7.1 to 8.4 Ghz utilizes a waveguide mode for operation, but is supplied with either coaxial or waveguide terminals. Calibration is supplied in 50 Mhz increments over the tuning range.

Specifications for the model GC384 are: 3-db bandwidth, 33 Mhz; 40-db bandwidth, 165 Mhz maximum; insertion loss, 1.0 db maximum; 1.5 vswr max. within ± 4 Mhz of center frequency; connectors, BRM; construction, aluminum dip-brazed; weight, approximately 2 lbs.

Gombos Microwave Inc., Webro Road, Clifton, N.J., 07012. [391]

Variable attenuators cover wide band

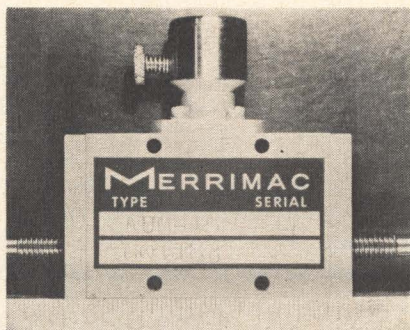

A series of miniature, continuously variable attenuators for the 2- to 8-Ghz band are useful for power control and level setting either in the laboratory or in the field. The units, model AUM-15A, weigh 2½ oz and measure ½ x 1 x 1¾ in.

Other models in this series are available from 0.5 to 12 Ghz. At-

tenuation ranges from 0 to 25 db at frequencies from 1 to 8 Ghz.

A patented ridge coaxial line provides smooth control and high maximum attenuation with a relatively short body length. In this design, twin vanes of a lossy material move back and forward inside the unit's cavity. The vanes interfere with the electrical field between a strip line and the walls at one end of the cavity. The ridged configuration creates sharp corners near the strip line's inner edge causing higher field densities which, in turn, increase the range and efficiency of the unit.

Other performance characteristics of the AUM-15A include an insertion loss of 0.5 db maximum; vswr (2 to 8 Ghz), 1.5:1 maximum; impedance, 50 ohms; power, 2 watts average. The unit has two OSM female connectors and can be adjusted with a screwdriver.

Price is \$170; delivery in small quantities, from stock.

Merrimac Research and Development, Inc., 41 Fairfield Place, West Caldwell, N.J., 07007. [392]

Compact water loads dissipate 20 kw average

Small and rugged ceramic-block water loads measure extremely high powers in all types of microwave transmitters. Standard models operate in bands between 2.6 and 18.0 gigahertz.

Mrr's Lincoln Laboratory successfully tested the L112BA2 X-band model, rated for 75 kw c-w, at a c-w power of 105 kw. Other standard loads dissipate up to 20 kw of average power and up to 14 Mw of peak power when pressurized with 30 lbs-per-sq-in.-gage of dry air. The power rating is raised to 100 Mw peak with 40 lbs-per-sq-in.-absolute of sulfur hexafluoride in the waveguide.

Designed for the WR-284 and smaller waveguide, the units have a maximum vswr of 1.15 over a 15% bandwidth. Lower values of vswr can be provided for narrower band units.

These loads have three principal

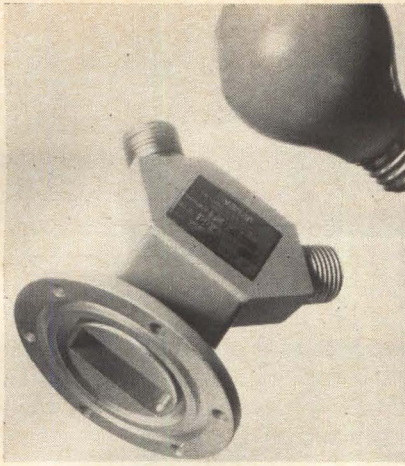

parts: a waveguide flange, a ceramic block window, and a small metal tank. The largest water load is the S-band model, which weighs 8 lbs and measures 11x1.8x3.3 in. The smallest is the K-band model, weighing 6 oz and measuring 2x0.75x1.5 in.

Varian, Palo Alto Tube division, 601 California Ave., Palo Alto, Calif., 94303. [393]

Small ferrite section gives high isolation

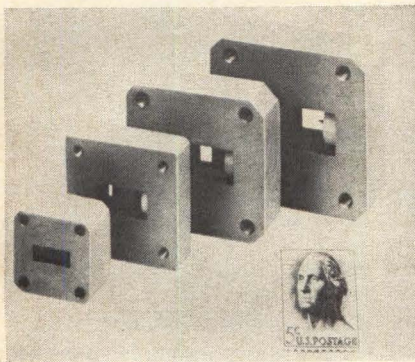

Miniature waveguide ferrite isolators, operating in the frequency range of 7.0 to 25 Ghz weigh less than 3 ounces and have isolation greater than 20 db. Bandwidth of any unit is 200 megahertz.

Power ratings vary from 50 kilowatts peak and 50 watts average in the large X-band sizes to 5 Kw peak and 5 w average at 25 Ghz.

Designed for lightweight radars, communications systems and missile applications, the isolators have a maximum insertion loss of 0.3 db. Vswr is 1.20:1 maximum, and temperature range is -40°C to $+85^{\circ}\text{C}$. Shock and vibration meet MIL-E-5400 specifications.

Microwave Associates, Burlington, Mass. [394]

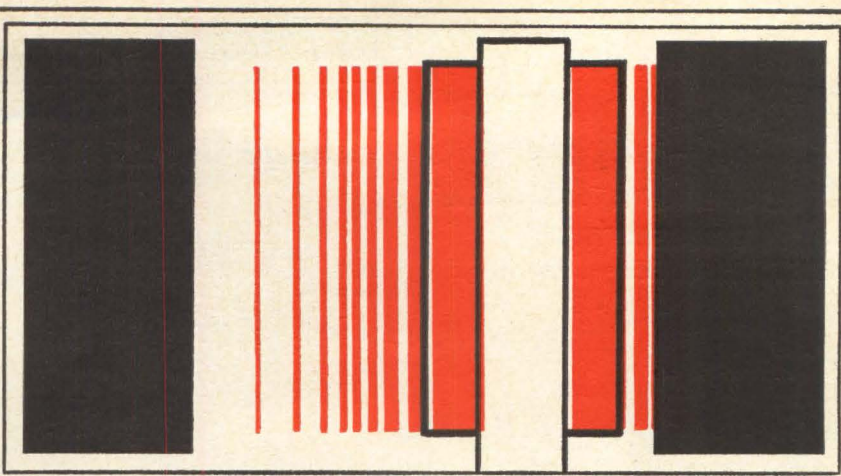

Why is a Jennings vacuum relay the only choice for high voltage switching?

There's nothing to it!

That's right. Only a vacuum dielectric can provide a solution to almost every high-voltage switching problem—and only a Jennings vacuum relay offers the numerous advantages unequalled by any other relay type. You pick a Jennings vacuum relay when you want the utmost in performance for switching sonar transducers, switching between antenna couplers, tap changing on rf coils, switching between transmitters, antennas, and receivers, and many similar applications in airborne, mobile, or marine communication systems. In fact, in any application where reliability is a must and space is minimal.

Why?

Check these features: High RF Current Ratings • Faster Operation • Highest Voltage Ratings • Long Contact Life • No Contact Maintenance • Impervious To Environment • Models To Interrupt High DC Power...*plus* the reliability and quality backed by more than 24 years experience in the design and manufacture of

vacuum electronic components.

If you have a high-voltage switching problem, Jennings probably already has a solution. If not, no one is better experienced to find one. For complete information write for our relay catalog No. 102. ITT Jennings, a subsidiary of International Telephone and Telegraph Corporation, 970 McLaughlin Avenue, San Jose, California 95108.



JENNINGS ITT

NEW EG&G PHOTODIODE

HIGH SENSITIVITY
FAST RESPONSE • LOW NOISE

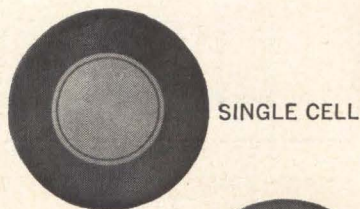

SINGLE CELL

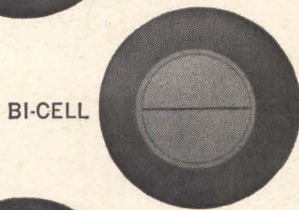

BI-CELL

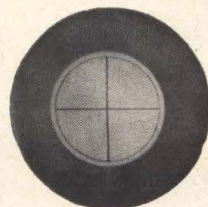

QUAD-CELL

SGD-444 SERIES

The new SGD-444 Series complements versatile, new EG&G SGD-100 Photodiode. Improved diffused guard ring construction permits higher sensitivity, lower noise and faster response factors than ever before available in large (1 cm² active) area diodes.

Bi-cell and quadrature cell configurations with isolations of greater than 20 to 1 are standard. The photodiodes are oxide-passivated and hermetically sealed in a TO-36 package.

Sensitivity 0.4 μ A/ μ W @ 0.9 μ
(55% Quantum Efficiency)
Spectral Range 0.35 to 1.13 μ
Leakage 0.5 μ A @ 250 volts
Rise Time 10 nanoseconds
NEP 1.0 x 10⁻¹² watts
Linearity of Response Over 7 decades

Applications include CW, pulsed light and laser detection and measurement, star tracking, optical navigation and guidance, and range-finding systems. The new SGD-444 series is in quantity production for fast delivery at low price.

For information, write EG&G Inc., 166 Brookline Avenue, Boston, Massachusetts 02215. Or phone 617-267-9700. TWX: 617-262-9317.



New Production Equipment

Bubble the dirt away

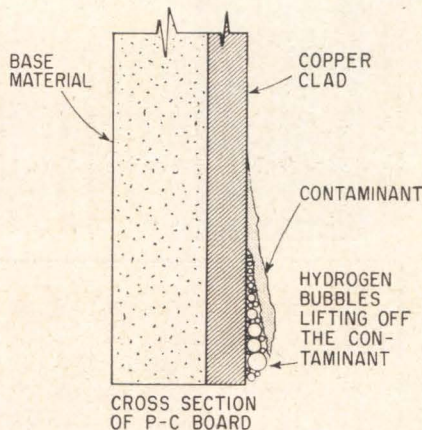

Bubbles of hydrogen gas scrub the dirt off electronic components in a new cleaning process. Flux, for example, can be safely cleaned from assembled printed-circuit boards.

The bubbles are produced by hydrolysis in a water solution of an alkaline detergent called Hydrochemex, developed by the Solutech Corp. The parts to be cleaned are immersed in the solution.

The technique is reportedly faster and less costly than either ultrasonic cleaning or vapor degreasing and is more gentle to components than the ultrasonic cavitation action. Other applications of the technique include the removal of fingerprint oils, greases and organic contaminants from circuit board laminates and the cleansing of thin film circuits and the delicate assemblies in cathode-ray tube electron guns and klystron tubes.

Direct current applied across the cleaning tank breaks the water down into its hydrogen and oxygen components. The pieces to be cleaned are made the cathode—where the hydrogen is liberated from the detergent solution—and the stainless steel walls of the tank are the anode at which the oxygen is formed.

Bubbles of hydrogen are produced so rapidly that the contaminated parts are literally scrubbed clean. To clean parts that are non-conductive, such as printed-circuit boards, stainless steel screens are used as the cathode. The boards are sandwiched between the screens.

Solutech says there is absolutely no danger of an explosion from the hydrogen that bubbles to the surface of the tank. Not very much hydrogen is produced to begin with, and the gas coming to the surface is saturated with steam being evaporated from the solution.

Solutech provides both the detergent and the tanks. A portable unit available now has a 2½-gallon capacity and weighs about 40 pounds. It consists of a cleaning tank, 8 x 12 x 7 inches deep, a d-c, 40-ampere, 0 to 12-volt power supply and part-holding screens.

A 750-watt heater brings the tank solution to its cleaning temperature of 180°F.

Larger units will be ready shortly and will have a capacity of 70 to 100 gallons and a filtration unit for reclaiming the detergent.

In the portable unit, the detergent is thrown out when it gets dirty.

Solutech Corp., 5903 Seminole Blvd., Largo, Fla. 33540 [401]

Electroplating unit fits on table top

An electroplating plant so compact that it fits on a table can be used by electronics firms in electroplating miniaturized components, printed circuit tabs and prototypes. The Techi-Lab will make it possible to develop in-house plating capabilities for jobs too small to be handled efficiently by a job shop. Research and development engineers can handle their own plating using the Techi-Lab. The electroplating plant includes a power supply providing 0 to 5 amps, three heaters, two thermostatically controlled heating areas, and two timers.

The unit is 72 in. long, 24 in. wide, and 8 in. high, not including tanks. Six polyethylene tanks come in two sizes: 11x6⅜ in. with a depth of 5 in. for rack plating, or 11x7x10 in. for barrel plating. Technic, Inc., P.O. Box 965, Providence, R.I., 02901. [402]

WHEREVER COMPUTER PEOPLE MEET—THE TALK IS...

THE NEW COMCOR Ci-500

SAME COMPONENTS AS Ci-5000



ALL SOLID-STATE



160 OPERATIONAL AMPLIFIERS



IT'S MEDIUM SIZE

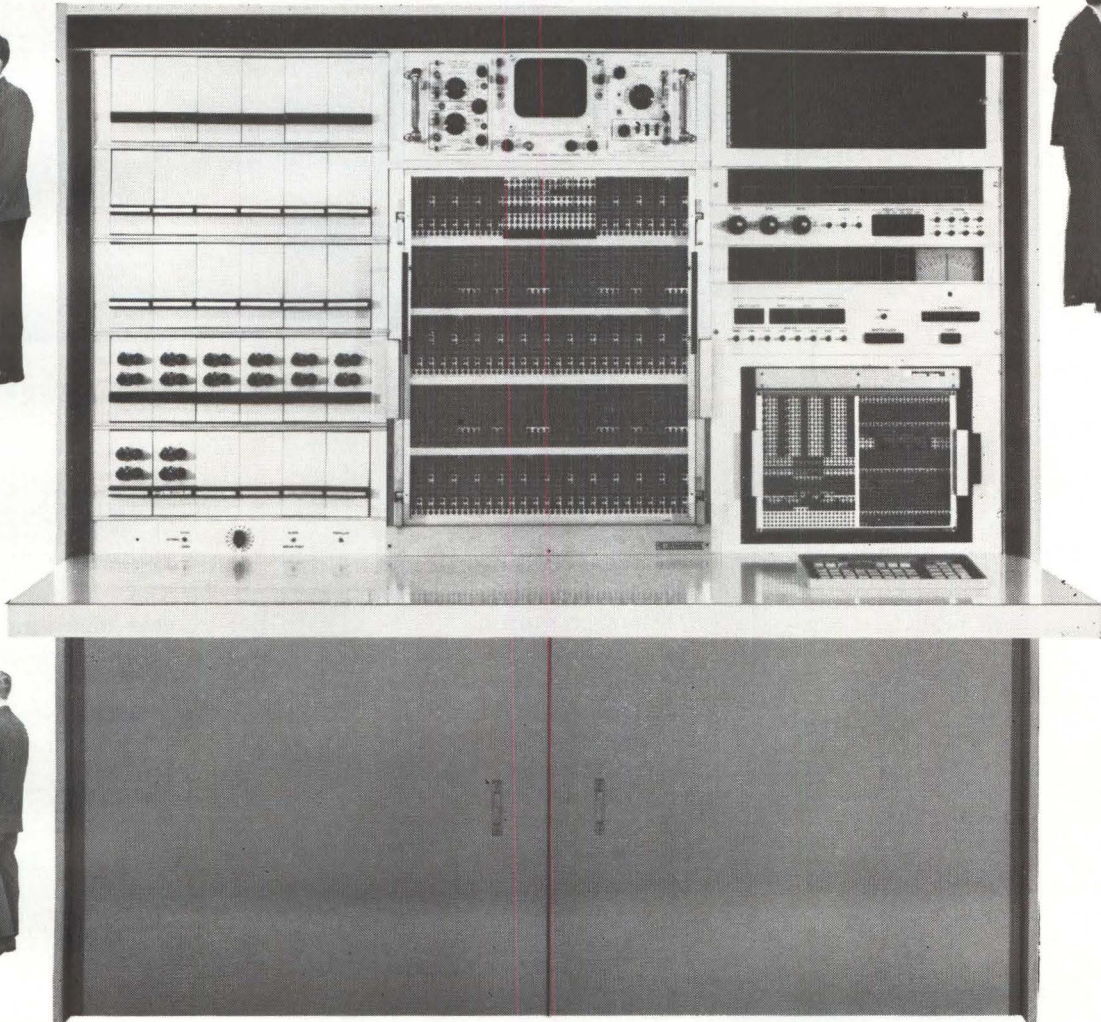
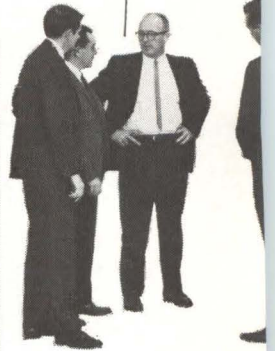

ANALOG/HYBRID



FLEXIBLE



First delivery of our newest system, the Ci-500 took place in October 1966. The Ci-500 is a medium-scale general-purpose analog/hybrid computer that will accommodate up to one-hundred and sixty 100-volt, 50-ma operational amplifiers. All computing components are identical to those used in the larger field-proven Ci-5000 system. High-speed digital logic circuits are used for address and



control functions—the flexibility inherent in all COMCOR systems makes interface with digital equipment for hybrid operation simple and inexpensive. The Ci-500 is the perfect system for simulating and solving your research, development, production, and processing problems. For delivery date, see your COMCOR representative or contact COMCOR direct. (714) 772-4510 TWX: 714-776-2060.

COMCOR
A SUBSIDIARY OF ASTRODATA, INC.

PUT COMCOR IN YOUR PROGRAM!

1335 SOUTH CLAUDINA STREET / ANAHEIM, CALIFORNIA 92803

Career opportunities available now in engineering and marketing.

Circle 147 on reader service card



PEAK LOK
measures and holds
1 μ s voltage peaks

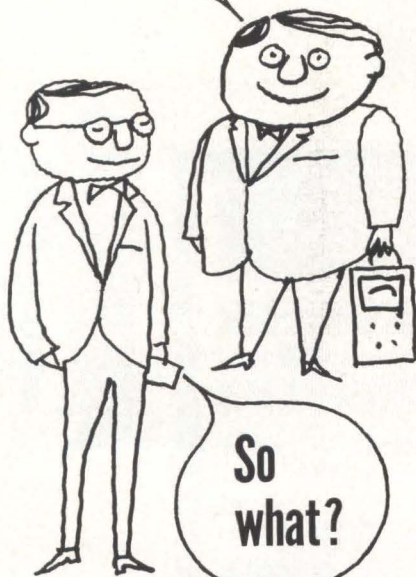

Here's what. Now you can sample that peak or break point—no matter how brief the duration—with a degree of accuracy not previously possible.

Peak Lok is already being used to measure transient voltage peaks, break points, shock peaks and a variety of other physical phenomena in research laboratories and industry.

Take a closer look. You'll see a number of ways you can use Peak Lok too.

With Peak Lok, measured voltage, in pulses as brief as one microsecond, is held in an analog state. DC coupling is provided and input ranges are from 0.1 to 1000 volts. Output for logging —0 to 5 volts with 1% absolute accuracy. And it's available in portable and rack mounted versions.

For a closer look, call or write PEAK LOK, Dept. 705, La Jolla Division, Control Data Corporation, 4455 Miramar Road, La Jolla, California 92037. Phone (714) 453-2500.

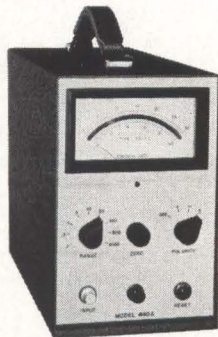

CONTROL DATA

CORPORATION

4455 Miramar Road, La Jolla, Calif.

New Materials

Transducer sounds off at 400°C

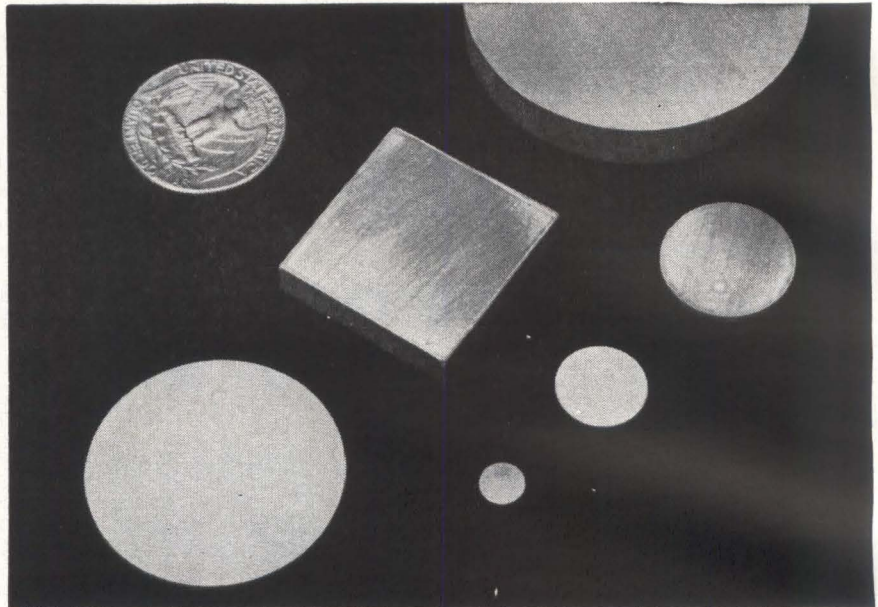

Lead metaniobate, a ferroelectric ceramic for ultrasonic transducers and probes, is available commercially from the Industry Control department of the General Electric Co. It has been used in military applications because it retains its piezoresistivity at high temperatures and pressures.

The material, says GE, has the highest Curie point and the lowest mechanical Q of any piezoelectric material. The Curie point for GE's patented version is 550°, about 20° lower than the pure compound $Pb(NbO_3)_2$. Its piezoresistivity starts to drop at about 300°C, but with special circuitry it can be used in ambient temperatures as high as 400°C. Barium titanate, in comparison, gives out below 100°C.

As a result of the low mechanical Q, the material quickly damps itself when the applied voltage is removed. This factor is helpful for many wideband applications and in ultrasonic fault finders since defects as close as 0.1 inch from the probe can be displayed on a cathode-ray tube. With other piezoelectric materials, GE notes, undamped oscillations obscure the signal returning from the fault. One researcher is investigating the possibility of replacing dental X-rays with an ultrasonic probe, to sidestep X-ray health hazards. The high

Curie point is important in examining metals just out of the oven.

The ceramic can also be used in under-water research equipment and force gauges in high ambient temperatures because lead metaniobate continues to operate under pressures as great as 10,000 pounds per square inch. In addition, GE reports, the material shows only a negligible decrease in its piezoelectric constant with aging.

The manufacturer polarizes the ceramic—a brittle, crystalline compound—by applying a voltage at an elevated temperature. The usual configuration is a disc 0.25 to 1.25 inches in diameter and as thin as 11 mils. At present, operating frequencies range from 100 khz, for 0.5 inch-thick disc, to 5.8 Mhz; the goal, GE says, is 10 Mhz. Initial prices range from \$15 to \$80 per wafer.

Specifications

Mechanical Q	5, longitudinal; 10, radial
Density	6 g/cu. cm
Dielectric constant	240, at 1 khz
Piezoelectric strain constant on vertical axis	2.25×10^{-7} in./v
Piezoelectric voltage constant on vertical axis	6.1 v/in./psi
Frequency constant, longitudinal	54 khz-in./sec.

Industry Control department, General Electric Co., 1501 Roanoke Blvd., Salem, Va., 24153 [406]

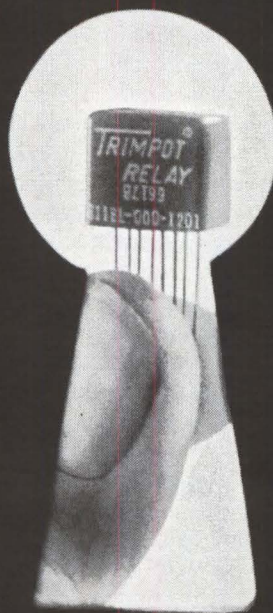

What design doors can you open with the world's smallest industrial relay?

Our new Model 3118 TRIMPOT® DPDT Relay weighs in at 1.8 grams, yet switches a one-amp load along with the heavy-weights. Only 1/6 the size of a conventional crystal-can unit, it's the smallest industrial relay in existence. It brings high quality and performance to your applications at low cost.

Designed specifically for industrial use, the Model 3118 clearly reflects Bourns' long experience in military relays. It has the same type motor assembly and structure as the highest quality MIL unit and provides the same 100,000-cycle life. Also, it undergoes the same 5000-operation run-in as well as the rigorous final inspection for coil resistance, dielectric strength, operate and release time, pickup and dropout values, contact resistance and contact bounce. In addition, its damped return spring and balanced armature design assure excellent resistance to shock and vibration.

The 0.1" grid spaced pins let you plug the Model 3118 right into your printed circuits. Units are available immediately from the

factory with operating voltages of 6, 12 and 26.5 VDC, and in three terminal types. Write today for complete technical data.

Size:	0.26" x 0.53" x 0.43"
Pick-up sensitivity:	200 mw, max.
Contacts: DPDT; rating:	1.0 amp resistive at 28 VDC
Operating temp. range:	-55 to +85°C
Shock:	50 G, 11 ms
Vibration:	10 G, 5-3000 cps
Std. coil resistances:	60Ω to 1200Ω
Life:	100,000 cycles at rated load
Pin spacing:	0.10" grid



BOURNS, INC., TRIMPOT DIVISION, 1200 COLUMBIA AVE., RIVERSIDE, CALIF.
PHONE 684-1700 • TWX: 714-682 9582 • CABLE: BOURNSINC.

TRIMPOT means BOURNS—BOURNS means QUALITY
TRIMPOT is a registered trademark of Bourns, Inc.

TRIMPOT® AND PRECISION POTENTIOMETERS—RELAYS—MICROCOMPONENTS: TRANSFORMERS, INDUCTORS, RESISTORS AND CAPACITORS

 **New and Important**
from McGraw-Hill

1. ELECTRONICS AND NUCLEONICS DICTIONARY, 3rd Edition. By JOHN MARKUS.

Anyone in any way connected with electronics or nucleonics, even a stenographer or typist, should have this book at his fingertips. It makes instantly available the spelling, hyphenation and meaning of more than 16,000 terms (many of them new)—25% more than the previous edition—and contains more than a thousand illustrations. **650 pp., \$16.50.**

2. ELECTRONIC TESTING. By L. L. FARKAS.

In clear, simple language, this book uses a minimum of mathematics to describe major types of electronic equipment and how to use them, and indicates methods of aligning them and testing their performance. This one volume presents essential information and techniques normally accessible only in a number of scattered sources. **300 pp., \$12.00.**

3. ON-LINE COMPUTER SYSTEMS. By WALTER J. KARPLUS.

The on-line computer system permits innumerable users to have satisfactory access to the services of the same computer. This thorough, lucid book provides an essential overall view of in-line operations and shows how you can share in their great advantages. **375 pp., \$14.50.**

4. CIRCUIT DESIGN FOR AUDIO, AM/FM, AND TV. By The Engineering Staff of Texas Instruments Incorporated, Dallas, Texas.

This fifth book in the Texas Instruments Electronics Series covers the important aspects of circuit design in four different areas. It discusses output and driver design and input design; amplifiers, tuners, and applications; VHF, tuners, video IF amplifiers, automatic gain control, audio amplifier system, sync separators, and oscillators—both vertical and horizontal. Each topic is discussed in detail and many topics have illustrative examples showing specific design procedures. **366 pp., \$14.50.**

At Your Bookstore or
Direct from Publisher for

10 DAYS FREE EXAMINATION

McGraw-Hill Book Co. Dept. 23L-1226
330 West 42 Street, New York, N. Y. 10036

Send me the book(s) encircled below for 10 days, on approval. In 10 days I will remit for book(s) I keep, plus a few cents for delivery costs, and return other book(s) postpaid.

1 2 3 4

NAME (print) _____

ADDRESS _____

CITY _____

STATE _____ ZIP CODE _____

For prices and terms outside U. S. write McGraw-Hill
Int'l. NYC. **23L-1226**

New Books

Basic antennas

Antenna Analysis
Edward A. Wolff
John Wiley & Sons, Inc., 514 pp., \$25

This work is best described as an anthology of mathematical derivations relating to antenna performance. The author reviews and consolidates previous books and reports and summarizes analytical methods drawing heavily on the classic works of Schelkunoff, Silver, Kraus and Jasik. All the basic antennas, such as wire, aperture, slot, reflector and lens, in the usual geometric variations, are covered.

Though the emphasis is on analysis, the material is restricted to the simpler problems which, by their nature, lend themselves to treatment by classical techniques. Many advanced concepts and topics of current interest are omitted; for example, the polarization properties of reflector antennas and the mutual impedance and element performance of scanning array antennas. Other advanced topics get only scant coverage. Wolff's attempt to analyze frequency-independent antennas, for instance, is no more than a review of the equations expressing their geometry.

It is plain that Wolff took considerable care in organizing material from many diverse sources, and he is consistent both in method and in terminology. Still, the text is a bit formidable, not so much in mathematical sophistication, but because Wolff concentrates on derivations at the expense of narrative explanation. Frequently, the results of a particular analysis are neither obvious nor are they emphasized. All of which leads to confusion when the author attempts to handle more difficult problems requiring advanced concepts.

Despite the book's limitations, it does present a unified approach to a wide selection of problems. As such, it deserves space on the antenna designer's reference shelf.

Yet it will probably serve best as a text for graduate students since the volume gives considerable insight into methods of analysis. Supplementary material emphasizing the conclusions, however, would be necessary.

The author, who has been active in antenna design since 1951, currently manages the Space Engineering Laboratory at Aero Geo Astro, a division of Keltec Industries.

Henry L. Bachman
Wheeler Laboratories, Inc.
Great Neck, N.Y.

Rx for doctors

Medical Electronics Equipment, 1966-67
Edited by G.W.A. Dummer and J. MacKenzie Robertson
Pergamon Press, 892 pp., \$26

Manufacturers' data sheets from much of the world—the United States, England, France, Germany, Italy, Japan, the Netherlands and Scandinavia—are collected in this volume devoted to electronic instruments that measure, analyze, compute and control medical findings.

The intention to provide a single source of information about this area is a good one. The medical electronics field, however, is rapidly changing, and equipment often becomes obsolete quickly. A check with one U.S. manufacturer revealed that many of his devices listed in this book have been superseded or improved and that the new models are already available.

A listing of manufacturers, cross-indexed by the kinds of equipment they make, would have been a valuable supplement to this compilation.

The editors have thoughtfully included a bibliography of magazine articles and published conference papers on the applications of electronics to medicine. Here again the time between compilation and publication posed a problem, solved with a supplementary section that includes most articles of 1965 and a few items from early 1966.

Recently published

Magnetolectric Devices: Transducers, Transformers and Machines, G.R. Slemmon, John Wiley & Sons, Inc., 544 pp., \$11.50
The author, head of the University of Toronto's electrical engineering department, emphasizes equivalent circuit models of devices in his treatment of transducers, actuators, transformers, magnetic amplifiers and rotating machines. The text is aimed at third- and fourth-year students who have studied electrical physics and circuit analysis.

NEW LOW PRICE! **\$9.20*** ELAPSED TIME INDICATORS



Now, at low cost, you can get an indication of the operating time of any electronic or electrical equipment. Here are rugged, accurate, elapsed time indicators that tell you when lubrication, overhaul, adjustment or replacement of components is due on machine tools, computers, industrial machinery and test equipment or complete processing systems. Six-digit displays read either "hours and tenths", "minutes and tenths", or "seconds". Three different types of mounting are available as shown. All models have synchronous motors; nominal power requirement is 2.5 watts. Both bezel mountings are to standard NEMA dimensions.

* 1-3 units . . . volume prices even lower

AWHAYDON
THE COMPANY

232 North Elm Street
Waterbury, Conn. 06720
4060 Ince Boulevard
Culver City, Calif. 90231

Timing & Stepper Motors • Electromechanical & Electronic Timing Devices & Systems
Circle 182 on reader service card

SUBMINIATURE TOGGLE SWITCHES

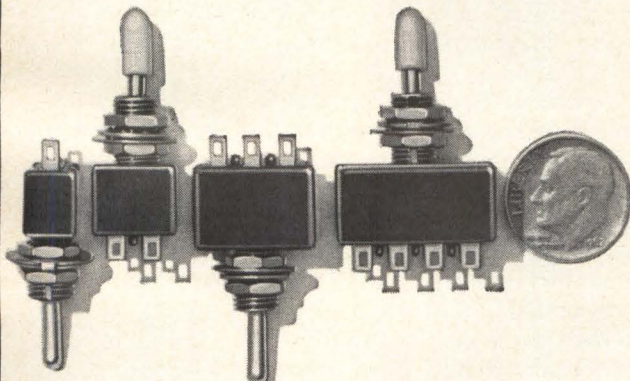

- SPDT**
- DPDT**
- 3PDT**
- 4PDT**

Designed to meet the highest standards of reliability, C&K's quality subminiature toggle switches combine maximum performance with small size! They feature rugged construction, simple mounting, excellent appearance, and long, trouble-free operation!

A competitively-priced, made-in-America product. Write for literature today!

C&K
COMPONENTS, INC.

quality electro-mechanical products
103 Morse Street, Watertown, Massachusetts 02172
Telephone: 617 926-0800

C&K also manufactures a quality line of magnetic code converters, timers and logic elements.

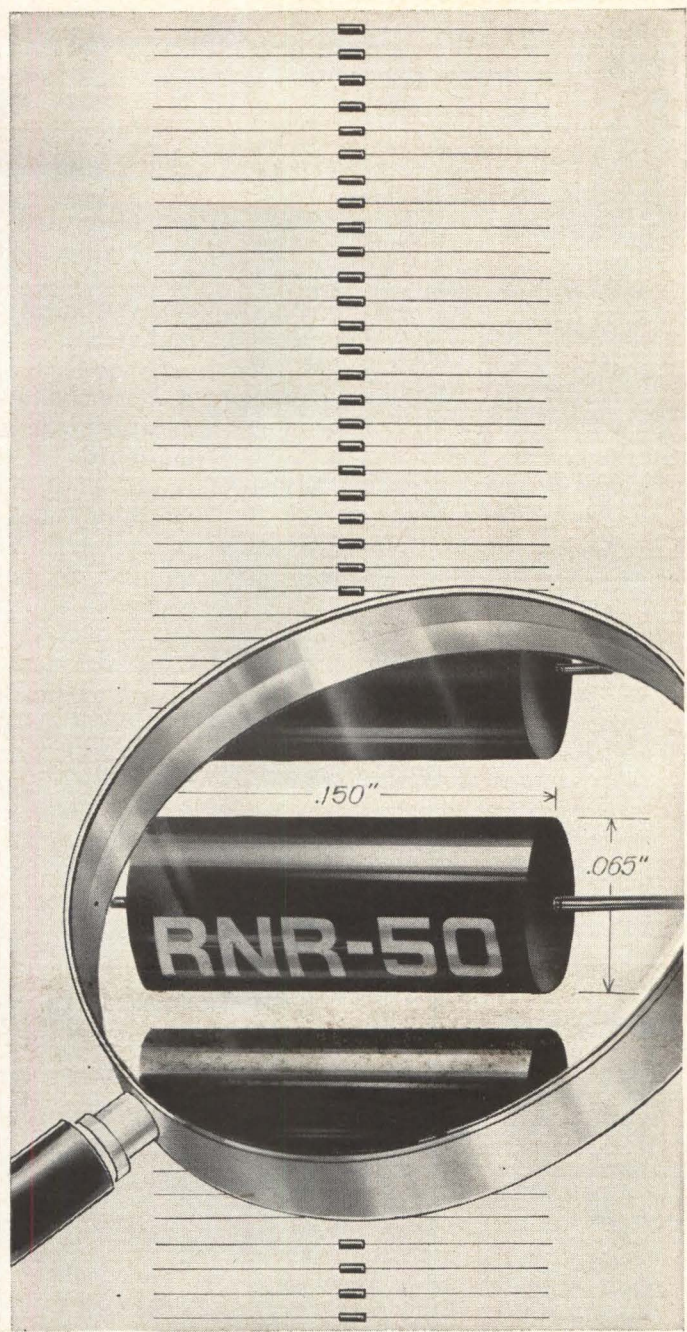

MEPCO HAS UNIFORM DIMENSIONAL CONFIGURATIONS EVEN IN ITS

1/20 WATT

METAL FILM RESISTORS.

- Molded epoxy enclosure assures repeatable dimensions
- Cap and lead terminations
- Extensive moisture testing proves the superiority of Mepco's transfer encapsulation enclosures
- Meets RNR-50 (H Characteristic).

Write or call today for complete technical data

MEPCO
MANUFACTURERS OF PRECISION ELECTRONIC DEVICES

MEPCO, INC.
Columbia Rd., Morristown,
New Jersey 07960
(201) 539-2000
TWX (201) 538-6709

Technical Abstracts

Rating shields

A method of determining the comparative shielding effectiveness of cables, duct and conduit
George A. Long
Rome Air Development Center, N.Y.

Shielding qualities of ducting, conduit and coaxial cable can be compared by converting the ducting or conduit into an equivalent of the coax. A center conductor is positioned in the duct or conduit and it is substituted for the cable in the test setup. The measurements made on a standard type of cable are the basis for comparison.

To set up the test, a length of coaxial cable is shorted at one end and connected at the other to a signal generator outside the room. The standing waves cause leakage radiation, which is measured in the room by a frequency-selective voltmeter connected to an antenna. If another cable, of equal length, is substituted for the first cable, the two sets of measurements are comparable. Results are repeatable within 3 or 4 decibels if input power is kept constant.

Little, but lossy

Losses in microstrip transmission systems for integrated microwave circuits
J.D. Welch and H.J. Pratt,
Lincoln Laboratory,
Massachusetts Institute of Technology,
Lexington

Microwave designers have great expectations for microstrip transmission lines—integrated circuits made of thin-film conductors on semiconductor dielectric. But designers are hampered by the paucity of data on microstrip attenuation characteristics and the variations between theoretical and measured values.

Apparently, nobody has measured the loss tangents of silicon or gallium arsenide, two important dielectrics. If the loss tangent is known, polarization and ohmic losses can be calculated. The authors are measuring the loss tangent for gallium arsenide to assess its usefulness for microstrip. Measurements for silicon don't seem

The duct or conduit is prepared by putting a conductor through it, capping both ends of the duct and attaching the conductor to type N connectors installed in the caps. The conductor size and position should be chosen so that the enclosure closely matches the signal generator in impedance. The shield of an RG-214 cable is suitable for duct and the shield of an RG-17 cable for conduit.

Experiments showed that the impedance was close to 50 ohms when the cable was about $\frac{5}{32}$ inch from the bottom of the duct. The duct is, in effect, an eccentric cable. Since the conductor is close to the ground plane, the dimensions of the duct are unimportant and this configuration can be used for any size of duct.

Measurements from 50 khz to 30 Mhz were made with a loop antenna and a 41-inch rod antenna, with identical results. From 30 Mhz to 1 Ghz, a dipole was used. There was no measurable difference in shielding effectiveness between RG-9 cable, duct and conduit at frequencies to 1 Mhz. Above this, the ducts leaked more, depending on their radio-frequency tightness.

Presented at the 15th Annual Wire and Cable Symposium, Atlantic City, Dec. 7-9

to be a likely possibility; silicon's resistivity is relatively low and frequencies above 100 gigahertz are needed to detect a loss tangent of 0.001.

Meanwhile, the authors have worked out some modifications and applications of strip-line theory that should help resolve some of the existing data conflicts. To obtain the dielectric attenuation constant, the transmission-line expressions have been revamped. The expressions concern the TEM propagation mode, which doesn't strictly apply to microstrip. However, it does yield a good approximation. Suitable expressions for conductor attenuation are available. Those expressions for conductors in composite dielectrics have been modified for microstrip. With some exceptions, calculations based on these agree well with measurements of attenuation in silicon-based microstrip.

Presented at the Northeast Research and Engineering Meeting, Boston, Nov. 2-4.

Ultrasonic magic

The Lincoln Wand
Laurence G. Roberts
Lincoln Laboratory,
Massachusetts Institute of Technology,
Lexington

An ultrasonic position-sensing device has been designed, which adds another dimension of control to computer displays. The Wand, which is now installed on the MIT TX-2 computer, operates in an extremely large working space (4 x 4 x 6 feet) and thus permits an entirely new set of pointing functions not directly connected with the normal display control.

The Wand system comprises four ultrasonic transmitters permanently mounted at the four corners of a display console, and a receiver built into a movable pointing device. Each transmitter is pulsed in sequence to produce a 20 μ s burst of energy, of frequencies between 20 and 100 kilohertz. The burst arrives at the receiver after a delay proportional to the distance between the transmitters and receiver. On receipt of the signal, the receiver produces a pulse which stops a counter that was started by the transmitter pulse; this eliminates any errors due to reflections.

The next transmitter is pulsed 10 milliseconds after the first, and so on, until four vector distances to the receiver are determined, and the position of the receiver in space can be calculated. The major advantage of this ultrasonic delay method is that position is measured in terms of delay, which can be read out digitally. A software program calculates the x, y and z coordinates from the four distances.

The three-dimensional capability of the Wand makes it practical to draw lines and curves in three dimensions. Solid objects drawn on the display can be rotated, translated and viewpoints can be readily changed. In applications where a two-dimensional display is sufficient, the z dimension can be used as a scalar control to call up spare parts or extra functions more conveniently than is now done with a light pen or Rand tablet. Cost of the Wand should be competitive with two-dimensional sensors.

Presented at the 1966 Fall Joint Computer Conference, San Francisco, Nov. 7-10.

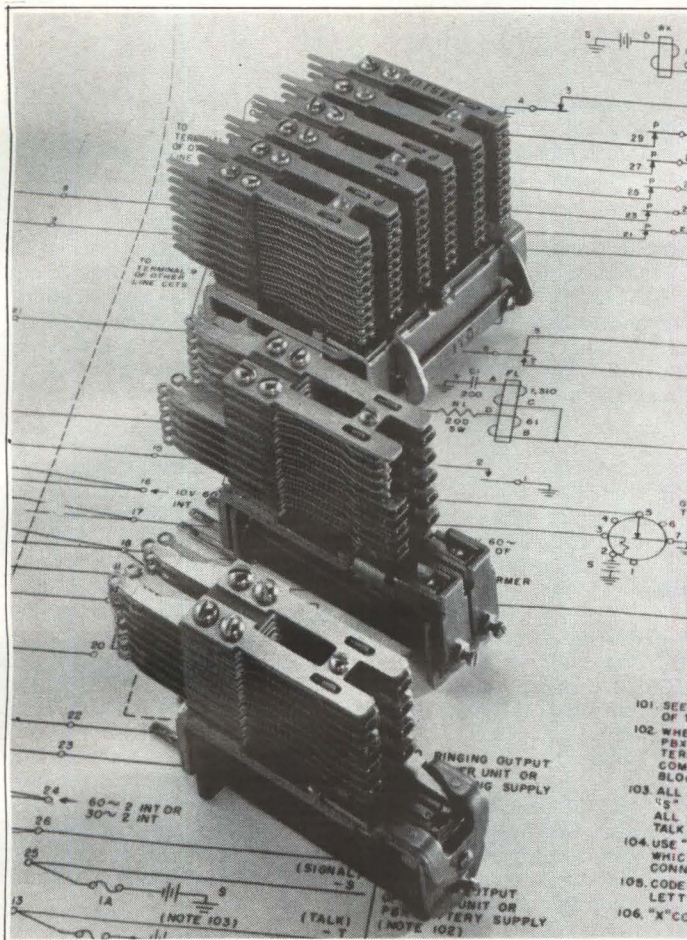

telephone quality relays

There is no higher standard for relays. Specify famous Stromberg-Carlson . . . known to telephony since 1894.

TYPE A: general-purpose relay. Up to 20 Form "A" spring combinations.

TYPE B: multi-contact relay. Up to 60 Form "A" spring combinations.

TYPE BB: multi-contact relay. Up to 100 Form "A" springs.

TYPE C: two relays on one frame; mounts in same space as one Type A.

TYPE E: general-purpose relay; universal mounting; interchangeable with relays of other manufacturers.

Write for complete technical data.

Stromberg-Carlson

A SUBSIDIARY OF GENERAL DYNAMICS CORPORATION

114 Carlson Road • Rochester, N. Y. 14603

Circle 184 on reader service card



All you need to solve most transformer design problems is a TRIAD catalog...



And your phone.

TRIAD distributors are practically everywhere, offering you over 1700 off-the-shelf transformers for immediate delivery. Chances are the unit you thought would have to be custom-made is at your TRIAD distributor's now. Of course, when you do need a custom job, turn to TRIAD too, for the best answer to your transformer, inductor and filter problems. Send for your catalog today. TRIAD Distributor Division, 305 North Briant St., Huntington, Indiana.

Triad Distributor Division
of Litton Industries

New Literature

Video amplifier. American Electronic Laboratories, Inc., P.O. Box 552, Lansdale, Pa., 19446, has published a bulletin describing the model 153A video amplifier designed for testing high impedance microwave crystal detectors.
Circle 420 on reader service card

Photoresist spinners. Headway Research, Inc., 3713 Forest Lane, Garland, Texas, 75040, has available 16 pages of literature, including detailed prices on its line of photoresist spinners. [421]

Power hybrids. Adams-Russell Co., 280 Bear Hill Road, Waltham, Mass., 02154, has issued a data sheet describing a series of power hybrids designed to handle power levels useful for transmission as well as receiver applications from 2 to 76 Mhz. [422]

Retaining rings. Waldes Kohinoor, Inc., 47-16 Austel Place, Long Island City, N.Y., 11101, has published a 128-page technical manual containing complete engineering dimensions and specifications for its line of Truarc retaining rings and assembly tools, which have many applications in the electronics industry. [423]

Data transmitter. UGC Instruments, Inc., 56100 Parkersburg Drive, Houston, Texas, offers a bulletin on the series 4 data transmitter that is designed to interface with the DataPhone 402 communications system. [424]

Computer memory technology. Computer Test Corp., 3 Computer Drive, Cherry Hill, N.J. A brochure describes the company's facilities and capabilities in the automatic test equipment field in the area of computer memory technology. [425]

Trimming potentiometers. SP Elettronica SpA, Via Carlo Pisacane 10/4, Pero (Milan), Italy. Short form catalog 1005 illustrates and describes, complete with specifications, a line of Spectrol trimming potentiometers. [426]

Permanent magnets. General Electric Co., P.O. Box 72, Edmore, Mich. Bulletin GEA-8243 deals with a line of Lodex permanent magnets for applications requiring intricate shapes and close physical and magnetic tolerances. [427]

Microwave oscillators. Terra Corp., 505 Wyoming Blvd., N.E., Albuquerque, N.M., 87112, offers a short form catalog illustrating and describing several of its microwave oscillators. [428]

Hybrid computers. Beckman Instruments, Inc., Systems division, 2500 Harbor Blvd., Fullerton, Calif., 92634.

A family of totally integrated, general-purpose hybrid computers is described in 16-page technical bulletin 1003. [429]

Logical design philosophy. Canoga Electronics Corp., 8966 Comanche Ave., Chatsworth, Calif., 91311, has available a handbook intended to help both new and experienced engineers learn the design philosophy of the company's 13-series line of microcircuit digital logic cards. [430]

Capacitance measurement. Micro Instrument Co., 12901 Crenshaw Blvd., Hawthorne, Calif., 90250, offers a four-page technical paper entitled "Theory and Applications of Capacitance Measurements." [431]

Ceramic coating material. Aremco Products, Inc., P.O. Box 145, Briarcliff Manor, N.Y., 10510. Product bulletin 512 describes Ceramacoat 512, a high-temperature ceramic material suitable to 2,500° F. [432]

Electronic choppers. Solid State Electronics Corp., 15321 Rayen St., Sepulveda, Calif., has available a comparative data profile for 20 different models of its line of solid state electronic choppers. [433]

Fiber optic magnifiers-minifiers. Corning Glass Works, Corning, N.Y., has available a data sheet on fiber optic magnifiers that magnify or reduce information through light transmission pathways considerably shorter than conventional lens systems. [434]

Thermoelectric module. EG&G, Inc., Products division, 160 Brookline Ave., Boston, Mass., 02215, has published a four-page data sheet on the model H9-65 thermoelectric module, a device having an unloaded temperature differential of 65°C at 9 amps. [435]

Snap-reed switch. Cherry Electrical Products Corp., P.O. Box 439, Highland Park, Ill., 60036, offers a brochure on the E66 series, which weds the mechanical utility of the snap-action switch to the electrical reliability of the reed switch in a single, compact and convenient package. [436]

Feed-through terminals. Taurus Corp., Academy Hill, Lambertville, N.J., 08530, has released a catalog on the SFU series subminiature feed-through terminals designed for snap-fit installation into predrilled or prepunched chamfered holes in electronic chassis. [437]

Carbon film resistors. Pyrofilm Resistor Co., Inc., 3 Saddle Road, Cedar Knolls, N.J. A four-page folder describes a line of hermetically glass-sealed, deposited carbon film resistors. [438]

Noise generator. Signalite Inc., 1933

Heck Ave., Neptune, N.J., has issued a two-page illustrated data sheet on the type TN-1 miniature X-band noise generator. [439]

Current-to-current converter. Fischer & Porter Co., 108 Jacksonville Rd., Warminster, Pa., 18974. Specification 50EK1000 describes a converter for transforming current signals, in selected ranges up to 50 ma, to a proportional 4 to 20 ma current signal. [440]

Tunable electronic filters. Spectrum Instruments, Inc., P.O. Box 474, Tuckahoe, N.Y., 10707, offers a technical data sheet on its line of type LH-42D spectrum analog electronic filters, which are active network devices usable singly or in pairs to accomplish a wide variety of frequency selective functions. [441]

Magnetic shielding foil. Magnetic Shield division, Perfection Mica Co., 1322 No. Elston Ave., Chicago, Ill., 60622. Four-page data manual 185 gives technical data on a new rust-inhibited Blue Netic magnetic shielding foil plus a multitude of applications for other magnetic foil shielding. [442]

Folded-array memory. Indiana General Corp., Crows Mill Road, Keasbey, N.J. A miniaturized, folded-array memory, the Microstack, is described in an eight-page booklet. [443]

Potentiometers. Helipot division of Beckman Instruments, Inc., 2500 Harbor Blvd., Fullerton, Calif., 92634, has available a 72-page catalog covering precision potentiometers, trimmers, dials and servo system components. [444]

Elapsed time indicators. The A.W. Haydon Co., 232 North Elm St., Waterbury, Conn., 06720. Bulletin M1603 describes the 19200, 19600 and 19700 series of microminiature elapsed time indicators for operation on 400 hz, 60 hz, and 28 v d-c respectively. [445]

Magnet wire insulation stripper. The Lea Manufacturing Co., 237 E. Aurora St., Waterbury, Conn., 06720. Bulletin 160 covers Insulstrip 220, which will effectively remove such high-temperature magnet wire insulations as ML, Allex, A1-200, Isomid and other polyamide and amide-imide wire coatings. [446]

Wire data guide. Hudson Wire Co., Ossining, N.Y., offers a pocket-size reference card containing important data on both single end-annealed copper wire (8 to 56 Awg), and stranded silver-plated and nickel-plated copper conductors (4 to 36 Awg). [447]

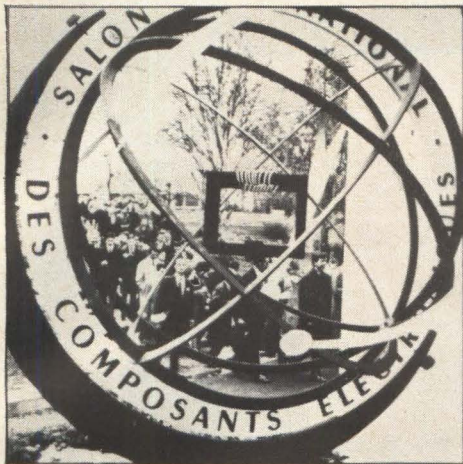

PARIS
porte de
versailles
From 5 April
through
10 April 1967

Visitors from the 4 corners of the world take part in the 2 most important shows of the year.

INTERNATIONAL
EXHIBITION OF

ELECTRONIC COMPONENTS

and international
Exhibition of

AUDIO EQUIPMENT

The Electronic Components Exhibition, created in 1934, but International since 1958, comprises 900 manufacturers, half of whom are non-French.

At the same time, the Audio Equipment Exhibition will take place in an adjacent area, where engineers & technicians from all countries will be welcomed.

International Seminar on Space Electronics

Paris from 10 through 15 April, 1967.
Reservations should be made.



The aim of the seminar is to study how the electronics industry has adapted and up-dated itself in relation to the development in aerospace activities.

S.D.S.A. - RELATIONS EXTERIEURES
16, RUE DE PRESLES - 75 - PARIS 15^e

Official Carrier for the Exhibition: Call Air France for Information

Circle 181 on reader service card

I want Q curves like this . . .
. . . specify Tohoku Neferrite
pot cores!

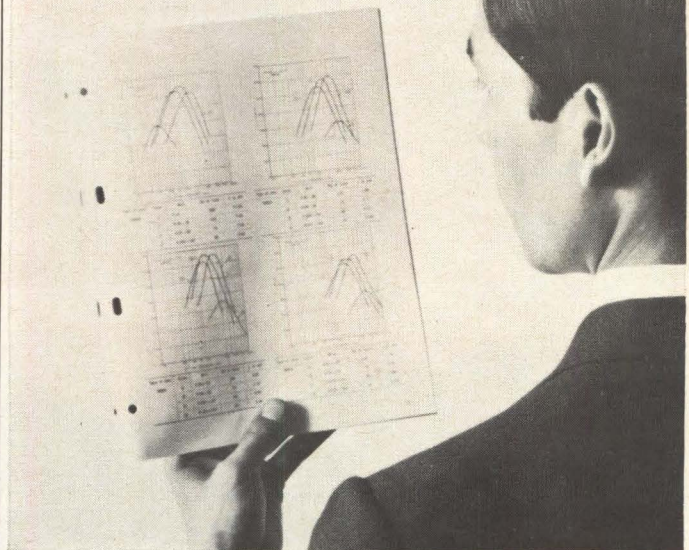

Designed in association with Japan's famous Nippon Electric Company, and featuring new NEFERRITE Mn-Zn ferromagnetic ferrite, Tohoku pot cores make possible drastic reductions in the size and weight of quality coils. NEFERRITE's own high quality standard is evidenced by the Temperature Factor of Initial Permeability ($\Delta\mu/\mu^2/0^\circ\text{C}$) which is $(0.8 \pm 0.5) \times 10^{-6}$ from 0° to 40°C —and a loss factor ($\tan \delta/\mu$) of 2×10^{-6} at 100 Kcs. These and other improved characteristics offer important design advantages—giving Tohoku pot cored coils exceptionally high Q value with low distortion over a wide frequency range.

For further information, specifications, comprehensive characteristics data and sample core, write for our free booklet, "Neferrite & Ferribro".



Fundamental Characteristics of NEFERRITE

Item	Grade 1	Grade 2
μ_0	2000	2000
B_{10} (Gauss)	4200	4200
B_r (Gauss)	1000	1000
H_c (Oersted)	0.3	0.3
$\frac{\tan \delta}{\mu_0}$		
10 Kc	0.7×10^{-6}	0.7×10^{-6}
100 Kc	2×10^{-6}	2×10^{-6}
500 Kc	15×10^{-6}	15×10^{-6}
h_{10} (cm/A)		
10 Kc	15	15
100 Kc	20	20
T. F	$\pm 0.5 \times 10^{-6}$	$(0.8 \pm 0.5) \times 10^{-6}$
T. C ($^\circ\text{C}$)	180	180
D. F	3×10^{-6}	3×10^{-6}
ρ ($\Omega\text{-cm}$)	700	700

U.S. Pat. No. 3106534



Tohoku Metal Industries, Ltd.

7-4, GINZA-HIGASHI, CHUO-KU, TOKYO, JAPAN
Telephone: Tokyo (542) 6171 Cable Address: TOHOKUMETAL TOKYO

Circle 155 on reader service card

155

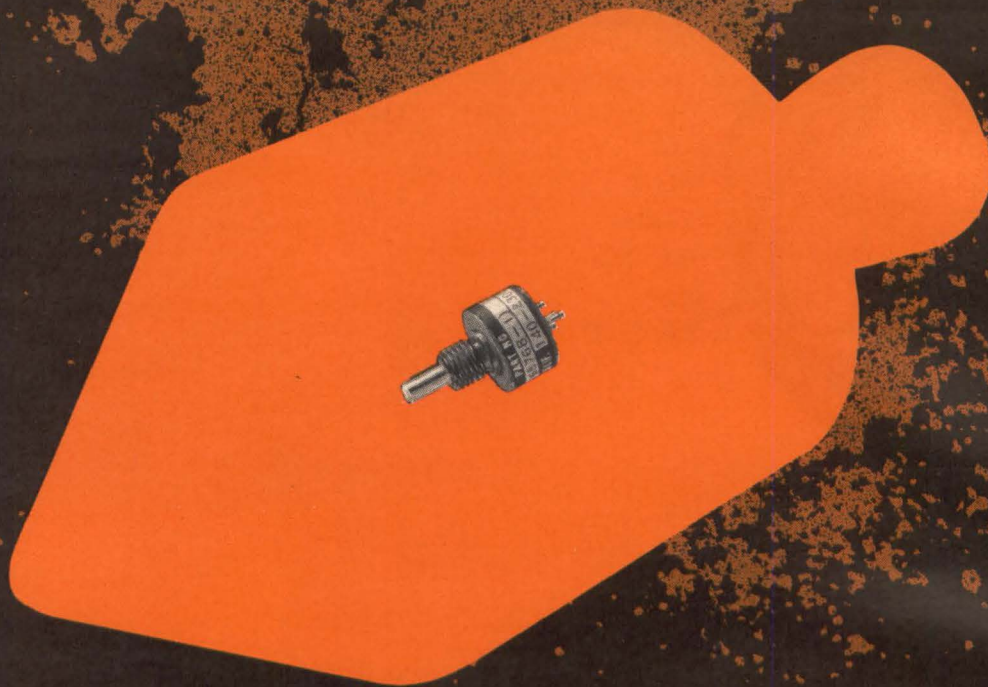

Big systems "go" only when small components do!

That's why for projects like Apollo, NASA hand-picks its primes. That's why each prime hand-picks its subs. And that's why each sub hand-picks the components that go into its NASA equipment. And, in this manned space venture, every link in the "High Reliability" chain must be as strong as modern technology can make it. And that's why "standard" components are usually considered "substandard."

But not so with the "standard" Spectrol Model 140, single-turn, precision potentiometer. Here's a standard component that qualified for Apollo simply "by having its hair combed and its face washed."

True! The only difference between a standard Spectrol Model 140 potentiometer and the high-rel component that Spectrol provides for the Apollo Command Module is a tighter starting

torque band. The rest of the story is told by the rigorous "Quality Assurance Program" established by Spectrol to the stringent Apollo specifications. If you would like an outline of this comprehensive program, write for your copy of the "Spectrol High-Rel Potentiometer Program for Project Apollo." Our experience is our greatest asset—we'd like to share it with you.

Better Components for Better Systems

SPECTROL ELECTRONICS CORPORATION
17070 E. GALE AVENUE, CITY OF INDUSTRY, CALIFORNIA 91745



Electronics index

Technical articles

Volume 39, 1966

Technical articles

A

ADVANCED TECHNOLOGY

Continuous operation is near for uncooled diode lasers p. 95 Jan. 10
Filling in the blanks in the laser's spectrum p. 82 Apr. 18
Holography's practical dimension p. 88 July 25
Lenses guide optical frequencies to low-loss transmission p. 83 May 16
Many colors are better than one p. 84 July 11
Storing data with light p. 82 Feb. 21
Training a machine to read with nonlinear threshold logic p. 86 Aug. 22
Vortexes are creating a stir in the superconductor field p. 100 June 13

AMPLIFIERS

Amplifier provides 10^{15} -ohm input resistance p. 99 Aug. 22
Amplifiers and triggers simulate blood pressure p. 68 Oct. 31
Bias control and low parasitics shorten amplifier rise time p. 73 Jan. 24
D-c logarithmic amplifier compresses input current p. 91 May 16
Direct-coupled amplifier cuts cost of d-c voltmeter p. 109 June 13
Fast-pulse amplifier drives 50-ohm load p. 76 Jan. 24
Glass reed switch controls operational amplifier p. 97 Aug. 22
Hydrophone preamplifier cuts cable noise p. 120 Aug. 8
IC amplifier provides variable reference voltage p. 88 Oct. 17
Linear amplifier circuit eliminates transformers p. 99 Mar. 21
Logarithmic amplifier has 66-db range p. 89 Oct. 17
Low-pass amplifier with adjustable bandwidth p. 90 May 30
Nomograph finds output voltage error p. 126 Nov. 14
Overload protection for d-c amplifier p. 91 Apr. 4
Sense amplifier fits any memory p. 89 Sept. 5

ANTENNAS

Faster, lighter 3-D radars in sight for tactical warfare p. 80 June 27

Helix antennas take turn for better p. 100 Aug. 22

AVIONICS

Air navigation system testing grounded by signal simulator p. 151 Sept. 19
Built-in testing, once a luxury, is essential for mission success p. 103 Oct. 17
Computers save time and missions p. 109 Oct. 17
Divic gives answers to complex navigation questions p. 105 Sept. 5

C

CIRCUIT DESIGN

Adjustable current limiter for regulated power supply p. 107 Mar. 7
Analyzing networks with state variables p. 63 Dec. 26
AND gate protects system should the voltage fail p. 79 July 11
Apc amplifier handles 60-db range p. 81 Nov. 28
Apc circuit possesses 60 decibel gain p. 107 Dec. 12
Bias control and low parasitics shorten amplifier rise time p. 73 Jan. 24
Bistable multivibrator immune to noise p. 97 Mar. 21
Bipolar pulse generator tests fast flip-flops p. 109 Dec. 12
Charge feedback increases pulse-rate meter accuracy p. 85 Feb. 7
Circuit protects meter from periodic current spikes p. 108 June 13
Circuit samples a signal, holds it up to 1 minute p. 106 Oct. 3
Clip couples neon oscillators p. 77 May 2
Computer-aided design, part 1: Man-machine merger, The p. 110 Sept. 19
Computer-aided design, part 2: Computer excels as analyst, The p. 68 Nov. 28
Computer-aided design, part 3: Analyzing circuits with symbols p. 92 Dec. 12
Control is accurate to 0.01°C p. 111 June 13
Converting audio oscillators to square-wave generators p. 123 Aug. 8
Current dividers convert digital signals into analog voltages p. 142 Nov. 14
Curves speed design of multiplier circuits p. 104 Jan. 10
D-c converter circuit capacitors p. 97 Mar. 21
Delay circuit varies turn-on, turn-off p. 92 Apr. 4
Detector stores peaks of video bursts p. 104 Oct. 3

Differential discriminator rejects common mode noise p. 101 July 25
Diode and resistor increase input resistance of Schmitt p. 110 June 13
Diode bias replaces batteries in logarithmic converter p. 123 Nov. 14
Diode quad modulator suppresses carrier 65 db p. 97 Apr. 18
Direct-coupled amplifier cuts cost of d-c voltmeter p. 109 June 13
Direct current regulator drives fluorescent lamps p. 94 Aug. 22
Electronic thermostat controls temperature to within 0.1°C p. 100 Jan. 10
Exclusive OR circuit requires no voltage supply p. 94 Apr. 18
Fail-safe frequency divider p. 127 Sept. 19
Fast-pulse amplifier drives 50-ohm load p. 76 Jan. 24
Fast-pulse generator tests digital circuit delay p. 88 Feb. 21
Feedback choke reduces power supply ripple p. 74 June 27
Feedback improves parallel-T filter p. 99 Sept. 5
Feedback turns fixed capacitor into variable capacitance p. 80 Nov. 28
FET converts transducer for use in a-c bridge p. 84 Feb. 7
FET insures stable sawtooth wave p. 122 Aug. 8
FET's call the tune in active filter design p. 98 Oct. 3
For a good mixer, add one FET p. 109 Mar. 21
Forward feed stabilizes d-c differential amplifier p. 84 Nov. 28
Frequency-modulated output from low-cost unijunction p. 122 Nov. 14
Front-end nuvistor lowers transistor amplifier noise p. 71 Oct. 31
Full-wave detector without transformer p. 100 July 25
Gamble that paid off, The: a solid state 50-MHz oscilloscope p. 95 July 25
Gate varies rewards from teaching machine p. 92 May 16
Getting the most out of feedback p. 66 Jan. 24
High-speed level shifter p. 105 Mar. 7
High-speed wideband gate provides 70-db isolation p. 69 Oct. 31
High voltage, high current in electro-optic modulator p. 98 Mar. 21
Hydrophone preamplifier cuts cable noise p. 120 Aug. 8
Interlock protects display tube p. 125 Sept. 19
Latching gate removes counter ambiguity p. 91 Apr. 4

Linear amplifier circuit eliminates transformers p. 99 Mar. 21

Low-cost emitter-follower extends voltmeter's range p. 87 Feb. 7

Low-cost strobe built with scr in trigger p. 80 July 11

Low-current alarm p. 105 Mar. 7

Low-drift current generator compensates for temperature p. 108 June 13

Low-frequency oscillator supplies high pulse power p. 90 Oct. 17

Low-pass amplifier with adjustable bandwidth p. 90 May 30

Multirange d-c voltmeter p. 126 Sept. 19

Multivibrator controls single-diode gate p. 101 July 25

Multivibrator provides continuous phase control p. 102 July 25

New twist for backward diode: help from low-noise amplifier p. 74 July 11

Nomograph finds output voltage error p. 126 Nov. 14

Nomographs calculate values for twin-T notch filter p. 88 Apr. 18

No pulse-forming network in scr trigger generator p. 97 Sept. 5

One-megahertz flip-flop saves standby power p. 106 June 13

One-shot multivibrator with zero recovery time p. 75 Jan. 24

Pairing Schmitt triggers produces lower hysteresis and faster switching p. 75 Nov. 28

Period of sawtooth ramp extends to 5 hours p. 78 June 27

Powerful logic from power-less circuits p. 133 Mar. 7

Power supply reduces ripple by varying series resistance p. 74 Jan. 24

Pulsed oscillator conserves power p. 98 Aug. 22

Reducing transients in switched inductive loads p. 88 Oct. 17

Ringing choke simplifies d-c to d-c conversion p. 90 Apr. 18

Sawtooth generator drives cathode-ray tube p. 124 Sept. 19

Scattering parameters speed design of high-frequency transistor circuits p. 78 Sept. 5

Scr bridge inverter eliminates transformers p. 98 Sept. 5

Scr triggered by capacitor lowers cost of oven control p. 83 Nov. 28

Series gating reduces components in counter p. 81 July 11

Series regulator gives overload protection p. 104 July 25

Silicon switch turns off stalled servomotors p. 90 May 16

Simple mercury relay circuit develops single clean pulse p. 89 Feb. 21

Simulator circuit generates video or noise pulses p. 78 May 2

Single component changes bandpass into filter p. 95 Apr. 18

Square-law detector has 40-db dynamic range p. 95 Sept. 5

Suppressed carrier modulator with noncritical components p. 70 Oct. 31

Switch converts multivibrator from a stable to one-shot p. 80 Nov. 28

Switching amplifier converts unipolar to bipolar pulses p. 103 Oct. 3

Thermistor measures negative resistance of tunnel diode p. 95 Aug. 22

Thermistor regulator provides fast response p. 106 Mar. 7

Time will tell how fast a motor revs up p. 82 Nov. 28

Topology cuts design drudgery p. 112 Nov. 14

Transistor switch for clickless keying p. 68 Oct. 31

Transmission lines couple multiple-driver receivers p. 121 Aug. 8

Triangle waveform generator resets automatically p. 78 July 11

Tuning fork drives portable frequency standard p. 122 Nov. 14

Tunnel-diode pulser measures cable delay p. 87 Feb. 21

Tunnel diodes lock output of servocircuit p. 106 Dec. 12

Two events, in sequence, produce detector output p. 120 Aug. 8

Two unijunction transistors produce three-state circuit p. 100 Jan. 10

Unijunction controls spacing between pulses p. 82 July 11

Using strip transmission line to design microwave circuits, part I p. 72 Feb. 7

Using strip transmission line to design microwave circuits, part II p. 90 Feb. 21

Using transistor circuits to multiply and divide p. 109 Apr. 4

Voltage-controlled multi produces triangular output p. 72 Oct. 31

Voltage splitter balances floating power supply p. 96 Mar. 21

Warning lights monitor d-c supply voltage p. 106 Dec. 12

COMMUNICATIONS

Adding scr's to get high power means smaller transmitters p. 119 June 13

Automated ground station will check out Saturn p. 103 Feb. 7

Bit by bit, Japan is speeding its data communications links p. 147 Dec. 12

Communications satellites: 1966 and beyond p. 83 May 2

Communications satellites, part 2: Design choices for the future p. 109 May 30

Dial any channel to 500 Mhz p. 60 May 2

Double-phase-shift keying speeds data over voice channels p. 91 Oct. 31

For a pilot over the ocean a satellite link to home p. 100 May 2

Helix antennas take turn for better p. 100 Aug. 22

Integrated circuits and pulse coding mean new gains for telephony p. 139 Sept. 19

Japanese stay with pcm to meet mushrooming growth in telephony p. 134 Dec. 12

Latest word in space talk: it can come from anywhere p. 117 May 30

Lenses guide optical frequencies to low-loss transmission p. 83 May 16

Messages sent in symbols will link multilingual troops p. 108 July 25

Military services' satellites will ring the earth p. 96 May 2

Nomograph simplifies design of f-m/f-m telemetry systems p. 101 Mar. 21

Pcm telephone exchange switches digital data like a computer p. 119 Oct. 3

Satellites to be airliners' traffic cop p. 104 May 2

Tunnel-diode oscillator expands f-m system's channel capacity p. 105 Jan. 10

COMPONENTS

Harmonic testing pinpoints passive component flaws p. 93 July 11

Looking through glasses for new active components p. 129 Sept. 19

Putting semiconductors to work p. 95 Feb. 7

Tiny filters block the path of radio-frequency interference p. 58 Oct. 31

Voltage transients tamed by spark-gap arresters p. 109 Apr. 18

COMPUTERS

Automated ground station will check out Saturn p. 103 Feb. 7

Automatic diagnosis of engine ailments p. 70 May 2

Bit by bit, Japan is speeding its data communications links p. 147 Dec. 12

Complex integrated circuit arrays: the promise and the problems p. 111 July 11

Computer-aided design, part 1: Man-machine merger, The p. 110 Sept. 19

Computer-aided design, part 2: Computer excels as analyst, The p. 68, Nov. 28

Computer-aid designs, part 3: Analyzing circuits with symbols p. 92 Dec. 12

Computers save time and missions p. 109 Oct. 17

Current dividers convert digital signals into analog voltages p. 142 Nov. 14

Divic gives answers to complex navigation questions p. 105 Sept. 5

Fast-moving queue for better computer service p. 102 Jan. 24

For a crew in lonely orbit, something to lean on in space p. 129 Oct. 3

Great shmoo plot, The: testing memories automatically p. 127 July 25

Integrated circuits replace the electromechanical resolver p. 90 Jan. 10

Integrated scratch pads sire new generation of computers p. 118 Apr. 4

On the horizon: better hospital care through computer time-sharing p. 93 Jan. 24

Power switching trims digital system weight, cost p. 135 June 13

Sense amplifier fits any memory p. 89 Sept. 5

Success story: Japanese originals p. 93 June 27

Time-shared troubleshooter repairs computer on-line p. 97 Jan. 24

Wiring design helps core memory work at rapid cycle time p. 83 Oct. 31

CONSUMER ELECTRONICS

For a good mixer, add one FET p. 109 Mar. 21

Integrated circuits make a low-cost f-m receiver p. 133 Aug. 8

Multipurpose chips cut costs of f-m receiver p. 80 May 16

No moving parts in auto tachometer p. 77 May 2

P-i-n diode and FET's improve f-m reception p. 115 Aug. 22

Simpler circuits trace Sony's path to innovation p. 155 Nov. 14

Solid state makes debut in big screen color tv p. 99 Apr. 18

D

DESIGNER'S CASEBOOK

Adapter for curve tracer tests FET's at high voltage p. 104 Mar. 7

Adding transistors makes voltage shifter adjustable p. 108 Dec. 12

Adjustable current limiter for regulated power supply p. 107 Mar. 7

Agc amplifier handles 60-db range p. 81 Nov. 28

Agc circuit possesses 60-decibel gain p. 107 Dec. 12

Amplifier provides 10¹⁵-ohm input resistance p. 99 Aug. 22

Amplifiers and triggers simulate blood-pressure p. 68 Oct. 31

AND gate protects system should the voltage fail p. 79 July 11

Audio discriminator measures large frequency changes p. 76 May 2

Bias control and low parasitics shorten amplifier rise time p. 73 Jan. 24

Biassing on FET for low drift p. 92 May 30

Bipolar pulse generator tests fast flip-flops p. 109, Dec. 12

Bistable multivibrator immune to noise p. 97 Mar. 21

Breadboarding IC systems with color-coded modules p. 102 Jan. 10

Capacitor charging controls variable ramp generator p. 91 May 30

Charge feedback increases pulse-rate meter accuracy p. 85 Feb. 7

Circuit protects meter from periodic current spikes p. 108 June 13

Circuit samples a signal, holds it up to 1 minute p. 106 Oct. 3

Clip couples neon oscillators p. 77 May 2

Control is accurate to 0.01°C p. 111 June 13

Converting audio oscillators to square-wave generators p. 123 Aug. 8

Cross-coupled transistors form balanced mixer p. 91 Oct. 17

Curves speed design of multiplier circuits p. 104 Jan. 10

D-c converter circuit uses capacitors p. 97 Mar. 21

D-c logarithmic amplifier compresses input current p. 91 May 16

Delay circuit varies turn-on, turn-off p. 92 Apr. 4

Detector stores peaks of video bursts p. 104 Oct. 3

Differential discriminator rejects common-mode noise p. 101 July 25

Diode and resistor increase input resistance of Schmitt trigger p. 110 June 13

Diode bias replaces batteries in logarithmic converter p. 123 Nov. 14

Diode lowers multi's reset power level p. 76 June 27

Diode quad modulator suppresses carrier 65 db p. 97 Apr. 18

Direct-coupled amplifier cuts cost of d-c voltmeter p. 109 June 13

Direct current regulator drives fluorescent lamps p. 94 Aug. 22

Electronic thermostat controls temperature to within 0.1°C p. 100 Jan. 10

Emitter follower enhances oscillator's frequency variation p. 73 Dec. 26

Exclusive OR circuit requires no voltage supply p. 94 Apr. 18

Fast-pulse amplifier drives 50-ohm load p. 76 Jan. 24

Fast pulse generator tests digital circuit delay p. 88 Feb. 21

Feedback choke reduces power supply ripple p. 74 June 27

Feedback improves parallel-T filter p. 99 Sept. 5

Feedback turns fixed capacitor into variable capacitance p. 80 Nov. 28

Ferrite cylinder modulates microwave signals p. 96 Aug. 22

FET converts transducer for use in a-c bridge p. 84 Feb. 7

FET insures stable sawtooth wave p. 122 Aug. 8

FET's produce stable oscillators p. 102 Oct. 3

FET stabilizes amplitude of Wien bridge oscillator p. 107 Oct. 3

Forward feed stabilizes d-c differential amplifier p. 84 Nov. 28

Frequency-modulated output from low-cost unijunction p. 122 Nov. 14

Front-end nuvistor lowers transistor amplifier noise p. 71 Oct. 31

Full-wave detector without transformer p. 100 July 25

Gate varies rewards from teaching machine p. 92 May 16

Glass reed switch controls operational amplifier p. 96 Aug. 22

High MOS impedance benefits pH measurement p. 79 July 11

High-speed level shifter p. 105 Mar. 7

High-speed wideband gate provides 70 db isolation p. 69 Oct. 31

High voltage, high current in electro-optic modulator p. 98 Mar. 21

Hydrophone preamplifier cuts cable noise p. 120 Aug. 8

IC amplifier provides variable reference voltage p. 88 Oct. 17

Integrated circuits quickly assembled p. 103 July 25

Interlock protects display tube p. 125 Sept. 19

Latching gate removes counter ambiguity p. 91 Apr. 4

Light-sensitive FET p. 124 Nov. 14

Linear amplifier circuit eliminates transformers p. 99 Mar. 21

Logarithmic amplifier has 66-db range p. 89 Oct. 17

Low-cost emitter-follower extends voltmeter's range p. 87 Feb. 7

Low-cost strobe built with scr in trigger p. 80 July 11

Low-current alarm p. 105 Mar. 7

Low-drift current generator compensates for temperature p. 108 June 13

Low-frequency oscillator supplies high pulse power p. 90 Oct. 17

Modified tape recorder stores timing signals p. 75 June 27

Multivibrator controls single-diode gate p. 101 July 25

Multivibrator provides continuous phase control p. 102 July 25

Neon tube staircase generator performs two jobs p. 74 Dec. 26

No moving parts in auto tachometer p. 77 May 2
 No pulse-forming network in scr trigger generator p. 97 Sept. 5
 One-megahertz flip-flop saves standby power p. 106 June 13
 One-shot multivibrator with zero recovery time p. 75 Jan. 24
 Overload protection for d-c amplifier p. 91 Apr. 4
 Period of sawtooth ramp extends to 5 hours p. 78 June 27
 Power supply reduces ripple by varying series resistance p. 74 Jan. 24
 Pulsed oscillator conserves power p. 98 Aug. 22
 Reading and writing with electron beams p. 80 May 30
 Reducing transients in switched inductive loads p. 88 Oct. 17
 Sawtooth generator drives cathode-ray tube p. 124 Sept. 19
 Scr bridge inverter eliminates transformers p. 98 Sept. 5
 Scr triggered by capacitor lowers cost of oven control p. 83 Nov. 28
 Series gating reduces components in counter p. 81 July 11
 Series regulator gives overload protection p. 104 July 25
 Silicon switch turns off stalled servomotors p. 90 May 16
 Simple mercury relay circuit develops single clean pulse p. 89 Feb. 21
 Simulator circuit generates video or noise pulses p. 78 May 2
 Single component changes bandpass into general filter p. 95 Apr. 18
 Square-law detector has 40-db dynamic range p. 95 Sept. 5
 Suppressed carrier modulator with noncritical components p. 70 Oct. 31
 Switch converts multivibrator from a stable to one-shot p. 80 Nov. 28
 Switching amplifier converts unipolar to bipolar pulses p. 103 Oct. 3
 Thermistor measures negative resistance of tunnel diode p. 95 Aug. 22
 Thermistor regulator provides fast response p. 106 Mar. 7
 Time will tell how fast a motor revs up p. 82 Nov. 28
 Transistor switch for clickless keying p. 68 Oct. 31
 Transmission lines couple multiple-driven receivers p. 121 Aug. 8
 Transistors control small d-c motor p. 93 Apr. 4
 Transistors replace diodes in milliohmmeter circuit p. 97 Sept. 5
 Triangle waveform generator resets automatically p. 78 July 11
 Tuning fork drives portable frequency standard p. 122 Nov. 14
 Tunnel-diode pulser measures cable delay p. 87 Feb. 21
 Tunnel diodes lock output of servocircuit p. 106 Dec. 12
 Two events, in sequence, produce detector output p. 120 Aug. 8
 Two unijunctions form low-cost level detector p. 94 Apr. 18
 Two unijunction transistors produce a three-state circuit p. 100 Jan. 10
 Unijunction controls spacing between pulses p. 82 July 11
 Unijunction memory stores until readout p. 125 Nov. 14
 Voltage-controlled multi produces triangular output p. 72 Oct. 31
 Voltage splitter balances floating power supply p. 96 Mar. 21
 Warning lights monitor d-c supply voltage p. 106 Dec. 12
 Zener diode allows delay without large capacitors p. 93 May 30
 Zener diode controls variable phase shifter p. 72 Dec. 26

I

INDUSTRIAL ELECTRONICS

Microwaves on the production line p. 123 Mar. 7
 Noise simulators help find peril in power-line defects p. 117 Mar. 7
 Pumping new life into ruby lasers p. 115 Sept. 5

INSTRUMENTS

Automatic diagnosis of engine ailments p. 70 May 2
 Charge feedback increases pulse-rate meter accuracy p. 85 Feb. 7
 Correlation entering new fields with real-time signal analysis p. 75 Oct. 31
 Dial any channel to 500 Mhz p. 60 May 2
 Digital meters for under \$100 p. 88 Nov. 28
 Gamble that paid off, The: a solid state 50-Mhz oscilloscope p. 95 July 25
 Harmonic testing pinpoints passive component flaws p. 93 July 11
 Instrument outlook: growth and diversification p. 110 Aug. 8
 Low-cost emitter-follower extends voltmeter's range p. 87 Feb. 7
 Low-frequency noise predicts when a transistor will fail p. 95 Nov. 28
 Multirange d-c voltmeter p. 127 Sept. 19
 Noise simulators help find peril in power-line defects p. 117 Mar. 7
 Phase-locked marker improves spectrum analyzer's accuracy p. 88 Feb. 7

Scattering parameters speed design of high-frequency transistor circuits p. 78 Sept. 5
 Selecting the right digital voltmeter p. 84 Apr. 4
 Six clues to nanovolt signals p. 114 June 13

INTEGRATED CIRCUITS

A-c testing of wafer components sounds early circuit warning p. 94 Oct. 17
 Automated electron beams process thin-film components p. 110 Mar. 7
 Breadboarding IC systems with color-coded modules p. 102 Jan. 10
 Complex integrated circuit arrays: the promise and the problems p. 111 July 11
 Digital meters for under \$100 p. 88 Nov. 28
 General-purpose IC chips speed analog design work p. 88 Mar. 21
 Gold-plated nickel wiring debugs parallel-gap welding of IC's p. 115 July 25
 IC industry: picture of health p. 114 Aug. 8
 Improving the performance of multipurpose IC's with feedback p. 70 June 27
 Integrated circuits and pulse coding mean new gains for telephony p. 139 Sept. 19
 Integrated circuits in action, part 1: Great design dilemma, The p. 68 Oct. 17
 Integrated circuits in action, part 2: Trends and trade offs p. 128 Nov. 14
 Integrated circuits in action, part 3: Getting your money's worth p. 56 Dec. 26
 Integrated circuits make a low-cost f-m receiver p. 133 Aug. 8
 Integrated circuits quickly assembled p. 103 July 25
 Integrated circuits replace the electromechanical resolver p. 90 Jan. 10
 Large-scale logic arrays: testing for the millions p. 98 Oct. 17
 Multipurpose chips cut costs of f-m receiver p. 80 May 16
 New dimensions in IC's through films of glass p. 108 Oct. 3
 Packaging revolution, The, part V: Simpler designs for complex systems p. 109 Feb. 7
 Packaging revolution, The, part VI: Converting to microelectronics p. 103 Feb. 21
 Pattern of tests changing for integrated circuits p. 93 Oct. 17
 Reducing analog IC cost with multipurpose chips p. 84, Mar. 21
 Strips of nickel foil automate welding of flatpack assemblies p. 128 June 13
 Training a machine to read with nonlinear threshold logic p. 87 Aug. 22
 Ultrahigh-speed IC's require shorter, faster interconnections p. 103 July 11

M

MANUFACTURING

Automated electron beams process thin-film components p. 110 Mar. 7
 Belting out plastic transistors on mechanized assembly lines p. 84 Jan. 24
 Ceramic handles and ultrasonic bonders upgrade hybrid assembly p. 110 Feb. 21
 Coordinate measurer puts old boards into new line p. 118 Apr. 18
 Fixture shaves 10-minutes from module-making time p. 117 Apr. 18
 Gold-plated nickel wiring debugs parallel-gap welding of IC's p. 115 July 25
 Graphs reveal reasons for high cost of maintenance p. 101 Sept. 5
 Integrated circuits quickly assembled p. 103 July 25
 Machine soldering gets IC's into tighter spots p. 116 Apr. 18
 Modular arrays—the path to single-circuit systems p. 115 Feb. 21
 Modules are mass-produced, but systems are one-of-a-kind, The p. 102 June 27
 Multilayer circuit boards: sharpening an imperfect art p. 141 Aug. 8
 Packaging revolution, The, part V: Simpler designs for complex systems p. 109 Feb. 7
 Packaging revolution, The, part VI: Converting to microelectronics p. 103 Feb. 21
 Pattern trims design time for multilayer circuit boards p. 148 Aug. 8
 Strips of nickel foil automate welding of flatpack assemblies p. 128 June 13
 Ultrahigh-speed IC's require shorter, faster interconnections p. 103 July 11

MARKETS

Electronics markets: faster growth in 1966 p. 117 Jan. 10
 European electronic markets 1967 p. 79 Dec. 26
 How the West was won p. 102 Aug. 8
 IC industry: picture of health p. 114 Aug. 8
 Instrument outlook: growth and diversification p. 110 Aug. 8
 IEEE Show: few surprises p. 88 Mar. 7
 Microwave—in tune with the times p. 106 Aug. 8

MATERIALS

Looking through glasses for new active components p. 129 Sept. 19
 New dimensions in IC's through films of glass p. 108 Oct. 3

MEASUREMENTS

A-c testing of wafer components sounds early circuit warning p. 94 Oct. 17
 Adapter for curve tracer tests FET's at high voltage p. 104 Mar. 7
 Audio discriminator measures large frequency changes p. 76 May 2
 Automatic diagnosis of engine ailments p. 70 May 2
 Built-in testing, once a luxury, is essential for mission success p. 103 Oct. 17
 Correlation entering new fields with real-time signal analysis p. 75 Oct. 31
 Fast pulse generator tests digital circuit delay p. 88 Feb. 21
 Harmonic testing pinpoints passive component flaws p. 93 July 11
 High MOS impedance benefits pH measurement p. 79 July 11
 Large-scale logic arrays: testing for the millions p. 98 Oct. 17
 Low-frequency noise predicts when a transistor will fail p. 95 Nov. 28
 Modified tape recorder stores timing signals p. 75 June 27
 Pattern of tests changing for integrated circuits p. 93 Oct. 17
 Phase-locked marker improves spectrum analyzer's accuracy p. 88 Feb. 7
 Scattering parameters speed design of high-frequency transistor circuits p. 78 Sept. 5
 Selecting the right digital voltmeter p. 84, Apr. 4
 Six clues to nanovolt signals p. 114 June 13
 Tunnel-diode pulser measures cable delay p. 87 Feb. 21

MEDICAL ELECTRONICS

Correlation entering new fields with real-time signal analysis p. 75 Oct. 31
 Keeping the heart alive with a biological battery p. 105 Mar. 21
 On the horizon: better hospital care through computer time-sharing p. 93 Jan. 24

MICROELECTRONICS

See integrated circuits

MICROWAVES

Charting the bandwidth of isolating r-f chokes p. 112 June 13
 Curves optimize lead impedance p. 89 June 27
 Ferrite cylinder modulates microwave signals p. 96 Aug. 22
 Generating power at gigahertz with avalanche-transit time diodes p. 126 Aug. 8
 Increasing r-f power by summing p. 101 May 30
 Microwave—in tune with the times p. 106 Aug. 8
 Microwaves on the production line p. 123 Mar. 7
 New twist for backward diode: help from low-noise amplifier p. 74 July 11
 Overlay transistors move into microwave region p. 93 Mar. 21
 Scattering parameters speed design of high-frequency transistor circuits p. 78 Sept. 5
 Transmission lines couple multiple-driver receivers p. 121 Aug. 8
 Using strip transmission line to design microwave circuits, part I p. 72 Feb. 7
 Using strip transmission line to design microwave circuits, part II p. 90 Feb. 21

MILITARY ELECTRONICS

Faster, lighter 3-D radars in sight for tactical warfare p. 80 June 27
 Messages sent in symbols will link multi-lingual troops p. 108 July 25
 Military services' satellites will ring the earth p. 96 May 2
 War that needs electronics, The p. 96 May 16

O

OCEANOGRAPHY

OPINIONS

Journey to East Europe, A p. 158 Aug. 8
 Myth of obsolescent knowledge, The p. 142 June 13
 Other side of the recruiting coin, The p. 100 Oct. 31
 Plain talk about obsolescence p. 143 Oct. 3
 Recruiting merry-go-round, The p. 108 June 27
 Rumania's blueprint to build an electronics industry p. 166 Aug. 8
 Theory is fine, but application is better p. 169 Aug. 8

R

RADAR

S

SOLID-STATE ELECTRONICS

Adding scr's to get high power means smaller transmitters p. 119 June 13
 At the end of the laser beam, a more sensitive photodiode p. 94 May 30
 Avalanche transistors drive laser diodes hard and fast p. 137 Nov. 14
 Diode lowers multi's reset power level p. 76 June 27
 Diode sheds its costly package with beam-lead construction p. 77 Jan. 24
 Generating power at gigahertz with avalanche-transit time diodes p. 126 Aug. 8

Ghost balloons riding the skies will report the world's weather p. 98 Nov. 28
 Improving the performance of multipurpose IC's with feedback p. 70 June 27
 Integrated circuits replace the electro-mechanical resolver p. 90 Jan. 10
 New twist for backward diode: help from low-noise amplifier p. 74 July 11
 Overlay transistors move into microwave region p. 93 Mar. 21
 P-i-n diode and FET's improve f-m reception p. 114 Aug. 22
 Solid state makes debut in big-screen color tv p. 99 Apr. 18
 Zener diode allows delay without large capacitors p. 93 May 30

SPACE ELECTRONICS

Apollo: the goal is in sight p. 111 Dec. 12
 Automatic celestial guidance, part 2: New challenge to designers' ingenuity p. 94 Apr. 4
 Celestial successor to inertial guidance p. 115, Mar. 21
 Communications satellites: 1966 and beyond p. 83 May 2
 Communications satellites, part 2: Design choices for the future p. 109 May 30
 For a crew in lonely orbit, something to lean on in space p. 129 Oct. 3
 For a pilot over the ocean a satellite link to home p. 100 May 2
 Increasing r-f power by summing p. 101 May 30
 Latest word in space talk: it can come from anywhere p. 117 May 30
 Military services' satellites will ring the earth p. 96 May 2
 Night and day, Nimbus 2 transmits its cloud pictures p. 121 Aug. 22
 Satellites to be airliners' traffic cop p. 104 May 2

T

TRANSISTORS

Adding transistors makes voltage shifter adjustable p. 108 Dec. 12
 Avalanche transistors drive laser diodes hard and fast p. 137 Nov. 14
 Belting out plastic transistors on mechanized assembly lines p. 84 Jan. 24
 Biasing an FET for low drift p. 92 May 30
 Cross-coupled transistors form balance mixer p. 91 Oct. 17
 FET converts transducer for use in a-c bridge p. 84 Feb. 7
 FET insures stable sawtooth wave p. 122 Aug. 8
 FET's call the tune in active filter design p. 98 Oct. 3
 FET's produce stable oscillators p. 102 Oct. 3
 FET stabilizes amplitude of Wien bridge oscillator p. 107 Oct. 3
 For a good mixer, add one FET p. 109 Mar. 21
 Light-sensitive FET p. 124 Nov. 14
 Low-frequency noise predicts when a transistor will fail p. 95 Nov. 28
 Overlay transistors move into microwave region p. 93 Mar. 21
 Powerful logic from power-less circuits p. 133 Mar. 7
 Scattering parameters speed design of high-frequency transistor circuits p. 78 Sept. 5
 Transistors control small d-c motor p. 93 Apr. 4
 Transistors replace diodes in milliohmmeter circuit p. 97 Sept. 5
 Two unijunctions form low-cost level detector p. 94 Apr. 18
 Two unijunction transistors produce three-state circuit p. 100 Jan. 10
 Unijunction memory stores until readout p. 125 Nov. 14
 Using transistor circuits to multiply and divide p. 109 Apr. 4

Author Index

A

Abramson, P., et al, Powerful logic from power-less circuits p. 133 Mar. 7
 Adelman, A., et al, For a crew in lonely orbit, something to lean on in space p. 129 Oct. 3
 Alford, C. H., et al, Modules are mass-produced, but systems are one-of-a-kind, The p. 102 June 27
 Althouse, J., IC amplifier provides variable reference voltage p. 88 Oct. 17
 Linear amplifier circuit eliminates transformers p. 99 Mar. 21
 Ambrozny, A., Thermistor measures negative resistance of tunnel diode p. 95 Aug. 22

B

Barnett, G. O., et al, On the horizon: better hospital care through computer time-sharing p. 93 Jan. 24
 Barney, W., Instrument outlook: growth and diversification p. 110 Aug. 8

Microwave—In tune with the times p. 106 Aug. 8
 Bartnik, J., Increasing r-f power by summing p. 101 May 30
 Bellissimo, J., Fixture shaves 10 minutes from module-making time p. 117 Apr. 18
 Blachowicz, L. F., Dial any channel to 500 Mhz p. 60 May 2
 Brainerd, G. R., et al, Adding scr's to get high power means smaller transmitters p. 119 June 13
 Braverman, N., Satellites to be airliners' traffic cop p. 104 May 2
 Bray, D., Solid state makes debut in big-screen color tv p. 99 Apr. 18
 Brown, H. E., et al, Avalanche transistors drive laser diodes hard and fast p. 137 Nov. 14
 Buchholz, R. T., Biasing an FET for low drift p. 92 May 30
 Buckland, J. A., Fast-moving queue for better computer service p. 102 Jan. 24

C

Candel, G. W., D-c logarithmic compresses input current p. 91 May 16
 Carpenter, R., et al, Computer-aided design, part 3: Analyzing circuits with symbols p. 92 Dec. 12
 Chan, S. P., Topology cuts design drudgery p. 112 Nov. 14
 Chapman, R., Period of sawtooth ramp extends to 5 hours p. 78 June 27
 Chatelon, A. E., Pcm telephone exchange switches digital data like a computer p. 119 Oct. 3
 Integrated circuits and pulse coding mean new gains for telephony p. 139 Sept. 19
 Chetlan, R., Machine soldering gets IC's into tighter spots p. 116 Apr. 18
 Christiansen D., Computer-aided design, part 1: Man-machine merger, The p. 110 Sept. 19
 Integrated circuits in action, part 1: Great design dilemma, The p. 68, Oct. 17
 Integrated circuits in action, part 2: Trends and trade offs p. 128 Nov. 14
 Cliff, R. A., Power switching trims digital system weight, cost p. 135 June 13
 Cistola, A.B., Neon tube staircase generator performs two jobs p. 74 Dec. 26
 Cohen, C. L., et al, Simpler circuits trace Sony's path to innovation p. 155 Nov. 14
 Cohen, J. J., Military services' satellites will ring the earth p. 96 May 2
 Colwell, J. M., Direct-coupled amplifier cuts cost of d-c voltmeter p. 109 June 13
 Corley, G. W., et al, Graphs reveal reasons for high cost of maintenance p. 101 Sept. 5
 Crapuchettes, P. W., Microwaves on the production line p. 123 Mar. 7
 Cuikay, R. S., Circuit samples a signal, holds it up to 1 minute p. 106 Oct. 3
 Curry, J. E., No pulse-forming network in scr trigger generator p. 97 Sept. 5

D

Dangl, J. R., et al, Using strip transmission line to design microwave circuits, part 1 p. 72 Feb. 7
 Using strip transmission line to design microwave circuits, part 2 p. 90 Feb. 21
 D'Asaro, L. A., et al, At the end of the laser beam, a more sensitive photodiode p. 94 May 30
 Delagrange, A. D., Amplifier provides 10¹⁵-ohm input resistance p. 99 Aug. 22
 Delpech, J. F., Audio discriminator measures large frequency changes p. 76 May 2
 Logarithmic amplifier has 66-db range p. 89, Oct. 17
 Denes, P. A., et al, Tiny filters block the path of radio-frequency interference p. 58 Oct. 31
 de Pian, L., Analyzing networks with state variables p. 63 Dec. 26

E

Eberle, A. C., Low-cost strobe built with scr in trigger p. 80 July 11
 Eimbinder, J., General-purpose IC chips speed analog design work p. 88 Mar. 21
 Elad, E., FET insures stable sawtooth wave p. 122 Aug. 8
 Ellis, W. H. Jr., Diode quad modulator suppresses carrier 65 db p. 97 Apr. 18
 Agc circuit possesses 60-decibel gain p. 107 Dec. 12
 Elovic, A., Wiring design helps core memory work at rapid cycle time p. 83 Oct. 31
 Evanzia, W. J., Faster, lighter 3-D radars in sight for tactical warfare p. 80 June 27

F

Farrell, E. J., et al, Celestial successor to inertial guidance p. 115 Mar. 21
 Feller, J. F., Agc amplifier handles 60-db range p. 81 Nov. 28
 Field, E. L., Breadboarding IC systems with color-coded modules p. 102 Jan. 10
 Flynn, M. J., Complex integrated circuit arrays: the promise and the problems p. 111 July 11
 Fox, D. K., Putting superconductors to work p. 95 Feb. 7

G

Galluzzi, P., Adjustable current limiter for regulated power supply p. 107 Mar. 7

Gaon, J., Diode and resistor increase input resistance of Schmitt p. 110 June 13
 Feedback turns fixed capacitor into variable capacitance p. 80 Nov. 28
 Garth, E. C., et al, Ultrahigh-speed IC's require shorter, faster interconnections p. 103 July 11
 Gaytan, S. I., Low-frequency oscillator supplies high pulse power p. 90 Oct. 17
 Geisler, L. E., Cross-coupled transistors form balanced mixer p. 91 Oct. 17
 Gersbach, J. E., Great schmo plot, The: testing memories automatically p. 127 July 25
 Gerst, C. W., et al, Helix antennas take turn for better p. 100 Aug. 22
 Gilbert, J., High-speed wideband gate provides 70-db isolation p. 69 Oct. 31
 Goodykooztz, J. R., Pattern trims design time for multilayer circuit boards p. 148 Aug. 8
 Goubau, G., Lenses guide optical frequencies to low-loss transmission p. 83 May 16
 Greenfield, A. R., et al, FET converts transducer for use in a-c bridge p. 84 Feb. 7
 Greenstein, D. S., Detector stores peaks of video bursts p. 104 Oct. 3
 Grein, W., et al, Gamble that paid off, The: a solid state 50-Mhz oscilloscope p. 95 July 25
 Grounds, H. K., Built-in testing, once a luxury, is essential for mission success p. 103 Oct. 17
 Computers save time and missions p. 109, Oct. 17
 Grover, D. J., Capacitor charging controls variable ramp generator p. 91 May 30
 Gutsmuth, H. R., Messages sent in symbols will link multilingual troops p. 108 July 25

H

Habegger, M. A., et al, Many colors are better than one p. 84 July 11
 Haggen, D., Switch converts multivibrator from astable to one-shot p. 80 Nov. 28
 Hanson, C. C., Low-drift current generator compensates for temperature p. 108 June 13
 Harper, E. T., Charting the bandwidth of isolating r-f chokes p. 112 June 13
 Hattaway, D. P., et al, Training a machine to read with nonlinear threshold logic p. 86 Aug. 22
 Haynes, J. L., Reducing transients in switched inductive loads p. 88 Oct. 17
 Henkel, R., Communications satellites: 1966 and beyond p. 83 May 2
 Herbert, J. Jr., Reading and writing with electron beams p. 80 May 30
 Hirsch, P., Automatic diagnosis of engine ailments p. 70 May 2
 Hohberger, C. P., Fast pulse generator tests digital circuit delay p. 88 Feb. 21
 Hoisington, D. B., Direct current regulator drives fluorescent lamps p. 94 Aug. 22
 Hoo, C. C., Sawtooth generator drives cathode-ray tube p. 124 Sept. 19
 Horna, O. A., Bipolar pulse generator tests fast flip-flops p. 109 Dec. 12
 Howell, J. F., Ringing choke simplifies d-c to d-c conversion p. 90 Apr. 18

I

Inose, H., et al, Diode lowers multi's reset power level p. 76 June 27
 Japanese stay with pcm to meet mushrooming growth in telephony p. 132 Dec. 12
 Irvine, J. A., No moving parts in auto tachometer p. 77 May 2

J

Jarosik, N. A., et al, Gold-plated nickel wiring debugs parallel-gap welding of IC's p. 115 July 25
 Johnson, B., Sense amplifier fits any memory p. 89 Sept. 5
 Johnson, C. F., High voltage high current in electro-optic modulator p. 98 Mar. 21
 Johnson, F. M., Filling in the blanks in the laser's spectrum p. 82 Apr. 18

K

Kalal, T.T., Zener diode controls variable phase shifter p. 72 Dec. 26
 Kardash, J., et al, A-c testing of wafer components sounds early circuit warning p. 94 Oct. 17
 Kason, J. M., Voltage splitter balances floating power supply p. 96 Mar. 21
 Kay, B. G., Selecting the right digital voltmeter p. 84 Apr. 4
 Kennedy, E. J., Fast-pulse amplifier drives 50-ohm load p. 76 Jan. 24
 Kennett, G., Reducing analog IC cost with multipurpose chips p. 84 Mar. 21
 Kindimann, P. J., Tunnel-diode pulser measures cable delay p. 87 Feb. 21
 King, W., Simple mercury relay circuit develops single clean pulse p. 89 Feb. 21
 Kohnke, G. H. P., Electronic thermostat controls temperature to within 0.1° C p. 100 Jan. 10
 Korb, R. W., Multilayer circuit boards: sharpening an imperfect art p. 141 Aug. 8

Korvin, W., et al, latest word in space talk: it can come from anywhere p. 117 May 30
 Koryu, T., et al, Ferrite cylinder modulates microwave signals p. 96 Aug. 22
 Kuipers, G. C., Front-end nivistor lowers transistor amplifier noise p. 71 Oct. 31
 Kurzrok, R., Single component changes bandpass into general filter p. 95 Apr. 18

L

LaPlante, D. E., Scr triggered by capacitor lowers cost of oven control p. 83 Nov. 28
 Lamorte, M. F., Continuous operation is near for uncooled diode lasers p. 95 Jan. 10
 Lavigne, R. C., et al, Pulsed oscillator conserves power p. 98 Aug. 22
 Lee, H. C., et al, Overlay transistors move into microwave region p. 93 Mar. 21
 Lefferts, P., Transistors replace diodes in milliohmeter circuit p. 97 Sept. 5
 Lefrak, F. H., Tunnel-diode oscillator expands f-m system's channel capacity p. 105 Jan. 10
 Leith, E., Holography's practical dimension p. 88 July 25
 Lichfield, E. W., et al, Ghost balloons riding the skies will report the world's weather p. 98 Nov. 28
 Lillestrand, R. L., et al, Automatic celestial guidance, part 2: New challenge to designers' ingenuity p. 94 Apr. 4
 Lind, J. W., Large-scale logic arrays: testing for the millions p. 98 Oct. 17
 Little, J. M., Transistor switch for clickless keying p. 68 Oct. 31
 Loe, J. M., FET's call the tune in active filter design p. 98 Oct. 3
 LuBow, B., Correlation entering new fields with real-time signal analysis p. 75 Oct. 31

Mc

McDermott, C. H., Suppressed carrier modulator with noncritical components p. 70 Oct. 31
 McGee, M. E., et al, One-megahertz flip-flop saves standby power p. 106 June 13
 McKechnie, J. C., Tunnel diodes lock output of servo-circuit p. 106 Dec. 12
 McLeod, D. D., Bias control and low parasitics shorten amplifier rise time p. 73 Jan. 24

M

Mackenzie, J. D., Looking through glasses for new active components p. 129 Sept. 19
 Malm, R. G., Unijunction memory stores until readout p. 125 Nov. 14
 Marosi, G., High-speed level shifter p. 105 Mar. 7
 Voltage-controlled multi produces triangular output p. 72 Oct. 31
 Martens, A. E., Other side of the recruiting coin, The p. 100 Oct. 31
 Marzolf, J. M., D-c converter circuit uses capacitors p. 97 Mar. 21
 Mason, J. F., War that needs electronics, The p. 96 May 16
 Matheson, R. J., Square-law detector has 40-db dynamic range p. 95 Sept. 5
 Melcher, H. T., Modular arrays—the path to single-circuit systems p. 115 Feb. 21
 Mergner, F. L., P-i-n diode and FET's improve f-m reception p. 114 Aug. 22
 Moody, J. C., et al, Night and day, Nimbus 2 transmits its cloud pictures p. 121 Aug. 22
 Mora, C. R., Delay circuit varies turn-on, turn-off p. 92 Apr. 4
 Moskowitz, C., Pattern of tests changing for integrated circuits p. 93 Oct. 17
 Integrated circuits in action, part 3: Getting your moneys' worth p. 56 Dec. 26

N

Nickus, G. M., Frequency-modulated output from low-cost unijunction p. 122 Nov. 14
 Nisbett, R. K., Diode bias replaces batteries in logarithmic converter p. 123 Nov. 14
 Noda, K., Success story: Japanese originals p. 93 June 27
 Nuckolls, R. L. III, Warning lights monitor d-c supply voltage p. 106 Dec. 12

O

P

Panico, J. J., FET stabilizes amplitude of Wien bridge oscillator p. 107 Oct. 3
 Parini, J. A., Divic gives answers to complex navigation questions p. 105 Sept. 5
 Payerl, L., Overload protection for d-c amplifier p. 91 Apr. 4
 Pearl, J., Vortexes are creating a stir in the superconductor field p. 100 June 13
 Peddie, J. G., Two unijunctions form low-cost level detector p. 94 Apr. 18
 Penfield, H., Glass reed switch controls operational amplifier p. 97 Aug. 22
 Pennington, G. S. Jr., et al, Gate varies rewards from teaching machine p. 92 May 16

Perlman D., Silicon switch turns off stalled servomotors p. 90 May 16
 Perri, J. A., et al, New dimensions in IC's through films of glass p. 108 Oct. 3
 Peterson, V., et al, Harmonic testing pinpoints passive component flaws p. 93 July 11
 Pittman, C., et al, Circuit protects meter from periodic current spikes p. 108 June 13
 Platzler, G. E. Jr., Using transistor circuits to multiply and divide p. 109 Apr. 4
 Plemenos, F. A., Packaging revolution, The, part VI: Converting to microelectronics p. 103 Feb. 21
 Plevy, A. L., et al, Fail-safe frequency divider p. 127 Sept. 19
 Poppe, M., Double phase-shift keying speeds data over voice channels p. 91 Oct. 31
 Potter, G. B., et al, Integrated scratch pads sire new generation of computers p. 118 Apr. 4
 Prosser, T. F., FET's produce stable oscillators p. 102 Oct. 3
 Pulfer, J. K., et al, Nomograph simplifies design of f-m/f-m telemetry systems p. 101 Mar. 21
 Purnhagen, T. G., Nomographs calculate values for twin-T notch filter p. 88 Apr. 18

Q

Quatse, J. T., Feedback choke reduces power supply ripple p. 74 June 27
 Time-shared troubleshooter repairs computers on-line p. 97 Jan. 24

R

Rhea, J., Apollo: the goal is in sight p. 111, Dec. 12
 Rhinehart, W. A., et al, Six clues to nanovolt signals p. 114 June 13
 Rice, R., Packaging revolution, The, part V: Simpler designs for complex systems p. 109 Feb. 7
 Ridenour, A. M., et al, Unijunction controls spacing between pulses p. 82 July 11
 Risley, R. E., Power supply reduces ripple by varying series resistance p. 74 Jan. 24
 Robinson, A. S., Zener diode allows delay without large capacitors p. 93 May 30
 Roess, D., et al, Pumping new life into ruby lasers p. 115 Sept. 5
 Rossoff, A. L., Curves optimize lead impedance p. 89 June 27
 Roy, O. Z., Keeping the heart alive with a biological battery p. 105 Mar. 21
 Rux, P. T., One-shot multivibrator with zero recovery time p. 75 Jan. 24

S

Salter, F., Differential discriminator rejects common-mode noise p. 101 July 25
 Integrated circuits quickly assembled p. 103 July 25
 Sanford, R. C., Series gating reduces components in counter p. 81 July 11
 Sanguini, R. L., Integrated circuits make a low-cost f-m receiver p. 133 Aug. 8
 Multipurpose chips cut costs of f-m receiver p. 80 May 16
 Scheffel, S. V., Tuning fork drives portable frequency standard p. 122 Nov. 14
 Schmid, H., Current dividers convert digital signals into analog voltages p. 142 Nov. 28
 Digital meters for under \$100 p. 88 Nov. 28
 Integrated circuits replace the electromechanical resolver p. 90 Jan. 10
 Schuck, E., Nomograph finds output voltage error p. 126 Nov. 14
 Scidmore, A. K., Low-cost emitter-follower extends voltmeter's range p. 87 Feb. 7
 Selleck, R. S., Converting audio oscillators to square-wave generators p. 123 Aug. 8
 Shapiro, A., AND gate protects system should the voltage fail p. 79 July 11
 Shockley, W. L., et al, Ceramic handles and ultrasonic bonders upgrade hybrid assembly p. 110 Feb. 21
 Shollenberger, G. D., Automated ground station will check out Saturn p. 103 Feb. 7
 Silverman, G., Modified tape recorder stores timing signals p. 75 June 27
 Sideris, G., Belting out plastic transistors on mechanized assembly lines p. 84 Jan. 24
 Silverman, G., Emitter follower enhances oscillator's frequency variation p. 73, Dec. 26
 Simister, R. W., Bistable multivibrator immune to noise p. 97 Mar. 21
 Smith, B. R., Light-sensitive FET p. 124 Nov. 14
 Smith, K. D., Generating power at gigahertz with avalanche-transit time diodes p. 126 Aug. 8
 Smith-Saville, R. J., et al, Charge feedback increases pulse-rate meter accuracy p. 85 Feb. 7
 Soltz, D. J., High MOS impedance benefits pH measurement p. 79 July 11
 Sordello, F. J., Forward feed stabilizes d-c differential amplifier p. 84 Nov. 28
 Spitalny, A., Computer-aided design, part 2: Computer excels as analyst, The p. 68 Nov. 28
 Springer, K. E., Interlock protects display tube p. 125 Sept. 19
 Stapleton, R. S., Air navigation system testing grounded by signal simulator p. 151 Sept. 19
 Stewart, R. D., Storing data with light p. 82 Feb. 21
 Strattan, J., Feedback improves parallel-T filter p. 99 Sept. 5
 Summer, S. F., Two unijunction transistors produce three-state circuit p. 100 Jan. 10

Swartz, D. B., Curves speed design of multiplier circuits p. 104 Jan. 10
 Swinnen, M. E., Amplifiers and triggers simulate blood pressure p. 68 Oct. 31
 Sylvan, T. P., Exclusive OR circuit requires no voltage supply p. 94 Apr. 18

T

Tandon, M. L., Noise simulators help find peril in power-line defects p. 117 Mar. 7
 Teeter, R. G., Triangle waveform generator resets automatically p. 78 July 11
 Tesic, S., Multivibrator provides continuous phase control p. 102 July 25
 Thomas, J. E., Jr., et al, Diode sheds its costly package with beam-lead construction p. 77 Jan. 24
 Tibbets, L. M., Scr bridge inverter eliminates transformers p. 98 Sept. 5
 Tiedemann, J. B., Transistors control small d-c motor p. 93 Apr. 4
 Toria, M. A., Series regulator gives overload protection p. 104 July 25
 Traina, R., Multirange d-v voltmeter p. 126 Sept. 19
 Time will tell how fast a motor revs up p. 82 Nov. 28
 Trollope, G. A. R., Thermistor regulator provides fast response p. 106 Mar. 7
 Tsao, S. H., Multivibrator controls single-diode gate p. 101 July 25
 Turf, L., Simulator circuit generates video or noise pulses p. 78 May 2

U

Uzunoglu, V., Improving the performance of multi-purpose IC's with feedback p. 70 June 27

V

van der Geer, K., Control is accurate to 0.01°C p. 111 June 13
 van der Ziel, A., et al, Low-frequency noise predicts when a transistor will fail p. 95 Nov. 28
 Vodicka, V. W., Voltage transients tamed by spark-gap arresters p. 109 Apr. 18
 Vollenweider, W., Low-current alarm p. 105 Mar. 7
 von Ardenne, M., et al, Automated electron beams process thin-film components p. 110 Mar. 7

W

Wallace, W., How the West was won p. 102 Aug. 8
 Wallenstein, G. D., Myth of obsolescent knowledge, p. 142 Jun 13
 Walters, J. E., Adding transistors makes voltage shifter adjustable p. 108 Dec. 12
 Watlington, F., Hydrophone preamplifier cuts cable noise p. 120 Aug. 8
 Weaver, S. M., For a good mixer, add one FET p. 109 Mar. 21
 Weinert, F., Scattering parameters speed design of high-frequency transistor circuits p. 78 Sept. 5
 Weisz, T., Pairing Schmitt triggers produces lower hysteresis and faster switching p. 75 Nov. 28
 White, F. C., For a pilot over the ocean a satellite link to home p. 100 May 2
 White, V. M., et al, Strips of nickel foil automate welding of flatpack assemblies p. 128 June 13
 Williams, D. D., Communications satellites, part 2: Design choices for the future p. 109 May 30
 Williams, R., Adapter for curve tracer tests FET's at high voltage p. 104 Mar. 7
 Wilson, C. W., Phase-locked marker improves spectrum analyzer's accuracy p. 88 Feb. 7
 Wilson, M. G., Low-pass amplifier with adjustable bandwidth p. 90 May 30
 Wilson, R. A., Latching gate removes counter ambiguity p. 91 Apr. 4
 Two events, in sequence, produce detector output p. 120 Aug. 8
 Woody, R. F. Jr., Clip couples neon oscillators p. 77 May 2
 Wright, R. O., New twist for backward diode: help from low-noise amplifier p. 74 July 11

X

Y

Yarker, C., Full-wave detector without transformer p. 100 July 25
 Yokoi, M., et al, Bit by bit, Japan is speeding its data communications links p. 147 Dec. 12
 Young, L. H., Journey to East Europe, A p. 158 Aug. 8

Z

Zellmer, N. A., Getting the most out of feedback p. 66 Jan. 24

For reprints, use the reader service card at the back of this issue.
 © copyright 1966, Electronics®
 A McGraw-Hill Publication

Skiing, hunting, beautiful surroundings, hiking, the University of Colorado, culture, stimulating people, a tremendous climate . . . and IBM Boulder, Colorado

Who could ask for anything more? You could if you're looking for a career with a future.

And that's what you'll find at IBM's New Boulder, Colorado facility—an opportunity to develop and grow in your career as rapidly and as far as your talents and ambitions will allow.

You'll be working for one of America's leaders in science and technology. And you'll be working on almost everything in the world today. New knowledge, new problems, and solutions to older problems. But most of all you'll be working in a climate of creative freedom and career opportunity.

So ask for one more thing. An interview with an IBM representative. Openings exist in the following category.

SYSTEMS MANUFACTURING DIVISION

Quality Engineers: BSEE, BSME, BSIE, with at least two years' experience in quality control. Must plan quality programs, perform design analysis, define quality oriented product. Experience in evaluation of data-processing systems and statistical application desirable.

Components Engineers: BSIE, BSME, minimum two years' experience to define critical characteristics or electromechanical components and assemblies. Must be able to understand part function, define gauging requirements, and apply statistical techniques.

Magnetic Head Design: BSME or BSEE. Must have two years' experience in magnetic head design. Must be familiar with procedures required in magnetic head development, building and evaluation. Ferrite experience desired.

Magnetic Head Manufacturing: BSME or BSEE. Must have three years' experience in magnetic head manufacturing, including initial tooling and process control for product engineering work on magnetic heads in production.

Mechanical Engineer: MS or Ph.D. to perform engineering design, testing, and evaluation of electromechanical and mechanical components and systems as applied to digital magnetic tape transports. Evaluation will consist of analytical and experimental applications.

Component Reliability Engineer: BSME with one to three years' experience solving mechanical engineering problems affecting reliability of parts, assemblies, and machines. Will include directing technicians and providing consultation and technical assistance to other functional areas.

Please write, outlining your qualifications and interests, to: K. L. McBride, Dept. 554-24M, IBM Corporation, P.O. Box 1900, Boulder, Colorado.

IBM

An Equal Opportunity Employer

CLASSIFIED ADVERTISING
 **SEARCHLIGHT SECTION**
 BUSINESS OPPORTUNITIES
 USED OR SURPLUS EQUIPMENT

2? 3? 4? 5? 6?
FORGET 'EM ALL!

When you do business with Number One, you can afford to forget Number 2, 3, 4, 5, and 6! We want to buy electronics and test equipment—both military and commercial. If you have a single piece or a trainload—we'll pay you the top dollar bar none! We airmail your check the same day your goods arrive and we pay the freight! Save time, money, headaches and aggravation! Tell us what you have—what you want! And P.S.: Do it today!

COLUMBIA ELECTRONICS, Dept. EL
 4365 West Pico Blvd., Los Angeles, Calif. 90019
 Phone: (213) 938-3731

CIRCLE 966 ON READER SERVICE CARD

RADAR AUTO-TRACK & TELEMETRY ANTENNA PEDESTALS
 3 & 10 CM. SCR 584 AUTOTRACK RADARS. M-33 RADAR
 TPS-1D SEARCH. APS-45 TPS-10D HT. FINDERS. WX RADARS.
 FPN-32GCA. APS-10 APS-15B APS-27 (AMTI) SEARCH. ■ ■
 APN-102 DOPPLER. DOZENS MORE. CARCINOTRONS. PFW'S.
 25-5-1-2-3-6 MEGAWATT PULSE MODULATORS. CAVITIES.
 PULSE TRANSFORMERS. IF STRIPS. WAVEGUIDE. BENDS
 200 MC. 1 KMC. 3 KMC. 6 KMC. 9 KMC. 24 KMC. RF PKGS.

RADIO RESEARCH INSTRUMENT CO.
 550 5TH AVE., NEW YORK 36, N. Y. JU 6-4691

CIRCLE 967 ON READER SERVICE CARD

New VACUUM PENCIL

for picking up miniature parts

Selected Distributorships available.

PHILIP FISHMAN COMPANY
 7 CAMERON ST., WELLESLEY, MASSACHUSETTS

CIRCLE 968 ON READER SERVICE CARD

PROFESSIONAL SERVICES

GIBBS & HILL, Inc.

Consulting Engineers

Systems Engineering
 Operations Research • Development
 Field Studies • Design • Procurement
 Power • Transportation • Communications
 Water Supply • Waste Treatment

393 Seventh Avenue New York 1, N. Y.

YOU'RE HIRED!

Do you need electronics engineers or technical management men? Electronics magazine is the way to recruit them. Electronics is designed specifically for the working engineer. 68,000 subscribers and an additional 133,000 pass-along readers turn to it to keep up with their industry. You can find the man that meets your qualifications with an advertisement in the Employment Opportunities Section.

For rates & information write: Electronics, a McGraw-Hill Publication. Classified Advertising Division, Post Office Box 12, New York 10036.



A new approach to engineering

At Hewlett-Packard you can take your engineering training to market.

There's little point to designing and manufacturing an electronic measuring instrument unless it's going to be useful to someone. That's why, at Hewlett-Packard, many engineers make a career of marketing.

All engineers at Hewlett-Packard are marketing oriented, but a defined and trained group is assigned the engineering task of helping customers. These engineers work at our headquarters, at operating divisions and in the field, helping customers select, apply and get the best use out of their instrumentation.

With our concept that every new instrument must make a contribution to the science of measurement, our instruments and marketing engineers create new markets, and the sales engineer finds his stimulation...and success...in defining and exploring these markets and in helping to solve the measurement problems found there. And at Hewlett-Packard you can start as a design engineer and later move into marketing.

If, as an engineer, this type of dynamic work interests you, we'd be interested in talking to you. At Hewlett-Packard marketing is a career, and our sales success—over \$200 million this year—is an ever growing challenge to our marketing engineers. Would you like to join them?

Write Ray Wilbur, Vice President, 1501 Page Mill Road, Palo Alto, California 94304. An equal opportunity employer.

HEWLETT  **PACKARD**

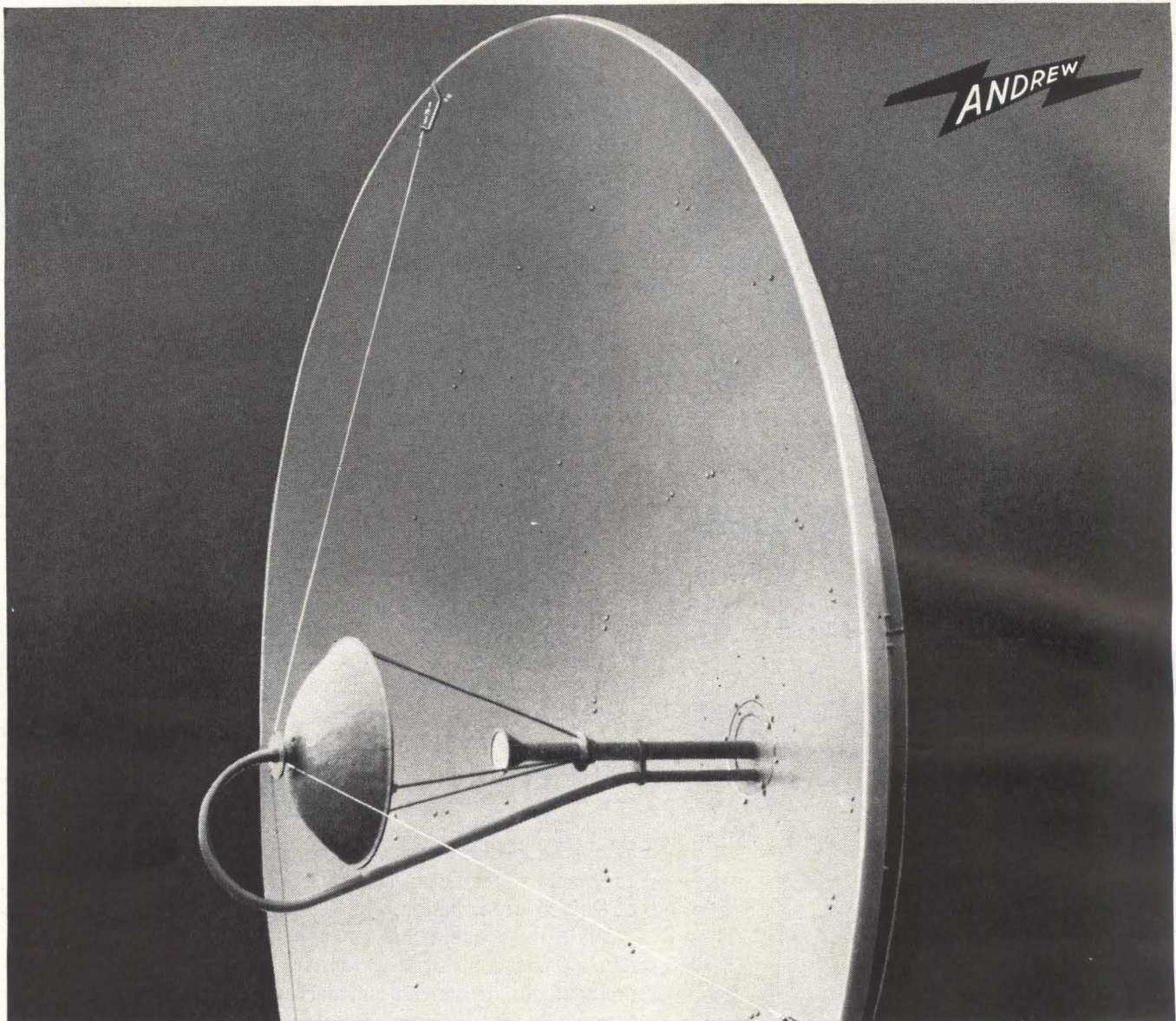

Andrew doesn't just make antennas...we create them

Advanced technology, practical engineering, and extensive field testing are the Andrew formula for effective antenna designs. ■ The new 4-port antenna shown above is an exciting breakthrough in microwave communications. For dual frequency systems in the 5.9-6.4 GHz and 10.7-11.7 GHz bands, it eliminates the need for

a frequency combiner. Dual polarized inputs serve each frequency band. This Andrew advanced development meets tomorrow's communications needs today! ■ Contact your regional Andrew sales engineer or contact Andrew Corporation, P. O. Box 807, Chicago, Illinois, U.S.A. 60642.

9-66

TELEMETRY ANTENNAS

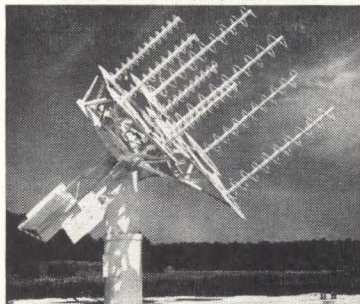

FIXED STATION ANTENNAS

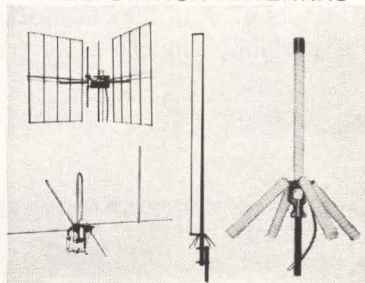

LARGE ANTENNAS

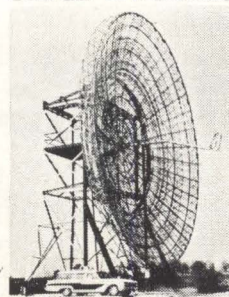

Andrew
CORPORATION
29 YEARS OF ENGINEERING INTEGRITY

IN EUROPE: Andrew Antenna Systems, Lochgelly, Fife, Great Britain

Newsletter from Abroad

December 26, 1966

Europe agencies aim for 1971 satellite launch

European space officials now expect to get a communications satellite all their own into a stationary orbit by 1971. Three major space organizations are preparing for the effort, which could lead to a European counterpart of the United States' National Aeronautics and Space Administration.

This month, the European Conference for Satellite Communications (CETS), set up in 1964 to work out participation by European governments in the International Telecommunications Satellite Consortium, awarded a preliminary communications satellite contract to the European Space Research Organization. Under the contract, ESRO will draw up parameters for the European satellite.

The European Launcher Development Organization, meanwhile, asked European aerospace companies to submit proposals by mid-April for a successor to the Europa-1 rocket ELDO is developing. ELDO's aim is to add apogee and perigee motors to the Europa-1 third stage; the improved rocket could then put a 440-pound satellite into stationary orbit [Electronics, July 25, p. 230].

The over-all aim is a 1971 launching by ELDO of an ESRO communications satellite partly financed by CETS. But there may be a single European space organization before then. This month, ELDO and ESRO set up a committee to study ways of merging.

Soviet 1967 budget to boost electronics

The Soviet Union will mount a drive next year to expand its output of electronics equipment. In presenting the 1967 budget this month, Finance Minister Vasily F. Garbuzov singled out electronics as a "top priority" industry earmarked for maximum growth.

How much the government plans to pour into electronics next year is a secret, as most of the electronics industry works for military programs. But Garbuzov said the government will put special emphasis on instruments and computers. The target in computer production is a 24% gain from 1966.

Despite this stress on industrial gear, consumers also will benefit from the increased electronics outlays. The Soviets plan to boost television-receiver production to 4.9 million sets from this year's 4.4 million. In addition, 13 new tv broadcasting centers will go on the air in Russia during 1967, including Moscow's new prestressed concrete transmitter tower—higher than the Empire State Building—that will extend Muscovites' tv fare from two channels to six.

U.K. scores again in East European computer market

British computer makers are deepening their inroads in the East European market. The latest batch of orders, for four installations totalling \$1.4 million, went to Elliott-Automation Ltd. a fortnight ago. Two other heavyweights in the British computer industry, English Electric-Leo-Marconi Computers Ltd. and International Computers & Tabulators Ltd., closed big sales with East European countries this fall [Electronics, Oct. 31, p. 150].

Largest of Elliott's new orders is for a \$630,000 system based on an NCR-Elliott 4100 machine for Czechoslovakia's computer research institute. The Czechs will use the system to handle both scientific and economic problems and to evaluate computer configurations.

Newsletter from Abroad

Another 4100 installation — valued at \$350,000 — will be used by Hungary's state-run Csepel industrial complex for stock control and production planning. The purchase of this Elliott system represents the first step toward an extensive data-processing system for Csepel, Hungary's largest manufacturing organization.

Elliott also received a \$280,000 contract for additional equipment for an existing Elliott computer system used by the Soviet Union's Gosplan central planning organization, and a Rumanian order for a \$140,000 Arch process-control computer.

The latest orders will bring to 36 the number of Elliott systems in Eastern Europe.

Italians want NATO to lift ban on NC exports to East

Italian machine-tool producers are campaigning to get the North Atlantic Treaty Organization to ease its embargo on exports of three-axis numerical-control machine tools to the East bloc. The Italians maintain that the Soviet Union will be able to produce sophisticated NC machines within a few years and so Western NC manufacturers should be allowed to sell to the Soviets while there's still a market.

An Italian NC specialist just back from Russia after talks with factory managers there says the Soviets already have developed three-axis NC. But Soviet experts admit the controls "don't always work as well as we want them to."

Lifting the NATO embargo would help the Italians strengthen their foothold in Russia, where Fiat is building an auto plant. The Russian factory, though, won't be on a par with Western auto plants unless it has sophisticated three-axis machines. Some British and French companies, too, want the embargo eased since they would pick up part of the Russian business. But so far the Johnson Administration shows no sign of relaxing its stiff position against exports of three-axis NC to Russia. The NATO embargo can't be lifted unless the U.S. agrees.

Philips and Thorn vie for Pye

Thorn Electrical Industries Ltd. now seems to have the edge in the struggle to take over Pye of Cambridge Ltd., an ailing British television and telecommunications producer. Thorn last week topped an offer of about \$55 million for Pye's stock made late last month by Philips Gloeilampenfabrieken NV of the Netherlands, which already holds a minority interest in Pye.

Pye's board favors the Thorn offer and has recommended it to stockholders, but the battle continues. Philips may make a counteroffer, and still a third contender may enter the fray. An unknown buyer has been bidding for big blocks of Pye on the London stock market recently.

Siemens may buy interest in German computer firm Zuse

Siemens AG plans to strengthen its position against stiff U. S. competition in the German computer market. The German company is holding talks with Brown, Boveri & Cie, the giant Swiss electrical-equipment maker, concerning joint control of Zuse AG, a Brown-Boveri affiliate and Germany's oldest computer producer.

Rumors last fall that Brown-Boveri planned to sell Zuse to the Control Data Corp. had German computer companies on edge [Electronics, Oct. 3, p 258]. U. S. computer makers have already cornered about 85% of the German market.

Japan

Readers' corner

The Hayakawa Electric Co., producer of desk calculators and consumer electronics products, is fast chipping out a niche for itself in the semiconductor business.

Hayakawa hasn't set its sights on mass-production of integrated circuits or for that matter even transistors and diodes. Instead, the company is specializing in semiconductor components for optical readers. Although it's just really getting started in semiconductors, Hayakawa's sales of reader elements have hit a rate of \$350,000 yearly and are rising fast.

Much of the business is coming from companies that mass-produce standard semiconductors themselves; some have even developed laboratory versions of reader elements. But rather than go into small-scale production, they've turned to Hayakawa for special devices.

Monolithic. Hayakawa this month strengthened its bid to corner a solid share of the reader-element market by adding monolithic character-recognition sensors to its line. For customers who want solid-state readers, Hayakawa offers gallium-arsenide diodes whose light output is a good match for the solar-cell sensors. GaAs sources have a narrow frequency spectrum that peaks at 9,100 angstroms; as a result, there is less noise in the sensor output.

The basic version of the new sensor consists of a single straight row of 36 small solar cells laid down on a silicon wafer about $\frac{3}{4}$ -inch long. Each cell measures about 16 mils on a side and the cells are spaced on approximately 20-mil centers. At a light level of 1000 lux, cell output is 0.4 volt, with short-circuit current of 1.4 microamps.

Hayakawa has set a price of \$333

to Japanese customers for the 36-element sensor. A similar device with a pair of 36-cell rows goes for \$500. The line also includes sensors with single rows of 42 or 60 cells and a two-row device with 159 cells. The latter is about as far as anyone has yet gone in packing solar cells onto a monolithic sensor for commercial use. The Semiconductor division of Fairchild Instrument & Camera Corp., for example, is selling a 120-cell sensor—priced at \$788—originally developed for scanning reconnaissance photos.

Readings. In character readers, the sensors are used behind optical lenses that focus an enlarged real image of the characters onto the cells. From the combination of cell outputs, the character can be identified.

Hayakawa, of course, won't disclose how its customers use the double-row devices. One customer hints that the first row's job in his equipment is to sense the height of characters before the second row gives the actual readout. Another customer suggests the first row senses the start of characters passing the element and then the

second row provides the readout.

Well lit. The solar-cell sensors will work with tungsten-filament lamps but perform even better with gallium-arsenide diodes as light sources. The diodes are not sensitive to machine vibrations as are tungsten filaments.

Hayakawa has diodes in two sizes for reader applications. The larger of the two puts out 100 microwatts for a direct-current input of 100 milliamps. It can handle 5-microsecond pulses up to 15 amps. The semiconductor chip has a hemispherical shape to improve its light output.

The smaller diode, which can be mounted on 90-mil centers, can handle 2-amp pulses of 5 μ sec duration. Energy output is 8 microwatts for a d-c input of 100 ma.

Added competition

The desk-calculator market is growing fast in Japan and so is competition.

Last month, the Hayakawa Electric Co. showed the prototype of an integrated-circuit machine [Electronics, Nov. 14, p. 345]. This month, two of Hayakawa's major

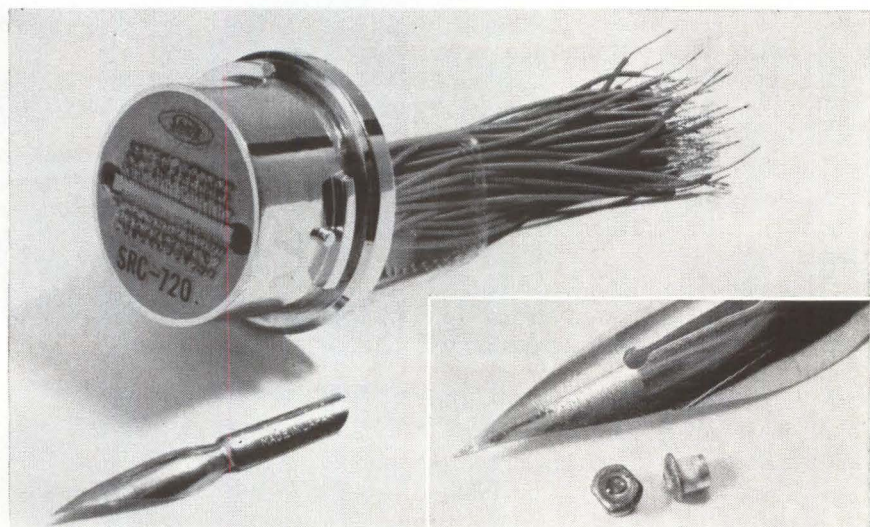

Character-recognition sensor has two rows of 36-cells on a single silicon wafer about $\frac{3}{4}$ -inch long. Light output of tiny GaAs diodes closely matches sensor's response.

competitors countered with new models and a flurry of publicity about these machines' advanced technology. Neither contains ic's, but both will be on the market by next spring, a half-year or more before Hayakawa will have its ic desk-calculator in production.

Diminutive drum. The Cannon Camera Co., Japan's second-ranking calculator producer, has equipped its new machine with a magnetic drum memory, a device more often used in computers. This calculator will be marketed in February at a price of \$1,460.

The magnetic drum boosts the computing capability of the calculator considerably. Although the readout has only 16 digits, pairs of 15-digit numbers can be multiplied together to obtain a 30-digit answer. Half the answer is stored in an accumulator and the other half in a register on the drum, and either half can be read out on the display. The drum also permits automatic computation of square roots for numbers of up to 15 digits.

The drum itself measures 1.2 inches in diameter and is about 2 inches long. It has 11 tracks and heads, a capacity of 3,000 bits, and runs at 9,300 revolutions a minute on a 60-hertz power supply. Five of the tracks store 15-digit constants, while two are 15-digit accumulators. Two serve as 15-digit registers for arithmetic operations, and the remaining two handle control operations such as preventing an overflow of digits.

Because of the drum, the new Cannon calculator has less circuitry than the company's previous models. The drum replaces a pair of semiconductor registers and a semiconductor accumulator. The logic circuitry is diode-transistor logic.

Thin film. The Ricoh Co. is banking on thin-film parametrons to secure its place in this increasingly competitive market. Parametrons are majority logic devices developed in Japan and currently used in a small Nippon Electric Co. computer [Electronics, Sept. 6, 1965, p. 155].

Ricoh will introduce a 10-digit calculator priced at \$1,000 in February and a 12-digit version costing

\$1,470 in April. The Oi Electric Co. is manufacturing the calculators for Ricoh.

The larger of the two machines uses 2,500 parametrons operating at a clock frequency of 15 kilohertz. The parametron count is very close to the number of diodes that would be needed in a comparable calculator using diode-transistor logic.

Ricoh's decision to build calculators around thin-film parametrons will put it at a disadvantage when Hayakawa and, later, other manufacturers have ic machines available. The thin-film parametrons don't offer the same room for improvement that a switch to ic's does for calculators using diode-transistor logic. Ricoh's calculator, therefore, figures to be the last parametron business machine.

Great Britain

Light touch

Soon after it introduced its four-Plumbicon color-television camera in Britain last year, the Marconi Co. found it had a best seller. Sales are already at the 200 mark, over 80% of them to North American broadcasters.

A trio of improvements by Marconi, a subsidiary of the English

Electric Co., points to even higher sales ahead. The improved version can produce broadcast-quality color at the studio light levels commonly used for black-and-white transmissions.

The original camera could handle lighting levels of 30 foot-candles, too low for cameras with image-orthicon tubes [Electronics, March 21, p.221]. But improved optics and circuit refinements let the new version, at full gain and aperture, pick up acceptable color pictures at light levels down to 15 foot-candles. Marconi recommends light levels between 80 and 100 foot-candles, the usual limits in black-and-white studios.

Joystick. Along with higher sensitivity, Marconi offers a pair of options that improve performance. One is remote control for color balance among the three Plumbicon tubes that produce chrominance signals to "color" the black-and-white image picked up by the fourth Plumbicon, the luminance tube. The control is a joystick linked mechanically to the gain controls for the color channels.

Once the controls are set for initial color balance, minor adjustments to compensate for over-bright objects in a scene are made by the joystick, which resets all three color channels but keeps their mean signal level unchanged. The initial balance can be obtained



Hot prospect. Marconi's four-Plumbicon color-tv camera, already a best seller in North America, may find a market in the Soviet Union. Here a Russian official looks over an improved version, introduced this month.

quickly at any time by shifting the remote-control joystick back to its center position.

The second optional feature adds vertical aperture correction to the standard horizontal correction to obtain sharper images. The vertical correction, applied in the luminance channel, enhances sudden signal changes between adjacent points in a vertical line.

Ready for orbit

The first British-built satellite will soon begin a journey that will end next spring in a 325-mile-high orbit around the earth. The British bird, the UK-3, will be shipped next month to the United States for an early-spring launching by a Scout rocket from the Western Test Range in California.

A prototype of the experimental satellite was sent late last month to the rocket-builder's plant in Dallas, Texas, for mechanical-fit and radio-interference checks. These checks are to be followed by tests with the tracking and data acquisition network of the National Aeronautics and Space Administration at the Goddard Space Flight Center in Maryland.

UK-3 will be launched as part of the Anglo-American cooperative space research program. The first two satellites launched under the program, UK-1 and UK-2, carried British experiments but were built in the U.S.

Shared responsibility. Britain's Science Research Council, the agency that handles the government's effort in fundamental science, is in over-all charge of the latest satellite project. But except for determining the five experiments that UK-3 will carry, the council turned the project over to the Ministry of Aviation, which, in turn, tapped the British Aircraft Corp. to build the airframe and the Applied Electronics Laboratory of Britain's General Electric Co. to supply the electronics. GEC isn't affiliated with GE of the U.S.

Total cost of the UK-3 project is \$4.2 million with the electronics hardware GEC supplied accounting for about \$800,000 of this. The

GEC equipment includes a regulated power supply, high-speed and low-speed data-handling systems, a programmer, a tape recorder, telemetry transmitters and a telecommand receiver with decoding and logic circuits.

School ties. The five experiments UK-3 will carry are the work of British universities and research stations. One, from the government's Radio and Space Research Station, will measure the characteristics of radio-frequency emissions from terrestrial sources such as thunderstorms. Another, from the famed Jodrell Bank radio-astronomy laboratory, will check low-frequency galactic radio noise that cannot be picked up by earth stations.

Radar birdwatcher

Serious birdwatchers in Britain generally get by with an old tweed suit, a pair of binoculars and a notebook, but not Loughborough University researcher Glenn Shaeffer. His kit includes a World-War-II-vintage radar.

Shaeffer, though, hasn't turned to electronics to go one-up on fellow members of a local birdwatching society. He's using the ancient radar to collect data on the migration habits of bird species so that aircraft can avoid bird-caused crashes.

Modern high-power radar installations at airports can spot flocks of migrating birds and give last-minute warnings to pilots, but they're not much help in plotting migration patterns for planned avoidance.

With his second-hand radar, bought for \$420, Schaeffer can track individual birds. Some 90% of migration, it's been found, involves single birds taking off at sundown. The radar has a maximum range of five miles but can pick up a small bird at two miles and a duck at four miles. Fed to a cathode-ray tube, return echoes from individual birds show up as violently oscillating traces that match the beats of the bird's wings. The species can be identified from the wing-beat rate.

Sweden

To market

Swedish scientists, researchers and inventors can now turn to a special company to get their products into production and onto the market. Incentive AB, a holding company whose specialty is backing technically oriented companies and which is in turn backed by a large commercial bank, has formed a subsidiary called Incentive Research and Development AB. IRD will organize, finance, and market scientific equipment and will, in certain cases, establish a separate company to take over the product. Like its American predecessors—among them North American Aviation Inc.'s Navan Inc.—the Swedish group intends to get the latest scientific developments on the market quickly and profitably.

IRD's first board chairman is Sven Malmstrom, ex-managing director of LKB-Produkter AB, a scientific and medical instrument firm. Malmstrom is confident that IRD can help product developers overcome such problems as lack of time, money and marketing know-how. While he was at LKB-Produkter, a mass spectrometer developed by two university researchers was put into production and within a year had produced about \$1.5 million in sales.

France

African campaign

France failed to win Western Europe as a market for her Secam (for sequential and memory) color television system but seems well on the way to nailing down French-speaking Africa.

This month a consortium of French companies, with strong backing from the government, closed a \$10-million deal to install a nationwide black-and-white network in Algeria. Paris sees the deal as long-term insurance that Secam will have the inside track when Al-

geria and the other French-speaking African countries swing to color in the late 1970's.

To make sure the French consortium would land the contract despite strong competition from American, British and Czechoslovakian suppliers, Paris came through with long-term credits for about half the cost and a short-form loan for the balance. To further bolster its position in Africa, the government announced it would put up a pair of communications satellites in 1970. One will be spotted to serve as a link between France, Africa and the Middle East. The characteristics of the satellites still have to be elaborated and the launchers for them developed.

Trio. Three French firms make up the consortium that will supply the gear for Algeria's nationwide tv network. They are Compagnie Française Thomson Houston-Hotchkiss Brandt, CSF-Compagnie Générale de Télégraphie sans Fil and Société de Télécommunications Radio-électriques et Téléphoniques (TRT), an affiliate of Philips Gloeilampenfabrieken NV of the Netherlands. Thomson-Houston will supply studio equipment and field-reporting vans, CSF three high-power transmitters and TRT the microwave links.

The French equipment will give Algeria national tv coverage on a 625-line standard within two years. Currently, only the three major cities—Algiers, Constantine and Oran—have stations with low-power transmitters.

United Arab Republic

Comings and goings

Japan and Hungary moved fast this month as each tried to snap up the large share of the \$5-million Egyptian electronics market held by the Radio Corp. of America.

Less than a fortnight after the Arab countries announced they'd added RCA to their list of companies boycotted because they do business with Israel, agents of

major Japanese companies and of two big Hungarian state-owned export corporations handling components started angling for deals with Egyptian equipment assemblers.

Japan and Hungary previously sold small-screen television sets, transistor radios and some components in the Egyptian market, but RCA so far has had the bulk of the components business for 19-inch and 21-inch tv sets, the kingpin segment of the market. Over the last five years, Egypt bought about 450,000 tv sets.

RCA reports that the listing has not yet been converted into a ban on its components. But the company hasn't budged on its intentions to do business in Israel. The official statement: "There is no change in RCA's commercial relations with Israel and none is contemplated."

Despite the Japanese and Hungarian offers, Egypt may find it hard to quickly replace the American supply of components. Along with consumer-set components, RCA supplies parts for studio equipment and transmitters. And Egypt has a growing need for sophisticated electronics like air traffic control hardware, process controls, and navigation aids for the Suez Canal. Along with learning how to deal with the semiskilled assembly workers in Egypt, alternative suppliers would have to extend big credit lines since Egypt's foreign-exchange situation is tight.

Australia

New market

The Collins Radio Corp. of Dallas, Texas, may have the inside track in obtaining orders for ground satellite installations in Australia.

The company has already received the contract for Australia's first commercial ground satellite station in Moree, New South Wales [Electronics, Dec. 12, p. 26]. Collins is further reinforcing its position in the country by building a factory near Melbourne. The new

factory won't be completed in time to contribute significantly to Collins' work on the Moree station, but should be ready for future contracts. Thus Collins seemingly has an edge if Australia goes ahead with plans to establish a westward-looking station to service the Indian Ocean satellite of the global Intelsat-3 series.

The east-looking Moree station, slated for completion in late 1967, will initially be capable of handling 600 telephone channels and one television channel.

Around the world

Britain. The Racal Co., a recent addition to the ranks of British IC manufacturers, is planning to produce "special" linear integrated circuits for use initially in the company's own communications gear.

Spain. With traffic jams an everyday occurrence in Madrid and Barcelona, officials of these cities have decided to install electronically controlled traffic-light systems. U.S., French, Italian and British concerns are competing for the contracts.

Sweden. A million-dollar contract for a computer-operated warehouse has been awarded to the Westinghouse Electric Corp. by Scania Vabis AB, a Swedish truck and bus manufacturer. Included in the package: a Prodac 50 computer system, storage racks, stacker cranes, conveyors and an electrical system. The 31,000-square-foot facility is scheduled to go into operation in the spring of 1968.

South Africa. The Burroughs Corp. has successfully broken into the British-dominated South African computer market with a \$17.4 million order. Burroughs is to supply six B3500 computers and related equipment to the Trust Bank of South Africa's main branches in Johannesburg, Cape Town and Durban.

Britain. A subminiature rate gyro manufactured by Elliott-Automation, Ltd., has been ordered for incorporation into the guidance head of the Anglo-French Martel

air-to-surface tactical missile. The gyro is fluid damped, is unheated and is contained in a cylinder one inch in diameter and two inches long. It is based on the GR-H4 gyro developed by the Nortronics Division of the Northrup Corp.

Soviet Union. Further evidence that the Russians plan to step up semiconductor production turned up this month in Britain when the Thermal Syndicate group got a Soviet order for \$860,000 worth of machinery and know-how for a synthetic silica glass plant. Silica glass serves as a substrate and encapsulation material for transistors. The machinery is destined for a plant the Russians will build near Moscow early next year.

East Africa. The 2,000-mile telephone trunk ring that loops through Kenya, Uganda and Tanzania will be completed next year. A contract for the last two links, which will join Kampala, Uganda and Dodoma, Tanzania, has been awarded to Britain's Marconi Co. by the East African Posts and Telecommunications Administration. The two links will be tropospheric scatter systems with quadruple diversity receivers. Drive amplifiers will have 1-kilowatt power for the Kampala-Mwanza link across Lake Victoria. For the Mwanza-Dodoma land link, 10-kw amplifiers will be used.

Scandinavia. A special three-nation committee on satellite communications has recommended that the Scandinavian countries build their own ground station. At present, calls between North America and Scandinavia via satellite are handled by the Goonhilly Downs station in Cornwall, England. The estimated cost of the station is \$3.5 million, but the committee's studies showed it would be a money-saving investment.

Common Market. The Commission of the European Economic Community plans to formulate a common policy for research and technological development for the six nations. The first step has been the selection of Paris-based consultants, Bureau d'Information et Prévisions Economiques, to survey research practices, licensing arrangements, financing and the like.



$\pm .0025\%$ Transportable Accuracy $1\mu\text{v}$ to 10v Range

DIAL-A-SOURCE

DIALABLE "ZERO IMPEDANCE" VOLTAGE SUPPLY

- 1 PPM RESOLUTION
- SECONDARY STANDARD
- 25 M.A. (ZERO IMPEDANCE)
- 1 MICROVOLT TO 10 VOLT RANGE
- SHORT-CIRCUIT PROOF
- 5 PPM OUTPUT REGULATION (NO LOAD TO 25 M.A.)
- DIALABLE IN-LINE VOLTAGE READOUT
- ± 10 PPM STABILITY
- FLOATING OUTPUT; 1000 MEGS ISOLATION
- REMOTE SENSING SUPPLIES .0025% CALIBRATED VOLTAGE AT THE LOAD
- NOISE AND RIPPLE LESS THAN 3 PPM OF OUTPUT OR 20 MICRO VOLTS PEAK

Also available . . . MODEL DAS46 $\pm .005\%$, \$875.00

Free!

HURRY Supply Limited

Evaluate the General Resistance DIAL-A-SOURCE and receive with our compliments a personalized Old English Coffee Mug



Write for Bulletin 512-2

GENERAL RESISTANCE, INC.

430 Southern Blvd., Bronx, New York, 10455
Tel.: 212-292-1500 TWX 212 824-4880

Circle 171 on reader service card

To order reprints: Fill in, cut out coupon below, insert in envelope and mail to: Electronics Reprint Dept., 330 W. 42nd Street, New York, N.Y. 10036

Reprint order form

For listing of reprints available see the Reader Service Card.

Computer-aided Design: Part I, The Man-machine Merger.

Send me reprints of Key no. R-01 at \$1.25 each.

For reprints of previous special reports fill in below:

Send me reprints of Key No.(s) @¢ each.

(For prices, see Reader Service Card)

Name

Number of street

City, State, Zip code

Electronics advertisers

December 26, 1966



ADC Products Incorporated John Gompper & Associates	27, 28	Fairchild Semiconductor Incorporated Faust/Day Incorporated	110	Phelps Dodge Electronic Products Corporation Smith, Dorian & Burman Incorporated	130
Adams & Westlake Company E.H. Brown Advertising Agency Inc.	33	Fluke Manufacturing Company, John Bonfield Associates Incorporated	15	Philips, Eindhoven Media International Div. of Vaz Dias International N. V.	OAS 1, 9
Airpax Electronics Incorporated Welch, Mirabile & Company Incorporated	124	General Electric Company, Semiconductor Products Division George R. Nelson Incorporated	135	Plessey Electronics Company Roles & Parker Ltd.	OAS 4, 5
Air Products & Chemicals Incorporated Arthur Falconer Associates	22	General Radio Company K. E. Morang Company	2nd Cover	Primo Company Ltd. General Advertising Agency	138
Amelco Semiconductor Division of Teledyne Incorporated Sturges & Associates	45	General Resistance Company Sam Goldstein Advertising Agency	171	Princeton Applied Research Corporation Mort Barish Associates Incorporated	109
Andrew Corporation Fensholt Advertising Inc.	164	Haydon Company, A. W. Chambers, Wiswell & Moore Incorporated	151	Radio Corporation of America Al Paul Lefton Company	43, 123, 4th Cover
Babcock Relays Div. of Babcock Electronics Corporation Leland Oliver Company	137	Hewlett Packard Loveland Division Tallant/Yates Incorporated	3rd Cover	S. D. S. A. Public Service Agency	155
Barnes Development Corporation Industrial Public Relations Inc.	120	Hewlett Packard Microwave Division Lennen & Newell Incorporated	2	Semtech Corporation Burruss Advertising	7
Beckman Instrument International Hixson & Jorgensen Incorporated	OAS 2	Hewlett Packard Moseley Division Lennen & Newell Incorporated	1	Sierra/Philco Corporation Hall Lawrence Incorporated	24
Bendix Scintilla Corporation MacManus, John & Adams Inc.	34	Honeywell Company, Micro Switch Division Batten, Barton, Durstine & Osborn Inc.	32	Singer Company, Metrics Division Hepler & Gibney Incorporated	133
Bourns Incorporated Trimpot Division The Lester Company	149	Honeywell Test Instruments Division Campbell Mithun Incorporated	71	Sorenson Operation/Raytheon Company James Advertising Incorporated	11
Bulova Watch Company, Electronics Division Frank Best & Company Inc.	128	Indiana General Corporation, Ferrites Division Griswold & Eshleman Company	21	Souriau & Cie Ariane Publicite	OAS 10
Burton Research Laboratories The Lester Company	115	International Nickel Company Incorporated The Marschalk Company	18, 19	South Dakota Industrial Development Expansion Agency Maurice Paulsen Advertising	173
C & K Components Incorporated Van Christo Associates	151	ITT Cannon Electric West, Weir & Bartel Incorporated	122	Spectral Electronics Corporation Jones, Maher Roberts Advertising	156
C.S.F. SPI Agency	OAS 6	ITT Jennings Radio West, Weir & Bartel Incorporated	145	Speer Carbon Company Division of Air Reduction Company Hazard Advertising Company Inc.	41
CTS Corporation Burton Browne Advertising	131	ITT Semiconductors Neals, & Hickok Incorporated	174	Sprague Electric Company, The Harry P. Bridge Company, The	5, 10, 16
Canoga Electronics Corporation Farrell, Bergmann & Wilson Advertising	141	Jerrold Corporation, Government & Industrial Division Lescarboura Advertising Agency	14	Standard Telephone & Cable Ltd. Brockie Haslem & Company	OAS 11
C.P. Clare & Company Reincke, Meyer & Finn Incorporated	12, 13	Johnson Company, E. F. Midland Associates Incorporated	107, 108	Stromberg-Carlson Rumrill Hoyt Incorporated	153
Clifton Precision Products Company, Div. of Litton Industries Ivey Advertising Inc.	117	Litton Industries Incorporated, Triad Division West, Weir & Bartel Incorporated	153	TRW Capacitors Division Fuller, & Smith & Ross Incorporated	127
Codex Corporation Weston Associates Incorporated	20	Litton Industries Incorporated, Winchester Electronics Division West, Weir & Bartel Incorporated	17	Tektronix Incorporated Hugh Dwight Advertising Inc.	52
Control Data Corporation, LaJolla Division Barnes Champ Advertising	148	Lockheed Missiles & Space Company McCann-Erickson Company	134	Tohoku Metal Industries Ltd. Kokusai Tshushin-Sha KK Agency	155
Corning Glass Works, Capacitor Division Rumrill-Hoyt Company Incorporated	78	McGraw Hill Book Company	150	Ultra Carbon Corporation Church & Guisewite Advertising	144
Couch Ordnance Incorporated Culver Advertising Inc.	119	Mallory & Company Incorporated, P. R., Manufacturing Division Aitkin-Kynett Company Incorporated	51	Union Carbide Corporation, Electronics Division J. M. Mathes Incorporated	105
Comcor Incorporated, Sub of Astrodats Incorporated Marketing Directions	147	Marconi Instruments Ltd. Lovell & Rupert Curtis Ltd.	OAS 12	Vari-L Company William Hill Field Advertising	132
Conductron MRC Division Gray & Kilgore Incorporated	134	Markem Machine Company Culver Advertising Incorporated	118	Vector Electronics Company VanDer Boom, McCarron Incorporated	136
Dale Electronics Incorporated, Sub. of Lionel Corporation Swanson, Sinkey, Ellis Incorporated	48	Mepco Incorporated Ray Ellis Advertising Corporation	151	Westinghouse Semiconductor Division ITSM Division of McCann Erickson	53
Duetsch Company, The B. Wesley Olson Company	76, 77	Metrix Corporation PVP Agency	OAS 3		
Dorne & Margolin Incorporated Snow & Depew Advertising	139	Microsonics Incorporated S. Gunnar Myrbeck & Company	173		
DuPont de Nemours & Company, Freon Division Batten, Barton, Durstine & Osborn Inc.	129	Monsanto Company, Inorganic Division Foote, Cone & Belding Incorporated	30, 31		
DuPont de Nemours & Company, Mylar Division Batten, Barton, Durstine & Osborn Inc.	121	Navigation Computer Corporation Industrial Public Relations Inc.	39		
DuPont de Nemours & Company, Teflon Division Batten, Barton, Durstine & Osborn Inc.	6	Nexus Research Laboratories Larcom Randall Advertising Inc.	106		
EG & G Incorporated Culver Advertising Incorporated	146	North Atlantic Industries Incorporated Murray Heyert Associates	9		
E M I Electronics Ltd. Bonner Hodgson & Partners Ltd.	OAS 8	Nytronics Incorporated The Stukalin Advertising Agency	8		
Eastman Kodak Company Rumrill-Hoyt Incorporated	29	Perfection Mica Company, Magnetic Shield Division Burton Browne Advertising	138		
Electronic Communications Incorporated Neals & Hickok Incorporated	46, 47, 143				
Esterline Angus Instrument Company Caldwell, Larkin & Sidener-Van Riper Inc.	54				

Classified Advertising

F.J. Eberle, Business Mgr.	
PROFESSIONAL SERVICES	162
EMPLOYMENT OPPORTUNITIES	162-163
EQUIPMENT (Used or Surplus New) For Sale	162

ADVERTISERS INDEX

Columbia Electronics	162
Fishman Co., Philip	162
Hewlett-Packard	163
International Business Machines	162
Radio Research Instrument Co.	162

For more information on complete product line see advertisement in the latest Electronics Buyers' Guide
 Advertisers in Overseas Advertising Section following newsletter from abroad

**LIVE (REALLY LIVE)
and PROFIT
IN THIS ALL SEASON
VACATIONLAND**



*Let us show you
how to mix pleasure
with your profits!*



Millions of Americans have made SOUTH DAKOTA their ideal vacationland . . . Now they're learning that it's also a great BUSINESS-land . . . Big, uncluttered, lots of hunting, fishing, and just plain liveability . . . Yet close to everywhere at the continent's crossroads. 5¢ postage may be all that stands between you and a new future in uncrowded SOUTH DAKOTA. Let us send you our new portfolio today.



South Dakota
"A NEW LOOK AT OPPORTUNITY"

**GET THE SOUTH DAKOTA
STORY**

CONTACT
James W. Monroe, Director
Industrial Development & Expansion Agency
Room K
Pierre, South Dakota 57501
Ph. 224-5911 Area Code 605

Circle 186 on reader service card



Advertising sales staff

Frank E. LeBeau [212] 971-6464

Advertising sales manager

Wallis Clarke [212] 971-2187
Assistant to sales manager

**Atlanta, Ga. 30309: Michael H. Miller, 1375
Peachtree St., N.E.,
[404] TR 5-0523**

**Boston, Mass. 02116: William S. Hodgkinson
McGraw-Hill Building, Copley Square,
[617] CO 2-1160**

**Chicago, Ill. 60611: Robert M. Denmead,
J. Bradley MacKimm, Ralph Hanning,
645 North Michigan Avenue,
[312] MO 4-5800**

**Cleveland, Ohio 44113: William J. Boyle, 55
Public Square, [216] SU 1-7000**

**Dallas, Texas 75201: Richard P. Poole, 1800
Republic National Bank Tower,
[214] RI 7-9721**

**Denver, Colo. 80202: Joseph C. Page, David
M. Watson, Tower Bldg., 1700 Broadway,
[303] 255-5484**

**Detroit, Michigan 48226: J. Bradley
MacKimm, 856 Penobscot Building
[313] 962-1793**

**Houston, Texas 77002: Kenneth George,
2270 Humble Bldg.,
[713] CA 4-8381**

**Los Angeles, Calif. 90017: Ian C. Hill,
John G. Zisch, 1125 W. 6th St.,
[213] HU 2-5450**

**Minneapolis, Minn. 55402: J. Bradley
MacKimm, 1104 Northstar Center
[612] 332-7425**

**New York, N. Y. 10036:
Donald R. Furth [212] 971-3615
James R. Pierce [212] 971-3615
George F. Werner [212] 971-3615
500 Fifth Avenue**

**Philadelphia, Pa. 19103:
Warren H. Gardner, Jeffrey M. Preston,
6 Penn Center Plaza,
[215] LO 8-6161**

**Pittsburgh, Pa. 15222: Warren H. Gardner,
4 Gateway Center, [412] 391-1314**

**Portland, Ore. 97204: James T. Hauptli,
218 Mohawk Building, 223 S.W. Morrison
Street, Phone [503] 222-5118**

**Rochester, N.Y. 14534: William J. Boyle,
9 Greylock Ridge, Pittsford, N.Y.,
[716] 586-5040**

**St. Louis, Mo. 63105: Robert M. Denmead
The Clayton Tower, 7751 Carondelet Ave.
[314] PA 5-7285**

**San Francisco, Calif. 94111:
James T. Hauptli, 255 California Street,
[415] DO 2-4600**

**London W1: John W. Patten, Edwin S.
Murphy Jr., 34 Dover Street,
Hyde Park 1451**

**Milan: I, via
Baracchini Phone: 86-90-617
86-90-656**

**Frankfurt/Main: Gerd Hinske, Dieter
Rothenbach, Elsa-Brandstroem Str. 2
Phone: 72 01 81**

**Geneva: Michael R. Zeynel,
1, rue du Temple
Phone: 31 95 60**

**Paris VIII: Denis Jacob, Kenneth Davey,
17 Avenue Matignon Phone: 359 6637**

**Tokyo: Nobuyuki Sato, 1, Kotohiracho
Shiba, Minato-Ku [502] 0656**

**Osaka: Ryosi Kobayashi, 163, Umegee-cho,
Kilta-ku [362] 8771**

**George F. Werner [212] 971-2310
Manager Electronics Buyers' Guide**

**Donald J. Austermann [212] 971-3139
Promotion manager**

**Milton Drake [212] 971-3485
Research and circulation manager**

**Wallace C. Carmichael [212] 971-3191
Business manager**

**Stephen R. Weiss [212] 971-2044
Production manager**

**Thomas M. Egan [212] 971-3140
Production manager Electronics Buyers' Guide**

**HIGH
STABILITY
CRYSTAL
OSCILLATORS**



Compact modules contain glass-sealed crystal units, transistorized circuitry, and proportional control ovens for freedom from RFI. For precision frequency or time base reference in counters, signal generators, and master oscillator systems. Industry's smallest package sizes, lowest power requirements, and fastest warm-up time. Custom-designed units such as multiple-frequency oscillators also available.

SPECIFICATIONS

- Frequency Range**
10 kc to 100 mc
- Short Term Stability**
up to 1 part in 10⁹
- Long Term Stability**
up to 1 part in 10⁸
- Ambient Temperature Range**
-55°C to 95°C
- Oscillator Supply**
±6 V, ±12 V, +24 V, +28 V, etc.
- Oven Supply**
+28 vdc or 115 vac
- Standard Oven Sizes (inches)**
2 x 2 x 4; 1.5 x 1.5 x 3.25
- Output Power**
up to 500 mw
- Output Waveform**
Sine, square, or special

Write for Bulletin 6350



MICROSONICS, INC.

a subsidiary of the
SANGAMO ELECTRIC COMPANY

**60 Winter Street
Weymouth, Massachusetts 02188
Area Code 617 337-4200**

Circle 173 on reader service card

173

Learn why

Please send me a FREE copy of "Transistor characteristics related to circuit performance," along with detailed specifications on ITT strip line transistors.

Name Title

Company

Address

City State Zip

ITT's exclusive strip line packaging makes VHF/UHF transistor circuits work better

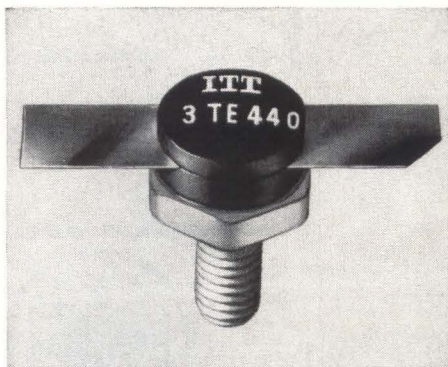

The strip line package reduces or eliminates many of the difficulties that were formerly inevitable when working with high-power VHF-UHF transistors.

Consider these advantages: strip line configuration simplifies final tune-up by virtually eliminating instability; low-inductance package means easier matching to driver stages and broad bandwidth. For 400 MHz application, you may select the 3TE440 (15 watts output) or the 3TE450 (4 watts output).

For full details fill in the coupon above. Or see for yourself — sample quantities are available off the shelf from your ITT distributor or factory representative.

ITT
SEMICONDUCTORS

ITT SEMICONDUCTORS IS A DIVISION OF INTERNATIONAL TELEPHONE AND TELEGRAPH CORPORATION, 3301 ELECTRONICS WAY, WEST PALM BEACH, FLORIDA. FACTORIES IN WEST PALM BEACH, FLORIDA; PALO ALTO, CALIFORNIA; LAWRENCE, MASSACHUSETTS; HARLOW AND FOOTSCRAY, ENGLAND; FREIBURG AND NURENBERG, GERMANY

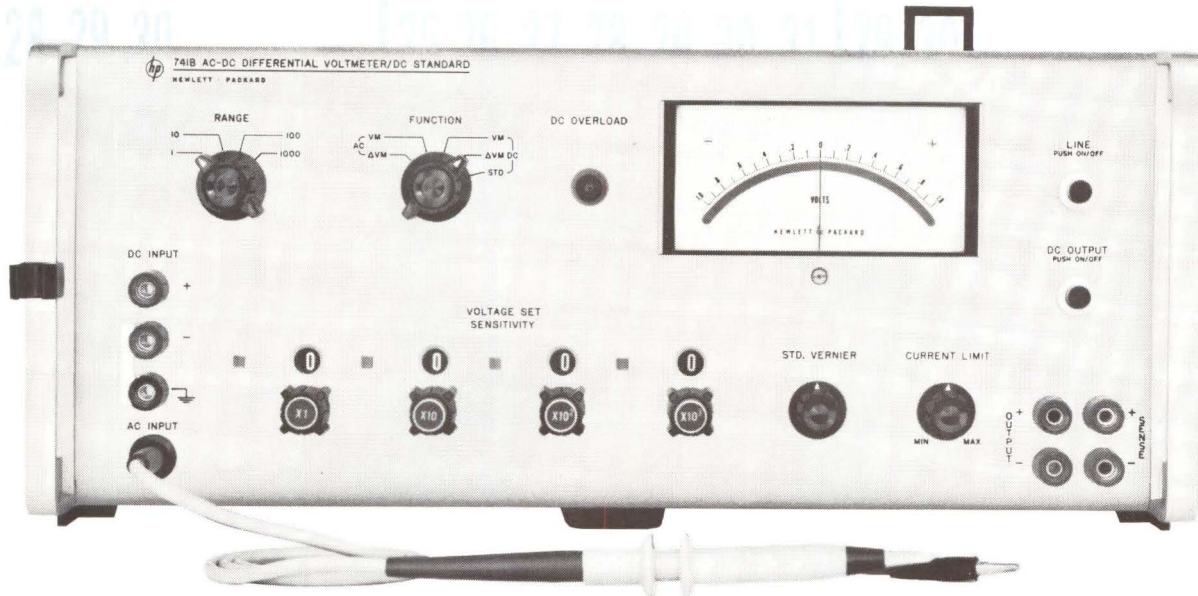

New Low-cost Δ VM / DC Standard Gives **0.01% FOR 90 DAYS**

... and five multi-purpose functions as well, for less than you normally pay for a single-function instrument! Reason for the superior stability of this all-solid-state calibrating tool: use of precision hp wire-wound resistors in the decade and range dividers, plus a temperature-compensated Zener diode reference supply. Other advantages include an input impedance greater than 10^9 ohms in DC Δ VM, and VM independent of null, 5-digit resolution, automatic decimal point, floating input, recorder output, plus overload and short-circuit protection. Calibration labs save high-cost time with 90-day calibration cycle, and **simple two-step calibration from DC to 20 kHz**. Compare price (\$1675) and specs:

DC STANDARD, 90-DAY CYCLE, $\pm 0.01\%$ or 0.001% FS (whichever is greater) from 0-1000 volts. Output resolution is 1 ppm on any range. Short-term stability typically better than 20 ppm/mo. Remote sensing permits output regulation at point of measurement. Temperature coefficient is less than 3 ppm/ $^{\circ}$ C from 0-50 $^{\circ}$ C.

AC DIFFERENTIAL VOLTMETER, 90-DAY CYCLE $\pm 0.02\%$ + 0.01% of range from 400 Hz to 5 kHz (with reduced accuracy to 100 kHz). TC is less than 20 ppm/ $^{\circ}$ C, 20 Hz to 10 kHz, 5-40 $^{\circ}$ C. Input capacitance of less than 5 pf reduces loading errors and

circuit instabilities during measurement. Input impedance is 1 megohm.

DC DIFFERENTIAL VOLTMETER, 90-DAY CYCLE $\pm 0.02\%$ or $\pm 0.002\%$ FS (whichever is greater) from 0-1000 volts. Input impedance is greater than 10^9 ohms on all ranges independent of null — an ideal characteristic for drift measurements when null cannot be maintained. TC is less than 3 ppm/ $^{\circ}$ C from 0-50 $^{\circ}$ C.

AC-DC VOLTMETER/POWER AMPLIFIER provides greater than 10^9 ohms input on all DC ranges plus high AC input impedance (10^6 ohms shunted by less than 5 pf). In addition to the five functions shown, this calibration lab instrument provides a $\pm 0.02\%$ unity-gain amplifier from 0-1000 volts.

DC DIFFERENTIAL VOLTMETER OPTION 741B 01 provides $\pm 0.01\%$ DC Δ VM, and $\pm 0.02\%$ DC standard. Other specs identical. Ask for a demonstration or contact Hewlett-Packard, Palo Alto, California, 94304. Tel. (415) 326-7000. In Europe: 54 Route des Acacias, Geneva. 116A

HEWLETT  PACKARD
An extra measure of quality



The new RCA **2N3839** for critical low-noise UHF applications in Military and Aerospace equipment is...

directly interchangeable with the low-noise RCA 2N2857... **and has a 1.1 dB lower NF**

That's right! The famous, field-proved transistor family that brought you the low-noise RCA 2N2857, with types which meet requirements of MIL-S-19500/343 USAF, now gives you even lower noise capability in amplifier, oscillator and converter applications with the new RCA 2N3839.

Formerly known as developmental type TA2363, the new RCA 2N3839 silicon n-p-n epitaxial transistor offers the superior performance and reliability features of the 2N2857, with a substantially lower noise figure... *only 3.4 dB max. at 450 MHz!* And power gain is 12.5 dB min. at 450 MHz. Furthermore, RCA can supply these new, high reliability UHF transistors in production quantities.

For complete pricing and delivery information on the new, low-noise 2N3839, call your RCA Field Representative. Ask him, too, about RCA developmental types which can meet even lower NF requirements, as well as information on ultra-reliable versions of the RCA 2N2857. For technical data sheets, write RCA Commercial Engineering, Sec. CN12-4, Harrison, N.J. 07029. Also available through your RCA distributor.

RCA Electronic Components & Devices



The Most Trusted Name in Electronics

Circle 902 on reader service card