

# Twisted Pair FDDI Magnetics Overview and Recommendations

National Semiconductor  
Application Note 902  
Todd Vafiades  
July 1993



## 1.0 INTRODUCTION

The use of twisted pair cable for high speed LAN signalling necessitates the inclusion of transmit and receive magnetics to couple the transmission signal to and from the copper media. The choice of magnetics in a given implementation can have a significant effect on the integrity of the transmission signal. Several important factors must be considered when choosing the magnetics for FDDI twisted pair PMDs. This application note discusses key performance parameters of magnetics suitable for use within a PMD designed for ANSI X3T9.5 FDDI Twisted Pair Draft Proposal compliance. Although magnetics are required for both shielded and unshielded twisted pair media, this note focuses specifically on magnetics suitable for FDDI signalling over Category 5 Unshielded Twisted Pair. This note includes layout recommendations for a typical PMD transceiver implementation employing the National Semiconductor DP83223 TWISTER transceiver and suggests the use of some readily available magnetics.

## 2.0 WHAT ARE MAGNETICS?

In the case of Twisted pair FDDI signal transmission, the term "magnetics" refers to the one-to-one isolation transformers and common mode choke transformers which couple the signal to and from the twisted pair media. These elements couple the serial data stream from one FDDI node to the twisted pair media and again from the twisted pair media to another FDDI node. It is also possible that these transformers may coexist with other filter elements, such as resistors or capacitors, which attempt to enhance the integrity of the transmitted and/or received FDDI data stream. These additional filter elements may or may not be described as part of the magnetics depending on the individual vendor's perspective. As a point of clarification, ferrite beads or inductors, sometimes used to decouple sensitive power and ground pins from potential noise sources on transceiver ICs, may also be referred to as magnetics. This application note is only intended to report on the media coupling magnetics.

## 3.0 WHY ARE MAGNETICS REQUIRED?

In most electrical signal transmission systems, the data moving between two nodes is AC coupled in order to isolate potential system ground differences between the transmitter and receiver which could interfere with proper signal transfer. A one-to-one isolation transformer is a convenient component for use in signal transfer for several reasons: DC current blocking (system ground differences are isolated from one another), end stations protection from static charges that may build up on the cable, inherent differential signal coupling and common mode rejection.

When using the DP83223 Twisted Pair Transceiver, it is not necessary to employ complex multiple pole LC filters which are commonly found in many 10BASE-T, Token Ring and FDDI implementations. Due to the controlled output transition times of the DP83223, simple networks which include only the termination resistors, isolation transformers and common mode chokes may be all that are required. Some designers may choose to add simple filtering at the receive end of a system in order to reduce the susceptibility to transient or continuous noise injected onto the media from outside sources. This note contains example schematics detailing components and interconnection.

## 4.0 KEY PARAMETERS

Magnetics play an essential role in ensuring signal integrity within a transmission system. Parameters such as Insertion Loss, Crosstalk and Transition Time contribute greatly to the performance of the magnetics within a system. This application note briefly examines several important parameters which contribute to the effectiveness of a given magnetics design.

### 4.1 Insertion Loss

This is the loss introduced by the insertion of the magnetics and can be generally expressed as:

$$I_L(\text{dB}) = 20 \text{ Log } \left| \frac{V_{IN}}{V_{OUT}} \right|$$

where  $V_{IN}$  is the voltage across the input of the magnetics while  $V_{OUT}$  represents the voltage across the output of the magnetics in an appropriately configured system. Some factors which may contribute to loss include: DC resistance of the windings, variation from a true one-to-one (primary to secondary) winding relationship resulting in a "step-down" effect, core loss as well as the inherent loss of additional filtering. It is important to consider insertion loss when setting specified transmit amplitudes for standard compliant Twisted Pair FDDI signalling.

### 4.2 Return Loss

This is a measure of the match between the two impedances on either side of a junction point, defined by:

$$R_L(\text{dB}) = 20 \text{ Log } \left| \frac{Z_1 + Z_2}{Z_1 - Z_2} \right|$$

where  $Z_1$  and  $Z_2$  are the complex impedances of the two halves of the circuit. If an impedance mismatch does exist, signal reflections will measurably decrease the performance of a given system. The effects of Return Loss are significantly reduced by the controlled output transition times of the DP83223. These controlled transition times basically eliminate the need for additional filtering which can increase the potential for a mismatch in transmit and receive impedances.

### 4.3 Common Mode Rejection

This is the ability of the magnetics, either transmit or receive, to reject common mode energy which may exist in the transmission signal. Also, the ability of the magnetics to not impart any common mode energy to the signal. Common Mode Energy can be described as some potential existing equally (in phase) on each side of a differential pair with respect to some fixed potential such as ground. As an example, some twisted pair conductors are routed through typical office locations which contain significant ambient energy. This can inject as much as 30V AC (in some cases even higher) of common mode potential to the twisted pair. If this common mode voltage is not blocked, the line receiver, which may be powered by a single 5V rail, will fail to receive a signal that is well outside of its specified operating range.

### 4.4 Crosstalk

This is the amount of energy coupled from the transmit channel to the receive channel within the magnetics. The effects of this type of crosstalk are virtually eliminated due to the physical isolation between transmit and receive magnetics as shown in subsequent connection diagrams.

### 4.5 Output Transition Time

This is the standard "rise and fall time" as measured from 10% to 90% of full amplitude. With MLT-3, it is important to measure both rise times and both fall times of the three level signal. Again, due to the controlled output transition time of the DP83223, additional wave shaping filters required by some implementations are unnecessary.

### 4.6 Overshoot

Given a square wave, overshoot may be defined as the amount of energy above or below the intended final high or low voltage level(s) as expressed in percent. Overshoot may result from unintentional emphasis of some high frequency harmonics and or transitions coincident with reflections. Due to the controlled transmit transition times of the DP83223, the potential for overshoot is reduced by the inherent decrease in high frequency energy of the transmitted transition times.

### 4.7 Baseline Wander

In an AC coupled digital transmission system, baseline wander is the variation in the DC content of the transmitted datastream at any point in time. This phenomenon is dependent on the digital content of a given data stream and the low frequency cutoff of the magnetics. The scrambled FDDI line code generated by a twisted pair FDDI PMD can result in run lengths (no transitions) of up to 480 ns. If the magnetics low frequency pole is not sufficiently low to allow, without attenuation, a 480 ns static condition, then the attenuation at the critical frequencies will result in a "droop" or "tilt" of the waveform during the run length. This droop will effectively offset the baseline reference of the datastream result-

in baseline wander. An increase in baseline wander contributes directly to increased jitter. In general, the higher the OCL (open circuit inductance), the lower the low frequency pole for the magnetics bandpass region and the less severe the Baseline Wander.

### 4.8 Conducted Power Spectrum

This is the power spectrum of a properly terminated PMD transmitter (including the magnetics) as measured by direct connection into a spectrum analyzer. This spectrum analysis is a convenient method of comparing the results of different signalling techniques. The degree of randomness within the data stream as well as the differences between binary and MLT-3 are easily compared via conducted emissions.

### 4.9 Radiated Emissions

This is the radiated power spectrum of a properly terminated PMD transmitter (including the magnetics) as measured by a near field antenna within a strictly controlled environment. Although this application note does not report on the radiated emissions results of the recommended magnetics it remains a very important parameter. It is the responsibility of the systems vendor to ensure that the performance lies within mandated limits set forth by the various and appropriate regulatory agencies.

### 4.10 EMI Susceptibility

This is a measure of the tolerance of a working TP-PMD receiver to a controlled ambient field of radiation imposed on the twisted pair cable carrying the scrambled FDDI line code. The receive-end magnetics can be supplemented with some degree of high frequency filtering to afford greater immunity to susceptibility.

## 5.0 RECOMMENDED MAGNETICS

This application note highlights specific magnetics from four vendors. It is important to understand that this note does not suggest preference to any one vendor or magnetics solution. The results herein are made available strictly as a means of objective comparison intended to assist the system designer in making the best possible choice for a given implementation. Due to the relative immaturity of Twisted Pair FDDI, this application note reports on only a limited number of magnetics solutions. Future updates or addendums to this application note will include a larger selection of magnetics suggested for use with National Semiconductor PMD solutions. The four magnetics solutions are listed, in alphabetical order, by company name followed by product number. (Contact information for each of the vendors is located at the end of this applications note.)

Bel Fuse—# 0556-3899-04

Coilcraft—# Q3950-C

Pulse Engineering—# PE-65620M

Valor—# ST6021

Please contact each individual magnetics vendor for the latest product information and part numbers.

## 6.0 PARAMETER MEASUREMENT

This section summarizes pertinent data as measured from some of the key parameters mentioned previously. All tests were performed using the same specially designed evaluation platform. This platform consists of a multi-layer “ODL replacement” emulation board fitted with a DP83223 transceiver in order to duplicate, as closely as possible, the performance of a true TP-PMD application. Each of the four magnetics solutions were tested against the same DP83223 transceiver in the same environment to ensure comparable conditions. All tests were performed identically on each of the magnetics solutions for both binary and MLT-3 encoded data transmission unless otherwise noted. Again, it is very important to understand that any data reported herein is preliminary and is provided for reference. Each magnetics vendor should be contacted for the latest performance information.

### 6.1 Insertion Loss

Insertion loss is measured in two steps. First, the magnetics under test are replaced by shorting wires which DC couple the transmitted signal to the digitizing oscilloscope and the transmit waveform is calibrated to exactly 2V peak-peak differential. Second, the magnetics under test are reinserted and a second peak-peak differential measurement is performed. The Insertion Loss resulting from scrambled FDDI code is tabulated below.

Insertion Loss (dB)	Bel Fuse	Coilcraft	Pulse	Valor
Scrambled FDDI	-0.26	-0.67	-0.26	-0.35

### 6.2 Return Loss

Although this parameter was not measured, the return loss due to the magnetics alone should be minimal because complex filtering is not required. Potential return loss may be inferred by examining the magnetics vendor’s manufacturing tolerances.

### 6.3 Common Mode Rejection

This parameter was not tested. Refer to each vendor’s datasheet for performance specifications.

### 6.4 Crosstalk

The virtual absence of Interchannel crosstalk between the transmit and receive magnetics is due to sufficient physical separation of the components as specified by National Semiconductor. There will be some degree of crosstalk that occurs between the transmit and receive channel outside of the magnetics which will most likely occur within the media connector and within the media itself. This effect can be minimized by observing good high speed layout practices and will not be increased by the use of the magnetics solutions outlined herein.

## 6.5 Output Transition Time

The rise and fall times of a transmitted signal are a direct indication of the bandwidth of the transmit channel. The transition time specification depends somewhat on results of EMI radiation testing and other performance tests. Slower transition times can be achieved using different magnetics components. To test the rise and fall times of the magnetics, the input of the magnetics were presented with the 2.0 ns transition times generated by the DP83223 TWISTER. The output of each magnetics solution was then measured to determine the transition time performance.

Transition (ns)	Bel Fuse	Coilcraft	Pulse	Valor
Binary Rise	2.41	3.25	2.37	2.34
Binary Fall	2.63	3.12	2.29	2.18
MLT-3 Rise (-1 to 0)	2.40	3.16	2.37	2.38
MLT-3 Rise (0 to 1)	2.67	3.32	2.59	2.43
MLT-3 Fall (1 to 0)	2.48	3.08	2.25	2.19
MLT-3 Fall (0 to -1)	2.76	3.32	2.49	2.36

(Refer to Figures 1 and 2.)

### 6.6 Overshoot

Overshoot, especially in MLT-3 mode, will decrease the noise margin of the transmitted signal. Serious overshoot may also contribute to unwanted bit errors in the received signal. The overshoot at the output of the magnetics is minimized because the input signal to the magnetics includes the controlled transition times generated by the DP83223 TWISTER. Overshoot of less than 2% can be considered negligible.

Overshoot (%)	Bel Fuse	Coilcraft	Pulse	Valor
Binary	<2.0	<2.0	<2.0	<2.0
MLT-3	<2.0	<2.0	<2.0	<2.0

(Refer to Figures 3 and 4.)

### 6.7 Baseline Wander

The effects of baseline wander can be directly inferred by measuring the magnetics droop characteristic over a worst case run length period of 480 ns for scrambled FDDI code. The baseline wander is arrived at by doubling the percentage droop exhibited by a given magnetics solution.

Baseline Wander (%)	Bel Fuse	Coilcraft	Pulse	Valor
480 ns Width	5.6	12.1	5.6	6.9

(Refer to Figure 5.)

### 6.8 Conducted Power Spectrum

The conducted Power Spectrum offers a convenient method of understanding and comparing the differential power spectrum of a given set of magnetics. Due to the similarities between the conducted spectra of each of the magnetics tested herein, only typical measurements are presented. Of specific interest are the differences between the binary and MLT-3 encoded conducted power spectrum for scrambled line code. Although MLT-3 suffers from 6 dB lower noise immunity than binary given equal transmit amplitudes, MLT-3 does exhibit an improvement in the reduction of differential conducted power at key frequencies.

Conducted Power (dBm)	Binary	MLT-3
@31.25 MHz	-47.0	-53.0
@62.50 MHz	-53.0	-62.0

(Refer to Figures 6 and 7.)

### 6.9 Radiated Emissions

Currently, no data is provided for this parameter. However, preliminary data will be available soon. Please contact National Semiconductor for information pertaining to the Radiated Emissions of suggested PMD implementations.

### 6.10 EMI Susceptibility

Currently, no data is provided for this parameter. However, preliminary data will be available soon. Please contact National Semiconductor for information pertaining to the EMI Susceptibility of suggested PMD implementations.

### 7.0 ADDITIONAL PARAMETERS

Ultimately, the most important performance factor of Twisted Pair FDDI signaling is long term, error free data transmission. To ensure that each of the four magnetics solutions tested herein will support error free transmission, 16 separate bit error rate (BER) tests were performed. Each of the four magnetics were tested against themselves and each other at both the transmit and receive ends of the transmission system. Specifically, each test was performed using 130 meters of Category 5 cable with scrambled code set at 2.0V peak-to-peak differential transmit voltage. These tests were performed for both Binary and MLT-3 signal encoding. Each of the 16 BER tests passed proving acceptable interoperability in terms of the magnetics to the TP-PMD standard BER limit of  $<10E-12$ .

Several additional electrical parameters exist for each of the magnetics solutions presented herein. Although these parameters are not included in this analysis, they are nonetheless important and may help to further inform the system designer regarding performance. Each of the magnetics vendors publish a list of these specifications, tolerances and test conditions included where applicable, to accompany their solutions. It is best to refer to these figures for a more comprehensive understanding of performance. Some of the standard parameters associated with magnetics include:

- Turns Ratio
- OCL (open circuit inductance)
- LL (leakage inductance)
- Cw/w (interwinding capacitance)
- DCR (DC resistance)
- HI POT (high voltage tolerance)
- CMR (common mode rejection)

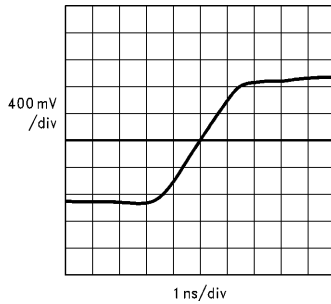

TL/F/11894-1

FIGURE 1. Typical Binary Transitions

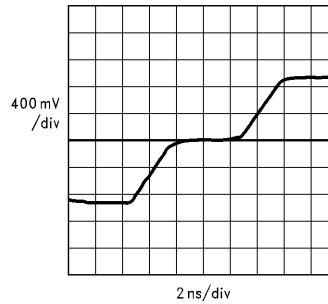

TL/F/11894-2

FIGURE 2. Typical MLT-3 Transitions

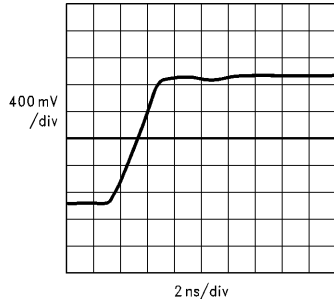

**FIGURE 3. Typical Binary Overshoot**

TL/F/11894-3

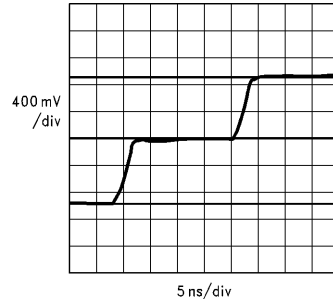

**FIGURE 4. Typical MLT-3 Overshoot**

TL/F/11894-4

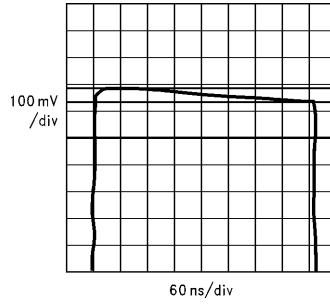

**FIGURE 5. Typical Binary Droop**

TL/F/11894-5

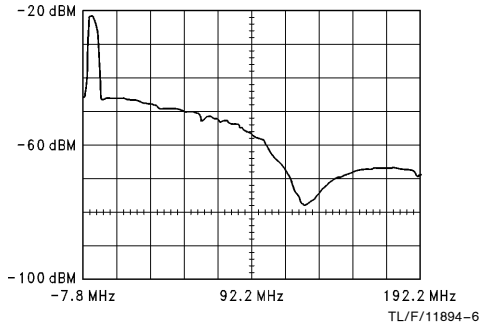

**FIGURE 6. Typical Binary Conducted Power Spectrum**

TL/F/11894-6

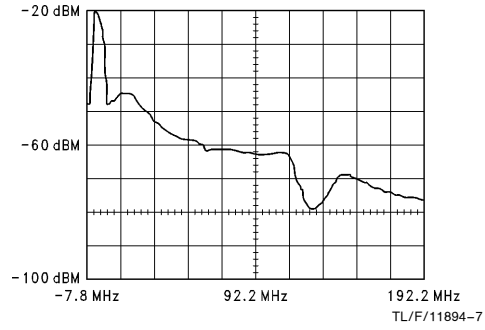

**FIGURE 7. Typical MLT-3 Conducted Power Spectrum**

TL/F/11894-7

## 8.0 UTP-PMD MAGNETICS CONNECTION

This section focuses on suggested interconnection and layout of the magnetics solution within the PMD. Due to the high speed nature of Twisted Pair FDDI, careful layout practices are advised. Maintaining a  $50\Omega$  signal impedance and keeping high speed signal traces as short as possible are important design factors. The following design example highlights several key areas of concern and also suggests possibilities for improved overall system performance.

*Figure 8* illustrates a typical magnetics layout using the National Semiconductor DP83223 Twisted Pair Transceiver. This layout example assumes the use of four planes to accommodate the required power and signal routing as described in the cross sectional view provided in the Legend (*Figure 9*). Additionally, the Legend provides component type and values as well as identification of various signal paths and power planes. Circuit details of the layout follow:

**Capacitor C1** optionally helps to ensure that high frequency energy outside of the intended passband across R3 will be attenuated.

**Capacitors C2, C3 and C4** provide power supply decoupling for each of the designated power planes. C2 decouples noise from TXV<sub>CC</sub> to TXGND. C3 decouples noise from RXV<sub>CC</sub> to RXGND. Finally, C4 decouples noise from ECLV<sub>CC</sub> to ECLGND.

**Ferrite Beads FB1 through FB4** provide good isolation between unique supply islands and planes. FB1 isolates the RXGND (Receive Ground) island from the ECLGND plane. FB2 isolates the RXV<sub>CC</sub> (Receive Power) island from the ECLV<sub>CC</sub> plane. FB3 isolates the TXGND (Transmit Ground) island from the ECLGND plane. And F4 isolates the TXV<sub>CC</sub> (Transmit Power) island from the ECLV<sub>CC</sub> plane. While many implementations employ standard inductors of various values for power supply isolation, National Semiconductor recommends the use of Ferrite beads for improved isolation and enhanced performance. Ferrite beads provide damping of high frequency noise while not creating problems caused by high Q inductors.

**Resistors R1, R2 and R3** form a voltage divider in which the receive signal, as presented to the DP83223, is attenuated relative to the full receive amplitude. This amplitude reduction is a good method of ensuring maximum operational headroom of the embedded adaptive equalizer and associated circuitry within the DP83223. In addition, this attenuation can be adjusted to accommodate for magnetics insertion loss.

**Resistors R4 and R5** form the back termination for the transmit signal path. These resistors are terminated directly to the TXGND (Transmit Ground) plane. Since the DP83223 TWISTER allows these back termination resistors to be referenced to ground, the noise coupled to the transmitted signal is less than those implementations which reference the output to V<sub>CC</sub>.

**Resistors R6 through R9** provide the two unused twisted pairs within the 4-pair bundle with  $100\Omega$  differential termination.

**Resistors R10 through R13** provide good common mode termination for each of the four twisted pairs within the bundle. More specifically, R10 and R11 terminate the two unused twisted pairs while R12 and R13 terminate the two active twisted pairs. R12 is connected between the primary center tap of the receive transformer and the common mode common point while R13 is connected between the secondary center tap of the transmit transformer and the common mode common point. Within some magnetics the transmit channel isolation transformer primary and receive channel isolation transformer secondary center taps are pinned out. The example shown in *Figure 8* assumes these pins float.

Although the common mode termination design presented here is a viable option, other designs may potentially provide improved performance as well. An additional point of clarification: to date, the ANSI subcommittee on Twisted Pair FDDI has not yet defined common mode termination of any kind. However, data has been presented that indicates a significant enhancement in EMC performance for Category 5 cable fitted with common mode termination.

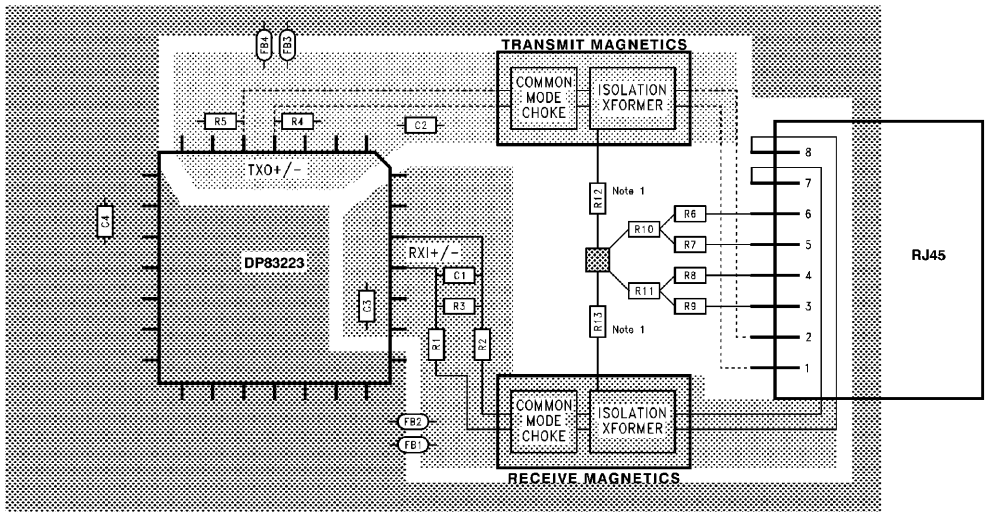

FIGURE 8. Typical Magnetics Layout Using DP83223 Transceiver

TL/F/11894-8

<p>R1, R2 = 20Ω chip resistor (receive end termination)  R3 = 60Ω chip resistor (receive end termination network)  R4 thru R9 = 50Ω chip resistor (balanced back termination)  R10 thru R13 = 75Ω chip resistor (common mode termination)  C1 = 0.01 μF chip cap (optional high frequency receive filtering)  C2, C3, C4 = 0.1 μF chip cap (decoupling caps)  FB1 thru FB4 = Fair-Rite Bead #724-3019-446 (supply chokes)</p>	<p>----- = Bottom routed signals (50Ω microstrip)  ——— = Top routed signals (50Ω microstrip)  [Pattern] = Common mode termination common point  [Pattern] = ECL Power planes (power and ground overlaid)  [Pattern] = TX Power planes (power and ground overlaid)  [Pattern] = RX Power planes (power and ground overlaid)</p>
<p>Board cross-section  Layer Allocation</p>	<p>Note 1: This resistor connects the common mode termination common point to the isolation transformer center tap (media side)</p>

FIGURE 9. Legend

TL/F/11894-9

**9.0 MAGNETICS PACKAGING**

Package type information includes: package encasement, footprint and pinout for each of the three vendor's products. For precise mechanical information on each of the magnetics, please refer to the appropriate vendor's datasheet. The order of description is alphabetical by vendor name. Please contact each vendor for the latest package information.

**Bel Fuse: Product #0556-3899-04**

One 0556-3899-04 required for transmit channel  
 One 0556-3899-04 required for receive channel  
 Through-hole/6-pin SIP/100 mil pin spacing

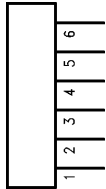

TL/F/11894-10

Undesignated pins are no-connects

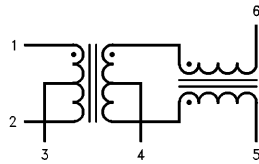

TL/F/11894-11

**Pulse Engineering: Product #PE-65620M**

One PE-65620M required for transmit channel  
 One PE-65620M required for receive channel  
 Plastic/surface mount/16-pin DIP/50 mil pin spacing/  
 300 mil device width

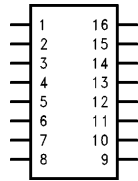

TL/F/11894-14

Undesignated pins are no-connects

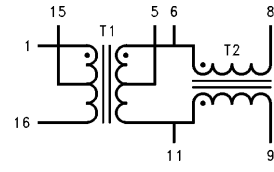

TL/F/11894-15

**Valor: Product #ST6021**

One ST6021 required for transmit channel  
 One ST6021 required for receive channel  
 Plastic/surface mount/16-pin DIP/50 mil pin spacing/  
 300 mil device width

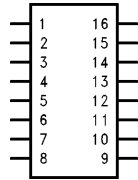

TL/F/11894-16

Undesignated pins are no-connects

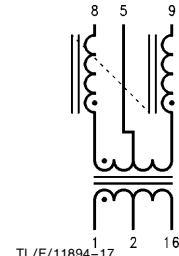

TL/F/11894-17

**Coilcraft: Product #Q3950-D**

One Q3950-C required for transmit channel  
 One Q3950-C required for receive channel  
 Through-hole/6-pin SIP/100 mil pin spacing

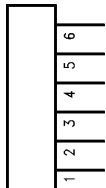

TL/F/11894-12

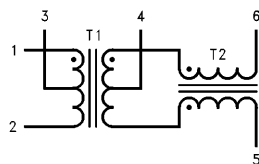

TL/F/11894-13



**VENDOR INFORMATION**

Bel Fuse, Inc.  
5362 W. 78th St.  
Indianapolis, IN 46268-4147  
(317) 876-0044

Coilcraft, Inc.  
1102 Silver Lake Rd.  
Cary, Illinois 60013  
(708) 639-6400

Pulse Engineering, Inc.  
P.O. Box 12235  
San Diego, CA 92112  
(619) 674-8100

Valor Electronics, Inc.  
9715 Business Park Ave.  
San Diego, CA 92131  
(619) 537-2619

**REFERENCES**

1. National Semiconductor DP83223 device specification.
2. FDDI TWISTED PAIR PHYSICAL LAYER MEDIUM DEPENDENT (TP-PMD) Working Draft Proposed American National Standard Rev. 0.3 dated 2/17/93.
3. Bell, David A., *Solid State Pulse Circuits*, Reston Publishing, (1981).
4. Various, *Reference Data For Radio Engineers*, Sams, (1981).

**LIFE SUPPORT POLICY**

NATIONAL'S PRODUCTS ARE NOT AUTHORIZED FOR USE AS CRITICAL COMPONENTS IN LIFE SUPPORT DEVICES OR SYSTEMS WITHOUT THE EXPRESS WRITTEN APPROVAL OF THE PRESIDENT OF NATIONAL SEMICONDUCTOR CORPORATION. As used herein:

1. Life support devices or systems are devices or systems which, (a) are intended for surgical implant into the body, or (b) support or sustain life, and whose failure to perform, when properly used in accordance with instructions for use provided in the labeling, can be reasonably expected to result in a significant injury to the user.
2. A critical component is any component of a life support device or system whose failure to perform can be reasonably expected to cause the failure of the life support device or system, or to affect its safety or effectiveness.



**National Semiconductor Corporation**  
 1111 West Bardin Road  
 Arlington, TX 76017  
 Tel: 1(800) 272-9959  
 Fax: 1(800) 737-7018

**National Semiconductor Europe**  
 Fax: (+49) 0-180-530 85 86  
 Email: onjwge@tevm2.nsc.com  
 Deutsch Tel: (+49) 0-180-530 85 85  
 English Tel: (+49) 0-180-532 78 32  
 Français Tel: (+49) 0-180-532 93 58  
 Italiano Tel: (+49) 0-180-534 16 80

**National Semiconductor Hong Kong Ltd.**  
 19th Floor, Straight Block,  
 Ocean Centre, 5 Canton Rd.  
 Tsimshatsui, Kowloon  
 Hong Kong  
 Tel: (852) 2737-1600  
 Fax: (852) 2736-9960

**National Semiconductor Japan Ltd.**  
 Tel: 81-043-299-2309  
 Fax: 81-043-299-2408

National does not assume any responsibility for use of any circuitry described, no circuit patent licenses are implied and National reserves the right at any time without notice to change said circuitry and specifications.