

PCI IDE Application Note

National Semiconductor
Application Note 963
Lakhdar Iguelmamen
Hans Wang
September 1994



ERRATA

Description

The current BIOS (AMI, Award) will take Read/Write action towards the "Base Address Register" when it detects the PCI device through the "PCI configuration space" during power-on self-test. Different makers of BIOS will assign different values to the "Base Address Register". However, none of these values can be used as the default value of the legacy IDE HDD device. Which means that the "IDE port I/O space" resident on the chip has been redirected by the BIOS, and the system would not be able to communicate with the IDE device.

The outcome is "System could not boot through IDE HDD". National provides hardware and software solutions and both of them will not have any impact on system performance.

Software Solution

- BIOS needs to be changed
- No changes to software drivers
- No extra glue logic

Typically, BIOS use the "Sub-class code (01h) and program interface register (00h)" to detect whether the attached device is legacy IDE controller chip or not. Currently different BIOS vendors remap IDE's Base Address Register to different address shown in the next table.

National Semiconductor is working with AMI, Award, and Phoenix to get BIOS modified to fix this anomaly.

Here are the required address changes for AMI and Award BIOS.

We suggest that the BIOS vendors make the following changes once the Legacy-mode IDE is detected.

- Keep the "Base Address Register" untouched.
- Write the default address for channel 0 and channel 1 back to the "Base Address Register" once the "Legacy IDE" is detected.

Overview

The hardware patch solution is designed to fix the problem of existing demo boards' incompatibility with existing BIOS. This solution uses a GAL to fix the problem and works with existing BIOS without any power-on procedures. But it requires software changes to run on/off the hardware patch.

Hardware Patch Solution

This document describes how to modify the existing demo board and what software drivers changes are required to turn on/off the software patch.

Hardware Patch

- Requires a PAL
- No BIOS change required
- Wire the following signals to the GAL socket

Pin #	Connect
1	PCI CLK
2	FRAME #
3	IDSEL (from the PCI local bus)
4	C_BE0 #
5	C_BE1 #
6	RST #
7	C_BE2 #
8	C_BE3 #
9	AD7
10	GND
11, 20	VCC
12	IDSEL_OUT (pin-99 or PC87410 "IDSEL")
15	AD6
16	AD5
17	AD4

For more details, please refer to the schematic of PCI-IDE controller with patch logic.

Address Register	Default Value	AMI BIOS	Award BIOS (a)	Award BIOS (b)
Reg. 0 (10h-13h)	00 00 01 F1	00 00 FC F9	00 00 D0 01	00 00 50 01
Reg. 1 (140h-17h)	00 00 03 F5	00 00 FC F5	00 00 D1 01	00 00 51 01
Reg. 2 (18h-1Bh)	00 00 01 71	00 00 FC F9	00 00 D2 01	00 00 52 01
Reg. 3 (1Ch-1Fh)	00 00 01 75	00 00 FC F9	00 00 D2 01	00 00 53 01

Award: a.) version: 4.50 date code: 002194 Pentium-S
b.) version: 4.50 date code: 122793 Pentium

PATCH LOGIC

The following is the patch logic for PC87410 PCI-IDE controller with National's OPAL format. The PAL device could be either G16V8 or P16R4. See attached schematics with Patch Logic.

```
begin header
end header
begin definitions
device gal 16v8;
input clk=1, frame=2, idsel=3, cbe0=4, cbe1=5, reset=6, cbe2=7, cbe3=8, ad7=9,
AD6=15, AD5=16, AD4=17;
output (com) idsel_out=12;
feedback st=13, st1=14;
end definitions
{
CLK FRAME IDSEL CBE0 CBE1 RESET
ST ST1 IDSEL_OUT
}
```

Begin Equations

```
g1 = !frame * idsel * cbe3 * !cbe2 * cbe1 * !cbe0 * ad7;
st := reset * ( st * !g1 + !st * g1 );
{st.re = reset;}
st.c = clk;
g2 = frame * !st;
st1 := reset * ( st1 * !g2 + !st1 * st * frame );
{st1.re = reset;}
st1.c = clk;
idsel_out = idsel * (st1 + ad7 + ad6 + ad5 + !ad4);
End Equations
```

State Machine: Bubble Diagrams for PCI_GAL.OPL

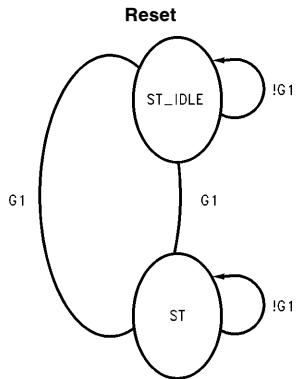

TL/F/12303-3

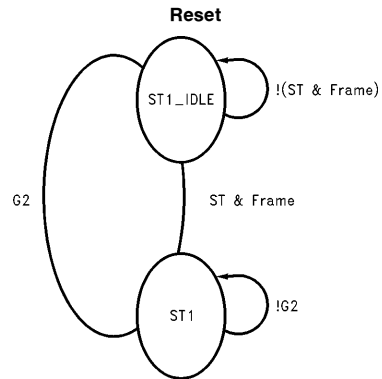

TL/F/12303-4

The schematic with patch logic is as follows:

PCI-IDE Controller with Patch Logic

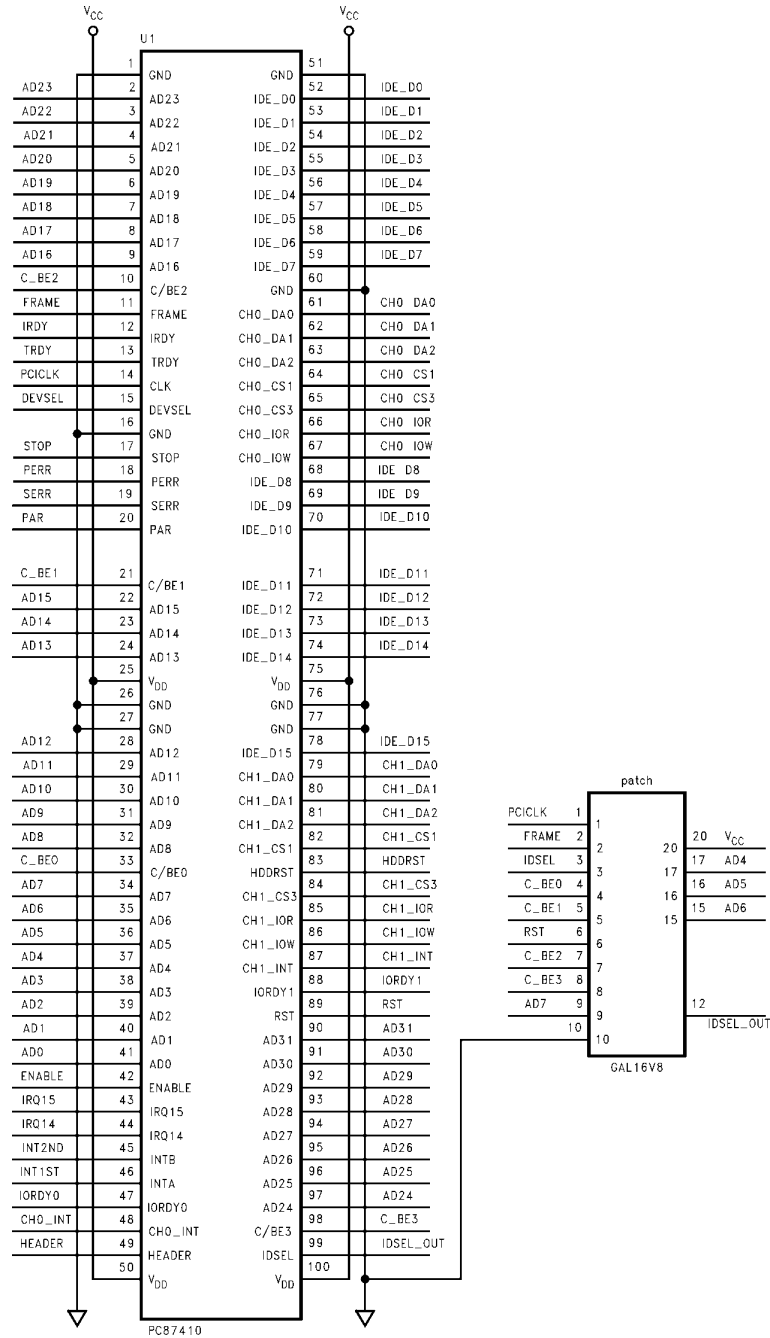

TL/F/12303-5

PCI-IDE Controller with Patch Logic

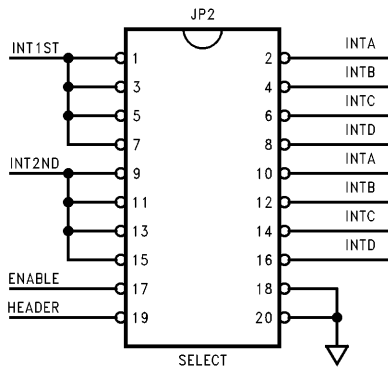
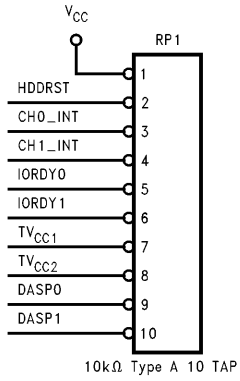
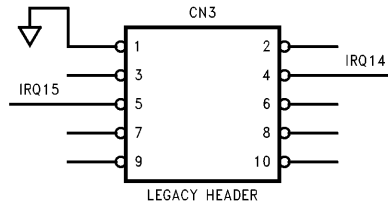
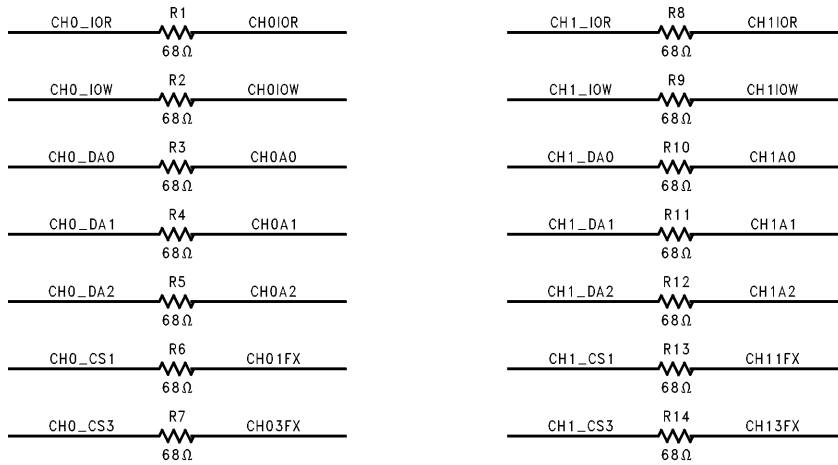

TL/F/12303-6

PCI-IDE Controller with Patch Logic

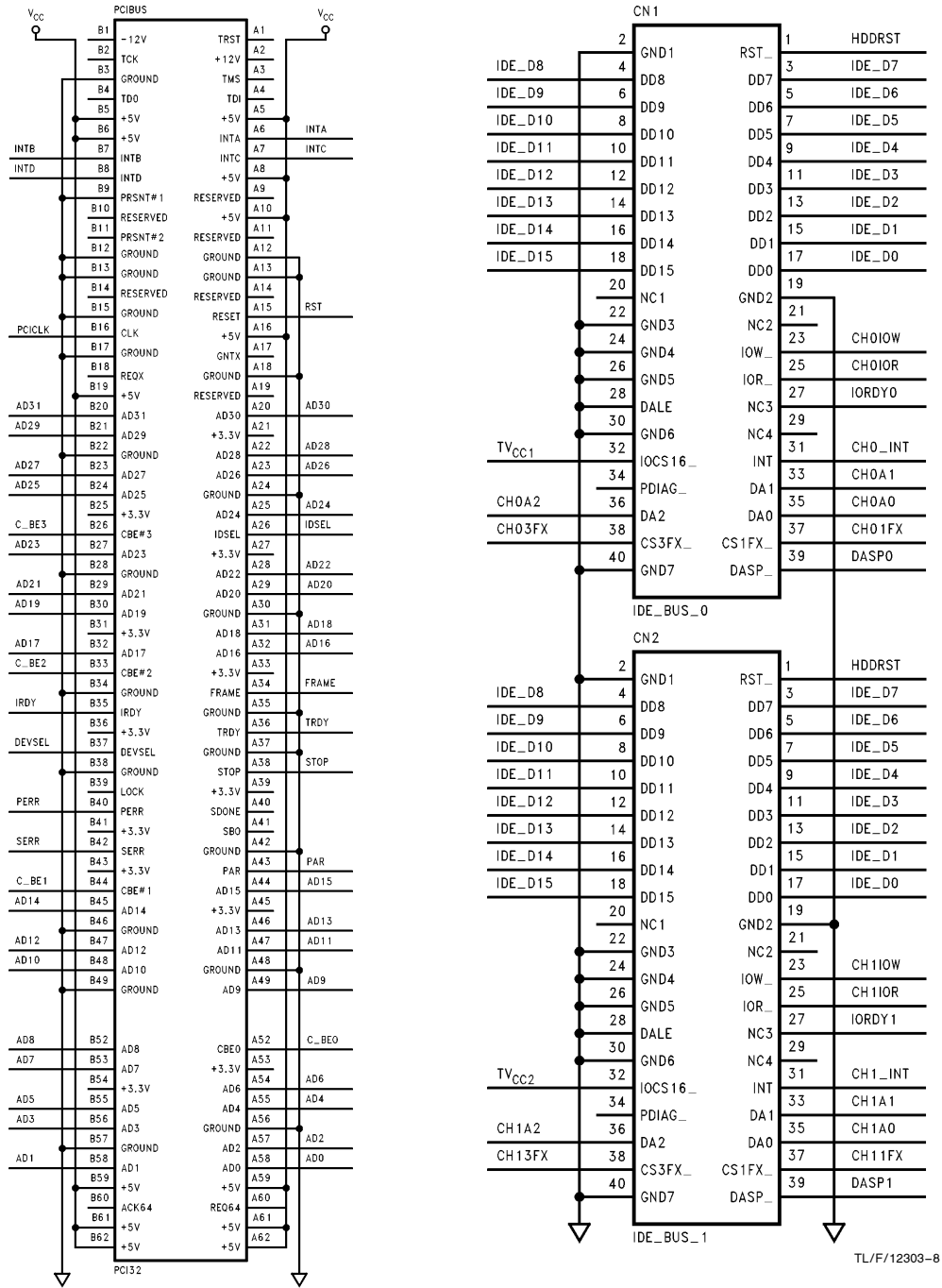

TL/F/12303-7

TL/F/12303-8

BILL OF MATERIAL

a. Active Devices

Item	Quantity	Reference	Remarks and Part No
1	1	U1	PC87410 PDI-IDE Controller

b. Passive Devices

Item	Quantity	Reference	Remarks and Part No
2	1	R1	10 kΩ Type A 10 TAP (resistor pack)
3	14	R1 ... R14	68Ω
4	2	R15/R16	270Ω
5	1	R17	560Ω

c. Connector

Item	Quantity	Reference	Remarks and Part No
6	1	CN1	IDE Channel 0 2 x 20
7	1	CN2	IDE Channel 1 2 x 20
8	1	JP1	To LED 2
9	1	CN3	Legacy Header 2 x 5
10	1	JP2	Selector for INTA and INTB 2 x 10

PCI-IDE Controller

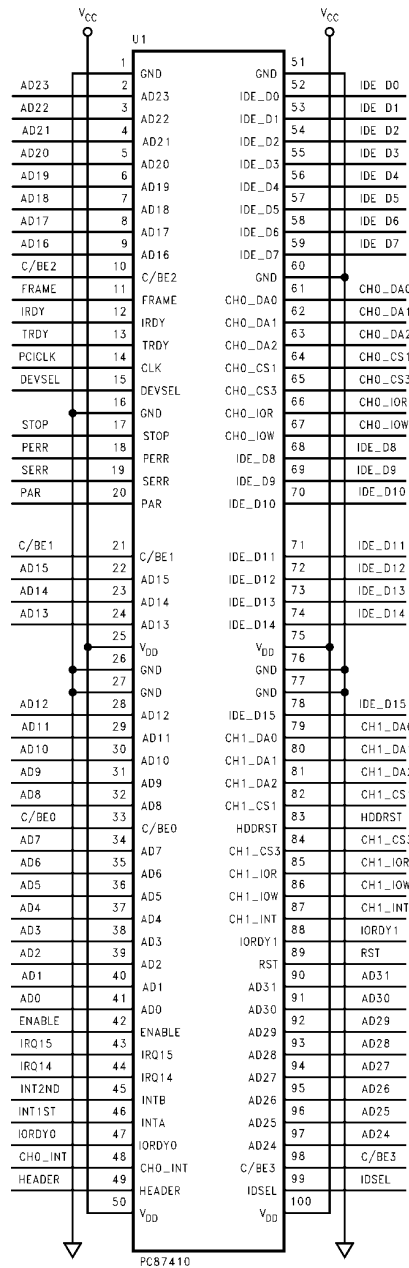

PC87410

TL/F/12303-9

SCHEMATICS

PCI-IDE Controller

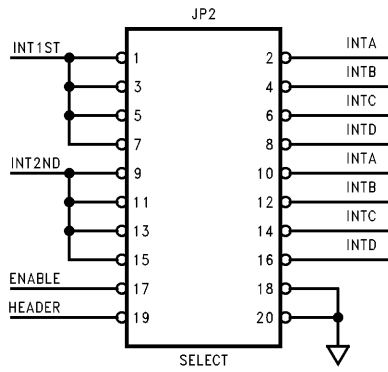
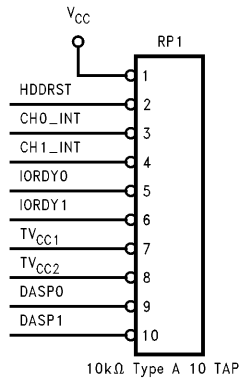
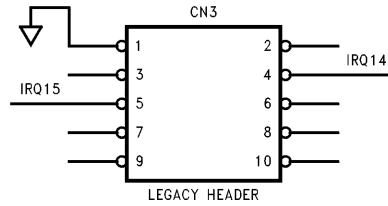
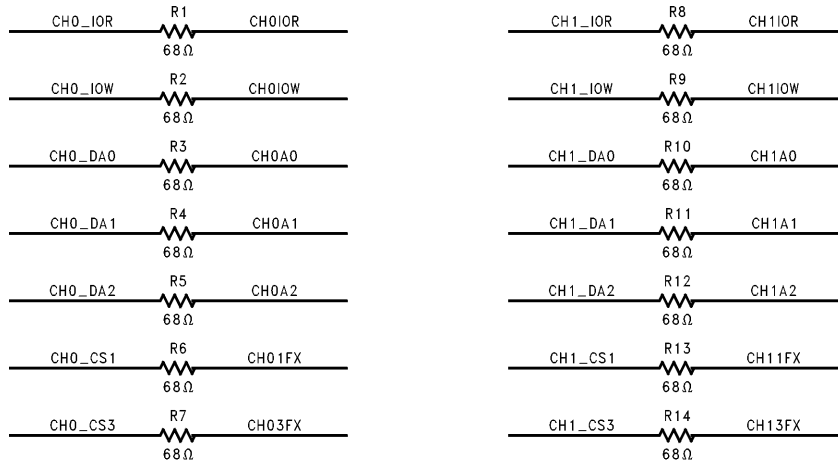

TL/F/12303-10

PCI-IDE Controller

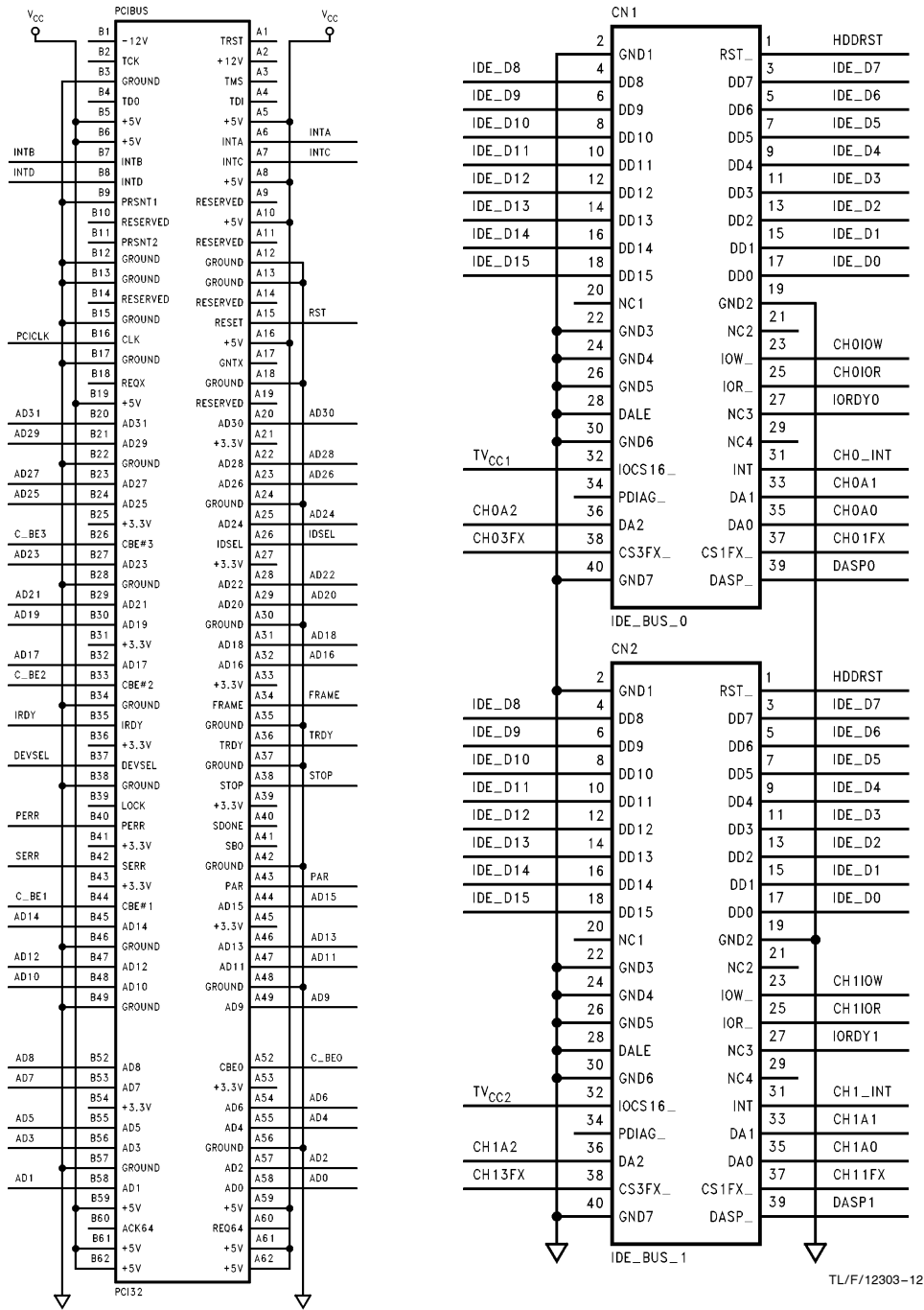

TL/F/12303-11

TL/F/12303-12

PCI-IDE Paddle Card

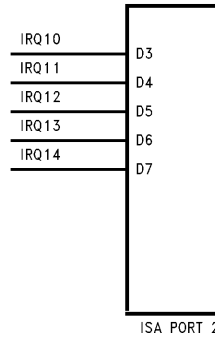
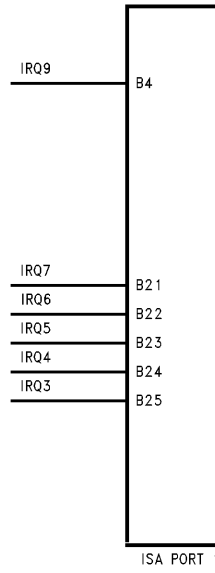
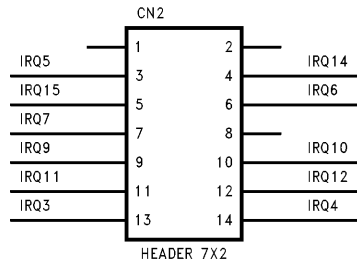
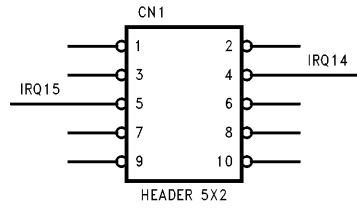

TL/F/12303-13

LIFE SUPPORT POLICY

NATIONAL'S PRODUCTS ARE NOT AUTHORIZED FOR USE AS CRITICAL COMPONENTS IN LIFE SUPPORT DEVICES OR SYSTEMS WITHOUT THE EXPRESS WRITTEN APPROVAL OF THE PRESIDENT OF NATIONAL SEMICONDUCTOR CORPORATION. As used herein:

1. Life support devices or systems are devices or systems which, (a) are intended for surgical implant into the body, or (b) support or sustain life, and whose failure to perform, when properly used in accordance with instructions for use provided in the labeling, can be reasonably expected to result in a significant injury to the user.
2. A critical component is any component of a life support device or system whose failure to perform can be reasonably expected to cause the failure of the life support device or system, or to affect its safety or effectiveness.



National Semiconductor Corporation
 2900 Semiconductor Drive
 P.O. Box 58090
 Santa Clara, CA 95052-8090
 Tel: 1(800) 272-9959
 TWX: (910) 339-9240

National Semiconductor GmbH
 Livny-Gargan-Str. 10
 D-82256 Fürstenfeldbruck
 Germany
 Tel: (81-41) 35-0
 Telex: 527849
 Fax: (81-41) 35-1

National Semiconductor Japan Ltd.
 Sumitomo Chemical
 Engineering Center
 Bldg. 7F
 1-7-1, Nakase, Mihama-Ku
 Chiba-City,
 Chiba Prefecture 261
 Tel: (043) 299-2300
 Fax: (043) 299-2500

National Semiconductor Hong Kong Ltd.
 13th Floor, Straight Block,
 Ocean Centre, 5 Canton Rd.
 Tsimshatsui, Kowloon
 Hong Kong
 Tel: (852) 2737-1600
 Fax: (852) 2736-9960

National Semicondutores Do Brazil Ltda.
 Rue Deputado Lacorda Franco
 120-3A
 Sao Paulo-SP
 Brazil 05418-000
 Tel: (55-11) 212-5066
 Telex: 391-1131931 NSBR BR
 Fax: (55-11) 212-1181

National Semiconductor (Australia) Pty, Ltd.
 Building 16
 Business Park Drive
 Monash Business Park
 Nottingham, Melbourne
 Victoria 3168 Australia
 Tel: (3) 558-9999
 Fax: (3) 558-9998

National does not assume any responsibility for use of any circuitry described, no circuit patent licenses are implied and National reserves the right at any time without notice to change said circuitry and specifications.