

For Your Creative Products

---

# ELECTRONIC COMPONENTS

---



# CONTENTS

Fundamental Orientation and Vision Concerning the Environment .....	2
---	---

## STN CSTN TFT CG Silicon

LCD Modules .....	8
-------------------	---

## EL

EL Display Modules.....	13
-------------------------	----

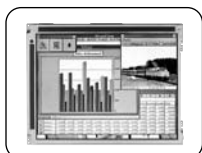

## LSI

### CMOS IMAGE SENSORS

CMOS Camera Modules .....	14
---------------------------	----

### CCDs

CCD Camera Modules .....	15
Peripheral LSI for CCD Camera Modules .....	15
Power Supply ICs for CCD Camera Modules.....	15
Higher-resolution CCDs .....	16
1/3-type CCDs.....	16
1/4-type CCDs.....	17
1/3-type CCDs with Dual-power-supply (5 V/12 V) Operation .....	17
CCD Peripheral ICs/LSIs.....	18

### LSIs FOR LCDs/ANALOG ICs

For Notebook PCs, PC Monitors and LCD TVs.....	24
For Mobile Equipment .....	25
For Cellular Phones.....	26
Peripheral ICs for LSIs for LCDs .....	27

### SYSTEM LSIs

Special-function LSIs .....	29
ARM RISC CORE LSIs .....	30
ARM Universal Microcontroller.....	31
Development Environment for ARM Microprocessors.....	32
IPs.....	33

### SMART CARD SYSTEMS

Smart Cards/LSI Modules for Smart Cards .....	34
Reader/Writer for Smart Cards .....	35
SDK (Software Development Kit) for Smart Cards.....	35

### FLASH MEMORIES AND COMBINATION MEMORIES

FLASH MEMORIES .....	36
----------------------	----

SYSTEM-FLASH .....	36
--------------------	----

#### HIGHLY FUNCTIONAL FLASH MEMORIES

Boot Block Type 3 V Page Mode Flash Memories.....	38
---	----

#### STANDARD FLASH MEMORIES

Boot Block Type 3 V Flash Memories.....	39
---	----

#### SYSTEM-FLASH

FWH Interface System-Flash for PCs .....	39
--	----

Fast-Reprogramming System-Flash for Digital Equipment ..	39
--	----

System-Flash for Amusement Products.....	40
--	----

System-Flash for In-vehicle Use .....	40
---------------------------------------	----

#### COMBINATION MEMORIES

Boot Block Type Flash Memory + Pseudo SRAM .....	41
--	----

### POWER DEVICES/ANALOG ICs

Low Power-Loss Voltage Regulators.....	42
--	----

Surface Mount Type Low Power-Loss Voltage Regulators ...	44
--	----

Surface Mount Type Chopper Regulators (DC-DC Converters) .....	47
Chopper Regulators (DC-DC Converters).....	48
Power Supply ICs for CCDs/CCD Camera Modules .....	49
Power Supply ICs for TFT-LCDs.....	49
LED Drivers .....	50

### ANALOG ICs

Video Interface ICs for TFT-LCDs.....	51
---------------------------------------	----

Power Amplifiers for Wireless LAN .....	52
---	----

Laser Diode Drivers.....	53
--------------------------	----

IC for Cameras .....	53
----------------------	----

Compandor.....	53
----------------	----

ICs for Audio Equipment.....	53
------------------------------	----

### PACKAGES

CSP (Chip Size Package).....	54
------------------------------	----

LGA (LAND Grid Array Package) .....	55
-------------------------------------	----

SiP (System in Package) .....	56
-------------------------------	----

SOF (System on Film) .....	58
----------------------------	----

Package Lineup.....	59
---------------------	----

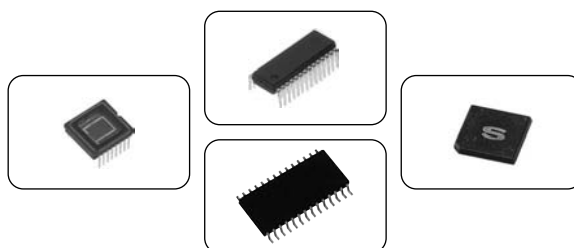

## OPTO

### OPTOELECTRONICS

Photocoupler Index Tree .....	65
-------------------------------	----

#### Photocouplers

Phototransistor Output.....	66
-----------------------------	----

OPIC Output .....	71
-------------------	----

#### Phototriac Coupler Index Tree

Phototriac Couplers .....	74
---------------------------	----

#### Solid State Relay Index Tree

Solid State Relays .....	78
--------------------------	----

#### Photointerrupter Index Tree

Photointerrupters <Transmissive type> .....	83
---	----

Single Phototransistor Output.....	83
------------------------------------	----

Darlington Phototransistor Output .....	85
---	----

OPIC Output .....	87
-------------------	----

Photointerrupters <Reflective type> .....	87
---	----

Single Phototransistor Output.....	87
------------------------------------	----

Darlington Phototransistor Output .....	88
---	----

OPIC Output .....	89
-------------------	----

Photointerrupters for Specific Applications .....	90
---	----

Transmissive Type.....	91
------------------------	----

Reflective Type.....	92
----------------------	----

#### Phototransistor Index Tree

Phototransistors.....	94
-----------------------	----

#### Photodiodes/OPIC Light Detectors

PIN Photodiodes.....	95
----------------------	----

PSD (Position Sensitive Detector) .....	95
---	----

Blue Sensitive Photodiodes.....	95
---------------------------------	----

Laser Power Monitoring Photodiodes .....	96
--	----

for Optical Disc System .....	96
-------------------------------	----

OPIC Light Detectors.....	96
---------------------------	----

#### Infrared Emitting Diode Index Tree

Infrared Emitting Diodes .....	100
--------------------------------	-----

#### Optical-Electric Sensor Index Tree

Distance Measuring Sensor Lineup.....	102
---------------------------------------	-----

Wide Angle Sensor Lineup .....	102
--------------------------------	-----

High-Precision Displacement Sensor .....	102
--	-----

Paper Size Sensor Lineup.....	102
-------------------------------	-----

Dust Sensor Unit Lineup .....	102
Color Toner Concentration (Deposition Amount) Sensor Lineup .....	102
Distance Measuring Sensors .....	103
Wide Angle Sensors.....	104
Paper Size Sensors.....	105
High-Precision Displacement Sensor.....	106
Dust Sensor Units .....	106
Color Toner Concentration (Deposition Amount) Sensors ..	106
<b>Fiber Optics Index Tree</b> .....	107
Fiber Optics Lineup for Audio Equipment.....	107
Transmission/Reception Devices for MOST Compatible Optical Fiber.....	107
Fiber Optic Transmitters .....	108
Fiber Optic Receivers.....	109
Transmission/Reception Devices for MOST Compatible Optical Fiber.....	110

## LED

### LED

High-Luminosity LED Lamps.....	111
LED Lamps .....	113
Dichromatic LED Lamps .....	115
High-Luminosity Chip LEDs .....	116
Chip LEDs.....	117
High-Luminosity Dichromatic Type Chip LEDs.....	118
Dichromatic Type Chip LEDs.....	118
High-Luminosity White Type Chip LEDs (with Blue Chip) ....	118
High-Luminosity Dichromatic Type Chip LEDs (RGB 3-color)...	119
LEDs for Camera Data Back.....	119



## LASER

### LASER DIODE

Laser Diodes.....	120
Hologram Lasers.....	121



## RF

### RF COMPONENTS

Low Noise Blockdown Converter .....	123
Europe: LNB for Broadcasting Satellite.....	123
U.S.A.: LNB for FSS Broadcast/(Others: LNB for Communication) .....	123
Japan/Asia/Australia: LNBs for CS Digital Satellite Broadcast.....	124
Japan: LNBs for BS/CS 110° Satellite Broadcast.....	124
Digital DBS Front-End Units.....	125
QPSK Demodulator Circuit Built-in Type .....	126
8 PSK Demodulator Circuit Built-in Type.....	126

Combination Front-End for Digital Terrestrial and Digital Satellite Broadcasting.....	127
Digital Terrestrial Front-End Unit.....	128
Front-End Units for ISDB-T/DVB-T .....	128
Two-In-One RF Units .....	129
Analog Terrestrial RF Front-End Unit.....	130
RF Front-End Units.....	130
Ultra Compact Front-End Units.....	131
2.4 GHz Band Wireless Image Transmission Module.....	132
USB Interface Wireless LAN Module.....	133
Wireless LAN Cards .....	134
Wireless Mini PCI Module .....	135

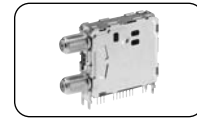

## IR

### IR DEVICE

<b>Infrared Data Communication Device Index Tree</b> .....	136
Infrared Data Communication Devices .....	137
Infrared Audio Transmission Device.....	138
<b>IR Detecting Unit for Remote Control Index Tree</b> .....	139
IR Detecting Unit for Remote Control .....	140



## POWER

AC adapters (Custom) .....	142
Switching Power Supplies (Custom).....	142
SWITCHING POWER SUPPLY WITH INTEGRATED HIGH/LOW VOLTAGE CIRCUIT (Custom) .....	143

## PCB

### PRINTED CIRCUIT BOARD

Advanced Flex Printed Circuit Boards .....	144
Flexible Build-up Multilayer PCBs.....	145
Flexible Printed Circuit Boards .....	146

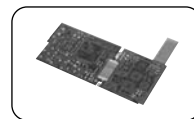

## UNIT

### PICKUP

Slim Combo Drive Pickup .....	147
Ultra Slim DVD-ROM Drive Pickup .....	147
Slim DVD-ROM Drive Pickup.....	147
DVD Pickup for Automotive Use .....	147

# Fundamental Orientation and Vision Concerning the

In accordance with environmental guidelines established under the Basic Environmental Philosophy, the Sharp Group Charter of Corporate Behavior, and the Sharp Code of Conduct,\* Sharp is pursuing environmental conservation in all aspects of its business activities. Since fiscal 2004, Sharp has raised its mid-term objective of becoming an “environmentally advanced company” with the new corporate vision of achieving “zero global warming impact by 2010.” In future, the company will further strengthen its efforts in environmental conservation.

## Basic Environmental Philosophy

### Creating an Environmentally Conscious Company with Sincerity and Creativity

## The Sharp Group Charter of Corporate Behavior

### Contribution to Conservation of the Global Environment

The Sharp Group will fulfill our responsibility for environmental conservation by promoting the creation of proprietary technologies that contribute to protection of the global environment, and by carrying out our product development and business activities in an environmentally conscious manner.

## The Sharp Code of Conduct

### Contribution to Conservation of the Global Environment

#### 1. To Conserve the Environment:

- ① We will comply with all applicable environmental laws, regulations and territorial agreements, and work to practice efficient use and conservation of resources and energy voluntarily, in the recognition that environmental conservation is an essential facet of corporate and individual pursuits.
- ② We will ensure proper use and control of chemical substances in our business activities including research, development and manufacturing, meeting or exceeding levels determined by laws and regulations.
- ③ We will engage in the active acquisition, reporting and promotion of environmental information at an international level, as the Sharp Group companies promote communication with shareholders and local residents.
- ④ We understand the importance of internal company systems and related details in acquiring third-party certification and recertification of our ISO environmental management systems, and we will conduct our business operations in accordance with relevant internal guidelines.

#### 2. To Develop Environmentally Conscious Products and Services, and Conduct Our Business Operations in an Environmentally Conscious Manner:

- ① We will engage positively in the minimization of resource use, reduction in the size and weight of products, use of recycled materials, and the development of long-lasting, energy-saving, energy-creating products.
- ② We will work to compile information related to harmful substances that might damage the environment or human health, and will not, as a matter of principle, make use of these harmful substances in our products, services and business activities.
- ③ We will use recyclable materials wherever possible, with product development focused as a matter of policy on structures that are detachable or capable of dismantling, and suited to recycling.
- ④ We will work aggressively to reduce greenhouse gas emissions in the full range of our business activities, in order to contribute to the prevention of global warming.
- ⑤ We will work to conduct our business in such a way to select and purchase materials that are harmless to the global environment, and to local residents and employees, for the resources needed for business activities (equipment, raw materials, subsidiary materials, tools, etc.).
- ⑥ We realize that waste material is a valuable resource, and we will actively conduct our business operations in such a way as to maximize the 3Rs (reduce, recycle and reuse) and will contribute to minimizing the amount of waste sent for permanent landfill disposal.

\* The Sharp Group Charter of Corporate Behavior and the Sharp Code of Conduct were instituted in May 2005 as a revised edition of the preceding Sharp Charter of Conduct (instituted in 2003). The section above is an excerpt from descriptions of Sharp's environmental conservation efforts. For more information: <http://sharp-world.com/corporate/eco/report/index.html>



# Environment

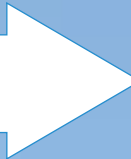

## Corporate Vision of Achieving “Zero Global Warming Impact by 2010”

Sharp will limit to the greatest extent possible the amount of the greenhouse gas emissions resulting from its business activities around the world, while at the same time, significantly help reduce greenhouse gas emissions based on the energy-creating effects of solar cells and the energy-saving effects of new products. The idea is for the amount of greenhouse gas emissions reduced to exceed the amount emitted by fiscal 2010.

Sharp’s greenhouse gas emissions in fiscal 2005 were approximately 1.53 million t-CO<sub>2</sub>. At the same time, it is estimated that the solar cells Sharp produced over the 20 years up to fiscal 2004 generated approximately 878 GWh<sup>\*1</sup> in fiscal 2005. This is equivalent to a reduction in greenhouse gas emissions of approximately 0.37 million t-CO<sub>2</sub><sup>\*2</sup>.

\*1 Calculation based on 844 MW, Sharp’s total solar cell production over 20 years from 1985 to 2004.  
 \*2 Calculated using a CO<sub>2</sub> emission unit of 0.421 kg/kWh (fiscal 2004) at the receiving end, announced by the Federation of Electric Power Companies of Japan.

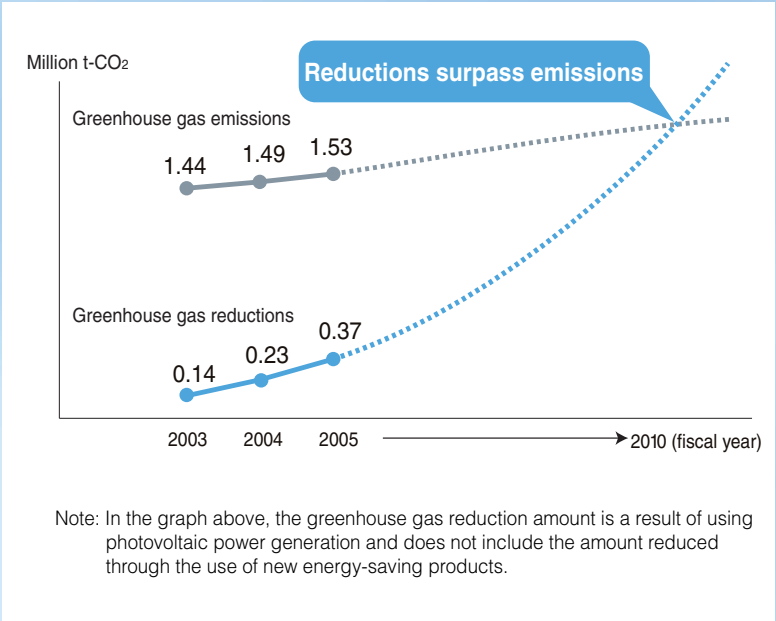

## Super Green Strategies to Become an Environmentally Advanced Company

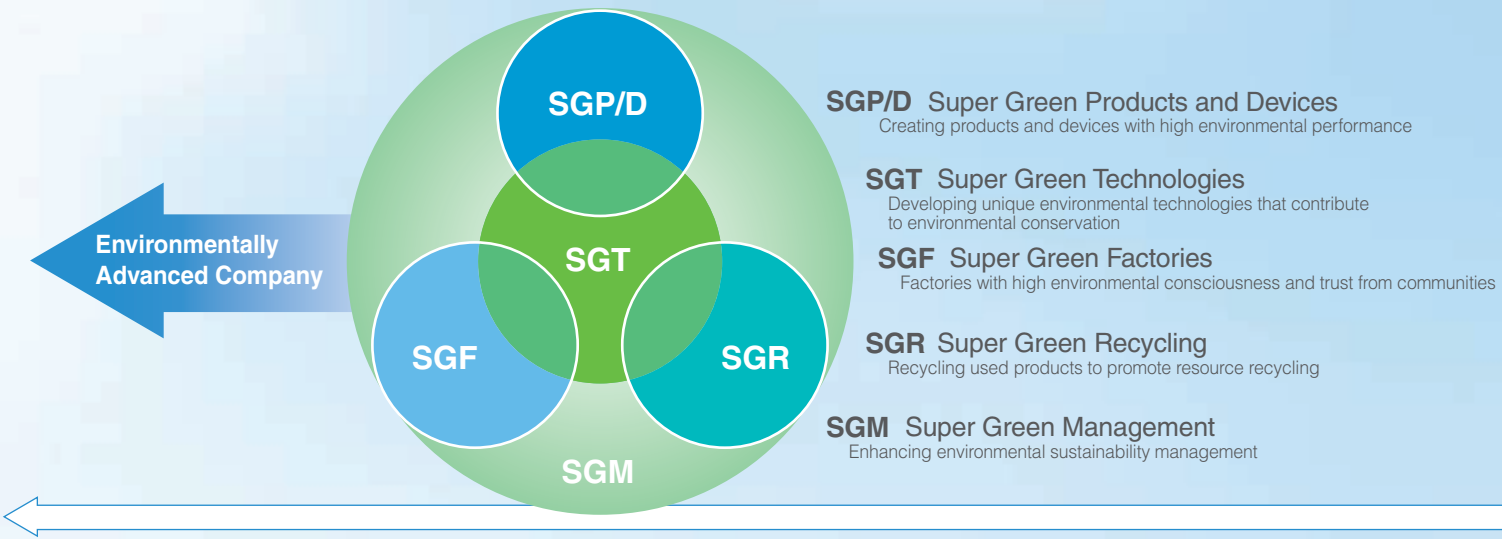

# Becoming an Environmentally Advanced Company—

## Developing Super Green Technologies

To achieve Sharp's corporate vision of becoming a company that has "zero global warming impact by 2010," the development of superior environmental technologies is an essential factor in the environmental performance of products and devices and the reduction of environmental impact during production.

Sharp classifies environmental technologies into two categories: (1) technologies that have no impact on global warming, and (2) technologies that contribute to

environmental conservation. Category (2) is further divided into three fields: effective use of resources, elimination of harmful substances, and health and cleanliness.

In environmental technologies that cover these five fields, Sharp envisions the most important theme in each as a One-of-a-Kind Environmental Technology, and aggressively promotes its further development based on corporate-wide technological development strategies. Unique technologies evolving from these developments, which contribute to environmental conservation, are what Sharp calls Super Green Technologies.

■ One-of-a-Kind environmental technological development fields that give birth to Super Green Technologies

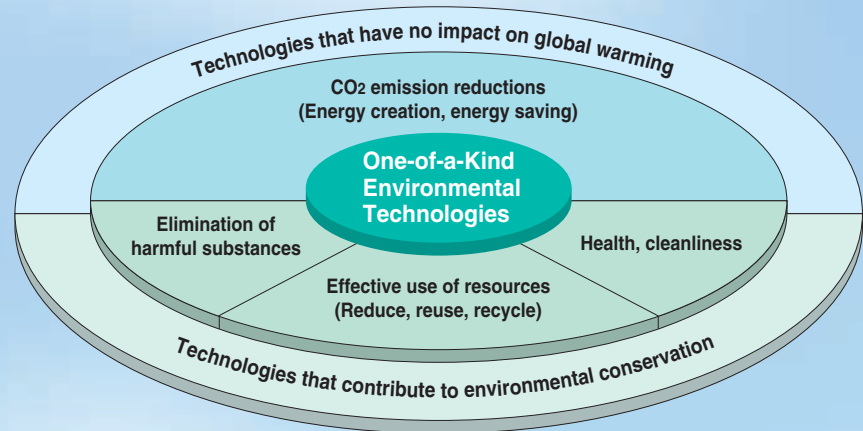

## Development of Green Devices and Super Green Devices

Environmentally conscious devices are what Sharp calls "Green Devices." To define the standards and assessment method for their development, Sharp established guidelines based on seven concepts, which were implemented in April 2004. Starting from fiscal 2005, Sharp has certified devices that have an even higher standard of environmental performance<sup>\*1</sup> than Green Devices, referred to as "Super Green Devices."

The development of Green Devices begins at the planning stage, where the environmental consciousness of the product is discussed in every aspect. Sharp then sets specific objectives based on the assessment items of the Green Device Standard Sheet. In the prototype and mass production stages, Sharp certifies the product by determining how well the actual product has met the objectives initially set out for it.

In fiscal 2005, Sharp achieved the goal for the ratio of Green Devices and Super Green Devices to total net sales, with plans to increase ratios in the future.

<sup>\*1</sup> Certification criteria for Green Devices and Super Green Devices in fiscal 2005: Green Devices had to satisfy at least 90% or more of all 21 assessment items (9 of which are compulsory) listed in the Environmental Performance Criteria. Super Green Devices will have to satisfy at least 95% or more the 21 assessment items (10 of which are compulsory) listed in the Environmental Performance Criteria. At the same time, they must be either the industry's No. 1, or the industry's first devices in at least one item of the External Environmental Claim Standards.

(Regarding part of Super Green Devices, those developed in fiscal 2004 were certified based on the standards in fiscal 2005.)

■ The Green Device concept

Energy saving	Reduce total power consumption and reduce power consumed in standby mode compared to previous models
Recyclability	Use standard plastic or materials that are easy to separate and disassemble (target: LCD devices)
Resource saving	Reduce weight or volume compared to previous models
Green material	Use no RoHS-designated <sup>*2</sup> substances or substances prohibited under Sharp standards
Long life	Extend the life of the product with exchangeable parts and consumables (target: LCD devices)
Packaging	Reduce packaging materials
Information disclosure	Provide information on chemical substances

<sup>\*2</sup> RoHS: An EU directive on the "Restriction on the use of certain Hazardous Substances." RoHS prohibits the use of lead, mercury, cadmium, hexavalent chromium, polybrominated biphenyl (PBB) and polybrominated diphenyl ether (PBDE) in electrical and electronic equipment released in the EU after July 1, 2006.



## Achievement of a Super Green Factory

Sharp is systematically acting to enhance the environmental consciousness of its production sites worldwide. Sharp has established proprietary assessment standards to rank factories with high environmental consciousness as Green Factories, and those with extremely high environmental consciousness as Super Green Factories, Sharp is planning to convert all its production sites around the world into Green Factories or higher by fiscal 2007.

### ■ The Green Factory concept

Greenhouse gases	Minimize emission of greenhouse gases	Atmosphere, water, soil	Minimize environmental burden on the atmosphere, water and soil
Energy	Minimize energy consumption	Harmony with nature	Endeavor to preserve nature both on and off site
Waste	Minimize discharge of waste	Harmony with the community	Encourage harmony with the local community
Resources	Minimize resource consumption	Environmental consciousness	High environmental awareness among employees
Chemical substances	Minimize risk of environmental pollution and accidents caused by chemical substances	Information disclosure	Disclose information on the environment

## Certification of Green Factories and Super Green Factories

Based on evaluation by the 21 environmental performance criteria quantified in five fields, a plant scoring 70 points or more out of a possible 100 is certified as a Green Factory, and one scoring 90 points or more is certified as a Super Green Factory.

With regard to the construction of new factories, from the early planning stages, Sharp will realize high environmental consciousness through approaches based on environmental assessment in order to achieve Super Green Factory status. Moreover, Sharp is continually improving environmental performance at its existing plants to promote their step-by-step upgrade. In fiscal 2005, overseas production plants greatly improved environmental consciousness, with the number of certification of Green Factories exceeding the target.

The office equipment manufacturing plant of Sharp Manufacturing France S.A. has become the first-ever overseas factory to be certified as a Super Green Factory.

### ■ Process required to achieve Super Green Factories

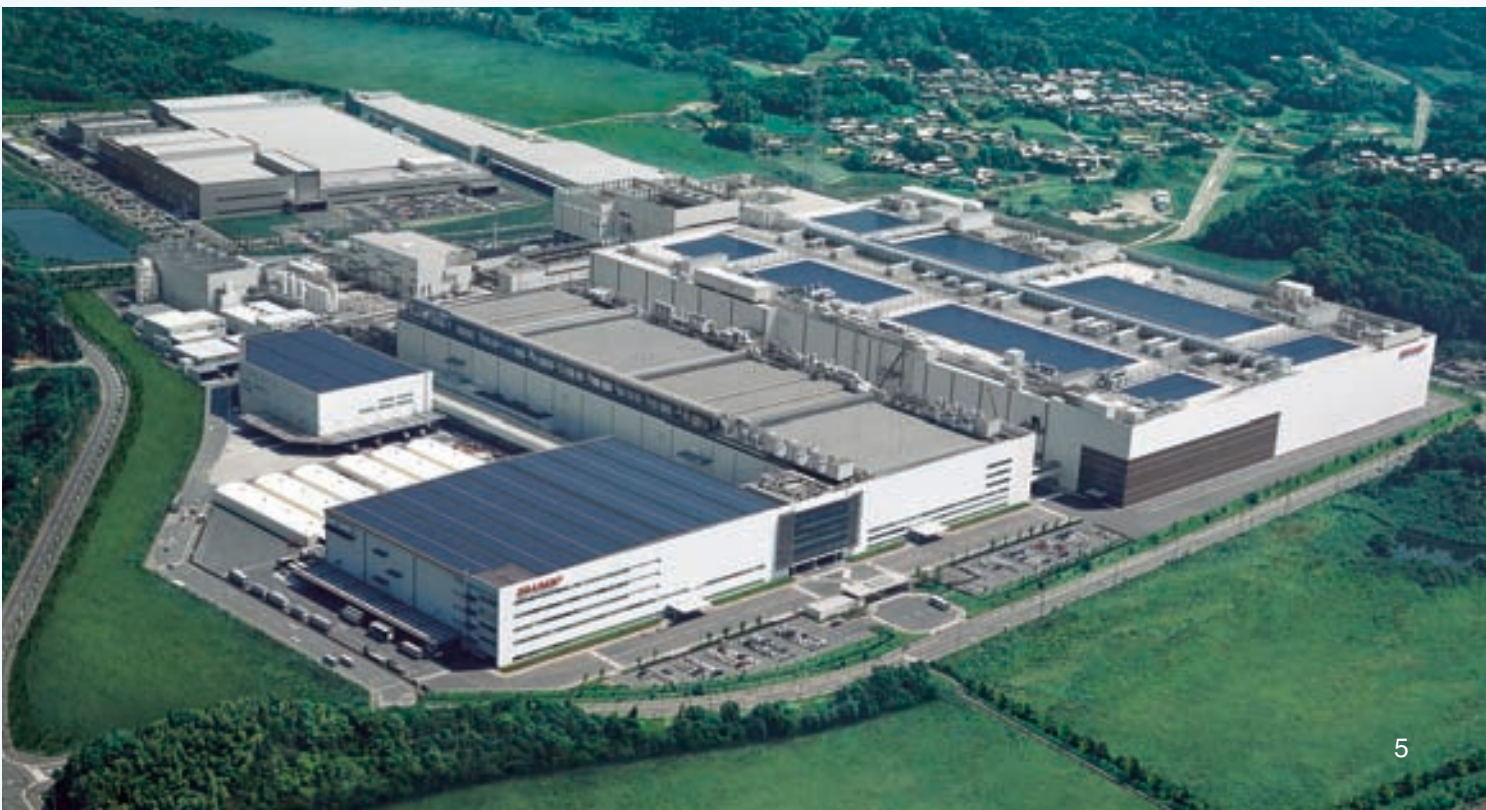
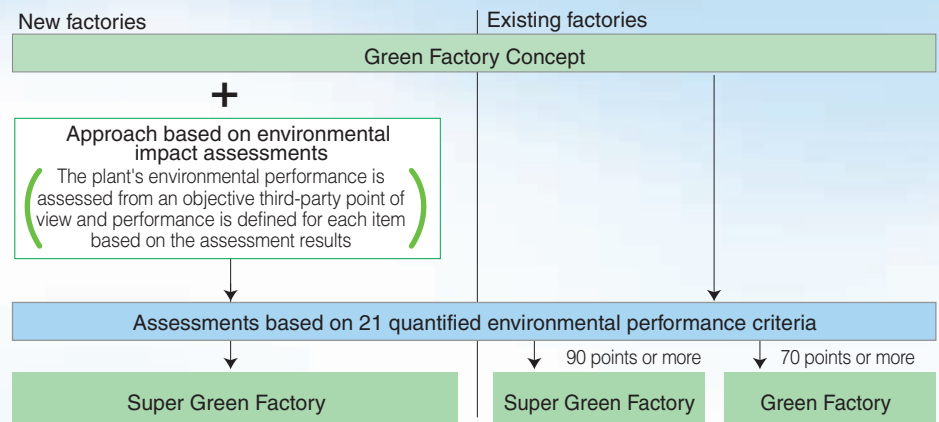

# From “Green” Factories to “Super Green” Factories

## Sharp’s First Super Green Factory Kameyama Plant

### AVC Liquid Crystal Display Group (Kameyama, Mie Prefecture)

The Kameyama Plant is Sharp’s first “Super Green Factory”, a compilation of the company’s environmental protection technologies. In preparing for construction, we gave a great deal of careful consideration to protecting the environment, beginning at the initial design stage. Working in consultation with local governments and with nearby residents, we carefully selected the parameters that would be subject to environmental protection measures. We chose the standards that would apply, and confirmed them through evaluation by independent experts. Prior to construction, we transported many of the trees on the site to another location, then replanted them around the factory once construction was complete, thereby mitigating the impact of the work on the local ecosystem.



### The Kameyama Plant Receives Japan Sustainable Management Award

The Kameyama Plant in Japan was recognized for its outstanding environmental sustainability management by being chosen from among 125 applicants for the highest honor, the Sustainable Management Pearl Award, in the 2004 Japan Sustainable Management Awards\* (sponsored by the Japan Sustainable Management Awards Committee and Mie Prefecture). This award shows the high esteem for the environmental measures—including 100% recycling of manufacturing process wastewater, the introduction of an LNG cogeneration system and the installation of a photovoltaic power system—taken by the Kameyama Plant, Sharp’s first Super Green Factory.

The Kameyama Plant received the first Minister of Economy, Trade and Industry Award in the 8th Japan Water Prize (2006) and the Energy Saving Encouraging Prize in the 4th Excellent Cogeneration System Commendation (FY 2005) sponsored by the Japan Cogeneration Center.

\* The Japan Sustainable Management Awards honor all organizations across the nation, no matter what their size or type of business—including private companies, NPOs and schools—that demonstrate outstanding results of their environmental sustainability management efforts.

### An Efficient and Environment-Friendly Integrated Production System

The entire process is carried out in a single plant—from fabricating the LCD panels to final assembly. This system makes it possible to consolidate technical departments and strengthen our development capabilities, as well as shorten the lead-time from order to shipping. Eliminating the need to ship sub-assemblies between distant plants has also enabled us to slash the amount of packaging materials required for shipping and reduce emissions such as carbon dioxide (CO<sub>2</sub>).

### Energy-saving Cogeneration System utilizing Waste Heat\*

The Kameyama plant generates one-third of its annual electricity, 12,000 kW, using LNG, and utilizes generated waste heat for air conditioning system, hot-water supply or steam. Emission of CO<sub>2</sub> is decreased by about 40% over the current level. LNG, volume of 12 tanker trucks, is supplied through 17 km of pipelines from Suzuka city to Kameyama city, which eliminates auto exhaust caused by tanker truck transportation.

\* Cogeneration system: A system designed to save energy by using city gas to generate electricity. The waste heat generated is then used in applications such as air conditioning, hot water supply and steam electric generation.

### Creating Energy at the Factory for Energy-Saving Products, Using PV Modules

600 light-through PV modules designed like “AQUOS” are installed on the wall of the administrative building between the LCD panel factory and the TV assembly factory. Together with 200 modules on the wall of the cogeneration building, about 48,000 kWh is generated a year.

### Water Purifying System—100% Water Recycling in the Production Process

The plant collects all the wastewater from the production process of liquid crystal panels, etc. (max. 9000 tons a day) and recycles it 100% with water purification techniques using microorganism treatment. Malodorous wastewater containing chemicals is deodorized using peat moss\* from Ishikari River, Hokkaido.

\* Bog moss decomposed and piled up for several thousands of years.

\* The results described above are those of Kameyama Plant No. 1. Kameyama Plant No. 2 (currently under construction) will be an even more environmentally friendly factory, complete with one of the world’s greatest photovoltaic power generation systems (5,150 kW) and one of Japan’s greatest fuel cells (1,000 kW).

## Mie Plant Becomes First Existing Factory to Achieve Super Green Status

### Zero Discharge to Landfill

In April 2004, the Mie Plant achieved zero discharge to landfill. It eliminated waste by recycling at every step of the manufacturing process, with measures that included introducing a system to recycle 100% of the hydrofluoric acid wastewater and using the gloves from the clean rooms as roadbed material.

### Scrubber to Reduce Odors

Exhaust gas from manufacturing processes contains chemical substances that cause air pollution and foul odors if released into the atmosphere directly. To reduce each of these substances (acids, alkalis, isopropyl alcohol) and thus control such releases, the Mie Plant installed a scrubber.

In fiscal 2004, the plant also installed an electrolysis device on a scrubber that absorbs and eliminates acetic acid. This device causes strong oxidation that breaks down the acetic acid into water and carbon dioxide. The result is higher performance for the scrubber.

### Photovoltaic Power System

The Mie Plant No. 3 installed a 1,246-m<sup>2</sup>, 180-kW photovoltaic power system on its south exterior wall. The system began generating electricity in March 2005. Used mainly to provide lighting for all non-manufacturing rooms, the system is expected to contribute to the reduction of 50 tons of CO<sub>2</sub> emissions a year.

### PFC Scrubbers to Reduce Greenhouse Gas Emissions

Guidelines issued by the Japanese LCD industry (JEITA: Japan Electronics and Information Technology Industries Association) aimed at reducing emissions of PFCs state that manufacturers must install scrubbers on all production lines that started running after 2001, as well as on all production lines started prior to 2001 and that will be operating in 2010. In line with this policy and under orders from Sharp top management, the Mie Plant began installing scrubbers in fiscal 2003 with the goal of completing installation on all production lines during fiscal 2004. This goal was achieved in January 2005, with scrubbers installed on all production lines, including those built before 2001. The plant can now reduce PFC gas emissions to less than 10% of what they were before scrubbers were installed. By promptly responding to LCD industry objectives, Sharp has made a significant contribution to preventing global warming.

## Mobile Liquid Crystal Display Groups No. 1 and No. 2 (Taki, Mie Prefecture)

The results described above are major efforts in upgrading to a Super Green Factory.

### Fluoric Acid Effluent Recycling System Honored at 2004 WASTEC Award

The Mie Plant No. 3 uses fluorine acid in its Continuous Grain Silicon production process. The plant developed this system and has been using it since 2004 to recover and recycle the fluorine acid effluent. This system was recognized for its excellence and won the Business Activity Category Prize at the 2004 WASTEC (Waste Control and Recycling Technology Exhibition) Awards in Japan in November 2004. Prior to the introduction of this system, the fluorine acid from the effluent was used to make cement. Now it can be used repeatedly at the production site, while the distilled water from the effluent can be used as pure water.





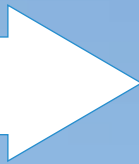

# Green Factory Activities at Key Electronic Device Factories



**Advanced Development and Planning Center/  
Corporate Research and Development Group  
(Tenri, Nara Prefecture)**

ISO 14001 certification: December 3, 1996

### Adoption of a cogeneration system\*

About 26% of facility power is provided through private power generation. Waste heat is used for heating or cooling and also supplied to a steam generator for power generation. This cuts facility CO<sub>2</sub> emissions by about 13%.

Municipal gas is supplied by pipeline, so there is no discharge of CO<sub>2</sub>, nitrogen oxides or other pollutants from truck transport.

\* An energy saving system that generates power using municipal gas and uses the produced waste heat for heating or cooling, hot water supply and steam generation, etc.

### Installation of a solar generation system

Installation of solar panels with a generating capacity of 40 kW.

### Relations with the local community

In August of each year, this center invites employees and their families and local people to a "Sharp Festa." An environmental exhibition space is prepared to showcase the environmental activities of the center.

### Waste fluid processing system based on natural purification\*

Waste and the pollution load of released water are reduced by using a waste fluid treatment system for waste water containing alcohol or other organic components. After treatment, water is given further high-level treatment and used as intermediate factory water, to ensure more effective use of water resources.

\* A natural purification system based on micro-organisms, developed independently by Sharp. (Patented)

### Promotion of zero emissions\*

Zero emissions were achieved in 2002 through reclamation of waste into useful resources for other business fields. Efforts will continue to further reduce waste emissions.



**Solar Systems Group  
Electronic Components Group  
(Katsuragi, Nara Prefecture)**

ISO 14001 certification: June 25, 1996

### Prevention of water pollution

All waste water from production processes and laboratories is purified at a waste water treatment station within the factory. Water is released into the sewer only after treatment based on voluntary standards stricter than environmental standards.

### Prevention of air pollution

Waste gases from acids and organic solvents produced by production processes and laboratories are purified with two types of waste gas treatment equipment, depending on the properties of the chemical substances. Eight acid scrubbers and 11 solvent scrubbers are installed on the roof of the Katsuragi Plant, and these keep atmospheric emissions of chemical substances below 1/10th of regulatory levels.

### Promotion of zero emissions\*

In 2001, the factory achieved zero emissions through recycling of all materials. It is now working to reduce waste volume with the goal of a final disposal rate of 0.3%.

### Installation of solar generation system

In 2003, solar panels were installed at the solar park on the roof of the No. 3 Plant and on the employee recreation building. At present the solar generation system has a total capacity of 194.5 kW, and this electricity is used for tasks such as air conditioning.

### Relations with the local community

In October of each year, the factory holds a "Katsuragi Festa" to improve relations with the local community and showcase the site's environmental activities.

### From a Green Factory to a Super Green Factory

With the aim of becoming a Super Green Factory in 2007, the site is working to reduce emissions of harmful chemical substances used in processes and to recycle cleaning water used in production.



**LSI Group  
(Fukuyama, Hiroshima  
Prefecture)**

ISO 14001 certification: September 24, 1996

### Inauguration of a non-dilution nitrogen treatment plant

This Group built a new plant that uses the world's first non-dilution treatment technology on the nitrogen contained in semiconductor plant waste water. The technology combines "micro-nanobubble technology" with a unique micro-organism treatment technology Sharp developed in June 2005. Operation of the plant began in July 2006 and we are going to reduce the amount of nitrogen effluent to about 1/3 of previous levels.

### Promotion of zero emissions\*

Zero emissions were achieved in 2001 through ongoing efforts such as in-house treatment of developing fluid by means of our own micro-organism treatment technology, reduction of the volume of process sludge produced, and recycling of waste into useful material.

### Prevention of global warming

An energy conservation committee has been formed to promote energy conservation efforts involving the entire Group. Efforts such as building a unique energy-saving outer air treatment system have been highly regarded, and the Group received a "2005 Excellent Energy Conservation Factory & Building (electricity category)" award from the Director-general of the Agency for Natural Resources and Energy.

### Relations with the local community

In August of each year, employees and their families and local people are invited to the "Family Day in Sharp (Summer Festival)." At this festival, an environmental exhibition space is prepared to provide an opportunity for people to experience nature and to introduce the environmental protection efforts of the facility.

The plant also implemented the semiconductor industry's first full-scale risk communication (July 2005), and in cooperation with the local community, jointly produced a large communication panel (4 m x 6 m) called "Daimoncho—Yesterday and Today." The panel is on display at our premises and is being used to introduce our business and Daimoncho to visitors.

Communication activities such as these have been highly evaluated, and the Group received the "2005 PRTR Prize" sponsored by the Center for Environmental Information Science.



**Electronic Components Group  
Mihara Plant  
(Mihara, Hiroshima Prefecture)**

ISO 14001 certification: November 17, 2003

### Prevention of global warming

The precise air-conditioning necessary for production activities is maintained by operating coolers and boilers on municipal gas, which produces little CO<sub>2</sub>. The turbo coolers provided in air-conditioning equipment use a waste heat recovery system. A remover optimized for greenhouse gases is provided to suppress emission of such gases and prevent global warming.

### Promotion of zero emissions\*

Zero waste emission has been achieved through active efforts to reduce and reclaim waste, instituted from the beginning of the facility.

### Efforts to prevent pollution

After treatment at an in-house facility, all process waste water is discharged into the public sewer only after clearing voluntary standards stricter than waste water standards. Sludge produced in waste water treatment is sorted by type and reclaimed.

Measures are taken such as installing equipment indoors to prevent noise escaping to the surrounding area from noisy equipment, such as large fans and large compressors. Noise levels at the site boundary are within regulation values.

The plant is working to improve management of chemical substances, prevent accidents and environmental disasters, and reduce environmental impact.

### Efforts to contribute to the local community

Through efforts such as inviting local people to festivals and activities to protect forests, the plant aims to deepen relations with people in the local area and protect the environment.

Efforts are being made to beautify the area by participating in greenification activities in the Mihara Western Industrial District where this facility is located.

Efforts are being made to issue a pamphlet introducing the facility and to disclose information. The pamphlet contains environmental activity records and other information.

\* Sharp defines this as bringing the amount of buried waste (final disposal amount) as close to zero as to be negligible. In figures, a final disposal rate of less than 0.5% (final disposal rate = buried amount / total discharged amount x 100) is taken to be zero emissions.

☆New product  
★Under development



## ■ LCD Modules

<For industrial appliances (middle size)>

	Display size (cm) ["]	Model No.	Dot format H × V (dot)	Pixel pitch H × V (mm)	Active area H × V (mm)	Input signal system	Input video signal	Back-light	Luminance (cd/m <sup>2</sup> ) (TYP.)	Power consumption (mW) (TYP.)	Overall dimensions* <sup>5</sup> W × H × D (mm) (TYP.)	Weight (g) (TYP.)	Remarks
STN	12 [4.6]	LM046QB1S02	320 × 240	0.295 × 0.295	94.4 × 70.8	4-bit parallel	4-bit parallel	Built-in 1CCFT	100	140/920* <sup>7</sup>	134.0 × 100.0 × 8.5	140	Transflective type STN, Black & white display
	14 [5.7]	LM32019T		0.36 × 0.36	115.2 × 86.4					1 182	166.0 × 109.0 × 7.5 (MAX.)	160	Transmissive type STN, Blue mode display
	21 [8.1]	LM081HB1T01B	640 × 240	0.30 × 0.30	192.0 × 72.0	8-bit parallel	8-bit parallel	Built-in 1CCFT	150	1 605	249.0 × 99.4 × 8.5	260	Transmissive type STN, Black & white display
	22 [8.5]	☆LM085YB1T01	800 × 480	0.231 × 0.231	184.8 × 110.9				T.B.D.	T.B.D.	222.7 × 134.0 × 8.5	T.B.D.	Transmissive type black & white STN, Crosstalk reduction using Sharp addressing technology
	22 [8.9]	LM089HB1T04	640 × 240	0.33 × 0.33	211.2 × 79.2				250	2 300	258.8 × 109.8 × 10.0	320	Transmissive type STN, Blue mode display
CSTN	13 [5.0]	LM050QC1T01	320 × RGB × 240* <sup>1</sup>	0.315 × 0.315	100.8 × 75.6	8-bit parallel	8-bit parallel	Built-in 1CCFT	100	1 740	134.0 × 100.0 × 8.5	145	Transmissive type Color STN, Long life B/L
	20 [7.7]	☆LM077VS1T01	640 × RGB × 480* <sup>2</sup>	0.246 × 0.246	157.4 × 118.1			Built-in 2CCFT	T.B.D.	T.B.D.	195.2 × 137.5 × 7.1	T.B.D.	Transmissive type Color STN, Crosstalk reduction using Sharp addressing technology
	22 [8.5]	★LM085YS1T01	800 × RGB × 480* <sup>4</sup>	0.231 × 0.231	184.8 × 110.9			222.7 × 134.0 × 8.5					
TFT	14 [5.7]	LQ057Q3DC12	320 × RGB × 240* <sup>1</sup>	0.360 × 0.360	115.2 × 86.4	6-bit digital RGB	6-bit digital* <sup>6</sup>	Built-in 1CCFT	500	3 879	144.0 × 104.6 × 13.0	220±20	Transmissive type TFT, High luminance, Wide viewing angle, Long life B/L, 260K-color display
	16 [6.4]	LQ064V3DG01	640 × RGB × 480* <sup>2</sup>	0.204 × 0.204	130.6 × 97.9			Built-in 2CCFT	350	3.3 V: 4 657 5 V: 4 700	161.3 × 117.0 × 12.0	280 (MAX.)	Transmissive type TFT, High luminance, Wide viewing angle, Long life B/L, AG coat, Easily replaceable B/L, 260K-color display, Wide temperature range, 3.3V/5V drive
	21 [8.4]	LQ084V1DG21		0.267 × 0.270	170.9 × 129.6			Built-in 1CCFT	300	3.3 V: 5 453 5.0 V: 5 600	216.0 × 152.4 × 12.0	410	Transmissive type TFT, High luminance, 3.3V/5V drive, Long life B/L, Easily replaceable B/L, 260K-color display
		LQ084S3DG01	800 × RGB × 600* <sup>3</sup>	0.213 × 0.213	170.4 × 127.8			Built-in 2CCFT	350	6 019	199.5 × 149.5 × 11.6	405 (MAX.)	Transmissive type TFT, High luminance, Wide viewing angle, Easily replaceable B/L, 260K-color display

\*1 Number of Pixels: 76 800

\*2 Number of Pixels: 307 200

\*3 Number of Pixels: 480 000

\*4 Number of Pixels: 384 000

\*5 Excluding FPC for connection and other excessing parts.

\*6 Video interface: CMOS

\*7 Reflective mode: 140 mW Lit mode: 920 mW

(Note) Please refer to the latest relevant specification sheets before using these devices.



LM089HB1T04



LM050QC1T01



LQ064V3DG01



LQ084S3DG01

### Notice

In the absence of confirmation by device specification sheets, SHARP takes no responsibility for any defects that may occur in equipment using any SHARP devices shown in catalogs, data books, etc. The models listed on this page are lead-free solder compatible. For details, please inquire with SHARP. Contact SHARP in order to obtain the latest device specification sheets before using any SHARP device.

## <For industrial appliances (large size)>

	Display size (cm) ["]	Model No.	Number of pixels*1	Dot format H x V (dot)	Active area H x V (mm)	Number of colors (color)	Overall dimensions*2 W x H x D (TYP.) (mm)	Backlight	Video interface (Input video signal)	Remarks		
TFT	26 [10.4]	☆LQ104V1DG61/LG61	307 200	640 × RGB × 480	211.2 × 158.4	262 144	246.5 × 179.4 × 13.7	Built-in (2CCFT)	CMOS (DG61) LVDS*3 (LG61)	Wide temperature range*5, High luminance (450 cd/m <sup>2</sup> ), Easily replaceable B/L (slide type), Supply voltage (+3.3 V/+5 V)		
		LQ104V1DG51	307 200	640 × RGB × 480	211.2 × 158.4		246.5 × 179.4 × 15.5		CMOS (6-bit)	Wide temperature range*4, High luminance (350 cd/m <sup>2</sup> ), Easily replaceable B/L (slide type), Supply voltage (+3.3 V/+5 V)		
		LQ104S1DG21/LG21	480 000	800 × RGB × 600	211.2 × 158.4		246.5 × 179.4 × 15.5		CMOS (DG21) LVDS*3 (LG21) (6-bit)	Wide temperature range*4, High luminance (350 cd/m <sup>2</sup> ), Easily replaceable B/L (slide type), Supply voltage (+3.3 V/+5 V)		
		LQ104V1DW02	307 200	640 × RGB × 480	211.2 × 158.4		246.5 × 179.4 × 15.5 (MAX.)		CMOS (6-bit)	Top/bottom and left/right angle of view 160° (CR>0), High luminance (380 cd/m <sup>2</sup> ), Easily replaceable B/L (slide type), Supply voltage (+3.3 V/+5 V)		
	31 [12.1]	☆LQ121S1DG61/LG61	480 000	800 × RGB × 600	246.0 × 184.5		276.0 × 204.0 × 11.0		CMOS (DG61) LVDS*3 (LG61)	Wide temperature range*5, High luminance (450 cd/m <sup>2</sup> ), Easily replaceable B/L (slide type), Supply voltage (+3.3 V/+5 V)		
		LQ121S1DG41/LG41	480 000	800 × RGB × 600	246.0 × 184.5		276.0 × 209.0 × 11.0		CMOS (DG41) LVDS*3 (LG41) (6-bit)	Wide temperature range*4, High luminance (370 cd/m <sup>2</sup> ), High contrast (450:1) Narrow frame, Easily replaceable B/L (slide type), Supply voltage (+3.3 V/+5 V)		
		☆LQ121S1LW01	480 000	800 × RGB × 600	246.0 × 184.5		276.0 × 209.0 × 11.0		LVDS*3	Top/bottom and left/right angle of view 170° (CR>10), High contrast (800:1) Easily replaceable B/L (slide type), Supply voltage (+3.3 V/+5 V)		
	38 [15]	LQ150X1LGB1	786 432	1 024 × RGB × 768	304.1 × 228.1		16 194 277		331.6 × 254.8 × 12.5	Built-in (4CCFT)	LVDS*3 (6-bit + 2-bit FRC)	High luminance (600 cd/m <sup>2</sup> ), High contrast (350:1) Easily replaceable B/L (slide type), Supply voltage (+3.3 V)
		LQ150X1LW71N							331.6 × 254.76 × 12.5			Top/bottom and left/right angle of view 170° (CR ≥ 10), High contrast (400:1) Easily replaceable B/L (slide type)

\*1 Pixel means a set of each RGB dot. Figures may be rounded up if necessary.

\*2 Excluding FPC for connection and other excessing parts.

\*3 LVDS: Low Voltage Differential Signaling

\*4 Wide temperature range specifications (Operating temperature range: -10 to +65°C (ambient), storage temperature range: -30 to +70°C)

\*5 Wide temperature range specifications (Operating temperature range: -30 to +80°C (panel surface), storage temperature range: -30 to +80°C)

(Note) Please note that the specifications are subject to change without prior notice for production improvement.

## <For LCD TV>

	Display size (cm) ["]	Model No.	Number of pixels*1	Dot format H x V (dot)	Active area H x V (mm)	Number of colors (color)	Overall dimensions*2 W x H x D (TYP.) (mm)	Backlight	Video interface (Input video signal)	Remarks
TFT	64.8 [26]	LQ255T3LZ44	1 049 088	1 366 × RGB × 768	564.8 × 317.6	16 777 216	626.0 × 373.0 × 48.0	Built-in	LVDS*3 (8-bit digital)	ASV*4 LCD, Wide viewing angle, High luminance, High contrast, Built-in inverter
	80 [32]	LQ315T3LZ44	1 049 088	1 366 × RGB × 768	697.69 × 392.26		760.0 × 450.0 × 48.0			
	94 [37]	LK370T3LZ51	1 049 088	1 366 × RGB × 768	819.6 × 460.8		877.0 × 514.6 × 56.0			
		LQ370D3LZ14	2 073 600	1 920 × RGB × 1 080	819.4 × 460.9		877.0 × 516.0 × 56.0			

\*1 Pixel means a set of each RGB dot.

\*2 Excluding FPC for connection and other excessing parts.

\*3 LVDS: Low Voltage Differential Signaling

\*4 ASV: Advanced Super View

(Note) Please note that the specifications are subject to change without prior notice for production improvement.

### Notice

In the absence of confirmation by device specification sheets, SHARP takes no responsibility for any defects that may occur in equipment using any SHARP devices shown in catalogs, data books, etc. The models listed on this page are lead-free solder compatible. For details, please inquire with SHARP. Contact SHARP in order to obtain the latest device specification sheets before using any SHARP device.



☆New product  
★Under development

<For automotive applications> (1)

- LQ065T9DR51U/52U, LQ070T5GG30, LQ080T5GG01C, LQ088H9DR01U:

operating temperature (panel surface temperature) -30 to +85°C storage temperature -30 to +85°C

All others: -40 to +85°C

	Display size (cm) ["]	Model No.	Dot format H x V (dot)	Pixel pitch H x V (mm)	Active area H x V (mm)	Input signal system	Input video signal	Back-light	Luminance (cd/m <sup>2</sup> ) (TYP.)	Power consumption (mW) (TYP.)	Overall dimensions* <sup>9</sup> W x H x D (mm) (TYP.)	Weight (g) (TYP.)	Remarks	
TFT	7.8 [3.1]	☆LQ031B5DG01	270 x RGB x 96* <sup>1</sup>	0.273 x 0.273	73.7 x 26.2	6-bit digital RGB	6-bit digital	Built-in 9LED	350	700	85.4 x 38.8 x 10.2	44	Wide viewing angle, 260K-color display, LED backlight, RoHS compliant	
	8.3 [3.3]	★LQ033B5DG02	160 x RGB x 176* <sup>2</sup>	0.351 x 0.349	56.2 x 61.4			290	1 800	73 x 78.3 x 12.5	90	Wide viewing angle, 260K-color display, High-speed response (low temperature), Portrait, RoHS compliant		
	13 [4.9]	LQ049B5DG04	320 x RGB x 96* <sup>3</sup>	0.375 x 0.375	120.0 x 36.0			Built-in 1CCFT	350	2 800	142 x 54 x 13	110	260K-color display, Wide screen (10:3)	
	15 [5.8]	LQ058T5GG06	400 x RGB x 234* <sup>4</sup>	0.318 x 0.307	127.2 x 71.8	NTSC/PAL* <sup>10</sup>	TFT specific analog RGB* <sup>11</sup>	470	3 900	142 x 83.5 x 8.5	140 (Max)	140 (Max)	Thin, Wide screen (16:9)	
		LQ065T5GG61	400 x RGB x 234* <sup>4</sup>	0.359 x 0.339	143.4 x 79.3								400	3 300
		☆LQ065T5CGxx	400 x RGB x 234* <sup>4</sup>	0.359 x 0.339	143.4 x 79.3	6-bit digital RGB	6-bit digital	Composite analog RGB	Built-in 2CCFT	635	6 000	157.2 x 91.9 x 18.5	281	High luminance, Wide screen (16:9), All in one, RoHS compliant
	16 [6.5]	LQ065T9DR51U/52U	400 x RGB x 240* <sup>5</sup>	0.359 x 0.331	143.4 x 79.3			Built-in 1CCFT	220	5 200	155 x 89.2 x 12.5	205 (Max)	Advanced TFT (Transmissive/reflective), 260K-color display, Wide screen (16:9)	
		LQ065Y5DG02	800 x RGB x 480* <sup>6</sup>	0.18 x 0.163	144.0 x 78.2	500	5 100	160 x 94 x 8.2	185 (Max)	High resolution (W-VGA), High luminance, 260K-color display, Thin, Wide screen (17:9), RoHS compliant				

\*1 Number of Pixels: 25 920

\*4 Number of Pixels: 93 600

\*7 Number of Pixels: 112 320

\*9 Excluding FPC for connection and other protruding parts.

\*10 MBK-PAL system is adopted as PAL. The LCD panel has 234 (240) scanning lines, and displays a picture of 273 (274) virtual scanning lines.

\*11 Video interface: External (Device specific external video interface IC is available.)

(Note) Please refer to the latest relevant specification sheets before using these devices.

\*2 Number of Pixels: 28 160

\*5 Number of Pixels: 96 000

\*8 Number of Pixels: 153 600

\*3 Number of Pixels: 30 720

\*6 Number of Pixels: 384 000

**Notice**

In the absence of confirmation by device specification sheets, SHARP takes no responsibility for any defects that may occur in equipment using any SHARP devices shown in catalogs, data books, etc. The models listed on this page are lead-free solder compatible. For details, please inquire with SHARP. Contact SHARP in order to obtain the latest device specification sheets before using any SHARP device.

## <For automotive applications> (2)

### ● LQ065T9DR51U/52U, LQ070T5GG30, LQ080T5GG01C, LQ088H9DR01U:

operating temperature (panel surface temperature) -30 to +85°C storage temperature -30 to +85°C

All others: -40 to +85°C

	Display size (cm) ["]	Model No.	Dot format H × V (dot)	Pixel pitch H × V (mm)	Active area H × V (mm)	Input signal system	Input video signal	Back-light	Luminance (cd/m <sup>2</sup> ) (TYP.)	Power consumption (mW) (TYP.)	Overall dimensions* <sup>9</sup> W × H × D (mm) (TYP.)	Weight (g) (TYP.)	Remarks
TFT	18 [7]	LQ070T5GG12	480 × RGB × 234* <sup>7</sup>	0.326 × 0.352	156.2 × 82.4	NTSC/PAL* <sup>10</sup>	TFT specific analog RGB* <sup>11</sup>	Built-in 1CCFT	400	3 500	167 × 93 × 6.9	195 (Max)	Thin, Wide screen (17:9), RoHS compliant
		LQ070T5CRxx	480 × RGB × 234* <sup>7</sup>	0.321 × 0.372	154.1 × 87.0		Composite analog RGB	Built-in 2CCFT	500	11 400	192.4 × 109.5 × 19.4	370	High luminance, Wide screen (16:9), All in one
		LQ070T5GG30	480 × RGB × 234* <sup>7</sup>	0.321 × 0.372	154.1 × 87.0		TFT specific analog RGB* <sup>11</sup>	Built-in 1CCFT	400	3 600	164.4 × 99.5 × 8.2	240 (Max)	Equipped with transmissive touch panel, Thin, Wide screen (16:9), RoHS compliant
		LQ070Y5DR04	800 × RGB × 480* <sup>6</sup>	0.191 × 0.191	152.4 × 91.4	6-bit digital RGB	6-bit digital		400	6 000	165 × 105.5 × 12	240	High resolution (W-VGA), 260K-color display, Wide screen (15:9)
		☆LQ070Y5DG05	800 × RGB × 480* <sup>6</sup>	0.195 × 0.1725	156.0 × 82.8			460	3 600	167 × 93 × 7.2	196 (Max)	High resolution (W-VGA), 260K-color display, Thin, Wide screen (17:9), 7-inch (GG12) vertical/horizontal compatible, RoHS compliant	
	20 [8]	LQ080T5GG01C	480 × RGB × 234* <sup>7</sup>	0.368 × 0.424	176.4 × 99.2	NTSC/PAL* <sup>10</sup>	TFT specific analog RGB* <sup>11</sup>	Built-in 2CCFT	400	5 800	193.3 × 116.5 × 8.8	250	Thin, Wide screen (16:9), RoHS compliant
		LQ080Y5DR02	800 × RGB × 480* <sup>6</sup>	0.218 × 0.218	174.0 × 104.4	6-bit digital RGB	6-bit digital		625	6 200	190 × 120 × 13	385	High resolution (W-VGA), High luminance, 260K-color display, Wide screen (15:9)
	22 [8.8]	LQ088H9DR01U	640 × RGB × 240* <sup>8</sup>	0.327 × 0.327	209.3 × 78.5			220	7 000	231.6 × 103.25 × 14.4	370 (Max)	Advanced TFT (Transmissive/reflective), 260K-color display, Wide screen (8:3)	
	24 [9.5]	LQ095Y5DR01	800 × RGB × 480* <sup>6</sup>	0.258 × 0.258	206.4 × 123.8			Built-in 4CCFT	380	9 300	229 × 149 × 13.9	475 (Max)	High resolution (W-VGA), 260K-color display, Wide screen (15:9)

\*1 Number of Pixels: 25 920

\*4 Number of Pixels: 93 600

\*7 Number of Pixels: 112 320

\*9 Excluding FPC for connection and other protruding parts.

\*10 MBK-PAL system is adopted as PAL. The LCD panel has 234 (240) scanning lines, and displays a picture of 273 (274) virtual scanning lines.

\*11 Video interface: External (Device specific external video interface IC is available.)

(Note) Please refer to the latest relevant specification sheets before using these devices.

\*2 Number of Pixels: 28 160

\*5 Number of Pixels: 96 000

\*8 Number of Pixels: 153 600

\*3 Number of Pixels: 30 720

\*6 Number of Pixels: 384 000

#### Notice

In the absence of confirmation by device specification sheets, SHARP takes no responsibility for any defects that may occur in equipment using any SHARP devices shown in catalogs, data books, etc. The models listed on this page are lead-free solder compatible. For details, please inquire with SHARP. Contact SHARP in order to obtain the latest device specification sheets before using any SHARP device.

### <For portable AV>

	Display size (cm) ["]	Model No.	Dot format H x V (dot)	Pixel pitch H x V (mm)	Active area H x V (mm)	Input signal system	Input video signal	Back-light	Luminance (cd/m <sup>2</sup> ) (TYP.)	Power consumption (mW) (TYP.)	Overall dimensions* <sup>6</sup> W x H x D (mm) (TYP.)	Weight (g) (TYP.)	Remarks
CG Silicon	6.4 [2.5]	LS025A8GY02	920 x 234* <sup>1</sup>	0.055 x 0.162 (Dot pitch)	50.6 x 37.9	NTSC/PAL* <sup>3</sup>	CG Silicon specific analog RGB* <sup>4</sup>	Built-in LED	260	415	60.8 x 48.1 x 3.8	21	Super Mobile LCD with high outdoor visibility due to transreflectivity, Top/bottom and left/right angle of view 160° (CR ≧ 5), High resolution (215,000 pixels), RGB delta configuration, High luminance, RoHS compliant, Lead-free solder compatible
TFT	6.4 [2.5]	★LQ025A3DS01	480 x RGB x 240* <sup>2</sup>	0.104 x 0.156	49.87 x 37.44		TFT specific analog RGB* <sup>5</sup>		250	T.B.D.	60.0 x 44.3 x 2.7	T.B.D.	RGB delta configuration, FPC side positioning, RoHS compliant, Lead-free solder compatible

\*1 Number of Pixels: 71 760

\*2 Number of Pixels: 115 200

\*3 MBK-PAL system is adopted as PAL. The LCD panel has 234 (220) scanning lines, and displays a picture of 273 (256) virtual scanning lines.

\*4 Video interface: External (Device specific external video interface IC is available.)

\*5 Video interface: Internal

\*6 Excluding FPC for connection and other excessing parts.

\* CG Silicon ... Continuous grain silicon technology developed jointly with Semiconductor Energy Laboratory Co. Ltd. is used.

(Note) Please refer to the latest relevant specification sheets before using these devices.

### <For cellular phones>

	Display size (cm) ["]	Model No.	Dot format H x V (dot)	Pixel pitch H x V (mm)	Active area H x V (mm)	Input video signal	Back-light	Contrast ratio (Transmissive/Reflective)	Luminance (cd/m <sup>2</sup> ) (TYP.)	Overall dimensions W x H x D (mm) (TYP.)	Weight (g) (TYP.)	Remarks
CG Silicon	5.6 [2.2]	★LS022Q8Axxx	240 x RGB x 320* <sup>1</sup>	0.141 x 0.141	33.84 x 45.12	18-bit Digital RGB/ CPU bus	Built-in LED	T.B.D.	180	40.85 x 57.98 x 4.48	T.B.D.	Super Mobile LCD with high outdoor visibility due to transreflectivity, Top/bottom and left/right angle of view 160° (CR ≧ 5), High contrast, 260k-color display
CSTN	4.5 [1.8]	★LM18TGFNZ19	128 x RGB x 160* <sup>2</sup>	0.219 x 0.219	28.019 x 35.028	CPU bus		30 : 1	180	38.4 x 47.1 x 3.9	T.B.D.	Transmissive type, 65k-color display, Low price, RoHS compliant
	3.9 [1.5]	★LM15TGFNZ24	128 x RGB x 128* <sup>3</sup>	0.204 x 0.220	26.097 x 28.145	CPU bus		45 : 1	120	34.8 x 41.31 x 3.8	T.B.D.	Transmissive type, 65k-color display, Low price, RoHS compliant
		★LM15TGFNZ26	128 x RGB x 128* <sup>3</sup>	0.204 x 0.220	26.1 x 28.15	CPU bus		45 : 1	160	35.0 x 41.5 x 3.0	T.B.D.	Transmissive type, 65k-color display, Module thickness 3 mm MAX., RoHS compliant
		LM15SGFNZ16	128 x RGB x 128* <sup>3</sup>	0.204 x 0.220	25.908 x 28.14	Serial 8-bit CPU bus	20	110	33.4 x 41.6 x 3.3	6.5	Transmissive type, 65k-color display, RoHS compliant	

\*1 Number of Pixels: 76 800

\*2 Number of Pixels: 20 480

\*3 Number of Pixels: 16 384

\* CG Silicon ... Continuous grain silicon technology developed jointly with Semiconductor Energy Laboratory Co. Ltd. is used.

(Note) Please refer to the latest relevant specification sheets before using these devices.

#### Notice

In the absence of confirmation by device specification sheets, SHARP takes no responsibility for any defects that may occur in equipment using any SHARP devices shown in catalogs, data books, etc. The models listed on this page are lead-free solder compatible. For details, please inquire with SHARP. Contact SHARP in order to obtain the latest device specification sheets before using any SHARP device.





■ EL Display Modules

Display size (cm) [ " ]	Model No.	Dot format H x V (dot)	Dot pitch H x V (mm)	Active area H x V (mm)	Areal luminance (cd/m <sup>2</sup> ) (TYP.)	Supply voltage (V)	Power consumption (W) (TYP.)	Operating temperature (°C)	Overall dimensions W x H x D (mm) (TYP.)	Weight (g) (TYP.)	Remarks
23 [8.9]	LJ64H034	640 x 400	0.30 x 0.30	191.9 x 119.9	110*1	+5, +12	11	-5 to +55	246.0 x 175.0 x 19.0	450	High luminance, Wide viewing angle
	LJ089MB2S01				60				246.0 x 158.0 x 26.0	390	Wide viewing angle

\*1 In case of frame frequency = 120 Hz  
 (Note) Please refer to the latest relevant specification sheets before using these devices.



LCD / EL

**Notice**  
 In the absence of confirmation by device specification sheets, SHARP takes no responsibility for any defects that may occur in equipment using any SHARP devices shown in catalogs, data books, etc. The models listed on this page are lead-free solder compatible. For details, please inquire with SHARP. Contact SHARP in order to obtain the latest device specification sheets before using any SHARP device.

## ■ CMOS Camera Modules

Module configuration : CMOS image sensor, CDS/AGC/10-bit ADC, timing generator, DSP, lens (for UXGA/SXGA/VGA)

CMOS image sensor, CDS/AGC/8-bit ADC, timing generator, DSP, lens (for CIF)

Color filter : R, G, B primary color mosaic filters

Operating temperature : -20 to 60°C

Optical format	Image format	Optical function	Model No.	Features	Output pixels (H x V) MAX.	Lens			Output signal	Supply voltage (V)	Power consumption (mW) TYP.	Package		
						F No.	Con-figuration	Horizontal viewing angle (°)						
1/3.2 type	UXGA	Macro function	LZ0P3955	<ul style="list-style-type: none"> <li>UXGA to SubQCIF</li> <li>15 fps at UXGA/30 fps at SVGA</li> <li>5x electronic zoom at QVGA size (MAX.)</li> <li>Image inversion function (right and left)</li> </ul>	1 600 x 1 200	F3.4	3 pcs.	53	UYVY	2.8/1.8 (I/O : 1.8 or 2.8 V)	290 (at 7.5 fps)	28LCC type (Can be socket-mounted)		
		Auto focus function	★LZ0P3954										57	
		–	★LZ0P39A7										55	
1/4 type	–	Macro function	LZ0P393E	<ul style="list-style-type: none"> <li>SXGA to SubQCIF</li> <li>15 fps at SXGA/30 fps at QSXGA</li> <li>4.2x electronic zoom at QVGA size (MAX.)</li> <li>Image inversion function (right and left)</li> </ul>	1 280 x 1 024	F2.8	3 pcs.	58	UYVY	2.8/1.8 (I/O : 1.8 or 2.8 V)	150 (at 15 fps)	24LCC type (Can be socket-mounted)		
		–	LZ0P3936										56	
1/4 type	SXGA	Macro function	LZ0P393D	<ul style="list-style-type: none"> <li>SXGA to SubQCIF</li> <li>15 fps at SXGA/30 fps at QSXGA</li> <li>4.2x electronic zoom at QVGA size (MAX.)</li> <li>Image inversion function (right and left)</li> </ul>	1 280 x 1 024	F3.2	2 pcs.	56	UYVY	2.8/1.8 (I/O : 1.8 or 2.8 V)	220 (at 15 fps)	24LCC type (Can be socket-mounted)		
			★LZ0P393Y										58	
		–	LZ0P393M										F3.4	56
			★LZ0P398x										F3.2	58
1/6 type	VGA	–	LZ0P394U	<ul style="list-style-type: none"> <li>VGA to SubQCIF</li> <li>30 fps at VGA</li> <li>2x electronic zoom at QVGA size (MAX.)</li> <li>Image inversion function (right and left)</li> </ul>	640 x 480	F2.8	2 pcs.	52	UYVY	2.8/1.8 (I/O : 1.8 or 2.8 V)	110 (at 30 fps)	24LCC type (Can be socket-mounted)		
			LZ0P394K										54	
1/7 type	CIF	–	LZ0P392N	<ul style="list-style-type: none"> <li>CIF/QCIF</li> <li>30 fps at CIF</li> <li>Image inversion function (right and left)</li> </ul>	352 x 288	F2.8	Single	58	UYVY	2.5 (I/O : 2.8 V)	35 (at 15 fps)	24LCC type (Can be socket-mounted)		
			LZ0P392L										65	
			★LZ0P39xx										2 pcs.	52

## ● Outline Dimensions

Model No.	Outline dimensions (mm) TYP.	Package
LZ0P3955	9.5 x 9.5 x (H) 7.0	28LCC type (Can be socket-mounted)
★LZ0P3954	12.0 x 12.0 x (H) 7.2	
★LZ0P39A7	8.0 x 8.0 x (H) 5.0	
LZ0P393E	9.0 x 9.0 x (H) 6.6	24LCC type (Can be socket-mounted)
LZ0P3936	9.0 x 9.0 x (H) 6.4	
LZ0P393D	8.4 x 8.4 x (H) 5.3	
★LZ0P393Y	8.0 x 8.0 x (H) 4.4	
LZ0P393M	8.0 x 8.0 x (H) 4.9	
★LZ0P398x	8.0 x 8.0 x (H) 4.3	
LZ0P394U	5.8 x 5.8 x (H) 3.7	
LZ0P394K	6.2 x 6.5 x (H) 4.3	
LZ0P392N	6.5 x 6.5 x (H) 4.5	
LZ0P392L	6.5 x 6.5 x (H) 3.8	
★LZ0P39xx	6.0 x 6.0 x (H) 3.1	

## ● System Configuration Example

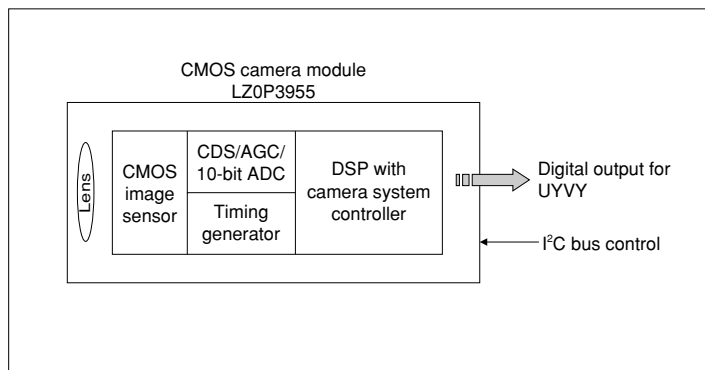



**■ CCD Camera Modules**

Module configuration : CCD, CDS/AGC/10-bit ADC, timing generator, V driver, DSP\*, lens, peripheral components

Color filter : R, G, B primary color mosaic filters

Operating temperature : -20 to 60°C

\* LZ0P3751/LZ0P3758: External setting

Optical format	Total pixels	Optical function	Model No.	Features	Output pixels (H x V) MAX.	Lens			Output signal	Supply voltage (V)	Power consumption (mW) TYP.	Package
						F number	Con-figuration	Horizontal viewing angle (°)				
1/2.5 type	3.37 M	Auto focus function	LZ0P375D	<ul style="list-style-type: none"> <li>• 2 048 x 1 536 to SubQCIF</li> <li>• 4.5 fps at 2 048 x 1 536/ 10 fps at VGA</li> <li>• 6.4x electronic zoom at QVGA size (MAX.)</li> <li>• Image inversion function (right and left)</li> </ul>	2 048 x 1 536	F2.8	3 pcs.	54	RGB Bayer	1.8, 3.0, 15, -8	400 (at 4.5 fps)	52LCC type
		2x optical zoom/auto focus function	LZ0P3758			F2.8 to 4.1	6 pcs.	Wide : 61 Tele : 33				400 (at 4.5 fps)/ 900 (at motor operation)
1/4 type	1.36 M	Macro function	LZ0P374R	<ul style="list-style-type: none"> <li>• 1 280 x 960 to SubQCIF</li> <li>• 7.5 fps at 1 144 x 880/ 15 fps at QVGA</li> <li>• 4x electronic zoom at QVGA size (MAX.)</li> <li>• Image inversion function (right and left)</li> </ul>	1 280 x 960	F3.4	3 pcs.	60	UYVY	1.8, 3.0, 15, -8 (I/O : 1.8 or 3.0 V)	370 (at 7.5 fps)	64LCC type
			LZ0P374P									54LCC type
		Auto focus function	LZ0P374H			F2.8	46	48LCC type				
1/7 type	350 k	-	LZ0P371K	<ul style="list-style-type: none"> <li>• VGA/CIF/QVGA/ QCIF/SubQCIF</li> <li>• 15 fps</li> <li>• 2x electronic zoom at QVGA size (MAX.)</li> <li>• Image inversion function (right and left)</li> </ul>	640 x 480	F2.4	2 pcs.	58	1.8, 3.0, 15, -8 (I/O : 3.0 V)	240 (at 12 fps)	36LCC type	
			LZ0P371L									

**● Outline Dimensions**

Model No.	Outline dimensions (mm) TYP.	Package
LZ0P375D	22.0 x 13.5 x (H) 9.9	52LCC type
LZ0P3758	20.0 x 10.0 x (H) 23.2	40FPC type
LZ0P374R	19.5 x 11.9 x (H) 5.2	64LCC type
LZ0P374P	10.4 x 12.9 x (H) 6.2	54LCC type
LZ0P374H	20.3 x 14.9 x (H) 7.4	48LCC type
LZ0P371K	10.0 x 13.0 x (H) 4.3	36LCC type
LZ0P371L	10.4 x 8.0 x (H) 5.2	

(H) : Module height

**● System Configuration Example**

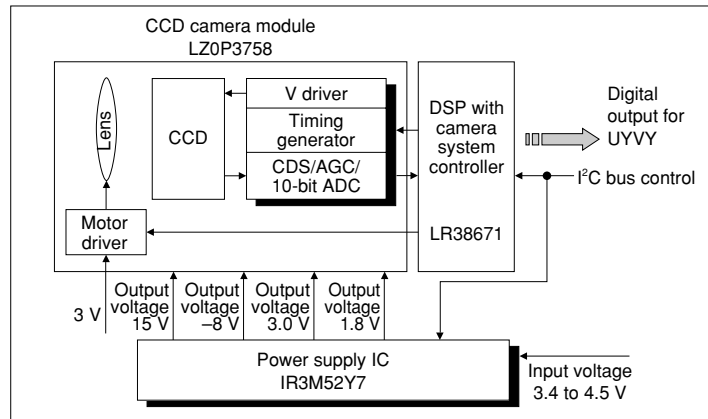

**■ Peripheral LSI for CCD Camera Modules**

Model No.	Function	Features	Package
LR38671	DSP for 3.37-Mpixel CCD camera modules	CCD signal processing circuit, YUV digital output, RGB bayer data output, processing circuit for AWB/AE control, auto white defect detection, stepless electronic zoom, motor driver control, timing generator serial control	TFBGA152-0808

**■ Power Supply ICs for CCD Camera Modules**

Model No.	Function	Output voltage 1 (V) for CCD	Output voltage 2 (V) for CCD	Output voltage 3 (V) for CCD	Output voltage 4 (V) for DSP	Output voltage 5 (V) for I/O	Input voltage (V)	Package
IR3M48U6	Multi-output power supply for 1/7-type 350-kpixel CCD camera modules	15	-8	-	1.8	-	2.7 to 3.2	P-VQFN032-0505
IR3M52Y7	Multi-output power supply for 1/2.5-type 3.37-Mpixel, 1/4-type 1.36-Mpixel CCD camera modules			2.5 to 3.3	1.2/1.8	2.5 to 3.3	2.7 to 5.5*1	41WL-CSP*2

\*1 Since output voltages 3, 4 and 5 are outputs for LDO, an input voltage 0.2 to 0.3 V higher than the output voltages is required.

\*2 3.97 mm x 3.97 mm x 0.82 mm (TYP.)



## ■ Higher-resolution CCDs

Optical format	Total pixels	Color filter	Model No.	30 fps VGA movie	Resolution		Pixel size H x V (μm <sup>2</sup> )	Sensitivity (mV) TYP.	Smear ratio (dB) TYP.	Package
					Image pixels (H x V)					
1/1.7 type	10 540 k	R,G,B primary color mosaic filters	RJ21W3BA0ET	○ (25 fps VGA movie)	3 704 x 2 784	2.05 x 2.05	80	-88	P-SOP032-0525	
			RJ21W3CA0ET	-						
			★RJ21W3BB0ET	○ (25 fps VGA movie)			100			
			★RJ21W3AB0ET	-						
1/1.8 type	8 500 k		RJ21V3BC0ET	○	3 320 x 2 496	2.2 x 2.2	105			
			RJ21V3CC0ET	-						
1/2.5 type	5 190 k		RJ23S3BC0ET	○	2 600 x 1 944	2.2 x 2.2	130			
			RJ23S3CC0ET	-						
			★RJ23S3BD0ET	○						
			★RJ23S3CD0ET	-						
	6 360 k		RJ23T3BA0ET	○	2 872 x 2 160	2.05 x 2.05	80			
			RJ23T3CA0ET	-						
		RJ23T3BB0ET	○	100						
		RJ23T3CB0ET	-							
7 400 k	RJ23U3BA0ET	○	3 096 x 2 328	1.9 x 1.9	95	-83				
	RJ23U3CA0ET	-								

## ■ 1/3-type CCDs

Total pixels	Standard		Model No.	Electronic shutter (s)	Resolution		Pixel size H x V (μm <sup>2</sup> )	Sensitivity (mV) TYP.	Smear ratio (dB) TYP.	Package
					Horizontal TV lines	Image pixels (H x V)				
270 k	Color	NTSC	RJ2311AA0PB	1/60 to 1/10 000	330	512 x 492	9.6 x 7.5	1 300	-120	P-DIP016-0500C
320 k		PAL	RJ2321AA0PB	1/50 to 1/10 000		512 x 582	9.6 x 6.3			
410 k		NTSC	RJ2351AA0BB	1/60 to 1/10 000	480	768 x 494	6.4 x 7.5	800	-105	N-DIP016-0450
		★RJ2351BA0AB	1 200					-120		
470 k		PAL	RJ2361AA0BB	1/50 to 1/10 000	752 x 582	6.5 x 6.3	750	-105		
			★RJ2361BA0AB				6.53 x 6.39	1 100	-120	



## ■ 1/4-type CCDs

Total pixels	Standard		Model No.	Electronic shutter (s)	Resolution		Pixel size H x V (μm <sup>2</sup> )	Sensitivity (mV) TYP.	Smear ratio (dB) TYP.	Package
					Horizontal TV lines	Image pixels (H x V)				
270 k	Color	NTSC	RJ2411AA0PB*	1/60 to 1/10 000	330	512 x 492	7.2 x 5.6	800	-105	P-DIP014-0400A
			RJ2411AB0PB					1 200	-120	
			RJ2411BA0PB*							
			RJ2411BB0PB							
320 k		PAL	RJ2421AB0PB	1/50 to 1/10 000	480	512 x 582	7.2 x 4.7	720	-105	
			RJ2421BB0PB				7.2 x 4.73	1 100	-120	
410 k		NTSC	RJ2451AA0PB	1/60 to 1/10 000	480	768 x 494	4.9 x 5.6	400	-90	
470 k		PAL	RJ2461AA0PB	1/50 to 1/10 000	480	752 x 582	5.0 x 4.7			

\* Suitable for intense light exposure.

## ■ 1/3-type CCDs with Dual-power-supply (5 V/12 V) Operation\*1

Total pixels	Standard		Model No.	Electronic shutter (s)	Resolution		Pixel size H x V (μm <sup>2</sup> )	Sensitivity (mV) TYP.	Smear ratio (dB) TYP.	Package
					Horizontal TV lines	Image pixels (H x V)				
270 k	B/W	EIA	LZ2316A3	1/60 to 1/10 000	380	512 x 492	9.6 x 7.5	3 300*2	-110	N-DIP016-0500C
320 k		CCIR	LZ2326A3	1/50 to 1/10 000		512 x 582	9.6 x 6.3	3 000*2		

\*1 With mirror image function

\*2 When IR cut-off filter is not used.

## ■ CCD Peripheral ICs/LSIs

Description	Model No.	Features	Package	
Single-chip driver (Timing generator + Synchronous signal generator)	LR385851	For 270-k/320-kpixel CCDs with dual-power-supply operation (5 V/12 V)	Electronic shutter, electronic exposure, mirror image function, for B/W CCDs, level shifter, smooth shutter, line lock function	P-QFP048-0707
Signal processor	IR3Y30M2	Available for signal processing from CCD output to 75 Ω video output, for B/W CCDs, comparator for electronic exposure, high-speed S/H circuit, H aperture, LPF, AGC		P-QFP048-0707
V driver	LR366851	Vertical pulse driver for CCDs, 2-level output x 2, 3-level output x 4, 2-level output circuit for electronic shutter		P-SSOP024-0275
	LR36687U/Y	Vertical pulse driver for CCDs, 2-level output x 10, 3-level output x 10, 2-level output circuit for electronic shutter		P-VQFN064-0808/ TFBGA068-0606
	LR36689U	Vertical pulse driver for CCDs, 2-level output x 4, 3-level output x 8, 2-level output circuit for electronic shutter		P-VQFN036-0505
CDS/PGA/ADC	IR3Y48A3/A5	Low power consumption [80 mW (TYP.) ], high-speed S/H circuit, high-gain PGA circuit, 10-bit ADC (18 MHz)		P-QFP048-0707/ P-VQFN052-0707
	IR3Y60U6	Low power consumption [69 mW (TYP.) ], high-speed S/H circuit, high-gain PGA circuit, 10-bit ADC (20 MHz)		P-VQFN032-0505
	IR3Y50U6	Low power consumption [75 mW (TYP.) ], high-speed S/H circuit, high-gain PGA circuit, 12-bit ADC (25 MHz)		P-VQFN036-0606
Timing generator + V driver + CDS/PGA/ADC	LR38667	For 1/2.5 type 5 190-kpixel CCDs with/without movie function	<Timing generator> Monitoring mode/still mode <V driver> Vertical pulse driver for CCDs, 2-level output x 10, 3-level output x 10, 2-level output circuit for electronic shutter <CDS/PGA/ADC> 30 MHz (LR38667)/ 36 MHz (LR38675/LR38678/LR38674/LR38677), high-speed S/H circuit, high-gain PGA circuit, 12-bit ADC	LFBGA192-1010
	LR38675	For 1/2.5 type 6 360-kpixel CCDs with/without movie function		
	LR38678	For 1/2.5 type 7 400-kpixel CCDs with/without movie function		
	LR38674	For 1/1.8 type 8 500-kpixel CCDs with/without movie function		
	LR38677	For 1/1.7 type 10 540-kpixel CCDs with/without movie function		
V driver + DSP	★LRS5753	For 270-k/320-k/410-k/ 470-kpixel CCDs	<V driver> Vertical pulse driver for CCDs, 2-level output x 2, 3-level output x 2, 2-level output circuit for electronic shutter <DSP> YUV digital output, NTSC/PAL analog output, mirror image function, 9-bit DAC, synchronous signal generation circuit, CCD drive timing generator, processing circuit for AWB/AE control, Y/C separation analog output, line lock function	LFBGA144-0808
V driver + CDS/PGA/ADC + DSP	LR386431/33		<V driver> Vertical pulse driver for CCDs, 2-level output x 2, 3-level output x 2, 2-level output circuit for electronic shutter <CDS/PGA/ADC> 18 MHz, high-speed S/H circuit, high-gain PGA circuit, 10-bit ADC <DSP> YUV digital output, NTSC/PAL analog output, mirror image function, 9-bit DAC, synchronous signal generation circuit, CCD drive timing generator, processing circuit for AWB/AE control, supports monitoring output	LFBGA168-1212/ LFBGA171-0811
	LR38653	For 270-k/320-k/410-k/ 470-kpixel CCDs	<V driver> Vertical pulse driver for CCDs, 2-level output x 2, 3-level output x 2, 2-level output circuit for electronic shutter <CDS/PGA/ADC> 25 MHz, high-speed S/H circuit, high-gain PGA circuit, 12-bit ADC <DSP> YUV digital output, NTSC/PAL analog output, mirror image function, 10-bit DAC, synchronous signal generation circuit, CCD drive timing generator, processing circuit for AWB/AE control function, auto white blemish detection and compensation function, lens shading correction function	LFBGA171-0811

## ■ CCD Peripheral ICs/LSIs (cont'd)

Description	Model No.	Features	Package
DSP + Flash memory + SDRAM	LR38682	For 6 000-kpixel-class CCDs (MAX.)	FBGA424-1414
	LR38683	For 10 000-kpixel-class CCDs (MAX.)	
DSP	LR386032	For 270-k/320-k/410-k/ 470-kpixel CCDs	P-LQFP080-1212
	LR386071		P-LQFP100-1414
	★LR38627		P-TQFP128-1414
	LR38669A		TFBGA260-1313
Power supply IC for CCDs and peripheral ICs/LSIs	IR3M55U*	For 270-k/320-kpixel CCDs	P-VQFN032-0505
	IR3M59U		
	★IR3M61U*		
	★IR3M63U		

\* For in-vehicle use

## ● System Configuration Examples

### • High-resolution Digital Camera System with Three-chip Configuration

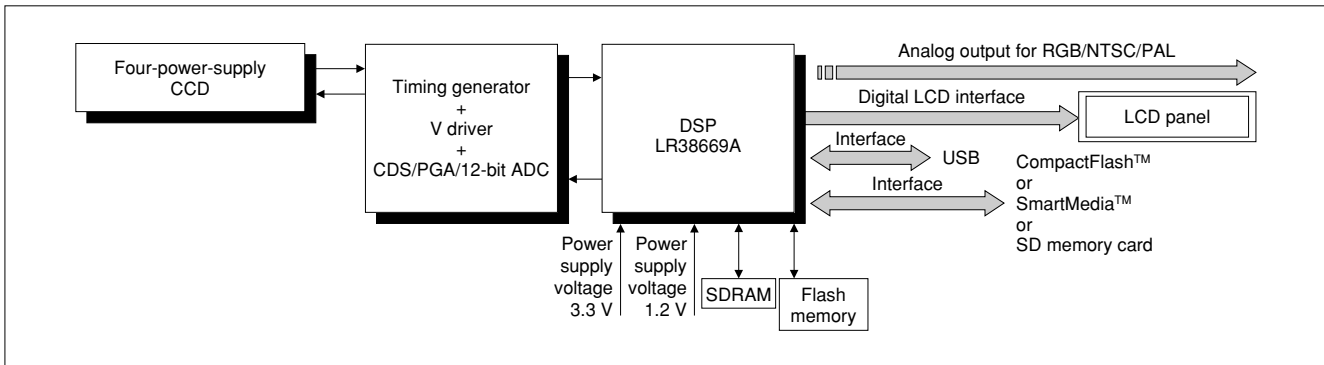

### Four-power-supply CCDs and peripheral LSIs

CCD			30 fps VGA movie	Timing generator + V driver + CDS/PGA/ADC	DSP
1/1.7 type	10 540 k pixels	RJ21W3BA0ET	○ (25 fps VGA movie)	LR38677	LR38669A
		RJ21W3CA0ET	—		
		★RJ21W3BB0ET	○ (25 fps VGA movie)		
		★RJ21W3AB0ET	—		
1/1.8 type	8 500 k pixels	RJ21V3BC0ET	○	LR38674	
		RJ21V3CC0ET	—		
1/2.5 type	5 190 k pixels	RJ23S3BC0ET	○	LR38667	
		RJ23S3CC0ET	—		
		★RJ23S3BD0ET	○		
		★RJ23S3CD0ET	—		
	6 360 k pixels	RJ23T3BA0ET	○	LR38675	
		RJ23T3CA0ET	—		
		RJ23T3BB0ET	○		
		RJ23T3CB0ET	—		
		RJ23U3BA0ET	○		
		RJ23U3CA0ET	—		
7 400 k pixels			LR38678		

### • Color Security Camera System with Two-chip Configuration [Low Power Consumption Type]

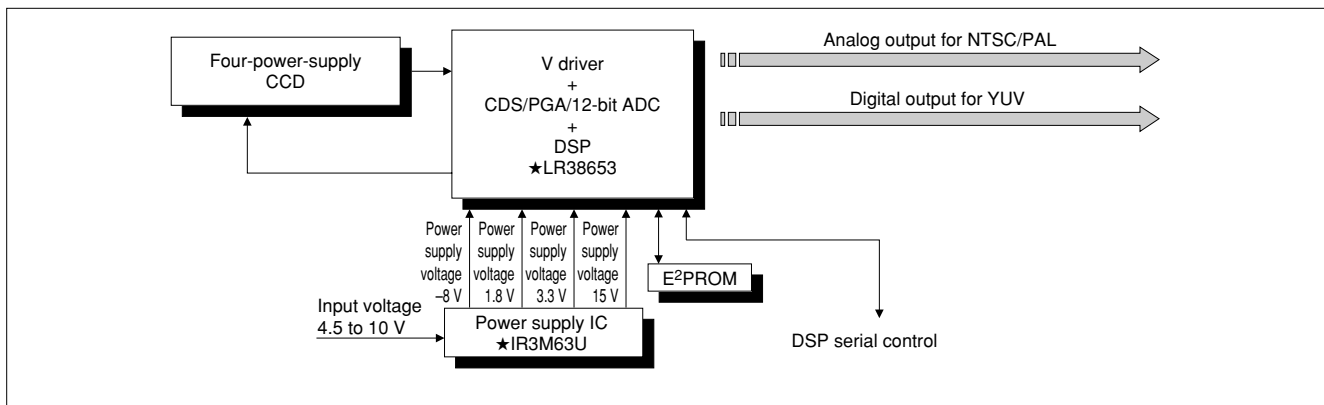



**Four-power-supply CCDs and peripheral IC/LSIs**

CCD		V driver + CDS/PGA/ADC + DSP	Power supply IC	
1/3 type	270 k pixels	RJ2311AA0PB	—	
	320 k pixels	RJ2321AA0PB		
	410 k pixels	RJ2351AA0BB		
		★RJ2351BA0AB		
	470 k pixels	RJ2361AA0BB		
★RJ2361BA0AB				
1/4 type	270 k pixels	RJ2411AA0PB	★LR38653	
		RJ2411AB0PB		
		RJ2411BA0PB		
		RJ2411BB0PB		
	320 k pixels	RJ2421AB0PB		★IR3M63U
		RJ2421BB0PB		
	410 k pixels	RJ2451AA0PB		—
	470 k pixels	RJ2461AA0PB		

**• Color Security Camera System with Two-chip Configuration**

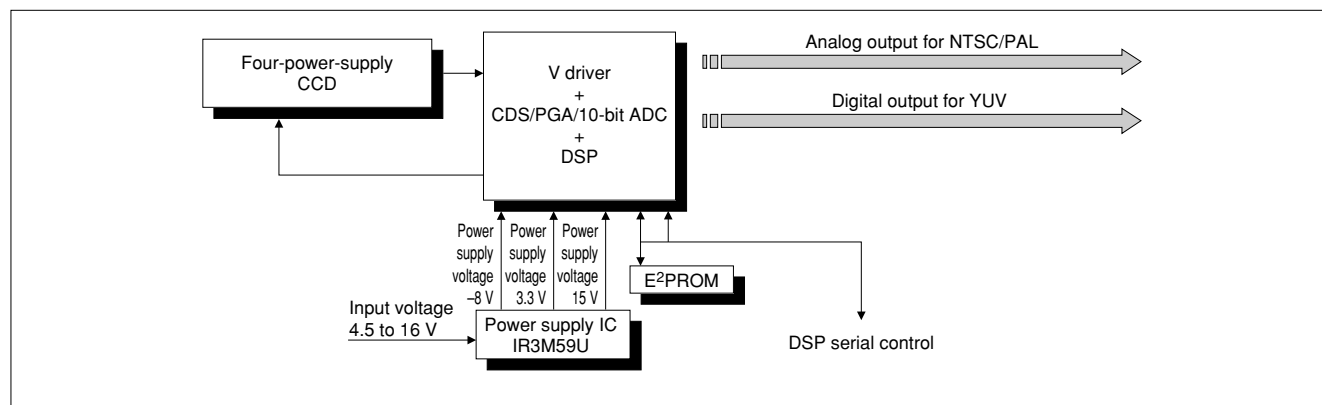

**Four-power-supply CCDs and peripheral IC/LSIs**

CCD		V driver + CDS/PGA/ADC + DSP	Power supply IC	
1/3 type	270 k pixels	RJ2311AA0PB	—	
	320 k pixels	RJ2321AA0PB		
	410 k pixels	RJ2351AA0BB		
		★RJ2351BA0AB		
	470 k pixels	RJ2361AA0BB		
★RJ2361BA0AB				
1/4 type	270 k pixels	RJ2411AA0PB	LR386431/LR386433	
		RJ2411AB0PB		
		RJ2411BA0PB		
		RJ2411BB0PB		
	320 k pixels	RJ2421AB0PB		IR3M59U
		RJ2421BB0PB		
	410 k pixels	RJ2451AA0PB		—
	470 k pixels	RJ2461AA0PB		

### • Color Security Camera System with three-chip Configuration

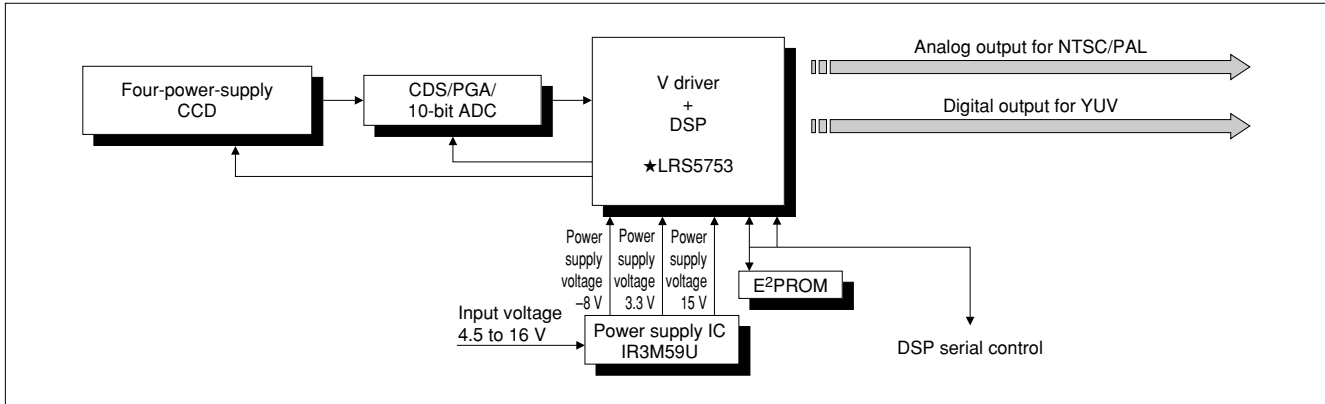

### Four-power-supply CCDs and peripheral ICs/LSI

CCD		CDS/PGA/ADC	V driver + DSP	Power supply IC		
1/3 type	270 k pixels	RJ2311AA0PB	IR3Y60U6/IR3Y48A3	★LRS5753	—	
	320 k pixels	RJ2321AA0PB				
	410 k pixels	RJ2351AA0BB			IR3M59U	
		★RJ2351BA0AB				
	470 k pixels	RJ2361AA0BB			—	
★RJ2361BA0AB						
1/4 type	270 k pixels	RJ2411AB0PB			IR3M59U	
		RJ2411BB0PB				
	320 k pixels	RJ2421AB0PB				—
		RJ2421BB0PB				
	410 k pixels	RJ2451AA0PB				
470 k pixels	RJ2461AA0PB					

### • Color Security Camera System with Four-chip Configuration

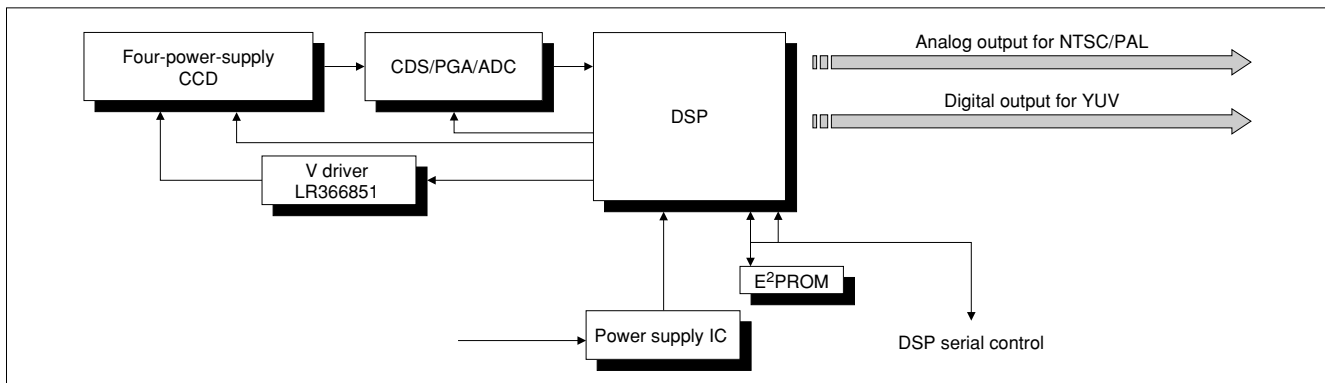

★Under development



## Four-power-supply CCDs and peripheral ICs/LSIs (1)

CCD		V driver	CDS/PGA/ADC	DSP	Power supply IC		
1/3 type	270 k pixels	RJ2311AA0PB	LR366851	IR3Y60U6 + IR3Y48A3	—		
	320 k pixels	RJ2321AA0PB					
	410 k pixels	RJ2351AA0BB			IR3M59U		
		★RJ2351BA0AB					
	470 k pixels	RJ2361AA0BB			—		
★RJ2361BA0AB							
1/4 type	270 k pixels	RJ2411AB0PB			IR3Y50U6	★LR38627	IR3M59U
		RJ2411BB0PB					
	320 k pixels	RJ2421AB0PB					
		RJ2421BB0PB					
	410 k pixels	RJ2451AA0PB	—				
	470 k pixels	RJ2461AA0PB					

## Four-power-supply CCDs and peripheral ICs/LSIs (2)

CCD		V driver	CDS/PGA/ADC	DSP	Power supply IC
1/3 type	270 k pixels	RJ2311AA0PB	LR366851	IR3Y50U6	—
	320 k pixels	RJ2321AA0PB			
	410 k pixels	RJ2351AA0BB			★IR3M63U
		★RJ2351BA0AB			
	470 k pixels	RJ2361AA0BB			—
★RJ2361BA0AB					
1/4 type	270 k pixels	RJ2411AB0PB			★IR3M63U
		RJ2411BB0PB			
	320 k pixels	RJ2421AB0PB			
		RJ2421BB0PB			
	410 k pixels	RJ2451AA0PB	—		
	470 k pixels	RJ2461AA0PB			

## • B/W Security Camera System

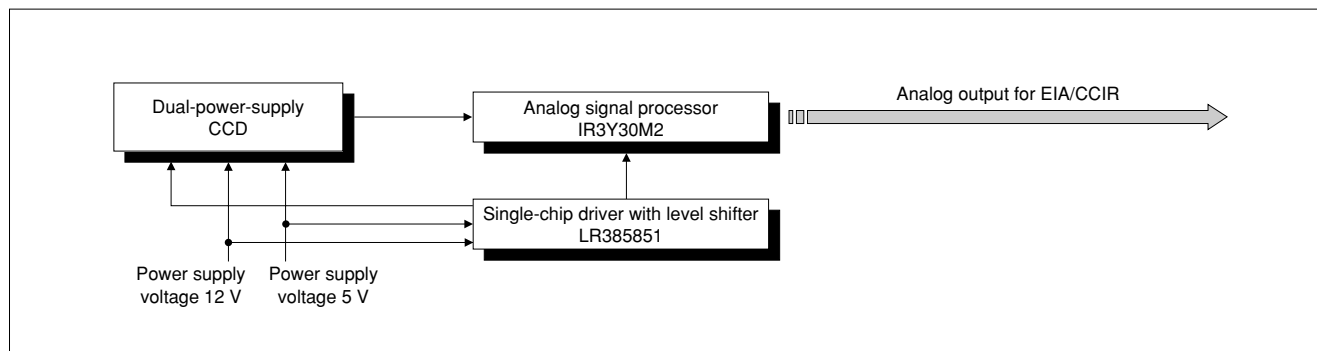

## Dual-power-supply CCDs and peripheral IC/LSI for analog interface

CCD		Single-chip driver (Timing generator + Synchronous signal generator)	Signal processor
1/3 type	270 k pixels	LR385851	IR3Y30M2
	320 k pixels		

**■ For Notebook PCs, PC Monitors and LCD TVs**
**● TFT-LCD Drivers**

Drive function		Model No.	Gray scale	No. of LCD drive outputs	Display voltage (V) MAX.	Clock frequency (MHz) MAX.	Supply voltage (V)	Description	Package
Source driver	Dot inversion drive	LH16AM	64 levels	384	13.5	85	2.7 to 3.6	Low EMI*1 using RSDS™*2 interface, built-in reference voltage generation circuit, R-DAC system	SOF
		LH16B6		414/420/432			2.3 to 3.6		
		LH16AD		480/504/516/528			2.7 to 3.6		
		LH16B0		600			2.3 to 3.6		
		LH16B1		618					
		LH16B2		630					
		LH16B3		642					
		LH16B5		630/642					
	LH168R	256 levels	384	13	65	2.7 to 3.6	2-port data input, built-in reference voltage generation circuit, R-DAC system	TCP/SOF	
	LH16AE			15	85		Low EMI*1 using RSDS™*2 interface, built-in reference voltage generation circuit, R-DAC system	SOF	
	LH16AW		384/414/420	16	2.5 to 3.6	65	Selectable clock single-edge (2-port input) or clock dual-edge (1-port input) (built-in data sampling switching function), built-in reference voltage generation circuit, R-DAC system	TCP/SOF	
	LH168V		480	13					
	LH16AF			15					85
	Line inversion drive	LH16A1	64 levels	384	5.5	57	2.7 to 3.6	2-port data input, built-in reference voltage generation circuit, R-DAC system	TCP/SOF
	Gate driver	LH1691	-	240	33	0.1	3.0 to 5.5	Selectable 1-pulse (normal) or 2-pulse (continuous/jumping) scanning, usable with both positive/negative power supplies	TCP/SOF/COG
LH1694		256		42	2.7 to 3.6		Output signal masking function, usable with both positive/negative power supplies, enables chain connection	TCP/SOF	
LH169G		202/242/258/263/272		45	0.2	2.4 to 4.2	Output signal masking function, enable constructing the module without substrate	SOF	

\*1 EMI : Electro-Magnetic Interference

\*2 RSDS™ : Reduced Swing Differential Signaling



## ■ For Mobile Equipment

### ● TFT-LCD Drivers

Drive function		Model No.	Gray scale	No. of LCD drive outputs	Display voltage (V) MAX.	Clock frequency (MHz) MAX.	Supply voltage (V)	Description	Package
Source driver	Dot inversion drive	★LH16AV	64 levels	402/480/516	13.5	65	2.7 to 3.6	Built-in reference voltage generation circuit, R-DAC system, power saving function	COG
	Line inversion drive	LH168Y		240	5.5	35	2.5 to 5.5	Built-in reference voltage generation circuit, R-DAC system, power saving function, polarity inversion of input data	
		LH16AR		480			2.5 to 3.6	Built-in R-DAC system, power saving function, polarity inversion of input data	
		LH1687	Analog	240	12.5	3.0 to 5.5	Selectable three-point simultaneous or normal sampling (Sampling frequency : 25 MHz), power saving function, 3 V drive (MIN.), prechargeless output	TCP/SOF/COG	
Gate driver		LH1691	-	240	33	0.1	Selectable 1-pulse (normal) or 2-pulse (continuous/jumping) scanning, usable with both positive/negative power supplies	COG	
		★LH169H		240/244/258	40		2.5 to 3.6		Output signal masking function, enables chain connection

### ● STN-LCD Drivers

Drive technology	Drive function	Model No.	No. of LCD drive outputs	Duty ratio	Display voltage (V) MAX.	Data input	Clock frequency (MHz) MAX.	Supply voltage (V)	Package
New drive technology*1	Segment	LH1583	160	to 1/240	+5.5	4/8-bit parallel	12 (at 2.4 V) / 20 (at 5 V)	2.4 to 5.5	TCP/SOF
		LH1580	240	to 1/480		8/12-bit parallel	30 (at 2.5 V) / 55 (at 5 V)	2.5 to 5.5	
	Common	LH1537	200/240	1/200, 1/240	+45	-	3 (at 2.4 V) / 4 (at 5 V)	2.4 to 5.5	
		LH1538	120/128	to 1/480	+80		3 (at 2.5 V) / 4 (at 5 V)		
Conventional drive technology*2	Segment	LH1542	80	to 1/240	+30	4-bit parallel	8	2.5 to 5.5	
		LH1549	160	to 1/480	+42	4/8-bit parallel	12 (at 2.5 V) / 20 (at 5 V)		
		LH1548	240			8/12-bit parallel	12 (at 2.5 V) / 25 (at 5 V)		
	Common (Pin-selectable)	LH1530	120	to 1/480	+42	-	3 (at 2.5 V) / 4 (at 5 V)		
		LH1565	160	to 1/240	+30		4/8-bit parallel (at segment drive)		[Segment mode] 8 [Common mode] 4
		LH1560		to 1/480	+42				[Segment mode] 8 (at 2.5 V) / 14 (at 5 V) [Common mode] 4
LH1562	240				[Segment mode] 12 (at 2.5 V) / 20 (at 5 V) [Common mode] 4				

\*1 New drive technology : A drive technology which drives LCDs with low voltage of 5 V on segment side and drives LCDs with high voltage on common side. Driving with low voltage on segment side enables LCDs to reduce power consumption and shadowing.

\*2 Conventional drive technology : A drive technology which drives LCDs with high voltage on both segment and common sides.

### ● Power Supply IC for STN-LCD Drivers

Model No.	Description	Supply voltage (V)	Package
LR3697A	For STN LCD drivers with new drive technology* DC-DC converter for LCD drive power supply, built-in bias voltage generation circuit for LCD drive, electronic volume control circuit	2.4 to 3.3 (V <sub>DD</sub> , V <sub>P</sub> )	P-QFP072-1010

\* New drive technology : A drive technology which drives LCDs with low voltage of 5 V on segment side and drives LCDs with high voltage on common side. Driving with low voltage on segment side enables LCDs to reduce power consumption and shadowing.





## ■ For Cellular Phones

### ● TFT-LCD Controller/Driver with Two-chip Configuration (LR38825 + LH169C)

Model No.	No. of LCD drive outputs		Display colors MAX.	Display RAM capacity (bit)	a-Si	Function	CPU interface	External image interface	Supply voltage (V)			Package
	Source	Gate							Core	Host I/F	Display	
LR38825	528	—	262 144 colors	240 x 176 x 18	○	<ul style="list-style-type: none"> <li>Versatile graphic functions</li> <li>Window display function</li> <li>Write mask function</li> <li>Bit built function</li> <li>Built-in gray-scale control circuit</li> <li>Built-in timing generator</li> </ul>	80-family (8/16/18-bit parallel, serial)	RGB : respective 6-bit parallel	1.65 to 1.95	1.65 to 3.6	4.75 to 5.25	COG
LH169C	—	240		—	○	<ul style="list-style-type: none"> <li>Built-in DC-DC converter, VCOM generation circuit</li> </ul>	—	—	2.75 to 3.3		26.5 (MAX.)	

### ● Single-chip TFT-LCD Controller/Driver

Model No.	No. of LCD drive outputs		Display colors MAX.	Display RAM capacity (bit)	a-Si	Function	CPU interface	External image interface	Supply voltage (V)			Package
	Source	Gate							Core	Host I/F	Display	
LR38826	396	176	262 144 colors	176 x 132 x 18	○	<ul style="list-style-type: none"> <li>Versatile graphic functions</li> <li>Window display function</li> <li>Write mask function</li> <li>Bit built function</li> <li>Built-in gray-scale control circuit</li> <li>Built-in timing generator, DC-DC converter, VCOM generation circuit</li> </ul>	80-family (8/16/18-bit parallel, serial)	RGB : respective 6-bit parallel, YUV format	1.65 to 1.95	1.65 to 3.6	2.75 to 3.3 <small>(Using built-in power supply -Source : 4.0 to 5.5 -Gate : 20 to 27.5)</small>	COG

### ● TFT-LCD Controllers

Model No.	LCD interface (pixel) MAX.	Display colors MAX.	Display RAM capacity (bit)	a-Si	Function	CPU interface	External image interface	Supply voltage (V)		Package
								Core	Host I/F	
LR38822A	176 x 240	65 536 colors	176 x 240 x 16	○	<ul style="list-style-type: none"> <li>Built-in timing generator, clock generator</li> </ul>	80-family (8/16-bit parallel, serial)	RGB : respective 6-bit parallel	2.25 to 2.75	3.0 to 3.6	TFBGA112-1010
LR38869A	240 x 400	262 144 colors	240 x 400 x 18	○	<ul style="list-style-type: none"> <li>MDDI* compliant</li> <li>Main/sub LCD controller</li> <li>Graphic processing</li> <li>Parallel bus host interface</li> </ul>	MDDI* for MSM series/ 80-family (8/9/16/18-bit parallel)	—	1.65 to 1.95	1.65 to 3.6	TFBGA176-0909

\* MDDI (Mobile Display Digital Interface) : The serial interface standard developed by QUALCOMM.

### ● TFT-LCD Driver

Model No.	No. of LCD drive outputs		LTPS*	Function	External image interface	Supply voltage (V)		Package
	Source	Gate				Core	Display MAX.	
LH16AP	240	—	○	<ul style="list-style-type: none"> <li>Built-in timing generator, DC-DC converter, VCOM generation circuit</li> </ul>	RGB : respective 6-bit parallel	2.2 to 3.6	5.5	COG/SOF

\* LTPS : Low Temperature Poly-Silicon

### ● Color STN-LCD Controllers/Drivers

Display colors MAX.	Drive function	Model No.	No. of LCD drive outputs		Display RAM capacity (bit)	Duty ratio	Display voltage (V) MAX.	Data input	Clock frequency (MHz) MAX.	Supply voltage (V)	Package
			Segment	Common							
256 colors	Segment and Common	LH15H1	288	66	96 x 66 x 8	1/10, 1/18, 1/26, 1/34, 1/42, 1/50, 1/58, 1/66	+13.2	8/16-bit parallel, serial	4 (at 3 V)	1.8 to 3.3	TCP/SOF
4 096 colors		LH15JA	—	132	132 x 132 x 12	1/33, 1/39, 1/68, 1/74, 1/133, 1/139	+18	8-bit parallel, serial	3 (at 2.5 V)	1.65 to 3.3	COG
65 536 colors		LH15KA	396	176	132 x 176 x 16	to 1/176 (Selectable per 1 line)	+18.6	8/16-bit parallel, serial	4 (at 3 V)	1.8 to 3.3	COG/SOF
262 144 colors		LH15LA	—	162	132 x 162 x 18	to 1/162 (Selectable per 1 line)	±18				

## ●Color STN-LCD Controller

Model No.	LCD interface (pixel) MAX.	Display colors MAX.	Function/Feature	CPU interface	Display RAM capacity (bit)	Supply voltage (V) TYP.	Package	
LR38844A	128 x 164	65 536 colors	<ul style="list-style-type: none"> <li>High-speed host access</li> <li>Display colors selectable : 256/4 096/65 536 colors</li> <li>Power saving function reduces the power consumption in standby mode</li> <li>Built-in CPU interface, LCD interface, clock generator, display memory</li> </ul>	Recommended to be used together with LH15H1	68-family/80-family (8/16 bits)	128 x 164 x 16	2.5	TFBGA081-0808

## ■ Peripheral ICs for LSIs for LCDs

### ●Video Interface ICs for TFT-LCDs

Model No.	Input signal				Color decode	LCD panel				Serial data control	Supply voltage (V) TYP.	Power consumption (mW) TYP.	Package	
	Composite video	Y/color difference	Analog RGB	OSD (Digital)		± power source	+ power source	Low voltage source	Digital input					
IR3Y18A1	○				NTSC/PAL	○	○				4.5/12 or 4.5/-7.5	130	P-QFP048-0707	
IR3Y26A2/A6			○ <sup>3</sup>		-			○			5/7.5	140	P-QFP048-1010/ P-QFP048-0707	
IR3Y29A1/B1	○		○		NTSC/PAL			○				190	P-QFP048-0707	
IR3Y31M1	○		○		NTSC/PAL	○	○				4.5/12 or 4.5/-7.5	160		
IR3Y34M1		○	○	○	-		○				3/12	88		
IR3Y37A1		○(Common terminal)		○	-			○			3/6.5	106/88 <sup>*5</sup>		
RB5P0010M2			○ <sup>3</sup>	○	-	○	○			○	3/12 or 3/4.5/-7.5	92		
RB5P0020M2		○(Common terminal)		○	-			○			3/5	70/57 <sup>*5</sup>		
RB5P0050M2		○(Common terminal)		○	-			○		○		95/80 <sup>*5</sup>		
RB5P0060M2	○		○		NTSC/PAL			○		○	3/5/13	120		P-QFP048-1010
RB5P006AM2	○		○		NTSC/PAL			○		○				
RB5P0070M <sup>*1</sup>	○		○	○	NTSC/PAL				○	○	3/7	330		P-QFP072-1010
RB5P0090M	○		○ <sup>3</sup>		NTSC/PAL (automatic identification)			○		○	5/13	250	P-QFP048-1010	
LRS5751 <sup>*2</sup>	○		○		NTSC/PAL			○			3.3/5/7.5	197	P-LQFP100-1414	
LRS5752 <sup>*2</sup>	○		○ <sup>3</sup>		NTSC/PAL (automatic identification)			○		○	3.3/5/13	257		
★IR3Y63M	○	○	○ <sup>4</sup>	○ (Built-in)	NTSC/PAL/SECAM			○		○	5	300		

\*1 For digital signal input panels

\*2 Built-in timing generator

\*3 Two inputs

\*4 Digital RGB input is also available.

\*5 At analog input for RGB



### ●Power Supply ICs for TFT-LCDs

Model No.	Application/Function	Oscillation frequency (kHz)	Supply voltage (V)	Package
IR3M16U	For small TFT-LCD panels, charge pump system DC-DC converter (15.3 V, 5.1 V, -10.2 V)	100	2.6 to 3.6	P-HQFN020-0404
IR3M30M/U	For small/medium TFT-LCD panels, PWM switching system DC-DC converter (Output voltage (3ch) : External setting)	70 to 1 000	2.7 to 5.5	P-QFP048-0707/ P-VQFN036-0505
IR3M58M/U		70 to 500	4.5 to 28	

### ●Gray-scale ICs for TFT-LCDs

Model No.	Panel type	Function	No.of output circuits	Output current (mA) MAX.	Common output current (mA) MAX.	Supply voltage (V)	Package
IR3E2015	<ul style="list-style-type: none"> <li>• Small panels</li> <li>• Line inversion drive</li> </ul>	$\gamma$ correction, gray-scale voltage generator for LCD drivers, built-in dividing resistors	10	$\pm 1$	$\pm 1$	4.5 to 5.5	P-MFP018
IR3E2045			5			4.6 to 5.5	
IR3E3XX*							
IR3E11P1	<ul style="list-style-type: none"> <li>• Large panels</li> <li>• Up to 20-inch panels</li> <li>• SXGA/UXGA</li> <li>• Dot inversion drive</li> </ul>	$\gamma$ correction, gray-scale voltage generator for LCD drivers	10	$\pm 15$	$\pm 150$	7 to 14	P-QFP048-0707
IR3E11A1			7 to 15				
IR3E11M1			7 to 14				
IR3E12M1			7 to 15				
IR3E13N/U			<ul style="list-style-type: none"> <li>• Medium/large panels</li> <li>• Dot inversion drive</li> </ul>			6	

\* SHARP can offer semi-custom-made gray-scale ICs in accordance with the characteristics of LCD panels.

## Special-function LSIs

Model No.	Function	Features	Supply voltage (V)	Package
LR35501/Y	Home & amusement processor	<ul style="list-style-type: none"> <li>• Capable of moving picture play/record, thanks to real-time image compression and extension technology</li> <li>• Real images, backgrounds and sprites can be superimposed</li> <li>• Built-in sprite processor</li> <li>• Built-in color object detector</li> <li>• Built-in Bluetooth interface</li> <li>• Built-in sound generator (ADPCM/PSG)</li> <li>• Built-in CMOS camera module interface</li> <li>• Built-in video encoder : NTSC/PAL compatible signal output</li> <li>• Analog RGB signal output</li> <li>• CPU : Z80 compatible</li> <li>• PIO, UART, SIO, MMU, NAND flash memory I/F, ADC, etc.</li> </ul>	Core : 1.8 ± 0.18 I/O : 3.3 ± 0.3	P-QFP128-1420/ TFBGA160-1212
★LR38886	Image detection engine	<ul style="list-style-type: none"> <li>• High-speed image processing : 960 MOPS (MAX.)</li> <li>• Built-in camera interface : 8-bit digital input (UYVY etc.), Can be connected to a camera directly, up to 4-million pixel camera</li> <li>• Built-in SDRAM interface : 512 Mbits (MAX.)</li> <li>• Universal I/O : 32 bits (MAX.)</li> <li>• Serial interface (SPI)</li> <li>• Bus interface (Bus Master/Slave)</li> <li>• Built-in PLL</li> <li>• Low power consumption : 250 mW (at 15 fps/VGA)</li> </ul>	Core : 1.8 (TYP.) I/O : 3.3 (TYP.)	P-LQFP176-2424
LR38875	RSDS transmitter	<ul style="list-style-type: none"> <li>• RSDS™*1 spec. V095 compliant</li> <li>• Low EMI*2 generation</li> <li>• Low current consumption : 50 mA (MAX. at 85 MHz)</li> <li>• High noise rejection</li> <li>• Data rate : 50 to 180 Mbps (CLK : at 25 to 90 MHz)</li> <li>• Clock delay timing of RSDS™*1 output can be controlled by external register</li> <li>• RSDS™*1 swing output voltage can be controlled by external load resistor</li> </ul>	3.3 ± 0.3	P-TQFP100-1414
LR38888	H. 264 decoding signal processor	<ul style="list-style-type: none"> <li>• Built-in video (H. 264) and audio (MP3/AAC/AAC + SBR) decoding functions</li> <li>• Low current consumption : 125 mA (at 1.3 V)</li> <li>• Fast play</li> <li>• Built-in memory (DRAM)</li> <li>• Input signal : MPEG2-TS</li> <li>• Image size : QVGA</li> <li>• Frame rate : 15 frames/s</li> <li>• Output signal format : Image UYVY/RGB for video, I<sup>2</sup>S for audio</li> <li>• Output interface : CPU bus, camera interface</li> </ul>	Core : 1.3 (TYP.) I/O : 1.8 (TYP.)	TFBGA208-1010
LR388B3	Video processing LSI for IrSimple	<ul style="list-style-type: none"> <li>• IrSimple protocol compliant fast data transfer at 4 Mbps</li> <li>• Built-in JPEG decoder</li> <li>• SDTV and HDTV video outputs</li> <li>• Easy operability, like TV remote controller</li> </ul>	Core : 1.2 (TYP.) I/O : 3.3 (TYP.)	TFBGA180-1313
LR388B6	Front-end LSI for IrSimple, IrDA, and IR remote controller	<ul style="list-style-type: none"> <li>• Simple function LSI for IrSimple, IrDA, and IR remote controller</li> <li>• Built-in 4 160-byte buffer</li> <li>• System proposal with SHARP front-end module</li> </ul>	Core : 1.8 (TYP.) I/O : 3.3 (TYP.)	TFBGA056-0808
LR38669A	DSP for 1 300-k to 10 000-kpixel-class CCDs	<ul style="list-style-type: none"> <li>• Built-in CCD signal processing circuit, ARM core, JPEG (hardware), memory controller, video encoder (NTSC/PAL), analog output for RGB, USB line driver</li> <li>• Supports CompactFlash™/SmartMedia™/SD memory card interfaces</li> <li>• Capable of using a mobile SDRAM</li> <li>• Supports of LCD digital interfaces</li> <li>• Support for CCDs with movie function</li> </ul>	Core : 1.2 (TYP.) I/O : 3.3 (TYP.)	TFBGA260-1313
LR388733	USB On-The-Go controller	<ul style="list-style-type: none"> <li>• USB2.0 supplemental standard OTG1.0 compliant</li> <li>• Connectable to a product whose data transfer speed 12 Mbps and 1.5 Mbps</li> <li>• Built-in 2-ch USB line driver (2-port root HUB function)</li> <li>• Asynchronous SRAM-compatible interface</li> <li>• Supports 4 transfer modes (control, bulk, interrupt and isochronous)</li> </ul>	Core : 3.3 (TYP.) I/O (USB) : 5 (TYP.)	P-QFP072-1010

\*1 RSDS™ : Reduced Swing Differential Signaling

\*2 EMI : Electro-Magnetic Interference

## ARM RISC Core ASSPs for Mobile Equipment



Model No.	Core CPU	Configuration	Operating frequency (MHz) MAX.	Supply voltage (V)	Power consumption (mW) MAX.	Package	Remarks
LH79532A/Y	ARM7TDMI	Cache memory (4 Kbytes) + UART + PIT + RTC + PWM + INTC + PIO + WDT + RPC + Color LCDC + DMAC + SDRAMC + PLL	50	Core : 2.35 to 2.75 I/O : 3.0 to 3.6	325 (at 50 MHz)	P-LQFP176-2424/ TFBGA180-1212	<ul style="list-style-type: none"> <li>ASSP for color and B/W LCDs</li> <li>LCDC : Supports TFT/CSTN/STN, single/dual scanning, SVGA [800 x 600 pixels] (MAX.)</li> </ul>
LH79533A	ARM7TDMI	UART + PIT + RTC + PWM + INTC + PIO + WDT + RPC + Color LCDC + DMAC + SDRAMC + PLL + SRAM (16 Kbytes)	50	Core : 1.62 to 1.98 I/O : 3.0 to 3.6	200 (at 50 MHz)	P-LQFP144-2020	<ul style="list-style-type: none"> <li>ASSP for color and B/W LCDs</li> <li>LCDC : Supports CSTN/STN, VGA [640 x 480 pixels] (MAX.)</li> </ul>

## Startup Kit for ARM Embedded Linux™\* (LH0E776)

The LH0E776 is a startup kit which facilitates the evaluation and debugging of the ARM RISC core ASSP, LH79532A and ARM embedded Linux™. It incorporates the LH79532A as a CPU, memories (including a flash memory and SDRAMs) and communication ports (including Ethernet and RS-232C), as well as a JTAG port for debugging. SHARP is also able to provide an embedded Linux™ source.

### Features

#### Simple operability

Simply applying power enables evaluation of Linux™ and LH79532A.

#### Compact board

A7 size

#### Mounting devices

CPU: LH79532A (ARM7TDMI core)

Flash memory: 4 Mbytes (2 Mwords x 16 bits)

SDRAM: 32 Mbytes (8 Mwords x 32 bits)

Ethernet communication port: 1 ch

RS-232C communication port: 2 ch

JTAG connector

\* Joint development with AXE Inc.

### Board Configuration

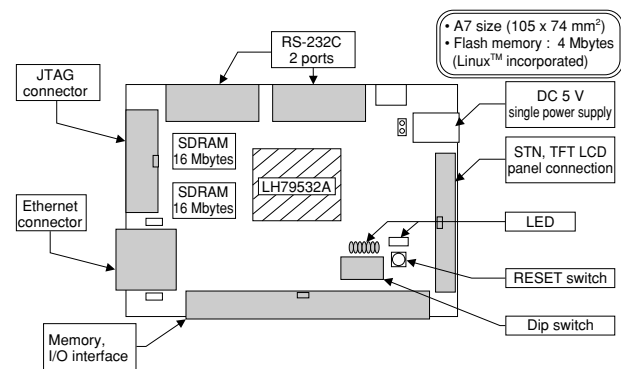

## Development Environment for ARM Microprocessors

In order to ensure the functionality of a system LSI based on a RISC processor and speedy development of the products, an advanced software development environment, a real-time OS and middleware are required.

The required development environment and tools, such as software, real-time OS and middleware can be obtained by customers from third party vendors.

### Software Environment

RealView v2.0	ARM Ltd.
MULTI-2000 IDE	Green Hills Software Inc.

### Emulator

RealView, Multi-ICE	ARM Ltd.
MAJIC, JEENI	Embedded Performance Inc.
advicePLUS	Yokogawa Digital Computer Corporation

### Real Time OS

μITRON 4.0	eSOL Corporation, ACCESS Corporation, Elmic Systems Inc.
Linux™, Embedded Linux™	Lineo Inc., Red Hat Inc., Montavista Software Inc., AXE Inc., ELT Inc.

### Middleware

TCP/IP, PPP, IPv6	ACCESS Corporation, eSOL Corporation
Graphics, File system	Elmic Systems Inc., AXE Inc.





## ARM Universal Microcontroller

Model No.	Core CPU	Configuration	Operating frequency (MHz) MAX.	Supply voltage (V)	Power consumption (mW) Typical	Power consumption (mW) MAX.	Package	Remarks
LH75400	ARM7TDMI	SRAM (32 Kbytes) + LCDC + CAN + 10-bit ADC + UART + Timer + RTC + PMC + WDT + DMAC	84	Core : 1.7 to 1.98 I/O : 3.0 to 3.6	149 (At 84 MHz)	209 (At 84 MHz)	144LQFP	<ul style="list-style-type: none"> <li>• ASSP for B/W LCDs</li> <li>• LCDC : Supports STN, XGA [1 024 x 768 pixels] (MAX.)</li> <li>• CAN-Ver 2.0B</li> </ul>
LH75401	ARM7TDMI		84	Core : 1.7 to 1.98 I/O : 3.0 to 3.6	149 (At 84 MHz)	209 (At 84 MHz)	144LQFP	<ul style="list-style-type: none"> <li>• ASSP for color and B/W LCDs</li> <li>• LCDC : Supports XGA [1 024 x 768 pixels] (MAX.), 4 K colors (MAX.)</li> <li>• CAN-Ver 2.0B</li> </ul>
LH75410	ARM7TDMI	SRAM (32 Kbytes) + LCDC + 10-bit ADC + UART + DMAC + Timer + RTC + PMC + WDT	84	Core : 1.7 to 1.98 I/O : 3.0 to 3.6	149 (At 84 MHz)	209 (At 84 MHz)	144LQFP	<ul style="list-style-type: none"> <li>• ASSP for B/W LCDs</li> <li>• LCDC : Supports STN, XGA [1 024 x 768 pixels] (MAX.)</li> </ul>
LH75411	ARM7TDMI		84	Core : 1.7 to 1.98 I/O : 3.0 to 3.6	149 (At 84 MHz)	209 (At 84 MHz)	144LQFP	<ul style="list-style-type: none"> <li>• ASSP for color and B/W LCDs</li> <li>• LCDC : Supports XGA [1 024 x 768 pixels] (MAX.), 4 K colors (MAX.)</li> </ul>
LH79520	ARM720T	Cache memory (8 Kbytes) + MMU + SRAM (32 Kbytes) + LCDC + DMAC + UART + Timer + RTC + PWM + PMC + WDT	77.4	Core : 1.62 to 1.98 I/O : 3.0 to 3.6	92 (At 77.4 MHz)	128 (At 77.4 MHz)	176LQFP	<ul style="list-style-type: none"> <li>• ASSP for color and B/W LCDs</li> <li>• LCDC : Supports SVGA [800 x 600 pixels] (MAX.), 64 K colors</li> </ul>
LH79524	ARM720T	Cache memory (8 Kbytes) + MMU + SRAM (16 Kbytes) + LCDC + USB + Ethernet MAC + DMAC + 10-bit ADC + UART + Timer + RTC + PWM + PMC + WDT	76.2	Core : 1.7 to 1.9 I/O : 3.0 to 3.6	181 (At 76.2 MHz)	247 (At 76.2 MHz)	208CABGA	<ul style="list-style-type: none"> <li>• ASSP for color and B/W LCDs</li> <li>• LCDC : Supports SVGA [800 x 600 pixels] (MAX.), 4 K colors (LH79525)/ 64 K colors (LH79524)</li> <li>• USB 2.0 (Device, Full speed)</li> <li>• Ethernet MAC</li> </ul>
LH79525	ARM720T		76.2	Core : 1.7 to 1.9 I/O : 3.0 to 3.6	181 (At 76.2 MHz)	247 (At 76.2 MHz)	176LQFP	
LH7A400	ARM922T	ICache memory (8 Kbytes) + DCache memory (8 Kbytes) + MMU + SRAM (80 Kbytes) + LCDC + RTC + DMAC + USB + UART + Timer + SmartCard + MMC + WDT + PMC	200 250	<At 200 MHz> Core : 1.71 to 1.89 I/O : 3.0 to 3.6 <At 250 MHz> Core : 2.0 to 2.2 I/O : 3.0 to 3.6	247 (At 200 MHz)	417 (At 200 MHz)	256PBGA 256CABGA	<ul style="list-style-type: none"> <li>• ASSP for color multimedia and portable applications.</li> <li>• LCDC : Supports XGA [1 024 x 768 pixels] (MAX.), 64 K colors</li> <li>• USB 2.0 (Device, Full speed)</li> </ul>
LH7A404	ARM922T	ICache memory (8 Kbytes) + DCache memory (8 Kbytes) + MMU + SRAM (80 Kbytes) + LCDC + RTC + DMAC + USB (Device/Host) + UART + Timer + SmartCard + MMC + WDT + PMC + 10-bit ADC	200 266	<At 200 MHz> Core : 1.7 to 1.98 I/O : 3.0 to 3.6 <At 266 MHz> Core : 2.0 to 2.2 I/O : 3.0 to 3.6	287 (At 200 MHz)	565 (At 200 MHz)	324CABGA	<ul style="list-style-type: none"> <li>• ASSP for color multimedia and portable applications.</li> <li>• LCDC : Supports XGA [1 024 x 768 pixels] (MAX.), 64 K colors</li> <li>• USB 2.0 (Device, Full speed)</li> <li>• USB 2.0 (Host, Full speed)</li> </ul>

### Sales Contact

#### SHARP MICROELECTRONICS OF THE AMERICAS (SMA)

**North American Head Office**  
 Address : 5700 NW Pacific Rim Boulevard, Camas, Washington 98607  
 Phone : (1) 360-834-2500  
 Fax : (1) 360-834-8903  
<http://www.sharpmcu.com>

## ■ Development Environment for ARM Microprocessors

### ● Compilers / Assemblers

ARM Developer Suite, ADS v1.2	ARM Ltd.
ARM RealView Developer Suite	ARM Ltd.
MULTI IDE	Green Hills Software Inc.
EWARM	IAR Systems Inc.
GCC	GNU

### ● JTAG Debuggers

Multi-ICE	ARM Ltd.
Slingshot, Probe	Green Hills Software Inc.
BDI 2000	Abatron Inc.
Vitra, Genia, Opella, PathFinder	Ashling Microsystems Ltd.
JTAGjet-ARM	Signum Systems Corporation
TRACE32 In-Circuit Debugger	Lauterbach Inc.
EMUL-ARM	Nohau a DBA of Knowit LLC
MAJIC-ICE	Embedded Performance Inc.

### ● Evaluation Boards / Single Board Computers

Zoom Starter Kits, Integrated	Logic Product Development Inc.
Developers Kit, Card Engines	
Single Board Computers	Revely Microsystems
Single Board Computers	Cogent Computer Systems Inc.
Evaluation Boards	Yokogawa Digital Computer Corporation

### ● RTOS / OS / BSP

Windows CE .NET	Microsoft Corporation
Windows CE .NET 4.2 BSP	BSQUARE Corporation
Windows CE .NET 5.0 BSP, Linux	Logic Product Development Inc.
Windows CE 5.0 BSP	Sharp Microelectronics of the Americas
Linux 2.4 BSP	Metrowerks V2.4
Linux 2.6 BSP	Sharp Microelectronics of the Americas
ThreadX	Express Logic Inc.
Nucleus+	Accelerated Technologies Inc.
VxWorks	Wind River Systems Inc.

### ● Design Services

Full service, Mechanical, Industrial, Electrical, Systems & Software, PCB Design & Layout, FPGA	Logic Product Development Inc.
Full service, Mechanical, Industrial, Electrical, Systems & Software, PCB Design & Layout, FPGA	Wind River Systems Inc.

The IPs contribute to shorter development time, effective use of existing software and improvement in reliability. SHARP is promoting a comprehensive range of IPs to provide support for top-down design using logic synthesis.

## ■ CPU Cores

IP	Macro	Function	Data type	
			Hard	Soft
ARM	ARM7TDMI	32-bit RISC ARM7TDMI CPU Core (16-bit Ins. mode supported)	○	○
	ARM720T	ARM7TDMI + MMU + 8-Kbyte Cache	○	
	ARM922T	ARM9TDMI + MMU + 8-Kbyte I-cache + 8-Kbyte D-cache	○	
	ARM946E-S	ARM9E + PU + I-cache (configurable) + D-cache (configurable) + TCM (configurable)		○
	ARM926EJ-S	ARM9E + MMU + I-cache (configurable) + D-cache (configurable) + TCM (configurable) + Java		○

## ■ Peripherals

IP	Macro	Function	Data type	
			Hard	Soft
Bus Interface				
PCMCIA	PCMCIA1	PCMCIA PC card interface		○
	82365SL	PCMCIA card interface controller		○
IEEE1284	1284	IEEE 1284 host parallel port		○
I2C	I2C	I <sup>2</sup> C bus interface		○
FDD-cntl	FDC78	High performance PC compatible floppy disk controller system (82078SL)		○
	765A78	Extended features floppy disk controller core for FM and MFM formats		○
Microcontroller & Microprocessor				
8-bit-cntl	8051	High performance industry compatible 8-bit microcontroller with 2 timers		○
Microprocessor Peripheral				
SDRAMC		Synchronous DRAM Controller		○
DMA	8237A	General purpose programmable 4-channel DMA controller		○
LCDC		Color LCD Controller (TFT, HR-TFT, CSTN, STN, DMTN)		○
PIT	8254	Extended feature 3-channel Programmable Interval Timer (PIT)		○
RTC	146818	Ultra-low-power real time clock with up to 114 bytes of RAM		○
PIC	8259A	8-channel cascadable Programmable Interrupt Controller (PIC)		○
PPI	8255	General purpose Programmable Peripheral Interface (PPI)		○
INTC		Interrupt Controller		○
Serial Communication				
USB-OTG		Universal Serial Bus On The Go Controller Full Speed (12 MHz)/ Low Speed (1.5 MHz)/High Speed (480 MHz)		○
USART	8251A	Universal Synchronous/Asynchronous Receiver/Transmitter (USART)		○
SSP		Synchronous Serial Port		○
SCC	85C30	SCC 2-channel Serial Communications Controller with FIFOs		○
UART	16550A	Universal Asynchronous Receiver/Transmitter (UART) with FIFO		○
	6402	Compact Universal Asynchronous Receiver/Transmitter (UART)		○

## ■ Analog Cells

IP	Macro	Function	Data type	
			Hard	Soft
ADC	High Speed ADC	8-bit AD (80 MHz), 10-bit AD (80 MHz), 6-bit AD (80 MHz)	○	
	Voice ADC	12-bit AD/14-bit AD (8 to 32 kHz)	○	
	Audio ADC	20-bit AD (44.1 kHz)	○	
DAC	High Speed DAC	8-bit DA/9-bit DA (30 MHz)	○	
	Voice DAC	10-bit DA (8 to 32 kHz)	○	
	Audio DAC	20-bit DA (44.1 kHz)	○	

## ■ Analog PLL (Phase Locked Loop)

IP	Macro	Function	Data type	
			Hard	Soft
PLL	PLL	Fout : 100 to 200 MHz	○	
		Fout : 200 to 400 MHz	○	
		Fout : 400 to 800 MHz	○	
		Fin : 32 kHz, Fout : 33 to 134 MHz	○	

## ■ Others

IP	Macro	Function	Data type	
			Hard	Soft
LVDS	LVDS Receiver	Input signal : 7-bit 3 ch (6 bits for RGB), 85 MHz (MAX.)	○	
		Input signal : 7-bit 4 ch (8 bits for RGB), 85 MHz (MAX.)	○	
RSDS	RSDS Transmitter	Input signal : 8 bits for RGB, 90 MHz (MAX.)	○	

Contact a SHARP sales office about applicable series. A use-fee and license-fee are required for use of the above IPs.



## Smart Cards/LSI Modules for Smart Cards

Type		Communication standards	Protocol	Transmission speed (kbps) MAX.	Nonvolatile memory capacity	Cycling capability	CPU	Security system
SJCard 211	Contact	ISO/IEC7816	T = 1	19.2	1 Mbyte (Flash memory)	100 000 times	16 bits	RSA, DES, T-DES, etc. high-speed cryptographic authentication with built-in coprocessor, hardware-based random number generator
	Contactless	ISO/IEC14443 Type B	ISO/IEC14443-4	424				
★JCOP*	Contact	ISO/IEC7816	T = 0, 1	76.8	1 Mbyte (Flash memory)	100 000 times	16 bits	(Under development)
	Contactless	ISO/IEC14443 Type B	ISO/IEC14443-4	424				
(Under development)	Contact	ISO/IEC7816	T = 0, 1	76.8	1 Mbyte (Flash memory)	100 000 times	32-bit MIPS	(Under development)
	Contactless	ISO/IEC14443 Type B	ISO/IEC14443-4	424				



**SJ card211**

- Java Card™ 2.1.1 compliance
- Capable of developing applications using Java language



**★JCOP\* card**

- Java Card™ 2.2 compliance
- GP (Global Platform) 2.1.1 compliance
- EMV 2000 compliance
- With built-in USIM interface
- Capable of developing applications using Java language



**★32-bit MIPS card**

- With built-in 32-bit MIPS on CPU
- Security upgrades thanks to secure controller, MIPS32™ 4Ksd™

\*JCOP : JCOP means IBM's Java Card Open Platform, which was developed by IBM Corporation as an embedded Operating System (OS) for smart cards which conforms to the standards of Java and Global Platform. This platform ensures the security of applications working on various mobile terminals, such as a USB key and a smart card suitable for multiple applications.

## ■ Reader/Writer for Smart Cards

Type	Model No.	Communication standard	Host interface	Transmission speed between smart card and RW (kpbs)	Smart card operation method	Outline dimensions W x H x D (mm)	Mass (g)	Power supply
Contact type	RW4040	ISO/IEC7816 (T = 0, 1)	USB1.1 (Included driver soft)	9.6 to 153.6	Manual insertion/ Manual ejection	70.4 x 14.1 x 60.5	Approx. 65	DC 5 V (USB connector)
	LR550R03	ISO/IEC7816 (T = 0, 1)	PC card interface Type II	10.8 to 344.1		54 x 5 x 85.6	Approx. 30	DC 5 V (PC card connector)



Contact type reader/writer (RW4040)  
 • High-speed data communication  
 • Conforms to PC/SC standard  
 • USB interface



Contact type reader/writer (LR550R03)  
 • High-speed data communication  
 • PC card interface Type II

## ■ SDK (Software Development Kit) for Smart Cards

SDK type	Contents
For SJCard 211	Development kit CD for SJCard SJCard simulator Contact type reader/writer (1 set)



## Highly Functional Flash Memories

### ● Boot Block Type 3 V Page Mode Flash Memories: LH28FXXXBF Series

Capacity (bit)	Bit configuration	Erasable block size		Operating temp. (°C)	Model No.	Remarks
32 M	x 16	4 Kwords x 8, 32 Kwords x 63	Top boot	0 to 70	LH28F320BF-PTTL	<ul style="list-style-type: none"> <li>Built-in dual work function</li> <li>Built-in OTP function [4 words (factory area) + 4 words (user area)]</li> </ul>
				-40 to 85	LH28F320BFH-PTTL	
			Bottom boot	0 to 70	LH28F320BF-PBTL	
				-40 to 85	LH28F320BFH-PBTL	
64 M	x 16	4 Kwords x 8, 32 Kwords x 127	Top boot	0 to 70	LH28F640BF-PTTL	
				-40 to 85	LH28F640BFH-PTTL	
			Bottom boot	0 to 70	LH28F640BF-PBTL	
				-40 to 85	LH28F640BFH-PBTL	
128 M	x 16	4 Kwords x 8, 32 Kwords x 255	Top boot	0 to 70	LH28F128BF-PTTL	
				-40 to 85	LH28F128BFH-PTTL	
			Bottom boot	0 to 70	LH28F128BF-PBTL	
				-40 to 85	LH28F128BFH-PBTL	

## Standard Flash Memories

### ● Boot Block Type 3 V Flash Memories: LH28FXXXBJ Series

Capacity (bit)	Bit configuration	Erasable block size		Operating temp. (°C)	Model No.	Remarks
8 M	x 8	8 Kbytes x 8, 64 Kbytes x 15	Top boot	0 to 70	LH28F008BJ-TTL	-
			Bottom boot	0 to 70	LH28F008BJ-BTL	
	x 8/ x 16	4 Kwords x 8, 32 Kwords x 15 (or 8 Kbytes x 8, 64 Kbytes x 15)	Top boot	0 to 70	LH28F800BJ-PTTL	<ul style="list-style-type: none"> <li>Built-in OTP function [4 words (factory area) + 3 963 words (user area)]</li> </ul>
				-40 to 85	LH28F800BJH-PTTL	
			Bottom boot	0 to 70	LH28F800BJ-PBTL	
				-40 to 85	LH28F800BJH-43	
16 M	x 8/ x 16	4 Kwords x 8, 32 Kwords x 31 (or 8 Kbytes x 8, 64 Kbytes x 31)	Top boot	-40 to 85	LH28F160BJH-PTTL	-
				-40 to 85	LH28F160BJH-PBTL	
			Bottom boot	-40 to 85	LH28F160BJH-PBTL	
				-40 to 85	LH28F160BJH-PBTL	

## FWH\* Interface System-Flash for PCs

Capacity (bit)	Bit configuration	Erasable block size		Operating temp. (°C)	Model No.
8 M	x 8	8 Kbytes x 8, 64 Kbytes x 15	Top boot	0 to 85	LHF00L04
			Symmetrical block	0 to 85	LHF00L21

\* FWH : Firmware Hub



## Fast-Reprogramming System-Flash for Digital Equipment

Capacity (bit)	Bit configuration	Erasable block size		Operating temp. (°C)	Model No.	Remarks
16 M	x 16	4 Kwords x 8 + 32 Kwords x 1, 64 Kwords x 15	Top boot	-40 to 85	LHF00L24	<ul style="list-style-type: none"> <li>• Fast-reprogramming (4-Kword blocks)</li> <li>• Built-in OTP function [4 words (factory area) + 4 words (user area)]</li> </ul>
			Bottom boot	-40 to 85	LHF00L25	
32 M	x 16	4 Kwords x 8 + 32 Kwords x 1, 64 Kwords x 31	Top boot	-40 to 85	LHF00L08	
				-40 to 85	LHF00L10	
				-40 to 85	LHF00L14	
			Bottom boot	-40 to 85	LHF00L09	
				-40 to 85	LHF00L11	
				-40 to 85	LHF00L15	

## System-Flash for Amusement Products

Capacity (bit)	Bit configuration	Erasable block size		Operating temp. (°C)	Model No.	Remarks
32 M	x 16	4 Kwords x 8 + 32 Kwords x 1, 64 Kwords x 31	Top boot	0 to 70	LHF00L34	• 44 SOP industry standard package
256 M	x 16	16 Kwords x 4, 64 Kwords x 255	Top boot	0 to 85	LH28F256BF-PTSL	• 70 SSOP industry standard package
512 M	x 16	(16 Kwords x 4, 64 Kwords x 255) x 2	Top/Top boot	0 to 70	LH28F512BF-PTSL	• Compact FBGA (CSP) package
				0 to 85	LH28F512BF-PTSL	• 70 SSOP industry standard package

## System-Flash for In-vehicle Use

Capacity (bit)	Bit configuration	Erasable block size		Operating temp. (°C)	Model No.	Remarks
32 M	x 16	4 Kwords x 8, 32 Kwords x 63	Top boot	-40 ~ 85	LH28F320BFH-PTTL	<ul style="list-style-type: none"> <li>• Employs copper frame</li> </ul>
64 M	x 16	4 Kwords x 8, 32 Kwords x 127	Top boot	-40 ~ 85	LH28F640BFH-PTTL	
			Bottom boot		LH28F640BFH-PBTL	
128 M	x 16	4 Kwords x 8, 32 Kwords x 255	Top boot	-40 ~ 85	LH28F128BFH-PTTL	
	x 16	(4 Kwords x 8, 32 Kwords x 127) x 2	Top/Bottom boot		LH28F128BFH-PWTL	
256 M	x 16	(4 Kwords x 8, 32 Kwords x 255) x 2	Top/Top boot	-40 ~ 85	★LH28F256BFH-PTTL	
	x 16	16 Kwords x 4, 64 Kwords x 255	Top boot	-40 ~ 85	LH28F256BFH-PTSL	<ul style="list-style-type: none"> <li>• Employs copper frame</li> <li>• 1.8 V core voltage/ 3 V I/O voltage</li> </ul>



## ■ Boot Block Type 3 V Page Mode Flash Memories: LH28FXXXBF Series

Supply voltage		32 M : $V_{CC} = 2.7$ to $3.6$ V, $V_{PP} = 2.7$ to $3.6$ V or $11.7$ to $12.3$ V 64 M : $V_{CC} = 2.7$ to $3.6$ V, $V_{PP} = 1.65$ to $3.6$ V or $9.0$ to $10.0$ V 128 M : $V_{CC} = 2.7$ to $3.6$ V, $V_{PP} = 2.7$ to $3.6$ V or $9.0$ to $10.0$ V								
Capacity (bit)	Bit configuration	Erasable block size		Model No.	Access time (ns) MAX.	Page mode access time (ns) MAX.	Read current (mA) MAX. $f = 5$ MHz (CMOS)	Standby current ( $\mu$ A) MAX. (CMOS)	Operating temp. ( $^{\circ}$ C)	Package
32 M	x 16	Parameter : 4 Kwords x 8 Main : 32 Kwords x 63	Top boot	LH28F320BFEB/B-PTTL70	70	25	25	20	0 to 70	P-TSOP048-1220 (Normal bend)/ TFBGA048-0808
				LH28F320BFHE/B-PTTL70					-40 to 85	
				LH28F320BFHG-PTTLZK	80	35			TFBGA048-0707	
			Bottom boot	LH28F320BFEB/B-PBTL70	70	25	25	20	0 to 70	P-TSOP048-1220 (Normal bend)/ TFBGA048-0808
				LH28F320BFHE/B-PBTL70					-40 to 85	
				LH28F320BFHG-PBTLZL	80	35			TFBGA048-0707	
64 M	x 16	Parameter : 4 Kwords x 8 Main : 32 Kwords x 127	Top boot	LH28F640BFEB-PTTLHDA	70	30	25	20	0 to 70	P-TSOP048-1220 (Normal bend) TFBGA060-0811
				LH28F640BFEB-PTTL70A						
				LH28F640BFHE-PTTLHFA					-40 to 85	
				LH28F640BFHB-PTTL70A						
			Bottom boot	LH28F640BFEB-PBTLHEA	70	30	25	20	0 to 70	P-TSOP048-1220 (Normal bend) TFBGA060-0811
				LH28F640BFEB-PBTL70A						
				LH28F640BFHE-PBTLHGA					-40 to 85	
				LH28F640BFHB-PBTL70A						
128 M	x 16	Parameter : 4 Kwords x 8 Main : 32 Kwords x 255	Top boot	LH28F128BFT/B-PTTL75A	75	25	35	40	0 to 70	P-TSOP056-1420 (Normal bend)/ LFBGA072-0811
				LH28F128BFT/B-PTTL75A					-40 to 85	
			Bottom boot	LH28F128BFT/B-PBTL75A	75	25	35	40	0 to 70	
				LH28F128BFT/B-PBTL75A					-40 to 85	

Contact a SHARP sales office for other packages and top boot/bottom boot models other than those listed above.

# STANDARD FLASH MEMORIES / SYSTEM-FLASH



## ■ Boot Block Type 3 V Flash Memories: LH28FXXXBJ Series

Supply voltage		$V_{CC} = 2.7$ to $3.6$ V, $V_{CCW} = 2.7$ to $3.6$ V or $11.7$ to $12.3$ V							
Capacity (bit)	Bit configuration	Erasable block size		Model No.	Access time (ns) MAX.	Read current (mA) MAX. f = 5 MHz (CMOS)	Standby current ( $\mu$ A) MAX. (CMOS)	Operating temp. ( $^{\circ}$ C)	Package
8 M	x 8	Boot : 8 Kbytes x 2 Parameter : 8 Kbytes x 6 Main : 64 Kbytes x 15	Top boot	LH28F008BJT-TTLZ2	100	25	15	0 to 70	P-TSOP040-1020 (Normal bend)
			Bottom boot	LH28F008BJT-BTLZ1	100	25	15	0 to 70	
	x 8/ x 16	Boot : 4 Kwords (8 Kbytes) x 2 Parameter : 4 Kwords (8 Kbytes) x 6 Main : 32 Kwords (64 Kbytes) x 15	Top boot	LH28F800BJE-PTTL90	90	25	15	0 to 70	P-TSOP048-1220 (Normal bend)
				LH28F800BJHE-PTTL90				-40 to 85	
			Bottom boot	LH28F800BJE-PBTL70	90	25	15	0 to 70	
				LH28F800BJE-PBTL90				-40 to 85	
x 8/ x 16	Boot : 4 Kwords (8 Kbytes) x 2 Parameter : 4 Kwords (8 Kbytes) x 6 Main : 32 Kwords (64 Kbytes) x 31	Top boot	LH28F160BJHE-PTTL70	70	25	15	-40 to 85	P-TSOP048-1220 (Normal bend)	
		Bottom boot	LH28F160BJHE-PBTL70	70	25	15	-40 to 85		

Contact a SHARP sales office for other packages and top boot/bottom boot models other than those listed above.

## ■ FWH\* Interface System-Flash for PCs

Supply voltage		$V_{CC} = 3.0$ to $3.6$ V							
Capacity (bit)	Bit configuration	Erasable block size		Model No.	Operating frequency (MHz)	Read current (mA) MAX. f = 33 MHz (CMOS)	Standby current ( $\mu$ A) MAX. (CMOS)	Operating temp. ( $^{\circ}$ C)	Package
8 M	x 8	Boot : 8 Kbytes x 8 Main : 64 Kbytes x 15	Top boot	LHF00L04	33	15	15	0 to 85	P-TSOP040-1020 (Normal bend)
			Symmetrical block	LHF00L21	33	15	15	0 to 85	P-TSOP032-0813 (Normal bend)

\* FWH : Firmware Hub

Contact a SHARP sales office for other packages and top boot/bottom boot models other than those listed above.

## ■ Fast-Reprogramming System-Flash for Digital Equipment

Supply voltage		$V_{CC} = 2.7$ to $3.6$ V, $V_{PP} = 11.7$ to $12.3$ V								
Capacity (bit)	Bit configuration	Erasable block size		Model No.	Access time (ns) MAX.	4-Kword reprogramming time (s)	Read current (mA) MAX. f = 5 MHz (CMOS)	Standby current ( $\mu$ A) MAX. (CMOS)	Operating temp. ( $^{\circ}$ C)	Package
16 M	x 16	Parameter : 4 Kwords x 8 + 32 Kwords x 1 Main : 64 Kwords x 15	Top boot	LHF00L24	70	0.31	17	10	-40 to 85	TFBGA048-0608
				LHF00L28					P-TSOP048-1220 (Normal bend)	
			Bottom boot	LHF00L25	70	0.31	17	10	-40 to 85	TFBGA048-0608
				LHF00L29					P-TSOP048-1220 (Normal bend)	
32 M	x 16	Parameter : 4 Kwords x 8 + 32 Kwords x 1 Main : 64 Kwords x 31	Top boot	LHF00L08	90	0.31	17	10	-40 to 85	TFBGA048-0608
				LHF00L10					TFBGA048-0707	
				LHF00L14					P-TSOP048-1220 (Normal bend)	
			Bottom boot	LHF00L09	90	0.31	17	10	-40 to 85	TFBGA048-0608
				LHF00L11					TFBGA048-0707	
				LHF00L15					P-TSOP048-1220 (Normal bend)	

Contact a SHARP sales office for other packages and top boot/bottom boot models other than those listed above.

Flash Memories/  
Combination Memories

## ■ System-Flash for Amusement Products

Supply voltage		32 M : $V_{CC} = 2.7$ to $3.6$ V    256 M/512 M : $V_{CC} = 1.7$ to $1.95$ V, $V_{CCQ} = 2.7$ to $3.6$ V, $V_{PP} = 0.9$ to $1.95$ V or $8.5$ to $9.5$ V									
Capacity (bit)	Bit configuration	Erasable block size		Model No.	Access time (ns) MAX.	Page mode access time (ns) MAX.	Read current (mA) MAX. f = 5 MHz (CMOS)	Standby current ( $\mu$ A) MAX. (CMOS)	Operating temp. ( $^{\circ}$ C)	Package	
32 M	x 16	Parameter : 4 Kwords x 8 + 32 Kwords x 1 Main : 64 Kwords x 31	Top boot	LHF00L34	90	–	17	10	0 to 70	P-SOP044-0600	
256 M	x 16	Parameter : 16 Kwords x 4 Main : 64 Kwords x 255	Top boot	LH28F256BFN-PTSLZ2	100	25	22	60	0 to 85	P-SSOP070-0500	
512 M	x 16	Parameter : 16 Kwords x 4 Main : 64 Kwords x 255	x 2 Top/ Top boot	LH28F512BFBD-PTSLZ4	85	25	22	120	0 to 70	LFBGA072-0811	
				LH28F512BFBD-PTSLZ2	90				0 to 70	LFBGA072-0811	
				LH28F512BFND-PTSLZ1	100				0 to 85	P-SSOP070-0500	

Contact a SHARP sales office for other packages and top boot/bottom boot models other than those listed above.

## ■ System-Flash for In-vehicle Use

Supply voltage		See notes below.									
Capacity (bit)	Bit configuration	Erasable block size		Model No.	Access time (ns) MAX.	Page mode access time (ns) MAX.	Read current (mA) MAX. f = 5 MHz (CMOS)	Standby current ( $\mu$ A) MAX. (CMOS)	Operating temp. ( $^{\circ}$ C)	Package	
32 M	x 16	Parameter : 4 Kwords x 8 Main : 32 Kwords x 63	Top boot	LH28F320BFHE-PTTLE0*1	70	25	25	20	–40 to 85	P-TSOP048-1220 (Normal bend)	
64 M	x 16	Parameter : 4 Kwords x 8 Main : 32 Kwords x 127	Top boot	LH28F640BFHE-PTTLH1A*2	70	30	25	20	–40 to 85	P-TSOP048-1220 (Normal bend)	
			Bottom boot	LH28F640BFHE-PBTLHK*2	70	30	25	20	–40 to 85		
128 M	x 16	Parameter : 4 Kwords x 8 Main : 32 Kwords x 255	Top boot	LH28F128BFHT-PTTLT1A*3	75	25	35	40	–40 to 85	P-TSOP056-1420 (Normal bend)	
			x 2 Top/ Bottom boot	LH28F128BFHED-PWTLT2*4	70	30	25	40	–40 to 85	P-TSOP048-1220 (Normal bend)	
256 M	x 16	Parameter : 4 Kwords x 8 Main : 32 Kwords x 255	x 2 Top/ Top boot	★LH28F256BFHTD-PTTLZ3*3	75	25	35	80	–40 to 85	P-TSOP056-1420 (Normal bend)	
			Top boot	LH28F256BFHT-PTSLZ6*5	100	25	22	60	–40 to 85		

\*1  $V_{CC} = 2.7$  to  $3.6$  V,  $V_{CCQ} = 2.7$  to  $3.6$  V,  $V_{PP} = 2.4$  to  $V_{CCQ} + 0.4$  V or  $11.7$  to  $12.3$  V

\*2  $V_{CC} = 2.7$  to  $3.6$  V,  $V_{CCQ} = 2.7$  to  $3.6$  V

\*3  $V_{CC} = 2.7$  to  $3.6$  V,  $V_{CCQ} = 2.7$  to  $3.6$  V,  $V_{PP} = 2.4$  to  $V_{CCQ} + 0.4$  V or  $9.0$  to  $10.0$  V

\*4  $V_{CC} = 2.7$  to  $3.6$  V,  $V_{CCQ} = 2.7$  to  $3.6$  V,  $V_{PP} = 1.65$  to  $3.6$  V or  $9.0$  to  $10.0$  V

\*5  $V_{CC} = 1.7$  to  $1.95$  V,  $V_{CCQ} = 2.7$  to  $3.6$  V,  $V_{PP} = 2.7$  to  $3.6$  V or  $8.5$  to  $9.5$  V

Contact a SHARP sales office for other packages and top boot/bottom boot models other than those listed above.



## ■ Boot Block Type Flash Memory + Pseudo SRAM

### ● 1.8 V models with 1.8 V I/O voltage

Model No.	Flash memory block configuration	Capacity (bit) [Bit configuration]		Access time (ns) MAX.						Supply voltage (V)			Package
		Flash memory	Pseudo SRAM	Flash memory			Pseudo SRAM			Flash memory core voltage	Pseudo SRAM core voltage	I/O voltage	
				Random mode	Page mode	Synchronous burst mode	Random mode	Page mode	Synchronous burst mode				
LRS1890A	Bottom boot	256 M [x 16]	64 M [x 16]	85	25	-	70	20	-	1.7 to 1.95	1.7 to 1.95	1.7 to 1.95	LFBGA072-0811
LRS18A6			128 M [x 16]							1.7 to 1.9	2.7 to 3.1	1.7 to 1.9	LFBGA072-0811
LRS1897	Bottom/Top boot	512 M [x 16]	128 M [x 16]	85	25	-	70	20	-	1.7 to 1.9	2.7 to 3.1	1.7 to 1.9	LFBGA072-0811
LRS18CC	Bottom/Top/Bottom boot	740 M [x 16]	256 M [x 16]	93	25	52 MHz	70	20	83 MHz	1.7 to 1.95	1.7 to 1.95	1.7 to 1.95	LFBGA088-0912

### ● 1.8 V models with 3 V I/O voltage

Model No.	Flash memory block configuration	Capacity (bit) [Bit configuration]		Access time (ns) MAX.						Supply voltage (V)			Package								
		Flash memory	Pseudo SRAM	Flash memory			Pseudo SRAM			Flash memory core voltage	Pseudo SRAM core voltage	I/O voltage									
				Random mode	Page mode	Synchronous burst mode	Random mode	Page mode	Synchronous burst mode												
LRS18BK	Top boot	128 M [x 16]	32 M [x 16]	85	25	54 MHz	65	20	-	1.7 to 1.95	2.7 to 3.1	2.7 to 3.1	LFBGA088-0811								
LRS18BL	Bottom boot												64 M [x 16]	-	LFBGA072-0811						
LRS18C8A														54 MHz	LFBGA088-0811						
LRS18BN			54 MHz			LFBGA088-0811															
LRS18AZ*	256 M [x 16]		64 M [x 16]			85							25	54 MHz	65	20	-	1.7 to 1.95	2.7 to 3.1	2.7 to 3.1	LFBGA088-0811
LRS18B0*																					-

\* This flash memory is divided into two banks, each including an enable signal.

### ● 3 V models with 3 V I/O voltage

Model No.	Flash memory block configuration	Capacity (bit) [Bit configuration]		Access time (ns) MAX.						Supply voltage (V)			Package																		
		Flash memory	Pseudo SRAM	Flash memory			Pseudo SRAM			Flash memory core voltage	Pseudo SRAM core voltage	I/O voltage																			
				Random mode	Page mode	Synchronous burst mode	Random mode	Page mode	Synchronous burst mode																						
LRS18BT	Bottom boot	32 M [x 16]	8 M [x 16]	85	-	-	85	-	-	2.7 to 3.1	2.7 to 3.1	2.7 to 3.1	LFBGA072-0811																		
LRS1871A	Top boot	64 M [x 16]	16 M [x 16]	85	35	-	85	-	-	2.7 to 3.3	2.7 to 3.1	2.7 to 3.1	LFBGA072-0811																		
LRS1872A	Bottom boot												LFBGA072-0811																		
LRS18BP	Top boot		32 M [x 16]										65	25	-	65	20	-	2.7 to 3.1	2.7 to 3.1	2.7 to 3.1	LFBGA088-0811									
LRS18BR	Bottom boot																					LFBGA088-0811									
LRS18831	Top boot																					70	35	-	60	-	-	2.7 to 3.1	2.7 to 3.1	2.7 to 3.1	LFBGA072-0811
LRS18841	Bottom boot																														LFBGA072-0811

\*The datasheet which is linked from model number, still shows the lead contained model except for several models.  
 If latest specification is necessary, please contact to SHARP sales representative.  
 The production of the leaded models had been terminated by the end of March 2005.



## Low Power-Loss Voltage Regulators

### TO-220 type

(Ta = 25°C)

Model No.	Features	Absolute maximum ratings				Electrical characteristics			Built-in functions						Package Package shape type <sup>*7</sup>										
		Output current I <sub>o</sub> (A)	Input voltage V <sub>in</sub> (V)	Power dissipation (W)		Output voltage V <sub>o</sub> <sup>*3</sup> (V) TYP.	Output voltage precision (%)	Dropout voltage V <sub>i.o</sub> <sup>*5</sup> (V)	Overheat protection	Overcurrent protection	ON/OFF control	Low dissipation current at OFF state	Variable output voltage	Lead forming available											
				Pd <sup>*1</sup>	Pd <sup>*2</sup>																				
PQxxRD08J00H series	ASO protection function	0.8	20	1.25	10	5, 9, 12	±3	0.5	○	○	○	○	○	○	○	○	TO-220	A							
PQ3RD083J00H						3.3												A							
PQ6RD083J00H						6.3												A							
PQxxRA11J00H series	Low dissipation current at OFF state (I <sub>qs</sub> : 1μA (MAX.))	1	35	1.5	15	5, 9, 12	±2.5	0.5	○	○	○	○	○	○	○	○	TO-220	B							
PQxxRD11J00H series						ASO protection function												20	1.4	5, 9, 12	±3	○	○	○	○
PQxxxRDA1SZH series	ASO protection function, low dissipation current at OFF state (I <sub>qs</sub> : 5μA (MAX.))	2	24	-	-	5, 8, 9, 12	±2.5	0.5	○	○	○	○	○	○	○	○	TO-220	A							
PQxxxRDA2SZH series						ASO protection function												20	-	-	3.3, 5, 9, 12	±2.5	○	○	○
PQ3RD13J000H	ASO protection function	1	10	1.4	15	3.3	±3	0.5	○	○	○	○	○	○	○	○	TO-220	A							
PQxxEF01SZH series						Minimum operating input voltage : 2.35 V (4 terminals)												2	1.4	15	1.5, 1.8, 2.5, 3.3	±2.5	○	○	○
PQxxEF02SZH series	General purpose	1	35	1.5	18	5, 9, 12	±2.5	0.5	○	○	○	○	○	○	○	○	TO-220	B							
PQxxRF11J00H series						ASO protection function												20	1.4	15	3.3	±3	○	○	○
PQxxRH11J00H series	General purpose	1.5	35	1.5	18	5, 9, 12	±2.5	0.5	○	○	○	○	○	○	○	○	TO-220	B							
PQ3RD23J000H						ASO protection function												2	35	1.5	18	5, 9, 12	±2.5	○	○
PQxxRD21J00H series	High output current	3.5	1.8	1.8	18	3.3	±2.5	0.5	○	○	○	○	○	○	○	○	TO-220	B							
PQxxRF21J00H series						General purpose												10	1.4	15	1.5 to 7	±2 <sup>*4</sup>	○	○	○
PQ3RF23J000H	Minimum operating input voltage : 2.35 V (4 terminals)	1	10	1.4	15	1.5 to 7	±2 <sup>*4</sup>	0.5	○	○	○	○	○	○	○	○	TO-220	A							
PQ3RF33J000H						High output current												2	1.4	15	1.5 to 7	±2 <sup>*4</sup>	○	○	○
PQ070XF01SZH	Minimum operating input voltage : 2.35 V (5 terminals)	1	10	1.4	15	1.5 to 7	±2 <sup>*4</sup>	0.5	○	○	○	○	○	○	○	○	TO-220	E							
PQ070VK02FZH						ASO protection function												2	1.4	15	1.5 to 7	±2 <sup>*4</sup>	○	○	○
PQ15RW08J00H	ASO protection function, minimum operating input voltage : 3.5 V	0.8	20	1.25	10	3.0 to 15	±2.5 <sup>*4</sup>	0.5	○	○	○	○	○	○	○	○	TO-220	A							
PQ15RW11J00H				1	1.4													15	○	○	○	○	○	A	
PQ15RW21J00H				2	1.4													15	○	○	○	○	○	A	
PQ150RWA2SZH	ASO protection function	0.5	24	-	-	3.0 to 20	±2.5 <sup>*4</sup>	0.5	○	○	○	○	○	○	○	TO-220	A								
PQ20RX05J00H	Variable output voltage, output ON/OFF control	1	35	1.5	18	1.5 to 15	±2 <sup>*4</sup>	0.5	○	○	△ <sup>*6</sup>	○	○	○	○	○	TO-220	C							
PQ20RX11J00H						ASO protection function												17	12.5	1.5 to 15	○	○	○	○	C
PQ150VB01FZH	Overheat shutdown circuit, minimum operating input voltage : 2.35 V (5 terminals)	2	17	12.5	1.5 to 15	1.5 to 15	±2 <sup>*4</sup>	0.5	○	○	○	○	○	○	○	○	TO-220	E							
PQ150VB02FZH						ASO protection function												17	12.5	1.5 to 15	○	○	○	○	E
PQ30RV11J00H	Variable output voltage	1	35	1.5	18	1.5 to 30	±2 <sup>*4</sup>	0.5	○	○	△ <sup>*6</sup>	○	○	○	○	○	TO-220	B							
PQ30RV21J00H						2												2	20	○	○	△ <sup>*6</sup>	○	○	B
PQ30RV31J00H						3												2	20	○	○	△ <sup>*6</sup>	○	○	B
PQ7RV4J0000H						4.6												10	1.8	18	1.5 to 7	○	○	△ <sup>*6</sup>	○

\*1 At self-cooling

\*2 With infinite heat sink attached

\*3 The xx/xxx in the model No. refer to the output voltage values of the model (e.g. 05/050 for 5 V, 12/120 for 12 V, 015 for 1.5 V).

\*4 Reference voltage accuracy

\*5 Current ratings are defined individually.

\*6 △ : Available by adding circuit

\*7 Refer to page 63





## ●High output current type [TO-220 high heat radiation type, TO-3P type]

(Ta = 25°C)

Model No.	Features	Absolute maximum ratings				Electrical characteristics			Built-in functions				Package
		Output current I <sub>o</sub> (A)	Input voltage V <sub>in</sub> (V)	Power dissipation (W)		Output voltage V <sub>o</sub> (V)	Output voltage precision (%)	Dropout voltage V <sub>i-o</sub> *4 (V)	Overheat protection	Overcurrent protection	ON/OFF control	Variable output voltage	
				Pd*1	Pd*2								
PQ5EV3J0000H	High output current, minimum operating input voltage : 2.35 V	3.5	7	1.6	45	1.5 to 5	±1*3	0.5	○	○	○	○	TO-220 (heat sink exposure)
PQ5EV5J0000H		5							○	○	○	○	
PQ5EV7J0000H		7.5							○	○	○	○	
PQ7DV5J0000H	High output current, minimum operating input voltage : 3 V	5	10	2.2	60	1.5 to 7	±2*3		○	○	○	○	TO-3P
PQ7DV10J0000H		10							○	○	○	○	

\*1 At self-cooling

\*2 With infinite heat sink attached

\*3 Reference voltage accuracy

\*4 Current ratings are defined individually.

## ●Low output current type [TO-92 type]

(Ta = 25°C)

Model No.	Features	Absolute maximum ratings			Electrical characteristics			Built-in functions		Package
		Output current I <sub>o</sub> (A)	Input voltage V <sub>in</sub> (V)	Power dissipation Pd*1 (W)	Output voltage V <sub>o</sub> (V) TYP.	Output voltage precision (%)	Dropout voltage V <sub>i-o</sub> (V)	Overheat protection	Overcurrent protection	
PQ033ES1MXPQ	Low output current type with general purpose TO-92 package (for auxiliary power supply)	0.15	16	0.52	3.3	±2	0.4 (I <sub>o</sub> = 150 mA)	○	○	TO-92
PQ050ES1MXPQ					5			○	○	
PQ033ES3MXPQ		0.3	9		3.3		0.7 (I <sub>o</sub> = 300 mA)	○	○	
PQ050ES3MXPQ					5			○	○	

\*1 At self-cooling

☆New product  
★Under development



## ■ Surface Mount Type Low Power-Loss Voltage Regulators

### ● SOT-23-5 type

(Ta = 25°C)

Model No.	Features	Absolute maximum ratings			Electrical characteristics				Built-in functions				Package
		Input voltage Vin (V)	Power dissipation Pd*1 (W)	Output current Io (A)	Output voltage Vo*2 (V) TYP.	Output voltage precision (%)	Dropout voltage Vi-o (V)	Overheat protection	Overcurrent protection	ON/OFF control	Low dissipation current at OFF state		
PQ1Uxx1M2ZPH series	Compact, low output current	16	0.35	0.18	1.8, 2.5, 2.8, 3.0, 3.3, 3.5, 5.0	± 2.0 (3.0 V output)	0.26 (Io = 60 mA)	○	○	○	○	SOT-23-5	
PQ1Xxx1M2ZPH series	Compact, ceramic capacitor compatible	9			*3	± 2.0		○	○	○	○		
☆PQ1XAx1M2ZPH series	Compact, ceramic capacitor compatible, high reliability				*4	± 2.0		○	○	○	○		

\*1 When mounted on a board

\*2 The xx in the model No. refer to the output voltage values of the model (e.g. 50 for 5.0 V, 18 for 1.8 V).

\*3 1.5, 1.8, 2.5, 2.6, 2.7, 2.8, 2.9, 3.0, 3.3, 3.5, 3.7, 4.0, 4.5, 5.0 \*4 1.5, 1.8, 2.5, 3.0, 3.3, 5.0

### ● SOT-23L type

(Ta = 25°C)

Model No.	Features	Absolute maximum ratings			Electrical characteristics				Built-in functions				Package
		Output current Io (A)	Input voltage Vin (V)	Power dissipation Pd*1 (W)	Output current Io (A)	Output voltage Vo*2 (V) TYP.	Output voltage precision (%)	Dropout voltage Vi-o (V)	Overheat protection	Overcurrent protection	ON/OFF control	Low dissipation current at OFF state	
PQ1RxxJ0000H series	Compact, surface mount type, low dissipation current at OFF state (Iqs : 0.1 μA (MAX.))	—	16	0.4	0.18	*3	± 2.7 (3.0 V output)	0.26 (Io = 60 mA)	○	○	○	○	SOT-23L
PQ1Kxx3M2ZPH series	Compact, surface mount type, high ripple rejection, output current of up to 300 mA	0.3	9		—	1.8, 2.5, 3.0, 3.3, 3.6, 5.0	± 2.0 (3.0 V output)	0.7 (Io = 300 mA)	○	○	○	○	
PQ1KAx3M2ZPH series	Compact, surface mount type, output current of up to 300 mA, ceramic capacitor compatible		15		—	1.5, 1.8, 2.5, 3.3, 5.0, 9.0	± 2.0 (3.0 V output)	0.7 (Io = 300 mA)	○	○	○	○	

\*1 When mounted on a board

\*2 The xx in the model No. refer to the output voltage values of the model (e.g. 25 for 2.5 V, 47 for 4.7 V, 50 for 5.0 V).

\*3 1.8, 2.0, 2.3, 2.5, 2.7, 2.8, 2.9, 3.0, 3.2, 3.3, 3.4, 3.5, 3.7, 3.8, 4.0, 4.2, 4.4, 4.7, 4.9, 5.0, 5.2

### ● SOT-89 type

(Ta = 25°C)

Model No.	Features	Absolute maximum ratings			Electrical characteristics			Built-in functions					Package
		Output current Io (A)	Input voltage Vin (V)	Power dissipation Pd*1 (W)	Output voltage Vo*2 (V) TYP.	Output voltage precision (%)	Dropout voltage Vi-o*3 (V)	Overheat protection	Overcurrent protection	ON/OFF control	Low dissipation current at OFF state	Variable output voltage	
PQ1Lxx3M2SPQ	Compact, high radiation package, low dissipation current at OFF state (Iqs : 1 μA (MAX.))	0.3	16	0.9	1.5, 1.8, 2.5, 3.0, 3.2, 3.3, 5.0	± 2.0 (3.0 V output)	0.7	○	○	○	○	SOT-89	
PQ1LAXx3MSPQ	Compact, high radiation package, low dissipation current at OFF state (Iqs : 1 μA (MAX.)), ceramic capacitor compatible		15		0.5	1.5, 1.8, 2.5, 3.3, 5.0, 9.0		± 2.0	○	○	○		○
☆PQ1LAXx5MSP series	Compact, high radiation package, ceramic capacitor compatible					1.5, 1.8, 2.5, 3.3, 5.0		± 2.0	○	○	○		○
PQ1LAX95MSPQ	Ceramic capacitor compatible, variable output voltage	0.5	9	0.9	1.5 to 9.0	± 2.0*6	0.7	○	○	○	○	SOT-89	
PQ1Mxx5M2SPQ	Compact, high output current, ceramic capacitor compatible				1.8, 2.5, 3.3, 5.0	± 2.0 (5.0 V output)		○	○	○	○		
PQ1MX55M2SPQ	Ceramic capacitor compatible, variable output voltage				1.3 to 5.0	± 2.0*6		○	○	○	○		
PQ1Nxx3MxSPQ	Reset signal output function*4, ceramic capacitor compatible	0.35	6	0.9	2.5, 3.3	± 2.0	—	○	○	○	○	SOT-89	
★PQ1MGxx8MSPQ	Compact, ceramic capacitor compatible	0.8			0.8, 1.0, 1.2	± 2.0		○	○	○	○		
★PQ1MGX38MSPQ	Compact, ceramic capacitor compatible, variable output type				0.5 to 3.5	± 2.0		○	○	○	○		
PQ2Lxxx2MSPQ	Compact, high radiation package, 2 outputs	0.25/ch	9	0.9	*5	—	0.4	○	○	○	○	SOT-89	

\*1 When mounted on a board

\*2 The xx in the model No. refer to the output voltage values of the model (e.g. 25 for 2.5 V, 50 for 5.0 V). [Except PQ2Lxxx2MSPQ]

\*3 Current ratings are defined individually.

\*4 Reset detection voltage : 4.2 V, 3.8 V

\*5 Output voltage combination : 3.3/3.3 V, 3.3/2.5 V, 3.3/1.8 V, 3.3/1.5 V, 2.5/1.8 V, 2.5/1.5 V

\*6 Reference voltage accuracy



## ● SC-63 type

(Ta = 25°C)

Model No.	Features	Absolute maximum ratings			Electrical characteristics			Built-in functions						Package Package shape type <sup>*6</sup>		
		Output current I <sub>o</sub> (A)		Input voltage V <sub>in</sub> (V)	Power dissipation P <sub>d</sub> <sup>*1</sup> (W)	Output voltage V <sub>o</sub> <sup>*2</sup> (V) TYP.	Output voltage precision (%)	Dropout voltage V <sub>1.0</sub> <sup>*3</sup> (V)	Overheat protection	Overcurrent protection	ON/OFF control	Low dissipation current at OFF state	Variable output voltage		Taped package	
		0.5	1													1.5
PQ07VR5MAPH series	Reset signal generation function (input voltage drop detection)	○			10	1.5 to 7	±2.0 <sup>*3</sup>		○	○			○	○	F	
PQ3DZ53J000H	ASO protection function, low dissipation current at OFF state (I <sub>qs</sub> : 5 μA (MAX.))	○				3.3			○	○	○	○		○	F	
PQ3DZ13J000H				○					○	○	○	○		○	F	
PQxxDZ51J00H series				○						○	○	○	○		○	F
PQxxDZ11J00H series				○			5, 9, 12	±3.0		○	○	○	○		○	F
PQxxxDNA1ZPH series		Ceramic capacitor compatible, ASO protection function, low dissipation current at OFF state (I <sub>qs</sub> : 5 μA (MAX.)), solder dip compatible lead shape			○		3.3, 5, 8, 9, 12	0.5		○	○	○	○		○	G
PQxxxDZ01ZPH series	Low dissipation current at OFF state (I <sub>qs</sub> : 5 μA (MAX.))			○	9, 10	3.3, 5			○	○	○	○		○	F	
PQxxxEZ5MZPH series	Minimum operating input voltage : 2.35 V	○				1.5, 1.8, 2.5, 3.0, 3.3	±2.5 <sup>*4</sup>		○	○	○	○		○	F	
PQxxxEZ01ZPH series				○					○	○	○	○		○	F	
PQxxxEZ01ZPH series	Minimum operating input voltage : 2.35 V, solder dip compatible lead shape			○					○	○	○	○		○	G	
PQxxxEZ01ZPH series	Minimum operating input voltage : 2.35 V, ceramic capacitor compatible, solder dip compatible lead shape			○	10	1.5, 1.8, 2.5, 3.3	±2.5		○	○	○	○		○	G	
PQxxxEZ1HZPH series				○					○	○	○	○		○	G	
PQxxxEZ02ZPH series	Minimum operating input voltage : 2.35 V			○		1.5, 1.8, 2.5, 3.0, 3.3	±2.5 <sup>*4</sup>	1.0	○	○	○	○		○	F	
PQxxxEZ02ZPH series				○		1.5, 1.8, 2.5	±2.5 <sup>*4</sup>	0.5	○	○	○	○		○	F	
PQxxxFZ5MZPH series	Minimum operating input voltage : 1.7 V (Dual power supply type)	○				1.0, 1.2	±30 mV		○	○	○	○		○	F	
PQxxxFZ01ZPH series				○					○	○	○	○		○	F	
PQxxGN01ZPH series	Minimum operating input voltage : 1.7 V (Dual power supply type), ceramic capacitor compatible, solder dip compatible lead shape			○	5.5	0.8, 1.0, 1.2	—	—	○	○				○	G	
PQxxGN1HZPH series				○					○	○				○	G	
PQ070XZ5MZPH series	Minimum operating input voltage : 2.35 V	○							○	○	○	○		○	F	
PQ070XZ01ZPH				○					○	○	○	○		○	F	
PQ070XN01ZPH	Minimum operating input voltage : 2.35 V, solder dip compatible lead shape			○				0.5	○	○	○	○		○	G	
PQ070XNA1ZPH	Minimum operating input voltage : 2.35 V, ceramic capacitor compatible, solder dip compatible lead shape			○	10	1.5 to 7			○	○	○	○		○	G	
PQ070XNAHZPH				○					○	○	○	○		○	G	
PQ070XZ1HZPH	Minimum operating input voltage : 2.35 V			○				1.0	○	○	○	○		○	F	
PQ070XZ02ZPH				○				±2.0 <sup>*3</sup>	0.5	○	○	○	○		○	F
PQ015YZ5MZPH	Reference voltage (V <sub>ref</sub> ) : 1.0 V, minimum operating input voltage : 1.7 V (Dual power supply type)	○				1.0 to 1.5	±3.0 <sup>*3</sup>		○	○			○	○	F	
PQ015YZ01ZPH				○					○	○			○	○	F	
PQ035ZN01ZPH	Reference voltage (V <sub>ref</sub> ) : 0.6 V, minimum operating input voltage : 1.7 V (Dual power supply type), ceramic capacitor compatible, solder dip compatible lead shape			○	5.5	0.8 to 3.5	±30 mV	—	○	○			○	○	G	
PQ035ZN1HZPH				○					○	○			○	○	G	
PQ20VZ51J00H	Minimum operating input voltage : 4.5 V	○				1.5 to 20	±2.0 <sup>*3</sup>		○	○	○	○		○	F	
PQ20VZ11J00H				○					○	○	○	○		○	F	
PQ20WZ51J00H	Minimum operating input voltage : 3.5 V, ASO protection function, low dissipation current at OFF state (I <sub>qs</sub> : 5 μA (MAX.))	○			24	3.0 to 20	±2.5 <sup>*3</sup>	0.5	○	○	○	○		○	F	
PQ20WZ11J00H				○					○	○	○	○		○	F	

\*1 With infinite heat sink attached

\*2 The xx/xxx in the model No. refer to the output voltage values of the model (e.g. 033 for 3.3 V, 05/050 for 5 V, 12/120 for 12 V).

\*3 Reference voltage accuracy \*4 The value is defined as ± 50 mV in some models. \*5 Current ratings are defined individually. \*6 Refer to page 63

☆New product  
★Under development



### ●SC-63 type (cont'd)

(Ta = 25°C)

Model No.	Features	Absolute maximum ratings			Electrical characteristics			Built-in functions						Package Package shape type <sup>*6</sup>		
		Output current I <sub>o</sub> (A)			Input voltage V <sub>in</sub> (V)	Power dissipation Pd <sup>*1</sup> (W)	Output voltage V <sub>o</sub> <sup>*2</sup> (V) TYP.	Output voltage precision (%)	Dropout voltage V <sub>i-o</sub> <sup>*3</sup> (V)	Overheat protection	Overcurrent protection	ON/OFF control	Low dissipation current at OFF state		Variable output voltage	Taped package
		0.5	1	1.5												
PQ200WNA1ZPH	Minimum operating input voltage : 3.5 V, ASO protection function, low dissipation current at OFF state (I <sub>qs</sub> : 5 μA (MAX.)) ceramic capacitor compatible, solder dip compatible lead shape	○			24	8	3.0 to 20			○	○	○	○	○	SC-63	G
☆PQ200WN3MZPH	Minimum operating input voltage : 3.5 V, low dissipation current at OFF state (I <sub>qs</sub> : 5 μA (MAX.)), ceramic capacitor compatible, current limit : 800 mA	○ (2 A)			24	6.8	5.0 to 20	±2.5 <sup>*3</sup>	0.5	○	○	○	○	○		

\*1 With infinite heat sink attached

\*2 The xx/xxx in the model No. refer to the output voltage values of the model (e.g. 033 for 3.3 V, 05/050 for 5 V, 12/120 for 12 V).

\*3 Reference voltage accuracy \*4 The value is defined as ± 50 mV in some models. \*5 Current ratings are defined individually. \*6 Refer to page 63

### ●SOT-263 type

(Ta = 25°C)

Model No.	Features	Absolute maximum ratings			Electrical characteristics			Built-in functions						Package
		Output current I <sub>o</sub> (A)	Input voltage V <sub>in</sub> (V)	Power dissipation Pd <sup>*1</sup> (W)	Output voltage V <sub>o</sub> <sup>*2</sup> (V) TYP.	Output voltage precision (%)	Dropout voltage V <sub>i-o</sub> <sup>*4</sup> (V)	Overheat protection	Overcurrent protection	ON/OFF control	Low dissipation current at OFF state	Variable output voltage	Taped package	
PQxxY053ZPH	High output current (minimum operating input voltage : 2.35 V)	5.0	7	35	1.5, 2.5, 3.3	1.0	0.5	○	○	○	○	○	○	TO-263
PQ05VY053ZPH					1.5 to 5	1.0 <sup>*3</sup>		○	○	○	○	○		
PQxxY3H3ZPH		3.5			1.5, 2.5, 3.3	1.0		○	○	○	○	○		
PQ05VY3H3ZPH					1.5 to 5	1.0 <sup>*3</sup>		○	○	○	○	○		
★PQxxEHS2ZPH	2 A output (minimum operating input voltage : 2.35 V), built-in soft start function	2.0	10	35	1.2, 1.5, 1.8, 2.5, 3.3	±2.5	0.5	○	○	○	○	○	TO-263	
PQxxEH02ZPH	2 A output (minimum operating input voltage : 2.35 V)				1.5, 1.8, 2.5	±2.0 <sup>*3</sup>		○	○	○	○			
PQ070XH02ZPH		1.0			1.5 to 7	±2.0 <sup>*3</sup>		○	○	○	○			
PQxxEH01ZPH	1 A output (minimum operating input voltage : 2.35 V)				1.5, 1.8, 2.5	±2.5		○	○	○	○			
PQ070XH01ZPH			1.5 to 7	±2.0 <sup>*3</sup>	○	○	○	○						

\*1 With infinite heat sink attached

\*2 The xxx in the model No. refer to the output voltage values of the model (e.g. 015 for 1.5 V, 025 for 2.5 V, 033 for 3.3 V).

\*3 Reference voltage accuracy

\*4 Current ratings are defined individually.

### ●SOP-8 type

(Ta = 25°C)

Model No.	Features	Absolute maximum ratings			Electrical characteristics		Built-in functions			Package
		Output current I <sub>o</sub> (A)	Input voltage V <sub>in</sub> (V)	Power dissipation Pd <sup>*</sup> (W)	Output voltage V <sub>o</sub> (V) TYP.	Output voltage precision (mV)	Overheat protection	Overcurrent protection	Taped package	
★PQ1DX095MZPQ	Built-in sink source function (For DDR II memory)	±0.8	6	0.6	V <sub>DD</sub> × 1/2 (V <sub>DDQ</sub> : 1.5 V (MIN.))	—	○	○	○	SOP-8
PQ1DX125MZPQ	Built-in sink source function (For DDR memory)				V <sub>DD</sub> × 1/2 (V <sub>DDQ</sub> : 2.3 V (MIN.))	± 35	○	○	○	

\* When mounted on a board



## ■ Surface Mount Type Chopper Regulators (DC-DC Converters)

(Ta = 25°C)

Model No.	Features	No. of output circuits	Output type			Built-in SW Tr	Input voltage range Vin (V)	Switch current Isw (A)	Output voltage Vo (V)	Oscillation frequency fo (Hz) TYP.	Package
			Step down	Step up	Inversion						
PQ6CU11X1APQ	<ul style="list-style-type: none"> <li>High voltage CMOS output : 30 V (MAX.)</li> <li>White LED driver for back light</li> <li>Output ON/OFF control function</li> <li>Overvoltage/overcurrent protection circuits</li> <li>Soft start function</li> </ul>			○			up to 5.5	—		SOT-23-6	
PQ6CB11X1AP	<ul style="list-style-type: none"> <li>High voltage CMOS output : 30 V (MAX.)</li> <li>White LED driver for back light</li> <li>(Capable of driving up to 4 LEDs in series connection)</li> <li>Output ON/OFF control function</li> <li>Overvoltage/overcurrent protection circuits</li> <li>Soft start function</li> </ul>			○			2.7 to 5.5	0.25*1	1.2 M	USB-6	
PQ6CB11X1CP	<ul style="list-style-type: none"> <li>High voltage CMOS output : 30 V (MAX.)</li> <li>White LED driver for back light</li> <li>(Capable of driving up to 6 LEDs in series connection)</li> <li>Output ON/OFF control function</li> <li>Overvoltage/overcurrent protection circuits</li> <li>Soft start function</li> </ul>			○			up to 30				
PQ6CU12X2APQ	<ul style="list-style-type: none"> <li>High switching voltage : 40 V (MAX.)</li> <li>For tuner power supply</li> <li>Output ON/OFF control function</li> </ul>			○			3.0 to 5.5		up to 36	300 k to 800 k*7	SOT-23-6W
★PQ7L2010BP	<ul style="list-style-type: none"> <li>Possible to correspond also to operation in the minute lighting mode</li> <li>High frequency PWM control for brightness adjustment</li> <li>Output ON/OFF control function</li> </ul>			○			2.7 to 5.5	up to 30	2 M	USB-10	
PQ1CZ38M2ZPH series	<ul style="list-style-type: none"> <li>PWM chopper regulator (high oscillation frequency)</li> <li>Output ON/OFF control function</li> <li>Overcurrent/overheat protection circuits</li> <li>For light load</li> </ul>			○				0.8*1	VREF*2 to 35*5	300 k	SC-63
PQ1CZ21H2ZPH	<ul style="list-style-type: none"> <li>PWM chopper regulator</li> <li>Output ON/OFF control function</li> <li>Overcurrent/overheat protection circuits</li> <li>Low dissipation current at OFF state (Standby current &lt;I<sub>SD</sub>&gt; : 1 μA (MAX.))</li> </ul>			○			up to 40	1.5*1	(step-down type)/ -VREF*2 to -30*5 (inverting type)	100 k	
PQ1CZ41H2ZPH	<ul style="list-style-type: none"> <li>PWM chopper regulator (high oscillation frequency)</li> <li>Output ON/OFF control function</li> <li>Overcurrent/overheat protection circuits</li> </ul>			○						300 k	
PQ1CX12H2ZPQ	<ul style="list-style-type: none"> <li>Bootstrap system for high efficiency (Efficiency 90% (TYP.))</li> <li>Low dissipation current</li> </ul>			○				2.5*1	VREF*3 to 24*5 (step-down type)	150 k	SOP-8
PQ1CX22H2ZPQ	<ul style="list-style-type: none"> <li>Bootstrap system for high efficiency (Efficiency 90% (TYP.))</li> <li>Low dissipation current</li> <li>Low voltage output : 1.2 V (MIN.)</li> </ul>			○			up to 33				
★PQ1CX41H2ZPQ	<ul style="list-style-type: none"> <li>Bootstrap system for high efficiency (Efficiency 91% (TYP.))</li> <li>Low voltage output : 0.8 V (MIN.)</li> <li>Ceramic capacitor compatible</li> </ul>			○			up to 28	1.5*1	VREF*4 to 24*5 (step-down type)	400 k	
PQ1CY1032ZPH	<ul style="list-style-type: none"> <li>PWM chopper regulator</li> <li>Output ON/OFF control function</li> <li>Overheat protection/overcurrent shutdown circuits</li> <li>High output current type</li> </ul>			○				3.5*1	VREF*2 to 35*5 (step-down type)/ -VREF*2 to -30*5 (inverting type)	150 k	TO-263
PQ1CYxx3HZPH series PQ1CYxx3LZPH series	<ul style="list-style-type: none"> <li>PWM chopper regulator</li> <li>Fixed output voltage : 3.3 V or 5 V</li> <li>Output ON/OFF control function</li> <li>Overheat protection circuit</li> </ul>			○			up to 40				
IR3M18N	<ul style="list-style-type: none"> <li>Soft start function</li> <li>Undervoltage protection circuit</li> <li>Timer latch short-circuit protection circuit</li> <li>Standby function</li> </ul>			○			2.2 to 6.0		(Determined by external Tr)	100 k to 1 M*7	P-SSOP008-0150
IR3M19N	<ul style="list-style-type: none"> <li>High transient load characteristics from built-in current control circuit</li> <li>Soft start function</li> <li>Overcurrent/overvoltage/undervoltage protection circuits</li> <li>Internal reference voltage accuracy (±1%)</li> </ul>			○	External		4.5 to 22	(Determined by external Tr)	1.24 to input voltage	220 k	
★IR3M56N	<ul style="list-style-type: none"> <li>High efficiency synchronous rectified step-down converter</li> <li>Current mode control</li> <li>Soft start function</li> <li>Overcurrent/overvoltage/undervoltage/overheat protection circuits</li> </ul>			○			4.5 to 36		0.8 to 6.3	200 k/300 k/ 400 k/500 k/ external sync.	

\*1 Peak current (absolute maximum ratings) \*2 VREF nearly equal to 1.26 V (TYP.) \*3 VREF nearly equal to 1 V (TYP.) \*4 VREF nearly equal to 0.8 V (TYP.)  
 \*5 Output voltage variable range \*6 The xx in the model No. refer to the output voltage values of the model (e.g. 33 for 3.3 V, 50 for 5.0 V). \*7 Selectable oscillation frequency range

Power Devices/  
Analog ICs



★Under development



## ■ Surface Mount Type Chopper Regulators (DC-DC Converters) (cont'd)

(Ta = 25°C)

Model No.	Features	No. of output circuits	Output type			Built-in SW Tr	Input voltage range Vin (V)	Switch current Isw (A)	Output voltage Vo (V)	Oscillation frequency fo (Hz) TYP.	Package
			Step down	Step up	Inversion						
IR3M17U	<ul style="list-style-type: none"> <li>Standby function (output ON/OFF control function for each channel)</li> <li>Soft start function</li> <li>Undervoltage protection circuit</li> </ul>	2	○	○		External	2.2 to 6.5	(Determined by external Tr)	100 k to 500 k <sup>*3</sup> /external sync.	P-HQFN020-0404	
★IR3M57N	<ul style="list-style-type: none"> <li>High efficiency two channel synchronous rectified step-down converter</li> <li>Current mode control</li> <li>Soft start function</li> <li>Overcurrent/overvoltage/undervoltage/overheat protection circuits</li> </ul>		○	○	○		4.5 to 36				(Determined by external Tr)
IR3M30M/U	<ul style="list-style-type: none"> <li>ON/OFF sequence setting</li> <li>Timer latch short-circuit protection circuit</li> <li>Soft start function</li> <li>Overcurrent/undervoltage/overheat protection circuits</li> </ul>	3	○	○		External	2.7 to 5.5	1 <sup>*2</sup> (when using internal Tr)	External setting	70 k to 1M <sup>*3</sup>	P-QFP048-0707/ P-VQFN036-0505
IR3M58M/U	<ul style="list-style-type: none"> <li>ON/OFF sequence setting without external control</li> <li>Timer latch phase fault protection circuit</li> <li>Soft start function</li> <li>Overcurrent/undervoltage/overheat protection circuits</li> </ul>		○	○	○						

\*1 Built-in SW Tr can be used in step-up mode ; external SW Tr is required in step-down or inverting mode.

\*2 Constant current (MAX.)

\*3 Selectable oscillation frequency range

## ■ Chopper Regulators (DC-DC Converters)

### ●TO-220 type

(Ta = 25°C)

Model No.	Features	Absolute maximum ratings			Electrical characteristics			Package	
		Switch current Isw (A)	Input voltage Vin (V)	Power dissipation Pd <sup>*1</sup> (W)	Output voltage Vo <sup>*2</sup> (V)	Oscillation frequency fo (kHz) TYP.	Output saturation voltage Vsat (V) TYP.		Outline shape type <sup>*5</sup>
PQ1CG38M2FZH	<ul style="list-style-type: none"> <li>PWM chopper regulator (high oscillation frequency)</li> <li>Built-in overcurrent/overheat protection circuits</li> <li>Output ON/OFF control function</li> <li>For light load</li> </ul>	0.8 <sup>*3</sup>	40	14	VREF <sup>*4</sup> to 35 (step-down type)/ -VREF <sup>*4</sup> to -30 (inverting type)	300	0.9	TO-220	E
PQ1CG38M2RZH									D
PQ1CG21H2FZH	<ul style="list-style-type: none"> <li>PWM chopper regulator</li> <li>Built-in overcurrent/overheat protection circuits</li> <li>Output ON/OFF control function</li> </ul>	1.5 <sup>*3</sup>	40	14	VREF <sup>*4</sup> to 35 (step-down type)/ -VREF <sup>*4</sup> to -30 (inverting type)	100	1.0		E
PQ1CG21H2RZH									D
PQ1CG41H2FZH	<ul style="list-style-type: none"> <li>PWM chopper regulator (high oscillation frequency)</li> <li>Built-in overcurrent/overheat protection circuits</li> <li>Output ON/OFF control function</li> </ul>	1.5 <sup>*3</sup>	40	14	VREF <sup>*4</sup> to 35 (step-down type)/ -VREF <sup>*4</sup> to -30 (inverting type)	300	0.9		E
PQ1CG41H2RZH									D
PQ1CG2032FZH	<ul style="list-style-type: none"> <li>PWM chopper regulator</li> <li>Built-in overcurrent/overheat protection circuits</li> <li>Output ON/OFF control function</li> </ul>	3.5 <sup>*3</sup>	40	14	VREF <sup>*4</sup> to 35 (step-down type)/ -VREF <sup>*4</sup> to -30 (inverting type)	70	1.4		E
PQ1CG2032RZH									D
PQ1CG3032FZH	<ul style="list-style-type: none"> <li>PWM chopper regulator (high oscillation frequency)</li> <li>Built-in overcurrent/overheat protection circuits</li> <li>Output ON/OFF control function</li> </ul>	3.5 <sup>*3</sup>	40	14	VREF <sup>*4</sup> to 35 (step-down type)/ -VREF <sup>*4</sup> to -30 (inverting type)	150	1.4		E
PQ1CG3032RZH									D
PQ2CF1J0000H	<ul style="list-style-type: none"> <li>PWM chopper regulator</li> <li>Built-in overcurrent/overheat protection circuits</li> </ul>	2.5 <sup>*3</sup>	35	15	4.5 to 35 (step-up type)	50	0.6	E	

\*1 With infinite heat sink attached

\*2 Output voltage variable range

\*3 Peak current

\*4 VREF nearly equal to 1.26 V (TYP.)

\*5 Refer to page 63

■ Power Supply ICs for CCDs/CCD Camera Modules

Model No.	No. of output circuits	Input voltage range (V)	Output voltage (V)	System	Switching frequency (Hz)	SW Tr	Switching current (mA) [Built-in SW Tr]	Drive capacity (pF) [External SW Tr]	Package	
IR3M52Y7	5	2.7 to 5.5	15	Step-up type PWM + REG	1 M	Built-in	20 (DC)	–	41WL-CSP*2	
			–8	Inverting type PWM		External	–	1 000		
			2.5 to 3.3	REG	–	–	–	100 (DC)		–
			2.5 to 3.3	REG				100 (DC)		–
			1.8/1.2	REG				100 (DC)		–
★IR3M61U*1/63U	4	4.5 to 10	15	Charge pump	200 k	–	1.2 (DC)	–	P-VQFN032-0505	
			–8	Negative charge pump			2.5 (DC)	–		
			3.3	Step-down type PWM + REG	1 M	Built-in	120 (DC)	–		
			1.8	Step-down type PWM + REG			50 (DC)	–		
IR3M49U6	4	2.7 to 5.5	15	Step-up type PWM + REG	1 M	Built-in	600 (DC)	–	P-VQFN036-0505 (*3)	
			External setting	Step-up, step-down, step-up/down type PWM			–	1 000		
				Inverting type PWM	–	1 000				
			REG	–	–	170 (DC)	–			
IR3M55U*1/59U	3	4.5 to 16	15/12	Charge pump	200 k	–	10/20 (DC)	–	P-VQFN032-0505	
			–8/–5	Negative charge pump			2/5 (DC)	–		
			3.3	Step-down type PWM + REG	1 M	Built-in	150 (DC)	–		
IR3M48U6	3	2.7 to 3.2	15	Charge pump + REG	300 k	–	6 (DC)	–	P-VQFN032-0505 (*3)	
			–8	Negative charge pump + REG			7 (DC)	–		
			1.8	REG	–	–	50 (DC)	–		

\*1 For in-vehicle use

\*2 3.97 mm x 3.97 mm x 0.82 mm (TYP.)

\*3 Contact a SHARP sales office regarding a wafer-level CSP.

■ Power Supply ICs for TFT-LCDs

Model No.	No. of output circuits	Input voltage range (V)	Output voltage (V)	System	Switching frequency (Hz)	SW Tr	Switching current (mA) [Built-in SW Tr]	Drive capacity (pF) [External SW Tr]	Package	
IR3M58M/U	3	4.5 to 28	External setting	Step-up (20 V (MAX.) ) / step-down type PWM	70 k to 500 k	Built-in (Step-up type)	400	1 000	P-QFP048-0707 / P-VQFN036-0505	
				Step-down type PWM		External	–			
				Step-up, step-down type PWM		External	–			
IR3M30M/U	3	2.7 to 5.5	External setting	Step-up, step-down, step-up/down type PWM	70 k to 1 M	Built-in (Step-up type)	1 000	–	P-VQFN036-0505	
				Step-up, step-down, step-up/down, inverting type PWM		Built-in (Step-up type)	1 000	–		
				Step-up, step-down, step-up/down, inverting type PWM		External	–	1 000		
IR3M16U	3	2.6 to 3.6	External setting	15.3	100 k	–	0.1 (DC)	–	P-HQFN020-0404	
				5.1		Charge pump + REG	–	5 (DC)		–
				–10.2		Negative charge pump	–	0.1 (DC)		–



■ LED Drivers

● Built-in step up circuit

Model No.	Function	Features	No. of output circuits	Number of LEDs	Booster method	Built-in constant current circuit	Built-in SW Tr	Input voltage range (V)	Output current (mA) MAX.	Oscillation frequency fo (Hz) TYP.	Package
PQ6CU11X1APQ	White LED driver for back light (For small panel)	<ul style="list-style-type: none"> <li>High voltage CMOS output : 30 V (MAX.)</li> <li>Output ON/OFF control function</li> <li>Overcurrent/overvoltage protection circuits</li> <li>Soft start function</li> </ul>	1	3 (Series connection)	PWM	*1	○	Up to 5.5	250*2	1.2 M	SOT-23-6
PQ6CB11X1AP				4 (Series connection)		*1	○	2.7 to 5.5			USB-6
PQ6CB11X1CP				6 (Series connection)		*1	○				
★PQ7L2010BP				4 (Series connection)		*1	○	2.0 M			USB-10
IR2E46U6*/Y6	RGB LED driver for picture lights and illuminations	<ul style="list-style-type: none"> <li>I<sup>2</sup>C bus control</li> <li>Illumination mode (64 levels/ch)</li> <li>Picture light mode (32 levels/ch)</li> <li>Brightness adjustment</li> <li>Standby function/soft start function</li> <li>Overcurrent/undervoltage/overheat protection circuits</li> </ul>	3	3		○	○	2.7 to 4.5	155/ch*3 (in picture light mode)	1.2 M	33WL-CSP*5
IR2E47U6	White LED driver for back light (for small panels)	<ul style="list-style-type: none"> <li>Independent current control for two systems (4 outputs and 2 outputs)</li> <li>LED non-connected judging function</li> <li>Brightness adjustment</li> <li>Undervoltage/overheat protection circuits</li> </ul>	6	4 + 2	Charge pump	○	—	2.7 to 5.5	20/ch*3	1 M	P-HQFN024-0404
IR2E49U	White LED driver for back light (for medium panels)	<ul style="list-style-type: none"> <li>Built-in 150 mA driver for each channel</li> <li>Step-up DC-DC output short-circuit protection function</li> <li>Current driver output open detection</li> <li>Capable of external brightness adjustment using PWM input signal</li> <li>Overcurrent/overvoltage/undervoltage/overheat protection circuits</li> </ul>	5	35	PWM	○	External	6 to 28	150/ch*3 (600 mA in total)	100 k to 1 M*4	P-VQFN036-0606
IR2E50Y6	LED driver for back light and call alert display LED driver (auto brightness adjustment)	<ul style="list-style-type: none"> <li>Capable of direct connection of ambient light sensor</li> <li>Brightness adjustment by ambient illuminance feedback (16-step ambient illuminance/128-level illuminance) (for main LCDs)</li> <li>Non-external coil thanks to charge pump drive</li> <li>Capable of driving 4 main-LEDs, 2 sub-LEDs, and 3 call alert LEDs with a single device.</li> <li>I<sup>2</sup>C interface</li> <li>Standby function/power on reset function/soft start function</li> </ul>	9	4 + 2 + 3	Charge pump	○	—	3.0 to 4.5 (for drive)/ 2.3 to 3.2 (for control)	25/ch*3	500 k	33WL-CSP*5

\*1 LED constant current value can be set by external resistors.

\*2 Peak switch current

\*3 Constant current (MAX.)

\*4 Selectable oscillation frequency range

\*5 3.57 mm x 3.57 mm x 0.82 mm (TYP.)

● External power supply for LEDs

Model No.	Function	Features	Supply voltage (V)	Package
IR2D20U	24-dot LED panel driver with constant-current sink outputs	<ul style="list-style-type: none"> <li>Output current (constant current sink output) : 30 mA (MAX.) (setup by external resistor)</li> <li>Gradation function (clock cycle setting or external synchronization)</li> <li>Independent current control for three systems (for RGB LED)</li> <li>LED drive voltage : 15 V</li> <li>Rated output voltage : 20 V (MAX.)</li> <li>f<sub>CLK</sub> : 20 MHz (MAX.)/16.6 MHz (MAX.) (at cascade connection)</li> </ul>	4.5 to 5.5	P-HQFN052-0707
IR2D07N1	16-dot LED panel driver with constant current sink outputs	<ul style="list-style-type: none"> <li>Output current (constant-current sink output) : 60 mA (MAX.) (setup by external resistor)</li> <li>Rated output voltage : 7 V (MAX.)</li> <li>f<sub>CLK</sub> : 20 MHz (MAX.)/16.6 MHz (MAX.) (at cascade connection)</li> </ul>	3.0 to 5.5	P-SSOP040-0300

**Video Interface ICs for TFT-LCDs**

Model No.	Input signal				Color decode	LCD panel				Serial data control	Supply voltage (V) TYP.	Power consumption (mW) TYP.	Package
	Composite video	Y/color difference	Analog RGB	OSD (Digital)		± power source	+ power source	Low voltage source	Digital input				
IR3Y18A1	○				NTSC/PAL	○	○				4.5/12 or 4.5/-7.5	130	P-QFP048-0707
IR3Y26A2/A6			○ <sup>3</sup>		-			○			5/7.5	140	P-QFP048-1010/ P-QFP048-0707
IR3Y29A1/B1	○		○		NTSC/PAL			○				190	P-QFP048-0707
IR3Y31M1	○		○		NTSC/PAL	○	○			4.5/12 or 4.5/-7.5	160		
IR3Y34M1		○	○	○	-		○			3/12	88		
IR3Y37A1		○(Common terminal)		○	-			○		3/6.5	106/88 <sup>*5</sup>		
RB5P0010M2			○ <sup>3</sup>	○	-	○	○			3/12 or 3/4.5/-7.5	92		
RB5P0020M2		○(Common terminal)		○	-			○		3/5	70/57 <sup>*5</sup>		
RB5P0050M2		○(Common terminal)		○	-			○	○		95/80 <sup>*5</sup>		
RB5P0060M2	○		○		NTSC/PAL			○	○	3/5/13	120	P-QFP048-1010	
RB5P006AM2	○		○		NTSC/PAL			○	○				
RB5P0070M <sup>*1</sup>	○		○	○	NTSC/PAL				○	3/7	330	P-QFP072-1010	
RB5P0090M	○		○ <sup>3</sup>		NTSC/PAL (automatic identification)			○	○	5/13	250	P-QFP048-1010	
LRS5751 <sup>*2</sup>	○		○		NTSC/PAL			○		3.3/5/7.5	197	P-LQFP100-1414	
LRS5752 <sup>*2</sup>	○		○ <sup>3</sup>		NTSC/PAL (automatic identification)			○	○	3.3/5/13	257		
★IR3Y63M	○	○	○ <sup>4</sup>	○ (Built-in)	NTSC/PAL/SECAM			○	○	5	300		

\*1 For digital signal input panels

\*2 Built-in timing generator

\*3 Two inputs

\*4 Digital RGB input is also available.

\*5 At analog input for RGB

## ■ Power Amplifiers for Wireless LAN

Model No.	Application	Operating frequency (GHz)	Supply voltage (V) TYP.	Output power (dBm) TYP.	Supply current (mA) TYP.	Gain (dB) TYP.	Detection function	Matching circuit	Package	
IRM046U7	For 2.4 GHz wireless LAN (IEEE 802.11b/g)	2.4 to 2.5	3.3	18 (at EVM 3%)	105	30	○	–	P-HQFN024-0404	
	For 5 GHz wireless LAN (IEEE 802.11a)	4.9 to 5.9		18 (at EVM 2%)	140	25	○	–		
IRM046U8	For 2.4 GHz wireless LAN (IEEE 802.11b/g)	2.4 to 2.5		18 (at EVM 3%)	105	30	○	–		P-HQFN016-0303
	For 5 GHz wireless LAN (IEEE 802.11a)	4.9 to 5.9		18 (at EVM 2%)	140		○	–		
★IRM065U6	For 2.4 GHz wireless LAN (IEEE 802.11b/g)	2.4 to 2.5		18 (at EVM 3%)	130	28	○	Built-in (IN/OUT)	P-HQFN016-0303	
	For 5 GHz wireless LAN (IEEE 802.11a)	4.9 to 5.9		18 (at EVM 3%)	155		○	Built-in (IN/OUT)		
IRM047U7	For 2.4 GHz wireless LAN* (IEEE 802.11b/g)	2.4 to 2.5		18 (at EVM 3%)	105	30	○	–	P-HQFN024-0404	
IRM049U6				16 (at 802.11 b)/ 16 (at 802.11 g)	65 (at 802.11 b)/ 90 (at 802.11 g)	28/31	–	–	P-HQFN016-0303	
★IRM060U6	For 2.4 GHz wireless LAN (IEEE 802.11b/g)	2.4 to 2.5		16 (at EVM 2%)	75	27	○	Built-in (IN/OUT)		
IRM052U6				18 (at EVM 3%)	120	29	○	Built-in (IN/OUT)		
IRM063U6	For 2.4 GHz wireless LAN (IEEE 802.11b/g)	2.4 to 2.5		18 (at EVM 3%)	120	30	○	Built-in (IN/OUT)	P-HQFN014-0202	
IRM063U7				18 (at EVM 3%)	120		○	Built-in (IN/OUT)	P-HQFN010-0202	
IRM048U6	For 5 GHz wireless LAN (IEEE 802.11a)	4.9 to 5.9		18 (at EVM 2%)	140	30	○	–	P-HQFN024-0404	
IRM048U7						25	○	–		
IRM053U6					150	31	○	Built-in (IN/OUT)	P-HQFN016-0303	
★IRM061U6					15 (at EVM 3%)	100	30	○		Built-in (IN/OUT)

\* Can be used as a power amp for PHS and DECT (1.9 GHz band), or as a driver amp for FWA (1.9 to 2.6 GHz band).



## ■ Laser Diode Drivers

Model No.	Application	Function	Drive mode	Maximum output current (mA) MIN.	Applicable SHARP diode type	Supply voltage (V)	Package
IR3C14N1	For Mini Disc players	Built-in 100 mA driver, APC function	DC mode	100	—	2.4 to 3.5	P-SSOP008-0150
IR3C22N	For CD/DVD players	Built-in APC function, with inhibit input pin	—	150	P (Single power supply)	4.5 to 5.5	

## ■ IC for Cameras

Model No.	Function	Output/input element	Supply voltage (V)	Package
IR3S881	AF/AE/thermometry/AD (10-bit serial output for each datum), AF lens/shutter/IX magnetic head driver, zoom/film pre-driver, battery check, DC-DC converter	AF : Infrared LED, PSD* <sup>1</sup> (active type, 1 beam), AE : SPD* <sup>2</sup> (available for 2-part SPD)	2.2 to 6.0	P-QFP048-0707

\*1 PSD : Position Sensitive Detector

\*2 SPD : Silicon Photo Diode

## ■ Compandor

Model No.	Function/Feature	Supply voltage (V)	Operating current (mA) TYP.	Output dynamic range (mVrms) TYP.	Package
IR3N74A1	Compression and expansion of speech signal, small package	2.4 to 5.5	3.4	900	P-SSOP012-0225

## ■ ICs for Audio Equipment

Model No.	Description	Function	Supply voltage (V)	Package
IR3R55M1	RF amp IC for Mini Disc players	Built-in RF amp, ADIP detection circuit, connectable to hologram pickup	2.4 to 3.3	P-TQFP048-0707
IR3R58M1		Built-in 2x speed RF amp, ADIP detection circuit, connectable to hologram pickup		
IR3R61U	Audio amp IC	Built-in serial control input ATT and mike amp	±2.0 to ±3.25	P-HQFN020-0404
IR3R59N1		Built-in serial control input ATT and filter amp	±1.2 to ±3.25	P-SSOP024-0275
IR3M17U	Power supply IC	Two outputs (step-up, step-up/down type PWM, and step-up, step-down, step-up/down, inverting type PWM), switching frequency : 500 kHz (MAX.), external synchronization	2.2 to 6.5	P-HQFN020-0404
IR3C14N1	Laser diode driver for Mini Disc players	Built-in 100 mA driver, APC function	2.4 to 3.5	P-SSOP008-0150



## ■ CSP

### ● CSP (Chip Size Package)

The FBGA (commonly known as CSP) has an area array terminal structure with solder balls on the bottom, to give it a near chip-size footprint. This high-density, compact and low-profile package technology will greatly help in the design of compact mobile equipment, such as cellular phones and digital cameras.

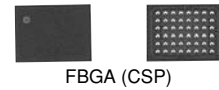

FBGA (CSP)

### Features

- **Compact and lightweight**  
Ability to create a near-chip size and lighter-weight package in comparison with conventional plastic packages.
- **High reliability**  
Comparable high reliability with that of conventional plastic packages.
- **Mountability**  
Conventional mounting system is available for CSP. SOP and QFP can be mounted together with CSP.

Terminal pitch	0.8 mm	0.65 mm	0.5 mm	0.4 mm
Maximum terminal counts	288 (16 mm x 16 mm)	352 (16 mm x 16 mm)	424 (14 mm x 14 mm)	264 (10 mm x 10 mm)
Nominal dimensions	6 mm x 6 mm to 16 mm x 16 mm			5 mm x 5 mm to 10 mm x 10 mm

### Cross section example

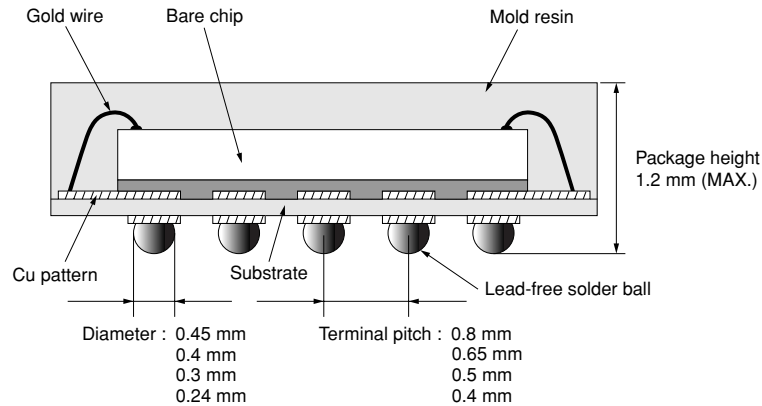

### ● Wafer-level CSP

The wafer-level CSP (WL-CSP) is a kind of chip-size package which is manufactured by assembling directly onto the finished wafer.

### Features

- **Compact and thinner size**  
It makes it possible to create an almost bare-chip-size and lighter-weight package.
- **Mountability**  
The conventional CSP mounting system can be also used in that of wafer-level CSP, which facilitates chip mounting more than bare-chip mounting does. It can be mounted together with other existing packages and passive components. (The use of underfill is recommended to improve the reliability of assembly.)

Chip size*	4 mm x 4 mm		3.5 mm x 3.5 mm		3 mm x 3 mm		2.5 mm x 2.5 mm	
Pad pitch	0.5 mm	0.4 mm	0.5 mm	0.4 mm	0.5 mm	0.4 mm	0.5 mm	0.4 mm
Maximum terminal counts	49 (7 x 7)	81 (9 x 9)	36 (6 x 6)	49 (7 x 7)	25 (5 x 5)	36 (6 x 6)	16 (4 x 4)	25 (5 x 5)

\* Rectangular chip form is also available.

### Cross section example

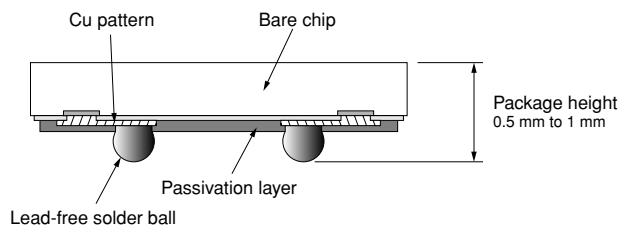



## ■ LGA

### ● LGA (Land Grid Array Package)

The LGA package has basically the same structure as the CSP, enabling a thin package by removing the solder balls from the bottom of the package. The LGA package contributes to the compact and thinner design of applications, such as cellular phones and digital cameras.

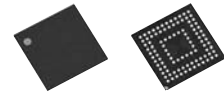

<b>Features</b>	<ul style="list-style-type: none"> <li>● <b>Lower package height</b> Achieves 0.5 mm Max. in package height.</li> <li>● <b>High reliability</b> Comparable high reliability with that of conventional plastic package.</li> <li>● <b>Excellent mountability</b> Conventional mounting system is available for LGA. SOP and QFP can be mounted together with LGA.</li> </ul>					
	<table border="1"> <tr> <td>Terminal pitch</td> <td>0.5 mm</td> </tr> <tr> <td>Maximum terminal count</td> <td>216 (10 mm x 10 mm)</td> </tr> <tr> <td>Nominal dimensions</td> <td>6 mm x 6 mm ~ 10 mm x 10 mm</td> </tr> </table>	Terminal pitch	0.5 mm	Maximum terminal count	216 (10 mm x 10 mm)	Nominal dimensions
Terminal pitch	0.5 mm					
Maximum terminal count	216 (10 mm x 10 mm)					
Nominal dimensions	6 mm x 6 mm ~ 10 mm x 10 mm					

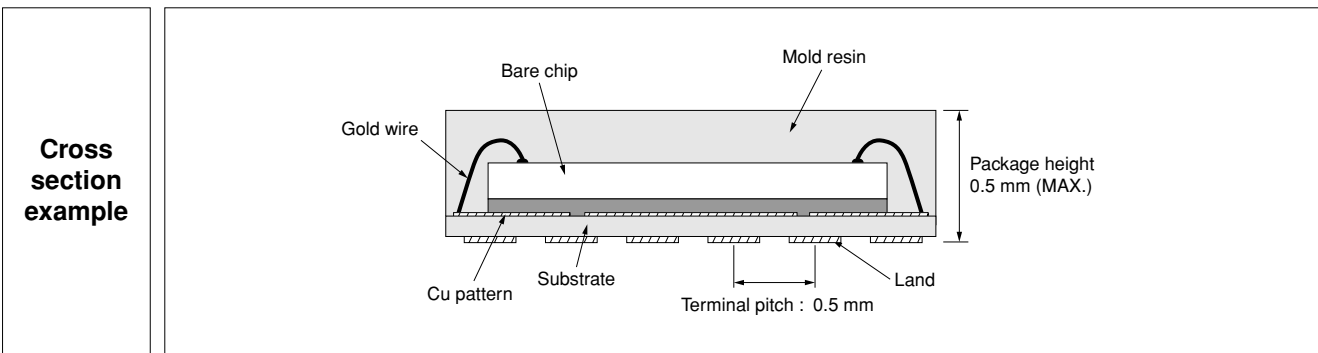



■ SiP (System in Package)

System in Package is an original SHARP high-density mounting technology that achieves high-density memory capacity and multiple functions by stacking multiple bare chips or multiple packages. This technology has two major streams. One method refers to a chip-stacked package technology that can achieve up to 5-chip mounting by stacking chips in a single package. The other method refers to a package stack technology with which it is possible to stack a package of over 5 chips, by stacking multiple packages in which 1 to 2 chips are stacked. The System in Package technology contributes to higher functionality of applications, such as cellular phones and digital cameras, as well as to reduction in size and weight.

● Chip Stacked CSP

<b>Features</b>	<ul style="list-style-type: none"> <li>● <b>Wide variety of lineup</b> It is possible to provide a wide lineup of stacked CSPs, including 2-chip, 3-chip, 4-chip and 5-chip stacked CSPs, to respond to customer needs.</li> <li>● <b>Compact and thinner size</b> Encapsulating multiple bare chips into an existing plastic package contributes to decreasing the mounting area. In addition, SHARP's wafer thinning technology makes it possible to achieve 1.4 mm package height.</li> <li>● <b>Multiple functions</b> Multiple bare chips of different sizes and functions, such as logic LSIs and memories, can be incorporated in a single package, making possible multiple functions.</li> <li>● <b>Same-size chip stacking technology</b> SHARP's stacking technology enables stacking of multiple same-size bare chips, contributing to higher memory density.</li> </ul> <p><b>(4-chip stacked CSP)</b> When using a SHARP four-chip stacked CSP, the mounting area and weight of a package can be decreased by half in comparison with using two 2-chip stacked CSPs, or a 3-chip stacked CSP and a conventional CSP.</p>
-----------------	--

<b>Cross section example</b>	<p>(5-chip stacked CSP)</p>
------------------------------	-----------------------------

● Chip Stacked TSOP/QFP\*/VQFN/HQFN

<b>Features</b>	<ul style="list-style-type: none"> <li>● <b>Decreased mounting area</b> By encapsulating two identical or different types of bare chips into a single conventional plastic package, the mounting area of the package can be decreased.</li> <li>● <b>Multiple functions</b> Thanks to the incorporation of different sizes and functions of multiple bare chips, such as logic LSIs and memories, the functionality increases.</li> <li>● <b>Higher memory density</b> When incorporating two identical memory bare chips into a single package, memory density doubles on the same mounting area.</li> </ul>
-----------------	---

<b>Cross section example</b>	
------------------------------	--

\* Including TQFP and LQFP.





## ● Package Stacked

### Features

- **Multi stacking**

The package stacking technology makes it possible to increase the memory capacity and create a combined system with memory and logic LSI. In the case of combination memories, memory capacity can be increased by stacking multiple 0.5 mm height packages in which 1 to 2 chips are stacked.

- **Decreased mounting area and height**

The package stacked technology makes it possible to decrease the mounting area by stacking multiple packages in which 1 to 2 chips are stacked, also achieving 1.5 mm height when six chips are stacked.

- **Multiple functions**

Thanks to the combination of packages in which various kinds of LSIs are mounted, such as a memory and ASIC, achieving an increase in and enhancement of functionality is easy.

### Cross section example

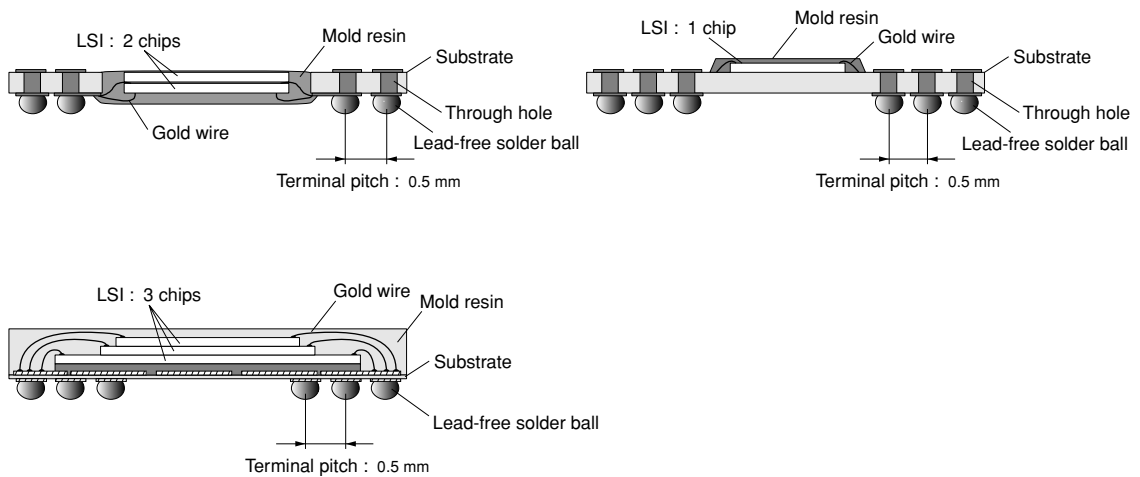

#### Examples of 3D-SiP composition

- High-density combination memory (3-package stacking)

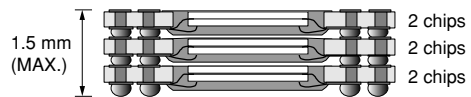
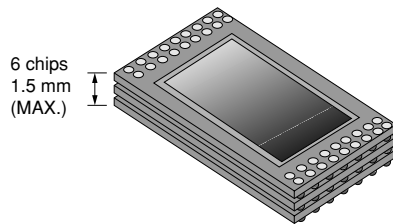

- System LSI (Logic LSI + Memory) (2-package stacking)

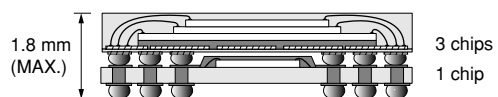
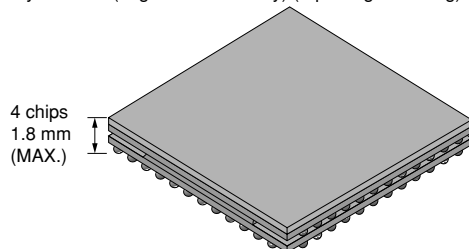



■ SOF

● SOF (System On Film)

SOF is a highly flexible thin film package, created from SHARP's TCP technologies. It can be easily bent, and contributes to thin and compact design of products. Peripheral circuit components can also be mounted.

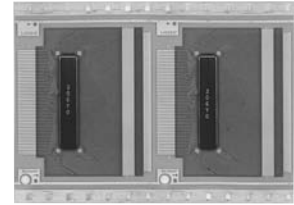

<b>Features</b>	<ul style="list-style-type: none"> <li>● <b>Highly flexible and thin film package</b> By using highly flexible and thin film, SOF contributes to creating thin and compact products. It can also achieve finer terminal pitches and multiple outputs easily, and pattern layout on a film under the chip makes it possible to improve the flexibility of the pattern layout.</li> <li>● <b>Multiple chip mounting</b> Plural bare chip mounting and incorporation of peripheral components contribute to the higher functionality of products.</li> </ul>
-----------------	---

<b>Cross section example</b>	
------------------------------	--

<b>Film specifications</b>	<table border="1"> <tr> <td>Film width : W<sub>1</sub></td> <td>35 mm super wide</td> <td>48 mm super wide</td> <td>70 mm wide</td> </tr> <tr> <td>Maximum pattern layout area : W<sub>2</sub></td> <td>28.6 mm</td> <td>41.6 mm</td> <td>59.0 mm</td> </tr> <tr> <td>Maximum device pitch : L</td> <td colspan="3">15 sprockets</td> </tr> <tr> <td>Copper foil thickness</td> <td colspan="3">8 μm</td> </tr> <tr> <td>Copper foil type</td> <td colspan="3">Rolled or electrolytic</td> </tr> <tr> <td>Copper foil plating</td> <td colspan="3">Tin (Sn)</td> </tr> <tr> <td>Minimum pattern pitch</td> <td colspan="3">0.029 mm</td> </tr> <tr> <td>Sprocket hole : A</td> <td colspan="3">1.981 mm (wide) / 1.42 mm (super wide)</td> </tr> <tr> <td>Sprocket hole : B</td> <td colspan="3">1.981 mm (wide) / 1.42 mm (super wide)</td> </tr> </table> 	Film width : W <sub>1</sub>	35 mm super wide	48 mm super wide	70 mm wide	Maximum pattern layout area : W <sub>2</sub>	28.6 mm	41.6 mm	59.0 mm	Maximum device pitch : L	15 sprockets			Copper foil thickness	8 μm			Copper foil type	Rolled or electrolytic			Copper foil plating	Tin (Sn)			Minimum pattern pitch	0.029 mm			Sprocket hole : A	1.981 mm (wide) / 1.42 mm (super wide)			Sprocket hole : B	1.981 mm (wide) / 1.42 mm (super wide)		
Film width : W <sub>1</sub>	35 mm super wide	48 mm super wide	70 mm wide																																		
Maximum pattern layout area : W <sub>2</sub>	28.6 mm	41.6 mm	59.0 mm																																		
Maximum device pitch : L	15 sprockets																																				
Copper foil thickness	8 μm																																				
Copper foil type	Rolled or electrolytic																																				
Copper foil plating	Tin (Sn)																																				
Minimum pattern pitch	0.029 mm																																				
Sprocket hole : A	1.981 mm (wide) / 1.42 mm (super wide)																																				
Sprocket hole : B	1.981 mm (wide) / 1.42 mm (super wide)																																				

<b>Other components</b>	Bare chips and peripheral circuit components can be mounted on the film.
-------------------------	--

In addition to the SOF described above, a conventional TCP (Tape Carrier Package) is also available.



## Package Lineup

### Surface-mount Type

Package type	Appearance (Package material)	Package code	No. of terminals	Terminal pitch mm	Nominal dimensions mm	Package width & length x (seated height [MAX.]) mm	
FBGA (GSP)		TFBGA048-0608	48	0.8	6 x 8	6.0 x 8.0 x (1.2)	
		TFBGA048-0808			8 x 8	8.0 x 8.0 x (1.2)	
		TFBGA056-0808	56		8 x 11	8.0 x 11.0 x (1.2)	
		TFBGA060-0811	60 (48)*				
		TFBGA064-0811	64				
		TFBGA072-0811	72 (64)*				
		LFBGA072-0811			8.0 x 11.0 x (1.4) / (1.6)		
		TFBGA081-0808	81		8 x 8	8.0 x 8.0 x (1.2)	
		LFBGA085-0811	85		8 x 11	8.0 x 11.0 x (1.4) / (1.6)	
		LFBGA087-0811	87				
		LFBGA088-0811	88		9 x 12	9.0 x 12.0 x (1.4) / (1.6)	
		LFBGA088-0912					
		LFBGA090-0811	90		8 x 11	8.0 x 11.0 x (1.4) / (1.6)	
		TFBGA096-1010	96		10 x 10	10.0 x 10.0 x (1.2)	
		LFBGA107-0912	107		9 x 12	9.0 x 12.0 x (1.4) / (1.6)	
		TFBGA112-1010	112		10 x 10	10.0 x 10.0 x (1.2)	
		LFBGA115-0914	115		9 x 14	9.0 x 14.0 x (1.4) / (1.6)	
		LFBGA116-1010	116		10 x 10	10.0 x 10.0 x (1.4) / (1.6)	
		LFBGA130-1013	130		10 x 13	10.0 x 13.0 x (1.4) / (1.6)	
		TFBGA160-1212	160		12 x 12	12.0 x 12.0 x (1.2)	
		LFBGA168-1212	168			12.0 x 12.0 x (1.4) / (1.6)	
		TFBGA180-1212	180		14 x 14	14.0 x 14.0 x (1.2)	
		TFBGA184-1212	184			16.0 x 16.0 x (1.4) / (1.6)	
		TFBGA240-1414	240				
		LFBGA280-1616	280				
		TFBGA064-0606	64		0.65	6 x 6	6.0 x 6.0 x (1.2)
		LFBGA160-1010	160			10 x 10	10.0 x 10.0 x (1.4) / (1.6)
		TFBGA180-1313	180			13 x 13	13.0 x 13.0 x (1.2)
		LFBGA192-1010	192			10 x 10	10.0 x 10.0 x (1.4) / (1.6)
		LFBGA208-1212	208			12 x 12	12.0 x 12.0 x (1.4) / (1.6)
		LFBGA224-1313	224			13 x 13	13.0 x 13.0 x (1.4) / (1.6)
		TFBGA260-1313	260				13.0 x 13.0 x (1.2)
		TFBGA068-0606	68		0.5	6 x 6	6.0 x 6.0 x (1.2)
		TFBGA100-0707	100			7 x 7	7.0 x 7.0 x (1.2)
		TFBGA108-0707	108				
		TFBGA120-0707	120				
		LFBGA144-0808	144			8 x 8	8.0 x 8.0 x (1.4) / (1.6)
		TFBGA152-0808	152				8.0 x 8.0 x (1.2)
		LFBGA171-0811	171			8 x 11	8.0 x 11.0 x (1.4) / (1.6)
		TFBGA176-0909	176			9 x 9	9.0 x 9.0 x (1.2)
		TFBGA180-0909	180				
		TFBGA188-0909	188				
TFBGA208-1010	208						
FBGA424-1414	424						
WFBGA144-0606	144	0.4	6 x 6	6.0 x 6.0 x (0.75)			
TFBGA168-0707	168		7 x 7	7.0 x 7.0 x (1.2)			
TFBGA204-0808	204		8 x 8	8.0 x 8.0 x (1.2)			

\* Figures in brackets indicate available terminal counts.





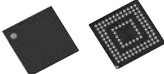



●Surface-mount Type (cont'd)

Package type	Appearance (Package material)	Package code	No. of terminals	Terminal pitch mm	Nominal dimensions mm	Package width & length x (seated height [MAX.]) mm
FBGA (CSP)		TFBGAXX-0606	to 36	0.8	6 x 6	6.0 x 6.0 x (1.2)
		TFBGAXX-0707	to 49		7 x 7	7.0 x 7.0 x (1.2)
		TFBGAXX-0808	to 81		8 x 8	8.0 x 8.0 x (1.2)
		TFBGAXX-0909	to 100		9 x 9	9.0 x 9.0 x (1.2)
		TFBGAXX-1010	to 121		10 x 10	10.0 x 10.0 x (1.2)
		TFBGAXX-1111	to 144		11 x 11	11.0 x 11.0 x (1.2)
		TFBGAXX-1212	to 196		12 x 12	12.0 x 12.0 x (1.2)
		TFBGAXX-1313	to 216		13 x 13	13.0 x 13.0 x (1.2)
		TFBGAXX-1414	to 240		14 x 14	14.0 x 14.0 x (1.2)
		TFBGAXX-1515	to 280		15 x 15	15.0 x 15.0 x (1.2)
		TFBGAXX-1616	to 280	16 x 16	16.0 x 16.0 x (1.2)	
		TFBGAXX-0606	to 49	0.65	6 x 6	6.0 x 6.0 x (1.2)
		TFBGAXX-0707	to 81		7 x 7	7.0 x 7.0 x (1.2)
		TFBGAXX-0808	to 121		8 x 8	8.0 x 8.0 x (1.2)
		TFBGAXX-0909	to 144		9 x 9	9.0 x 9.0 x (1.2)
		TFBGAXX-1010	to 196		10 x 10	10.0 x 10.0 x (1.2)
		TFBGAXX-1111	to 224		11 x 11	11.0 x 11.0 x (1.2)
		TFBGAXX-1212	to 256		12 x 12	12.0 x 12.0 x (1.2)
		TFBGAXX-1313	to 272		13 x 13	13.0 x 13.0 x (1.2)
		TFBGAXX-1414	to 304		14 x 14	14.0 x 14.0 x (1.2)
		TFBGAXX-1515	to 320		15 x 15	15.0 x 15.0 x (1.2)
		TFBGAXX-1616	to 352	16 x 16	16.0 x 16.0 x (1.2)	
		TFBGAXX-0606	to 100	0.5	6 x 6	6.0 x 6.0 x (1.2)
		TFBGAXX-0707	to 132		7 x 7	7.0 x 7.0 x (1.2)
		TFBGAXX-0808	to 164		8 x 8	8.0 x 8.0 x (1.2)
		TFBGAXX-0909	to 192		9 x 9	9.0 x 9.0 x (1.2)
		TFBGAXX-1010	to 216		10 x 10	10.0 x 10.0 x (1.2)
		TFBGAXX-1111	to 244		11 x 11	11.0 x 11.0 x (1.2)
		TFBGAXX-1212	to 268		12 x 12	12.0 x 12.0 x (1.2)
		TFBGAXX-1313	to 296		13 x 13	13.0 x 13.0 x (1.2)
		TFBGAXX-1414	to 320		14 x 14	14.0 x 14.0 x (1.2)
		TFBGAXX-1515	to 348		15 x 15	15.0 x 15.0 x (1.2)
		TFBGAXX-1616	to 372	16 x 16	16.0 x 16.0 x (1.2)	
TFBGAXX-0505	to 100	0.4	5 x 5	5.0 x 5.0 x (1.2)		
TFBGAXX-0606	to 144		6 x 6	6.0 x 6.0 x (1.2)		
TFBGAXX-0707	to 168		7 x 7	7.0 x 7.0 x (1.2)		
TFBGAXX-0808	to 204		8 x 8	8.0 x 8.0 x (1.2)		
TFBGAXX-0909	to 228		9 x 9	9.0 x 9.0 x (1.2)		
TFBGAXX-1010	to 264		10 x 10	10.0 x 10.0 x (1.2)		
FLGA (LGA)	 (Plastic)	XFLGA100-0707	100	0.5	7 x 7	7.0 x 7.0 x (0.5)

XXX : Terminal counts



## ●Surface-mount Type (cont'd)



Package type	Appearance (Package material)	Package code	No. of terminals	Terminal pitch mm (mil)	Nominal dimensions mm (mil)	Package width & length x (seated height [MAX.]) mm	Lead frame material	
							Alloy42	Copper alloy
SOP		P-SOP044-0600	44	1.27 (50)	15.2 (600)	13.2 x 28.2 x (3.1)	○	○
SSOP		P-SSOP008-0150	8	0.65	4.5 (150)	3.0 x 3.0 x (1.1)	-	○
		P-SSOP012-0225	12	0.75	5.7 (225)	4.4 x 5.0 x (1.8)	○	-
		P-SSOP024-0275	24	0.65	7.0 (275)	6.0 x 7.8 x (1.27)	-	○
		P-SSOP040-0300	40		7.6 (300)	6.3 x 13.5 x (1.8)	-	○
		P-SSOP070-0500	70	0.8	12.7 (500)	12.7 x 28.6 x (3.05)	-	○
MFP	P-MFP018	18	0.8	-	6.0 x 7.5 x (1.8)	○	-	
	P-MFP020	20	0.75	-	6.0 x 7.5 x (1.8)	○	-	
TSOP	 (Plastic)	P-TSOP040-1020	40	0.5	10 x 20	10.0 x 18.4 x (1.2)	○	○
		P-TSOP048-1220	48		12 x 20	12.0 x 18.4 x (1.2)	○	○
		P-TSOP056-1420	56		14 x 20	14.0 x 18.4 x (1.2)	○	○
QFP		P-QFP048-0707	48	0.5	7 x 7	7.0 x 7.0 x (1.65)	○	-
		P-QFP048-1010		0.75	-	10.0 x 10.0 x (1.82)	○	-
		P-QFP064-1010	64	0.5	10 x 10	10.0 x 10.0 x (1.8)	○	-
		P-QFP072-1010	72				○	-
		P-QFP128-1420	128	0.4	14 x 20	14.0 x 20.0 x (2.3)	○	-
		P-QFP156-1420	156				○	-
LQFP		P-LQFP080-1212	80	0.5	12 x 12	12.0 x 12.0 x (1.7)	○	-
		P-LQFP100-1414	100		14 x 14	14.0 x 14.0 x (1.7)	○	-
		P-LQFP144-2020	144		20 x 20	20.0 x 20.0 x (1.7)	-	○
		P-LQFP176-2424	176		24 x 24	24.0 x 24.0 x (1.7)	-	○
		★P-LQFP256-2828	256		28 x 28	28.0 x 28.0 x (1.7)	-	○
TQFP	 (Plastic)	P-TQFP048-0707	48	0.5	7 x 7	7.0 x 7.0 x (1.2)	○	-
		P-TQFP100-1414	100		-	14.0 x 14.0 x (1.2)	○	-
		P-TQFP128-1414	128	0.4	14 x 14	14.0 x 14.0 x (1.2)	○	-
VQFN		P-VQFN020-0404	20	0.5	4 x 4	4.2 x 4.2 x (1.0)	-	○
		P-VQFN028-0505	28		5 x 5	5.2 x 5.2 x (1.0)	-	○
		P-VQFN032-0505	32		6 x 6	6.2 x 6.2 x (1.0)	-	○
		P-VQFN036-0606	36		7 x 7	7.2 x 7.2 x (1.0)	-	○
		P-VQFN048-0707	48	0.4	5 x 5	5.2 x 5.2 x (1.0)	-	○
		P-VQFN036-0505	36		7 x 7	7.2 x 7.2 x (1.0)	-	○
		P-VQFN052-0707	52		8 x 8	8.2 x 8.2 x (1.0)	-	○
		P-VQFN064-0808	64		8 x 8	8.2 x 8.2 x (1.0)	-	○
HQFN*	 (Plastic)	★P-HQFN010-0202	10	0.4	2 x 2	2.0 x 2.0 x (0.35)	-	○
		★P-HQFN014-0202	14			2.2 x 2.2 x (0.55)	-	○
		P-HQFN016-0303	16	0.5	3 x 3	3.0 x 3.0 x (0.85)	-	○
		P-HQFN016-0404				0.65	-	○
		P-HQFN020-0404	20	0.5	4 x 4	4.0 x 4.0 x (1.0)	-	○
		P-HQFN024-0404	24			4.0 x 4.0 x (0.85)	-	○
		P-HQFN028-0505	28			4.2 x 4.2 x (1.0)	-	○
		P-HQFN028-0505	28			5 x 5	5.0 x 5.0 x (1.0)	-
P-HQFN052-0707	52	0.4	7 x 7	7.2 x 7.2 x (1.0)	-	○		

\* HQFN is a higher heat dissipation package of VQFN.

100 mil = 2.54 mm

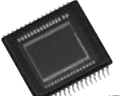
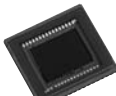

### ●For CCDs

Package type	Appearance (Package material)	Package code	No. of terminals	Terminal pitch mm	Nominal dimensions mm (mil)	Package width & length x (seated height) mm
DIP	 (Plastic)	P-DIP014-0400A	14	1.27	10.16 (400)	10.0 x 10.0
		P-DIP016-0500C	16	1.78	12.7 (500)	12.4 x 14.0
		P-DIP020-0400	20	1.00	10.16 (400)	10.0 x 10.0
	 (Ceramic)	N-DIP016-0450	16	1.27	11.43 (450)	11.4 x 12.2
		N-DIP016-0500C		1.78	12.7 (500)	12.4 x 14.0
SOP	 (Plastic)	P-SOP028-0400	28	0.69	10.16 (400)	10.0 x 10.0 x (3.5)
		P-SOP032-0525	32	0.78	13.3 (525)	12.0 x 13.8 x (3.9)
LCC	 (Ceramic)	N-LCC028-S450B	28	0.80	11.5	11.5 x 11.5 x (1.62)
		N-LCC032-R543	32	0.80	13.8	12.9 x 13.8 x (1.35)

100 mil = 2.54 mm

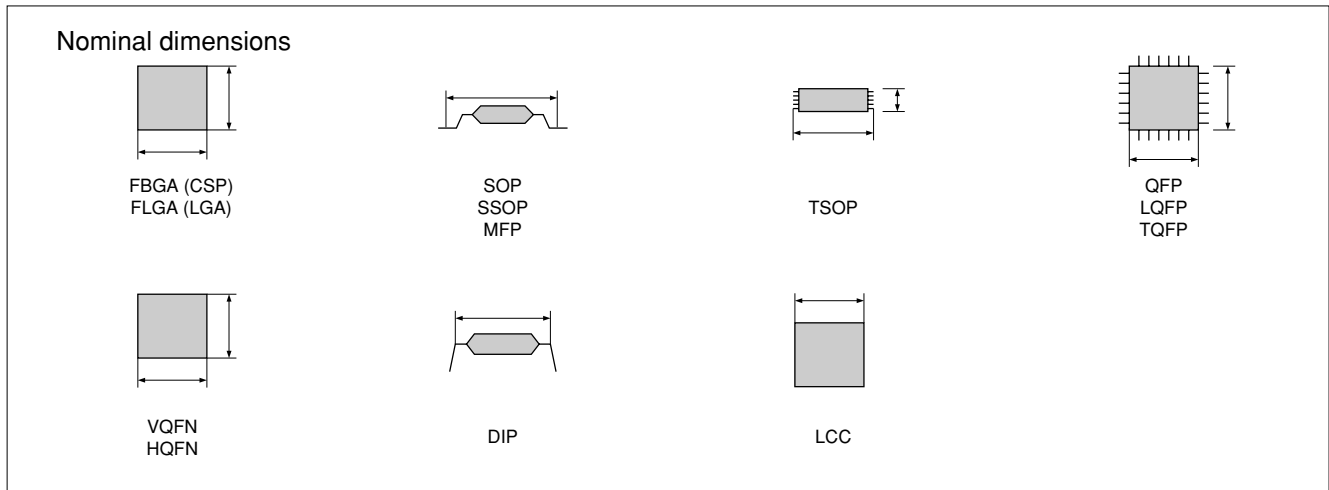

- FBGA : fine-pitch ball grid array package
- FLGA : fine-pitch land grid array package
- SOP : small outline package
- SSOP : shrink small outline package
- MFP : mini flat package
- TSOP : thin small outline package
- QFP : quad flat package

- LQFP : low profile quad flat package
- TQFP : thin quad flat package
- VQFN : very thin quad flat non-leaded package
- HQFN : heat sink quad flat non-leaded package
- DIP : dual in line package
- LCC : leadless chip carrier







## ●Lead-inserting Type Packages [For regulators: PQ series]

Package type	Appearance (Package material)	No. of terminals	Terminal pitch mm	Outline dimensions (Width x Thickness x Height) mm	Lead frame material
TO-3P	 (Plastic)	5	2.54	17 (MAX.) x 4.5 x 39 <sup>*2</sup>	Cu
TO-220 (Heat sink exposure) [Lead forming type]	 (Plastic)	5	(1.7) <sup>*1</sup>	10.2 (MAX.) x 3.5 x 25.2 <sup>*2</sup>	Cu
TO-220	<b>A</b>  (Plastic)	4	2.54	10.2 (MAX.) x 4.5 x 29.1 <sup>*2</sup>	Cu
TO-220 (Full mold)	<b>B</b>  (Plastic)	4	2.54	10.2 (MAX.) x 4.5 x 29.1 <sup>*2</sup>	Cu
TO-220 (Full mold) [Lead forming type]	<b>C</b>  (Plastic)	5	(1.7) <sup>*1</sup>	10.2 (MAX.) x 4.5 x 24.6 <sup>*2</sup>	Cu
TO-220 [Lead forming type]	<b>D</b>  (Plastic)	5	(1.7) <sup>*1</sup>	10.2 (MAX.) x 4.5 x 24.6 <sup>*2</sup>	Cu
TO-220 [Lead forming type]	<b>E</b>  (Plastic)	5	(1.7) <sup>*1</sup>	10.2 (MAX.) x 4.5 x 24.6 <sup>*2</sup>	Cu
TO-92	 (Plastic)	3	2.5	5.2 (MAX.) x 4.2 (MAX.) x 18.2 (MAX.) <sup>*2</sup>	Cu

\*1 The figure in parentheses indicates reference value.

\*2 Including lead length

## ●Surface-mount Type Packages [For regulators/LED drivers: PQ series]







Package type	Appearance (Package material)	No. of terminals	Terminal pitch mm	Outline dimensions (Width x Height x Thickness) mm	Lead frame material
TO-263	 (Plastic)	5 (Heat sink not included)	(1.7) <sup>*1</sup>	10.6 (MAX.) x 13.7 (MAX.) <sup>*2</sup> x 3.5	Cu
SC-63	<b>F</b>  (Plastic)	5 (Heat sink not included)	(1.27) <sup>*1</sup>	6.6 (MAX.) x 9.7 (MAX.) <sup>*2</sup> x 2.3	Cu
SC-63	<b>G</b>  (Plastic)	5 (Heat sink included)	(1.27) <sup>*1</sup>	6.6(MAX.) x 9.7 (MAX.) <sup>*2</sup> x 2.1	Cu
SOP-8	 (Plastic)	8	1.27	5 x 6.2 <sup>*2</sup> x 1.55 <sup>*2</sup>	Cu

\*1 The figure in parentheses indicates reference value.

\*2 Including lead length



### ●Surface-mount Type Packages [For regulators/LED drivers: PQ series] (cont'd)

Package type	Appearance (Package material)	No. of terminals	Terminal pitch mm	Outline dimensions (Width x Height x Thickness) mm	Lead frame material
SOT-89	 (Plastic)	6	1.5	4.5 x 4.3*2 x 1.5	Cu
SOT-23-6	 (Plastic)	6	0.95	2.9 x 2.8*2 x 1.3	Cu
SOT-23-6W	 (Plastic)	6	0.95	2.9 x 2.8*2 x 1.3	Cu
SOT-23-L	 (Plastic)	6	(0.95)*1	(3.4)*1 x 3.3*2 x 1.4 (MAX.)	Cu
SOT-23-5	 (Plastic)	5	(0.95)*1	(2.9)*1 x 2.8*2 x 1.3 (MAX.)	Cu
USB-6		6	0.5	2.0 x 1.8 x 0.8	Cu (Terminal material)/ Au plating (Terminal finish)
USB-10		10	0.5	2.8 x 2.0 x 0.8	—

\*1 The figure in parentheses indicates reference value.

\*2 Including lead length

The companies listed below own the trademarks of the relevant LSIs.

ARM, ARM7TDMI, ARM720T, ARM922T, ARM946E-S, ARM926EJ-S, Multi-ICE, RealView and Developer Suite are trademarks of ARM Ltd.  
 MULTI, Slingshot and probe are trademark of Green Hills Software Inc.  
 EWARM is a trademark of IAR Systems Inc.  
 BDI 2000 is a trademark of Abatron Inc.  
 Vitra, Genia, Opella and Pathfinder are trademark of Ashling Microsystems Ltd.  
 JTAGjet-ARM is a trademark of Signum Systems Corporation.  
 TRACE32 is a trademark of Lauterbach Inc.  
 EMUL-ARM is a trademark of Nohau a DBA of Knowit LLC.  
 MAJIC and JEENI are trademarks of Embedded Performance Inc.  
 Zoom is a trademark of Logic Product Development Inc.  
 Windows is a trademark of Microsoft Corporation.  
 ThreadX is a trademark of Express Logic Inc.  
 Nucleus+ is a trademark of Accelerated Technologies Inc.  
 VxWorks is a trademark of Wind River Systems Inc.  
 Ball Grid Array and BGA are trademarks of Motorola Nippon Ltd.  
 RSDS is a trademark of National Semiconductor Corporation.  
 Java and Java Card are trademarks of Sun Microsystems, Inc.  
 SmartMedia is a trademark of Toshiba Corporation.  
 Z80 is a trademark of ZiLOG, Inc.  
 CompactFlash is a trademark of SanDisk Corporation.  
 Linux is a trademark of Linus Torvalds.  
 MIPS, MIPS32, 4KSD are trademarks of MIPS Technologies, Inc.  
 Ethernet is a trademark of Xerox Corporation.  
 QUALCOMM and MSM are trademarks of QUALCOMM Incorporated.  
 All other product or company names are trademarks of their respective holders.

#### Notice





In the absence of confirmation by device specification sheets, SHARP takes no responsibility for any defects that may occur in equipment using any SHARP devices shown in catalogs, data books, etc. Contact SHARP in order to obtain the latest device specification sheets before using any SHARP device.





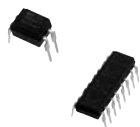

## ■ Photocoupler Lineup

### <Phototransistor output type>

Package type	Output type	Features	Model No. (series)	Page			
4-pin SOP Compact, SMT type 	Single phototransistor	General purpose, High collector-emitter voltage, etc.	PC35x series/PC451J0000F	66			
		AC input response	Low input current PC367NJ0000F	66			
		High sensitivity, High collector-emitter voltage	Low input current PC354NJ0000F	66			
	Darlington phototransistor	Single phototransistor	High collector-emitter voltage	Low input current PC364NJ0000F	66		
			AC input response	PC355NJ0000F/PC452J0000F	66		
			Low input current	PC365NJ0000F	66		
Compact, Half pitch (lead space), SMT type 	Single phototransistor	General purpose, High collector-emitter voltage, etc.	PC3Hx series	67			
		AC input response	Low input current PC3H71xNIP0F	67			
		High collector-emitter voltage	PC4H510NIP0F	67			
		AC input response	PC3H3J0000F/PC3H4J0000F	67			
		4-channel output	Low input current PC3H41xNIP0F	67			
		AC input response	PC3Q62J0000F/PC3Q67QJ000F	67			
	Darlington phototransistor	Single phototransistor	AC input response	Low input current PC3Q71xNIP0F	67		
			4-channel output	PC3Q63J0000F/PC3Q64QJ000F	67		
			AC input response	Low input current PC3Q41xNIP0F	67		
		Darlington phototransistor	Single phototransistor	General purpose	PC3H5J0000F	67	
				High collector-emitter voltage	Low input current PC3H510NIP0F	67	
				4-channel output	PC4H520NIP0F	67	
			Darlington phototransistor	Single phototransistor	4-channel output	PC3Q65J0000F	67
					AC input response	Low input current PC3Q510NIP0F	67
					Isolation thickness: 0.4 mm or more Creepage distance: 6.4 mm or more	PC123J0000F series	68
DIP type (4/16-pin) 	Single phototransistor	Approved by safety standards other than UL	Low input current PC1231xNSZ0F	68			
		General purpose, High collector-emitter voltage, etc.	PC817XJ0000F/PC847XJ0000F/ PC851XJ0000F	68			
		AC input response	Low input current PC817xxNSZ0F	68			
		Built-in SBD/High response speed	PC814XJ0000F/PC844XJ0000F	68			
		Low input current	PC8141xNSZ0F	68			
	Darlington phototransistor	Single phototransistor	General purpose, High collector-emitter voltage	PC8150NSZ0F	68		
			General purpose, High collector-emitter voltage	PC815XJ0000F/PC845XJ0000F/ PC852XJ0000F/PC853XJ0000F	68		
			Low input current	PC81510NSZ0F	68		
			General purpose, High collector-emitter voltage, etc.	PC7xxV0NSZXF	69		
			AC input response	PC733J0000F/PC733HJ0000F	69		
DIP type (6-pin) 	Darlington phototransistor	General purpose, High collector-emitter voltage, etc.	PC7x5V0NSZXF	69			
		General purpose, High collector-emitter voltage, etc.					
Case type (Approved by safety standards other than UL) 	Single phototransistor	Isolation thickness: 9.5mm or more Creepage distance: 11.5mm or more	PC512J0000F	70			

### <OPIC output type>

Package type	Output type	Features	Model No. (series)	Page
Compact, SMT type 	Digital output	General purpose, High response speed, 2ch, etc.	PC4xxJ0000F/PC456L0NIP0F/ PC41xS0NIP0F/PC410L0NIP0F/ PC411L0NIP0F/PC4D10SNIP0F/ PC4D1ASNIP0F	71
	Analog/Digital output	High CMR	PC457S0NIP0F/PC457L0NIP0F	72
DIP type, SMT type 	Digital output	General purpose, High response speed, etc.	PC9xxV0NSZXF/PC956L0NSZ0F/ PC910L0NSZ0F/PC911L0NSZ0F/ PC912L0NSZ0F	72
	Built-in base amplifier	For inverter control/For inverter control, Built-in short-circuit protection circuit	PC928J0000F/PC929J0000F/ PC942J0000F/PC92xL0NSZ0F series	73
	Analog/Digital output	High speed, High CMR, etc.	PC957L0NSZ0F	73



## ■ Photocouplers

### ◆ Phototransistor Output

#### <Compact, SMT type>

○: Approved, △: Under application

(Ta = 25°C)

Output Type	Model No.	Internal connection diagram	Features	Approved by safety standards*2	Package	Absolute maximum ratings			Electro-optical characteristics						
				UL		Forward current I <sub>F</sub> (mA)	Isolation voltage (AC) Viso (rms) (kV)	Collector-emitter voltage V <sub>CEO</sub> (V)	Current transfer ratio			Response time			
									CTR (%) MIN.	I <sub>F</sub> (mA)	V <sub>CE</sub> (V)	t <sub>r</sub> (μs) TYP.	I <sub>C</sub> (mA)	R <sub>L</sub> (Ω)	V <sub>CE</sub> (V)
Single phototransistor output	PC357NJ0000F		General purpose	○*	Mini-flat 4-pin	50	3.75	80	50	5	5	4	2	100	2
	PC352NJ0000F		General purpose, high resistance to noise*1	○		50	3.75	80	90	5	5	4	2	100	2
	PC451J00000F		High collector-emitter voltage	○*		50	3.75	350	40	5	5	4	2	100	2
	PC353TJ0000F		With base terminal	○	Mini-flat 5-pin	50	3.75	80	50	5	5	4	2	100	2
	PC367NJ0000F		Low input current, high CMR (MIN. 10kV/μs)	○	Mini-flat 4-pin	10	3.75	80	100	0.5	5	4	2	100	2
	PC354NJ0000F		AC input response	○*		±50	3.75	80	20	±1	5	4	2	100	2
	PC364NJ0000F		Low input current, high resistance to noise*1, AC input response	○		±10	3.75	70	50	±0.5	5	4	2	100	2
PC355NJ0000F		High sensitivity	○*	50		3.75	35	600	1	2	60	2	100	2	
Darlington photo-transistor output	PC452J00000F		High collector-emitter voltage	○*	Mini-flat 4-pin	50	3.75	350	1 000	1	2	100	20	100	2
	PC365NJ0000F		High sensitivity, low input current	○		10	3.75	35	600	0.5	2	60	2	100	2

\*1 CMR: MIN.10 kV/μs

\*2 Please refer to Specification Sheets for model numbers approved by safety standards.

\* A VDE approved type is optionally available.

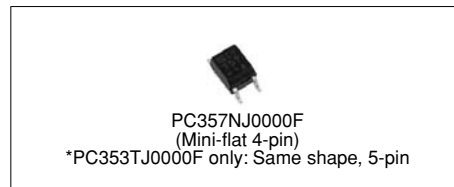

#### Notice

In the absence of confirmation by device specification sheets, SHARP takes no responsibility for any defects that may occur in equipment using any SHARP devices shown in catalogs, data books, etc.

Except where specially indicated, models listed on this page comply with the RoHS Directive\*. For details, please contact SHARP. \*RoHS Directive: Prohibits use of lead, cadmium, hexavalent chromium, mercury and specific brominated flame retardants (PBBs and PBDEs), with certain exceptions.

Contact SHARP in order to obtain the latest device specification sheets before using any SHARP device.



## ◆ Phototransistor Output <Compact, half pitch (lead space) SMT type>

○: Approved, △: Under application

(Ta = 25°C)

Type	Model No.	Internal connection diagram	Features	Approved by safety standards*3	Package	Absolute maximum ratings			Electro-optical characteristics								
						Forward current I <sub>F</sub> (mA)	Isolation voltage (AC) V <sub>iso</sub> (rms) (kV)	Collector-emitter voltage V <sub>CEO</sub> (V)	Current transfer ratio			Response time					
									CTR (%) MIN.	I <sub>F</sub> (mA)	V <sub>CE</sub> (V)	t <sub>r</sub> (μs) TYP.	I <sub>c</sub> (mA)	R <sub>L</sub> (Ω)	V <sub>CE</sub> (V)		
Single phototransistor output	PC3H2J00000F		High resistance to noise*1	○	Mini-flat 4-pin	50	2.5	80	20	1	5	4	2	100	2		
	PC3H7J00000F		Standard	○*2		50	2.5	80	20	1	5	4	2	100	2		
	PC3H71xNIP0F		High resistance to noise*1, low input current	○		10	2.5	80	100	0.5	5	4	2	100	2		
	PC3H3J00000F		AC input response, high resistance to noise*1	○		±50	2.5	80	20	±1	5	4	2	100	2		
	PC3H4J00000F		AC input response	○*2		±50	2.5	80	20	±1	5	4	2	100	2		
	PC3H41xNIP0F		AC input response, high resistance to noise*1, low input current	○		±10	2.5	80	50	±0.5	5	4	2	100	2		
	PC4H510NIP0F		High collector-emitter voltage	○		50	2.5	350	40	5	5	4	2	100	2		
	Single phototransistor output	PC3Q67QJ000F		4-ch type		○*2	Mini-flat 16-pin	50	2.5	80	50	5	5	4	2	100	2
		PC3Q62J00000F		High resistance to noise*1, 4-ch type		○		50	2.5	80	20	1	5	4	2	100	2
		PC3Q71xNIP0F		High resistance to noise*1, 4-ch type, low input current		○		10	2.5	80	100	0.5	5	4	2	100	2
PC3Q63J00000F		AC input response, high resistance to noise*1, 4-ch type		○	±50	2.5		80	20	±1	5	4	2	100	2		
PC3Q64QJ000F		AC input response, 4-ch type		○*2	±50	2.5		80	20	±1	5	4	2	100	2		
PC3Q41xNIP0F		AC input response, high resistance to noise*1, low input current, 4-ch type		○	±10	2.5		80	50	±0.5	5	4	2	100	2		
Darlington photo-transistor output	PC3H5J00000F		High sensitivity	○*2	Mini-flat 4-pin	50	2.5	35	600	1	2	60	2	100	2		
	PC3H510NIP0F		High sensitivity, low input current	○		10	2.5	35	600	0.5	2	60	2	100	2		
	PC4H520NIP0F		High collector-emitter voltage	○		50	2.5	350	1 000	1	2	100	2	100	2		
	PC3Q65J00000F		4-ch type, high sensitivity	○*2	Mini-flat 16-pin	50	2.5	35	600	1	2	60	2	100	2		
	PC3Q510NIP0F		4-ch type, high sensitivity, low input current	○		10	2.5	35	600	0.5	2	60	2	100	2		

\*1 CMR: MIN.10 kV/μs

\*2 A VDE approved type is optionally available.

\*3 Please refer to Specification Sheets for model numbers approved by safety standards.

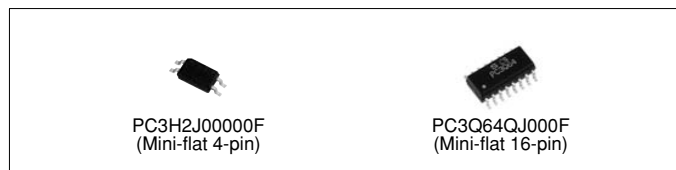

PC3H2J00000F  
 (Mini-flat 4-pin)

PC3Q64QJ000F  
 (Mini-flat 16-pin)

### Notice

In the absence of confirmation by device specification sheets, SHARP takes no responsibility for any defects that may occur in equipment using any SHARP devices shown in catalogs, data books, etc. Except where specially indicated, models listed on this page comply with the RoHS Directive\*. For details, please contact SHARP. \*RoHS Directive: Prohibits use of lead, cadmium, hexavalent chromium, mercury and specific brominated flame retardants (PBBs and PBDEs), with certain exceptions. Contact SHARP in order to obtain the latest device specification sheets before using any SHARP device.



## ◆ Phototransistor Output <DIP type (4/16-pin)>

○: Approved, △: Under application

(Ta = 25°C)

Output Type	Model No.	Internal connection diagram	Features	Approved by safety standards*8			Package	Absolute maximum ratings			Electro-optical characteristics			
				UL	VDE	Others		Forward current I <sub>F</sub> (mA)	Isolation voltage (AC) V <sub>iso</sub> (rms) (kV)	Collector-emitter voltage V <sub>CEO</sub> (V)	Current transfer ratio CTR (%) MIN.	I <sub>F</sub> (mA)	t <sub>r</sub> (μs) TYP.	R <sub>L</sub> (Ω)
Single phototransistor output	PC123J0000F*1		High isolation voltage, long creepage distance	○	○*2	○*3	4-pin DIP	50	5.0	70	50	5	4	100
	PC1231xNSZ0F		High isolation voltage, long creepage distance, low input current, high resistance to noise*4	○	○*2	-		10	5.0	70	50	0.5	4	100
	PC817XJ0000F*5, *6, *7		High isolation voltage	○	○*2	-	4-pin DIP	50	5.0	80	50	5	4	100
	PC847XJ0000F*5, *9		High isolation voltage (4-ch)	○	○*2	-	16-pin DIP	50	5.0	80	50	5	4	100
	PC8171xNSZ0F		High isolation voltage, low input current, high resistance to noise*4	○	-	-	4-pin DIP	10	5.0	70	100	0.5	4	100
	PC851XJ0000F		High isolation voltage, high collector-emitter voltage	○	-	-		50	5.0	350	40	5	4	100
	PC814XJ0000F*5, *6		High isolation voltage, AC input response	○	○*2	-	4-pin DIP	±50	5.0	80	20	±1	4	100
	PC844XJ0000F		High isolation voltage, AC input response (4-ch)	○	○*2	-	16-pin DIP	±50	5.0	80	20	±1	4	100
	PC8141xNSZ0F		High isolation voltage, AC input response, low input current, high resistance to noise*4	○	-	-	4-pin DIP	±10	5.0	80	50	±0.5	4	100
PC81100NSZ0F		Built-in schottky barrier diode, toff: 35μs TYP. (In saturation, R <sub>L</sub> = 100kΩ)	○	-	-	50		5.0	70	50	5	ton: TYP. 9	100	
Darlington phototransistor output	PC815XJ0000F		High isolation voltage, high sensitivity	○	-	-	4-pin DIP		5.0	35	600	1	60	100
	PC845XJ0000F		High isolation voltage, high sensitivity (4-ch)	○	-	-	16-pin DIP		5.0	35	600	1	60	100
	PC81510NSZ0F		High isolation voltage, high sensitivity, low input current	○	-	-	4-pin DIP	10	5.0	35	600	0.5	60	100
	PC852XJ0000F*5, *6		High isolation voltage, high collector-emitter voltage	○	○*2	-		50	5.0	350	1 000	1	100	100
	PC853XJ0000F*5, *6		High isolation voltage, high collector-emitter voltage	○	○*2	-		50	5.0	350	1 000	1	100	100

\*1 Wide lead spacing type (F type) is also available. Creepage distance PC123: 6.4 mm or more, PC123F: 8 mm or more

\*2 Optionally available.

\*3 BSI, SEMKO, DEMKO, NEMKO, FIMKO, CSA

\*4 CMR: 10 kV/μs MIN.

\*5 Lead forming type (I type) is also available for surface mounting.

\*6 Taped package of lead forming type for surface mounting is also available.

\*7 Wide lead spacing type (F type) is also available. Lead forming type (FI type) of F type is also available. Taped package is also available for I and FI type of lead forming type.

\*8 Please refer to Specification Sheets for model numbers approved by safety standards.

\*9 Approved by UL as multi-channel type of PC817.

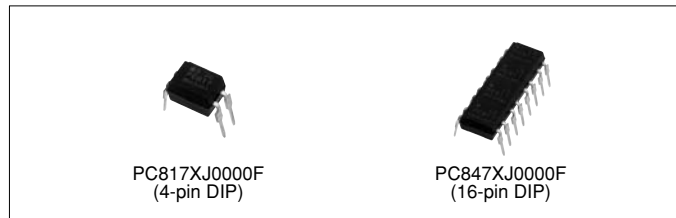

PC817XJ0000F  
(4-pin DIP)

PC847XJ0000F  
(16-pin DIP)

### Notice

In the absence of confirmation by device specification sheets, SHARP takes no responsibility for any defects that may occur in equipment using any SHARP devices shown in catalogs, data books, etc.

Except where specially indicated, models listed on this page comply with the RoHS Directive\*. For details, please contact SHARP. \*RoHS Directive: Prohibits use of lead, cadmium, hexavalent chromium, mercury and specific brominated flame retardants (PBBs and PBDEs), with certain exceptions.

Contact SHARP in order to obtain the latest device specification sheets before using any SHARP device.



## ◆ Phototransistor Output <DIP type (6-pin)>

○: Approved, △: Under application

(Ta = 25°C)

Output Type	Model No.	Internal connection diagram	Features	Approved by safety standards*4		Package	Absolute maximum ratings			Electro-optical characteristics			
				UL	VDE		Forward current I <sub>F</sub> (mA)	Isolation voltage (AC) V <sub>iso</sub> (rms) (kV)	Collector-emitter voltage V <sub>CEO</sub> (V)	Current transfer ratio		Response time	
										CTR (%) MIN.	I <sub>F</sub> (mA)	t <sub>r</sub> (μs) TYP.	R <sub>L</sub> (Ω)
Single phototransistor output	PC714V0NSZXF*4		High isolation voltage	○	○*3	6-pin DIP	50	5.0	80	50	5	4	100
	PC724V0NSZXF*4		High isolation voltage, large input current	○	—		150	5.0	35	20	100	4	100
	PC713V0NSZXF*4		High isolation voltage	○	○*3		50	5.0	80	50	5	4	100
	PC733J00000F		High isolation voltage, AC input response	○	—		±50	5.0	35	15	±1	4	100
	PC733HJ00000F*1, *2		High isolation voltage, large input current drive, AC input response	○	—		±150	5.0	35	20	±100	4	100
Darlington phototransistor output	PC715V0NSZXF*4		High isolation voltage, high sensitivity	○	○*3	50	5.0	35	600	1	60	100	
	PC725V0NSZXF*4		High isolation voltage, high sensitivity, high collector-emitter voltage, high power	○	○*3	50	5.0	300	1 000	1	100	100	

- \*1 Lead forming type (I type) is also available for surface mounting.
- \*2 Taped package of lead forming type for surface mounting is also available.
- \*3 Optionally available.
- \*4 Please refer to Specification Sheets for model numbers approved by safety standards.

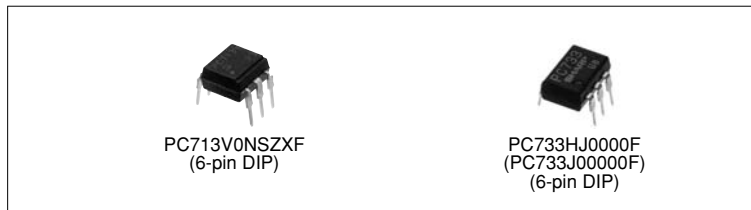

### Notice

In the absence of confirmation by device specification sheets, SHARP takes no responsibility for any defects that may occur in equipment using any SHARP devices shown in catalogs, data books, etc. Except where specially indicated, models listed on this page comply with the RoHS Directive\*. For details, please contact SHARP. \*RoHS Directive: Prohibits use of lead, cadmium, hexavalent chromium, mercury and specific brominated flame retardants (PBBs and PBDEs), with certain exceptions. Contact SHARP in order to obtain the latest device specification sheets before using any SHARP device.



## ◆ Phototransistor Output <Case type>

○: Approved, △: Under application

(Ta = 25°C)

Output Type	Model No.	Internal connection diagram	Features	Approved by safety standards*2			Package	Absolute maximum ratings			Electro-optical characteristics			
				UL	VDE	Others		Forward current I <sub>F</sub> (mA)	Isolation voltage (AC) Viso (rms) (kV)	Collector-emitter voltage V <sub>CEO</sub> (V)	Current transfer ratio		Response time	
											CTR (%) MIN.	I <sub>F</sub> (mA)	t <sub>r</sub> (μs) TYP.	R <sub>L</sub> (Ω)
Single phototransistor output	PC512J00000F		High isolation voltage, long creepage distance	○	○	○*1	PWB mounting type 4-pin	50	5.0	35	10	20	3	100

\*1 BSI, SEMKO, DEMKO, FIMKO, CSA

\*2 Please refer to Specification Sheets for model numbers approved by safety standards.

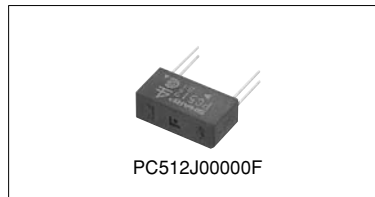

### Notice

In the absence of confirmation by device specification sheets, SHARP takes no responsibility for any defects that may occur in equipment using any SHARP devices shown in catalogs, data books, etc.  
 Except where specially indicated, models listed on this page comply with the RoHS Directive\*. For details, please contact SHARP.  
 \*RoHS Directive: Prohibits use of lead, cadmium, hexavalent chromium, mercury and specific brominated flame retardants (PBBs and PBDEs), with certain exceptions.  
 Contact SHARP in order to obtain the latest device specification sheets before using any SHARP device.

# PHOTOCOUPLERS



## ◆OPIC\* Output <Compact, SMT type> (1-1)

\* "OPIC" (Optical IC) is a trademark of SHARP Corporation. An OPIC consists of a light-  
detecting element and a signal-processing circuit integrated onto a single chip.

○: Approved, △: Under application

(Ta = 25°C)

Model No.	Internal connection diagram	Features	Approved by safety standards <sup>*2</sup>		Package	Absolute maximum ratings		Electro-optical characteristics <sup>*1</sup>						
			UL	VDE		Forward current IF (mA)	Isolation voltage (AC) Viso (rms) (kV)	Low level output voltage			Threshold input current			
								VOL (V) MAX.	Ta (°C)	IoL (mA)	IF (mA)	IFHL (mA) MAX.	IFLH (mA) MAX.	RL (Ω)
PC400J00000F		Digital output, normal-off operation	○	-	Mini-flat 5-pin	50	3.75	0.4	0 to +70	16	4	2.0	-	280
PC401J00000F		Digital output, normal-on operation	○	-		50	3.75	0.4	0 to +70	16	0	-	2.0	280
PC456L0NIP0F		Built-in preamplifier, high speed transmission (2 Mb/s), For soldering flow	○	○ <sup>*3</sup>	Mini-flat 5-pin	25	3.75	0.6	-40 to +85	4.4	10	5.0	-	20 k
PC410L0NIP0F		High speed (10 Mb/s), High CMR (10 kV/μs), For soldering flow	○	○ <sup>*3</sup>		20	3.75	0.6	-40 to +85	13	5	5.0	-	350
PC410S0NIP0F		High speed (10 Mb/s), High CMR (10 kV/μs), For soldering flow, Solder heat resistance: 270°C	○	○ <sup>*3</sup>	SOP 8-pin	20	3.75	0.6	-40 to +85	13	5	5.0	-	350
PC412S0NIP0F		High speed (25 Mb/s), High CMR (10 kV/μs), For soldering flow, Solder heat resistance: 270°C	○	-	SOP 8-pin	- <sup>*4</sup>	3.75	1	-40 to +85	4	V <sub>IN</sub> = V <sub>IL</sub>	-	-	-
PC411L0NIP0F		High speed (15 Mb/s), High CMR (10 kV/μs), For soldering flow	○	○ <sup>*3</sup>	Mini-flat 5-pin	20	3.75	0.1	-40 to +85	0.02	12	6.0	-	-
PC411S0NIP0F		High speed (15 Mb/s), High CMR (10 kV/μs), For soldering flow, Solder heat resistance: 270°C	○	○ <sup>*3</sup>	SOP 8-pin	20	3.75	0.1	-40 to +85	0.02	12	6.0	-	-
PC4D10SNIP0F/ PC4D1ASNIP0F		High speed (10 Mb/s), For soldering flow, Solder heat resistance: 270°C 2ch output	○	-	SOP 8-pin	20	3.75	0.6	-40 to +85	13	5	5/3	-	-

A: Rated voltage circuit

\*1 Each item is measured at V<sub>CC</sub>=5V. (PC400, PC401)

\*2 Please refer to Specification Sheets for model numbers approved by safety standards.

\*3 Optionally available.

\*4 No forward current rating for voltage input (rated input voltage: -0.5 to 6.0 V).

### Notice

In the absence of confirmation by device specification sheets, SHARP takes no responsibility for any defects that may occur in equipment using any SHARP devices shown in catalogs, data books, etc.  
Except where specially indicated, models listed on this page comply with the RoHS Directive\*. For details, please contact SHARP.  
\*RoHS Directive: Prohibits use of lead, cadmium, hexavalent chromium, mercury and specific brominated flame retardants (PBBs and PBDEs), with certain exceptions.  
Contact SHARP in order to obtain the latest device specification sheets before using any SHARP device.





## <Compact, SMT type> (1-2)

○: Approved, △: Under application

(Ta = 25°C)

Model No.	Internal connection diagram	Features	Approved by safety standards*1		Package	Absolute maximum ratings		Electro-optical characteristics							
			UL	VDE		Forward current IF (mA)	Isolation voltage (AC) Viso (rms) (kV)	Current transfer ratio				Propagation delay time			
								CTR (%) MIN.	IF (mA)	Vo (V)	VCC (V)	tPHL (μs) TYP.	tPLH (μs) TYP.	RL (Ω)	IF (mA)
PC457L0NIP0F		High speed (1 Mb/s), high CMR (15 kV/μs), For soldering flow	○	○*2	Mini-flat 5-pin	25	3.75	19	16	0.4	4.5	0.2	0.6	1 900	16
PC457S0NIP0F		High speed (1 Mb/s), high CMR (15 kV/μs), For soldering flow, Solder heat resistance: 270°C	○	○*2	SOP 8-pin	25	3.75	19	16	0.4	4.5	0.2	0.6	1 900	16

\*1 Please refer to Specification Sheets for model numbers approved by safety standards.

\*2 Optionally available.

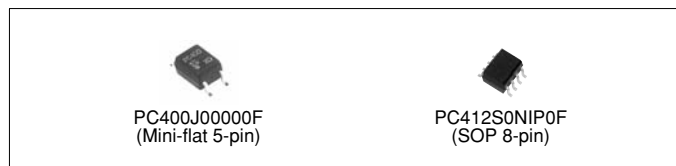

## ◆OPIC Output

### <DIP type, digital output>

○: Approved, △: Under application

(Ta = 25°C)

Model No.	Internal connection diagram	Features	Approved by safety standards*6		Package	Absolute maximum ratings		Electro-optical characteristics*1						
			UL	VDE		Forward current IF (mA)	Isolation voltage (AC) Viso (rms) (kV)	Low level output voltage			Threshold input current			
								VOL (V) MAX.	Ta (°C)	IoL (mA)	IF (mA)	IFHL (mA) MAX.	IFLH (mA) MAX.	RL (Ω)
PC900V0NSZXF*2, *3, *6		Digital output, normal-off operation	○	○*4	6-pin DIP	50	5.0	0.4	0 to +70	16	4	2.0	-	280
PC901V0NSZXF*6		Digital output, normal-on operation	○	○*4		50	5.0	0.4	0 to +70	16	0	-	2.0	280
PC956L0NSZ0F		Built-in preamplifier, high speed transmission (2 Mb/s) For soldering flow	○	○*4	8-pin DIP	25	5.0	0.6	-40 to +85	2.4	10	5.0	-	20 k
PC910L0NSZ0F		Digital output, High speed (10 Mb/s), high CMR (20 kV/μs) For soldering flow	○	○*4		20	5.0	0.6	-40 to +85	13	5	5.0	-	350
PC911L0NSZ0F		High speed (15 Mb/s), high CMR (10 kV/μs), For soldering flow	○	○*4		20	5.0	0.1	-40 to +85	0.02	12	6.0	-	-
PC912L0NSZ0F		Digital output, High speed (25 Mb/s), high CMR (20 kV/μs)	○	○*4		-*5	5.0	1.0	-40 to +85	4	VIN = VIL	-	-	-

A: Rated voltage circuit

\*1 Each item is measured at Vcc=5V.

\*3 Taped package of lead forming type for surface mounting is also available.

\*5 No forward current rating due to voltage input. (rated input voltage: -0.5 to 6.0 V)

\*6 Please refer to Specification Sheets for model numbers approved by safety standards.

\*2 Lead forming type (I type) is also available for surface mounting.

\*4 Optionally available.

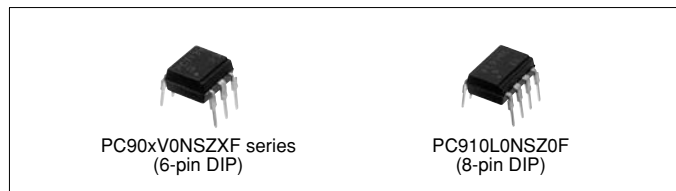

#### Notice

In the absence of confirmation by device specification sheets, SHARP takes no responsibility for any defects that may occur in equipment using any SHARP devices shown in catalogs, data books, etc.

Except where specially indicated, models listed on this page comply with the RoHS Directive\*. For details, please contact SHARP. \*RoHS Directive: Prohibits use of lead, cadmium, hexavalent chromium, mercury and specific brominated flame retardants (PBBs and PBDEs), with certain exceptions.

Contact SHARP in order to obtain the latest device specification sheets before using any SHARP device.





## ◆OPIC Output <DIP type, built-in base amplifier>

○: Approved, △: Under application

(Ta = 25°C)

Model No.	Internal connection diagram	Features	Approved by safety standards*3		Package	Absolute maximum ratings			Electro-optical characteristics					
			UL	VDE		Forward current I <sub>F</sub> (mA)	Isolation voltage (AC) V <sub>iso</sub> (rms) (kV)	Output current I <sub>o1</sub> (A)	Propagation delay time					
									t <sub>PHL</sub> (μs) TYP.	t <sub>PLH</sub> (μs) TYP.	V <sub>CC</sub> (V)	I <sub>F</sub> (mA)	R <sub>L1</sub> (Ω)	R <sub>L2</sub> (Ω)
PC942J00000F		For controlling inverter-controlled air-conditioner	○	○*2	8-pin DIP	25	5.0	0.5	2.0	2.0	6	5	5	10
PC923L0NSZ0F*1		<ul style="list-style-type: none"> <li>Built-in drive circuit directly connectable to MOS-FET and IGBT</li> <li>Low dissipation current (I<sub>cc</sub> = TYP. 1.3 mA)</li> <li>High resistance to noise (CMR: MIN. 15 kV/μs)</li> </ul>	○	○*2		20	5.0	0.1	0.3	0.3	24	5	R <sub>G</sub> = 47	-
PC924L0NSZ0F*1		<ul style="list-style-type: none"> <li>Built-in drive circuit directly connectable to MOS-FET and IGBT</li> <li>Low dissipation current (I<sub>cc</sub> = TYP. 1.3 mA)</li> <li>High resistance to noise (CMR: MIN. 15 kV/μs)</li> </ul>	○	○*2		25	5.0	0.1	1.0	1.0	24	10	R <sub>G</sub> = 47	-
PC925L0NSZ0F		<ul style="list-style-type: none"> <li>Built-in drive circuit directly connectable to MOS-FET and IGBT</li> <li>Peak output current: 2.5 A</li> <li>Low dissipation current (I<sub>cc</sub> = TYP. 5 mA)</li> <li>High resistance to noise (CMR: MIN. 15 kV/μs)</li> </ul>	-	-		-	5.0	2.5	MAX. 0.5	MAX. 0.5	24	10	R <sub>G</sub> = 10	-
PC928J00000F		For driving inverter IGBT, built-in short protection circuit	○	○*2	14-pin SMT (Half pitch lead)	25	4.0	0.1	1.0	1.0	24	10	R <sub>G</sub> = 47	-
PC929J00000F		For driving inverter IGBT, high speed, built-in short protection circuit	○	○*2		20	4.0	0.1	0.3	0.3	24	5	R <sub>G</sub> = 47	-

\*1 Lead forming type (I type) is also available for surface mounting. Taped package of lead forming type for surface mounting is also available.

\*2 A VDE approved type is optionally available.

\*3 Please refer to Specification Sheets for model numbers approved by safety standards.

## ◆OPIC Output <DIP type, analog/digital output>

○: Approved, △: Under application

(Ta = 25°C)

Model No.	Internal connection diagram	Features	Approved by safety standards*3		Package	Absolute maximum ratings		Electro-optical characteristics							
			UL	VDE		Forward current I <sub>F</sub> (mA)	Isolation voltage (AC) V <sub>iso</sub> (rms) (kV)	Current transfer ratio			Propagation delay time*1				
								CTR (%) MIN	I <sub>F</sub> (mA)	V <sub>o</sub> (V)	V <sub>CC</sub> (V)	t <sub>PHL</sub> (μs) TYP.	t <sub>PLH</sub> (μs) TYP.	R <sub>L</sub> (Ω)	I <sub>F</sub> (mA)
PC957L0NSZ0F		High speed (1 Mb/s), high CMR (15 kV/μs), for soldering flow	○	○*2	8-pin DIP	25	5.0	19	16	0.4	4.5	0.2	0.6	1 900	16

\*1 V<sub>CC</sub> = 5V

\*2 Optionally available.

\*3 Please refer to Specification Sheets for title(s) of safety standards.

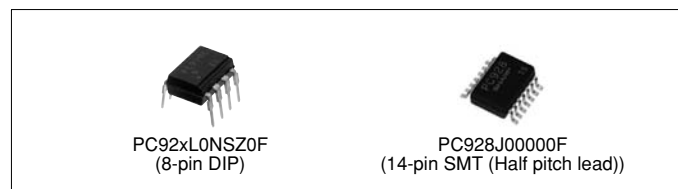

PC92xL0NSZ0F  
(8-pin DIP)

PC928J00000F  
(14-pin SMT (Half pitch lead))

### Notice



In the absence of confirmation by device specification sheets, SHARP takes no responsibility for any defects that may occur in equipment using any SHARP devices shown in catalogs, data books, etc.

Except where specially indicated, models listed on this page comply with the RoHS Directive\*. For details, please contact SHARP. \*RoHS Directive: Prohibits use of lead, cadmium, hexavalent chromium, mercury and specific brominated flame retardants (PBBs and PBDEs), with certain exceptions.

Contact SHARP in order to obtain the latest device specification sheets before using any SHARP device.



## ■ Phototriac Coupler Lineup

Package	Applied voltage	ON-state current (rms)	Features	Model No.	Page	
Mini-flat (SMD) 	AC 200 V lines (V <sub>DRM</sub> = 600V)	0.05 A	General purpose	S2S3000F*4 / S2S5A00F*4	75	
				Built-in zero-cross circuit	S2S4000F*4	75
			Reinforced isolation	PC3SG11YIZ0F*4	75	
				Built-in zero-cross circuit	PC3SG21YIZ0F*4	75
DIP type (4-pin) 	AC 200 V lines (V <sub>DRM</sub> = 600V)	0.1 A	General purpose	PC3ST11NSZAF	75	
				Built-in zero-cross circuit	PC3ST21NSZBF*3	76
			Reinforced isolation	PC3SH11YFZAF*4 / PC3SH13YFZAF*4	75	
				Built-in zero-cross circuit	PC3SH21YFZBF*3	76
DIP type (6-pin) 	AC 100 V lines (V <sub>DRM</sub> = 400V)	0.1 A	General purpose (5th-pin cut)	PC2SD11NTZAF*4	75	
			AC 200 V lines (V <sub>DRM</sub> = 600V)	0.1 A	General purpose (5th-pin cut)	PC3SD12NTZAF*4 / PC3SD11NTZAF*4 / PC3SD11NTZBF*3 / PC3SD11NTZCF*2 / PC3SD11YTZDF*1 / PC3SD21YTZEF*5
					Built-in zero-cross circuit	PC3SD21NTZBF*3 / PC3SD21NTZCF*2 / PC3SD21NTZDF*1 / PC3SF23YVZSF*3 / PC3SD23YTZCF*2
			Reinforced isolation (5th-pin cut)	PC3SF11YVZAF*4 / PC3SF11YVZBF*3	75	
			Built-in zero-cross circuit	PC3SF21YVZAF*4 / PC3SF21YVZBF*3	76	
	AC 200 V lines (V <sub>DRM</sub> = 800V)	0.1 A	General purpose	PC4SD11NTZBF*3 / PC4SD11NTZCF*2	75	
				Built-in zero-cross circuit	PC4SD21NTZCF*2 / PC4SD21NTZDF*1	76
			Reinforced isolation	PC4SF11YVZAF*4 / PC4SF11YVZBF*3	75	
		Built-in zero-cross circuit	PC4SF21YVZBF*3 / PC4SF21YVZCF*2	76		

Minimum trigger current: \*1 I<sub>FT</sub> ≤ 3 mA, \*2 I<sub>FT</sub> ≤ 5 mA, \*3 I<sub>FT</sub> ≤ 7 mA, \*4 I<sub>FT</sub> ≤ 10 mA, \*5 I<sub>FT</sub> ≤ 2 mA

# PHOTOTRIAC COUPLERS



## Phototriac Couplers

○: Approved, △: Under application

(Ta = 25°C)

Type	Model No.	Internal connection diagram	Features	Approved by safety standards*4			Package	Absolute maximum ratings			Electro-optical characteristics			
				UL	VDE	Others*5		ON-state current I <sub>T</sub> (rms) (A)	Repetitive peak OFF-state voltage V <sub>DRM</sub> (V)	Isolation voltage (AC) V <sub>iso</sub> (rms) (kV)	Min. trigger current I <sub>FT</sub> (mA) MAX.	V <sub>D</sub> (V)	R <sub>L</sub> (Ω)	
For triggering	S2S3000F		200 V lines	○	○*6	○	Mini-flat 4-pin	0.05	600	3.75	10	6	100	
	S2S5A00F		200 V lines	○	○*6	○		0.05	600	3.75	10	6	100	
	PC3SG11YZ0F		200 V lines, reinforced insulation (isolation thickness: 0.4 mm)	○	○	—		0.05	600	3.75	10	6	100	
	S2S4000F		200 V lines, built-in zero-cross circuit	○	○*6	○		0.05	600	3.75	10	6	100	
	PC3SG21YZ0F		200 V lines, reinforced insulation (isolation thickness: 0.4 mm), built-in zero-cross circuit	○	○	—		0.05	600	3.75	10	6	100	
	PC3SD12NTZAF*9		200 V lines	○	○*6	○		6-pin DIP*1,3	0.1	600	5.0	10	6	100
	PC2SD11NTZAF*8		100 V lines	○	—	○			0.1	400	5.0	10	6	100
	PC3SD11NTZAF		200 V lines	○	○*6	○			0.1	600	5.0	10	6	100
	PC3SD11NTZBF		200 V lines	○	○*6	○			0.1	600	5.0	7	6	100
	PC4SD11NTZBF		200 V lines, repetitive peak-OFF-state voltage	○	○*6	○			0.1	800	5.0	7	6	100
	PC3SD11NTZCF		200 V lines	○	○*6	○			0.1	600	5.0	5	6	100
	PC3SD11YTZDF		200 V lines, low input drive	○	○	○			0.1	600	5.0	3	6	100
	PC4SD11NTZCF		200 V lines, repetitive peak-OFF-state voltage	○	○*6	○			0.1	800	5.0	5	6	100
	PC3SF11YVZAF		200 V lines, reinforced isolation	○	○	○*2			0.1	600	5.0	10	6	100
	PC3SF11YVZBF		200 V lines, reinforced isolation	○	○	○*2			0.1	600	5.0	7	6	100
PC4SF11YVZAF	200 V lines, reinforced isolation, repetitive peak-OFF-state voltage		○	○	○*2	0.1	800		5.0	10	6	100		
PC4SF11YVZBF	200 V lines, reinforced isolation, repetitive peak-OFF-state voltage		○	○	○*2	0.1	800		5.0	7	6	100		
PC3ST11NSZAF			200 V lines, compact	○	○	○	4-pin DIP		0.1	600	5.0	10	6	100
PC3SH11YFZAF			200 V lines, compact, reinforced isolation	○	○	○*2			0.1	600	5.0	10	6	100
PC3SH13YFZAF		200 V lines, compact, reinforced isolation, High noise resistance	○	○	○*2	0.1		600	5.0	10	6	100		

For the note \*1 to \*9, see next page.

### Notice

In the absence of confirmation by device specification sheets, SHARP takes no responsibility for any defects that may occur in equipment using any SHARP devices shown in catalogs, data books, etc. Except where specially indicated, models listed on this page comply with the RoHS Directive\*. For details, please contact SHARP. \*RoHS Directive: Prohibits use of lead, cadmium, hexavalent chromium, mercury and specific brominated flame retardants (PBBs and PBDEs), with certain exceptions. Contact SHARP in order to obtain the latest device specification sheets before using any SHARP device.

☆New product



## Phototriac Couplers

○: Approved, △: Under application

(Ta = 25°C)

Type	Model No.	Internal connection diagram	Features	Approved by safety standards <sup>*4</sup>			Package	Absolute maximum ratings			Electro-optical characteristics		
				UL	VDE	Others <sup>*5</sup>		ON-state current I <sub>T</sub> (rms) (A)	Repetitive peak OFF-state V <sub>DRM</sub> (V)	Isolation voltage (AC) Viso (rms) (kV)	Min. trigger current I <sub>FT</sub> (mA) MAX.	V <sub>D</sub> (V)	R <sub>L</sub> (Ω)
For triggering	PC3SD21NTZBF		200 V lines, low zero-cross voltage: MAX. 20 V, built-in zero-cross circuit	○	○ <sup>*6</sup>	○	6-pin DIP <sup>*1,3</sup>	0.1	600	5.0	7	4	100
	☆PC3SF23YVZSF		200 V lines, built-in zero-cross circuit, High pulse/noise resistance (TYP. 2 kV)	—	—	—		0.1	600	5.0	7	—	—
	PC3SD21NTZCF <sup>*10</sup>		200 V lines, low zero-cross voltage: MAX. 20 V, built-in zero-cross circuit	○	○ <sup>*6</sup>	○		0.1	600	5.0	5	4	100
	☆PC3SD23YTZCF		200 V lines, built-in zero-cross circuit, High pulse/noise resistance (TYP. 2 kV)	—	—	—		0.1	600	5.0	5	—	—
	PC3SD21NTZDF		200 V lines, low zero-cross voltage: MAX. 20 V, built-in zero-cross circuit	○	○ <sup>*6</sup>	○		0.1	600	5.0	3	4	100
	PC3SD21YTZEF <sup>*7</sup>		200 V lines, built-in zero-cross circuit, Low input drive	○	○	○		0.1	600	5.0	2	4	100
	PC4SD21NTZCF		200 V lines, built-in zero-cross circuit, repetitive peak-OFF-state voltage	○	○ <sup>*6</sup>	○		0.1	800	5.0	5	4	100
	PC4SD21NTZDF		200 V lines, built-in zero-cross circuit, repetitive peak-OFF-state voltage	○	○ <sup>*6</sup>	○		0.1	800	5.0	3	4	100
	PC3SF21YVZAF		200 V lines, reinforced isolation built-in zero-cross circuit	○	○	○ <sup>*2</sup>		0.1	600	5.0	10	4	100
	PC3SF21YVZBF		200 V lines, reinforced isolation built-in zero-cross circuit	○	○	○ <sup>*2</sup>		0.1	600	5.0	7	4	100
	PC4SF21YVZBF		200 V lines, reinforced isolation, built-in zero-cross circuit, repetitive peak-OFF-state voltage	○	○	○ <sup>*2</sup>		0.1	800	5.0	7	4	100
	PC4SF21YVZCF		200 V lines, reinforced isolation, built-in zero-cross circuit, repetitive peak-OFF-state voltage	○	○	○ <sup>*2</sup>		0.1	800	5.0	5	4	100
			PC3ST21NSZBF		200 V lines, compact, built-in zero-cross circuit	○		○ <sup>*6</sup>	○	4-pin DIP	0.1	600	5.0
PC3SH21YFZBF		200 V lines, compact, reinforced isolation, built-in zero-cross circuit	○		○	○ <sup>*2</sup>	0.1	600	5.0		7	6	100

\*1 Lead forming type for surface mounting is also available.

\*2 In conformance with BSI, SEMKO, DEMKO, and FIMKO

\*3 These are molded pin No. 5.

\*4 Please refer to Specification Sheets for model numbers approved by safety standards.

\*5 CSA approval

\*6 Optionally available

\*7 Surface mount type

\*8 An equivalent model (I<sub>FT</sub> MAX.: 15 mA) with overseas brand compatibility is also available. (PC1S3021NTZF)

\*9 An equivalent model with overseas brand compatibility is also available. (PC1S3052NTZF)

\*10 An equivalent model with overseas brand compatibility is also available. (PC1S3063NTZF)

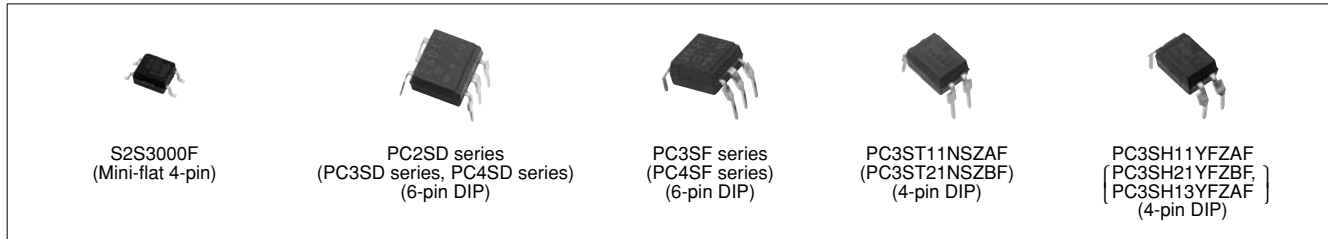

### Notice

In the absence of confirmation by device specification sheets, SHARP takes no responsibility for any defects that may occur in equipment using any SHARP devices shown in catalogs, data books, etc.

Except where specially indicated, models listed on this page comply with the RoHS Directive\*. For details, please contact SHARP. \*RoHS Directive: Prohibits use of lead, cadmium, hexavalent chromium, mercury and specific brominated flame retardants (PBBs and PBDEs), with certain exceptions.

Contact SHARP in order to obtain the latest device specification sheets before using any SHARP device.



## ■ Solid State Relay Lineup

Package	Applied voltage	Features	Model No.	Page
 DIP 6-pin	AC 100 V lines	General purpose	PR22MA11NTZF	78
	AC 200 V lines	General purpose	PR31MA11NTZF / PR32MA11NTZF	78
 DIP 8-pin	AC 100 V lines	General purpose	PR23MF11NSZF / PR26MF series / PR29MF series	78
		Built-in zero-cross circuit	PR26MF21NSZF / PR29MF21NSZF	78
	AC 200 V lines	General purpose	PR33MF11NSZF / PR36MF series / PR39MF series / PR49MF11NSZF / PR3BMF11NSZF	78/79
		Built-in zero-cross circuit	PR36MF series / PR39MF series / PR3BMF21NSZF	78/79
 SIP 4-pin Sx0xT0xF series 	AC 100 V lines	General purpose	S102T01F / S108T01F / S101S05F / S102S01F / S112S01F / S116S01F	80
		Built-in zero-cross circuit	S102T02F / S108T02F / S101S06F / S102S02F / S116S02F	80
		Built-in snubber circuit	S102S11F	80
		Built-in zero-cross/snubber circuit	S101S16F / S102S12F	80
	AC 200 V lines	General purpose	S202T01F / S208T01F / S202S01F / S212S01F / S216S01F	80
		Built-in zero-cross circuit	S202T02F / S208T02F / S201S06F / S202S02F / S216S02F	80/81
		Built-in snubber circuit	S202S15F / S202S11F	80/81
		Built-in zero-cross/snubber circuit	S202S12F	81
		Reinforced isolation	S202SE1F / S216SE1F	81
		Built-in zero-cross circuit	S202SE2F / S216SE2F	81

## ■ Solid State Relays

### <DIP type> (1)

○: Approved, △: Under application

(Ta = 25°C)

Model No.	Internal connection diagram	Features	Approved by safety standards*1			Package	Absolute maximum ratings			Electrical characteristics		
			UL	CSA	VDE		ON-state current I <sub>T</sub> (rms) (A)	Repetitive peak OFF-state voltage V <sub>DRM</sub> (V)	Isolation voltage (AC) V <sub>iso</sub> (rms) (kV)	Min. trigger current I <sub>FT</sub> (mA) MAX.	V <sub>D</sub> (V)	R <sub>L</sub> (Ω)
PR31MA11NTZF		200 V lines, compact	○	○	*2,3○	6-pin DIP	0.06	600	5.0	10	6	100
PR22MA11NTZF		100 V lines, 150 mA output in a small package	○	○	*2,3○		0.15	400	5.0	10	6	100
PR32MA11NTZF		200 V lines, 150 mA output in a small package	○	○	*2,3○		0.15	600	5.0	10	6	100
PR23MF11NSZF		100 V lines, compact	○	○	-	8-pin DIP	0.3	400	4.0	10	6	100
☆PR33MF51NSZF		200 V lines, compact	○	○	*2,3○		0.3	600	4.0	10	6	100
PR26MF11NSZF		100 V lines, compact	○	○	-		0.6	400	4.0	10	6	100
PR26MF12NSZF		100 V lines, compact, low input current	○	○	-		0.6	400	4.0	5	6	100
PR29MF11NSZF		100 V lines, compact	○	○	-		0.9	400	4.0	10	6	100
PR29MF12NSZF		100 V lines, compact, low input current	○	○	-		0.9	400	4.0	5	6	100
PR26MF21NSZF		100 V lines, compact (built-in zero-cross circuit)	○	○	-		0.6	400	4.0	10	6	100
PR29MF21NSZF		100 V lines, compact (built-in zero-cross circuit)	○	○	-		0.9	400	4.0	10	6	100
☆PR36MF51NSZF		200 V lines, compact	○	○	*2,3○		0.6	600	4.0	10	6	100
PR36MF11YSZF		VDE standard compatible, 200 V lines, compact	○	○	*2○		0.6	600	4.0	10	6	100
PR36MF12NSZF		200 V lines, compact, low input current	○	○	-		0.6	600	4.0	5	6	100
PR36MF12YSZF		VDE standard compatible, 200 V lines, compact, low input current	○	○	*2○		0.6	600	4.0	5	6	100
PR39MF11NSZF		200 V lines, compact	○	○	-		0.9	600	4.0	10	6	100
PR39MF11YSZF		VDE standard compatible, 200 V lines, compact	○	○	*2○		0.9	600	4.0	10	6	100
PR39MF12NSZF		200 V lines, compact, low input current	○	○	-		0.9	600	4.0	5	6	100
PR39MF12YSZF		VDE standard compatible, 200 V lines, compact, low input current	○	○	*2○		0.9	600	4.0	5	6	100
PR39MF51NSZF		200 V lines, compact	○	○	*2,3○		0.9	800	4.0	10	6	100
PR49MF11NSZF		200 V lines, compact, high isolation voltage	○	○	*2,3○		0.9	800	4.0	10	6	100

\*1 Please refer to Specification Sheets for model numbers approved by safety standards.

\*2 VDE (EN60747-5-2) compatible.

\*3 Optionally available.

#### Notice

In the absence of confirmation by device specification sheets, SHARP takes no responsibility for any defects that may occur in equipment using any SHARP devices shown in catalogs, data books, etc.  
 Except where specially indicated, models listed on this page comply with the RoHS Directive\*. For details, please contact SHARP.  
 \*RoHS Directive: Prohibits use of lead, cadmium, hexavalent chromium, mercury and specific brominated flame retardants (PBBs and PBDEs), with certain exceptions.  
 Contact SHARP in order to obtain the latest device specification sheets before using any SHARP device.

# SOLID STATE RELAYS



## <DIP type> (2)

○: Approved, △: Under application

(Ta = 25°C)

Model No.	Internal connection diagram	Features	Approved by safety standards*1			Package	Absolute maximum ratings			Electrical characteristics		
			UL	CSA	VDE		ON-state current I <sub>T</sub> (rms) (A)	Repetitive peak OFF-state voltage V <sub>DRM</sub> (V)	Isolation voltage (AC) V <sub>iso</sub> (rms) (kV)	Min. trigger current I <sub>FT</sub> (mA) MAX.	V <sub>D</sub> (V)	R <sub>L</sub> (Ω)
PR36MF22NSZF		200 V lines, compact (built-in zero-cross circuit), low input current	○	○	—	8-pin DIP	0.6	600	4.0	5	6	100
PR36MF22YSZF		VDE standard compatible, 200 V lines, compact (built-in zero-cross circuit), low input current	○	○	*2○		0.6	600	4.0	5	6	100
PR39MF22NSZF		200 V lines, compact (built-in zero-cross circuit), low input current	○	○	—		0.9	600	4.0	5	6	100
PR39MF22YSZF		VDE standard compatible, 200 V lines, compact (built-in zero-cross circuit), low input current	○	○	*2○		0.9	600	4.0	5	6	100
PR36MF21NSZF		200 V lines, compact (built-in zero-cross circuit)	○	○	—		0.6	600	4.0	10	6	100
PR36MF21YSZF		VDE standard compatible, 200 V lines, compact (built-in zero-cross circuit)	○	○	*2○		0.6	600	4.0	10	6	100
PR39MF21NSZF		200 V lines, compact (built-in zero-cross circuit)	○	○	—		0.9	600	4.0	10	6	100
PR39MF21YSZF		VDE standard compatible, 200 V lines, compact (built-in zero-cross circuit)	○	○	*2○		0.9	600	4.0	10	6	100
☆PR3BMF21NSZF		200 V lines, compact (built-in zero-cross circuit)	○	○	*2,3○		1.2	600	4.0	10	6	100
PR3BMF11NSZF			200 V lines, compact, High-temperature operation	○	○		—	1.2	600	4.0	10	6

\*1 Please refer to Specification Sheets for model numbers approved by safety standards.

\*2 VDE (EN60747-5-2) compatible.

\*3 Optionally available.



### Notice

In the absence of confirmation by device specification sheets, SHARP takes no responsibility for any defects that may occur in equipment using any SHARP devices shown in catalogs, data books, etc. Except where specially indicated, models listed on this page comply with the RoHS Directive\*. For details, please contact SHARP. \*RoHS Directive: Prohibits use of lead, cadmium, hexavalent chromium, mercury and specific brominated flame retardants (PBBs and PBDEs), with certain exceptions. Contact SHARP in order to obtain the latest device specification sheets before using any SHARP device.



## <SIP type> (1)

○: Approved, △: Under application

(Ta = 25°C)

Model No.	Internal connection diagram	Features	Approved by safety standards*6			Package	Absolute maximum ratings			Electrical characteristics		
			UL	CSA	TÜV EN 60950		ON-state current I <sub>T</sub> (rms) (A)	Repetitive peak OFF-state voltage V <sub>DRM</sub> (V)	Isolation voltage (AC) Viso (rms) (kV)	I <sub>FT</sub> (mA) MAX.	V <sub>D</sub> (V)	R <sub>L</sub> (Ω)
S102T01F		100 V lines, low profile	○	○	-	4-pin SIP	2	400	3.0	8	12	30
S108T01F		100 V lines, low profile	-	-	-		8*2	400	3.0	8	12	30
S101S05F		100 V lines	○	○	-		3*3	400	3.0	15	12	30
S102S01F		100 V lines	○	○	-		8*2	400	4.0	8	12	30
S112S01F		100 V lines	○	○	-		12*4	400	4.0	8	12	30
S116S01F		100 V lines	○	○	-		16*5	400	4.0	8	12	30
S102T02F			100 V lines, low profile (built-in zero-cross circuit)	○	○		-	2	400	3.0	8	12
S108T02F	100 V lines, low profile (built-in zero-cross circuit)		-	-	-		8*2	400	3.0	8	12	30
S101S06F	100 V lines (built-in zero-cross circuit)		○	○	-		3*3	400	3.0	15	6	30
S102S02F	100 V lines (built-in zero-cross circuit)		○	○	-		8*2	400	4.0	8	6	30
S116S02F	100 V lines (built-in zero-cross circuit)		○	○	-		16*5	400	4.0	8	6	30
S102S11F	100 V lines (built-in snubber circuit)		○	○	-		8*1	400	4.0	8	12	30
S101S16F			100 V lines (built-in snubber circuit, built-in zero-cross circuit)	○	○		-	3*3	400	3.0	15	6
S102S12F		100 V lines (built-in snubber circuit, built-in zero-cross circuit)	○	○	-		8*1	400	4.0	8	6	30
S202T01F		200 V lines, low profile	○	○	-		2	600	3.0	8	12	30
S208T01F		200 V lines, low profile	-	-	-		8*2	600	3.0	8	12	30
S202S01F		200 V lines	○	○	-		8*2	600	4.0	8	12	30
S212S01F		200 V lines	-	-	-		12*4	600	4.0	8	12	30
S216S01F		200 V lines	-	-	-		16*5	600	4.0	8	12	30
S202S15F		200 V lines, built-in snubber circuit	-	-	-		8*6	600	3.0	10	12	30
S202T02F		200 V lines, low profile (built-in zero-cross circuit)	○	○	-		2	600	3.0	8	12	30
S208T02F		200 V lines, low profile (built-in zero-cross circuit)	-	-	-		8*2	600	3.0	8	12	30
S201S06F		200 V lines (built-in zero-cross circuit)	○	○	-		3*3	600	3.0	15	6	30
S202S02F		200 V lines (built-in zero-cross circuit)	○	○	-		8*2	600	4.0	8	6	30
S216S02F		200 V lines (built-in zero-cross circuit)	-	-	-		16*5	600	4.0	8	6	30

\*1 to \*6: Please refer to the next page.

### Notice

In the absence of confirmation by device specification sheets, SHARP takes no responsibility for any defects that may occur in equipment using any SHARP devices shown in catalogs, data books, etc. Except where specially indicated, models listed on this page comply with the RoHS Directive\*. For details, please contact SHARP. \*RoHS Directive: Prohibits use of lead, cadmium, hexavalent chromium, mercury and specific brominated flame retardants (PBBs and PBDEs), with certain exceptions. Contact SHARP in order to obtain the latest device specification sheets before using any SHARP device.



# SOLID STATE RELAYS



## <SIP type> (2)

○: Approved, △: Under application

(Ta = 25°C)

Model No.	Internal connection diagram	Features	Approved by safety standards*6			Package	Absolute maximum ratings			Electrical characteristics		
			UL	CSA	TÜV EN 60950		ON-state current I <sub>T</sub> (rms) (A)	Repetitive peak OFF-state voltage V <sub>DRM</sub> (V)	Isolation voltage (AC) V <sub>iso</sub> (rms) (kV)	Min. trigger current I <sub>FT</sub> (mA) MAX.	V <sub>D</sub> (V)	R <sub>L</sub> (Ω)
S202S11F		200 V lines (built-in snubber circuit)	○	○	—	4-pin SIP	8*1	600	4.0	8	12	30
S202S12F		200 V lines (built-in snubber circuit, built-in zero-cross circuit)	○	○	—		8*1	600	4.0	8	6	30
S202SE1F		200 V lines, reinforced isolation	○	○	○		8*2	600	3.0	8	12	30
S216SE1F			—	—	○		16*5	600	3.0	8	12	30
S202SE2F		200 V lines (built-in zero-cross circuit), reinforced isolation	○	○	○		8*2	600	3.0	8	6	30
S216SE2F			—	—	○		16*5	600	3.0	8	6	30

\*1 T<sub>c</sub> ≤ 88°C

\*2 T<sub>c</sub> ≤ 80°C

\*3 T<sub>c</sub> ≤ 100°C

\*4 T<sub>c</sub> ≤ 70°C

\*5 T<sub>c</sub> ≤ 60°C

\*6 Please refer to Specification Sheets for model numbers approved by safety standards.



**Notice**

In the absence of confirmation by device specification sheets, SHARP takes no responsibility for any defects that may occur in equipment using any SHARP devices shown in catalogs, data books, etc. Except where specially indicated, models listed on this page comply with the RoHS Directive\*. For details, please contact SHARP. \*RoHS Directive: Prohibits use of lead, cadmium, hexavalent chromium, mercury and specific brominated flame retardants (PBBs and PBDEs), with certain exceptions. Contact SHARP in order to obtain the latest device specification sheets before using any SHARP device.



## ■ Photointerrupter Lineup

### <Transmissive type>

Output type	Package type	Outline	Mounting method	Model No. (series)	Page	
Single phototransistor	Compact	General purpose	PWB mounting type	GP1S2x series/GP1S37J0000F	83	
High response speed		High resolution	PWB mounting type/ Soldering reflow	GP1S2xJ0000F series/GP1S092HCPIF/ GP1S9xJ0000F series/ GP1S09xHCZ0F series/ GP1S19xHCZ0F/GP1S19xHCxSF	83	
		Two-phase PT output	PWB mounting type	GP1S39J0000F	83	
		Case type	General purpose	Snap-in	GP1S566VJ00F	84
			High resolution	PWB mounting type, etc.	GP1S5x series/GP1S5xVJ000F series/ GP1S56x series	84
			Horizontal slit, High resolution	PWB mounting type	GP1S59J0000F/GP1S525VJ00F	84
			With connector	General purpose	Snap-in	GP1S74PJ000F
Darlington phototransistor	Case type	General purpose	PWB mounting type, etc.	GP1L5xJ series/GP1L5xV series	85	
High sensitivity		Wide gap	PWB mounting type	GP1L57J0000F	85	
Digital output	Compact	Low voltage operation	PWB mounting type	GP1A6xL series/GP1A91 series	85	
(OPIC output)	Case type	High resolution	PWB mounting type	GP1A5x series	86	
		Wide gap	Both-side/PWB mounting type	GP1A5xHR series/GP1A52LRJ00F	86	
	With connector	General purpose	Screw mounting type/Snap-in	GP1A05 series/GP1A7x series/ GP1A07x series	87	

### <Reflective type>

Output type	Package type	Outline	Mounting method	Model No. (series)	Page
Single phototransistor	Compact, DIP	General purpose	PWB mounting type	GP2S2x series	87
High response speed		Long focal distance	PWB mounting type	GP2S40J0000F	87
		Leadless	Long focal distance	PWB mounting type	GP2S700HCP
	Compact, thin (leadless)	General purpose	PWB mounting type	GP2S60	87
	Case type	Long focal distance	Snap-in	GP2S28	88
Darlington phototransistor	Compact, DIP	General purpose	PWB mounting type	GP2L24J0000F	88
High sensitivity					
OPIC output	With connector	Light modulation type, Sensitivity adjusted	Screw mounting type/ Compact snap-in/ Inverter light countermeasures	GP2A2x series, GP2A200LCS0F/ GP2A231LRSAF, GP2A240LCS0F	89

### <Application-specific photointerrupter lineup>

Detection type	Outline (Output type etc.)	Mounting method	Model No. (series)	Page	
Transmissive type	With connector With actuator (Phototransistor output)	Snap-in	GP1S44S1J00F	90	
	With connector With actuator (OPIC output)	Snap-in	GP1A44E1J00F	90	
	Compact, [built-in ball]	(2-phase PT output) 3 direction detection	PWB mounting type	GP1S36J0000F	91
		(2-phase PT output) 4 direction detection	PWB mounting type	GP1S036HEZ	91
	Case type With encoder function	Resolution: Disk slit pitch: 0.7 mm	Side mounting type	GP1A3xR series	91
	Phase A (digital output) Phase B (digital output)	Resolution: Linear scale slit pitch: 0.17/0.14 mm	PWB mounting type	GP1A038RBK0F/GP1A046RBZLF/ GP1A047RBZLF/GP1A038RCK0F/ GP1A044RCCKLF	91
		Resolution: Linear scale slit pitch: 0.085	PWB mounting type	GP1A037RDJKF/GP1A047RDZLF	91
	Reflective type	Injection For prism system (Single phototransistor)	Screw mounting	GP2S29SJ000F	92
For amusement industry		–	GP2A221HRKA/GP2A222HCKA	92	

## ■ Photointerrupters

### <Transmissive type>

#### ◆ Single phototransistor output

### <Compact type>

(Ta = 25°C)

Model No.	Internal connection diagram	Features	Detecting and emitting gap (mm)	Slit width (mm)	Electro-optical characteristics						
					Current transfer ratio			Response time			
					CTR (%) MIN.	If (mA)	VCE (V)	tr (μs) TYP.	Ic (mA)	RL (Ω)	VCE (V)
GP1S22J0000F ▲		High resolution, with mounting hole, PWB mounting type	1.2	0.3	2.0	5	5	50	0.1	1 000	5
GP1S23J0000F ▲		High resolution, with mounting hole, PWB mounting type	2.0	0.3	0.8	5	5	50	0.1	1 000	5
GP1S24J0000F ▲		High resolution, wide gap, with positioning pin, PWB mounting type	3.0	0.3	0.8	5	5	50	0.1	1 000	5
GP1S25J0000F		Side lead type, For soldering reflow	1.6	0.3	1.0	5	5	35	0.1	1 000	5
GP1S27J0000F		PWB mounting type	0.9	0.8	4.3	1.5	5	50	0.1	1 000	5
GP1S092HCPIF		Height: 2.9 mm, For soldering reflow, with positioning boss	2.0	0.3	2.0	5	5	50	0.1	1 000	5
GP1S37J0000F		PWB mounting type	2.0	0.8	1	3	5	50	0.1	1 000	5
GP1S93J0000F		Wide gap, low profile (3.1 mm)	2.0	0.3	2.0	5	5	50	0.1	1 000	5
GP1S093HCZ0F		Wide gap, low profile (2.9 mm)	2.0	0.3	2.0	5	5	50	0.1	1 000	5
GP1S94J0000F		Wide gap, with positioning pin	3.5	0.3	0.8	5	5	50	0.1	1 000	5
GP1S094HCZ0F		Wide gap, with positioning pin, PWB mounting type (5.5 × 2.6 × 4.8 mm)	3.0	0.3	0.8	5	5	50	0.1	1 000	5
GP1S95J0000F		High resolution, thin detector type	1.6	0.3	1.0	5	5	35	0.1	1 000	5
GP1S96J0000F		Low profile (3.5 × 2.6 × 3.1 mm)	1.0	0.3	2.0	5	5	50	0.1	1 000	5
GP1S096HCZ0F		Low profile (3.5 × 2.6 × 2.9 mm)	1.0	0.3	2.0	5	5	50	0.1	1 000	5
☆GP1S194HCZ0F		Compact, wide gap, size: 3.7 × 2.0 × 2.7 mm	1.7	0.3	1.0	5	5	–	–	–	–
GP1S195HCZSF GP1S195HCPSF		Compact, wide gap, surface mount compatible, size: 3.5 × 2.0 × 2.7 mm	1.5	0.3	1.0	5	5	–	–	–	–
GP1S196HCZ0F		Compact, Low profile (3.1 × 2.0 × 2.7 mm)	1.1	0.3	2.0	5	5	50	0.1	1 000	5
GP1S196HCZSF		Surface mount, for soldering reflow, compact, low profile (3.1 × 2.0 × 2.7 mm)	1.1	0.3	2.0	5	5	50	0.1	1 000	5
GP1S97J0000F		High resolution, wide gap, with mounting hole, PWB mounting type	2.2	0.3	1.6	5	5	50	0.1	1 000	5
GP1S097HCZ0F	High resolution, wide gap, with mounting hole (4.5 × 2.6 × 4.5 mm)	2.0	0.3	2.0	5	5	50	0.1	1 000	5	
GP1S39J0000F		PWB mounting type, two-phase output type	1.5	0.6*1	3.3	4	5	50	0.1	1 000	5

※ Topr: -25 to +85 °C

\*1 Reading pitch

The model marked with ▲ may not be available in the near future. Contact with SHARP for details before use.

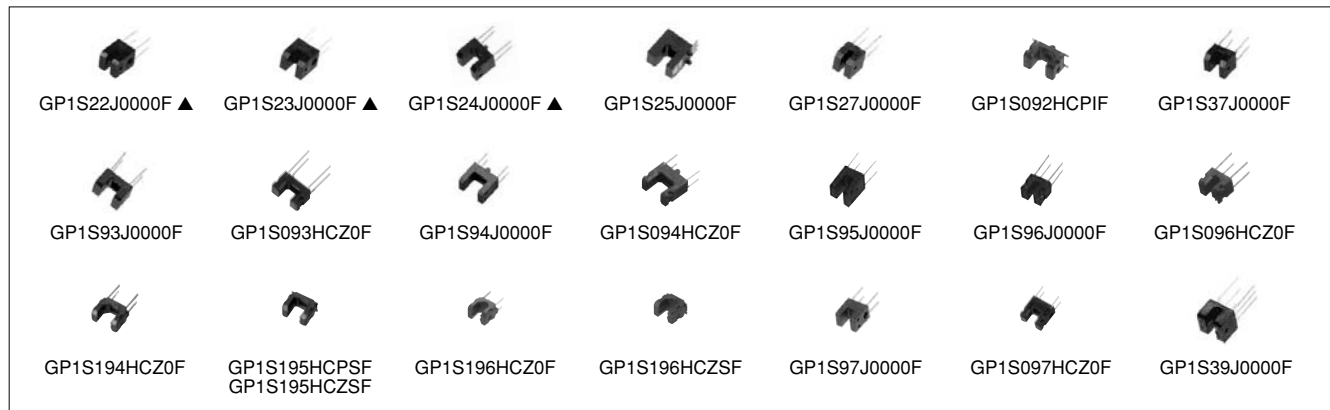

#### Notice

In the absence of confirmation by device specification sheets, SHARP takes no responsibility for any defects that may occur in equipment using any SHARP devices shown in catalogs, data books, etc.

Except where specially indicated, models listed on this page comply with the RoHS Directive\*. For details, please contact SHARP. \*RoHS Directive: Prohibits use of lead, cadmium, hexavalent chromium, mercury and specific brominated flame retardants (PBBs and PBDEs), with certain exceptions.

Contact SHARP in order to obtain the latest device specification sheets before using any SHARP device.



### <Case type>

(Ta = 25°C)

Model No.	Internal connection diagram	Features	Detecting and emitting gap (mm)	Slit width (mm)	Electro-optical characteristics						
					Current transfer ratio			Response time			
					CTR (%) MIN.	IF (mA)	VCE (V)	tr (μs) TYP.	IC (mA)	RL (Ω)	VCE (V)
GP1S566VJ00F		Long case, snap-in mounting type	3.0	0.5	2.5	20	5	3	2	100	2
GP1S50J0000F		High resolution, both-side mounting type	3.0	0.5	2.5	20	5	3	2	100	2
GP1S51VJ000F*1		High resolution, side mounting type	3.0	0.5	2.5	20	5	3	2	100	2
GP1S52VJ000F*1		High resolution, PWB mounting type	3.0	0.5	2.5	20	5	3	2	100	2
GP1S53VJ000F		High resolution, PWB mounting type	5.0	0.5	2.5	20	5	3	2	100	2
GP1S54J0000F		High resolution, with positioning pin, PWB mounting type	3.0	0.5	2.5	20	5	3	2	100	2
GP1S56TJ000F		High resolution, with positioning pin, PWB mounting type	2.0	0.15	2.0	20	5	38	0.5	1 000	2
GP1S58VJ000F		High resolution, with positioning pin, PWB mounting type	5.0	0.5	2.5	20	5	3	2	100	2
GP1S59J0000F		High resolution, horizontal slit, with positioning pin, PWB mounting type	4.2	0.5	2.5	20	5	3	2	100	2
GP1S525VJ00F		Short lead type with easy board mounting, horizontal slit, high precision positioning (lead: within ø1.2 mm)	5.0	0.5	3.25	20	10	3	2	100	2

\* Topr: -25 to +85 °C

\*1 High reliability types: GP1SQ51VJ00F, and GP1SQ52J000F are also available.

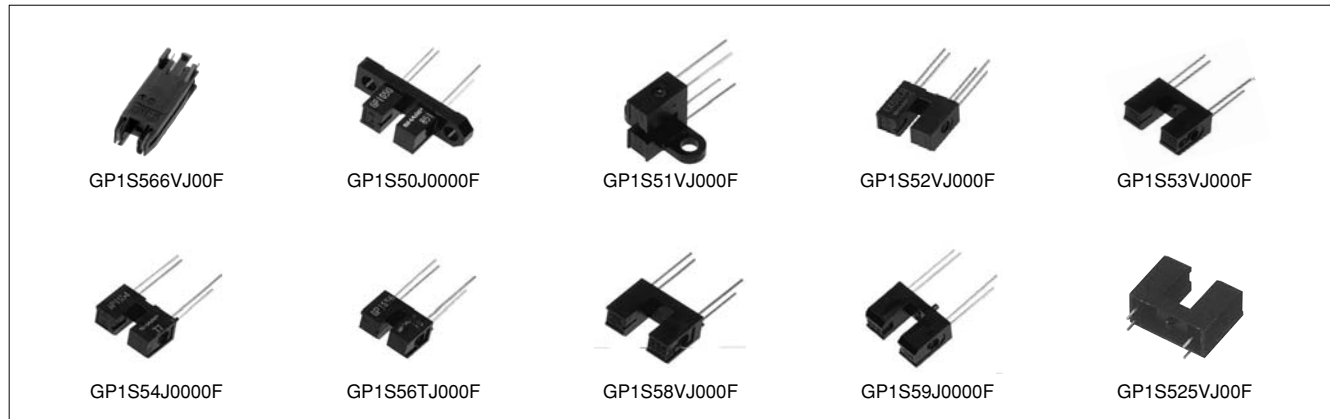

### <With connector type>

(Ta = 25°C)

Model No.	Internal connection diagram	Features	Detecting and emitting gap (mm)	Slit width (mm)	Electro-optical characteristics						
					Current transfer ratio			Response time			
					CTR (%) MIN.	IF (mA)	VCE (V)	tr (μs) TYP.	IC (mA)	RL (Ω)	VCE (V)
GP1S74PJ000F		Snap-in mounting type with connector Applicable to 3 kinds of thickness of mounting boards	5.0	0.5	2.5	20	5	3	2	100	2

\* Topr: -25 to +85 °C



#### Notice

In the absence of confirmation by device specification sheets, SHARP takes no responsibility for any defects that may occur in equipment using any SHARP devices shown in catalogs, data books, etc.  
 Except where specially indicated, models listed on this page comply with the RoHS Directive\*. For details, please contact SHARP.  
 \*RoHS Directive: Prohibits use of lead, cadmium, hexavalent chromium, mercury and specific brominated flame retardants (PBBs and PBDEs), with certain exceptions.  
 Contact SHARP in order to obtain the latest device specification sheets before using any SHARP device.



## ◆Darlington phototransistor output <Case type>

(Ta = 25°C)

Model No.	Internal connection diagram	Features	Detecting and emitting gap (mm)	Slit width (mm)	Electro-optical characteristics						
					Current transfer ratio			Response time			
					CTR (%) MIN.	IF (mA)	VCE (V)	tr (μs) TYP.	IC (mA)	RL (Ω)	VCE (V)
GP1L50J000F		High resolution, both-side mounting type	3.0	0.5	50	1	2	80	2	100	2
GP1L51J000F		High resolution, side mounting type	3.0	0.5	50	1	2	80	2	100	2
GP1L52VJ000F		High resolution, PWB mounting type	3.0	0.5	50	1	2	80	2	100	2
GP1L53VJ000F		High resolution, PWB mounting type	5.0	0.5	30	1	2	80	2	100	2
GP1L57J0000F		Wide gap, PWB mounting type	10.0	1.8	70	1	2	130	2	100	2

\* Topr: -25 to +85 °C



## ◆OPIC type ( "OPIC" (Optical IC) is a trademark of SHARP Corporation. An OPIC consists of a light-detecting element and signal-processing circuit integrated onto a single chip. ) <Compact type>

(Ta = 25°C)

Model No.	Internal connection diagram	Features	Detecting and emitting gap (mm)	Slit width (mm)	Electro-optical characteristics							
					Threshold input current			Propagation delay time				
					IFLH (mA) MAX.	IFHL (mA) MAX.	VCC (V)	tPLH (μs) TYP.	tPHL (μs) TYP.	IF (mA)	RL (Ω)	VCC (V)
GP1A68LJ000F ▲		Compact, PWB mounting, low operating voltage (1.4 V to 7.0 V), low dissipation current	0.9	(0.3) *1	-	2.5	3	10.0	3.0	5	3 000	3
GP1A91LRJ00F		Compact, PWB mounting, low operating voltage (1.4 V to 7.0 V)	1.2	(0.23) *1	-	3.5	3	10.0	3.0	5	3 000	3
GP1A91LCJ00F		Compact, PWB mounting, low operating voltage (1.4 V to 7.0 V)	1.2	(0.23) *1	-	3.5	3	10.0	3.0	5	2 500	3

\* Topr = -25 to +85°C

\*1 Resolution of detecting portion

The model marked with ▲ may not be available in the near future. Contact with SHARP for details before use.

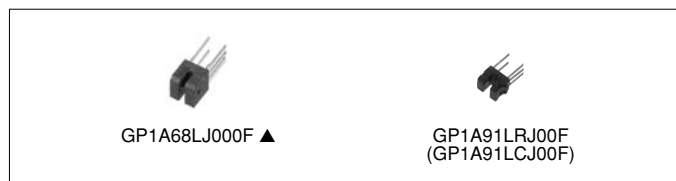

### Notice

In the absence of confirmation by device specification sheets, SHARP takes no responsibility for any defects that may occur in equipment using any SHARP devices shown in catalogs, data books, etc.  
 Except where specially indicated, models listed on this page comply with the RoHS Directive\*. For details, please contact SHARP.  
 \*RoHS Directive: Prohibits use of lead, cadmium, hexavalent chromium, mercury and specific brominated flame retardants (PBBs and PBDEs), with certain exceptions.  
 Contact SHARP in order to obtain the latest device specification sheets before using any SHARP device.



### <Case type>

(Ta = 25°C)

Model No.	Internal connection diagram	Features	Detecting and emitting gap (mm)	Slit width (mm)	Electro-optical characteristics							
					Threshold input current			Propagation delay time				
					IFLH (mA) MAX.	IFHL (mA) MAX.	VCC (V)	tPLH (μs) TYP.	tPHL (μs) TYP.	IF (mA)	RL (Ω)	VCC (V)
GP1A50HRJ00F		Both-side mounting type	3.0	0.5	5	–	5	3	5	5	280	5
GP1A51HRJ00F		Side mounting type	3.0	0.5	5	–	5	3	5	5	280	5
GP1A52HRJ00F		PWB mounting type	3.0	0.5	5	–	5	3	5	5	280	5
GP1A53HRJ00F		PWB mounting type	5.0	0.5	8	–	5	3	5	8	280	5
GP1A57HRJ00F		PWB mounting type, with positioning pin	10.0	1.8	7	–	5	3	5	7	280	5
GP1A58HRJ00F		PWB mounting type, with positioning pin	5.0	0.5	8	–	5	3	5	8	280	5
GP1A52LRJ00F		PWB mounting type	3.0	0.5	–	5	5	5	3	5	280	5

\* Topr = -25 to +85°C



GP1A50HRJ00F

GP1A51HRJ00F

GP1A52LRJ00F  
(GP1A52HRJ00F)

GP1A53HRJ00F  
(GP1A58HRJ00F  
with positioning pin)

GP1A57HRJ00F

#### Notice

In the absence of confirmation by device specification sheets, SHARP takes no responsibility for any defects that may occur in equipment using any SHARP devices shown in catalogs, data books, etc.  
 Except where specially indicated, models listed on this page comply with the RoHS Directive\*. For details, please contact SHARP.  
 \*RoHS Directive: Prohibits use of lead, cadmium, hexavalent chromium, mercury and specific brominated flame retardants (PBBs and PBDEs), with certain exceptions.  
 Contact SHARP in order to obtain the latest device specification sheets before using any SHARP device.

# PHOTOINTERRUPTERS

☆New product



◆OPIC type ( "OPIC" (Optical IC) is a trademark of SHARP Corporation. An OPIC consists of a light-detecting element and signal-processing circuit integrated onto a single chip. )

<With 3-pin connector terminal>

(Ta = 25°C)

Model No.	Internal connection diagram	Features	Detecting and emitting gap (mm)	Slit width (mm)	Electro-optical characteristics					
					Supply voltage V <sub>CC</sub> (V)		V <sub>OL</sub> (V) MAX.	Low level output voltage		
					MIN.	MAX.		Light cut-off	I <sub>OL</sub> (mA)	V <sub>CC</sub> (V)
GP1A05AJ000F		Either-side mounting type	5.0	0.5	4.5	5.5	0.35	No	16	5
GP1A05A2J00F		Either-side mounting type	5.0	0.5	4.5	5.5	0.35	No	16	5
GP1A05A5J00F		Either-side mounting type	5.0	0.5	4.5	5.5	0.35	No	16	5
GP1A73AJ000F		Compact, snap-in mounting type	5.0	0.5	4.5	5.5	0.35	No	4	5
☆GP1A073LCS		Compact, snap-in mounting type, low voltage operation	5.0	0.5	2.7	5.5	0.35	No	4	5
GP1A75EJ000F		Either-side mounting type	5.0	0.5	4.5	5.5	0.35	Yes	16	5
GP1A05EJ000F		Either-side mounting type Screw mounting type	5.0	0.5	4.5	5.5	0.4	Yes	16	5
GP1A05E2J00F			5.0	0.5	4.5	5.5	0.4	Yes	16	5

\* Topr: -20 to +75°C



## Photointerrupters

<Reflective type>

◆Single Phototransistor output

<Compact>

(Ta = 25°C)

Model No.	Internal connection diagram	Features	Focal distance (mm)	Electro-optical characteristics							
				Current transfer ratio			Response time				
				CTR (%) MIN.	I <sub>F</sub> (mA)	V <sub>CE</sub> (V)	t <sub>r</sub> (μs) TYP.	I <sub>C</sub> (mA)	R <sub>L</sub> (Ω)	V <sub>CE</sub> (V)	
GP2S24J0000F		Compact (DIP), visible light cut-off	0.7	0.5	4	2	20	0.1	1 000	2	
GP2S27J0000F		Compact, allow reflow soldering, visible light cut-off	0.7	0.5	4	2	20	0.1	1 000	2	
GP2S40J0000F		Compact, long focal distance, visible light cut-off	3	2.5	20	5	50	0.1	1 000	2	
GP2S700HCP		Compact, long focal distance, surface mounting leadless type	3	1.5	4	2	20	0.1	1 000	2	
GP2S60		Thin (3.2 × 1.7 × t: 1.1 mm), leadless type	(0.5)	1.75 <sup>*1</sup> TYP.	4	2	20	0.1	1 000	2	

\* Topr: -25 to +85°C

\*1 Detection area

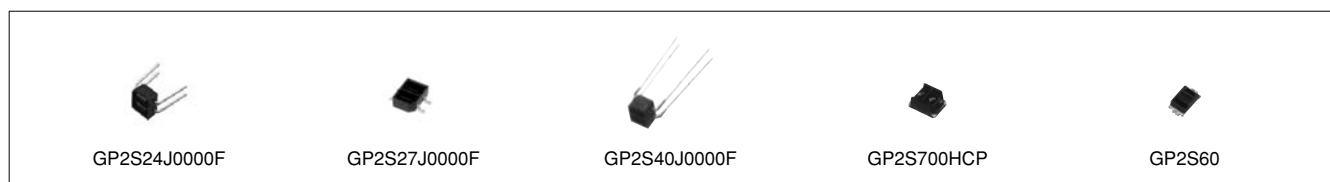

### Notice

In the absence of confirmation by device specification sheets, SHARP takes no responsibility for any defects that may occur in equipment using any SHARP devices shown in catalogs, data books, etc. Except where specially indicated, models listed on this page comply with the RoHS Directive\*. For details, please contact SHARP. \*RoHS Directive: Prohibits use of lead, cadmium, hexavalent chromium, mercury and specific brominated flame retardants (PBBs and PBDEs), with certain exceptions. Contact SHARP in order to obtain the latest device specification sheets before using any SHARP device.



### <Case type>

(Ta = 25°C)

Model No.	Internal connection diagram	Features	Focal distance (mm)	Electro-optical characteristics							
				Current transfer ratio			Response time				
				CTR (%) MIN.	IF (mA)	VCE (V)	tr (μs) TYP.	Ic (mA)	RL (Ω)	VCE (V)	
GP2S28		Long focal distance, compact, Snap-in mounting	6	0.2	20	5	20	0.1	100	2	

\* Topr: -25 to +85°C



### ◆Darlington Phototransistor output

#### <Compact>

(Ta = 25°C)

Model No.	Internal connection diagram	Features	Focal distance (mm)	Electro-optical characteristics							
				Current transfer ratio			Response time				
				CTR (%) MIN.	IF (mA)	VCE (V)	tr (μs) TYP.	Ic (mA)	RL (Ω)	VCE (V)	
GP2L24J0000F		Compact (DIP), visible light cut-off	0.7	12.5	4	2	80	10	100	2	



#### Notice

In the absence of confirmation by device specification sheets, SHARP takes no responsibility for any defects that may occur in equipment using any SHARP devices shown in catalogs, data books, etc.  
 Except where specially indicated, models listed on this page comply with the RoHS Directive\*. For details, please contact SHARP.  
 \*RoHS Directive: Prohibits use of lead, cadmium, hexavalent chromium, mercury and specific brominated flame retardants (PBBs and PBDEs), with certain exceptions.  
 Contact SHARP in order to obtain the latest device specification sheets before using any SHARP device.





◆ **OPIC output** (“OPIC” (Optical IC) is a trademark of SHARP Corporation. An OPIC consists of a light-detecting element and signal-processing circuit integrated onto a single chip.)

**<With 3-pin connector terminal>**

(Ta = 25°C)

Model No.	Internal connection diagram	Features	Optimum detecting distance (mm)	Electro-optical characteristics					
				Supply voltage Vcc (V)		Dissipation current Icc (mA) MAX.	Low level output voltage		
				MIN.	MAX.		Vcc (V)	VoL (V) MAX.	Vcc (V)
GP2A22J0000F	(Following diagram)	Multi types of paper detectable, light modulation type, with connector, sensitivity adjusted	9 to 15	4.75	5.25	30*1	5	0.4	5
GP2A200LCS0F		Multi types of paper detectable, light modulation type, with connector, sensitivity adjusted	5 to 15	4.75	5.25	30*1	5	0.4	5
GP2A240LCS0F		Improved light-resistance characteristic for inverter lighting (500 lx), light modulation type, connector output	5 to 15	4.75	5.25	30*1	5	0.4	5
GP2A250LCS0F		Static electricity resistant, improved light-resistance characteristic for inverter lighting (500 lx), light modulation type, connector output	5 to 15	4.75	5.25	30*1	5	0.4	5
GP2A25J0000F		Multi types of paper detectable, light modulation type, with connector, sensitivity adjusted	3 to 7	4.75	5.25	30*1	5	0.4	5
GP2A231LRSAF		Compact, Hook type, Multi types of paper detectable, light modulation type, with connector, sensitivity adjusted	3 to 7	4.75	5.25	20*1	5	0.4	5
GP2A25NJJ00F		Multi types of paper detectable, light modulation type, sensitivity adjusted, applicable to inverter fluorescent lamp, built-in visible light cut filter	3 to 6	4.75	5.25	30*1	5	0.4	5
GP2A25BJ000F		Multi types of paper detectable, light modulation type, with connector, sensitivity adjusted	3 to 7	4.75	5.25	30*1	5	0.4	5
GP2A28AJ000F		Multi types of paper detectable, light modulation type, with connector, sensitivity adjusted, detecting portion with flat configuration	3 to 7	4.75	5.25	30*1	5	0.4	5

\* Top: -10 to +60°C (GP2A22J0000F, GP2A25J0000F, GP2A25BJ000F)

\*1 Smoothing value RL = ∞

[Internal connection diagram]

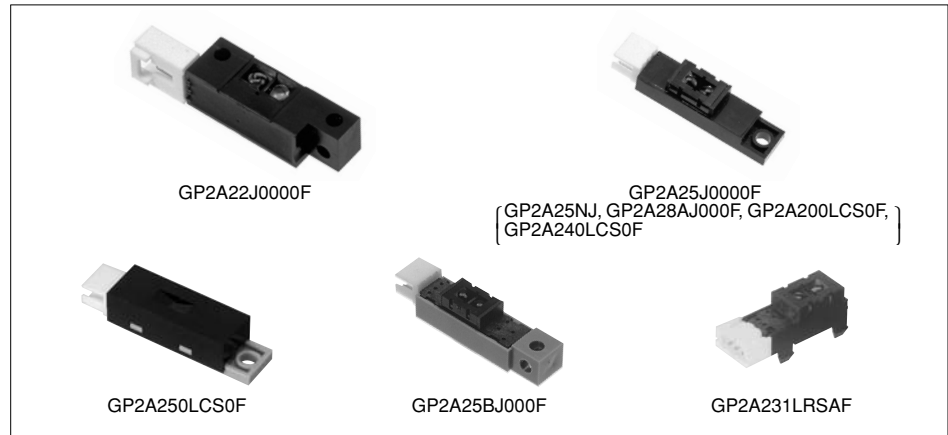
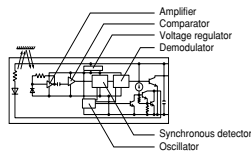

**Notice**

In the absence of confirmation by device specification sheets, SHARP takes no responsibility for any defects that may occur in equipment using any SHARP devices shown in catalogs, data books, etc. Except where specially indicated, models listed on this page comply with the RoHS Directive\*. For details, please contact SHARP. \*RoHS Directive: Prohibits use of lead, cadmium, hexavalent chromium, mercury and specific brominated flame retardants (PBBs and PBDEs), with certain exceptions. Contact SHARP in order to obtain the latest device specification sheets before using any SHARP device.



## ■ Photointerrupters for Specific Applications

### ◆ Transmissive type

#### <Single phototransistor output type with actuator and 3-pin connector terminal>

(Ta = 25°C)

Model No.	Internal connection diagram	Features	Actuator lever starting torque (Initial) MAX.	Electro-mechanical characteristics*1									
				Light beam interrupted					Light beam uninterrupted				
				Dissipation current		Collector current			Dissipation current		Collector current		
				Icc1 (mA)	Vcc (V)	Ic1 (μA)	Vcc (V)	Vo (V)	Icc2 (mA)	Vcc (V)	Ic2 (mA)	Vcc (V)	Vo (V)
GP1S44S1J00F		Spring lever type actuator United with connector	1 × 10 <sup>-4</sup> N•m or less	20 MAX.	5	50 MAX.	5	5	20 MAX.	5	0.25 MIN.	5	5

\* Topr: -25 to +75 °C

\*1 Operating voltage: 4.5 to 5.5 V



#### <OPIC type with actuator and 3-pin connector terminal>

(Ta = 25°C)

Model No.	Internal connection diagram	Features	Absolute maximum ratings		Electro-mechanical characteristics	Electro-mechanical characteristics*1										
			Supply voltage Vcc (V)	Output current IOL (mA)		Actuator lever starting torque	Light beam interrupted					Light beam uninterrupted				
							Dissipation current		Low level output voltage			Dissipation current		High level output voltage		
							Iccl (mA)	Vcc (V)	VOL (V)	Vcc (V)	IOL (mA)	Icch (mA)	Vcc (V)	VOH (V)	Vcc (V)	RL (kΩ)
GP1A44E1J00F		Spring lever type actuator, United with connector	10	50	1 × 10 <sup>-4</sup> N•m or less	20 MAX.	5	0.4 MAX.	5	16	20 MAX.	5	Vcc × 0.9 MIN.	5	47	

\* Topr: -25 to +75 °C

\*1 Operating voltage: 4.5 to 5.5 V



#### Notice

In the absence of confirmation by device specification sheets, SHARP takes no responsibility for any defects that may occur in equipment using any SHARP devices shown in catalogs, data books, etc.  
 Except where specially indicated, models listed on this page comply with the RoHS Directive\*. For details, please contact SHARP.  
 \*RoHS Directive: Prohibits use of lead, cadmium, hexavalent chromium, mercury and specific brominated flame retardants (PBBs and PBDEs), with certain exceptions.  
 Contact SHARP in order to obtain the latest device specification sheets before using any SHARP device.

## <Compact, 2-phase phototransistor output type>

(Ta = 25°C)

Model No.	Internal connection diagram	Features	Electro-optical characteristics						
			Current transfer ratio			Response time			
			CTR (%) MIN.	IF (mA)	VCE (V)	tr (μs) TYP.	IC (mA)	RL (Ω)	VCE (V)
GP1S36J0000F		Built-in ball (2 phase output), compact, PWB mounting type	1.2	5	5	50	0.1	1 000	5
GP1S036HEZ		Built-in ball (2 phase output), compact, PWB mounting type, 4-direction detection	1.1	5	5	50	0.1	1 000	5

\* Topr: -25 to +85 °C



## <Case type, with encoder function>

(Ta = 25°C)

Model No.	Absolute maximum ratings			Output signal	Electro-optical characteristics			
	Vcc (V)	Topr (°C)	Operating voltage Vcc (V)		Resolution	Response frequency		Dissipation current (output side) Icc (mA) MAX.
GP1A30RJ000F ▲	7	0 to +70	4.5 to 5.5	Phase A (Digital output) Phase B (Digital output)	Disk slit pitch 0.7 (mm)	5	30	20
GP1A038RBK0F*1, *3	7	0 to +70	2.7 to 5.5		Linear scale slit pitch 0.17 (mm)	20	11	5
GP1A038RCK0F*1, *3	7	0 to +70	2.7 to 5.5		Linear scale slit pitch 0.14 (mm)	20	11	5
GP1A037RDKJF*1, *3	7	0 to +70	2.7 to 5.5		Linear scale slit pitch 0.0847 (mm)	40	25	10
GP1A044RCKLF*1	—	-10 to +60	2.7 to 5.5		Linear scale slit pitch 0.14 (mm)	20	15	5
GP1A046RBZLF*1	—	-10 to +60	2.7 to 5.5		Linear scale slit pitch 0.17 (mm)	20	20	5
☆GP1A047RBZLF	—	0 to +60	2.7 to 5.5		Linear scale slit pitch 0.17 (mm)	20	20	7
☆GP1A047RDZLF	—	-10 to +60	2.7 to 5.5		Linear scale slit pitch 0.0847 (mm)	120	20	7

\*1 High precision read and low affection of angle error from vibration thanks to the multi-segment PD system

\*2 Duty ratio: 50±10%, phase difference: 90±30°

\*3 Duty ratio: 50±20%, phase difference: 90±45°

The model marked with ▲ may not be available in the near future. Contact with SHARP for details before use.



### Notice

In the absence of confirmation by device specification sheets, SHARP takes no responsibility for any defects that may occur in equipment using any SHARP devices shown in catalogs, data books, etc.

Except where specially indicated, models listed on this page comply with the RoHS Directive\*. For details, please contact SHARP. \*RoHS Directive: Prohibits use of lead, cadmium, hexavalent chromium, mercury and specific brominated flame retardants (PBBs and PBDEs), with certain exceptions.

Contact SHARP in order to obtain the latest device specification sheets before using any SHARP device.

☆New product



## ◆ Reflective type

### <Case type, phototransistor output>

(Ta = 25°C)

Model No.	Internal connection diagram	Features	Focal distance (mm)	Electro-optical characteristics							
				Current transfer ratio			Response time				
				CTR (%) MIN.	IF (mA)	VCE (V)	tr (μs) TYP.	Ic (mA)	RL (Ω)	VCE (V)	
GP2S29SJ000F		Long focal distance (with prism system), compact, screw mounting type	*1	1.0*1	20	5	38	0.5	1 000	2	

\* Topr: -25 to +85°C

\*1 Space between prism and sensor is 8 mm.



### <For the amusement industry>

(Ta = 25°C)

Model No.	Features	Electro-optical characteristics		
		Supply voltage Vcc	Dissipation current Icc (mA)	Response frequency f (Hz)
GP2A221HRKA	Employs reflective type, pinball detector, connector with lock	4.5 to 15	MAX. 10	MAX. 500
☆GP2A222HCKA	Employs reflective type, pinball detector, connector with lock In conjunction with an IC, detects beam interruption*1	4.5 to 16.5	MAX. 10	MAX. 500

\*1 Used together with interface IC for control (IR3N184)



#### Notice

In the absence of confirmation by device specification sheets, SHARP takes no responsibility for any defects that may occur in equipment using any SHARP devices shown in catalogs, data books, etc.  
 Except where specially indicated, models listed on this page comply with the RoHS Directive\*. For details, please contact SHARP.  
 \*RoHS Directive: Prohibits use of lead, cadmium, hexavalent chromium, mercury and specific brominated flame retardants (PBBs and PBDEs), with certain exceptions.  
 Contact SHARP in order to obtain the latest device specification sheets before using any SHARP device.



## ■ Phototransistor Lineup

Package	Output type	Features	Half sensitivity angle	Model No.	
				Standard	Visible light cut-off
Epoxy resin with lens (ø3 mm)	Single phototransistor	General purpose	±20°	PT380	PT380F
	Darlington phototransistor	High sensitivity	±20°	PT381	PT381F
Epoxy resin with lens	Single phototransistor	General purpose/Narrow acceptance	±13°	PT480E0000F	PT480FE0000F
		Compact, thin	±35°	PT4800E0000F	PT4800FE000F / PT4850FE000F
	Darlington phototransistor	High sensitivity/Narrow acceptance	±13°	PT481E00000F	PT481FE0000F
		High sensitivity/Narrow acceptance/Long lead	±13°	—	PT483F1E000F
		High sensitivity/Compact, thin	±35°	PT4810E0000F	PT4810FE000F
		High sensitivity/Intermediate acceptance	±40°	—	PT491FE0000F
		High sensitivity/Intermediate acceptance/Long lead	±40°	—	PT493FE0000F
TO-18	Single phototransistor	Narrow acceptance	±6°	PT501 ▲	—
		Narrow acceptance/With base terminal	±6°	PT510 ▲	—
	Darlington phototransistor	Narrow acceptance/With base terminal	±6°	PT550 ▲	—
		Wide acceptance/With base terminal	±50°	PT550F ▲	—
Surface mounting leadless type	Single phototransistor	Compact	±60°	PT600T	—
		Compact (surface mounting type)	±70°	PT200MC0NP	—
		Compact (infrared cut type)	±60°	PT202MR0MP1	—
	Darlington phototransistor	Compact (side view/top view mounting possible)	±15°	PT100MC0MP	PT100MF0MP
		Compact	±60°	PT601T	—
		Compact (side view/top view mounting possible)	±15°	—	PT100MF1MP
		Compact (side view/top view mounting possible)	±15°	—	PT100MF1MP

The model marked with ▲ may not be available in the near future. Contact with SHARP for details before use.



## Phototransistors

(Ta = 25°C)

Type	Model No.	Package	Absolute maximum ratings			Ic (mA)				ICEO(A)		Dq (°) TYP.	λp (nm) TYP.	
			VCEO (V)	Pc (mW)	Topr (°C)	MIN.	MAX.	VCE (V)	Ee (mW/cm²)	MAX.	VCE (V)			
Single	PT380	ø3 epoxy resin	35	50	-25 to +85	0.16	1.17	5	Ev, 100 lx	1 × 10 <sup>-7</sup>	20	±20	800	
	PT380F*1		35	50	-25 to +85	0.095	0.9	5	Ev, 100 lx	1 × 10 <sup>-7</sup>	20	±20	860	
	PT600T	Surface mounting leadless type	35	50	-25 to +85	0.7	TYP. 3.5	5	5	1 × 10 <sup>-7</sup>	20	±60	880	
	PT200MC0NP		50	50	-25 to +85	0.016	0.059	5	0.1	1 × 10 <sup>-7</sup>	20	±70	930	
	PT202MR0MP1*2		5	5	-30 to +85	—	TYP. 0.043	1.5	Ev, 100 lx	1 × 10 <sup>-7</sup>	1.5	±60	620	
	PT100MC0MP		35	75	-30 to +85	1.7	5.1	5	1	1 × 10 <sup>-7</sup>	20	±15	900	
	PT100MF0MP*1		35	75	-30 to +85	1.15	3.45	5	1	1 × 10 <sup>-7</sup>	20	±15	910	
	Epoxy resin with lens	PT480E0000F	Epoxy resin with lens	35	75	-25 to +85	0.4	TYP. 1.7	5	1	1 × 10 <sup>-7</sup>	20	±13	800
		PT480FE0000F*1		35	75	-25 to +85	0.25	TYP. 0.8	5	1	1 × 10 <sup>-7</sup>	20	±13	860
		PT4800E0000F		35	75	-25 to +85	0.12	TYP. 0.4	5	1	1 × 10 <sup>-7</sup>	20	±35	800
		PT4800FE0000F*1		35	75	-25 to +85	0.08	TYP. 0.25	5	1	1 × 10 <sup>-7</sup>	20	±35	860
		PT4850FE0000F*1		35	75	-25 to +85	0.12	0.56	5	1	1 × 10 <sup>-7</sup>	20	±35	860
TO-18	PT501 ▲	TO-18	45	75	-25 to +125	2.5	TYP. 10	5	10	1 × 10 <sup>-7</sup>	30	±6	800	
	PT510 ▲		35	75	-25 to +125	2.5	TYP. 20.0	5	10	1 × 10 <sup>-7</sup>	30	±6	800	
Darlington	PT381	ø3 epoxy resin	35	50	-25 to +85	0.12	1.5	10	Ev, 2 lx	1 × 10 <sup>-6</sup>	10	±20	800	
	PT381F*1		35	50	-25 to +85	0.07	1.08	10	Ev, 2 lx	1 × 10 <sup>-6</sup>	10	±20	860	
	PT481E0000F	Epoxy resin with lens	35	75	-25 to +85	1.5	25	2	0.1	1 × 10 <sup>-6</sup>	10	±13	800	
	PT481FE0000F*1		35	75	-25 to +85	0.9	27	2	0.1	1 × 10 <sup>-6</sup>	10	±13	860	
	PT4810E0000F		35	75	-25 to +85	0.45	7.0	2	0.1	1 × 10 <sup>-6</sup>	10	±35	800	
	PT4810FJE000F*1		35	75	-25 to +85	0.27	6.0	2	0.1	1 × 10 <sup>-6</sup>	10	±35	860	
	PT483F1E000F*1		35	75	-25 to +85	1.5	4.0	2	0.1	1 × 10 <sup>-6</sup>	10	±13	860	
	PT491FE0000F*1		35	75	-25 to +85	0.2	0.8	2	Ev, 2 lx	1 × 10 <sup>-6</sup>	10	±40	860	
	TO-18	PT493FE0000F*1	TO-18	35	75	-25 to +85	0.2	0.8	2	Ev, 2 lx	1 × 10 <sup>-6</sup>	10	±40	860
		PT550 ▲		35	150	-25 to +125	3	TYP. 20.0	5	0.1	1 × 10 <sup>-6</sup>	10	±6	800
	PT550F ▲	35	150	-25 to +125	3	TYP. 20.0	5	1.0	1 × 10 <sup>-6</sup>	10	±50	800		
	Leadless chip type	PT601T	Leadless chip type	35	50	-25 to +85	0.03	0.3	10	0.01	1 × 10 <sup>-6</sup>	10	±60	880
Surface mounting leadless type	PT100MF1MP*1	Surface mounting leadless type	35	75	-30 to +85	0.2	1.2	5	0.01	1 × 10 <sup>-6</sup>	10	±15	860	

\*1 Visible light cut-off type

\*2 Infrared cut-off type

Note) Some products are handled by the Compound Semiconductor Division.

The model marked with ▲ may not be available in the near future. Contact with SHARP for details before use.

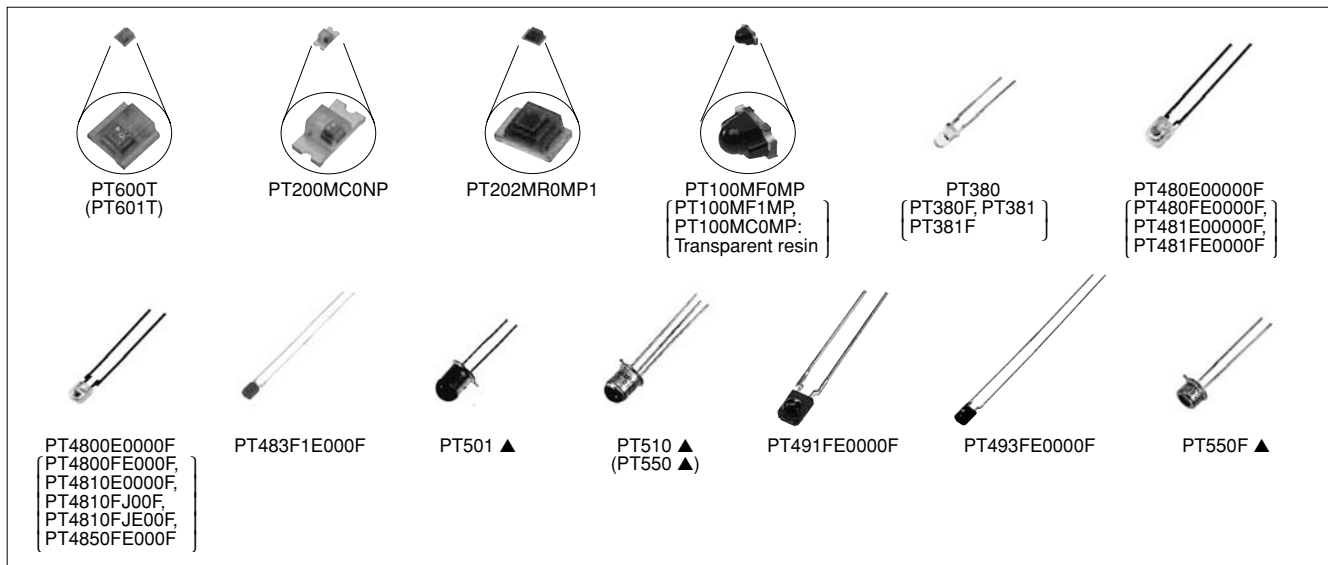

### Notice

In the absence of confirmation by device specification sheets, SHARP takes no responsibility for any defects that may occur in equipment using any SHARP devices shown in catalogs, data books, etc.

Except where specially indicated, models listed on this page comply with the RoHS Directive\*. For details, please contact SHARP. \*RoHS Directive: Prohibits use of lead, cadmium, hexavalent chromium, mercury and specific brominated flame retardants (PBBs and PBDEs), with certain exceptions.

Contact SHARP in order to obtain the latest device specification sheets before using any SHARP device.



## ■ PIN Photodiodes

(Ta = 25°C)

Model No.	Features	Package (Material)	Active area (mm <sup>2</sup> )	Topr (°C)	Isc (μA) MIN.	Ev (lx)	Id (A) MAX.	VR (V)	tr, tf (μs) TYP.			λp (nm) TYP.
									VR (V)	RL (kΩ)	RL (kΩ)	
PD49PIE000F*1	PIN type	Visible light cut-off epoxy resin	7.73	-25 to +85	2.4	100	3 × 10 <sup>-8</sup>	10	0.2	10	1	1 000
PD410PI2E00F*1		Visible light cut-off epoxy resin with condenser (lens)	3.31	-25 to +85	2.5	100	1 × 10 <sup>-8</sup>	10	0.2	10	1	1 000
PD411PI2E00F		Epoxy resin with transparent condenser (lens)	3.31	-25 to +85	5.0	100	1 × 10 <sup>-8</sup>	10	0.2	10	1	960
PD412PI2E00F*2		Epoxy resin with transparent condenser (lens)	3.31	-25 to +85	3.5	100	1 × 10 <sup>-8</sup>	10	0.25	10	1	800
PD413PI2E00F*1	PIN type IrDA1.0	Visible light cut-off epoxy resin with condenser (lens)	3.31	-25 to +85	MIN. 4.5 (TYP. 5.4)	100	1 × 10 <sup>-8</sup>	10	0.2	10	1	960
PD481PIE000F*1	PIN type	Visible light cut-off epoxy resin	7.73	-25 to +85	3.5	100	3 × 10 <sup>-8</sup>	10	0.2	3	1	960
PD60T	Chip device type	Transparent resin	-	-25 to +85	TYP. 4	1 000	1 × 10 <sup>-8</sup>	10	0.1	10	1	960
PD100MC0MP	Surface mounting leadless type	Transparent epoxy resin board with lens	-	-30 to +85	0.6	100	1 × 10 <sup>-8</sup>	10	0.01	15	0.18	820
PD100MF0MP*1	Surface mounting leadless type	Visible light cut-off epoxy resin board with lens	-	-30 to +85	0.4	100	1 × 10 <sup>-8</sup>	10	0.01	15	0.18	850

\*1 Visible light cut-off type

\*2 Tape packaging type (PD412TNE00F)

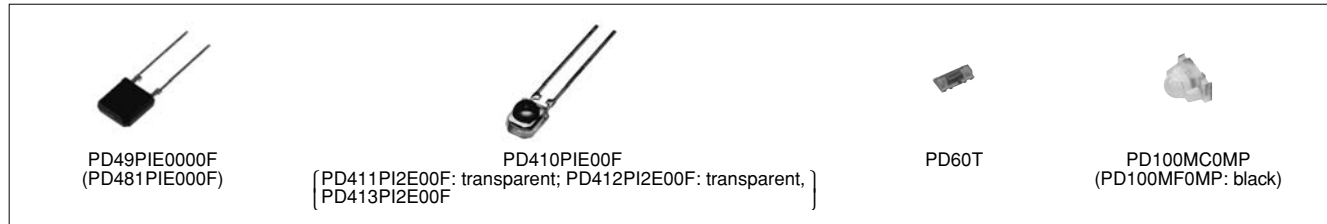

## ■ PSD (Position Sensitive Detector)

(Ta = 25°C)

Model No.	Features	Package (Material)	Active area (mm <sup>2</sup> )	Topr (°C)	IL (μA) MIN.	Ev (lx)	Interelectrode resistance (kΩ) TYP.		tr, tf (μs) TYP.			Position detection error (μm) MAX.
							VR (V)	VR (V)	RL (kΩ)	RL (kΩ)		
PD3122FE000F	Position sensitive detector With mounting hole	Visible light cut-off epoxy resin	1.2 (1.0 × 1.2 mm)	-25 to +85	6.4	1 000	110 to 170	1	5	1	1	±25

Custom-made products (detecting portion changed products) are also available.



## ■ Blue Sensitive Photodiodes

(Ta = 25°C)

Model No.	Features	Package (Material)	Active area (mm <sup>2</sup> )	Topr (°C)	Isc (μA) MIN.	Ev (lx)	Id (A) MAX.	VR (V)	λp (nm) TYP.



### Notice

In the absence of confirmation by device specification sheets, SHARP takes no responsibility for any defects that may occur in equipment using any SHARP devices shown in catalogs, data books, etc. Except where specially indicated, models listed on this page comply with the RoHS Directive\*. For details, please contact SHARP. \*RoHS Directive: Prohibits use of lead, cadmium, hexavalent chromium, mercury and specific brominated flame retardants (PBBs and PBDEs), with certain exceptions. Contact SHARP in order to obtain the latest device specification sheets before using any SHARP device.



## ■ Laser Power Monitoring Photodiodes for Optical Disc System

(Ta = 25°C)

Model No.	Features	Package (Material)	Active area (mm)	Topr (°C)	Isc (mA) TYP.	Ev (lx)	Id (A) MAX.	VR (V)	λp (nm) TYP.



## ■ OPIC Light Detectors ( "OPIC" (Optical IC) is a trademark of the SHARP Corporation. An OPIC consists of a light-detecting element and signal-processing circuit integrated onto a single chip. )

(Ta = 25°C)

Model No.	Type	Package	Absolute maximum ratings				Electro-optical characteristics							
			Vcc (V)	P (mW)	Io (mA)	Topr (°C)	EVLH (lx) MAX.	EVHL (lx) MAX.	Vcc (V)	tPLH (μs) TYP.	tPHL (μs) TYP.	Vcc (V)	Ev (lx)	RL (Ω)
IS485E	Built-in schmidt trigger circuit, amplifier and voltage regulator	Transparent epoxy resin with condenser (lens)	-0.5 to +17	175	50	-25 to +85	-	35	5	5	3	5	50	280
IS486E			-0.5 to +17	175	50	-25 to +85	35	-	5	3	5	5	50	280



## <Low-voltage operation>

(Ta = 25°C)

Model No.	Type	Package	Absolute maximum ratings				Electro-optical characteristics							
			P (mW)	Io (mA)	Topr (°C)	Operating supply voltage (V)	EVLH (lx) MAX.	EVHL (lx) MAX.	Vcc (V)	tPLH (μs) TYP.	tPHL (μs) TYP.	Vcc (V)	Ev (lx)	RL (Ω)
IS489E	Built-in Schmidt trigger circuit and amplifier	Transparent epoxy resin with condenser (lens)	80	2	-25 to +85	1.4 to 7.0	-	15	3	1.3	8.5	3	125	3 000



### Notice

In the absence of confirmation by device specification sheets, SHARP takes no responsibility for any defects that may occur in equipment using any SHARP devices shown in catalogs, data books, etc.  
 Except where specially indicated, models listed on this page comply with the RoHS Directive\*. For details, please contact SHARP.  
 \*RoHS Directive: Prohibits use of lead, cadmium, hexavalent chromium, mercury and specific brominated flame retardants (PBBs and PBDEs), with certain exceptions.  
 Contact SHARP in order to obtain the latest device specification sheets before using any SHARP device.



# OPIC LIGHT DETECTORS

☆New product  
★Under development



## <Model employing a light modulating system>

(Ta = 25°C)

Model No.	Type	Package	Absolute maximum ratings				Electro-optical characteristics*2						External disturbing light illuminance EvDX(lx) TYP.
			Vcc (V)	P (mW)	Io (mA)	ToPr (°C)	VOL (V) MAX.	VOH (V) MIN.	tPLH (μs) TYP.	tPHL (μs) TYP.	Vcc (V)	RL (Ω)	
IS471FE*1, *3	Built-in pulse driver circuit at the emitter side, synchronous detector circuit, amplifier circuit and demodulator circuit	Visible light cut-off epoxy resin	-0.5 to +16	250	50	-25 to +60	0.35	4.97	400	400	5	280	7 000

\*1 IS471FE is less susceptible to disturbing effects thanks to the light modulation system

\*2 Vcc = 5 V

\*3 Straight lead type (IS471FSE) is also available.



## <For laser beam printers (laser origin detection)>

(Ta = 25°C)

Model No.	Type	Package	Electro-optical characteristics			
			Recommended supply voltage Vcc (V)	VOH (V) MIN.	VOL (V) MAX.	H → L delay time variation ΔtPHL (ns) MAX.
GA220T2L1Z	2PD, differential type	Transparent epoxy resin 18-pin	4.5 to 5.5	4.9	0.6	±8.5



## <Illuminance sensor>

(Ta = 25°C)

Model No.	Type	Package	Absolute maximum ratings			Electro-optical characteristics					
			Vcc (V)	Io (mA)	ToPr (°C)	Recommended supply voltage Vcc (V)	Recommended illuminance range Ex (lx)	Current consumption Icc (μA) MAX.	Peak sensitivity wavelength λp (nm)	Output current	
									Io1 (μA) TYP.	Io2 (μA) TYP.	
★GA1A0S100WP	Built-in amplification circuit Peak sensitivity characteristic close to human visual sensitivity Output characteristic: Linear current output for illuminance	Compact (1.5 mm x 1.5 mm) Leadless	-0.3 to +7.0	5	-25 to +85	2.7 to 3.6	10 to 10000	675	560	-	-
☆GA1A1S200WP	Built-in amplification circuit Peak sensitivity characteristic close to human visual sensitivity Output characteristic: Logarithmic current output for illuminance	Compact (2.0 mm x 1.6 mm) Leadless	-0.3 to +7.0	1	-40 to +85	2.3 to 3.2	3 to 55000	150	555	20 (at Ev = 100 lx)	30 (at Ev = 1000 lx)

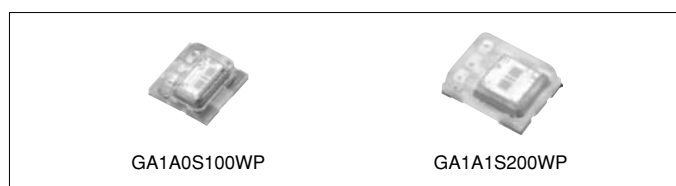

### Notice

In the absence of confirmation by device specification sheets, SHARP takes no responsibility for any defects that may occur in equipment using any SHARP devices shown in catalogs, data books, etc.

Except where specially indicated, models listed on this page comply with the RoHS Directive\*. For details, please contact SHARP.  
\*RoHS Directive: Prohibits use of lead, cadmium, hexavalent chromium, mercury and specific brominated flame retardants (PBBs and PBDEs), with certain exceptions.

Contact SHARP in order to obtain the latest device specification sheets before using any SHARP device.

☆New product



## <Optical disk devices for RF signal detection>

(Ta = 25°C)

Model No.	Type	Package	Absolute maximum ratings			Electro-optical characteristics					
			Vcc (V)	P (mW)	Topr (°C)	Icc (mA) TYP.	Response frequency		Output noise level		
							Vcc (V)	fc*1 (MHz) TYP.	Vn (dBm) TYP.	Main Ch. f (Hz)	
IS1682Q	Built-in amplifier circuit, built-in RF addition amplifier (6-division PINPD + IC), for x50 CD-ROM	Transparent 10-pin package	6.0	–	–30 to +80	14.8	5	(72/70) 72/70	5	–81	23.1M
GA250T6C3SY	Built-in amplifier circuit, (6-division PINPD + IC), for CD player Low operating voltage (MIN. 2.5 V)	Transparent 10-pin package	7.0	–	–20 to +75	6	5	5/0.3	5	(–78)	2.8M
GA250T6C4SY											
IS1623Q	Built-in amplifier circuit, (8-division PINPD + IC), switchable of sensitivity due to playback/recording mode for MD	Transparent flat 10-pin package	6.0	150	–20 to +70	4.2/ 4.6*2	3	5.3/3.8*2	3	–90	720k
IS1684Q	Built-in RF amplifier, for x6 DVD-ROM drive	Transparent flat 10-pin package	6.0	–	–30 to +80	14.8	5	(70/60) 70/50	5	–81	23.1M
GA210TXV8SY*3	For 2-wavelength laser (For DVD player), 10-division PD pattern	Transparent flat 12-pin package (4 x 5.0 mm)	6.0	–	–10 to +70	17	5	–75	5	–80	23M
GA230TXW1SY	For x16 DVD-R/RW, +R/W ultra-writable drive High-precision 3-step gain compatible	Transparent flat 14-pin package	6.0	–	–20 to +80	–	5	140	5	–	–
☆GA202TXV15K	For 2-wavelength laser (For DVD player), 10-division PD pattern	Transparent 12-pin package (3 x 4 mm) Gull wing lead	6.0	–	–30 to +80	MAX. 19	5	40/40 30/30	5	–	–
☆GA202TXV15J		Flat lead									
GA201TXR1ZY	For x20 CD-R writable drive, for x8 DVD-ROM read only (For slim combo drive)	Transparent flat 12-pin package (3.2 x 4.0 mm)	6.0	–	–10 to +80	21	5	(90/75) 80/75	5	–85	45M
GA301TXW5MZ	For x16 DVD-R/RW, +R/W ultra-writable drive For MAX. x60 CD-R writable drive (For HiHi combo drive), settling time: 13 ns DVD-ROM: for MAX. x16 read only, built-in bypass condenser for power supply, WPP system (Gain x4 switching)	Leadless chip-type	6.0	–	–20 to +85	38	5	110	5	(–78)	72M
GA103TXR1MZ	For x8 DVD-R/RW, +R/W writable drive For MAX. x60 CD-R writable drive (For HiHi combo drive), settling time: 7 ns DVD-ROM: for MAX. x16 read only CD-ROM: for MAX. x60 read only, built-in bypass condenser for power supply	Leadless chip-type	–	–	–20 to +80	–	5	MIN. 90/ MIN. 60	–	–	–
GA100TXR1MZ	For MAX. x60 CD-R writable drive, DVD-ROM: for MAX. x16 read only CD-ROM: for MAX. x60 read only, DVD-RAM: for writable drive, built-in bypass condenser for power supply	Leadless chip-type	–	–	–20 to +80	–	5	MIN. 90/ MIN. 60	–	–	–
GA100TX02MZA	Built-in RF amplifier, built-in bypass condenser for power supply, for x16 DVD-ROM drive, 12-division PD type	Leadless chip-type	6.0	–	–10 to +80	–	5	(130/115) 115/100	5	–80	72M

\*1 (RF/main) ... 650 nm, RF/main ... 780 nm

\*2 Playback/recording mode

\*3 We can supply custom orders for modified PD patterns, packages, and lead shapes for 2-wavelength laser compatible OPIC light detectors.

\*4 L gain mode/M gain mode

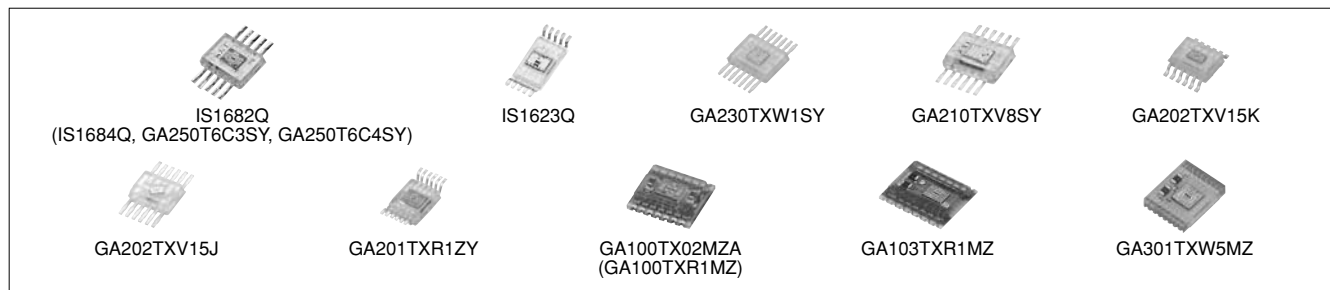

### Notice

In the absence of confirmation by device specification sheets, SHARP takes no responsibility for any defects that may occur in equipment using any SHARP devices shown in catalogs, data books, etc.  
Except where specially indicated, models listed on this page comply with the RoHS Directive\*. For details, please contact SHARP.  
\*RoHS Directive: Prohibits use of lead, cadmium, hexavalent chromium, mercury and specific brominated flame retardants (PBBs and PBDEs), with certain exceptions.  
Contact SHARP in order to obtain the latest device specification sheets before using any SHARP device.

# OPIC LIGHT DETECTORS



## <Laser power monitoring diode for optical disc system>

(Ta = 25°C)

Model No.	Type	Package	Absolute maximum ratings			Electro-optical characteristics			
			Vcc (V)	P (mW)	Topr (°C)	Icc (mA) TYP.	Vcc (V)	fc (MHz) MIN.	Vcc (V)
GA104T1M1MZ	For x48 CD-R writable drive built-in amplifier circuit	Leadless chip-type [3.0 x 3.5 mm]	6.0	—	−20 to +70	20	5	50	5

\*1 Power monitoring photodiodes are also available. Please refer to the page for photodiodes.



**Notice**

In the absence of confirmation by device specification sheets, SHARP takes no responsibility for any defects that may occur in equipment using any SHARP devices shown in catalogs, data books, etc. Except where specially indicated, models listed on this page comply with the RoHS Directive\*. For details, please contact SHARP. \*RoHS Directive: Prohibits use of lead, cadmium, hexavalent chromium, mercury and specific brominated flame retardants (PBBs and PBDEs), with certain exceptions. Contact SHARP in order to obtain the latest device specification sheets before using any SHARP device.



## ■ Infrared Emitting Diode Lineup

Type	Package	Features	Half intensity angle	Model No.
Single-end lead (Top view type)	Epoxy resin with lens ( $\phi 3$ mm type)	General purpose	$\pm 13^\circ$	GL380
		High output type	$\pm 13^\circ$	GL381
		High speed signal transmission (12 MHz)	$\pm 17^\circ$	GL382
	Epoxy resin (Arch type)	General purpose	$\pm 18^\circ$	GL390
		Low forward voltage type	$\pm 18^\circ$	GL390V
Single-end lead (Side view type)	Epoxy resin with lens	General purpose/Narrow beam angle	$\pm 13^\circ$	GL480E00000F
	Flat epoxy resin	Compact and thin	$\pm 30^\circ$	GL4800E0000F
		Wide beam angle	$\pm 90^\circ$	GL4100E0000F
	Epoxy resin with lens	Compact package, bi-directional emitting type	Bidirectional	GL453E00000F ▲
Single-end lead (Top view type)	TO-18	High reliability	$\pm 50^\circ$	GL513F ▲
		High reliability/Narrow beam angle	$\pm 7^\circ$	GL514 ▲
	Epoxy resin with lens ( $\phi 5$ mm type)	Low forward voltage type	$\pm 21^\circ$	GL560
		Low forward voltage type/Narrow beam angle	$\pm 13^\circ$	GL561
		High output type	$\pm 25^\circ$	GL537
		High output type/Narrow beam angle	$\pm 13^\circ$	GL538
Surface mount type	Leadless	Compact	$\pm 60^\circ$	GL610T
	Epoxy resin with lens/ leadless  (Mountable for Top view/ Side view type)	Compact/Narrow beam angle	$\pm 10^\circ$	GL100MN0MP
		High output type (Output: radiant flux/ radiant intensity indicated)	$\pm 10^\circ/\pm 9^\circ$	GL100MN1MP / GL100MN3MP
			Compact/Wide beam angle	$\pm 80^\circ$

The model marked with ▲ may not be available in the near future. Contact with SHARP for details before use.

# INFRARED EMITTING DIODES



## ■ Infrared Emitting Diodes

(Ta = 25°C)

Model No.	Package, features	Absolute maximum ratings				Φe (mW)			VF (V)			Δθ (°) TYP.	λp (nm) TYP.
		IF (mA)	VR (V)	P (mW)	Topt (°C)	MIN.	TYP.	IF (mA)	TYP.	MAX.	IF (mA)		
GL380	ø3 epoxy resin	60	6	150	-25 to +85	4.5*1	11*1	50	1.3	1.5	50	±13	950
GL381		60	6	150	-25 to +85	8.5*1	20*1	50	1.3	1.5	50	±13	950
GL382	ø3 epoxy resin, for high speed signal transmission:12 MHz	60	4	-	-25 to +85	6	18	50	1.5	1.7	50	±17	880
GL390	Arch type	60	6	150	-25 to +85	7*1	13*1	50	1.3	1.5	50	±18	950
GL390V		60	6	150	-25 to +85	9*1	16*1	50	1.3	1.5	50	±18	950
GL453E00000F ▲	Resin with bidirectional lens	50	6	75	-25 to +85	0.85	1.3	20	1.2	1.5	20	(Bidirectional)	950
GL480E00000F	Epoxy resin with lens	50	6	75	-25 to +85	0.7	-	20	1.2	1.4	20	±13	950
GL480E00000F		50	6	75	-25 to +85	0.7	1.6	20	1.2	1.4	20	±30	950
GL4100E0000F	Side-view flat type, Epoxy resin	50	6	75	-25 to +85	1.0	-	20	1.2	1.4	20	±90	950
GL513F ▲	TO-18	150	6	250	-40 to +125	1.44	2.88	100	1.35	1.6	100	±50	950
GL514 ▲		150	6	250	-40 to +125	3.31	5.35	100	1.35	1.6	100	±7	950
GL560	ø5 epoxy resin	100	6	150	-25 to +85	5*1	14*1	50	1.25	1.37	50	±21	940
GL561		100	6	150	-25 to +85	12*1	25*1	50	1.25	1.37	50	±13	940
GL537		100	6	150	-25 to +85	6*1	13*1	50	1.3	1.5	50	±25	950
GL538		100	6	150	-25 to +85	15*1	30*1	50	1.3	1.5	50	±13	950
GL610T	Leadless chip type	50	6	150	-25 to +85	0.7	2	20	1.3	1.5	50	±60	950
GL100MN0MP	Surface mounting leadless type, Epoxy resin board with lens	50	6	75	-30 to +85	1.0	3.0 (MAX.)	20	1.2	1.4	20	±10	940
GL100MN1MP	Surface mounting leadless type, Epoxy resin board with lens, high output type	50	6	75	-30 to +85	2.0	6.0 (MAX.)	20	1.2	1.5	20	±10	940
GL100MN3MP	Surface mounting leadless type, Epoxy resin board with lens, high output type	50	6	75	-30 to +85	3.0*1	6.0*1	20	1.25	1.5	20	±9	940
GL100MD1MP1	Surface mounting leadless type, Epoxy resin board with lens, wide beam angle	50	6	75	-30 to +85	-	6.0 (MAX.)	20	-	1.5	20	±80	940

\*1 Radiant intensity mW/sr

Note) Some products are handled by the Compound Semiconductor Division.

The model marked with ▲ may not be available in the near future. Contact with SHARP for details before use.



### Notice

In the absence of confirmation by device specification sheets, SHARP takes no responsibility for any defects that may occur in equipment using any SHARP devices shown in catalogs, data books, etc.

Except where specially indicated, models listed on this page comply with the RoHS Directive\*. For details, please contact SHARP. \*RoHS Directive: Prohibits use of lead, cadmium, hexavalent chromium, mercury and specific brominated flame retardants (PBBs and PBDEs), with certain exceptions.

Contact SHARP in order to obtain the latest device specification sheets before using any SHARP device.



## Distance Measuring Sensor Lineup

Output	Range of distance measuring	Features	Model No.	
1-bit digital output according to distance measuring	3 to 30 cm	1-bit digital output (detected distance: 15/17.5/13 cm)	GP2D150AJ00F/GP2D150MJ00F/GP2Y0D413K0F	
	10 to 80 cm	1-bit digital output (detected distance: 24 cm)	GP2D15J0000F	
		General purpose	GP2Y0D21YK0F	
	20 to 150 cm	1-bit digital output (detected distance: 80 cm)	GP2Y0D02YK0F	
			Battery drive compatible, compact, operating supply voltage (2.7 V to 6.2 V), 1-bit digital output (detected distance: 5/10 cm)	GP2Y0D805Z0F/GP2Y0D810Z0F
Output according to distance measuring		Compact, thin 1-bit digital output (detected distance: 10/40 cm)	GP2Y0D310K/GP2Y0D340K	
	4 to 30 cm	Analog voltage output	GP2D120XJ00F/GP2Y0A41SK0F	
	10 to 80 cm	8-bit serial (External control signal required)	GP2D02J0000F	
		Analog voltage output	GP2D12J0000F	
			General purpose	GP2Y0A21YK0F
	20 to 150 cm	Analog voltage output	GP2Y0A02YK0F	
100 to 500 cm	Analog voltage output	GP2Y0A700K0F		

## Wide Angle Sensor Lineup

Output	Range of distance measuring	Detection angle of view	Model No.
Voltage output according to distance measuring	4 to 30 cm	25° (When using 5 beams)	GP2Y3A001K0F
	20 to 150 cm	25° (When using 5 beams)	GP2Y3A002K0F
	40 to 300 cm	25° (When using 5 beams)	GP2Y3A003K0F

## High-Precision Displacement Sensor

Output	Range of distance measuring	Features	Model No.
Voltage output according to distance measuring	4.5 to 6.0 mm	Resolution: 50 μm	GP2Y0AH01K0F

## Paper Size Sensor (Using Optical Distance Measuring Method) Lineup

Output	Features	Model No.	
8-bit serial output	1-beam	GP2D06J0000F/GP2D061J000F/GP2D062J000F	
		Thin type (T: 11 mm)	GP2Y2E101K0F
	2-beam	GP2D03J0000F/GP2D032J0000F	
	3-beam	GP2D07J0000F/GP2D071J000F/GP2D072J000F	
		Thin type (T: 11 mm)	GP2Y2E301K0F
1-bit output	1-beam (detection height: 60 mm)	Thin type (T: 11.5 mm)	GP2Y2D160K0F
Analog output relative to measuring distance	1-beam (detection height: 80 mm)	Thin type (T: 11.5 mm)	GP2Y2A180K0F
	2-beam (detection height: 80 mm)	Thin type (T: 11.5 mm)	GP2Y2A280K0F

## Dust Sensor Unit Lineup

Output	Features	Model No.
Analog output	With peak-hold circuit	GP2U06J0000F
	Pulse analog output, single-shot detection of house dust, General purpose	GP2Y1010AU0F

## Color Toner Concentration (Deposition Amount) Sensor Lineup

Output	Features	Model No.
Analog output	Employs diffuse reflection system	GP2TC1J0000F
	Employs diffuse reflection system + mirror reflection system	GP2TC2J0000F

## Distance Measuring Sensors

(Ta = 25°C)

Model No.	Features	Absolute maximum ratings		Electro-optical characteristics*1				
		Vcc (V)	Topr (°C)	Distance measuring range (cm)	VOH (V) MIN.	VOL (V) MAX.	Dissipation current	
							Operating (mA)	Standby (µA)
GP2D02J0000F ▲	Distance measuring sensor united with PSD*, infrared LED and signal processing circuit, 8-bit serial output	-0.3 to +10	-10 to +60	10 to 80	Vcc - 0.3	0.3	MAX. 35	MAX. 8
GP2D12J0000F	Distance measuring sensor united with PSD*, infrared LED and signal processing circuit, Linear voltage output	-0.3 to +7	-10 to +60	10 to 80	Vo (TYP.) = 0.4 V (at L = 80 cm), ΔVo (TYP.) = 2.0 V (at L: 80 cm → 10 cm)		MAX. 50	-
GP2Y0A21YK0F	Distance measuring sensor united with PSD*, infrared LED and signal processing circuit, Linear voltage output	-0.3 to +7	-10 to +60	10 to 80	Vo (TYP.) = 0.4 V (at L = 80 cm), ΔVo (TYP.) = 1.9 V (at L: 80 cm → 10 cm)		MAX. 40	-
GP2D120XJ00F	Distance measuring sensor united with PSD*, infrared LED and signal processing circuit, Linear voltage output	-0.3 to +7	-10 to +60	4 to 30	Vo (TYP.) = 0.4 V (at L = 30 cm), ΔVo (TYP.) = 2.25 V (at L = 30 cm → 4 cm)		MAX. 50	-
☆GP2Y0D805Z0F	Light detector, infrared LED and signal processing circuit, short distance measuring sensor unit, battery drive compatible (operating power supply: 2.7 to 6.2 V)	-0.3 to +7	-10 to +60	-	Vcc - 0.6	0.6	MAX. 6.5	MAX. 8
☆GP2Y0D810Z0F	Light detector, infrared LED and signal processing circuit, short distance measuring sensor unit, battery drive compatible (operating power supply: 2.7 to 6.2 V)	-0.3 to +7	-10 to +60	-	Vcc - 0.6	0.6	MAX. 6.5	MAX. 8
GP2Y0D310K	Digital voltage output according to the measured distance (at 10 cm) of GP2Y0D340K	-0.3 to +7	-10 to +60	-	Vcc - 0.3	0.6	MAX. 35	-
GP2Y0D340K	Compact, thin type (15 x 9.6 x 8.7 mm: sensor part), Light detector, infrared LED and signal processing circuit, Digital voltage output according to the measured distance (at 40 cm)	-0.3 to +7	-10 to +60	-	Vcc - 0.3	0.6	MAX. 35	-
GP2D15J0000F	Distance measuring sensor united with PSD*, infrared LED and signal processing circuit, Digital voltage output	-0.3 to +7	-10 to +60	10 to 80	Vcc - 0.3	0.6	MAX. 50	-
GP2Y0D21YK0F	Distance measuring sensor united with PSD*, infrared LED and signal processing circuit, Digital voltage output	-0.3 to +7	-10 to +60	10 to 80	Vcc - 0.3	0.6	MAX. 40	-
☆GP2Y0A41SK0F	Distance measuring sensor united with PSD*, infrared LED and signal processing circuit, Short measuring cycle (16.5 ms)	-0.3 to +7	-10 to +60	4 to 30	Vo (TYP.) = 0.4 V (at L = 30 cm), ΔVo (TYP.) = 2.25 V (at L = 30 cm → 4 cm)		MAX. 22	-
GP2D150AJ00F	Distance measuring sensor united with PSD*, infrared LED and signal processing circuit, Digital voltage output	-0.3 to +7	-10 to +60	3 to 30	Vcc - 0.3	0.6	MAX. 50	-
GP2D150MJ00F	Distance measuring sensor united with PSD*, infrared LED and signal processing circuit, Digital voltage output	-0.3 to +7	-10 to +60	3 to 30	Vcc - 0.3	0.6	MAX. 50	-
GP2Y0D413K0F	Distance measuring sensor united with PSD*, infrared LED and signal processing circuit, Digital voltage output	-0.3 to +7	-10 to +60	3 to 30	Vcc - 0.3	0.6	-	-
GP2Y0D02YK0F	Distance measuring sensor united with PSD*, infrared LED and signal processing circuit, long distance measuring sensor unit (No external control signal required), Digital voltage output according to the measured distance (at 80 cm)	-0.3 to +7	-10 to +60	20 to 150	Vcc - 0.3	0.6	MAX. 50	-
GP2Y0A02YK0F	Distance measuring sensor united with PSD*, infrared LED and signal processing circuit	-0.3 to +7	-10 to +60	20 to 150	Vo (TYP.) = 0.4 V (at L = 150 cm), ΔVo (TYP.) = 2.0 V (at L = 150 cm → 20 cm)		MAX. 50	-
GP2Y0A700K0F	Distance measuring sensor united with PSD*, infrared LED and signal processing circuit	-	-10 to +70	100 to 500	-		TYP. 33	-

\*1 Vcc = 5 V

\* PSD: Position Sensitive Detector

The model marked with ▲ may not be available in the near future. Contact with SHARP for details before use.

### Notice

In the absence of confirmation by device specification sheets, SHARP takes no responsibility for any defects that may occur in equipment using any SHARP devices shown in catalogs, data books, etc.  
 Except where specially indicated, models listed on this page comply with the RoHS Directive\*. For details, please contact SHARP.  
 \*RoHS Directive: Prohibits use of lead, cadmium, hexavalent chromium, mercury and specific brominated flame retardants (PBBs and PBDEs), with certain exceptions.  
 Contact SHARP in order to obtain the latest device specification sheets before using any SHARP device.

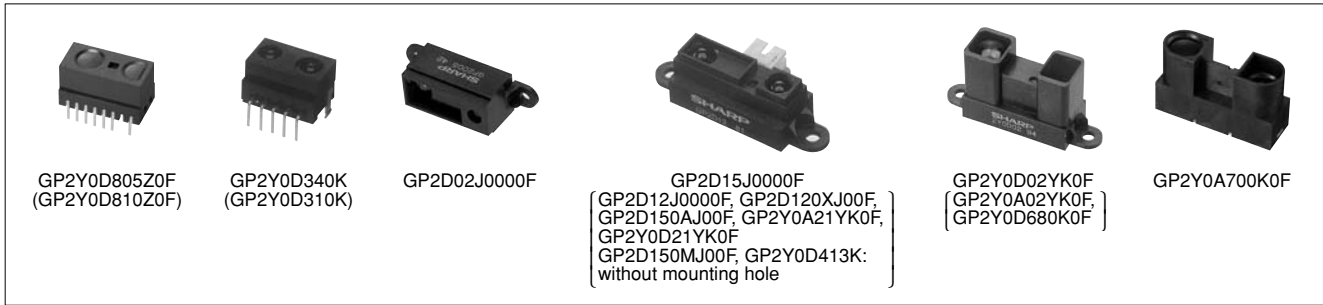

## Wide Angle Sensors

(Ta = 25°C)

Model No.	Features	Absolute maximum ratings		Electro-optical characteristics					
		Vcc (V)	Topr (°C)	Distance measuring range (cm)	Output terminal voltage (V)	Output voltage difference (V)	Input voltage (V)		
							V <sub>INH</sub>	LEDL	
GP2Y3A001K0F	Distance measuring sensor united with PSD*, infrared LED and signal processing circuit, Distance measuring sensor application product, Wide range (field of view) detection using 5 infrared beams	-0.3 to +7	-10 to +60	4 to 30	TYP. 2.8*1	TYP. 1.6*4	MIN. 4.5	MAX. 0.5	
GP2Y3A002K0F		-0.3 to +7	-10 to +60	20 to 150	TYP. 2.3*2	TYP. 1.6*5	MIN. 4.5	MAX. 0.5	
GP2Y3A003K0F		-0.3 to +7	-10 to +60	40 to 300	TYP. 2.2*3	TYP. 1.2*6	MIN. 4.5	MAX. 0.5	

- \* PSD: Position Sensitive Detector
- \* Reflector used: White paper (Gray chart R-27/white surface, made by Kodak Corp., reflectance 90%)
- \*1 L = 4 cm                      \*4 Change in output voltage from L = 4 cm to 10 cm
- \*2 L = 20 cm                   \*5 Change in output voltage from L = 20 cm to 80 cm
- \*3 L = 40 cm                   \*6 Change in output voltage from L = 40 cm to 100 cm

L = Reflector - Sensor distance



### Notice

In the absence of confirmation by device specification sheets, SHARP takes no responsibility for any defects that may occur in equipment using any SHARP devices shown in catalogs, data books, etc. Except where specially indicated, models listed on this page comply with the RoHS Directive\*. For details, please contact SHARP. \*RoHS Directive: Prohibits use of lead, cadmium, hexavalent chromium, mercury and specific brominated flame retardants (PBBs and PBDEs), with certain exceptions. Contact SHARP in order to obtain the latest device specification sheets before using any SHARP device.





## ■ Paper Size Sensors

(Ta = 25°C)

Model No.	Features	Operating temperature	Supply voltage	Paper detection height	LED beam pitch	Approved value of paper position sliding	Paper detection density	Dissipation current
		Topr (°C)	Vcc (V)	H (mm)	Lp (mm)	Δx (mm)	OD	Icc (mA)
GP2D03J0000F GP2D032J0000F*4	8-bit serial output using optical distance measuring method (2-beam)	0 to +60	5 ±0.5	TYP. 60	TYP. 21	MAX. ±6	0.7 or less*1	TYP. 30
GP2D06J0000F GP2D061J0000F*2 GP2D062J0000F*2	8-bit serial output using optical distance measuring method (1-beam)	0 to +60	5 ±0.5	TYP. 60	—	MAX. ±6	0.7 or less*1	TYP. 33
GP2Y2E101K0F	Thin type (T: 11 mm) 8-bit serial output using optical distance measuring method (1-beam)	0 to +60	5 ±0.5	TYP. 85	—	MAX. ±6	0.7 or less*1	—
GP2Y2D160K0F	Thin type (T: 11.5 mm) using optical distance measuring method (1-beam) Digital output (1-bit)	-10 to +60	5 ±0.5	TYP. 60	—	MIN. ±7.5	0.7 or less*1	—
GP2D07J0000F GP2D071J0000F*3	8-bit serial output using optical distance measuring method (3-beam)	0 to +60	5 ±0.5	TYP. 60	TYP. 36	MAX. ±6	0.7 or less*1	TYP. 33
GP2Y2E301K0F	Thin type (T: 11 mm) 8-bit serial output using optical distance measuring method (3-beam)	0 to +60	5 ±0.5	TYP. 85	TYP. 33	MAX. ±6	0.7 or less*1	—
GP2Y2A180K0F	Thin type (T: 11.5 mm) Analog output using optical distance measuring method (1-beam)	-10 to +60	5 ±0.5	TYP. 80	—	—	—	MAX. 25
GP2Y2A280K0F	Thin type (T: 11.5 mm) Analog output using optical distance measuring method (2-beam)	-10 to +60	5 ±0.5	TYP. 80	—	—	—	MAX. 50

\* This table shows the characteristics when configured in the paper size sensor system.

\*1 Reflectivity: 18% or more, OD = log (1/T), T: Reflectivity

\*2 Paper detection height GP2D061: TYP. 45 mm GP2D062: TYP. 90 mm

\*3 Paper detection height GP2D071: TYP. 45 mm

\*4 Paper detection height GP2D032: TYP. 45 mm



**Notice**

In the absence of confirmation by device specification sheets, SHARP takes no responsibility for any defects that may occur in equipment using any SHARP devices shown in catalogs, data books, etc. Except where specially indicated, models listed on this page comply with the RoHS Directive\*. For details, please contact SHARP. \*RoHS Directive: Prohibits use of lead, cadmium, hexavalent chromium, mercury and specific brominated flame retardants (PBBs and PBDEs), with certain exceptions. Contact SHARP in order to obtain the latest device specification sheets before using any SHARP device.



## High-Precision Displacement Sensor

(Ta = 25°C)

Model No.	Features	Topr (°C)	Operating supply voltage (V)	Dissipation current (mA)	Distance measuring range (mm)	Distance characteristic of output
GP2Y0AH01K0F	Resolution: 50 μm	-10 to +60	4.5 to 5.5	TYP. 20	4.5 to 6.0	TYP. 1.73 V Variation in output over range (4.5 to 6.0 mm)



## Dust Sensor Units

(Ta = 25°C)

Model No.	Features	Topr (°C)	Electro-optical characteristics				
			Operating supply voltage (V)	Dissipation current (mA)	Detection sensitivity V/(0.1 mg/m <sup>3</sup> )	Output voltage at no dust Voc (V)	Output voltage range Voh (V)
GP2U06J0000F	Built-in infrared emitting diode, photodiode and signal processing circuit	-10 to +65	4.5 to 5.5	TYP. 15	TYP. 0.5	MAX. 1	MIN. 3.2
GP2Y1010AU0F	Compact, single-shot detection of house dust	-10 to +65	4.5 to 5.5	TYP. 11	TYP. 0.5	TYP. 0.9	MIN. 3.4

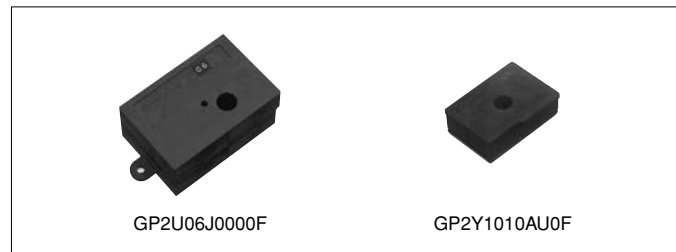

## Color Toner Concentration (Deposition Amount) Sensors

(Ta = 25°C)

Model No.	Features	Topr (°C)	Electro-optical characteristics		
			Dissipation current (mA)	Output voltage V <sub>01</sub> (V)	Output voltage V <sub>02</sub> (V)
GP2TC1J0000F	Employs diffuse reflection system, high-precision detection of toner concentration on photo-sensitive drum, 2-line analog output	0 to +60	TYP. 4* <sup>1</sup>	TYP. 1.06* <sup>2</sup>	TYP. 2.63* <sup>2</sup>
GP2TC2J0000F	Employs diffuse reflection system + mirror reflection system, high-precision detection of toner concentration on transfer belt, 2-line analog output	0 to +60	TYP. 4	TYP. 1.17* <sup>2</sup>	TYP. 2.81* <sup>2</sup>

\*1 Dissipation current with LED drive current of I<sub>F</sub> = 0 mA

\*2 With reflection object A (Reflectance: 15.6%)

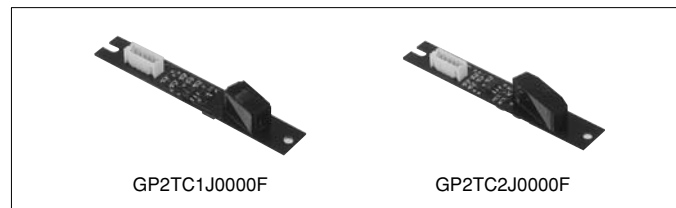

### Notice

In the absence of confirmation by device specification sheets, SHARP takes no responsibility for any defects that may occur in equipment using any SHARP devices shown in catalogs, data books, etc. Except where specially indicated, models listed on this page comply with the RoHS Directive\*. For details, please contact SHARP. \*RoHS Directive: Prohibits use of lead, cadmium, hexavalent chromium, mercury and specific brominated flame retardants (PBBs and PBDEs), with certain exceptions. Contact SHARP in order to obtain the latest device specification sheets before using any SHARP device.



## ■ Fiber Optics Lineup for Audio Equipment

Connector type	Type	Features	Model No.				
			Supply voltage 2.5 V	Supply voltage 3.0 V	Supply voltage 5.0 V		
Square connector (EIAJ RC-5720B)	Fiber optic transmitter	Compact (without mounting hole)	High speed signal transmission (13.2 Mb/s MAX., 15.5 Mb/s MAX.*, 50 Mb/s MAX.**), With shutter	–	GP1FM313TZ0F*/ GP1FMV31TK0F*	GP1FM513TZ0F/ GP1FM55HTZ0F**	
	Fiber optic receiver	with mounting hole	High speed signal transmission (13.2 Mb/s MAX. [15.5 Mb/s MAX.*, 25 Mb/s MAX.**], 50 Mb/s MAX.***)	–	GP1FA352TZ0F*/ GP1FAV30TK0F*	GP1FA553TZ0F	
				–	TTL drive compatible GP1FA313TZ0F*/ GP1FAV31TK0F*	GP1FA554TZ0F/ GP1FAV50TK0F	
				–	TTL drive compatible GP1FA514TZ0F/ GP1FAV51TK0F	GP1FA513TZ0F	
		Electric jack integrated type (Transmission speed 13.2 Mb/s)	With shutter	–	–	High speed signal transmission GP1FAV55TK0F***/ GP1FA51HTZ0F**	GP1FA52HTZ0F**
				–	–	TTL drive compatible GP1FA513TK0F	GP1FP513TK0F
				–	–	–	–
	Fiber optic receiver	Compact (without mounting hole)	High speed signal transmission (13.2 Mb/s MAX., 15.5 Mb/s MAX.*, 25 Mb/s MAX.**)	–	GP1FM313RZ0F*/ GP1FMV31RK0F*	GP1FM513RZ0F/ GP1FMV51RK0F	
				–	GP1FA352RZ0F*/ GP1FAV30RK0F*	GP1FA553RZ0F/ GP1FAV50RK0F	
		Electric jack integrated type (Transmission speed 13.2 Mb/s)	With shutter	–	–	GP1FA313RZ0F*/ GP1FAV31RK0F*	GP1FA513RZ0F/ GP1FAV51RK0F
–				–	GP1FA51HRZ0F**	GP1FP513RK0F	
ø3.5 mm Optical mini-jack (JIS C6560 & EIAJ RC5720B)	Fiber optic transmitter	Thin type (t: 4.4 mm)	Low operating voltage	Reflow compatible	GP1FC300TP0F		
	Fiber optic receiver	Thin type (t: 4.2 mm)			GP1FD210TP0F	GP1FD310TP0F/ GP1FD320TP0F	
		Thin type (t: 4.2 mm)	Low operating voltage			GP1FD210RP0F	–

## ■ Transmission/Reception Devices for MOST\*1 Compatible Optical Fiber

Connector type	Type	Features	Transmission speed	Operating voltage	Model No.
MOST ver1.1 standard compatible	Optic transmission device	Wide operating temperature range (–40°C to +105°C)	25Mb/s as optic fiber link (Biphase)	5 V	GP5FM5T01AZ
	Optic reception device	Wide operating temperature range (–40°C to +105°C)	25Mb/s as optic fiber link (Biphase)	5 V	GP5FM5R01AZ

\*1 "MOST" is a registered trademark of MOST Cooperation.



## ■ Fiber Optic Transmitters (Square Connector)

(Ta = 25°C)

Model No.	Features	Absolute maximum ratings			Electro-optical characteristics					
		Vcc (V)	Vin (V)	Topr (°C)	Supply voltage (V)	Propagation delay time		Dissipation current Icc (mA) MAX.	Pulse width distortion Δtw (ns)	Transmission speed T (Mb/s) MAX.
						tPLH (ns) MAX.	tPHL (ns) MAX.			
GP1FM313TZ0F	Compact (without mounting hole), With shutter, High response speed (up to x2)	-0.5 to +7	-0.5 to Vcc + 0.5	-20 to +70	2.7 to 3.6	180	180	12	±15	15.5
GP1FMV31TK0F	Compact (without mounting hole), With shutter, High response speed (up to x2)	-0.5 to +7	-0.5 to Vcc + 0.5	-20 to +70	2.7 to 3.6	180	180	12	±15	15.5
GP1FM513TZ0F	Compact (without mounting hole), With shutter, High response speed (up to x2)	-0.5 to +7	-0.5 to Vcc + 0.5	-20 to +70	4.75 to 5.25	180	180	13	±15	13.2
GP1FMV51TK0F	Compact (without mounting hole), With shutter, High response speed (up to x2)	-0.5 to +7	-0.5 to Vcc + 0.5	-20 to +70	4.75 to 5.25	180	180	13	±15	13.2
GP1FM55HTZ0F	Compact (without mounting hole), With shutter, High response speed (up to x2)	-0.5 to +7	-0.5 to Vcc + 0.5	-20 to +70	4.75 to 5.25	180	180	13	±15	50
GP1FA352TZ0F ▲	With mounting hole, Low voltage drive, High response speed (up to x2)	-0.5 to +7	-0.5 to Vcc + 0.5	-20 to +70	2.7 to 3.6	180	180	12	±15	15.5
GP1FAV30TK0F	With mounting hole, Low voltage drive, High response speed (up to x2)	-0.5 to +7	-0.5 to Vcc + 0.5	-20 to +70	2.7 to 5.25	180	180	12	±15	15.5
GP1FA553TZ0F ▲	With mounting hole High response speed (up to x2)	-0.5 to +7	-0.5 to Vcc + 0.5	-20 to +70	4.75 to 5.25	180	180	13	±15	13.2
GP1FA554TZ0F ▲	With mounting hole, High response speed (up to x2), TTL drive compatible	-0.5 to +7	-0.5 to Vcc + 0.5	-20 to +70	4.75 to 5.25 Input voltage: MIN. 2.0 V	180	180	13	±15	13.2
GP1FAV50TK0F	With mounting hole, Mass-market model, High response speed (up to x2), TTL drive compatible	-0.5 to +7	-0.5 to Vcc + 0.5	-20 to +70	4.75 to 5.25 Input voltage: MIN. 2.0 V	180	180	13	±15	13.2
GP1FA513TZ0F ▲	With mounting hole, High response speed (up to x2), With shutter	-0.5 to +7	-0.5 to Vcc + 0.5	-20 to +70	4.75 to 5.25	180	180	13	±15	13.2
GP1FA514TZ0F ▲	With mounting hole, High response speed, With shutter, TTL drive compatible	-0.5 to +7	-0.5 to Vcc + 0.5	-20 to +70	4.75 to 5.25	180	180	13	±15	13.2
GP1FAV51TK0F	With mounting hole, Mass-market model, High response speed, With shutter, TTL drive compatible	-0.5 to +7	-0.5 to Vcc + 0.5	-20 to +70	4.75 to 5.25	180	180	13	±15	13.2
GP1FA313TZ0F ▲	With mounting hole, With shutter, Low voltage drive, High response speed	-	-	-20 to +70	2.7 to 3.6	-	-	12	-	15.5
GP1FAV31TK0F	With mounting hole, With shutter, Low voltage drive, High response speed	-	-	-20 to +70	2.7 to 5.25	-	-	12	-	15.5
GP1FA51HTZ0F ▲	With mounting hole, High response speed (up to x4), With shutter	-	-	-20 to +70	4.75 to 5.25	-	-	13	-	25
GP1FA52HTZ0F ▲	With mounting hole, High response speed (up to x4), With shutter, TTL drive compatible	-	-	-20 to +70	4.75 to 5.25 Input voltage: MIN. 2.0 V	-	-	13	-	25
GP1FAV55TK0F	With mounting hole, High response speed (50 Mb/s), With shutter	-	-	-20 to +70	4.75 to 5.25	-	-	13	-	50
GP1FP513TK0F	Electric jack/optical connector integrated type	-0.5 to +7	-0.5 to Vcc + 0.5	-20 to +70	4.75 to 5.25	180	180	13	±15	13.2

The model marked with ▲ may not be available in the near future. Contact with SHARP for details before use.

### Notice

In the absence of confirmation by device specification sheets, SHARP takes no responsibility for any defects that may occur in equipment using any SHARP devices shown in catalogs, data books, etc.  
 Except where specially indicated, models listed on this page comply with the RoHS Directive\*. For details, please contact SHARP.  
 \*RoHS Directive: Prohibits use of lead, cadmium, hexavalent chromium, mercury and specific brominated flame retardants (PBBs and PBDEs), with certain exceptions.  
 Contact SHARP in order to obtain the latest device specification sheets before using any SHARP device.



## ■ Fiber Optic Transmitters (ø3.5 mm Optical Mini-jack)

(Ta = 25°C)

Model No.	Features	Absolute maximum ratings			Electro-optical characteristics					
		Vcc (V)	Vin (V)	Topr (°C)	Supply voltage (V)	Propagation delay time		Dissipation current Icc (mA) MAX.	Pulse width distortion Δtw (ns)	Transmission speed T (Mb/s) MAX.
						tPLH (ns) MAX.	tPHL (ns) MAX.			
GP1FC300TP0F ▲	Thin type, optical mini-jack (low voltage drive), for reflow soldering	-0.5 to +7	-0.5 to Vcc + 0.5	-20 to +70	2.7 to 3.6	180	180	12	±30	8
GP1FD210TP0F	Compact, Thin type (t: 4.2 mm), Optical mini-jack (low voltage type)	-0.5 to +7	-0.5 to Vcc + 0.5	-20 to +70	2.2 to 3.0	180	180	10	±30	8
GP1FD310TP0F	Compact, Thin type (t: 4.2 mm), Optical mini-jack (low voltage type)	-0.5 to +7	-0.5 to Vcc + 0.5	-20 to +70	2.7 to 3.6	180	180	12	±30	8
GP1FD320TP0F	Compact, Thin type (t: 4.2 mm), Optical mini-jack (low voltage type)	-	-	-20 to +70	2.3 to 5.5	-	-	12	-	25

The model marked with ▲ may not be available in the near future. Contact with SHARP for details before use.

## ■ Fiber Optic Receivers (Square Connector)

(Ta = 25°C)

Model No.	Features	Absolute maximum ratings			Electro-optical characteristics					
		Vcc (V)	IOL (mA)	Topr (°C)	Supply voltage (V)	Propagation delay time		Dissipation current Icc (mA) MAX.	Pulse width distortion Δtw (ns)	Transmission speed T (Mb/s) MAX.
						tPLH (ns) MAX.	tPHL (ns) MAX.			
GP1FM313RZ0F ▲	Compact (without mounting hole), With shutter, High response speed (up to x2)	-0.5 to +7	10	-20 to +70	2.7 to 3.6	180	180	15	±20	15.5
GP1FMV31RK0F	Compact (without mounting hole), With shutter, High response speed (up to x2)	-0.5 to +7	10	-20 to +70	2.7 to 3.6	180	180	15	±20	15.5
GP1FM513RZ0F ▲	Compact (without mounting hole), With shutter, High response speed (up to x2)	-0.5 to +7	10	-20 to +70	4.75 to 5.25	180	180	25	±20	13.2
GP1FMV51RK0F	Compact (without mounting hole), With shutter, High response speed (up to x2)	-0.5 to +7	10	-20 to +70	4.75 to 5.25	180	180	25	±20	13.2
GP1FA352RZ0F ▲	With mounting hole, Low voltage drive, High response speed	-0.5 to +7	10	-20 to +70	2.7 to 3.6	180	180	15	±20	15.5
GP1FAV30RK0F	With mounting hole, Low voltage drive, High response speed	-0.5 to +7	10	-20 to +70	2.7 to 3.6	180	180	15	±20	15.5
GP1FA553RZ0F ▲	High response speed (up to x2)	-0.5 to +7	10	-20 to +70	4.75 to 5.25	180	180	25	±20	13.2
GP1FAV50RK0F	With mounting hole, Mass-market model, High response speed (up to x2)	-0.5 to +7	10	-20 to +70	4.75 to 5.25	180	180	25	±20	13.2
GP1FA513RZ0F ▲	High response speed (up to x2), with shutter	-0.5 to +7	10	-20 to +70	4.75 to 5.25	180	180	25	±20	13.2
GP1FAV51RK0F	High response speed (up to x2), with shutter	-0.5 to +7	10	-20 to +70	4.75 to 5.25	180	180	25	±20	13.2
GP1FA313RZ0F ▲	With mounting hole, With shutter, Low voltage drive, High response speed (up to x2)	-	-	-20 to +70	2.7 to 3.6	-	-	15	-	15.5
GP1FAV31RK0F	With mounting hole, With shutter, Low voltage drive, High response speed (up to x2)	-	-	-20 to +70	2.7 to 3.6	-	-	15	-	15.5
GP1FA51HRZ0F	With mounting hole, High response speed (up to x4), with shutter	-	-	-20 to +70	4.75 to 5.25	-	-	15	-	25
GP1FP513RK0F	Electric jack/optical connector integrated type	-0.5 to +7	10	-20 to +70	4.75 to 5.25	180	180	25	±20	13.2

The model marked with ▲ may not be available in the near future. Contact with SHARP for details before use.

### Notice

In the absence of confirmation by device specification sheets, SHARP takes no responsibility for any defects that may occur in equipment using any SHARP devices shown in catalogs, data books, etc.  
 Except where specially indicated, models listed on this page comply with the RoHS Directive\*. For details, please contact SHARP.  
 \*RoHS Directive: Prohibits use of lead, cadmium, hexavalent chromium, mercury and specific brominated flame retardants (PBBs and PBDEs), with certain exceptions.  
 Contact SHARP in order to obtain the latest device specification sheets before using any SHARP device.

☆New product



## ■ Fiber Optic Receivers (ø3.5 mm Optical Mini-jack)

(Ta = 25°C)

Model No.	Jack	Features	Absolute maximum ratings			Electro-optical characteristics					
			Vcc (V)	IOL (mA)	Topr (°C)	Supply voltage (V)	Propagation delay time		Dissipation current Icc (mA) MAX.	Pulse width distortion Δtw (ns)	Transmission speed T (Mb/s) MAX.
							tPLH (ns) MAX.	tPHL (ns) MAX.			
GP1FD210RP0F	ø3.5	Thin (thickness: 4.2 mm), optical mini-jack (low voltage drive)	-0.5 to +7	4	-20 to +70	2.4 to 3.0	180	180	7.5	±30	8

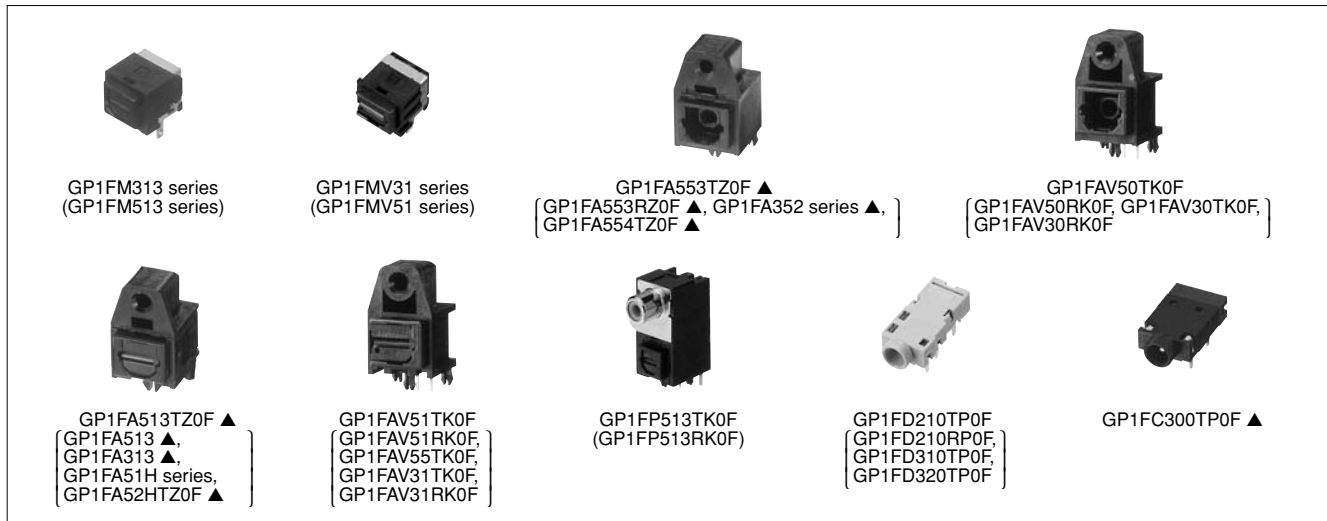

## ■ Optical Transmission Device

Model No.	Features	Operating temperature (°C)	Optic output (dBm)	Operating voltage (V)	Transmission speed T (Mb/s)
☆GP5FM5T01AZ	<ul style="list-style-type: none"> <li>• MOST standard compatible</li> <li>• Wide operating temperature range</li> </ul>	-40 to +105	-9 to -1.5	4.75 to 5.25	25 (Biphase)

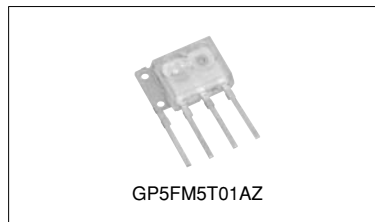

## ■ Optical Reception Device

Model No.	Features	Operating temperature (°C)	Optic output (dBm)	Operating voltage (V)	Transmission speed T (Mb/s)
☆GP5FM5R01AZ	<ul style="list-style-type: none"> <li>• MOST standard compatible</li> <li>• Wide operating temperature range</li> </ul>	-40 to +105	-24 to -2	4.75 to 5.25	25 (Biphase)

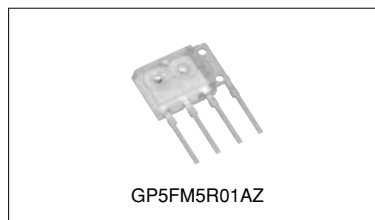

### Notice

In the absence of confirmation by device specification sheets, SHARP takes no responsibility for any defects that may occur in equipment using any SHARP devices shown in catalogs, data books, etc. Except where specially indicated, models listed on this page comply with the RoHS Directive\*. For details, please contact SHARP. \*RoHS Directive: Prohibits use of lead, cadmium, hexavalent chromium, mercury and specific brominated flame retardants (PBBs and PBDEs), with certain exceptions. Contact SHARP in order to obtain the latest device specification sheets before using any SHARP device.



## High-Luminosity (AlGaInP) LED Series

(Ta = 25°C)

Radiation color	Green	Yellow-green	Amber	Sunset orange	Orange	Red	
Series	ZG, JG	ZE, JE	ZV, JV, YV	ZS, JS, YS	ZJ, JJ, YJ	ZR, JR	JU
Dominant emission wavelength (nm)	(560)	(572)	(588)	(605)	(618)	(630)	(638)
Radiation material	AlGaInP on GaAs						

## High-Luminosity (InGaN) LED Series

(Ta = 25°C)

Radiation color	Blue	Green
Series	BC	GC
Dominant emission wavelength (nm)	(470)	(525)
Radiation material	InGaN	

## White Type LED Series

(Ta = 25°C)

Radiation color	White
Series	BW
Color range (x, y)	(0.31, 0.31)
Radiation material	InGaN + Fluorescent powder

## LED Series

(Ta = 25°C)

Radiation color	Green	Yellow-green	Yellow-green (High-luminosity)	Yellow	Sunset orange	Red	Red	Red (High-luminosity)	Red (High-luminosity)	Red
Series	KG, K	EG, E, C*	FG, F	HY, H	HS, S	HD, D	HA, A	TR, T	UR, U	PR, P
Peak emission wavelength (nm)	555	565	565	585	610	635	650	660	660	695
Radiation material	GaP	GaP	GaP	GaAsP on GaP	GaAsP on GaP	GaAsP on GaP	GaAsP on GaP	GaAlAs on GaAs Single hetero	GaAlAs on GaAlAs Double hetero	GaP

\* C is the opposite polarity of EG's.

## High-Luminosity (AlGaInP) LED Lamps

(If = 20 mA, Ta = 25°C)

Appearance	Radiation shape (mm)	Resin type	High-luminosity												
			JG, ZG (Green)		JE, ZE (Yellow-green)		JV, ZV (Amber)		JS, ZS (Sunset orange)		ZJ, JJ (Orange)		ZR, JR, JU (Red)		
			Model No.	Luminous intensity (mcd) TYP.	Model No.	Luminous intensity (mcd) TYP.	Model No.	Luminous intensity (mcd) TYP.	Model No.	Luminous intensity (mcd) TYP.	Model No.	Luminous intensity (mcd) TYP.	Model No.	Luminous intensity (mcd) TYP.	
Cylinder	ø3	●	GL3JG402B0SE	85	GL3JE402B0SE	200	GL3ZV402B0SE	400	GL3ZS402B0SE	400	GL3ZJ402B0SE	400	GL3ZR402B0SE	250	
													GL3JR402B0S3	200	
		●					GL3ZV802B0SE	200	GL3ZS802B0SE	210	GL3ZJ802B0SE	230	GL3ZR802B0SE	150	
							GL3JV404B0SE	280	GL3JS404B0SE	280	GL3JJ404B0SE	200			
		●					GL3JV804B0SE	110	GL3JS804B0SE	120	GL3JJ804B0SE	100			
							GL5ZV152B0SE	2 700	GL5ZS152B0SE	3 000	GL5ZJ152B0SE	3 000	GL5ZR152B0SE	2 000	
	ø5	●					GL5ZV302B0SE	900	GL5ZS302B0SE	1 000	GL5ZJ302B0SE	900	GL5ZR302B0SE	600	
							GL5JV302B0SE	640	GL5JS302B0SE	680	GL5JJ302B0SE	570			
		●				GL0ZV042B0S	16 900	GL0ZS042B0S	22 600	GL0ZJ042B0S	18 500				
	Oval	Long: 5.8 Short: 4.6	●					GL6ZV27	750	GL6ZS27	850	GL6ZJ27	750	GL6ZR27	360
								GL5JV7D2D0SE	210	GL5JS7D2D0SE	230	GL5JJ7D2D0SE	190		

Taped model is also available.

### Notice

In the absence of confirmation by device specification sheets, SHARP takes no responsibility for any defects that may occur in equipment using any SHARP devices shown in catalogs, data books, etc. Except where specially indicated, models listed on this page comply with the RoHS Directive\*. For details, please contact SHARP. \*RoHS Directive: Prohibits use of lead, cadmium, hexavalent chromium, mercury and specific brominated flame retardants (PBBs and PBDEs), with certain exceptions. Contact SHARP in order to obtain the latest device specification sheets before using any SHARP device.

☆New product



## High-Luminosity LED Lamps

(If = 20 mA, Ta = 25°C)

Appearance	Radiation shape (mm)	Resin type					High-luminosity							
		Colored diffusion	Colored transparency	Colorless transparency	Milky diffusion	BC (Blue)		GC (Green)		TR, T (Red)		UR, U (Red)		
						Model No.	Luminous intensity (mcd) TYP.	Model No.	Luminous intensity (mcd) TYP.	Model No.	Luminous intensity (mcd) TYP.	Model No.	Luminous intensity (mcd) TYP.	
Cylinder	ø3	●								GL3TR8	60	GL3UR8	300	
				●						GL3TR44	110	GL3UR44	250	
			●							GL3TR43	20	GL3UR43	100	
					●	☆GL3BC302B0S2	900							
					●								GL3UR402B0S	350
		ø5				GL3B2402B0SC	650	GL3G2402B0SC	2 800					
	●									GL5TR8	80			
				●								GL5UR44	850	
			●									GL5UR2K	2 000	
			●									GL5UR3K	3 000	
Oval	Long: 5.8 Short: 4.6											GL5UR2K1	2 000	
										GL5TR43	500	GL5UR2K1	2 000	
												GL5UR3K1	3 000	
												GL6UR11T*1	300	
												GL6UR31	950	
Rectangle	2.0 × 5.0 1.8 × 3.9	●								GL8TR21	4	GL8UR21	16	
		●								GL8TR42	4			

\*1 With tie-bar

Taped model is also available.

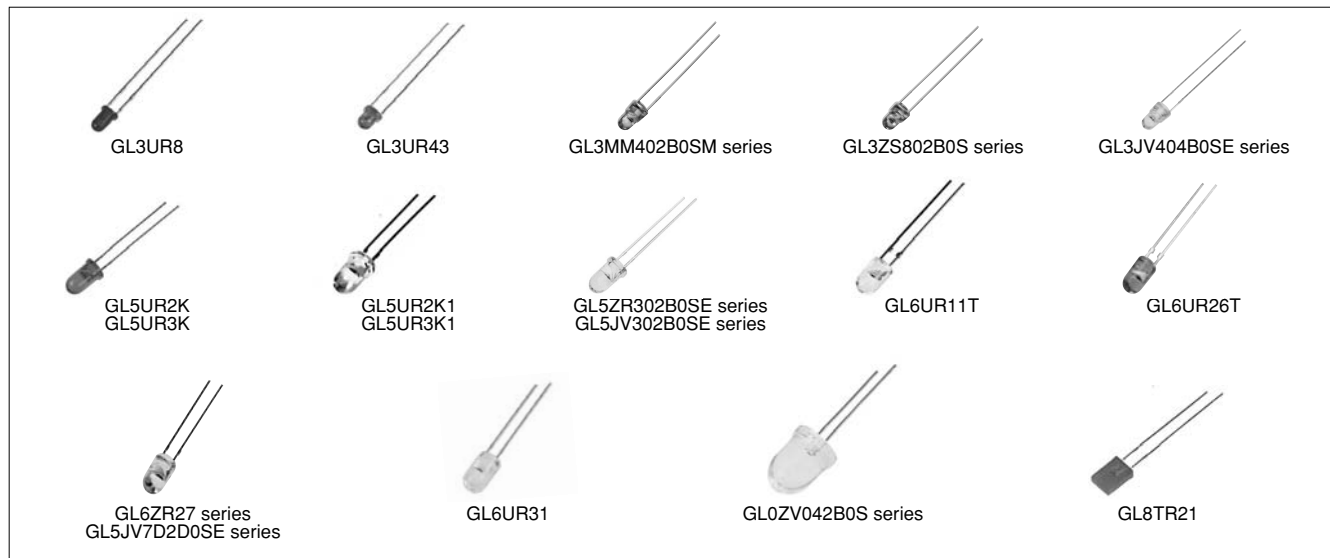

### Notice

In the absence of confirmation by device specification sheets, SHARP takes no responsibility for any defects that may occur in equipment using any SHARP devices shown in catalogs, data books, etc. Except where specially indicated, models listed on this page comply with the RoHS Directive\*. For details, please contact SHARP. \*RoHS Directive: Prohibits use of lead, cadmium, hexavalent chromium, mercury and specific brominated flame retardants (PBBs and PBDEs), with certain exceptions. Contact SHARP in order to obtain the latest device specification sheets before using any SHARP device.





## LED Lamps

(I<sub>F</sub> = 20 mA\*<sup>1</sup>, T<sub>a</sub> = 25°C)

Appearance	Radiation shape (mm)	Resin type				KG		EG		FG		HY		HS		HD		PR	
		Colored diffusion	Colored transparency	Colorless transparency	Milky diffusion	Green (555 nm)	Luminous intensity (mcd) TYP.	Yellow-green (565 nm)	Luminous intensity (mcd) TYP.	Yellow-green (HL) (565 nm)	Luminous intensity (mcd) TYP.	Yellow (585 nm)	Luminous intensity (mcd) TYP.	Sunset orange (610 nm)	Luminous intensity (mcd) TYP.	Red (635 nm)	Luminous intensity (mcd) TYP.	Red (695 nm)	Luminous intensity (mcd) TYP.
Cylinder	ø3	●				GL3KG8	30	GL3EG8	60			GL3HY8	55	GL3HS8	60	GL3HD8	40	GL3PR8	8
		●						GL3EG41	130										
			●			GL3KG44	60	GL3EG44	130			GL3HY44	100	GL3HS44	100	GL3HD44	110	GL3PR44	12
			●			GL3KG43	20	GL3EG43	38			GL3HY43	25	GL3HS43	25	GL3HD43	25	GL3PR43	3
			●			GL3KG62	22	GL3EG62	65			GL3HY62	40	GL3HS62	40	GL3HD62	50		
			●			GL3KG63	6	GL3EG63	18			GL3HY63	16	GL3HS63	15	GL3HD63	17	GL3PR63	2
			●					LT3E31W* <sup>2</sup>	18			LT3H31W* <sup>2</sup>	15			LT3D31W* <sup>2</sup>	15	LT3P31W* <sup>2</sup>	1.5
	ø4	●				GL4KG8	30	GL4EG8	100			GL4HY8	110	GL4HS8	80	GL4HD8	110	GL4PR8	15
		●						GL5EG4	20							GL5HD4	25	GL5PR4	3
			●			GL5KG8	60	GL5EG8	150			GL5HY8	120	GL5HS8	80	GL5HD8	80	GL5PR8	15
			●			GL5KG41	70	GL5EG41	160			GL5HY41	100	GL5HS41	100	GL5HD41	150	GL5PR41	15
				●		GL5KG44	70	GL5EG44	160			GL5HY44	100	GL5HS44	100	GL5HD44	100	GL5PR44	15
				●				GL5EG261B0SB	150							GL5HD261B0SB	80	GL5PR261B0SB	15
				●				GL5EG40	250			GL5HY40	250	GL5HS40	200	GL5HD40	250	GL5PR40	35
					●	GL5KG43	120	GL5EG43	300	GL5FG43	600	GL5HY43	250	GL5HS43	250	GL5HD43	300		
					●			GL5EG60	23							GL5HD60	8		
					●			GL6EG11T* <sup>3</sup>	120										
		ø5 (Inverted cone)	●					GL5EG47	15					GL5HS47	6	GL5HD47	8		
Oval	Long: 5.8 Short: 4.6	●				GL6EG26T* <sup>3</sup>	140												
Convex	ø2	●				GL2EG6	15			GL2HY6	12			GL2HD6	12	GL2PR6	1.5		
Arch	2.5 × 5.0	●				GL8EG2	30							GL8HD2	30				
	2.0 × 3.1	●				GL8EG4	50							GL8HD4	40				
Rectangle	1.8 × 3.9	●			GL8KG42	1.5	GL8EG42	5			GL8HY42	6		GL8HD42	5	GL8PR42	0.7		
	1.9 × 3.9	●					GL8EG5	28			GL8HY5	25		GL8HD5	22				
	2.0 × 3.2	●			GL8KG25	9	GL8EG25	12			GL8HY25	12	GL8HS25	10	GL8HD25	12	GL8PR25	1.5	
	2.0 × 3.2	●			GL8KG29	5	GL8EG29	12			GL8HY29	10	GL8HS29	7			GL8PR29	3	
	2.0 × 4.5	●					GL8EG23	6			GL8HY23	8			GL8HD23	6			
	2.0 × 5.0	●			GL8KG21	4	GL8EG21	8			GL8HY21	8	GL8HS21	8	GL8HD21	8	GL8PR21	0.7	
		●			GL8KG26	4	GL8EG26	8			GL8HY26	8		GL8HD26	8	GL8PR26	0.7		
Square	5.0 × 5.0	●			GL8KG22	3.5	GL8EG22	6			GL8HY22	5	GL8HS22	5	GL8HD22	8	GL8PR22	1.2	
Triangle	Isosceles triangle	●														GL8PR28	0.9		

\*1 PR series (Red): I<sub>F</sub> = 5 mA (GL8PR25, GL8PR29: I<sub>F</sub> = 10 mA)

\*2 Taped model

\*3 With tie-bar

HL: High-luminosity

Taped model is also available.

### Notice

In the absence of confirmation by device specification sheets, SHARP takes no responsibility for any defects that may occur in equipment using any SHARP devices shown in catalogs, data books, etc.

Except where specially indicated, models listed on this page comply with the RoHS Directive\*. For details, please contact SHARP.

\*RoHS Directive: Prohibits use of lead, cadmium, hexavalent chromium, mercury and specific brominated flame retardants (PBBs and PBDEs), with certain exceptions.

Contact SHARP in order to obtain the latest device specification sheets before using any SHARP device.



**Cylinder**



GL3PR8 series



GL3PR44 series



GL3HY43 series



GL3KG62 series



LT3E31W series



GL3PR63 series



LT3E65W series



GL4PR8 series



GL5PR4 series



GL5HS8 series



GL5KG41 series



GL5PR44 series



GL5EG40 series



GL5HY43 series



GL5EG60 series



GL6EG11T



GL5HD47 series

**Oval**



GL6EG26T



GL2HY6



GL8EG2 series



GL8HD4 series

**Convex**

**Arch**

**Rectangle**



GL8KG42 series



GL8KG25 series



GL8HY29 series



GL8HD23 series



GL8HS21 series



GL8HY26 series

**Square**

**Triangle**



GL8HD22 series



GL8PR28

**Notice**

In the absence of confirmation by device specification sheets, SHARP takes no responsibility for any defects that may occur in equipment using any SHARP devices shown in catalogs, data books, etc. Except where specially indicated, models listed on this page comply with the RoHS Directive\*. For details, please contact SHARP. \*RoHS Directive: Prohibits use of lead, cadmium, hexavalent chromium, mercury and specific brominated flame retardants (PBBs and PBDEs), with certain exceptions. Contact SHARP in order to obtain the latest device specification sheets before using any SHARP device.

# DICHROMATIC LED LAMPS



## ■ Dichromatic LED Lamps

(The values in luminous intensity are radiation color order) (I<sub>F</sub> = 20 mA\*1, T<sub>a</sub> = 25°C)

Appearance	Radiation shape (mm)	Resin type				E J J		C U *		E P		E D		E H		H P	
		Colored diffusion	Colored transparency	Colorless transparency	Milky diffusion	Yellow-green + Orange (HL)	Luminous intensity (mcd) TYP.	Yellow-green + Red (HL)	Luminous intensity (mcd) TYP.	Yellow-green + Red	Luminous intensity (mcd) TYP.	Yellow-green + Red	Luminous intensity (mcd) TYP.	Yellow-green + Yellow	Luminous intensity (mcd) TYP.	Yellow + Red	Luminous intensity (mcd) TYP.
Cylinder	ø3				●							GL3ED8	20/15				
	ø5				●	GL5EJJ502C0X*2	110/170			GL5EP5	40/9	GL5ED5	40/25			GL5HP5	15/9
				●				GL5CU44	100/240			GL5ED44	80/50				
				●				GL6CU7	120/250			GL5ED60	11/8				
Rectangle	1.9 × 3.9				●							GL8ED5	10/6.5			GL8HP5	3/1.5
	2.0 × 5.0				●							GL9ED2	8/3	GL9EH2	6/2	GL9HP2	1/0.8
	5.0 × 5.0				●							GL9ED4	7/4				

\* CU series: Common anode pin connection

\*1 P (Red) and H (yellow): I<sub>F</sub> = 10 mA

\*2 Taped model

HL: High-luminosity

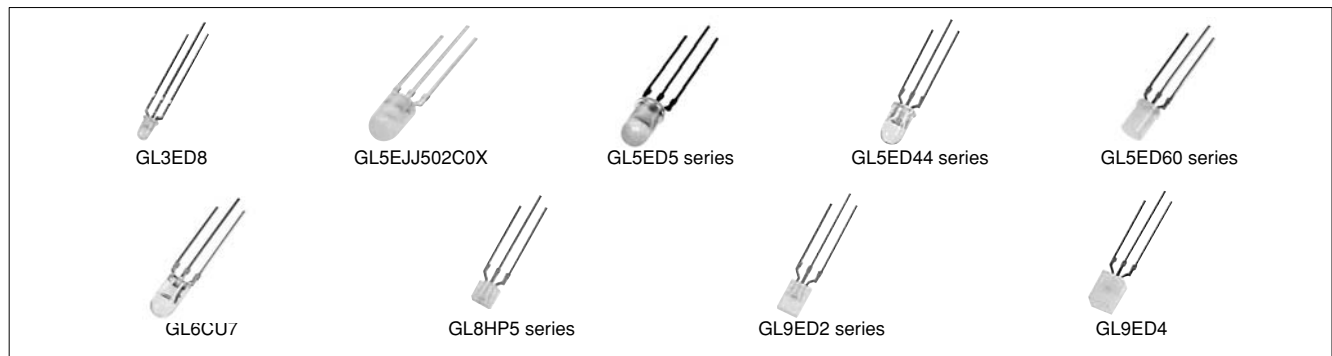

### Notice

In the absence of confirmation by device specification sheets, SHARP takes no responsibility for any defects that may occur in equipment using any SHARP devices shown in catalogs, data books, etc. Except where specially indicated, models listed on this page comply with the RoHS Directive\*. For details, please contact SHARP. \*RoHS Directive: Prohibits use of lead, cadmium, hexavalent chromium, mercury and specific brominated flame retardants (PBBs and PBDEs), with certain exceptions. Contact SHARP in order to obtain the latest device specification sheets before using any SHARP device.

☆New product  
★Under development



## High-Luminosity (AlGaInP) Chip LEDs (Taped Models Only)

(I<sub>F</sub> = 20 mA, T<sub>a</sub> = 25°C)

Outline dimensions (mm)	Resin type				JESE		ZVJV		ZSJS		ZJJJ		ZRJR	
	Colored diffusion	Colored transparency	Colorless transparency	Milky diffusion	Yellow-green	Luminous intensity (mcd) TYP.	Amber	Luminous intensity (mcd) TYP.	Sunset orange	Luminous intensity (mcd) TYP.	Orange	Luminous intensity (mcd) TYP.	Red	Luminous intensity (mcd) TYP.
1.6 × 0.8 (T: 0.35)			●		GM1JE35200AE*1	13	GM1JV35200AE*1	18.8	GM1JS35200AE*1	19	GM1JJ35200AE*1	19	GM1JR35200AE*1	13
1.6 × 0.8 (T: 0.55)			●		GM1JE55200AE*1	13	GM1JV55200AE*1	16.8	GM1JS55200AE*1	20.9	GM1JJ55200AE*1	19		
1.6 × 0.8 (T: 0.8)			●				GM1ZV80300AE	75	GM1ZS80300AE	75	GM1ZJ80300AE	75	GM1ZR80300AE	55
			●				LT1JV67A*1	16.5	LT1JS67A*1	14.1				
2.0 × 1.25 (T: 0.8)			●				GM1ZV40300AE	60	GM1ZS40300AE	78	GM1ZJ40300AE	60	GM1ZR40300AE	55
			●				GM1JV40300AE	11	GM1JS40300AE	12	GM1JJ40300AE	9.5		
3.2 × 2.8 (T: 1.9)			●				★GM5ZV96260AE	320					★GM5ZR96260AE	300
			●				★GM5JV96210A	140					★GM5JR96210A	120
6.0 × 5.0 (T: 2.5)			●				GM5ZV01200A*2	500	GM5ZS01200A*2	700	GM5ZJ01200A*2	500	GM5ZR01200A*2	400
			●		GM5SE01200A*2	400					GM5SJ01250AL	1 050		
6.0 × 5.0 (T: 2.3) (board insertion type)			●				GM5ZV03200Z*2	500	GM5ZS03200Z*2	700	GM5ZJ03200Z*2	500	GM5ZR03200Z*2	400
2.8 × 1.2 (T: 0.8) (Side emitting)			●				★GM4ZV83200AE	(100)	★GM4ZS83200AE	(150)	★GM4ZJ83200AE	(150)	☆GM4ZR83200AE	(90)
5.0 × 5.0 (T: 1.5)			●										☆GM5ZR05240A	3 000

\*1 LT1JS67A, LT1JV67A, GM1JV55200AE series, GM1JV35200AE series, GM1JV40300AE series: I<sub>F</sub> = 5 mA

\*2 GM5ZR01200A series, GM5ZR03200Z series: I<sub>F</sub> = 60 mA

## High-Luminosity (InGaN) Chip LEDs (Taped Models Only)

(I<sub>F</sub> = 10 mA, T<sub>a</sub> = 25°C)

Outline dimensions (mm)	Resin type				BC		GC	
	Colored diffusion	Colored transparency	Colorless transparency	Milky diffusion	Blue	Luminous intensity (mcd) TYP.	Green	Luminous intensity (mcd) TYP.
1.6 × 0.8 (T: 0.35)				●	☆GM1BC35370AC*1	23		
1.6 × 0.8 (T: 0.55)			●		★GM1BC55255AC*1	23	★GM1GC55310AC*4	100
3.2 × 2.8 (T: 1.9)			●		★GM5BC96210AC*2	150	★GM5GC96210AC*2	250
			●		★GM5BC96260AC*2	300	★GM5GC96260AC*2	700
6.0 × 5.0 (T: 2.5)			●		☆GM5BC01250AC*3	400	☆GM5GC01250AC*3	1 200
6.0 × 5.0 (T: 2.3) (board insertion type)			●		☆GM5BC03210Z*3	400	☆GM5GC03210Z*3	1 200
2.8 × 1.2 (T: 0.8) (Side emitting)			●		★GM4BC83200AC*2	(150)	★GM4GC83200AC*2	(300)
5.0 × 5.0 (T: 1.5)			●		★GM5BC05240AC*2	2 000	★GM5GC05240AC*2	4 000

\*1 GM1BC35370AC, GM1BC55255AC: I<sub>F</sub> = 5 mA

\*2 GM5BC96210AC series, GM4BC83200AC series, GM5BC05240AC series: I<sub>F</sub> = 20 mA

\*3 GM5BC01250AC series, GM5BC03210Z series: I<sub>F</sub> = 50 mA

\*4 GM1GC55310AC: I<sub>F</sub> = 10 mA

### Notice

In the absence of confirmation by device specification sheets, SHARP takes no responsibility for any defects that may occur in equipment using any SHARP devices shown in catalogs, data books, etc.  
Except where specially indicated, models listed on this page comply with the RoHS Directive\*. For details, please contact SHARP.  
\*RoHS Directive: Prohibits use of lead, cadmium, hexavalent chromium, mercury and specific brominated flame retardants (PBBs and PBDEs), with certain exceptions.  
Contact SHARP in order to obtain the latest device specification sheets before using any SHARP device.



## Chip LEDs (Taped Models Only)

(If = 20 mA\*1, Ta = 25°C)

Outline dimensions (mm)	Resin type				Green	Luminous intensity (mcd) TYP.	E F E G		Yellow-green	Luminous intensity (mcd) TYP.	H H Y		Yellow	Luminous intensity (mcd) TYP.
	Colored diffusion	Colored transparency	Colorless transparency	Milky diffusion										
1.6 × 0.8 (T: 0.35)			●					GM1EG35200A	19					
1.6 × 0.8 (T: 0.55)			●					GM1EG55200A	19		GM1HY55200A		11.5	
1.6 × 0.8 (T: 0.8)				●	LT1K67A	3.8		LT1E67A LT1F67A LT1F67AF	23		LT1H67A		8.3	
2.0 × 1.25 (T: 0.8)				●	LT1K40A	5		LT1E40A	19		LT1H40A		10.8	
3.2 × 2.8 (T: 1.9)			●					GM5EG95200A	18.1					

Outline dimensions (mm)	Resin type				S H S		D H D		U U R		P	
	Colored diffusion	Colored transparency	Colorless transparency	Milky diffusion	Sunset orange	Luminous intensity (mcd) TYP.	Red	Luminous intensity (mcd) TYP.	Red (HL)	Luminous intensity (mcd) TYP.	Red	Luminous intensity (mcd) TYP.
1.6 × 0.8 (T: 0.55)			●		GM1HS55200A	11.4	GM1HD55200A	12.5	GM1UR55200A	29.7		
1.6 × 0.8 (T: 0.8)				●	LT1S67A	6.9	LT1D67A	8.8	LT1U67A	29.7	LT1P67A	1.3
2.0 × 1.25 (T: 0.8)				●	LT1S40A	9.4	LT1D40A	11.9	LT1U40A	35.6	LT1P40A	1.3
3.2 × 2.8 (T: 1.9)			●				GM5HD95200A	13.8	GM5UR95200A	80		

\*1 P (Red) series: If = 5 mA

HL: High-luminosity

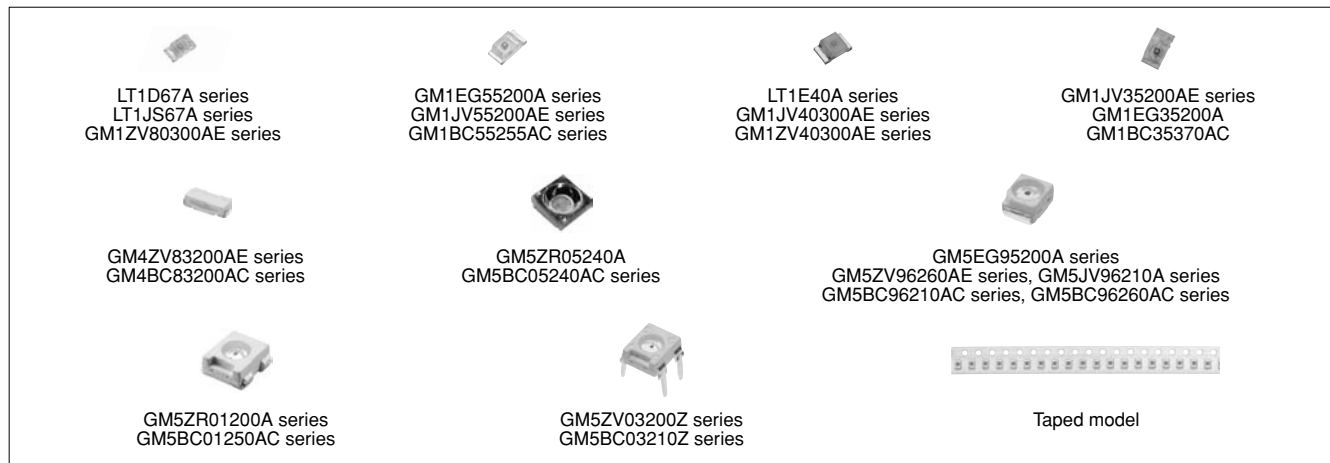

### Notice

In the absence of confirmation by device specification sheets, SHARP takes no responsibility for any defects that may occur in equipment using any SHARP devices shown in catalogs, data books, etc. Except where specially indicated, models listed on this page comply with the RoHS Directive\*. For details, please contact SHARP. \*RoHS Directive: Prohibits use of lead, cadmium, hexavalent chromium, mercury and specific brominated flame retardants (PBBs and PBDEs), with certain exceptions. Contact SHARP in order to obtain the latest device specification sheets before using any SHARP device.

☆New product  
★Under development



## High-Luminosity Dichromatic Type Chip LEDs (Taped Models Only)

(I<sub>F</sub> = 40 mA, T<sub>a</sub> = 25°C)

Outline dimensions (mm)	Resin type					BC GC Blue + Green		BC ZR Blue + Red		GC ZR Green + Red	
	Colored diffusion	Colored transparency	Colorless transparency	Colorless transparency	Milky diffusion	Luminous intensity (mcd) TYP.	Luminous intensity (mcd) TYP.	Luminous intensity (mcd) TYP.	Luminous intensity (mcd) TYP.		
6.0 × 5.0 (T: 2.5)			●			GM5BG01210A	300/860	GM5ZRB01210A	300/580	GM5ZRG01210A	860/580

## Dichromatic Type Chip LEDs (Taped Models Only)

(I<sub>F</sub> = 20 mA, T<sub>a</sub> = 25°C)

Outline dimensions (mm)	Resin type					E H Yellow-green + Yellow		E D Yellow-green + Red		K S Green + Sunset orange	
	Colored diffusion	Colored transparency	Colorless transparency	Colorless transparency	Milky diffusion	Luminous intensity (mcd) TYP.	Luminous intensity (mcd) TYP.	Luminous intensity (mcd) TYP.	Luminous intensity (mcd) TYP.		
1.6 × 1.6 (T: 0.8)					●	LT1EH67A	19/8.3	LT1ED67A	19/8.3	LT1KS67A	3.8/6.9



## High-Luminosity White Type Chip LEDs (with Blue Chip) (Taped Models Only)

(T<sub>a</sub> = 25°C)

Outline dimensions (mm)	Color coordinates (x, y)	Radiation color	BW White	
				Luminous intensity (mcd) TYP.
2.8 × 1.2 (T: 0.8)	(0.30, 0.29)	White	☆GM4BW83310A	1 000
			★GM4BW83360A	1 500
			★GM4BW83380A	1 700
3.85 × 1.2 (T: 1.6)	(0.30, 0.29)	White	★GM4BW63360A	1 550
3.2 × 2.8	(0.31, 0.31)	White	★GM5BW96310A* <sup>1</sup>	(700)
			★GM5BW96320A* <sup>1</sup>	(1 400)
5.0 × 5.0 (T: 1.5)	(0.31, 0.31)	White	☆GM5BW05340A* <sup>1</sup>	10 000
6.0 × 5.0 (T: 1.5) 6-terminal leadless	(0.31, 0.31)	White	☆GM5BW01300A* <sup>2</sup>	4 200
6.0 × 5.0 (T: 2.5) 4-terminal leadless	(0.31, 0.31)	White	☆GM5BW01301A* <sup>3</sup>	1 800

\*<sup>1</sup> GM5BW96310A, GM5BW96320A, GM5BW05340A, GM4BW83310A series, GM4BW63360A: I<sub>F</sub> = 20 mA  
\*<sup>2</sup> GM5BW01300A: I<sub>F</sub> = 35 mA/chip      \*<sup>3</sup> GM5BW01301A: I<sub>F</sub> = 40 mA



### Notice

In the absence of confirmation by device specification sheets, SHARP takes no responsibility for any defects that may occur in equipment using any SHARP devices shown in catalogs, data books, etc.  
Except where specially indicated, models listed on this page comply with the RoHS Directive\*. For details, please contact SHARP.  
\*RoHS Directive: Prohibits use of lead, cadmium, hexavalent chromium, mercury and specific brominated flame retardants (PBBs and PBDEs), with certain exceptions.  
Contact SHARP in order to obtain the latest device specification sheets before using any SHARP device.

# CHIP LEDs / LEDs FOR CAMERA DATA BACK

☆New product  
★Under development



## High-Luminosity Dichromatic Type Chip LEDs (RGB 3-color) (Taped Models Only)

(Ta = 25°C)

Outline dimensions (mm)	Resin type				Luminous intensity (mcd) TYP.
	Colored diffusion	Colored transparency	Colorless transparency	Milky diffusion	
1.6 × 1.6 (T: 0.55)				●	☆GM1WA55360A*1
				●	GM1WA55310A*6
3.2 × 2.8 (T: 1.4)			●		★GM5WA94200A*8
6.0 × 5.0 (T: 2.5) 6-terminal leadless			●		GM5WA06250A*3
			●		GM5WA06260A*2
			●		☆GM5W06256A*7
			●		GM5WA06270A*4, 5
6.0 × 5.0 (T: 2.3 [resin part]) 6-terminal			●		GM5WA06250Z*3

- \*1 GM1WA55360A: If = 10 mA (Red, Green, Blue)  
 \*2 GM5WA06260A: If = 40 mA (Red, Green), If = 20 mA (Blue)  
 \*3 GM5WA06250A, GM5WA06250Z: If = 35 mA (Red, Green), If = 20 mA (Blue)  
 \*4 GM5WA06270A: If = 35 mA (Red, Green, Blue)  
 \*5 GM5WA06270A: T: 2.4 mm  
 \*6 GM1WA55310A: If = 5 mA (Red, Green, Blue)  
 \*7 GM5WA06256A: If = 22 mA (Red), If = 35 mA (Green), If = 13 mA (Blue)  
 \*8 GM5WA94200A: If = 20 mA (Red, Green, Blue)



## LEDs for Camera Data Back

(If = 1 mA, Ta = 25°C)

Model No.	No. of dots	Outline dimensions (mm)	Radiation color	Luminous intensity (mcd)
GW01M59001PE	7	2.6 × 2.9 (T: 0.9) Surface-mount type	Amber	(MIN. 0.4 TYP. 0.8)

( ) indicates reference value.



### Notice





In the absence of confirmation by device specification sheets, SHARP takes no responsibility for any defects that may occur in equipment using any SHARP devices shown in catalogs, data books, etc.  
 Except where specially indicated, models listed on this page comply with the RoHS Directive\*. For details, please contact SHARP.  
 \*RoHS Directive: Prohibits use of lead, cadmium, hexavalent chromium, mercury and specific brominated flame retardants (PBBs and PBDEs), with certain exceptions.  
 Contact SHARP in order to obtain the latest device specification sheets before using any SHARP device.

☆New product  
★Under development



## ■ Laser Diodes

### ◆ Model Configurations

Wavelength (nm)	Optical power output (Pulse) (mW) MAX.	Package			
		 ø5.6 mm Metal type	 ø3.3 mm Metal type	 1.8 mm Resin type	 ø5.6 mm Resin type
650 band	240	GH06P24A2C		GH16P24A8C	
	300	★GH06P30A1C		★GH16P30A8C	
	350			★GH16P35A8C	
780 band	5*1				GH17805B2AS
	7*1	GH07807E1C			
	240	☆GH07P24C1C	GH07P24C4C	GH17P24C8C	
	280	GH07P28A1C	☆GH07P28A4C	★GH17P28A8C	

\*1 Optical power output (CW) MAX. (mW)

### ◆ Specifications

(T<sub>c</sub> = 25°C)

Model No.	Wave-length (nm)	Optical power output (mW) MAX.		Features	Applications	Terminal connections
		CW	Pulse			
GH06P24A2C	650 band	100	240	High power, ø5.6 mm, operating temperature: 75°C MAX. (pulse drive)	Double-layer DVD x4 writing	B
★GH06P30A1C		120	300	High power, ø5.6 mm, operating temperature: 75°C MAX. (pulse drive)	Double-layer DVD x8 writing	
GH16P24A8C		100	240	High power, 1.8 mm frame package, operating temperature: 75°C MAX. (pulse drive)	Double-layer DVD x4 writing	C
★GH16P30A8C		120	300	High power, 1.8 mm frame package, operating temperature: 75°C MAX. (pulse drive)	Double-layer DVD x8 writing	
★GH16P35A8C		125	350	High power, 1.8 mm frame package, operating temperature: 75°C MAX. (pulse drive)	Double-layer DVD x16 writing	
GH17805B2AS	780 band	5	–	Resin package, operating temperature: 70°C MAX.	CD-ROM, CD-Audio	A
GH07807E1C		7	–	Multi mode, ø5.6 mm, operating temperature: 70°C MAX.	CD-read	B
☆GH07P24C1C		120	240	High power, ø5.6 mm, operating temperature: 75°C MAX. (pulse drive)	CD-R/RW (MAX. x48 to x52 writing)	
GH07P28A1C		150	280	High power, ø5.6 mm, operating temperature: 75°C MAX. (pulse drive)	CD-R/RW (MAX. x48 to x52 writing), LightScribe*	
GH07P24C4C		120	240	High power, compact ø3.3 mm package, operating temperature: 75°C MAX. (pulse drive)	CD-R/RW (H/H, slim dual-purpose) (MAX. x48 to x52 writing)	
☆GH07P28A4C		150	280	High power, compact ø3.3 mm package, operating temperature: 75°C MAX. (pulse drive)	CD-R/RW (H/H, slim dual-purpose) (MAX. x48 to x52 writing), LightScribe*	C
GH17P24C8C		120	240	High power, 1.8 mm frame package, operating temperature: 75°C MAX. (pulse drive)	CD-R/RW (H/H, slim dual-purpose) (MAX. x48 to x52 writing)	
★GH17P28A8C		150	280	High power, 1.8 mm frame package, operating temperature: 75°C MAX. (pulse drive)	CD-R/RW (H/H, slim dual-purpose) (MAX. x48 to x52 writing), LightScribe*	

\* LightScribe is a registered trademark of the Hewlett-Packard Development Company, L.P.

### • Terminal Connections

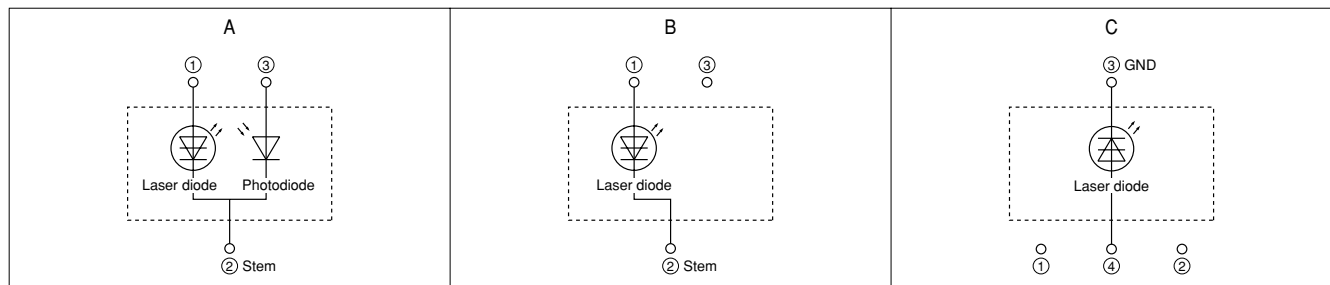



#### Notice

In the absence of confirmation by device specification sheets, SHARP takes no responsibility for any defects that may occur in equipment using any SHARP devices shown in catalogs, data books, etc.  
Except where specially indicated, models listed on this page comply with the RoHS Directive\*. For details, please contact SHARP.  
\*RoHS Directive: Prohibits use of lead, cadmium, hexavalent chromium, mercury and specific brominated flame retardants (PBBs and PBDEs), with certain exceptions.  
Contact SHARP in order to obtain the latest device specification sheets before using any SHARP device.



## ■ Hologram Lasers

### ◆ Lineup

Application	Features	Package		
		 3.0mm resin type	 4.8mm resin type	 4.8mm metal type
DVD/DVD-ROM	×10 read only, phase shift DPP method compatible	GH6D410B5A*		
Recordable DVD	×8 writable, double-layer ×4 writable			☆GH5VV24A3C*
CD-Audio	3V operating built-in OPIC		GH6CD05E3A*	
	For car CD, operating temperature: MAX. 80°C, 3V operating built-in OPIC			GH5CD05B3D*
	For car CD, operating temperature: MAX. 85°C, 3V operating built-in OPIC		☆GH6CD05E3L*	
CD-R/RW	×24 writable, sample-hold system	☆GH6RT20A5C*		GH5R51RA3C*
	×52 writable			GH5RT24A3C*

\* Built-in OPIC type

( "OPIC" (Optical IC) is a trademark of SHARP Corporation. An OPIC consists of a light-detecting element and signal-processing circuit integrated onto a single chip. )

### ◆ Specifications

(T<sub>c</sub> = 25°C)

Model No.	Wavelength (nm)	Optical power output* (mW) MAX.	Pulse optical output* (mW) MAX.	Threshold current (mA) TYP.	Operating current (mA) TYP.	Operating voltage (V) TYP.	Beam	Power supply
GH6D410B5A	650 band	9	–	30	37*1	2.2*1	3 beam	Dual power supply
☆GH5VV24A3C		90	216	70	180*2	2.6*2		–
GH5CD05B3D	780 band	4.3	–	25	36*3	1.75*3		Dual power supply
GH6CD05E3A	795 band					1.85*3		
☆GH6CD05E3L								
GH5R51RA3C	780 band	108	162	30	141*4	2.2*4		–
☆GH6RT20A5C			180		125*4			
GH5RT24A3C			216		130*4			

\* Output power from hologram laser

\*1 P<sub>H</sub>: 7.0 mW

\*2 P<sub>H</sub>: 90 mW

\*3 P<sub>H</sub>: 3.0 mW

\*4 P<sub>O</sub>: 100 mW

#### Notice

In the absence of confirmation by device specification sheets, SHARP takes no responsibility for any defects that may occur in equipment using any SHARP devices shown in catalogs, data books, etc. Except where specially indicated, models listed on this page comply with the RoHS Directive\*. For details, please contact SHARP. \*RoHS Directive: Prohibits use of lead, cadmium, hexavalent chromium, mercury and specific brominated flame retardants (PBBs and PBDEs), with certain exceptions. Contact SHARP in order to obtain the latest device specification sheets before using any SHARP device.



### ◆Light detectors for signal detection\*

#### For CD-Audio <GH6CD05E3A>

(Tc = 25°C)

Parameter	Conditions	Rating
RF output amplitude	$P_H = 2.5 \text{ mW}^*$	TYP. 1.66 V
Focus error signal output amplitude	$P_{RF} = 1.1 \text{ V}$	TYP. 0.70 V
Radial error signal output amplitude		TYP. 0.36 V
Focal offset		MAX. $\pm 0.7 \mu\text{m}$
OPIC operation voltage	–	TYP. 3.0 V
OPIC response frequency	$V_{CC} = 3 \text{ V}, -3 \text{ dB}$	MIN. 12 MHz

\* Optical system is specified separately.  
 $P_H$  = Output power from hologram laser

### ◆Light detectors for signal detection\*

#### For DVD-ROM Drives (x10) <GH6D410B5A>

(Tc = 25°C)

Parameter	Conditions	Rating
RF output amplitude	$P_H = 7.0 \text{ mW}^*$	TYP. 1.32 V
Focus error signal output amplitude	$V_{RF} = 1.32 \text{ V}$	TYP. 0.83 V
Focal offset		TYP. $-0.2 \mu\text{m}$
OPIC operation voltage	–	TYP. 5.0 V
OPIC response frequency	$V_{CC} = 5 \text{ V}, -3 \text{ dB}$	MIN. 60 MHz

\* Optical system is specified separately.  
 $P_H$  = Output power from hologram laser

### ◆Light detectors for signal detection\*

#### For CD-R/RW Drives (x52 writable) <GH5RT24A3C>

(Tc = 25°C)

Parameter	Conditions	Rating
RF output amplitude	Collimated lens output power 1.2 mW, High gain	TYP. 1.00 V
Focus error signal output amplitude		TYP. 0.59 V
Radial error signal output amplitude		TYP. 0.19 V
Focal offset		MAX. $\pm 0.7 \mu\text{m}$
OPIC operation voltage	–	TYP. 5.0 V
OPIC response frequency	$V_{CC} = 5 \text{ V}, -3 \text{ dB}$	MIN. 45 MHz

\* Optical system is specified separately.  
 Refer to specification sheets for details of each model.

### ◆Light detectors for signal detection\*

#### For Recordable DVD Drives (x8 writable, double-layer x4 writable) <GH5VV24A3C>

(Tc = 25°C)

Parameter	Conditions	Rating
RF output amplitude	Collimated lens output power 1.1 mW, High gain	TYP. 0.33 V
Focus error signal output amplitude		TYP. 0.38 V
Focal offset		MAX. $\pm 14\%$
OPIC operation voltage	–	TYP. 5.0 V
OPIC response frequency	$V_{CC} = 5 \text{ V}, -3 \text{ dB}$	MIN. 60 MHz

\* Optical system is specified separately.  
 Refer to specification sheets for details of each model.

#### Notice

In the absence of confirmation by device specification sheets, SHARP takes no responsibility for any defects that may occur in equipment using any SHARP devices shown in catalogs, data books, etc.  
 Except where specially indicated, models listed on this page comply with the RoHS Directive\*. For details, please contact SHARP.  
 \*RoHS Directive: Prohibits use of lead, cadmium, hexavalent chromium, mercury and specific brominated flame retardants (PBBs and PBDEs), with certain exceptions.  
 Contact SHARP in order to obtain the latest device specification sheets before using any SHARP device.

## ■ Europe: LNB for Broadcasting Satellite

### ◆ Features

- (1) Wide band type receiving all broadcasting channels (analog & digital) of Europe. [Universal LNB]
- (2) Originally developed feed-horn waveguide makes the wide-band, low-noise characteristics possible.
- (3) One of the industry's most compact and lightweight package
- (4) Low consumption current design for energy saving [80 mA (TYP.): BS1R8EL100A]

### ◆ Specifications

Destination	Europe, Astra/Eutelsat Satellite etc.		
Receiving polarization	Horizontal/Vertical polarization		
Model No. <Type>	BS1R6EL400A <4 output>	BS1R5EL200A <2 output>	BS1R8EL100A <1 output>
Input frequency (GHz)	10.7 to 11.7 [Low band], 11.7 to 12.75 [High band]		
Output frequency (MHz)	950 to 1 950 [Low band], 1 100 to 2 150 [High band]		
Local oscillation frequency (GHz)	9.75 [Low band], 10.6 [High band]		
NF (dB)	1.3 (TYP.) [Low band], 1.1 (TYP.) [High band]	0.7 (TYP.)	0.8 (TYP.)
Conversion gain (dB)	46 (MIN.)		
Phase noise	-50 dBc/Hz @1 kHz (MAX.)		-55 dBc/Hz @1 kHz (TYP.)
Cross-polar discrimination (dB)	25 (TYP.)/20 (MIN.)		
Supply voltage (V DC) (Polarization switching voltage)	Vertical polarization	11.5 to 14.0 (0/22 kHz)	
	Horizontal polarization	16.0 to 19.0 (0/22 kHz)	
Power consumption (mA)	290 (MAX.)	190 (TYP.)/250 (MAX.)	80 (TYP.)/120 (MAX.)
Waveguide	Feed-horn (F/D = 0.6)		
Output impedance ( $\Omega$ )	75		
Output connector (F-type)	4-output (H/V, High and low switching)	2-output (H/V, High and low switching)	1-output (H/V, High and low switching)
Outline dimensions (mm)	63.4 × 138.2 × 152.4	61.5 × 135.6 × 129.5	107.3 × 60.0 × 60.0
Weight (g)	Approx. 460	Approx. 430	Approx. 145



BS1R6EL400A



BS1R5EL200A



BS1R8EL100A

## ■ U.S.A.: LNB for FSS Broadcast/(Others: LNB for Communication)

### ◆ Specifications

Receiving system	U.S.A.: FSS, Japan and others: for communication
Receiving polarization	Horizontal/vertical polarization
Model No.	BS1C1UR100A
Input frequency (GHz)	11.7 to 12.2
Output frequency (MHz)	950 to 1 450
Local oscillation frequency (GHz)	10.75
NF (dB)	0.7 (TYP.)/0.9 (MAX.)
Conversion gain (dB)	50 to 62
Phase noise	-60 dBc/Hz @1 kHz (TYP.)
Cross-polar discrimination (dB)	—
Supply voltage (V DC)	12 to 24
Power consumption (mA)	120 (TYP.)/150 (MAX.)
Waveguide	WR-75
Output impedance ( $\Omega$ )	75
Output connector (F-type)	1-output
Outline dimensions (mm)	48.6 × 96.3 × 45.5
Weight (g)	Approx. 100



BS1C1UR100A

#### Notice

In the absence of confirmation by device specification sheets, SHARP takes no responsibility for any defects that may occur in equipment using any SHARP devices shown in catalogs, data books, etc. Contact SHARP in order to obtain the latest device specification sheets before using any SHARP device.

## Japan/Asia/Australia: LNBs for CS Digital Satellite Broadcast

### ◆ Specifications

Destination	Japan, Asia, Australia, CS Satellite	
Receiving polarization	Horizontal/Vertical polarization	
Model No. <Type>	BS1R5AQ100A	
Input frequency (GHz)	12.25 to 12.75	
Output frequency (MHz)	950 to 1 450	
Local oscillation frequency (GHz)	11.3	
NF (dB)	0.6 (TYP.) / 1.0 (MAX.)	
Conversion gain (dB)	50 (MIN.)	
Phase noise	-75 dBc/Hz @1 kHz (TYP.)	
Cross-polar discrimination (dB)	25 (TYP.)/20 (MIN.)	
Supply voltage (V DC) (Polarization switching voltage)	Vertical polarization	11.5 to 14.0
	Horizontal polarization	16.0 to 19.0
Power consumption (mA)	80 (TYP.)120 (MAX.)	
Waveguide	Feed-horn (F/D = 0.6)	
Output impedance ( $\Omega$ )	75	
Output connector (F-type)	1-output (H/V switching)	
Outline dimensions (mm)	140 × 60 × 60	
Weight (g)	Approx. 180	



BS1R5AQ100A

## Japan: LNBs for BS/CS 110° Satellite Broadcast

### ◆ Features

- (1) Can receive 2 satellite broadcasts of 110° BS/CS digital  
[Employs wide-band (1 GHz) circular' linear polarization conversion technology (septum waveguide structure)]
- (2) Outstanding noise figure (NF) characteristics enabling compact design of antenna diameter. [NF: 0.45 dB (TYP.)/BS1F6JU300A]
- (3) Low current consumption design for improved energy saving. [80 mA (TYP.)]

### ◆ Standard Specifications

Destination	Japan BS/CS 110° Satellite		
Receiving polarization	Right circular polarization		Right/Left circular polarization
Model No.	BS1F6JU300A	BS1F6JP300A	BS1F6JP100A
Input frequency (GHz)	11.71023 to 12.751		
Output frequency (MHz)	1 032.23 to 2 073		
Local oscillation frequency (GHz)	10.678		
NF (dB)	0.45 (TYP.) / 0.6 (MAX.)	0.7 (TYP.) / 1.1 (MAX.)	
Conversion gain (dB)	48 to 60		
Phase noise	-65 dBc/Hz @1 kHz (TYP.)		
Cross-polar discrimination (dB)	25 (TYP.)/20 (MIN.)		
Supply voltage (V DC) (Polarization switching voltage)	Right circular polarization	9.5 to 18.0	13.5 to 16.5
	Left circular polarization	—	9.5 to 12.0
Power consumption (mA)	80 (TYP.)/110 (MAX.)		
Waveguide	Feed-horn (F/D=0.5)		
Output impedance ( $\Omega$ )	75		
Output connector (F-type)	1-output	1-output (R/L switching)	
Outline dimensions (mm)	96 × 53.07 × 71		
Weight (g)	Approx. 130 (not including outer cabinet)		



BS1F6JP300A

\* Outer cabinet is made upon request.

#### Notice

In the absence of confirmation by device specification sheets, SHARP takes no responsibility for any defects that may occur in equipment using any SHARP devices shown in catalogs, data books, etc. Contact SHARP in order to obtain the latest device specification sheets before using any SHARP device.

## ■ Digital DBS Front-End Units

**D**BS front-end unit for digital broadcasting features high quality of signal transmission and improved elimination ability of various kinds of rejection thanks to using Sharp's original ICs.

### ◆ Features

- (1) Equipped with a direct conversion IC developed by Sharp. Reliability is improved by reducing power consumption and component counts.
- (2) Compact and thin design enabling installation on a personal computer PCI card. [Thickness: 12.9 mm (MAX.)]
- (3) Wide-band reception design also covering CS broadcast band. [Reception frequency: 950 to 2 150 MHz]
- (4) Wide product line-up of LINK integrated types for contributing to set development time reduction. [Compatible with QPSK/8PSK demodulation]
- (5) User support tools can be provided. [Sample/evaluation boards and software are available.]

### ◆ Standard Specifications

Destination	Europe/U.S.A./Japan		
Input type	1-input	1-input, 1-loop through output	1-input
Model No.	BS2S7VZ0302A	BS2S7HZ0302A	BS2S7HZ6306
Input frequency (MHz)	950 to 2 150		
Input signal level (dBm)	-65 to -25		
The 1st intermediate frequency (MHz)	Zero-IF (Direct conversion)		
Base band frequency bandwidth	10 to 30, 2.0 MHz step (BB LPF)		
RF input local leak (dBm)	-63 (MAX.)		
PLL phase noise (dBc/Hz)	10 kHz offset	-75 (TYP.)	
	1 kHz offset	-70 (TYP.)	
Output type	I/Q		
Channel selection system	PLL (I <sup>2</sup> C-bus)*1		
Noise figure (dB)	12 (MAX.)		
Tuning voltage (V DC)	(Not required)*2		
Supply voltage (V DC)	3.3		
LNB power supply	DC 25 V, 400 mA (MAX.)		
Input impedance (Ω)	75		
Outline dimensions (mm)	29.6 × 37.9 × 11.0		30.6 × 25.0 × 11.7

- ※ Contact SHARP for custom design product.  
 \*1 I<sup>2</sup>C-bus is a trademark of Philips Corporation.  
 \*2 Terminal supply voltage is not required.

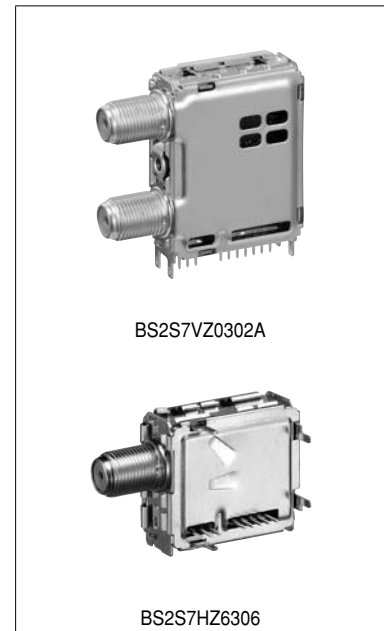

BS2S7VZ0302A

BS2S7HZ6306

## ■ Digital DBS Front-End Units (QPSK Demodulator Circuit Built-in Type)

### ◆ Specifications <QPSK demodulator circuit built-in type>

Destination	Europe/U.S.A./Japan		
Input type	1-input, 1-loop through output		1-input, 1-loop through output (super compact type)
Model No.	BS2F7VZ0194A	BS2F7VZ0724	BS2F7VZ7294
Input frequency (MHz)	950 to 2 150		
Input signal level (dB m)	-65 to -25		
The 1st intermediate frequency (MHz)	Zero-IF (Direct conversion)		
Base band frequency bandwidth (MHz)	10 to 30, 2.0 MHz step (BB LPF)		
RF input local leak (dB m)	-63 (MAX.)		
Output type	8-bit transport		
Symbol rate (M baud)	45 (MAX.)		
BER (Viterbi output)	Eb/No = 5.5 dB (Max.) [PR = 3/4, BER = 2 x 10 <sup>-4</sup> ]		
Channel selection system	PLL (I <sup>2</sup> C-bus)*1		
Noise figure (dB)	12 (MAX.)		
Tuning voltage (V DC)	(Not required)*2		
Supply voltage (V DC)	3.3, 2.5	3.3, 1.8	3.3, 2.5
LNB power supply	25 V DC, 400 mA (MAX.)		
Input impedance (Ω)	75		
Outline dimensions (mm)	55.1 x 37.9 x 11.0		57.5 x 29.6 x 13.2

\* Contact SHARP for custom design product.

\*1 I<sup>2</sup>C-bus is a trademark of Philips Corporation.

\*2 Terminal supply voltage is not required.

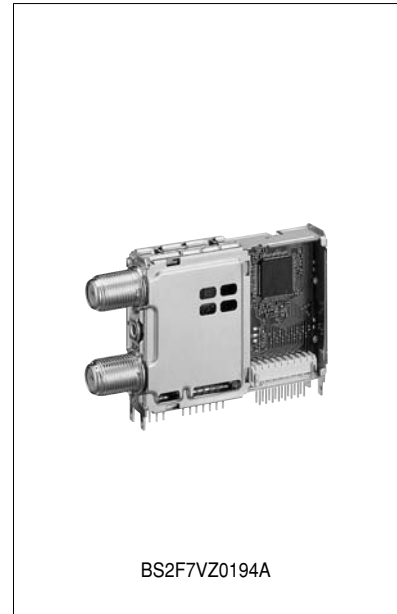

## ■ Digital DBS Front-End Units (8 PSK Demodulator Circuit Built-in Type)

### ◆ Specifications <8 PSK demodulator circuit built-in type>

Destination	Japan	
Input type/Features	1-input	1-input, 1-loop through output
Model No.	BS2F7HZ6460	BS2F7VZ0460
Input frequency (MHz)	950 to 2 150	
Input signal level (dB m)	-65 to -25	
The 1st intermediate frequency (MHz)	Zero-IF (Direct conversion)	
Base band frequency bandwidth (MHz)	22 (BB LPF) variable type	22.5 (BB LPF) variable type
RF input local leak (dB m)	-63 (MAX.)	
Output type	Serial transport output	Parallel/serial transport output
Symbol rate (M baud)	28.86	
Channel selection system	PLL (I <sup>2</sup> C-bus)*1	
Noise figure (dB)	8 (TYP.)	
Tuning voltage (V DC)	(Not required)*2	
Supply voltage (V DC)	3.3, 1.5	
LNB power supply	25 V DC, 400 mA (MAX.)	
Input impedance (Ω)	75	
Outline dimensions (mm)	65.8 x 26.0 x 13.7 (MAX.)	55.1 x 37.9 x 11.0

\*1 I<sup>2</sup>C-bus is a trademark of Philips Corporation.

\*2 Terminal supply voltage is not required.

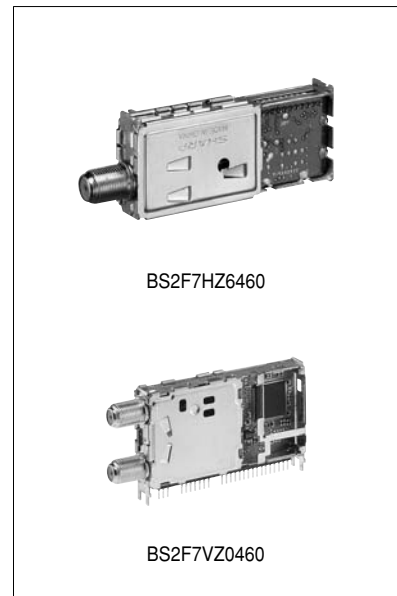

#### Notice

In the absence of confirmation by device specification sheets, SHARP takes no responsibility for any defects that may occur in equipment using any SHARP devices shown in catalogs, data books, etc. Contact SHARP in order to obtain the latest device specification sheets before using any SHARP device.

## ■ Combination Front-End for Digital Terrestrial and Digital Satellite Broadcasting

### ◆ Features

- (1) Enables simultaneous reception of digital terrestrial and digital satellite broadcasting.
- (2) Contributes to making LCD TVs, etc. thinner.
- (3) Combination reception module for terrestrial digital:  
A tuner circuit, a demodulator, an MPEG decoder and a video encoder combined in a single module.

### ◆ Standard Specifications

Destination	Japan	
Model No.	VA1W1JF9003	
RF circuit system	Digital terrestrial	Digital DBS
	Single conversion type	Direct conversion type
Input frequency (MHz)*1	VHF, UHF, CATV VHF Low: 93 to 159 VHF High: 167 to 351 UHF: 357 to 767	950 to 2 150
Input signal level*2 (dBm)	-75 to -20	-65 to -25
Output type	Direct IF [Balance] (Output frequency: 57MHz)	I/Q
IF bandwidth (MHz)	6	-
Base band frequency bandwidth	-	10 MHz to 30 MHz, 2.0 MHz step (BB LPF)
Noise figure (dB)	6 (TYP.)	6 (TYP.)
PLL phase noise (dBc/Hz)	-90 (TYP.) at 10kHz offset	-80 (TYP.) at 10kHz offset
Image rejection (dB)	65 (TYP.)	-
Channel selection system	PLL (I <sup>2</sup> C-bus)*3	
Power consumption (W)	1.57 (TYP.) (When the digital terrestrial and digital satellite broadcasting are received simultaneously)	
Supply voltage (V DC)	5	3.3*4
Outline dimensions (mm)	60.9 × 42.1 × 12.6	

\*1 An RF front-end unit is additionally required to receive analog broadcasting.

\*2 It conforms to the ARIB standard.

\*3 I<sup>2</sup>C-bus is a trademark of Philips Corporation.

\*4 DC 5V type of supply voltage is also available.



#### Notice

In the absence of confirmation by device specification sheets, SHARP takes no responsibility for any defects that may occur in equipment using any SHARP devices shown in catalogs, data books, etc. Contact SHARP in order to obtain the latest device specification sheets before using any SHARP device.

## ■ Front-End Units for ISDB-T/DVB-T

### ◆ Features

- (1) Low phase noise characteristics, high elimination of adjacent channel interference.
- (2) Transport stream output front-end units with built-in OFDM demodulation IC. [VA1L5JF6013/VA1J5ED5055]
- (3) Compact, low power consumption.
- (4) Other types are available with various forms of chassis (vertical or horizontal type) and input connectors (F or DIN type), etc.

### ◆ Standard Specifications

Destination	Japan		Europe/Asia		
Product name	ISDB-T front end (IF output)	ISDB-T front end (built-in OFDM demodulation)	DVB-T front end (IF output)		DVB-T front end (built-in OFDM demodulation)
Model No.	VA1T1JF2091	VA1L5JF6023	VA1T1ED5065	VA1H1ED5265	VA1K5ED5255
Input frequency (MHz)*1	VHF, UHF, CATV VHF Low: 93 to 159 VHF High: 167 to 351 UHF: 357 to 767		VHF: 143.5 to 430 UHF: 430 to 862		VHF: 143.5 to 430 UHF: 430 to 862
Output	Direct IF	Transport stream (Built-in OFDM demodulation)	Direct IF		Transport stream (Built-in OFDM demodulation)
IF bandwidth (MHz)	6		7, 8, selectable		
Mode	Mode 1, 2, 3		2k, 8k, both compatible		
Input sensitivity	—	-79 dBm (TYP.) [in mode 3, 64 QAM, CR = 7/8 (QEF)]	—		-81 dBm (TYP.) [at 2 k, 64 QAM, CR = 2/3 (QEF)]
Noise figure (dB)	6 (TYP.)				
Phase noise	-90 dBc/Hz (TYP.) [at 10 kHz offset]		-90 dBc/Hz (TYP.) [at 10 kHz offset]		
Image rejection (dB)	65 (TYP.)	—	55 (TYP.)		—
C/N	—	22.3 dB (TYP.) [at input level: -45 dBm, in mode 3, 64 QAM, CR = 7/8 (QEF)]	—		17.2 dB (TYP.) [at input level: -50 dBm, 64 QAM, CR = 2/3 (QEF)]
Channel selection/control system	PLL (I <sup>2</sup> C-bus)*2				
Power consumption (W)	1.15	1.6	0.75	0.85	1.33
Supply voltage (V DC)	5, 30	1.5, 3.3, 5, 30	5 (DC-DC converter)		5, 3.3, 1.8 (DC-DC converter)
Outline dimensions (mm)	52.0 x 35.9 x 13.4	80.0 x 35.9 x 13.4	52.0 x 35.9 x 13.4	47.7 x 29.6 x 13.2	70.0 x 29.6 x 13.2

\*1 An RF front-end unit is additionally required to receive analog broadcasting.

\*2 I<sup>2</sup>C-bus is a trademark of Philips Corporation.



VA1T1JF2091

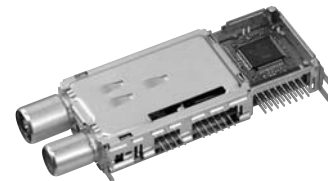

VA1L5JF6023

VA1S1ED5056  
(VA1S8ED5056)

VA1K5ED5255

#### Notice

In the absence of confirmation by device specification sheets, SHARP takes no responsibility for any defects that may occur in equipment using any SHARP devices shown in catalogs, data books, etc. Contact SHARP in order to obtain the latest device specification sheets before using any SHARP device.



## Two-In-One RF Units (RF Front-End Unit + PIF Unit)

### ◆ Features

- (1) High performance RF front-end unit and PIF unit are integrated in one unit, resulting in a short developing time.
- (2) A composite unit structure improves operability during mounting.
- (3) Horizontal shaped models for LCD TVs/LCD monitors are available.  
(Vertical shaped models are also available.)

### ◆ Specifications

TV system	Japan				U.S.A.				China				
Model No.	★ VT2A5JW250				VT2W5UF250				VT2W5CD551				
Receiving channels (ch)	VHF		UHF		VHF		UHF		VHF		UHF		
	Air	CATV	CATV	Air	Air	CATV	CATV	Air	Air	CATV	CATV	Air	
	1 to 12	C13 to C52	C53 to C63	13 to 62	2 to 13	A-5 to W+11	W+12 to W+84	14 to 69	1 to 12	1A, Z1 to Z33	Z34 to Z38	13 to 57	
Band split	BL: 1 to 3, C13 to C22 BH: 4 to 12, C23 to C52 BU: 13 to 62, C53 to C63				BL: 2 to 6, A-5 to B BH: 7 to 13, C to W+11 BU: 14 to 69, W+12 to W+84				BL: 1 to 5, 1A, Z1 to Z4 BH: 6 to 12, Z5 to Z33 BU: 13 to 57, Z34 to Z38				
Intermediate frequency (MHz)	Video	58.75				45.75				38.0			
	Audio	54.25				41.25				D/K: 31.5, I: 32.0, B/G: 32.5, M/N: 33.5			
Detection system	Pseudo synchronization detection system, split-carrier audio receiving system												
Terminals	Input/loop-through output: F-type junction				Input: F-type junction				Input: DIN type terminal				
Input impedance (Ω)	75												
RF with loop through*2	○				—*2				—*2				
B voltage (V DC)	MB: 5/BT: 31.5				MB: 5/BT: 31				MB: 5/BT: 31				
RF front-end	Noise figure (dB)	9.5	9.5	9.5	9.5	4	6	5	5	6	7	6	6
	Type	CATV receiver front end											
	Channel selection system	PLL (I <sup>2</sup> C-bus)*1											
	Image rejection (dB)	VL: 85, VH: 75		75		VL: 75, A5 to I: 80, J to W+84: 60		60		VL: 70, VH: 70		55	
	IF rejection (dB)	VL: 80, VH: 95		95		VL: 90, VH: 100		100		VL: 50 to 70, VH: 90		90	
	IF	Video output level (Vp-p)	1.0				1.0				1.0		
	Video output S/N (dB)	47				48				44			
	Noise limit sensitivity (dBμ) at S/N = 30 dB	45				43				42			
	Audio output level (mVrms)	—				290				290			
	Audio output S/N (dB)	—				55				45			
	Audio frequency characteristics (at 70 kHz)	—				-1 (at 80 kHz)				-0 (at 10 kHz)			
SIF output	Possible to SIF output												
Outline dimensions (mm)	50.3 × 38.4 × 12.7				60.9 × 41.5 × 15.0								

\*1 I<sup>2</sup>C-bus is a trademark of Philips Corporation.

\*2 Compatible with RF loop through type.

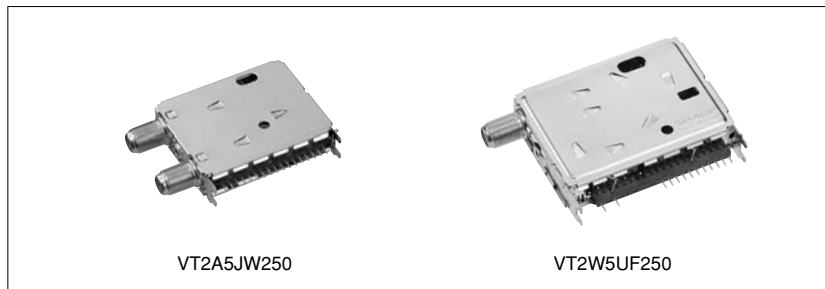

#### Notice

In the absence of confirmation by device specification sheets, SHARP takes no responsibility for any defects that may occur in equipment using any SHARP devices shown in catalogs, data books, etc. Contact SHARP in order to obtain the latest device specification sheets before using any SHARP device.

## RF Front-End Units

### <VT1Y Series>

#### ◆ Features

- (1) Miniature size achieved using thin profile, low height design in industry standard RF front-end unit (terminal shape and terminal pin arrays)
- (2) Model lineup corresponding to domestic product standards of Europe, China, Japan and the United States.

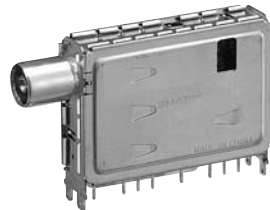

DIN-type junction input type

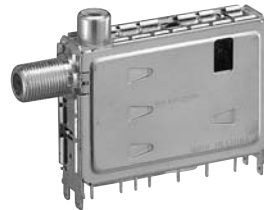

With RF output terminal type

#### ◆ Specifications (Major models of VT1Y series)

Destination	Europe				U.S.A.				China				Japan							
Type	CS, for frequency synthesizer IF output*1: No equilibrium				With PLL, for frequency synthesizer, F-type junction input				GB, hyper, for frequency synthesizer				With PLL, for frequency synthesizer			With PLL, for frequency synthesizer, with RF output				
Model No.	VT1Y5ED211				VT1Y5UF201				VT1Y5CD201				VT1Y5JF201			VT1Y5JB201				
Receiving channel (ch)	VHF		UHF		VHF		UHF		VHF		UHF		VHF		UHF		VHF		UHF	
	Air	CATV	CATV	Air	Air	CATV	CATV	Air	Air	CATV	CATV	Air	Air	CATV	CATV	Air	Air	CATV	CATV	Air
	2 to 12	X to S36	S37 to S41	21 to C57	2 to 13	A-5 to W+11	W+12 to W+84	14 to 69	1 to 12	1A, Z1 to Z33	Z34 to Z38	13 to 57	1 to 12	C13 to C52	C53 to C63	13 to 62	1 to 12	C13 to C52	C53 to C63	13 to 62
Band split	BL: 2 to 4, X to S6 BH: 5 to 12, S7 to S36 BU: 21 to C57, S37 to S41				BL: 2 to 6, A-5 to B BH: 7 to 13, C to W+11 BU: 14 to 69, W+12 to W+84				BL: 1 to 5, 1A, Z1 to Z4 BH: 6 to 12, Z5 to Z33 BU: 13 to 57, Z34 to Z38				BL: 1 to 3, C13 to C22 BH: 4 to 12, C23 to C52 BU: 13 to 62, C53 to C63			BL: 1 to 3, C13 to C22 BH: 4 to 12, C23 to C52 BU: 13 to 62, C53 to C63				
Intermediate frequency (MHz)	Video				Video				Video				Video							
	Audio				Audio				Audio				Audio							
B voltage (V DC)	+B: 5/BT: 31				+B: 5/BT: 31.5				+B: 5/BT: 31				+B: 5/BT: 31.5							
Input impedance (Ω)	75																			
VSWR	2	2	2	1.5	1.5	1.5	1.5	2	2	2	1.5	1.5	1.5	-	-	-	-	-	-	-
Noise figure (dB)	5	7	6	5	5	6	5	7	6	4	5	4.5	8	9	8.5					
Power gain (dB)	40	38	40	39	39	37	40	38	40	40	37	40	36	33	36					
Image rejection (dB)	VL: 70 VH: 65		60		VL: 70 VH: 60		60		VL: 70 VH: 65		60		VL: 85 VH: 85		80		VL: 85 VH: 85		80	
IF rejection (dB)	VL: 70 VH: 90		90		VL: 80 VH: 90		85		VL: 70 VH: 90		90		VL: 85 VH: 85		100		VL: 85 VH: 85		100	
Outline dimensions (mm)	53.0 × 33.6 × 14.3																			

(Note) The figures in the table are typical values.

\*1 Available IF output equilibrium

#### Notice

In the absence of confirmation by device specification sheets, SHARP takes no responsibility for any defects that may occur in equipment using any SHARP devices shown in catalogs, data books, etc. Contact SHARP in order to obtain the latest device specification sheets before using any SHARP device.

# ANALOG TERRESTRIAL RF FRONT-END UNIT

## ■ Ultra Compact Front-End Units

### <VT2V Series>

#### ◆ Features

- (1) Compact and thin design suitable for building into a portable unit with LCD monitor. (Circuit area of 11.4 cm<sup>3</sup>)
- (2) Contribute to simplifying developing process and saving space thanks to the built-in VIF/SIF circuit.

#### ◆ Specifications

Destination		Japan/U.S.A.			
Model No.		VT2V8UP5510			
Receiving channel		VHF	UHF	CATV	FM Radio
		JPN: 1 to 12 USA: 2 to 13	JPN: 13 to 62 USA: 14 to 69	JPN: C13 to C63 USA: A-5 to W+84	JPN: 76 to 90 MHz USA: 88 to 108 MHz
The 1st intermediate frequency (MHz)	Video	45.75			
	Audio	41.25			
Supply voltage (V DC)		5 single (DC-DC converter)			
Power consumption (W)		0.8 (TYP.)			
Input impedance (Ω)		75			
Video S/N (dB)		50 (TYP.)			
Audio S/N (dB)		53 (TYP.)			
Noise limit sensitivity (dB)		42 (TYP.)			
Video frequency characteristics		-1.0 dB (TYP.) at 3.58 MHz			
Audio frequency characteristics		-1.5 dB (TYP.) at 80 kHz			
Outline dimensions (mm)		49.9 × 28.0 × 7.7			



#### Notice

In the absence of confirmation by device specification sheets, SHARP takes no responsibility for any defects that may occur in equipment using any SHARP devices shown in catalogs, data books, etc. Contact SHARP in order to obtain the latest device specification sheets before using any SHARP device.

## ■ 2.4 GHz Band Wireless Image Transmission Module

### ◆ Features

- (1) Enables wireless transmission from VTR and DVD players of high-quality video images. Outstanding image quality is achieved via an error correction and resend function for received data.
- (2) Real-time video and audio processing is achieved using MPEG2 encoding.
- (3) Remote-control-through function (The remote control of the equipment with the transmitter of the module is also capable of sending signal through the one with the receiver.)
- (4) Compact design: 92 x 60 x 10 mm

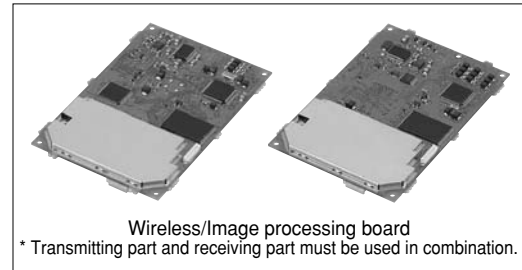

### ◆ Specifications

Standard	Japan/NTSC (PAL & NTSC models are also available.*1)	
Model No.	☆ DC2F1AZ073*1	
Frequency range (MHz)	2 400 to 2 497 (Select from Ch1, 7, 13, 14, or Auto)	
Output level (dB m)	17 (MAX.)	
Occupied bandwidth (MHz)	20 (MAX.)	
Data transmission rate (Mbps)	11	
Security	Pairing of transmitter and receiver via ID matching	
Input/ Output inter- face		Composite video, S video, (component video*1) signals compatible
	[Transmitter]	Power supply ON/OFF SW, DC input (9 V), Composite input x 1 (NTSC 1 V p-p), S video input x 1, (Component video input x 1)*2, Audio input x 1 (L/R, 2 V p-p), Input image signal switching control (1 bit), Image quality selection (2 bit), Channel selection (4 bit), IR control output, LED control [Power supply status (2 bit)], Serial port (Tx, Rx), Antenna connector x 2
	[Receiver]	Power supply ON/OFF SW, DC input (9 V), Composite output x 1 (NTSC 1 V p-p), S video output x 1, (Component video output x 1)*2, Audio output x 1 (L/R, 2 V p-p), IR control input, LED control 1 [Power supply status (2 bit)], LED control 2 [Reception status (2 bit)], Serial port (Tx, Rx), Antenna connector x 2
Supply voltage (V DC)	9	
Power consumption (W)	[Transmitter] 3.8, [Receiver] 2.8 (MAX.)	
Outline dimensions (mm)	92 × 60 × 10 (12.8 MAX.)	
Weight (g)	[Transmitter] Approx. 40, [Receiver] Approx. 35	

\*1 Models corresponding to PAL & NTSC are also available.

\*2 Component video signal input/output are optional.

#### Notice

In the absence of confirmation by device specification sheets, SHARP takes no responsibility for any defects that may occur in equipment using any SHARP devices shown in catalogs, data books, etc. Contact SHARP in order to obtain the latest device specification sheets before using any SHARP device.

## ■ USB Interface Wireless LAN Module

### ◆ Features

- (1) Interface: USB2.0
- (2) Supports security functions.  
 [Encryption method: WEP (64 bit/128 bit), TKIP, AES  
 Authentic method: IEEE802.1x (TLS/PEAP/LEAP), WPA (TLS/PEAP)]

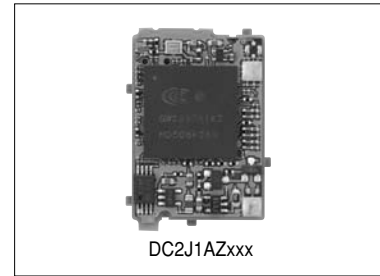

### ◆ Specifications

Standard	IEEE802.11b (option: IEEE802.11g)
Model No.	DC2J1AZxxx (Japan)*1
Output connector	B to B, 10 pin & Antenna connector
Power amp.	Included
Current	Uplink (FTP): 440 mW (typ.)*2 Downlink (FTP): 410 mW (typ.)*2
FTP throughput (Mbps)	4.5 (typ.) [Using FTP 'get' command]*2
Clock (MHz)	40 (included)
Voltage (V DC)	3.3±5%
Outline dimensions (mm)	20 × 30 × 3.8

Driver software consults separately.

\*1 Different models are available in accordance with the laws of the country where the product is to be sold or used.

\*2 Measurement of FTP of specifications description.

#### Notice

In the absence of confirmation by device specification sheets, SHARP takes no responsibility for any defects that may occur in equipment using any SHARP devices shown in catalogs, data books, etc. Contact SHARP in order to obtain the latest device specification sheets before using any SHARP device.

## Wireless LAN Cards

### ◆ Features

- (1) Equipped with "SuperG mode"\*<sup>2</sup> [DC2B1DZ074] or "SuperA/G mode"\*<sup>2</sup>, which combined with dedicated software and a special access point enables even higher speed communication than ordinary .11g and .11a mode. [DC2B1EZ093]
- (2) Supports advanced security functions  
[Encryption method: WPA (Tkip, AES), WEP (64, 128, 152 bit)  
Authentic method: IEEE802.1x (EAP-TLS/PEAP/LEAP), WPA (EPA-TLS/PEAP)]
- (3) Compact design with built-in diversity antenna
- (4) Card Bus 32 bit compatible
- (5) Compatible with driver software  
OS: Windows 2000/XP



### ◆ Specifications

Standard	IEEE 802.11b/g	IEEE 802.11a/b/g
Model No.	DC2B1DZ074 (Japan)*	DC2B1EZ093 (Japan)*
Frequency range (GHz)* <sup>1</sup>	2.4 to 2.4835	2.4 to 2.4835 (at .11g/b mode), 5.15 to 5.25 (at .11a mode)
No. of communication channels* <sup>1</sup>	13 ch (channel span over 30 MHz)	13 ch (at .11g/b mode)* <sup>3</sup> , 4 ch (at .11a mode)* <sup>3</sup>
Transmission output (dBm)	16 or less	
Communication system	Half duplex	
Modulation system	DBPSK, DQPSK, CCK, OFDM	
Data transfer rate (Mbps)	1/2/5.5/11 (in .11b mode) 6/9/12/18/24/36/48/54 (in .11g mode)	6/9/12/18/24/36/48/54 (in .11b mode, .11g mode, .11a mode)
Antenna system	Diversity with built-in 2 antennas (With external antenna connector)	Diversity with built-in 2 antennas
Supply voltage (V DC)	3.3	
Current consumption	Up-link: 530 mA (TYP), Down-link: 520 mA (TYP.)	Up-link: 460 mA (TYP.), Down-link: 400 mA (TYP.)
Outline dimensions (mm)	110.1 × 54.0 × 7.2	
Weight (g)	Approx. 40	

\* Different models are available in accordance with the laws of the country where the product is to be sold or used.

\*<sup>1</sup> Number of channels that can be used (available frequency range) may differ according to the country's laws.

\*<sup>2</sup> "SuperG mode" and "SuperA/G mode" are trademarks of Atheros Communications Inc.

\*<sup>3</sup> Channel span should be over 30 MHz.

#### Notice

In the absence of confirmation by device specification sheets, SHARP takes no responsibility for any defects that may occur in equipment using any SHARP devices shown in catalogs, data books, etc. Contact SHARP in order to obtain the latest device specification sheets before using any SHARP device.

## ■ Wireless Mini PCI Module

### ◆ Features

- (1) Equipped with "SuperA/G mode"\*2, which combined with dedicated software and a special access point enables even higher speed communication than ordinary .11g and .11a mode.
- (2) Mini PCI Type III B compatible: Can be easily built into equipment using a PC standard compatible I/F module.
- (3) Supports advanced security functions  
[Encryption method: WPA (TkiP, AES), WEP (64, 128, 152 bit)  
Authentic method: IEEE802.1x (EAP-TLS/PEAP/LEAP), WPA (EPA-TLS/PEAP)]
- (4) Compatible with driver software  
OS: Windows 2000/XP
- (5) Compatible with diversity antenna

### ◆ Specifications

Standard	IEEE 802.11a/b/g
Model No.	DC2G1EZ094 (Japan)*
Frequency range (GHz)*1	2.4 to 2.4835 (at .11g/b mode), 5.15 to 5.25 (at .11a mode)
Data transfer rate (Mb/s)	6/9/12/18/24/36/48/54 (in .11b mode, .11g mode, .11a mode)
No. of communication channels*1	13 ch (at .11g/b mode)*3, 4 ch (at .11a mode)*3
Modulation system	CCK, DQPSK, DBPSK, OFDM
Supply voltage (V DC)	3.3
Current consumption (mA)	Up-link: 460 (TYP.), Down-link: 400 (TYP.)
Outline dimensions (mm)	59.6 × 44.6 × 3.5



\* Different models are available in accordance with the laws of the country where the product is to be sold or used.

\*1 Number of channels that can be used (available frequency range) may differ according to the country's laws.

\*2 "SuperG mode" and "SuperA/G mode" are trademarks of Atheros Communications Inc.

\*3 Channel span should be over 30 MHz.

#### Notice

In the absence of confirmation by device specification sheets, SHARP takes no responsibility for any defects that may occur in equipment using any SHARP devices shown in catalogs, data books, etc. Contact SHARP in order to obtain the latest device specification sheets before using any SHARP device.



## ■ Infrared Data Communication Device Lineup

Communication system	Transmission speed	Transmission distance	Features	Operating supply voltage	Model No.		
IrDA data (IrDA 1.x)	FIR 4 Mb/s	100 cm	Compact, thin (height: 2.5 mm), low voltage operation type, LP/HP mode switching function	2.4 to 3.6 V	GP2W1004YP0F		
			Compact	2.7 to 5.5 V	GP2W1001YP0F		
		70 cm	LP/HP mode switching function		GP2W1010YP0F		
		50/20 cm	LP/HP mode switching and remote control transmission functions		GP2W3120YP0F		
	MIR 1.152 Mb/s	100 cm	Compact, low dissipation current		2.4 to 3.6 V	GP2W1002YP0F	
			70 cm		2.4 to 3.6 V	GP2W1302YP0F	
			50 cm		2.4 to 3.6 V	GP2W1304YP	
	SIR 115.2 kb/s	100 cm	Compact, low dissipation current		2.4 to 5.5 V	GP2W0004YP0F/ GP2W0004XP0F	
			80 cm	Remote control transmission function, compact, low dissipation current	2.4 to 5.5 V	GP2W3020YP	
	SIR LP 115.2 kb/s	20 cm	Built-in LED constant current circuit, 3-state output		2.0 to 3.6 V	GP2W0110VX/ GP2W0110VY	
			Compact		2.0 to 3.6 V	GP2W0116YP0F	
			(Height: 1.5 mm)		2.4 to 3.6 V	GP2W0150YP0F	
			Built-in LED constant current circuit, 3-state output, top view type		2.0 to 3.6 V	GP2W0114YP0F	
			Compact		2.0 to 3.6 V	GP2W0118YP0F	
			(Height: 2.1 mm)		2.4 to 3.6 V	GP2W0150XP0F	
			Built-in LED constant current circuit, 3-state output, low voltage operation type, low dissipation current type		1.8 to 2.5 V	GP2W0112YP0F	
			Remote control transmission func- tion (built-in drive circuit)		$\lambda$ p: 870, 940 nm	2.4 to 3.6 V	GP2W3240YP
					$\lambda$ p: 890 nm	2.4 to 3.6 V	GP2W3250YP
					(Height: 1.5 mm)	2.4 to 3.6 V	GP2W3270YP0F
					Top view type	2.4 to 3.6 V	GP2W3270XP0F

## ■ Infrared Audio Transmission Device Lineup

Communication system	Features	Operating supply voltage	Model No.
Infrared system (1-bit audio transmission)	For designing compact, low-power-consumption audio transmission systems	2.4 to 3.6 V	GP2WVR01YP0F/ GP2WVC01MP0F (Transmission LSI)



# INFRARED DATA COMMUNICATION DEVICES

★Under development



## ■ Infrared Data Communication Devices

### ◆ IrDA FIR/IrDA MIR Compliant Devices

Model No.	Communication system	Transmission rate	Description	Transmission distance (cm)	Supply voltage (V DC)	Outline dimensions (mm)
★GP2W3120YP0F	Bi-directional (half-duplex) communication	9.6 k to 4 Mb/s	Compatible with IrDA FIR, with remote control transmission function	50/20*1	2.4 to 3.6	7.16 × 2.73 × 1.82
★GP2W1010YP0F	Bi-directional (half-duplex) communication	9.6 k to 4 Mb/s	Compatible with IrDA FIR	70	2.4 to 3.6	7.9 × 2.85 × 2.15
★GP2W1004YP0F	Bi-directional (half-duplex) communication	9.6 k to 4 Mb/s	Compatible with IrDA FIR	100	2.4 to 3.6	7.9 × 2.85 × 2.5
GP2W1001YP0F	Bi-directional (half-duplex) communication	9.6 k to 4 Mb/s	Compatible with IrDA FIR	100	2.7 to 5.5	10.01 × 4.4 × 3.5
GP2W1002YP0F	Bi-directional (half-duplex) communication	9.6 k to 1.152 Mb/s	Compatible with IrDA MIR	100	2.4 to 3.6	8.0 × 3.0 × 2.5
GP2W1302YP0F	Bi-directional (half-duplex) communication	9.6 k to 1.152 Mb/s	Compact, compatible with 2.15 mm height for cellular phone	70	2.4 to 3.6	7.9 × 2.85 × 2.15
GP2W1304YP	Bi-directional (half-duplex) communication	9.6 k to 1.152 Mb/s	Compact, compatible with 1.82 mm height for cellular phone	50	2.4 to 3.6	7.16 × 2.73 × 1.82

\*1 MIN. 50 cm at 250 mA/20 cm at 150mA

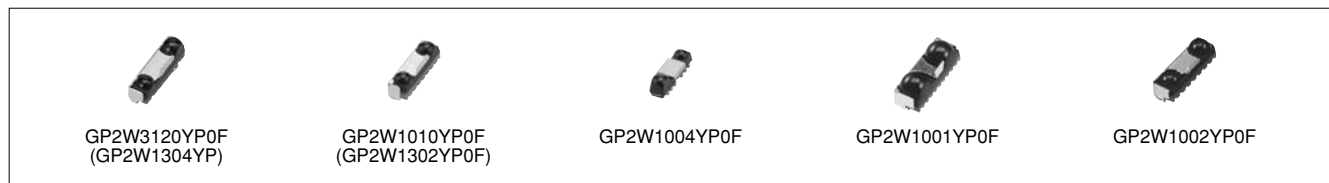

### ◆ IrDA SIR Compliant Front-Ends

Model No.	Communication system	Transmission rate	Description	Transmission distance (cm)	Supply voltage	Outline dimensions (mm)
GP2W0004YP0F	Bi-directional (half-duplex) communication	9.6 k to 115.2 kb/s	Low dissipation current (Icc: 130 μA MAX.)	100	2.4 to 5.5 V	9.21 × 3.76 × 2.71
GP2W0004XP0F	Bi-directional (half-duplex) communication	9.6 k to 115.2 kb/s	Low dissipation current (Icc: 130 μA MAX.)	100	2.4 to 5.5 V	9.2 × 3.35 × 2.95
GP2W3020YP	Bi-directional (half-duplex) communication	9.6 k to 115.2 kb/s	With remote control transmission function (Transmission distance TYP. 7 m, I <sub>F</sub> = 350 mA) Low dissipation current during shutdown (Icc: 130 μA MAX.)	80	2.4 to 5.5 V	7.9 × 2.85 × 2.15



#### Notice

In the absence of confirmation by device specification sheets, SHARP takes no responsibility for any defects that may occur in equipment using any SHARP devices shown in catalogs, data books, etc.  
 Except where specially indicated, models listed on this page comply with the RoHS Directive\*. For details, please contact SHARP.  
 \*RoHS Directive: Prohibits use of lead, cadmium, hexavalent chromium, mercury and specific brominated flame retardants (PBBs and PBDEs), with certain exceptions.  
 Contact SHARP in order to obtain the latest device specification sheets before using any SHARP device.



### ◆ IrDA SIR LP Compliant Front-Ends

Model No.	Communication system	Transmission rate	Description	Transmission distance (cm)	Supply voltage (V DC)	Outline dimensions (mm)
GP2W0110VX/VY	Bi-directional (half-duplex) communication	2.4 k to 115.2 kb/s	Top-view and side view compatible (Model name is prescribed based on the packaging status.), lead-free type available	20	2.0 to 3.6	6.8 × 2.35 × 2.1
GP2W0112YP0F	Bi-directional (half-duplex) communication	2.4 k to 115.2 kb/s	Low voltage operation, low dissipation current, 3-state output type, independent power supply for light-emitting and light-detecting circuits	20	1.7 to 2.5	7.9 × 2.85 × 2.15
GP2W0150YP0F	Bi-directional (half-duplex) communication	2.4 k to 115.2 kb/s	Compact, thin, low dissipation current (I <sub>cc</sub> : 100 μA MAX.)	20	2.4 to 3.6	7.6 × 2.4 × 1.5
GP2W0150XP0F	Bi-directional (half-duplex) communication	2.4 k to 115.2 kb/s	Compact, thin, low dissipation current (I <sub>cc</sub> : 100 μA MAX.) Top view type	20	2.4 to 3.6	8.3 × 2.1 × 1.7
GP2W0116YP0F	Bi-directional (half-duplex) communication	2.4 k to 115.2 kb/s	Compact, thin, low dissipation current (I <sub>cc</sub> : 120 μA MAX.)	20	2.0 to 3.6	7.2 × 2.75 × 1.85
GP2W0118YP0F	Bi-directional (half-duplex) communication	2.4 k to 115.2 kb/s	Compact, thin, low dissipation current (I <sub>cc</sub> : 120 μA MAX.) Top view type	20	2.0 to 3.6	7.9 × 2.25 × 2.0
GP2W3240YP	Bi-directional (half-duplex) communication	2.4 k to 115.2 kb/s	With remote control transmit function (with remote control drive circuit) (λ <sub>p</sub> = 940 nm) IR communication part (λ <sub>p</sub> = 870 nm)	20	2.4 to 3.6	8.6 × 2.85 × 1.85
GP2W3250YP	Bi-directional (half-duplex) communication	2.4 k to 115.2 kb/s	Remote control transmission function, shared IR communication section (λ <sub>p</sub> = 890 nm)	20	2.4 to 3.6	7.2 × 2.55 × 1.85
GP2W3270YP0F	Bi-directional (half-duplex) communication	2.4 k to 115.2 kb/s	Remote control transmission function, shared IR communication section (λ <sub>p</sub> = 890 nm)	20	2.4 to 3.6	7.6 × 2.4 × 1.5
GP2W3270XP0F	Bi-directional (half-duplex) communication	2.4 k to 115.2 kb/s	Remote control transmission function, shared IR communication section (λ <sub>p</sub> = 890 nm) Top view type	20	2.4 to 3.6	8.3 × 2.1 × 1.7

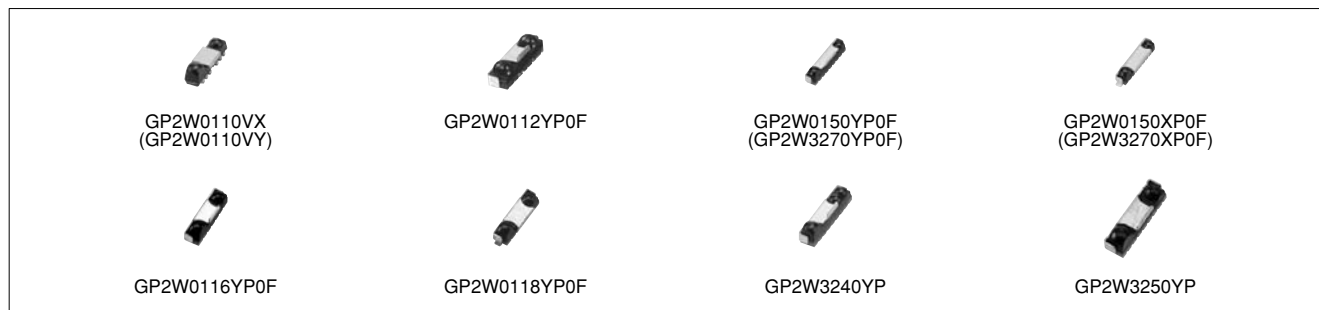

### ■ Infrared Audio Transmission Device

Model No.	Communication system	Features	S/N ratio	Supply voltage (V DC)	Outline dimensions (mm)
GP2WVR01YP0F (Reception Device)	1-bit audio transmission (1.5 MHz)	Compact, low power consumption type Simple circuit configuration: Used in combination with transmission LSI (GP2WVC01MP0F) and transmission device (GP2W1004YP0F, etc.)	70 dB	2.4 to 3.6	2.5 × 8 × 3



**Notice**  
 In the absence of confirmation by device specification sheets, SHARP takes no responsibility for any defects that may occur in equipment using any SHARP devices shown in catalogs, data books, etc.  
 Except where specially indicated, models listed on this page comply with the RoHS Directive\*. For details, please contact SHARP.  
 \*RoHS Directive: Prohibits use of lead, cadmium, hexavalent chromium, mercury and specific brominated flame retardants (PBBs and PBDEs), with certain exceptions.  
 Contact SHARP in order to obtain the latest device specification sheets before using any SHARP device.

## IR Detecting Unit for Remote Control Lineup

Type	Package		Features	Model No.			
	Form	Detection position*5 (from PCB)		Operating voltage: 3 V	Operating voltage: 5 V	Operating voltage: 3 to 5 V	
IR detecting unit for remote control	Lead L bend with holder	16.0 mm*1	Compact size	GP1UE28XK0VF series	GP1UM28XK0VF series		
			Compact size, Strengthened resistance to electromagnetic induction noise (Mesh type)	GP1UE28RK0VF series	GP1UM28RK0VF series		
			Low dissipation current			GP1UD28XK00F series	
		12.0 mm*2	Compact size	GP1UE27XK0VF series	GP1UM27XK0VF series		
			Compact size, Strengthened resistance to electromagnetic induction noise (Mesh type)	GP1UE27RK0VF series	GP1UM27RK0VF series		
			Low dissipation current			GP1UD27XK00F series	
		6.8 mm*3	Compact size	GP1UE26XK0VF series	GP1UM26XK0VF series		
			Compact size, Strengthened resistance to electromagnetic induction noise (Mesh type)	GP1UE26RK0VF series	GP1UM26RK0VF series		
			Low dissipation current			GP1UD26XK00F series	
		Lead straight with holder	19.0 mm	Compact size, Strengthened resistance to electromagnetic induction noise (Mesh type)	GP1UE29QK0VF series	GP1UM29QK0VF series	
				Compact size	GP1UE28YK0VF series	GP1UM28YK0VF series	
				Compact size, Strengthened resistance to electromagnetic induction noise (Mesh type)	GP1UE28QK0VF series	GP1UM28QK0VF series	
				Low dissipation current			GP1UD28YK00F series
		Compact, thin type SMD (4.1 × 3.84 × 0.95 t mm)	GP1US30XP series				
			Holderless	Lead straight 6.0 mm		GP1UX31QS series	GP1UX51QS series
Lead L bend*4 5.3 mm		GP1UX31RK series		GP1UX51RK series			

\*1 Mesh type (strengthened resistance to electromagnetic induction noise): 16.4 mm

\*2 Mesh type: 12.4 mm

\*3 Mesh type: 7.2 mm

\*4 Mesh type: 5.3 mm

\*5 Lead straight: Distance from lens center to mounting board upper surface

No mesh lead L bend: Distance from tip of lens to mounting board upper surface

Mesh-type lead L bend: Distance from tip of mesh to mounting board upper surface



## IR Detecting Units for Remote Control

(Ta = 25°C)

Series No.	Absolute maximum ratings		Electrical characteristics				Size (mm)	Remarks
	Vcc (V)	To <sub>pr</sub> (°C)	I <sub>cc</sub> (mA) MAX.	V <sub>OH</sub> (V) MIN.	V <sub>OL</sub> (V) MAX.	f <sub>o</sub> (kHz) TYP.		
GP1UM26XK0VF <sup>*12</sup>	0 to 6.0	-10 to +70	0.6 (0.65) <sup>*18</sup>	V <sub>cc</sub> -0.5 <sup>*10</sup>	0.45 <sup>*10</sup>	40 <sup>*3</sup>	5.6 × 9.6 × 6.8	<sup>*5</sup>
GP1UM27XK0VF <sup>*12</sup>	0 to 6.0	-10 to +70	0.6 (0.65) <sup>*18</sup>	V <sub>cc</sub> -0.5 <sup>*10</sup>	0.45 <sup>*10</sup>	40 <sup>*3</sup>	5.6 × 9.6 × 12.0	<sup>*5</sup>
GP1UM28XK0VF <sup>*12</sup>	0 to 6.0	-10 to +70	0.6 (0.65) <sup>*18</sup>	V <sub>cc</sub> -0.5 <sup>*10</sup>	0.45 <sup>*10</sup>	40 <sup>*3</sup>	5.6 × 9.6 × 16.0	<sup>*5</sup>
GP1UM28YK0VF <sup>*12</sup>	0 to 6.0	-10 to +70	0.6 (0.65) <sup>*18</sup>	V <sub>cc</sub> -0.5 <sup>*10</sup>	0.45 <sup>*10</sup>	40 <sup>*3</sup>	5.6 × 8.6 × 12.5(9.6) <sup>*2</sup>	<sup>*5</sup>
GP1UM26RK0VF <sup>*4, 12</sup>	0 to 6.0	-10 to +70	0.6 (0.65) <sup>*18</sup>	V <sub>cc</sub> -0.5 <sup>*11</sup>	0.45 <sup>*11</sup>	40 <sup>*3</sup>	5.6 × 9.6 × 7.2	<sup>*5</sup>
GP1UM27RK0VF <sup>*4, 12</sup>	0 to 6.0	-10 to +70	0.6 (0.65) <sup>*18</sup>	V <sub>cc</sub> -0.5 <sup>*11</sup>	0.45 <sup>*11</sup>	40 <sup>*3</sup>	5.6 × 9.6 × 12.4	<sup>*5</sup>
GP1UM28RK0VF <sup>*4, 12</sup>	0 to 6.0	-10 to +70	0.6 (0.65) <sup>*18</sup>	V <sub>cc</sub> -0.5 <sup>*11</sup>	0.45 <sup>*11</sup>	40 <sup>*3</sup>	5.6 × 9.6 × 16.4	<sup>*5</sup>
GP1UM28QK0VF <sup>*4, 12</sup>	0 to 6.0	-10 to +70	0.6 (0.65) <sup>*18</sup>	V <sub>cc</sub> -0.5 <sup>*11</sup>	0.45 <sup>*11</sup>	40 <sup>*3</sup>	5.6 × 9.0 × 12.5(9.6) <sup>*2</sup>	<sup>*5</sup>
GP1UM29QK0VF <sup>*4, 12</sup>	0 to 6.0	-10 to +70	0.6 (0.65) <sup>*18</sup>	V <sub>cc</sub> -0.5 <sup>*11</sup>	0.45 <sup>*11</sup>	40 <sup>*3</sup>	5.6 × 16.2 × 21.9(19) <sup>*2</sup>	<sup>*5</sup>
GP1UE26XK0VF <sup>*8</sup>	0 to 6.0	-10 to +70	0.4	V <sub>cc</sub> -0.5 <sup>*9</sup>	0.45 <sup>*9</sup>	40 <sup>*16</sup>	5.6 × 9.6 × 6.8	<sup>*5</sup>
GP1UE27XK0VF <sup>*8</sup>	0 to 6.0	-10 to +70	0.4	V <sub>cc</sub> -0.5 <sup>*9</sup>	0.45 <sup>*9</sup>	40 <sup>*16</sup>	5.6 × 9.6 × 12.0	<sup>*5</sup>
GP1UE28XK0VF <sup>*8</sup>	0 to 6.0	-10 to +70	0.4	V <sub>cc</sub> -0.5 <sup>*9</sup>	0.45 <sup>*9</sup>	40 <sup>*16</sup>	5.6 × 9.6 × 16.0	<sup>*5</sup>
GP1UE28YK0VF <sup>*8</sup>	0 to 6.0	-10 to +70	0.4	V <sub>cc</sub> -0.5 <sup>*9</sup>	0.45 <sup>*9</sup>	40 <sup>*16</sup>	5.6 × 8.6 × 12.5(9.6) <sup>*2</sup>	<sup>*5</sup>
GP1UE26RK0VF <sup>*8</sup>	0 to 6.0	-10 to +70	0.4	V <sub>cc</sub> -0.5 <sup>*14</sup>	0.45 <sup>*14</sup>	40 <sup>*16</sup>	5.6 × 9.6 × 7.2	<sup>*5</sup>
GP1UE27RK0VF <sup>*8</sup>	0 to 6.0	-10 to +70	0.4	V <sub>cc</sub> -0.5 <sup>*14</sup>	0.45 <sup>*14</sup>	40 <sup>*16</sup>	5.6 × 9.6 × 12.4	<sup>*5</sup>
GP1UE28RK0VF <sup>*8</sup>	0 to 6.0	-10 to +70	0.4	V <sub>cc</sub> -0.5 <sup>*14</sup>	0.45 <sup>*14</sup>	40 <sup>*16</sup>	5.6 × 9.6 × 16.4	<sup>*5</sup>
GP1UE28QK0VF <sup>*8</sup>	0 to 6.0	-10 to +70	0.4	V <sub>cc</sub> -0.5 <sup>*14</sup>	0.45 <sup>*14</sup>	40 <sup>*16</sup>	5.6 × 9.0 × 12.5(9.6) <sup>*2</sup>	<sup>*5</sup>
GP1UE29QK0VF <sup>*8</sup>	0 to 6.0	-10 to +70	0.4	V <sub>cc</sub> -0.5 <sup>*14</sup>	0.45 <sup>*14</sup>	40 <sup>*16</sup>	5.6 × 16.2 × 21.9(19) <sup>*2</sup>	<sup>*5</sup>
GP1UD26XK00F <sup>*8</sup>	0 to 6.0	-10 to +70	0.2 (V <sub>cc</sub> = 3 V)	V <sub>cc</sub> -0.5 <sup>*9</sup>	0.5 <sup>*9</sup>	40 <sup>*3</sup>	7.3 × 13.1 × 6.8	<sup>*5</sup>
GP1UD27XK00F <sup>*8</sup>	0 to 6.0	-10 to +70	0.2 (V <sub>cc</sub> = 3 V)	V <sub>cc</sub> -0.5 <sup>*9</sup>	0.5 <sup>*9</sup>	40 <sup>*3</sup>	7.3 × 13.1 × 12.0	<sup>*5</sup>
GP1UD28XK00F <sup>*8</sup>	0 to 6.0	-10 to +70	0.2 (V <sub>cc</sub> = 3 V)	V <sub>cc</sub> -0.5 <sup>*9</sup>	0.5 <sup>*9</sup>	40 <sup>*3</sup>	7.3 × 13.1 × 16.0	<sup>*5</sup>
GP1UD28YK00F <sup>*8</sup>	0 to 6.0	-10 to +70	0.2 (V <sub>cc</sub> = 3 V)	V <sub>cc</sub> -0.5 <sup>*9</sup>	0.5 <sup>*9</sup>	40 <sup>*3</sup>	7.3 × 8.4 × 13.0(9.6) <sup>*2</sup>	<sup>*5</sup>
GP1UV70QS00F <sup>*13</sup>	—	-10 to +70	1.5	V <sub>cc</sub> -0.5 <sup>*11</sup>	0.45 <sup>*11</sup>	40 <sup>*3</sup>	5.6 × 6.2 × 7.6(6.0) <sup>*2</sup>	<sup>*5</sup> , Pin configuration (Pin No. 2: GND)
GP1UW70QS00F <sup>*7</sup>	—	-10 to +70	0.6	V <sub>cc</sub> -0.5	0.45	40 <sup>*3</sup>	5.6 × 6.2 × 7.6(6.0) <sup>*2</sup>	<sup>*5</sup> , Pin configuration (Pin No. 2: GND)
GP1UX51QS <sup>*13</sup>	0 to 6.0	-10 to +70	0.6	V <sub>cc</sub> -0.5 <sup>*11</sup>	0.45 <sup>*11</sup>	40 <sup>*16</sup>	5.5 × 5.3 × 7.5	<sup>*5</sup> , Pin configuration (Pin No. 2: GND)
GP1UX51RK <sup>*13</sup>	0 to 6.0	-10 to +70	1.5	V <sub>cc</sub> -0.5	0.45	40 <sup>*3</sup>	5.5 × 5.3 × 7.5	<sup>*5</sup> , Pin configuration (Pin No. 2: GND), Folded lead
GP1UX31QS <sup>*7</sup>	0 to 6.0	-10 to +70	0.4	V <sub>cc</sub> -0.5 <sup>*14</sup>	0.45 <sup>*14</sup>	40	5.5 × 5.3 × 7.5	<sup>*5</sup> , Pin configuration (Pin No. 2: GND)
GP1UX31RK	0 to 6.0	-10 to +70	0.4	V <sub>cc</sub> -0.5 <sup>*14</sup>	0.45 <sup>*14</sup>	40	5.5 × 5.3 × 7.5	<sup>*5</sup> , Pin configuration (Pin No. 2: GND), Folded lead
GP1US30XP <sup>*6, 17</sup>	—	-30 to +85	0.6	V <sub>cc</sub> -0.5 <sup>*11</sup>	0.45 <sup>*19</sup>	40	4.1 × 3.95 × 0.95	<sup>*5</sup> , Surface mount compatible

\*1 When no signal is input (during input light).

\*2 Figures in parentheses indicate the distance to the light detection center.

\*3 In addition to the f<sub>o</sub> = 40kHz type, types f<sub>o</sub> = 36, 38, 36.7, 56.8, 32.75 kHz are also available.

\*4 Type with strengthened resistance to electromagnetic induction noise.

\*5 A voltage regulator circuit is built-in but may be affected by the usage environment. Install with an externally mounted C and R as a power supply filter.

\*6 Allows reflow soldering.

\*7 Operating voltage: 2.4 to 3.6 V (2.7 to 3.6 V for f<sub>o</sub> = 56.8 kHz type)

\*8 Operating voltage: 2.7 to 5.5 V

\*9 Distance to transmitter on optical axis is 0.2 to 10.0 m. Ev < 10 lx when burst wave is input as shown in the right figure.

\*10 Distance to transmitter on optical axis is 0.2 to 10.0 m. Ev < 10 lx when burst wave is input as shown in the right figure. (f<sub>o</sub> = 56.8 kHz: 0.2 to 9.0 m)

\*11 Distance to transmitter on optical axis is 0.2 to 8.5 m. Ev < 10 lx when burst wave is input as shown in the right figure. (f<sub>o</sub> = 56.8 kHz: 0.2 to 7.0 m, f<sub>o</sub> = 32.75 kHz: 0.2 to 6.5 m)

\*12 GP1UM series operating voltage: 4.5 to 5.5 V

\*13 Operating voltage: 4.5 to 5.5 V

\*14 Distance to transmitter on optical axis is 0.2 to 8.0 m. Ev < 10 lx when burst wave is input as shown in the right figure.

\*15 Distance to transmitter on optical axis is 0.2 to 6.5 m. Ev < 10 lx when burst wave is input as shown in the right figure.

\*16 Types f<sub>o</sub> = 32.75, 36, 36.7, and 38 kHz are also available.

\*17 Operating voltage: 2.4 to 5.5 V

\*18 f<sub>o</sub> = 56.8 kHz

\*19 Distance to transmitter on optical axis is 0.2 to 5.0 m. Ev < 10 lx when burst wave is input as shown in the right figure.

<Burst wave>

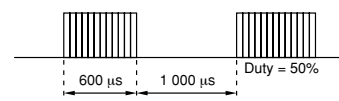

GP1UD series, GP1UM series, GP1UE series have different to values for each model.

### Notice

In the absence of confirmation by device specification sheets, SHARP takes no responsibility for any defects that may occur in equipment using any SHARP devices shown in catalogs, data books, etc.

Except where specially indicated, models listed on this page comply with the RoHS Directive\*. For details, please contact SHARP. \*RoHS Directive: Prohibits use of lead, cadmium, hexavalent chromium, mercury and specific brominated flame retardants (PBBs and PBDEs), with certain exceptions.

Contact SHARP in order to obtain the latest device specification sheets before using any SHARP device.

# IR DETECTING UNIT FOR REMOTE CONTROL



GP1UD28XK00F



GP1UM28XK0VF  
(GP1UE28XK0VF)



GP1UM28RK0VF  
(GP1UE28RK0VF)



GP1UM29QK0VF  
(GP1UE29QK0VF)



GP1UD27XK00F



GP1UM27XK0VF  
(GP1UE27XK0VF)



GP1UM27RK0VF  
(GP1UE27RK0VF)



GP1UV70QS00F  
(GP1UW70QS00F)



GP1UD26XK00F



GP1UM26XK0VF  
(GP1UE26XK0VF)



GP1UM26RK0VF  
(GP1UE26RK0VF)



GP1UX51QS  
(GP1UX31QS)



GP1UD28YK00F



GP1UM28YK0VF  
(GP1UE28YK0VF)



GP1UM28QK0VF  
(GP1UE28QK0VF)



GP1US30XP

**Notice**

In the absence of confirmation by device specification sheets, SHARP takes no responsibility for any defects that may occur in equipment using any SHARP devices shown in catalogs, data books, etc.  
 Except where specially indicated, models listed on this page comply with the RoHS Directive\*. For details, please contact SHARP.  
 \*RoHS Directive: Prohibits use of lead, cadmium, hexavalent chromium, mercury and specific brominated flame retardants (PBBs and PBDEs), with certain exceptions.  
 Contact SHARP in order to obtain the latest device specification sheets before using any SHARP device.

### ■ AC adapters (Custom)

#### ◆ Features

- (1) Energy-saving circuit (reducing power loss during standby) can be installed. (Power loss without load: Achieves 0.1 W/36 W/60 W class)
- (2) Available of built-in harmonic current distortion (active filter) circuits type.
- (3) Compatible with Japanese (100 VAC) specifications and worldwide (90 to 264 VAC) specifications
- (4) Compatible with worldwide safety standards
- (5) Environmentally safe types are also available. [RoHS, lead-free]

#### ◆ Specification examples

Application	Portable OA equipment, Music instrument, LCD TV (6 to 22") etc.				
Input voltage (V AC)	90 to 110		90 to 264		90 to 264
Frequency (Hz)	50/60	50/60	50/60	50/60	50/60
Output voltage (V)	+12	+13	+12	+12	+13
Output power (W)	36	60	36	54	91*3
Stand-by power loss (W)	0.1 (without load)*1	0.1 (without load)*1	0.3 (without load)*1	0.55 (without load)*2	1.0 (with 10 mA load)
Protection function	Overcurrent and overvoltage protection				
Input configuration	A type AC plug (A-1)	AC inlet (2-pin)	AC inlet (3-pin)	AC inlet (2-pin)	AC inlet (2-pin)
Appearance	Resin case				
Outline dimensions (mm)	103 × 64 × 36.6	136 × 68 × 32	125 × 60 × 33	136 × 68 × 32	180 × 72 × 44

\*1 at input voltage = 100 V AC

\*2 at input voltage = 230 V AC

\*3 Compatible with IEC1000-3-2/EN61000-3-2 harmonics limitation.

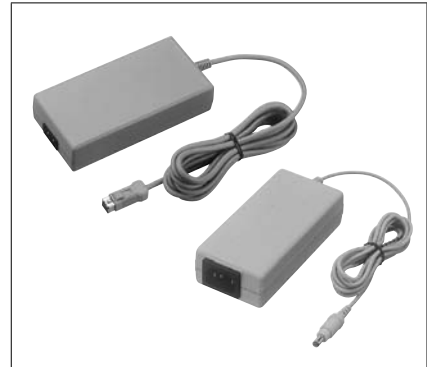

### ■ Switching Power Supplies (Custom)

#### ◆ Features

- (1) Satisfies energy saving regulations thanks to the high conversion efficiency
- (2) Compact and high reliability thanks to the modulated main switching and chopper circuits
- (3) EMI filter built-in, low noise design
- (4) Environmentally safe types are also available. [RoHS, lead-free]

#### ◆ Specification examples

Applications	LCD TV (20 to 22")	LCD TV (26 to 32")	Laser-beam printer/Scanner/FAX
Input voltage (V AC)	90 to 110	90 to 264	85 to 138
Input frequency (Hz)	50/60	50/60	50/60
Output voltage (V) (Current capacity)	+24 (1.9 A) +12 (3.5 A)	+24 (5.0 A) +12 (4.0 A) +5 (5.5 A) +5 (1.5 A) +3.3 (3.0 A)	+3.3 (0.25 A) +5 (1.1 A) +12 (0.13 A) +24 (2.0 A)
Rated output power (W)	87.6	213	55.9
Stand-by power loss (W)	0.3 (without load)	0.1	—
Protection circuit	Overcurrent and overvoltage protection		
Configuration	On-board		
Outline dimensions (mm)	118 × 208 × 36	140 × 244 × 35.6	204 × 124 × 40

\* Types with input voltage of AC 100 V, 120 V, 200 V are also available. Types with other specification are also available upon request.

#### Notice

In the absence of confirmation by device specification sheets, SHARP takes no responsibility for any defects that may occur in equipment using any SHARP devices shown in catalogs, data books, etc. Contact SHARP in order to obtain the latest device specification sheets before using any SHARP device.

## ■ SWITCHING POWER SUPPLY WITH INTEGRATED HIGH/LOW VOLTAGE CIRCUIT (Custom)

### ◆ Features

- (1) Realizes compact and low cost thanks to the integrated high/low voltage circuit
- (2) Easy connection between high voltage and low voltage circuits
- (3) Highly efficiency energy saving power supply at standby mode can be installed for low voltage circuit
- (4) Environmentally safe types are also available. [RoHS, lead-free]

### ◆ Specifications

		Sharp 'Green Power Supply' adapting with integrated high/low voltage circuit regulation
High voltage	Switching power supply system	Pulse width control or RCC method
	Input voltage (V DC)	24
	Output voltage (kV DC)	+5.5 (+280 $\mu$ A)/-5.5 (-560 $\mu$ A), etc.
Low voltage	Switching power supply system	Pulse width control or RCC method
	Input voltage (V AC)	100, 120, 230
	Power capacity (W)	184

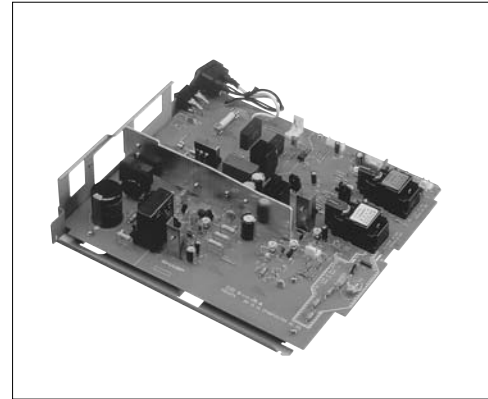

#### Notice

In the absence of confirmation by device specification sheets, SHARP takes no responsibility for any defects that may occur in equipment using any SHARP devices shown in catalogs, data books, etc. Contact SHARP in order to obtain the latest device specification sheets before using any SHARP device.

## Advanced Flex Printed Circuit Boards

The advanced flex printed circuit board is a multilayered composite wiring board comprised of flexible printed circuits (FPC) laminated into a multilayer configuration. The PWBs and FPCs are connected to each other via copper-plated through holes. It is ideal for compact, light-weight equipment design.

### ◆ Features

- (1) For selecting optimal specifications to suit specific applications, special specifications such as for mobile phones are available.
  - Minimum thickness in multi-layer part: 0.26 mm (4-layer), 0.33 mm (6-layer)
  - Minimum pattern width/pitch: 0.06/0.07 mm
  - Flexibility of single/double sided FPC part (dedicated for hinge): More than 200 000 times 180-degree bending of radius 3 mm
- (2) Capable of board-to-board connection without connectors, which enables space-saving and 3-dimensional equipment assembly.
- (3) Through hole plating connection of multi-layer (3 to 8) part to flexible part significantly improves reliability.
- (4) Blind Via Hole (BVH) forming with laser via drilling of small diameter.
- (5) Sheet design provides excellent mountability, equivalent to that of PWB.

### ◆ Outline Specifications

Type	Folding type/Flying tail type	
Min. base thickness	0.26 mm (4-layer), 0.33 mm (6-layer), 0.40 mm (8-layer)	
Min. line width/spacing	0.06/0.07 mm	
Min. through hole diameter	ø0.25 mm	
Min. via hole land diameter	Through hole	Outer layer: ø0.5 mm, Inner layer: ø0.5 mm
	Blind via hole	ø0.09 mm
	Inner via hole	ø0.30 mm
Solder resist	Multi layer: Liquid photo solder resist, FPC: Film cover ray	
Surface finish	Heat-resistant preflux, Ni-Au plating (Ni-Au plating for flying tail)	
Safety standard (UL approval)	94V-0	

Construction of Advanced Flex Board (6-layer sample)

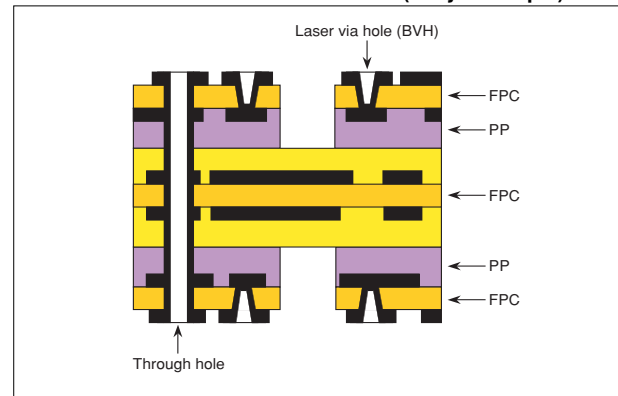

#### Notice

In the absence of confirmation by device specification sheets, SHARP takes no responsibility for any defects that may occur in equipment using any SHARP devices shown in catalogs, data books, etc. Contact SHARP in order to obtain the latest device specification sheets before using any SHARP device.



## ■ Flexible Build-Up Multilayer PCBs

### <Flex-rigid specifications>

Advanced flex specifications are used for the inner layer core material of this build-up multilayer PCB, so the board can handle finer mounting patterns and achieve connectorless between-board connections using an inner layer flexible printed circuit (FPC). This facilitates greater equipment design flexibility and ultra-compact designs.

### ◆ Features

- (1) Multiple build-up layers are connected internally with an FPC, thereby improving connection reliability between multilayer boards and reducing both connection space and connector weight.
- (2) Enables narrow pitch (0.5 mm) CSP and bare chip mounting, and thus greater equipment compactness through ultra-high density mounting.
- (3) Enables via-on-inner-via-hole configurations, and makes it possible to achieve ultra-high density wiring designs.  
(Facilitates a diverse range of designs for greater compactness and thinness.)

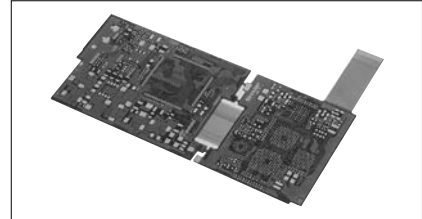

### ◆ Outline Specifications

Type	F1 (6- to 8-layer)	
No. of build-up layers	1 for each side of core layer	
Core layer configuration	3 to 6 layers (Polyimide, FR-4)	
Min. board thickness*1	0.8 mm (6-layer), 0.87 mm (8-layer)	
Via hole diameter	Conformal via hole	ø0.09 mm/ø0.30 mm
Land hole diameter	Stacked via hole	—
Via-on inner via hole	Available	
Inner via hole diameter	ø0.2 mm	
Min. line width/spacing*2	0.09 mm/0.09 mm	
CSP mountable pitch	0.5 mm	
Safety standard	UL (94V-0)	

\*1 Consult with SHARP if a thinner type is required for special designs.

\*2 Values are measured at build-up portion.

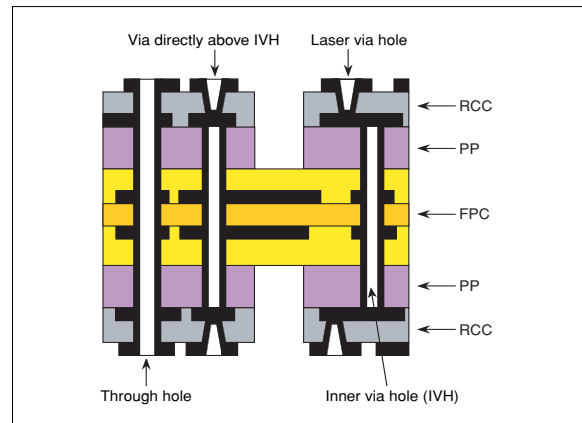

#### Notice

In the absence of confirmation by device specification sheets, SHARP takes no responsibility for any defects that may occur in equipment using any SHARP devices shown in catalogs, data books, etc. Contact SHARP in order to obtain the latest device specification sheets before using any SHARP device.

## Flexible Printed Circuit Boards

The flexible printed circuit board is designed for high space efficiency and product design flexibility, which are now aiming at more compact and higher density mounting. It also contributes to the reduction of assembly process and to the enhancement of the reliability.

### ◆ Features

- (1) High density mounting circuit, SMT and other most suitable flexible PCB are available.
- (2) High precision type for COF with flip chip mounting and wire bonding capabilities and other connector mounting type are available.

### ◆ Standard specifications

Number of layers	One side	Both-side through-hole
Substrate materials	Polyimido film, non-adhesive polyimido	
Design pattern width	0.02 mm (MIN.)	0.05 mm (MIN.)
Design pattern spacing	0.04 mm (MIN.)	0.05 mm (MIN.)
Through-hole / land diameter	—	ø0.1 mm / ø0.3 mm (MIN.)
Cover lay	Polyimido film, heat resistant ink, liquid soldering resist	
Safety standard	UL (94V-0)	

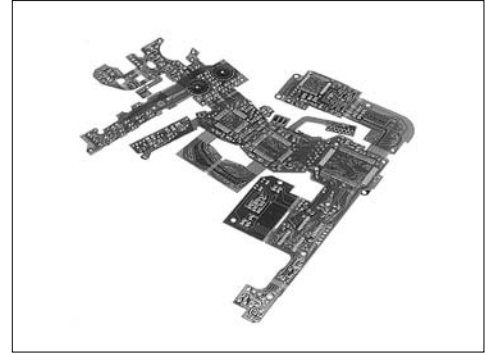

### ◆ Line-up

Multi-layer flexible PCB
Single-layer flexible PCB
Single-side high precision flexible PCB

Both-side flexible PCB
Flex-rigid PCB
Both-side high precision flexible PCB

### Other line-up

Bonding Ni-Au plating
Highly flexible (bending capacity)
High density SMT

#### Notice

In the absence of confirmation by device specification sheets, SHARP takes no responsibility for any defects that may occur in equipment using any SHARP devices shown in catalogs, data books, etc. Contact SHARP in order to obtain the latest device specification sheets before using any SHARP device.

## ■ Slim Combo Drive Pickup <DD-55>

### ◆ Features

- Thin type pickup compatible with half-inch-height drive (12.7 mm thickness)
- Playback speed: ×8 (DVD-ROM), ×24 (CD-ROM)
- Recording speed: ×24 (CD-R), ×24 (CD-RW)
- DVD-RAM readable
- Outline dimensions: W 38.6 × H 7.3 × D 48.7 (mm)
- Weight: Approx. 15 g

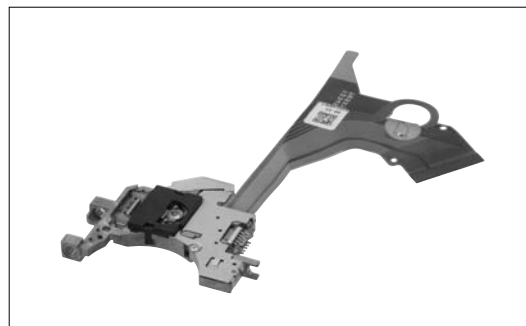

## ■ Ultra Slim DVD-ROM Drive Pickup <DD-71>

### ◆ Features

- Thin type pickup compatible with ultra slim drive (9.5 mm thickness)
- Playback speed: ×8 (DVD-ROM), ×24 (CD-ROM)
- Recording speed: ×16 (CD-R), ×10 (CD-RW)
- DVD-RAM readable
- Outline dimensions: W 37.7 × H 5.25 × D 48.7 (mm)
- Weight: Approx. 13 g



## ■ Slim DVD-ROM Drive Pickup <DD-30>

### ◆ Features

- Thin type pickup compatible with half-inch-height drive (12.7 mm thickness)
- Playable disk: DVD-ROM/RAM, CD-ROM
- Playback speed: ×8 (DVD-ROM), ×24 (CD-ROM)
- Outline dimensions: W 38.7 × H 7.3 × D 48.7 (mm)
- Weight: Approx. 8 g

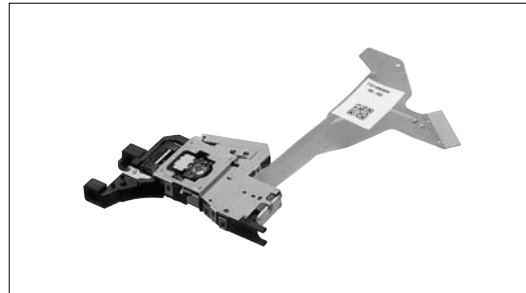

## ■ DVD Pickup for Automotive Use <HPD-60>

### ◆ Features

- Compact, thin (7.3 mm) pickup
- Playable disk: DVD-ROM, CD-ROM
- Operating temperature: -20 to +80°C
- Outline dimensions: W 37.2 × H 7.3 × D 48.7 (mm)

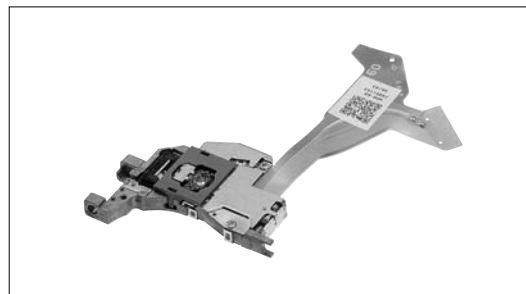

#### Notice

In the absence of confirmation by device specification sheets, SHARP takes no responsibility for any defects that may occur in equipment using any SHARP devices shown in catalogs, data books, etc. Contact SHARP in order to obtain the latest device specification sheets before using any SHARP device.

## ARM

ARM720T .....	31/33
ARM7TDMI .....	31/33
ARM922T .....	31/33
ARM926EJ-S .....	33
ARM946E-S .....	33

## BS

BS1C1UR100A .....	123
BS1F6JP100A .....	124
BS1F6JP300A .....	124
BS1F6JU300A .....	124
BS1R5AQ100A .....	124
BS1R5EL200A .....	123
BS1R6EL400A .....	123
BS1R8EL100A .....	123
BS2F7HZ6460 .....	126
BS2F7VZ0194A .....	126
BS2F7VZ0460 .....	126
BS2F7VZ0724 .....	126
BS2F7VZ7294 .....	126
BS2S7HZ0302A .....	125
BS2S7HZ6306 .....	125
BS2S7VZ0302A .....	125
BS520E0F .....	95

## DC

DC2B1DZ074 .....	134
DC2B1EZ093 .....	134
DC2F1AZ073 .....	132
DC2G1EZ094 .....	135
DC2J1AZxxx .....	133

## DD

DD-30 .....	147
DD-55 .....	147
DD-71 .....	147

## GA

GA100TX02MZA .....	98
GA100TXR1MZ .....	98
GA103TXR1MZ .....	98

GA104T1M1MZ .....	99
GA1A0S100WP .....	97
GA1A1S200WP .....	97
GA201TXR1ZY .....	98
GA202TXV15J .....	98
GA202TXV15K .....	98
GA210TXV8SY .....	98
GA220T2L1Z .....	97
GA230TXW1SY .....	98
GA250T6C3SY .....	98
GA250T6C4SY .....	98
GA301TXW5MZ .....	98

## GH0

GH06P24A2C .....	120
GH06P30A1C .....	120
GH07807E1C .....	120
GH07P24C1C .....	120
GH07P24C4C .....	120
GH07P28A1C .....	120
GH07P28A4C .....	120

## GH1

GH16P24A8C .....	120
GH16P30A8C .....	120
GH16P35A8C .....	120
GH17805B2AS .....	120
GH17P24C8C .....	120
GH17P28A8C .....	120

## GH5

GH5CD05B3D .....	121
GH5R51RA3C .....	121
GH5RT24A3C .....	121/122
GH5VV24A3C .....	121/122

## GH6

GH6CD05E3A .....	121/122
GH6CD05E3L .....	121
GH6D410B5A .....	121/122
GH6RT20A5C .....	121

## GL0

GL0ZJ042B0S .....	111
GL0ZS042B0S .....	111
GL0ZV042B0S .....	111

## GL1

GL100MD1MP1 .....	101
GL100MN0MP .....	101
GL100MN1MP .....	101
GL100MN3MP .....	101

## GL2

GL2EG6 .....	113
GL2HD6 .....	113
GL2HY6 .....	113
GL2PR6 .....	113

## GL3

GL380 .....	101
GL381 .....	101
GL382 .....	101
GL390 .....	101
GL3B2402B0SC .....	112
GL3BC302B0S2 .....	112
GL3ED8 .....	115
GL3EG41 .....	113
GL3EG43 .....	113
GL3EG44 .....	113
GL3EG62 .....	113
GL3EG63 .....	113
GL3EG8 .....	113
GL3G2402B0SC .....	112
GL3HD43 .....	113
GL3HD44 .....	113
GL3HD62 .....	113
GL3HD63 .....	113
GL3HD8 .....	113
GL3HS43 .....	113
GL3HS44 .....	113
GL3HS62 .....	113
GL3HS63 .....	113

GL3HS8 .....	113
GL3HY43 .....	113
GL3HY44 .....	113
GL3HY62 .....	113
GL3HY63 .....	113
GL3HY8 .....	113
GL3JE402B0SE .....	111
GL3JG402B0SE .....	111
GL3JJ404B0SE .....	111
GL3JJ804B0SE .....	111
GL3JR402B0S3 .....	111
GL3JS404B0SE .....	111
GL3JS804B0SE .....	111
GL3JV404B0SE .....	111
GL3JV804B0SE .....	111
GL3KG43 .....	113
GL3KG44 .....	113
GL3KG62 .....	113
GL3KG63 .....	113
GL3KG8 .....	113
GL3PR43 .....	113
GL3PR44 .....	113
GL3PR63 .....	113
GL3PR8 .....	113
GL3TR43 .....	112
GL3TR44 .....	112
GL3TR8 .....	112
GL3UR402B0S .....	112
GL3UR43 .....	112
GL3UR44 .....	112
GL3UR8 .....	112
GL3ZJ402B0SE .....	111
GL3ZJ802B0SE .....	111
GL3ZR402B0SE .....	111
GL3ZR802B0SE .....	111
GL3ZS402B0SE .....	111
GL3ZS802B0SE .....	111
GL3ZV402B0SE .....	111
GL3ZV802B0SE .....	111

## GL4

GL4100E0000F .....	101
GL453E00000F .....	101

GL4800E0000F .....	101
GL480E00000F .....	101
GL4EG8 .....	113
GL4HD8 .....	113
GL4HS8 .....	113
GL4HY8 .....	113
GL4KG8 .....	113
GL4PR8 .....	113

## GL5

---

GL513F .....	101
GL514 .....	101
GL537 .....	101
GL538 .....	101
GL560 .....	101
GL561 .....	101
GL5CU44 .....	115
GL5ED44 .....	115
GL5ED5 .....	115
GL5ED60 .....	115
GL5EG261B0SB .....	113
GL5EG4 .....	113
GL5EG40 .....	113
GL5EG41 .....	113
GL5EG43 .....	113
GL5EG44 .....	113
GL5EG47 .....	113
GL5EG60 .....	113
GL5EG8 .....	113
GL5EJJ502C0X .....	115
GL5EP5 .....	115
GL5FG43 .....	113
GL5HD261B0SB .....	113
GL5HD4 .....	113
GL5HD40 .....	113
GL5HD41 .....	113
GL5HD43 .....	113
GL5HD44 .....	113
GL5HD47 .....	113
GL5HD60 .....	113
GL5HD8 .....	113
GL5HP5 .....	115
GL5HS40 .....	113

GL5HS41 .....	113
GL5HS43 .....	113
GL5HS44 .....	113
GL5HS47 .....	113
GL5HS8 .....	113
GL5HY40 .....	113
GL5HY41 .....	113
GL5HY43 .....	113
GL5HY44 .....	113
GL5HY8 .....	113
GL5JJ302B0SE .....	111
GL5JJ7D2D0SE .....	111
GL5JS302B0SE .....	111
GL5JS7D2D0SE .....	111
GL5JV302B0SE .....	111
GL5JV7D2D0SE .....	111
GL5KG41 .....	113
GL5KG43 .....	113
GL5KG44 .....	113
GL5KG8 .....	113
GL5PR261B0SB .....	113
GL5PR4 .....	113
GL5PR40 .....	113
GL5PR41 .....	113
GL5PR44 .....	113
GL5PR8 .....	113
GL5TR43 .....	112
GL5TR8 .....	112
GL5UR2K .....	112
GL5UR2K1 .....	112
GL5UR3K .....	112
GL5UR3K1 .....	112
GL5UR44 .....	112
GL5ZJ152B0SE .....	111
GL5ZJ302B0SE .....	111
GL5ZR152B0SE .....	111
GL5ZR302B0SE .....	111
GL5ZS152B0SE .....	111
GL5ZS302B0SE .....	111
GL5ZV152B0SE .....	111
GL5ZV302B0SE .....	111

## GL6

---

GL610T .....	101
GL6CU7 .....	115
GL6EG11T .....	113
GL6EG26T .....	113
GL6UR11T .....	112
GL6UR26T .....	112
GL6UR31 .....	112
GL6ZJ27 .....	111
GL6ZR27 .....	111
GL6ZS27 .....	111
GL6ZV27 .....	111

## GL8

---

GL8ED5 .....	115
GL8EG2 .....	113
GL8EG21 .....	113
GL8EG22 .....	113
GL8EG23 .....	113
GL8EG25 .....	113
GL8EG26 .....	113
GL8EG29 .....	113
GL8EG4 .....	113
GL8EG42 .....	113
GL8EG5 .....	113
GL8HD2 .....	113
GL8HD21 .....	113
GL8HD22 .....	113
GL8HD23 .....	113
GL8HD25 .....	113
GL8HD26 .....	113
GL8HD4 .....	113
GL8HD42 .....	113
GL8HD5 .....	113
GL8HP5 .....	115
GL8HS21 .....	113
GL8HS22 .....	113
GL8HS25 .....	113
GL8HS29 .....	113
GL8HY21 .....	113
GL8HY22 .....	113
GL8HY23 .....	113

GL8HY25 .....	113
GL8HY26 .....	113
GL8HY29 .....	113
GL8HY42 .....	113
GL8HY5 .....	113
GL8KG21 .....	113
GL8KG22 .....	113
GL8KG25 .....	113
GL8KG26 .....	113
GL8KG29 .....	113
GL8KG42 .....	113
GL8PR21 .....	113
GL8PR22 .....	113
GL8PR25 .....	113
GL8PR26 .....	113
GL8PR28 .....	113
GL8PR29 .....	113
GL8PR42 .....	113
GL8TR21 .....	112
GL8TR42 .....	112
GL8UR21 .....	112

## GL9

---

GL9ED2 .....	115
GL9ED4 .....	115
GL9EH2 .....	115
GL9HP2 .....	115

## GM1

---

GM1BC35370AC .....	116
GM1BC55255AC .....	116
GM1EG35200A .....	117
GM1EG55200A .....	117
GM1GC55310AC .....	116
GM1HD55200A .....	117
GM1HS55200A .....	117
GM1HY55200A .....	117
GM1JE35200AE .....	116
GM1JE55200AE .....	116
GM1JJ35200AE .....	116
GM1JJ40300AE .....	116
GM1JJ55200AE .....	116
GM1JR35200AE .....	116

GM1JS35200AE.....	116	GM5GC01250AC.....	116	GP1A05EJ000F.....	87	GP1FM313RZ0F.....	109
GM1JS40300AE.....	116	GM5GC03210Z.....	116	GP1A073LCS.....	87	GP1FM313TZ0F.....	108
GM1JS55200AE.....	116	GM5GC05240AC.....	116	GP1A30RJ000F.....	91	GP1FM513RZ0F.....	109
GM1JV35200AE.....	116	GM5GC96210AC.....	116	GP1A44E1J00F.....	90	GP1FM513TZ0F.....	108
GM1JV40300AE.....	116	GM5GC96260AC.....	116	GP1A50HRJ00F.....	86	GP1FM55HTZ0F.....	108
GM1JV55200AE.....	116	GM5HD95200A.....	117	GP1A51HRJ00F.....	86	GP1FMV31RK0F.....	109
GM1UR55200A.....	117	GM5JR96210A.....	116	GP1A52HRJ00F.....	86	GP1FMV31TK0F.....	108
GM1WA55310A.....	119	GM5JV96210A.....	116	GP1A52LRJ00F.....	86	GP1FMV51RK0F.....	109
GM1WA55360A.....	119	GM5SE01200A.....	116	GP1A53HRJ00F.....	86	GP1FMV51TK0F.....	108
GM1ZJ40300AE.....	116	GM5SJ01250AL.....	116	GP1A57HRJ00F.....	86	GP1FP513RK0F.....	109
GM1ZJ80300AE.....	116	GM5UR95200A.....	117	GP1A58HRJ00F.....	86	GP1FP513TK0F.....	108
GM1ZR40300AE.....	116	GM5W06256A.....	119	GP1A68LJ000F.....	85	GP1L50J0000F.....	85
GM1ZR80300AE.....	116	GM5WA06250A.....	119	GP1A73AJ000F.....	87	GP1L51J0000F.....	85
GM1ZS40300AE.....	116	GM5WA06250Z.....	119	GP1A75EJ000F.....	87	GP1L52VJ000F.....	85
GM1ZS80300AE.....	116	GM5WA06260A.....	119	GP1A91LCJ00F.....	85	GP1L53VJ000F.....	85
GM1ZV40300AE.....	116	GM5WA06270A.....	119	GP1A91LRJ00F.....	85	GP1L57J0000F.....	85
GM1ZV80300AE.....	116	GM5WA94200A.....	119	GP1FA313RZ0F.....	109	GP1S036HEZ.....	91

## GM4

GM4BC83200AC.....	116
GM4BW63360A.....	118
GM4BW83310A.....	118
GM4BW83360A.....	118
GM4BW83380A.....	118
GM4GC83200AC.....	116
GM4ZJ83200AE.....	116
GM4ZR83200AE.....	116
GM4ZS83200AE.....	116
GM4ZV83200AE.....	116

## GM5

GM5BC01250AC.....	116
GM5BC03210Z.....	116
GM5BC05240AC.....	116
GM5BC96210AC.....	116
GM5BC96260AC.....	116
GM5BG01210A.....	118
GM5BW01300A.....	118
GM5BW01301A.....	118
GM5BW05340A.....	118
GM5BW96310A.....	118
GM5BW96320A.....	118
GM5EG95200A.....	117

## GP1

GP1A037RDKJF.....	91
GP1A038RBK0F.....	91
GP1A038RCK0F.....	91
GP1A044RCKLF.....	91
GP1A046RBZLF.....	91
GP1A047RBZLF.....	91
GP1A047RDZLF.....	91
GP1A05A2J00F.....	87
GP1A05A5J00F.....	87
GP1A05AJ000F.....	87
GP1A05E2J00F.....	87

GP1A05EJ000F.....	87	GP1FM313RZ0F.....	109
GP1A073LCS.....	87	GP1FM313TZ0F.....	108
GP1A30RJ000F.....	91	GP1FM513RZ0F.....	109
GP1A44E1J00F.....	90	GP1FM513TZ0F.....	108
GP1A50HRJ00F.....	86	GP1FM55HTZ0F.....	108
GP1A51HRJ00F.....	86	GP1FMV31RK0F.....	109
GP1A52HRJ00F.....	86	GP1FMV31TK0F.....	108
GP1A52LRJ00F.....	86	GP1FMV51RK0F.....	109
GP1A53HRJ00F.....	86	GP1FMV51TK0F.....	108
GP1A57HRJ00F.....	86	GP1FP513RK0F.....	109
GP1A58HRJ00F.....	86	GP1FP513TK0F.....	108
GP1A68LJ000F.....	85	GP1L50J0000F.....	85
GP1A73AJ000F.....	87	GP1L51J0000F.....	85
GP1A75EJ000F.....	87	GP1L52VJ000F.....	85
GP1A91LCJ00F.....	85	GP1L53VJ000F.....	85
GP1A91LRJ00F.....	85	GP1L57J0000F.....	85
GP1FA313RZ0F.....	109	GP1S036HEZ.....	91
GP1FA313TZ0F.....	108	GP1S092HCPIF.....	83
GP1FA352RZ0F.....	109	GP1S093HCZ0F.....	83
GP1FA352TZ0F.....	108	GP1S094HCZ0F.....	83
GP1FA513RZ0F.....	109	GP1S096HCZ0F.....	83
GP1FA513TZ0F.....	108	GP1S097HCZ0F.....	83
GP1FA514TZ0F.....	108	GP1S194HCZ0F.....	83
GP1FA51HRZ0F.....	109	GP1S195HCPSF.....	83
GP1FA51HTZ0F.....	108	GP1S195HCZSF.....	83
GP1FA52HTZ0F.....	108	GP1S196HCZ0F.....	83
GP1FA553RZ0F.....	109	GP1S196HCZSF.....	83
GP1FA553TZ0F.....	108	GP1S22J0000F.....	83
GP1FA554TZ0F.....	108	GP1S23J0000F.....	83
GP1FAV30RK0F.....	109	GP1S24J0000F.....	83
GP1FAV30TK0F.....	108	GP1S25J0000F.....	83
GP1FAV31RK0F.....	109	GP1S27J0000F.....	83
GP1FAV31TK0F.....	108	GP1S36J0000F.....	91
GP1FAV50RK0F.....	109	GP1S37J0000F.....	83
GP1FAV50TK0F.....	108	GP1S39J0000F.....	83
GP1FAV51RK0F.....	109	GP1S44S1J00F.....	90
GP1FAV51TK0F.....	108	GP1S50J0000F.....	84
GP1FAV55TK0F.....	108	GP1S51VJ000F.....	84
GP1FC300TP0F.....	109	GP1S525VJ00F.....	84
GP1FD210RP0F.....	110	GP1S52VJ000F.....	84
GP1FD210TP0F.....	109	GP1S53VJ000F.....	84
GP1FD310TP0F.....	109	GP1S54J0000F.....	84
GP1FD320TP0F.....	109	GP1S566VJ00F.....	84

GP1S56TJ000F.....	84
GP1S58VJ000F.....	84
GP1S59J0000F.....	84
GP1S74PJ000F.....	84
GP1S93J0000F.....	83
GP1S94J0000F.....	83
GP1S95J0000F.....	83
GP1S96J0000F.....	83
GP1S97J0000F.....	83
GP1UD26XK00F.....	140
GP1UD27XK00F.....	140
GP1UD28XK00F.....	140
GP1UD28YK00F.....	140
GP1UE26RK0VF.....	140
GP1UE26XK0VF.....	140
GP1UE27RK0VF.....	140
GP1UE27XK0VF.....	140
GP1UE28QK0VF.....	140
GP1UE28RK0VF.....	140
GP1UE28XK0VF.....	140
GP1UE28YK0VF.....	140
GP1UE29QK0VF.....	140
GP1UM26RK0VF.....	140
GP1UM26XK0VF.....	140
GP1UM27RK0VF.....	140
GP1UM27XK0VF.....	140
GP1UM28QK0VF.....	140
GP1UM28RK0VF.....	140
GP1UM28XK0VF.....	140
GP1UM28YK0VF.....	140
GP1UM29QK0VF.....	140
GP1US30XP.....	140
GP1UV70QS00F.....	140
GP1UW70QS00F.....	140
GP1UX31QS.....	140
GP1UX31RK.....	140
GP1UX51QS.....	140
GP1UX51RK.....	140

## GP2

GP2A200LCS0F.....	89
GP2A221HRKA.....	92
GP2A222HCKA.....	92

GP2A22J0000F.....	89
GP2A231LRSAF.....	89
GP2A240LCS0F.....	89
GP2A250LCS0F.....	89
GP2A25BJ000F.....	89
GP2A25J0000F.....	89
GP2A25NJ000F.....	89
GP2A28AJ000F.....	89
GP2D02J0000F.....	103
GP2D032J0000F.....	105
GP2D03J0000F.....	105
GP2D061J000F.....	105
GP2D062J000F.....	105
GP2D06J0000F.....	105
GP2D071J000F.....	105
GP2D07J0000F.....	105
GP2D120XJ00F.....	103
GP2D12J0000F.....	103
GP2D150AJ00F.....	103
GP2D150MJ00F.....	103
GP2D15J0000F.....	103
GP2L24J0000F.....	88
GP2S24J0000F.....	87
GP2S27J0000F.....	87
GP2S28.....	88
GP2S29SJ000F.....	92
GP2S40J0000F.....	87
GP2S60.....	87
GP2S700HCP.....	87
GP2TC1J0000F.....	106
GP2TC2J0000F.....	106
GP2U06J0000F.....	106
GP2W0004XP0F.....	137
GP2W0004YP0F.....	137
GP2W0110VX/VY.....	138
GP2W0112YP0F.....	138
GP2W0116YP0F.....	138
GP2W0118YP0F.....	138
GP2W0150XP0F.....	138
GP2W0150YP0F.....	138
GP2W1001YP0F.....	137
GP2W1002YP0F.....	137
GP2W1004YP0F.....	137

GP2W1010YP0F.....	137
GP2W1301YP0F.....	137
GP2W1302YP0F.....	137
GP2W1304YP.....	137
GP2W3020YP.....	137
GP2W3120YP0F.....	137
GP2W3240YP.....	138
GP2W3250YP.....	138
GP2W3270XP0F.....	138
GP2W3270YP0F.....	138
GP2WVR01YP0F.....	138
GP2Y0A02YK0F.....	103
GP2Y0A21YK0F.....	103
GP2Y0A41SK0F.....	103
GP2Y0A700K0F.....	103
GP2Y0AH01K0F.....	106
GP2Y0D02YK0F.....	103
GP2Y0D21YK0F.....	103
GP2Y0D310K.....	103
GP2Y0D340K.....	103
GP2Y0D413K0F.....	103
GP2Y0D805Z0F.....	103
GP2Y0D810Z0F.....	103
GP2Y1010AU0F.....	106
GP2Y2A180K0F.....	105
GP2Y2A280K0F.....	105
GP2Y2D160K0F.....	105
GP2Y2E101K0F.....	105
GP2Y2E301K0F.....	105
GP2Y3A001K0F.....	104
GP2Y3A002K0F.....	104
GP2Y3A003K0F.....	104

## GP5

GP5FM5R01AZ.....	110
GP5FM5T01AZ.....	110

## GW

GW01M59001PE.....	119
-------------------	-----

## HPD

HPD-60.....	147
-------------	-----

## IR2

IR2D07N1.....	50
IR2D20U.....	50
IR2E46U6.....	50
IR2E46Y6.....	50
IR2E47U6.....	50
IR2E49U.....	50
IR2E50Y6.....	50

## IR3

IR3C14N1.....	53
IR3C22N.....	53
IR3E11A1.....	28
IR3E11M1.....	28
IR3E11P1.....	28
IR3E12M1.....	28
IR3E13N.....	28
IR3E13U.....	28
IR3E2015.....	28
IR3E2045.....	28
IR3E3XX.....	28
IR3M16U.....	28/49
IR3M17U.....	48/53
IR3M18N.....	47
IR3M19N.....	47
IR3M30M.....	28/48/49
IR3M30U.....	28/48/49
IR3M48U6.....	15
IR3M48U6.....	49
IR3M49U6.....	49
IR3M52Y7.....	15/49
IR3M55U.....	19/49
IR3M56N.....	47
IR3M57N.....	48
IR3M58M.....	28/48/49
IR3M58U.....	28/48/49
IR3M59U.....	19/22/23/49
IR3M61U.....	19/49
IR3M63U.....	19/21/23/49
IR3N74A1.....	53
IR3R55M1.....	53
IR3R58M1.....	53

IR3R59N1.....	53
IR3R61U.....	53
IR3S881.....	53
IR3Y18A1.....	27/51
IR3Y26A2.....	27/51
IR3Y26A6.....	27/51
IR3Y29A1.....	27/51
IR3Y29B1.....	27/51
IR3Y30M2.....	18/23
IR3Y31M1.....	27/51
IR3Y34M1.....	27/51
IR3Y37A1.....	27/51
IR3Y48A3.....	18/23
IR3Y48A5.....	18
IR3Y50U6.....	18/23
IR3Y60U6.....	18/23
IR3Y63M.....	27/51

## IRM

IRM046U7.....	52
IRM046U8.....	52
IRM047U7.....	52
IRM048U6.....	52
IRM048U7.....	52
IRM049U6.....	52
IRM052U6.....	52
IRM053U6.....	52
IRM060U6.....	52
IRM061U6.....	52
IRM063U6.....	52
IRM063U7.....	52
IRM065U6.....	52

## IS

IS1623Q.....	98
IS1682Q.....	98
IS1684Q.....	98
IS471FE.....	97
IS485E.....	96
IS486E.....	96
IS489E.....	96

## LH0

LH0E776.....	30
--------------	----

## LH1

LH1530.....	25
LH1537.....	25
LH1538.....	25
LH1542.....	25
LH1548.....	25
LH1549.....	25
LH1560.....	25
LH1562.....	25
LH1565.....	25
LH1580.....	25
LH1583.....	25
LH15H1.....	26
LH15JA.....	26
LH15KA.....	26
LH15LA.....	26
LH1687.....	25
LH168R.....	24
LH168V.....	24
LH168Y.....	25
LH1691.....	24
LH1691.....	25
LH1694.....	24
LH169C.....	26
LH169G.....	24
LH169H.....	25
LH16A1.....	24
LH16AD.....	24
LH16AE.....	24
LH16AF.....	24
LH16AM.....	24
LH16AP.....	26
LH16AR.....	25
LH16AV.....	25
LH16AW.....	24
LH16B0.....	24
LH16B1.....	24
LH16B2.....	24
LH16B3.....	24

LH16B5.....	24
LH16B6.....	24

## LH2

LH28F008BJ-BTL.....	36
LH28F008BJ-TTL.....	36
LH28F008BJT-BTLZ1.....	39
LH28F008BJT-TTLZ2.....	39
LH28F128BF-PBTL.....	36/38
LH28F128BF-PTTL.....	36/38
LH28F128BFH-PBTL.....	36/38
LH28F128BFH-PTTL.....	36/37/38
LH28F128BFH-PWTL.....	37
LH28F128BFHED-PWTLT2.....	40
LH28F128BFHT-PTTLT1A.....	40
LH28F160BJH-PBTL.....	36
LH28F160BJH-PTTL.....	36
LH28F160BJHE-PBTL70.....	39
LH28F160BJHE-PTTL70.....	39
LH28F256BF-PTSL.....	37
LH28F256BFH-PTSL.....	37
LH28F256BFH-PTTL.....	37
LH28F256BFHT-PTSLZ6.....	40
LH28F256BFHT-PTTLZ3.....	40
LH28F256BFN-PTSLZ2.....	40
LH28F320BF-PBTL.....	36/38
LH28F320BF-PTTL.....	36/38
LH28F320BFH-PBTL.....	36/38
LH28F320BFH-PTTL.....	36/37/38
LH28F320BFHE-PTTLE0.....	40
LH28F320BFHG-PBTLZL.....	38
LH28F320BFHG-PTTLZK.....	38
LH28F512BF-PTSL.....	37
LH28F512BFBD-PTSLZ2.....	40
LH28F512BFBD-PTSLZ4.....	40
LH28F512BFND-PTSLZ1.....	40
LH28F640BF-PBTL.....	36
LH28F640BF-PTTL.....	36
LH28F640BFB-PBTL70A.....	38
LH28F640BFB-PTTL70A.....	38
LH28F640BFE-PBTLHEA.....	38
LH28F640BFE-PTTLHDA.....	38
LH28F640BFH-PBTL.....	36/37

LH28F640BFH-PTTL.....	36/37
LH28F640BFHB-PBTL70A.....	38
LH28F640BFHB-PTTL70A.....	38
LH28F640BFHE-PBTLHGA.....	38
LH28F640BFHE-PBTLHK.....	40
LH28F640BFHE-PTTLH1A.....	40
LH28F640BFHE-PTTLHFA.....	38
LH28F800BJ-PBTL.....	36
LH28F800BJ-PTTL.....	36
LH28F800BJE-PBTL70.....	39
LH28F800BJE-PBTL90.....	39
LH28F800BJE-PTTL90.....	39
LH28F800BJH-43.....	36
LH28F800BJH-PBTL.....	36
LH28F800BJH-PTTL.....	36
LH28F800BJHB-43.....	39
LH28F800BJHE-PBTL90.....	39
LH28F800BJHE-PTTL90.....	39

## LH7

LH75400.....	31
LH75401.....	31
LH75410.....	31
LH75411.....	31
LH79520.....	31
LH79524.....	31
LH79525.....	31
LH79532A.....	30
LH79532Y.....	30
LH79533A.....	30
LH7A400.....	31
LH7A404.....	31

## LHF

LHF00L04.....	36/39
LHF00L08.....	37/39
LHF00L09.....	37/39
LHF00L10.....	37/39
LHF00L11.....	37/39
LHF00L14.....	37/39
LHF00L15.....	37/39
LHF00L21.....	36/39
LHF00L24.....	37/39



LHF00L25.....	37/39
LHF00L28.....	37/39
LHF00L29.....	37/40
LHF00L34.....	37/40

## **LJ**

LJ089MB2S01.....	13
LJ64H034.....	13

## **LK**

LK370T3LZ51.....	9
------------------	---

## **LM**

LM046QB1S02.....	8
LM050QC1T01.....	8
LM077VS1T01.....	8
LM081HB1T01B.....	8
LM085YB1T01.....	8
LM085YS1T01.....	8
LM089HB1T04.....	8
LM15SGFNZ16.....	12
LM15TGFNZ24.....	12
LM15TGFNZ26.....	12
LM18TGFNZ19.....	12
LM32019T.....	8

## **LQ**

LQ025A3DS01.....	12
LQ031B5DG01.....	10
LQ033B5DG02.....	10
LQ049B5DG04.....	10
LQ057Q3DC12.....	8
LQ058T5GG06.....	10
LQ064V3DG01.....	8
LQ065T5CGxx.....	10
LQ065T5GA02.....	10
LQ065T5GG61.....	10
LQ065T9DR51U.....	10
LQ065T9DR52U.....	10
LQ065Y5DG02.....	10
LQ070T5CRxx.....	11
LQ070T5GG12.....	11
LQ070T5GG30.....	11

LQ070Y5DG01.....	11
LQ070Y5DG05.....	11
LQ070Y5DR04.....	11
LQ080T5GG01C.....	11
LQ080Y5DR02.....	11
LQ084S3DG01.....	8
LQ084V1DG21.....	8
LQ088H9DR01U.....	11
LQ095Y5DR01.....	11
LQ104S1DG21.....	9
LQ104S1LG21.....	9
LQ104V1DG51.....	9
LQ104V1DG61.....	9
LQ104V1DW02.....	9
LQ104V1LG61.....	9
LQ121S1DG41.....	9
LQ121S1DG61.....	9
LQ121S1LG41.....	9
LQ121S1LG61.....	9
LQ121S1LW01.....	9
LQ150X1LGB1.....	9
LQ150X1LW71N.....	9
LQ255T3LZ44.....	9
LQ315T3LZ44.....	9
LQ370D3LZ14.....	9

## **LR3**

LR35501.....	29
LR35501Y.....	29
LR366851.....	18/23
LR36687U.....	18
LR36687Y.....	18
LR36689U.....	18
LR3697A.....	25
LR385851.....	18/23
LR386032.....	19/23
LR386071.....	19/23
LR38627.....	19/23
LR386431.....	18/22
LR386433.....	22
LR38653.....	18/21
LR38667.....	18/20
LR38669A.....	19/20/29

LR38671.....	15
LR38674.....	18/20
LR38675.....	18/20
LR38677.....	18/20
LR38678.....	18/20
LR38682.....	19
LR38683.....	19
LR38822A.....	26
LR38825.....	26
LR38826.....	26
LR38844A.....	27
LR38869A.....	26
LR388733.....	29
LR38875.....	29
LR38886.....	29
LR38888.....	29
LR388B3.....	29
LR388B6.....	29

## **LR5**

LR550R03.....	35
---------------	----

## **LRS**

LRS1871A.....	41
LRS1872A.....	41
LRS18831.....	41
LRS18841.....	41
LRS1890A.....	41
LRS1897.....	41
LRS18A6.....	41
LRS18AZ.....	41
LRS18B0.....	41
LRS18BK.....	41
LRS18BL.....	41
LRS18BN.....	41
LRS18BP.....	41
LRS18BR.....	41
LRS18BT.....	41
LRS18C8A.....	41
LRS18CC.....	41
LRS5751.....	27/51
LRS5752.....	27/51
LRS5753.....	18/23

## **LS**

LS022Q8Axxx.....	12
LS025A8GY02.....	12

## **LT1**

LT1D40A.....	117
LT1D67A.....	117
LT1E40A.....	117
LT1E67A.....	117
LT1ED67A.....	118
LT1EH67A.....	118
LT1F67A.....	117
LT1F67AF.....	117
LT1H40A.....	117
LT1H67A.....	117
LT1JS67A.....	116
LT1JV67A.....	116
LT1K40A.....	117
LT1K67A.....	117
LT1KS67A.....	118
LT1P40A.....	117
LT1P67A.....	117
LT1S40A.....	117
LT1S67A.....	117
LT1U40A.....	117
LT1U67A.....	117

## **LT3**

LT3D31W.....	113
LT3D65W.....	113
LT3E31W.....	113
LT3E65W.....	113
LT3H31W.....	113
LT3H65W.....	113
LT3P31W.....	113
LT3P65W.....	113
LT3S65W.....	113

## **LZ0**

LZ0P371K.....	15
LZ0P371L.....	15
LZ0P374H.....	15

LZ0P374P.....	15
LZ0P374R.....	15
LZ0P3758.....	15
LZ0P375D.....	15
LZ0P392L.....	14
LZ0P392N.....	14
LZ0P3936.....	14
LZ0P393D.....	14
LZ0P393E.....	14
LZ0P393M.....	14
LZ0P393Y.....	14
LZ0P394K.....	14
LZ0P394U.....	14
LZ0P3954.....	14
LZ0P3955.....	14
LZ0P398x.....	14
LZ0P39A7.....	14
LZ0P39xx.....	14

## LZ2

LZ2316A3.....	17
LZ2316A3.....	23
LZ2326A3.....	17
LZ2326A3.....	23

## PC1

PC1231xNSZ0F.....	68
PC123J00000F.....	68

## PC2

PC2SD11NTZAF.....	75
-------------------	----

## PC3

PC352NJ000F.....	66
PC353TJ0000F.....	66
PC354NJ0000F.....	66
PC355NJ0000F.....	66
PC357NJ0000F.....	66
PC364NJ0000F.....	66
PC365NJ0000F.....	66
PC367NJ0000F.....	66
PC3H2J00000F.....	67
PC3H3J00000F.....	67

PC3H41xNIP0F.....	67
PC3H4J00000F.....	67
PC3H510NIP0F.....	67
PC3H5J00000F.....	67
PC3H71xNIP0F.....	67
PC3H7J00000F.....	67
PC3Q41xNIP0F.....	67
PC3Q510NIP0F.....	67
PC3Q62J0000F.....	67
PC3Q63J0000F.....	67
PC3Q64QJ000F.....	67
PC3Q65J0000F.....	67
PC3Q67QJ000F.....	67
PC3Q71xNIP0F.....	67
PC3SD11NTZAF.....	75
PC3SD11NTZBF.....	75
PC3SD11NTZCF.....	75
PC3SD11YTZDF.....	75
PC3SD12NTZAF.....	75
PC3SD21NTZBF.....	76
PC3SD21NTZCF.....	76
PC3SD21NTZDF.....	76
PC3SD21YTZEF.....	76
PC3SD23YTZCF.....	76
PC3SF11YVZAF.....	75
PC3SF11YVZBF.....	75
PC3SF21YVZAF.....	76
PC3SF21YVZBF.....	76
PC3SF23YVZSF.....	76
PC3SG11YIZ0F.....	75
PC3SG21YIZ0F.....	75
PC3SH11YFZAF.....	75
PC3SH13YFZAF.....	75
PC3SH21YFZBF.....	76
PC3ST11NSZAF.....	75
PC3ST21NSZBF.....	76

## PC4

PC400J00000F.....	71
PC401J00000F.....	71
PC410L0NIP0F.....	71
PC410S0NIP0F.....	71
PC411L0NIP0F.....	71

PC411S0NIP0F.....	71
PC412S0NIP0F.....	71
PC451J00000F.....	66
PC452J00000F.....	66
PC456L0NIP0F.....	71
PC457L0NIP0F.....	72
PC457S0NIP0F.....	72
PC4D10SNIP0F.....	71
PC4D1ASNIP0F.....	71
PC4H510NIP0F.....	67
PC4H520NIP0F.....	67
PC4SD11NTZBF.....	75
PC4SD11NTZCF.....	75
PC4SD21NTZCF.....	76
PC4SD21NTZDF.....	76
PC4SF11YVZAF.....	75
PC4SF11YVZBF.....	75
PC4SF21YVZBF.....	76
PC4SF21YVZCF.....	76

## PC5

PC512J00000F.....	70
-------------------	----

## PC7

PC713V0NSZXF.....	69
PC714V0NSZXF.....	69
PC715V0NSZXF.....	69
PC724V0NSZXF.....	69
PC725V0NSZXF.....	69
PC733HJ0000F.....	69
PC733J00000F.....	69

## PC8

PC81100NSZ0F.....	68
PC8141xNSZ0F.....	68
PC814XJ0000F.....	68
PC81510NSZ0F.....	68
PC815XJ0000F.....	68
PC8171xNSZ0F.....	68
PC817XJ0000F.....	68
PC844XJ0000F.....	68
PC845XJ0000F.....	68
PC847XJ0000F.....	68

PC851XJ0000F.....	68
PC852XJ0000F.....	68
PC853XJ0000F.....	68

## PC9

PC900V0NSZXF.....	72
PC901V0NSZXF.....	72
PC910L0NSZ0F.....	72
PC911L0NSZ0F.....	72
PC912L0NSZ0F.....	72
PC923L0NSZ0F.....	73
PC924L0NSZ0F.....	73
PC925L0NSZ0F.....	73
PC928J00000F.....	73
PC929J00000F.....	73
PC942J00000F.....	73
PC956L0NSZ0F.....	72
PC957L0NSZ0F.....	73

## PD

PD100MCOMP.....	95
PD100MF0MP.....	95
PD101SC0SS0F.....	96
PD3122FE000F.....	95
PD410PI2E00F.....	95
PD411PI2E00F.....	95
PD412PI2E00F.....	95
PD413PI2E00F.....	95
PD481PIE000F.....	95
PD49PIE0000F.....	95
PD60T.....	95

## PQ0

PQ015YZ01ZPH.....	45
PQ015YZ5MZPH.....	45
PQ033ES1MXPQ.....	43
PQ033ES3MXPQ.....	43
PQ035ZN01ZPH.....	45
PQ035ZN1HZPH.....	45
PQ050ES1MXPQ.....	43
PQ050ES3MXPQ.....	43
PQ05VY053ZPH.....	46
PQ05VY3H3ZPH.....	46

PQ070VK01FZH..... 42  
 PQ070VK02FZH..... 42  
 PQ070XF01SZH..... 42  
 PQ070XF02SZH..... 42  
 PQ070XH01ZPH..... 46  
 PQ070XH02ZPH..... 46  
 PQ070XN01ZPH..... 45  
 PQ070XNA1ZPH..... 45  
 PQ070XNAHZPH..... 45  
 PQ070XZ01ZPH..... 45  
 PQ070XZ02ZPH..... 45  
 PQ070XZ1HZPH..... 45  
 PQ070XZ5MZPH series..... 45  
 PQ07VR5MAPH series..... 45

## PQ1

PQ150RWA2SZH..... 42  
 PQ150VB01FZH..... 42  
 PQ150VB02FZH..... 42  
 PQ15RW08J00H..... 42  
 PQ15RW11J00H..... 42  
 PQ15RW21J00H..... 42  
 PQ1CG2032FZH..... 48  
 PQ1CG2032RZH..... 48  
 PQ1CG21H2FZH..... 48  
 PQ1CG21H2RZH..... 48  
 PQ1CG3032FZH..... 48  
 PQ1CG3032RZH..... 48  
 PQ1CG38M2FZH..... 48  
 PQ1CG38M2RZH..... 48  
 PQ1CG41H2FZH..... 48  
 PQ1CG41H2RZH..... 48  
 PQ1CX12H2ZPQ..... 47  
 PQ1CX22H2ZPQ..... 47  
 PQ1CX41H2ZPQ..... 47  
 PQ1CY1032ZPH..... 47  
 PQ1CYxx3HZPH series..... 47  
 PQ1CYxx3LZPH series..... 47  
 PQ1CZ21H2ZPH..... 47  
 PQ1CZ38M2ZPH series..... 47  
 PQ1CZ41H2ZPH..... 47  
 PQ1DX095MZPQ..... 46  
 PQ1DX125MZPQ..... 46

PQ1KAxx3MZPH series..... 44  
 PQ1Kxx3M2ZPH series..... 44  
 PQ1LAX95MSPQ..... 44  
 PQ1LAXx3MSPQ..... 44  
 PQ1LAXx5MSP series..... 44  
 PQ1Lxx3M2SPQ..... 44  
 PQ1MGX38MSPQ..... 44  
 PQ1MGxx8MSPQ..... 44  
 PQ1MX55M2SPQ..... 44  
 PQ1Mxx5M2SPQ..... 44  
 PQ1Nxx3MxSPQ..... 44  
 PQ1RxxJ0000H series..... 44  
 PQ1Uxx1M2ZPH series..... 44  
 PQ1XAxx1MZPH series..... 44  
 PQ1Xxx1M2ZPH series..... 44

## PQ2

PQ200WN3MZPH..... 46  
 PQ200WNA1ZPH..... 46  
 PQ20RX05J00H..... 42  
 PQ20RX11J00H..... 42  
 PQ20VZ11J00H..... 45  
 PQ20VZ51J00H..... 45  
 PQ20WZ11J00H..... 45  
 PQ20WZ51J00H..... 45  
 PQ2CF1J0000H..... 48  
 PQ2Lxxx2MSPQ..... 44

## PQ3

PQ30RV11J00H..... 42  
 PQ30RV21J00H..... 42  
 PQ30RV31J00H..... 42  
 PQ3DZ13J000H..... 45  
 PQ3DZ53J000H..... 45  
 PQ3RD083J00H..... 42  
 PQ3RD13J000H..... 42  
 PQ3RD23J000H..... 42  
 PQ3RF23J000H..... 42  
 PQ3RF33J000H..... 42

## PQ5

PQ5EV3J0000H..... 43  
 PQ5EV5J0000H..... 43

PQ5EV7J0000H..... 43

## PQ6

PQ6CB11X1AP..... 47/50  
 PQ6CB11X1CP..... 47/50  
 PQ6CU11X1APQ..... 47/50  
 PQ6CU12X2APQ..... 47  
 PQ6RD083J00H..... 42

## PQ7

PQ7DV10J000H..... 43  
 PQ7DV5J0000H..... 43  
 PQ7L2010BP..... 47/50  
 PQ7RV4J0000H..... 42

## PQx

PQxxDZ11J00H series..... 45  
 PQxxDZ51J00H series..... 45  
 PQxxRA11J00H series..... 42  
 PQxxRD08J00H series..... 42  
 PQxxRD11J00H series..... 42  
 PQxxRD21J00H series..... 42  
 PQxxRF11J00H series..... 42  
 PQxxRF21J00H series..... 42  
 PQxxRH11J00H series..... 42  
 PQxxxDNA1ZPH series..... 45  
 PQxxxDZ01ZPH series..... 45  
 PQxxxEF01SZH series..... 42  
 PQxxxEF02SZH series..... 42  
 PQxxxEH01ZPH..... 46  
 PQxxxEH02ZPH..... 46  
 PQxxxEHS2ZPH..... 46  
 PQxxxEN01ZPH series..... 45  
 PQxxxENA1ZPH series..... 45  
 PQxxxENAHZPH series..... 45  
 PQxxxEZ01ZPH series..... 45  
 PQxxxEZ02ZPH series..... 45  
 PQxxxEZ1HZPH series..... 45  
 PQxxxEZ5MZPH series..... 45  
 PQxxxFZ01ZPH series..... 45  
 PQxxxFZ5MZPH series..... 45  
 PQxxxGN01ZPH series..... 45  
 PQxxxGN1HZPH series..... 45

PQxxxRDA1SZH series..... 42  
 PQxxxRDA2SZH series..... 42  
 PQxxxY053ZPH..... 46  
 PQxxxY3H3ZPH..... 46

## PR

PR22MA11NTZF..... 78  
 PR23MF11NSZF..... 78  
 PR26MF11NSZF..... 78  
 PR26MF12NSZF..... 78  
 PR26MF21NSZF..... 78  
 PR29MF11NSZF..... 78  
 PR29MF12NSZF..... 78  
 PR29MF21NSZF..... 78  
 PR31MA11NTZF..... 78  
 PR32MA11NTZF..... 78  
 PR33MF51NSZF..... 78  
 PR36MF11YSZF..... 78  
 PR36MF12NSZF..... 78  
 PR36MF12YSZF..... 78  
 PR36MF21NSZF..... 79  
 PR36MF21YSZF..... 79  
 PR36MF22NSZF..... 79  
 PR36MF22YSZF..... 79  
 PR36MF51NSZF..... 78  
 PR39MF11NSZF..... 78  
 PR39MF11YSZF..... 78  
 PR39MF12NSZF..... 78  
 PR39MF12YSZF..... 78  
 PR39MF21NSZF..... 79  
 PR39MF21YSZF..... 79  
 PR39MF22NSZF..... 79  
 PR39MF22YSZF..... 79  
 PR39MF51NSZF..... 78  
 PR3BMF11NSZF..... 79  
 PR3BMF21NSZF..... 79  
 PR49MF11NSZF..... 78

## PT

PT100MCOMP..... 94  
 PT100MF0MP..... 94  
 PT100MF1MP..... 94  
 PT200MCONP..... 94

PT202MR0MP1 .....	94
PT380 .....	94
PT380F .....	94
PT381 .....	94
PT381F .....	94
PT4800E0000F .....	94
PT4800FE000F .....	94
PT480E00000F .....	94
PT480FE0000F .....	94
PT4810E0000F .....	94
PT4810FJE00F .....	94
PT481E0000F .....	94
PT481FE0000F .....	94
PT483F1E000F .....	94
PT4850FE000F .....	94
PT491FE0000F .....	94
PT493FE0000F .....	94
PT501 .....	94
PT510 .....	94
PT550 .....	94
PT550F .....	94
PT600T .....	94
PT601T .....	94

## RB

---

RB5P0010M2 .....	27/51
RB5P0020M2 .....	27/51
RB5P0050M2 .....	27/51
RB5P0060M2 .....	27/51
RB5P006AM2 .....	27/51
RB5P0070M .....	27/51
RB5P0090M .....	27/51

## RJ

---

RJ21V3BC0ET .....	16/20
RJ21V3CC0ET .....	16/20
RJ21W3AB0ET .....	16/20
RJ21W3BA0ET .....	16/20
RJ21W3BB0ET .....	16/20
RJ21W3CA0ET .....	16/20
RJ2311AA0PB .....	16/21/22/23
RJ2321AA0PB .....	16/21/22/23
RJ2351AA0BB .....	16/21/22/23

RJ2351BA0AB .....	16/21/22/23
RJ2361AA0BB .....	16/21/22/23
RJ2361BA0AB .....	16/21/22/23
RJ23S3BC0ET .....	16/20
RJ23S3BD0ET .....	16/20
RJ23S3CC0ET .....	16/20
RJ23S3CD0ET .....	16/20
RJ23T3BA0ET .....	16/20
RJ23T3BB0ET .....	16/20
RJ23T3CA0ET .....	16/20
RJ23T3CB0ET .....	16/20
RJ23U3BA0ET .....	16/20
RJ23U3CA0ET .....	16/20
RJ2411AA0PB .....	17/21/22
RJ2411AB0PB .....	17/21/22/23
RJ2411BA0PB .....	17/21/22
RJ2411BB0PB .....	17/21/22/23
RJ2421AB0PB .....	17/21/22/23
RJ2421BB0PB .....	17/21/22/23
RJ2451AA0PB .....	17/21/22/23
RJ2461AA0PB .....	17/21/22/23

## RW

---

RW4040 .....	35
--------------	----

## S1

---

S101S05F .....	80
S101S06F .....	80
S101S16F .....	80
S102S01F .....	80
S102S02F .....	80
S102S11F .....	80
S102S12F .....	80
S102T01F .....	80
S102T02F .....	80
S108T01F .....	80
S108T02F .....	80
S112S01F .....	80
S116S01F .....	80
S116S02F .....	80

## S2

---

S201S06F .....	80
----------------	----

S202S01F .....	80
S202S02F .....	80
S202S11F .....	81
S202S12F .....	81
S202S15F .....	80
S202SE1F .....	81
S202SE2F .....	81
S202T01F .....	80
S202T02F .....	80
S208T01F .....	80
S208T02F .....	80
S212S01F .....	80
S216S01F .....	80
S216S02F .....	80
S216SE1F .....	81
S216SE2F .....	81
S2S3000F .....	75
S2S4000F .....	75
S2S5A00F .....	75

## VA

---

VA1H1ED5265 .....	128
VA1K5ED5255 .....	128
VA1L5JF6023 .....	128
VA1T1ED5065 .....	128
VA1T1JF2091 .....	128
VA1W1JF9003 .....	127

## VT

---

VT1Y5CD201 .....	130
VT1Y5ED211 .....	130
VT1Y5JB201 .....	130
VT1Y5JF201 .....	130
VT1Y5UF201 .....	130
VT2A5JW250 .....	129
VT2V8UP5510 .....	131
VT2W5CD551 .....	129
VT2W5UF250 .....	129

## NOTICE

The circuit application examples in this publication are provided to explain representative applications of SHARP devices and are not intended to guarantee any circuit design or license any intellectual property right. SHARP takes no responsibility for any problems related to any intellectual property right of a third party resulting from the use of SHARP devices.

SHARP reserves the right to make changes in the specifications, characteristics, data, materials, structures and other contents described herein at any time without notice in order to improve design or reliability.

Contact SHARP in order to obtain the latest device specification sheets before using any SHARP device. Manufacturing locations are also subject to change without notice.

In the absence of confirmation by device specification sheets, SHARP takes no responsibility for any defects that occur in equipment using any SHARP devices shown in catalogs, data books, etc.

The devices listed in this publication are designed for standard applications for use in general electronic equipment. SHARP's devices shall not be used for or in connection with equipment that requires an extremely high level of reliability, such as military and aerospace applications, telecommunication equipment (trunk lines), nuclear power control equipment and medical or other life support equipment (e.g. Scuba). SHARP takes no responsibility for damage caused by improper use of device, which does not meet the conditions for use specified in the relevant specification sheet.

If the SHARP devices listed in the publication fall within the scope of strategic products described in the Foreign Exchange and Foreign Trade Law of Japan, it is necessary to obtain approval to export such SHARP devices.

This publication is the proprietary product of SHARP and is copyrighted, with all rights reserved. Under the copyright laws, no part of this publication may be reproduced or transmitted in any form or by any means, electronic or mechanical for any purpose, in whole or in part, without the express written permission of SHARP. Express written permission is also required before any use of this publication may be made by a third party.

Contact and consult with a SHARP representative if there are any questions about the contents of this publication.

# SHARP

## SHARP CORPORATION

SALES PROMOTION PLANNING DEPARTMENT  
GLOBAL BRAND STRATEGY GROUP  
22-22, NAGAIKE-CHO, ABENO-KU, OSAKA 545-8522, JAPAN  
PHONE: +81-6-6621-1221  
FAX: +81-6117-725300, 6117-725301, 6117-725302  
<http://sharp-world.com/products/device/>

■ Specifications are subject to change without notice.

### Countries and Areas

#### U.S.A.

##### SHARP MICROELECTRONICS OF THE AMERICAS

###### ■ North American Head Office

5700 NW Pacific Rim Boulevard Camas,  
Washington 98607 USA  
PHONE: +1-360-834-2500  
FAX: +1-360-834-8903  
<http://www.sharpsma.com>

###### ■ Western Area

1980 Zanker Road, San Jose, CA 95112  
PHONE: +1-408-436-4900  
FAX: +1-408-436-0924

###### ■ Eastern Area

5901 Bolsa Ave.  
Huntington Beach, CA 92647-2053  
PHONE: +1-714-903-4600  
FAX: +1-714-903-0295

###### ■ Eastern Area

85 W. Algonquin Road, Suite 280  
Arlington Heights, IL 60005  
PHONE: +1-847-258-2750  
FAX: +1-847-439-2479

6303 Commerce Drive, Suite 175 Irving, TX  
75063  
PHONE: +1-972-582-1710  
FAX: +1-972-580-7537

8911 Capitol of Texas Hwy. Suite 3130  
Austin, TX 78759  
PHONE: +1-512-349-7262  
FAX: +1-512-349-7002

3001 West Big Beaver Road, Suite 722  
Troy, MI 48084  
PHONE: +1-248-458-1527  
FAX: +1-248-458-6255

200 Wheeler Rd., Burlington, MA 01803  
PHONE: +1-781-270-7979  
FAX: +1-781-229-9117

8000 Regency Parkway, Suite 280 Cary,  
NC 27518  
PHONE: +1-919-460-0695  
FAX: +1-919-460-0795

#### EUROPE

##### SHARP MICROELECTRONICS EUROPE a division of Sharp Electronics (Europe) GmbH

###### ■ Head Office

Sonninstrasse 3, 20097, Hamburg, Germany  
PHONE: +49-1805-073507  
FAX: +49-40-2376-2232  
<http://www.sharpsme.com/>

###### Germany:

###### ■ SME Munich Office

Landsberger Strasse 398, 81241 Munich, Germany  
PHONE: +49-89-54 6842 0  
FAX: +49-89-54 6842 50

###### France:

###### ■ SME Paris Office

1 Rue Raoul Follereau Bussy Saint Georges  
77608 Marne la Vallee Cedex 3  
PHONE: +33-1 6476 22 22  
FAX: +33-1 6476 22 23

###### Italy:

###### ■ SME Milano Office

Centro Direzionale Colleoni  
Palazzo Taurus Ingresso 2  
20041 Agrate Brianza, Milano, Italy  
PHONE: +390-39-68 99 946  
FAX: +390-39-68 99 948

###### U.K.:

###### ■ SME London Office

Centennial Court, Easthampstead Road,  
Bracknell, Berkshire RG12 1YQ, United Kingdom  
PHONE: +44-1344-86 99 22  
FAX: +44-1344-36 09 03

###### Ireland:

###### ■ SME Dublin Office

7 Chetnut Road Donboyne  
Co meath Ireland  
PHONE: +353-1-842 87 05  
FAX: +353-1-842 84 55

#### ASIA

##### SHARP ELECTRONICS (SHANGHAI) CO., LTD.

###### Microelectronics Sales & Marketing Division

16F, King Tower, 28 Xin Jin Qiao Road,  
Pudong DIST, Shanghai 201206 P.R. China  
PHONE: +86-21-5854-7710/21-5834-6056  
FAX: +86-21-5030-4510/21-5834-6057  
<http://sharp-world.com/products/device-china/index.html>

###### ■ Registered Address

No. 273, De Bao Road, Xin Development BLDG  
58 Wai Gao Qiao Free Trade Zone, Shanghai  
200131, P.R. China

###### ■ Beijing Office

19F, Lian He Building, No. 20, Chao Wai Da  
Road, Chao Yang DIST, Beijing 100020, P.R.  
China  
PHONE: +86-10-6466-7543/10-6466-6561  
FAX: +86-10-6468-8920

###### SHARP-ROXY (HONG KONG) LTD.

Device Sales Division, 17/F, Admiralty Centre,  
Tower 1, 18 Harcourt Road, Hong Kong  
PHONE: +852-28229311  
FAX: +852-28660779  
<http://www.sharp.com.hk>

###### ■ Shenzhen Representative Office

Room 13B1, Tower C, Electronics Science &  
Technology Building, 2070 Shen Nan Zhong  
Road, Shenzhen, P.R. China  
PHONE: +86-755-83273731  
FAX: +86-755-83273735

##### SHARP ELECTRONIC COMPONENTS (TAIWAN) CORPORATION

8F-A, No. 16, Sec. 4, Nanking E. Rd., Taipei,  
Taiwan  
PHONE: +886-2-2577-7341  
FAX: +886-2-2577-7326/2-2577-7328

##### SHARP ELECTRONICS (SINGAPORE) PTE., LTD.

396 Alexandra Road, UOB  
Alexandra Building, #07-00, Singapore 119954  
PHONE: +65-6271-3566  
FAX: +65-6271-3855  
<http://www.seel-sharp.com>

##### SHARP MICROELECTRONICS TECHNOLOGY (M) SDN BHD.

1A Persiaran Kuala Langat, Section 27  
40400 Shah Alam, Selangor Darul Ehsan,  
Malaysia  
PHONE: +60-3-5192-5692  
FAX: +60-3-5192-9971

##### SHARP ELECTRONIC COMPONENTS (KOREA) CORPORATION

5F, Jeil Pharm B/D, 745-5, Banpo 1-dong,  
Seocho-ku, Seoul 137-810 Korea  
PHONE: +82-2-711-5813  
FAX: +82-2-711-5819

Distributed by



This brochure uses 100% recycled paper and soyoil ink approved by the American Soybean Association.

Ref. No. HT9A2D

The contents of this catalog as of June, 2006.

SHARP CORP. JUN. 2006 H2.3 Printed in Japan