

# COMPUTER DESIGN

THE MAGAZINE OF DIGITAL ELECTRONICS

JANUARY 1979

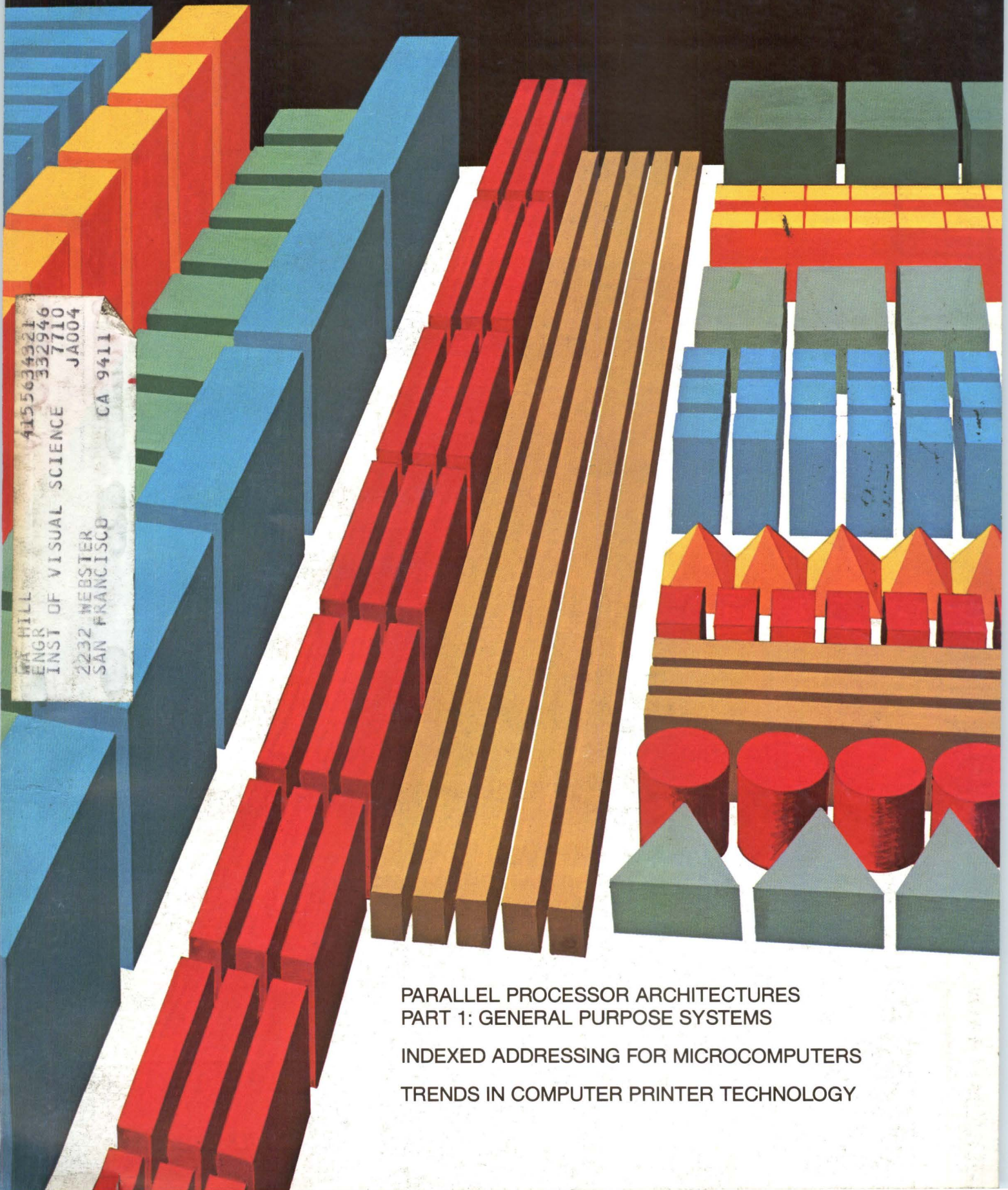

4155634921  
332946  
7710  
JA004  
CA 9411  
WA HILL  
ENGR  
INST OF VISUAL SCIENCE  
2232 WEBSTER  
SAN FRANCISCO

PARALLEL PROCESSOR ARCHITECTURES  
PART 1: GENERAL PURPOSE SYSTEMS

INDEXED ADDRESSING FOR MICROCOMPUTERS

TRENDS IN COMPUTER PRINTER TECHNOLOGY

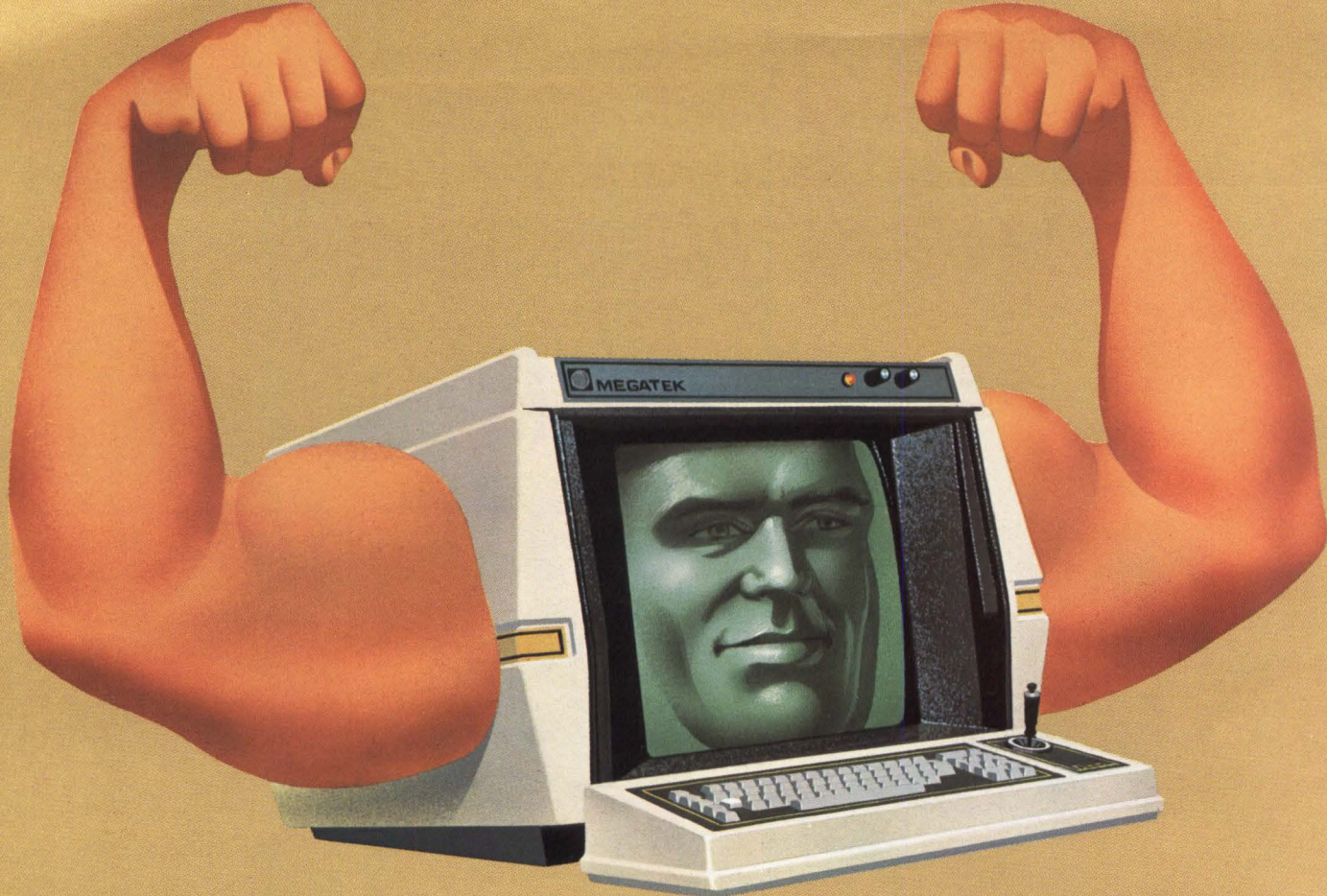

# All muscle and no fat.

Most refresh graphic systems are flabby. With lots of features you don't need. Without a few you do.

The MEGATEK 7000 is built lean. You get fast graphics throughput. A high resolution, real-time, interactive display. Complete system modularity. An unmatched refresh graphics system. At a price that makes sense.

A built-in 32-bit microcomputer with a 64K byte, 32-bit wide refresh memory, expandable to 128K. Lets you process graphics data fast. And, saves you host computer time. Add MEGATEK's advanced vector generator and you get unbeatable graphics throughput.

Vectors and characters are displayed instantly. With precision end point matching. And constant intensity. 12-bit resolution is standard. Vector quality that outclasses every other refresh system.

Easy-to-use real-time interactive graphics. Outstanding display



dynamics. Hardware translation, blink, dashed lines. Absolute and relative jump. All standard. And, hardware clip, rotate, scale, and zoom are available as well.

Plus, the MEGATEK 7000 is easy to look at. 16 levels of image intensity. 8 programmable character sizes. The screen is clear and readable, even in a brightly lit room. And, with selective erase, you don't have to blank the screen to change a vector or symbol.

Add a universal computer interface that connects to any host computer. Field-proven software that cuts system development cost. A full line of

peripherals and accessories. Even color, if you need it. And, you have the most powerful refresh graphics terminal for your dollar on the market today.

But, don't take our word. Prove it to yourself. Call or write for a demonstration. And remember, the MEGATEK 7000 is backed by a national service network with fast, hot-line access.

For full details, write or call Peter J. Shaw, MEGATEK, 3931 Sorrento Valley Blvd., San Diego, CA 92121. (714) 455-5590. TWX: 910-337-1270. (European office: 14, rue de l'Ancien Port. 1201 Geneva, Switzerland. Phone: (022) 32.97.20 Telex: 23343.)

## The Visible Difference



**MEGATEK**  
CORPORATION

CIRCLE 1 ON INQUIRY CARD

# Kennedy Digital Tape Transports and the QUALITY EXPLOSION.

In every industry, one product sets a standard of quality. In tape peripherals, it's Kennedy.

Years of experience resulted in unique, exclusive — and standard features such as:

- A position arm anticipatory sensing system. An exclusive Kennedy feature, the linear, non-contact (Mag Pot) position sensor requires no lamp source and assures performance for the life of the machine.
- Interchangeable electronics on all Series 9000 transports, reduce stocking costs and down time.
- Front-accessible off-line test panel; marginal skew check; threshold scanning which automatically compensates for drop-ins or drop-outs; Read-After-Write shortened skew gate; simplified tape path and quick release hubs.

- All models are available with either 7 or 9 track, 800 NRZ1, 1600 PE or 800/1600 NRZ1/PE.
- 7 and 9 track NRZ1 and PE format/control units to simplify customer electronics. Also, a variety of popular mini-computer mag tape controllers are available. Series 9000's performance is as impressive as its features, with data transfer rates to 72KHz, and tape speeds from 10 to 45 ips.

Kennedy Digital Tape Transports have quite simply changed the industry by introducing the missing ingredient, quality of product.

## KENNEDY CO.

540 W. WOODBURY RD., ALTADENA, CALIF. 91001  
(213) 798-0953



# KENNEDY-QUALITY-COUNT ON IT

CIRCLE 2 ON INQUIRY CARD

# FOR OFFICES THAT WANT TO KEEP IT QUIET, THE NEW TALLY HUSH-TONE KEEPS THE LID ON NOISE.

If printer noise disturbs your office serenity, you'll appreciate the mel-low decibels of the whisper-quiet Tally Hush-Tone. Our special acoustically designed enclosure attenuates printing noise level down to an unheard of quiet level. When not printing, the Hush-Tone is totally quiescent.

## **TALLY<sup>®</sup>** **PRINTERS** **WORLDWIDE**

### **OEM SALES OFFICES**

Boston (617) 272-8070  
New York (516) 694-8444  
Chicago (312) 885-3678  
Los Angeles (213) 378-0805  
Miami (305) 665-5751  
Philadelphia (215) 628-9998  
San Jose (408) 247-0897  
Seattle (206) 251-6730

San Antonio (512) 733-8153  
Washington, D.C. (703) 471-1145

**BUSINESS SYSTEMS SALES**  
Orinda, CA (415) 254-8350

**CIRCLE 3 ON INQUIRY CARD**

Available at 125 and 200 lines per minute, the Tally Hush-Tone is easy to live with, easy to operate. And easy on the pocketbook. It's the newest member of the Tally T-2000 series—the most reliable (and lowest cost of ownership) line printers you can buy. Remember, Tally line printers never need adjustments, lubrication nor preventive maintenance. And you can always count on consistent print quality.

The Tally Hush-Tone. You get more than quiet performance. You get up-time performance.

Call or write today. Tally Corporation, 8301 South 180th Street, Kent, Washington 98031. Phone (206) 251-5500.



# COMPUTER DESIGN

THE MAGAZINE OF DIGITAL ELECTRONICS

JANUARY 1979

VOLUME 18, NUMBER 1

## DEPARTMENTS

- 6 LETTERS TO THE EDITOR**
- 10 CALENDAR**
- 12 COMMUNICATION CHANNEL**  
Emerging laws, policies, and regulations may threaten free flow of data across national borders with particular impact on computer communications
- 34 DIGITAL TECHNOLOGY REVIEW**  
Advances in semiconductor technology expand the online information flow of this general purpose computer while advanced programming functions simplify the operator interface
- 63 DIGITAL CONTROL AND AUTOMATION SYSTEMS**  
Examination of specialized monitoring and control applications reveals practicality of using microprocessor based systems or programmable controllers
- 124 DESIGN BRIEF**
- 126 MICRO DATA STACK/ PROCESSORS AND ELEMENTS**  
Construction of freerunning, programmable, and time-of-day realtime clocks utilizes an assortment of hardware and software instructions
- 142 MICRO DATA STACK/ COMPUTERS AND SYSTEMS**  
The AMI/Berkeley Match Program involves graduate students in a microcomputer project laboratory; Part 1 examines the program and an EEG/EKG waveform filter
- 162 AROUND THE IC LOOP**  
Evolution of UV EPROM technology provides families of integrated subsystem components for use in microcomputer systems
- 168 PRODUCT FEATURE**  
Single-board 1200-bit/s direct connect modem, intended for installation in data communication terminal, is FCC registered as a permissive device
- 209 LITERATURE**
- 210 GUIDE TO PRODUCT INFORMATION**
- 214 ADVERTISERS' INDEX**

Reader Service Cards  
pages 217-220



CIRCULATION: 67,155  
(JUNE 1978)

Copyright 1979, Computer Design Publishing Corp.

## FEATURES

### PARALLEL PROCESSOR ARCHITECTURES— PART 1: GENERAL PURPOSE SYSTEMS 89 by Kenneth J. Thurber

Survey of high performance computing systems, both general and special purpose, covers architectural classification of multiprocessors, pipeline processors, array/associative processors, and scientific processors. Part 1 of 2-part discussion deals with applications, implementations, and operation of pipeline and functional configurations

### INDEXED ADDRESSING FOR MICROCOMPUTERS 99 by William Hertz

Indexed addressing modes for microcomputer processing of sequentially structured data blocks and tables within system memory are explained for hardware designers unfamiliar with the required programming techniques

### TRENDS IN COMPUTER PRINTER TECHNOLOGY 107 by Irving L. Wieselman

Computer printer technology is surveyed by a comprehensive look at available hardcopy techniques. An inspection of recent design innovations suggests the nature of forthcoming devices

### SOFTWARE MINIMIZES MULTIPLE OUTPUT BOOLEAN FUNCTIONS 118 by Cecil E. Beeson

Logic design problems that involve several inputs and outputs are lengthy and routine tasks. Use of a computer program can significantly reduce the effort required to manually obtain an optimum solution

## CONFERENCES

### COMPCON 79 SPRING 72

Topics including reliable computer systems, hardware and software standards, and state-of-the-art in computer security technology will be covered in 25 program sessions and three preconference tutorials

### IEEE INTERNATIONAL SOLID STATE CIRCUITS CONFERENCE 80 ISSCC 79 will offer 88 papers detailing design, performance, fabrication, test, and applications of solid-state circuits

# The New Slimline Series From Okidata

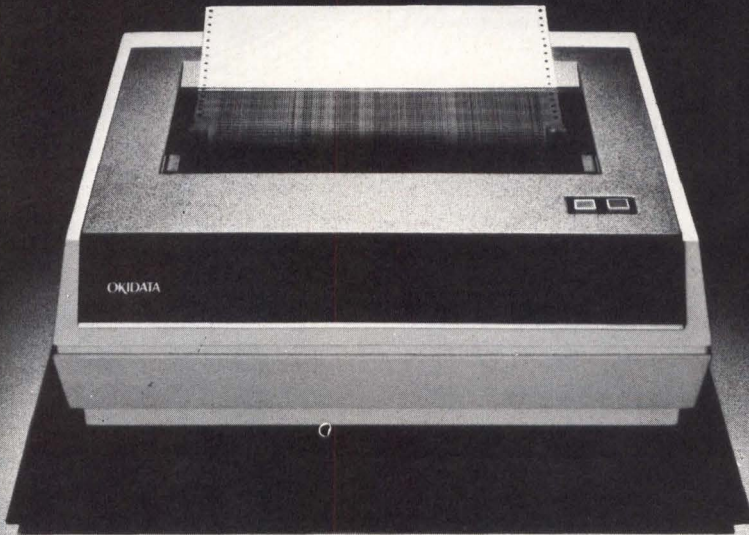

## Line Printers That Sell Minisystems

The Okidata Slimline Series, a new family of microprocessor-controlled, 132 column line printers. A wide range of speeds, options and plug-compatible interfaces, all supported with common spares.

Common spares but uncommon price, performance and reliability. OEM prices that create new mini-system opportunities, print quality that helps sell the businessman and Okidata reliability and maintainability—unmatched in the industry. A 500,000,000 character head warranty and stored program machine history that replaces customer installation records.

The Slimline, available in 300, 250, 160 and 125 LPM models. Twelve program-selectable fonts, 5 x 7, 7 x 7 and 9 x 7 characters, and graphics capability. The Slimline, backed by a worldwide sales and service organization.

# OKIDATA

Okidata Corporation  
111 Gaither Drive  
Mount Laurel, New Jersey 08054  
Telephone: 609-235-2600

## STAFF

Publisher and  
Editorial Director  
**Robert Brotherston**

Associate Publisher  
**Anthony Saltalamacchia**

Editor  
**John A. Camuso**

Managing Editor  
**Sydney F. Shapiro**

Technical Editor  
**George V. Kotelly**

West Coast Editor  
**Michael Chester**  
Arcadia, Calif.  
(213) 574-7447

Associate Editors  
**Peggy Killmon**  
**James W. Hughes**

Assistant Editor  
**Joanne O'Donnell**

Editorial Assistant  
**Winifred L. Helfrich**

Editorial Advisory Board  
**Brian W. Pollard**  
**Ralph J. Preiss**  
**Rex Rice**

Contributing Editors  
**Richard Ahrons**  
**A. S. Buchman**  
**H. S. Miller**  
**Harold H. Seward**

Production Manager  
**Judy Lober**

Advertising Production  
**Linda M. Wright**

Art Director  
**James Flora**

Technical Illustrator  
**Charles Manchester**

Circulation Manager  
**Alma Brotherston**

Marketing Manager  
**Geoffrey Knight, Jr.**

Marketing Production  
**Megan Kern**

Research Associate  
**Sidney Davis**

Business Manager  
**David C. Ciommo**

Vice President-Sales  
**Lindsay H. Caldwell**

---

### Editorial & Executive Offices

11 Goldsmith St.  
Littleton, MA 01460  
Tel. (617) 486-8944  
(617) 646-7872

Editorial manuscripts should be addressed to Editor, Computer Design, 11 Goldsmith St., Littleton, MA 01460. For details on the preparation and submission of manuscripts, request a copy of the "Computer Design Author's Guide."

---

Computer Design is published monthly. Copyright 1979 by Computer Design Publishing Corporation. Controlled circulation postage paid at Pontiac, Ill. No material may be reprinted without permission. Postmaster: CHANGE OF ADDRESS—FORM 3579 to be sent to Computer Design, Circulation Dept., P.O. Box A, Winchester, MA 01890. Subscription rate is \$24.00 in U.S.A., Canada and Mexico, and \$40.00 elsewhere. Microfilm copies of Computer Design are available and may be purchased from University Microfilms, a Xerox Company, 300 N. Zeeb Rd, Ann Arbor, MI 48106.

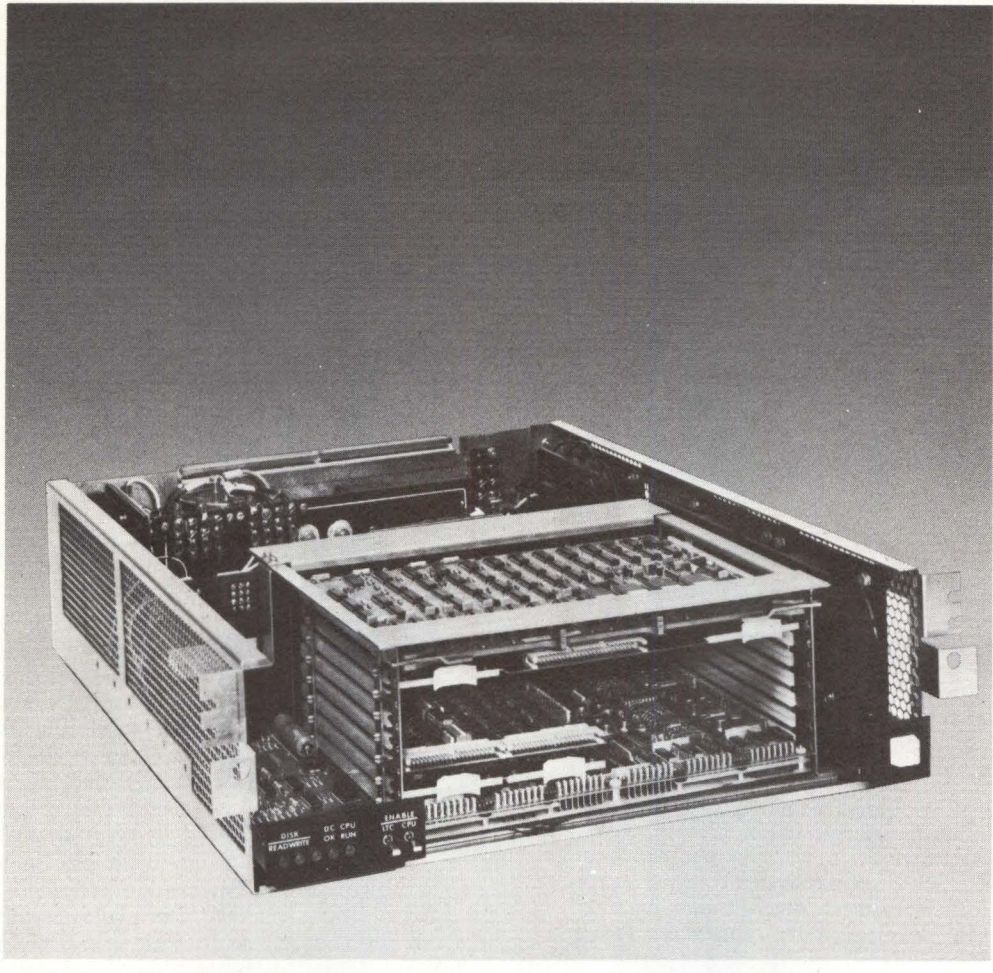

# DO-IT-YOURSELF LSI-11<sup>®</sup> KIT

**Dataram offers LSI-11 users everything they need — chassis, memory, controllers, even an LSI-11 micro — to get the most out of their microcomputer system**

Dataram Corporation offers LSI-11 users a PDP<sup>®</sup>-11/03 compatible chassis with a wide range of memory and controller modules that lets you enhance your LSI-11 configuration, and save money while doing it.

They're available now from Dataram, 30 days from order, and include —

- |          |  |
|----------|--|
| B03      | 5¼", eight slot chassis (24 amps on 5-volt supply) |
| KD11-HA  | DEC <sup>®</sup> LSI-11/2 microcomputer            |
| 32K x 18 | DR-115S dual board, semiconductor ADD-IN           |
| 16K x 18 | DR-115 quad board, core ADD-IN                     |
| C03      | RF-11/RF-05 compatible cartridge disc controller   |
| T03      | TM11/TU10 compatible magnetic tape controller      |

We've been noted for our leadership in core and semiconductor memory systems, and now, as a result of our acquisition of Dynus Incorporated, we are offering the well-accepted disc and tape controllers previously marketed under the Dynus name. If desired, we can also supply the DEC-manufactured KD11-HA dual LSI-11 microcomputer board.

DEC, LSI-11, and PDP are registered trademarks of Digital Equipment Corporation.

I'd like to learn more about LSI-11 compatible modules

Chassis     Memory     Controllers

Please send information.

Please have a salesman contact me.

Name \_\_\_\_\_

Title \_\_\_\_\_ Phone \_\_\_\_\_

Company \_\_\_\_\_

Address \_\_\_\_\_

City \_\_\_\_\_ State \_\_\_\_\_ Zip \_\_\_\_\_

Also send me information about Dataram's LSI-11 compatible fixed head disk emulation systems.



PRINCETON-HIGHTSTOWN ROAD CRANBURY, NEW JERSEY 08512  
TEL: 609-799-0071 TWX: 510-685-2542

**CIRCLE 5 ON INQUIRY CARD**

# LETTERS TO THE EDITOR

To the Editor:

There seem to be some serious typographical errors in the signal averaging routine on p 94 of the article "Providing Software Flexibility for Optical Processor Noise Analysis" by Richard G. Lyons (*Computer Design*, July 1978, pp 89-96). I would appreciate it if you would provide a corrected listing of that program.

Herbert T. Zipper  
State University of New York  
Agricultural and Technical College  
Farmingdale, NY

*The Author Replies:*

Thank you for your interest in my article. Your use of the phrase "serious typographical errors" was an understatement. Following is a correct listing of the signal averaging routine.

Richard G. Lyons  
NSA/CSS Europe  
Frankfurt  
APO New York

To the Editor:

The scheme suggested by Mr Harri- man ("Letters to the Editor," *Computer Design*, Dec 1978, p 6) was considered during the design of the algorithm but was rejected in favor of the one presented in the article "Software-Based Single-Bit I/O Error Detection and Correction Scheme" (*Computer Design*, Sept 1978, pp 130-137). The reason was simply to conserve memory. A table lookup scheme was indeed used in the encoding subroutine where there were only 16 entries to contend with, but a table lookup for the decoding subroutine would occupy at least 128 words for storing the table alone. The decoding subroutine DECODE, as presented, occupies 73 words including portions for data storage, making its total length about one-half that required by a program based on table lookup. It should, however, be noted that certain types of computers may have word widths and/or instruction sets which would make table lookups more attractive. In order to make the program more universal, a very primitive instruction set was assumed.

Mr Lee's remarks ("Letters to the Editor," *Computer Design*, Dec 1978, p 6) are perfectly correct. Each of the 16 code words is separated from 7 others by a Hamming distance of exactly 3. Since there are  $7!/3!4! = 35$  distinct error templates having 3 errors, the probability that a triple error would be received as if it were correct (assuming each template is equally likely) is  $7/35$  or 0.20.

George M. White  
Institut de Recherche d'Informatique  
et d'Automatique  
Le Chesnay, France

## 8080A Assembly Listing to Perform Signal Averaging on 64 Scans of 128-Element Photodetector Array

```

SUB   A           ; clear A
MOV   D,A        ; clear D
MVI   A,100      ; number of sums to be taken
STA   6          ; sum counter in location 6
START: EI        ; interrupt enable
      HLT        ; wait for new input block
MVI   A,200      ; number of detectors
STA   7          ; detector counter in location 7
LXI   SP,300     ; location of first data accumulator
LXI   B,100      ; location of first word of input block
SUM:  POP H       ; load data accumulator into CPU
      LDAX B     ; load input data word into CPU
      MOV E,A    ; move data word to E
      DAD D     ; 16-bit add to data accumulator
      PUSH H    ; store updated data accumulator
      INX B     ; increment input data pointer
      INX SP    ; increment data accumulator pointer by two because
      INX SP    ; SP must point to a new 16-bit value
      LDA 7     ; check detector counter
      DCR A     ; decrement detector counter
      JNZ SUM  ; if A ≠ 0, continue summing
      LDA 6     ; check sum counter
      DCR A     ; decrement sum counter
      JNZ START ; if A ≠ 0, jump to START
      LXI SP,300 ; location of first data accumulator
      LXI H,1000 ; location of first quotient
      MVI A,200  ; number of quotients to be calculated
      STA 7     ; quotient counter in location 7
DIV:  MVI B,6   ; set divisor equal to 26
      XRA A     ; clear carry bit
      POP D     ; load dividend into register pair D,E
MO:   MOV A,D   ; begin division by rotation
      RAR      ; rotate 8 MSBs right
      MOV D,A
      MOV A,E
      RAR      ; rotate 8 LSBs right
      JNC AA   ; check state of carry bit
      CMC     ; clear carry bit
AA:   MOV E,A   ; decrement divisor counter
      DCR B
      JNZ MO   ; if B ≠ 0, continue divide routine
      MOV M,A  ; store quotient
      INX SP   ; increment data accumulator pointer
      INX SP
      INX H    ; increment quotient location pointer
      LDA 7    ; check quotient counter
      DCR A    ; decrement quotient counter
      JNZ DIV  ; if A ≠ 0, obtain new quotient
      HLT     ; signal averaging routine completed

```

Letters to the Editor should be  
addressed:

Editor, *Computer Design*  
11 Goldsmith St  
Littleton, MA 01460



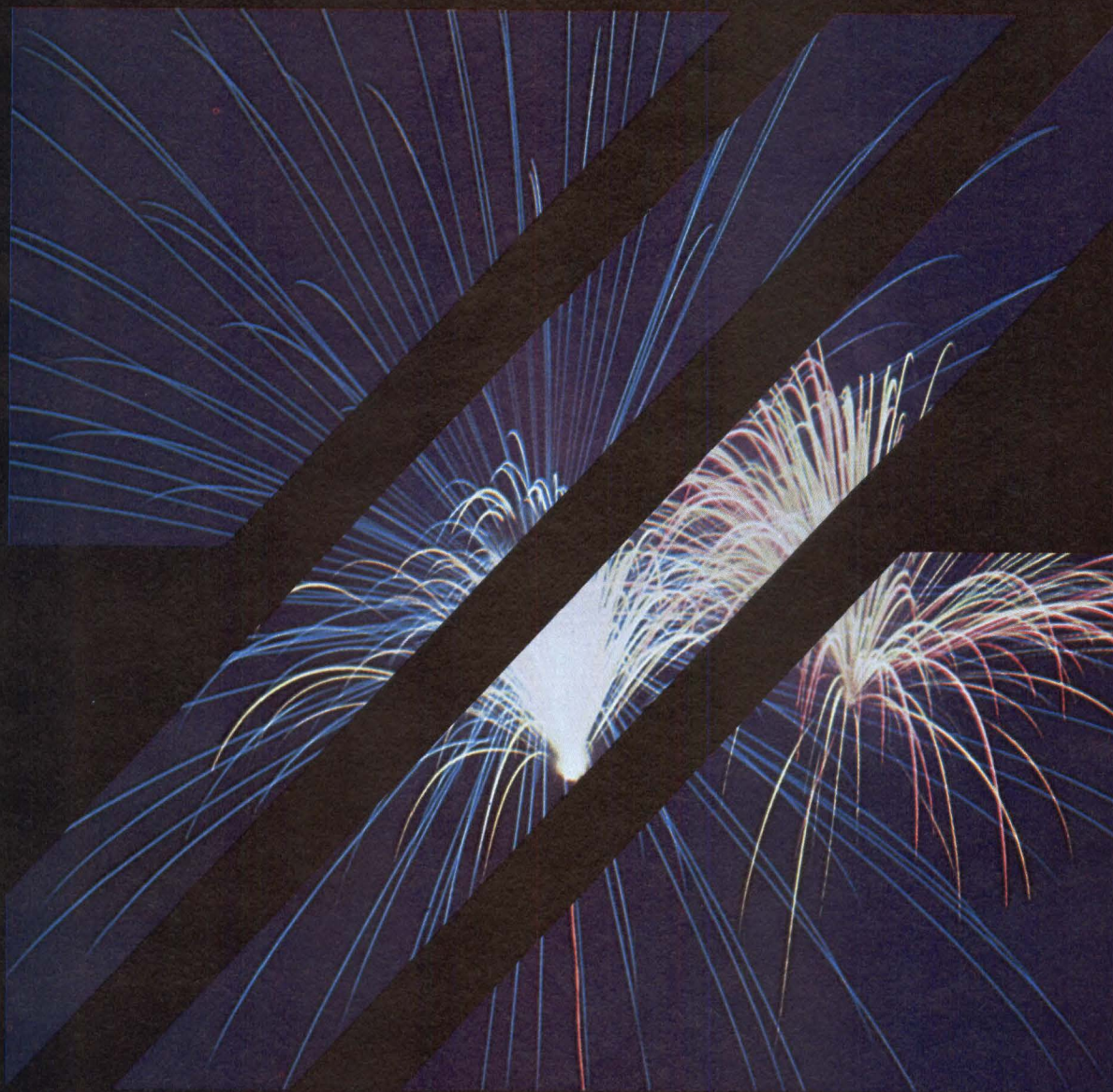

**The fireworks have just begun!**

# IMAGINE

## Zilog rockets out in front again to launch a new generation.

For the first time, the architectural sophistication and data processing capabilities of large, main-frame computers has been captured in the cost-effective, easy to use format of the microprocessor. Now you can have the freedom to create entirely new, innovative systems, unhindered by the primitive architectures of previous microprocessors.

## Flexibility soars to new heights.

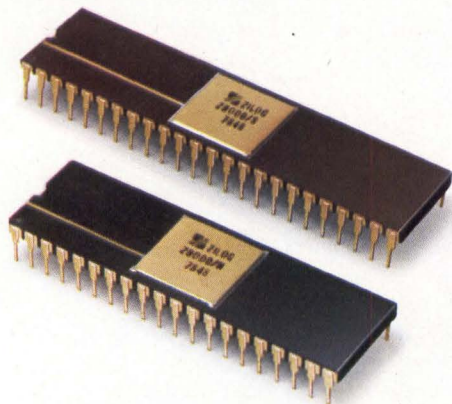

The Z8000 allows you to directly address up to 8 MB of memory. All 16 registers are a full 16 bits wide and are completely general purpose. The powerful, problem-solving instruction



## A revolution in sophistication.

The Z8000 has been designed from the ground up with options to fit your application needs exactly. For the full 8 MB addressing capability, choose the 48 Pin DIP

version. Its companion device, the Memory Management Unit, opens the way to dynamic relocation, memory protection and multi-tasking applications.

set supports 7 different data types from bits to 32 bit words, has 8 addressing modes and 418 usable opcode combinations. The general register architecture helps avoid the well-known bottlenecks inherent in dedicated register designs. When this architecture is combined with the powerful instruction set, the Z8000 system throughput is an explosive 50% greater than any other 16 bit microprocessor available today.

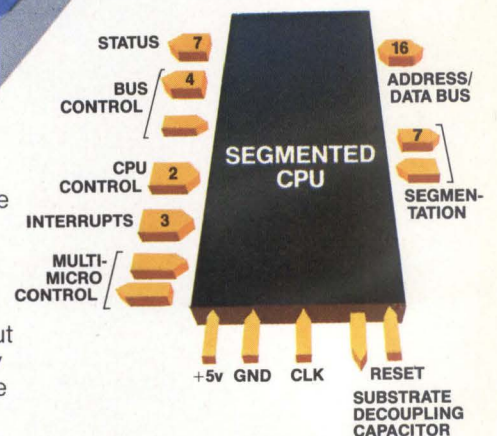

# IMAGINE

# A REVOLUTIONARY NEW WAY TO THINK ABOUT MICROPROCESSOR SYSTEMS. INTRODUCING ZILOG'S Z8000.

For smaller, less memory-intensive applications, select the 40 Pin version of the Z8000. It's software compatible with the 48 Pin Z8000 but addressing is limited to 64KB in each of its six address spaces. It comes in a standard 40 Pin package.

## Wait 'till you meet the family.

We're starting off this new microprocessor era with a bang, but it's just the beginning. Soon to come are the Memory Management Unit, peripheral interfaces, FIFO buffer elements, universal peripheral controller and memories for any application you might have.

And, all the new I/O chips, memories and, of course, the companion Z8, take advantage of the flexible Z-BUS architecture to maximize performance, ease of interconnection and minimize PC board area.

## Zilog delivers on the next generation of microprocessors. Again!

With the introduction of the Z8000, microprocessor technology explodes to new heights. Bursting with a rich and sophisticated architecture, the Z8000 not only opens the way to revolutionizing your next generation

### PERFORMANCE/PRICE RATIO

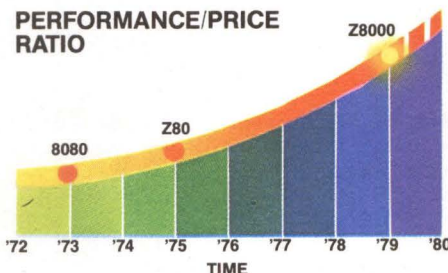

of products, it has the built-in growth potential to carry your product development efforts out to totally new and unexplored horizons.

## Imagine the possibilities, then light your own fuse!



Sound exciting? It is. Get your own fireworks blazing by placing your order today with your nearest Zilog distributor.

In the meanwhile, give your engineering staff a headstart on the fireworks by ordering the Z8000

literature package; in the U.S. order directly from Zilog, elsewhere from your Zilog distributor.



10460 Bubb Road, Cupertino, CA 95014  
(408) 446-4666 TWX 910-338-7621  
EASTERN REGION: (617) 667-2179  
MIDWESTERN REGION: (312) 885-8080  
SO. WESTERN REGION: (714) 549-2891  
NO. WESTERN REGION: (408) 446-4666  
EUROPE (ENGLAND): (0628) 36131/2/3  
WEST GERMANY: (08106) 4035  
JAPAN: 03-476-3010

An affiliate of  
**EXON** ENTERPRISES INC.



CIRCLE 6 ON INQUIRY CARD

The fireworks have just begun!



# CALENDAR

## CONFERENCES

**FEB 26 and MAR 29—Invitational Computer Conf**, Atlanta, Ga, and Dallas, Tex. INFORMATION: B. J. Johnson & Associates, 2503 Eastbluff Dr, Suite 203, Newport Beach, CA 92660. Tel: (714) 644-6037

**FEB 14-16—IEEE Internat'l Solid State Circuits Conf (ISSCC)**, Philadelphia Sheraton and Holiday Inn, Philadelphia; Pa. INFORMATION: Lewis Winner, 301 Almeria Ave, PO Box 343788, Coral Gables, FL 33134. Tel: (305) 446-8193

**FEB 26-MAR 1—COMPCON Spring**, San Francisco, Calif. INFORMATION: COMPCON Spring 79, PO Box 639, Silver Spring, MD 20901. Tel: (301) 439-7007

**FEB 26-MAR 2—INTELCOM**, Dallas Convention Ctr, Dallas, Tex. INFORMATION: M. Rafferty, Mgr of Promotion, Horizon House Internat'l, 610 Washington St, Dedham, MA 02026. Tel: (617) 326-8220

**FEB 27-MAR 2—NEPCON WEST**, Anaheim Convention Ctr, Anaheim, Calif. INFORMATION: Industrial and Scientific Conf Management, Inc, 222 W Adams St, Chicago, IL 60606. Tel: (312) 263-4866

**FEB 28-MAR 2—Internat'l Computer Expo**, Harumi Fairgrounds, Tokyo, Japan. INFORMATION: Golden Gate Enterprises, Inc, 1307 S Mary Ave, Suite 210, Sunnyvale, CA 94087. Tel: (408) 735-1122

**MAR 4-8—Business Systems Exhibition**, U.S. Trade Ctr, Tehran, Iran. INFORMATION: Susan Blackman, Project Mgr, Commerce Action Group for the Near East (CAGNE), Rm 6015B, Washington, DC 20230. Tel: (202) 377-2952

**MAR 6-8—Optical Fiber Communication**, Shoreham Americana Hotel, Washington, DC. INFORMATION: Optical Society of America, 2000 L St, NW, Suite 620, Washington, DC 20036. Tel: (202) 293-1420

**MAR 14-16—Simulation Sym**, Causeway Inn, Tampa, Fla. INFORMATION: Sudesh Kumar, NCR Corp, 4045 Sorrento Valley Blvd, San Diego, CA 92121

**MAR 19-21—Federal DP Expo**, Sheraton Park Hotel, Washington, DC. INFORMATION: Dick Rusch, Interface Show Group, 160 Speen St, Framingham, MA 01701. Tel: (617) 879-4502

**MAR 19-21—IECI Conf and Exhibit on Industrial and Control Applications of Microprocessors**, Philadelphia, Pa. INFORMATION:

S. J. Vahaviolos, Physical Acoustics Corp, PO Box 3135, Princeton, NJ 08540. Tel: (609) 799-8266

**MAR 25-28—Numerical Control Society Annual Meeting and Technical Conf**, Marriott Hotel, Los Angeles, Calif. INFORMATION: Joyce Scholl, Numerical Control Society Headquarters, 1800 Pickwick Ave, Glenview, IL 60025

**APR 3-5—Specifications of Reliable Software Conf**, Hyatt Regency Hotel, Cambridge, Mass. INFORMATION: Software Engineering, PO Box 639, Silver Spring, MD 20901. Tel: (301) 439-7007

**APR 6-8 and MAY 18-20—Personal and Business Computer Shows**, Hynes Auditorium, Boston, Mass; and National Guard Armory, Washington, DC. INFORMATION: Mid-Atlantic Expositions, Inc, PO Box 3315, Annapolis, MD 21403. Tel: (301) 263-8044

**APR 9-12—INTERFACE**, McCormick Pl, Chicago, Ill. INFORMATION: Sheldon G. Adelson, President, Datacomm Interface, Inc, 160 Speen St, Framingham, MA 01701. Tel: (617) 879-4502

**APR 23-25—Relay Conf**, Stillwater, Okla. INFORMATION: Engineering Extension, Oklahoma State U, Stillwater, OK 74074. Tel: (405) 624-5146

**APR 23-25—Sym on Computer Architecture**, Marriott Hotel, Philadelphia, Pa. INFORMATION: Dr Barry Borgerson, Sperry Univac, PO Box 500, Blue Bell, PA 19422. Tel: (215) 542-2013

**APR 24-26—Electro**, New York Coliseum and Americana Hotel, New York, NY. INFORMATION: William C. Weber, Jr, General Mgr, Electronic Conventions, Inc, 999 N Sepulveda Blvd, El Segundo, CA 90245. Tel: (213) 772-2965

**APR 24-26—Reliability Physics Sym**, Airport Hilton, San Francisco, Calif. INFORMATION: Dr Frank B. Micheletti, Rockwell International, Electronics Research Ctr, D/545, 022-HA27, 3370 Miraloma Ave, Anaheim, CA 92803. Tel: (714) 632-4380

**MAY 1-3—DATA Computer Show and Data Communications Conf**, Toronto, Canada. INFORMATION: Kimberly Coffman, 2 Bloor St W, Suite 2504, Toronto, Ontario M4W 3E2, Canada

**MAY 8-10—Society for Information Display Internat'l Sym**, Chicago Marriott Hotel, Chicago, Ill. INFORMATION: Lewis Winner, 301 Almeria Ave, PO Box 343788, Coral Gables, FL 33134. Tel: (305) 446-8193

**MAY 17—Trends and Applications: Advances in Systems Technology Sym**, National Bureau of Standards, Gaithersburg, Md. INFORMATION: Trends and Applications, PO Box 639, Silver Spring, MD 20901. Tel: (301) 439-7007

**MAY 21-23—European Hybrid Microelectronics Conf and Exhibition**, Internat'l Congress Centre, Ghent, Belgium. INFORMATION: Prof R. Govaerts, Katholieke Universiteit Leuven, Afdeling E.S.A.T., Kardinaal Mercierlaan 94, B-3030 Heverlee, Belgium

## SEMINARS

**MAR 19-28—8080/8085 Design, Microcomputer Interfacing, Software Design, and Digital Electronics Workshops**, Virginia Polytechnic Institute, Blacksburg, Va. INFORMATION: Dr Linda Leffel, C.E.C., Virginia Polytechnic Institute and State U, Blacksburg, VA 24061. Tel: (703) 961-5241

**MAR 28-30—Surge Protection of Electronic and Telecommunications Equipment**, University of Wisconsin, Madison, Wis. INFORMATION: Willis F. Long, Dept of Engineering and Applied Science, U of Wisconsin-Extension, 432 N Lake St, Madison, WI 53706. Tel: (608) 262-2061

## SHORT COURSES

**FEB 28-MAR 2—Software Design for Data Communication Systems; MAR 12-16—Distributed Processing: Concepts and Techniques; and MAR 19-21—Modern Integrated Circuits**, George Washington U, Washington, DC. INFORMATION: Director, Continuing Engineering Education, George Washington U, Washington, DC 20052. Tel: (202) 676-6106

Announcements intended for publication in this department of *Computer Design* must be received at least two months prior to the date of the event. To ensure proper timely coverage of major events, material preferably should be received six months in advance.

# INTRODUCING THE DSD 440. DOUBLE DENSITY, DELIVERED.

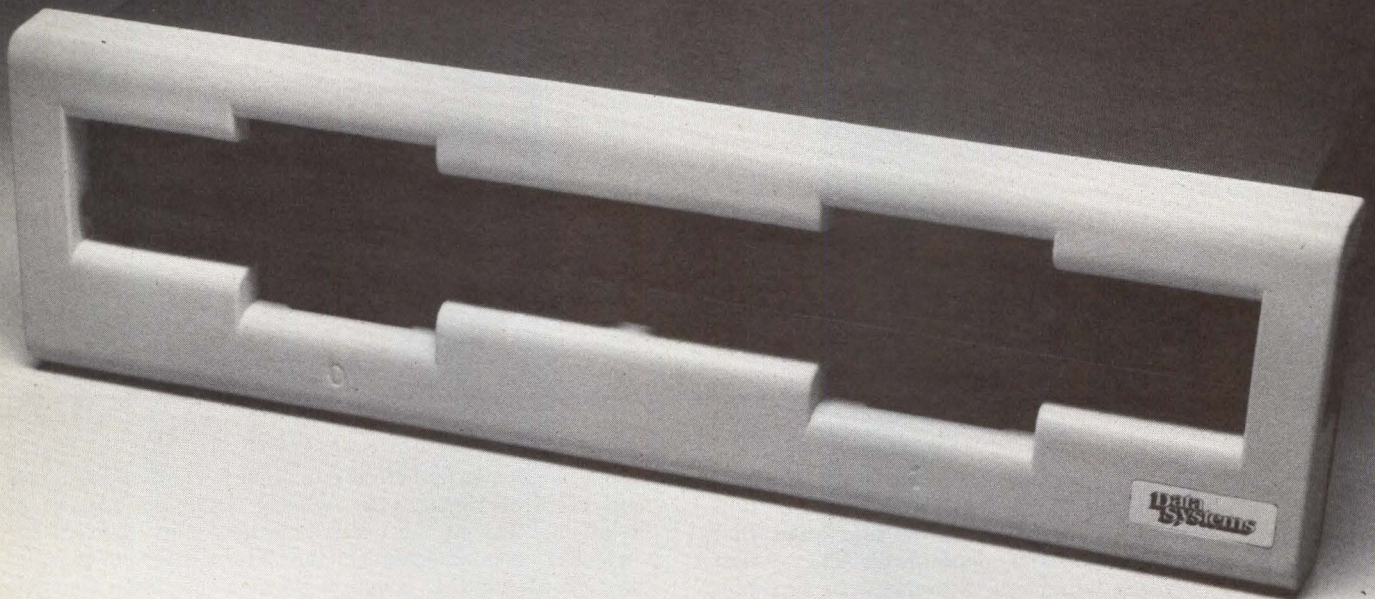

## **The DEC® RXO2 – Compatible Flexible Disk System with 30 day delivery.**

Our new DSD 440 records data in both DEC double density and IBM 3740 single density formats. It is 100% software, hardware and media compatible with DEC LSI-11, LSI-11/2, PDP-11 and PDP-8 computers including those equipped with extended memory. The DSD 440 can be set to emulate either the RXO1 for downward compatibility or the RXO2 for increased storage capacity and throughput.

### **Hardware Bootstrap**

A 512-word hardware bootstrap is built into the interfaces for the PDP-11, LSI-11 and LSI-11/2 systems. In addition to bootstrapping both single and double density configurations, it also performs diagnostics on the CPU memory, and the disk interface and controller.

### **“Hyperdiagnostics”**

Microprogrammed self-diagnostics are built into the drive and controller unit. User-selectable, stand-alone “Hyperdiagnostics” simplify maintenance and alignment procedures.

The DSD 440 data storage capabilities include write protection, power loss data protection, single track and complete diskette formatting. Diskettes can be formatted using sequential or user-selected sector interleaving. Special sector interleaving schemes can be implemented during formatting to improve system throughput.

### **Megabyte System**

This powerful megabyte flexible disk system is packaged in a low profile 5¼-inch chassis.

The DSD 440 is being shipped in quantity now. Delivery is 30 days.

To find out more about it, contact Data Systems Design today. A data sheet and price list will be forwarded to you immediately.

## **Data Systems**

3130 Coronado Drive, Santa Clara, CA 95051  
(408) 249-9353 TWX: 910-338-0249

© Registered trademark of Digital Equipment Corporation

**CIRCLE 7 ON INQUIRY CARD**

## TRANS-NATIONAL DATA REGULATION

**J. W. Hughes,**  
Associate Editor

Last month's retrospective Communication Channel column by John Buckley reviewed significant events in the world of communications during the nine years that he contributed articles to this department. That 9-year period brought about what was tantamount to a revolution in popular concepts affecting communications. It saw, among other things, the rise and growth of a wholly new and innovative industry, unleashed as a result of the famous Carterfone decision; the emergence of specialized common carriers and value-added networks; public packet-switched networks; the rapid spread of national and international satellite communication systems; the Consumer Communications Reform Act; two computer inquiries; and rewrite of the Communications Act of 1934. All of these had and will continue to have a potentially profound effect on the computer and communications industry, from the OEM to the ultimate user of products and services. These changes did not just happen. They were forced by the onrush of technological advances, most of which had their origins on the computer designer's drawing board. Today communications and computer technologies are, for all practical purposes, indistinguishable.

That the December column was retrospective, however, by no means signifies the end of an era or any respite in changes and the problems that result. A subject that we are hearing about more and more these days is that of transnational data flow, and the host of agreements, decisions, and regulations that may affect this activity. Legislation enacted or being considered by developed and developing countries that will affect the flow of information across national borders is not only likely to restrict the free flow of data throughout the world, but may have an adverse impact on national economies, and exacerbate tensions over inflation, unemployment, and global trade. This was the principal finding of the June 1978 meeting of The Brussels Mandate in London, as revealed by the report on that conference received

in our offices shortly before press time.<sup>1</sup> The London meeting was a continuance of a dialog begun in Brussels in February 1978 on the need for a new world agenda for computer, communications, and information policy. The Brussels Mandate is a not-for-profit organization founded to facilitate informal, ongoing discussions of these issues. Much of the substance of this article is drawn from the report of that London conference.

Again, it is plain that continuing technological advances are having their effect on the socio-economic, political, and legislative aspects of computer communications. New international communications protocols, the transparency of telecommunications networks to the passage of data, and the establishment of large, centralized data bases have caused concern among many nations. This concern has generally stemmed from the hardly arguable concepts of "privacy" and "human rights," and has resulted in a patchwork of regulations set up by several European countries that affect the transfer of personal data across as well as within national borders. The implications of these actions are of a potentially heavy regulatory environment for vendors, users, and the business community.

A sharp focus was placed on these implications by the welcoming speaker at the Brussels Mandate conference, Mr Hugh Donaghue. He is vice president of Control Data Corp, and chairman of the U.S. State Department Advisory Committee on Transborder Data Flow.

Speaking as a member of his corporation, he said ". . . We have three major areas of concern with regard to the issue of transborder data flow. A major part of our business is the offering of data services, worldwide. The effects upon that aspect of our business is of serious

1. Interested readers may obtain copies of the conference report and summary, free of charge, by writing or calling: The Brussels Mandate, Attn: Kate McCarry, 1742 N St, NW, Washington, DC 20036. Telephone: 202/785-4837.

# OEM's. Why waste \$1,000 on every line printer you ship?

By switching to Centronics' 6000 Series Band Printers, you can reduce your direct costs and improve your margins by thousands of dollars. Immediately. On every system.

That's a strong claim. But we can back it up. Our 6000 series band printers cost up to 40% less than conventional line printers. That's a savings of thousands of dollars on every printer.

OEM's ARE JUMPING ON THE CENTRONICS' BAND-WAGON. Substantial savings and easy, economical operation have

convinced over 100 OEM's to switch to Centronics' band printers. *That makes us the world's largest supplier of band printers to the OEM market.*

**DON'T WAIT ANY LONGER.** Every system you ship without a Centronics' 6000 series band printer wastes money and needlessly lowers your profits. But Centronics is poised to offer a quick solution. Call us day or night at our Toll-Free number. But do it right away. The longer you wait, the more money you're wasting.

## 800 528-6050

In Arizona call 800 325-0458

### CENTRONICS® PRINTERS Simply Better

## With every PDP-11/34 memory quote we'll give you a gift.....

Until you get our OEM quote for PDP-11/34 memories you won't know for sure if you're getting the best memory or the best price. And you certainly won't know about our unique OEM agreement that can save you hundreds of dollars over the life of your contract.

**Higher reliability.** Our customers usually tell us they experience a much higher acceptance rate with our memories than from other suppliers. The reason is simple. Better design, full spec. components and testing procedures that are the toughest and most thorough in the industry.

**Better delivery.** Multiple sourcing of components, especially memory elements, and our recently expanded facilities give us the advantage. Since the introduction of our PDP-11/34 memories, over 95% of all orders have been shipped on time.

### **MSC 3606 PDP-11/04/34/60 memory.**

Up to 128K words, with or without parity in a hex wide SPC slot.

Totally PDP-11/04/34/60 hardware and software compatible.

Expandable in 16K word increments to 128K words.

No separate parity controller required.

One year warranty on parts and labor.

Delivery, stock to 30 days ARO.

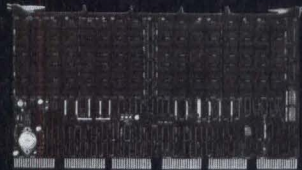

### **MSC 3501 & 3603 PDP-11/04/34 memory.**

Up to 64K words, with or without parity, in a hex wide SPC slot.

Totally PDP-11/04/34 hardware and software compatible.

Expandable in 4K word increments to 16K words (MSC 3501) and in 16K word increments to 64K words (MSC 3603).

One year warranty on parts and labor.

Delivery from stock.

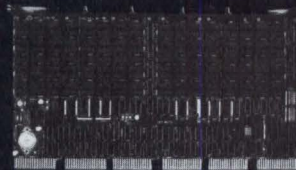

**Check us out.** We're happy to supply demonstration units and customer references. We're even happier to give you a quotation. But having you become our customer makes us happiest of all.

Call or write today.

**DEC compatible memories... from the first.**



Monolithic  
Systems corp

14 Inverness Drive East  
Englewood, CO 80112  
303/770-7400

Circle number 9 for a quotation.  
Circle number 168 for literature.

DEC and PDP are registered trademarks of Digital Equipment Corp.

©1978, Monolithic Systems Corp.



Peace of mind.



# If you're in the market for intelligent terminals, you could waste a lot of time wandering from A to Z.

Specifying the optimum terminal for your data or word processing system used to be a real problem. Should it be dumb? Smart? Or intelligent? Clustered or stand alone? And which of the 88 plus terminal manufacturers can best fulfill your system requirements?

We've just solved the problem for you.

With the introduction of our new ZMS family of intelligent terminals, we can offer you three intelligent solutions: the ZMS-50, ZMS-70 and ZMS-90. They're all 8080A microprocessor-based. All user programmable. And their fundamental microcomputer bus architecture and modular design offer you considerable system flexibility.

## The I.Q. test: how much native intelligence do you need?

Zentec ZMS intelligent terminals are designed as building blocks, each one offering you a wide

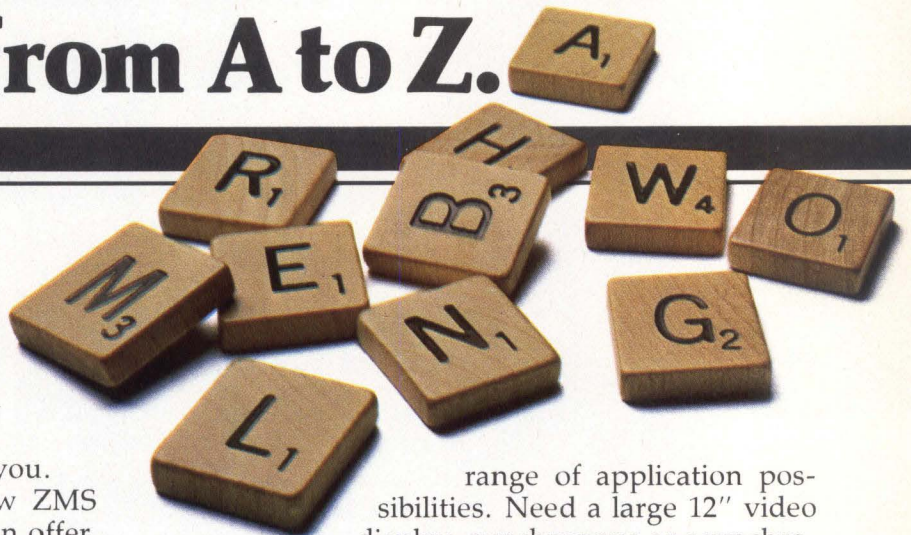

range of application possibilities. Need a large 12" video display, synchronous or asynchronous interface and up to 12KB of downloading capability... all at a "smart" price? The ZMS-50's your answer. Want powerful text editing capability, 143,000 bytes of on-line mass storage and a sophisticated set of pre-programmed software routines? Specify the ZMS-70. Or if you need a large video display, detachable keyboard, synchronous interface and 16K bytes of RAM that's expandable to 64K bytes, consider the ZMS-90. Whichever one you start with, its fundamental microcomputer bus architecture, list driven structure and choice of software and firmware modules offer you an almost endless array of system possibilities.



# Or you could start with Zentec ...the last word in intelligent terminals.

**Flexible  
& functional,  
by design**



All Zentec ZMS terminals are user programmable and include easily modified software, making them simple to use, simple to re-program. Sophisticated, pre-programmed software routines can also be built-in, easily. And list driven architecture provides superior video flexibility, enabling you to change video fonts, select video enhancements and format data to suit your application

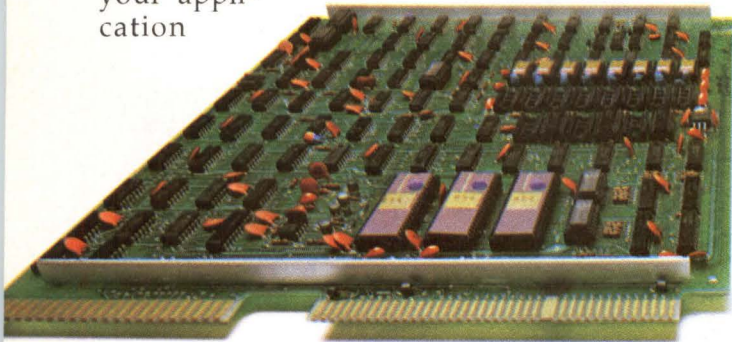

requirements. So you can blink. Blank. Reverse video. Underscore. Double character width. Even re-structure characters called up from the standard 128 character set. And Zentec's unique video circuitry enables you to display non-contiguous data, contiguously. There's even a 25th line added to the standard  $24 \times 80$  character line format, reserved for the operator messages and status information, enabling the operator to bypass the video display to communicate with a host computer.

## Have it your way

Equally important ... at Zentec, our philosophy is to be as flexible as our products. So we don't just stop with our standard configurations. Our



application engineers will help you analyze your data or word processing system. Help you select the right combination of hardware, firmware and software. And, where practical, even suggest custom configurations like special keyboards, enclosure modifications, customized firmware and specialized interfaces and protocols. The only thing we won't change is our commitment to quality. From materials to manufacture to MTBF tests, each Zentec intelligent terminal is designed and produced to meet a prescribed set of rigid performance standards.

## Addressing the problem

So if you're in the market for intelligent terminals, don't spend your valuable time sorting through a myriad of manufacturers. Call us at (408) 246-7662. Or write to us: Zentec Corporation, 2400 Walsh Avenue, Santa Clara, CA 95050. If you need even more immediate response, call one of our sales offices listed below. We'd like to tell you more about how Zentec can be your most intelligent choice for intelligent terminals.



*... the last word in intelligent terminals.*

Sales Offices—Southern California: Los Angeles, CA, (714) 661-2583; Mid-West: Palatine, IL, (312) 991-0105; Northeast: White Plains, NY, (914) 428-2801, Boston, MA, (617) 935-4511; Southeast: Washington, DC, (703) 941-9270; Austria: Tonko, 425-451; England: Zygol Dynamics, 02405-75681; Finland: Videodata, 90-578-877; France: Tekelec, (1) 027-7535; Switzerland: Atek, 041-831043.

**CIRCLE 10 ON INQUIRY CARD**

concern to us. Second, we are a multinational company, as many of the companies around this table may be. We are concerned about the effect of this issue on our planning process for the future, and how we shall operate as a multinational in an environment whereby data flows are cut off at various borders. Third, we are the manufacturer of very large computers. These are usually used in centralized systems and, if indeed again, transborder data flows are cut off and different types of systems evolve, another major portion of our business will be affected."

"... As we move into the information world of the future, and as more data passes across borders, I'm concerned that some countries may take advantage of this situation by building barriers to trade. Hopefully this is not so, but I think it is something that we need to lay on the table and that we need to discuss."

Mr Donaghue went on to discuss the activity of the Advisory Committee, which "is there to advise on policies being developed by someone else." The activity is narrow, in that it addresses only the personal privacy aspect of U.S. policy in the international field. Current activity is in assisting the government in developing an OECD (Organization for Economic Cooperation and Development) set of guidelines. Another area under scrutiny is the developing U.S. information policy, to make sure that whatever develops as policy in the U.S. gets equal treatment internationally. "Our past laws have only addressed domestic issues in the U.S., but I don't think that we can do that any longer."

Mr Donaghue further pointed out other U.S. activities addressing issues related to transborder data flow. Task forces for this purpose have been assembled by the Chamber of Commerce, National Association of Manu-

facturers, AFIPS (American Federation of Information Processing Societies), ADAPSO (Association of Data Processing Service Organizations), and CBEMA (Computer and Business Equipment Manufacturers Association).

Several specters were brought up by other participants in the conference. One, the European PTT (Postal Telephone and Telegraph) administrations discussions on private vs public networks, and fixed rate vs volume-sensitive charges on the flow of data. As one speaker put it, "The U.S. Postal Service is not alone in a sea of red ink; the European government-operated monopoly PTTs suffer as well, and need to find new money to subsidize the mails... They see a new technology that allows millions of bits of information to be transmitted across borders for the price of one phone call as an attractive revenue target of opportunity. They want to charge for the amount of information carried on the circuit, not for the time the circuit is used... a dramatic increase in the cost of doing business abroad would be the result."

Another imminent concern noted at the meeting is the forthcoming WARC (World Administrative Radio Conference), a function of the ITU (International Telecommunication Union). At this meeting, to be convened in September 1979, the entire electronic spectrum will be up for grabs for the first time in 20 years, and it is expected to be rearranged. WARC will help determine communications flows and technology, and will probably affect the transmission of computer information as well.

Therefore, with this nutshell view of but a few of the issues covered by the Brussels Mandate, it appears that the computer communications industry is by no means clear of the winds of change, and that there are extremely interesting days—more likely years!—ahead.

# SHUGART SERENADE

If you want your machine to play, give it quality mini magnetic media. And at Verbatim Corporation the whole message is quality.

Would Victor Borge kid you?

For the name of your nearest Verbatim distributor, call toll free: (1) 800-821-7700, Ext. 515. (In Missouri call: 800-892-7655, Ext. 515).

**Verbatim Corporation**  
FORMERLY INFORMATION TERMINALS CORP  
323 Soquel Way, Sunnyvale,  
CA 94086. (408) 245-4400  
TWX: (910) 339-9381

PEOPLE WHO PLAY THE COMPUTER  
**Specify Verbatim**  
CIRCLE 11 ON INQUIRY CARD



# THESE 16-BIT DAC'S FIT 12-BIT BUDGETS!

$$\begin{array}{cccccccc}
 14 & 7 & 13 & 8 & 12 & 10 & 15 & 11 \\
 +2 & +9 & +3 & +8 & +4 & +6 & +1 & +5 \\
 \hline
 16 & 16 & 16 & 16 & 16 & 16 & 16 & 16
 \end{array}$$



\$39\*



\*DAC71-CSB-I (100's)

## ...YOU ADD IT UP!

...linearity,  $\pm 0.003\%$ ; total accuracy drift,  $15\text{ppm}/^\circ\text{C}$ ; settling time,  $< 10\mu\text{sec}$  FS; complete with output amplifier and internal reference.

The sum of it all? DAC71/DAC72; compact IC's priced from \$39.00.

With a highly effective price/performance balance and 16 times more resolution than 12-bit DAC's you gain significant system design flexibility. Eighteen models let you select from three codes (unipolar, bipolar, BCD)... voltage or current output...two temperature ranges (0 to

$+70^\circ\text{C}$  or  $-25^\circ\text{C}$  to  $+85^\circ\text{C}$ )...and welded, hermetic metal or ceramic, 24-pin packages ( $1\frac{1}{8}'' \times \frac{3}{4}'' \times \frac{1}{4}''$ ).

In early 1975 we introduced DAC70, industry's first integrated circuit 16-bit DAC. Now, with fewer chips, an automatic laser trimmed single chip resistor network, and lots of experience, we've made 16-bit DAC's practical for demanding instrumentation applications where high performance at low price is specified.

Burr-Brown, P.O. Box 11400, Tucson, Arizona 85734.

**BURR-BROWN**



Putting Technology  
To Work For You

AMSTERDAM, BOSTON, CHICAGO, LONDON, LOS ANGELES, NEW YORK, PARIS, SAN FRANCISCO, STUTTGART, TOKYO, TUCSON, ZURICH

CIRCLE 12 ON INQUIRY CARD

“...And for higher performance,  
we'll specify Harris Data Acquisition  
components.”

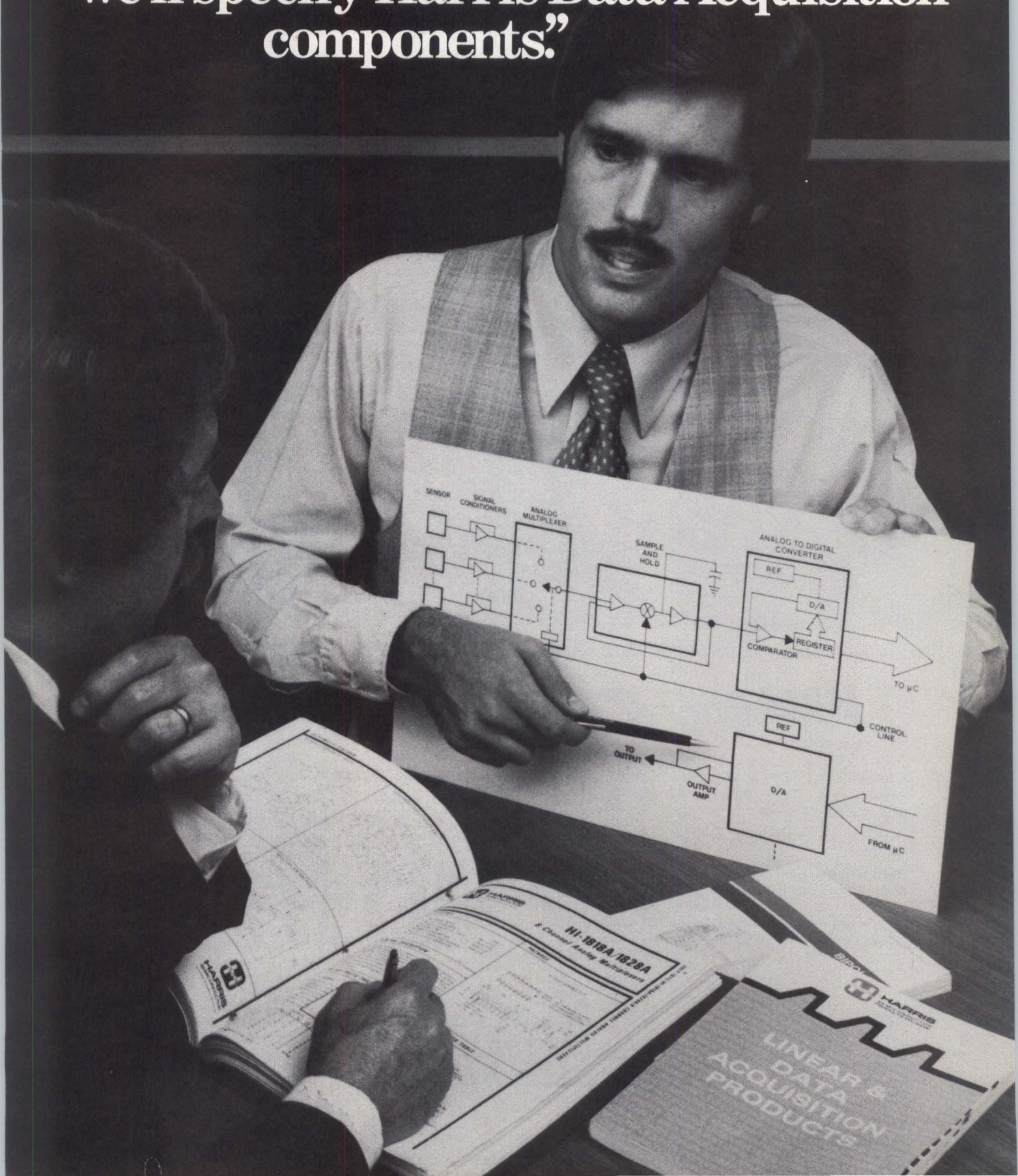

# Harris high performance components assure superior speed and accuracy.

Now Harris can provide you with a complete selection of data acquisition products—from op amps to digital-to-analog converters—with the highest performance available anywhere.

It's what you expect from Harris—the leading supplier of monolithic sample-and-hold, high performance multiplexers and switches. And producer of the first 12-bit monolithic D/A converter... which has led to the most advanced family of DACs in the industry.

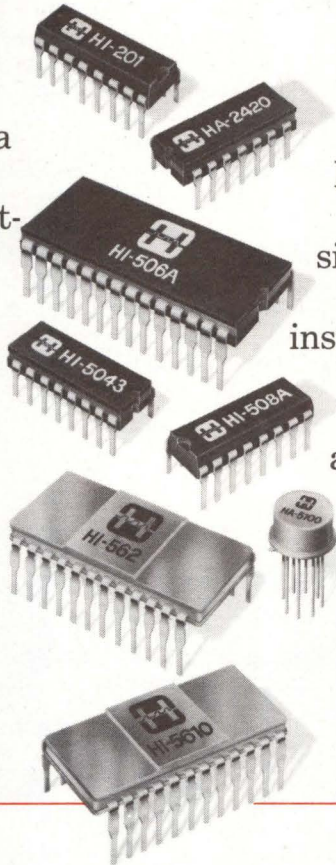

Harris data acquisition components provide the high speed, high accuracy and high throughput you need for processing fast signals in all types of applications—military, aerospace/ avionic, instrumentation, industrial process control, and others. To get top performance in your data acquisition systems, all you have to know is Harris. For fast facts, call the Harris Hot Line, or write: **Harris Semiconductor Products Division, Box 883, Melbourne, Florida 32901.**

## HARRIS DATA ACQUISITION PRODUCTS

### DIGITAL-TO-ANALOG CONVERTERS

The fastest, most accurate monolithic DACs available. Monotonic over temperature. Designed for minimum glitches.

- HI-562 — 12-bit, 200 ns to 0.01%
- HI-5612 — 12-bit, 150 ns to 0.01%
- HI-5610 — 10-bit, 85 ns to 0.05%
- HI-5608 — 8-bit, 50 ns to 0.19%\*

### ANALOG-TO-DIGITAL CONVERTERS

12-bit ADCs soon to be introduced will offer precisions and conversion speeds in microprocessor-compatible versions.

- HI-5712 — 12-bit, 6  $\mu$ s conversion\*
- HI-5812 — 12-bit, precision\*

### CMOS ANALOG MULTIPLEXERS

Latch-proof, Single/Differential, 8/16 channel. Overvoltage protected versions can withstand transients up to 1000 volts and inputs of  $\pm 20$  volts greater than either supply.

- HI-506A/7A — 16-channel, overvoltage protected
- HI-506/7 — 16-channel
- HI-508A/9A — 8-channel, overvoltage protected
- HI-1818A/28A — 8-channel
- HI-1840 — 16-channel, high Z, overvoltage protected

### CMOS ANALOG SWITCHES

Two popular series feature several latch-proof configurations with high-speed, low-on-resistance, and low-power versions.

- HI-200/201 — Dual/Quad, 180 ns, 55 ohms, 15 mW
- HI-5040 series — 370 ns, 25 ohms, 1.5 mW

### MONOLITHIC SAMPLE-AND-HOLD

Low droop rate coupled with fast acquisition time furnishes the speed and precision needed for 12-bit systems.

- HA-2420 — 4  $\mu$ s to 0.01% acquisition, 5 pA drift current

### VOLTAGE REFERENCES

Two new laser trimmed +10 volt references offer industry milestones in precision and stability.

- HA-1600 — +10 volt,  $\pm 1$  ppm/ $^{\circ}$ C
- HA-1610 — +10 volt,  $\pm 5$  ppm/ $^{\circ}$ C

### SIGNAL CONDITIONERS

New precision BIFET op amps to complement the Harris high-performance line. Laser trimmed for low offset voltage.

- HA-5100/5110 — Wide band BIFET
- HA-5150/5160 — High slew BIFET\*

### FAST-SETTLING OP AMP

The fastest monolithic true op amp in the world has superior settling times for voltage output DACs.

- HA-5190 — 100 ns to 0.01%, 200 V/ $\mu$ s Slew

### COMPARATORS

A family of fast quad comparators is coupled with a soon-to-be-introduced, high-speed precision single comparator for use in ADCs. The 4950 will give true 12-bit accuracy with no sacrifice in throughput.

- HA-4950 — 35 ns response, with 100  $\mu$ V resolution\*

\*To be introduced

**HARRIS HOT LINE!**  
**1-800-528-6050, Ext. 455**

Call toll-free (except Hawaii & Alaska) for phone number of your nearby Harris sales office, authorized distributor or expedited literature service.

*Harris Technology*  
*... Your Competitive Edge*



**HARRIS**  
**SEMICONDUCTOR**  
**PRODUCTS DIVISION**  
A DIVISION OF HARRIS CORPORATION

## Monolithic PCM Filter for Digital Telephone Systems Has Integral Transmit/Receive Sections

Pulse code modulation (PCM) filter 2912, a fully integrated line filter, includes transmit and receive filters, input amplifier, 50/60-Hz notch filter, and an independent output power amplifier, all packaged in a 16-pin DIP. It meets specifications for digital Class 5 central office filters, with no external components or frequency response adjustments. Available from Intel Corp, 3065 Bowers Ave, Santa Clara, CA 95051, the filter is a companion device to the codec (coder/decoder) which converts analog telephone signals to digital and vice versa, and has two independent sections, transmit and receive.

Main purpose of the transmit filter in PCM voice transmission is to perform the anti-aliasing function needed for the 8-kHz sampling system in the codec. The filter removes out-of-passband frequencies that can be modulated and demodulated by the encoding/decoding system and appear as unwanted signals within the 200- to 3000-Hz voice band at the receiving end of the system. Within the passband, the transmit filter meets the requirements of  $\pm 0.125$ -dB flatness from 300 to 3000 Hz, as well as other CCITT and AT&T specifications. The filter includes a 50- to 60-Hz rejection filter. Min rejection

is -18 dB at 50 Hz and -26 dB at 60 Hz, for attenuation of any induced power line signals. Input to the transmit filter is through an onchip op amp with up to 20-dB adjustable gain, which can be connected in non-inverting, inverting, or differential modes. The filter has an inherent 3-dB passband gain, and its output can be capacitively coupled directly to 2910/2911 codecs.

The receive filter removes high frequency components from the codec output. The characteristics of most codecs reduce the high frequency response within the desired passband. The 2912 receive filter compensates

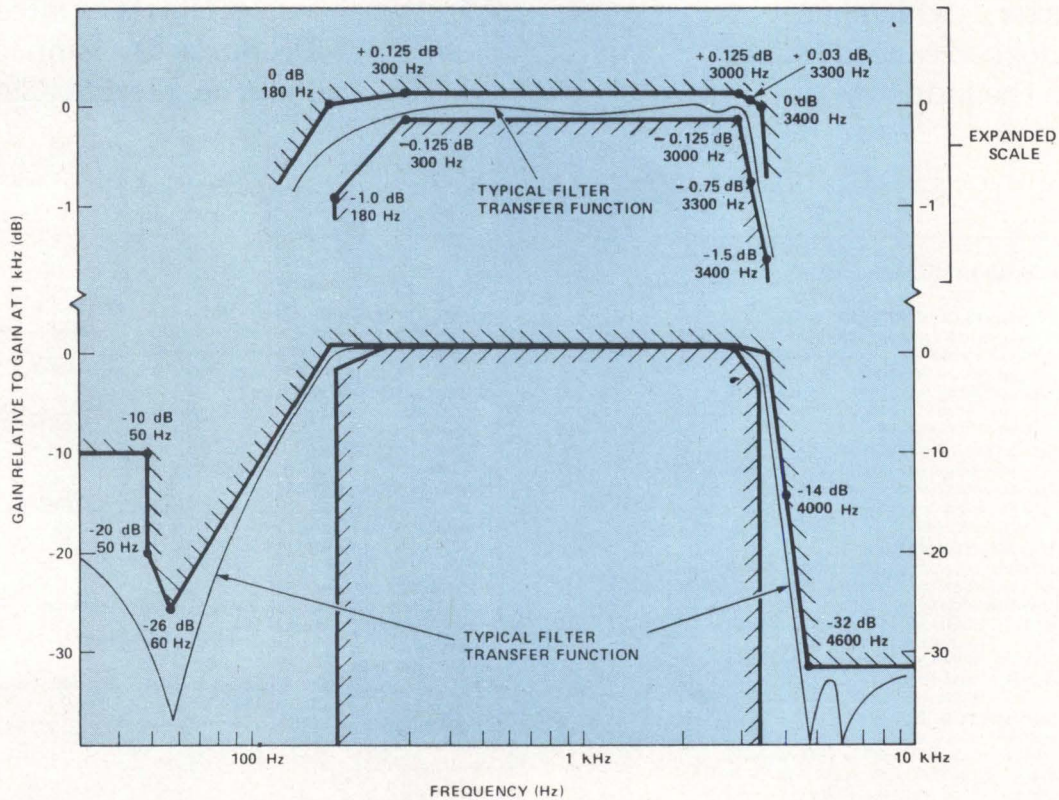

Transmit filter characteristics. Passband flatness and stopband attenuation exceed AT&T D3 and D4 specification as well as CCITT G712 recommendation. Filter specification meets digital class 5 central office switching system requirements. Integral notch section rejects 50- and 60-Hz components of input signal. Gain at 180 Hz is between 0 and -0.5 dB (relative to gain at 1 kHz)



**TEKTRONIX**  
thinks your logic analyzer  
should be as versatile  
as you are

So ours let you see analog and digital displays *at the same time.*

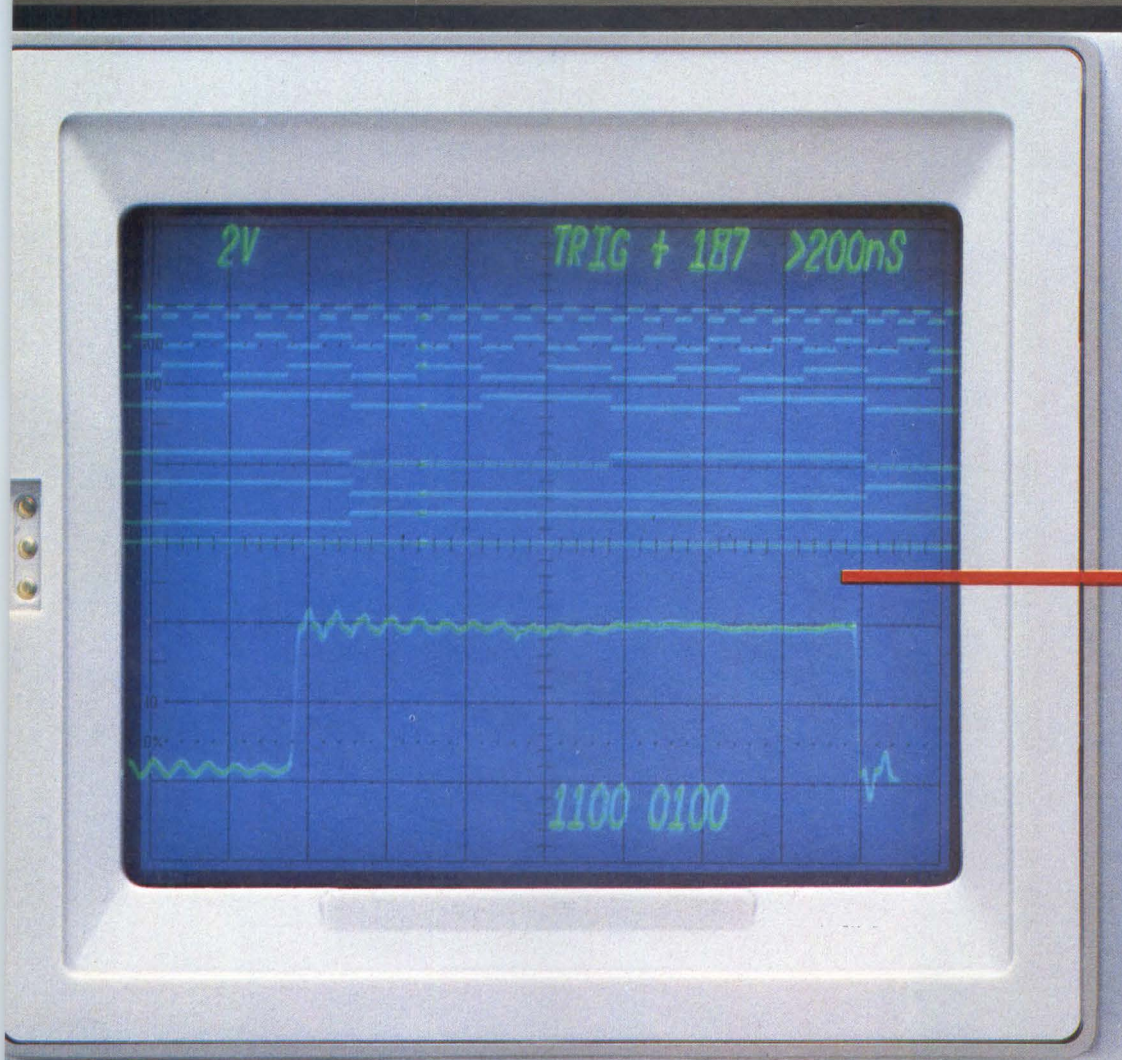

Verify logic and  
analog relationships  
at a glance

Digital troubleshooting usually involves two steps: First, logic analysis to find where the problem is located. Then analog measurement to pinpoint the source.

Tektronix 7000-Series Plug-Ins give you both steps. Presented together on the same display: a complete picture of the analog/digital relationship.

Many Tektronix 7000-Series Mainframes allow the 7D01 Logic Analyzer plus vertical amplifier and time base

plug-ins to all be housed in a single mainframe. The same configuration gives you full analog *and* digital capability. First, locate a logic problem with the 7D01's timing display and retain it on the screen through memory. Next, make the analog measurement and put it up on the same display. Both sides of the problem are now revealed in a single image.

**Simultaneous analog/digital display: it helps make our Logic Analyzer**

**versatile. So you can do today's job and tomorrow's. So you can change applications without changing your logic analyzer.**

Contact Tektronix Inc., P.O. Box 500, Beaverton, OR 97077. In Europe, Tektronix Ltd., P.O. Box 36, St. Peter Port, Guernsey, Channel Islands.

For technical data,  
circle 14 on Inquiry Card.  
For a demonstration,  
circle 15 on Inquiry Card.

**Tektronix**  
COMMITTED TO EXCELLENCE

For immediate action, dial our toll free automatic answering service: 1-800-547-1512

TEKTRONIX LOGIC ANALYZERS THE VERSATILE ONES

# Here's the sensible way to select your next logic analyzer.

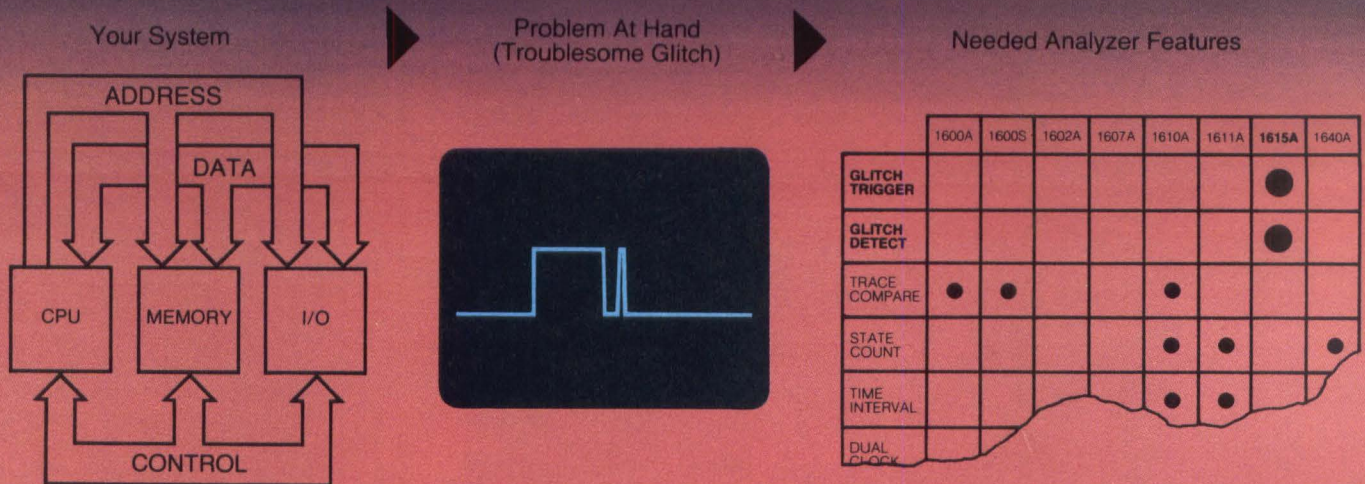

HP has made it easier to choose the right logic analyzer for your application.

We've developed a logical procedure to help you select the correct combination of features to solve your problems. Now, you can quickly make the transition from system to potential problems to features to a specific model. Here's how it works.

Suppose your system resembles the one shown in the above block diagram. A problem you're likely to encounter is glitches on a control line—leading to disruptive signals being generated within your system. That's where a logic analyzer comes in. But which one?

In this case, the two features you need which are central to glitch analysis are GLITCH DETECT and GLITCH TRIGGER. One look



▶ Appropriate Model

at the Logic Analyzer Selection Chart and you'll find that both features are available in HP's 1615A Logic Analyzer. With a few simple keyboard entries you'll be able to trigger on the glitch and perform cross-bus analysis for rapid troubleshooting.

HP can show you a logical selection process for your design and troubleshooting problems. From system . . . to potential problems . . . to features . . . to a specific model.

Simply send for the **HP Logic Analyzer Selection Guide**. It will take you through the step-by-step sequence and help you discover which HP Logic Analyzer is best for your application. Or, for immediate assistance, give your local HP field engineer a call today.

**Please send me a free copy of the HP Logic Analyzer Selection Guide.**

Name/Title \_\_\_\_\_

Company \_\_\_\_\_

Address \_\_\_\_\_

City/State/Zip \_\_\_\_\_

Mail to: Hewlett-Packard, 1507 Page Mill Road, Palo Alto, California 94304

CD 1/79



1507 Page Mill Road, Palo Alto, California 94304

For assistance call: Washington (301) 948-6370, Chicago (312) 255-9800, Atlanta (404) 955-1500, Los Angeles (213) 877-1282

**CIRCLE 16 ON INQUIRY CARD**

# ROLM'S 1602B: An Army Standard Computer Designed for Full Integrated Logistics Support

## IT'S A COMPLETE PROCESSOR IN A SINGLE 20" CHASSIS.

The 1602B (AN/UYK-19) has space for 7 I/O modules, control panel interface, CPU and 64K of directly addressable memory. An additional 15 I/O slots can be made available with ROLM's 2150 Expansion Chassis.

## INDEPENDENT CARDS & INTERCHANGEABLE I/O SLOTS.

Single board peripheral controllers and interchangeable I/O slots allow field reconfiguration without rewiring. A single CPU board implements all processor operations. Logistics and support are simplified.

## IT HAS SINGLE SIDED ACCESS.

Maintenance is simplified by quick, easy access to the interior of the conductively cooled chassis. The 1602B also has a new plug-in AC or optional DC power supply.

## EXCELLENT DELIVERY WITH FULL SUPPORT.

Since AN/UYK-19 processors are in continuous production, delivery is no problem. They are fully mil-qualified and backed up by complete training and documentation. And ROLM's extensive software has really impressed program managers. They find that our total support program can't be matched.

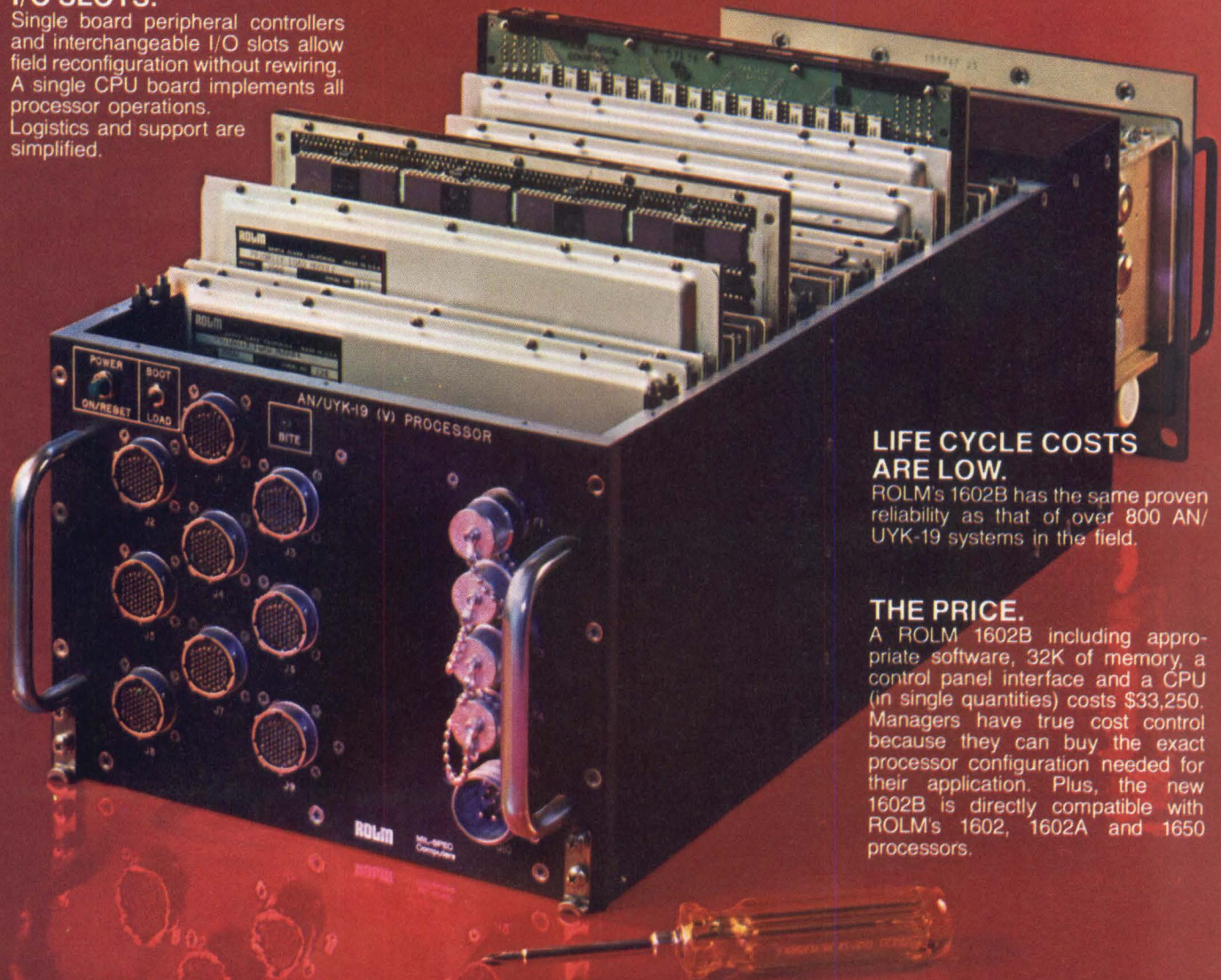

## LIFE CYCLE COSTS ARE LOW.

ROLM's 1602B has the same proven reliability as that of over 800 AN/UYK-19 systems in the field.

## THE PRICE.

A ROLM 1602B including appropriate software, 32K of memory, a control panel interface and a CPU (in single quantities) costs \$33,250. Managers have true cost control because they can buy the exact processor configuration needed for their application. Plus, the new 1602B is directly compatible with ROLM's 1602, 1602A and 1650 processors.

**That's Why We're #1 in Mil-Spec Computer Systems**

**ROLM**

MIL-SPEC  
Computers

4900 Old Ironsides Drive, Santa Clara, CA 95050. (408) 988-2900. TWX 910-338-7350.

In Europe: Muehlstrasse 19 D-6450, Hanau, Germany, 06181 15011, TWX 4-184-170.

CIRCLE 17 ON INQUIRY CARD

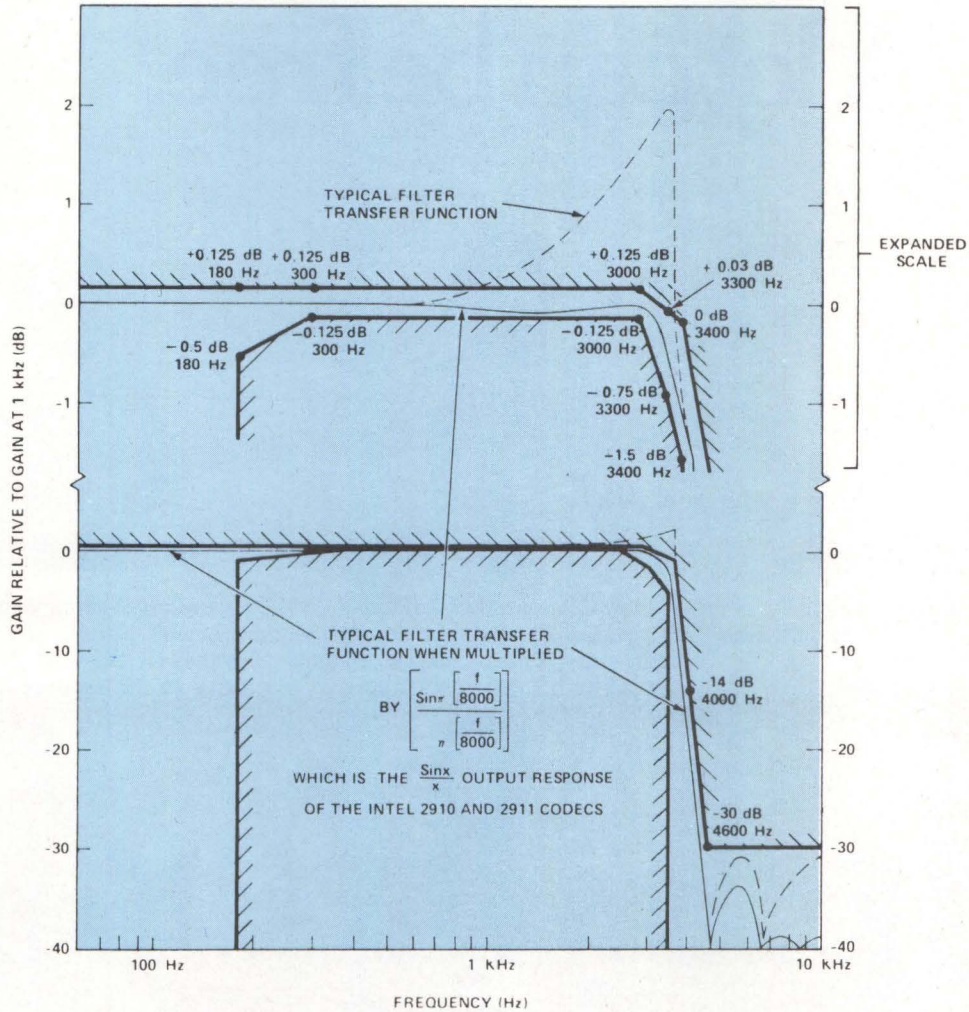

Receive filter characteristics. Passband flatness and stopband rejection meet D3/D4 requirements when used with decoder that contains sample/hold amplifier at its output. Filter provides required compensation for  $\sin x/x$  response for such decoders

for this falloff and restores to the filter-codec combination the required flat characteristics from 300 to 3000 Hz. Receive filter output can directly drive a high impedance electronic hybrid. An independent power amplifier is also provided to drive low impedance transformer units, such as 600- to 900- $\Omega$  hybrids. If not required for a particular application

the power amplifier can be deactivated.

Cutoff frequency of both transmit and receive filters is determined by the clock. A selection pin provides for clock frequencies of 1.544, 1.536, or 2.048 MHz, common clock frequencies for D3/D4 channel banks, 24-channel, and 32-channel systems respectively.

Power supply requirements are  $\pm 5$  V. Power down capability is through a single TTL compatible power control pin. When in power down mode device draws 75 mW, and outputs are placed in high impedance state. The 2912 can be used immediately with existing codecs, IC or not, then continued in use for new designs.

Circle 400 on Inquiry Card

# A little knowledge about computers can be expensive. A lot can be free.

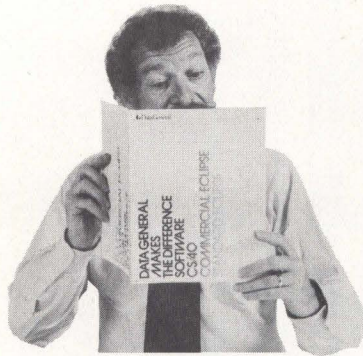

1. The inside story on how our full **PRODUCT LINE** makes the difference to you.

**CIRCLE 18 ON INQUIRY CARD**

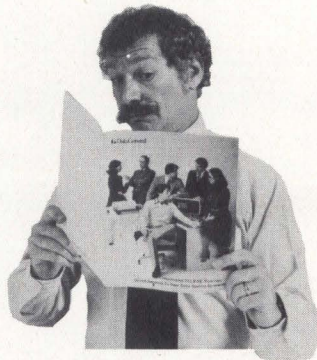

2. How **Commercial ECLIPSE** Systems answer the diverse demands business makes today on a data system.

**CIRCLE 19 ON INQUIRY CARD**



3. The secret of having computer power where your business needs it. Our book on **CS/40 SMALL BUSINESS SYSTEMS** tells.

**CIRCLE 20 ON INQUIRY CARD**

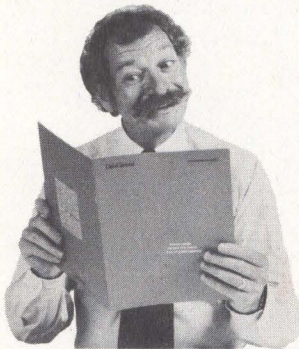

4. Describes seven important **SUPPORT SERVICES** that get systems up and running, then keep them there.

**CIRCLE 21 ON INQUIRY CARD**



5. Find out how our **Real-Time Disc Operating System SOFTWARE** can get you on-line fast, and keep you there.

**CIRCLE 22 ON INQUIRY CARD**

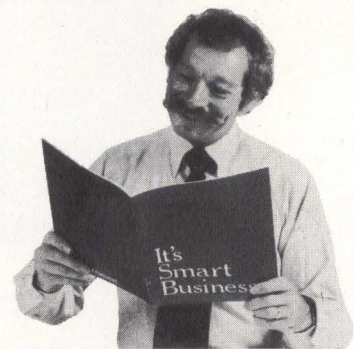

6. **IT'S SMART BUSINESS** to know how our way of doing business benefits our customers.

**CIRCLE 23 ON INQUIRY CARD**

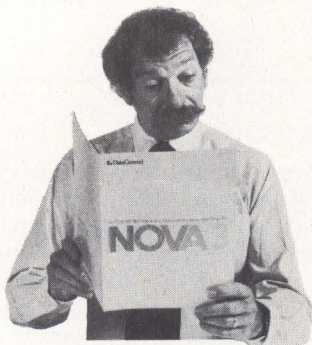

7. How **OEM's** solve the dilemma of keeping their system costs down with our **NOVA 3 COMPUTER FAMILY**.

**CIRCLE 24 ON INQUIRY CARD**



8. What you need to know about getting everything for a **DATA ACQUISITION and CONTROL** system from one place.

**CIRCLE 25 ON INQUIRY CARD**



9. The last word in microprocessor-based **microNOVA** systems with full **16-bit NOVA** architecture.

**CIRCLE 26 ON INQUIRY CARD**

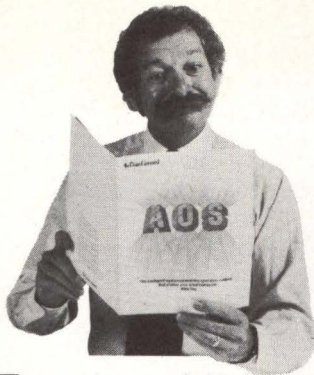

10. The amazing story behind our unique heuristic MULTI-PROGRAMMING operating system.  
**CIRCLE 27 ON INQUIRY CARD**

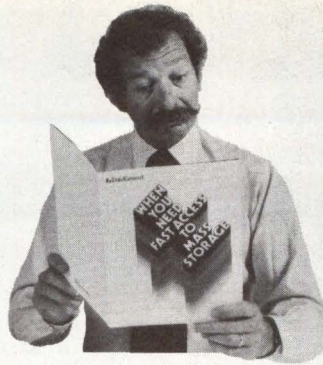

11. What to do when you need fast, fast access to MASS STORAGE.  
**CIRCLE 28 ON INQUIRY CARD**

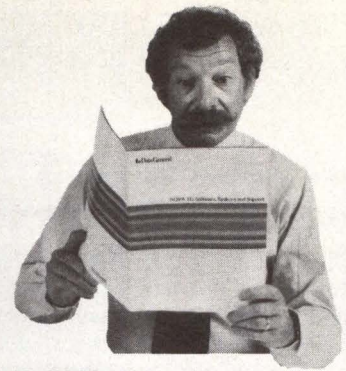

12. NOVA 3 systems, software and support let you customize a system to your application.  
**CIRCLE 29 ON INQUIRY CARD**



13. A wealth of information about how our computers are being used in actual APPLICATIONS.  
**CIRCLE 30 ON INQUIRY CARD**

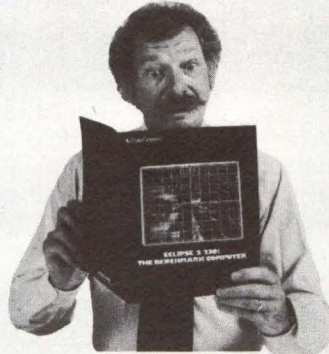

14. Wonder what sets the benchmark for big performance computer systems? Wonder no more, it's ECLIPSE S/230.  
**CIRCLE 31 ON INQUIRY CARD**



15. Is there a sensible way to use computers in DATA COMMUNICATIONS? The message comes through clear.  
**CIRCLE 32 ON INQUIRY CARD**

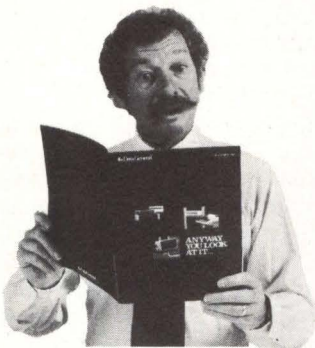

16. What's the most you can expect to get from a mid-range mini today? What you get with an ECLIPSE S/130—the standard setter.  
**CIRCLE 33 ON INQUIRY CARD**

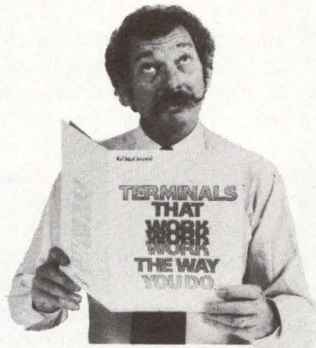

17. You want terminals that work the same way you do? You want the facts on our DASHER TERMINALS.  
**CIRCLE 34 ON INQUIRY CARD**



18. Our whole SPARE PARTS catalog. They're too important to be kept a mystery.  
**CIRCLE 35 ON INQUIRY CARD**



19. 1978 was a very good year. Our ANNUAL REPORT could be good for you.  
**CIRCLE 36 ON INQUIRY CARD**

Mail to: Data General, Westboro, MA 01581 CD-179

Yes, I'd like to pick your brains. Please send me the brochures I have circled.

I'm in a hurry. Have your sales representative bring in the brochures I have circled.

Brochure numbers: 1 2 3 4 5 6 7 8 9 10 11 12 13 14 15 16 17 18 19

Name \_\_\_\_\_ Title \_\_\_\_\_

Company \_\_\_\_\_

Address \_\_\_\_\_ Tel. \_\_\_\_\_

City \_\_\_\_\_ State \_\_\_\_\_ Zip \_\_\_\_\_

Data General Corporation, Westboro, MA 01581, (617) 366-8911. Data General (Canada) Ltd., Ontario, Data General Europe, 61 rue de Courcelles, Paris, France, 766.51.78. Data General Australia, (03) 89-0633. Data General Ltda., Sao Paulo, Brazil, 543-0138. Data General Middle East, Athens, Greece, 952-0557. © Data General Corporation, 1978.

© Nova and ECLIPSE are registered trademarks of Data General Corp., 1978. DASHER is a trademark of Data General Corporation.

# Data General

We make computers that make sense.

## System Adds Intelligence to Terminal Installations

In addition to BASIC commands, the Comm-Stor IV includes a second command set of data communication and file management functions, for simplification of data entry, storage, and transmission applications. The system comes with either a single- or dual-floppy diskette drive, from 4k to 40k bytes of user program memory, and communication ports for connection to an asynchronous RS-232 terminal, printer, and modem. Extended BASIC interpreter, file manager, and data communication system are all resident as firmware in an additional 40k bytes of ROM. According to Sykes Datatronics, Inc, 375 Orchard St, Rochester, NY 14606, the system offers a quick and economical means of adding intelligence to existing terminal installations, and can provide many of the data processing and storage features normally found on timesharing computers.

Data entered or sent to a Comm-Stor IV are stored on diskettes as files, with individual file names automatically catalogued in a directory. After receiving data from a terminal at low speed, an unattended unit can send batched data at high speeds over communication lines and can interact with most asynchronous communication protocols. Data are written on diskettes in IBM 3740 compatible format, easily transferrable between systems.

Users have a choice of sequential file access, sequential with random repositioning, random file access, and physical track/sector access. Regardless of the technique used, files are recorded contiguously on diskette. Files contain only user-created data and there are no system control codes, indices, or tables.

For commercial applications, the system offers a PRINT USING command to format data output to I/O ports and diskette files. In addition, a READ USING command, compatible with the PRINT USING command, provides complete format control of input data. Binary data in any code combination may be input from any port or diskette file in free form and written to a file without the need for delimiter or control codes. For realtime tasks, a data buffering system automatically buffers and holds data input to the terminal

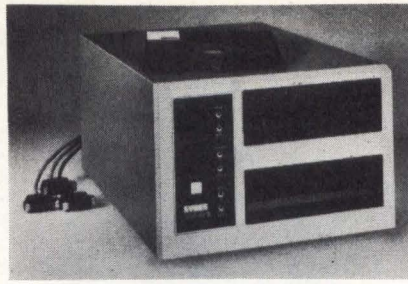

and modem ports until a BASIC program requests it.

A realtime clock, seven commands, and a 7-level priority interrupt structure are included for applications requiring responses to realtime events. Users may also break large BASIC programs into small segments, using LINK and CALL commands. LINK allows programs to be chained to one another in any combination. CALL operates in a similar manner, allowing one program to call another and pass to it all of the current variables, arrays, and strings.

Circle 401 on Inquiry Card

## Architecture Expands Computer Network Interaction

BNA (Burroughs network architecture) enables users' computer networks to interact on a far greater scale than previously possible, according to Burroughs Corp, Detroit, MI 48232. The architecture, under a control concept called Host Services, provides the links by which data bases throughout a network can be accessed by computers and terminals, job tasks and data files can be transferred from one host computer to another, jobs can be shared by host computers, and processing and computational resources available in a network can be used by any participant.

Another control concept called Network Services allows individual network elements to be linked on a logical and dynamic rather than a fixed and arbitrary basis. It was evolved by extending capabilities of the company's current data communications and networking software, relieving the user of the necessity to install specialized equipment or to switch to an unfamiliar system software. Computers can be linked by dedicated or dial-up lines, or through packet switching services via the X.25 international standard communications protocol. Systems in a BNA network may be programmed

to communicate with non-Burroughs systems and networks via presently available NDLL (network definition language) and MCS (message control system) capabilities. Applicable with most small to very large scale Burroughs computers, BNA is expected to be available beginning fourth quarter 1979.

Circle 402 on Inquiry Card

## Office Communication System Includes Text Handling Capabilities

3730 distributed office communication system includes 3732 text display station for keyboard entry and retrieval, and 3736 55-char/s bidirectional printer. It allows computer users to extend their distributed processing applications to include a variety of text handling capabilities. It was announced recently by IBM Corp, Data Processing Div, 1133 Westchester Ave, White Plains, NY 10604, that the 3730 will be marketed initially in seven U.S. cities—New York, Chicago, Los Angeles, San Francisco, Dallas, Boston, and Washington—where education and support centers will be available.

Supported by new models of the 3791 communications controller, the system is designed to be attached to a host System/370, and enables users to retrieve and electronically process documents based on customer-written text applications, such as centralized electronic document filing, retrieval, and distribution. Where two or more 3730s are combined with the host computer, terminals in one office system can distribute information to the other systems. The controller, alone or attached to a host, can also handle both text and data processing applications concurrently. 3791 controller models can support up to twelve 3732 display stations and as many as eight 3736 printers. Deliveries are scheduled for the 3730 as a host-attached system for the first quarter of 1980, and as a standalone system for the first quarter of 1979.

Circle 403 on Inquiry Card

## Network Expands 1200-Baud Coverage, Local Access

Tymnet, Inc, 20665 Valley Green Dr, Cupertino, CA 95014, has expanded



# A FLAT CABLE BEST SELLER FREE FROM BRAND-REX.

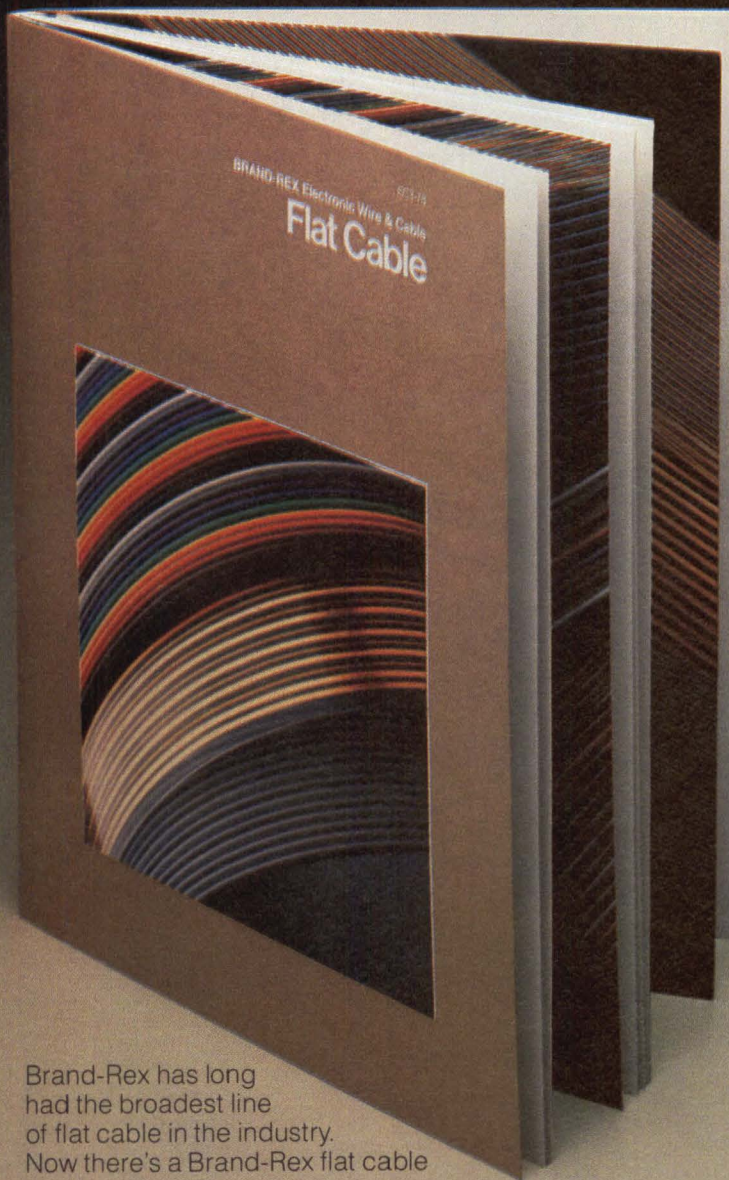

Brand-Rex has long had the broadest line of flat cable in the industry. Now there's a Brand-Rex flat cable catalog to match.

It runs 28 pages, covering the unique benefits of flat, ribbon or Tape Cable® and the highly flexible configurations available from Brand-Rex. It treats conductor insulations, jacketing, shielding, harnesses, cable systems, jumper cables, woven/knitted cable and Brand-Rex's special capability for custom cable design and assembly.

Get your copy. Just write to Brand-Rex Company, Electronic and Industrial Cable Division, Willimantic, CT 06226. Or call 203/423-7771.

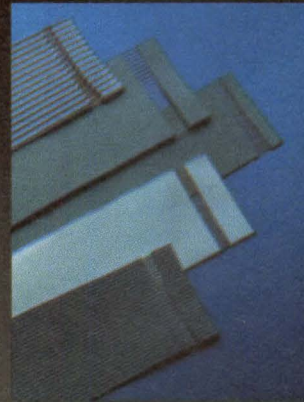

Signal Tape Cable®  
Round Conductors — PVC Insulation



Signal Tape Cable®  
Color-Coded Conductors

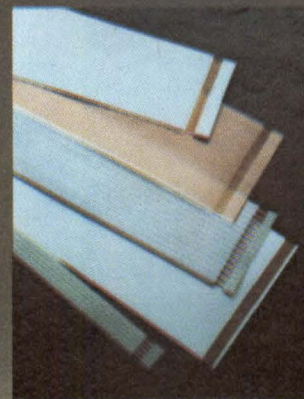

Flat Conductor  
Tape Cable®

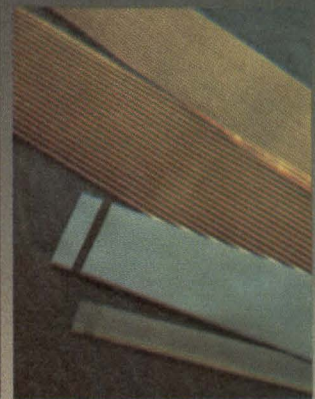

Transmission  
Tape Cable®

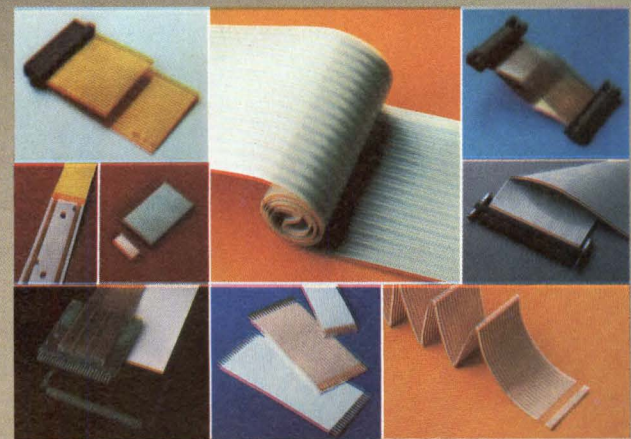

Tape Cable® Systems

## BRAND-REX

ELECTRONIC & INDUSTRIAL CABLE DIVISION

Other Brand-Rex Divisions:

Abbott & Co., wiring harnesses

Nonotuck Manufacturing Co., copper wire

Pyle-National Co., electrical connectors

Telecommunications Cable Division

Teltronics, Inc., telephone equipment and components

Brand-Rex, Ltd. (Scotland), wire and cable

**CIRCLE 37 ON INQUIRY CARD**

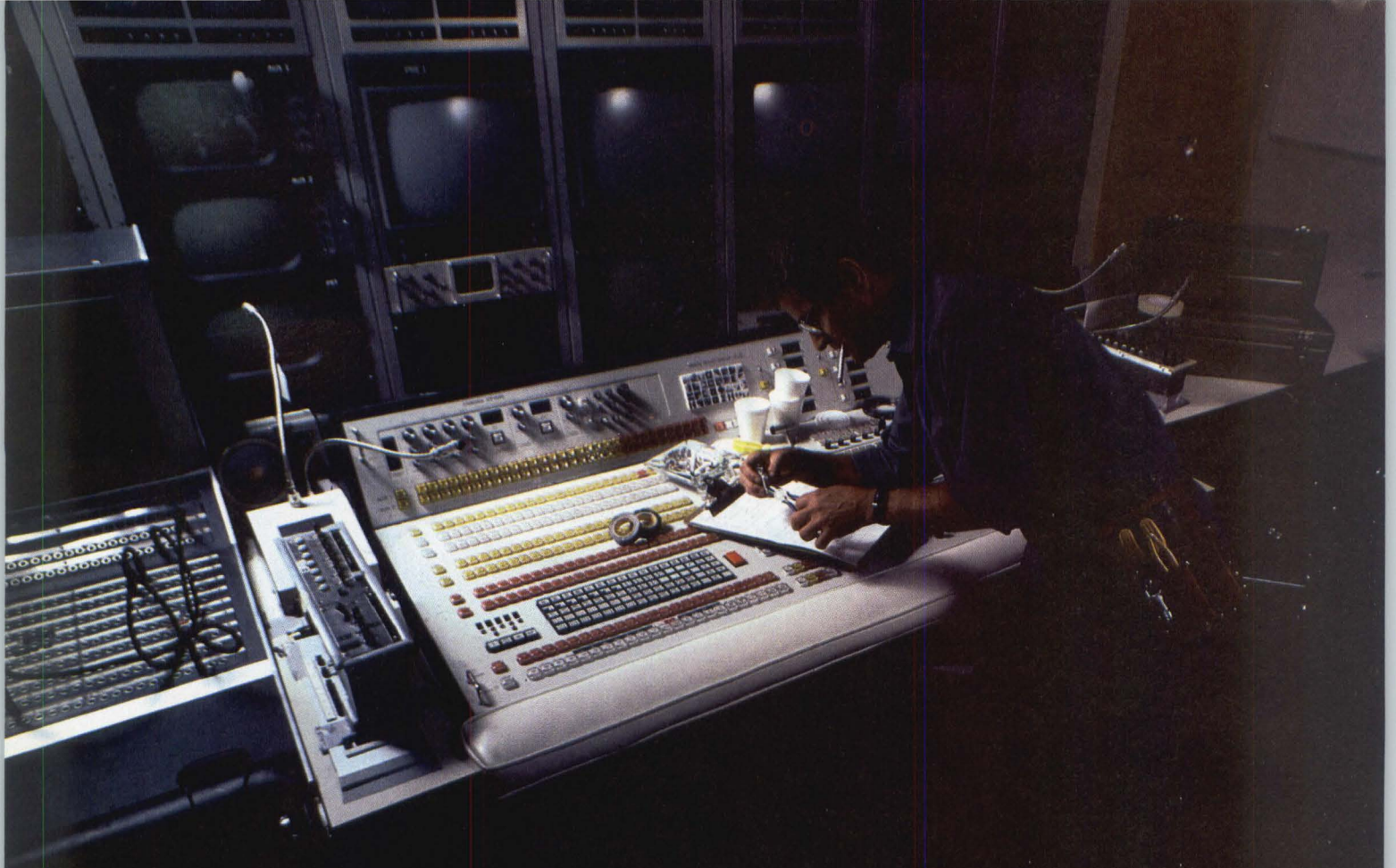

## You may not know how expensive a pushbutton really is until months after it's paid for.

The true measure of a pushbutton's cost isn't so much what you pay. It's how many times you pay it.

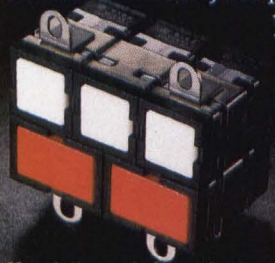

If you spend less in the first place, you could end up with a higher price tag from what you spend over and over in repair costs and downtime.

That's why it's worth it to specify the MICRO SWITCH Advanced Manual Line (AML) of pushbuttons, rockers, paddles and indicators. It's the most complete line of manual controls ever offered, designed to save you money from start to finish.

AML is easy to wire, thanks to single-level termination, simple snap-in PC board mounting and sub-panel mounting that uses individual, strip or matrix hardware (see inset). The result is low installed cost.

And of course, you get traditional MICRO SWITCH reliability and long life. Which means money savings over the long haul.

No matter how many words you use to describe the broad AML lineup, it all comes

down to just two: cost effectiveness. For a panel that's pleasing to the eye as well as the budget.

If you'd like a personal demonstration just call 815/235-6600.

MICRO SWITCH is also ready to provide you with field engineers for application assistance and a network of authorized distributors for local availability.

AML. It's the closest a line of pushbuttons can come to paying for itself.

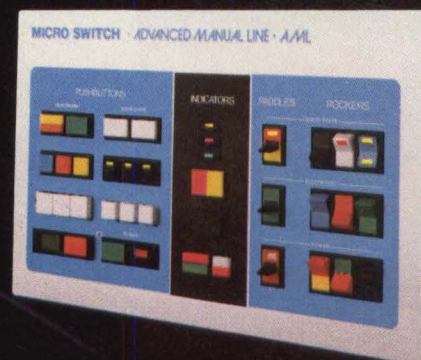

**MICRO SWITCH**  
 FREEPORT, ILLINOIS 61032  
 A DIVISION OF HONEYWELL

its public packet communications network by addition of the 31st location with 1200-baud local terminal access support. Since April 1978 the company has added 1200-baud access in 10 cities, including Portland, Ore; Louisville, Ky; Seattle, Wash; El Segundo, Calif; Phoenix, Ariz; Darien and Hartford, Conn; New Orleans and Baton Rouge, La; and Memphis, Tenn.

In the past three months more toll-free access has been added, bringing the total number of local access locations to more than 150. These sites are complemented by nationwide WATS coverage. New local access locations include: Chattanooga, Knoxville, and Nashville, Tenn; Charleston and Columbia, sc; Fresno and Hayward, Calif; Lexington, Ky; Jackson, Miss; Greensboro, NC; Manchester, NH; Spokane, Wash; Savannah, Ga; and Plymouth, Mich.

International access has also expanded with the addition of Austria, Italy, Hong Kong, and Singapore. Service is currently available in 15 foreign countries through arrangements with u.s. international record carriers and foreign postal telephone & telegraph administrations. Approval for service from 3 other countries is expected soon.

The Tymnet network now contains more than 350 nodes and is expanding at an average rate of more than 2 nodes per week. It supports access to about 200 host computers representing 50 distinct models from 15 manufacturers. More than a million user connections per month, involving up to 1800 simultaneous users, result in some 400k connect hours and 9.5G i/o characters per month.

### Revisions in Low-Speed Private Wire Rates Filed

A revision of rates for private wire and other transmission services up to 1200 bits/s has been filed with the Federal Communications Commission (FCC) by Western Union, Upper Saddle River, NJ 07458. Subject to FCC action, the rates will be effective Feb 1, 1979. The revised rates are expected to bring the company additional revenues of about \$3 million/year, and will be used to partially offset increased charges, dating from October 1978, for lines leased from the Bell system.

### Fiber Optic Cable Prices Reduced

Price reductions of as much as 40% on all PFX fiber optic cables have been announced by the Du Pont Co, Wilmington, DE 19898. Prices are based on quantity shipped. As examples, PFX-s120, hard plastic clad silica core cable has been reduced from \$2.25/m to \$1.95/m for less than 2 km, and \$1.35/m for 50 km

or more. PFX-140 all plastic cable, previously \$1.50/m, is now \$1.45/m for less than 2 km, and \$1.25/m for 50 km or more. PFX-PR140 lower attenuation all plastic cable, has been reduced from \$2.25/m to \$1.95/m for less than 2 km, and \$1.75/m for 50 km or more.

The company says that the lower prices are possible because of improved production technologies and increased sales volume. □

## The difference is operational reliability

PDP-11  
NOVA  
ROLM  
INTER  
DATA

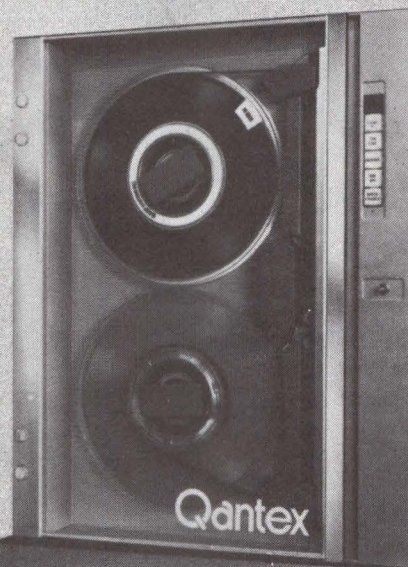

QANTEX  
TDX  
SERIES

- 75 IPS Industry Compatible
- Controllers for Minicomputers
- NRZ-800 BPI/PE-1600 BPI
- FLOATING SHUTTLE™ RESULTS:  
No tension arms/vacuum columns  
No down time/noise
- 300 IPS REWIND
- LOW POWER
- SOFTWARE COMPATIBILITY
- LOW COST

For more information on the Model TDX, call Leon Malmed, Sales Manager

**Qantex** DIVISION  
NORTH ATLANTIC INDUSTRIES, INC.

60 PLANT AVE., HAUPPAUGE, NEW YORK 11787 • 516-582-6060 • TWX: 510-227-9660

## Compact Mainframe Improves Productivity With Hardware/Software Advances

Hardware and programming technologies used in the System/38 combine to produce online power while supporting batch operations in a multiprogramming environment. Comprehensive workstation support, single level storage management virtual storage concept, and data base and online programming facilities are among the features incorporated in the machine by International Business Machines Corp, General Systems Div, PO Box C-1645, Atlanta, GA 30301.

Integral to the system's performance, reliability, and compactness, innovative semiconductor technologies allow the system to provide high levels of functionality with cost-performance improvements. Compared with those of the System/3, the processor's logic and RAM chips have up to 28 and 32 times the circuits and storage cells, respectively. RAM modules have densities of up to 256k bits using 64k-bit chips (see *Computer Design*, Jan 1979, pp 170). Also included are 36k- and 128k-bit modules that make use of 18k- and 32k-bit chips. Chip densities allow the memory to achieve eight times the packaging density of equivalent System/3 memory.

Advanced LSI technology, resulting in logic chips 4.6 mm square that contain up to 704 TTL circuits, implemented in the system allows the CPU to be packaged on a 10 x 15" (25.4 x 38.1-cm) planar board. Compared with the 25 circuits/chip and operating speeds of 8 to 12 ns of

the System/3, these LSI chips have 28 times the number of circuits and a nominal speed of 3 to 5 ns/circuit.

System/38 consists of IBM 5381 System Unit that includes processing unit, main storage, disc storage, console keyboard/display, diskette magazine drive, and workstation controller. Two performance level models—models 3 and 5—have nominal main storage cycle times of 1.100  $\mu$ s and 600 ns, respectively, per 4-byte access.

Main storage capacities of 512k, 768k, and 1024k are available for models 3 and 5; 1280k and 1536k capacities will be available in February 1980 for the model 5 only. From one to six spindles of non-removable disc storage provide capacities for from 64.5M to 387.1M bytes of data. Transfer occurs at 1031k bytes/s. The units have a 27-ms average seek time, 9-ms minimum seek, and 46-ms maximum seek. Single level storage management capability permits both main and disc storage to be managed as one system resource. Virtual address translation converts virtual storage addresses to real addresses. Incorporated in the high level object oriented instruction set are many basic supervisory, resource, security, and data base management functions.

System console is a standard CRT display and keyboard with 24 command function keys. Full console function is available at any attached 5251/5252 display except system power-on IMPL, start CPF, and other

functions requiring operator service panel.

Standard on all models are two 10-diskette magazine drives providing 12M bytes/magazine. With three individual diskette slots accommodating 1, 2, or 2D diskettes the units transfer at speeds to 125k bytes/s.

The control program facility operating system serves to transfer the burden of managing system operation and resources from the user to the computer. RPG III language and online programming facilities allow efficient development of workstation applications. Single level storage management based on virtual storage techniques isolates the user from problems of transient areas, program overlays, partition, and other storage management tasks. The system manages both main and disc storage facilities to give the appearance of a single large virtually addressed storage space.

Communications support is provided by the system for host to remote 5250 information display system devices. Ability for System/38 to be used as a terminal under SNA/SDLC protocol to System/370 IMS/VS or CICS/VS on models 135 through 168, and 3031, 3032, and 3033 processors, will be available in February 1980.

A complete System/38 will lease for \$2790/mo on a 3-yr lease; purchase price will be \$91,780. Deliveries are scheduled to begin in August. Circle 170 on Inquiry Card

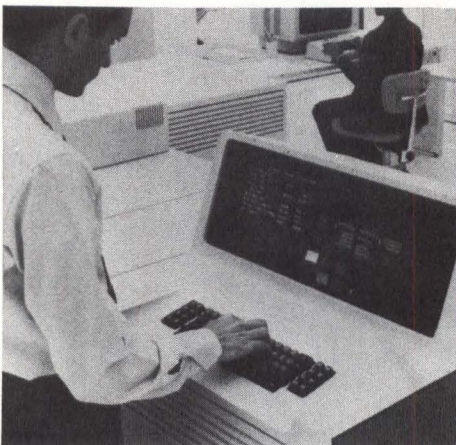

IBM's System/38 incorporates advanced architecture to accommodate online applications. Software takes over data management functions to make system easy to use and semiconductor technologies allow all to be provided in compact, price effective unit

## Optical Recording System Stores $10^{10}$ Data Bits On a 12" Disc

A diode laser optical recording system stores up to  $10^{10}$  bits of information on a pregrooved double sided 12" (30.48 cm) disc. Representing a 10 times increase in capacity over currently available magnetic disc pack systems, the system also provides access to any address in an average of 250 ms. In developing the system, researchers at Philips Data Systems, PO Box 523, Eindhoven, The Netherlands, used techniques

# NEC's Spinwriter repair kit.

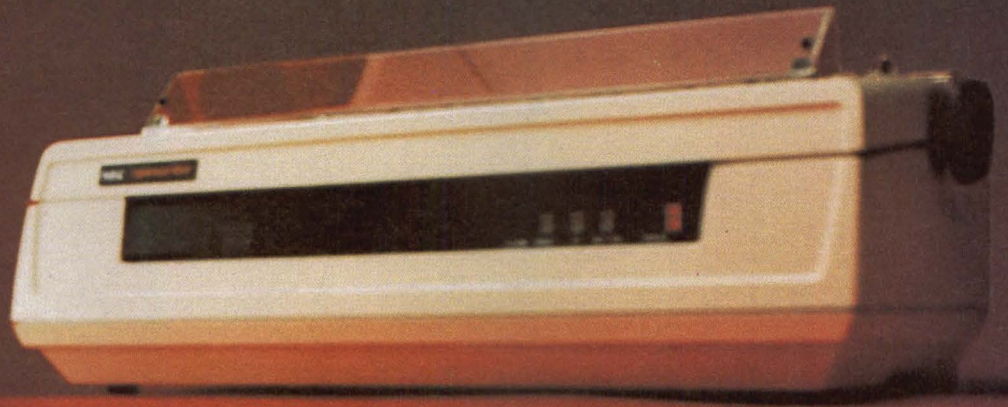

## One screwdriver. 30-minute MTTR.

NEC's Spinwriter character printers are a serviceman's dream.

That's because 90 per cent of all routine service problems can be fixed with nothing more than a #2 Phillips screwdriver. Result: your service rep can fix almost any printer problem in less than a half-hour.

Take the carriage assembly, for example. With most printers, it's a huge time-consumer to fix, and often requires shipment of the printer back to the factory. With Spinwriter printers, you remove three screws, lift the carriage out, insert a new one, and replace the screws. That simple. Ten minutes, no more.

Or printed circuit boards. Any one or all can be replaced by removing just two screws—so a Spinwriter board can be changed in just three minutes. Much faster than on other printers.

The operator control panel. A cinch. Remove four screws, and the entire assembly comes off—right down to the baseplate. The same is true with power

supply, fan, inverter block and keyboard assemblies. The only tool: a #2 Phillips.

Extraordinary serviceability? Sure. Now add to MTTR the Spinwriter MTBF—more than 2000 hours, the highest in the industry—and you get a printer that not only can be fixed faster, but one that needs very little service at all.

There's much more to Spinwriter printers: the superior print quality that comes from its unique thimble print element, the wide range of available fonts and forms-handling options, the eight most popular interfaces, and the whisper-quiet operation.

Find out more about Spinwriter character printers. And when you do, ask about our brand new Trimliner™ series of line printers too.



**NEC**

**NEC Information Systems, Inc.**

Eastern Office: 5 Militia Drive, Lexington, MA. 02173. (617) 862-3120  
Central Office: 3400 South Dixie Drive, Dayton, OH. 45439. (513) 294-6254  
West Coast Office: 8939 S. Sepulveda Blvd., Los Angeles, CA. 90045. (213) 670-7346

CIRCLE 40 ON INQUIRY CARD

# The Bantam.

## The cocky new \$599\* CRT that just changed the pecking order.

User Need	Feature	P-E BANTAM	LSI ADM-3A	Hazel- tine 1400	Hazel- tine 1500	Adds Regent 100
Easy to read display	7 x 10 matrix for highly legible characters	Yes	No	No	Yes	No
	Black on white or white on black display	Yes	No	No	Yes	Yes
	Display set deep in hood to reduce glare	Yes	No	No	No	No
	Full 24 x 80 display	Yes	Yes	Yes	Yes	Yes
	Full upper and lower case	Yes	Option	No	Yes	Yes
	Non-glare screen	Option	Yes	No	Yes	Yes
High operator throughput, low operator fatigue	Tab stops/tab key	Yes	No	No	Yes	Yes
	Backspace key	Yes	No	No	Yes	Yes
	Repeat key	Yes	Yes	No	No	Yes
	Shiftlock key	Yes	No	No	No	No
	Separate print key	Yes	No	No	No	Yes
Convenient switching Local/on-line	Local—remote key	Yes	No	Option	Option	Yes
International Character sets	French/German/Swedish/Danish/British/Spanish	Option	Option	No	Option	Option
High speed numeric	Integrated numeric pad	Yes	Option	No	Yes	Yes
Convenient system interfacing	RS-232/CCITT-V24	Yes	Yes	Yes	Yes	Yes
	Current loop	Option	Yes	No	Yes	Yes
Simplified program debugging	Transparent mode and displayable control characters	Yes	No	No	No	No
Faster maintenance	Self-test	Yes	No	Yes	No	Yes
Minimum desk space	Small size	15Wx 19Dx 14H	15.5Wx 20.2Dx 13.5H	15.5Wx 20.5Dx 13.5H	15.5Wx 20.5Dx 13.5H	21Wx 23Dx 14.5H
Printer port	Printer port	Option	Yes	No	Yes	Option
Cost effectiveness	Qty. 100 OEM price	\$599†	\$740	Less than \$550 in quantity 1000	\$860	\$895

\*In quantities of 100.  
†Qty. 1, End User Price \$966.

Nobody ever offered you a tough, high quality, compact CRT like the BANTAM before. At \$599 or any price. Designed for hectic office environments. And, human engineered to make an operator's life easier.

**You get everything you need for cleaner input and faster throughput.** An upper and lower case character set displayed on a sharp 7 x 10 dot matrix. A full 24-line by 80-character screen. A complete, sure-touch keyboard with shadow numeric pad.

You get complete tabbing. Full cursor addressing. Repeat, backspace and shiftlock keys. A transparent mode with displayable control characters to simplify host program debugging. And, a self-test mode for easy maintainability.

**And, you get everything your operators need to make their jobs a joy.** A hooded display that cuts glare. A wide bandwidth monitor for sharp images everywhere on the screen. Below-the-line character descenders<sup>1</sup> to make reading easier.

A switchable white-on-black or black-on-white display, whichever your operator prefers. An easy-to-find cursor that frames the entire character position in a transparent, inverted video block.

**Plus plenty of options you can't get with CRTs costing much more.** Like our low-cost Pussycat page printer. A full range of foreign language character sets. We even have a model you can switch from ASCII to full overstrike APL.

**But that's not all.** The BANTAM's compact good looks fit any decor. It's handsome enough for executive row and rugged enough for the stockroom. Silent? The BANTAM's fan-free design makes it quieter than an electric typewriter. And, the BANTAM only weighs 28 pounds.

**Only an industry leader like Perkin-Elmer could do it.** We designed a powerful, custom LSI controller chip that makes the BANTAM the one and only high quality CRT in its class.

But see for yourself. Use the comparison chart. Learn why we're so proud to add this \$599 CRT to the 250,000 peripherals that bear our good name.

And, remember our terminals come equipped with a No Hassle, 800 toll-free service phone number.

**One call does it all.** We give you service *where* you need it, when you need it. We're there. Not just "worldwide," but wherever you are.

For more information call or write Perkin-Elmer Terminals Division, Randolph Park West, Route 10 & Emery Avenue, Randolph, N.J. 07801 (201) 366-5550. Or contact any of our sales offices. Then watch the feathers fly.

## The Bantam's available at all these places

### PERKIN-ELMER SALES OFFICES

Santa Clara, CA (408) 249-5540.

Tustin, CA (714) 544-9093.

Atlanta, GA (404) 393-8440.

Arlington Heights, IL (312) 437-3547.

Waltham, MA (617) 890-1305.

Oceanport, NJ (201) 229-4471.

McLean, VA (703) 827-5900.

Singapore, Republic of  
Singapore 2200949

Sydney (North Ryde), Australia  
887-1000.

Toronto (Mississauga), Canada  
(416) 677-8990.

Slough, England 753-34511.

Paris, France 664-1858.

Munich, Germany 089-753081.

Schiphol-Oost,

The Netherlands 020-458-269.

### PERKIN-ELMER SERVICE CENTERS

Randolph, NJ; Oceanport,

NJ; West Long Branch, NJ;

Rochester, NY; Boston, MA;

Hartford, CT; Philadelphia,

PA; Pittsburgh, PA;

Washington, DC; Atlanta,

GA; Orlando, FL; Cleveland,

OH; Dayton, OH; Englewood

Cliffs, NJ; Detroit, MI;

Chicago, IL; Minneapolis,

MN; Kansas City, KS; Tulsa,

OK; Dallas, TX; Houston, TX;

Denver, CO; Phoenix, AZ;

Seattle, WA; San Francisco,

CA; Los Angeles, CA;

Orange County, CA; San

Diego, CA.



**PERKIN-ELMER**

Data Systems

# Grinnell has your display...

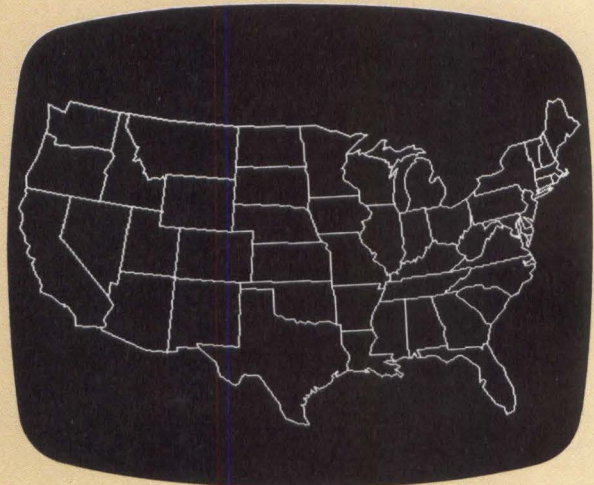
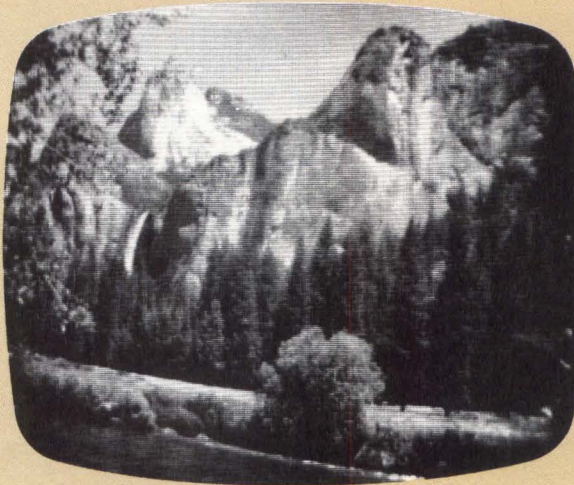
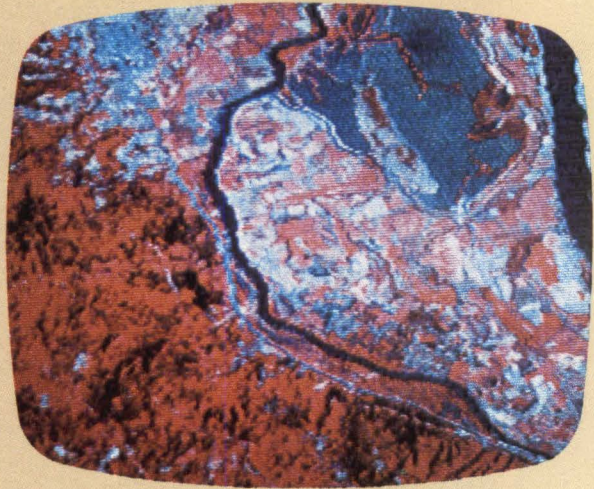
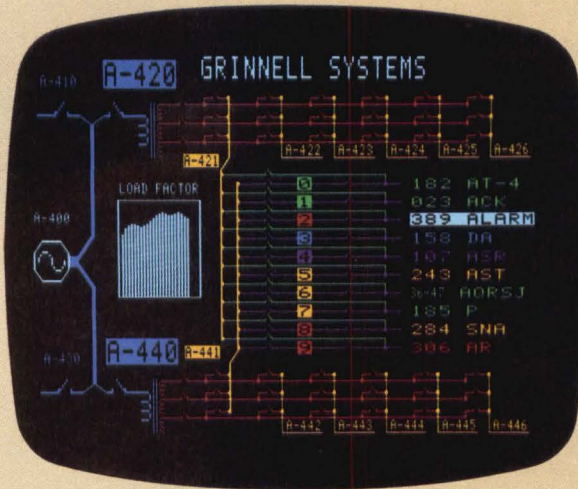

## from low cost imaging and graphics to full color image processing

Our modular, solid state systems can meet your computer display requirement, easily and economically.

And, they're intelligent. Every system has a complete alphanumeric and graphics package, and a powerful instruction set that simplifies programming—no need for complex macro-instructions and high order programming languages.

There's also a choice of standard resolutions: 256 x 256, 256 x 512, 512 x 512 (30 Hz or 60 Hz refresh) and 1024 x 1024. Plus plug compatible interfaces for most minis.

Options include overlays, function memories, pseudo-color tables, zoom and pan, independent cursors with trackball and joystick controls, split-screen, image toggling, and real time digitizers that grab and store images and sum consecutive frames.

Grinnell displays are already used for tomography, ERTS imaging, process control, image processing, animation and much more. All systems drive standard TV monitors.

So before you choose a display system, let our experts show you how to maximize performance and minimize cost. For details, and/or a quote, call or write.

# GRINNELL SYSTEMS

2986 Scott Boulevard, Santa Clara, California 95050 (408) 988-2100

CIRCLE 42 ON INQUIRY CARD



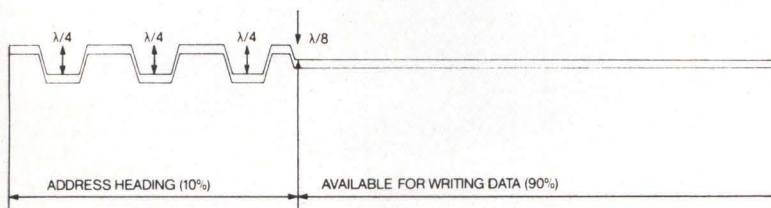
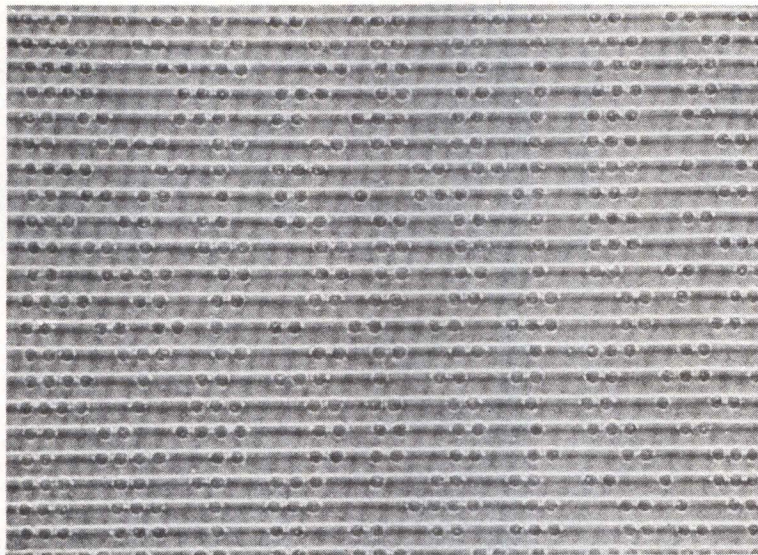

Detailed electron microscope photo of pregrooved track on disc used with Philips' diode laser recording system. Spiral groove measures  $0.6 \mu\text{m}$  wide and  $0.06 \mu\text{m}$  deep; distance between tracks is  $1.67 \mu\text{m}$ . Cross-section diagram shows pregrooved track on which data may be written together with one-quarter wavelength headings

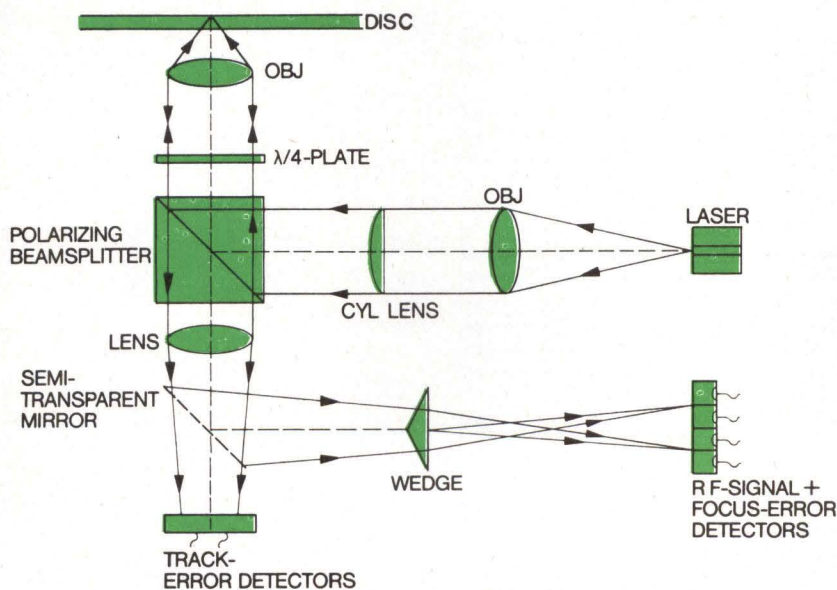

Optical system of Philips' diode laser recorder serves to concentrate laser light power into  $1\text{-}\mu\text{m}$  spot size on recording layer and to generate suitable signals for focusing and tracking errors of spot

similar to those developed for video long play systems.

An AlGaAs DH type diode laser employing a  $0.1\text{-mm}$  square semiconductor chip housed in a transistor sized encapsulation is mounted in a compact 40-g optical system which also contains the electro-optics for radial tracking and focusing. The recording medium is a sensitive tellurium-based material with an air sandwich construction to protect data while maintaining recording sensitivity.

The discs are formed by using video long play (VLP) techniques to produce relief headings in plastic substrates with a shallower pregroove between headings. The recording material is evaporated onto the surface of the disc and two discs are placed back to back in the sealed air sandwich construction. The 1-mm thick plastic substrate provides optimum protection from dust, fingerprints, and scratches. The objective lens of the optical system is positioned 2-mm away from the surface of the substrate, eliminating the low clearance problem of magnetic systems.

The diode laser system writes data by melting micron sized holes into the recording medium. Data written this way are read in reflection. The system detects the difference between a high light level coming from the reflective surface and a low light level coming from the hole where the majority of the light escapes. These light levels are converted into corresponding electronic binary signals to represent data bits.

Random access to data is provided by the use of a pregrooved track having a depth of one-eighth of a wavelength, together with address headings. The optical system tracks along the pregroove, finding and reading headings. There are 128 sectors/track and 45,000 spiral tracks; each sector can store 1k bits. With a disc rotation speed of 2.5 r/s,  $5 \times 10^9$  bits can be accessed in an average of 250 ms.

While the need for absolute positioning accuracy is eliminated by use of the pregroove, precise, rapid positioning is still necessary. This is achieved by mounting the optical system on an arm driven by a linear motor. An optical grating on the arm quickly brings the optics to within 10 tracks, and track reading followed by sector reading takes over. With this technique only 100

Who do you think of  
for a complete line of 8-bit microprocessors?

# Next time,

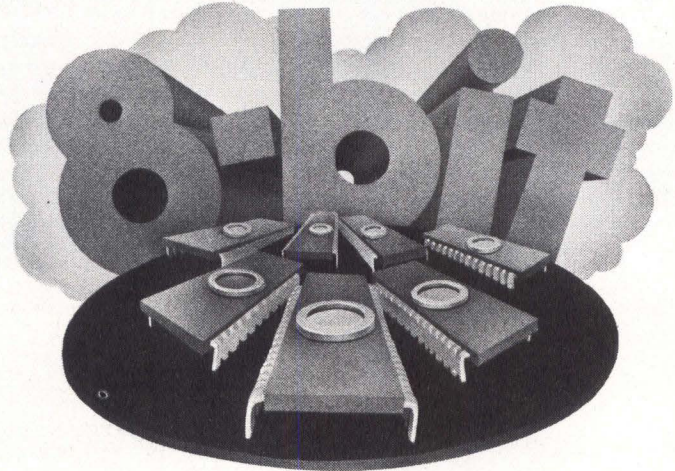

If you haven't checked into our 8-bit line recently, take a look at what you've been missing.

We've got everything you need in 8-bit

### Our 8-bit Families

$\mu$ PD 8080AF	$\mu$ PD 8085A	$\mu$ PD 8048	$\mu$ PD 780
$\mu$ PD 8080AF	$\mu$ PD 8085A	$\mu$ PD 8048	$\mu$ PD 780
$\mu$ PD 8080AF-2	$\mu$ PD 8085A-2	$\mu$ PD 8049	$\mu$ PD 780-1
$\mu$ PD 8080AF-1		$\mu$ PD 8039	
$\mu$ PD 8041		$\mu$ PD 8035	
	$\mu$ PD 8155		
	$\mu$ PD 8156		
$\mu$ PB 8212			
$\mu$ PB 8214			
$\mu$ PB 8216/26			
$\mu$ PB 8224			
$\mu$ PB 8228/38			
		$\mu$ PD 8243	
$\mu$ PD 8251/A			
$\mu$ PD 8253			
$\mu$ PD 8255/A-5			
$\mu$ PD 8257			
$\mu$ PD 8259			
$\mu$ PD 8279-5			
	$\mu$ PD 8355		
$\mu$ PD 765			

processors—plus a full assortment of industry standard peripherals and memories. And we've got them all in volume, ready to ship.

Not only do we support the entire 8080A family; we also offer the lower-cost single-chip 8048 family and the higher-performance 8085A series.

And for those with applications that require the capability of a Z80™ we have

the fully compatible  $\mu$ PD780—supported by the full family of 8080 peripherals.

TM Zilog

REPS: Action Unlimited, Arlington, TX; Spring, TX. Burton-Medley Associates, Grandview, MO. Cerco, San Diego, CA. Contact Sales, Inc. Burlington, MA. D/Z Associates, Inc., Denver, CO. Electronic Innovators, Inc., Minneapolis, MN. Eltron, Phoenix, AZ. HLM Assoc., Northport, NY; Parsippany, NJ. Imtech, Inc., Cleveland, OH; Dayton, OH. Kaytronics Limited, Ville St. Pierre, Quebec; Downsview, Ontario; Surrey, British Columbia. L & M Associates, Pikesville, MD; Montpelier, VA. Harry Nash Associates; Willow Grove, PA. R.C. Nordstrom & Company, Lathrup Village, MI. Perrott Associates, Inc., Fort Lauderdale, FL; Clearwater, FL; Orlando, FL. Santana Sales, Costa Mesa, CA. Stone Component Sales, Waltham, MA. Technology Sales, Inc., Palatine, IL. Trident Associates, Inc., Sunnyvale, CA. Tri-Tronix, Albuquerque, NM. Tri-Tronix, NW., Mercer Island, WA. 20th Century Marketing, Inc., Huntsville, AL; Greenville, TN. Wolff's Sales Service Company, Raleigh, NC.

DISTRIBUTORS: Almo Electronics Corp., Philadelphia, PA. Baltimore, MD. Bell Industries, Bellevue, WA. Century Electronics, Albuquerque, NM; Wheatridge, CO; Salt Lake City, UT. Norman Davis Electronics, South Euclid, OH. Diplomat/Westland, Inc., Sunnyvale, CA. Diplomat/Southland, Inc., Clearwater, FL. Diplomat/Lakeland, Inc., Elk Grove Village, IL. Diplomat/IPC of Mass., Chicopee Falls, MA. Diplomat, Holliston, MA. Diplomat/Northland, Inc., Farmington, MI. Diplomat/Electro-Com

# think NEC.

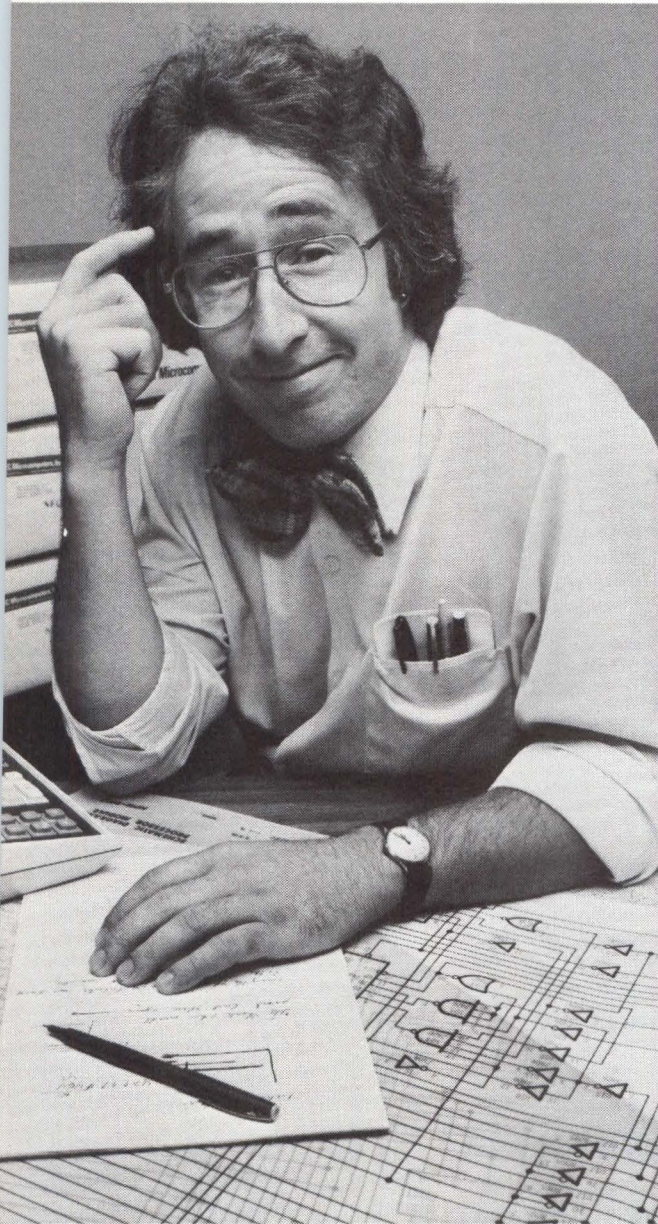

We can also fill your needs for a wide range of high-performance peripherals, including our IBM-compatible, double-density, double-sided floppy disc controller, the  $\mu$ PD765.

NEC not only means advanced technology and volume delivery; we also offer remarkable product reliability—thanks to experienced designers and meticulous manufacturing techniques, backed up by 100% burn-in and testing with MIL-STD-883 methods.

What's more, we give you thorough support—including documentation, design assistance, and product development services. And our engineers are always available to help with specific application problems.

Our new catalog will give you a better idea of just how much we can do for you, not just in 8-bit products, but also in 4-bit single-chip processors and 1K, 4K and 16K memories.

For your free copy, clip your business card or letterhead stationery to this page and send to:

NEC Microcomputers, Inc.,  
173 Worcester Street, Wellesley, MA 02181.

If you haven't thought of NEC before, you will.  
Next time.

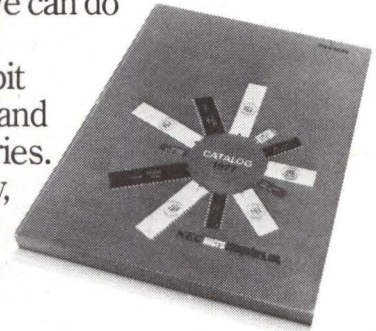

## NEC Microcomputers, Inc.

Corp., Minneapolis, MN. Diplomat/St. Louis, Inc., St. Louis, MO. Diplomat/IPC Corp., Totowa, NJ; Mt. Laurel, NJ. Diplomat Electronics Corp., Woodbury, NY. Diplomat/Alta-Land, Inc., Salt Lake City, UT. Future Electronics Corp., Montreal, Quebec; Rexdale, Ontario; Ottawa, Ontario. Hughes-Peters, Inc., Cincinnati, OH; Columbus, OH. Intermark Electronics, Sunnyvale, CA; Santa Ana, CA; San Diego, CA. Kent Electronics, Houston, TX. G.S. Marshall, Sunnyvale, CA; Irvine, CA; El Monte, CA; San Diego, CA; Phoenix, AZ. Milgray Electronics, Inc., Freeport, NY; Orange, CT. Reptron Electronics, Inc., Livonia, MI. Resco/Raleigh, Raleigh, NC. Semiconductor Specialists, Inc., Chicago, IL; Burlington, MA; Farmington, MI; Minneapolis, MN; Hazelwood, MO; Pittsburgh, PA; Dallas, TX; Milwaukee, WI. Sterling Electronics, Phoenix, AZ; Sun Valley, CA; San Diego, CA; Baton Rouge, LA; Waltham, MA; Albuquerque, NM; Dallas, TX; Houston TX; Seattle, WA. Summit Distributors, Inc., Buffalo, NY. Summit Elec. of Roch., Inc., Rochester, NY. Technico, Inc., Columbia, MD; Roanoke, VA. Western Microtechnology Sales, Sunnyvale, CA.

REGIONAL SALES OFFICES: Western Region, NEC Microcomputers, Orange, CA (714) 633-2980. Eastern Region, NEC Microcomputers, Melville, NY (516) 293-5660.

CD-1-2

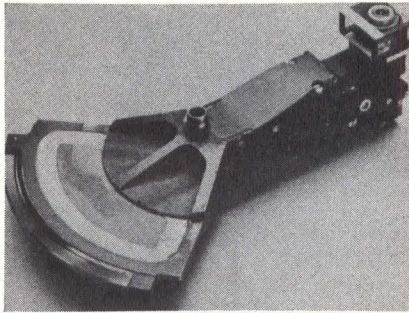

Rapid yet precise positioning of optical system is achieved by mounting system (top right corner) on arm which is driven by linear motor. Optical grating on the arm brings optics within 10 tracks; track and sector reading accomplish precise positioning

ms is required to go from outer to inner track.

When the required address is reached a voice coil is used to control the position of the objective lens relative to the recording layer to within 1  $\mu\text{m}$ . The same linear motor used for random access is used for tracking; eccentricities of up to 100  $\mu\text{m}$  are reduced to a track error of 0.1  $\mu\text{m}$ .

Virtually error free retrieval of data is achieved using a combination of data modulation, interleaving of code words throughout a sector, and 20% redundancy. In this way, 99.9% of all errors are detected and automatically corrected; the remaining 0.1% are detected within the system and data from the affected sector are rewritten into a new sector.

The system's high recording density, combined with archival storage retention, provides the potential for magnetic tape and disc replacement in a range of applications. Improvements in data density as the technique develops should provide future costs per bit that are significantly less than others available.

Circle 171 on Inquiry Card

### Additions to Computer Line Extend Flexibility And Cost-Effectiveness

Making system configuration simpler and ensuring the ability of systems to expand to meet requirements, additions to the vs computer line include enhanced capabilities, communications controllers, input/output processors, and peripheral options.

The products add features to the line that increase its attractiveness in the distributed processing network environment, to first time users, and in system conversion areas, according to Wang Laboratories, Inc, One Industrial Ave, Lowell, MA 01851.

The 2249V-6 remote cluster controller capable of supporting up to six serial workstations or serial printers for remote operation; 2246R workstation capable of functioning as a standalone unit supporting its own printer; and 22V06-3 communications i/o processor which can support three bisynchronous communications lines comprise the communications offerings. The 2249V-6 serves as the nucleus of a remote processing center consisting of as many as six serial workstations and printers, each located up to 2000 ft (609 m) from the remote controller.

Serving as a self-contained remote terminal with its own communications controller, the 2246R has a built-in parallel interface that permits a single parallel printer to be connected to the workstation for hard-copy output at the terminal site. It may be extended an unlimited distance from the central processing unit via telephone lines operating at speeds up to 9600 bits/s. Both remote cluster controller and remote workstation contain microprocessor driven communications controllers which communicate with 22V06 series input/output processors using a user-transparent protocol.

Supporting a single bisynchronous, two separate, or three separate lines, the 22V06-1 provides an automatic calling unit, while models -2 and -3 supply capability to independently and concurrently handle more than one type of communications protocol. This approach gives the user the ability to use either single or multi-user remote interactive processing or to combine the two.

A serial workstation, the 2246S, contains a CRT screen with 24 lines of 80 char/line, capable of displaying the u/lc ASCII char set. The workstation input/output processor (IOP) supports up to 16 serial workstations and printers at distances up to 2000 ft (609 m). IOPs control operation of i/o devices to relieve the CPU of handling individual device operation. Each has its own path to main memory so that i/o can be performed concurrent with processing, enhancing performance and speed

and forming an efficient system architecture.

Offered with one 15M-byte removable and one 15M-byte fixed disc platter, one removable and two fixed, or one removable and three fixed platters, the 2280V disc drive provides for critical backup of files and data records. In addition, it provides improved and more efficient accessing and copying speeds. The 22V08 IOP controls four disc drives in any combination of 2280V and 2265V, making it easier to configure a system to meet specific application needs.

A 9-track tape transport and IOP (2209V-2 and 22V05-2) offer large capacity storage that is interchangeable between vs and other company systems. Supporting both 800- and 1600-bit/in (315 and 630/cm) recording densities, the transport moves tape at 75 in (190 cm)/s during read and write operation, and at up to 200 in (508 cm)/s during rewind. The unit provides for read after write verification and automatic correction of single track errors and detection of multiple track errors.

Circle 172 on Inquiry Card

### Minicomputer Analyzes ATE Generated Data, Develops Tester Software

A high performance host computer system, Integrator™ II provides a central data base for processing and analyzing data generated by automatic test systems. In addition, the system, introduced by the Test Systems Group of Fairchild Camera and Instrument Corp, 1725 Technology Dr, San Jose, CA 95110, can be used for developing tester software, and providing data analysis, report generation, display, and communication of data.

With five times the processing power of its predecessor achieved through expanded hardware and software, the basic system consists of a Hewlett-Packard Series 1000 computer system (see *Computer Design*, Nov 76, pp 27, 30; June 78, pp 42, 46) modified with microcoded instructions.

The CPU has 19.6M bytes of disc storage and 128k bytes of main memory. Disc is expandable in increments of 19.6M or 50M bytes to a maximum of 400M bytes. Other hardware includes a standard video keyboard terminal, medium speed printer, and 800-bit/in (314/cm) magnetic tape drive.

Processing speed and arithmetic precision are provided by a combina-

# more electro-optical solutions!

OUR  
**10<sup>TH</sup>**  
ANNIVERSARY

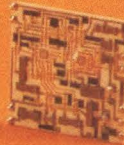
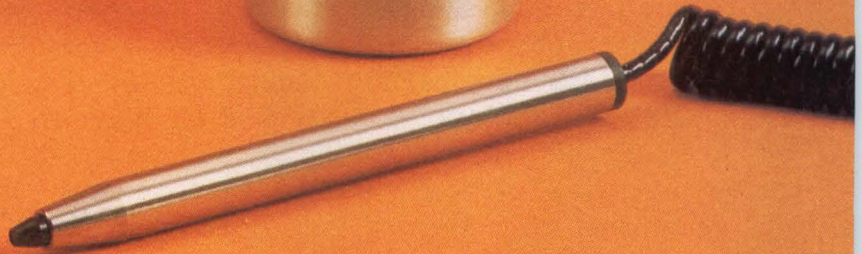
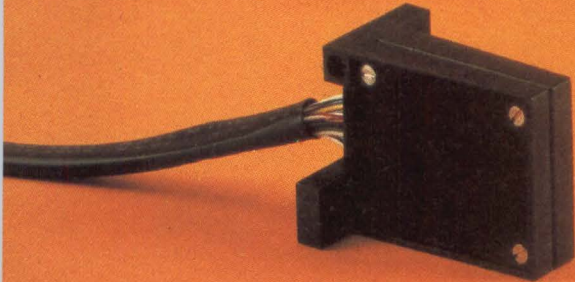
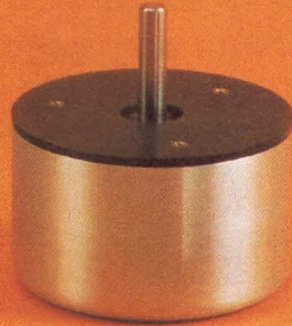

It's ten years since HEI produced the industry's first optical switch, and our capabilities have grown with the years. Take a look at a few of our latest electro-optical solutions.

1. Hand-fed Card Reader — reads both punches and marks with no adjustment. Thirteen channel square-wave output with strobe. Can be custom configured, and carries lowest price on the market. **Circle 43**

2. Incremental Encoder — low cost encoder includes disk and sensors. Provides square-wave output and broad temperature capability. Built to last. **Circle 44**

3. Compact Light Pen — extra slim stainless-steel case, integral hybrid circuitry. Can be ordered with specified field of view and sensitivity. Needs only 5VDC. One of several in our light pen family. **Circle 45**

4. Custom Optical Switch — contains light source(s) and sensor(s) plus hybrid control circuit. Square-wave output. Customer specifies size and gap spacing. **Circle 46**

5. Hybrid Circuit — HEI specializes in high-density thick film circuits. We are competitive at any quantity level or circuit complexity. Experienced supplier to demanding customers for a decade. Need design help? Ask us. **Circle 47**

6. Multi-Channel Reader — economical 2 to 14 channel optical reader widely used for high-speed printer control. TTL outputs with up to ten fanouts per channel. **Circle 48**

This is just a sample of HEI products. We also supply a variety of optical switches, arrays, shaft encoder devices. If you can't find just what you need, HEI will build it at the right price. Got problems? HEI has electro-optical solutions!

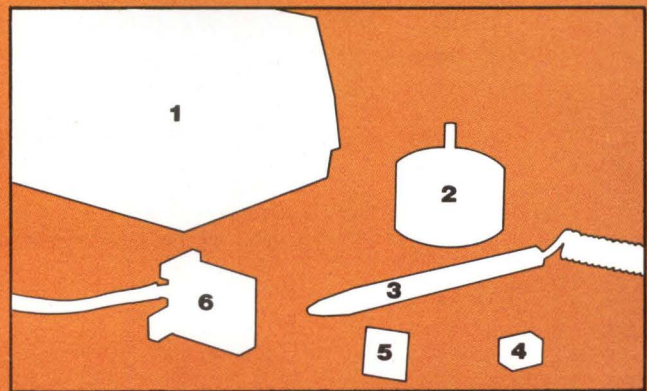

The Optoelectronic Specialists

**HEI inc.**

Jonathan Industrial Center • Chaska, MN 55318 • 612/448-3510

# HIGH RELIABILITY DIP SOCKETS.

**Robinson Nugent "side-wipe" DIP sockets make 100% greater contact than any edge-bearing socket on the market.**

This 100% greater contact with the wide, flat surface of your IC leads is your guarantee of unmatched reliability. This RN "side-wipe" contact provides constant low contact resistance. No edge-bearing contact can possibly deliver this long term dependability. This designed-in reliability of RN DIP sockets is your assurance of trouble-free IC interconnects—yet they cost no more than ordinary sockets.

**Put an end to troublesome junk sockets!** Get your copy of the new R-N "Short-Form" Catalog of production DIP sockets—both solder and wrap-pin. It is available now from R-N—the people who make more kinds of high reliability IC sockets than anyone.

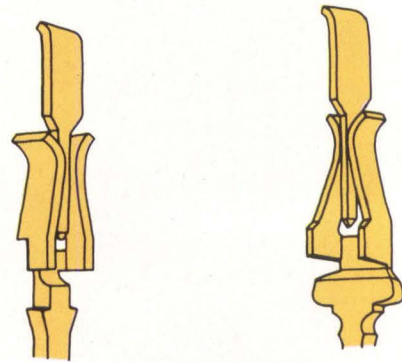

**IC Lead frame in place in an ordinary edge bearing contact.** The rough, irregular edge of the IC lead can scar and abrade the socket contact. Electrical contact is degraded, resistance is increased and reliability may be impaired.

**IC Lead frame in place in R-N "Side-Wipe" contact.** Here the smooth, flat side of the IC lead mates with the contact. Contact surface integrity is maintained, socket reliability is greatly enhanced. And you pay no more for this R-N reliability.

Get the **high reliability** that eliminates trouble. RN DIP sockets make contact with the wide, flat sides of your IC leads. This provides **100% greater surface contact** for positive electrical connection.

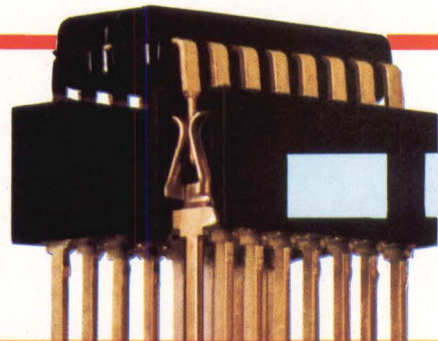

**WRITE TODAY** for latest R-N "Short Form" Catalog of R-N production DIP sockets. Contains full specs, dimensions and material data. Get yours now.



# **RN** **ROBINSON NUGENT, INC.**

800 East Eighth Street • New Albany, Indiana 47150 • Phone: (812) 945-0211 • TWX: 810-540-4082

CIRCLE 49 ON INQUIRY CARD

...for the price you're  
paying for junk!

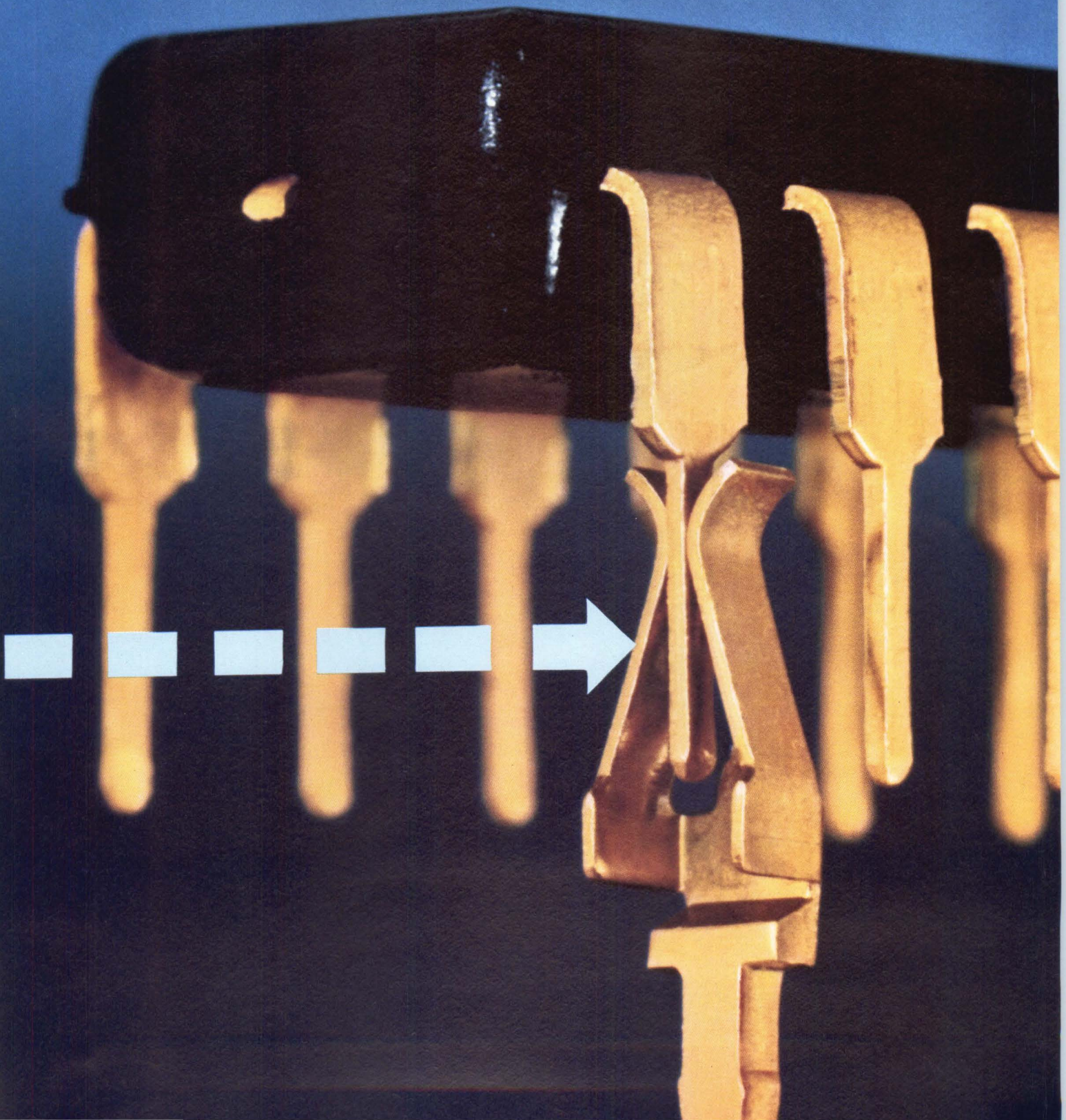

# $\mu$ P $\mu$ P and away



*Futuredata introduces  
the development system  
that sets you free.*

This newest development in development systems sets you free to cope with the expanding world of  $\mu$ P-based product design. Free to design with the 8086, 8085, 8080, 6800, 6802 or Z-80 and free to add many other processors soon. This system puts universal hardware and software development capabilities at your fingertips: real-time in-circuit emulation to 5 MHz, real-time 48-channel logic analyzer, up to 2 megabytes of disk memory, and every software aid, including high level language compilers,

relocating macro-assemblers and disassembling symbolic debuggers. CPU, CRT and keyboard are all neatly integrated in one compact, mobile station to liberate more of your bench space. It's the universal, compact, state-of-the-art AMDS — Advanced Microcomputer Development System. Futuredata, 11205 S. La Cienega Blvd., Los Angeles, CA 90045. (213) 641-7700 TWX: 910-328-7202.

**futuredata**



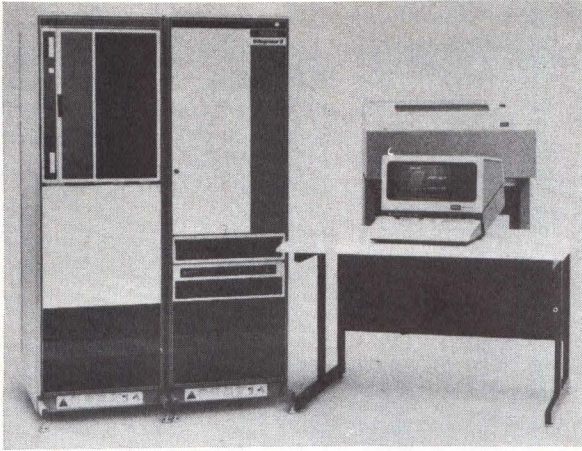

Fairchild's Integrator™ II serves as host computer to automatic test equipment, providing data base for processing and analyzing tester generated data. It can also be used to develop software for Sentry testers

tion of a high speed central processor, high performance floating-point processor, and fast FORTRAN processor. The floating-point processor executes single and extended precision operations in 4.9 to 6.2  $\mu$ s; the fast FORTRAN processor speeds up common FORTRAN routines by a factor of 2 to 20. Data analysis capabilities include histograms, wafer maps, scatter plots, trend reports, detail listings, and schmoo plots.

Multiple test engineers can write and edit programs using FACTOR, the Sentry™ test language, and can then download them via the communications link to the test system. A master test program library can be developed on the system, giving all testers access to the same up to date programs.

The system is capable of interfacing with up to eight testers simultaneously. Up to 32 terminals can be hardware connected from distances to 16,000 ft (4876 m) or can be connected via dial-up or leased phone lines. Compatibility with Sentry magnetic formats allows the system to support remote testers not connected to the system. An interface with IBM System/360, /370 computers is also available.

Circle 173 on Inquiry Card

**Desktop and Full-Featured Units Added to Hardcopy Terminal Line**

Hardcopy terminals added to the DECwriter line are claimed to extend the line in terms of both price and functionality. Models introduced by Digital Equipment Corp, Maynard, MA 01754 consist of 180-char/s LA120 and two tabletop IV series units, the LA34 and LA38.

Created for use in a business office, series IV units are similar to electric typewriters in basic operation and appearance, with a contoured keyboard, snap-in ribbon cartridge, and quiet operation. The LA34 uses a rubber platen and accepts roll type or sheet paper. The LA38, a tractor feed version, also has a separate keypad for numeric entry.

Both serial asynchronous terminals use a 9 x 7 dot-matrix character to provide upper and lower case output. Users can select any of four character sizes including a compressed font which can put 132 char on an 8.5" (21.59-cm) wide piece of paper.

Output rate of 30 char/s is maintained using a buffer that stores characters being received while the unit is executing a carriage return. Burst mode accelerates the print head until it catches up with the transmission.

Intended for use as console terminal in standalone and timesharing computer systems, the DECwriter III is designed for applications requiring a high rate of data transfer and a high degree of interaction between

computer and user. A special purpose microprocessor permits selection of 45 features either from the keyboard or under program control.

The bidirectional printer has logic that moves the print head to the margin closest to its position when it ends a line. Also incorporated are a 1k-char buffer and logic which permits it to skip over areas not requiring printing. This allows the unit to accept data at a 1200-baud rate. Although intended for use at 1200 baud, the unit can communicate at rates from 50 to 9600 bits/s.

Eight font sizes (based on a 7 x 7 dot matrix) are offered—from 5 to 16.5 char/in (1.9 to 6.5/cm). Using compressed font, the unit can print 216 columns across 14.875" (37.78-cm) wide forms. Six different line spacings can be specified.

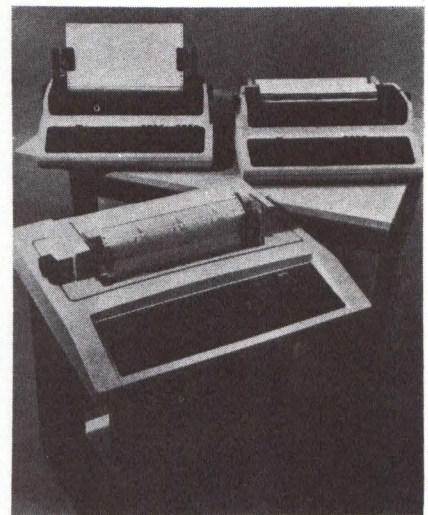

Digital Equipment's LA120 (foreground) prints copy bidirectionally at 180 char/s, offers choice of eight character spacings, has 1k-char input buffer, and uses microprocessor controlled logic to permit more than 45 settings by keyboard selection. Tabletop DECwriter IV units (background) have size, weight, and layout of electric typewriters

Circle 174 on Inquiry Card

# Interconnections driving you haywire?

See page 75

## Multiprocessor Computer System Delegates Functions Between CPUs

Meeting the goals of large online storage capability and high throughput, the MICOS 300 results from application of microprocessor technology wherever it provides the maximum return in performance. The supermini class computer designed by Mini-Computer Systems, Inc, 525 Executive Blvd, Elmsford, NY 10523 improves file operation speed by increasing sector size from 512 to 2048 bytes. CPU operating speed is improved by performing application program execution in a separate CPU, terminal related processing in a separate front-end processor, and arithmetic operations in a separate arithmetic processor.

A typical configuration consists of host processor, providing all operator control and high level peripheral file operations; attached processor for terminal related processing and application program execution; high speed interprocessor bus; decimal arithmetic processor; microprocessor driven 8-port multiplexers; 80M- or 300M-byte disc drives, 300- or 600-line/min printer, system console, and up to 24 CRTs. The 300M-byte disc drives have a directly addressable capacity of 256M bytes, giving total system capacity of 1G bytes.

Available on any of the company's systems, the MICOS Asynchronous Communications Controller (MACC) is a microprocessor driven device which performs character by character processing formerly done by the system CPU. Each controller requires a single CPU card slot and contains microprocessor, 2k-byte ROM program storage, 2k-byte RAM working storage, I/O bus interface, and eight asynchronous line interfaces.

A decimal arithmetic processor is available to provide processing for decimal arithmetic functions and data conversions, including I/O conversions and data reformatting. Fast bipolar devices in the unit offer increased speed in arithmetic operations and a concurrent decrease in CPU load and memory requirements. Components include a fast decimal ALU, 8k-byte ROM program storage, 128-byte RAM working storage, and I/O bus interface. Operating system software incorporated on the board provides all functional operations.

Circle 175 on Inquiry Card

## Backup Feature Provides Processor Redundancy in Network System

A dual processor network processing system allows users to configure a completely redundant backup system without purchasing two sets of peripheral units. Specifically designed for critical applications the SyFA Cloned-Processor System (SYCLONE™) represents a further step in the Virtual Network™ concept developed by Computer Automation, Inc, 2181 Dupont Dr, Irvine, CA 92713.

Included in the dual processor system are a primary processor, a backup redundant processor, and a switching station module. The redundant processor is an exact duplicate of the primary processor, and the switching station is used to transfer control of peripheral units from primary to redundant processor in case of processor failure.

If a problem occurs in the primary processor, the system operator need only unlock a master key switch on the switching station and press an appropriate button. This brings the redundant processor online and places all peripheral devices under its control. When the problem has been resolved, the switching station is reactivated, returning control to the primary processor.

A desktop enclosure houses the processors and disc drives; the switching station is freestanding. The system may contain up to 8 disc drives in any mix of 32M-, 80M-, or 300M-byte units, 32 CRT terminals, 4 spooled line printers, 32 character printers, and 2 concurrent synchronous communication channels. The system operates under the standard version of the SyFA Concurrent Logic Operating System, a virtual storage system which supports concurrent execution of 32 interactive foreground applications programs, 16 batch background jobs, 4 printer spooling jobs, plus 2 synchronous communication tasks.

Circle 176 on Inquiry Card

## Logic Analyzer Supplies Triggering/Recording For Software Debugging

A desktop logic analyzer that retains the versatility necessary for software

debugging, the 2701D measures 9.5 x 13" (24.1 x 33 cm) and weighs 7 lb (3 kg) yet supplies the triggering and data recording capabilities found on larger instruments. Introduced by Gould Inc's Biomation Div, 4600 Old Ironsides Dr, Santa Clara, CA 95050, the instrument can capture and record on 27 input channels, permitting simultaneous recording of ad-

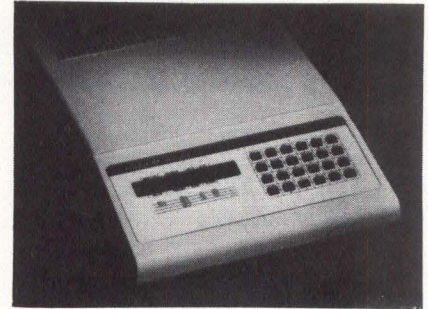

Biomation's compact 2701D logic analyzer triggers on any combination of 1s, 0s, and don't cares, and operates in three display modes to provide the flexibility necessary for software debugging of system under development

dress and data buses and microprocessor status information, and storing up to 64 words at a 10-MHz clock rate.

Trigger event can be specified as any combination of 1s, 0s, or don't cares. The recording sequence is initiated by the Arm button on the keyboard, and allows recording of address and data patterns executed after a specified precondition. Nested triggering can be implemented using a sequence of clock pulses, plus 32 clock intervals.

The analyzer operates in three display modes via its LED readout: specify, memory, and calculate. Specify allows conditions for recording to be entered through the keyboard. In memory mode, data from the system under test are recorded and displayed; in calculate, addition, subtraction, and radix conversion are performed in octal, decimal, or hexadecimal.

Recording data, address, and status from system under development in memory mode allows direct comparison of memory to program listing by selecting the correct radix and stepping through word by word. Keyboard controls allow recordings to be made and displayed to assist the user in setting up the analyzer with a non-working system under development. Circle 177 on Inquiry Card

# MICROPROGRAMMING?

# STEP UP TO STEP-2

THE FIRST REAL TIME IN-CIRCUIT DEVELOPMENT SYSTEM FOR ALL BIPOLAR PROCESSORS.



STEP ENGINEERING'S STEP-2 is a compact, affordable instrument containing all the features necessary for rapid system debug. Our customers find it so easy to use that they have it up and running the day it arrives. And, STEP-2 is so powerful, they have experienced a 50% savings in their development cycle. Join our other satisfied customers — find out how simple microprogramming can be —

## STEP UP TO STEP-2!

For more information contact:

STEVE DRUCKER, V.P. MARKETING  
STEP ENGINEERING  
714 PALOMAR AVENUE  
SUNNYVALE, CA 94086  
(408) 733-7837

### STEP-2 LOOKS INTERESTING!

- I have  an immediate need (0-3 mo.).  
 a potential need (3-6 mo.).  
 a lot of curiosity.
- I need  data sheets on STEP-2.  
 an obligation-free demo.  
 to talk to someone knowledgeable.
- Name \_\_\_\_\_
- Company \_\_\_\_\_
- Address \_\_\_\_\_
- City \_\_\_\_\_ State \_\_\_\_\_ Zip \_\_\_\_\_
- Phone \_\_\_\_\_
- I am using \_\_\_\_\_ chip set with  
\_\_\_\_\_ PROM type

STEP ENGINEERING  
P.O. Box 61166, Sunnyvale, CA 94088

**STEP-2'S REAL TIME (45 ns) RAM MEMORY** simulates the system control store for fast trial of object code. Word widths from 8 to 96 bits can be efficiently achieved and memory reconfiguration can be accomplished in seconds. You can emulate two independent memories simultaneously for multiprocessor or unique architecture systems.

**STEP-2'S ROM SIMULATION PLUG-INS** make interconnection to your system a one-step operation. Seventeen field-upgradeable models emulate over 200 ROMs and PROMs.

**STEP-2'S WORD ORIENTED EDITOR** simplifies locating and patching problems in your code. Features include octal or hex representation, binary readout and easy word/bit modification. Blocks of code can be moved in memory to insert additional lines or save a routine before editing. And our search command can locate all instructions containing a specified field or bit pattern.

**STEP-2'S DIAGNOSTIC FACILITY** speeds debug. Direct control of processor HALT, RUN, STEP, CYCLE, and RESET is accomplished through the keyboard. Real time break points/triggers can be set without disturbing processor activity. Breakpoint state and processor activity is displayed on the CRT, allowing you to quickly verify processor operation.

**STEP-2 IS COMPATIBLE WITH YOUR EXISTING SOFTWARE.** A full range of serial communications options makes it simple to connect to any computer system from a large computer, timesharing service or an Intel® Development System. Downloading your existing object code takes only minutes using either STEP-2's generalized PROM I/O routine (GENPROM)<sup>TM</sup> or word-oriented I/O routine (MICROWORD)<sup>TM</sup>.

**STEP-2 HAS COMPLETE SOFTWARE SUPPORT.** Our Transportable Meta Assembler, (TMA), is completely compatible with AMDASM and can be installed on an Intel® Development System or 16 bit (or larger) computer with Fortran. The TMA is easy to understand and use — powerful conditional assembly statements and cross reference tables simplify code generation. The assembled code can be downloaded directly into STEP-2 for testing and verification.

# For Fast, Accurate Data Entry.

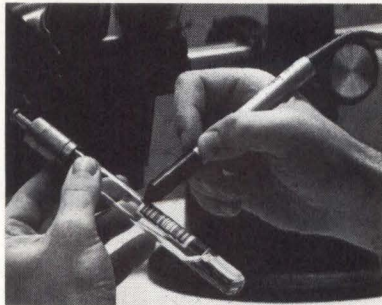

Bar code gives you virtually error free input, confirmed by an audible read signal.

Unskilled factory workers achieve data entry rates of several hundred characters per second with virtually no training.

Typical Applications  
**Production Control**  
**Inventory Control**  
**Wholesale Distribution**  
**Hospital Records Systems**  
**Libraries**

Intermec bar code printers and readers are microprocessor based for system flexibility and compatibility.

- Multiple Bar Codes
- User Selectable Protocol
- Readers with Dual I/O Connectors
- Specialized Printer Keyboard Logic for Maximum Data Preparation Efficiency
- RS232C • ASCII

Intermec manufactures a complete line of bar code printers and readers which have become standards of the industry.

**For more information contact:**  
 Interface Mechanisms, Inc.,  
 P.O. Box "N", Lynnwood, WA  
 98036, Phone (206) 743-7036,  
 TWX (910) 449-0870

# INTERMEC®

Expert in Bar Code

||| READERS ||| PRINTERS |||  
 ||| WANDS |||

## DIGITAL TECHNOLOGY REVIEW

### SOFTWARE

#### 3270 Emulation/ Asynchronous Protocol Support Online Interaction

Added interactive communications capabilities for Series 21 distributed data processing systems broaden users applications alternatives. 3270 and asynchronous communications support for the series, announced by Mohawk Data Sciences Corp, 1599 Littleton Rd, Parsippany, NJ 07054, allows users to design the application for interactive inquiry into a remote host system, batch transmission to the host, or to combine local processing with interactive inquiry against local or remote files.

Allowing System 21/40 (see *Computer Design*, Apr 1977, p 55) or /50 to emulate terminals in the IBM 3270 family, network interface modules include a display station emulator, which supports data entry, inquiry into local or central data bases, and online transaction processing; an in-

telligent network interface, which supports online interaction between a remote system and a host mainframe; and a batch utilities package that enables users to transmit data to a host via 3270 protocol with minimal operator intervention. The basic asynchronous emulator allows Series 21 operator stations to function as non-intelligent conversational terminals, transmitting to or receiving data from a mainframe, character at a time or in batch mode. An enhanced asynchronous emulator (not to be available until third quarter 1979), will add features such as data formatting, operator prompting, and display screen functions.

Addition of the emulators to the line allows users to satisfy both existing interactive requirements as well as local processing requirements. Conversely, users operating in remote batch mode are provided with the flexibility to expand into online interaction with a host.

Circle 178 on Inquiry Card

#### Timesharing System Serves as Extension to Operating System

A multiterminal timesharing system for the V77 series minicomputer, CP-77 provides facilities for entering and editing source code, submitting job streams to the background job queue, and executing and debugging tasks directly from the terminal. Designed by Sperry Univac Mini-Computer Operations, PO Box 500, Blue Bell, PA 19422 as a compatible extension to the VORTEX II operating system, the package operates with or without VTAM communications access. In addition, it serves for development of applications programs designed to run under the PRONTO transaction processor.

Major capabilities provided by the system include creation of program source files and job stream command files, editing of files containing alphanumeric data, and terminal user submission of job stream command files to an input queue for execution in VORTEX II background batch mode. With the package, terminal users

can execute VORTEX II foreground programs with or without interactive diagnostic tools. Program output and alphanumeric file contents can be directed by the terminal user to an output spooling facility.

The system maintains a terminal oriented file system and provides each user with four unique logic units which may be assigned to system peripherals. It also maintains user IDs and passwords required for terminal access. Terminal users are given the ability to inquire on status of the system and on the background input queue. They can also send messages to other terminals or to the system operator's terminal.

The package was developed by the Laboratory for Advanced Methods in Biological Data Acquisition at Brown University. It is available on 7- or 9-track magnetic tape. Operating on any VORTEX II configured system, minimum hardware required includes a V77 minicomputer (or V70 with extended instruction set), 96k main memory, 4M-byte disc storage, magnetic tape unit, and two character mode terminals. □

Circle 179 on Inquiry Card

# A PART THAT SETS US APART

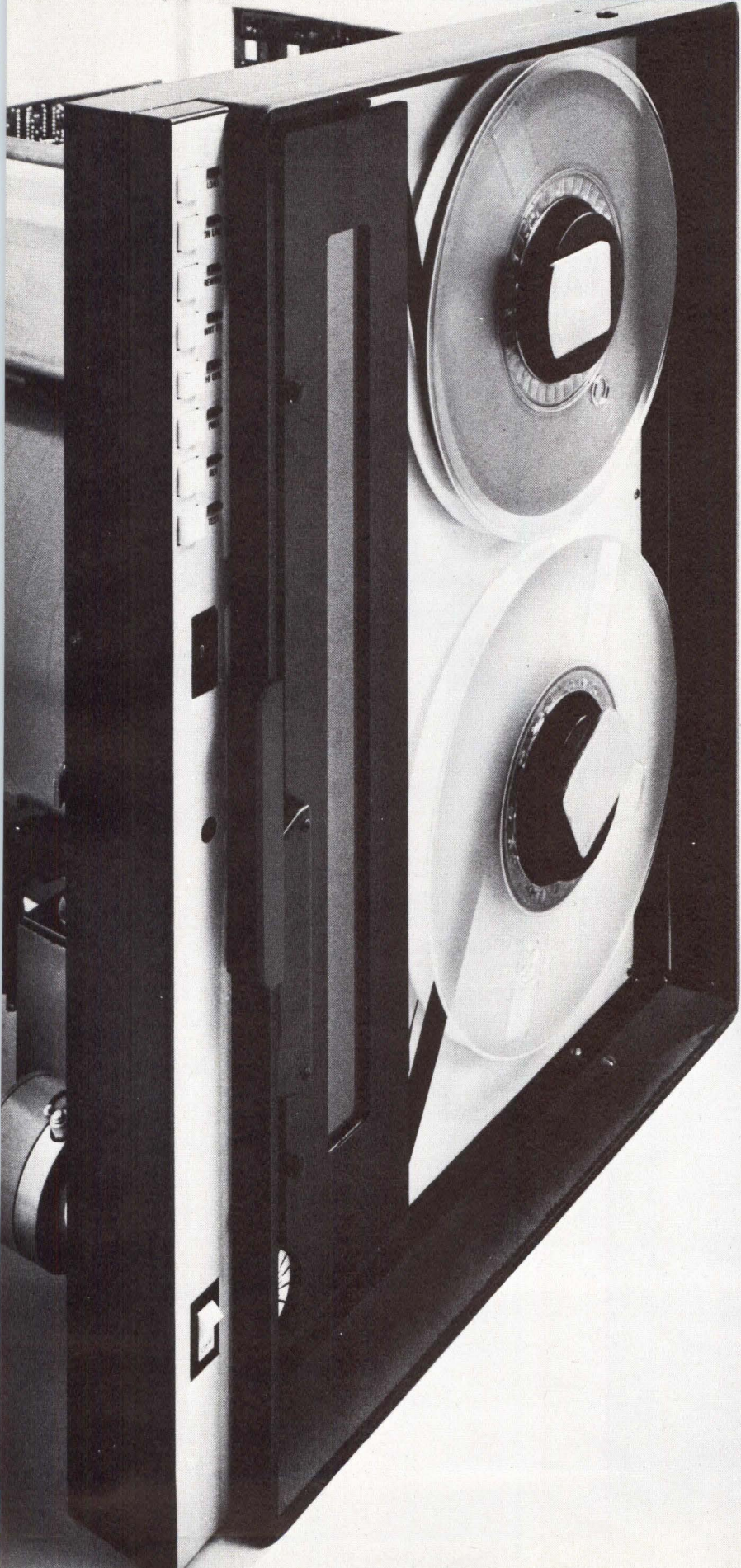

## The Z-80 Microprocessor

Complete microprocessor control in a vacuum column tape drive is now available in the Cipher Data Products' 900X 75 ips and 125 ips models—enhancing performance, reducing power requirements and component count, and significantly increasing reliability.

Total control of tape during critical load and unload and even power failure, is a reality. And, because exact tape position is sensed and controlled by the microprocessor, maximum possible speed is maintained throughout the rewind operation.

Built in diagnostics and service aids, unique to the Series 900X drives, are made possible by Z-80 intelligence. Decision making logic in ROM is automatically tested during power up and, if not successful, the drive shuts down with fault indications clearly given on the front panel. Possible damage to tape or machine is avoided and repair areas are readily identified.

Now look at all the other parts—like the dual density databoard, beltless direct drive, switched linear servo system, optical file protect and modulated tape sensor system. The Series 900X vacuum tape drive is far ahead of the market in design while still fully compatible with today's industry standards.

Do your part. Call for full information and OEM quantity price competitive quotes. Cipher Data Products, Inc.  
5630 Kearny Mesa Road  
San Diego, California 92111  
(714) 279-6550

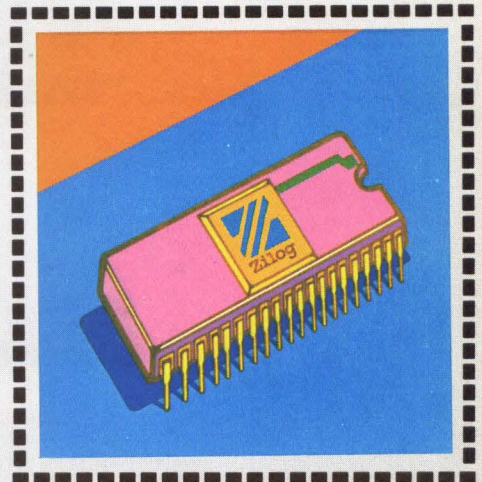

**Cipher**  
Data Products

CIRCLE 53 ON INQUIRY CARD

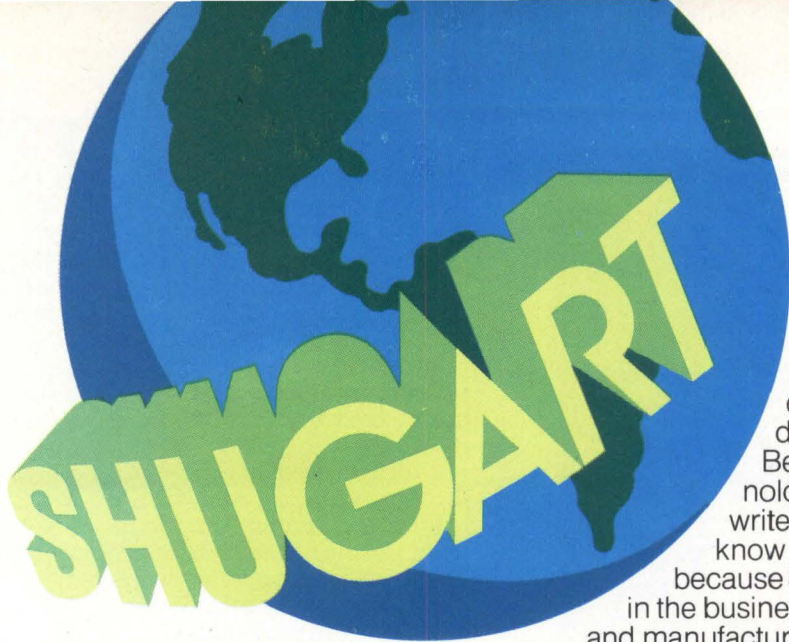

The SA800 and the SA850.

Whether you use our SA800/801, the world's most demanded floppy disk drive, or our SA850/851 — the world's first IBM-compatible, double-sided, double density disk drive — you're sure to get ahead. Why? Because only Shugart controls the head technology that gives you the best ceramic read/write heads on the market. And our OEM's know that they are buying the latest technology, because Shugart is the only independent company in the business which controls its own head R&D and manufacturing. That's why we're the only company in the business to have delivered over half a million of these heads.

# Two great ahead with

Why the SA800/801 is the industry standard. It's no secret that the SA800/801 floppy drive has become the industry standard. Its performance results directly

from our proprietary head technology. When you talk about a media life of over 3.5 million passes and a head life that exceeds 15,000 hours, you're talking about standard-setting performance. Add to that a choice of 400 kbytes or 800 kbytes (unformatted) and single or double density capability on the same drive for the same price. And then settle the matter with system performance like soft read error rates of  $1/10^9$ , hard read errors of  $1/10^{12}$ , and seek errors of  $1/10^6$ .



The SA850/851. First and first with Fasflex™. Which means the SA850/851 double-sided floppy is the first independently manufactured drive to double data storage capacity. And it's the first to cut access time to 3 milliseconds with the Fasflex™ actuator. And the SA850 offers maximum media flexibility, too. Storage? A double-sided, double density SA850 gives you up to 1600 kbytes (unformatted). It can utilize FM, MFM, or M<sup>2</sup>FM encoding. Access time? Shugart's proprietary Fasflex metal band actuator gives you a 3ms track to track access time with an average seek time, including settling, of 91ms. Yet Fasflex requires only half the power of lead screw actuators. Media flexibility?

Whether you use conveniently obtainable Shugart media, or other brands, the SA850 drive family reads and writes data on single and double density media, and on single and double-sided media.

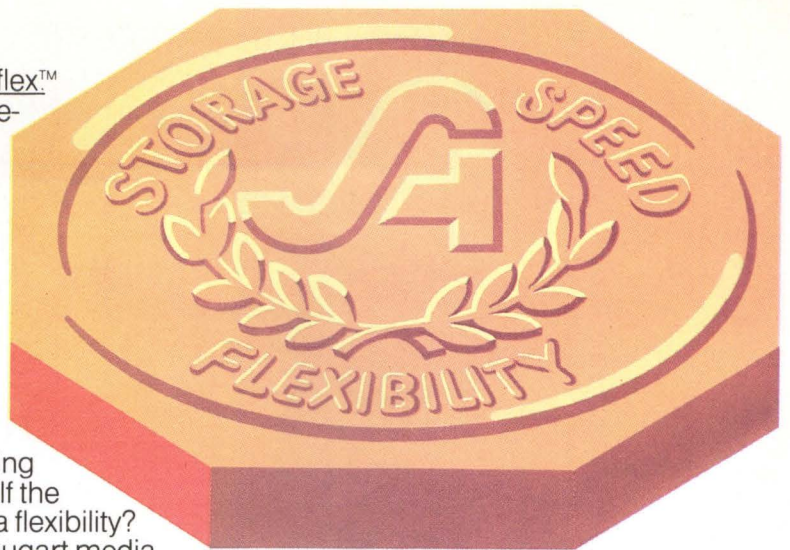

# ways to get Shugart.

Two out of three OEM's specify Shugart. During 1979, more than a quarter million Shugart floppy disk drives will be installed throughout the world. No other manufacturer comes close to that magnitude of delivery. The reason? OEM's rely on our total commitment to R&D.

That commitment means we deliver state-of-the-art, low cost,

rotating memory products that have a track record for quickly becoming industry standards. Our success comes from our grasp of where performance in low cost, rotating memory originates: the head technology.

That's our strength; it's why we're called The Headstrong Company. Shugart Associates

Headquarters: 435 Oakmead Parkway, Sunnyvale, California 94086 (408) 733-0100; West Coast Sales/Service: (408) 252-6860;

Midwest Sales/Service: (612) 574-9750;

East Coast Sales/Service: (617) 893-0560;

Europe Sales/Service: Paris (1) 686-00-85;

Munich (089) 176006; Shugart products

are also available off the shelf from local Hamilton Avnet outlets.

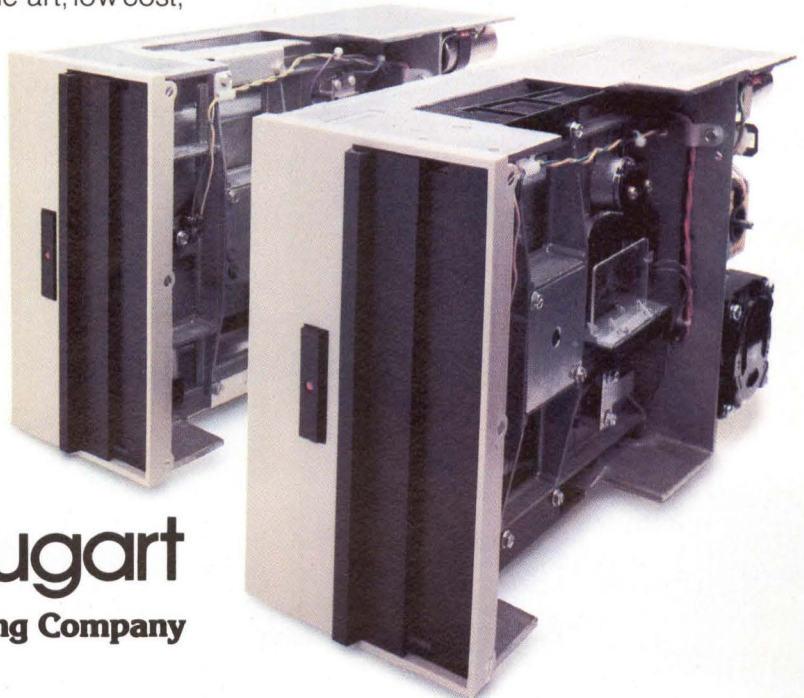

 **Shugart**  
The Headstrong Company

CIRCLE 54 ON INQUIRY CARD

# Longer Life, Greater Reliability

The key to our unique Golden Touch capacitive keyboard is our patented, hinged moving plate design.

We create our capacitive effect with a hinged moving plate and one fixed plate, both attached to the printed circuit board. This gives our keyswitch much greater capacitance, at any given displacement, than the sponge-on-a-stick design used in other capacitive keyboards.

As a result, our keyswitch is virtually impervious to dust, debris, moisture and electrical noise. That's why we rate our Golden Touch at 250,000,000 MCBF—double anybody else's rating.

It also is why we guarantee a 1% AQL and give a 2-year warranty.

All our Golden Touch keyboards are designed precisely to your specifications—because we sell only to volume OEMs—so you can get whatever options, circuitry and configuration you want.

All this at competitive prices.

## ***DIGITRAN***

The Digitran Company, a division of Becton, Dickinson and Company

855 South Arroyo Parkway • Pasadena, California 91105

Phone: (213) 449-3110 • TWX 910-588-3794, TELEX 67-5485

**CIRCLE 55 ON INQUIRY CARD**





# DIGITAL CONTROL AND AUTOMATION SYSTEMS

## Microprocessor Based Systems Expand Process Monitoring and Control Capabilities

Digital control of processes or of individual machines involved in the carrying out of those processes has grown dramatically in scope over the past several years. As illustrated in this magazine section each month, both the systems and the applications have become more sophisticated and have encompassed more procedures.

In line with that trend, a number of specialized monitoring and control systems, typified by those described below, have been announced recently by American manufacturers. Not surprisingly, all are microprocessor based.

Two standalone systems included in these announcements are a burner management system which insures that fuel is delivered to boilers or furnaces and is burned safely, and an automatic controller for batch process units. The burner control system safeguards the boiler or furnace with which it is used and, possibly even more importantly, protects the personnel who operate and maintain it; the batch process control system allows engineers to perform automatic logging, sequencing, critical timing, and control of multiple process units.

However, smaller systems also must be controlled and here programmable controllers are sometimes more practical. Several such controllers with varying input/output capacities and other capabilities are available for control of single or multiple machines or devices in mixing, batching, laboratory, and diverse other applications of moderate scope.

### Safety Burner Control System For Industrial Process Steam Generation

Levels of safety and function beyond the capacities of comparable conventional solid-state systems are anticipated for a microprocessor based burner control system dedicated to industrial process steam generation applications. This system is said to perform all customary burner management functions while providing significant advancements in the critical areas of safety, system security, self diagnostics, and operator communications. Particular advantages are claimed for use with multi-burner boilers and process heaters.

Flame supervisory and sequence logic systems are commonly used with boilers or furnaces to insure that fuel is delivered and burned safely. Typically such systems are made up of flame detectors, logic cabinets, operator interfaces, field sensors, and fuel safety shut-off valves. They protect both the boilers and furnaces and the personnel who operate and maintain them.

Depending on user requirements, the DSC 8000 digital safety burner control system introduced by Honeywell, Inc, Process Control Div, 1100 Virginia Dr, Ft Wash-

ington, PA 19034 can be housed either in a single cabinet at the boiler or in two or more cabinets in a centralized control room. System architecture is partitioned functionally into control, remote process interface, and operator interface subsystems. Custom system configurations are implemented through selection of appropriate hardware and firmware modules and packaging to address the number of fuels; number, arrangement, and location of burners; and other application-dependent operating and environmental considerations.

The control subsystem is made up of a controller file, power supplies, and cable termination panels. In essence a logic processing and control interface, the controller file houses the central processing unit (CPU), memory (program firmware) modules, operator interface input/output (I/O) modules, error and fault detection circuitry, and peripheral interface modules. As many as 17 modules can be accommodated. A system may contain multiple controller files interfaced to and controlled by a single CPU.

Through hardware and firmware interaction the controller file directs all signal flow within the system. Its CPU, which uses an Intel 8080A microprocessor as its principle logic and control element, is the equivalent of 649 logic gates and can execute an entire typical system program once every 25 ms.

The CPU performs logic functions based on preprogrammed instructions which reside in nonvolatile programmable read-only memory (PROM). This program constitutes the system firmware and includes the custom sequence of operation, dynamic safety, annunciation, diagnostic, and optional communications programs. Data relating to the current status of variable system I/O are stored in solid-state random access memory (RAM).

System I/O interface modules that condition and direct bidirectional signal flow among CPU, operators interface, and field mounted equipment are also in the controller file. System load drivers multiplex/demultiplex signals to and from the remote process I/O to allow the CPU to monitor and sequence the field hardware. A realtime communications link to the operator interface is provided by local I/O modules.

The remote process interface (or I/O) subsystem consists of I/O tracks, load track interfaces, and discrete, optically isolated plug-in digital I/O modules or solid-state relays. Its function is to convert line voltage signals to logic level signals for inputs, convert logic level signals to line voltage signals for outputs, and multiplex/demultiplex logic signals to and from the system load drivers in the controller file via prefabricated multicon-

# Our new Sub-M

## Beauty More than Skin Deep.

You might agree that our new RS/RT Series of single and triple output switchers are nicely packaged. The *real* beauty, however, of these high-performance supplies lies *under* their covers. Designed for high-reliability applications, they consist of three separate function sub-modules. An input board, converter board and an output board are joined by a mother strip to eliminate all interconnecting harnessing.

Utilizing the latest technology, the switchers feature soft-start; LSI circuit modulator chip; low ESR capacitors for reduced ripple and noise; and an impressive 40 MSEC *minimum* holdover storage capability. To make sure that they keep on performing way past their 5-year warranty, we subject every unit to a rigorous testing program: 100% component screening; numerous in-process electrical inspections; each module is functionally tested; the complete unit is burned-in for 48 hours at 50°C, and the supply is then computer tested to all its performance specifications.

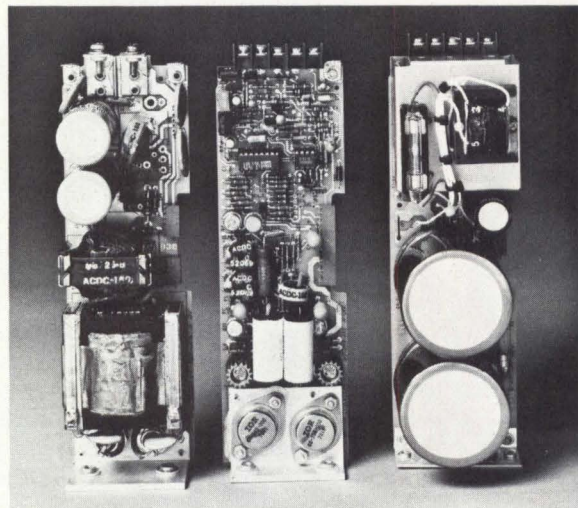

Output Module

Converter Module

Input Module

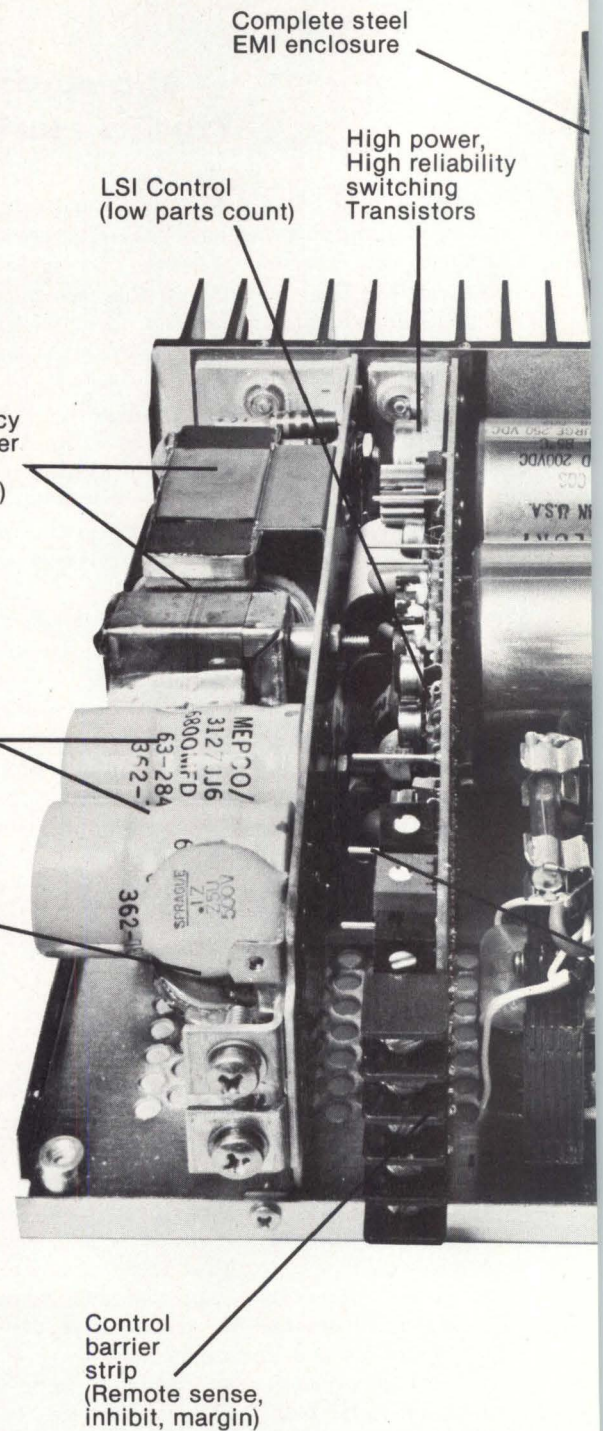

Complete steel EMI enclosure

High power, High reliability switching Transistors

LSI Control (low parts count)

High frequency shielded power magnetics (low radiation)

Low ESR output Capacitors

2 section output Filter (low ripple)

Control barrier strip (Remote sense, inhibit, margin)

# acdc ele

401 Jones Road, Oceanside, Calif  
211 West Clay Avenue, Roselle Park, Ne

# Modular Switcher

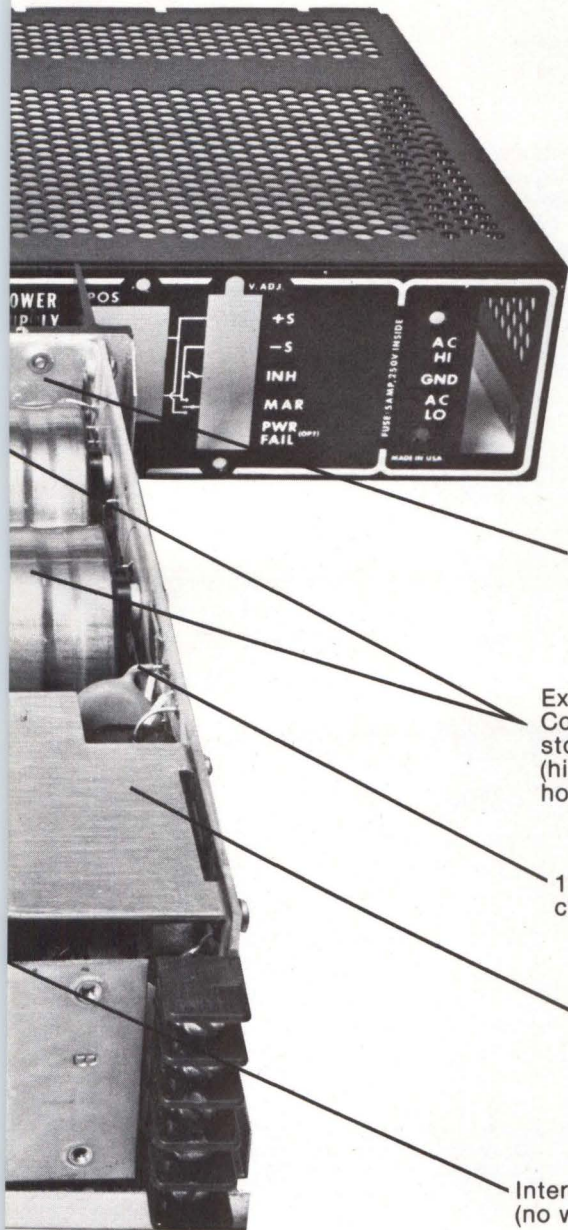

Soft start Thermistor (low line inrush)

Extra large Computer grade storage Capacitors (high reliability holdover time)

115 VAC/230 VAC changeover

EMI Filter (VDE 0875N)

Interconnecting strip (no wire harness)

## Computerized Quality Assurance

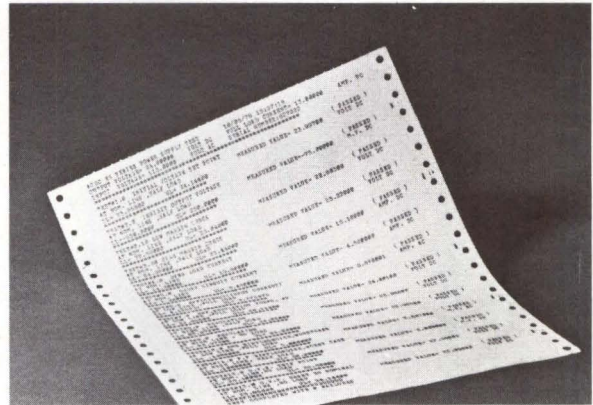

You receive a copy of this test report as a print-out with every RS/RT supply we deliver! Your assurance that once you've installed one into your system, it'll keep on working.

A 12-page brochure gives complete details including how the series meets the stringent VDE requirements for EMI. Send for it now.

## Models

### RS Series - Single Output

CASE SIZE	OUTPUT CHARACTERISTICS	VOLTAGE (ADJUSTABLE $\pm 5\%$ )				PRICE* (FOR 1-9) \$
		5V	12V	15V	24V	
		M5	MAX. CURRENT AMPS	10.0	4.5	
M10	MAX. CURRENT AMPS	20.0	9.0	7.2	5.0	259
M15	MAX. CURRENT AMPS	30.0	13.5	10.8	7.0	279
M30	MAX. CURRENT AMPS	60.0	27.0	21.0	13.0	395

### RT Series - Triple Output

CASE SIZE	OUTPUT CHARACTERISTICS	VOLTAGE (ADJUSTABLE $\pm 5\%$ )		PRICE* (FOR 1-9) \$
		5V/12V/12V	5V/15V/15V	
		T10	MAX. CURRENT AMPS	
T15	MAX. CURRENT AMPS	30/5/2	30/4/2	415
T30	MAX. CURRENT AMPS	60/5/5	60/4/4	525

\*Ask About Quantity Discounts

# electronics

via 92054 Telephone: (714)757-1880

Jersey 07204 Telephone: (201)241-6077

# DIGITAL CONTROL AND AUTOMATION SYSTEMS

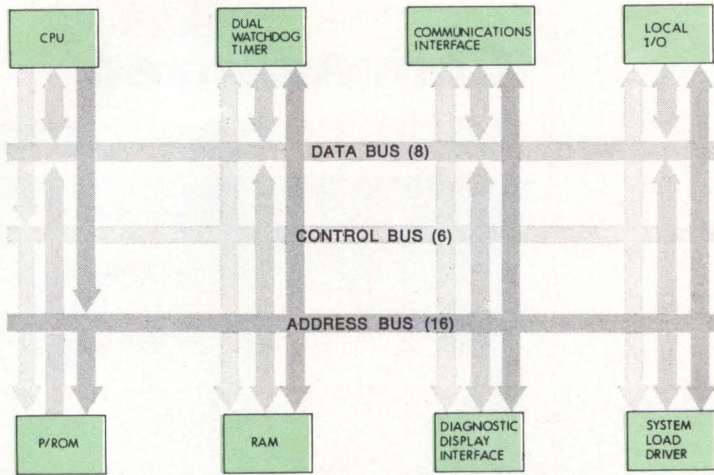

Controller file subsystem and associated electronic modules, part of Honeywell's microprocessor based burner safety control system. Maximum memory capacity is 48k words of UV erasable P/ROM and solid-state RAM. Dual watchdog timer verifies operation of 8-bit 8080A microprocessor based CPU by timing two program scans performed simultaneously by CPU

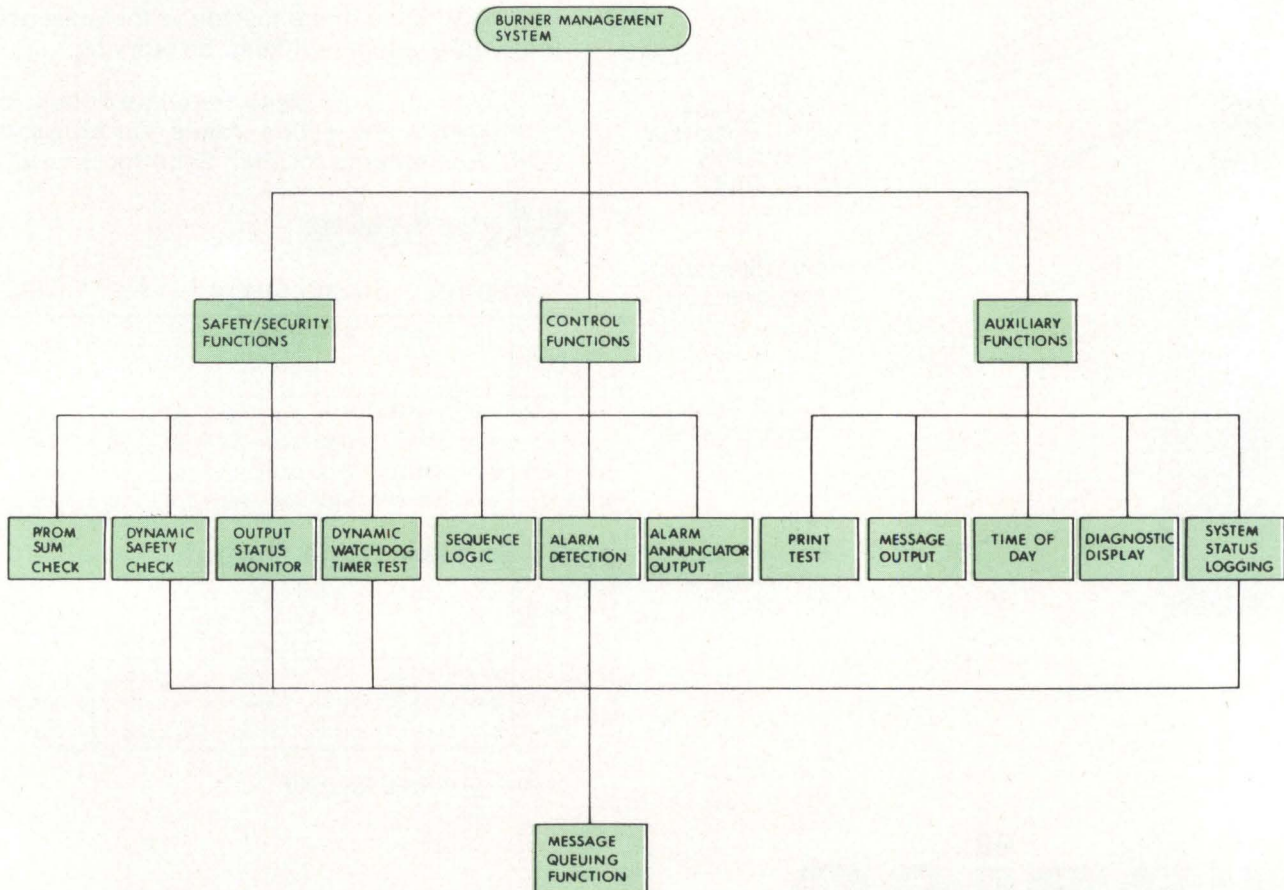

Burner safety control system firmware structure. Safety/security and control functions are standard in each system; auxiliary and message queuing functions are implemented only when their associated peripheral functions are elected by user

**Why buy a  
technical computer  
from a stranger...**

when you can buy one



# from Hewlett-Packard?

So why don't you get together with a company that has 25,000 technical computer installations to its credit? We're listed in the White Pages of your phone book. Or write for complete information about the HP 1000 family to Hewlett-Packard, Attn. Bob Puette, Dept. 1242, 11000 Wolfe Road, Cupertino CA 95014.



CIRCLE 57 ON INQUIRY CARD

# QUALITY: The first reason to choose Mostek's LSI-11/2\* add-in memory.

**2** Optional on-board parity generation and checking.

**3** Mostek's industry-standard MK 4116 dynamic RAMs.

**4** Internal distributed refresh.

**5** Totally hardware and software compatible with LSI-11/2 and LSI-11.

**6** \$1200: 32K x 18. (Single quantity price. OEM discounts available.)

Immediate delivery.

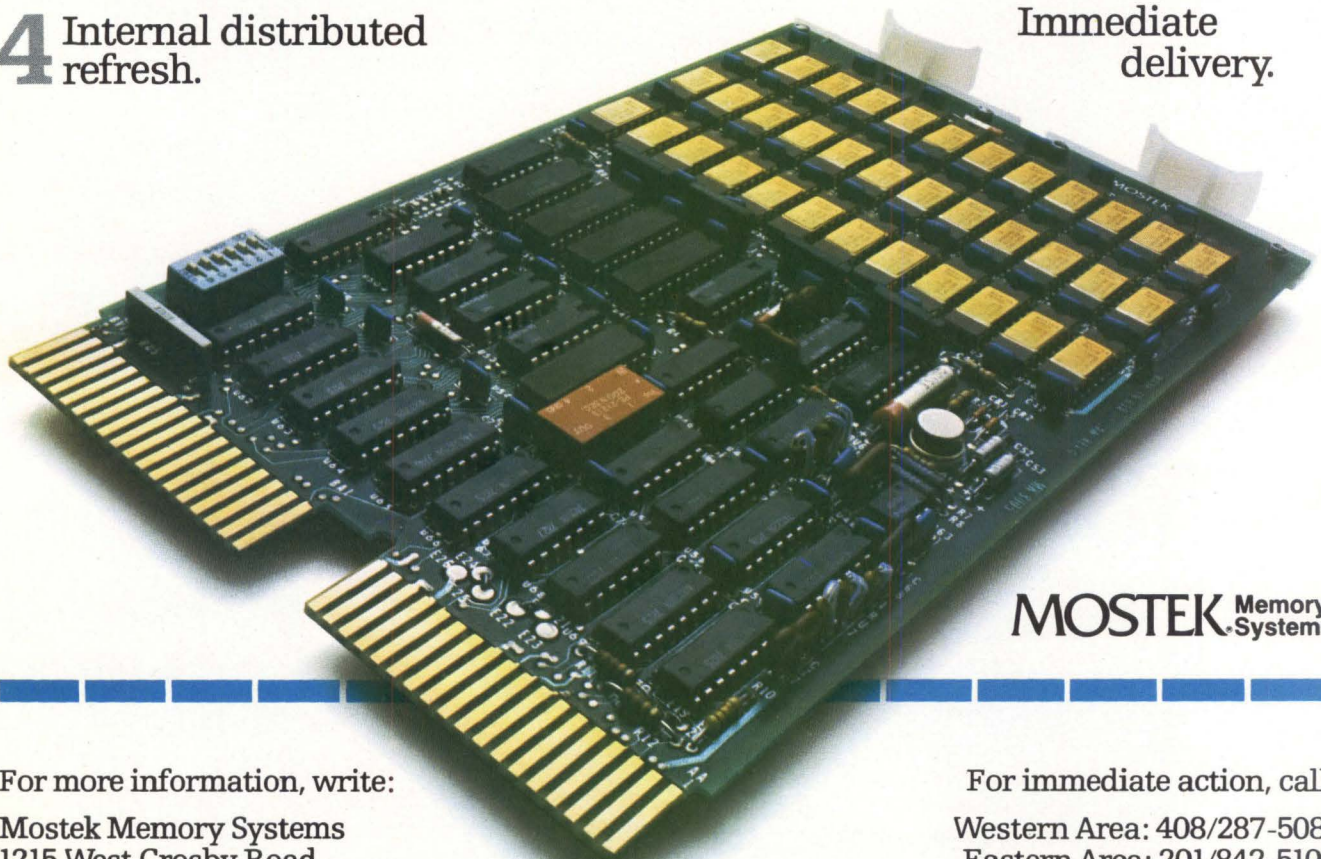

**MOSTEK** Memory Systems

For more information, write:

Mostek Memory Systems  
1215 West Crosby Road  
Carrollton, Texas 75006

For immediate action, call:

Western Area: 408/287-5081  
Eastern Area: 201/842-5100  
Memory Systems Marketing:  
214/242-0444 ext. 2552

My need is:  now  3-6 months  6+ months

I'm interested in:  LSI-11/2  PDP11\*  PDP-11/70\*  Nova 3\*\*  Eclipse\*\*

Name/Title \_\_\_\_\_

Company \_\_\_\_\_ Phone ( ) \_\_\_\_\_

Address \_\_\_\_\_

\*TM of Digital Equipment Corp. \*\*TM of Data General Corp. © 1979 Mostek Corp.



ductor cable. Because of this subsystem, boiler field termination cabinets can be up to 500 ft (150 m) from the control subsystem.

System load drivers form the interfaces between the CPU and the processor I/O track system for discrete digital ac and dc I/os. They provide two basic functions: signal conditioning, data storage, and logic control, plus timing and synchronization. Each driver contains timing, memory, decoding, and scanner circuitry to sequentially interrogate each input block, set each output block, and store information on each block in its memory.

The CPU accesses driver memory to read the value of remote inputs and to set field outputs. When doing so, the CPU momentarily interrupts the driver I/O scan function to prevent timing problems that would be created if both the CPU and system load driver scanner were accessing the same memory location simultaneously. After the CPU has completed its access it releases the scanner to continue its scan. Total scan time is 2 ms for the maximum I/O complement.

Total system capacity is 2048 ac and/or dc I/O intermixed in any arrangement (16 I/O per track, 16 tracks per system load driver, 8 load drivers per system). Additional versatility is provided by the ability to deploy tracks associated with one load driver to several locations within that load driver.

The operator interface subsystem is a custom designed control panel arranged in functional groups such as first-out annunciation, purge initiation and status, header control and indication, and individual burner start/stop and status functions. A compact printer can be provided as part of this panel, or a desktop or free standing RS-232-C/20-mA compatible printer can be interfaced to provide alarm, diagnostic, and system status logging as desired.

Circle 290 on Inquiry Card

#### **Process Control System for Automatic Control of Batch Process Units**

A high level batch language and a realtime batch executive enable users of the FLIC 1/60 process control system to perform sequencing, critical timing, and control of multiple batch process units. A color graphic video display illustrates changing process conditions and 16 function buttons are provided for placing any chosen batch unit in a desired state.

As with other members of the FLIC Series 1 family from Metromation, Inc, 1101 State Rd, Princeton, NJ 08540, this microcomputer based batch controller can operate in a multitasking environment either standalone or linked to other family units in a distributed network. The system includes a batch task protocol and batch executive designed to support individual and multiple-unit step logic sequencing. Unit status information is maintained for each process unit, thereby permitting step logic to be applied on a per-unit basis.

BCS, a high level process automation language specifically developed for process control applications, is

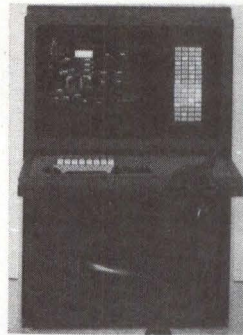

Metromation FLIC 1/60 microcomputer-based batch control system includes CRT operator console and work station. Color graphics provide overview or detailed illustration of batch status and operations

an extended version of BASIC. It enables engineers to develop, modify, and execute programs in a load-and-go mode from source language, thereby eliminating time-consuming intermediate steps and machine-level debugging.

English commands that can be user-defined have been included for batch process applications. Additional English commands can be added to the BASIC batch language to provide unique self-documenting batch control.

CRT displays at operator and engineer workstations implement communications with batch units. Color graphics present pictures of batch status and operations from overview to full detail. Monitoring of individual and/or multiple batch control performance is straightforward because of the unit display hierarchy.

Design of the 16-bit microcomputer is based on bit-slice technology. The standard 32k-word memory capacity can be expanded to 64k. Other system components include modular process I/O, CRT operator console, floppy disc for system backup, extended batch software, self-diagnostic capability, and watchdog timer. CPU, RAM, floppy disc controller, and asynchronous interface are on separate boards.

Circle 291 on Inquiry Card

#### **Programmable Controllers for Small and Intermediate Systems**

Microprocessor technology has had a strong influence on the latest group of programmable controllers. Each uses at least one microprocessor as the central processing unit and various forms of compatible semiconductor memory. For the most part, both speed and capability are improved over the lines of programmable controllers available previously.

The half dozen microprocessor based programmable controllers described here are typical. All incorporate features and advantages of current technology. They function by detecting input signal state changes from sensors and producing correction output signals to field devices. Application areas include both small and intermediate systems.

—Industrial Timer Corp, U.S. Highway 287, Parsippany, NJ 07054 claims that its "workhorse of industry" ITC 2524 electronic programmable control system "offers greater programming ease, greater flexibility, and more in-plant growth potential than any other system avail-

## DIGITAL CONTROL AND AUTOMATION SYSTEMS

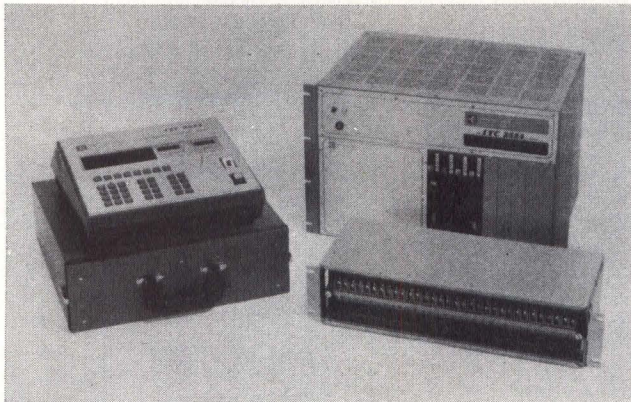

Programmable control system from Industrial Timer Corp consists of portable programmer/monitor (left), dual-microprocessor controller (rear), and I/O tracks. Single programmer can be used for several controllers and tracks within a plant. Free format programming is performed with standard relay ladder diagram logic symbols in free format

able." The all solid-state system performs the same functions as a relay control or discrete solid-state logic control system and can be used in any process or numerical control application.

The system is made up of three basic components: programmable controller, I/O, and portable programmer/monitor. Two microprocessors and memory are housed in the controller. One, which can have up to 64k of main memory, controls overall system operation; the other controls I/O scan. Standard user memory consists of 2k to 8k of nonvolatile electrically-alterable read-only memory. This capacity is expandable to 24k by the addition of memory boards.

Up to 2048 I/Os can be handled in any combination at a maximum scan distance of 3000 ft (914 m). Scan timing requires a constant 10 ms regardless of the number of I/Os or amount of user memory. There are no special programming languages. Memory is programmed from a program monitor keyboard in free format with standard relay ladder diagram logic symbols using 11 programming, 6 editing, and 2 troubleshooting instructions.

Circle 292 on Inquiry Card

—Cincinnati Milacron, Electronic Systems Div, Lebanon, OH 45036 includes a standard 1k 16-bit words of nonvolatile electrically-alterable ROM (expandable to 4k in 1k increments) in its MaxiMiser programmable controller. Up to 20 I/O modules fit into a basic unit and up to 20 more can be accommodated in an expansion chassis. Each module handles 16 input and 8 output signals.

Maximum contact addressability is 256 outputs, 512 inputs, 256 internal contacts, and 512 auxiliary contacts. Cycle scan rate is 5 ms/1k memory.

A single programmable controller runs as many as four machines, processes, or systems at a distance up to 1 mi (1.6 km). A suitcase type programmer is used for programming in symbolic ladder diagram language. The full program or program changes can be set up offline and loaded into a tape cassette, then inserted into the controller.

Eight timers on a plug-in module run either when circuits are energized or de-energized. Time ranges are adjustable through DIP switches from 0.01 to 1.0 s or from 1.0 to 100 s. Precise times can be set for each function, programmed for instantaneous or delayed normally open or normally closed.

The controller will function within a temperature range of 32 to 140 °F (0 to 60 °C) at up to 95% relative humidity (noncondensing). It operates off a 115-Vac power supply or can be set up for 220 Vac, both at 50/60 Hz.

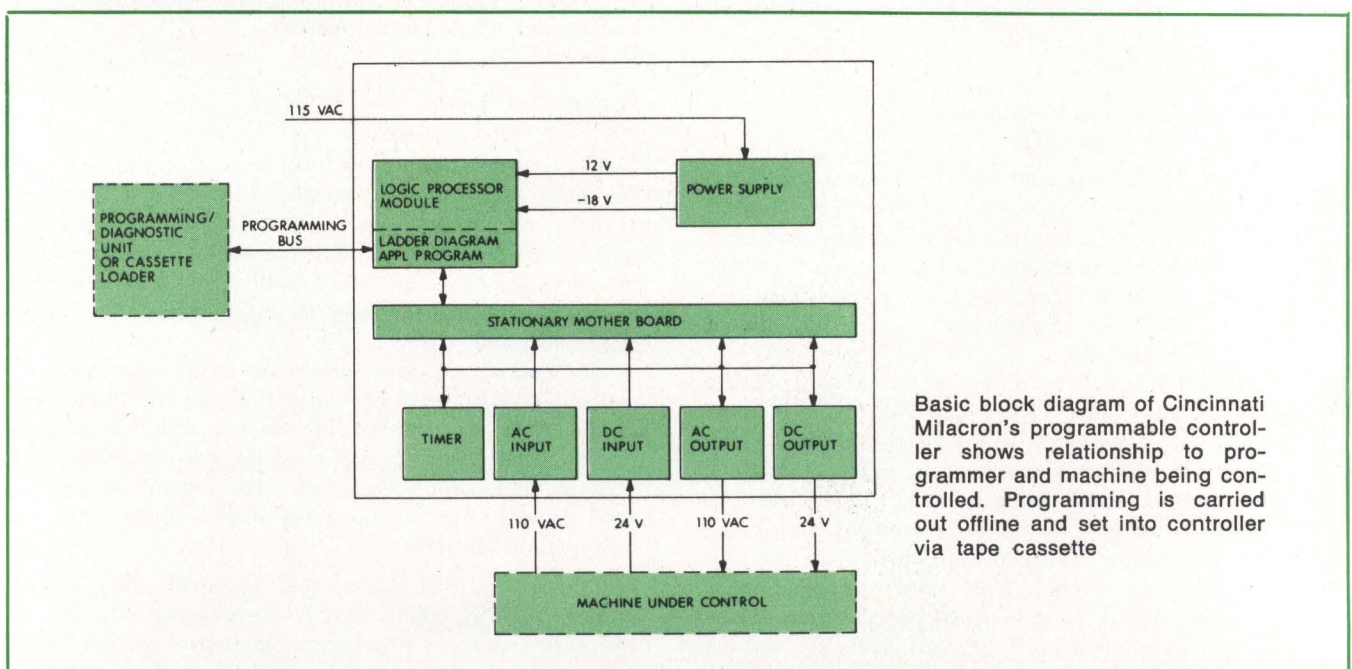

Basic block diagram of Cincinnati Milacron's programmable controller shows relationship to programmer and machine being controlled. Programming is carried out offline and set into controller via tape cassette

Circle 293 on Inquiry Card

# “New all-plastic AMPLIMITE connectors increase production rates and lower costs”

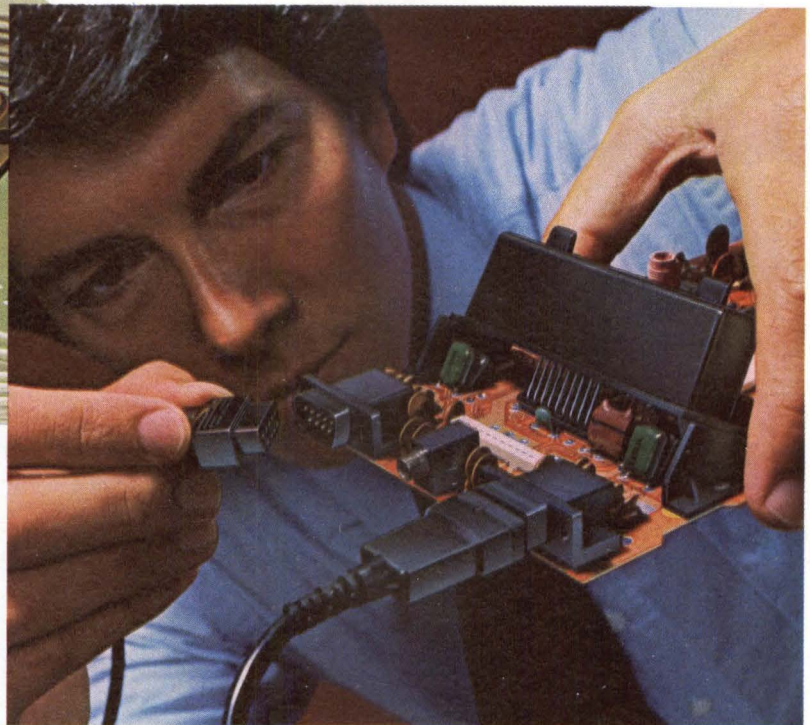
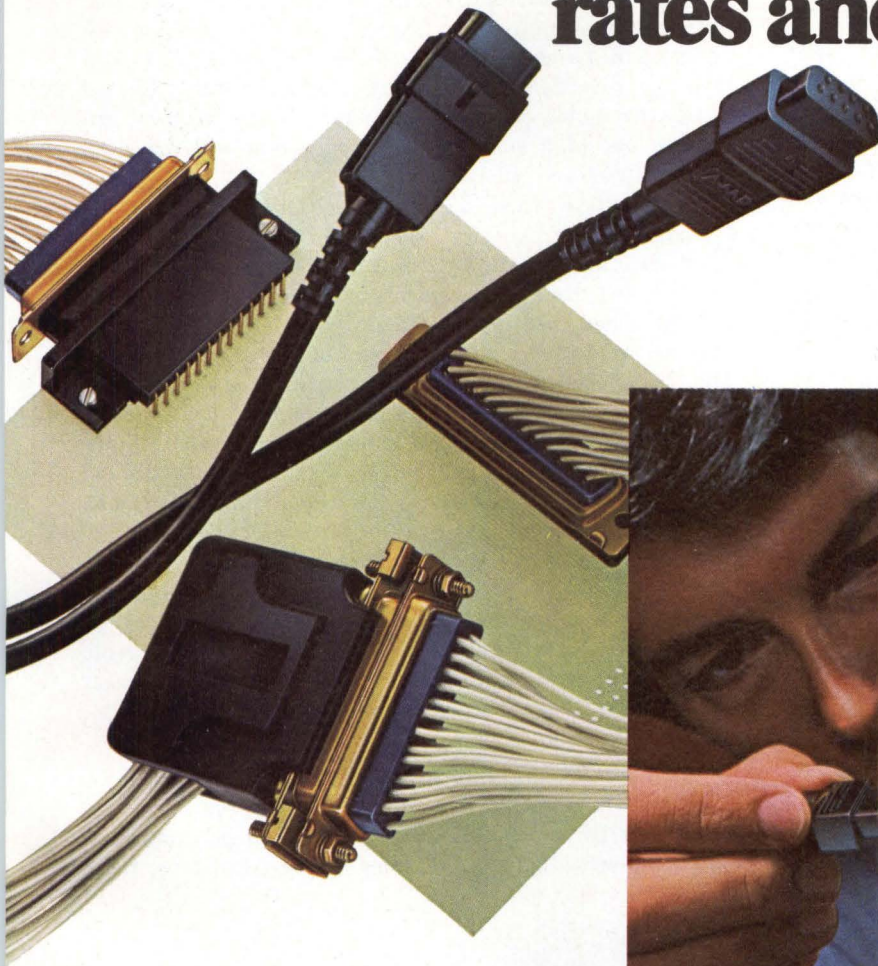

With both board and cable halves in flame-resistant thermoplastics, these nine- and fifteen-position AMPLIMITE subminiature D type connectors feature a unique inner construction that simplifies assembly. Coupled with all-plastic right angle and vertical board mount connectors, hardware costs are further reduced. They speed mounting. And are available selectively loaded. What's more, with AMP's Stripper/Crimper machine, AMPLIMITE connectors further reduce your total costs.

Are AMPLIMITE metal shell connectors now obsolete? No way! They're the only connectors of their kind approved to MIL C 24308 and its latest amendments. And they feature slide latches and interchangeable contacts with spacings as small as .090".

Both types of AMPLIMITE connectors meet communications specifications RS 232 and RS 449. They come, of course, with all the well-known dependability of AMP technical service and support. So bring us in early. We'll stay with you the whole way...on everything from electronic games to industrial controls.

**Want to know more?** Call our Customer Service at (717) 564-0100. Or write AMP Incorporated, Harrisburg, PA 17105.

AMP is a trademark of AMP Incorporated

# AMP

INCORPORATED

AMP has a better way.

## DIGITAL CONTROL AND AUTOMATION SYSTEMS

—Allen-Bradley, 1201 S Second St, Milwaukee, WI 53204 has enlarged its PLC family of programmable controllers with the addition of the PLC-2 Bulletin 1772-LN Mini-Processor and the Bulletin 1771 I/O system. The company claims that smaller control system configurations are now feasible at correspondingly lower prices but without much loss of control capability, compatibility, and programming features.

Controller, I/O modules, and power supply can be mounted on the same rack to provide a compact installa-

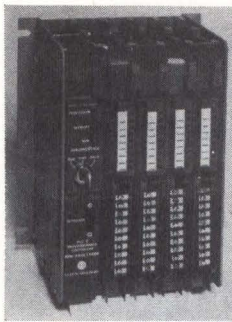

Smaller applications requiring economical control system are targets for Allen-Bradley's PLC-2 Mini-Processor. Companion I/O unit (not shown) provides interface to from eight to 128 control or monitor points

tion. From 8 to 128 I/O points can be serviced by the small system, or full system capacity of 1024 points can be attained by adding processors.

The processor, control center for the system, scans the user program and generates logic commands that control and monitor user devices via I/O modules. Internal diagnostic checks monitor system status and trigger visual signals if internal malfunctions occur. Programming is based on common ladder diagram relay symbols.

Functions of the processor include energizing and de-energizing outputs and latches, performing counting and timing operations, doing data comparisons and transfers, and executing 4-function arithmetic operations. Up to 2k words of user memory are available in 512-word RAM segments that plug into a memory module. A battery backup system provides standby power to the memory segments.

Circle 294 on Inquiry Card

—General Electric Co, General Purpose Control Dept, PO Box 2913, Bloomington, IL 61701 uses dual switchable memory systems in its Logitrol 550 programmable controller central processing units. Complementary metal oxide semiconductor (CMOS) RAM is used for program development and backup and P/ROM is used for online operation. A switch on the memory card allows either memory to be chosen.

Self-monitoring diagnostics are used for troubleshooting and maintenance. Standard diagnostic checks are made for dc power, sweep, battery, and outputs.

Four controller sizes are offered: 32, 64, 96, and 128 programmable relays. I/O capacity is 128 inputs and 128 outputs for each.

Power requirements are 115 or 230 Vac  $\pm 10\%$ , 50/60 Hz. Ambient temperature range is 32 to 140 °F (0 to 60 °C), at 0 to 95% humidity, noncondensing.

Circle 295 on Inquiry Card

—Tenor Co, Inc, 17020 W Rogers Dr, New Berlin, WI 53151 provides a compact programmable controller as a replacement for small relay systems used in machine and process control. A Mini-PC with 64 I/Os can be housed in a standard enclosure as shallow as 6" (15.25 cm) or directly on the machine under control. Use of CMOS ICs holds power requirements to 10 W max, enabling use of a small power supply that will drive up to 128 I/Os and 32 timers.

A standard card file is completely wired for the maximum I/O capacity whether or not all card slots are used initially. I/O cards with eight circuits can be added as system requirements increase.

The timer card contains a DIP switch for selection of one of four ranges for each pair of the eight timers on the card. Timers can operate between 10 ms and 256 s, with fine adjustment within ranges made by a potentiometer on the board or externally if desired. Since timers are addressed through a serial port they do not reduce system I/O capacity. Additional timer cards can be added if necessary.

Program memory capacity is 1k or 2k words of ultra-violet erasable P/ROM. A 128 x 1 RAM scratchpad is available for intermediate data storage. The upper 64 bits have battery backup. A programmer is available for erasing and writing into P/ROM or a bulk eraser will handle four chips simultaneously.

Circle 296 on Inquiry Card

—Struthers-Dunn, Inc, Systems Div, PO Box 1327, Bettendorf, IA 52722 has supplemented its earlier series with the Director 3001 programmable logic controller. This "intermediate size" system contains 128 I/Os, twice

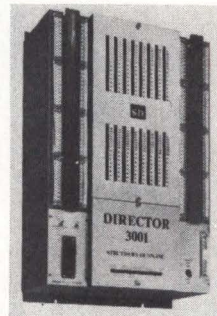

Intermediate size programmable logic controller from Struthers-Dunn has 128 I/Os, with all connections within the 17.5 x 28.25" (44.5 x 71.8 cm) cabinet. 32 timers can be programmed individually

the capacity of the earlier series, but costs only 60% more.

Up to 3k of user programmed nonvolatile memory can be used. Preprogrammed light erasable ROM protects against loss of capacity when special features are added. Relay ladder format is used to program 32 timers individually with 4-digit fixed or alterable presets.

A built-in fault monitoring system automatically checks for problems. Identification of a fault inhibits the output circuits and lights a LED indicator on the CPU.

Options are provided for selecting various data handling software. Added software extends controller capabilities to include simple arithmetic, comparison of numbers, and the ability to move data. □

Circle 297 on Inquiry Card

## TRS-80 SERIAL I/O

● RS-232 compatible ● Can be used with or without the expansion bus ● On board switch selectable baud rates of 110, 150, 300, 600, 1200, 2400, parity or no parity odd or even, 5 to 8 data bits, and 1 or 2 stop bits. D.T.R. line. Board only \$19.95 Part No. 8010, with parts \$59.95 Part No. 8010A, assembled \$79.95 Part No. 8010C. No connectors provided, see below.

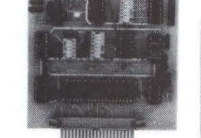

EIA/RS-232 connector Part No. DB25P \$6.00, with 9' 8 conductor cable \$10.95 Part No. DB25P9.

3' ribbon cable with attached connectors to fit TRS-80 and our serial board \$19.95 Part No. 3CAB40.

## HEX ENCODED KEYBOARD

This HEX keyboard has 19 keys, 16 encoded with 3 user definable. The encoded TTL outputs, 8-4-2-1 and STROBE are debounced and available in true and complement form. Four onboard LEDs indicate the HEX code generated for each key depression. The board requires a single +5 volt supply. Board only \$15.00 Part No. HEX-3, with parts \$49.95 Part No. HEX-3A. 44 pin edge connector \$4.00 Part No. 44P.

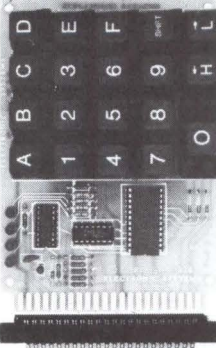

## 4K EPROM

This board is designed to operate with any speed or power 1702A. Addressable in 4K byte increments and can be configured to occupy either 2K or 4K segments. It can be populated one memory chip at a time. Bare board \$30, board with parts \$200, assembled \$230. Part No. EPM-1

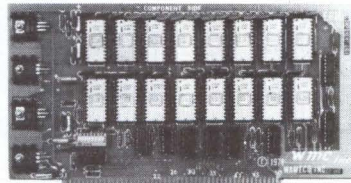

## 16K OR 32K EPROM

Designed to operate with any speed or power 2708 or single voltage (+5V) 2716. Addressable in 4K increments and can occupy multiples of 4K. It can be populated one memory chip at a time. Has bank addressing and Phantom Disable. The board comes with an exclusive software program that can be placed in a 2708 or 2716 that will, when used in conjunction with a RAM memory board, check out every line on the EPM-2. Bare board \$30, board with parts with 2708 \$455, assembled \$485. Board with parts with 2716 \$1,225, assembled \$1,255. Part No. EPM-2

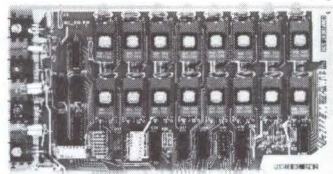

## 65K DYNAMIC RAM

Main memory for microcomputers, intelligent terminals, business systems, medical systems, and OEM systems. ● High density random access memory 48K bytes or 64K bytes ● Fully buffered ● S-100 bus compatible ● Low power (dynamic memory) ● Transparent refresh ● Digital delay line techniques for reliable operation ● Multiple boards allowed using hardware or software controlled bank select ● "Phantom" signal for RAM/ROM overlap ● All boards are fully tested prior to shipment. Operating System test and extensive bit pattern testing. ● Works directly in 8080A processors or Z-80 environment at 2MHz ● Currently used by industry ● 1 year warranty. Only available assembled and tested with 48K \$1,250 Part No. 48K, or with 65K \$1,475 Part No. 65K

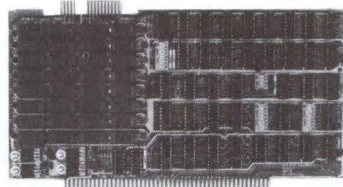

## 8080A CPU (With Eight Level Victor Interrupt Capability)

Uses the 8080A and the 8224 clock chip. The crystal frequency used is 18 MHz and the vector interrupt chip is the 8214. The board will function normally without the interrupt circuitry. When the interrupt circuitry is built up, the board will respond to eight levels of interrupts. Designed to be a plug-in replacement for the IMSAI CPU board and will work in other computers with the appropriate modifications made to the ribbon cable connector pin out from the front panel. The board will work in systems without a front panel if the system has a PROM board that simulates the functions of the front panel. Bare board \$30, with parts \$185, assembled \$220. Part No. CPU-1

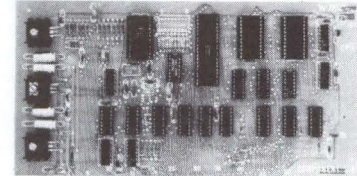

## 16K STATIC RAM

Operates with any speed or power 2114. All input and output lines are fully buffered. Addressable in 4K byte increments. If the system has a front panel, the board will allow itself to be protected. If there is no front panel, the board will not allow itself to be protected. The board has Bank Address capability, Phantom Disable, MWRITE, and selectable wait states. Bare board \$30, board with parts \$665. Part No. MEM2

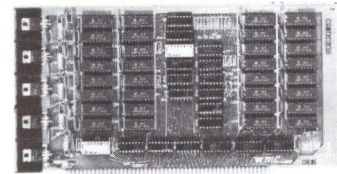

## 8K EPROM

Saves programs on PROM permanently (until erased via UV light) up to 8K bytes. Programs may be directly run from the program saver such as fixed routines or assemblers. ● S-100 bus compatible ● Room for 8K bytes of EPROM non-volatile memory (2708's). ● On-board PROM programming ● Address relocation of each 4K or memory to any 4K boundary within 64K ● Power on jump and reset jump option for "turnkey" systems and computers without a front panel ● Program saver software available ● Solder mask both sides ● Full silkscreen for easy assembly. Program saver software in 1 2708 EPROM \$25. Bare board \$35 including custom coil, board with parts but no EPROMS \$139, with 4 EPROMS \$179, with 8 EPROMS \$219.

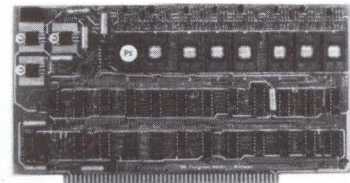

## S-100 BUS ACTIVE TERMINATOR \*

Board only \$14.95 Part No. 900, with parts \$24.95 Part No. 900A

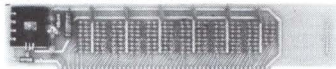

## 9 AND 13 SLOT MOTHER BOARDS

All traces are reflow solder covered and both sides are solder masked. The connectors used on these boards are the IMSAI™ type (.125" between pins, .250" between rows). Spacing between connectors is .750". All lines, except power and ground, have a passive RC network termination available. There is a kluge area available that will accept two 40 pin sockets and one 36 pin socket. The circuitry for supplying three separate regulated voltages to the kluge area is contained on the board. Part No. GMB-12 \$40 bare, \$105 kit, \$120 assembled. Part No. GMB-9 \$35 bare, \$90 kit, \$105 assembled.

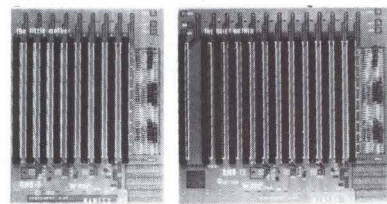

**To Order:** Mention part number, description, and price. In USA, shipping paid for orders accompanied by check, money order, or Master Charge, BankAmericard, or VISA number, expiration date and signature. Shipping charges added to C.O.D. orders. California residents add 6.5% for tax. Outside USA add 10% for air mail postage and handling, no C.O.D.'s. Checks and money orders must be payable in US dollars. Parts kits include sockets for all ICs, components, and circuit board. Documentation is included with all products. Prices are in US dollars. No open accounts. To eliminate tariff in Canada boxes are marked "Computer Parts." Dealer inquiries invited. 24 Hour Order Line: (408) 226-4064



\* Circuits designed by John Bell

For free catalog including parts lists and schematics, send a self-addressed stamped envelope.

**ELECTRONIC SYSTEMS** Dept. CD, P.O. Box 21638, San Jose, CA. USA 95151

# Your Computer Design Bookstore

(An easy way to order your professional books by mail.)

## MICROPROCESSORS AND MICROCOMPUTER SYSTEMS

By G.V. Rao. A completely up-to-date report on the state of the art of microprocessors and microcomputers, written by one of the nation's leading experts. It thoroughly analyzes currently available equipment, including associated Large Scale Integration hardware and firmware. Topics in the book facilitate communication between hardware and software specialists, as well as between marketing and training personnel. An essential reference for engineers, designers and computer specialists. 260 pp., 8½ x 11, \$24.50. Circle #142 on Reader Inquiry Card.

## A PROGRAMMED REVIEW FOR ELECTRICAL ENGINEERING

By James H. Bentley and Karen M. Hess. For candidates preparing for the Professional Engineering Examination in Electrical Engineering. A step-by-step review of electrical engineering fundamentals that presents the kind of questions you'll be asked. Each problem illustrates a specific concept, and its solution is clearly explained. Included is a wide variety of tables, formulas, charts, graphs, and schematic diagrams. 240 pp., illus., 8½ x 11, \$15.95. Circle #143 on Reader Inquiry Card.

## SYSTEMS DESIGN AND DOCUMENTATION:

### An Introduction to the HIPO Method

By Harry Katzan. Introduces HIPO (Hierarchy, plus Input, Process and Output) as a highly effective method for designing and documenting computers and information systems. HIPO describes systems in terms of their inputs, outputs and constituent processes, and places these functions in a meaningful hierarchy. Emphasizing a system's function rather than its structure, HIPO is one of the most effective aids to planning, analysis and decision making available. 157 pp., illus., 6 x 9, \$13.95. Circle #144 on the Reader Inquiry Card.

## COMPOSITE/STRUCTURED DESIGN

By Glenford J. Myers. Provides a methodology for producing less expensive programs that are also more reliable, extensive and maintainable. By discussing underlying theory and then using procedural examples, case studies and exercises, the book tells how to design the structure of medium- or large-sized programs. The author covers the relationships of design to programming languages, the "Jackson design method", and other programming methodologies. 174 pp., illus., 6 x 9, \$15.95. Circle #145 on Reader Inquiry Card.

Just published!

## MICRO-ANALYSIS OF COMPUTER SYSTEM PERFORMANCE

By Boris Beizer

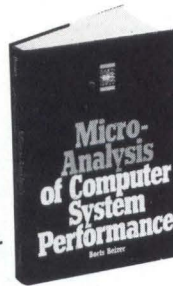

Here are proven techniques for analyzing system performance. Analytical methods—as contrasted with simulation—are featured, providing you with an easy-to-follow approach to the construction, validation and use of analytical models. Only expressions that can be programmed with relative ease are included. Mathematical prerequisites are minimal and formal derivations are used only when they serve to explain, illustrate or build intuition. This book will save you countless hours of experimentation and reinvention of analytical methods.

### Gives you thoroughly tested procedures.

All the techniques have been proven in practice and can be directly used in the performance analysis of systems based in mini- or microcomputers, analysis of component elements of a large system, and the kinds of analyses done with limited resources such as a calculator or a pocket computer. The assembly language and system programmer will find tools for optimizing the design of individual routines or program modules; the system user and designer will find most of the analytical techniques likely to be required; and the system modeler will find practical methods that quickly get to the heart of a problem. The book includes numerous illustrations and examples that help answer the questions you face daily. 402 pp., illus., 6 x 9, \$22.50. Circle #141 on Reader Inquiry Card.

## ENCYCLOPEDIA OF COMPUTER SCIENCE

Edited by Anthony Ralston and C.L. Meek. A comprehensive reference containing over 480 articles and 1,000 illustrations, tables and charts. Featuring contributions from over 200 computer science authorities, the volume covers data processing, computer science, information processing, and symbol manipulation. All areas of software, hardware, languages, programs, systems, mathematics, networks, applications, theory, history, and terminology are investigated. 1,523 pp., illus., 7 x 10, \$60.00. Circle #146 on Reader Inquiry Card.

## DATA COMMUNICATIONS DICTIONARY

By Charles J. Sippl. An indispensable reference for keeping pace with the rapidly expanding field of data communications. It defines 14,500 terms, concepts, acronyms and abbreviations used in data processing and communications, and is the first dictionary to cover these interrelated areas in one convenient volume. The dictionary clarifies terminology relating to the most important procedures, processes, equipment, capabilities and software. It provides current, concise definitions in new areas such as microcomputers, multi-mini computer systems, and developments in satellite, "packet" and laser communications. 545 pp., 6 x 9, \$19.95. Circle #147 on Reader Inquiry Card.

## RISS: A Relational Data Base Management System for Minicomputers

By Monte Jay Meldman, Dennis J. McLeod, Robert J. Pellicore, and Morris Squire. Describes a complete minicomputer relational data base management system and its implementation. Reveals how novice users can interact with a computerized data base without needing a programmer—an important cost-saving feature. Also covered are the design approach and structure, user interfaces, and examples of how RISS can be put into practice. 128 pp., illus., 6 x 9, \$14.95. Circle #148 on Reader Inquiry Card.

## TOP-DOWN STRUCTURED PROGRAMMING TECHNIQUES

By Clement L. McGowan and John R. Kelley. Defines structured programming and sets forth how it is applied. Computer scientists in private industry, the federal government, major universities, and in a growing number of commercial software companies are advocates of the techniques in this handbook. It covers software, the use of the DOWHILE, loop invariants, program correctness and structured programs, structured flow-of-control in FORTRAN, structured flow-of-control in COBOL, and how to structure unstructured codes. 288 pp., illus., 6 x 9, \$16.95. Circle #149 on Reader Inquiry Card.

### 15-DAY FREE EXAMINATION

To order free-trial copies of any of these books, simply circle the appropriate number(s) on the Reader Inquiry Card at the back of this magazine. At the end of 15 days if satisfied, send remittance plus postage, handling, and your local sales tax. Otherwise, return the books and owe nothing.

**SAVE:** If you prefer to enclose payment now, we will pay postage and handling charges. Same return privilege, full money-back guarantee. Your local sales tax must be included with payment.

Offer good in U.S.A. only. Payment must accompany order with P.O. box addresses. Prices subject to change.

C4012

 **VAN NOSTRAND REINHOLD**

# We've Earned Our Stripes

## With The Only Plug Compatible Microprocessor I/O System In The Industry

Opto 22 combines the latest and best in I/O modules with plug compatibility to single board computers. Opto 22 I/O Systems are available in plug compatible racks holding eight, sixteen or twenty-four modules. These highest quality Input/output modules are available for 5, 15, or 24-volt logic—all employing 2500 volts RMS photo-isolation.

Simplified installation and maintenance are important features of the systems. Barrier-type screw terminals, LED status lights, pull-up resistors and plug-in fuses are mounted on the racks. Changes and replacements are easily made without removing wires.

Because we concentrate solely on photo-isolated SSR's, you get quality, reliability and innovation at the best prices.

Plug compatibility with:

- |  |   |
|--|---|
| <input type="checkbox"/> Intel                         | <input type="checkbox"/> General Automation |
| <input type="checkbox"/> Motorola                      | <input type="checkbox"/> Iasis              |
| <input type="checkbox"/> Burr-Brown                    | <input type="checkbox"/> Mostek             |
| <input type="checkbox"/> Computer Automation           | <input type="checkbox"/> National           |
| <input type="checkbox"/> Control Logic                 | <input type="checkbox"/> Texas Instrument   |
| <input type="checkbox"/> Data General                  | <input type="checkbox"/> Western Digital    |
| <input type="checkbox"/> Digital Equipment Corporation | <input type="checkbox"/> Zilog              |



5842 Research Drive, Huntington Beach, CA 92649, (714) 892-3313

**CIRCLE 61 ON INQUIRY CARD**

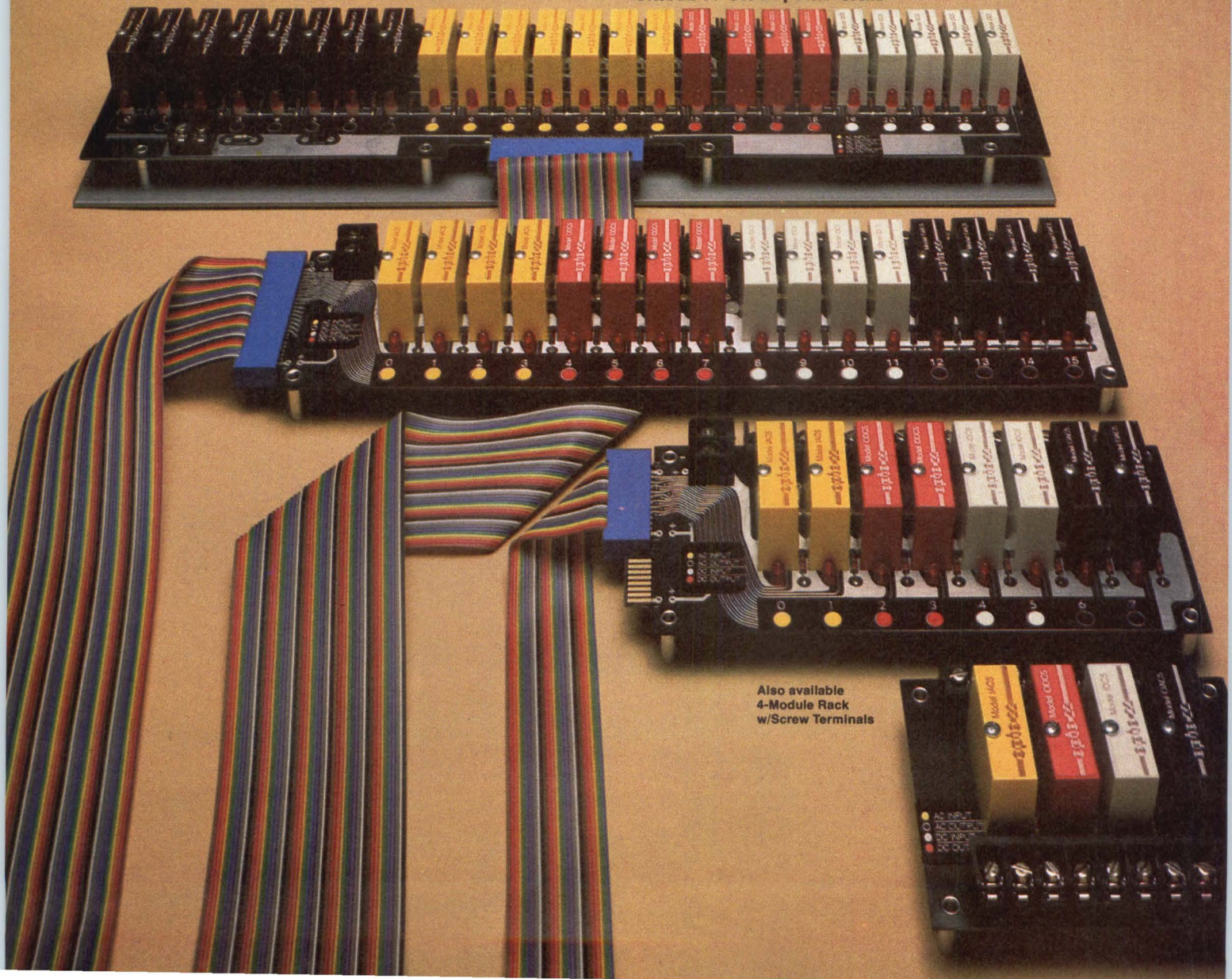

Also available  
4-Module Rack  
w/Screw Terminals





# Zap! Your system's tested.

**Test in "real time" up to 5 megahertz and drastically cut development time and costs.**

With the force of the MicroSystem Analyzer, developing diagnostics now can be a snap. Operating in real time at microprocessor speeds up to 5 MHz, the MicroSystem Analyzer speeds total development time, performs hardware/software integration, and gets your prototype into production faster.

## **A Whole New Way of Microprocessor System Testing**

With the MicroSystem Analyzer, you now can control your system with In-Circuit Emulation, and find faults with Signature Analysis, Time and Frequency measurements.

No other system available combines the elements to let you control and test at *all levels*—system, board, and component—in real time. The MicroSystem Analyzer lets you discover intermittent problems over a wide range of temperatures, operate without a built-in test source, and perform fault detection in multiboard systems. Test programs are easier and faster to develop, more complete and more accurate.

## **Universal—Both Today & Tomorrow**

The MicroSystem Analyzer plugs directly into the most common microprocessor sockets—Z80, 8085A, 6800, 8080, with more to come—and uses a series of personality cards and probes to let you thoroughly isolate faults to the subsystem and component level. No matter what major microprocessor you are using in product development or in production test, the

MicroSystem Analyzer is the one universal and portable instrument for you.

## **Get Your Products into Production Faster**

The MicroSystem Analyzer eliminates the need for long and expensive test fixture development, so you can move onto the next project sooner. Plus, with the diagnostics developed you have provided total production, depot repair and field test support!

**Complete the coupon below for details  
on the most advanced microprocessor  
test instrument available today.**



# **MILLENNIUM**

MILLENNIUM SYSTEMS, INC.  
19020 Pruneridge Avenue, Cupertino, CA 95014  
Phone: (408) 996-9109 TWX: 910-338-0256  
A subsidiary of American Microsystems, Inc.

Gentlemen:

OK, you got my attention. Now I'd like you to prove your MicroSystem Analyzer can shorten my development cycle, test systems and boards faster than anybody else, and save me a ton of money in the process.

PLEASE:

- Call me to set up a live demo on my Z80A, 8085A, 6800, or 8080 system.
- Send me complete information on the MicroSystem Analyzer today!

NAME \_\_\_\_\_  
TITLE \_\_\_\_\_  
COMPANY \_\_\_\_\_  
ADDRESS \_\_\_\_\_  
CITY \_\_\_\_\_ STATE \_\_\_\_\_ ZIP \_\_\_\_\_  
PHONE \_\_\_\_\_ EXTENSION \_\_\_\_\_

**CIRCLE 62 ON INQUIRY CARD**

# COMPCON 79

## Spring IEEE Computer Society International Conference

February 26-March 1  
Jack Tar Hotel, San Francisco, California



Dean Brown  
General Chairman

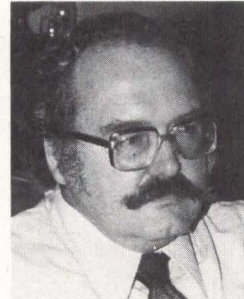

Fred Buelow  
Program Chairman

"Exploding Technology/Responsible Growth" will be the theme of COMPCON 79 Spring. Dean Brown, general chairman, and Fred Buelow, program chairman, will officially open the conference at 9 am Tuesday, February 27. Two authors will address the conference theme in the keynote session. John Linvill, department chairman and professor of electrical engineering at Stanford University will speak on "Research and Development in Semiconductors and Solid-State Technology: The Need for Integrated Systems." "New Developments in Software" will be presented by Robert McClure, consultant.

The keynote session will conclude with a symposium on the implications of the conference theme for economic management, political international relations, environment, and limits of growth. Serving as panelists will be William Miller, professor of computer science, vice-president, and provost, Stanford University; Arnold Mitchell, senior social economist, SRI International; Robert C. Seamans, dean of engineering, MIT; Henry R. Luce, professor of environment and public policy, MIT; and Cuthbert C. Hurd, Cuthbert C. Hurd Associates, and president, Holistic Construction Co.

With 25 technical program sessions, the conference will cover topics including reliable computer systems, hardware and software standards, database computer architecture, distributed database management, and state-of-the-art in computer security technology. The short-note session on Wednesday morning will feature 5-minute papers reporting recent results and accomplishments.

Pre-conference tutorial sessions will again be scheduled this year. Three sessions will be held from 8:30 to 5 pm on Monday, February 26. Thomas E. Everhart, professor of electrical engineering and computer

sciences, University of California, will instruct "Electron Beam Lithography—An Emerging New Capacity for VLSI Designers." Everhart will include fundamental background material in his presentation of the advantages and disadvantages of computer controlled fabrication. "Computer Graphics—An Overview of Graphics Hardware and Software for Managers, Users, and Analyst/Programmers" will be Kellogg S. Booth's tutorial. Booth, an assistant professor of computer science at the University of Waterloo, Canada, will address fundamental hardware and software issues in his introductory computer graphics course, with an emphasis on decision-making in the acquisition, implementation, and use of graphics systems. Donald J. Reifer, senior staff engineer, TRW Digital Avionics Laboratory, will present "Software Management—Planning, Controlling, Organizing, Staffing, and Directing," an introductory course addressing the basic functions involved in managing a medium-to-large scale programming project or data processing operation.

Prior to February 12, registration fees will be \$50/65 for COMPCON only (member/non-member), \$50/65 for tutorial only, and \$100/130 for both. Registration after February 12 will be \$60/75, \$60/75, and \$120/150, respectively. The tutorial fee includes one copy of the tutorial text and luncheon. (Luncheon will be guaranteed for advance registrants only.) The COMPCON fee includes a copy of the *COMPCON Digest of Papers*; additional copies of the digest will be available for \$18.75/25 (members/non-members).

Advance registrations should be mailed to Ms Terry Contreras, L-307, COMPCON 79 Spring, Lawrence Livermore Laboratory, PO Box 808, Livermore, CA 94550.

The following technical program review includes information available at press time.

# See what you're missing... it's time to ask for a sample of "Vision One" quality image processing: the first choice of specialists.

## Comtal is image processing.

By definition, an *image* is the digitally stored representation of the shape and shadings of objects, people or scenes. And, *processing* is the enhancement of brightness, color and definition of the image.

Printed reproductions cannot do justice to the quality of Vision One Image Processing Systems. To see what you're missing, send to Comtal for samples of Vision One image quality and standard interactive processing features.



Vision One is delivered ready to operate on digitized imagery without a host system/software development or time-consuming software installation or integration.

To get the full story on what Vision One image processing can offer you, write to COMTAL Image Processing Systems, P.O. Box 5087, Pasadena, California 91107 • (213) 793-2134 • TWX 910-588-3256



Vision One is an intelligent image processing system featuring real-time, completely operator interactive image processing for black and white or full 24-bit color (8 bits each of red, green and blue). Image resolution is 256x256, 512x512, or 1024x1024 pixels with internal solid state memory for up to fifteen 512x512 images (8-bit) and sixteen 512x512 graphic (1-bit) overlays.

Comtal is the acknowledged leader in digital image processing and offers the first commercial system with these features:

Real-time roam of multiple displays in very large data base memories (1977), stand-alone image processing systems, real-time small area independent color correction, and real-time convolution processing (1975). Also, 1024x1024, 256 shade soft-copy display image processing system (1974), full 24-bit color and digital image function and pseudo-color image processing (1973), with single standard digital interface for all features and options (1972).

Comtal has the only commercial systems with real-time operator interactive image processing and hardware generated display of image processing test patterns.

**COMTAL**<sup>®</sup>  
IMAGE PROCESSING SYSTEMS

## Technical Program

### Tuesday Afternoon

Session 1 3:30-5 pm

#### Design Automation for VLSI Systems

Chairman: W. M. vanCleemput, Stanford University

"Design Automation Requirements for VLSI," W. M. vanCleemput, Stanford University

"A VLSI Design Philosophy and Support Software," J. Gray, California Institute of Technology

"A Hierarchical VLSI Design Automation System," P. Weil, *et al*, Hughes Aircraft Co

"An Automatic VLSI Layout System," E. Porter, Microtechnology Corp

Session 2 3:30-5 pm

#### Can Computer Technology Contain the Cost of Health Care?

Chairwoman: T. Estrin, University of California

Panelists: E. Van Brunt, Permanente Medical Group; M. Cook, El Camino Hospital; S. A. Glantz, University of California; A. I. Wasserman, University of California

Session 3 3:30-5 pm

#### Voice Systems

Chairman: K. Berney, Centigram Corp

"Medical Applications of Voice Systems," J. Clark, University of California

"Low Cost Voice Recognition," B. Georgiou, California State University

"Commercial Speech Recognition: Definitions, Capabilities, Applications," J. Postas, Centigram Corp

Session 4 3:30-5 pm

#### State of the Art in Computer Security Technology

Chairman: E. Burke, MITRE Corp

"Computer Security Technology: The Second Generation," E. Burke, MITRE Corp

"The Kernelized Secure Operating System," E. J. McCanley, Ford Aerospace and Communication Corp

"Steps Toward Provably Secure Operating Systems," L. DeLashmutter, Dept of Defense

### Wednesday Morning

Session 5 8:45 am-12 noon

#### Reliable Computer Systems

Chairman: E. J. McCluskey, Stanford University

"The PLURIBUS Fault-Tolerant Multiprocessor," J. Robinson, Bolt, Beranek and Newman

"A Study of Failures in the Slac Triplex Multiprocessor," D. Beaudry, Stanford University

"Demands of the Commercial Marketplace on Fault-Tolerant Equipment," J. Katzman, Tandem Computers

"Recovery Strategies for the Fault-Tolerant Spaceborne Computer," H. Hecht, SOHAR, Inc

Session 6 8:45 am-12 noon

#### Architecture and Technology for Data Management

Chairman: H. Barsamian, UNIVAC

"Trends in Data Base Architecture," G. Champine, UNIVAC

"System R," J. N. Gray, IBM Corp

"Architecture of a Data Base Machine," V. Maller, ICL, England

"Storage Technology: Capabilities and Limitations," A. Hoagland, IBM Corp

"Technology for Storage Hierarchy Architecture," S. Puthuff, Memorex

"Memory Hierarchy Configuration Analysis," T. Welch, Sperry Research

Session 7 8:45-10:30 am

#### Microcomputer Operating Systems

Chairman: K. Kahn, IntelCorp

"Fast—A Facility for Analyzing Microprocessor System Performance," S. Kerman, Intel Corp

"A System Programming Toolbox for Microcomputers," T. Snook, Zilog

Session 8 8:45 am-12 noon

#### Short Notes

Chairman: M. Graham, University of California

Session 9 10:30 am-12 noon

#### Multiple Microprocessor Architecture and Software

Chairman: D. West, Millenium Systems, Inc

"Multiple Microprocessor Systems: Goals, Limitations and Alternatives," R. Childs, Intel Corp

"A 16-Bit Microprocessor of Dual-Bus Architecture for a Multiprocessor System," K. Tanabe, Nippon Electric Corp

"System Architectures for Compatible Distributed Processing," M. McKenzie, Zilog

### Wednesday Afternoon

Session 10 1:30-3 pm

#### Hardware Testing

Chairman: J. F. Wakerly, BNR, Inc

"Test Generation Method for Highly Sequential Circuits," T. Yamada, *et al*, NEC-Toshiba Information Systems, Inc

"User Testing of Microprocessors," S. M. Thatte and J. A. Abraham, Coordinated Science Laboratory, University of Illinois

Session 11 1:30-3 pm

#### Distributed Data Base Management

Chairman: W. W. Chu, University of California

"A Distributed Data Base Architecture," D. Small, *et al*, Naval Ocean System Center; and W. W. Chu, University of California

"A Model for Optimal Query Access for Distributed Data Bases," W. W. Chu and P. J. Hurley, University of California

Panel Discussion—Current Issues of Distributed Data Bases, W. W. Chu, University of California; J. N. Gray, IBM Research; A. Shoshani, Lawrence Berkeley Laboratory; and P. Chang

Session 12 1:30-3 pm

#### Small Business Systems

Chairwoman: A. Algren, Cromemco

"A Microcomputer Based Business System," H. Garland, Cromemco

"The HP 300," Hewlett-Packard

"The IBM System/38"

Session 13 1:30-3 pm

#### Software Standards

Chairman: R. E. Langer, Lawrence Livermore Laboratory

"Architectural Issues for Data Base Standards," D. R. Deutsch, *et al*, National Bureau of Standards

"Will PASCAL be the Next Standard Language?" B. W. Ravenal, Language Resources

"Implications of Floating Point Standardization," M. H. Payne, Digital Equipment Corp

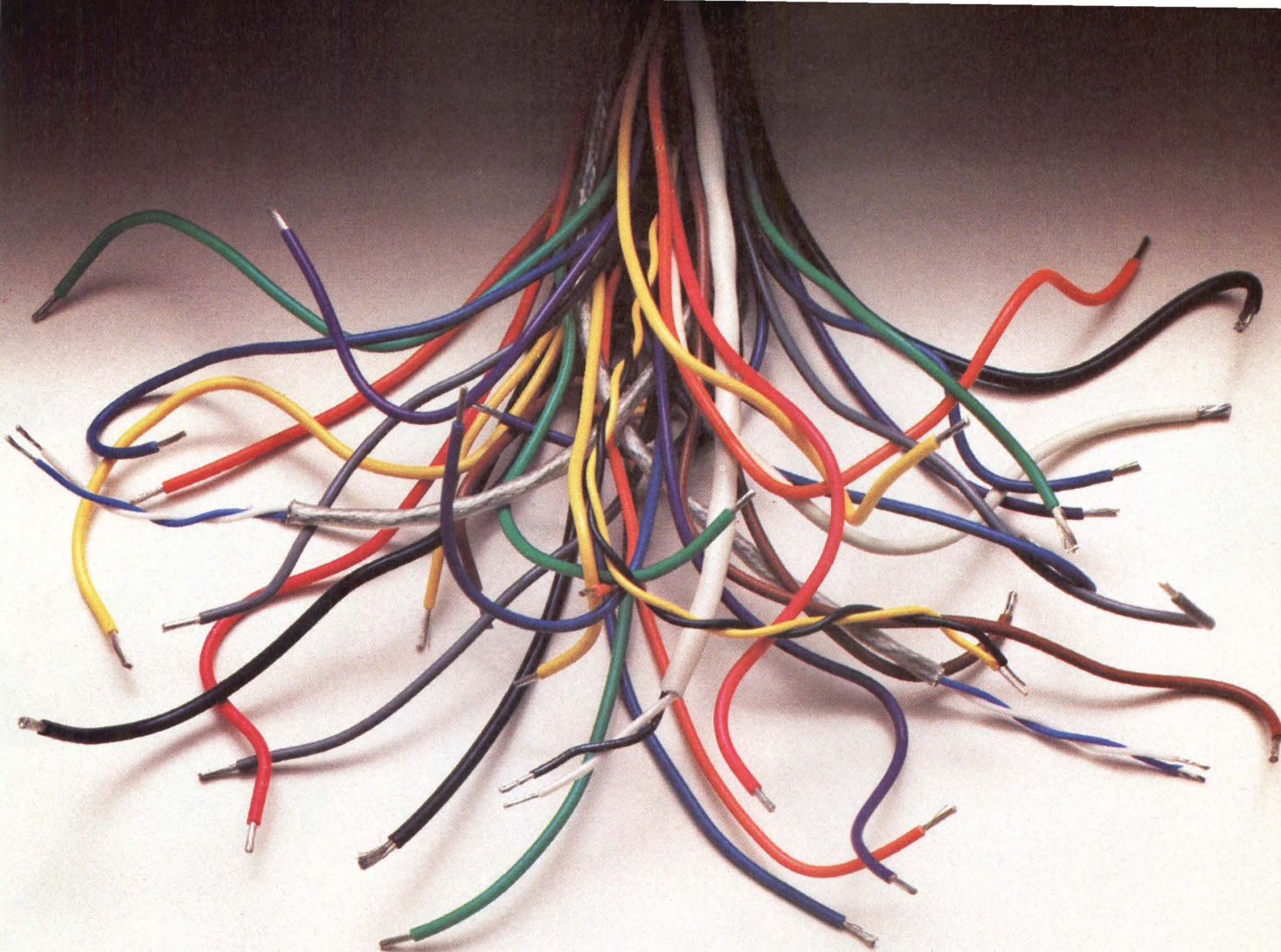

# We'll take it from here.

Let's face it, interconnections can really leave you at loose ends.

So we're offering to take total responsibility for solving your mass termination problems.

We're Spectra-Strip, and what we make is exactly what you need to get your job done right, reliably and within reason.

For all your interconnect needs from jumpers and flat cables to IDC connectors and ready-to-go standard and custom planar assemblies, just check us

out. You won't need to call anyone else.

For the name and number of our nearest distributor or rep, write Spectra-Strip, an Eltra Company, 7100 Lampson Avenue, Garden Grove, CA 92642. Or call (714) 892-3361 today.



When you're down to the wire

CIRCLE 64 ON INQUIRY CARD



# **Introducing SUMMIT.**

## **No longer must your minicomputer system be hampered by a one-track mind.**

Up to now, most minicomputer systems could only have one thing on their mind at a time.

If they could handle one set of tasks, they couldn't handle another. Not concurrently, at least.

That's why Sperry Univac is bringing you SUMMIT—Sperry Univac Minicomputer Management of Interactive Terminals. A powerful, flexible, new operating system.

One that lets you coordinate all your data processing needs and lets your system perform them concurrently.

SUMMIT is a terminal-oriented, message-driven operating system that lets you perform timeshare, transaction processing, and batch processing.

Our simple new query language and our data base management system give you complete data base access, file access security, inquire, and report facilities.

With SUMMIT you can use PASCAL. A powerful new language for scientific, commercial and system programming that most competitive systems still can't speak. (Naturally, SUMMIT also speaks COBOL, FORTRAN, and RPG II.)

It gives you terminal independence. So you can use buffered, block-mode terminals. Character-mode terminals.

Uniscope terminals. 3270 terminal clusters. Concurrently.

You can perform on-line program development with line, screen, and text editors and submission of tasks to background queue.

SUMMIT also gives you enhanced file structure. With a surprisingly large file capacity. And that, of course, provides outstanding text processing capability.

What's more, SUMMIT has connections. Distributed processing connections for Sperry Univac 90 and 1100 Series and our powerful minis (like the new V77-800), as well as 370's.

You get all this only with SUMMIT from Sperry Univac.

For more information, write to us at Sperry Univac Mini-Computer Operations, 2722 Michelson Drive, Irvine, California 92713. Or call (714) 833-2400, ext. 536.

In Europe, write Headquarters, Mini-Computer Operations, London NW10 8LS, England.

In Canada, write Headquarters, Mini-Computer Operations, 55 Centre City Drive, Mississauga, Ontario.

We're Sperry Univac.

And we think it's time minicomputer systems were put under new operating management.

**SPERRY**  **UNIVAC**  
SPERRY UNIVAC IS A DIVISION OF  
SPERRY RAND CORPORATION

# INTRODUCING THE AUTOMATIC CARD TESTER YOU CAN'T OUTGROW.

**EMULATION/SIMULATION OPTION:** Allows you to generate your own test programs without buying an expensive stand-alone system.

**ANALOG OPTION:** Greatly simplifies the testing of both analog and hybrid boards.

**HIGH-SPEED CLIP OPTION:** Permits faster, more accurate testing of sensitive, high-speed boards by minimizing cross-talk and loading.

**ADVANCED FAULT RESOLUTION (AFR) OPTION:** Isolates and identifies any faulty component by part number and location.

**REAL-TIME OPTION:** Permits high-speed testing of microprocessor — and LSI based boards.

One year on-site warranty on entire system.



You're looking at a CAPABLE™ Tester from ComputerAutomation. But what's more important, you're looking at an automatic card tester that's truly modular in design.

And that makes it totally different from any other brand of tester on the market today.

Designed-in modularity means no matter how complex your boards become, they can't outgrow a CAPABLE Tester.

Designed-in modularity means the end of expensive overbuying, too. Because with a CAPABLE, you simply buy what you need — when you need it.

#### An Ample Example.

Take our CAPABLE Tester Model 4100. It's perfect for fast production-line testing and fault isolation. While keeping overall costs down.

What's more, you get all the basics. A powerful ComputerAutomation LSI-2 computer. 32K words of memory. A rugged floppy disk drive. A full-function CRT. Plus a comprehensive software package that includes computer Guided Fault Isolation (GFI), Fault Detection Verification (FDV) and Automatic Fault Isolation (AFI).

Where you grow from there, though, is entirely up to you.

You can keep things small, relatively specialized. Or, you can build your CAPABLE up into a model like the

4400 (as shown) to test complex boards containing LSI, VLSI and microprocessor components.

#### No more growing pains. Ever.

The CAPABLE's designed-in modularity makes it remarkably easy to add-on whatever you need. More programmable pin modules. Real-time testing. Advanced Fault Resolution (AFR). Or an analog test option.

You can even expand your CAPABLE into a full-blown Logic Simulation System and develop your own test programs.

Best of all, no matter how far you grow, ComputerAutomation provides you with all the operating software you need — absolutely free — including enhancements, updates and new features.

So, before you buy an automatic card tester that will literally stunt your growth, look into the CAPABLE Family from ComputerAutomation.

We have a way of growing on you.

 **ComputerAutomation**  
Industrial Products Division

**We're making history in ATS.**

2181 Dupont Drive, Irvine, California 92713, (714) 833-8830. Or, call one of the following regional offices in: Bloomfield, NJ, (201) 338-8870; Des Plaines, IL, (312) 297-1606; Santa Clara, CA, (408) 985-6800. District offices located in Dallas, TX; Waltham, MA; Falls Church, VA; Santa Ana, CA; Kettering, OH; and Toronto, Canada. In Europe: CAL, Ltd., 44-27324140; CAL G.m.b.H., 49-61033627.

CIRCLE 66 ON INQUIRY CARD



Session 14

3:15-5 pm

### **Novel Technologies— Are They Applicable to Computers?**

Chairman: L. C. Topham, Amdahl Corp

"Fiber Optic Data Links for Distributed Computer Communications," D. Hanson, Hewlett-Packard

"Superconducting Josephson Computers," H. L. Caswell, IBM Corp

"New Amorphous Materials for Computer Use," S. Ovshinsky, Energy Conversion Devices, Inc

Session 15

3:15-5 pm

### **Data Base Computer Architecture**

Chairman: J. W. S. Liu, University of Illinois

"A System Architecture for Distributed Data Base Management," F. Maryanski, *et al*, Kansas State University

"A Binary Data Store Scheme for Magnetic Bubble Memories," K. M. Chung, University of Illinois; F. Luccio and C. K. Wong, IBM Research

"Status of RAP Technologies," S. A. Schuster, Intel Corp; and K. C. Smith, University of Toronto

"Current Research Activities on Data Base Computer Architecture," G. Champine, UNIVAC, and David Hsiao, Ohio State University

Session 16

3:15-5 pm

### **Computer Peripherals**

Chairman: R. P. Lee, IBM Research

"An Application of CCD Technology to a Large-System Paging Store," R. Hancock, Storage Technology Corp

"Microprocessor Control of a Disk Memory," R. Higgins, Magnetic Peripherals, Inc

"A Single-Chip Peripheral Unit"

Session 17

3:15-5 pm

### **Hardware Standards**

Chairman: A. J. Stripeika, Lawrence Livermore Laboratory

"Directions in Network Interface and Protocol Standards," T. N. Pyke, National Bureau of Standards

"Proposed Small Computer Bus Standards," G. Morrow, Thinker Toy Co

"Proposed Small Computer Bus Standards," R. Garrow, Intel Corp

Panel Discussion: G. Morrow and R. Garrow

## **Thursday Morning**

Session 18

8:45 am-12 noon

### **Integrating Semiconductor Memories into Systems**

Chairman: J. M. Lee, Intel Corp

"What's New in Semiconductor Memories," R. Alquist, Intel Corp

"CCD for High Density Storage," D. Laufer, NCR Corp

"An Economic Analysis of the Test Problem," S. Margossian, Amdahl Corp

"Reliability Considerations for Semiconductor Memories," V. Ohm, Amdahl Corp

"Soft Failures in MOS Dynamic Memories," M. Geilhufe, Intel Corp

Session 19

8:45-10:30 am

### **Interprocess Communication**

Chairman: D. Hunt, Bolt, Beranek and Newman

"Interprocess Communication and Control in the PLURIBUS Operating System," E. Roberts and A. Lake, Bolt, Beranek and Newman

"Interprocess Communication in PRIMOS," L. Scheffler, Prime Computer

"Selection of Message Primitives for a Distributed System," E. Basart, Hewlett-Packard

"Implementation of the HXDP Executive," D. Cornhill and W. Boehert, Honeywell

Session 20

8:45 am-12 noon

### **The Application of Computer Graphics**

Chairman: R. Williams, IBM Research

"The Role of Computer-Generated Movies in Scientific Research," D. L. Vickers, Lawrence Livermore Laboratory

"Data Base Requirements for Graphics," D. Weller and F. Palermo, IBM Research

"A Picture Building System," D. Weller and F. Palermo, IBM Research

"A Graphical Editor for Programming Using Structured Charts," N. Ng, IBM Research

"Tell: A System for Graphically Representing Software Designs," P. G. Hebalkar and S. Zilles, IBM Research

Session 21

10:30 am-12 noon

### **Local Area Computer Network Technology**

Chairman: K. J. Thurber, UNIVAC

"Local Area Computer Network Architectures," K. J. Thurber and H. A. Freeman, UNIVAC

"Overview of Hyperchannel," J. Thornton, Network Systems Corp

"A Serial Data Bus System for Local Processing Networks," R. C. Kuhns and M. C. Shoquist, UNIVAC

"Architectural and System Implications of Local Computer Networking," P. C. Patton and A. Franck, University of Minnesota

## **Thursday Afternoon**

Session 22

1:30-5 pm

### **Packaging for High Performance**

Chairman: M. Chiang, Amdahl Corp

"Considerations for High Performance LSI Applications," A. Vacca, Control Data Corp

"Performance Vs Circuit Package Density," W. Vilkelis, IBM Corp

"Packaging Tradeoffs for a High Performance Computer," W. Chow, Amdahl Corp

"Custom MSI for Very-High-Speed Computers," D. Eberlein, Cray Research

Panel Discussion: Session Speakers

Session 23

1:30-3:15 pm

### **Plug-Compatible, Small-to-Medium Computers**

Chairman: J. Morris, National Semiconductor Corp

Session 24

1:30-5 pm

### **Software Design Techniques**

Chairman: E. F. Miller, Jr, Software Research Associates

"The Warnier-Orr Diagram," A. Goodman and P. Verdegraal, Michigan Department of State

"A COBOL Block-Structuring Technique for Program Maintenance," D. G. Dzamba, IBM Corp

"Automated Support Tools for Software Engineering," E. Miller and W. Fricke, Software Research Associates

"Auditing Software Development Projects," M. G. Walker, Computer Science Corp

"ATOM: A Component Approach to Software Systems Development," R. T. Nicholson and K. E. Shez, Hewlett-Packard

"Experience in a Software Test Factory," T. A. Bubb, University of California; H. M. Sneed, Software Research Associates; and M. Majoras, szki

Session 25

3:15-5 pm

### **Plug-Compatible Large Computers**

Chairman: R. Whitcomb, Intel Corp

Panelists: J. Bock, Intel Corp; K. Spiro, Amdahl Corp; and R. Chu, Exsysco Div, National Semiconductor □

# IEEE International Solid State Circuits Conference

ISSCC 79, a global forum for the presentation of advancements in all aspects of solid-state circuits, will contain papers by participants from the U.S., Japan, The Netherlands, England, Germany, France, and Belgium. Under the direction of program chairman Walter F. Kosonocky of RCA Laboratories, this assemblage will present 88 papers detailing design, performance, fabrication, test, and application of solid-state circuits, device structures, phenomena, and systems. Topics that include electron beam ROM, 64k MOS and VMOS dynamic RAMs, static RAMs, logic arrays and innovations, and other LSI applications demonstrate the increasing relevance of the subject matter to those involved in computer technology. Sponsors are the IEEE Solid State Circuits Council, Philadelphia Section, and the University of Pennsylvania.

Conference chairman John D. Heightley of Sandia Laboratories and executive committee chairman J. A. A. Raper of General Electric Co will welcome attendees to the formal opening of the Conference at 1:30 pm on Wednesday. Included in the ceremonies will be the annual presentation of awards, among which are the ISSCC Beatrice Winner Award for Editorial Excellence, the IEEE Frederik Philips Award, and the ISSCC Best Paper Awards.

Highlight of these formalities will be the Keynote Address, "Are We Really Ready for VLSI<sup>2</sup>?" in which G. E. Moore, president and chief executive officer of Intel Corp, will point out the growing disparity between industry's ability to construct complex circuit functions and its ability to conceive and design products utilizing those functions. Remarking on observable indications that the industry will not continue to be driven by the technology, Mr Moore will attempt to describe principal changes that are occurring which could have a profound effect on the structure of the industry.

Informal evening discussion sessions, a tradition at ISSCC, will be held on Wednesday and Thursday evenings beginning at 8 pm. Topics on the agenda include the impact of VLSI on the electronics industry, logic implementation for VLSI, third generation microprocessors, technology alternatives for the home computer, microprocessor support and interface circuits, and MOS and bipolar analog techniques.

Advance registration fees are \$50 for members and \$70 for nonmembers; at the Conference, fees will be \$60 for members, \$80 nonmembers. Registrants will receive a copy of the *Digest of Technical Papers*; additional copies are \$20 each for members and \$30 each for nonmembers.

For conference information contact Lewis Winner, 301 Almeria/PO Box 343788, Coral Gables, FL 33134 (telephone 305/446-8193).

**February 14-16**  
**Philadelphia Sheraton Hotel**  
**and Holiday Inn**  
**Philadelphia, Pennsylvania**



**Walter F. Kosonocky**  
Program Chairman

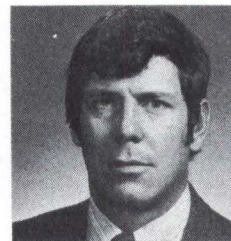

**John D. Heightley**  
Conference Chairman

## Technical Program Excerpts

### Wednesday Morning

Session I                      9-12:00 am                      Grand Ballroom

#### Memory Technology

Chairman: R. W. Owen, Mostek Corp

"A 65-mW 128k Electron Beam ROM," K. Kiuchi, *et al*, Nippon Tel-Tel Musashino Electrical Communication Laboratory, Tokyo, Japan

"A Self-Refreshing 4k RAM," J. M. Caywood, *et al*, Intel Corp

"A 1M-Bit Full Wafer MOS RAM," Y. Egawa, *et al*, Nippon Tel-Tel Musashino Electrical Communication Laboratory, Tokyo, Japan

"Charge Transfer Sense Amplifier," L. G. Heller, IBM General Technology Div

"Static Bipolar RAM Cell with Compact Punch Through Loads," J. Lohstroh, Philips Research Laboratories, Eindhoven, Netherlands

"Taper Isolated Dynamic Gain RAM Cell," P. K. Chatterjee, *et al*, Texas Instruments

Session 2                      9-12 am                      Pennsylvania Ballroom

#### Telecommunication Circuit Techniques

Chairman: R. Blauschild, Signetics Corp

"CMOS Switched-Capacitor Filters for a Two-Chip PCM Codec," R. Gregorian, *et al*, American Microsystems, Inc

"A Multichannel Codec and Filter Subsystem," P. J. Schwarz and V. Blatt, Plessey Research, Ltd, Northamptonshire, England; and C. Priest, Plessey Telecommunications Research, Ltd, Berkshire, England

"An Optically-Coupled High-Voltage PNP Crosspoint Array," H. Mori, *et al*, Oki Electric Industry Co, Ltd, Tokyo, Japan; K. Kato, Nippon Tel-Tel Musashino Electrical Communication Laboratory, Tokyo, Japan; and S. Ohkoshi, Nippon Tel-Tel Yokosuka Electrical Communications Laboratory, Kanagawa, Japan

"A Monolithic PSK Encoder/Transmitter," J. Silverman, Exar Integrated Systems, Inc



# Now in volume production: magnetic bubble memories. From Texas Instruments.

TI's 92K bit TIB0203 magnetic bubble memory is readily available in quantity. Delivery 4 to 6 weeks ARO.

**Many design advantages**  
Volume availability is only one good reason for designing in the TIB0203. There are many more:

- The interface and peripheral circuits you'll need to build a compact, high-density system around the TIB0203 are ready now. Including the controller which provides high level interface between the microprocessor and the bubble memory. All from the
- same dependable source—Texas Instruments.
- The TIB0203 offers an efficient, modular approach to building any size memory.
- Solid-state technology provides inherently greater reliability.
- The TIB0203 incorporates an asymmetric chevron geometry chip for superior performance.
- An evaluation board, complete with TIB0203, is available and provides TTL interface to the bubble memory via custom ICs.
- Already applications proven, the TIB0203 is ideal as non-volatile, small capacity storage for port-

ble data entry terminals. Industrial controller systems. And mini-floppy disk replacement. Which assures the TIB0203 a long product life.

### High volume, low price

In 100 pieces, the TIB0203 is economically attractive for widespread use. Only \$100.00.

### Get your 92Ks today

For fast delivery on the 92K bubble memory, call your nearest authorized TI distributor. Or write Texas Instruments Incorporated, P.O. Box 225012, M/S 308, Dallas, Texas 75265.



**TEXAS INSTRUMENTS**  
INCORPORATED

CIRCLE 67 ON INQUIRY CARD

**Now supports F8, 3870, 3872.**

**Our system  
emulates the 8080 and  
the 8085. The Z80.  
The 6800. The TMS 9900.  
And that's just  
for openers.**

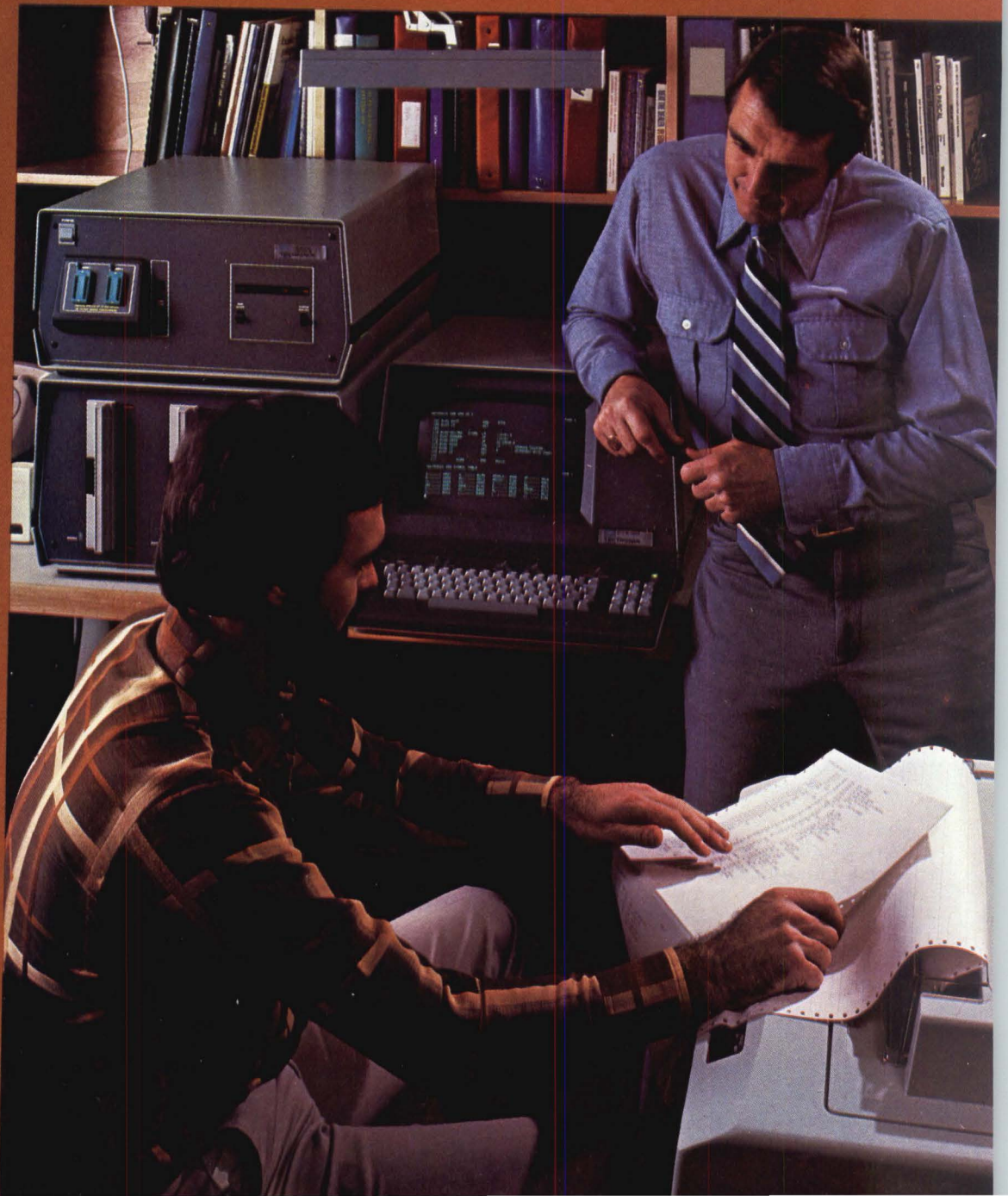

# Because who has time to learn a new system when a better chip comes along?

Prototype control probe runs prototype hardware and software under control of the microprocessor lab while you maintain access to program activity.

## **JOB AFTER JOB, OUR SYSTEM STAYS WITH YOU.**

We know time spent learning equipment is best spent on equipment that's going to stay around.

That's why we engineered the first development lab for designers like us who work with major microprocessors.

Now you needn't depend upon one chip vendor. Or buy and learn an entirely new system when you change chips.

## **THE BEST IDEAS**

Our features are the kind of ideas you'd probably engineer for yourself... the kind of system you get from a chip user, not a chip vendor.

## **DISC BASED SYSTEM**

Includes text editor, macro relocatable assembler, debugging software and file management utilities, to help simplify software preparation and debugging.

## **REAL TIME PROTOTYPE ANALYZER**

This invaluable option lets you easily track down timing or program

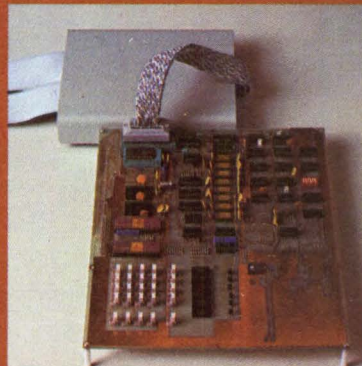

logic problems by dynamically monitoring the microprocessor bus.

## **ENHANCED BASIC**

This specially enhanced, compiler version of BASIC is compatible with the 8080 and 8085, and includes a subset of Z80 instructions. Extensions include comprehensive interrupt handling and optimization features to produce compact code.

## **PARALLEL DEVELOPMENT INTEGRATED TESTING**

Hardware and software engineers can test, trace, and debug independently up to the point of integration. Then they can work together, productively.

If you're concerned about how you spend your time, take a close look at a design lab you can use time and again... even when a better chip comes along.

Contact your local Tektronix Sales Office, or write or call Tektronix, Inc., P.O. Box 500, Beaverton, OR, (503) 644-0161. In Europe, Tektronix, Ltd., P.O. Box 36, St. Peter Port, Guernsey, Channel Islands.

**Tektronix**  
COMMITTED TO EXCELLENCE

For 3870 information circle 68,  
For literature circle 69,  
For a demonstration circle 166.

FOR FAST REPLY, CALL TOLL  
FREE (800) 547-1512.  
In Oregon, collect 694-9051.

**Tektronix  
microprocessor  
development labs.**

**Designed by  
people on your side  
of the bench.**

# Fast, high resolution plotting.

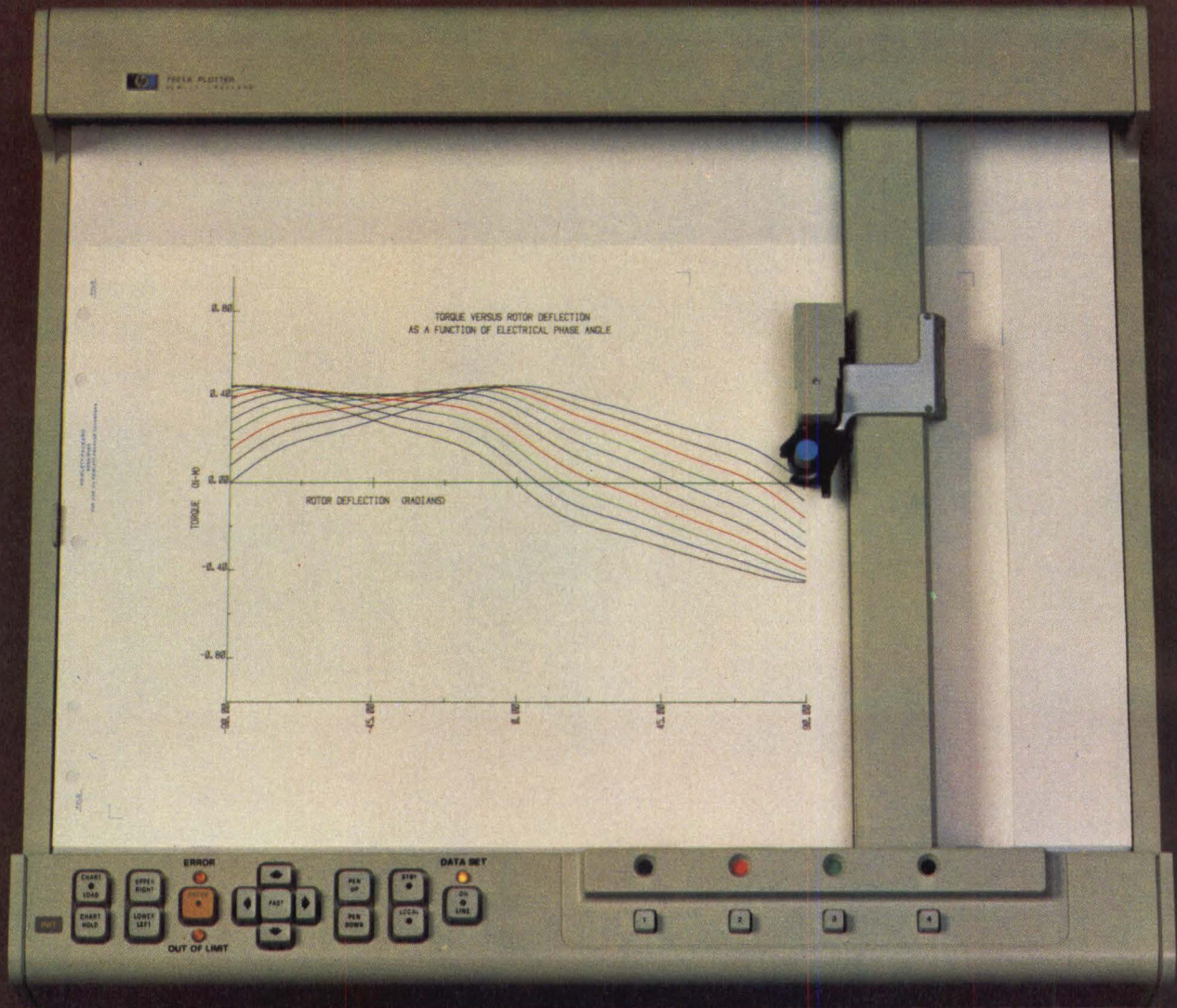

## Brought to you in color by Hewlett-Packard.

Hewlett-Packard's remarkable four color graphics plotter, Model 7221A, quickly generates professional, hard copy graphics from your design and computational data. A sophisticated microprocessor utilizes 41 easy-to-use commands for programmable selection of pen color, pen speed, character style, arc and circle generation, and an almost unlimited variety of user-defined line styles.

Programmable color comes from four long-life pens that remain stowed away until needed. Under program command, the plotter picks the color you se-

lect, draws, and puts the pen back—with the cap on!

With the standard RS232C/CCITT V.24 interface\*, the plotter easily connects to most minicomputers, ASCII terminals and timeshare systems, directly or remotely through data communication modems. An internal data buffer stores plotter commands and data until needed, saving both computer and communication time. And your most frequently used shapes and symbols can be stored in the buffer as macro-instructions for execution with one simple command.

Call your Hewlett-Packard sales office today for complete details on our remarkable four color graphics plotter. Priced at only \$4600 (U.S. domestic price only), it gives you everything you'd expect from a Hewlett-Packard Plotter. In color.

*\*Model 9872 has an HP-IB (IEEE 488-1975) interface. 11804*

**HEWLETT  PACKARD**

1507 Page Mill Road, Palo Alto, California 94304

For assistance call Washington (301) 948-6370, Chicago (312) 255-9800, Atlanta (404) 955-1500, Los Angeles (213) 877-1282

CIRCLE 70 ON INQUIRY CARD

Session 3 9-12 am Peale Ballroom-Holiday Inn

### Logic Innovations

Chairman: K. Zaininger, U.S. Army Electronics and Device Laboratory

"A 3G-Bit ECL Multiplexer," J. B. Hughes, *et al*, Philips Research Laboratories, Redhill, England; and Th. v. d. Hurk and B. J. v. d. Bergh, N. V. Philips, Eindhoven, Netherlands

"ECL 8-Bit Slices with Subnanosecond Performance," C. Chu, *et al*, Fairchild Camera and Instrument Corp

"CMOS/SOS LSI Implementation of Viterbi Error Correction Circuitry," T. W. Doak, Ford Aerospace and Communications; and R. M. Orndoff, Rockwell International

"A Microprocessor for Digital Tuners," M. Ariizumi, *et al*, Nippon Electric Co, Ltd, Kawasaki, Japan

"Performance Comparison of ISL and IIL," J. Lohstroh, Philips Research Laboratories, Eindhoven, Netherlands

### Wednesday Afternoon

Session 6 3:15-6 pm Grand Ballroom

#### Logic Arrays

Chairman: P. A. Buffet, Digital Equipment Corp

"A 5000-Gate 1 $\mu$ L Masterslice LSI," M. Usami, *et al*, Hitachi Device Development Ctr, Tokyo, Japan; and A. Yoshi'i and T. Adachi, Nippon Tel-Tel Musashino Electrical Communication Laboratory, Tokyo, Japan

"A 1500-Gate Random Logic LSI Masterslice," R. J. Blumberg and S. Brenner, IBM Systems Div

"One Micron MOSFET PLAS," P. W. Cook, *et al*, IBM Research Center

"A Subnanosecond Masterslice Array Offering Logic plus Memory," W. Braeckelmann, *et al*, Siemens AG, Munich, Germany

Session 8 3:15-6 pm Peale Ballroom-Holiday Inn

#### Advances in Devices and Technology

Chairman: R. C. Joy, IBM Corp

"Silicon MESFET Circuit Performance for VLSI," T. W. Houston, *et al*, Texas Instruments, Inc

"Submicron Channel MOS IC Technology," T. Yamaguchi, *et al*, Tektronix Laboratories

"Gate Associated Transistor," H. Kondo, *et al*, Mitsubishi Electric Corp, Itami, Japan

"Bipolar Circuit Scaling," P. M. Solomon and D. D. Tang, IBM Research Center

"Proximity Effect Correction in Electron Beam Lithography for VLSI Microfabrication," N. Sugiyama, *et al*, VLSI Technology Research Association Cooperative Laboratories, Kawasaki, Japan

### Wednesday Evening

WE 1 8 pm Grand Ballroom/West

#### Impact of VLSI on the Electronics Industry

Moderator: L. Terman, IBM Research Center

Panel Members: E. Bloch, IBM Corp; K. Garbrecht, Siemens AG, Munich, Germany; T. Longo, Fairchild Camera and Instrument Corp; G. Moore, Intel Corp; R. Petritz, Inmos, Ltd; M. Watanabe, Nippon Tel-Tel Musashino Electrical Communication Laboratory, Tokyo, Japan; and J. Welty, Motorola, Inc

WE 3 8 pm Pennsylvania Ballroom

#### High End Microprocessors: Third Generation

Moderator: W. W. Lattin, Intel Corp

Panel Members: G. Daniels, Motorola, Inc; D. R. Dickhut, Digital Equipment Corp; L. Lopp, Hewlett-Packard Co; C. Mead, California Institute of Technology; B. Pueto, Zilog Corp; and W. Pohlman, Intel Corp

WE 5 8 pm Hall of Flags

#### Technology Alternatives for the Home Computer

Moderator: A. R. Sass, General Instrument Corp

Panel Members: D. Chung, Video Brain Computer Co; H. Cotterman, Intel Corp; C. Dages, Jerrold Electronics Corp; D. Harrower, General Instrument Corp; T. Takezawa, Hitachi, Ltd, Yokohama, Japan; R. E. Wiles, Bally Manufacturing Corp

### Thursday Morning

Session 9 9 am-12:15 pm Grand Ballroom

#### Static RAMs

Chairman: N. deTroye, Philips Research Laboratories, Eindhoven, The Netherlands

"Bipolar Memory LSI Chips for Computers," A. Hotta, *et al*, Hitachi, Ltd, Kanagawa, Japan

"A 25-ns 4k Static RAM," R. M. Jecmen, *et al*, Intel Corp

"An ECL 100k Compatible 1024 x 4-Bit RAM with 15-ns Access Time," U. Buerker and H. Glock, Siemens AG, Munich, Germany

"16k CMOS/SOS Asynchronous Static RAM," A. G. F. Dingwall and R. G. Stewart, RCA Solid-State Technology Center

"A 16k x 1-Bit Static RAM," R. D. Pashley, *et al*, Intel Corp

Session 11 9 am-12:15 pm Peale Ballroom-Holiday Inn

#### Data Acquisition I

Chairman: J. E. Solomon, National Semiconductor Corp

"Monolithic Expandable 6-Bit, 16-MHz CMOS/SOS A-D Converter," A. G. F. Dingwall, RCA Solid-State Technology Center

"A Monolithic, Fully Parallel 8-bit A-D Converter," J. G. Peterson, TRW, Inc

"A 100- $\mu$ V 120-ns Strobed Comparator," R. W. Webb and R. T. Barroso, Harris Semiconductor

"A 7-Bit A-D Converter," R. J. v. d. Plassche and R. E. J. v. d. Grift, Philips Research Laboratories, Eindhoven, The Netherlands

"An NMOS Operational Amplifier," E. Toy, Signetics Corp

### Thursday Afternoon

Session 12 1:30-5 pm Grand Ballroom

#### Dynamic Memories

Chairman: V. A. Dhaka, Xerox Corp

"The Design of the MOS Dynamic RAM," R. C. Foss, Mosaid, Inc

"An 80-ns 5-V-Only 16k Dynamic RAM," R. Breivogel, *et al*, Intel Corp

"A 5-V-Only 2k x 8 Dynamic RAM," S. S. Eaton, Mostek Corp

"A 64-Bit MOS Dynamic RAM," I. Lee, *et al*, National Semiconductor Corp

"A 64k-Bit VMOS RAM," D. V. Essl, *et al*, Siemens AG, Munich, Germany

"A Fault-Tolerant 64k Dynamic RAM," R. P. Cenker, *et al*, Bell Laboratories

Session 14 1:30-5 pm Peale Ballroom-Holiday Inn

#### Data Acquisition II

Chairman: A. B. Grebene, Exar Integrated Systems, Inc

"A Monolithic Charge-Balanced Successive-Approximation A-D Technique," T. P. Redfern, *et al*, National Semiconductor Corp

"An Inherently Monotonic 12-Bit DAC," J. A. Schoeff, Advanced Micro Devices

"A 13-Bit Integrated Circuit ADC," H. Yamada, *et al*, Masushita Electric Industrial Co, Ltd, Osaka, Japan

"A Temperature-Compensated Quad Analog Switch," A. R. Hamade and P. M. Brown, Precision Monolithics, Inc

"A Monolithic CMOS 12-Bit Simultaneous Integration ADC," K. Hareyama, *et al*, Nippon Electric Co, Ltd, Kawasaki, Japan

"An MOS 12-Bit Monotonic, 25- $\mu$ s ADC," B. Fotouchi and D. A. Hodges, University of California

Session 15 1:30-5 pm Hall of Flags

#### Solid-State Imaging and Biomedical Applications

Chairman: J. D. Plummer, Stanford University

"An NPN Structure 484 x 384 MOS Imager for a Single-Chip Color Camera," N. Koike, *et al*, Hitachi Central Research Laboratory, Tokyo, Japan

"Second Generation CCD Line Imaging Devices," W. Steffe and D. Wen, Fairchild Camera and Instrument Corp

"Integrated Signal Conditioning for Diaphragm Pressure Sensors," J. M. Borky, Air Force Institute of Technology; and K. D. Wise, University of Michigan

"A Monolithic Signal Processor for Multichannel Implantable Telemetry," C. S. Sander, *et al*, Stanford University

## Thursday Evening

THE 6 8 pm Grand Ballroom/West

### The 64k RAM and Beyond

Moderator: R. C. Foss, Mosaid, Inc, Ottawa, Canada

Panel Members: S. Chou, Intel Corp; N. M. Donofrio, IBM Corp; K. Hoffman, Siemens AG, Munich, Germany; K. Miyasaka, Fujitsu Inc, Ltd, Kawasaki, Japan; R. J. Proebsting, Mostek Corp; M. Rao, Texas Instruments, Inc; and R. Wakefield, IRT Semiconductors, Kent, England

THE 7 8 pm Grand Ballroom/East

### Logic Implementation for VLSI

Moderator: L. J. Sevin, Mostek Corp

Panel Members: D. D. Eberlein, Cray Research; F. Faggin, Zilog, Inc; D. P. Siemiorek, Carnegie-Mellon University; H. Stopper, Burroughs Corp; and L. C. Wu, Amdahl Corp

THE 8 8 pm Pennsylvania Ballroom/West

### Microprocessor Support and Interface Circuits

Moderator: P. Verhofstadt, Fairchild Camera and Instrument Corp

Panel Members: N. Bhandari, Signetics Corp; B. Clayton, Standard Microsystems Corp; P. Jones, Intel Corp; R. Morrison, Burr-Brown Research; S. Simonson, Advanced Micro Devices; A. Suri, Fairchild Camera and Instrument Corp; and M. Timko, Analog Devices

THE 9 8 pm Pennsylvania Ballroom/East

### Lithography for VLSI

Moderator: R. C. Joy, IBM Corp

Panel Members: W. G. Howard, Motorola, Inc; M. C. King, Perkin-Elmer Corp; R. P. Kramer, Philips Research Laboratory, Eindhoven, The Netherlands; R. D. Moore, IBM Corp; R. F. W. Pease, Stanford University; G. L. Resor III, GCA/Burlington Div; and H. I. Smith, MIT Lincoln Laboratories

THE 11 8 pm Hall of Flags

### Precision Analog Techniques: MOS Vs Bipolar

Moderator: A. P. Brokaw, Analog Devices Semiconductor

Panel Members: R. A. Blauschild, Signetics Corp; G. Erdi, Precision Monolithics, Inc; T. M. Frederiksen, National Semiconductor, Inc; D. A. Hodges, University of California; J. M. Huggins, Intel Corp; R. v. d. Plassche, N. V. Philips, Eindhoven, The Netherlands; and R. W. Ulmer, Motorola, Inc

## Friday Morning

Session 16 9 am-12:15 pm Grand Ballroom

### LSI Application

Chairman: R. C. Jaeger, IBM Corp

"An LSI Processor for Automatic Character Reading," M. C. Rahier and P. G. A. Jaspers, Catholic University of Louvain, Louvain-La-Neuve, Belgium

"A Multichannel Programmable Sound Generator IC," S. Burstein, General Instrument Corp

"An Analog Input/Output Microprocessor for Signal Processing," M. E. Hoff and M. Townsend, Intel Corp

"Bipolar Floppy Disc Control Chip," W. J. Price, Scientific Microsystems Corp; and P. H. Scott and D. Y. Yu, Signetics Corp

"A Double Density Floppy Disc Controller," Y. Kawakami, *et al*, Nippon Electric Co, Ltd, Kawasaki, Japan

Session 17 9 am-12:15 pm Pennsylvania Ballroom

### Linear Circuit Features

Chairman: W. F. Davis, Motorola, Inc

"5-A Regulator with Thermal Gradient-Controlled Current Limit," R. C. Dobkin, National Semiconductor Corp

"Monolithic Multiplier/Divider," J. C. Schmoock, Raytheon Co

"A 50-MHz Phase and Frequency-Locked Loop," R. R. Cordell, *et al*, Bell Laboratories

"A 300-V/ $\mu$ s Monolithic Voltage Follower," G. Erdi, Precision Monolithics, Inc

Session 18 9 am-12:15 pm Peale Ballroom-Holiday Inn

### Computer-Aided Design Techniques

Chairman: R. C. Smith, Hewlett-Packard Co

"CAD Tools for Designing VLSI in Japan," M. Watanabe, Nippon Tel-Tel Musashino Electrical Communication Laboratory, Tokyo, Japan

"Process Simulation for Device Design and Control," R. W. Dutton, Stanford University; and D. A. Antoniadis, MIT

"An Interactive Graphics System for Custom Physical Design," P. M. Carmody, *et al*, IBM Data Systems Div

"Layout and Test Design of Dynamic LSI Structures," C. Mulder, *et al*, Philips Research Laboratories, Eindhoven, The Netherlands

"Testing a High Density Logic Masterslice," R. P. Lowden, IBM Data System Div

"Automatic Test Generation for LSI Chips and Printed Circuit Boards," P. S. Bottoroff, IBM Corp

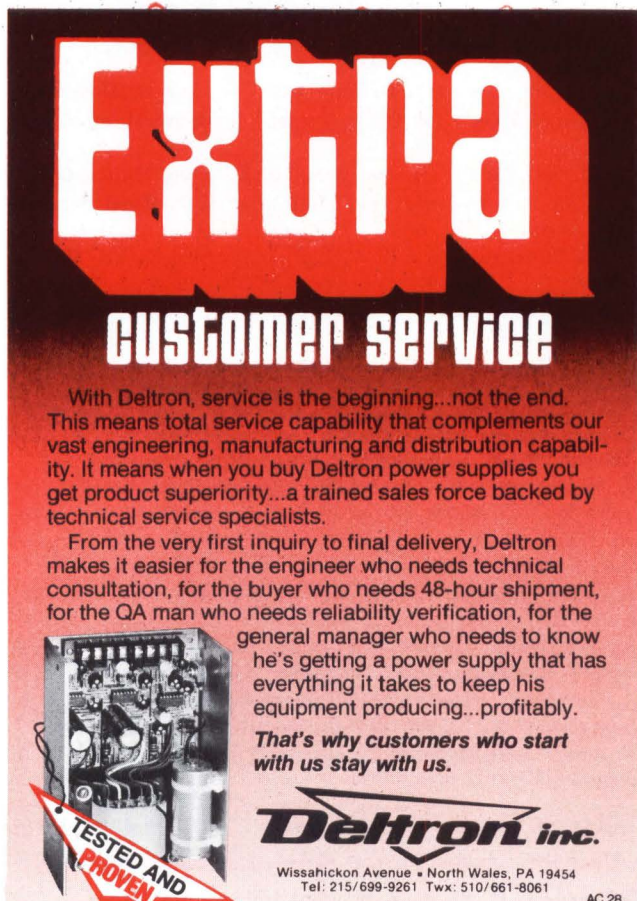

**Extra**  
customer service

With Deltron, service is the beginning...not the end. This means total service capability that complements our vast engineering, manufacturing and distribution capability. It means when you buy Deltron power supplies you get product superiority...a trained sales force backed by technical service specialists.

From the very first inquiry to final delivery, Deltron makes it easier for the engineer who needs technical consultation, for the buyer who needs 48-hour shipment, for the QA man who needs reliability verification, for the general manager who needs to know he's getting a power supply that has everything it takes to keep his equipment producing...profitably.

*That's why customers who start with us stay with us.*

**Deltron inc.**  
Wissahickon Avenue • North Wales, PA 19454  
Tel: 215/699-9261 Tlx: 510/661-8061

TESTED AND PROVEN

AC 28



# A new source for plasma display heads and panels.

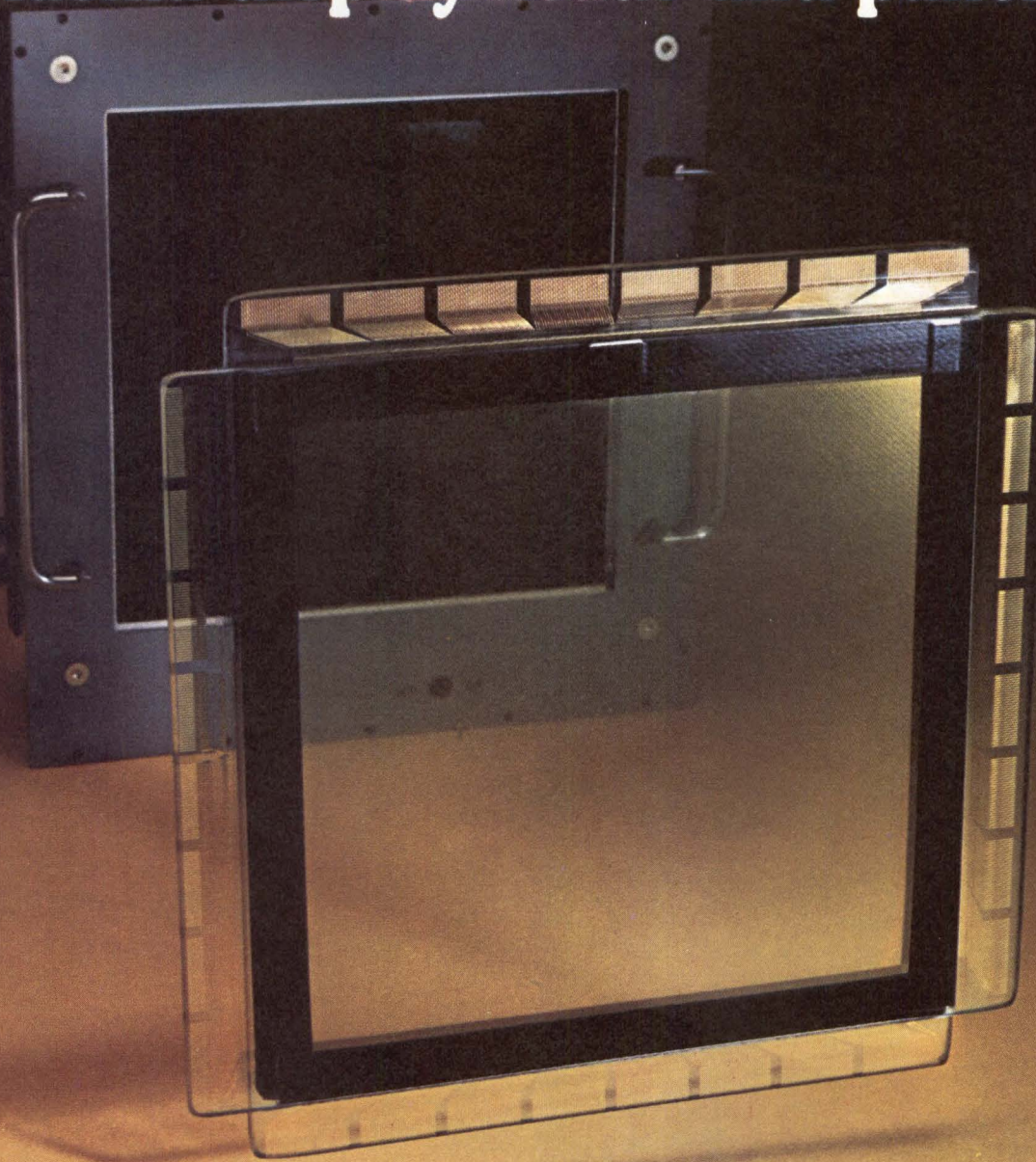

Plasma technology has come into its own at Interstate Electronics!

To respond to new requirements and to meet increasing demand, we have rounded out our plasma product family by adding glass panel production. Our new panel manufacturing source is solidly in production to meet all of your program requirements.

This means immediate availability to you of "off the shelf" plasma display panels and heads, as well as all of the other products in our plasma display family.

You now have a complete source for plasma products—Display heads, terminals, special-requirement

products, and panels.

Call today for complete details on availability, quantity, prices and special sizes. Write or call Don Poulos, Product Manager, Interstate Electronics

Corporation, 1001 East Ball Road, P.O. Box 3117, Anaheim, CA 92803. Telephone (714) 635-7210.

Remember, that's Interstate Electronics—specialists in information processing and display for more than 20 years.

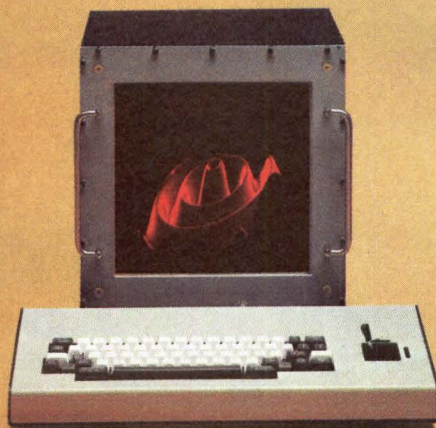

**INTERSTATE  
ELECTRONICS  
CORPORATION**

SUBSIDIARY OF **ATC**

Information Processing and Display.  
Systems. Products. Services.

**CIRCLE 72 ON INQUIRY CARD**

Until now, you've either had to forego 16-bit pricing to get 32-bit performance, or you've had to give up 32-bit performance just to keep the budget in line.

No longer. Now you can invest in a full-blown 32-bit computer and pay no more than you would for a 16-bit computer. And not have to worry about insufficient power for future needs.

The SEL 32/30 is the smallest of the SYSTEMS hierarchy of 32-bit computers. But don't

let its small size fool you. This MAXIBOX is big in performance and throughput, ideally suited for scientific or process control applications such as telemetry, simulation, industrial or laboratory automation. And it costs you no more than a 16-bit computer.

The SEL 32/30 is value-engineered for the OEM. It is a single chassis, fully integrated system that is upward compatible with the entire SEL family of 32-bit computers. So even if you start with a minimal investment, it will continue to

pay off as your customers' applications expand.

If power and performance are what you need, and budget is a definite consideration, talk to us. We'll make sure that when you invest in a SEL 32/30 MAXIBOX, more dollars will flow to your bottom line.

Call us. We're easy to talk to. (305) 587-2900  
6901 West Sunrise Boulevard  
Ft. Lauderdale, Florida 33313.

**New Developments for the OEM...**

# **The SEL 32/30 MOS MAXIBOX.™**

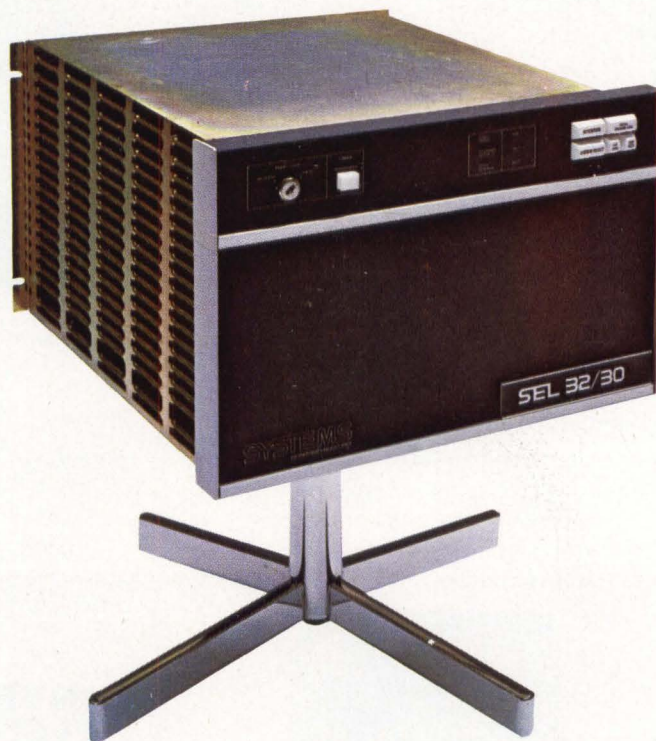

**SYSTEMS**  
ENGINEERING LABORATORIES

---

# PARALLEL PROCESSOR ARCHITECTURES—PART 1: GENERAL PURPOSE SYSTEMS

---

System architectures of multiprocessor, pipeline, and functional systems are investigated in an attempt to compare parallel processor concepts, performance, and potential applications

---

**Kenneth J. Thurber**      Sperry Univac, St Paul, Minnesota

---

**D**ifferent interpretations, concepts, and models of large computer systems are alleged to provide parallel processing facilities and/or be parallel processors. However, no clear definition exists of what constitutes high performance parallel processing. Instead of generating a dogmatic definition, some important hardware systems generally categorized as high performance parallel processors are examined and their attributes summarized.

Parallelism can be viewed in four major system contexts.

*General concurrency*—Real hardware concurrency and apparent software concurrency due to cooperating process considerations<sup>1</sup>

*Multiple processor systems*—Multiprocessors, special-purpose computers, functional systems, and pipeline systems<sup>2,3</sup>

*Special-purpose computers*—Parallel array and associative processors<sup>4</sup>

*Scientific-attached processors*—Pipeline and array processors designed to be attached to mainframes for scientific applications<sup>5</sup>

Primary reasons for the development, purchase, and application of high performance parallel processors are to provide high throughput; to configure highly flexible systems; in certain applications, to provide a specified level of system availability sometimes entail-

ing resource sharing considerations; and to achieve a high level of reliability.

## Potential Applications

In general, other than multiprocessors, the machines considered contain hardware that orients them toward processing of arrays or vectors. Many problems can be formulated in a solution form suitable for matrix oriented processors. Other problems (eg, pattern recognition) can be structured for solution on a processor in which some hardware interconnection structure exists that reflects the problem's topological structure. Problems of interest to both the commercial and military fields can be categorized as (1) Signal processing—weather prediction, Doppler radar, sonar, image processing, seismic, biomedical analysis, and magnetic anomaly detection; (2) Optimization and planning—nuclear analysis, power grid systems, structural analysis, dynamic programming, and linear programming; and (3) Scientific and economic—econometrics, wind tunnel analysis, geophysical analysis, energy management, resource optimization and modeling, pollution analysis, image enhancement, and medical analysis.

Typical computations involve linear programming, vector processing, computation of fast Fourier transforms (FFTs), and digital filtering. Such applications are well-suited, albeit only solvable, for computation on high performance parallel processors.

## Architectural Models

Many approaches to classification of computer architectures are possible. Most techniques classify only global architecture properties and, thus, are valid only within limited ranges. Discussion of the main classification techniques provides a framework within which to evaluate the processors under consideration.

Flynn<sup>6</sup> proposes a classification scheme that divides systems into categories based upon their instruction and data streams, as follows:

*SISD (Single Instruction, Single Data Stream)*—a uniprocessor such as a single processor IBM System/360.

*MISD (Multiple Instruction, Single Data Stream)*—a processor concept that might not be physically realizable. Interpreted by some designers as a pipeline system.<sup>4</sup>

*SIMD (Single Instruction, Multiple Data Stream)*—an associative or parallel processor such as ILLIAC IV<sup>7</sup>, and a pipeline system such as STAR.<sup>8</sup>

*MIMD (Multiple Instruction, Multiple Data Stream)*—a multiprocessor such as a UNIVAC 1108.

Based upon parallelism properties, a classification technique proposed by Murtha and Beadles<sup>9</sup> differentiates between multiprocessors and highly parallel organizations as follows:

*General purpose network with centralized common control*

*General purpose network with identical processors*—processors have independent instruction execution actions

*Special purpose network with global parallelism*—used for pattern processing

*Special purpose network with global parallelism*—used for associative processing

*Nonglobal, semi-independent network with local parallelism*—this category is a catchall for machines that do not fit into other categories in the scheme.

Another possible classification, suggested by Hobbs, et al.<sup>10</sup> includes multiprocessor, associative processor, network or array processor, and functional machines. Furthermore, they suggest that architectures could be classified based upon the amount of parallelism in control, processing units, and data streams. However, it is noted that these parameters are present in all highly parallel machines and are, therefore, not adequate to define a machine architecture.

In an article opposing parallel processors, Shore<sup>11</sup> presents a classification technique that derives machine descriptions from the description of a uniprocessor. The machine categories considered are

*Machine I*—a uniprocessor

*Machine II*—a bit-slice associative processor built from Machine I by adding bit-slice processing and access capability (eg, STARAN<sup>12</sup>)

*Machine III*—an orthogonal computer derived from Machine II by adding parallel word processing and access capability (eg, OMEN<sup>13</sup>)

*Machine IV*—a machine derived from Machine I by replicating the processing units (eg, PEPE<sup>14</sup>)

*Machine V*—a machine derived from Machine IV by adding interconnections between processors (eg, ILLIAC IV)

*Machine VI*—a machine derived from Machine I by integrating processing logic into every memory element (eg, Kautz's logic-in-memory computers<sup>15</sup>)

Higbie<sup>16</sup> classifies computers using Flynn's four basic categories, but expands the SIMD category into the following four subcategories:

*Array processor*—a processor that processes data in parallel and addresses data by address instead of by tag or value

*Associative memory processor*—a processor that operates on data addressed by tag or value rather than by address. (Note that this definition does not require parallel operation, however, it does allow for machines that operate on data in parallel.)

*Associative array processors*—a processor that is associative and also operates on arrays of data. (Typically, operations are on a bit-slice basis, ie, a single bit of many words.)

*Orthogonal processor*—a processor with two subsystems, that is, an associative array processor subsystem and a serial (SISD) processor subsystem which share a common memory array.

These categories provide for the identification of the ability to perform parallel, associative, and serial processing. A parallel processor is defined as any computer that contains multiple arithmetic units and operates on multiple data streams. Clearly, all four subcategories of SIMD processors fit this definition of a parallel processor.

Händler<sup>17</sup> offers a classification scheme for high performance processors that is based upon noting the number of control units, arithmetic and logic units, and logic circuit complexity of a system. These capabilities are written as a three-tuple in a mathematical function notation, ie, as an ordered triple of values (k, d, w), where k indicates the number of control units, d represents the number of arithmetic and logic units, and w represents the logic circuit complexity. Thus, a machine's description can be expressed as:  $t(\text{machine}) = (k, d, w)$ , where  $t(\text{machine})$  indicates the triple of a machine, and k, d, and w provide the machine's system description. Triples for some common computers are:  $t(\text{Burroughs—ILLIAC IV}) = (1, 64, 64)$ ,  $t(\text{Goodyear—STARAN B}) = (1, 8192, 1)$ ,  $t(\text{Carnegie Mellon—C.mmp}) = (16, 1, 16)$ , and  $t(\text{Texas Instruments—ASC}) = (1, 4, 64 \times 8)$  where pipelining is indicated via a crossproduct. This classification scheme provides a unique ability to specify a system architecture semiprecisely.

Although the classification schemes presented are not mathematically precise, they are included to place parallel processors in perspective. Clearly, one of the most difficult problems in system architecture is to derive meaningful machine models that illustrate more

than a few important capabilities of an architecture. Such models are necessary not only for design and simulation purposes, but also for comparison purposes in the selection of current competitive systems.

## Multiprocessor Systems

A common form of a high performance parallel processor is that of the multiprocessor. Because of the wide variety and availability of such systems, only the more important generic architectures are summarized. The main generic multiprocessor system concepts are common bus multiprocessor, crossbar switch multiprocessor, and multiport memory multiprocessor. Multiprocessor systems are used in general purpose applications that range from business accounting systems and typesetting systems to military realtime command and control systems.

The common bus multiprocessor (Fig 1) consists of a number of processors, memories, and input/output (I/O) devices connected onto a common bus. More than a single bus may be provided for throughput or reliability reasons. Typically, the common bus architecture is characterized by (1) low functional complexity, (2) low processor interconnection cost, (3) ease of adding processors to the configuration, (4) bus bandwidth constraints that limit capacity, (5) potential single-point failure mode due to the bus, and (6) usually feasible only for small systems. Common bus configurations are used in smaller systems or in the I/O subsystem of large systems such as the Microdata Micro 1600 D or Control Data Cyber-76.

Operation of the common bus multiprocessor is dependent on bus design. Access to the bus is usually controlled by an arbitrator, and requests for access are honored based upon an algorithm. Once the sender is granted control of the bus, a message is sent to the destination. Usually, all devices monitor the bus for their device code. When a message contains the appropriate device code, the message is read from the bus. In many cases, the bus and arbitrator are designed to permit easy addition of devices to the bus; however, because bus bandwidth does not change when a device is added, device addition eventually will degrade overall system performance. Many contemporary common bus systems are currently using or considering the use of high speed bit-serial bus structures.

The crossbar switch multiprocessor (Fig 2) is predicated upon having a hardware path to each memory module. Processors and I/O then interconnect to these memory paths. This system type may be viewed as a set of intersecting lines where connection routing is specified by a crosspoint at each line intersection. Characteristics of the crossbar switch multiprocessor include (1) complex interconnection system, (2) high capacity for data transfer, (3) large number of additional crosspoints required for system expansion, (4) potential for easy removal of malfunctioning device, (5) potential for increased reliability through addition of redundant paths to the switch, and (6) viable for large systems, depending on the switch design. Examples of such systems are the Burroughs D-825 and B-7700.

The primary difficulty with a crossbar switch system is that switch hardware complexity grows at the rate of  $n^2$  for  $n$  devices. Thus, it is difficult to build large

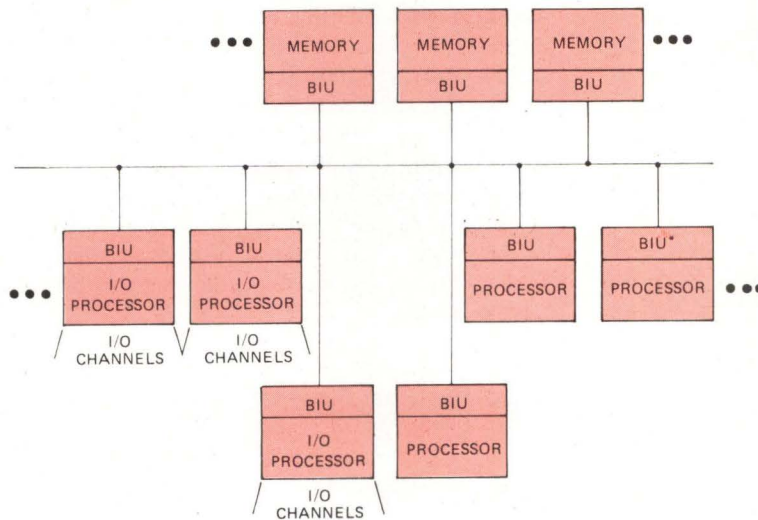

\*BIU - BUS INTERFACE UNIT

Fig 1 Common bus multiprocessor. Processors, memories, and I/O processors are interconnected using bus structure onto which all subsystems join. Operation typically consists of processor requesting control of bus, receiving control of bus, transmitting (or fetching from memory), waiting for appropriate unit response, and relinquishing bus control. Key advantages are simplicity and low cost

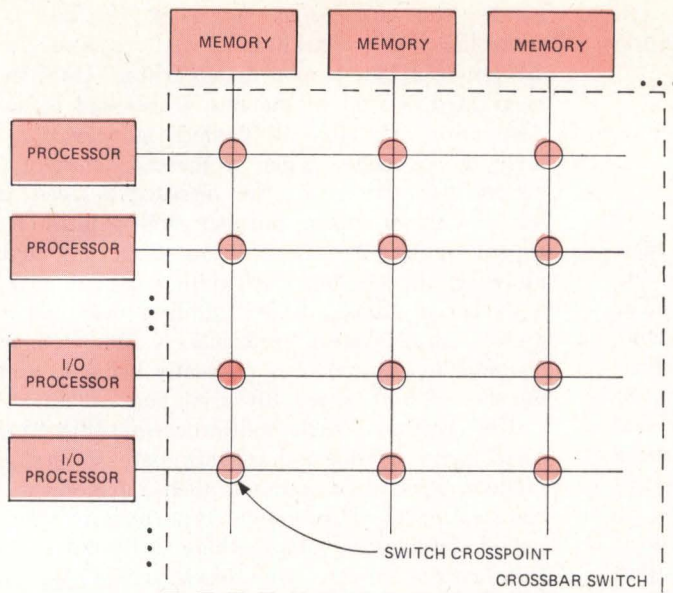

Fig 2 Crossbar switch multiprocessor. Processors and I/O processors are allowed access to each individual memory unit. Therefore, access path is provided for each indivisible section of memory, many transfers can occur simultaneously, and system expansion may be easy to achieve (depending on switch design). Unfortunately, switch complexity growth rate is high, developing modular switch is difficult, and switch hardware may represent substantial portion of overall system hardware

systems based on the crossbar switch concept. One technique is to reduce switch complexity by decomposing the switch into a set of subswitches, thereby providing the same connection capability with less hardware. These switches trade control complexity and delay

time for a reduction in the amount of required hardware.

A multiport memory multiprocessor (Fig 3) essentially centralizes the arbitration and priority logic necessary to build a crossbar switch multiprocessor at the memory interface. This organization is useful for a wide variety of system configurations because the priority and arbitration logic can be used to make portions of the memory inaccessible to designated devices. Main characteristics of such systems are (1) expensive memory control, (2) expansion from uniprocessor to multiprocessor configuration using the same hardware, (3) system is limited by memory port design, (4) system can be made fault-tolerant, and (5) extensive amounts of point-to-point cabling are required. Typical systems include UNIVAC 1100/80, IBM System/360 model 65, and IBM System/370 model 168 MP.

Even though the multiport memory system is a common design, it suffers from the problem of memory access conflicts. Typically, from a hardware standpoint, it is easy to add processors to the system; however, in practice, when the number of processors has been four or more, substantial performance degradation has been observed.

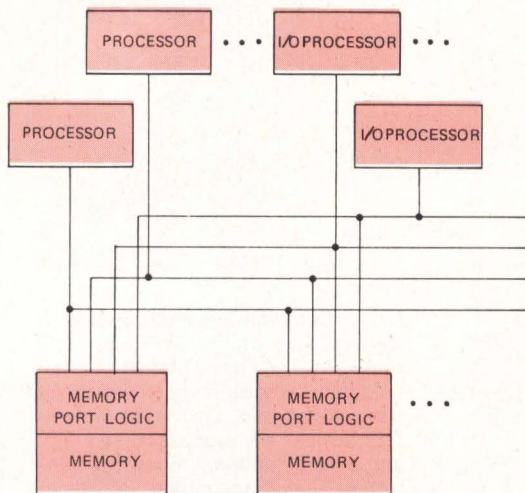

Fig 3 Multiport memory multiprocessors. Memory interface units perform functions of control, priority arbitration, and switching between processors. To accomplish this, each memory interface unit is provided with input port from all processors. Request responses are then controlled at interface. Concept can be viewed as form of distributing hardware of crossbar switch in Fig 2 to memory units

## Pipeline and Functional Systems

High performance parallel processing can be accomplished by executing instructions concurrently in time. Such techniques are generally called pipeline machines. The execution of instructions or operations, or the fetching of operands, overlapped in time can be achieved by two major methods. Information can be piped through a single machine; alternatively, it can be routed to a set of functional units that are computing in parallel, depending upon the program. Three ma-

chines that exhibit pipeline architecture are Control Data STAR<sup>8</sup>—a 2-pipe processor, Texas Instruments ASC<sup>10</sup>—a 4-pipe processor, and Cray Research CRAY-1<sup>20</sup>—a functional unit processor.

## STAR System

The Control Data Corp STAR computer\* is a vector oriented processor. In vector mode, it is capable of producing 100M 32-bit floating point results/s. Major STAR functional units (Fig 4) include a high speed main memory containing 32 interleaved banks of 2048 512-bit words configured for a 0.5M-word system. A 1M-word system has twice as many words, but the number of banks and interleaving are fixed at the same values for both configurations. Also incorporated are a pair of read and write buffers, two nonhomogeneous pipeline processors, a vector oriented control unit, and an I/O section.

Memory interleaving and pipeline processor design make STAR very efficient for processing vectors. Furthermore, its overall system design allows highly efficient scalar processing as well. The key application design issue for the system is to structure the problem around vectors. Many problems, such as polynomial evalua-

tion, weather data processing, and nuclear data processing, can be expressed in terms of vectors. The difference in programming techniques is demonstrated by

	Normal Program	STAR Program
	1. Initialize Index	1. Initialize vectors (length, start address)
More data to be processed	2. Process data set associated with index	2. Process vectors
	3. Alter index	3. End
	4. Compare index to end value	
Finished	5. Jump	
	6. End	

Designers of the STAR system chose to provide software aids to enable the programmer to reach the hardware support capabilities. Since vectors were the prime data structure considered, they supplied a

\*Portions of the STAR architecture description were excerpted, with permission, from *Data Structures and Computer Architecture: Design Issues at the Hardware/Software Interface*, K. J. Thurber and P. C. Patton, D. C. Heath, Lexington, Mass, 1977.

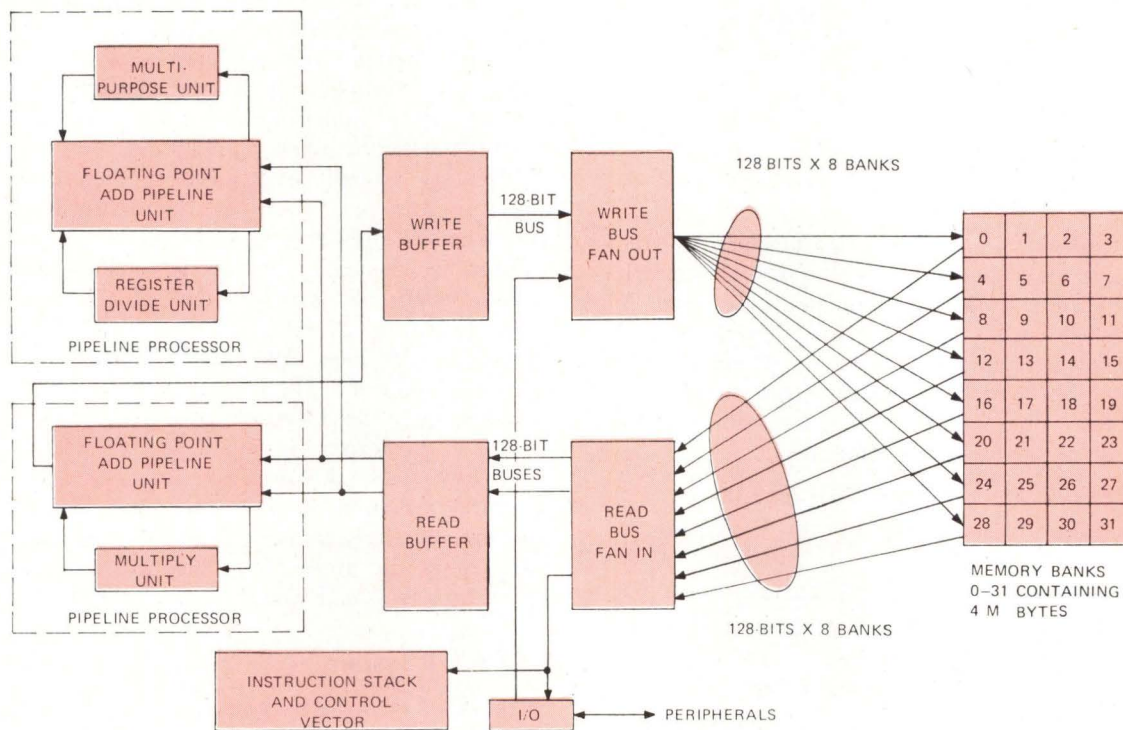

Fig 4 STAR system. Architecture consists of two pipeline processors, control unit, read/write buffers, I/O, and very large memory. One pipeline processor contains multipurpose unit, floating-point adder, and register divide unit. Other processor consists of multiply unit and floating-point adder

FORTRAN compiler with the extended capabilities of loop recognition and translation, and vector extensions to FORTRAN.

Loop recognition portions of the compiler are intended to change the detailed FORTRAN code into a single STAR instruction. For example, a FORTRAN DO loop, consisting of a DO statement followed by a pair of addition operations completing the DO loop, would be converted to a vector. The following pair of statements serves as an example.

DO 20 INDEX = 1,100	Sets up control for repeated add operations
20 A(INDEX) = B(INDEX) + C(INDEX)	Adds designated elements of B and C each time statement is executed

During compilation these two statements would be converted to a single, STAR, add-vector instruction. Compiler routines have been developed that are capable of searching for, identifying, and converting loops into STAR vector instructions. When the compiler changes a loop, it notifies the programmer what replacements have been made. However, loop recognition is a difficult task and, as such, the compiler cannot detect complex loops. The portion of the compiler that detects vector operations is commonly called the vectorizer. FORTRAN language has been extended on STAR to allow the programmer direct access to vector operations. The notation is a sequence of subscript values that may be specified through an implied DO notation, as follows:

$M_1:M_2:M_3$   
 $M_1:M_2$   
 $*$   
 $M_1:*:M_3$   
 $M_1:*$

where  $M_1$  values are indexing parameters as they appear in DO statements.  $M_1$  is the initial subscript value,  $M_2$  is the terminal subscript value, and  $M_3$  is the index increment. The "\*" may be used to denote the declared length in the dimension statement; note that  $M_1$  and  $M_3$  are both assigned the value of 1, when omitted. For example, if DIMENSION X(10), Y(10,3) is given, the following values result:

X(2:9:3)	Represents elements X(2), X(5), and X(8)
Y(2:5:3)	Represents elements Y(2,3), Y(3,3), Y(4,3), and Y(5,3)
Y(8,*)	Represents elements Y(8,1), Y(8,2), and Y(8,3)
X(2:10:2)	Represents elements X(2), X(4), X(6), X(8), and X(10)
Y(7,2:*)	Represents elements Y(7,2) and Y(7,3)

Using STAR vector assignment statements, the programmer can effectively describe an entire loop in one statement. The statement A(5:100) = B(6:101) + C(5:100) is equivalent to the following DO loop:

DO 20 I = 5,100	Sets up control of addition process
20 A(I) = B(I+1) + C(I)	Adds selected elements of B and C. Note that index (I) of B is set to one above that of C and result A

Other FORTRAN extensions allow the use of conditional referencing of array elements. As an example, assume that the following is given:

LOGICAL L (6)	Declares a logical vector
REAL X (6), Y(10,10)	Declares a real vector X and a real array Y
DATA L/ . TRUE . , . FALSE . , . FALSE . , . FALSE . , . FALSE . , . TRUE ./	Declares a set of initialization values for L

Then, the following results:

X(L)	Represents X(1) and X(6)
X(7,L)	Represents Y(7,1) and Y(7,6)

Furthermore, the programmer can escape from FORTRAN code directly into mnemonic assembly language so that vector portions of the machine can be reached directly to achieve maximum hardware performance.

## Advanced Scientific Computer

The Advanced Scientific Computer (ASC) of Texas Instruments is a pipeline processor system, consisting of up to four homogeneous pipeline processors, more than 1M words of memory, a set of high speed disc and tape units, and a set of peripheral processors (Fig 5). A complete system of four pipelines operating in 32-bit vector mode performing dot-product operations can produce up to 100M results/s. The pipeline processors are used to run application programs and compilation jobs. All other system software, such as the operating system, runs on peripheral processors; these processors contain no private memory and, instead, execute in conjunction with main memory, which is shared among the pipeline processors.

Memory is built with an 8-way interleave and has a theoretical cycle time of 2.5 ns/word if there are no memory interference problems. Each pipeline processor is oriented to process in either scalar or vector mode on 16-, 32-, or 64-bit data. The processor instruction format is 32 bits, and the processor contains 48 registers (16 base, 16 accumulator, 8 index, and 8 vector parameter). The processors are primarily oriented toward high speed vector dot-product operations. Like STAR, a vectorizer is available for ASC to optimize FORTRAN code; the primary language is an extended FORTRAN. Similar to STAR, ASC uses a pipeline architecture, but it is important to note that architecturally, ASC relies on up to four identical pipelines whereas STAR uses two nonhomogeneous pipelines.

## CRAY-1 System

Cray Research's CRAY-1 computer<sup>20</sup> is a function oriented, general purpose computer incorporating scalar and vector capabilities (Fig 6). Vector processing provides extremely high throughput rates. The CRAY-1 is interfaced into a computing complex with other machines that provide its I/O and high speed peripherals. (A more detailed description of the CRAY-1 computer can be found in "An Introduction to Vector Processing," P. M. Johnson, *Computer Design*, Feb 1978, pp 89-97.)



### Comparison of Major Architectural Features

Characteristic	STAR	CRAY-1	ASC
Instruction Word Size	32 and 64 bits	16 and 32 bits	32 bits
Data Word Size	1, 8, 32, 64, and 128 bits	64 bits	16, 32, and 64 bits
Memory Size	1M 64-bit words	1M 64-bit words	8M 64-bit words
Architecture	2 nonhomogeneous pipes	Specialized functional units	1 to 4 homogeneous pipes
Operation Modes	Scalar/vector instructions	Scalar/vector instructions	Scalar/vector instructions
Input/Output	Programmed I/O	12 channels I/O	Programmed I/O
FORTRAN Optimizer/Vectorizer	Yes	Yes	Yes
Speed of Operation*			
Scalar	0.5 to 1.5	2 to 3	0.5 to 1.5
Vector	5 to 10	6 to 10	3 to 10

\*Maximum rate estimates, CDC 7600 = 1

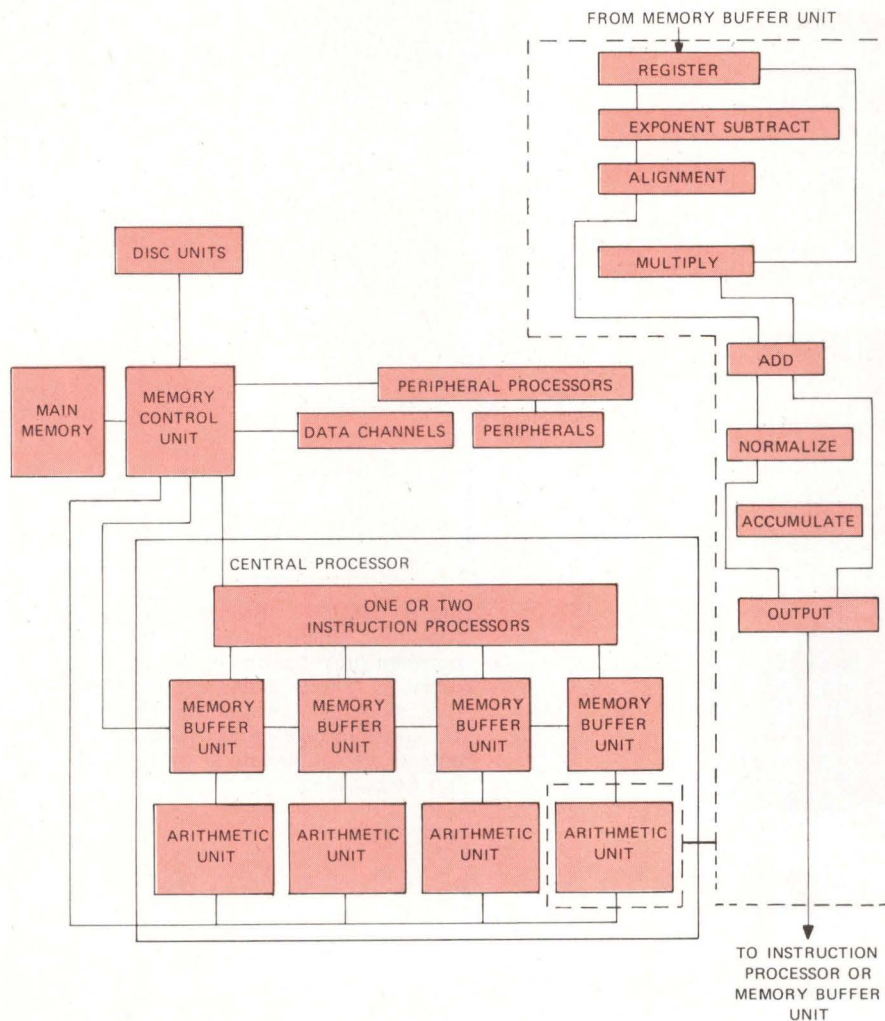

Fig 5 Advanced scientific computer architecture. Central processor consists of instruction processor, up to four memory buffer units, and up to four identical arithmetic units. Path selection is provided in each arithmetic unit for each operation, and is performed by instruction processor. Two possible paths are shown in exploded view: on left is path for floating-point addition; on right, path for fixed-point multiplication

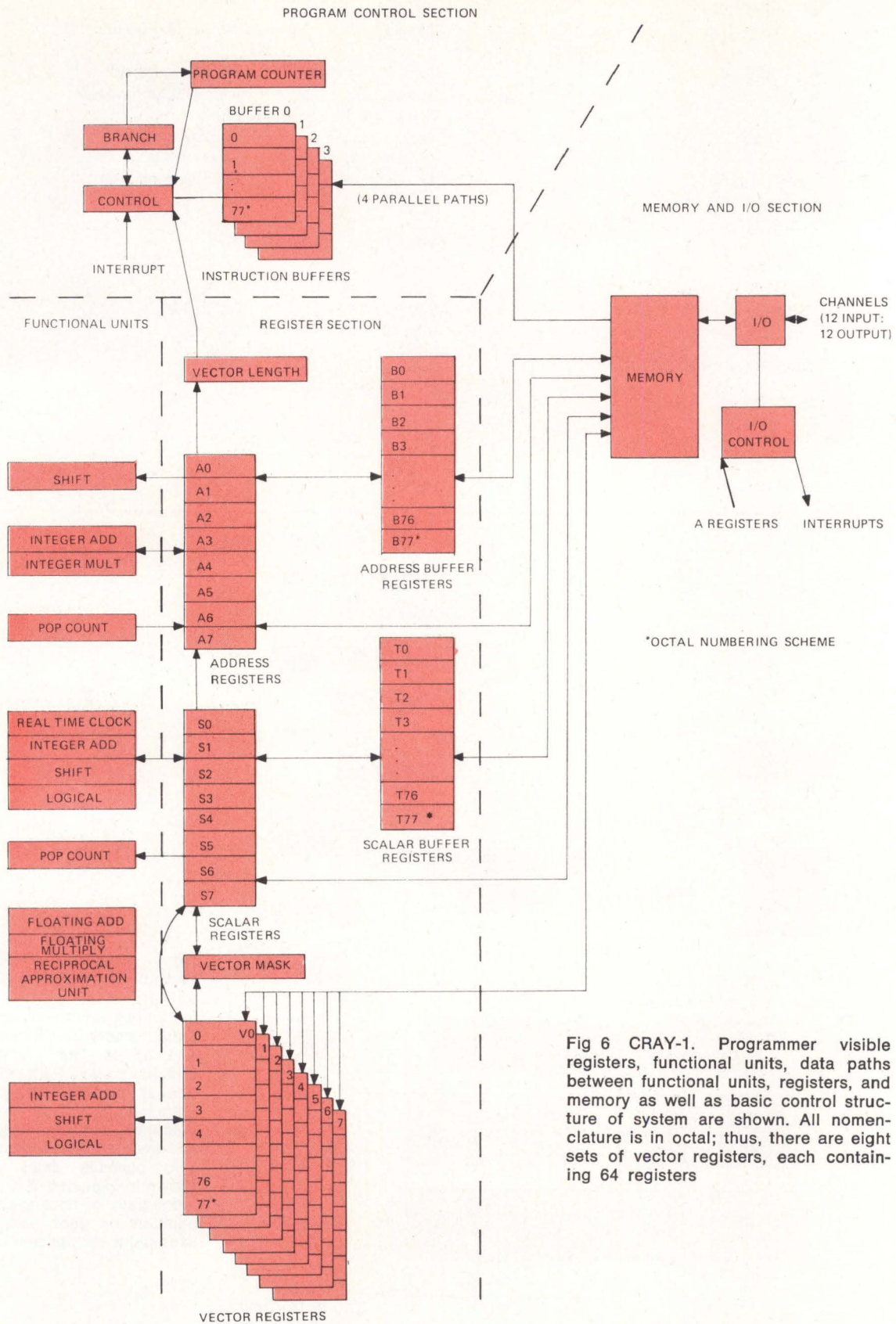

Fig 6 CRAY-1. Programmer visible registers, functional units, data paths between functional units, registers, and memory as well as basic control structure of system are shown. All nomenclature is in octal; thus, there are eight sets of vector registers, each containing 64 registers

While the CRAY-1 implicitly limits vector length by providing fixed-length (although very high speed) vector registers and provides only a reciprocal approximation of the divide operation, STAR handles very large vectors and provides a direct, precise division operation. STAR pays for this flexibility in increased complexity. In CRAY-1, vectors with more than 64 elements are processed in groups of 64 (with a possible residue) by vector chaining operations under program control.

## Architecture Comparisons

In contrasting the ASC, STAR, and CRAY-1, extreme architecture strategies can be noted. STAR relies upon dual unique pipelines; ASC is designed to utilize from one to four identical pipelines; and CRAY-1 is designed to extend the independent functional unit concepts developed in early CDC 6000 and 7000 series equipments. Both STAR and ASC can suffer in performance because of the time required to set up vector operations in pipeline hardware. While the CRAY-1 avoids some setup problems, its architecture suffers from the fixed vector length. Vector chaining is a method to circumvent the fixed vector length problem of CRAY-1. However, sophisticated programmers could perform analogous operations in STAR or ASC. Ultimately, the question of which machine is best suited for an application must be determined by benchmarks on difficult problems, because there is no intrinsic proof of superiority based upon architecture comparisons. Major performance characteristics for the three computers are summarized in the Table.

## Summary

High performance parallel processors constitute a class of computer architectures that promises high throughput, flexibility, system availability, and reliability. A survey of such processors focusing on potential applications, different models, multiprocessors, and pipeline and function systems shows potential applications to be both numerous and specialized. Thus, a variety of architectures is available, but generally the number of systems sold is small due to exceptionally high cost. The complex architectures make it difficult to develop consistent models that illustrate the major architectural capabilities of a wide variety of actual systems.

The discussion of general purpose system architectures briefly explains the architectures of the most common generic multiprocessors: multiport memory, crossbar switch, and common bus. In contrasting the STAR, ASC, and CRAY-1, the differences between pipeline and functional machines have been pointed out. Of these systems, it is desirable to host the CRAY-1 processor in a larger system, while both STAR and ASC are specifically designed for standalone operation. CRAY-1 utilizes a set of function units tailored for vector processing; whereas STAR and ASC utilize general purpose pipelines.

Part 2 of this discussion, to appear in February, will deal with special purpose machines and scientific attached processors, which are suitable for a limited

set of applications. These systems gain their proficiency through associated memory or the capability to provide associative addressing and matrix operations. Study of individual architectures reveals severe limitations of each in application scope, while examination of matrix operations yields information on performance characteristics.

## References

1. H. Lorin, *Parallelism in Hardware and Software: Real and Apparent Concurrency*, Prentice Hall, Englewood Cliffs, NJ, 1972
2. P. H. Enslow, "Multiprocessor Organization—A Survey," *ACM Computing Surveys*, Mar 1977, pp 103-129
3. C. V. Ramamoorthy and H. F. Li, "Pipeline Architecture," *ACM Computing Surveys*, Mar 1977, pp 61-102
4. K. J. Thurber, *Large Scale Computer Architecture: Parallel and Associative Processors*, Hayden, Rochelle Park, NJ, 1976
5. R. A. Caspe, "Array Processors," *Mini-Micro Systems*, July 1978, pp 54-63
6. M. J. Flynn, "Some Computer Organizations and Their Effectiveness," *IEEE Transactions on Computers*, Sept 1972, pp 948-950
7. D. L. Slotnick, "Unconventional Systems," *AFIPS Conference Proceedings*, Spring Joint Computer Conference, 1967, pp 477-481
8. R. G. Hintz and D. P. Tate, "Control Data STAR-100 Processor Design," *Digest of Papers, IEEE Computer Society Internat'l Conf*, 1972, pp 1-7
9. J. C. Murtha and R. L. Beadles, "Survey of the Highly Parallel Information Processing Systems," Office of Naval Research Report No. 4755, Nov 1964
10. L. C. Hobbs and D. J. Theis, "Survey of Parallel Processor Approaches and Techniques," *Parallel Processor Systems, Technologies, and Applications*, Spartan Books, New York, NY, 1970, pp 3-20
11. J. E. Shore, "Second Thoughts on Parallel Processing," *Computing and Electrical Engineering*, Vol 1, Pergamon Press, Oxford, England, 1973, pp 95-109
12. K. E. Batcher, "STARAN Series E," *Parallel Processing Symposium*, Aug 1977
13. L. C. Higbie, "The OMEN Computers: Associative Array Processors," *Digest of Papers, IEEE Computer Society Internat'l Conf*, 1972, pp 287-290
14. R. O. Berg, et al, "PEPE—An Overview of Architecture, Operation, and Implementation," *Proceedings of National Electronics Conference*, 1972, pp 312-317
15. W. H. Kautz, "An Augmented Content-Addressed Memory Array for Implementation with Large-Scale Integration," *Journal of the ACM*, Jan 1971, pp 19-33
16. L. C. Higbie, "Supercomputer Architecture," *Computer*, Dec 1973, pp 48-58
17. W. Handler, "The Impact of Classification Schemes on Computer Architecture," *Parallel Processing Symposium*, Aug 1977
18. W. A. Wulf and C. G. Bell, "C.mmp—A Multi-Mini Processor," *AFIPS Conference Proceedings*, Fall Joint Computer Conference, 1972, pp 765-777
19. W. J. Watson and H. M. Carr, "Experiences With The  $\pi$  Advanced Scientific Computer," *AFIPS Conference Proceedings*, National Computer Conference, 1974, pp 389-392
20. Cray Research, *CRAY-1 Computer System Reference Manual*, Cray Research, Inc, Minneapolis, Minn, 1976



Kenneth J. Thurber received his PhD in electrical engineering from Montana State University. Dr Thurber is currently a senior staff scientist at Sperry Univac where he serves as a consultant to the signal processing department on high performance architectures. His interests include high performance architecture and computer communication concepts for distributed processors.

# SUPER SCHOTTKY

## We made Schottky faster-acting and easier to take.

Until now, to get Schottky speed, you had to live with certain design headaches. Heavy power consumption and noise sensitivity, to name a couple.

But those days are over. Fairchild has made a whole Schottky TTL logic family called Fairchild Advanced Schottky TTL. Or, FAST. It delivers up to 75% more speed than Low Power Schottky. Up to 20% more speed than Schottky. With only 25% of Schottky's power requirement.

### High-potency logic.

So now you can drive more circuits with less power. And put the power you save to work somewhere else. But the best part is, FAST extends the life of your TTL logic designs and equipment by cutting the difference between Schottky and 10K ECL to almost nothing. And with FAST, there's no need to learn a new logic system.

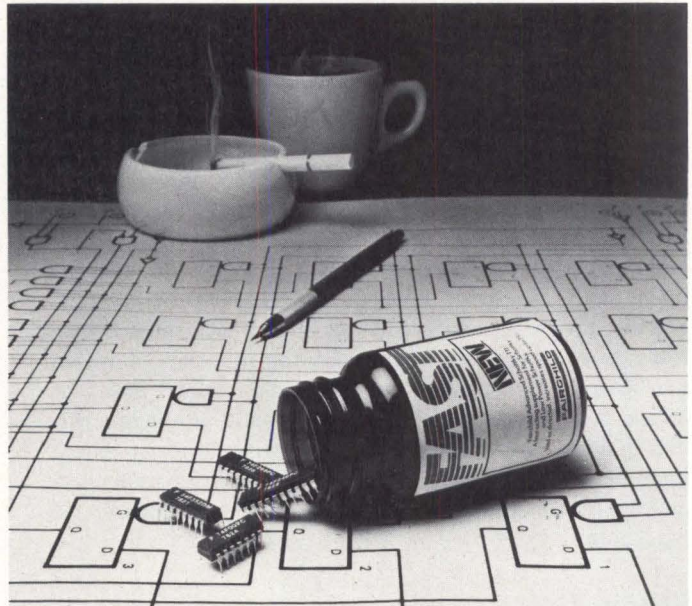

Part#	$t_{PHL}$ (ns)	$t_{PLH}$ (ns)
74F00PC	2.6	2.9
74F02PC	2.6	3.5
74F04PC	2.5	2.7
74F08PC	3.6	4.1
74F10PC	2.7	2.9
74F11PC	3.7	4.2
74F20PC	2.8	2.9
74F32PC	3.5	3.9
74F64PC	2.8	3.6

Typical 15 pF Gate Delays  
FAST

FAST gives you external gate delays of 4-4.5 ns over the full commercial and military temperature and voltage ranges while driving 50 pF load capacitance. Internal gate delays are 1.5 ns and power consumption is typically 4 mW per gate function. Input thresholds are 1.5 V and output drive is identical to 20 mA Schottky.

Yet, as revolutionary as FAST is, it's proven. It's manufactured using Fairchild's patented, time-honored Isoplanar process. You can depend on it.

### The basic ingredients.

These nine FAST parts are available now, with many more familiar functions coming soon. To get FAST facts, just call toll-free (800) 227-8158 or (800) 982-5805 in California. Or, contact your Fairchild sales office, distributor or representative. Fairchild Camera and Instrument Corporation, P.O. Box 880A, Mountain View, CA 94042. TWX: 910-379-6435.

**FAIRCHILD**  
**Call us on it.**

---

# INDEXED ADDRESSING FOR MICROCOMPUTERS

---

System software frequently processes data arranged in blocks or tables. For hardware designers with restricted programming expertise, efficient microcomputer handling of such data necessitates an understanding of addressing modes and, in particular, indexed addressing for sequential and orderly access to areas of system memory

---

**William Hertz**     GTE Laboratories, Waltham, Massachusetts

---

**M**ost microcomputer instructions contain at least a single operand; that is, the entity on which the instruction is to operate. This operand is either a register or a memory location within the architecture of the particular machine for which the instruction is written. In many cases, the operand is "implied," meaning that the operand need not be specified because it is inherent to the instruction itself. For example, the complement instruction in a single-accumulator microcomputer would have the accumulator as an implied operand without having to name it specifically in the instruction.

Indexed addressing is defined as a mode of memory reference in which the effective (actual) address of the operand is determined at execution time, and is dependent upon the current contents of an index register. This general definition includes indirect addressing, if the definition of index register is stretched to include an arbitrarily defined memory location. Both indexed and indirect addressing are distinguished from other addressing modes in that the address of the instruction's operand can be computed by the program in which it is contained.

Current microcomputer instruction sets include various addressing modes. Comprehension of the available addressing modes can lead to efficient and easily understood program code.

## Instruction Formats

General assembly language instruction formats for the 6800 and 8080 microprocessors are shown in Fig 1(a),

along with an example for each. These formats are typical of most common microcomputers. The only significant differences between the 8080 and 6800 formats are that the 8080 assembler program requires that a semicolon designate the beginning of the comment field while the 6800 does not, and the 8080 format also includes a colon following the label field. (Using the semicolon at the start of a 6800 comment field will do no harm.)

Four instruction fields shown in Fig 1(a) are interpreted by an assembler program for the particular machine being programmed. The actual machine code is derived by the assembler from the opcode and operand fields. These two fields can be conceptually grouped together to form an instruction field. Fig 1(b) shows the machine code generated by the assembler programs for the instructions of Fig 1(a). The information from the opcode and operand fields in both cases generates a 3-byte instruction. The first byte (B6 for the 6800, 3A for the 8080) informs the A or accumulator register that it is to be loaded with the contents of a memory location, and the address of that memory location is to be found in the next two instruction bytes. These address bytes differ for the 6800 and 8080 only in that the 6800 instruction contains the high order address byte first and the low order byte second, while the 8080 does the opposite.

The LABEL field of an instruction is used by the assembler in order that the instruction itself can be referred to elsewhere in the program. An important use of the label is to allow an instruction to be branched to.

	LABEL	INSTRUCTION		COMMENTS
		OPCODE	OPERAND	
6800	START	LDAA	\$3001	Get Contents of Location 3001 into A Register
8080	BEGIN:	LDA	3001H	; Get Contents of Location 3001 into A Register

(a)

	ASSEMBLY CODE	MACHINE CODE
6800 Instruction	LDAA \$3001	B63001
8080 Instruction	LDA 3001H	3A0130

(b)

Fig 1 General assembly language type of instructions. Formats for assembly code of 6800 and 8080 microcomputers (a) show various fields. Corresponding machine code translations of sample instructions (b) are listed

Extended	STA A	\$2CFD	Store Contents of A Reg into Location \$2CFD
Extended	JMP	\$10FA	Jump to Instruction at \$10FA
Direct	JMP	\$3D	Jump to Instruction at \$3D (Zero Page)

(a)

CLR A	Clear A Register
INC B	Increment B Register

(b)

BRA	\$20	Branch to Instruction Located \$20 Bytes Past Location Following this Instruction
-----	------	---

(c)

LDX	#\$2DFB	Load X Reg with Value \$2DFB
LDA A	#\$4C	Load Reg A with Value \$4C

(d)

CLR	0,X	Clear Location Whose Address is in X Register
CLR	3,X	Clear Location Whose Address is Found by Adding 3 to Contents of X Register

(e)

Fig 2 Addressing modes of 6800 microprocessor. In (a), two forms of absolute addressing—extended and direct—are shown for comparison. Nonmemory reference instructions (b) are demonstrated. Reference address (c) is computed relative to instruction address; immediate mode (d) includes data in instruction itself; and indexed instructions (e) include value to be added to X register contents in order to compute operand memory address

The COMMENT field—ignored by the assembler—explains the function of the instruction.

Both instructions of Fig 1(a) direct the microcomputer to load the A register with the contents of memory location 3001<sub>16</sub>. Another difference between the assembly

language of the 6800 and the 8080 is the way in which numbers are flagged as hexadecimal. The 6800 language requires that hexadecimal numbers be preceded by a dollar sign (\$), while in 8080 language, hexadecimal numbers are followed by the letter H.

## Addressing Modes

Addressing modes of the 6800 microprocessor can be grouped into the following categories: absolute memory addressing, register reference, relative memory addressing, immediate mode, and indexed mode. (The manufacturer's classifications of these categories have been further expanded for the purposes of this article.) Examples of these instruction modes are listed in Fig 2.

### Absolute Addressing

Absolute memory addressing has been demonstrated by the examples of Fig 1. In this addressing mode, the instruction itself includes the actual memory address of the operand. The memory location may be used as a program jump address, the source of a data byte, the destination of a data byte, or for some other operation specified by the opcode. Literature for the 6800 refers to direct and extended addressing modes; actually, these are both absolute memory addressing instructions. The extended mode is shown in Fig 2(a); the absolute address is a 2-byte value in the machine instruction. Direct mode is a special case of absolute memory addressing in which the address is specified by a single byte of the instruction [Fig 1(a)]. This mode allows the address to take on a value between 0 and  $255_{10}$  and it can only be used to refer to memory within this page zero (also referred to as page one) area of memory.

A page is a segment of contiguous memory; this allows memory address space to be treated as a series of pages of some fixed size (usually a power of two). In 6800 architecture, a page is 256 bytes long, with page zero occupying locations 0 through  $255_{10}$ . The JMP  $\$3D$  instruction of Fig 2(a) refers to location  $3D_{16}$ , which is in the page zero area of memory and can therefore be defined by a single-byte address.

### Register Reference

This addressing mode [Fig 2(b)] includes instructions that require no access to memory. All operations are performed in one or more of the machine's working registers. The CLR A instruction of Fig 2(b) causes the A register value (all eight bits) to be set to zero. The INC B instruction adds one to the value contained in the B register prior to executing this instruction.

### Relative Memory Addressing

This type of instruction [Fig 2(c)] refers to a memory location by specifying the difference between the address of the instruction itself and the address of the operand. For example, the BRA  $\$20$  instruction causes the computer to execute the instruction located at the memory address that is  $20_{16}$  bytes past the instruction following the BRA  $\$20$  instruction. The method by which the microcomputer obtains this relative address is as follows. After the second (final) byte of the BRA  $\$20$  instruction has been fetched from memory by the central processing unit (CPU), the program counter (the internal register that points to the next instruction to be executed) contains the address of the instruction following the BRA  $\$20$  instruction. During the execute phase of the BRA  $\$20$  instruction, the value  $20_{16}$  is added to the contents of the program counter, thereby causing a branch in the program sequence.

## Immediate Addressing

In the immediate mode of addressing [Fig 2(d)], the operand is stored along with the instruction. The first byte of machine code defines the operation and the fact that the operand data are in the next consecutive memory location(s). The first instruction of Fig 2(d), LDX  $\#\$2DFB$  instructs the microcomputer to set the value of the 16-bit X register to  $2DFB_{16}$ . Likewise, LDA A  $\#\$4C$  causes the A register to be loaded with the value  $4C_{16}$ . The important point is that operand data are stored immediately after the instruction in memory.

### Indexed Addressing

For the purpose of this article, indexed addressing [Fig 2(e)] includes examples in which the instruction specifies a register (or possibly a memory location) containing the location of the operand. In 6800 architecture, the first byte of machine code of an indexed instruction designates the instruction as one of the indexed type, and specifies the operation. The second byte contains a number (0 to  $255_{10}$ ) that is to be added to the X or index register in order to obtain the memory address of the operand. The CLR 0,X instruction directs the microcomputer to clear the memory location whose address is contained in the index register. For instance, CLR 3,X causes the clearing of the memory location whose address is obtained by adding 3 to the contents of the index register.

*6800 Block Clear Program*—To further explain this concept of indexed addressing, consider its use in a 6800 program. (All program listings are in assembly language.) Assume that 10 consecutive storage locations are to be cleared (set to zero) using the 6800 indexed mode of addressing (Program 1). Accumulator register B initializes with the count of 10. Accumulator register A contains the zero value to be stored in each of the 10 locations. Index register X points to the memory byte that is currently being cleared. Each pass through the loop clears the byte whose address is in the X register. Thus, the X register is incremented to point to the next byte in memory. Finally, the count is decremented and tested for zero. The count in register B will be zero after the tenth byte has been cleared, and the program will continue rather than execute the loop again.

The important aspect of Program 1 is that the index register always contains the address of the byte to be operated on (in this case, cleared). The instruction that utilizes the indexed mode of addressing is STA A 0,X. In words, this instruction states: store the contents of the A register into the byte whose memory address is obtained by adding zero to the contents of the X register. Note that for the 6800, zero can be replaced by any value up to 255, and that the zero value adds no information to the instruction. In fact, the index register of the 6800 when used in this manner is totally analogous to the HL register pair of the 8080 microprocessor. This may not be self-evident since the 8080 literature refers to the use of the HL register pair as "implied" memory addressing.

*8080 Block Clear Program*—To more clearly illustrate the similarity, an 8080 program that accomplishes the 6800 10-byte clearing operation of Program 1 is shown in Program 2. No claim is made that either of

### PROGRAM 1

#### 6800 Block Clear

```

LDA B    #10      ;INITIALIZE COUNT
LDA A    #0       ;CLEAR REG A
LDX      #TABLE   ;POINT X AT 1ST ENTRY TO BE CLEARED
LOOP    STA A    0,X ;CLEAR BYTE POINTED TO BY X REG
        INX      ;INCREMENT X REG
        DEC B    ;DECREMENT COUNT
        BNE     LOOP ;DO AGAIN IF TENTH NOT DONE

```

### PROGRAM 2

#### 8080 Block Clear

```

MVI     B,10      ;INITIALIZE COUNT
MVI     A,0       ;CLEAR A REG
LXI     H,TABLE   ;POINT HL PAIR AT 1ST ENTRY TO BE CLEARED
LOOP    MOV     M,A ;CLEAR BYTE POINTED TO BY HL PAIR
        INX     H   ;INCREMENT HL PAIR
        DCR     B   ;DECREMENT COUNT
        JNZ     LOOP ;DO AGAIN IF TENTH NOT DONE

```

### PROGRAM 3

#### Conventional 6800 Block Move

```

LDA B    #10      ;INITIALIZE COUNT
LDX      #DEST    ;POINT X AT DESTINATION AREA
STX      TMPDEST  ;SAVE ADDRESS OF DESTINATION
LDX      #SOURCE   ;POINT X AT SOURCE AREA
LOOP    LDA A    0,X ;GET BYTE FROM SOURCE AREA
        INX      ;INCREMENT SOURCE POINTER
        STX     TMPSOURCE ;SAVE SOURCE POINTER
        LDX     TMPDEST  ;GET DESTINATION POINTER
        STA A    0,X ;STORE BYTE IN DESTINATION AREA
        INX      ;INCREMENT DESTINATION POINTER
        STX     TMPDEST  ;SAVE DESTINATION POINTER
        LDX     TMPSOURCE ;GET SOURCE POINTER
        DEC B    ;DECREMENT COUNT
        BNE     LOOP ;DO AGAIN IF TENTH NOT DONE

```

### PROGRAM 4

#### Conventional 8080 Block Move

```

MVI     B,10      ;INITIALIZE COUNT
LXI     H,SOURCE  ;POINT HL PAIR AT SOURCE AREA
LXI     D,DEST    ;POINT DE PAIR AT DESTINATION AREA
LOOP    MOV     A,M ;GET BYTE FROM SOURCE AREA
        STAX   D    ;STORE BYTE IN DESTINATION AREA
        INX     H   ;INCREMENT SOURCE POINTER
        INX     D   ;INCREMENT DESTINATION POINTER
        DCR     B   ;DECREMENT COUNT
        JNZ     LOOP ;DO AGAIN IF TENTH NOT DONE

```

### PROGRAM 5

#### 6800 Block Move Utilizing Stack Pointer

```

SEI      ;DISABLE INTERRUPTS
STS      STKSAV  ;SAVE STACK POINTER
LDA B    #10      ;INITIALIZE COUNT
LDS      #SOURCE-1 ;POINT STACK POINTER AT SOURCE AREA
LDX      #DEST    ;POINT X AT DESTINATION AREA
LOOP    PUL A    ;GET BYTE FROM SOURCE AREA
        STA A    0,X ;STORE BYTE IN DESTINATION AREA
        INX      ;INCREMENT DESTINATION POINTER
        DEC B    ;DECREMENT COUNT
        BNE     LOOP ;DO AGAIN IF TENTH NOT DONE
LDS      STKSAV  ;RESTORE STACK POINTER
CLI      ;ENABLE INTERRUPTS

```

### PROGRAM 6

#### 6800 Addition Utilizing Displacement Field of Indexed Instructions

```

LDA B    #10      ;INITIALIZE COUNT
LDX      #TABLE   ;POINT X AT BEGINNING OF TABLE
LOOP    CLR     3,X ;CLEAR UPPER BYTE OF RESULT
        LDA A    0,X ;PUT 1ST NUMBER INTO A REG
        ADD A    1,X ;ADD 2ND NUMBER TO A REG
        BCC     NEXT1 ;SKIP NEXT INSTR IF NO CARRY
        INC     3,X ;PUT CARRY INTO UPPER BYTE OF RESULT
        ADD A    2,X ;ADD 3RD NUMBER TO A REG
        BCC     NEXT2 ;SKIP NEXT INSTR IF NO CARRY
        INC     3,X ;ADD CARRY TO UPPER BYTE OF RESULT
        STA A    4,X ;STORE A REG INTO LOWER BYTE OF RESULT
        INX      ;INCREMENT INDEX REGISTER FIVE TIMES
        INX      ; TO POINT TO NEXT TABLE ENTRY
        INX      ;
        INX      ;
        INX      ;
        DEC B    ;DECREMENT COUNT
        BNE     LOOP ;DO AGAIN IF TENTH NOT DONE

```

### PROGRAM 7

#### 6800 Block Move Utilizing Vector Mode of Indexed Addressing

```

LDA B    #10      ;INITIALIZE COUNT
LDX      #0       ;INITIALIZE INDEX REGISTER
LOOP    LDA A    SOURCE,X ;GET BYTE FROM SOURCE AREA
        STA A    DEST,X ;STORE BYTE INTO DESTINATION AREA
        INX      ;INCREMENT INDEX
        DEC B    ;DECREMENT COUNT
        BNE     LOOP ;DO AGAIN IF TENTH NOT DONE

```

### PROGRAM 8

#### 6800 Addition Utilizing Vector Mode of Indexed Addressing

```

LDA B    #10      ;INITIALIZE COUNT
LDX      #0       ;INITIALIZE INDEX REGISTER
LOOP    CLR     SUMH,X ;CLEAR UPPER BYTE OF RESULT
        LDA A    NUMBA,X ;PUT 1ST NUMBER INTO A REG
        ADD A    NUMBB,X ;ADD 2ND NUMBER INTO A REG
        BCC     NEXT1 ;SKIP NEXT INSTR IF NO CARRY
        INC     SUMH,X ;PUT CARRY INTO UPPER BYTE OF RESULT
        ADD A    NUMBC,X ;ADD 3RD NUMBER INTO A REG
        BCC     NEXT2 ;SKIP NEXT INSTRUCTION IF NO CARRY
        INC     SUMH,X ;ADD CARRY TO UPPER BYTE OF RESULT
        STA A    SUML,X ;STORE A REG INTO LOWER BYTE OF RESULT
        INX      ;INCREMENT INDEX
        DEC B    ;DECREMENT COUNT
        BNE     LOOP ;DO AGAIN IF TENTH NOT DONE

```

the programs represents the most efficient method of accomplishing the sample task in either microprocessor language. Rather, they are intended to introduce the concept of addressing memory via the contents of a register. In both programs, the address is a 16-bit value contained in a register (or register pair) that can be incremented. This provides a convenient method to operate on successive entries in memory address space.

The limitation of this indexed addressing mode is

that the actual address of the memory byte to be operated on is held in the index register. This means that the index register can operate conveniently on only one block of contiguous memory locations at a time. Of course, the contents of the index register can be shuffled back and forth between the index register and other temporary storage when required; in fact, block data transfers are normally handled this way in a 6800 program.



**6800 Block Move Program**—Program 3 lists a 6800 example for moving 10 bytes from an area beginning with the label SOURCE to an area beginning with the label DEST. In this program, the index register serves the same purpose as in Program 1, but here it does so for two separate areas of memory. Two temporary storage locations (TMPDEST, TMP SOURC) are used so that the indexed mode of addressing can operate on the two memory areas. This type of application led to the design concept of including a second index register in microprocessors, such as implemented in the Zilog Z80. The second index register eliminates the shuffling of addresses back and forth between the index register and temporary storage. Applications do exist, however, in which more than two memory blocks are being operated on. These require “shuffling,” even on microprocessors with two index registers.

**8080 Block Move Program**—In Program 4, a block move segment of an 8080 program, the implied mode of addressing works efficiently with the HL and DE register pairs acting as index registers. Obviously, the extra index register makes the simple block move program cleaner. Also shown is the advantage of dual index register architecture, which leads to a clever 6800 programming scheme.

**6800 Block Move Using Stack Pointer**—Since the 6800 microprocessor has only one real index register, it seems that the temporary storage shuffling method must be used (Program 3). There is, however, another 6800 register—the 16-bit stack pointer (SP)—that can be used as an index register. By making the source area look like a “stack” in memory, instructions that relate to the stack pointer can be used; simply stated, the stack pointer is made to point to the beginning of the source area. Then, a PUL A instruction (Program 5) pulls a byte from the source area (top of the stack), inserts this byte into the A register, and increments the stack pointer. However, it is very important that the interrupts are disabled throughout this program segment because the interrupt mechanism manipulates the stack pointer. Furthermore, the contents of the stack pointer must be saved upon entry to the program segment and restored upon exit. Note in Program 5 that the stack pointer is initialized to point to the byte before the first entry in the source block, due to the nature of the PUL A instruction. This instruction first increments the stack pointer, then loads the byte being pointed to into the A register. This auto-increment of the stack pointer makes the segment even cleaner.

### Vector Mode of Indexed Addressing

The programs presented thus far have been limited to those that operate on, at most, two separate blocks of memory. Also, as mentioned earlier, these programs have not taken advantage of the displacement field of the 6800 indexed instructions. This field is a number or expression that can take on a value from 0 to  $255_{10}$ , as restricted by the machine code format for these instructions. Indexed instructions are two bytes long, with the first byte containing the op code and the second byte containing the displacement value. The op code specifies the operation to be performed while the address of the data to be operated on is found by adding the displacement value to the contents of the index register.

A conventional use of the “index register plus displacement” format is presented to explain the underlying concept. Consider a block of data in memory, in which the data are to be interpreted as a table with 10 contiguous entries of five bytes each. The first three bytes of each entry represent three numbers that are to be added together; the fourth and fifth bytes are reserved for the result of the addition. (A 2-byte area is always large enough to hold the summation result of the addition of three 1-byte values.) Program 6 performs these additions by making use of the displacement option of the 6800 indexed instructions.

To interpret this program, visualize that the index register always points to a table entry five bytes long. These five bytes are individually addressed by using the 6800 indexed instructions with a displacement value of 0 through 4 in the instruction code. This same technique can handle much larger data structures since the displacement value can be as large as 255. This does not solve the block move problem, since the relationship between the source and destination areas of memory is usually not fixed as it is in this table form of structure.

A less obvious technique enables the 6800 indexed instructions to perform data block manipulations. This makes use of the often overlooked fact that in a 6800 assembly language program the displacement field of an indexed instruction can be replaced by an expression that evaluates to a single byte. Add to this the observation that any byte that lies in the first 256 locations of the 6800 address space can be referred to with a 1-byte address. The 6800 has a special addressing mode—direct addressing—for referring to these 256 locations. Locations outside this page zero area are referenced by the extended mode of addressing. This means that two full bytes of the instruction are utilized for the address of the referenced data in an extended mode instruction, while only one byte is utilized for this purpose in a direct mode instruction.

The point to be emphasized is that the label for any byte in the page zero area of memory is evaluated to a single byte by the 6800 assembler. This means that the displacement field of an indexed instruction can be a label that corresponds to a page zero memory location. Consider the instruction LDAA TAG, X. Assuming that TAG is the label of location  $100_{10}$  in memory, the instruction is translated into machine code as load accumulator A with the contents of the byte whose address is found by adding 100 (TAG) to the contents of the index register (X). (Note that this is a page one location.) Now, if the index register contains a zero, that address will be 100; if the index register contains a one, the address will be 101. For this instruction format, the index register is actually holding the displacement value in a data block whose first location is represented by the label in the actual displacement field. In fact, the real key to this format is the reversal of roles of the index register and the displacement field. This technique can be used without an assembler by just putting a single-byte address in the displacement field. This form of indexed addressing is henceforth referred to as the vector mode. In this mode, the machine instruction contains a memory address—as in the case of absolute addressing—but also specifies that an index register contains a value to be added to the memory address in order to obtain the actual memory address of the

operand data. Conceptually, this allows absolute addressing of a vector (block) of data in memory by modifying the index register during execution.

**6800 Block Move In Vector Mode**—Program 7 presents the simplest block move program thus far (Programs 3, 4, and 5). The advantage of this mode is that the data block being accessed is referred to by its label, while the offset into the block is contained in a register. This means that the corresponding entry in many data blocks can be manipulated at once. Changing the contents of the index register alters the entry that will be accessed in all the blocks. This is very similar to the concept of subscripted variables in a high level language. In this application, the current subscript value is held in the index register. Instruction `SOURCE,X` has the same intrinsic meaning as `SOURCE (X)` found in higher level languages. Both imply the existence of a data block named `SOURCE` with multiple entries. The entry being referenced is determined by the current value of `X`.

This vector addressing mode in the 6800 appears to be highly beneficial; however, the limitations must be stressed. This mode only works for data blocks that start in the first 256 memory locations for the reasons already stated. This might have been removed in the 6800 by making the displacement field of indexed instructions a full two bytes long, which would, of course, lead to more memory being used by all instructions that utilize indexing. More important, however, is the fact that any memory address (up to 16 bits long) could replace the displacement field.

The concept is implemented in the MOS Technology 6500 series of microprocessors. The 6501 CPU architecture includes a pair of 8-bit index registers that function in indexed instructions. These instructions specify one of the index registers to be added to a base address field of the instruction. This field can be either a 1- or 2-byte address, thereby giving a true vector mode addressing capability.

**6800 Addition Program In Vector Mode**—Since the vector mode simplifies a block move program, it is now utilized to implement the addition of Program 6. Data organization for the vector mode is different from that required for the original program. The new program assumes that there are five 10-byte blocks of memory, with the first byte of each of these blocks identified by a label. Program 8 contains the revised addition program. Several advantages are obtained over Program 6. First, the five blocks of data (`NUMBA`, `NUMBB`, `NUMBC`, `SUMH`, `SUML`) do not have to be in any particular location with respect to each other in memory. However, the 10 bytes in each block must be in contiguous locations. Another improvement is that only a single `INX` (increment index) instruction is necessary for each pass through the program loop, as compared with five `INX` instructions in Program 6. Finally, there is an obvious improvement in the readability of the program due to the labels.

These examples demonstrate the overall advantages of the vector mode of indexed addressing. The easiest way to improve on the current 6800 instruction set would be to extend the displacement field of the instruction to two bytes, as done on the 6501. However, this has the single disadvantage of taking up an extra memory location for every indexed instruction used. The 6501

has allowed for an indexed instruction to maintain the 1-byte address field when referencing a page zero variable.

Some natural extensions of the vector addressing mode are possible. Program 8 is structured such that on any pass through the loop, the number in each of the five data blocks that is referred to has the same offset from the beginning of the block. This offset is the value currently held in the index register. However, since the address field could be an expression to be evaluated by the assembler, other members of the block could be referenced. Consider the instruction `LDAA TABLE +3, X`—namely, load register A with the contents of the byte whose address is `TABLE +3` plus the current contents of the index register (`X`).

In this instruction, the assembler program interprets `TABLE +3` as the memory address that is three locations past the one assigned the label `TABLE`. At execution time, the operand address is obtained by adding the contents of the `X` register to the address that is three past location `TABLE`. This allows the programmer to reference a location within the block that is not exactly offset from the beginning by the value stored in the `X` register.

## Summary

Several 6800 and 8080 program types and applications emphasize indexed addressing. The vector mode of indexed addressing is extremely useful, but the related instruction set is limited by the size of the opcode field. In most microprocessors, this field is eight bits long, thereby allowing up to 256 opcodes. Since, however, the normal index register plus displacement mode could be altered to allow the displacement field to occupy two full bytes, this capability could easily be added to existing instruction sets. The decision to allow the displacement field of indexed instructions to be either one or two bytes long in the 6501 instruction set is partially possible because of other instructions from the 6800 instruction set that are not implemented on the 6501. As usual, optimizing instruction sets and machine architecture always requires a thorough analysis of design tradeoff decisions.

## Bibliography

- Intel Corp, "8080 Microcomputer System Manual," Santa Clara, Calif, 1975
- Motorola Semiconductor Products, Inc, "Programming Manual—M6800 Microprocessor," Phoenix, Ariz, 1975
- A. Osborne, *8080 Programming for Logic Design*, Adam Osborne and Associates, Inc, Berkeley, Calif, 1976
- B. Souček, *Microprocessors and Microcomputers*, John Wiley and Sons, New York, 1976

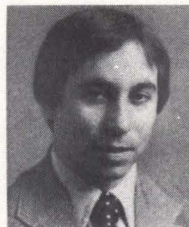

*William Hertz is a member of the technical staff at GTE Laboratories. He is currently working on microprocessor applications in telephone systems, and has experience in both hardware and software systems design. He has received an AAS in electronics technology from the Union County Technical Institute, a BS in engineering from Rutgers University, and an MS in electrical engineering and computer science from MIT.*

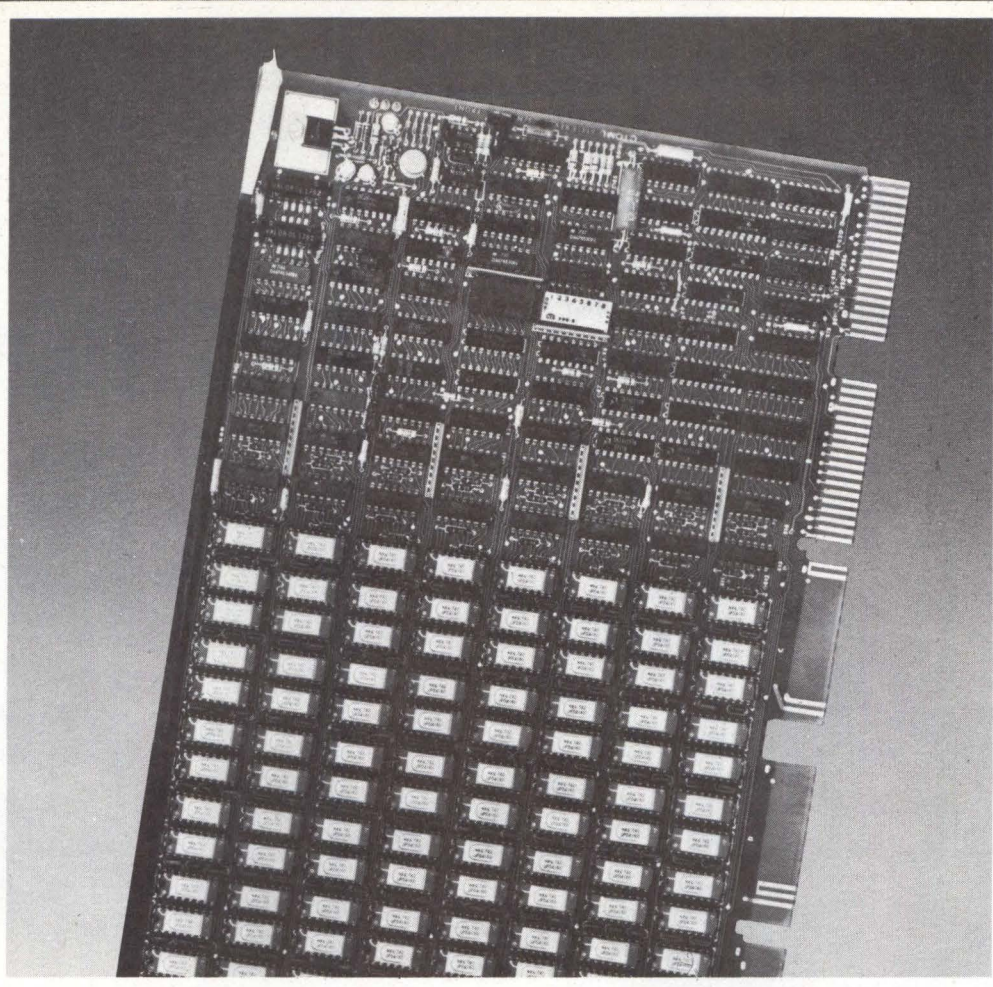

# THE INDUSTRY'S FIRST 128K<sup>x</sup>18 PDP<sup>®</sup>-11 ADD-IN

Now you have your choice of core or semiconductor memory to expand your PDP-11 minicomputer. Both from Dataram. And both top choices.

In semiconductor, you can get 16K, 32K, 64K, 96K and 128K on a single board. In core, you can get 32K x 18 on a single board. Or 128K x 18 in a Dataram-supplied double-system unit.

If you're looking for a practical way to go beyond DEC<sup>®</sup>'s 128K addressing limitation, you can do it with Dataram's BULK CORE disk emulation system — microsecond speed at the price of a peripheral. Best of all, it's completely software compatible. Ideal for multi-program and/or multi-terminal installations.

And all are available now from Dataram Corporation.

DEC and PDP are registered trademarks of Digital Equipment Corporation.



PRINCETON-HIGHTSTOWN ROAD CRANBURY, NEW JERSEY 08512  
TEL:609-799-0071 TWX:510-685-2542

**Canada:** Ahern & Soper Ltd., Alberta, British Columbia, Ontario, Quebec • **Finland:** Systek OY, 90-737-233 • **France:** YREL, 956 81 42 • **Italy:** Macronics Italia, 02/35 36 041 • **Sweden:** M. Stenhardt AB, (08) 739 00 50 • **Switzerland:** ADCOMP AG, 01/730 48 48 • **United Kingdom/Ireland:** Sintrom Ellinor Ltd. (0734) 85464 • **West Germany/Austria:** O.E.M.-Elektronik GmbH, 07 11-79 80 47 • **Australia/New Zealand:** Anderson Digital Equipment, (03) 543 2076 • **India:** Industrial Electronic Instruments, 79281 • **Israel:** K.D.M. Electronics, 921513 • **Japan:** Matsushita Electric Trading Co., Ltd., 03 (435) 4501 • **Taiwan/Republic of China:** Syscom Computer Engineering Co., (02) 7022156.

**CIRCLE 75 ON INQUIRY CARD**

# OEMS. TAKE A FREE TRIAL SPIN ON US, HARDTOP OR CARTRIDGE.



### The Proven MX Winchester Technology Family

From the world's largest alternative manufacturer of Winchester technology disk drives, Fujitsu offers excellent price/performance and reliability. The M2251, M2252, and M2253 provides 12.5, 25, or 50 megabytes of unformatted storage along with flexible program or data loading from a variety of external sources: diskette drives, cartridge drives, storage module drives, tape drives, and communications lines. MTBF is in excess of 10,000 power-on hours. Access times are 10-ms track-to-track, with 40-ms average. And pricing in 100 quantities is very aggressive.

### The Unique, Front Loading SMD-Compatible M2201

As the only front loading drive around, the M2201 offers new convenience and flexibility in configuring your small business systems, intelligent terminals and other micro/minicomputer based systems. It offers 50 megabyte capacity. Has a reliability factor that's 50% better than the industry average (6,000 POH MTBF). And stores at an off-line cost that's lower than either top loading cartridge or storage module drives. Access times are

6-ms track-to-track. There are no data staging requirements. Plus, a servo/track record system assures cartridge interchangeability.

### Free Offer

For a limited introductory time, Fujitsu is providing no-strings-attached evaluation units, including paid freight, to qualified OEMs. Order yours now by calling Byron Wicks, Marketing Director, collect at 408/985-2300. NOTE: reference your call to the operator as the Fujitsu Evaluation Offer. Or send the coupon to: Fujitsu America Inc., 2945 Oakmead Village Court, Santa Clara, CA 95051 Telex: 357402 TWX: 910-338-0047 Tel: 408/985-2300. Offer subject to change without notice.

- I want an evaluation unit. Now.
- Please send data on your Winchester technology products
- Please send data on the M2201
- Have product representative call on application

Application area \_\_\_\_\_

Name/Title \_\_\_\_\_

Organization \_\_\_\_\_

Street/City \_\_\_\_\_

State/Zip/Telephone \_\_\_\_\_

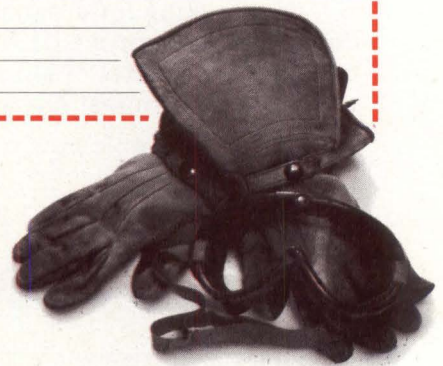

**FUJITSU**

**OEMS. YOU'RE IN THE DRIVER'S SEAT WITH FUJITSU.**

---

# TRENDS IN COMPUTER PRINTER TECHNOLOGY

---

Basic printing techniques are examined as to their significant attributes and limitations. Applications, printing speeds, flexibility, and costs are presented for designer evaluation. New printer designs should evolve from refinements in existing microelectronics, materials, and processes, rather than from dramatic breakthroughs

---

**Irving L. Wieselmann**

Dataproducts Corporation, Woodland Hills, California

---

**C**ontinuing expansion of centralized electronic data processing facilities and the growth of decentralized and distributed processing have brought profound changes to computer printer technology. A decade ago most printers were relatively expensive, formed character, electromechanical devices with limited speed ranges. Low speed serial printers were primarily used in telecommunication applications, higher speed serial printers served as online hardcopy terminals, while medium to high speed line printers handled most bulk printing tasks.

Rapid advances in minicomputer development, followed closely by the dramatic growth in microcomputers, created new standalone processing applications, resulting in a demand for less expensive printers having broader speed ranges. At the same time, general purpose computers became more sophisticated and permitted distributed and remote batch processing with a requirement for moderately priced, medium speed printers in remote locations. They also expanded the classical "computer-room capability," requiring extremely high throughput with correspondingly higher printer prices. Because of these diverse requirements, computer printer technology has been challenged to provide a broader range of printing capabilities and prices.

The industry has met this challenge by developing printers that use about a dozen different technologies, all of which serve to record information on paper (see Panels, pages 108 and 110). Each technology has distinct advantages as well as limitations.

## Printer Mechanism Types

Computer printers are classified into three primary categories: impact or nonimpact, dot matrix or fully formed character, and serial or line. In general, impact printers have either front or rear striking mechanisms. With front striking techniques, a typeface character or matrix pins strike a ribbon against the paper to form an image. The serial character forming element may be an embossed sphere, daisy wheel, cylinder, or dot matrix array. Because of the relatively high inertia of the typeface carrier element, printing speed is usually below 60 char/s. With dot matrix heads, speeds above 300 char/s are attainable. Few line printers use front striking mechanisms, with the notable exception of the 2000 line/min IBM 3211.

In rear striking printers, a hammer mechanism forces the paper and ribbon against a typeface character to form an image. The characters are on drums, trains, chains, belts, or bands. Speeds of these printers typically range from about 100 to 3000 lines/min.

Nonimpact printers are divided according to the type of paper used. Plain untreated paper printers employ ink-jet techniques for both low speeds (under 300 lines/min) and very high speeds (45,000 lines/min). Xerographic printers also use plain paper and have speed ranges from 4000 to 14,000 lines/min. Specially treated or sensitized papers change color or attract colored toner to show print images based on several physical

## Impact Printer Technologies

**A. Cylinder printer.** Complete character set is embossed in series of rings around cylinder printing mechanism. Cylinder is rotated and shifted up and down on its axis to move appropriate character into position; then, a hammer strikes cylinder

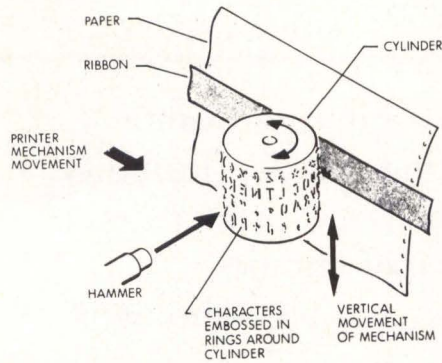

**B. Ball printer.** Updated version of cylinder printer uses spherical print mechanism. Sphere rotates on its axis to move selected character into position; sphere itself strikes paper

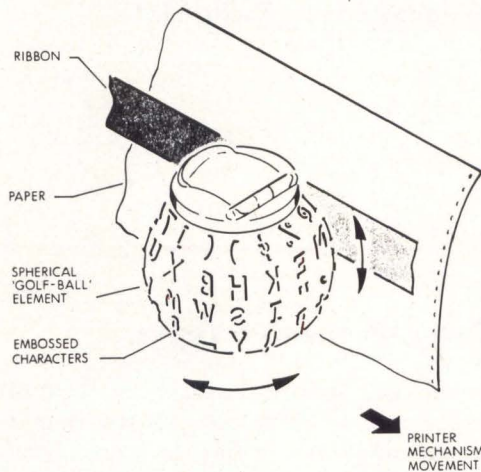

**C. Daisy wheel printer.** Set of spokes or arms, each with single character embossed at its end, radiates from wheel hub. Hub rotates to bring desired character into position, where it is struck by hammer mechanism

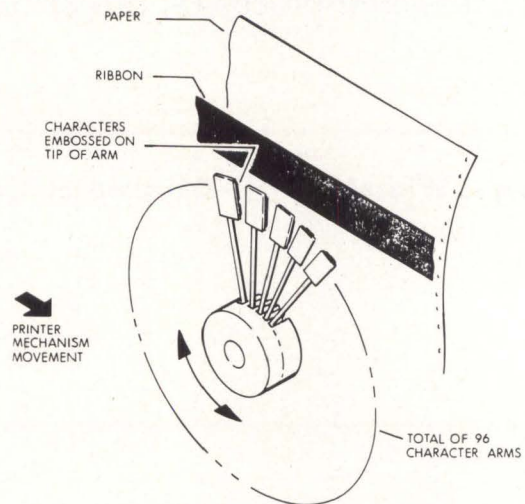

phenomena. Special paper printers include thermal units with speeds less than 100 lines/min; electrostatic units with speeds from 300 to 18,000 lines/min; and electro-sensitive units ranging from 100 to 1500 lines/min. Non-impact printers have two major limitations: they cannot make multiple copies, and if they require special paper, costs are higher than for plain paper.

Fully formed or shaped characters [Fig 1(a)], with an appearance as found in printed books or generated by typewriters, are generally associated with impact printers. These printers are favored for external reports, financial documents, checks, and other forms where appearance, clarity, and legibility are critical application factors. They are somewhat restricted in the number of characters supplied, simply because each character must be mechanically fashioned and assembled in a set. Drum printers typically have 64-, 96-, or 128-char sets. Band, chain, and train printers have 48-, 60-, 64-, 96-, 120-, or 128-char sets. With formed character printers, the

entire image forming medium must be replaced in order to change character sets. This may be either inexpensive, in the case of a ball type mechanism, or require substantial investment, in the case of train printers. Bands, chains, or trains are more versatile than drums, but they still require physical replacement of the print medium to change character sets.

An array of dots forms dot matrix character symbols [Fig 1(b)]. Arrays vary considerably in size from the relatively small 5 x 7 matrix (35 dots) and 9 x 7 matrix (63 dots) up to 24 x 40 (960 dots) and, recently, 30 x 50 (1500 dots). If a small matrix is used (less than 100 dots), the individual dots in each character are distinctly visible. Characters created by larger arrays (more than 200 dots) closely approximate the image of a formed character. Furthermore, an array with 8 to 11 vertical dots permits ascenders and descenders—printing above the lines, such as superscripts, or below the lines, such as lower case “p”s.

**D. Impact matrix printer.** Serial printhead consists of vertical column or columns of needles that move across page. Characters are formed as needles are selectively forced against paper. Each complete sweep of printhead across page produces line of print. In line printer, set of raised dots or needles is mounted on wide horizontal bar or comb. Bar slides from left to right, and needles strike to form character dots that produce one row. Complete characters are formed as paper is moved to successive rows

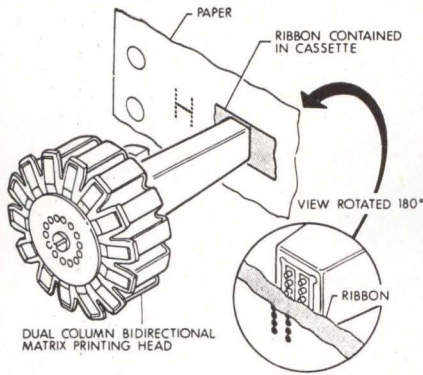

**E. Drum printer.** Drum, with characters embossed on each print position on its periphery, revolves past hammer bank. Hammer impact occurs when characters on drum are in proper position. Rear-striking hammer motion then forces paper and ribbon against drum to form character on paper

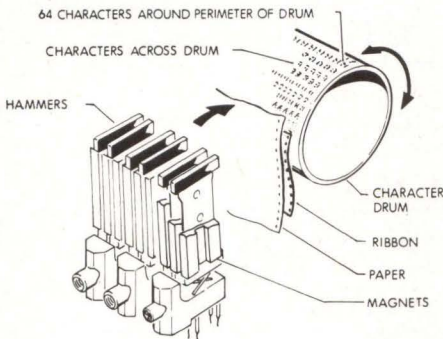

**F. Chain or train printer.** Array of character slugs moves horizontally past set of hammers—one hammer for each print position. Chain drive mechanisms have print slugs that are connected to pull one another around horizontal track, while train mechanisms have unconnected slugs that push one another along track. Hammers behind paper fire precisely against each character to be printed as it rotates into position

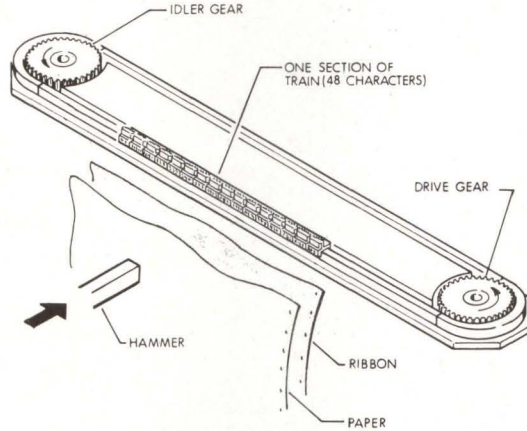

**G. Band or belt printers.** These printers use same techniques as train printers, but characters are carried by bands or belts. Illustrated is steel band containing embossed or etched characters. Another polyurethane belt mechanism carries slugs with type faces

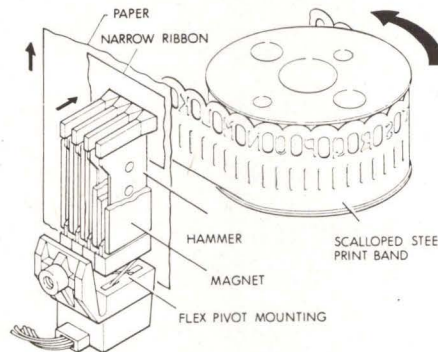

Modern matrix printers are less constrained than formed character printers in the number of character sets available. Characters and character sets are formed electronically from matrix print images stored in memories, such as read-only memories (ROMs). By simply exchanging one ROM chip for another, the font, style, or number of symbols may be changed. On some matrix printers, character spacing, height, and width may also be varied under switch or program control [Fig 1(c)].

The differences between serial printers and line printers are printing speed and the number of characters printed at the same time. Serial printer mechanisms generally move from left to right across a page, printing one column or one character at a time. Recent models print serially in either direction, which effectively gives them increased speed. Printing speeds range from 10 to 600 char/s. Line printers actually form characters sequentially on the same line; however, printing occurs so quickly that it appears that an entire line has been

printed at once. Line printer speeds range from 100 to 15,000 lines/min.

Printer categories are not mutually exclusive. Dot matrix character formation, for example, is applicable in very high speed nonimpact line printers, as well as low speed serial impact printers. Formed characters are primarily in the domain of impact printers, both serial and line. Printer technologies, speeds, advantages, limitations, and costs are summarized in Tables 1 and 2.

## Print Output Quality

Print output quality ranges from high (letter quality) to barely legible. Appearance and legibility of printing depend on such factors as printing technology, type of ribbon, quality and type of paper, number of multiple copies, and printer maintenance.

Excellent print quality is obtainable with some front striking impact mechanisms. In fact, the IBM Selectric

## Nonimpact Printer Technologies

**A. Thermal matrix printer.** Heat sensitive paper changes color with applied heat. Characters are formed by selectively heating head matrix elements while moving across paper

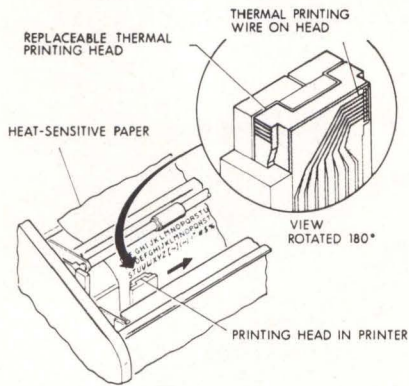

**B. Electrosensitive printer.** Thin metallic coating of electrosensitive paper burns away with applied head voltage, exposing the black underlayer. Voltage is selectively applied to head matrix as it moves across paper to form characters

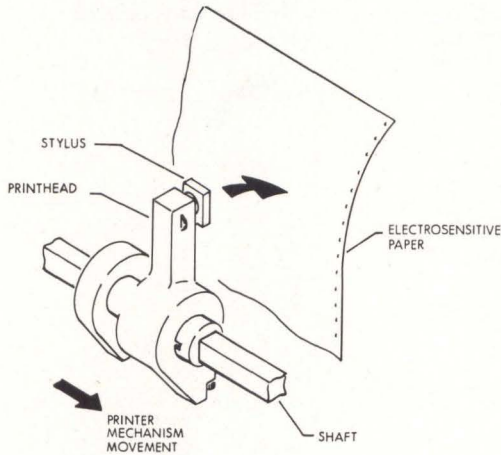

**C. Electrostatic printer.** Specially coated dielectric paper is passed over array of stylus needles. Voltage is selectively applied to needles, and characters are formed as charged spots on paper. Paper is then passed through toner where charged areas attract black particles

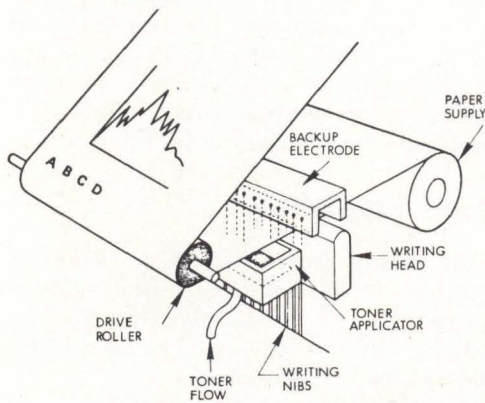

**D. Xerographic printer.** Latent image from light source is created on intermediate, photoconductive surface; this surface is toned with ink powder, and image is transferred electrostatically to output paper and fused into place. One technique uses light source and photographic image to produce latent image. In another approach, laser beam is used to generate high quality dot matrix character

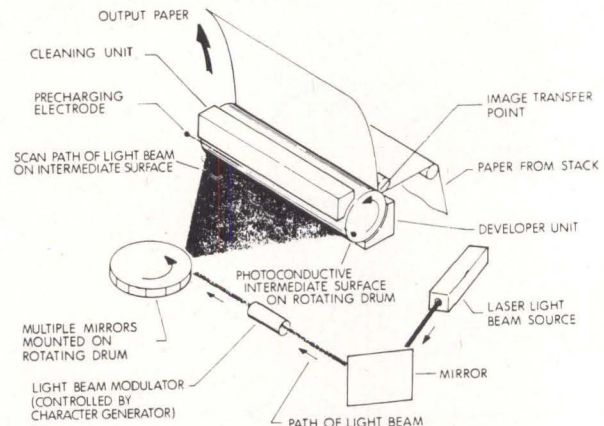

**E. Continuous stream ink-jet printers.** Controlled, continuous stream of ink droplets forms desired image on paper. Droplets charged according to desired image are aimed by electric field deflectors. Unneeded droplets are deflected down to gutter for recycling

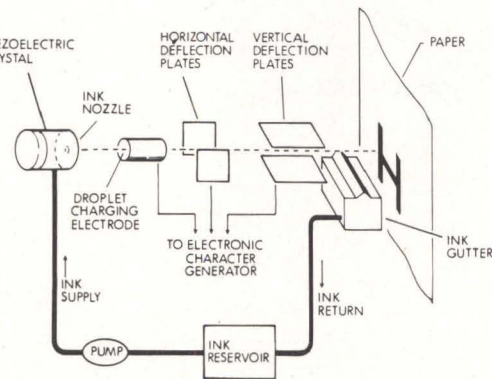

**F. Ink-on-demand ink-jet printers.** Droplets are created when desired by ink injection chambers from ink supply. Droplets so produced form matrix characters similar to those formed by impact matrix heads

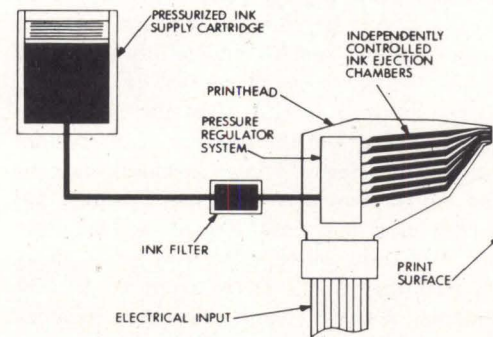



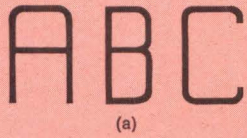

Fig 1(a) Shaped character printout. Techniques are similar to book printing since characters are created from solid character images transferred by impact to paper

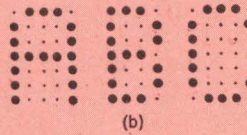

Fig 1(b) Dot matrix printout. Sets of dots form character shape. As dots increase in number, appearance approaches that of shaped characters

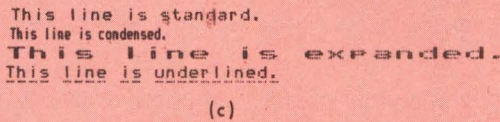

Fig 1(c) Dot matrix variations. Technique permits selectable fonts of variable character height, size, and spacing under switch or program control

at 15 char/s with a Mylar single-strike ribbon is considered to be the standard of print quality against which others are compared. Other front striking formed character serial printers, such as daisy wheels, can produce excellent to letter quality printing, while Teletype model 33 printing is generally considered to be of utility quality.

The quality of rear striking printers is slightly less than letter quality. Moreover, printing technologies used in these units can cause line smear or character misregistration. Horizontal moving fonts, such as trains and bands, may have horizontal misregistration, whereas vertical moving fonts, such as drums, may produce vertical misregistration or wavy lines.

All nonimpact printers use dot matrix techniques, and print legibility varies from poor at low dot density to good for high dot density. Print quality for special paper printers varies with the type of paper and the printing technology. Thermal papers generally have a pleasant appearance and print in blue or black. Electro-sensitive paper has a metallic appearance and prints in black. The IBM 6640 ink-jet printer produces letter quality while the sparse matrix of the high speed Mead "Dijit" produces low quality. Xerographic printers, such as the Xerox 9700, have excellent print quality, while the IBM 3800 has good computer output quality.

### Speed vs Cost Factors

Currently, more than 300 different printers or printer families are available with speeds ranging from 10 char/s

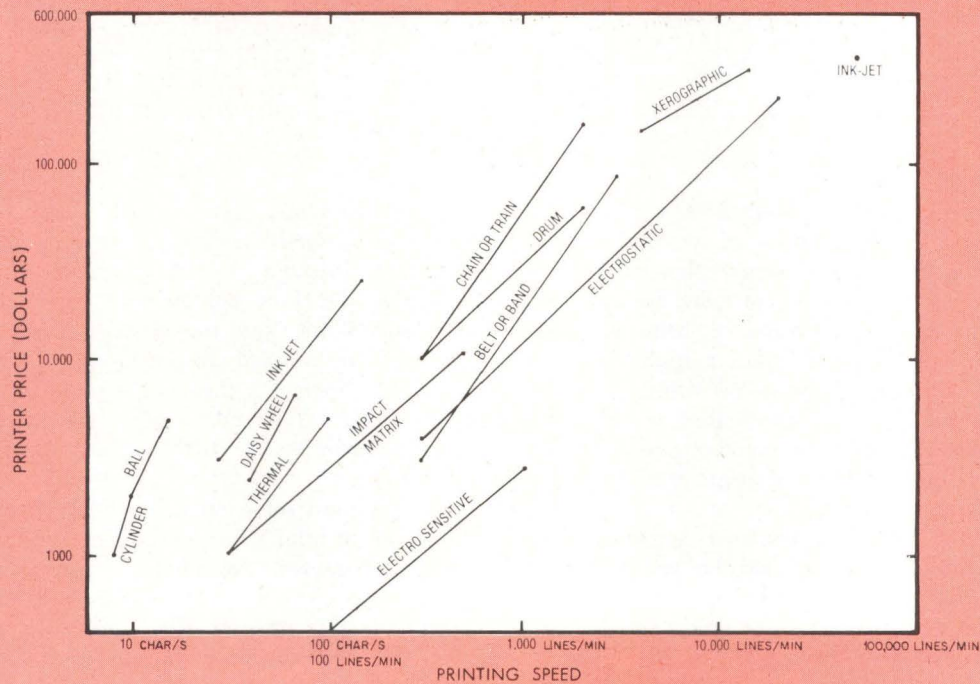

Fig 2 Printing speed vs cost. Computer printer speed and prices are a function of technology used to form images. Prices for similar speed ranges vary considerably; therefore, selection usually includes other factors such as duty cycle, print quality, reliability, and printer noise

**TABLE 1**  
**Summary of Impact Printer Technologies**

<u>Technology</u>	<u>Type</u>	<u>Speed</u>	<u>Advantages</u>	<u>Limitations</u>	<u>Price and Typical Manufacturer(s)</u>
Cylinder	Serial	10 char/s	Low cost	Slow speed, low reliability, low print quality, noisy	\$1000 to \$2000 Teletype Corp
Ball	Serial	to 15 char/s	Excellent print quality, large character set, interchangeable fonts, low cost	Slow speed, relatively noisy	\$2000 to \$5000 IBM Corp
Daisy wheel	Serial	30 to 55 char/s	Good reliability, good print quality, interchangeable fonts, higher speed than ball	Slower speed than matrix	\$1400 to \$7000 Diablo Systems Inc
Impact matrix	Serial or line	30 to 330 char/s (serial), to 600 lines/min (line)	High resolution with dense matrix, ROM changeable fonts, graphics capability, medium speed	Low reliability with high duty cycles, low resolution with sparse dot matrix	\$1000 to \$10,000 Centronics Data Computer Corp (serial); Printronix (line)
Drum	Line	300 to 2000 lines/min	High reliability, good medium to high duty cycle	Limited character fonts, slight vertical misregistration	\$10,000 to \$60,000 Dataproducts Corp
Chain or train	Line	300 to 2000 lines/min	Good print quality, interchangeable character sets, up to 128 characters	Chain or train track wear	\$10,000 to \$112,000 IBM Corp
Band or belt	Line	30 char/s to 3000 lines/min	Interchangeable fonts good print quality, high reliability	Belt and drive wear, entire band replacement for individual worn character	\$3000 to \$87,000 General Electric Co (low speed) IBM Corp (medium speed) Dataproducts Corp (high speed)

to 45,000 lines/min at prices of from \$500 to \$365,000. With this diversity, the application of a printer for a computer system is similar to the selection of a component or subsystem in an engineering design case. Printers generally follow performance criteria. High speed and print quality usually entail a high price. In addition, printer technology affects performance, characteristics, and price. The combined effect is shown in Fig 2. Proper printer application involves assessment of appropriate speed, duty cycle, and print quality of the application to minimize cost.

The first selection factor to consider is the desired printing speed. This decision should be based on the output print volume (Fig 3) and the availability of data from the computer or the communication line.

Very high speed printers, from 4000 to 18,000 lines/min, are intended for high volume printing with large mainframe systems. These printers should be considered when output production is more than 1M sheets/mo. High speed printers, from 900 to 2000 lines/min, are usually associated with medium or large scale computers. This speed range is capable of producing from 100k to 500k sheets/mo. Low speed printers, from 120 char/s

to 200 lines/min, are generally used with small mini-computers, small business systems, local terminals, and terminals linked with high speed modems (from 1200 to 2400 baud). Low volume printing ranges from 1k to 40k sheets/mo. Very low speed printers, from 10 to 100 char/s, are generally not considered for use in volume printing. Normally, these units serve in communications, with under 1200-baud modems, for interactive terminals, console printers, or high quality word processing applications.

The second selection factor, duty cycle, refers to the ratio of printing time to number of hours the printer is under power. An average medium or high speed printer duty cycle is about 25%, with a practical maximum of 40%. Slower serial printers, from 100 char/s to 100 lines/min, usually operate in the 10 to 15% duty cycle range.

Relationships among printer speed, duty cycle, and output production are best illustrated by a typical example. Assume that the system designer anticipates printing an average of 44 lines out of the 66 lines available on a standard paper form. A 300 line/min medium speed impact printer produces a maximum of 6.8 forms/

**TABLE 2**  
**Summary of Nonimpact Printer Technologies**

<u>Technology</u>	<u>Type</u>	<u>Speed</u>	<u>Advantages</u>	<u>Limitations</u>	<u>Price and Typical Manufacturer(s)</u>
Thermal matrix	Serial	30 to 120 char/s	Low cost, low noise	Slow speed, special paper, no preprinted forms	\$1000 to \$5000 Texas Instruments Inc
Electro-sensitive	Serial	160 to 2200 char/s	Low cost, medium speed	Special paper, wrinkles easily, attracts fingerprints, low print-quality	\$400 to \$3000 Scope Data Inc (low speed) SCI Systems Inc (high speed)
Electro-static	Line	300 to 18,000 lines/min	Graphics capability, versatile fonts, high speed	Special paper, wet toner	\$5000 to \$165,000 Versatec Inc (low speed) Honeywell Inc (high speed)
Xerographic	Line	4000 to 14,000 lines/min	High speed, high resolution, quiet, multiple character sets, 132-col wide data, eliminates preprinted forms	High cost, high maintenance, high volume applications	\$145,000 to \$310,000 Xerox Corp (high speed) IBM Corp (higher speed)
Ink-jet	Serial or line	30 char/s to 45,000 lines/min	Plain paper, forms flexibility including envelopes, quiet, high resolution at low speeds	Reduced print quality at high speeds, reduced reliability	\$2500 to \$25,000 IBM Corp (low speed), \$5800/mo Mead Digital Systems Inc (high speed)

NOTE: All nonimpact printers have matrix-generated type fonts, and all are limited to single copy output

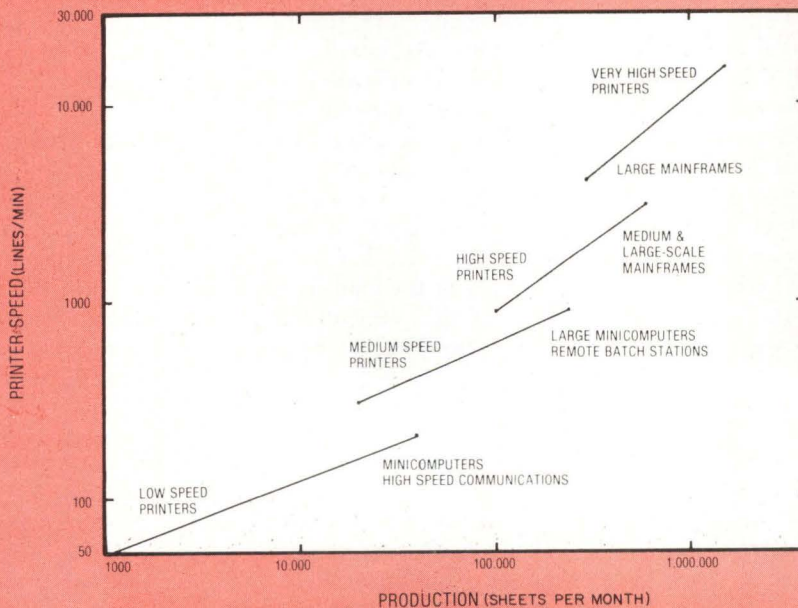

Fig 3 Printer production vs speed. First consideration in selecting a printer is production volume, which is related to printer speed and duty cycle. Illustration indicates printed sheet volume as a function of printer speed range and general application

min, or 408 forms/h. Statistically, 1.8 sheets/form yield a maximum possible operating production of 736 sheets/h. A printer operating for an 8-h day, 5-day work week (173 h/mo) equates to about 127,000 sheets/mo. With a 20% duty cycle, the production volume of sheets would be around 25,000 sheets/mo.

Note that the example assumes an impact printer that is capable of handling multipart forms. Since nonimpact printers produce only one copy, and speed does not depend on lines printed in most cases, 20% and 40% duty cycle production rates would be approximately 9500 and 19,000 sheets/mo, respectively, for a speed of 300 lines/min. In either case, if anticipated production pushes the duty cycle above 40%, the system designer should consider either operating an additional shift or procuring a faster printer.

## Recent Printer Enhancements

Computer printers today are evolving from enhancements in existing technologies rather than from dramatic new developments or innovations. Basic subassemblies continue as they already exist in function, but are taking different shapes with different manufacturing methods to achieve a balance between performance and cost. Typically, a printer design lifetime is about five to seven years and, as older products are replaced by newer designs, current techniques and processes are incorporated.

The expanding role of microprocessors and large-scale integration (LSI) circuits has had a significant effect on printer technology. These devices are providing improved control systems with greater flexibility and programmability at lower costs.

In recent printers, microprocessor/LSI subsystems are performing functions that previously had to be achieved by costly electromechanical units. For example, vertical format for paper forms is now being controlled by a semiconductor memory device instead of by a paper tape. Formats are entered once from a tape or from the CPU and stored in memory, and then paper form positioning occurs without further attention, eliminating the hazard and inconvenience of a broken tape. As new printers are developed, larger memories will be incorporated so that numerous formats may be stored and selected as paper forms are changed.

Microprocessors also permit printer control functions that are too complex to be implemented with discrete logic devices. For example, the Dataproducts M-200 serial printer incorporates buffer storage devices that allow printing from left to right and right to left. Look-ahead logic places the printhead at the correct starting position, eliminating unnecessary carriage returns. As a result, throughput is greatly improved.

In addition, flexibility in reconfiguring printers for

different interfaces is now accomplished by modifying firmware instead of hardware. Prior to microprocessor control, interface reconfiguration required hardware changes to switch signals and to perform different logical functions. It is now possible to design interfaces with microprogram control that permit inexpensive changes in signal operations and logic functions without changing hardware. The IBM 6440 high resolution ink-jet dot matrix printer uses 960 dots/char, made possible by new high density, low cost ROMs. A 96-char set could require up to 23 4k-bit ROMs or only two 64k-bit ROMs. When only 35 dots are used to represent characters, a 96-char set requires only one 4k-bit ROM. Hence, as ROM capacity increases and cost reduces, higher resolution characters become cost effective.

Microprocessor capability extends beyond printer control functions into improved diagnostics. This aspect is receiving significant attention in system design, especially where printers are to be used in remote locations or by inexperienced personnel. Microprogrammed control permits functional states to be displayed while the printer is operating. When a fault is detected, the system indicates which major function was being performed at the time. Display devices quickly identify minor faults, such as open platen gaps or low paper. Displays also indicate major fault conditions that require the attention of service personnel. This capability reduces overall operating costs, since repair personnel need only be called when the local operator cannot take care of the problem.

Overall improvements in reliability and reduced costs in mechanical assemblies have been achieved and will continue. New magnetic materials and plastics have reduced printer size and weight, and have improved hammer system operation. For example, Dataproducts' band printers now use samarium-cobalt magnets, rather than those made with the conventional Alnico-8. This new material substantially reduces hammer driver currents, cutting heat dissipation and eliminating the need for discrete power transistors in drive circuits. In earlier comparable models, the cost of the hammer activation subsystem consisted of 20% for the hammers and magnets, 10% for the cooling system, 50% for electronics including power supply, and 20% for housing. The new magnetic material has changed these percentages significantly. For the total hammer subsystem cost, the hammer and magnets went up by 10%; however, the need for a cooling system was eliminated. Both the electronics and housing costs were cut by 50%, giving an overall cost reduction of 43%.

Other new plastics have reduced service calls. Dataproducts' new hammer backstop components absorb energy from the hammer and dampen the motion without permanent compression. Their characteristics do not change with heat produced during high duty cycle operations. This material has an order of magnitude better compression resistance and increases the time between adjustment of hammer backstops from 50 million actuations

to 500 million. Basic plastics and epoxies used in this hammer produce expected lifetimes of 4000 million actuations.

Similar advances have been made with print font materials. Researchers have discovered that corrosion, not hardness, was directly related to character wear. By developing a softer material—a chromium and nickel alloy for corrosion resistance—character life has been lengthened from 18 million to 40 million impacts. New manufacturing methods have been introduced for impact printers. Electroetching processes have been developed for producing shaped characters on the bands for band type printers. Electrodes, in the shape of each letter or character, discharge current to stainless steel modules, eroding the steel in the shape desired. This new process is two to three times more accurate than older manufacturing methods, and it is also suitable for high volume automation.

## Future Trends

As new printers are evolved, more sophisticated prompting and diagnostics will be incorporated. Future printers might have ROM based instructions to guide printer use. Also, they will be able to diagnose not only printer faults but also related problems in the interface or modem. As printers become intelligent, remote diagnostic capability will be incorporated, permitting service personnel to examine the printer by telephone communication techniques and perhaps instruct the operator with diagnostic guidelines.

Besides changes in printer technologies, other system changes will affect printing requirements and capabilities. Three dominant forces producing these changes are convenience and flexibility, communication and satellite networks, and business information systems.

The convenience and flexibility of word processing has resulted in the computer controlled text editor and in the intelligent typewriter. By adding communications capability to typewriters, systems will be linked to form an electronic mail or information distribution system. The resulting requirements for high speed output or text editing and low speed output for letter transmittal have created the need for dot matrix printers with variable dot structures to meet differing speed needs with differing print quality.

Satellite communication systems hold the potential for very high speed, low cost transmissions, enabling the possibility of batch document distribution systems. Future mail may be delivered electronically at 30 to 60 pages/min. High speed, nonimpact printers will have the ability to transmit, receive, and produce output quality comparable to today's copiers, a great improvement over present facsimile machines.

Perhaps the largest impact will be the emergence of the intelligent copier. This device will combine copier

technology with imaging technology, such as a laser scanner. The intelligent copier will be capable of acting as an output printer, a facsimile machine that transmits information via communication lines, and also as a copier. Information will be stored electronically, and then printed on an intelligent copier, terminal, or typewriter, or even sent to a computer for additional processing.

## Summary

The future will provide many alternatives to output printing with improved printers based on present technologies. Price/performance ratios will be lower, reliability will be improved, and output flexibilities will be increased. Additional graphic capabilities already exist in many forms of output equipment, and they will continue to expand as new equipment combines graphics with text or with facsimile. Impact printers will still dominate the market for most general applications, but there will be increased use of nonimpact printers for specific applications where price/performance or convenience is superior to other approaches.

## Bibliography

- J. C. Burns, "The Evaluation of Office Information Systems," *Datamation*, Apr 1977, pp 60-64
- Datapro Research Corp, "All About Digital Plotters," *Datapro 70*, Jan 1978, Delran, NJ
- K. C. Freund, "Make No Mistakes When You Buy Your Next Printer," *Electronic Products*, Apr 28, 1978
- K. C. Freund, "Printer Advances Promise Increased Diversity," *Computerworld*, June 26, 1978
- P. S. Strassman and C. F. Willard, "The Evaluation of the Page Printer," *Datamation*, May 1978, pp 167-170
- E. Webster, "Figuring the Economics of New Page Printers," *Datamation*, May 1978, pp 171-176
- I. L. Wieselmann, "Hard Copy Computer Output and Its Future," *AFIPS Conference Proceedings*, National Computer Conference, 1977, pp 363-370
- I. L. Wieselmann, "What's 'In' With Output," *Data Management*, Nov 1977, pp 28-31
- I. L. Wieselmann, "Printers," *Mini-Micro Systems*, Jan 1978, pp 52-57



Irving L. Wieselmann is vice president of technology assessment at Dataproducts Corp. His responsibilities include long range planning, and analyzing impacts of changing technology and of new business opportunities. He holds a BA and an MA in Physics from UCLA. In 1960-61, he was awarded the Louis Lipsky Fellowship at the Weizmann Institute of Science in Israel for the academic year.

# Come to our Boston seminar and get the latest on...

# 16-BIT MICROCOMPUTER DESIGN AND MANAGEMENT

At this seminar/workshop, you will have the unique opportunity to acquire up-to-date, in-depth information on new and soon-to-be-introduced products. We will provide you with extensive manufacturers' literature, demonstrations of development systems, and an opportunity to obtain technical details through presentations and application case studies.

An outstanding faculty will be available for informal discussions during mealtimes and after-hours. Our faculty includes:

Dr. Glendon Marston  
Vice President, Institute for  
Advanced Professional Studies

Mr. Peter Alfke, Manager  
Component Product Marketing  
and Applications, Zilog, Inc.

Dr. James Bell, Manager  
Research and Development  
Digital Equipment Corp.

Mr. Stan Mazor, Manager  
of Curriculum Development  
Intel Corp.

Mr. Tom Miller, Manager  
Strategic Marketing,  
16-Bit Microcomputers  
Texas Instruments, Inc.

Mr. Robert Nobis, Manager  
Strategic Planning — Micro-  
computers, Motorola, Inc.  
Integrated Circuit Division

Mr. Edward Zander  
Marketing Manager —  
Microproducts  
Data General Corp.

The 4-day program provides:

- understanding of 16-bit microprocessor operation, architecture, and instruction set
- tools and techniques for hardware/software integration
- methodology and experience with equipment for system development and debug
- detailed application case studies
- comparison of available systems and preview of products due for near-term introduction

## Program:

### 1. Microcomputer architecture

- A) CPU
  - data size (8-bit, 16-bit, 32 bit)
  - number of registers
  - instruction set features
  - addressing techniques and stack operations
  - speed
- B) input/output
  - available peripherals and interface chips
  - interrupts and power fail/auto restart as well as other system error traps
  - DMA
  - real time clock
- C) Memory
  - memory types available
  - battery backup
- D) power requirements
  - supply voltages
  - regulation and noise immunity

### 2. System development tools

- A) software operating system
  - assembler
  - linking loader
  - debug package
  - I/O drivers
  - high level language capabilities
  - scientific and mathematical packages
- B) hardware
  - in-circuit emulators: as a development tool, as a debug tool
  - logic analyzers
  - development systems

### 3. Attributes of specific microprocessors or microcomputers

- A) DEC LSI 11/2
- B) Intel 8086
- C) Motorola 68000

# CROCOMPUTERS:

## MINICOMPUTER COMPARISON / March 5-8, 1979

- D) Data General Micronova
- E) Zilog Z8000
- F) TI 9900

#### 4. Microcomputer/ minicomputer comparison & benchmarks

#### 5. Case studies of microcom- puter applications empha- sizing hardware and software development techniques and component selection

- A) development cost
- B) development time
- C) design flexibility
- D) recurring costs
- E) available support

#### 6. Trends in languages and microcomputer architecture

#### Co-sponsors:

Polytechnic Institute of New York was formed in 1973 by a merger of the Polytechnic Institute of Brooklyn and the New York University School of Engineering and Science. Both institutions were 120 years old when their merger produced New York's largest technological university.

Institute for Advanced Professional Studies is a leading consulting and research firm that works closely with universities, industry, government agencies and professional societies to plan, design and implement continuing education programs for professionals. This collaboration includes: long-range and immediate learning needs assessment; faculty selection; instructional design; marketing; and development and production of multi-media instructional materials.

#### Tuition, schedule and con- tinuing education credits

Tuition is \$450. This includes an extensive set of course notes and the Monday evening reception with faculty. The seminar is scheduled for 8:30 a.m. Monday, March 5, 1979 through 4:30 p.m. Thursday, March 8. Course certificate and 3 continuing education units will be offered by Polytechnic Institute of New York to participants completing the course.

#### Hotel accommodations and program location

A block of rooms has been reserved for seminar participants at The Ramada Inn in Woburn, Massachusetts. Please make your reservations early, directly with the hotel. Be sure to mention this conference to obtain the special room rates.

#### Further information

For additional information on course administrative matters, course content, objectives, and intended audience, you can call the course coordinator, Dr. Marston, at the Institute for Advanced Professional Studies, at (617) 964-1412. Participants are urged to register early as enrollment is limited.

#### Additional courses:

On April 23-27, 1979, in Boston, we will repeat the highly successful lecture/workshop:

PASCAL PROGRAMMING for Mini and Microcomputers.

Call us for a detailed course description. Early registration is recommended as enrollment is strictly limited.

#### Registration information:

— Please register by mail using the form provided, or register by phone directly with the Institute for Advanced Professional Studies.

Institute for Advanced Professional Studies  
One Gateway Center  
Newton, Massachusetts 02158  
Tel. (617) 964-1412

#### Course Registration Form

Please register me for the 4-day course 16-BIT MICROCOMPUTERS: DESIGN AND MINICOMPUTER COMPARISON to be held at the Ramada Inn, Woburn, Massachusetts, March 5-8, 1979.

Tuition is \$450. *Make check payable to Institute for Advanced Professional Studies.*

Name	Job title	
Employer	Business phone	
Business address		
City	State	Zip
Home address		

#### Return this segment to:

Institute for Advanced Professional Studies  
Suite 306, One Gateway Center  
Newton, MA 02158 Tel: (617) 964-1412

Please add me to your mailing list.

# Software Minimizes Multiple Output Boolean Functions

---

A computer program has been developed that minimizes multiple-output Boolean functions by handling from three to ten input variables and one to ten output functions. From designer-specified input parameters, the program calculates all nonredundant 2-level logic gate configurations by the Quine-McCluskey modified tag technique

---

**Cecil E. Beeson**      American Telephone and Telegraph Long Lines, San Francisco, California

---

**A** computer program that minimizes single- and multiple-output Boolean functions has been developed. By using this program, the designer is relieved of time-consuming, error-prone computations that characterize most practical logic circuit design problems.

The designer supplies certain configuration and cost parameters. Then, the program computes all prime

implicants by the Quine-McCluskey modified tag method, forms the prime implicant table(s), develops all possible 2-level solutions, finds all minimal 2-level solutions, and prints important information.

Fig 1 shows a typical 2-level configuration before application of the minimization procedure.  $F_1$ ,  $F_2$ , and  $F_3$  are functions of logical variables  $W$ ,  $X$ ,  $Y$ ,  $Z$ , and respective comple-

ments. Fig 2 shows the one minimal solution which saves 3 gates, 12 first-level inputs, and 2 second-level inputs. Details of the solution are included in problem 3, Appendix 3.\*

Most practical logic design problems have several solutions. Designers must decide which parameters are important, and, ultimately, which solutions should be implemented. Factors to be considered include



# Genisco High Resolution Displays.

## Let us make your computer graphics 'crystal-clear'- fast!

Your future in graphics and image processing can't help being bright with all the Genisco Raster Display "good-omen" benefits going for you. Like ultra-high resolution, nanosecond processing, reliable performance, synergistic software, and modular architecture — that lets you quickly go "on-line" at minimal cost and expand as your needs dictate. Yet, with all this sophistication they're thin-pocket-book priced.

**16K MOS/RAM Refresh Memories** that go up to 1280 pixels/line X 1024 lines, in 16 gray scales, and 1024<sup>2</sup> full color versions. And, they're all directly addressable.

**16-Bit User Programmable Graphics Processor** lets you realize optimum operation with 150 ns cycle time manipulation, a set of 55 mnemonic instructions, automatic DMA access, selective erase, user selection from 4096 colors or 256 gray shades, and over 32 refresh memory planes control — using a unique "group select" method. We even offer a scroll and zoom, and a character/vector generator.

**Versatile Output.** Up to 12 monitors can be operated from a single system. TV/video mixing. Remote monitoring. RS232 ports. Automatic "Circumfill". These are but a smattering of the many advanced monitor control benefits offered by Genisco.

**Full Complement of Interfaces** for most popular minicomputers are available as standards, and we can economically fabricate a specific configuration where a stock unit won't do.

**Flexible FORTRAN Software** puts you "on-line" quickly, economically. Present offerings include a comprehensive set of Basic Graphics instructions, an efficient Cross Assembler, and our special GRASP package of FORTRAN callable sub-routines — to simplify programming of your particular display configurations. With all this to back your display developments, a bright and 'crystal-clear' future is assured.

Contact Genisco, a name that has been synonymous with technological advances for more than 30 years, for all the particulars — and get a fast start on the path to good fortune.

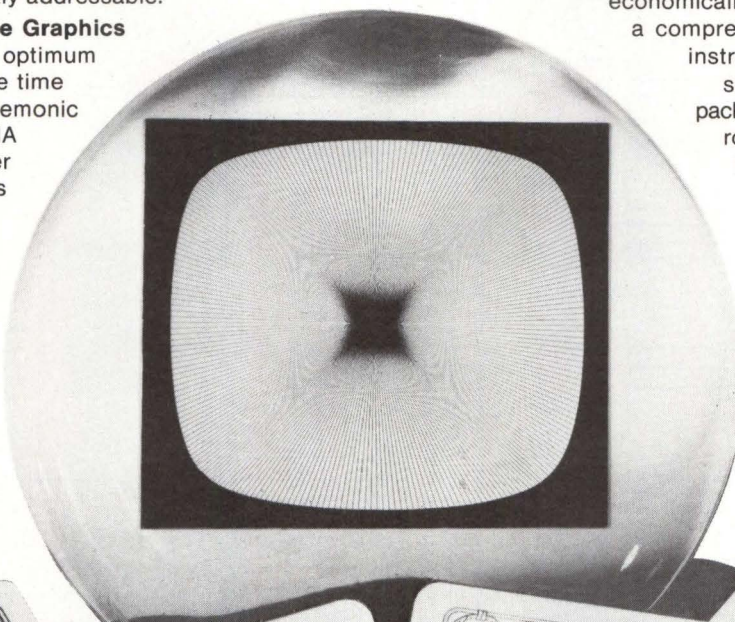

### GENISCO COMPUTERS

A DIVISION OF GENISCO TECHNOLOGY CORP.

17805 Sky Park Circle Dr., Irvine, CA 92714 • (714) 556-4916



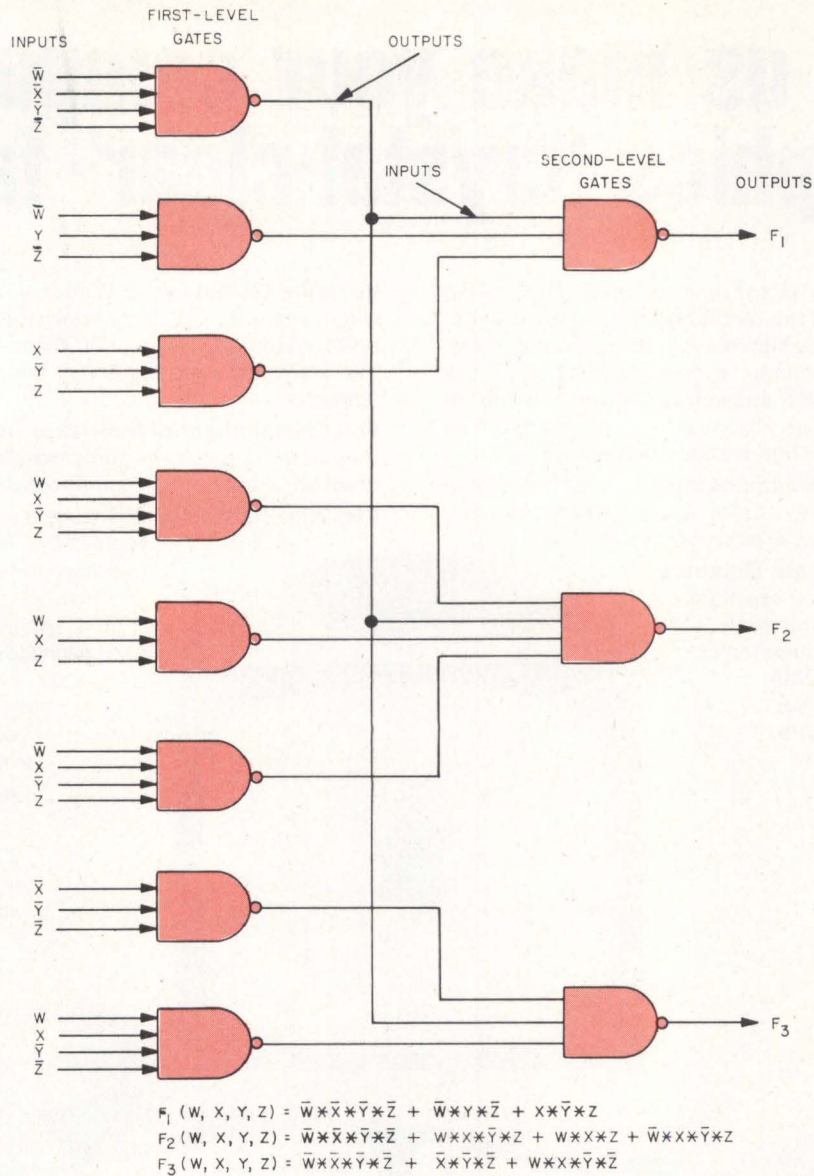

Fig 1 Typical 2-level NAND/NAND logic configuration. Before application of minimizing technique, network consists of 11 gates, 28 first-level inputs, and 10 second-level inputs

number of gates, fanin, fanout, and number of interlevel gate connections.

For purposes of this discussion, an optimum solution is one that minimizes an arbitrary cost function of the following form:

$$C = W_1 * C_1 + W_2 * C_2 + W_3 * C_3 + W_4 * C_4 + W_5 * C_5 + W_6 * C_6 + W_7 * C_7$$

$$\text{or } C = \sum_{i=1}^7 W_i * C_i$$

Where the computer program generates values for

$C$  = Cost of specific solution

$C_1$  = Number of first-level gates

$C_2$  = Number of second-level gates

$C_3$  = Number of uninverted inputs (variables) to first-level gates

$C_4$  = Number of inverted inputs (variables) to first-level gates

$C_5$  = Number of inputs to second-level gates

$C_6$  = Number of inputs that exceed fanin limit for all gates

$C_7$  = Number of outputs that exceed fanout limit for all gates

The designer chooses a value for each  $W$ . These coefficients reflect the relative importance, or weight, of each factor in comparison to all other

# THE OTHER FOUR SLOTS ARE FOR YOU.

Behind the panel of the 5¼-inch high Ampex 8MS5 Minicomputer, there's an 800 nanosecond CPU and as much as 64K words (128K bytes) of memory. All on a single board.

Leaving four big slots for your own cards. 15 x 15 inch boards, with whatever you need to realize the goals of your system. Insert controllers for disk, tape, printers or terminals. As long as the controller is compatible with NOVA\*, it'll be compatible with the Ampex 8MS.

That's because Ampex designed this minicomputer to take full advantage of the environment that has grown up around NOVA computers. But *this* mini has some extras you never expected to see in a mini.

Like front access to all components. And a programmer's console with octal pad input, octal readout and LED indicators. Plus a single bus structure.



Charley Penrose has some suggestions about achieving big system capability in the little 8MS cabinet. Call him at 213/640-0150. Or write to him at Ampex Memory Products Division, 200 North Nash Street, El Segundo, California 90245.

\*NOVA is a trademark of Data General Corporation.

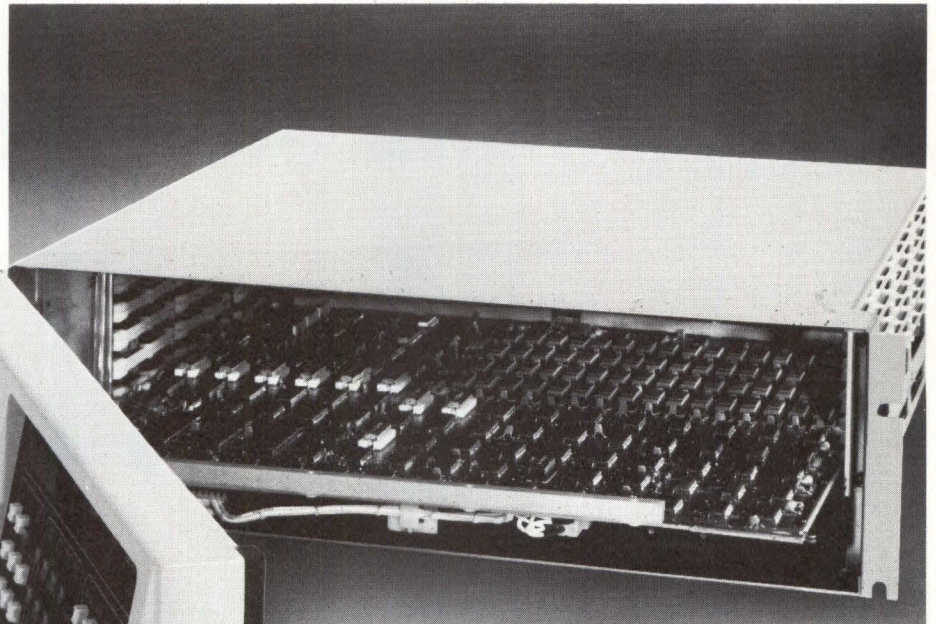

## AMPEX MINICOMPUTERS COMBINE CPU AND 64K MEMORY ON ONE BOARD.

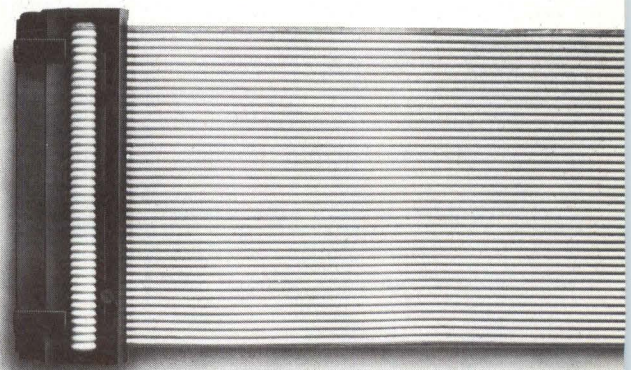

# AMPEX MAKES IT EASY.

CIRCLE 77 ON INQUIRY CARD

factors. For example, assume that the costs of first- and second-level gates are equal, costs of all gates are three times more than those of first-level inputs, and costs of second-level inputs are negligible. Whenever fanin or fanout limits are exceeded, which probably means additional gates, extra inputs are five times as expensive as first-level inputs.

The  $W$  factors assume the values

$$W_1 = W_2 = 3.0$$

$$W_3 = W_4 = 1.0 \text{ (reference values)}$$

$$W_6 = W_7 = 5.0$$

Another example, setting  $W_1 = W_2 = W_3 = W_4 = W_6 = W_7 = 0.0$ , and  $W_5 = 1.0$  (second-level inputs), could measure the effects of connections between levels of gates. This consideration is important in designing integrated circuits, where the designer's general goal is to minimize the number of first-level gate outputs that become inputs to second-level gates.

### Program Organization

Fig 3 shows a general flowchart of the computational process. The original version of the program consisted of a series of FORTRAN IV and IBM 370 assembler language routines. The complete program listing is tabulated in Appendix 1.\* Designed to run in batch mode, the program could easily be modified to execute in an interactive environment.

Three subroutines (ONES, IAND, and IOR) involve logical operations with bit strings and would normally be coded in assembler language. However, since FORTRAN is a more familiar language and can be executed on a wide variety of computers with minimal or no changes, these three routines have been coded in FORTRAN IV and are listed in Appendix 2.\*

### Program Input Parameters

The designer must supply certain input parameters. Among the more important are number of output functions, number of input variables, number of input terms, value for each input term, form of input/output relations, whether or not variables are missing from input terms, and weighting factors for cost func-

tion. Appendix 3\* depicts the input sequence and Appendix 4\* shows solutions for four problems that illustrate the various types of configurations that can be handled.

### Summary

The program can accommodate from three to ten input variables and from one to ten output functions. These

constraints result from main memory capacity and 32-bit word length considerations.

Each solution assumes infinite fanin and fanout. Of course, in the real world, every gate has a maximum loading capacity. This condition, however, is partially acknowledged by two coefficients ( $W_6$  and  $W_7$ ) in the cost equation.

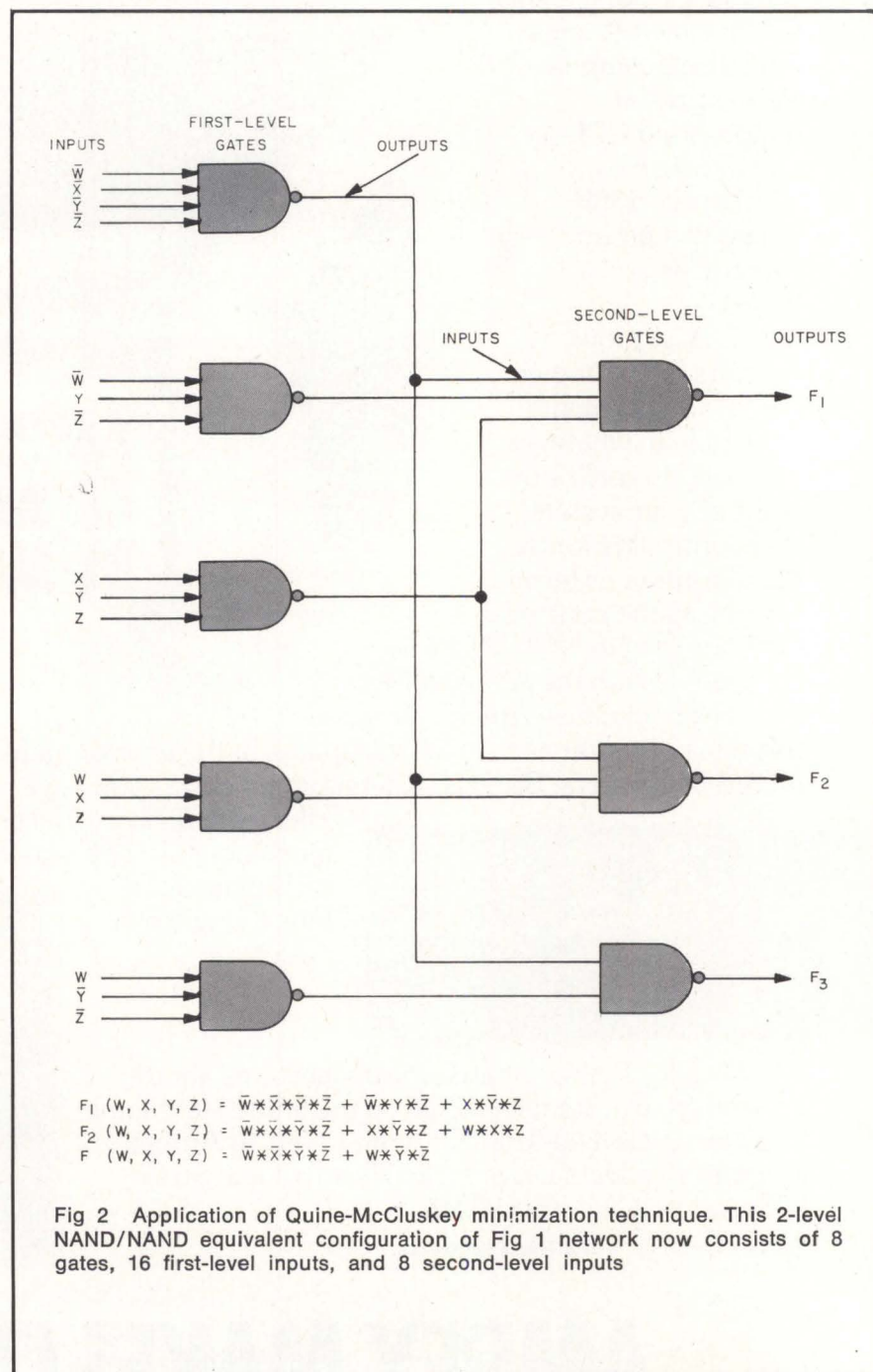

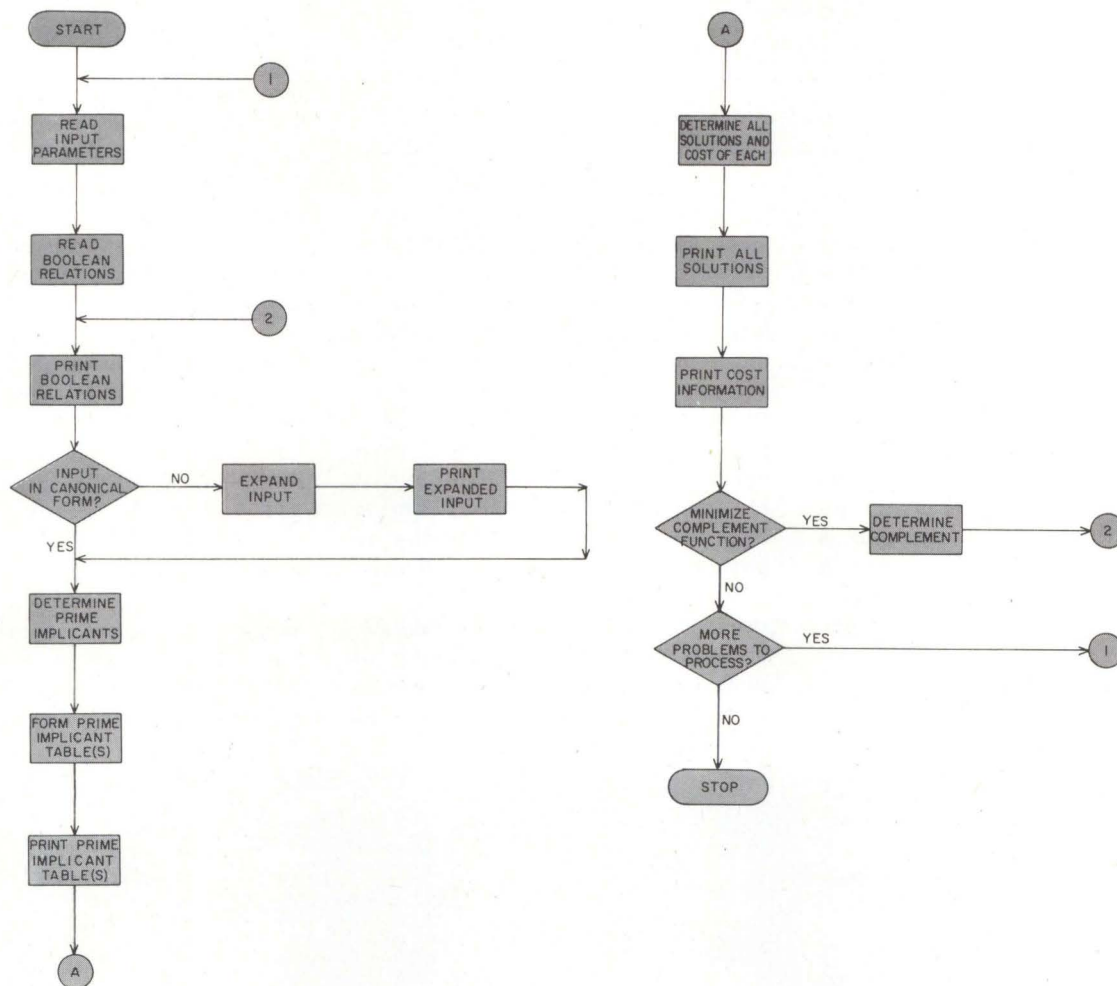

Fig 3 Minimization program flowchart. Major computational segments and decision points are depicted

Running time of the program is difficult to determine because of several factors, eg, number of variables, terms, and solutions. The examples in Appendix 4\* execute in approximately 15 central processing unit seconds on an IBM 370/145 under os/vsl.

Application of the Quine-McCluskey modified tag method generates a 2-level configuration. A more minimal solution could be realized by

factoring to three levels of gates; however, a general purpose algorithm is not currently available.

### Bibliography

- B. T. Engel and P. R. Thorne, "Convert Boolean Algebra to Arithmetic," *Electronic Design*, Oct 25, 1969, pp 82-84
- H. L. Harrison, "Optimize Switching Circuits Using Karnaugh Maps," *Control Engineering*, Aug 1969, pp 87-89
- M. Krieger, *Basic Switching Circuit Theory*, New York, 1967

E. J. McCluskey, *Introduction to the Theory of Switching Circuits*, New York, 1965

H. Mergler, "A System Approach—The Key to Optimum Logic Design," *Control Engineering*, Jan 1967, pp 68-77

\*Interested readers may obtain a copy of Appendices 1 through 4 for Mr Beeson's computer program by requesting them in writing from the Editor, *Computer Design Magazine*.



# "WITH THE MODCOMP CLASSIC, WE DON'T HAVE TO TRADE PERFORMANCE TO GET RELIABILITY."



Bill Greene, Staff Engineer  
Process Computer Systems Group  
Chemicals & Plastics Division Engineering  
Union Carbide Corporation

Bill Greene is a staff engineer for the Process Computer Systems Group which is responsible for designing, building, testing and installing process control computer systems in the company's manufacturing plants.

Because of their experience, we gave them our new Classic 7860 super mini to test. Their experience with it was summed up in three words. "We love it."

**"It's a reliable machine. And reliability is the name of the game."**

"We'll trade performance for reliability anytime," said Bill. "But with the Classic, we don't have to.

"The Classic hardware is very solid. Especially for a new product. "The performance characteristics of the Classic are impressive, too. With its extremely fast floating point processor, the Classic can run through a program more than 3.7 times as fast as a MODCOMP II."

**"A working computer with software that doesn't work is useless."**

"We've been running the MAX III operating system for five years and the MAXNET III network extension for the past two years. They've performed well under very demanding conditions. In fact, over the past year, we've had more than 99.5% uptime on more than 30 installed MAX III systems.

"However, we're installing larger process computer networks now with more and more satellites. So we need increased host computer hardware and software capabilities.

"Our tests with MODCOMP's enhanced MAX IV

operating system in the Classic have been very encouraging.

"MAX IV and the new MAXNET IV will help us relieve bottlenecks so that we can add more links and do more work with the computer. We also expect that File Manager, which can create a new file anywhere on a disc, will be a useful tool."

**"We install 15-20 systems a year, so ease of implementation is important."**

"Even though the Classic is a powerful and sophisticated machine, it should be an easy system for our project teams to implement. MODCOMP provides plenty of documentation and they've always been very helpful in working with us to get our systems up and running.

"In fact, we think so highly of MODCOMP and the Classic, we've already ordered two MODCOMP Classic 7860's to be used as host computers in large process control distributed networks."

**It takes a tough computer to satisfy a tough customer.**

At MODCOMP, we specialize in building real-time computers. They work in chemical plants. In petroleum refineries. In steel foundries. In jet propulsion labs. In electric power plants. In some of the harshest industrial environments you can imagine. Nevertheless, independent surveys have rated MODCOMP computers the most reliable systems on the market.

If you want reliability, but you don't want to trade performance to get it, do what Union Carbide did. Buy a MODCOMP Classic.



Modular Computer Systems, Inc.  
1650 W. McNab Road Ft. Lauderdale, FL 33309  
(305) 974-1380

**CIRCLE 162 ON INQUIRY CARD**

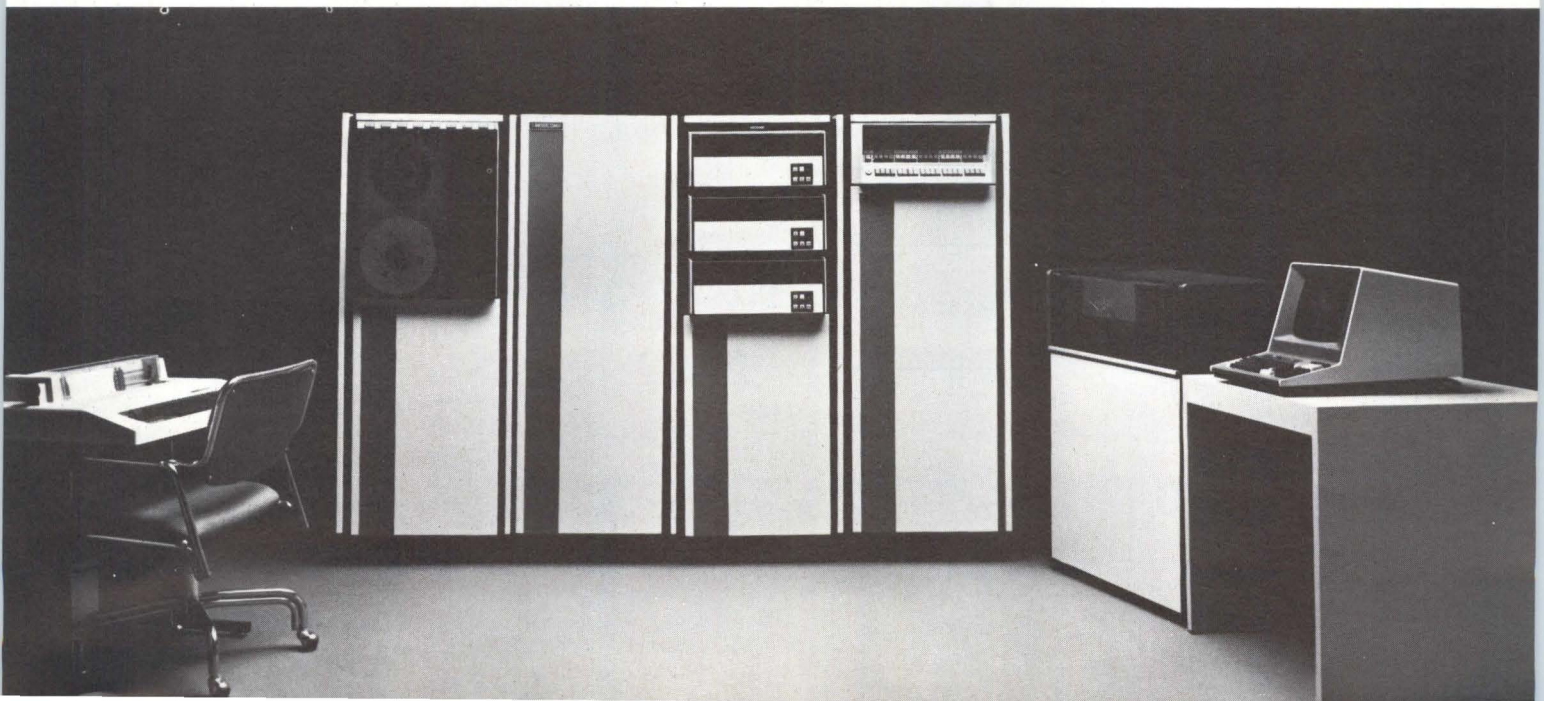

# INTERFACING FUNDAMENTALS: REALTIME CLOCK HARDWARE AND SOFTWARE

**Peter R. Rony and David G. Larsen**  
Virginia Polytechnic Institute and State University

**Jonathan A. Titus and Christopher A. Titus**  
Tychon, Inc

To continue the discussion of realtime clocks and their characteristics, diverse hardware devices and software instructions can be implemented to build and use a realtime clock. Perhaps the simplest one that can be built is a freerunning realtime clock. The schematic for such a device is shown in Fig 1. The "heart" of this circuit is the Mostek Corp MK5009, a counter/time base driven by a 1-MHz quartz crystal. This device contains a number of divide-by-10 counters from which the user may select one to drive the MK5009's output. Four digital inputs to

the device are used to select the required decade counter. The truth table for these inputs and the resulting output frequencies are also listed in Fig 1. For input values greater than  $1000_2$ , the counter/time base generates frequencies that are not multiples of 10.

In the Fig 1 schematic, a 4-bit latch (SN7475) is used in the realtime clock interface, between the 8080 based microcomputer and the MK5009. The latch is used to program the counter/time base for a particular frequency; the output clocks a D flip-flop whose output goes to some

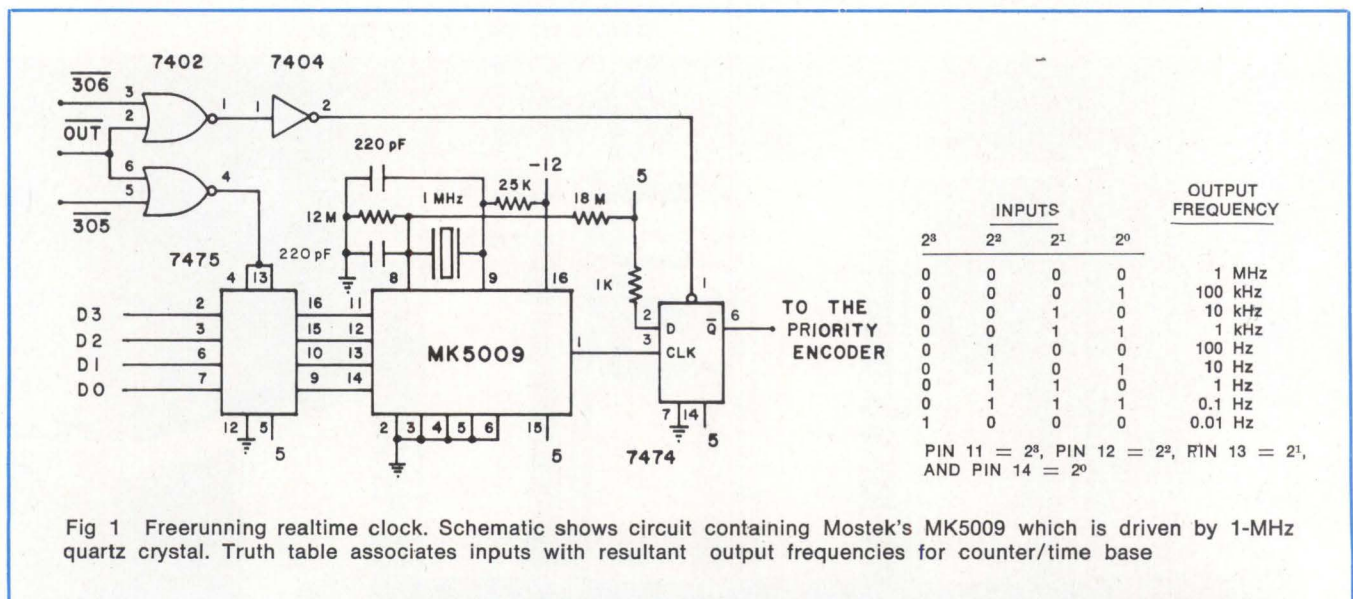

Fig 1 Freerunning realtime clock. Schematic shows circuit containing Mostek's MK5009 which is driven by 1-MHz quartz crystal. Truth table associates inputs with resultant output frequencies for counter/time base



# Formula for memory metamorphosis



## High-speed Static NMOS memory from EMM

Are you condemning your system to dynamic memory speeds? It's time to move up to high-speed static NMOS memory technology.

The EMM MICRORAM 3420 is your formula. It contains 32K by 21 bits of memory on a single pluggable module. Yet it accesses in 200 nsec, and cycles in 300. And it incorporates a Late Data Control which allows a delay in the execution of a write cycle pending the arrival of data.

The 3420 saves power, too. Typically it draws less than 30 watts in standby, less than 40 watts in operate mode. System design is very simple, as the static RAMs require no charge pump or

refresh circuitry. And they don't generate soft-bit errors, so reliability is much higher than with dynamic RAM systems.

Other versions of the MICRORAM 3400 Series are available in 16 to 22 bit configurations, 8 to 32K capacities, and access times as low as 180 nsec.

Transform your system from sluggish dynamic to reliable high speed static NMOS memory. Call or write today for full technical details as well as price and delivery information.



**EMM** CSD The OEM Systems Division of Electronic Memories and Magnetics Corp.  
12621 Chadron Ave., Hawthorne, Calif. 90250 • (213) 644-9881

**PROGRAM 1**

**Instructions for the MK5009 Counter/Time Base**

```

*000 000
START, LXISP /Load stack pointer with
      STACK /R/W memory address because
      0 /interrupts can occur.
      MVIA /Then load A register with
      003 /00000011.
      OUT /Output this value to
      305 /MK5009 (1-kHz operation).
      OUT /Clear flip-flop that is
      306 /wired to MK5009.
      EI /Enable interrupt,
      • /then execute remainder
      • /of program.
      •

*000 070
RTCISS, • /Realtime clock interrupted
      • /microcomputer, so service
      • /some of peripheral devices.
      OUT /Then clear flip-flop that
      306 /caused interrupt (MK5009).
      EI /Re-enable interrupt
      RET /and return to task that
      /was interrupted.
    
```

additional interrupt interface hardware. It will be assumed that this hardware produces an rst7 instruction when the 8080 acknowledges the interrupt. For additional information on interrupt hardware, see Refs 1, 2, and 3.

Instructions that can be used to program the MK5009 are listed in Program 1. After the stack pointer is loaded, the A register is loaded with the value 00000011<sub>2</sub>. This value is transferred to output port 305, which is the SN7475 latch in the realtime clock interface. The four least significant bits of this value are the only bits within the 8-bit byte that are actually latched by the SN7475, and the MK5009 is programmed for 1-kHz operation by this value (0011<sub>2</sub>). Once the counter/time base has been programmed, the interrupt flip-flop (SN7474) is cleared by the second OUT instruction and the interrupt is enabled (EI).

In 1 ms or less, the 8080 microprocessor will be interrupted by the realtime clock. It has been assumed that when the realtime clock interrupts the 8080, it is vectored to memory location 000 070<sub>8</sub> by the interrupt hardware.<sup>1,2,3</sup> This is where the realtime clock interrupt service subroutine must be stored in memory. In this subroutine, the microprocessor may have to transfer some data between itself and a peripheral device, or it may simply turn some lights and values on or off. However, once these tasks are performed the SN7474 interrupt flip-flop [Fig 1 (a)] is cleared and the interrupt re-enabled. The microprocessor then returns to the program interrupted by the realtime clock.

One characteristic of this realtime clock is that it is freerunning—it cannot be turned off or stopped. It will always generate a square wave with a frequency of 1 kHz.

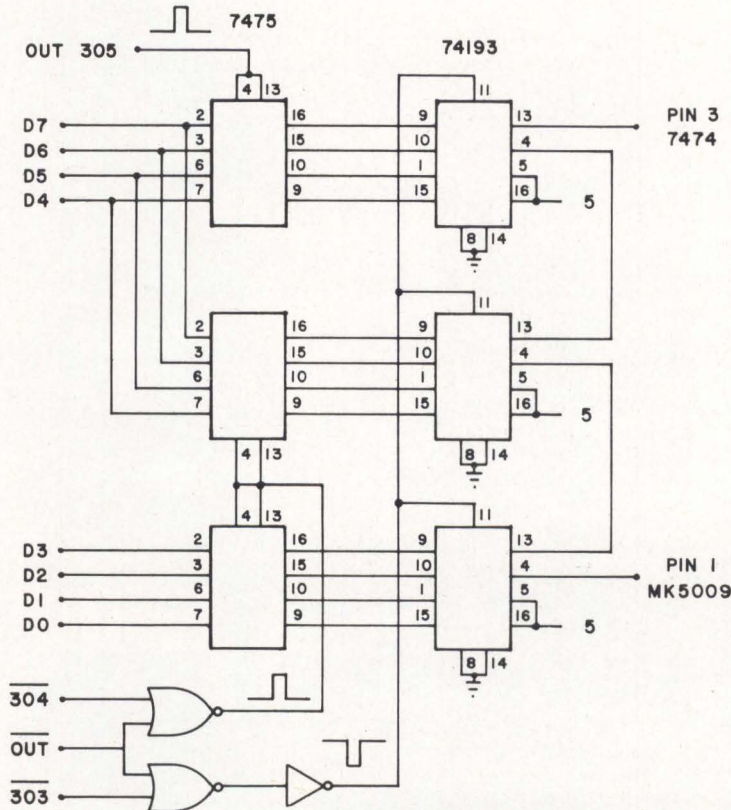
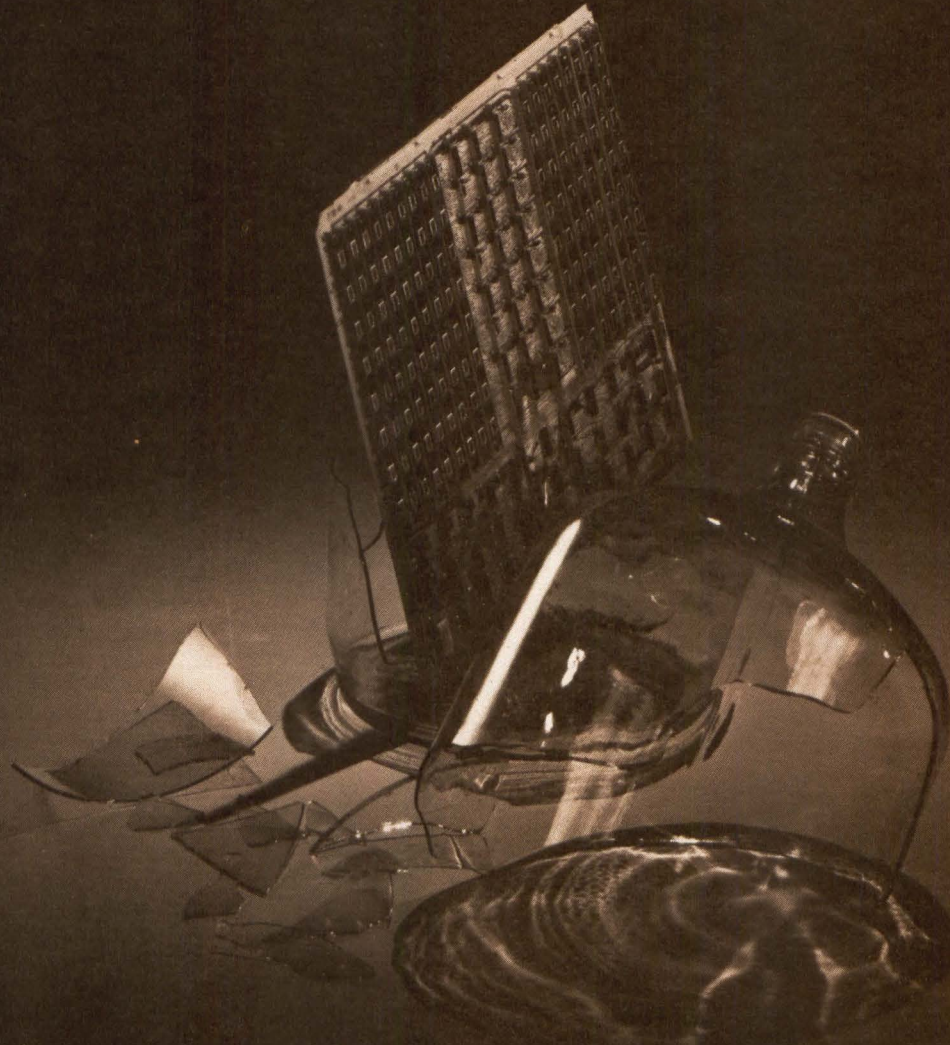

Fig 2 Programmable realtime clock. Addition of programmable down-counters allows interrupts to be generated every 15 or 20 ms. Latches and counters added to interface are wired to the 8080 microprocessor and MK5009 counter/time base

# Break the Nova 3 bottleneck



## with EMM 128K word memory

Let's face it. Even the Nova 3/12\* has a limited number of card slots. In typical system applications, there just are not enough slots to accommodate needed memory, controllers, and usual options. It's the classic bottleneck and something has to give.

Relax. That's a thing of the past. With EMM's 7706 add-in memory you can put all the memory the system can handle — 128K words — into a single slot. That frees up 3 slots when compared with memory available from the

computer manufacturer. If you don't need that much memory immediately, the 7706 is available in 32 and 64K versions as well. All are expandable to 128K. All offer significant cost advantages.

The 7706 is physically, electrically and functionally compatible with the Nova 3/4 and 3/12.

Call or write us today for complete details.



\*Nova 3 is a trademark of Data General Corporation.

**EMM** CSD The OEM Systems Division of Electronic Memories and Magnetics Corp.  
12621 Chadron Ave., Hawthorne, Calif. 90250 • (213) 644-9881

**PROGRAM 3**

**Time-of-Day Clock Software  
Without a Counter Chain**

**PROGRAM 2**

**Programming the Counters and MK5009  
For a 20-ms Interval**

```

*000 000
START, LXISP /Load stack pointer with
STACK /R/W memory address because
0 /interrupts can occur.
MVIA /Then load A register with
003 /0000 0011, to program most
OUT /significant counter with 0
305 /and MK5009 (1 kHz).
MVIA /Then load A register with
024 /00010100 so that two least
OUT /significant counters are
304 /loaded with decimal 20.
OUT /Clear interrupt flip-flop.
306
OUT /Then transfer content of
303 /latches to counters.
EI /Enable interrupt and
• /then execute remainder
• /of program.
•
*000 070
RTCISS, • /Realtime clock interrupted
• /microcomputer, so service
• /some of peripheral devices.
OUT /Then clear flip-flop that
306 /caused interrupt and
OUT /reload counters with
303 /content of latches.
EI /Re-enable interrupt
RET /and return to task that
/was interrupted.
    
```

```

/This is a time-of-day clock program
/(This is the start of the "Main Task")
*002 000
START, MVIA /Load A register with
006 /word that will program
OUT /MK5009 for 1-Hz operation
305 /and then output it to latches.
LXIH /Load register pair H with ad-
CURTIM /dress where current time (CURTIM)
0 /is stored in memory (BCD format).
MVIB /Load B register with
003 /number of locations used by CURTIM.
ZERO, MVIM /Load memory location with 000.
000
INXH /Increment memory address.
DCRB /Decrement word count.
JNZ /If count is nonzero,
ZERO /set another memory location
0 /to 000.
SKIP, LXISP /Load stack pointer because
STACK /an interrupt can occur.
0
OUT /Clear interrupt flip-flop.
306
EI /When done, enable interrupt
• /and continue to execute
• /"Main Task."
•
/This is the interrupt service subroutine. The
/interrupt hardware generates an RST7 instruction
*000 070
CLOCK, PUSHPSW /When interrupt occurs, save
PUSHB /all of registers on stack.
PUSHD
PUSHH
ISCNT, LXIH /Load register pair H with address
    
```

*(Continued on p 132)*

The only method of preventing the 8080 microprocessor from being interrupted by this device is to disable the interrupt by executing a DI instruction. One limitation of this realtime clock is the fact that it can only be programmed to generate the frequencies listed in the truth table of Fig 1.

One of the more practical methods of using this device to generate an interrupt every 15 or 20 ms would be to add some programmable down-counters to the realtime clock. The MK5009 can be used to clock these counters and when they have counted down to zero, the interrupt flip-flop is clocked so that an interrupt occurs. The latches and counters are wired to the microprocessor and counter/time base as shown in Fig 2. The content of the A register is latched by this interface when an OUT 304 or OUT 305 instruction is executed. When an OUT 303 is executed, the content of the latches is loaded into the

counters. Since three 4-bit counters are used, the counters can be loaded with any number between 0 and 1111111111<sub>2</sub>. Placement of these three counters between the counter/time base and interrupt flip-flop allows the counter/time base to generate a maximum of 4096 output pulses (to the counters) before an interrupt will occur. (Note that the latches in Fig 2 are needed only if the same time interval will be used over and over again; they serve to simplify the software drivers.)

Once these counters and latches are added to the interface, the problem remains of writing a set of instructions that will program the realtime clock for an interval of 5 or 20 ms. For an interval of 20 ms, the software in Program 2 can be executed. This software loads the counters with the number 000000010100<sub>2</sub> and also programs the MK5009 for 1-kHz operation (1-ms time interval). Note that this software not only has to output

# NOW YOU CAN GET ZENITH QUALITY IN YOUR CRT DISPLAY

Quality and performance have made Zenith the standard of the home electronics industry for sixty years. And our track record continues. Not only is Zenith the leading producer of color TV receivers but our black and white sets have led the market for twenty years.

And now the same commitment to quality, reliability and technical innovation that has earned our leadership position in television, is available to you in our CRT displays. We proudly introduce the Zenith D-12 12-inch diagonal CRT display.

## **ADVANCED COMPONENTRY – LONG TERM RELIABILITY.**

Zenith's engineering expertise and production experience combine to give you the kind of reliability you need.

**Reserve Capacity.** Components in the CRT display are designed with reserve capacity for low maintenance and continued reliability.

**Special Deflection Transformer.** The Zenith CRT display is equipped with a Zenith designed and built deflection transformer. It not only gives a

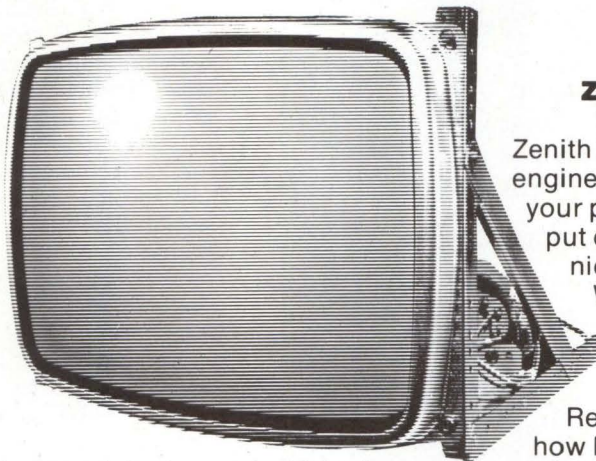

consistent scan, but it is also imbedded in epoxy for long-term reliability and the elimination of audible high frequency squeal.

**Fewer Controls.** The Zenith CRT display is precision engineered. No linearity controls are required and the CRT display's vertical and horizontal synchronization is automatic.

**The Zenith Adjustable Frame.** Zenith engineering has already solved what can be a big hassle. With our adjustable frame, we can mount the CRT at virtually any angle you want, without having to have a frame custom-made.

These are just a few of the many value plusses you'll find in a Zenith CRT display.

## **ZENITH ENGINEERS WORK WITH YOU.**

Zenith believes in application engineering. We're willing to make your problem our problem, and put our engineering and technical resources to work on it. We'll even align our CRT display to your specs.

## **NO ORDER TOO BIG OR TOO SMALL.**

Rest assured that no matter how large or how small your CRT display order, you will be accommodated in the Zenith tradition. A tradition that begins with a promise of on-time delivery. A tradition that has provided care and quality to our customers for over half a century.

This is just the start of something good. The 12-inch D-12 CRT display is only the first in a series from Zenith. Talk to us about your requirements for other screen sizes as well.

For further information and specifications, write CRT Display Engineering Division, Zenith Radio Corporation, 1000 Milwaukee Avenue, Glenview, Illinois 60025. Or call 312-773-0074.

**ZENITH**<sup>®</sup>

The quality goes in before the name goes on<sup>®</sup>

(Program 3 continued)

	TOPVAL	/of table that contains max
	0	/number of seconds, minutes, and hours.
	LXID	/Then load register pair
	CURTIM	/D with address where
	0	/time is stored.
	MVIB	/Load B register with number
	003	/of memory locations involved.
UPONE,	LDAXD	/Get number.
	ADI	/Add one to it
	001	
	DAA	/and adjust result.
	STAXD	/Save new time.
	CMPM	/Is it too large?
	JNZ	/No, so return from interrupt.
	MIDNGT	
	0	
NEXT,	MVIA	/Load A register with zero.
	000	
	STAXD	/Then save it in current time.
	INXH	/Increment table address.
	INXD	/Increment current time address.
	DCRB	/Decrement number of locations.
	JNZ	/Count is nonzero, so
	UPONE	/next consecutive memory location
	0	/can be incremented.
MIDNGT,	POPH	/Time is valid, so get all
	POPD	/registers off stack.
	POPB	
	POPPSW	
	OUT	/Now clear interrupt flip-
	306	/flop wired to MK5009.
	EI	/Enable interrupt
	RET	/and return to "Main Task."
CURTIM,	000	/Number of BCD seconds here.
MIN,	000	/Number of BCD minutes here.
HOURS,	000	/Number of BCD hours here.
TOPVAL,	140	/Max number of BCD seconds—60.
	140	/Max number of BCD minutes—60.
	044	/Max number of BCD hours—24.

values to the latches in the interface, but also that these values have to be transferred from the latches to the counters. Therefore, an OUT 303 instruction must also be executed when this interface is used.

Other values could have been used to program the realtime clock so that an interrupt occurs every 20 ms. The value  $200_{10}$  could have been loaded into the counters and the counter/time base would have been programmed for 10-kHz (0.1-ms time interval) operation. A value of  $2000_{10}$  could also be used if the counter/time base is programmed for 100-kHz (0.01-ms time interval) operation. In fact, the value of  $2000_{10}$  and a 100-kHz frequency is the best combination, because they generate a time interval that has the greatest resolution, ie, a maximum error of 1 part in  $2000_{10}$ .

When the realtime clock interrupts the 8080, the microprocessor services some peripheral devices and then

clears the interrupt flip-flop (OUT 306). The count is then transferred from the latches to the counters when the OUT 303 instruction is executed. This must be done because the counters, after counting to zero, are next decremented to  $1111111111_2$ . Therefore, if the counters were not reloaded, the microprocessor would be interrupted 4096 clock pulses later, rather than the number stored in the latches. After re-enabling the interrupt, the microprocessor returns to the task that was interrupted.

Adding the three 4-bit counters to the realtime clock interface increases its capabilities. Intervals of from  $1 \mu\text{s}$  to  $4.096 \times 10^5 \text{ s}$  (4.74 days) can be timed. A far greater variety of interrupt intervals also can be selected than were possible with the basic eight frequencies generated by the counter/time base alone.

Another application of a realtime clock is a time-of-day clock, which is simply a peripheral device, or series of memory locations, where the current time of the day is stored and updated. The time may be updated every second or hundredth of a second, depending on the hardware, software, and uses of the clock. One method of constructing a time-of-day clock would be to program the MK5009 for 1-Hz operation and then wire the output of the MK5009 to a counter or divider chain. These chains consist of a divide-by-10 and a divide-by-6 counter for seconds, a divide-by-10 and a divide-by-6 counter for minutes, and a divide-by-3 and a divide-by-10 counter for hours. Rather than use a divide-by-3 and a divide-by-10 counter for a 24-h format, a divide-by-2 and a divide-by-10 counter could be used for a 12-h format. The counter outputs could be wired through 3-state interface devices to the microcomputer's data bus. The microcomputer would then have to execute some accumulator input/output (i/o) or memory-mapped i/o instructions<sup>3,4</sup> to read the time from the time-of-day clock. By using this method, no interrupts are required and the software instructions required to read the time are very simple.

Additional instructions could be added so that a time is entered into the microcomputer by means of a cathode-ray tube or teletypewriter. This time would then be written out to the time-of-day clock, so that it is programmed for the correct time when the microcomputer is started. This can only be done if programmable counters are used in the time-of-day clock interface. Of course, at this point it is not necessary to use an MK5009 as a 1-Hz clock source. A 60-Hz signal could be derived from the 110/220-Vac power lines and divided by 60 before being applied to the counter chain.

Hardware for the time-of-day clock can be greatly simplified, but at the expense of more software instructions. In fact, the original freerunning realtime clock (Fig 1 schematic) can still be used. However, the counter/time base will be programmed for 1-Hz operation. This means that if the 8080 microprocessor's interrupt is enabled, it will be interrupted once every second. When this occurs, the interrupt service subroutine must be composed of instructions that cause the time (wherever it is stored) to be incremented by one. Since there is no way of knowing what the microprocessor will be doing when it is interrupted, the time will be stored in three memory locations, rather than in some of the microprocessor's general purpose registers. Therefore, if a program needs to know the time, it will have to read the time from these three memory locations, rather than from a peripheral device.

# The new features in this Ball high performance monitor will save you money tomorrow.

20 MHz bandwidth

Electronic horizontal  
video centering

100% silicon  
circuitry

Electronic vertical  
linearity control

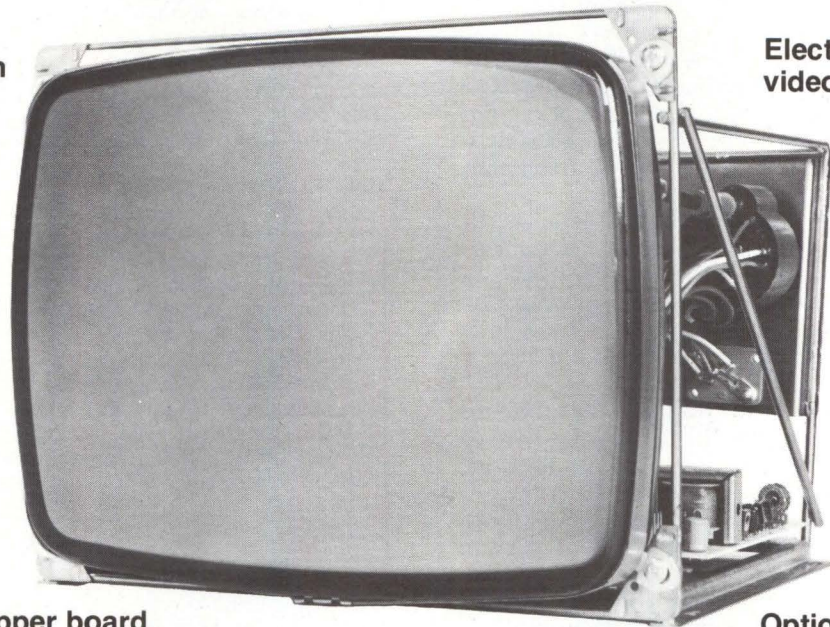

Modular sync stripper board  
converts to EIA composite input

Optional dynamic focus  
and skip-scan

## The new low price will save you money today.

Ball's 2nd generation TTL-series monitors cost less to operate because of the way we build them — built for reliable service with long life and low maintenance requirements.

For example, we've added more electronic controls for faster set-up and service. Widened the bandwidth to 20 MHz for better performance. Expanded our simple subassembly interconnection idea for greater versatility. We've even reduced the size of our 12" model so it fits where no competitor can.

For video quality, our specially selected CRT gun and deflection assembly delivers the kind of bright, well detailed characters you demand in a high performance unit.

### **Compare life cycle costs. You'll have a Ball.**

If you've been waiting to upgrade to Ball quality, now's your chance. Not only are our new TTL-120 and 150 monitors fully interchangeable with our present TTL-12 and TTL-15 units, but drop-in models for other makes are available as well.

Give us a call and find out how Ball can lower your costs at a new low price.

**Ball Electronic Display Division**

P.O. Box 3376, St. Paul, Mn. 55165 (612) 786-8900. TWX: 910-563-3552

**General Sales Offices:**

Addison, Illinois (312) 279-7400

Santa Clara, California (408) 244-1474

Ocean, New Jersey (201) 922-2800

Upland, California (714) 985-7110



**Electronic  
Display  
Division**

Software for a time-of-day clock without a counter chain is listed in Program 3. The instructions that begin at START simply program the counter/time base for 1-Hz operation, set three consecutive memory locations to zero, clear the interrupt flip-flop, and then enable the interrupt. When an interrupt is generated by the counter/time base, the 8080 microprocessor will be vectored to 000 070<sub>8</sub> by the interrupt interface hardware.

When this happens, the microprocessor saves all of the general purpose registers on the stack. The time is then incremented by one, since the last interrupt occurred 1 s ago. The time is stored in three memory locations in a packed binary coded decimal (BCD) format. The number of seconds is stored in CURTIM, the number of minutes in MIN, and the number of hours in HOURS. Once the microprocessor has incremented the time by one, it executes the instructions at MIDNCT. These instructions pop all of the registers off of the stack, clear the interrupt flip-flop, re-enable the interrupt, and cause the microprocessor to return to the task that was interrupted by the freerunning realtime clock.

Although this software appears long and complex, the microprocessor needs at most only 194  $\mu$ s (assuming a 500-ns cycle time) to increment the time by one and return to the task that was interrupted. The microprocessor is interrupted every second for this amount of time, so an extremely small portion of its time (0.0194%) is used to service this interrupt and update the time.

Notice that the instructions at START initialize the time-of-day clock to a time of 00:00:00. If the time is really 10:45:37 am, the packed BCD number 10 could be stored in the HOURS memory location, the number 45 in the MIN memory location, and the number 37 in the CURTIM memory location. If this is done, the instructions at START

would not be executed; instead, program execution would begin at SKIP.

## References

1. D. G. Larsen, J. A. Titus, and P. R. Rony, "Microcomputer Interfacing: Microcomputer Interrupts," *Computer Design*, Nov 1976, pp 142-143
2. J. A. Titus, P. R. Rony, and D. G. Larsen, "Microcomputer Interfacing: The Vectored Interrupt," *Computer Design*, Dec 1976, pp 112-114
3. P. R. Rony, D. G. Larsen, and J. A. Titus, *The 8080A Bugbook, Microcomputer Interfacing and Programming*, Howard W. Sams & Co, Inc, Indianapolis, Ind, 1977
4. J. A. Titus, P. R. Rony, and D. G. Larsen, "Microcomputer Interfacing: Accumulator I/O Versus Memory I/O," *Computer Design*, June 1976, pp 114, 116

This article is based, with permission, on a column appearing in *American Laboratory* magazine.



**Note:** An expanded series of four 3-day hands-on workshops on 8080/8085 design, microcomputer interfacing, software design, and digital electronics are being given by Peter Rony, Paul Field, Christopher Titus, and David Larsen. Participants will have the option of retaining equipment used in these courses. Dates are March 19 to 28, 1979. For more information, contact Linda Leffel, C.E.C., Virginia Polytechnic Institute and State University, Blacksburg, VA 24061, tel: (703) 961-5241.

## Printing Data and Graphics on the same card

doesn't have to throw you a curve...

**Our DMTP-9 programmable card printer/plotter does both — prints the full alphanumeric ASCII character set, and prints graphics for plotting too.**

All it took was combining our long-life 5 x 7 dot matrix needle head with a stepping motor that controls ticket positioning until the message (alphanumeric or graphics) is complete. Result: both analog and digital data, on the same card.

Use it with blood — gas and other medical analysis instruments. Extend the capabilities of a weighing system. Add a new dimension to time card and production control. And, print on either multi-part forms or single cards... on impact-sensitive paper or with ribbon. Even program character pitch for standard or enhanced printing for up to 32 characters per line, and approximately 39 lines.

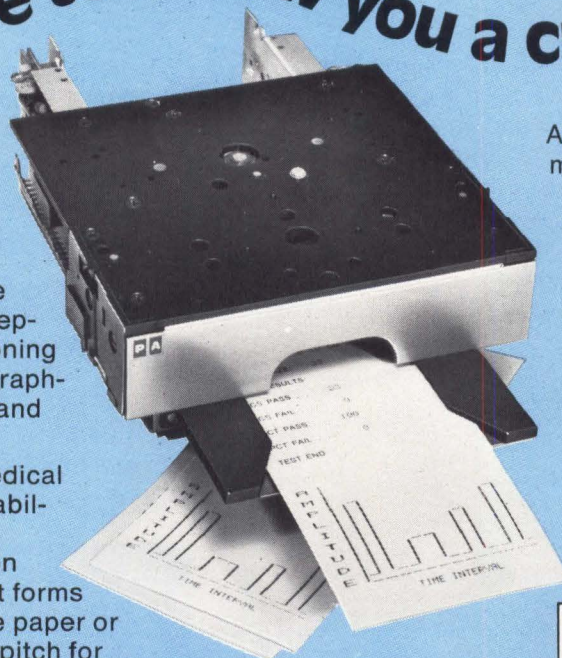

Adjustable for table-top or wall mounting, the DMTP-9 is available with controllers, power supplies and interconnect cable systems for complete microprocessor/microcomputer compatibility. For more details, call or write:  
 Practical Automation, Inc.,  
 Trap Falls Road,  
 Shelton, CT 06484;  
 (203) 929-5381



**PRACTICAL  
 AUTOMATION  
 INC.**



# FREE! SPEED READING COURSE.

DECITEK's free SPEED READING COURSE gives full details on new Model 262D9 desktop punched tape reader. (The model that reads 300 cps and recognizes XON and XOFF ASCII characters as well.)

Please rush details. I understand this brush-up course on the latest in tape readers does not obligate me in any way.

Name \_\_\_\_\_ Position \_\_\_\_\_

Firm \_\_\_\_\_

Street \_\_\_\_\_

City \_\_\_\_\_ State \_\_\_\_\_ Zip \_\_\_\_\_

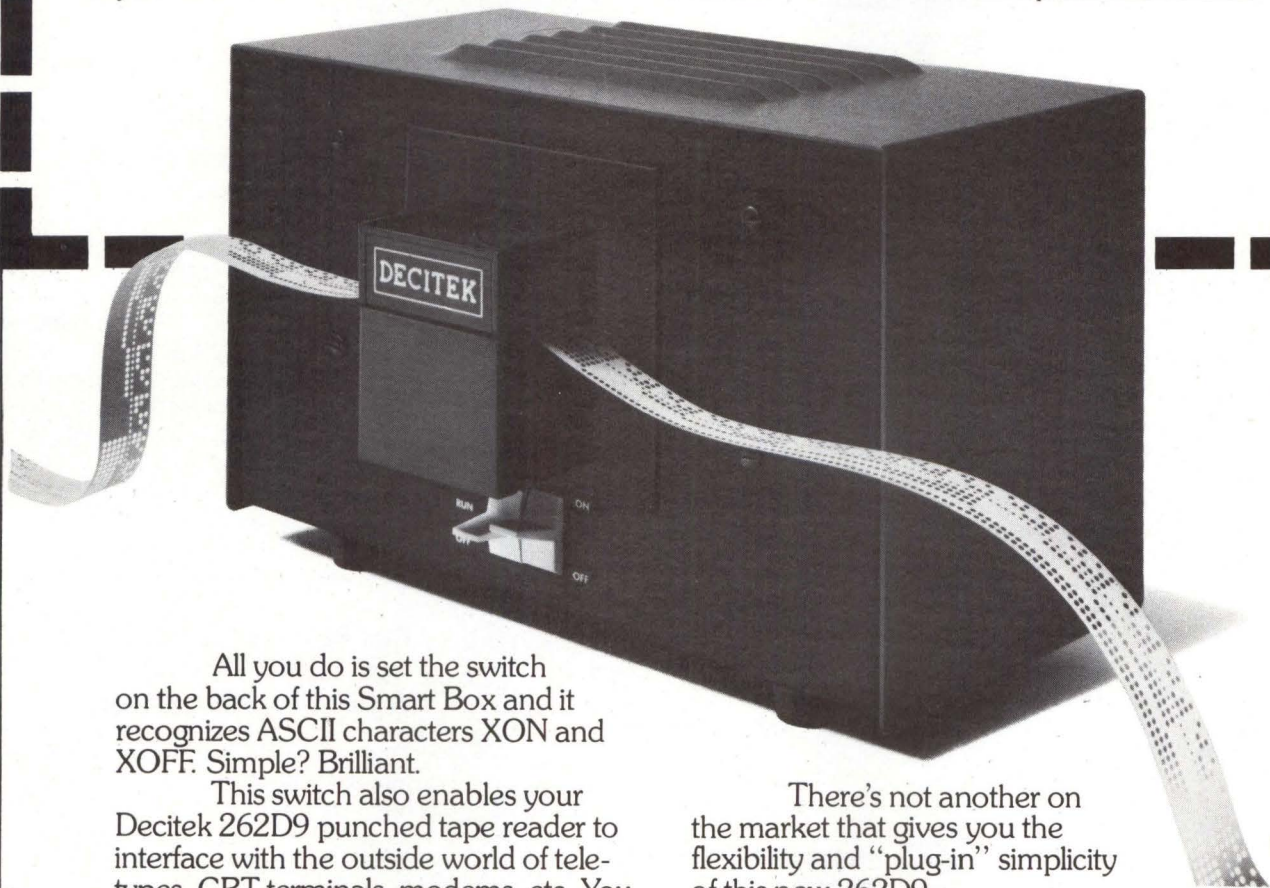

All you do is set the switch on the back of this Smart Box and it recognizes ASCII characters XON and XOFF. Simple? Brilliant.

This switch also enables your Decitek 262D9 punched tape reader to interface with the outside world of teletypes, CRT terminals, modems, etc. You select it, the Smart Box does it without internal programming by jumpers.

Then, using the second mode selector on the rear panel, you can program transmission rate (from 110 to 9600 baud), word length, parity and number of stop bits.

There's a lot more to this intelligent box. Dual-sprocket drive, 25,000 hour light source with fiber optics and stepper motor drive — that's a lot of tape reader. Add-on fan-fold boxes and 19" wing adapters provide installation versatility if you need it.

There's not another on the market that gives you the flexibility and "plug-in" simplicity of this new 262D9.

That's a fact. Another fact that will interest you is the reasonable cost of this improved Smart Box. So, do the smart thing. Mail the coupon for the FREE Speed Reading Course. Or, if you're in a hurry, call (617) 366-8334. Get the facts over the phone.

When reading matters

## DECITEK

A Division of Jamesbury Corp.

129 Flanders Road, Westboro, Massachusetts 01581

## Microprocessor Analyzer Solves Hardware/ Software Problems of 8080 or 8085 Systems

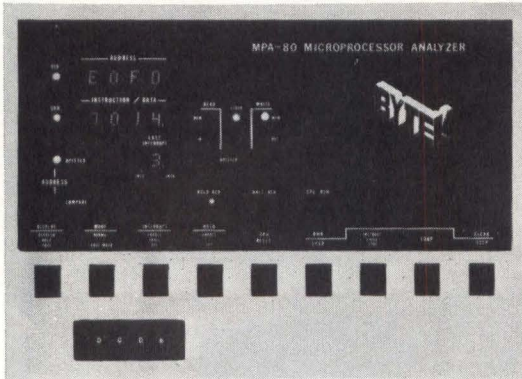

Microprocessor analyzer from Bytek solves hardware or software problems in 8080 or 8085 based systems. Tool examines processor's operation or single steps program by instruction or machine cycle

The MPA-80 microprocessor analyzer is both a hardware and software tool, providing realtime examination of the 8080 or 8085 processor's operation. The program can also be single-stepped by instruction or machine cycle. Manufactured by Bytek, PO Box 3026, Burbank, CA 91504, the unit may be used for software and hardware development, production testing, and field service.

Program breakpoints are selected by means of hexadecimal thumbwheel switches. These breakpoints, which may be the address of an instruction data byte, memory location, or I/O port, enable the single-step mode, provide a program loop point, or select a single address for examination. Reverse-trace mode presents the address and opcode of the last instruction executed prior to the breakpoint.

Controlled by special logic, hexadecimal displays provide useful information for each type of instruction (eg, opcode, one or two data bytes, memory address, or actual branch address). Status indicators (LEDs) alert the operator to the type of operation being performed by the processor. The six LEDs arranged in three columns represent, from left to right, CPU read operation, stack read or write, and CPU write operation.

Interrupt and hold (DMA) requests may be disabled to facilitate debugging of routines. A sync test point triggers an oscilloscope or other equipment upon comparison of the CPU address bus. An external gate input disables the sampling operation in RUN mode until an external event occurs.

Personality modules (MPM-8080 or MPM-8085) are required to provide

the interface to the system under test. These modules contain the microprocessor, plus logic to gain control over its operation. Line drivers buffer all data, address, and control lines going to the analyzer.

Speed, which is system dependent, is up to 5 MHz; loading is 0.4 mA maximum/CPU output. The interface is low power Schottky TTL. Operating temperature is 0 to 55 °C, storage temperature is -40 to 75 °C.

The analyzer measures 13.25 x 10.5 x 3.5" (33.7 x 26.7 x 8.9 cm) while the personality module measures 4.25 x 6.5 x 2.75" (10.8 x 16.5 x 6.99 cm). Price of the analyzer is \$845, plus \$145 for either personality module.

Circle 410 on Inquiry Card

## Increased Speeds Augment 4-Bit Bipolar Microprocessor

Improvements to operating speeds, obtained through a 25% reduction in the die size, have enabled Advanced Micro Devices Inc, 901 Thompson Pl, Sunnyvale, CA 94086 to introduce the Am2901B. The pin compatible, plug-in replacement for the Am2901 and 2901A likewise is a microprogrammable data processor slice containing an 8-function arithmetic logic unit, a 2-port 16-word scratchpad memory, additional accumulator register, and shifting and control logic. It is built with low power Schottky processing technology.

Propagation delay in the critical speed path from the RAM address in-

puts to the propagate and generate outputs has been reduced from a maximum of 65 ns to 50 ns. Minimum cycle time for a register-to-register add in a 16-bit configuration has been cut from 143 ns to 123 ns. This spec includes the pipeline register, carry look-ahead unit delays, and 2901 delays.

Units undergo 100% processing to MIL-STD-883 requirements. Prices in 100-unit quantities start at \$9.95.

Circle 411 on Inquiry Card

## Prices Are Reduced on High Speed Bipolar Microprocessor Slice

A reduction in price has been effected on the DM2901A-1 4-bit bipolar microprocessor slice, manufactured by National Semiconductor Corp, 2900 Semiconductor Dr, Santa Clara, CA 95051 using SCL technology that combines internal circuitry with Schottky I/O level translators. In a ceramic package, the -1DC costs \$14.95 in 100-piece quantities, while the plastic package -1NC is \$11.90.

## Bus Buffers/Separators and Latch/Decoders Are Added to 1800 Family

Two CMOS 4-bit bus buffers/separators—an I/O bus control and memory bus control—and two CMOS 4-bit memory latch/decoders have been added by Hughes Aircraft Co's Solid State Products Div, 500 Superior Ave, Newport Beach, CA 92663 to its family of 1800 microprocessor components. HCMP 1856 and 1857 provide noninverted bidirectional buffered data transfer and increase the drive capability to the bus. System expansion is provided for by means of a chip-enable input.

General applications are as quad transceivers consisting of four bus drivers and four bus receivers, both with 3-state outputs. Each driver output is internally connected to a receiver input.

The latch/decoder circuits allow direct control of 4k bytes of memory, with a chip enable input provided for expansion of memory systems beyond the 4k bytes. HCMP 1858 is designed

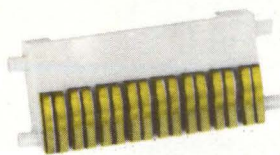
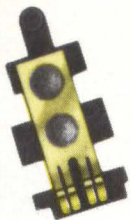

# SPRING ASSEMBLIES

**Instrument Specialties assumes all the headaches and guarantees quality!**

Until recently, Instrument Specialties was known only for the superb quality and performance of our beryllium copper springs and spring contacts. Customers bought the springs, and frequently assembled them into molded blocks in their own plants—with varying degrees of success.

Now, Instrument Specialties can eliminate this divided responsibility. We can supply your contact springs attached to molded bases, and *guarantee to meet the specifications of the entire assembly!* We'll take complete responsibility for producing the plastic block, manufacturing the springs to exact specifications, and then assembling the parts through heat staking, press fitting, or ultrasonic welding. We can also weld or solder springs to other metal components.

Of course, this eliminates a lot of your procurement and assembly headaches. But most important, your assemblies fit and work the way you specified—Instrument Specialties guarantees it!

We'll be happy to discuss your specific needs—just phone. Or, for a free catalog, write today to Dept. CD-84.



**INSTRUMENT SPECIALTIES CO., INC.**

Little Falls, New Jersey 07424

telephone: 201-256-3500 twx: 710-988-5732

*Specialists in beryllium copper since 1938*

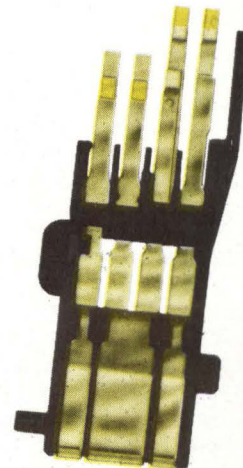
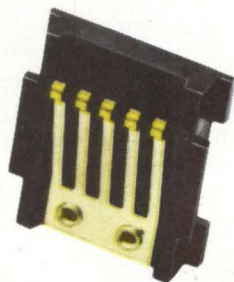
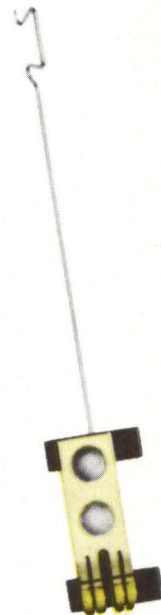
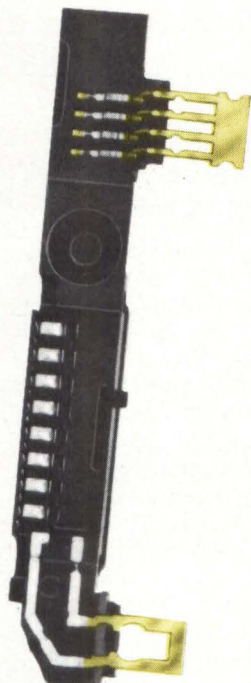

for a 1024 x 1 memory configuration, while the 1859 is for a 256 x 4 configuration. The 16-pin devices interface directly with an 1802 microprocessor.

All devices are available in ceramic packages (-55 to 125 °C temp range) or plastic packages (-40 to 85 °C temp range) with either 3- to 12-, or 4- to 6-V operating ranges. Price for a 4- to 6-V plastic device in 100-quantity is \$2.

Circle 412 on Inquiry Card

---

### Multiple Programmable Timer Module Is EXORciser Compatible

A support module for M6800 microprocessors, the 9640 is pin and outline compatible with the Motorola EXORciser™ and Micromodules™ as well as other cards. Each timer in the array of eight MC6840 triple programmable timers occupies eight locations of memory address space; boundaries for the array can be strapped for any 64-byte region of system memory. The 24 individual onboard timers perform frequency or one-shot pulse generation, realtime clocking, and event counting.

Creative Micro Systems, 6773 Westminster Ave, Westminster, CA 92683 has buffered all system bus lines and timer I/O lines, which are available to the user at two flat cable connectors at the top edge of the card. Single-quantity price is \$395; a partially populated module is available for \$295.

Circle 413 on Inquiry Card

### SOFTWARE

### Software Board for 9900 μProcessors Offers Limited Development Uses

The TM990/302 board is an alternative software development tool for the 9900 family of microprocessors, enabling software generation using assembly language or the company's POWER BASIC™ language. It is suited

to applications in which the user can trade some development capability for reduced cost. The board is a bus compatible member of the TM990 family manufactured by Texas Instruments, Inc, PO Box 5012, Dallas, TX 75222.

EPROM resident software development tools on the board include a text editor, symbolic assembler, debug package, relocating loader, EPROM programmer, and EIA Uplink to a TI990/4 or 990/10 minicomputer. The programmer verifies erasure, reads, programs, and verifies TMS 2708/16 and TMS 2508/16/32 EPROMS. Mass storage is contained offboard via an interface to audio cassettes.

The entry level tool, priced at \$625 in 1-piece quantities, is for use with an existing EIA terminal, power supplies, and TM990/100 or /101 microcomputer board. Separate EPROM personality modules to program the various EPROM series cost \$60 each.

Circle 414 on Inquiry Card

---

### FORTTRAN Operates on 8002 Microprocessor Development Lab

The FORTRAN-80 package from Microsoft, 300 San Mateo NE, Suite 819, Albuquerque, NM 87108 operates under the TEKDOS disc operating system of Tektronix, to allow development and debugging of programs written in FORTRAN on the 8002 Microprocessor Development Lab (see *Computer Design*, Aug 78, p 134). The FORTRAN compiler can be used in the development of microprocessor based systems that use Intel 8080A, 8085A, and Zilog Z80 chips.

An assembly language development package that accompanies the compiler includes a relocating assembler and linking loader. FORTRAN object code is generated in binary relocatable modules, which are linked to separately compiled FORTRAN or assembly modules. A system library containing standard I/O and arithmetic routines is provided.

All of ANSI Std FORTRAN X3.9-1966 except the COMPLEX data type are included in FORTRAN-80. Enhancements to the standard are mixed mode arithmetic, logical operations on integer data, ENCODE/DECODE for for-

mat operations to memory, and end of file and error condition trapping for R/W operations. Added functions, single-byte integers, hexadecimal constants, and ability to create FORTRAN programs to be placed in ROM facilitate microprocessor software development.

Circle 415 on Inquiry Card

---

### Software Provides Program Development Capability for 8086

A series of computer programs to support applications development for the Intel 8086 16-bit microprocessor operate in conjunction with PDP-11 and LSI-11 computers. Included in the Microbench™ 8086 software are a relocating assembler, linking loader, librarian, and object file formatter.

The assembler supports macro and conditional assembly capabilities, and cross reference listings; it also provides for memory addressing beyond 64k bytes. The loader provides linkage facilities, selective loading from libraries, and directives for specifying ROM/RAM alignment boundaries. Object file formatter produces binaries in compatible formats to be used with P/ROM programmers and emulation systems.

Virtual Systems, Inc, 1500 Newell Ave, #406, Walnut Creek, CA 94596 has added the software to the existing Microbench line which is coded in Macro-11 (see *Computer Design*, May 1978, p 230).

Circle 416 on Inquiry Card

---

### Relocatable Assemblers and Linking Loaders Support 6800 and 1802

Written in ANSI Std FORTRAN IV to operate on any computer with a word length of at least 16 bits, relocatable assemblers and linking loaders are designed for the 6800 and 1802 microprocessors. Features of the assemblers are conditional assembly, macro assembly, and a symbol or cross-reference table. They provide for program, data, and COMMON segments. The 6800 assem-



Of course  
our Floppys  
aren't cheap.

Quality never is.

It's no use trying to hide the fact: Maxell Floppy Disks give you the finest quality you can buy no matter how much you spend. And more and more of you are agreeing that your data is worth our perfection.

**Our floppys work better with your drive.**

Naturally, our floppys conform to ISO and IBM specifications. More important, they have also been approved by major OEMs, the people who recommend only those few floppys they are certain will work best with their hardware. So although we obviously don't know which drive system you are using, it makes no difference. Maxell Floppy Disks are so good they actually work better with any drive.

**What it all means for you.**

Yes, you can pay less for some other floppys. But lost data is a terrible price to pay when quality is what you want. And Maxell Floppy Disks help you profit in the very parameters you use this medium for: storing more data with virtually no down-time.

The level of modulation uniformity in every Maxell floppy is vital to double density recording and readout. It

means no peak shift, complete freedom from dropouts, total absence of particle orientation. Plus longer life, greater overall durability, and significantly less oxide build-up and head abrasion.

So when you have to depend on full data retrieval, a few cents can make a big difference. Depend on Maxell Floppy Disks. They can really save you.

Maxell offers the full range of Floppy Disks from standard 8-inch to 5 1/4 -inch plus Data Cassettes. *Dealer inquiries invited.*



Maxell Corporation of America, Data Products Group  
60 Oxford Drive, Moonachie, NJ 07074 Tel. (201) 440-8020

# Canon

## Camera Quality

in  
**d.c.**

## Motors

for

## Computer Peripherals

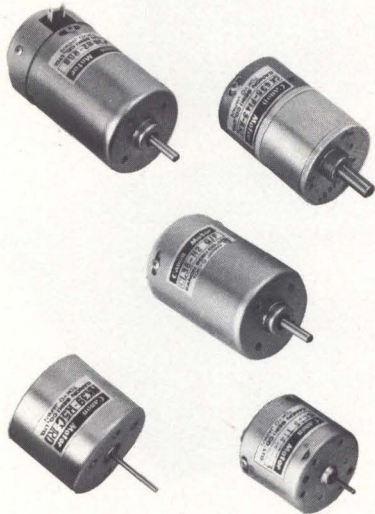

You probably know us for our line of fine cameras. But did you know that we are also one of the world's largest manufacturers of subfractional h.p. (below 1/50) permanent magnet d.c. motors?

We produce a very broad line of high quality motors equally as respected among OEM users as our cameras are in their field.

Our line includes

- Diameters from 22 to 38 mm
- Stall torques to 35 oz.-in.
- Tachometers, a.c. and d.c.
- Gearheads

*If you need a reliable source for subfractional h.p. d.c. motors noted for reliability and long life, call Canon. We probably have a model to fit your need and certainly can respond quickly to meet a custom requirement.*

**Send for FREE catalog. In a hurry? Call 516-488-6700 and ask for Electronic Components Division.**

# Canon<sup>®</sup>

U.S.A., Inc.

Electronics Components Div.  
10 Nevada Drive,  
Lake Success, L.I., N.Y. 11040

516/488-6700  
Telex No. 96-1333  
Cable—Canon USA LAKS

**MICRO DATA STACK**  
PROCESSORS AND ELEMENTS

bler provides for a base page segment while the 1802 allows for relocation of short branch instructions. Object module output of the assemblers may be in relocatable format or produced directly in absolute format using the manufacturer's standard format.

Linking loaders combine independently assembled object modes into one absolute module according to user commands; large programs can be subdivided into smaller units, reducing assembly time and allowing program errors to be corrected efficiently. Object module output is in the manufacturer's absolute format and may include a symbol table for simulation.

Microtec, PO Box 60337, Sunnyvale, CA 94088 offers the programs on several types of media. The package for either microprocessor type is priced at \$1250.

Circle 417 on Inquiry Card

### Systems Support Most Microprocessor Software Development

A line of tools and systems are available to programmers to facilitate microprocessor software development. Systems can be configured for one or several simultaneous users.

High speed cross assemblers, linkage editors, and simulator debuggers can convert inhouse computers into microprocessor software development systems. Written in the assembly language of Digital Equipment's RDP-11 and DECsystem 10 and 20, as well as Data General Novas and Eclipses, the software permits microprocessor program development on a computer having a high speed CPU, adequate memory and peripherals, a text editor, and multiuser capability.

The software may also be used via timesharing anywhere in the U.S. through a local phone call. An in-circuit emulator such as the Tektronix 8001 microprocessor lab may be connected directly to any of the systems. If an 8001 or 8002 is used, Boston Systems Office, 469 Moody St, Waltham, MA 02154 will supply the necessary software interface, at no additional charge, to perform up- and downline loading. □

# You definitely get more with DEC<sup>®</sup>



## With every RP04/5/6,<sup>\*</sup> you get a controller:

To get mass storage for your PDP-11,<sup>®</sup> you can use DEC's RJP04 or 05 with their 88 megabyte drives, or the RJP06 with its 176 megabyte drive. After installing DEC's four-board RH11<sup>®</sup> interface, drives can be added up to a maximum system capacity of 1408 megabytes.

But each drive you add comes with its own controller, the large box on the side of the drive. This adds hundreds of IC's to your system, and thousands of dollars to your system costs.

\*Registered trademark of Digital Equipment Corporation.

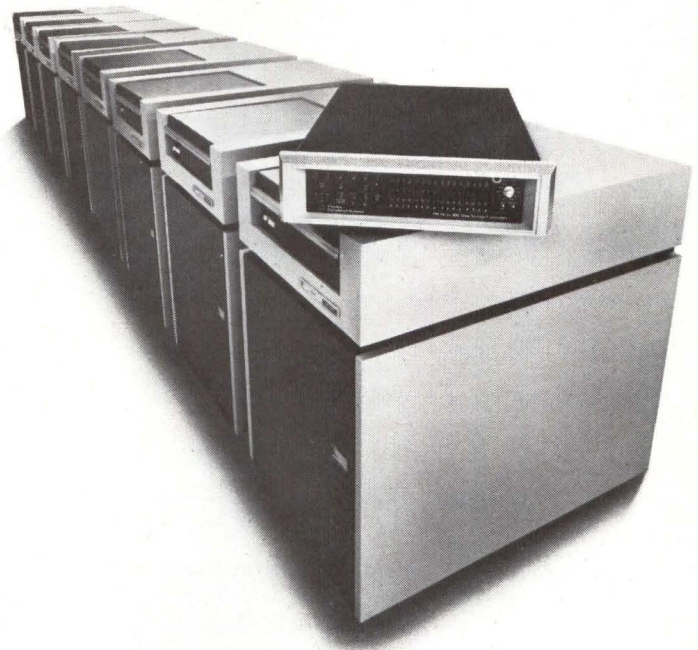

## Plessey controls your costs:

Our PM-DS11/300C mass storage systems are direct replacements for DEC's RJP04/5/6 systems, but store up to 45% more and cost 30% less.

Fully compatible with standard DEC diagnostics and operating systems, Plessey mass storage systems use a single microprocessor-based controller to handle up to eight of our 254 megabyte drives for a total system capacity of 2000 megabytes. The PM-DC11/300C controller includes power-on and off-line diagnostics, software error detection and correction, adjustable DMA control and dual Unibus<sup>®</sup> ports. System expansion requires no special device drivers, and *no* additional controllers.

The PM-DC11/300C controller is available in a 5¼" expansion chassis with a diagnostic panel, or may be embedded in only two system units of your PDP-11 cpu.

Providing more reliable yet less expensive products has made us the largest independent supplier of DEC-compatible peripherals. Our product line presently includes add-in/add-on core and semiconductor memories, cartridge disc systems, floppy disc systems, mag tape systems, complete computer-based systems, and a wide variety of backplanes, expansion chassis and other accessories.

We're the only real alternative to DEC for all your miniperipherals, a complete single source. For all the details, please contact the nearest Plessey sales office today.



## Plessey Peripheral Systems

17466 Daimler, Irvine, California 92714, (714) 540-9945

## **THE AMI/BERKELEY MATCH PROGRAM— AN INDUSTRY SPONSORED MICROCOMPUTER PROJECT LABORATORY, PART 1**

**Harold S. Stone\***

University of Massachusetts, Amherst, Massachusetts

**T**he Match Program, comprised of three groups—industry, the university, and the student—is designed, as the name implies, such that all parties contribute and all gain. It operates as a 2-quarter laboratory course using the existing university facilities, which are further enhanced by state-of-the-art microcomputers and digital components contributed by industry. Students contribute their time and ideas, learning through the design experience of a challenging microcomputer project.

Specific parties involved in this venture are American Microsystems, Inc (AMI) of Santa Clara, Calif and the Electrical Engineering and Computer Science Department of the University of California at Berkeley. By injecting AMI's equipment into the laboratory project, the student is able to pursue ideas without having to surmount obstacles caused by lack of parts or lack of development tools. More often than not the problems found to be most challenging lie in unexpected areas such as noise and ground loops, analog signaling, or interfacing with electrical isolation, rather than in the strictly digital areas where timing, logic, sequencing, and the like can be dealt with using techniques learned in the classroom.

In each case, the starting point for the student projects was an AMI EVK-200 evaluation kit for the 6800 microprocessor. This kit contains the 6800 microprocessor, six 8-bit input/output (I/O) ports, a serial RS-232 port, 1k bytes of random-access memory (RAM), and sufficient read-only memory (ROM) to hold an onboard monitor and assembler/disassembler. There is space to mount up to 2k bytes of electrically programmable ROM (EPROM), and an onboard EPROM burner with drive software makes it simple to incorporate system software into a project.

Boards can be interfaced into larger systems rather easily and are versatile enough to satisfy many different functions as they stand or with small modifications. One inventive student satisfied his need for an additional 512 bytes of ROM by piggybacking an extra EPROM on top of an existing chip. In a few instances, the board layout did not satisfy constraints of the project so the students scavenged the parts that came with the board and simply set the board aside. One project, for example, was an entry for the Institute of Electrical and Electronics Engineers Micro Mouse contest. Here the requirement was to build a self-contained and self-powered, microcomput-

er controlled "mouse" that could run a maze with walls placed on 6" (15.3-cm) centers. The two students involved in this project clearly sought density and low power consumption which the EVK board could not satisfy.

At two points during the 5-month project the students gave formal oral presentations before technical staff members from AMI. The first was during the initial project proposal period, at which time the company's engineers responded with technical advice and suggestions on the projects. The second presentation came at the end when the students met at the company to give live demonstrations of their projects. At this point, a winning project was selected based on the concept, on the oral presentation, and on a written project proposal and final report. The winning project, an electroencephalogram/electrocardiogram (EEG/EKG) system is described later. All participants were permitted to retain the parts donated by the company.

In comparing the Match projects with other projects that were mounted without the support of AMI, it is immediately evident that students who had the evaluation kits to begin with could look at system-wide aspects of their problems from the start. The Match projects generally took the view that the kits could be extended, altered, or scavenged as necessary to meet the needs of the project. Other projects using the university's existing facilities were constrained to use the facilities without modification, and consequently largely became software projects with a minimal amount of interfacing.

Benefits for the participating groups are multifaceted. The students' laboratory experiences become more realistic due to their exposure to real world tools and requirements, while the university gains better laboratory equipment at a time when it is most cost-effective to purchase parts lagging the state-of-the-art and operated into obsolescence. Finally, industry obtains technical feedback on their products, and new ideas and applications are brought to light. Students introduced to a product line and trained on specific equipment are more likely later to design with this product, and in some cases may join the company as employees.

As a result of this jointly sponsored AMI/Berkeley Match Program, the students were able to produce a wide range

\*During the period in which this Match Program was conducted, Prof Stone was a Visiting Professor in the Electrical Engineering and Computer Science Dept of the University of California at Berkeley.



# No more square tails in round holes.



## Introducing the wave solder PC connector.

What an electronic design engineer will make-do with in a pinch is astonishing. For example — converting wire wrap\* PC connectors to wave solder.

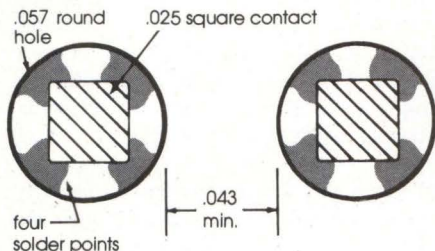

How it's done: you saw off the square .025" tail and push it through a .057" round hole in the PC board. You get only 4 contact points for solder. And there's room for only one tracing between holes. But, so what...it works.

### At last — The obvious answer

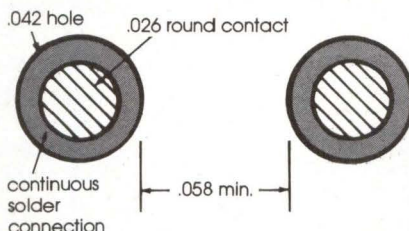

Our own design engineers, not afraid of doing the obvious and simple thing, have done just that. They've taken a series of our PC wire wrap connectors — and given them .026" round tails. Everything else stays the same: the insulator, semi-bellows contacts, pin and row spacing.

### So what?

So — the .026" round pin slips into a .042" round hole in your PC board for an excellent solder connection. So — you can now get multiple tracings between rows.

We have two tail lengths: a .200" short one and a .250" longer one to take the AS400 Solderpak\*\* System. These are available in connectors with contacts on .100", .125" and .156" centers, and in layouts from 6 to 50 positions.

Use our coupon and we'll send you all the details.

**There's more.** There are some things we haven't told you — including materials and other details you need to know. Ask us for the literature.

NAME \_\_\_\_\_

TITLE \_\_\_\_\_ TELEPHONE \_\_\_\_\_ EXT. \_\_\_\_\_

COMPANY \_\_\_\_\_

ADDRESS \_\_\_\_\_

CITY \_\_\_\_\_ STATE \_\_\_\_\_ ZIP \_\_\_\_\_



Viking Industries, Inc./21001 Nordhoff Street, Chatsworth/CA 91311 U.S.A.

(213) 341-4330/TWX: 910-494-2094

\*A registered trademark of the Gardner-Denver Company. \*\*A registered trademark of the Raychem Corporation.

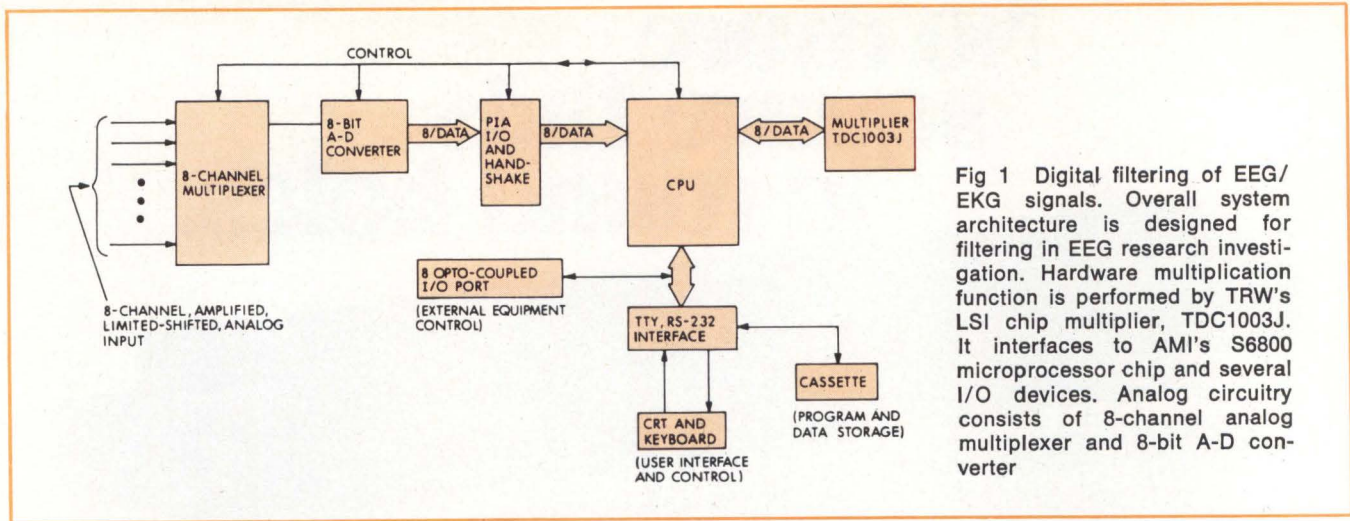

Fig 1 Digital filtering of EEG/EKG signals. Overall system architecture is designed for filtering in EEG research investigation. Hardware multiplication function is performed by TRW's LSI chip multiplier, TDC1003J. It interfaces to AMI's S6800 microprocessor chip and several I/O devices. Analog circuitry consists of 8-channel analog multiplexer and 8-bit A-D converter

of microprocessor projects. Highlights of several of them are worth examining.

### Microcomputer Digital Filtering

The intent of this project by Douglas Marquardt is to create a digital filter capable of analyzing EEG/EKG signals using microcomputer technology. The major problem with present purely analog equipment is that the signals to be filtered are very low frequency, typically in the range of 0.1 to 10 Hz, so that active filters must have very high Qs to be acceptable. This greatly constrains the operational amplifiers in the analog filters in terms of dynamic range, frequency, and noise.

Digital filtering is an attractive alternative to analog filtering for this application because the digital devices are not subject to the operational constraints and stability problems of the analog devices, periodic recalibration becomes unnecessary, and logic is essentially immune to temperature variations. Even with digital filtering there is, by necessity, some analog circuitry involved in the system, principally in the form of sample-and-hold circuits or analog-to-digital (A-D) converters. Hopefully the problems of analog circuitry cited above can be virtually eliminated by having the analog portions of the system operate only on input data, immediately converting this into digital form for further processing.

Within the system is a basic nonrecursive digital filter that computes

$$x_{out\ t} = h_0x_t + h_1x_{t-1} + h_2x_{t-2} + \dots + h_r x_{t-r}$$

where  $h_i$  represents stored filter coefficients and  $x_{t-1}$  is successive samples of the input waveform. Although this is conceptually very simple, the challenge is to perform this calculation repeatedly in real time with a microprocessor based system. The system necessities dictate that the filter should be able to perform two separate filtering operations on input data, one for alpha signals (8 to 12 Hz) and the other for theta signals (4 to 7 Hz), filtering on eight EEG channels of data concurrently. Even though the signaling speed is low frequency, the total computational requirements can severely tax an 8-bit microprocessor, especially because such microprocessors do not have built-in multiplication for the filtering operations.

Fig 1 shows the approach taken in this project. Key to handling the high speed computation requirements is the TDC1003J multiplication chip donated by TRW, Inc. It performs 8-bit multiplication in combinational logic using a basic clock with four times the clock speed of the microprocessor. There is a significant speed improve-

ment with the use of this device and a slow microprocessor, yet the cost of the system is below that of a microcomputer with higher overall performance specifications.

This multiplier chip is interfaced to the central processing unit (CPU) together with several other I/O devices. The analog circuitry consists solely of an 8-channel analog multiplexer and an 8-bit A-D converter. Some signal preamplification and level shifting may also be incorporated depending on the signal source, in order to meet the signal constraints at the input of the 8-channel multiplexer.

Design of the CPU departed from the evaluation kit; instead it was built from a 6800 microprocessor with an S-100 compatible bus so that S-100 memories and peripheral control cards could easily be accommodated at later stages. Since the S-100 originally was designed to support the 8080 family of microprocessors and memories, the S-100 bus signals had to be slightly redefined to handle the AMI 6800 type of clocking. Although the result is not strictly an S-100 bus, many memory and I/O boards for the S-100 will correctly mate and work with the computer design.

The principal idea to come out of the project is that a microcomputer and digital techniques can feasibly replace more conventional analog filtering techniques. In this system the microcomputer acts more like a controller than a computer, in that the computation and input data conversion are done in the supporting chips for high speed, with the microcomputer managing the flow of data through the system.

### Conclusion

Projects submitted for the program indicate the depth and variety of activities performed in the laboratory. Besides the digital filter described in this part, two additional papers focusing on a voice controlled wheelchair and an enhanced character graphics system will be summarized in Part 2 of this report. Other projects treated multicomputer systems, microcomputer controlled telephone interfaces, and digital pulse sampling. The evaluation kits gave the projects a head start in every case, and the students branched out beyond the kits to create a complete microcomputer based system. Where more equipment was needed, it came from AMI for the most part, with other donations from National, Intel, Motorola, Fairchild, and Zilog to provide the components necessary for carrying out other functions.

SEE THE LEADING LINEUP OF COMPUTER PERIPHERAL

# OEM MECHANISMS

PRINTERS ■ DOT MATRIX ■ FULLY FORMED CHARACTERS ■ TAPE PUNCH

These high quality, high profit to OEM mechanisms are backed by the worldwide reputation of EPSON's parent, Shinshu Seiki Co., Ltd., Japan. All mechanisms guarantee long-life construction, competitive OEM pricing and many valuable design innovations.

## MODEL 3110 DOT MATRIX PRINTER MECHANISM with 80 column format

Designed for use in small-business and home computers, the long-life, low-cost Model 3110 features a 100,000,000 character dot head, 150 characters per second, with 5X7 dot matrix character.



**NEW**

CIRCLE 89 ON INQUIRY CARD

## MODEL 512 DOT MATRIX PRINTER MECHANISM with 40 column format

This compact printer has the same 100,000,000 character dot head as the Model 3110, with MCBF of  $5 \times 10^6$ . It prints at a rate of 3 lines per second.

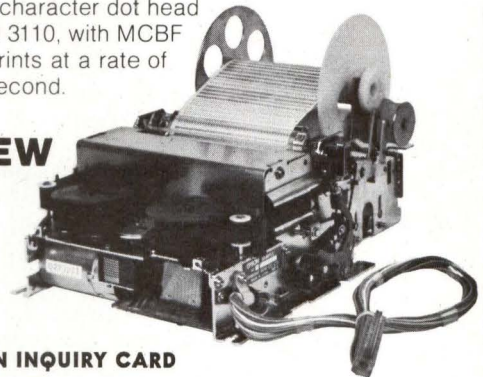

**NEW**

CIRCLE 91 ON INQUIRY CARD

## MODEL 2610 LINE PRINTER MECHANISM with fully formed characters

An EPSON-designed belt-impact printing mechanism gives clear, readable, fully formed characters. Model 2610 prints 150 lines per minute using a 64 character set, 80 column format.

A complete line printer with case, the Model 10, also is available.

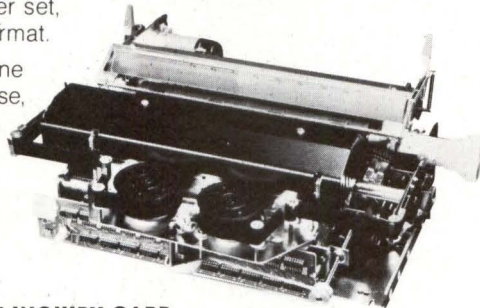

CIRCLE 90 ON INQUIRY CARD

## MODEL 6110 TAPE PUNCH MECHANISM with full-size operation in a miniature chassis

A long-life punchblock that punches 100,000,000 characters with normal paper tape.

Unique brushless motor affords long life, low power operation. Size is only 4" w x 6" d x 4 1/4" h. Operates at 50 characters per second.

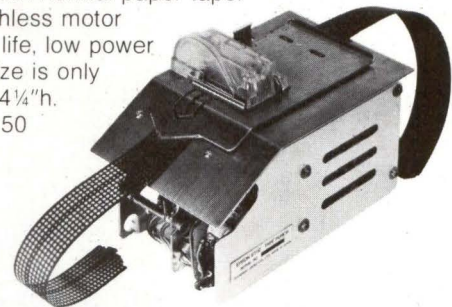

CIRCLE 92 ON INQUIRY CARD

write for complete information and OEM prices

# EPSON

**EPSON AMERICA, INC.**

23844 Hawthorne Blvd., Torrance, CA 90505  
Telephone (213) 378-2220 · TWX 910 344-7390

## Militarized Version of Microcomputer Produces High Speed Processing Under Harsh Conditions

A fully militarized version of the Miproc high speed microcomputer has been built by Plessey Microsystems, 19546 Clubhouse Rd, Gaithersburg, MD 20760 from standard multisourced Schottky TTL devices. The multichip architecture allows design modification to suit specific applications with a choice of speed, power consumption, and packaging options.

Withstanding hostile environments, the Miproc 16M conforms to relevant sections of MIL-E-5400 Class 2 (airborne), MIL-E-16400 (shipboard), and MIL-E-4158 (land based), and is available in ATR or double Euro-card sizes. The system is also approved by the British Ministry of Defense and the Civil Aviation Authority.

The processor has been optimized for speed, with over 3.6M instructions/s. Separate program and data memory structures enable instruction pipelining techniques to be used to

maximize the processor performance. Overlapping of fetch and execute phases of the instruction cycle allows peak performance to be maintained using a slower program memory, reducing cost and power consumption.

Up to 64k words of program memory and 64k words of data memory are addressed by the processor using seven powerful address modes. I/O transfer rate exceeds 1M words/s under program control, and is up to 10M words/s with DMA.

A multiprocessor system is configured using shared I/O and memory resources, with each processor allocated specific tasks within the system concept. Available units include the MPC 515M 275-ns cycle time processor; MPC 169M index/interrupt unit with five extra address modes and 8-level priority vectored interrupt systems; MPC 407M application memory with 4k words of program

P/ROM, 1k words of data P/ROM, and 256k words of data RAM; MPC 433 2k program or data RAM; and MPC 505 8k program or data P/ROM.

Software compatibility with commercial Miproc 16S and 16F processors allows software to be developed, using standard commercial products, in parallel with the design of military hardware. A software development package includes a Digital Equipment Corp PDP-11 computer connected to a Miproc system containing a firmware module for interactive debugging of user programs. Programs edited and assembled on the PDP-11 are loaded into the Miproc, where they are run and debugged under breakpoint control using commands entered at the PDP-11 console. Compiler packages for PL Miproc and CORAL 66 are available for use with the development system.

Circle 418 on Inquiry Card

## Video RAM Interfaces Between Microprocessor and TV Monitor

MTX-2064 and MMD-2480 have been added to the family of video RAM (VRAM) TV CRT controllers for use in systems that require display of alphanumeric data. For input, the devices directly connect to bus organized systems, and appear as a

1280 or 4098 x 8-bit static RAM with a 500-ns access time. Output of the MTX-2064 is a video signal providing a flicker free display of 20 lines x 64 upper and lower case characters. MMD-2480 provides 24 lines x 80 characters and limited graphics capability. No external refresh or memory is required. Characters may be displayed as normal, inverse, or blink.

Matrox Electronic Systems Ltd, 2795 Bates Rd, Montreal, Quebec H3S 1B5, Canada has designed the bus structure to permit direct interfacing to most micro- and minicomputers. The full processor instruction set is available for display manipulations.

The self-contained units include sync generator, RAM, ROM, and bus interface. For video mixing, a universal phase lock loop module allows the -2480 to be locked to an external sync source such as a TV camera. Either American or European TV standard field rates are available. They are housed in pin compatible 4.5 x 6 x 0.5" (11.4 x 15 x 1.3-cm) modules and draw under 800 mA from a single 5-V power supply.

Circle 419 on Inquiry Card

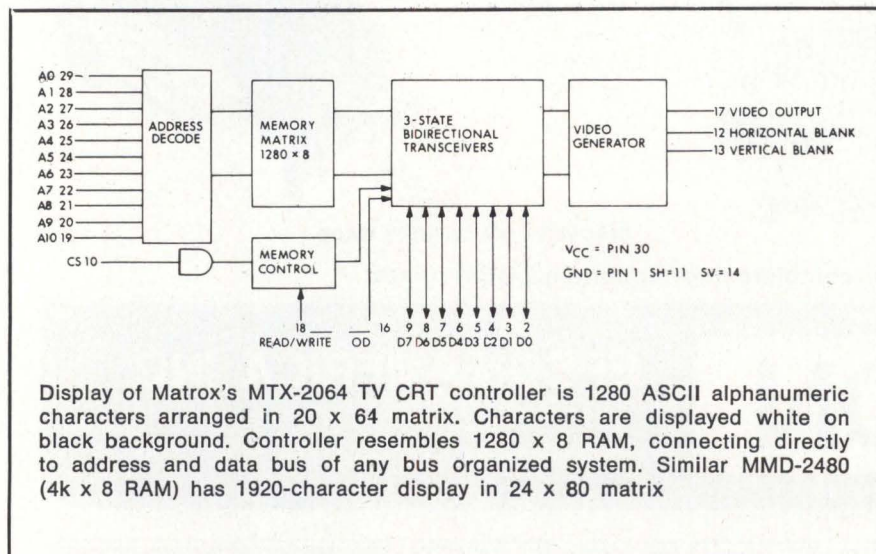

## Military/Severe Environment $\mu$ Computer Serves OEM Applications

Designed to meet MIL-E-5400, MIL-E-16400, and MIL-E-4108 specs, the SECS 80/10A is a ruggedized version of the Intel iSBc 80/10A unit for OEMs, meeting military and other severe environment applications. The

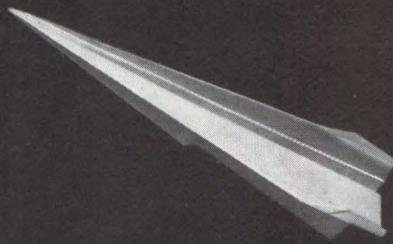

**TRANSMISSION:**  
Page; Field; Modified  
Field; Prompted  
Transmission; Device  
Status; Function Keys.

**INTERFACE:**  
EIA RS-232; Current  
Loop; 17 data rates  
(switch selectable)  
including 19, 200  
chars/sec; Half duplex  
support; Line  
turnaround characters;  
Reverse channel.

**EDITING  
FUNCTIONS:**

Insert/Delete line and  
character; Columnar  
Tabbing; Cursor  
Addressability; Cursor  
Sense; Numeric Only  
fields; Security fields;  
Erase Variable/  
Protected fields.

**OPTIONS:**

Buffered Printer  
Interface (RS-232  
and parallel),  
separately  
addressable from  
the CPU;  
Standard Polling;  
Paging.



**VIDEO:**

Normal; Reverse;  
Blink; Low/half  
intensity; Underline.

"OFFHAND, WHAT MORE  
COULD YOU WANT?"

**KEYBOARD:**

Removable, solid  
state with international  
character layouts.



When it comes to flexibility, the Infoton 400 Data Display terminal can hand you all you need.

Designed around the Z-80 microprocessor, it offers complete control of all Blocking and Editing functions through software settable modes. One thing that's especially easy to handle about the I-400 is that it's the most versatile terminal you can get your hands on for the price.

More information on the I-400 is quickly within your grasp. Call Infoton toll-free today at (800) 225-3337 or 225-3338. Ask for Barbara Worth. Or write Barbara Worth today at Infoton, Second Avenue, Burlington, MA 01803. We have offices throughout the United States, Canada and Europe. In Canada, contact Lanpar Limited, 85 Torbay Road, Markham, Ontario, L3R 1G7. (416) 495-9123.

Created by Chickering/Howell Advertising, Los Angeles

**CIRCLE 93 ON INQUIRY CARD**

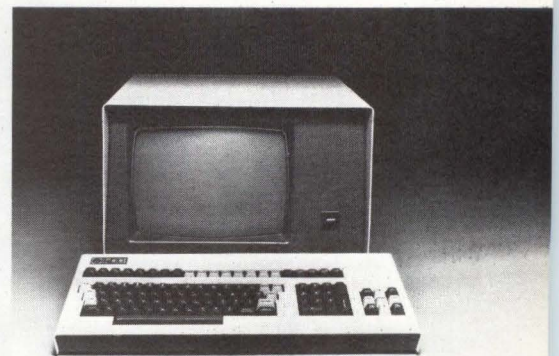

**INFOTON 400**

microcomputer is the first of a family of isbc-80™ compatible products that the Severe Environment Systems Co, Electronic Memories and Magnetics Corp, 20630 Plummer St, Chatsworth, CA 91311 is developing in conjunction with, and manufacturing under license to, Intel Corp.

The microcomputer is functionally identical to the standard Intel system and works with the same software and development packages. It may be mounted in a sealed package to protect it from corrosive and other hostile conditions. It is compatible with full ATR packaging requirements.

The Severe Environment Computer System (SECS) is mounted on a single 9 x 6" (23 x 15-cm), shock and vibration resistant board. The system includes the Intel 8080A microprocessor, up to 8k bytes of EPROM, 1k bytes of RAM, synchronous and asynchronous I/O compatible with teleprinters, and up to 48 channels of discrete I/O.

Also featured are six interrupt request lines and serial communications. Synchronous characteristics include internal or external character synchronization, automatic sync insertion, and 5- to 7-bit characters. Asynchronous characteristics are break character generation; false start bit protectors; 1, 1½, or 2 stop bits; and 5- to 8-bit characters.

Wedge lock type screw clamps hold the board in the chassis. This provides a positive thermal path for conducting heat out of the board, via integral heat sinks, into the chassis. Electrical connection is made by means of a single 150-pin NAFI fork and blade-type connector resistant to open connection under high vibration and shock. Operating temperature is -55 to 85 °C. Quantity-100 price is \$1703.

Circle 420 on Inquiry Card

### Expanded Bus Structure Handles Functionality of Single-Board Computer

To accommodate the applicability of the isbc 86/12™ single-board computer, the structure of the Multibus™ system bus has been expanded by Intel Corp, 3065 Bowers Ave, Santa Clara, CA 95051 to support 20 bits of address and 16 bits of data. The

inclusion of control lines allows both 8- and 16-bit data transfers. The board can access data in byte and word quantities, and directly addresses 1M bytes of system memory while remaining compatible with the isbc-80 family. Both 8- and 16-bit single-board computers can be interfaced over the same bus with one another in multiprocessing configurations, as well as with the isbc™ line of memory, I/O, communications, and peripheral controller boards.

Based on the 16-bit, 5-MHz HMOS 8086 microprocessor, the board includes 32k bytes of dual port dynamic R/W memory with onboard refresh and four sockets for up to 16k bytes of ROM. The RAM is accessible by the CPU and the Multibus via a dual port controller. Other Multibus masters can directly access the RAM without using additional RAM expansion boards. Memory can be reserved in 8k-byte segments up to 32k bytes for exclusive use by the CPU. ROM may be added in 2k-byte quantities up to a maximum of 4k bytes using 2758 EPROMS; in 4k-byte increments up to 8k bytes using 2716 EPROMS or 2316E masked ROMS; or in 8k-byte increments up to 16k bytes using 2332 ROMS.

The I/O structure incorporates interfaces for parallel and serial I/O. Using an 8255A programmable peripheral interface device, 24 programmable I/O lines are available for parallel I/O operations. System software configures these lines in combinations of uni- and bidirectional I/O ports.

An RS-232-C interface works with an onboard USART, which handles serial communications capability. Standard baud rates are accommodated by the programmable baud rate generator. Data format, operation mode, control character format, and parity are under program control. Two general purpose timers that operate in BCD or binary mode are available using an 8253 programmable interval timer device. Nine levels of vectored priority interrupts are expandable to 65 levels over the Multibus.

Intellec Series II microcomputer development system and software for high level language development support the computer. Being introduced with the computer is the isbc 957™ interface and execution package that permits software modules developed on an Intellec system to

be downloaded into the 86/12 board for full speed execution and debug. System development, therefore, can be started immediately with the computer, using the software development system offered for isbc 80 products.

The package includes an isbc 86/12 monitor residing on four 2716 EPROMS and a diskette containing Intellec resident communications software that links the computer with the Intellec system. Most effective use of the package is with the 86/12 computer, isbc 660™ system chassis for power and system expansion, and one or more isbc 032™, 048, or 064 RAM boards for programs requiring more than 32k bytes of RAM. The 86/12 computer is priced at \$2140, and the 957 package is \$2145.

Circle 421 on Inquiry Card

### 64k-Byte Memory Expands 8- or 16-Bit Microcomputers

CR-8080 memory module, compatible with 8- and 16-bit Multibus<sup>®</sup> based systems, features expansion to 32k, 48k, or 64k bytes on a single board. Chrislin Industries, Inc, Computer Products Div, 31312 Via Colinas #102, Westlake Village, CA 91361 has designed the memory for Intel's Intellec<sup>®</sup> MDS-800 SBC 80/10, SDK-86, and BLC 80/10 microcomputers.

Memory is addressable in 4k increments up to 64k words. Maximum processor throughput is obtained with the use of onboard refresh control logic. Data access time is 270 ns; cycle time is 400 ns.

Power consumption of the 6.75 x 12" (17.15 x 30.5-cm) device is under 7 W. Battery backup capability is available. Single quantity price is \$390 for the 16k x 8 board and \$890 for the 64k x 8.

Circle 422 on Inquiry Card

### Microcomputer Utilizes Magnetic Bubble Memory For Mass Storage

A line of general purpose, portable microcomputers features a BASIC operating system, bubble memory mass storage, upper and lower case characters, alphanumeric plasma display, and printer combined in a single unit weighing less than 20 lb (9 kg). Model 256 of the FINDEX<sup>®</sup> line, developed by Findex, Inc, 1625

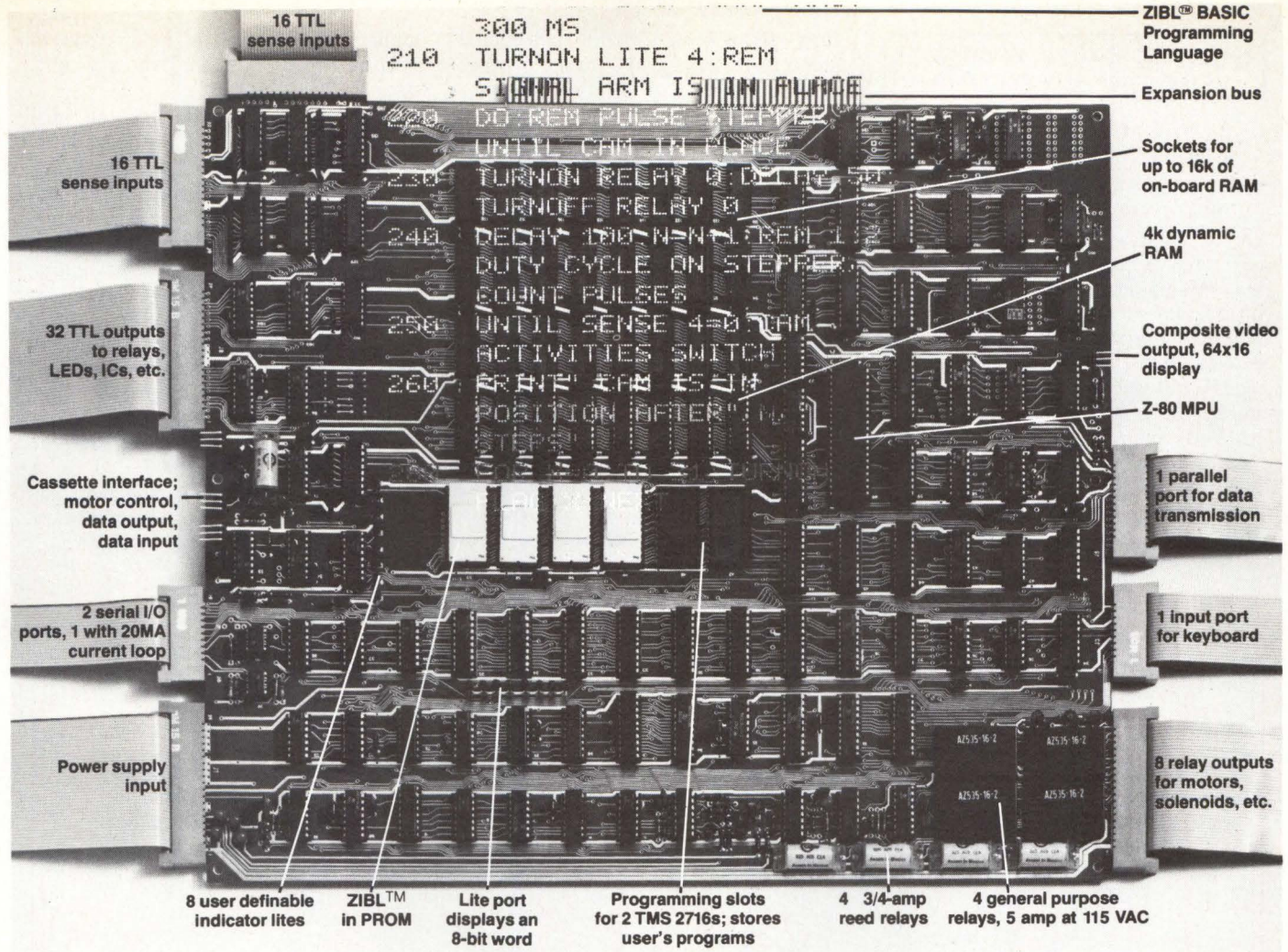

## WHAT CAN “CONVERSATIONAL FLEXIBILITY” DO FOR YOU?

### SOLVE A COSTLY PROBLEM.

That's why we created the DYNABYTE BASIC CONTROLLER™. Up to now, you've had good reason for not taking full advantage of microcomputers. Inflexible interface and the lack of suitable, *simple* programming languages have left your control applications neglected and expensive to handle.

Writing and debugging software has been difficult. Great effort has gone into learning new languages. Special control circuits had to be constructed.

Microcomputers have been neither conversational nor flexible. And, you have been paying the price—with inadequate hardware or no hardware at all.

### THE SOLUTION.

The new DYNABYTE BASIC CONTROLLER™ is designed for you. Now you can have a controller that gives you *flexible interface* and *conversational programming*.

It's a self-contained, single-board computer that is oriented toward control applications. You will have everything you need—relays, lites, video display, flag outputs, sense inputs, tape cassette interface, communication interfaces, EPROM programmer and much more.

Its enhanced version of BASIC and ease of interface makes the DYNABYTE BASIC CONTROLLER™ ideal for a variety of control applications. You will get results easily and efficiently, even if you have little or no experience with computers.

Finally, you will have Conversational Flexibility.

### WHERE TO USE IT.

Just about anywhere. Some of the applications in which the BASIC CONTROLLER™ is now solving problems are electronic equipment testing . . . medical instrumentation . . . temperature and PH control in chemical labs . . . animation . . . solar power system management . . . psychological experiments . . .

discotheque lighting . . . agricultural control . . . pollution monitoring and control . . . satellite earth station control . . . and many more.

### WHO USES IT.

Hundreds of BASIC CONTROLLERS™ are being used by organizations like Honeywell, Johns Hopkins, Motorola, NOAA, Signetics, Johnson Control, Mission Bell Telephone, EPA and numerous universities.

They're solving problems and getting results with Conversational Flexibility, with the DYNABYTE BASIC CONTROLLER™.

Call and ask for Rick Mehrlich. He'll tell you more.

1005 Elwell Ct., Palo Alto, CA 94303 (415) 965-1010

# DYNABYTE

CIRCLE 94 ON INQUIRY CARD

W Olympic Blvd #707, Los Angeles, CA 90015, incorporates a high capacity 256k magnetic bubble memory (for a technology description, see "Magnetic Bubble Systems Approach Practical Use," J. E. Juliusen, *Computer Design*, Oct 76, pp 81-91). As a lower cost alternative, model 180 offers 180k bytes of mass storage in a microfloppy disc housed inside the computer case.

Built-in memory for the microcomputer is 48k bytes of dynamic RAM and 1k bytes of static RAM, expandable to over 2M bytes, plus 8k bytes of ROM expandable to 16k. External

disc drives can provide additional storage. Peripheral units, other INDEX units, and larger computers



interface to the system with its parallel and serial I/O capability.

A flat gas plasma display panel offers six rows of 40 dot matrix, upper/lower case characters. For most applications a large screen is

unnecessary since the field of view can be rapidly scanned over any data base.

The machine automates all accounting functions, suiting it to both small and larger businesses. It is functional for overall company or individual use. Also performed are other business operations, and scientific, engineering, and design computations. Addition of a model 49 interactive terminal provides 49k of RAM for scratchpad computing, independent of the main computer.

The microcomputer, priced from less than \$4900, is programmed in Business BASIC, supplied with support documentation. Also included is a comprehensive file management capability which supports a large library of business applications programs. Circle 423 on Inquiry Card

Innerhalb einer auf zukunftsorientierte Technologien ausgerichteten und in ihrer Sparte weltweit führenden internationalen Unternehmensgruppe nimmt die sehr expansive deutsche Gesellschaft einen nach Umsatz und Ertrag bedeutenden Rang ein. Diese Gesellschaft verfügt nicht nur über eine eigene Fertigung, sondern stellt gleichzeitig auch ein bedeutendes und selbstständig operierendes Entwicklungszentrum der Gruppe dar. Gegenstand der Entwicklung sind komplexe Mikro-Computer-Systeme mit „verteilter Intelligenz“ einschließlich Peripheriegeräten und umfangreicher Software.

## Leiter Bereich Entwicklung

### Internationales Unternehmen - Mikrocomputer-Systeme

Die Aufgabenstellung dieser dem Vorstand unmittelbar unterstellten Position besteht darin, im Sinne einer ständigen Rückkoppelung zwischen Markt und Entwicklung den vom Vertrieb erkannten Bedarf als Impuls aufzunehmen, umgekehrt aber auch eigene Produktideen zu konzipieren und unter Einhaltung der vorgegebenen Kosten und Termine vom Entwurf bis zur Fertigungsreife und Softwareausstattung zu entwickeln. Aus der Mitwirkung an internationalen Entwicklungsprojekten der Gruppe ergibt sich außerdem eine enge Zusammenarbeit mit den ausländischen Konzerngesellschaften. Diese interessante und herausfordernde Aufgabenstellung in einem bedeutenden Wachstumsunternehmen erfordert einen Diplom-Ingenieur der Fachrichtung Elektrotechnik oder Diplom-Physiker bis zu etwa 40 Jahren, der bereits Führungsaufgaben im Entwicklungsbereich der Sparten Mittlere Datentechnik oder EDV-Peripherie mit Erfolg wahrgenommen hat, sowohl Hardware- als auch Software-Erfahrungen besitzt und in Theorie und Praxis mit dem neuesten technischen Stand auf diesem Gebiet vertraut ist. Er muß über technische Phantasie und Führungsstärke wie über die Fähigkeit zur marktorientierten Bewertung und methodischen Realisierung von Produktideen verfügen. Dazu gehören auch praktische Erfahrungen im Projektmanagement. Wegen der internationalen Zusammenarbeit sind gute englische Sprachkenntnisse unbedingt erforderlich. Als persönlicher Berater des Vorstandes stehe ich Ihnen für weitere Informationen und ein erstes vertrauliches Gespräch telefonisch zur Verfügung: 06 11-63 20 36. Natürlich können Sie auch schriftlich mit mir Verbindung aufnehmen: Postfach 701225, 6000 Frankfurt am Main 70. Ihre Kontaktaufnahme unterliegt absoluter Vertraulichkeit, und ich verbürge mich für die Einhaltung jeder Art von Diskretion, die von Ihnen gewünscht wird.

**HEINRICH C. SCHÖN**

Unternehmensberatung Dr. Rochus Mummert und Heinrich C. Schön



# MDS 2021/2022 CARTRIDGE TAPE DRIVE -a miniperipheral with big capabilities

We've shed light upon a 3M-compatible\* cartridge tape drive that is in use by more OEM's than any other cartridge drive. It's simple to see why.

You'll find the flexibility you need for virtually any digital data handling requirement. Features like 30 ips read/write, 90 ips search and rewind, read-after-write checking, 800/1600 bpi recording density, and phase or biphas encoding on 1, 2, or 4 tracks. Storage capacity per cartridge is up to 23 million bits. But there's more to this drive's wide acceptance than meets the eye. Features like interchangeable printed circuit boards, long-life motor, and initial

low cost have made this unit particularly suitable for small system integration where cost/performance, reliability and serviceability are of utmost concern.

Applications like remote data collection, data communications, word processing, POS, and data entry are just a few ways that these drives are handling data in thousands of systems today.

To get all the facts on the MDS 2021/2022 Cartridge Tape Drive, mail the attached coupon, or call us collect today.

\*3M DC300A Data Cartridge



**MDS**

**Mohawk Data Sciences  
OEM Division  
Palisade Street,  
Herkimer, N.Y. 13350**

East Coast-Contact: H. Johnson (315) 866-5300  
West Coast-Contact: J. Engstrom (714) 772-0803

Please send me information on the MDS 2021/22 Cartridge Tape Drive.

Name \_\_\_\_\_

Title \_\_\_\_\_

Company \_\_\_\_\_

Street \_\_\_\_\_

City \_\_\_\_\_ State \_\_\_\_\_ Zip \_\_\_\_\_

I'm in a hurry. Have a representative call me at: (\_\_\_\_) \_\_\_\_\_

CD 179

CIRCLE 96 ON INQUIRY CARD

## Computer System Is Configured Upon Base System Chassis

A totally enclosed, rack mount cabinet measuring 5.25 x 17 x 12" (13.3 x 43 x 30.5 cm) serves as the base system chassis for Digital Equipment Corp's LSI-11 computer systems. BA/x3 is compatible with the LSI-11 Q-Bus, and accommodates all standard LSI-11 modules and interfaces.

Manufactured by General Robotics Corp, Components Div, 57 N Main St, Hartford, WI 53027, the chassis includes two ventilation fans and power supplies that provide 5- and 12-V power to the 8-quad slot (16-dual slot) Q-Bus backplane with card cage. Also included is a TBC terminator/bootstrap/clock module, which provides Q-Bus termination, realtime clock, power sequencing, and run enable/halt switch module. Single-quantity price is \$1650.  
Circle 424 on Inquiry Card

## Remote, Standard Typewriter Keyboard Connects to $\mu$ Computer

Touchtyping data entry to the Commodore PET™ computer is obtained with the addition of PERK™, the professional encoded remote keyboard. The typewriter style, 56-key ASCII, alphanumeric keyboard supplements the computer's half-size built-in calculator type keyboard.



The desktop, steel enclosed keyboard connects to the computer through a plug-in interface card. Once installed, it is usable on all existing software. Sharing the computer's internal keyboard interface allows the two keyboards to be used interchangeably; thus, the remote unit can be used for normal data entry and the built-in unit for numerics or graphics.

Upper and lower case characters are standard. George Risk Industries, Inc, GRI Plaza, Kimball, NE 69145 has included an alpha-lock feature for entry of upper case only or TTY mode operation. Standard CRT terminal control functions handle cursor control; full screen editing capabilities are provided.

Several keyboards may be attached to a single computer for multiple operator data entry. A UL listed power supply activates the attached keyboard and interface, eliminating any drain on the computer's power supply.  
Circle 425 on Inquiry Card

## Multiple Output dc Power Supplies Have Improved Efficiency

"Power Miser" dual and triple output high efficiency linear series regu-

lated dc power supplies are 30 to 40% higher in efficiency and 30 to 45% smaller than other series regulators. Models feature 53 to 56% efficiency, MTBF of 60k to 80k hours,  $\pm 0.05\%$  line or load regulation, 5-mV peak-to-peak ripple, tempco of 0.02%/°C, and stability of  $\pm 0.1\%$  for 24-h period after 30-min warmup. Also included are remote sensing, overload and short-circuit protection, reverse polarity protection, and inductive load protection.

Available from Adtech Power, Inc, 1621 S Sinclair St, Anaheim, CA 92806, dual output model DEMPS 12-6 is rated at  $\pm 12$  V at 6 A; model 15-5.5 is  $\pm 15$  V at 5.5 A. Triple output models are TEMPS-3 rated at 5 V at 12 A or  $\pm 12$  V at 2 A, and -4 rated at 5 V at 18 A or  $\pm 12$  V at 3 A. On 5-Vdc output units, ac input is 105 to 125 Vac, 47/440 Hz; on all others it is 105 to 125/210 to 250 Vac, 47/440 Hz.  
Circle 426 on Inquiry Card

## Error Correcting Memory Boards Support 8086 Based Products

The line of Intel Multibus™ compatible memory boards, available in 16k-, 32k-, 48k-, and 64k-word sizes, has been expanded by MuPro, 424 Oakmead Pkwy, Sunnyvale, CA 94086 to support 8086 based systems, such as the Intel i86™ 86/12. Boards are strappable for either 16-bit word or 8-bit byte memory transfers.

Three configurations are available for all four boards: single-bit error correction; double-bit error detection, single-bit parity; or without parity or error correction. Diagnostic indicators that precisely pinpoint the erring memory chip are supplied on all error correcting configurations. Error status is also available to the CPU via software control.

Additional features are onboard dynamic RAM refresh, provision for external refresh synchronization, and battery backup. Refresh logic and circuitry to power the RAM devices are connected to a separate backup power distribution bus. An input line for externally generated R/W memory protects against spurious R/W cycles during power fail switching periods. Single-quantity prices range from \$1375 (16k words/32k bytes of memory) to \$4250 (64k words/128k bytes with error checking and correction).

Circle 427 on Inquiry Card

# Interconnections bending your brain?

See page 75

# Model 820, 150 cps, 80-column, dot matrix impact print mechanism...

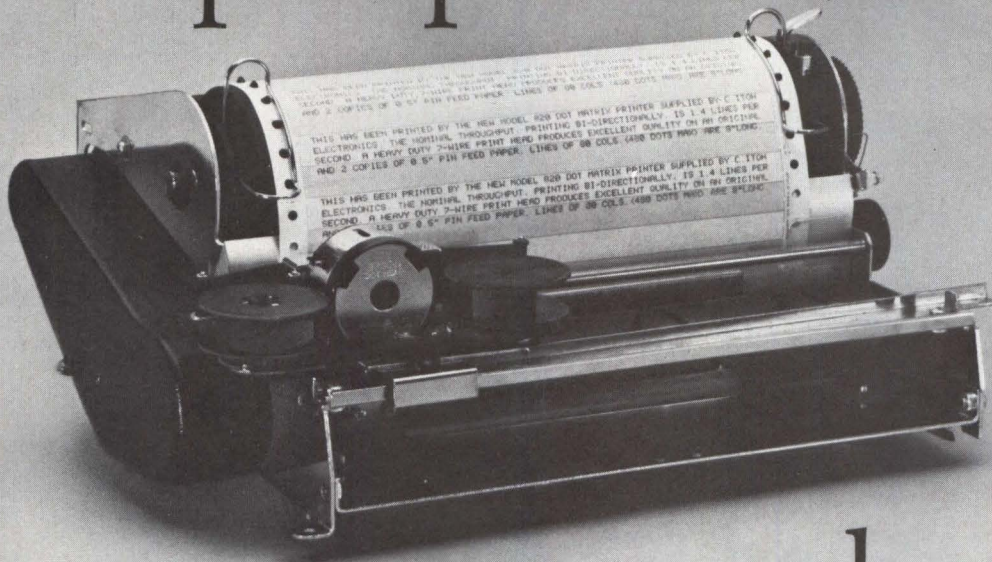

Here's the low cost bi-directional 150 cps print mechanism you've been waiting for. It's an 80-column dot-matrix impact print mechanism with a 7-wire heavy-duty, jeweled head that permits a life of 100-million characters! The mechanism utilizes an extremely simple design to achieve its cost performance and high reliability. It's the perfect OEM unit for computer output, communication terminals, data loggers, and general business applications. A sprocket paper-feed mechanism accepts standard 9.5" wide multi-ply pin-feed paper. Print line position is adjustable vertically, and paper can be loaded from the bottom or from the rear. Price, in quantities of 500, is \$230.00\* each. For detailed specifications, write or call today.

*\*Domestic U.S.A. price only.*

## **C. Itoh Electronics, Inc.**

5301 Beethoven Street, Los Angeles, CA 90066

Call: 213 390-7778 • Telex: WU 65-2451

East Coast

280 Park Avenue, New York, NY 10017

Call: 212 682-0420 • Telex: WU 12-5059

*C. Itoh means excellence in printers*

*C. Itoh Electronics is part of the 118-year-old C. Itoh & Co. Ltd. world-wide trading organization.*

**CIRCLE 97 ON INQUIRY CARD**

# When it comes to computers, SAMS PUBLISHES THE BOOKS

Introducing...



THE **BLACKSBURG** CONTINUING EDUCATION SERIES™

It has long been the objective of the "Blacksburg Group" to develop timely and effective educational materials and aids that will permit students, engineers, scientists and others to quickly learn how to apply new technologies to their particular needs. The members of the group have long been involved in digital electronics, minicomputers, and microcomputers.

The Blacksburg Continuing Education Series™ is an easy to read format consisting of 16 titles. Subjects range from basic electronics through microcomputers, operational amplifiers and active filters. Each title in the series includes detailed experiments, "hands-on" learning experiences, and examples to reinforce basic concepts. Book Size 5½" x 8½", softbound.

## Howard W. Sams & Co., Inc.

4300 West 62nd Street  
P.O. Box 558  
Indianapolis, Indiana 46206

### ORDER FORM

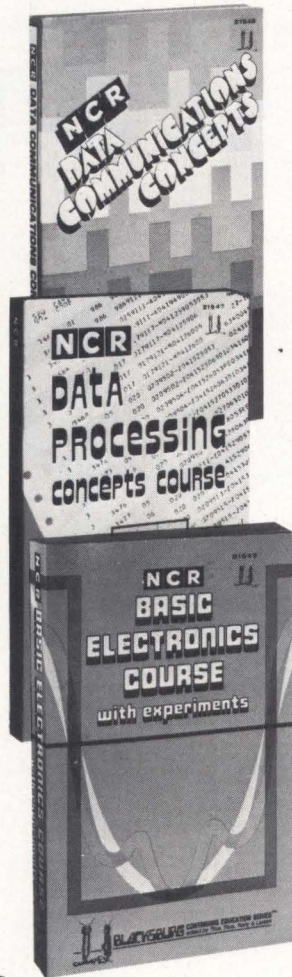

#### NCR Data Communication Concepts

An excellent introduction to the principles of data communications over transmission lines. While written mainly for telephone-based communication systems, the principles explored are applicable to most other forms of communications. Topics discussed include: basic carrier systems, transmission lines, telephone systems, modulation, modems and more. Reference tables, an extensive glossary and test questions are provided so that the book is easily used for classroom use or for self-study.

No. 21548 \$6.95

#### NCR Data Processing Concepts Course

A general introduction to computers and data processing for people who do not have a great deal of experience in programming or electronics. Sections include explanations of digital logic, computer operations, input/output devices, memories and programming in an easy to read format. A perfect starting place for both technical and non-technical people who are interested in learning more about computer operations. An excellent book for self-study, since review questions and a final exam are provided, with answers.

No. 21547 \$7.95

#### NCR Basic Electronics Course, with Experiments

A basic self-teaching course that covers basic electricity through transistors. Experiments are provided to reinforce the concepts presented in the text. The circuit elements discussed are shown in various applications that clearly illustrate their use. This book will provide an excellent foundation in basic electronics for someone who is just getting started or who just wants to know more about electronic devices and circuits. Review questions and a final test are provided so that your progress can be checked.

No. 21549 \$9.50

**PLUS . . .** there's 13 more timely computer titles. Order Today! See the complete selection on the order form below.

Quantity Ordered

- \_\_\_\_\_ DBUG: An 8080 Interpretive Debugger No. 21536 \$4.95
- \_\_\_\_\_ Design of Active Filters, with Experiments No. 21539 \$7.95
- \_\_\_\_\_ Design of Op-Amp Circuits, with Experiments No. 21537 \$7.95
- \_\_\_\_\_ Design of Phase-Locked Loop Circuits, with Experiments No. 21545 \$8.95
- \_\_\_\_\_ Interfacing and Scientific Data Communications Experiments No. 21546 (December 1978 Publication Date) \$5.95 (Tentative)
- \_\_\_\_\_ Introductory Experiments in Digital Electronics and 8080A Microcomputer Programming and Interfacing Book 1 No. 21550 \$12.95
- \_\_\_\_\_ Book 2 No. 21551 (December 1978 Publication Date) \$12.95 (Tentative)
- \_\_\_\_\_ Two Volumes No. 21552 \$23.95 (Tentative)
- \_\_\_\_\_ Logic and Memory Experiments Using TTL Integrated Circuits Book 1 No. 21542 \$10.50
- \_\_\_\_\_ Book 2 No. 21543 (December 1978 Publication Date) \$9.95 (Tentative)
- \_\_\_\_\_ Two Volumes No. 21544 \$18.95 (Tentative)
- \_\_\_\_\_ Microcomputer—Analog Converter Software and Hardware Interfacing No. 21540 \$9.50
- \_\_\_\_\_ 8080/8085 Software Design No. 21541 \$9.50
- \_\_\_\_\_ NCR Basic Electronics Course, with Experiments No. 21549 \$9.50
- \_\_\_\_\_ NCR Data Communications Concepts No. 21548 \$6.95
- \_\_\_\_\_ NCR Data Processing Concepts Course No. 21547 \$7.95

Quantity Ordered

- \_\_\_\_\_ 555 Timer Applications Sourcebook, with Experiments No. 21538 \$5.95
- \_\_\_\_\_ The 8080A Bugbook® Microcomputer Interfacing and Programming. Bugbook® is a registered trademark of E & L Instruments, Inc., Derby, Connecticut 06418. No. 21447 \$10.50

- \_\_\_\_\_ Sub Total
- \_\_\_\_\_ Add local sales tax where applicable.
- \_\_\_\_\_ Total Amount

Name \_\_\_\_\_

Address \_\_\_\_\_

City \_\_\_\_\_ State \_\_\_\_\_ Zip \_\_\_\_\_  
(please print)

Save handling charges by enclosing payment with order.

- Payment Enclosed (No Shipping and Handling Charge)
- Bill Me (Shipping and Handling Charge will be added)
- Send me Free Sams Book Catalog

Prices subject to change without notice. 406

Return To:  
Attention: Sales Department  
**Howard W. Sams & Co., Inc.**  
4300 West 62nd Street • P.O. Box 558 • Indianapolis, IN 46206

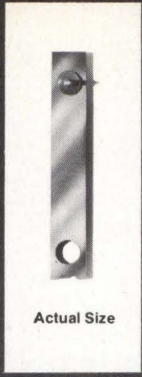

From an elegantly simple print mechanism based on this unique leaf spring hammer and advanced matrix line printing technology . . . print quality and reliability no other impact printer can match . . . plus full plotting capability at no extra cost that band, drum or chain printers can't provide at any price.

# PRINTRONIX..today's 'First Family' in medium speed impact printers.

In 1975, Printronix introduced the first printer designed to fill the need for medium speed impact printing at practical prices. The unique concept and design of this matrix impact line printer brought unequalled print quality to impact printing. Its elegant simplicity, with up to 50% fewer parts than band, drum or chain printers, also established proportionately higher levels of reliability. Today, they are available in 150, 300 and 600 line-per-minute models priced about the same or less than medium speed band, drum or chain printers. They're warranted for one full year while 90 days is typical for others. And they all offer you one feature band, drum or chain printers can't: full graphics plotting capability. Get acquainted with our family. You might be captivated by their cost/performance and cost of ownership attributes. They're all up for adoption. Printronix, Inc., 17421 Derian Ave., P.O. Box 19559, Irvine, CA 92713. (714) 549-8272. TWX: (910) 595-2535.

**PRINTRONIX**  
CIRCLE 164 ON INQUIRY CARD

150 lpm P150



300 lpm P300

600 lpm P600

## 1k, 2k, 4k EPROM Programmer Covers Eight Microcomputers

Software for programming and verifying programming is available for the 6800, 8080, 8085, Z80, 6502, F8, 1802, and 2650 based microcomputers with the EP-2A-79 EPROM programmer. Supplied as a listing, the software requires approximately 256 bytes of RAM; instructions are included for relocating it.

Packaged in a sloping panel aluminum case, the unit connects to the microcomputer with a 14-pin ribbon cable through 1½ I/O ports. Optimal Technology, Inc, Blue Wood 127, Earlsyville, VA 22936 supplies the personality modules that plug into the front panel mounted socket for programming Intel 2708, 2716, Texas Instruments TMS 2716, 2708, 2532, and 2732 EPROMS. Power requirements are 115 Vac, 50/60 Hz at 15 W.

Circle 428 on Inquiry Card

## Single Cabinet Houses µComputer With Double-Density Floppy Discs

DSC-80 is an SBC-80 compatible microcomputer with two Shugart double-density floppy discs in a single cabinet. An 8080 CPU card, choice of 32k or 64k RAM card, multidensity DMA disc controller, two Shugart 800 disc drives, power supply, and fan comprise the system.

The CPU card includes an 8080 microprocessor, realtime clock, interrupts, four RS-232 ports, and the interface to the disc controller. The motherboard has slots for five cards with space for three wirewrap cards.

The disc controller uses IBM 3740 format or a double-density format of 571k bytes/single-sided diskette (77 tracks of 58 sectors with 128 bytes/sector). Data transfers for sector R/W are handled through a DMA interface, permitting concurrent processor execution.

Digital Microsystems, 4448 Piedmont Ave, Oakland, CA 94611 supplies the CP/M operating system, BASIC-E, CBASIC, FORTRAN, PASCAL, and COBOL. The complete system with 32k memory is \$5685; with 64k, it is \$6185. Circle 429 on Inquiry Card

## Sense Option With Multibus DAC Maintains 12-Bit Performance

The Intel 735/DAC series of D-A converters, built on 12 x 6.75" (30.5 x 17.1-cm) PC boards, plug directly into the Multibus™ of Intel SBC-80/10 and /20 systems. The unit contains up to four 12-bit DACs with double buffered latches and programmed pulse circuit for scope blanking and recorder pen control. For scope driving applications, two signals are available for blanking or unblanking of the CRT trace.

Introduced by Adac Corp, 15 Cummings Pk, Woburn, MA 01801, the system has an optional third wire sense lead from each DAC that allows 12-bit performance to be maintained even when the DAC outputs are to be run a distance to the loads. Rejection of differences of potential up to 1.5 V between the computer ground and load ground are possible with the option.

For industrial applications, the DACs may be supplied with voltage to current amplifiers to convert the precise output voltage of the DAC into a 4- to 20-mA programmable constant current supply. Total load resistance from 0 to 500 Ω can be accommodated.

Also provided are uncommitted 8-bit read and separate 8-bit write registers; alternately, the output of the write register may be connected to the read lines to provide an 8-bit R/W register. Each of the eight output lines are also connected to high current output drivers so that the lines may sink 300 mA each from loads returned up to 32 V. These lines can be used to directly drive incandescent lamps or relays.

Circle 430 on Inquiry Card

## Controller Interfaces Disc Drives to S-100 Bus Microcomputer Systems

SMC-100 controller interfaces up to four storage module technology disc drives to S-100 bus based microcomputer systems. Storage of from 14M to 1.2G bytes is provided.

The controller uses a DMA scheme to transfer 64k bytes of data in less than 350 ms. Data are transferred in

blocks using two machine cycles/byte (slower if the user's memory requires). Each sector is fully buffered on the controller.

Konan Corp, 1434 N 27th Ave, Phoenix, AZ 85009 developed the controller to use I/O commands for all functions. The unit may be used with or without formatting, and features automatic error recovery and multiple sector transfers. A driver/ROM is also available, which performs the indicated disc operations along with automatic error recovery and multiple sector transfers.

Circle 431 on Inquiry Card

## Desktop Computer Configures All Elements Into Single Unit

PCC 2000 business computer system combines a 3-MHz 8085A microprocessor; two 32k memory boards; two FD514 double-density, 8.5" (21.6-cm) floppy disc drives; and 12" (30.5-cm) video display monitor with upper and lower case letters in one desktop unit. A detachable keyboard provides a 63-key alphanumeric area, with a 15-key numeric entry capability and 12-key function pad with edit and cursor control capabilities.

Pertec Computer Corp's Microsystems Div, Chatsworth, CA 91311 has added more memory capacity by moving the refresh control logic to the CPU card. Using eight levels of vectored interrupts, the computer also has 4-channel DMA. The pair of floppy disc drives store 1M bytes of data online. Interface to the FD double-density controller is on the same board as the controller for an optional line printer.

Standard 24 lines of 80 characters is provided on the display, with a 7 x 9 dot matrix. Lower case characters are shifted downward by two dots to provide descenders, giving an apparent 7 x 11 dot matrix. Graphics are created through specification of horizontal, vertical, and double vertical lines.

Applications software is available for general ledger, accounts receivable, payroll, and inventory management. A disc extended BASIC operating system handles applications programming.

Circle 432 on Inquiry Card

# THIS IS THE ONLY DECENT LOW COST 165 CPS MATRIX PRINTER YOU CAN GET IN VOLUME RIGHT NOW.

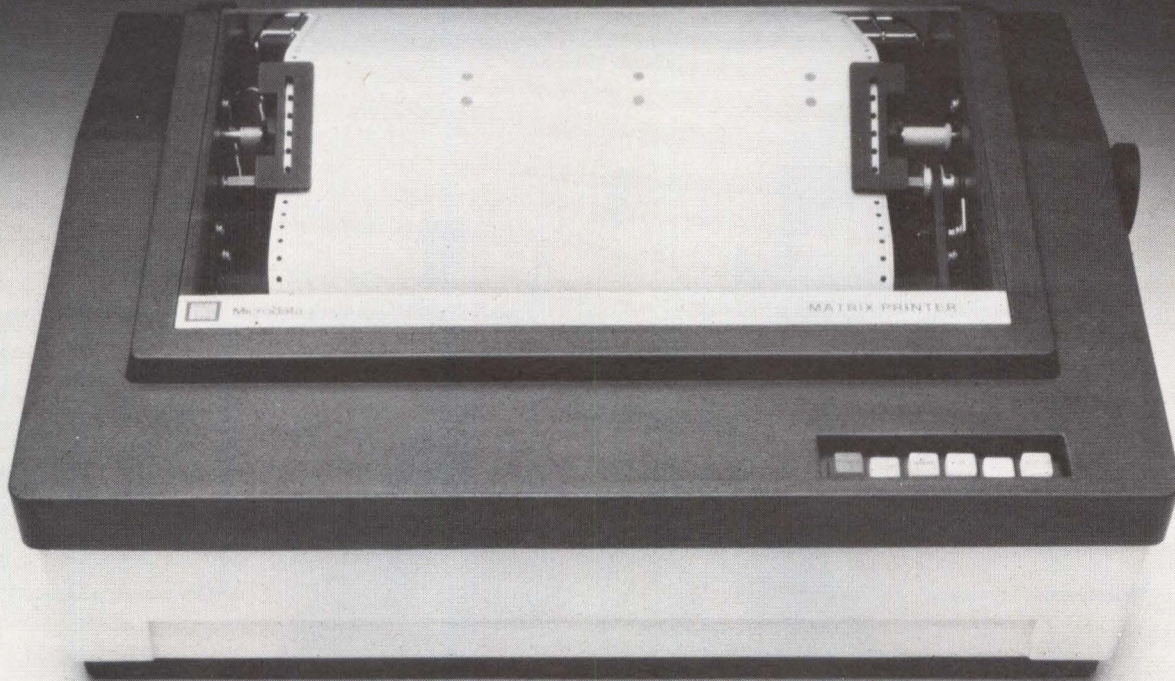

Other people make them, of course. But you can't get them in volume. Unless you're willing to wait a very long time. And in this business a printer you can't get is about as useful as all those wonderful products that haven't been invented yet.

Even if you did have a wide variety to choose from, you'd probably choose our Matrix printer anyway. Micro-processor control makes it efficient, fast and reliable. And it's programmable from your computer or optional keyboard.

Bidirectional printing and paper feed gives you true graphics capabilities. Special character sets, including foreign language alphabets, provide incredible flexibility. And when you add the optional keyboard, it becomes a remote communications terminal.

Matrix is compatible with all industry standard RS-232-C or parallel interfaces, so you can plug it in just about anywhere.

If you need a good matrix printer in volume and you can't wait forever, contact one of our local sales offices or the Director of OEM Sales, Microdata Corporation, 17481 Red Hill Avenue, P.O. Box 19501, Irvine, CA 92713. Telephone: 714/540-6730. TWX: 910-595-1764.

#### **SALES OFFICES**

Boston 617/890-2020  
Chicago 312/364-5820  
Los Angeles 714/533-8035  
San Jose 408/245-5013  
Washington, DC 703/620-3995

## **Microdata** OEM Products

**A significant difference.**

**CIRCLE 100 ON INQUIRY CARD**

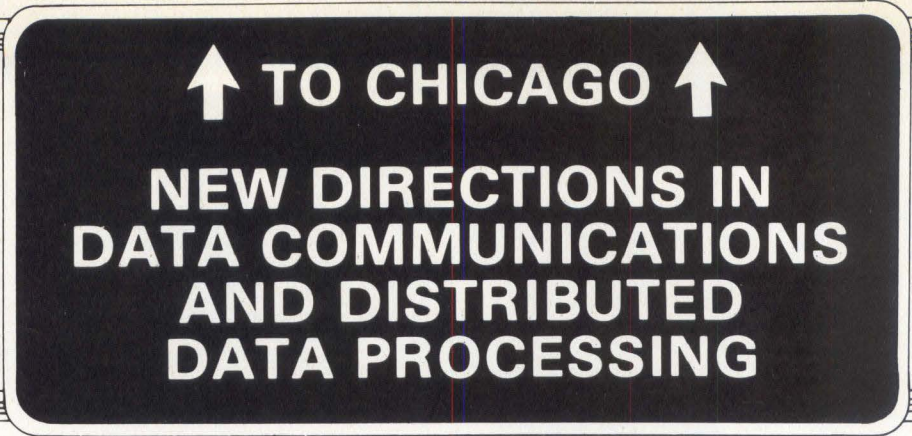

OVER  
**70**  
SESSIONS

OVER  
**800**  
EXHIBIT  
BOOTHs



## NEW DIRECTIONS

*In DDP -- FUTURE TRENDS*

*In DDP Management -- ORGANIZING FOR TOMORROW*

*For the new user -- DATACOMM SCHOOL*

*For the experienced user -- APPLICATIONS FORUMS*

*In software -- MERGING THE DATA BASE AND DATACOMM ENVIRONMENTS*

*In total network services -- ACS, SBS, XTN*

*In office communications -- THE 'DISTRIBUTED' OFFICE*

*In terminals -- MORE INTELLIGENCE AT LESS COST*

*On the international scene -- EXPANDING MULTINATIONAL LINKS*

*In security -- MAINTAINING DATA AND SYSTEM INTEGRITY*

*In technology -- MICROS, MEDIA AND MESSAGES*

The new directions that data communications and DDP are taking today are pointing the way to tomorrow's world of processing data. Plan now to be well along that road.

**Plan now to attend INTERFACE '79 . . .**

**The largest data communications conference and exposition in the world.**



# Data Communications INTERFACE '79

The Seventh Annual National Data Communications Conference and Exposition

Co Sponsored by DATAMATION Magazine

**McCormick Place, Chicago  
April 9-12, 1979**

Conference and Exposition Management  
by **THE INTERFACE Group**  
160 Speen St., Framingham, MA 01701  
Call toll-free (800) 225-4620.  
In Massachusetts call (617) 879-4502.



# Quality print is Sprint 5's trademark.

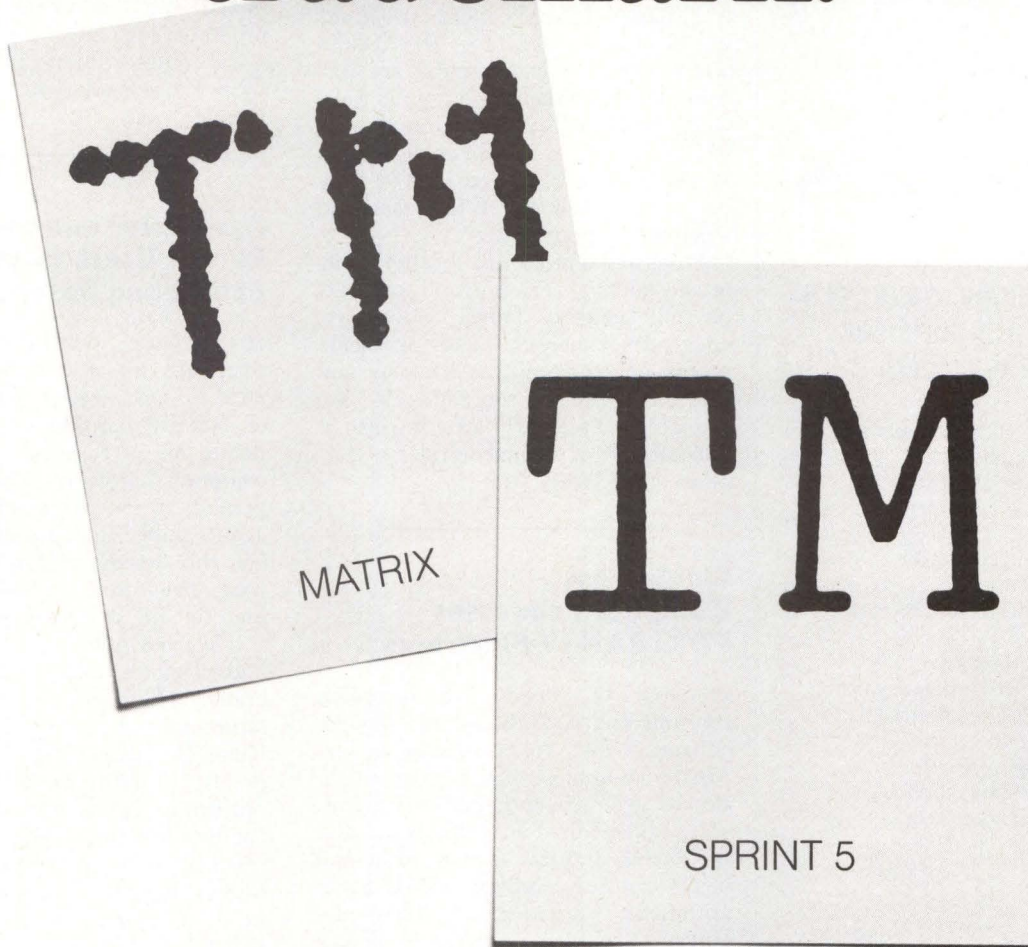

For all those times when you wish your computer could print letter quality, you need a Sprint 5 Daisywheel Terminal from Qume.

Its fully-formed characters are always clear, distinct, eminently readable. (Even after they've been enlarged 1000%.)

Perfect for executive reports, financial statements, and any other application where neatness counts.

But the Sprint

5 does more than give you outstanding print quality. Much more.

Thanks to our dynamic positioning feature, it easily plots, creates

graphs, and justifies text. With switch selectable 10 or 12 character per inch spacing.

What's more, Sprint 5 comes with a wide selection of MultiColor™ ribbons including red/black. And over 60 different typefaces.

The Sprint 5 Daisywheel Terminal and RO Printer from Qume.

When it comes to dots versus daisies, our advantages are easy to see.

**Qume**<sup>®</sup>  
the printed word



For more information, contact your nearest data terminal dealer or Qume, 2323 Industrial Parkway West, Hayward, California 94545.



## 950 Series MICRO-DISCS

**Finest minidisc recorders.**  
Technically superior,  
yet low priced.

- Desktop & rackmount models
- Uses 5¼" minidiskettes
- Double density 200,000 characters per disc side—first in the industry
- Automatic "next location" recording
- File directory recorded on each disc
- Disc Editor—character insertion/deletion, data expansion, file update/delete/append, GO TO commands
- Character string search
- File/Batch/Binary modes
- High speed random access—all modes
- Multiple rates—110 to 9600 Baud
- Dual RS232 interfaces—terminal/modem
- 8085 microprocessor controlled—powerful

priced from \$1395.00

Also datacassette recorders  
from \$950.00  
Portable hand-held systems  
from \$825.00

**Send for full details:**

**TECHTRAN**  
INDUSTRIES, INC

200 Commerce Drive  
Rochester, New York 14623  
Tel: 716-334-9640  
TWX: 510-253-3246  
Calif. 213-391-0507

### SOFTWARE

#### Ready-to-Run Software Provides $\mu$ Computer With Application Programs

A library of applications programs specifically written for the Radio Shack TRS-80 microcomputer are distributed on diskettes by AJA Software, PO Box 2528, Orange, CA 92669. Minimum system configuration is TRS-80 BASIC, one or more floppy disc drives, and 8k of free memory; a printer is optional.

Programs offered are a letter writer, accounts receivable and payable, payroll, general ledger, inventory, sales/sales analysis, and medical/professional billing; TRS-80 BASIC and disc BASIC tutorial programs also are available. Packages are priced at \$35 each, with documentation.

Circle 433 on Inquiry Card

#### Single-Pass Compiler Processes FORTRAN IV Programs

FORTRAN IV version 2.9 compiler, meeting the ANSI Standard, has an enhanced disc I/O package, an extensive subroutine library, and facilities to generate and manage relocatable object modules. Random disc file access, transfer of control at end of file or error condition, mixed mode arithmetic, hexadecimal constants, logical variables, logical do loops, and 16-digit double precision arithmetic are added compiler enhancements.

The compiler processes several hundred statements/min in a single pass, using less than 24k bytes of memory to compile most programs. The revised version of Microsoft FORTRAN offers additional diskette protection and program error security.

Relocatable code is generated enabling the user to write and test programs in modules. IMSAI Manufacturing Corp, 14860 Wicks Blvd, San Leandro, CA 94577 has devised it this way so that only a changed module has to be recompiled.

FORTRAN and/or assembler modules are linked using a compatible assembler and linking loader. Only

subroutines and system routines that are needed to run a FORTRAN program are loaded before execution. Once loaded, the machine language image can be saved so that the program can later execute directly. A subroutine library is also utilized. Circle 434 on Inquiry Card

#### Assembler and Simulator Permit Users to Write and Debug Software

A software development package that runs on any of the company's MCZ or ZDS systems with 60k bytes of memory permits users to write and debug Z8 software without Z8 microcomputer hardware. Two major components of the package by Zilog, Inc, 10340 Bubb Rd, Cupertino, CA 95014 are the assembler for the Z8 PLZ/ASM structured assembly language and the Z8 simulator. Price is \$950.

The assembler allows relocatable and absolute object code to be generated. High level control and data structures enable the user to balance structured programming practices with machine dependent operations. Special features include conditional statements, statements to execute one of several groups of instructions depending on the value in a selector register, looping construct, and procedures. Data structures include bytes, words, arrays, and records. Data and instructions can be mapped into any of the microcomputer's three address spaces: register, data, and program.

The simulator allows the user to set and display simulated memory, set breakpoints, and access simulated external memory. It also handles ports, provides for code execution timing, logs its output, and has macro capability. A shadow memory tells the user whether a particular memory location has been read, written, or executed. The user verifies only time-dependent code since a program can be completely debugged using the simulator before it is put onto the Z8 microcomputer. □ Circle 435 on Inquiry Card

**C-R-T, C-R-T, alpha-numericity,  
ASCII-key, multi-key, programmability,  
Blinkity, blankety video-bility,  
Up-down-left-right cursing, absolute addressing,  
Insert string, delete string, erase and back-tabbing,  
Editing,  
editing,  
C-R-T editing ...**



## **No bones about it.**

What you need now is some straight talk about Smart Editing CRT Terminals.

Selecting the right CRT for your system isn't easy. You're trying to find a fully capable Editing Terminal in a CRT marketplace that's crowded with a dizzying array of contenders at prices ranging all the way from a few hundred dollars to several thousands.

You'll be glad to know that for \$1500 or less, you can buy all the performance, reliability and support you need in a Smart Editing Terminal from at least four manufacturers — ADDS, Beehive, LSI, and EECO, of course. That's the conclusion of a comprehensive, straightforward report that frankly compares your alternatives model by model, spec for spec.

Get it straight — write for your free copy of "Choosing the right Smart Editing Terminal from the crowd of CRT's" today.

# **EECO** editor

EECO, 1441 East Chestnut Avenue, Santa Ana, CA 92701 • (714) 835-6000



## UPDATE ON EPROMS

**Manolito Adan and Scott Smith**

Integrated Computer Systems  
Santa Monica, California

Inherent design qualifications of ultraviolet erasable programmable read-only memories provide particular benefits for use in microcomputer systems. They offer functional compatibility with masked read-only memories and even with static random-access memories, and are upward compatible as new techniques are developed. Also, because microcomputer manufacturers have been regularly including them in their systems, ultraviolet erasable programmable read-only memories have attained even further improvements in architecture and have evolved into being among the best integrated subsystems in the microcomputers.

### Basic Theory of Operation

An ultraviolet (uv) erasable programmable read-only memory (EPROM) is a read-only memory whose data are stored "permanently" as charges on the gates of single MOSFET transistors. Each transistor contains a select gate and a floating gate as shown in Fig 1. These gates are electrically isolated and are programmed by injection with a charge of high energy electrons, accomplished by placing a high voltage potential (25 V is typical) across the substrate and either the source or drain. This results in "hot" electrons injecting across the silicon dioxide barrier to charge the floating gate. The charge on the floating gate increases the threshold voltages at the select gate, and the operating characteristics of the transistor are thereby altered. When the transistor is accessed, its normal or altered threshold is translated as a 1 or 0.

The memory can be erased by subjecting it to a strong uv light. This causes the electrons in the floating gate to excite to such a high level that they "bleed" off into the channel regions. All words are erased, with the required exposure time varying from 10 to 30 minutes.

### System Operating Features and Consideration

When implementing multichip memory systems, it has been traditional to solve bus contention conflicts as in Fig 2, utilizing a single control line on the memory chip called chip select (cs). This worked well in older slower microprocessor systems in which the CPU chip was the limiting speed factor, with the times required for decoding the memories being almost leisurely in comparison.

However, with the appearance of fast microprocessors having demanding memory cycle speed requirements, the older single control line approach runs into difficulty. There is a possibility that the address decode and chip select propagation delays might cause a memory device to place its data on the data bus before a previously selected device had removed its contents. This could result in two devices (one with 1 data, the other with 0 data) shorting the power supply to ground for a brief

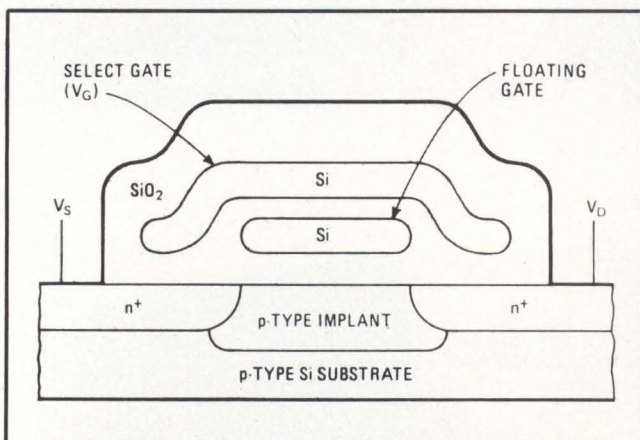

Fig 1 Basic EPROM memory cell.<sup>1</sup> Floating gate is central feature of this semiconductor component. Not electrically connected to anything, it is accessed via injection of electrons resulting from short but powerful pulse applied between substrate and either V<sub>s</sub> or V<sub>o</sub> (Reprinted from *Electronics*, Mar 3, 1977. Copyright McGraw-Hill, Inc 1977)

# A ChainTrain® by any other name is still the best Line Printer you can own.

Yet, when it comes to Line Printers, our popularity is exceeded only by our anonymity. Outside of a select group of the best OEM's in the computer industry who proudly put their label on our ChainTrain Line Printers, not a heckuva lot of people know who we are.

But that's alright. We didn't set out to make a name for ourselves. We set out to make the best damned Line Printer money can buy. And that's what we've been doing for the past 10 years... building reliable, dependable, field-proven Printers offering the best price/performance features on the market.

Building a complete, compatible family of Printers to meet any need - 16 models, 160 to 1200 LPM, 48-64-96-&-128 character sets. We also built-in remarkable flexibility - 96 and 128 characters in Standard, European, and Exotic fonts.

And ChainTrain's perfect print alignment produces crystal clear multi-copies up to 6 parts.

With all this in mind, you owe it to yourself to find out more about Data Printer Corp's ChainTrain Line Printer. Compare us free for 30 days and really check us out. To know us is to love us.

CD-1

Yes, I'm interested in your printers.

Send me more information.

Have your representative contact me.

Name \_\_\_\_\_ Title \_\_\_\_\_

Company \_\_\_\_\_

Address \_\_\_\_\_

City/State/Zip \_\_\_\_\_

Telephone \_\_\_\_\_

Mail to: Nick Siedun  
Data Printer Corp  
99 Middlesex St., Malden, MA 02148



DATA PRINTER CORP  
99 Middlesex Street, Malden, MA 02148  
Tel: (617) 321-2400 TWX: 710-348-0794  
Regional Sales Offices: Clifton, NJ, Costa Mesa, CA



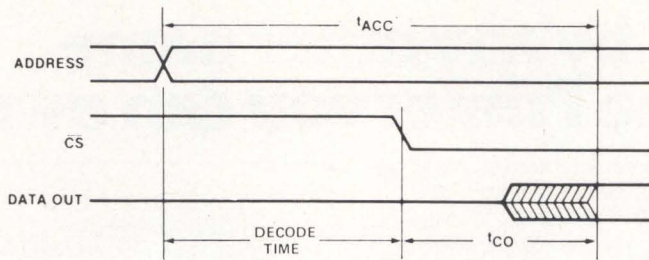

(a)

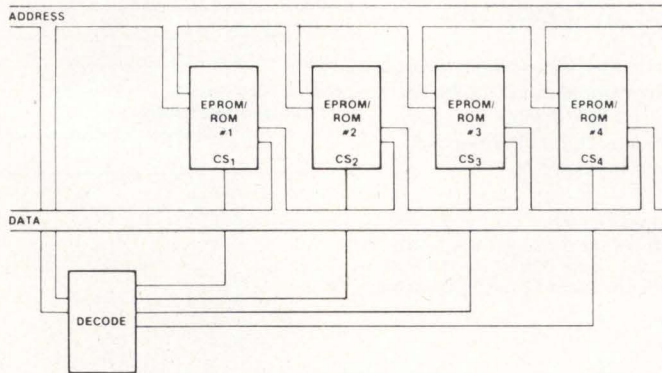

(b)

Fig 2 Memory select architecture utilizing chip select line only.<sup>2</sup> In this strategy, address decoding within chip is augmented by external decode circuit which selects device on basis of higher order address bits. Note that any glitches in address or CS lines are carried over in time via  $t_{ACC}$  and  $t_{CO}$  delays and can cause conflicts on data bus (Reprinted by permission of Intel Corp)

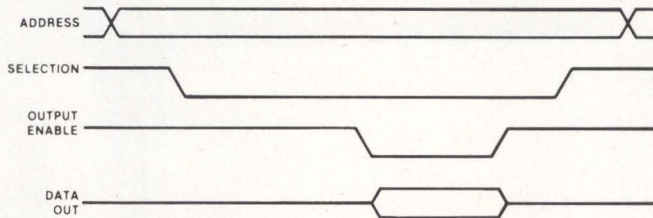

(a)

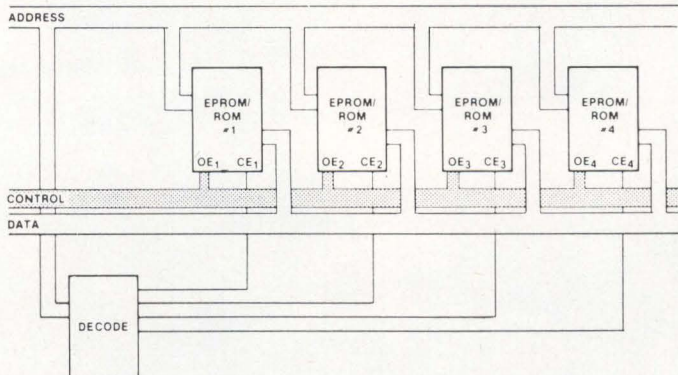

(b)

Fig 3 Memory select architecture utilizing chip select and output enable time.<sup>2</sup> Any possible bus contention resulting from addressing propagation delays is at least confined to data out "window" defined by output enable line. Not only does this constrain possibility of two devices "colluding" to short power to ground (power "glitches") but it also makes data bus available for use by non-memory components such as I/O ports (Reprinted by permission of Intel Corp)

# Versatec outdraws CalComp!

"A CalComp drum plotter needed 175 twenty-four-hour days to plot the 9000 drawings. Versatec did the job in less than 15 hours."

"CPU time is no problem. Total I/O and CPU time for 33,000 vectors is less than ten seconds."

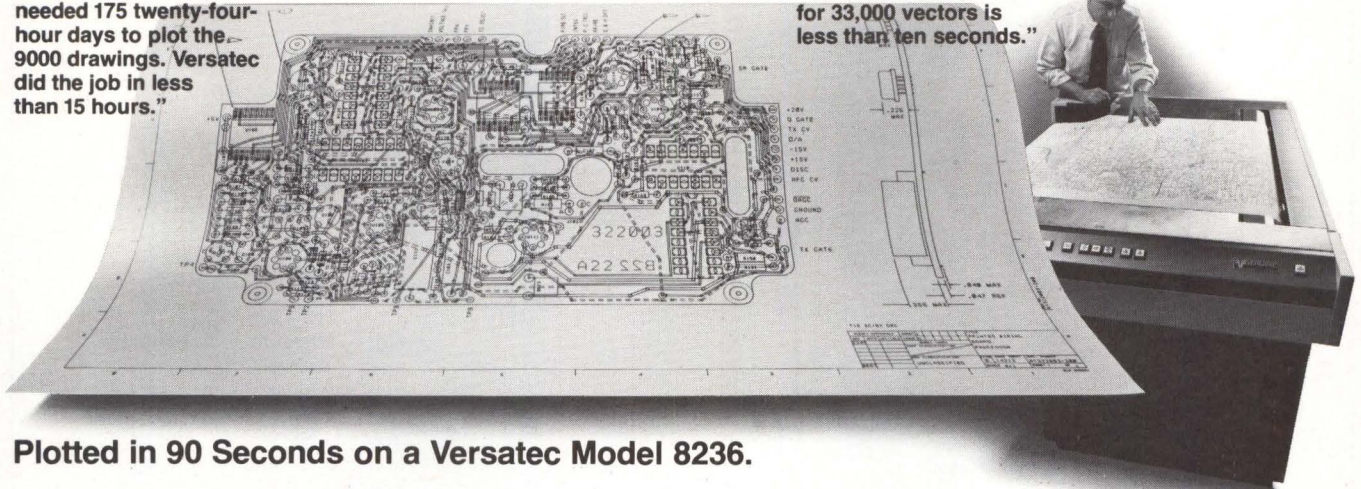

**Plotted in 90 Seconds on a Versatec Model 8236.**

## Versatec challenges pen plotters to a "draw-out."

**Name your plot.** Scientific graphics or business PERT charts. Maps or production drawings. Engineering simulations or circuit designs. Versatec will draw them faster, more reliably, and with far more expression than any other plotter.

Why wait minutes, even hours for pen plots? Versatec can produce a typical E-size drawing in less than sixty seconds.

Think what this speed could do for your own computer plotting. More throughput. Faster turnaround. Practical updates that give you visualizations now, not later.

**Draw with more eloquence.** High data density slows pen plotters to a crawl, but Versatec maintains constant speed. Produce subtle shading, toned patterns and variable line widths that are impractical, difficult, even impossible for pen plotters.

**Print as you draw.** Lettering is a problem for pen plotters, but not for Versatec. Display captions, legends and other alphanumeric data without losing a second. A simultaneous print/plot feature permits overlay of plot data and hardware generated print characters on the same scan line.

**Enjoy troublefree plotting.** Versatec electrostatics write without cranky mechanical arms and sputtering pens. No smears, skips or overshoots. Plot with fewer adjustments, less waste and less downtime.

**Draw for less.** With all these advantages, a Versatec electrostatic still costs about the same as a drum plotter system or about half as much as a comparable flatbed.

**We've got you covered.** Paper widths of 8½", 11", 20", 22", 24", 36", 42" and 72". Software that links directly to your existing application programs. Controllers that connect Versatec to all popular computers. On-line and off-line systems for IBM 360/370 users that plot drawings from vector data in seconds without changing IBM hardware, operating systems or graphics software.

**So challenge us.** Circle our readers' service number for a brochure or fill out the coupon for specific information and plot samples. Better yet, call Versatec to arrange your own "draw-out."

2805 Bowers Avenue  
Santa Clara, California 95051  
(408) 988-2800

Please send literature:

- Plotters, printers and printer/plotters
- Hard copy direct from CRT
- Versaplot software
- The IBM/370 plotting system

Please send samples:

- Business graphics
- Computer aided design
- Mapping
- Scientific applications
- Production drawings

computer model and operating system

name

telephone

organization

address

city, state and zip

**VERSATEC**  
A XEROX COMPANY

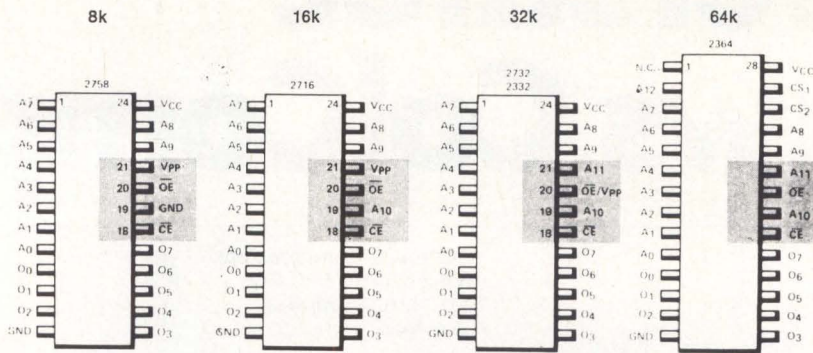

(a)

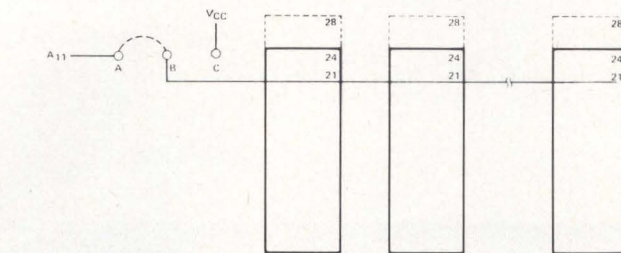

32k-Bit Density and Higher

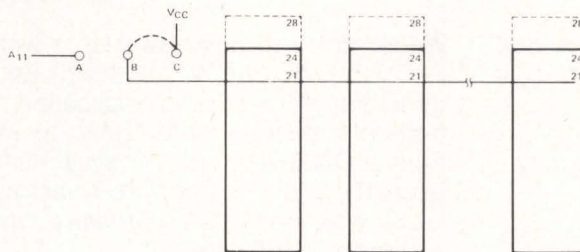

8k- and 16k-Density Devices

(b)

Fig 4 Upward compatibility among EPROMs.<sup>2</sup> Basic ROM pin layout is shown for 8k device (a). Memory is upgraded by simply changing one pin for each doubling of capacity. For example, upgrading from 16k to 32k can most easily be accomplished by incorporating jumper in original design (b) Reprinted by permission of Intel Corp)

period. Even if chip damage does not result, the instantaneous and severe loads could place an impossible demand on the power supply's regulating capacity. Consequently, glitches could occur in the supply voltage, and the other circuits could frequently malfunction, particularly if they are bipolar.

A solution is implemented in newer memories in the form of an output enable line (Fig 3). This line gates the output of the memory on the data bus and is not affected by address or chip select propagation delays. Consequently, bus contention by two devices resulting from propagation delays can be eliminated.

### EPROM/ROM Compatibility

As semiconductor technology has evolved, producing denser memories, upward compatibility of EPROM/ROM families has often played an important role in the design of microcomputer systems. When software, usually in EPROM, stabilizes during the development cycle, users

eventually opt for denser, less expensive memory in the form of ROMs, thus modularizing firmware and minimizing device counts.

Pinout evolution of EPROMs can be traced to the introduction of the Intel 1702A and its ROM counterpart, the 1302. One can surmise that, at any point in time, the present industry standard EPROM determines the pinout for the next generation ROM. For example, the 2708 EPROM (developed to be compatible with the 8080 both in access time and voltage supply requirements) has a ROM counterpart in the newly developed 2308 ROM. Since ROM density usually leads EPROM density by a factor of two and ROM density can always be adapted to any specified EPROM density, users generally can obtain a ROM that is pin compatible with any given EPROM.

Introduction of third generation microprocessors such as the 3-MHz Intel 8085A and the 5-MHz 8086 necessitates the development of compatible devices in terms of single power supply as well as speed requirements. New 5-V EPROM families developed by Intel and Texas Instru-



# Remex vs. the two-headed monster.

Were all those dual-head promises just fairy tales?

A lot of people are starting to think so.

They waited. And they waited. And what they finally got for their trouble was trouble — a two-headed monster that ate diskettes.

Until the Remex RFD 4000 rode in on a white horse, that is.

## Is it taps for dual-head technology?

Tap, tap, tap went the heads against the diskettes.

In no time at all tap tests showed that dual-head drives not only offered twice the bytes, they took twice the bites out of the media.

Diskettes just wore out too fast, causing errors.

"Off with their heads," shouted customers.

## Rejoice. Two heads really are better than one.

Remex RFD 4000 to the rescue.

Its improved dual head and carriage assembly treat diskettes gentle as a lamb. The ceramic bottom head is fixed in a special lightweight carriage while the top head is mounted via a movable load arm.

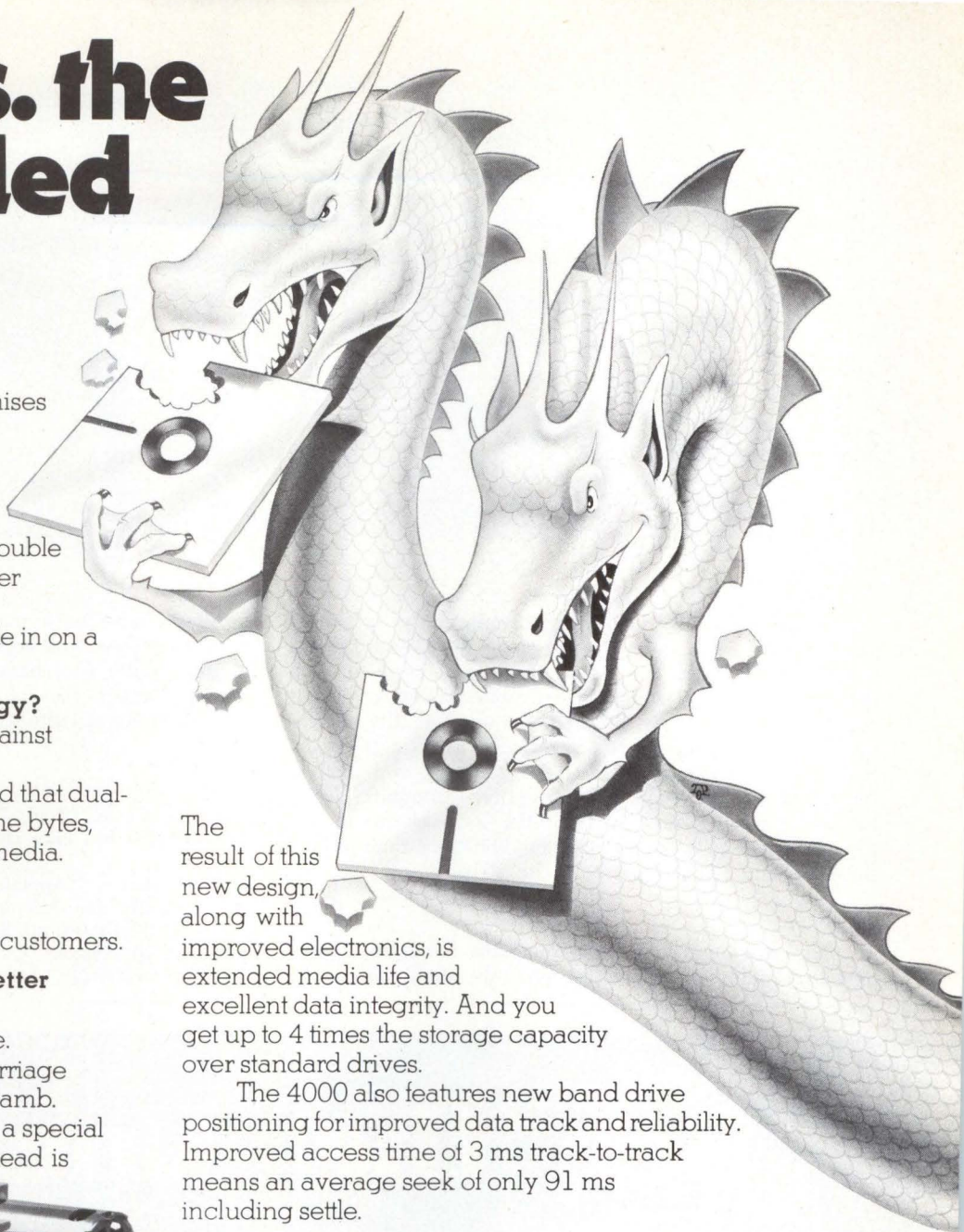
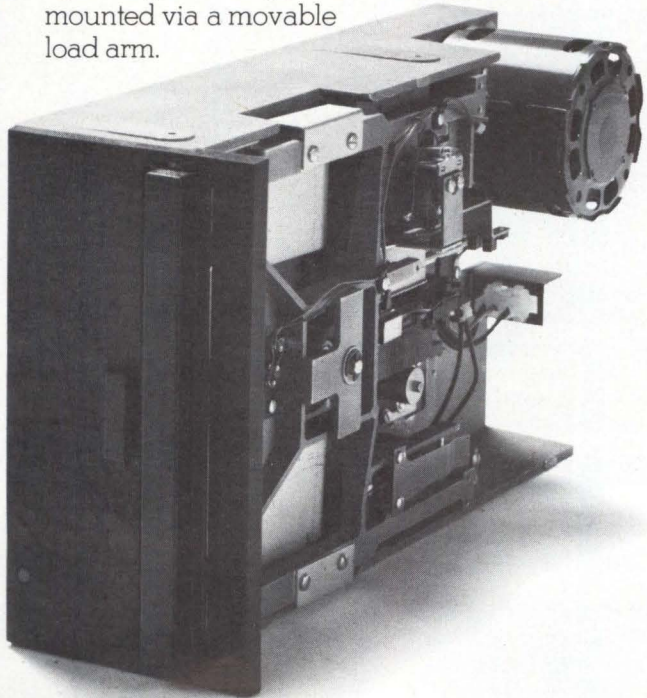

The result of this new design, along with improved electronics, is extended media life and excellent data integrity. And you get up to 4 times the storage capacity over standard drives.

The 4000 also features new band drive positioning for improved data track and reliability. Improved access time of 3 ms track-to-track means an average seek of only 91 ms including settle.

## Shugart/IBM-compatible

What's more, it's physically and electrically compatible with systems designed to use other popular dual-head drives. And it's backed by one of the strongest companies in the realm.

Ex-Cell-O Corporation, Remex Division, 1733 E. Alton St., P.O. Box C19533, Irvine, CA 92713. Phone: 714/557-6860.

TWX: 910/595-1715.

Call us if you're in distress.

Ex-Cell-O Corporation

**REMEX** DIVISION

**Paper isn't the only thing we look good on.**

CIRCLE 106 ON INQUIRY CARD



Typical Commercially Available MOS EPROMs (UV Type)

Vendor	Model No	Interchangeable ROM	Size	Organization	Maximum Access Time (ns)	Power Supply	Maximum Active	Current (mA) Standby
Intel	1702A	1302	2k	256 x 8	1000	5, -9	65	65
Intel	2704	—	4k	512 x 8	450	12, ±5	65	65
Intel	2708	2308	8k	1024 x 8	450	12, ±5	65	65
Intel	2716	2316E	16k	2048 x 8	450	5	100	100
TI	2716	—	16k	2048 x 8	450	12, ±5	45	45
TI	2516	—	16k	2048 x 8	450	5	100	25
Intel	2732	2332	32k	4096 x 8	300	5	40	15
TI	2532	4732	32k	4096 x 8	450	5	168	10

Data in part from Ref 3

ments offer versatility in upward compatibility by simply reassigning the functions of four pins (Fig 4 and Table).

Texas Instruments has noted that many users develop their software in RAM and then switch over to EPROM when the programs are finished. To assist in the switch-over, Texas Instruments has introduced a static 16k RAM, the 4016, that is compatible with their 2k x 8 EPROM, the 2516. In the read mode, functional compatibility is complete; when switching from the RAM to the EPROM the user needs to make no other modifications than pulling the 4016 and replacing it with the 2516.

Summary

EPROMs have evolved from a specialized unique component to a highly evolved integrated subsystem component.

Efforts have been made to generate families of masked ROM, EPROM, and RAM in which the components can be functionally interchanged with each other. These developments assure the role of the EPROM as a basic component in the architecture of microcomputer systems.

References

1. R. Green, *et al*, "The biggest erasable PROM yet puts 16,384 bits on a chip," *Electronics*, Mar 3, 1977, pp 108-111
2. R. Green, "Application of Intel's 5-V EPROM and ROM Family for Microprocessor Systems," Application Note AP-30, Intel Corp, Santa Clara, Calif, 1978, pp 1-7
3. E. R. Hnatek, "Current Semiconductor Memories," *Computer Design*, Apr 1978, pp 118-119

# See the Unexpected



When unexpected or out-of-sequence events occur in your system, the Model 532 Intelligent Logic State Analyzer can show you exactly what happened.

But that's not all. As an intelligent analysis tool, the Model 532 contains an unexpected number of powerful features in its compact, 10-pound package:

- Broad Monitoring**  
32 channels with 250 words of storage.
- Display Versatility**  
Hexadecimal or binary; use a scope, video terminal, or LED readouts.
- Triggering Flexibility**  
21 different modes.
- Signature Analysis**  
Computes signature of data collected.
- Programmability**  
Stores tests in RAM or UV PROMS for later automatic playback.
- Automatic Operation**  
Offers remote testing via RS-232 or IEEE-488 bidirectional interfaces.

The Model 532 is also unexpectedly cost-effective and easy-to-use. Use our toll-free hotline to arrange a demonstration or for additional information.

**PARATRONICS INC.**

800 Charcot Avenue • San Jose • CA 95131 • Tel: (408) 263-2252/TWX: 910-338-0201  
Outside California — CALL TOLL FREE: (800) 538-9713

# When it comes to superior graphics, no job's too small for CalComp.

You can think small and think big at the same time. Simply by thinking CalComp.

Because now there's a CalComp plotter that brings our high-performance technology down to a size — and price — that's easy to handle.

We call it the CalComp Model 1012. It's a high-speed *drum* plotter with honest desk-top dimensions.

What's more, it uses convenient 11-inch wide Z-fold paper instead of the usual single cut-sheets to minimize operator-related paperwork. And to deliver crisp "A" and "B" size drawings at a brisk clip of 10 inches-per-second.

Best of all, our Model 1012 desk-top plotter comes through with the same 4-pen versatility and outstanding reliability that CalComp's "big drums" are famous for. For a price that's amazingly competitive with many cut-sheet desk-top plotters.

Which means, quite frankly, that CalComp quality and

throughput are more affordable today than ever before.

We cut the cost. Not the quality. Because obviously, you can't cut corners and expect to produce CalComp-quality graphics.

That's why we loaded the Model 1012 with many of the same high-performance features found on our top-of-the-line plotters. Like microprocessor-based electronics. D.C. servomotors for increased accuracy. A special linear pen drive mechanism for consistently superior line quality.

There's also a built-in controller with its own RS-232-C interface to make system integration — in most remote and time-sharing environments — simple and straightforward.

Naturally, it's all backed by a CalComp service and support network that's worldwide. And second to none.

So write or call today for all the desk-top details. Because when it comes to superior graphics, no one rolls out a finer line than CalComp.

**CALCOMP**

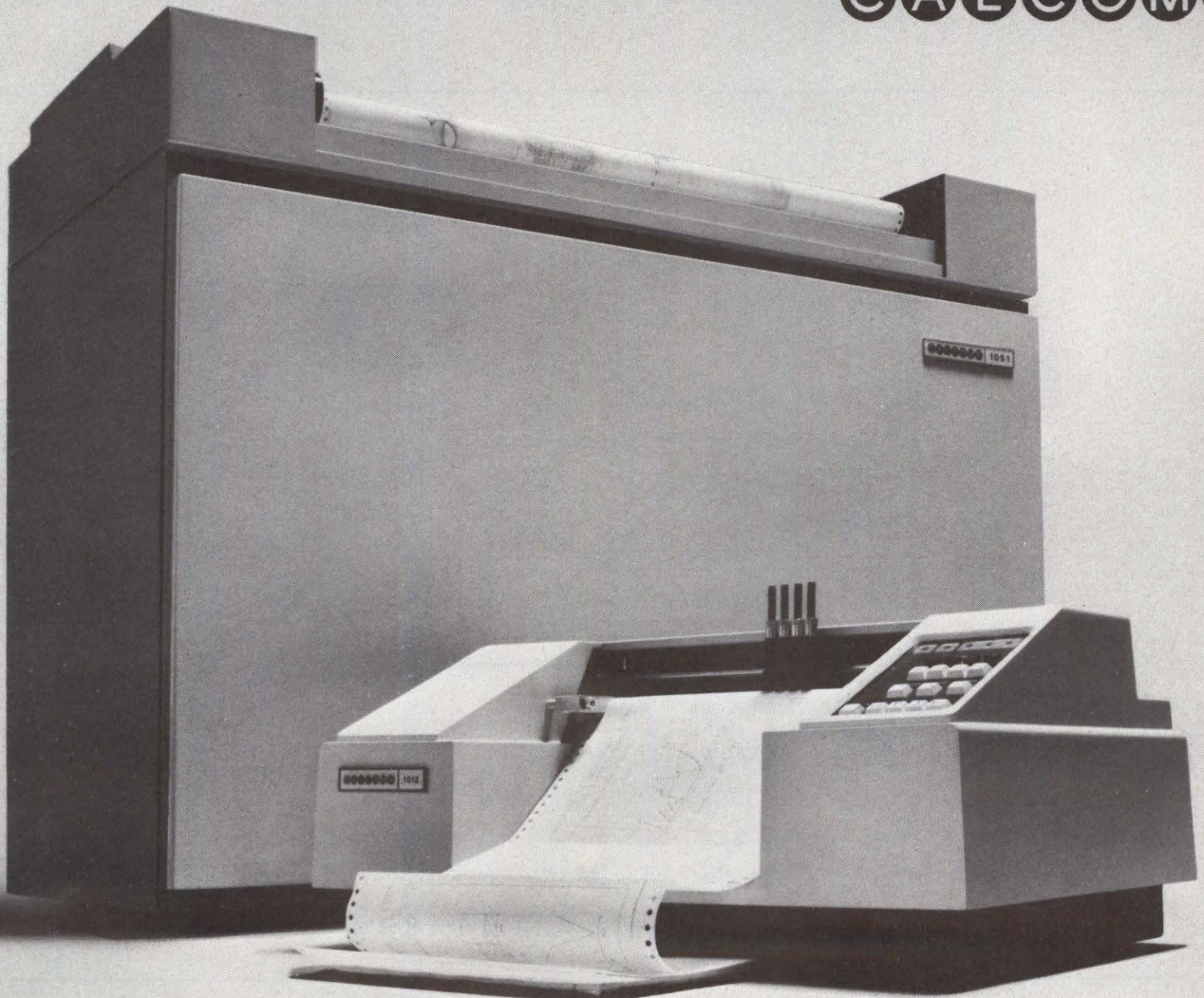

## High Density RAMs And Logic Circuitry Enhance Systems Design

A 64k-bit random-access memory chip and a 3-ns LSI logic circuit have been identified as key components in recently announced systems produced by International Business Machine Corp's General Technology Div, Essex Junction, VT 05452. The memory and logic devices are to be used in certain models of both the 8100 information system and the System/38 (*Computer Design*, Dec 1978, pp 42, 47, and Jan 1979, pp 34) manufactured by other divisions.

Described as the densest MOSFET memory ever produced by this manufacturer, the 64k RAM is one in a series of devices, along with 32k-bit (190 ns) and 18k-bit (90 ns) memories. Respective worst case access times for the three devices are 440, 285, and 140 ns. All of these chips are internally timed, with only a single select pulse required in each cycle.

A total of 65,636 usable bits are actually contained in the 64k chip,

each stored in a cell  $166 \mu\text{m}^2$  in area. An 8-bit register is provided in the data I/O path, allowing up to 8 bits to be read sequentially from the chip at a 100-ns data rate for each access. The read-modify-write cycle is eliminated for this RAM because of an onchip storage capability of one through eight bytes. Buffer operation is essentially independent of the main array and can be used to obtain data from the chip during a refresh operation. The 6.35 mm<sup>2</sup> device utilizes 38 I/O connections and dissipates a maximum of 360 mW.

Organized as 8k x 4, the 32k RAM has an additional store feature, allowing from one to four bits to be stored for increased flexibility at the system level, eliminating the need for a read-modify-write cycle on this chip also. The 6.3-mm square chip utilizes 31 I/O connections and dissipates a maximum of 612 mW.

The 18k RAM is organized as 2k x 9, with internal division into three

independent functional islands, each containing redundant bits. It utilizes 45 I/O connections and has linear dimensions of 4.8 x 5.5 mm, with maximum power consumption of 690 mW. This device is utilized in the 8775 terminal of the 8100 system.

For both the 32k and 64k devices, internal organization provides two redundant functional islands, each containing redundant bits. A bidirectional data bus minimizes interconnections at the multichip module level.

The LSI logic device includes 704 bipolar TTL circuits on a chip 4.6 mm on a side. More than 7000 individual components are included in this configuration. Computer controlled electron beam (E-beam) circuit fabrication is used to establish the wiring pattern or "personality" of each chip, configuring the 704 available logic cells, whose possible patterns of interconnection provide an astronomical number of selectable

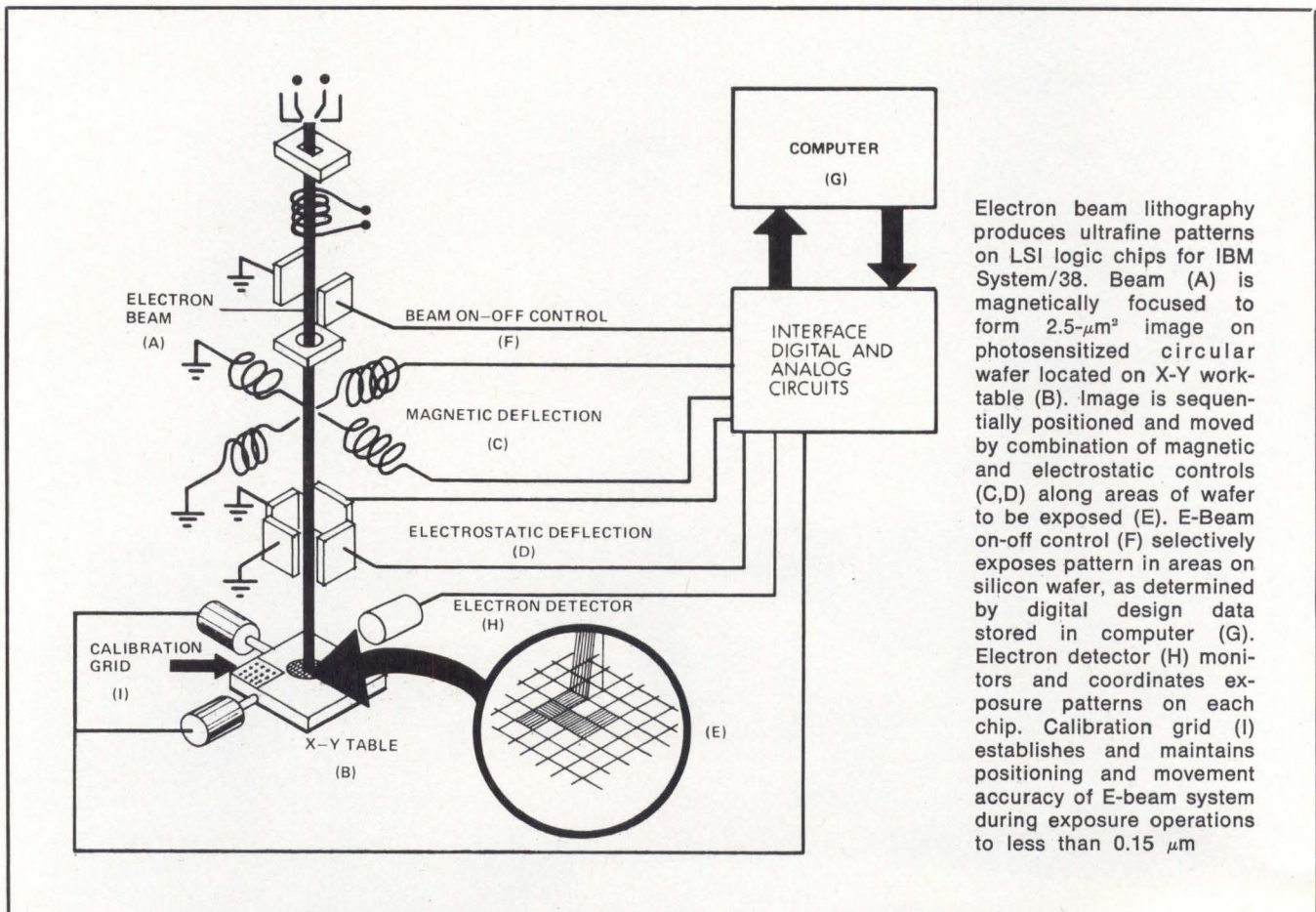

# If you think of us only for core memory, think again.

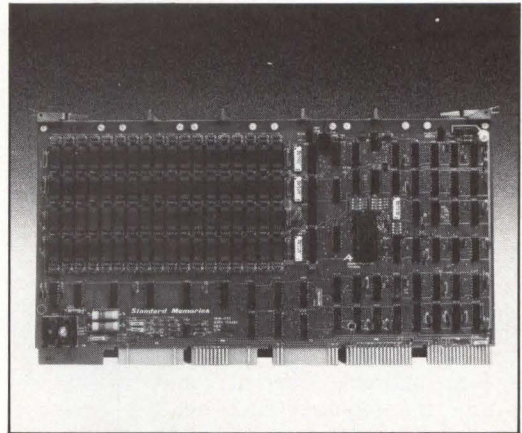
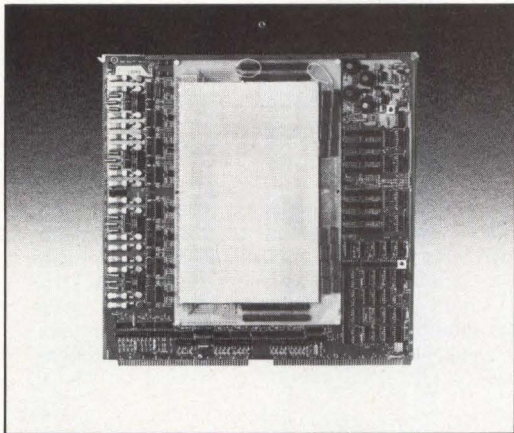

## Introducing PINCOMM® PS. The New PDP-11 Semiconductor Memory from Standard Memories.

It's the first...with more on the way! PINCOMM PS is a 64K pin-compatible add-in memory for DEC PDP-11 minicomputers. Using 16K MOS memory chips, PINCOMM PS is available in depopulated versions of 48K, 32K and 16K. Features include 100 nsec write access, 350 nsec read access and 450 nsec cycle time. Plus, a parity option that eliminates the need for the DEC parity card, increasing CPU space and memory throughput.

**Next in line**... semiconductor memory for General Automation and Data General NOVA minicomputers. So start thinking of Standard Memories for your semiconductor needs, as well as core memory. We continue to provide a complete line of add-in and add-on core memory for Data General, DEC, General Automation, IBM and Interdata CPU models.



For an instant quotation call the Memory Man toll free: (800) 854-3792, (in California) (800) 432-7271.

Data General, DEC, General Automation, IBM and Interdata are recognized registered trademarks.

**STANDARD MEMORIES**

*has grown into a new name*

**A Applied Magnetics  
Trendata**

3400 West Segerstrom Ave.,  
Santa Ana, CA 92704. (714) 540-3605

arrangements. The E-beam technique, by exposing the silicon wafer to a precisely oriented stream of electrons, eliminates the need for photo-masks in personalization. That, in turn, results in greater flexibility, faster verification of chip designs, fewer manufacturing processing steps, and more rapid turnaround time.

### IC Functions as Floppy Disc Read-Amplifier

Combining linear and digital functions in a single integrated circuit, a flexible disc read-amplifier provides signal processing from the read head through to the standard TTL digital output. Contained in the circuit are the required gain stages, an active differentiator-comparator for peak detection, and a time domain filter for wave shaping and elimination of false outputs. External connections for the required filter network and active differentiator and timing control components allow the system designer flexibility in meeting system performance requirements. Amplitude and waveform variations present at the read head do not appear in the output, and a maximum unadjusted peak shift of 5.0% is guaranteed.

Produced by Motorola Semiconductor Products Inc, PO Box 20912, Phoenix, AZ 85036, the MC3470 is available in an 18-pin plastic DIP. The 100-up price per unit for the device has been set at \$5.95.

Circle 351 on Inquiry Card

### Analog Multiplexers In CMOS Feature Low On-Resistance

An on-resistance of only 270  $\Omega$  is featured in a family of analog multiplexers. This series of monolithic CMOS devices, manufactured by a dielectric isolation process, includes 8- and 16-channel single-ended models (MV-808 and MV-1606) as well as 4- and 8-channel differential models (MVD-409 and MVD-807).

The channel address inputs interface directly with TTL or CMOS logic and draw less than 5- $\mu$ A input cur-

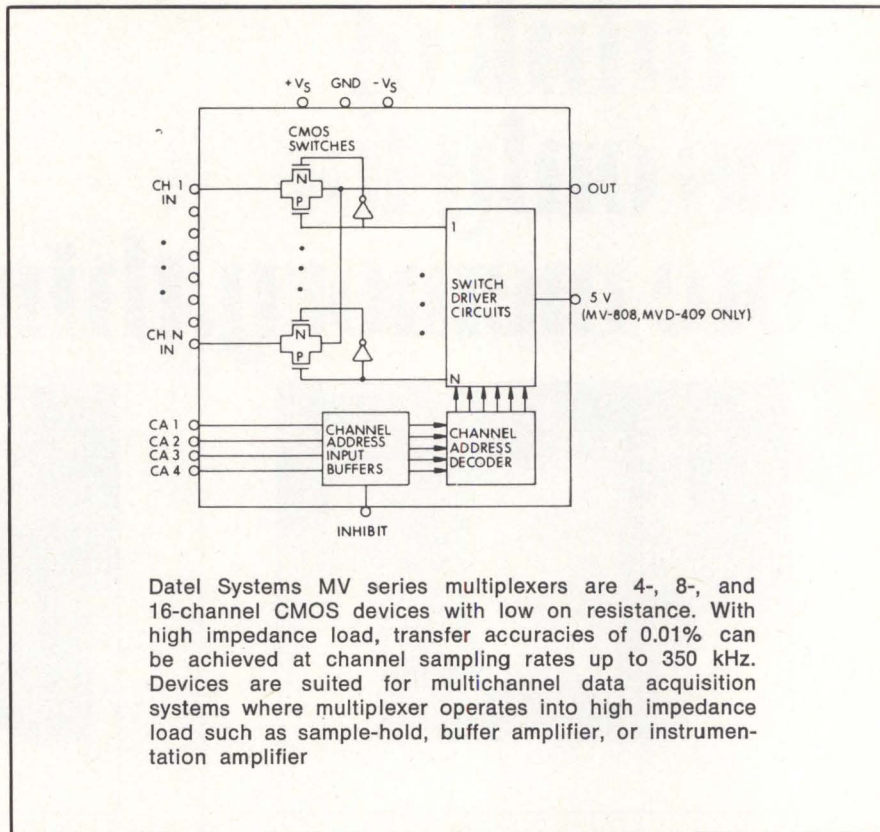

Datal Systems MV series multiplexers are 4-, 8-, and 16-channel CMOS devices with low on resistance. With high impedance load, transfer accuracies of 0.01% can be achieved at channel sampling rates up to 350 kHz. Devices are suited for multichannel data acquisition systems where multiplexer operates into high impedance loads such as sample-and-hold, buffer amplifier, or instrumentation amplifier

rent in either the high or low state. Channel addressing is done by a 2-, 3-, or 4-bit binary code. An inhibit input enables or disables the entire device to permit expansion of the number of channels by using several devices together. Another important feature is break-before-make switching, which insures that no two channels are ever momentarily shorted together.

Transfer accuracies of 0.01% or better are realized when the devices are used with a high impedance load such as an operational amplifier input. In switching from channel to channel, the settling time is 1.2  $\mu$ s (to 0.1%) and 2.8  $\mu$ s (to 0.01%).

Switching turn-on time is 350 ns, turn-off time is 250 ns, and break-before-make delay is 100 ns or less. The analog input voltage range is a full  $\pm 15$  V.

Produced by Datal Systems Inc, 1020 Turnpike St, Canton, MA 02021, the MV series of multiplexers operate from 0 to 70  $^{\circ}$ C in standard versions and from -55 to 125  $^{\circ}$ C in military versions. The MV-808 and MVD-409 are packaged in 16-pin ceramic DIPs and have a  $\pm 15$ -V and 5-V power supply requirement, while the MV-1606 and MVD-807 are packaged in 28-pin ceramic DIPs and require a  $\pm 15$ -V supply.

Circle 352 on Inquiry Card

### Programmable Timer Is 6800 Compatible

Designed to provide variable system time intervals, the S6840 is a programmable subsystem component of the S6800 family. This 28-pin device, produced by American Microsystems Inc (3800 Homestead Rd, Santa Clara, CA 95051), contains three 16-bit binary counters, three correspond-

ing control registers, and a status register. The counters are under software control and may be used to cause system interrupts or generate output signals.

Full bus compatibility with the S6800 microprocessor family is provided, and the device performs functions in hardware that formerly had to be handled in software. As a result, system efficiency is improved,

# The new Diablo 1650. First we build it. Then you design it.

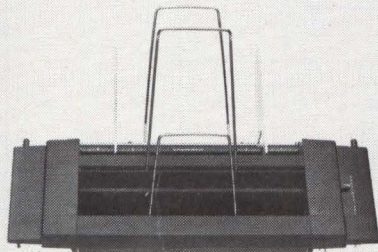

*HyFeed Cut Sheet Feeder*

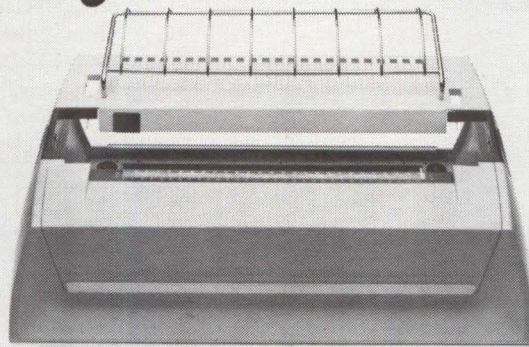

*RO and KSR Cover Sets*

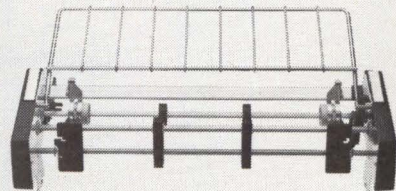

*Unidirectional and Bidirectional Tractors*

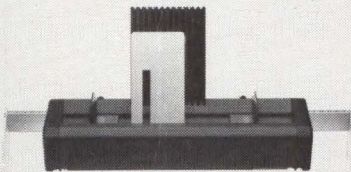

*Mechanical and Auto Front Feeders*



*Friction and Pin Feed Platens*

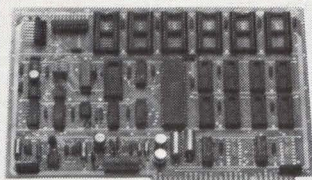

*Options... Yours and/or Ours*

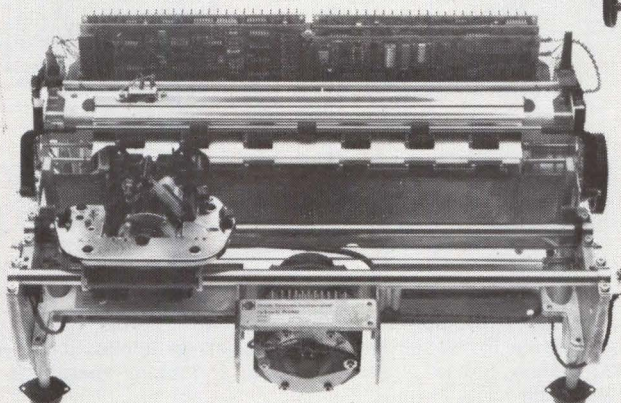

*1650 Print Mechanism*

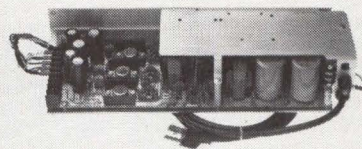

*Power Supplies, Strappable for Foreign and Domestic Use*

*Firmware Options*



*Multi-strike, Fabric, Color, and Two-color Ribbons*



*2K Buffer Expansion*



*Operator Control Panel*



*Interface Options*



*7 Standard Keyboards Including ASCII, APL and European*

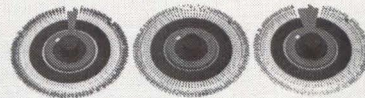

*88, 92, 96 Character Long-life Metal Print Wheels*

The new Diablo 1650 Series Printers and Terminals are what you make them. Because you have a lot more options with Diablo than you'll find with other manufacturers. So now you can design the exact communications, word processing, or data processing printing system you need, and easily change it as your needs change.

You can select interface options, paper handling options, as well as expanded processing options. If you'd like to know more about the 1650 Series, call collect (415) 786-5207, or write us at 24500 Industrial Blvd., Hayward, CA 94545. We'll be happy to discuss your options with you. And you'll see the advantages of having equipment designed by the leading authority in the field. You.

## Diablo Systems

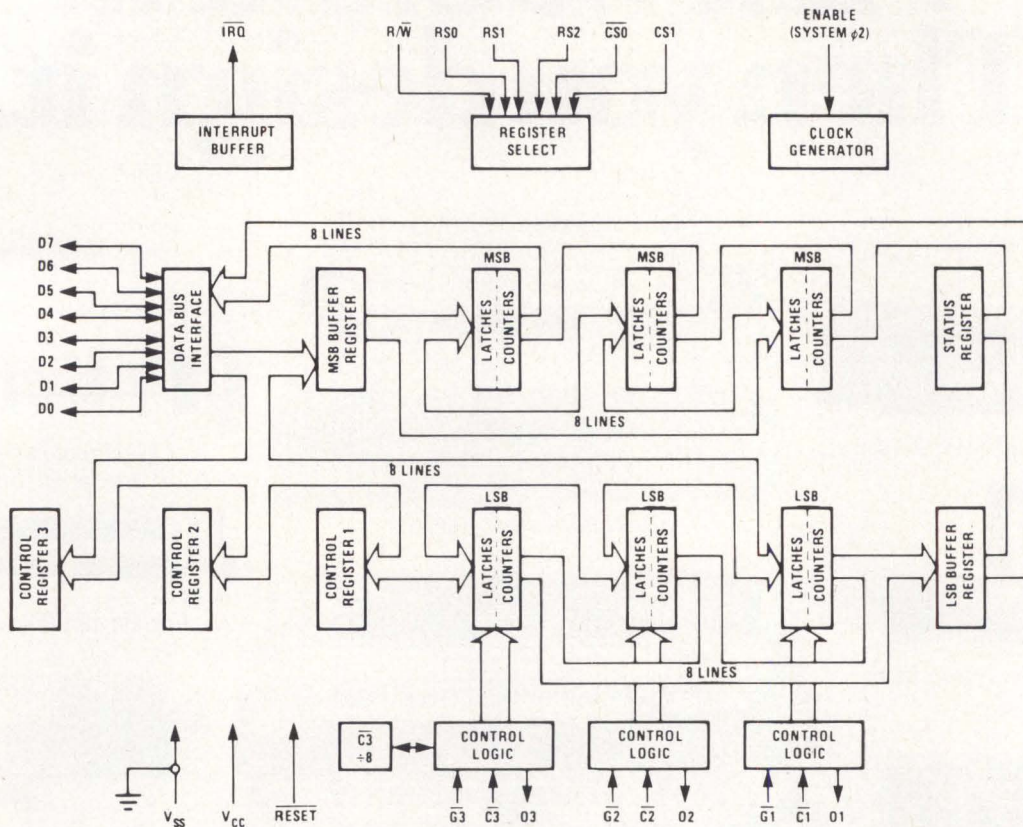

American Microsystems S6840 programmable timer. Three internal timers can be independently programmed to operate in modes fitting wide variety of applications. Device is fully bus compatible with S6800 system and is accessed by load and store operations from MPU much as memory devices would be

and the microprocessor itself is freed to handle more supervisory or control tasks.

Applications for the timer include frequency measurements, event counting, interval measuring, and similar tasks. It can be used for square wave generation, gated delay signals, single pulses of controlled duration, and pulse width modulation.

A selectable prescaler on timer 3 is capable of operating with a 4-MHz input. Programmable interrupts can

be output to the MPU, and all three outputs are maskable. The status register contains four interrupt flags (with the four remaining bits defaulted to zero during a read); three are assigned to the timers and the fourth is a composite interrupt flag. Each of the timers consists of a 16-bit addressable counter and 16 bits of addressable latches. The counters operate in modes for single-shot timing, interval timing, frequency comparison or period mea-

surement, and pulse width comparison.

Fabricated in n-channel MOS technology, the device requires a single 5-Vdc power supply and utilizes the system clock. Absolute maximum ratings specify that supply and input voltages must lie between -0.3 and 7.0 V. Temperature must be between 0 and 70 °C during operation and between -55 and 150 °C during storage.

Circle 353 on Inquiry Card

### 12-Bit DAC is Accurate Over Wide Range Of Temperature

Guaranteed for monotonic operation from -55 to 125 °C, a hybrid 12-bit

digital-to-analog converter provides a total error within ±0.3% and a linearity error no greater than 1 LSB over that temperature range. Produced by Burr-Brown Research Corp (PO Box 11400, Tucson, AZ 85734),

the DAC87 is a later generation of the DAC85 by the same manufacturer. It is pin compatible with DAC80/85 families, and maintains standard pin configuration for complete 12-bit DACs.



# It's yours!

The fastest, most reliable  
alternative to fixed-head disk.

IMPERIAL TECHNOLOGY'S  
**MAXiRAM**  
STORAGE SYSTEM

- RANDOM ACCESS
- HIGH SPEED
- ZERO LATENCY
- SOLID STATE RELIABILITY

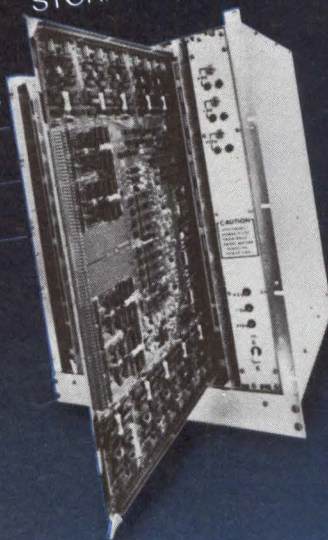

Here's the best alternative to  
fixed-head disk for cost-conscious  
users of PDP-11 & Nova computers.

- High speed random access.
- Solid state reliability.
- Pluggable modules of 0.524 megabytes each; expansion capability to 8.388 megabytes.
- 1.5 microseconds access time.
- Transfer rate of 525,000 words/second.
- Zero latency.
- No data loss in event of power failure.
- No moving parts. Low maintenance.

*The MaxiRAM System  
is also available for use  
with other computer  
types.*



Order your FREE copy today! Find out  
how the MaxiRAM Storage System offers  
unmatched economy and performance for  
your memory requirements.

CIRCLE 112 ON INQUIRY CARD



**Imperial Technology, Inc.**

831 S. Douglas Street  
El Segundo, California 90245

## AROUND THE IC LOOP

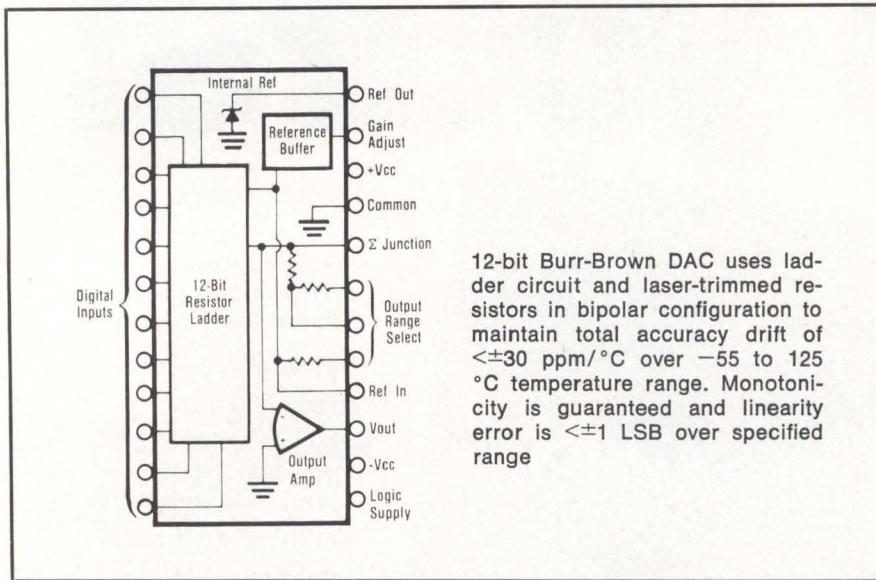

12-bit Burr-Brown DAC uses ladder circuit and laser-trimmed resistors in bipolar configuration to maintain total accuracy drift of  $<\pm 30$  ppm/ $^{\circ}\text{C}$  over  $-55$  to  $125$   $^{\circ}\text{C}$  temperature range. Monotonicity is guaranteed and linearity error is  $<\pm 1$  LSB over specified range

Housed in a  $1.4 \times 0.8 \times 0.22$ " ( $3.6 \times 2.0 \times 0.56$ -cm) welded, leak-proof, hermetically sealed package, the device is designed for use in hostile environments, in applications where the cost of a MIL screened part is impractical. A second model, DAC87Q, is burned in for 160 h at  $125$   $^{\circ}\text{C}$  and then inspected to method 2017 of MIL-STD-883. This model, while not a qualified standard QPL DAC, offers a less expensive option for manufacturers who perform their military screening at the systems level.

Additional features include a stable, laser-trimmed reference cir-

cuit and an internal output amplifier to simplify circuit design, reduce parts count, and improve reliability. Both current and voltage models of the DAC are available.

The internal laser-trimmed resistors allow selection of output ranges of  $\pm 2.5$ ,  $\pm 5$ ,  $\pm 10$ , 0 to 5, and 0 to 10 V (voltage model), or  $\pm 1$  and 0 to  $-2$  mA (current model). Digital inputs are guaranteed to be compatible with low power TTL over the full temperature range. Typical power supply sensitivity is  $\pm 0.002\%$  of full scale reading per percent of supply.

Circle 354 on Inquiry Card

## High Resolution 16-Bit ADC Provided in 32-Pin DIP

A successive approximation analog-to-digital converter, claimed by its manufacturer to be the industry's first 16-bit ADC ever available in a dual inline package, provides a linearity error of  $\pm 0.003\%$  at room temperature and  $\pm 0.006\%$  over the 0 to  $70$   $^{\circ}\text{C}$  operating range, with offset and gain tempcos of 15 and 7 ppm/ $^{\circ}\text{C}$ , respectively. The MN5280, produced by Micro Networks Corp (324 Clark St, Worcester, MA 01606) utilizes ultrastable, laser-trimmed thin film nichrome resistor networks in a microprocessor com-

patible unit. Applications for the high resolution device include precision measurement and data acquisition systems and other uses requiring high resolution data digitizing.

The ADC features an internal clock, six user selectable input ranges, optional offset and gain adjustment, and short cycling capability. Maximum conversion time is  $100$   $\mu\text{s}$  for 16 bits, and the maximum power consumption of  $1500$  mW is less than half the power consumed by modular and PC card units offering comparable resolution.

Packaged in a 32-pin DIP, the device measures  $1.72$ " in length  $\times$   $1.12$ " in width ( $4.37 \times 2.85$  cm), occupying less than one-fourth the space re-

quired by a typical  $2 \times 4$ " ( $5 \times 10$ -cm) module. The cost per device in hundreds is \$178 each.

Absolute maximum ratings limit supply voltages to  $\pm 18$  V, logic supplies to 7 V, and analog inputs to  $\pm 25$  V, and require that digital inputs lie between 0 and 5.5 V. Operating temperature must lie between 0 and  $70$   $^{\circ}\text{C}$  and storage temperature must be between  $-65$  and  $150$   $^{\circ}\text{C}$ .

Circle 355 on Inquiry Card

## Controller/Generator Provides Wide Variety Of Video Display Modes

All logic needed for character generation, video attributes, and graphics is provided in an NMOS LSI chip. The CRT 8002 video display controller/video generator (VDAC<sup>TM</sup>) is produced by Standard Microsystems Corp, 35 Marcus Blvd, Hauppauge, NY 11787.

This device acts as a complement to the CRT 5027 video timing and controller chip, which provides the logic functions to generate all timing signals for presentation and formatting of video data in a CRT system. Together the two chips comprise all the circuitry required for the terminal portion of a CRT video terminal. Contained in the 8002 are a  $7 \times 11 \times 128$  character generator ROM, a wide and thin graphics mode, external input mode, character address/data latch, field and/or character attribute logic, attribute latch, four cursor modes, two programmable blink rates, and a high speed video shift register.

The four cursor modes are underline, blinking underline, reverse video block, and blinking reverse video block. Any one of these can be mask programmed as the cursor function. There is a separate cursor blink rate that can be mask programmed to provide a 15- to 1-Hz blink rate.

Display attributes include reverse video, character blank, blink, underline, and strike-through. Character blink rate is mask programmable from 7.5 to 0.5 Hz and has a duty cycle of 75/25. Underline and strike-through are similar but independently controlled functions and can be mask programmed to any number of raster lines at any position in the character block. These attributes are available in all modes.

In the wide graphics mode, a graphic entity the size of the char-



## Is the real cost of your next disk controller being buried?

If you're about to buy a new micro-controller for your Mass Storage System, watch out for buried costs. Eighty-six percent of the real cost of a *nontransparent* disk controller could be spent in future upkeep of mainframe software. This means you could end up paying seven times the purchase price of that 'economical' controller you are now considering! As a money-saving alternative, consider the AED 8000 micro-controller. It *emulates* OEM disk controllers such as RP-03, RP-04 and RP-06, even if that hardware is changed through several generations. Think of the money saved by not having to write a software driver

when you first get the controller; plus the additional savings you'll gain by not having to rewrite the driver each time your mainframe manufacturer releases a new OS. The AED 8000 controller not only runs all software for the emulated disk, without patches or software revisions, but also runs mainframe manufacturer's disk diagnostics. And the 8000 now interfaces with Storage Module Drives *including* Winchester Technology — all for a one time purchase price that is surprisingly low. Write or call our Marketing Manager today for the facts. He'll make your new controller's future look a lot brighter!

**ADVANCED ELECTRONICS DESIGN** 440 Potrero Ave., Sunnyvale CA 94086. Tel. 408-733-3555

Branch Offices: Boston (617) 275-6400, Los Angeles (714) 738-6688

**CIRCLE 113 ON INQUIRY CARD**



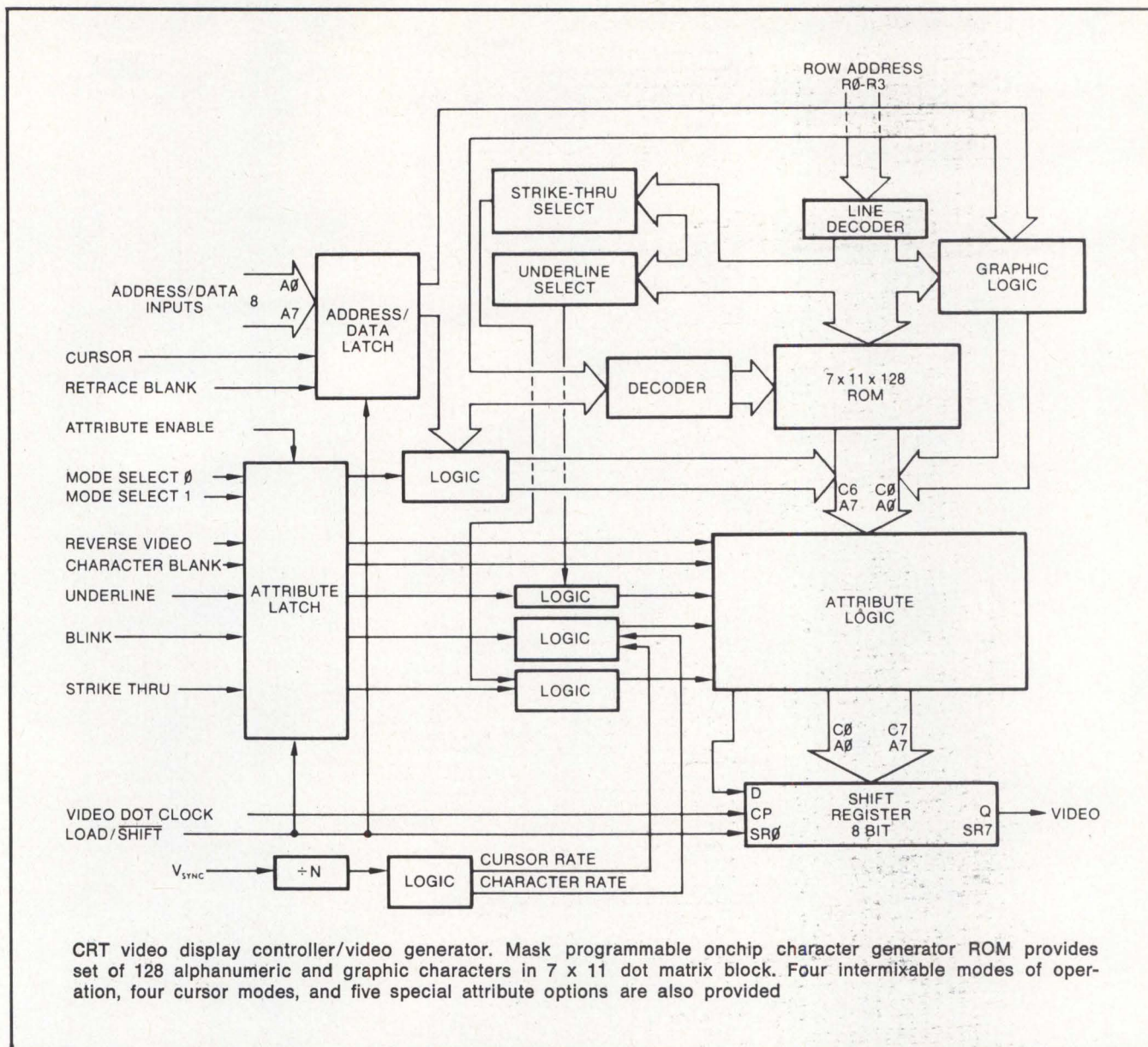

CRT video display controller/video generator. Mask programmable onchip character generator ROM provides set of 128 alphanumeric and graphic characters in 7 x 11 dot matrix block. Four intermixable modes of operation, four cursor modes, and five special attribute options are also provided

acter block is produced. The graphic entity contains eight parts, each of which is associated with one bit of graphic byte, thereby providing for 256 unique graphic symbols. Thus, an alphanumeric symbol or a graphic entity can be produced, depending on the mode selected. Mode can be changed on a per character basis. The thin graphics mode enables the user to create single line drawings and forms.

External mode enables the user to extend the onchip ROM character set and/or the onchip graphics capabilities by inserting external symbols. These external symbols can come from either RAM, ROM, or P/ROM.

Three models of the device, CRT 8002A/B/C, each have a different maximum frequency for the onchip video shift register. These frequencies are 20 MHz for the A model, 15 MHz for the B, and 10 MHz for the C. Access time in all three cases is 400 ns.

Operating from a single 5-V power supply, the controller/generator has maximum guaranteed ratings that include voltage limits of -0.3 and 8.0 V on any pin with respect to ground. The temperature range must be between 0 and 70 °C during operation and between -55 and 150 °C during storage.

Circle 356 on Inquiry Card

### Dual ADC Chip Drives Bar-Graph Display

Having all the functions to drive a gas discharge bar-graph panel, a dual analog-to-digital converter is implemented on a single chip. The manufacturer, Signetics, 811 E Arques Ave, Sunnyvale, CA 94086, states that this is the first dual monolithic ADC on the market.

Designated the NE580, the device inputs accept an analog voltage in the range of 0 to 2.5 V. The circuit performs an A-D conversion with reference to a fixed input voltage at the reference terminal. Onchip functions include a clock generator,

# HOW TO MAKE YOUR OWN THERMAL PRINTER.

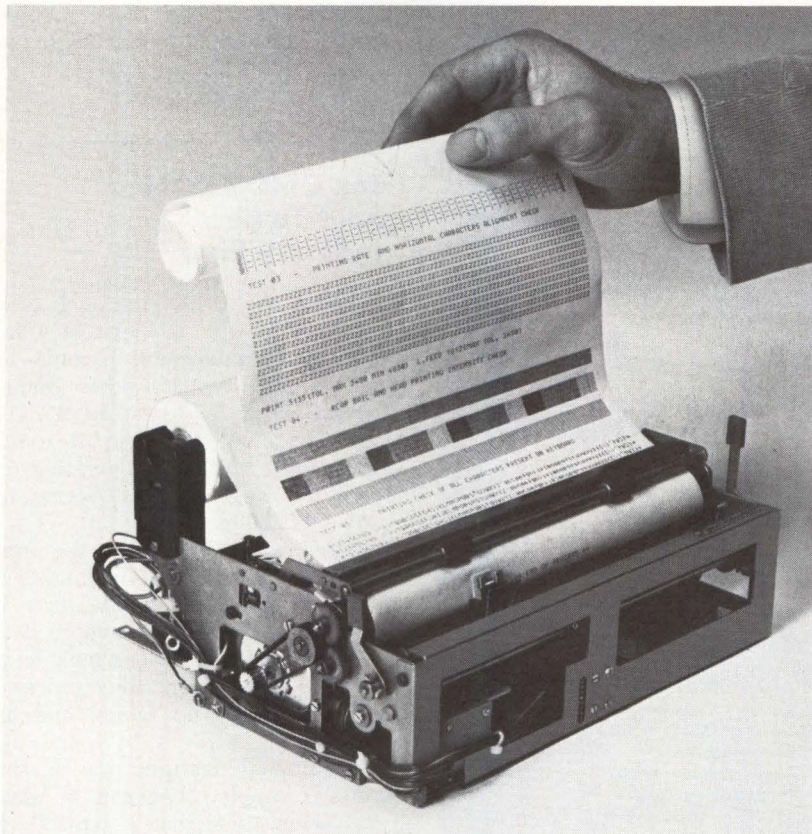

dot-per-inch horizontal and vertical resolution.

Which means you can design your own thermal printer to print almost anything a CRT can display.

But above all, the T-80M offers renowned Dataproducts dependability for your own specific system or application.

And at a very low cost of entry and operation.

So if you're into small systems, CRT manufacturing, medical, engineering, meteorological, measurement or similar applications, now you can design the thermal printer that's both versatile and dependable.

You have the know-how. We have the heart.

## Start with the heart of our T-80.

If you want to design your own thermal printer, start with the heart of our dependable T-80 thermal printer.

The T-80M mechanism module.

We've got the heart and you've got the brainpower to build a winner.

Take the T-80M, add your own control logic and power, and you've got a low cost, high-speed dependable thermal printer.

What's more, you can instruct it to print alphanumeric at 80 cps in a 5 x 7 dot matrix, or graphics with 70

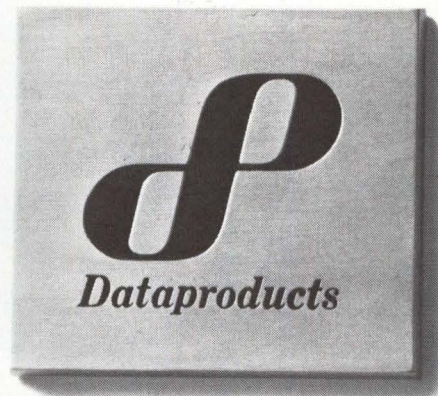

## THE PRINTER COMPANY.

Call or write for your nearest Sales Office or Distributor. 6219 DeSoto Ave., Woodland Hills, Ca. 91365. Tel: (213) 887-8451  
Telex: 67-4734 • Darmstaedter Landstrasse 199, Frankfurt, W. Germany. Tel: 681-034, Telex: 841-416344.

## AROUND THE IC LOOP

linear ramp generator, control logic, and read-only memory decoding. Output functions comprise two anode control lines, two overrange indication outputs, six cathode phase outputs, and a cathode reset output.

A minimum of external components are required for the whole conversion and display system. The device can be expanded to handle more analog channels using comparators. Either LM393A or LM339A type comparators will function well. In addition, a few external low cost logic packages can provide binary or BCD encoded data to interface with a logic control system.

The ADC is configured to drive a 201-element bar-graph in either 5-

or 6-phase operation. Phase number selection is obtained by applying a logic 0 or 1 level to the phase select pin. Three-phase operation for a 101 element device can be attained by a wire-OR connection of adjacent cathode phase outputs.

Other characteristics include operation from a single 5-V power supply, equivalent 8-bit resolution of displayed information, and the ability of the device to be custom masked for different cathode segment counts up to a maximum of 240. The device is supplied in a 22-pin plastic molded or ceramic dual-inline package.

Circle 357 on Inquiry Card

### 16k CMOS ROM Said To Be Industry First

Believed to be the first such device available in the industry, a 16k-bit CMOS read-only memory provides high noise immunity, low power requirements (typically less than 2 mA at 5 V), wide voltage range (4- to 12-V operation), and wide operating temperature range. Typical access time at 5 V is 750 ns.

Organized as 2k x 8, the HCMP-1835 ROM is produced by Hughes Aircraft Co, Solid State Products Div (500 Superior Ave, Newport Beach, CA 92663). Applications include program storage for microprocessors, storage for lookup tables, and logic translations.

Additional features are a single voltage supply (between 4 and 12 V), access time that is typically 850 ns at  $V_{DD} = 5$  V and 400 ns at  $V_{DD} = 10$  V, and compatibility with the 1802 microprocessor. Furthermore, the device is pin-compatible with the 8k HCMP-1833 ROM by the same manufacturer.

A 16-bit address is time-multiplexed on the eight address lines, with the eight most significant address bits latched onchip by the clock input. The address may be decoded by mask option to allow the ROM to operate in any 2048-byte area within the 65,536-byte memory space. In addition, chip-select and chip-enable signals may be decoded for simplified system interfacing.

The ROM is mask-programmed to the customer requirements. A 4-week turnaround from customer specification to sample hardware is offered by the manufacturer.

Circle 358 on Inquiry Card



**T-bar®**  
INTRODUCES

**a new 6PDT  
miniature  
latching relay  
with T-bar®  
reliability**

T-BAR's new 205 miniature latching relay for computers, voice/data communications, instrumentation, medical electronics and process control applications . . .

- 6 pole double throw
- printed circuit board mountable\*
- unique bistable action
- T-BAR Sit Still™, Must Operate reliability
- Edge-to-Dome® low level dual contacts with orthogonal wiping action
- 2,500,000 operations
- available now

for further information contact: T-Bar, Incorporated, Switching Components Division, 141 Danbury Road, Wilton, Connecticut 06897.  
Phone: 203/762-8351.  
TWX: 710/479-3216.

**T-bar®**  
INCORPORATED

\*subject to care in cleaning

Actual size.

# “Performance, Reliability, and Responsiveness.

## That's why we use the Xylogics 211.”

The Inforex System 5000 file management system features king-size disk storage — up to 1.2 billion bytes. Bringing that much disk capacity to the market in a profitable package was the job of Inforex design engineers.

According to Neil Frazer, Principal Engineer, “When our design group was surveying the marketplace for disk controllers, we turned to Xylogics. On paper, there were quite a few disk controllers that could meet Inforex specifications. But Xylogics showed us outstanding responsiveness in helping us evaluate the 211, a reliable product that was immediately available to meet our particular performance specifications.

“Initially, the 211 was used with a PDP-11/05 for all our evaluation work. The reliability of the 211, in conjunction with the responsiveness of Xylogics, convinced us to incorporate the 200 formatter with an Inforex-designed interface adapter. We were able to introduce the large disk option into the System 5000 quickly, easily, and with confidence.

“We find Xylogics to be an excellent OEM supplier. They are very accommodating and responsive to our needs.”

JOIN THE DESIGNERS ACROSS THE UNITED STATES AND OVERSEAS WHO HAVE PUT MORE THAN 1,000 XYLOGICS DISK CONTROLLERS — INCLUDING 400 XYLOGICS 211's — TO WORK IN THEIR SYSTEMS. CALL OR WRITE. TODAY.



Neil D. Frazer, Principal Engineer, INFOREX

### Xylogics 211 features include:

- Multiple Computer Access
- Dual Port Capability
- Mass Direct Data Transfer
- Unique Direct Access Memory (DMA) Throttle Control
- Compatible with All Popular “Storage Module” Disk Drives



Xylogics, Inc., 42 Third Avenue, Burlington, Massachusetts 01803 (617) 272-8140

**We did it with . . . . innovation/imagination/integrity**

## Dual-Density Controller Interfaces CPU to Four Floppy Drives

Requiring only a single 5-V power supply, a single/double-density floppy disc controller is implemented on a single chip. The  $\mu$ PD765C contains circuitry and control functions for interfacing a CPU to four separate drives.

Features include multiple sector transfer capability, programmable head load time, multiple device select lines, multiple head select lines (double-sided), and IBM 3740 (single-density) and IBM Systems/34 (double-density) compatibility. Only a single-phase clock is required, and use of support ICs is minimized. Multiple status registers provide detailed information to the user about each disc operation.

The LSI device is produced by NEC Microcomputers, Inc, 173 Worcester St, Wellesley, MA 02181. It is available in a standard 40-pin, plastic dual-inline package.

Circle 359 on Inquiry Card

## 12-Bit ADC Offers Versatile Interfacing

A 3-state output enables the ICL7109 analog-to-digital converter to be directly interfaced to virtually any 8- to 16-bit wide microprocessor data bus. In its byte-organized parallel mode, the 12-bit monolithic device can interface with the data buses of such microprocessors as the Intersil 6100, the Motorola MC6800, and the Intel 8080 and 8048. There are 14 data output lines, providing 12 magnitude bits plus polarity and out-of-range bits. The output lines can be grouped in two 8-bit bytes, each activated by its own byte-enable signal, plus a master chip-enable line.

For remote data transmission applications, the ADC has a handshake capability so that it may also be directly interfaced with universal asynchronous receiver/transmitter (UART) logic. When triggered into the handshake mode, the device provides all the control and flag signals necessary to sequence the two bytes of data into the UART and initiate their transmission in serial form. This greatly eases the task and reduces the cost of designing remote data

acquisition stations, using serial data transmission to minimize the number of lines to the central controlling processor.

The device is available from stock in 40-pin plastic or ceramic dual-inline packages. Prices at the 100-piece level are \$10.00 and \$19.80, respectively. The manufacturer is Intersil, Inc, 10710 N Tantau Ave, Cupertino, CA 95014.

Circle 360 on Inquiry Card

## Static RAM Offered In Military Version

A military version of the industry standard 2114 static RAM, designated M2114, has been made available by EMM Semi Inc, 3883 N 28th Ave, Phoenix, AZ 85017. The device meets MIL-STD-883 requirements for operation from  $-55$  to  $125$  °C. (Another version of the military device, operating from  $-35$  to  $85$  °C, is also available.)

Access time for the  $1k \times 4$  memory is 450 ns. A common I/O structure with compatible 3-state outputs matches bus requirements. Simplifications result because only a single 5-Vdc power supply is required and the device does not require a chip select pulse to begin a cycle.

Commercial versions of the device, operating over the same temperature ranges (but not screened to MIL-STD-883) are also available. These commercial devices are subjected to a 168-h burn-in at the MIL spec operating temperature, in contrast to the standard commercial product, which normally receives a 24-h burn-in and operates in the temperature range from 0 to 70 °C.

Circle 361 on Inquiry Card

## Timer/Counter Provides Delays of From 1 $\mu$ s to 3 Years

A single  $\mu$ A2240 programmable timer/controller IC can produce accurate time delays ranging from 1  $\mu$ s to five days. Long delays, up to three years, can easily be generated by cascading two timers.

The timer consists of a timebase oscillator, programmable 8-bit counter, and a control flip-flop. An external resistor-capacitor (RC) net-

work sets the oscillator frequency and allows delay times from one RC to 255 RC to be selected. In the astable mode of operation, 255 frequencies or pulse patterns can be generated from a single RC network. The frequencies or pulse patterns can also be easily synchronized to an external signal.

Trigger, reset, and outputs are TTL and DTL compatible for easy interface with digital systems. As a result of its high accuracy and versatility in producing a wide range of time delays, the device provides a direct replacement for mechanical or electromechanical devices.

Operating as a second source to Fairchild's  $\mu$ A2240, Texas Instruments Inc, PO Box 5012, Dallas, TX 75222 is offering the timer/counter in either 0 to 70 °C (C suffix) or  $-55$  to 125 °C (M suffix) operating temperature range. It is available in 16-pin plastic (N suffix) or ceramic (J suffix) DIPs.

Circle 362 on Inquiry Card

## V-F Converter Uses Fast ECL

A high speed precision voltage-to-frequency converter utilizes linear LSI technology to provide a fully contained 12-bit data conversion element. Speed, accuracy, and temperature performance of the 4153 converter are achieved by incorporating high speed ECL, a high gain, wide bandwidth op amp, and an ion-implanted buried zener reference on a single monolithic chip.

An analog input signal to the device is converted into a proportional serial pulse train output with scaling selectable over a wide dynamic range ( $>100$  dB). Comparable performance is available in the frequency-to-voltage mode, making the converter a building block for accurate, wideband isolation amplifiers and 3-wire analog data links.

Features include a dynamic range extending from less than 0.1 Hz to over 250 kHz, a 0.01% full-scale maximum nonlinearity error (0.1 to 10 kHz), a 150-ppm/°C maximum gain tempco, and a 7.3-V onboard reference. The device is provided by Raytheon Semiconductor (350 Ellis St, Mountain View, CA 94042) in a standard plastic dual-inline package.

Circle 363 on Inquiry Card



# Four years ago, this man bet his job on our \$2400.00 single-board disk controller.

## Both are still working.

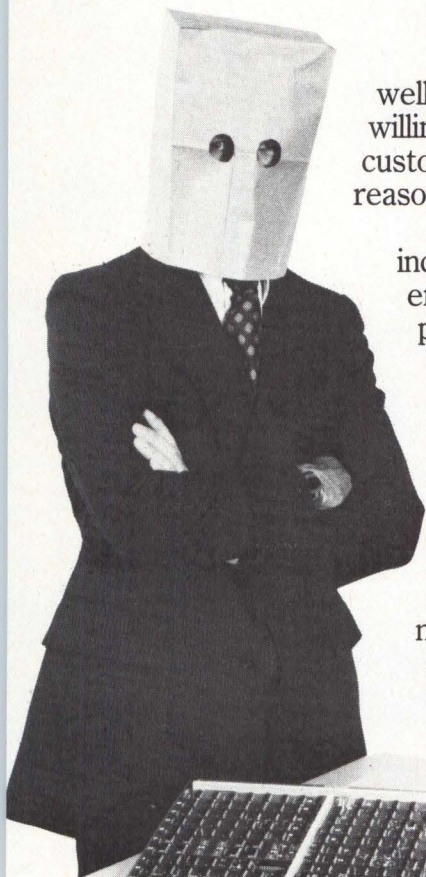

The man in the bag is product manager for a very well known company. Like all the rest of our customers, he's willing to give us a solid testimonial. However, like most of our customers, he happens to be an OEM. He has some pretty good reasons for wanting to remain anonymous.

But the point is, everyone who has ever paid our incredibly low price for one or a hundred disk controllers has ended up happy. We've given them as much or more performance than they could have bought for twice or even four times the money. Which is why we now have more than 2500 units installed.

Example: Our SMC11 for DEC PDP-11 computers will give you, among a lot of other things, contiguous sector data transfer and hardware error correction. Everything a big, expensive black box will do. For any storage module compatible disk drive. All on a single hex-wide board. All for \$3580. We have similar models to interface with Data General and Interdata. Floppy disk controllers, too.

Mail us the coupon now. It's an opportunity for you to find out how the least expensive disk controllers you can buy can also be the best. It's also a great chance for you to become unknown.

MiniComputer Technology



2470 Embarcadero Way • Palo Alto, California 94303 • (415) 321-7400

**The single-board disk controller company.  
For DEC, Data General, and Interdata Computers.**

**Gentlemen:  
Please send more information.**

Name \_\_\_\_\_

Title \_\_\_\_\_

Computer Type \_\_\_\_\_ Drive Type \_\_\_\_\_

Company \_\_\_\_\_

Address \_\_\_\_\_

City \_\_\_\_\_ State \_\_\_\_\_ Zip Code \_\_\_\_\_

Telephone (    ) \_\_\_\_\_

CIRCLE 117 ON INQUIRY CARD

183

When you integrate hardware and software . . .

# act 1 solves your time problem

- Real Time Operational Analysis
- Reduced Software Debug Time
- Timely Development and Production

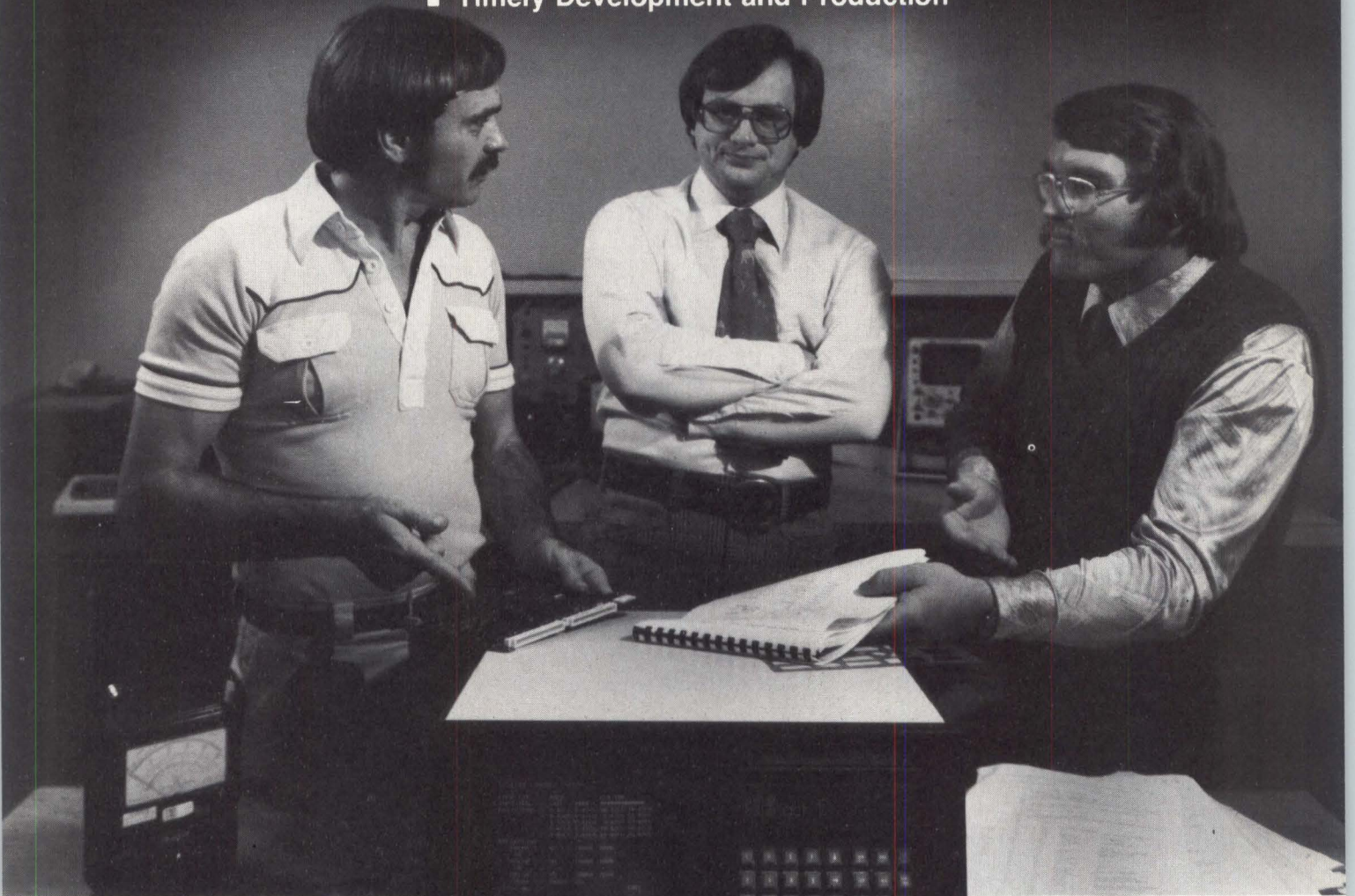

The easy-to-use "act 1" makes short work of that frustrating and costly problem of overall systems analysis. It puts an end to finger pointing by giving both hardware and software designers a fast way of coordinating their work in the system environment, thereby reducing expensive over-design of both equipment and programs. You can inspect, modify, and correlate computer and computer controlled systems in real time . . . and more importantly your development program will be "on-time."

"act 1" saves systems development time by providing hardware and software timing analysis, and automatic testing capability, simultaneously.

So before you waste another nanosecond, take a long look at the many advantages of having your own versatile "act 1." We know from experience that it will pay for itself on your first computer programming (or reprogramming) development — no matter which side you're on. Call or write for information and a hands-on demonstration.

## act 1

**CONIC DATA SYSTEMS**  
LORAL CORPORATION

9020 Balboa Ave. / San Diego, CA 92123 Tel. (714) 279-0411 / TWX 910-335-1183

CIRCLE 165 ON INQUIRY CARD

COMPUTER DESIGN/JANUARY 1979

# “BEEP! BEEP!”

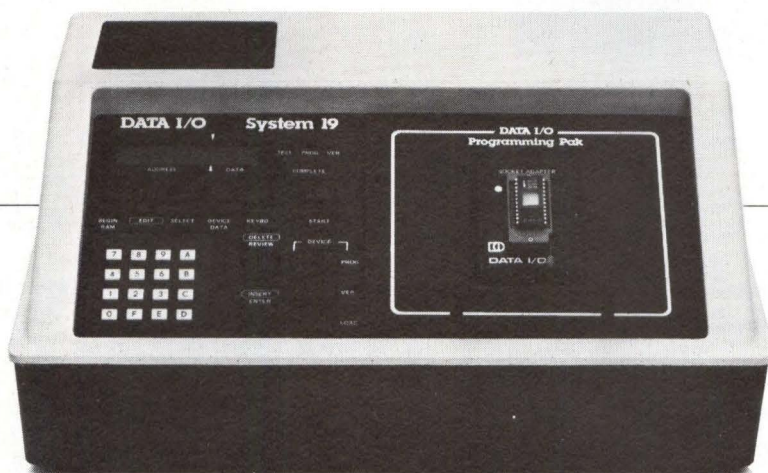

## Data I/O's System 19 PROM programmer talks back to save you time and money.

It's a state of the art programmer that tells you when things are right, or if they're wrong, it tells you why.

Switch it on and the System 19 checks all its components: I/O port, microprocessor, RAM, bus, front panel and even its own software.

During the programming sequence, the System 19 conducts an illegal bit check, blank check, sum check on the newly programmed device and data verification at high, low and mid point voltages as required to make sure the device meets manufacturer's operating specifications.

The System 19 gently warns the operator when a simple procedural error is made and locks up before the operator can make a serious error and waste a device.

If something goes wrong during operations, the System 19 flashes one of 27 error codes on the readout to lead you to the specific problem quickly.

With a System 19, you can program every type of programmable logic device including FPLA. And with its unique gang module, you can program up to eight MOS devices at once.

Best of all, Data I/O's System 19 is priced within just about everyone's budget.

You haven't shopped around until you've looked at Data I/O. Let us show you the difference. Circle the reader service number or contact Data I/O, P.O. Box 308, Issaquah, WA 98027. **For answers fast, call toll free: 800-426-9016.**

# Good idea! DATA I/O

Programming systems for tomorrow...today

## PRODUCT FEATURE

# FCC Registered PC Board Modem Designed for Unattended Operation

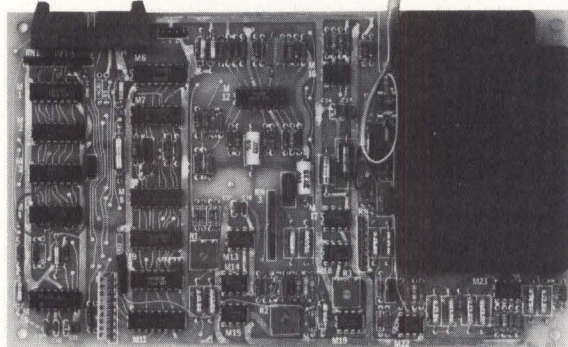

A 0- to 1200-bit/s, half-duplex, Bell 202c/s compatible modem registered for permissive connection to a switched telephone network, the direct connect vs1200P is a single-board unit intended for installation within a data communication device. The 5 x 8" (13 x 20-cm) PC board introduced by Racal-Vadic attaches to the communication device through use of four mounting holes provided. All terminal TTL interface and dc power connections are made via a common 20-pin ribbon cable connector and the modem is FCC approved for direct connection to a telephone line through standard telephone company supplied voice or data jacks.

### General Operation

Calls can be originated from the modem by any of four methods: through the modem's TTL interface, using an RJ11C voice jack and a standard telephone; using an RJ41S or RJ45S data jack or an RJ11C voice jack and a Racal-Vadic registered telephone; using an RJ11C voice jack, a standard telephone, and a Racal-Vadic voice/data switch and duplex adaptor; or using an RJ41S or RJ45S data jack and a telephone company 503 or 2503 dataphone. The modem permits either automatic or manual origination of calls.

For unattended operation, a strap option enables the modem to gen-

erate an automatic disconnect if a line current interrupt is detected, such as when a call is terminated prior to transmitting a dial tone. Therefore, the modem hangs up automatically whenever a telephone connection is broken.

The transmitter is phase coherent frequency shift keyed (FSK) with a request to send (RTS) signal controlling the carrier. If a data terminal ready (DTR) signal is present, the modem will go off hook upon detection of a ring signal and will transmit an answer back tone. Turning RTS on releases the transmitter and starts a clear to send (CTS) delay; when RTS is turned off, the transmitter will transmit a soft carrier for 25 ms.

The receiver demodulates FSK signals from -8 to -45 dBm. This demodulated signal becomes the receive data. A carrier detector is on for signals above -45 dBm and off for signals below -52 dBm. If a soft carrier is detected, the carrier detector is forced off. An analog loop-back test of the modem causes the transmitter signal to be fed back to the receiver.

### Specifications

Modulation is binary, and data format is serial, binary, asynchronous. Output circuits can drive two TTL loads.

Transmit frequencies are 1300 Hz  $\pm 1\%$  mark, 2100 Hz  $\pm 1\%$  space,

900 Hz  $\pm 2\%$  soft carrier, and 2025 Hz  $\pm 1\%$  answer tone. Transmit level is  $-10 \pm 1$  dBm. Request to send/clear to send delay is  $200 \pm 20$  ms (shorter times are available for custom applications), soft carrier timing is  $25 \pm 5$  ms, and answer tone timing is  $3.5 \pm 0.5$  s.

Receive frequencies are 1200 or 1300 Hz mark, 2100 or 2200 Hz space. Carrier detect delays are  $23 \pm 5$  ms off to on,  $6 \pm 1.5$  ms on to off. Dynamic range is  $-8$  dBm to sensitivity.

Error rate is 1 in  $10^5$  bits with a signal-to-noise ratio of 14 dB back to back over a simulated worst case line, down to  $-40$  dBm. Distortion is less than 10% peak over a worst case line.

Temperature ranges are 0 to 65 °C ambient operating,  $-20$  to 85 °C storage, both at 0 to 95% relative humidity noncondensing. Power requirements are 5 V at 25 mA max, 12 V at 90 mA max, and  $-12$  V at 60 mA max.

### Price and Delivery

Single-unit price for the vs1200P printed circuit board modem is \$260; quantity discounts are available. Delivery is 30 days ARO. Racal-Vadic, 222 Caspian Dr, Sunnyvale, CA 94086. Tel: 408/744-0810.

**For additional information circle 199 on inquiry card.**

# MICRO POWER

## R6500 any way you like it. That's Rockwell Micropower.

Rockwell's R6500 microcomputer system consists of a family of ten software-compatible CPUs featuring 13 powerful addressing modes.

You get general-purpose I/O, communications interface, standard memory, and combination memory-I/O-timer circuits. Our intelligent peripheral controllers provide cost effective software/hardware tradeoffs. And there's even a single-chip R6500/1 microcomputer.

To give you a headstart in microcomputing, AIM 65 (R6500 Advanced Interactive Microcomputer) puts a terminal style keyboard, 20-character alphanumeric printer and display, cassette interface, and more at your fingertips for only \$375.

To put your design effort in high gear, Rockwell's SYSTEM 65 is a powerful, easy-to-use development system with two integral mini-floppy disk drives. High level PL/65 language designed to increase programming productivity is also available.

More to choose from in 1979 from the fastest selling microprocessor in 1978. That's Rockwell Micropower.

For more information, contact Department 727-A2, Microelectronic Devices, Rockwell International; P.O. Box 3669; Anaheim, CA 92803, or phone (714) 632-3729.

R6500 CPU Options

	40-Pin DIP		28-Pin DIP				
	R6502	R6512	R6503 R6513	R6504 R6514	R6505 R6515	R6506	R6507
On chip clock							
External Clock							
Memory Address Space	65K	65K	4K	8K	4K	4K	8K
Interrupts — Maskable — Non-Maskable	Yes Yes	Yes Yes	Yes Yes	Yes No	Yes No	Yes No	No No
SYNC — Output indicates op code fetch cycle	Yes	Yes	No	No	No	No	No
RDY — Single step and slow memory synchronization	Yes	Yes	No	No	Yes	No	Yes
$\Phi_1$ Clock Output	Yes	Yes	No	No	No	Yes	No
DBE — Extended Data Bus Hold Time	No	Yes	No	No	No	No	No



**Rockwell International**

...where science gets down to business

# PRODUCTS

## Microprocessor Based Data Loggers Serve as Standalone or Frontend Units

Up to 5 frontend modules (FEMs), each containing 20 points of analog multiplexing and signal conditioning for thermocouples, other voltage sources, RTDs, or current transmitters, can be plugged into the 230A mainframe; or one or more can be remoted up to 1 mi (1.6 km) from the unit via a 4-conductor cable. FEMs communicate digitally with the mainframe. An additional 196 points of digital status information can be handled with resolution of  $0.5 \mu\text{V}$  and  $0.1^\circ\text{C}$  or  $^\circ\text{F}$ . Front touchpanel command entry allows the user to program function, alarm limits, output relays, date/time, time intervals, and arithmetic functions such as  $mx + b$ , averaging, and point difference. Output is fully buffered to allow independent log processes at different intervals to different devices to occur simultaneously. Output log devices can also be program selected. Other features include 140-dB common mode rejection, CMOS or reed relay multiplexer switches, and internal silent alphanumeric printer with mes-



sage printing via remote terminal or computer. **Doric Scientific, Div of Emerson Electric Co**, 3883 Ruffin Rd, San Diego, CA 92123.

Circle 200 on Inquiry Card

## Portable Multimode Data Communications Tester Provides Onsite Service



The 832 Data Comm Tester offers many diagnostic capabilities previously found only in bench type analyzer/emulators. Operators can verify system performance, identify and troubleshoot faulty system elements, solve hardware handshake problems, and perform alignments and adjustments with a minimum of time and trouble. Requiring only a few hours of training to operate, the unit weighs 5 kg and measures 33 x 10 x 31 cm. For use in servicing all major components of a data communication system which has either EIA Std RS-232-C or CCITT V.24 or current loop interfaces, the device operates in monitor, simulate, echo, or repeat modes on either full- or half-duplex lines with characters from 5 to 8 bits long and with odd, even, or no parity. Baud rates are switch selectable at 50, 75, 110, 134.5, 150, 200, 300, 600, 1200, 1800, 2400, 4800, or 9600 bits/s, or can be synchronized to either the DTE or DCE system clocks. Receive buffer memory allows storing of data for observation and evaluation. **Tektronix, Inc**, PO Box 500, Beaverton, OR 97077.

Circle 201 on Inquiry Card

## 2-Way Electronic Optical Link Couples Digital Signals

An all electronic device for 2-way optical coupling of digital signals across an rf gap, ElectroFlash™ optical link FTB-205-0L couples digital information between isolated sections of high voltage assemblies. The device permits remote control and monitor systems to be installed on the ground side of the assemblies. Both sides of the link are independently powered with an input of 120/240/480 Vac, 50 or 60 Hz. The device allows transmission of data between points requiring an isolation capability of 15 kV rms at 1 MHz, or higher isolation at lower frequencies. Using CMOS compatible circuitry, the solid-state device accepts positive pulse inputs from 0 to 35 mA and outputs from 0 to 35 Vac, up to 10 kHz max. Basic configuration is two similar electrical housing assemblies, each containing identical optical coupler interface circuits, attached to opposite ends of an insulator assembly. The lower electrical assembly has provisions for mounting the optical link. The insulator assembly is a high voltage bushing insulator containing dual fiber optic paths. **Flash Technology Corp of America**, 55 Lake St, Nashua, NH 03060.

Circle 202 on Inquiry Card

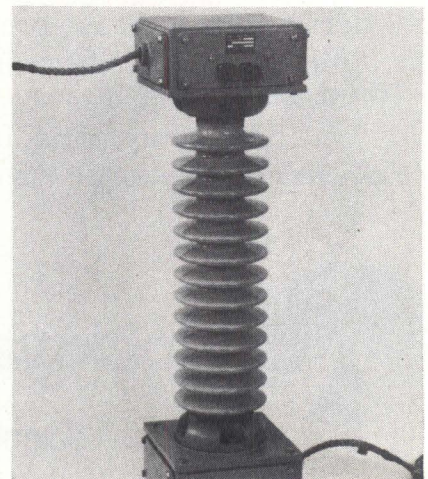



# We're introducing a paper tiger. In 90 days.

It's our newest, smart impact mini-printer. Designed to meet the tough standards of small-systems OEMs.

From the people who invented the smart impact printer.

Take it from us. This is one paper tiger worth waiting for.



Integral Data Systems, Inc. 14 Tech Circle, Natick, MA 617 237-7610

CIRCLE 120 ON INQUIRY CARD

## PRODUCTS

### INTERACTIVE GRAPHIC SYSTEM WORKSTATION

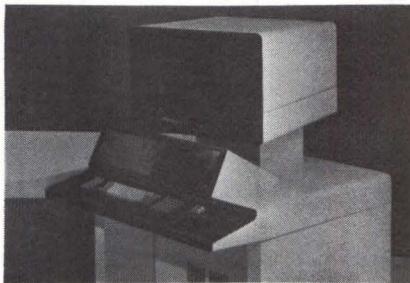

Intelligent CC-80 workstation contains a microprocessor to relieve the burden on the host CPU. Choice of 19" (48-cm) or 25" (64-cm) graphic CRT with elevate and swivel controls, 9" (23-cm) alphanumeric CRT with selectable screen formats, local and remote communications capability, and up to 4 240-position menu function keyboards/station are consolidated in the unit. CRT features refresh and simultaneous storage display. The system uses the AD/380 family software. **Auto-trol Technology Corp.**, 5650 N Pecos St, Denver, CO 80221.

Circle 203 on Inquiry Card

### MULTITERMINAL BUSINESS COMPUTER

Easing the transition from manual accounting methods to computers, the System 410 base configuration consists of 40k bytes of system memory, 14M-byte disc storage system, video display terminal, and bidirectional printer. A mag tape cartridge drive with removable 9.2M bytes allows backup and offline storage. The CPU is a microprogrammed computer; the Basic Operating Software System (BOSS) utilizes 32k bytes of protected operating system memory and 8k bytes of user memory. **Basic Four Corp.**, PO Box C-11921, Santa Ana, CA 92711.

Circle 204 on Inquiry Card

### PRODUCTION LINE EPROM COPIER

Standalone unit can duplicate EPROMs including 2704, 2708, 2758, 2716-3, 2716-1, 2732, and 2532. Model 7818 copies both 1- and 3-supply types, and can program from 1 to 8 duplicates simultaneously. Copier automatically checks to see that copy EPROMs are erased, automatically verifies each copy after programming, indicating failures in either step with LEDs. Verify light flashes to alert operator of verification failures. **SMR Electronics**, 3 Haven Rd, Medfield, MA 02052.

Circle 205 on Inquiry Card

### TEMPERATURE COMPENSATED CRYSTAL OSCILLATOR

Model ZT-182, featuring ECL output in a hybrid package, is available at any frequency in the range of 10 to 100 MHz, meeting a stability of  $\pm 5 \times 10^{-6}$  over 10 to 50 °C. The device drives up to 10 ECL gates and operates from a std -5.2-V input. The solder sealed, metal enclosed package, measuring 0.87 x 0.50 x 0.36" (2.2 x 1.3 x 0.9 cm), plugs into a 14-pin DIP socket. External mechanical frequency adjustment is possible. **Greenray Industries, Inc.**, 840 W Church Rd, Mechanicsburg, PA 17055.

Circle 206 on Inquiry Card

### CONTROL SYSTEM ENHANCEMENTS

Single-loop microprocessor controllers, offering more than 100 algorithms including adaptive gain; distributed data acquisition subsystems allowing acquisition and transmission of up to 1024 remote input signals to central system; and fully redundant electronics have been added to MOD III control system. Control mode, response settings, setpoint, output, output limits, and selection of setpoint source may be controlled directly from the command console. **Taylor Instrument Co, Div of Sybron Corp.**, 95 Ames St, Rochester, NY 14601.

Circle 207 on Inquiry Card

# ADVANCED TECHNICAL

Course 142 — Five days

## Troubleshooting Microprocessor-Based Systems

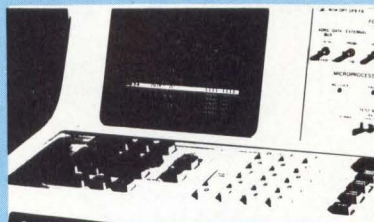

**LOS ANGELES**  
March 12-16

**WASHINGTON, D.C.**  
March 19-23

**DALLAS**  
March 26-30

**BOSTON**  
April 23-27

**PHILADELPHIA**  
April 30-May 4

**NEW YORK**  
May 14-18

Nearly all manufacturers, OEMs and end users are suffering from major production bottlenecks and customer service problems directly caused by the unavailability of trained personnel to test and troubleshoot microprocessor systems. This unique course is specifically designed for engineers and senior technicians involved in production testing, field service and design of microprocessor-based systems. The course provides these personnel with the practical knowledge they require, including an in-depth understanding of: a) microprocessor software and hardware; b) how to apply the most powerful microprocessor debugging technique and c) how to use microprocessor troubleshooting equipment.

- **Hardware Design Fundamentals**
- **Programming Fundamentals**
- **Overview of Microprocessor System Troubleshooting**
- **Writing Diagnostic Software**
- **Troubleshooting & Test Equipment**
- **Using Logic Analyzers**
- **In-Circuit Emulators**
- **Signature Analysis Techniques**
- **Microcomputer Development Systems**
- **Pre-Planning Requirements**

Course 365 — Four days

## Computer Graphics

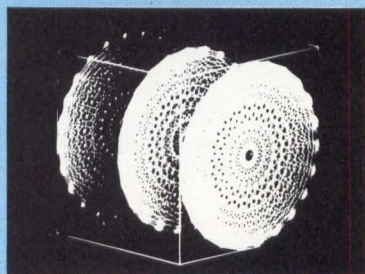

**NEW YORK**  
February 13-16

**LOS ANGELES**  
February 27-March 2

**DALLAS**  
March 20-23

**WASHINGTON, D.C.**  
March 27-30

**DETROIT**  
April 17-20

**BOSTON**  
April 24-27

**SAN FRANCISCO**  
May 8-11

Hardware elements of computer graphics systems are presented at the level required for detailed system specification, selection and acquisition. Software techniques for computer graphic systems are developed from the elementary level of line generation and continue through advanced approaches to animated three-dimensional color displays with hidden surface removal. Off-the-shelf, commercially available software packages are analyzed and evaluated. Emphasis is placed on hardware/software tradeoffs, cost effectiveness and the advantages and limitations of alternative approaches.

- **Display Hardware**
- **Color Display Techniques**
- **Two Dimensional Graphics**
- **Three Dimensional Graphics**
- **Transformations**
- **Software Structures**
- **The Hidden Line Problem**
- **The Hidden Surface Problem**
- **Software 'Build or Buy'**
- **Selection Methodology**

Course 412 — Five days

## Digital Signal Processing

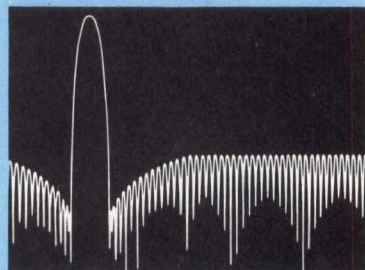

**FT. LAUDERDALE**  
February 12-16

**DALLAS**  
March 12-16

**LOS ANGELES**  
March 19-23

**PHILADELPHIA**  
April 2-6

**WASHINGTON, D.C.**  
April 23-27

**BOSTON**  
April 30-May 4

The objective of this course is to present the necessary fundamentals of digital signal processing in a clear and comprehensible manner, to develop an understanding of new processing techniques, to survey the state of the art of hardware and software available, and to apply this information to a range of concrete design examples. The course is of benefit both for those who wish to achieve a basic understanding of this exciting area, and for those whose interest is in advanced techniques and the implementation of practical systems.

- **An Overview of Applications**
- **Digital vs. Analog Signals**
- **Operations on Digital Signals**
- **Recursive Filters**
- **Nonrecursive Filters**
- **Design Techniques**
- **Computer Aided Design**
- **Statistical Approaches**
- **Spectral Estimation**
- **Application Case Study**

### COURSE ENROLLMENT INFORMATION

#### Course Hours:

**Orientation (First Day):** 8:15-9:00 A.M.  
**Lecture Sequence:** 9:00 A.M.-4:30 A.M.  
**Informal Discussion Session with Instructor:** 4:30-6:30 P.M.

#### Course Fees:

**Four-Day Courses:** (365, 445, 440): **\$695.00** (U.S.)  
**Five-Day Courses:** (412, 142): **\$795.00** (U.S.)  
**Microprocessors and Microcomputers Series**  
**Individual Courses:** 111 or 102s (One Day): **\$195.00** (U.S.)  
130 (Three Days): **\$495.00** (U.S.)  
**Combinations:** 111 and 102s (Two Days): **\$390.00** (U.S.)  
102s and 130 (Four Days): **\$595.00** (U.S.)  
**Complete Series:** 111/102s/130 (Five Days): **\$695.00** (U.S.)

**Course Fees Include:** lectures, lecture-coordinated notes, extensive reference materials, luncheon & coffee breaks.  
**Team/Group Discount:** 10% reduction for three or more participants from the same organization, if invoiced at the same time.

#### DIPLOMA/CONTINUING EDUCATION UNITS

Each attendee receives a Course Completion Certificate awarding one Continuing Education Unit (CEU) for each ten hours of class participation. The CEU is a nationally recognized unit awarded by universities and educational organizations for participation in continuing educational programs.



Course 445 — Four days

## Data Communications

Digital Techniques and System Design

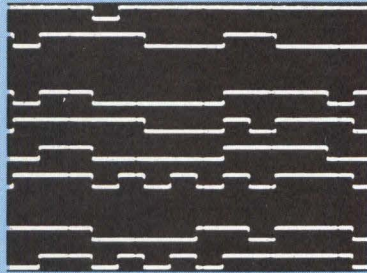

**CHICAGO**  
February 6-9

**WASHINGTON, D.C.**  
March 13-16

This course is designed for engineers, scientists and system designers who are involved in the planning, design or implementation of all types of digital communications systems. The course covers the fundamental principles of signal conversion, encoding/modulation, data transmission and error control. It analyzes the individual elements of a data communication system and clearly describes how these elements may be synthesized to form a system which best meets application specific objectives.

- Coding for Data Transmission
- Detection of Data in Noise
- Digital Modulation
- Security Considerations
- Errors and Error Control
- Analog to Digital Conversion
- Pulse Code Modulation (PCM)
- Signal and Video Encoding
- Packet Switching/ Packet Radio
- Implementing a Data Communications System

Course 440 — Four days

## Fiber Optic Communication Systems

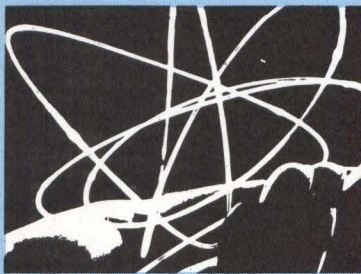

**WASHINGTON, D.C.**  
February 27-March 2

**DALLAS**  
March 13-16

**LOS ANGELES**  
April 3-6

**NEW YORK**  
May 1-4

This course is designed for engineers, scientists and managers involved in the planning, design and implementation of all types of communication systems. The course covers the fundamental principles of fiber optic based systems, and the state of the art in system components including light sources, optical fibers, single and multifiber cabling, fiber coupling, photodetectors, receiver and repeater technology, and fiber optic networks. Commercially available components will be surveyed to illustrate design techniques for the cost effective, practical application of this important new technology.

- Advantages of Fiber Optics
- Optical Fiber Transmission
- Cabling Technology
- Light Sources
- Detection Technology
- Receiver/Transmitter Technology
- Modulation Techniques
- Digital Communications
- Data Bus Design
- System Design and Analysis

### FIVE-DAY COURSE SERIES MICROPROCESSORS & MICROCOMPUTERS

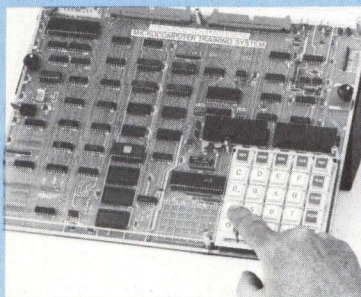

**FT. LAUDERDALE**  
February 5-9

**WASHINGTON, D.C.**  
February 26-March 2

**NEW YORK**  
March 12-16

**PHILADELPHIA**  
April 2-6

Course 111: One day — Monday

#### MICROPROCESSOR PROJECT MANAGEMENT

From design through manufacture, QA and field service

Course 102s: One day — Tuesday

#### MICROPROCESSORS AND MICROCOMPUTERS:

A Comprehensive Technical Introduction and Survey

Course 130: Three days — Wed., Thurs., Fri.

#### HANDS-ON MICROCOMPUTER PROGRAMMING AND INTERFACING WORKSHOP

EACH student receives a complete 8080 micro-computer and interfacing system for his personal use throughout the course.

PLEASE ENROLL ME IN COURSE: \_\_\_\_\_

CITY \_\_\_\_\_

DATE(s) \_\_\_\_\_

#### MAIL TO:

Integrated Computer Systems, Inc.  
3304 Pico Blvd., P.O. Box 5339  
Santa Monica, CA 90405

OR:  
Integrated Computer Systems, Inc.  
300 N. Washington St., Suite 103  
Alexandria, VA 22314

#### OR CALL:

(213) 450-2060  
LOS ANGELES

OR

(703) 548-1333  
WASHINGTON, D.C.

Name \_\_\_\_\_ Job Title \_\_\_\_\_

Company \_\_\_\_\_ Mail Stop \_\_\_\_\_

Address \_\_\_\_\_

City \_\_\_\_\_

State \_\_\_\_\_ Zip \_\_\_\_\_ Telephone \_\_\_\_\_

Please send FREE BROCHURES describing these courses.

Please put me on your mail list to receive future course schedules.

A confirmation letter with complete details will be forwarded to you.

# MDB gets your IBM Series/1 together with more than 30 different line printer models, over 100 different terminals (TTY/RS232 type), or wire wrap for your special requirements.

MDB interfaces provide peripheral variety for the IBM Series/1 computer system. No longer limited to the manufacturer's models, you can select from the almost unlimited peripheral devices available in the minicomputer market. User flexibility is the benefit of MDB interface products.

The MDB Line Printer Controller for IBM Series/1 computers gives total printer capability with no change in system software. Microprocessor controlled, the interface allows maximum data transfer to any printer. The single board module operates in cycle-stealing mode or under Direct Program Control; character code and transfer belt conversion is available to match any printer.

The MDB Serial interface Board provides user flexibility in attachment of the Teletype or equivalent device to the Series/1 computer. This board also permits use of any CRT or similar device through use of RS232 circuitry. The TTY board has RS232, and 422, as well as current loop modes of operation. It is double buffered to minimize data over-run; baud rates of 50 to 19.2K are switch selectable.

Unique interface design requirements are facilitated by the WW72 and WW64 wire wrap boards for Series/1 computers. Up to 72 twenty-pin or 64 sixteen-pin IC posi-

tions are available respectively; numerous other IC size combinations can be developed by the user. These boards include pins in the user wirewrap portion with pads provided for discrete components. The MDB boards can accommodate any .300, .400 or .600 center dual in-line packages; two 40-pin ribbon-cable edge connectors are provided.

MDB interface products always equal or exceed the host manufacturer's specifications and performance for a similar interface. MDB interfaces are completely software transparent to the host computer. MDB products are competitively priced, delivery is 14 days ARO or sooner.

MDB places an unconditional one year warranty on its controllers and tested products. Replacement boards are shipped by air within twenty-four hours of notification. Our service policy is exchange and return.

MDB also supplies peripheral device controllers, GP logic modules, systems modules and communications/terminal modules for DEC PDP-11 and LSI-11\*, Data General and Interdata computers. Product literature kits are complete with pricing.

**MDB** 1995 N. Batavia Street  
Orange, California 92665  
714-998-6900  
**SYSTEMS INC.** TWX:910-593-1339

\*TM Digital Equipment Corp.

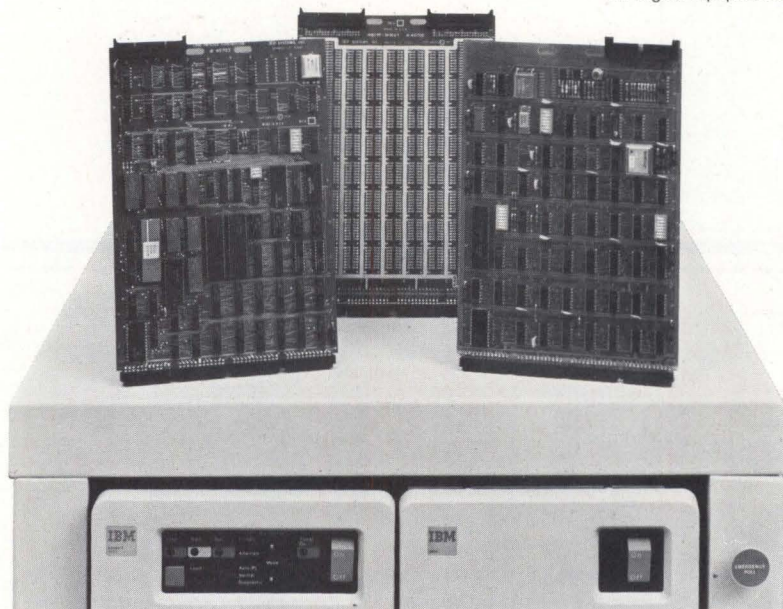

Circle 122 for IBM; 123 for PDP; 124 for LSI; 125 for DG; 126 for Interdata  
192

## PRODUCTS

### SIMPLIFIED EIA PRINTER INTERFACES

Serial interfaces CSP-100 and CSP-200 for Centronics printers are designed to offer a low cost EIA level serial interface with power supplied from the printer. CSP-100 is unbuffered and the microprocessor controlled CSP-200 has a 256-char buffer and features auto-parity. Units are supplied with cables, connectors, and mounting tape. **Via West, Inc.**, 2739 W Palm Lane, Phoenix, AZ 85009.

Circle 208 on Inquiry Card

### 225-W SWITCHING POWER SUPPLY

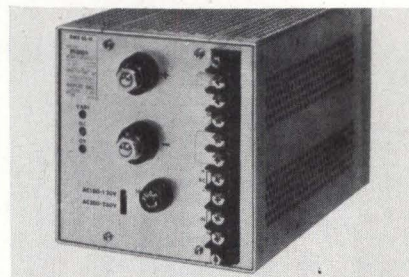

Series-N, consisting of 6 225-W models, is output voltage adjustable from -30 to 10%. Std voltages are 5, 9, 12, 15, 24, and 28 V. Featured are adjustable current limiting, adjustable overvoltage protection, selectable 115/230-Vac input, remote on/off control, soft start input surge limiting circuit, and 25-kHz conversion for up to 80% efficiency. **Kepeco, Inc.**, 131-38 Sanford Ave, Flushing, NY 11352.

Circle 209 on Inquiry Card

### 220-Vac 50-W POWER SUPPLY

190- to 260-V/rms line range,  $\pm 0.05\%$  or  $\pm 10$ -mV line regulation, 0.2% or 10-mV load regulation, 0.8% or 100-mV ripple and noise are electrical specs listed for 5 x 8.6 x 1.95" (12.7 x 21.8 x 4.95-cm) E series supplies. Std models are E5T10 (5 V at 10 A), E12T5 (12 V at 5 A), E15T4 (15 V at 4 A), E28T2R25 (28 V at 2.25 A) and E48T1R5 (48 V at 1.5 A). **Etatech, Inc.**, 187-M W Orangerthorpe, Placentia, CA 92670.



Circle 210 on Inquiry Card

## MULTIPLE OUTPUT SWITCHING POWER SUPPLIES

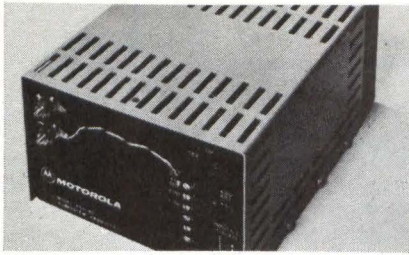

400-W, 25-kHz pulse-width-modulated supply series offers remote turn-on/turn-off, soft start circuitry, overcurrent protection, and overvoltage protection with automatic reset. Specs include 300-ms hold-up time, <10-mV rms ripple and noise, and <0.02%/°C tempco. Outputs are as follows: PSN1801—5 Vdc at 80 A max; PSD1802—5 Vdc at 60 A max, and 12 Vdc at 8 A max; PST1803—5 Vdc at 60 A max, and two 12 Vdc at 4 A max. **Motorola Semiconductor Products, Inc.**, PO Box 20912, Phoenix, AZ 85036. Circle 211 on Inquiry Card

## ADD-ON MEMORY FOR IBM 3030 SERIES COMPUTERS

Two add-on memories, 33031 and 33032 for IBM 3031 and 3032 computers, respectively, are available in data storage increments of 1M bytes for addition to systems with a min of 2M bytes of IBM host memory. The 33101 memory, which attaches to IBM 3033 systems, requires a min of 4M bytes of IBM memory, and is offered in increments of 2M bytes. Memory up to a max system storage capacity of 16M bytes can be added. **Control Data Corp.**, Box O, Minneapolis, MN 55440.

Circle 212 on Inquiry Card

## 1200-BIT/s DIRECT CONNECT AUTOANSWER MODEM

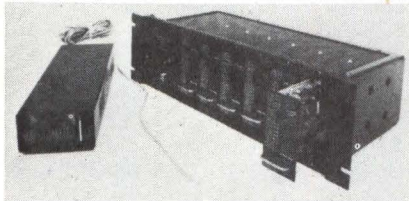

Simplex/half-duplex, 2-wire, Bell-compatible P-202S interfaces directly with 2-wire dial-up switched network through a 97A or 97B jack. Modular unit can be connected to the switched network in programmable, fixed loss, or permissive modes. Available in card and standalone versions, unit provides a serial binary asynchronous format, -3- to -12-dB transmit level, -48-dBm receiver sensitivity and FSK modulation, and built-in diagnostic capability. **Prentice Corp.**, 795 San Antonio Rd, Palo Alto, CA 94303.

Circle 213 on Inquiry Card

## WIREWRAP BOARD

ProtoHex boards permit mixed placement of DIPs, quad-inline packages, or discrete components on both sides of the board. Capacity is related to component size. Bottom edge of std hex width board inserts into a PDP-11 SPC slot or equivalent backplane. Power and ground locations are provided throughout the board; filter or decoupling capacitors may be installed as required. Board is supplied with 1500 wirewrap pins and a pin insertion tool. **Associated Computer Consultants**, 228 E Cota St, Santa Barbara, CA 93101.

Circle 214 on Inquiry Card

## FAST IR FIBER OPTIC EMITTER

Etched-well series FR4000 IR LEDs transfer 50  $\mu$ W into a 200- $\mu$ m fiber or 1.5 mW into a 7-fiber 20-mil (0.5-mm) bundle while handling a 10M-bit/s data rate. 4-mW power output and 20-ns rise-time gives a 2.0 x 10<sup>6</sup>-W/s power/speed product. The series emits at 880 nm, has a 50-nm spectral line halfwidth, 7-V max reverse voltage, and 85 °C max operating case temp. Diodes are delivered in TO-46 packages; they are also available in TO-5 packages. **IAV, Inc.**, 15818 Arminta St, Van Nuys, CA 91406.

Circle 215 on Inquiry Card



# Give your PDP-11 a Calendar.

When you equip your computer with a TCU-100, you'll automatically have the date and time available when you power up.

It's an easy way to keep track of downtime, too. Furthermore, you can use the unit like an alarm clock. Set it to interrupt at preset times—or at intervals as short as 1/2048 second.

TCUs are shipped preset to your local time, but can be set to any time you want by a simple software routine. The built-in battery back-up is good for months with out computer power.

For the LSI-11 user, we offer the TCU-50 — the same reliable timekeeper without the interrupt capability. With either unit, time is cheap. The TCU-100 is just \$495. And the TCU-50 is only \$325.

Time is only one way we can help you upgrade your PDP-11 or LSI-11 system. We'd also like to tell you about the others.

So contact Digital Pathways if you're into -11's. *We are too.*



**DIGITAL PATHWAYS INC.**

4151 Middlefield Road • Palo Alto, California 94306 • Telephone (415) 493-5544

CIRCLE 127 ON INQUIRY CARD

193

## PRODUCTS

### DATA COMMUNICATIONS MONITORING SYSTEM

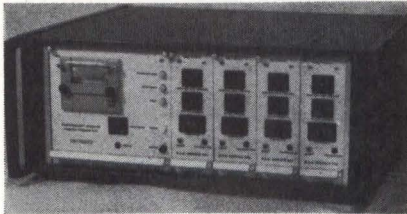

Consisting of a series of modules which capture data about the communications line and present it in statistical format, model 500 can recover response time and line utilization information under a variety of std protocols. Printer/controller/power supply module tracks date and time and configures individual modules for frequency of printing, type of statistics, and whether resetting is automatic or individually controlled. Communications modules are individually set for threshold levels such that any parameter exceeding that threshold automatically forces a print along with time of day. **Questronics, Inc.**, 3565 S W Temple, Salt Lake City, UT 84115. Circle 216 on Inquiry Card

### FLAT CABLE MASS TERMINATION CONNECTOR

The 60-contact 3322 connector features durable sidewall construction, which adds ruggedness for I/O applications. It is suited to systems requiring T-taps from a cable bus or I/O interfacing. Scotchflex connectors contain beryllium copper U-contact technology for gas-tight insulation-displacement mass terminating. Accessories include mounting flanges, strain relief clips, and polarizing keys. **3M Co., Electronic Products Div.**, Box 33600, St Paul, MN 55133. Circle 217 on Inquiry Card

### 25-MHz LSI MEMORY TESTER

With a 40-ns period capability, the M-1 system tests 4k and larger static MOS RAMs at 25 MHz. It has built-in capability to test 16k and 64k dynamic MOS RAMs at 20 MHz with full split cycle timing; 25-MHz capability includes bipolar and ECL RAM testing. Lightweight test head interfaces with commercial probers and handlers and a special hybrid comparator package allows measurement and error processing at the end of cable. Computer control is based on the DEC LSI-11. Operator I/O is through a std video terminal plus hard-copy printout. **Macrodata Corp.**, 21135 Erwin St, Woodland Hills, CA 91365. Circle 218 on Inquiry Card

### COMPILER FOR PDP-11 OPERATING SYSTEMS

Compiler supports facilities of the complete C programming language, including bit fields and defined types. Versions are available for Western Electric UNIX and for DEC RT-11, RSTS-E, RSX-11M, and IAS systems. Unit operates in three sequential passes, and can replicate itself with 167k words of user memory under UNIX and with 20k and 1 disc drive on an LSI-11. Runtime library is complete and systematic. **Whitesmiths, Ltd.**, 127 E 59th St, New York, NY 10022. Circle 219 on Inquiry Card

### ADVANCED COMMUNICATIONS PROCESSOR

Programmable CC-85 processes more than 400k char/s sustained for synchronous transmission, with peak capabilities approaching 1M char/s. Unit features microprocessor controlled color CRT console, and can be used with all System/360/370/303X models. Other features are ability to handle any mix of line speeds to 900 lines, automatic baud rate detection, automatic polling, internal cycle time of less than 90 ns, 8 groups of 16 registers, and 32 hardware interrupt levels. **Computer Communications Inc.**, 2610 Columbia St, Torrance, CA 90503. Circle 220 on Inquiry Card

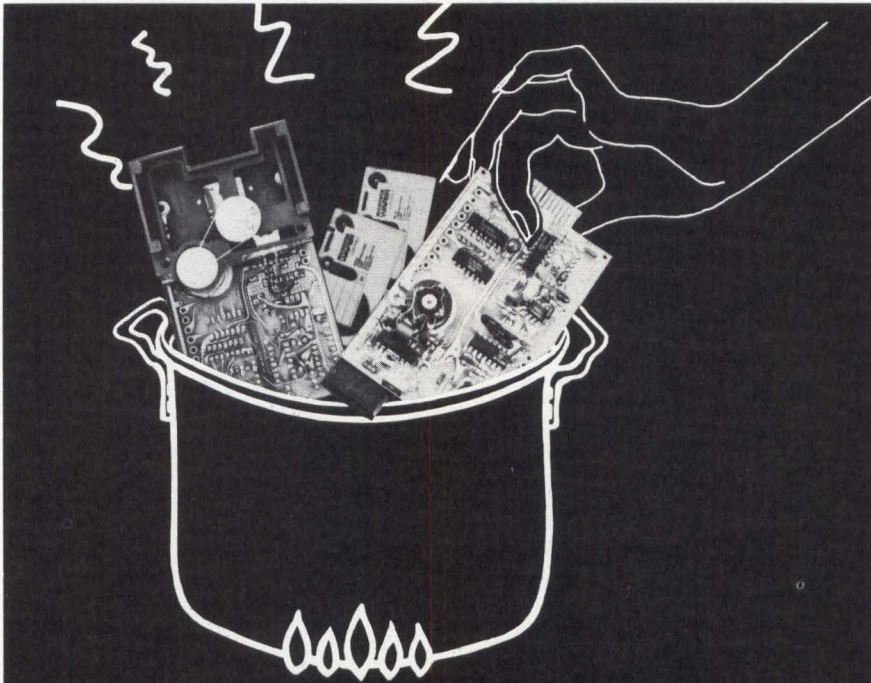

a word about **mini** tape transports for those who are cooking up something big in a micro-processor system.

Just as a gourmet dish is prepared only from high quality ingredients, so too a superb micro-processor system is constructed only from high-performance components. We are delighted to offer you the pièce de résistance of miniature tape transports. Our **new** MICRO read/write digital tape system.

Our MICRO read/write digital

tape system is **both** TTL and CMOS compatible. In performance, it has both **double** the recording density (3200 fci) and **double** the data transfer rate (4800 baud) of any comparable unit on the market. At \$69.00 per R/W system (in OEM quantities), our unit is available at about **half** the competitor's price. (Note: "Barebones" mechanical transport also available.)

Call or write today for details.



**MICRO COMMUNICATIONS CORP.**  
80 BACON STREET  
WALTHAM, MASS. 02154  
617/899-8111

A BUCKEYE INTERNATIONAL COMPANY

## LED DISPLAY/ KEYBOARD TERMINAL

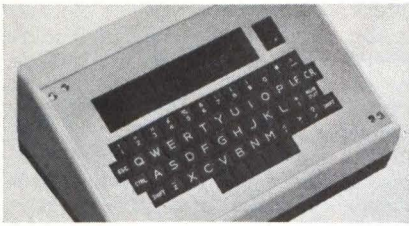

SR100 series MINTYPE computer terminals, designed to replace teletype-writers or video display terminals, have an interface for a low cost thermal printer. A teletypewriter compatible keyboard is used. Display section consists of 15 alphanumeric 16-segment LED elements that utilize a 64-char ASCII subset. Online mode of operation is full duplex; a local facility is also provided. EIA and 20-mA current loop are std. Selectable baud rates are from 50 to 2400. **Warren Logic Ltd**, Hockley Rd, Broseley, Salop TF12 5HT, England. Circle 221 on Inquiry Card

## SINGLE MODULE 2-SPEED S-D CONVERTER

Unit accepts two synchro or resolver inputs from 2-speed system and combines them into a digital word with resolution to 18 bits and accuracy to 0.003°. 3.125 x 2.625 x 0.82" (7.928 x 6.667 x 2.08-cm) unit operates from 0 to 70 or -55 to 105 °C on 15 Vdc at 50 mA and 5 Vdc at 400 mA. Gear ratios include 9:1, 18:1, 32:1, 36:1, and 64:1. Other features include transformer isolated input and reference voltages and 1440-deg/s tracking rate. **Transmag-netics, Inc**, 210 Adams Blvd, Farmingdale, NY 11735. Circle 222 on Inquiry Card

## X-Y PLOTTER

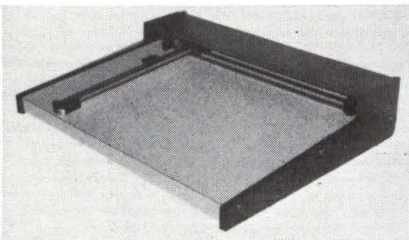

Interfacing to any 8-bit TTL parallel port, this unit combines a plotter, drawing surface, electronics, and power supply. Pen holder accepts any writing instrument or stylus 0.3 to 0.4" (7 to 11 mm) in dia; it is encoded for 0.01" (0.25 mm)/pulse, with 0.005" (0.127 mm) optional. Pen travel speed is 2.5" (63.5 mm)/s max with 24-V supply. A basic 8080 program is included. Plot driver software is available as ASCII source files on paper tape, CP/M small disc formats. **Sylvan Hills Laboratory, Inc**, PO Box 646, Pittsburg, KS 66762. Circle 223 on Inquiry Card

## 200-LINE/MIN MATRIX PRINTER

Compatible with DEC, Data General, Hewlett-Packard, Interdata, and other minicomputer systems, the M-200 also has an optional S-100 microcomputer compatible mode or an asynchronous RS-232 serial interface. Featuring a 14-pin wire matrix head, the unit prints in either expanded, condensed, or std char and provides up to 6 clear copies. Forms are loaded from front or bottom. A diagnostic display permits monitoring of machine status. **Southern Systems, Inc**, 3000 NE 30th Pl, Fort Lauderdale, FL 33306. Circle 224 on Inquiry Card

## HERMETICALLY SEALED ULTRAPRECISION RESISTOR

Protected against moisture, the VHM-1 miniresistor is 0.23" (5.84 mm) in dia and 0.21" (5.33 mm) high, offering both low profile and high packaging density for PC boards. It weighs 0.5 g. "Bulk metal" resistor technology achieves a TCR of 2.5 ppm/°C with tracking of 3 ppm/°C typ; inductance of 0.08 μH typ; rise time of 1 ns at 1 kΩ typ; and noise of -32 dB or better. The device is available from 50 Ω to 20 kΩ, tolerance to ±0.02%. Rated working voltage is to 45 V. **Vishay Resistive Systems Group**, 63 Lincoln Hwy, Malvern, PA 19355. Circle 225 on Inquiry Card



# Give your PDP-11 some Bank- Switched ROM.

It will be the best investment you ever made. ROM means rapid access and permanent storage.

One board gives you 16k of ROM or EPROM (using Intel 2716's). You can add as many boards as you like, using manual or program control to enable the memory in banks as small as 4k.

You can program the EPROM's in place on your PDP-11 or use the handy remote programmer. Either way, you'll stretch your system capacity with no fuss — and at very low cost. Only \$895. And the remote programmer is just \$250. In case you don't need bank switching, we have a 24k ROM system with conventional addressing for \$450.

By the way, you can get equivalent capability for the LSI-11.

So contact Digital Pathways if you're into -11's. We are too.



**DIGITAL PATHWAYS INC.**  
4151 Middlefield Road • Palo Alto,  
California 94306 • Telephone (415) 493-5544

## PRODUCTS

### DISKETTE DRIVE POWER SUPPLIES

Providing all required voltages and current capabilities specified by the manufacturer, CP272 powers Persci models 70, 270, and 277; CP302 handles the 299; and HTAA-16W supplies the 1070 controller. Units accept 115/230-Vac input and provide foldback overload protection, and 30- $\mu$ s transient response. Line regulation is  $\pm 0.05\%$  for

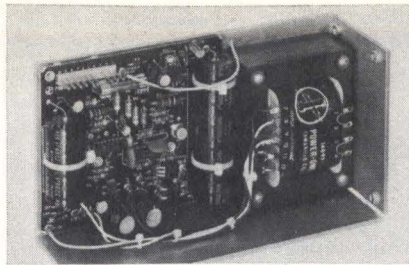

a 10% input change and load regulation is  $\pm 0.05\%$  for a 50% load change. Output ripple is 3.0 mV pk-pk max. **Power-One Inc**, Power One Dr, Camarillo, CA 93010. Circle 226 on Inquiry Card

### TIGHT TOLERANCE HYBRID CLOCK OSCILLATORS

Frequency tolerances, which include calibration, op temp range of 0 to 70 °C, load change, and voltage change, are  $\pm 25$  and  $\pm 50$  ppm for the K1144A and K1145A oscillators, respectively. Frequency range is 250 kHz to 25 MHz on  $\pm 50$ -ppm units and 4 to 25 MHz on the  $\pm 25$ -ppm units. **Motorola Inc**, Component Products, 2553 N Edgington, Franklin Park, IL 60131. Circle 227 on Inquiry Card

### LINE VOLTAGE MONITOR



Linesensors models 829R and 829T directly monitor line voltage for high and low limits. Limits are programmed by potentiometers molded into the case. No power supply is required since units run off voltage being monitored. When out of the window the 829R has a relay output and the 829T has an isolated open-collector output. Response time is 100 ms max to change in average, and 16 ms max to line dropout. **Calex Mfg Co, Inc**, 3355 Vincent Rd, Pleasant Hill, CA 94523. Circle 228 on Inquiry Card

### AXIAL METAL CERMET FUSIBLE RESISTORS

Rugged, flameproof FH series resistors withstand overloads of 1000 times rated wattage without danger of flame or explosion. Fusible characteristics range from 0.05 to 100  $\Omega$ . Available in 1- and 2-W ratings, resistors fuse within 15 s at 20 times overload. Tolerance availability is 1, 2, 5, or 10%. **Central Resistor Corp**, 507 Factory Rd, Addison, IL 60101. Circle 229 on Inquiry Card

### DISKETTE I/O UNITS

Remote flexible diskette I/O support has been added to PIX-II "Virtual" data links, which provide a virtual data path from the byte multiplexer channels of IBM 360/370 or 303X central processors to 1 or more remote locations. Data can be transmitted from remote peripheral devices over a single line via SDLC protocol without teleprocessing software or a front end communications controller at the host. Single-density diskette units feature 250k bytes/disc and can R/W IBM 3741-type

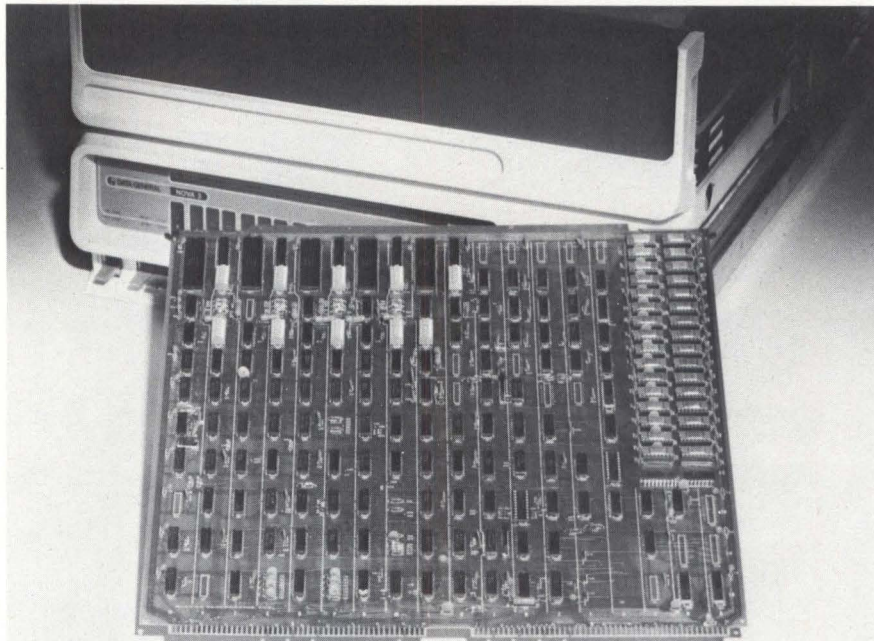

## Our Quintroller can make your Nova 3/4\* a systems star!

The Quintroller can slash system cost and bulk by making a 4-slot Data General NOVA 3/4 chassis do the work of a 12-slot chassis. That's because a 15" x 15" Quintroller card contains a 64KB MOS memory plus four additional functions: four asynchronous communications channels, parallel line printer interface, real time clock, and TTY port. This card replaces four individual boards from Data General. Quintroller software compatibilities include:

- Communication channels—DG 4060 Multiplexer
- Printer—DG 4034/4193 Controller
- Clock & TTY—DG 4008 & 4010
- Memory—DG 8547.

The printer controller interfaces Data Products, Centronics, Printronics, Tally and equivalent printers. The Model 28XX Quintroller, configured to your requirements, with cable set and documentation, can be delivered in 30 days from

 **RIANDA**  
ELECTRONICS, LTD.

2535 Via Palma Ave. • Anaheim, CA 92801  
Telephone: (714) 995-6552

Contact us for all your Data General controller needs.

\*Registered Trade Mark of Data General Corp.



#### MINIATURE T-3¼ INCANDESCENT LAMP

To aid energy conservation, the 120-Vac lamp is rated for 20-mA operation, and consumes no more than 2.5 W while providing typ brightness of 2.0 mean spherical candle power. Avg life is rated at 5k hours. Operation from std 120-Vac line power sources eliminates the need for transformers or power supplies. Unit is available with either screw or bayonet base and can be coated in any color to meet user specs. **Chicago Miniature Lamp Works, General Instrument Corp, 4433 N Ravenswood Ave, Chicago, IL 60640.** Circle 233 on Inquiry Card

created diskettes. **Paradyne Corp, 8550 Ulmerton Rd, Largo, FL 33541.** Circle 230 on Inquiry Card

#### POWER LINE ISOLATION DEVICE

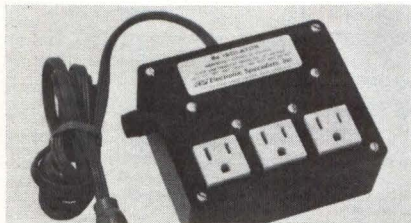

Isolating peripherals, disruptive line hash, and damaging power line surges, the Isolator is comprised of 3 individually filtered 3-prong ac sockets with integral surge suppression. Each socket is isolated from the others, eliminating equipment interactions for error- and glitch-free operation. Connecting to a 120-Vac line with a std 3-prong plug and 15-A fuse, the device can accommodate an 1875-W total load, with each socket capable of handling a 1000-W load. **Electronic Specialists, Inc, 171 S Main St, Natick, MA 01760.** Circle 231 on Inquiry Card

#### UNIDIRECTIONAL JOURNAL PRINTER

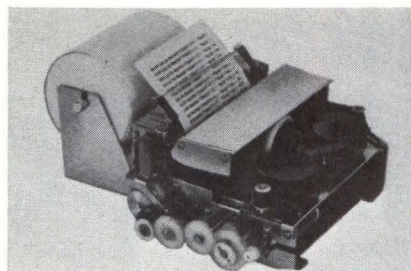

Model 511L serial impact dot matrix printer features enlarged char size of 3.1 mm high, 6.0-mm line spacing, and print speed of 2.2 lines/s. Reliability specs include  $5 \times 10^6$ -line mean cycles before failure, and printhead life of  $100 \times 10^6$  char ( $5 \times 7$  font, 25 °C). Font has 480 dot positions available, with max 240 dots printable/wire/line (7 wires). It is suited to printing tickets and providing master-to-slave intercommunications. **C. Itoh Electronics, Inc, 280 Park Ave, New York, NY 10017.** Circle 232 on Inquiry Card

#### LINE PRINTERS WITH GRAPHICS CAPABILITIES

Graphics capabilities added to micro-processor controlled Slimline series of line printers enable drawings, graphs, bar codes, charts, logos, halftones, or anything displayed on a CRT screen to be reproduced. The option is available on the 125- and 250-line/min models, which have Dataproducts and Centronics compatible interfaces. Horizontal dot density is 60 dots/in (24/cm) permitting up to 792 dots to be placed across 13.2" (33.5 cm). Vertical density is 72 dots/in (28/cm). **Okidata Corp, 111 Gaither Dr, Mount Laurel, NJ 08054.** Circle 234 on Inquiry Card

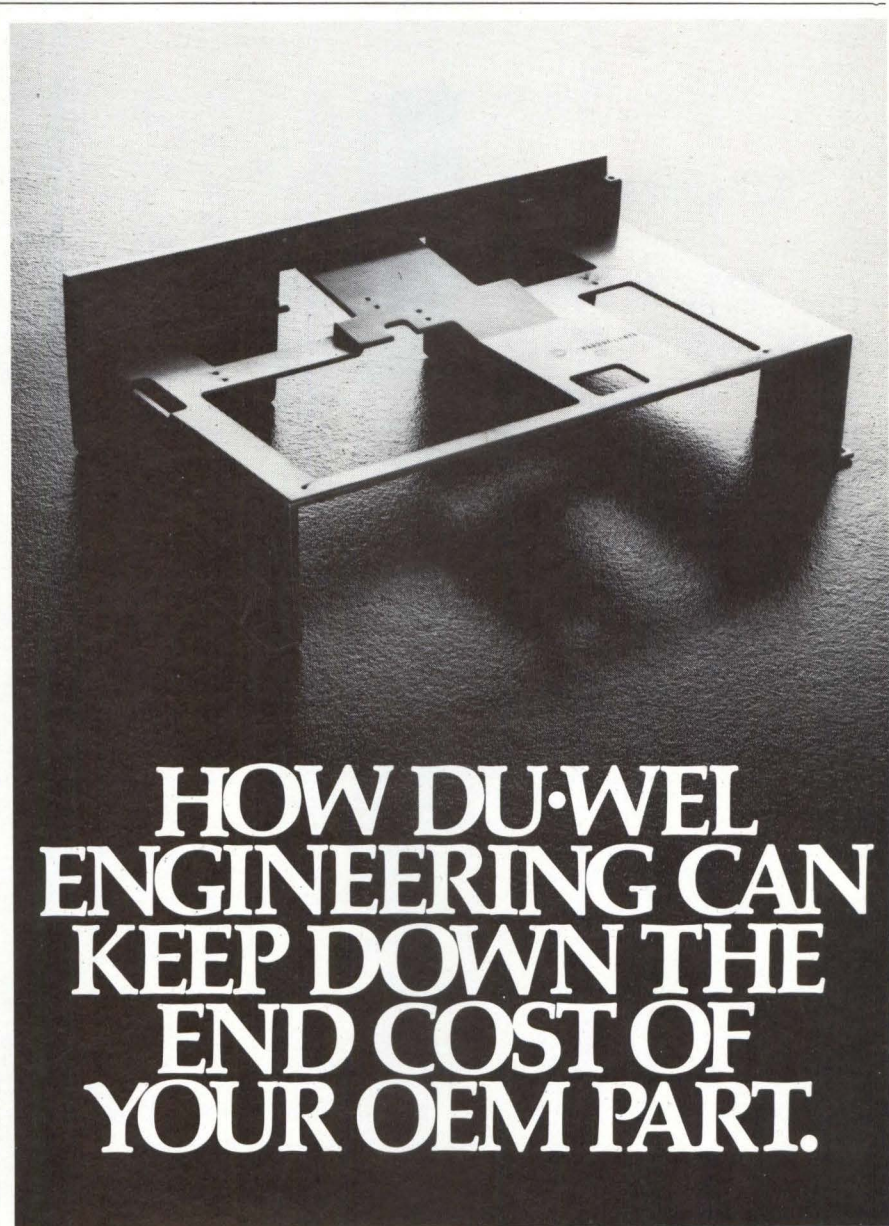

# HOW DU·WEL ENGINEERING CAN KEEP DOWN THE END COST OF YOUR OEM PART.

Die casting has some inherent problems and specific advantages of which many engineers and designers may not be aware. That's why many Du-Wel customers get our engineers involved in a project right from the start. Often, this results in spotting potential problems before they become major problems . . . and can produce a better part for less money.

Our die cast engineers pride themselves on being real craftsmen, and this attitude is reflected in the final outcome of our products.

Du-Wel spends approximately 1.5 times the industry average on engineering services, on a percent-of-sale-basis.

And that's why, if your requirements are high volume, high quality, die cast or injection

molded plastic OEM parts . . . we should talk. Call Harlon McMillian at (616) 427-7901.

That's just part of the reason why at Du-Wel, we not only do the job well. We do it better.



**Du-Wel Products, Inc.**  
Box 160, Dept. 357C  
Bangor, MI 49013  
Ph. (616) 427-7901

## PRODUCTS

### SWEEPABLE FUNCTION GENERATOR

Model 2001 is a 4-waveform function generator, electronically sweepable over a 10:1 to 100:1 range. Sine, triangle, square, and TTL square waves from 1 Hz to 100 kHz are offered in 5 push-button selectable overlapping ranges, tuned with a 10:1 vernier dial featuring 50 increments, and an accuracy of  $\pm 5\%$  of the dial setting. TTL output

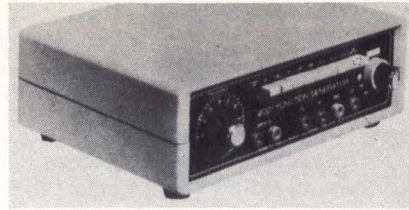

will drive 10 TTL loads with rise and fall times of  $< 25$  ns. Voltage controlled sweeping oscillator may be 0 referenced from any frequency setting. **Continental Specialties Corp**, 70 Fulton Ter, New Haven, CT 06509. Circle 235 on Inquiry Card

### RFI/EMI SWITCH SHIELDING

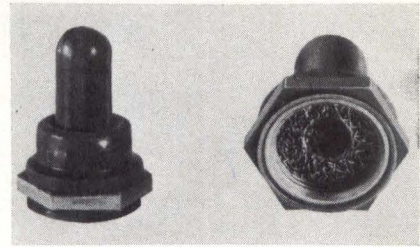

Two versions of switch seals are available with built-in rfi/emi suppression capabilities using either internally stuffed or molded-in knitted monel wire mesh, or conductive elastomers. Meeting industrial requirements, they comply with MIL-S-5423B. Silicone rubber Hexseals™ include a molded-in hexnut that replaces the switch's original nut. Internal and external sealing to pressures up to 15 lb/in<sup>2</sup> (103.5 kPa) protect against dust and liquid contaminants. **APM-Hexseal Corp, Div of APM Corp**, 44 Honeck St, Englewood, NJ 07631. Circle 236 on Inquiry Card

## CIQ Series

### 9" and 12" CRT DISPLAY MONITORS with a Horizontal Rate of 15.72 KHz

Compatible with TV120 or TV90  
Priced Below the Competition  
Built-in Quality, Performance, Dependability

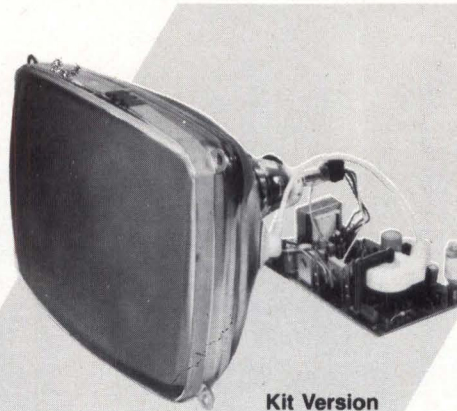

Kit Version

The low-cost CIQ-9 and CIQ-12 CRT Display Monitors with a horizontal rate of 15.72 KHz provide data equipment manufacturers with sharp, highly reliable image presentation.

Separate horizontal drive, vertical drive, and video signal inputs mean elimination of composite sync and video signal processing and simple output circuitry.

The completely new design of the compact integrated PCB utilizes the latest semiconductor and other components, providing a dependable performance level never before possible.

Delivered with P4 phosphor as standard. Available options are P31 and P39 phosphors, sturdy zinc chromate plated chassis and a power supply module which is compatible with practically any power supply standard in the world.

#### FEATURES

- Uniform High Resolution
- Integrated PC Board
- Dependable Construction
- Squareness of Picture

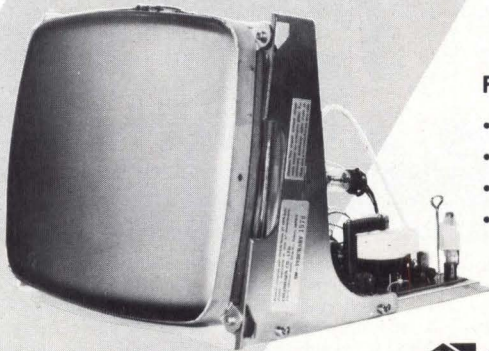

Chassis Version

#### C. ITOH ELECTRONICS, INC.

5301 Beethoven Street Los Angeles, Calif. 90066  
Telephone: (213) 390-7778 Telex: (WU) 65-2451

280 Park Avenue, New York, NY 10017  
Telephone: (212) 682-0420 Telex (WU) 12-5059

### NONINDUCTIVE POLYESTER FILM CAPACITORS

Flame retardant epoxy coated type SHR capacitors feature extended foil non-inductive windings and an op temp range from  $-55$  to  $125$  °C. Capacitance range is 0.001 to 1.0  $\mu$ F, and capacitance tolerance is  $\pm 10\%$  ( $\pm 5\%$  optional). Voltage range is 100 to 600 WVdc. Either long or cut and formed radial mounting leads are available. There are approx 300 std configurations; custom values can be supplied. **Illinois Capacitor, Inc**, 6284 W Oakton St, Morton Grove, IL 60053. Circle 237 on Inquiry Card

### INTERFERENCE MEASURING MODULE

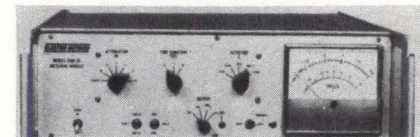

CRM-25, containing full CISPR/VDE/ANSI capability, combines with the Electro-Metrics model EMC-25 to provide readings of true rms levels and ratios of true rms to other detector levels for emi at frequencies from 10 kHz to 1000 MHz. The model provides an instantaneous measure of  $v_a$ , which is defined as the ratio of rms-detected to average-detected noise readings. It also provides the noise analyst with capability to read the ratio of rms to peak or quasi-peak-detected levels. **Penril Corp**, 5520 Randolph Rd, Rockville, MD 20852. Circle 238 on Inquiry Card



## MULTIPLE-OUTPUT SWITCHING POWER SUPPLIES

Switchers using pulse-width-modulated inverter, feature up to 60k hours MTBF at 80 °C baseplate, 300k hours at 40 °C baseplate. Dual outputs of ac to dc models are  $\pm 12$  V at 5 A to  $\pm 15$  V at 5 A. Dc to dc 28- and 48-Vdc input models feature outputs of  $\pm 12$  V at 5 A to  $\pm 15$  V at 4 A. Ac to dc and dc to dc triple output models range from 5 V at 10 A/ $\pm 12$  V at 2.5 A to 5 V at 10 A/ $\pm 15$  V at 2 A. Models are available with 5 V at 10 A/ $\pm 12$  V at 2.5 A and either -9 or -5 V at 2.5 A for the third output. **Adtech Power, Inc.**, 1621 S Sinclair St, Anaheim, CA 92806. Circle 239 on Inquiry Card

## MINIATURE PIN PROGRAMMING MATRIX

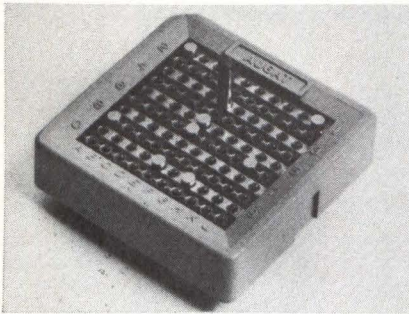

Complex circuits can be switched or programmed using a microminiature, reusable, 100-point program matrix. Designed for PC board mounting, it contains 200 precision machined beryllium copper Holtite<sup>®</sup> contacts which are gold plated to ensure low resistance connections. Any point on X axis (1 to 10) may be connected to any point on the Y axis (A to K) by inserting 1 of 10 gold plated shorting pins. All contacts and pins are spaced at 0.1" (2.5-mm) centers. **Augat Inc, Interconnection Products Div**, 33 Perry Ave, Attleboro, MA 02703.

Circle 240 on Inquiry Card

## PRINTER GRAPHICS MODIFICATION

Providing vector generated graphics, expanded character styles, improved speed, and various options as std, the Graphics II system consists of a plug-compatible replacement circuit board for the DECwriter II. The system allows printing of a dot anywhere on the page, a total of 1M addressable points/page. Bidirectional line feed is added and vector graphics capability allows a line to be printed between any 2 points on the page by specifying end point coordinates using ASCII char. **Selanar Corp**, 3054 Lawrence Expwy, Santa Clara, CA 95051.

Circle 241 on Inquiry Card

## TRANSIENT VOLTAGE SUPPRESSORS

With applied voltage capabilities up to 600 Vac rms Z-MOV Zenamic<sup>®</sup> voltage suppressors Z7, Z10, Z15, and Z21 feature surge current capacities up to 2000 A and max clamping voltages of 1 kV at 1 mA. Devices are designed to protect semiconductors in inductive switching circuits and to absorb surges associated with lightning and switching. Units are metal oxide varistors having nonlinear current voltage characteristics which are claimed to sustain an almost constant voltage over a range of current. **International Rectifier Corp, Semiconductor Div**, 233 Kansas St, El Segundo, CA 90245.

Circle 242 on Inquiry Card

## FULLY PROGRAMMABLE COAXIAL SCANNER

With a 1.8-ms risetime and 240-MHz typical bandwidth, model FX36 can sequentially scan 100 coaxial pins in a "one of" format. Only one pin can be programmed at a time, but it can be assigned to any one of four channels, giving a 4 x 1 x 100 switching capability. Programmable to a single point or in multipoint scan modes, a 3-digit LED readout displays selected channel and pin numbers. **Autek Systems Corp**, 790 Arques Ave, Sunnyvale, CA 94086.

Circle 243 on Inquiry Card

# GRANT'S 4900 SLIDE: ALL-STEEL STRENGTH

Strength for today and precision for tomorrow. You buy both with the 4900 Slide. It's a full extension, complete ball bearing action slide which operates at a low noise level. Load capacity is 100 lbs. per pair. Space requirements are just 1/2" at each side and 1 7/8" height. (All this at an unbeatable price!)

Complete data available on request.

# GRANT<sup>®</sup>

Grant Hardware Company

A Division of Buildex Inc.

7 Hoover Avenue, Haverstraw, N.Y. 10927

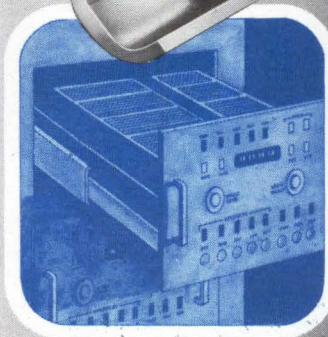
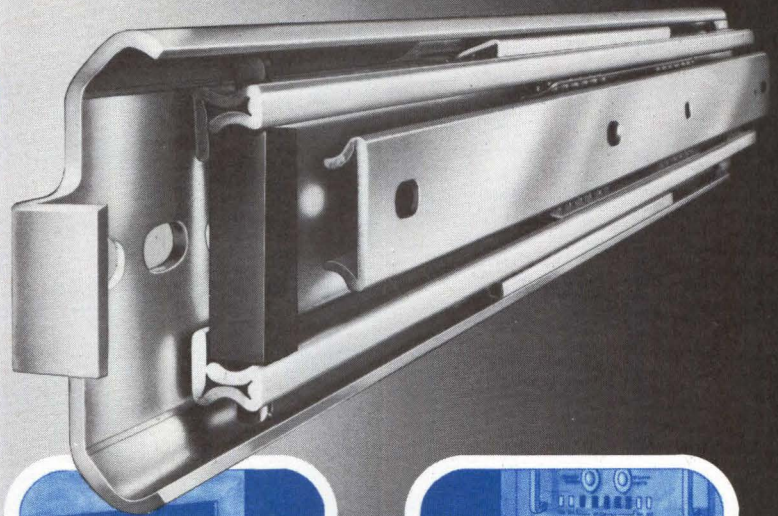

# DELTA DASH® GETS YOUR SMALL PACKAGE THERE IN A BIG HURRY.

Delta handles more over-the-counter shipments of 50 lbs. or less than any other certificated airline. And DASH (Delta Airlines Special Handling) serves 86 U.S. cities plus San Juan. Any package up to 90 inches, width + length + height, and up to 50 pounds is acceptable. DASH packages accepted at airport ticket counters up to 30 minutes before flight time, up to 60 minutes at cargo terminals.

Rate between any two of Delta's domestic cities is \$30. (\$25 between

Dallas/Ft. Worth and Los Angeles or San Diego or San Francisco). Pick-up and delivery available at extra charge. Call 800-638-7333, toll free. (In Baltimore, call 269-6393).

You can also ship via DASH between Delta cities in the U.S. and Montreal, Nassau, Bermuda, Freeport and London, England. For details, call Delta's cargo office. **DELTA**  
The airline run by professionals

**DELTA IS READY WHEN YOU ARE®**



**By anyone's measure**

**The industry standard**

Raymond's Model 6406 Raycorder has long been the standard by which other digital cassette recorders are measured. It's now available with new, easier to use interface electronics, including an 8-bit parallel interface compatible with the popular microprocessors, at new lower prices.

For complete information contact:

Raycorder Products Division  
**Raymond Engineering Inc.**  
 217 Smith Street, Middletown, Connecticut 06457-(203) 632-1000  
*a subsidiary of Raymond Industries*

## PRODUCTS

### MINICOMPUTER PRINTING SYSTEMS

For use with Data General Nova<sup>®</sup> and Eclipse<sup>®</sup> and Digital Equipment Corp PDP<sup>®</sup>-11 minicomputers, Supermini series printing systems include either a 300- or 600-line/min matrix impact printer or a 600- or 1000-line/min chain printer and appropriate controller. Matrix units feature raster matrix impact printing capabilities and multiple print quality. Chain printers are microprocessor controlled units which provide a 64-char ASCII set and print lines up to 132 char in length. **California Computer Products, Inc.**, 2411 W LaPalma Ave, Anaheim, CA 92801.  
Circle 244 on Inquiry Card

### DOUBLE-DENSITY MINI-FLOPPY DISC SYSTEM

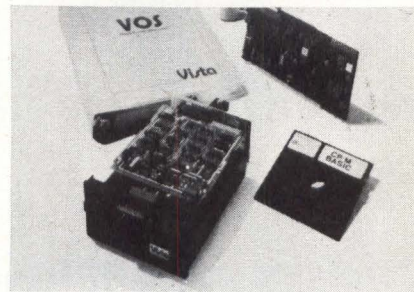

V200 series, with std Digital Research CP/M operating system, offers storage for up to 64 dynamically allocated named files on each 5.25" (13.34-cm) diskette with file size of up to 200k bytes. Total package for each system includes minifloppy disc drive with dc power regulator, S-100 bus controller card that plugs into Z80/8080 computer; I/O cable that connects controller to drives; system software; and operating/instruction manuals. **Vista Computer Co.**, Dept P2, 2807 Oregon Ct, Torrance, CA 90503.  
Circle 245 on Inquiry Card

### ENHANCEMENTS TO REMOTE INFORMATION SYSTEMS

With the addition of up to 8 remote operator workstations, files resident on model 85 remote information systems can be accessed via a multidrop secondary communications line using a synchronous interactive protocol at 4800 bits/s. Expanded memory option increases the system's max capacity to 256k bytes; min system size is increased to 128k bytes. Disc storage capacity has also been increased to 245.6M bytes. **Data 100 Corp.**, 6110 Blue Circle Dr, Minneapolis, MN 55435.  
Circle 246 on Inquiry Card

### HANDHELD INDUSTRIAL CONTROL/DISPLAY UNIT

Updated version of HT/2 operates on 5 Vdc, generating the needed  $\pm 12$  Vdc for RS-232-C interface internally. Housed in a 7 x 4.25 x 2.25" (17.8 x 10.8 x 5.7-cm) Lexan<sup>®</sup> case, unit features 2-line display of ten 0.27" (0.69-cm) char/line, keyboard, full- or half-duplex operation, adjustable speed, formatting, and parity. Unit can transmit and display 128 ASCII char and control codes. **Termiflex Corp.**, 17 Airport Rd, Nashua, NH 03060.

Circle 247 on Inquiry Card

### ELECTRONIC DOWNTIME RECORDER



Industrial machine performance monitoring is performed by the DTR100 series, which accumulates downtime and downtime event occurrences in high noise immunity CMOS memory. Units are housed in NEMA 12 cabinets with a front panel, 4-digit, 7-segment LED display for data. A crystal controlled timebase and key lock switch are std. Multi-station capability is optional by providing multiple contact closure inputs to multiple memories sharing the common, selectable display. **Niagara Scientific, Inc.**, 118 Boss Rd, Syracuse, NY 13211. Circle 248 on Inquiry Card

### CIRCUIT PROTOTYPING PLUG-IN BREADBOARD

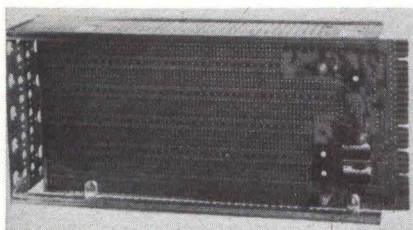

Plug-in compatible with Tektronix TM-500 series, PI-910 features built-in 5-V at 1-A and  $\pm 15$ -V at 350-mA adjustable power supplies, with provisions for adding an adjustable -5-V supply, a pair of + and - fixed supplies, and components for rectifying and filtering the two 25-Vac supplies from power module. Unit can accommodate a max of 39 16-pin wirewrap DIP sockets, and other DIP sockets with 0.1 x 0.35 to 0.1 x 0.6" (2.54 x 8.89 to 2.54 x 15.2-mm) pin spacings. **Pulse Instruments Co.**, 1536 W 25th St, San Pedro, CA 90732. Circle 249 on Inquiry Card

### DUAL OUTPUT POWER SUPPLIES

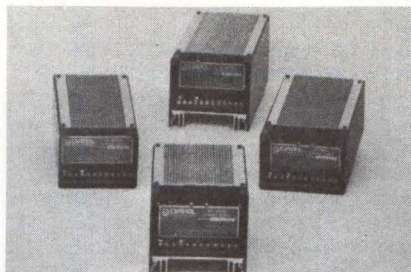

Six models of MP series line operated power supplies offer outputs of  $\pm 12$  and  $\pm 15$  Vdc at 1, 1.5, and 3 A, operating from 115/230 Vac at 50 to 60 Hz with no derating for 50-Hz operation. Full rated output is provided over an amb temp range of 0 to 65 °C with a 15% derating at 71 °C. Also incorporated are a Faraday shield, barrier strip I/O connector, aluminum ventilating protective cover, and 3 mounting positions. Specs include output ripple of 1 mV rms max, and line and load regulation of 0.05%. **Datel Systems, Inc.**, 1020 Turnpike St, Canton, MA 02021. Circle 250 on Inquiry Card

### MAGNETIC STRIPE DATA TERMINAL

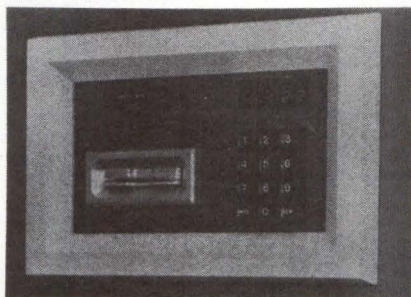

Model 2000 is a data entry terminal equipped to read data from magnetic stripe cards and to accept numeric data through its 10-digit keypad. The unit readily interfaces to any computer via an RS-232 interface and may be

controlled directly from high level languages, eliminating the need for special interfaces or device drivers. The unit's card reader features no moving parts. Applications include industrial data collection and access control. **Amtron Systems, Inc.**, 2052 Concourse Dr, St Louis, MO 63141.

Circle 251 on Inquiry Card

### STANDARD FIBER OPTIC COMPUTER CABLE

DC-PC08-02 duplex cable is flexible, crush-resistant and recommended for distances up to 1 km. Designed for computer and data terminal transmissions, the cable is totally dielectric, immune to induced noise, and transmits clean data with no greater losses as bandwidth increases. Large core conductors allow low cost terminations while maximizing input coupling from LED sources. It is available with connectors as separate components or pre-terminated to special lengths. **Valtec Corp, Communications Fiberoptics Div.**, West Boylston, MA 01583.

Circle 252 on Inquiry Card

### SPEECH SYNTHESIZER SOFTWARE PACKAGE

Designed for use with CT-1 speech synthesizer board, Software Package II contains CTEDIT, a parameter editor; CSEDIT, an editor for CSR1 input; CTEST, a CT-1 hardware diagnostic; PLAYDATA, to hear data files; MEMVOICE, a vocal memory dumper; KEYPLAY, a subroutine to play letters/digits; and PIANO, a simple musical keyboard. Written in 8080 assembly language and including source codes, the package is available on C/pm 8" (20-cm) diskette, North Star, Micropolis, Tarbell, CUTS, CUTS for SOL, MITS ACR, and paper tape. **Computalker Consultants**, 1730 21st St, Suite A, Santa Monica, CA 90404.

Circle 253 on Inquiry Card

# Interconnections scrambling your cerebellum?

See page 75

## PRODUCTS

### IIL CIRCUIT CONSTANT CURRENT DC POWER SUPPLY

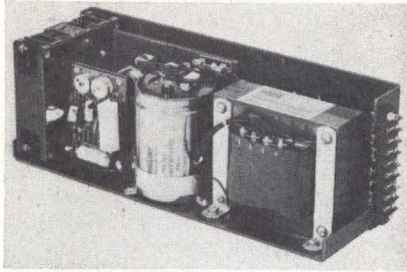

Designed to control current to within 0.1% for special inductive load requirements, the SCC 250-15 is suited for circuits incorporating lamps or LEDs and for designs incorporating IIL circuits. The fan cooled unit operates from 115/230 Vac  $\pm 10\%$ , and provides current regulation to 0.1%. Compliance voltage to 15 Vdc and adjustable current ratings from 0.1 to 15 A are supplied. Other specs include 0.1% ripple, 50- $\mu$ s response time, 0 to 50 °C tempco, and UL recognition. **Standard Power, Inc.**, 1400 S Village Way, Santa Ana, CA 92705.

Circle 254 on Inquiry Card

### SINGLE-BOARD 4-DISC CONTROLLER

Occupying a single slot in the host computer mainframe, the 3255 disc controller board can interface up to 4 storage module, Winchester, or 3330-type disc drives to any Data General NOVA or ECLIPSE computer, providing online storage capability up to 1.2G bytes. It provides multiplex capability for disc files with data transfer rates ranging from 806k to 1.2M bytes/s. The microprocessor based device features error correction, multiple record length format, and automatic diagnostics. **Ball Computer Products**, 860 E Arques Ave, Sunnyvale, CA 94086.

Circle 255 on Inquiry Card

### INTELLIGENT PRINTER TERMINAL

8-bit microcomputer allows 150-char/s matrix printer terminal to be programmed to meet specific application requirements, and reprogrammed by replacing P/ROM chips when requirements change. Std features for the IPS-7326 include movable data input station consisting of gas discharge display and ASCII keyboard, and IBM-2848 compatible serial interface; 20-mA current loop and other serial interfaces are available as options. **Dataroyal, Inc.**, Main Dunstable Rd, Nashua, NH 03060.

Circle 256 on Inquiry Card

### CHASSIS MOUNT DC-DC CONVERTERS

All 11 models in the CC series feature floating single outputs with input-to-output isolation of 300 Vdc and 100 M $\Omega$  in shunt with 50 pF. Available inputs include 9 to 18, 18 to 36, and 35 to 70 Vdc. Fixed outputs available are 5 Vdc at 2.0 or 3.0 A with 55 to 65% efficiency, 12 Vdc at 1 A with 70 to 80% efficiency, and 15 Vdc at 0.8 or 1.0 A with 70 to 80% efficiency. Converters measure 2.5 x 3.5 x 2" (6.35 x 8.9 x 5 cm). **Semiconductor Circuits, Inc.**, 306 River St, Haverhill, MA 01830.

Circle 257 on Inquiry Card

### SWITCHING POWER SUPPLY FOR PRINTERS

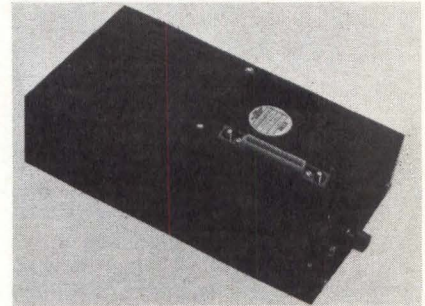

OL 153E, a self-contained power module for Qume printers, provides up to 180-W continuous power and 300-W peak power in an enclosure measuring 10.5 x 5.8 x 2.8" (26.7 x 14.7 x 7.1 cm) and weighing 4.5 lb (2.0 kg). Enclosure contains power supply, line filter, fan, fuse, connector, and power switch pre-assembled and ready to install with 2 std connections. Std models are available in both 115- and 230-V line inputs. Other std features include reverse voltage protection and a series resistor that reduces line surges at turn-on. **Boschert, Inc.**, 384 Santa Trinita Ave, Sunnyvale, CA 94086.

Circle 258 on Inquiry Card

## INTELLIGENT RS-232 STORAGE SYSTEMS

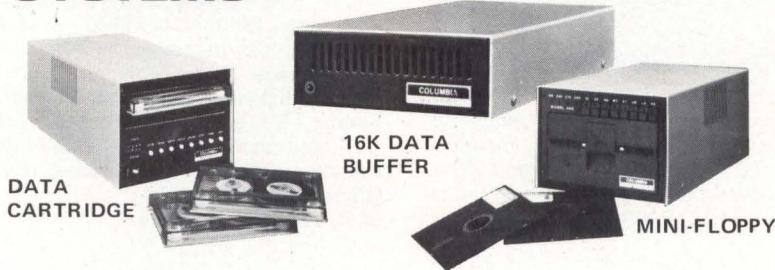

- DATA CARTRIDGES RS-232

Dual RS-232 Interfaces  
Up to 3½ Million Characters  
Data Rates to 19,200 Baud

- DATA CARTRIDGES Parallel

Parallel Interfaces  
Up to 7½ Million Characters  
Data Rates to 10,000 Char./Sec.  
Power Fail Option

- SOLID STATE BUFFERS Up to 16,000 Characters

Baud Rate Converter  
Context Editor  
Auto Answer

- MINI DISKS Up to 358,000 Characters

Data Rates to 19,200 Baud  
Powerful Editor  
File Directory  
No Program Disk Required

**COLUMBIA**

DATA PRODUCTS, INC.

*We also quote on customized applications.*

6655 Amberton Drive • Baltimore, MD 21227  
301/796-2300 • TWX: 710-862-1949

### IBM 3780 PROTOCOL CONVERSION DEVICE

Z80 based standardized interface unit for use between asynchronous devices and host computers supports IBM 3780 protocol. Available with up to 32k bytes of buffer memory, CA12-SIU/3780 operates on 2 A, 117 Vac, 60 Hz. When not performing its data communications function, the 5.25 x 16.88 x 15" (13.34 x 42.88 x 38-cm) unit conducts a self-test.



It can also be remotely tested over phone lines by means of a modem. Changes in communications capabilities are optional. **Industrial Computer Controls Inc.**, 400 Memorial Dr, Cambridge, MA 02139.

Circle 259 on Inquiry Card

### 10-ns LOGIC PROBE

PRB-1 detects pulses as short as 10 ns and has frequency response to better than 50 MHz, automatic pulse stretching to 50 ns ( + and - ), 120-kΩ impedance, power lead reversal protection, and overvoltage protection to ±70 Vdc. The unit is fully compatible with RTL, DTL, HTL, TTL, MOS, CMOS, and microprocessor logic. LEDs are constant brightness over 4- to 15-V supply voltage range. 6' (1.8-m) coiled power cord and tip protector are included. **OK Machine and Tool Corp.**, 3455 Conner St, Bronx, NY 10475.

Circle 260 on Inquiry Card

### DOUBLE DENSITY DISC DRIVE

Model 8650 offers 635M bytes of data storage per spindle by doubling the track density from the model 8350. The drive is housed in the same physical dimensions as the 8350, allowing users to satisfy immediate needs and field upgrade later. In a typical installation, the unit is claimed to offer a cost/megabyte reduction of 30%. **Storage Technology Corp.**, 2270 S 88th St, Louisville, CO 80027.

Circle 261 on Inquiry Card

### UNIVERSAL MULTIPURPOSE 3-PORT OPTICAL COUPLER

Single-ended duplex Model O-OCS-3-10120 has wave length range of 600 to 1100 nm, 4.8-dB splitting loss, and 3.7-dB excess loss. Measuring 4 x 3 x 1" (10.2 x 7.6 x 2.54 cm) and weighing 12 oz (336 g), 3-port coupler has a 0.4 numerical aperture and 0.5-dB port-to-port variation. Short optical length inhibits degradation in bandwidth of operating system. **Olektron Corp.**, 61 Sutton Rd, Webster, MA 01570.

Circle 262 on Inquiry Card

### COMPUTER BACKPLANE EXTENDER BOARDS

Family of extender boards is available for use in all PDP-8, PDP-11, and LSI-11 DEC-type backplanes. Extended length boards are the single width DEX 1, dual width DEX 2, quad width DEX 4, and hex width DEX 6. None of the contact fingers are interconnected. **Computer Extension Systems, Inc.**, 17511 El Camino Real, Houston, TX 77058.

Circle 263 on Inquiry Card

### HIGH EFFICIENCY LED LOGIC FAULT INDICATORS

LST-4053F red T-1¼ LED lamps operate at low current as logic fault indicators. They are packaged in a high contrast epoxy lens that is 0.250" (0.635 cm) high. Typ luminous intensity is 0.5 mcd at a forward current of 5 mA; units will operate at very low forward currents of 1 to 3 mA. Orange, green, and yellow versions are also available. Applications include computer fault indications, scanner channel indicators, and logic troubleshooting probes. **OPCOA, Div of IDS Inc.**, 330 Talmadge Rd, Edison, NJ 08817.

Circle 264 on Inquiry Card

### INDUSTRIAL OPTICAL BCD ENCODERS

Mechanical shaft rotation is converted to an accurate electronic output in BCD format using the TO series encoder. The device provides a BCD output with an angular range of 359, and accuracy of ±1 bit. Noncontacting optical, rugged mechanical design allows for high speed, low torque operation in heavy-duty industrial use. LEDs serve as light sources. Low input power requirements of 5 Vdc are specified for both the TTL and CMOS versions with no external electronics. **Theta Instrument Corp.**, 24 Dwight Pl, Fairfield, NJ 07006.

Circle 265 on Inquiry Card

# \$24.95

## ...AND HOLDING

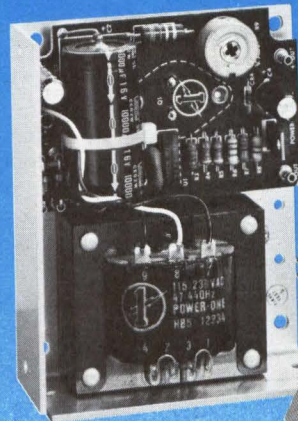

Model HB5-3/OVP

### 5V at 3A with Built-in OVP

Power One's B Case models started at \$24.95. Over 100,000 models and five years later, they're still only \$24.95!

- 115/230 VAC Input
- OVP Built-in
- .05% Regulation
- 2-Year Warranty
- 2-Hour Burn-in
- UL Recognized
- CSA Certified

Get all the details on our 84 standard open frames in our new 1978 catalog.

### IN-STOCK NATIONWIDE... FOR IMMEDIATE DELIVERY

ARIZ.: Scotsdale, PLS Assoc. (602) 994-5461 CAL.: Pasadena, A-F Sls Engr. (213) 681-5631; San Jose, Richards Assoc. (408) 246-5860 COL.: Denver, PLS Assoc. (303) 773-1218 CT.: Litchfield, Digital Sls. Assoc. (203) 567-9776 FLA.: Orlando, Gra-Mar (305) 894-3351 ILL.: Chicago, Coombs Assoc. (312) 298-4830 IND.: Indianapolis, Coombs Assoc. (317) 897-5424 MD.: Lanham, Brimberg Sls. Assoc. (301) 946-2670; Baltimore, Brimberg Sls. Assoc. (301) 792-8661 MASS.: Waltham, Digital Sls. Assoc. (617) 899-4300 MINN.: Minneapolis, Engr. Prod. Assoc. (612) 925-1883 N.J.: Whippany, Livera-Polk Assoc. (201) 377-3220 N.M.: Albuquerque, PLS Assoc. (505) 255-2330 N.Y.: Roslyn Hts., Livera-Polk Assoc. (516) 484-1276; Syracuse, C.W. Beach (315) 446-9587 ORE.: Portland, Jas. J. Backer (503) 297-3776; Salem, Jas. J. Backer (503) 362-0717 TEX.: Dallas, Advance Technical Sls. (214) 361-8584; Solid State Electr. (214) 352-2601; Houston, Advance Technical Sls. (713) 469-6668; Solid State Electr. (713) 785-5436 WASH.: Seattle, Jas. J. Backer (206) 285-1300; Radar Elec. Co. (206) 282-2511 WIS.: Milwaukee, Coombs Assoc. (414) 671-1945 EUROPE: Hanex, L.A., CA (213) 556-3807 CANADA: Duncan Instr. Weston, Ontario (416) 742-4448

"Think about

**POWER-ONE** INC.  
D.C. POWER SUPPLIES

Power One Drive • Camarillo, CA 93010 • Phone: 805/484-2806 • TWX: 910-336-1297

SEE OUR COMPLETE PRODUCT LISTING IN EEM & GOLDBOOK

## BELTING INDUSTRIES'...

Semi-Stretch Belt Users All Say —

**"THANKS for  
the MEMORY"**

Belting Industries makes belts for use on common shafts and equipment where there is no allowance for take-up, especially computer disk and paper transport drives.

What puts Binco ahead in belting technology is their use of a more advanced style of weave — a weave which keeps the belts' basic dimensions the same even after constant stretching pressure. That's called "Belt Memory", and the better the memory, the longer the life of the belt.

Binco — one of the nation's largest suppliers of belts, with five convenient locations throughout the country to serve you.

You'll be thanking them for the memory.

**BINCO "It Gets Around"**

**BELTING INDUSTRIES CO. INC.**

20 Boright Ave., Kenilworth, N.J. 07033, (201) 272-8591

**CIRCLE 137 ON INQUIRY CARD**

## Planning Tech Control?

We have prepared a guide that takes the confusion out of planning Tech Control Systems. It's free, and it contains all you need to know about:

- Patching and Switching
- Fault Isolation, Diagnostics and Circuit Restoration
- Computer and Remote Controlled Switching
- Cost Effective Network Management

### May We Help...

Call or Write For Your Free Copy.

**Dynatech Data Systems**  
7644 Dynatech Ct., Springfield, VA 22153 | A Dynatech Company  
Phone: 703-569-9000

EUROPEAN MANUFACTURING AND SALES:  
DYNATECH DATA COMMUNICATIONS, LTD.  
145 Rue de la Tour, Centra 120  
94566 Rungis, Cedex, France  
TEL: (1)-687-0579  
TWX: 250 304 Public Rungis

CANADIAN SALES:  
ELECTRONIC SYSTEMS, LTD.  
62 Ainess Street, Downsview  
Ontario, M3J 2H1 Canada  
Phone: (416) 661-3673  
Telex: 06-23240

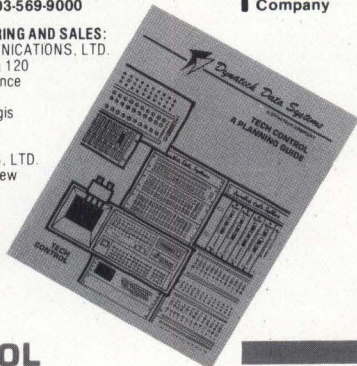

**TECH CONTROL**

**CIRCLE 138 ON INQUIRY CARD**

## PRODUCTS

### VT52 EMULATION CRT TERMINAL



Emulating the code structure and functions of DEC's VT52<sup>®</sup>, VT52-Compat includes 15" (38-cm) non-glare screen, compact size, and detachable keyboard. All keys are typamatic; and all operating controls are set from the keyboard. The unit measures 15 x 14 x 13.6" (38 x 35.6 x 34.5 cm) plus keyboard; weight is

35 lb (15.75 kg). Display is 24 lines of 80 u/lc char formed in a 7 x 7 dot matrix in a 10 x 10 dot field. Cursor is a blinking field. The terminal includes an 81-key detachable keyboard which generates the full 128-char ASCII set. A separate numeric pad and cursor control keys are std. Use of shift, control, and caps lock keys is identical to the VT52. Up to 28 additional special function keys are available. **Ann Arbor Terminals, Inc.**, 6107 Jackson Rd, Ann Arbor, MI 48103.

Circle 266 on Inquiry Card

### 113A-TYPE REPLACEMENT DATA MODEM

Replacing 113A-type units, the T113C transmits and receives asynchronous serial data full duplex at rates up to 300 bits/s in originate mode over the 2-wire DDD network. LSI design improves unit reliability and decreases its size; LED lamps monitor EIA RS-232-C digital interface leads and status of data modem while in various operational and test modes. Self-test word generator and comparator send a 300-bit/s dot pattern and check for excessive bias distortion. Provision for analog and digital loopback is included. Alternate voice is provided via the std 502, 2502, 503, or 2503 telephone; one of these is provided as part of the FCC connection arrangement (USOC-RTC). **Rixon Inc.**, 2120 Industrial Pkwy, Silver Spring, MD 20904.

Circle 267 on Inquiry Card

### 30-MHz PULSE/FUNCTION GENERATOR



Model 734 combines a true pulse generator with single pulse, double pulse, pulse delay, ECL and TTL, and complement ECL and TTL outputs available simultaneously along with the main output. Pulse delay is controlled with a 7-position rotary switch and a 10:1 vernier over a range of 20 ns to 10 ms in 6 overlapping ranges. A seventh position provides delay range. Pulse width is controlled by an 8-position rotary switch and a 10:1 vernier over a range of 10 ns to 10 ms in 6 overlapping ranges. A seventh position allows the user to install a capacitor for a custom width range. Normal and complement simultaneous TTL outputs are provided at 3 V pk capable of driving 50-Ω loads. Normal and complement simultaneous ECL outputs are provided with typ risetimes less than 1 ns. **Exact Electronics Inc.**, 455 SE 2nd Ave, Hillsboro, OR 97123.

Circle 268 on Inquiry Card

## DIGITAL PROCESSING OSCILLOSCOPE

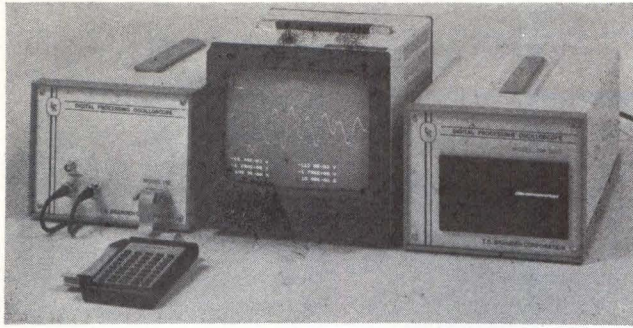

A complete system for waveform acquisition, processing, displaying, and interfacing to a wide range of peripherals, Smartscope™ series units make dual beam digital processing oscilloscope performance available at a price comparable to that of equivalent bandwidth analog storage scopes. An operator/display dialog using a calculator style keypad simplifies operation. Menu selection and English prompting messages are used instead of front panel switches, knobs, and variable controls. High accuracy alphanumeric readout of waveform values eliminates errors due to switch multiplying factors and variable control settings; all waveforms and alphanumerics are displayed on a bright 9" (22.9-cm) video display monitor. Operator functions are controlled by a 16-bit microprocessor. **T. G. Branden Corp**, 5565 SE International Way, Portland, OR 97222.

Circle 269 on Inquiry Card

## HIGH DENSITY MINI-PUSHBUTTON SWITCH

Offering maintained action and accepting LEDs, series 39 switches are available in momentary and maintained action in lighted, nonlighted, and indicator-only versions. LEDs, which may be user installed, are available in red, yellow, or green. Bifurcated switch contacts provide the switching integrity required for logic loads. The units mount directly to a PC board or optional connector. Connector mounting options are std inline or right angle for applications such as computer card files. Mounting centers of switches can be as small as 0.390" (10 mm) in X and Y directions. Depth from panel to PC board is 0.625" (16 mm) max. Ratings are 0.25 A, 30 Vdc max. **Licon, a div of Illinois Tool Works, Inc**, 6615 W Irving Park Rd, Chicago, IL 60634.

Circle 270 on Inquiry Card

## MILITARIZED MAGNETIC TAPE CARTRIDGE RECORDER

Providing cartridge operation as well as reel interchangeability with IBM compatible magnetic tape transports, the CR-600 is designed to meet all applicable requirements of MIL-E-5400 Class 1A equipment, including operation to 30k-ft (9-km) altitude. The recorder features a protective tape cartridge [7.4 x 7.4 x 1.70" (18.8 x 18.8 x 4.3 cm)] which assures reliable operation in severe environments and provides operator-proof data security.

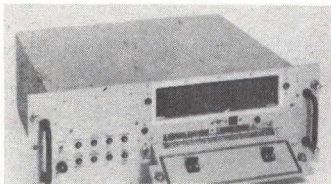

Reel interchangeability with IBM compatible transports is achieved by storing 600' (182 m) of 0.5" (1.27-cm) magnetic tape on std 7" (17.8-cm) reels. The supply reel within the cartridge can be removed for loading and processing on any IBM compatible magnetic tape unit. The recorder operates at 25" (63.5 cm)/s; rewind occurs at 50" (127 cm)/s. **Miltope Corp**, 9 Fairchild Ave, Plainview, NY 11803.

Circle 271 on Inquiry Card

# We top them all!

Up to 50% Savings on minicomputer mag tape systems? The *guaranteed* total compatibility of Digi-Data systems with most minicomputers means you can bank on it.

Whether you're talking operating software or hardware, our systems and theirs are completely interchangeable. With one major difference: the proven ultra-simple Digi-Data design that saves you money also provides greater reliability and the time/cost economy of simplified maintenance. And, in many cases we offer improved features over the tape drive system supplied by your minicomputer manufacturer.

It's all part of the philosophy of excellence behind our 17-year record of corporate stability. You'll see more proof of it in the fast 30-day ARO delivery and competent service that back up our line of minicomputer mag tape systems.

**To free yourself from the big-name, big-price squeeze, call or write for details of our full line of transports, formatters, computer interfaces and buffered tape systems.**



**DIGI-DATA CORPORATION**

8580 Dorsey Run Road, Jessup, MD 20794  
(301) 498-0200

® ... **First In Value**



**CIRCLE 139 ON INQUIRY CARD**

# Compact Cooling Power

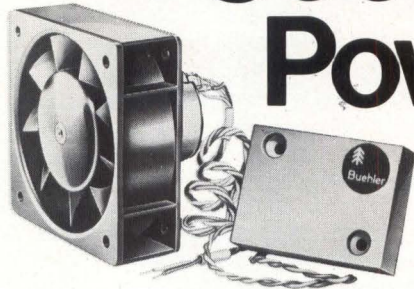

Buehler miniature brushless DC fans meet OEM product cooling requirements for optimum performance and compact design (2.443" sq. x 1.791" deep). Model 69.11.2 is a natural for computer peripheral equipment, electronic test systems, power supplies, communications equipment, optical systems and other high packing density products. Long service life. Quiet operation. Permits temperature regulated air flow. Available off-the-shelf. Get all the facts on these cool little performers from Buehler Products. Complete specifications available on request.

**FHP permanent magnet DC motors  
Miniature brushless DC fans  
Miniature gear motors**



BUEHLER PRODUCTS INC., P.O. BOX A, HIGHWAY 70 EAST,  
KINSTON, NORTH CAROLINA 28501, (919) 522-3101

**CIRCLE 140 ON INQUIRY CARD**

## 6800 SOFTWARE

### BUSINESS BASIC COMPILER

- 10 Digits BCD
- Formatted Output
- String Manipulation
- Disk File I/O
- Error Trapping Under Program Control
- Long Variable Names
- If - Then - Else
- Fast Execution
- SDOS Compatible

### SDOS - SD'S OPERATING SYSTEM

- Files to 2.15 Billion Bytes
- Dynamic Allocation and Expansion of Files
- Random and Sequential Access
- Supports Floppies and Large Drives Simultaneously
- Long File Names
- Easily Interfaced to New Drives and Peripherals
- Simple Command Interface
- Command Files
- Extensive Error Reporting
- Interrupt-Driven

### MAL - 6800 ASSEMBLER

- Long Labels
- Conditional Assembly
- Sorted Symbol Table Dump
- Extended Arithmetic Operations
- Motorola Compatible
- Error Cross Reference
- SDOS Compatible

### EDIT - CONTEXT EDITOR

- Change, Delete, Replace Text with Automatic Display of Change
- Single Keystroke 'Display Next Line
- Powerful Macro Facilities
- More Useful than Motorola's Editor
- SDOS Compatible

### IDB - INTERPRETIVE DEBUGGER

- Single Step with Register Display
- 4 Realtime Conditional Breakpoints
- Several Display Modes
- MIKBUG Compatible
- Much More Useful than MIKBUG
- Requires 3K ROM, no special hardware

Software available on Smoke Signal, MSI, EPA, Wavemate, Cincinnati Milacron, Motorola MDOS, Conrac 480, Mizar Labs, and more.



**SOFTWARE DYNAMICS**

2111 W. Crescent, Suite G  
Anaheim, CA 92801  
(714)635-4760

## PRODUCTS

### PROGRAMMABLE DATA LOGGER

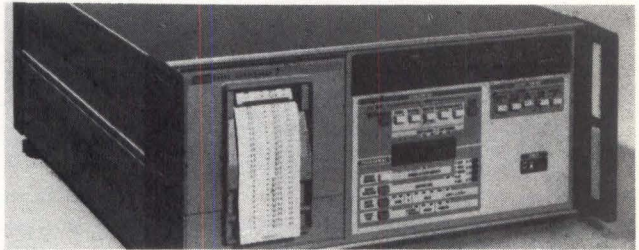

The 2200B features simplified programming and expanded alarm capabilities for voltage, current transmitter, thermocouple, and RTD inputs. Up to four limit alarms can be preset for each channel or group. A programmable internal clock provides time of day in hours, minutes, and seconds up to 24 h with precise scan control. A program list documenting the exact program parameters and limits is available from the onboard printer. Included in the basic system are 10-channel low level scanner and high performance A-D converter with low thermal offset voltages and 1- $\mu$ V resolution; an isothermal input connector can be used to connect voltage inputs and up to four types of thermocouple inputs simultaneously. Equipped for 60-channel operation, the unit expands to 100 channels using a separate scanner extender chassis. **John Fluke Mfg Co, Inc**, PO Box 43210, Mountlake Terrace, WA 98043.

Circle 272 on Inquiry Card

### COMPUTER POWER ISOLATION AND REGULATION MODULES

Combining noise filtering capabilities of an isolation transformer with voltage regulation of a ferroresonant transformer. Isoreg™ module electrically isolates the computer from the utility power supply, and delivers power at voltages regulated

within  $\pm 0.5\%$  even when line voltages deviate by as much as 15 to  $-25\%$  of nominal. Single-phase models are rated at 250, 375, 750, 1250, 2500, 5000, 7500, 10k, and 15k W; 3-phase models have power ratings from 6 to 75 kVA. Other specs include 3% harmonic distortion, elec-

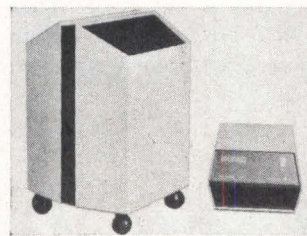

trical efficiencies approaching 90%, and common mode noise rejection of 140 dB. **Frequency Technology, Inc**, TDC Div, 410 Great Rd, Littleton, MA 01460.

Circle 273 on Inquiry Card

### 4- to 50-MHz CRYSTAL CLOCK OSCILLATORS

Hybrid crystal oscillators, series M1100 through M1145, are TTL crystal oscillators in the frequency range of 4.0 to 50 MHz and are available in graded frequency stabilities from  $\pm 2.5$  to  $\pm 0.0025\%$  (25 ppm). The 0.200" (5.08-mm) low profile devices have pins for either PC or socket mounting in a std DIP configuration. For added reliability, all devices at frequencies of 20 MHz and higher use third-overtone crystals which have three times the thickness of fundamental crystals, making the units resistant to shock and vibration, and increasing the electrical stiffness of the crystal by a factor of (harmonic order)<sup>2</sup> = 9. **MF Electronics Corp**, 118 E 25th St, New York, NY 10010.

Circle 274 on Inquiry Card



## P/ROM PROGRAMMER PACKAGE

CDP18S480, a hardware/software package designed to work with COSMAC Development System CDS II (CDP18S005) for programming industry standard P/ROMs, includes a plug-in module for the CSI II and software containing a versatile operating program. The system will program Intel 2704, 2708, 2716, 2758, and equivalent P/ROMs. It can program the 2704 in <1.5 min, and facilitates rapid programming of multiple P/ROMs from the same source consecutively. In addition, the package can read Intel 1702 type P/ROMs, thereby providing a means of copying them onto others. Differing only in the software media with which they operate, three versions are the disc based CDP18S480, paper tape -V1, and magnetic tape cassette -V2. **RCA Solid State Div, Box 3200, Somerville, NJ 08876.**

Circle 275 on Inquiry Card

## MICROPROCESSOR CONTROLLED 125-IN/s TAPE DRIVE

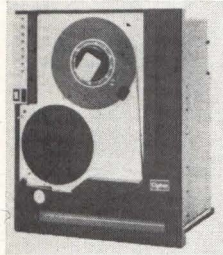

Featuring total tape control, low power consumption, small size, built-in diagnostics, and a significant reduction in drive design complexity, the vacuum column 900X incorporates a Z80 microprocessor. In conjunction with switching servos, the microprocessor maintains total servo control during critical load and unload functions, eliminating tape snap, whip, or slack.

Servo control is also retained in

power-fail situations including high speed rewind. The Z80 draws power from servos and transmits it to electronics so that a controlled stop can be effected. Other microprocessor functions include precise BOT/EOT sensing, optical write protect, and built-in diagnostics and service aids, which automatically test ROM and RAM logic, indicating any fault conditions on front panel indicators. **Cipher Data Products, 5630 Kearny Mesa Rd, San Diego, CA 92111.**

Circle 276 on Inquiry Card

## INCREMENTAL DIGITAL CASSETTE RECORDER

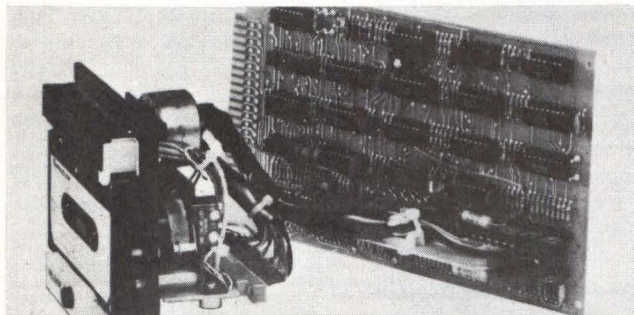

Minicorder™ model 333C-1 allows users to store data on universally available std Philips cassettes. It accepts asynchronous data without buffering circuits, is simple to install, and interfaces easily to a microprocessor. With options it becomes a low power read/write data logging recorder. Using no unnecessary tape, the unit accepts ASCII or 8-bit parallel input/output and reads files at 100 char/s. It is CMOS and TTL compatible and has storage capacity for 72k char. Operating modes are automatic load forward, backspace, fast rewind, and search. Read and write circuitry are separate so that all information written passes through the read system as well as onto tape, thereby providing a circuit check on information recorded. **Memodyne Corp, 220 Reservoir St, Needham Heights, MA 02194.**

Circle 277 on Inquiry Card

# New Fixed Head Digital Thermal Printers & Mechanisms

Complete printers with case, interface and drive electronics or stripped down mechanisms.

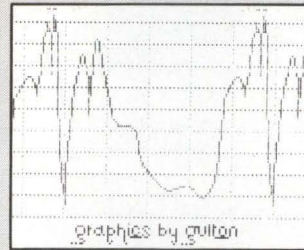

GAP-101M Graphics.  
100 million dot line MTBF.

I AM GULTONS NEW  
MODEL AP-20 THERMAL  
PRINTER... CAPABLE  
OF PRINTING UP TO  
20 COLUMNS OF UPPER  
CASE ASCII CODE

@ABCDEFGHIJKLMNPOQRS  
TUUVWXYZ[\]^\_`!\"#\$%&'  
(\*)+,-./0123456789:;  
<=>?

AP-20/20M Printout.  
20 million character lines MTBF.

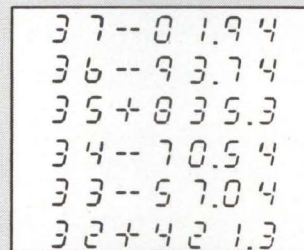

NP-7/7M Printout.  
10 million character lines MTBF.

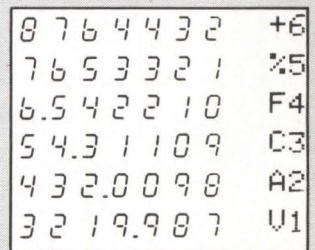

ANP-9/9M Printout.  
10 million character lines MTBF.

Gulton's fixed head printers give you printouts like these with the quietness of non-impact thermal printing and the reliability of solid state switching.

You get these advantages, 1) only one moving part—the paper drive, 2) independence from ink supplies and ribbon mechanisms, 3) high character quality and 4) extremely high reliability.

Compare the advantages of Gulton's fixed head printing technique to the drawbacks of other printing methods: the noise created by the hammer and drum technique, the unreliability of the moving head wire matrix technique with its routine solenoid failure, or the electrosensitive technique with its RFI and contamination problems.

### Complete Printers/Mechanisms

- AP-20/AP-20M alphanumeric printer with exclusive overlapping dots for exceptional character definition . . . 20 columns of 5 x 7 characters at up to 2.5 lines/sec.
- NP-7/NP-7M has seven columns of exceptional character quality 7 segment numbers at up to 4 lines/sec.
- ANP-9/ANP-9M is same as NP-7/NP-7M, but has two additional dot matrix I.D columns, up to 2.5 lines/sec.
- GAP-101M is for simultaneous analog, alphanumeric (10 columns 7 x 9 or 14 columns 5 x 7) and grid pattern printing. Up to 30 overlapping dot lines/sec. for exceptional graphics and character definition.

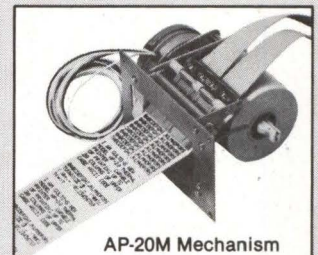

AP-20M Mechanism



NP-7 Numeric Printer

Write or call now for detailed catalogs.

**gulton®**

Measurement & Control Systems Division  
Gulton Industries Inc., East Greenwich, Rhode Island 02818  
401-884-6800 • TWX 710-387-1500

CIRCLE 151 ON INQUIRY CARD

# Retro-Graphics™

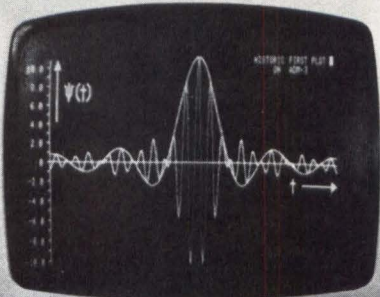

**For your Dumb Terminal®** The Retro-Graphics PC card mounts easily in the Lear Siegler ADM-3A to provide you with an affordable graphics computer terminal.

#### Features:

- Z-80 Based
- 512 by 250 Dot Matrix
- Simple Plug-in Interconnect
- Point Plotting
- Automatic Vector Generation
- Optional TEKTRONIX Software Compatibility

You will be impressed with the packaging, performance and price of the Retro-Graphics card. Write or phone today for complete specifications.

#### DIGITAL RESEARCH & ENGINEERING

5223 Glide Drive • Davis, CA 95616  
(916) 756-8055

Dumb Terminal is a registered trademark of Lear Siegler Inc.

**CIRCLE 152 ON INQUIRY CARD**

## Magnetic Memories

Apply your interest and knowledge of media and heads for tape and disk drives and magnetic bubble devices. You will supply technical direction to a variety of engineering and manufacturing in these areas.

Your background should include experience with magnetic devices and media and a detailed knowledge of the physics of magnetic materials.

Tektronix, Inc. develops, manufactures and markets internationally recognized precision electronic measurement instruments, computer peripherals and related electronic instrumentation. Located near Portland, Oregon we are within a two hour drive of the Cascade Mountains and Ocean Beaches. The close-by natural playgrounds and the City of Portland provide a variety of recreational and cultural interests.

Salary is open. Benefits include educational support, insurance and profit sharing programs.

Send detailed resume and salary history to Roy Epperson, Tektronix, Inc., P.O. Box 500, J41, Beaverton, Oregon 97077.

An Equal Opportunity Employer m/f/h

**Tektronix®**  
COMMITTED TO EXCELLENCE

**CIRCLE 153 ON INQUIRY CARD**

## PRODUCTS

### WAVEFORM ANALYZER

An improved version of the 1010, model 1020 provides programmable measurement of parameters, remote program display, time range from 200 ps to 1 s, and voltage range from 2 mV to 100 V. Unit is a dual channel, programmable sampling waveform analyzer, providing direct readout of voltage measurement on either of the 2 channels and time measurements on either channel or between channels. A 1011 probe multiplexer may be added to provide up to 40 individually se-

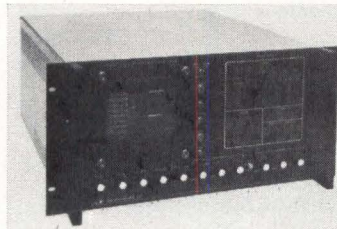

lectable and programmable inputs for convenience in test fixturing. Flexible measurement circuitry permits direct measurement of common digital and sine wave parameters such as amplitude, risetime, falltime, width delay, and period as well as more complex measurements including baseline offset, overshoot, undershoot, droop, and pulse top noise. **E-H International Inc.**, 515 11th St, Oakland, CA 94607.

Circle 278 on Inquiry Card

### 100-MHz STORAGE OSCILLOSCOPE

Portable dual-trace scope with writing speeds up to 1000 divisions/ $\mu$ s over the entire screen area, the PM3266 uses a specially developed high speed transfer storage CRT with scan magnification in the vertical direction to provide high

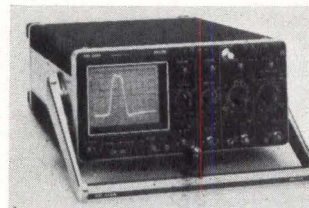

writing speed and enable storage of single shot signals up to the max vertical bandwidth. Storage time at max speed varies from 15 s to 1 h, depending on intensity. Autoerase facility provides a continuously refreshed display. View time is variable

between 3 and 8 s, with fixed position in which the view time is infinite, extending up to the max storage time. Display intensity can be controlled continuously, enabling storage times of up to 1 h. Variable persistence mode can provide a high contrast display with writing speed up to 0.25 divisions/ $\mu$ s. Persistence is variable between 0.5 and 60 s. Max write mode increases write speed to 2.5 divisions/ $\mu$ s. **Philips Test & Measuring Instruments**, 85 McKee Dr, Mahwah, NJ 07430. Circle 279 on Inquiry Card

### 100-HOUR LASER DIODES

Single-mode gallium arsenide-gallium aluminum arsenide double heterostructure injection laser diodes, with a projected lifespan of >100k hours, model GOLS-1 features low threshold, high quantum efficiency, and high linearity. The diodes have a bandwidth of >1.2 GHz. They are unusually efficient, requiring no more than 130 mA of current to produce 5 mW of power output per mirror. Both laser mirrors are easily accessible, allowing the second mirror to be used as a feedback circuit to stabilize output by regulating the input current. The devices are packaged on a heat sink measuring 0.1875 x 0.2188 x 0.125" (4.76 x 5.56 x 3.8 mm) with a special coating on both laser mirrors for ambient operations. The devices are guaranteed to produce 5-mW continuous wave output for 10k hours. **General Optronics Corp.**, 375 Park Ave, New York, NY 10022.

Circle 280 on Inquiry Card

## Fiber Optic Interconnections

Catalog furnishes descriptions, photos, engineering drawings, design specs, performance characteristics, and cable stripping instruction drawings for single- and multi-fiber, single- and multichannel connectors; cable assemblies; and optical polishing tools. **Amphenol North America Div, Bunker Ramo Corp**, Danbury, Conn. Circle 300 on Inquiry Card

## Word Processing Software

Series of 1-p flyers outline three support packages: Sort, for simple, field, and multikey sorting; Math Support Package; and password-entry System Security Option. **Wang Laboratories, Inc**, Lowell, Mass.

Circle 301 on Inquiry Card

## Disc Drives

Illustrated booklet includes directions for room temp and power supply, preferred cabinet types, contamination avoidance techniques, proper maintenance supplies, and suggestions for ideal installation procedures. **Pertec Computer Corp, Pertec Div**, Chatsworth, Calif.

Circle 302 on Inquiry Card

## Precision Miniature ac and dc Motors

Descriptions, dimensions, and specs for EM series motors, gearmotors, fans, blowers, and motor/tachometers are detailed in 24-p catalog. **TRW Globe Motor Div**, Dayton, Ohio.

Circle 303 on Inquiry Card

## Instruments and Breadboarding Equipment

Catalog of electronic prototyping, digital troubleshooting, and measurement products aimed at professional and industrial users includes solderless breadboard products. **Continental Specialties Corp**, New Haven, Conn.

Circle 304 on Inquiry Card

## Digital and Linear ICs

Catalog presents differential amplifiers, level detectors, dc/dc converters, timing circuits, motor speed controls, optical detector systems, camera control systems, and flip chips, including diagrams, photos, specs, and application information. **Cherry Semiconductor Corp**, Cranston, RI. Circle 305 on Inquiry Card

## Electrical Connectors

Featuring 18 major connector product lines, the 206-p catalog includes dimension drawings, photos, charts, and graphs. **ITT Cannon Electric Div**, Santa Ana, Calif.

Circle 306 on Inquiry Card

## Portable Oscilloscopes

Information package contains data sheets featuring photos, selection criteria, and specs for 200-, 300-, 400-, and T900-Series units. **Tektronix, Inc**, Beaverton, Ore.

Circle 307 on Inquiry Card

## Logic Test Instrumentation

Brochure explains where logic probes, logic analyzers, logic stimulus, and automatic board and IC testers are used in laboratory, production, and service environments. **Hewlett-Packard Co**, Palo Alto, Calif.

Circle 308 on Inquiry Card

## Data Logger

Applications, configurations, operation, programming, and specs for the RAMP (Remote Analog Multiplexing Processor) are detailed in 16-p brochure. **Kaye Instruments, Inc**, Bedford, Mass.

Circle 309 on Inquiry Card

## Graphics Software

Brochure describes library of graphics software, detailing four levels: basic, functional, application, and PACE (interactive graphics editing). **California Computer Products, Inc**, Anaheim, Calif.

Circle 310 on Inquiry Card

## Stepper Motors

Explaining stepper motor technology and applications, handbook includes specs, torque vs step rate graphs, wiring diagrams, and dimensional drawings for 11 series of motors. **North American Philips Controls Corp**, Cheshire, Conn.

Circle 311 on Inquiry Card

## Microcomputer/Digital Logic Modules

Microcomputer systems, microcomputer and digital logic modules, card files, and accessory hardware are grouped by type and function in 14-p price list. **Wyle Laboratories/Computer Products**, Hampton, Va. Circle 312 on Inquiry Card

## Dual-Inline Ceramic Capacitors

Std ratings and performance characteristics of series 920C multilayer ceramic capacitors are supplied in engineering bulletin. **Sprague Electric Co**, North Adams, Mass. Circle 313 on Inquiry Card

## Electronic Cabinets and Desks

The 9500/9200 line of upright cabinets, electronic desks, consoles, printer stands, workstations, plus factory installed options are featured in 12-p brochure. **General Devices, Vent-Rak Div**, Indianapolis, Ind. Circle 314 on Inquiry Card

## Medium Speed Printers

Report covers some of the different types of medium speed printers available for use with minicomputers, terminals, and small business systems. **Tally Corp**, Kent, Wash. Circle 315 on Inquiry Card

## Photocells/Photodiodes

Specs for UV to IR and visible to IR photocells are furnished in 16-p catalog which describes silicon photocells and GaAsP photodiodes for low level light detection and general purpose applications. **Hamamatsu Corp**, Middlesex, NJ.

Circle 316 on Inquiry Card

## Used Communications Equipment

Catalog lists current sale and lease prices as well as the original prices of ICC modems, adapters and accessories, solid-state buffers, test sets, and registered connecting devices. **Racal-Milgo Information Systems, Inc**, Miami, Fla.

Circle 317 on Inquiry Card

## Resistors/Converters/Detectors

Catalog furnishes specs, dimensional drawings, and descriptions of miniature high megohm resistors, impedance converters/amplifiers, and pyroelectric IR and laser detectors. **Eltec Instruments, Inc**, Daytona Beach, Fla.

Circle 318 on Inquiry Card

## Solid-State Relays

In addition to device descriptions, catalog provides selection factors as well as engineering information necessary to properly specify and apply solid-state relays. **Grayhill, Inc**, La Grange, Ill. Circle 319 on Inquiry Card

# GUIDE TO PRODUCT INFORMATION

NOTE: The number associated with each item in this guide indicates the page on which the item appears—not the reader service number. Please do not circle the page number on the reader service card.

HARDWARE	PAGE	COMPONENTS AND ASSEMBLIES	PAGE	SWITCHES	PAGE
<b>BREADBOARDS</b>		<b>CAPACITIVE COMPONENTS</b>		Panel Switches	
Breadboard		Capacitors		<b>Micro Switch/Honeywell</b> .....	<b>32</b>
Pulse Instruments .....	201	Illinois Capacitor .....	198	Pushbutton Switch	
<b>CONNECTORS AND INTERCONNECTION SYSTEMS</b>		Union Carbide/Electronics-Components ..	215	Licon/Illinois Tool Works .....	205
Connectors		<b>MOTORS; ROTATIVE COMPONENTS</b>			
<b>AMP</b> .....	65	DC Motors			
PC Connectors		Canon U.S.A./Electronics Components ..	140		
<b>Viking Industries</b> .....	143	<b>PHOTODEVICES; PHOTODEVICE ASSEMBLIES</b>			
Flat Cable Connector		Optical Scanner			
3M/Electronic Products .....	194	<b>Reticon</b> .....	216		
Interconnection Systems		Optical Subsystems			
<b>Spectra-Strip</b> .....	47, 75, 152, 201	<b>HEI</b> .....	43		
<b>FANS AND BLOWERS</b>		Optical Coupler			
DC Fans		<b>Olektron</b> .....	203		
<b>Buehler Products</b> .....	206	Fiber Optic Emitter			
<b>INDICATORS; READOUTS; DIGITAL DISPLAYS; LAMPS</b>		<b>IAV</b> .....	193		
Fault Indicators		Miniature Incandescent Lamp			
<b>OPCOA/IDS</b> .....	203	Chicago Miniature Lamp Works/			
<b>MOUNTING HARDWARE</b>		General Instrument .....	197		
Rackmount Cabinet		<b>POWER SOURCES, REGULATORS, AND PROTECTORS</b>			
General Robotics/Components .....	152	Power Supplies			
<b>PANELS AND BACKPLANES</b>		<b>adcc electronics</b> .....	56, 57		
Backplane Extender Boards		<b>Adtech Power</b> .....	152, 199		
Computer Extension Systems .....	203	<b>Datel Systems</b> .....	201		
Wirewrap Board		<b>Deltron</b> .....	86		
Associated Computer Consultants .....	193	<b>Etatech</b> .....	192		
<b>PARTS</b>		<b>Power-One</b> .....	196, 203		
Plastic Parts		Standard Power .....	202		
<b>Du-Wel Products</b> .....	197	Switching Power Supplies			
Semistretch Belts		<b>Boschert</b> .....	202		
<b>Beltling Industries</b> .....	204	<b>Kepeco</b> .....	192		
Spring Assemblies		<b>Motorola Semiconductor Products</b> .....	193		
<b>Instrument Specialties</b> .....	137	DC-DC Converters			
Sprockets		Semiconductor Circuits .....	202		
<b>La Vezzi Machine Works</b> .....	214	Transient Voltage Suppressors			
<b>PROGRAMMING BOARDS AND MODULES</b>		International Rectifier/			
Programming Matrix		Semiconductor .....	199		
Augat/Interconnection Products .....	199	Line Voltage Monitor			
<b>SHIELDING</b>		<b>Calex Mfg</b> .....	196		
Rfl/emi Switch Shielding		Power Line Isolation Device			
<b>APM-Hexseal/APM</b> .....	198	Electronic Specialists .....	197		
<b>SLIDES</b>		Power Isolation and Regulation Modules			
Slides		Frequency Technology/TDC .....	206		
<b>Grant Hardware</b> .....	199	<b>RELAYS</b>			
<b>SOCKETS</b>		Latching Relays			
Sockets		<b>T-Bar/Switching Components</b> .....	180		
<b>Robinson Nugent</b> .....	44, 45	<b>RESISTIVE COMPONENTS</b>			
<b>WIRE AND CABLE</b>		Cermet Resistors			
(See also under Connectors)		Central Resistor .....	196		
Flat Cable		Precision Resistors			
<b>Brand-Rex</b> .....	31	Vishay Resistive Systems .....	195		
Fiber Optic Cable		<b>SEMICONDUCTOR COMPONENTS</b>			
Communications Fiberoptics/Valtec .....	201	Laser Diodes			
		General Optronics .....	208		

CIRCUITS	PAGE
<b>DIGITAL AND INTERFACE INTEGRATED CIRCUITS</b>	
(See also Semiconductor Memories under Memory/Storage Equipment)	
Single-Chip Microcomputer	
<b>Rockwell International</b> .....	187
Microprocessors	
Advanced Micro Devices .....	136
National Semiconductor .....	136
<b>NEC Microcomputers</b> .....	40, 41
<b>Zilog</b> .....	7-9
Microprocessor Support Circuits	
Hughes Aircraft/Solid State Products .....	136
Schottky TTL ICs	
<b>Fairchild Semiconductor</b> .....	98
16k ROM	
Hughes Aircraft/Solid State Products .....	180
Static RAM	
<b>EMM Semi</b> .....	182
64k RAMs; LSI Logic Circuits	
International Business Machines/General Technology .....	170
Flexible Disc Drive Controller IC	
<b>NEC Microcomputers</b> .....	182
Flexible Disc Read-Amplifier IC	
<b>Motorola Semiconductor Products</b> .....	172
Graphic Subsystem Chip	
Standard Microsystems .....	176
A-D Converter ICs	
<b>Intersil</b> .....	182
<b>Signetics</b> .....	178
D-A Converter ICs	
<b>Burr-Brown Research</b> .....	19, 174
<b>Harris Semiconductor Products</b> .....	20, 21
Timer IC	
American Microsystems .....	172
Timer/Controller IC	
Texas Instruments .....	182
<b>HYBRID CIRCUITS</b>	
Hybrid A-D Converter	
Micro Networks .....	176
Hybrid Clock Oscillators	
Motorola/Component Products .....	196
<b>LINEAR INTEGRATED CIRCUITS</b>	
Analog Multiplexer ICs	
<b>Datel Systems</b> .....	172
V-F Converter IC	
<b>Raytheon Semiconductor</b> .....	182
<b>OSCILLATORS</b>	
Hybrid Clock Oscillators	
Motorola/Component Products .....	196

	PAGE
Crystal Oscillators	
Greenray Industries .....	189
MF Electronics .....	206
<b>MEMORY/STORAGE EQUIPMENT</b>	
<b>FLEXIBLE DISC UNITS</b>	
Flexible Disc Drive	
Ex-Cell-O/Remex .....	167
Shugart Associates .....	52, 53
Flexible Disc Systems	
Data Systems Design .....	11
Vista Computer .....	200
Flexible Disc Recorders	
Techtran Industries .....	160
<b>MAGNETIC CORE MEMORIES</b>	
Core Memories	
Dataram .....	105
Imperial Technology .....	175
<b>MAGNETIC DISC AND DRUM UNITS</b>	
(See also Flexible Disc Units)	
Disc Drives	
Fujitsu America .....	106
Storage Technology .....	203
Disc Controllers	
Advanced Electronics Design .....	177
Ball Computer Products .....	202
Konan .....	156
Minicomputer Technology .....	183
Xylogics .....	181
<b>MAGNETIC TAPE UNITS</b>	
Tape Transports	
Cipher Data Products .....	51, 207
Kennedy .....	1
Tape Systems	
Digi-Data .....	205
Micro Communications .....	194
Cassette Recorders	
Memedyne .....	207
Raymond Engineering .....	200
Cartridge Tape Drive	
Mohawk Data Sciences .....	151

	PAGE
Cartridge Tape System	
Qantex/North Atlantic Industries .....	33
Cartridge Tape Recorder	
Miltope .....	205
<b>OTHER TYPES OF MEMORY/STORAGE EQUIPMENT</b>	
Add-On Memory	
Control Data .....	193
<b>ROM/RAM PROGRAMMERS AND SIMULATORS</b>	
EPROM Programmer	
Optimal Technology .....	156
P/ROM Programmer Package	
RCA Solid State .....	207
EPROM Copier	
SMR Electronics .....	189
<b>SEMICONDUCTOR MEMORIES</b>	
64k RAMs; LSI Logic Circuits	
International Business Machines/	
General Technology .....	170
Static RAM	
EMM/SEMI .....	182
16k ROM	
Hughes Aircraft/Solid State Products .....	180
Magnetic Bubble Memories	
Texas Instruments/Ccomponents .....	81
Semiconductor Memory Systems	
Chrislin Industries/Computer Products .....	148
Dataram .....	105
Digital Pathways .....	195
Electronic Memories &	
Magnetics/CSD .....	127, 129
Mostek Memory Systems .....	62
MuPro .....	152
Standard Memories .....	171
<b>INPUT/OUTPUT AND RELATED EQUIPMENT</b>	
<b>BAR CODE EQUIPMENT</b>	
Bar Code Equipment	
Interface Mechanisms .....	50
<b>COMPUTER PERIPHERALS</b>	
Militarized Peripherals	
Rolm .....	26

	PAGE
<b>DATA TERMINALS</b>	
(See also Graphic Equipment)	
Printer Terminals	
Dataroyal .....	202
Diablo Systems/Xerox .....	173
Qume .....	159
CRT Display Terminals	
Ann Arbor Terminals .....	204
EECO .....	161
Infoton .....	147
Perkin-Elmer Data Systems .....	36, 37
Zentec .....	16, 17
LED Display Terminals	
Termiflex .....	201
Warren Logic .....	195
<b>DISPLAY EQUIPMENT</b>	
(See also Data Terminals and Graphic Equipment)	
CRT Displays	
Ball Electronic Display .....	133
C. Itoh Electronics .....	198
Zenith Radio .....	131
<b>GRAPHIC EQUIPMENT</b>	
Color Graphic Display Terminals	
Ramtek .....	Cover IV
Color Graphic Display System	
Grinnell Systems .....	38
Plasma Graphic Displays	
Interstate Electronics .....	87
Graphic Display	
Genisco Computers .....	119
Graphic Subsystem Chip	
Standard Microsystems .....	176
Graphic Subsystems	
Digital Research & Engineering .....	208
Matrox Electronic Systems .....	146
Graphic System Workstation	
Auto-trol Technology .....	189
<b>INTERFACE EQUIPMENT; CONTROLLERS</b>	
Controller Boards	
Rianda Electronics .....	196
Tape and Disc Controllers	
Dataram .....	5

# Gray Scale High Fidelity

The CEC 912 N Gray Scale Printer. 16 true gray tone steps. Each step contains 200 picture elements per inch, horizontally and vertically, or 40,000 per square inch. So the hard copy graphic printouts show remarkable resolution and detail.

These extraordinary images are produced instantly, permanently. No warm-up. No processing, heating, or toners. Archival quality? Unquestionably. Storage life of the paper before or after recording is practically limitless — it is unaffected by light or changes in temperature and humidity under normal conditions.

The computer controlled CEC 912 N is built for OEM installation. It's a quietly efficient instrument. Reliable. Economical. There is much more we'd like to tell you about this amazing new printer. Send today for the complete brochure. Or, if you'd prefer immediate, personal particulars, call the CEC Division of Bell & Howell, Pasadena, California, at (213) 796-9381. Ask for Ira White.

## CEC DIVISION

360 SIERRA MADRE VILLA • PASADENA, CA 91109

 BELL & HOWELL

© Bell & Howell 1979

CEC is a registered trademark of Bell & Howell

	<b>PAGE</b>
Disc Controllers	
Ball Computer Products .....	202
Konan .....	156
<b>Minicomputer Technology</b> .....	<b>183</b>
Xylogics .....	181
Flexible Disc Drive Controller IC	
NEC Microcomputers .....	182
Interface Boards	
<b>MDB Systems</b> .....	<b>192</b>
Printer Interfaces	
Via West .....	192
Communications Interface	
Industrial Computer Controls .....	202
Paradyne .....	196

**KEYBOARD EQUIPMENT**

Keyboards	
<b>Digitran</b> .....	<b>54</b>
George Risk Industries .....	152

**MAGNETIC CARD EQUIPMENT**

Magnetic Stripe Terminal	
Amtron Systems .....	201

**PLOTTING EQUIPMENT**

Digital Plotter	
<b>Houston Instruments</b> .....	<b>Cover III</b>
Drum Plotter	
<b>California Computer Products</b> .....	<b>169</b>

X-Y Plotter	
Sylvanhills Laboratory .....	195
<b>PRINTER/PLOTTERS</b>	
Electrostatic Printer/Plotter	
<b>Versatec/Xerox</b> .....	<b>165</b>
Printer Graphics Subsystem	
Selanar .....	199
<b>PRINTING EQUIPMENT</b>	
Printers	
<b>Centronics Data Computer</b> .....	<b>13</b>
<b>Dataproducts</b> .....	<b>179</b>
<b>Integral Data Systems</b> .....	<b>189</b>
<b>NEC Information Systems</b> .....	<b>35</b>
<b>Printronix</b> .....	<b>155</b>
Tally .....	2
Line Printers	
<b>Data Printer</b> .....	<b>163</b>
<b>Okidata</b> .....	<b>4, 197</b>
Matrix Printers	
<b>Microdata</b> .....	<b>157</b>
Southern Systems .....	195
Hardcopy Printer	
<b>Bell &amp; Howell/CEC</b> .....	<b>211</b>
Ticket Printers	
C. Itoh Electronics .....	197
<b>Practical Automation</b> .....	<b>134</b>
Printing Systems	
California Computer Products .....	200
Printer Mechanisms	
<b>Epson America</b> .....	<b>145</b>
<b>Gulton Industries/Measurement &amp; Control Systems</b> .....	<b>207</b>
C. Itoh Electronics .....	153
Printer Interfaces	
Via West .....	192
<b>PUNCHED TAPE EQUIPMENT</b>	
Punched Tape Reader	
<b>Decitek/Jamesbury</b> .....	<b>135</b>
Tape Punch Mechanism	
<b>Epson America</b> .....	<b>145</b>

# Here's low cost, high performance Zilog Z80A emulation for your Intel development system

Only RELMS offers you the powerful Z80 in-circuit emulator (ICE) and the Z80 system adaptor module (SAM) for hardware and software development. And only RELMS gives you such price/performance value. The complete Z80 ICE is priced at \$2,195; SAM is only \$1,695.

ICE and SAM are totally transparent and compatible with your Series II or Intellec 8 development system. SAM supports all the Z80 features with a Z80 CPU board that replaces your 8080 processor card, an ISIS compatible Z80 relocatable disk macro assembler and a Z80 monitor for extensive software debugging.

ICE features full speed emulation of the Z80A with 256 x 40 bit trace, memory mapping, hardware BREAKREGION™ selectable clock speed and RAM based control program. All come with complete documentation.

Learn more about ICE and SAM, the affordable development tools for your Intellec® system. Both are available for immediate delivery. Call or write today for full details.

Inquiries from qualified sales representatives welcomed.



# relms

Relational Memory Systems, Inc.  
P.O. Box 6719, San Jose, CA 95150, (408) 248-6356

BREAKREGION™ is a trademark of RELMS. Series II and Intellec 8 are trademarks of Intel Corporation.

**COMPUTERS AND COMPUTER SYSTEMS**

<b>BUSINESS COMPUTERS</b>	
Business Computer System	
Pertec Computer/Microsystems .....	156
Multiterminal Business Computer	
Basic Four .....	189
<b>GRAPHICS PROCESSORS</b>	
Graphics Processor	
<b>Megatek</b> .....	<b>Cover II</b>
Image Processor	
Comtal .....	73
<b>MICROCOMPUTERS AND MICROPROCESSORS</b>	
Microprocessors	
Advanced Micro Devices .....	136
National Semiconductor .....	136
<b>NEC Information Systems</b> .....	<b>35</b>
Single Chip Microcomputer	
<b>Rockwell International</b> .....	<b>187</b>
Microcomputers	
Digital Microsystems .....	156
Findex .....	148
<b>Plessey Peripheral Systems</b> .....	<b>141</b>
Zilog .....	7-9
Militarized Microcomputers	
Severe Environment Systems/Electronic Memories & Magnetics and Intel .....	146
Plessey Microsystems .....	146
Microcomputer Development System	
<b>Futuredata</b> .....	<b>46</b>
Microprocessor Development System	
<b>Tektronix</b> .....	<b>82, 83</b>
Development System	
<b>Step Engineering</b> .....	<b>49</b>
In-Circuit Emulator	
<b>Relational Memory Systems</b> .....	<b>212</b>
Software Development Board	
Texas Instruments .....	138
Microprocessor Analyzer	
Bytek .....	136
Microcomputer Software	
AJA Software .....	160
Zilog .....	160
Microprocessor Software	
Boston Systems Office .....	140

	PAGE
Microsoft .....	138
Microtec .....	138
Software Dynamics .....	206
Virtual Systems .....	138
<b>MINICOMPUTERS; SMALL- AND MEDIUM-SCALE COMPUTERS</b>	
Minicomputers	
Ampex Memory Products .....	121
Data General .....	28, 29
Hewlett-Packard .....	59-61
Modular Computer Systems .....	125
Sperry Univac .....	76, 77
Systems Engineering Laboratories .....	88
<b>TIMESHARING/DISTRIBUTED PROCESSING COMPUTERS AND SYSTEMS</b>	
Multiterminal Business Computer	
Basic Four .....	189
Remote Information Systems	
Data 100 .....	200
<b>DATA COMMUNICATIONS EQUIPMENT</b>	
<b>COMMUNICATIONS INTERFACES</b>	
Communications Interfaces	
Industrial Computer Controls .....	202
Paradyne .....	196
<b>COMMUNICATIONS MONITORS</b>	
Communications Monitors	
Penril .....	198
Questronics .....	194
<b>COMMUNICATIONS PROCESSORS</b>	
Communications Processor	
Computer Communications .....	194
<b>COMMUNICATIONS TERMINALS</b>	
Communications Terminals	
Columbia Data Products .....	202
<b>DATA TRANSMISSION EQUIPMENT</b>	
Optical Data Link	
Flash Technology .....	188
<b>MODEMS; DATA SETS</b>	
PC Board Modem	
Racal-Vadic .....	186
Data Modems	
Prentice .....	193
Rixon .....	204
<b>OTHER DATA COMMUNICATIONS EQUIPMENT</b>	
Communications Equipment	
Dynatech Data Systems .....	204
<b>DATA ACQUISITION AND CONTROL EQUIPMENT</b>	
<b>A-D AND D-A CONVERTERS</b>	
D-A Converter ICs	
Burr-Brown Research .....	19, 174
Harris Semiconductor Products .....	20, 21
D-A Converters	
Adac .....	156
Hybrid A-D Converter	
Micro Networks .....	176
A-D Converter ICs	
Intersil .....	182
Signetics .....	178
<b>ANGLE AND POSITION ENCODERS</b>	
Optical Encoders	
Theta Instrument .....	203
<b>DATA TRANSFER AND INTERFACE EQUIPMENT</b>	
Expanded Bus Structure	
Intel .....	148
<b>INSTRUMENTATION RECORDERS</b>	
Microprocessor Based Data Loggers	
Doric Scientific/Emerson Electric .....	188
Programmable Data Logger	
John Fluke Mfg .....	206
Event Recorder	
Niagara Scientific .....	201
<b>MONITORING AND CONTROL EQUIPMENT</b>	
Control System Enhancements	
Taylor Instrument/Sybron .....	189
<b>SCANNERS</b>	
Coaxial Scanner	
Autek Systems .....	199
<b>S-D AND D-S CONVERTERS</b>	
S-D Converter Module	
Transmagnetics .....	195

	PAGE
<b>TEST AND MEASUREMENT EQUIPMENT; INSTRUMENTATION</b>	
<b>COUNTERS; TIMERS</b>	
Time/Calendar Module	
Digital Pathways .....	193
Timer Module	
Creative Micro Systems .....	138
<b>DATA GENERATORS</b>	
Pulse/Function Generator	
Exact Electronics .....	204
<b>DIGITAL EQUIPMENT TESTERS</b>	
Logic Analyzers	
Hewlett-Packard .....	24, 25
Paratronics .....	168
Tektronix .....	23
Logic Probe	
OK Machine and Tool .....	203
LSI Memory Tester	
Macrodata .....	194
Microprocessor Analyzer	
Bytek .....	136
Portable Data Communications Tester	
Tektronix .....	188
<b>FUNCTION GENERATORS AND SYNTHESIZERS</b>	
Function Generator	
Continental Specialties .....	198
<b>OSCILLOSCOPES</b>	
Storage Oscilloscope	
Philips Test and Measuring Instruments .....	208
Digital Processing Oscilloscopes	
T. G. Branden .....	205
<b>OTHER TEST AND MEASUREMENT EQUIPMENT</b>	
Waveform Analyzers	
E-H International .....	208
<b>SIGNAL AND CODE CONVERTERS</b>	
V-F Converter IC	
Raytheon Semiconductor .....	182
<b>OTHER PRODUCTS; SERVICES</b>	
<b>EDP ACCESSORIES AND SUPPLIES</b>	
Magnetic Media	
Verbatim .....	18
Flexible Discs	
Maxell America .....	139
<b>EDUCATION</b>	
Education	
Institute for Advanced Professional Studies .....	116, 117
Seminars	
Integrated Computer Systems .....	190, 191
<b>EMPLOYMENT OPPORTUNITIES</b>	
Employment Opportunities	
Heinrich C. Schön .....	150
Tektronix .....	208
Tennessee Valley Authority .....	215
<b>EXHIBITIONS</b>	
Exhibition	
Interface 79 .....	158
<b>MARKET REPORTS</b>	
Market Reports	
Frost & Sullivan .....	214
<b>PUBLICATIONS</b>	
Publication	
Digital Equipment .....	213
Books	
Blacksburg Continuing Education Series 154	
Van Nostrand Reinhold .....	68
<b>SERVICES</b>	
Transportation	
Delta Airlines .....	200
<b>SOFTWARE</b>	
Microcomputer Software	
AJA Software .....	160
Zilog .....	160
Microprocessor Software	
Boston Systems Office .....	140
Microsoft .....	138
Microtec .....	138
Software Dynamics .....	206
Virtual Systems .....	138
Speech Synthesizer Software	
Computalk Consultants .....	201
Compilers	
IMSAI Manufacturing .....	160
Whitesmiths .....	194

# FOR THE SERIOUS STUDENT OF HARDWARE SYSTEMS DESIGN

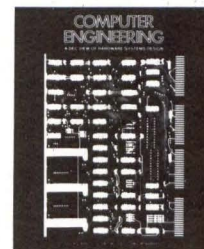

"This is an excellent book...a major contribution to the literature of computer hardware."

—Gerrit A. Blaauw  
Technical University of Twente  
Enschede, Netherlands

"...a valuable historical record and a fascinating reference work for engineers and computer scientists to gain insight into the issues and traps of developing and marketing complex products in a fast changing field."

—Jack B. Dennis  
Massachusetts Institute of Technology

*Computer Engineering: A DEC View of Hardware Systems Design* by C. Gordon Bell, J. Craig Mudge, and John E. McNamara is the story of hardware systems design practiced at Digital Equipment Corporation over the past 20 years.

*Computer Engineering* is written for people who want to or must understand the evaluation of hardware systems design. The focus of the engineer and student of design will be primarily on the highly technical discussions, while that of the manager/planner will be more on the economic and marketplace issues.

The three introductory chapters discuss computer systems from seven different perspectives; technology evolution; packaging and manufacturing. Five major sections follow: "In the Beginning" (transistor circuitry and DEC modules) "The Beginning of the Minicomputer" (18-bit computers, 12-bit computers, and structural levels of the PDP-8), "The PDP-11 Family" (from the beginning of the Family through VAX), "The Evolution of Computer Building Blocks" (RTMs, LSI processor bit slices, and multi-microprocessors), and "The PDP-10 Family." Three appendices cover the ISPS and PMS notations, and measuring computer performance. A bibliography and index are included.

585 pages, 83 tables, 364 figures, hardcover, \$19.95 (U.S. only).

Send check or money order to: Dept. CE, Educational Services, Digital Equipment Corporation, Crosby Drive, Bedford, MA 01730.

**digital**

I would like to order \_\_\_\_\_ copy(ies) of *Computer Engineering: A DEC View of Hardware Systems Design*.

Enclosed is a check or money order for \$ \_\_\_\_\_.

Please ship book(s) to:

Name \_\_\_\_\_

Company/University \_\_\_\_\_

Department \_\_\_\_\_

Street \_\_\_\_\_

City \_\_\_\_\_ State \_\_\_\_\_ Zip \_\_\_\_\_

CD19

# ADVERTISERS' INDEX

acdc electronics .....	56, 57	Du-Wel Products, Inc. ....	197
Advanced Electronics Design .....	177	Dynabyte .....	149
AMP, Inc. ....	65	Dynatech Data Systems .....	204
Ampex Memory Products Div. ....	121	EECO .....	161
Ball Electronic Display Div. ....	133	EG&G Reticon .....	216
Bell & Howell, .....		Electronic Memories & Magnetics Corp.,	
CEC Div. ....	211	EMM/CSD/OEM Systems Div. ....	127, 129
Belting Industries Co., Inc. ....	204	Electronic Systems .....	67
Blacksburg Continuing Education Series .....	154	Epson America, Inc. ....	145
Brand-Rex Co. ....	31	Ex-Cell-O Corp.,	
Buehler Products, Inc. ....	206	Remex Div. ....	167
Burr-Brown Research Corp. ....	19	Fairchild Semiconductor Corp.,	
California Computer Products .....	169	Operations Div. ....	98
Canon, U.S.A., Inc. ....	140	Fujitsu America, Inc. ....	106
Centronics Data Computer Corp. ....	13	Futuredata Computer Corp. ....	46
Cipher Data Products, Inc. ....	51	Genisco Computers,	
Columbia Data Products, Inc. ....	202	a div. of Genisco Tech. Corp. ....	119
Computer Automation .....	78	Grant Hardware Co. ....	199
Comtal Corp. ....	73	Grinnell Systems, Inc. ....	38
Conic Data Systems .....	184	Gulton Industries, Inc.,	
Data General Corp. ....	28, 29	Measurement & Control Systems Div. ....	207
Data I/O .....	185	Harris Semiconductor Corp. ....	20, 21
Data Printer Corp. ....	163	HEI, Inc. ....	43
Dataproducts .....	179	Heinrich C. Schön .....	150
Dataram Corp. ....	5, 105	Hewlett-Packard Co. ....	24, 25, 59-61, 84
Data Systems Design, Inc. ....	11	Houston Instrument,	
Decitek,		Div. of Bausch & Lomb .....	Cover 111
a div. of Jamesbury Corp. ....	135	Imperial Technology .....	175
Delta Air Lines, Inc. ....	200	Infoton Corp. ....	147
Deltron, Inc. ....	86	Institute for Advanced Professional Studies .....	116, 117
Digi-Data Corp. ....	205	Instrument Specialties Co., Inc. ....	137
Digital Equipment Corp. ....	213	Integral Data Systems .....	189
Digital Pathways, Inc. ....	193, 195	Integrated Computer Systems, Inc. ....	190, 191
Digital Research & Engineering .....	208	Intelligent Systems Corp. ....	214
The Digitran Co. ....	54	Interface '79 .....	158

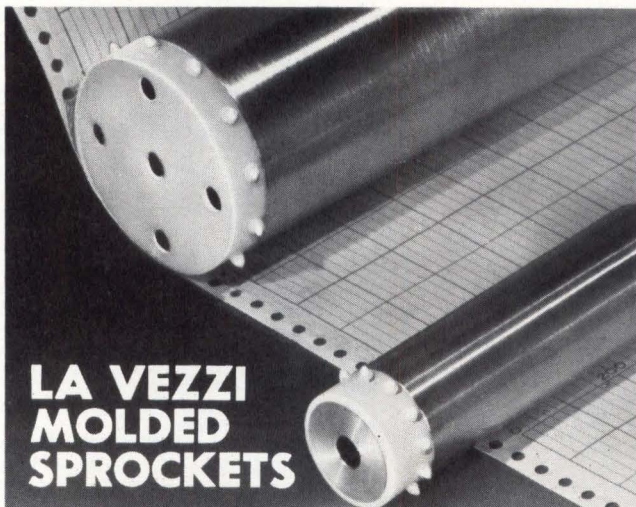

## LA VEZZI MOLDED SPROCKETS

### A PRECISE WAY TO DRIVE CHARTS ECONOMICALLY

Drives perforated materials with unvarying accuracy. Maintains chart integrity. 10, 12 and 24-tooth thermo-plastic sprockets are formed to exacting specifications. 1/4", 1/10" and 5mm pitch. Immediate delivery.



Our catalog tells all.  
*LaVezzi* machine works, inc.

900 N. Larch Ave. • Elmhurst, Ill. 60126 • (312) 832-8990



# \$6500

**The Intecolor 8080 Development System Gives You Total In-House Control.** You probably already realize that an in-house development system would give you a lot more control, flexibility and efficiency.

You may not realize that now you can afford one. Our new low-cost 8080 development system features a 19-inch, 8-color data entry terminal with an Intel 8080 micro computer. A 110 CPS bi-directional desk top printer. A dual mini disk drive and our 2708/2716 PROM programmer. It also includes a sophisticated ROM-based Text Editor and Assembler. And as an option, a FORTRAN compiler with double precision by Microsoft®

Call 800/241-9699 toll-free for a demonstration. (In Georgia, call 404/449-5961.)

Color Communicates Better  
**Intelligent Systems Corp.**



5965 Peachtree Corners East/Norcross, Georgia 30071  
Telephone 404/449-5961 TWX: 810-766-1581



Interface Mechanisms, Inc. ....	50
Interstate Electronics .....	87
C. Itoh Electronics, Inc. ....	153, 198
Kennedy Co. ....	1
La Vezzi Machine Works, Inc. ....	214
Maxell Corp. of America .....	139
MDB Systems, Inc. ....	192
Megatek Corp. ....	Cover II
Micro Communications Corp. ....	194
Microdata Corp. ....	157
Micro Switch, a div. of Honeywell .....	32
Millennium Systems, Inc. ....	70, 71
Minicomputer Technology .....	183
Modular Computer Systems, Inc. ....	125
Mohawk Data Sciences .....	151
Monolithic Systems Corp. ....	14, 15
Mostek .....	62
NEC Information Systems .....	35
NEC Microcomputers, Inc. ....	40, 41
Okidata Corp. ....	4
Opto 22 .....	69
Paratronics, Inc. ....	168
Perkin-Elmer Corp., Terminals Div. ....	36, 37
Plessey Peripheral Systems .....	141
Power-One, Inc. ....	203
Practical Automation, Inc. ....	134
Printonix .....	155
Qantex, Div. of North Atlantic Industries .....	33
Qume .....	159
Ramtek Corp. ....	Cover IV

Raymond Engineering Corp. ....	200
Relational Memory Systems .....	212
Rianda Electronics, Ltd. ....	196
Robinson-Nugent, Inc. ....	44, 45
Rockwell International .....	187
Rolm Corp. ....	26
Shugart Assoc. ....	52, 53
Software Dynamics .....	206
Spectra-Strip .....	47, 75, 152, 201
Sperry-Univac Mini-Computer Operations .....	76, 77
Standard Memories .....	171
Step Engineering .....	49
Systems Engineering Laboratories, Inc. ....	88
Tally Corp. ....	2
T-Bar, Inc. ....	180
Techtran, Inc. ....	160
Tektronix, Inc. ....	23, 82, 83, 208
Tennessee Valley Authority .....	215
<b>TEXAS INSTRUMENTS INCORPORATED,</b> Components Div. ....	81
Union Carbide Corp. ....	215
Van Nostrand Reinhold, Inc., a div. of Litton Industries .....	68
Verbatim Corp. ....	18
Versatec, a Xerox Co. ....	165
Viking Connectors, Inc. ....	143
Xerox Corp., Diablo Div. ....	173
Xylogics, Inc. ....	181
Zenith Radio Corp., CRT Display Engineering Div. ....	131
Zentec Corp. ....	16, 17
Zilog, Inc. ....	7-9

## "BLUE MAX" DID IT!

Datapoint Corp. of San Antonio, Tex. needed a capacitor of miniature size, with maximum CV ratings, of consistent quality, and at a competitive price. They chose the KEMET "Blue Max" dipped monolithic ceramic capacitor. It comes in three dielectrics, six case sizes, with more than 350 CV ratings, in capacitance values from 2.2 pF to 4.7 µF, in 50, 100 and 200V ranges. For more information, write: Components Dept., Union Carbide Corporation, P.O. Box 5928, Greenville, SC 29606. Phone: (803) 963-6300. Or see your local KEMET Capacitors Distributor.



Datapoint 5500  
Advanced Business Processor

## KEMET® OFFERS YOU MORE.

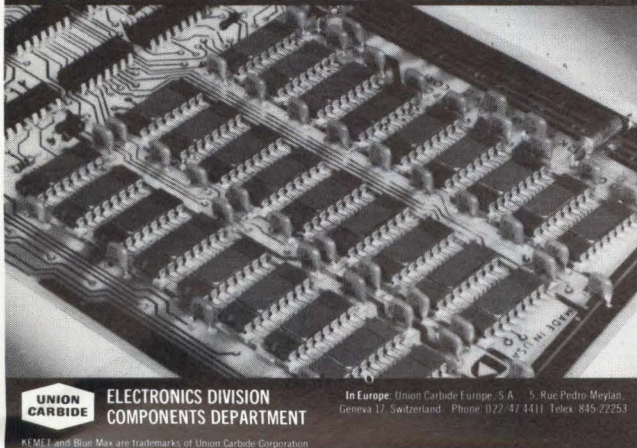

**UNION CARBIDE**  
ELECTRONICS DIVISION  
COMPONENTS DEPARTMENT

In Europe: Union Carbide Europe, S.A., Rue Pedro Meylan,  
Geneva 17, Switzerland. Phone 022 47 1411 Telex 845-22253

KEMET and Blue Max are trademarks of Union Carbide Corporation.

## POWER SUPPLY ANALYST

(Systems Analyst/  
Programmer)  
Casper, Wyoming And  
Chattanooga, Tennessee

The Tennessee Valley Authority has an attractive career opening for a systems analyst with extensive experience in commercial time sharing networks. Candidate should have a degree in computer science, math, business, or engineering (preferably mining). Typical duties include communication with system users to define problems; system specifications; evaluation of present systems, and recommendation of new systems improvements. The position requires several years experience with computer operations, management information services and data gathering techniques. Salary range \$19,390 to \$30,140, commensurate with experience. Excellent benefits are provided. Send resume (including Social Security number with name) in confidence to Carolyn Grandin:



**TENNESSEE VALLEY AUTHORITY**  
EMPLOYMENT BRANCH CD0103  
301 Power Building  
Chattanooga, Tennessee 37401

TVA may consider for appointments only U.S. citizens and others eligible for payments under section 602, Pub. L. 94-363, and section 750, Pub. L. 94-419.

An Equal Opportunity Employer

# Put image data on the Intel Multibus<sup>T.M.</sup>

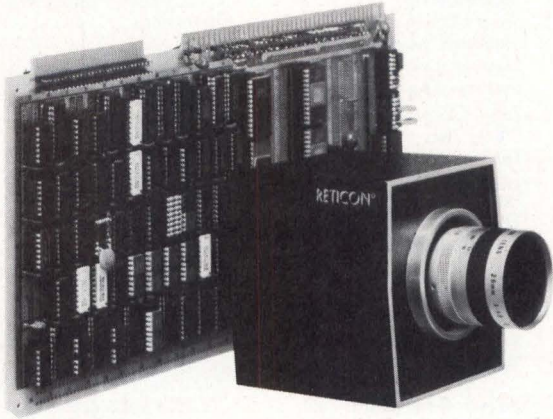

## Our plug-compatible board directly couples Reticon imaging cameras to Intel SBC/Multibus<sup>T.M.</sup> systems

Now you can apply computer power for processing signals from Reticon imaging cameras to achieve greater control and flexibility of non-contact inspection and measurement applications. The RSB-6020 interface boards contain these features.

- Collects data from one or two linear or matrix array cameras.
- Provides on-board preprocessing of signal data for faster and easier computer processing.
- Contains dual RAM memories with relocatable system address space.
- Provides multiple modes of data compression to handle high speed camera scan rates.

Write or call any of the Reticon offices for more information or application assistance.

Boston (617) 246-2718  
Chicago (312) 640-7713  
Los Angeles (213) 995-4663  
Sunnyvale (408) 738-4266

 **EG&G RETICON**

345 Potrero Avenue  
Sunnyvale, California 94086  
(408) 738-4266 TWX: 910-339-9343

### SALES OFFICES

#### NEW ENGLAND AND UPSTATE NEW YORK

CALDWELL ENTER-  
PRISES, INC.  
Lindsay H. Caldwell  
129 Cedar Hill Rd.  
East Dennis, MA 02641  
(617) 385-2533

#### LONG ISLAND AND MIDDLE ATLANTIC STATES

CALDWELL ENTER-  
PRISES, INC.  
Richard V. Busch  
Princeton, N.J. area  
(609) 924-6300

#### SOUTHEASTERN STATES

COLLINSON & CO., INC.  
Newton B. Collinson, III  
Anthony C. Marmon  
4419 Cowan Rd., Suite 302  
Tucker, GA 30084  
(404) 939-8391

#### MIDWESTERN STATES

Berry Conner, Jr.  
88 West Schiller St.  
Suite 2208  
Chicago, IL 60610  
(312) 266-0008

#### WESTERN STATES

BUCKLEY/BORIS  
ASSOC., INC.  
Terry Buckley  
Tom Boris  
John Sabo  
912 South Barrington Ave.  
Suite 202  
Los Angeles, CA 90049  
(213) 826-4621

# The DP-8 36" Digital Plotter gives you more

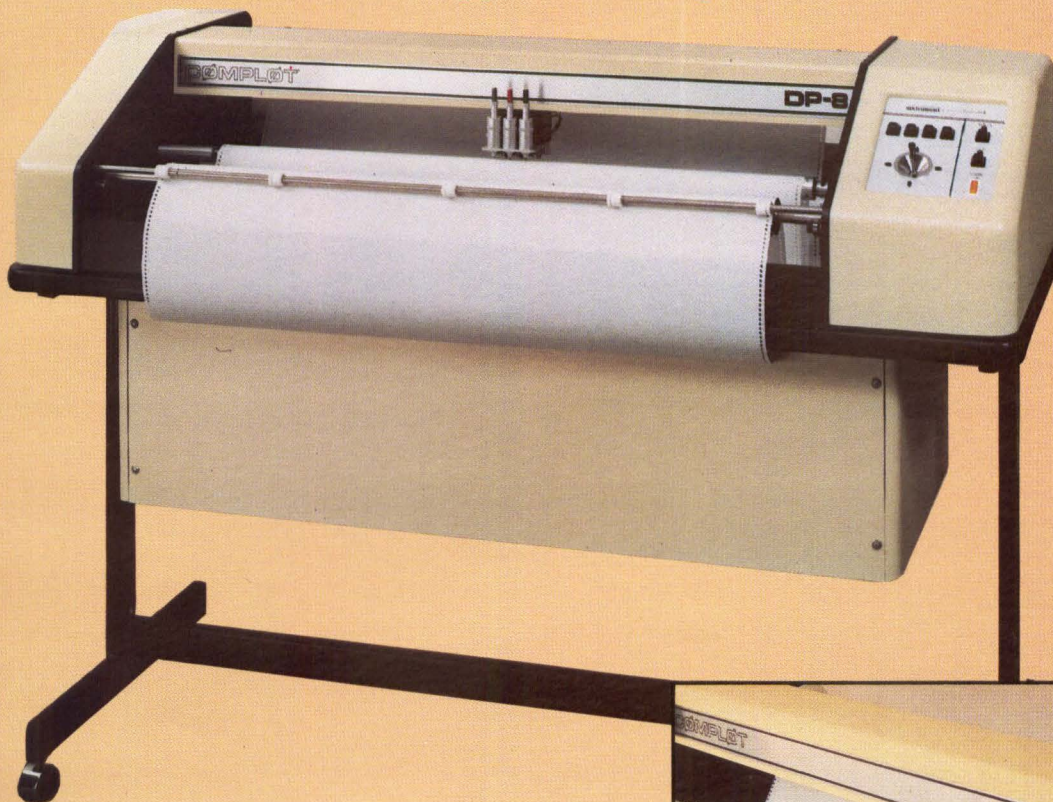

## More resolution

The DP-8 features 6 switch selectable step sizes (English or Metric) with pen speeds of up to 4.5 IPS (3600 steps per second).

## More plot media

Quality graphics can be produced on a number of plotting surfaces including paper, vellum, clear or matt Mylar.

## More models to choose from

The DP-8 is available in a variety of models: the 3 pen DP-8-S3; the single pen multi resolution DP-8S; and the single pen fixed resolution DP-8V. Even a stretch version with a 42" wide plot capability is available. Choose the one that's right for your application.

For rush literature requests or local sales office information only, persons outside Texas call toll free 1-800-531-5205

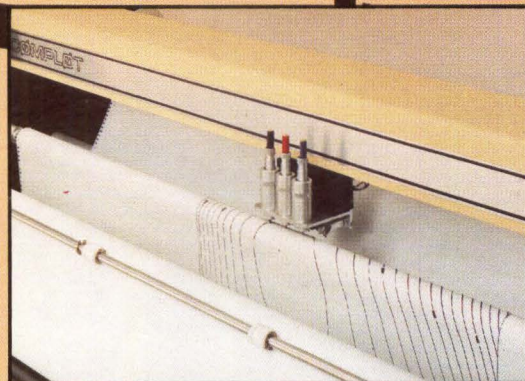

and less . . .  
less noise  
less maintenance  
less cost.

DP-8V, \$7,600\*

**houston  
instrument**

ONE HOUSTON SQUARE  
(512) 837-2820

EUROPEAN HEADQUARTERS

DIVISION OF BAUSCH & LOMB

AUSTIN, TEXAS 78753  
TWX 910-874-2022

Rochester/Leban 6 8240 Gistel Belgium  
Phone 069/277445 Telex Bausch 81399

*"the graphics - recorder company"*

\*U S Domestic Price only

CIRCLE 160 ON INQUIRY CARD

# When you need color graphics, Ramtek has it all.

Color. A surprisingly powerful way to add information, manage it, increase the efficiency of its use. However you plan to use it, there is only one company with the breadth of line, the technological mastery, to give you the choices you need without compromise—or needless costs.

It's Ramtek. For color graphics. For imaging. Ramtek has what you need:

**The Ramtek 3000.** Eight models let you explore the possibilities of color graphics the moment you plug in your application software. Stand alone image processing and graphics. Fully integrated and ready to go. Desk configuration.

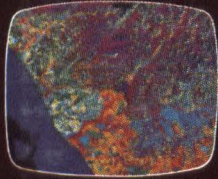

**The Ramtek 9000 Series Display Controller.** Four models. Total modularity. Buy just what you need; add to it at any time. The high-performance family.

The industry standard in imaging and graphics raster scan color.

**The Ramtek 9050 Series Display Controller.** Four models. The most popular elements of the 9000 Series are here packaged for economy. All

are software compatible with the 9000, have expandable memory and interactive capabilities.

**The Ramtek Colorgraphics Computer Terminals.**

Three models let you choose between economy, optimum price-performance, or maximum resolution-performance. Easy

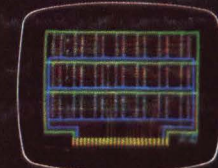

to program. Easy to use. Easy to interface. Interfaces to the Xerox 6500 Color Graphic Printer for color hard copy output. These are the price, industry and performance leaders in raster scan color graphics terminals.

**The Ramtek Monitor Family.**

Nine models. Up to 1024 line addressability on the screen in color or black and white. CRT sizes 13" or 19" Cabinet or rack mounted versions.

**Ramtek Large Screen Projection.**

Interface Ramtek's or your own large screen projection unit easily, quickly. And there's more to come. From Ramtek, the world's largest independent manufacturer of raster scan color graphics and imaging equipment. Direct sales in the U.S. and Canada. Distributors worldwide plus a worldwide network of customer service and depot repair stations.

For more information, write:

Ramtek, 585 N. Mary Ave.,  
Sunnyvale, CA 94086.



**ramtek**  
Our Experience Shows

REGIONAL OFFICES: Sunnyvale, California (408) 735-8400 • Newport Beach, California (714) 979-5351 • Dallas, Texas (214) 422-2200 • Huntsville, Alabama (205) 837-7000 • Cleveland, Ohio (216) 464-4053 • Washington, D.C. (301) 656-0350 • Boston, Massachusetts (617) 862-7720 • West Germany (0611) 771070