

# COMPUTERS

*a n d* A U T O M A T I O N

DATA PROCESSING • CYBERNETICS • ROBOTS

JULY 1957

**A Survey Course in  
Automatic Data  
Processing Systems**

**Syntax Patterns  
In English by  
Electronic Computer**

**"LEPRECHAUN" —  
Digital Computer  
The Size of a  
Television Set**

VOL. 6 - No. 7

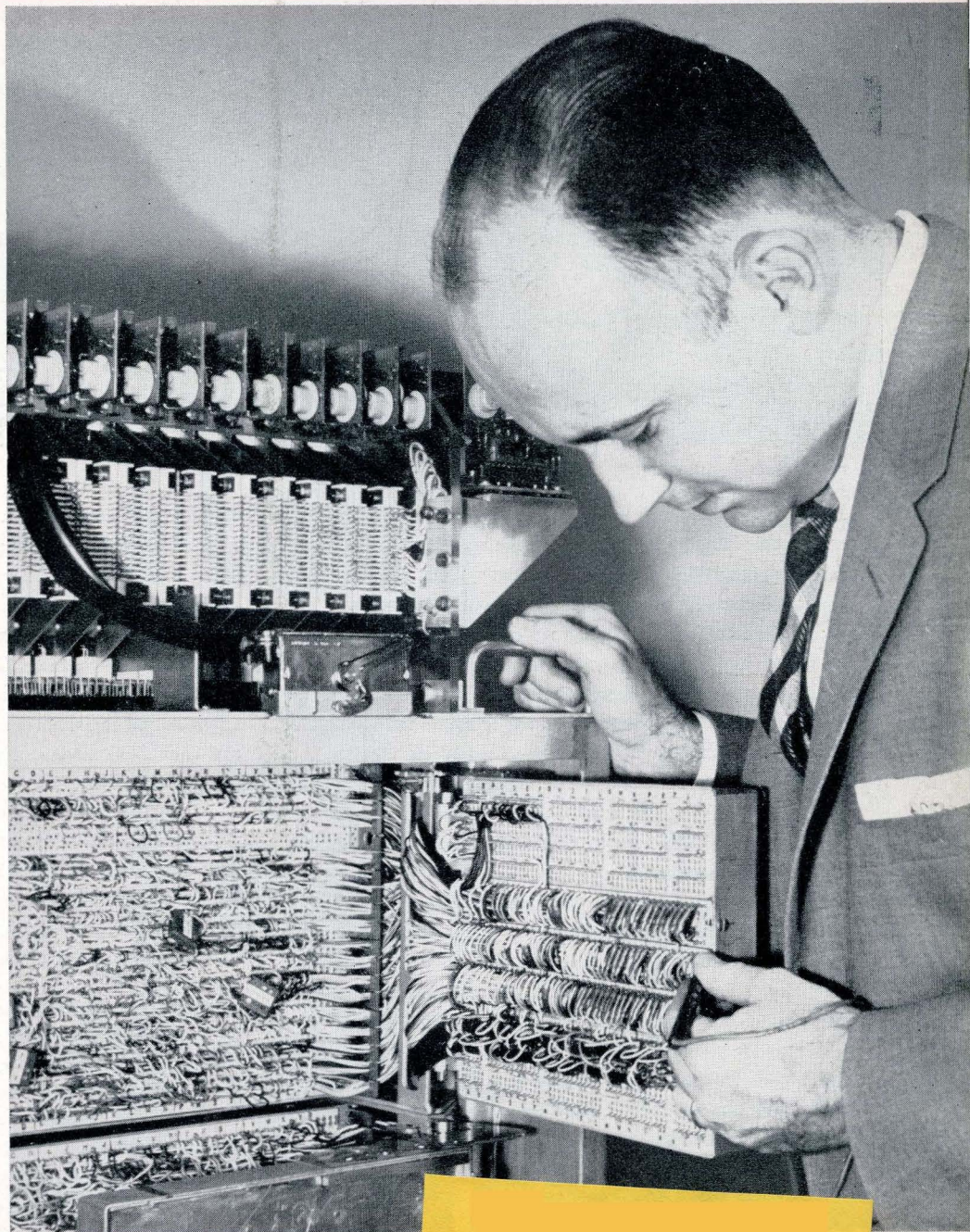



# Technical Management and Systems Engineering

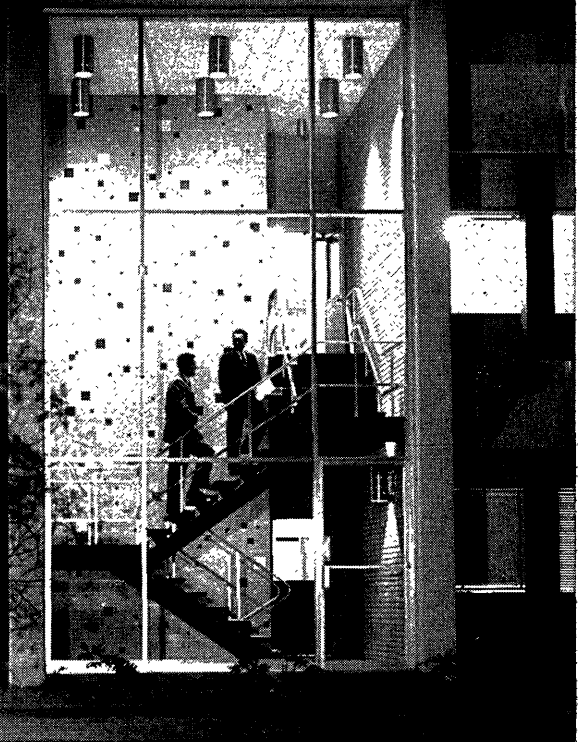

In systems engineering work, it is necessary to bring together a team that includes scientists and engineers of a wide range of technical specialties. In major weapons-systems projects, such teams will include hundreds of scientists and engineers.

But the assembly of a large group of scientists and engineers, no matter how capable they may be individually, does not of itself ensure good systems-engineering performance. The caliber of the project management has a major effect upon its technical accomplishment. It is not easy to coordinate the activities of large numbers of scientists and engineers so as not to stifle their creativeness on the one hand, nor to permit the various development sub-efforts to head toward mutually incompatible objectives on the other.

Of primary importance for good systems management is the philosophy underlying the selection of the supervisory personnel. The head of a technical activity should, first of all, be a competent scientist or engineer. A common mistake — nearly always fatal in systems work — is to fill such positions by non-technical men who have been trained only in management techniques. In the highly complex activities of major systems work, what is required is *technical management*, and of the two words, the word *technical* must never be overlooked.

In the selection of scientists and engineers for technical management, it is essential that the men chosen be broad in their training and approach. Each principal department head, for example, must have a good basic understanding of the technical facts of life of the other departments. When these people get

together they need to speak a common language and understand each other's fields, so that proper decisions can be made on the many interrelated problems that come up. The higher the organizational responsibility of a technical manager, the more important this factor becomes.

The Ramo-Wooldridge Corporation is engaged almost entirely in systems work. Because of this, the company has assigned to scientists and engineers more dominant roles in the management and control of the business than is customary or necessary in most industrial organizations.

*Scientists and engineers who are experienced in systems engineering work, or who have specialized in certain technical fields but have a broad interest in the interactions between their own specialties and other fields, are invited to explore openings at The Ramo-Wooldridge Corporation in:*

Guided Missile Research and Development  
Aerodynamics and Propulsion Systems  
Communications Systems  
Automation and Data Processing  
Digital Computers and Control Systems  
Airborne Electronic and Control Systems  
Basic Electronic and Aeronautical Research

## The Ramo-Wooldridge Corporation

5730 ARBOR VITAE ST. • LOS ANGELES 45, CALIF.

COMPUTERS and AUTOMATION for July, 1957

# FOR DATA PROCESSING COMPONENTS AND SYSTEMS

# SPECIFY POTTER

*Potter instruments and systems are unexcelled in reliability, accuracy and flexibility. The equipment shown is typical of many more available as individual components or in integrated systems to meet specific requirements.*

*Write for brochure describing these and other Potter units, including special products. For detailed technical specifications on any of the Potter Products listed above, contact your Potter Representative or the factory.*

## DATA-HANDLING EQUIPMENT



Digital Magnetic  
Tape Handlers



Perforated  
Tape Readers

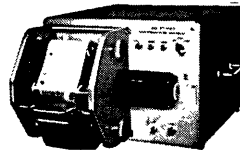

"Quick Look" Recorders

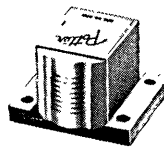

Record-  
Playback  
Head  
Assemblies



Record-Playback Amplifiers

## PRESET INTERVAL GENERATORS

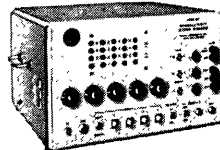

Preset Interval and Delay Generators

## HIGH SPEED ACCESS REGISTERS

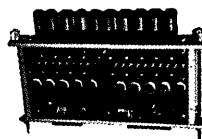

Ten-Bit Parallel  
Output (Serial Input) Using Magnistors

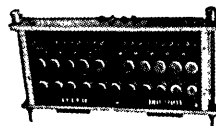

Ten-Bit Serial Output  
(Parallel Input) Using Magnistors



Six-Bit Digital  
Comparator Using Magnistors

## News Note

### SPECIAL COMPUTER PREDICTS FALL-OUT

To determine the best time to fire the most recent series of atomic bomb blasts in Nevada, the Atomic Energy Commission for the first time relied upon an electronic computer.

Into the computer was fed, via dial settings, the direction and speed of winds at various altitudes for several miles up into the air, the expected shape and size of the atomic cloud, and the characteristics of the radioactive elements anticipated in the cloud. The computer digested the input, and within one-tenth of a second predicted where the radiation fall-out would land and how intense it would be at various locations within 200 miles. The speed of the calculation is 18,000 times faster than by hand.

Two new elements constitute part of the computer. One, developed by the National Bureau of Standards, produces a "map" on what looks like a television set. The other, developed by the Laboratory of the A.E.C. at Sandia, New Mexico, writes the answer on a roll of paper in the form of a graph.

The new brain caused the cancellation of the first detonation for 12 consecutive days because of winds which could have meant at least some harm to neighboring communities.

(For other News Notes and information about New Products and Ideas see pages 11, 14, 24, 25, 26.)

## INDEX OF NOTICES

For Information on:	See Page:
Advertising Index . . . . .	34
Back Issue Copies . . . . .	26
Robots to Rent or Buy . . . . .	31
Subscription Information . . . . .	26
Reader's Inquiry Form . . . . .	32
Special Issues . . . . .	See Mar. Issue
Manuscripts . . . . .	See Mar. Issue

Change of Address: If your address changes, please send us both your new address and your old address (as it appears on the magazine address sticker), and allow three weeks for the change to be made.



**POTTER INSTRUMENT COMPANY, INC.**

115 Cutter Mill Road

Great Neck, L. I., N. Y.

# COMPUTERS

*a n d* A U T O M A T I O N

DATA PROCESSING • CYBERNETICS • ROBOTS

Volume 6  
Number 7

JULY 1957

Established  
September 1951

## RCA COMPUTER TUBES

for  
Sustained Reliability

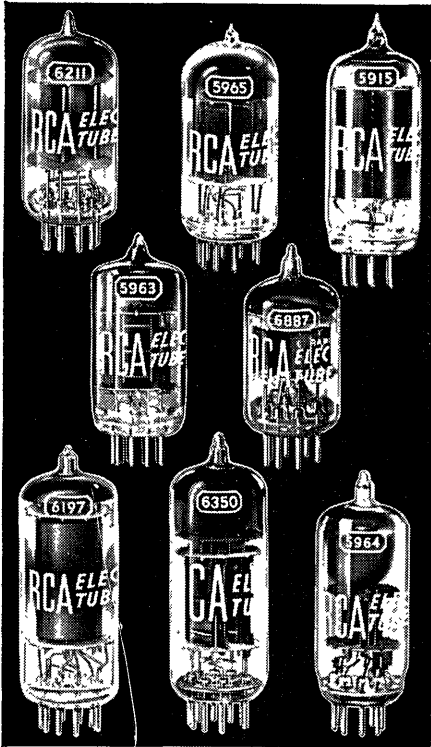

For high emission capabilities even after long periods of operation under cutoff conditions...for exceptional consistency of plate current during "On" time...for long, reliable service, specify RCA Computer Tubes. Quality performance is assured by: (1) rigid 100% microscopic inspection at every phase of tube manufacture, (2) factory tests under typical electronic computer operating conditions—including checks for cathode interface, interelectrode leakage, high-resistance, and intermittent shorts, and (3) tube life tests for conduction, standby operation, stability, and survival rate.

See your RCA Industrial Tube Distributor for the computer tube types you need. For prompt service, call him.

For free technical data on any of the following RCA Computer Tube types: 5915, 5963, 5964, 5965, 6197, 6211, 6350, 6887, write RCA Commercial Engineering, Section G-90-Z, Harrison, New Jersey.

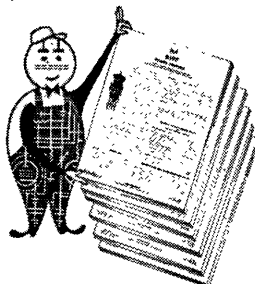

**TUBES FOR INDUSTRY**

Radio Corporation of America

© Tube Division Harrison, N. J.

### ARTICLES

- "Leprechaun"—An Automatic Digital Computer  
the Size of a Television Set ..... 10
- A Survey Course in Automatic Data Processing Systems ..... 12  
LOWELL H. HATTERY AND CHARLES H. PHILLIPS
- Syntax Patterns in English Studied by Electronic Computer ..... 15  
NATIONAL BUREAU OF STANDARDS

### REFERENCE INFORMATION

- Association for Computing Machinery Meeting at  
Houston, Texas—Program, Titles, Abstracts ..... 18
- Readers' Forum ..... 7, 11
- Books and Other Publications ..... 27
- New Patents ..... 34
- The Editor's Notes ..... 6
- New Products and Ideas ..... 24
- Index to Advertisers ..... 34

### EDITOR

Edmund C. Berkeley

### ASSISTANT EDITORS

Ed Burnett      Neil D. Macdonald      F. L. Walker

### CONTRIBUTING EDITORS

Andrew D. Booth      Ned Chapin      John W. Carr, III      Alton S. Householder

### ADVISORY COMMITTEE

Samuel B. Williams      Herbert F. Mitchell, Jr.      Howard T. Engstrom  
Alston S. Householder      H. Jefferson Mills, Jr.

### SALES AND SERVICE MANAGER

Milton L. Kaye, 601 Madison Ave., New York 22, N. Y. Plaza 5-4680

### ADVERTISING REPRESENTATIVES

New York 22: Milton L. Kaye, 601 Madison Ave. .... Plaza 5-4680

San Francisco 5: W. A. Babcock, 605 Market St. .... Yukon 2-3954

Los Angeles 5: Wentworth F. Green, 439 S. Western Ave.. Dunkirk 7-8135

Elsewhere: The Publisher

COMPUTERS AND AUTOMATION is published monthly by Berkeley Enterprises, Inc., 815 Washington St., Newtonville 60, Mass. — Decatur 2-5453 or 2-3928. Printed in U.S.A.

SUBSCRIPTION RATES: (United States) \$5.50 for 1 year, \$10.50 for 2 years; (Canada) \$6.00 for 1 year, \$11.50 for 2 years; (Foreign) \$6.50 for 1 year, \$12.50 for 2 years.

ENTERED AS SECOND CLASS MATTER at the Post Office at Hanover, Pennsylvania. Copyright, 1957, by Berkeley Enterprises, Inc.



Who produces more  
custom-built delay lines  
than any other  
company in America?

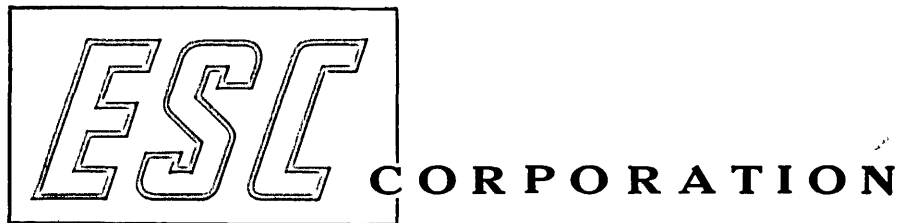

**1st in sales!**



**1st company devoted exclusively to the  
manufacture of delay lines!**



**1st in research, design and development  
of custom-built delay lines!**

**Exceptional employment opportunities for engineers experienced in pulse techniques.**



**ESC CORPORATION**  **534 BERGEN BOULEVARD • PALISADES PARK • NEW JERSEY**

COMPUTERS and AUTOMATION for July, 1957

# The Editor's Notes

## LETTERPRESS

THIS IS THE first issue of **Computers and Automation** by letterpress. For 5 and  $\frac{3}{4}$  years we have published by purple ditto and photo-offset.

We hope you like the letterpress style. If you don't like it (or don't like some things about it) please tell us; and if you do like it, please tell your friends.

Essentially, this magazine does not belong to us, but to the people in the computer field, whose best interests we desire to serve as fully as it may be in our power to do so. Please tell us what you want.

Computer people in these years have the good fortune to be on the ground floor of the harnessing of machines to the reasonable handling of information. It is a development much harder to use for evil than atomic fission. And no man lives who can see the limits of the powers of such machines that are now opening up. Perhaps in another 20 years, these machines will be able to guide the people of the world towards the peaceful and equitable use of all the powers of modern technology.

\* \* \*

## EDUCATION AND COMPUTERS — JUNE, 1957, REPORT

AT THE MEETING of the Association for Computing Machinery in June at the University of Houston, Houston, Tex., a panel discussion on "The Role of Computers in High School Science Education" was held on Thursday morning, June 20.

The members of the panel were: George Forsythe, chairman of the panel, Dept. of Numerical Analysis, Univ. of Calif. at Los Angeles, Los Angeles 24, Calif.; W. Eugene Ferguson, chairman of the Mathematics Department, Newton High School, Newtonville, Mass.; D. L. Trautman, Hughes Aircraft Co., Culver City, Calif.; and Richard W. Melville, Stanford Research Institute, Stanford, Calif.

Many important statements were made; a few of them are reported below. The subject of computers is just part of science and mathematics teaching in high schools. Science and mathematics teachers are in desperately short supply. Low salaries for teachers make teaching very unattractive; and it is impossible for many teachers to make a living without taking a second job. Many modern aids for teachers should be made available. Model hardware should be made available for high school use, such as a patchboard made by Hughes Aircraft for showing computing and reasoning problems. A speakers' bureau might be set up by the Association for Computing Machinery. The curriculum in mathematics and science in high schools needs changing. Industries and businesses have started to assist schools in very important ways. Personnel exchanges between school and industry have begun. Computer seminars for teachers have begun, organized by industry. Industries have started summer time employment for teachers in

mathematical and computing fields. And more besides. A fuller report of this discussion is to be published in **Computers and Automation** for August.

The lively discussion that took place showed a great deal of interest among members of the audience, and two proposals were voted by the meeting. The first proposal voted by the meeting was that the Council of the Association adopt a resolution as follows (and this was adopted at the Council meeting on Thursday evening):

"The Council of the Association notes that better education in science and mathematics in primary and secondary schools cannot be expected without higher salaries for teachers of science and mathematics, at least. The Council urges members of the Association, if they see fit, to work for such higher salaries in their own communities. The Council also urges members of the Association for Computing Machinery, if they see fit, to make their time and talents available to the schools of their communities for collateral educational activities."

The second proposal voted at the meeting was that the Council of the Association be asked to organize an "education section" of the Association for Computing Machinery consisting of those members interested in education and computers — a kind of "animated mailing list" or "professional group" on education. The main function of such a section would be (1) to maintain and issue from time to time a list of names and addresses of members of the Association interested in this field, so that they could communicate with each other, and (2) send out to this list information and references about reports, ideas, ways, and means of improving and expanding school education in mathematics, science, and computers. In support of this proposal to the Council, 46 members of the audience signed up on sheets, signifying their desire to participate in an "education section" of the Association. The Council, however, at its meeting on Thursday night, rejected this proposal — perhaps because it was not clearly enough presented amid the rush of business before the Council, or because the Council felt the recommendation should come from the education committee.

The next day, Friday, the education committee of the Association for Computing Machinery was formally reconstituted. It now consists of: George Forsythe, chairman of the committee; W. Eugene Ferguson, speaker on the panel; Alston Householder, Oak Ridge National Laboratory, Oak Ridge, Tenn.; Wallace Givens, Wayne State University, Detroit, Mich.; and E. C. Berkeley of **Computers and Automation**. It seems clear that the education committee will probably consider the organization of an education section of the Association for Computing Machinery.

All computer people who would like to find out more about and help in "the problems of school education in

science, mathematics, and computers" are invited to write to:

Dr. George Forsythe  
Chairman ACM Educ. Comm.  
Numerical Analysis Dept.  
Univ. of California at Los Angeles  
Los Angeles 24, Calif.

\* \* \*

#### A NAME

WE HAVE ASKED our readers whether they favor change of the name of this magazine from "Computers and Automation" to "Computers and Data Processing" or perhaps "Computers and Data Automation."

Our first name (1951-52) was "Roster of Organizations in the Computing Machinery Field." Our second name (Sept. 1952 to early 1953) was "The Computing Machinery Field." Our third name was and is "Computers and Automation", since early 1953.

More votes have been received for the name "Com-

puters and Data Processing" than have been received for the name "Computers and Automation". But there is a strong viewpoint expressed by several very well-informed readers, who have pointed out that in the next few years complete control of automatic processes by very intelligent computers is in the cards; this is a highly developed and natural form of sophisticated automation. Then the name "Computers and Automation" will be even more appropriate than it now is. So our present decision is to keep the name "Computers and Automation" for a while longer at least, until more evidence has been collected.

#### CORRECTION

ON PAGE 90 of the June issue, the advertisement of National Analysts, Inc., 1015 Chestnut St., Phila., in line 7, should offer "systems studies, programming services, and computer applications services", instead of "systems studios, . . ." We regret the typographical error.

---

## Readers' Forum

### PAN AMERICAN WORLD AIRWAYS — REQUIREMENTS FOR AUTOMATIC DATA PROCESSING

Daniel B. Priest  
Pan American World Airways System  
135 East 42 St., New York 17, N. Y.

WE ARE IN the process of revamping our entire reservation machinery. Toward that end, we have asked for proposals from leading manufacturers of data processing equipment that will help us solve our problems.

It occurred to me that an item in your publication would help spread the word of our search and would inspire response from any manufacturers that Pan American has not contacted directly.

Our reservation and space control work load has been growing at a staggering rate. With the jet age only a year away, we find that our present system will no longer be able to keep pace with the demands that will be placed upon it. Some idea of our needs can be seen from the following statistics:

In 1956, Pan American operated 112,239 separate flight departures that were open to passenger and cargo bookings. Four different classes of service are offered on some routes: de luxe, first class, tourist or thrift service. They may also reserve berths or staterooms. Their personal needs may require bassinets, special diets and preferred seat assignments.

Last year, we carried 2,592,000 passengers and 1,021,191 cargo shipments. It is estimated that we receive an average of three inquiries as to its availability for every seat occupied by a passenger and we average two bookings for every passenger actually flown.

Pan American's general anticipated growth approximates 15 percent for 1957 and from 10 to 15 percent for each of the next five years.

The new system should provide instantaneous, remote and visual availability of space on our flights by segment at as many sales points throughout the world as feasible for as far ahead of departure as called for by booking habits on the particular route. Where practical or economic limitations exist for such instantaneous availability a secondary means of providing similar availability at a sacrifice of speed should be devised. When space on a particular flight or flight segment is sold out, the system should be capable of offering alternate flights, dates or routes.

#### Other Requirements

The system should provide means for instantaneous and remote recording of sales and cancellations, preferably by passenger name, at a central point or points and for simultaneous recording at the point of sale. The central record should encompass, if possible, identification of the sales point, the date of booking and a listing of any special requests for baby service, special meals, or inclusion in a group booking. At point of sale the record must also include the passenger's or shipper's telephone number or address.

Availability and inventory should distinguish between de luxe, first, tourist and thrift classes whenever these are offered in combination on the same flight. They should also contain the capacity for offering and recording berths and staterooms whenever this service is available.

Availability and inventory keeping, as outlined above, must be applied similarly to cargo space. This is a straightforward operation, the only differentiations necessary to cargo shipments being those which would identify animal shipments and emergency cargo.

We should be glad if interested firms would contact us.

[Please turn to page 11]

# New Computer

Types 2N 377....2N 385

*Stability during life  
sets new standard for reliable use*

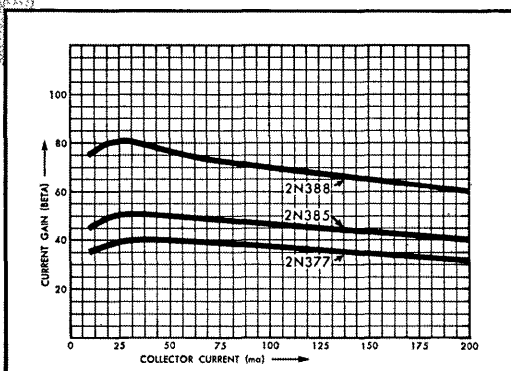

Typical current gain vs. collector current

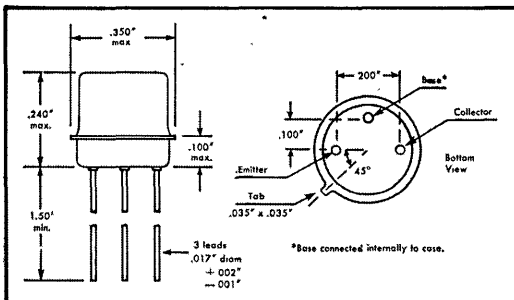

Triangular basing arrangement of the new computer transistors lends itself to printed circuit board insertion and dip soldering techniques.

New Sylvania NPN germanium alloy junction transistors, types 2N385, 2N377 and 2N388, are specifically designed for computer use. Higher, more constant beta over a wide range of operating conditions and fast switching time make the new Sylvania units ideal for computer and switching applications. They meet environmental tests typical of those required in military applications. In addition, the new Sylvania computer transistors meet RETMA size group 30 dimensions.

The outstanding characteristics of the new Sylvania transistors have been achieved in two ways—by new non-symmetrical design and by additional production steps. The optimum size relationship between emitter and collector has been determined for superior collector efficiency. This inherently better design is stabilized in production by carefully controlled surface treatment.

New Sylvania techniques are not only responsible for higher beta in the 2N385, 2N377 and 2N388 but for more constant beta at changing current levels. In addition, the design of the three types significantly improves leakage stability. Total dissipation is conservatively rated at 150 mw with ambient temperature at 25° C.

Thus, new and greater stability and reliability for computer and switching operations are built into these latest transistor developments from Sylvania. Call your Sylvania representative for further information.

“Sylvania—synonymous with  Semiconductors”



# Transistors

.... 2N 388

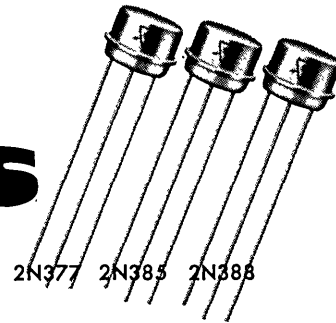

1,000-hour evaluation of the new Sylvania transistors at 100° C shows a new high in beta stability throughout the test after a small initial change.

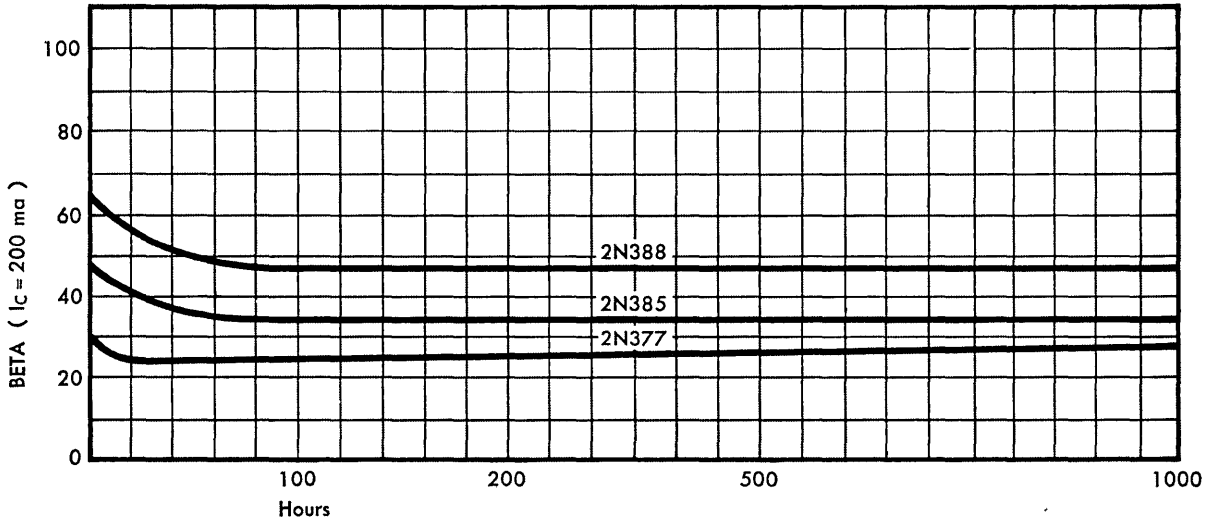

### Typical Characteristics (25°C)

	2N385	2N377	2N388
<b>Collector Cut-off Current, <math>I_{CO}</math></b> $V_{CB} = 25.0$ emitter open	5 $\mu$ a	6 $\mu$ a	6 $\mu$ a
<b>Emitter Cut-off Current, <math>I_{EO}</math></b> $V_{EB} = 15.0$ , collector open	5 $\mu$ a	6 $\mu$ a	6 $\mu$ a
<b>Current gain, B</b> $V_{CE} = 0.75$ , $I_C = 30$ ma	60	40	80
<b>Current gain, B</b> $V_{CE} = 0.75$ , $I_C = 200$ ma	45	30	60
<b>Frequency Alpha Cut-off, <math>F_{\alpha CO}</math></b> $V_{CE} = 5.0$ , $I_C = 10$ ma	6.0 Mc	4.0 Mc	8.0 Mc
<b>Collector Current <math>I_C</math> (-5, 10K)</b> $V_{CE} = 20$ V, $R_{BE} = 10K$ , $V_{BB} = -5V$	10 $\mu$ a	10 $\mu$ a	10 $\mu$ a
<b>Storage or junction temperature</b>	100° C.	100° C.	100° C.



SYLVANIA ELECTRIC PRODUCTS INC.  
1740 Broadway, New York 19, N. Y.  
In Canada: Sylvania Electric (Canada) Ltd.  
Shell Tower Bldg., Montreal

# “LEPRECHAUN”:

*An Automatic Digital Computer  
The Size of a Television Set*

A HIGH-SPEED digital computer, not much larger than a home television set and requiring less power to operate, has been developed at Bell Telephone Laboratories.

This newest addition to the family of electronic “brains” was developed under an Air Force contract. It has been named “Leprechaun,” after the tricky sprite of Irish folklore.

Compared with previous computers, Leprechaun operates with a drastically reduced number of components. Excluding its magnetic cores, it uses only about 9,000 electrical components. More than half of these are transistors, the tiny electronic devices invented at Bell Laboratories. Some 5,000 of them are used in Leprechaun. The use of transistors makes possible the small size and low power requirements of the computer.

Leprechaun represents a significant advance in computer design. One of its outstanding features is its flexibility. Its components can be easily connected and disconnected. This allows the computer to be used as a test model for research on digital computers designed for military applications. Proposed new designs can be laboratory-tested through the use of Leprechaun without resorting to construction of new equipment.

## Magnetic Core Memory

Another feature of the new computer is its transistor-driven “random-access magnetic core memory.” The machine can take its instructions immediately from its memory, no matter where the desired instruction may be stored. This process differs from that of computers with a “revolving drum memory” which may require time for the rotation of the drum before the instruction can be taken from its storage location.

Very swift solutions to the problems to be solved are provided by Leprechaun since any of its stored instructions is immediately available. Each instruction consists of the operation to be performed, such as addition, multiplication, etc., and the location of the data in the memory.

The machine can store 1,024 “words” in its memory. These words consist of 18 binary digits, representing instructions or data to be used in solving problems. In this computer, all information is translated into a code which uses only combinations of 0 and 1. These binary digits can be represented in Leprechaun by the flow or absence of electricity in the transistors, by the direction of magnetization in the memory cores, or by holes in punched paper tape.

One reason for building Leprechaun was to demonstrate the feasibility of “direct-coupled transistor logic.” This is a switching circuit technique in which transistors are used to perform logical or “brain” operations as well as to provide power.

Compared with previous computers, the circuits of Leprechaun are very simple and easily understood. This is an advantage in engineering and maintenance since personnel with less experience are required to keep it

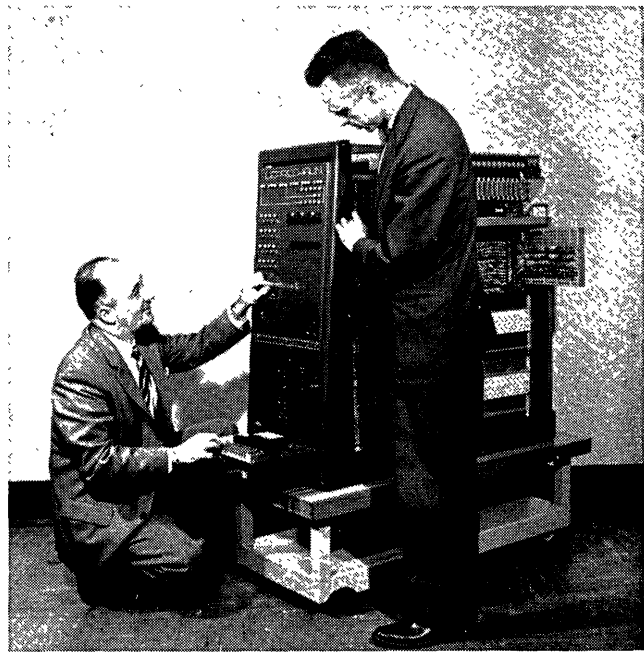

Showing the control panel and the size of “Leprechaun”, a new high-speed miniature automatic digital computer.

in operating condition. Leprechaun’s simplicity and small number of components result in small size and weight and will permit the use of automation techniques in manufacturing. All these features insure greater reliability, something of primary importance in military operations.

While Leprechaun is still in the experimental stage, the techniques developed are expected to have many future applications, particularly in research in programming and logical design for digital computers for real-time control in military applications.

A major factor in the reduction in size and power consumption of this computer is the introduction of the direct-coupled transistor logic (DCTL) circuitry mentioned above. The accompanying diagram shows a sample of this type of circuitry, and indicates how the great reduction in number and variety of components is achieved. A major objective in the development of this computer was to demonstrate the feasibility of the DCTL system.

## Extreme Flexibility

Since Leprechaun can be used for research in computer design for military applications, it was designed to have extreme flexibility. Mechanical and electrical arrangements are such that the various components can be easily connected, disconnected, and interconnected to test proposed new designs. Interconnections consist of jumpers with taper pin terminals, thus making it possible to set up an entirely new circuit in a relatively short space of time.

Word length, determined by the control application, is 17 binary digits including sign. Except for this limitation, Leprechaun is a general-purpose computer, and





# A SURVEY COURSE IN AUTOMATIC DATA PROCESSING SYSTEMS

Lowell H. Hattery and Charles A. Phillips

The American University, Washington, D. C.

**M**EETING the need for management training to develop and administer automatic data processing systems (ADPS) is a major problem of the day. Understanding of electronic computers, their characteristics, potential usefulness and limitations comes with much more stubbornness than do most innovations in management. Although automatic data processing involves much more than electronic computers, knowledge and understanding of equipment capabilities is essential.

For two or three years training in ADPS has been provided almost exclusively by manufacturers of electronic computing equipment. They have provided an important service through their orientation courses for management as well as the more technical courses in programming and equipment operation and maintenance. There are inherent dangers in manufacturers' courses however. Quite naturally the instruction is oriented to a single manufacturer's equipment. There is also an ever-present temptation to soft-pedal limitations of equipment — at the very least it is unlikely that an instructor will point out competitive equipments in which such limitations may not exist.

We do not intend in any sense to bemean the training activities of equipment manufacturers, which are generally very good. However, we do want to point out the need for training which is not related to a single manufacturer's equipment and which can put basic problems into a realistic frame of reference. The universities, that several years ago had moved swiftly to fill the need for training in electronic computer engineering, are now providing courses in automatic data processing systems to supplement standard courses and experience in management.

On the basis of a survey in mid-1956 the Comptroller-ship Foundation lists 17 universities including American University offering such courses. On the basis of correspondence and other communication, we estimate that the number will reach 75 by the fall of 1957.

A survey course in Automatic Data Processing Systems was introduced at the American University in the fall of 1956.<sup>1</sup> One section of the course was offered in the after-hours program for Department of Defense employees in the Pentagon Building, the other at the university's downtown center. The majority of the students were from middle management levels in government and industry with a sprinkling of full-time students.

<sup>1</sup>Technical courses in design of electronic computers and programming for scientific problems had been offered in earlier semesters. Five-day Institutes in Electronics in Management were introduced in 1955.

A condensed syllabus of the course is presented here in the hope that it may be useful both to those who may be planning training courses in universities, business or government, and to individuals who may want a guide to self-study.

Such an outline necessarily leaves much unsaid. For example, a field trip was included for each class, one to the Air Force IBM 705 in the Pentagon, the other to the new Datatron installation in the Geological Survey Bureau of the Interior Department. We used visual aids such as the American Management Association strip film, **Data and Decision**. Guest experts supplemented the regular instructors for certain technical topics; it should be pointed out however that "technical" matters were included only to the degree to which we believed management personnel needed background.

The syllabus has been revised in the light of a semester's experience taking into account our own estimate of desirable changes supplemented by student suggestions. From our experience we are convinced that the course fills a void in current management training.

The new equipments and concepts of electronic computers, common language media, integrated data processing, and management science are powerful new tools for management if they are introduced with informed understanding. We hope that our courses and the sharing of our classroom experience may both contribute to this understanding.

## SYLLABUS

### Automatic Data Processing Systems

#### Objective of the Course

To provide a basis for understanding the equipment, the processes, and the management of automatic data processing systems.

#### Persons for Whom the Course Is Intended

1. Students who are candidates for degrees who want to develop their understanding of this important, developing contribution to management.
2. Management specialists who want an understanding of the fundamentals of office automation for application in their organizations.
3. Automatic data processing specialists who want a general orientation to the field in which they have specialized competency.

The course is not designed to train persons in programming, machine operation and maintenance or other technical specializations.

## Assignments

1. Read from the texts and additional materials as indicated in the outline.
2. Prepare an individual **Automatic Data Processing Manual** to include notes and materials related to the subject matter of the course. The **Manual** should be organized as a reference source for use in actual practice.
3. Submit written reports as assigned.

## Texts:

George Kozmetsky and Paul Kircher, **Electronic Computers and Management Control**. New York: McGraw-Hill Book Company, 1956. 296 pp.

Lowell H. Hattery and George P. Bush, editors, **Electronics in Management**. Washington, D. C.: University Press of Washington, D. C., 1956. 207 pp.

## Schedule of Topics and Readings

### Meeting No. 1 and 2

Concept of automation; factory and office automation; integrated data processing.

History of electronic computer development; scope of electronic computer applications; essential differences from other methods and machines; including punched card equipment.

Hattery and Bush, Chapters 1, 2 and Appendix B.  
Kozmetsky and Kircher, Chapters 1, 2, 4 and 6.

### Additional Reading:

**Automatic Control**. New York: Simon and Schuster, 1955. 148 pp.  
Collection of articles which have appeared in **Scientific American**.

Edmund C. Berkeley and Lawrence Wainwright, **Computers — Their Operation and Application**. New York: Reinhold Publishing Corporation, 1956. 333 pp.

A semi-technical description of the principles of automatic computers, both digital and analog, and their applications.

John Dicbold, **Automation, The Advent of the Automatic Factory**. New York: D. Van Nostrand Company, Inc., 1952. 181 pp.

An early, general statement about automation. Includes attention to management problems.

**Keeping Pace with Automation**, Special Report No. 7. New York: American Management Association, n.d. 136 pp.

Papers on factory automation presented at a conference of the American Management Association in October 1955.

R. H. Macmillan, **Automation, Friend or Foe?** Cambridge: Cambridge University Press, 1956. 100 pp.

Primarily concerned with the concepts of factory automation but devotes one chapter to electronic computers.

Herbert Solow, "Automation": News Behind the Noise," **Fortune**, April 1956, pp. 150-153 ff.

An attempt to assess progress and significance of both factory and office automation.

E. M. Hugh-Jones, **Automation in Theory and Practice**. Oxford: Basil Blackwell, 1956. 140 pp.

A collection of lectures delivered at Oxford University.

U. S. Congress, Joint Committee on the Economic Report, Subcommittee on Economic Stabilization. **Hearings, Automation and Technological Change**, October 14-28, 1955. Washington: Government Printing Office, 1955.

Includes testimony of leaders from government, industry and labor on the concepts, the potential and the problems of automation.

### Meeting No. 3

Punched card systems; other common language systems; comparative characteristics for electronic

systems in terms of speed, flexibility and other factors.

Burton D. Friedman, **Punched Card Primer**. Chicago: Public Administration Service, 1955. 77 pp.

Gives a good understanding of punched-card accounting.

### Meeting No. 4

Feasibility surveys; cost factors, auditing.

Kozmetsky and Kircher, Chapters 5 and 11.

Hattery and Bush, Chapters 9 and 10.

### Additional Reading:

Richard G. Canning, **Electronic Data Processing for Business and Industry**. New York: John Wiley and Sons, Inc., 1956. pp. 134-160.

This book is a good survey of automatic data processing. Some universities have adopted it as a text in similar courses.

**Electronics Applied to Business in the Oil Industry**. New York: Arthur Young and Company, December 1955. 53 pp.

Report of a survey of progress and plans for electronic computer systems in the oil industry.

**Workshop for Management**. Greenwich, Connecticut: Management Publishing Corporation, 1956. pp. 259-291.

Record of a seminar on "Organizing for an Electronics Survey" at the 1955 annual conference of the Systems and Procedures Association of America. Several points of view are represented.

Klingman, Herbert F., **Electronics in Business: A Case Study in Planning: Port of New York Authority**. New York: Controllershship Foundation, Inc., January 1956. 121 pp.

Lowell H. Hattery, "Executive Responsibility for Automatic Data Processing Systems" **Advanced Management**, December 1956, pp. 11-14.

Frank Wallace, **Appraising the Economics of Electronic Computers**. New York: Controllershship Foundation, 1956. 107 pp.

Includes general suggestions for feasibility studies and systems installation in addition to treatment of cost factors.

"The Auditor Encounters Electronic Data Processing." A report prepared by Price Waterhouse and Company for the International Business Machines Corporation. n.d. 24 pp.

### Meeting No. 5

Selection of equipment; preparation for installation.

Hattery and Bush, Chapter 5.

### Meeting No. 6

Principles and methods of programming; examples.  
Kozmetsky and Kircher — Appendix 2.

### Additional Reading:

Canning, *op. cit.*, pp. 103-133.

Ben Conway, "How Computers Can Help to Create Their Own Programs," **Office Management**, October 1955, pp. 24-26 ff.

Discussion of automatic coding; defines kinds of automatic coding routines and uses of each.

**Data Processing by Electronics**. New York: Haskins & Sells, 1955. pp. 16-18 et passim.

This primer on electronic data processing includes a highly simplified example of programming.

### Meeting No. 7

Preparing problems for application; flow diagrams.  
Kozmetsky and Kircher, Chapter 6.

### Additional Reading:

Canning, *op. cit.*, pp. 161-225.

Julius Shiskin, "Seasonal Computations on Univac," **The American Statistician**, February 1955, pp. 19-23.

In addition to describing work done at the Bureau of the Census, the author makes suggestions for future time-series computations.

A. B. Toan, Jr., "Auditing, Control, and Electronics," *The Journal of Accountancy*, May 1955, pp. 40-45.

Workshop for Management, *op. cit.*, pp. 324-395.

Reports of seminar discussions on preparing various applications for ADPS. Systems and Procedures Association of America annual conference.

Joe M. Foster and Viola D. Hovsepian, *A Plan for Processing the Ships Parts Control Center Inventory Control on the Univac*. Research and Development Report 916. Washington, D. C.: Navy Department, The David W. Taylor Model Basin, June 1955. 209 pp.

#### Meeting No. 8

Mid-semester summary; mid-semester examination.

#### Meeting No. 9

Procedural and organizational adjustments; case examples.

Hattery and Bush, Chapters 11 and 15.

Kozmetsky and Kircher, Chapter 12.

#### Additional Reading:

Robert M. Smith, "Is This a Blueprint for Tomorrow's Offices?" *Office Management*, August 1955, pp. 12-14 ff.

A report of the organizational arrangements of Sylvania Electronic Products, Inc. for a centralized data processing center.

#### Meeting No. 10

Personnel program: recruitment, selection, training, classification, pay and morale.

Hattery and Bush, Chapters 12 and 13.

#### Additional Reading:

Harold F. Craig, *Administering A Conversion to Electronic Accounting*. Boston: Division of Research, Graduate School of Business Administration, Harvard University, 1955. 224 pp.

Reports the human relations problems in making a substantial change in office systems. Contains a detailed record of personal reactions of employees.

Lowell H. Hattery, "Electronic Computers and Personnel Administration," *Personnel Administration*, March-April 1956, pp. 7-13.

Arvid W. Jacobson, Editor, *Proceedings of the First Conference on Training Personnel for the Computing Machine Field*. Detroit: Wayne University Press, 1955. 104 pp.

Includes papers presented at a Wayne University Conference. It is divided into four sections: (1) Manpower requirements in the computer field; (2) Educational programs; (3) Influence of automatic computers on technical and general education; and (4) Co-operative efforts for training and research.

#### Meeting No. 11

Logic of the computer

Kozmetsky and Kircher, Chapter 3 and Appendix 1.

#### Additional Reading:

Canning, *op. cit.*, pp. 247-297.

Ben Conway, "Random Access — Its Meaning and Its Implications," *Office Management*, March 1956, pp. 24-25 ff.

W. J. Eckert and Rebecca Jones, *Faster, Faster*. New York: McGraw-Hill Book Company, Inc., 1955. 160 pp.

A simplified description of the NORC, large computer at the Watson Scientific Computing Laboratory, Columbia University.

Howard S. Levin, *Office Work and Automation*. New York: John Wiley and Sons, Inc. pp. 18-44.

A discussion of communication language for office machines with primary emphasis on five-channel tape.

#### Meeting No. 12, 13 and 14

Large-scale computing equipment.

Medium-sized computing equipment.

Tailored equipment, scientific computers, small computers, use at service centers.

Hattery and Bush, Chapters 4, 8 and 9.

Kozmetsky and Kircher, Chapter 10.

#### Additional Reading:

Students are referred to manufacturers' literature for information on various equipments.

#### Meeting No. 15

Impact on management: reporting, centralization-decentralization, decision-making and public relations.

Hattery and Bush, Chapters 16 and 17.

Kozmetsky and Kircher, Chapter 12.

#### Additional Reading:

Levin, *op. cit.*, pp. 110-196.

An excellent, simplified discussion of the role of statistics in decision-making and other management implications of "office automation."

Julius Shiskin, "An Application of Electronic Computers to Economic Time-Series Analysis," *The Analysts Journal*, May 1955, pp. 35-37.

Description of economic time series analysis performed on UNIVAC at the U. S. Bureau of the Census. Suggests the potential contribution of electronic computers to economic and business forecasting.

*Strengthening Management for the New Technology*. New York: American Management Association, Inc., November 1955. 64 pp.

Papers presented at a conference of the Association. Stimulating and forward looking statements on the effects on management of automation, operations research and other developments.

#### Meeting No. 16

(a) Outlook. (b) Final Examination.

---

## UNIVERSITY OF PENNSYLVANIA COMPUTING CENTER

**T**HE new Computing Center of the University of Pennsylvania, built around the gift of a Univac electronic computing system valued at \$1,500,000 presented by the Remington Rand Division of the Sperry Rand Corporation, was dedicated in June in the Physical Sciences Building at 33rd and Walnut Sts., Philadelphia, next door to the Moore School of Electrical Engineering where the first all-electronic digital computer, Eniac, was constructed in 1945.

Some of the initial computing projects of the Center are: one from the University's School of Medicine exploring the chemistry of respiration; one from the School of Fine Arts to solve a zoning problem; one from the Wharton School of Finance and Commerce, to analyze certain labor statistics bearing on family finances; one from the Swarthmore College physics department, to solve a problem in electromagnetic fields.

Louis Stein, president of Food Fair Stores, Inc., and chairman of a 32-member committee organizing support for Center operations, reported that installation and first-year operating costs are estimated at \$350,000. Of this, \$200,000 is available in University funds and through grants from two foundations. He said the committee is now inviting 220 business firms to become partners in the Center's work.



# SYNTAX PATTERNS IN ENGLISH STUDIED BY ELECTRONIC COMPUTER

National Bureau of Standards  
Washington, D. C.

**W**ITHIN the scope of natural English language, an infinite number of different sentence structures is possible. One might expect that some of these structures occur much more frequently than others and account for the bulk of sentences actually used. Information about such occurrences would be of interest in many fields, scientific as well as literary, and the question has therefore often been discussed. More specifically, information is needed on the statistical frequencies with which different structures are used. The complexity of this problem is such, however, that little or nothing appears to have been definitely established concerning it.

Recently the National Bureau of Standards completed a brief exploratory study of the problem with the help of its automatic digital computer SEAC (Standards Electronic Automatic Computer)<sup>1</sup>. Carried out by R. B. Thomas and P. I. Herzbrun of the Bureau's data processing laboratory, this study suggests, at least, that the problem is not entirely insoluble. Although only a small sample (550 sentences) was studied, some of the results are believed sufficiently interesting to justify further investigation along the same lines. The research is being supported by the U. S. Patent Office.

## Mechanized Patent Search

The Bureau's interest in linguistics stems from the need for better structural understanding of language in many data processing applications — in particular, the expression of information for mechanized searching of patents. In addition, structural research may ultimately yield useful techniques for machine translation of languages.

In any statistical study of syntactical forms, there are a number of difficulties that must be taken into account. One difficulty is that the same thing can be said in several ways and by means of different syntactical structures. On the other hand, the same expression may be susceptible of several different meanings and may perform different functions in the sentence. Just which interpretation is correct depends in a complicated way on the verbal context. Also dependent on complicated contextual clues are the meanings that must often be read "between the lines." Moreover, to mention only one more difficulty, there are the complications introduced by words that indicate the mood or attitude of the author — approval or disapproval, doubt or assurance, enthusiasm or irony.

In the Bureau's study, the sentences analyzed were selected, with a rough attempt at randomization, from scientific sources — journal articles and books. It was hoped that this would provide a maximum of straightforward, factual statements and a minimum of am-

biguity and emotional or attitudinal factors. In any case, attitudinal factors were ignored. Since scientists are supposedly disciplined in the careful definition and use of terms, some surprise was occasioned by the amount of ambiguity that was found. However, though considerable effort was required at times, the ambiguities were in all cases satisfactorily resolved.

A crucial feature of such an investigation is the system of syntactical concepts to be adopted. Feasible systems of many kinds can be devised, of varying complexity. In an effort to keep the problem tractable, a simple and coherent but relatively coarse-grained scheme was devised. This consists, first, of six major categories, with code numbers 1 to 6: 1 — Subject. 2 — Object (direct or indirect). 3 — Predicate nominative. 4 — Adjectival modifier. 5 — Adverbial modifier. 6 — Verb.

Second, there are three coordinate categories, coded by the letters A, B, C. In connection with categories 1 to 5, A stands for a lexical unit (e.g., "neutron," "mother-in-law," "John Smith," "collides," or "world-wide"); B stands for a phrase; and C represents a dependent clause. In connection with verbs, the letters stand for main, auxiliary, and modal auxiliary, respectively. Thus 1B is the code for a subject expressed by a phrase, 4A stands for an adjectival modifier consisting of a lexical unit, and 6B stands for an auxiliary verb.

Only independent clauses were analyzed and coded in terms of their elements. Other structures were coded by one notation each (a "notation" consists of a number followed by a letter) to represent the function of the whole structure. Connectives, absolutes, appositives, and similar elements that do not affect the basic structure of the independent clause were not coded. Also ignored were elements which modify B and C elements that have already been coded.

The following sentences illustrate the coding scheme:

1A 6B 6A —5B—

We are living in a world of expanding parameters.

1A 6A

We observe

—————2C—————  
that a lion has at least the connectivity of the torus.

The phrase "of expanding parameters" was not coded because it modifies a portion of the preceding B element. Although the letters A, B, C were used in coding the sentences, no statistical use was made of them in this first phase of the Bureau's study; the letters are therefore omitted from the illustrations of coded sentences given below.

Coding of the sample sentences was done by hand; the trick of doing this with fair speed is soon acquired. Coding by machine would, of course, be preferable; but

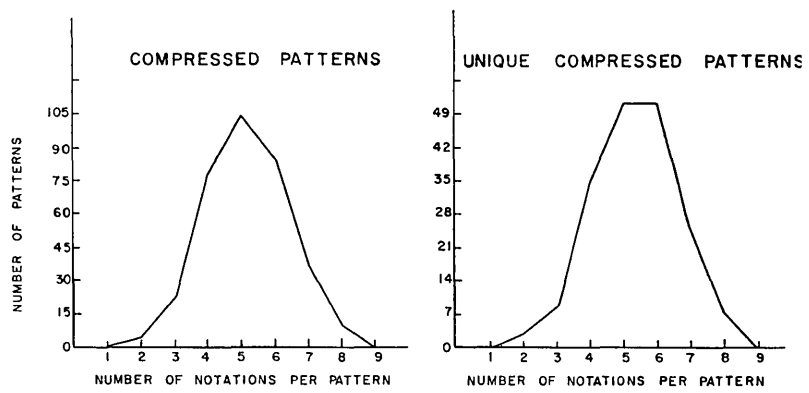
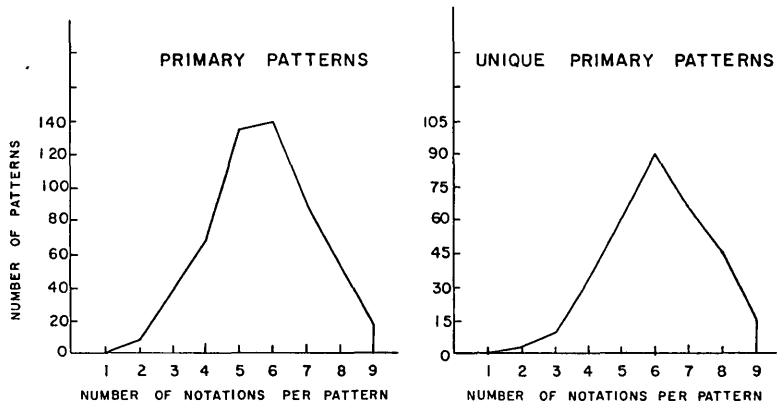
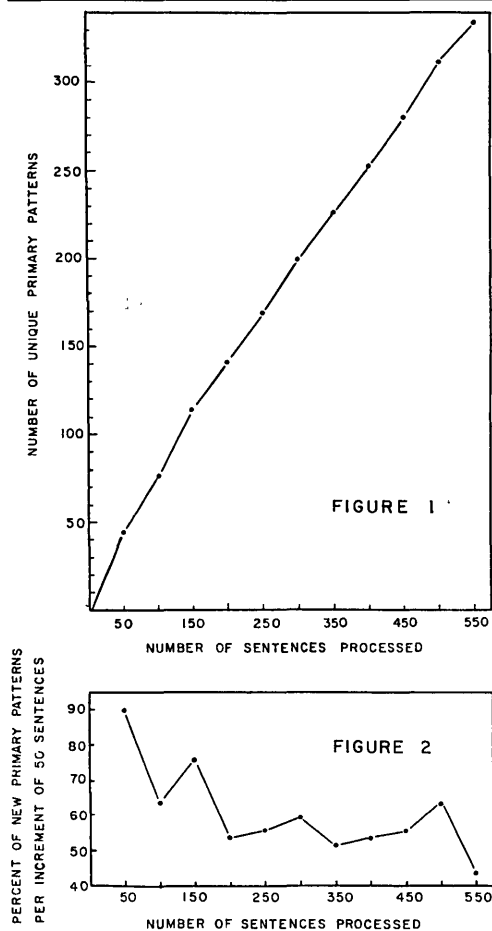

**FIGURE 1.** Graph showing the rate at which the number of primary syntactical patterns in English sentences increased with the number of sentences examined in an exploratory study by the National Bureau of Standards. Such investigations are expected to help in adapting automatic computers to the processing of data in the form of ordinary language. A simple code was used to express sentence structure as a series of numbers, and the results were analyzed with the help of the Bureau's automatic electronic computer, SEAC. If most sentences fell into only a few forms, the graph would be expected to "saturate" (i.e., become horizontal) fairly rapidly. In the present small sample of 550 sentences, only a slight tendency in this direction seems to be indicated. Figure 2, based on the same data, exhibits this tendency somewhat more clearly.

**FIGURE 2.** Number of new primary syntactical patterns found in successive groups of 50 English sentences examined in an exploratory study by the National Bureau of Standards. A tendency for the number of new patterns to decrease as further sentences are examined appears to be indicated. In view of the small size of the total sample, this result is considered quite tentative, though sufficiently interesting to justify further study along the same lines.

**FIGURE 3.** Distribution of primary syntax patterns of English sentences with respect to number of notations, based on data obtained in an exploratory study by the National Bureau of Standards. Each "notation" is a code number corresponding to a single structural element such as a subject or a verb. Sentences requiring more than nine notations were ignored in the Bureau's study. These graphs indicate, among other things, that this omission is not an important one. Left: Distribution of all primary patterns. Right: Distribution of unique primary patterns, where "unique" means that each different pattern was counted only once, regardless of the number of sentences with that structure.

**FIGURE 4.** Distribution of compressed syntax patterns with respect to number of notations, as found in an exploratory study by the National Bureau of Standards. The "compressed" patterns were obtained from the primary patterns in accordance with a rule which considers, for example, a sequence of adjectives (e.g., "long, narrow, winding . . .") as a single adjective, and a sequence of verbs (e.g., "would have gone") as a single verb. Left: Distribution of all compressed patterns. Right: Distribution of unique compressed patterns.

in the current state of the art, machines cannot, for example, choose among the different interpretations of ambiguous expressions in a limited context. In fact, one of the ultimate aims of studies such as the present one is to make possible machine operations of this kind. SEAC, on the other hand, did perform three very valuable functions: accurate high-speed tabulation, precise comparison of data, and compression of coded data in terms of syntactical equivalence relationships (see below).

### Primary Search

In the first part of the study, the "primary" sentence patterns — the patterns comprising the sequence of code numbers — were intercompared. One hexadecimal digit (i.e., four binary digits) was used to express each coded element and two hexadecimal digit positions were reserved for counting. Since SEAC can handle numbers up to 11 hexadecimal digits in length (plus one binary digit for algebraic sign), coded patterns were limited to nine hexadecimal digits, leaving two digit

positions for counting. Extremely few sentences would have required more than this number of code figures, and the limitation is considered negligible.

The computer program calls for the first incoming sentence-code (containing numbers and letters) to be reduced to its numerical pattern, which is then stored. A sentence with the primary pattern, 1665, for instance, would be stored in the form 16650000000. Each subsequent pattern is reduced in the same way, and its numerical pattern is compared with all stored patterns. If a candidate pattern is identical with a stored pattern, a recurrence tally of 1 is added into the last place of the stored pattern, and the candidate pattern is rejected. Thus, when the pattern 1665 appears for the second time, the stored number becomes 16650000001. If the candidate pattern is new, it is stored along with the others. Check routines are also included to reject erroneously prepared data.

When all sentences have been processed, the resultant unique primary patterns, with their tallies, emerge from the computer via high-speed magnetic wire recording. These are accompanied by other tallies showing (a) the number of sentences processed, (b) the number of unique patterns obtained, (c) the number of sentences rejected for errors in preparation, and (d) the number of patterns having one digit, two digits, . . . nine digits. After each group of 50 sentences, SEAC prints out the total number of sentences processed and the number of unique patterns held in storage.

Among the 550 sentences thus far studied, 335 unique primary patterns were found. When the number of unique patterns is plotted against the number examined (Figure 1), the graph shows little tendency to reach zero slope. The rate of occurrence of new patterns within each increment of 50 (Figure 2) barely suggests a falling off in the number of new patterns.

The maximum recurrence of any primary pattern was 12, for each of two patterns: 41665 (e.g., "The dog has run across the street") and 414665 ("The dog with floppy ears has run across the street"). The next most common pattern showed 11 recurrences — 16434 ("This is a dog with floppy ears"); and the next showed 10 recurrences — 162 ("Dogs eat bones"). Thus the most common primary pattern represented only 2.2 percent of the whole sample and the rest of the patterns showed a roughly even distribution of nonsignificant recurrence.

### Compressed Search

A study was also made of the effect of "compressing" the primary patterns. For example, when the subject of the sentence is preceded by two or more successive adjectival expressions, the latter would be considered as a single adjective. Thus, "The little red hen clucks" (44416) was considered syntactically equivalent to "The hen clucks" (416). Similarly, a string of verbs is compressed into a single verb. The same syntactical form would therefore be assigned to "The hen will cluck" (4166) as to "The hen clucks" (416). In general, then, the computer program for the "compressed" search rejects all but one of any digit that is contiguously repeated within a pattern; so that 444166665500 becomes 41650000000, but 41465600000 is unchanged.

A "1" was added to the tally of each primary pattern

Table 1. Five most common compressed patterns, with examples illustrating each structure and approximate distribution in percentage of patterns compared.

Percent	Pattern	Example
12.5	4165	The dog ran across the street.
9.2	41465	The dog with floppy ears ran across the street.
8.0	165	He ran across the street.
5.5	416424	The dog ate the bone which he had dug up.
5.0	162	Dogs eat bones.

before compression, to show the actual number of occurrences in each case. The compressed patterns are then compared, each with all the others — since a number of patterns whose primary forms were different would probably be identical in their compressed forms. When SEAC finds that two compressed patterns are identical, their respective tallies (carried over from the primary comparison) are added together. The sum is stored in the least-significant places of the first pattern in question and the other pattern is cleared to zeros. At the end of the comparison the unique compressed patterns, with their tallies, are printed out on wire, together with (a) the number of compressed patterns remaining as unique and (b) the number of unique compressed patterns with a given number of digits (1 to 9).

The compressed patterns showed the expected higher degree of identity. There were only 189 unique compressed patterns, as against the 335 primary patterns in the sample. The five most common compressed patterns are listed in Table 1, with the approximate percentage of the sample having each structure and with illustrative sentences. The first three of these patterns show that about 30 percent of the sample comprised sentences built around verbs which lack objects but have adverbial modifiers. With the aid of supplementary routines in the program, it was possible to plot (Figures 3 and 4) the distribution of patterns (all primary, unique primary, all compressed, and unique compressed) with respect to the number of notations per pattern. In each case a very rough approximation to normal Gaussian distribution was found.

In the hope of obtaining data of greater statistical significance, further searches will be conducted on a much larger body of source sentences. The first reduction of data to numerical terms only (at the start of the primary search) and the second reduction by omission of repeated digits (i.e., the compression) seem to be useful techniques for examining structure. Both reductions are accomplished in terms of logical equivalence, and so do not affect the validity of the search within the framework of the present coding scheme. This method of examination may shed some light on the problem of structural transformations in English. An understanding of this problem is needed, for example, in developing means of "translating from English into English" — that is, from ordinary English into a form better adapted for use as a computer input or, perhaps, as a preliminary step to translation into another language.

The electronic computer proved admirably suited to

[Please turn to page 32]



# MEETING OF ASSOCIATION FOR COMPUTING MACHINERY HOUSTON, TEXAS, JUNE 19 TO 21, 1957

## PROGRAM, TITLES, AND ABSTRACTS

**T**HE 12th National Meeting of the Association for Computing Machinery took place at University of Houston, Houston, Texas, Wednesday, June 19, to Friday, June 21, 1957. Following are the program, the titles of papers and talks, and the abstracts of certain papers. Two sessions ran concurrently throughout the meeting. It is expected that no proceedings of the meeting will be published. For more information about any paper, please inquire directly of the author, whose address is given in the program.

The number in parentheses following a paper refers to the number of the abstract. An asterisk in parentheses (\*) denotes an invited paper.

### PROGRAM

Wednesday Morning, June 19, 1957

#### A1. OPENING SESSION

A. D. Bruce, Chancellor, University of Houston; J. W. Carr III, President, Association for Computing Machinery

#### B1. PETROLEUM PRODUCTION

Computer Technology Applied to Petroleum Reservoirs, Julius Aronofsky, Magnolia Field Laboratories, Dallas, Texas (\*)  
Numerical Solution of Two-Dimensional Moving Boundary Problems, D. W. Peaceman, Jim Douglas, Jr., A. O. Garder, Humble Oil & Refining Company, Houston, Texas (\*)

#### B2. COMPUTER DESIGN I

Errors Due to Overflow in Arithmetic Operations Particularly as Regards Finac Electronic Computer, Paolo Ercoli and Roberto Vacca, Istituto Nazionale per le Applicazioni del Calcolo, Rome, Italy (8)

A Method of Minimizing Additions During Binary Multiplication, George W. Reitwiesner, Aberdeen Proving Ground, Maryland (31)

A Binary, Parallel Arithmetic Unit with Separate Carry Storage, Gernot A. Metzger, University of Illinois, Urbana, Illinois (26)

Wednesday Afternoon, June 19, 1957

#### C1. NUMERICAL ANALYSIS I

Error Analysis in Floating Point Arithmetic, John W. Carr III, University of Michigan, Ann Arbor, Michigan (52)

The Perturbation Method—With Linear and Non-Linear Illustrations, George M. Kuby, Bell Aircraft Corporation, Buffalo, New York (25)

Kutta Integration with Error Control, Lester D. Earnest, Massachusetts Institute of Technology, Lincoln Laboratory, Lexington, Massachusetts (23)

Automatic Error Control in the Solution of Differential Equations on the IBM 650, W. Barkley Fritz and N. Moraff, Westinghouse Electric Corporation, Air Arm Division, Baltimore, Maryland (47)

Truncation Error in the Partial Difference Representations of Differential Equations, A. S. Householder, Oak Ridge National Laboratory and Mathematics Research Center, U. S. Army (30)

On the Asymptotic Behavior of the Method of Steepest Descent, R. J. Arms, U. S. Naval Proving Ground, Dahlgren, Virginia (29)

Studies of a Monte Carlo Method Applied to the Ising Lattice Problem, L. D. Fosdick, Midwestern Universities Research Association, Madison, Wisconsin (27)

A Numerical Method of Solving a Stefan-like Problem, Louis W. Ehrlich, The Ramo-Wooldridge Corporation, Inglewood, California (22)

#### C2. COMPUTER DESIGN II

A Functional Description of the Pegasus Computer, Christopher Strachey, National Research Development Corporation, London, England (\*)

A High-Scanning-Rate Storage Device for Computer Applications, D. M. Baumann, Massachusetts Institute of Technology, Cambridge, Massachusetts (11)

Magnacard — A New High Speed Filing System, Jerome B. Wiener, The Magnovox Company, Los Angeles, California (17)

#### C3. PETROLEUM EXPLORATION CALCULATIONS

Interpretation of Magnetic and Gravimetric Surveys with the Aid of 704, E. Kogbetliantz, The Service Bureau Corporation, IBM, New York, New York (3)

Evaluation of Integrals Involving Combinations of Bessel Functions and Circular Functions, L. de Witte and Kenneth Fournier, Lane Wells Company, San Gabriel, California (7)

Some Computing Problems in Petroleum Exploration, Gerald Webster, Carter Oil Company, Tulsa, Oklahoma (\*)

Thursday Morning, June 20, 1957

#### D1. NUMERICAL ANALYSIS II

Computation of Square Roots, Diran Sarafyan, Lamar State College of Technology, Beaumont, Texas (2)

Obtaining the Roots of a Polynomial with Complex Coefficients, D. M. Brown and James H. Brown, The University of Michigan, Willow Run Laboratories, Ypsilanti, Michigan (6)

An Integrated Set of Programs for Curve and Surface Fitting on Unequally Spaced Points, Albert Newhouse and Charles Hobby, University of Houston, Houston, Texas (28)

Second Order Formulas for Fourier Coefficients, Henry F. Hunter, General Electric Company, Schenectady, New York (48)

The Inversion of Nearly Singular Matrices, Christopher Strachey, National Research Development Corporation, London, England (\*)

Eigenvalues and Eigenvectors of General Matrices, Morton A. Hyman, Remington Rand Univac, Philadelphia, Pennsylvania (32)

Finding Zeros of Arbitrary Functions, Werner L. Frank, The Ramo-Wooldridge Corporation, Los Angeles, California (21)

#### D2. ANALOG AND DIGITAL SIMULATION

Didas, George R. Slayton, Lockheed Aircraft Corporation, Marietta, Georgia (33)

Methods of Simulating a Differential Analyzer on a Digital Computer, H. Fred Lesh, (formerly with Jet Propulsion Laboratory), Electro-Data Division, Burroughs Corporation, Pasadena, California, and William R. Hoover, California Institute of Technology, Jet Propulsion Laboratory, Pasadena, California (38)

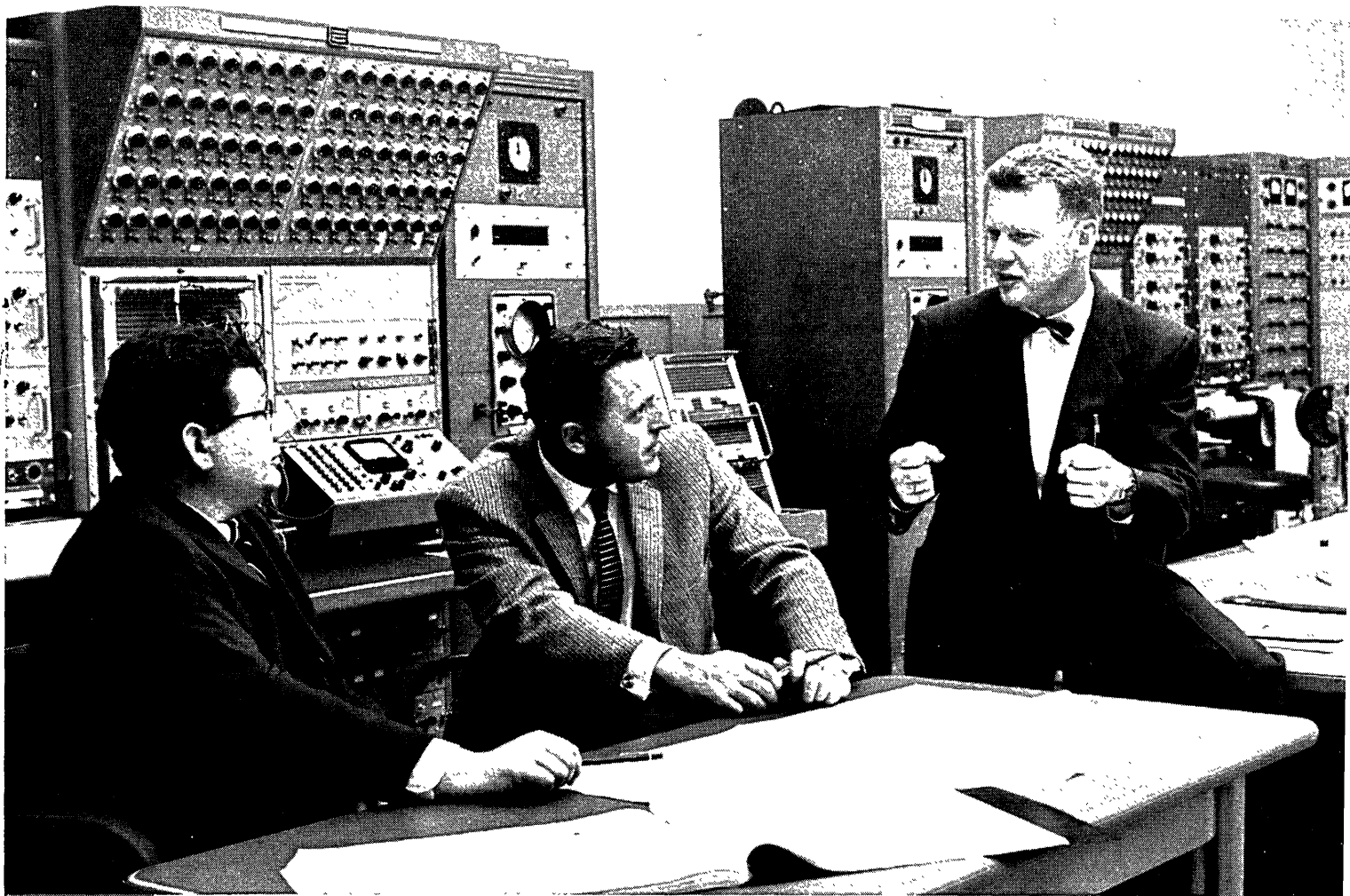

*Here G. D. Schott (right), Flight Controls Department head, discusses computer solutions of control and guidance problems with E. V. Stearns (center), Inertial Guidance Department head, and J. E. Sherman, Analog Computer Section head.*

## **MISSILE FLIGHT CONTROLS**

*— the creative field for engineers*

Few fields equal missile systems flight controls in the need for original thinking. The ever-increasing performance of missiles presents problems that grow constantly in complexity. At Lockheed, weapon systems programs demand important advances in flight controls. Emphasis is on new ideas, new techniques.

Positions are open on the Sunnyvale, Palo Alto and Van Nuys staffs for engineers possessing strong ability and interest in: Research and development of advanced flight control systems for controlling missiles and rockets; system synthesis by application of control system feedback techniques; analysis and design of nonlinear servo systems; development of transistor and magnetic amplifier techniques in the design of advanced flight control systems; analysis and simulation of the dynamic performance of the guidance — autopilot — airframe combination; development of systems utilizing advanced types of inertial and gyroscopic instruments; analysis and design of hydraulic servo systems for controlling missiles at high Mach numbers; environmental and functional testing of prototype flight control systems.

Inquiries are invited from engineers possessing a high order of ability. Address the Research and Development Staff, Palo Alto 3, California. (CA No. 49)

*Lockheed*

**MISSILE SYSTEMS DIVISION**

LOCKHEED AIRCRAFT CORPORATION

**PALO ALTO • SUNNYVALE • VAN NUYS • CALIFORNIA**

Gas Dynamics Facility Plant Simulator, George McKay, Jr., Aro, Inc., Tullahoma, Tennessee (35)  
Plant Simulation: A Common Problem with Unusual Requirements, J. S. Bonner, Bonner & Moore Engineering Associates, Houston, Texas (58)

### D3. THE ROLE OF COMPUTERS IN HIGH SCHOOL SCIENCE EDUCATION

Panel Discussion:  
George Forsythe, Chairman, University of California at Los Angeles;  
Richard Melville, Stanford Research Institute, Stanford, California;  
D. L. Trautman, Hughes Aircraft Co., Culver City, California;  
W. Eugene Ferguson, Newton High School, Newtonville, Massachusetts (\*)

Thursday Afternoon, June 20, 1957

#### E1. AUTOMATIC CODING

Dynamic Flow Diagrams: A New Concept in Computer Programming, R. P. Mayer, Massachusetts Institute of Technology, Lincoln Laboratory, Lexington, Massachusetts (43)  
Algebraic Formulation of Flow Diagrams, Edward A. Voorhees, University of California, Los Alamos Scientific Laboratory, Los Alamos, New Mexico (4)  
The IBM 705 Autocoder System, Stanley J. Szabronski, IBM Corporation, New York, New York (19)  
Use of the Autocoder in Technical Computing on the IBM Type 705 EDPM, R. W. Schrage, Esso Standard Oil Company, Linden, New Jersey (53)

#### E2. DATA PROCESSING

Programming an Automatic On-Line Wind Tunnel Data Reduction System, John N. Walz, Aro, Inc., Tullahoma, Tennessee (34)  
A First Approach to the Patent Search on a Digital Computer (SEAC), Harold Pfeffer, Herbert R. Koller and Ethel Marden, National Bureau of Standards, Washington, D. C. (24)  
Condensation and Look Up Procedures for Double Entry Tables, Nathaniel Macon, General Electric Company, Evendale, Ohio (16)

#### E3. PROBLEMS OF UNIVERSITY COMPUTER LABORATORIES

Panel Discussion, Introductory Remarks, Paul Brock, Purdue University  
Discussion, Paul Brock, Chairman:  
Interdepartmental Liaison and Curricula, M. H. Wrubel, University of Indiana;  
Equipping and Staffing a University Computing Center, A. J. Perlis, Carnegie Institute of Technology;  
Development of Student Interest - A Comprehensive Orientation Program, R. F. Reeves, Ohio State University;  
The ACM - An Agency for Interuniversity Co-operation, John W. Carr III, University of Michigan

Friday Morning, June 21, 1957

#### F1. PETROLEUM REFINERY PROBLEMS

Integration of Linear Programming and Other Mathematical Techniques in Refinery Calculations, Frank Pfaff, Bayway Refinery, Esso Standard Oil Company, Linden, New Jersey (\*)  
Mathematical Programming Experience in Refinery Simulation, R. B. Grant, Phillips Petroleum Company, Bartlesville, Oklahoma (\*)

#### F2. NUMERICAL ANALYSIS III

Random Walk with Steps of Unequal Length Applied to the Solution of First Boundary Value Problem, Valdemars Punga, Hartford Graduate Center, Rensselaer Polytechnic Institute, East Windsor Hill, Connecticut (12)  
An Iterative Method for Determining a Differential Equation, James A. Ward, Holloman Air Force Base, New Mexico (9)  
A System for Integrating Differential Equations in a Dual Computer, Charles J. Swift, Convair, San Diego, California (1)

#### F3. USE OF DIGITAL COMPUTERS IN DESIGN

Calculator Characteristics Which Will Reduce Program Check-

out Time, Marvin S. Maxwell, U. S. Naval Proving Ground, Dahlgren, Virginia (50)

A Study of the Order Types and References to Store in Some ILLIAC and FERUT Library Routines, J. H. Chung and C. C. Gottlieb, University of Toronto, Toronto, Ontario, and D. E. Muller, University of Illinois, Urbana, Illinois (54)

Automatic Implementation of Computer Logic, E. F. Morris and T. E. Wohr, IBM Corporation, Poughkeepsie, New York (37)

A Versatile Digital Programme for Calculating Complex Plots from Feedback Circuit Diagrams, Thomas Guenther and Eldo C. Koenig, Allis-Chalmers Manufacturing Company, Milwaukee, Wisconsin (55)

#### F4. DIGITAL COMPUTER APPLICATIONS

On the Use of a Computer in the Design of High Energy Accelerators, James N. Snyder, Midwestern Universities Research Association, Madison, Wisconsin (70\*)

Language Translation, A. F. R. Brown, Georgetown University, Washington, D. C. (71\*)

Friday Afternoon, June 21, 1957

#### G1. EFFICIENT OPERATION OF COMPUTERS IN CODE CHECKING AND COMPUTATION

Panel Discussion, Joseph Wegstein, Chairman, National Bureau of Standards, Washington, D. C.

The great cost of large computers is forcing users to economize in the use of their machines by minimizing dead time, simplifying operator responsibilities, simplifying coding, and speeding up code checking. Accordingly, several installations have developed systems for easy and efficient use of their computers. Several representatives for these systems have been invited to participate. Some members will discuss systems which have been in use for some time and others will discuss systems which are being planned. Members have been asked to briefly describe their systems and, where applicable, to discuss the economics of teletype tape use, card use, magnetic tape and drum use, computer time, and code preparation time. Each member will speak for 20 minutes followed by a 10 minute question and discussion period. The audience is urged to ask questions which will illuminate the discussion. Questions may be asked from the floor or submitted in written form to the Chairman in advance.

1. GMR Input-Output System, George Ryckman, General Motors Research Laboratory
2. The Boeing Compiler for the 1103A, Don Cook, Boeing Airplane Company
3. ILLIAC Operations, D. E. Muller, University of Illinois
4. GP and LARC, Anatol Holt, Sperry-Rand Corporation
5. FORTRAN, John Backus, International Business Machines Corporation
6. A Proposed MIT Automatic Coding System, Frank Helwig, Massachusetts Institute of Technology

#### G2. SWITCHING THEORY

Quantifier Elimination in a Problem of Logical Design, Calvin C. Elgot and J. B. Wright, The University of Michigan, Willow Run Laboratories, Ypsilanti, Michigan (15)

Equivalent Sequential Circuits, William J. Cadden, Bell Telephone Laboratories, Whippany, New Jersey (10)

An Illiac Program for Simulating the Behavior of Asynchronous Logical Circuits and Detecting Undesirable Race Conditions, W. S. Bartky and D. E. Muller, University of Illinois, Urbana, Illinois (57)

Some Bounds on Binary Logical Programs, C. Y. Lee, Bell Telephone Laboratories, Whippany, New Jersey (20)

## ABSTRACTS

1. A SYSTEM FOR INTEGRATING DIFFERENTIAL EQUATIONS IN A DUAL COMPUTER  
C. J. SWIFT

A dual computer containing both analog and digital parts has been formed at Convair. The use of this computer to solve sets of differential equations is being tried to obtain some of the ad-





WELL I'LL BE DIPPED...better  
...because the NEW **AMP** SNAPIN

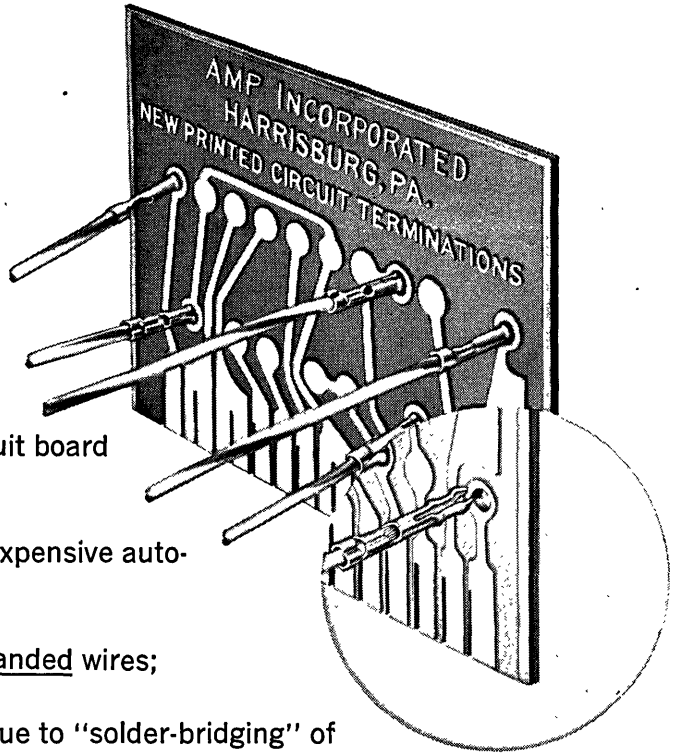

- Gets leads to the printed circuit board in one assembly operation;
- Eliminates an investment in expensive automation equipment;
- Can be applied to solid or stranded wires;
- Eliminates danger of shorts due to "solder-bridging" of insecure leads;
- Has construction details that promote good capillary flow of solder during the dipping process;
- Is self-retaining, with no damage to the printed circuit board during pre-assembly operations;
- Is self-aligning—no further positioning or deformation is required.

*Write today for additional information on the NEW A-MP SNAPIN, the AMP-EDGE Connector and other A-MP products designed for printed circuit applications.*

## **AMP INCORPORATED**

### **GENERAL OFFICE:**

**3112 Eisenhower Boulevard, Harrisburg, Pennsylvania**



Wholly Owned Subsidiaries: Aircraft-Marine Products of Canada Ltd., Toronto, Canada • Aircraft-Marine Products (Great Britain) Ltd., London, England • Societe AMP de France, Le Pre St. Gervais, Seine, France • AMP—Holland N.V. 's-Hertogenbosch, Holland

Distributor in Japan: Oriental Terminal Products Co., Ltd., Tokyo, Japan

vantages of both types of computers. A third order Kutta process was picked because of the ease of meshing with the analog methods.

An analysis of the truncation errors is given for the combined computer. Some results should be obtained shortly.

## 2. COMPUTATION OF SQUARE ROOTS

DIRAN SARAFYAN

The aim of this paper is a new method of computation of square roots and the related error estimation. The intersection of  $y = x^2$  and  $y = x-a$  is determined first algebraically then by a graphical limiting process. Equating both results one gets the formula

$$\sqrt{n} = 1 - 2 \{[(x_1^2 + x_1)^2 + x_1]^2 + \dots + x_1\}$$
$$\text{where } x_1 = (1-n)/4 = 0.25(1-n).$$

The  $j$ -th approximation of  $\sqrt{n}$  is obtained through  $(j-1)$  squarings. No use is made of the arithmetical operation of division, however it is required  $0 < n < 1$ . A convenient decimal multiple is substituted for  $n > 1$ . In the  $j$ -th approximation an upper-bound to the error  $\xi$  is given by  $\xi < \frac{k^{j+1}}{2}$  with  $1 - \sqrt{n} < k < 1$ .

## 3. INTERPRETATION OF MAGNETIC AND GRAVIMETRIC SURVEYS WITH THE AID OF 704

E. KOGBETLIANTZ

The interpretation of magnetic and gravimetric surveys should be based on a *correct* estimate of regional effects (to be subtracted from the observed station-values) and on an *excellent* interpolation at the corners of a rectangular or triangular network of corrected station-values which are known at irregularly distributed station-locations only.

But a correct estimate of regional effects and a good interpolation necessitate such an enormous amount of numerical computations that in general graphical methods are used. They save time and effort but introduce large errors.

The use of electronic computing equipment solves the problem and allows at the same time a very rapid and very accurate transformation of field data into maps of residual anomalies, of vertical derivative of observed quantity and of continuation of anomalies downward; making thus a correct geological interpretation of mapped data possible and easy.

## 4. ALGEBRAIC FORMULATION OF FLOW DIAGRAMS

EDWARD A. VOORHEES

Probably the prime difficulty in describing problems for coding by automatic-coding systems lies in the area of stating the control (or logic) of the problem. A possible solution to this difficulty is proposed in which the problem is divided into two parts; (a) the equations or statements of work to be done, and (b) the control statements which define the order of and conditions for the execution of the equations. This paper attempts to demonstrate the feasibility of writing such control statements in simple algebraic language, thereby making the total description of the problem algebraic.

## 6. OBTAINING THE ROOTS OF A POLYNOMIAL

D. M. BROWN AND J. H. BROWN

This report describes a method of mechanization of the "Downhill" scheme for obtaining the roots of a polynomial with complex coefficients. The rules for mechanization permit the most efficient use of a fixed-point computer with regard to scaling and accuracy for general polynomials of large degree. The method of mechanization uses the techniques of synthetic division and inverse roots to confine the points at which the polynomial is evaluated within the unit circle; thus the point of evaluation needs no scaling.

This method has been programmed for the MIDAC and a brief resume of results and running time for the program is included.

## 7. EVALUATION OF INTEGRALS INVOLVING COMBINATIONS OF BESSEL FUNCTIONS AND CIRCULAR FUNCTIONS

L. de WITTE AND KENNETH FOURNIER

A method is discussed for the evaluation of integrals containing combinations of Bessel Functions and circular functions in which the non-circular part of the integral is fitted by sums of simple polynomials and exponentials. Towards the limits of zero and infinity asymptotic expression are used, derived from the

series expansions for the Bessel Functions for small and large values of the argument. The products of all these expressions with the circular functions can be integrated formally, yielding expressions in terms of sines, cosines, logarithms, exponentials and integral sines and cosines. These need to be evaluated only at a relatively small number of predetermined points and can be pre-tabulated. This method gives large savings in computer time and has favorable accuracy compared with methods using numerical integration.

## 8. ERRORS DUE TO OVERFLOW IN ARITHMETIC OPERATIONS PARTICULARLY AS REGARDS FINAC ELECTRONIC COMPUTER

PAOLO ERCOLI AND ROBERTO VACCA

The paper defines what may be termed overflow in arithmetic operations performed on binary numbers expressed in complement notation. The operations of addition, subtraction, positive shift, complementation and multiplication are examined in order to determine general rules and examples are given for the different cases. Attention is drawn to an artifice used in the logical design of an overflow detecting device installed in FINAC, which allows the carrying out of overflow checks without making it necessary to store supplementary bits to the left of the highest order bit in the registers of digital computers.

## 9. AN ITERATIVE METHOD FOR DETERMINING A DIFFERENTIAL EQUATION

JAMES A. WARD

This is a method to determine the coefficients of a differential equation from a numerical solution if the form of the equation is known. The simplest case is to find  $P$  and  $Q$  in  $\ddot{y} = Py + Q\dot{y}$ . We begin with  $\bar{P}$  and  $\bar{Q}$  as approximations and for each data point change  $\bar{P}$ ,  $\bar{Q}$ , or neither, (whichever is appropriate) in such a way that the new approximation is always an improvement.

The procedure converges rapidly even if the data is noisy and the initial approximation has a large error. The method may also be used if  $P$  and/or  $Q$  are variables.

## 10. EQUIVALENT SEQUENTIAL CIRCUITS

W. J. CADDEN

Previous authors have considered the concept of equivalent sequential circuits when the circuits are all of the same type (i.e., either synchronous or asynchronous). It is of interest to broaden this concept of equivalence and to develop methods for finding equivalent circuits of different types (for example, an asynchronous circuit which is equivalent to a given synchronous circuit). In this paper three types of sequential circuits will be defined, and methods for transforming a given type of circuit to equivalent circuits of the other types will be given.

## 11. A HIGH-SCANNING-RATE STORAGE DEVICE FOR COMPUTER APPLICATIONS

D. M. BAUMAN

The results of an investigation of the use of photographic techniques for high-scanning-rate digital storage are presented.

The most promising technique, that of utilizing a projection system and a rotating mirror, is described in detail. In this system, the binary-digital information recorded on a photographic medium in the form of spots is projected on a rotating mirror by a device similar to a common slide projector. The image reflected from the rotating mirror sweeps past a row of stationary photoelectric transducers and causes the transducers to read the stored information.

Experiments conducted with a simple slide projector and a rotating mirror resulted in a reading rate of 250,000 cps, with a mirror speed of 3600 rpm and a memory pattern of 110 lines per inch.

A system using a memory pattern that is 4 by 4 inches and that contains  $16 \times 10^6$  bits of information, each bit being 0.0005 by 0.002 inch, is proposed. This information would be written in parallel channels, each approximately 36 bits in width and 4 inches in length. Schemes for reading each of the channels repeatedly and for reading the channels successively are discussed. The reading rate should be greater than 1 million words per second.

## 12. RANDOM WALK WITH STEPS OF UNEQUAL LENGTH APPLIED TO THE SOLUTION OF FIRST BOUNDARY VALUE PROBLEM

VALDEMARS PUNGA

We discuss the Monte Carlo method of the solution of an elliptic differential equation with prescribed boundary conditions in the region covered by an irregular rectangular lattice, i.e., if the steps of random walk are of unequal length.

Our formulas can be utilized also in case of a square net at the lattice points near the curved boundary, which are usually at the irregular distance from the boundary.

## 15. QUANTIFIER ELIMINATION IN A PROBLEM OF LOGICAL DESIGN

C. C. ELGOT AND J. B. WRIGHT

A fundamental problem in the theory of logical design is that of expressing behavior realizable by computer circuits. For time-independent circuits, formulas of the propositional calculus have been helpful in expressing behavior. For time-dependent circuits, attempts have been made to use, for this purpose, formulas in which time variables may be quantified.

By the method of quantifier elimination we find the expressive power of a certain class of formulas which has been used in attempts to describe circuit behavior. As a corollary we prove the inadequacy of these formulas for expressing a kind of computer behavior.

## 16. CONDENSATION AND LOOK UP PROCEDURES FOR DOUBLE ENTRY TABLES

N. MACON

Suppose  $Z = f(x, y)$  is given at  $m \cdot n$  tabular points  $Z_{ij} = f(x_i, y_j)$ , ( $i = 1, 2, \dots, m; j = 1, 2, \dots, n$ ), and that an accuracy requirement is established. Methods are described for condensing the table to the extent that the accuracy requirement will permit, and for approximating  $Z$  from the condensed table. Only linear interpolation is required. The procedure is well suited for representing "pathological" functions when storage capacity is limited.

## 17. "MAGNACARD"—A NEW HIGH SPEED FILING SYSTEM

JEROME WIENER

A new type of high speed, large capacity, automatic filing system is described in which the basic storage medium used is a card coated with magnetically sensitive material. These cards are handled on vacuum drums at bit rates of up to 450 kc and in file blocks having a total capacity of up to  $1.3 \times 10^9$  bits per file block.

Two of the possible file organizations are also described including a file which automatically orders the cards in the file by frequency of interrogation of these cards. An outline is provided of some of the advantages of the ordering being performed automatically.

## 19. THE IBM 705 AUTOCODER SYSTEM

S. J. SZABRONSKI

This paper describes an automatic coding system which has been developed for the IBM 705 EDPM and the experience with it at a number of data processing installations. Among the features included in this system are the ability to describe items by meaningful English names; an expanded set of operations called macro-instructions; and the facility of using operands which are the literal equivalents of the articles addressed. The Autocoder performs a systematic check upon the program being compiled, and upon detection of errors diagnoses the intention of the programmer and, if possible, corrects these errors. In one machine run almost all clerical and technical errors may be detected. Experiences described will illustrate how a system of this nature can make an important contribution towards lessening coding time and effort.

## 20. SOME BOUNDS ON BINARY LOGICAL PROGRAMS

C. Y. LEE

Several ways of programming binary expressions are considered and some bounds on sequence length and number of binary operations are given.

## 21. FINDING ZEROS OF ARBITRARY FUNCTIONS

WERNER L. FRANK

A method for finding real and complex roots of polynomial equations, due to D. Muller, is applied to finding roots of general equations of the form  $f(x) = 0$ , where  $f(x)$  is analytic in the neighborhood of the roots. The procedure does not depend on any prior knowledge of the location of the roots nor any special starting process. All that is required is the ability to evaluate  $f(x)$  for any desired value of  $x$ . Multiple roots can also be obtained. A general purpose program, prepared for the UNIVAC Scientific 1103 and 1103A is described and numerical results are presented for the following applications: finding eigenvalues of differential operators; finding eigenvalues of arbitrary matrices; finding zeros of the generalized eigenvalue problem; finding roots of a number of transcendental equations.

## 22. A NUMERICAL METHOD OF SOLVING A STEFAN-LIKE PROBLEM

LOUIS W. EHRLICH

A one-dimensional heat flow problem is considered which involves the melting of a solid without removal of the liquid. Results obtained in solving the problem by a finite difference procedure on a high speed computer are discussed. Special finite difference formulas are needed near the interface. The difference equations are solved by a direct method, whereas as iterative procedure is used at each time to determine the slope and position of the interface. The accuracy of the method is investigated by comparison with analytic solutions where available and with results obtained by varying the mesh sizes.

## 23. KUTTA INTEGRATION WITH ERROR CONTROL

LESTER D. EARNEST

In programming digital computers to perform the step-by-step integration of simultaneous differential equations, it is advantageous to use methods which do not require preceding function values to be known. For maximum effectiveness, such methods must include some means for estimating the truncation error so as to provide a criterion for the automatic selection of step size. It is also desirable to minimize the number of storage registers required. From an approach which was generalized by Kutta, a process is developed which satisfies these requirements with fourth order accuracy.

## 24. A FIRST APPROACH TO THE PATENT SEARCH ON A DIGITAL COMPUTER (SEAC)

HAROLD PFEFFER, HERBERT R. KOLLER AND ETHEL MARDEN

Description of a literature search of an encoded library of technical documents embracing patents, periodicals, and other publications. The type of search is that performed by the U.S. Patent Office. The first data to be searched on the SEAC has been limited to chemical literature: Specifically, chemical patents.

## 25. THE PERTURBATION METHOD—WITH LINEAR AND NON-LINEAR ILLUSTRATIONS

GEORGE M. KUBY

Perturbation—the method of determining neighboring solutions to an equation (or set of equations) by expanding the neighboring solutions as power series in parameters which measure the difference between the neighboring and original equations—is described and illustrated mainly in the problems of:

1. The improvement of inverse matrices.
2. The abstraction of roots of polynomial, by digital computation, both in cases normally easily solvable and cases abnormally difficult to solve.
3. Eigenvalue and Eigenvector computation.
4. Simultaneous non-linear differential equations of a special form.

Numerical examples are given and problems associated in their digital computation are discussed.

## 26. A BINARY, PARALLEL ARITHMETIC UNIT WITH SEPARATE CARRY STORAGE

GERNOT A. METZE

In most binary, parallel arithmetic units it is necessary each time the adder is used to wait for the carries to propagate through the entire adder. It will be shown that the use of a separate  
[Please turn to page 28]

# NEW PRODUCTS *and* IDEAS

## REMOTE CONTROL FOR A VEHICLE

A UNIQUE system has been introduced by Lear, Inc., Grand Rapids, Mich., for remote control of vehicles. Equipped with this system, a vehicle may be used for obtaining data or information from remote, hazardous, or otherwise inaccessible areas via a television transmitter. The system is easily installed in any tracked or wheeled vehicle and uses electromechanical actuators to control the functions usually performed by the driver. The vehicle may be controlled by radio or through an electrical cable which permits a variety of remote locations for the driver. Ordinary manual operation of the vehicle is not hampered, and quick switch-over from manual to remote control is easily accomplished.

### How Controls Work

A push-button starts the engine, and an aircraft-type control-stick steers the vehicle with right-and-left movement at the same time that it controls the throttle with fore-and-aft movement. Moving the control stick all the way to the rear position applies the brake. Other push-buttons on the control box shift the vehicle into any gear selected by the operator.

The system was designed ruggedly so as to operate under the most extreme environmental conditions. It has been used in actual testing of US Marine Corps landing vehicles under dangerous surf conditions. In this application, the LVT was controlled by radio from a hovering helicopter or from an observation post on the beach.



Marine Corps LVT is guided through rough surf by Lear Remote Control in helicopter.

## "MOBIDIC" BEING DEVELOPED BY SYLVANIA ELECTRIC

TO MOST users, the word computer implies a fairly large installation, a sense of permanence, and fixed equipment in a specially designed room to which problems are brought.

A new computer, "Mobidic" (MOBILE Digital Computer), which is being developed for the solution of U. S. Army military problems by the Waltham Laboratories of Sylvania Electric Products, Inc., upsets most of these concepts. For this is a computer designed to move to the problem, and to function at or near battlefields, anywhere in the world.

This mobile field computer fits into a standard air-conditioned trailer about 28 feet long, and is reputed to be one of the most versatile multi-purpose mobile computers yet designed for general military service.

The applications which are visualized for "Mobidic" include logistics, combat surveillance, analytic computation, battle strategy evaluation, air traffic control, artillery target calculations, etc. Emphasis is placed on rugged, reliable subminiature transistors, components, and circuitry.

Sylvania is developing "Mobidic" under a contract for over \$1,000,000 with the U. S. Army Signal Engineering Laboratories of Fort Monmouth, N. J., which has specified its design and performance requirements.

\* \* \*

## NEW HOURLY-COMPUTED INDEX OF STOCK PRICES

STOCK analysts, brokers, and investors now have a dramatic hourly proof of the value of computers in a new stock market average introduced by Standard & Poor's which includes 500 common stocks embracing 90 percent of the total value of some 1100 common stocks listed on the New York Stock Exchange.

The computer which makes possible publications on news tickers of a new average every hour during trading is a Datatron made by Electrodata Division of Burroughs Corporation. The application of the Datatron to the stock market was made by Melpar, Inc., of Boston, a subsidiary of Westinghouse Air Brake Co., after several years of development. The Melpar engineers developed a computer that takes in every ticker transaction as it happens, but then selects only transactions affecting the 500 common stocks which make up the index. The machine is programmed so that it announces any ticker tape error sizeable enough to arouse suspicion. And it remembers significant digits on all prices so that it adjusts automatically during any spurt in trading activity where to speed transmission and permit the ticker tape to catch up with sales, less significant digits are dropped off the tape.

The new computed average is expected to answer a host of criticisms of other stock averages based on weighted samples of trading activity. Charles A.

Schmutz, President of Standard & Poor's, called the new index "the most complete and technically accurate measure of the stock market ever devised."

\* \* \*

### LARGER RAPID MEMORY FOR THE IBM 704

THE FIRST model of a larger high speed memory unit, which will more than double the effectiveness of an IBM 704 electronic computer on many problems, has been introduced at Rand Corporation, Santa Monica, Calif. This memory consists of a system of small doughnut-shaped magnetic ferrite cores.

The expanded storage unit, called the IBM 738, contains up to 32,768 machine words of stored information, four times the former maximum storage of the IBM 704. A machine word in the IBM 704 is the equivalent of a six-letter English word. The machine has access to stored words in 12 millionths of a second.

The Rand Corporation estimates that some of its problems will run five times faster with the IBM 738 storage unit, because of the increase of rapid memory accessible to the computer. The Rand 738 is a pilot model, but IBM has stated that the unit will soon be put into production, and that orders for it have been received from a number of major industrial firms.

\* \* \*

### PUSH-BUTTON AIR-GROUND COMMUNICATION

A NEW visual electronic system called TACAN (TACTical Air Navigation) Data Link, which can transmit information between airplane pilots and a traffic control tower, without tying up radio voice channels, has been developed by Federal Telecommunications Laboratories, a subsidiary of International Telephone and Telegraph Co.

The sender unit in the plane automatically transmits up-to-the-second information to the air traffic control center, giving the plane's position, altitude, course, and speed. The control tower can respond, sending instructions which appear on the appropriate dials of the plane's instruments, thus correlated at once with readings of the plane's instruments.

## Top companies in the computer field

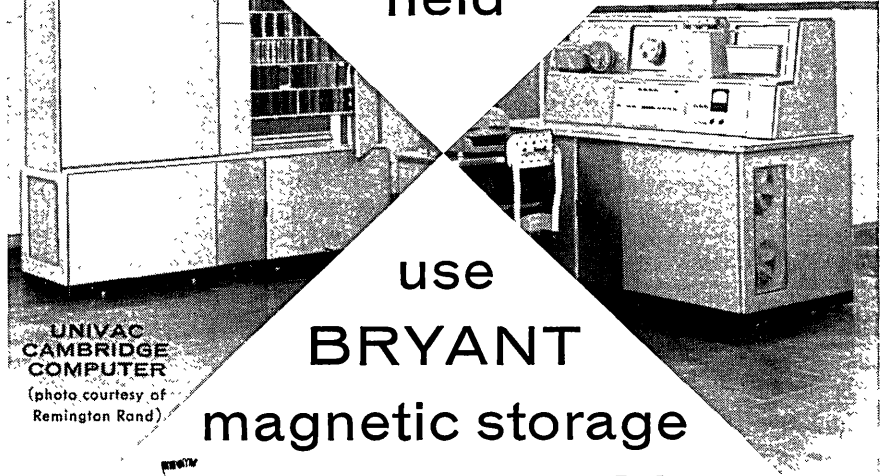

UNIVAC CAMBRIDGE COMPUTER  
(photo courtesy of Remington Rand)

## use BRYANT magnetic storage DRUMS!

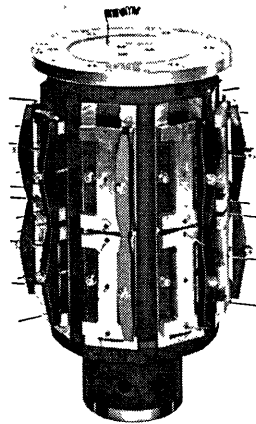

Bryant Magnetic Drums are used extensively by Remington Rand—Univac and other leading manufacturers of electronic computers, because of their accurate, dependable performance. These drums are used not only in digital computers, inventory control systems and tape-to-card converters, but also as delay lines, synchronizers and frequency generators.

### FEATURES

- Designed to purchasers' requirements
- Guaranteed accuracy of drum runout .00010" T. I. R. or less
- Air bearings or super-precision ball bearings
- Belt drive or integral motor drive, speeds to 100,000 RPM or more
- Capacities to 5,000,000 or more binary digits
- Vertical or horizontal housing
- Head mounting surfaces to suit
- High density magnetic oxide coating

**BRYANT GAGE and SPINDLE DIVISION**  
P. O. Box 620-K, Springfield, Vermont, U. S. A.  
DIVISION OF BRYANT CHUCKING GRINDER CO.



**IN THE COMPUTER FIELD**  
**WHO? WHAT? WHERE?**

*Answers,*  
*Basic Source Information,*  
*Available to You from*  
**COMPUTERS**  
*and* **AUTOMATION**

**PEOPLE: Who's Who in the Computer Field, 1956-57.** Over 12,000 entries (names, addresses, and other information) including 4500 new entries since 1955 .....\$17.50

Mailing Plates for over 15,000 computer people; includes additions and corrections since the Who's Who was published . . . we address your envelopes ..... \$19 per M

**ORGANIZATIONS: The Computer Directory and Buyers' Guide, 1957** (the June 1957 issue of *Computers and Automation*): 790 organization listings, 1370 product and service listings \$6.00

**MACHINES: (Source information in back issues)** Types of Automatic Computing Machines and Components, March 1957 .....\$1.25

Roster of over 220 Automatic Computers, June 1956 .....\$4.00

Commercial Automatic Computers, Dec. 1956 .....\$1.25

**GLOSSARY OF TERMS AND EXPRESSIONS:** Over 480 careful, clear, understandable definitions. 4th cumulative edition, as of October, 1956 (20 or more copies, 10% discount) ..\$1.00

**SUBSCRIPTION INFORMATION:** U. S. A. one year ..\$5.50; two years ..\$10.50; add 50¢ per year for Canada, \$1.00 per year elsewhere. Save 5% on 2, 9% on 3, 16% on 4 to 6, 24% on 7 or more prepaid subscriptions sent together directly to us.

**BACK COPIES:** (for six years of publication) If available, \$1.25 each, except Directory issues June 1955, 1956, each ..\$4.00, June 1957 ..\$6.00

Send orders prepaid, or requests for more information, to us:

**COMPUTERS and AUTOMATION**  
815 Washington St., Dept. R-206  
NEWTONVILLE 60, MASS.

If not satisfactory, returnable in seven days for full refund.

In addition, the pilot can send any one of a library of 21 messages by pushing the appropriate button. The answer is flashed back and appears visually on the instrument for messages. Since the system is visual, problems of international language differences do not arise, thus eliminating one source of possible difficulty in the control of international flights.

\* \* \*

**COMPUTERS AT THE  
UNIVERSITY OF MICHIGAN**

THE UNIVERSITY has five analog computing facilities: four on the campus, and one at the Willow Run Laboratories of the Engineering Research Institute.

The electronic differential analyzer of the Aeronautical Engineering Department is a general-purpose analog computer of medium size, which can be used to solve high-order linear and nonlinear differential equations and to simulate complex physical systems.

The Electrical Engineering Department maintains a relatively small general-purpose electronic differential analyzer. Its linear elements permit the simultaneous solution of sets of up to five second-order linear differential equations. By means of multipliers it can solve linear equations with variable coefficients and a variety of nonlinear differential equations.

The Civil Engineering Department's analog computer was designed specifically for solving problems encountered in the analysis of structural frames loaded either statically or dynamically. Since it is capable of solving simultaneously up to 10 linear algebraic equations or 10 second-order differential equations or several nonlinear differential equations, its use is by no means limited to structural stress analysis.

A small analog computer is operated by the Chemical and Metallurgical Engineering Department in conjunction with its Spectroscopy Laboratory. This computer can solve 12 simultaneous linear algebraic equations. It is used primarily to resolve mathematically the cracking patterns of complex mixtures.

Digital computer facilities are located in the Tabulating Service and the Statistical Research Laboratory.

At the present time the Electrical Engineering Department is in the final phases of designing and constructing an electronic digital computer capable of adding numbers in 70 millionths of a second. This computer, called MIC (Michigan Instructional Computer), will be used exclusively for teaching University engineering students how to design and modify computers. Students will continually dismantle and reassemble it to modify components, add new units, rearrange old ones, and test new theories.

MIC is made up of five main units: a "memory drum" for storing about 1000 "words" of information; a machine similar to an electric typewriter for introducing information and presenting answers; a logic section, which will select information from the drum, make computations, and then check back for further instruction; a 15-ampere power supply; and a control panel for observing, modifying, starting, and stopping operations. Many of the basic units were designed by the students and purchased from manufacturers, while others were planned and built on the scene.

# BOOKS and OTHER PUBLICATIONS

(List published in "Computers and Automation", Vol. 6, No. 7, July, 1957)

**W**E publish here citations and brief reviews of books, articles, papers, and other publications which have a significant relation to computers, data processing, and automation, and which have come to our attention. We shall be glad to report other information in future lists if a review copy is sent to us. The plan of each entry is: author or editor/title/publisher or issuer/date, publication process, number of pages, price or its equivalent/comments. If you write to a publisher or issuer, we would appreciate your mentioning **Computers and Automation**. In the case of a review with a by-line, the opinions expressed are those of the reviewer and not necessarily the views of **Computers and Automation**.

The following reviews are by Ned Chapin, Menlo Park, Calif.

Kircher, Paul/"Case Study of Electronics Computer System at Farmers Insurance Group", Management Science Research Report No. 52, 12 pp./Management Sciences Research Project, University of California, Los Angeles 24, Calif./Feb. 1957, mimeographed, free, 12 pp.

During the period 1953 through 1955, the Farmers Insurance Group of Companies made a feasibility study, decided upon the use of an IBM-705, prepared and programmed their applications, and in 1956 were actively using the equipment. The interesting features of this particular installation are: (1) the small staff that prepared the applications and the programming; (2) the efficiency of the systems work and associated programming. Some of the factors that contributed to this efficiency were: (1) the company had a history of attempting to make use of the most advanced data processing techniques available at the time; (2) the company management clearly defined to the active group precisely what was expected of the automatic computer and of them; (3) the group that was doing the analysis and programming had a very thorough knowledge of the input data that was to be used.

\* \* \*

Rawlings, Edwin W./"What Military Management Expects from the Computer," pp. 151-159 in *Pioneering in Electronic Data Processing*/American Management Association, Inc., 1515 Broadway, New York 36, N. Y./1956, printed, \$3.75.

The size and complexity of Air Force logistics problems has since 1948 forced the Air Force into active consideration of means of improving the flow of data that occupies the major portion of the time required between the initiation of a requisition for supplies and parts and the actual receipt of requisitioned material. The major difficulties have been and remain: (1) obtaining, training, and retaining qualified manpower; (2) providing accurate and timely input to the automatic computer; and (3) rethinking the entire data processing system so as to achieve the maximum benefits from the use of an automatic computer.

\* \* \*

Guest, Jr., Leon C./"Administrative Automation at Sylvania: A Case Study: Centralized Data Processing—Decentralized Management," pp. 28-37 in *Office Management, Series 144*/American Management Association, Inc., 1515 Broadway, New York 36, N. Y./1956, printed, \$1.75.

The author points out that in another 15 years, if nothing is done about it, a severe clerical shortage will exist. In order to make clerical work more productive and more efficient, the author proposes the use of automatic computers and associated peripheral equipment. On the basis of analysis at Sylvania it was found that "a high speed digital computer would solve our problem by eliminating the drudgery of a man's work, thus allowing him more time for constructive thinking. The continuance of decentralized record-keeping was a luxury which we could no longer afford, though we must retain our decentralized operating procedure and philosophy."

In order to be able to process data centrally yet maintain decentralized administration in a company as far-flung as Sylvania, it was necessary to give close attention to the problem of communication of large amounts of data over considerable distances. Western Union supplied an adequate communication network to meet this requirement. With this problem workably solved, a data processing center was established in Camillus, N. Y.

Significantly, the center was made organizationally independent of any near-by organizational unit. The function of the data processing center is to receive information, to process it, and to transmit it. It is only a service activity.

\* \* \*

Gallagher, James D./"Administrative Automation at Sylvania: A Case Study: The Program in Operations," pp. 47-72 in *Office Management, Series 144*/American Management Association, Inc., 1515 Broadway, New York 36, N. Y./1956, printed, \$1.75.

In preparing the data transmission system to be used with the Data Processing Center of Sylvania, attention had to be given to the use of the transmission equipment both for data to be processed and for normal administrative messages transmitted among the various organizational units. In order to make such a system workable, some automatic routing and classification was necessary in which routine decision-making was minimized, especially at the message-sending location. Considerable uniformity had to be obtained throughout the company to make the transmission system work adequately.

The paper also discusses the organization used at the Data Processing Center and lists the type of work to be performed at the Center. The author stresses the importance of uniformity and accuracy of input data for adequate performance from the computer.

\* \* \*

Weik, Martin H./"A Survey of Domestic Electronic Digital Computing Systems" (Ballistic Research Laboratories Report No. 971/available as PB 111996, Office of Technical Services, U. S. Department of Commerce, Washington 25, D. C./Dec. 1955, 272 pp., offset, \$4.75.

This bulletin provides a description of 84 electronic machines, most of them automatic computers and many of them not commercially available. The description is in terms of the following major categories: General System, Numerical System, Arithmetic Unit, Storage, Input, Output, Circuit Elements, Checking Features, Physical Factors, Manufacturing Record, Cost, Personnel, Reliability and Operating Experience, Additional Features and Remarks.

Under each major category, an attempt has been made to provide equivalent information for each machine. Machine-to-machine comparison should be made only with caution, however, because only incomplete editing for comparability was done. Most descriptions are accompanied by at least one photograph of the machine.

The last 70 pages of the bulletin are devoted to an explanation of the information covered by each descriptive category. In addition, some summary information is provided, such as machines by manufacturer, machines by word length, machines by quantities of tubes, machines by power requirements, etc. The bulletin closes with a 450 item glossary.

\* \* \*

Bradshaw, T. F./"Automatic Data Processing Methods", pp. 3-27 in "Proceedings: Automatic Data Processing Conference"/Graduate School of Business Administration, Harvard University, Boston 63, Mass./1956, printed, \$3.50.

This article is fundamentally a representation with the same illustrations as the material presented at an American Management Association Conference in early 1955. In this article, as in the former one, the author develops the idea that the "building blocks" of data processing are "classifying, sorting, calculating,

[Please turn to page 31]

carry storage register permits sequences of additions without carry propagation. The contents of accumulator and carry register need be combined by means of "carry assimilation" only for purposes of storing sums, etc. Sequences of additions will therefore be speeded up, as will be multiplications and divisions. Problems arising from providing for overflow detection and floating point operation will be discussed.

## 27. STUDIES OF A MONTE CARLO METHOD APPLIED TO THE ISING LATTICE PROBLEM

L. D. FOSDICK

The two-dimensional Ising lattice is a simple model of a ferromagnet with qualitatively correct and exactly known properties. It is thus an interesting test model for numerical procedures on similar, more complex systems. Accordingly, an investigation of the accuracy achievable in an application of a Monte Carlo method to the two-dimensional Ising lattice problem has been made. The dependence of the computed energy and magnetization on lattice size, number of iterations, and initial state of the system was observed. Away from the Curie Temperature, results with less than 1% error were achieved in reasonable computing times, and even in the neighborhood of the Curie Temperature errors remained less than 5%. Computations were performed on the ILLIAC at the University of Illinois.

## 28. AN INTEGRATED SET OF PROGRAMS FOR CURVE AND SURFACE FITTING ON UNEQUALLY SPACED POINTS

CHARLES HOBBY AND ALBERT NEWHOUSE

The use of orthogonal polynomials for least square curve fitting on *unequally* spaced points is a relatively new numerical approach, though not necessarily a new concept.

A general plan for curve fitting and surface fitting with orthogonal polynomials which places no restriction on argument spacing is presented. The new feature of this plan is the construction of a set of orthogonal polynomials to fit the particular problem. The plan is described in terms of a proposed set of comprehensive and integrated computer programs for curve and surface fitting. A mathematical statement of the problem and the proposed order of computation is included.

The plan has been applied on a medium scale computer and found satisfactory. Complete program writeups for the particular machine used are available.

## 29. ON THE ASYMPTOTIC BEHAVIOR OF THE METHOD OF STEEPEST DESCENT

R. J. ARMS

Let  $(x^{(n)})$  be a sequence of iterates of the classical method of minimizing the quadratic  $\phi(x)$ ,

$$\phi(x) = (x - A^{-1}b, Ax - b).$$

The symbol  $(x, y)$  or  $x^T y$  denotes the usual scalar product. It is assumed that  $A$  is a positive definite matrix. Thus

$$\begin{aligned} x^{(n+1)} &= x^{(n)} - r_n^{-1} r^{(n)}, \\ r^{(n)} &= Ax^{(n)} - b, \\ r_n &= (Ae^{(n)}, e^{(n)}), \\ e^{(n)} &= r^{(n)} / \sqrt{(r^{(n)}, r^{(n)})}. \end{aligned}$$

A. I. Forsythe and G. E. Forsythe, ["Punched-card experiments with accelerated gradient methods for linear equations," N.B.S. Applied Mathematics Series 39 (1954), pp. 55-70] have made a conjecture to the effect that  $e^{(n)}$  is asymptotically in a plane  $\pi$  determined by two vectors  $u_1$  and  $u_2$  which are eigenvectors of  $A$ . It was further conjectured that, in general,  $u_1, u_2$  are associated, respectively, with the least and largest eigenvalues of  $A$ . Proofs of these conjectures have been obtained. These results appear consistent with experience on computers indicating that the convergence of  $r^{(n)}$  to zero is usually rather slow.

## 30. TRUNCATION ERROR IN THE PARTIAL DIFFERENCE REPRESENTATIONS OF DIFFERENTIAL EQUATIONS

ALSTON S. HOUSEHOLDER

The partial difference representation of linear partial differential equations leads to a linear algebraic system of the form  $An = b$ ,

where the form of the matrix  $A$  depends upon the scheme of representation and upon the differential equation. The truncation error satisfies a system differing only in the vector  $b$ . This fact is used to obtain explicit bounds for the error in the Crank-Nicolson solution of the heat equation. Three measures of error are considered: the maximal deviation, the mean absolute deviation, and the square root of the mean square deviation.

## 31. A METHOD OF MINIMIZING ADDITIONS DURING BINARY MULTIPLICATION

GEORGE W. REITWIESNER

Under conventional binary multiplication procedures an addition (equivalently, a subtraction) is performed for each non-zero digit of the multiplier or its absolute value, and the statistically expected number of additions per multiplication is one-half the number of these digits.

This discussion develops Boolean functions for the recursive definition of substitute sets of multiplier digits for which the numbers of non-zero are irreducible with statistically expected values very near one-third the number of digits which express the signed multiplier and applies these functions to the three known binary representations: 2's complement, 1's complement, and magnitude with appended sign.

## 32. EIGENVALUES AND EIGENVECTORS OF GENERAL MATRICES

MORTON A. HYMAN

This paper presents a method, believed convenient for use with computing machines, which yields the eigenvalues and eigenvectors of a general (complex elements, no symmetry) matrix  $A$ . By a *finite* number of rotations (real or complex, depending on  $A$ ) a matrix  $B = R^{-1}AR$  is produced which has only zeros above the first super-diagonal. For any trial eigenvalue  $\lambda$ , the characteristic polynomial  $F(\lambda)$  is easily evaluated by a simple recursive process, yielding as by-product an approximation  $X$  to the corresponding eigenvector. Using a zero-finding procedure based on interpolation, sequences of  $\lambda$ 's and (simultaneously)  $X$ 's are constructed which converge to the eigenvalues  $E_i$  and eigenvectors  $\xi_i$  of  $B$ . The eigenvectors found can if necessary be refined very rapidly using an idea of Wielandt. The eigenvalues and eigenvectors of  $A$  are  $E_i, R\xi_i$ .

## 33. DIDAS

GEORGE R. SLAYTON

DIDAS is an IBM 704 DIGital Differential Analyzer Simulator which provides a quick and easy means of obtaining the solution to large systems of  $n$ th order, non-linear, simultaneous ordinary differential equations. The aim of DIDAS is to combine the program simplicity of a differential analyzer with the accuracy, capacity, and flexibility of an IBM 704. Programming consists of two parts:

1. A conventional digital differential analyzer mapping.
2. The clerical task of filling the mapping information into a fixed coding format.

Since the program is in floating point arithmetic, no scaling of the problem is required. Provisions have also been made for easily introducing empirical functions into the equation.

## 34. PROGRAMMING AN AUTOMATIC ON-LINE WIND TUNNEL DATA REDUCTION SYSTEM

JOHN N. WALZ

This discussion of the automatic on-line wind tunnel data reduction system presently in use at the Gas Dynamics Facility, Arnold Engineering Development Center includes a statement of the objectives of the system, what has been accomplished with it, and what is anticipated in the future.

All parameters of the system are discussed from the point of view of programming the system. Major emphasis has been placed on problems that are peculiar to an automatic on-line data reduction system.

## 35. GAS DYNAMICS FACILITY PLANT SIMULATOR

GEORGE MCKAY, JR.

It is desired to simulate a controlled high pressure air supply to provide flow through supersonic and hypersonic wind tunnels for the purpose of developing automatic control systems, training operators, and determining optimum characteristics for future addi-

tions to the plant. Simulation is to be accomplished by means of both hydraulic and electronic analog systems, the former to duplicate operating conditions of servo valves, and the latter to provide flow equations, choked-unchoked valve characteristics, line loss coefficients, stilling chamber heater effects, equivalent transducer outputs, etc. Consideration is given to the elimination of parameters not contributing significantly to overall performance though circuits for providing these functions are presented.

### 37. AUTOMATIC IMPLEMENTATION OF COMPUTER LOGIC

E. F. MORRIS AND T. E. WOHR

A program is described whereby the information contained in a circuit design manual is stored in a computer and then operated upon to produce circuits which will function in a specified logical chain. This technique can be applied to any type of circuit whether it be tube, transistor, or diode. However, due to the present emphasis on solid state devices, the report is devoted exclusively to transistor circuits as used in computer logic.

### 38. A METHOD OF SIMULATING A DIFFERENTIAL ANALYZER ON A DIGITAL COMPUTER

H. FRED LESH AND WM. R. HOOVER

As digital computers become larger and faster, the ratio between problem preparation time and solution time grows distressingly large, and it becomes a pressing problem to find quicker, more efficient ways to present problems to computers. This observation has led in recent years to the development of a host of compilers, formula translators, and interpretive routines for general problems, but in the specific field of differential equations less seems to have been done. The system with which this paper is concerned is one for simulating an electronic analog computer on a digital computer using interpretive techniques and Runge Kutta integration. This system maintains the flexibility and ease of programming of an electronic analog computer while also incorporating all the advantages of a digital computer.

### 43. DYNAMIC FLOW DIAGRAMS: A NEW CONCEPT IN COMPUTER PROGRAMMING

ROLIN P. MAYER

A *dynamic flow* diagram represents a computer program in such a way that a clear and detailed understanding of its operation can be grasped easily. Every step of the program, all references to individual stored parameters and variables, and all modifications to instructions, references to subroutines, etc., are clearly shown *in time sequence*. Such diagrams are being used in checking the computer programs for a very large real-time control system. The same technique can be used to circulate ideas between programmers of completely different machines. The technique can also be used to simplify the initial preparation of a program.

### 47. AUTOMATIC ERROR CONTROL IN THE SOLUTION OF DIFFERENTIAL EQUATIONS ON THE IBM 650

W. B. FRITZ AND N. MORAFF

An IBM 650 routine for automatic error control in the numerical integration of linear and nonlinear systems of differential equations is presented. The control is achieved by applying a variation of the method commonly called "extrapolation to zero-step size." Advantages of this particular procedure are its speed, improved accuracy of results, and general applicability. It proves to be a convenient compromise between complete control and no control over the error in problems in which nonlinear behavior is evident. The error control method has been used in conjunction with the modified-Euler integration procedure, but it is easily adaptable to any other single step procedure. Use of the routine has led to a considerable reduction in elapsed time between problem formulation and numerical solution.

### 48. SECOND ORDER FORMULAS FOR FOURIER COEFFICIENTS

HENRY F. HUNTER

The use of a digital computer for the calculation of Fourier coefficients of empirical functions requires formulas for the numerical evaluation of integrals of the form

$$\int_0^{2\pi} y \sin nx \, dx \text{ and } \int_0^{2\pi} y \cos nx \, dx .$$

If the empirical data are originally in the form of a graph, such as an oscillograph tracing, and if there are a great many such tracings requiring harmonic analysis, then the large part of the human labor is in the reading and recording of enough points to represent the curves with sufficient accuracy. The usual formulas for Fourier coefficients require that points be read at equal intervals close enough together so that the polygon connecting successive points is a reasonably good fit to the original curve even in the region of greatest curvature. In order to reduce the number of points to be read, without sacrificing accuracy, formulas were developed for Fourier coefficients of the piecewise parabolic curve through the triples of points determined by successive pairs of unequal intervals.

### 50. CALCULATOR CHARACTERISTICS WHICH WILL REDUCE PROGRAM CHECKOUT TIME

M. S. MAXWELL

This paper discusses many of the existing characteristics plus some new ideas for computer characteristics which will reduce program checkout time. There is a special emphasis of the characteristics which will increase the effectiveness of interpretive routines and other programmed aids. Some of the items discussed will include a different approach to console organization by use of a special punched card for presetting console switches, computer controlled program transfers on specified operand addresses, and more flexible breakpoint controls.

### 52. ERROR ANALYSIS IN FLOATING POINT ARITHMETIC

JOHN W. CARR III

The use of built-in floating point arithmetic in modern digital computers means large problems are being attacked generally without adequate error analysis.

An attempt is made in this paper to analyze two different floating-point machine systems, the "normalized" notation, and the "significant" notation. The former assumes all results are normalized, the latter that results will carry information about the significance of the numbers involved.

An analysis similar to that given by Householder in his book is given for several basic problems, including polynomial evaluation, and the laws of associativity and distributivity.

### 53. USE OF THE AUTOCODER IN TECHNICAL COMPUTING ON THE IBM TYPE 705 EDPM

ROBERT W. SCHRAGE

The IBM Type 705 EDPM installed at the Bayway refinery of Esso Standard Oil Company is used for both data processing and technical computing. Programming for the latter activity has been based exclusively on the Autocoder, supplemented by a specially developed library of routines. This composite, called Autocoder A, provides a general purpose technical programming system of great flexibility. The external specifications, and internal operations, of the library routines have been interrelated for efficiency and ease of programming. Experience with this approach to technical computing on the 705 has been quite satisfactory.

### 54. A STUDY OF THE ORDER TYPES AND REFERENCES-TO-STORE IN SOME ILLIAC AND FERUT LIBRARY ROUTINES

J. H. CHUNG, C. C. GOTLIEB AND D. MULLER

Interpretive routines were written on ILLIAC and FERUT, for counting the number of instructions of each type obeyed during the execution of a program. These counts were taken on a number of library programs and the results are given, along with some additional tables to show the fraction of machine time used for executing the instructions, for finding the operands, and for finding the instructions. The interpreters also listed the number of references to the most frequently used store locations. Some statistics regarding the use of B-lines in FERUT programs are presented.

### 55. A VERSATILE DIGITAL PROGRAMME FOR CALCULATING COMPLEX PLANE PLOTS FROM FEEDBACK CIRCUIT DIAGRAMS

ELDO C. KOENIG AND THOMAS GUENTHER

The programme described is applicable to linear control systems, or to any linear system described by an analog computer diagram, for determining stability or for checking analog computer results, and there is no limit on the size or degree of complexity of the

**RCA offers opportunities**

# IN MISSILE TEST Data Reduction

*for*

- ▶ **MATHEMATICIANS**
- ▶ **STATISTICIANS**
- ▶ **PHYSICISTS**
- ▶ **ASTRO-PHYSICISTS**

Degree plus experience in reduction of test data, applied mathematics, statistical techniques, or observatory practices. Positions now available on Florida's central east coast.

Liberal company benefits—Relocation assistance.

*For information and arrangements for personal interview, send complete resume to:*

**Mr. H. Storz, Mgr.**  
**Technical Employment, Dept. N-14G**  
**RCA Service Co., Inc.**  
**Missile Test Project, Mail Unit 114**  
**Patrick Air Force Base, Florida**



**RADIO CORPORATION OF AMERICA**

system. The data for the programme is obtained directly from the block diagrams of the control system or analog computer diagram. Information is obtained for drawing the inverse or direct complex plane plots.

#### 57. AN ILLIAC PROGRAM FOR SIMULATING THE BEHAVIOR OF ASYNCHRONOUS LOGICAL CIRCUITS AND DETECTING UNDESIRABLE RACE CONDITIONS

W. S. BARTKY AND D. E. MULLER

The analysis of asynchronous circuits is somewhat difficult in that one must try to keep in mind all probable paths a circuit may follow after first being placed in an initial state. The extension from all probable paths to all possible paths mathematically simplifies the model of a circuit; however in most instances, the number of such paths increases and the task becomes physically impossible. In particular the design of circuits, whose final behavior is an invariant of the path taken, "semi-modular circuits," was impeded, since a means of analyzing them must necessarily examine all possible paths. This paper is a discussion of a computer program which was written to analyze these circuits. A sufficient amount of material on semi-modular circuits is also presented, so that the paper is complete within itself.

#### 70. ON THE USE OF A COMPUTER IN THE DESIGN OF HIGH ENERGY ACCELERATORS

JAMES N. SNYDER

The Midwestern Universities Research Association (MURA) is a not-for-profit corporation made up of fifteen midwestern universities. The goal of this organization is to design, construct, and operate a high-energy particle accelerator of novel and advanced design. New concepts of particle acceleration and control developed by MURA make feasible the consideration of machines whose effective energies could only be achieved by conventional accelerators of energies near one trillion electron volts.

The theoretical and design problems encountered in treating accelerators of this new kind are not tractable to analysis. Therefore, the effective exploitation of high speed computers has been central to the MURA design effort. The programs and methods used on both the ILLIAC and the MURA IBM 704 will be described.

#### 71. CONCLUSIONS ON LANGUAGE TRANSLATION

A. F. R. BROWN

A method for translating chemical French has been evolved which is probably applicable to any language translation problem. Rules are evolved sufficient to translate successively more trial sentences. When about 200 trial sentences have been satisfactorily dealt with, (a matter of 100 hours work), the method is programmed for a computer, and long passages are translated to find inadequacies. Further rules, when evolved, are inserted in the dictionary, which is capable of indefinite expansion. A dictionary entry consists of a number of possible meanings, together with instructions for selecting and permuting these meanings. One very important feature is that each set of instructions is numbered, and the method of translation consists of obeying the linguistic instructions for a whole sentence in numerical order, and not necessarily in the order in which the word occurs in the sentence.

### **WHO'S WHO in the COMPUTER FIELD 1956-57**

Vital information about almost every person interested in any phase of the computer field.

Over 200 Pages, 12000 Entries  
\$17.50 per copy from:

**COMPUTERS and AUTOMATION**  
**Berkeley Enterprises, Inc.**

815 Washington Street

Newtonville 60, Mass.

COMPUTERS and AUTOMATION for July, 1957



summarizing, and recording." In this article, as in the previous one, there is still a lack of full justification that these "building blocks" are of any practicable significance in the design of automatic data processing systems. And there is the one statement in this article which leaves the reviewer wondering: "... a programmer is a highly trained man who starts off with a fine logical mind—a really difficult combination."

In spite of such shortcomings, the author does say some things in the article that are of value and that bear repeating. For example, he points out that the costs of preparing for an automatic computer are not small. He points out, although he mentions it very softly, that the effective use of an automatic computer may involve doing things in a new way. And he points out that the use of an automatic computer can make available to management information which was previously unobtainable within a reasonable time.

\* \* \*

Gregory, Robert H./"Document Processing", pp. 56-60 in Proceedings of the Eastern Joint Computer Conference/Institute of Radio Engineers, Inc., One E. 79 St., New York 21, N. Y./1956, printed, \$3.00.

The documents the author refers to are primarily business forms. Some business forms are used only within a firm and some are used between various firms. It is the author's feeling that the intra-firm documents are much more susceptible to being handled in one of three alternative ways to the present methods of handling. These three alternative ways are: (1) "make the document independent of manual processing either after generation, or at generation and thereafter"; (2) "separately process the information and the documents"; (3) "eliminate a document by making some other document serve the purpose or by entirely dispensing with documentation."

The first concept of making the document independent of manual processing is substantially the first principle advocated in integrated data processing. Considerable work is being done to make integrated data processing effective at a number of companies at present.

The second concept, to process separately the information and the document, is considerably more difficult to carry out. The author cites one proposal for its use in the reconciliation of government checks by the Treasury Department.

The third concept, to eliminate the document entirely, appears attractive at first glance, but very little work has been done on it so far. The author points to Bureau of Standards' experiments with SEAC and DYSEAC to indicate that machine-to-machine communication is possible without the use of documents.

The author closes his paper with a suggestion that present precision in data processing operations in business may not all be entirely necessary.

\* \* \*

Slater, Robert E./"Electronic Data Processing in an Insurance Company" pp. 33-39 in "Pioneering in Electronic Data Processing"/American Management Association, 1515 Broadway, New York 36, N. Y./1956, printed, \$4.75.

The author indicates that in the late 1940's, John Hancock Co. began to investigate the possibilities of improved methods of processing data in business. The decision made at that time was that it would be wise for them in their circumstances to convert to punched card equipment until automatic computing equipment adequate to the company's needs became available.

The company converted between 1948 and 1955. In 1954, the company actively began the investigation of the use of an automatic computer of large size. Applications were selected from the areas of premium billing, premium accounting, dividend accounting, commission accounting, loan accounting, valuation of policies liabilities, dividend calculation, mortality studies, and new issues and termination. Rather than convert from present procedures to automatic computer procedures on a policy by policy basis, the conversion was made for all policies on the application bases just listed.

real . . .  
rational . . .  
remarkable . . .

# ROBOTS

for trade shows, sales meetings, exhibits, etc., guaranteed to STOP every person attending the show and make him notice your display —

## RELAY MOE

A robot that will play the game Tit-Tat-Toe with a human being and either win or draw all the time, or (depending on the setting of a switch) will sometimes lose so as to make the game more encouraging for the human being. Pictured in Life Magazine, Radio Electronics. Has drawn crowds in Dallas, Texas, Atlantic City, and New York. Scheduled to go to Stockholm, Sweden, for 2-week exhibit.

## CYCLOPS

An improved electronic robot squirrel with a single photoelectric eye and a scoop, that will "hunt" for a "nut" indicated by a person in the audience, pick it up in his "hands", take the "nut" to his "nest", there leave it, then hunt for more nuts. Operates in lighted areas.

## REMOTE CONTROL "STEAM" SHOVEL

Miniature electric power shovel. Moves forward and back, turns right or left, raises or lowers boom, raises or lowers shovel, extends or retracts shovel. Operates at end of a cable; radio remote control being developed also.

And other fascinating, intelligent small robots finished or being developed: FRANKEN, MARBELLINA, SIMON, SQUEE, . . . . .

-----Mail This Coupon or a copy of it-----  
To: Berkeley Enterprises, Inc., 513 Ave. of the Americas, R-205, New York 11, N. Y.  
Please send me free data on Berkeley Robots for rent or sale. The application we have in mind is:  
.....  
From: Name .....Title .....  
Organization .....Address .....

U. S. Navy Department/"Introduction to Electronic Data Processing Machine Applications" (NAVSANDA Publication #283)/Bureau of Supplies and Accounts, Code S-1, Navy Department, Washington 25, D. C./March 1955, offset, 162 pp., price and availability unknown.

The chapter headings in this paper-bound report are: Development of Data Processing Machines; What are Electronic Computers and Data Processing Machines; Binary Numbers; Methods of Storing Information; Input-Output Devices; How an EDPM Works; Management Looks at EDPM; An EDPM Program; Decision; Mathematics in Business; Justifying an EDPM Installation; Problem Definition; Problem Specification; Programming; EDPM Personnel; Electronics and the Clerical Worker; Steps to the Future.

This material has apparently been put together from a number of sources, since there is very little original material in the volume and since in content and treatment it is reminiscent of other publications in the computer field. In particular, this material has a very strong IBM slant. One serious typographical error noted by the reviewer is in paragraph 2.51, where what should read "Distributon" actually reads "Distribution."

\* \* \*

Brayer, Herbert O./"Small Firms Can Afford Electronic Processing", pp. 19, 44 in American Business, Vol. 26, No. 6, June, 1956/Dartnell Publications, Inc., 4660 N. Ravenswood, Chicago 40, Ill./1956, printed, \$4.00 per year.

The author indicates that in his view, many smaller companies cannot justify the purchase or lease of automatic computers. But many of these same companies can justify the use of data processing services such as provided by some services on a contract basis. The author indicates that savings on the order of 50 percent can sometimes be realized.

\* \* \*

Alexander, Samuel N./"Integrated Data Processing", pp. 3-10 in Office Management, Series Number 144/American Management Association, Inc., 1515 Broadway, New York 36, N. Y./1956, printed, \$1.75.

The author points out that since its start, IDP has stressed the origination of information in a form that can be processed by machine without human transcription. As an extension of this, IDP has also increasingly come to stress the need for viewing

business information processing as a unified whole, not as separate bits and pieces. This stress results in a more goal-oriented information-processing system from origination to final use, rather than just the processing of "horizontal" pockets of high-volume repetitive work.

\* \* \*

Groelinger, Herbert J./"Use of Electronic Computers for Business Management," pp. 295-299 in Journal of Industrial Engineering, Vol. 7, No. 6, Nov.-Dec. 1956/American Institute of Industrial Engineers, Inc., 145 N. High St., Columbus 15, Ohio/1956, printed, \$6.00 per year.

This introductory article is more concerned with automatic computers as machines than with the use of these machines. The uses, very briefly cited, are exemplified by American Airlines, U. S. Defense Department, "several national magazines," U. S. Bureau of the Census, and the U. S. Navy. In addition, payroll and raw material accounting are mentioned in passing. The bulk of the article discusses the distinction between analog and digital computers, the functional organization of a digital computer, its "performance," coding, storage, arithmetic and logic.

## Syntax Patterns

[Continued from page 17]

this type of search. To duplicate the work on other types of equipment would require considerably more time and more complicated operations, especially in the comparison and compression phases. The actual computer time consumed, from primary pattern formation through the compression and comparisons to the final data output stage, was about 30 minutes for the whole group of sentences examined.

<sup>1</sup>Further technical details are given in The use of SEAC in syntactic analysis, by R. B. Thomas, which will be published in Monograph Series in Linguistics and Language Studies, No. 10, Georgetown University Press, scheduled to appear November 1957.

Paste label on envelope ↓

Enclose form in envelope ↓

**5¢ POSTAGE WILL BE PAID BY —**

**Berkeley Enterprises, Inc.**  
815 Washington St.  
Newtonville 60, Mass.

**BUSINESS REPLY LABEL**

NO POSTAGE NECESSARY IF MAILED IN U.S.A.

FIRST CLASS  
PERMIT NO. 33531  
Sec. 34.9 P. L. & R.  
BOSTON, MASS.

### READER'S INQUIRY FORM

Name (please print).....

Your Address?.....

Your Organization?.....

Its Address?.....

Your Title?.....

Please send me additional information on the following subjects for which I have circled the CA number:

1	2	3	4	5	26	27	28	29	30	51	52	53	54	55	76	77	78	79	80	101	102	103	104	105	126	127	128	129	130
6	7	8	9	10	31	32	33	34	35	56	57	58	59	60	81	82	83	84	85	106	107	108	109	110	131	132	133	134	135
11	12	13	14	15	36	37	38	39	40	61	62	63	64	65	86	87	88	89	90	111	112	113	114	115	136	137	138	139	140
16	17	18	19	20	41	42	43	44	45	66	67	68	69	70	91	92	93	94	95	116	117	118	119	120	141	142	143	144	145
21	22	23	24	25	46	47	48	49	50	71	72	73	74	75	96	97	98	99	100	121	122	123	124	125	146	147	148	149	150

**REMARKS:**

# IMPORTANT NEWS

*For former users  
of Western Electric  
Polar Relays*

## **New Series PTW Polar Relay replaces WE 255A ... and costs less!**

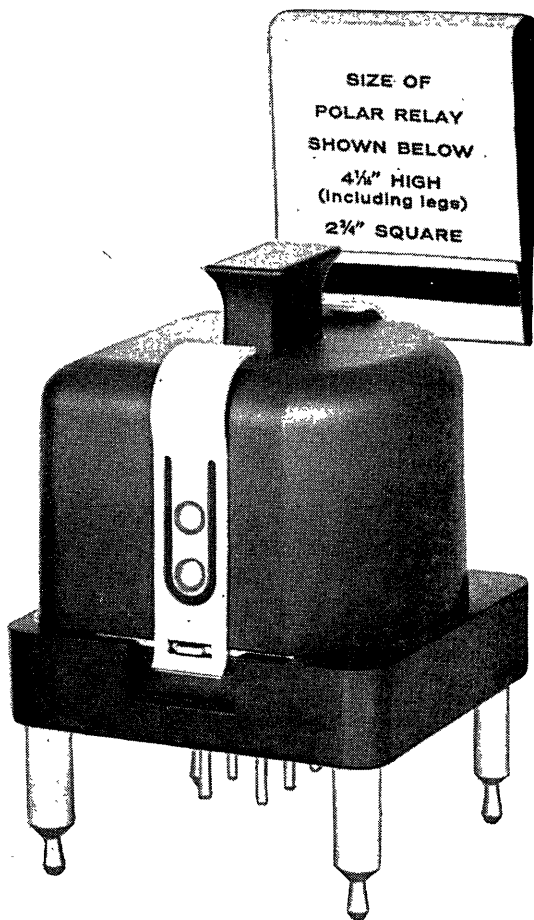

Since Western Electric announced their polar relays are no longer available, many relay users have been looking for a suitable replacement.

Look no longer! Automatic Electric's new PTW Polarized Relay is the complete equivalent of WE 255A relays in data transmission circuits. And the PTW series offers outstanding advantages over the relays you have been using.

Lower cost, for one thing. Less maintenance, for another. A new concept of relay design assures adjustments that stay put practically forever. It's small . . . fast . . . sensitive. Adaptable for new or existing installations.

More good news—we can supply PTW series in practically any quantity—and *on short notice*. If you'd like a complete briefing before you order, write for Circular 1821. Automatic Electric Sales Corporation, Northlake, Illinois.

*In Canada: Automatic Electric Sales (Canada) Ltd., Toronto. Offices in principal cities.*

**AUTOMATIC  ELECTRIC**  
A member of the General Telephone System -  
One of America's great communications systems 

# NEW PATENTS

RAYMOND R. SKOLNICK, Reg. Patent Agent

Ford Inst. Co., Div. of Sperry Rand Corp.  
Long Island City 1, New York

**T**HE following is a compilation of patents pertaining to computers and associated equipment from the "Official Gazette of the United States Patent Office," dates of issue as indicated. Each entry consists of: patent number/inventor(s)/assignee/invention. Printed copies of patents may be obtained from the U. S. Commissioner of Patents, Washington 25, D. C., at a cost of 25 cents each.

- March 5, 1957: 2,783,650/Leslie J. Street, Basingstoke, Eng./Kelvin & Hughes Lim., Glasgow, Scotland/A multiplying and dividing mechanism.
- 2,783,941/Arthur F. Naylor, Haddonfield, N. J./Radio Corp. of America, Del./A computing device for solving simultaneous equations.
- 2,783,942/William H. Newell, Mt. Vernon, N. Y./Sperry Rand Corp., Del./A navigational Rhumb line computer.
- 2,784,324/Leonard J. Craig, Beverly Hills, Calif./Hughes Aircraft Co., Culver City, Calif./A D.C. multiplier employing magnetic amplifiers.
- 2,784,389/Martin J. Kelley, Endicott, N. Y./International Business Machines Corp., New York, N. Y./An electrical information storage unit.
- 2,784,390/Kun Li Chien, Haddonfield, N. J./Radio Corp. of America, Del./A static magnetic memory.

- 2,784,391/Jan. A. Rajchman, Princeton, and Richard O. Endres, Moorestown, N. J./Radio Corp. of America, Del./A magnetic memory system.
- 2,784,396/Harold R. Kaiser, Woodland Hills, Claude A. Lanc, Culver City, and Wilford S. Shockency, Torrance, Calif./Hughes Aircraft Co., Del./A high speed electronic analog to digital converter system.
- March 12, 1957: 2,784,906/Donald W. Davies, Southsea, Eng./National Research Development Corp., London, Eng./An electronic digital computer with pulse widening means.
- 2,784,907/Frederic C. Williams, Timperley, and Tom Kilburn, Davyhulme, Manchester, Eng., and Dennis L. Gibbings, Croydon, New South Wales, Australia/National Research Development Corp., London, Eng./An electronic adding device.
- 2,784,908/John W. Gray, Cambridge, and William D. Green, Jr., and David Sayre, Boston, Mass./U.S.A./An electrical navigation apparatus.
- 2,784,909/George M. Kirkpatrick, Syracuse, N. Y./General Electric Company, New York/An electronic multiplying apparatus.
- 2,785,304/John Bruce, London, Keith G. Huntley, Harlington, Hayes, and Eric L. White, Iver, Eng./Electric & Musical Industries Lim., Hayes, Eng./An electronic register for binary digital computing apparatus.
- March 19, 1957: 2,785,853/Etienne Augustin Henri Honoré and Emile Leon Gabriel Torcheux, Paris, and Roger Desire Camille Roy, St. Cloud, Fr./Guy C. J. Cordice-Roy/An electric analog computer and similar circuits.
- 2,785,854/Adam Chaimowicz, Paris, Fr./Compagnie des Machines Bull, Paris, Fr./A computing apparatus for multiplying a multiplicand expressed in the binary system and represented by an initial time spaced pulse train by a decimal multiplier.
- 2,785,855/Frederic Calland Williams, Timperley, Tom Kilburn, Davyhulme, Manchester, and Geoffrey Colin Tootill, Hollinwood, Eng./National Research Development Corp., London, Eng./An electrical storage apparatus for the storage of digital information.

## ADVERTISING INDEX

Following is the index of advertisements. Each item contains: Name and address of the advertiser / page number where it appears / CA number in case of inquiry (see note below) / name of the agency if any.

- AMP, Inc., Harrisburg, Pa./Page 21/CA No. 41/M. Russell Berger, Inc.
- Automatic Electric Co., Northlake, Ill./Page 33/CA No. 42/Proebsting, Taylor, Inc.
- Berkeley Enterprises, Inc., 513 Ave. of the Americas, New York 11, N. Y./Page 31/CA No. 43.
- Bryant Chucking Grinder Co., Springfield, Vt./Page 25/CA No. 44/Henry A. Loudon Advertising, Inc.
- Computers and Automation, 815 Washington St., Newtonville 60, Mass./Page 26/CA No. 45.
- Douglas Aircraft Co., Inc., Santa Monica, Calif./Page 35/CA No. 46/J. Walter Thompson Co.
- Electronic Associates, Inc., Long Branch, N. J./Page 36/CA No. 47/Halsted & Van Vechten, Inc.
- ESC Corp., Palisades Park, N. J./Page 5/CA No. 48/Keyes, Martin & Co.

- Lockheed Missile Systems Div., Box 504, Sunnyvale, Calif./Page 19/CA No. 49/Hal Stebbins, Inc.
- Potter Instrument Co., Inc., Great Neck, N. Y./Page 3/CA No. 50/Duncan-Brooks, Inc.
- RCA Service Co., Missile Test Project, Patrick Air Force Base, Florida/Page 30/CA No. 51/Al Paul Lefton Co., Inc.
- RCA, Harrison, N. J./Page 3/CA No. 52/Al Paul Lefton Co., Inc.
- Ramo-Wooldridge Corp., 5730 Arbor Vitae St., Los Angeles, Calif./Page 2/CA No. 53/The McCarty Co.
- Sylvania Electric Products, Inc., 1740 Broadway, New York 19, N. Y./Pages 8, 9/CA No. 54/J. Walter Thompson Co.

### READER'S INQUIRY

If you wish more information about any products or services mentioned in one or more of these advertisements, you may circle the appropriate CA Nos. on the Reader's Inquiry Form on p. 32 and send that form to us (we pay postage; see the instructions). We shall then forward your inquiries, and you will hear from the advertisers direct. If you do not wish to tear the magazine, just drop us a line on a postcard.

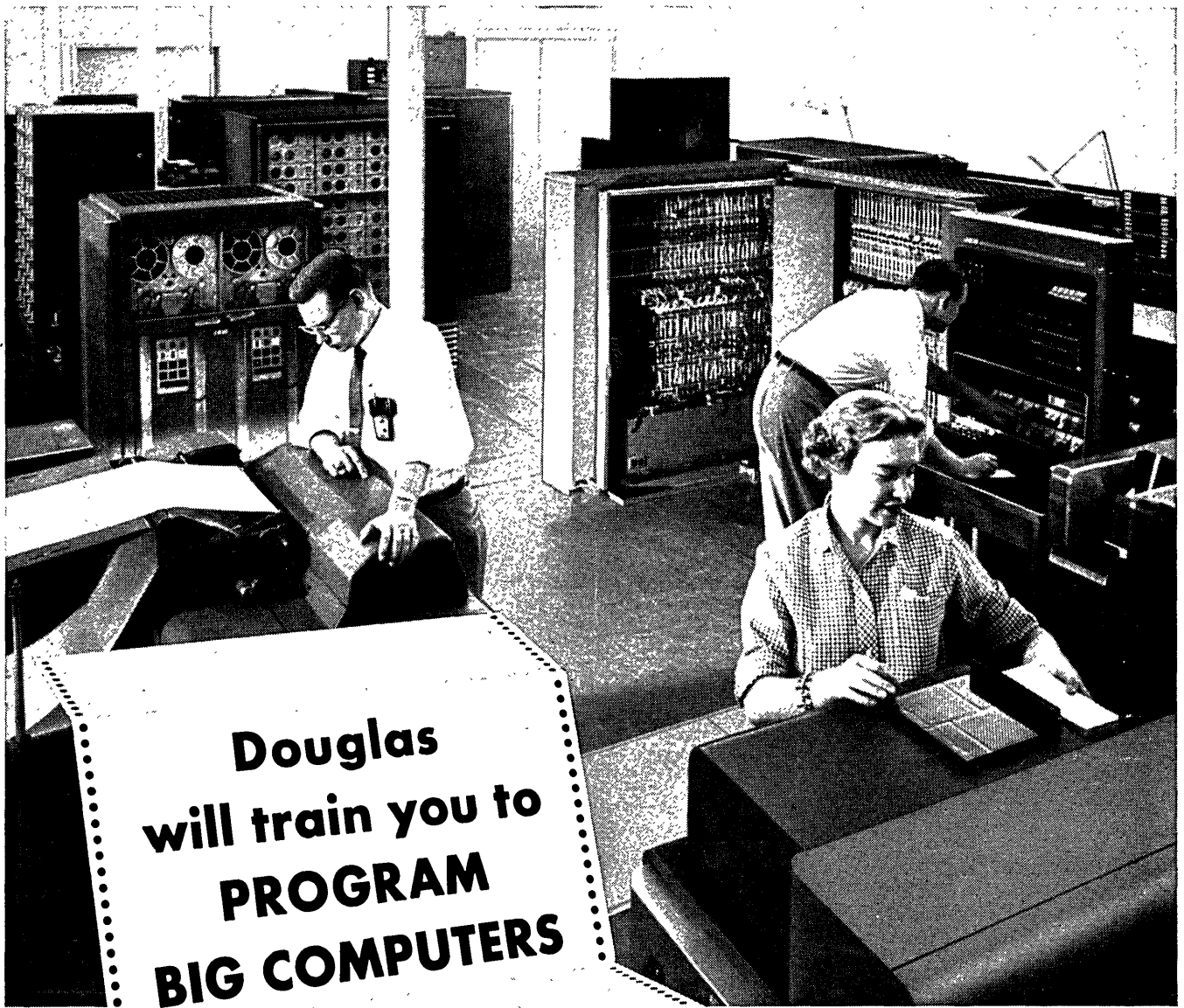

...a challenging new field that offers ground-floor opportunities to qualified personnel

Five years ago, there were less than 100 specialists programming big computers. It is expected that by 1965, industry's needs will exceed 100,000.

Douglas Aircraft, a pioneer in this field, is rapidly expanding its computing operations. You will be trained while working with expert programmers. In Southern California, you can conveniently attend some of the nation's leading universities offering specialized courses in computing. Advancement will be as rapid as your ability to apply your new talents.

Our computing engineers are involved in every phase of aircraft and missiles work...including many long-range commercial and military projects of vital importance.



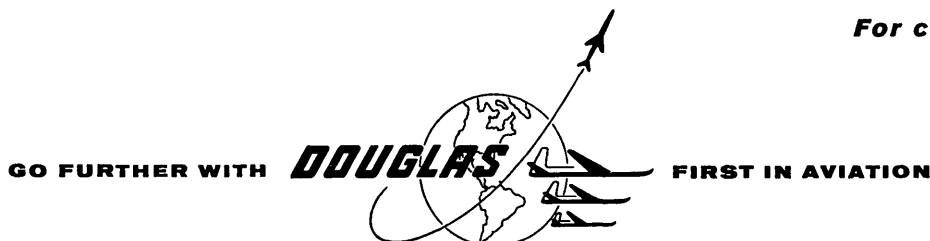



























Programming requires an alert and logical mind and the ability to organize large projects without losing sight of details. If you have had formal training in mathematics, science or engineering, your professional future at Douglas in programming can be unlimited.



**For complete information, write:**

JOHN LOWE  
CHIEF, COMPUTING  
ENGINEERING SECTION  
DOUGLAS AIRCRAFT COMPANY  
BOX 620-M  
SANTA MONICA, CALIFORNIA



31 DAYS <b>AUGUST</b> 31 DAYS						
SUN.	MON.	TUE.	WED.	THU.	FRI.	SAT.
						
						
						
						
						

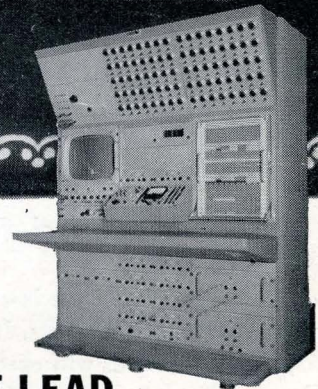

## EACH DAY ANOTHER COMPANY TAKES THE LEAD WITH PACE

Wherever engineers assemble, the name PACE has become known as the signature for the latest developments in the art of Analog Computing. The industry has confidence in EAI's PACE Analog Computing Equipment, because it has a proven record, in actual operating hours, of unbeatable accuracy, unmatched speed, and complete dependability. Pictured above are the PACE Analog Computing Systems 16-31R and 16-131R. Write for full details on PACE Equipment and on time rental at EAI's Computation Centers in Princeton, N. J., Los Angeles, Calif., and Brussels, Belgium. Please address all inquiries to: Electronic Associates, Inc., Dept. , Long Branch, N. J.

**ELECTRONIC  
ASSOCIATES**

*Incorporated*

E A I S E T S T H E

**P A C E**  
PRECISION ANALOG COMPUTING EQUIPMENT

LONG BRANCH • NEW JERSEY

®