

COMPUTERS

a n d AUTOMATION

DATA PROCESSING • CYBERNETICS • ROBOTS

**Flight Simulators in
the Jet Age**

**Time Sharing in Large
Fast Computers**

**Business-Type
Problems From a
Computer Standpoint**

**Machine Translation
in the Soviet Union**

AUGUST

1959

•

VOL. 8 - NO. 8

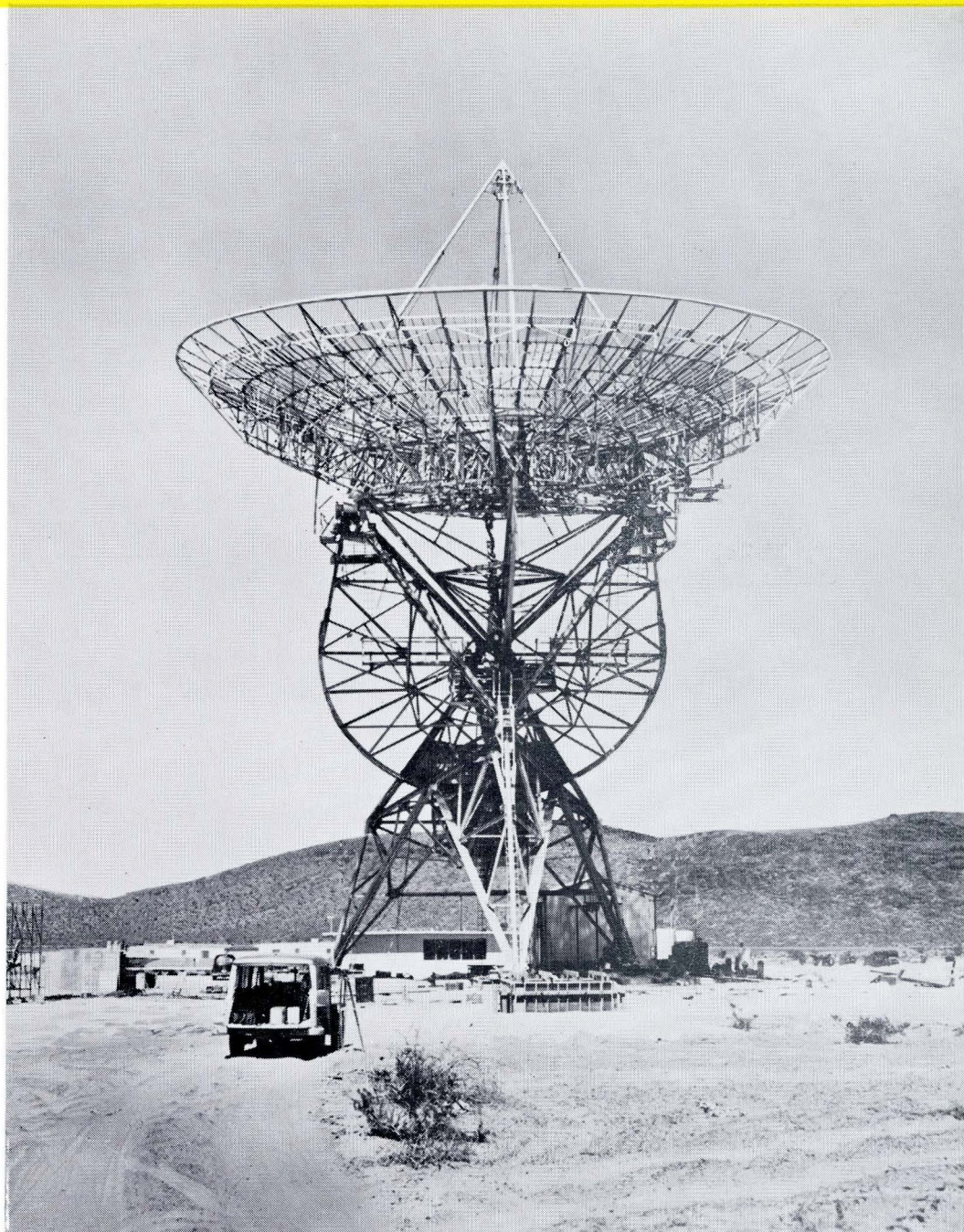

Bendix G-15

PUNCHED CARD AND TABULATOR COUPLER

*... a new accessory for the Bendix G-15 Digital
Computer for low cost, high performance
punched card computing*

Now, at a cost significantly below that of any similar equipment, Bendix provides a complete computing system with 100 card per minute punched card input and output, and 100 line per minute tabulation.

Heart of the system is the Bendix G-15 general purpose digital computer, which has proven its performance in well over 150 successful installations.

The CA-2 coupler, a newly developed G-15 accessory, enables the computer to operate in conjunction with

conventional punched card and tabulating equipment.

A full 80 columns of numeric, alphabetic, or special character information can be accommodated using only the CA-2 as a connecting link between the card equipment and the G-15. Any column of the card can contain any one of the three types of information.

Three input-output units may be connected simultaneously . . . one for input, one for output, and a third for input or output. Data may be read or punched by standard card units, or printed by standard tabulators. All input and output is under complete control of the computer. Computation can proceed during the input or output cycle, thus assuring maximum over-all computing speed.

In addition to the CA-2, the computer's typewriter and paper tape equipment, and auxiliary magnetic tape storage units may be used for completely versatile input, output, and storage. Both power and space requirements of the complete punched card computer system are approximately half that of other systems of this type.

A system that includes the G-15 computer, the CA-2 coupler, two summary punches and a tabulator, leases for approximately half the price of a typical medium-priced system with similar capabilities.

Whether you are now using punched card or computing equipment, or if you are delaying such plans due to high costs, you will want to learn more about this inexpensive, efficient equipment. Detailed technical information on the G-15 and the CA-2 will be sent on request. Write to the Bendix Computer Division of Bendix Aviation Corporation, Los Angeles Dept. D-11

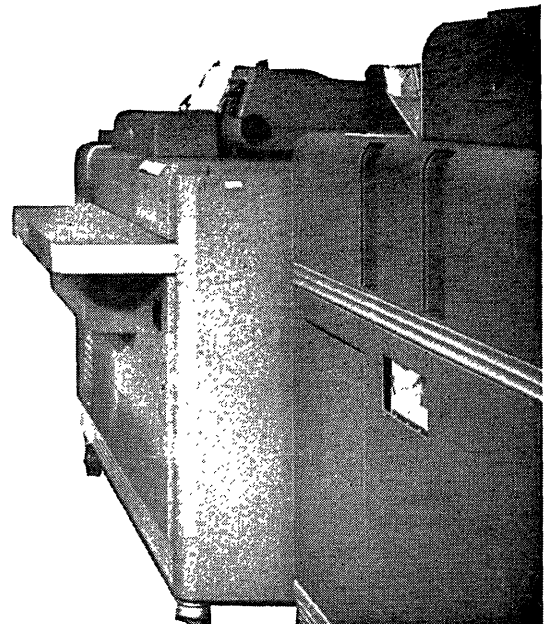
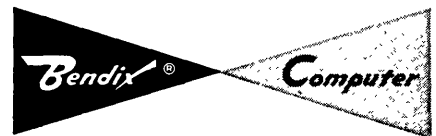
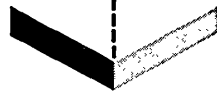

The Ultimate in Advanced Data Processing

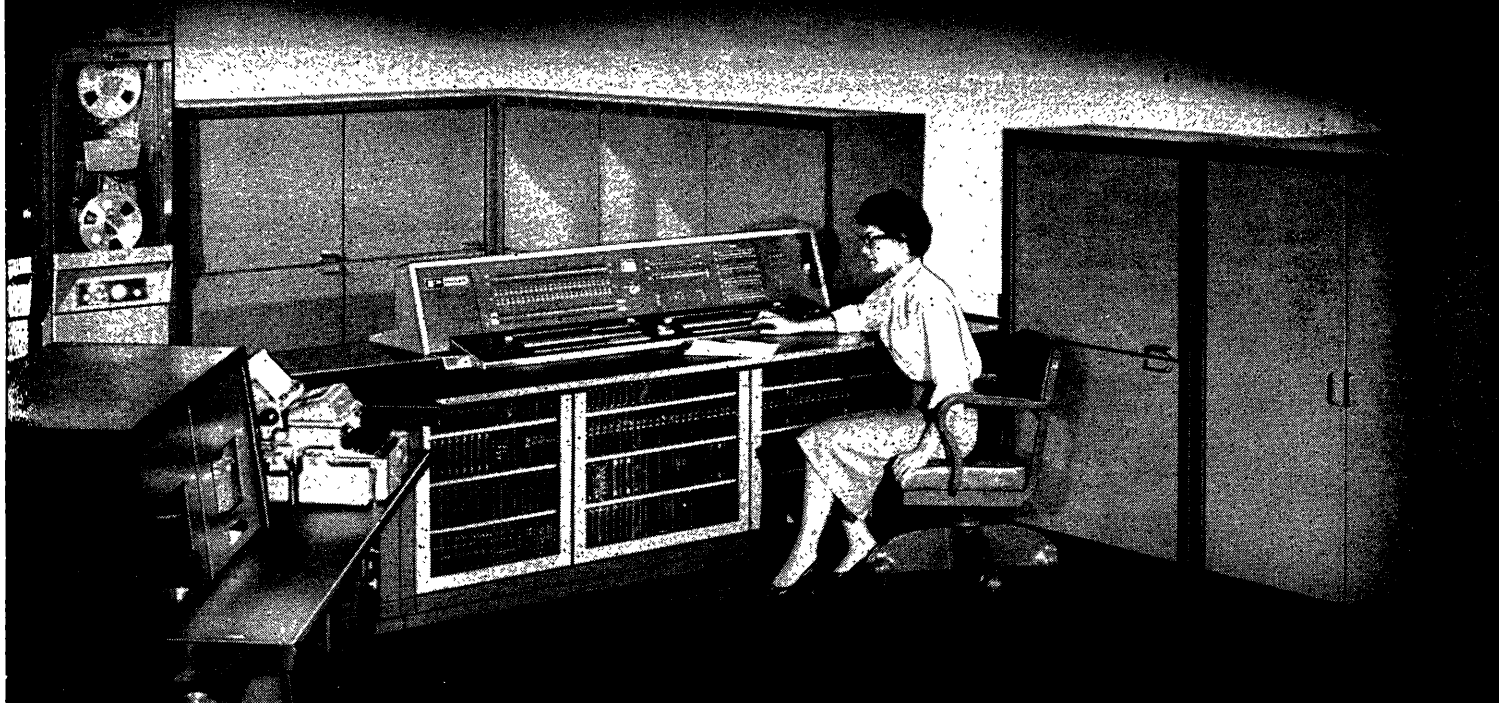

transac® S-2000

by PHILCO

...First in Transistorized Data Processing

Conceived and created by the top technical skills in the industry, TRANSAC S-2000 all-transistor data processing equipment is recognized as the first and finest. With unmatched speed and incomparable quality, TRANSAC S-2000 is the ultimate for accurate, uninterrupted data processing . . . a new horizon in the state of the art. Philco has the resources and the organization to solve your data processing problems and assure you long and dependable service.

PHILCO®

Government and Industrial Division

4700 Wissahickon Avenue, Philadelphia 44, Pennsylvania

COMPUTERS

and AUTOMATION

DATA PROCESSING • CYBERNETICS • ROBOTS

Number 8
Volume 8

AUGUST, 1959

Established
September 1951

EDMUND C. BERKELEY *Editor*
H. JEFFERSON MILLS, JR. *Assistant Editor*
NEIL D. MACDONALD *Assistant Editor*

SERVICE AND SALES DIRECTOR

MILTON L. KAYE MURRAY Hill 2-4194
535 Fifth Ave. New York 17, N.Y.

CONTRIBUTING EDITORS

ANDREW D. BOOTH
JOHN W. CARR, III
NED CHAPIN
ALSTON S. HOUSEHOLDER

ADVISORY COMMITTEE

MORTON M. ASTRAHAN
GEORGE E. FORSYTHE
ALSTON S. HOUSEHOLDER
SAMUEL B. WILLIAMS
HOWARD T. ENGSTROM
RICHARD W. HAMMING
HERBERT F. MITCHELL, JR.

ADVERTISING REPRESENTATIVES

Middle Atlantic States MILTON L. KAYE
535 Fifth Ave. New York 17, N.Y.
MURRAY Hill 2-4194
Washington 6, D.C. ROBERT CADEL
1519 Connecticut Ave. Columbia 5-9727
San Francisco 5 A. S. BABCOCK
605 Market St. YUKON 2-3954
Los Angeles 5 W. F. GREEN
439 S. Western Ave. DUNKIRK 7-8135
Elsewhere THE PUBLISHER
Berkeley Enterprises, Inc.
815 Washington St., Newtonville 60, Mass.
DECATUR 2-5453 or 2-3928

FRONT COVER

Computer Input from Forty Million Miles Away . . . 1, 6

ARTICLES

Flight Simulators in the Jet Age, C. D. CARDER . . . 8
Time Sharing in Large Fast Computers, C. STRACHEY . . . 12
Business-Type Problems From a Computer Standpoint,
PAUL BROCK . . . 18
Machine Translation in the Soviet Union, I. A. MELCHUK . . . 23

READERS' AND EDITOR'S FORUM

Education for Computers, ARNOLD LERNER . . . 5
Computer Design . . . 11

REFERENCE INFORMATION

Survey of Recent Articles, MOSES M. BERLIN . . . 26
Books and Other Publications, MOSES M. BERLIN . . . 30

INDEX OF NOTICES

Advertising Index . . . 34
Back Copies . . . see June, page 85
Bulk Subscriptions . . . see June, page 85
The Computer Directory & Buyer's Guide, 1959
see June, page 91
Manuscripts . . . 28
Who's Who Entry Form . . . 32
Reference and Survey Information . . . 29

COMPUTERS and AUTOMATION is published monthly at 160 Warren St., Roxbury 19, Mass., by Berkeley Enterprises, Inc. Printed in U.S.A.

SUBSCRIPTION RATES: (United States) \$5.50 for 1 year, \$10.50 for 2 years; (Canada) \$6.00 for 1 year, \$11.50 for 2 years; (Foreign) \$6.50 for 1 year, \$12.50 for 2 years.

Address all Editorial and Subscription Mail to Berkeley Enterprises, Inc., 815 Washington St., Newtonville 60, Mass.

ENTERED AS SECOND CLASS MATTER at the Post Office at Boston 19, Mass.

POSTMASTER: Please send all Forms 3579 to Berkeley Enterprises, Inc., 160 Warren St., Roxbury 19, Mass.

Copyright, 1959, by Berkeley Enterprises, Inc.

CHANGE OF ADDRESS: If your address changes, please send us both your new address and your old address (as it appears on the magazine address imprint), and allow three weeks for the change to be made.

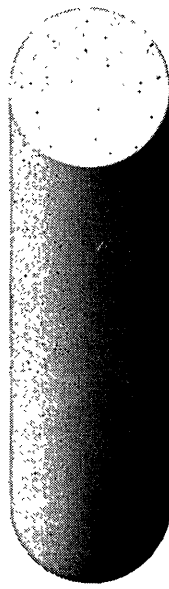

pinboard programming: easy as putting a round peg in a round hole

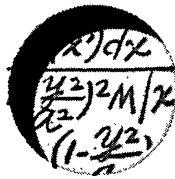

Simplified pinboard programming of the Burroughs E101 electronic digital computer multiplies technical talent. Scientific personnel report time savings of 20 to 1 over manual calculators. Ease of operation makes practical the "open shop" computer approach, with extensive savings of high-priced man hours in scores of installations. Optional input-output units for punched paper tape and punched cards further extend data-handling / problem-solving capacity. From small computers to giant data processing systems, Burroughs equipment means new efficiency...and profits...for you. Write for E101 Brochure today. ElectroData Division, Pasadena, California.

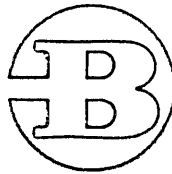

Burroughs Corporation

"NEW DIMENSIONS/in electronics and data processing systems"

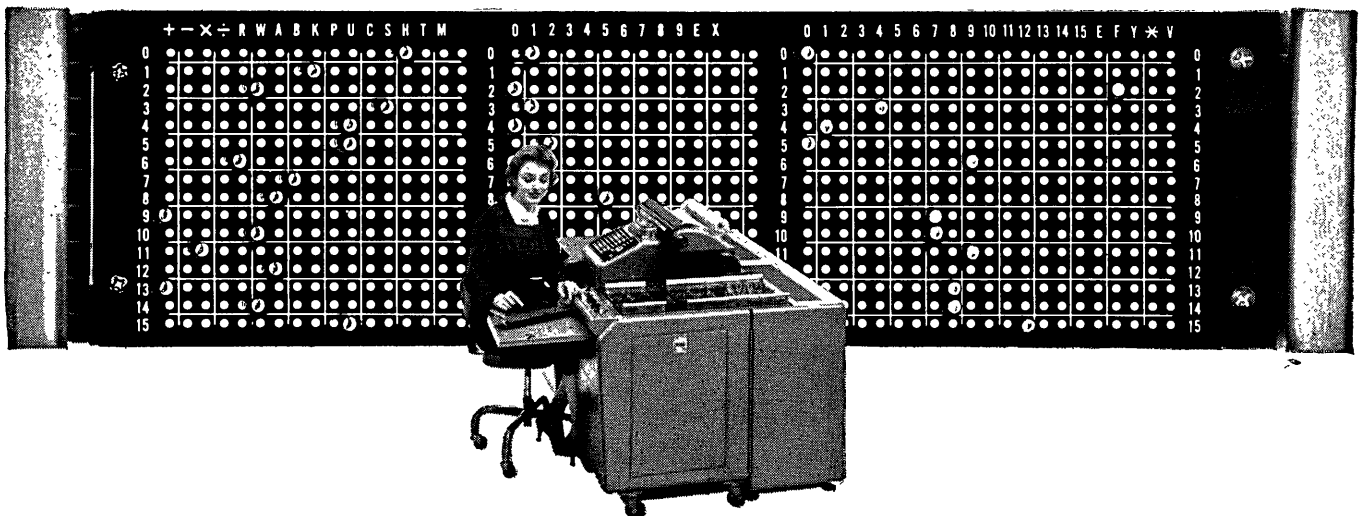

Readers' and Editor's Forum

FRONT COVER: COMPUTER INPUT FROM FORTY MILLION MILES AWAY

The front cover shows an 85-foot diameter steel "dish" antenna capable of receiving radio signals from a space vehicle. The signals can be received from more than 400,000 miles away in space in 1959 and from 40 million miles away in 1960, as the antenna sensitivity is increased and space vehicle radios become more powerful.

Blaw-Knox Company, Pittsburgh, designed, engineered, and fabricated the unit, which weighs 200 tons, is 110 feet high, and has 6000 square feet of reflecting surface.

It is situated in a natural bowl-shaped area in a remote part of the Camp Irwin Armor Combat Training Center reservation of the United States Army near Goldstone Dry Lake in California. This remoteness tends to eliminate unwanted signals from Earth transmitters.

This installation is specifically designed for tracking and communicating with space vehicles, as a part of the space exploration program of the United States. When tracking and receiving radio signals from a space vehicle, the parabolic surface of the antenna reflects incoming radio waves to a central focus where a second "pickup" antenna is located. This focus is supported by the huge "quadripod" attached to the reflector.

From the pick up antenna, the data goes to a highly sensitive receiver, is recorded on magnetic tape, and then dispatched to the Jet Propulsion Laboratory of California Inst. of Technology in Pasadena for computer analysis.

EDUCATION FOR COMPUTERS

Arnold Lerner

International Business Machines Corp.
White Plains, N.Y.

A new four-million dollar education center was dedicated on May 22 in Poughkeepsie, N.Y. by International

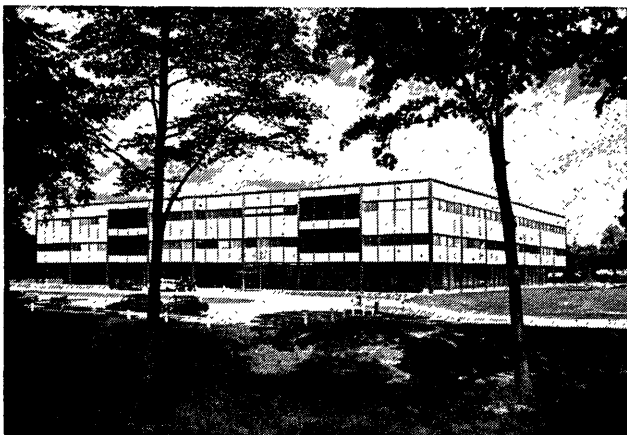

Figure 1 — IBM's new three-story education center in Poughkeepsie, N.Y.; it is designed for many kinds of education, and contains a closed circuit television network which is used to transmit lectures and machine demonstrations into classrooms.

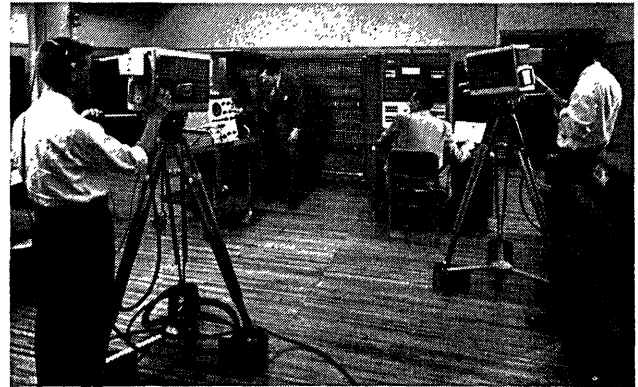

Figure 2 — TV cameras focus on a demonstration of computer maintenance techniques which is being telecast to classroom groups in the new education center.

Business Machines Corporation. The new building is located on a five-acre tract adjacent to the company's manufacturing plant four miles south of the town.

The new education center contains complete facilities for education of IBM customer executives, IBM salesmen and customer engineers, and also facilities for other specialized education programs, such as the company's general education program for its employees.

The training of customer executives is designed to help customers get the greatest benefit from their equipment. Courses of instruction cover a wide range of subject matter from punched card equipment to large-scale data processing systems.

The education building also houses the test center for the company's data processing in Poughkeepsie. This contains several of the company's most advanced computers, including the large-scale 705-III and 709 systems. Here, customers may come to test their computer programs in advance of installing this equipment in their own offices.

The building is of modern design and is built around a large, landscaped center court which looks like a campus. The building is constructed of steel, concrete, and glass with glazed brick and fieldstone on the outside, and stainless steel trim. It is three-stories high, contains 124,000 square feet of floor space, and is completely air-conditioned. Parking facilities for 600 cars have been provided next to the building.

A two-purpose auditorium can hold an audience of 400 people, or can be divided into sections for classrooms.

The education center contains its own closed-circuit television network. This is used to transmit lectures, demonstrations, machine operating procedures, and service techniques into the classrooms.

[Please turn to page 26]

"THE PROGRAMMING FIELD is on the verge of tremendous changes. If we consider the developments in programming techniques and computer hardware that are currently in progress, these alone are enough to make one pause. Added to this are the new uses to which digital computers are being put, such as in management and process control systems. These new uses have created classes of problems for which we do not even have an adequate language to formulate the problems.

"We at SDC are aware of these imminent changes and are preparing for them by extensive activity in pure and applied research in computer programming. Realizing that a large computer based system consists of many integrated components, we are also undertaking interdisciplinary research among such diverse fields as computer programming, electrical engineering, psychology, and operations research.

"If you are a senior member of the programming profession and would like to participate in advanced research projects, you are invited to contact Mr. William Keefer at System Development Corporation, 2406 Colorado Ave., Santa Monica, Calif."

Robert Bosak

Robert Bosak, Head, Data Processing Research Staff



Flight Simulators In The Jet Age

C. D. Carder

Erco Division, ACF Industries
Alexandria, Va.

MAN'S ability to design and build supersonic aircraft has far outdistanced his ability to fly and operate them as military weapon systems. That is why complex electronic and electro-mechanical devices are called upon to help him fly, direct, and use aircraft for specific missions.

As speeds, altitudes and weapon systems capabilities increase through continuing research and development, the training of the airmen responsible for using the aircraft to its fullest potential must be more varied and intense. At speeds of Mach 2 and beyond, any delay in reaction would almost certainly mean the loss of men and equipment. Men must be trained to react almost instantaneously.

The use of the aircraft itself as the training device is prohibitive not only because of the risk of lives and equipment but also because it takes the weapon out of readiness for use.

How therefore is man to control and operate supersonic aircraft, with maximum effectiveness and efficiency without intolerable risk of life and property?

This problem became apparent shortly after the end of World War II, when jets passed from the development stage to reality. The training of pilots and crews for the jet age imposed severe demands in terms of time, money and the teaching of the new skills required to handle the ever-growing complexities of the aircraft, particularly in the area of electronics.

The need for more comprehensive training was brought out sharply by an increase in the accident rate, as pilots and crews went through the transition phase from conventional aircraft to jet engine aircraft.

Synthetic Training Devices

Thus a new industry began to take form, separate and distinct from airframe manufacturing. It was the development and production of synthetic training devices. This young industry already has produced these devices — more commonly known as electronic flight simulators — for nearly every postwar military aircraft used by the Navy and Air Force.

One of the pioneers in the simulator field was the Engineering and Research Corporation, now the Nuclear Products — Erco Division of ACF Industries, Incorporated. It has developed and built nearly 150 training devices for 15 basic types of Navy and Air Force aircraft, including a Navy blimp used for anti-submarine warfare. Erco has simulated the flight and tactics charac-

teristics of more military planes than any other company. Since 1949, when it produced its first simulator (for the Navy F9F-2 Grumman Panther), Erco's sales in this field have totaled about \$74,000,000, not including numerous contracts for modification and maintenance work.

What is a Simulator?

Basically, a simulator is a device that duplicates an equipment's operation. This device becomes the actual classroom and can be either stationary or mobile. In the case of a flight simulator, the aerodynamic and power-plant characteristics are presented to the pilot in visual, aural, and instrument indications, with corresponding "feel" and environment. Normal or emergency flight conditions, and meteorological, navigation, and communication data are programmed into the simulators by the instructor-operator.

Faithful duplication of all these flight characteristics is provided by analog computers that function as the "mind" of the simulator. These computers cause the instruments and controls to respond in all situations that would be encountered in the actual aircraft. Any movement of the pilot's control column, rudder pedals, trim controls or throttles is transmitted to the appropriate computer or computers. These calculate the exact effect which such movement would have in the actual aircraft in change of direction, or speed, or both. Through servo-mechanisms the computers alter the readings of the related instruments and trigger the hydraulic actuators to impart any resulting motion in pitch or roll to the cockpit. If throttle settings are changed, the fuel consumption computer, the tachometers and other engine instruments are affected and the readings of the fuel gauges change. Raising or lowering the flaps and landing gear directly affects the indications of air speed and trim. As the simulated aircraft "gains altitude," its normal increase in true airspeed and decrease in indicated airspeed and fuel consumption are continuously calculated by the altitude computer, which transmits its finding to the altimeter, airspeed and Mach indicators and fuel consumption gauges.

In fact, practically any action by any of the flight personnel which would affect the performance of the actual aircraft produces an identical result in the simulator. This realism is one of the principal reasons why simulators have proved so successful in modern flight training programs.

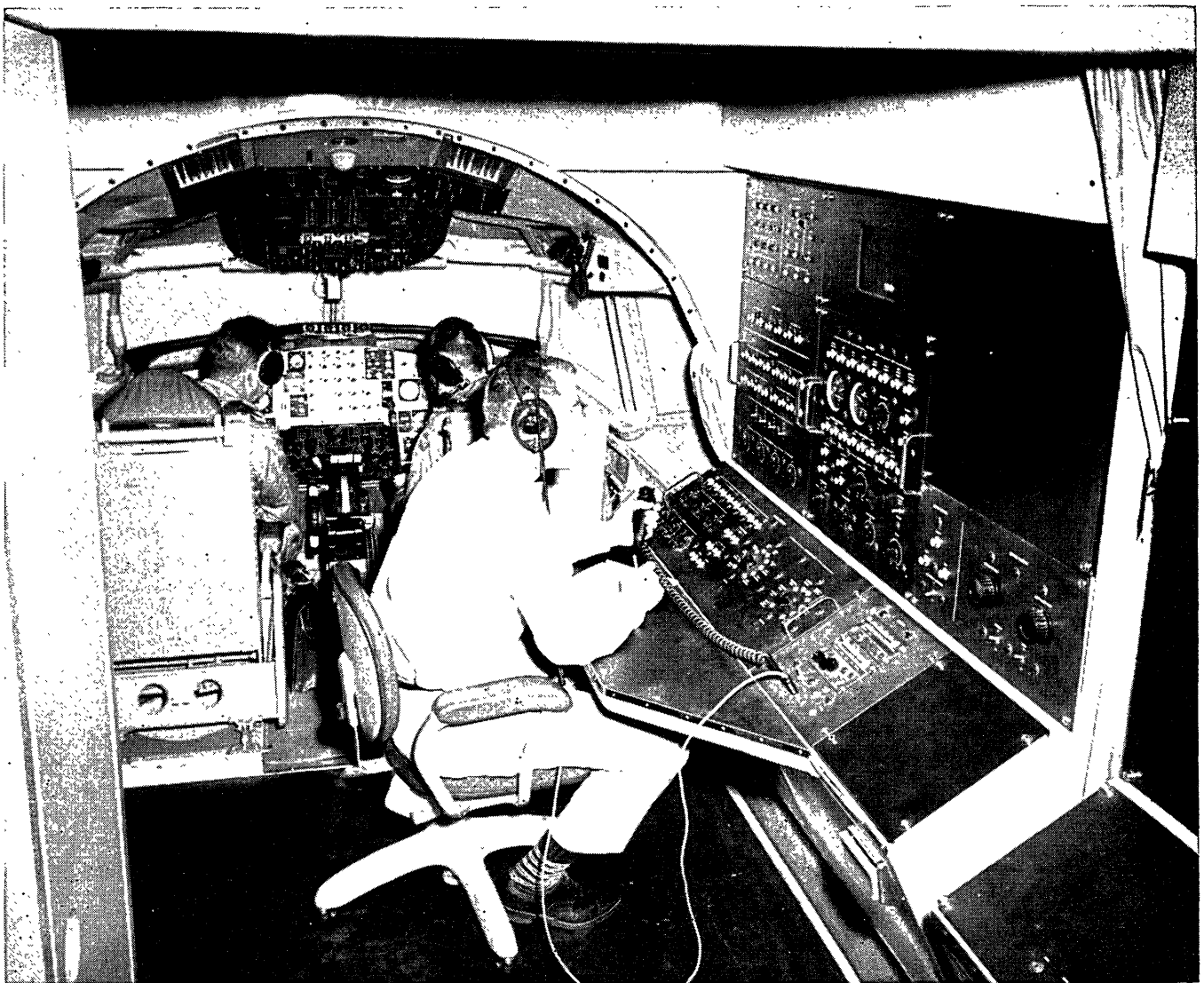

Figure—Checking out a huge electronic flight simulator for the Air Force's KC-135 four-jet tanker are these Strategic Air Command pilots. They're "flying a problem" created by the instructor at panel at right. One of the most realistic training devices ever built, its array of computers reproduces all characteristics of the aircraft in flight, including sounds, motion, odors and "feel" under every possible combination of speed, altitude, weather and physical-hazard conditions. The first of 11 KC-135 simulators built by the Erco plant of ACF Industries, Incorporated, was delivered to the Air Force before the aircraft itself was operational. Erco currently is building five additional KC-135 simulators for the Air Force.

Checking Performance of Pilots

In addition to faithfully reproducing an aircraft's flight characteristics, Erco simulators provide methods for monitoring the student's performance as a pilot. In-flight checks concerning radar, weather observation, navigation, tactics proficiency, and observation of reactions to emergency conditions can be made by the instructor.

The instructor is supplied with controls enabling him to set up specific flight problems for the student to solve. A "function failure panel" permits the instructor to create those emergency conditions which might be expected to occur during any state of flight. Plotting and scoring devices enable the instructor to keep a record of navigational and tactical problems. The instructor also is provided with a means of checking the student's cockpit instruments at all times.

Uses and Advantages of Simulators

The use of synthetic training devices has become standard instructional procedure with both the military and commercial airlines. Pre-flight students become familiar with an aircraft before they ever report to the flight line. Accomplished pilots are checked out in new types of aircraft by means of simulators. The job of the simulator continues after the initial training period to maintain pilot efficiency in emergency procedures. To impose emergency conditions while in flight would of course be extremely hazardous.

Commercial airlines use synthetic training devices to train pilots making the transition from one type of aircraft to another. Recent strides in turbo-prop and jet airliners have greatly increased the demand for this type of training.

Saving in Cost

Cost-saving is just as important as time-saving in flight training. A comparison of the operating cost of a simulator with that of the actual aircraft will show a figure very much in favor of the simulator. For example, it is estimated that flying time in a multi-engine aircraft costs about \$550 per hour, in addition to the cost of a sizable maintenance crew to keep the aircraft operational. "Flying" time for a multi-engine simulator costs about \$63 per hour, and only a minimum of maintenance is required.

Gain in Safety

Cost factors are, of course, secondary to the pilot safety factor. The simulator allows students to practice emergency procedures until the proper corrective actions become automatic reactions — an immeasurable contribution to pilot safety. "Crashing" a simulator — and they do "crash" — results in nothing more serious than an ear-splitting sound effect followed by silence and a bruised ego for the chastened student.

After a "crash" the instructor may reset the problem at the point of the student's mistake and repeat the flight from that point. The instructor also can "freeze" a flight problem at any point and discuss alternative actions with the student. By successfully coping with problems in the simulator, the student is able to approach his first actual flight with much more knowledge and confidence.

Training of Entire Crews

Multi-engine aircraft simulators can train entire aircraft crews simultaneously and thus help develop crew teamwork. This type of instruction is utilized either when an existing crew is assigned to a new type multi-engine aircraft or when a new crew of experienced men is formed to fly a familiar type of aircraft.

Another major advantage of the simulator is that it permits military aircraft to remain in combat readiness at all times. Without the simulator, a considerable amount of the aircraft's operational life would be tied up in training missions.

Experimenting with Flight Techniques

The simulator also may be used as a laboratory for experiments with flight techniques. For example, should a pilot wish to determine the correct rate of climb, flap position and airspeed to use in continuing a take-off after an engine failure, he can experiment in the simulator until he finds the best technique. This sort of experimentation could not even be considered in actual aircraft.

Discovery of Aircraft Failures

In one instance, at the Erco Plant in Riverdale, Maryland, an Air Force acceptance test was in progress when a "fire" was introduced into one of the engines of a multi-engine bomber simulator. The pilot took proper corrective action to extinguish the fire but, to his distress, discovered that he had lost aileron boost. As a result he lost control of the aircraft and "crashed." Investigation showed that under similar circumstances the actual aircraft would have met the same fate and all operational models were ordered grounded pending correction of the fault.

The "Dutch Roll" Story

In another instance, Erco engineers were readying the prototype simulator for the Air Force KC-135 four-engine jet tanker for Air Force officers who were to begin final acceptance tests on the trainer the next day. At high speeds the simulator controls indicated a peculiar wobble, known familiarly to pilots as a "Dutch Roll." Erco engineers double-checked their own data and tried again. Again the "Dutch Roll" occurred. They concluded that something was wrong within the trainer's huge array of computers. Extra work shifts were ordered and soon the cause of the puzzling symptom was found and eliminated.

In the morning, the engineers watched anxiously as the Air Force pilots checked out the simulator and "flew" a maneuver that called for maximum stress on the aircraft. The engineers were relieved when the controls refused to indicate any roll. But the Air Force pilots looked puzzled. The senior officer turned to the engineers and asked, "Where's the roll motion we've been getting in our planes? It should show up under these conditions. It does on the plane itself!"

Needless to say, the "Dutch Roll" was replaced before the Air Force accepted the simulator.

Timetable of Design and Development of Simulators

The training of pilots in the simulator before their first training flight in the aircraft is perhaps the greatest duty the simulator can perform. During the early days of simulator procurement by the military, this was not possible. An aircraft, by its very nature, undergoes many changes in the early period of its development. Since the simulator manufacturer could design the trainer only according to data received from the airframe manufacturer, this data was either obsolete or received at such a late date that the development lead time of the simulator prohibited the incorporation of the most-recent data. In other words, the simulator manufacturer was forced to deliver a training device designed on the basis of very preliminary performance data, or schedule its delivery late enough so that accurate aircraft data would be available for design. Either alternative greatly reduced the purpose and effectiveness of a simulator.

However, early in 1957 Erco accomplished what hitherto had been impossible. It delivered the first of an 11-unit order for KC-135 simulators to the Air Force well enough in advance of the arrival of production versions of the aircraft for crews to be completely trained to take over the four-jet Strato Tankers.

The procedure that accomplished this design and production speed, now accepted as standard for the industry, called for a close working relationship between the simulator manufacturer, the airframe manufacturer, and the cognizant government agency. Rather than wait for data to be accumulated after the flight of a prototype aircraft, engineers now start their design work on an Erco simulator as soon as the aerodynamic data is received from the airframe manufacturer. These data, in the form of mathematical equations, are reduced to a series of simplified terms representing the forces on the aircraft that must be present in the trainer. The reduced data is passed on to the computer group for mechanization, which involves the translations of the equations into the "hardware" of amplifiers and servo-mechanisms

that make up the simulator's computers. This close liaison continues through preliminary aircraft testing, permitting incorporation of changes in the simulator concurrently with their incorporation in the aircraft. The result is that a simulator representing every detail of the operational plane is made available to the using agency before delivery of the aircraft itself.

For its achievement in delivering the first KC-135 simulator in advance of delivery of the production aircraft, Erco was cited in the Congressional Record. The company is currently building five additional KC-135 simulators under a \$3,500,000 Air Force follow-on contract.

Increased Complexity

The growing complexities of military aircraft as complete weapon systems present the greatest challenge to simulator developers, according to Erco engineers. They say it is now more important to simulate the tactics of the airplane than to simulate only its flight characteristics.

The development and use of aircraft for anti-submarine warfare by the Navy probably is the best example of the need for tactical training. These aircraft, such as the Grumman S2F and Lockheed P2V Neptune series, require up to eight crew members to perform all the functions that make them effective weapons against submarines. Each member of the crew has an assigned responsibility and the flight and tactics simulator must accurately duplicate each function of the task to which a crew member is assigned.

Trainers for the various models of the S2F and P2V simulate — in addition to flight — airborne countermeasures, sonic submarine detection, all phases of weapons delivery and, radar location of water or ground targets. Anti-submarine simulators accomplish training

missions that heretofore had been considered too complex to be reproduced synthetically.

Trailer Versions

Reference was made earlier to the fact that simulators can be either stationary or mobile. "Mobile" in this case refers to an Erco-developed technique of housing all the simulator's components in a trailer which can be moved under its own power or air-lifted from base-to-base. The principal advantage of putting the "school on wheels" is that it can be used at widely separated points.

The Future for Simulators?

With today's emphasis on unmanned missiles, what does the future hold for the simulator market? Best estimates by the military and simulator manufacturers is that flight simulators for air crew training will be phased out of military production in about 10 years. But during this period, and even afterward, the market for synthetic training devices will probably grow. There are several reasons for this outlook.

First, the speeds and complexities of aircraft now going into operational status with the Navy or Air Force are far greater than those of their predecessors. They may remain in operational inventory for as long as five and possibly ten years. New crews will have to be trained to replace crew members who leave the military or who are relieved from flying status for health or age reasons.

Furthermore, aircraft well along in development, such as the F-108 fighter and the B-70 chemical-fueled bomber, will be so costly that crews may have to be trained in their use almost entirely in simulators and be given transition training in the actual aircraft on perhaps a once-a-month basis.

COMPUTER DESIGN

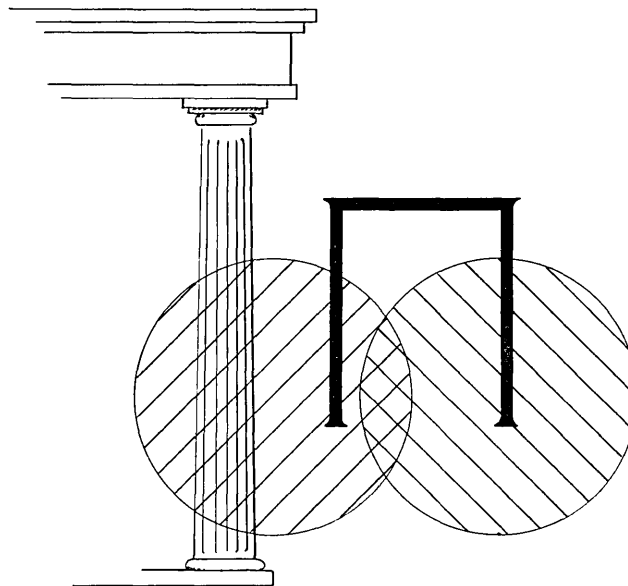

The computer field is affecting art and design: here is a motif echoing the product of classes in Boolean algebra, the sign for continued product in mathematics, the Greek capital pi, and its echo the Greek column.

TIME SHARING IN LARGE FAST COMPUTERS

C. Strachey,

National Research Development Corporation,
London, United Kingdom

(Paper given at the International Conference on Information Processing, Paris, France,
June 13-20, 1959)

ONE of the most difficult problems which face the designer of an electronic computing machine is the serious imbalance which exists between the speed of the electro-mechanical equipment used for input and output, and the speed of operation of the wholly electronic internal arithmetic and control circuits.

The solution adopted by most of the fast large-scale computers in use today is to have wholly or partly autonomous units, each with its own buffer store.

The disadvantage of this plan is largely an economic one, for as the demands on the system have grown, so the autonomous units have become more and more complex and expensive, until we have reached the position where the peripheral equipment is more expensive than the main computer.

The difficulty is that the logical complexity of the operations required of the autonomous units is quite great. It is true that the rate at which these operations have to be performed is not very high, but unfortunately the cost of a special purpose computer is determined more by its logical complexity than its speed, so that it is not much cheaper to build a slow unit. In fact one of the main economic reasons for building faster computers is that operation for operation they are a great deal cheaper than slow ones.

A concrete example may, perhaps, help to define our ideas somewhat more clearly. I give below the specification of a possible set of functions (or subroutines) for dealing with magnetic tape. (I have purposely oversimplified this example in some respects.)

Magnetic Tape Operations

Properties of Magnetic Tape System

- Information transferred in blocks of fixed length
- Each character on tape has a parity check bit
- Each word in the main store has a parity check bit
- Each block on tape has a check sum
- Reading and writing can be done on one direction only
- There is a reading head immediately following the writing head to allow a writing check. The separation between these two heads cannot be guaranteed closely so that their timing is not connected.

Facilities to be Provided.

A. Four orders: —

- i) Read a block from tape unit x into the main store starting at address y
- ii) Write a block to tape unit x from the main store starting at address y
- iii) Skip y blocks on tape unit x

- iv) Search tape unit x for a block starting with a word identical to the word in main store address y .

B. Checks as follows: —

Parity check on characters, sum check on blocks for reading, skipping and searching (orders i, iii and iv) For writing (ii), insert sum check and perform word by word read-back check.

Automatic re-read or re-write on check failure up to a maximum of 4 times, accumulating tallies of errors for each tape unit. Special alarm after 4 re-runs.

C. Lock Outs

During reading or writing the main computer is to be locked out from the single block of store starting at address y until the magnetic tape operation has been completed and successfully checked.

It will be seen that there is a considerable logical complexity in this specification. It is rather improbable that any autonomous buffer unit would be able to fulfill all these requirements; almost certainly the designated main store address y would be confined to the buffer store so that the magnetic tape order would have to be associated with another transfer order between the main store and the buffer. Even this degree of complexity is not as much as may be required. If the requirement of a check sum for each block is removed, it becomes possible to use each word of the main store as soon as it has been dealt with (instead of waiting till the end of the block). This allows much simpler tape copying schemes, but introduces some very severe complications if an error is detected (by parity or read back) in the middle of a block. This sort of situation is beyond the power of a reasonably simple special purpose system, but is relatively easy to programme if the full facilities of the central computer are available.

Time-Sharing Solution

We are thus led to consider the possibilities of 'borrowing' the central computer for a short time in order to control the magnetic tape operations. This will only be practicable if the computer is a very fast one (preferably in the microsecond speed range) and if the 'borrowing' is organized automatically whenever it is required so that the programmer need not be aware of it. One possible way of arranging this is as follows.

The magnetic tape unit has two single word registers associated with it. One of these is a shifting register and is used to assemble a complete word from the characters as they come off the magnetic tape. When a word is complete it is transferred to the second register and

an 'interrupt program' signal is sent to the central computer. This causes the computer to stop obeying the main program and enter a special sequence of orders to deal with the word from tape; at the same time it records the place where it left the main program. The special sequence of orders checks the parity of the word from magnetic tape, adds it to the sum check if necessary and stores it in the appropriate part of the main store. It then advances the count or index register. If the end of the block has not yet been reached, the computer then returns to the main program. At the end of the block the appropriate checking is done before returning to the main programme.

This plan leaves several difficulties unresolved; it makes, for example, no provision for lock-out during transfers. Another important difficulty is the possibility of several 'interrupt program' signals coming at the same time (from different units) or of one special sequence of orders being interrupted by another (or even worse, by itself).

A fairly straightforward way out of these difficulties is to divide all possible interrupt signals into a small number of classes. The classes are allotted an order of priority, and any interrupt signal can only interrupt the program immediately if this is of a lower priority class. If the program being executed is of the same or higher priority class, the interrupt signal is merely stored. At the end of a sequence of orders of one priority, the machine scans the waiting list and starts to operate on the call with the highest remaining priority.

The top priority class would contain operations which cannot afford to wait e.g. transfer of words to or from magnetic tape. The lowest priority would be the main program. There might have to be one or two intermediate classes, the principle of classification being that those processes which have inertia must have a higher priority than those which have none.

It is interesting to consider the timing problems in somewhat more detail. Suppose, for example, that the rate of transfer of information from magnetic tape is one word in 200 us and that the length of time required for the sequence which stores this word is 5 us. It may well be that the word is only available for part of interval between successive words, so that, for instance, it must be used within 150 us of its first appearance. It is clear then, that the maximum number of tape units which could be in operation at once is 30 and that these would use 75% of the total available computer time; the remaining 25% would always be available for lower priority programs. Suppose, however, that we do not want to have a shifting register with each magnetic tape unit, but wish to use the central computer to assemble each word as it comes from the magnetic tape character by character. In this case we can assume that the character interval is 30 us; we will assume no buffer store so that the character is only available for a short time — say 10 us. The sequence of orders required to assemble a single word is quite short, but the partly assembled word would have to be stored; it seems reasonable to assume a time of 2 us for this operation. With these figures a maximum of 5 magnetic tape units could be in use at the same time and these would use 33% of the total machine time. However we still have to put the completed word away. If this still takes 5 us as in the earlier ex-

ample and we leave the end of word sequence in the same priority class as the character sequence, we shall have to limit the number of magnetic tape units to two. If we can relegate the end of word sequence to a lower priority class, so that it can be interrupted by other character assembly sequences, there is plenty of time to fit it in so that it does not restrict the number of magnetic tape units.

Once more I must emphasize that the examples given here are deliberately simplified. There are a number of other considerations which must be taken into account when calculating timings. For example some operations, such as multiplication and division may be relatively slow. If an interrupt call occurs during one of these, the operation, in all probability, will have to be completed. It depends on the details of the logical design of the machine whether this time has to be added to the maximum time for each magnetic tape sequence or whether the relatively simple operations required to deal with magnetic tape can take place while the multiplication or division is being completed. Then again some of the high priority programs will need to use the arithmetic unit; once more depending on the characteristics of the machine it may be necessary to store the contents of various arithmetic and index registers before proceeding with the new program. If this is necessary the general rule should be to store them in locations which are associated with the interrupting program and to restore them again at the end of that program. The amount of information to be stored is determined by what use the interrupting program makes of these common registers. In this way no time will be wasted storing more information than is necessary.

It will be evident that the system of time sharing so far described is quite complex in its operation. I do not know of any already existing computer which uses a system of this sort, though I believe that there are machines under construction which will have time-sharing facilities on this scale.

It seems to me however, that the scheme described above does not go far enough, and that for a relatively small increase in hardware a very considerably better system can be obtained. The crucial point comes, I think, when we consider the problems of operating a very fast computer.

Operating Problems

The increasing speed of computers will make the problem of keeping them busy considerably more complicated. Although the major reason for building very large and fast machines may be existence of problems which cannot be done without them, I think there will always remain far more rather smaller problems. As I have already pointed out, fast machines are much cheaper per operation provided they can be used efficiently. A machine in the microsecond class will be one thousand times as fast as a machine in the millisecond class, but it is not likely to cost more than fifty times as much. We have a factor of twenty to save if we can use it.

The great difficulty, of course, is to keep a very fast machine continuously busy on problems which, for it, are very small. By other standards, of course, these problems are not so small: a problem which involves inverting twelve 20 x 20 matrices or solving a set of

65 linear equations would not be called small by most standards. This sort of problem would take 30 minutes to an hour on a machine such as Pegasus or IBM 650; one or two minutes on a Mercury or an IBM 709 and one or two seconds on a microsecond class of machine.

Keeping a steady flow of problems to the machine is obviously going to present very great difficulties and I do not think it will be possible not to lose a few seconds between each problem. It seems worthwhile considering time sharing between operators so that if one operator is idling another may be using the machine. Another possibility is to have a 'base load' program in the machine the whole time. This would be a large program which would take a long time to run. It would have the lowest priority and come into operation whenever there was a gap between two shorter programmes.

There are at least two other activities in which a computer is, at present, very inefficiently used. The first of these is programme checking. For many purposes the best method of programme checking is for a skilled programmer to sit at the operating console of the machine and to plan his operations according to the results produced by the machine. Unfortunately this method is so grossly wasteful of machine time, even with relatively slow machines, that it is generally not allowed except for a few very special problems. The concept of time sharing between operators makes it possible once more to allow this manual program checking at a special console, without seriously interfering with the amount of machine time available for ordinary computing.

The other activity which makes very inefficient use of a computer is the maintenance and adjustment of the peripheral equipment such as paper tape readers and magnetic tape units. Some of these need a considerable amount of adjustment which can only be done satisfactorily by using the computer. If this part of the maintenance can be carried out on a time-sharing basis, it should be possible to reduce the total machine time used for maintenance quite considerably.

Several new problems appear as soon as it becomes possible to have several variable programmes in the machine at the same time. The most important of these is the necessity of seeing that the programmes do not interfere with each other. This is particularly important, of course, if one of the programmes concerned is still under development and so is liable to 'run wild.' The solution to this difficulty is to provide for interlocks on the main store so that each program is restricted to altering (and perhaps also to reading) numbers in its own section of the store. This in its turn introduces the problem of altering the interlocks. It is evident that it would be possible to change them when required (or it would be impossible to use the whole machine on a single large problem) and for reasons of speed it is obviously desirable to have them altered by a machine instruction. The problem is to ensure that even if a program runs wild so that it obeys a completely unpredictable series of orders, it still shall not be able to alter the interlocks and spoil another program.

The other rather difficult problems are concerned with the best method of program checking on a machine of this sort. The majority of programmes (and programmers) are not suitable for the manual checking methods.

It is therefore necessary to make some provision for other methods of program checking, and it is likely that there will be a considerable amount of this work. A particular problem which arises in this context is the difficulty of determining when a program under test is in error and has come to a loop stop. If this is not detected rapidly, it can waste a disproportionate amount of computer time.

The Director

The general organization of the computer may now appear to be formidably complicated. If it were necessary to design and build special hardware to perform all these functions, it would be a somewhat daunting task. Fortunately, however, it is not necessary to do this. The computer itself is designed to deal with just such complicated logical problems, and viewed as problems for a computer programme, the organization of the machine is by no means unusually difficult or complicated. We therefore seek to control the organization of the machine by means of a programme which I shall call the Director.

The first important characteristic of the Director is that it is a fixed program. This means that it can, and should, be kept in a special part of the store which is non-erasable. It is a fortunate fact that it is relatively cheap and easy to provide a non-erasable store with a very fast read-out time (of the order of $1/5$ us.). This reduces the time spent in the Director and ensures that the program of the Director can never be destroyed.

The second fact is that the Director requires some working space which is immune from interference by other programmes. That is to say that we require some ordinary erasable store which can only be altered by instructions in the Director.

The fact that the Director is in a special, fixed part of the store makes it possible to introduce machine instructions which are only accessible to the Director. If the instructions which alter the main store interlocks are of this sort, it is quite easy to arrange that no program can alter the interlocks of any other program, and thus to give protection against programmes under test running wild.

Hypothetical Machine

In order to clarify and give precision to the ideas discussed so far, I propose to describe, in outline, a possible design for a large fast computer making extensive use of time sharing. I must make it quite clear that the machine I am going to describe is not, so far as I know, an actual or projected computer. The performance figures I use have no secret significance, they are merely estimates of what I consider reasonable either now or in the near future. In fact the main characteristics of the machine would not be critically dependent on the actual speeds assumed.

The machine is intended for mathematical work. It is a binary machine with both fixed and floating point arithmetic. The word length is between 40 and 50 bits. It has a main store of 32,000 words or more (on ferrite cores) with a cycle time of 1 — 2 us. It also has a fixed (non-erasable) store of 1000-4000 words with a read-out time of $1/5$ us. There is a special working store

of a few hundred words which is only accessible from instructions in the fixed store.

Arithmetic operations (addition, multiplication, division fixed or floating point) take from 2-10 us, including access time. Red Tape instructions require 1-2 us if obeyed from the main store and from $\frac{1}{4}$ to $\frac{1}{2}$ us if obeyed from the fixed store.

The details of the order structure and the provision of modifier registers (index registers) will not be fully discussed. The number of modifier registers available will influence the method used to change from one programme to another, and in particular, if the number is very small (say two or three) it may be desirable to have special loading and dumping instructions for them.

The backing store for the machine will be magnetic tape using fixed block lengths. The transfer rate will be 20,000 to 60,000 6-bit characters per second which is equivalent to one word every 100-300 us. Normally speaking each magnetic tape unit will have two one-word buffers associated with it as described in section 3 above. There will be 8-10 units associated with the main computer.

Input and Output Equipment

There will be up to 20 slow input/output stations. Each consists of a paper tape reader (200 characters/sec), a paper tape punch and printer (or an electric typewriter) and a magnetic tape mechanism, together with a working space and a few control keys. The magnetic tape mechanism can be considerably simpler than the ones associated with the main machine as it is not required to work nearly so fast.

In addition there will be fast input/output stations viz: a punched card input and output, a line printer (or perhaps two) and probably a graphical output. Each of these will have an associated magnetic tape unit.

Operators' Consoles

There will be three operators' consoles: an engineer's console for maintaining and testing the machine, a programme-testing console with various visual displays and at least an electric typewriter, and a main operator's console. All three will have fairly extensive facilities for intervening in the course of a calculation.

In addition each of the input/output stations will have sufficient control keys to allow them to be operated as if they were off-line mechanisms.

Method of Operation

In normal operation there would be time sharing among up to four variable programmes.

i) A 'base load' program. This is a long term program which has already been checked. It is set up initially from the main operator's console and given the lowest priority. It is used to fill in the gaps between other programmes.

ii) A series of short run programmes. These are run in sequence from the main operator's console. They constitute the majority of short and medium length programmes. In general they will have been written with the aid of some form of automatic coding routine and

will have been translated into machine code and stored in sequence on magnetic tape in a form suitable for the input routine.

iii) A programme being manually checked at the programme-testing console.

iv) An engineer's test routine being used to service part of the peripheral equipment.

In addition to these a number of the slow input/output stations will be in use. These have three main functions.

i) The initial input of program (and data) would be from punched paper tape. This would be read in from one of the stations and immediately stored (probably without much translation) on magnetic tape. At some later time a special translating run would be initiated by the operator at the main console and the resulting programmes stored in a single magnetic tape for later running.

ii) The stations would also be used for printing the results of programmes whose volume of output did not warrant the use of the line printer. These results would be stored by the main computer on the magnetic tape of one of the input/output stations and later printed out.

iii) The third use of the stations would be for post mortem printing when testing a program which did not require manual testing. When a program being tested in this way was finished, or if it broke down in any detectable way or if it had been running for longer than was forecast, the contents of various prearranged parts of the store (probably the whole store used by the problem) would be output (by the Director) onto magnetic tape. It would then be possible for the programmer at some later time to print out any parts of the store he required by using a punched paper steering tape at one of the input/output stations. If after further thought he needed more information, a further steering tape would provide it.

This illustrates one way in which the difficulty of loop stops can be dealt with. It would be mandatory for the programmer to supply a time-estimate for his program. (For standard programmes, such as matrix inversion, which were data-dependent, this would be calculated by an interlude on input. If the programmer omitted to give an estimate, a standard one of one second could be used.) The Director would keep a record of the length of time spent in each program, and if the estimate were exceeded by, say, a factor of two, treat it as a program error.

In the normal course of events the line printer and other fast input/output devices would be used with their associated magnetic tape units as if they were off-line.

In this way, during the normal running of the machine several operators are using the machine during the same time. To each of these operators the machine appears to behave as a separate machine (smaller, of course, and slower than the real machine). Nevertheless whenever it becomes desirable the entire machine can be devoted to a single large scale problem.

Interlock Problems

There are one or two difficulties connected with interlocks which were mentioned above but left without any

very precise solution. It is now possible to suggest rather more detailed solutions for them in the framework of the hypothetical machine.

To prevent one variable program interfering with another, each program is required to be compact in the store. (This is quite easily arranged if automatic coding is used). On input the Director assigns an unused block of store to the problem, inserts the relevant addresses in the instructions and establishes the store limits inside which the problem must lie. While the problem is being run these limits are held in two special 'limit registers' and are compared with the address register of the main store every time this is used. If the address called for is not in the correct part of the program a program error is indicated to the Director. This comparison need not slow down the process of reading from store. It can proceed in parallel with the read out, and if the address is out of limits, the same number is merely written back into the store again.

The instructions setting the limit registers are only available to the fixed store, and it is part of the function of the Director to set them correctly whenever control is moved to a fresh program. The allocation of store is thus a function of the Director. Any program can remove itself (for example when it comes to an end) but no variable program can remove another. Only the Director, can forcibly remove a program, and it will only do this if there is a program error (e.g. a call for a number outside its limits) or if the program overruns its time limit.

When fixed programmes (such as those for magnetic tape) are required to use part of the store belonging to a variable program, they (or the Director) will check on first entry that the part of the store they are being asked to use is a permissible one. It is also desirable to provide a temporary lock-out while transferring blocks of data to and from magnetic tape (see section 3). This can be done rather neatly if there is a parity check bit on words in the main store. The suggestion is that the parity bit should be reversed for the period when it is necessary to lock out the main computer (but not the magnetic tape fixed programme). This involves providing instructions (accessible only from the fixed store) for reading and writing in the main store with reversed parity. An attempt by the main program to read a word with reversed parity would lead (as all error indications would lead) to a sequence in the Director. This would determine whether a magnetic transfer involving that address was in process. If it were, it would delay the main program; if not it would signal a store error.

Conclusion

The overall aim of the system which has been described above is to decouple the various operations which are time sharing as much as possible, while still preserving the possibility of running the whole machine as a single unit. The advantages which follow are firstly a cheaper machine because the peripheral equipment is simpler, secondly a more efficient use of the machine, because it is more continuous and lastly, considerably greater flexibility, because various time-sharing schemes can be tried without very great expense by merely rewriting the Director.

Functions of the Director.

1. Priority shifting sequences.

- a) On moving to higher priority.
 - Store present control number and priority.
 - Copy accumulators, modifiers etc., as required for interrupting program. The storage registers used are allocated to the interrupting program.
 - Alter store address limit registers.
 - Enter interrupting program.
- b) On moving to lower priority (i.e. at 'wait' order).
 - Restore accumulators, modifiers etc., control no., store address limit register.
 - Prepare to enter program. If another interrupt of higher priority is still in force, enter the appropriate sequence instead.

2. Arrange allocation of store during input and freeing of store at end of program.
3. Keep time for programmers being checked (and possibly others).
4. If unexpected overflows, or forbidden store references, or non-existent orders or other incorrect instructions occur, treat as a program error.
5. Special operation for machine errors and power failure.
6. Monitoring printing at main console.

Orders only available to Fixed Store.

- Access to special working store
- Set limit registers
- Read and write in main store with reversed parity
- Operate peripheral equipment
- Operate mechanical interlocks on magnetic tape units.

Tentative Priority List for Director.

High Priority

- Power Failure
- Machine Breakdown
- Director priority changing sequences
- Magnetic Tape read/write
- Line Printer
- Paper Tape input
- Monitoring printing
- Output and post mortem printing
- Other Director functions
- Engineers Testing
- Manual program testing
- Short run programmes

Low Priority

- Base Load program.

It may be desirable to divide these into various groups, or even to allow the priority of a program to be decided by the Director.

автоматический перевод
вычислительные машины
способствуют исследова-
нию языков

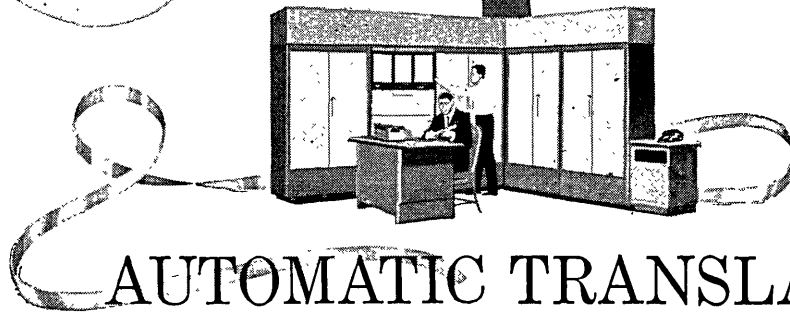

AUTOMATIC TRANSLATION

Computing machines aid language research at Ramo-Wooldridge

To formulate rules for automatic language translation is an enormously subtle and complex project. Yet significant progress is being made. During the past year of research at Ramo-Wooldridge over 60,000 words of Russian text have been translated and analyzed using an electronic computer. From the beginning several hundred syntactic and semantic rules have been used to remove ambiguities that are otherwise present in "word for word" translation. Our present computer program for automatic translation is a considerable improvement over earlier attempts.

Apart from the question of translation itself, electronic computers are invaluable for language research. The expansion of existing knowledge of the rules of language, through statistical analysis, is made practical by mechanized procedures. A clear symbiosis between linguistics and computer technology has emerged.

Automatic translation research is one of many R-W activities addressed to problems of communication of

scientific information. These problems are increasing at an accelerating pace. In this area, as in others, scientists and engineers find at Ramo-Wooldridge challenging career opportunities in fields important to the advance of human knowledge. *The areas of activity listed below are those in which R-W is now engaged and in which openings also exist:*

- Missile electronics systems
- Advanced radio and wireline communications
- Information processing systems
- Anti-submarine warfare
- Air navigation and traffic control
- Analog and digital computers
- Infrared systems
- Electronic reconnaissance and countermeasures
- Basic and applied physical research

For a copy of our brochure or other information, write to Mr. Donald L. Pyke.



RAMO-WOOLDRIDGE

P. O. BOX 90534, AIRPORT STATION • LOS ANGELES 45, CALIFORNIA
a division of **Thompson Ramo Wooldridge Inc.**

Business-Type Problems From a Computer Standpoint

Dr. Paul Brock

Hughes Aircraft

Culver City, Calif.

(Based on a talk given at a conference on "Techniques of Operations Research" at the Illinois Institute of Technology)

A computer is a tool. It is a tool that performs computations that are placed upon it. From a computer point of view, there is absolutely no significance to the motivation of a problem. If a computer is used to solve a system of equations, it is of no importance whatsoever to the computer where these equations come from.

From a somewhat converse consideration, when a problem is considered for machine solution, it must be expressed in an analytic fashion, all quantities must be very well defined, and no vague statements are admissible. Every problem must be reduced to an explicit set of computations. These are the computations that the computer performs. It is a difficult task to extract the explicit representation from a problem occurring in business-type operations that may at times be quite nebulous, so that a computer can be effectively used.

We may consider many different problems that arise in business operations and classify these according to the explicit analytical problem that the computer is asked to work on. It is this type of classification that I shall discuss today.

As an instance, we find that such dissimilar problems as pay-roll preparation, utility billing, and insurance policy handling are essentially of one type. This does not imply that one machine code will suffice for all problems of this type. What it does imply, however, is that all problems of this type can be handled by similar coding procedures. I do not mean to imply in this classification of problems that all problems of business fall under these classifications. There are several types of problems that are altogether inapplicable to a computer. Consider questions that involve the handling of individuals where the psychological reactions of the individuals must be taken into account. Though in many instances individuals may be treated statistically or analytically (say on the question of wages), it may be preferable from a management point of view to handle this problem on an individual basis for the morale effect that it achieves.

There are decisions of top management that require subjective considerations that cannot be analytically expressed, and hence cannot be made by computer. There are not too many decisions of this type, however. H. R. J. Grosch expressed the situation with great perspicacity in a description he gave of his interviews with various levels of management of a large national or-

ganization. His conclusion was that each supervisor agreed that all operations below him could easily be automatized.

Single File Problems

The first type of problem might be called the "single file problem." It is characterized by the existence of a single file of information that must be used in the solution of the problem.

First, let me define what I mean by a file. A file is an ordered sequence of items, called unit records. Each unit record consists of two parts, a key and a tail. The key is that information upon which the file is ordered, and the tail is the rest of the information that is essential to the application. As an example, consider a payroll problem. Here the file consists of records that may be ordered by employee number or lexicographically, by employee name. The number or name as the case may be, constitutes the key. The remainder of the required information, such as gross salary to date, number of deductions, weekly rate, etc., constitutes the tail.

Basic Operations on Files

There are a number of operations that one performs with a file:

A. Query: The information in the unit record is used as a basis for performing subsequent operations. Here again the payroll is an excellent example in that the information in an employee's file is used to determine the information that will be printed out on his paycheck.

B. Checking: In operation by exception (that I shall discuss later), the information in a unit record is checked to determine whether any special operation has to be performed for that record. Thus for example, in utility billing a standard charge is made to most customers based on their meter rates. The file is used to check whether any non-standard charges are to be made, whether any payment lapses exist, etc.

C. Up-dating: The information of the unit record must be altered to reflect the most recent information available. Thus in a payroll file the cumulative salary to date will be up-dated during each payroll computation.

D. Stretching: This is the process whereby additional unit records are inserted into a file. This is perhaps the most complicated of all single file operations if the file is on rolls of magnetic tape, as is the case in most digital computer operations. The file must be re-written

Here's how General Electric solves typical DC power-supply problems

for computers and special applications

PROBLEM

"We need to devote our engineering time to designing our electronic circuitry . . . not the power components."

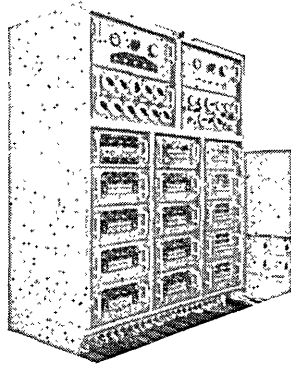

SOLUTION

This is a frequent problem facing computer manufacturers. General Electric's Rectifier Department has complete engineering and manufacturing capability not only to design and apply all types of power supplies, but also to incorporate power supplies into completely integrated systems.

These systems could include load distribution, supply sequencing, protection for power supply and load, and complete power distribution. Let General Electric tackle your DC power problems such as those associated with load IR drop, "cross talk," and other nuisance-type problems plaguing your engineers.

PROBLEM

"It's always a problem making sure transistorized equipment is safe from its power supply."

SOLUTION

To alleviate this problem, General Electric has developed several methods of making transistorized equipment safer in this respect. With G-E protective circuits, shorting a plus high-voltage bus to a plus or minus low-voltage bus would not cause the low-voltage bus to exceed a small percentage of nominal rated value.

General Electric power supplies protect completely transistorized pieces of equipment from large losses due to over-voltage failures.

PROBLEM

"My power supply requirements fluctuate so much . . . big jobs, little jobs, all in between."

SOLUTION

G.E. has built individual power supplies and complete systems ranging from less than one watt up to 35,000 kilowatts. These power supplies span the complete range of DC power—regulated and unregulated—applying all types of components. G-E experience includes completely transistorized supplies, and supplies with the new controlled rectifier, magnetic amplifiers, voltage stabilizing transformers, and motor-alternator "brute force" systems.

PROBLEM

"We have a real low-voltage power distribution problem with our computer."

SOLUTION

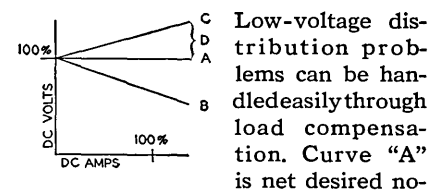

Low-voltage distribution problems can be handled easily through load compensation. Curve "A" is net desired no-load to full-load regulation at load point. "B" is regulation at load without remote sensing or load compensation. "C" represents IR compensation in power supply itself. "D" is amount of IR or load compensation.

NO MATTER WHAT your computer and other special power-supply problems are, General Electric can help you economize—economize by helping you free your engineers of these problems. For more information on power-

supply products and services, contact your nearest General Electric Apparatus Sales Office or write to Section E 535-2, General Electric Company, Schenectady, New York.

Progress Is Our Most Important Product

GENERAL  **ELECTRIC**

up to the point of insertion, then the item inserted and the remainder of the file re-written. There are several ways of getting around this: one is to leave spaces in the file where information is expected to be inserted; another is to use a random key so that additional information can be added at the end of the file.

E. Deletion: When unit records of a file become obsolete, it is desirable to remove them. In files of equal length of unit record, these unit record spaces and key numbers may be re-used. In files of unequal unit records occasional compressing of these records should be performed. This is to prevent the file from becoming artificially long. The time of computation for a file problem depends directly upon the length of the file. Computer time is quite expensive.

These basic operations that are performed on files are the core of the single file problem.

Subsidiary Operations

There are many other operations that may be performed in connection with the file to satisfy the requirements of the particular problem, but they may be considered subsidiary to the file operations above. These subsidiary operations may be extremely important and complex affairs. Some of these subsidiary operations are:

a) Pre-sorting: The input information of a file problem that refers to a unit record, must have the same key as that unit record. This input data should be arranged in the same ordered sequence as the file itself. This preliminary arrangement is known as pre-sorting. It is an operation that does not require computer time and can be handled on an off-line basis. If the input information to the computer is in the form of IBM punched cards, pre-sorting can very readily be done with an IBM sorting machine. This is an inexpensive and rapid piece of equipment. Since the operation is off-line, there is generally not too much time pressure involved.

b) Arithmetic: In most file operations there is a certain amount of arithmetical computation that must be performed as a subsidiary operation.

c) Checking: Since the information on the file is the repository of original data, it must be very carefully checked to make sure that there are no inaccuracies in the information or in its transmission to or from the tape units.

d) Input-output: In many operations there is extensive input or output for a single file problem. In utility billing for example, the output is enormous and the peripheral high speed mechanisms necessary to turn out the required billing are highly complex and expensive pieces of equipment. But even an operation of this type must be considered subsidiary to the basic single file operation itself.

Multifile Problems

The second type of problem is deceptively close to the single file problem in appearance. However, it is of a different order of magnitude so far as difficulty of its computer solution is concerned.

We shall call problems of the second type multiple file (or multifile) problems. They are characterized by the existence of two or more files with a necessity for cross-referencing during the problem solution. Several examples of double file problems are the following:

1) Customer Accounting: If a large manufacturer has a substantial number of dealer outlets and produces a wide variety of items, the manufacturer must maintain a file of his dealers and a file of his production items. The basic problem of customer accounting in this case is the handling of purchase requisitions of the dealers for items that they desire. In determining the billing price, for example, the dealer must be looked up in the dealer file so that his classification as a dealer may be determined and his records can be up-dated. Then the item file must be searched for each item individually to determine the quoting price of the item based on the dealer classification and amount of order. Simultaneously the item file must be up-dated if any attempt is made to use the system as a means of inventory control.

2) Trust Accounting: A bank that deals in trust accounts must maintain a file of these accounts and must also maintain a file of the securities in its portfolio. The standard action on the trust files normally involves an adjustment of the individual trust portfolio. Thus must be reflected in the security file. Conversely if the bank decided to make an adjustment of its own security portfolio, this must be reflected and adjusted as it affects the individual trusts.

In both of these operations the critical difficulty is the fact that a pre-sort on one file is not sufficient. An intermediary random access to the security file appears necessary. This can generally be replaced by internal sorting procedures.

Sorting is an essentially difficult task for a computer. That is, it is a relatively slow and expensive task for a computer. There is much tape handling and there is much computing in the form of comparisons and machine bookkeeping to perform a sorting on a computer. Thus, for double file problems to be handled by computers, very fast, hence very expensive, computers are necessary. There are several computer systems available today that perform sorting as a buffered operation. Although this is an improvement, the basic problem still remains.

Double file problems can possibly be handled using random access memories. There are several machine memories today that have some of the characteristics of random access memories. These are in an early stage of development.

I know of no practical examples of problems that involve more than a double file. In many cases a company that feels that it has a double file problem should look at the problem critically, because it may be possible, by some minor adjustment of operational procedure, to reduce the problem to one of two single file problems. These are a lot easier to handle than one double file problem.

Management Statistics

The next general classification under which business problems fall is in the area of management statistics. These problems generally are ideally suited to the general purpose computer that exists today. In problems of this class one computes averages, deviations, correlations, time sequence information, etc. Examples of these are: average daily dollar volume; the going wage rate in an area; exploratory calculations to determine trends, in order to anticipate reordering needs or to note potential weaknesses in out-lying district operations. An auto in-

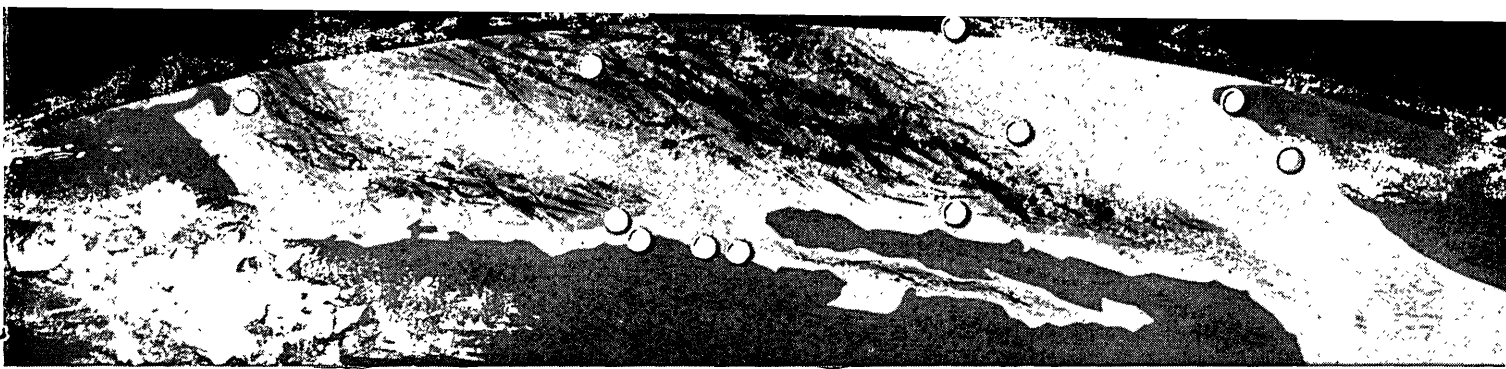

Where the shape of things to come

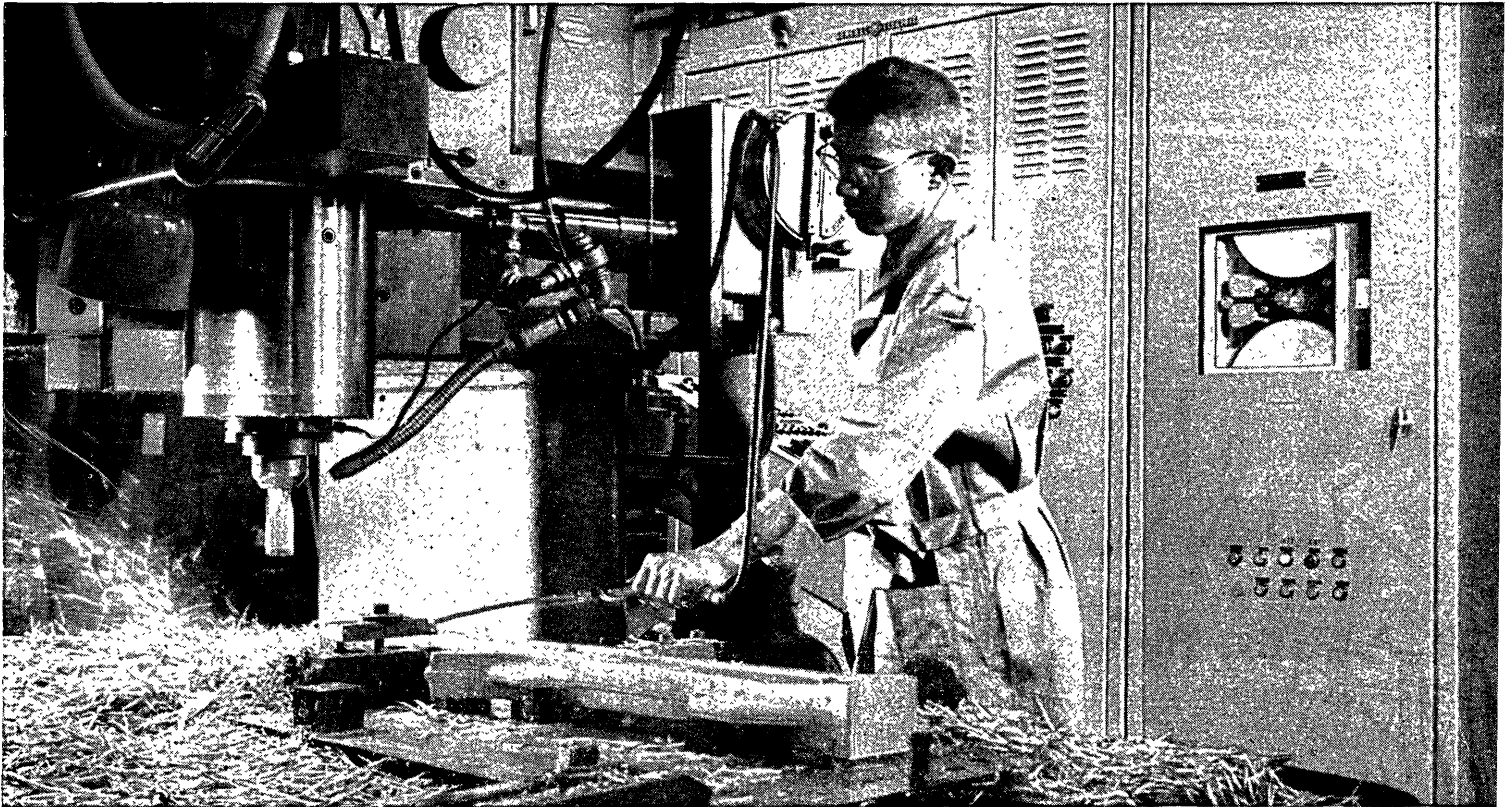

is programmed by AMPEX tape recorders

The profiler above is shaping parts for new Lockheed Electras. Exact tool positions are being defined by command signals—as many as 200 per second—from the Ampex FR-100 in the control system to the right of the machine.

The accuracy of such a milling operation increases with the number of points defined per inch of tool motion. One reel of magnetic tape defines millions of points, programming up to 1½ hours of continuous machine operation. Recycling a tape loop will program an entire run of identical work-pieces.

Shaping parts by command signals from Ampex-equipped automatic control systems is now routine production operation at such places as Lockheed in Burbank, Martin at Denver, Rohr at Chula Vista, Convair at Ft. Worth and San Diego, and Giddings & Lewis at Fond Du Lac, to mention only a few.

Even though punched cards and paper tape are still proving

adequate for many of today's less-sophisticated automatic control installations, systems engineers are increasingly interested in the superior speed and data-handling advantages of magnetic tape. An Ampex FR-300, for instance, can extract a short burst of digital information equal to that on an entire punched card in less than 4 milliseconds, including start and stop.

In configurations like the one illustrated, the advanced Ampex FR-100A, with its 14 tracks on 1-inch tape, has ample reserve for extra functions. Six tracks may be used for tool-position coordinates; others for start, stop, coolant, or even voice instructions.

Whether you believe the future of automatic control lies in point-to-point positioning, continuous-path control, or both—Ampex magnetic tape recorders have built-in reserve capabilities which make them worthy of consideration as a component for any control system designed for tomorrow's needs.

First in magnetic tape instrumentation



AMPEX INSTRUMENTATION DIVISION
934 Charter Street, Redwood City, California
Offices in USA and Canada. Engineering representatives cover the world.

insurance company will perform large numbers of correlations to determine premium rates for selected classes of its insurees.

The prime characteristic of statistical problems is that the output should be small.

Large amounts of data are reduced to a few significant quantities. This leads me to the concept of management by exception.

Management by Exception

The traditional bible for the management of a company has been the periodic "Report (or reports) of Operation." This tome is circulated in whole or in part throughout the administrative echelons of the company. It is a complete, detailed listing of all company activities and includes many different types of breakdowns of the basic data. This volume is ceremoniously received and perused with different degrees of thoroughness dependent on the nature, duties, and responsibilities of the recipients.

To facilitate the reading of this information, companies have used such expedients as summaries, diagrams, tabular highlights, color emphasis and many other sugar-coatings.

What is the purpose of this extremely expensive operation? It is expensive in cost of preparation and in executive time for consumption. The reader is supposed to go through the report and either say, "things look O.K.," or he points to some areas of activity that are not "O.K." Although the report has some other purposes, the principal purpose is to ascertain the level of all activities of the company in order that difficulties may be spotted and presumably corrected.

To achieve this purpose, the "Report of Operation" is not necessary in this standard form. In fact it is a highly inefficient and wasteful operation. It is an operation that can be tremendously improved by the use of computers.

In principle, the management of the company expect a certain level of operation within certain deviations for all activities of the company. This is precisely what the management check in the "Report of Operation." If this information is given to a computer, the computer can prepare a full "Report of Operation" from the same input data that is normally used, and check its detailed results against the extrapolations made by management. Only those items having greater variance than the allowed tolerance determined by management in advance, would be collected as an "Exception Report." In such report all items have significance for management personnel.

With each such "Exception Report," action can be taken by management and revisions can be made to the information given by management to the computer, for its use in the preparation of its next "Exception Report." Some advantages of this type of Management by Exception are

- a) it is less expensive
- b) it eliminates wasted time of checking normal operation
- c) it reduces delay time of corrective action for company difficulties
- d) it is more accurate
- e) all exceptions are reported, none are missed
- f) it allows for company expansion that would

normally be difficult because of paperwork loads

I mentioned that the "Report of Operation" may be used for other purposes. Management may want a detailed listing of all activities in a certain geographical region to use in connection with a major decision in that area. Such a listing can always be obtained from the computer because in essence the full "Report of Operation" exists, within the memory of the computer itself.

A final remark on this subject will point out that the suggested "Exception Report" is not a "Summary Report." Although summaries serve a very useful purpose, they tend to hide large detailed deviations that are the critical points to be assessed.

Mathematically Complex Problems

A fourth type of problem that arises in business is the one that has mathematical complexity associated with it. Consider a business type problem that a pipe line company has. They must know the effect of a shock wave on the fluids in their lines, when delivery must be cut off at certain points due to severely inclement weather that curtails the use of delivery vehicles at those points. This problem resolves itself into an extremely technical mathematical problem. Problems of this type, however, are not commonplace in all companies.

The mathematical problems associated with optimizing operations are more common, and have been the subject of many talks and discussions at operations research conferences.

Executives are not Mathematicians

Let me conclude my talk by relating an incident that occurred a few years ago. A transit company wanted to analyse its bus scheduling problem to improve its operation. When I visited the company and spoke with the executive involved, he said that two eminent mathematicians had studied the problem in detail and presumably had solved it. He took a copy of their report from his desk and handed it to me. "I do not understand a word or symbol in it," he said, "nor do I expect my bus checkers to be mathematicians. This solution is of no use to me."

It is clear that there is more to solving a mathematically complex problem than just applying correct mathematical techniques.

References:

- Rhodes, Ida, and Stevens, M.E., "Preliminary Report on a Combined Sorting-File-Merging Method for Electronic Data Processing," NBS report 3155, 1954.
- Seward, H. H., "Information Sorting in the Application of Electronic Digital Computers to Business Operations." MIT Project Whirlwind report R-232, 1954.

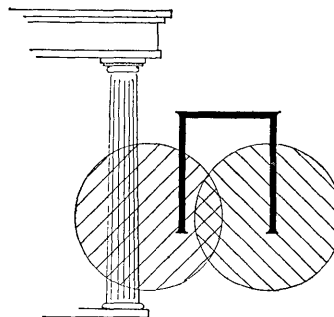

MACHINE TRANSLATION IN THE SOVIET UNION

I. A. Melchuk

Moscow, U.S.S.R.

(Based on a translation from *Vestnik Akademii Nauk U.S.S.R.*, No. 2, 1959)

Work on machine translation began in our country in 1955, at the Precision Mechanics and Computational Techniques Institute and the V.A. Steklov Mathematical Institute of the USSR Academy of Sciences. They were later joined by the Linguistics Institute of the USSR Academy of Sciences; the Leningrad University, which set up a machine-translation laboratory; the Computing Center of the Academy of Sciences of the Armenian Soviet Socialist Republic; the Electronics, Automation and Telemechanics Institute of the Academy of Sciences of the Georgian Soviet Socialist Republic; and other institutions.

Compilation of "Algorithms"

At the first stage, the work consisted mainly of compiling the so-called algorithms of machine translation. For a machine to translate a text from one language into another all the necessary operations must be given as a special set of rules. These rules must be precisely formulated and perfectly clear; must permit of mechanical performance; and constitute a logically coherent system providing for all possible cases.

A number of algorithms were compiled in 1955-1957: a French-Russian, two English-Russian, a Chinese-Russian, a German-Russian, a Japanese-Russian, a Hungarian-Russian. The French-Russian and one English-Russian were programmed and tested on computers; that is, translations were made of passages from French and English scientific (mathematical) texts into Russian. The other algorithms are in the programming stage.

At present, work on machine translation is proceeding along the following three main lines: investigation of possible ways of machine translation for selection of the best; development, by close collaboration of mathematicians and linguists, of precise (primarily mathematical) methods of language description; and study of interconnection between machine translation and other practical applications of linguistics with a view to generalizing and most fully applying the results achieved in allied fields.

Problem: To Work Out General Theory

What are the basic problems of this work?

Whereas three years ago the cardinal task was that of making up algorithms and applying them, now that we already have composed and applied algorithms, chief attention is focused on generalizing the results obtained.

The primary task now is to work out a general theory

of compiling translation algorithms (notably, to work out a universal form of translation algorithm as such, and rules of applying the form to concrete languages). When this task is successfully accomplished, it will become possible to have the machine itself compile translation algorithms on the basis of glossaries and parallel texts prepared in advance.

A System of Operators

Of great importance for the general theory of translation algorithms is a system of operators worked out at the Mathematical Institute. Under this system the translation process is broken up into a number of standard acts which take place in translating from any language into another. Such an elementary act, together with its corresponding standard computer program, is called an operator. Any algorithm may be represented as a sequence of operators. Recording algorithms in terms of operators makes it possible to mechanize the highly laborious process of programming translation algorithms. Thus, in programming a part of the Hungarian-Russian algorithm, five programs were compiled within five minutes, which, if done in the usual way, would require from 20 to 30 man-days. Operator recording is also very important theoretically since it makes it easier to unify algorithms and work out a single universal form of translation algorithm.

Next, An Electronic Editor

Today machine translation is regarded only as the first stage toward solving a more general and more important problem: by most fully using electronic machines as auxiliary tools of human thinking, to make the machine capable of performing the widest possible operations with texts written in different languages, to enable it not only to translate but also to edit, make abstracts, furnish bibliographical and other references, etc. All these operations boil down to extracting from the text required information and to recording that information in some other form. To carry out these operations a special "language" is needed in which the information from the text would be recorded.

Such a language should (1) ensure a simple and accurate recording of the extracted information, and (2) be convenient for translating into it texts written in natural languages. This language can be used both for recording and storing information in the machine (the language in which the information is recorded for stor-

ing in the machine is called "information language"), and as an intermediary for machine translation. In translating from many languages into many others in any direction it is possible to translate from the source language into the intermediary language, and from the latter into the target language. This makes it possible not only to reduce the number of algorithms necessary for direct language-to-language translation, but also makes it easier to unify them. The basic problem of most work on machine translation in our country now is to build up an intermediary language.

Of the many possible ways of building up an intermediary language, two are being actively investigated, and it is one them that we shall dwell.

A New Language?

One consists in producing an intermediary language as some artificial language possessing its own vocabulary, morphology and syntax (i.e., similar to natural languages or artificial languages like Esperanto). The components of the intermediary language are determined by statistical investigation of the languages in question: only those phenomena are imparted to the intermediary language which are widespread in all or most of these concrete languages, with each allowed a share in proportion to the number of people speaking it.

Such an intermediary language will be an "intersection" product, as it were, of a number of given (natural) languages, for which a system of symbols has been worked out. In the future this formal-logic system is expected to be used as an information language.

The other way is to construct the intermediary language only as a system of correspondences between natural languages. The correspondences are established at three levels: vocabulary (between words and idioms of various languages), morphological and word-building, and syntactical (between elementary syntactical constructions).

Translation-equivalent words of different languages (bundles of lexical correspondences) form sets and these sets constitute the words of the intermediary language; its syntactical relations are bundles of syntactical correspondences. The whole thing boils down to the following: It is assumed that the intermediary language is an "aggregate" of all the languages under review; this means that any differences occurring in all these languages may be expressed in the intermediary language. May, but not must; they are expressed not obligatorily, but on occasion, if they occur in the source language.

Bundles of morphological correspondences are regarded as words of the intermediary language (like the bundles of vocabulary correspondencies). These words

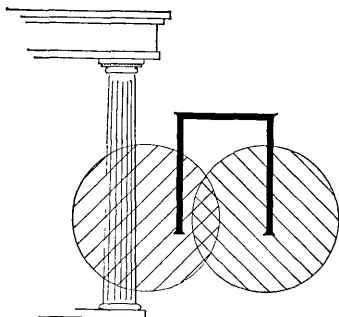

may and may not occur: thus, the noun number category will be expressed in the intermediary language when translating from languages where it exists (Russian, English, Armenian, Hungarian, etc.), and will not be expressed when translating from Chinese where this category does not exist. This has been done in order to avoid losses of relevant information and to avoid producing superfluous information, no matter what pair of languages are involved in translation.

The intermediary language obligatorily expresses only two kinds of differences: lexical and syntactical (words and relations between them), i.e., differences which exist in all human languages and without which any language is unthinkable.

On the whole, the proposed intermediary language to certain extent resembles, on the one hand, the so-called *Uhrsprachen* of comparative linguistics (which likewise constitutes a system of correspondences between languages), and, on the other hand, calculuses of mathematical logic ("words" and "syntactical relations" of the intermediary language correspond to the alphabet and the formation rules of formal-logic languages).

Translation by Tables

The intermediary language as a system of correspondences can be set up in tables with vertical columns and horizontal lines. The columns are assigned to different languages; each line, to translation equivalent units of different languages. The numbers of the lines containing lexical and morphological equivalents represent words of the intermediary language; the numbers of the lines containing syntactical correspondences represent its syntactical relations.

The process of translation by means of an intermediary language is divided into two phases: analysis, or translation from the source language into the intermediary language, i.e., the numbers of the respective lines in the tables, are, by means of special routines, referred to various units of the source language; and synthesis, or translation from the intermediary language into the target language, i.e., units of the target language, selected from bundles of correspondences, are given the proper morphological forms and lined up in accordance with the laws of the target language.

A model of an intermediary language is now being developed for short passages from mathematical texts. Algorithms of independent analysis and synthesis are being devised for a number of languages; work has begun on establishing word correspondences between the major European languages.

Syntactical analysis, as a result of which syntactical connections between all the words of the translation text are determined, is the central part of an algorithm for machine translation. This is done by means of a list of elementary syntactical constructions (configurations) occurring in the texts of the given type, and by means of rules for detecting them in the text. Therefore, to build up an algorithm it is necessary to have sufficiently full lists of configurations for all the languages used.

Language Peculiarities Cause Problems

There are a number of other, purely linguistic, problems, the solution of which is necessary to construct an algorithm and which requires independent research. The

latter includes, among others, the problem of finding redundancies in a language, i.e., historically-evolved categories which in the system of a modern language perform no meaningful function. Thus, the gender category of the Russian verb has become almost entirely redundant, the inflections of Russian and French adjectives are largely redundant, the form differences of the Russian dative and local cases are always redundant and of the nominative and accusative cases are nearly always redundant, etc. The problem of redundancy in a language is of great importance also for communications engineering, as the elimination of textual redundancies makes it possible to increase many times the effectiveness of transmitting and receiving devices. Therefore, the efforts of machine translation specialists and communications engineers are being pooled to solve this problem.

Statistical Approach Necessary

Linguistic research on machine translation must be based on many-sided statistical investigation of the text. Statistics are necessary to limit the material under investigation, to isolate the range of phenomena to be described and systematized. Quantitative characteristics make it possible to appreciate the specific weight of various language phenomena in order to concentrate attention on essentials, leaving aside secondary aspects; they are also needed to assess the efficacy of one or another solution. Lastly, since absolutely precise solutions of one or another linguistic problem are not always possible, statistics help to find approximate, more plausible solutions.

Statistical description of speech is of considerable interest not only for machine translation, but also for

communication engineering, printing, language teaching methods, etc. It is therefore a primary task to carry on statistical investigations in different languages, Russian first and foremost, on an appropriately large scale.

For these investigations to be effective it is necessary to use widely analytical and electronic computing machines, which again calls for close contact of linguists with specialists in other respective fields.

Specialized "Language" Computer

In conclusion, we should like to mention one more field in which linguists, mathematicians and electronic engineers should cooperate: designing of special translation and information machines for all kinds of work connected with language. (Up to this date in our country and abroad experimental translations are made on general-purpose computers not adapted for this purpose.)

Coordination of research in all these lines was in no small measure facilitated by the First All-Union Conference on Machine Translation, held in Moscow in May 1958.

Imparting Human Speech to Electronic Machines

All research on machine translation should be regarded as the initial stage of a wider range of work the goal of which is to impart human speech to electronic machines. Achievement of that goal will produce a real revolution in science and technology. And solution of the machine translation problem now directly confronting researchers will be a step forward toward that goal.

This is our line

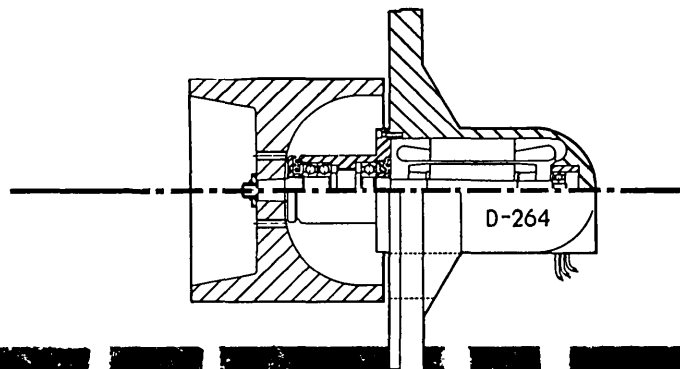

If you're establishing the requirements for a magnetic storage drum, you have to consider storage capacity, density, signal frequency, access time.

We think of the same drum in terms of the accurate distribution of mass about an axis, in terms of machining to minute tolerances, preloading and lubrication of precision bearings, and in terms of precise dynamic balance.

We've always specialized in designing and building precision rotary machinery, including many highly successful magnetic storage devices — small ones and large ones, drums and discs — with speeds to 30,000 rpm, eccentricities under fifty millionths (.00005"), and with manufacturing costs at sensible levels. We'd like to tell you about them and offer you the benefit of our considerable experience in the field.

The Whitnon Manufacturing Company
Route 6 and New Britain Avenue . . . ORchard 7-2607
Farmington, Connecticut

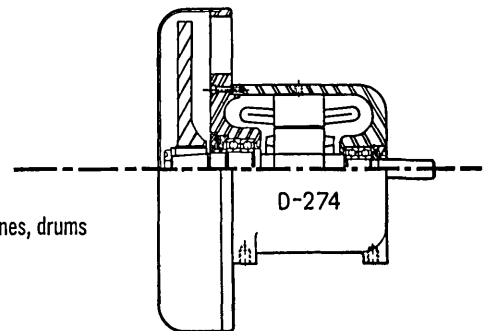

SURVEY OF RECENT ARTICLES

Moses M. Berlin

Cambridge, Mass.

A New Concept in Computing / R. L. Wigington, National Security Agency, Dept. of Defense, Ft. Meade, Md. / *Proceedings of the IRE*, vol. 47, no. 4, April, 1959, p 516 / Institute of Radio Engineers, Inc., 1 East 79 St., New York 21, N.Y.

This paper is an explanatory statement of a new computing scheme which was proposed by von Neumann in a patent submitted in 1954. Described in detail is the concept of using the phase of a sine-wave signal as an information-bearing medium, which together with majority logic permits the realization of logic operations. Simple logical aggregates of elements are given as examples. The article mentions the development by the Japanese of a subharmonic oscillator computer based on some of the concepts proposed by von Neumann.

Computer Courses for the Press / D. Whipp / *Automation and Automatic Equipment News*, vol. 4, no. 8, April, 1959, p 1076 / A. & A.E.N., 9 Gough Square, Fleet St., London, E. C. 4 /

In an attempt to enlighten, subsequently, the general public on electronic computers, International Computers and Tabulators, Ltd., has organized a series of courses on computers for newspaper reporters. The course includes an explanation of the processes used to feed the computer, and subsequent computer-operations of storage and control.

How Chains are Moving into Automation / S. O. Kaylin, Executive Editor, *Chain Store Age* / *Chain Store Age*, April, 1959, p 25 / *Chain Store Age*, 440 Boston Post Rd., Orange, Conn. / A progress report on data processing in retailing, which makes it clear that the computer and associated equipment are emerging as practical tools in retail distribution. The report explains how

companies have gradually implemented data processing to their particular, though varied, needs.

Generalization: Key to Successful Electronic Data Processing / W. C. McGee, General Electric Co., Richland, Wash. / *Journal of A. C. M.*, vol. 6, no. 1, Jan., 1959, pp 1-23 / *Assoc'n for Computing Machinery*, 2 East 63 St., New York 21, N.Y.

A new method to minimize costly experimentation with new systems, and revision of existing systems. A program is used which allows the computer to prepare a file of records of changes made, and routines are generalized so that all information can be contained in one source file.

How Canada is Applying Automation to Highway Engineering Calculations / A. Kirby / *Automation and Automatic Equipment News*, vol. 4, no. 8, April, 1959, p 1086 / A. & A. E. N., 9 Gough Square, Fleet St., London, E. C. 4

The largest roadbuilding company in Canada applies computers to the problems of highway engineering. The electronic systems eliminate lengthy computation time and costly errors, perform computation of earth-quantity problems, grade calculations, and horizontal curve calculations.

On-Line Computation with General Purpose Computers / L. S. Michels, Bendix Computer Div. / *Automatic Control*, vol. 10, no. 4, April, 1959, p 2 DC / Reinhold Publishing Corp., 430 Park Ave., New York 22, N.Y.

Computers used to solve complex mathematical and "decision" problems, are to be used to control the processes involving those problems. Some of the operations of a computer in on-line applications, are listed, and the use of two computers on the USS Compass Island is described.

Evaluating Intelligence for Programming Systems / R. W. Bemer, IBM Corp., / *Automatic Control*, vol. 10, no. 4, April, 1959, p 22 DC / Reinhold Pub. Corp., 430 Park Ave., New York 22, N.Y.

Typical "intelligence questions" for computers are listed, in processor and supervisor categories. The article describes the attempt being made to systematically classify the various devices for "educating the computer" to take over "the decision-making functions of one or many" human beings.

Digital Building Blocks Form Go/No-Go Timers / J. Mitchell, and G. L. King, Packard Bell Electronics / *Control Engineering*, vol. 6, no. 4, April, 1959, p 132 / McGraw-Hill, 330 West 42 St., New York 36, N.Y. /

A digital timer designed and assembled from "shelf-item computing 'building-blocks,'" for use during qualification testing of ground support equipment for the missile, THOR. It contains characteristics requisite for tests in the milli-second-to-quarter-hour category.

Magnetic Tape System for Analog, PDM, or FM / K. Fetty, Datatape Div., Consolidated Electrodynamics Corp. / *Instruments & Control Systems*, vol. 32, no. 3, March, 1959, p 392 / Instruments Publishing Co., Inc., 845 Ridge Ave., Pittsburgh, Pa.

A versatile tape system handles analog, PDM, and FM signals. It is designed for use where high-speed acquisition of large amounts of data is required. The description of the system includes amplifiers, power supplies, and auxiliary equipment.

The Digital Magnetic Tape Recorder / C. Kezer, Fairchild Camera and Instrument Corp. / *Instruments & Control Systems*, vol. 32, no. 3, March, 1959, p 389 / Instruments Publishing

Readers' and Editor's Forum

[Continued from page 6]

The building began to be occupied in 1958. It now houses more than 700 students, instructors, and service personnel.

The new center is one of 26 education centers that IBM maintains at manufacturing and sales locations throughout the United States.

Figure 3 — A student group watches a demonstration of computer maintenance techniques being presented via television to classes. The telecast originated from the building's data processing test center and was transmitted by a closed circuit television. The TV network is used as an educational tool to transmit lectures, demonstrations, machine operating procedures, and service techniques into classrooms.

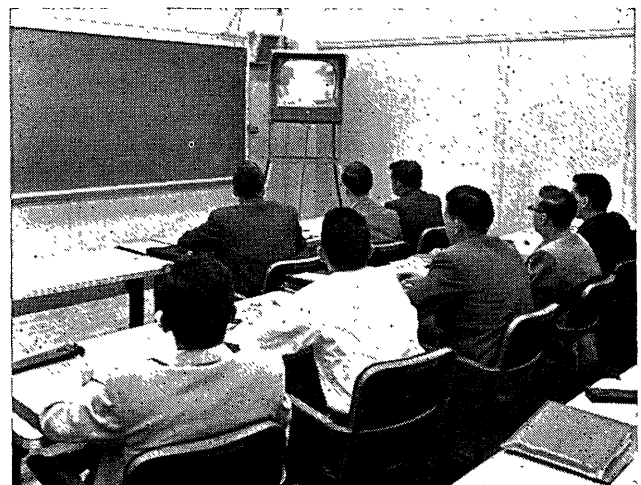

Corp., Inc., 845 Ridge Ave., Pittsburgh 12, Pa.

The characteristics of the "digital" magnetic tape recorder differ greatly from those of the analog recorder. These differences are mentioned, while the digital recorder is discussed in greater detail.

Generation of Permutations and Combinations / T. R. Hoffmann, Mechanical Engineering Bldg., Univ. of Wisconsin, Madison, Wisc. / abstract in Bulletin of the Operations Research Society of America, vol. 7, supplement 1, 1959, p B-20 / Oper. Res. of Amer., Dr. H. J. Miser, Route 2, Box 211, Vienna, Va.

This paper presents a mechanistic method involving "precedence matrices" which generate the relatively few sequences of permutations that may be practical in a particular situation. The method of generation can be programmed for a digital computer, and the technique has had successful application in the assembly-line balancing problem.

Mathematical Models of Some Post Office Problems / R. Oliver, Broadview Research Corp., Burlingame, Calif. / abstract in Bulletin of the Operations Research Society of America, vol. 7, supplement 1, 1959, p B-25 / Oper. Res. Soc. of Amer., Dr. H. J. Miser, Route 2, Box 211, Vienna, Va.

A mathematical model which has been optimized to obtain lower values of delays, has been developed and experimentally used in a large U.S. Post Office, to handle, sort, and transport first-class letter mail.

COMPUTER ENGINEER

Challenging position for experienced Mechanical Engineer, Chemical Engineer, or Applied Physicist with good background in Mathematics. Computer Experience desirable. Duties consist of analysis and programming of engineering problems for Datatron 205 Computer. Citizenship preferred. Reply with complete confidential resume to:

RESEARCH DIVISION

THE
FLUOR

CORPORATION, LTD.

ENGINEERS - CONSTRUCTORS

BOX 510

WHITTIER, CALIFORNIA

A Systems Analysis of Pre-Registration Scheduling in a University with Emphasis on the Use of the Digital Computer / A. G. Holzman, Industrial Engineering Dept., University of Pittsburgh, Pa. / abstract in Bulletin of the Operations Research Society of America, vol. 7, supplement 1, 1959, p B-15 / Oper. Res. Soc. of Amer., Dr. H. J. Miser, Route 2, Box 211, Vienna, Va.

A flow chart has been designed for a digital computer system of analyzing the various factors involved in formulating a pre-registration schedule for a student. The student's academic status, his average and type of program are among the considered factors.

Use of a Computer for Scheduling Students / G. R. Sherman, Statistical Laboratory, Purdue University, West Lafayette, Ind. / abstract in Bulletin of the Operations Research Society of America, vol. 7, supplement 1, 1959, p B-15 / Oper. Res. Soc. of Amer., Dr. H. J. Miser, Route 2, Box 211, Vienna, Va.

A process has been devised in which a digital computer is used in establishing schedules for college students. This paper describes the problems encountered in the system, and briefly explains methods of solving them.

Magnetic Tape Dropouts / E. Franck, Reeves Soundcraft Corp. / Instruments & Control Systems, vol. 32, no. 3, March, 1959, p 390 / Instruments Publishing Co., Inc., 845 Ridge Ave., Pittsburgh 12, Pa.

Despite reasonable precautions in manufacture, the surface of tape is not completely smooth and homogeneous, and this causes the occurrence of surface defects. However, as better tapes are produced, the author says dropouts should be regarded as a "property of the system, rather than of the tape alone."

How a Computer Saved \$13,000 in Its First Year / F. D. Bauce, Cost Control Mgr., Torrington Mfg. Co., Torrington, Conn. / The Office, vol. 49, no. 4, April, 1959, p 120 / Office Publications, Inc., 232 Madison Ave., New York 16, N.Y.

A firm producing wire forming machines and auxiliary equipment realized the \$13,000 saving, by applying the computer to payroll preparation, with by-product applications in labor distribution, and cost accounting. By making use of the full potential of the computer, the company will add to the savings. They plan to automate inventory and production control in each of their manufacturing units, establishing a master deck of punched cards with information on the unit of time required for each shop-operation involved in the making of machine parts. The computer will enable the firm to meet shipping dates with greater precision, and make more (and more fully informed) purchasing decisions.

Feasibility Studies / O. Nielsen / Machine Accounting & Data Processing, vol. 1, no. 3, March-April, 1959, p 15 /

AEROJET-GENERAL CORPORATION

offers

challenging positions

on the nation's largest, most advanced IRBM, ICBM and space flight projects

704 COMPUTER PROGRAMERS — These highly responsible positions involve application of computers in research and design of missile weapons and liquid and solid rocket propulsion systems.

Bachelor's degree in mathematics, engineering, or physical sciences required, with a minimum of one year of experience in programing 701, 704 or 709 computers.

MATHEMATICIANS — Creative geometers to analyze the burning pattern of solid rocket fuels, derive burning surface functions of complex grain shapes, and prepare problems for digital and analog computers. (Two 704 computers and a 100 amplifier analog computer available.)

These openings are in a rapidly expanding Design Research Section, contributing to the advanced design of POLARIS, MINUTEMAN, and other important missiles. Publication in professional journals encouraged.

Bachelor's or masters degree in applied mathematics required, with proficiency in vector analysis, differential equations, and advanced calculus. Minor in thermodynamics, heat transfer or physics desirable though not mandatory.

Address inquires to:

E. P. James

Aerojet-General Corporation

P.O. Box 1947U,

Sacramento, California

AEROJET-GENERAL CORPORATION

A Subsidiary of The General Tire & Rubber Company
Azusa & Near Sacramento, California

MANUSCRIPTS

WE ARE interested in articles, papers, reference information, and discussion relating to computers and automation. To be considered for any particular issue, the manuscript should be in our hands by the first of the preceding month.

ARTICLES: We desire to publish articles that are factual, useful, understandable, and interesting to many kinds of people engaged in one part or another of the field of computers and automation. In this audience are many people who have expert knowledge of some part of the field, but who are laymen in other parts of it.

Consequently, a writer should seek to explain his subject, and show its context and significance. He should define unfamiliar terms, or use them in a way that makes their meaning unmistakable. He should identify unfamiliar persons with a few words. He should use examples, details, comparisons, analogies, etc., whenever they may help readers to understand a difficult point. He should give data supporting his argument and evidence for his assertions.

We look particularly for articles that explore ideas in the field of computers and automation, and their applications and implications. An article may certainly be controversial if the subject is discussed reasonably. Ordinarily, the length should be 1000 to 3000 words. A suggestion for an article should be submitted to us before too much work is done.

TECHNICAL PAPERS: Many of the foregoing requirements for articles do not necessarily apply to technical papers. Undefined technical terms, unfamiliar assumptions, mathematics, circuit diagrams, etc., may be entirely appropriate. Topics interesting probably to only a few people are acceptable.

REFERENCE INFORMATION: We desire to print or reprint reference information: lists, rosters, abstracts, bibliographies, etc., of use to computer people. We are interested in making arrangements for systematic publication from time to time of such information, with other people besides our own staff. Anyone who would like to take the responsibility for a type of reference information should write us.

NEWS AND DISCUSSION: We desire to print news, brief discussions, arguments, announcements, letters, etc., anything, in fact, if it is not advertising and is likely to be of substantial interest to computer people.

PAYMENTS: In many cases, we make small token payments for articles, if the author wishes to be paid. The rate is ordinarily $\frac{1}{2}$ c a word, the maximum is \$15, and both depend on length in words, whether printed before, etc.

All suggestions, manuscripts, and inquiries about editorial material should be addressed to: *The Editor, COMPUTERS and AUTOMATION, 815 Washington Street, Newtonville 60, Mass.*

Gille Associates, Inc., 956 Maccabees Building, Detroit 2, Mich. /

Discusses the nature and importance of feasibility studies, relative to the installation of an electronic data processing system. Among the aspects discussed are short-term and long-term considerations, the small company and the computer, and costs of installations.

Medium-Sized Computers / N. Chapin / Machine Accounting and Data Processing, vol. 1, no. 3, March-April, 1959, p 18 / Gille Associates, Inc., 956 Maccabees Bldg., Detroit 2, Mich. /

The most popular computer in use is the medium-sized one; they lead the "on-order" list. Factors which have caused this effect are high costs of large computers, the piecemeal applications which frequently can be done on smaller computers, and the fact that a number of smaller companies find the space required by the larger computer impractical.

An Electronic Network for Better Defense / Brig. Gen. W. P. Battell, USMC / Systems, vol. 23, no. 2, Mar-Apr., 1959, p 3 / Systems Magazine, 315 Fourth Ave., New York 10, N.Y.

A medium-sized computer helps the USMC to control its supply system efficiently and economically. A completely integrated system has been established, using the computer to determine inventory, replenish, and adjust supplies, and to furnish managerial control reports.

The Auditor Encounters Computers / C. E. Grody, N.Y. Life Insurance Co. / The Internal Auditor, Mar., 1959, p 31

The relationship between an auditor and the computer should be such that he controls the operations of the computer from a business — not technical — viewpoint. This article outlines an auditor's functions, gives a check list of control points, and a sample of some audit program procedures.

Data Processing Horizons / J. Rosenzweig / Machine Accounting and Data Processing, vol. 1, no. 3, March-April, 1959, p 6 / Gille Associates, Inc., 956 Maccabees Bldg., Detroit 2, Mich.

This article discusses the potential of the computer and asserts that in the future the computer will have wider application. Cited as a reason for a lack of use of full potential, is the fact that emphasis has been placed on immediate cost and immediate result.

Flow . . . Without Boundaries / R. Wright, Controller, The Mennen Co., Morristown, N. J. / Systems, vol. 23, no. 2, Mar.-Apr., 1959, p 22 / Systems Magazine, 315 Fourth Ave., New York 10, N.Y. /

A large company achieves highly integrated data processing, with a computer used to forecast and schedule various factors in production. The system includes file maintenance of accounts receivable, and provides sale analyses and inventories of raw materials and finished goods.

A Pattern Punched Card System for Data Retrieval / F. E. Lynch, Controller,

and J. F. Glenn, Res. Chemist, L. D. Caulk Co., Milford, Dela. / *The Office*, vol. 49, no. 5, May, 1959, p 79 / Office Publications, Inc., 232 Madison Ave., New York 16, N.Y. /

By adding to its tabulating system, a sorting attachment, this firm is able to retrieve one or many abstract cards out of a file. The operation now takes a few seconds, where previously it took 30 minutes. The system, and provision for continual additions of new data are both described.

Organizing a Network of Computers / NBS Technical News Bulletin, vol. 43, no. 2, Feb., 1959, p 26 / Supt. of Documents, U.S. Govt. Printing Office, Washington 25, D.C.

The Bureau investigated the problems arising when several computers are linked together to work on a particular problem, and set up a theoretical "model network." The operations of the network are described, and possibilities for improvement, modification, or extension are suggested.

Special Electronic Equipment for the Analysis of Statistical Data / E. R. Carlson and others, Lewis Research Center, Nat'l Aeronautics and Space Admin., Cleveland, Ohio / Proc. of the IRE, vol. 47, no. 5, part 1, May, 1959, p 956 / IRE, Inc., 1 East 79 St., New York 21, N.Y.

In the analysis of noise signals, among the instruments that are useful, is a correlation computer. The authors describe a system of instrumentation in which the data involved are treated statistically and reduced to processing by analog and analog-digital methods.

Pulsed Analog Computer for Simulation of Aircraft / A. W. Herzog, U.S. Naval Training Device Center, Port Washington, N.Y. / Proc. of the IRE, vol. 47, no. 5, part 1, May, 1959, p 847 / Institute of Radio Engineers, Inc. / 1 East 79 St., New York 21, N.Y.

A description of the logical design of a pulsed analog-digital computer, with a magnetic drum to perform the functions of storing the program. The computer could be used to solve the system of non-linear differential equations normally encountered in the simulation of an aircraft. A feature of the system is a type of "floating point" arrangement which automatically scales all voltages within optimum levels.

Integrated Communications Systems for Management / N. J. Ream, Lockheed Aircraft Corp., Burbank, Calif. / Systems & Procedures, vol. 10, no. 2, May, 1959, pp 10-17 / S & P Assoc., 4463 Penobscot Bldg., Detroit 26, Mich.

Interest in integrated systems resulted from studies to develop improved control of manufacturing with electronic data processing. Consequently, the system proposed by the author has its "inputs," such as information garnered from engineers and other sources, while, following the computer pattern, it has "outputs" consisting of various reports on production control, parts requisitions and disbursement lists.

**Get Your Reference and
Survey Information
in the Computer field from**

COMPUTERS AND AUTOMATION

Keep This List for Handy Reference

Computers and Automation now publishes more than 20 kinds of reference and survey information. Here is our latest inventory, of kind of information and issues when published. . . . Subscribe to *Computers and Automation* and have this information at your elbow!

Organizations:

- Roster of Organizations in the Computer Field (June 1959)
- Roster of Consulting Services (June 1959)
- Roster of Computing Services (June 1959)
- Survey of Computing Services (July 1958)

Computers and Data Processors:

- Survey of Special Purpose Digital Computers (Sept. 1958)
- Survey of Commercial Computers (Nov. 1958)
- Annual Computer Census (May 1958)
- Types of Automatic Computing Machinery (Nov. 1958)
- Roster of Automatic Computers (June 1956)

Products and Services in the Computer Field:

- Products and Services for Sale or Rent (June 1959)
- Classes of Products and Services (June 1959)
- Types of Components of Automatic Computing Machinery (Nov. 1958)
- Survey of Basic Computer Components (Feb. 1959)

Applications:

- Important Applications of Computers (Oct. 1958)
- Novel Applications of Computers (Mar. 1958, Mar. 1959)

Markets:

- Computer Market Survey (May 1957; next one, Sept. 1959)
- The Market for Computers in Banking (Sept. 1957)
- The Market for Computers in the Oil and Natural Gas Industry (Nov. 1957)

People:

- Who's Who in the Computer Field (various issues)

Pictorial Reports:

- 1958 Pictorial Report on the Computer Field (Dec. 1958)
- A Pictorial Manual on Computers (Dec. 1957, Jan. 1958) (reprint available)

Words and Terms:

- Glossary of Terms and Expressions in the Computer Field (Oct. 1956, reprint available)

Information and Publications:

- Books and Other Publications (many issues)
- New Patents (many issues)
- Computer Talks (many issues)
- Survey of Recent Articles (many issues)

With the ever-increasing expansion of the field of automatic handling of information, it is easy to predict that more and more reference information of these and other kinds will need to be published; and this we shall do. For it is a fact that reference information of the kind here described is not computable from automatic computing machinery—instead, it comes from collecting observations and reports about the real world. This is our job.

-----MAIL THIS COUPON (or a copy of it)-----

To: **COMPUTERS and AUTOMATION**
815 Washington St., R142
Newtonville 60, Mass.

- Please enter my subscription to **Computers and Automation**
I enclose \$5.50 for one year,
 \$10.50 for two years,
— for U.S.A. (add 50 cents a year for Canada; \$1.00 a year elsewhere)
- Please send me the following back copies:

.....
.....
.....

I enclose \$1.25 for each one, except the June Computer Directory issues, \$6 (1959), \$4 (prior years).

I understand any of these are returnable in 7 days if not satisfactory for full refund (if in good condition).

My name and address are attached.

Join with
Physicists and
Mathematicians
at the Knolls
Atomic Power
Laboratory —
now entering
a New Stage in
Nuclear Power
Development

▶ Starting Salaries to \$12,000

Theoretical and experimental programs in progress at KAPL show indications of opening the way to a new generation of nuclear powerplants with vastly extended efficiency and service life.

Mathematicians or Physicists with significant related experience in the fields below are invited to inquire about current opportunities.

PHYSICS

- Theoretical reactor physics
- Experimental reactor physics
- Nuclear analysis

MATHEMATICS

- Advanced numerical analysis (PhD required)
- Advanced engineering mathematics (PhD required)
- Mathematical statistics & design of experiments (PhD)
- Mathematical analysis and computer programming
- Computer operation

U. S. Citizenship Required

To expedite your inquiry, forward one or more copies of your resume, including salary requirement. Please also state your particular job interests. Address:

Mr. A. J. SCIPIONE, DEPT. 21-MH



Knolls Atomic Power Laboratory
OPERATED FOR A.E.C. BY

GENERAL ELECTRIC

Schenectady, New York

BOOKS and OTHER PUBLICATIONS

Moses M. Berlin
Cambridge, Mass.

WE PUBLISH HERE citations and brief reviews of books and other publications which have a significant relation to computers, data processing, and automation, and which have come to our attention. We shall be glad to report other information in future lists if a review copy is sent to us. The plan of each entry is: author or editor / title / publisher or issuer / date, publication process, number of pages, price or its equivalent / comments. If you write to a publisher or issuer, we would appreciate your mentioning **Computers and Automation.**

Canadian Conference for Computing and Data Processing—Proceedings / University of Toronto Press, Toronto, Ontario, Canada / 1958, 383 pp., \$5.00

This book contains 38 papers concerning the theory, role, and application of computers and data processors in education, government, medicine, science, banking, business, industry and transportation. The papers were presented at the Conference in June, 1958, at the University of Toronto. Some of the topics covered are "The Computer in Canadian Railroading," "Planning a Data Processing System," "Some Mathematical and Programming Problems Encountered in the Operation of a Scientific Computing Facility," "A Computer Program for System Optimization."

Perry, J. W., Allen Kent, and J. L. Melton, editors / Tools for Machine Literature Searching / Interscience Publishers, Inc., 250 Fifth Ave., New York 1, N.Y. / 1958, 972 pp., \$27.50

This Volume I in the Library Science and Documentation Series includes the following parts: Introduction to Machine Literature Searching; Engineering of Machine Literature Searching Systems; Procedures for Analyzing, Encoding and Searching of Recorded Information; and finally, A Thesaurus of Scientific and Technical Terms: The Semantic Code Dictionary. Treatment of the subject is thorough and exhaustive. Words and terms are tabulated with their "semantic codes" in "machine language," and the use of the semantic code in literature searching is carefully explained. Erratum: On p. 747, the word explanation of B-FL is in error.

Culbertson, James T. / Mathematics and Logic for Digital Devices / D. van Nostrand Co., Inc., 120 Alexandra St., Princeton, N.J. / 1958, printed, 224 pp., \$4.85

In his text, Mr. Culbertson develops the mathematics related to digital computers. His early chapters deal with such algebraic topics as permutations, combinations and probability, then with number systems as they apply to computers. The author proceeds to Boolean Algebra and finally to its application to switching circuits. Many applicable problems are included; the text is amply illustrated.

Feinstein, Amiel / Foundations of Information Theory / McGraw-Hill Book Co., Inc., 330 West 42 St., New York 36, N.Y. / 1958, printed, 137 pp., \$6.50.

This author seeks to expound the mathematics so far proved to be fundamental to information theory: he attempts an "up to date and . . . reasonably complete" presentation of such fundamental mathematical theory. Information theory, he says, can be divided into two distinct branches—one dealing with the various general theorems suitable for transmitting information, and the other dealing with the actual implementation of such general theorems. The reader must have some knowledge of probability theory and mathematics if he is to understand the text material.

Vazsonyi, Andrew / Scientific Programming in Business and Industry / John Wiley & Sons, Inc., 440 Fourth Ave., New York 16, N.Y. / 1958, printed, 474 pp., \$13.50.

Mr. Vazsonyi seeks to help management personnel find scientific solutions to its problems. The material of the text is presented "in a mathematical language which can be understood by businessmen." Chapters include: The Use of Mathematical Models in Business; Transportation Allocation by Linear Programming; Convex Programming; Dynamic Programming; and Statistical Inventory Control. Many actual case histories are given. The author is an editor of *Management Science*, and has been manager of the Management Consulting Services of the Ramo-Wooldridge Corp.

Oldfield, R. L. / The Practical Dictionary of Electricity and Electrons / American Technical Society, 848 East 58th St., Chicago, Illinois / 1959, 216 pp., \$5.95

This excellent small dictionary brings together in one volume the basic vocabulary of modern electricity and electronics. It includes 38 pages of a handbook section, containing useful tables, formulas, symbols, circuit symbols and definitions, etc.

Jury, Eliahu I. / Sampled-Data Control Systems / John Wiley & Sons, Inc., 440 Fourth Ave., New York 16, N.Y. / 1958, printed, 453 pp., \$16.00

The author of this book, an authority on control systems, is now Associate Professor of Electrical Engineering at the University of Calif., Berkeley. The nine chapters of the book discuss the various

applications of the z-transform method; the synthesis problem; the continuous-compensation method; applications of both the z-transform and the modified z-transform in the approximate analysis of continuous systems and in the operational solution of difference equations; exact analysis and stability study of sampled-data systems with finite pulse width; and the p-transform method and its applications to pulse-modulated feedback systems. Augmented with extensive examples and problems, the book describes the theory through a general approach to mixed digital-analog linear systems. Problems arising in feedback control systems are solved and discussed by means of application of digital computers. This study places special emphasis on the organization, integration, and extension of material governing industrial control methods. An excellent bibliography of more than 100 items supplements the text.

McCorkle, Paul / *The Physical World* / McGraw-Hill Book Co., Inc., 330 West 42nd St., New York 36, N.Y. / 1956, 465 pp., \$5.95

Dr. McCorkle is head of the Department of Physics at Roanoke College, Virginia. The book is a survey and orientation course in the physical sciences, designed to be part of a college and university general-education program. The solar system; the earth's crust, rocks, and minerals; atomic radiation; energy and its relation to machines; sound, heat and light; electronic applications—are among the many topics discussed in 29 chapters and 9 appendices. The book is well illustrated. Experimental exercise at the end of each chapter supply suitable material for laboratory work. Questions and problems are given at the end of each chapter.

Krauskopf, Konrad / *Fundamentals of Physical Science* / McGraw-Hill Book Co., Inc., 330 West 42 St., New York 36, N.Y. / 1959, printed, 649 pp., \$6.95

This book on the physical sciences contains 43 chapters grouped into six parts: "The Solar System," "Matter and Energy," "The Structure of Matter," "Fundamental Processes," "The Biography of the Earth," and "Stars and Galaxies." The text is all interesting and thorough college-level treatment of physics for students with lively curiosity; it does not require advanced mathematical knowledge for understanding. Review questions are included at the end of each chapter.

Langer, Rudolph E., editor / *On Numerical Approximation* / University of Wisconsin Press, 811 State St., Madison, Wisconsin / 1959, 462 pp., \$4.50

This volume contains 21 papers delivered at the Symposium on Numerical Approximations at the Mathematics Research Center, United States Army, University of Wisconsin in April, 1958. The papers present "recent developments in the field of numerical approximation centered around" Linear Approximation, External Approximation, and Algorithms. Among topics included are "Trends and Problems in Numerical Approximation," "Numerical Evaluation of Multiple Inte-

ADVANCED DIGITAL TECHNIQUES, COMPUTERS AND CONTROL SYSTEMS

- ▶ AIRBORNE DIGITAL EQUIPMENT
- ▶ NUMERICAL MACHINE CONTROL
- ▶ HYBRID ANALOG-DIGITAL SYSTEMS
- ▶ ADVANCED STORAGE TECHNIQUES
- ▶ NEW LOGICAL STRUCTURES

Engineers and scientists needed with experience in all phases of digital computer technique and equipment development. Systems organization, logical design, transistor circuitry, magnetic core and drum memories, input-output equipment, packaging. Applications, both commercial and military, include airborne digital equipment, numerical machine control, and hybrid analog-digital systems. Advanced development and research on a wide variety of new components and logical structures.

We think you will find this work unusually stimulating and satisfying; we would welcome the opportunity to discuss it with you in person. Comfortable and pleasant surroundings in suburban Detroit. If interested, please write or wire Fred A. Barry, Research Laboratories Division, Bendix Aviation Corporation, Southfield, Michigan.

Research Laboratories Division

P.O. BOX 5115
DETROIT 35, MICHIGAN



sig- nificantly!

Every NJE Solid State Transistorized Power Supply is built with components that are significantly derated under the most severe combination of line, load and ambient conditions. Components are the highest quality military and commercial types available (every transformer and choke is a MIL-T-27A style unit, every resistor is wire-wound). Proven reliability makes NJE your best Power Supply buy! 14 standard models cover virtually every job. Here's one:

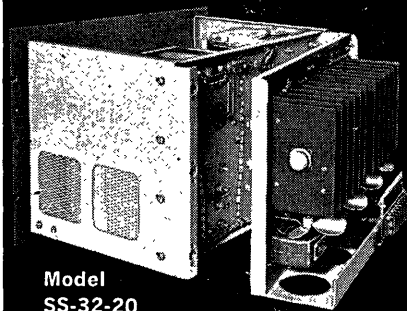

Model
SS-32-20

Output, volts: 0-32.
Output, amps: 0-20.
RMS ripple: 1 millivolt.
Regulation, load: $\pm 0.015\%$
or ± 1 MV.
Regulation, line: $\pm 0.03\%$
or ± 2 MV.
Internal Impedance DC-20KC:
0.02 ohms.

PRICE: \$990

FOB Kenilworth, N. J.

Write today for
this new 16-page
Power Supply catalog!



NJE
CORPORATION
20 Boright Ave., Kenilworth, N. J.
Br 2-6000

grals," "Survey of Recent Russian Literature on Approximation," and "Special Polynomials in Numerical Analysis."

Stewart, W. Earl / Magnetic Recording Techniques / McGraw-Hill Book Co., 330 West 42 St., New York 18, N.Y. / 1958, 272 pp, \$8.50

This book has been written for engineers and others who are working, or who wish to work, in the technical areas of the magnetic recording field. The basic principles have been presented broadly, so that they may be applied widely. Physics and mathematics background has been held to a minimum. The six chapters are: the magnetic recording process; magnetic recording media; the magnetic reproducing process; magnetic recording mechanisms; ferromagnetism; and magnetic recording standards. The book is easy to understand, useful, and contains many references. Nine appendices cover 66 pages. The author is Chief Product Engineer at the Standard Register Co., Dayton, Ohio.

Diebold, John / Automation: Its Impact on Business and Labor / National Planning Association, Washington, D.C. / 1959, printed, 64 pp, \$1.00

This study by the head of a management consulting firm advocates exploring the actual social and economic consequences of automation. In chapters titled "Automation in Practice," "Toward an Economic Study of Automation," "The Social Consequences," "The Search for Solutions," and "Guide to a Study of Automation in the U.S. Economy," the author discusses the real effects of automation on present and future society.

In fear that "we are very close to the point of formulating national policies (about automation) on the basis of conjecture and myth," the author recommends an industry-by-industry study of automation. The text is preceded by a policy statement by the NPA committee on automation.

Hopper, Dr. Grace M. / Automatic Programming for Business Applications / Remington Rand Univac, 315 Fourth Ave., New York 10, N.Y. / 1959, photo-offset, free.

The development of automatic programming for business electronic systems is described in this pamphlet. The author discusses some of the difficulties in designing such systems, arising out of the fact that business routines require extensive diversification. Program compilation has been effected; attempts are being made to advance further into the area of programming by using existing automatic coding systems.

Gordon, Colver, editor, and 45 authors / Ideas for Management (Proceedings 11th Annual Meeting) / The Systems and Procedures Assn., 4463 Penobscot Bldg., Detroit, Mich. / 1959, printed, 440 pp, price ?

This edition covers the proceedings of the 11th annual International Systems Meeting, with full texts of all speeches, papers and seminars. The speeches were delivered by leaders in business, science,

WHO'S WHO IN THE COMPUTER FIELD

From time to time we bring up to date our "Who's Who in the Computer Field." We are currently asking all computer people to fill in the following Who's Who Entry Form, and send it to us for their free listing in the Who's Who that we publish from time to time in **Computers and Automation**. We are often asked questions about computer people—and if we have up to date information in our file, we can answer those questions.

If you are interested in the computer field, please fill in and send us the following Who's Who Entry Form (to avoid tearing the magazine, the form may be copied on any piece of paper).

Name? (please print)
Your Address?
Your Organization?
Its Address?
Your Title?
Your Main Computer Interests?

- Applications
- Business
- Construction
- Design
- Electronics
- Logic
- Mathematics
- Programming
- Sales
- Other (specify):

.....
.....
Year of birth?
College or last school?
Year entered the computer field?.....
Occupation?
Anything else? (publications, distinctions, etc.)

.....
.....
.....
.....
.....
.....
.....
.....
.....
.....

When you have filled in this entry form please send it to: Who's Who Editor, **Computers and Automation**, 815 Washington Street, Newtonville 60, Mass.

military affairs, and education. They discuss the comparisons and contrasts to be found between American and foreign systems, with an occasional discussion of the role of the computer.

In a section devoted to "Systems Communications and Electronics," a paper by John Diebold, president of a management consultant firm, discusses "Bringing Management to Electronic Data Processing." A group of four papers, "Automation in Factory and Business," describe the development and implementation of integrated data processing systems.

Control Engineering, staff of, and numerous contributors / Manual of Digital Techniques / Control Engineering, 330 West 42 St., New York 36, N.Y. / 1959, printed, 140 pp, \$1.00

This manual reprints a number of articles appearing in the "Digital Application Series," and the "Basic Digital Series" of Control Engineering. The articles are written by computer specialists in industry and research. Discussed mainly are techniques for practical application of digital equipment to the solution of problems in business and the military.

The first part of the manual consists of fourteen articles in the digital applications group. They include, "Data Processing Systems — How They are Used," "Fitting the Digital Computer into Process Control," and "The Digital Answer to Data Telemetry." Five articles from the "basic digital series" are included in part II of the manual including "The Computer's Memory," and "Control Elements in the Computer."

Occupational Analysis Branch, U.S. Employment Service / Occupations in Electronic Data-Processing Systems / U.S. Govt. Printing Office, Washington 25, D.C. / 1959, printed, 44 pp, 25c

This pamphlet contains a list and description of 13 occupations in electronic data-processing systems.

The descriptions are of the following occupations: Card-Tape-Converter Operator, Coding Clerk, Computing Analyst, Console Operator, Data Typist, Electronics Mechanic (Computer), High-Speed-Printer Operator, Programmer, Chief Programmer, Project Planner (Data-Processing System), Supervisor, Data Processing System, Systems Analyst, Tape Librarian. A glossary and bibliography follow the listings, and two appendices include information on worker traits and sources of additional information.

Seshu, Sundaram, and Norman Balabanian / Linear Network Analysis / John Wiley & Sons, Inc., 440 Fourth Ave., New York 16, N.Y. / 1959, printed, 571 pp, \$11.75

This book expounds network theory, from fundamental principles to some of the more advanced concepts in the theory. In developing the foundations of network theory, the authors, professors of Electrical Engineering at Syracuse University, discuss the transitions between steady-state and transient responses, time and frequency responses, and analysis and synthesis.

The book discusses computation of net-

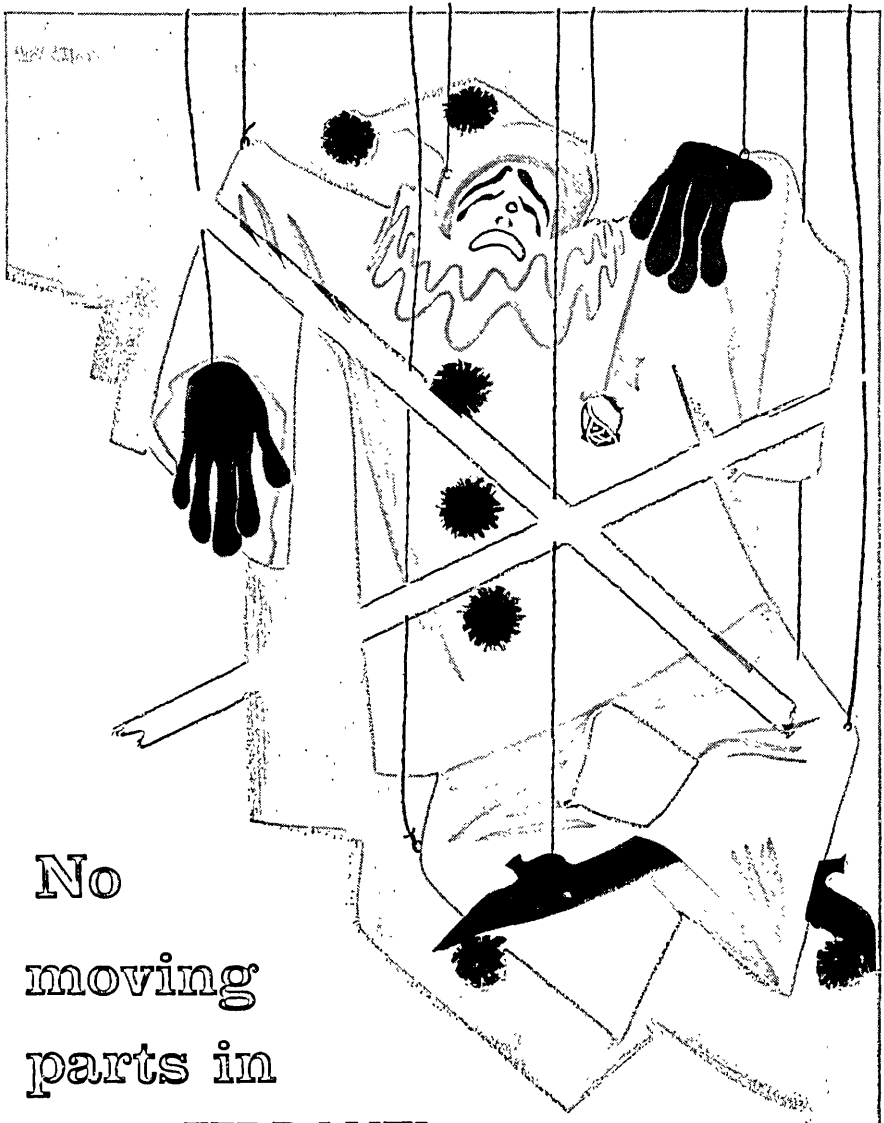

No
moving
parts in

FERRANTI Magnetostriction Delay Lines

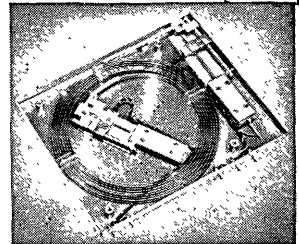

Ferranti engineers have a depth of experience unmatched in this specialty. We can provide stock units that have been proved in performance — or custom design to your special applications.

Features that characterize Ferranti Delay Lines:
Temperature stable . . . wide temperature operating range . . .
High digit rates up to 1 Mc/s for delays up to 3 milliseconds . . .
Small size, light weight . . . No moving parts . . . Low cost, highly reliable elements for delay, storage and correlation — fixed and variable.

Write for detailed literature

FERRANTI ELECTRIC, INC.

ELECTRONICS DIVISION

95 MADISON AVENUE

HEMPSTEAD, N. Y.

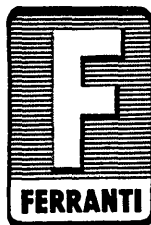

work functions from given real part, magnitude or angle, integral relationships between real and imaginary parts, and analytic properties of network functions; and treats simultaneously, active and passive networks. All assumptions made in the development are clearly explained.

A long appendix (pp 505-60) on various topics in the theory of functions, provides a useful refresher for those previously familiar with these topics, and serves as a basic introduction to the eleven chapters of the text.

Kirchmayer, Leon K. / *Economic Operation of Power Systems* / John Wiley & Sons, Inc., 440 Fourth Ave., New York 16, N.Y. / 1958, printed, 260 pp., \$12.00.

Mr. Kirchmayer discusses theoretical developments and computer uses in problems experienced by electric utilities. Utilization of computers and "electronic brain" methods for solving such problems have successfully achieved economy in production of power in many actual cases. The text demonstrates how to derive transmission loss formulas; it includes mathematical models, analytical methods and computer applications to "prediction and improvement" of systems performance.

Anonymous / *Matrix Math Compiler* — Univac I Data Automation System / Remington Rand Univac, 315 Fourth Ave., New York, N.Y. / 1958, photo offset, 78 pp, limited distribution.

A manual which explains the efficient application of a coding system involving the use of a compiler. Clearly written and arranged in three parts, the manual provides a detailed description of the functions of the compiler, and descriptions of library routines. The Matrix Math Compiler was developed at the Franklin Institute Laboratories, with the

initial aid of the Computational Division of the United States Air Force.

Shell, D. L., and 10 more authors / "The Share 709 System" in the April, 1959 issue, vol. 6, no. 2, of the "Journal of the Association for Computing Machinery" / Association for Computing Machinery, 2 East 63 St., New York 21, N.Y. / 1959, printed, 312 pp. \$2.50

This issue contains six papers on the "Share 709 System," a system for reducing redundant effort in programming among-users of the IBM 709. The papers are: "The Share 709 System"—"A Co-operative Effort"; "Programming and Modification"; "Machine Implementation of Symbolic Programming"; "Input-Output Translation"; "Programmed Input-Output Buffering"; and "Supervisory Control." Although the papers deal only with one machine, many of the techniques described are new and of general interest, applicable probably to the design of similar programming systems in the future.

Wrubel, Marshal H. / *A Primer of Programming for Digital Computers* / McGraw-Hill Book Co., Inc., 330 West 42 St., New York 36, N.Y. / 1959, printed, 230 pp, \$7.50

This book, intended for beginners, seeks to answer the questions: what kinds of problems are solvable with a computer? and how is the computer used to solve them? Using a number of simple examples chosen from problems encountered at the Research Computing Center of Indiana University, the book presents a clear discussion of electronic computation.

In the first part, "Elementary Programming," the simple instructions are discussed, with chapters on flow diagrams, subroutines, loops and branches. The

programming method FORTRAN is mentioned, but the author refers the interested reader to more advanced manuals. The second part discusses advanced programming, with a more detailed description of some basic machine-language. A glossary of terms follows.

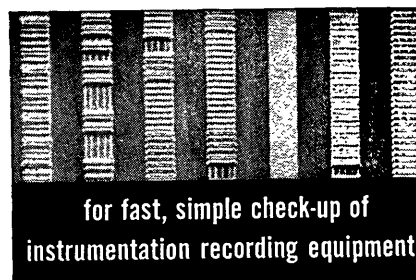

for fast, simple check-up of instrumentation recording equipment

new Soundcraft MAGNA-SEE Kit makes magnetic tracks visible!

- Checks for: • *Track placement*
• *Head alignment* • *Pulse definition (size and width)*
• *Drop-out areas and other trouble-spots*

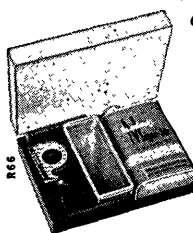

Magna-See Kit contains: ½ pint Magna-See Solution • Plastic bath • Eye-piece magnifier • Pressure sensitive tape • 5 glass slides for permanent copies of tracks, and complete instructions.

For free MAGNA-SEE brochure, write

REEVES SOUND CRAFT CORP.

GREAT PASTURE ROAD, DANBURY, CONNECTICUT
West Coast: 342 N. La Brea., Los Angeles 36, Calif.
Canada: 700 Weston Road, Toronto 9, Ont. Canada

ADVERTISING INDEX

Following is the index of advertisements. Each item contains: Name and address of the advertiser / page number where the advertisement appears / name of agency if any.

Aerojet-General Corp., A Subsidiary of The General Tire & Rubber Co., Azusa & Near Sacramento, Calif. / Page 27 / D'Arcy Advertising Co.

Ampex Corp., 934 Charter St., Redwood City, Calif. / Page 21 / McCann Erickson, Inc.

Bendix Aviation Corp., Computer Div., 5630 Arbor Vitae St., Los Angeles, Calif. / Page 2 / Shaw Advertising Inc.

Bendix Aviation Corp., Research Laboratories Div., P.O. Box 5115, Detroit 35, Mich. / Page 31 / MacManus, John & Adams, Inc.

Computers and Automation, 815 Washington St., Newtonville 60, Mass. / Page 29 / —

ElectroData Div. of Burroughs Corp., 460 N. Sierra Madre Villa, Pasadena, Calif. / Page 5 / Carson Roberts Inc.

Ferranti Electric, Inc., Electronics Div., 95 Madison Ave., Hempstead, N.Y. / Page 33 / Adams & Keyes, Inc.

The Fluor Corp., Ltd., Box 510, Whittier, Calif. / Page 27 / Nelson Advertising Agency

General Electric Co., Apparatus Sales Div., Schenectady 5, N.Y. / Page 19 / G. M. Basford Co.

General Electric Co., Knolls Atomic Power Laboratory, Schenectady, N.Y. / Page 30 / Deutsch & Shea, Inc. NJE Corp., 345 Carnegie Ave., Kenilworth, N.J. / Page 32 / Keyes, Martin & Co.

Philco Corp., Government & Industrial Div., 4700 Wisahickon Ave., Philadelphia 44, Pa. / Page 3 / Maxwell Associates, Inc.

Ramo-Wooldridge, A Div. of Thompson Ramo Wooldridge Inc., P.O. Box 90534, Airport Station, Los Angeles 45, Calif. / Page 17 / The McCarty Co.

Reeves Soundcraft Corp., Great Pasture Rd., Danbury, Conn. / Page 34 / The Wexton Co., Inc.

Space Technology Laboratories, Inc., P.O. Box 95004, Los Angeles 45, Calif. Page 35 / Gaynor & Ducas System Development Corp., Santa Monica, Calif. / Page 7 / Stromberger, LaVene, McKenzie

Technical Operations, Inc., Washington Research Office, 3520 Prospect St., N.W., Washington, D.C. / Page 36 / Dawson MacLeod & Stivers

The Whitton Manufacturing Co., Route 6 and New Britain Ave., Farmington, Conn. / Page 25 / English & Co.

FROM LAGRANGIAN TO LIFT-OFF

Sometimes forgotten during the thundering ascent of a space probe rocket are months of meticulous analysis, engineering and planning. The staff of Space Technology Laboratories is now engaged in a broad program of space research for the Air Force, the National Aeronautics and Space Administration and the Advanced Research Projects Agency under the direction of the Air Force Ballistic Missile Division. For space probe projects STL provides the total concept approach, including preliminary analysis, sub-system development, design, fabrication, testing, launch operations and data evaluation. The total task requires subtle original analysis in many fields as well as sound technical management.

The STL technical staff brings to this space research the talents which have provided system engineering and technical direction since 1954 to the Air Force Ballistic Missile Program. Major missile systems currently in this program are Atlas, Titan, Thor and Minuteman.

The scope of STL's responsibilities offers creative engineers, physicists and mathematicians unusual opportunities to see their ideas tested in working hardware. Inquiries are invited regarding staff openings in the areas of Advanced Systems Analysis, Rocket Propulsion, Space Flight Mechanics, Dynamics, Structural Analysis, and Aerodynamics.

Space Technology Laboratories, Inc.
P. O. Box 95004, Los Angeles 45, California

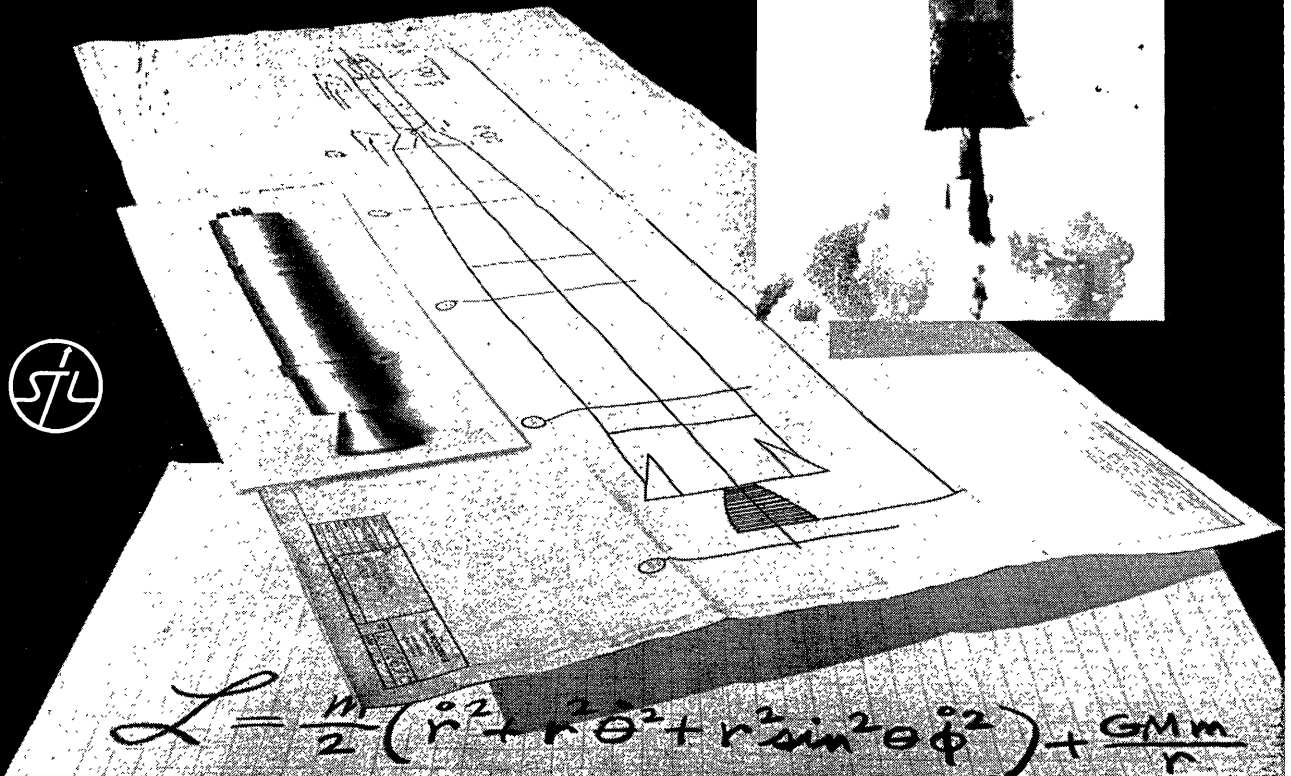
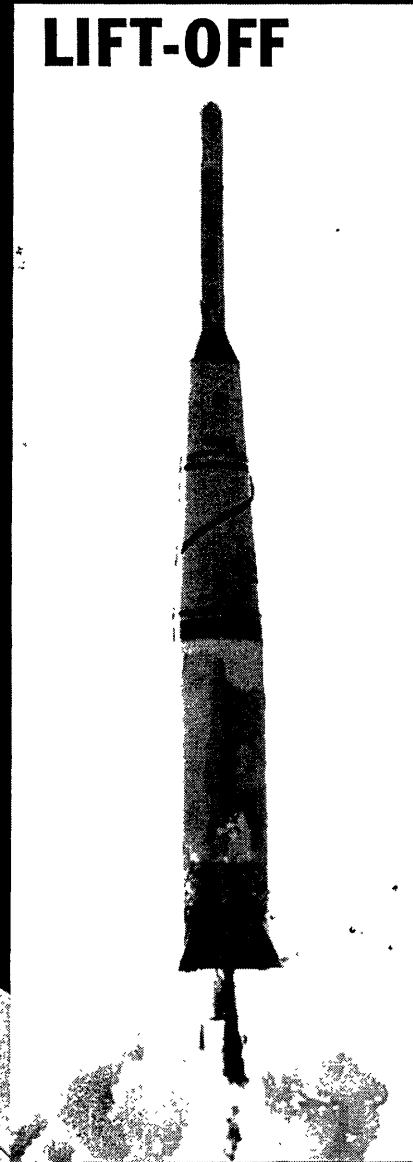

$$L = \frac{M}{2} \left(\dot{r}^2 + r^2 \dot{\theta}^2 + r^2 \sin^2 \theta \dot{\phi}^2 \right) + \frac{GMm}{r}$$

**How to make
your move
without
making a
move...**



• Tired? We've made it easy for you. Western Union, open-handed and large-hearted as ever was, has agreed to bring us your message at *no cost to you*. All you do is hand Western Union the blank below (tear out the whole page, if you feel strong enough) with check marks in the right places. We do the rest.

For example, we'll send you information about the broadly varied opportunities at *tech/ops*, and an illustrated brochure about this medium-sized and growing research and development firm with the usual benefits and an *unusual* profit-sharing plan. But do it today.

DOMESTIC SERVICE	
Check the class of service desired; otherwise this message will be sent as a fast telegram	
TELEGRAM	<input type="checkbox"/>
DAY LETTER	<input type="checkbox"/>
NIGHT LETTER	<input type="checkbox"/>

\$
S
E

WESTERN UNION TELEGRAM

1206 (4-55)

W. P. MARSHALL, PRESIDENT

INTERNATIONAL SERVICE	
Check the class of service desired; otherwise the message will be sent at the full rate	
FULL RATE	<input type="checkbox"/>
LETTER TELEGRAM	<input type="checkbox"/>
SHORE SHIP	<input type="checkbox"/>

NO. WDS.-CL. OF SVC.	PD. OR COLL.	CASH NO.	CHARGE TO THE ACCOUNT OF	TIME FILED

Send the following message, subject to the terms on back hereof, which are hereby agreed to

I am now a

- senior mathematician with a Ph.D. in mathematics or physics and experience with digital computers and modern programming techniques 1
- analysis division director with a Ph.D. and eight years of experience since my B.S. or B.A. degree 2
- senior OR analyst with a graduate degree in mathematics or the physical sciences and experience in OR and/or systems analysis 3

associate OR analyst with a graduate degree in mathematics or the physical sciences 4

research aide 5

I am interested in hearing more about positions available at tech/ops.

NAME _____

ADDRESS _____ TELEPHONE _____

Mr. Kingsley S. Andersson

Technical Operations, Incorporated

Washington Research Office

3520 PROSPECT STREET, N. W. • WASHINGTON, D. C.

