

DATA MATI^{ON}

'73

January

project management

...the big news of '72,
dp salary administration,
designing reliable software...

Varian's Statos® 31 has interface plus. It plugs directly into all major minis, including DEC, HP, Interdata and Data General—and ours—with full interfacing and software, including drivers and test/diagnostics. XDS and CDC midis are on-line with Statos, too. And Statos even interfaces off-line with the room-sized giants.

Why is Statos so compatible? It has bus architecture and supports all modes of computer operation including DMA, interrupts, and programmed I/O—because we design computers as well as printer/plotters.

This compatibility means that you can take advantage of the total capability of both your computer and your printer/plotter—without degrading the performance of either. But if you don't already have a computer, Varian can supply the whole graphics system with special 620 and V73 systems pricing. Along with total system service.

Performance is also a key. Statos 31 prints upper and lower case characters (132 columns) at 1000 lines per minute with excellent definition. It also produces a 14 inch plot with 100 lines per inch resolution at 2.2 inches per second.

And don't forget our comprehensive plot software (Dataplot for minis and GPR for maxis). We've got a whole book of information available.

Call or write
Varian Data
Machines, 611
Hansen Way, Palo
Alto, Calif. 94303
(415) 493-4000

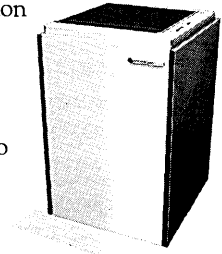

varian data machines 
Statos: the output choice.

Another great thing about our printer/plotter. It plugs into everybody else's mini, too.

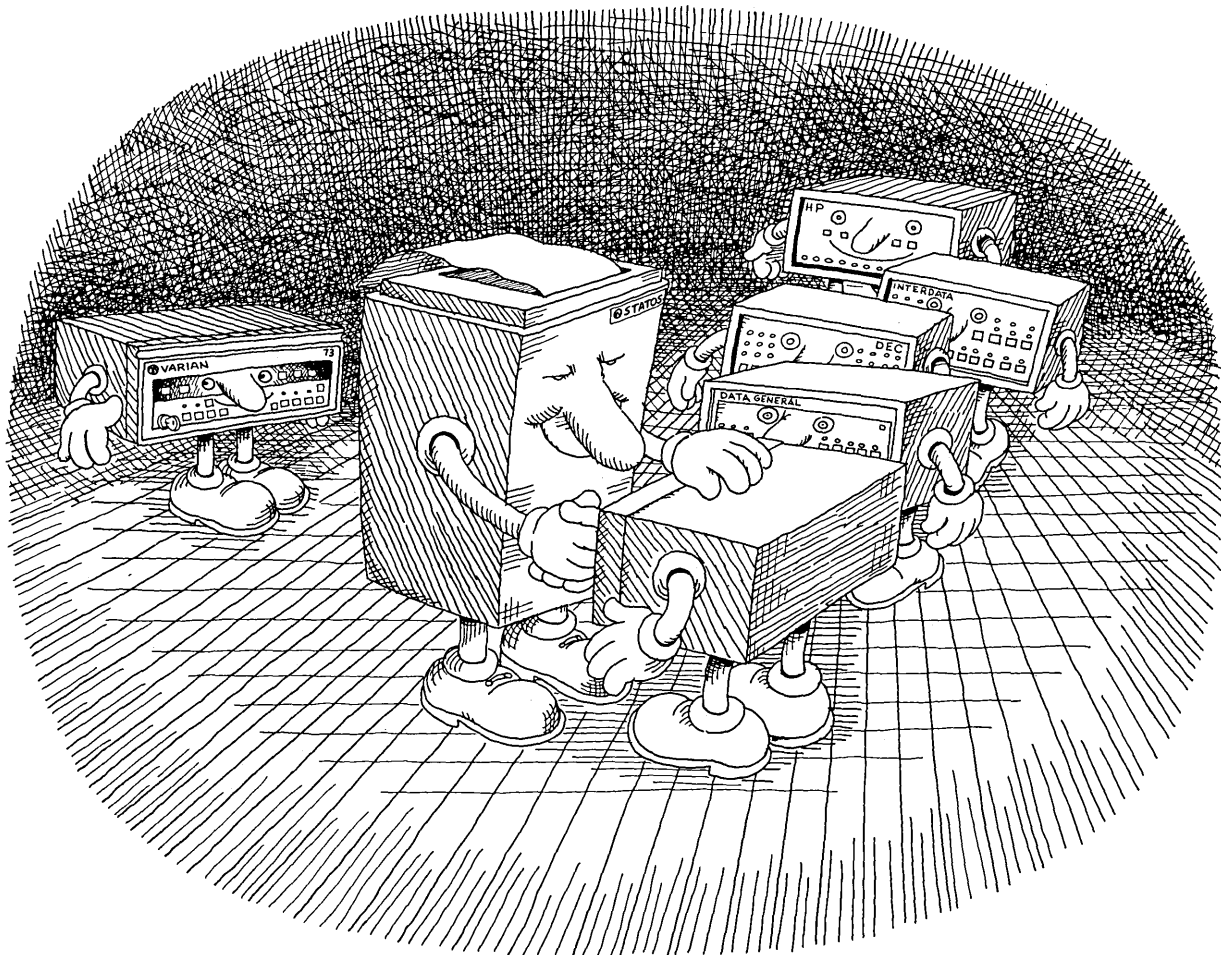

LET'S MAKE A DEAL!

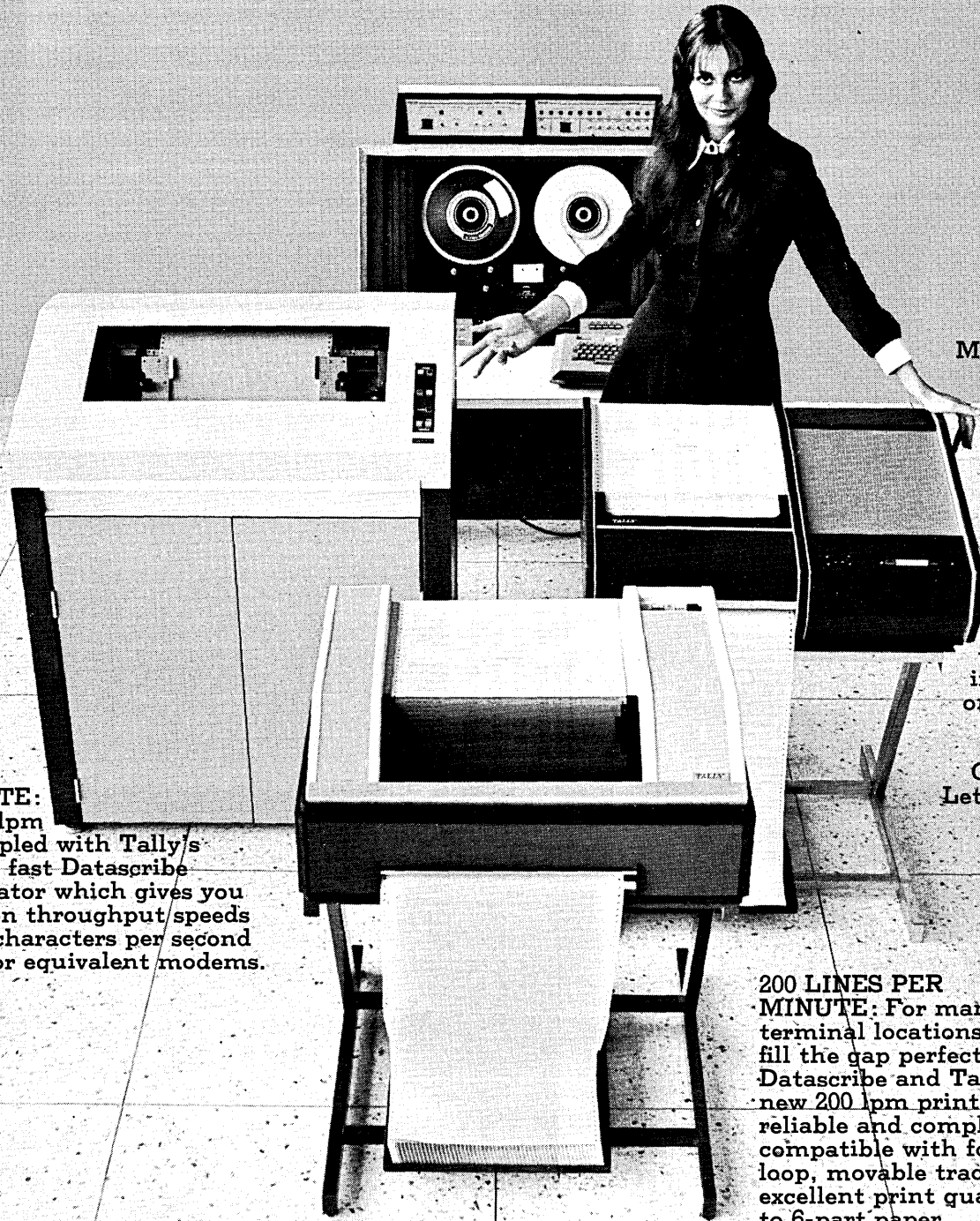

600 LINES PER MINUTE: Tally's 600 lpm printer coupled with Tally's exceedingly fast Datascribe Communicator which gives you transmission throughput speeds up to 1200 characters per second using Bell or equivalent modems.

100 LINES PER MINUTE: Tally's super reliable 100 lpm impact printer gives you a third alternative in matching printer speeds to the varying requirements of your remote locations. And they're all plug interchangeable on the powerful, flexible Tally Datascribe Communicator. Let's make a deal.

200 LINES PER MINUTE: For many terminal locations, you can fill the gap perfectly with the Datascribe and Tally's terrific new 200 lpm printer. Completely reliable and completely compatible with forms control loop, movable tractors and excellent print quality on up to 6-part paper.

TALLY

Tally Corporation, 8301 South 180th Street, Kent, Washington 98031. Phone (206) 251-5500. In New York, (212) 490-2430; Chicago, (312) 298-6710; Atlanta, (404) 633-1991; Los Angeles, (714) 542-1196; San Francisco, (415) 989-5375.

Data Terminals • Printers • Disc Memories • Card Reader Terminals • Paper Tape Peripherals

CIRCLE 4 ON READER CARD

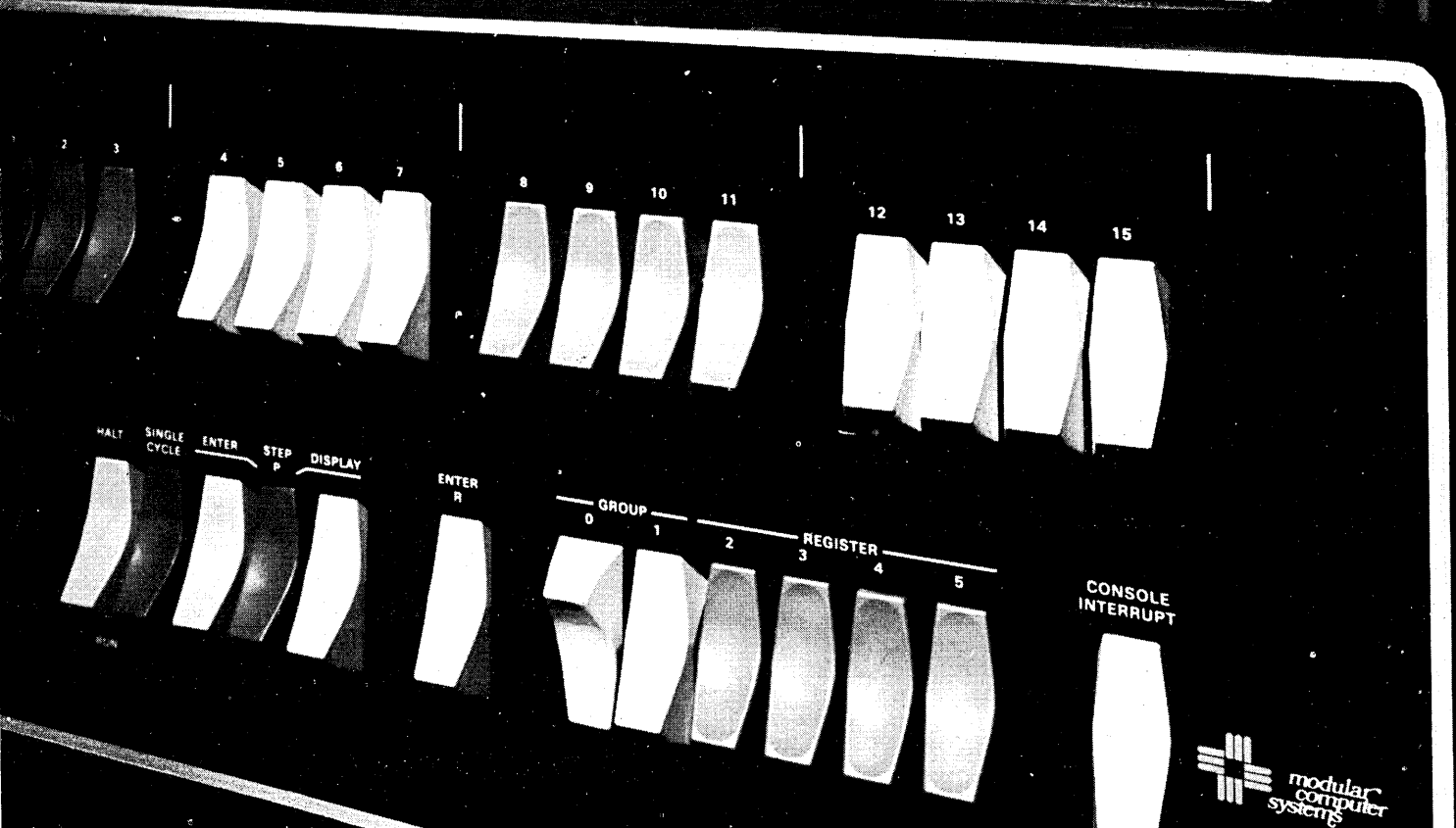
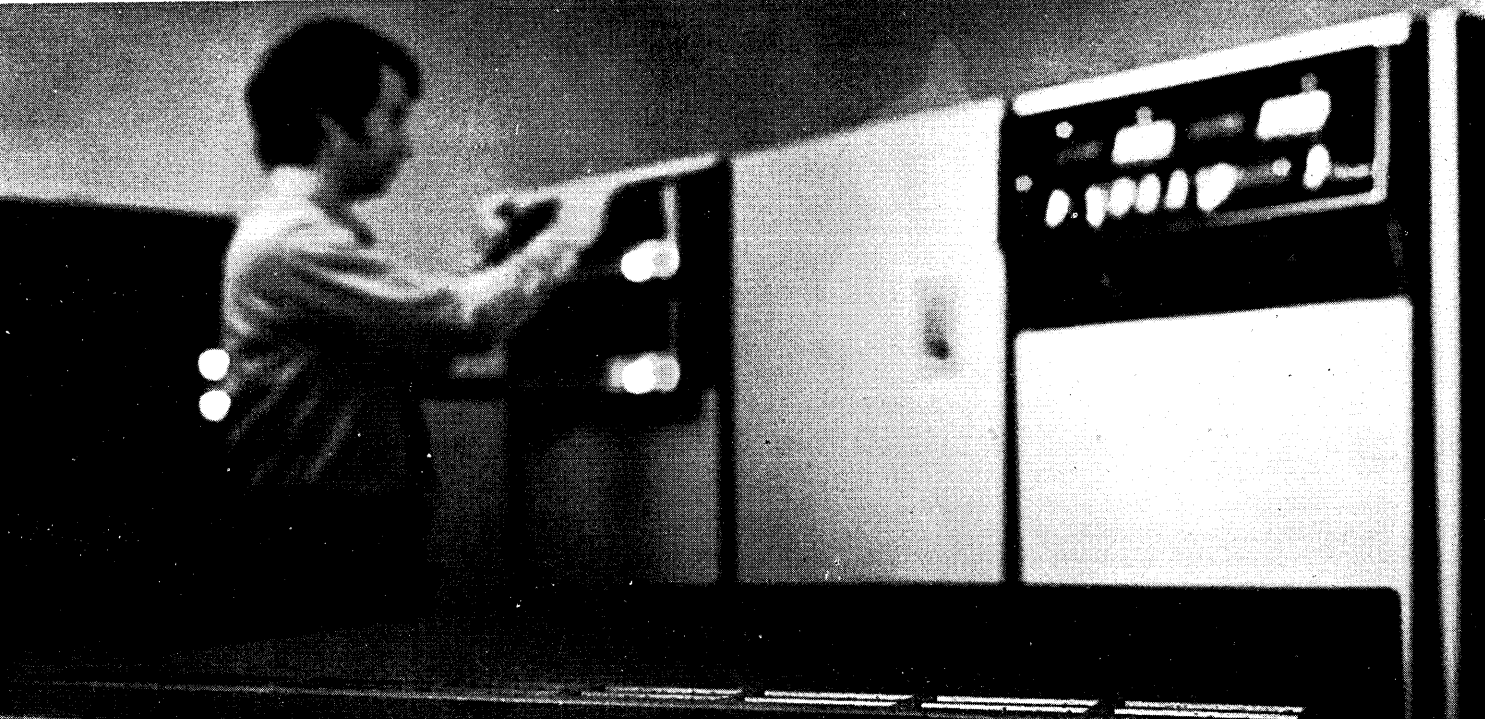

I For The Money II For The Go.....

If you have a real-time job, we have a MODCOMP computer system that fits. MODCOMP I is our dedicated controller.

It starts at \$3800 list. And big OEM discounts apply. MODCOMP II also starts small (photo foreground). But it expands large — to 64K words — with fast floating point hardware, 4 memory ports, executive and protect features . . . It runs our MAX III real-time multiprogramming software, FORTRAN IV with process control extensions plus subscript and block optimization, BASIC, file management . . . And a MODCOMP II with 16K words of 800 nanosecond memory lists at only \$9500. Available now!



Send for the MODCOMP[®] facts

1650 West McNab Road, Fort Lauderdale, Florida 33309 • Telephone: 305 974-1380

CIRCLE 31 ON READER CARD

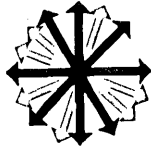

JANUARY, 1973

volume 19 number 1
This issue 116,803 copies

departments

<i>Look Ahead</i>	7
<i>Calendar</i>	15
<i>Letters to the Editor</i>	23
<i>Editor's Readout</i>	41
<i>News in Perspective</i>	96
<i>Hardware</i>	126
<i>Software & Services</i>	132
<i>Literature</i>	134
<i>Books</i>	136
<i>People</i>	139
<i>Index to Advertisers</i>	141
<i>The Forum</i>	147

42 Making Project Management Work

IVARS AVOTS. Some lessons from experience in choosing the best organizational and operational alternatives.

47 The Time-Estimating Myth

THOMAS R. GILDERSLEEVE. Suppose there were a simple way to estimate the time needed for systems and programming jobs. Would they get done on time?

49 Improving Software Reliability

JERRY L. OGDIN. Design policies that will reduce the bug content of software systems and avoid the errors common to manufacturer-supplied software.

56 Salary Administration in the DP Function

ROBERT J. GREENE. The air of mystery about classifying dp jobs can be dispelled by a careful comparison with job levels in other functions.

62 Computers and Cryptology

FREDERICK W. CHESSON. The silent struggle between cryptographers and cryptanalysts has stimulated the development of data processing, from mechanical devices to present-day computers.

83 South African Data Processing

E. DANA GIBSON and ROSEMARY P. GIBSON. Installations and telecommunications are growing fast; education and training are lacking; consultants and service bureaus are going through a shake-out.

88 1972: The Battle Lines Were Drawn

TOM MC CUSKER. With major lawsuits, new communications developments, and automation of your favorite bookie, it was a year that promised bigger developments ahead.

96 News in Perspective

CONFERENCES	96	COMMUNICATIONS	105
PROCUREMENT	101	TRANSPORTATION	108
SOFTWARE	103	HEALTH CARE	120
BENCHMARKS	122		

147 The Forum

EVELYN BEREZIN. Choosing the ECMA standard for cassettes violates reason, experience, and common sense.

**There's a vital difference
between comfort air conditioning
and Process Cooling.
Babies and computers understand.**

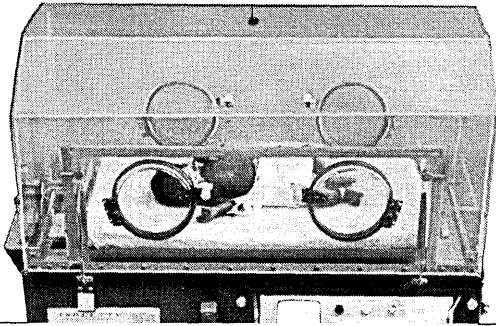

Computers require care, concern and a special environment, too. This calls for EDPAC Process Cooling. The positive way to help prevent an economic catastrophe of cooling failure and downtime in a computer room.

In addition, EDPAC Process Cooling provides computer room features not available with comfort air conditioning: Modular systems accommodate anticipated growth and expansion • Provides redundancy • Environment is

maintained at ideal 72° F and 50% RH • Eliminates hot spots.

Whether you're installing your first computer room or expanding your present system, protect your investment. Investigate Process Cooling. Write today for your free copy of "Process Cooling for Computers is Different".

EDPAC
PROCESS COOLING FOR COMPUTERS

AC MANUFACTURING COMPANY

Old Cuthbert & Deer Road, Cherry Hill, New Jersey 08034, (609) 428/9800, (215) WA 3/5775
CIRCLE 70 ON READER CARD

**Smile
when you
say**

Beta COM

Our customers do, because they get their film or fiche fast. Beta COM accepts their tapes without re-formatting because it has a mini inside. Alphanumerics and graphics. Let us show you with *your* tape. Call us: (617) 969-6510. Gould, Inc., Data Systems Division, Newton Upper Falls, Massachusetts 02164.



CIRCLE 99 ON READER CARD

DATAMATION.

EDITORIAL STAFF

Editor	Robert B. Forest
Articles Editor	William J. Rolph
International Editor	Angeline Pantages
Communications Editor	Phil Hirsch
Technology Editor	Richard A. McLaughlin
Industry Editor	W. David Gardner
Products Editor	Michael William Cashman
Letters/Calendar Editor	Janet Eyster
News Editor	Tom McCusker
Bureau Managers	
San Francisco	Edward K. Yasaki
Los Angeles	Edith D. Myers
Washington, D.C.	Phil Hirsch
New York	Angeline Pantages
New England	W. David Gardner
Correspondents	
Minneapolis	James K. Johnson
Southwest	Robert F. Alexander
Europe	Pearce Wright
Australia	Frederick A. Bland
Editorial Assistant	Mary Ellen McCoy
Editorial Advisor	Robert L. Patrick
Technical Advisor	Lowell Amdahl
Contributing Editors	Paul Armer, Howard Bromberg, Philip H. Dorn, Louis B. Marienthal, Milton R. Wessel, F. G. Withington

EDITORIAL OFFICES

Headquarters: 1801 S. La Cienega Blvd., Los Angeles, CA 90035. Phone (213) 559-5111. **Eastern:** 35 Mason St., Greenwich, CT 06830, (203) 661-5400. 19 Marlborough St., Boston, MA 02116, (617) 267-9414. 9805 Singleton Dr., Bethesda, MD 20034, (301) 530-7271. **Southwestern:** 2711 Cedar Springs, Dallas, TX 75201, (214) 744-0161. **Western:** 61 Renato Ct., Redwood City, CA 94061, (415) 364-3171. **Foreign:** 65, Hill Road, Chelmsford, Essex, England. 322, Park Regis, Park St., Sydney, NSW 2000, Australia.

GRAPHIC DESIGN & PRODUCTION

Art & Production Director Cleve Marie Boutell
Production Manager Marilee Pitman

CIRCULATION

35 Mason Street, Greenwich, CT 06830
Circulation Director Suzanne A. Ryan
Circulation Manager Mae Van Rennes
Marketing Research Director Douglas De Carlo
Publisher James M. Morris

Circulation audited by Business Publications Audit



Member, American Business Press, Inc.



DATAMATION is published monthly on or about the first day of every month by Technical Publishing Company, 1301 South Grove Ave., Barrington, Illinois 60010; Arthur L. Rice, Jr., President; Gardner F. Landon, Executive Vice President. Executive, Circulation and Advertising offices, 35 Mason Street, Greenwich, CT 06830, (203) 661-5400. Editorial offices, 1801 S. La Cienega Blvd., Los Angeles, CA 90035. Published at Chicago, Ill.

DATAMATION is circulated without charge by name and title to certain qualified individuals who are employed by companies involved with automatic information handling equipment. Available to others by subscription at the rate of \$18 annually in the U.S. and Canada. Reduced rate for qualified students. Foreign subscriptions are available for £12.50 or for the equivalent of \$30 U.S. in most West European currencies. Sole agent for all subscriptions outside the U.S.A. and Canada is J. B. Tratsart, Ltd. 154 A Greenford Road, Harrow, Middlesex HA13QT, England. No subscription agency is authorized by us to solicit or take orders for subscriptions. Controlled circulation paid at Columbus, OH and Form 3579 to be sent to Technical Publishing Company, P.O. Box 2000, Greenwich, CT 06830. Copyright 1973, Technical Publishing Company. Microfilm copies of DATAMATION may be obtained from University Microfilms, A Xerox Company, 300 No. Zeeb Road, Ann Arbor, Michigan 48106. Printed by Beslow Associates, Inc.

DATAMATION

360/CORE FROM CAMBRIDGE MEMORIES IS WINNING ALL THE BIG ONES.

Our compact 360/CORE replacement or expansion memory for System/360 computers offers you more and saves you more than any other system. That's why our compact 360/CORE is winning big government contracts, lessors' contracts, and with individual users as well.

IT'S COMPATIBLE-PLUS.

360/CORE is fully 360-compatible – plus it's upward and downward compatible and model to model compatible, all in the same box. That means fast on-site installation, fewer spare parts and minimum servicing and interruptions.

RECENT 360/CORE WINNERS	
*U.S. Army BASOPS	37 Models 30s (16-128K)
U.S. Navy	8 Models 30, 40, 50
Leasing Companies:	
Randolph	Multiple Models 30, 40, 50
DPF	Multiple Models 30, 40, 50
Diebold	Multiple Models 30, 40, 50
EDP Resources	Multiple Models 30, 40, 50
And a growing list of individual 360 users.	

*Largest add-on core award in history

IT'S ULTRA-COMPACT.

360/CORE is available in a desk high unit, as well as in a 5-ft. high "tall boy." In one desk high cabinet we store 128K bytes plus "bump" (auxiliary) storage. And our desk-high is available for all models – 22, 30, 40 and 50. That means we take less floor space, provide your operators with precious counter space, and increase the efficiency of your computer room operations.

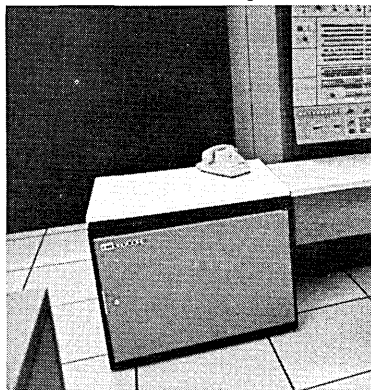

CAMBRIDGE.

A good place to put your information.

IT'S COVERED.

360/CORE uses the latest advanced core technology. That means more core in less space, plus maximum reliability. Then we back that with the best, most qualified field maintenance available. Fast. Knowledgeable. Expert coverage. In addition to our own 360/CORE specialists, we also have contracted with both Comma Corp. and Honeywell to give the best and broadest national maintenance coverage available.

THE COMPACT 360/CORE LINE		
Expand or replace memory on your System/360 whether it's owned, rented or leased:		
CMI Model	IBM Model	Expansion to:
CC22	360/22	64K bytes
CC30	360/30	128K bytes
CC40	360/40	448K bytes
CC50	360/50	1024K bytes

IT'S FROM CMI.

360/CORE is a product of Cambridge Memories, Inc., a company young enough to care, but old enough to have over 5,000 memory systems in operation. Our products include add-on memories for minicomputers (we were first), MOS semiconductor memories (again, CMI was first) and a full line of advanced memory systems in wide use by OEM manufacturers. We have a fully staffed R & D department that has developed some of the newest,

most advanced technologies available, including a domain tip technology we call DOT. This promises low-cost, high-speed, all-electronic mass memory for future computers.

360/CORE is the winner in the 360-compatible core market. Contact our nearest sales office and let us tell you why.



CAMBRIDGE MEMORIES, INC., 285 Newtonville Avenue
Newton, Mass. 02160, 617-969-0050 Telex: 92-2405

Boston (617-969-0050)
Chicago (312-341-0480)
Hartford (203-247-4500)
Atlanta (404-256-4565)
New York (212-868-4936)

Dayton (DPS) (513-275-6781)
Detroit (DPS) (313-557-3164)
North New Jersey (201-947-0184)
Pittsburgh (DPS) (412-922-6219)
Toledo (DPS) (419-472-0111)

Minneapolis (612-890-6810)
Rochester, N.Y. (716-244-1430)
Philadelphia (609-227-2203)
Louisville (DPS) (502-897-5881)

Los Angeles (213-281-4844)
San Francisco (415-692-4806)
D.C. Metropolitan Area (301-657-9105/6)
Indianapolis (DPS) (317-251-6471)

Houston (ACS) (713-461-1333)
Cincinnati (DPS) (513-961-0776)
Cleveland (DPS) (216-886-2090)
Columbus (DPS) (614-224-4081)

"Lynn, show them how our new data terminal cuts their line costs."

At 30 c.p. s. you not only save on line costs, you reduce computer connect time and free up needed telephone lines.

It's done with our EDT-300 MSR (Magnetic Send Receive) data terminal. The EDT-300 in KSR and ASR models is already working for many of our customers. With the cassette buffer it can work even harder. And it leases for as little as \$160 a month.

The EDT-300 MSR can send or receive at 10, 15 or 30 c.p.s. and with optional wiring can go to 120 c.p.s.

But this cassette buffer wouldn't be an improvement if only an engineer could operate it. That's why we've made it as small and as easy to operate as a portable tape-recorder, with push-button controls and front-loading cassette.

Nothing complicated. After all, we're trying to solve your problems, not add to them.

And because terminal problems vary, we have developed various ways to help you.

We provide 62 terminal models with 112 options,

and our systems planning experts will help you decide which ones you really need for an efficient system.

We try to stop problems before they arise by setting up your system, and testing it in its natural systems environment. And if any problems do come up, we're ready to handle them with Termicare, our terminal support program.

A variety of models, systems engineering and support—all give you the ideal source for the multi-terminal user.

For information on the EDT-300 MSR or our range of other terminals contact

Z. V. Zakarian at 800-631-7050 (N. J. 201-631-7050), or write: 16 McKee Drive, Mahwah, N. J. 07430.

"It's easy, Mr. Zakarian.
I use this cassette buffer.
It transmits data at 30 c.p.s."



data services company

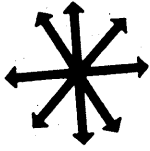

Look Ahead

ANTITRUST: WHY THE TRIP TO NASA?

The press didn't get very far in its efforts to cover the IBM antitrust tour that witnessed the last Apollo shot. A spokesman at NASA's public information office in Washington said the Justice Dept. had asked that the press be excluded from the tour, which IBM maintained would help acquaint the parties in the Justice antitrust suit with electronic data processing.

IBM had been pressing for months to get the group to visit the NASA facilities. (The case transcripts carry a statement that an attorney representing IBM threatened to go to the White House to obtain clearance for the trip.)

At any rate, many thought IBM had scored a significant coup in getting the court to visit the NASA facilities. The Justice Dept.'s case charges IBM with monopolizing the general-purpose digital computer market, and NASA computers are chiefly employed in a special-purpose mode. Moreover, IBM computers are not as dominant at NASA as they are at most other large computer installations. Indeed, some think that the new Inventory of ADP Equipment in the U.S. Government will show that Univac has more NASA computers, or at least is a close second to IBM.

LEARSON LEAVES IN A TRIMMING MOOD

The image may have been unfair, but T. Vincent Learson depicted as IBM's hatchet man. Appropriately, perhaps, he left his job at year-end swinging an axe. Having trimmed the computer colossus' annual payroll by \$250 million a year since 1970, Learson left the company just as its Data Processing Div. was being trimmed to four regions from six. And there was word that the number of DPD branches would be cut back too. IBMers in the division received news of the latest belt tightening at just the point when they thought things were beginning to loosen up. We hear, though, that IBM is determined to continue the chopping and trimming without any sizeable layoffs.

HONEYWELL: MULTICS FOR THE WORLD?

All those private discussions Honeywell has been having with some of its large users over the past 18 months may bear fruit after all: Watch for Honeywell to announce soon an interactive processing system based on the experimental Multics system at MIT's Project MAC. One user, who has been close enough to the project to know, says it is the most advanced system he has seen in the industry and, further, that Honeywell considers it to be its most advanced system. The Multics privacy protection locks could well push the state of the art.

LEASE PACKAGES: ANOTHER ENTRANT

Itel and Telex, who offer 360 and 370 lease package plans in configuration with their own peripherals, are being joined by Computer Investors Group, which has announced a package plan for 155s with Data Recall memory and Century disc drives. CIG won't be far behind Itel in delivering a three-megabyte memory for the 155. And the leasing company thinks its package for the 155 II (with DAF box) will be price/performance competitive with the IBM 158.

Others study the full-system lease concept: Memorex says it has yet to make the decision. Ampex is holding talks with three financial institutions. Meanwhile, Storage Technology Corp. denies

Look Ahead

rumors it will build its own cpu, configured around its tape drives, ISS discs, and Intel semiconductor add-on memory. And Mohawk Data Sciences, busy marketing the 2400 data entry system, has quietly dropped plans for now to lease IBM 370s as a package with its peripherals.

THE BITE WAS A BLESSING

IBM's bite is as good as its blessing, say some memory makers who think the IBM attack on them last year helped promote the idea of add-ons. Roger Goetz of Computer Investors Group says they were shipping six times more Data Recall memory by year-end than at the end of '71. Cambridge Memories' Joseph Kruey says 45% of all his shipments were in the last quarter. Information Control, with some 70 installations shipped during the past year and a half, said half of these were delivered between June and January.

The reason is the increasing number of large (512K to 2-megabyte) memories going to 360/65 and 370/155 installations. Goetz thinks the virtual memory announcement helped, since users pulled back 155 orders to await 158s and are beefing up their 65 memories for the interim. Cambridge and Information Control are signing longer term leases for 360 add-ons, and Kruey thinks this is a sign that many 360 users may be "sitting out" IBM's 370 line until a new generation appears in '75 or '76.

The 370 market, though, appears the most lucrative to the independents. Data Recall's Stuart Lotwin thinks his company, Cambridge, and Intel will ship a total of about 150 million bytes of memory to 370 owners in 1973.

CAN A 360/30 BECOME A 370/135?

We hear Computer Hardware Consultants and Services of Warrington, Pa., is developing ways to alter 360/30s into machines with roughly the power of 360/40s and 370/135s. Among the proposed changes: upgrading channel capacity, changing the cpu so that two bytes are accessed each 1.5-usec memory cycle instead of one, and changing the addressing scheme to accommodate much more memory--even up to 16 megabytes of real memory. Whether they can bring it off is another question--nobody at CHCS will comment on the project.

BIG STAKES AT OTB AGAIN

New York's Off Track Betting Corp. should about now be announcing its choice of a single vendor from among Computer Sciences Corp., Amtote, and Ticketron. It's expecting to save \$300,000 a month by the move. CSC's contract won't affect the outcome, since it contains a 30-day cancellation clause.

FIZZLED DREAMS--BYE BYE BURROUGHS

Barclays Bank of London wouldn't talk to the press, leaving it with a gnawing question: Why did it opt to shove out \$8-10 million worth of computers (three dual B6700s) it owns for two new 370/165s? The ready answer is that its on-line real-time dreams for account updating have fizzled. The Burroughs machines were configured for that, and the batch operation Barclays is settling for was programmed on IBM gear. Burroughs says it passed acceptance tests so this isn't a TWA replay, although it is helping Barclays decide where to put or dispose of the 6700s. After all, Burroughs has sold \$26 million worth of TC 500 terminals to the bank. Sad for them is loss of this prestigious account, which pioneered as a B8500 buyer and now is

(Continued on page 145)

HERE'S WHY THE SYCOR 340 IS SO POPULAR FOR ORDER ENTRY.

JOHNSON MANUFACTURING CO., INC.
SALES ORDER

DATE 07-01-72

SOLD TO: CARLSON ELECTRONICS
2278 SALISBURY DRIVE
SAN DIEGO, CALIFORNIA 92123

SHIP TO: CARLSON ELECTRONICS
3729 CIRCLE STREET
PLYMOUTH, MICHIGAN 48170

CUSTOMER NO. 363650 SALESMAN MATLIN SHIPPING POINT CHICAGO SHIPPED VIA 1. PREPAID

SALESMAN'S NO. 1103 SHIPPING DATE 08-10-72 2. EXPRESS 3. FREIGHT

PRODUCT CODE	DESCRIPTION	QUANTITY	PRICE	AMOUNT
301	DIODE, 1N1201A	12	1.82	21.84
340	DIODE, 1N645	6	1.45	8.70
303	DIODE, 1N5404	18	.61	10.98
3420	TRANSISTOR, 2N4036	25	1.32	33.00
3421	TRANSISTOR, 2N3054	30	1.25	37.50
302	DIODE, 1N3826A	15	1.69	25.35
3457	TRANSISTOR, 2N3133	33	.66	21.78
3459	TRANSISTOR, 2N5687	9	2.50	22.50

NET AMOUNT 181.65 TAX % 5 TAX AMOUNT 9.08 SHIPPING CHARGES 1.27 TOTAL AMOUNT 192.00

SPECIAL INSTRUCTIONS:

CONSTANT provided by program

AUTOMATIC DUPLICATION on each order

RANGE CHECK within one year from current date

CAPACITY CONTROL field must be completely filled

CHECK DIGIT VERIFICATION

TABLE LOOKUP
1 = prepaid
2 = express
3 = freight

EQUAL COMPARE against table of valid numbers

RANGE CHECK according to product code

OMISSION DETECTION AND RANGE CHECK
301-380
3401-3482

MULTIPLY quantity by price

COMPARE to minimum order quantity according to product code

ACCUMULATE total of all items above

MULTIPLY net amount by tax %

ADD to total amount

User programmable with T.A.L. (Terminal Application Language)
 CRT for display and edit of labels, data and error messages
 Cassette storage of control formats and data (400,000 characters)
 1200-4800 baud IBM compatible binary synchronous communications
 Unattended communications and remote control of peripherals
 30 cps to 200 lpm printing on 132-column multipart forms
 Proven capability—5000 Sycor Terminals already installed



100 Phoenix Drive Ann Arbor, Michigan 48104 (313) 971-0900

The Sycor 340 Intelligent Communications Terminal.

In 1966 there were about 8500 computer terms . . .

Today's computer professionals must know over 22,000 definitions and concepts.

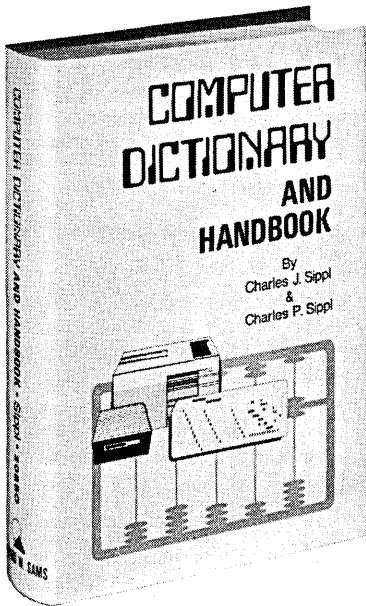

Don't trust your memory. Trust the recognized authority—the

Computer Dictionary and Handbook.

Newly updated and more valuable than ever.

In 1966 the first edition of this book contained 8500 definitions and explanations. The latest edition was compiled from an information base of over 22,000 separate definitions and concepts. This explosion of information *can't* be trusted to memory.

The 1972 edition of the Computer Dictionary and Handbook contains 778 pages of "everyday information." Information you need to keep up with new terms, changing definitions, and new concepts. All contained in these pages, skillfully compiled and presented.

Dictionary of Terms

This has been termed "the most complete dictionary in the computer industry." And with good reason.

It starts with the definition of ABA—

ABA—Abbreviation for American Bankers Association.

abacus—1. A device for performing calculations by sliding beads or counters along rods. 2. An early (3000 B.C.) form of biquinary calculator.

ABA number—A coding number assigned to banks by the American Bankers Association to assist in check clearing.

Abnormal statement—The optional Abnormal statement permits increased optimization of

—and ends 477 pages later with these very timely definitions—

control action occurs.

zone, plus—A set of characters in a particular code which is associated with the adjacent bit which represents a plus sign.

zone punch—An additional punch, or punches, in a card column for purposes of expanding the number of characters that may be represented.

ZOOM—1. An assembler or compiler routine [part of GAP (General Assembly Program)], that writes statements (called macrostatements) which can be translated into more than one machine instruction—or, one can write single GAP mnemonics. In other

The Second Half of the Book

After the definitions comes a comprehensive collection of appendices . . .

Introduction to Computer System Principles and Procedures • Computer Systems Personnel • Management Science Topics • Transition Criteria and Procedures • Model Building Techniques • Operations Research • Mathematical Definitions • Statistical Definitions • Number Systems • Flowcharting-Logic, Symbols, Abbreviations • Computer Languages • Acronyms and Abbreviations • The Progress, Impact, and Future of Computers

With an information explosion like this—the first edition won't do. Your job needs up-to-date information—and the *Computer Dictionary and Handbook* is where to get it.

Get your copy now at your bookstore or use the handy order form below:



HOWARD W. SAMs & CO., INC. DA 013
4300 West 62nd Street
Indianapolis, Indiana 46268

Please send the Computer Dictionary and Handbook (2nd Edition) at \$16.95 each. Enclosed find check or money order for \$_____ for _____ copies.

(Include sales tax where applicable.) Price in Canada is \$22.25

Name _____
Company _____
Address _____
City _____ State _____ Zip _____

Our 18/30 DMS was designed to appeal to 40% of all IBM 1130 users.

Our new 'Mini' DMS should get the other 60%.

When we introduced our 18/30 Disk Monitor System, we stressed that it was designed as a direct replacement for the IBM 1130, with *significantly* more throughput for about the same cost.

We also took the liberty of mentioning that our 18/30 DMS runs all your present 1130 software and that all programs written under DM2 operate directly on the 18/30 DMS. Finally, we noted the availability of a complete library of our own field-proven software as well as a whole line of faster peripherals like mag tapes, big disks, card readers and line printers. For 40% of you (namely, those of you who've already reached the throughput limit of your 1130), the 18/30 DMS is great news.

In fact, we've sold nearly 100 systems to date!

The other 60%.

But what about all the rest of you who don't need all that extra throughput or all the added peripherals?

For you, we've got the new 'Mini' DMS. Also a direct replacement for the IBM 1130.

Yet significantly less expensive to use. (*Up to 40% less expensive per month!*)

But that's not all. Because it makes use of our powerful 18/30 computer, the new 'Mini' DMS will still give you at least as

much throughput as your 1130 and in some cases (in disk-type applications) much, much more. And, with the new 'Mini' DMS you can still run all your existing 1130 programs *and* you can still choose from a complete library of our own field-proven software.

How can we get you?

It should be obvious by now that, if you're operating an IBM 1130 system, we want your business.

And now, we've got you covered from both ends.

With our super-throughput 18/30 DMS.

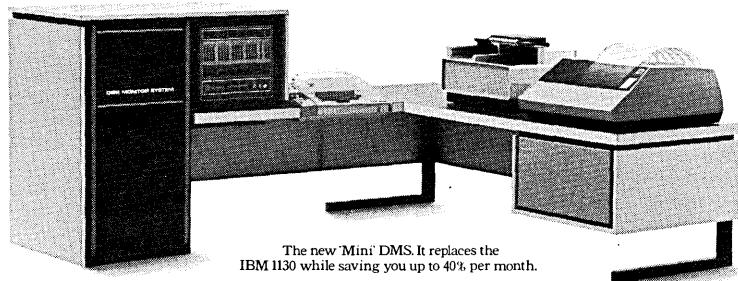

The new 'Mini' DMS. It replaces the IBM 1130 while saving you up to 40% per month.

Or our new money-saving 'Mini' DMS. Both built and backed by General Automation.

To arrange for a demonstration, please call (714) 778-4800. Or write General Automation, 1055 S. East St., Anaheim, California

General Automation

We make exactly what you need.

New Intelligence from Inforex

KeyScan™

A faster, more economical way to process
turnaround documents and check remittances.

KeyScan helps you reduce your float and speed check deposits more efficiently than present methods.

KeyScan combines OCR, automatic check processing, and operator keyboard intervention within a single, integrated system which reduces the number of steps necessary for efficient handling of remittance payments.

KeyScan eliminates separate check-endorsing and MICR-inscribing operations, and produces a pre-balanced, computer-compatible output tape at the same time. Operators process documents faster. The potential for error is reduced and you cut handling costs per document.

KeyScan includes from one to seven KeyScan stations, a supervisor's command station and a control unit which permits simultaneous processing of checks and turnaround documents. A single line of typed or high-speed printer USASI numeric characters is read from the document and the check is automatically MICR-inscribed and endorsed in one operation.

KeyScan is fully described in a brand new brochure which gives you all the cost-saving facts. Send for your free copy today. Write Inforex, Inc., 21 North Avenue, Burlington, Mass. 01803.



New Intelligence from Inforex

In-LineTM Data Entry

The closest thing to being on-line,
without the on-line costs.

In-Line Data Entry from Inforex provides all the functions of keypunch, key-to-tape and present key-to-disc systems as standard capabilities. Most important, In-Line Data Entry lets you specify the most exacting edits and checks including field-to-field relationships, record flagging, branching and validation. Editing may occur during data entry/verification, or when you transfer complete batches from disc to tape or tape to tape. You get total data preparation capability independent of the CPU and its associated peripherals.

In-Line Data Entry incorporates a totally new processor, up to two advanced tape transports and a field-proven disc drive . . . all designed and manufactured as an integral package by Inforex. Data on tape may be entered into the CPU via high speed tape drives, or transmitted via the Off-Line communications feature between Inforex Systems, or directly to and from IBM 360/370 Computers using the On-Line capability.

In-Line Data Entry, the newest member in the growing family of Inforex application-oriented computer systems, is completely compatible with earlier Inforex systems. It provides a scope and depth of capabilities to satisfy your data preparation requirements today and in the future. Our latest brochure tells the complete story of In-Line Data Entry. Send for your copy. Write: Inforex, Inc., 21 North Avenue, Burlington, Mass. 01803.



Leader in intelligent
key-to-disc data entry systems.

MARK IV: the mark of excellence.

Theirs: Hardware

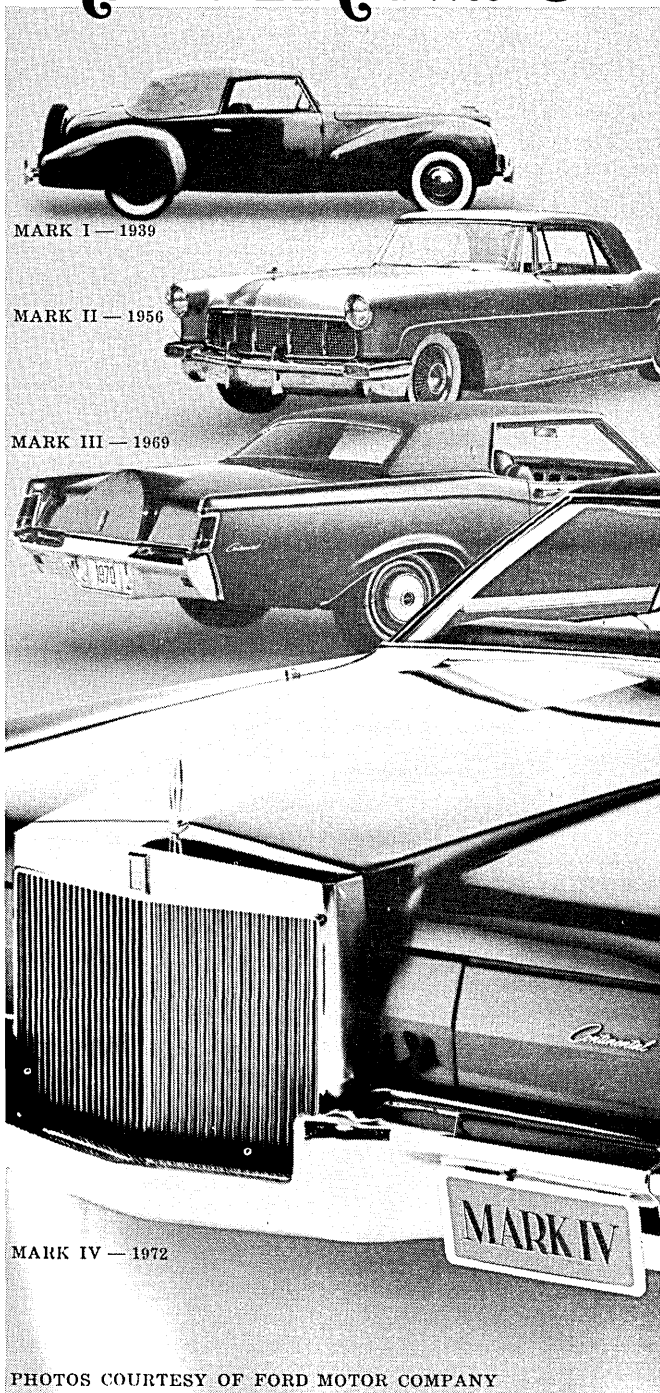

Ours: Software

Our carefully engineered computer software products have grown and improved during the past five years—improving with deliberate built-in excellence.

In order to measure up to our reputation for producing the finest software products in the world—we cannot allow the smallest design detail to go unnoticed. Our models are internationally famous also and carry our trademark:



*Automatic
General Purpose
Computer Software
for all
Data Processing*

With more than 550 satisfied users, our MARK IV File Management Systems have undergone over 1200 improvements since the original. And our newest model fulfills the most sophisticated data processing requirements for IBM 360/370 and Univac Series 70 computer users.

If you want to ride in Mark IV elegance, see your Lincoln dealer.

If you want to compute in MARK IV elegance, see Informatics.

*North America —
Software Products Co.
21050 Vanowen Street
Canoga Park, California 91303
Telephone (213) 887-9121*

*Europe —
Informatics S.A.
12a Route de Meyrin,
CH 1202 Genève, Suisse
Telephone 022/34.42.42*

informatics inc



Calendar

JANUARY

Organizing for Innovation: Towards the Computer Utility, Jan. 18-19, Blacksburg, Va. Conference to bring together a representative cross-section of faculty and administration to discuss problems associated with the campus computer utility and regional networks. Sponsored by Virginia Polytechnic Inst. & State Univ. with the College and University Systems Exchange. General and informal sessions. Fee: \$25. Contact: Dr. Robert C. Heterick, Director of the Computing Center, Room 112 Burruss Hall, VPI&SU, Blacksburg, VA 24061.

FEBRUARY

Micrographics Science-1973, Feb. 1-2, New Orleans. Sponsored by Society of Photographic Scientists and Engineers. Sessions on information storage and retrieval, COM, micro-publishing, and future directions in micrographics. Exhibits in hospitality suites. Fee: \$80. Contact: Robert H. Wood, SPSE, 1330 Massachusetts Ave., N.W., Washington, DC 20005.

American Bankers Assn. Financial Information Systems Workshop, Feb. 25-27, Houston. Registration: \$100, bankers; \$125, others. Contact: Phyllis Barnett, ABA, 1120 Connecticut Ave., N.W., Washington, DC 20036.

The Development of an Electronic Funds Transfer System, Feb. 26-28, Atlanta. A review of the entire Atlanta Payments Project development being advanced by the major Atlanta banks through the Committee on Paperless Entries, which is implementing an automated clearinghouse system and completing study of the feasibility of a retail point-of-sale terminal system, the latter to be reported upon during the last two days of the symposium. Fee: \$250. Contact: Mary Floyd, Atlanta Payments Project, Federal Reserve Station, Atlanta, GA 30303.

COMPCON 73: Seventh Annual IEEE Computer Society International Conference, Feb. 27-March 1, San Francisco. Program will focus on factors relative to all practical computing network systems. Exhibits. Registration: advance (until Feb. 15)—\$40 IEEE members, \$50 others; at conference—\$50 IEEE members, others \$60. Contact: Ben E. Britt, IBM General Products Div., H75/141, Monterey & Cottle Roads, San Jose, CA 95114 (408/227-7100 X7736).

MARCH

Sixth Annual Simulation Symposium, March 7-9, Tampa. Conference on latest developments in digital computer simulation. Fee: \$85; students, \$45. Contact: Annual Simulation Symposium, P.O. Box 22573, Tampa, FL 33622.

Development and Evaluation of Educational Programs in Computer Science and Data Processing, March 9, St. Louis. Fourth annual Assn. for Educational Data Systems conference. Fee: \$40. Contact: Ralph E. Lee, Director of AEDS

Workshop, P.O. Box 951, Rolla, MO 65401 (314/341-4841).

APL Conference, March 12-14, Greenbelt, Md. Meeting for the exchange of ideas between APL users, developers, computer manufacturers, time-sharing service bureaus, and terminal manufacturers. No registration fee. For invitation, contact: Cyrus J. Creveling, Code 260, Goddard Space Flight Center, Greenbelt, MD 20771 (301/982-6126).

19th Annual Systems Management (EDP) Conference, March 12-14, Americana Hotel, New York City. Sponsored by American Management Assn. Follow-up briefing **March 14-16** on Systems Performance Measurement: The Key to Increased Productivity. Fee schedule: Conference—AMA members \$150, others \$175; briefing—\$250 members, \$280 others; both meetings—\$350 members, \$400 others. Contact: Vern R. Lautner, AMA, 135 W. 50th St., New York, NY 10020 (212/566-8100).

IEEE INTERCON/73, March 26-30, New York City. Exhibits March 27-30. Theme: Solid State Shapes the Future. Seminar-type sessions on Computers and Information; Communication and Data Transmission; Energy Utilization and Control; Electro Mechanical Technology; Solid State Devices—Circuits; Electro Optical; Instruments and Instrumentation; Technical Applications; Marketing (EIA sponsorship); Film Theater. Registration: \$5, members; \$6, others. Contact: Don Larson, IEEE, 345 E. 47th St., New York, NY 10017.

Profit Workshop on Manufacturing Management Systems—What Are They? How Are They Started? Where's the Payoff? March 28-30, Los Angeles. For manufacturing executives. How to select, install, use, and measure the various new management systems. Cosponsored by UCLA, American Production and Inventory Control Society, Informatics Inc. Fee: \$100. Contact: UCLA Extension, Los Angeles, CA 90024.

Tenth Symposium on Biomathematics and Computer Science in the Life Sciences, March 29-31, Houston. Session topics will include mathematical, statistical, and computing applications in biology and medicine. Registration fee not available at press time. Contact: Office of the Dean, The Univ. of Texas Graduate School of Biomedical Sciences, Div. of Continuing Education, P.O. Box 20367, Houston, TX 77025.

APRIL

Information Industry Assn. Fifth National Meeting, April 1-4, Philadelphia. Theme: Information: The Industry of the 70s? Purpose to promote the growth and development of information industry companies. Fee schedule: \$100, members (\$50, each additional company registrant); \$150, others; government, \$40. For information and call-for-papers instructions, contact: IIA, 904 Montgomery Bldg., Washington, DC 20014 (301/654-4150).

“Hycom’s new data products offer the OEM improved systems performance and lower costs.

Better yet, they give his new product even greater advantages.”

Dave Redick, Hycom's director of marketing

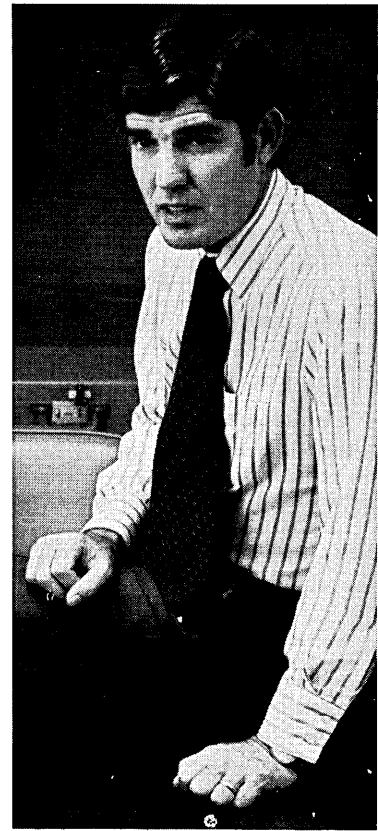

When an OEM brings his product to market, he's got to come on strong with price and performance.

Hycom can help him, right from technical conception through mass production.

We design and build MOS/LSI products, like the first reverse channel, MOS/LSI high speed modem for use over switched networks. Then our link with a \$500-million electronics manufacturer brings all the economies of large-scale production.

In partnership with the OEM, we can give the end user better systems, with increased capacity, while

reducing operating and total costs. And our OEMs also profit by getting new products on-stream much faster.

We'd like to work with you on future projects and quote on your current needs. To find out how high-quality, high-performance Hycom components fit into your systems, contact the Marketing Department at Hycom, 1641 McGaw Ave., Santa Ana, CA 92705; phone (714) 557-5252.

HYCOM

DATAMATION

At last, a really new computer.

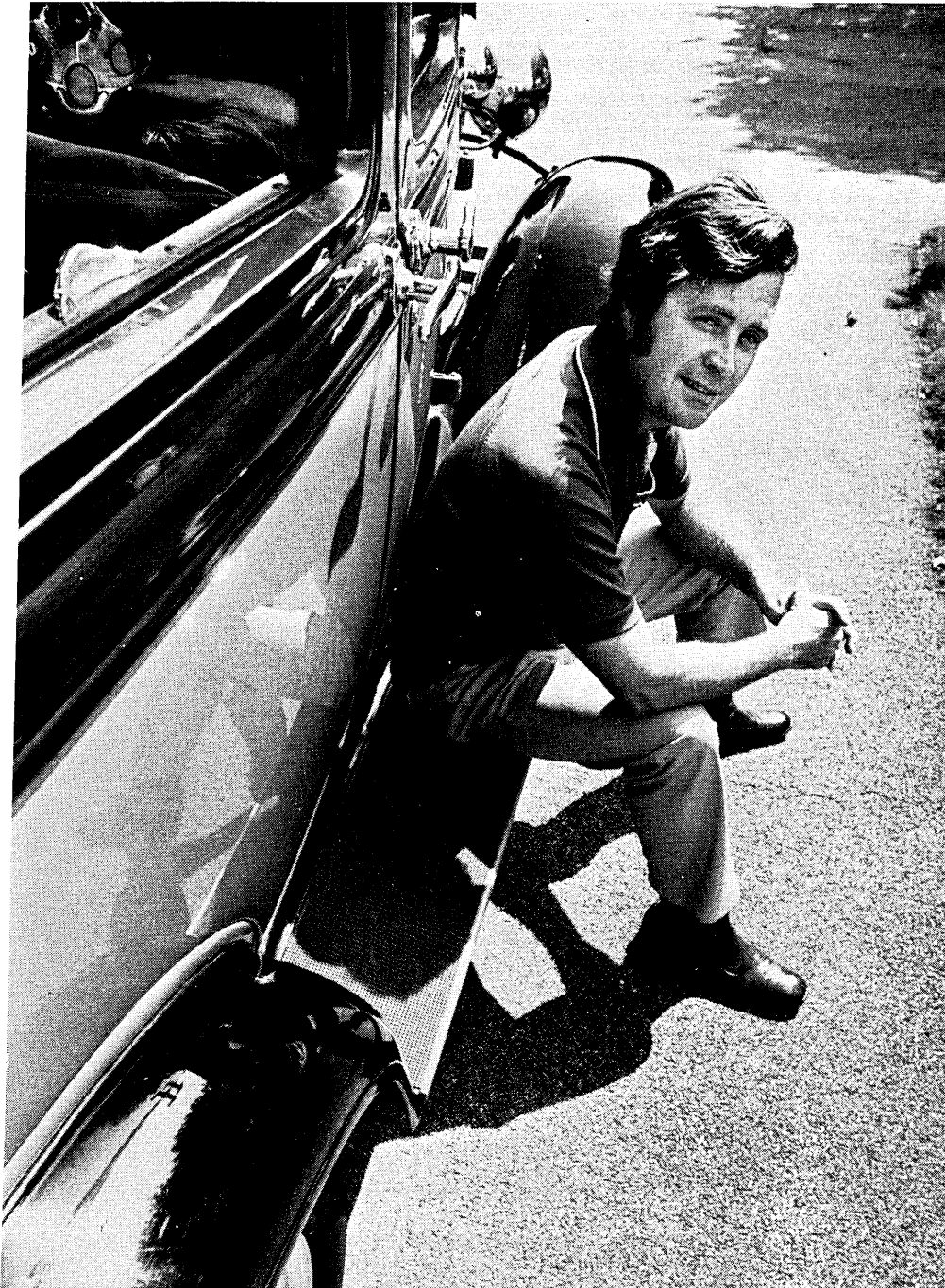

I may be different, but when another new computer comes along, I cringe. Do they really think I'll buy it because it has a Supersonic Omnibus, 66 Multifarious Registers, and the new universal language, FOLDEROL?

Imagine my surprise and delight to discover a company that designs computers for the way people really use them. Instead of chasing nanoseconds they put all of the systems software together first, and then built a fast, low-cost box where it could do its exercises. Finally, somebody has developed a system that asks not what the software can do for the hardware but vice versa. The result is a computer with more software available now than most computers ever hope to have: DOS, RTOS, FORTRAN IV, MACRO assembler, IOCS, the works. With that kind of software available, I wonder what's small about the PRIME 200?

The PRIME 200 16-bit computer raises a lot of interesting questions for which we have prepared detailed answers. Let us send them to you. Prime Computer, Inc., 17 Strathmore Road, Natick, Mass. 01760. (617) 655-6999.

Prime 200 small computer

Prime sales offices: Boston (617) 237-4565, New York (212) 896-6262, Washington D.C. (703) 533-9343, Philadelphia (215) 688-0396, Jacksonville (904) 396-5253, Chicago (312) 887-1845, Dayton (513) 435-1343, Detroit (313) 356-4840, Tulsa (918) 663-0518, Palo Alto (415) 968-6003, Los Angeles (213) 881-8433.

Authorized representatives: Phoenix (602) 957-9110, Albuquerque (505) 255-2330, Denver (303) 771-0140, Seattle (206) 454-9332.

TELEX Off-Line Printer System

One of a broad spectrum of TELEX Peripherals . . .
Tape Drives, Disk Drives, Printers and Memories.

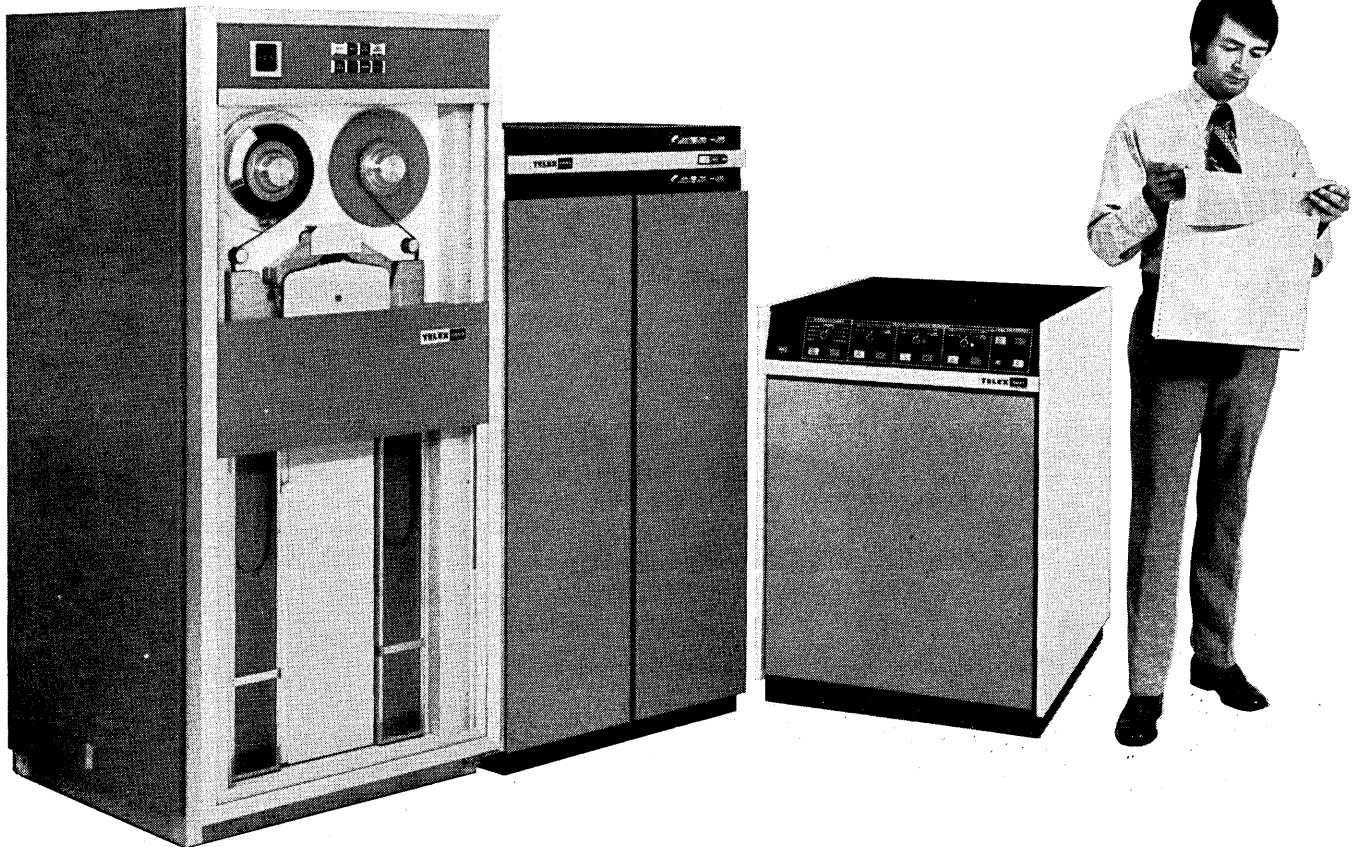

SO MUCH...

A proven TELEX Train Printer with 1200 LPM speed, outstanding print quality and superior multi-part copy capability—the same TELEX unit that replaces the 1403NI on-line—with superior quality—*now* in an off-line package.

A proven TELEX Controller ... a programmable mini-computer in itself for total format flexibility.

A fully maintained system with 24 hours a day, seven days a week service from the industry's No. 1 field service network ... included in the basic monthly rental.

A system with unlimited usage ... there's never an overtime or extra shift usage charge applied to any TELEX products.

A new standard for off-line printing systems ... frees system partitions for other processing and totally eliminates computers dedicated to printing.

FOR SO LITTLE! \$1588 PER MONTH

Complete system including full maintenance ...

1 TELEX Tape Drive, 1 TELEX Tape Adapter, 1 TELEX Controller and 1 TELEX Printer. 24 Month Fixed Commitment Plan

You'll get the full story from your TELEX representative. Or call or write us.



where the difference begins

TELEX[®]

the PERIPHERAL COMPANY

TELEX COMPUTER PRODUCTS, INC.
6422 East 41st Street • Tulsa, Oklahoma 74135 • (918) 627-1111

TELEX, LTD.
101 Duncan Mill • Don Mills, Ontario, Canada • (416) 445-8050

TELEX EUROPEAN GROUP
213 Oxford Street • London W1R 1AH, England • 01 734 9131
Paris • Frankfurt • Zurich

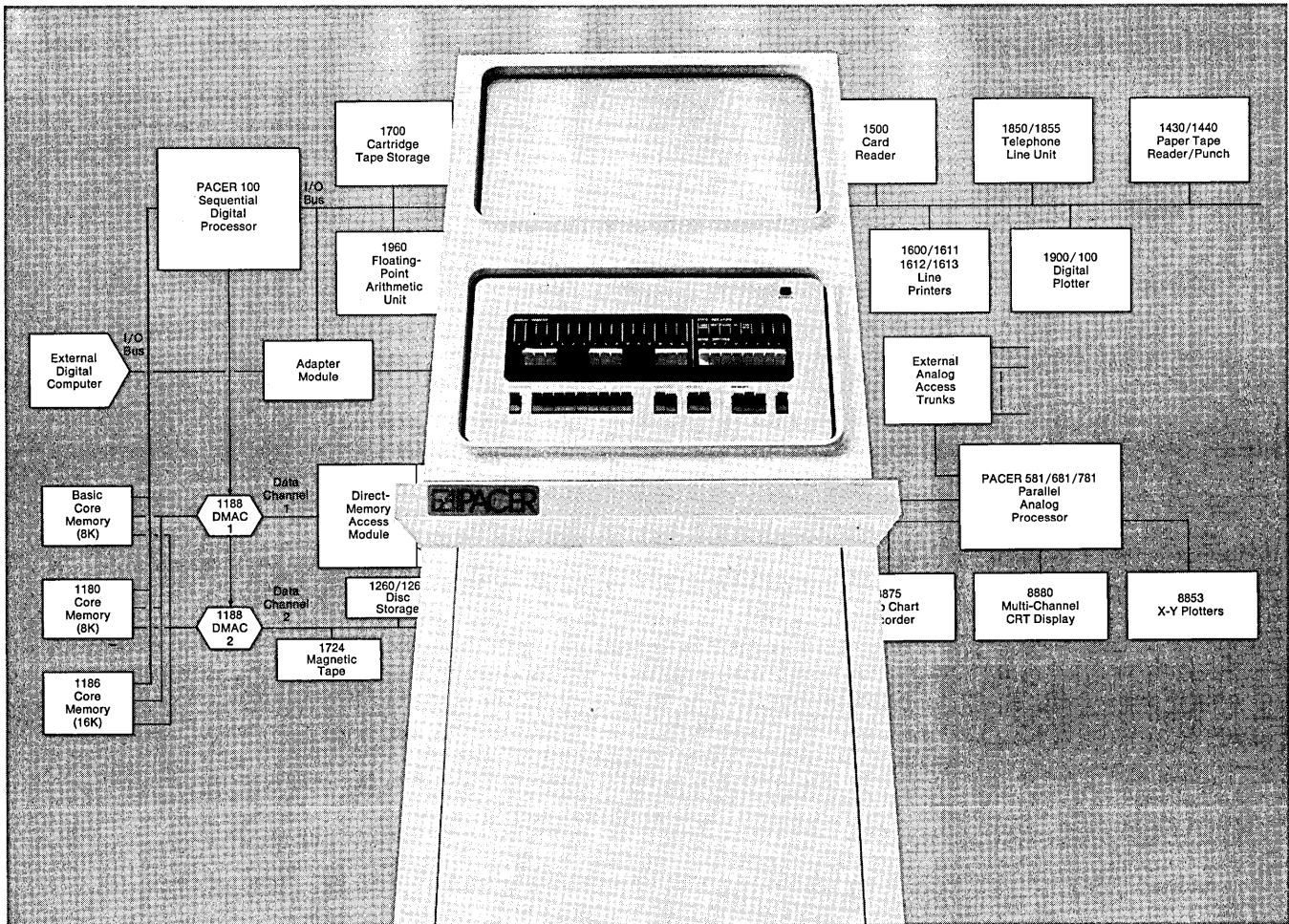

PACER 100

What a Way to Grow!

It's EAI's digital cornerstone. Our PACER™ 100 is no ordinary computer. It's the beginning of a new growth story, a digital especially designed to work with our new parallel processors. And work it does in expandable systems that provide unequaled throughput in scientific and engineering problem solving.

We put the PACER 100 at the digital corner of three different series of new PACER systems, each larger than the next: PACER 500. PACER 600. PACER 700.

Then we provided options to help you grow, to let you fine-tune your system to exactly the type and scale of problems you face. Up to giant-sized.

At each level, your PACER system can deliver far more scientific and engineering design-problem solutions—per day or per dollar—than any other system available.

Meanwhile, your techniques and solutions will be state-of-the-art in the areas you choose: Optimization. Simulation. Control. Design. Data Reduction.

Further, we have a huge library of software to help you—including a foreground/background Real-Time Operating System. And we have more than 5,000 case

histories of applications to prove our software expertise.

As you can see, we make no ordinary claims. Now, thanks in part to our new digital, we can make one more dramatic assertion: PACER systems can offer you performance/price ratios that run to over 100 times those of conventional digital systems.

That's the sort of efficiency that's worth writing home about or, more to the point, worth writing to us. The faster you do, the sooner we can send you more information to help you start a new growth story of your own.

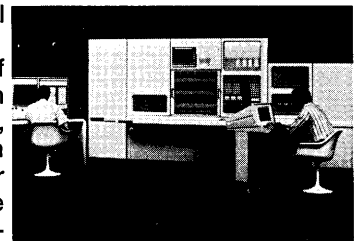

Electronic Associates, Inc.
185 Monmouth Parkway
West Long Branch, New Jersey 07764
(201) 229-1100

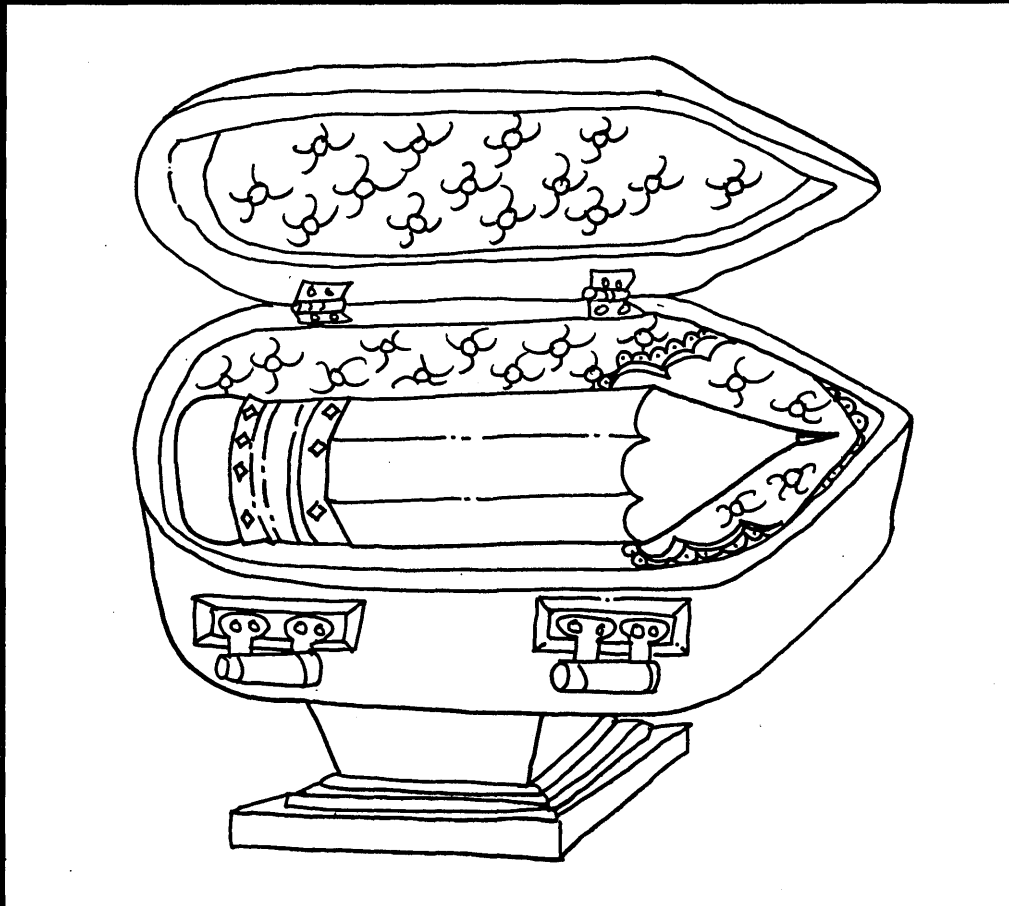

TMS eliminates this costly piece of computer hardware.

New TMS (Tape Management Software) does all of your record-keeping automatically.

Your operators don't have to write tape lists. There are no output labels to prepare. You don't make manual scratch records. Everything is automatic, even for no-label tapes.

At the same time, TMS has far greater abilities to help you reduce errors. It keeps track of off-site data sets, matches all your tapes against a master catalog, virtually eliminating the danger of clobbering (no

matter how chaotic the workload becomes), and predicts the state of your tape library in the weeks ahead.

TMS will forecast scratch lists by data set name, job name or volume serial number.

All this was designed to protect your data while lowering your operating costs. And it does. Because it puts your people to work more efficiently, reduces the opportunity for error, and increases throughput, mainly by eliminating the most expensive piece of

equipment you own.

The 5¢ pencil.

If you call me, Sterling Williams, Product Manager —Special Products at (214) 637-5010, I'll tell you more. Or mail this coupon.

Dear Mr. Williams:
Please give me more information about TMS.

- Send me the facts
 Have someone call on me

Name _____

Title/Company _____

Address _____

City/State/Zip _____

Phone _____

UCC
UNIVERSITY COMPUTING COMPANY
800 UCC Tower, P.O. Box 47911
Dallas, Texas 75247

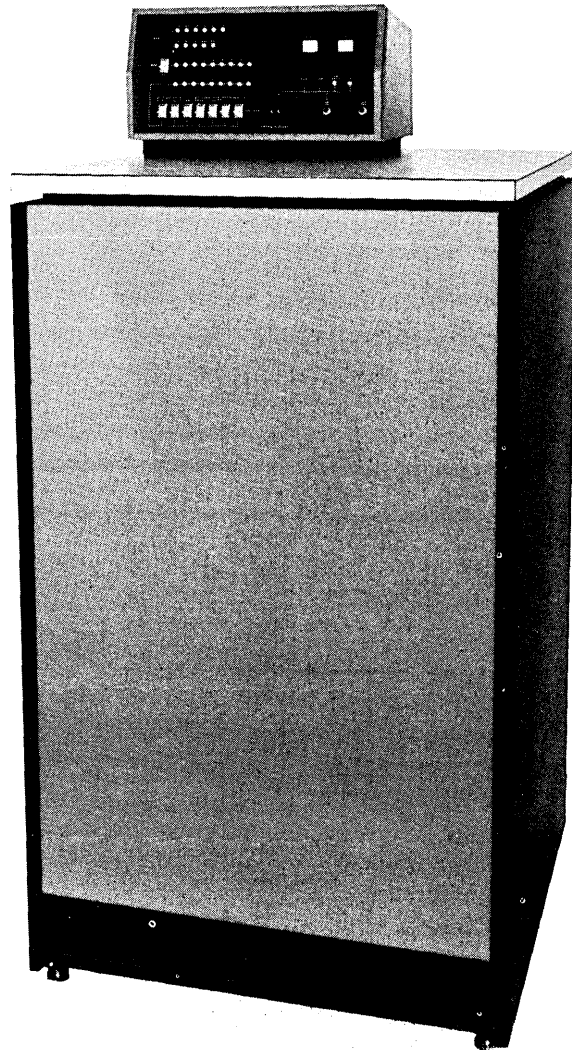

REMOTE YOUR 1403 WITH PIX!

PIX is the revolutionary new communications product that allows 360's or 370's to talk to remote I/O devices as if they were right in your computer room.

PIX extends standard IBM line printers, card readers, card punches, or computers to remote sites and drives them with standard IBM unit record software.

And PIX saves you money in the process. PIX

eliminates teleprocessing hardware and software including modems, terminals, BTAM and 270X.

PIX supports remote processing on your system regardless of configuration or core size.

Go remote. Put your card reader and line printer out where the application is, and let PIX handle the communications. Your system won't even realize the peripherals have been moved.

For detailed information, please call or write:

paradyne

PARADYNE CORP., 8550 ULMERTON ROAD
LARGO, FLORIDA 33540 (813) 536-4771

Letters

Ascii sweepstakes

I read with interest your item in the September Look Ahead (p. 8) concerning the expected NBS "assessment" of ASCII. One way to promote user interest in the standard is for manufacturers to *use* it. Right now the situation among time-sharing terminals which claim to use the ASCII code is so chaotic that I propose a contest to be held to focus attention on the problem. Contestants would supply as many endings as possible to the following sentence: "ASCII is a myth because . . ."

Examples of entries might be:

"ASCII is a myth because . . ."

1. At least one ASCII terminal substitutes the " " (not) for the "~" rather than the "^":

2. Communications controllers such as the IBM 2703 and purported compatible replacements terminate input on CNTL Q (alias DC1) which is nowhere defined as an EOT or EOB.

3. At least one ASCII terminal substitutes the "←" for the "—".

4. On some but not all ASCII terminals, a carriage return also implies a line feed.

5. Each ASCII terminal has unique requirements for the character sequence which it must receive to provide sufficient delays to complete mechanical functions, such as carriage return, tab, and line feed. (One terminal has the curious property of requiring more delay characters for short carriage returns than for long ones!)

6. Some communications controllers won't let certain characters pass through. (Remember, one man's control character is another man's data.)

7. Some ASCII terminals have the option of always sending a "1" in the parity bit position. (Thus, input programs can receive any of 192 distinct bit patterns to represent 128 characters. Is this ASCII-7-½?)

8. There is the vertical bar at position 7½ of the ASCII table, and then there is the vertical bar which may be substituted for the "!".

9. One ASCII terminal claims to handle the full 128-character set, but cannot print 32 of the graphics.

10. Some ASCII terminals support only upper case. (Are these half-ASCII?)

Suggested prizes for the contest would be:

First: An ASCII terminal of your choice.

Second: A lifetime exemption from having to program I/O routines for so-called ASCII terminals.

Third: A mirror so that you can see the in-core bit patterns of characters with the most significant bit on the left, rather than on the right as provided by

some communications controllers.

Fourth: Membership on X3.

Booby: Two ASCII terminals, each from a different manufacturer, with the stipulation that you use them interchangeably on your favorite time-sharing service.

THOMAS G. SANBORN

*Allen-Babcock Computing, Inc.
Los Angeles, California*

Bad bart

I was distressed to see the article, "Computers Run BART Trains," in the October issue (p. 127).

It was obvious that you had been sold a lot of boloney and incomplete information.

This is to be expected when the district is headed by an incompetent who was formerly a mediocre newspaper reporter and whose main concern immediately prior to the opening of the system was to get his own salary increased to more than \$60,000.

Each time I started to put together articles that would illustrate for you the problems of the district, something worse came to light. I think you must tell your readers that the system is now operating on the basis of an attendant at each station telephoning ahead to the next station to see if the track is clear before releasing the train. I don't believe that a human being is yet classed as a computer—despite the manner in which his brain works.

The Public Utility Commission has required manual control and manual operation on the new sections opened. The Legislative Analyst, Mr. A. Alan Post, has recommended that no part of the system requiring merging of lines be placed in operation until a control system can be devised.

ROBERT KAHN

Lafayette, California

See News in Perspective, p. 115.

Access methods

I read with interest your September article on IBM's Virtual Memory 370s (p. 58). What you didn't say about VSAM is that it will also replace the Sequential Access Method as well as ISAM. This was my understanding from a presentation by IBM. Although it will speed up indexed-type accessing, it will somewhat degrade sequential processing. This was indicated by an IBM instructor. Along with this would be a limited number of block sizes, rather than letting the user determine his own. I would appreciate your comments.

RICHARD M. MARCOTTE

St. Louis, Missouri

As we understand it, VSAM can be used to process regular sequential files, but it does not replace BSAM, QSAM, BTAM, or QTAM. A user can opt to standardize on VSAM even for sequential files, in which case his performance will be "very slightly" degraded on sequential files due to VSAM's extra overhead. There are reportedly no limitations on block sizes.

Someone may have been confused by VSAM's default options, but VSAM's choice of block size can be overridden by the user.

Defining file management

In October's DATAMATION, Mr. Welke, in "A Review of File Management Systems," comments on my article, "File Management Systems Revisited," as follows:

"Contrary to Mr. Steig, this writer feels that any of the 22 systems listed in the matrix might well be considered in a search for good file management software."

My final paragraph states:

"In conclusion, the file management systems discussed here offer many advantages to their users. A comparison of their features was made to illustrate their similarities and differences. Other systems can be evaluated by considering their relative merits across the same range of features. When the choice has been narrowed to two or three systems, a benchmark comparison among systems is a good way to make the final choice."

This passage makes it clear that I do not consider the four file management systems discussed in my article to be the only ones of value. The article was intentionally limited in scope.

I also question whether all of the 22 systems which Mr. Welke describes can really be considered file management systems. File management implies to me, at a very minimum, file creation and maintenance as well as reporting powers. The first two are lacking in several of the systems on which he provides information.

DONALD B. STEIG

Nutley, New Jersey

Unchecked example

The example given in the article, "How to Write a Readable FORTRAN Program" (Oct., p. 73), illustrates one of the most common faults of comments in programs—that the comments don't agree with the program. The program itself illustrates one of the commonest programming mistakes—the failure to check controlling parameters for limits.

Specifically, the last line of comment in the heading states reassuringly: "All input is checked for validity." So what happens? The very first READ statement reads four controlling parameters which are checked only by the field width in the format, not a very good way to do it. In particular, N is not checked for its limit of 80. The unchecked N is used to "check" the values of I and J. Hence, a too-large N may result in storing of data beyond the array bounds. The unchecked N also limits several DO loops in the program.

N. M. TAYLOR

Washington, D.C.

□

The Concentration of Knowledge The Crystallization of Technology

As the concentration of the learning and culture of the world resulted in the encyclopedia, so the crystallization of modern technology has produced the computer—now indispensable to handle the enormous amount of information and data necessary in an enterprise in this modern world.

The wide range of FACOM computers, developed by Fujitsu's unique technology, includes easy-to-use models to meet the needs of any business enterprise, however large or small.

Such diversified fields as business processing, data communication and technical calculations can be handled by the most-popular FACOM 230 Series, which includes 8 models from the 230-10E to the ultra-large 230-75.

Scientific calculations and process control are best handled by the FACOM 270 Series, with 4 models from the 270-10 to the 270-30.

For educational purposes, there is the specially developed FACOM Mate. And, for mini computer users, the FACOM U-200 and FACOM R-E. There is also a wide range of peripheral equipment and full software for each member.

This completes the FACOM Family, fifteen members with unique characteristics—the crystallization of Fujitsu's technological and engineering capabilities.

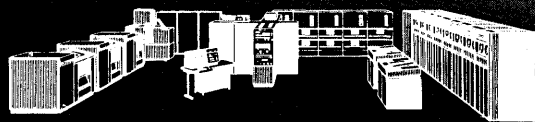
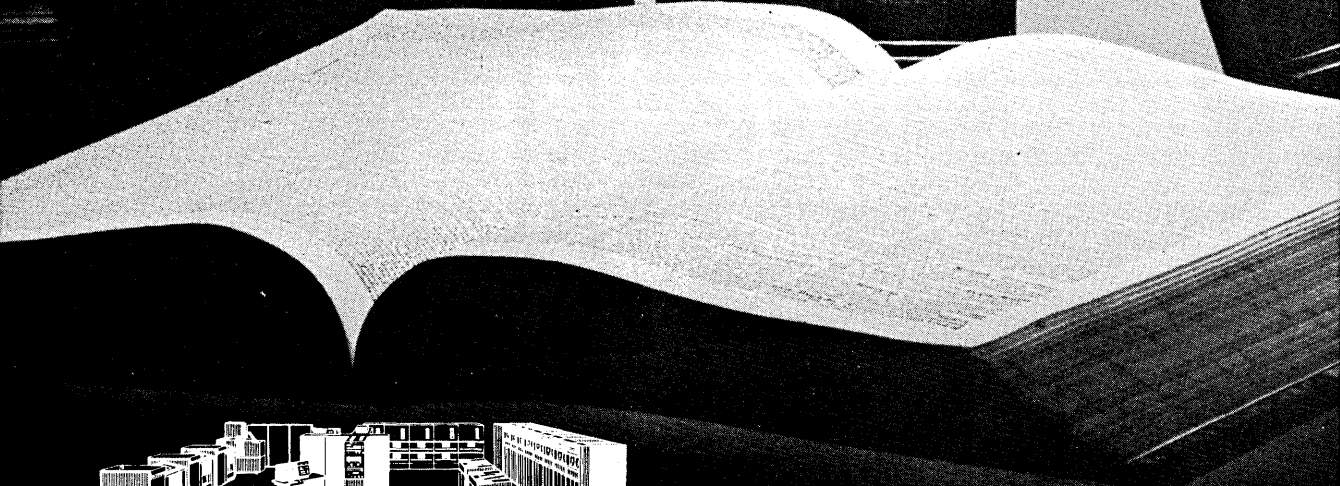
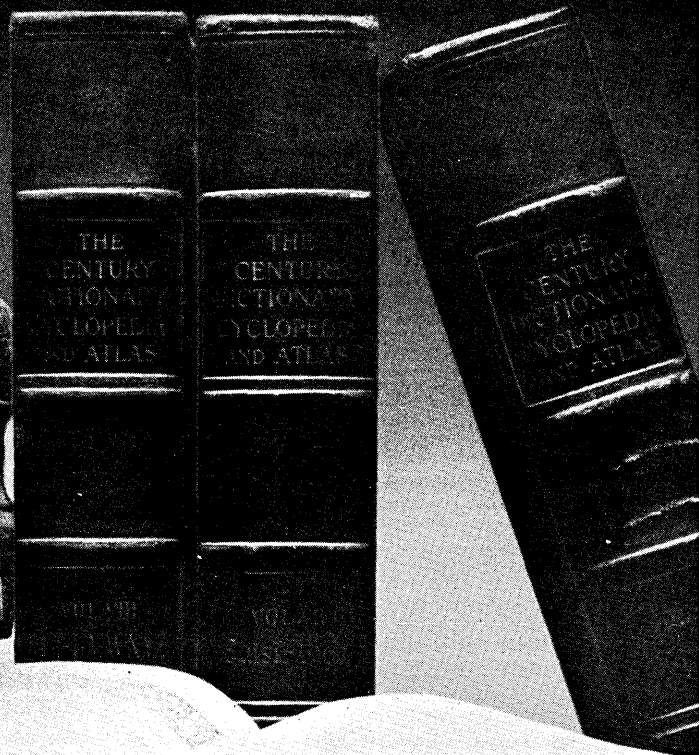

 **FUJITSU LIMITED**
Communications and Electronics
Marunouchi, Tokyo, Japan

MAIN PRODUCTS Telephone Exchange Equipment Carrier Transmission Equipment Radio Communication Equipment Space Electronics Systems Electronic Computer & Peripheral Equipment (FACOM) Telegraph & Data Communication Equipment Remote Control & Telemetry Equipment Electronic Components

Hazeltine 2000 System

1. Start with the CRT Terminal that's No. 1 in Price/Performance.

- 1998-Character Display
 - Selectable Transmission Rates up to 9600 bps
 - Full-Duplex, Half-Duplex and Batch Operating Modes
 - Two-Level Video Intensity
 - Split Screen
 - Automatic Tabulation
 - Editing Capability
 - Random Access Memory
- \$88 PER MONTH*

2. Add the powerful, high-speed "dual" Tape Cassette Unit.

- On/Off-Line Data Storage & Retrieval
 - Paper Tape Emulation and Page Operating Modes
 - 2400 Baud Data Transfer Rate.
- \$79 PER MONTH*

3. Or add the Printer Unit for silent hard copy.

- Conversation and Page Operating Modes
 - Print Rates up to 30 Characters Per Sec.
- \$78 PER MONTH*

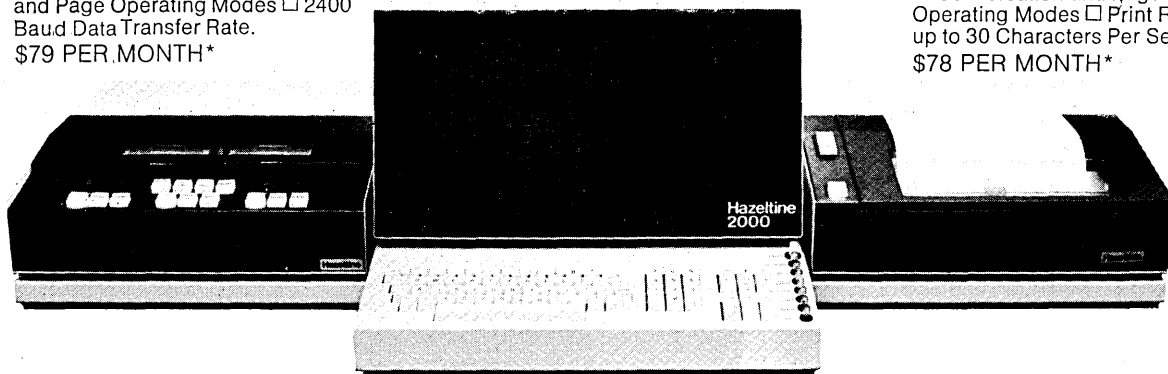

4. Put them all together for complete System capability.

- \$245 PER MONTH*

*12-MONTH RENTAL, MAINTENANCE INCLUDED.
ASK FOR A DEMONSTRATION.

Hazeltine Corporation

Computer Peripheral Equipment Greenlawn, N.Y. 11740 (516) 549-8800

EAST: NEW YORK (212) 586-1970 BOSTON (617) 588-8700 EDISON, N.J. (201) 828-5678 PHILADELPHIA (215) 676-4348
MIDWEST: MINNEAPOLIS (612) 854-6555 CHICAGO (312) 986-1414 CLEVELAND (216) 752-1030
DETROIT (313) 355-3510 PITTSBURGH (412) 343-4449
SOUTH: DALLAS (214) 233-7776 ATLANTA (404) 458-9360 HOUSTON (713) 622-0551 WASHINGTON, D.C. (703) 979-5500
WEST: SAN FRANCISCO (415) 398-0686 DENVER (303) 388-8844 LOS ANGELES (213) 479-6800
IN CANADA: CAE ELECTRONICS, LTD. (514) 341-6780

CIRCLE 26 ON READER C.

SMALL CARTRIDISC DRIVES
iodisc Series One — 500,000 bytes

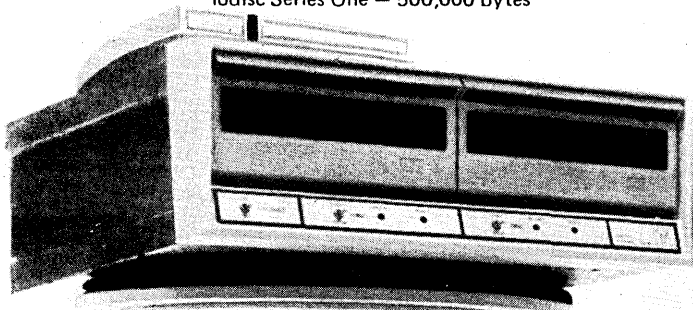

LINE PRINTER
Model 200 — 200 to 526 lpm

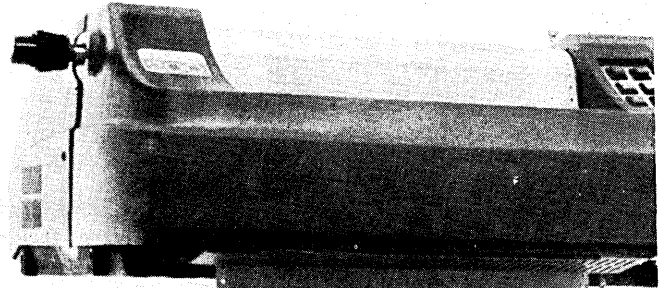

TAPE READERS
Series 2000 — 150 to 1000 cps

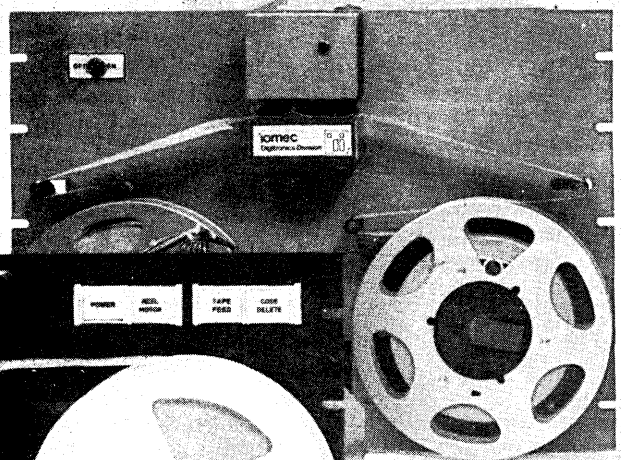
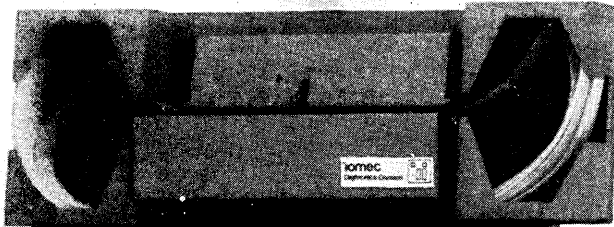

TAPE PUNCHES
Series 100 — 20 to 70 cps

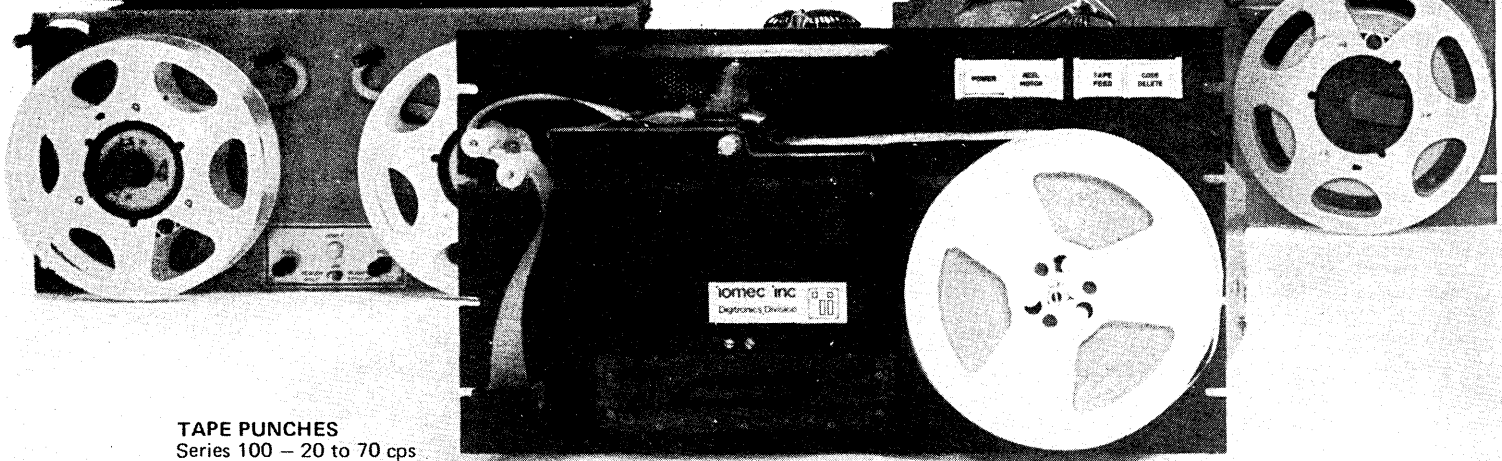

All you add is the minicomputer.

The iomates — Everything you need to mate with your minicomputer, data terminal or digital system.

A full range of advanced, high-performance data storage devices — disc drives including the iodisc Series One and the iodisc 2001, 2002, and 2004 cartridge and fixed-disc systems.

Magnetic tape transports, both mini-cartridge and IBM-compatible. The pace-setting Model 200 line printer, which gives you big-printer performance at a little-printer price. And a whole series of perforated tape readers, handlers, punches and punch-reader combinations. Plus mini-computer plug-compatible sub-systems with controllers and formatters for end-users and system integrators.

All designed to give you the performance you need at the price you want.

All built to give you reliability and flexibility along with the iomec quality you've come to expect.

And all — for the first time ever — available from the same place. With all the dollar-volume savings the OEM can get from a single source. iomec.

The iomates. A whole new family of peripherals.

LARGE DISC DRIVES
iodisc Series 2000 — 10,240,000 bytes

LARGE TAPE DRIVES
iotape Series Ten — 45 ips, 800/1600 bpi

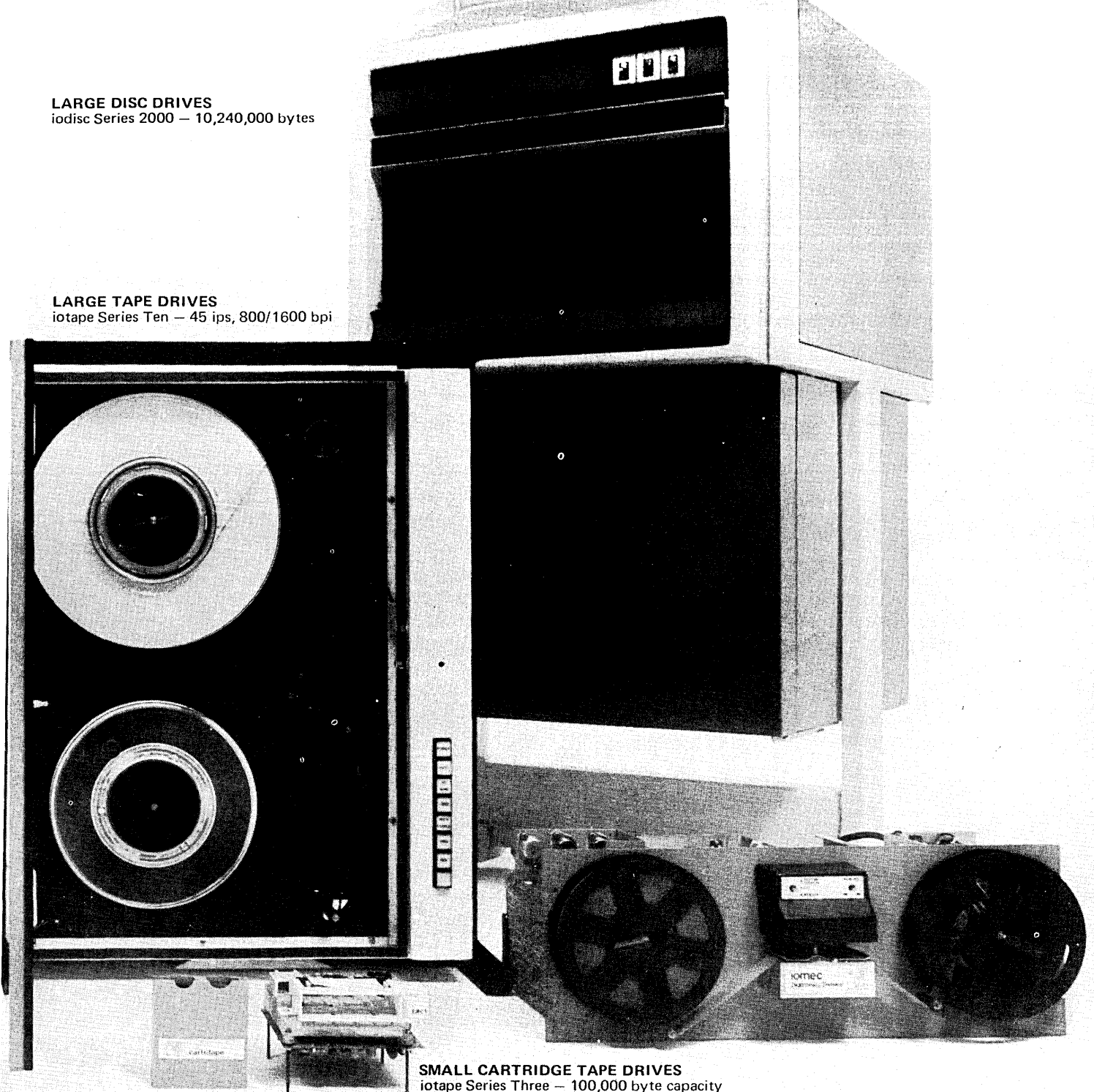

SMALL CARTRIDGE TAPE DRIVES
iotape Series Three — 100,000 byte capacity

See the new iomates in the Computer Caravan.

iomec inc.
Route 9, Southboro, Massachusetts 01772

Please send more detailed information on the iomates indicated below:

- iodisc Series One
- iodisc Series 2000
- Model 200 line printer
- iotape Series Three mini-cartridge transport
- iotape Series Ten IBM-compatible transports
- Series 100 paper tape punches
- Series 7000 punch-reader systems
- Series 2000 perforated tape readers

My minicomputer is a _____

Name _____

Title _____

Company _____

Address _____

City _____ State _____ Zip _____

iomec inc

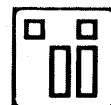

On November 27, 1972, a message only 1/1,000 of an inch high was discovered in a pyramid.

*This is the message, reprinted
in full:*

We understand that people have been inquiring about the whereabouts of a company called Reproduction Systems Inc.

We are alive and well in a pyramid.

On November 27th we moved our corporate headquarters into new offices in San Francisco's most most talked-about landmark . . . the Transamerica Pyramid.

And to commemorate the historic event, we changed our name.

From Reproduction Systems Inc. . . . to SynerGraphics.

We simply outgrew ourselves; building-wise and image-wise.

Modest users of microfilm still know us as a service bureau network across the U.S. But today as

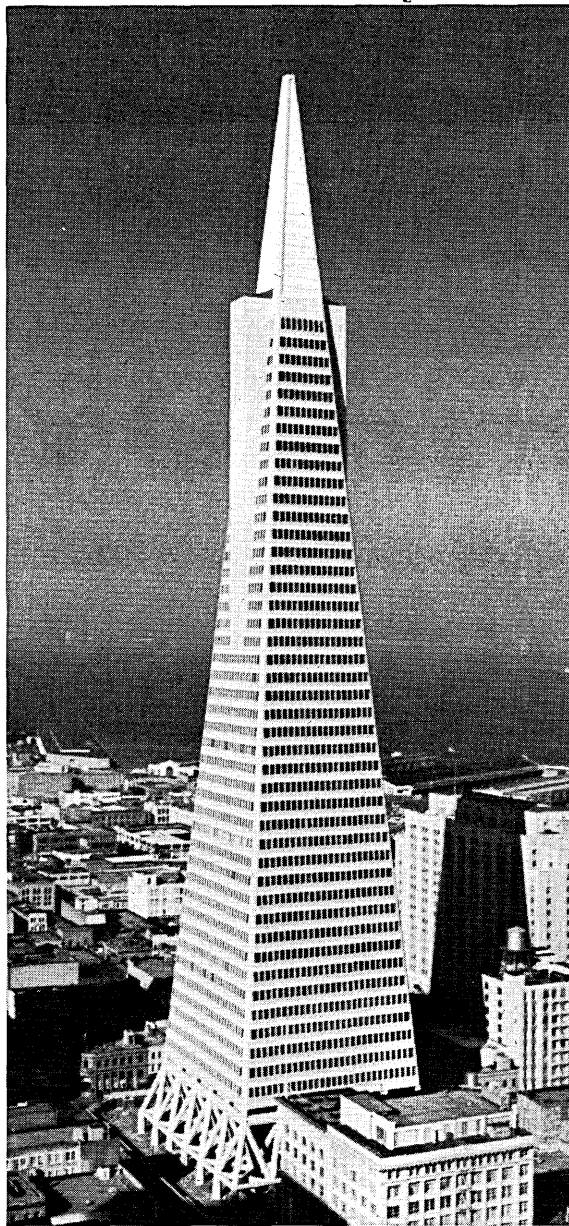

your requirements expand, so do our services. We'll analyze your operation, select the best equipment for you (any kind including our own excellent COM and reader units). We design your layout. Train your people. Install the equipment. And even provide you with film and chemicals.

Like many other companies today, we're synergistic. Our various services and capabilities reinforce each other.

Our corporate headquarters number at the Pyramid is (415) 983-5200. SynerGraphics Inc., Transamerica Pyramid, P.O. Box 7958, San Francisco, CA 94120.

It may seem strange that this message was found on a piece of microfilm. But then again, this is no ordinary pyramid.

SynerGraphics

A Microfilm Service of
Transamerica Corporation

Along with some of the newest and most sophisticated modules in the business.

Because we're big and bright enough to stockpile and document every advance we make so that when we obsolete a module, we don't obsolete what you're doing with it.

We promised to back up the first module we made back in 1957.

You buy the same module today, we'll make the same promise.

And we'll let you buy as little

as one or two at a time, anytime you need them.

Which is one reason why a lot of people like you, like doing business with us.

And one reason why it really isn't worth your time, trouble and talent to try to make them yourself.

Fifteen years ago, we sold our first module.



One more thing.
Every module we design, we design more conservatively than any other module maker.
Which is why we can back them up longer, unless you try to make them do something they weren't designed to do in

the first place.
In which case, we could design you a special one, to do whatever you want it to do.
Like interfacing one of ours or anybody's computers.
Which is one more thing we've been doing better longer than most people have been in the business.

We're the Logic Products Group, Digital Equipment Corporation, Maynard, Massachusetts 01754, (617) 897-5111 (Ext: 2785) in the U.S.
81 route de l'Aire, 1211 Geneva 26/(022) 42 79 50 in Europe.

digital

We still do.



CIRCLE 19 ON READER CARD

We give you a problem, free.

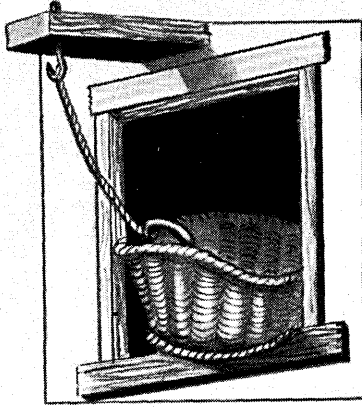

©1972
Cathy Hill

The No-Problem Tape Presents the Fire Escape Problem.

A farmer, his wife, dog and baby were so poor, they had to live in a hayloft over the barn.

As a precaution, in the event of fire, the farmer ran a rope over a pulley suspended near a window in the loft, and hung a large basket from each end of the rope.

One basket could then be used as a fire escape by placing an object in the other basket to act as a counterweight.

However, nothing weighing more than 30 pounds can safely be lowered in one basket while the other is empty. And, when each basket is carrying a weight, the safe limit of difference is 30 pounds.

The farmer weighed 90 pounds, and his wife weighed 210 pounds; the baby and dog, neither of whom is capable of getting into or out of a basket unaided by the farmer or his wife, weighed 30 and 60 pounds respectively.

Each basket is large enough to hold the four of them at once, but the farmer had no counterweights to use in the baskets —

only the man, woman, dog and child are to be involved in the escape.

In the event of a fire, what is the most efficient way in which all four can get safely to the ground?

Blurb.

While you're worrying about getting the farmer and his family safely to the ground, we'd like to say a few words about something you won't have to worry about: new Capitol/Audev 6400 computer tape.

New 6400 has 6400 fci capability, hence its name. 6400 fci has at least twice the capacity of the tape you're now using. Yet Capitol/Audev 6400 performs at any existing system density.

And it performs beautifully. Without oxide shedding. With virtually no head wear. And with the guarantee of no first pass permanent errors at the specified density — 100% certified.

For the answer to the Fire Escape Problem and for more information about a computer tape that presents no problem at all, write today to Dept. 12, Audio Devices, Inc., 100 Research Drive, Glenbrook, Conn. 06906.

And a problem-free computer tape.

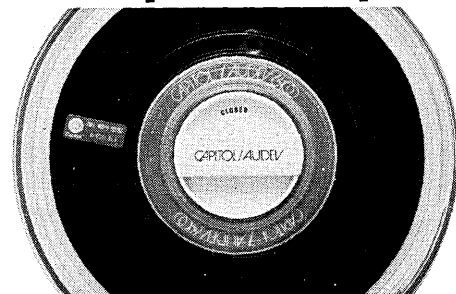

Capitol/Audev

the centronics phenomenon: after 2 instant successes, could we have 3 more in the wings?

The 101 and 101A. In less than a year and a half, they became the best selling medium-speed printers. Anywhere.

Now, ready in the wings...

The 306. The fastest, low-cost 80-column impact printer. And it's in production.

The 102A. At 125 lines/min., it's twice as fast as our first models. And it's in production.

The 401. A 132-character crt terminal that adds display/editing capabilities to our printers. At low cost. And it's in production.

To get the facts of success, phone or write Department 1055.

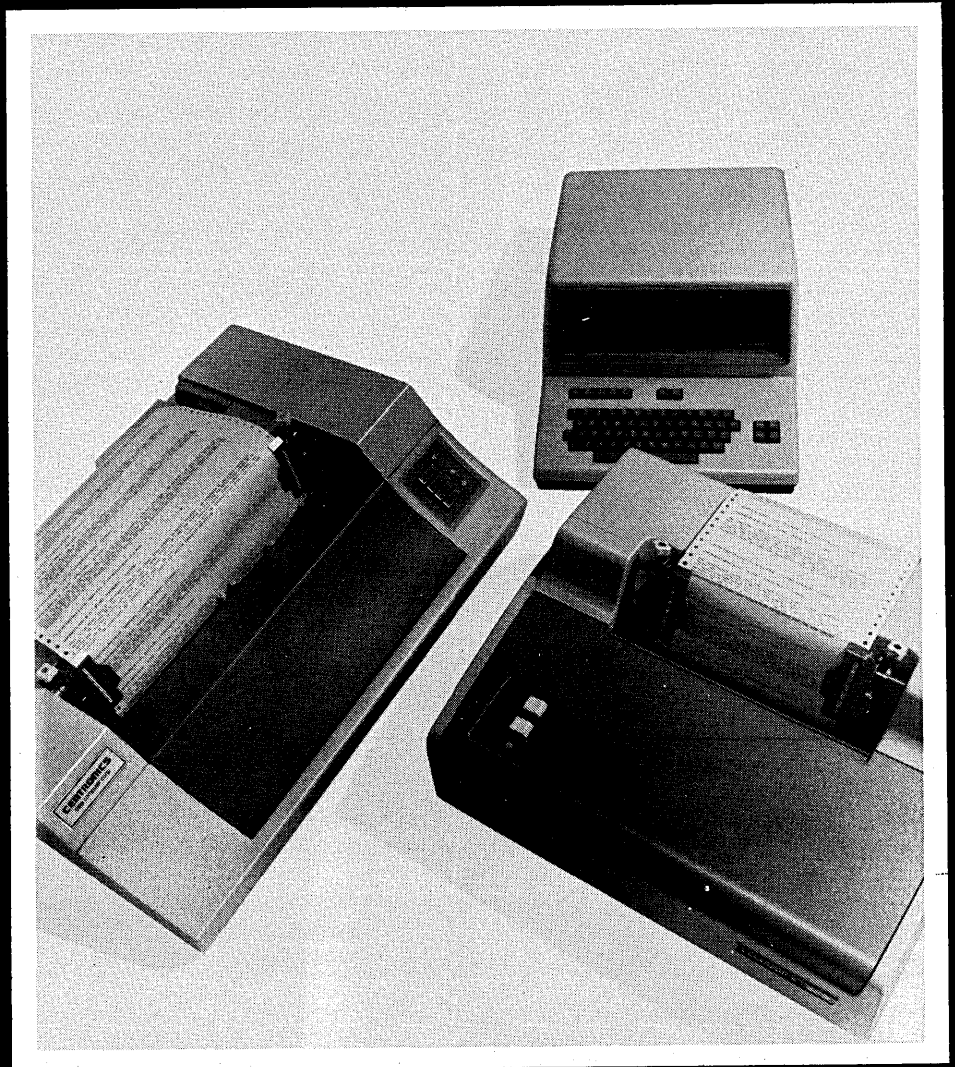

CENTRONICS

centronics data computer corp.
one wall street, hudson, n. h. 03051
telephone (603) 883-0111

central region: (513) 294-0070 (ohio)
western region: (415) 228-7178 (calif.)

CIRCLE 12 ON READER CARD

Big advantages



n small packages!

This new low-priced
NCR Century 101 system offers
small and medium size businesses
the big kind of computer power
they need to grow.

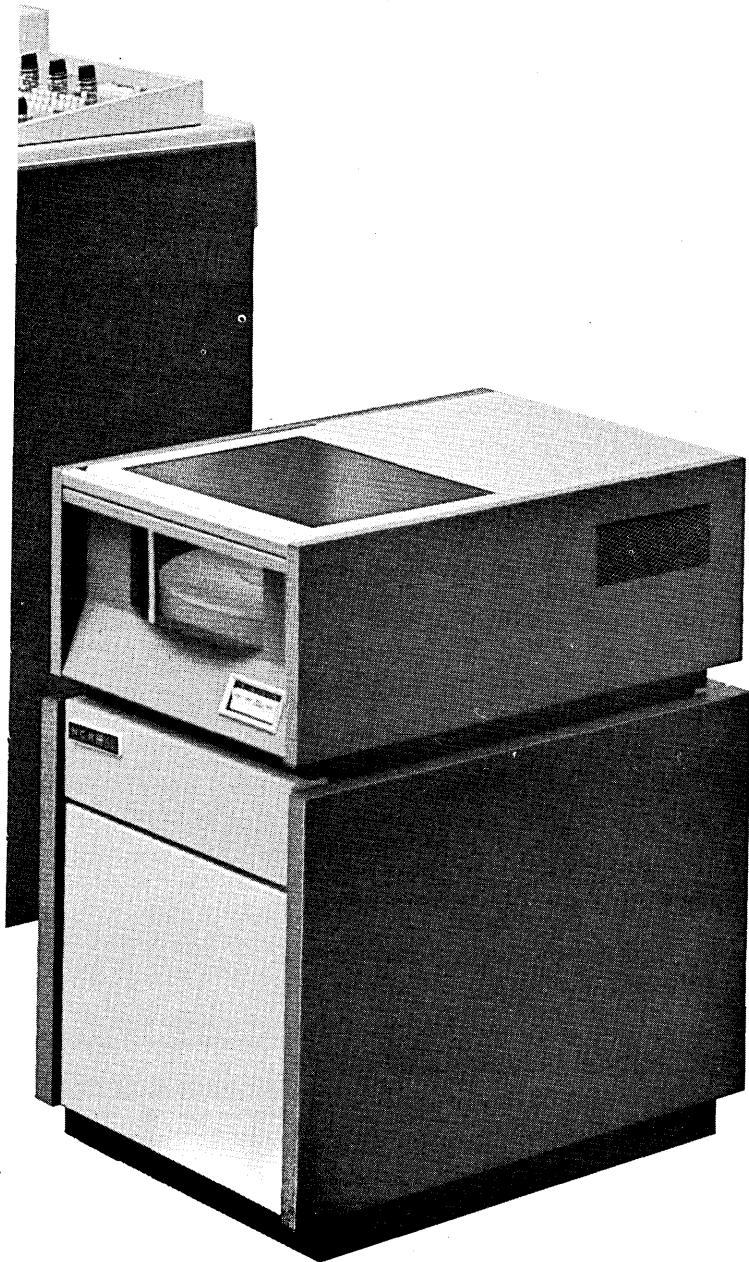

The newly released peripherals for the NCR Century 101 processor require a minimum of space, yet they provide the power and versatility of units twice their size.

The basic system, including processor, card or paper tape reader, line printer, and one dual platter disc unit covers no more space than 2½ feet by 10 feet! It can be placed in rooms where larger computers just won't fit. And, because it generates little heat, air conditioning requirements are minimal.

Big advantages in small packages include free standing add-on dual platter disc units, each having a storage capacity of 10 million bytes. A line printer that turns out 300 lines of crisp printing per minute. And an optional 30-character per second I/O Writer.

The 101 processor, heart of the system, includes features like a high-speed memory that can expand in practical increments from 16K to 64K. An optional multiplexor that provides control for 10 communications lines, with no increase in cabinetry. Seven-way to nine-way simultaneity. And many other features just as significant.

Later, as your business grows, you can expand this modular system to meet increased information requirements. Larger capacity disc units and higher speed printers can be added if and when you need them.

For the price, this new system from NCR offers big performance for businesses on the grow. Average systems range from just \$1820 to \$3800 per month!

Call your local NCR office for the specific advantages your business can expect from this newest member of the NCR Century family.

NCR

Computers & Terminals

Acco is the only manufacturer to offer retractable hooks on all 14-7/8" x 11" data binders at no extra cost.

Versatile, high-impact plastic Accodata hooks. Slide out easily for hanging. Push-in flush for everyday use. Permanently attached to all our 14⁷/₈" x 11" (9007) P1P, P4P and P6P Accodata Binders. No extras to buy. No hooks to get lost. Our famous Accodata Binders come in 20 pt. genuine pressboard in 7 colors. 23 pt. Accohide* in 4 colors and heavy-duty 90 pt. Accohide* in

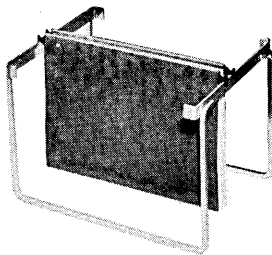

2 colors—practically indestructible. New, all metal binding mechanisms provide greater compression. Steel Dataflex™ posts. Top and bottom loading for easy access. Holds up to 8" burst or unburst printout. See your Acco Representative for complete details. Acco products are advertised regularly in leading office products magazines. Seeing's believing.

*A chemical resin.

Innovators . . . by design



ACCO INTERNATIONAL INC.

5150 N. Northwest Highway/Chicago, Illinois 60630

New York, Los Angeles, Boston/Canada/England/Holland/Mexico/Venezuela/El Salvador/Jamaica/Japan

Now you see 'em

...now you don't.

UNIVAC 3760 out in front of IBM systems.

You don't have to modify your 370/360 to get the lower cost, higher performance advantages of UNIVAC® communications terminals.

The UNIVAC 3760 communications controller gives you plug-to-plug compatibility with the IBM* 370/360, emulating IBM 2701, 2702 and 2703 data transmission units. And without changing your present operating system software or applications software. Step by step, you can move up to a full network control package.

The UNIVAC 3760 is a programmable processor with a memory of 16,000 bytes, expandable in 16,000-byte increments to 131,000 bytes. It gives you direct memory accessing and full memory-addressing, with a memory cycle time of 750 nanoseconds. It can accommodate up to 192 full-duplex lines.

And with your 3760 you can take advantage of the powerful capabilities of the UNIVAC UNISCOPE® 100 display terminal, the DCT 500

keyboard-printer and the DCT 1000 remote-batch terminal.

All this, with no change to your IBM system, for 15% to 25% less than processors that aren't nearly so capable.

And these are only a few of the lower cost, higher performance benefits offered by

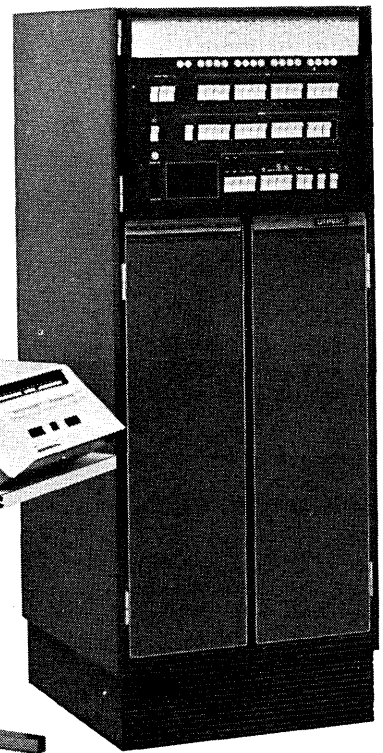
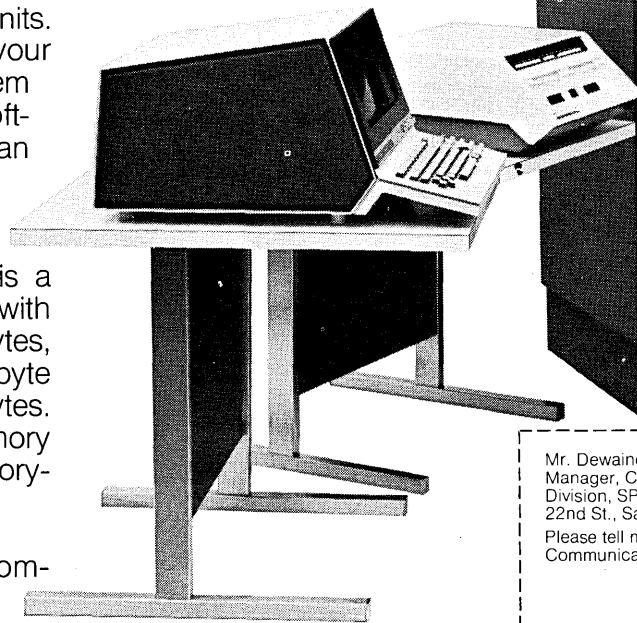

Mr. Dewaine L. Osman, V.P. and General Manager, Communications and Terminals Division, SPERRY UNIVAC, 322 North 22nd St., Salt Lake City, Utah 84116
Please tell me more about your 3760 Communications Controller:

NAME _____
TITLE _____
COMPANY _____
ADDRESS _____
CITY _____
STATE _____ ZIP _____

the UNIVAC 3760 to IBM users. To learn about more, clip and send the coupon. Or call 801-328-8066.

The UNIVAC 3760 COMMUNICATIONS SYSTEM

SPERRY+UNIVAC

Only when our customers succeed do we succeed.

A lot of companies have inventors. But only one communications company has Bell Labs.

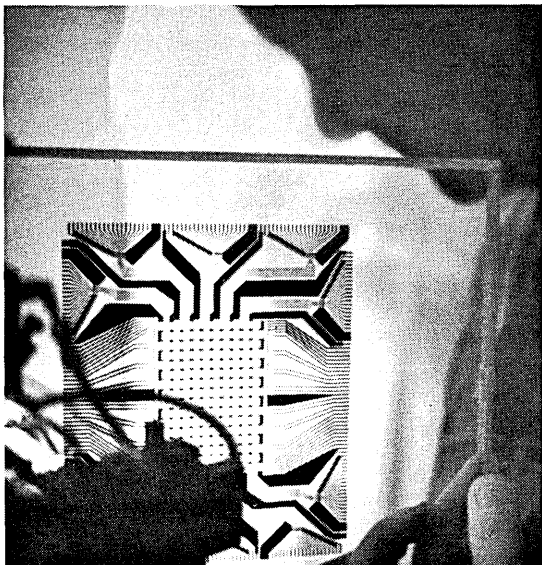

That company includes, of course, your local Bell Company.

Let's say we run into a baffling problem while repairing your computer's telecommunications system.

The first thing we do is call in the experts.

They might be people from Western Electric. The people who built your equipment.

Or even the people from Bell Labs who developed your equipment

in the first place. Bell Labs is where computers learned to talk over the telephone.

Or if something as totally disruptive as a natural disaster puts your communications out of whack, our repair force has the people and resources of 22 other associated Bell Companies to back them up.

We've airlifted a lot of people and equipment into a lot of places over the years. And we're ready to go again. Any time we're needed.

Depth of service like this makes Bell System maintenance one of the best bargains in your phone bill.

AT&T and your local Bell Company.



100 million bits without an error!



EPI's new STR-200™ Digital Cassette Recorder.

Now, at last, a digital cassette recorder that gives you everything you're looking for—all in one compact, convenient package. Portability. Battery operation. And above all, *reliability*.

It's the new STR-200 from EPI. Repeated tests show its bit error rate to be well below one soft error per 10^8 bits!

The secret is in the new STR recording technique—Speed Tolerant Recording—perfected and patented by Electronic Processors, Inc. STR eliminates the need for ultra-precise drive mechanisms and produces a single-track, self-clocking recording that is compatible with any digital computer system.

The STR-200 is a replacement for your paper tape punch/reader. Other STR-200 advantages include high information density (2 million bits per cassette), an ability to accept or play back data at 125 characters per second, and a reusable recording medium that maintains

data sequencing at all times.

Yet the STR-200 costs only \$495 (two for \$920)... far less than other systems with lower capabilities. For more information on the STR-200 and Speed Tolerant Recording, send in the coupon. Or phone us at 303/798-9305.

Send me literature on EPI's new STR-200 Digital Cassette Recorder.

I'd like to talk to a sales engineer.

My requirement will be

- Immediate
 6 Months
 1 Year

**ELECTRONIC PROCESSORS
INCORPORATED** 
A Subsidiary of Samsonite Corporation

5050 South Federal Blvd., Englewood, Colorado 80110

Name _____

Title _____

Company _____

Address _____ Phone _____

City _____

State _____ Zip _____

CIRCLE 28 ON READER CARD

You design software for end users. We have the systems they need.

Why stop at selling or leasing software systems to end users? Now you can offer them complete minicomputer package systems.

This way they'll be able to get everything they need from you. And you'll be able to get everything you need from us.

Wider choice of peripherals We offer a full line of peripherals to go with our SUE and MAC minicomputers: IBM compatible 5440 disks, CRT/keyboards, printers from 100 cps to 600

lpm, magnetic tapes, cassettes, 80 or 96 column punched card devices, paper tapes and synchronous and asynchronous modem controllers. Anything your customer needs. And when his needs change, so can the system. Easily. Even by factors of 2 or 3.

Complete software tools

To make your programming burden lighter we offer a full set of software tools: Fortran, assemblers, utilities, RTOS, sort/merge, DOS and RPG/SUE. That last item is 98% compatible with RPG II by the way.

And we're the only company we know of that unconditionally warrants all our software for a full year.



Maintenance too We'll handle any and all problems your customers might have, promptly and expertly, anywhere. (We recently solved a problem in Bangkok, for instance.) And we'll do it by contract or on call, either way you want it.

We also offer training classes in maintenance as well as in programming.

Add it up So what you'll have is a more salable package to offer an end user. Everything he'll ever want or need in a minicomputer system, right down to the enclosures. (Which we'll put your name on, if you wish.)

Everything ready and working from the minute it's wheeled in his door.

And you'll be dealing with an established, reputable company. One that will be there when you need us.

Let's talk. Call the number below, collect, or write us at 6201 E. Randolph Street, Los Angeles, California 90040.

YOUR NAME

213/722-6810

**Lockheed
Electronics**

Data Products Division

Let's talk.

See SUE systems on the Computer Caravan.

CIRCLE 46 ON READER CARD

Editor's Readout

Convalescing

It's that time of year again. I can tell. Howard Cosell doesn't invade my living room Monday nights any more, and there's a bit of snow up on the mountains out toward San Berdoo. It's time to trot out the old year, shake it off, and see if it really made any sense at all. And take a cautious if not a fearful peek at the new one coming up.

I often tell people that being editor of *DATAMATION* is a bit like reporting a three-ring circus at an insane asylum . . . that's on fire. And that it's pretty interesting work, once you get used to the sounds of the wounded and the dying.

The screams weren't quite so loud and long this year past. They were, in fact, rather muted, if not drowned out by the murmurs of pleasure over the upsurge in business that culminated with a healthy last Fall Joint. Despite the turnaround, a lot of computerniks remained out of work or out of the industry. One man we know who was labeled "World's Greatest Programmer" (by his knowledgeable boss) is studying to be a court reporter.

Maybe the biggest boost to business was provided by IBM when it "discovered" virtual memory after letting others push its development on the market for 10 years. The announcement triggered a huge flap in the flock of headless chickens who think that IBM is the world's only manufacturer of computers.

What these loyal fowl forget is that they really haven't mastered all the goodies (baddies) made available to them by the Benevolent Giant from Armonk, and that virtual memory and the new systems it will trigger are bound to cost more in equipment, manpower, training, and conversion than they could dream or nightmare. The sane people we talk to want to return to the relative haven of version X and try to make things work at that level. But then some people never learn, a fact that has probably kept the industry alive till now.

Elsewhere, the antitrust case finally

started to generate some action, and even a sluggish press was forced into paying it some attention, after what appeared a concerted effort by all hands involved to keep the most important event in the history of the industry locked in a dark closet.

The turmoil and conflict within AFIPS and its member societies didn't reach the law courts, but that's probably because the parties involved don't have enough money to attract legal hawks. Watch AFIPS start to shrivel up and turn into a captive conference/exhibits producer for ACM and the IEEE Computer Society, who may merge and decide they are *the* industry's professional society. They'll probably continue to ignore DPMA, which kicked out the executive who helped drag it out of the tab shop and into the computer room.

The user groups, meanwhile, continue to use secret passwords and hide behind tech weenie buzz words, thrilling to the special inside information they get about the manufacturers' plans . . . and acting in general like college fraternities. They'll *never* grow up.

On the brighter side, there have been some promising startups, some new products from companies that may even survive long enough to get swallowed by someone else struggling to survive. Wall Street doesn't start cursing when the word computer is mentioned anymore . . . it just looks bored and turns away.

We have a hunch that 1973 will be—as Frank Sinatra says—a *very* good year for most manufacturers. Most users probably won't discover right away that most of the new software systems should be labeled "hazardous to your health." Nevertheless, some new systems will be installed, even if they're not on time and don't work quite right at first. We wouldn't know what to do if they did. I imagine all of us will get through the year somehow. We always do, and it's always challenging, exciting, fun.

If only they'd put out that darn fire.

—Bob Forest

Determining the real needs and attitudes of the people involved is at least as important as choosing the proper technical approaches

Making Project Management

Most system managers can point to a number of projects both large and small which have failed to meet schedules, have overrun budgets, or whose products simply have not met the expectations of the user. Some of these projects have probably used elaborate techniques for cost and schedule control, while others have probably been run by the seat of the pants. On the surface, it is often difficult to tell why one project turns out successfully while another fails. Looking at the experience with most systems development projects, it is not readily apparent what organizational and operational features were responsible for success or failure.

The question for the systems manager is how to evaluate the available organizational and operational alternatives to determine the best management approach for his projects. Identifying the alternatives is not a problem, since a number of books and articles have been written on project management in the past few years, and at least 20 software packages are available for the job. The real issue is—what will work in a particular organization, and will the investment pay for itself? To determine this, the system manager needs an understanding of the factors which are important to the success of project management in software development.

Project management typically involves the organization and performance of an integrated effort leading toward a specific objective, such as the development of a software system. Usually, the immediate project organization is set up to meet that specific objective and to dissolve after it has been accomplished.

Project management techniques involve planning of work by defining the tasks to be done and establishing their interdependencies, scheduling and assigning the tasks, and maintaining a status reporting system which permits management to track progress and ini-

tiate any necessary control actions. Although project management sometimes is not extended to costs, it normally should include budgeting, establishment of cost targets, allocation of manpower and other resources, and the related reporting and control. Project managers typically use such tools as work breakdown structures, critical path planning or PERT, milestone charts, resource allocation algorithms, and exception reports.

The three principal areas where the success of a system development project is determined are: (1) organizational compatibility, (2) technical adequacy, and (3) method of operation.

Organizational compatibility

Organizational compatibility relates to the management attitude, the expectations of the programming groups and the real interests of personnel and managers when faced with the need for planning and control of their work. The difference between organizational situations is illustrated by the fact that project management systems which have been successfully used in one company often fail in another. This does not necessarily happen because of weaknesses in the systems, but more often because they are not compatible with the organization.

Management Attitude. It seems to be fashionable for top management today to proclaim full support of project management. Unfortunately, there are many instances when the actions do not follow the words. For example, when a major bank decided to implement a full-scale project management system, a readily available, but at the same time weak and ineffective individual, was appointed to head this effort. Only after a considerable delay, management realized that successful implementation of the system depended on capable and aggressive leadership. Appropriate personnel changes

had to be made before the effort got on the right track.

Aside from failing to support project management with the required resources, top management may also undermine the project manager's authority by dealing directly with parties with whom the project manager has to work, such as users. Sometimes, management may impose their decisions on a project or even change the budget without the project manager's participation.

Experience shows that such actions contribute to project failures. One of the probable reasons they take place is the fact that few top managers have arrived at their present positions through a project-oriented organization, and they do not fully understand the problems of project management. While it may be fashionable to talk about project management, it may not be the most popular thing to build up the necessary discipline at the expense of old line organizations.

Group Acceptance. Introduction of a formal project management system affects people at all levels. They have a natural concern about the effects of the new system on their lives. For example, if they are required to do more detailed planning than before, what are the potential penalties for errors? And will the new system require a change in the accustomed work style of the group? Some organizations are less formal than others and much can be said for such approaches as ego-less programming. The programmers individually and as a group should have a clear understanding of the effects the introduction of project management will have on their accustomed work practices.

When the management system includes manloading, it gets into the area of manpower management and career development. In those projects where task assignments are made on an informal basis, the supervisor has consider-

Work

by Ivars Avots

able latitude in assigning personnel in accordance with their goals, job expectations and temperaments. For example, he can recognize the fact that not all programmers want to advance to more complex and more responsible work. On the other hand, when programmer names and skills are entered into a data bank and the assignment is made more or less by computer, as some of the more sophisticated systems envision, the programmer can have a real concern about the loss of personality and individuality and the potential effects of the system on his career development.

Project management systems require that task objectives, schedules and budgets be set out in considerable detail. Participation of the group in development of these detailed tasks is important. If programmers participate in the planning process, they gain a better understanding of the goals—and their commitments to the project become more meaningful. Such commitment is important, because the nature of the programming job is such that some types of errors or deviations may not show up until systems test or operations and extra effort may be needed to meet schedules. If a programmer feels that a management system represents an obstacle and a strait jacket, his feelings may be reflected in the quality of code produced.

The enthusiasm of the project manager himself is important to the success of the system. Like programmers, some project managers feel their real contribution is in the creative activity, and they go along with management systems only because they have no other choice. Other project managers, on the other hand, approach project management systems with enthusiasm and try to exploit every potential that such systems offer. They volunteer for pilot studies, make special efforts to make the system work and recommend it to others, even knowing that the system

may still be going through growing pains. Enthusiasm on behalf of the project manager is probably the most worthwhile asset a project management system can have, and the personnel responsible for implementation should spare no effort to keep this enthusiasm high.

Technical adequacy

Except in very small jobs, system development projects usually require a computer program to keep track of schedules, costs and personnel assignments. Depending on the complexity of application, this can be a simple critical path planning program run at a service bureau or a complex on-line system designed specifically to handle all aspects of a large project's organization. In fact, the first decision in implementing a project management system usually is whether to buy an existing software package or develop a special program. Systems which are developed in-house tend to be fairly simple and if normal progress is made their capabilities are soon outgrown. However, the pride of the developers in the system may linger on and prevent them from scrapping it in favor of another system.

In selecting a software package, one usually looks not only for the immediate requirements but also for growth capability. The criteria considered generally include the program's capabilities in schedule planning and control, cost control, and manpower loading. Further possibilities include exception reporting, availability of graphic outputs, ease of modification and expansion of the system, and continued support by the developer.

Although many software packages for controlling system projects are on the market, nearly every one of them has some limitation or weakness. Several packages advertise complete project control in every situation, but provide no direct tie-in to the scheduling system. When resource allocation is of-

fered, this feature may be extremely unwieldy or even unworkable. One company gave up on their resource allocation module when the computer was still grinding away on a 200-activity test network after three hours. Another company installed a program which provided exceptionally suitable graphic output, only to find that their plotting capability was too slow to permit utilization of this feature. A government agency spent \$15,000 for a package, and then forked out another \$25,000 of their own programming time to get it going.

Method of operation

Implementation of a project management system (PMS) is a project of its own, and a specific group is usually created to install the software, develop the procedures, conduct the pilot test, arrange training, and assist the project managers in its operation. Typically, the project managers may develop rough network plans and task lists which are then transferred into work breakdown structures and detailed networks by the PMS group. What happens at this point, however, is critical. The PMS should be an integral part of system development operations and not a toy maintained in an obscure corner of the building. The most successful applications are those where the project manager is a focal point for effective use of the system, and he does not depend on a coordinator from the PMS office to do the planning and control for him.

The structure of PMS represents only the form, and it should be recognized as such. The real substance behind PMS is the system development process or system life cycle which is practiced by the organization. While there have been attempts to develop systems through a series of free-form study and design activities, a more common approach involves structuring of the development process in a series of phases,

Project Management

activities, tasks and subtasks. As each step in this development cycle is accomplished, it must be documented, reviewed and approved. Checkpoints are set for reviews of program objectives, schedules, and costs. This process must be appropriately formalized and understood by all members of the system development organization before PMS can be effectively applied. Development of work breakdown structures, sizing of work packages, and the levels of change control are largely influenced by the system development process as it is practiced in each particular instance.

Introduction of PMS is a complex effort which requires time. Since planning and control capabilities must be developed as the system grows, the schedule cannot be too fast if the organization is not to suffer from indigestion. Usually, work breakdown structures and network plans are introduced first. Budgeting and cost control follows next, with manpower loading and resource allocation as longer range objectives. A lag of six months or a year between these phases is not at all uncommon.

Although it may not be obvious, each organization follows a certain work philosophy and has a way of thinking which permeates every aspect of operations. For example, people may be used to looking at targets and not detailed schedules, or to measuring man-hour expenditures and not dollar costs. Emphasis may be on start dates and not completions. In an ego-less programming environment, programmers may be used to signing off each other's work and not checking with a supervisor. In introducing PMS one must be careful not to upset any established philosophy or practice. If changes are necessary, they have to be done gradually or else they may be rejected.

Performance Reporting. Performance measurement and reporting are important elements in the operation of PMS—and the result should be information, not data. While information is necessary to support management actions, reporting systems often provide much data without a commensurate amount of useful information. Data is not information unless it is pertinent, timely and applicable in solving a problem.

Keeping in mind this fact, it becomes obvious that data which are highly useful at one management level and therefore represent information may be completely useless at another level. The objective of the information system should be to provide the right information, at the right time, in the

appropriate amount, at a cost which is commensurate with the results to be achieved. The information requirements at various levels of project management should follow these principles.

Mere availability of performance information through PMS reports does not assume that this information will be used. One way of dealing with this problem is to present reports to higher management in such a manner as to initiate questions which lead to investigation and corrective actions at lower levels. In other words, the system does not assume that everybody is an effective and stimulated manager, but that a certain amount of direct interest from higher levels is necessary to keep managers performing at a satisfactory level.

As an illustration of this concept, assume that a change in the network plan has caused some schedule dates to fall outside the slack band available for the activities in question. Analysts can find this condition and work it out with the project manager, then re-run the network before passing the reports out to higher management. In this manner, the reports always show true status information, but the project manager learns to depend on the analysts to clean up such situations after the fact. Furthermore, the reports are delayed by at least a day.

On the other hand, if the report is released with the delayed schedule dates, higher management may immediately question the project manager. The manager, of course, will answer that the problem is a technicality caused by changes, and the report will be fixed. However, it may take only a few inquiries of this type before the project manager begins to realize that to avoid questions he should consider impact on established schedule dates when contemplating changes. This is his responsibility as a manager which he really should have observed to begin with, but which he had been neglecting. Thus, management information may include indications whose only purpose is to signal that a problem exists. The objective in this case is not to initiate resource re-allocation or other defensive measures, but simply to drive home the need for effective management and consideration of all related factors to gradually improve the management of the system development efforts.

In contrast, project reports should exclude any data which are not pertinent to potential action at the given level of management. For example, activity slack may be very useful to the first line manager, but may only confuse the project manager and higher levels. General emphasis at higher levels must be on milestones representing points in the progress of the project, and should exclude the type of detailed

information needed for analysis of a problem.

Project Cost Control. A cost control system for large-scale software development programs should provide "cradle-to-grave" cost visibility. It should also identify variances in a timely manner, so that the reasons for such variances can be determined and related to the organizational units responsible for them. Direct cost variances will usually be the responsibility of the project manager, while indirect cost variances are likely to reflect transactions in other administrative units. Both types of variances should be of concern to the systems development department as a whole.

Any changes in the scope of the project (as compared to the feasibility study) must be properly identified and costed out to provide visibility over the changing cost of the project and permit maintenance of a cost baseline reflecting the changes which may be authorized from time to time.

In controlling costs, project management should emphasize costs at completion of major subsystems and overall trends rather than short-term fluctuations. In the short run, variances may result from a number of minor disturbances in the system or simply from the available techniques for estimating progress and cost of work performed. In most cases, detailed analysis of such sporadic variances will not be worth the investment of management time. On the other hand, trends in costs at completion of subtasks will usually be very significant. They must be related to schedule performance, and followed up with aggressive management actions to prevent cost overruns.

Considerations for success

Considering the organization, technical and operational factors which can affect the success or failure of a project management system, what can a systems manager do to achieve satisfactory project control and minimize any adverse effects on the organization? Until recently, management specialists focused on the technology and the procedural aspects of such systems. In the past few years, however, there has been a growing emphasis on the human factors. Although much research is still to be done in this area, new techniques are emerging which will assist management in selecting and implementing PMS systems in a way which will cause the least disruption, and which will increase acceptability.

A systematic approach to the design of project management systems has been suggested by Professor Lawrence Bennis of the Harvard Business School in what he terms the "strategic approach."¹ This approach seeks to

determine what is really important in a given project, considering the various aspects of system design and their interaction. This is in contrast to the comparison of organization structures, project managers' authority, and planning and control tools which represent tactical considerations. The first step in a strategic approach is to identify the project criteria which are of strategic importance to the successful accomplishment of the project. These may include time and cost, or efficiency of the program. Usually, there are only a few such criteria which are really important to the success of the project, and there may be several tactical alternatives for achieving them.

Once the strategically important characteristics of a project have been determined, one can proceed to evaluate the management approach which is likely to get the job done. Project management systems can be evaluated independently of the task itself by applying such criteria as obtaining commitment of individuals to project goals, achieving adequate coordination and collaboration, providing visibility of relevant status information, satisfying personal and job security needs of project personnel, and achieving an orderly termination of the project. The criteria selected from these two sets represent the strategic goals to guide all tactical decisions in the design of a project management approach.

Separate evaluation of available, tactical alternatives can be carried out with regard to project organization, selection of managers, choice of planning and control tools and development of the project information system. More possibilities arise when the strategic approach is combined with relevance analysis. Through a rating procedure carried out by groups of people knowledgeable in the organization as well as with the project to be carried out, specific relevance numbers can be assigned to each alternative.

Another recent technique is designed to help project managers to determine where coordination is needed, when it is needed, and what ways to coordinating will be effective. Known as TREND² (Transformed Relationships Evolved from Network Data), this approach provides a method for analyzing the coordination requirements of groups by drawing on three independently developed theories describing the relative importance of interdependence, uncertainty and prestige. Once a general planning network has been established, it is related to an organization chart to identify those

groups or individuals who are interdependent, those activities where a large amount of uncertainty exists, and those situations where a prestige consideration is involved. Such analyses can be projected for several points in the life of a project providing clues to the communications needs, the reporting systems and organizational flexibility which is desirable.

Software Evaluation. The adequacy of the software used as the basis for running the project management system is an important consideration which justifies careful study. Unfortunately, in selecting a system one usually has to rely on the unsubstantiated claims of software salesmen. The least one can do is to visit other companies using the specific package, and discuss the problems experienced. Consultants who have seen a number of applications can also be of use; however, one must be careful even here, since there are some consultants who will accept commissions from vendors of software packages they have recommended. Naturally, they may not approach the evaluation with the required objectivity.

Another criticism which is sometimes made of consultants is that they may endorse one particular system because they have most experience with it. While this may be a valid criticism in some cases, experience with a system often is the best proof of its workability. Provided that the software is sufficiently flexible to be adapted to the particular needs of the organization, the fact that a system works may be the best argument in its favor (at least until the organization develops a degree of sophistication in project management).

Recognizing the Human Element. In any project, one of the principal and at the same time more difficult tasks is establishing a collaborative environment. People must be able to work with people, and groups must be able to work with other groups. As Professor Gerald M. Weinberg of the State University of New York has observed,³ programmers work in a rich and complex environment which is full of human involvement, change, and misleading appearances. The life and the performance of the systems project team is influenced by such factors as:

1. Individual strengths and weaknesses
2. The manner of setting goals
3. Structure of the programs being produced
4. Leadership structure imposed on the project
5. The gender of certain members and the attitudes of other members

about that gender

6. Communication between the team and its environment

7. Technical competence of the team leader

Managers of system projects seldom come equipped with the training in human relations which is required to properly recognize these factors, and the leadership qualities necessary to deal with them. In recognition of this fact, management may support the project manager with a counselor whose functions include:

1. Periodic discussion with project personnel of their personal and professional progress, needs, and development to provide a communications link between programmers and the administrators whose actions can affect them.

2. Serving as an impartial monitor of the project to relate its progress to the overall directions of the organization. For example, he should communicate with the future users of the system to verify that project progress is in fact in agreement with user expectations.

3. Working with systems and programming personnel to identify common interest groups and help them form meaningful relationships which will eventually result in more effective performance on the project. With the support of project management, the counselor can help to catalyze completely new functional groups in the project, if it appears that such new groups increase effective operation.

Whatever particular methods are used in project management, they generally work when their primary emphasis is on realistic and sensitive human relations. When the emphasis is on the tools and mechanisms, projects tend to fail regardless of the technical brilliance of the methods. □

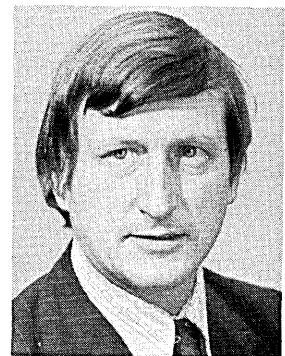

Mr. Avots is a senior member of the Management Sciences Division, Arthur D. Little, Inc. He has applied management planning and control techniques to a variety of projects in the U.S. and abroad and lectured on project management here and in Europe. He is a director of the Project Management Institute and has an MBA from the Univ. of Pennsylvania.

¹Lawrence A. Bennigson, "The Strategy of Running Temporary Projects," *Innovation* 24, September 1971.

²Lawrence A. Bennigson, "TREND: New Management Information from Networks," *Proceedings of INTERNET-72*, Stockholm, May 1972.

³Gerald M. Weinberg, *The Psychology of Computer Programming*, van Nostrand Reinhold Co., New York, 1971, p. 91.

Optical Data Entry

Recording information at its source—with a pen or pencil—entering and automatically verifying data directly into a data collection or processing system—quickly and conveniently—remotely or locally—and at a low cost! This is the great unrealized potential of optical data entry!

Well, Optical Data Entry Has Come of Age!

DECISION introduces the first dramatic innovation in low cost optical data entry, the **OMR 6500**.

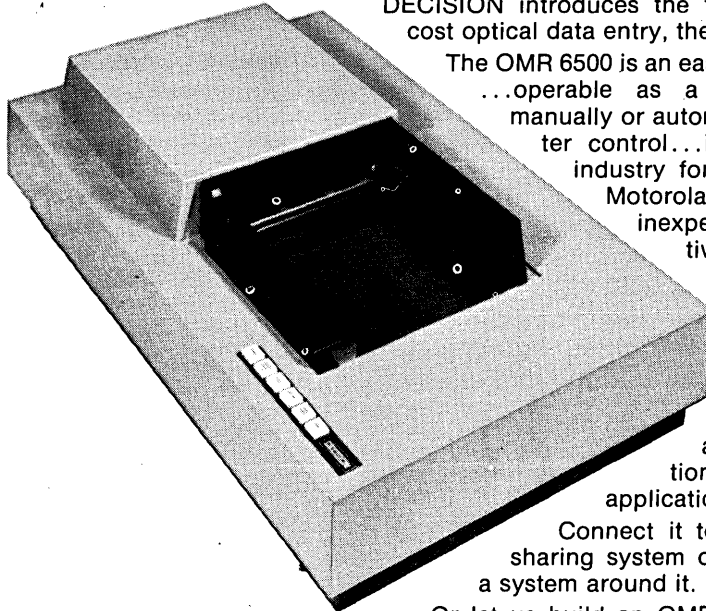

The OMR 6500 is an easy to use, compact, optical reader...operable as a peripheral or terminal...feeds manually or automatically under complete computer control...is compatible with all standard industry formats (IBM formats, Opscan, Motorola, etc.) and, most important, it's inexpensive enough to be cost-effective for thousands of potential applications.

In fact, it's 1/10th as expensive as the new IBM 3881 Optical Reader.

The OMR 6500 solves data entry problems and saves time and money in Business, Education, Medicine, and Government applications.

Connect it to your existing computer, time-sharing system or remote batch terminal. Design a system around it.

Or let us build an OMR 6500-based Optical Data Entry System to your specifications. We'll design and print your forms and take full system responsibility

Check our prices, OEM & delivery schedules.

Send us your name... we'll send you some OMR 6500 Optical Data Entry solutions or provide you with a demonstration in return.

Innovation in Optical Data Entry



San Francisco 415-654-8626 • New York 203-743-7447 • Los Angeles 213-822-1419

Decision, Inc. 5601 College Ave., Oakland, CA 94618

Gentlemen:

I am interested in using the OMR 6500 with the following computer system_____.

- Rush me further information on Decision optical data entry equipment.
- Contact me to arrange a demonstration.

Name _____

Position _____

Company _____

Address _____

City _____ State _____ Zip _____

Phone _____

Is the problem of accurate time estimating really a major obstacle in successful project management?

The Time-Estimating Myth

by Thomas R. Gildersleeve

In the past four years I've spent considerable time conducting workshops on, consulting on, developing materials on, and talking to people about project management. In the context of project management, one topic that almost always arises, and about which the greatest anxiety is frequently shown, is time estimating. Now, I doubt if anybody has ever said this in so many words, but the message that seems to be coming across on this topic goes something like this: "If I could only figure out some way of reliably estimating the time required to get my jobs done, my biggest management problems would be solved."

At first I interpreted the anxiety associated with this topic as genuine concern for repeated failure to solve a vexing problem. But as time passed, and certain other evidence forced itself into my consciousness, I became more cynical. Suppose, I said to myself, that it was possible to come up with a simple, foolproof way of telling just how long it should take to do various systems and programming jobs—then what would people use as an excuse for not getting done on time?

The first discrepancy between the facts and this missionary zeal to find the time estimating touchstone took the following shape. Since time esti-

imating has to do with what's going to happen in the future, it is, by its nature, an iffy business. As a result, nobody gets very upset if actual varies from estimated by some small amount. What gets people angry is the consistency with which we in data processing overrun our estimates by the hundreds of percent. And of those instances I've

... with all this concern about the ability to project time requirements, you would expect to find an effort to establish and refine time-estimating standards . . .

investigated, little of the overrun can be attributed to poor estimates. Instead, I find that:

1. The user wasn't firmly identified, or
2. Research was confused with production, or
3. Firm commitments were made on the basis of inadequate specifications, or
4. An adequate set of functional specifications wasn't developed, or
5. User approval of the functional

specifications wasn't required, or

6. A request for change procedure wasn't enforced, or
 7. Design review committee approval of the design specifications wasn't required, or
 8. User agreement as to what constituted system acceptance wasn't obtained before acceptance testing, or
 9. Necessary tasks were overlooked, or
 10. Task dependencies were overlooked, or
 11. Clearance was not obtained on the delivery dates and turn-around rates on which planning was based, or
 12. The project leader was overburdened with detailed tasks, or
 13. Plans made no allowance for contingencies, or
 14. Checkpoints weren't used to monitor progress, or
 15. Performance wasn't adequately controlled, or
 16. Communications broke down, or
 17. Morale was lowered, or
- Some combination of these failures in management occurred.
Of course, management is damned

COMPUTER SCIENCE CONFERENCE

February 20-22, 1973
Neil House
Columbus, Ohio

RESEARCH REPORTS
INVITED PAPERS
EMPLOYMENT REGISTER
BOOK EXHIBIT
SIGCSE
ASEE

An Innovative COMPUTER SCIENCE CONFERENCE . . . devoted to short current research reports. Invited speakers will include Bernard Galler, Michael Harrison, Allen Newell, Alan Perlis, and Joseph Traub.

An employment register, book exhibit and joint meetings of the Association for Computing Machinery Special Interest Group on Computer Science Education and the American Society for Engineering Education, Computers in Engineering Education Committee will also be held at Neil House.

The Conference is sponsored by the National Science Foundation and several universities and industrial organizations. Registration fee: \$10. Students, \$3.

For further information:

Marshall C. Yovits
COMPUTER SCIENCE CONFERENCE
101 Caldwell Laboratory
2024 Neil Avenue
The Ohio State University
Columbus, Ohio 43210

Time- Estimating Myth

hard work even when you know what you're doing, and as long as nobody has come up with any good estimating techniques . . . well, rationalization is a universal human condition. (Please note that universal includes me.)

A second discrepancy which I can't help noticing is that, wherever progress in time estimating has occurred—as a matter of fact, wherever any progress in human knowledge and the ability to predict is concerned—the first feeble step has always been to start developing models. In time estimating circles, these models are called time estimating standards, and with all this concern about the ability to project time requirements, you would expect to find an effort to establish and refine time-estimating standards in almost every installation, wouldn't you? I know how many I've found. How many can you count?

Of course, to be effective in model building, one needs a history of experience. (You might even call it a data base.) Then one can study this accumulated experience, find patterns, build models, make projections, and compare predicted with actual. Any good data processor knows that.

They are not project management systems—that is, they are not systems which manage projects.

On the surface, at least, we do seem to be collecting this data. The majority of installations do have their people fill out a timecard of one sort or another. And under these circumstances, it seems legitimate to ask: Why isn't this data base being used for developing estimating standards? Unfortunately, I think I know the answer—the data being collected is so distorted that it's not worth working with.

The time reporting systems with which I'm familiar are one of two types.

1. They feed the payroll system. The primary rule here seems to be: You can put anything you want to on your timecard, but be sure it adds up to 40 hours.

2. They feed so-called "project management" systems. I have several things I'd like to say about such systems.

a. They're misnamed. They are not project management systems—that is, they are not systems which manage projects. They are, in fact, time reporting systems that have the ability to generate variance reports. (Some also have the ability to keep track of personnel availability and make time estimates, which are nice planning tools,

but that still doesn't make them management systems. If you don't agree with me, ask yourself this question: Of the 17 management problems listed above, how many do these systems solve?)

b. I can understand why they're misnamed. If I were selling such a package, I'd call it a project management system, too. After all, how many prospects think they have a time reporting problem? (Notice that this is a different question than, "How many installations have a time reporting problem?" to which the answer must be, "Most or all.")

c. The problem arises when management tries to use their system according to its name. Thus, instead of using variance reports to try to refine their estimating techniques, they use them to evaluate personnel performance. It's sad to see that, of all the ways to evaluate performance, management chooses the least effective—the time report.

d. The inevitable consequence is that personnel see their timecards as a pawn in the game of getting ahead (or staying even). As a result, the data collected on a timecard tends to be more a reflection of the employee's ingenuity than of how he used his time.

Arg! Is it any wonder that, when someone starts talking to me about the problems he has with time estimating, my mind begins to cloud over with a thin film of depression? When we start to use time reports exclusively to find out how people use their time, then we may start to improve our estimating techniques. And when we begin to recognize that time estimating is only a small part of our management responsibilities, then our performance may begin to track our projections. □

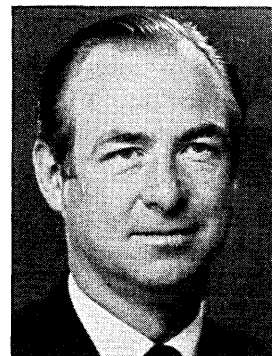

Mr. Gildersleeve has been in the dp field since 1954 and has worked for Univac and Computer Usage. In 1969 he participated in founding Newkirk, Gildersleeve, Prendergast & Assoc., Inc., a Connecticut-based education and consulting firm where he serves as vice president. He has authored four books on data processing, and this article has been adapted from his work on a fifth.

Principles of program structure,
with an explanation of the relationships
among modules, tasks, and other elements

Improving Software Reliability

by Jerry L. Ogdin

In the July, 1972, issue I showed how computer software is basically unreliable today. The reliability improves with age, until the system is modified: then reliability deteriorates. Now I'd like to offer some suggestions and methods for improving software reliability.

Everybody talks about modularity, but nobody *does* anything about it. Most of the literature on the subject assumes that the reader is already familiar with the principle, but it is seldom described. Furthermore, the relationships among *modules, functions, tasks, procedures, processes, etc.*, are seldom defined.

There are interesting parallels between mathematics and computer programs. In the world of mathematics there exists, somewhere, a function that computes the square root of a real, non-negative number. In the functional notation, a mathematician might write:

$$\text{sqrt}(x)$$

to invoke that function. The real, non-negative value of x is an argument to the square root function, and the value of the function is the square root of the argument. The set of all the permissible values of x is called the *domain* of the function. The domain of the *sqrt* function is the set of non-negative real numbers. For each value supplied as an argument that is within the domain of the function there is one unique

result (in this particular case). The possible resulting values of any function constitute the *range* of the function. Finally, a function is undefined for arguments outside the domain. A program exhibits similar properties.

In Fig. 1, the similarities and differences of mathematical functions and programmed procedures are summarized. A procedure has a domain—the set of values that may be supplied as valid input. In the example of Fig. 1, the domain includes:

1. For the first argument, a character

string composed of characters zero through nine, and

2. For the second argument, an integer greater than zero but less than 10. The range of a procedure is that set of values that may result from the application of this procedure over the domain. In this example, the range is quite simple. The algorithm, or well-defined set of rules for the solution in a finite number of steps, is the procedure. But, whereas a function does not exist outside the domain, a procedure must have a predictable penalty for

FUNCTIONS		PROCEDURES	
Example (sqrt(x))	Description	Description	Example (Character to integer conversion)
x real, ≥ 0	Domain	Input	Characters '0' through '9' String Length positive integer less than 10
real, ≥ 0 y , such that $y = \sqrt{x}$	Range Transformation	Output Algorithm	integer, $\geq 0, < 10^9$ $n \leftarrow 0$ for $i \leftarrow 1$ step 1 to length begin $r \leftarrow \text{nextinputcharacter}$ if $0 \leq r \leq 9$ then $n \leftarrow n \cdot 10 + r$ else $n \leftarrow -1$ return end return
	Undefined Outside Domain	Predictable Penalty	

Fig. 1. Similarities and differences between functions and procedures.

Software Reliability

supplying data outside the domain of the procedure. In this example, the value returned from the procedure is specific, but outside the range of the function. There are several other ways of communicating penalties, as described by Hill.¹

When output data from one procedure is to be used as input data to another procedure, the range of the first function must lie within the domain of the second. With this as a basic premise, a considerable amount of automatic checking can be built into a program to simplify debugging.

Tasks and modules

A *task* is a completely specified program or part of a program that has four attributes:

1. A domain, or set of permissible input values
2. A range, or set of possible output values
3. An algorithm, or procedure for transforming the input data into output data, and
4. A set of side-effects.

In some particular task, some of these attributes may be missing. The possible combinations are summarized in Fig. 2.

	Input	Output	Procedure	Side-Effects
Most Common Task	X	X	X	X
Data Generator Task		X	X	X
Unrestricted Domain Task	X	X	X	
Side-Effect Only Task	X		X	X

Fig. 2. Possible task types.

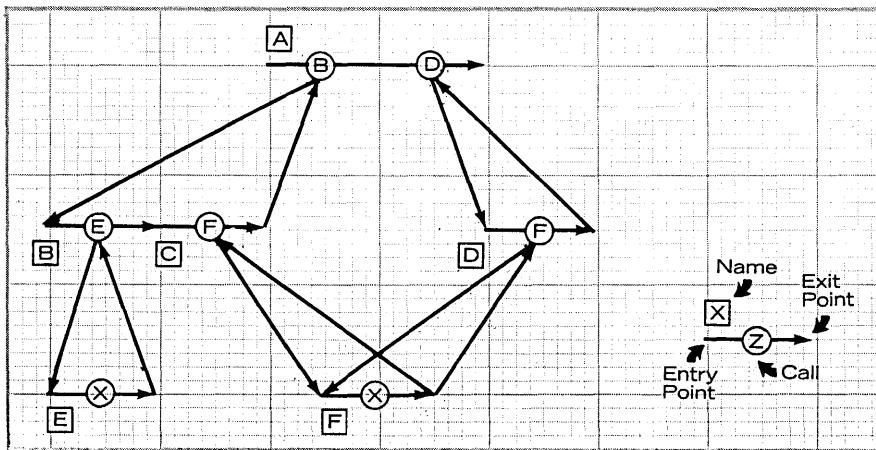

Fig. 3. A structure of task calls.

The side-effects of a task are important, and the most often overlooked element. If a task for computing the square root is implemented, a side-effect might be the issuance of a diagnostic message upon recognition of a negative argument. Usually, the task must also supply some output in this case; the output value would probably be some specific real number outside the range of the function. The rest of the task that follows and operates on the result of the task that failed should *not* be performed. It is not generally a good practice for a side-effect of a task to be the termination of a sequence of tasks. Some other task should make that decision.

Given a collection of tasks, there is a particular hierarchy of tasks for each execution. Notice that this relationship among the tasks need not be static, but might be constantly changing. This can typically occur in a multiterminal multiprogramming system. In Fig. 3, a hypothetical sequence of tasks is outlined. A line from one level to another implies that the task on the upper level depends upon the completion of the invoked task before the upper level task can continue.

A basic principle of proper program design is to keep decisions of program control at the highest possible level. If task F, for example, has the predict-

able penalty of a result outside the range of the function, then that task should always return to the task that invoked it. That task (D) might return a result outside its own range, as a result of F's failure. The decision to terminate the process and abort the program should be made as near the top of the hierarchy as possible (preferably in task A). This assures that low-level tasks do not control the overall flow of control, but merely perform assigned duties.

Once a task is defined (with the four attributes) it is given a name or identification. The square root task, for example, might be given the name *SQRT123*. Once an identification is assigned to a task, the specifications of that task are frozen forever. The *specifications* for a task should never be changed. The particular programming statements that implement the specifications are changed only if it is found that the procedure does not conform to the specifications.

If the specifications are ever found to be deficient in some respect, a new task must be defined, and a new identification is then assigned. In this way, the tasks that make use of this task are not implicitly changed. This is one of the major faults with most manufacturer-supplied software—one of the low-level tasks of the system is changed in a new release of an operating system, and nothing works. Since programs in the field expect the previous task attributes, programs that refer to that task are implicitly changed. By requiring a name change with a specification change, each higher-level or successor task must be explicitly changed. While this requires some effort, the program is now aware of the change explicitly, and can re-test and be on guard for new program bugs.

Notice that maintenance programming means making sure that the program conforms to the specifications. Modification programming involves changing the specifications, and then programming. This practice assures that the maintenance programmers don't inadvertently modify the system.

A bug is a defect. In particular, a debugged task is one for which, as yet, the input data that will make the task fail has not been supplied. A software task is utterly dependent upon the data supplied being within the domain of the function. Input data outside that domain must yield a predictable penalty, such as the issuance of a diagnostic message and the return of a specific result value. Since programs are made up of tasks, a debugged program is one for which input data that will induce failure has not yet been supplied.

It is important to note that the act of debugging a task may uncover bugs, but the act of debugging does *not* as-

1. Hill, I. D., Faults in functions, in *ALGOL and FORTRAN*, The Computer Journal, Vol. 14, No. 3, pp 315-316.

sure that there are no remaining bugs. Even exhaustive testing might not uncover all the bugs. There are three classes of program bugs:

1. A function does not work as intended, and there is no alternative task or way of processing.
2. A function does not work as intended, but the same results can be obtained another way in the system.
3. A function permits input outside the domain without a predictable penalty.

The usual debugging techniques will normally uncover the first and second kinds of bugs. In the first case, a repair is probably mandatory. In the second case, a repair might be deferred. In practical programs, the third class of defect is the most common found remaining in operational systems. The reason, of course, is that no attention has been paid to the domain of the tasks.

The definition of a debugged program is important. It implies that:

1. Software is untrustworthy (it might fail in the future).
2. If input is assured to be within certain bounds, then reliability can be high.

We have intuitively used this knowledge. In commercial applications there is often a separate first pass at the input data which "filters" it, allowing only clean, consistent data into subsequent processes. Once the data is "clean," then whether it is processed or written out, no further program bugs appear, *even though the bugs still exist.*

Each task must be tested for conformity to its specifications. Once several tasks have been satisfactorily debugged, they can be combined into a group of tasks and that group should be independently tested. Testing has always proceeded from the bottom upward (although there are signs that this technique will change).

A *module* is a particular physical combination of program instructions that is independent of others with respect to compiling, assembling and loading. There is no other fundamental relationship between tasks and modules. A module might contain the program statements for exactly one task. A module might contain the statements for two or more tasks; that is common when two tasks are similar and share some statements. Such a module could be split into separate and distinct modules, with a new module containing the common statements. A module might also contain only part of a task, when the task is simply too large for one module. Usually, however, a task that large should be broken up into a sequence of subtasks.

Since popular program topography associates one module with one task, the term "program modularity" is

sometimes used. What is really meant, however, is the separation of programs into distinct tasks. The choice of modular organization of the topography of a program is more of a programmer convenience than a fundamental design consideration.

Other differences between tasks and modules:

1. A task contains executable code (and maybe some data); a module may contain a task, or might just be data.
2. A task is scheduled and executed; a module is only loaded.

An environment for change

The vast majority of programs written today are not modular, regardless of whether the modularity is considered at the task or program topography level. While the basic precepts of modularity are given lip-service, few programmers actually know how to write programs that are modular.

One way to conceive of a modular program, or modular system of programs is illustrated in Fig. 4. *Activities* are the things the system user sees. These are the activities the user may be expected to require in the accomplishment of his job in the organization. Typical activities might be:

1. Retrieve and display a record
2. Update a set of records
3. Produce a report, etc.

Today a separate program would be written for each activity. This practice has several deficiencies. Since the separate programs are not (by definition) identical, subtle errors may occur that are caused by two opposing procedures. For example, a program that creates a record might not be wholly compatible with the program that modifies the record. These kinds of errors commonly occur in software

systems, and are sometimes caught during the "system integration" phase of the implementation cycle. However, more subtle differences may not be discovered until later, when the system is in use and "live" data has been affected.

There is a popular notion of using a library of common subroutines in different programs in order to enforce commonality. However, that strategy often fails for one reason: it isn't carried far enough. Typically, the common subroutines are designed first (bottom-up), and then the balance of the programs are written. Later, if there are similar sequences of statements in separate programs, it is not a popular practice to extract them and define a new common procedure. So the problem persists, because of a desire to avoid disturbing a "debugged" program.

The approach suggested by Fig. 4 is that *activities* be defined as sequences of tasks to be invoked. The activity takes the place of the more conventional application program. An activity is a simple program that is restricted to the supervision of tasks. In other words, an activity is a "supertask" that is restricted to invoking other tasks and monitoring the tasks' performance.

The only difference between a task and an activity is that the activities are restricted to invoking tasks, while tasks may not invoke other tasks directly. Finally, an activity may invoke another activity. In addition to being modular, the hierarchy of activities from very elementary to very complex may be designed to any desirable depth. In practice, however, there will normally be only two levels—activities and tasks. A new activity can be defined by invoking the various tasks. If the new activity needs a new task, then that task is added to the system as well.

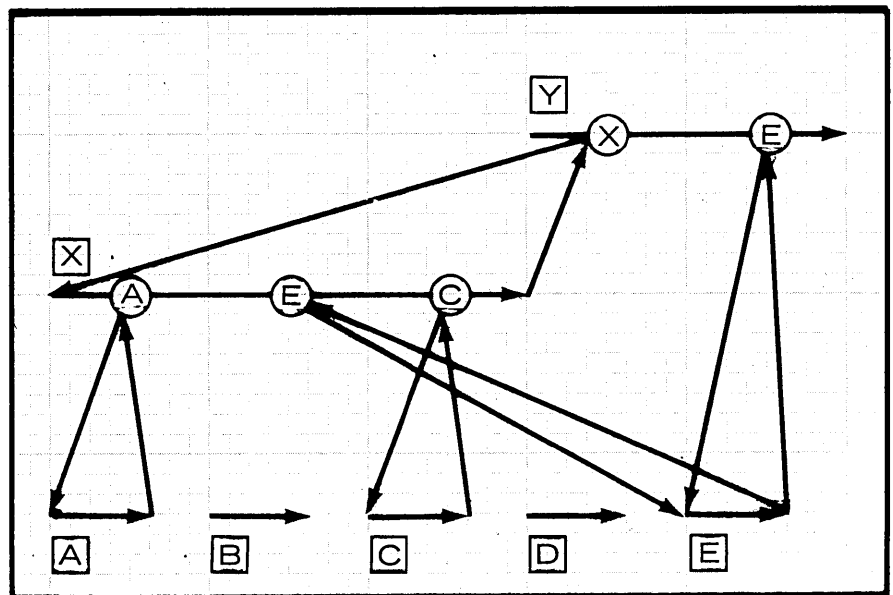
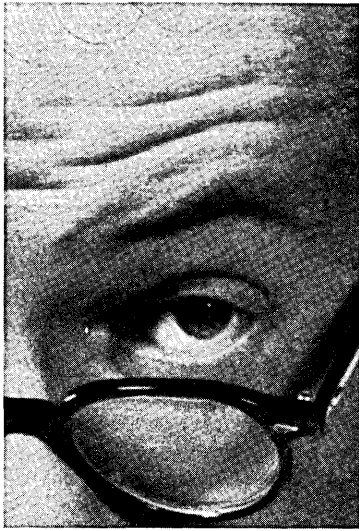

Fig. 4. Definition of two activities, X and Y.



Do you have many of these left in your data acquisition system?

If so, look into our optical bar code reading systems. They can save you a lot of money. (The days of slow, "eyeball" acquisition are gone!)

By making any moving or stationary item machine-identifiable, Identicon drastically reduces labor and eliminates errors. Data can be fed directly to your computer or stored off-line for automated recording, controlling, billing. Coding is easy; positioning not critical.

We can demonstrate systems for automotive, mass merchandising, food processing, mail order, packaging, pharmaceutical, plastic, textile, toiletries, transportation and many other industries. We can show you installations. Systems generally pay for themselves in just a year. Write for application sheets pertinent to your industry.

**Identicon**

Optical Reading Systems
300 Second Ave.
Waltham, Mass. 02154
(617) 890-6600

Software Reliability

The major advantage of this organization is in the sharing of tasks and the more elementary activities by higher-level activities. There is little redundancy among the actual sequences of instructions, since any redundancy is naturally placed in a single task where it is invoked from several different activities.

This concept carries the idea of a subroutine library to the logical extreme. Wherever possible, a new application is created out of existing tasks and activities. Some experience shows that the amount of time necessarily expended to add a new activity is low when compared to the more conventional "reinvent-the-wheel" approach. The effort of programming is minimized, since most of the "worker" code already exists. Debugging is simplified, because most of the code is already debugged. Additionally, since a given task is simply used more often, it is likely to have been more thoroughly debugged than similar instruction sequences separately embodied in multiple programs.

Since each task is uniquely identified, the domain and range of each can be defined in some system tables so that testing, debugging and system integration can be automated to a degree. Good program design practice is encouraged, if the necessary discipline is ruthlessly enforced. To avoid the common facilities that ensure good practices means that the programmer has to expend an awesome amount of redundant effort.

Efficiency

Some reservations are likely to be raised about the efficiency of a software system based on these concepts. As an industry-wide practice we seem to spend days of programming manpower to save microseconds of cpu time. While detailed techniques are beyond the scope of this paper, it should be noted that no consideration has been given to how *data* is passed along from task to task. Ultimately, modularity does *not* depend upon the passing of lengthy argument lists from task to task. Again, this is often a matter of program topography.

In a real-time environment, for instance, only a pointer to some common data space need be passed down to a task—and that would probably be in an index register.

There is some overhead associated with the generalized nature of tasks in this scheme. What might have been constants in an in-line procedure are probably variables in a task or activity. However, this cost must be balanced

against the consideration of the costs associated with unreliability, program code redundancy, and lengthy program implementation cycles.

On smaller computers, space is usually at a premium and execution time can be sacrificed to save on memory occupancy. In this scheme, there is little redundant programming to eat up space. Additionally, since tasks can be equated to topographic modules, only those tasks required at once need be kept in memory. A few additional tasks to maintain the required tasks in memory can return large volumes of memory for useful instructions and data.

On larger computers, execution times are attaining values that make considerations of application timing often unimportant. Even more importantly, since tasks and activities can be centralized, task timing can exert leverage on the system as a whole. Thus, a small improvement in one common, frequently used task can have dramatic effects of improvement on the entire system. Contrasted with the problems of speeding up each individual program, the effects are tremendous. Where an organization might spend man-months of effort over dozens of programs, a small team could effect the same change by selectively improving a few, smaller tasks in a much shorter time.

Acknowledgement. This paper is the direct result of the evolution of concepts discussed in seminars the author has conducted on "Data Communications Systems" and "Compiler Writing Techniques." I would like to extend my appreciation to the Institute for Advanced Technology for the opportunity, and to the numerous seminar participants who contributed to these concepts by sharing their own (usually painful) experiences. □

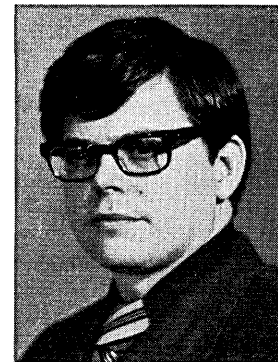

Mr. Ogdin is a consultant to The Institute for Advanced Technology, Washington, D.C. In 15 years he has accumulated a diverse background in systems development and programming, including experience with real-time, time-sharing, and communications-oriented systems as well as computer language processors.

Only 3 out of 10 jobs are so special they demand a Datacraft computer... but for those jobs you can't beat Datacraft.



Datacraft machines are not computers for all reasons.

We make a line of computers for sophisticated applications where a high power-to-low cost ratio is critical. You will most often find Datacraft computers harnessed to scientific applications that require real-time control and complex calculations.

For such jobs you need Datacraft's raw number crunching capability. Jobs that demand floating point calculations. Jobs that are a breeze with hardware square root. Jobs that are just too big for a minicomputer...and too small for expensive large-scale computing systems. Datacraft created computers to bridge that gap.

The demands of this special market dictated the architecture of the Datacraft computer family.

For general purpose applications line printers or cardreaders transfer pro-

grammed data in and out as a matter of routine. But, for real-time applications...

You do need the very latest in I/O capability.

You do need the flexibility of Datacraft's priority interrupt system to meet the conditions of your individual application.

You do need our Disc Monitor System to control the prime application in real time while using the background for batch processing. That's why, for example, you will often find 24-bit Datacraft computers used in the nuclear data acquisition and simulation fields.

Do-it-yourself programming is necessary in your work. So we gave all Datacraft computers an optimum 24-bit word length to make them easier and less costly to program than 16-bit machines.

We spent four years to develop and prove our support software under field conditions. It is strongly oriented toward scientific problem solving. MACRO assemblers and diagnostics are provided with all machines. FORTRAN IV is just one of the languages available.

Datacraft's family of computers cost from \$10,900 to \$51,400. All are I/O and software compatible.

Now, you can make your own evaluation about which Datacraft computer is best for your application. Send for your **FREE Datacraft Discovery Kit** so you can prove to your own satisfaction the advantages of Datacraft computers.

DATA-CRAFT DISCOVERY KIT
Datacraft Corporation, Rm 201F
P.O. Box 23550,
Fort Lauderdale, Fla. 33307

Datacraft

Introducing Bruning. The bold new force

The Foundation

For years, Bruning has been coming up with better ideas and products for engineering graphics. That's the Bruning tradition. Now, this pattern of leadership has put us in a front-running position to supply micrographics systems for the general business market.

The evolution was natural enough: our big specialty for many years has been the diazo coating process for efficient, high-quality document reproduction. This led us to significant achievements in dry diazo microfilm for image duplication. Today's Bruning diazo film is easier to use than silver halide film, images have better resolution, costs are lower, and through-put time is sharply reduced.

The Development

Bruning several years ago began development of a series of advanced machines for producing hard copy from microfilm. To accelerate our expansion into micrographics,

we have recently acquired the Microfilm Division of Kleer-Vu Industries, an acknowledged leader in the field.

Our Bruning machines now being released, combined with Kleer-Vu's complementary machines and broad line of software, give Bruning a major capability in microfilm systems for information distribution.

Ingredients of Our Systems Capability

First, of course, there's the great Bruning dry diazo microfilm. Next, a remarkable range of enlargers, duplicators, printers, readers, and collators—for use with roll film, fiche, or aperture-card formats. Many of these machines perform several functions in space-saving, time-saving, cost-cutting combination.

Add in our comprehensive software line developed by Kleer-Vu, and you get the picture of Bruning's broad systems capability.

The People

But hardware and software don't develop efficient micrographics systems. People do. And, traditionally, that's where Bruning excels. Bruning Micrographics System Specialists are in place now across the country to serve you—along with the broadest network of sales and service people in the business.

So if you are already in micrographics, or feel you are ready to take advantage of this advanced method of information distribution, call your local Bruning Sales Office today. We have lots to show you. Bruning, 1834 Walden Office Square, Schaumburg, Ill. 60172.

The bold new force in micrographics.

in micrographics.



BRUNING



DIVISION OF ADDRESSOGRAPH MULTIGRAPH CORPORATION

Data processing departments have reached the stage of maturity that allows job levels and salaries to be compared to those in other parts of the organization

Salary Administration in the DP Function

by Robert J. Greene

“One of our employees does systems analysis, writes programs, operates the computer and takes care of customer billing complaints. What should this person be paid? Should the salary range for his job be higher or lower than the ranges for our engineers or our accountants?”

Questions such as this arise frequently, particularly when the salary administrator is not familiar with the duties being performed on the job in question. Too often the questions go unanswered and that employee with the mixed job is paid according to the “best guess” technique. The purpose of this article is to look at some of the problems encountered when data processing employees must be hired, retained and motivated within the constraints of a firm’s compensation program. Basic salary administration techniques will not be dwelled upon. Rather, the intent will be to suggest some strategies and types of analysis which are particularly well suited to fitting the data processing function to the organization’s salary structure.

Within the data processing function there are usually several distinct categories of activities which must be performed. A list of activities common to many firms might be:

1. Management
2. Systems analysis
3. Applications programming
4. Systems programming
5. Computer operation
6. Keypunch
7. Unit record
8. Record (input-output) control
9. Facilities and hardware planning

There are many other combinations of, or additions to, the above. For the sake of simplicity let us assume this to be a complete list of activities which must be performed. The first step towards effective operation is to organize these activities properly. To help visualize a common organizational structure within the data processing function, consider the chart in Fig. 1.

This type of organizational structure establishes the data processing function as an entity reporting to top management.

It embraces the centralized approach and bases internal reporting structure on the type of activity performed. Much discussion has occurred as to which top executive the data processing manager should report to. If there has been a consensus, it is that the executive should not have a strongly vested interest in one aspect of the firm’s operation (accounting, marketing, etc.). Data processing applications should work towards the achievement of the overall objectives of the firm, not just towards those of a single department or division. This consideration should be given a great deal of thought by a firm, taking into account their particular applications and the personalities involved.

Once an overall organization has been decided upon, each function should be further defined. Selecting one function, systems analysis, we can look at the various levels within a job family. The level represents the complexity of the tasks performed and the degree of supervision required. Consider the levels and the accompanying

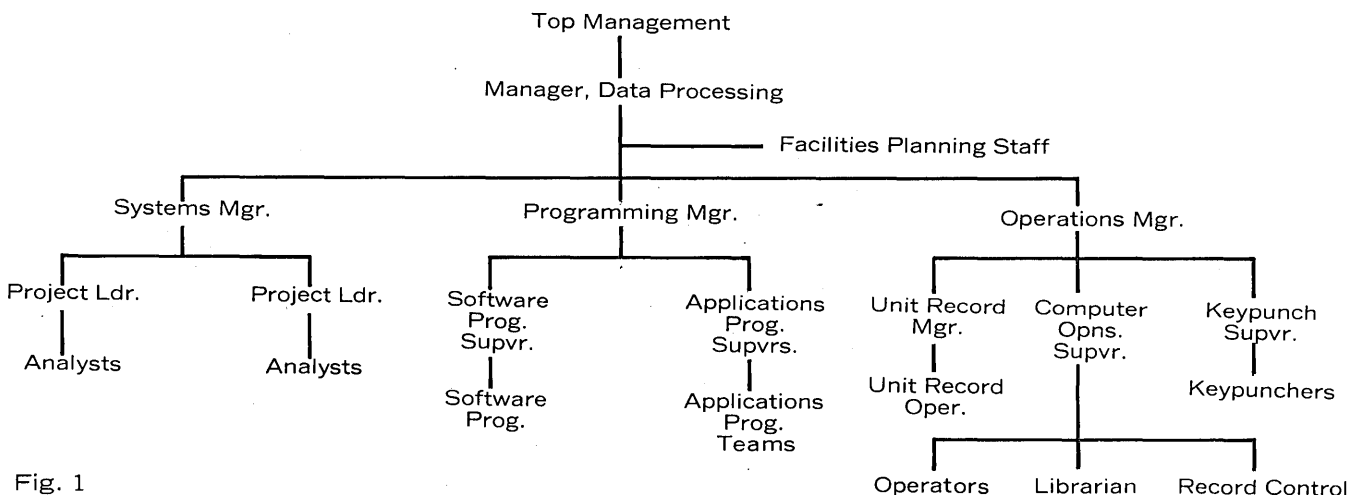

Fig. 1

HEWLETT  PACKARD

Hewlett-Packard
16399 West Bernardo Drive, San Diego, California 92127

Please send me a free copy of "The Story of Computer Graphics."

Name _____

Title _____

Company _____

Address _____

City _____

State _____ Zip _____

Plotter Application _____

If you're still wading through reams of computer data and drawing your own charts and graphs, take ten minutes to read our new book: "The Story of Computer Graphics."

You'll learn how H-P's 7200 Series Graphics Plotter can transform the output of your terminal into concise, meaningful charts, curves and graphs...

directly from the keyboard, paper tape, cassette or a card reader. With no special operating or programming/language needed on your part.

Now that our new high speed model is available, there's a 7200 Graphic Plotter for everybody... for every terminal. And it's so easy to set up, understand and use that our storybook has a short-form order blank on the last page.

You can buy, rent, or rent to buy, by mail.

Use the coupon above to order your free copy of "The Story of Computer Graphics." It's full of sample graphs and illustrations. There's even a full size fold-out of the 7200 Graphic Plotter. Hold it up next to your terminal and see how uncomplicated life can be.

H-P's simple little \$3,300 Graphic Plotter can uncomplicate your life.

Send for the big new picture book that shows you how.

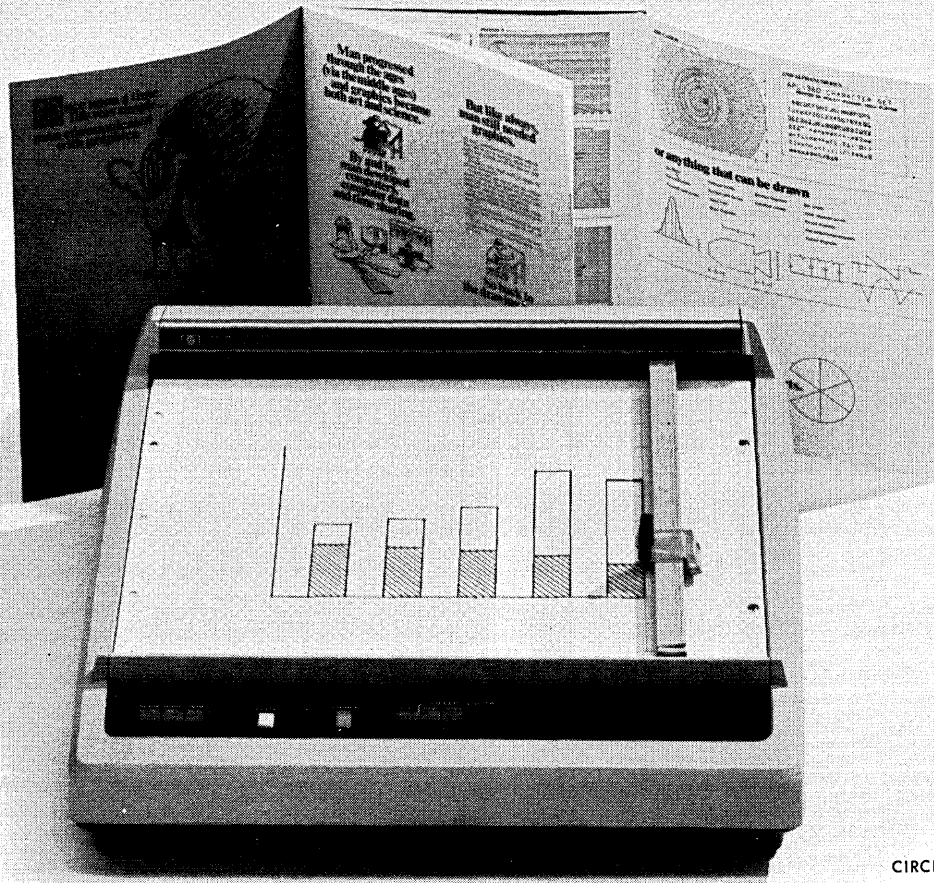

CIRCLE 29 ON READER CARD

Salary Administration

descriptions shown in Fig. 2:¹

Establishing several job levels within the family has benefits. Most important is that salary ranges can be established for each of the levels. Systems analysts can earn from \$8,000 to \$25,000 and the adoption of only two levels, such as junior and senior, will result in extremely wide salary ranges. One of the problems of a range which is too wide is that an employee near the top of his range may view the minimum as demeaning and someone near the bottom may view the maximum as not believable (as a "carrot" placed in front of his nose by management).

Another advantage of the six delineated levels is that the employee may be shown a clear career path. As he attains higher levels of expertise the employee is awarded promotions which acknowledge his technical progress. The new job title is accompanied by a higher salary range and, presumably, a salary increase to further acknowledge his accomplishments. During periods of wage controls, the clearly defined job levels can act as objective justification for salary adjustments. Governmental inspectors are predictably wary of an increase "due to

promotion," but are usually assuaged when the firm can produce their standards for job performance and show that they have been well thought out and documented.

The job description accompanying each of the job levels should be equally well thought out and documented. Many competent authors have described the process of writing a good job description and the subject is outside the scope of this article. One technique for analyzing "mixed" jobs should be described, however. Let's go back to our employee in the opening paragraph of this article. He does systems analysis, programs, operates the computer and handles customer billing complaints. To classify this employee, ask him to fill in the grid in Fig. 3, indicating the level at which he operates when performing each of the tasks. Further, have him think about the percentage of his time spent on each of these tasks and place those percentages next to the check marks. It is unlikely he will be able to do more than approximate the figures, but this information helps analyze the importance of each task.

It is clear that if we wish to fit this employee in one of the specific data processing job families and establish the level, we would classify him as a programmer A. Reassigning the other

tasks out of his jurisdiction is a matter of choice, probably dependent on whether or not these "sidelines" adversely affect the performance of his basic task.

Mixed jobs often seem to be convenient, particularly when there are sideline tasks which are essential but would not justify a full-time employee. The old problem of justifying the typing of research reports by a senior engineer is an example. The contention here is that the volume could not keep a typist busy full time and also that it would take the engineer longer to explain it than to do it himself. But it is wise to consider the negative aspects of this practice. It is doubtful that the engineer would be a proficient typist and one may certainly question what job satisfaction he would derive from the activity. Additionally, it is an underutilization of a scarce talent. This example can be brought back into the context of data processing by considering the typing of systems and programming documentation. Though necessary, documentation is a thorn in the side to a technician who is beset by user groups demanding new applications and improvements in existing applications. Nowhere in the literature concerning job enrichment via vertical loading is it suggested that additional tasks be loaded on the *bottom* side.

Even if the mixed job consists solely of "rewarding" work, the salary administrator pays a penalty due to its existence. When using salary survey information he can be left without data on the mixed job because no reporting is done on a job with equivalent content. Comparing the programmer A we previously classified to programmer A's in other firms may be valid, since only 15% of his time is spent on other functions. But what if he spent 40% of his time on customer complaints? The comparison would then seem to be shaky at best.

Assuming that the organization structure of the data processing function has been completed along the lines discussed earlier, and that all jobs have been classified into levels, there is a

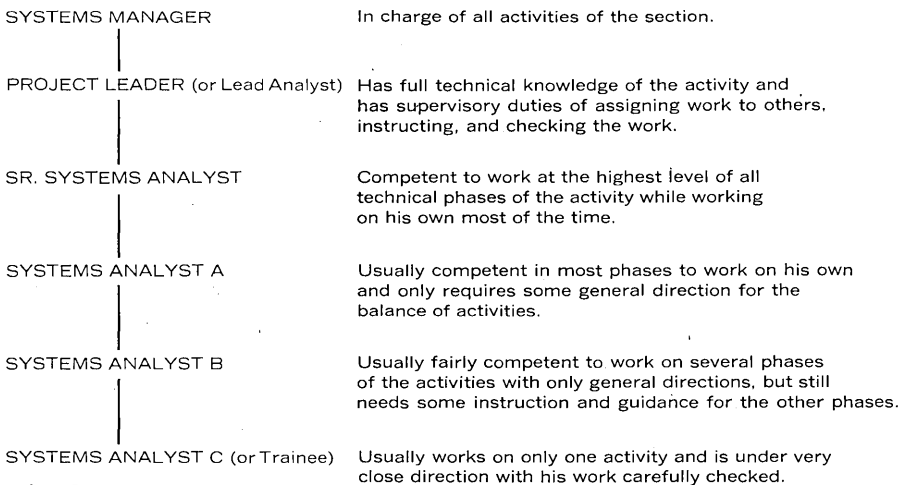

Fig. 2

Level of Work	Systems	Programming	Operations	Customer Complaints
Manager				
Lead				
Senior				
A		X (85%)	X (1%)	X (9%)
B				
C	X (5%)			

Fig. 3

1. *Position Descriptions For Data Processing Personnel*, published by Philip H. Weber Salary

Administration Services, A. S. Hansen, Inc., 1080 Green Bay Road, Lake Bluff, Ill. 60044.

useful technique for determining the appropriate position grades for the jobs within the function. Consider the chart in Fig. 4.²

This is a portion of the chart displayed earlier, but with one concept added; the comparative level of the jobs by position grade. This chart does not imply a systems analyst is universally rated higher than an applications programmer. It merely indicates that in this particular firm the systems manager has been classified two grades above the applications programming manager. It may be that in this environment the systems function is more complex and that the systems people define their work down to the logic, leaving only the coding operation to the applications programmers.

Once this chart has been completed and the inconsistencies corrected, an additional step can be taken. Other

functions within the company can be plotted alongside the data processing group, as shown in Fig. 5.

This type of comparison can do much to identify inequities in the position grade classification of specific jobs. Any job evaluation plan will erode somewhat over time, due to reclassifications, reorganizations and newly added jobs. Periodic updating and review of a chart such as this can allow inequities to be identified and corrected. The classical technique of "empire building," that of inserting assistant managers and assistant supervisors and gradually reclassifying jobs upward, is especially vulnerable to this type of cross-functional analysis. We are assuming, of course, that at least one function has remained "pure," so the comparison can be made.

Once jobs have been defined, the organizational structure solidified and

functional comparisons made, a verification of the firm's pay levels with prevailing market rates is valuable. Since data processing salaries have changed rather dynamically in comparison to the more "settled" functional disciplines, more frequent comparisons are recommended. The comparison process is a difficult one. Salary data which truly reflect market rates are expensive to accumulate and the mathematical calculations to make them meaningful are time consuming. Yet a salary structure which is internally equitable but fails to be comparable to prevailing market rates can cause the firm severe staffing problems.

The one question most often asked about the data processing function relates to the exempt/nonexempt status of the various jobs under the Fair Labor Standards Act. Many firms consider programmers and systems ana-

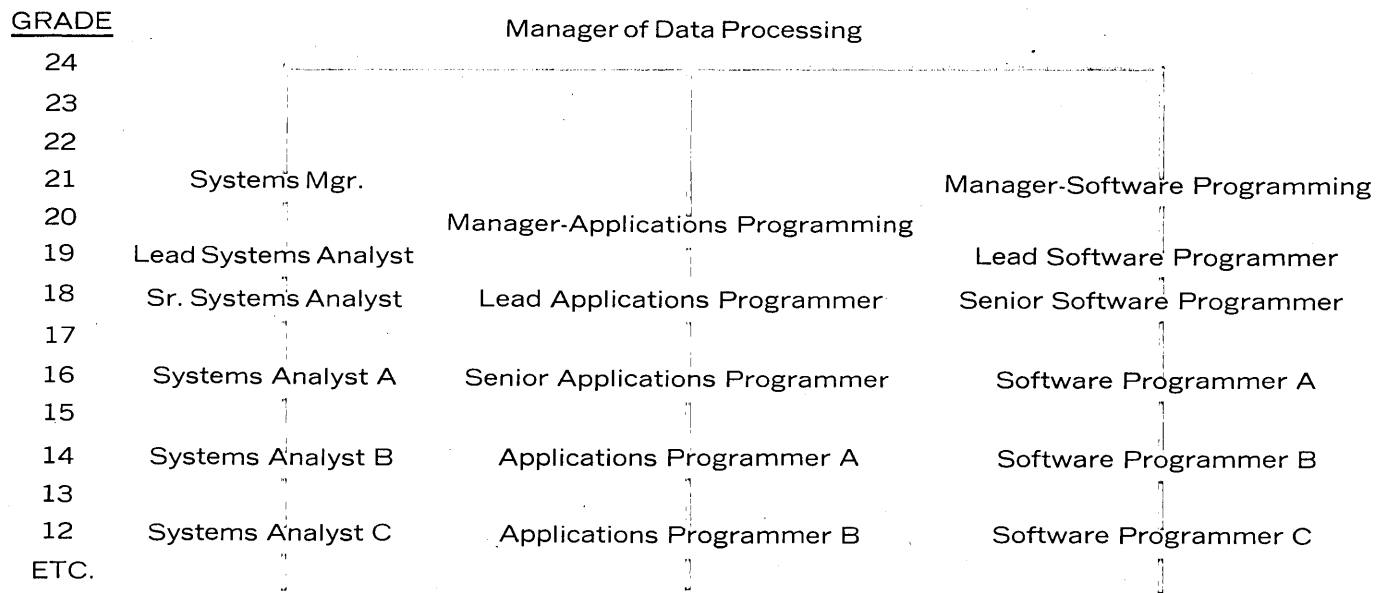

Fig. 4

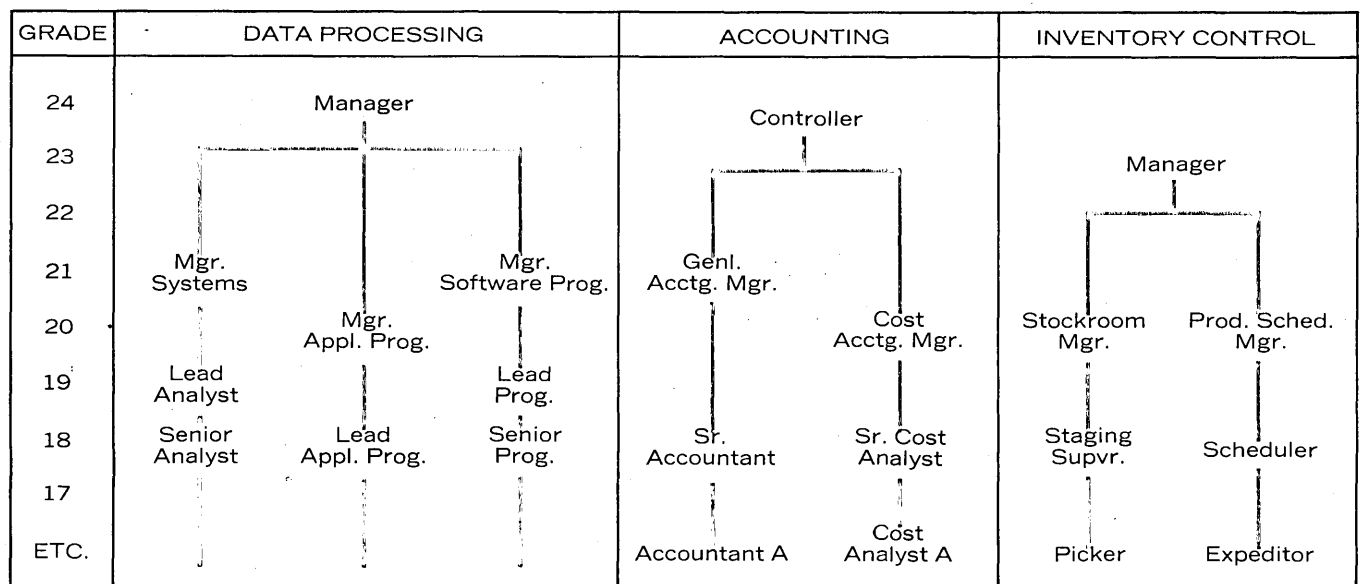

Fig. 5

2. 1972 Salary Survey Report on Data Processing Positions in the United States, published by Phil-p H. Weber Salary Administration Services,

A. S. Hansen, Inc., 1080 Green Bay Road, Lake Bluff, Ill. 60044.

Your Happy Hookup.

Now even more to make you smile.

New portable TELETERMS:

CDI 1030/APL—a full character set for all APL users, featuring both ASCII and IBM2741 compatible EBCD codes.

CDI 1030/MULTICS—with a special MULTICS configuration keyboard for ACK/NAK and upper/lower case convenience.

CDI 1030/ACT—for fast, two-way communications to other 1030's, remote TTY's, and your time-sharing computer system.

CDI's new family of TELETERM time-sharing terminals has everything you're looking for: Smooth quiet operation. Real portability. Speeds up to three times faster than conventional terminals. And low prices that include features others charge extra for.

Hundreds of CDI customers are now happily hooked up to their computers. Do yourself a favor and become a happy hookup-er, too!

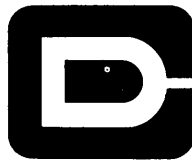

**COMPUTER
DEVICES INC.**

9 Ray Avenue

Burlington, Mass. 01803

(617) 273-1550

a TechVen Corporate Partner

CIRCLE 97 ON READER CARD

SILENT TTY REPLACEMENT

Model 440
DATA-SCREEN™ Terminals

COMMUNICATE
100 TIMES FASTER
THAN TTY'S



With data transfer rates to 9600 baud, plus the ability to transmit data at one speed (as fast as the fastest operator) and receive it at another speed, data throughput using Model 440 DATA-SCREEN Terminals can be almost 100 times faster than conventional devices limited to 110 baud.

RS-232, Current Loop or TTL interface is exact, plug-for-plug TTY replaceable. Separate keyboard duplicates TTY keyboard layout.

These features enhance Model 440's speed and efficiency:

- 72 or 80 character line (switch selectable), 24 lines
- bottom line data entry and line feed
- automatic carriage return and automatic line feed that eliminates end-of-line hang-ups typical of TTY's

Model 440 eliminates paper problems, but provides hard copy connector for essential data printout. Without keyboard, the Model 440 functions ideally as a read-only terminal—it's silent!

Free, 8-page full color brochure describes this solid state, maintenance-free terminal...also describes nine other DATA-SCREEN Terminal models offering parallel, serial and serial, polling interfaces.

call (602) 297-1111 or write
TEC, Incorporated, 9800 North Oracle Road
Tucson, Arizona 85704



CIRCLE 84 ON READER CARD

Salary Administration

lysts to be managerial people, and therefore exempt. Considering the Standards Act, we find that justification for that position can only occur under two of the six allowed categories: administrative or professional. Professional status has not been officially awarded to the data processing field. Administrative status requires that work performed must be directly related to management policies and that it be performed for a proprietor or in a bona fide executive and administrative capacity. The best advice any consultant can give a client with respect to exempt/nonexempt classification is that the client should familiarize himself with the Fair Labor Standards Act in its most recently amended version and then take the matter up with the legal counsel retained by the firm. Any general advice regarding the provisions of the act must be suspect, since the true content and level of a job with a specific title will vary significantly between firms. Though complex, the possible economic impact on the firm makes it an unavoidable consideration.

Summary

Basic salary administration techniques are no less valid for the data processing function than for any other. Some of the techniques mentioned above have been found to be particularly well suited to data processing jobs, but are not limited to data processing alone. The main objective of this article is to point out to the salary administrator that the techniques he has been using in other areas of the firm are likely to succeed for the dp function also. □

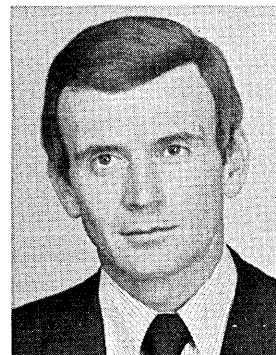

Mr. Greene is a consultant in data processing management and compensation for Philip H. Weber Salary Administration Services of A. S. Hansen, Inc. He has a BA in economics from the Univ. of Texas and is completing an MBA at the Univ. of Chicago. He has written articles for AMA publications and been a lecturer at AMA seminars.

Any media storage cabinet you buy now may be obsolete before it is delivered...

before you buy, find out about the improved storage efficiency and cost advantages of new optimedia™ cabinets

Two years ago we decided that it didn't make much sense to keep designing cabinets that were locked-in to the storage of cards only or tape only or one type of disk pack. So we studied the total media storage problem from all angles and came up with what we believe is the ideal solution, optimedia™ coordinated cabinets can store all types and sizes

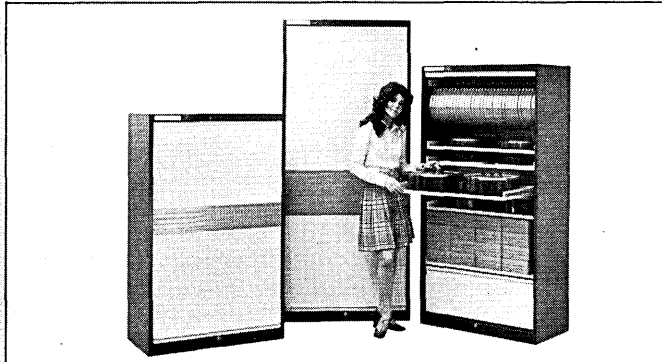

of data processing media. They can store them in virtually any combination you desire, and — when your storage requirements change, optimedia cabinets can adapt to the changes. They're sort of a "living" storage system that won't become obsolete or leave you with excess capacity for one medium and not enough for another.

optimedia™ coordinated cabinets have other benefits such as "Action Level" storage that lets you place all media at the most convenient retrieval height, smooth operating roll up doors that open all the way leaving the entire inside fully accessible, and up to 20% extra storage capacity when compared to other cabinets with the same outside dimensions.

So . . . hold up that purchase requisition until you can hear the full story on optimedia™ coordinated cabinets. That way you may avoid buying something that's obsolete before it's delivered.

For the complete story on optimedia™ coordinated cabinets, call your local Wright Line office. You'll find it listed in the yellow pages in all major cities or contact us by writing direct or circling the readers' service number. Wright Line, a Division of Barry Wright Corporation, 160 Gold Star Boulevard, Worcester, Massachusetts 01606.

Wright
LINE

MEDIA MANAGEMENT SYSTEMS



CIRCLE 79 ON READER CARD

Communications and computers have close ties to the historical development of making and breaking codes

Computers and Cryptology

by Frederick W. Chesson

Cryptology, the art and science of secret writing, has done much to nurture the growth of data processing and computer technology. From the top secret research and development laboratories of the nation's intelligence gathering departments, especially the ultra-hush-hush National Security Agency, have filtered breakthroughs in the state of the art. The current rash of minicomputers and pocket electronic calculators can be traced back to official needs for smaller and faster communication systems. Other improvements stemming from secret research include programming and memory-organization theory.

Crypto-terminology

Just as the data-processing world has its particular terminology . . . on-line, random access memory, time-sharing . . . so does cryptology. The word itself covers all manner of secret communications, including invisible inks, micro-microfilms (called microdots), and a host of concealments which can be traced back to antiquity. Some authors include electronic jamming and counter-counter measures in the field as well.

Cryptography refers to secret writing, generally a message which undergoes a transformation to prevent its text from being understood by outsiders. *Enciphering* is the process by which this transformation takes place. *Deciphering* is the reverse, usually associated with the legitimate recipients of the message. The scrambled message is called the *cryptogram*. An attempt to read this cryptogram by unauthorized parties ("codebreaking") is variously called *decrypting* or *cryptanalysis*. The latter word has come to be associated with a systematic attack upon a cryptogram, involving specific mathematical tests and analytical procedures. When large volumes of messages are intercepted, data processing techniques are indispensable, and only a computer can begin to handle operations which compare one message against another.

A *cipher* generally refers to the technique by which a group of messages are made secure. There are three general techniques, all of which are suitable for data processing operations. *Code* is a process by which a complete

word or phrase is replaced by a group of letters or numbers. Thus: "Cargo Arrived In Good Condition" becomes AQUTC, in one commercial code, thus saving a considerable sum in cable tolls. Code groups, whether commer-

```

                                F. W. CHESSON
C                                CRYPTANALYSIS
C
    INTEGER ALPHA(27), BLANK, R, W
    DIMENSION KRYPT(200),KTA(200),LTRS(26),LIST(26),KALL(26),KOLL(26)
    DATA ALPHA / 'A','B','C','D','E','F','G','H','I','J','K','L','M',
    1'N','O','P','Q','R','S','T','U','V','W','X','Y','Z' /
    BLANK = 16448
    R = 2
    W = 3
    ALPHA(27) = ALPHA(1)
    DO 1 J = 1,200
    KRYPT(J) = BLANK
    1 KTA(J) = BLANK
    DO 2 K = 1,26
    2 KOLL(K) = 0
    DO 3 K = 1,26
    3 LIST(K) = 0
C   NOTE---IF THE NUMBER OF CRYPTOGRAM CARDS DOES NOT EQUAL FOUR,
C   BE SURE TO MAKE UP THE DIFFERENCE WITH BLANK CARDS.
    READ (R,4) (KRYPT(J), J = 1,200)
    4 FORMAT (50A1)
C   NOTE---IF CRYPTOGRAM IS KNOWN NOT TO BE CAESAR TYPE, INSERT
C   A 'GO TO 20' CARD HERE.
C   CAESAR-CIPHER TEST SUB-PROGRAM
    WRITE(W,5)
    5 FORMAT (1H1,/,45X,'CAESAR RUNDOWN',/)
    WRITE (W,6) (KRYPT(J), J = 1,100)
    6 FORMAT (5X,100A1)
    WRITE (W,66)
    66 FORMAT (5X,100('-'))
    DO 7 J = 1,100
    7 KTA(J) = KRYPT(J)
    DO 11 I = 1,25
    DO 10 J = 1,100
    DO 9 K = 1,26
    IF (KTA(J) - ALPHA(K)) 9,8,9
    8 KTA(J) = ALPHA(K + 1)
    GO TO 10
    9 CONTINUE
    10 CONTINUE
    WRITE (W,6) KTA
    11 CONTINUE
C   NOTE---IF CRYPTOGRAM IS KNOWN TO BE CAESAR TYPE, INSERT
C   A 'GO TO 50' CARD HERE.
C   FREQUENCY COUNT SUB-PROGRAM
    20 CONTINUE
    WRITE(3,21)
    21 FORMAT (1H1,/,13X,'FREQUENCY COUNT',/)
    NK = 0
    DO 24 J = 1,200
    DO 23 K = 1,26
    IF (KRYPT(J) - ALPHA(K)) 23,22,23
    22 LIST(K) = LIST(K) + 1
    NK = NUMBER OF LETTERS IN CRYPTOGRAM.
    NK = NK + 1
    GO TO 24
    23 CONTINUE
    24 CONTINUE
C   COLLATION ROUTINE

```

Fig. 1. Fortran program for cryptanalysis of simple cipher systems.

cial or private, can also be enciphered for secrecy purposes.

A *transposition* cipher keeps the original word letters, but scrambles them in a predetermined order: SECRET might then become TECERS. Geometrical patterns are often used in transposition ciphers. World War II resistance groups frequently made use of such systems, which require only paper and pencil for operation.

Much more common are *substitution* ciphers. These replace the original letters with other letters, or numbers, according to rules of essentially mathematical equations. Substitution ciphers are more amenable to mechanical manipulation, as each letter, or letter pair, is operated on individually, while the transposition cipher requires a "batch" type operation of the entire message, or large portions (blocks) of it. Consequently nearly all modern secure transmission methods involve

some sort of substitution technique.

Historical perspective

To mention computers and cryptography in the same sentence evokes images of men and machines locked in a silent struggle with their enemy counterparts, endeavoring to break the opposition's ciphers while devising more intricate systems to protect their own communications.

Our National Security Agency is so secretive that even the 1952 Executive Order establishing it remains under wraps today. Only in rare instances, like the spectacular defection of mathematicians Martin and Mitchel to Russia in 1960, are any portions of the "American Black Chamber" briefly illuminated.

Such revelations plus collected public gleanings indicate that the NSA has not only profited from the normal commercial growth of electronic data

processing systems, but has stimulated the development of second and third generation computers and their peripheral subsystems.

Besides obviously designing a host of "in-house" special purpose machines, the agency was a purchaser of such giants as the IBM STRETCH. In addition, exotic integrated circuit modules for compact airborne gear have forced the industry to new plateaus in the state of the art. One gem, the "R-13" module, is said to have been supplied by most of the IC makers in the country.

With the arrival of pulse code modulation (PCM), even voice communications have become digitized, and hence subject to advanced encipherment techniques. Such complexities have introduced their own problems, as when atmospheric conditions and Mach 3 aircraft speeds contribute to phase shifts and the loss of vital data bits.

When traditional letter-for-letter encipherment has yielded to linear algebra, matrix and involuted transformations, it is obvious that an on-line computer is a necessity for even the legitimate recipient to decipher the message in time to make use of its contents.

Time-varying keys and microsecond synchronization requirements may well have contributed to the *Pueblo* fiasco. The NSA-designed computer-radio demanded such absolute synchronization that Commander Bucher once tried in vain for 14 hours to establish contact with his home base in Yokosuka, Japan. Those engineers who have attempted to match two or more computers by microwave data link may have some sympathy for the *Pueblo* and her hapless crew.

A mirror of technology

As soon as a civilization reaches a certain level of literacy and familiarity with the written word, the need for secrecy seems to follow. In many cases of archeological record, such infant cryptography stems from the needs of the priestly class to protect their divine spells from the grasp of the multitude.

The martial arts of Greece and Rome brought about more practical developments as protracted campaigns, intrigues, and diplomatic maneuvering required secret communications among the warring factions. The so-called Caesar Cipher was probably known long before the canny Julius enciphered his dispatches by displacing each letter by a fixed amount. If the displacement was four, then GAUL would be transformed into KEYP, a device of sufficient bewilderment to the preliterate Gallic and Alpine tribesmen.

After centuries of both cryptographic and cultural darkness, the Renaissance dawned in Europe on

F. W. CHESSON

```
C   TO SAVE TIME, ASSUME NO LETTER EXCEEDS 25PC OF TOTAL.
      KL = 0
      IK = NK/4
      DO 26 I = 1,IK
      DO 26 K = 1,26
      IT = IK - I
      IF (LIST(K) -IT) 26,25,26
25  KL = KL + 1
      KOLL(KL) = LIST(K)
      KALL(KL) = ALPHA(K)
26  CONTINUE
      DO 27 K = 1,26
27  WRITE (W,28) ALPHA(K), LIST(K), KALL(K), KOLL(K)
28  FORMAT (10X,A1,' ' ,',I2,9X,A1,' ' ,',I2)
      WRITE (W,29) NK
29  FORMAT (///,5X, 'NO. OF LETTERS IN CRYPTOGRAM = ',I3)
C   SUBSTITUTION SUB-PROGRAM
C   INSERT N = I CARD HERE. I = NO. OF LETTER CARDS TO RUN.
      N = 15
      NL = 0
30  WRITE (W,31)
31  FORMAT (1H1, 40X, 'TRIAL SUBSTITUTIONS' )
32  DO 33 K = 1,26
33  LTRS(K) = BLANK
      READ (R,34) LTRS, NR
34  FORMAT (26A1, 3X, I2 )
      NL = NL + 1
      DO 35 J = 1,200
35  KTA(J) = BLANK
      DO 38 J = 1,200
      DO 37 K = 1, 26
      IF (KRYPT(J) - KALL(K) ) 37,36,37
36  KTA(J) = LTRS(K)
      GO TO 38
37  CONTINUE
38  CONTINUE
C   PRINT-OUT ROUTINE
      WRITE (W,40) NR, LTRS
40  FORMAT(///,5X,'TRIAL DECIPHERMENT NO.',I3,' , USING- ',26(A1,1X),///)
      MA = 1
      MB = 50
41  WRITE (W,42) (KRYPT(M), M = MA, MB)
42  FORMAT (5X,50(A1,1X))
      WRITE (W,43) (KTA(M), M = MA,MB )
43  FORMAT (5X,50(A1,1X),/)
      IF (MB - 200 ) 44,46,46
44  IF (NK - MB ) 46,46,45
45  MA = MA + 50
      MB = MB + 50
      GO TO 41
46  IF (NL - N) 47,50,50
47  IF (NL - 5) 32,30,48
48  IF (NL - 10) 32, 30, 49
49  IF (NL - 15) 32,30,32
50  CALL EXIT
      END
```

Computers and Cryptology

both indigenous advances in secret writing and new ideas filtering in from the East, where Moslem civilization had kept the lamp of learning alight. Frequency analysis was discovered. The cipher secretaries of the Italian city-states, including the Vatican, fought back with multi-substitutional replacements for E and other common letters. Finally, multi-alphabets and baroque-engraved cipher discs appeared, to offer great secrecy—at the price of speed in operation against the more preferred *nomenclator*, an early form of codebook. Included in the average nomenclator of the day were such useful phrases as: FRA . . . “May It Please Your Gracious Majestie.”

In America, Thomas Jefferson, foremost innovator in technical as well as political improvements, invented a cylindrical cipher device so secure and far ahead of its time that actual implementation by the U.S. Army had to wait some 130 years.

The telegraph and the Civil War added incentives to all areas of scientific application and, in the field of patents, by which any nation's technological progress may be measured, primitive cipher mechanisms began to appear.

The art was not confined to America. A Swedish device patented in 1894 utilized replaceable letters for quick key changes and enclosed the hand-operated disc device in a cover guarded by self-devouring dragons of Old Norse mythology.

Mechanical cryptographic devices finally reached their zenith during World War II, as typified by the M-209, a hand-held marvel whose variable gears and intermittent cams produced keys over 100,000,000 letters in length. Well over 100,000 were turned out for Army use.

With the development of electro-mechanical devices, the inventors found new encouragement for their cryptographic efforts. Hardly had the teletypewriter begun to clatter its automatic letters across the telegraph's once sacrosanct wires, when its output was scrambled by its own developers.

In 1917, Gilbert Vernam of AT&T developed a means for ensuring absolute secrecy in a punched paper tape which enciphered each text letter with its own cipher letter. If the key tape was as long as the message and its key perfectly random, the text was theoretically unbreakable. Only the inconvenience of preparing miles of tape for high-volume traffic, and the security problems of guarding tape supplies and accounting for active and cancelled tape rolls, stands in the way of univer-

sal usage.

A practical compromise between convenience and security is the *pseudo-random* key generator. Pseudo-random events are those which appear to be as unpredictable as those generated by white noise and other physical phenomena, but in truth are developed from a reproducible mathematical relationship. A 20-stage shift register could in theory provide a maximum period length of $2^{20}-1$ or 1,048,575 bits.

With the continuing shrinkage of large-scale integrated circuits, pseudo-random keying devices have become physically smaller and the key lengths longer until it seems that the useful life span of the communication equipment whose security they are safeguarding will have expired before the end of the first key period.

With the codebreakers

While the cryptographers were taking advantage of every new development for greater cipher security, the

cryptanalysts (those who *break* ciphers) were forced to live by their wits, employing the purest of mathematics in statistical attacks upon the new machines. The computer's ancestor, the Hollerith punch card tabulator—which could have done simple frequency counts—arrived with the Gay Nineties, but the first recorded use of such equipment in cryptanalysis does not surface until about 1932.

From then on, automated code-breaking began to make slow but steady use of commercial calculating machines and card readers. In World War II, the chief belligerents were using various electromechanical techniques to assist their overburdened cryptanalysts.

The electronic computer was appropriated by the cryptologists almost as soon as it reached the practical state, leading eventually to a point where there were more machines engaged in the cipher war than in the halls of ivy.

In the academic field, computers
(Continued on page 77)

CAESAR RUNDOWN	
NYHNBFYACIHGIPYMAUCHMNVULNBWACHUHMUNXUQH	Cryptogram (Ciphertext)

OZIOCGZBDJIHJQZNVBVDINOXVMCCVBDIDVINVOYVRI	
PAJPDHACEKJIKRADWCWEJOPYWNPDWCEJEWJOWPZWSJ	
QBKQETBDFLKLJSBPDXFKPQZXOQEXDFKFXKXPQAXTK	
RCLRFEJCEGMLKMTCCQYEGYGLQRAYPRFYEGLYLQYRBYUL	
SDMSGKDFHMLNDRZFZHMRSBZQSGZFHHMZMRZSCZVHI	
TENTHLEGIONMOVESAGAINSTCARTHAGINIANSATDAWN	Solution (plaintext)
UFOUTMFHJPONPWF TBHBJOTUDBSUIBHJOJBOTBUEBXO	
VGPVJNGIKQPOGXGUCICKPUVECTVJCIKPKCPUCVFCYP	
WHQWKOHJLRQPRYHVDJDLQVWFUWUWJLQLDQVDWGDZQ	
XIRXLPKMSRQSZIWEKEMRWXGEVXLEKMRMERWEXHEAR	
YJSYMQLNTRSRTAJXFLFNSXYHFYWMFLNSNFSXFYIFBS	
ZKTZNRKMOUTSUBKYGMGOTYZIGXZNGMOTOGTYGZJGCT	
ALUAOSLNPVUTVCLZHNHPUZAJHYAONHPUPHUZHAKHDU	
BMVBPTMOQWVUWDMATIQVABKIZBPIOQVQIVAIBLIEV	
CNWCQUNPRXWVXENBJPJRWBCLJACQJPRWRJWBJCMJFW	
DOXDRVOQSYXWYFQCKQKSCDMKPRDRKQSKXKXCKDNKGX	
EPYESWPRTZYXZGPDRLTYDENLCESLRITYLYDLEOLHY	
FOZFTXQSUAZYAHQEMSMUZEFOMDFTMSUZUMZEMFPMIZ	
GRAGUYRTVBAZBIRFNTNVAFGPNEGUNTVAVNAFGQNJJA	
HSBHVZSUWCBACJSGOUOWBGHQOFHVOUWBWOBGOHROKB	
ITCIWATVXDCBDKTHPVXCHIRPGIWPVXCPCHPISPLC	
JUDJXBWYEDCELUIQWQYDIJSQHJXQWYDYQDIQJQTQMD	
KVEKYCVXZFEDEFI:VJRXRZEJKTRIKYRXZEZREJRKURNE	
LWFLZDWYAGFEGNWKSYSAFKLUSJLZSYAFASFKSLVSOF	
MXGMAEXZBHGHOXLTZTBGLMVTKMATZBGBTGLTMWTPG	

Fig. 2. Automated solution of Caesar-type cipher. Key = 20.

GTE INFORMATION SYSTEMS

**What happens between
you and your computer
is our business**

Nationwide Service

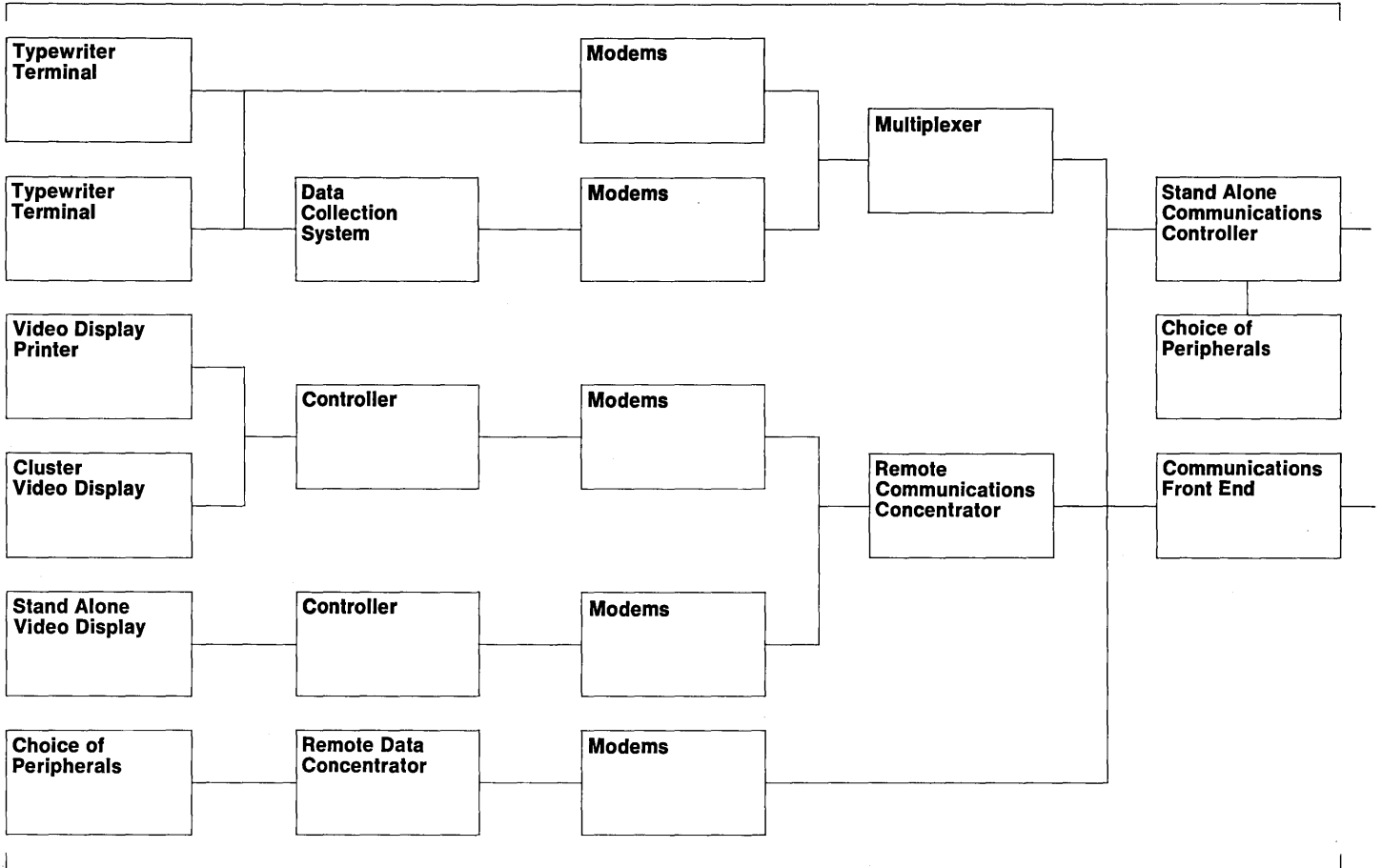

Programming

We belong between you and your computer

Look at this chart. See what's happening in the computer business.

It used to be nothing but data processing.

But today, outside the computer room is an entirely new system. One that's just as complex and important as the one inside. A far-flung network of terminals, modems, multiplexers, satellite computers, software . . .

And people.

Everything has to interface with something else. (Including you.)

Then tie in with a transmission line.

Then interface again, once data reaches the computer.

Without distortion or error. And with the highest speed possible.

All in all, there's a whole new industry added to data processing.

We call it data communications . . .

Outside the computer room.

And it's here that the special systems expertise of GTE Information Systems can work for you.

Since we manufacture virtually everything but the mainframe, we have no reason to recommend anything but what does your job best.

And, since we're nationwide, so is our service organization. You're never more than a few hours away from help if it's needed.

In the next pages, we'd like to guide you through data communications as it looks to us . . . outside the computer room.

To show you what happens when we really get between you and your computer.

CPU



JIMMY PRODUCTION ESTIMATES:

RAW MATERIAL	FINISHED GOODS	SHIPMENTS	VALUE
1047	650	24	04,532.00
1073	957	50	6,021.04
2146	1000	146	13,465.70
2077	1005	119	9,041.05

GTE INFORMATION SYSTEMS

IS/7100



Seeing is believing, but maybe you want it in writing, too

To talk to your computer, you need a terminal. And the kind of terminal depends on how fast you want to talk. How fast you need your answer. And whether you want a permanent record of the communication.

From GTE Information Systems, your choice of terminals is as broad as your system's requirements.

For virtually instant response, look at our family of video terminals. The stand-alone terminal gives you a display of up to 1920 alphanumeric characters on 6, 12 or 24 lines, up to 80 characters wide . . . and transmission speed of 1200 or 2400 baud. For a cluster system, speeds up to 9600 baud are available and, depending on the number of terminals, the display can have as many as 1920 characters.

(In considering stand-alone vs. cluster systems, remember: the stand-alone unit gives direct computer access but requires its own control unit. A cluster arrangement can provide this access for a whole group of terminals using a common control unit. Both types are available for either local or remote operations.)

A video display is a transient thing. If you want a permanent record along with the CRT's speed, we can give you either a desk-top thermal printer to make single copies at up to 30 characters per second; or an impact printer, for an original and up to 5 copies. Both are buffered.

Then, there're our typewriter terminals. Here, too, we can furnish everything your data communications system needs.

These terminals include buffered storage capacity of up to 790 characters. This means that data entered at typist's speed can be transmitted later at 2400 baud. In the receiving mode, buffering now permits receipt of a 2400-baud message and delivery at 15 characters a second.

And, if you'd like to do better than that, our high-speed printer delivers data at 30 characters a second.

Finally, if you can afford to wait and transmit your data in a batch mode, the cassette recorder stores up to 73,000 characters, for high-speed transmission at a later time.

This first step between you and your computer may sound complicated, but it's really fairly simple. That's what we're here for.

PRODUCTION ESTIMATE

SERIAL	PRICE	QUANTITY	TOTAL
1001	100	10	10000
1002	200	5	10000
1003	300	5	15000

5550

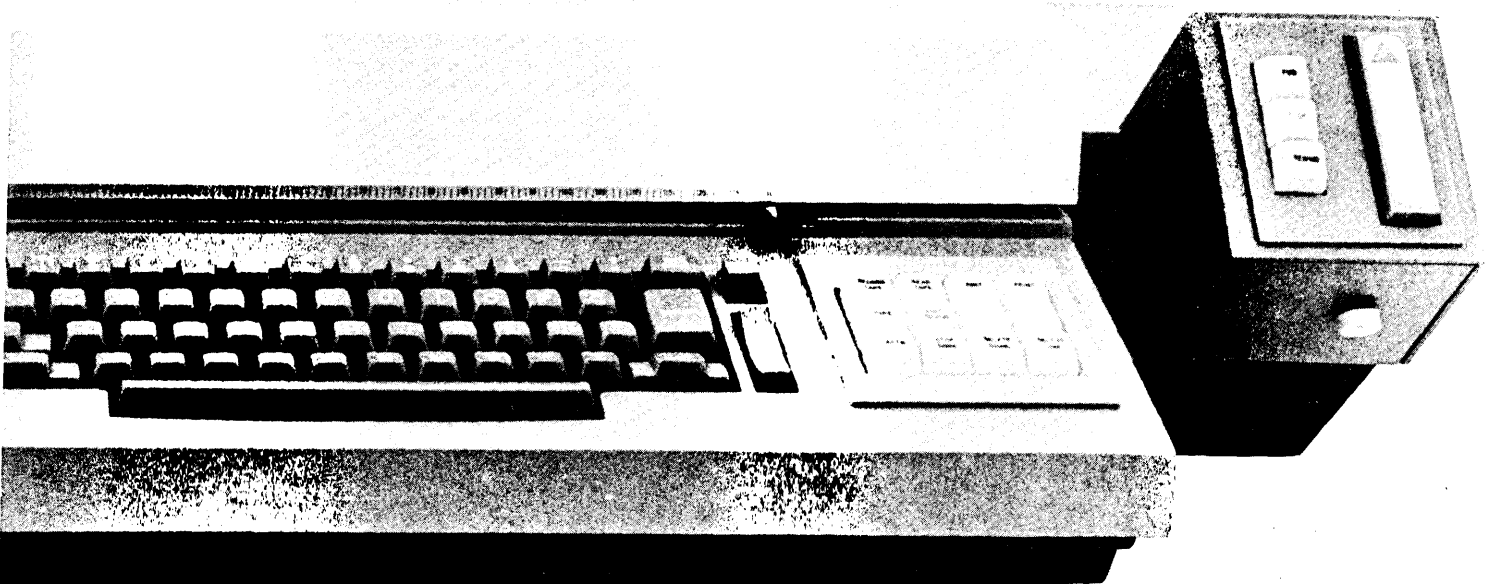

Pick the modem that's just your speed

Next step in the data communications chain—the modem.

You might be surprised at how much you can save by having the right modems married to the right terminals married to the . . . but you get the idea.

It really boils down to how fast the terminal talks. And, since there's such a variety in that, GTE Information Systems has put together a family of modems to handle just about any problem.

Our smallest model, a 300-baud modem, comes in five variations: acoustic-coupled or hard-wired originate-only; hard-wired answer-only; and data-card file answer-only in two file-card storage capacities.

Our 1200 and 2400-baud modems have a change-over feature that lets you switch from your dedicated line to the dial-up network at the press of a button.

For high-speed transmission, there's our 4800-baud unit. Using duo-binary coding, it eliminates the dc component in the signal, allowing you to transmit more error-free data over standard Series 3002 lines with C2 conditioning.

All our modems are economical, and telephone company-compatible. And all have pushbutton troubleshooting, so problems can be isolated in minutes.

In most cases, you'll find our modems cost less than comparable units. And they're all available from stock.

When our modems get between you and your computer, you get top efficiency. And save money, too.

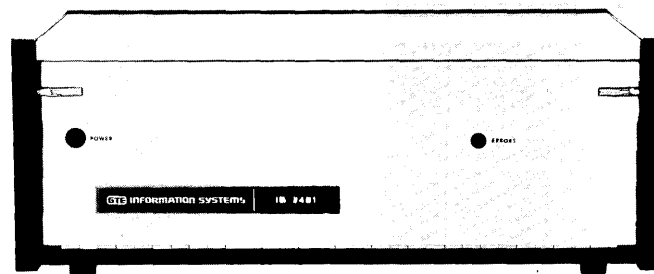
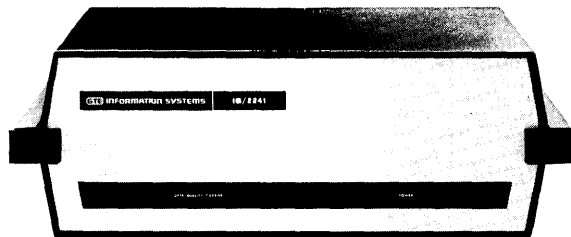
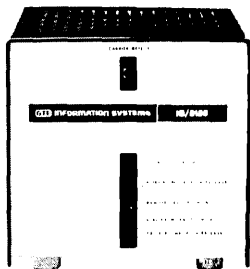

TDM or FDM?

The wrong decision can cost you money

You've got the terminals and the modems. Now for the multiplexers.

The question is, when do you need them, and what kind do you need?

From the systems viewpoint, the answer comes from your total requirements.

Everybody knows that multiplexers literally multiply the effectiveness of your leased lines. Either by time division or frequency division, they combine many channels into a single high-speed output for your leased lines. We make both kinds.

When you operate only a few channels, chances are, you ought to aim for FDM, frequency division multiplexing. Roughly speaking, each FDM channel will cost you about \$600.

GTE Information Systems has FDM units that will handle up to 23 channels on voice-grade line and 25 channels on a conditioned line.

If your bottom channel requirement is around 13, you probably ought to consider time division. The first channel costs a lot—around \$4,000. But the cost per channel drops rapidly. At 16 channels, the cost is about \$8,000.

We have TDM's that can handle up to 54 channels.

How do you know what you need? Guidelines like these help. It's even more helpful, we think, to talk to the people who make everything for total data communications. Everything that stands between you and your computer.

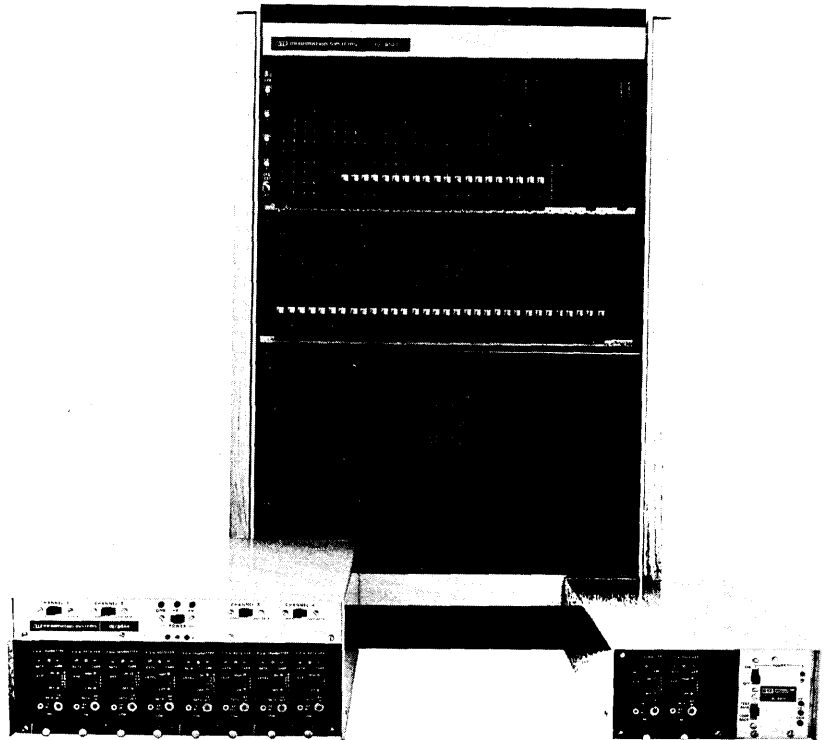

A little concentration can solve your data flow problems

Until now, we've talked about how complex and interrelated the parts of data communications systems are.

Now, here's a problem that arises because systems like these exist.

It's simply the vastness of the systems.

There's an incredible number of repetitive functions called for in today's state-of-the-art operations: jobs like polling, queuing, reformatting, addressing.

The kind of things any computer can do.

But your mainframe's main job is processing information. And every microsecond away from that is a loss of time and money.

Solution? Give your computer a computer. One that can handle these "housekeeping" chores of a wide-spread system.

GTE Information Systems makes a line of small computers for such jobs. For use as front ends; or as stand-alone message switches, controllers, data concentrators and intelligent terminals.

These are real computers . . . with memories up to 131K . . . programmable. They can handle codes and formats that haven't been invented yet.

It's a very efficient way to take some load off the main computer.

Because we were between you and your computer in the first place.

MULTIPLEXERS/COMMUNICATIONS PROCESSORS

GTE INFORMATION SYSTEMS

A program that treats your computer right can be a treat to your pocketbook, too

Software. It's what makes your system work.

Since it's the part of the system that tells the central computer what to do, you might even think software is the most important part of all.

At GTE Information Systems, we have developed software programs for many computer system needs. We are one of the country's leading creators of tailored programs.

We have also developed a state-of-the-art system, FCF (Front-end Communications Facility) that handles all network control, message processing and assembly, switching and data collection. It's one of the first marriages of software and hardware for the front-end part of the computer.

Programs? Intercomm™, for one. It allows you to move from batch to on-line without replacing your computer.

Minicomm™. For smaller systems, it can put you on-line with as little as 24K memory—without adding core.

Score. It converts ordinary language into a Cobol program.

... to say nothing of special programs for industries from banking to publishing ... from credit card to parking ticket record handling.

The wrong program can waste time for your whole system. Our programs, between you and your computer, can keep things running smoothly.

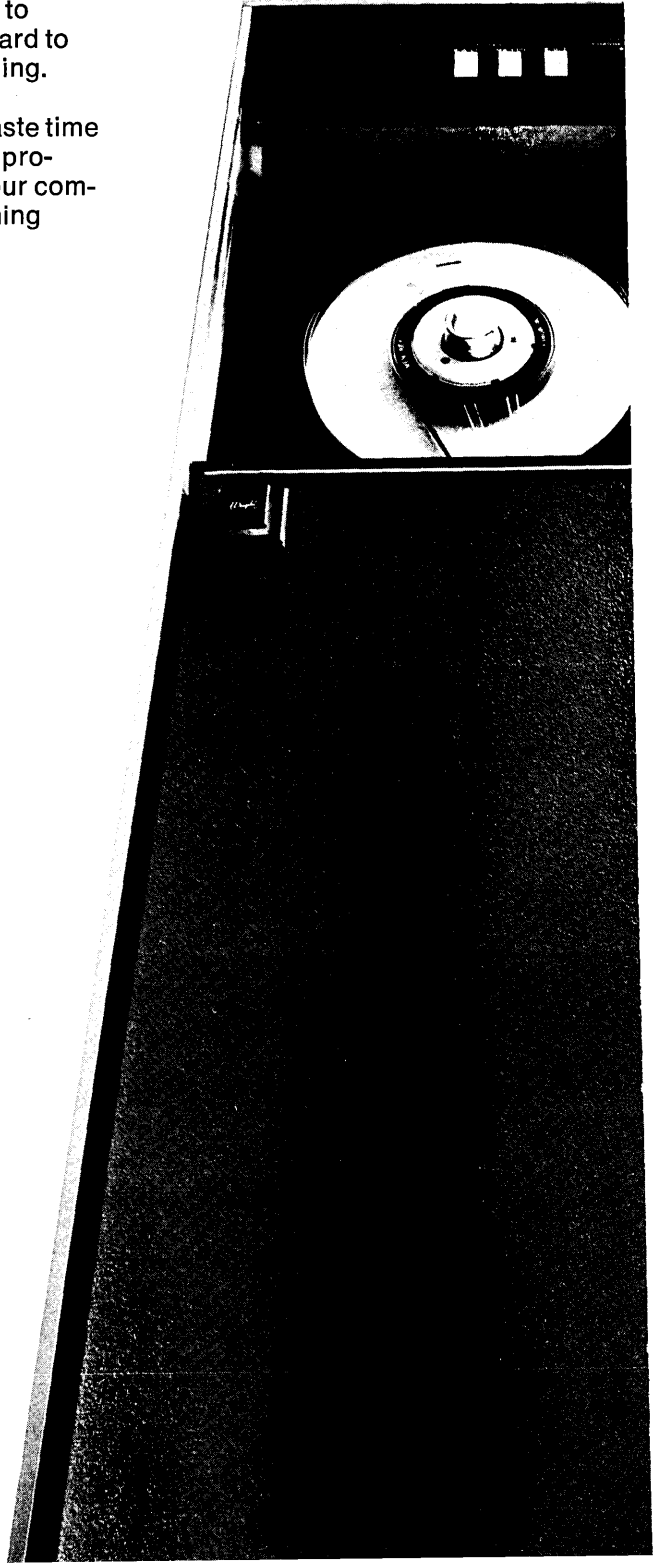

We'll keep you on speaking terms with your computer

Think of what's happened outside the computer room.

A whole new business has evolved: data communications. A business we helped create.

It's entirely new—and nobody understands it better than we do. Used properly, it can help you make data processing a very senior management tool.

GTE Information Systems covers the data communications business totally . . . from you to the computer. We provide the hardware and the software, and furnish the service. Coast to coast. Continent to continent.

No system is too widespread, or too complex.

For example, we created and operate one of the largest privately owned communications systems in the world. Serving the brokerage industry worldwide, it's a 100,000-mile network encompassing 21,000 terminals, 33 satellite computer locations and a master computer center.

It provides brokers throughout the world with all the vital information they need—as it occurs and as it changes. Instantly.

The point is: we can supply everything from a single terminal to a global network. The products. The experience. The programming. The operation and service. All with complete inter- and intra-system compatibility.

When we get between you and your computer, everybody talks the same language.

If you'd like to see how we talk your language, too—or for specific details on any equipment or service we offer—mail the postcard.

GTE INFORMATION SYSTEMS

Printed in USA

I'd like to know more about

- | | |
|---|--|
| <input type="checkbox"/> The whole data communications system | <input type="checkbox"/> Multiplexers |
| <input type="checkbox"/> Video terminals | <input type="checkbox"/> Communications processors |
| <input type="checkbox"/> Typewriter terminals | <input type="checkbox"/> Programming |
| <input type="checkbox"/> Modems | <input type="checkbox"/> Service capability |

Name _____ Title _____

Company _____

Address _____

City _____ State _____ Zip _____

Phone _____ Extension _____

Printed in USA

Computers and Cryptology

have been used in not always successful attempts to decipher dead languages of antiquity, medieval manuscripts like the celebrated *Voynitch Manuscript*, and historic ciphers dealing with the rise and fall of empires, royal personages, and scheming adventurers.

Even the treasure hunting field has been computerized. The famous *Beale Papers*, relating to a fortune in buried gold near Lynchburg, Va., consist of three pages covered with numbers. Using the *Declaration of Independence* as a key, one paper has been deciphered, describing the scope of the treasure trove and its history. The other two, said by the first to contain the names of the gold hunters and the exact location of the cache, have so far defied both cryptanalysts and pick and shovel wielders alike.

The only person known to profit
Key = 4-3-5-7-7.

from the illusive treasure trove appears to have been Dr. Carl Hammer, of Washington's Univac Systems Center, whose paper "Signature Simulation and Certain Cryptographic Codes" won the \$500 first prize at the Third Annual Simulation Symposium at Tampa, Fla., in 1970.

Program languages for cryptanalysis

Simple languages are suitable for simple ciphers. Assembly and machine language is adequate for simple substitution and many geometric transposition ciphers. For increasing sophistication, both in cipher structure and program scope, COBOL offers many powerful routines, such as its EXAMINE verb and associated modifiers.

FORTRAN is equal or better, due to extensive floating point capacity for Chi-Square and other common statistical tests of cryptanalysis, and is generally available for disc operating systems.

For character string manipulation,

identification of repeated patterns, SNOBOL may be valuable; or a specialized language may be developed to meet the particular needs of a special cipher.

A practical program

The program shown in Fig. 1 was written in FORTRAN for an IBM 1130. It is instructionally oriented, as an analog of manual methods using paper and pencil, or blackboard, chalk and eraser. The normal alphabet is written into the program body as a Data statement, rather than being read in from a punch card, to give the analog of this information already being present in the memory of the human cryptanalyst. Although of great simplicity, this short program will solve directly or aid materially in the solution of a variety of ciphers.

The first stage is devoted to the solution of the ancient but still common Caesar cipher, which has been described earlier. The manual solution for this cipher consists of "running down the alphabet"; that is, putting the next letter of the alphabet beneath each cipher letter and repeating the process until columns 25 letters long stand beneath the cipher text. The deciphered message will "automatically" appear on one horizontal line crossing the columns. In the program, this process is accomplished by three nested DO loops. Fig. 2 shows the decipherment of such a Caesar cipher.

Increasing in sophistication are those ciphers, keyed by a repeating series of numbers. For the key 6-7-1-3-2, CAESAR would become IHFVCX. This variety of cipher is called the Gronsfeld, and a decipherment using the Caesar rundown is shown in Fig. 3. More complex ciphers of the Vigenere class, using alphabetic keys, may also be discovered, especially if the printout is extended to include the entire message.

If, instead of a cipher message, a 26-letter mixed alphabet is read in, the rundown will produce a 26 x 26 letter table, or *tableau*, which may be used for manual encipherment purposes.

Progressing to the next stage of the program, which may be entered immediately via an inserted control card, the cryptogram is subjected to a frequency count, with the results tabled both alphabetically and in descending order of occurrence. An examination of this tabulation will usually tell at a glance if the cipher is of the transposition or substitution type. Should common letters like E, T, and A predominate, the cipher is of the transposition variety, and will be handled in another program. Fig. 4 shows a typical tabulation.

Assuming the cipher to be mono-alphabetic ("simple") substitution, the

CAESAR RUNDOWN	
GRSAHGWILTSONAPSQJEWIUYABIVIHFRLLQAMYFUZTOFJL	Cryptogram
HSTBIHXJMUTPOBQTRKFXJVZBCJWJIGSMMPBNZGVAUPGKM	
ITUCJIYKNVUQPCRUSLGYKWACDKXKJHTNNQCOAHWBVQHLN	
JUVDKJZLOWVRQDSVTMHZLXBDELYLKIUOORDPBIXCRWIMO	
KVWELKAMPXWSRETWUNIAMYCEFMZMLJVPPEQJCJYDXSJNP	
LWXFMLBNQYXTSFUXVOJBNDZFGNANMKWQOTFRDKZEYTKQG	
MXYGNCORZYUTGVYWPCKOAEHOBONLXRRUGSELAFLZULPR	
NYZHONDPSAZVUHWZXLQDPBFHIPCPOMYSSVHTFMEGAVMQS	
OZAIPOEQTBAWVIXAYRMEQCGIJQDQPNZTTWUIGNCHBWNRT	
PABJQPFTRUCBXWJYBZSNFRDHJKRERQOAUUXJVHODICXOSU	
QBCKRQGSVDQYKXZCATOGSEIKLSFSRBPVVYKWIPEJDYPTV	
RCDLSRHTWEDZYLADBUPHTFJLMTGTSQCWWZLXJQFKEZQWU	
SDEMTSIUXFEAZMBECVQIUGKMNUHUTRDXXAMYKRGLFARVX	
TEFNUTJYVYGFANCFDWRJVHLNOVIVUSEYYBNZLSHMGBSWY	
UFGOVUKWZHGCBOGDGEXSKWIMOPWJWVTFZZCOAMTINHCTXZ	
VGHPWVLXAIHDCPEHFYTLXJNPQXXWUGAADPBNUJOIDUYA	
WHIQXWYBJIEDQFIGZUMYKQORLYXVHBBEQCOVKPJEVZB	
XIJRYXNZCKJFERGJHAVNZLPRSZMZYWICCFRDPWLQKFWAC	
YJKSZYOADLKGFSHKIBWOAMQSTANAZXJDDGSEQXMRGLXBD	
ZKLTAZPBEMLHGTILJXCXPBNRTUBOBA Y KEEHIFRYNSMHYCE	
ALMUBAQCFNMIHUJMKDYQCOSUVCPCBZLFFIUGSZOTNIZDF	
BMNVCBRDGONJIVKNLEZRDPITVWDDQCAMGGJVHTAPUOJAFEG	
CNOWDCSEHPQJWLQMFASEQUWXEREDBNHHKWIUBOVPKBFH	
DQPXEDIFIQPLKXMPNGBFRVXYFSFECOILXJYCRWQLCGI	
EPOYFEUGJROMLYNQOHCUGSWYZGTGFDPJJMYKWDSEXRMHDJ	
FQRZGFVHKSRRMZORPIDVHTXZAHUHGEQKKNZLXETYSNETK	
CONTACT DEMOLITION EXPERT TUESDAY NIGHT AT NANS PLACE	Solution

Fig. 3. Computer-assisted solution of Gronsfeld-type cipher. Key = 4-3-5-7-7.

SILENT 700
electronic data terminals

Texas Instruments announces...



the twin-cassette "Silent 700" ASR terminal for \$2,750

(KSR terminal for \$1500)

Here is a powerful improvement over conventional paper-tape ASR (automatic send-receive) teletypewriters . . . at half the cost of other equipment with comparable performance.

In *Silent 700** ASR terminals, TI has combined sophisticated magnetic tape cassette data storage with the field-proven features of *Silent 700* keyboard data terminals.

Speed. Quietness. Reliability

Data transmission rates up to 120 characters-per-second can significantly reduce line charges. And quiet, 30 characters-per-second electronic printing makes the *Silent 700* acceptable to any office environment. Field operating experience has proven that *Silent 700* terminals typically require only one or two remedial service calls per year.

Communications Economy

Off-line data preparation and transmission from cassette storage reduces errors, line costs and operator time. Simultaneous transmit/receive and simultaneous on-line/off-line operation permit maximum system utilization.

Powerful Data Editing

Data is recorded in ANSI standard block format. Block or character data editing capability is combined with high-speed tape duplicating and an optional automatic record locator for fast search of cassette files.

Reliable Data Storage

Philips-type digital-grade cassettes store 800 bits-per-inch for up to 310,000 characters storage per two-track cassette. Bit-error rates are typically no more than one in 10⁷.

Modular Expandability

Simplified design permits easy addition of other optional features including automatic remote control of record-playback functions, answer-back memory, and built-in modems. The compact \$1500 KSR (keyboard send-receive) model is easily converted to the standard \$2750 ASR model by addition of the cassette module.

OEM and quantity discounts are available. Contact the nearest TI office listed below for more information on how *Silent 700* terminals can cost-effectively improve your data communications system performance. Or contact Texas Instruments Incorporated, Digital Systems Division, P.O. Box 1444, Houston, Texas 77001, phone (713) 494-5115, ext. 2126.



Arlington, Va. (703) 525-1444 • Atlanta, Georgia (404) 458-7791 • Chicago, Illinois (312) 593-2340 • Cleveland, Ohio (216) 464-1192 • Dallas, Texas (214) 238-3881 • Dayton, Ohio (513) 294-0774 • Denver, Colorado (303) 758-5536 • Detroit, Michigan (313) 352-5720 • Houston, Texas (713) 494-5115 ext. 2562 • Los Angeles, Calif. (213) 860-1379 • Minneapolis, Minn. (612) 941-4384 • Newark, N.J. (201) 467-2670 • Orlando, Florida (305) 644-3535 • Philadelphia, Penn. (215) 643-6450 • San Francisco, Calif. (408) 732-1840 • Waltham, Mass. (617) 890-7400 • Elizabeth, S. Australia 552066 • Bedford, England 58701 • Paris, France 6450707 • Frankfurt, Germany 726441 • Bad Godesberg, Germany 65534 • Toronto, Ontario, Canada (416) 889-7373

*Trademark of Texas Instruments Incorporated

TEXAS INSTRUMENTS
INCORPORATED

Computers and Cryptology

third stage of the program operates upon the collated table of descending values by substituting a series of trial alphabets. These are based on permutations of the standard frequency table for English: E T A O I N S H R D L U C M F W Y P V B G K Q J X Z. If the plain-text message was of "normal" distribution, only one trial, in theory, would be necessary. However, the shorter the message, the more variation may be expected, and many "puzzle" type messages deliberately suppress or distort letter frequencies.

In practice, it has been found that 15 trial alphabets of 20 letters each give sufficient leverage to break the average cipher, especially where word divisions have been retained. Fig. 5 shows the first two trial decipherments of a cryptogram of 200 letters. With the information supplied, the reader may complete the solution easily, noting that the six occurrences of the trigram PIL indicate a high probability that PIL represents THE, the most common English three-letter group.

The search for and identification of common digrams and trigrams such

as IT, IS, OF and THE, AND, ING is an obvious sophistication for this basic program. Optical display with light-pen techniques for operator variation of trial letters is another improvement.

Programs for trial solutions of

FREQUENCY COUNT			
A = 0	L = 30		
B = 0	P = 26		
C = 6	I = 19		
D = 5	G = 16		
E = 11	N = 16		
F = 13	F = 13		
G = 16	Z = 12		
H = 1	E = 11		
I = 19	K = 10		
J = 0	T = 8		
K = 10	U = 8		
L = 30	C = 6		
M = 5	D = 5		
N = 16	M = 5		
O = 1	R = 4		
P = 26	X = 4		
Q = 3	O = 3		
R = 4	S = 2		
S = 2	H = 1		
T = 8	O = 1		
U = 8	A = 0		
V = 0	B = 0		
W = 0	J = 0		
X = 4	V = 0		
Y = 0	W = 0		
Z = 12	Y = 0		

NO. OF LETTERS IN CRYPTOGRAM = 200

Fig. 4. Tabulations of frequency count of cryptogram in alphabetic order and descending order of occurrence.

transposition ciphers involve integer manipulation and printout pattern variation through sequential steps of interested loops. Counting the vowel-consonant distribution of trial rows and columns will help in identifying the pattern by which the rows and/or columns containing the plain-text were shuffled.

Those wishing practice may find cryptograms on the crossword puzzle page of many Sunday newspapers and a few dailies. A far wider variety of ciphers, as well as historical and technical information, may be found in *The Cryptogram*, the bimonthly publication of the American Cryptogram Association.

Cryptology has already been introduced into the educational stream, on levels varying from means to heighten participation in elementary mathematics to senior seminar topics and graduate programs involving computer programming and the development of cipher-oriented languages for on-line solution.

We have seen how cryptology and the modern computer have grown up together, nourished and cross-fertilized by the growth of common technologies and the byproducts of common progress.

TRIAL SUBSTITUTIONS

TRIAL DECIPHERMENT NO. 1, USING- E T A O I N S H R D L U C F G M P V W Y	
Z R G G U R C Z N N E F P I L M E N I G H N I G N P L C E F P I L U L S E C N N L Z P T G K P X G F	S G O O L G U S I I H N T A E F H I A O W I A O I T T E U H N T A E L E V H U I T I E S T D O R T M O N
L U L R K L L N Z F U P I E K P L L F D E F Q P L N F G K P I L Z N P Z F U M X F G K P I D Z E F M	E L E G R E E I S N L T A P R T E E N C H N P T E I N O R T A E S I T S N L F M N O R T A C S H N F
K Z F O I N L S L F P I C E D M L Z N P N E U L N I G G P T K G D P I C L T P L X L G T P I L U L Z	R S N Y A I E V E N T A U H C F E S I T I H L E I A O O T D R O C T A U E D T E M E O D T A E L E S
P I N I L Z U Z M L L C E F L T K G D P I L P K L L P I K G Q R I P I L N I G P T E T P X T P G Q P	T A I A E S L S F E E U H N E D R O C T A E T R E E T A R O P G A T A E I A O T D H D T M D T O P T
TRIAL DECIPHERMENT NO. 2, USING- T E A O N I S H D R L U F C G M V P W Y	
Z R G G U R C Z N N E F P I L M E N I G H N I G N P L C E F P I L U L S E C N N L Z P T G K P X G F	S G O O L G U S N N H I E A T C H N A O W N A O N E T U H I E A T L T P H U N N T S E R O D E M O I
L U L R K L L N Z F U P I E K P L L F D E F Q P L N F G K P I L Z N P Z F U M X F G K P I D Z E F M	T L T G D T T N S I L E A H D E T T I F H I V E T N I O D E A T S N E S I L C M I O D E A F S H I C
K Z F O I N L S L F P I C E D M L Z N P N E U L N I G G P T K G D P I L T P L X L G T P I L U L Z	D S I Y A N T P T I E A U H F C T S N E N H L T N A O O E R D O F E A U T R E T M T O R E A T L T S
P I N I L Z U Z M L L C E F L T K G D P I L P K L L P I K G Q R I P I L N I G P T E T P X T P G Q P	E A N A T S L S C T T U H I T R D O F E A T E D T T E A D O V G A E A Y N A O E R H R E M R E O V E
TRIAL DECIPHERMENT NO. 3, USING- E T O A I N H S R D U L C F M G P V Y W	
Z R G G U R C Z N N E F P I L M E N I G H N I G N P L C E F P I L U L S E C N N L Z P T G K P X G F	H M A A U M L H I I S N T O E F S I O A Y I O A I T E L S N T O E U E V S L I I E H T D A R Y G A N

Fig. 5. Printout of first two trial decipherments of mono-alphabetic (simple substitution) cryptogram. Re-incipherment of famous literary crypto-

gram. Original text was undivided. Hint: message begins; A GOOD GLASS

The appearance of a cryptogram in a programmer's input should cause no more concern than a problem in statistical analysis, which it basically is. The challenge can be a rewarding one; his response should not be a panicky urge to "Call Exit," but recognition of an opportunity to make use of knowledge from an art centuries old and a science as contemporary as the computer he uses.

References

The Codebreakers, by David Kahn, The Macmillan Company, New York, 1967, is the definitive book on cryptology. Chapter 19 is devoted to the N.S.A. Chapters 3, 4, and 5 for Renaissance and later history.

Electronic News, a weekly trade paper of Fairchild Publications, New York, often contains items of crypto-computer interest. In particular: "Spy Agency in Big IC Buy", page 4 April 1, 1968, and special "Pueblo" section in Feb. 24, 1969, issue, both by Jack Robertson.

Patents: *The Official Gazette* is the weekly publication of the U.S. Patent Office. Patents relating to cryptographic systems are most frequently found under the following classifications: 178-5.1, 178-22, 179-1.5, and 197-4. Individual patents may be obtained at 50 cents each from The Commissioner of Patents, Washington, D.C. 20231.

"Zodiac Case": Lead article in *Argosy Magazine*, by Gene Lowall, September, 1970, issue.

OCAS-On-line Cryptanalytic Aid System, by D. J. Edwards. Project MAC. Massachusetts Institute of Technology, May, 1966. MAC-TR-27

Cryptology As A Senior Seminar Topic, by Dr. D. C. B. Marsh, Colorado School of Mines. Reprint from the American Mathematical Monthly for August-September, 1970.

The Cryptogram, a bimonthly publication of the American Cryptogram Association, 9504 Forest Road, Bethesda, Md. 20014. \$3 per year. □



Mr. Chesson does free lance work in programming and technical writing and was formerly in charge of technical publications for Technical Instruments, Inc. He has been a member of the American Cryptogram Association since 1958. He has a BS in physics from the Univ. of Connecticut.

New!

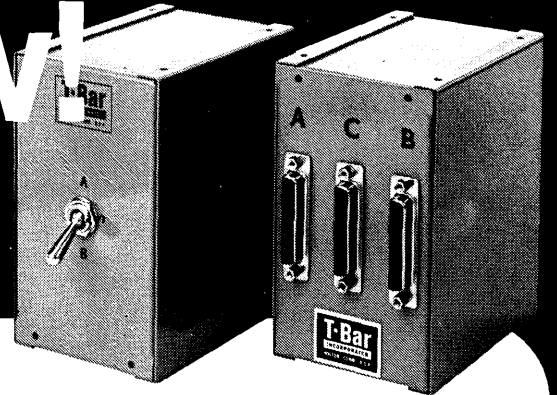

Increase equipment utilization ... maintain system integrity with 5700 Series RS 232 EIA/TELCO Switches!

COMPUTER PORT MODEM INTERFACE ... only \$97.10

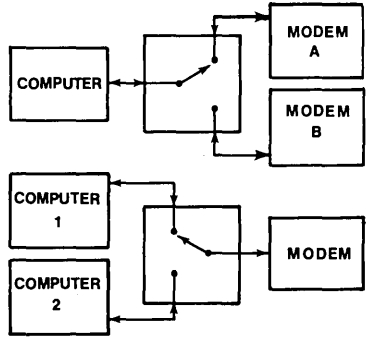

SPARE MODEM SWITCH ... only \$175.00

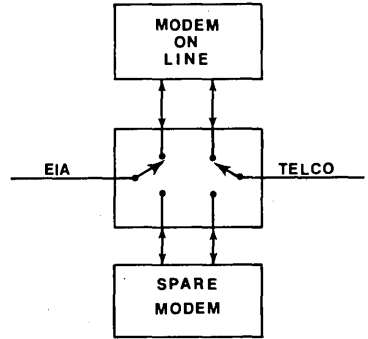

4 SEPARATE CHANNELS OF DIAL-UP BACK UP ... all for \$98.50

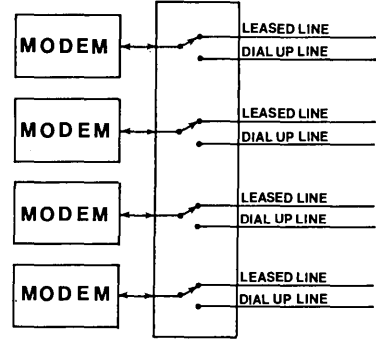

16-CHANNEL REMOTE PUSH BUTTON SWITCHING AND CONTROL FOR SYSTEM RECONFIGURATION ... only \$160/CHANNEL

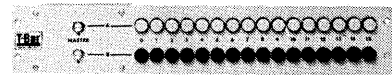

... Plus many many more ... all using T-Bar's exclusive high reliability DATA-RITE™ switching devices.



These T-Bar® EIA/TELCO DATACOMM Switches now provide the Communications Systems Engineer and the Communications Manager with a system cost effectiveness that really works. Write or phone today for complete literature...

141 Danbury Rd., Wilton, Connecticut 06897 Telephone: 203/762-8351

What the industry taught us about minicomputer software.



You name it, we got it.

You can't get no for an answer.

Ask for any software package these days and everybody claims to have it. What they really mean is they may have something they can adapt or piece together or disguise or — most likely — start working on fast.

And next year sometime . . .

Free for the asking.

The biggest come-on of all. Not only do they claim to have all this wonderful software, but they're willing to give it away.

Problem is, what they're willing to give you for nothing is probably priced just about right. And by the time you add development costs for about 7K words at \$15 a word — just to make it work — it's anything but free.



Introducing the Interdata family of Operating Systems.

Here's a whole family of minicomputer software packages that's different.

The Interdata RTOS, for example, is the most comprehensive minicomputer Real-Time Operating System available today. It has a dynamic core allocation system with 16 priority levels, supports a full range of peripherals and is field-proven.



Our RTEX is a multi-programming real-time executive system which gives you high throughput with low overhead. DOS is particularly easy to use for program development, supports file handling on a disc and can operate in either batch or interactive mode. BOSS is perfectly matched to small systems, and supports many devices such as disc, tape or cassette.

And there's plenty of basic software as well as high level language programs such as Interactive FORTRAN and FORTRAN IV. They've all been proved on the Interdata New Series family of minicomputers. They all can be expanded or modified to match your configuration. And they're all backed by the Interdata warranty to make sure you're satisfied.

What you need is what you get.
And that's what's so different.

INTERDATA®

2 Crescent Place, Oceanport, New Jersey 07757. (201) 229-4040. Boston — (617) 890-0557. Chicago — (312) 437-5120. Dallas — (214) 238-9656. Denver — (303) 758-0474. Detroit — (313) 356-5515. Houston — (713) 783-1830. Los Angeles — (213) 640-0451. Palo Alto — (415) 969-1180. Washington — (703) 525-4806. Toronto — (416) 678-1500. United Kingdom — Uxbridge 52441. Sydney — NSW 439-4155. West Germany — 0811/160031. Tokyo — 270-7711.

About 600 computers have been installed, with IBM and ICL accounting for over half in a market that may grow 20% a year for the next decade

South African Data Processing

by E. Dana Gibson and Rosemary P. Gibson

South Africa is a paradox of data processing and other ideas, attitudes, and practices. The country has some of the best dp/systems installations seen anywhere, but it has some that are not well run. It is changing faster and more drastically than most of its citizens realize. In this respect, it reminds us of the U.S. during the sixties.

The railroads and their associated transport agencies are a credit to any nation, and South Africa's better insurance and building society groups are models of good data processing operation. The recent international mining symposium held in Johannesburg is evidence that the mining (and the oil) companies know how to use their dp facilities effectively. Governmental use, while not up to these standards, does have many good operations—city (municipal), provincial (state), and national.

Data processing personnel

Most universities are just beginning to do something about the computer science emphasis needed by engineers, mathematicians, and other science-oriented students. The earliest computer science program is probably not over three or four years old. As yet, little has been done to supply the dp curriculum needed by business students and by dp majors. If schools are not yet turning out computer people, where are they coming from? Manufacturers, as has been true everywhere, have been training most of the people now working in computer centers.

Almost all "home" training is of the "on-the-job" type. Years of practice in one center may give some breadth, but not that needed to take advantage of the newest software, hardware, or techniques. Even this lack wouldn't be so ominous if the home "expert" had a good educational background to begin with. But we found the average general education of a data processing supervisor, or even higher level person, to be about the tenth grade.

In larger installations, the education, dp training, and background of those hired would compare favorably with their counterparts around the world. This is not always so true of "top man-

agement" personnel. Very few prospective "top management" people now in South African universities are yet receiving this needed introduction to management data processing.

Personnel selection and training are complicated by the fact that workers may be white or nonwhite, even though present laws often prohibit the use of the latter. Theoretically, the two groups cannot meet, but in practice rules often go down the drain when necessity demands a certain type of worker.

In any case, nonwhites are finding dp jobs to their advantage, as the pay rates are higher than in most other jobs available to them. While they may be paid less than whites, it is still a step up for nonwhites, and pay rates are beginning to equalize. Data processing managers report nonwhite workers more stable and loyal than similar groups of white workers.

Many dp managers stated they preferred hiring bright, nonwhite persons with ability, so they could train them in their own methods.

Women are also becoming more numerous in computer centers at most levels, although not in programming or systems analysis. While in some cases they have 50% of the total dp jobs, they had not moved into supervisory echelons in any significant numbers. We did see an all-woman-operated computer center, a programming group that was 50% female, and even a systems analyst now and then who was a woman, but nowhere did we find a woman in charge of a computer center, or even second in command. However, the Computer Society of South

Africa recently had a woman president, Ms. Virginia Marting, one of the country's outstanding computer consultants.

Data processing salaries range from poor to good. Poor means the key-punch operator, who may get as low as \$60 a week and averages only \$76 a week, according to the figures given us. The dp manager, on the other hand, may get as much as \$267 a week, but averages \$238.

Computers

There are more computers in South Africa than in all the rest of Africa. Before we arrived, correspondents estimated that there might be 700 computers in all Africa, with 380 plus installed in South Africa as of the end of 1970. A recent issue of *Management*, a South African publication,¹ reported about 530 installed by mid-1971. This figure was probably nearer 550 by mid-1972.

This is not a one-sided market, although IBM and ICL dominate it. Based on an average of the computers listed in *Management* and our own 1972 estimate, the breakdown is as shown in Fig. 1.

Most computers in South Africa are small-to-medium, if we classify IBM's 360/30 through 360/50 as medium-sized computers. Probably close to 50% of the computers installed fall into this category; but there are many large computers installed as well. The latter do a disproportionate amount of the actual work done, and they also account for much of the money spent each month for computers. Transportation, mining, government, automo-

Firm ²	Mid-1971	%	May	%
	Computers Installed	Total	1972 Est.	Total
IBM	200	41%	225	41%
ICL	160	32	160	29
NCR	70	14	90	17
Burroughs	42	9	50	9
CDC	15	3	15	3
Univac	6	1	6	1
	493	100%	546	100%

Fig. 1. Computers installed in South Africa.

¹Management Magazine 2:43, Feb., 1972, a Financial Mail publication, Carlton Center, Box 9959, Johannesburg, Republic of South Africa.

²The figures do not show the computers of firms like Honeywell, DEC, Siemens, and others.

Actually, South Africa should have around 600 computers of all kinds installed, omitting the visible-record type. Nixdorf, a latecomer, may have a number of these installed, as have other manufacturers.

South African dp

bile manufacturers, service bureaus, and quasi-government organizations (such as public utilities) are some of the major users of large computers.

Computer centers in South Africa are joining the trend toward separate identities, with managers reporting directly to top management or immediately below. Few report to the accounting or finance department head, although some still do. Some firms have even set up the computer center as a separate service bureau corporation, as at the SANLAM Insurance Company in Cape Town.

Probably most computer centers originally were poorly installed. This is not quite so true at present, since better advice is being obtained before the installation of a computer. One sign of a poor installation is too large a computer, with the center taking in outside business to make ends meet. Another sign is a one-shift operation, even after several years of work, too often stemming from the dp manager's intentions to move to a larger computer when his one shift is fully occupied—and refusing to go to another shift or enlarge his present system. However, we were told that employees also refuse evening or night shift work. Round-the-clock, or even extended-day schedules, are not yet accepted practice in some areas.

Trends

Computers should have a good future here, most people agreed. They estimated a 20%-a-year increase for the next ten years. Once the present business upturn gets fully operational, the market should become excellent. However, computer centers have been through a retrenchment phase, and firms are cautious about adding to or installing computers. Unfortunately, a lot of computers were originally installed to "keep up with the Joneses," and no thorough feasibility study was made. This situation is being corrected and firms are now calling in experts to help reorganize or install computers.

Software packages are poorly and sometimes seldom used. A lot more will have to be done to convince dp managers of their worth. Quite a few managers said they distrusted manufacturers' software packages and even more so those from software firms. Many said they preferred their own software, although all reported they had libraries of most of their manufacturer's software—but were making little use of them. We feel this is a shortsighted policy that can have repercussions later.

Operations research techniques have had good use in mining, oil, and some manufacturing firms. But many people

asked what we meant by operations research when we tried to talk to them about its use. While most of this was at the small computer center level, it points up one problem area. Many small-computer center managers have limited general education and insufficient advanced dp education. As a result, they are worried to death someone will find out they don't know everything, or that someone working for them will become more knowledgeable than they are. Thus, they frown on advanced ideas, new methods, etc., and in this way limit the more sophisticated work such centers could do in the future. A computer consultant said such managers were often hostile when consultants were called in to improve a poor installation.

Telecommunications should grow rapidly. The GPO (General Post Office) has just strengthened its microwave system around the country, is putting in coaxial cables in the Johannesburg/Reef area, and is installing many of the phones and exchanges that have been needed for some time. They have announced that about 35,000 individuals will get phones this year, and that they are considering a satellite ground station to provide backup and expansion to their foreign cable service.

MICR will come into its own within two years. The banking system has already decided to go to MICR by the E13B route. Problems are now being worked out and should be overcome soon.

Optical scanning is suffering from a lack of confidence, and only minor use is being made of it at present. Until South African dp managers come to believe it can be trusted to do what they want done, it won't be used to any extent. While it will grow slowly and has a bright future, not much growth is likely for the next two or three years.

Government may soon be the big user of dp equipment. While business and industry are having doubts, or are just dragging their feet, government officials appear quite optimistic about their need for, and their ability to obtain and use, new and better equipment. City, provincial, and federal governments should all need more dp help as the nonwhite population integrates into the business, political, and general life of South Africa.

Conclusions

South Africa's economy is viable, dynamic, and growing faster than its problems. The future looks good, when nonwhites become accepted as workers—as they are and will be. But the dual or triple costs involved in separate facilities for each of the three or four main national groups is presently a stultifying factor. On the other hand, the nonwhites seem reasonably willing

to work within the framework of the present political system for change.

Foreign firms are likely to grow in importance as outside capital is needed. Many foreign firms are paying the highest nonwhite wages in the country.

Consultants and service bureaus are overextended in South Africa. Too many persons viewed these two areas as "get-rich" opportunities, rather than as solid service organizations. Consequently, some of the greatest failures and consolidations are taking place in both—even though there are praiseworthy examples of each to be found.

It would seem that South Africa should be a natural place for the assembly or manufacture of dp equipment. Its present low installation volume, of course, will not support such an operation. But if conditions change so that South Africa can export to nearby African countries, dp equipment may well become a profitable assembly or production item. □



Dr. Gibson is professor of information systems at California State Univ., San Diego. He and his wife are now writing a book on data processing in Africa and have published two others on the use of computers abroad. He was the international representative for DPMA in 1962-3 and has been a member of many other business and computer organizations. He has an EdD from New York Univ.



Mrs. Gibson has been a teacher of business administration and since 1965 a co-author with Dr. Gibson of the books *Latin American Data Processing*, *International Data Processing*, and the present project on Africa. She is a graduate of Carnegie-Mellon Univ.

CLAIM TO FAME

A Medicare Claims Coding Form.

A combination of handprinted, computer-printed and typewritten information.

For the health care insurance industry, an effective data entry pain killer; for Scan-Data, just what the doctor ordered.

Because it gives us a chance to prove what we've been saying all along: that the real-world answer to today's complex data input problem is an integrated data entry system that brings the computer closer to the source. Without much of the costly, time-consuming, error-creating middle steps.

A system that *is* what direct source data scanning is all about. That handles pages, documents and journal tape. In a variety of sizes, weights and grades. That reads an almost endless list of fonts that ranges from OCR-A and OCR-B upper and lower case to handprint. And includes, with our new Multifont 10/12 feature, just about all of the commonly used elite and pica typewriter fonts, intermixed.

A system that offers "one-key" entry of rejected characters, without reference to the source document and without interruption of scanning throughput.

And a system that integrates, for the first time, the familiar keypunch keyboard, allowing you to key-verify critical data, or keyboard data such as handwritten names and addresses.

System capabilities that have made believers of health care insurance organizations from Massachusetts to Louisiana; from Florida to Colorado.

A system that should be resident wherever there are 15 or more keyboard operators now.

The SCAN-DATA 2250 Data Entry System.
The right prescription.

476
MEDICARE CLAIMS CODING FORM
00000284
YNNN 00 2304-30310 2322 N 438-16-7035-A DOE J N 4042 0766 N N 23JUN72

2172-38809
N | DOE J | 438-16-7035-A | N |

JANE | DOE | RT 1 BX 254 | EVANGELINE | LA 70537

000284 SAM SAMSON 0 P4 00000284 01

0111171120210359004 000700
022 1005210158999 00080000080050
03
04
05
06
07
08
09
10
11
12
13

Form courtesy of Pan-American Life Insurance Company



SCANDATA

More than OCR. Data Entry.

Scan-Data Corporation
800 East Main Street
Norristown, Pennsylvania 19401
215-277-0500 Telex: 846485

From Ma



A Mariner photo is sent back in a radio stream of 580,000 signals coded for light-to-dark intensity. UNIVAC computer 1230 MTC takes those signals and enhances them subtly to make darks darker and lights lighter. The resulting contrast brings out obscure terrain features.

s, a Univac computer story.

Were the erosion patterns in the valley walls caused by water run-offs? (Mars isn't supposed to have that much water.) Or were they caused by volcanic action or savage windstorms?

These are questions that will be answered by the scientists at Cal Tech's Jet Propulsion Laboratory. UNIVAC® computer 1230 helps by making good photos out of so-so photos.

When a picture of Mars is first received from NASA's Mariner satellite, it's been radioed across 140 million miles of space and it can be dimmed by glare and dust on the planet's surface. Usually it isn't much to look at.

But after it's been touched up by 1230, there's plenty to look at.

Suddenly canyons yawn, mountains thrust up, craters deepen and all kinds of questions arise about how it all could have happened.

It used to take six months to reconstruct a Mars photo satisfactorily. 1230 does the job in less than six minutes. But speed isn't 1230's only attribute.

The computer was also built for strength because it would have to travel to Florida to help with the Mariner launch. This ruggedness got an unexpected test when part of the lab roof fell in during an earthquake.

After the shower of ceiling tiles and debris was cleared away, however, technicians found that 1230 had never missed a beat.

Not all UNIVAC computer systems live the exciting, far-out life of 1230. But around the world, for a growing variety of customers, they are successfully taking projects that used to be thought impossible and reducing them to mere routine.

Mere routine that calls for excellent equipment, hard work and creative worry.

SPERRY UNIVAC

Only when our customers succeed do we succeed.

It was the year of the lawsuits and the stirrings of change, as the general public became steadily more aware of computer activities

1972: The Battle Lines Were Drawn

by Tom McCusker, Senior Associate Editor

In 1972, for every 2,400 persons in the U.S. there was one computer.

So vast was its expansion beyond the traditional uses in billing and payroll and in getting earthlings to the moon, that the impact to John Q. Public of the computer's omnipresence could be compared to that of a wet towel in the face.

In New York, the corner bookie was being displaced by a computer betting system. In Northridge, Calif., a clerk in Bullock's department store said customers grumbled at computerized cash registers which "checked up on them all the time." In Chicago, the friendly supermarket checker population was being trimmed by speedy computer-linked cash registers. One even wrote your check for you. Elsewhere, the credit manager who once inspected your honest face—and then called the bank—now pressed a button for a credit record that went back seven years. Taxpayers received polite but impersonal computer letters notifying them of errors in arithmetic. Despite Congressional concern over huge criminal "justice" files that also contained the names of persons arrested but not convicted, legislators held their peace, fearing to be identified as opponents of "law and order" in an election year.

And one Monday morning in mid-October, the Justice Dept. announced in court that IBM—the perpetrator that the public most identified with the proliferation of this monstrous electronic snoop—might be broken up. So widespread was the impact that IBM asked the court to relax an IBM-inspired court order prohibiting both sides from talking to the press about the four-year-old case. IBM claimed some stockholders and employees actually believed that what the Justice Dept. *wanted* to happen had actually *happened*. They said it would never happen.

The case, of course, had nothing to do with curbing the spread of computerized systems. The antitrust suit charges that IBM's dominance of the industry is unfair to the competition. The suit, which had been virtually submerged since its filing in January, 1969, merely had surfaced in 1972, albeit dramatically. And the subject promised to be more lively this year, when it may go to trial.

Three other suits against IBM—

each brought by competitors—began to take clearer shape. Essentially, the antitrust battle lines were drawn last year and the actual battles—the trials—were expected to get under way this year.

One case, filed by Greyhound Computer Corp., was won by IBM last summer, but was appealed in the fall. Greyhound, which leases computers in competition with IBM, had charged IBM with monopolization, violation of the Sherman antitrust laws and other violations. In the court ruling, however, IBM was judged to have achieved its place in the industry "as the result of superior skill, foresight, and industry."

Control Data Corp.'s case is the most important of the others, since CDC has been generating the information and documents that are being used by attorneys opposing IBM in the other cases. IBM, for example, has turned over more than 27 million documents to CDC. The trial is scheduled to start in November.

In a fourth antitrust case against IBM, Telex Corp. created a Roman circus atmosphere around IBM's normally precision-like product announcements last summer. In this case, Telex attempted unsuccessfully to halt IBM's

Computer Almanac

The past is all right but the future's more fun. Again this year, New England Editor Dave Gardner offers his predictions of what's to come.

January

Burroughs, Honeywell and Memorex announced they are entering the data processing office equipment business and each firm unveils an extensive selection of chairs, tables and cabinets for use with data processing equipment. "This will be a multimillion-dollar business for us," says a Honeywell spokesman.

February

In an exclusive report, Jack Anderson reveals that Thomas and Arthur Watson have secretly been wearing fire engine red undershirts under their white dress shirts for years. To back up his charges, Anderson produces an IBM purchase order for five fire engine red undershirts. It is signed "TJW Jr."

March

Mohawk, NCR and Telex launch their new data processing office equipment line, featuring chairs, cabinets and tables for use with

data processing equipment. "This market is booming out of sight," says a Telex spokesman.

April

The board of directors of the Computer and Business Equipment Manufacturers Association issues an angry report condemning the wave of public discontent against computers. It is the people behind the computers, says CBEMA, who have been doing sloppy programming that has led to credit card overcharges, lost bills and election returns snafus. CBEMA prints four million bumper stickers bearing the slogan "Support Your Local Computer."

May

IBM announces a line of dp equipment with prices triple those of the competition. The IBM chairs, tables and cabinets all feature controllers that are meshed into the main memories of IBM 370 cpu's.

announcement of its new virtual memory equipment. As the year wore on, Telex continued its suit and widened its charges. The case is expected to go to trial this year too.

Sluggish progress

The Justice Dept. has shown very real signs of being bogged down in its case and, indeed, transcripts from pre-trial proceedings in the U.S. Federal District Court in New York are riddled with statements by Justice Dept. attorneys saying they don't understand the computer industry. Nor has the snail's pace been pushed forward by complicated ancillary issues—such as a flap over restrictive press coverage—which have tended to delay it. But Judge David N. Edelstein, who is presiding over the case, is believed to be pressing for a trial later this year. The judge, who also negotiated the 1956 Consent Decree in the Justice Dept.'s previous antitrust case against IBM, dimmed chances for a Consent Decree settlement when he said the case would go to trial.

National politics bubbled around the case. At one point last year, an IBM attorney said the case was a "political football." The case was filed on the last day of the Democratic

Johnson administration, while on the other hand IBM's two Watson brothers—Thomas Jr. and Arthur—are ardent supporters and financial backers of Republican President Richard Nixon. Some have read political implications into both facts.

There were rumblings in 1972 that the days of the monstrous central computer were numbered, giving way to "distributed" computing and the increased use of minicomputers in distributed networks. Said the Navy's Cmdr. Grace Hopper: managements who still want to think they have a big computer should install "a big gray wall and flashing lights."

The trend, if there is one, was reflected in a flurry of maneuverings in the world of computer communications. One was the continuing battle for government authorization to connect independently-made equipment to the telephone company's dial-up network, as independent communications equipment makers tried to break what they claim is Ma Bell's long-established monopoly position in the terminal market.

AT&T won a victory last July when it was allowed by the Federal Communications Commission (FCC) to impose new charges for data sets, con-

necting arrangements, multiplexors and related facilities. Some rates were increased and some were decreased, but the net effect was to make Bell terminal equipment economically more attractive compared to the independent manufacturers' offerings. The independent Data Communications Manufacturers Association said AT&T was artificially lowering prices on its competitive offerings and making it up by hiking prices on the non-competitive offerings. An FCC hearing on the complaint probably will begin this year.

New blood

It was a startup year for the specialized common carriers. Datran, the subsidiary of University Computing Co., won FCC approval to build the first portion of its projected nationwide switched network, and MCI received a green light to expand its Chicago-St. Louis system—eastward to Boston, New York and Washington, and westward to Dallas, Denver and Minneapolis. The approved routes cover about 4,500 miles, roughly one-third of MCI's planned network. But both MCI and Datran have had to scratch for capital—a good deal of it is coming from abroad in each case—

June

The National Computer Conference opens with a surprise visit by President Richard Nixon. In commemoration of the event, the President proclaims "National Computer Week" and voices his admiration for the marvels of computer technology. At the show, a computer overcharges President Nixon \$19,098.56 for his show ticket; a computerized baggage system loses his baggage; and a special computerized election return system reveals that Senator George McGovern won the last Presidential election by a landslide. In the meantime, Presidential aide Henry Kissinger experiments with a computerized dating service at the show and is matched up with Phyllis Diller.

July

White House press secretary Ronald Ziegler announces the receipt of 350 abacuses from the People's Republic of China to replace all White House computers, which have been donated to the Smithsonian Institution.

August

IBM files suit to enjoin Xerox salesmen from referring to Xerox com-

puters as IBM machines. A few hours later, an angry Xerox counters by filing a suit against IBM to enjoin its salesmen from referring to IBM office copiers as Xerox machines.

September

New York's Off-Track Betting Corp. announces that its software contractors have ironed out all the bugs in the system. At the festive announcement, preceded by a ticker tape parade on Fifth Avenue and punctuated by the popping of champagne corks, the Off-Track Betting Corp. says that the system will be proven the next day, the last racing day of the season at Aqueduct. That night, New York experiences unseasonably heavy snows and the next day New York is paralyzed, thousands are left without power and telephone services and hundreds of events are canceled including the last day of racing at Aqueduct.

October

H. Ross Perot, head of Electronic Data Systems, appears at a computer trade show sporting a bushy handlebar moustache, shoulder

length hair and a wide lapel suit. The following day, the stock of Electronic Data Systems drops 20 points and several customers cancel contracts with EDS.

November

A clean-shaven, crew-cutted H. Ross Perot wearing a three-piece blue serge suit with white socks addresses a group of Wall Street securities analysts. The following day, Electronic Data Systems' stock climbs 25 points and Perot announces the receipt of a clutch of big new orders.

December

The first annual meeting of the users' groups of General Electric, Viatron and RCA computers is held on the Steel Pier in Atlantic City. Members are required to arrive in either an Edsel or a Studebaker or, for those traveling by train, by Penn Central. The dinner is catered by Bon Vivant Foods and is served with cyclamate-flavored soft drinks. Guest speaker Dita Beard is presented a pair of Corfam shoes as a memento of the event. □

General Electric's answer
to costly volume data traffic



The new TermiNet* 1200 Printer

120 characters per second
Replaces 12 conventional printers
Reduces operator costs
Reduces line costs

Moving high volumes of data in your communication system with conventional printers creates unnecessary costs. Equipment costs. Operator costs. Line costs.

General Electric's new TermiNet 1200 prints 120 characters per second and transmits 1200 baud rates. You reduce operator costs because you can handle the same data load as 12 conventional printers. You save on equipment costs. And, 1200 baud transmission optimizes the use of public and private lines. More efficient transmission means time and money saved.

The same engineering and manufacturing technology that made the TermiNet 300 printer (10, 20, 30 cps) so successful is built into the TermiNet 1200 printer, and at only a 30% increase in price. Most options are interchangeable and no extra operator training is required.

Find out more about General Electric's answer to efficiently moving high volumes of data — the TermiNet 1200 printer. Write Data Communication Products Department, Section 794-05, P. O. Box 4197, Lynchburg, Virginia 24502.

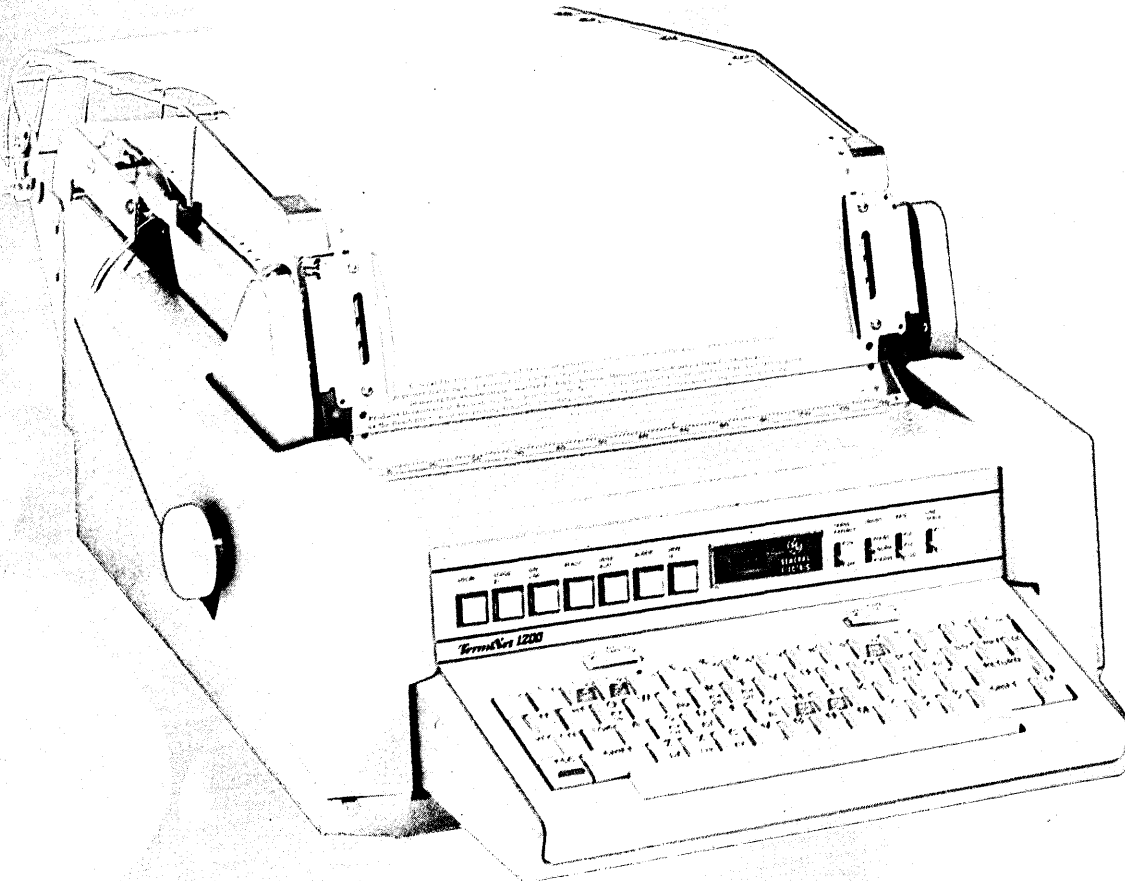

GENERAL  ELECTRIC

CIRCLE 36 ON READER CARD

1972: Battle Lines

and it still isn't clear whether they will raise enough money to realize their present plans without some slippage and/or shrinkage.

The specialized carriers were also threatened by rate competition from the established suppliers. Western Union had already been allowed by the FCC to impose new rates between Chicago and St. Louis, matching those of MCI. And AT&T clearly was getting ready to launch a similar attack. Late in 1972, the phone company received FCC permission to build the first portion of its long-heralded digital data system (DDS), which will provide point-to-point service initially—competing with MCI—and switched service later, in competition with Datran. Bell has been authorized in effect to price the new service competitively, and has made it clear it interprets this to mean rates based on “incremental” costs. The specialized carriers insist that “fully allocated” costs should be used instead. This scheme would produce significantly higher rates. A full-scale battle over these two concepts is likely in 1973.

Other Events in 1972

Mainframers: IBM again had a new top man—Frank T. Cary, named chairman on the last day of the year, succeeding T. Vinson Learson. Univac—once the No. 1 in computers—became firmly entrenched as No. 2, retaining more than 90% of the RCA customer base it acquired a year ago. Burroughs threatened IBM's lower end market with the highly versatile B 1700. In Minneapolis, Control Data Corp. skidded to a virtual halt in large computer systems. It lost an order from General Motors for the big STAR 100 computer, lost the STAR czar James E. Thornton, who took a sabbatical, and said goodbye to Seymour Cray, the reclusive genius of Chippewa Falls, Wisc. National Cash Register named a new president, William S. Anderson, and launched a joint venture peripherals company with CDC. Xerox retired the name “Xerox Data Systems” in a fast shuffle last spring, then purchased Diablo to enter the printer business and possibly the type-writer market as well.

The independents: The Computer Industry Association of some eight companies was formed in July, headed by ex-XDS president Dan McGurk and aimed at finding a way to solve the problem of IBM's dominance of the computer peripherals industry. ITEL took IBM to court and won an out-

of-court concession when IBM threatened to stop maintenance of systems that had been modified to use add-on memories supplied by independents. The add-on memory business—at least in the 360 market—seemed to thrive, with Data Recall continuing as the front-runner. CDC entered the market, buying a third of Fabri-Tek's production. A fire sale on 360/65s coming off lease attracted a horde of smart buyers who combined the power of the machine with independently-supplied memories to bridge the gap between IBM's 155s and 165s and the availability of 158 and 168 virtual machines. Memorex jumped into the mainframe business. Other independents formed “total system” leasing companies, offering 360s and 370s and their own peripherals. At year-end other independents were seriously looking at this approach and some thought of making their own mainframes.

Marketing: IBM, with its virtual memory system, took another whack at competing independents by making 512K of memory unreplaceable, and forcing disc suppliers to come up with a controller to handle 16 disc spindles in competition with IBM's controller that was part of the cpu. Customers who purchased 155 and 165 systems were whacked with penalties of \$250K to \$500K to move up to virtual systems.

Measurement: It became fashionable to measure computer performance. The Fall Joint Computer Conference scheduled some 30 papers on the subject. The government gave the science its blessing, publishing a General Accounting Office report which

said federal dp costs could be cut “several million dollars a year” if performance measurement tools were used more extensively.

Professional Societies: They appeared to be in financial trouble. The retiring president of ACM wondered why only 10% of those in the computer profession who qualified to be ACMers were actually paid members. Attendance and exhibitor interest in the joint computer conferences—a large source of income for the societies—began to wane. The semi-annual JCCs were to be replaced with a single conference and show this June in New York.

Standards: Standards efforts continued to be dominated by the manufacturers to the frustration of users. It could be an even more confusing issue if IBM is broken up, giving users three or four more computer companies, each claiming theirs is THE standard.

Software: The Supreme Court said software was unpatentable, turning the issue over to Congress. Software was an “intangible” that couldn't be claimed as a capital investment for federal tax relief, yet in California it was adjudged a “tangible” on which a property tax was to be levied. Users kept their eye on the California issue where a battle raged over the kinds of software that can be taxed.

The People: Scattered attempts to organize dp people into unions were evident. Brian Cunningham, the IBMer in San Jose who was trying to organize fellow workers, left the company for a law firm. George King tried to form a company union in Alabama. He's no longer with IBM. □

Technology 1972: Faster Than the Naked Eye

1972 was the only year, in our memory, that the data processing industry ever understated its achievements. Maybe the downhill run of the computer recession made judgments more deliberate. But most people just didn't get excited about an Intel production line that turned out thousands of 4-bit and 8-bit computers on chips, or about real live deliveries of laser holographic memories, or even about “another moonlanding.”

Yet 1972 was an important year. It was the year that some of the things promised long ago were delivered. No, we didn't get Frank Marchuk's laser computer, or even the Control Data STAR supercomputer. But we did get the world's first ILLIAC IV from Burroughs, a machine so powerful that it noticeably affected the sum of the

world's computing resources when installed at NASA's Ames Research Center in Mountain View, Calif. The first Ampex Terabit (trillion bit) tape memory went to another federal agency.

The first laser holographic memories were being tested: one as a demo system by Hitachi; another as part of a commercially available credit verification system by Optical Data Systems; and the most impressive of all, a 400,000-bit read-write version delivered almost secretly to a military agency by a midwest non-computer firm.

Other advanced memory systems were also coming along. North American Rockwell delivered a test copy of a magnetic domain “bubble” memory to the Air Force, and Monsanto of-

1972: Technology

ferred do-it-yourself bubble memory kits. IBM got its foot in the door with a patent for bubble sensors, and Bell Labs with a patent for growing the stuff they build bubbles out of. Cambridge Memories was already offering to deliver a related technology called DOTRAM. All of them were spurred by market projections of \$1 billion by 1980.

Ovonic Memories was not able to produce the super-dense storage medium based on Stanford Ovshinsky's "rusty nail" effect, but in trying to do it they developed a way to store data on regular discs at three times IBM's best packing density. So the company changed its name and started selling that instead.

Continuing to think small, we learned that minicomputers are not the low end of the computer line. Calculators are. New technologies began to show up first in these tiniest of devices, including chip-computers in H-P's 9-ounce trig and log function model, and also liquid crystal displays in North American Rockwell's.

In communications, a laser data set capable of 1.54 megabit transmissions was offered, and Hughes Aircraft researchers built one that could send even through fog (or smog?). An Argonne Labs systems used muons (light nuclear particles) instead of lasers; it could even send through concrete.

1972 also saw the 10th birthday of the installation of the Burroughs 5000 virtual memory computer, and IBM beat that anniversary by only a few weeks in announcing its own Virtual Storage systems. Although not among the first to offer the technology, the big company opened the capability to far more people than it had ever been previously available. Remember, they weren't first with computers either. IBM also showed what looked like the first part of a new computer line in the "satellite processors" architecture of the 370/125.

Meanwhile Burroughs—maybe 10 years ahead again—offered a new computer line, the B1700, that had bit-addressable memory. It also had variable micrologic that allowed it to switch machine states several hundred times a second—becoming an "ideal" COBOL machine for a moment, then maybe an "ideal" FORTRAN engine a few microseconds later.

That air traffic control system so long contested by the FAA and Raytheon, among others, was finally installed and working although not with real air traffic. Thought to be obsolete

before it was turned on, the IBM 360/65-based system had an immediate competitor in a 500-million-instruction-per-second supercomputer called STARAN from Goodyear (yep, the tire people).

In a more down-to-earth (bread and butter) application, a New Jersey firm called Threshold Technology developed a supermarket checkout system where the clerks simply spoke the prices of the items they were bagging. It was about the first voice response system that could understand more than just its master's voice.

Computer performance measurement also gained strongly in popularity, and at nearly the last minute a range of measurement and control units was announced by Tesdata that could not only determine what the computers were doing inefficiently, but could do something about it.

Some nearly predictable things did not come to pass, including the deaths of paper tape, the 80-column card, and those things called accounting machines. (Even with the advent of the System/3 and all the minicomputers, companies like Hewlett-Packard, Olivetti, and Monroe were

betting on supercalculators for people who were afraid to have real computers.)

Some things we didn't get were peripheral file managers (auxiliary processors that manage disc, drum and tape resources), and content addressable memory (although Goodyear's STARAN seemed very, very close).

We didn't see much in the way of new languages or data base management software breakthroughs (some vendors may disagree with that statement, obviously), but the CODASYL Data Base Task Group did come up with a set of recommendations that may yet lead to working DBMS systems.

1972 was a very good year (in spite of Sinatra's retirement). If we have trouble seeing what the most important developments were, we can sympathize with Congress in its establishment of an Office of Technology Assessment. We may have to develop many more groups like that before we can really appreciate—and again be excited by—the rapid advances being made.

—Richard A. McLaughlin

The 1972 International Scene

The world looked on while the Justice Department and the press struggled with the IBM antitrust case. Major industrial nations were interested because they each have a giant problem: how to develop a successful indigenous computer industry without IBM-like resources.

The European Economic Community began to develop its technological policy and even made antitrust moves affecting multinationals in other industries, but there was no indication that it is considering legal curbs against IBM itself. Instead it set about to encourage partnerships among companies—such as that of Siemens-Philips-CIL—and to make sure that Common Market and national procurement policies favored the home-grown company.

Germany's Siemens, Netherlands' Philips, and France's CII diligently worked through the year to detail their cooperative plan for an IBM-compatible line. No public pronouncement had been made at this writing, but reports said that Philips would make the small machine in the line, CII would produce a medium-scale and large-scale system, and Siemens would develop a second medium-scale system. Too, we heard there would be three operating systems. It all smacks of coordination problems the magnitude of the French-English Concorde, but we anxiously

await reassuring details on money, managers, and machines.

ICL changed its face by bringing in ex-IBM'er Thomas Hudson and ex-Univac executive Geoffrey Cross at the one and two spots to revamp the frayed organization. But it didn't change its mind: it haughtily maintained its distance from the new European triumvirate because it just doesn't want to be IBM-compatible. At year end, however, the door for discussion was reopened by the governments of the U.K., Germany, France and Holland. They agreed to computer talks on both the national and manufacturer level.

Japan, which has the best articulated plan for an information society, decided in 1972 that its six computer manufacturers were just too many for survival and urged them into three partnerships: Hitachi and Fujitsu, Nippon Electric and Toshiba, and Oki and Mitsubishi. These companies have not really merged, however, but are just talking plans for the future.

Two industry spokesmen saw chances for competitive survival differently: Dr. H.R.J. Grosch forecast doom by 1980 for most manufacturers of Japan, Europe and the U.S. unless they banded together as a consortium with competitive lines, a la General Motors, to stave off the monolithic

(Continued on page 122)



Cynthia Jose is working on your software. On our payroll.

Cynthia Jose works on Operating Systems – the systems you use to develop your applications programs on our Nova computers.

The better they are, the faster and cheaper you're going to get your system up and running.

That's why we have our best people working on them.

That's why we've just announced three major extensions that make our powerful Real-time Disc Operating System even more effective.

First, we've made RDOS a foreground/background system, so

you can work on new applications without interrupting on-going jobs.

Second, we've made it a multi-partitioning system, to let you use memory resources very flexibly.

Third, we've made it so that two processors can share a disc, for backup and a common data base.

The new RDOS still supports all our system software (including Macro Assembler, Extended FORTRAN IV, and Extended ALGOL) and our peripherals (including discs, mag tapes, cassettes, and communications interfaces and terminals).

If you don't need RDOS now, we have compatible Operating Systems for smaller configurations.

The one that runs in your Nova computer is available for that system. Free.

For more information on the Operating Systems, contact Data General, Southboro, Mass. 01772, (617) 485-9100.

 **DATA GENERAL**
Southboro, Massachusetts 01772

CIRCLE 20 ON READER CARD

You're right.

**Retiring
an old friend
should never be a
hasty decision.**

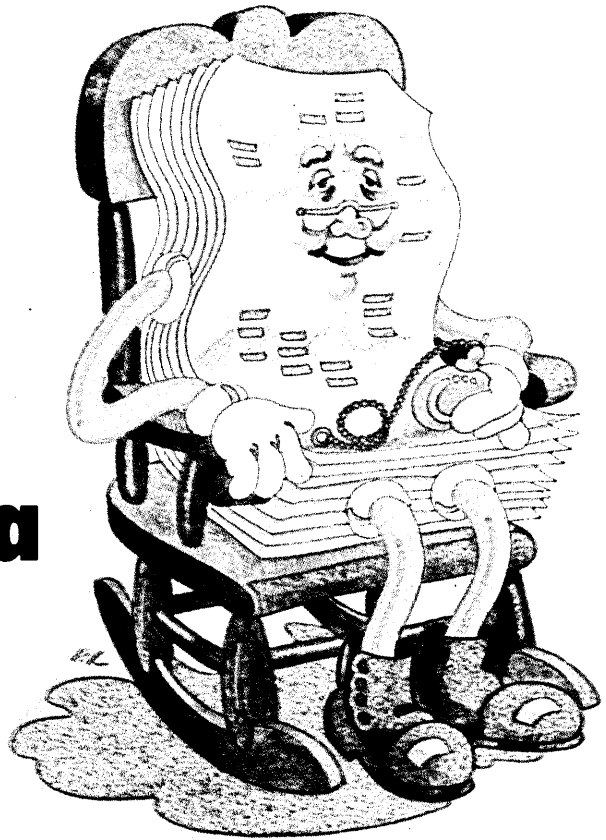

You're used to the punch card and its pokey, unbending ways. People have been adapting data to it longer than you or your computer have been around:

But right there is the real Achilles heel. Everybody's data just isn't the same as two cards in a punch.

We saw that early on, as well as the greater throughput you can get with key-to-tape.

Mohawk Data started with the stand-alone Data Recorder, and we've never stopped teaming it with options.

We pioneered cluster key-to-tape systems.

We went on to key-to-disk with tutorial CRT display in our System 2400.

Point is, today we're the only supplier who has all the options key-to-tape.

We've got choice, not a challenge.

Instead of force-fitting you to a single line of hardware, we've got all the hardware to tailor a system to you. Your documents, your volume, your locations, all the formats you need.

So take the time to hear your options.

After all, you're after the most in throughput with the least in equipment, people and space. We became the Peripheral Power by showing an awful lot of people how.

Call our nearest sales office. Or write for our new brochure that describes a choice, not a challenge.

Mohawk Data Sciences Corp.,
World Headquarters, Utica, N. Y. 13503.

CIRCLE 24 ON READER CARD

MS.

The Peripheral Power



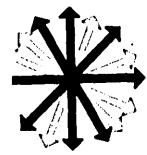

News in Perspective

All sorts of concessions show up in the new Federal Supply Schedule (page 101). Four mainframers agree to allow the government to add "foreign" peripherals to leased systems and to provide the related technical information. IBM will provide increased maintenance on third-party leases. GSA drops its stringent liability clause...

A user says a programmer's efficiency is increased two to five times when he uses IBM's PL/I. Yet, this slow, fat, hard-to-learn, not-standardized language is used by only a few. But, what these few have to say about it (page 103) would indicate that predictions of its death by 1977 are highly exaggerated...

Western Union was expected to drop a bombshell on the "interconnection" issue with a new tariff being prepared last month by the big communications carrier (page 105). Although WU won't comment, it's learned the company was preparing to significantly liberalize interconnection terms to its customers who utilize independently supplied terminals...

An accident last fall on San Francisco's Bay Area Rapid Transit System (BART) seemed, at first, to be traceable to a computer error. Here's a report explaining how the accident happened and that the system is not computer-controlled, only computer supervised (page 108).

Conferences

The Fall Joint: Deals, Frisbees And Users Restless for Answers

On the last day of the Fall Joint Computer Conference, held Dec. 5-7 in Anaheim, Calif., the general conference chairman Robert Spinrad received a hasty summons to an "emergency" meeting of the conference steering committee. He entered the meeting room to a barrage of foam rubber "frisbees" thrown by members of his boisterously happy committee. They had just received word that the last of the joints had comfortably exceeded the attendance goal of 20,000.

Later that evening when the committee gathered again in a hotel near Disneyland to present Spinrad with the chairman's present—a Mickey Mouse alarm clock—someone noted the contrast between the friendly frisbee attack this year and the brickbats and epitaphs hurled at organizers of the three recent recession-ridden affairs. Poor attendance and waning exhibitor interest forced the sponsoring American Federation of Information Processing Societies to replace the twice-a-year conference with one National Computer Conference, the first to be held June 4-8 in New York's Coliseum.

So high was their exuberance with the Anaheim event that AFIPS predicted at a press briefing that the New York show would draw 30,000 to 50,000 qualified people. The 21,096 who turned out in Anaheim—a large mix of users and original equipment manufacturers who were in a serious mood to buy—delighted virtually all of the exhibiting companies. And they kept coming. "On the last day of most previous shows, you could shoot a cannon down the aisles," said Bill Wiesman, product manager of Electronic Engineering Co. of Calif., which makes paper tape readers. "This year they were four-deep in front of our booth right up to when the lights began blinking at closing time." Based on a solid demand for new paper tape applications, which it discovered from people at the exhibit, Wiesman said EECO is going to develop a new reader.

It was a conference of transition—transition from two annual events to the one, from a recession to a healthier economy, from a designer-oriented affair to one that was user-oriented. It was oriented to the use who was set-

tling down to make his systems work for him, rather than to the man who is interested in moving up to the next bigger, faster box. There were six sessions on computer performance measurement and several more that stressed system reliability and availability.

Even the far-out sounding session, "Impact of New Technology on Architecture," concerned itself in part with self-testing and repairing machines. And one of the speakers at that session, R. B. Conn, seemed to reflect the mood of users when he complained: "We still try to solve all problems with hardware technology, doing every little in software technology. The tools I use to debug and test programs are virtually the same as what we had in the mid-'50s. I would like to see the user thought of more intensely."

Anxious for solutions

The user seemed restless for solutions at the conference and impatient when these weren't forthcoming. A session on "User Requirements of an Information System" opened with people standing along the wall on three sides of the 1,200-capacity room. By the time it was over, the room was half full. It seemed to be a session which posed problems but really didn't offer solutions. It was generally agreed that defining and identifying user requirements prior to the design of an information system is highly desirable, but no clear way to do this emerged.

Dan Teichroew of the Univ. of Michigan suggested there is a need for a Problem Statement Language and for different sets of languages for different stages of the process of developing an information system. John Farquar of Rand Corp. wondered how we define the information that a manager needs. Then he stated: "We can't do it right now because generally there are several different users and each has a different decision-making style." He said many of today's systems do not necessarily make for better decisions, only faster decisions, and it can be more damaging to make bad decisions fast than bad decisions slowly. "Information requirements should push technology . . . management information systems must necessarily be adaptive

systems."

Tom Hagenstock of the General Accounting Office, who is working on a study for Congress, said his group follows a three-step method to identify user needs. First step is research on their own; second is interviews with users; and the third is projections based on the first two. He pointed out that it is important to identify actual users—that the decision makers are not necessarily the system users, as in the case of Congressmen who rely on their staffs, who are the real users. In the interview portion of his three-step approach, he noted there is an inherent danger when the interviewed user often translates the question "what are your information needs" into "what are your informational needs which are unfulfilled right now," which "leads you into minor matters and you miss basic needs."

Measure what?

A theme of frustration ran through most of the performance measurement sessions: We agree that measurement is important; we just don't know what it is we should measure or how to use the measurements. Said Arnie Goodman of McDonnell-Douglas Astronautics: Measurement is "an art looking for a science." Richard Hamming of Bell Laboratories, who coined the term "compumetrics" in September of 1970, said "computer science may turn out to be closer to social science than physical science . . . it may never be a firm science." Hamming spoke at a session on "System Performance." Goodman talked at the session, "Measurement of Computer Systems: Executive Viewpoints."

The problem seems to be that although measurement people have learned how to install and operate hardware and software monitors, they have not learned how to repeat their experiments and get the same results, or how to predict the performance of a new machine configuration, or how to compare the performance of two installations. Further, they become hopelessly entangled where multiple processors are concerned, and aren't sure at all what to do with virtual memory.

One session on measurement did stand out from the others—"Case Studies," chaired by Jack Van Paddenburg of North American Rockwell. Included in the presentation of real case histories involving measurement were: (1) a study of an overloaded machine did not justify new equipment as expected; (2) a detailed set of measurement experiments defined but never carried out (they found an easier way to configure the machine that did not involve measurement); (3) a case

where the measurement people still don't know why their management is getting a newer, bigger machine.

Conclusions from the measurement sessions: "Don't benchmark if you can avoid it" (J. C. Strauss, Washington Univ.); "Measuring to prove a hypothesis is a good way to go, but not the reverse" (Robert L. Patrick, computer specialist); and "Configuring a machine to handle a given workload is not within the state of the art" (also Patrick).

Sessions that were added to the conference to attract dp people in banking, medicine, and manufacturing drew a mixed attendance. There were some 600 persons at a conference on computers in banking and the electronic payments mechanism, while a session on computers in medicine and health care drew an ambulatory crowd with the attendance fluctuating during the day from 75 to 150. Some 300 turned out for the manufacturing sessions.

It appeared to be the consensus of both speakers and attendees at the banking talks that widespread use of electronic payments mechanisms, encompassing both banks and retailers, is coming faster than most people realize, but not because banks are about to strangle on mountains of paper. "The banking industry is not in trouble," said Russell Fenwick, vice president, planning, Bank of America.

"Demand deposit accounting is not going to blow up," said John Reed, executive vice president, First National City Bank, New York. "The driving force in changing the payment mechanism is the competitive drive for market share." Reed made a strong case for preserving competition among banks as payment mechanisms undergo change. "There is nothing wrong with a number of banks getting together on one system," he said, "but no one market should be without alternative systems."

The session's luncheon speaker, Donald I. Baker, director of policy

planning with the Justice Dept's Antitrust Div., also was interested in preserving the competitiveness of the banking industry as it moves "into the age of the computer." "I view with particular skepticism," he said, "the argument, often heard, that a clearly anticompetitive merger proposal is necessary to optimize the applicant's computer operation." He advocated instead as a means of bringing economies of scale in computation to all of banking joint computer centers, and joint systems such as have been set up by banks for credit card processing.

Most of the panelists made the point that public acceptance is a stumbling block in the path toward total automation of banking. Said George Mitchell of the Federal Reserve System: "We are going to need a little muscle and a lot of persuasion."

At the medical sessions, the speakers didn't seem sure just who was there. Sometimes they seemed to be directing their remarks to medical people who had only recently heard about these things, and other times they addressed "you of the data processing industry." The question-and-answer session made it clear—again—that some doctors, especially internists, are reluctant to accept any of the shortcuts offered by the computer people. The overworked nurses, however, are the computer vendor's best friend.

Goodyear's Staran computer, generally considered to be an air traffic controller, turned out to be excellent at handling *commercial* data processing, according to a presentation by the company at a session on supercomputers attended by some 800. In an example of personnel file application, implemented in a language that looked easier than BASIC, Goodyear explained how the machine can process unordered data, make searches with complex constraints, and process the answers with terrific speed—all without file structures as we know them and without file management

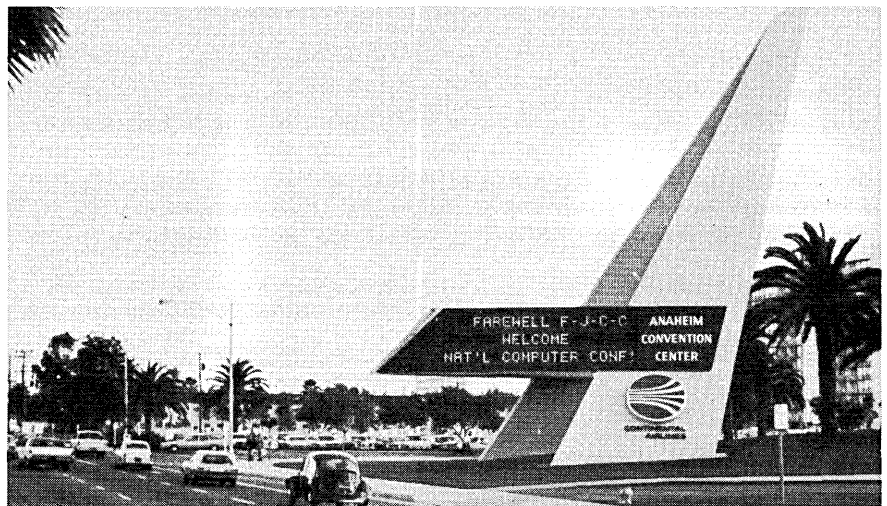



Hewlett-Packard Series 9800. The Name And Number That'll Shorten Your Path From Concept To Final Solution.

Get your hands on a Series 9800 Calculator System and you'll experience why it's the shortest, simplest path. From the outset you're certain to notice four outstanding features.

The modular, *plug-in architecture* that lets you design your own keyboard. The choice of *memories* that lets you pick the capacity you need today—with room to grow for tomorrow. The extensive line of Series 9800 *Peripherals* that lets you handle data in the form best for your operation. And the *instrument interface* that lets you plug in test instruments for real-time data acquisition.

But one Series 9800 feature really stands out. *Conversation*. Our calculators "speak" English, German, French, Italian, Spanish — even Japanese. In complete words and sentences, and scientific symbols. To solve a problem you set up a dialogue with your 9800 Calculator. Talk to it through the key-



board. It talks back to you through its exclusive alphanumeric printer (and display on some models).

That's the idea. Here's the payoff. On the left is a typical equation solved with the HP Alpha Printer. On the right, the same equation solved without alpha.

SOLUTION TO QUADRATIC EQUATION OF THE FORM 2 $AX^2+BX+C=0$	1.000*
ENTER A=	1.000*
ENTER B= 1.000*	-0.500 -0.866
ENTER C= 1.000*	-0.500 0.866
COMPLEX ROOTS REAL PART=	
-0.500	
IMAGINARY PART=	
0.866	

The benefits? Instant verification of your program and input data. Positive

identification of each portion of your solution. And the confidence that you can send data to your colleagues and have them understand it.

Moreover, with these easy-to-comprehend user instructions, your assistants can confidently and reliably operate a 9800 Calculator with no computer training whatsoever.

Series 9800 users in science, engineering, medicine, and business have been telling us this silent, built-in "mini-typewriter" is the greatest boon to problem solving since the invention of the electronic calculator. (Note: If you need the formatting versatility of a full-fledged typewriter, we offer one of those. Also with complete Alphanumerics.)

This Printer is but one example of the technology that's enabled us to offer the widest and most exciting line of computing alternatives in the scientific com-

munity. Today, our line starts with the dynamic Model 35 Calculator—a shirt-pocket size electronic super slide rule. Goes to our Series 9800 Programmable Calculators. To our 2100 Minicomputer family. On through to our System 3000, a multi-lingual, multi-programming computer.

The shortest, simplest path? We'll send you maps in the form of definitive literature. Or we'll be happy to guide you with a demonstration of the Series 9800—right at your desk. Call your HP Sales Office. Or write: Hewlett-Packard, P.O. Box 301, Loveland, Colorado 80537. In Europe: P.O. Box 85, CH-1217 Meyrin 2, Geneva, Switzerland.

092/6

HEWLETT  PACKARD

HP sales, service, and support in 172 cities in 65 countries.
For more information, circle reader service no. 40.
For a demonstration, circle reader service no. 41.
For information on the HP-35, circle reader service no. 42.

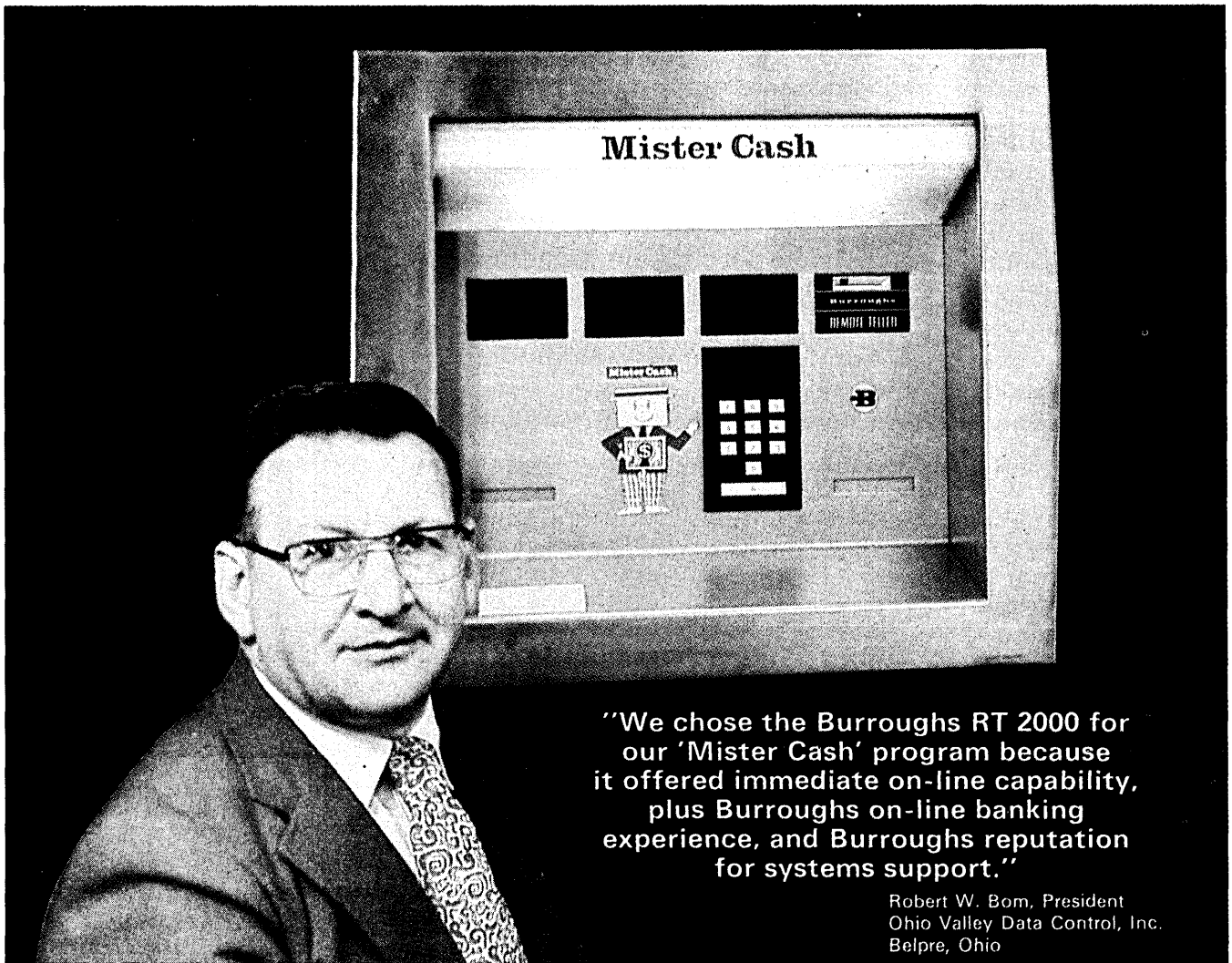

"We chose the Burroughs RT 2000 for our 'Mister Cash' program because it offered immediate on-line capability, plus Burroughs on-line banking experience, and Burroughs reputation for systems support."

Robert W. Bom, President
Ohio Valley Data Control, Inc.
Belpre, Ohio

ON-LINE CASH DISPENSING

While others are still talking about it- Burroughs RT 2000's are doing it!

"Our 'MISTER CASH' program is the first cash dispensing system in the world known to be operating on-line to a central computer," states Mr. Bom. "Right now, in several West Virginia cities, Burroughs RT 2000 Remote Teller Systems are dispensing cash 24 hours a day, seven days a week to customers of five different banks. Simultaneously, their memo DDA files are being updated in our Burroughs B 3500 computer located in Belpre, Ohio.

"Because we employ an area-wide bank interchange concept, participating banks are getting their first taste of an electronic funds transfer system (EFTS). They like it. And their customers

do too because they can go to ANY of the participating banks' 'MISTER CASH' terminals to obtain cash.

"With the security, accuracy and customer appeal offered by the Burroughs RT 2000 System, we're planning to extend the scope of the 'MISTER CASH' program to many other banks throughout West Virginia and Ohio."

What's happening in West Virginia could be happening in your area. Call your Burroughs Representative so he can tell you about Burroughs Remote Teller Systems.



overhead. The presentation even received an accolade from outspoken computer consumer advocate Herb Grosch of the National Bureau of Standards. Restating his conviction that all conventional data processing will be overturned by 1976, Grosch called the Staran concept "revolutionary."

Grosch's presence was felt throughout the conference. He wrote off the designers of low-priced microprocessors as "mad tool artists looking for something to make . . . scouring the face of the earth for users to take what is made, not what he needs." Virtual memory was "a conscious attempt to screw the customer." Computer technology should allow us "to be doing things ten thousands times more cheaply than we did a decade ago . . . but it still takes all morning to put out the payroll." Grosch agreed with Walter F. Bauer at a session on historical perspectives "that nothing has happened in software development for 10 years." He barged into a press conference given by Anthony Oettinger, the luncheon speaker, to engage in an argument over the National Academy of Science's right to represent the computer community in government and was told by the Harvard professor to "go to journalism school."

Meanwhile, down on the floor of the exhibit hall, there was a kind of excitement that had been missed at recent JCCs. Courier Terminal Systems of Phoenix signed an order for six multistation terminal systems at its booth. A man from the Dept. of Agriculture said his organization was getting ready to place an order for 160 computers. Financially troubled Ampex Corp. said it would meet its current bank installment payment by a comfortable \$5 million margin and took a large, gaudily decorated island booth with a puppet show to advertise the solvency of its Computer Products Div. General Automation displayed a mincomputer-based automobile test system and then gave away the car (a Honda) at the end of the conference. Control Data suddenly showed up as a last-minute entry to advertise its recently formed third-party maintenance operation, which claims seven customers.

Deals seemed to be going on everywhere. Tesdata and Computer Synectics announced their merger (and showed off a neat \$3,000 crt computer monitor). Vermont Research Corp.'s acquisition of OMI, the disc memory company, wasn't complete till halfway through the conference. Wangco, the Santa Monica builder of tape and disc

drives, distributed 1,000 twenty-cent foam discs which everyone soon discovered could be used as effective frisbees—as the delighted Robert Spinrad learned at that happy afternoon meeting.

Procurement

Mainframers, Feds Accept Concessions

IBM and Honeywell signed Federal Supply Schedules (FSS) contracts with the General Services Administration last month which may give independent peripheral makers a bigger slice of the federal market. Earlier, CDC and Univac signed similar agreements. The four contracts set prices and terms for much of the edp to be purchased by the feds in FY'73.

The government won the right, unilaterally, to add "foreign attachments"—independently made extension memories and other peripherals—to the systems leased from each of the four manufacturers, who also agreed to provide related technical information. This concession is intended to make federal dp systems procurement much more competitive. A user who wants to upgrade or expand his system hopefully will have a much greater choice of suppliers.

There were two other significant changes in the contract: IBM agreed to provide increased maintenance on its equipment when leased by federal agencies from third parties, and GSA dropped its demands that contractors assume unlimited liability for consequential damages.

IBM, CDC, Univac, and Honeywell supplied well over half of the \$511 million worth of hardware and software procured under last year's Federal Supply Schedule. Most of the rest came from Xerox, Burroughs, and NCR; they're still negotiating contracts for the current fiscal year.

The foreign attachment clause requires disclosure of "technical information" needed to permit substitution or addition of independently made equipment. But interface specs aren't specifically mentioned which may enable the manufacturers to withhold them. If they do, independent peripheral suppliers are sure to scream. This is because the foreign attachment clause won't bring them much additional business *unless* interface specs are disclosed.

The stakes in this battle are suggested by the protracted dispute be-

tween Burroughs and Sci-Tek, a Wilmington, Del., terminal developer (Nov. 1, '71, p. 50). Essentially, Sci-Tek wants to interface a newly developed RJE terminal directly to the I/O channel of the Burroughs 3500 being used by the Air Force to support its Phase II base level standardization system. Phase II is a worldwide network tying together some 300 sites.

Sci-Tek says its new terminal would save the taxpayers a lot of money and meet all Air Force requirements. Burroughs, which has a competing terminal, refuses to provide the interface specs, and the Air Force, so far, has gone along with Burroughs. The two suppliers are competing for a contract that may be worth \$9 million.

Burroughs hasn't yet signed a supply schedule contract for 1973, but a GSA source said last month he was "optimistic" that negotiations with all three of the major holdouts—Burroughs, Xerox, and NCR—would be completed within 60 days. Since four major suppliers have already agreed to the foreign attachments clause, Burroughs will have a hard time not doing likewise. The real question, though, is whether the "technical information" mentioned in that clause encompasses interface specs. The answer probably won't be known until later this year, when the Air Force releases a final rfp for the Phase II upgrade and decides whether Burroughs is obligated to provide the information sought by Sci-Tek.

Meanwhile, GSA's success in increasing IBM's maintenance of systems leased by the feds from third parties may enable independent lessors to win some new business from Uncle Sam. A leasing company spokesman says the new terms will lead to "a significant increase in business." Until now, he explains, IBM has provided only "commercial level" maintenance on its equipment when leased to the feds from third parties. Systems leased direct qualify for "government level maintenance," which includes a number of extra features. For example, IBM allows the "direct" customer a credit if his system is down 12 hours or more within any 24-hour period and guarantees that a technician will normally arrive within two hours after the user asks for help. Under the new FSS contract, the latter feature—but not the former—will be included in IBM's maintenance of systems leased to the Feds by third parties, said the spokesman. "We feel the gap hasn't been closed, but it has been narrowed significantly." Another factor that will help the independents get more federal business, he added, is GSA's plan to replace hundreds of IBM systems, now rented on a direct basis under 30-

Extend a little, replace a lot,

360 users get any size they want with Fabri-Tek 360 core.

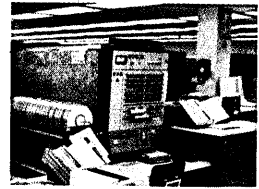

Model 65 — extended from
256K to 512K.
Western Airlines
Los Angeles, Calif.



Model 40 — extended from
32K to 384K.
University of South Dakota
Vermillion, South Dakota

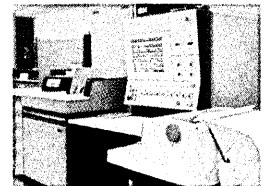

Model 22 — extended from 24K
to 64K.
United Farm Agency
Kansas City, Missouri

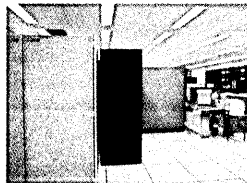

Model 50 — extended from
512K to 768K.
University of Wisconsin
Madison, Wisconsin



Model 30 — extended from
32K to 64K.
Chi., Mil., St. Paul & Pac. R.R.
Chicago, Illinois
Leased from Dearborn Leasing



Model 22 — extended from 32K
to 64K.
Computer Graphic Systems
Toronto, Ontario, Canada
Leased from Greyhound Leasing

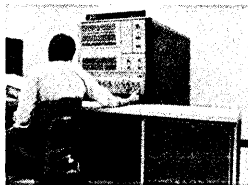

Model 30 — extended from 32K
to 64K.
Medtronic, Inc.
Minneapolis, Minnesota



Model 30 — extended from
64K to 128K.
American Broadcasting
Company
Hollywood, California



Model 30 — extended from 8K
to 64K.
Gant Shirtmakers
New Haven, Connecticut
Leased from Rockwood Leasing

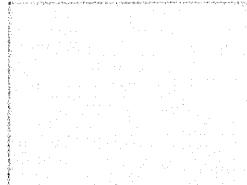

This could be your installation.
We've got any capacity you need.



Model 30 — extended from
64K to 128K.
XCS Management
Vancouver, British Columbia
Leased from National Computer Rental



Model 40 — extended from
64K to 128K.
Further expansion to 192K
planned
Graco, Minneapolis, Minnesota

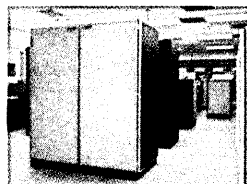

Model 50 — extended from
256K to 512K.
State Comp. Insurance Fund
San Francisco, California



Model 30 — extended from
64K to 96K.
Toronto School Board
Toronto, Ontario, Canada
Leased from Greyhound Leasing

To date, Fabri-Tek has over 150 installations of 360 extension memories. And, IBM has agreed to maintain all these CPU's which have been modified by the addition of Fabri-Tek extension core memories. For further information, call (612) 935-8811 or write FABRI-TEK INC., 5901 South County Road 18, Minneapolis, Minnesota 55436, leader in Memory Technology For Over A Decade.



FABRI-TEK.

360 CORE YOU CAN TRUST

FABRI-TEK SALES OFFICES

New England

Boston (Auburndale), Mass.
(617) 969-5077

Eastern

Stamford, Conn.
(203) 359-1315
Blue Bell, Pa.
(215) 643-6950
Pittsburgh, Pa.
(412) 391-6390
New York (Parsippany, N.J.)
(201) 263-2330
Rochester, N.Y.
(716) 586-1960

Southeastern

Miami (Melbourne), Fla.
(305) 724-0900
Washington, D.C. (Rosslyn, Va.)
(703) 525-6435
Atlanta, Ga.
(404) 457-0821

Midwestern

Chicago, Ill.
(312) 437-4116
Columbus, Ohio
(614) 262-7966
Minneapolis, Minn.
(Data Serv Equipment Co.)
(612) 546-4422
Kansas City, Mo.
(816) 531-4431
St. Louis, Mo.
(314) 721-0004

Central

Denver, Colo.
(303) 573-5535
Oklahoma City, Okla.
(405) 843-6444
Houston, Texas
(713) 772-7050
Dallas, Texas
(214) 233-0872
Salt Lake City, Utah
(801) 359-4594

Western

Phoenix, Ariz.
(602) 266-4448
San Francisco (Sunnyvale), Calif.
(408) 739-4780
Los Angeles (Long Beach), Calif.
(213) 420-2493
Seattle, Wash.
(Computer Supplies)
(206) 623-2413
Portland, Ore.
(Computer Supplies)
(503) 222-2006



January, 1973

news in perspective

day cancellation clauses with systems supplied by third parties (Nov., p. 215).

The new language regarding consequential damages represents a truce in a battle that has been raging, largely between IBM and GSA, for roughly the past year. Originally, GSA negotiators wanted the systems manufacturer to assume unlimited liability for consequential damages. They ended up with much more limited language developed originally for use in DOD procurement regulations. This language will remain in force only until next April 15. By then, a joint industry-government study group, formed to work out a final statement of contract reliability for consequential damages, is expected to finish its work. Their recommendations will be cranked into FY'74 FSS contracts.

—Phil Hirsch

Software

PL/I: Where Are You Now?

PL/I—slow, fat, hard to learn, not standardized, supported only by IBM, known in *all* its glory by an elite few. With this popular description, perpetuated by its large cadre of opponents, is there any wonder that PL/I use has only inched ahead as the years have passed?

Still, a worried European consultant writes us that IBM is telling its users there that PL/I is making great strides in the U.S. now. A DATAMATION user survey last year didn't provide much proof of that: Of 458 IBM 360 and 370 installations, PL/I was listed as a primary language in only 24 installations, or less than 5%. About 115 users said they were using PL/I, but most of these listed three or more languages.

We talked to users, nonusers, and standards makers to see if there was really anything new. A safe guess is that PL/I may not be dead by 1977, as Fred Gruenberger of California State Univ. at Northridge has publicly predicted. In fact, in the next two years, it should become more respectable than ever before. Even if it doesn't sweep COBOL and FORTRAN out of most installations as promised, it cannot help but increase in use.

One of the reasons is that it is well down the road toward standardization. All major modifications to the language have been made. American National Standards Institute committees are now working on language descrip-

tion. By year end, the final drafts for three standards—the full language, a large subset, and a process control subset—will be submitted to ANSI and the European Computer Manufacturers Assn. The International Standards Organization decided in December that it would base its standard on the full language draft. Users are predicting that conversion from PL/I to ANSI PL/I will be easier than COBOL to ANSI COBOL because of the improvements in the latest IBM compiler.

Enter the dwarfs

A second big reason is that the dwarfs are beginning to announce their own PL/I versions. One vendor, asked how big was the customer demand for PL/I, would only say "big enough to make us announce a compiler." Burroughs was the first to announce, late last year. Honeywell has had prerelease versions out for the 6000 series, with a generally available product due out "soon." Both those vendors, we're told, have stayed close to current draft standards. Control Data's PL/I is imminent, if not announced, by publication time. Univac has a private, experimental version.

The third reason for hope is that IBM's PL/I optimizer compiler (at \$250/month) has passed through its "first-year problems" and reportedly provides big improvements in execution speed and efficiency over the PL/I F (version 5) compiler. Some of its users were reticent to part with benchmark test data, but one noted that he found it, for his applications, equal in speed to FORTRAN H and winner "hands down" over COBOL for input/output tasks.

IBM's figures say that cpu time in execution of a sample of scientifically oriented programs was 50% less with the optimizer than with PL/I F. Savings on individual programs ranged from 10-60%. For a sample of commercially oriented programs, execution time was 30% less, with an individual program savings range of 20-35%.

At universities, where compile time is critical to the cost of student jobs, IBM's sluggish PL/I products were prohibitively expensive. Cornell Univ.'s version, PL/C, however, has successfully tackled that problem, and tests show it to be several times faster than the F version and the optimizer. It is doing for PL/I "what WATFIVE from the Univ. of Waterloo did for FORTRAN," we're told. At \$1500 a copy, it's been sold to 90-100 universities and companies.

With these relatively new compilers, standards prospects, and the dwarfs'

news in perspective

participation, there are now, or will be, a few chinks in the old arguments against PL/I. Save this, the proponents are just as rabid, the opponents just as opposed as they were before.

The alternatives

Howard Bromberg, president of Information Management Inc., maintains that whatever is coming, COBOL still has the advantages of more programmers who know it, more subroutines and utility programs available from a variety of sources, more literature and education courses to support it. It has a long-standing on-going development group. From another angle, even if PL/I may be technically better for data base management than COBOL, there is still no development for PL/I in any data base standards development. CODASYL's controversial Data Base Task Group effort picked COBOL for its first data description and manipulation language specifications, so it has a jump in time—again.

The State of West Virginia is symbolic of two PL/I roadblocks. Two of its departments were using PL/I for new program development. But then it centralized the data processing of its

36 departments and adopted ANSI COBOL as the state language. Clifford Ramsey, manager of hardware and software systems, noted that most state departments are involved with their federal counterparts and receive applications packages from them—written in the federally adopted ANSI COBOL. Further, he points out that their centralization effort is under the gun to show results, so using PL/I and being locked into IBM equipment now would prevent them from seeking cost-saving alternatives.

Another oft-stated problem is training. A manager from a large insurance company feels that while PL/I is not difficult for a computer professional to learn, the "armies of COBOL programmers financial institutions hire just can't learn PL/I well enough to justify the conversion—and don't want to." What's a professional? "The kind of programmer that reads programming books and manuals and computer magazines, joins professional societies and user groups, and doesn't consider himself a nine-to-five coder."

Dr. Martin Solomon, director of the Univ. of Kentucky computer center, put it another way: "He's the kind of

programmer who reads the manual while shaving." Solomon's written a book on PL/I for beginners, *Eight Statement PL/C (PL/ZERO) Plus PL/I*, and he wouldn't write a program in any other language. But he won't allow his small staff to switch from COBOL. "Programming is less than half what they do, so why should I take proficient programmers and make them trainees in PL/I?" PL/I, he says, "doesn't offer nearly the advantages to offset the additional costs in computer time, training, and reliability."

Hard to learn?

Prof. Gerald Weinberg, State Univ. of New York at Binghamton, rebuts the idea that PL/I is hard to learn, "if it's taught properly." (He's the author of *PL/I Programming: A Manual of Style*.) Very basically, that means teaching it in stages, allowing the student to stop and program for a time at each succeeding level. Eastman Kodak, which uses PL/I as the corporate language, uses this philosophy in training.

Weinberg regards PL/I as the preferred language for education, because "it encompasses more of the ideas of computing than any other language" and prepares the student best to learn other languages. (Some feel there will

The OpScan[®] 17 reads hand print

Rents for less than \$308 a month

This new concept scanner reads hand-print or machine-printed numerics. And ordinary pencil marks as well.

It's a money saving machine! Ready now to read your source documents for computer processing at a cost so low it's hard to believe. \$308 a month is the maximum rental price. You may well pay less.

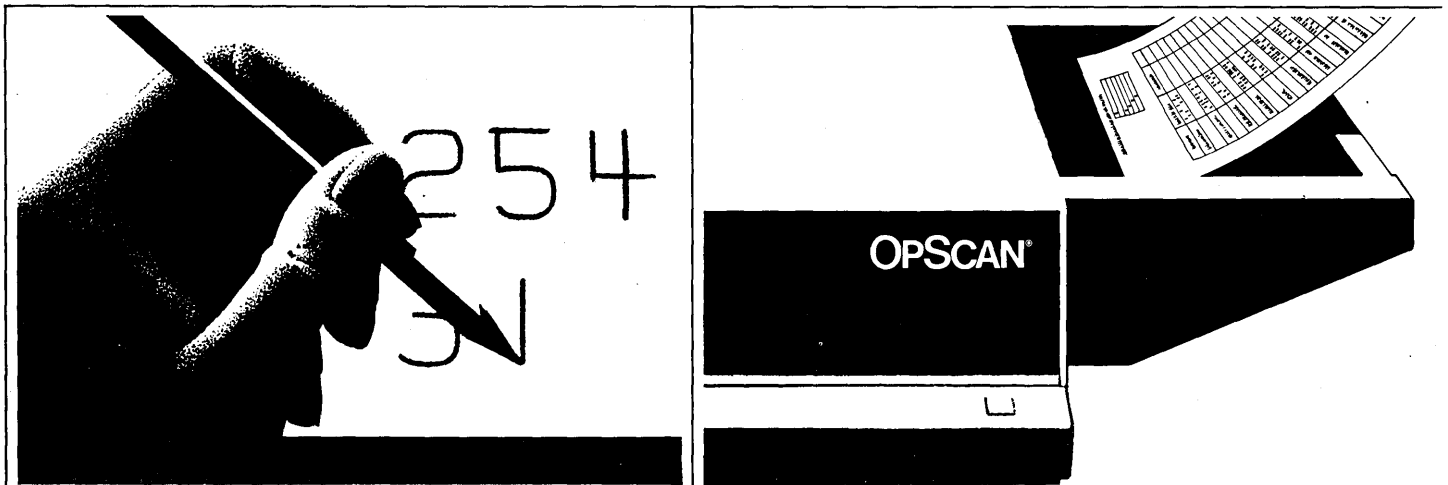

be a gradual shift from FORTRAN to PL/I for student courses in universities.) He's found that programmer efficiency is increased two-five times by using PL/I. He pointed to one case in which a graduate, going to a job at a commercial installation, was assigned to do a business package in COBOL in eight weeks. He did it in PL/I in 10 days.

Loving PL/I has been almost a religion, and if you get enough proponents in one company, sometimes management can't resist. Union Carbide is one such firm, once stacked with PL/I fans. Like most, it has moved to PL/I slowly, converting only those COBOL programs needing major modification and putting all new programs into PL/I. About 40% of its library is now PL/I. Standard Oil of California is doing the same for all corporate programs, although the operating companies are staying with COBOL and FORTRAN.

Stromberg Carlson is part of General Dynamics, whose companies mostly use COBOL. But Stromberg, which doesn't have common projects with its sister companies, opted to go from AUTOCODER on second generation to PL/I when it got its first 360—a situation similar to that of Eastman Kodak. Eryth Rea, manager of data systems and programming, said Strom-

berg plans ultimately to move into teleprocessing and interactive applications. PL/I, he felt, was best for them. While PL/I was taking more core and computer time, the staff was more efficient—and with a “small staff relative to the installation, their time was more important.” He likes PL/I's advantages of modularity in programming and debugging. “You can learn it in a modular fashion, too.”

Cincinnati Inc. in Ohio has gradually moved to PL/I from COBOL. It has converted 45% of those programs and is thinking of supplanting FORTRAN. It prefers PL/I for data base development; the data base system has obsoleted old COBOL programs, so conversion has not been difficult.

Bell Laboratories at Holmdell, N.J., has one-third of its programs in PL/I—for program development, system development, text-processing, report generation, accounting, payroll, and other commercial jobs. Another third are in FORTRAN, and one-third are in other languages, very little in COBOL. At Bell's Indian Hill site, all general-purpose work is in PL/I. But at its Business Information Systems Div., the language is COBOL because it is developing programs for Western Electric and operating phone companies, and right now COBOL is the language that can be used on different vendor

equipment.

It still stands that COBOL and FORTRAN got there before PL/I. Someone said 38,000 installations use COBOL. Our survey across 1,027 installations of all vendors shows that COBOL is the primary language in 351 of them. Still, with PL/I coming of age in the industry, in standardization, in more widespread knowledge and publication, its future progress might be measured in feet rather than inches.

—Angeline Pantages

Communications

WU Will Ease Some Interconnect Terms

Western Union is ready to offer much more liberal interconnection terms to its Telex and TWX customers. A number of features long sought by independent modem and terminal makers are included in a tariff proposal the company will file shortly, possibly before this issue of DATAMATION appears. Although Western Union won't comment, sources within the company list these key provisions:

Users of independently supplied terminal equipment will pay no more to access the Telex/TWX network than users of Western Union-provided

Interfaces with standard hardware — Solves data handling problems

Numerous outputs—modem, keypunch adapter, cassette, magnetic tape, printer and CRT—make the scanner extremely versatile. And it may be used on-line too.

Just a few examples—order entry, accounts payable, data bank information, master file creation, opinion surveys, time sheets, insurance claims—and many, many more. Contact us today. There finally is a better way.

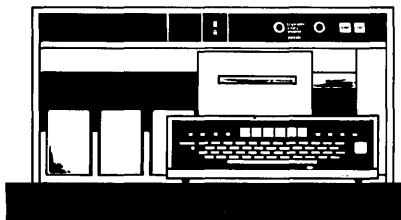
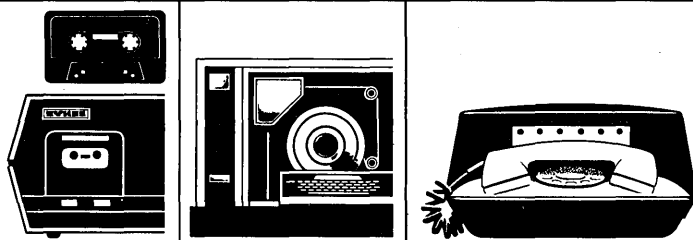

Alexandria, Va.703/370-2402	New York, N.Y.212/279-8401
Atlanta, Ga.404/633-4475	San Francisco, Cal. 415/781-7448
Dallas, Tex.214/358-3571	Montreal, Canada .514/488-6010
Chicago, Ill.312/527-3195	Ottawa, Canada .613/235-9254
Los Angeles, Cal. .213/380-7171	

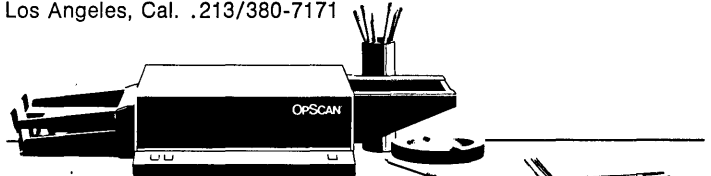

Optical Scanning Corporation

Newtown, Pennsylvania 18940
Phone: (215) 968-4611



DATA 100 offers users a versatile family of remote batch terminals with a wide range of peripheral capabilities. Emulation of most popular terminals eliminates the need for main frame software modification. Superior price performance, peripheral selection and service are the major reasons over 1,300 terminal users selected DATA 100.

Call your nearest sales office and let the DATA 100 team of specialists solve your data communications problems with reliable, economical DATA 100 products.

EASTERN:

Hartford, CT 203/525-7701
Boston, MA 617/749-2683
Parsippany, NJ 201/263-1565
Buffalo, NY 716/691-6036
New York, NY 212/541-8033
Philadelphia, PA 215/896-8677
Pittsburgh, PA 412/391-8401

SOUTHEASTERN:

Washington, DC 703/790-5560
Orlando, FL 305/644-1616
Atlanta, GA 404/631-5318
Greensboro, NC 919/273-6789
Raleigh, NC 919/782-2185
Nashville, TN 615/329-3699

MIDWESTERN:

Chicago, IL 312/992-0850
Indianapolis, IN 317/542-1411
Davenport, IA 319/322-4421
Detroit, MI 313/358-5065
Lansing, MI 517/489-1700
Minneapolis, MN 612/941-6500

MIDWESTERN:

Kansas City, MO 816/333-6744
St. Louis, MO 314/878-4911
Cleveland, OH 216/831-9244
Dayton, OH 513/278-6723
Dallas, TX 214/638-7946
Houston, TX 713/771-5778

Newly Expanded DATA 100 TERMINAL LINE Offers Greater Flexibility

MODEL 70

Now available with up to 1250 LPM printer on 19.2 KB lines, this 2780 plug compatible terminal requires no software modification.

MODEL 74

This new low-cost interleaving HASP work station replaces Model 360-20's and 30's and also offers 2780, 3780, and 2922 capabilities. Additional features allow emulation of DCT-2000, 1004, and 200 U. T.

MODEL 75

1250 LPM print power for your main frame installation, a true tape-to-print "freedom" machine for all central processors regardless of manufacture.

MODEL 78

The leader in providing communication versatility and cost performance now includes industry standard RPG programming language for enhanced off-line processing and a full line of I/O devices, communication disciplines and transmission speeds.

MODEL 88

Data entry terminal devices providing key entry, powerful editing capabilities, and 2780 compatible communications.

WESTERN:

Los Angeles, CA 213/645-4300
San Francisco, CA
415/328-2100
Denver, CO 303/759-2928
Seattle, WA 206/228-4770

CANADIAN:

Montreal, Quebec 514/842-1721
Toronto, Ontario 416/449-1080

EUROPEAN:

London, England (01)579-6751
Poynton, Cheshire, England
Poynton 2129
Frankfurt/Main, Germany
74-5072

Rijswijk, Netherlands
The Hague 94.92.11

DATA 100

C O R P O R A T I O N

equipment. Independently supplied Telex terminals will be allowed to perform network control signaling, and the Telex connecting arrangement (WU calls it an "interface adapter") will not balance longitudinal impedance, nor will it isolate terminal-generated direct current from the network.

The AT&T connecting arrangement includes both of these capabilities. AT&T also imposes an additional monthly charge on foreign attachment users who interconnect with the dial-up network, and insists on performing network control signaling with its own equipment.

Independent data terminal equipment makers have been objecting vigorously to each of these conditions for years. The fact that a major carrier has now backed them up almost certainly will give the independents a powerful new argument to apply against Ma Bell.

The pending tariff changes, if accepted by the FCC, reportedly would be followed by a similar liberalization of WU's broadband exchange (BEX) tariff, although when this will occur

hasn't been decided. BEX is a dial-up service which interconnects 49 cities in the U.S. and 32 in Canada. It accommodates high-speed as well as low-speed terminals. Telex and TWX, by comparison, support terminals having a maximum keying speed of 150 baud.

The proposed Telex/TWX tariff will require foreign attachments to satisfy specified signal limits, and before the equipment can be permanently inter-connected to either network, it will have to be tested on-site from the related central office. But there will be no precertification of foreign attachments, nor will Western Union require users of "customer-provided terminals" (CPTs) to undergo, and pay for, periodic inspection of the equipment after it goes into regular operation. We are told that in the protracted discussion at the FCC regarding alternatives to present interconnect restrictions, precertification and post-inspection have tied up the participants in semantic and procedural knots.

Currently, TWX/Telex users pay WU about \$65/month for each terminal. This charge covers the equipment and the network access; i.e., the interface,

local loop, and related central office facilities. Under the proposed tariff, network access and terminal equipment will be priced separately.

A typical TWX terminal obtained from WU—say, a model 33 ASR teleprinter—will cost \$62/month, and the access charge will be \$11.50/month. Also, there will be a one-time \$50 network access installation charge imposed, regardless of whether the terminal is provided by WU or an independent supplier. For Telex customers, the typical terminal charge—for a model 32 ASR teleprinter—will be \$49.50/month. Network access will cost \$24/month, and there will be a \$50 installation fee. Our sources emphasize that all of these rates were tentative and might be changed before their tariff was submitted.

The tariff imposes a limit of one milliwatt on signals generated by customer-provided TWX terminals. This limit applies to signal levels at the terminal interface. Also, "the total power of the signal at the Telegraph Company's TWX exchange (shall) not exceed 12 db below one milliwatt when averaged over any three-second interval."

Transportation

BART: Supervision Yes; Control, No

Despite all that publicity about a computer-controlled rapid transit system in the San Francisco Bay Area (Oct., p. 127), the derailment of a two-car train last fall wasn't caused by a computer.

In fact, the Bay Area Rapid Transit (BART) system was designed not as a computer-controlled system, as the publicity indicated, but as a *computer-supervised* system. Direct control of the trains is accomplished by units located alongside the track and at each station in the network. The designers, placing almost total reliance on automation, provided few controls for the attendant on board. And so, even during the ruckus over the Automatic Train Control (ATC) system that continues as this is being written, trains are being run automatically. But new measures have been instituted to keep the trains separated by a much wider gap than was originally targeted.

It was less than a month after revenue service was started in September along one leg of the network that a train ran off the end of the track at the southern terminus of the line, injuring several passengers and the attendant. An inquiry by BART indicated that a

(Continued on page 115)

We'll give you 40 good reasons to install the MMS General Ledger.

Our customer list — more than 40 of the largest and most profitable corporations — includes three of the four great growth companies listed on the NYSE. They all have money, and could have developed their own corporate financial systems. But they didn't. They chose ours.

If your company is a leader — or wants to be — call or send the coupon today. We'll show you how you can join the select group of successful users presently making the MMS General Ledger System pay off.

I would like to see some of those 40 good reasons. Please send me more on users and your other packages.

- General Ledger Accounts Payable Accounts Receivable
 Inventory management

Name _____ Title _____
Company _____ Street _____
City _____ State _____ Zip _____
Computer System _____ Phone _____



Send to:
SOFTWARE INTERNATIONAL CORPORATION

A Subsidiary of MMS, Inc.
279 Cambridge St., Burlington, MA 01803 (617) 272-2970

New Wilson Jones DataCenter II
with woodgrain worktop turns
printout housing space into work space,
and gives you

more printout retention space per dollar

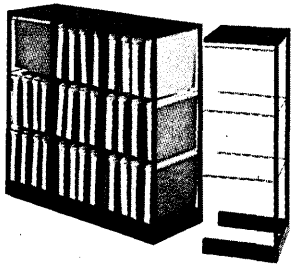

...plus unique 3-way
retrieval. And add-on
units that let you
increase housing
capacity when you
need it.

New Wilson Jones DataCenter II is the printout housing system that grows with your increasing needs. And gives you valuable reference space 45" high, instead of wasted housing space.

The larger unit holds up to 37,000 bound printouts in only 6 sq. ft. It holds 36 nylon post binders, yet costs only \$195.00*. The 4½ sq. ft. unit holds 24 binders, or up to 24,600 printout sheets, costs a low \$130.00*. Binders with T-bars slide into channels for easy retrieval from front, back and side—for unburst sheets.

Either unit expands by adding on the "add-on". At right-angles or either end. That adds 12,300 printouts. And each "add-on" costs only \$70.00*.

To find out how to turn each new foot of printout housing space into work space, just fill in the coupon.

 **Data
Systems**

Wilson Jones
A Division of Swingline Inc.
Dept. D-1, 6150 Touhy Ave.,
Chicago, Ill. 60648

Please send me information on Wilson Jones Data Center II.

Name

Company

Address

City State Zip

*Suggested retail price.





NOT EVERYBODY LAUGHED WHEN WE Some just smiled, installed an ENTREX

When we first claimed our key-to-disk data entry system was the best, lots of people laughed. And said we couldn't deliver.

Today, more than 100 ENTREX System 480's, with nearly 2,000 DATA/SCOPE keystations are installed across the country. And the number is increasing — more than 20 System 480's are being shipped monthly.

Other doubters said our system wasn't all that good. Yet System 480 is

proving to be the best. Users are saving money because throughput is dramatically increased. Operators take to the DATA/SCOPE like it was designed for them (it was—especially our exclusive "HELP!" button). *And our software is the most comprehensive in key-to-disk, letting you do everything you've always wanted to do in data entry.*

Now you have no more excuses. System 480 is working for satisfied

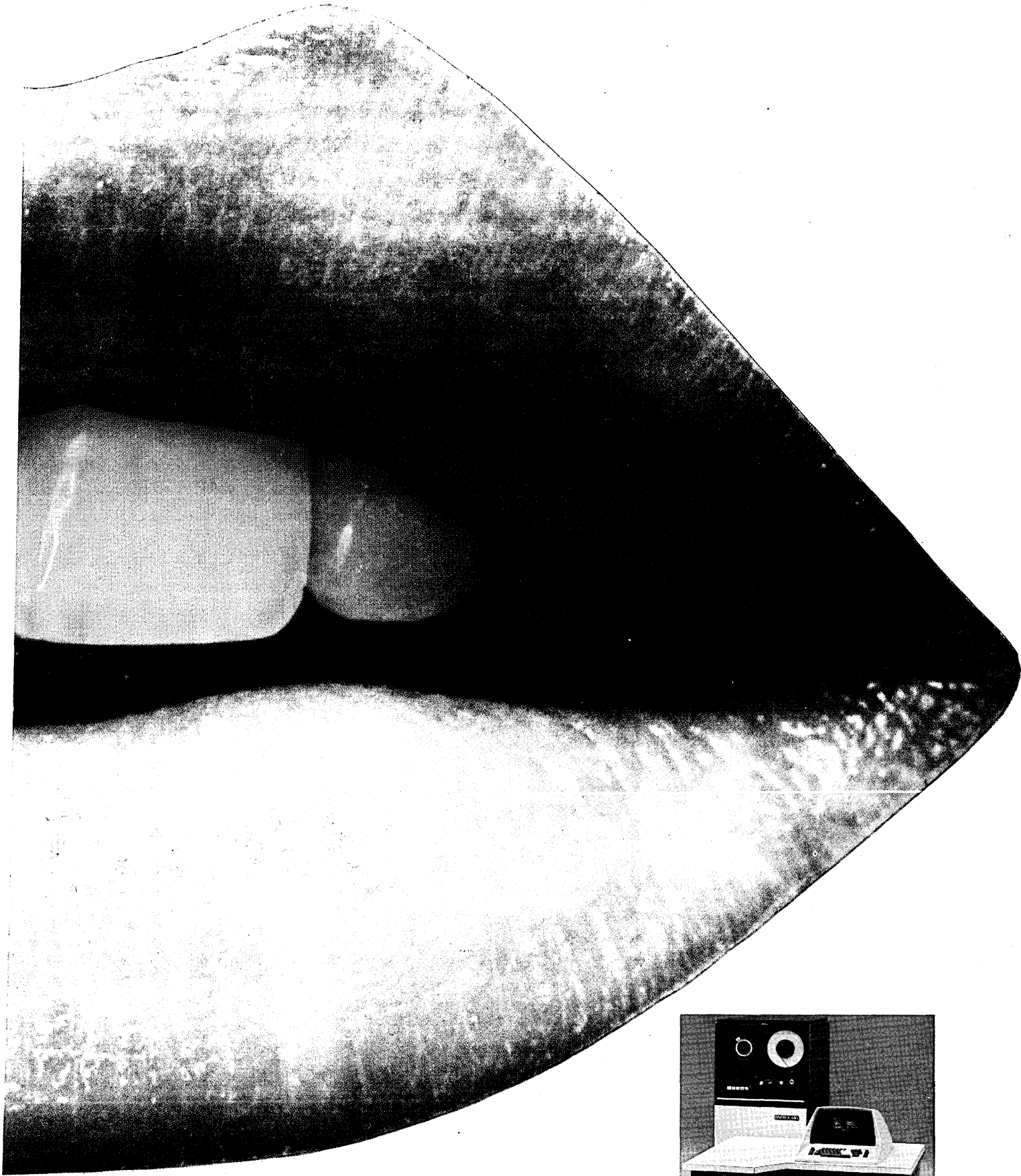

SAID OURS IS THE BEST. 480, and saved money.

users. It does everything we said it could do, and then some. We'll even install a System 480 at your site, free of charge for 30 days.

There you have it. We've put our whole story where our mouth is. To make it easy for you to put your money where yours is, we have a variety of lease, lease-purchase and purchase plans. Get an ENTREX System 480. And smile at real data entry savings . . . from the best.



ENTREX

ENTREX, INC.

168 Middlesex Turnpike, Burlington, Massachusetts 01803

617-273-0480

CIRCLE 32 ON READER CARD

**For years,
people thought
Teletype[®]
machines only
talked to
themselves.**

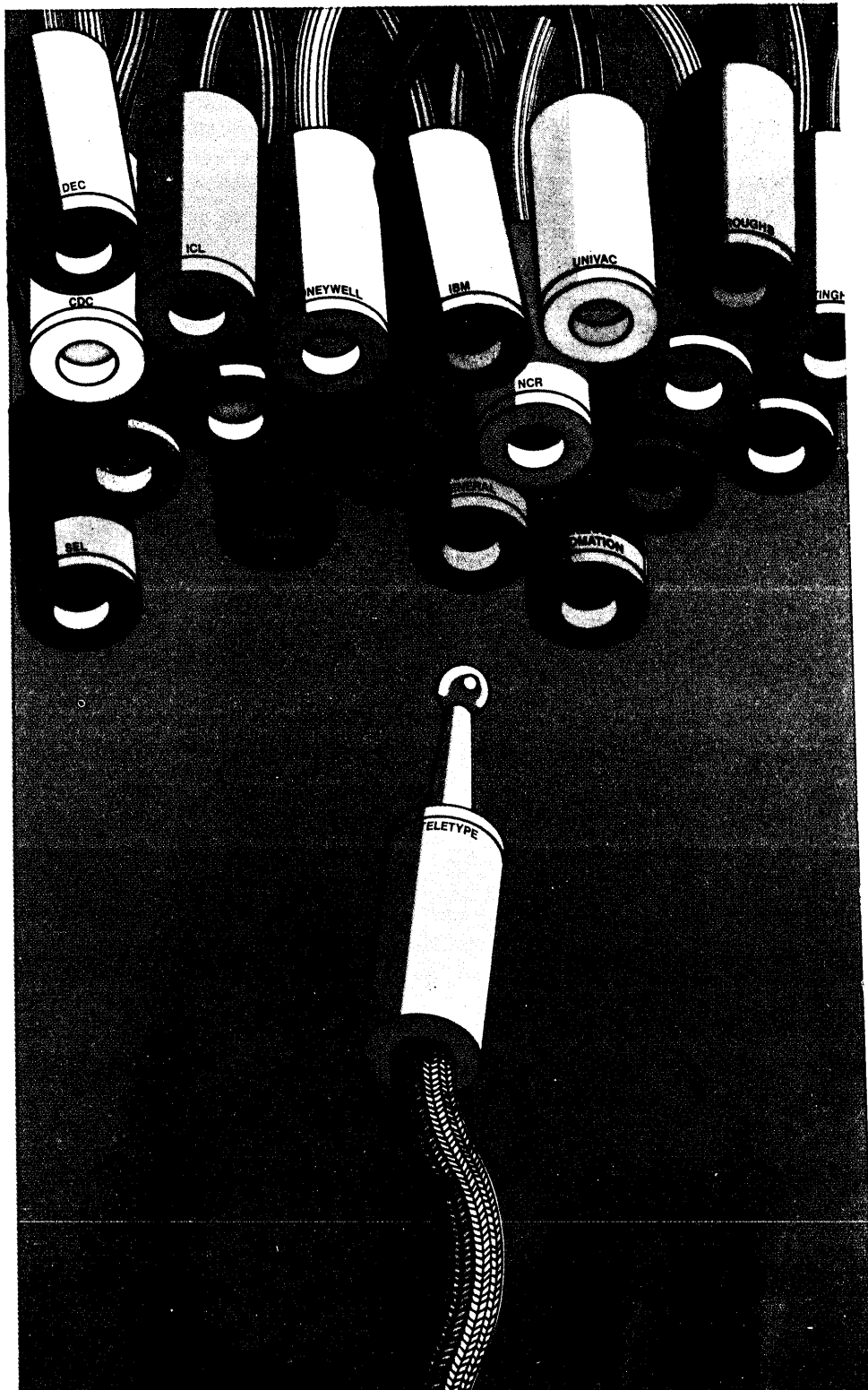

Nothing could be further from the truth.

Fact is, Teletype machines have been carrying on intelligent conversations with some of the fastest information movers in the world. Computers.

Teletype Corporation's technology has become virtually synonymous with office-to-office communications. But we've earned a good, solid name for ourselves in computer communications, too. Because Teletype equipment is compatible with practically any computer-based communications system.

Our product line proves the point.

Take a look at our model 33 series. At 100 wpm, it's the number-one standard-duty data terminal in the industry. Outstanding reliability, flexibility and economy are the reasons why.

Big system features at economy system prices? That's the forte of our new wide-platen model 38 series. Because it's the logical extension of the model 33, it's designed for plug-to-plug compatibility.

Looking for heavy-duty, year in and year out operation with minimum maintenance requirements? Take a look at our model 35 series. You'll also find a broad range of features at an economical price.

Our model 37 series handles all the requirements of complex data systems. It offers the utmost in flexibility and vocabulary at 150 wpm. In addition to the ASCII characters, you can add up to 32 special characters of your own.

For paper tape systems, we've got equipment with capabilities to send and receive up to 2400 wpm.

Our 4210 magnetic tape terminal—which interfaces with all our eight-level terminals—offers easy data handling and storage, at an on-line speed of 2400 wpm.

As you can see, our reputation in point-to-point communications has served us well in computer terminals. With a prod-

uct line-up that no one comes close to in reliability, flexibility and economy.

It takes more than manufacturing facilities to build the machines Teletype Corporation offers. It also takes commitment. From people who think service is as important as sales. In terminals for computers and point-to-point communications.

That's why we invented a new name for who we are and what we make. The Computer-communications people.



For more information about any Teletype product, write or call **TERMINAL CENTRAL:** Teletype Corporation, Dept. 81F, 5555 Touhy Avenue, Skokie, Illinois 60076. Phone 312/982-2500

Teletype is a trademark registered in the United States Patent Office.

United wrote the book on shipping computers without damage. Read it. Free.



We pioneered this unique way to ship delicate gear. Our "Soft Touch" system gives your equipment a damage-free ride—hugged safely inside our special containers.

Write for our free brochure. You'll see how our "Soft Touch" way offers greater reliability.

And lets you sell small or big orders almost everywhere.

Fast.

Write for this free "Soft Touch" brochure:
 United Air Lines, Inc.,
 111 N. Canal St.,
 Chicago, Ill. 60606.
 Att. "Soft Touch."



"Hugger" straps secure your delicate equipment in our special "Soft Touch" container—no skids or pallets needed.

Pinpoint delivery with "Soft Touch."

We can put your shipments on the exact spot your customer wants it. At LTL costs. And we'll arrange everything.



United Air Lines
Jet Freight No. 1 in the U.S. sky

malfunction in an on-board speed control crystal oscillator circuit, which reportedly caused a slow-down message to be converted into a speed-up command. By the time the attendant realized he was going too fast and pressed the stop button, it was too late.

The gap widens

A month after this incident, the state's bipartisan legislative analyst A. Alan Post released a report of an investigation his office had begun earlier this year. Among its disclosures was the ATC's inability to consistently detect a stalled train on the tracks. For the first time, the BART staff publicly acknowledged this, saying it now had an attendant posted at every other station, using a telephone to coordinate train departures and arrivals. Under the new measure, a two-station separation is to be maintained between trains, no train leaving one station until the previous train has departed from two stations ahead. Under automatic control, the gap was to have been at least one "block," which is defined as a varying length of track equal to the maximum stopping distance required. It ranges from 50-1,000 feet.

And yet, analyst Post found: "While the manual system is functioning, communication errors have resulted in trains operating within the same block on at least two occasions during revenue service." Additionally, he finds that "the train detection circuit intermittently generates false occupancy signals in advance of moving trains, which results in automated emergency braking." Such phantom trains could wreak havoc on standing passengers.

The low bidder

The unconventional and untested ATC system employed by the low bidder, Westinghouse Electric, was one of the points raised by the legislative analyst. Although four competitive systems were tested on a 4.5-mile track, and although Westinghouse's system wasn't considered one of the most effective, the low bidder won out. However, the report states: "The competitive bid with which Westinghouse won the ATC contract was based upon a system design which was totally different from the design which it subjected to test on the Diablo Test Track. Its proposed design featured a new approach to track circuits and a time-division-multiplexing technique, which at the time was unproven by Westinghouse or any other control system supplier . . . In awarding the contract, BART accepted the proposal of the lowest

bidder without requiring prior demonstration of the proposed system before giving a go-ahead for final design and installation."

To top that, it is charged, the first leg of the network was opened to revenue service last September when "it was evident that the ATC system was not fully operational and qualified as required for revenue service. Much work remained to be done and some major problems existed which negated full operation of the ATC system at that time."

Thus, not only did BART contract for a pioneering system to control its trains, but it apparently also acquired one without a fail-safe backup. This can be remedied, says BART, and trains can be rolling into San Francisco along about next September as scheduled. Not so, says Post. The entire ATC will have to be redesigned to make the anti-collision system work.

Interestingly, while this hassle continues, passengers merrily ride the rails. On the day after the October 2 derailment, the number of BART riders actually increased. And, of course, the number of passengers was extremely
(Continued on page 120)

Most Manageable Mini

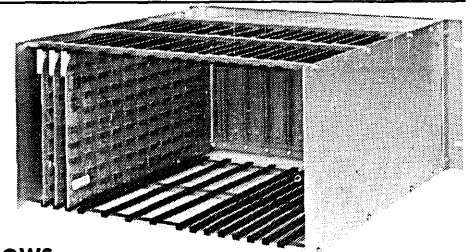

A VIEW FROM THE BUSINESS END SHOWS:

1. Three boards which comprise the complete Central Processing Unit and Bus Controller.
2. A Universal Bus with 12 slots for memory and peripheral interfaces.
3. Vertical mounted boards large enough to accommodate 100 integrated circuits.

WHAT THESE THREE PROVIDE FOR YOU:

1. A CPU with 8, 16 and 24 bit instructions with 69 basic commands and hundreds of permutations of each. You can address: directly to 65K, relative, indexed, indexed plus displacement and indexed with automatic increment or decrement. A CPU with 16 levels of priority interrupt and each level with 8 16-digit registers to allow real time and multi-processing through one computer. A CPU which is controlled by memory or I/O speed. Therefore memory can range from nanosecond bipolar to microsecond core or millisecond peripherals. A CPU with basic bootstrap and teletype loader routines built into the hardware.
2. A Universal Bus which allows you to start with a basic, simple, powerful computer at lowest cost. When YOU want to add memory or I/O controllers, simply plug them in. You can get 65K bytes in the box and still have slots for 8 I/O interfaces. A Universal Bus allows peripherals to communicate with each other or with memory without consultation with the central processor. Direct memory access is standard.
3. Vertical mounted boards with convection cooling and a large number of integrated circuits per board minimize the number of connectors. Further, because we operate all components at a fraction of their rating and use large connector fingers with low density spacing, we offer you an ultra-reliable computer.

ABOUT THE FRONT OF THE BOX:

It has 4 sense switches, push buttons for run, halt/step, reset, load and interrupt. There is a key switch to enable. Then there are lights to indicate run, halt, link and overflow. — Oh yes, it is only 8¾" high and with the rack ears attached, fits a standard rack.

WHY IT IS ABSOLUTELY AFFORDABLE:

Because what you see is what you get, a power packed CPU for a very manageable \$1160, in OEM quantities.

A LOT OF MANAGEABLE POWER IN A LITTLE BOX FROM A:

Most Manageable Mini

ELDORADO

ELDORADO ELECTRODATA CORPORATION
601 CHALOMAR ROAD • CONCORD, CALIF. 94518 U.S.A. • TEL. (415) 686-4200
CIRCLE 98 ON READER CARD

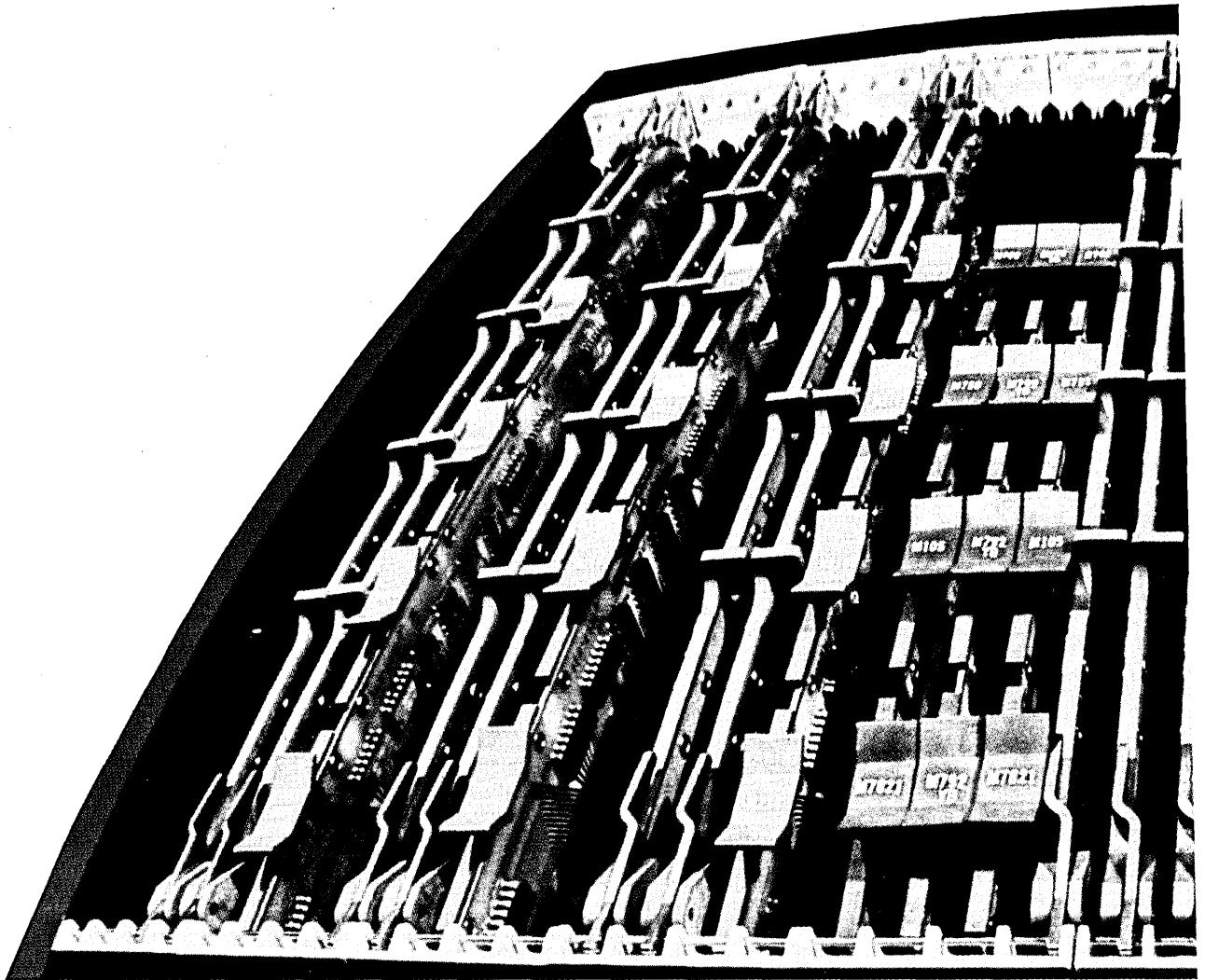

Once you've seen PDP-11/45's to look at other medium

Open up a PDP-11/45[®] and you'll see the whole computer — floating point, memory management, solid-state memory, processor and peripheral control — all inside a space that measures only 19" x 22" x 30".

It's a beautifully unified design, as indeed it had to be. All that PDP-11/45 had to be packed that close to make the computer 300 nanoseconds fast. So it

could do double precision floating point (64-bit) multiply in 9 microseconds and single precision multiply in 6 microseconds. No other medium scale computer can give you that.

But then, no other medium scale computer can give you 64-bit multi-accumulator floating point hardware, either. Or for that matter, memory expansion to

248K bytes. Complete memory management hardware for dynamic relocation and protection. Dual ported memories. Three protected processor environments for multi-programming. 16 general purpose registers. Stack and double-address operations.

But most of all, no other medium scale computer can give you all that for anywhere near our price. A PDP-11/45, com-

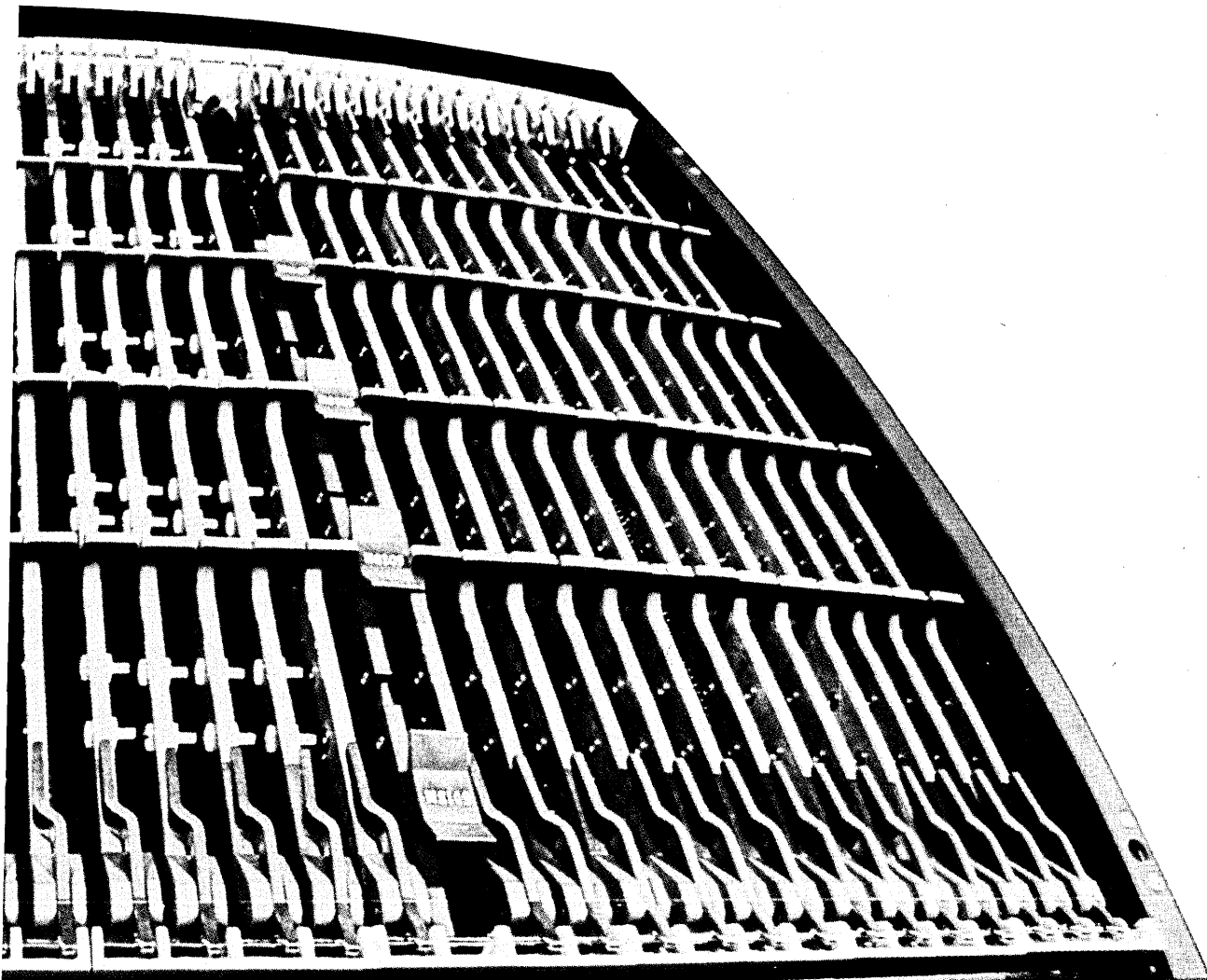

architecture, you'll never be able scale computers the same way.

plete with 16K of parity memory and
30CPS console terminal costs \$26,950.

PDP-11/45 has become the hottest
selling computer we've ever made.
We're delivering them, too. There are
already over 100 very happy PDP-11/45
owners. And there's going to be a lot
more. Over 50 PDP-11/45's are coming
off our production line every month.

Get the literature and you'll want to
get the computer. Write Digital Equip-
ment Corporation, Maynard, Mass.
01754. (617) 897-5111. European head-
quarters: 81 route de l'Aire, 1211, Geneva
26. Tel.: 42 79 50. Digital Equipment of
Canada Ltd. P.O. Box 11500, Ottawa,
Ontario, K2H 8K8 (613) 592-5111.

digital

PDP 11/45 is a registered trademark of
Digital Equipment Corporation.

Can't afford computer output microfilm? Sure you can.

You don't have to buy a computer output microfilmer or even rent one. Just call on a service bureau equipped with a Kodak Kom microfilmer.

Using a service bureau is similar to time-sharing. You get all the savings of computer output microfilming. Without a big investment.

The service bureau can handle all the details for you. It will convert your tape data to microfilm, process the film, and get it back to you fast.

Take your pick of microforms. Depending on your application requirements, you can instruct the service bureau to microfilm in roll or fiche formats. You can even have your business forms superimposed on the microfilm images.

When you select a service bureau equipped with a Kodak Kom microfilmer, you can do so with confidence. Kodak backup makes the difference. Full software support. Kodak



service. Information management know-how. Everything that's needed to make the most of COM.

Get all the facts.

For more information on computer output microfilming, please write us. Eastman Kodak Company, Business Systems Markets Division, Dept. DP509, Rochester, N. Y. 14650.

For better information management.



More than half the people who buy bench-top digital-IC testers buy this one.

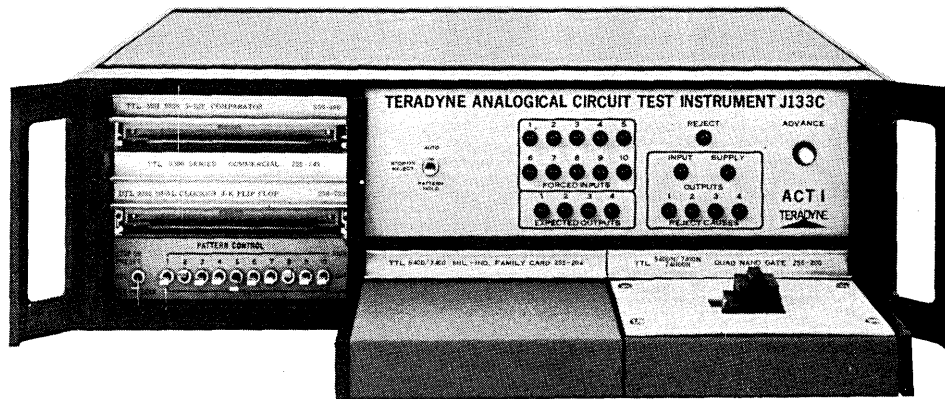

Here's why.

It's Thorough

The J133C makes both functional and dc parametric tests, based on field-tested plug-in program cards that ensure correlation with vendors' specs.

It's Versatile

Program cards are available for thousands of ICs, from flip-flops to ROMs and RAMs, from TTL and DTL to CMOS. The J133C even tests 24-pin devices.

It's Easy to Use

No setup; just turn it on and use it. No programming; plug-in program cards do it all. No operator controls; just insert the IC to be tested. No meters to read; just watch the pass/fail lamps.

It's Expandable

The J133C can grow as your needs grow. With its evaluation test deck, you can look at function, voltage, or current at any pin. With the pattern control unit, you can functionally evaluate bad devices. With blank program cards, you can even "write" your own programs if you choose.

It's Compatible

Interfaces are available for automatic handlers, wafer probers.

It's Dependable

The J133C is built to take hard industrial use. That means no calibration adjustments, no fans, 100%-tested components, plus a 10-year warranty for extra peace of mind.

It's Inexpensive

The J133C costs so little it can pay for itself in months, at even moderate IC usage rates.

Most important, when a J133C says an IC is good, you can put that IC in your product without worry. And that, of course, is the real reason why industry has settled on the J133C as the best answer to the IC-inspection problem. Learn more. Write: Teradyne, 183 Essex Street, Boston, Mass. 02111. In Europe: Teradyne Europe S.A., 11 bis, rue Roquépine, 75 Paris 8^e.

TERADYNE

IN THE U.S.: CHICAGO (312) 298-3600/DALLAS (214) 231-5384/NEW ENGLAND (617) 245-5340/NEW YORK (201) 871-4052/PALO ALTO (415) 493-2340
IN EUROPE: LONDON (093-28) 61111/PARIS 265 72 62/ROME 59 47 62/MUNICH (0811) 33 50 61

high during the Oakland A's World Series games, for the one leg of the line that's open runs past the Oakland Coliseum. —Edward K. Yasaki

Health Care

Hospitals Forced Into 20th Century

Health care institutions, still pretty much 19th century in their economic structures, are being forced into the 20th century by rapidly changing requirements which are a function of government and prepaid insurance.

This is the opinion of Thomas Patterson, president of Marcom Applied Systems, Sherman Oaks, Calif., a consulting firm specializing in health care systems. Patterson believes national health care will arrive this year and with it, increasing informational problems for hospitals which have long been short on operations data.

Patterson believes total hospital information systems are needed but must come about as a result of "phased evolution, not revolution." Most hospitals with more than 500 beds, he said, "can afford a computer, but there are problems with dp staffing. Hospitals are not happy places to work. Pay is modest." And 70% of the hospitals in the U.S. are under 200 beds.

The earliest hospital dp use by smaller institutions was through service bureaus. Then came medical service bureaus, and now there are small computers available. Burroughs offers support for hospitals with its B 1700. Medical Data Systems Corp., a Warner-Lambert subsidiary in Detroit, has installed some 12 DEC PDP-12 based systems in the past year. Its systems are designed for hospitals of more than 300 beds and include modules for patient data, diagnostics, nurses station, ancillary services, history screening, and general hospital information.

The City of Hope National Medical Center in Duarte, Calif., wanted all these things in late 1969. Robert Sloane, administrator of the 212-bed hospital, which he described as "a pilot medical center, one out front with medical advances, administrative advances, and anything that will benefit hospitals anywhere," said they decided early that the costs of development and for necessary expertise precluded in-house capability.

So, the City of Hope began looking for a vehicle, a cosponsor, that could provide the services it needed and

make them available to other hospitals. It found one in University Computing Co., Dallas. Together, the City of Hope and ucc early last year formed a separate nonprofit corporation called Health DataNet to provide turnkey-type services for hospitals. The company calls the system it is offering HOPE—Hospital Oriented Processing Environment. The system is being implemented in stages.

"We started with accounting," said Kenneth Pierce, formerly with City of Hope data processing and now vice president of Health DataNet. The new firm acquired 11 accounting packages from ucc which "had been successfully used in 11 hospitals in the East. They were reworked and combined "to accommodate regulations that are always changing."

The accounting portion of the system has been implemented at the City of Hope, and Sloane said "it's working



Candy Winn, registered nurse at Long Beach's Memorial Hospital Medical Center, learns how to use a nursing station terminal.

just fine. Patient charges which weren't being captured before are now being captured almost 100%." Actually, within the general framework of accounting, the City of Hope is using some 30 separate applications, Sloane said, including census, admitting, accounts payable, and accounts receivable.

Phase II: a terminal

The hospital last month completed testing of a specially designed nursing station terminal which is part of Phase II on the HOPE schedule, nursing station data entry and retrieval. A prototype designed by Pierce was tested by City of Hope nursing personnel with what Sloane described as "intrigued reaction." The terminal now is being modified according to suggestions from the nurses, and Pierce expects it will be back in use at the City of Hope for final testing in about two months. He expects it to be generally available

by the end of next year.

The terminal is designed to accommodate 99% of the kinds of ordering a nursing station normally handles. English language input is via a telephone company Magna Dial with a numeric keyboard used for quantity only. In addition to order input for relay to proper dispensing points, the terminal outputs a strip of pressure-sensitive tape for application to patient charts.

One of the modifications suggested by the nurses was output of a specimen collection label for bottles. This will require both hardware and software changes, said Pierce, "but it will be done." A second modification will be the addition of a nixie tube display so nurses can see what they're inputting.

Health DataNet intends to implement five phases of its system over the next six years, and some of these, Pierce says, have been only broadly defined so far. "We want participating hospitals to help us refine the definitions." The first such participating hospital was due to be signed up late last month, and Pierce said the organization had letters of intent from two more.

Following accounting and the nursing station entry phases will come automation of lab systems, patient monitoring, multitest screening, and patient scheduling. Phase IV will be area-wide medical information systems involving blood availability, emergency facilities, and diagnosis. Phase V would be a cooperative tumor registry, drug control, a rare disease index, and hospital modeling.

And while Health DataNet has seen fit to design its nursing station terminal from the ground up, another hospital this month is implementing a system that includes 35 modified general-purpose terminals. Modifications to the Digital Equipment VTO-5s are push-button instead of keyboard input and the addition of a badge reader capability for security purposes.

The system is being implemented by Memorial Hospital Medical Center of Long Beach, which, with 690 beds, falls well into Patterson's category of hospitals which can afford their own system. The hospital is a long-time dp user, having done a \$100,000 three-year study of hospital dp in the early '60s funded by the National Institutes of Health and culminating in its purchase in 1967 of a Control Data 3300 for administrative work.

The new system adds, in addition to the terminals, a DEC PDP-15. It uses a DEC operating system, which has the unhealthy name of MUMPS, along with hospital-developed applications software. The first step in the program,

GE's new Mark III. It's time-sharing. It's remote batch. It's a worldwide network.

In fact, it's the world's only integral combination of all three powerful capabilities: the response of interactive time-sharing . . . the economy of remote batch processing . . . the reach of a worldwide communications network.

The interactive time-sharing has new features and controls to make time-sharing more powerful, less expensive, and more easily managed. Yet, it is fully compatible with GE's Mark II, today's most widely used service.

Remote batch processing brings you the economies and power of large-scale data processing. With Mark III, you can save one-half or more of your processing costs just by moving your time-sharing programs into remote batch operation. Yet you still have the ease of use and the service quality that are characteristic of GE time-sharing.

The network is a system that gives local phone call access from over 250 locations in North America and Europe. No matter how you're decentralized, all your locations can share a single system, a single data base. And this information processing network can interact directly with your own computers.

General Electric introduced the first time-sharing service in 1965. In 1970, GE established the first international information processing network. And now, Mark III.

It's time to make a serious comparison of Mark III with whatever information service you now use. Phone 800-638-0971 or write us at 7735 Old Georgetown Rd., Bethesda, Md., 20014. We're ready to help.

291-82

GENERAL  ELECTRIC

WORLD LEADER
IN INFORMATION
SERVICES

on-line patient admission, is to be implemented this month. Subsequent steps will include extending the network to the pharmacy and laboratory

and the development of an order system for drugs and lab tests.

—Edith Myers

Benchmarks

Crime of the Future: A programmer who removed a copy of a remote plotting program stored in the system of a competing remote-access service bureau pleaded guilty to criminal charges last month and was given a heavy fine and three years' probation. Jeffrey Ward was earlier fined \$2,750 in a civil case (see Oct., p. 100) in which he admitted the deed. This time he drew a fine of \$5,000 for what the Alameda, Calif., County Probation Dept. termed "the crime of the future." The presentence report noted that monetary gain was not the motivation for what Ward did, and acknowledged the absence of "any yardstick by which to determine a proper sentence." Ward, however, did face a maximum of 1-10 years or a year and a \$5,000 fine.

Diablo's Printer?: A new and advanced printer, introduced last spring by Diablo Systems Inc., led to that small Hayward, Calif., firm being acquired by Xerox Corp. for some \$29 million. Since that time, at least one other equipment manufacturer was known to be designing a system around the printer. But it may not be long before Xerox comes out with one first. A hint of this comes with the announcement by Itel Corp., once a principal backer of Diablo, that it has a contract from Xerox to manufacture "a minimum of \$15 million worth of office equipment over an 18-month period." Neither company will say so, but immediate speculation is that it will be word processing equipment incorporating that new printer. Manufacturing is to be done by Itel's subsidiary, Information Storage Systems, in Cupertino, Calif., whose facilities are being enlarged.

More Than Computing and Software: Cordura is a Spanish word meaning practical wisdom and judgment. It will be the new name of Computing and Software, Inc., Los Angeles, following shareholder approval in February. Said president Norman Friedmann: "For some time the corporation has been engaged in much more than either the computing or software industries." He said it is a business services company for clients in a wide range of industries.

Add a Computer: The Business Equipment Manufacturers Assn. has a new name. Last month it became the Computer and Business Equipment Manufacturers Assn. (CBEMA), and this month newly elected board officers took over its direction. They are Henry S. Forrest, senior vice president, government relations, Control Data Corp., chairman; Charles L. Davis, president and chief executive officer, Addressograph-Multigraph Corp., vice chairman; Robert Sayed, director, data entry and data transmission products, Burroughs Corp., chairman of the Data Processing Group; and Warren R. Rothwell, president, General Binding Corp., chairman of the Office Machines and Office Furniture and Equipment Group.

A Fundamental Right: In Colorado anyway, the storage or transmission of criminal history information on persons arrested for criminal acts but never convicted is now illegal. The state's Supreme Court, in a decision which bars such action, stated: "There exists in the individual a fundamental right of privacy—the right to be left alone." The suit which led to the decision was brought by Dorothy Davidson, executive director of the Colorado American Civil Liberties Union.

Good Year for CDC: Control Data Corp. was anticipating earnings of some \$63 million for fiscal 1972, based partially on the fact that fourth quarter computer operations were solidly in the black. This would be up from \$35.8 million in 1971; and Marvin Rogers, vice president, finance, said he anticipates further increases this year. Of the anticipated 1972 total, some \$55 to \$56 million were expected to come from wholly owned Commercial Credit Corp.

Expansion in Wichita: The National Cash Register Co. said it will build a new \$6 million small computer production facility in Wichita, Kansas, boosting employment in the area from 425 to 1,000 by early 1974. The new plant will take over production of the NCR 399 computer series now being manufactured at the company's Cambridge, Ohio, plant and the NCR 725 "in-store" retail computer currently being produced at San Diego. □

(Continued from page 92)

1972: Battle Lines

IBM. (Well, monolithic unless the courts decide differently.) Jacques Maisonrouge, president of IBM World Trade Corp., disagreed totally, predicting a continuing increase in competition for his salesmen.

The last few years have seen many U.S. firms sail their wares east and west, and 1972 was no different, particularly in Japan. But the European and Japanese invasion of the U.S. market gathered momentum in 1972. Most of the activity involved software companies, and indeed most of that entailed agreements by U.S. firms to market foreign packages.

The most notable direct entry from abroad was Germany's Nixdorf Computer A.G.—one of the top manufacturers of small business computers in Europe. It is not starting from scratch, having bought up Victor's computer division, which has been buying and marketing Nixdorf systems since 1968. So for a mere \$10 million, what will become Nixdorf Computer Inc. starts with 1,000 installations, a backlog which includes a 1,000-system order from Commercial Credit Corp., 470 people, and 36 sales and/or service outlets.

The confusion of competing on a world scale was underlined by the events of 1972: the monetary crises, the increase in membership and power of the Common Market, U.S. troubles with Japan in balance of trade, new trade agreements with the Soviet Union and China, the threat of foreign trade restrictions if the U.S. passes bills, like Hartke-Burke, which seek to curtail U.S. company investments overseas. Each affects the computer industry as never before.

On the user side, problems and promises were the same worldwide. A Paris hotel, promising to be the most automated in the world, found implementation less glorious than the plan. The *Economist* took a swipe at British air traffic control for ordering IBM gear in spite of the U.S. Federal Aviation Agency troubles with IBM and Raytheon.

The banner of social responsibility was taken up by the leaders of countries like France and Germany, as they expressed concern over computer-caused threats to individual freedom and privacy—and made proposals for safeguards.

Finally, 1972 was the year DATAMATION started its international editions, going to more than 27,000 readers outside the U.S.

—Angeline Pantages

GE's new Mark III can cut your time-sharing costs by a third

What we're offering is not a miracle, but a new approach to information processing: Mark III. It's a single, unified service that combines the response of interactive time-sharing, the economy of remote batch processing, and the reach of a worldwide communications network.

Your total savings depend on your own applications, but our estimate of one-third may be conservative. For example, with Mark III you can save one-half or more of your processing costs just by moving your time-sharing programs into remote batch operation. In addition, Mark III includes new time-sharing capabilities that can lower your costs dramatically. To tie it all together, a new budget allocation and control system helps you get the most out of each computing dollar.

General Electric introduced the first time-sharing service in 1965. In 1970, GE established the first

international information processing network linking over 250 locations in North America and Europe.

And now Mark III—an integrated network of nearly 100 interconnected computers. With a network this size, each computer performs that task for which it's best suited—communications, interactive time-sharing, or batch processing. The result is a service that can tackle your computing needs easily, reliably . . . and, most important, economically.

If you're a Mark II user, Mark III offers major new features and is fully compatible. If you're not, it's time to make a serious comparison of Mark III with whatever information service you now use. Phone 800-638-0971 or write us at 7735 Old Georgetown Rd., Bethesda, Md., 20014. We're ready to help.

291-83

GENERAL  **ELECTRIC**

**WORLD LEADER
IN INFORMATION
SERVICES**

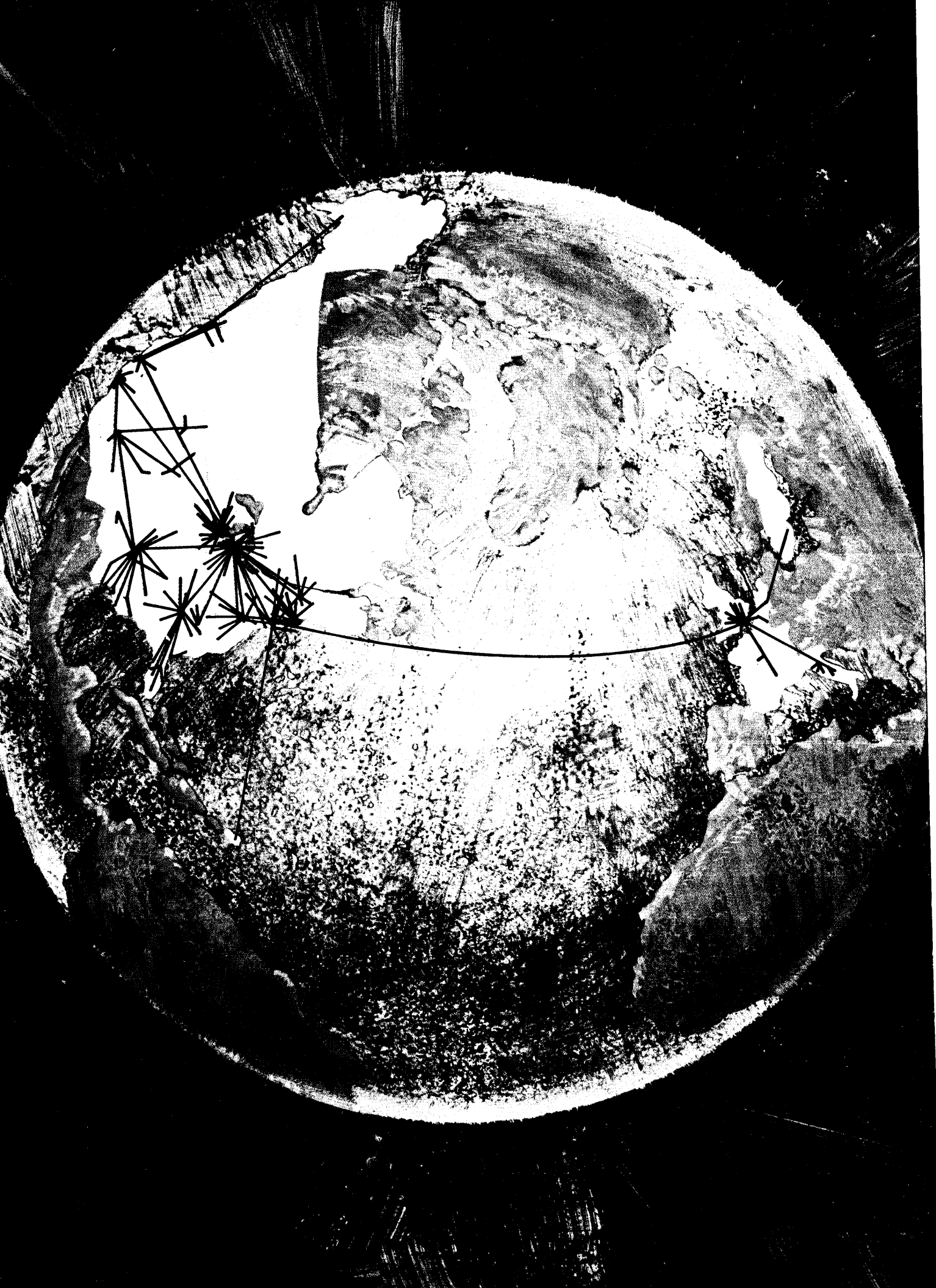

GE's new Mark III lets you create a worldwide order processing network.

Immediately.

Computerized order entry systems are not new. What is new is a complete service that requires no capital investment. A service with local phone access available from hundreds of international locations. A service whose cost is proportional to your use.

It's called Mark III, and it's ready to become your order processing network starting today.

You can tie together your sales office, factories, and warehouses to enter orders and fill them. Many companies are already using this network. Their businesses range from food processing . . . to auto manufacturing . . . to insurance services . . . to chemical production.

Salesmen can instantly verify inventory status, check buyers' credit, place orders, and mortgage

inventory. Capturing the order information in a single data base also opens up other valuable management uses, such as sales control and forecasting.

Mark III is an integrated network of nearly 100 computers, interconnected and accessible from over 250 cities in North America and Europe. This international network has been used commercially since 1970—and it is ready for you right now.

If you use GE's Mark II, Mark III offers major new features and is fully compatible. There's much more to this exciting new opportunity. For the facts, phone 800-638-0971 or write us at 7735 Old Georgetown Rd., Bethesda, Md., 20014. We're ready to help.

291-85

GENERAL  **ELECTRIC**

**WORLD LEADER
IN INFORMATION
SERVICES**

Hardware

Hardware Notes . . .

Field engineers may be heard but not seen around Ultimacc Systems' nationwide small business computer installations in the future. The Maywood, N.J., manufacturer can run diagnostic programs by phone to determine whether or not field service is required. If the engineer is needed, he'll probably have a good idea what the problem is by the time he arrives on site. Sounds like an idea that might be copied by others.

Bell Laboratories' fascination with lasers continues. One possible use in information processing is a display resembling a crt screen, but with information, both textual and graphic, generated by a laser writing on liquid crystal molecules sandwiched between two glass panes. Such a device would probably be more reliable than a crt, possibly cost less, and not have to be constantly refreshed by the host computer. Bell has also developed a technique for making microfilm copies of photographs or entire newspaper pages in about four seconds.

The proliferating minicomputer has greatly increased the market for teleprinters and interface engineering services, according to Z. Zakarian, president of Western Union Data Services Co. "Whenever a minicomputer manufacturer sells a system, its customer will require on the average five terminals, usually the Teletype Corp. model 33." WUDSC markets this terminal—and a number of others—with interfaces for a large number of minicomputers.

With the U.S. manned moon exploration program now complete, cosmologists will once again rely heavily on computer-aided ground observations to further their research. At New Mexico Institute of Mining and Technology, a 360/44 and an optical telescope have been linked to search for exploding stars which may provide clues to the origin of matter and the universe. During a four-hour observation period, the 360 aims the telescope at 4,000 galaxies that might contain these stars. The light intensity of each galaxy is measured, digitized, stored, and compared to previous readings. When a difference in intensity is detected, astronomers are notified so they can direct their attention to that particular object.

Matrix Printer

Simplicity and low price characterize the 4553 page printer. The vendor claims that the 15-cps/80-column printer has only about eight moving parts. Presumably that count includes the 5 x 7 matrix print head as one part. The 64-character device uses pressure-

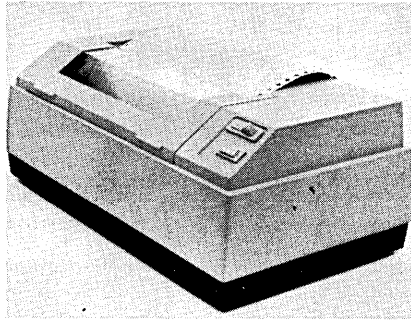

sensitive forms and so does not require a ribbon or ink supply. It is available with an ASCII interface now, and a tty interface is in the works.

Individual units will be sold to oem's for about \$900, but in large quantities may run something over half of that. Deliveries are scheduled for this quarter. FACIT-ODHNER INC., Secaucus, N.J. For information:

CIRCLE 221 ON READER CARD

\$1000 Crt

The only catch to this offering of a tty-compatible crt terminal for \$1000 or less is that it will be sold only in large quantities. But for oem's with need for 100 or more, the display is a real bargain. It shows six lines of 80 characters (eight lines optionally) and has a full-screen Mos buffer so that switch-selec-



table line speeds of 9600 baud can be used. Features include block transmission and forms protect (where a fixed display with fill-in blanks can be reserved from operator error).

The device is only 8 inches high, and is packaged so that there are only about three internal modules to replace in case of failure. The vendor claims that the rate of failure and cost to repair the modules are so low that some hardware maintenance firms don't want to be bothered with it. CONRAC CORP., Covina, Calif. For information:

CIRCLE 222 ON READER CARD

Programless Plotter

If you can produce a list of X and Y values on your supercalculator or terminal, you can plot those values simultaneously on a 2020 series x-y plotter. Although you would be responsible for making sure that the scale of the plot was right for the paper size, you would have no need for plot-driving subroutines. The 2020 takes two values at a time, each from -1000 to +1000, and interpolates a path to the point represented, drawing at up to 3 inches/second.

Several models are available, including the 2020, which plots on single 11 x 17-inch sheets with an ink pen; the 2021, which does the same thing with ball-point; and the 2024, which plots on 11 x 13½ fanfold forms. Prices range from about \$2650 to about \$3600. ASCII or EBCDIC interfaces are included, and line speeds of 10, 15, or 30 cps can be accommodated. VALTEC CORP., Irvine, Calif. For information: CIRCLE 225 ON READER CARD

Supercalculator

The differences between minicomputers and calculators become less and less apparent. Consider the series 9800 model 30, modestly billed as "the world's most powerful desk-top calculator." It has 4K to 8K bytes of semiconductor user memory, up to 16K bytes of preprogrammed read-only memory, a programming language, and even a 15KB "operating system."

One of the features that marks it as a calculator is that its BASIC interpreter and many of its functions are hardwired. Another is that its keyboard, 32-character display, 80KB random-access tape cassette, and 80-column/250-lpm thermal printer are built into one unit. Also, its cpu takes 12 usec to add two 16-bit words.

Still, it offers its single user interactive debugging and keyboard functions like program scrolling, statement fetching, and program loading. The calculator is base priced at \$5975; the printer runs an extra \$2975; and the 2K ROM application programs go for \$485 each. The system can't do as much as one of HP's own 2100A minis (at about \$6900 plus peripherals), but is expected to sell to people who would be afraid to have a real computer. HEWLETT-PACKARD CO., Palo Alto, Calif. For information:

CIRCLE 226 ON READER CARD

Floppy Disc

This firm might have set a record by bringing its first product to market three months after the company's

foundings. The product is the MU/200 series of floppy discs, which spans from 0.5 to 2.0 million bits by combining up to four cartridges. The units are fast; access times are quoted as 17.5 msec average, and transfer rates are given as 980,000 bps. Aimed at minicomputers, calculators, and smart terminals, the MU/200s may actually be too powerful for some of those applications.

The vendor claims that the noncontact start/stop and read/write is an innovation of its own. Prices start at \$1650 for one, falling to \$1085 in quantities. INTELLIGENT MEMORY SYSTEMS, INC., Boulder, Colo. For information:

CIRCLE 227 ON READER CARD

Unusual Floppy Disc

Everything seems to be done differently with this random access "floppy disc" drive. For starters, there really is no disc. Instead, the memory medium is a 9 x 11-inch sheet of computer-grade mag tape stretched over a plastic frame. On top of that, the read/write head spins over the stationary disc—rather than the disc spinning under the head—and the head is in constant contact with the tape.

The unit is called the Diskette. It stores up to one million bits of data on 64 tracks on the cartridge. Accessing that data takes 5 msec (to go from one track to another), plus 25 msec settling time, plus latency time.

Benefits include low price (\$990 for

a single drive), low media price (single cartridges sell for \$10), and reliability (the vendor claims that the head can ride on the same track for 24 hours without losing data due to tape wear). Also, the quarter-inch thick cartridge can be stored in a manila folder, mailed, and even washed in cold water. Interfaces to Digital Equipment PDP-8s and PDP-11s, and to Data General Novas will be available. INNOVEX CORP., Bedford, Mass. For information:

CIRCLE 228 ON READER CARD

Tape Reel Display

When operators pick up several tape reels at a time to hang them on waiting drives in response to multiple console

product spotlight



Performance Monitors to Job Stream Controllers

The merger of Tesdata Systems and Computer Synektics is being celebrated with the announcement of six lines of computer performance-related products that range from a \$3000 crt monitor (that tells what the system is doing) up to a \$150,000 attached processor (that tells what the system should be doing and reconfigures the job stream to make it happen).

The \$3000 unit should be the most popular. Known both as the model 1010 and as Micro-Sum, the 10-inch high device has a bar-chart crt display that shows eight functions at a time. Bar one, for instance, shows percentage cpu utilization. Bar three shows channel one, four shows channel two, and another shows channel/cpu overlap. A rotary allows the operator to dial any of up to 15 protect keys to find active programs. Another allows selecting the time intervals to be averaged; activities lasting only 25 nsec can be measured.

Options include up to 20 sensors, display expansions to up to 16 bars, a real-time clock, printer, cassettes (which allow you to "rerun" any part of the day's activity), and batch software to generate activity reports. Not a minicomputer, the 1010 can be hardwired or plugboard programmed. Units with all the options may go as high as \$8000, and slave displays for the scheduling clerks or manager's of-

fices are available.

The 1100 series includes the \$26,000 model 1155 and the \$50,000 model 1185. The smaller unit has only a binary display and a 7- or 9-track drive for recording activity. It has 32 to 96 sensors, a plugboard for programming, a 4K to 8K core, and from 8 to 32 counters. It can measure not only the use of hardware resources, but the activity of programs in memory (real or virtual) and the utilization of data sets or operating system routines stored on disc (which it gets through the disc controller). Tesdata claims that a typical 360 or 370 os installation experiences 30% operating system overhead and that this can be cut to about 15% just by knowing better what system components to assign to disc. Further improvement can come from implementing Tesdata's optimized os code, if the user wants to go that far.

The 1185 can measure smaller intervals (to 5 nsec rather than 30 nsec), has a 16K Interdata 70 mini instead of a plugboard, offers more counters (up to 144), can map many more memory segments, and has a graphic display.

The 1200 series is like the 1185 but will run its utilization analysis program interactively instead of saving data for batch processing. To do this, it gets a disc that the 1100 series goes without.

Dynamic job scheduling capabilities come in with the 1300 series, machines that have only limited hardware per-

formance measurement capabilities. The units have the ability, for instance, to get a profile of hardware use, including cpu or device or channel activity. They cannot map program or memory use.

The 1300s can emulate an operator's console—complete with operator. They connect to a selector channel and act something like a replacement for a second cpu running under IBM's Attached Support Processor monitor. Using a program called Streamline, they access and update a previously developed data base of job descriptions and schedules and resources. Constantly monitoring the job queue, the 1300s change job priorities and otherwise juggle the load to improve throughput. The systems can coordinate the workloads of up to four computers at a time. They sell for about \$100,000, but are claimed to be able to compress three shifts' worth of 165 workload down to two shifts.

The 1400s do all of that and also have all the measurement capability of the 1100s, making the resource utilization that much more efficient. They run about \$125,000.

If that isn't enough, consider the top of the line 1500s. For \$150,000 they can do everything mentioned—the measuring, the resource allocating, the schedule updating, the job queue alterations, the software monitoring, etc.—and can control and schedule the computer shop's other functions like key-punching.

All of these work on os or vs, reportedly, and will be available by summer. The Micro-Sum and the 1100s are available now.

A rule of thumb we've heard is that an installation can afford a monitor whose price is equivalent to one month's computer rental. If that works, there's something here for everyone. TESDATA SYSTEMS, Chevy Chase, Md. For information:

CIRCLE 220 ON READER CARD

hardware

messages, there is cause for some concern: The Volume Serial Number Display helps insure that the right reel is hung on each drive by intercepting console messages—or messages sent over a communications channel that

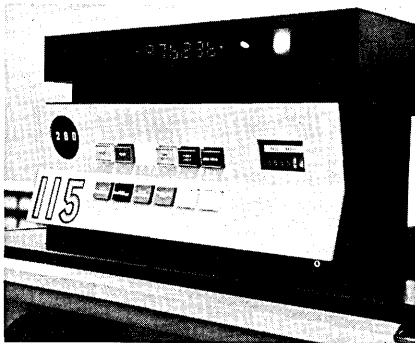

thinks the vsn is a 2741 terminal—and displaying the reel numbers on the tape drives. The displays on waiting drives show a flashing green light until the reel is mounted.

Operating under OS on 360s or 370s, the system includes a controller that can handle up to 64 displays. A 12-display system sells for \$6780 or rents for \$228. ADVANCED DIGITAL SYSTEMS, INC., Mohawk, N.Y. For information: CIRCLE 223 ON READER CARD

Display Cluster

When a set of IBM 2260 or 3270 displays is turned down in favor of the PTS-100 programmable terminal system, this vendor claims that less money is spent and several IBM options are thrown in free. Included as standard features are tab, printer support, 029-compatible keyboard, controlled non-destructive cursor, and erase EOL.

Complemented by a controller with an MOS memory of from 8K to 64K bytes, the displays can show 480, 960, or 1920 characters and come with either a 67- or 82-key keyboard. With 960-character displays, a four-scope system sells for \$13,050 (or \$505/month including maintenance). RAYTHEON DATA SYSTEMS, Norwood, Mass. For information:

CIRCLE 229 ON READER CARD

3705 Replacement

The COPE 4705 communications controller incorporates a little known minicomputer built by UCC, the model 12. The mini provides the IBM-dedicated system with from 8K to 64K (16-bit words) of 1.1-usec core memory and 2K of 250-nsec control store. Coupled with the right line adapters, it can control 75- to 9600-bps transmissions over up to 180 lines.

The UCC 12's software can make the 4705 emulate the IBM 3705 communi-

cations front-end or a 270X running under BTAM, QTAM, or TCAM. The system supports terminals and line speeds not normally configured on IBM equipment through a code conversion feature. A configuration with 20 300-bps asynchronous lines and two 9600-bps synchronous lines is priced at \$50,000 or \$1200/month including maintenance. UCC COMMUNICATION SYSTEMS, INC., Dallas, Texas. For information: CIRCLE 230 ON READER CARD

Terminal Saver

There's no sense in having your teletypewriter terminal working when nothing's happening, so this shut-off timer is provided. When messages have not been received or sent for a short time (from 30 seconds to 5 minutes of idle time, as you choose), the power is turned off. Power goes on automatically when the next message comes in. Think of it as \$87.50 worth of preventive maintenance. COMPUTER MAINTENANCE SERVICE, Pleasant Hill, Calif. For information:

CIRCLE 231 ON READER CARD

Facsimile Transmitter

Facsimile transmission systems may one day be remote page reading terminals. The model 603 vrc portable Remotecopier looks like it is halfway there. A battery-powered unit housed in an attaché case-like cover, the terminal unit has a built-in acoustic cou-



pler and can transmit an 8½ x 11 page in three minutes over voice-grade lines. Its normal resolution is equivalent to 64 lines per inch in each direction, but can be increased at will to 96 lines per inch for slower transmissions. Prices aren't firm, but the 603 is expected to sell for about \$1500 and lease for \$55/month. 3M CO., St. Paul, Minn. For information:

CIRCLE 224 ON READER CARD

Teletypewriter Buffer

Oem's can make a teletypewriter into a high-speed terminal to sell for approximately \$2000 using the 7132 terminal buffers. Built to fit into the kneewell of a terminal, the buffers provide from

November 10, 1972

This announcement is neither an offer to sell nor a solicitation of offers to buy any of these securities. The offering is made only by the Prospectus.

279,383 Shares



Computer Automation, Inc.

Common Stock

Price \$13.25 Per Share

Copies of the Prospectus may be obtained from such of the undersigned and others as may lawfully offer these securities in this State.

New York Securities Co.
Incorporated

Seidler, Arnett, Spillane & Harris
Incorporated

Burnham & Company Inc.

Clark, Dodge & Co.
Incorporated

Faulkner, Dawkins & Sullivan
Securities Corp.

Robert Fleming
Incorporated

Harris, Upham & Co.
Incorporated

Hayden Stone Inc.

W. E. Hutton & Co.

F. S. Moseley & Co.

F. S. Smithers & Co., Inc.

C. E. Unterberg, Towbin Co.

Estabrook & Co., Inc.

William D. Witter, Inc.

Ball, Burge & Kraus

Crowell, Weedon & Co.

A. G. Edwards & Sons, Inc.

Elkins, Morris, Stroud & Co.

Kohlmeier & Co.

Mitchum, Jones & Templeton
Incorporated

Moore & Schley, Cameron & Co.

Piper, Jaffray & Hopwood
Incorporated

Rauscher Pierce Securities Corporation

Sutro & Co.
Incorporated

4K to 16K of MOS storage and can operate with lines to 2400 baud. The simplest of the units performs certain kinds of input editing, too, including allowance for backspacing, line deletions, and clearing memory. An editing option can make the device operate as a stand-alone text editing system. A 4K unit sells for \$1200. PULSE COMMUNICATIONS, INC., Falls Church, Va. For information:

CIRCLE 232 ON READER CARD

Hardcopy Terminal

Production has begun on the Concept 30 hardcopy terminals, so deliveries should be quick, especially to sites that can use the standard ASCII version. Able to print up to six copies of forms to 14 $\frac{7}{8}$ inches, the device runs at up to 30 cps using a 64-character set. Available as a receive-only unit for \$1895, the 30 can have a parallel interface and keyboard which bring the price to \$2095. Options include EBCDIC or Baudot input, paper and mag tape peripherals, and punched card gear. COMSTAR CORP., Edina, Minn. For information:

CIRCLE 233 ON READER CARD

Smart Terminals

The TC 3500 is the latest in a line of intelligent terminals that started with what was claimed to be the industry's first, the TC 500 (which came out in 1967). Primarily intended for communications purposes, the 3500 has two buffered channels which can handle asynchronous or synchronous data to 9600 bps using Burroughs' or IBM's line control procedures. It also has from 2K to 44K characters of 1.5-usec semiconductor user memory and a cpu cycle time of 3 usec.

Programmed in a COBOL subset, the 3500 is able to handle any applications programs written for other TC series terminals and can even do sorts if given several mag tape cassette peripherals. Prices start at \$12,900 for a unit with 12KB of user memory (plus 12KB of micrologic), a 15 $\frac{1}{2}$ -inch printer, and keyboard. BURROUGHS CORP., Detroit, Mich. For information:

CIRCLE 234 ON READER CARD

Page Reader

For about half the rental of the other Input 80 optical page readers, a lower volume shop can have the Model C. The difference is strictly one of paper-moving speed; the C's throughput is from 50% to 20% less.

The unit has a maximum reading speed of 3,600 cps, just like other 80s. It handles forms from 4 x 5 $\frac{3}{4}$ inches to 9 x 14, and can read 15 lines on 8 $\frac{1}{2}$ x 11 pages at a rate of 32 pages/minute. It comes with two 9-track, 800-bpi tape drives (one is usually used for

records with unreadable characters), a 16K cpu, a line printer (300, 500, or 900 lpm), and a 10-cps console typewriter.

Systems to read single fonts (and some handprinting) start at \$6275/month or \$259,250. Multiple-font systems (many fonts but one at a time) and multifont systems (mix up to 14 fonts) are also available. RECOGNITION EQUIPMENT, Dallas, Texas. For information:

CIRCLE 235 ON READER CARD

Voice Response

Users who don't have to multiplex their audio response output might find a real winner in the Digivox digital-to-voice converter. Digivox has two things going for it: price and ease of use. The device costs only \$1925—compare that with an IBM 7770 or with a Wavetek system—and is made to emulate a Teletype.

The unit has a limited vocabulary, 48 tracks of about 12 words each, but has the advantage of producing normal-sounding speech, its vendor claims. Banking systems are offered, for instance, that can say all the numbers from zero dollars and zero cents up to \$9,999,999.00 and say them the way we would, including saying "sixteen" instead of "one six." All that Digivox requires of its host computer is that its 10 single-digit registers be filled. INSTRUMENTATION SYSTEMS, INC., Garland, Texas. For information:

CIRCLE 236 ON READER CARD

96-Column Card Gear

Sounding almost embarrassed that they ever offered 80-column cards, Burroughs announced four 96-column card machines for off-line operation. The PC 910 data recorder (keypunch and verifier) puts out up to one card per second under four-level programs entered on punched cards (presumably 96-column). The PC 920 adds interpreting to the 910's functions. The 930 has all of those functions, and it can sort on alpha or numeric fields at 300 cpm using six hoppers. Finally, the 990 sorter has 11 pockets and runs at 1,500 cpm.

Prices for the data recorders range from \$6950 to \$12,530 with options (gang punching, reproducing, interpreting, and merging). The 990 runs from \$6500 to \$8840. BURROUGHS CORP., Detroit, Mich. For information:

CIRCLE 237 ON READER CARD

Batch Terminal

Although the "Sensible Terminal" has a built-in 4K mini and can emulate the IBM 2780 or other batch terminals, it is not user-programmable. It is programmed at the factory to match on-

AJ630



Here's a printer terminal that's

QUIET

(No impacting of paper)

FAST

(Up to 30 characters per second)

RELIABLE

(All solid state)

It's the AJ630 Solid State Keyboard Printer Terminal that offers selectable printing speeds of 10, 15, or 30 characters per second. Here are just two of the many features: (1) a wide carriage—140 characters per line; (2) remote setting of tabs by the computer. More features and the complete story are in the AJ630 Brochure. Write for it now. Better yet, ask for a *quiet* demonstration. You'll see why...

you're in better company with

**ANDERSON
JACOBSON**

1065 Morse Avenue ■ Sunnyvale
California 94086 ■ (408) 734-4030
Sales offices in principal cities throughout the U.S.A.

CIRCLE 95 ON READER CARD

Have we got a show for you!

Last year we had an idea. A new kind of computer show. A show that would let computer people talk to other computer people and independent experts about current, practical problems. A show that would repeat itself in major cities across the U.S., so everyone would be able to get there. And a show that would exhibit the latest EDP equipment and services in a pleasant, uncrowded atmosphere.

It was this idea that became the first Computer Caravan. And it was successful beyond expectation. Thousands attended our Forums and Exhibition, and a large majority said that not only would they come back, but they would encourage other middle and top management people in their organizations to take part in the future.

With these comments in hand, we've built an even better show: The Computer Caravan/73.

Forums Users talk to users and independent experts in these unique panel discussions and shirtsleeve workshops. Overall topics include:

- Day 1 - Data Entry**
- Day 2 - Data Communications**
- Day 3 - Installation Management**

Open Sessions New this year, we'll have open sessions each afternoon at 2:30. Anyone with a Forum or an Exhibition Hall ticket can attend at no charge.

- Day 1 - Data Communications Planning**
- Day 2 - Software Evaluation Panel**
- Day 3 - Small Systems Panel**

Exhibition A show is known by the companies it keeps. And we've got some of the best. Here are some of the people who will be showing you the latest in EDP products and services each afternoon and evening, in the pleasant, uncrowded atmosphere of the Caravan Exhibit Hall:

Anderson Jacobson	Entrex	Modular Computer
AT & T	General Computer Systems	Penril
Auerbach	Hazeltine	Prime Computer
Boeing	Hewlett-Packard	Sierra
Centronics	Incoterm	Sycor
CIG	Inforex	Techtran
Computer Devices	Interdata	Tektronix
Courier Terminal	ICC-Milgo	Teletype
Data Disc	I/O Devices	Texas Instruments
Data General	Iomec	Western Union Data Services
Data Products	Kodak	
Delta Data	Lockheed Electronics	

Schedule

City	Dates	City	Dates
Boston	Feb. 13-15	Anaheim	Mar. 27-29
Washington	Feb. 20-22	San Francisco	Apr. 3-5
New York	Mar. 5-7	Kansas City	Apr. 11-13
Atlanta	Mar. 13-15	Chicago	Apr. 17-19
Houston	Mar. 20-22	Cleveland	Apr. 24-26



The Computer Caravan/73



COMPUTERWORLD

To: **Walter Boyd**
 The Computer Caravan/73
 797 Washington Street, Newton, Mass. 02160

I'd like to get all the details about attending the Computer Caravan. Please make sure you send me literature and registration forms in plenty of time for me to enroll for your Forums. I understand that if I wish to attend only the Exhibits and open sessions no advance registration is required.

Name _____
 Title _____
 Company _____
 Address _____
 ZIP _____

hardware

line and off-line applications, and changes to those installed programs are made over a phone line by the vendor at no charge.

What the user gives up in flexibility, he reportedly gets back in reduced rentals. For instance, a unit with a 256-character crt, a 7- or 9-track built-in tape drive, a 135-lpm printer, and a 500-cpm card reader would lease for \$675/month on a three-year basis. The closest 2780 would rent for a little under \$1000/month. At \$42,300, the purchase savings are not nearly as great. Faster printers—to 600 lpm—are available as options. DIGITAL INFORMATION DEVICES, INC., Lionville, Pa. For information:

CIRCLE 238 ON READER CARD

Accounting Machine

When sitting among its peripherals, the P603 "Electronic Office Microcomputer" looks like a calculator someone accidentally left on the computer console. But the 603 is the driving element of an insurance office accounting system. Programmed by magnetic cards delivered from the vendor, the machine posts ledgers and figures commissions and prepares paper tape for a service bureau doing the tougher data processing. Priced at \$6200 for the calculator and typewriter console, the 603's peripherals include a random access mag tape cartridge (\$2185), a paper tape reader (\$1205), and tape punch (\$1595). OLIVETTI CORP. OF AMERICA, New York, N.Y. For information:

CIRCLE 240 ON READER CARD

Disc Packs

This source of IBM-compatible 3336 disc packs begins its pricing at "under \$700" even for single units and claims that its packs can perform reliably even after 30,000 head loadings. As usual, the packs are initialized at the factory and defective tracks are flagged. CFI MEMORIES, INC., Anaheim, Calif. For information:

CIRCLE 239 ON READER CARD

360/65 Memory

IBM may not have intended that its 65 ever grow big enough to challenge sales of larger machines or to stall sales of 370s, but 360/CORE 65 might make that happen. The add-on and replacement memory is available in increments exactly like IBM's except that the upper limit is 2MB instead of 1MB. In addition, it offers the fail-softness of reassigning 256KB pieces to high core if they falter, thereby putting off maintenance for awhile. Prices start at

\$84,000 (\$2683/month) for 256KB and go to \$215,000 (\$6868/month) for a megabyte. CAMBRIDGE MEMORIES, INC., Concord, Mass. For information:

CIRCLE 243 ON READER CARD

Mini Discs

From 25 to 100 megabits of storage is provided by the top-loading DP Series minicomputer disc systems starting at \$7500. A head-per-track disc cartridge system, called the D series, is also available. It runs \$6000 and up (including controller) and provides from 40,000 to 500,000 16-bit words. PERIPHERAL DATA MACHINES, INC., Hicksville, N.Y. For information:

CIRCLE 241 ON READER CARD

Small Air Conditioners

First-time computer users and shops that need extra capacity are offered a special range of air conditioning systems. Called the 42/52 series, the systems provide close-tolerance two-stage heating and cooling for computers the size of an NCR Century 50 or IBM System/3. The 42/52s come in three versions—for air, water, or glycol cooling—and put out roughly 4 $\frac{1}{3}$ or 5 $\frac{3}{4}$ tons, depending on the model. Prices start at \$2700. BLAZER CORP., East Rutherford, N.J. For information:

CIRCLE 242 ON READER CARD

96-column Punch

The 96-column card may be, among other things, IBM's mechanism for moving System/3 users to larger machines. Other manufacturers can take advantage of the eventual migration with the 9640 printing punch, a fully buffered unit which runs at from 120 to 240 cpm and can print a full 128 positions (four rows of 32 characters). Features include a 1,000-cpm pre-punch read option which can be field-installed. Single-unit prices begin at \$6900; the read feature runs \$850. Delivery takes four months. DECISION DATA COMPUTER CORP., Horsham, Pa. For information:

CIRCLE 244 ON READER CARD

Computer/Controller

The dividing line between computers and controllers falls somewhere around the C-A-S-H-8, a microprogrammable device that can have either all read-only memory (which would make it a controller) or can mix ROM and read/write memory. The \$600 machine has a 53-instruction set, a 16-bit word size, 16 registers, power fail protect, separate input and output busses, and a minimum of 512 words of ROM (expandable to 64K). Its full cycle time of 600 nsec equates to 200 nsec/microinstruction. STANDARD LOGIC INC., Santa Ana, Calif. For information:

CIRCLE 245 ON READER CARD

WANTED

**FOR AGGRAVATED
ASSAULT
ON DISC PACKS**

DESCRIPTION:
ALCOHOL: 91% isopropyl alcohol, 9% de-ionized water. Masquerades as a disc cleaning solution. Recognized by the residue it leaves.
TISSUES: Beware of soft paper exterior. Goes under the alias "Lint-Free".
TONGUE DEPRESSOR: Dangerous hard stick!! Previous Occupation: tongue-squeezing throat inspector.



IF SEEN, NOTIFY YOUR RANDOMEX PACK CLEANING SPECIALIST AT ONCE.

REWARD

Pack and drive performance such as you've never known, when we capture contamination from your packs in your installation. Call now for an eye witness demonstration on your problem packs.

RANDOMEX AUTOMATIC CLEANERS FOR 1316-2316-3336 PACKS
SALES • LEASES • CLEANING SERVICE

randomex, inc.
27303 Warrior Drive
Palos Verdes Peninsula, Ca. 90274
213-377-9887

CIRCLE 88 ON READER CARD

Software & Services

Software Notes . . .

"If your shop is committed to IBM, you will be committed to virtual storage," says Boyd Munro, designer of the GRASP I/O spooling module marketed by Software Design Inc., Burlingame, Calif., to DOS users (and eventually to DOS/VS users). Reaction to the virtual memory announcement also continues to come from initial users of the VS-1 replacement for OS/MFT. Their conclusions, aired at the recent GUIDE user's group meeting in Montreal, were that the monitor does work; that its performance is down slightly from the OS it replaces (which maybe isn't so bad considering that we are seeing the initial releases of the new monitor); that jobs dealing with index sequential files take twice as long to run, and that the job accounting problem (resource billing) is more acute than ever.

Digital Equipment Corp. has been chosen by the National Science Foundation as publisher of the Huntington II simulation project. The government-funded program supplies computer simulation programs on a nonprofit basis to all interested educational institutions, but the BASIC-language programs are geared toward high school and college freshmen students. By June 30 of this year it is anticipated that 30 programs will be available for work in the fields of biology, chemistry, earth sciences (including pollution), physics, social studies, and mathematics, and for teacher assistance. The program groups are supplied in paper tape form for either \$1 or \$2 each, including a teacher's and student's manual. DEC claims that its computers are used by more than one million students each year.

Informatics' Mark IV file management system was pitted against a garbage truck for a portion of the Univ. of West Virginia's 1972 capital expenditures. It won. The university decided it could wait another year for a new \$20,000 garbage truck and allotted \$22,000 for Mark IV, which is now installed and running. Mark IV, with 550 installations in 33 countries, was recently awarded a British patent, and president John Postley says Informatics Software Products will continue to apply for patent protection wherever it is available, despite the U.S. Supreme Court's recent negative ruling.

Mini Virtual OS

cvs/72 is a combination of a virtual memory operating system and a programming language (a subset of BASIC) that is offered to users of the Data General Nova minicomputer line for commercial applications. The commercial bias is seen in such features as leading blank suppression, automatic decimal placement, string operation capability, and formatted i/o routines being present, and also because there are no floating-point arithmetic or matrix-handling capabilities. Control of the 256-word (16 bits to the word) pages is done totally with software, implying substantially degraded system performance, but the developers claim that page swap times ranging typically from 40-60 msec are "virtually" equivalent to the time required to execute one or two BASIC statements. That's not a bad penalty to pay for virtual capability, and considering that program overlays are no longer needed for large programs, it would seem worth it. A fixed-head disc improves this performance.

Two versions of cvs have been developed: A single-user version that fits into 4K of memory and sells for \$2950, and an eight-user version that runs in 8K and sells for \$6900. Both systems require a tty or crt display terminal and at least one moving-head disc drive. The programs are supplied in binary form on a tape. Users having special i/o drive routines that must be incorporated into cvs/72 are supplied relocatable modules. Documentation for the monitors isn't quite what the vendor would like it to be yet, but it's being worked on. The eight-user version is scheduled to be ready by March, and the single-user version should be ready to go when you read this. COMPUTER SYSTEMS DESIGN INC., Manhattan, Kan. For information:

CIRCLE 261 ON READER CARD

DOS Data Base Management

Nearly eight years have gone by since IBM's announcement of Disc Operating System, and there is now finally an IBM-supplied file management system that runs with it. Actually there are two programs: Data Language/I DOS/VS for 370 virtual memory machines, and one called Vancouver Data Language-One which runs in a partition size of 14K bytes on non-virtual-memory 360 and 370 cpu's. The two programs are similar in all other respects, basically being upward-compatible subsets of the IMS/360 data management programs os users have had for some time, excluding the more complex functions that only os users really need.

Among the capabilities of the two packages are the ability to add new categories of data to the files, change record sizes, load and dump the files from tape to disc, etc. The total size of the data base is constrained only by the number of disc units available. Security is called "segment sensitivity" in the programs, which a user can use to restrict selected programs and instructions from operating on the files. Users can write application programs, including the required report generators, in COBOL, PL/I, and assembly language. Vancouver Data Language-One is available now under a license agreement for a monthly charge of \$350. Data Language/I will be available in the last quarter of this year under a similar agreement for a monthly charge of \$300. IBM CORP., White Plains, N.Y. For information:

CIRCLE 262 ON READER CARD

Conversion Service

This conversion service initially will be limited to converting IBM assembly language level F programs into Digital Equipment PDP-11 assembler. But the vendor will consider other target computers if there is sufficient response. The service is based on a nine-pass program that is being taught how to convert the IBM DOS release 26 monitor so that it will run on a 24K PDP-11! Another claim made for the service is that the nine passes convert very nearly 100% of the coding, in comparison with the 85-90% performance of other conversion programs. (An example of what can't be converted is a branching table.) The charge for the service is \$1 per source card (comment cards are free), and the conversion time is said to depend more on the U.S. mail than on anything else. CONVERSION SOFTWARE SYSTEMS CORP., Chicago, Ill. For information:

CIRCLE 263 ON READER CARD

Self-teaching MIS

RESULT is a management information system oriented toward nontechnical business personnel engaged in inventory control, sales analysis, production efficiency reporting, job costing, personnel records, and similar applications. It runs on Leasco's Response I time-sharing system nationwide in the U.S. and the U.K.

To use the service one need only install a conversational terminal, and, after dialing the appropriate phone number, typing in the word "AID." RESULT then issues instructions for enter-

ing data, maintaining the information file, displaying information for a complete record, designing procedures to get selected information, printing the specially selected information, listing or revising all descriptions stored in the user's information catalog, executing special programs written by the user, changing the data in these special programs, and signing off.

A record indexing method allows the user to replace data contained anywhere in the file, retrieve and display individual file records, and add or delete selected records without having to process the entire file. Safeguards protect the master file from access by unauthorized personnel, and from inadvertent clobbering by comparing data being entered against a set of user-supplied editing descriptions. The charges for the service are a little complicated: The first 25 hours of connect time are billed at \$8/hour; the next 25 hours at \$7/hour, etc. A charge of 75¢ is made for each 1,024 bytes of secondary (disc) storage. LEASCO RESPONSE INC., Washington, D.C. For information: CIRCLE 265 ON READER CARD

PL/1 Simulation Package

SIMPL/1 is a discrete simulation language equipped with a number of more powerful features than IBM's own GPSS (General Purpose Simulation System) that has been around for nearly a decade. Because of this, SIMPL/1 is for use by experienced programmers, where GPSS was designed for users with little or no computer experience.

These features make it possible to create dynamic data items, to make system components dynamically interact, and to do list processing. Lists can be inserted into other lists, enabling

hierarchies and tree-like structures to be built up. A special timing routine is responsible for the sequencing of all events, with virtually no limit to the number of items it can accommodate. The language is implemented by means of a preprocessor that takes a model written in SIMPL/1 and PL/1, and from it generates a PL/1 program which is then compiled and executed under OS releases 20.1 and later.

To use it requires any OS 360 or 370 with a region or partition size of at least 104K bytes, a linkage editor or loader (you probably already have one), and either the PL/1 optimizing compiler or the PL/1 checkout compiler, both of which rent for \$250/month, as does the SIMPL/1 package. IBM CORP., White Plains, N.Y. For information:

CIRCLE 266 ON READER CARD

File Load/Dump

FDR3330 is a disc dump/restore utility offered as a replacement for the standard IBM OS routine that performs the same functions. The advantages claimed for FDR3330 include an up to five-fold decrease in wall clock processing time using 50% less CPU time, with 30-80% fewer tape errors, 40-90% fewer disc errors, and the ability to store the file on one or two reels of tape, compared to up to four reels for the OS module. Up to nine packs can be dumped or restored during a single run. The package is priced at \$990 for the first computer and \$500 for each additional system. INNOVATION DATA PROCESSING, Flanders, N.J. For information:

CIRCLE 268 ON READER CARD

software spotlight

Data Base Aid

The DATA CATALOGUE system supplements the IBM IMS/360 and Cincom's TOTAL data base management programs to provide additional information to aid in the design and administration of the data base. The ANSI COBOL program requires approximately 100K bytes of storage to provide a number of capabilities. It can be used to explore the implication of changes to existing data bases by listing what program changes will be required.

In designing data files, DATA CATALOGUE can be used to define detail items independently of their being structured into a hierarchy. This allows the designer to first define the contents

of the data entities and to later decide on the actual organization of the file. Alternate or proposed data structures can be simulated, and an optional module produces a pictorial representation of the structure down to the segment level.

DATA CATALOGUE can be used in the administration of the data base by permitting the user to specify installation standards for data definitions which are then automatically enforced. A number of reports are generated for both the technical and nontechnical staffs. DATA CATALOGUE is supplied in object code form for \$6500, and it can also be rented and leased. Documentation is in the final stages of preparation, and tailoring of the package for other file management systems is planned. SYNERGETICS CORP., Burlington, Mass. For information:

CIRCLE 260 ON READER CARD

WHAT A PROGRAM GENERATOR AXIOM TWO IS!

BOY, IT SURE STOPPED 'EM AT THE SHOW!

YEAH, ONLY A HALF DOZEN PARAMETER STATEMENTS!

NO MORE WRITER'S CRAMP.

AND AXIOM ONE WORKS WITH IT.

...WELL, CIRCLE MY BINGO!

axiom two COBOL

a powerful program generator

GENERATES: Most types of COBOL programs.

FEATURES: Easy to use parameter statements ■ No special training required ■ Manufacturer independent

call or write for free descriptive literature:



DIMENSIONAL/EXPORT SOFTWARE CORPORATIONS
15910 Ventura Boulevard
Los Angeles, Calif. 91316/(213) 986-6555

(Subsidiaries of LSC)

CIRCLE 83 ON READER CARD

Literature

Multiple Data Set Systems

Twenty-page brochure describes vendor's 16-channel Multiple Data Set System for computer sites. It also covers a four-channel chassis for terminal

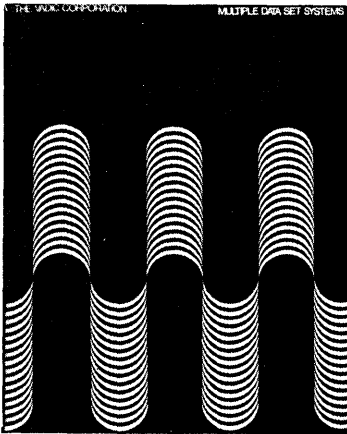

clusters and multiplexor sites and a number of one- and two-channel boxes for remote terminal applications. THE VADIC CORP., Mountain View, Calif. For copy:

CIRCLE 201 ON READER CARD

Microprogramming

Five-page brochure titled "Economic Advantages of Microprogramming" presents a set of economic arguments for the use of microprogrammed control in the place of random logic. SIGNETIC MEMORY SYSTEMS, Sunnyvale, Calif. For copy:

CIRCLE 202 ON READER CARD

Punched Tape Readers

A line of photoelectric punched tape readers is covered in a 56-page catalog which includes application information on punched tape materials, tape punching, field practices, EIA tape standards, and computer interfacing. ELECTRONIC ENGINEERING CO. OF CALIFORNIA, Santa Ana, Calif. For copy:

CIRCLE 203 ON READER CARD

Mexican Reps

A list has been compiled of representatives in Mexico who have the experience and technical knowledge needed to handle data processing equipment, supplies, and software. SEYMOUR A. ROBBINS AND ASSOC., P.O. Box 556, Teaneck, N.J. 07666.

Telecommunication Control

"A Management Guide to Telecommunications Control" is a 12-page guide describing the requirements in today's diversified and decentralized business for communications control and information handling systems that can accommodate both teleprinting and teleprocessing requirements. TELE-

SWITCHER CORP., Dallas, Texas. For copy:

CIRCLE 204 ON READER CARD

Management Seminars

Brochure describes data processing-related seminars presented under the sponsorship of the American Institute of Industrial Engineers (AIIE). Topics covered are Managing Computer Programming Projects, Effective Systems Analysis and Design, Designing EDP Financial Information Systems, EDP General Ledger Systems and Financial Reporting, and EDP Accounts Receivable and Credit Management. MANAGEMENT EDUCATION CORP., Los Angeles, Calif. For copy:

CIRCLE 205 ON READER CARD

Source Data Collection

A source data collection system, designed to be used in such applications as production progress reporting, time and attendance recording, hospital/medical data entry, library circulation systems, tool control, purchasing/receiving data, inventory and materials, control and ordering, and machine loading, is described in a brochure divided into 12 sections, each of which explains, where applicable, a unit's construction, assembly details, life expectancy, pricing, and major features. MOHAWK DATA SCIENCES CORP., Herkimer, N.Y. For copy:

CIRCLE 206 ON READER CARD

Time-Sharing Computer

Vendor's Timeshared-8 computer system is described in a 16-page brochure which covers hardware, software and support features, and applications. The system allows up to 17 users simultaneous access to a multilanguage, interactive, resource/time-sharing system. DIGITAL EQUIPMENT CORP., Maynard, Mass. For copy:

CIRCLE 207 ON READER CARD

International Data Bases

A new international computing service that allows U.S. and European operations of multinational firms to have local phone call access to decision-making data regardless of time zones, is described in a 13-page brochure which defines how multinational organizations can get common access to 22 large-scale computer systems containing their programs and data bases. TYMSHARE, INC., Cupertino, Calif. For copy:

CIRCLE 208 ON READER CARD

Time-Shared Plots

A manual for users of the HP PLOT software program was written for the

user of a time-share terminal equipped with an X-Y plotter but could be interesting to anyone required to plot computer data manually. It contains listings of commands, instructions, and sample plots. HEWLETT-PACKARD, Palo Alto, Calif. For copy:

CIRCLE 209 ON READER CARD

Tape Accessories

Sixteen-page catalog covers vendor's complete line of perforated tape accessories and supplies, including such new products as polyester-opaque Data-links (splicing tapes and patches) which feature a polyester/adhesive combination designed to prevent adhesive liquefaction or migration on all types of perforated tape. DATA-LINK CORP., San Diego, Calif. For copy:

CIRCLE 210 ON READER CARD

Programmer's Tool Kit

Data sheet describes a programmer's tool kit which is a set of 10 aids custom fitted into a leather briefcase. Tools include a hex calculator, conversion table, decimal calculator, slide rule, programmer's pencil, lead refills, ball-point pen, programming pad, and programming template. RADIX PRECISION CO., Atlanta, Ga. For copy:

CIRCLE 211 ON READER CARD

Disc Storage Systems

A series of head-per-track disc storage systems is described in a bulletin listing complete specifications for the systems, which are available in two rotational speeds—1,800 rpm and 3,600 rpm. Maximum storage is from 1.2 million bits to 13.6 million bits, and average access times are from 8.35 msec to 16.7 msec. PACIFIC MICRONETICS, INC., San Diego, Calif. For copy:

CIRCLE 212 ON READER CARD

Data Sets Catalog

Bell-compatible 300-, 1200- and 2400-bps modems are described in a short-form catalog which gives full specifications and Bell equivalency in chart form across the center spread. TELE-DYNAMICS, Fort Washington, Pa. For copy:

CIRCLE 214 ON READER CARD

Video Display Station

Four-page brochure describes a video display keystation that displays a complete 112-character data record plus 16 characters of mode and status information. The desk-top unit consists of a solid-state keyboard connected to a video display. COMPUTER MACHINERY CORP., Santa Monica, Calif. For copy:

CIRCLE 213 ON READER CARD

WILEY-INTERSCIENCE

Four volumes in the Wiley Communigraph Series on Business Data Processing, edited by Richard G. Canning and J. Daniel Couger

1. THE ORGANIZATION OF THE DATA PROCESSING FUNCTION

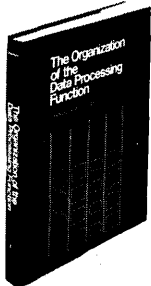

By Frederic G. Withington, Arthur D. Little, Inc.

Based on actual experiences of companies with data processing centers, this book evaluates the various ways of organizing the data processing function to improve effectiveness, morale, and productivity. Covering both real-time and multiple computer systems, it examines

the data processing function in terms of system development, data center operations, and its place within the parent structure.

1972 99 pages \$10.95

2. PERSONNEL IMPLICATIONS FOR BUSINESS DATA PROCESSING

By Robert A. Dickmann, U.S. Department of Labor, Manpower Administration

This practical guide is designed to assist in the selection, training, development, and evaluation of all levels of EDP personnel—from key punch operators to systems analysts. Reflecting all important management concerns, it covers such problems as staffing the EDP installation, selecting the inexperienced employee, selecting experienced computer personnel, and evaluating performance.

1971 117 pages \$10.95

3. DESIGN OF SEQUENTIAL FILE SYSTEMS

By T. R. Gildersleeve, Newkirk, Gildersleeve, Prendergast and Associates, Inc.

This book provides a step-by-step introduction to the fundamental concepts, organization, and problems of sequential data processing.

"On par with the best technical exposition I have ever read. Assumes little, moves in easy steps, avoids the confusing exceptions and elaborations, covers the subject thoroughly."

—Daniel D. McCracken, McCracken Associates, Inc.

1971 49 pages \$6.50

4. COBOL SUPPORT PACKAGES

Programming and Productivity Aids

By Stanley M. Naftaly, Woodbine Consulting, Inc., Bruce G. Johnson, U.S. Naval Supply System, and Michael C. Cohen, Woodbine Consulting, Inc.

COBOL Support Packages presents an organized approach to the use of COBOL which is also generally applicable to Fortran and other high level languages. An invaluable guide for those involved in the choice and use of programming languages, it describes and evaluates various types of software aids packages in terms of what they can do for the user.

1972 In Press

WILEY-INTERSCIENCE

a division of JOHN WILEY & SONS, Inc.
605 Third Avenue, New York, N.Y. 10016
In Canada: 22 Worcester Road, Rexdale, Ontario

5. PROGRAMMING TIME-SHARED COMPUTERS IN BASIC

By Eugene H. Barnett, TRW Systems, Inc.

A comprehensive and current treatment of all aspects of programming in BASIC language, this volume is designed to encourage the development of self-sufficient skills and to illustrate the importance of the time-sharing computer as a tool for solving diverse kinds of problems. Covering a wide range of subjects, it shows BASIC to be useful for both elementary and sophisticated problems.

1972 366 pages 360 illus. \$9.95

6. GPSS PRIMER

By Stanley Greenberg, Pratt & Whitney Aircraft Division of United Aircraft Corporation

Here is the first comprehensive description of GPSS geared specifically to the needs of students. Designed to serve as either a self-teaching guide or as the text for an instructor-led course, it covers all the major versions of GPSS including GPSS/360, GPSS V, GPS K, GPSS III, and Flow Simulator, and provides sample programs to illustrate the elements and features of the language.

1972 324 pages 102 illus. \$13.95

7. A GUIDE TO COBOL PROGRAMMING, Second Edition

By Daniel D. McCracken, McCracken Associates, Inc., and Umberto Garbassi, Esso Mathematics and Systems, Inc.

"This is a magnificent book!" —Computer Journal

"This book... will give the reader who is not familiar with COBOL a good description of the structure of the language and the situations in which COBOL is best utilized. The book is full of excellent examples and problems, and it uses three case studies that are worked out in sufficient detail for the reader to get an appreciation of the COBOL language..." —Computing Reviews

1970 209 pages 94 illus. \$9.50

8. A GUIDE TO FORTRAN IV PROGRAMMING, Second Edition

By Daniel D. McCracken, McCracken Associates, Inc.

The first edition of *A Guide to FORTRAN IV Programming* succeeded in showing readers with no previous background in computing, how to solve problems on a computer using FORTRAN. Now, expanded to include new illustrative, how-to-do-it examples and case studies, the second edition provides an up-to-date exposition of FORTRAN and its uses.

1972 304 pages (approx.) \$6.95

Available at your bookstore or from Dept. 092-A 1083-WI

WILEY-INTERSCIENCE, Dept. 092-A 1083-WI
605 Third Avenue, New York, N.Y. 10016

Please send me the books whose numbers I have circled:

1 2 3 4 5 6 7 8

My check (money order) for \$_____ is enclosed.
 Please bill me.

Name _____ Company _____

Address _____

City/State/Zip _____

Please add state and local taxes where applicable.

Books

Computer Dictionary and Handbook

by Charles J. and Charles P. Sippl
Howard W. Sams and Company, Inc.,
4300 W. 62nd St., Indianapolis,
Ind., 1972
778 pp. \$16.95

This is a weighty tome (3 pounds). The authors claim it contains 22,000 separate definitions and concepts. It is really two books in one. The first 490 pages contain an alphabetized set of definitions which range from ABA to ZOOM. In between the authors try to cover the terms and concepts concerned with "electronic data processing, information technology, computer science, and the many types of automation." They attempt to inform and explain; and where a word has several meanings, they list multiple definitions. In addition, there is extensive cross-referencing so you can look for many of our hyphenated terms under either the general concept or its modifier and still eventually find it. Superficially this looks like it is an excellent volume and one which should be in the hands of every computer professional.

The last 288 pages contain 13 tour guides through various aspects of computing. The topics touched on are:

an introduction, computer personnel, management science, system justification, model building, operations research, math, statistics, number systems, flow charting, computer languages, acronyms, and a view of the future. Just to choose these 13 topics requires an audacious spirit, and an attempt to cover computer languages in 43 pages would be creditable, if it were done well.

When one first opens the book he is struck by a flaw in the typography. The main body of text is set in double-column format similar to any good dictionary. However, the preface and other running prose is set in a wide, single-column format in small type. Unless one uses a straight edge to assist his eyes in tracking across the narrowly leaded wide lines, the text is difficult to read.

The dictionary

This volume is an update of the previous volume produced in 1966. Unfortunately, much of the 1966 material has been allowed to carry over. In a field that moves as rapidly as ours, material rapidly becomes dated. Prior to reissue, all dictionaries, glossaries, and word lists should be culled so that only current words and words of lasting interest remain. Further, in our field one should make an attempt to

associate all product-dependent words with the product they are associated with, its manufacturer, and always provide a date of introduction.

For example, FACT is described as a business data processing compiler from Honeywell. That's all very good, but I was project manager on that compiler at Computer Sciences Corp. in 1959 and it was built for the then new H-800 computer. If one is going to write a history, he needs dates and consistency. The dictionary does not cover either Flow-matic or COMTRAN, two other compilers of that early vintage.

As described above, the mechanical format is excellent: two columns, bold face for the words being defined, multiple definitions where appropriate, and cross-indexed. There is only one slight problem, which involves the use of hyphenated words. The hyphen and the blank are treated as null characters, giving some strange sequences: READ-GATHER, READ HEAD, READ-IN, READINESS REVIEW.

After pawing through the words a while, I conclude this team of academic authors (the elder is a college prof, the younger a student) is intent on translating the words and idiom of the computer field into nontechnical jargon for an audience of executives and administrators who are not in the field but come into contact with it occasionally.

Unfortunately, something frequently gets lost in the translation. Where a topic was not technical to begin with, the translation is pretty good (sometimes excellent), and the meaning of the words comes through. In other cases where the subject was technical or complex, the definitions fail to enlighten and in one or two cases reduce to blather. A few examples are in order.

TIME SHARING—The appointment of intervals of time availability of various items of equipment to complete the performance of several tasks by interlacing. (Contrasted with multiprogramming.)

This is good as far as it goes, but it does not mention that this is a mode of computer operation which attempts to appear to offer immediate service to several users through the use of an executive program designed to adaptively schedule machine resources so that all users can efficiently share a large central computer in an economic fashion. Further, it neglects mentioning that the users can be remotely located and through the use of terminals or other input/output devices can achieve access to the central computer facility to share resources, and where desirable may interact with a common data base. Keep in mind the Sippl definition was okay, but if you were a student or a senior executive or a foreign

370/165

REWARDING CAREERS for PROGRAMMERS

At Pratt & Whitney Aircraft ambitious programmers will find a sophisticated data processing environment that encourages fast professional and personal achievements. The projects are demanding; the equipment superior. For instance, third generation hardware including 360/50, 360/65, 370/165, 370/145 virtual concept and a host of teleprocessing terminals and peripheral devices.

Business Applications Programmers One to five years business programming experience on medium to large scale systems 360/370. Requires ANS COBOL and OS JCL knowledge.

Teleprocessing and Data Base Programmers One to five years programming experience using IMS V2 with ANS COBOL or BAL.

Software Programmers One to three years experience modifying system hardware and specialized software packages.

Scientific Programmers . . . to provide the analysis and programming for the solution of engineering problems on large digital computing systems. Programs are designed for operation in a batch mode on UNIVAC 1108's or in a time-sharing environment on an IBM 360/67.

Management Science Programmers One to five years experience in financial forecasting models and inventory simulations.

Please send your resume (including salary requirements) to Mr. H. M. Heldmann, Professional Placement, Office 100, Pratt & Whitney Aircraft, East Hartford, Conn. 06108.

Pratt &
Whitney
Aircraft

DIVISION OF UNITED AIRCRAFT CORP.
AU
AU

370/145

360/50

visitor, the concepts of economics, re-most access, and common data bases are rather fundamental.

In other cases, the definitions are downright poor.

RELOCATION, DYNAMIC-MEMORY—Frees programmer from keeping track of exactly where certain information is located in the system's memory. Another important attribute is its ability to keep programs flowing in and out of the memory in a highly efficient manner.

While those two statements may be true, I would prefer:

RELOCATION, DYNAMIC-MEMORY—A method, usually a blend of hardware and software, to increase the utilization of a moderate-sized memory and thereby increase overall system throughput without increasing cost. The method involves constructing computer programs, compatible with the memory management system, so that those computer programs, or a portion thereof, may be placed in any available block of memory and then have their address constants appropriately adjusted to allow them to execute properly from the memory locations to which they were dynamically assigned.

As one travels through the book he finds **DATA** and **INFORMATION** have been carefully defined, separately and correctly; but the other definitions don't use the terms consistently. The definitions for **ROLL-OUT** and **ROLL-IN** are not symmetrical; and in one case a

compiler is defined as an executive routine, but if one reads the definition for executive routine, clearly a compiler does not fall within the definition. The authors do make creditable attempts to define **ADDRESS**, **CHANNEL**, **COMPUTER**, **MEMORY**, **REAL-TIME**, and **MULTIPROGRAMMING**, so for coverage they get an A grade.

However, they didn't use an outline when they were writing definitions for the manufacturers' programming languages. Consequently they don't give the date of creation, its importance, the machine it was prepared for, and in some cases don't even give the name of the company that originated the effort.

The definitions of **UP TIME**, **DOWN TIME**, **SERVICEABILITY**, and **AVAILABILITY** are all adequate for the student when used in dictionary context, but are not sufficiently precise for use in contracts.

In summary, the dictionary portion of this tome is suitable for college professors—provided they are willing to sharpen and embellish these definitions for student use. They are not suitable for contracting. The technical editor will find them too imprecise to use in technical manuals, although they may be satisfactory for proposals. Finally, the secretary will be helped very little since she won't have the background to interpret what she reads and detect

the ambiguity or inconsistency in it.

From this drab beginning I plunged into the 13 vignettes in the last half of the book. The first appendix starts out at a very adolescent level, asking: "What is a computer?" It then moves at the speed of light, covering a computer in about a page, with a simplified sketch in another half a page, one page of supercilious flowcharts, a double page of graphics which are far from explanatory to an adolescent reader; and, suddenly, as we reach sonic speed, we have a layman's guide to computers with dog and camera. Even with my experience, I find the sudden shifts in level disconcerting as they cover input devices, the essence of the central processing unit, module miniaturization, large-scale integration, and semiconductor memories—in less than three pages!

Moving to the next theme on computer personnel, I find the definitions too academic, and they fail to reflect true knowledge of what goes on in the field. For instance, neither systems analysis or programming indicates that a programmer attempts to satisfy the functional requirements of the problem statement while retaining the proper balance between function, size, and performance. In addition, the programmer is constrained by the features in the operating system, the standards

RAPIDESIGN®

BEROL

1973 Catalog of Templates

AND LETTERING GUIDES

FREE

Send for the new 24 page Rapi-Design Catalog that fully illustrates more than 200 professional templates and lettering guides, including the new 1973 additions.

Templates are grouped for easy reference — General, Lettering, Ellipses, Electrical, Mechanical, Architectural, Processing, Programming, Metric and others.

Includes information for ordering Custom Templates.

RapiDesign is the world's largest manufacturer of professional templates, the industry standard for over 20 years.

To receive your free copy of the 1973 RapiDesign Catalog, write . . .

RAPIDESIGN, INC., Burbank, California 91505
a subsidiary of BEROL CORPORATION

CIRCLE 89 ON READER CARD

QUALIFIED ASSISTANCE TO USERS OF

IBM* CICS

IS NOW AVAILABLE —

- FEASIBILITY STUDIES AND SURVEYS
- INSTALLATION AND MAINTENANCE
- ENHANCEMENTS AND EXTENSIONS
- NON-STANDARD TERMINAL SUPPORT
- APPLICATIONS SYSTEMS
- SYSTEM UPGRADE AND CONVERSION

OS VERSION 1 DOS ENTRY
OS VERSION 2 DOS STANDARD

FROM LIMITED COUNSELING THROUGH FULL
"TURNKEY" RESPONSIBILITY — IN BOTH
"SYSTEMS" AND "APPLICATIONS" AREAS

*IBM IS A REGISTERED TRADEMARK OF INTERNATIONAL BUSINESS MACHINES, INC.

PHONE OR WRITE FOR ADDITIONAL
INFORMATION NOW

CONTACT: VICE PRESIDENT, MONITOR SYSTEMS DIVISION



**ON-LINE
SOFTWARE
INCORPORATED**

411 Hackensack Ave
Hackensack, N.J. 07601
PHONE (201) 489-0400
TWX (710) 581-3754

CIRCLE 75 ON READER CARD

books

in the users manual, the development schedule, and the skills of his teammates.

When looking at the definition for **WORK PROCESS SCHEDULER**, the authors dwell on efficient utilization and totally omit on-time delivery for production work—they wouldn't survive long in most of our computer shops that way.

In the operations research section they talk about PERT without ever telling what it is. In the mathematics section they define:

ALGORITHM—the art of computing in any particular way. We speak of the algorithm of numbers, imaginary quantities, etc. The word is of Arabic origin, and properly means the art of numbering readily and correctly.

If I were writing for a layman, I'd tell him an algorithm is a fancy name for an equation. If I were writing for a student, I'd tell him an algorithm is a series of equations, some of which may state inequalities which cause decisions to be made and the computational process to be altered based on these decisions.

The authors labor through number systems with most emphasis on binary. But then they sloppily march through

BCD, excess 3, and octal before doing a little Boolean algebra, set theory, and closing up on both truth tables and Venn diagrams. The level of the exposition is more like a refresher and is unsuitable for initial education. Blessedly they only devote 18 pages to it.

They properly introduce the ANSI standard flowchart symbols and then proceed to misuse them two pages later. In the section on languages, they claim that **ALGOL** and **FORTRAN** were developed in parallel, which is not exactly as my memory has it; but then they don't give John Backus the courtesy of a capital on his name where it appears.

In many places the authors are careful to constantly and consistently degrade the "giant brain" syndrome. They are not as careful in their languages section, as they still maintain that **FORTRAN** is machine independent. It seems that both myths deserve the same put-down.

The section on acronyms and abbreviations is a minidictionary of its own containing the flotsam and jetsam of the computer field (and several other fields thrown in). **ABM** is defined as automated batch mixing; **BTU** is British thermal unit; **CPR** is cam plate readout; **DECIT** is decimal digit; **EDD** is envelope delay distortion; and **FEAT** is Frequen-

cy of Every Allowable Term. In between are most of the public acronyms and many private acronyms from projects long dead or little known.

The last appendix presents nine pages of nothing-new comments on the future of computers. The last few pages of Sippl & Sippl touch on networks, the computer in society; and then, for some reason, medicine and education are singled out for special treatment. The book closes on an upbeat with a theme entitled the "Thinking Machine."

In summary, the definitions aren't informative enough for your wife or precise enough for your secretary. I'd hate to give this book to my boss because the important concepts don't always stand out clearly. I'm sure the book hoarders and librarians will lap it up as if it had been entitled "All I Ever Wanted To Know About Computers But Was Afraid To Ask." It must have been a gigantic labor. If only the authors had had a few more technicians participating in writing the definitions, if the definitions had been more carefully edited, and if all the typos had been eliminated—the book would have been a best seller and a service to the community. As it stands, it rates a "C" grade:

—Robert L. Patrick

? 3330 OR 2314 DUMP/RESTORE

TOO SLOW? TOO MANY EXCPs? PROBLEMS?

FAST DUMP RESTORE, the OS utility:

- FASTER
- LESS TAPE
- MORE RELIABLE
- FEWER EXCPs
- FREE 30 DAY TRIAL

! FAST DUMP RESTORE

FROM

INNOVATION DATA PROCESSING
P.O. DRAWER F, FLANDERS, N.J. 07836
TELEPHONE: 212 867-2555

EASTERN

PROGRAMMERS

- Minimum one year experience on IBM 360 equipment using BAL or PL/1 on OS and other large real time systems.

COMPUTER SPECIALISTS

- Graduate degree or comparable experience in applied mathematics, statistics, or operations research.
- Experience in the application of OR techniques and interactive computing concepts.
- Programming—FORTRAN or PL/1

Starting salaries commensurate with experience. Excellent career growth potential and company paid benefits, including pleasure air travel privileges. Send resume including salary history and requirements in confidence to:

Management Recruitment
Dept. F72

EASTERN AIRLINES

International Airport
Miami, Fla. 33148

An Equal Opportunity Employer

People

Under its new president TOM O'ROURKE, the Assn. of Data Processing Services Organizations (ADAPSO) in 1973 won't "joust at too many windmills." O'Rourke, president of



Tom O'Rourke

fields and the federal government. O'Rourke's Tymshare, founded in 1966, has grown to become one of the country's largest time-sharing companies, probably, says O'Rourke, close to IBM's Service Bureau Corp. and, with them, second to GE's Tymnet. Before founding Tymshare, O'Rourke was GE's western regional marketing manager.

Waning interest on the part of both attendees and exhibitors in the American Federation of Information Processing Societies (AFIPS) Joint Computer Conferences is the old chicken-and-egg routine, according to GERARD L. VAN DIJK, newly appointed manager for the annual National Computer Conference, debuting in June 1973 in New York City—and replacing the present twice-a-year exposition. It's hard to tell who Mr. van Dijk believes is the chicken and who the



Gerald L. van Dijk

egg. He feels that attracting attendees is far more important than wooing exhibitors, but he would like to extract from exhibitors a minimum quota guarantee of attendees, to be obtained by making personal appeals and writing letters to their customers urging them to show up—which would then make it worthwhile for the exhibitors to show up too. Van Dijk will settle for 30 to 40,000 attendees.

Describing himself as "bullish and excited by the challenge of the job," van Dijk is formulating plans to stimulate interest in a variety of ways. The format of technical sessions (mainly a lot of computer experts and scientists talking to each other in the past, according to some critics) has been widely expanded by conference general chairman HARVEY L. GARNER, Univ. of Pennsylvania, to include lots of user-oriented sessions—users talking to users, in many cases—plus six to eight sessions directed at special-interest groups: government, medicine, manufacturing, etc. The program is divided into three major segments: Science and Technology, Methods and Applications, and the third focusing on overall industry trends and general management issues.

Van Dijk also wants to see a broader and brighter use of public relations and hopes to gain exposure for the conference through participation on radio and tv talk shows. Growing interest, anxiety, and curiosity about an automated society have made the general public, as well as the users and vendors, a potential audience for the conference, and he feels that audience should be encouraged. There is no "wrong" kind of guy to talk to, he says—and the young businessman who may not buy a computer tomorrow will be ready next year or the year after that.

Tymshare, Inc., Cupertino, Calif., feels ADAPSO has made significant moves in the past three years on several fronts and will continue to do so, but "we will use prudence and make best use of our resources, which are limited." He said the group will continue to maintain interest in the IBM case (vs. Justice) "but we won't be in the courts." He sees as ADAPSO's most pressing problem the issue of tie-in sales and incremental pricing of computer services by large companies in other

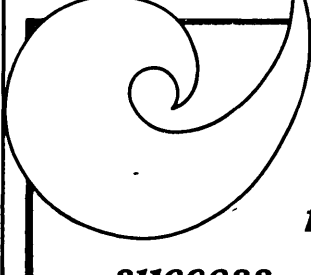

**Let's chart
your course
for career
success . . . together**

. . . so that you and our client companies will benefit. At COMPASS, we get to know you both, so that we can serve your needs more efficiently. It's this in-depth knowledge that makes our service so valuable.

If you're ready for a company that appreciates the real EDP professional, our clients have openings for individuals who have had experience as: Applications Programmers & Systems Analysts (with applications knowledge of manufacturing, banking, insurance, finance, marketing, or accounting systems); Software Programmers (experience modifying operating systems—IBM, CDC, Univac, etc.); Systems Designers (specific expertise on the detail design phases of large scale on-line OS projects), etc.

Please send your resume, including salary history, in complete confidence to:

compass, inc.

945 Asylum Avenue, Hartford, Connecticut 06105, 203-549-4240

"Directions in your EDP Career"

CIRCLE 402 ON READER CARD

Even Webster's Knows About QUEST

QUEST (kwĕst). v. 1. To make a search; to go on a quest.

QUEST SYSTEMS, INC. n. 1. A corporation founded in 1968. 2. The largest professional recruitment firm in the U.S. functioning solely in the computer sciences; its client companies pay all employment fees, interviewing and relocation expenses. Quest is known for its deep personal commitment to relate to each candidate as an individual with individual goals. 3. Its professional staff averages over 6 years of experience in EDP recruiting (additionally, staff members have direct hands-on experience in programming, systems, hardware sales, etc.) 4. Quest is presently searching for degreed programmers and analysts (commercial, scientific, systems software) for over 3,500 client companies in the U.S. *Quest has openings in over 700 U.S. towns and cities.* 5. Methodology — see Questsystem.

QUESTSYSTEM (kwĕst sis'tĕm). n. 1. Discussing with a man what he would like to be doing in light of what he has been doing. 2. Analyzing the realities of his objectives as they relate to the current job marketplace. 3. Contacting client companies and other Quest staff personnel to identify positions of possible interest. 4. Introducing the job candidate to his prospective employers by providing complete details to each about the other, ensuring the efficacious use of everyone's time. 5. Arranging interviews. 6. If employment offers are extended, Quest assists in evaluating the responsibilities, compensation and opportunities (and relates those to the initially stated objectives). The Questsystem has been working for thousands of professionals at no expense, whatsoever. Ask your friends of their past dealings with Quest. Then, put the Questsystem to work for you. For additional information on this subject, please inquire directly to Quest Systems, Inc. (All inquiries/resumes received will be responded to immediately and in confidence).



QUEST SYSTEMS INC

Linden Hill Towers, 5400 Pooks Hill Road
Washington, D.C. 20014 (301) 530-6700

FREE EMPLOYMENT SERVICE FOR PROGRAMMERS AND ANALYSTS

NY/NJ/PA/CONN/DEL/MD/DC/VA
and other eastern and national locations

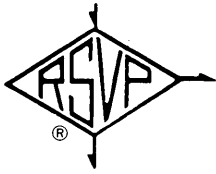

RSVP will provide free employment counselling and develop and selectively distribute your resume.

Typical openings (not necessarily current) include systems programming (SYSGEN, maintenance) and applications for IBM 360 OS/DOS and Univac 1108 Exec 8/Exec 2; telecommunications / teleprocessing / on-line

systems; BTAM/QTAM; BOMP/PICS/IMS; ABM/orbital analysis/radar systems; urban/social/transportation; OR/simulation/modeling; minicomputer software and applications; data base design; operating systems/compilers/data management; customer engineering; computer and peripheral marketing/sales; COBOL/FORTRAN / PL-1 / Assemblers; manufacturing/insurance/banking/brokerage/hospital,distribution/military.

Call or send resume or rough notes of objectives, salary, location restrictions, education and experience to any of our offices. Or check the reader service card for a free sample resume and sample job descriptions. We will answer all correspondence from U.S. citizens and permanent residents.

● Howard Levin, Director, RSVP SERVICES, Dept. M, One Cherry Hill Mall, Suite 714, CHERRY HILL, NEW JERSEY 08034, (609) 667-4488 ● Charlie Cooke, Manager, RSVP SERVICES, Dept. M, Suite 104, Towle Building, 1777 Walton Road, BLUE BELL, PENNA. 19422, (215) 643-5550 ● Bill Baxter, Manager, RSVP SERVICES, Dept. M, Suite 519, 1651 Old Meadow Road, McLEAN, VIRGINIA 22101, (703) 790-5166.

RSVP SERVICES

employment agency for computer professionals

CIRCLE 400 ON READER CARD

COMPUTER PERSONNEL

If You Earn \$10,000 to \$16,000 Base
Take 53 Seconds and Change Your Life

So you like data processing but have had second thoughts about who you work for. Perhaps the program challenge isn't there, maybe your income doesn't increase as it should, or you're just held back by the way your company is structured.

If you are even thinking of a change, Cadillac may be able to help. As the largest placement service for executives in the nation, we have had years of experience helping EDP personnel to positions where they achieve their full potential. Cadillac represents you in strict confidence in today's job market. Our service is absolutely free of charge to you. Client companies pay all fees and expenses. So tear out this ad and when the time is right, contact us. It will be a step in the right direction.

FREE JOB OPPORTUNITIES BULLETIN

Our bulletin, published quarterly, listing available opportunities in the Systems & Data Processing field is available free of charge and will be mailed to your home upon request.

For your free bulletin, without any obligation, circle reader service card #400. Please USE HOME ADDRESS ONLY!



E. W. Moore
Executive Vice President
CADILLAC ASSOCIATES, INC.
32 W. Randolph St., Chicago, Ill. 60601
(312) 346-9400

"Where More Executives Find Their Positions Than
Anywhere Else in the World"

CIRCLE 404 ON READER CARD

people

A 16-year veteran in the computer industry, van Dijk was formerly vp and sales manager of Ticketron, Inc. Prior to that he was vp of Cybernetics International Corp., following a nine-year stint in sales and sales management at IBM. He has never managed a conference before, but he has attended a great many in the roles of both user and vendor, has a great interest in the issues of the industry (particularly privacy), and he believes he knows what people want. What he wants to do now, he says, is make the National Computer Conference more attractive to the exhibitor, more relevant to the user, and to sell out the Coliseum in June '73—and he doesn't think it's going to be such a "hell of a chore."

It's fashionable to put down computers. But JOSEPH WIZENBAUM says he's not against computers. He is against the misuse of computers, saying: "There's a great temptation



Joseph Wizenbaum

to use them for inappropriate purposes." Wizenbaum, professor of Computer Science at MIT, is on leave and currently a Fellow at the Center for Advanced Study in the Behavioral Sciences, Stanford, Calif. There, his research is on the limits of artificial intelligence. Again, this does not imply an anti-AI viewpoint. Others have asked what computers cannot do. "That's not the important thing," says Weizenbaum. "The question that ought to be asked is: 'Are there problems with which we cannot properly confront a computer?'"

At the center, where he arrived last fall, he joins Paul Armer and the Program on Science, Technology and Society (see Sept., p. 168). After a year there, Wizenbaum is slated for a year at Harvard under a Vinton Hayes Senior Fellowship before returning to MIT. Long active in the computer field, he was formerly with GE on the original ERMA project.

LAWRENCE A. GOSHORN, president of General Automation, has always had this strange way of relaxing. After a tough week at the office, he drives to the Baja in Mexico, jumps on his Husqverna motorcycle, and roars around the tough Baja 500 course. Recently, though, Goshorn says he got "in over my head" on the rugged course and broke his foot in an accident. He rode his cycle 100 miles across the desert to his van and then drove another 200 miles to Anaheim. The foot was set in a cast that night, and Goshorn was at the office of his booming minicomputer firm as usual the next day. "I've been riding motorcycles for 20 years," says Goshorn. "And I've always been active on my off-time, but I think my escapades are going to slow down for awhile."

Dr. THOMAS A. VANDERSLICE, electronics technology pioneer and General Electric Co. vp, has stepped up to group executive of GE's new 35,000-man Special Systems and Products Group, which includes the Communication Systems Business and the Information Services Business divisions . . . Looking for a share of the boom in telecommunications, North American Rockwell Microelectronics Co. (NRMEC) has appointed H. A. (ANDY) BEALL to the new post of director, telecommunications development. Priority tasks: to assess prospects for existing communications products and new product investments . . . The man who introduced data processing to the retail industry in the mid-'50s, RICHARD E. SPRAGUE, has joined Pitney Bowes-Alpex in Danbury, Conn., as special products coordinator where he will explore potential applications for point-of-sale systems in untapped areas of retail and other industries. □

Advertisers' Index

A. C. Manufacturing Company	4	Entrex, Inc.	110, 111
ACCO International Inc.	36		
American Telephone and Telegraph Company	38	Fabri-Tek Inc.	102, 103
Anderson Jacobson	129	Fujitsu Limited	24
Antekna	28		
Audio Devices, Inc.	32		
		General Automation	11
Baymeadows Center	147	General Electric	121, 123, 124, 125
The Boeing Company	141	General Electric Data Communication Products Department	90
Bruning Division of Addressograph Multigraph Corporation	54, 55	Gould Inc.	4
Burroughs	100	GTE Automatic Electric	143
		GTE Information Systems, Inc.	65-76
Cadillac Associates, Inc.	140		
Cambridge Memories, Inc.	5	Robert Half Personnel Agencies	142
Centronics Data Computer Corp.	33	Hazeltine Corporation	25
Cincom Systems, Inc.	144	Hewlett-Packard	57, 98, 99
Collins Radio Company	148	Hycom	16
Compass, Inc.	139		
Computer Devices Inc.	60	Identicon	52
Computer Science Conference	48	Inforex, Inc.	12, 13
Computerworld	130	Informatics Inc.	14
		Innovation Data Processing	138
Data General	93	Interdata	82
Data 100 Corporation	106, 107	Iomec, Inc.	26, 27
Datacraft Corporation	53		
Datamation Industry Directory	149, 152	Lockheed Electronics	40
Decision Inc.	46		
Digital Equipment Corporation	30, 31, 116, 117	Modular Computer Systems	2
Dimensional/Export Software Corporations	133	Mohawk Data Sciences Corp.	94, 95
Eastern Airlines	138	The National Center for Voluntary Action	148
Eastman Kodak Company, Business Systems Markets Division	118	NCR	34, 35
Eldorado Electrodata Corporation	115		
Electronic Associates, Inc.	20		
Electronic Processors Incorporated	39		

BOEING

Computer Software Engineers.

Enjoy
life in the
Pacific
Northwest.

Positions are open in the Boeing aerospace program for engineers—experienced or beginners.

You would work in systems requirements analysis and design, computer program development and implementation, and computational analysis and algorithm development for realtime operational systems. Also includes development of programs to assist in debugging and testing of operational software systems.

Please send your resume to the Employment Office, The Boeing Company, P.O. Box 3707-EAE, Seattle, Washington 98124.

BOEING
An Equal Opportunity Employer

17 REASONS TO CONTACT ROBERT HALF FOR YOUR FINANCIAL & DATA PROCESSING PLACEMENT PROBLEMS

1. Success Record. Many of the most outstanding people in the Financial & Data Processing fields got their positions through Half.

2. Specialization Does a Better Job. Concentration in a confined area of employment eliminates hit and miss methods.

3. Makes Your Job Easier. If you're looking for competent personnel or searching for a better position, our efficient service works for you.

4. We've Been Around Since 1948... In fact, we pioneered specialized employment agencies.

5. Largest Organization of its Kind. More competent people. More specialized positions.

6. Network Action. Robert Half has offices in key centers throughout North America. We are geared to search the continent as quickly as we search a community.

7. We Know the Market. We are fully conscious of what's going on in our specialized fields. We are constantly surveying the market. The Robert Half Annual Salary Survey has been a standard since 1950.

8. Respected by Our Colleagues. You've got to be good to earn a fee from other personnel services to find financial executives for their own firms.

9. Ethical Business Practices. We never search our vast file of placed candidates. We never 'pump' applicants for 'leads'. We don't annoy companies

with 'canned' solicitations.

10. Best Placement Executives. Our placement managers are trained to understand the job order requirements, and examine the job-seeker's abilities. Their credentials read like "Who's Who in Financial & Data Processing."

11. Confidential Service. The name of the company is not revealed until they elect to see our candidate; and the employed job-seeker is protected against information getting back to his employer.

12. Exclusive. In many instances, Robert Half is the only source for certain competent personnel, and for selected positions.

13. Advertising. The Robert Half System is backed by a million dollar annual advertising budget.

14. Private Interviewing Facilities. All interviews are conducted in private offices; never in a staff room; and there is always an office available for our clients use too.

15. Consultation. We're always available to give free counsel regarding Financial & Data Processing employment.

16. Speed. Time is money. Our methods will generally produce the right situation faster and more efficiently.

17. We Succeed on Merit Alone. No placement . . . no fee. (Fee arrangements are with company clients exclusively.)



Professionals for Financial & EDP Personnel exclusively

Allentown, Hotel Traylor Building	(215) 439-1506
Atlanta, 235 Peachtree St., N.E.	(404) 688-2300
Baltimore, The Quadrangle - Cross Keys	(301) 323-7770
Boston, 140 Federal St.	(617) 423-6440
Charlotte, 4801 E. Independence Blvd.	(704) 535-3370
Chicago, 333 N. Michigan Ave.	(312) 782-6930
Cincinnati, 606 Terrace Hilton	(513) 621-7711
Cleveland, 1367 E. 6th St.	(216) 221-0670
Dallas, 2001 Bryan Tower	(214) 742-9171
Denver, 1612 Court Place	(303) 244-2925
Detroit, 140 Honeywell Center, Southfield	(313) 354-1535
Hartford, 111 Pearl St.	(203) 278-7170
Houston, 1200 Central Nat'l. Bank Bldg.	(713) 228-0056
Indianapolis, 9 North Illinois St.	(317) 636-5441
Kansas City, Mo., 127 West 10th St.	(816) 474-4583
Long Island, 585 Stewart Ave., Garden City	(516) 248-1234
Los Angeles, 3600 Wilshire Blvd.	(213) 381-7974

Memphis, 12 S. Main St.	(901) 527-7324
Miami, 1190 N.E. 163 St., N. Miami Beach	(305) 947-0684
Milwaukee, The Clark Bldg.	(414) 271-9380
Minneapolis, 822 Marquette Ave.	(612) 336-8636
Newark, 1180 Raymond Blvd.	(201) 623-3661
New York, 330 Madison Ave.	(212) 986-1300
Orange, Cal., 500 South Main	(714) 835-4103
Philadelphia, 2 Penn Center Plaza	(215) 568-4580
Phoenix, 1517 Del Webb TowneHouse	(602) 279-1688
Pittsburgh, Gateway Towers	(412) 471-5946
Portland, Ore., 610 S.W. Alder St.	(503) 222-9778
Providence, 400 Turks Head Bldg.	(401) 274-8700
St. Louis, 1015 Locust St.	(314) 231-0114
San Francisco, 111 Pine St.	(415) 434-1900
San Jose, 675 North First St.	(408) 293-9040
Stamford, Conn., 111 Prospect St.	(203) 325-4158
Toronto, 15 Toronto St.	(416) 868-1314
Washington, D.C., 7316 Wisconsin Ave. N.W.	(301) 654-1850

advertisers' index

New York Securities Co.
Incorporated 128

On-Line Software Incorporated 137

Optical Scanning Corporation . 104, 105

Paradyne Corp. 22

Prime Computer, Inc. 17

Pratt & Whitney Aircraft 136

Quest Systems Inc. 139

Randomex, Inc. 131

RapiDesign, Inc. 137

RSVP Services 140

Howard W. Sams & Co., Inc. 10

Scan-Data Corporation 85

Software International Corporation 108

Source EDP 146

Sperry-Univac 37, 86, 87

Sycor Inc. 9

SynerGraphics Inc. 29

Tally Corporation 1

T-Bar Incorporated 81

TEC, Incorporated 60

Tektronix, Inc. Cover 3

Teletype Corporation 112, 113, Cover 4

Telex Computer Products, Inc. . . . 18, 19

Teradyne 119

Texas Instruments Incorporated,
Digital Systems Division 78, 79

United Air Lines 114

University Computing Company ... 21

Varian Data Machines Cover 2

Western Union Data
Services Company 6

Wiley-Interscience a Division of
John Wiley & Sons, Inc. 135

Wilson Jones, A Division
of Swingline Inc. 109

Wright Line, A Division of
Barry Wright Corporation 61

Technical Publishing Company

Arthur L. Rice, Jr., President
Gardner F. Landon, Exec. Vice President
James B. Tafel, Exec. Vice President
Calverd F. Jacobson, Financial Vice President
Edwin C. Prouty, Jr., Secretary and Director
of Data Processing

Advertising Offices

Sales Manager and Vice President
John Brennan: Greenwich, Ct. 06830
35 Mason St. (203) 661-5400

Eastern District Managers
A. Treat Walker, Irwin L. Werfel,
Warren A. Tibbetts: Greenwich, Ct. 06830
35 Mason St. (203) 661-5400

New England District Manager & Vice President
Warren A. Tibbetts: Manchester, N.H. 03104
112 W. Haven Rd.
(603) 625-9498

Midwest District Manager
John M. Gleason: Chicago, Ill. 60606
205 W. Wacker Drive
(312) 346-1026

Western Manager and Senior Vice President
Hamilton S. Styron: Los Angeles, CA 90035.
1801 S. La Cienega Blvd.,
Phone (213) 559-5111.

District Manager
Alan Bolté, Jr.: Los Angeles, CA 90035.
1801 S. La Cienega Blvd.,
Phone (213) 559-5111.

Western District Manager
James E. Filiatrault: Redwood City, Ca. 94061
61 Renato Ct.
(415) 364-3171

England and Western Europe
Wallace K. Ponder: Wallace K. Ponder Co.
Pinner, Middlesex HA 5 1JU,
England
31 Lyncroft Avenue
(01) 868-9289

Other Technical Magazines

Plant Engineering Pollution Engineering
Power Engineering Purchasing World
Research/Development

January, 1973

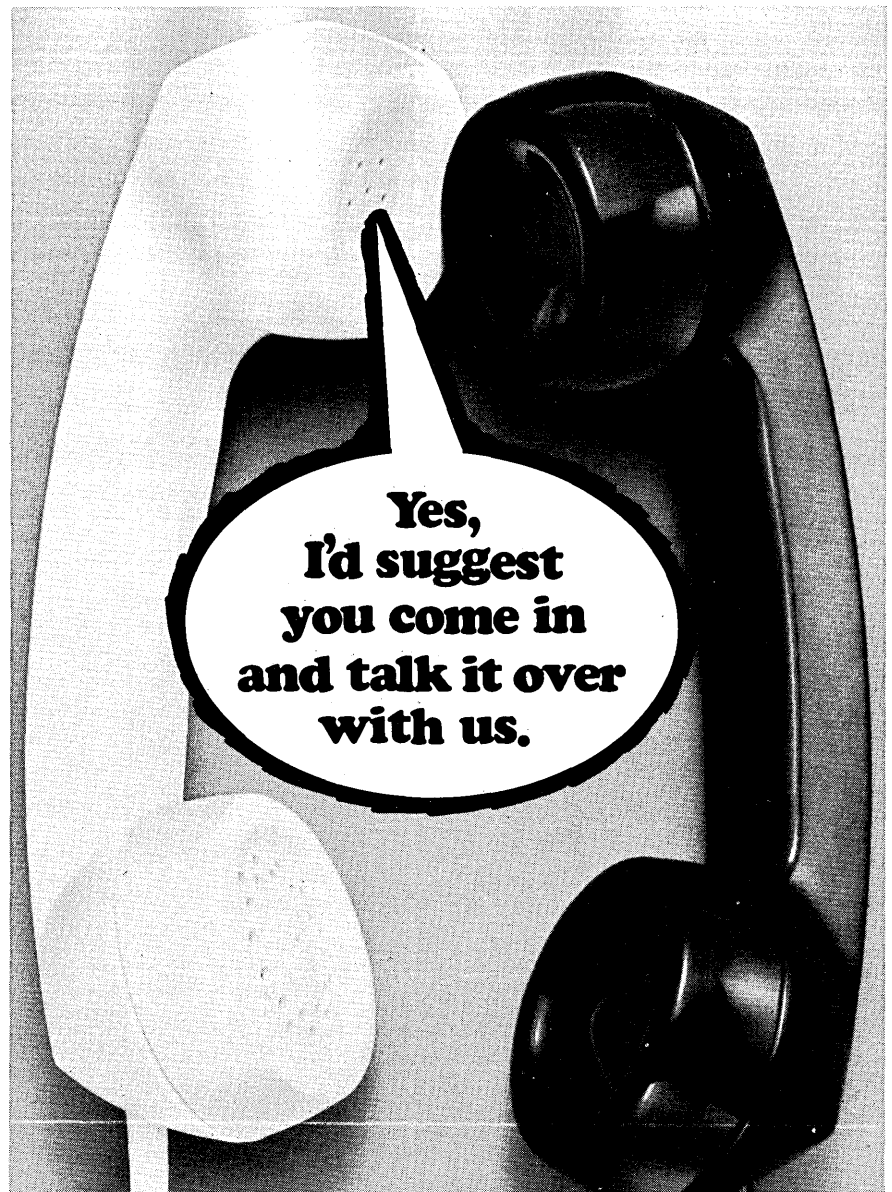

Are you turned off by the telephone business? Don't be. For the computer-wise, the tele-communications industry is a vast new field that requires imaginative, innovative, responsible people with your kind of training. Whether your career is in its early stages, or at a mature level in a specific discipline we can use you to help us grow in telephones. Some of the key job areas we have available include: *Common Control Design, System Hardware Design, Diagnostic Development, Software Development, Support Programmers.*

If there's interest here for you, send your resumé in complete confidence. If you'd like further information on job requirements/benefits/our growth and plans, just jot your name and address on a slip of paper; we'll send you a complete listing of the fine computer-wise opportunities we have, details on our company and other pertinent information.

Send to: Mr. Dennis Kave
Professional Employment

GTE AUTOMATIC ELECTRIC

400 North Wolf Road, Northlake, Illinois 60164

An Equal Opportunity Employer/MF
CIRCLE 408 ON READER CARD

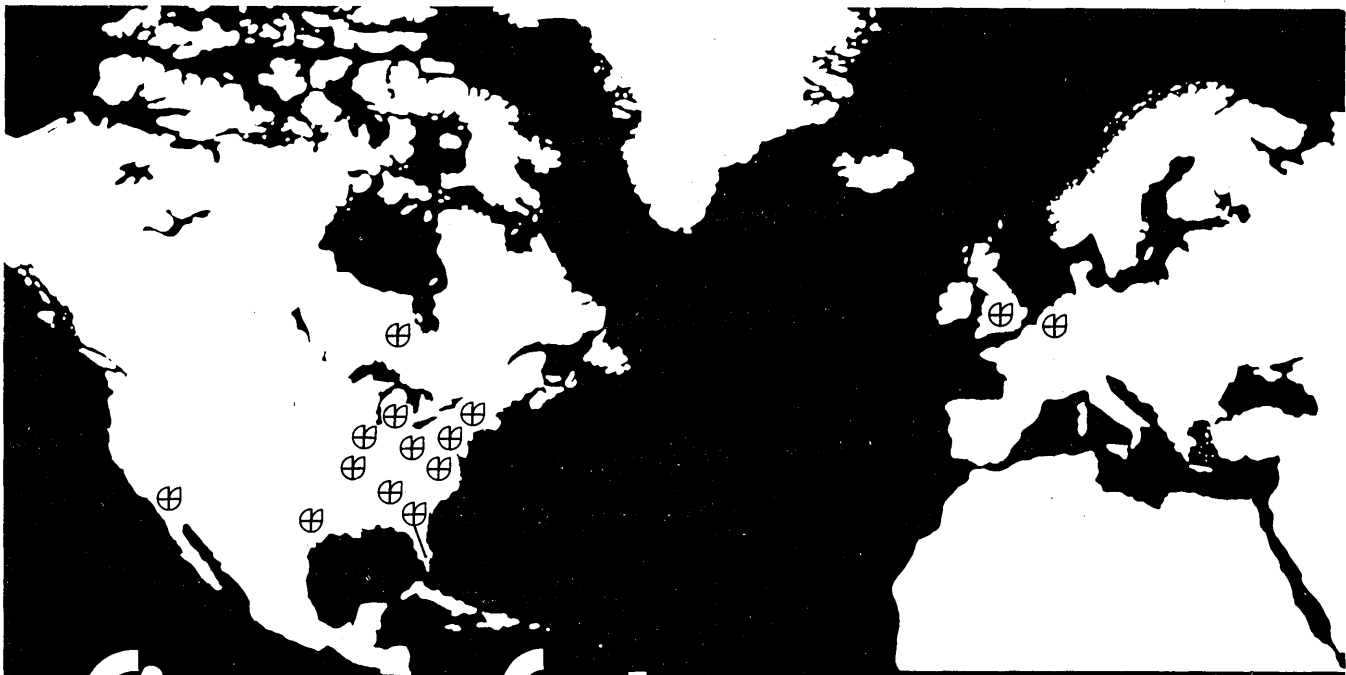

Cincom Systems now leads in the world of Data Base and On-Line Control Systems.

Cincom's TOTAL is perhaps the most widely and successfully used Data Base Management System in North America. TOTAL is also said to be the system most closely paralleling the recommendations of such groups as the Guide-Share and the CODASYL Data Base Task Group.

And ENVIRON/1 is likely the finest performing and most advanced On-Line Control System available anywhere.

But successful products are just the beginning.

Cincom's ongoing commitment to service and support is unparalleled. And our people are often said to be the most knowledgeable and experienced anywhere in the industry.

Cincom, now in its fifth year of specialty in this important field of integrated information systems, *continues* to expand its support and service capability.

With support centers already strategically located throughout all of North America, Cincom now announces the formation of Cincom Systems International in order to directly serve our rapidly expanding European User Group.

But most of all, we're proud of the success of our clients — now more than 250 worldwide.

If you're thinking Data Base, or On-Line processing, or if you're thinking of an exciting career with the leading company specializing in advanced information processing systems, give us a thought. Better still give us a try.

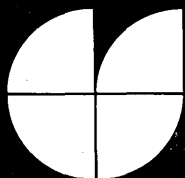

Cincom Systems Inc. We create efficiency.

2181 Victory Parkway / Cincinnati, Ohio 45206 / (513) 961-4110.

Offices also located in Boston, Massachusetts (617) 237-4807 • Sunnyvale, California (408) 735-1080 • Chicago, Illinois (312) 297-2280 • St. Louis, Missouri (314) 878-5080 • New York, New York (212) 869-3409 • Miami, Florida (305) 731-8440 • Detroit, Michigan (313) 559-5650 • Washington, D.C. (703) 631-0692 • Atlanta, Georgia (404) 636-7502 • Dallas, Texas (214) 661-0527 • Cincom Systems of Canada, Ltd., Toronto, Ontario (416) 279-4220 • Cincom Systems International, London, England Telex 851-847-081 • Brussels, Belgium.

Look Ahead

(Continued from page 8)

firmly back in IBM's jolly green hands.

COBOL VALIDATION GETS FEDERAL BLESSING

The Navy's long-heralded Cobol Validation Center should be operating government-wide before the end of June. It's also learned that at that time the General Services Administration will require that any Cobol compilers bid by a federal vendor be validated before being acquired.

But disagreement between the Defense Dept. and the National Bureau of Standards could delay the project. DOD wants to let military agencies use nonstandard compilers if they wish. NBS says such users would first have to apply to it for waivers. Both DOD and the Office of Management and Budget approved funds last month to operate the center in FY'74. That removes one major obstacle, assuming the next Congress concurs.

WHERE TO NOW, DR. HERB?

Dr. Herbert R.J. Grosch, the dp industry's most persistent gadfly, will leave the National Bureau of Standards "within six months." Relations with Dr. Ruth Davis, his boss and successor as head of the NBS computer directorate, "have never been better. There was no pressure on me to resign." Regarding the future, Grosch says he's considering possibilities in this country and abroad. "I'd like to ward off IBM's increasing dominance of the industry," he adds.

COMMUNICATIONS FOR KEY/DISC SYSTEM

A communications capability is about to be added to Computer Machinery Corp.'s shared-processor data entry systems. It's a combination hardware and software package that CMC will field install on existing systems to provide communications rates ranging from 1,800 to 19,200 baud on dial-up and dedicated lines, either off-line between systems or on-line to IBM 360s and 370s. Deliveries start in the third quarter.

RUMORS AND RAW RANDOM DATA

Stimulated by six to twelve months in back orders for the HP 35 minicalculator, HP is readying new lines of the hand-held devices, including, we hear, one for financial uses which will have buttons to calculate interest. Rumors also put HP in the consumer products business, maybe even a home weather station...NCR this month will announce the 251, a machine halfway between the Century 200 and 300 which will feature lower priced multiprogramming...Newest point-of-sale entrant: Addressograph-Multigraph with a terminal bankers say may be just the thing for banks and retailers hoping to get together on electronic payment transfer systems. No announcement had been made, but a photo of the device was shown at the FJCC by Gordon Jellife, president of City National Bank of Columbus, to illustrate a talk he gave on the ideal terminal for that kind of use...The appearance on an FJCC panel of T.C. Chen of IBM Research Labs prompted E.J. O'Brien of Burroughs to comment from the floor during the question-and-answer period: "Last August I was under the impression there were Russians in IBM Research when they claimed they'd invented virtual memory. Now I see they're Chinese"...First delivery of Amdahl Corp.'s large-scale computer is about a year away, says ex-IBMer Gene Amdahl of the Sunnyvale, Calif., firm. An initial private investment of \$30 million--Fujitsu was revealed one of the investors--should last the company into 1974. Its backlog is also \$30 million.

New... 1973 Computer Salary Data and Proven Career Advancement Techniques.

Yours Free.

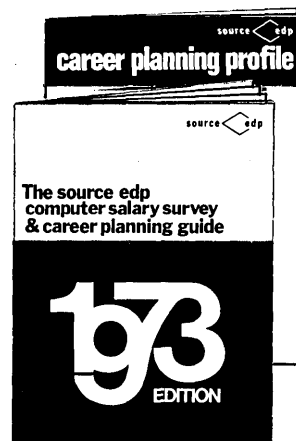

Source EDP's seventh annual Computer Salary Survey and Career Planning Guide is now available. This timely and exhaustive study provides a basis for ranking your current salary with those of your peers. It also analyzes current and future trends in the computer field, pinpoints career planning strategies to take advantage of these trends and reveals proven techniques for career advancement.

You will also receive the all new Source EDP Career Planning Profile. This important career tool allows you to measure your computer experience, both in quantity and quality. It highlights your specific experience strengths and weaknesses and serves as a basis for developing an intelligent career plan.

All this vital information has been compiled by Source EDP, the largest and most ethical nationwide recruiting firm devoted solely to computer professionals. **To speed delivery of your free copies call, write or visit your nearest Source EDP office or circle the reader inquiry card.**

source  edp

ATLANTA—W. G. Barnett, 11 Corporate Sq. 30329, (404) 634-5127
CHICAGO—T. D. Walsh, 100 S. Wacker Dr. 60606, (312) 782-0857,
903 Commerce Dr., Oak Brook, Ill. 60521, (312) 323-8980
and 540 Frontage Rd., Northfield, Ill. 60093, (312) 446-7155
DALLAS—P. E. Dittmer, 7701 Stemmons Fwy. 75247, (214) 638-4080
DETROIT—R. T. Stevens, 24500 Northwestern Hwy., Southfield, Mich. 48075,
(313) 352-6520
HOUSTON—S. A. Love, 4040 Southwest Fwy. 77027, (713) 626-8705
LOS ANGELES—W. R. Emigh, 3550 Wilshire Blvd. 90010, (213) 386-5500

MINNEAPOLIS—F. N. Anderson, 801 Nicollet Mall 55402, (612) 332-8735
NEW YORK—J. R. Masi, 600 Third Ave. 10016, (212) 682-1160
PALO ALTO—G. F. Best, 525 University Ave. 94301, (415) 328-7155
PHILADELPHIA—G. P. Ramming, 1700 Market St. 19103, (215) 665-1717
ST. LOUIS—R. H. Trumbull, 130 S. Bemiston Ave., Clayton, Mo. 63105,
(314) 862-3800
SAN FRANCISCO—R. M. Clark, 111 Pine St. 94111, (415) 434-2410
UNION, N.J.—D. A. Mickel, 2400 Morris Ave. 07083, (201) 687-8700

Client companies assume our charges.

This forum is offered for readers who want to express their opinion on any aspect of information processing. Your contributions are invited.

The Forum

The ECMA Cassette Standard: Wrong Choice

The September issue of *DATAMATION* published two articles on cassettes which contradicted each other in almost every possible way. Since the contradiction was not apparent, I think, to people who are not manufacturers of cassette transports, I feel compelled to bring the issue to the attention of your readers.

In one article, William W. Otterson described the advantages of the proposed ECMA standard for interchange of data on cassettes. He uses the analogy of the 1/2" wide computer-compatible magnetic tape transport, pointing out that there had been a number of different 1/2" tapes prior to the acceptance by the industry of this transport as an industry standard.

I would like to submit that this analogy is based on a false premise. The important difference between the IBM 1/2" tape drive and the proposed ECMA cassette standard is that the IBM proposal was a workable, sensible solution to the problem of recording on magnetic tape. Although the IBM solution became the industry's standard primarily because IBM was so overwhelmingly powerful in the industry, there never was any question about the viability of their proposal. In fact, the IBM 1/2" tape transports had worked well for a long time under actual field conditions before it became the industry standard.

By contrast, the so called ECMA standard is distinguished only by the fact that it works very badly, a characteristic matched only by the fact that it also costs too much to manufacture and therefore to sell.

A historical comparison with the way the IBM 1/2" tape became the industry standard is also rewarding. The "ECMA cassette" is one of the few computer standards that has been proposed by the European standards organization rather than the American standards organization. All of us who have ever worked on standards activities know of the strenuous competition between the two groups. The Americans feel that they have the most experience. The Europeans feel that their needs are not always best represented by the American proposals (with a justified feeling that the Americans are shoving stuff down their throats all the time).

The ECMA standard was proposed by N. V. Philips. Philips has a first-rate research, development, and manufacturing organization, and they are great on audio equipment. But Philips is inexperienced in manufacture of magnetic tape transports for the digital computer business. The cassette industry has unfortunately been plagued (this was mentioned by Mr. Otterson) by inexperienced engineers trying to convert audio cassette transports into high performance digital transports. None of them *ever* worked.

This point is supported by Philips' own experience. Having promoted the ECMA standard with great brouhaha, they



SERVICE BUREAUS: Build Your Computer A Better Home...In Florida's Unique Industrial Park.

Baymeadows Center is a professionally landscaped, well-lighted, 400 acre Industrial Park that looks like . . . a park. Safety, security and beauty make it unique. The Center is located in a growing section of Jacksonville, one of the fastest growing cities in the entire Southeast, and the opportunity to expand your business is unlimited. Jacksonville is a major rail hub, the site of an international airport, one of the South's largest seaports, the crossroads of major interstates and a major communications network. Jacksonville also serves as home office for many insurance companies and other service firms.

We realize the land requirements for facilities like yours . . . Baymeadows Center can easily meet them through sales or lease agreement. Then you build to meet your own needs for space and specifications for temperature and sound control.

We've thought of you and your employees, too. Baymeadows Center is minutes away from downtown Jacksonville, the ocean and many shopping centers. Close by are the luxurious residential developments of Deerwood and Ponte Vedra. And we'll show you other residential facilities designed to meet the needs of all your employees. For information contact Bill Drennon.

Baymeadows Center

7901 Baymeadows Way, Jacksonville, Florida 32216
(904-721-0331)

Developed by Stockton, Whatley, Davin & Company

When you need a
data transmission system

you'll benefit from
Collins'
experience in
data communications.

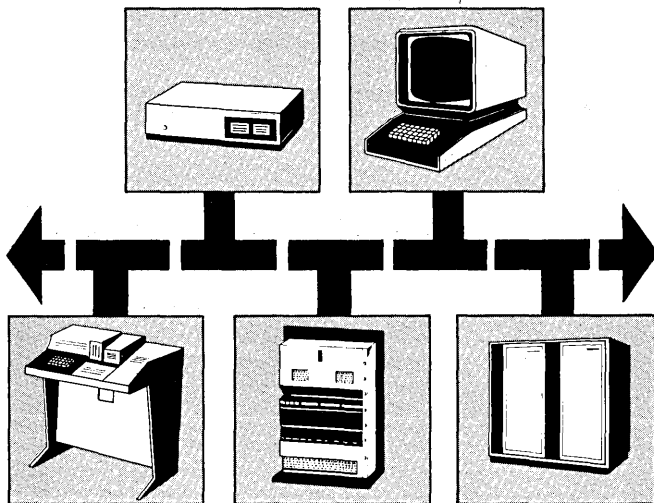

We've designed and implemented data systems for airlines, railroads, financial institutions, and industrial firms.

When we design your system, we'll provide:

- systems engineering which includes computerized network design and analysis
- data communications equipment. For example:
 - Frequency Division Multiplex: 75 bps; 150 bps; 300 bps
 - Asynchronous Frequency Shift Keying: 1200 bps; 1800 bps
 - Synchronous Phase Shift Keying: 1200 bps; 2400 bps; 4800 bps
- Multiple access coupler
- Network management equipment
- Technical control facility

We'll use Collins' equipment or other manufacturers' products.

We'll meet your specifications and your deadlines.

If you're planning a new data transmission system or upgrading an existing one, talk to the communications systems people. Collins Radio Company, Newport Beach, California 92663. Phone: (714) 833-0600.



the forum

proceeded to come out with a cassette transport which was indeed nothing more than a beefed-up audio system. It failed. They redesigned the entire transport and have recently begun to show the new one.

But the industry is still stuck with the ECMA proposal. All such ECMA-compatible standard cassette transports are much higher in cost and are intrinsically less reliable than many non-ECMA-standard transports. In spite of that, I would certainly expect that with the addition of engineering talent and money, reliable systems will emerge which are in conformity with the ECMA standards.

But the basic current fact is that a company completely ignorant of digital magnetic tape technology and having no experience in the field dictated a standard to the European Computer Manufacturers Association, which accepted it in all good faith. ANSI, sensitive to the possibility of being accused of being noncooperative, fell in with this bad solution and is now in the process of endorsing it against their own better judgment.

It must be said here that most of the major computer corporations who have designed and manufactured magnetic tape transports for many years and who are knowledgeable are very much against the ECMA standard for cassette transports. The only people who are for the ECMA standard are companies who want a standard at *any* price and see this as the only way of getting it quickly. I sympathize with them, but there must be a better way.

I find it particularly ironic that in the same issue of DATAMATION, in "The Forum" section, Nyal McMullin has written a very considered and intelligent article in which he points out that, for most cassette applications, what is needed is *high reliability* at *very low cost*. He points out that transports must cost under \$300 in order to meet the market need. I would like to express my wholehearted agreement with Mr. McMullin, and to add that there are a number of cassette transports (*not* ECMA-compatible) priced under \$200 which have extremely high reliability. I see no reason why, with the same investment required to improve an ECMA-compatible tape, it should not be possible to decrease that price considerably.

For an industry to spend so much time and trouble developing what is intrinsically a bad system proposed by an inexperienced manufacturer when other alternatives are available is inconceivable to me. The contrast of this development with that of 1/2" compatible tape, in which a reliable design was proposed by an experienced manufacturer, is ludicrous.

—Evelyn Berezin
President
Redactron Corp.

We need you.

If you can spend some time, even a few hours, with someone who needs a hand, not a handout, call your local Voluntary Action Center. Or write to "Volunteer," Washington, D.C. 20013.
The National Center for Voluntary Action.



LOW COST GRAPHICS

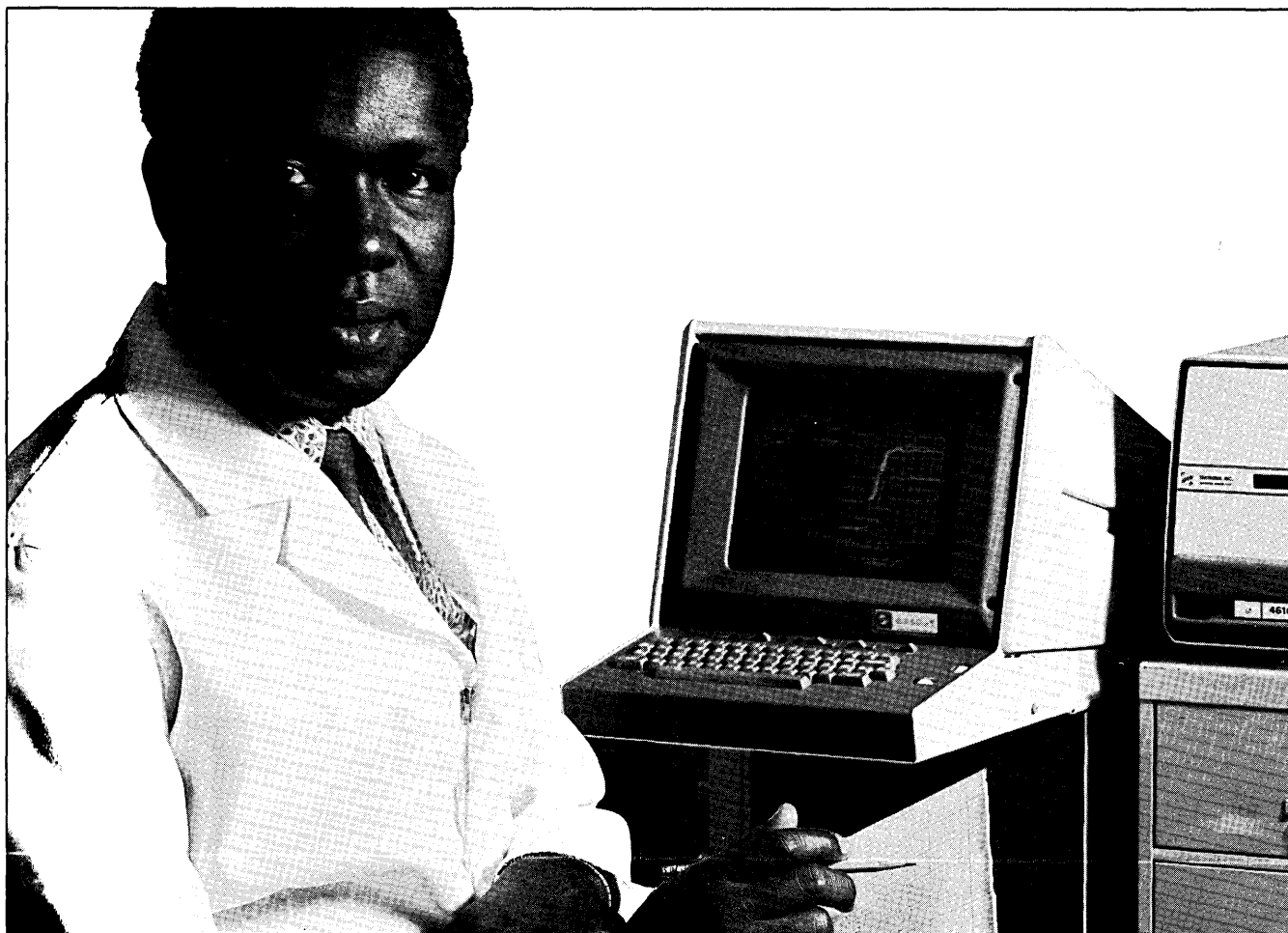

HELP THE INNOVATOR SEE NEW ALTERNATIVES.

There's more time to think, interpret. New relationships develop. In fact, display graphics let you test new ideas instantly. You can see the effects of two or more variables as they're plotted in relation to a set of conditions. And watch them unfold in a flash. In three dimensions if necessary.

Our graphic terminal lets you game more of your theories in an hour than you could in a day on a plotter/printer. It's like having a magic tablet. Control is at your fingertips.

We have the software, too. You can hook up to over 25 different computers. Just add our subroutine to your program and run. You can even do complex line drawing with automatic scaling, clipping and windowing.

The 4010 has alphanumeric with graphic capability. Want full upper and lower case along with graphics? You'll get it in our new 4012. And if you're into APL, we have the first graphic terminal on the market. The 4013. You can start with a 4010 for as low as \$3,950.

All of the 4010 series of terminals let you use our terminal peripherals; paper or mag tape readers and recorders. Even control remote display devices. When you need a record of an idea, push a button. Our 4610 Hard Copy Unit will reproduce your idea on the screen in 18 seconds.

We service what we sell, too. And guarantee it.

Now, wouldn't it be nice to have more time to innovate? Find out how. Write: Tektronix, Inc., Information Display Products Division, P.O. Box 500, Beaverton, Oregon 97005. Or call (503) 644-0161. or Tektronix Datatek N.V. P.O. Box 7718 Schiphol Airport The Netherlands.



TEKTRONIX®

Our new model 38 series.

Even the most
expensive ASR is
a very inexpensive
\$1430.

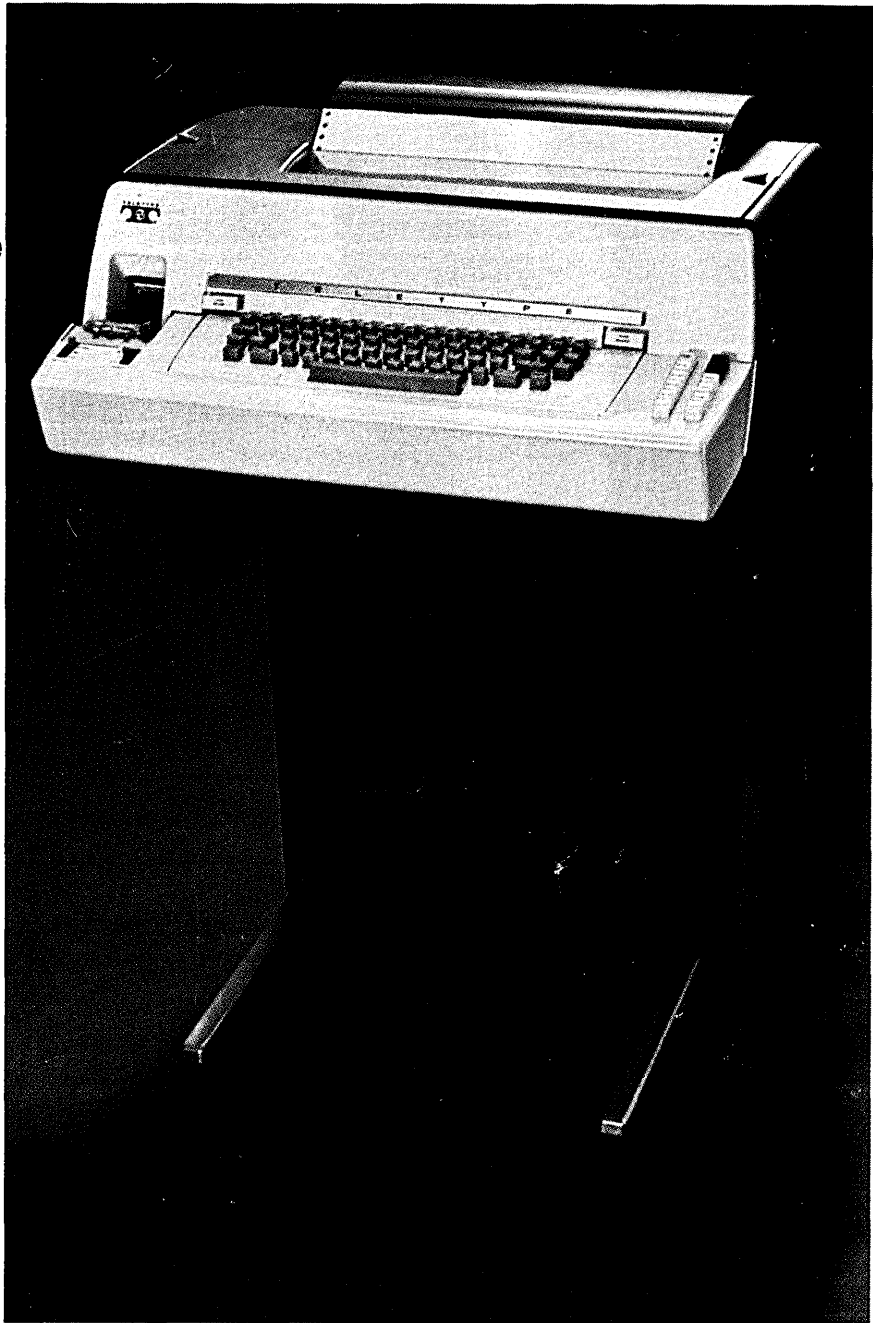

Teletype is a trademark registered in the United States Patent Office.

Just because you need big machine features, you don't have to pay big machine prices.

Not when you've got some new alternatives: the Teletype® model 38 series terminals. They offer a lot of features. For only a little money.

Prices for an RO model 38 start as low as \$905. KSR model 38 terminals begin at \$1168. Even ASR terminals go for as low as \$1402. And for less than \$200, you can equip any of them with a built-in, factory-tested modem.

Standard equipment on all model 38 terminals is a 132-character printing format on a 15-inch wide platen. Upper and lower case is also standard. So is two-color printing.

Speed? 100 words per minute. If you need more—up to 2400 wpm—the model 38 interfaces with the Teletype 4210 magnetic tape data terminal.

There's more, too. Like plug-to-plug compatibility with the model 33. So you can update your system without changing it.

The new Teletype model 38 series terminals. Where else can you get so much for so little?

It takes more than manufacturing facilities to build the machines Teletype Corporation offers. It also takes commitment. From people who think service is as important as sales. In terminals for computers and point-to-point communications.

That's why we invented a new name for who we are and what we make. The computer-communications people.



For more information about any Teletype product, write or call: TERMINAL CENTRAL; Teletype Corporation, Dept. 81N, 5555 Touhy Avenue, Skokie, Illinois 60076. Phone 312/982-2500

*Prices subject to change without prior notice.

CIRCLE 3 ON READER CARD