

## 1985 DP BUDGET SURVEY

THE CRAYETTES ARE COMING  
FAULT-TOLERANT BLUES  
UNDERSTANDING BABBAGE





# A printer should complement your computer, not compromise it.



It's a simple fact that your small computer can compute a lot faster than your printer can print. A problem that becomes even more frustrating in business, when your computer is tied up with your printer while you're ready to move on to other work.

Of course, the only thing more frustrating than waiting on a slow printer is waiting on a printer that's down. Unfortunately, chances are the initial printer you purchased with your computer system just isn't designed to work on continuous cycle high volume printing.

More than likely, you've already experienced one, if not both of these frustrations. But now, you can turn printer frustration into printing satisfaction with the new Genicom 3014, 3024, 3304 or 3404. Professional printers for personal computers...price/performance matched for small business systems.

Designed and built to increase productivity and maximize the value of your personal computer, the range of 3000 PC printers offers 160-400 cps draft, 80-200 cps memo, and 32-100 cps NLQ printing...performance for both high productivity and high quality printing.

The 3014/3024 models print 132 columns. The 3304 and 3404

models give you a full 136 column width, and offer color printing as well.

Each printer is easy to use, lightweight, functionally styled and attractive. And you can choose options from pedestals and paper racks to document inserters, sheet feeders and 8K character buffer expansion, plus more.

Genicom 3000 PC printers feature switch selectable hardware, dual connectors and dual parallel or serial interfaces. Plus the 3014 and 3024 emulate popular protocols for both Epson MX with GRAFTRAX-PLUS™ and Okidata Microline 84 Step 2™, while the 3304 and 3404 emulate popular protocols for Epson MX with GRAFTRAX-PLUS™. So your current system is most likely already capable of working with these Genicom printers without modification.

Most important, the Genicom 3000 PC printers are quality-built, highly durable printers designed for rapid, continuous duty cycle printing.

So why wait? And wait. And wait. Get a Genicom 3000 PC printer now.

Genicom Corporation, Department C411, Waynesboro, Virginia 22980. In Virginia, call 1-703-949-1170.

# GENICOM

## The New Printer Company.

For the solution to your printing needs call

### TOLL FREE 1-800-437-7468

In Virginia, call 1-703-949-1170.

Epson MX with GRAFTRAX-PLUS is a trademark of Epson America, Inc.  
Okidata Microline 84 Step 2 is a trademark of Okidata Corporation

**CIRCLE 1 ON READER CARD**

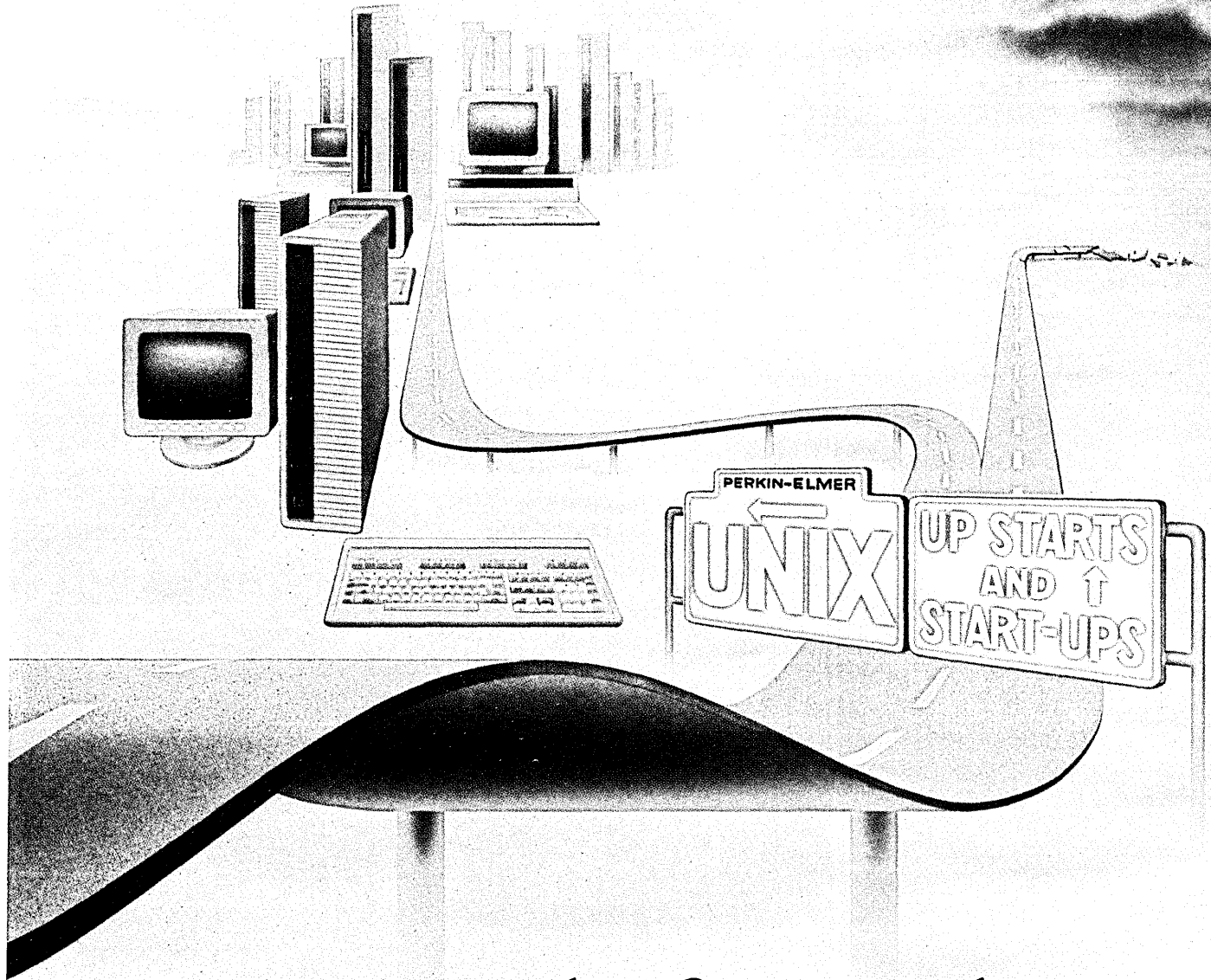

## Get on the fast track.

For low cost UNIX\* applications turn to Perkin-Elmer's 7350A supermicro.

Perkin-Elmer gives you a head start in the growing world of UNIX system computing with the fastest supermicro in its class.\*\* And we can keep you ahead because we're a Fortune 300 company with nearly a decade of experience with the UNIX operating system.

Move forward confidently with a fully supported, cost-effective solution; up to five users can share a single system. For the long haul, go the distance with the broadest range of compatible superminicomputers available today.

Why risk your future with start-ups or upstarts? Let Perkin-Elmer help put you on the path to success.

**Choose the fast track:  
call 1-800-631-2154.**

Or write to the Perkin-Elmer Corporation, Two Crescent Place, Oceanport, N.J. 07757. In N.J. call (201) 870-4712.

\*UniPlus, UNIX, RM-COBOL and SIBOL are trademarks of UniSoft, AT&T Bell Laboratories, Ryan-McFarland and Software Ireland, respectively.

\*\*In nine UNIX benchmark tests, the 7350A outperformed the published results of similar supermicrocomputers in its price range, while comparing favorably with many other larger and more costly systems. Prices and specifications subject to change without notice.

#### SPECIFICATIONS & OPTIONS

- 8MHz MC68000
- 512KB to 3MB RAM
- Floppy Disk
- 15MB or 40MB Winchester
- 12" or 15" Monochrome;  
13" Color Graphics Monitors
- 4 x RS-232C ports (Ethernet optional)
- UniPlus\* port of UNIX System III
- MenuMaker/C Shell/AT&T Shell
- Word Processing, Spreadsheet,  
Relational DBMS, Graphics Libraries
- C, FORTRAN, BASIC-PLUS, RM-COBOL\*,  
SIBOL\*
- System prices start at \$5,115  
(quantity 100, U.S. only)

# PERKIN-ELMER

CIRCLE 4 ON READER CARD

# Infotron's concept for network growth opens the world for you.

Infotron's concept for network growth  
puts it all your way.

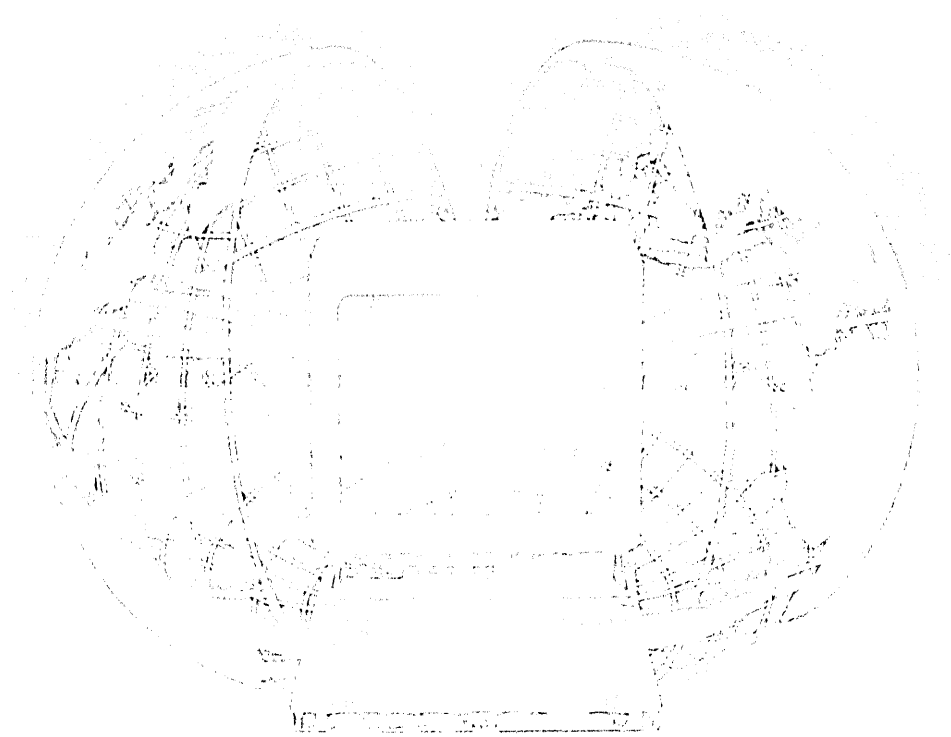

Infotron's  
concept for  
network growth

Infotron's concept for network growth opens the world for you. It's a concept that puts it all your way.

Infotron's concept for network growth opens the world for you. It's a concept that puts it all your way.

## OPEN UP.

The ADI 800 is a key component of Infotron's Advanced Network Integration, a concept for network growth that means the Infotron concept you buy now will pay for itself.

Infotron's concept for network growth opens the world for you. It's a concept that puts it all your way.

Infotron's concept for network growth opens the world for you. It's a concept that puts it all your way.

Infotron's concept for network growth opens the world for you. It's a concept that puts it all your way.

## OPEN UP.

The ADI 800 is a key component of Infotron's Advanced Network Integration, a concept for network growth that means the Infotron concept you buy now will pay for itself.

Infotron's concept for network growth opens the world for you. It's a concept that puts it all your way.

Infotron's concept for network growth opens the world for you. It's a concept that puts it all your way.



# DATA MATION

MARCH 15, 1985/\$3.00 U.S.A.  
VOLUME 31 NUMBER 6  
This issue, 185,445 copies

## FEATURES

### 30 IN FOCUS

As programmer costs rise and hardware costs fall, users are "Getting a Grip on Tools" to reduce software costs. Edith Myers reports that vendors are supplying the productivity packages like never before.

### 74 THE 1985 DP BUDGET SURVEY

**John Verity**

Dp budgets up. Pcs leveling off. Minis up. Mainframes down. Software up. 642 dp managers from variety of industries surveyed. Details within.

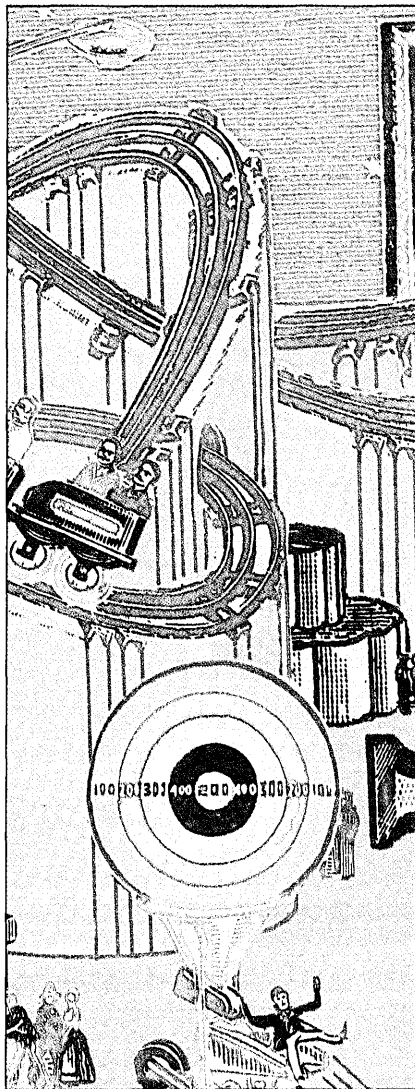

### 82 FAULT TOLERANT BLUES

**Omri Serlin**

Will a potential boom market be tolerant of the faults of new FT system suppliers?

### 105 GLOBAL, SHARED, LOCAL

**Cort Van Rensselaer**

After octupling the number of its computers and vigintupling the number of its workstations, Hewlett-Packard is still matching its information systems to its organization and management style.

### 119 BABBAGE OBSERVED

**Leopold Froehlich**

The Abner Doubleday of data processing is remembered.

### 128 IN SEARCH OF THE PERFECT PROGRAMMER

**Chandler M. Bush and Lawrence L. Schkade**

No ideal personality or cognitive style for the dp professional has emerged from the latest test results. What's needed is a good matchup of user and system.

## NEWS IN PERSPECTIVE

### 40 MAINFRAMES

Here come the Crayettes.

### 42 OFFICE AUTOMATION

Apple's new Mac push. An OA merger fails.

### 57 SOFTWARE

Keeping pirates at bay. Hard time for bank software.

### 66 PERIPHERALS

Terminal traumas.

### 70 BENCHMARKS

### 71 WORLD WATCH

## DEPARTMENTS

### 8 LOOKING BACK

### 13 LOOK AHEAD

### 18 CALENDAR

### 23 LETTERS

### 27 HARDCOPY

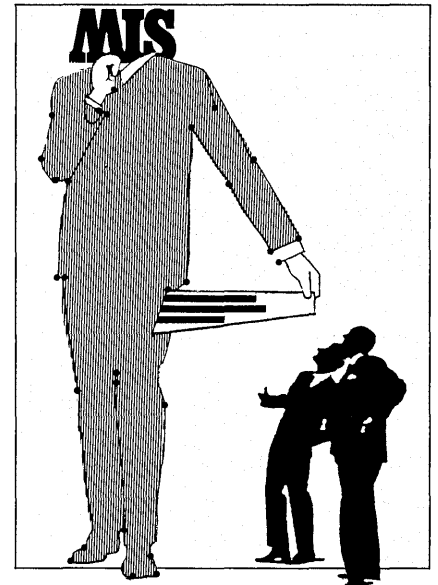

### 141 HARDWARE

### 149 SOFTWARE

### 156 MARKETPLACE

### 157 ON THE JOB

### 163 READERS' FORUM

### 168 ADVERTISERS' INDEX

## OEM SUPPLEMENT 136-1

### - 2 SUPERMINIS HEAT UP

### - 8 THE BINARY BADGE

### -17 FOR WHOM THE BABY BELL TOLLS

COVER ILLUSTRATION BY JOHN CRAIG

# If you want to implement a true corporate information strategy, here are the places to start.

IDMS/R, Cullinet's high performance relational database, provides the foundation for a successful corporate information system. And a Cullinet Seminar provides a thorough introduction to IDMS/R.\*

To arrange to attend one of the Seminars listed below, phone, toll-free, 1-800-225-9930. (In MA, the number is 617-329-7700.) Or simply return the coupon.

\*Cullinet also offers Seminars on our Human Resources Management System, Financial System, Manufacturing System and Information Center software products. Inquire about them when you call.

<b>ALABAMA</b>	Savannah . . . . . June 11	Kansas City . . . . . June 13	Harrisburg . . . . . Mar. 20
Birmingham . . . . . June 27	<b>IDAHO</b>	St. Louis . . . . . Mar. 26	Philadelphia . . . . . Apr. 3
Huntsville . . . . . May 16	Boise . . . . . May 15	St. Louis . . . . . May 23	Pittsburgh . . . . . Mar. 28
Montgomery . . . . . Mar. 19	<b>ILLINOIS</b>	St. Louis . . . . . July 9	Valley Forge . . . . . July 10
Montgomery . . . . . July 11	Chicago . . . . . May 8	Springfield . . . . . Mar. 21	York . . . . . May 8
<b>ALASKA</b>	Chicago . . . . . June 25	<b>NEBRASKA</b>	<b>QUEBEC</b>
Anchorage . . . . . June 20	Springfield . . . . . Mar. 28	Omaha . . . . . May 14	Montreal
<b>ALBERTA</b>	<b>INDIANA</b>	<b>NEW HAMPSHIRE</b>	(French) . . . . . May 9
Calgary . . . . . May 28	Indianapolis . . . . . July 26	Nashua . . . . . May 15	Montreal
Edmonton . . . . . May 21	South Bend . . . . . May 16	<b>NEW JERSEY</b>	(English) . . . . . May 17
<b>ARIZONA</b>	<b>IOWA</b>	Atlantic City . . . . . May 23	Quebec City
Phoenix . . . . . May 2	Davenport . . . . . Apr. 4	Fairfield . . . . . June 25	(French) . . . . . Mar. 27
<b>ARKANSAS</b>	<b>KANSAS</b>	Morristown . . . . . Mar. 29	Quebec City
Ft. Smith . . . . . May 14	Wichita . . . . . Mar. 19	Newark Airport . . . . . May 16	(French) . . . . . June 6
Little Rock . . . . . June 25	Wichita . . . . . June 4	Princeton . . . . . June 26	<b>RHODE ISLAND</b>
<b>BRITISH COLUMBIA</b>	<b>KENTUCKY</b>	<b>NEW YORK</b>	Providence . . . . . July 16
Vancouver . . . . . May 23	Lexington . . . . . July 10	Albany . . . . . May 2	<b>SASKATCHEWAN</b>
<b>CALIFORNIA</b>	Louisville . . . . . June 19	Buffalo . . . . . May 9	Regina . . . . . May 30
Berkeley . . . . . June 4	<b>LOUISIANA</b>	New York . . . . . Mar. 27	<b>SOUTH CAROLINA</b>
Los Angeles . . . . . Apr. 9	New Orleans . . . . . May 16	New York . . . . . May 15	Charleston . . . . . July 12
Los Angeles . . . . . June 25	<b>MAINE</b>	New York . . . . . June 18	Columbia . . . . . Mar. 19
Orange County . . . . . May 21	Portland . . . . . Apr. 10	New York . . . . . July 17	Columbia . . . . . June 25
Sacramento . . . . . May 9	<b>MANITOBA</b>	Long Island . . . . . Mar. 20	Spartansburg . . . . . May 23
San Diego . . . . . Apr. 2	Winnipeg . . . . . May 14	Long Island . . . . . June 19	<b>TENNESSEE</b>
San Diego . . . . . June 11	<b>MARYLAND</b>	Rye . . . . . Mar. 22	Chattanooga . . . . . Mar. 20
San Francisco . . . . . Mar. 28	Baltimore . . . . . Apr. 3	Rochester . . . . . June 19	Chattanooga . . . . . July 17
<b>COLORADO</b>	Baltimore . . . . . June 7	<b>NORTH CAROLINA</b>	Knoxville . . . . . June 5
Colorado Springs . . . . . Apr. 9	<b>MASSACHUSETTS</b>	Charlotte . . . . . May 21	Memphis . . . . . Apr. 17
Denver . . . . . May 8	Boston . . . . . May 15	Greensboro . . . . . Apr. 4	Nashville . . . . . May 15
<b>CONNECTICUT</b>	Braintree . . . . . June 11	<b>OHIO</b>	Nashville . . . . . June 26
Bridgeport/	Burlington . . . . . Mar. 20	Cincinnati . . . . . Apr. 9	<b>TEXAS</b>
New Haven . . . . . May 21	Springfield . . . . . Apr. 9	Cleveland . . . . . Mar. 26	Austin . . . . . May 15
<b>DISTRICT OF COLUMBIA</b>	<b>MICHIGAN</b>	Cleveland . . . . . June 5	Corpus Christi . . . . . Apr. 4
Washington . . . . . Apr. 5	Detroit . . . . . Mar. 18	Columbus . . . . . Apr. 5	Dallas . . . . . May 7
Washington . . . . . May 14	Detroit . . . . . May 21	Columbus . . . . . July 12	Ft. Worth . . . . . Apr. 9
Washington . . . . . June 20	Detroit . . . . . July 16	Dayton . . . . . May 3	Houston . . . . . May 30
<b>FLORIDA</b>	Grand Rapids . . . . . May 22	Toledo . . . . . May 15	Lubbock . . . . . May 21
Jacksonville . . . . . Mar. 26	Kalamazoo . . . . . Mar. 27	<b>OKLAHOMA</b>	San Antonio . . . . . Mar. 21
Miami . . . . . Apr. 4	Lansing . . . . . July 17	Oklahoma City . . . . . May 2	<b>VIRGINIA</b>
Miami . . . . . May 21	<b>MINNESOTA</b>	<b>ONTARIO</b>	Lynchburg . . . . . June 13
Orlando . . . . . June 6	Minneapolis . . . . . Apr. 10	Ottawa . . . . . Apr. 4	Norfolk . . . . . May 22
Tampa . . . . . May 9	Minneapolis . . . . . June 13	Ottawa . . . . . June 27	Roanoke . . . . . Apr. 11
<b>GEORGIA</b>	<b>MISSISSIPPI</b>	Toronto . . . . . May 7	<b>WASHINGTON</b>
Atlanta . . . . . May 15	Jackson . . . . . June 13	Toronto . . . . . June 25	Seattle . . . . . May 23
Augusta . . . . . June 26	<b>MISSOURI</b>	<b>PENNSYLVANIA</b>	<b>WISCONSIN</b>
Columbus . . . . . May 22	Kansas City . . . . . Apr. 2	Allentown . . . . . May 15	Appleton . . . . . May 7
Savannah . . . . . Apr. 3		Erie . . . . . Mar. 19	Milwaukee . . . . . Apr. 11

## DATAMATION

**Editor** Rebecca S. Barna  
**Managing Editor** Parker Hodges  
**Assistant Managing Editor** Florence Lazar  
**Assistant Managing Editor, News** Larry Marion  
**Features Editor** Kenneth Klee  
**International Editor** Linda Runyan  
**Senior Writer** John W. Verity  
**Assistant News Editor** Michael Tyler  
**Assistant Features Editor** Deborah Sojka  
**New Products Editor** Robert J. Crutchfield  
**Copy Editor** Theresa Barry  
**Assistant Copy Editor** Eric Brand  
**Assistant Editor** Mary Ann Hariton  
**Editorial Assistant** Deborah A. Young  
**Copy Assistant** John A. Hartshorn

### Bureau Managers

**Boston** R. Emmett Carlyle  
**Chicago** Karen Gullo  
**Los Angeles** Edith D. Myers  
**San Francisco** Charles L. Howe  
 Irene Fuerst

**Tokyo** Thomas Murtha

**Washington** Willie Schatz

**European Managing Editor** Paul Tate

**Technology Editor, Europe** Fred Lamond

**Foreign Correspondents** John Lamb, London;

James Etheridge, Paris; Peter Hidas, Oslo;

Norman Kemp, Sydney.

**Art Director** Kenneth Surabian

**Assistant Art Director** Susan M. Rasco

**Art/Prod. Coordinator** Catherine Kennedy

**Art/Production Assistant** Cheryl Storti

**Contributing Editors** Pamela Archbold,

Laton McCartney, Hesh Wiener

**Advisory Board** Lowell Amdahl, Philip H. Dorn,

Joseph Ferreira, Bruce W. Hasenyager, David

Hebditch, John Imlay, Louis Naugès, Irene Nesbit,

Angeline Pantages, Robert L. Patrick, Malcolm Peltu,

Russell Pipe, Carl Reynolds, F.G. Withington.

**Publisher** James M. Morris

**Executive Editor** John L. Kirkley

**Research Director** Laurie Schnepf

**Operations Manager** Patricia Adamo

**Production Manager** Anne Earley

**Circulation Vice President** Joseph J. Zaccaria

**Circulation Manager** Mary Agnes Glenister

### EDITORIAL OFFICES

Headquarters: 875 Third Ave., New York, NY 10022.

Phone (212) 605-9400; telex 429073. **New England:** 1

Chaucer St. RFD 2, Sandwich, MA 02563, (617) 888-6312.

**Washington, D.C.:** 4451 Albemarle St. NW, Washington,

DC 20016, (202) 966-7100; **Midwestern:** 303 E. Wacker Dr.,

Chicago, IL 60601, (312) 938-2900. **Western:** 1801 S. La

Cienega Blvd., Los Angeles, CA 90035, (213) 559-5111;

2680 Bayshore Frontage Rd., Suite 401, Mountain View, CA

94043, (415) 965-8222. **International:** 130 Jermyn St., Lon-

don SW1Y 4UJ, England, (441) 839-1840, telex 914911; 13

Stanley Place, Budd Lake, NJ 07828, (201) 691-0592, telex

499-4308; 1-3-37-507 Motoazabu, Minato-ku, Tokyo 106,

Japan, (813) 454-8384.

## Technical Publishing

**BB** a company of  
The Dun & Bradstreet Corporation

**VBA**

**ABP**

**DATAMATION** (ISSN 0011-6963) Magazine is issued twice monthly on the 1st and 15th of every month by Technical Publishing, a company of The Dun and Bradstreet Corp., John K. Abely, president. Executive, advertising, editorial offices, and subscription departments, 875 Third Ave., New York, NY 10022. Published at Lincoln, Nebr. Annual subscription rates: U.S. and possessions: \$50; Canada: \$75; Japan, Australia, New Zealand: \$140 air freight; Europe: \$120 air freight, \$225 air mail. All other countries: \$120 surface, \$225 air mail. Reduced rate for qualified U.S. students, public and school libraries: \$38. Single copy: \$3 in U.S. Sole agent for all subscriptions outside the U.S.A. and Canada is J.B. Tratsart, Ltd. 154 A Greenford Road, Harrow, Middlesex HA13QT, England, (01)422-8295 or 422-2456. No subscription agency is authorized by us to solicit or take orders for subscriptions. Second-class postage paid at New York, NY 10001 and at additional mailing office. ©Copyright 1985 by Technical Publishing Co., a Division of Dun-Donnelley Publishing Corp., a company of The Dun and Bradstreet Corp. All rights reserved. "Datamation" registered trademark of Technical Publishing Company. Microfilm copies of Datamation may be obtained from University Microfilms, A Xerox Company, 300 No. Zeeb Road, Ann Arbor, MI 48106. Printed by Foote & Davies/Mid-America. POSTMASTER: Send address changes to Datamation, 875 Third Ave., New York, NY 10022.

"Yes, I'd like to attend a Cullinet Seminar."

Please enroll me in the Seminar in \_\_\_\_\_ on \_\_\_\_\_  
 (CITY) (DATE)

Name \_\_\_\_\_ Title \_\_\_\_\_

Company/Department \_\_\_\_\_

Address \_\_\_\_\_ City \_\_\_\_\_

State/Zip \_\_\_\_\_ Telephone \_\_\_\_\_

# Cullinet

We understand business better than any software company in business.

Send to Cullinet Software, 400 Blue Hill Drive, Westwood, MA 02090-2198

DM315

CIRCLE 6 ON READER CARD



# This record is golden.



To date, there are 20,000 COMET International systems installed around the world, serving over 100,000 individual workstations.

In the EDP business, that's a golden record.

The reason for the success lies in the problem COMET software solves: decentralized control.

For most international companies, the software created for headquarters just won't work at the local level.

And the software created at the local level does not conform to headquarters' needs.

Makeshift solutions are expensive, and most often, they don't work very well.

COMET does.

COMET was designed to meet local managements' and headquarters' requirements at the same time.

It provides decentralized locations with stand-alone computer power, without sacrificing the head-office need for up-to-date information.

COMET does this by recognizing that every corporate structure is different. And that different local offices have radically different needs.

Each individual COMET system is tailor-made from an extremely large variety of products matched to

the needs of the departments where they will be used. These products are put together into one system which works.

As the company's requirements grow, COMET can be upgraded to work with them. Vital communication between the head office and the decentralized locations is never broken, and information flows smoothly both ways. All of this is supported by Nixdorf's international service and support organization. Our software specialists adapt COMET to keep up with changes in local laws and regulations.

COMET permits program modifications to be transmitted over telephone lines to local systems, saving time, effort, and expense.

All of this works to make our customers more competitive wherever they compete.

If our record is golden, it's because theirs is.

Nixdorf Computer Corporation, 300 Third Avenue, Waltham, MA 02154.

**NIXDORF**  
**COMPUTER**

# YOU ASKED.

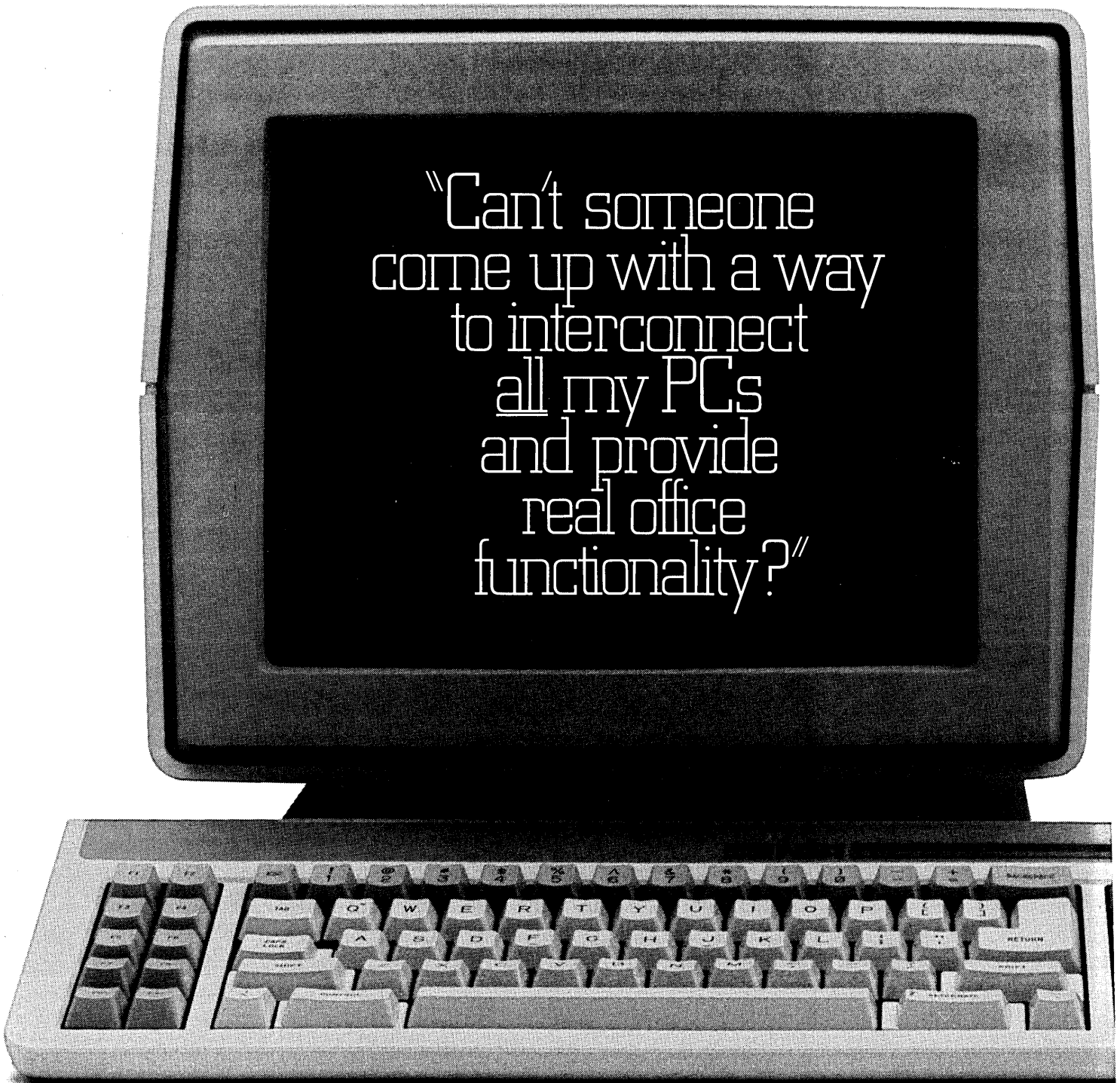

"Can't someone  
come up with a way  
to interconnect  
all my PCs  
and provide  
real office  
functionality?"



# WE ANSWERED.

## "SOMEONE HAS.

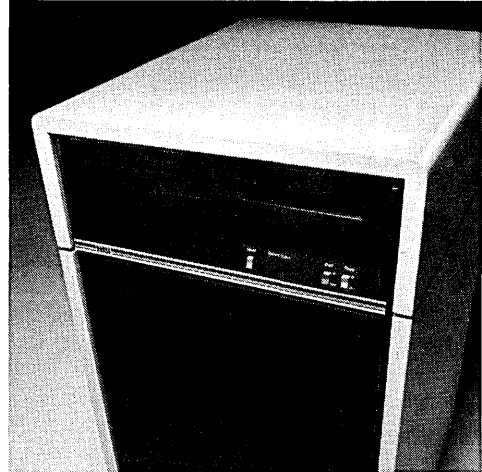

## US."

We call it the OASys 64. And it does the most important thing any computer-based system can do: save time and improve your people's productivity.

With the OASys 64, you can interconnect up to 100 IBM or NBI PCs. To let them share and exchange information. Without exchanging diskettes.

To let them use the same storage, printers, and software. And with our shared software plan, you no longer have to buy expensive software for each additional user.

And the OASys 64 doesn't stop there. It gives PCs the best word processing in the business. Or flexible communications options like 3270, for access to your mainframe information. All with the security options you know you need in today's PC environment.

It's a time-saver. A work-saver. And a people-saver.

You couldn't ask for much more. And if you could, chances are, if we haven't already built it, we're already working on it.

For you.

For more information write: NBI, Inc., Advertising Dept., 3450 Mitchell Lane, Boulder, CO 80301.



# NBI

OFFICE AUTOMATION SYSTEMS

CIRCLE 8 ON READER CARD

The  
Answer  
to More  
Than 250  
Preventive  
Maintenance  
Problems

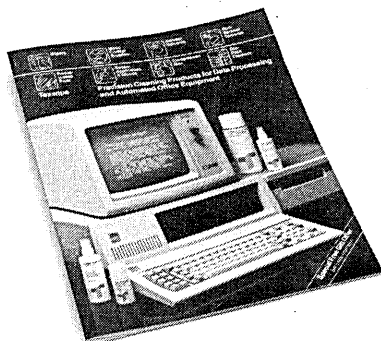

**The New TEXWIPE Computer Cleaning Products Catalog, Featuring More Than 250 Precision Cleaning Products for Data Processing, Office and Field Service**

- microcomputer cleaning products
- static control products
- tape transport cleaning products
- CRT terminal cleaning products
- micrographics cleaning products
- disc drive and disc pack cleaning products
- 52 full-color pages including 10-page care guide, indexed by product

TEXWIPE

FREE

Send for your **FREE** Computer Cleaning Products Catalog

NAME \_\_\_\_\_

TITLE \_\_\_\_\_

COMPANY \_\_\_\_\_

ADDRESS \_\_\_\_\_

P.O. BOX \_\_\_\_\_ CITY \_\_\_\_\_

STATE \_\_\_\_\_ ZIP \_\_\_\_\_

TEL.# ( ) \_\_\_\_\_



**TEXWIPE** DA31585  
650 East Crescent Avenue  
P.O. Box 308  
Upper Saddle River, NJ 07458  
Sales/Service (201) 327-5577  
Executive Office (201) 327-9100  
Telex 130370

CIRCLE 9 ON READER CARD

Twenty Years Ago/Ten Years Ago

# LOOKING BACK

## SMALL SYSTEMS AND SANDALS

March 1965: DATAMATION editor Robert B. Forest journeyed to Japan, where he found six major computer manufacturers and "got the impression that Japan does not believe that large computers are its meat." Why? Mostly because the Ministry of Trade was discouraging the importation of smaller systems, presumably to safeguard that segment of the market for Japanese vendors. Forest also discovered that the Ministry of Trade wanted to cull those six manufacturers down to three: Fujitsu, Oki, and Nippon Electric.

Despite the apparent small-system bias, Forest found that the only official government hardware research organization—Electro Technology Research Laboratories, roughly the equivalent of the U.S. National Bureau of Standards—concentrated exclusively on "big, big" systems. The 30 ETL researchers, who were earning about 50% less than they would have in private industry, had made important contributions in magnetic cores and drums, and in tunnel diode and thin-film memories. They had also built the six machines that were the foundation for the development of Japan's commercial computers. The latest of these, the ETL Mark VI, featured a wire memory with a .250 usec access and was said to be almost as fast as STRETCH, the powerful, solid-state computer IBM introduced in 1961.

While touring two plants, Forest observed that it seemed difficult for the Japanese to put the fruits of their research into mass production. Two or three workers, he said, might be found doing a job that "would be performed by one or less" in the U.S. As far as Forest could tell, there was little or no work in integrated circuits going on in the country. He was also struck by the fact that workers wore sandals in computer rooms.

## IBM DECISION REVERSED

March 1975: IBM's victory over Telex in the most controversial antitrust suit the computer industry ever witnessed had the

entire industry abuzz. The U.S. Court of Appeals for the Tenth Circuit in Denver reversed Judge A. Sherman Christensen's 1973 decision that IBM had used predatory acts against competition in the plug-compatible peripherals market. Telex's now-shattered victory would have enabled it to collect \$260 million from IBM in damages. The appeals court found the earlier decision to be totally erroneous because, it said, Christensen had used too narrow a definition of the market and therefore found IBM not to have any monopoly power after all. The judgment of the appeals court broadened the relevant product market to include "all peripheral products, those compatible not only with IBM cpus but those compatible with non-IBM systems . . . these products, although not fungible, are fully interchangeable and may be interchanged with minimal financial outlay."

Part of IBM's defense in the case was a list of companies claiming to manufacture "plug-compatible products"; it included no less than 1,786 companies, many of which were extinct. The Denver court also required Telex to pay IBM \$18.5 million for purloining IBM trade secrets.

## THE PC IS BORN

Featured in the March '75 issue's product spotlight, the Altair 8800 was a hacker's dream. When the system was first introduced in a *Popular Electronics* article, about 2,000 adventurers sent their orders (sight unseen) to MITS INC., a small Albuquerque firm. A true 16-bit (parallel 8-bit processor) "minicomputer" with 78 mnemonic instructions, MITS's machine sold for \$439, or \$621 assembled. Standard interface cards and a sophisticated bus structure on the 8800 allowed direct addressing of up to 256 I/O devices. The system included a lengthy list of peripheral options, and the memory complement could be expanded to 64K on the 2 usec machine. Switches and flashing lights on the front panel of a blue box were the Altair 8800's only communication methods.

—Mary Ann Hariton



# The first smart terminal under \$400.

THE NEW  
**QVT  
101™**

Block mode editing, multiple emulations, 16 host or user-programmable functions, a 14-inch screen, and more. All the editing power of the \$695 terminals, all for only \$395! Nothing is missing except the high price — you still get the industry's only one-year warranty. And its best reliability record.

No one else comes even close. Not Wyse. Not Esprit. Not TeleVideo. Only Qume can offer this unheard-of value, with smarter design, smarter sourcing, and greater resources behind us. For the best buy in VDT history, call (800) 223-2479. Qume Corporation, 2350 Qume Drive, San Jose, CA 95131. We'll be there.

**Qume®**  
A Subsidiary of **ITT**

CIRCLE 10 ON READER CARD

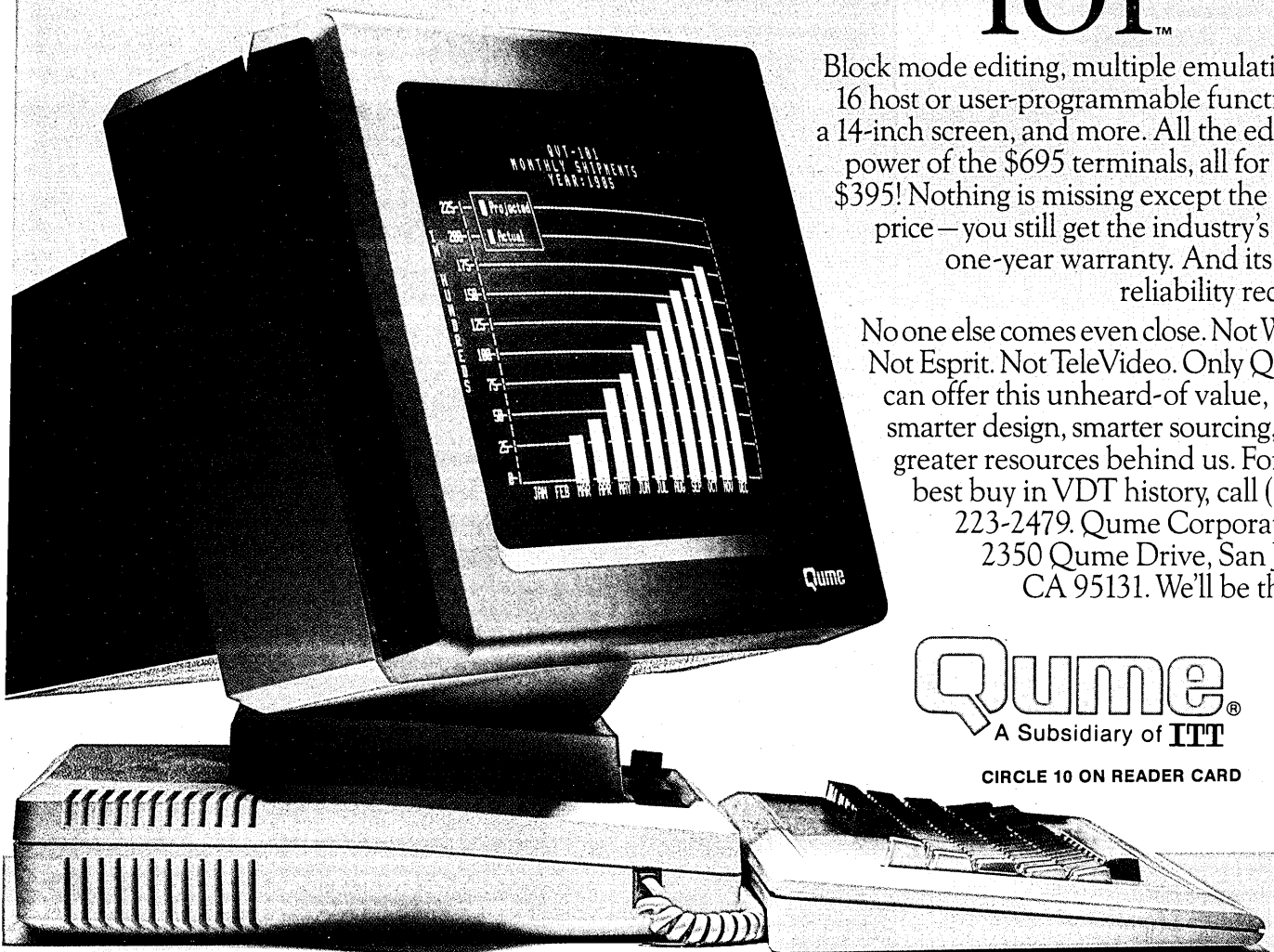



# **“MORE MANUFACTURERS CHOOSE US BECAUSE OF WHAT WE CHOSE: VAX.”**

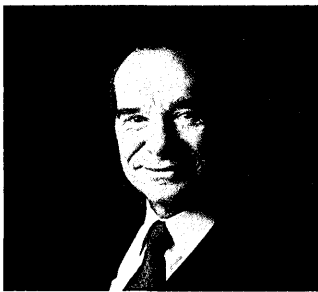

Mark W. Ciotek  
CEO and President  
NCA Corporation

American manufacturers are facing a fiercely competitive and highly aggressive environment that's global in scope.

The key to survival in the face of all this is control. Control over shrinking profitability, increasing costs and reduced planning times. Which means automation through computerization.

But computerizing the manufacturing process is no guarantee of survival. Choosing the

wrong approach could be just as costly as not automating at all.

As one person intimately involved with manufacturing, Mark W. Ciotek, explains: "Manufacturing today has to be treated as an integrated process instead of as isolated functions. Successful manufacturers are discovering that with the right approach to computer-integrated manufacturing (CIM), you can produce goods quickly without sacrificing quality."

Mark is CEO and president of NCA Corporation, a leading software developer and marketing company that's helping manufacturers stay competitive with a manufacturing resource planning (MRP II) system called MAXCIM.™

With 20 integrated modules, MAXCIM is designed to handle everything from financial planning in the executive office to job

tracking on the factory floor.

"Our comprehensive approach requires a flexible computer system with a wide range of solutions," Mark points out. "That's why we chose Digital's VAX™ computers for MAXCIM. And that's why manufacturers are choosing us."

---

**“VAX GIVES YOU  
THE WORLD'S MOST  
FLEXIBLE  
ARCHITECTURE!”**

---

Digital designed the VAX computing environment in a unique way – around one architecture and Digital's VMS™ operating system. "They're the only ones who have done this," Mark states. "As a result, we know we're working with the most flexible system available."

Included within the VAX computing environment is the VAX Information Architecture, a comprehensive system of integrated

information management software products. From this vast array of products, NCA's customers can select those best suited for their needs.

Three of these VAX Information Management products – FMS™ forms management system, DATATRIEVE™ query language and report writer, and Common Data Dictionary – are used in conjunction with MAXCIM. By incorporating these products, MAXCIM optimizes the user-interface, and provides easy access and universal definitions for all of your data.

Customers also have the option of adding other Digital software such as DECnet™ networking software. The tremendous communications capabilities between Digital systems allows for unequalled distributed processing power. So you can access and exchange information –



whether it's stored across the plant or at a plant across the country.

"Digital's approach to software is ideal for MAXCIM because the performance of an MRP II package is enhanced by the degree of integration between modules," Mark says. "And the superior integration within both MAXCIM and the VAX Information Architecture gives manufacturers the most flexible solution possible."

**"AS PRODUCTION INCREASES, SO CAN THE POWER OF VAX!"**

"The economies of manufacturing demand standardization and growth," Mark points out. "With VAX computers, our customers have both."

Every model in the best-selling 32-bit architecture, from the MicroVAX I™ system right up to the largest VAXcluster™ system, is compatible, providing an economical growth path from desktop to data center.

"Because of this compatibility, you can use MAXCIM across the entire line of VAX systems," Mark says. "So when our cus-

tomers upgrade, they can bring their existing applications right along with them."

This eliminates the need to convert databases, retrain people or totally abandon your investment. And VAXcluster systems provide enough computing resources to meet virtually any requirement.

"VAX computers let us meet the needs of just about any manufacturer," Mark says. "The low-end of the VAX family is ideal for smaller manufacturers, while clustering makes our solutions attractive to

Mark states. "After all, they're the leader in distributed processing and are committed to CIM with dedicated resources. And the VMS operating system provides an unparalleled path for growth."

In fact, Digital anticipates and meets manufacturers' needs so successfully that NCA developed MAXCIM to run exclusively on Digital systems.

"We've never felt the need to offer MAXCIM on any other sys-

*The Compatible VAX family*

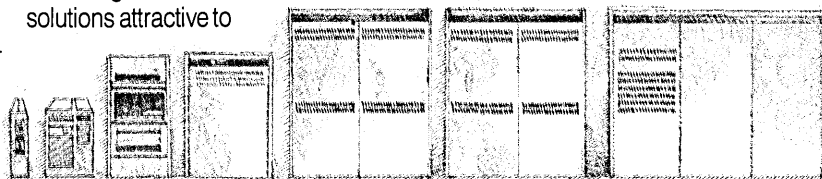

much larger companies. Some of our business now comes from existing customers who are upgrading their Digital systems to meet their growing needs."

**"DIGITAL IS THE LEADER IN THE MANUFACTURING MARKETPLACE!"**

"Digital has a solid reputation among manufacturers,"

Mark says. "They're the experts in systems and we're the experts in MRP II software. Together, we can offer manufacturers the most comprehensive solution.

"Our customers have found that this is the ideal solution for them. With this kind of success," Mark concludes, "we'll never second-guess

our choice of VAX computers."

**BEST ENGINEERED MEANS ENGINEERED TO A PLAN.**

VAX computers, like all Digital hardware and software products, are engineered to conform to an overall computing strategy. This means our systems are engineered to work together easily and expand inexpensively. Only Digital provides you with a single, integrated computing strategy direct from desktop to data center.

To learn about Digital's VAX system, call 1-617-467-CAEM. To learn about MAXCIM, call 1-800-622-6584.

Or write to Digital Equipment Corporation, 200 Baker Avenue, West Concord, MA 01742.

**THE BEST ENGINEERED COMPUTERS IN THE WORLD.**





# IDMS/R is proving to be what most people expected it to be: Simply the best.

For nearly a decade, in survey after survey of the data processing community, one database management system was consistently rated first in user satisfaction—IDMS.

So when we announced IDMS/R in April of 1983, expectations naturally were high for a versatile database management system that would combine the ease-of-use of a relational architecture with high performance.

That was the promise we made. And that, in fact, is the product we've delivered.

With IDMS/R, people whose only data processing experience is an encouraging "you can do it" from the dp department are finding themselves able to create their own customized applications. They're doing it quickly, easily and, best of all, *independently*. And that comes as a welcome relief for overburdened dp personnel.

As for complex, high-volume production applications, IDMS/R is without peer. Thanks to the unique architecture of IDMS/R, data processing can tune the database and thereby benefit from a dramatic boost in performance. Moreover, IDMS/R has the most sophisticated back-up and recovery capability of any dbms—an absolute must for on-line applications.

The  
**Complete  
Software  
Solution**

And when one considers that IDMS/R is the cornerstone of the only information management system available today that fully integrates database, applications and decision support software, choosing a relational dbms becomes a very simple decision.

Decision Support  
Applications  
Database

To attend a Cullinet Seminar, phone, toll-free,  
1-800-225-9930. In MA, 617-329-7700.

# Cullinet

We understand business better than  
any software company in business.

© 1985 Cullinet Software, Inc., Westwood, MA 02090-2198

CIRCLE 11 ON READER CARD

# LOOK AHEAD

## INSTALLED MIPS TO GROW TENFOLD BY 1990

In the next five years, IBM expects its typical big 370 user shop to have 1,000MIPS, 10,000MB of system memory, and 6,000GB of DASD installed, compared to 100MIPS, 200MB, and 300GB currently. Yet despite the growing demand, IBM told financial analysts in a post-Sierra meeting that it can't ship the quadratic Sierra 3090-400 until 1987 because it doesn't have enough people to test it and the dyadic 200 at the same time. Outsiders speculate, however, that IBM announced the 400 just to see what customer reaction would be, even as it continues to ship the now dead-ended 3084.

## NEW LOTUS LAN POLICY

Lotus Development Corp., Cambridge, Mass., will soon announce its long-awaited site licensing policy, but few users will be satisfied. "We have decided against site licensing," says a company source, but with one major exception. Local area network buyers of 1-2-3, Symphony, and Jazz need only purchase one copy if the network is deemed by Lotus to be "within certain prescribed limits. It will depend on each situation." The new policy contradicts Lotus's earlier plan of providing a comprehensive site licensing policy with hardware attachments to enforce it. Lotus now says it's anxious to maintain its relationship with each end user and doesn't want a site licensing policy as an obstacle. The new, admittedly indecisive, policy will be introduced with the first shipments of Jazz, scheduled early next month.

## TURNING THE TIDE ON PIRATES

ADAPSO's "four point program" on software piracy is already scoring points. The phone calls and letters have been pouring in to the trade association since it and Micropro sued American Brands Inc. and its Wilson Jones subsidiary for alleged software copyright infringement. The letters are also going out from ADAPSO, bearing threats to other supposedly offending firms. One company president, having received such a letter, called and said, "I hope I'm not on your list." If recipients ignore those letters, the next step is likely to be litigation, although a source promises that ADAPSO isn't "trigger happy" and will only bring litigation "responsibly."

## AN OLIVETTI SPREE?

Don't be surprised to hear of other acquisitions by AT&T's European partner, Olivetti, following its recent purchases of Exxon's European business and 49% of U.K. micro maker Acorn Computer. These are but the latest in the company's long list of investments, comprising about 30 companies

# LOOK AHEAD

## KEEPING THE THROTTLE OPEN

worldwide. That strategy of expansion through acquisition and alliance isn't over yet. Olivetti is working closely with AT&T to broaden its market and technology base, and both the Italian and the U.S. firms are keeping their eyes open for good buys in the U.S. and abroad.

Never one to slow down, IBM says it expects "the stream of new product introductions to come at an accelerating pace" this year -- not exactly great news for pcms and other competitors already hurting from IBM's frequent introductions in 1984. The total lifetime revenues of products introduced last year is expected to be \$40 billion, but the comparable figure for 1985 products is expected to be double that, despite ever-shorter life cycles. Not only that, senior vp of finance and planning Allen J. Krowe says, but the rate will continue accelerating through 1986 as well. IBM needs to keep up the pace if it is to meet its goal of matching the industry's 15% annual growth rate, a goal some analysts doubt is even possible.

## MOLECULAR TO SUPPLY BUNCH?

Look for Molecular Computer, San Jose, to ink oem pacts with a few BUNCH members for its Series 12 micro. Nearly 1,500 units of the IBM PC AT-compatible model (formerly known as Poppy) have been shipped in the year since its introduction. One likely candidate to sign is Sperry, which is currently oeming its pc from Mitsubishi. The mainframer has publicly said, though, that it may choose another oem for future micros.

## EUROPE'S MICRO SOFTWARE BID

Lotus's rumored development of a Unix-based integrated package -- a Symphony in C, as it were -- will have to emerge soon if Lotus wants to keep a grip on its business. Redwood International, one of Europe's oldest software houses, already gets 65% of its annual revenues from the U.S. from sales of its Uniplex II integrated package, and the St. Albans, England, firm is bidding for a bigger slice of the market. It is now negotiating for U.S. government contracts involving some 10,000 licenses, is poised to sign a coast-to-coast deal with a major U.S. retail chain, and is talking to a major computer vendor about a distribution deal. Uniplex is already sold by Altos, Zentec, Zilog, Cipher, Arete, and others.

## RUMORS AND RAW RANDOM DATA

Sources in Japan hint that Sperry may buy some mainframes from Fujitsu as a move toward IBM compatibility; Sperry's mainframes are currently its only major products still developed and built entirely in-house.



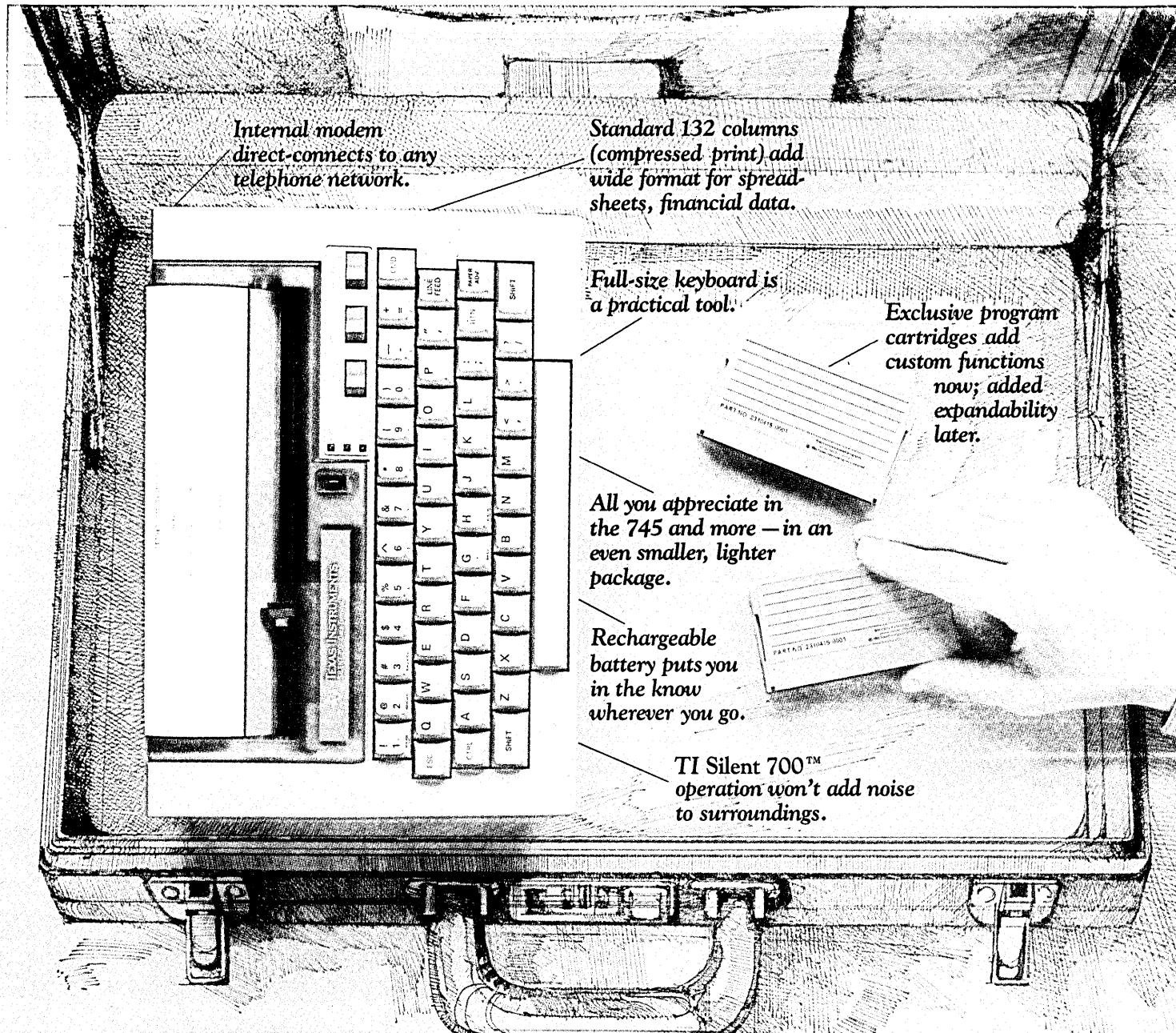

*Internal modem  
direct-connects to any  
telephone network.*

*Standard 132 columns  
(compressed print) add  
wide format for spread-  
sheets, financial data.*

*Full-size keyboard is  
a practical tool!*

*Exclusive program  
cartridges add  
custom functions  
now; added  
expandability  
later.*

*All you appreciate in  
the 745 and more — in an  
even smaller, lighter  
package.*

*Rechargeable  
battery puts you  
in the know  
wherever you go.*

*TI Silent 700™  
operation won't add noise  
to surroundings.*

# Only Texas Instruments packs more portable terminal into less space.

Here's a brief case for the Texas Instruments *Silent 700™* Model 707 Portable Data Terminal. It's the latest and lightest in a long line of standard-setting *Silent 700™* terminals. And it's the most versatile full-function portable anyone can pack into a briefcase.

By carrying TI's Model 745 one step further, we made the best even better. The 707's standard internal

modem connects to any telephone network while the optional acoustic coupler and battery pack make it fully portable. The spreadsheet size 132-column printer is now standard. And TI's solid state plug-in cartridges can add functions for your current use and later expansion.

For the standard-setting terminal that packs more product into less space, get the TI Model 707. At only six pounds, it packs more full-size

functions than any other portable ... all at a surprisingly low price. For more information contact: Texas Instruments Incorporated, P.O. Box 809063, Dept. DTB163DT Dallas, Texas 75380-9063. Telephone 1-800-527-3500.



**TEXAS  
INSTRUMENTS**  
Creating useful products  
and services for you. 2763-39MIS-R1

# Prime introduces more bang for the buck.

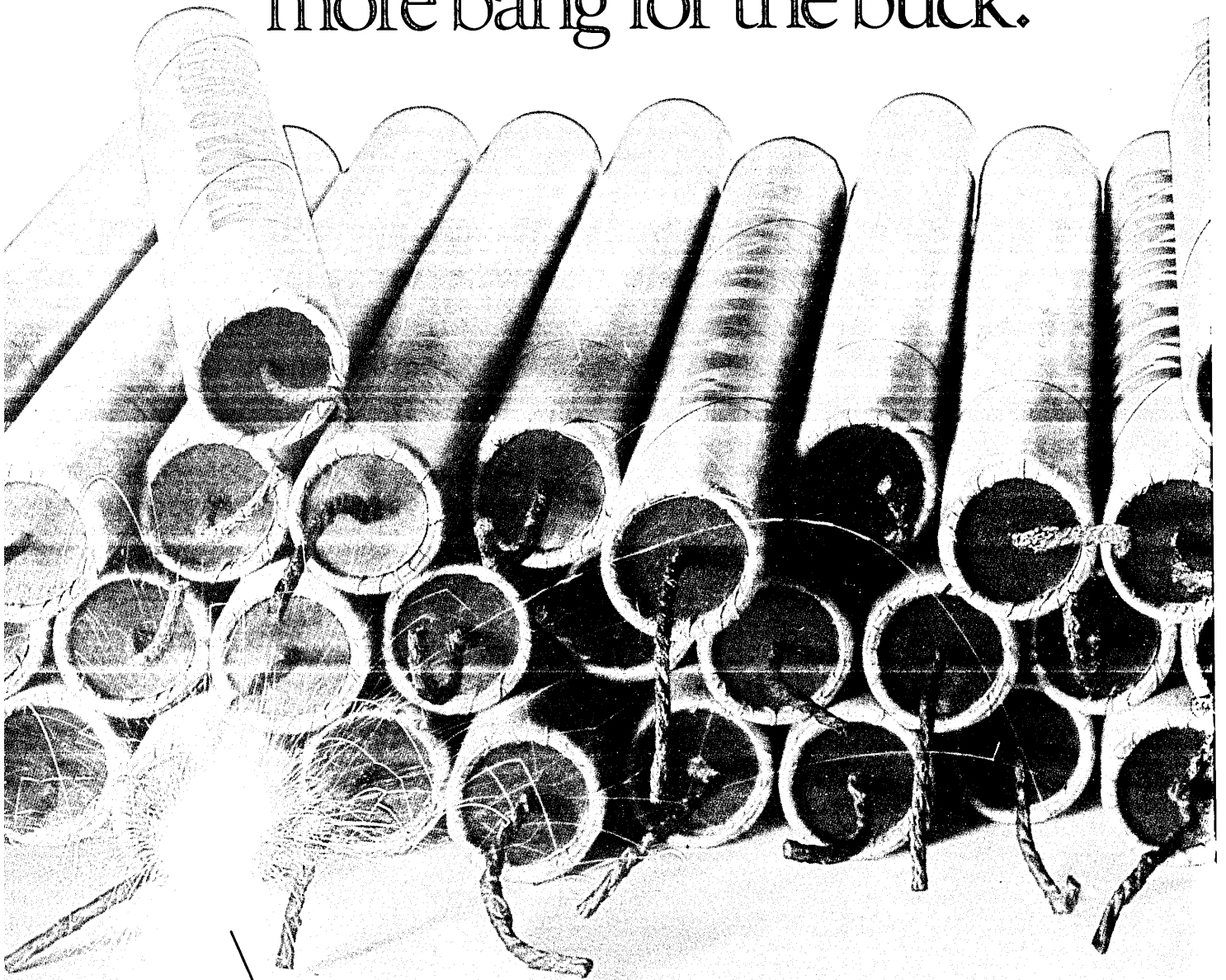

For the fifth time in little more than a year, Prime introduces an explosive advance in computer price/performance.

PRIME is a registered trademark of Prime Computer, Inc., Natick, Massachusetts.  
PRIME 9955 is a trademark of Prime Computer, Inc., Natick, Massachusetts.

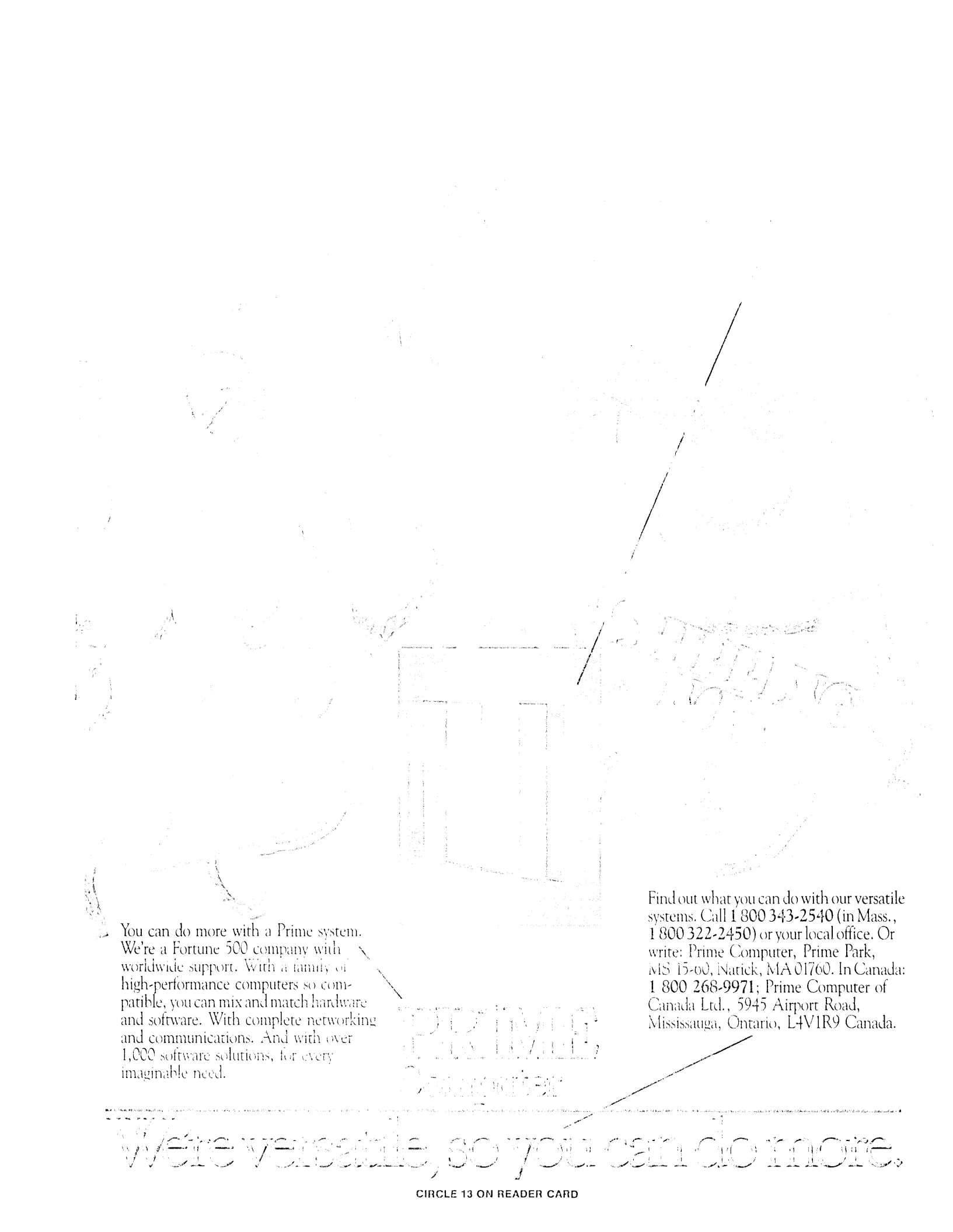

You can do more with a Prime system. We're a Fortune 500 company with worldwide support. With a family of high-performance computers so compatible, you can mix and match hardware and software. With complete networking and communications. And with over 1,000 software solutions, for every imaginable need.

Find out what you can do with our versatile systems. Call 1 800 343-2540 (in Mass., 1 800 322-2450) or your local office. Or write: Prime Computer, Prime Park, MS 15-00, Natick, MA 01760. In Canada: 1 800 268-9971; Prime Computer of Canada Ltd., 5945 Airport Road, Mississauga, Ontario, L4V1R9 Canada.

FOR THE  
FUTURE  
OF THE  
COMPUTER

We're versatile, so you can do more.

CIRCLE 13 ON READER CARD



# CALENDAR

## APRIL

### **Gulf Computer & Office Show.**

April 2-4, New Orleans. Contact Gulf Computer & Office Show, 119 Avant Garde Circle, Kenner, LA 70065, (504) 467-9949.

### **UNIX Systems Exposition '85.**

April 2-4, Paris. Contact Network Events Ltd., Printers Mews, Market Hill, Buckingham, MK18 1JX, England, tel. (0280) 815226, or Gin Piau, 272 rue de Faubourg Sainte Honore, 75008 Paris, tel. (1) 776 75 06.

### **Eighth Annual Rocky Mountain Data Processing Exposition & Conference.**

April 10-12, Denver. Contact Industrial Presentations West Inc., 12371 E. Cornell Ave., Aurora, CO 80014, (303) 696-6100.

### **Computer Graphics '85.**

April 14-18, Dallas. Contact National Computer Graphics Association, Suite 601, 8401 Arlington Blvd., Fairfax, VA 22031, (703) 698-9600.

### **1985 Hannover Fair.**

April 17-24, Hannover, West Germany. Contact Hannover Fairs Information Center, P.O. Box 338, Route 22 East, Whitehouse, NJ 08888.

### **Association for Information and Image Management (AIIM) Conference and Exposition.**

April 29-May 2, Washington, D.C. Contact AIIM, Department of Conference and Exposition, 1100 Wayne Ave., Silver Spring, MD 20910, (301) 587-8202.

### **Artificial Intelligence & Advanced Computer Technology Conference & Exposition.**

April 30-May 2, Long Beach, Calif. Contact Jim Hay, Tower Conference Management Co., 331 West Wesley St., Wheaton, IL 60187, (312) 668-8100.

## MAY

### **Scientific Computing and Automation Conference and Exposition.**

May 1-3, Atlantic City, N. J. Contact Expocon Management Associates Inc., 3695 Post Rd., Southport, CT 06490, (203) 259-5734.

### **COMDEX/Spring.**

May 6-9, Atlanta. Contact the Interface Group, 300 First Ave., Needham, MA 02194, (617) 449-6600.

### **EXPO L.A. '85 (Cash Management Information Exposition).**

May 7-8, Los Angeles. Contact Shel Kaplan, Executive Director, Cash Management Association of Southern California, P.O. Box 60270, Los Angeles, CA 90060.

### **Personal Computer Exposition/Conference.**

May 8-10, Montreal. Contact Personal Computer Association, 20 Butterick Rd., Toronto M8W 3Z8, (416) 252-7791.

### **Interconnections '85.**

May 15-17, Los Angeles. Contact the Independent Computer Consultants Association, P.O. Box 27412, St. Louis, MO 63141.

### **The Southern California Computer Faire.**

May 16-19, Los Angeles. Contact Computer Faire Inc., P.O. Box 106, Newton Highlands, MA 02161, (617) 965-8350.

### **1985 Trends and Applications Conference.**

May 21-22, Silver Spring, Md. Contact Madeleine R. Sparks, Trends & Applications 1985, c/o Systems Development Corp., 4810 Bradford Blvd., Huntsville, AL 35805.

### **International Computer Trade Show Europe Software+.**

May 22-24, Utrecht, the Netherlands. Contact Royal Netherlands Industries Fair (Jaarbeurs), P.O. Box 8500, 3503 RM UTRECHT, The Netherlands, tel. (30) 955911, telex 47132.

## JUNE

### **PHONE '85.**

June 4-6, London. Contact Network Events Ltd., Printers Mews, Market Hill, Buckingham, MK18 1JX, England, tel. (0280) 815226.

### **Government Computer Expo '85.**

June 11-13, Washington, D.C. Contact GCE, Conference Manager, 1620 Elton Rd., Silver Spring, MD 20903, (301) 445-4405.

### **INFO/WEST.**

June 12-14, Anaheim, Calif. Contact Show Manager, INFO/WEST, Clapp & Poliak, 708 Third Ave., New York, NY 10017, (212) 661-8010.

### **International Computer Show Cologne.**

June 13-16, Cologne, Germany. Contact John Lumborg, U.S. Embassy, Regional Export Development Office (Europe), Deichmanns Aue 29, 5300 Bonne 2, Germany, tel. (228) 339-2047.

### **PC Expo.**

June 17-19, New York. Contact Camille Caminiti, 333 Sylvan Ave., Englewood Cliffs, NJ 07632, (201) 569-8542.

### **Advanced Manufacturing Systems Exposition & Conference.**

June 18-20, Rosemont, Ill. Contact AMS '85, Cahners Exposition Group, 708 Third Ave., New York, NY 10017 (212) 661-8010.

### **Canadian Robotics Show.**

June 18-20, Toronto. Contact Ron McCreary, RIA, P.O. Box 1366, Dearborn, MI 48121, (313) 271-7800.

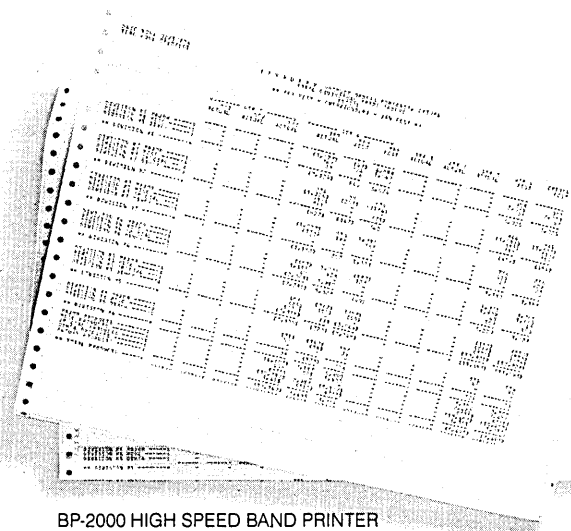

BP-2000 HIGH SPEED BAND PRINTER

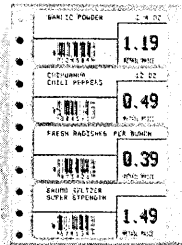

M-100L MATRIX PRINTER

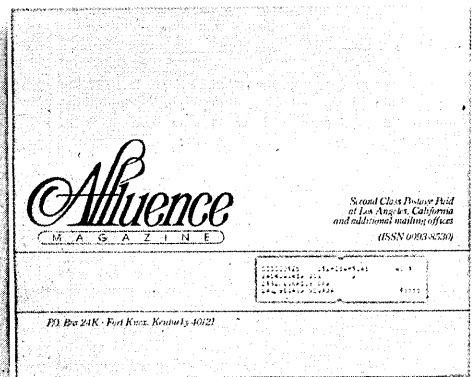

B-600 MEDIUM SPEED BAND PRINTER

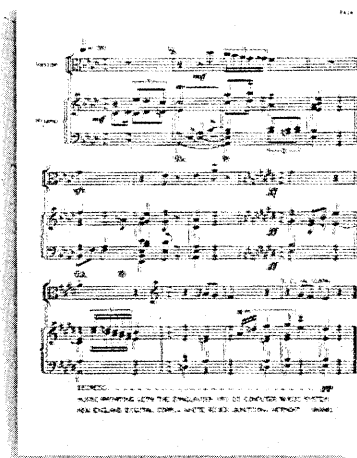

8010 MATRIX PRINTER

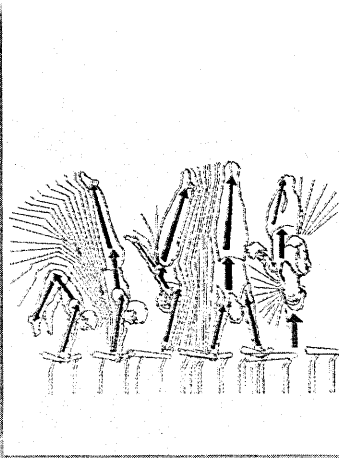

8020 MATRIX PRINTER

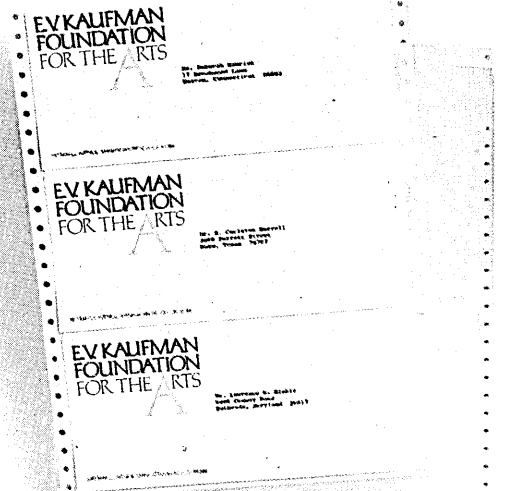

DP-55 DAISYWHEEL PRINTER

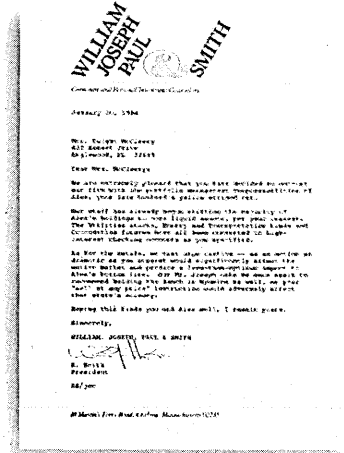

DP-35 DAISYWHEEL PRINTER

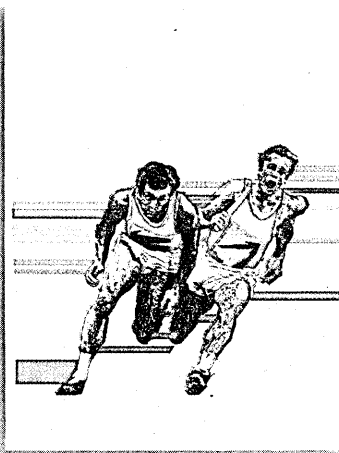

8050 MATRIX PRINTER



8070 MATRIX PRINTER

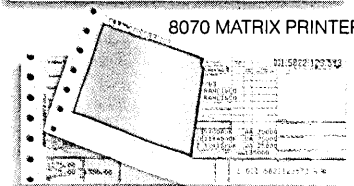

M-120 MATRIX PRINTER

...and so on.



**Dataproducts printers.**  
Nobody puts ideas on paper so many ways.

DATAPRODUCTS CORP., 6200 CANOGA AVE., WOODLAND HILLS, CA 91365. (818) 887-3924. IN EUROPE, 136-138 HIGH ST., EGHAM, SURREY, TW 20 9HL ENGLAND.

CIRCLE 14 ON READER CARD

A LITTLE SOMETHING  
TO GET YOU THROUGH  
THE PROBLEMS  
CAUSED BY DIVESTITURE.

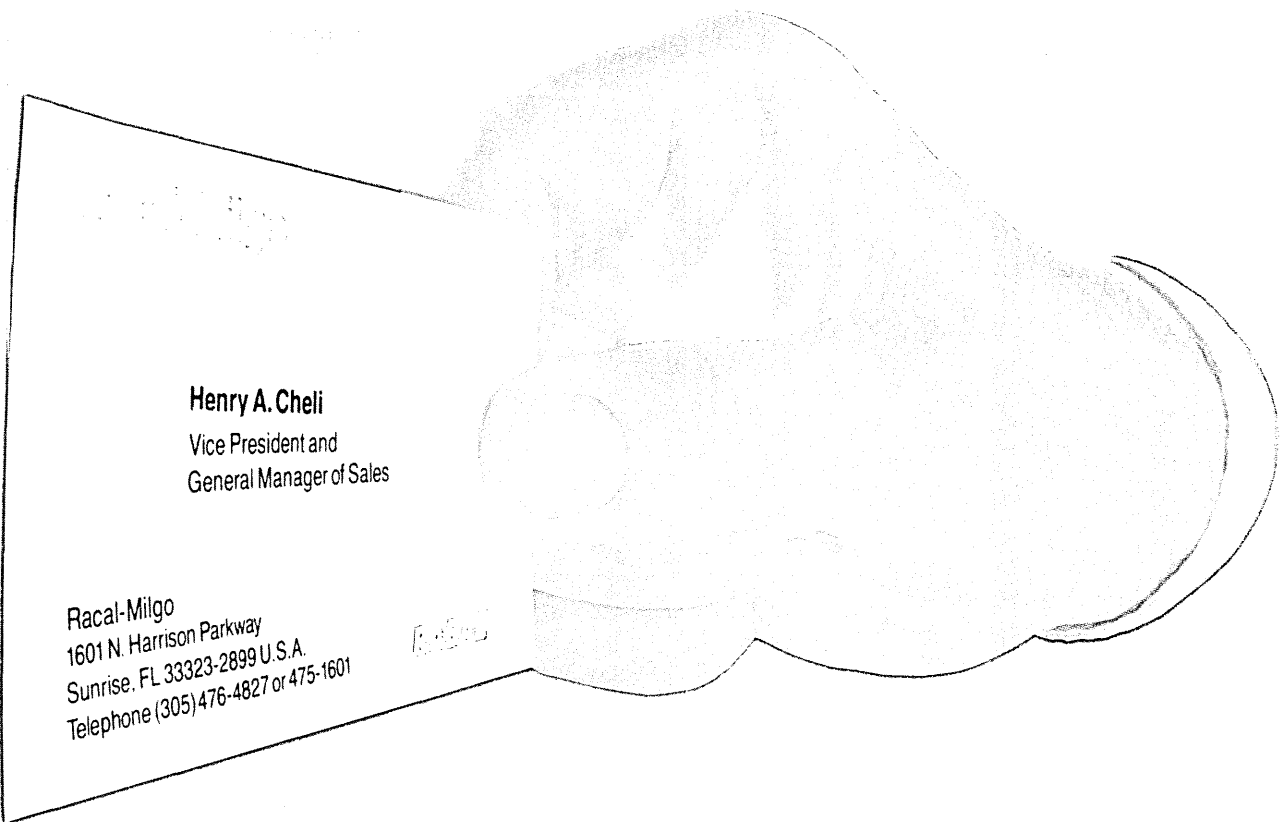

**Henry A. Cheli**  
Vice President and  
General Manager of Sales

Racal-Milgo  
1601 N. Harrison Parkway  
Sunrise, FL 33323-2899 U.S.A.  
Telephone (305) 476-4827 or 475-1601



**Racal-Milgo puts network control where it should have been all along. With you.**

Our CMS® network management systems and Omnimode® modems let you manage even the largest network from end-to-end. Remote unattended modem tests, fault isolation, dial back-up, and network restoral can all be accomplished from your central site. No matter how many regional phone companies are involved.

**You don't have to replace your modems to take control of your network.**

Not ready for Omnimode's advanced capabilities? No problem. Our TCM-7 test control module upgrades any non-diagnostic modem to a fully diagnostic unit, (even if you're still using Bell or equivalent leased line modems). So you can take advantage of CMS capabilities – without changing installed modems.

**Take the guesswork out of troubleshooting and long-term planning.**

Our SPAN system performance analyzer helps you fine tune your data network by providing statistics on response times and line utilization. Available as

a standalone unit or as an integrated option to CMS systems, SPAN simplifies configuration management and capacity planning.

**We can tell you more about your lines than the phone company can.**

Our new line parameter test capability in CMS systems and Omnimode modems can tell you at a glance whether a circuit is in or out of spec. So you can tell if your lines are up to the standards you're paying for. It's the most complete level of circuit test available from a single source. And all test procedures conform to Bell requirements.

**Get back to dealing with one vendor to solve all your network problems.**

With Racal-Milgo, you get the benefit of a system overview with a system solution. Because our field engineers are factory-trained in all areas of data processing and data communications. It's another way Racal-Milgo demonstrates its reputation for reliability. With our broad range of products and systems, backed by extensive service capability, there's not a problem in data communications we can't solve.

Racal-Milgo®

MS 1302  
P.O. Box 407044  
Ft. Lauderdale, FL 33340

**RACAL**

<b>Special Offer</b>	DAT 3/15/85
We're so certain we can solve your network problems that we've developed a "Problem Analysis Form." Just fill it out, return it, and we'll solve your problem fast. To receive your copy, call us right now at <b>1-800-327-4440, Ext. 2202</b> . In Florida, call <b>(305) 476-4812, Ext. 2202</b> . Or fill out and mail this coupon today.	
NAME/TITLE _____	
COMPANY _____	
ADDRESS _____	
CITY/STATE/ZIP _____	
PHONE ( ) _____	EXT. _____

© 1985 Racal-Milgo

Starting in this issue...  
A New Service for Datamation Subscribers!

# Datamation Instant Response Service

Now you can get product information direct from the advertiser... just by making one simple phone call.

**It's easy...it's fast.** Get all the product information you want...from as many advertisers as you wish with just one phone call.

**Call day or night...7 days a week.** Wherever you happen to be reading Datamation, in your office or at home, you can call for the product information you want.

**There's an "800" number to serve you.** Then, all you need is a touch-tone phone to put Datamation Instant Response System at your service.

**One call satisfies all inquiries.** Or call as often as you want. It's a different kind and quality of information system from the "Bingo Card." Provides instant shopping for all your information needs.

**As an additional service** some of our leading advertisers have agreed to provide you with information such as product specifications, availability and local dealer sources right on the phone. Or you can arrange for a follow-up call from the advertiser's technical department or to have a sales representative call. It's all coming in the March 15 issue of Datamation.

## DATAMATION

875 Third Avenue, New York, NY 10022

Technical Publishing

**TB** a company of  
The Dun & Bradstreet Corporation

# LETTERS

## LEMON AID

Philip H. Dorn's "Learning from Lemons" (Jan. 15, p. 72) was absolutely super, particularly in its five summary points. It should be required reading for venture capitalists and MBA students.

AL DE VITO  
Main Frame Software Products Corp.  
Wellesley, Mass.

Contrary to one of the "recollections" reported as a fact in Philip H. Dorn's otherwise excellent article, Modcomp is still an independent company; it has *not* been acquired by Gould as reported. In fact, on Jan. 2, 1985, Modcomp's 1,050 employees marked the 15th anniversary of the company's founding—and its independence.

To help set the record straight, a few years ago Gould actually acquired Systems Engineering Laboratories Inc. (SEL), another Fort Lauderdale-based minicomputer manufacturer (which coincidentally employed most of Modcomp's founders prior to their having followed entrepreneurial urges in 1970).

When writing magazine articles, one shouldn't always trust one's "memories" and "recollections" if the facts are readily available and ascertainable.

BERNARD M. HERBENICK  
General Counsel & Secretary  
Modcomp  
Fort Lauderdale, Florida

## CALL ME MODEM

"Modem Market Madness" (News in Perspective, Jan. 1, p. 44) is misleading. Not only is 9,600 bits per second speed here now, Gamma Technology is offering the modem as a plug-in card for the IBM PC XT and AT and compatibles. Shipments of the modem began last July. It is the only synchronous modem card operating above 2,400bps. The modem is controlled from the PC keyboard and features auto dialing, a telephone dialing directory, and

automatic fallback to 7,200bps or 4,800bps, depending on line quality.

Results are outstanding. The 9,600bps speed is automatically selected over 90% of the time, even on cross-country calls. At this speed, a 50-page document (approximately 100KB) is transmitted in under two minutes, fully error checked, and with all datacom overhead included.

MICHAEL A. LUTZ  
Marketing Vice President  
Gamma Technology Inc.  
Palo Alto, California

## BIG BLUE REPLIES

Your Jan. 1 editorial puzzled me. You seem to suggest IBM should be regulated, not on the basis of any existing violations of law—you cite none—but on the supposition that IBM's growth, if "unfettered," somehow would lead to a decline in competition and innovation. You offer no evidence to support this conclusion.

I believe your concerns are groundless. First, you take our rapid growth for granted, extrapolating from the position we have achieved in personal computers—an industry segment that did not exist 10 years ago and now is estimated to be a \$15 billion a year business. We certainly don't take future market success for granted. Our goal is to grow with the industry, but we will only do so if we continue to do what our customers have always insisted we do: provide them with the high-quality, innovative products they need at a price they can afford. There is nothing automatic about that. Our reputation for service and quality must be earned every day.

The pace of innovation in the industry has been dramatic. One dollar now buys 200 times the processing power it did 30 years ago. IBM is responsible for some of this innovation, as you are well aware, and we intend to continue to innovate, but, as you have frequently report-

ed, many others have innovated—and continue to do so.

The information industry has grown at an extraordinary rate on the strength of vigorous competition and rapid innovation. I am amazed that DATA-MATION, which has covered our industry virtually since its beginning, does not understand that.

JOHN R. OPEL  
Chairman of the Board  
IBM  
Armonk, New York

## CHALLENGE

I have always admired the thoroughness of your articles and their professional presentation, but I always felt they were somehow cerebral and taken out of the context of "real world" problems. David F. Noble's "Is Progress What it Seems to Be?" (Nov. 15, p. 140) has caused me to change my view. We need to be reminded of the relationships that link the powerful forces in our society. I look forward to more articles that challenge the values and directions of this technology I call my profession.

MORRIS KORNBLUTH  
Brooklyn, New York

## CORRECTIONS

In the "Systems Software Survey," (Dec. 1, p. 84) SAS Institute was inadvertently deprived of its initial "S" in the category, "Data Management & DBMS Aids."

In "Alas Poor VisiCorp," (Jan. 15, p. 93), the reference to PowerBase on p. 94 should have been to PowerText.

We are glad to report that Robb Wilmot is alive and well and continuing in his post as chairman of ICL. We erroneously stated that Wilmot had stepped down as ICL chairman in "Teamwork with Tokyo," which ran in our Jan. 1 international issue (p. 64-14).

# Where program their

If you want to take a look at programming from a different point of view, take a look at a Smart Desk equipped with an IBM 3270 Personal Computer.

The screen of the 3270 PC can be divided into several windows—including multiple PC sessions and up to four host sessions from the same or different computers.



In the blue window you can keep a menu of your function keys. It's easy to log on and connect to a host system for browsing a program listing in the yellow window.

To edit a second program, a single function key can download the source code to a PC session in the red window.

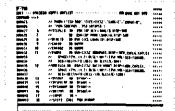

And, when you're finished editing, another function key can send the revised program back to the host.

These multiple windows are available in eight colors. They are ideal for reviewing more than one program at once. Or for the concurrent viewing and testing of source code.

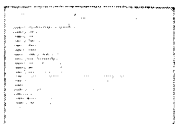

The end result is faster and more accurate programming with less demand on the host.

Any window can be viewed full screen for detailed analysis. Or it can be sized and moved to any area of the screen, so you can create the screen format that works best for you. You also get two handy notepad windows.

And, of course, the 3270 PC is backed by IBM's commitment to service and support.

One more point to keep in mind: The 3270 PC is available in quantity

3-15

IBM  
DRM, Dept. KP/82  
400 Parson's Pond Drive  
Franklin Lakes, NJ 07417

Please send me more information on the IBM 3270 Personal Computer.

Please have an IBM marketing representative contact me.

Name \_\_\_\_\_

Title \_\_\_\_\_

Company \_\_\_\_\_

Address \_\_\_\_\_

City \_\_\_\_\_ State \_\_\_\_\_ Zip \_\_\_\_\_

Phone \_\_\_\_\_

discounts. Your IBM marketing representative has all the details.

And if you want to receive literature on how the 3270 PC can expand your programming capabilities, call 1 800 IBM-2468, Ext. 82 or send in this coupon.



D--PC		WHAT DO YOU W
PF1	Logon to	
PF2	Connect	
PF3	Connect	
PF4	Connect	
PF5	Send dat	
PF6	Receive	
PF7	Other fu	
PF8	Logoff o	
PF9	Help	

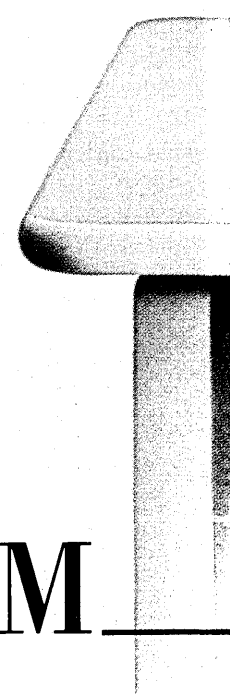

# The Smart Desk from IBM





THE LEADER IN LASERS  
PRESENTS THE  
28-PAGE-PER-MINUTE HOLOSCANI PRINTER

It's the fastest low-cost laser printer — with true letter quality — in the industry. By incorporating the most sophisticated diode laser with holographic scanning capabilities, General Optronics created the versatile HoloScan 28™ Laser Printer. Just look at what it offers!

• high resolution — 300 by 300 dots per inch • compatible with all computers • ideal for multi-user applications • nation-wide service available • prints on ordinary paper — 16 lb. to 28 lb. • accepts mixed paper sizes — 8 1/2" x 11" to 11" x 17" • prints portrait or landscape • merge front and back • prints multiple fonts on same page • 1250 sheets input capacity • compact and virtually silent • single quantity prices \$4,500 including video interface • controllers, Data Products and FIS-2828 interfaces available • supports the Data 630 escape codes

For information, call or write Charles Kaplan, National Sales Manager, General Optronics Corp., Optical Information Products Division, Two Clear Avenue, Edison, NJ 08820, 201-693-1100, FAX 201-693-6556. Distributor and OEM inquiries welcomed.

HOLOSCANI 28 LASER PRINTER



HOLOSCAN 28

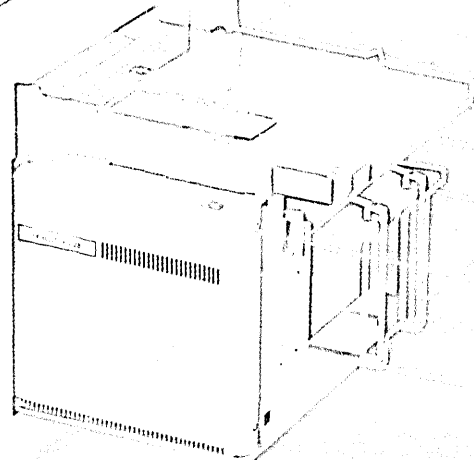



# HARDCOPY

## BREATHING SPACE

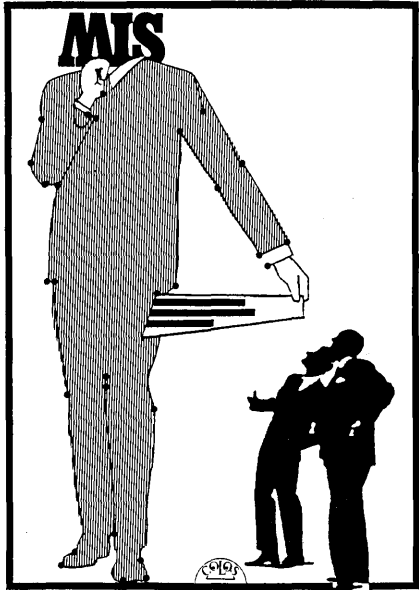

ILLUSTRATION BY FRANCOIS COLOS

It's not surprising that people enjoy DATAMATION's annual survey of MIS budgets so much: little is more compelling than the spending habits of others, particularly when those others are competitors. Too, investigative practitioners as diverse as Nero Wolfe and J. Edgar Hoover have proved that if you follow the money, it's very likely you'll be led to the real story.

This year, the numbers point in an interesting direction. Pc purchases as a percentage of MIS budgets are leveling off. Apparently, a lot of the people who need one already have one, or, at least, have access to one. And while the average company sampled is buying micros off the MIS budget, it does seem as though the race toward the machine-per-person office has been put into neutral for a while.

Why is this? Senior Writer John Verity speculates, "Corporate users are now more interested in pcs that can network directly with mainframes, as opposed to standalone machines." That makes a lot of sense. It also suggests that the vendor that comes up with the ultimate micro-mainframe connection will make vast profits and set off another pc boom.

The current slowdown, however, doesn't mean that MIS can suddenly start ignoring the pc. What it does mean is that MIS has time in which to integrate these devices that have transformed the way information is manipulated within the corporate structure.

Verity has another equally intriguing explanation for the leveling off: "This year's survey found that, on average, Fortune-class companies are spending \$128,000 on pcs outside the dp budget, and, among all sites surveyed, about \$73,000 is being spent outside the dp budget." Perhaps pc purchases aren't quite as level as they look. Other studies suggest that these pc purchases represent only the tip of the off-MIS-budget iceberg, with one half to two thirds of all corporate expenditures for information technology now being controlled by users in factories, laboratories, and offices. Follow this trail and you'll soon be led deep into a thicket of truisms about possession being paramount, and money and power being—if not synonymous—very securely wedded.

No matter who pays for the machinery, however, recent findings show that during the past five years the percentage of top MIS executives who report directly to the president or board of directors of their corporations has quintupled. Electronic manipulation of information is an acknowledged corporate asset, a competitive weapon to win markets and make sales, and it is to MIS that corporate officers turn when making decisions about technology and information policy. Whether the machines turn out to be micros, minis, or mainframes, MIS will have helped make the decision.

But the growth of off-budget computing suggests that the strength of MIS within the corporation cannot be taken for granted. If users can't feel secure that MIS will do what needs doing, that MIS will help them do what they want to do, then MIS could lose its power to implement information strategy. The information anarchy that threatened when pcs were brought into companies disguised as typewriter purchases or T&E expenses would no longer be just a possibility.

Still, the budget survey suggests that MIS has plenty of what it will take to set the pace for the use of information in the American corporation: MIS's percent of the total corporate budget has risen noticeably.

So, what the numbers say is that the mid-1980s is no time for business as usual. With more of the corporation's cash than usual to work with, and breathing space created by the leveling off of pc purchases, MIS must make ready to handle the complex job of integrating new machines, and new demands for communications, decision support, and end-user computing. If MIS budgets prove anything this year, it is that the due bill for lack of preparedness may be higher than anyone can afford. ©

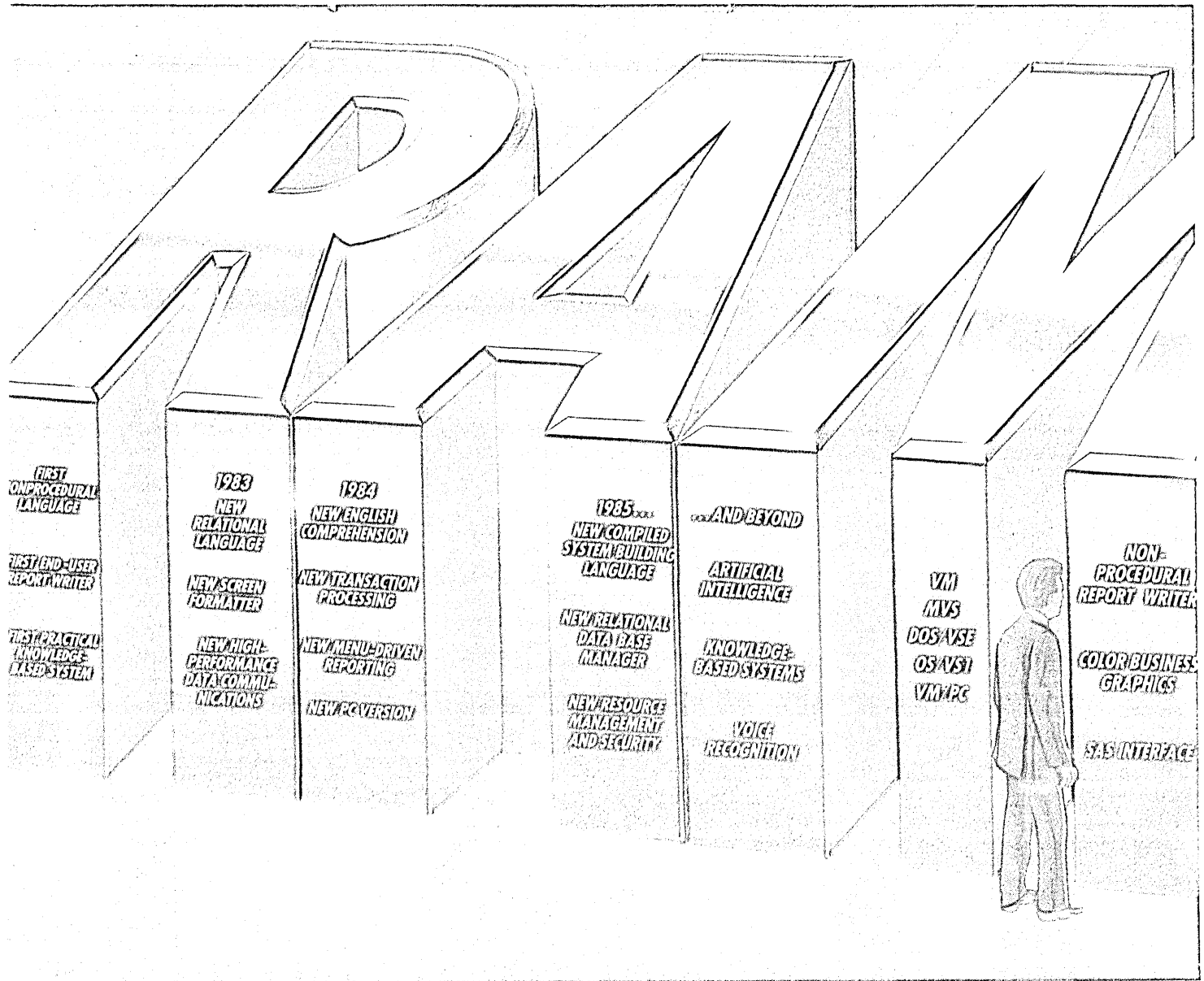

# The Past Present Future

RAMIS II: benchmark for an industry.

In the world of 4th-generation technology, Mathematica's record of software 'firsts' stands unmatched. From our invention of non-procedural programming in the 1960's, to our release of the first knowledge-based system in 1984, a unique blend of experience and innovation has made RAMIS II the most powerful and flexible software product on the market today.

The key word here is 'today.' Building on a distinguished history of achievement, today's RAMIS II is still the *newest* 4th-generation system you can buy in 1985. During the past two years alone, our

investment of more than \$10 million in R&D has produced dramatic advances in end-user computing and professional applications development.

In the Information Center, today's RAMIS II offers more choices to end users, including an intelligent, menu-driven report writer, natural English comprehension, and a simple yet complete relational language. Information Center staff also benefit from new choices in education, user assistance, and high-quality vendor service that dramatically reduce their support burden.

For Applications Development, today's RAMIS II combines 4th-generation flexibility with the efficiency of a compiled architecture to deliver the highest levels of productivity. With powerful new transaction processing and applications development languages, plus elegant and easy-to-use screen painting, no other software product does more to cut development time and costs.

Within the PC environment, today's RAMIS II integrates the best of mainframe and desktop technologies in a strategy designed for corporate



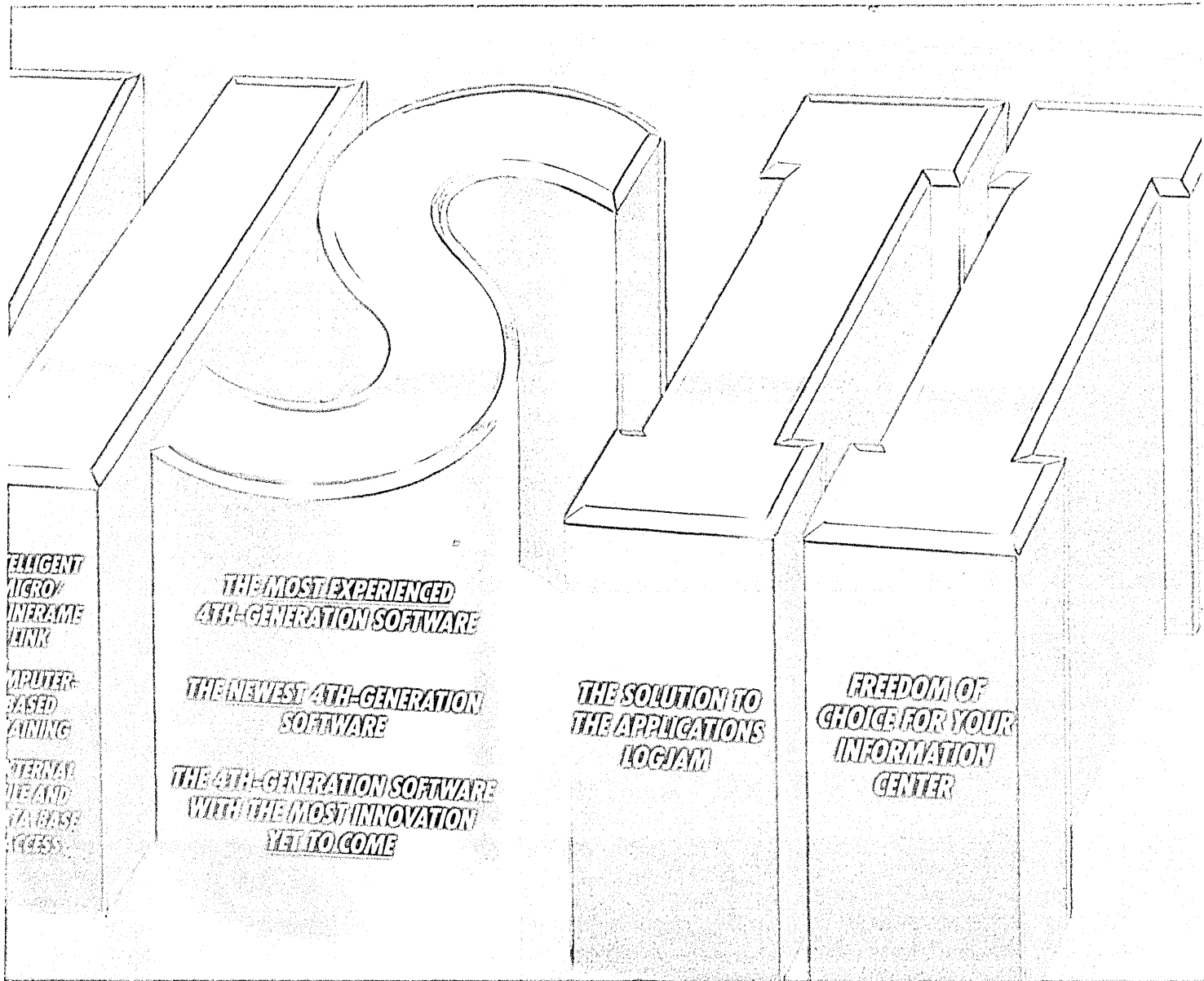

INTELLIGENT  
MICRO-  
MAINFRAME  
LINK

COMPUTER-  
BASED  
TRAINING

INTERNAL  
DEVELOPMENT  
LANGUAGES  
(COBOL)

THE MOST EXPERIENCED  
4TH-GENERATION SOFTWARE

THE NEWEST 4TH-GENERATION  
SOFTWARE

THE 4TH-GENERATION SOFTWARE  
WITH THE MOST INNOVATION  
YET TO COME

THE SOLUTION TO  
THE APPLICATIONS  
LOGJAM

FREEDOM OF  
CHOICE FOR YOUR  
INFORMATION  
CENTER

# Leader by Design.

PC users. Our new micro-to-mainframe link provides intelligent data transfer, immediately linking the mainframe with any PC product. And, a full-function PC version of RAMIS II now brings complete applications portability to the latest generation of desktop computers.

The future belongs to those with vision.

At Mathematica, our vision is supported by a strong commitment to R&D, and a determination to carry

RAMIS II's technological leadership well into the future. And with the backing of Martin Marietta, our Fortune 100 parent corporation (an innovator in such fields as artificial intelligence, satellite communications and the Space Shuttle program), this leading edge will be sharply advanced again in 1985.

To find out how you can benefit from the PastPresentFuture leadership of RAMIS II call us or return the coupon.

## RAMIS® II... THE LEADER BY DESIGN

CIRCLE 18 ON READER CARD

**MATHEMATICA**

P.O. Box 2392, Princeton, N J 08540  
**1-800-257-5175**

I'm interested in how RAMIS II can benefit me.

Send me information on *free* RAMIS II seminars.

Send me more information about RAMIS II.

\_\_\_\_\_  
Name

\_\_\_\_\_  
Title

\_\_\_\_\_  
Company

\_\_\_\_\_  
Address

\_\_\_\_\_  
City State Zip

\_\_\_\_\_  
Telephone

\_\_\_\_\_  
Computer Operating System

**MATHEMATICA**

MARTIN MARIETTA DATA SYSTEMS

DA3/15

# NEWS

## GETTING A GRIP ON TOOLS

**More than 275 programmer productivity packages are now available, with more coming almost daily. Hip hip hooray!**

by Edith Myers

John Rooney, data processing manager at Rockwell Autonetics, Anaheim, Calif., had a problem. His company was in a growth mode, generating mountains of paperwork. His users were pushing for an employment applicants tracking system.

"There are a number of these on the market," he says, "but our users wanted to take the same kinds of procedures they had been using and automate them."

Don Krehbill, the MIS director at Santa Monica Community College, was "wearying" of COBOL. "We'd always run in COBOL and it was difficult to make changes, do adaptation, and make new applications. Our backlog was getting longer and longer."

Dan Kramer, dp director at St. Croix Valley Memorial Hospital, St. Croix Falls, Wis., on the other hand, wanted COBOL. More specifically, he wanted some 300 programs written in an NCR proprietary language converted to or rewritten in COBOL.

All three were prime candidates for a proliferating class of software tools, designed for both information specialists and end users to simplify the development, modification, and ongoing support of computer-based information systems. These tools go by such names as development workbenches, relational database management systems, fourth generation languages, program generators, applications generators and sometimes, more generically, programmer productivity tools. Some vendors offer combinations of one or more of the above.

At last count some 275 vendors offered such tools for large systems and some 120 for micro-based systems. The vendors range from small startups to large mainframe manufacturers. A gaggle of new products either just introduced or soon to appear further crowds the market.

The vendors are counting on the fact that the need for such tools is a given in light of the increasing cost-effectiveness of hardware and an increase in the

hourly rate for programmers, making software a larger portion of total system cost. They reason that the way to reduce this portion is to make designers, programmers, and even end users more effective by providing them with tools.

Rooney of Rockwell isn't sure yet whether or not his problem has been solved, but he has "a high degree of confidence." His choice of tool was one of the new entries in the market, called Style. According to its developer, Foothill Research Inc., Milpitas, Calif., Style is a fourth generation programming language and database management system.

Don Johnson, product manager at Foothill Research, says Style was under development for six years. "We started serious marketing last August and have more than 30 installations." Style was initially offered on the Data General MV Series, AOS/VS. In late January, Johnson says, a purchased version for the DEC VAX was installed in a test site, as was a version for the fault tolerant computer produced by Stratus Computers, Westboro, Mass. He says Foothill Research had shipped beta test versions for the NCR Tower and Convergent Technologies Megaframe and that "we've just finished a Unix port so that it'll run on any 32-bit machine that runs Unix."

Because there are only 33 commands and 14 key words needed to program in Style, application programs can be developed fast, Johnson claims. "Using Style, programmers typically can increase overall productivity by at least five to one. In some cases, increases go as high as 10 to one."

Rooney hopes all this is true. "We're a test bed right now," he said in January. "We've had it on our machine for about a month. If it's all Foothill says it is, it'll solve a big problem for us."

Style already has solved some big problems for Krehbill, who was tiring of COBOL. "We have 32,000 students and a constant need for new applications," he says. "I had been using dBase II in commercial applications and decided I needed something like that for a larger machine." He also had been using Info, a fourth generation language built around an RDBMS from Henco Software, Waltham, Mass., on a superminicomputer system from Prime Computers Inc. of Natick, Mass. Although he generally uses the Prime for instructional purposes, he "bootlegged" two administrative applications—bookstore and radio station fund-raising—to it. "I liked Info and decided that was the way to go, but Info is interpretive and slows the Prime down. I also looked at Oracle [a relational database management system from Oracle Corp., Menlo Park, Calif.], but it had COBOL code embedded in it and I wanted to abandon

PHOTOGRAPH BY STEVE COOPER

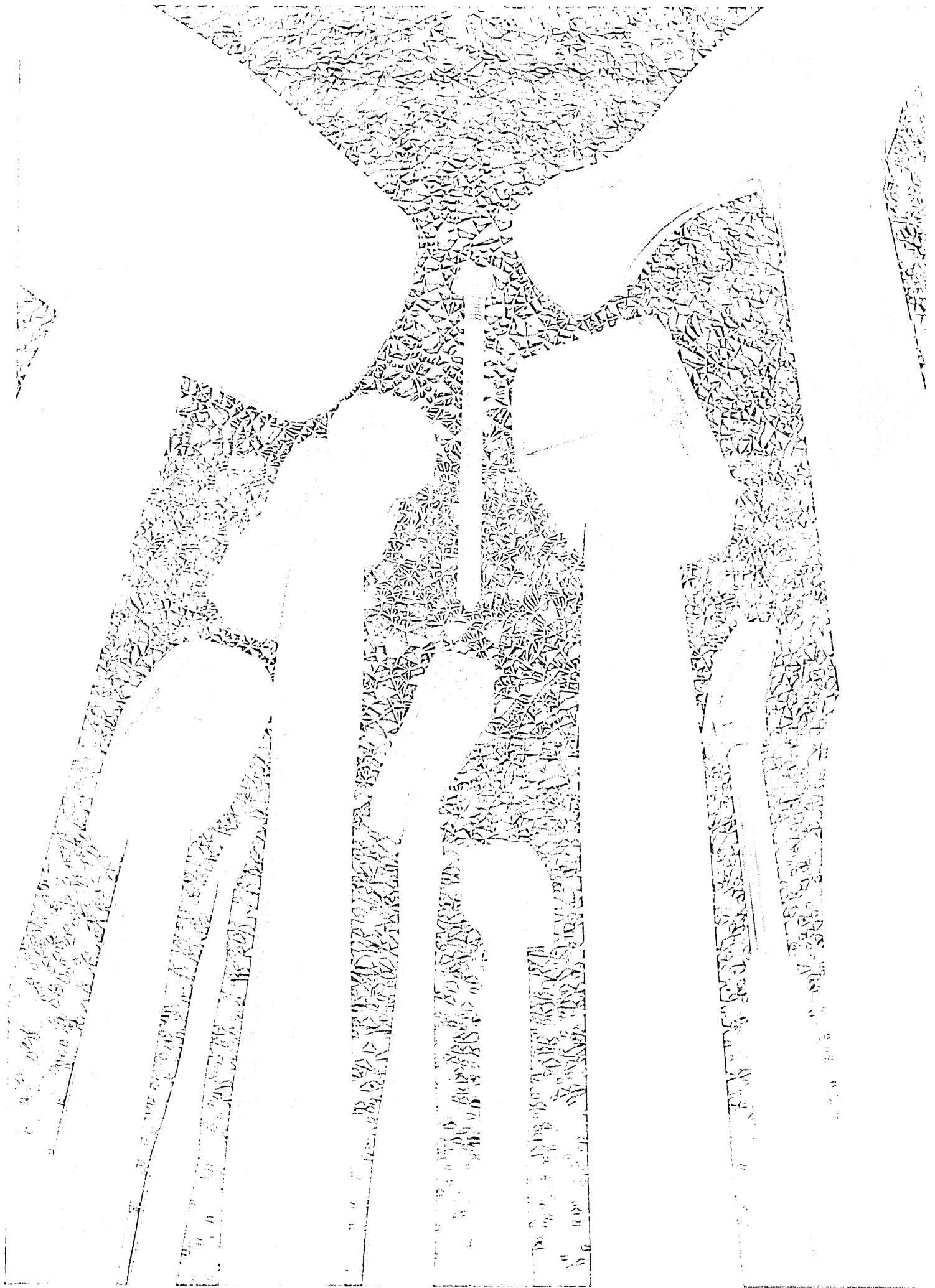

## IN FOCUS

COBOL." The clincher in his decision to go with Style was that "it is a full language implementation, a database management system both relational and hierarchical. You can create direct access files," he says. "It's flexible and you can design a database any way you like. The intriguing part is that it is indeed interpretive during the first execution of a piece code, but during that execution it is compiled and subsequent executions run on compiled code, which gives a tremendous performance edge."

Krehbill says his department's time spent creating new products is "a fraction of what it was with COBOL." How large or small that fraction is, he says, is a

### **"If someone were to ask me to locate all blue-eyed Indonesian students getting financial aid who are handicapped, I could find out 40 times faster with Style."**

function of how logic intensive an application is. Where it is very logic intensive, there is very little improvement, but "if someone were to come to me and ask me to locate all blue-eyed Indonesian students getting financial aid who are handicapped, I could factor that in at 40 to 1," he claims, contrasting Style with COBOL.

Krehbill is in the process of converting his bookstore and radio station applications from the Prime to Style and his Data General MV10000.

Kramer of St. Croix Valley Memorial Hospital chose another kind of productivity tool to solve his problem. He's using Cogen, a COBOL program generator produced by Bytel Corp. of Berkeley, Calif. Cogen runs on a wide variety of micros and minis and is priced, depending on hardware and operating environment, from a low of \$950 for versions for 8-bit and 16-bit micros to a high of \$7,500 for the VAX. David Norwood, Bytel's micro systems manager, says there are some 3,000 installations of the product, which was introduced in its original version four years ago. He says the vast majority of users are NCR or micro users and are using release 6.0, which has been out for almost two years.

"COBOL programmers love it," Norwood says. "It speaks to them the way COBOL programmers want to be talked to. It gives them source code to work with and they can add their own bells and whistles to the source code."

Kramer calls it "a very good tool. We were able to convert or rewrite our 300 programs in 18 months. We originally had figured it would take more than two and a half years. We're using it now for programs we have to write. We buy packages here and there but when we need to write our own we use Cogen to

get a formalized skeleton and add our customized code."

Are the programs he's creating with Cogen easier to maintain? "You bet. I wish we'd had Cogen years ago."

"We emphasize ease of maintenance as the biggest benefit in the long run," says Bytel's Norwood. "When you look at maintenance costs as opposed to development costs, you're looking at an 80 to 20 [ratio]. When a shop adopts a program generator as a way of doing business it gets consistent code. You know that works, so to find a problem, you look for code that is different."

Bytel, since the introduction of Cogen's release 6.0, has been concentrating on implementations on different hardware—a Data General version is in a beta test site—and on enhancements like the addition of a sort-merge capability.

Not so at Infocentre, headquartered in Montreal, which has been producing specialty software for the HP 3000 minicomputer since 1976. Bob Remillard, marketing manager, says Speedware, the company's fourth generation language for the 3000, has been installed in 300 sites around the world. Infocentre is currently readying a new product for spring introduction. It's called Micro-Speedware and differs quite a bit from its predecessor.

The HP 3000 Speedware consists of five modules. The first module, called Genesys/3000, is the language itself, and was introduced in 1980. "This is the core module of Speedware," says Remillard. It is nonprocedural and handles everything that is on-line and interactive, including menus. Our benchmarks tell us that 4,000 lines of COBOL can be reduced to from 40 to 70 lines in Genesys. Also, if you have a program in English, you can change one character and translate it into French, German, Spanish, Japanese, Swedish, or Hebrew."

The second module of Speedware, introduced in 1981, was the Documentor, which automatically generates user documentation manuals on any application written in Speedware. Third came Reactor, which Remillard describes as "two tools in one. It handles all batch and report writing, reads huge databases, and can create a sequential file and print a report out of it."

Reactor was introduced in May 1983, as was Designer, a designing tool for systems analysts. Instead of writing specs on paper, analysts put specs on the computer, which essentially paints a screen for the user. "When the user is satisfied, the analyst presses go and Designer turns around and creates a prototype. It's the ultimate prototyping tool," says Remillard. "The analyst then tells the user, 'Go back and play with your prototype and come back to me with any changes.'"

The last module, Speedex, was introduced in October 1984. Remillard calls it "an indexing system that sits on top of Image and makes it look relational." Image is Hewlett-Packard's database management system for the HP 3000.

Infocentre's micro product will include micro-Genesys and micro-Reactor and a new product called Speedbase, a relational database management system for MS/DOS and PC/DOS. Remillard sees the company's natural progression as leading to the Unix world to access AT&T, DEC, Data General, and some IBM machines.

"Networks are being downscaled from mainframes surrounded by minis to superminis surrounded by micros. We're the first to integrate superminis and micros around a fourth generation language. Speedbase is compatible with Image."

Sharing some characteristics with Speedware is USE.IT from High Order Software Inc., Cambridge, Mass., a company that is also readying a product for spring introduction. USE.IT currently is implemented on the VAX. The new offering will be for larger IBM mainframes.

High Order president Margaret Hamilton says the theory behind USE.IT has been around since 1969 or 1970. She was at MIT at the time, in charge of several hundred people analyzing software for the Apollo space program.

"It had to be reliable," she explains. "We analyzed all errors and categorized them, then analyzed different things to eliminate each class of errors. We developed a mathematical theorem to get rid of interface errors. We decided we could build a tool to do this, that no one else had done this, that we could model requirements logically."

The company built its first prototype in 1982. A year later it went into commercial production of the VAX version. "What it does," says Hamilton, "is allow you to model a system, putting down a model of your requirements with

### **"We were able to convert or rewrite our 300 programs in 18 months. We originally had figured it would take more than two and a half years."**

the tool. Then you use it to analyze, to tell you where your ambiguities are, to catch interface problems and logical areas. The next step is to produce source code in FORTRAN or COBOL. The IBM version will be for COBOL initially."

Hamilton says USE.IT can be used for any kind of system, including personnel and hardware systems. "It happens that most of our units [60 are installed] are in a software engineering environment." She says a Navy contractor is using it to define a personnel system, and



# Could you be earning more?

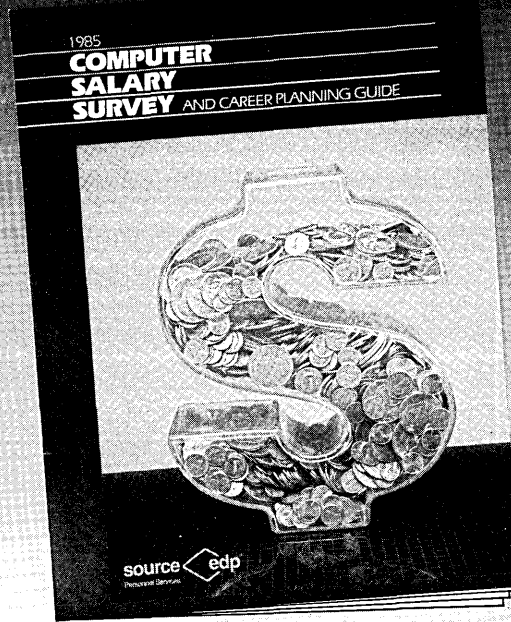

## New, free 1985 Survey shows sharp increases in salaries for computer professionals

With a strong economy, salaries for many computer professionals have soared since 1984 — in some cases as much as 22%!

### Our most comprehensive Survey ever

The new **1985 Computer Salary Survey and Career Planning Guide** is based on contacts with more than 48,000 information processing and computer professionals and 35,000 firms that hire them. Included is a review of salaries at sixty-three different position and experience levels. So no matter if you're in programming, systems analysis, design, software, communications, operations, sales, marketing or management;

you'll learn whether or not your salary is keeping pace with your peers—and what you can expect to earn as you advance.

In addition, the new Survey includes a number of comprehensive charts, exhibits and graphs which are designed to help you get a thorough understanding of emerging career trends and what you could do to capitalize on them.

### Free to computer professionals

The new 32-page Survey is free. Since 1966, we have distributed more than five hundred thousand Surveys to people who not only want success, but are determined to realize their fullest career potential.

You owe it to yourself—especially if most of your career lies ahead—to contact us today.

### Call today

To get your free copy, call the Source Edp office nearest you. Or if you prefer, write our headquarters address, which is listed below. Either way, we'll mail a copy to you in strict confidence, without obligation.

Write: Source Edp  
Department D2  
P.O. Box 7100  
Mountain View, CA 94039  
(When writing, please include your title.)

## Call today

**Alabama**  
Birmingham..... 205/322-8745

**Arizona**  
Phoenix..... 602/279-1010  
Tucson..... 602/792-0375

**California**  
Northern  
Mountain View..... 415/969-4910  
Sacramento..... 916/446-3470  
San Francisco..... 415/434-2410  
Walnut Creek..... 415/945-1910  
Southern  
Fullerton..... 714/738-1313  
Irvine..... 714/833-1730  
Los Angeles  
Downtown..... 213/688-0041  
South Bay..... 213/540-7500  
West..... 213/203-8111  
San Diego..... 619/231-1900  
San Fernando Valley 818/781-4800

**Colorado**  
Colorado Springs..... 303/632-1717  
Denver..... 303/298-8268  
Englewood..... 303/773-3700

**Connecticut**  
Danbury..... 203/797-0590  
Hartford..... 203/522-6590  
New Haven..... 203/787-4595  
Stamford..... 203/967-4888  
Stratford..... 203/375-7240  
Waterbury..... 203/574-5633

**Delaware**  
Wilmington..... 302/652-0933

**District of Columbia**  
Washington D.C..... 202/293-9255

**Florida**  
Fort Lauderdale..... 305/491-0145  
Jacksonville..... 904/356-1820  
Miami..... 305/624-3536  
Orlando..... 305/282-9455  
Tampa..... 813/251-3215

**Georgia**  
Atlanta/Downtown 404/588-9350  
Atlanta/North..... 404/953-0200  
Atlanta/Perimtr.-400. 404/255-2045

**Illinois**  
Chicago/E. Loop..... 312/861-0770  
Chicago/W. Loop..... 312/346-1280  
Oak Brook..... 312/986-0422  
Rolling Meadows..... 312/392-0244

**Indiana**  
Fort Wayne..... 219/432-7333  
Indianapolis..... 317/631-2900

**Iowa**  
Des Moines..... 515/243-0191

**Kansas**  
Overland Park..... 913/888-8885  
Wichita..... 316/688-1621

**Kentucky**  
Louisville..... 502/581-9900

**Louisiana**  
Baton Rouge..... 504/924-7183  
New Orleans..... 504/561-6000  
Shreveport..... 318/222-6188

**Maryland**  
Baltimore..... 301/727-4050  
Columbia..... 301/730-6833  
Greenbelt..... 301/441-8700  
Rockville..... 301/258-8800  
Towson..... 301/321-7044

**Massachusetts**  
Boston..... 617/482-7613  
Burlington..... 617/273-5160

Springfield..... 413/739-4083  
Wellesley..... 617/237-3120

**Michigan**  
Detroit..... 313/259-7607  
Grand Rapids..... 616/459-6539  
Lansing..... 517/484-4561  
Southfield..... 313/352-6520  
Troy..... 313/362-0070

**Minnesota**  
Minneapolis  
West..... 612/544-3600  
Downtown..... 612/332-6460  
St. Paul..... 612/227-6100

**Missouri**  
Kansas City..... 816/474-3393  
Clayton..... 314/862-3800  
St. Louis..... 314/576-4444

**Nebraska**  
Omaha..... 402/346-0709

**New Hampshire**  
Nashua..... 603/888-7650

**New Jersey**  
Cherry Hill..... 609/482-2600  
Edison..... 201/494-2800  
Lyndhurst..... 201/939-4300  
Morristown..... 201/267-3222  
Paramus..... 201/845-3900  
Princeton..... 609/452-7277  
Somerset..... 201/469-9444

**New Mexico**  
Albuquerque..... 505/247-4270

**New York**  
Albany..... 518/482-2035  
Buffalo..... 716/835-9630  
New York City  
Grand Central..... 212/557-8611  
Penn Station..... 212/736-7445  
Wall Street..... 212/962-8000

Rochester..... 716/263-2670  
Syosset, L.I..... 516/364-0900  
Syracuse..... 315/422-2411  
White Plains..... 914/694-4400

**North Carolina**  
Charlotte..... 704/552-6577  
Greensboro..... 919/379-1155  
Raleigh..... 919/847-7605  
Winston-Salem..... 919/724-0630

**Ohio**  
Akron..... 216/535-1150  
Cincinnati..... 513/769-5080  
Cleveland..... 216/771-2070  
Columbus..... 614/224-0660  
Dayton..... 513/461-4660  
Toledo..... 419/242-2601

**Oklahoma**  
Oklahoma City..... 405/722-7410  
Tulsa..... 918/599-7700

**Oregon**  
Portland..... 503/223-6160

**Pennsylvania**  
Harrisburg..... 717/233-8066  
King of Prussia..... 215/265-7250  
Philadelphia..... 215/665-1717  
Pittsburgh..... 412/261-6540

**Rhode Island**  
Providence..... 401/751-0065

**South Carolina**  
Columbia..... 803/256-7446  
Greenville..... 803/271-7044

**Tennessee**  
Nashville..... 615/256-0625

**Texas**  
Austin..... 512/479-0720  
Dallas  
Central..... 214/954-1100  
North..... 214/387-1600

El Paso..... 915/532-6316  
Fort Worth..... 817/338-9300  
Houston  
Downtown..... 713/751-0100  
Galleria/Post Oak..... 713/439-0550  
San Antonio..... 512/342-9898

**Utah**  
Salt Lake City..... 801/966-3900

**Virginia**  
McLean..... 703/790-5610

**Washington**  
Seattle..... 206/454-6400  
Spokane..... 509/838-7877

**Wisconsin**  
Green Bay..... 414/432-1184  
Madison..... 608/251-0104  
Milwaukee..... 414/277-0345

**Canada:**

**Alberta**  
Calgary..... 403/279-1940  
Edmonton..... 403/459-1153

**British Columbia**  
Vancouver..... 604/222-1155

**Manitoba**  
Winnipeg..... 204/942-1151

**Ontario**  
Mississauga..... 416/848-3344  
Toronto  
Royal Bank Plaza..... 416/865-1125  
Sun Life Centre..... 416/591-1110  
Willowdale..... 416/495-1551

**source edp**  
Personnel Services  
The world's largest recruiting firm devoted exclusively to the computer profession. Client companies assume our charges.

## IN FOCUS

that Data General is using it for hardware definition.

She likes to refer to USE.IT as, "CAD/CAM for software." It might also be referred to as the Cadillac of productivity tools, since it has a price tag of \$92,000 for the VAX version. "It's the most expensive product for the VAX, with the next most expensive being half that," says Hamilton. She says the price for the IBM version "will go up again because with IBM you have to hook onto a lot of different environments."

She points out the front-end emphasis of USE.IT. "With most other products, what's missing is up front."

Mitch Goozé had a different approach in 1982 when he founded SOLOsystems in San Jose. The company was to have built a workstation for software development for mainframes from coding through compiling, documentation, and debugging. "Most people address the market from a different aspect of the programming life cycle. Most address the front end of the life cycle," he says. "It's harder to address the back end, coding and debugging, and that's what we were going to do."

Goozé says lack of a market had nothing to do with his company's folding in late 1984. It was a problem of capital drying up. "We were blindsided by IBM," he notes. "When the PC AT came out, we already had spent much money and effort on a proprietary piece of hardware with enough horsepower to run our system. The AT brought horsepower to bear but we weren't on it and that made the venture capitalists wary."

He's still excited about what was to have been his market. "There are about 400,000 IBM mainframe COBOL programmers in the U.S. and that was the market we were going after. Somebody or somebodies are gonna make a lot of money in that business. It's as big or bigger than the market for CAE [computer aided engineering] workstations. There are more main-

frame programmers out there than there are design engineers."

Accounting firm Arthur Anderson & Co.'s Chicago office has released a study that predicts that workstations or workbenches for development purposes "will significantly increase MIS department productivity." The company has its own designer's workbench, Design/1, and claims it has increased productivity in the system design cycle an average of 30% to 40%. Glover Ferguson in the Chicago office says the firm isn't actively marketing the product but will sell it. Software cost is \$15,000 each in quanti-

### Arthur Anderson is working on a PC package that could be used as a programming tool.

ties of three and \$5,000 per copy after that. Purchase of three is the minimum allowed and quantity discounts are negotiable.

Arthur Anderson's Designer Work Bench includes an IBM PC or AT at extra cost. It includes bridges to get into the target mainframe environment. Ferguson says his company also is working on a programmer's workbench but that it is all software so far. "We're currently studying how much of the development task could sensibly be downloaded to a PC," he says. "We think we're going to get there but I don't think there's a current mainframe-to-micro link to support it."

He says there are a number of workbenches out there that accomplish some of the same tasks as Design/1, but that the only one with the same scope is Excelerator from Index Technology Corp., Cambridge, Mass. This product, designed to automate most of the time-consuming tasks of systems analysts, features mouse-driven graphics capabilities, screen and report generation, document production, word processing, and a data dictionary that integrates all functions. Some 125 have been installed.

Henry Davis of Software Engineering Associates in San Jose, likens Excelerator to still another system, called Document-Orr, developed by Kenn Orr Associates in Kansas City, and to systems he says are available from groups in Germany, France, and Japan.

But Davis, who consults with large companies on dp productivity, isn't so sure automation is the problem. He favors on the one hand development of a methodology and on the other, use of specific tools. As an example of an off-the-shelf methodology, he cites McAuto's Stradis, which he describes as a complete development methodology in a four-binder set. He says he keeps one of these to tailor for client companies. "There's no reason why these couldn't be automated, but until you have a manual system that works, you ought not to try to automate."

He contends that there are too many differences among dp shops to make off-the-shelf systems for automating development truly feasible. "Look at the biggest market of all, IBM COBOL programmers. It's not as homogeneous as you might think. Each installation is unique in how it programs and the tools it uses. That's a problem for dp tools companies. There's no nice, clear homogeneous market."

But there are niche markets and that is what DDI-Honeywell of Laguna Niguel, Calif. (formerly Digital Datacom Inc.), is after with its WorkForce Development System, introduced last April. It's an RM-COBOL applications generator for customizing applications. "We use it ourselves in-house," says James Camilleri, vice president of sales. "We sell manufacturing systems and every one of them is customized." He claims the company has sold about 30 of the systems to oems. "Everyone using it likes it."

A Jericho, N.Y., company, Computer Associates International Inc., could take heart from Davis's advocacy of specific tools. It has been offering CA-Optimizer, a COBOL optimizing tool it claims shortens code by as much as 60%. Three years ago it came out with CA-Eztest, which tests programs before they go into production and gets rid of redundant code. One and a half years ago it followed with CA-Flexiscreen for rapid program prototyping. A CA spokesperson says interest in her company's product has "definitely increased over the last year."

Some so-called productivity tools are little more than report generators when in the hands of end users, but have productivity aspects hidden from those users. Management Science America Inc.'s Information Expert family is one of these. The report and retrieval component, the first of the family to be offered, is essentially a report generator. But,

## AUTOS

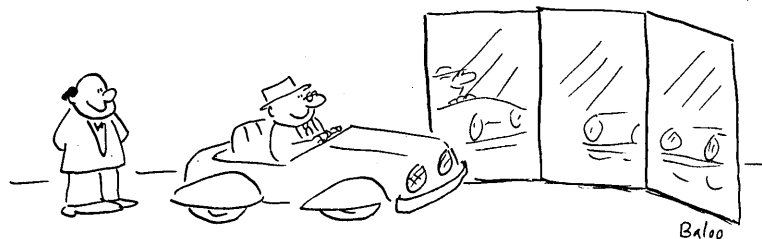

Baloo

CARTOON BY REX F. MAY

# OF THE BIG THREE IN BUSINESS SOFTWARE TODAY, WHO'LL BE ON TOP TOMORROW?

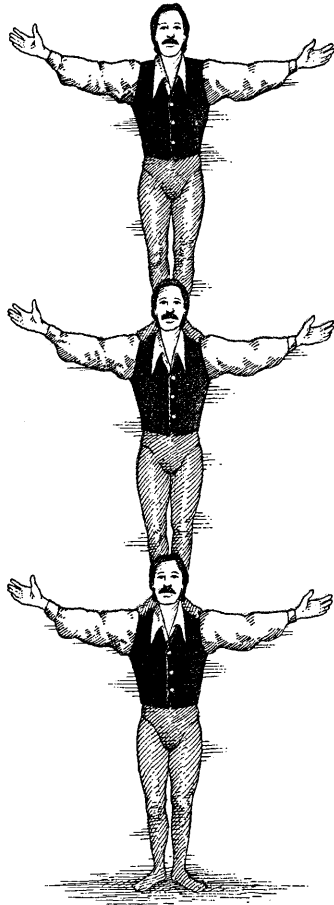

Obviously, the company that's on top tomorrow will be the company that's on top of your business problems today. With the solutions that are easiest to apply—the solutions that promise the fewest future headaches.

In other words, the most integrated product line.

But if you compare product lines, we believe you'll discover that two of the big three offer the mere appearance of integration, while one offers the real thing. Millennium. A true family of mainframe business systems in which the whole works as smoothly as any part. In which every package has the same query mechanism, the same report writers, the same screen generation, the same on-line documentation, security and real-time capabilities. Giving you more efficiency than ever before from all your data processing resources.

Of the big three in software today, who'll be on top tomorrow? When you evaluate them from top to bottom, you'll know who.

## WHEN YOU THINK ABOUT TOMORROW, MILLENNIUM MAKES SENSE TODAY.

**McCormack & Dodge**

**DB** a company of  
The Dun & Bradstreet Corporation

## IN FOCUS

notes Keith Cooley, director of environmental products group for MSA in Atlanta, "40% of code is report generation kinds of code. Information Expert replaces 40% of the code we used to have to write by hand for our product. We've reduced development internally to six man-months from a man-year."

And what of relational database management systems? Although they are not general purpose productivity tools, they have been around for a while and have always had characteristics that make them productivity aids. "Our users are using Ingres [an RDBMS] almost exclusively for productivity purposes," says Pete Tierney, vice president of marketing for Relational Technology Inc. (RTI), Berkeley, Calif. Ingres, he says, comes in four pieces—the database management system, a network capability, user interfaces, and application development tools. According to Tierney the last two are getting the most use today, the tools being the leader.

"Initially, people were buying Ingres and other relational database management systems to do ad hoc queries into databases," Tierney observes, "but there's been an evolution as the marketplace has become more educated. More and more use is being made of them [RDBMS] to

build applications."

He says a major influence on this trend was IBM's announcement of DB/2 in June of 1983 (to beta test November '83). "It was IBM's second relational product after SQL/s, so they were paying more than a one-off product kind of attention to relational systems. Then you had 30,000 IBM salespeople out selling the idea that relational systems could provide productivity, could create applications. Right after the announcement, IBM's ma-

**"In general, paper documentation will be replaced by electronic documents, but that will be the least of the changes."**

major software competitors began announcing relational systems or relational interfaces or claiming they were relational all along."

Tierney estimates that RTI has some 1,500 installations of Ingres on Unix and "several hundred" more through oem agreements with AT&T and NCR and soon will have more through an agreement with Burroughs.

That IBM's embracing of the relational systems concept is something good for RDBMS vendors was evident in January at the Uniforum show in Dallas, par-

ticularly in announcements by two of RTI's competitors, Relational Database Systems Inc. of Palo Alto and Oracle Inc. of Menlo Park, Calif.

Relational Database Systems president Roger Sippl announced at the Unix-oriented show that his company was embracing the IBM SQL approach and called upon the software industry to accept SQL as a standard database language. Toward this end, he offered to share his company's code with systems developers.

Oracle, at the same time, was loudly proclaiming its RDBMS, also called Oracle, to be "the only relational database management system which brings the full power of IBM's SQL query language to Unix users." Oracle is compatible with both SQL/DS and DB/2.

Arthur Anderson's report looks beyond today's productivity tools. "In general, paper documentation will be replaced by electronic documents," it reads. "However, that will be the least of the changes. Of greater significance will be the ability to record once, in an easily accessible dictionary, many components of design. Then, using artificial intelligence techniques, it will be possible to generate sample screen displays, data structures, and, potentially, processing programs for review by users and analysts." ©

SYSTEM V

# TRAINING

For 15 years, we've taught our own people to use the UNIX™ System. Now we can teach yours.

## WHY AT&T FOR UNIX SYSTEM TRAINING?

**AT&T offers** the most current and comprehensive training on UNIX Systems.

**AT&T provides** the best learning environment; one terminal per student; evening access to facilities; and expert instructors.

**AT&T has** the breadth of courses your staff needs to unlock the full power of UNIX System V.

**AT&T courses** signal your commitment to improving productivity with high-quality training for your employees.

## AT&T COURSES OFFER:

**The same training** and methods we use to

teach the UNIX System to our own people.

**Rigorous classes** designed to teach specific skills for job-specific applications.

**Five areas of instruction** ranging from introductory to advanced levels for Managers/Supervisors, Users, Systems Administrators, Applications Developers, and Systems Programmers.

**Frequent class offerings** so you won't have to wait for the courses you want.

**Conveniently located** training centers in Princeton, NJ; Columbus, OH; Lisle, IL; and Sunnyvale, CA. Or we'll bring our courses to your company and hold the training at your convenience.

**For more information**, a catalogue, or to register for classes, call 1-800-221-1647, Ext. 32.





# BECAUSE YOUR COMPUTER IS MORE THAN A MACHINE, DECISION DATA IS MORE THAN JUST SERVICE.

Decision Data Service solves computer service problems. We provide nationwide service for large and small installations, plus depot service for special situations.

Our innovative service programs and our depth of experience make us a valuable resource whether your problems run to mainframes or flocks of IBM PCs.

Our people are time-tested professionals. Which is why we've been selected by blue-chip manufacturers to provide service to their customers.

Not only do we get your system up and doing what you want it to do, but we help you make it do more. Economically. Especially for PCs. With Performance-Coupon™ pooling to help control maintenance problems and costs.

Call our president, William A. Catania, at 800-223-3622. In PA, 800-222-2271. You'll soon realize that we're the service organization you should have called in the first place.

**DECISION DATA:  
PROFESSIONAL SERVICE  
FOR  
PROFESSIONALS**



Decision Data Service Inc.  
400 Horsham Road, Horsham, PA 19044

A subsidiary  
of Decision Data Computer Corporation

**CIRCLE 21 ON READER CARD**



# "With deregulation, than ever to set up a

"AND  
MORE WAYS  
TO GET  
CONFUSED."



"LUCKILY  
THERE'S HELP.  
SOMEONE WHO  
UNDERSTANDS  
OUR STRENGTHS."

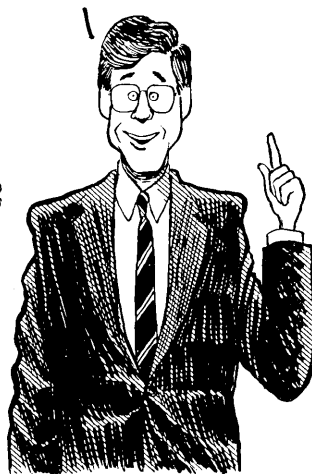

"WHO CAN  
FIGURE OUT  
THE BEST WAY  
TO INTEGRATE."



## Presenting the Honeywell Network Design Center.

Honeywell is committed to providing customers with the best products and services available to get the most out of their information resources.

That's why we created our Network Design Center.

With deregulation of the telephone industry and the evergrowing number of network options, choosing the right alternatives can be difficult.

By going with Honeywell, you're assured of a network based on a solid

# there are more ways network."

"FOR THE  
BEST PRICE.  
WITH THE  
LEAST RISK."



"SOMEONE  
JUST A  
PHONE CALL AWAY."



"HELLO  
HONEYWELL!"



understanding of your system's strengths. And how they can be best used and integrated.

You'll get expertise complemented by advanced analytic and simulation methods and techniques.

And, you'll get a realistic prediction of investment costs and potential savings opportunities relative to the design you choose.

Planning, support, problem analysis, and fine tuning are all part of our Network Design Center service.

It's only a part of what makes Honeywell's networking and data communications capabilities so worthwhile. And when you consider the very practical way it can help you *apply* our technology, it just might be the most important.

We know the value of good communications. Call us today and hear for yourself.

Call 1-800-328-5111 extension 2759. Or write: Honeywell Inquiry Center, MS 440, 200 Smith Street, Waltham, MA 02154.

**Together, we can find the answers.**

## Honeywell

# NEWS IN PERSPECTIVE

## MAINFRAMES

# HERE COME THE CRAYETTES

**A new class of computer is emerging, with near-supercomputer power at supermini prices.**

by R. Emmett Carlyle

In our performance-hungry industry, a supercomputer is jokingly referred to as the fastest machine available and the only one to come within a generation of true system requirements.

Until now, supercomputers have been neither geographically nor commercially widespread; nor, at an average price of \$10 million apiece, have they been within the budgets of any but the most price-insensitive government agencies and research facilities.

While supercomputers have yet to penetrate the banking and insurance sectors, commercial users are cottoning on to the notion that they can be used for more than just abstract scientific calculations. Supercomputers are increasingly being used for automotive and aircraft design and in the petroleum and nuclear areas. As markets broaden, the demand from existing vendors is fueled and a whole new wave of potential suppliers is attracted.

Cray Research, which owns about 60% of today's supercomputer business, is fully booked over the next two years for its new X-MP processors. The company freely admits that it's having to plow back almost 20% of its 1984 gross revenues of \$229 million into R&D to stay on top, and its profit margins are coming under increasing pressure. "Because of this," says one former executive, "Cray is unable to support university entry into the world of supercomputers, or to create new commercial product segments." Yet, of course, everybody would love Cray power if they could afford it.

To date, around 30,000 users timeshare some 100 Cray supercomputers, which typically span from 250 million floating point instructions per second (MFLOPS) to over 600MFLOPS. "Clearly there is a market for smaller timeshared Crays and even megaflop workstations," says Hanan Potash, principal engineer at Scientific Computer Systems (SCS), a budding supercomputer venture in Wilsonville, Ore.

The secret, according to Potash, is to build a \$7 million computer, using the

Cray instruction set, and offer it to the FORTRAN world for only \$500,000. Rather than being upset about this, Cray has licensed its instruction set, operating system, and FORTRAN compiler technology to the upstart so the "Crayette" can be built. The Minneapolis company's thinking, undoubtedly, is that little Crays grow up to be big Crays, and the potential upgrade business could be considerable.

With initial design efforts only a few months old, SCS ambitiously plans to deliver its first product, the scs-40 (25% of a Cray 1 for 5% of its price) next year. Another startup, Convex Computer, Richardson, Texas, is beta testing a Unix-based Crayette—this time without the Cray instruction set or operating system. A big attraction for both startups is Digital Equipment's VAX FORTRAN base of some 12,000 systems. Since both firms are claiming performance 10 to 40 times that of a VAX, and since DEC has been slow to upgrade its technology, there may be opportunities for the newcomers.

The Crayette market was pioneered several years ago by Floating Point Systems, Beaverton, Ore., which offered array processors that could be hung off of VAXs, IBM mainframes, or other target machines. As the market for array processors has matured, the company has created its 64-bit X64 family of vector processors to meet the rising demand for scientific, simulation, and modeling applications. The latest of these machines, the ECL-based FPS 264, claims a peak 38MFLOPS rating, offering three times the earlier 164 for twice its price.

While the title of supercomputer has been reserved for elite vector processors in the world of scientific and engineering FORTRAN users, these users aren't the only ones hungry for large-scale performance. "Many MIS managers waiting for IBM to ship its new mainframe family—more of the same, you might say—have lusted after Cray-like power in their shops," says one IBM user in the oil indus-

---

**Cray endorses Crayettes, in the belief that little Crays grow up to be big Crays with potentially big upgrade business.**

---

try. The user adds that IBM has so much suppressed demand for new MIPS that "it'll probably ship 5,000 to 6,000 of the new family." (Experts claim that by July IBM's current 308X series will reach 4,500 shipped units worldwide.) "Obviously, IBM doesn't need to stimulate demand," the user says, "and by the same token, there's little incentive for them to price aggressively or push the limits of the technology, either."

This prospect clearly troubles one of IBM's biggest commercial customers,

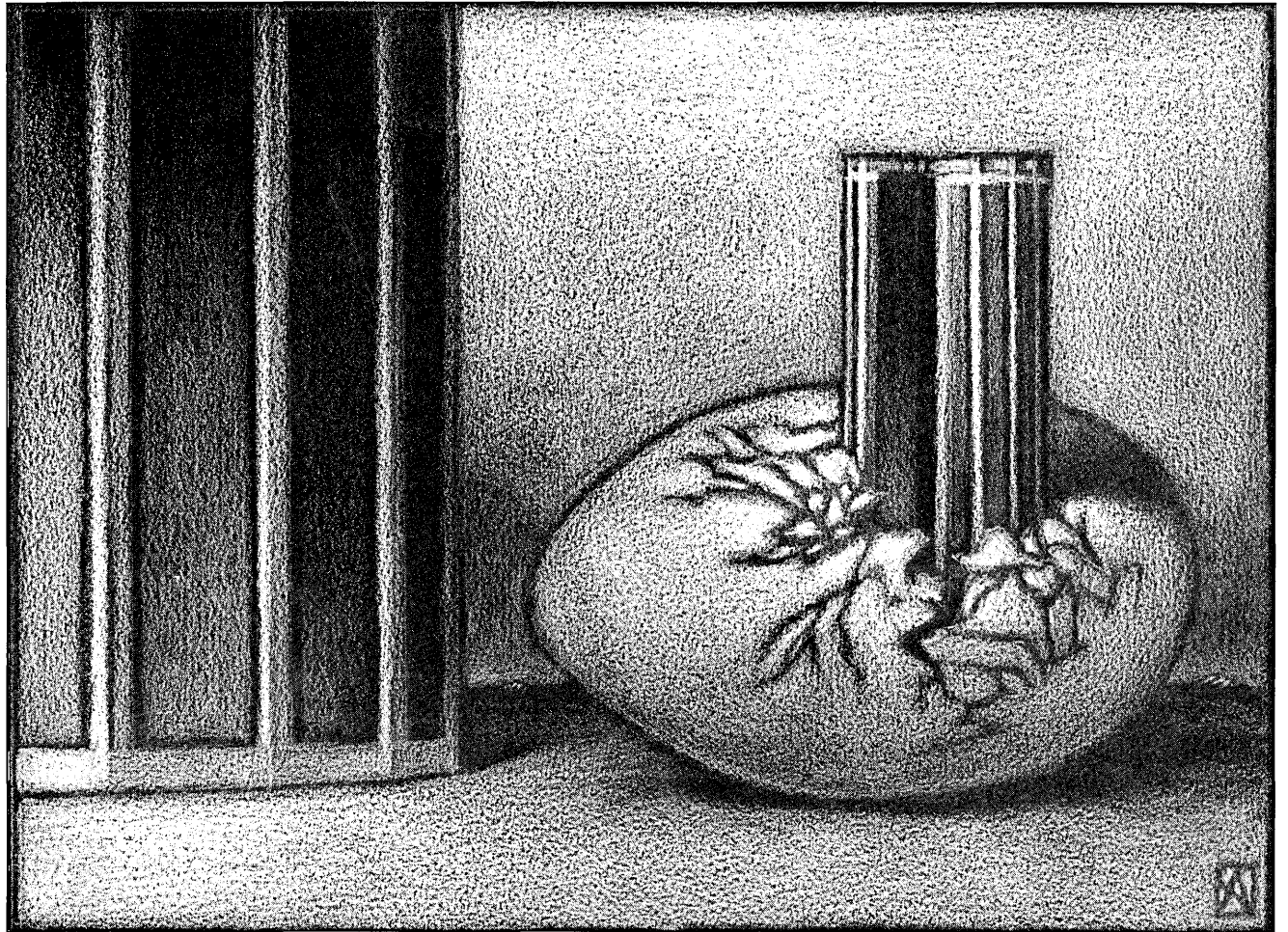

Aetna Life & Casualty Co., Hartford, Conn., as it looks ahead to 1990. The company has talked of adding numerous data centers (beginning next year and costing \$75 million each) just to stay even, and is scanning the horizon for alternatives to IBM that deliver higher performance.

The question that looms is, who, if anyone, will take up the mantle of Trilogy Systems Ltd.? That company tried and failed to create a whole new price/performance and technology curve for IBM's largest corporate customers using wafer-scale integration, but other firms have opted for other technologies that more closely resemble supercomputing.

The first deliverable product may come this summer, when a much-ballyhooed new venture, Encore, reveals its hand. Already there are parallels to Trilogy: Encore's triumvirate of Ken Fisher (founder and builder of Prime Computer), Henry Burkhardt (cofounder of Data General), and Gordon Bell (who invented the minicomputer for DEC and was its chief engineer) is at least the equal of Trilogy's Amdahl family; and, in like manner, it has the touch when it comes to raising great globs of venture capital on reputation before even so much as a pro-

TOTYPE goes out the door. Encore, still shy of its second birthday, has already raised \$25 million, and sources within the company say it expects to raise \$50 million to \$100 million more from a first public offering later this year—"if the market holds."

Only a few people in the industry have even the vaguest inkling what products will flow from Encore's Wellesley,

**Encore's whole strategy hinges on its price/performance edge over IBM and DEC increasing with every cpu it adds to the bus.**

Mass., facility. Yet despite this ignorance, the company currently has an \$80 million market valuation.

Capitalization and corporate mission aside, other parallels between Encore and Trilogy are hard to find. Trilogy bravely pioneered a path through revolutionary hardware technology; Encore's Bell reveals that he prefers a "low-risk approach." Trilogy gambled on silicon wafer levels of integration; Bell says it's okay to cut wafers into chips for microprocessors, memories, and peripherals. "We simply reconnect them and coordinate them via a new multiprocessing operating

system," he says.

The technique is also featured by another young startup, Elxsi, of San Jose, and has been adopted by other new wave companies with 1986 products. It calls for splitting the operating system into chunks, which are then handled by multiple microprocessor cpus. Synchronization of the cpus is not done in memory but by messages across the bus.

Sources say that Encore's first implementation of such an architecture will be a supermini of around 12MIPS built from multiple 1MIPS National Semiconductor 32032 CMOS micros. Encore's aptly named Hydra group has experienced some delays in getting volume on the chip, so an announcement before June is unlikely, it is believed.

The Encore computer will not only offer close to three times the performance of DEC 8600 and IBM high-end 4300 cpus, it will also be considerably less expensive, at about \$40,000/MIPS—half Venus's price and around one third the 4300's, if the venture can realize its plans.

Encore's whole strategy hinges on its price/performance edge over IBM and DEC increasing with every cpu it adds to the bus, which has been designed for a 10-year life. When 5MIPS CMOS microproces-

ILLUSTRATION BY DAN ADELL

## NEWS IN PERSPECTIVE

sors become available within the next two years and are added to the bus, quantum leaps in power will become possible. "Were it just one processor model," one Encore insider says, "IBM and DEC could strike back with discretionary pricing on that competitive model; but we intend to make them compete against a whole product line."

Floating Point is also hoping its architecture will bring it substantial Crayette business. Yet, despite its success so far with the 164—the company scored \$118 million in sales last year, more than half of which came from the X64 family—former employees are quick to point out that the 264 is just "a dressed up" array processor, with a serial mode operating system and a limited bus structure and bandwidth. "A dead-end architecture," one says.

"But our biggest mistake," a former staffer says, "was to build a machine with no applications of its own, and worse, one that lacks compatibility with the mainstream, either DEC or Cray. We ended up having to give away machines to third-party software developers in the hope that they would convert their application packages to run on them."

In addition, the company had to spend 2½ years to develop a FORTRAN compiler so that its machines could run third-party software. Today, some 30 packages, including the popular NAS-TRAN and SPICE, are offered with the 264. SCS will inherit many of those with no effort if its Crayette paper machine becomes a reality next spring.

The new Crayettes from SCS, FPS, Encore, and others all place emphasis on software unusual in the annals of supercomputing. If these companies want to attract corporate users to their machines, they have to blow their software horns. "Most MIS managers could care less about new technology and a bunch of new system builders promising the moon," Bell says.

"Clever engineers get so involved in the technology," one bemused IBM user in the banking industry says, "they forget why anybody buys a machine. It's not because of its 38 megaFLOPS, MOPS, MIPS, or because it's half a Cray, but because it runs the application you want." Another observer notes wryly that there is so much posturing by big-name engineers in startups that a more suitable measure of performance might be "machoflops."

The importance of software was not lost on one Garboesque startup secreted away in Acton, Mass. Alliant (formerly known as Data Flo) is believed to be working feverishly on advanced compilers that vectorize FORTRAN programs and allow them to run on true parallel processors as well. "We don't want to

talk," Alliant chief engineer Rick McAndrew says. "The theory and the comparisons with others—we avoid that stuff. What does it mean to the user? This is all that counts, and we'll know the answer to that when we offer it to him."

All of these companies intend to provide support, software expertise, and new levels of affordability to supercomputing to make the technology more attractive to hard-pressed corporations. "Make them aware of the new approach and its benefits," Bell says. ©

### OFFICE AUTOMATION

# APPLE'S NEW MAC PUSH

**Can Apple Computer succeed in wooing big companies with its Macintosh Office?**

**by Irene Fuerst**

With the announcement of the Macintosh Office at its latest dog and pony show, Apple Computer has laid the groundwork for a long-term company strategy that it hopes will bring Apple products into the offices of America's "Fortune 5 million." Experts concede Apple's likely success in capturing the hearts and minds of the smallest 4.999 million of those, but remain skeptical about the company's ability to penetrate the largest corporations.

Close on the heels of the Mac Office debut at Apple's annual meeting at the firm's Cupertino, Calif., headquarters on Jan. 23 came word that Apple co-founder Steve Wozniak had resigned to pursue other interests, which further clouded Apple's future.

Apple's strategy is to link users in work groups of about 25 individuals. The company says it will continue announcing products that will fully link standalone Macintoshes to each other and with the rest of the world. As with the Macintosh, introduced 14 months ago, Apple is relying on outside developers for software.

Part of Apple's strategy includes peaceful coexistence with IBM. Apple president John Sculley acknowledges IBM's lead by saying, "We're going to adjust to IBM's world. They're not going to adjust to ours because they don't have to."

Another ingredient is Apple's statement that the Macintosh Office is "primarily a retail solution." Apple intends Macintosh Office products to be

sold and supported by retailers, although it says it will use its national accounts sales force to sell to very large corporations. Direct sales failed for Apple when it tried to market the Lisa, which it has since renamed the Mac XL.

It's no secret that the company is trying to ally itself with vendors who are strong in the office automation market—Wang is frequently mentioned—in order to sell into large corporations where potential joint marketers already have a strong foothold.

The primary announcements at the meeting were the LaserWriter, a \$6,995 laser printer, and the AppleTalk personal network (formerly AppleBus), a \$50 extension cord—it's hard to call it a true network. The company says both products will be available this month.

Apple stands a strong chance of succeeding in moving Mac into the mainstream business environment, says Michele Preston, an analyst with L. F. Rothschild. Individuals have different needs, she says, and Macintosh can do "things the IBM PC can't do and never will be able to do. They're not trying to push IBM out."

Preston also says that the Macintosh office products are not difficult for retail outlets to sell. She feels that retailers, who currently sell over half of all personal computers, are an important sales channel, and that the retailers' outbound sales forces will attract serious buyers.

"The success of all this is not going to be determined overnight," Preston says.

"The best thing Sculley did was regroup," says Otis Bradley, an analyst with Alex. Brown & Sons in Baltimore. Apple was unsuccessful trying to sell the Lisa directly to corporations, Bradley says, and Sculley spent his first year with Apple reestablishing relations with dealers.

"I think Sculley's doing this the proper way," the analyst adds.

While users are beginning to show more respect toward the Mac Office than they had, they still see little reason to acquire Macintosh technology, they say. John Fitzgerald, vice president of technical services of San Francisco-based McKesson Corp., had about half a dozen Lisas but did not move on the Mac, a decision he says was dictated by his users. "People are moving aggressively to the [IBM] PC," he says.

Fitzgerald would be interested in the Macintosh Office concept, with Macs linked to IBM PCs, "if it works and when it works. There's nothing driving us to experiment."

Although Fitzgerald says there may be interest among art department users in time, "those folks have got to be





# Mega Group takes IBM® mainframes off the endangered species list.

You hear people say that mainframes are a dying breed. They believe the micros are taking over.

But what they don't know is that Mega Group software is dedicated to keeping mainframes alive and well. It's personal software that spreads mainframe power to everybody's individual workstation.

So that now, with any 3270-type terminal, you can do even more than you can do with a micro. Just as easily. Just as fast. And for a whole lot less money.

Mega Group's campaign to preserve the mainframe began with MegaCalc™, the first full function electronic spreadsheet for IBM and compatible mainframe systems.

Next came MegaFile™ and MegaGraph™. MegaFile allows you to join data from more than 35 MegaCalc spreadsheets. MegaGraph gives you presentation-

quality graphics for "picturing" MegaCalc data with eight different types of graphs.

With MegaCalc, you get up to 702 columns and 9,999 rows for entering an enormous amount of data. You can update it, change it, perform instant "what if" analysis, all on your CRT.

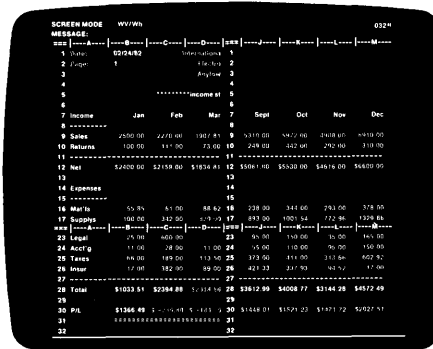

With full color capability and up to 100 windows, MegaCalc makes work sheets simple to set up and use. MegaCalc also has over 100 functions built in for advanced applications.

All of your microcomputer data and models from Lotus 1-2-3®, VisiCalc®, or SuperCalc® can also be up or down loaded directly into MegaCalc with a single command.

As far as cost goes, your data processing dollars have never gone further. MegaCalc will support every terminal and user on your mainframe for about the cost of a single microcomputer workstation. And we'll give you a 30-day, no obligation trial to prove it.

**Send for our free poster.** A 17" x 23" poster of our endangered species illustration above is yours for the asking. Just write or call to join the cause to Save the Mainframe.

Mega Group, 17701 Mitchell Avenue North, Irvine, CA 92714. (714) 474-0800.



™ MegaCalc, MegaFile and MegaGraph are Trademarks of Mega Group. © IBM is a Registered Trademark of International Business Machines Corp. Lotus 1-2-3 is a Registered Trademark of Lotus Development Corp. VisiCalc is a Registered Trademark of VisiCorp. SuperCalc is a Registered Trademark of Sorcim Corp.

## NEWS IN PERSPECTIVE

educated. You need somebody in the graphic arts department who is a champion of the Macintosh system."

Don Estes, vice president of administration for Van Waters & Rogers in San Mateo, Calif., says that his is "strictly an IBM shop" regarding micros, but that he has a Mac at home. The new Apple products may help Apple move Macintoshes into shops such as his, "but if you asked me 60 days ago I would have said no."

One factor that changed his mind is Lotus Development Corp.'s Jazz, the integrated software package created by the Cambridge, Mass., firm specifically for Mac. "If Jazz is everything I've read about," he says, he would have no hesitation introducing Macs to his 1,300 employees, "as long as they could make it compatible with IBM PCs."

IBM compatibility is essential at present, but could recede in importance as the technology progresses. "IBM is at its strongest now," Bradley says, "but the reasons for staying 100% with IBM will dissipate. The barriers of getting from one hardware device to another may be non-existent in the future."

Even if users embrace the Macintosh Office concept, Apple still needs to bring the technology to the customers.

Without a direct sales force that provides maintenance and support, some say, Macintosh will never make it in the large corporate arena. According to analyst Bill Coggeshall of Software Access International in Mountain View, Calif., even the large Businessland retail chain doesn't have the sophistication of internal support people.

"I'm bullish as long as they don't try to get into the Fortune 500. There I'm bearish," he says.

Response to the AppleTalk network itself has been mixed. One local area

### **While users show more respect toward the Mac Office than they had, they still see little reason to buy.**

network executive called it a toy. Others say that it's a product that fits its intended users. Apple does not refer to AppleTalk as a local area network, instead calling it a personal network.

AppleTalk products that talk to IBM are waiting in the wings. The AppleTalk PC card connects a PC to an AppleTalk network while another card links a PC to IBM's PC Net. The AppleTalk card should be available this fall, and the PC Net gateway should be available in the

summer.

Apple and third parties like 3Com are developing AppleTalk file servers and mass storage devices, which should start appearing in the second half of this year. All told, Apple says, more than 50 companies are developing AppleTalk products.

But in the short term, without networking software, file servers, or mass storage, AppleTalk will find utility only as a cable running between a Macintosh and a LaserWriter. Its acceptance will depend as much upon these future products as upon AppleTalk itself.

"The key factor is going to be whether they have software. AppleTalk is of zero value without software, and it's going to take a while to develop it," says Omri Serlin of ITOM International, a Palo Alto-based research firm. Serlin says the results should be apparent by the end of next year.

Technologically, AppleTalk does not impress. It's a shielded twisted pair CSMA/CD bus with an operating distance of 1,000 feet that transmits at a speed of 230.4Kbps among a maximum of 32 devices. Apple has already announced a gateway to Ethernet as well as the PC cards.

"Apple's intent seems to be to

**Qualified Assistance is Now Available to Users of**

# **CICS-IMS IDMS**

## **Applications**

- Functional Design
- Detailed Design
- Programming
- Implementation

## **Systems**

- Operating Systems
- Networking
- System Software Trouble-shooting
- Performance Evaluations and Tuning

## **Systems and Application Reviews**

## **Standards & Guidelines Developed for CICS and CICS/DL1**

For more information call Sonny Fusco:

**ON-LINE  
SOFTWARE  
INTERNATIONAL, INC.**

Two Executive Drive  
Fort Lee, N.J. 07024  
**(800) 526-0272**  
In N.J. (201) 592-0009



## **PRODUCTIVE EMPLOYEES ARE GOOD FOR YOUR SYSTEM.**

When mainframe or microcomputer operators learn their jobs with user support and training materials created by SDI, they learn fast.

That's why SDI is good for your staff, good for your system.

For more information, call Jack Tuttlebee, at 201-592-8745, or write: SDI, 222 Bridge Plaza South, Fort Lee, NJ 07024.

**SDI SUPPORT SYSTEMS**

DOCUMENTATION • INSTRUCTIONS • TRAINING AIDS • SALES SUPPORT

# NOMAD2 + SQL/DS:

## Made For Each Other

NOMAD2, the premier 4-GL/DBMS, and SQL/DS, IBM's wave-of-the-future database system, have been combined to form the single most powerful information management resource available. And those who have seen this dynamic combination in action agree that the two systems were made for each other.

The NOMAD2-SQL/DS combination is much more than just an interface. It is the blending of the best 4-GL with the best DBMS available that comprises an entity greater than the sum of its parts. More specifically, the broad spectrum of capabilities that comprises SQL/DS can be accessed and controlled by dealing solely with NOMAD2.

NOMAD2's single-command environment, unmatched report writer, statistical and interactive decision support capabilities and, most importantly, its richness of language have made it the hallmark 4-GL against which all others are measured. And it is through these attributes that the sheer power of SQL/DS can be fully realized.

The NOMAD2-SQL/DS interface represents the latest innovation from D&B Computing Services. In making NOMAD2 available for use on in-house mainframes, we have continued the evolutionary process we began in 1975 when NOMAD was first introduced. And it is this evolutionary process that has catapulted NOMAD2 to the leadership position it holds in the marketplace.

If you are currently using SQL/DS in your VM environment, or even if you're just considering it, take a look at NOMAD2 now. Most people who try NOMAD2 buy it. You owe it to yourself to find out why.

### **NOMAD2: An Innovation In End-User Computing From Dun & Bradstreet**

**D&B Computing  
Services**

**DB** a company of  
The Dun & Bradstreet Corporation

For more information call Roger Cox at (203) 762-2511. Or drop your business card into an envelope and mail it to Roger at D&B Computing Services, 187 Danbury Road, Wilton, CT 06897.

NOMAD is a registered trademark of D&B Computing Services, Inc. IBM is a registered trademark of International Business Machines, Inc. SQL/DS is a trademark of International Business Machines, Inc.

CIRCLE 26 ON READER CARD

## NEWS IN PERSPECTIVE

### MACS ON THE LEFT BANK

While Apple is distinctly a distant second pc vendor in corporate America's eyes, the firm's performance in Europe is the subject of considerable controversy. The company says it has withstood the challenge from IBM better in Europe than elsewhere, and that it is on an equal footing with Big Blue, holding 35% of the European market for professional micros. Independent research firms don't quite agree, however. As one market watcher even says, "You can't believe the figures that Apple puts out."

Henri Aebischer, marketing manager of Apple Computer Europe, says that his subsidiary sold 170,000 micros for revenues of \$243 million in 1984, accounting for 12.7% of the company's worldwide revenue. Market researchers such as the Swiss firm Maresco place the total number of micros sold in Europe last year at a maximum of 800,000, giving Apple, at best, a 21% market share, a far cry from Aebischer's contention of 35%.

Other research firms' estimates of Apple's 1984 market share diverge from Apple's own figures even more. Intelligent Electronics gives Apple the smallest share, 15%, while Frost & Sullivan and the Yankee Group hold a middle ground. (By comparison, researchers generally agree that IBM's share is 26% to 29%.)

Apple's share of the European market has held up surprisingly well, whichever figures you believe. "Our share of the European market has not fallen," Aebischer says. "It has risen and it is still rising, albeit very slowly." Apple is reaching the "saturation" point of its potential

market, he adds.

Apple's slice of the pie varies greatly from one country to another in Europe, according to Intelligent Electronics, ranging from as little as 5.4% in Scandinavia to as much as 35.7% in France. Apple Europe considers France its flagship, and no wonder. Sales in France accounted for over 40% of the European total in 1984.

In fact, the company almost pulled off a stupendous coup late last year, coming close to a deal that would have required several hundred thousand Macintoshes for schools and colleges throughout the country. The idea was abandoned, however, after intensive lobbying by French manufacturers. Those domestic pc makers will now get the business.

Apple remains philosophical about the Mitterrand administration's blatant chauvinism in nixing the order. "We were not surprised by the government's decision," observes Jean-Louis Gasse, chairman of Apple France, "but we were disappointed that it let slip an opportunity to acquire Macintosh technology at an attractive price. We were prepared to grant a manufacturing license to a French company."

Apple has not always been excluded from French public sector contracts. There are already some 20,000 Apple IIs installed in the nation's schools. France is also about the only market where Apple ran ahead of IBM in both units shipped and in revenues last year, according to Gasse, who forecasts that French reve-

nues will rise to \$160 million in 1985 from \$95 million last year.

As if to make up for losing its most recent bid in France, Apple recently launched a marketing offensive across the English Channel in the British education market. Apple's share of the British micro market was only 11% last year; Apple UK's new managing director, David Hancock, has set himself a target of 25% by July. To accomplish that rather optimistic level, Apple needs to displace Acorn Computer Ltd. as the primary supplier of micros to British schools. Acorn's BBC Micro now accounts for three quarters of the personal computers sold to Britain's primary and secondary schools, while Apples can be found in only 5% of the schools.

Apple has more momentum, however. In December, the company dealt Acorn a body blow by winning a \$550,000 contract to supply micros to secondary schools in Ireland, just after Acorn had established manufacturing facilities in Dublin. Now, Apple is offering a 50% discount to schools that buy in bulk.

Apple has shown its interest in the British market in other ways as well. It too has a plant in Ireland, at Cork, where it produces Apple IIs for the worldwide 220-volt market and does final assembly of Macs for the European market. For the time being, however, there is no likelihood of Apple establishing a factory in France or anywhere else on the Continent.

—James Etheridge

have AppleTalk attach to another network," says one source close to Apple, noting that AppleTalk is compatible with PC Net. "A mix of IBM PCs and Macs will be a common thing in the future," he says.

"They're really intending it as a local local network," Cogshall says. He guesses that what he calls the real local area networks are more attractive in large organizations than in small ones (which is where he feels Apple will be most successful), and he notes that "people are already joining networks."

"I don't view [the low transmission speed] as a problem," Cogshall says. "They'll be able to go beyond that transmission speed when they want to."

Joe Garappolo, senior consultant for Peat, Marwick, Mitchell's System Evaluation Approach and Computer Audit Support group—an AppleTalk beta test site—finds AppleTalk a good low-end solution. For a casual work group made up of four or five professionals and a few secretaries, lack of speed is not a problem at all, he says, although for an

experienced dp person it gets in the way. "The network runs at about the speed of a diskette," he says, so transferring a file takes about as long as making a copy.

Garappolo says he hasn't tried to push the network. "Most of the work we're doing is sharing a laser printer." He also says that a cache-equipped file server will improve performance.

"Something that shouldn't go unnoticed is the price," says Gregory Kelsey, a cofounder of startup San Francisco investment banking firm L. H. Alton & Co. "That's pretty darn cheap."

"I think that what Apple has done is make AppleTalk so cheap it's accessible to everybody," says Garappolo.

"The price differential is dramatic," says Serlin, comparing AppleTalk's \$50 per connection to PC Net's \$700 interface. Serlin warns that the price of the AppleTalk PC card, as yet unannounced, will play a big part in AppleTalk's entree into offices.

In contrast to AppleTalk's reviews, industry observers have given the LaserWriter an enthusiastic reception;

one hardware designer says, "To see one is to want one." The LaserWriter should appeal to many print shops, small businesses, and graphics or publications departments in large companies. The technological innovation, comparatively low price, and immediate utility of the LaserWriter may turn it into the tail that wags the dog—people may buy the printer and get a Macintosh to drive it. Indeed, some say that Apple can sell its entire production capacity of printers, estimated at about 5,000 per month, without selling to a single existing Mac user.

"I believe it will be a successful product," says Serlin, noting that for less than \$10,000 one gets close-to-typeset-quality printing.

"It's a really attractive alternative," says Cogshall. "Otherwise you have to go up to maybe \$20,000. We here would be attracted to it."

The printer is Apple's most powerful and sophisticated computer. It has a 68000 chip chugging away at 12MHz with 1.5MB RAM and 50KB of ROM, along with built-in AppleTalk and RS232C interfaces.

Based on the same 300-dot-per-inch Canon engine that's in HP's LaserJet, the LaserWriter uses Palo Alto-based Adobe Systems' proprietary PostScript page description language to compose pages that can be any combination of graphics and type. Output is of near-typeset quality.

As with the AppleTalk, however, the ultimate success of the LaserWriter depends on Apple's ability to crack the nation's largest corporations. If that does not occur, Apple may not get another chance. ©

## AN OA MERGER FAILS

**The collapse of NCI, the NBI-CCI "marriage made in heaven," may be a harbinger for small office automation vendors.**

by Lise Olson

When NBI Inc. of Boulder, Colo., and Computer Consoles Inc. of Rochester, N.Y., called off their well-publicized merger plan a few weeks ago, there was more than a little embarrassment among the principals. Executives at both companies were reticent at first, but industry observers were not.

"It's probably better for NBI this way," says Sanford J. Garrett, president of Garrett Research Inc., a New York-based venture capital consultancy. "But I can't say the same for CCI. NBI has what it takes to go it alone if it wants to, but CCI needs razzle-dazzle leadership and more marketing pizzazz to carry it into the future." Though the deal did not work out, the intentions of the two companies were reasonable enough. In office automation, where NBI is already strong and newcomer CCI is hoping to grab some turf, size and diversity can be important assets.

The intended \$160 million acquisition this month of CCI by NBI was indicative of both companies' response to the pressing demands of an office automation industry attaining maturity. "We recognize this as a high-risk course," said Jesse Simmons, vice president of finance at NBI, when his company's acquisition plan was first announced.

As the companies drew closer, they grew uneasy. "What it really came to," says Simmons, now that the deal has blown up, "is that there was just too much of a gap [between us] in operations management style. And, although many

# Graduate school for professional software engineers is here.



## The Wang Institute of Graduate Studies

Name: \_\_\_\_\_

Business Address: \_\_\_\_\_  
 \_\_\_\_\_  
 \_\_\_\_\_

Telephone: Home \_\_\_\_\_ Business \_\_\_\_\_

Years of Software Development Experience: \_\_\_\_\_

I am currently a  software professional  
 student  other D31585



For tomorrow's leading software engineers, the Wang Institute offers an unprecedented educational opportunity.

Students enrolled in our Master of Software Engineering (M.S.E.) program prepare for positions of increasing challenge and responsibility, while studying the latest technical and managerial aspects of software development.

Working in teams with other professionals, M.S.E. students learn how to plan, organize and supervise real-world software projects. With access to a large and growing collection of software tools, our students develop a thorough understanding of the entire software life-cycle. At the same time, our low student/faculty ratio of seven to one allows them to work closely with teachers who have significant industrial and academic experience.

The Wang Institute's M.S.E. program is open to all qualified software professionals. Currently more than 20 companies have sponsored M.S.E. students, who may choose either part- or full-time schedules of study. Graduate assistantships for unsponsored, full-time students are also available.

If you're ready to become one of tomorrow's leading software engineers, the Wang Institute of Graduate Studies is the place to be.

For further information, write or call Janis Ackerman, Wang Institute of Graduate Studies, School of Information Technology, Tyng Road, Tyngsboro, MA 01879 (617) 649-9731.

The Wang Institute of Graduate Studies is an independent, non-profit educational institution founded in 1979.



## NEWS IN PERSPECTIVE

people called the proposed merger a marriage made in heaven, it's one that never made it to the altar."

Analysts point to potential stumbling blocks that may have killed the deal. For one, the companies would have had a tough time merging their engineering departments. "Both companies are high-tech engineering companies," observes Wendy White, an analyst at the market research firm Sierra Group, Tempe, Ariz. "And there are egos in engineering."

She admits, however, that "the collapse of the deal surprised me. The two companies seemed perfect for each other. On one side, there was CCI, which has a knack for winning big orders. On the other, NBI has street savvy, a quality CCI lacks. "A merger would have meant that the OA industry would have a fresh factor, somebody to shake things up a little."

Patricia Seybold, publisher of *The Seybold Report*, Cambridge, Mass., was taken aback when the deal fell through. "It's sad," she says. "The merger would have created a viable power that could compete head-on with IBM and Wang."

NBI had been looking for an office automation partner for nearly two years. Faced with the kind of competition it has, the acquisition attempt should have come as no surprise. CCI and NBI, which combined were to have been called NCI, compete in markets led by IBM and contested by a flock of dedicated suppliers that includes Wang, Harris/AES Lanier, CPT, and Xerox. Diversified computer makers, including Data General, Datapoint, DEC, Apple, and AT&T and its partially owned Olivetti, also want in. The business is getting tougher for small firms, and they have to respond.

"A consolidation in the office automation market certainly has been happening," notes Seybold. Even in the wake of recent events, the trend will continue for the very reasons that the NBI-CCI merger seemed to make sense to many outsiders. Ed White, analyst at the market research firm Dataquest, says, "NCI had a shot at being third, after IBM and Wang, in OA." Both companies will now have to find some other solution to the increasingly tense OA scene.

"NBI has in the past been a niche player," says White of Sierra group, "and they'll probably stay that way. CCI, though, may attract new suits—a Harris or a Sperry. Sperry's looking at anything that moves these days."

Although the shakeout has barely begun, some of the participants in this market are having problems already. On Nov. 28, Exxon decided that its office systems division was a dry hole, and sold part of it to Olivetti. Xerox, despite its success in electronic typewriters, has not done well at the high end. Its sales of ad-

vanced OA equipment are lackluster, despite the company's place in history as the inventor of Ethernet and the Star family of workstations. The mini makers are meeting with mixed success in what has proved to be a fragmented market composed of users with high expectations.

While users of these vendors' products were aware that problems existed, few expected such dire results. "It doesn't surprise me Exxon's not been successful in office automation," says Rob Brownstein, a vice president at Regis McKenna, a public relations firm in Palo Alto. "But I thought Exxon was going to make a reasonably deep and sound investment in OA. I didn't think they'd back out of it as quickly as they did."

Now Regis McKenna is out of luck: it has about \$150,000 worth of Exxon office automation equipment, and just before Exxon announced it was selling its OA business, Brownstein approved the purchase of more Exxon systems. "If Exxon were to come to me tomorrow with the perfect solution for my office, a solution that I've been frustrated in trying to find, I'd be less than eager to sign on the dotted line," he states. The company plans to invest about half a million dollars

**"NBI has what it takes to go it alone if it wants to, but CCI needs razzle-dazzle leadership and more marketing pizzazz to carry it into the future."**

in OA and Brownstein says he is reluctant to stay with the vendor in the future. "I feel comfortable with the equipment we have," he declares, "but I would hesitate to order a next generation."

New York-based broker and investment banker Kidder Peabody & Co. Inc., whose research department was a showcase Ethernet installation, is now thinking about switching, rather than fighting the numerous changes within Xerox management. Peg Filan, an assistant vice president at Kidder Peabody, says, "When something is higher than the local level, such as a system or software upgrade, or things are promised and never delivered, that's when problems with Xerox get to an annoyance level." Her company has invested between \$1 million and \$2 million in Xerox office automation equipment. "It makes us question whether in the future we would go with Xerox or with another OA company," she says.

One problem facing office automation vendors is that nearly anything an OA workstation can do is within the capability of a personal computer, at least from a technical standpoint. Even IBM, which leads the pc business as well as the standalone word processor market, is wrestling with this issue. This year,

American business users alone will purchase 3.3 million personal computers from Big Blue and other suppliers, bringing the installed base in business to 8.8 million. Fifteen percent of these machines, or 1.3 million, will be used by clerical employees. In other words, by the end of this year, clericals will use a third more pcs than standalone word processors. And market research firm IDC of Framingham, Mass., forecasts that by 1988, some 22% of the installed base of 26 million pcs will be used by clerical workers, once the the primary market for dedicated office workstations.

The lines defining the office automation market are still fuzzy, admit industry analysts. The OA market includes both standalone and clustered word processors for office use. But office automation has expanded to include telephones, spreadsheets, databases, voice messaging, electronic mail, and multifunction workstations. In fact, word processors currently represent only a part of the OA market, and a shrinking part at that.

IDC says the standalone word processing market's growth is slowing, that shipments will peak in 1987 and start to taper off the following year. This year, 187,000 standalones will be shipped, bringing the U.S. base to 995,000. Next year, shipments will rise slightly, to 195,000; they will go up again in 1987, reaching 200,000, but will drop back to 185,000 in 1988 and will continue declining. By 1988, according to IDC, the U.S. installed base will have peaked with 1.3 million machines. Clustered word processing systems, which provide office automation for teams of information workers, will keep growing at least through the decade, says IDC. But 1988 will be the peak year for shipments of clustered word processors.

NBI apparently agreed with IDC's forecasts, and was casting around for a company that could help expand its product line. The veteran standalone word processor workstation vendor thought that a marriage to CCI would create a broad-based entity, with products spanning the market from NBI's \$3,000 standalone box to CCI's \$500,000 terminal complex with a fault-tolerant host.

Clearly, NBI needs some kind of help, because the strain of the pc revolution is showing. Profits were off for the most recent quarter, ended Dec. 30, to \$3 million from \$3.3 million; for the 12 months ending Sept. 30, 1984, NBI reported revenues of \$187 million and net income of \$14.9 million. The CCI move came after NBI made two other acquisitions last year: Commercial Office Products Co., an office supply concern in Denver, and Integrated Solutions Inc., the San Jose maker of the Unix-based

# THE NEW BUSINESS OPERATIONS SYSTEM FROM THE BUSINESS OPERATIONS GROUP

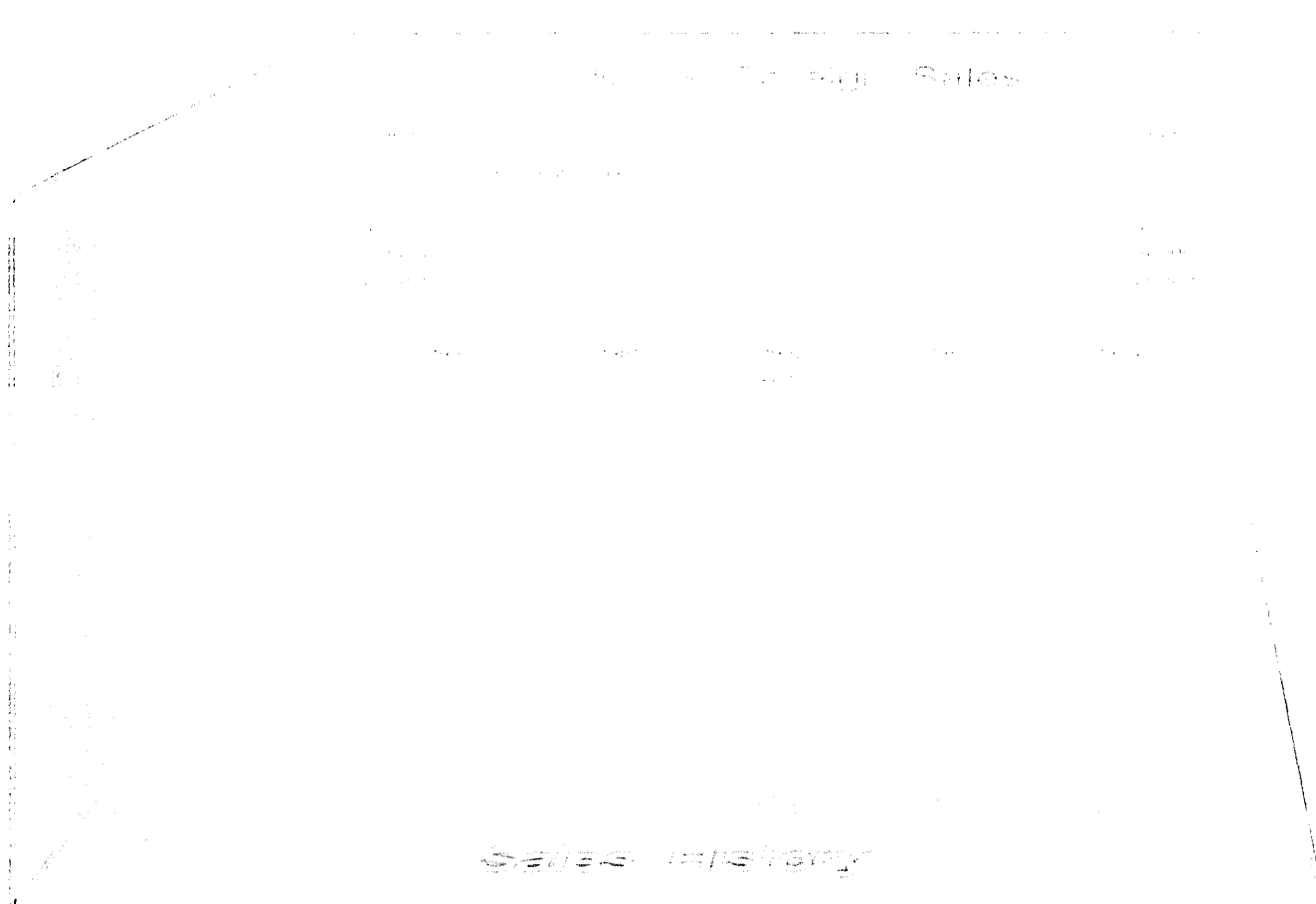

- Your Advertising Solution 3
- Your PC/ERP Solution 4
- Your Website/Printer Solution 5
- Your Mainframe Solution 6
- Your DBMS Solution 7

# The SAS® System...

## The Solution for Your Personal Computing Needs

You know the SAS System for its power and flexibility on mainframes and minicomputers. For its integration of data management, statistical analysis, graphics, forecasting, spreadsheets, and more.

Now we've carried the integration a step further. The SAS System runs on mainframes, minicomputers—and soon—microcomputers.

**Introducing the SAS System on the IBM PC.** It's the ideal solution for researchers, Information Center users, decision makers—in fact, for everyone in your organization.

Whether you're in a small company with limited needs and budget, or in a large corporation with hundreds of users at all levels, the SAS System is the solution for you.



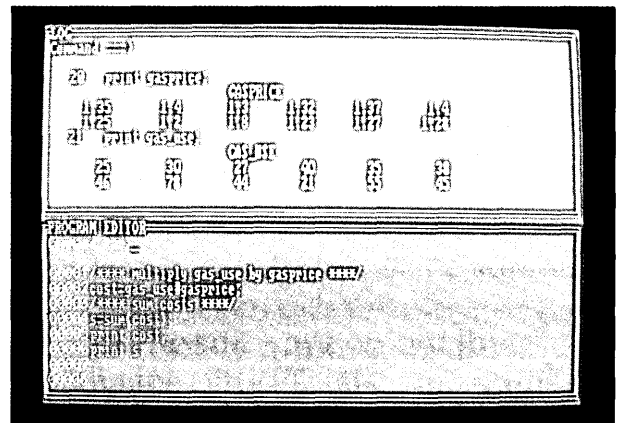
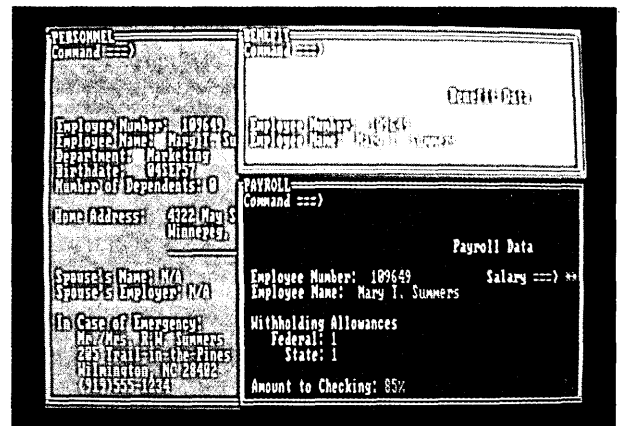
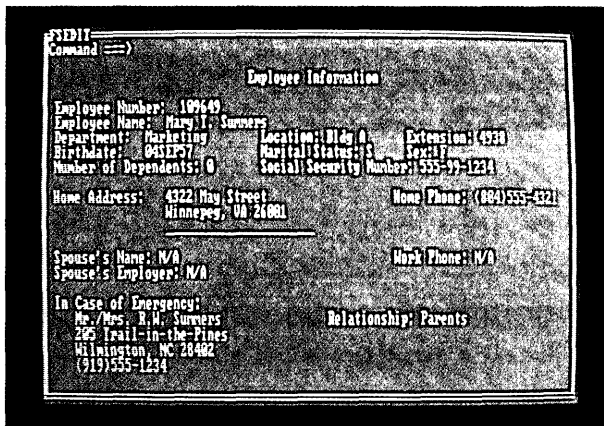

Your marketing staff can make analyses and write reports with ease.

Sales representatives can manage prospect files and the personnel department can keep track of employee records, insurance information, and more.

Your clerical staff can take orders, track inventories, and produce mass mailings.

Engineers, statisticians, mathematicians, and operations researchers can take advantage of a new product in the SAS System. SAS/IML™ software is a sophisticated interactive matrix language. You can enter and execute commands interactively, or store them for later execution. SAS/IML software is a complete data manipulation language, with features for arithmetic and character expressions, data input and output, and more. SAS/IML software lets you think directly in matrix terms.

In short, the SAS System goes everywhere your PC goes—to your researchers, your sales force, your clerical staff—right to your executive offices.

**Flexible software on flexible hardware.** The PC lets you zoom images, swap windows, and more. You can work in one window while a second job is running in the background.

There's one more reason you should get the SAS System for your IBM PC. It's high-quality software, backed by high-quality support.

**That's our  
PC solution.**

# The SAS® System...

## The Solution for Your Applications Development Needs

If you need all the power of a mainframe on your desktop, then the SAS System under VM/PC is your solution.

The SAS System runs on the IBM PC AT/370 and XT/370, just like it runs under CMS. All the commands are the same. The language is the same. The power is the same.

The SAS System under VM/PC is ideal for applications developers who need to test their programs without tying up the mainframe. You can write programs locally and easily transfer them into mainframe production. Or use the joint session capability for simultaneous mainframe-micro sessions.

Computer Center staff only have to install and maintain one system for all their users. An easy on-line menu lets you download the SAS software procedures you need.

You can take advantage of an entire integrated software system on your desktop. The simple SAS language and ready-to-use procedures make it easy to enter and analyze data, and write reports. Add

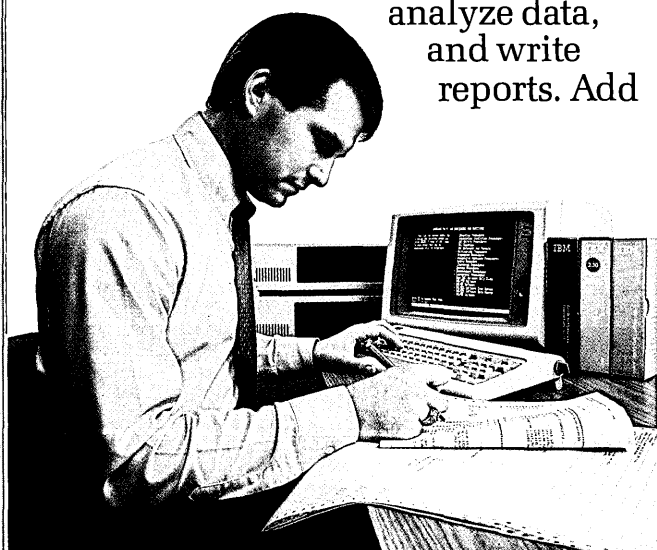

```

Command ==>                               Enter END to return to SAS
Note ==> For more information enter HELP keyword or HELP HELP
The TABULATE procedure constructs tables of descriptive
statistics from compositions of classification variables,
analysis variables, and statistic names. Tables may have up to
three dimensions: page, row, and column.

PROC TABULATE < DATA=SASdataset MISSING FORMAT=wd
ORDER=FREQ|DATA|INTERNAL|FORMATTED FORMCHAR=string' >;
< CLASS variables; >
< VAR variables; >
< FREQ variable; >
< WEIGHT variable; >
< BY variables; >
< FORMAT variables format. .... >
< LABEL variables=label .... >
TABLE < page expression, > < row expression, >
      column expression < / PRINTMISS
MISSTEXT='text' FUZZ=mnw RTS|RTSAPCE=n >;
< KEYLABEL keyword=text .... >

where
keyword is M MISS MEAN STD MIN MAX RANGE SUM VAR WSS
      CSS CV STDERR T PRT SUMGT PCTN PCTSUM ALL
  
```

Command ==> Procedure Output

Office Supply Company  
Sales by Product Division for Each State

		Product Division				
		FURNITURE	BUS. MACHINES	SUPPLIES	PAPER PRODUCT	ALL
		Sales (1,000s)	Sales (1,000s)	Sales (1,000s)	Sales (1,000s)	Sales (1,000s)
REGION	STATE	SUM	SUM	SUM	SUM	SUM
NORTH	NEW JERSEY	97.8	119.1	213.7	57.7	488.3
	NEW YORK	77.9	147.2	114.8	35.3	375.3
	All States	175.7	266.3	328.5	93.0	863.6

the new interactive applications development software tool in the SAS System, and you've got a combination that can't be beat. **(For more on that, read page 7.)**

The SAS System goes everywhere your PC/370 goes—from the data center, to the applications development staff, to your office.

There's one more reason the SAS System under VM/PC should be your solution. The price. You license the system according to the number of PC/370s you have. Call us for details.

## That's the PC/370 solution.



# The SAS® System...

## The Solution for Your Department's Needs

You've got a minicomputer dedicated to your department's work, but you need all the power of a mainframe software package to get the job done. The SAS System is your solution.

For years, minicomputer users have needed a powerful analytical tool for their research and engineering applications. The statistical capabilities in the SAS System are the best.

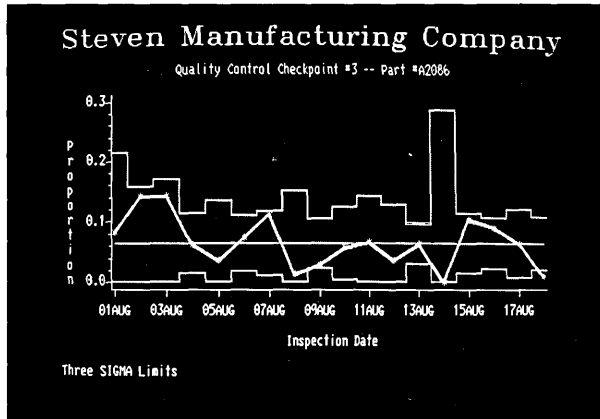

We offer a wide range of statistical tools—from simple descriptive statistics to complex regression, analysis of variance, discriminant analysis, clustering, and scoring techniques. We package these tools in ready-to-use procedures, so you don't have to be a statistician to produce the analysis you need.

Once you perform your analysis, you can present the results in easy-to-understand graphics. The SAS System includes procedures for routine lists, tables, reports, charts, plots, maps, and more.

You get all the data management, analysis, and reporting capabilities of the mainframe SAS System on your department's minicomputer.

The simple English-like commands and on-line help facility handle every application, quickly and easily.

In short, the SAS System goes everywhere you go, from the research lab to the boardroom.

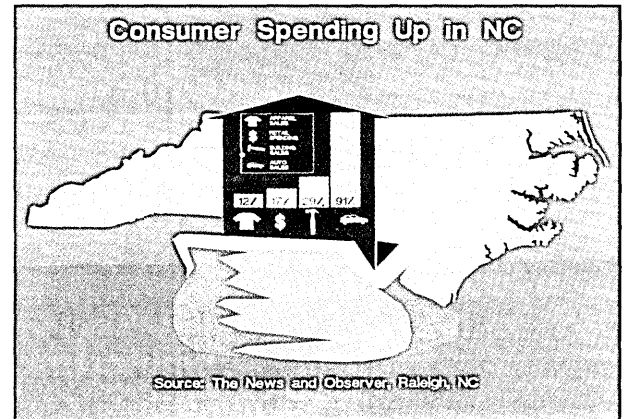

Best of all, you can enjoy the power and flexibility of mainframe software at a minicomputer price. We offer substantial discounts to our minicomputer customers. Call us to learn more.

The SAS System runs on these minicomputers: Digital Equipment Corp. VAX™ 11/7xx series under VMST™, Data General Corp. ECLIPSE® MV series under AOS/VS, and Prime Computer, Inc. Prime 50 series under PRIMOS®.

---

## Now that's some solution.

# The SAS® System...

## The Solution for All Your Company's Needs

You've read about how we've changed the meaning of integration. How we've brought the SAS System to microcomputers and minicomputers.

But we haven't forgotten those of you with mainframes. In fact, we're delivering a whole new system to you.

**Version 5. With more capabilities. Better integration. And a friendly touch.**

Increased interactivity was our number one goal. The SAS Display Manager System lets you interact with all parts of your SAS job—with your program statements, system messages, and your output. You never need to leave your desk to retrieve printouts, look up error codes, or get help.

Integration of products for all operating systems is accomplished in Version 5. The products work the same for our mainframe customers, our minicomputer customers, our PC/370 customers, and our PC

customers. Display manager is available for all.

And just like you'd expect, our current customers get Version 5 enhancements at no extra charge.

**But we didn't stop there. We enhanced the other products too.**

**Like SAS/GRAPH® software.**

Always the leader in information graphics, Version 5 of SAS/GRAPH software is now the choice for customized presentation graphics.

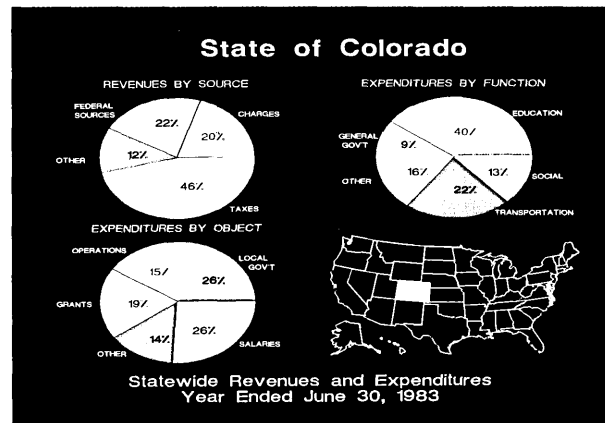

You can annotate your displays and put multiple graphs on the same page. We take advantage of the built-in intelligence of all the devices we support, so your presentations will be sharp. Up to 255 colors are available, depending on your device. We support most devices, ranging from low-cost ink-jet printers to high-resolution slide makers.

---

## Now that's a graphics solution.

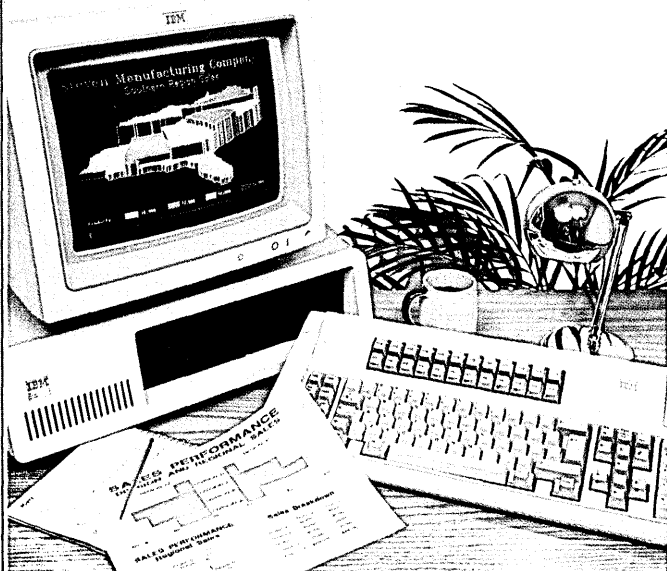

Version 5 has many enhancements. And a new product.

**Introducing SAS/AF™ software. Mainframe power with a friendly touch.**

SAS/AF software is a full-screen facility for developing applications on-line. It's a faster, easier way to structure SAS sessions for Information Center users. Easy-to-use menus let them run full-scale production jobs, reports, analyses, and more.

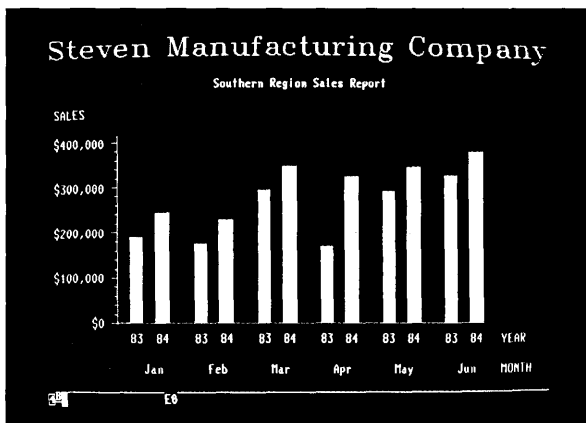
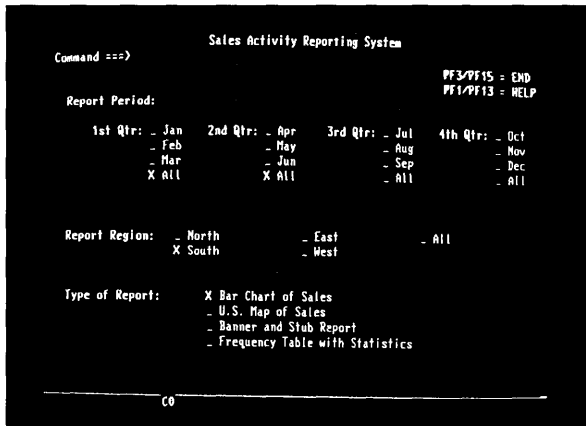

We provide sample menus to get you started, or you can create your own. Extensive on-line help facilities are available to users and programmers.

You can even train your staff with

SAS/AF software. You can write courses on any topic, or license courses from us.

**Announcing Computer-Based Training from SAS Institute.**

It's not like other CBT courses, where you test your skills in a simulated environment. It's CBT training about the SAS System, written in the SAS language. Your statements are submitted directly to the SAS System and executed. That's unique.

**There's more to the SAS System.** Like full-screen, interactive data entry, edit, query, letter writing, and spreadsheet capabilities. Integrated procedures for planning, forecasting, and financial modeling. A project optimization and decision support tool. And an interface to IBM DL/I products, with an easy-to-use menu for making DL/I calls interactively.

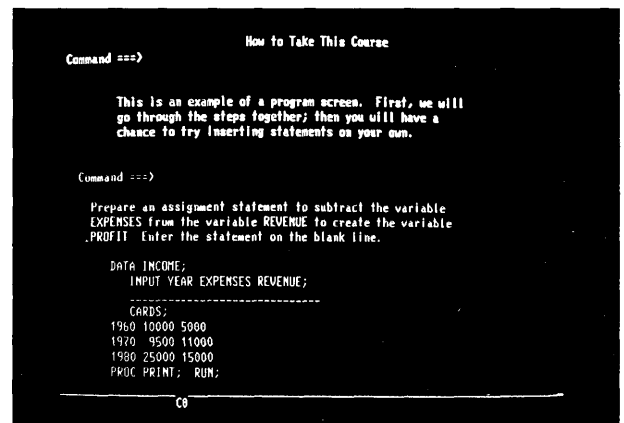

The SAS System runs on IBM 370/30xx/43xx and compatible machines under OS, TSO, CMS, DOS/VSE, SSX, and ICCF; on Digital Equipment Corp. VAX™ 11/7xx series under VMST™; on Data General Corp. ECLIPSE® MV series under AOS/VS; on Prime Computer, Inc. Prime 50 series under PRIMOS®; on IBM XT/370 and AT/370 under VM/PC; and on IBM PC under PC DOS.

# SYSTEM 2000®...

## The DBMS Solution for Your Information Center Needs

Just one more thing. We're bringing you a production data base management system for your Information Center. SYSTEM 2000 DBMS—it's the data base management system with built-in flexibility.

End users enjoy fast access to current, accurate data. Applications programmers can design, test, populate, and control data bases. Data base administrators can ensure data base security and integrity.

In short, SYSTEM 2000 makes your Information Center users more self-sufficient, reduces your applications backlog, and maximizes use of your information resources.

Need to produce reports? Gain ad hoc data base access? Extend your programming language? Build transactions on-line? SYSTEM 2000 makes it easy.

```

list accrued vacation, last name, first name, ordered by high accrued vacation.
.....
last name where employee status eq full time and accrued vacation ge 60.0:
.....
ACCRUED VACATION LAST NAME FIRST NAME
.....
96.0 FERNANDEZ SOPHIA
88.0 RICHARDSON TRAVIS
80.0 BROOKS RUBEN
80.0 COLLINS LILLIAN
80.0 GARCIA FRANCISCO
80.0 GARRETT DLAM
80.0 GIBSON GEORGE
80.0 JONES MICHAEL
80.0 KRATZ FREDIE
80.0 REID DAVID
80.0 SALAZAR YOLANDA
80.0 SAVAGE WILLIAM
80.0 SCHMIDT PENNY
80.0 SEATON GARY
.....
    
```

And soon, you'll be able to interface the SYSTEM 2000 DBMS with the SAS System to handle all your data base management and applications development needs. Call us for details.

SYSTEM 2000 DBMS runs on IBM 370 and compatible machines under OS, VM/CMS, and DOS/VS(E); Univac 1100 series under OS 1100; and CDC 6000/Cyber series under NOS and NOS/BE.



SAS Institute Inc.  
SAS Circle, Box 8000  
Cary, NC 27511-8000  
Telephone (919) 467-8000 x280

## We've got your solution.

### Tell me more about:

- the SAS® System on microcomputers
- the SAS System on the PC/370
- the SAS System on minicomputers
- the SAS System on mainframes

### I'm a current user. Send me more about:

- Version 5
- SAS/IML™ software
- SAS/AF™ software
- Computer-Based Training courses
- SYSTEM 2000®

### Please complete this coupon or attach your business card.

Name \_\_\_\_\_  
 Title \_\_\_\_\_  
 Company \_\_\_\_\_  
 Address \_\_\_\_\_  
 City \_\_\_\_\_ State \_\_\_\_\_ Zip \_\_\_\_\_  
 Phone (\_\_\_\_) \_\_\_\_\_

Mail to: SAS Institute Inc., SAS Circle, Box 8000, Cary, NC 27511-8000

SAS, SAS/FSP, SAS/GRAPH, SAS/IMS-DL/I, and SYSTEM 2000 are registered trademarks of SAS Institute Inc., Cary, NC, USA. SAS/ETS, SAS/OR, SAS/AF, SAS/IML, and SAS/REPLAY-CICS are trademarks of SAS Institute Inc. VAX and VMS are trademarks of Digital Equipment

Corp., Maynard, MA. ECLIPSE is the registered trademark of Data General Corp., Westboro, MA. PRIMOS is the registered trademark of Prime Computer, Inc., Natick, MA. Copyright © 1985 by SAS Institute Inc. Printed in the USA.

## NEWS IN PERSPECTIVE

computer NBI will use as a host in its largest systems.

CCI is slightly smaller, with revenues of \$135 million and net income of \$11.3 million for the year ended Sept. 30, 1984. CCI's main business is special systems for telephone companies, notably those used by directory assistance operators.

The failure of the NBI-CCI merger may signal further problems for small, aggressive, and independent-minded companies as they consider their alternatives in a market growing more receptive to the major players. And more users than Brownstein of Regis McKenna and Filan of Kidder Peabody will be singing the orphan hardware blues. ©

## SOFTWARE

# KEEPING PIRATES AT BAY

**The micro software industry is pulling out all the stops against corporate pirates, but that may not be enough.**

by Willie Schatz

Two centuries later, the pirates have traded gold and silver pieces of eight for hard and floppy disks. And just like in the old days, they're easy to find but damn difficult to stop.

Now at least someone's trying. ADAPSO and Micropro International Corp. have sued American Brands, number 79 on your Fortune 500 roster, and its Wilson Jones subsidiary for alleged unauthorized and infringing copying and distribution of computer programs. The suit should open up considerably what has heretofore been a closed subject. That doesn't mean, however, that users will be any more informed about whether they pay the right price for what they get.

"Unauthorized copying clearly hurts the user," contends John Baumgarten, a leading copyright attorney with Paskus, Gordon & Hyman in Washington. "It potentially increases prices. It can lead to defective or inefficient products. It could prove such a strain on a company that it can't afford adequate backup service. The cumulative impact is that companies go out of business and innovation is dampened."

That's just what ADAPSO and Micropro tell the judge:

"The unauthorized copying and distribution of computer programs is

costing microcomputer software companies billions of dollars annually in lost revenues. In turn, the unauthorized copying and distribution of computer programs inhibits the development of new, innovative, productivity-enhancing software for the consuming public and undermines the competitive position of microcomputer software companies both at home and around the world."

There are no hard numbers to support this theory, although a quick glance at the U.S. trade deficit tells you we ain't

what we used to be. A recent survey by Future Computing of Dallas says that piracy cost vendors \$1.3 billion in lost revenues between 1981 and 1984. The firm also estimates \$800 million in lost revenues for 1985. To arrive at that number, the survey assumed 25% of the unauthorized copies would otherwise have been bought legitimately. Future Computing also found that for every authorized micro business package, there is one unauthorized copy. Not a terrific money-making ratio, no matter how you num-

# OS/MVS Users

... over 500 users are using **FastDASD** to improve system performance.

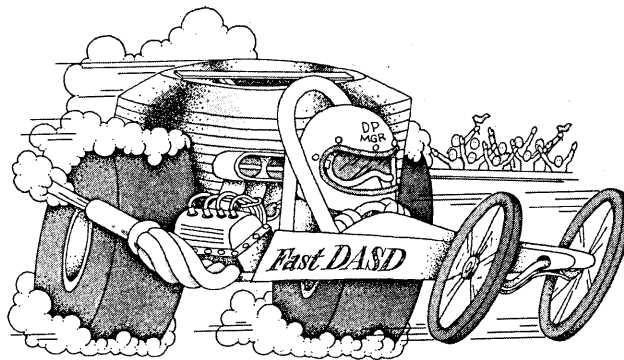

- Speeds Response Time
- Solves Problems Quickly
- Increases Throughput
- Saves People Time

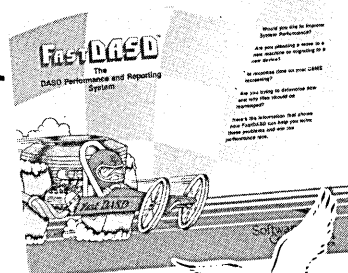

Software Corporation of America

360 Herndon Parkway  
Herndon, VA 22070  
Tel. (703) 471-1545

For faster results, call us today at our toll-free number 800 368-7638.

To get a Free FastDASD brochure, fill out and mail this coupon today.

Name \_\_\_\_\_

Title \_\_\_\_\_

Company \_\_\_\_\_

Phone (\_\_\_\_) \_\_\_\_\_

Address \_\_\_\_\_

City \_\_\_\_\_

State \_\_\_\_\_ Zip \_\_\_\_\_

OP SYS \_\_\_\_\_ CPU \_\_\_\_\_ #DASD Spindles \_\_\_\_\_

DAAD

CIRCLE 32 ON READER CARD



## NEWS IN PERSPECTIVE

ber-crunch it.

"They haven't realized the revenues from what would have been legitimate sales, and that's a significant problem for these companies," says David Readerman, an analyst with Smith Barney in New York. "For firms not well capitalized, lost revenues hurt marketing efforts and new product introduction.

"If Micropro had those revenues, it might have been able to push WordStar 2000 or another product a lot harder than it did. VisiCorp might still be in business. Software pirates are responsible for the demise of some companies, particularly VisiCorp," the analyst argues.

How much of a downer is this demise? According to Readerman, who cautions that his is "not *the* number," it was \$590 million between 1981 and July 1984.

### **"For software firms that are not well capitalized, lost revenues hurt marketing efforts and new product introduction."**

Readerman split the software universe into three solar systems: database programs, spreadsheet/accounting programs, and word processing programs. Spreadsheets edged word processing, \$262 million to \$230 million, for biggest total loser.

Micropro, based in San Rafael, Calif., was the biggest individual sufferer, losing \$177 million during this period. Lotus Development Corp., Cambridge, Mass., was next, at \$161 million, followed by Ashton-Tate, Culver City, Calif., with \$68 million. In all three cases, revenues lost from piracy over that 2½-year period exceeded actual revenues over the same period.

"Piracy comes with the territory," admits Micropro president Glen Haney. "But we don't take it into account in our pricing. We don't calculate the number of pirated copies.

"It's the piracy in industry that really upsets us. Early piracy was friend to friend. The whole thing is a holdover from the idea that everybody just Xeroxes copyrighted documents."

In other words, you want it, you take it, and you don't pay the price, but you might if ADAPSO succeeds.

"If ADAPSO wins, corporations will be more like policemen. They'll warn users, not encourage them. The suit won't have any effect on prices, but if piracy is effectively reduced, it will have a beneficial effect on users," who would presumably procure micro software through legitimate means rather than through piracy. Micro software vendors, Readerman says, would then be able to put that added revenue into their annual reports. "If analysts saw that \$161 million in Lo-

## STEMMING THE GLOBAL THREAT

Welcome to the international edition of Hill Street Blues, where the United States is going to do it to the Japanese before they do it to the U.S.

That is the motivation behind S.339, the International Computer Software Protection Act, recently introduced by Sen. Frank Lautenberg (D-N.J.). In his previous life, Lautenberg was president of Automatic Data Processing, so one can safely assume he knows something about the hard and soft side of computers.

His bill, which at press time had attracted six Republican and four Democratic sponsors, is targeted at nations that establish copyright protection periods of under 25 years for software or that lessen the protection in some other way. Under the bill, software developed in those foreign nations will receive no copyright protection in the U.S.

And what nation is thinking of changing the copyright protection it gives foreign software? It wouldn't be Japan, would it? Well, almost. A proposal by the Ministry of Trade and Industry (MITI) that would abandon copyright protection for software and substitute a new, shorter, intellectual property right scheme while allowing the government compulsory licensing almost passed the Japanese Diet last year. It was then supposedly given up for dead, but apparently it is still very much alive.

"That proposal is still kicking around," says Mitch Osterer, the sena-

tus's annual report, Wall Street would go wild."

They're not dancing on the Street yet, though. For that to happen, a few things have to transpire first. It would help, for example, if ADAPSO and Micropro were to win the suit, or at least work out a very favorable settlement. This is, as they say in the legal profession, a case of first impression. There have been other copyright infringement cases brought—Lotus vs. Rixon and Apple vs. Franklin, for starters—but those have all involved marketing. The factual setting in this one is new.

And if the plaintiffs prove their case, where is it written that unauthorized copying and distribution will automatically cease and desist? All available evidence indicates that legal threats surely aren't doing the job now. Even if one lawsuit under the Copyright and Lanham Acts, where the damages range from a low of \$10 for a copyright infringement to a trebling of actual damages for "trademark infringements, false designations of origin, false representations, and acts of unfair competition," proves successful, there is rampant piracy in government

tor's legislative assistant. "The U.S. thinks copyright is the proper form of intellectual protection. We don't want to see it abolished.

"Under the Universal Copyright Convention, if one nation provides a shorter term of protection for a class of works, the other nation is entitled to do the same. So if the Japanese provide no copyright protection, we don't have to. If they change the type of protection to something else, we don't have to use that. And they're the ones who wanted this Rule of the Shorter Term in the convention."

Japanese software isn't exactly overflowing dealers' shelves here. But they have made it clear that they are targeting the U.S. software industry. Sen. Lautenberg and the software backers of his bill, notably ADAPSO, are offering an alternative should the strong U.S. pressure that worked on MITI last time not succeed this time. And a recent Department of Commerce report on the competitiveness of the U.S. software industry cited foreign government involvement as a primary factor influencing the future of the industry.

"The Japanese seem to think 10 to 15 years is a long enough life for software," Osterer says. "They should try telling AT&T that Unix will be in the public domain in five years."

Give them time. They just might do that.

—W.S.

and schools, too. Let us not forget either the home user who makes three copies of WordStar for his friends.

"It's going on in all those places," says a knowledgeable legal observer. "The most attractive defendant is obviously the corporation. I think the software industry has a very valid claim here. If you want another copy, go buy one."

"Two parts of the survey surprised us," Haney says. "There's not much more piracy in the high end than the low end. It has more to do with the popularity of the product than the price. If somebody likes it, it will be stolen."

Micropro tried recently to make stealing difficult and installed a protective device in WordStar 2000 that would allow a maximum of three copies, but the technology wasn't exactly state of the art and made the product exceptionally difficult to use. After considerable complaining from customers, Micropro withdrew the device.

"Piracy is not stoppable, but it's controllable," Haney contends. "In general, corporate management doesn't consider the proliferation of personal computers as creating an exposure area



# BEING POWERLESS OVER POWER IS BAD NEWS FOR COMPUTERS

Suddenly and without any warning a black-out can hit and shut your computer down completely. When it does, critical data for systems such as accounting, inventory, telecommunications, security and process control can be altered or lost. Costly power-sensitive equipment can be damaged and expensive system downtime can hit your business profits hard.

Elgar's Uninterruptible Power Systems (UPS) protect you from costly problems such as these. Our on-line UPS provides precise computer-grade power at all times and guards your system from blackouts and from damaging line surges, noise and brownouts which occur daily in many areas.

For years, Elgar has led the industry in UPS performance, reliability and in operating efficiency which all adds up to big savings for you. And we offer an unbeatable value with many standard features plus an exclusive two year warranty that stands behind every on-line UPS we make.

We've got an UPS for any computer from micros to mainframes including our new "B" series engineered specifically for high speed mini computers such as IBM Systems 34 and 36, DEC VAX and others.

Check us out. Serious power problems can shut your business down at any time.

**POWER UP YOUR PROFITS**

**ELGAR**

An Onan/McGraw-Edison Company

9250 Brown Deer Road  
San Diego, CA 92121  
(619) 450-0085

CIRCLE 27 ON READER CARD

## NEWS IN PERSPECTIVE

for piracy, but most corporations should and must put in control programs. We tried ourselves, but it wasn't worth the price. We're willing to take the risk of more piracy in order to satisfy our customers, but we want to send a signal to the world that we're not inviting piracy."

The industry has a reasonable possibility of success in court. "It's doing what it should, combining a massive public relations campaign with litigation," the observer says.

"Whether there's more copying in the office or at home doesn't really matter. The price of software packages accounts for a substantial portion of the revenue loss attributable to piracy."

So maybe it is a floppy Blackbeard who's responsible for at least a piece of that \$495 or \$149.95 you just shelled out for the program nearest and dearest to your heart. Does every penny of that really go for research and development and manufacturing and marketing and distribution? If American Brands and Wilson Jones reproduced a number of unauthorized copies of MailMerge for use at sales seminars, as ADAPSO and Micropro allege, wouldn't it make sense to add that to the over-the-counter price?

"If ADAPSO wins, it's probably going to discourage firms from making illegal copies," says Stan Besen, an economist at the Rand Corporation in Washington. "The effect is that everybody stops copying. In that case, the price would go down. But the effect on consumers could be worse, because there would be fewer people to share with.

"If ADAPSO loses," the economist warns, "users would be worse off because the industry failed to discourage inefficient private copying. If that happens, [the industry] could fold their tents and go home. But they won't. They'll keep investing in more technical fixes, and then users might be worse off, because originals will cost more and be harder to copy."

Correct. But that is, after all, what the software industry wants. Criminal penalties are authorized under the Copyright Act, but ADAPSO and Micropro aren't trying to throw anyone in jail. They do, however, accuse the two defendants of reproducing and distributing programs of software packages of other ADAPSO members and "potential member companies which are not parties to this action."

Just in case the scope of that sentence isn't wide enough, the plaintiffs also want to enjoin American Brands and Wilson Jones from reproducing or distributing any "protected computer program or software developed by any ADAPSO member company, or potential ADAPSO member company." That about covers it, folks.

"We're not seeking criminal remedies," says ADAPSO general counsel Ron Palenski, who along with other interested parties was scheduled to hear the defendant's answer March 14. "I went to the Justice Department before I filed this and asked them what it would take for them to take action. They said to find them a 'copy mill'—a firm that has institutionalized unauthorized copying.

"This shouldn't be seen as 'we're going after you guys,' and it shouldn't be taken as a vendor-issue matter, either," Polenski says. "We don't want to create animosity in the user community. Our members depend on them for their success."

But they don't rely on customers to make them less successful than they can be. Who wants 98% when, but for users using you, you could have 100%? So far the software industry and its customers have had a pretty marriage. Maybe the parties need some counseling.

"There's a notion of implicit fairness here," Baumgarten contends. "If it's hardware, nobody goes to Computerland and thinks he should be allowed to walk out with a machine. Just because software's intangible rather than tangible doesn't make a difference."

It has made one so far. ©

## HARD TIME FOR BANK SOFTWARE

**Bank failures, unpaid debts, and other problems leave banking dp managers with little money for new software.**

**By Edith Myers**

Every regular reader of business news knows 1984 was not a good year for the banking industry. "In 1984, there were the largest number of bank failures in the history of banking," says Art Gillis of Computer Based Solutions, an Atlanta-based data processing consultant to banks. For many that survived, there wasn't much to brag about. Two of the three largest annual banking losses in U.S. history were expected to be posted for 1984—more than \$1 billion by Continental Illinois, Chicago, and \$324.4 million by Crocker National, San Francisco.

The pressures on banks are felt most keenly by their data processing departments. They trickle through to the outside vendors who provide the software to move traditional bank practices into

today's world. So the problems of bad corporate debts and foreign countries that fail to pay the interest on their debts are making life difficult for dp managers and software vendors.

Of the two companies offering banks the critical integrated software needed to tie together the complexities of this new world, one recently stumbled and one fell. And more competitors are on the horizon.

The company that fell, Anacomp Inc., Indianapolis, never did have a product that worked. The one that stumbled and may yet pick itself up, Hogan Systems Inc., Dallas, has a product that works. At last count the company claimed it was installed at more than 130 sites.

Anacomp started life as a small local service bureau founded by three Purdue University professors back in 1968. It grew through acquisitions into a diverse data processing services company and in its fiscal year ended June 1983 had revenues of \$172.2 million and financial commitments from some 30 big banks for development of its Continuous Integrated System (CIS). Unfortunately, CIS never got up and running. It failed in a trial at Provident National Bank in Philadelphia.

The CIS fiasco destroyed Anacomp financially. The firm—which changed its fiscal-year structure in 1984—lost \$116 million on sales of \$132 million in the fiscal year that ended last September. Write-offs pertaining to CIS contributed heavily to the loss. Thomas Lawton, editor of the Belmont, Mass.-based newsletter, *Computer Services Report*, says, "We've seen the last of CIS. Who's going to invest money in it?" He adds that Anacomp has put its banking software on a pay-as-you-go basis, meaning no further development unless somebody funds it. A company spokesperson conceded that a live installation of CIS in the near future is unlikely, but added that transaction accounting and customer service to components of CIS will be marketed independently.

Two of the banks that originally helped fund CIS, the Bank of Nova Scotia, Toronto, and Harris Trust & Savings Bank, Chicago, have purchased Hogan software. So Anacomp's problems appear to be a boost for Hogan. At first glance, industry observers and the stock market saw some dark clouds, though.

"Anacomp sent a lot of shivers through the market [for banking software]," says Terence M. Quinn, the software and services industry analyst with the stock brokerage firm Dean Witter Reynolds Inc., New York. "With Anacomp's stock down to zero and Hogan's not far behind, a lot of banks are bound to be nervous. But," he adds, "Hogan's product works and Anacomp never had



# Beehive Challenges You To Take The 3178 Screen Test

Who will win your award for best picture—IBM or Beehive? Find out by screening our “plug and play” ATL-178. You’ll see right away that our 3178 emulator is totally compatible with your IBM equipment. You’ll also see an unbeatable display on Beehive’s ATL-178.

Why? First, our terminal has a 14” screen, not just 12”. Viewing area and characters are some 17% larger. Thanks to our proprietary dual dynamic focus, characters are crisp and precisely detailed from the center of the screen to the very corners. Our anti-glare, micro-mesh filter screen further enhances your viewing pleasure.

Ergonomics of our elegant design extend to tilt/swivel features, plus a detachable, low-profile

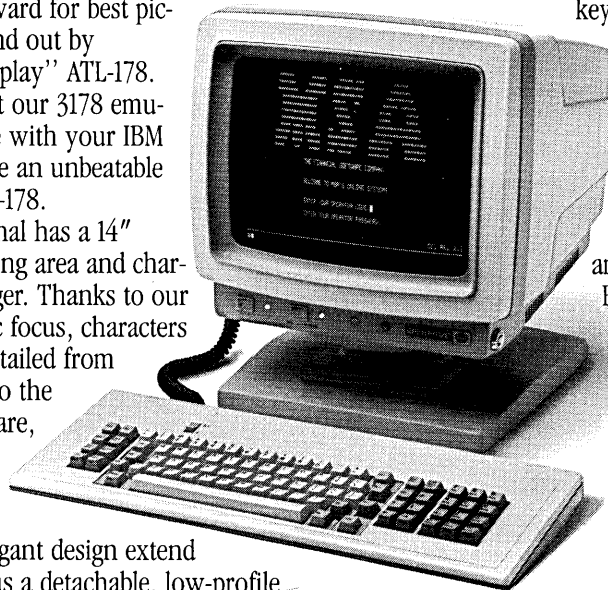

keyboard. As you’d expect, we’re 100% compatible with IBM in function and interface, side-stepping retraining and installation woes.

Beehive ATL-178 is available for immediate delivery in your choice of green and amber screens, with keyboard options like IBM’s C2, C3 and C4. And for \$470.00 less per copy! For details—for your own personal showing—contact: Beehive, 4910 Amelia Earhart Drive, Salt Lake City, Utah, 84116-2837.

Toll Free: 1-800-453-9454



**BEEHIVE™**

Sales Offices:

CALIFORNIA Costa Mesa 714/540-8404, Sunnyvale 408/738-1560 • ILLINOIS Arlington Heights 312/593-1565 • MASSACHUSETTS Woburn 617/933-0202 • NEW JERSEY Colonia 201/381-9883  
TEXAS Dallas 214/239-3330 • UTAH Salt Lake City 801/355-6000 • WASHINGTON, DC (VA) Falls Church 703/573-1261

## NEWS IN PERSPECTIVE

one that would."

Hogan had "disappointing" revenues for its latest quarter, ended Dec. 31, well below the expectations both of analysts and the company itself. On Jan. 4, its stock fell by 50% but it was inching back up in recent weeks.

"We're still assessing what factors contributed to our situation in the third quarter," said Steve Stibbens, a Hogan vice president, in mid-January. "We had a substantial amount of business that was to have closed that quarter. In the month

of December, on the 15th of the month, we were feeling comfortable that we would be closing with a good amount of business."

According to Stibbens, a lot of different reasons were given for delays in signing orders for \$1 million and up, such as, "We have to get back to the board of directors." He perceives a reluctance on the part of banks to spend money. "There are a lot of distractions for banks these days, like the competitive situation, acquisitions and mergers, loan losses, and

interstate banking issues in the South." Stibbens says that preoccupation with these pressures and the fact that "there's not the hot and furious urgency about deregulation that there was a couple of years ago" delayed some of the signings. "The business is there. It didn't go away, it just got delayed."

Warren Surcough of Hibernia National Bank, New Orleans, is an enthusiastic Hogan user who has his own explanation for the vendor's lackluster third quarter. "They should never expect a good third quarter. Their third quarter is our [his and most banks'] fourth quarter, and nobody buys software of that magnitude in that quarter. There's the trauma of year-end. You don't make a big capital outlay on the same day that its being determined if you are a \$20 billion bank or a \$200 million bank."

Surcough adds, "I've talked to \$10 million in potential business. The business is there. This business is from banks considering buying Hogan software who have visited Hibernia National Bank to see how it's running there."

Quinn of Dean Witter Reynolds says this is a common practice among

### Anacomp lost \$116 million on sales of \$132 million last year.

banks. "They're a close-knit community. They know what each other is doing. Hogan doesn't give out customer names but the banks know." He says that generally, "Hogan users are very supportive of the company. They're offering to do whatever they can to help: money, feedback, references, whatever."

Gillis of Computer Based Solutions adds that his clients "agreed independently if the company went belly-up, they'd step in and take over or pump money in. They've got a lot at stake. They're committed. Wherever I go and talk software [and he works exclusively with banks] they're all installing Hogan. It's not that it's perfect but there's no other choice."

Says Quinn, "They've got the only integrated software product out there and they have a one to one and a half year lead." He characterizes Hogan's situation as "not a product problem but a marketing one." Hogan initially would sell but not implement. "There are about 19 consulting groups qualified to implement Hogan software and they are of differing quality. Besides, you lose control of a sale when you are dependent upon a third party or the bank itself for implementation."

He contends Hogan is addressing this problem now. "They've expanded their service organization into the implementation area but it's a new area for them and they will encounter difficul-

## BEROL® CASSETTE™

### The new mechanical pencil with a cartridge refill system.

The Berol CASSETTE Pencil is a breakthrough in mechanical pencil technology. Just take an easy-loading, long-lasting cartridge of 15 leads and slide it in like a ballpoint refill! It's clean and simple and you never have to fool with one-at-a-time leads.

The special "shock-absorber" cushioned point helps reduce lead breakage.

And the automatic push-button lead advance keeps you writing. Berol CASSETTE . . . it's the most innovative mechanical pencil since mechanical pencils were invented.

Ask for it wherever fine writing instruments are sold.

"Shock-absorber" cushioned point reduces lead breakage.

Automatic push-button lead advance.

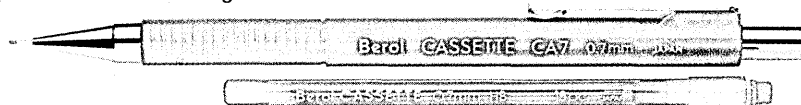

Available in .5mm and .7mm lead diameters.

Cassette cartridge holds 15 leads plus eraser.



CIRCLE 29 ON READER CARD

Berol USA  
Division of Berol Corporation  
Danbury, Connecticut 06810

©1985, Berol USA.

# Only one computer system does what we do.

*Control Data*

At Control Data, we don't just transfer data, we transfer our own systems. They're based on IBM and DEC systems as well.

That way we can maintain whatever needs to be maintained, even in multi-ventor environments.

We give our customers and their hands-on training. Classroom instruction. And ongoing courses developed by instructors like me, to keep our engineers abreast of the latest technology.

That's not to say training is the only thing that makes our service fast and flexible. We have a national network of parts warehouses. A Central Support Center staffed with hardware and software support experts. And a 24-hour parts response computer maintenance.

Control Data Engineering Services - using proven technology to solve computer maintenance problems worldwide. You can count on us. Even if it's not a Control Data system.

1-800-448-2343 ext. 5300, 110 W. Wisconsin, (612) 921-4400 ext. 5300. Outside the U.S. call your local office.

IBM is a registered trademark of International Business Machines Corporation. DEC is a registered trademark of Digital Equipment Corporation.





MY MANAGERS WANT VERSATILE  
SOFTWARE BUT THEY DEMAND  
IMMEDIATE RESULTS.  
HOW DO I CHOOSE?

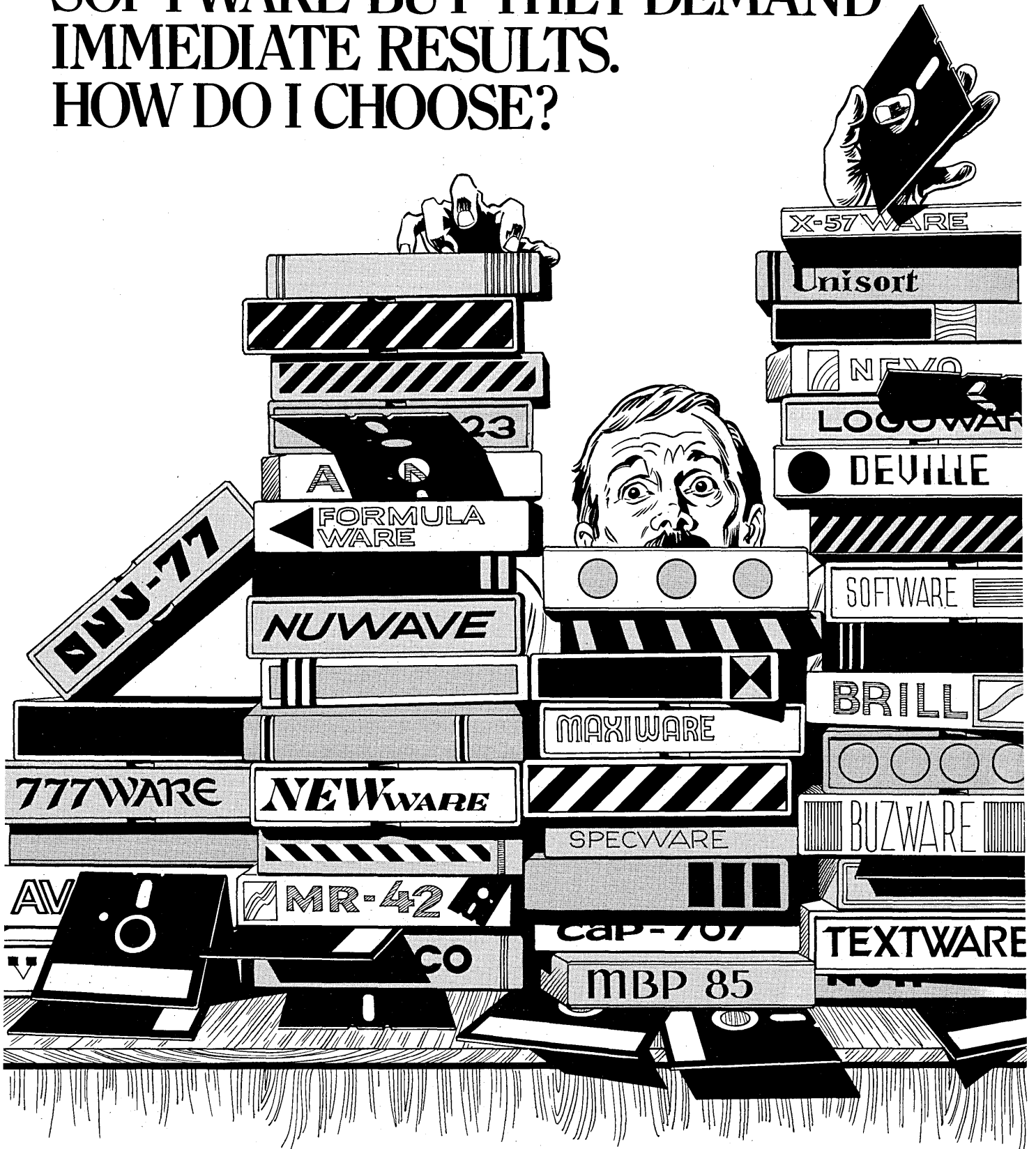

# HERE'S HOW:

---

## FRAMEWORK SOFTWARE

Framework™ saves time because it lets managers work efficiently using a single program. They can change from writing to data management or even graph creation without switching disks or having to flip-flop between different command languages.

Framework is easy to learn. Nine simple pull-down menus list all major commands. Framework puts the user in a familiar environment: there's a desktop, file cabinets and an "in-basket" which keeps track of the files on the desk.

Users can "see" a file moving from the desktop to the file cabinet (disk) when they store it, and the file directories "zoom" out of the disk drive symbol when they're called up.

Framework works like you do. If there are three files open, they're organized on the desktop with the

current open file on top. It's design like this which makes Framework intuitively easy, even for beginners.

Framework is versatile enough for serious spreadsheet or data management work, and its graphics capabilities can bring a little bit of "Star Trek" to even the most routine business report.

The final advantage is that Framework can create documents that include text, data and graphs all on one sheet of paper. Framework is a program that will make a big difference. Ask your managers after the first week.

For a dealer near you call (800) 437-4329, ext. 2223. In Colorado (303) 799-4900, ext. 2223.

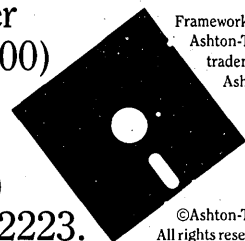

Framework and  
Ashton-Tate are  
trademarks of  
Ashton-Tate.

©Ashton-Tate 1985.  
All rights reserved.

---

Software from  
**ASHTON-TATE™**  
We'll put you in control.

CIRCLE 31 ON READER CARD

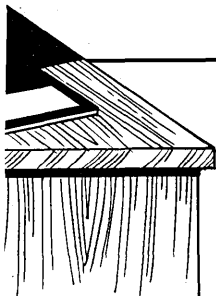

## NEWS IN PERSPECTIVE

ties." A new president from a more marketing oriented organization is apparently having an effect (see "Yankee Down South," Jan. 1, p. 129).

Quinn notes that Hogan already has "skimmed the cream" off the market, having sold to what he terms the leading-edge banks that don't worry so much about support and service. "Did they sell or did the software sell itself?" He says the market out there now is made up of banks that like to wait and see. "They're more tentative and require more hand-holding." Stibbens of Hogan calls the first tier "the bleeding edge. They'd buy FOB Dallas. They had large dp staffs and it was great for us." The next level down is the leading edge to Stibbens. "They're forward thinking but they're not first in line. Next come the followers and me-too's, and last, the screaming and kicking category." He isn't sure Hogan ever will see to the last group.

To date, Hogan's only real competition comes from Systematics Inc., Little Rock, Ark., which is primarily a facilities management company for small to medium banks but which has been talking about doing software packages for larger institutions. Quinn isn't high on Systematics' chances. "Talking and doing are two different things" he says. "They're getting into the independent software business because they've been forced to. Not many banks are willing to go to facilities management now. They see their dp departments as their key to the future. With software sales, Systematics will have to sell not just the head of the bank, but the dp manager as well and the dp manager is bound to be wondering if FM might not be part of the sale."

Future competition will come from Uccel, Dallas, and Cullinet, Westwood, Mass. Uccel has announced a \$6 million bank software development effort and a joint marketing agreement with EDS, which probably will be similar to one the big FM firm has with Hogan. Under the Hogan-EDS agreement, Stibbens explains, EDS has installed Hogan software at its processing centers and will offer it to some 700 banks it services for a price as yet unspecified and will pay Hogan a royalty.

Of both Cullinet and Uccel Quinn says, "They're selling futures now. They'll be competition [for Hogan] but it'll be a year to two years away." Uccel's LEAP (Leading Edge Applications Project), which it intends to use in its banking software development effort, is targeted at Hogan's Umbrella operating environment, he says, adding, "Some banks may be willing to wait and see."

As for Cullinet, Quinn expects it to have a narrower market than Uccel or Hogan. "They'll tie their banking soft-

ware with their database management system, and the number of banks with the overhead capacity for DBMS is much smaller than the 400 largest banks and thrifts targeted by Hogan."

Gillis worries that Hogan's current status as the only supplier of integrated software for big banks is "an all eggs in one basket situation, a monopoly almost. Banks can't afford to have a single-source vendor for all their software. Bankers won't do anything unless they're forced to. Bankers tend to react to adversity as opposed to planning for success."©

### PERIPHERALS

# TERMINAL TRAUMAS

**Cutthroat competition, sluggish sales, and low margins push terminal vendors to redefine and reposition their products.**

by Robert J. Crutchfield

Terminal vendors are at a crossroads. Personnel shake-ups, divestitures, lawsuits, and all the signs of unrest mark a significant turning point in the \$5 billion-a-year business. Another consolidation is in the works for what was once a stable and lucrative segment of the computer industry.

Today, besides competing among themselves, terminal makers TeleVideo, Telex, Lee Data, ADDS, Lear Sigler, Beehive, and others face renewed efforts from the giant hardware vendors. Both IBM and Digital Equipment Corp. recently increased their terminal production, and then followed this uppercut to the jaw with a wicked combination—new products containing sophisticated features that are forcing third-party terminal vendors to rethink their product mix. As an example, many vendors are getting into the faster-growing ANSI/ASCII market in addition to or instead of the 3270 business. According to Dataquest of San Jose, ANSI/ASCII terminals are the fastest growing market segment—up 16.4% in 1984 to \$122 million compared to the 3270 market, which grew more than 13.3% to \$220 million.

All these traumas could not have come at a worse time for the independent terminal makers. Over the past few years they got their fingers burned straying from what they know best—terminals. Companies like Zentec Corp. of Santa Clara, and TeleVideo Systems and Wyse Technology of San Jose were seduced into other areas and lost their focus.

• Zentec tried to market a 32-bit Unix-based multiuser system. Robert Angus, vice president of marketing, now says there is a big difference between selling terminals and selling complete systems. "It is a different marketplace with different distribution channels, and selling small business systems wasn't the same as selling terminals." The company, which pioneered programmable terminals, rode a financial roller coaster from being a profitable terminal company 10 years ago to losing money as a systems house. Now it is trying to rebuild by returning to its terminal roots.

• Initially Wyse offered an MS/DOS adapter that fit on its terminal. The adapter's major drawback was that it couldn't run a lot of the PC/DOS software. The company admits sales for this product haven't been good and it has introduced an IBM PC-compatible product. But unlike its direct competition, TeleVideo, Wyse will not offer the pc terminal through the retail channel. Steven Holtzman, director of planning, says the desktop box will be sold through direct sales and oems because the company doesn't want to compete for shelf space with Compaq, Corona, and especially IBM. Wyse, which went public late last year, managed to show a substantial profit, \$5.1 million on \$52.3 million in revenues over the past nine months.

• The plight of TeleVideo is especially poignant. After its 1975 storybook start in a garage and then soaring revenues gained by moving terminal production offshore while other companies refused to follow the lead of the television assemblers, the company's glorious financial track record crumbled last year and a key player resigned. Its belated move to offer a line of IBM PC-compatible boxes, after it had started down the CP/M road, cost the company dearly. Richard A. DuBridge, vice chairman and a charter member of the TeleVideo team that helped knock Lear Sigler, ADDS, and others out of terminal market leadership, voluntarily resigned from TeleVideo in the wake of a \$7.9 million fourth quarter loss. The company blames its problems on the pc market and increased competition in the terminal arena—a business it once dominated. Yet, despite losses associated with its personal computer endeavors, the company is still actively marketing its personal mini, an IBM PC-compatible multi-user computer that connects up to eight workstations.

After sounding the retreat from the headlong rush into personal computers, the independent terminal makers thought they had it made. "For a long time we all enjoyed high margin and high overhead," recalls Angus of Zentec, thinking about the late 1970s. "We had to

# SCIENCE / SCOPE

Two communications satellites rescued by NASA's space shuttle in November are being refurbished to be launched again. The spacecraft were brought back to Earth after shooting into wayward orbits nine months earlier when their rocket motors misfired. Spacecraft controllers at Hughes Aircraft Company spent months taming the satellites and bringing them into orbits low enough that they could be reached by the shuttle. Their efforts were the most sophisticated series of orbital maneuvers ever attempted. In addition, Hughes and NASA engineers worked tirelessly to develop hardware that permitted the actual recovery. The satellites emerged in good condition. Most of the electronics were never turned on, but certain items—batteries, thermal blankets, and thrusters—are being replaced.

Pilots of future aircraft may rely on artificial intelligence systems to help them assess combat situations and take appropriate offensive or defensive actions. Hughes engineers are conducting studies for the U.S. Air Force on potential uses of artificial intelligence for fire control and battle management. One focus is how to identify targets automatically and present this information for a pilot's use. Another aspect involves tactical analysis, including decision-making that advises a pilot whether to attack, flee, apply electronic countermeasures, or fly low-altitude routes. New automation techniques may be necessary for pilots to cope with the fire control systems now being designed for the next generation of military aircraft.

The feasibility of turning sea water into electricity is being studied in fusion energy experiments at Kyoto University in Japan. The studies involve a Hughes gyrotron, a microwave tube that uses a spiraling stream of electrons to produce extremely high power microwave frequencies. Fusion energy holds tremendous potential because its source of fuel (hydrogen) can be extracted from sea water. It could produce large amounts of power with little or no radioactive waste and no threat of meltdown or explosion. In fusion energy research, the gyrotron's high-power radio waves heat hydrogen particles (plasma) to temperatures of tens of millions of degrees. These particles fuse under pressure, causing a thermonuclear reaction that provides energy for driving steam turbines.

A new 5-volt-only, 256-bit nonvolatile random access memory combines the data retention capabilities of an EEPROM with the convenience of a CMOS RAM. The Hughes circuit, designated H13500, is designed for such applications as reconfigurable systems and fault protection without battery back-up. It is organized as 64x4 bits. Both the read and write operations are performed as in a standard CMOS RAM. A single store operation transfers all data in the RAM cells in parallel to the background EEPROM array. The recall operation restores data in parallel to foreground RAM cells.

A broad spectrum of technologies, many of which grew up within the past five years, are represented in the products of Hughes Industrial Electronics Group. Six divisions and two subsidiaries, each operated like a small high-tech company but backed by resources of its multibillion-dollar parent, offer career benefits to qualified engineers and scientists. Advancing technologies such as microwave and millimeter-wave communications, silicon and GaAs solid-state circuitry, fiber optics, and image processing equipment are pursued in facilities located in many of Southern California's most desirable coastal communities. Send your resume to B.E. Price, Hughes Industrial Electronics Group, Dept. S3, P.O. Box 2999, Torrance, CA 90509. Equal opportunity employer. U.S. citizenship required.

For more information write to: P.O. Box 11205, Dept. 67-8, Marina del Rey, CA 90295



## NEWS IN PERSPECTIVE

trim overhead, tighten our belts, and come out with some cleverly designed terminals."

Belt tightening and clever designs may not be enough. The ability to identify growing terminal markets and offer products in those areas, coupled with the sense to get out of diminishing markets, will separate successful terminal companies from survivors. With the oem vendors reasserting themselves, their primary business has never been tougher.

If there is a bright glow on the terminal market screen these days, it's the resiliency of its lowly product. All those obituaries about the pcs taking over appear premature. There are still millions of terminals out there. According to vendors, block-mode terminals have gained

### **"We had to trim overhead, tighten our belts, and come out with some cleverly designed terminals."**

in popularity because they are cheap to make and can emulate just about any asynchronous terminal.

Terminal prices have eroded from a high in the 1970s of more than \$4,000 to \$500 today. That's due to cost efficiencies and the relentless drive of technology, as well as a price a pc can't touch. For example, Angus of Zentec says RAM is down to a dollar a chip. Such cheap chips, coupled with offshore assembly, give block-mode terminal manufacturers some breathing room with margins but not much. Also, block-mode terminals are cheaper to make than 3270 terminals, and the circuitry lends itself to offshore assembly.

It turns out that the explosion of technology is opening up some new markets for terminals. Don Naples, vice president of Falco Data Products, Sunnyvale, Calif., a terminal company started in 1980 by former Lear Siegler executive Lee Falco, says the multi-user environments such as the IBM PC AT and the myriad of 32-bit superminicomputer systems offer new opportunities for ASCII terminal vendors. Furthermore, there's a miniboom in the custom terminal business. Falco recently joined Ampex in offering a terminal that emulates the Wyse 50 emulator. Comments Steven Holtzman, director of strategy planning at Wyse, "I guess we finally arrived."

A subset of the block-mode market is the DEC-compatible business. One forecast says the VT 220 market could hit the 450,000 unit mark this year. And many third-party vendors are entering the DEC-compatible business, as DEC introduced the VT 220 at \$1,300 and then raised the price to \$1,400. Many vendors, including Wyse, Beehive, and Zentec, countered DEC's move by offering VT 220

clones in the \$800 to \$1,000 range.

Perhaps taking a page out of the IBM book for dealing with clones, DEC is carefully studying the look-alikes. The company just filed a suit against C. Itoh and Co., seeking an injunction in U.S. District Court in Newark, N.J., that would prevent C. Itoh from further marketing, selling, or distribution of the CIT's 220 plus. So far, the federal judge has declined to rule on DEC's motion for an injunction, and C. Itoh says, based on that nonruling, it will continue to market the disputed terminal. This, however, puts the huge Japanese trading company in a delicate situation—at last fall's Comdex, salesmen for CIE terminals stessed the clone's compatibility with DEC's terminal, while at its future court date with DEC, C. Itoh will have to prove the opposite.

DEC is not confining its actions against VT 220 third-party vendors to the United States. DEC has also sent letters to Zentec, TeleVideo, and others, ordering these vendors to cease marketing their clones in the United Kingdom. While some of the vendors involved could not be reached or wouldn't comment on DEC's actions, Angus of Zentec, whose Zephyr 220 terminal is one of the challenged products, says, "They want us to stop selling the product. We looked at our design and on that basis we will continue to market the product. This is free enterprise. They [DEC] created the market and now they are not going to stop it."

Probably the maturest area of the terminal business is the 3270 market. Lawsuits and controversy have been absent from this market for a long time, but that may change. Witness IBM's announcement of the 3180 last year. Overnight it seized market share from Lee Data, which could only cry that the IBM 3180 contained many of the features of its 1220 all-in-one terminal. To counter Big Blue's advances and gain a share in the growing ASCII/ANSI business, Lee Data offered to buy in a stock swap Visual Technology of Tewksbury, Mass. Lee then had a change of heart and canceled the deal. Instead of buying VT, Lee is now considering an oem deal.

Another notable event in the 3270 market was the sale last year by Raytheon Corp. of Andover, Mass., of its terminal business to Telex Corp., Tulsa, Okla. Over the last several years Raytheon's terminal business lost a lot of money—according to one source more than \$100 million—but managed to hold 50% of the commercial airline business. Telex, with a broader base and better economies of scale, is supposedly making out like a bandit in the business. In the third quarter ending Dec. 31, Telex posted revenues of \$165 million, or double its 1983 revenues, and scored a 50% increase in earn-

ings. "The integration of Raytheon Data System continued to surpass budgeted expectations," contends Kenneth Ch'uan-k'ai Leung, an analyst for Smith Barney, Harris Upham & Co., adding that "at the same time basic terminal business is strong." With Raytheon out of the picture, forecasts for 1986 give IBM 62%, Telex 18%, ITT Courier 10%, Memorex 10%, Lee Data 3%, and another 3% to others in the 3270 market.

So with the price of a 3270 terminal around \$1,200, how do the third-party vendors compete? Last year saw an influx of 3270 clones that stressed ergonomic design. But to compete in the future, it will take more. Both Lee Data in the 3270 environment and Northern Telecom in the ASCII area are among many vendors beginning to offer combination voice/data terminals (see "Last Chance for NT," Feb. 15, p. 60). It still remains to be seen if users will pay upwards of \$1,500 for an integrated voice/data terminal when they can buy a \$600 ASCII terminal and use a standard telephone. Users probably won't, and prices in the voice/data terminal market may soon drop.

Another innovation may fare better. Sphere Technology of Providence, R.I., has the vs1000, a standalone device that enables users to do voice/data entry on 3270 terminals. This external box, which fits under a desk, hooks up to the 3270 terminal and is invisible to the mainframe. It also gives users the ability to create their own screen by reformatting the 3270 screen at the terminal without

### **DEC is taking a careful look at the VT clones.**

any changes in the program. The price however, is a hefty \$4,000.

Watch out for the emerging market of terminals that can do multiple emulation. Atlantic Research Corp. of Springfield, Va., recently introduced the Xpert packet terminal system for X.25 networks. It can interact with up to four different host computers at once—at a cost of more than \$3,000. The unit attaches directly to an X.25 network while simultaneously emulating four terminals.

Other innovations include better user interfaces and easier data entry. Software is also important. Lee Data, still smarting from the 3180 introduction, is attempting to rebound with new windowing software for use on its 3270 terminals.

Despite the promises innovation brings down the road, conditions today are still tough. When asked if as a venture capitalist they would invest in a startup terminal company, most vendors answered no. With that kind of no-confidence vote, it's no wonder the terminal business is in such sorry shape. ©



If you're stuck in the confusion surrounding business communications, we can help you out.

Try to follow the changes in business communications today and you could wind up feeling engulfed by the complexity of it all. But at NYNEX, we have the people to change all that.

Introducing the NYNEX advisors. They're trained professionals who've made it in the toughest communications market—the Northeast. So they have what it takes to guide you to the right choices in voice and data systems and networking for your business.

What's more, they'll even train your people. And handle installation.

Best of all, they'll stick with you. So you'll never be stuck again. To find out more, contact a NYNEX Account Executive—leader of a team of NYNEX advisors. 1 800 535-1535. Or send us the coupon below.

**NYNEX**

Business Information Systems



For more information, contact a NYNEX Account Executive at: 1 800 535-1535.

Or send in this coupon.

Please have a NYNEX Account Executive call me.

Please send me more information.

Name \_\_\_\_\_ Title \_\_\_\_\_

Company \_\_\_\_\_

Address \_\_\_\_\_

City \_\_\_\_\_ State \_\_\_\_\_ Zip \_\_\_\_\_

Telephone ( ) \_\_\_\_\_

NYNEX Business Information Systems  
P.O. Box 655, Room 423, White Plains, NY 10604-0655

CIRCLE 34 ON READER CARD



## NEWS IN PERSPECTIVE

### BENCHMARKS

**DOUBLE DENSITY:** IBM has finally trotted out its double-density versions of the 3380 DASD line, culminating months of industry speculation. The new models, the AE4 and BE4, can handle up to 5.04GB apiece, using the same 3MBps channels. IBM also announced a new single-density version of the 3380, which improves performance by up to 15% and costs 10% less than the original models in maintenance costs. The company brought out two new models of its 3380 controllers as well, which have 48MB and 64MB memories. Finally, IBM announced software additions to MVS to handle the new products. The Armonk giant said that the double-density disks have the same relative arrangement of tracks and cylinders as standard models, so that users will be able to expand their storage systems. No field upgrade from the original 3380 to the double-density model is possible, although the new 3380 single-density drives can be field upgraded to double density. Up to four of the double-density models can be linked together in a single string. The new single-density models cost \$88,780, while the double-density models cost \$134,740. Both have an average monthly maintenance fee of \$295 and can be leased rather than purchased.

### IBM GOES FAULT TOLERANT:

The leading computer maker has signed up Stratus Computer Inc., a five-year-old company based in Marlboro, Mass., to provide its complete line of fault-tolerant superminis. The nonexclusive agreement, the value of which was not disclosed by IBM or Stratus, marks the first time IBM has entered the fault tolerant market. Under the agreement, IBM will private label Stratus's 32-bit XA 400 and XA 600 products, although neither party would disclose how IBM will market them. Analysts noted that IBM's recognition of Stratus may have been due to inroads made by Stratus and other fault tolerant vendors into IBM's installed base of midrange minis, such as the Series/1, System/36, and 4361 models. The high-end Stratus products, which are a year old, cost between \$300,000 and \$400,000 in typical configurations, and contributed about half of the firm's fourth quarter revenues of \$14 million, says president William C. Foster. Stratus's remaining revenues come from the older 68000-based FT 200 line.

**EXTENSION:** Remember those "final" CoCom export regulations that the Department of Commerce issued on Dec. 31? It turns out that certain sections may not be so final after all. Due to what one industry source called "political heat," exporters have been given a 90-day grace

period to try to figure out exactly what they can and cannot ship, particularly in the embedded processors and software fields. Leading the industry charge was the Scientific Apparatus Makers Association (SAMA). It told DOC undersecretary for international trade Lionel Olmer that the "savings clause," which postponed the effective date for one month, needed to be extended for six months to prevent a "significant deterioration of our competitive position because other CoCom partners had not published their final rules." That, the association said, would have the effect of "unilateral U.S. controls."

The chorus was joined by Sen. Jake Garn (R.-Utah), chairman of the senate banking committee, and Rep. Don Bonker (D.-Wash.), chairman of the house subcommittee on international policy and trade. The two had been implacable foes during last fall's Export Administration Act soap opera, but agreed on this one. Bonker was "puzzled and distressed" over the possible increase in controls of low-technology items and "significant damage to U.S. international competitiveness." Undersecretary Olmer was finally convinced of the error of DOC's ways during a meeting with Rep. Ed Zschau (R.-Calif.). Informed that industry was "having problems" with the regulations, Olmer said "I didn't know that." A few days later, the savings clause was extended for three months to April 29. "We'd like to think we're the organization responsible," a SAMA spokesman said. "We got what we wanted, which was time. Trying to adjust in one day was difficult, even for us high-tech guys."

**SELLING EXCESS:** Following the lead of Eastman Kodak Inc., RCA Network Services Inc. has begun plans to sell excess capacity on its internal voice and data communications network. The subsidiary of RCA Corp. is currently building the nationwide network, which it expects to begin operating in June as a replacement for AT&T Communications' Enhanced Private Switched Communications Service. Dave Friedman, director of planning and development for RCA Network Services, which is based in Princeton, N.J., said that the subsidiary has already contacted many of America's largest corporations to discuss the network. While the network is being offered as an alternative to other common carrier private lines, "We're not looking for head-on competition," he said. Larry Driscoll, vice president and general manager of the subsidiary, said the sale of excess capacity on the network "is a business opportunity that we are looking at as a matter of course, but there are no firm plans." Selling network time would be RCA's debut in the voice carrier mar-

ket. The network will link about 130 sites nationwide, operating from major nodes in New York, Philadelphia, Atlanta, Indianapolis, and Los Angeles. RCA Network Services said the network will use satellite, microwave, and fiber-optic transmissions in the network.

**SINGING THE BLUES:** Hundreds of employees are finding themselves out of work as another round of layoffs hits beleaguered peripherals vendors. Miniscribe, the Longmont, Colo., disk drive maker, cut 41% of its U.S. work force, including 360 full-time employees and its entire roster of temporary workers. The cuts come on top of a 530-job layoff last fall, and leave the company with about 640 U.S. workers. The company is also reducing its occupied plant space as part of a decision to move its production offshore. Production in the company's Hong Kong and Singapore plants continues to increase, and the company expects more than 80% of all production to be handled out of those two countries by midyear. The move will enable the company to save up to 25% on its manufacturing costs on some products. Miniscribe can use the savings, since it lost \$6 million in 1984 on sales of \$123 million.

In Minneapolis, Lee Data Corp. cut 9% of its payroll, or 106 employees. The troubled manufacturer said the layoffs came from all aspects of the corporation, and were due to the firm's three consecutive down quarters in 1984.

**MORE MERGERS:** The computer, software, and services industries saw more mergers and acquisitions last year than they ever had in the past—256, up 80% over 1983—with dollar volume hitting \$4.32 billion. So says the Cerberus Group, a Frenchtown, N.J., market research firm. The value of those transactions was 351% greater than the sum of all mergers in 1983, said Charles C. Varga, chairman of the firm. Not that all deals were worth the average transaction value of \$16.9 million, of course; a single megabuy—General Motors' purchase of Electronic Data Systems—accounted for 59% of the total. The five biggest mergers, accounting for 75% of the total dollar volume, were GM/EDS (\$2.54 billion); McDonnell Douglas/Tymshare (\$307 million); Bell Atlantic/Sorbus Service division of Management Assistance Inc. (\$175 million); Combustion Engineering/Impell (\$105 million); and Bennett LeBow/Basic Four Information Systems division of Management Assistance Inc. (\$105 million). Without the unusual GM purchase of EDS, the 255 remaining mergers and acquisitions would have totaled \$1.77 billion, still 85% better than the \$956 million recorded in 1983. ©

# WORLD WATCH

MUNICH--When in Rom, do as the Germans do. Rumor has it that this will be IBM's PBX line if it ties up with German giant Siemens. Big Blue, which feels the Rom wares are too red, white, and blue for the European market, may be ready to reveal its new PBX pact at next month's Hannover Fair. Scuttlebutt has it that IBM will sell Siemen's PBX products in Europe, while the Munich manufacturer markets IBM's high-speed disks and controllers along with its own Fujitsu mainframes.

LONDON--When IBM wants to keep an account, almost anything goes. Anxious to persuade a key European customer to turn down a Japanese machine, Attila of Armonk enlisted the help of a top U.S. diplomat to apply some high-powered pressure. According to one ex-IBMer, such tactics are becoming increasingly common. Decisive, maybe, but it sure isn't diplomatic.

TOKYO--It took only six months for Apple Computer's distributorship deal with Canon Sales Inc. to turn sour. The marketing arm of the camera king came out with a new personal computer that was a little too Mac-like for Apple's taste. After Canon's surprise move, the U.S. micro maker quickly began to look for a more compatible partner. Canon, which borrowed some of Apple's user-friendly features for its pc, hasn't shed any tears over the estrangement. Apple, on the other hand, may well be bitter. After shelling out approximately \$10 million for a Japanese advertising campaign, the company still has only 1% of the local microcomputer market and no real distributor it can count on.

BRASILIA--Love is lovelier the second time around. Brazil, the third-world superpower, may find that out if it patches up its relationship with the Intergovernmental Bureau for Informatics in Rome. The Latin country's move to rejoin the fold would be welcomed by IBI, which just lost France and that country's 30% funding contribution.

OSLO--Amdahl has found friends in fjordland, one of whom will be taking delivery this summer of the vector-processing 1100. This will be the first supercomputer the California company has set up on European soil. The system, which is worth a whopping \$9 million, will be used in the offshore oil industry.

TOKYO--What do Bildschirmtext and baseball have in common? Answer: the Seibu Group. The proud owner of Japan's top-ranked baseball team, the Lions, has installed the German videotex service in some of its posh stores in Tokyo. The system enables the store to order from Deutschland the latest upmarket merchandise -- anything from furs to furniture.

STOCKHOLM--Volvo is turning into the fast technology lane through a new venture that teams it up with another Swedish powerhouse, LM Ericsson. The dynamic duo will develop and sell their own software through a joint company called Verimation.

# NOW IT ONLY TAKES ONE TO TANGO.



Introducing PhoneMail™, another unbeatable system from ROLM.

Say hello to the One Party Phone Call. No more waiting for the phone to ring, waiting for someone on the other end to appear, waiting for your telephone partner in another city, another meeting, another time zone. Waiting.

PhoneMail is a fully-integrated voice-

messaging system for your entire company that you can access from any touch tone™ telephone anywhere in the world, any time.

PhoneMail can answer your phone with your personal greeting. (If you'd prefer, your secretary can take the call and direct the caller to PhoneMail.) Then, because PhoneMail is part of an integrated computer-controlled business communication system, it really



begins to separate itself from those single phone answering gadgets.

PhoneMail will let you answer messages automatically. It can forward them, along with your comments, to dozens of your associates. Its voice prompts guide you step by step. There's no chance for miscommunication. Problems are solved. Decisions are moved along. Of course, only ROLM has PhoneMail.

That's not surprising. We're the people who taught telephones and computers and people how to work together. We can show you the most advanced ways to manage voice and data today, next year and into the next century.

If your business phone system has you talking to yourself, it's time to talk to ROLM.

**ROLM**

# 1985 DP BUDGET SURVEY

Market saturation seems to be slowing the pc's roller-coaster ride to success as a major budget line item, according to our survey of dp budget managers.

by John W. Verity

Is the corporate personal computer market slowing down after the past few years of explosive growth? It appears that way, according to a recent DATAMATION survey of data processing budgets at companies across the nation. While dp budgets as a whole will be up in 1985 an average of 7.4% over 1984, the portion of those budgets devoted to pcs has dropped for the first time since the ubiquitous machine entered the market eight years ago.

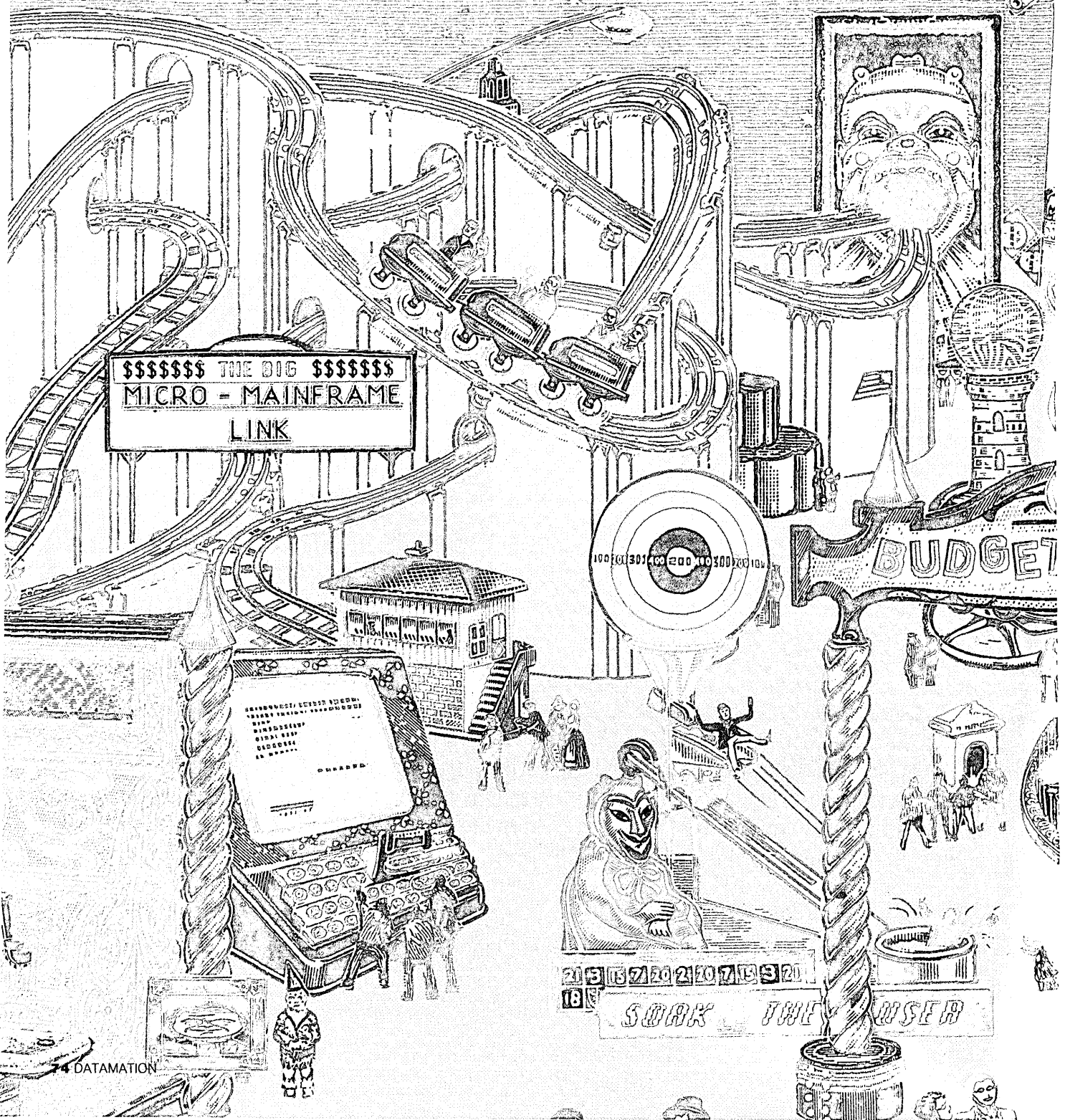

\$\$\$\$\$\$\$\$ THE DIG \$\$\$\$\$\$  
MICRO - MAINFRAME  
LINK

BUDGET

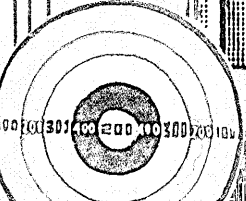

SOAK THE USER



The survey also found a slight decline in average spending for mainframes, a move matched by a slight increase in minicomputer spending. The portion of budgets set aside for software continued to increase, reflecting the long-evident desire of users for boosts in programmer productivity and general cost efficiency. Software for microcomputers showed a particularly strong increase, according to the survey, which tallied responses from 642

dp managers throughout the country and from a variety of industries, from both the manufacturing and services sectors.

The average dp budget for 1985 among the survey population will be \$452,000, up from the \$421,000 indicated for last year.

While there were no dramatic changes in the different line items for which dp managers are spending their money, the growth in purchases of per-

ILLUSTRATION BY JOHN CRAIG

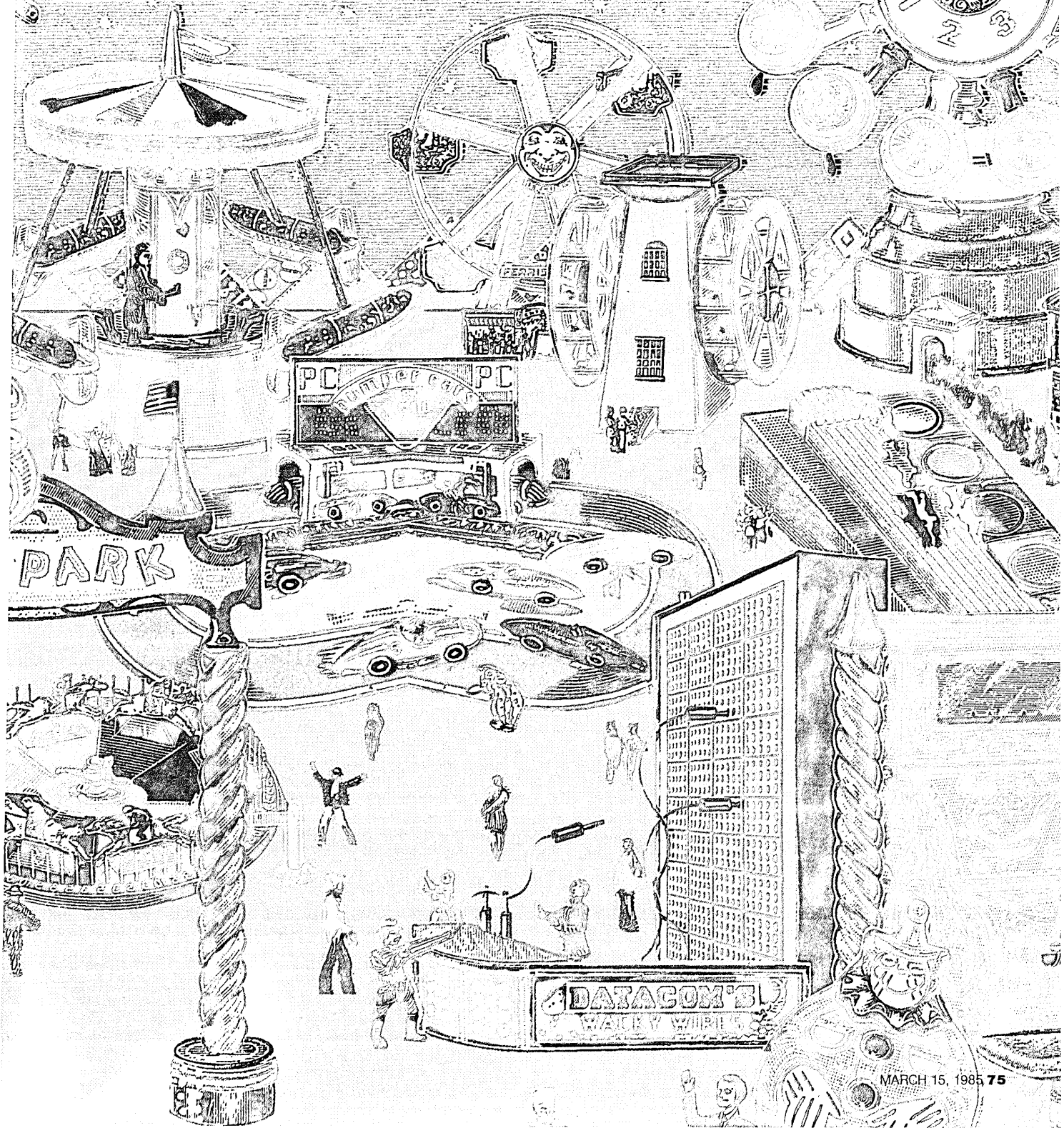



## "People often ask me how I did my job without a pc and I can't really answer them."

sonal computers does appear to be leveling off, albeit at a substantial and heady level. As some industry analysts have recently claimed, the corporate pc market's explosive growth is tempering this year, primarily because many end users that need pcs already have them, leaving the untapped market smaller than last year's.

"We said, 'Hey, we've got enough [pcs] for now,'" says Bob Cook, controller of Marine Bank Services Corp., Milwaukee, which supplies dp services to Marine Bank. The company has installed about 100 personal computers from IBM and Apple Computer to give desktop computing to end users. "If there's a dire need for another one, we'll get it, but I think things are slowing down."

Cook notes that Marine Services has had an information center offering end-user computing from a mainframe up and running for several years, but the personal computers have not reduced its use very much. Most of the applications brought up on pcs have been new ones, never before performed on computers at the company. "People often ask me how I did my job without a pc and I can't really answer them," he states.

Last year, spending for pcs accounted for 9.6% of the average dp budget at companies of all sizes, but in 1985 it will account for only 8.8%, according to the survey. On the other hand, spending for microcomputer software at sites of all sizes will rise almost 10% to 4.5% of the average total budget. Analysts have suggested that one out of three white-collar workers already has daily access to a pc of some kind; another figure that suggests growth in corporate personal computer installations may be tapering.

Observers had once expected the pc to continue moving into corporations at a rapid clip for several years beyond 1985. It now appears, however, that just as the home pc market may have seen better days, so too is the corporate arena approaching a saturation level. While there is certainly room for more pcs in the office, the huge sales of recent years won't be repeated.

### **MORE PCS IN FORTUNE COMPANIES**

On the other hand a somewhat different pattern can be discerned at large companies—those falling into the Fortune 1,000 industrial or Fortune 400 financial and services rankings—where spending for pcs will actually rise to 3.8% of the total dp budget this year, up almost a fifth from the 3.2% reported for last year. As predicted, these desktop machines are evidently being used to offload many computing tasks from host

mainframes and to enable managers, analysts, and others to perform local jobs such as word processing, spreadsheet analysis, and electronic mail.

At American Sterilizer Co., Erie, Pa., pcs will be installed this year to offload end users who have been "going crazy" with VM/CMS-based information center applications, according to John "Jack" Prehoda, assistant vice president of data processing. "The cost many of these people have incurred on the mainframe far exceeds the cost of a pc," Prehoda comments. "We hope to be able to eliminate an IBM 4381 that's now serving our information center's users. Most of them are doing spreadsheet analysis, which calls for high cpu utilization."

He notes that the company will move almost 60 people from the 4381 to pcs in the coming year, while the rest of the almost 500 people using information center applications like PROFS, SAS, and Dynaplan will be moved to a 3033 processor already installed. The survey revealed, however, that most pc users have yet to attach their desktop machines directly to mainframes, despite the widespread availability of so-called micro-to-mainframe links. That market is evidently still in its infancy, despite all the buzzwording that has surrounded it.

One speculative explanation for the apparent leveling of pc budgets is that corporate users are now more interested in pcs that can network directly with mainframes, as opposed to standalone machines. The most appropriate IBM products for that job are the PC/3270 and the PC AT, both of which are experiencing large backlogs and limited production at the company. Some observers suggest that the majority of standard PCs and PC XT's needed by corporate users may already have been installed.

It may also be that the corporate acquisition of pcs is now entered on the books outside the formal dp budget. This year's survey found that on average, Fortune-class companies are spending \$128,000 on pcs outside the dp budget and that among all sites surveyed, about \$73,000 is being spent that way. Similarly, Fortune companies on average will spend \$54,000 for pc software while all the surveyed companies will spend \$32,000 on average.

It is perhaps too early to tell if corporate pc installations have actually peaked for good, but—as forecast in last year's DATAMATION budget survey ("The Dp Budget Survey: Pcs Make Waves," April 15, 1984) and Cowen & Co./DATAMATION mini-micro survey ("Upstarts Outshine the Stars," Nov. 15, 1984)—certainly the past year has seen a real surge in their use.

"We've seen an explosion of personal computers," comments Tom Prinz, manager of resource planning and control at First National Bank of Louisville in Kentucky. He notes that the bank has also been expanding its mainframes "quite a bit" with processor upgrades to better handle a fast-expanding communications network and new applications software. Attached to the network are many automatic teller machines and a new administrative network bringing branch offices on-line. Next year, notes Prinz, teller stations may be added to the network.

Although faced with a "very tight budget" this year due to the controversy surrounding the Seabrook nuclear power station, Central Maine Power Co., Augusta, has also found "some cost-effective applications for pcs," according to Willi Hartung, manager of information systems. "We plan to expand their use in 1985," he says.

Mountain Fuel Supply Co., Salt Lake City, installed some 50 personal computers last year and will add another 70 this year, according to John Gogo, cost allocation administrator. Many of the machines are IBM's 3270 PC models, which are being used by systems developers in building programs. Gogo says the small machines have been able to take over substantial compiling tasks from the mainframe. Other pcs are in use for statistical analysis, forecasting, and geophysical computing, he notes, adding that the company has been able to install about 10 IBM PC AT's, despite IBM's inability to fill all orders for the recently introduced machine.

### **PERSONNEL STILL TOPS LIST**

The all-important category of personnel is naturally the far biggest line item in the typical dp budget: this year it is expected that personnel will take 38 cents of every dp dollar, up only slightly from the 37.8 cents indicated for last year's spending. The industry spending the most of its average budget on personnel this year is wholesale/retail distribution, with 48.2%, while the lowest spender in that budget category is transportation, with only 24.2%, according to the survey.

Dp managers said they would have an average of 20.1 people working for them this year, up from 18.5 last year.

The managers are apparently giving their staffs advanced software tools to increase productivity and cut down on staff growth. Spending on systems software is expected to be up, on the average, rising to about 1.5% of the total budget this year from 1.3% last year, the survey indicates.

FIG. 1

## THE TYPICAL DP BUDGET

BUDGET ITEM	ALL SITES		FORTUNE-CLASS SITES	
	1984	1985	1984	1985
Personnel	37.8%	38%	38.8%	38.1%
Mainframe cpus	7.7	7.5	14.1	13.7
Minicomputers	7.2	7.3	7.7	8.0
Mass storage	2.0	1.8	2.8	2.7
Terminals	2.4	2.7	4.0	4.2
Desktop systems	0.9	0.8	0.6	0.6
Personal computers	9.6	8.8	3.2	3.8
Printers and peripherals	3.6	4.4	2.8	2.9
Consultants	2.2	1.7	1.5	1.5
Outside dp services	3.2	2.7	2.5	2.7
Data communications	2.8	3.1	4.8	4.7
Applications software	2.6	2.5	2.9	2.9
Systems software	1.3	1.5	2.1	2.1
Microcomputer software	4.1	4.5	1.0	1.2
Supplies	7.6	7.9	6.2	6.2
Overhead, rent	4.4	4.0	4.5	4.1

FIG. 2

## CHANGES IN DP BUDGETS BY INDUSTRY, 1984 VS 1985

## INDUSTRY CATEGORY

Durable goods mfg.	7.4%
Consumer goods mfg.	6.1
Banking	-16
Financial services	5.6
Edp services	12
Transportation	29
Utilities	0
Medical and legal	6.2
Education	2.0
Government	29
Distribution	21.1
Other	5.1
Average	7.4

FIG. 3

## ESTIMATED DP SPENDING OUTSIDE OF DP BUDGET (MEAN)

	PC HARDWARE	PC SOFTWARE	OTHER HARDWARE	OTHER SOFTWARE	PROGRAMMERS	COMPUTING SERVICES	CONSULTANTS
Fortune Sites	\$128,000	54,000	130,000	32,000	107,000	\$40,000	47,000
All Sites	\$73,000	32,000	69,000	16,000	56,000	\$20,000	25,000

"The rise in people cost has been steep," notes Raymond Priore, vice president of systems and information processing at Consolidated Edison of New York, the electric utility. Con Ed's entire dp budget was up a full 30% from last year, due largely to the fact that the company has decided to purchase more of its IBM mainframe equipment rather than lease it. "No doubt software is increasing percentage-wise faster than anything else, but it gives our programmers more bang for the buck."

Priore, like other dp managers, has found systems software packages, fourth generation languages in particular, useful in boosting programmer productivity significantly. "The number of people will still escalate," he adds, "but not as rapidly as before."

Overall, the portion of budgets devoted to hardware—including mainframes, minicomputers, mass storage, terminals, single-function desktop computers, personal computers, printers, and all other peripherals—is seen as remaining at the 33%

level from 1984 to 1985. Software's percentage—including systems and applications software for mainframes and minis, consulting services, outside computing services, and all microcomputer software—on the other hand, will probably drop a little, to 12.9% in 1985 from 13.4% in 1984.

In software spending among the Fortune companies, a rise is indicated for this year only for pc packages, to 1.2% of the total budget this year from 1% last year. Spending on software for mainframes and minicomputers will remain level, at 2.9% for applications packages and 2.1% for systems packages, the survey found.

"We've historically bought our software on the outside," commented Bob Cook at Marine Bank Services in Milwaukee. "We rarely do our own."

Probably because of the large amount of batch processing they perform, consumer goods manufacturers and wholesale/retail distributors in the Fortune-class sample showed the highest planned budgets for mainframes, averages of 16% and

17.3%, respectively. Not surprisingly, educational organizations said they would spend only 2.4% of their dp budgets on mainframes this year: schools and universities have been using personal computers lately to provide their students with computer training.

Minicomputer budgets appear to be up slightly, rising to 7.3% from 7.2% of the total budget among the entire survey population, and to 8% from 7.7% among Fortune-class users. Durable goods manufacturers and financial services companies are spending the biggest portions of their budgets on minis, the survey revealed.

Data communications spending evidently will be up this year, but again only slightly. The total sample of respondents said they had used an average of 2.8% of their budgets last year for datacom, although they plan to boost that level to 3.1% in 1985. Among Fortune-class users, however, a slight drop in datacom spending levels is expected, 4.7% in 1985 compared with 4.8% last year. The transportation in-

# Master the advertising "game"..

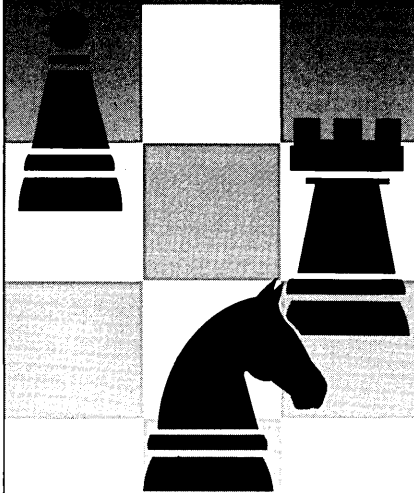

Supplement your full page advertising with an ad in the DATAMATION Marketplace. Or use it exclusively to reach 173,000 buyers/specifiers for only \$695 per 1/9 page.

It's the cost-effective way to contact qualified, BPA-audited information processing professionals with direct influence on hardware/software purchases.

For more details, call Kathy Monaghan or Shirley Stirling at (800) 223-0743. In New York, call (212) 605-9732/33.

*(Marketplace location listed in Table of Contents)*



**DATAMATION®**  
Serving the needs of  
information processing professionals  
... worldwide.

## METHODOLOGY

The 1984 DATAMATION poll was designed to directly reflect the spending patterns of the magazine's circulation base. This year the senior official at each of the Fortune 1,000 industrial firms and Fortune 400 financial and services firms that subscribes to the magazine received the two-page questionnaire. In addition, 3,500 questionnaires were sent to a random sampling of the key official at each site where DATAMATION is received. This combination approximates the population of the circulation base: one third working for Fortune firms, two thirds working for smaller firms and institutions.

Of the 4,900 questionnaires mailed last November, 642 were completed and returned before the mid-December cutoff date; 265 companies from the Fortune 1,000 and 400 groups are included in the database. The 13% response rate is typical for such surveys of DATAMATION readers when no financial incentive is offered.

Of the respondents, 35% are managers of computer operations, 5% are dp staffers, 28% are corporate officials, 8% are in the financial office, 7% are administrative personnel, and 6% are educators and consultants.

By industry, the percentage of respondents by their employers' primary business category are as follows: 25% durable goods, 13% consumer goods, 5% fi-

nancial services, 12% dp services, 7% educational institutions, 3% government offices, 8% wholesalers and retailers, and 21% miscellaneous. The large majority of the respondents were reporting the budgets for their employers' headquarters dp organizations.

The mean gross 1984 revenue of the respondents was about \$200 million in 1984, and the average site's dp spending in 1985 is expected to exceed \$452,000, a 7.4% increase over last year. The nominal mean dp expenditure in the most recent survey is not comparable to the prior year's survey owing to different methodology and sampling techniques employed.

Dp spending patterns vary widely, by type of industry as well as size of company. The mean revenue range was from \$15 million to \$516 million, while the mean dp budget range was \$98,000 to \$713,000. The 1984 mean annual revenue for the Fortune firms was \$426 million and their mean annual dp spending was \$752,000, with a range of from \$175,000 for a utility to \$1 million for the 13 Fortune-sized dp services firms responding to the survey. The Fortune firms responding to the survey indicated an average dp spending increase this year compared to 1984 of 8.3%, slightly larger than the increase expected by the group as a whole.

—Larry Marion

dustry seems to allocate the biggest portion of its average dp budget to datacom while educational users allocate the least.

## DATACOM TO GROW SLIGHTLY

"Data communications was responsible for all our growth in most business applications," says Prehoda at American Sterilizer, noting that the company currently has some 650 IBM 3270-type terminals connected from remote sites to the Erie data center's mainframes. Many pcs at the company will be attached to the mainframes as asynchronous and 3270-like devices via software called Tempus, which helps define IBM PC-like diskette files on mainframe disks and enables PC users to manipulate them with standard PC commands.

Asked if they had standardized on particular microcomputer applications software packages, dp managers at all sizes of companies were divided almost fifty-fifty. Of those that had standardized, the most popular package was, not surprisingly, Lotus Development Corp.'s 1-2-3, the integrated spreadsheet program. Among the 49% of large, Fortune-class users that had standardized, just over three quarters had picked Lotus, while among the total sample, closer to one half had picked it.

The organizations most likely to have standardized on micro applications software were found to be consumer goods

manufacturers, banks and other financial services organizations, and educational institutions. The least likely were medical and legal services companies.

Lotus 1-2-3 was followed by WordStar and dBase II/III as the most popular pc corporate applications package. Lotus's Symphony package was mentioned as first pick by only 8.8% of all respondents and 12.2% of the Fortune-class respondents.

As for micro-to-mainframe links—software that extracts and downloads host files to pcs—usage was found to be much higher among large users. Of the Fortune-type users, just over two fifths had such software installed, while only 27% of the entire survey population had them running. The most popular link software was that sold by On-Line Software, a GE subsidiary, followed by packages from Cullinet and McCormack & Dodge. ©

The 1985 DATAMATION budget survey is for sale in report form. It contains 250 pages of statistics and an executive summary prepared by the Market Research Department, covering 642 dp sites in 12 industry categories and including spending priorities for 16 dp budget items. A single copy is \$100. For more information, contact Laurie Schnepf, Research Director, Technical Publishing, 875 Third Ave., New York, NY 10022, or call (212) 605-9679.

# BACKLOGGED WITH END-USER REQUESTS?

**YOU CAN HIRE  
THIS COBOL  
PROGRAMMER...**

**OR YOU CAN HIRE  
THIS ONE.**



@ FOCUS

Cutting through the applications backlog using COBOL or PLI is pretty tough business. In order to catch up and "get current" with your end users' requests, you need a team of 8-armed programmers...or more realistically, you need FOCUS.

**4th Generation Technology**  
FOCUS is the 4th generation language/DBMS that handles the programming details for you—details that COBOL and other languages require you to specify at great length. It combines a non-procedural, natural language with advanced database and 3270 screen management technology. So, you can accomplish data analysis, storage and maintenance functions with a handful of simple English statements **instead of hundreds of lines of equivalent COBOL or PL1 code!**

**Reads All Data Center Files**  
FOCUS can access any existing file or database in your information center, including: VSAM, QSAM, IMS, IDMS,

TOTAL, ADABAS, MODEL 204, SYSTEM 2000 and DL/I. It increases programmer productivity by hundreds of per cent, even on the most complex and demanding applications. And with its new TableTalk™ windows, it provides non-technical end users with the ability to develop their own reports and graphs after just a few moments familiarization.

#### *Prototype On Your PCs!*

PC/FOCUS is a functionally equivalent FOCUS system for your PCs. With it, you can prototype applications without consuming mainframe resources. Procedures and files can then be uploaded for production execution.

#### *Put Application Backlogs Behind You With FOCUS*

It's the system that spans all of your application development needs, yet stays easy to use as those applications grow more complex. Find out how to put it to work for you, now. For details, write to Don Wszolek, Information Builders, Dept. F4, Inc., 1250 Broadway, New York, NY 10001.

INFORMATION  
BUILDERS, INC.

New York: (212) 736-4433 • Washington, D.C.: (703) 276-9006 • St. Louis: (314) 434-7500 • Chicago: (312) 789-0515  
Dallas: (214) 659-9890 • Palo Alto: (415) 324-9014 • Los Angeles: (213) 615-0735 • Houston: (713) 952-0260

CIRCLE 36 ON READER CARD

# Direct PC to System 34/36/38 Connections Using Standard Twinax Cable

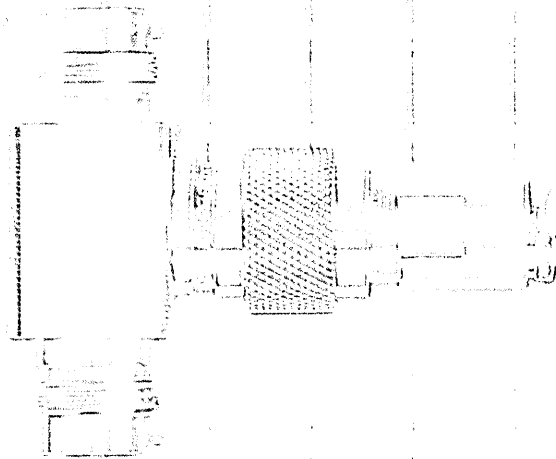

## It's Easy With AST-5251/11™: Fast Hookup, File Transfer and Extra Capabilities

**Standard Twinax Cable Support Makes Installation A Snap.** AST-5251/11 and twinax connection means easy, cost effective direct cable attachment of your PC to your IBM® System 34/36/38 – no expensive communications adapter necessary. Just plug our AST-5251/11 emulation board into your PC/AT/XT, portable or compatible and connect the twinax cable. With this complete hardware/software solution that's all it takes to use your PC just like a standard IBM 5251/11 display terminal.

**File Transfer Is Only The Beginning.** Use your PC as always, and emulate a Model 11 terminal – with extra capabilities – to access your powerful host minicomputer. Then transfer files bi-directionally between your host and PC, in a ready-to-use format.

**Use Your Favorite PC Software.** AST's file transfer support not only eliminates the burden and the errors of re-keying, it adds the ability to manipulate

transferred data using your favorite PC software packages, like Lotus 1-2-3™ and WordStar.® And our Hot-Key support lets you conduct concurrent DOS and host sessions, while our applications program interface (API) makes integrating PC and host applications simple.

**Even Greater Efficiency.** For configuration flexibility, AST-5251/11 provides host-addressable 5256 printer support in a background mode, and can effectively utilize low-cost PC-compatible printers.

This complete package – from the leader in PC enhancement products – is available from your neighborhood computer store. So is our AST-5151/12™ for remote connections. See your dealer today, or call our Customer Information Center (714) 863-1333 Ext. 5249 for more information. AST Research, Inc., 2121 Alton Avenue, Irvine, CA 92714 (714) 863-1333 TWX: 753699ASTR UR.



CIRCLE 44 ON READER CARD



**Most of the newer FT suppliers are having a rough time competing with traditional vendors.**

# FAULT TOLERANT BLUES

by Omri Serlin

Fault tolerant (FT) systems are so called because they continue to function well despite some internal failures. Currently, the key issue is whether the companies who make those systems—most of whom have suffered a series of painful setbacks—can manage a similar feat.

With the exception of Tandem Computers of Cupertino, Calif., and Stratus Computer of Marlboro, Mass., virtually all FT system suppliers have encountered significant product development problems and increasing difficulty in raising much needed additional funding. Reflecting these pressures, at least four firms (Auragen Systems, Fort Lee, N.J.; Parallel Computers,

Santa Cruz, Calif.; Synapse Computer, Milpitas, Calif.; and Tolerant Systems, San Jose) have installed new ceos in 1984. Along with Sequoia Systems in Marlboro, Mass., which changed its top management in 1983, they have also had to institute layoffs and other cutbacks.

Even Tandem's growth has moderated noticeably since 1982; and Stratus, while posting revenue gains reminiscent of Tandem's early years, has so far been unable to maintain a consistent growth in profits.

Still, long-term prospects for FT systems are excellent. As more workers come to rely on computers in the performance of their daily duties, the tangible and intangible costs of computer downtime escalate

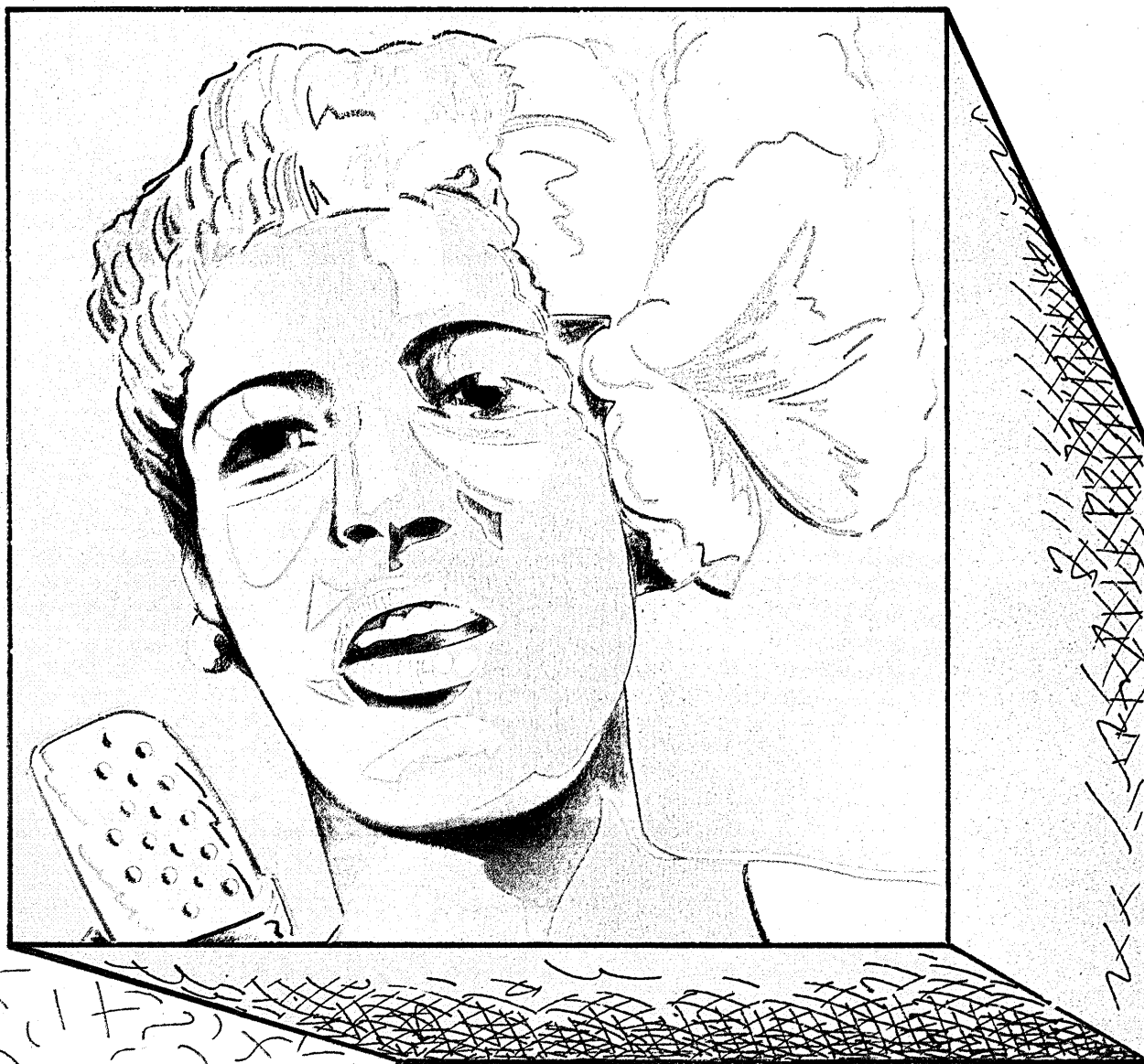

ble costs of computer downtime escalate sharply. Already there are many managers who must watch helplessly as workers idly mill around, waiting for their shared computer to be repaired. Customers who are frustrated because they can't obtain urgently needed cash from a malfunctioning ATM may consider switching to another bank. Increasingly, computer downtime affects the the profitability of a business, and management awareness of that fact will intensify the interest in FT systems.

FT systems are computers that are able, with a high degree of probability (but never a certainty), to detect and recover from some classes of internal failures—mostly hardware, but occasionally software errors, too. They do this before such fail-

ures affect the process being controlled, the database, or the end user.

High availability is especially desirable in two types of commercial applications: on-line transaction processing (OLTP), and "work group" servers, also known as team computers. Both are areas of very high growth. OLTP applications are characterized by a central database users can update and interrogate. The airline reservation systems of the mid-1960s were early examples of large-scale OLTP systems. Currently, OLTP applications are being fostered by the relentless drive to put all sorts of business applications on-line, including classical back-office tasks like accounting and inventory control. OLTP applications are the main target of Tandem and most of

the newer FT suppliers.

OLTP applications already consume the lion's share of the total throughput represented by mainframe shipments today, and a smaller but still significant share of supermini shipments. The potential OLTP market is measured in the billions. A recent survey of IBM mainframe installations, for example, found that nearly 70% employed CICS, while another 7% had IMS/DC or both; only 13% had no teleprocessing monitor of any kind.

The need for workgroup servers is created in part by the popularity of desktop computers, especially in offices. These servers act as custodians of shared databases, common depositories of private files, hubs of electronic mail systems, and arbiters of

ILLUSTRATION BY BERNARD BONHOMME



# New architectures can be successful in serving new market requirements, as IBM has proved with its PC and Apollo with its CAD/CAE workstations.

printers. Stratus, Parallel, and NoHalt Computers of Farmingdale, N.Y., are attempting to serve this marketplace.

While workgroup servers are still nascent, IBM for one has recognized their potential: recent moves strongly suggest it will position the System/36 line for "departmental" applications.

## FT MARKET NOT LIMITED

The potential market for FT systems is therefore not limited by lack of opportunities. Tandem Computers was the first to see this potential, and the loosely coupled, multiminicomputer system it began shipping in 1976 led to five years of torrid, 100% compound growth.

By 1980, Tandem's success inspired a new wave of FT suppliers, including Stratus Computer, Sequoia Systems, Synapse Computer, Auragen Systems, Tolerant Systems, Parallel Computers, and Computer Consoles of Rochester, N.Y. Capitalizing on the advances in microprocessor technology, these newcomers set out to develop clever and cost-effective multiprocessor architectures offering various degrees of fault tolerance. They were able to attract substantial support from venture capital firms and major investment funds. But, as noted above, virtually all have experienced difficulties recently. What went wrong?

*Product delays.* With the exception of Stratus, all of the new-wave players have encountered substantial product development delays. Although all base their products on off-the-shelf microprocessors (especially the Motorola 68000), the complexities introduced by the multiprocessing architecture and the FT features are at least an order of magnitude more severe than those encountered in designing a run-of-the-mill, single-processor system. Software in particular proved a tough nut to crack, both for those who decided to start from scratch (Synapse, Sequoia), as well as for those who tried to adapt Unix.

It is interesting to note that all of these startups were formed by people with little previous experience in commercial FT systems; even today there are no direct Tandem spin-offs. They therefore needed to learn on the job, a difficult task made harder by competitive pressures and by investors' impatience.

Stratus is the only new-wave company that has been able to bring out an initial product, along with an impressive array of software, less than two years after launch. It also managed to introduce two more advanced models about two years after the original product. Stratus has been able to achieve this principally because its

self-checking, "pair-and-spare" FT architecture is transparent to all user software and most system software. Thus, most software could be developed without reference to the FT intricacies, an important advantage.

*Financing.* An inability to demonstrate working products made it difficult for the startups to obtain orders. Auragen appeared to be an exception; in October 1982, it concluded an agreement with the West German firm, Nixdorf Computer AG. But that agreement, reached well in advance of the product's existence, was not a simple oem deal; rather, it was a technology exchange agreement, under which Nixdorf received manufacturing rights and exclusive marketing rights in parts of Europe.

While some players (including Auragen) eventually did manage to build working prototypes, in general they still required much more development work, especially in the area of FT features and software support. With the investment community becoming much more selective in its support of computer startups in 1984, the fledgling FT suppliers found themselves caught in a vicious circle. Incomplete product development made it hard to get orders, and the lack of orders made it impossible to raise the additional funds needed to complete product development.

## ACHIEVING FAULT TOLERANCE

*Compatibility.* Clever architectures have been devised by FT suppliers in order to achieve robust fault tolerance. Unfortunately, these architectures are drastically different from existing systems, especially the IBM mainframe line and the DEC VAX family. There are two main reasons for this. First, FT systems are based on multiprocessor architectures, whereas IBM and DEC offerings are implemented as conventional single-processor systems. Even the so-called multiprocessor models (IBM's 303X attached or multiprocessor complex, and 3084; DEC's VAX 11/782, and the VAXcluster) are essentially minimal extensions of the single-processor environment. Second, the instruction repertoire and I/O structure of individual processors in current FT systems are substantially different from IBM's or DEC's; Tandem's was influenced mainly by the HP3000, while the new-wave FT suppliers embrace the standards established by their microprocessing unit supplier; most of them use the Motorola 68000.

New architectures can be successful in serving new market requirements, as IBM has proved with its PC and Apollo with its CAD/CAE workstations. Organizations im-

plementing OLTP applications (e.g., banks, brokerage firms, and other financial institutions), however, tend to have a large investment in IBM mainframes and/or the DEC VAX line. Such investment includes not only the cpu and peripheral hardware, but also custom and packaged software and training for MIS staffs and end users. Users are becoming reluctant to accept systems that require substantial new investment in any of these areas.

Some FT suppliers—notably Auragen, Tolerant, Sequoia, and Parallel—hoped to overcome these objections by offering Unix compatibility. This hope has been thwarted so far by two factors. First, Unix is singularly unsuited for supporting multiprocessing environments and transaction processing missions, so much so that at least one FT vendor, Sequoia, decided to implement Unix compatibility by developing a completely proprietary kernel, discarding the one supplied by AT&T.

Second, end-user acceptance of Unix as a universal standard has been painfully slow, despite an apparent ground swell of support from major suppliers (Hewlett-Packard, Sperry, and even some IBM divisions). Few end users care about Unix per se; most are unlikely to be interested until convincing end-user software, available exclusively on Unix systems, begins to develop.

Tandem and Stratus have attempted to ameliorate the compatibility problem by offering high-level SNA compatibility. Their systems can coexist with IBM systems within the framework of an SNA network, in the sense that terminal users connected to any one of these systems can access application programs on any other.

*Competition from established suppliers.* Thus far, no conventional supplier has attempted to offer a standard system designed specifically for FT service. The problem these suppliers face is the other side of the compatibility coin: their range of design options is substantially restricted by the investment in existing architectures and software they (and their users) have made.

On the other hand, several conventional suppliers have developed a variety of loosely coupled solutions involving slightly modified existing products. Examples of this approach are the DEC VAXcluster, the NCR V8500/V8600 cluster with the Instant Ready software, and the Perkin-Elmer Series 3200 Resilient System, to name a few. IBM has been offering multiple-access disk, tape, and communications controllers for about 20 years now; such controllers have been used to construct multicomputer complexes for high-availability as well as high-throughput requirements.

# How to tell when an on-line application development system is exactly right for you.

If you're like most DP managers, you have a tremendous on-line application development backlog. And too few Command Level COBOL programmers. Which means you need an on-line application development system. The question is, which one?

Now there's a quick, simple, graphic way for you to find out.

## Define your parameters with The Resource Management Grid.

Based on experience with over 2,000 CICS users, Oxford Software has developed The Resource Management Grid. By plotting all the projects on your work list on this grid, you can define which on-line system best meets your own unique parameters.

### Upper-left-hand cluster: Optimum UFO performance.

When your on-line projects cluster in the upper-left-hand corner of the grid, delivery time is your main concern. So the system for you is UFO<sup>®</sup>, a fourth-generation solution to on-line application development in the CICS/VS and IMS/DC environments.

UFO dramatically reduces the time required to develop and maintain new programs. What might take months to put up and get running with Command Level COBOL can now be accomplished in as short a time as one day. Because UFO is so easy to use, your entire programming staff can develop applications with it. And even end users can participate in the development of programs and access data for one-time inquiries.

### Lower-right-hand cluster: Optimum UFO/COBOL performance.

When your on-line projects cluster in the lower-right-hand corner, your primary concern is machine-resource availability. Thus, UFO/COBOL<sup>®</sup> is appropriate for you, utilizing machine resources equal to Command Level with significant gains in the speed of developing new applications.

In UFO/COBOL, the CICS coding skills normally required of the programmer are inherent in the UFO/COBOL language. So complete, portable CICS programs can be written in standard ANSI COBOL in a familiar and natural way. While you're maintaining established shop standards.

The Application Development Resource Management Grid:

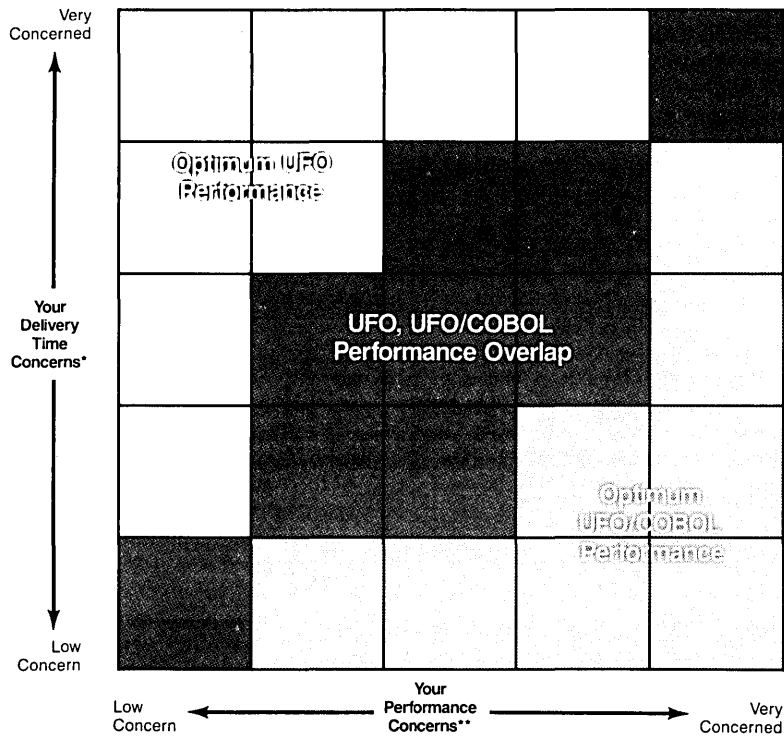

\* A Function of—Number of programmers, Number of applications, Skills available, Due dates.  
 \*\* A Function of—Machine resource availability, Application complexity, Transaction volume.

### No cluster pattern: UFO plus UFO/COBOL.

You may well find, however, that many of your projects cluster right in the middle of the grid. Or that there is no pattern. In that case, installing both UFO and UFO/COBOL is the most cost-efficient solution.

For example, you use UFO to get a program put up and running quickly, with the potential to convert it to UFO/COBOL for maximum running efficiency.

### Call or write for your Grid Kit.

Only you can decide, of course, which on-line application development system meets your needs best. Or which vendor can provide you with the most complete solution. But The Resource Management Grid Kit can be of immeasurable assistance in helping you make these assessments.

Call OXFORD today  
(800) 631-1615

**OXFORD SOFTWARE CORPORATION**  
 174 BOULEVARD/HASBROUCK HEIGHTS, NJ 07604/201 288-1515

Please send me your Grid Kit.  
 I'd like to schedule a  UFO and/or  UFO/COBOL demo.  
 Please call to set a date.

DM-32  
 Name \_\_\_\_\_  
 Title \_\_\_\_\_  
 Company \_\_\_\_\_  
 Address \_\_\_\_\_  
 City \_\_\_\_\_  
 State/Prov \_\_\_\_\_ Zip/Code \_\_\_\_\_  
 Phone ( ) \_\_\_\_\_

**OXFORD SOFTWARE CORPORATION**  
 174 BOULEVARD/HASBROUCK HEIGHTS, NJ 07604/201 288-1515

W.S.A. Outside North America, contact one of the following WSA companies; **Europe**—Austria 0222-31351840; Benelux (NL) 03402-61066; France (Paris) 1-294-2184; (Lyons) 7-233-7473; Greece 01-9590-631; Italy 011-517618; United Kingdom 01-950-3576; West Germany 02161-67604; Scandinavia (Sweden) 08-761-7380; Spain 01-279-6100; **Middle East/North Africa**—Greece 01-9590-631; **South Africa**—11-337-3040; **Israel**—4-256195; **Asia**—Hong Kong 05-666511-3; Japan (Nagoya) 052-211-5021; (Osaka) 06-445-7561; (Tokyo) 03-437-0921; Singapore 65-2253755; **Australia**—New South Wales 02-436-2477; **South America**—Brazil (Rio de Janeiro) 021-224-4379; (Sao Paulo) 011-258-1983.

# End-user acceptance of Unix has been painfully slow, despite an apparent ground swell of support from major suppliers.

## SOLUTIONS NOT COST-EFFECTIVE

Compared with "true" FT systems, such solutions are not cost-effective, because the smallest replicated module is a complete, standalone computer system with most of its own peripherals. They are also flawed in that the user must typically develop the software needed to implement automatic recovery from faults. Nevertheless, in situations where the user places a large value on the investment in existing facilities, such systems may be more appealing than the elegant solutions offered by the FT vendors.

**Transaction throughput.** Most current FT architectures employ multiple, relatively low-powered processors, where the individual processors are capable of handling about one to five transactions per second (tps). Such architectures can adequately handle low-to-medium transaction applications, where cpu requirements are light relative to I/O loads. When the application calls for processing power beyond the 100tps to 200tps range, or when the cpu load is heavy, an architecture using a small number of very powerful processors that take advantage of economies of scale may be more appropriate.

IBM has had notable success in penetrating these latter classes of applications, beginning with the airline reservation systems of the mid-1960s. The IBM Airline Control Program has since been substantially enhanced. This real-time transaction system, now renamed TPF2 (Transaction

Processing Facility, Version 2), has been selected by the Bank of America in California to support the next generation of on-line teller systems. Even though TPF2 has little in common with CICS, IMS, and IMS-FastPath, IBM's current flagships in transaction processing, the compatibility argument combined with the transaction throughput consideration often wins the day against the FT suppliers.

Similar compatibility and throughput considerations have excluded the FT suppliers from competing for the design prototypes of the computer systems to be installed in the 20 en route air traffic control centers (awarded in late 1983 to teams led by IBM using IBM gear and Sperry using IBM-compatible systems from Amdahl.) The high-availability system will replace the currently installed IBM 9020 triple-processor systems, in which the individual processors are essentially System/360 compatible.

**Increased reliability of conventional systems.** IBM staffers are fond of pointing out that some of their installations have never experienced a TCM failure. (TCMs, or thermal conduction modules, are the basic sealed component packages from which the 308X series machines are constructed.) Their point is that the reliability of conventional systems has reached such high levels as to obviate the need for special fault tolerant features.

It is certainly true that as more functions are compressed into fewer VLSI

chips, the reliability of systems offering a constant level of functionality and performance will improve, simply by virtue of reduced component counts. Desktop microsystems can already boast mean time between failures (MTBF) measured in years. Large-scale systems routinely offer 99% availability.

It is worth noting, however, that 99% availability is not especially high; it means, for example, that a system operated eight hours a day can be expected to be unavailable some five minutes every day. While the number of applications requiring better than 99% availability is relatively small, that number is increasing.

**Focusing on the problem.** Probably the most fundamental argument against current FT systems is that they are focusing on the wrong problem. Just about all FT suppliers offer systems that provide reasonably robust fault detection and recovery within the cpu proper, and which are capable of maintaining database integrity and consistency. Of course, the degree of such robustness is the subject of hot disputes among the competing firms.

## FACTORS CAUSING DOWNTIME

Unfortunately, high availability is not assured by a system's ability to recover from processor or disk failures. Several other factors contribute to downtime. Some are factors within the computer proper that reduce the system's availability and for which no effective solutions are known. These include operator errors, various software bugs, the installation of new operating system releases, and sometimes even the collection of database checkpoints needed to support database recovery. During the installation of new software, or database dumps, the system is generally unavailable for routine operation.

The design of the AT&T 3B20D fault tolerant supermini anticipated the following frequency of downtime causes (evidently based on accumulated experience with previous FT computers in the telephone network): hardware, 20%; system software, 15%; inability of recovery software to effect automatic recovery, 35%; and procedural (operator) errors, 30%. Note that at least 30%, and possibly 65%, of these causes are beyond a designer's control.

Still other factors are external to the computer. Although uninterruptible power systems are often installed to support critical on-line applications, few computers incorporate such systems as an integral part, and few computer suppliers undertake to supply them.

Unreliable communications lines

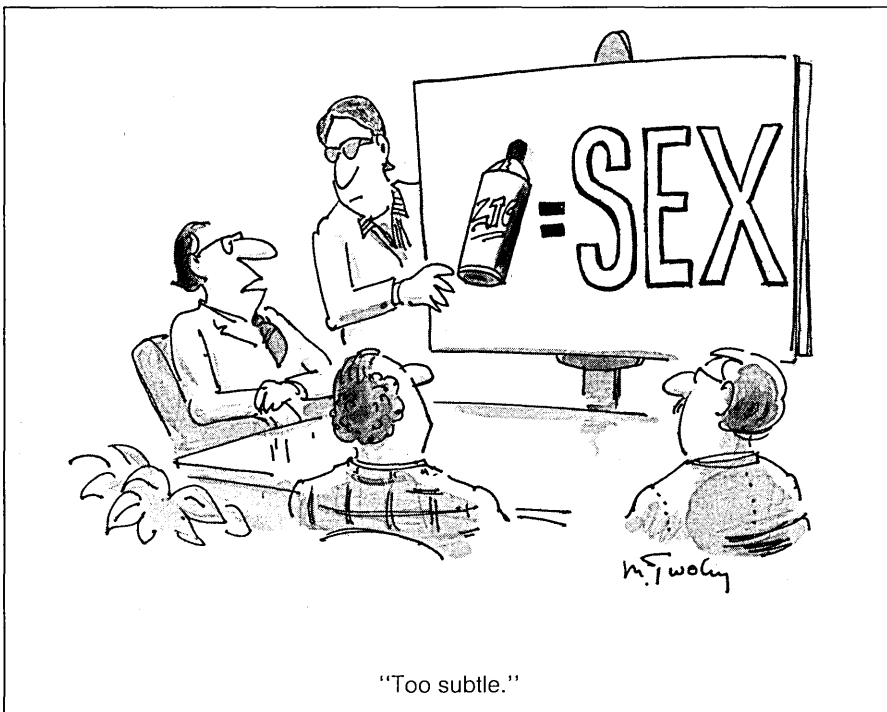

# The price is just one of its qualities.

The 921 is built to the highest quality standards in the industry—our own.

The efficient, contemporary case houses modular subassemblies. All components are pretested and pre-stressed. Boards are mounted vertically to run cooler and last longer. And there's even room for plug in upgrade options. Like our low cost, Tektronix® compatible graphics board.

Superior performance is another outstanding quality of the 921. You'll find it in a keyboard arranged for individual workstyles, with non-volatile function keys.

You'll find it in your choice of green or amber screens offering exceptional readability. And in the 921's code compatibility with our popular 925 family of products.

The TeleVideo® 921. Now you know that low price is just one of its qualities.

To know more, call toll free (800) 538-8725. In California, call (800) 345-8008.

## The TeleVideo 921

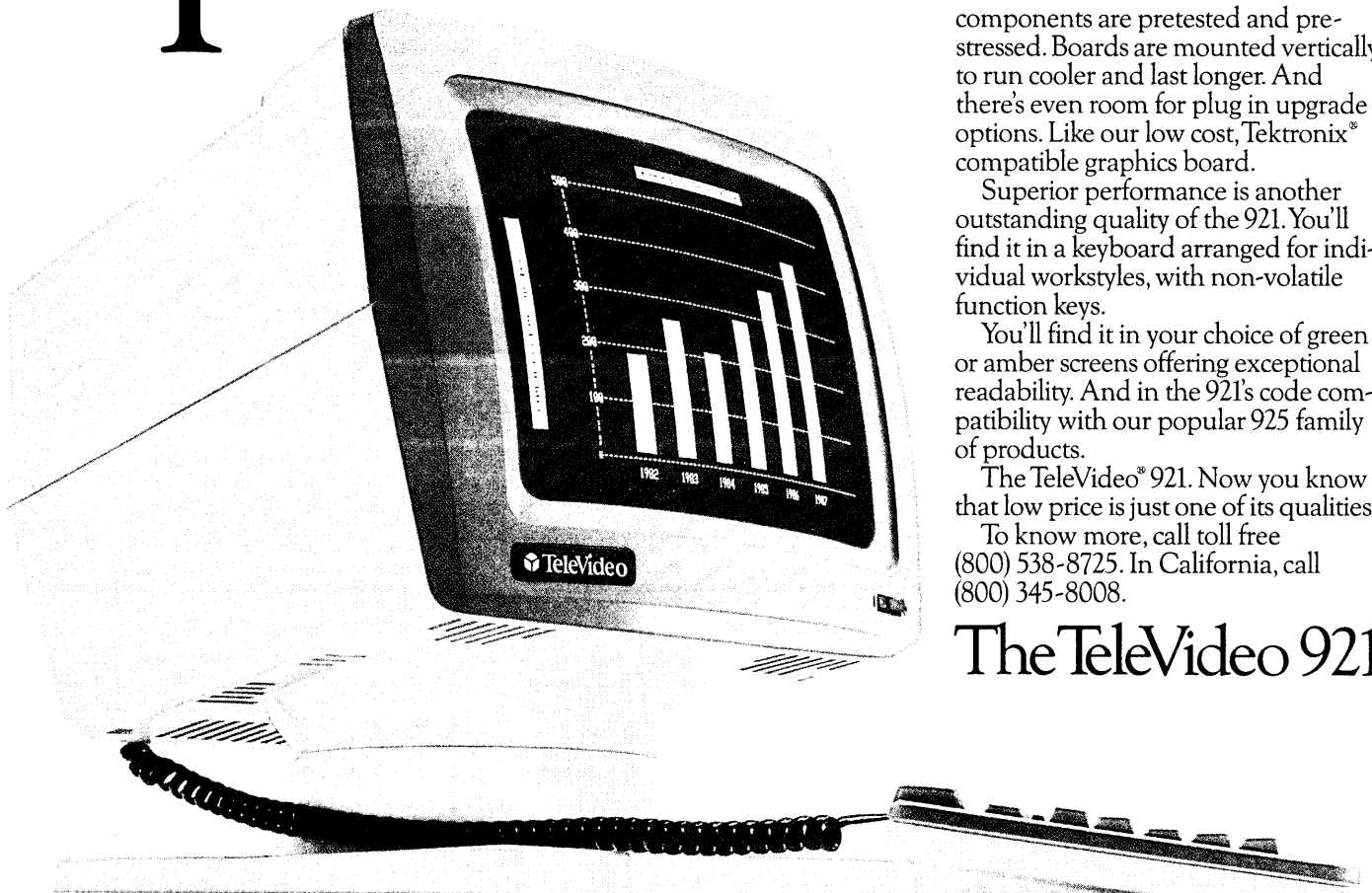

Tektronix is a registered trademark of Tektronix, Inc.



CIRCLE 39 ON READER CARD



## If these systems were offering 100% availability at no added cost, wouldn't everyone be buying them?

are another external factor. Data reported by the Bank of America, for example, based on early experience with its teller support system, which went into operation in 1978, suggest that some 50% of the causes of unavailability to end users resulted from communications line problems, not problems with the central or remote computer gear.

*The cost of fault tolerance.* It's commonly said that FT systems cost more, and that users are resisting them for that reason. To prove this, a bit of sophistry is used: if these systems were offering 100% availability at no added cost, wouldn't everyone be buying them? Since everyone clearly isn't buying FT systems, they must cost more.

In fact, historically there has been no added cost for fault tolerance. Tandem systems had a whopping price/performance advantage against mainframes, and were at least equal to other superminis, provided the load called for at least two processors. Stratus uses off-the-shelf microprocessors to implement a high degree of redundancy, while still offering systems

price competitive with superminis.

It is true that there may be instances of lost performance, especially when such mechanisms as disk mirroring and transaction logging are invoked. It is possible to argue, however, that the penalties incurred are balanced by improved performance on disk reads (in the case of disk mirroring), and by the fact that the transaction logs can be used to extract data needed for applications-oriented audit trails.

Users can quantify the value of an FT system with the formula, Saved Profits =  $F \times L$ , where F is the probability that the FT system will reduce service disruptions, and L is the annual loss of profits due to service disruptions experienced with existing systems.

The real problem is not the added costs, but the fact that current FT systems cannot provide 100% protection from all causes of unavailability. (This means, incidentally, that in the formula above, F must always be less than 1.)

So the MIS manager is faced with a dilemma. On the one hand, the new FT suppliers offer elegant systems that provide

good protection against some, but not all, of the causes of downtime. Unfortunately, the architectures they offer are incompatible with his existing gear. On the other hand, the conventional supplier (IBM, DEC, NCR, and so forth) probably has some sort of kludgy but workable solution to high-availability requirements. These, too, do not solve all problems; in fact, they aren't even as effective as true FT systems in recovering from basic cpu and disk failures. The big advantage, however, is that the architecture is a known entity, most investment in existing software can be salvaged, and little if any new training is called for.

These are pretty powerful incentives to stay with the conventional supplier. It isn't surprising that, more often than not, the conventional supplier wins. ©

Omri Serlin heads ITOM International Co., a research and consulting firm in Los Altos, Calif. His monthly newsletter, *FT Systems*, analyzes business and technical developments in fault tolerant systems. His other interests include supermicros and local area networks.

# FIRE... DESTROYS COMPUTERS

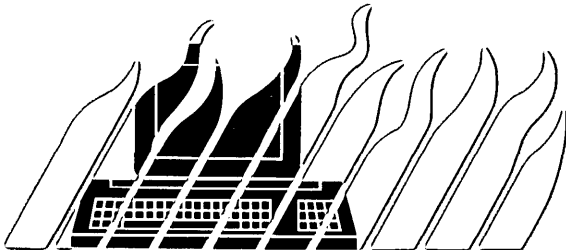

Worse, it can cause costly business interruptions. But take heart! Ansul, the world's leading manufacturer of fire protection systems, has developed ingenious, new, cost-effective solutions that you should know about.

Write for our new, useful (and free) booklet "Facts About Protecting Electronic Equipment Against Fire."

Ansul, Dept. 1D, Marinette, WI 54143. or call (715) 735-7411.

## ANSUL

## Payroll Savings, America's favorite way to save ...and that's no CROCK!

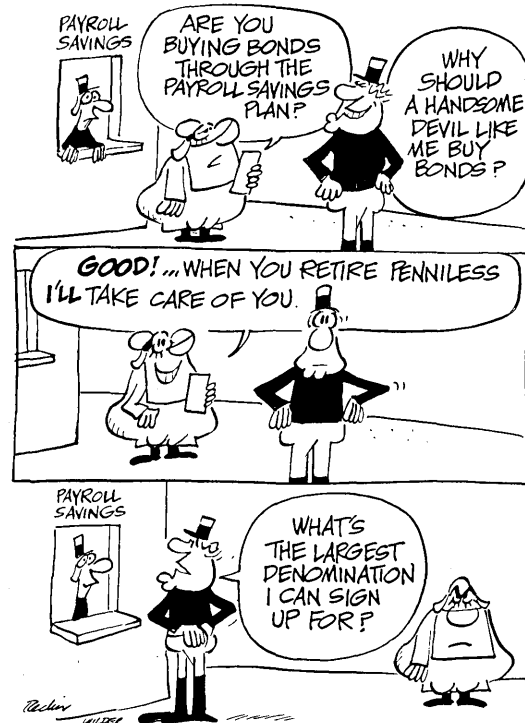

Field Enterprises, Inc., 1983



# GLOBAL, SHARED, LOCAL

by Cort Van Rensselaer

In April of 1979, a DATAMATION article ("Centralize? Decentralize? Distribute?" p. 88) described Hewlett-Packard's experience in matching its information systems to its organization and management style. Specific examples showed that our administrative data processing systems mirrored whatever environment was necessary: centralized, decentralized, or distributed.

The systems required to accommodate our business and geographic growth during the ensuing six years have resulted in an eightfold increase in the number of computers and a factor of 20 expansion in the number of workstations HP uses. The installation of hardware units has accelerated as more and more computing capability per dollar has become available with the passage of time. While the systems concepts we presented in 1979 remain true today, we have validated some new ideas through successful experience. In particular, we have improved our understanding of how to establish globally distributed information management tools that help our employees make significant contributions to companywide productivity.

To manage the rapid growth of computer resources more effectively we developed eight information systems management principles. Five of these principles (see Fig. 1) were covered in the 1979 article; the other three represent concepts developed more recently.

Fig. 2 provides a six-year comparison of our key data processing activities. During this period, Hewlett-Packard grew at a compound annual rate of 23%, from net sales of \$1.7 billion to \$6 billion. Catalog products more than tripled to 15,300; net earnings per equivalent share increased from 65 cents to \$2.13; and the number of employees increased to 82,000 from 42,400.

HP's annual expenditure to support business data processing activities runs about 3.5% of sales (\$210 million for 1984). To provide the information resources needed to support our expansion, we added 44 dp centers at our factory and sales and service locations, bringing the total to 110.

In terms of number of computers, our growth in business data processing took place entirely in minicomputers. These units support nearly all of our on-line transaction processing activities. The lack of growth in the number of mainframe computers is misleading because of the traditional 30% annual increase in computer cost performance. The 10 mainframes of 1984 provide many times the mass batch processing and companywide database management capability of the 11 mainframes installed in 1978. Of course, minicomputers have benefited from a similar increase, and have doubled in power approximately every two years. Taking this into account, we have increased our total computer power per employee at greater than a 60% annual rate during this six-year period.

It is also important to point out that when personal computers used for office applications are excluded, the computers supporting business data processing applications represent less than 15% of the total number used at HP. An additional 4,900 technically oriented desktop and minicomputers support data communication, engineering, and factory automation activities.

**WORLDWIDE DATACOM NETWORK** All our business computers are interconnected through a worldwide data communications network. This network provides both batch and real-time links, the appropriate transmission method being selected on the basis of cost and timing considerations. The cur-

rent volume is on the order of 3 billion characters per day (equivalent to the daily transmission of 45 copies of Webster's unabridged dictionary.) Along with our worldwide order processing system, the network supports procurement, quality, personnel, accounting, and electronic mail applications.

To ensure that systems at every level are attuned to business needs, we assign information management responsibility to appropriate managers throughout the organization. If management wants decision-making to occur as close as possible to the action, systems that support local activities must be decentralized. At the same time, there are certain activities, such as financial accounting and payroll, which must be centrally managed to satisfy government and legal requirements. Other activities, like order processing and procurement, may be centrally orchestrated if that's how business requirements are best satisfied. We call the systems that support these companywide activities global systems, since they use widely distributed computers supported by our data communications network.

Our policy of providing workstation access to decision-making information for a majority of our employees has also helped us achieve significant improvements in productivity and quality. For example, our inventories as a percent of net sales decreased to 17% in 1984 from 23% in 1978. Based on 1984 sales of \$6 billion, this reduction freed up in excess of \$350 million for other uses. Making procurement and inventory information readily accessible to a wide range of manufacturing employees was a key contributing factor to this success.

During the past six years, desktop computers have been widely deployed throughout HP's product development organizations; one is now assigned to essentially every engineer. Simultaneous growth

## It recently became more convenient and cost-effective to handle individual productivity applications on pcs rather than on minis.

in the number of terminals supporting administrative activities has set the stage for widespread introduction of personal computers to increase business productivity.

For a number of years now, the minicomputers supporting these terminals have been equipped with programs for word processing, spreadsheet analysis, computer graphics, and electronic mail. Consequently, users have had access to these personal productivity tools as well as to decision-making information resources. A large portion of our work force has become accustomed to using the computer to handle daily tasks.

It recently became more convenient and cost-effective to handle individual productivity applications on personal computers than on minicomputers. Therefore, during 1984 we added about 8,000 personal computers to our network, bringing the total number of business-oriented workstations to over 33,000 and the number of employees per workstation down to less than three. These pcs, operating as both intelligent terminals and standalone processors, give the users the same access to decision-making information that they had with terminals, plus the additional ability to perform local applications off-line.

The terminal and host minicomputer environment allows us a high level of security and control over our information resources. Our business systems give selective authority to access, update, or delete information. Extensive edits are included to ensure the integrity of data entered into the systems. Built-in backup and recovery procedures are included. Programs are available to enable our internal auditors to test the validity of stored data.

This approach has provided an orderly transition to increased use of personal computers. All the work we have done over the years to provide security, privacy, audit and control, and backup and recovery procedures to support our business applications remains in place in a fully functional mode. We are experiencing a "controlled pc revolution"! We are crossing to the point where more processing power is on desks than in the computing rooms. Obviously, we can more fully use this capability to support our transaction-based applications.

### THREE KINDS OF SYSTEMS

At HP, systems come in various flavors, depending upon where, how, and for what purpose they are used. A successful new product program calls for small divisional units to have local responsibility for tactical decisions. As they grow, HP divisions are often split to preserve the small organization in

FIG. 1

### HP INFORMATION SYSTEMS MANAGEMENT PRINCIPLES

1. Make information management responsibility an integral part of each manager's job.
2. Organize information systems to match the management structure.
  - Decentralize those systems that support locally managed operations.
  - Provide global systems to support the few activities that management decides must be centrally orchestrated to satisfy legal or companywide business requirements.
3. Design systems that can respond to geographic expansion, organizational change and the addition of new operating units.
4. Establish a long-range strategy to guide information systems evolution. Provide the architecture and standards required to ensure that business integrity will be maintained and to make independently developed systems play together.
5. Provide decision-making information and communication resources for all employees through workstations connected to a companywide network.
6. Leverage systems investment and support by making available a selection of shared systems to support local operating units.
7. Encourage development of applications locally, both to satisfy unique needs and to provide prototypes for future shared and salable systems.
8. Share our successful practices with HP customers by offering as products the application software we use to support internal operations.

which this entrepreneurial atmosphere can thrive.

As a balance to this decentralized divisional structure, HP is committed to being a unified company. It is essential to maintain a "one-company image" in a few important areas—customer relations, vendor relations, quality, personnel, and accounting. Not only does this approach help us provide direction for our companywide activities, it also helps us cope with government, legal, and taxation requirements.

As a result, we need to centralize some activities and decentralize others. The information systems required to support this dispersed but unified environment can be classified as global, shared, or local (see Fig. 3).

HP, like other organizations with distributed operations, has certain activities that management decided must be handled uniformly throughout. Most often, this is accomplished by establishing policies and charging local management with responsibility to see that they are followed. The task of checking policy compliance is often assigned to the internal audit department. We have found that global systems help us operate and control many of the activities that management has decided to handle uniformly across the company.

HP global systems use a distributed network of computers located at over a hundred geographically separate locations tied together with a worldwide telecom-

munications network. Since these systems provide essential support services such as orders for products and paychecks for employees, their use is required by divisions. Global systems tend to be HP specific because they mirror our unique management philosophy and policies.

Shared systems resemble global systems since they are installed in more than one location, but differ because they are not tied together with a multisite network. These systems provide the backbone of support for local activities such as materials and production management, cost and general accounting, and order processing. Since many HP divisions need the same system features, shared systems can provide substantial savings in design, enhancement, and support resources. The eighth information systems management principle (see Fig. 1) was to offer as products the application software that we use to support our internal operations. Shared systems, such as production planning, master scheduling and MRP, fall in this category since they support generic needs for a broad market.

Local systems are designed to satisfy unique needs or to provide prompt response to changing requirements. They can stand alone or be interfaced to global or shared systems. Many local systems are currently being implemented on HP personal computers. Local systems are used in a wide variety of applications including word processing, "what if?" modeling (using

spreadsheet analysis), forecasting, and budgeting. HP divisions are encouraged to develop applications locally to satisfy unique needs (principle 7, Fig. 1). These applications often become prototypes for shared systems or for HP products when the opportunity for widespread use is recognized.

Picturing how these different systems interact is difficult. To simplify matters, Fig. 4 illustrates the Hewlett-Packard Information Architecture. This is an excellent way to identify and explain the systems modules that are used to support business processes and the information relationships between them. Systems modules are usually defined rather narrowly so as to cover procedures used within a specific functional area.

**FRAME FOR INFO SYSTEMS**

We first developed a companywide information architecture at HP about 10 years ago. This was widely disseminated among managers throughout the company. It is periodically updated in response to changing business needs and to incorporate new systems as our information resource activities expand. Providing a framework for HP's information systems has helped us unify the development activities taking place throughout the company.

This somewhat oversimplified representation of the architecture appears as two decks of cards connected by five double-pointed arrows. Functional procedures used by the manufacturing facilities are on the left, and those used by the sales and service offices are on the right. In concept, each of the 50 manufacturing facilities and each of the 240 sales and service offices is represented by a card. The five global systems that provide the information structure to help HP's managers operate the company as one entity are shown in the middle. Since each of the global systems interfaces with all manufacturing facilities and with all sales and service offices, they provide a powerful unifying mechanism.

The product-development module appearing within the manufacturing area is used to support divisional engineering activities. Similarly, the order-management module supports factory-order processing activities. Administration functional procedures appear both in manufacturing and in sales and service entities since personnel and accounting activities are required throughout the HP organization.

The important concept of leverage is illustrated at the upper right corner of the manufacturing "deck." Many of the systems requirements for manufacturing entities are essentially the same. The order

management module shown is a shared system used by all entities. This type of module offers an opportunity for the HP divisions to improve their profitability by creating leverage in the development, enhancement, and support of their systems through sharing.

Each of the global systems interface to systems that operate at the manufacturing divisions or at the sales and service offices. These local interfacing systems may be centrally supported modules of the global systems, shared systems, or even local systems, depending on overall requirements and divisional needs. In the case of HP's companywide procurement system, the interfacing requirements are so stringent that local modules are centrally supplied and maintained. The same is true for the HP personnel system. On the other hand, for factory order processing, where divisional needs vary because of differing business requirements, divisions use a combination of shared and local systems. It should be noted that when unique local systems connect to global systems, divisions are required to adhere to companywide interfacing standards and must make systems changes locally as needed.

Another important concept illustrated by the information architecture is systems integration. Integrated systems use a common data resource. Systems supporting the various functions are tied together so that the information they provide supports the entire organization. This ensures consistency (marketing, manufacturing, and accounting all use the same numbers), and efficiency in data entry (one transaction updates all relevant records in the dif-

ferent functions). For example, a materials movement transaction will update manufacturing's inventory records and accounting's cost records.

**MODULE SET A KEY CONCEPT**

A key concept of HP's information architecture is that the set of systems modules used by each facility must support that entity's unique needs. Despite this diversity, there is also a great deal of commonality of information needs among HP entities. Besides the global systems contributing to commonality, certain functions, like factory order processing and materials management, have much in common with all HP manufacturing entities. Consequently, each HP division uses a combination of global, shared, and local systems, selected to support HP's overall business objectives along with the specific needs of the local entity.

Since the concept of global systems represents one of the three new information systems management principles we believe will be of special interest to other large multidivisional companies, some additional explanation should be given. Specific functions of global systems include the following:

- Offering an administrative framework that tells managers which areas require companywide consistency. Divisions can develop innovative solutions to local needs within those boundaries.
- Providing rapid and consistent consolidation and reporting of operations information. This early warning system gives HP management access to timely information on worldwide orders, shipments, and finan-

FIG. 2

**HP BUSINESS DATA PROCESSING STATISTICS**

	1978	1984	GROWTH FACTOR 84/78
<b>Net sales</b>	\$1.7B	\$6.0B	3.5
<b>Edp centers</b>	66	110	1.7
<b>Mainframe computers</b>	11	10	.9
<b>Minicomputers</b>	81	636 <sup>1</sup>	7.9
<b>Workstations</b>	1,600	33,500 <sup>1</sup>	20.9
<b>Employees</b>	42,400	82,000	1.9
<b>Employees/ Workstation</b>	27	2.5	.1
<b>Datacom Network Volume</b>	.16 bcpd <sup>2</sup>	2.7 bcpd <sup>2</sup>	16.9
<b>Sales/employee</b>	\$40,100	\$73,200	1.8

<sup>1</sup>Business data processing only. An additional 4,900 desktop and minicomputers and 5,300 workstations are used to support data communication, factory automation and engineering applications.

<sup>2</sup>Billion characters per day.

# We are crossing to the point where more processing power is on desks than in the computing rooms.

FIG. 3

## CATEGORIES OF INFORMATION SYSTEMS

CATEGORY	PURPOSE	CHARACTERISTICS	HP EXAMPLES	STRATEGY
<b>Global</b>	To help managers operate and control activities that must be handled uniformly on a company-wide basis	Distributed among computers in geographically separate locations, using a telecommunications network  HP specific	Sales and service  Procurement  Quality  Personnel  Accounting  Telecommunications	Local entity use required  Development, enhancement and support provided by dedicated staffs.  Changes initiated by corporate functions or user councils
<b>Shared</b>	To provide leverage in development, enhancement, and support of systems which help entities improve performance	Used in different geographical locations with central enhancement and support	Materials  Production  Quality  Cost accounting  General accounting  Order processing	System selection by local entity  Development by corporate function or HP Software Product Division  Enhancement and support by appropriate entity  Changes initiated by user councils
<b>Local</b>	To provide productivity tools that give prompt response to local information needs	Locally developed standalone or interfaced to global or shared systems	Applications tuned to local needs  Spreadsheets  "What if?" models  Word processing	Local entity development and enhancement

cial measures by product line, geographic location, and organizational entity.

- Permitting uniform application of companywide procedures and contractual arrangements. For example, the Purchasing Agreement Tracking System allows us to administer worldwide agreements with customers who buy our products at multiple sites.

- Facilitating response to changes in administrative policies and procedures that arise from new business requirements or legal obligations. Since global systems are installed in or accessed by all HP entities, centrally developed changes can be broadcast to all users for implementation at a specific time. Our companywide order processing system is changed regularly to support new marketing policies.

- Providing the necessary information tools to permit divisional entities to collaborate in carrying out companywide activities. An example is the procurement system that helps HP deal with its vendors as one company while preserving the decentralized character of its 75 local purchasing activities. By providing consolidated forecasts of materials requirements to our suppliers, this system helps us establish relationships that lead to improved quality, better ser-

vice, and lower cost.

- Maintaining standards required to generate consistent information. HP uses a set of companywide basic business codes to identify key items such as products, parts, customers, entities, accounts, and employees. Global systems provide edits that help preserve the integrity of these standards throughout the company. For example, HP has one, and only one, unique part number for each of some 150,000 replacement items held in inventory. This consistency generates significant savings in lower inventories and documentation, and in providing adequate levels of replacement parts.

- Creating an effective framework to support internal control. Data accuracy is improved by edits performed at local data entry points. Global systems also facilitate accurate consolidation of operating results. For example, the Financial Reporting System requires all entities to input their data consistently.

The global systems we use to support the sales and service, procurement, and personnel functions use databases that are distributed among our field offices and factories. As these applications do not require real-time updating of central records, we have been able to achieve significant

savings in data communication expense by distributing batch updated files. Field databases, located in regional headquarters, are accessed and updated interactively by local sales offices. Workstation access is provided in our factories. The central and distributed files are updated as often as required by the application. The frequency ranges from several times a day to once a month or even once a quarter. Over half of our data communications traffic is devoted to supporting these distributed databases.

### LIMIT GLOBAL USAGE

While global systems do help management implement common business procedures and information flows, we believe that their use should be limited to those critical areas where companywide consistency is essential. Furthermore, each global system should do only what is needed to support companywide activities and no more. HP management regularly reviews global systems plans to ensure that, as they evolve, we preserve a framework for decentralized decision-making.

The first information systems management principle, as illustrated in Fig. 1, was designed to make information manage-

**WANG  
IS ABOUT TO  
SHOOT HOLES  
IN IBM'S  
SYSTEM 36  
STORY.**

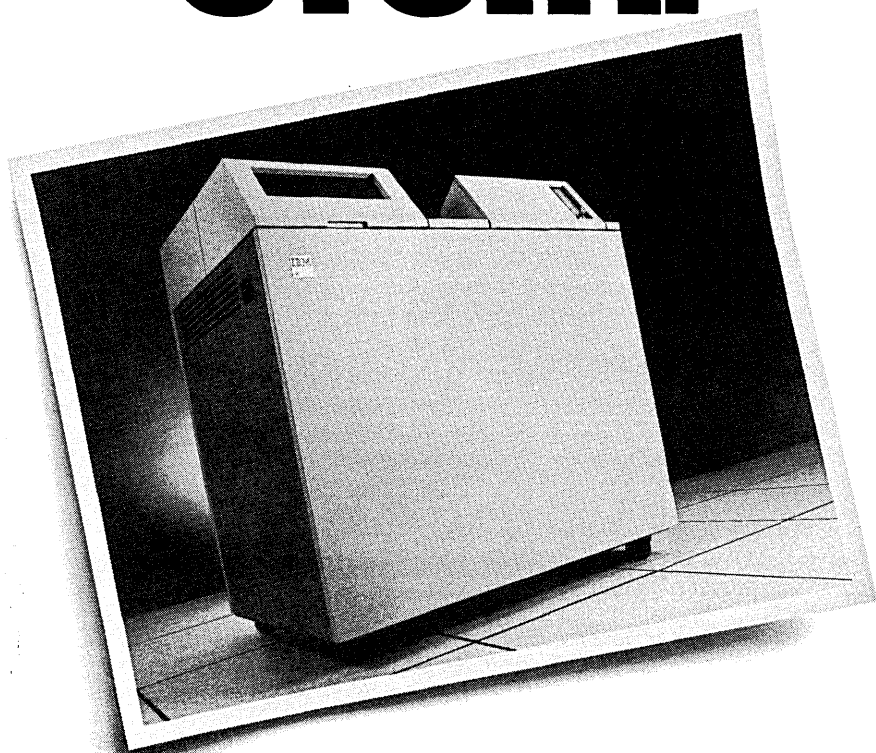



# JUST GIVE US ONE BLOW IBM OFF Y

If you're shopping for a solution to your departmental data processing needs, IBM's System 36

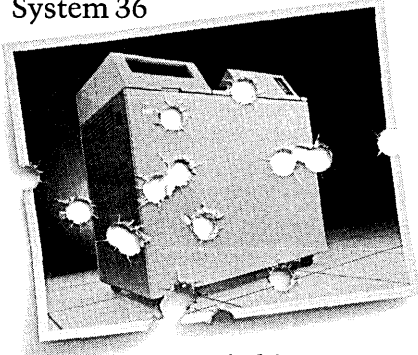

is probably on your short list of finalists. But it shouldn't stay there.

	WANG VS	IBM SYSTEM 36
Designed to integrate and distribute data processing and office automation	Yes	No
Sophisticated programmer productivity tools	Yes	No
Easily upgradeable	Yes	No
Local area networking	Yes	No
Intelligent workstations that offload the CPU	Yes	No
Easy user interface throughout system	Yes	No
Totally integrated office automation applications	Yes	No
Integrated graphics and text	Yes	No
Connects to PC network	Yes	No

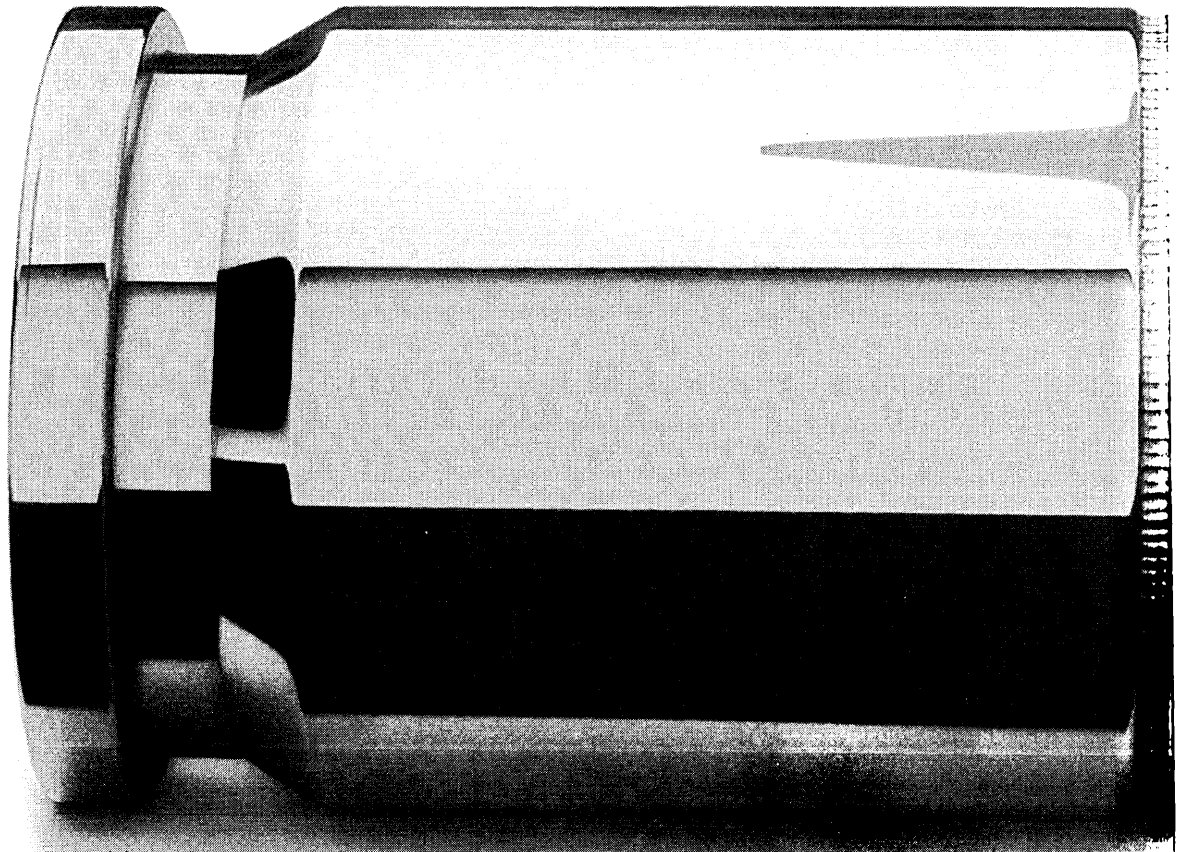

# WE SHOT AND WE'LL OUR SHORT LIST.

Because when you look at the facts, System 36 just doesn't stack up to the Wang VS.

For example, as the chart clearly shows, the Wang VS was designed to integrate data processing and office automation.

System 36 wasn't.

The Wang VS is easily upgradeable.

System 36 isn't.

The Wang VS gives you local area networking, intelligent workstations, a consistent user interface, integrated text and graphics, and programmer

productivity tools that can dramatically reduce your company's applications backlog.

System 36 doesn't.

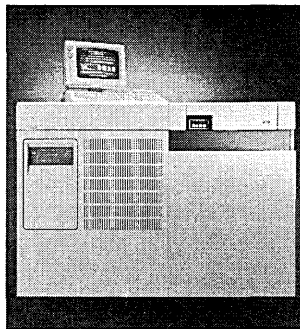

And every Wang VS computer is part of the Wang VS family, a fully compatible family of minicomputers that integrate data processing, word processing and graphics—all available for delivery now.

So look at their System 36. Carefully. Then call Wang at 1-800-225-9264 and challenge us to a benchmark

test. Or write to Wang Business Executive Center, One Industrial Avenue, M/S 5413, Lowell, MA 01851 for more information about the VS family.

Give us 20 minutes, and we'll help you cut that list down to just one name.

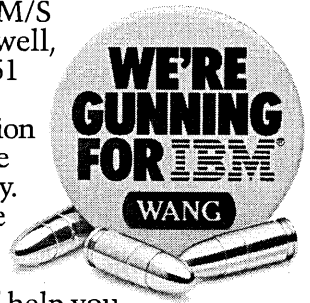

**WANG**

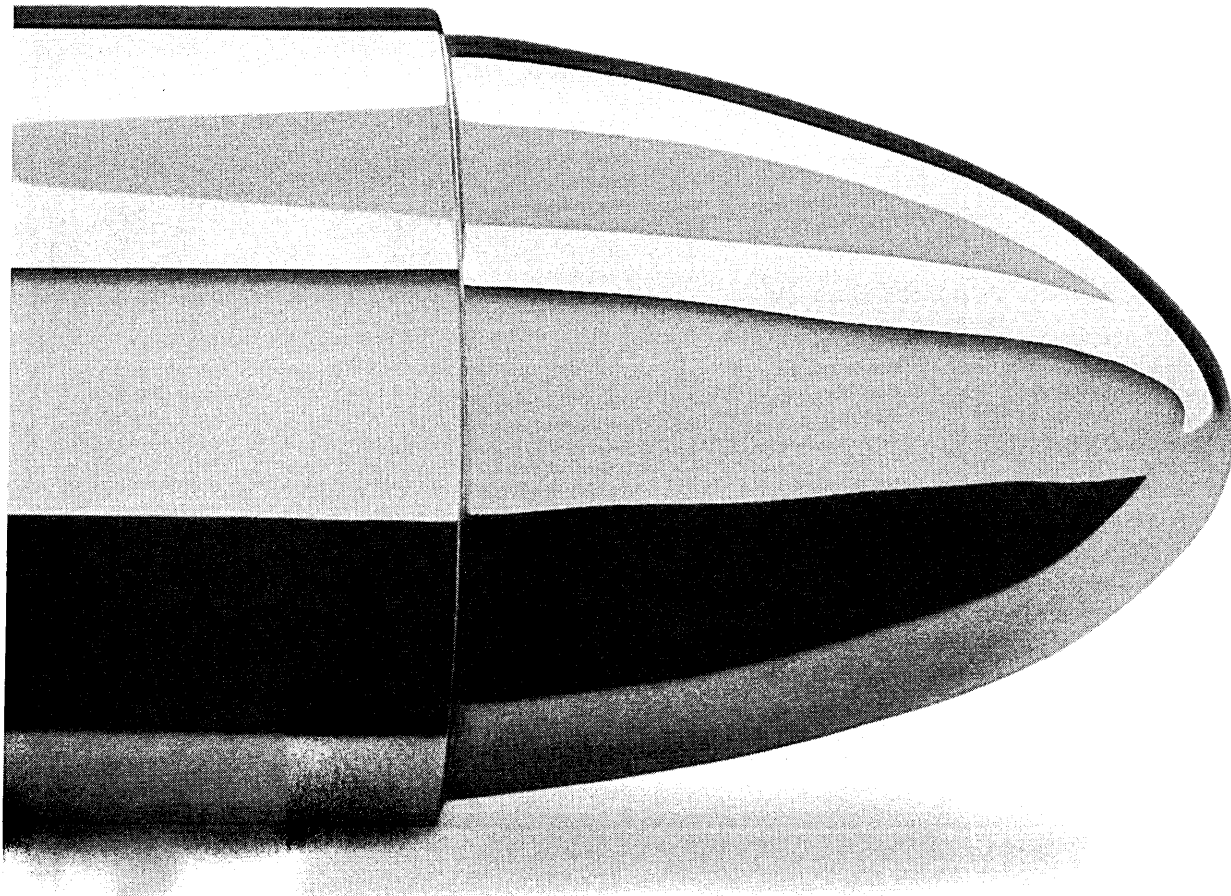

**Local systems are designed to satisfy unique needs or to provide prompt response to changing requirements.**

FIG. 4

**HP INFORMATION ARCHITECTURE**

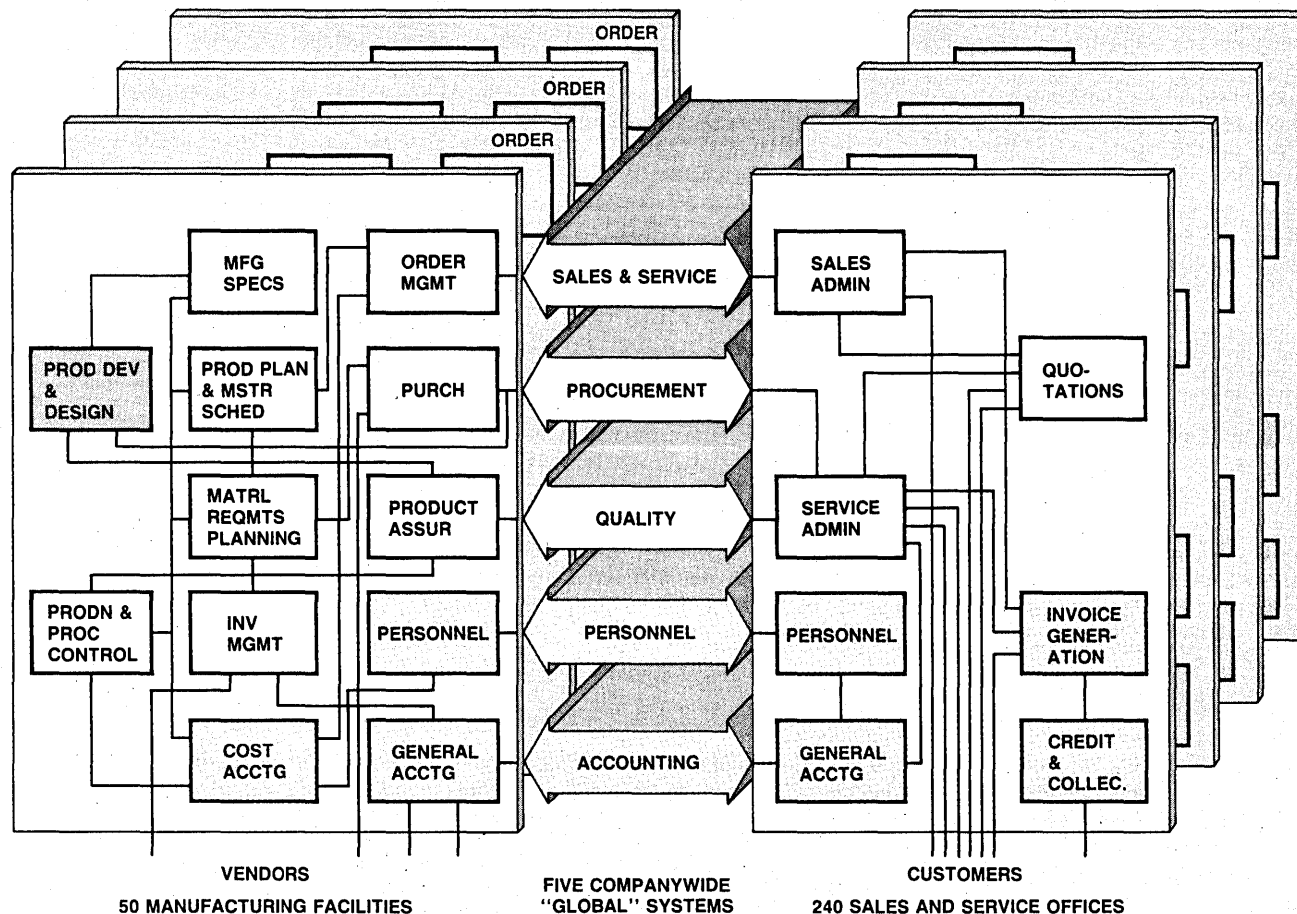

KEY: RED—SALES AND SERVICE  
BLUE—MANUFACTURING

GREEN—ADMINISTRATION  
BROWN—PRODUCT DEVELOPMENT

ment responsibility an integral part of each manager's job. As has been noted, this calls for assignment of responsibility for global systems ownership to functional managers at the corporate level and responsibility for local systems ownership to managers in the operating units. Coordination of these functionally oriented, geographically dispersed systems is handled by the Information Systems Steering Committee (ISSC), the centerpiece of the HP Information Systems Management Organization.

Each of the corporate executives responsible for a primary functional area—marketing, manufacturing, administration, and engineering—has an information systems department that develops and supports needed application programs. The

managers of these departments, along with the head of telecommunications and office systems, are members of the ISSC. Staff support is provided by a small group of systems specialists who perform many of the functions covered in the following paragraphs.

The ISSC's activities are reviewed by, and its recommendations approved by, the Information Systems Subcommittee of the HP Management Council, which is composed of HP's top operating executives. The objective of this subcommittee is to make information management an HP advantage. Through their efforts, information systems, as a service function, gets a full measure of strategic management attention.

The most important task of the ISSC

is the maintenance of an overall plan for the evolution of HP systems that will support the simultaneous development of compatible application software modules throughout the company. In line with HP's strategy to share our successful experience with our customers, the plan encourages use of HP hardware and software products to support internal activities. Progress toward the overall systems plan is continually monitored by the ISSC members, who initiate corrective action when needed.

Standards and guidelines must be followed if systems developed at different locations are to play together effectively. A key ISSC role is to establish, publish, and distribute the company's information systems policies, standards, and guidelines—

# In remote computing services, the time has passed for plain vanilla.

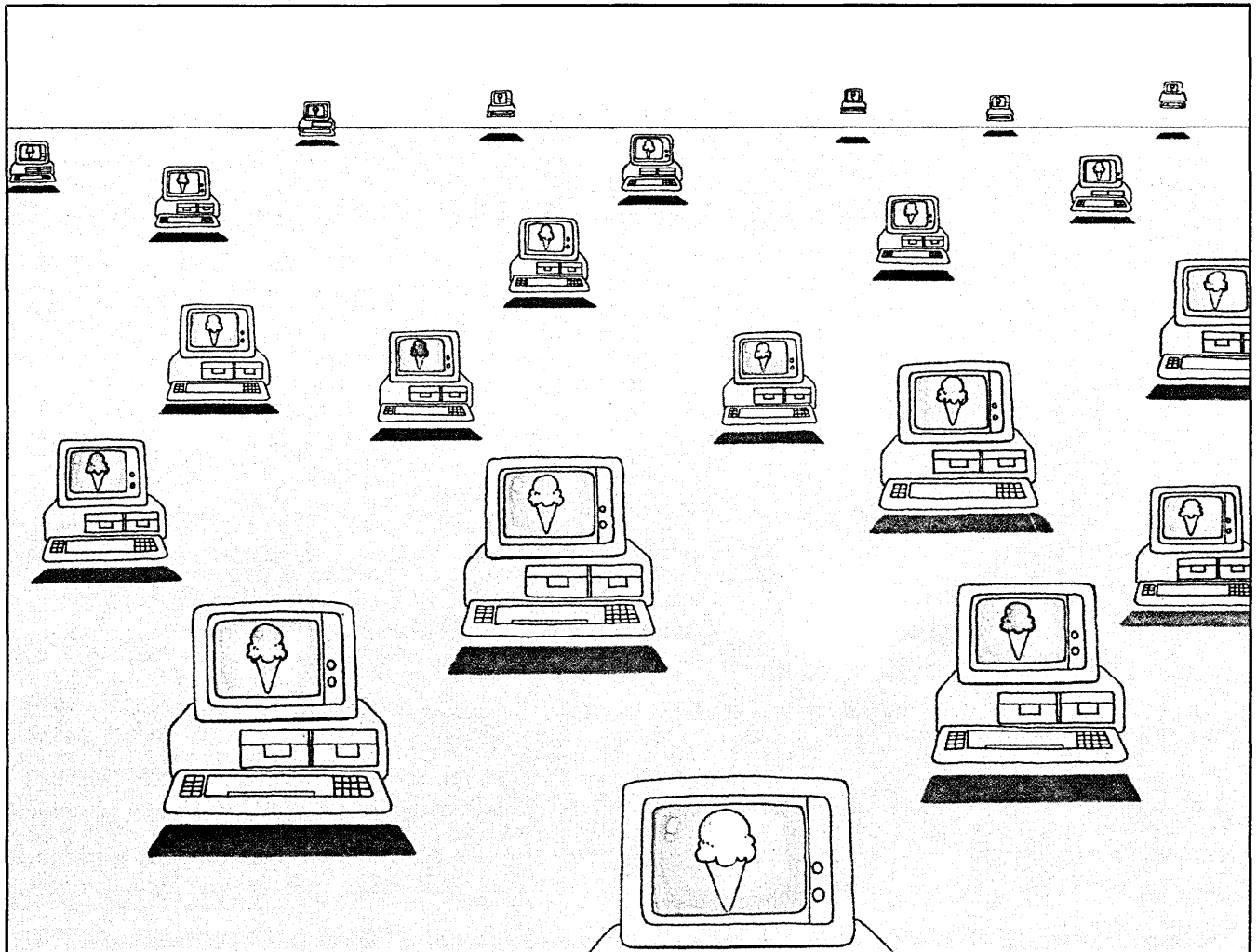

Today's information requirements call for more computing flavors than plain vanilla timesharing. That's why Boeing Computer Services is providing alternatives to our MAINSTREAM® teleprocessing service.

For example, Boeing now provides you service at fixed cost via our Equivalent Machine option, which simulates a minicomputer environment.

And we have a number of dedicated machine options that let you combine Boeing Systems Software and Service Management expertise with your own hardware, allowing you to concentrate on business, not managing your computers. The result: cost-controlled data processing.

We're offering advanced data base

management systems, too. Like Model 204, FOCUS\*, and other easy-to-use, end user Fourth Generation Languages, which can support large-scale data base processing.

These and other enhanced offerings

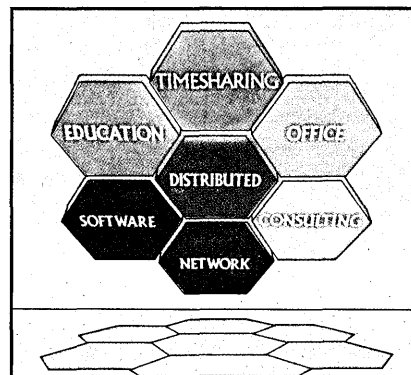

from Boeing illustrate our continuing effort to give you all the integrated information services you need. Including distributed processing and micro/mainframe links, office information systems, additional software solutions, education and training, and a variety of professional support services. All designed to let you maintain greatest possible control over your information processing at lowest possible cost.

For more information or the location of the sales office nearest you, call toll-free 1-800-447-4700. Or write BOEING COMPUTER SERVICES, M.S. CV-26-21Z, 7980 Gallows Court, Vienna, VA 22180. The flavor of computing has changed; our dedication to service hasn't.

## BOEING COMPUTER SERVICES

A Division of  
The  
Boeing Company

\*FOCUS is a trademark of Information Builders, Inc. MAINSTREAM is a registered service mark of The Boeing Company.

CIRCLE 42 ON READER CARD

## The use of global systems should be limited to critical areas where companywide consistency is essential.

and then to interpret, explain, and monitor their use. Hardware recommendations provide a listing of computer products, for selection by local entities, that will support the global and shared software applications. Software guidelines include crt screen format conventions that establish compatible user interfaces between different applications. The COBOL language is recommended for field-supported applications, although fourth generation languages are frequently employed in centrally supported shared systems and in local systems to increase developmental or operational efficiency.

As mentioned earlier, the ability of HP's functionally oriented, geographically separated systems to talk to each other has been greatly facilitated by a set of basic

business codes that identify and classify the objects of business administration. These codes apply to such items as products, parts, entities, accounts, customers, vendors, and employees. A standardized code is assigned to each item that must be uniquely identified on a companywide basis. Each code is "owned" by a corporate functional department, which has the responsibility for assigning values to the codes, or establishing, maintaining, and monitoring guidelines that permit local entities to assign the values. The ISSC maintains the master list of basic business codes.

As we've moved closer toward a cafeteria-style selection of application modules that will interface easily in user-selected combinations, the need for a broader set of data standards has become apparent. An

ISSC responsibility, in conjunction with the software division that produces manufacturing applications products, is to maintain a computerized data dictionary that provides the preferred data definitions as part of the software life cycle. New manufacturing application products are reviewed before being released, to ensure that their data are compatible with the dictionary.

We have found a few central activities to be effective in providing functional leadership for the 3,500 HP people who are engaged full-time in information systems work. Since these individuals report to local entities, job descriptions and position "scoping" are needed to provide equity and consistency in personnel administration. The ISSC members work with employees in the corporate personnel department to establish these guidelines. Also, the ISSC must ensure that appropriate dp and information systems training programs are available.

Communication is needed to keep information systems people apprised of constantly evolving issues such as newly available hardware and software, information systems strategies, and organization and personnel changes. A bimonthly information systems newsletter, containing information on these topics, is distributed to about 1,500 readers. In addition, the 110 operating unit information systems managers have established regional councils that meet quarterly to review items of common interest.

In addition to the quarterly meetings, HP's information systems managers attend an annual two- to three-day international meeting. Since it is usually held in California, this meeting provides an opportunity for managers from remote sites to make personal contact with HP's central activities. It is organized by the Divisional Information Systems Council and sponsored by the ISSC, which also provides staff support.

Lastly, statistics on information systems activities, many of which are cited in this article, are collected annually by the ISSC. This provides an in-depth look at the big picture for management and others as to the direction and magnitude of change in HP's information systems function. ©

Currently serving as manager of Corporate Manufacturing Information Systems, Cort Van Rensselaer has helped lead Hewlett-Packard's business dp systems since 1966. Van Rensselaer, who joined HP in 1942, has been the general manager of three divisions: the Colorado Springs Division, the Oscilloscope Division, and the Dymec Division (where HP's computer activities originated).

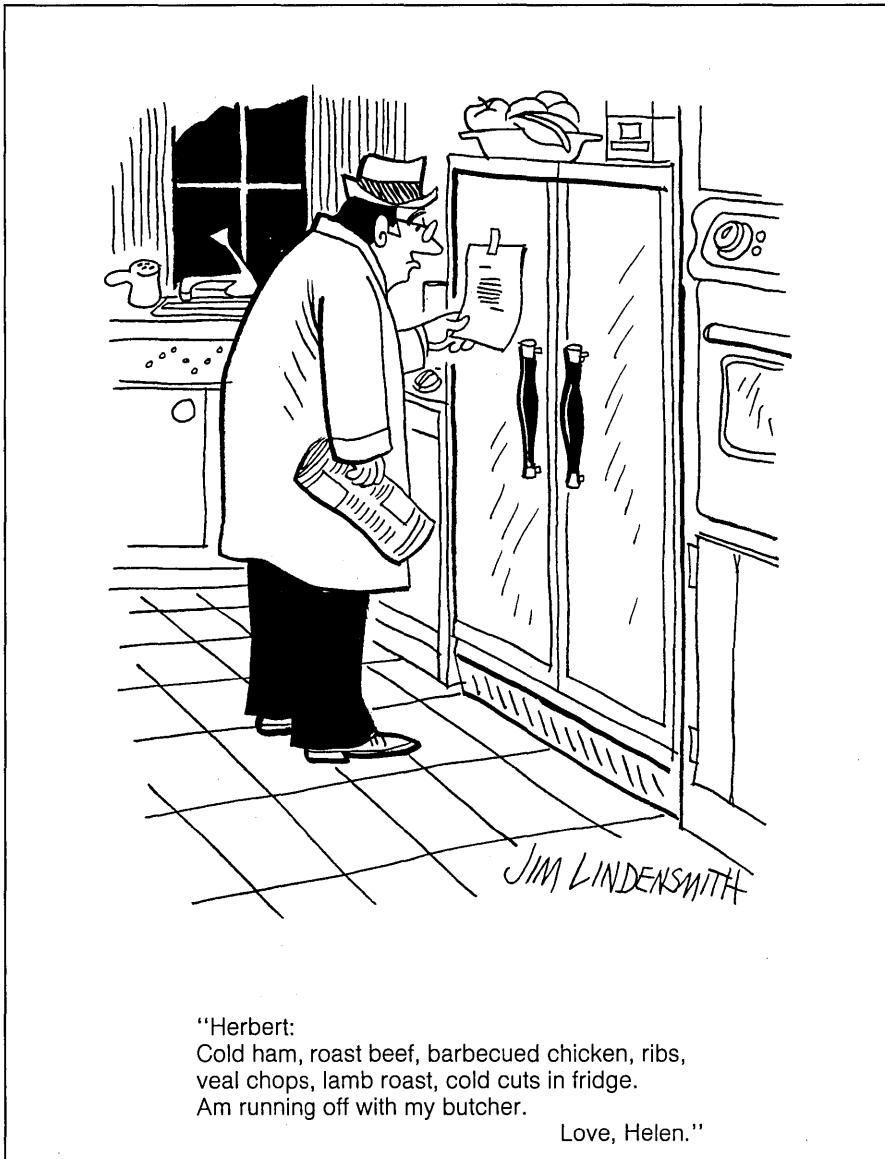

CARTOON BY JAMES E. LINDENSMITH

EVERYONE  
WILL BE MAKING  
HIGH SPEED  
MODEMS LIKE  
THIS.

IN THREE OR  
FOUR YEARS.



**H**ow did Codex come up with the 2600 Series, a new generation of modems running at speeds from 4800 to 16,800 bps that's so much more advanced than the competition?

By designing a revolutionary VLSI-based signal processing architecture teamed with the powerful Motorola MC68000 microprocessor.

A design that incorporates a unique Adaptive Rate System, which continuously adjusts the transmission speed of the Codex 2660 to the maximum rate the line will support. Allowing you to optimize throughput all the way up to 16,800 bps, without having to lift a finger.

A design that ensures data reliability with Trellis Code Modulation (TCM)—a significant advancement over uncoded modulation techniques in common use today.

In multipoint applications, the Codex 2640 can even handle mixed 9600, 7200 and 4800 bps inbound rates. So each drop can operate independently at maximum speed and efficiency.

Of course, with the Codex 2600 Series, network control is standard. So you can monitor line and modem performance from the front panel or from a central Codex DNCS system. Plus there's an optional downline-loading feature that lets you conveniently modify or enhance the functionality of remote, unattended modems.

The Codex 2600 Series.

In three or four years, our competitors will probably have modems just like them.

If you'd rather not wait, contact Codex today. We'll send you detailed information about these 2600 features and more. Much more.

Call 1-800-426-1212 Ext. 222. Or write: Codex Corporation, Dept. 707-222, 20 Cabot Boulevard, Mansfield, MA 02048.

**codex**  
 **MOTOROLA**





# YOUR TWO FAVORITE COMPUTERS NOW HAVE ONE THING IN COMMON. YOUR FAVORITE GRAPHICS TERMINAL.

**Introducing the new CX4100 Series of Tektronix high performance, yet affordable color graphics terminals.**

Now you can have the Tektronix PLOT 10 graphics command set you've always wanted while you use the host of your choice, IBM or DEC. Just by typing a single

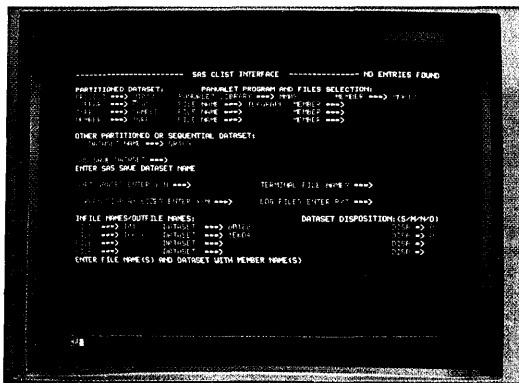

Familiar 3270 IBM-style alphanumeric output is fully emulated on all CX4100 terminals. Enhanced IBM-style keyboard is part of the package.

"switch-host" command.

Tek's CX4106, CX4107 and CX4109 are all directly plug compatible with both host environments. One coax to a standard IBM 3270 controller is all you need or one RS-232 connection to your DEC system.

To make your use of existing or new graphics data fast and friendly, the CX Series comes with an

IBM-style keyboard. Plus Tek enhancements: individual key programmability, user-selectable ten-key pad, and joydisk for quick cursor movement and graphics input.

Screen output will be just as familiar as keyboard layout. 32-line 3278/3279 alphanumeric emulation is built in. And so is full support for the 4957 Graphics Tablet, plus full hard copy and transparency output to a full range of Tektronix Color Graphics Copiers and the 4510 Color Graphics Rasterizer.

**IBM flexibility is matched by DEC flexibility. In RS-232 mode, the terminals can run all VT100 applications through the extended ANSI X3.64 command set.**

In addition to the host interface port that transmits data at rates up to 38.4k baud, CX terminals are provided with two additional RS-232 ports and a Centronics-style parallel port for connecting a wide range of peripherals.

But best of all you'll have great graphics and full software compatibility. The CX Series will accept many existing programs written for 4010, 4100, and 4110 Series terminals. And they're fully compatible with PLOT 10 IGL, GKS, and TCS programs as well as with popular third-party software such as SAS/GRAPH®, ISSCO's DISSPLA® and TELL-A-GRAF® and Precision Visuals' DI-3000®.

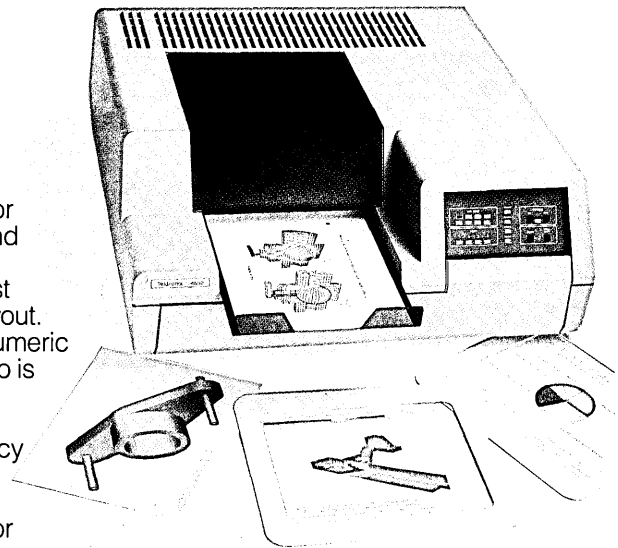

Tek's all new precision ink jet 4692 color copier produces very high quality full color transparencies or hard copy.

That's software investment protection—matched by technology protection. CX terminals feature a 60 Hz non-interlaced display with 4096 x 4096 addressability displayed in a 640 x 480 matrix.

16 colors, eight line styles, 11 marker types, rapid area fill, scalable/rotatable text, complete segment support, true zoom and pan, and separate dialog area. It's all there with the full PLOT 10 command set.

So don't wait. Set the best of three worlds on one desk: TEK, DEC, and IBM. Contact your local representative today for information on the CX4100 Series. Call 1-800-547-1512. In Oregon 1-800-452-1877.

**Tektronix®**  
COMMITTED TO EXCELLENCE

CIRCLE 37 ON READER CARD

# TKO

Twenty years of database software leadership—decades of service to The World's Largest Information Processing Organization—crowned us Champs! And ... it was done by a TKO\*! Our Model 204 Database Management System is a proven Champion for IBM Mainframes. Supported by the WORKSHOP/204 Application Development System, our Intelligent Information Center, and PROD/NET, the most complete office integration system available, you can become a Champion, too! Take on your Data Processing future ... Now! Growth. Power. Strength. Flexibility. Cost Control. Investment Protection. All yours with Computer Corporation of America's Championship Team!

For information on how to get into the Model 204 Database Training Camp, Call 1-800-252-4100 and we'll put you in touch with success.

\*Technical Knockout

Computer Corporation of America

4 Cambridge Center, Cambridge, MA 02142

CIRCLE 45 ON READER CARD

The inventor of the first universal digital computer  
was brilliant, irascible, and insatiably curious.

# BABBAGE OBSERVED



## by Leopold Froehlich

Near the northern pole of the moon there is a crater named for Charles Babbage. When he died in 1871, however, few people knew who he was. Only one carriage (the Duchess of Somerset's) followed in the burial procession that took his remains to Kensal Green Cemetery. The Royal Society printed no obituary, and the *Times* ridiculed him. The parts of the Difference Engine that had seemed possible of completion in 1830 gathered dust in the Museum of King's College.

In 1878 the Cayley committee told the government not to bother constructing Babbage's Analytical Engine. By the 1880s Babbage was known primarily for his reform of mathematics at Cambridge. In 1899 the magazine *Temple Bar* reported that "the present generation appears to have forgotten Babbage and his calculating machine." In 1908, after being preserved for 37 years in alcohol, Babbage's brain was dissected by Sir Victor Horsley of the Royal Society. Horsley had to remind the society that Babbage had been a "very profound thinker."

Charles Babbage was born in Devonshire in 1792. Like John von Neumann, he was the son of a banker—Benjamin (Old Five Percent) Babbage. He attended Trinity College, Cambridge, receiving his MA in 1817. As the inventor of the first universal digital computer, he can indeed be considered a profound thinker. The use of Jacquard punch cards, of chains and subassemblies, and ultimately the logical structure of the modern computer—all come from Babbage.

Popularly, Babbage is a sort of Abner Doubleday of data processing, a colorful fellow whose portrait hangs in the anteroom but whose actual import is slight. He is thought about, if at all, as a funny sort of distracted character with dirty collar. But Babbage was much more than that. He was an amazing intelligence.



## THE PHILOSOPHER

Babbage was an aesthete, but not a typical Victorian one. He found beauty in things: in stamped buttons, stomach pumps, railways and tunnels, in man's mastery over nature.

A social man, he was obliged to attend the theater. While others dozed at Mozart, Babbage grew restless. "Somewhat fatigued with the opera [Don Juan]," he writes in the autobiographical *Passages From the Life of a Philosopher*, "I went behind the scenes to look at the mechanism." There, a workman offered to show him

around. Deserted when his cicerone answered a cue, he met two actors dressed as "devils with long forked tails." The devils were to convey Juan, via trapdoor and stage elevator, to hell.

In his box at the German Opera some time later (again not watching the stage), Babbage noticed "in the cloister scene at midnight" that his companion's white bonnet had a pink tint. He thought about "producing coloured lights for theatrical representation." In order to have something on which to shine his experimental lights, Babbage devised *Alethes and Iris*, a ballet in which 60 damsels in white were to dance. In the final scene, a series of dioramas were to represent *Alethes'* travels. One diorama would show animals "whose remains are contained in each successive layer of the earth. In the lower portions, symptoms of increasing heat show themselves until the centre is reached, which contains a liquid transparent sea, consisting of some fluid at white heat, which, however, is filled up with little infinitesimal eels, all of one sort, wriggling eternally."

Two fire engines stood ready for the "experiment of the dance," as Babbage termed the rehearsal. Dancers "danced and attitudinized" while he shone colored lights on them. But the theater manager feared fire, and the ballet was never publicly staged.

Babbage enjoyed fire. He once was baked in an oven at 265°F for "five or six minutes without any great discomfort," and on another occasion was lowered into Mt. Vesuvius to view molten lava. Did he ponder Hell? Perhaps. He had considered

## “His ambitions probably delayed the exploitation of his own ideas for a century.”

becoming a cleric, but this was not an unusual choice for the affluent graduate with little interest in business or law. In 1837 he published his *Ninth Bridgewater Treatise*, to reconcile his scientific beliefs with Christian dogma. Babbage argued that miracles were not, as Hume wrote, violations of laws of nature, but could exist in a mechanistic world. As Babbage could program long series on his calculating machines, God could program similar irregularities in nature.

Babbage investigated biblical miracles. “In the course of his analysis,” wrote B.V. Bowden in *Faster than Thought* (Pitman, London, 1971), “he made the assumption that the chance of a man rising from the dead is one in  $10^{12}$ .” Miracles are not, as he wrote in *Passages*, “the breach of established laws, but . . . indicate the existence of far higher laws.”



### THE POLITICIAN

Of all his roles, Babbage was least successful at this one. He had himself to blame: he was too impatient, too severe with criticism, too crotchety. Bowden wrote that, in later life, Babbage “was frequently and almost notoriously incoherent when he spoke in public.” What ultimately kept him from building an Analytical Engine was not his inability to finish a project, but his inadequacies as a political man, as a persuader. His vision was not matched by his judgment, patience, or sympathy.

He was a confusing political figure. A liberal republican, he was pro-aristocratic and strongly antisocialist. Friend to Dickens and to the workman, he was a crony to the Midlands industrialist. The son of a Tory banker, he supported the cooperative movement and was twice an unsuccessful Whig candidate to Parliament. But his liberalism waned during the 1840s; by 1865, he was a conservative utilitarian for whom capitalism and democracy were incompatible.

In July of 1822, two days after Shel-

ley drowned near La Spezia, Babbage wrote a letter to the president of the Royal Society, describing his plan for calculating and printing mathematical tables by machine. By June of 1823 Babbage met with the Chancellor of the Exchequer, who granted money and told Babbage to proceed with the engine (which he did, starting work in July.) But no minutes were made of this initial meeting.

In August 1827, Babbage’s 35-year-old wife, Georgiana, died. Babbage traveled to the Continent. By the end of 1828 he returned to England, the initial £1,500 grant gone. Babbage was financing the construction himself. And the exchequer could not recall promising further funds.

Convincing the government to continue with two tons of brass, hand-fitted steel and pewter clockwork was not easy. In 1829 a group of Babbage’s friends solicited the attention of the Duke of Wellington, then Prime Minister. Wellington went to see a model of the engine, and in December ordered a grant of £3,000. Engineer Joseph Clement was hired to construct the engine for the government, and to oversee the fabrication of special tools.

By the end of 1830 Babbage wanted to move the engine’s workshop to his house on Dorset Street. A fireproof shop was built where Babbage’s stables had stood. A man of great ego, Clement refused to move from his own workshop, and made, according to Babbage, “inordinately extravagant demands.” Babbage would not advance Clement further money, so Clement dismissed his crew, and work on the Difference Engine ceased.

This did not seem to perturb Babbage. His initial scheme for the Difference Engine called for six decimal places and a second-order difference; now he began planning for 20 decimal places and a sixth-order difference. “His ambitions to build immediately the largest Difference Engine that could ever be needed,” wrote Bowden, “probably delayed the exploitation of his own ideas for a century.”

With Clement and his tools gone, Babbage wanted to meet with Prime Minister Lord Melbourne in 1834 to tell him of a new machine he had conceived—the Analytical Engine, an improved device capable of any mathematical operation. He contended it would cost more to finish the original engine than to construct this new one. But the government did not wish to fund a new engine until the old one was complete. “He was ill-judged enough,” wrote the Reverend Richard Sheepshanks, a secretary of the Royal Astronomical Society, “to press the consideration of this new machine upon the members of Govern-

ment, who were already sick of the old one.” (Sheepshanks was Babbage’s arch-enemy. In 1854 he published a vituperative 100-page work, “Letter to the Board of Visitors of the Greenwich Royal Observatory, in Reply to the Calumnies of Mr. Babbage” at its meeting in June 1853, and in his book entitled *The Exposition of 1851*.)

For the next eight years, Babbage continued to apply to the government for a decision on whether to continue the suspended Difference Engine or begin the Analytical, seemingly unaware of the social problems that preoccupied Britain’s leaders during what Macauley called the Hungry Forties. Although £17,000 of public money had been spent, and a similar amount by Babbage, the Prime Minister avoided him. “It is nonsense,” wrote Sheepshanks, “to talk of consulting a Prime Minister about the kind of Calculating Machine that he wants.” Prime Minister Robert Peel recommended that Babbage’s machine be set to calculate the time at which it would be of use. “I would like a little previous consideration,” wrote Peel, “before I move in a thin house of country gentlemen a large vote for the creation of a wooden man to calculate tables from the formula  $X^2 + X + 41$ .”

Finally, in November of 1842, the Chancellor of the Exchequer, having sought the opinion of Sir George Airy on the utility of the machine, and having been told it was “worthless,” said he and Peel regretted the necessity of abandoning the project. On the 11th of November, Babbage finally met with Peel, and was told the bad news.

By 1851 Babbage had “given up all expectation of constructing the Analytical Engine,” even though he was to try once more with Disraeli the next year. He wrote in the vitriolic *Exposition of 1851*: “Thus bad names are coined by worse men to destroy honest people, as the madness of innocent dogs arises from the cry of insanity raised by their villainous pursuers.”

Some believed Babbage had “been rewarded for his time and labor by grants from the public purse,” according to biographer Moseley Maboth (*Irascible Genius*, Hutchinson & Co., London, 1964). “We got nothing for our £17,000 but Mr. Babbage’s grumbings,” wrote Sheepshanks in his “Letter to the Board of Visitors of the Greenwich Royal Observatory.” “We should at least have had a clever toy for our money.”

Peel, however, declared in Parliament that Babbage “had derived no emolument whatsoever from the government.” Offered a baronetcy in recognition of his work, Babbage refused, demanding a life peerage instead. It was never granted.



## THE MUSIC HATER

Lady Lovelace wrote that Babbage hated music. He tolerated its more exquisite forms, but abhorred it as practiced on the street. "Those whose minds are entirely unoccupied," he wrote with some seriousness in *Observations of Street Nuisances* in 1864, "receive [street music] with satisfaction, as filling up the vacuum of time." He calculated that 25% of his working power had been destroyed by street nuisances, many of them intentional. Letters to the *Times* and the eventual enforcement of "Babbage's Act," which would squelch street nuisances, made him the target of ridicule.

The public tormented him with an unending parade of fiddlers, Punch-and-Judys, stilt-walkers, fanatic psalmists, and tub-thumpers. Some neighbors hired musicians to play outside his windows. Others willfully annoyed him with worn-out or damaged wind instruments. Placards were hung in local shops, abusing him. During one 80-day period Babbage counted 165 nuisances. One brass band played for five hours, with only a brief intermission. Another blew a penny tin whistle out his window toward Babbage's garden for a half an hour daily, for "many months."

When Babbage went out, children followed and cursed him. Adults followed, too, but at a distance. Over a hundred people once skulked behind him before he could find a constable to disperse them. Dead cats and other "offensive materials" were thrown at his house. Windows were broken. A man told him, "You deserve to have your house burnt up, and yourself in it, and I will do it for you, you old villain." Even when he was on his deathbed, the organ-grinders ground implacably away.

In Babbage's relation with "the Mob," we see his curious naïveté in matters social. Though he was far above the rabble—"not unknown" to the Duke of Wellington and Lord Ashley—he seemed

unaware of it at times. He expected the same civility from a drunken brothel-keeper as he would from a gentleman. In 1860, the London of the multitudinous poor was far from gentle. Yet, in his ingenuousness, he could fathom neither bums nor bamboozlers. He would cross town to check the tale of a mendicant, and frequently was surprised to encounter deceit.

Babbage once met a man who claimed not to have eaten for two days. Babbage invited him to breakfast. The next morning he called at Babbage's house, claiming hard times. Eventually, the man hired on as a steward on a small West Indian ship. "A few evenings after the ship had supposed to have sailed, he called at my house," wrote Babbage, "apparently much agitated and stated that, in raising the anchor, an accident had happened, by which the captain's leg had been broken." Babbage later tried to verify this tale, but found his steward "had been living riotously at some public-house in another quarter, and had been continually drunk."

Babbage never understood that the growth and crowdedness of London resulted from the industrial expansion he championed. By 1850 industry had taken over in Britain. "Many years before, I had purchased a house in a very quiet locality," he wrote in 1864. Then came a hackney-stand, and beer shops and coffeehouses, and people. The din beneath his window, the German bands, the pickpockets, came with industry. The railroad and factory brought crowds to London, and with them came meanness and thievery.



## THE NEWTONIAN

Like Newton, Babbage was Lucasian professor of mathematics at Cambridge. He founded both the British Association's Statistical Society and the Royal Astronomical Society. His Difference Engine calculated by Newton's method of successive differences, and would even accomplish "opera-

tions of human intellect" by motive power. Babbage believed in a world where, once all things were dutifully quantified, all things could be predicted. As such, he was a perfect Newtonian.

Nature, according to Question 31 of Newton's *Opticks*, is "very consonant and conformable to herself." Newton's program was official in Babbage's time. Science "consisted in isolating some central, specific act, and then using it as the basis for all further deductions concerning a given set of phenomena," writes Ilya Prigogine in *Order Out of Chaos* (Bantam, 1984). The Marquis Laplace, an avid Newtonian and friend of Babbage, said that if a mind could know everything about particle behavior, it could describe everything: "Nothing would be uncertain, and the future, as the past, could be present to our eyes."

Babbage wanted to quantify everything. Fact and data intoxicated him. He tried mathematically handicapping horse races (he was unsuccessful, and Lady Lovelace was nearly disgraced by gambling debts). Babbage's love of numbers was well known: in the mail he received requests for statistics. He would preserve any fact, simply because he thought "the preservation of any fact might ultimately be useful."

He would stop to measure the heartbeat of a pig (to be listed in his "Table of Constants of the Class Mammalia"), or to affix a numerical value to the breath of a calf. In 1856 he proposed to the Smithsonian Institution that an effort be made to produce "Tables of Constants of Nature and Art," which would "contain all those facts which can be expressed by numbers in the various sciences and arts."

Babbage delighted in the thought of having a daily account of food consumed by zoo animals, or the "proportion of sexes amongst our poultry." He proposed tables to calibrate the amount of wood (elm or oak) a man would saw in 10 hours, or how much an ox or camel could plow or mow in a day.

Babbage's unflagging fascination with statistics occasionally overwhelmed him, as is seen in the animation of his Smithsonian proposal. "If I should be successful," he wrote, "... it will thus call into action a permanent cause of advancement toward truth, continually leading to the more accurate determination of established fact, and to the discovery and measurement of new ones."

In *Mechanics Magazine* in 1857 Babbage published a "Table of the Relative Frequency of the Causes of Breaking of Plate Glass Windows," detailing 464 breakages, of which "drunken men, wom-



**“If I am successful,” he wrote, “it will call into action a permanent cause of advancement toward truth.”**

en, or boys” were responsible for 14. Babbage thought the table would be “of value in many respects,” and might “induce others to furnish more extensive collections of similar and related facts.”

Babbage faced significant problems with mechanical techniques. He had to invent the tools for his engines. His thought is so thoroughly modern that we wonder why he did not pursue electromechanical methods for his engines (especially after Faraday’s 1831 discovery of induction, and Babbage’s own electrical experiments). It is easy to forget how long ago Babbage worked.

Even under the best of circumstances, the limitations of Newtonian physics might have prevented Babbage from completing any Analytical Engine. He did not know the advances of Maxwell (and could not know those of Boltzmann, Gödel, and Heisenberg). Though he knew Fourier socially, Babbage did not seem to grasp the importance of his 1811 work on heat propagation. Nor did he seem to know of Joule’s efforts with heat and mechanical energy.

The reversibility of attraction is a basic tenet of Newtonian mechanics. A body, or piece of information, may retrace its path and return to where it started. In Babbage’s design for the Analytical Engine, the discrete functions of mill (in which “all operations are performed”) and store (in which all numbers are originally placed, and, once computed, are returned) rely on this supposition of reversibility.

In his 1824 essay on heat, Carnot formulated the first quantitative expression of irreversibility, by showing that a heat engine cannot convert all supplied heat energy into mechanical energy. Part of it is converted to useful work, but most is expelled into a low-temperature reservoir and is wasted.

From this came William Thomson’s discovery of the Second Law of Thermodynamics in 1852, and Rudolf Clausius’ discovery of entropy in 1865. In ideal, reversible processes, entropy remains constant. But in others, as Eddington showed with his “arrow of time,” entropy only increases. That means information cannot be shuttled between mill and store without leaking, like faulty sacks of flour. Babbage did not consider this, and it was perhaps his greatest obstacle to building the engine.

It is easy to forget that Babbage was essentially a child of the Enlightenment, and that his epoch was much different from our own. He resided in an era of wood and coal, and the later era of steel and oil would not begin for perhaps a decade after his death.



### THE INDUSTRIALIST

“Faith in machinery,” wrote Matthew Arnold in *Culture and Anarchy* in 1869, “is our besetting danger.” The Whiggery of the mid-Victorian era optimistically endorsed the principle of progress. Britain changed from the relatively pastoral society of 1820 to the brutishly materialistic one of the 1840s and 1850s.

Babbage shared his era’s enthusiasm for industry. His finest work, *On the Economy of Manufactures*, was published in 1832. In it, with watch in hand, Babbage discovers operational research, the scientific study of manufacturing processes. It is a tour of the manufacturing processes of the period, from needle-making to tanning. Babbage detailed how things both ornamental and functional were made in mid-nineteenth century Britain. His characteristically blunt analysis of the printing trade caused publishers to refuse his books.

Babbage worked when industry was in a frenzy to improve and expand. Increases in manufactories and population were viewed as “absolute goods in themselves,” noted Matthew Arnold. In *Das Kapital*, Marx quoted from *Economy of Manufactures* on this rage to improve: “Improvements succeeded each other so rapidly, that machines which had never been finished were abandoned in the hands of their makers, because new improvements had superceded their utility.”

Babbage disliked Plato, according to his friend Wilmot Buxton, because of Plato’s condemnation of Archytas, “who had constructed machines of extraordinary power on mathematical principles.” Plato thought such an application of geometry degraded a noble intellectual exercise, “reducing it to the low level of a craft fit only for mechanics and artisans.”

Babbage loved practical science, and was among the first to apply higher

mathematics to certain commercial and industrial problems. He took no part in what Anthony Hyman (in his book, *Charles Babbage*, Princeton University Press, 1982) called the era’s “growing divorce between academic science and engineering practice.”

Babbage had a forge built in his house on Devonshire Street, and accomplished, with his draftsmen, pioneering work in precision engineering. Because conventional mechanical drawing proved inadequate for his engines, he had to develop his own abstract notation. He called his work with mechanical notation “one of the most important additions I have made to human knowledge.”

With the die-cast pewter gear wheels of his Difference Engine, and with his design of lathes and tool-shapers, Babbage did much to advance the British machine tool industry. Sir Joseph Whitworth, foreman in Babbage’s shop, was responsible for the introduction of the first series of standard screw threads.

The expansion of the railways marked the grandest phase of the industrial revolution. Railroads freed manufacturing from its dependence on water transport, and opened new markets. When the first public railroad, the Stockton & Darlington, opened on Sept. 27, 1825, Babbage was 34. By 1841 there were over 1,300 miles of rail in Britain and 13,500 miles by 1870.

J.D. Bernal wrote in *Science and Industry in the Nineteenth Century* (University of Indiana Press, 1970), that “Babbage seems to have been one of the few who interested themselves scientifically in its [the railroad’s] working.” Babbage’s life was intertwined with the railroad. He invented a cow catcher in 1838, apparently the first in Britain. He was present for opening ceremonies of George Stephenson’s Manchester & Liverpool line in 1830. Of the cheering crowds at the initial run, he wrote, “I feared . . . the people madly attempting to stop by their feeble arms the momentum of our enormous train.”

Babbage’s great formal association with railroads came in 1837 and 1838, when he conducted experiments for I.K. Brunel’s Great Western Railway, which ran from London to Bristol. Babbage argued for the superiority of Brunel’s wide-gauge track. His research into the safety and efficiency of the line was, according to Bernal, “100 years ahead of his time.”

Babbage rode the rails like a river pilot rode the Mississippi: knowing every turn on the route, every crossing, every intersection. “My ear,” he wrote, “had become peculiarly sensitive to the distant sound of an engine.”

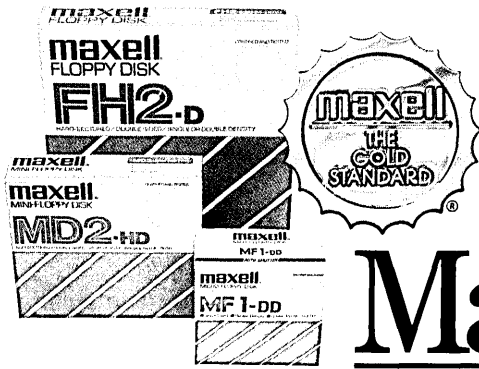

# Maxell Gold.

The floppy disk  
that helps IBM® PC AT™  
spell it out,  
keeps Data General  
specific,  
and suits AT&T to a T.

Tailored to surpass your most demanding specifications. Maxell. The Gold Standard in floppy disks. From high density floppys for PC AT (ours was the first commercially available) to standard formats for virtually every computer made, Maxell leads the way. Each comes with a lifetime warranty. And each carries the name to make your next floppy disk purchase decision a solid triumph.

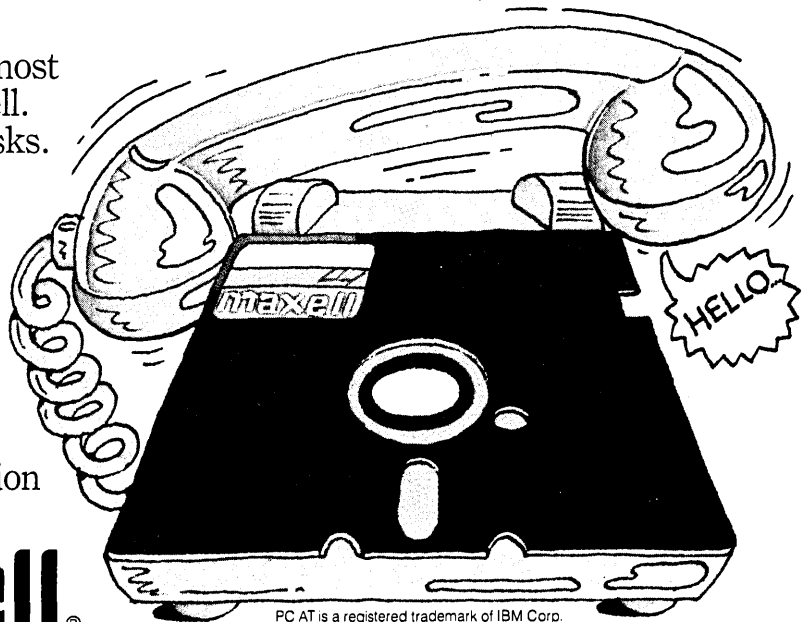

**maxell**®  
IT'S WORTH IT.

PC AT is a registered trademark of IBM Corp.

Maxell Corporation of America, 60 Oxford Drive, Moonachie, N.J. 07074

CIRCLE 46 ON READER CARD

**He said he'd never spent a happy day in his life, and would gladly give it up if he could live three days 500 years thence.**



**THE MISANTHROPE**

Babbage was known as a "mathematical Timon." In his later years he came to suffer from a mechanist's misanthropy, regarding men as fools and grubby thieves. By 1861 he said he had never spent a happy day in his life, and would gladly give up the rest of it if he could live three days 500 years thence.

Laughed at by costermongers and viscounts, met with diffidence by his lessers, the impatient Babbage grew angry, like the cave-dwelling Timon, with a changing world. Nevertheless, as his friend Lionel Tollemache wrote, "there was something harmless and even kindly in his misanthropy, for . . . he hated mankind rather than man, and his aversion was lost in its own generality."

Like Shakespeare's Timon, Babbage would have made a fascinating leader. (Sheepshanks, of course, disagreed: "I don't know any Government office or any other office for which he is fit, certainly none which requires sense and good temper.")

What a delightful, if distracting, place it would be where Babbage was in charge. Consider his plan in *Economy of Manufactures* for a "simple contrivance of tin tubes for speaking through." (Babbage calculated it would take 17 minutes for words spoken in London to reach Liverpool.) Or his plan for sending messages "enclosed in small cylinders," along wires suspended from high pillars (he thought

church steeples could be used for this purpose.)

In *Passages*, Babbage relates how, as a youth, he nearly drowned while testing his contrivance for walking on water. In *Conjectures on the Conditions of the Surface of the Moon*, we find him describing his 1837 experiments cooking a "very respectable stew of meat and vegetables" in blackened boxes (with window glass) buried in the earth. Toward the end of his life we find him mulling the prevention of bank note forgery and working in marine navigation we realize that, with his harlequin curiosity about all things, with his wonderfully human sense of wonder, Babbage escapes pathos and attains greatness. ©

Leopold Froehlich is a free-lance writer based in New York City.

Reprints of all DATAMATION articles are available in quantities of 100 or more. Details may be obtained by telephoning Donald Reid, (212) 605-9731.

**Heart disease or stroke can cheat you out of the best years of your life.**

Those are the years shared with people you love. And when a loved one is gone, everything changes. You can't imagine the loss, unless it happens to you. Last year, nearly one million Americans died of heart disease and stroke — 200,000 of them before retirement age.

The American Heart Association is fighting to reduce early death and disability from heart disease and stroke with research, professional and public education, and community service programs.

But more needs to be done.

You can help us save young lives by sending your dollars today to your local Heart Association, listed in your telephone directory.



**American Heart Association**

WE'RE FIGHTING FOR YOUR LIFE

# The full-time computer for part-time users

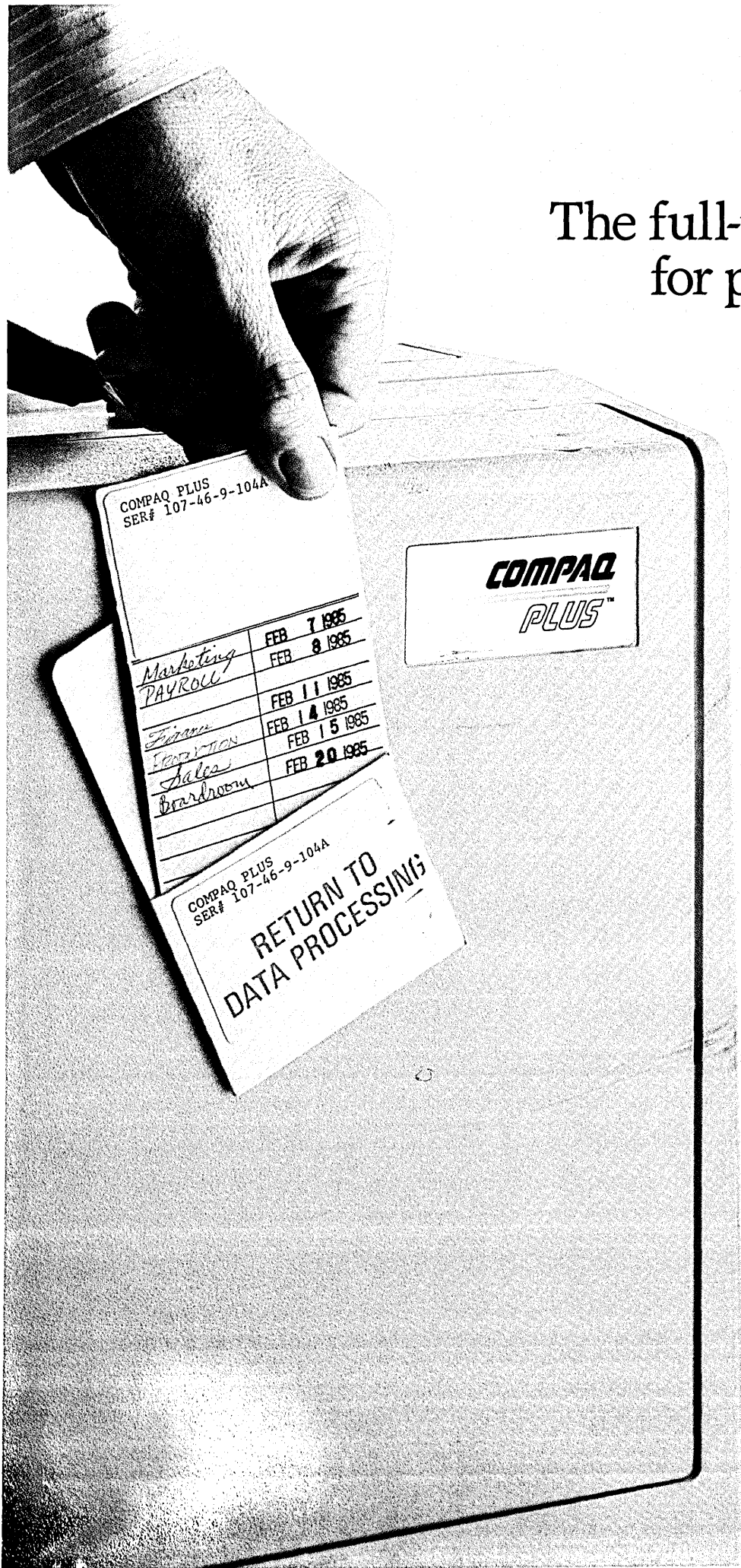

Not everyone who needs a personal computer in your company needs one full time. That's why full-function COMPAQ® portable computers give you more for your money than most desktop computers. They're built tough enough to share.

In a single day, your research department can use a COMPAQ portable to access information, accounting can borrow it to track receivables, and marketing can take it to make sales forecasts. Everyone can use it as an "extra" computer to take home or on the road.

COMPAQ's unique cross-braced aluminum frame, shock-mounted disk drives and outer case molded from the kind of plastic used to make bulletproof windows help it withstand the rigors of being passed around.

Plus COMPAQ portable computers are software and hardware compatible with the IBM® PC and XT, offer high-resolution text and graphics on one screen, and can expand to 10 megabytes of storage.

No wonder they outsell the IBM Portable Computer in retail stores by 6 to 1.

Every small company should have one. Large companies should have one for every department.

So check it out. For a free brochure or for the location of your nearest Authorized COMPAQ Computer Dealer, call 1-800-231-0900 and ask for Operator 2.

**COMPAQ®**

It simply works better.

COMPAQ® is a registered trademark and COMPAQ PLUS™ is a trademark of COMPAQ Computer Corporation. IBM® is a registered trademark of International Business Machines Corporation.

©1985 COMPAQ Computer Corporation

# WHAT WE BELIEVE

AS THE SOFTWARE COMPANY WE BELIEVE  
IN THE POWER OF SOFTWARE TO  
TRANSFORM THE WAY WE LIVE AND  
WORK. WE BELIEVE IN THE  
POWER OF SOFTWARE TO  
IMPROVE THE QUALITY OF  
LIFE.

# CA-SENTINEL™ BECAUSE WHEN THE SECURITY OF YOUR DATA IS AT RISK, THE WHOLE COMPANY IS AT RISK.

One product that protects both CICS and BATCH, that's CA-SENTINEL. After all, why lock the front door and leave the back door open? It's a risk you don't have to take. Only CA-SENTINEL gives you this cost-efficient, proven effective way to guard all environments against unfriendly intrusion and inadvertent mistakes. You'll know your data will always be safe, secure, available and reliable! And with workstations springing up throughout the company, security has to be, if it isn't already, your number one priority. And the number one way to go—the only way to go—is CA-SENTINEL. Call us at 800-645-3003, or 516-333-6700. You'll see very quickly why, when it comes to security, we're the leader.



© 1984 Computer Associates International, Inc., 125 Jericho Turnpike, Jericho, NY 11753

CIRCLE 48 ON READER CARD

C A - S E N T I N E L

I want to know more about the industry's best security system.  
Send further information.

Please have an Account Manager contact me.

Please fill out and mail to:

Computer Associates International, Inc.  
125 Jericho Turnpike, Jericho, New York 11753

Name \_\_\_\_\_

Title \_\_\_\_\_

Company Name \_\_\_\_\_

Company Address \_\_\_\_\_

Telephone \_\_\_\_\_

DMO



**Which personality traits point people toward success in the dp industry?**

# IN SEARCH OF THE PERFECT PROGRAMMER

**by Chandler M. Bush and Lawrence L. Schkade**

Can anyone define the computer programmer's mystique? We've all heard lines like, "I knew you were a computer expert," "He thinks just like a programmer," or "Well, here's another example of the programmer mentality." Such claims leave little doubt that computer professionals have an aura that readily identifies them to the perceptive observer.

This mystique sets a person apart from others and is beyond definition by outsiders. Certain behavior patterns or mannerisms reflect the mental processes that qualify an individual for the rigorous challenges of the computer trade. It would be beneficial if the dp manager had a definitive way to measure this mystique. Such a measure would help the manager select individuals for certain assignments and assign the proper mix of members to a project team. It could also help individuals plan their own careers.

This subject has attracted the interest of both researchers and practitioners. Reports of their efforts have appeared in trade magazines and scholarly publications. A DATAMATION article ("The Intuitive Computer Programmer," Oct. 15, p. 137) reported on attempts in Austin, Texas, to gain insight into the programmer's personality via the testing of 27 professionals. Coincidentally, we recently completed a similar study among computer professionals (40 programmer analysts from within computer organizations and 18 systems analysts from user organizations) at a north Texas high-technology aerospace firm, producing results that both support and in some ways contradict the findings previously reported. The results of these and other studies raise certain questions con-

cerning the traditional staffing practices of many computer organizations.

The test instrument common to both the studies is the Myers-Briggs Type Indicator (MBTI). This instrument provides a measure of the way an individual seeks out, perceives, and evaluates information. These information gathering and processing habits are often referred to as the individual's cognitive style. The MBTI is based on Jung's theory of personality type, which assumes that the way people take in information and how they decide to use it, while seemingly random, is actually orderly and consistent. Jung postulates that there are four separate scales relating to cognitive style, with each scale characterized by two essentially opposite methods of thinking. The MBTI determines the individual's primary preference or tendency to use one of the two methods on each scale. The four scales are:

- extroversion (E) vs. introversion (I)
- sensing (S) vs. intuitive (N)
- thinking (T) vs. feeling (F)
- judging (J) vs. perceiving (P)

The extroversion-introversion scale measures the individual's relative interest in the outer vs. the inner world. A person with a tendency toward extroversion is more likely to relate to the outer world of people and things, while a tendency toward introversion indicates that one is more apt to relate to the inner world of concepts, ideas, and theories. The fourth Jungian scale concerns the way a person deals with the world around him or her. The scale is labeled judging on the one hand and perceiving on the other. The judging individual prefers to live in a planned, decided, orderly way, and wants to regulate and control his life, while the perceiving individual likes to live in a flexible and spontaneous manner.

ILLUSTRATION BY BARRY ROOT



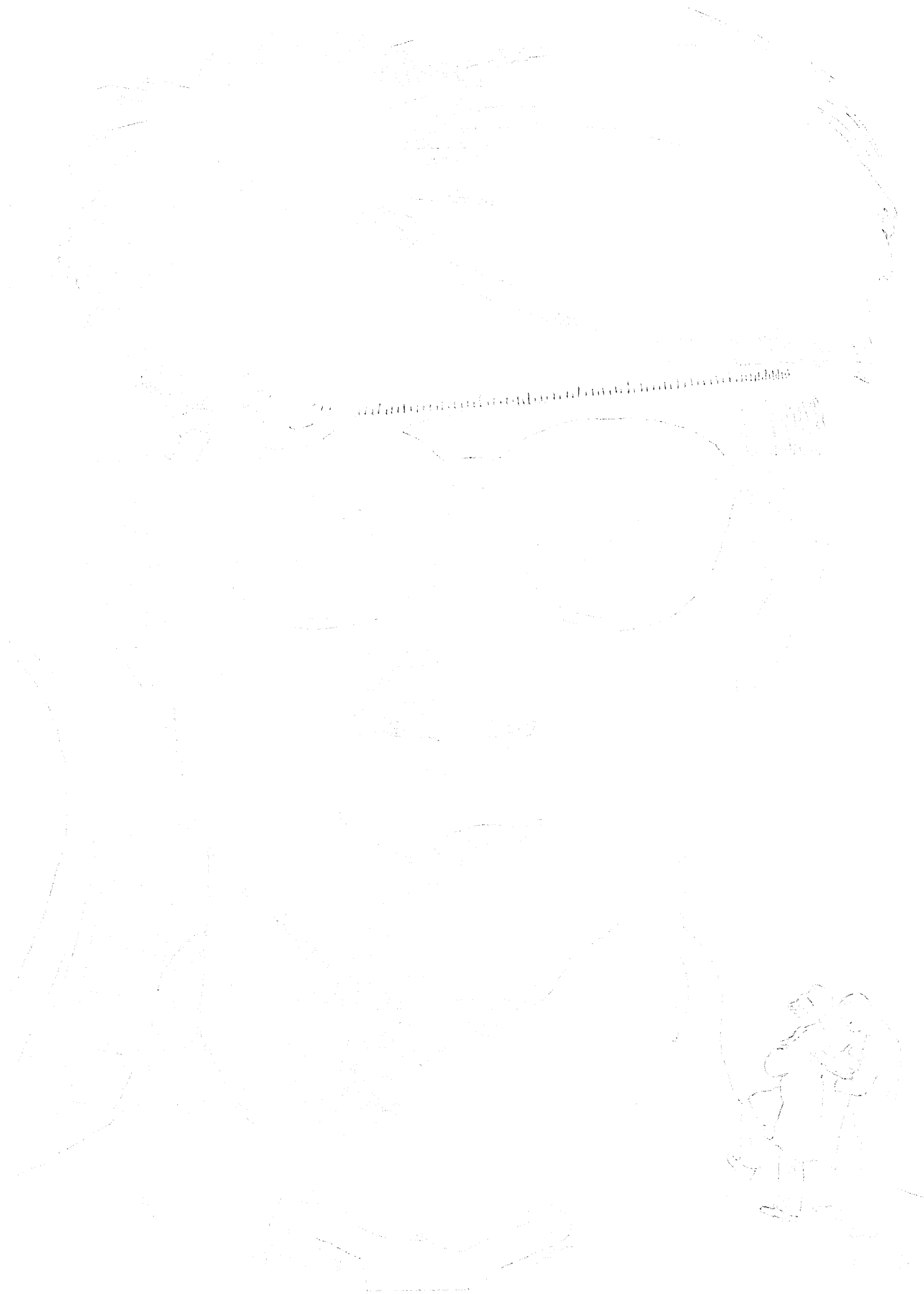

## The common thread running through the results of both studies is the prevalence of thinkers.

The second of the four scales measures the individual's method of finding out or acquiring the facts needed to solve the problem at hand. The opposite dimensions are labeled sensing and intuition. The sensing individual is described as having a preference for known facts and for reliance on concrete data and experience. The intuitive person is characterized as one who looks for possibilities and relationships and focuses on concepts and theory. The third MBTI scale—thinking vs. feeling—measures the way one uses information after it is acquired. The thinking individual prefers to make decisions based on impersonal analysis and logic, whereas the feeling individual bases his or her decisions on feelings and personal values.

### PAIRS ASSESSED FOR SCORE

Scoring the MBTI reveals each subject has a preference for one mode out of each of the four pairs. Thus, the subject might be assessed as an ENFJ, i.e., an extroverted, intuitive, feeling, and judging individual.

At this point, two questions should be asked. First, can the reader define which cognitive style types are exhibited by the typical dper? Second, what cognitive style types would define the individual most likely to be a successful programmer?

The U.S. Government's Office of Personnel Management undertook a five-year study ("Occupational Data Report-Computer Specialist Series, GS-334," 1981) of the job structure of its computer professionals. This study, involving thousands of dp professionals in government service, examined the task content of various dp jobs, including programmer and system analyst, and defined the tasks typically performed by individuals in each classification. The programmer's tasks were typified by the need for the individual to draw upon his education, training, and experience. Tasks like "determine details of module logic," "determine file layouts," and "code programs" show little requirement for interpersonal contact and reveal the programmer's work life as essentially a solitary one. On the other hand, the government study found that the system analyst's tasks have a high interpersonal component because of the analyst's heavy involvement with users.

In most dp organizations, however, the line between the analyst's job and that of the programmer is not clearly drawn. In fact, in many organizations it is not drawn at all, and a given individual can be called upon to code at one moment and to work with the user to develop new requirements at the next. Most systems design teams are

made up of members whose individual prime responsibilities vary all the way from a leadership role with heavy user involvement to coding from defined requirement specifications.

### GROUP TESTED IS ENTP TYPE

In the earlier study, the researchers asked a group of programmers to predict how other dper would respond to the MBTI. They predicted the responses would be ESTJ (extrovert, sensing, thinking, judging). The most common response from the test group turned out to be ENTP (extrovert, intuitive, thinking, perceiving). The researchers report that people with this combination of cognitive styles are typically analytical, independent, competitive, and nonconformist.

The north Texas study also established a pretest expected result. The subjects, all computer professionals, were expected to exhibit a preference for known facts, to make decisions on the basis of impersonal analyses and judgments, and to prefer a planned and orderly living environment. In other words, the expected result of the MBTI was STJ. A prediction of results on the E-I scale was not made because other researchers had reported finding no significance to the distribution of this measure among data processing professionals.

The results more nearly, although not completely, met the expectation than those in the previous study. The largest single cognitive style type among the subject population was ISTJ (introversion, sensing, thinking, judging). MBTI data collected over the years shows that 6% of the general population falls into this category as compared with almost 25% of the north Texas subjects. In a statistical sense this was a significant finding. Further, the second most frequently reported type was INTJ, with almost 16% of the subjects fitting in this category as compared with 1% of the general population. ENTPs, incidentally, accounted for 9% of the subjects in the sample compared to 5% in the general population.

The common thread running through the results of both studies is the prevalence of thinkers. In the north Texas study almost 74% of the subject population reported themselves to be thinkers as opposed to feelers. On the other hand, 70% of the sample population reported themselves to be judging as opposed to perceiving, while the most common type reported in the earlier Texas study was the perceiving dimension.

The results are still mixed and much further research is required. We're a long way from the day when cognitive testing

instruments can be used to accurately predict success in the dp profession. Certainly no one is in a position to advocate a given type. But we can learn a lesson from all the diverse results: no ideal personality or cognitive style for the dp professional has emerged. In the earlier study, the typical dper turned out to be extroverted, intuitive, thinking, and perceiving, a personality type referred to as the inventor. In the later study, the typical dp professional was revealed as introverted, thinking, judging, and either sensing or intuitive. Instead of the "intuitive computer programmer," we found computer professionals to be thinking, judging, rational people who rely on their education, training, and experience to solve problems.

To what factors can this difference be attributed and what are the consequences? First, the fact that the typical dp professional in one organization exhibits a given set of cognitive styles, or personality traits, and the typical dper in another organization a different set may be the result of what has been called the culture of the organization. This results from leadership's assumptions concerning what produces success in that organization. Another way of putting it is managers tend to hire the same type of people for the same type of job. They usually hire people that fit their own particular image of the typical successful dp professional. Hence, over a period of time, the organization will tend to be dominated by that type. And the image held by the managers in the earlier study could well be different from that held by the managers in the later study.

This condition is not good for the overall success of the organization in question. A study was recently conducted at the University of North Carolina at Greensboro by Kathy Brittain White. The results, based on the evaluations of users who were served by two MIS project teams, indicated that the dper exhibited a diverse set of cognitive styles. The challenges confronting the computer professional are many and varied. They include the ability to solve people problems, procedural problems, organizational problems, and timing and programming problems. W. Ross Ashby, author of *An Introduction to Cybernetics* (Wiley Press, New York, 1963) pointed out that it takes variety to conquer variety. In data processing, it takes a variety of mental processes, outlooks, and personalities to solve problems.

This might suggest to thoughtful managers that perhaps their organizations, and the profession as a whole, would be well served by a conscious attempt to diversify the styles, or personalities, of its mem-

# Test drive our Strategy.



Network Systems Corporation, the HYPERchannel® Company, invites you to check out our strategy.

**THE RIGHT NETWORK.** At Network Systems Corporation, our products are designed for a total networking strategy. With the right network, you can interconnect computer hardware from different manufacturers: super computers, mini and personal computers, workstations and terminals.

You've probably been told that a local area network lets you hook-up all types of computers and terminals, and everybody can then talk to each other. In the real world, it just isn't that simple. We offer what it really takes; hardware, software and system integration.

HYPERbus®, our 10 megabit network, will serve your user areas, providing the interconnection of mini-computers, PCs, workstations and terminals. Next, the user area should be linked to your larger mainframes to give users direct access to your integrated data bases. This is where HYPERchannel, our 50 megabit network, comes in. HYPERchannel gives you the power to move vast amounts of data between mainframes. The result is a truly responsive access path to the user area, which is the key to increased employee productivity. Finally, the different computers and terminals must be

able to talk to each other. NETEX® is our software product that lets them communicate in a common language.

With HYPERchannel, HYPERbus and NETEX applied to your **total** networking strategy, users can access and manipulate data like never before. Your data processing systems will work harder, faster and in unison.

**THE RIGHT COMPANY WITH THE RIGHT STRATEGY.** Networking is our only business and we want to be your networking company. We have the products, the experience and a field service organization that's there when you need them.

There are over 400 customers using our systems. If you are planning a network, call or write Network Systems Corporation. You'll see how our strategy can help you with your strategy.

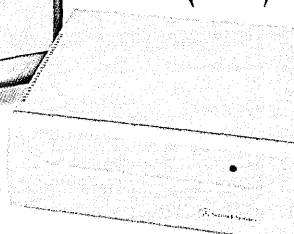
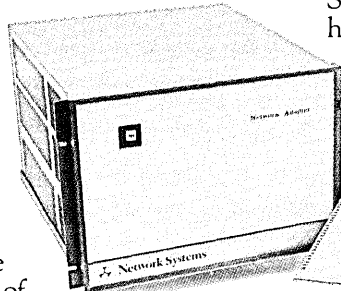

**Network Systems Corporation**

7600 Boone Avenue North  
Minneapolis, Minnesota 55428

**612/425-2202**

**Accept no limitations.™**

Offices in most major cities.

© 1984 Network Systems Corporation  
**CIRCLE 49 ON READER CARD**

## Perhaps organizations and professions as a whole would be well served by a conscious attempt to diversify the styles, or personalities, of their members.

bers. Rather than look for the stereotypical computer professional, managers should attempt to find individuals who are "cognitively fit" (as described by Hussein Mohammed Ali Alawi in his 1973 dissertation at the University of Southern California School of Business Administration). This cognitive fitness may be defined as the assignment of an individual with a particular set of mental processes and styles to a set of tasks that fit and can be most appropriately solved by his or her style. Achieving such a diversity in the dp organization would enable the manager to bring a richness of talents and viewpoints to bear upon the clients' problems.

What does this mean to the manager? Generally speaking, managers hire people with whom they feel comfortable—people they like. In spite of the fact that managers claim they look for employees

with certain technical capabilities and credentials, it is unusual for managers to hire people they dislike. Yet, the foregoing suggests this is exactly the course necessary to provide the required variety of mental processes and approaches to solve the problems at hand. For example, a programming manager may think that an individual with a reputation for socializing and politicizing has no place on the system design team. Two pieces of data imply that this opinion may be wrong. A recent study comparing the work habits of successful and unsuccessful managers of three different organizations showed that the successful manager spent 60% more time in just these activities than the less successful manager. Further, the Greensboro, N.C., study mentioned earlier indicated that the team judged more effective by their clients included individuals with heavy interpersonal components.

In Jungian terms, the more successful team included feelers as opposed to thinkers.

### THINKING TYPE IS PREVALENT

We should recall that the common thread running through the results of both of the Texas studies was the presence of thinking types. In fact, these results suggest that what has been identified is the thinking computer programmer rather than the intuitive computer programmer. When compared with the results of the North Carolina study, however, the Texas organization's findings appear to be missing an ingredient for success: the personality type or cognitive style that identifies with the client organization, relates to and internalizes its business problems and concerns, and is thus able to provide solutions the client can live with comfortably.

It appears to be time for dp managers, and probably managers in all professional fields, to recognize that there is no single style or personality type that fits one individual for life in a particular profession. It should be recognized further that a better product will result from the combined efforts of a variety of mental processes, outlooks, and values. The challenge of providing computer solutions to business problems is a difficult one. As the technology progresses into decision support and expert systems, the fit between the system and the user becomes more critical and the challenge greater. While much more research is needed before the suggestions made here become imperative, it seems the wise manager will abandon the image of the successful dper and enrich the collective mental processes of the staff for the good of the profession and the corporation. ©

Dr. Chandler M. Bush is the manager of business systems and advanced planning in the research and engineering department at the Vought Missiles and Advanced Program Division of the LTV Aerospace and Defense Co., Grand Prairie, Texas. He has over 20 years' experience in information systems design, development, and implementation.

Dr. Lawrence L. Schkade is Ashbel Smith professor and chairman of the Department of Systems Analysis at the University of Texas at Arlington. For a number of years, Schkade has conducted research on EEG wave forms and the cognitive styles of people in various professions. He is coauthor of *The General Theory of Systems Applied to Management and Organization* (Innersystems Publications, Seaside, Calif., 1980).

CARTOON BY SIDNEY HARRIS

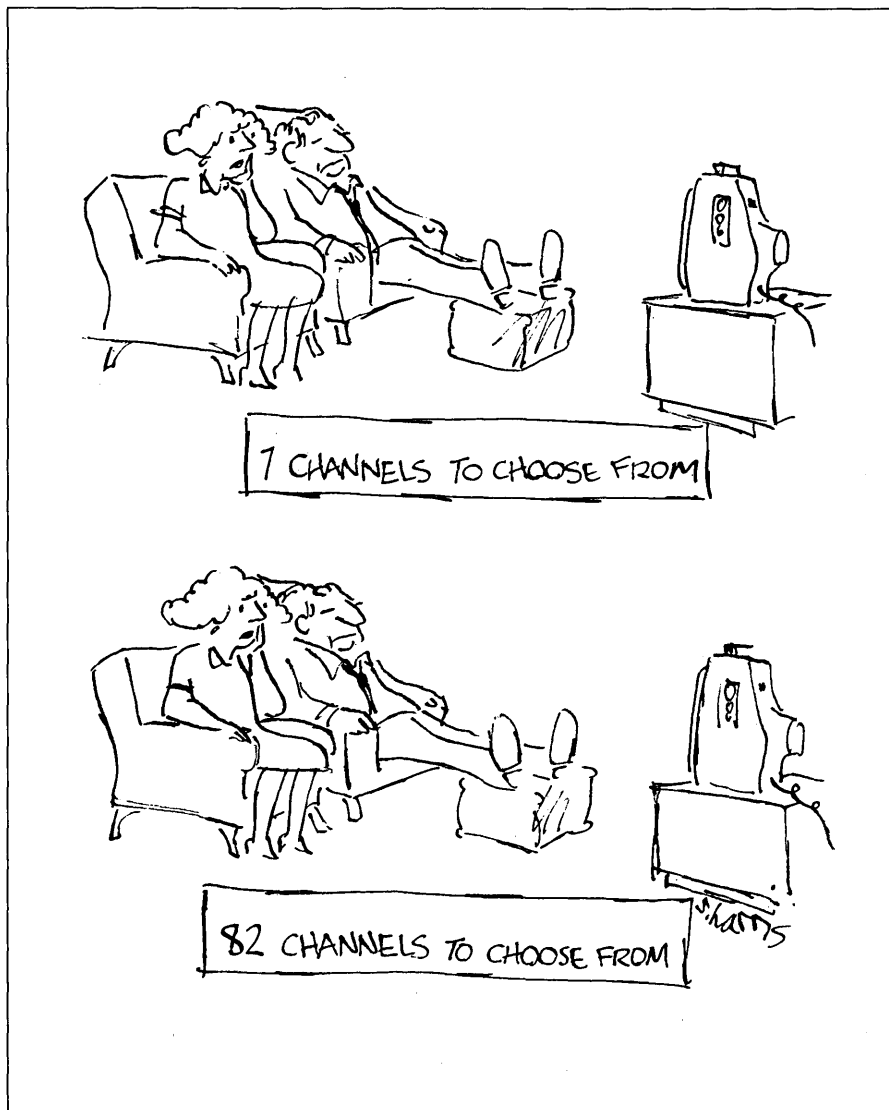

# FOUR LITTLE WORDS THAT STRIKE FEAR IN THE HEART IN THE 1980'S.



“The computer is down.”

It is ironic that when we become dependent on computers, we are at their mercy. As more and more companies go on line, the industry reliability standard of 98.5% becomes unacceptable because it means your computer is liable to go down once every two weeks, on a statistical average.

So, if you are a broker, banker, manufacturer, or businessman who relies on your computer more and more, take note: Stratus Computers are designed not to fail; not once every two weeks, or once every 200 weeks, or once every 2,000 weeks!

### Debunking The Myth That All Fault Tolerant Computers Cost More.

It is a common and reasonable assumption that because there is redundancy (extra programming, or extra components) in fault tolerant computers, that makes them cost more. Where the

	STRATUS XA400	IBM 4381	HP 3000 68	DEC VAX-11/782
RELATIVE PERFORMANCE*	125	100	64	109
PRICE	\$446,350	\$707,897	\$437,754	\$656,889
PRICE PERFORMANCE	\$ 3,571	\$ 7,079	\$ 6,840	\$ 5,999

Relative Price Performance Index  
\*Computerworld, August 20, 1984

All systems are comparably configured with identical amounts of memory, disk space, and communication lines. But, only the Stratus price includes fault tolerance.

redundancy is in expensive software, this is true. But Stratus has hardware-based fault tolerance that takes advantage of the extraordinary advances in chip technology. The result—price drops. The fact of the matter is, our hardware redundancy adds a mere fraction to our cost, and absolutely nothing to your purchase price. What's more, in overall price/performance comparisons against the top computer names, including IBM, DEC, and Hewlett Packard, Stratus was at the front of the pack, despite the fact that it included fault tolerance, while the others didn't.

### Why Stratus May Be The Best Computer For The Times, For The Money.

Considering its showing in overall price/performance comparisons against the most successful computers, Stratus must be considered. And when you take into account the added

efficiency and security of fault tolerance, and the fact that it is the world's most powerful fault tolerant transaction processing computer, Stratus truly becomes impossible to ignore. In the 1980's Stratus simply is the right computer, at the right price. For information, contact your local Stratus sales office, or call Peter Kastner in Massachusetts at (617) 460-2192, or toll-free at 1-800-752-4826.

**Stratus**<sup>®</sup>  
CONTINUOUS PROCESSING™

Now that the world relies on computers it needs a computer it can rely on.



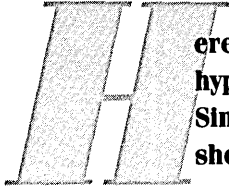

ere are the facts. Not vendor  
hype. Not empty promises.  
Simply the facts. And that  
should be refreshing.

**Users name SOFTWARE**  
**company with top DBMS**

# AG as and 4GL team!

## The word is out--and we're not surprised!

When Data Decisions decided to rate systems software packages, they went right to the people who really count. The users. Their 1984 Systems Software Users' Survey reveals ADABAS—for the third year in a row—to be the highest ranked data base management system for the IBM mainframe. And NATURAL was a top contender for best fourth-generation language.

Taken together, ADABAS and NATURAL make an absolutely unbeatable team! When we talk about product integration . . . it's not just

talk. Every product in our system is fully integrated.

At Software AG, we don't believe in surprises. We believe in providing our users with the most powerful software tools available anywhere. And that's the proper plan for the world leader in advanced systems software.

So if you want the facts about systems software, just ask our users. For starters, send us the coupon below and we'll rush you a reprint of the survey results. Or call us at 1-800-336-3761. (In Virginia and Canada, call 1-703-860-5050.)

Where the future  
comes as no surprise.

**Send me the facts.**

Name \_\_\_\_\_

Title \_\_\_\_\_

Company \_\_\_\_\_

Address \_\_\_\_\_

City \_\_\_\_\_

State \_\_\_\_\_

Zip \_\_\_\_\_

Complete and mail to: Software AG, 11800  
Sunrise Valley Drive, Reston, VA 22091.  
(Or call 1-800-336-3761. In Virginia and  
Canada, call 1-703-860-5050.)

© 1985 Software AG of North America, Inc.  
ADABAS and NATURAL are trademarks of  
Software AG of North America, Inc.

DM0315

# COMDEX WINTER HAS SOFTWARE FOR THE IT HARDWARE ... HARDWARE ALL FOR THE SOFTWARE.

**COMDEX brings you  
the whole computer industry under one roof  
—hardware, software and everything else you need  
to improve the profitability  
of your business.**

## COMDEX™ WINTER '85

**March 21-23, 1985  
Anaheim Convention Center  
Anaheim, California**



Presented by THE INTERFACE GROUP, Inc., world's leading producer of computer conferences and expositions including The Nationwide COMPUTER SHOWCASE EXPOS, COMDEX/Winter, COMDEX/Spring, COMDEX/Fall, COMDEX/Europe, COMDEX in JAPAN, INTERFACE, FEDERAL DP EXPO & CONFERENCE and THE BYTE COMPUTER SHOWS.  
300 First Avenue, Needham, MA 02194 • (617) 449-6600

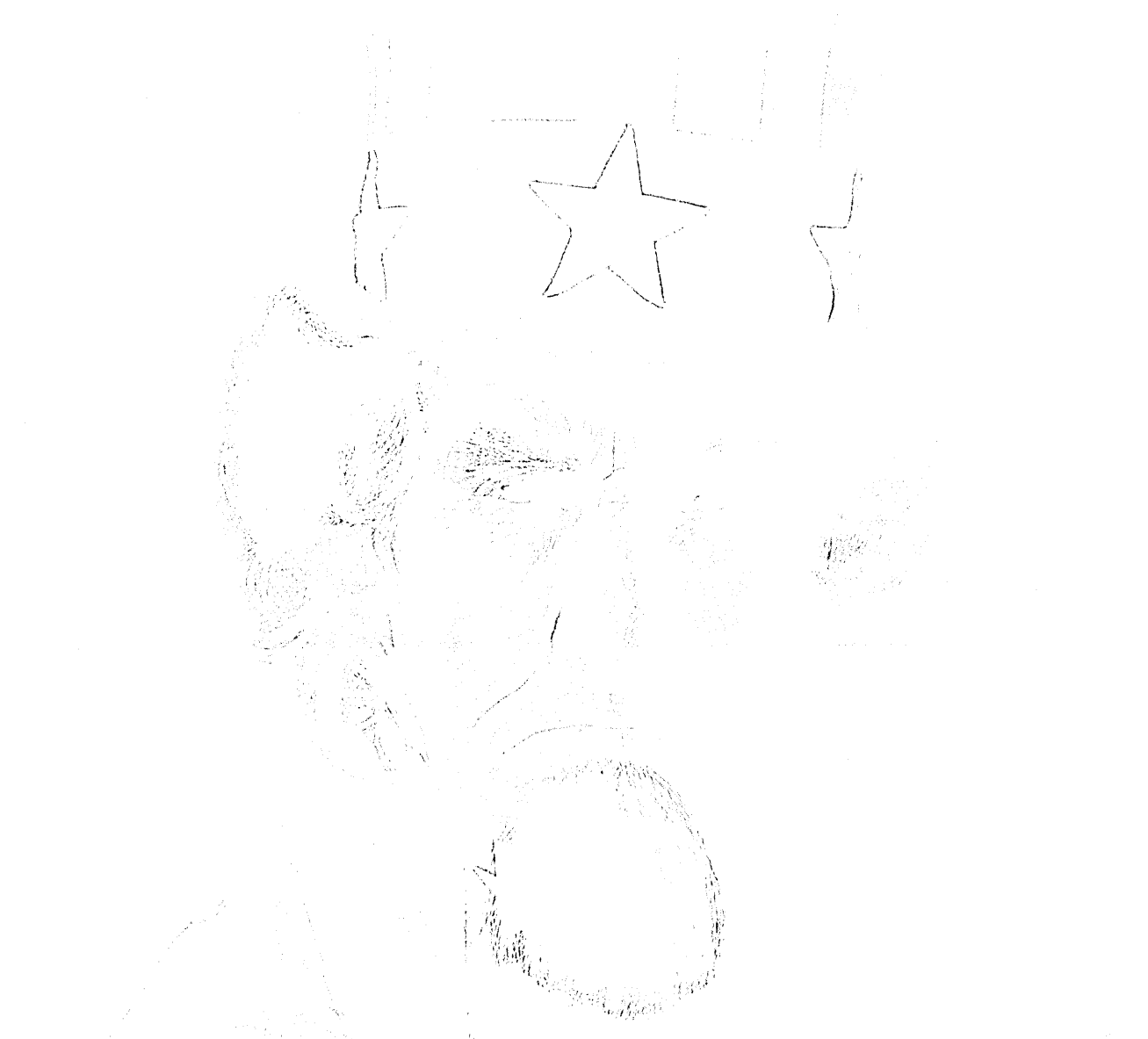

# The UPS manufacturer that sticks to the toughest customers.

Some UPS manufacturers have two standards of quality—the ultra-exacting quality specifications for their government contracts, and the “other” quality they give their commercial customers. But not at GPS.

At General Power Systems, we know that only one customer is tougher than Uncle Sam—the OEM. That's why *all* GPS uninterruptible power supplies—standby, on-line, and standby—are designed, produced, tested and inspected with the same stringent standards applied to our defense products. Components are traceable, reporting is exact, testing is multi-level and burn-in complete.

The result is the highest quality standby, on-line and the industry's most complete line of UPS—the only UPS products directed specifically to OEM requirements. GPS on-line models span the range from 500VA to 2000VA. Our standby units range from 1000VA to 2000VA. Inquire about our full line of products for OEM information.

All GPS uninterruptible power supplies have the high reliability transistor technology pioneered by GPS, plus state-of-the-art operating features. Unusually fast transient response, low output impedance and excellent efficiency characterize the on-line models. Standby units have set the standard with 2ms transition time.

So don't settle for second rate quality. Buy the U.S.S. — by General Power Systems.

Call or write today for complete information. General Power Systems, 1100 N. Dexter St., Anaheim, CA 92804, (714) 654-6200. (Circle 65 on Reader Card)

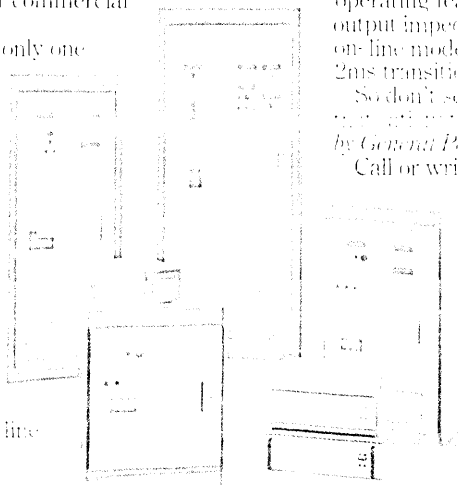

See us at COMDEX — Booth #444.

CIRCLE 65 ON READER CARD

OEM EDITION

**A \$7 billion market is branching off into both higher and lower ends of product lines.**

# SUPERMINIS HEAT UP

**by Lamont Wood**

Interested in a \$7 billion market with lots of action? Try superminicomputers.

But first, there is a question of terms. What is a superminicomputer? If the old-line minicomputers were multi-user, 16-bit machines, then superminis must be multi-user 32-bit machines. Some of the new supermicros, however, could also claim that distinction. Consider the following definitions.

"A supermini is basically a machine with full 32-bit architecture that uses a system bus, rather than channel-to-channel mainframe architecture," says Peter

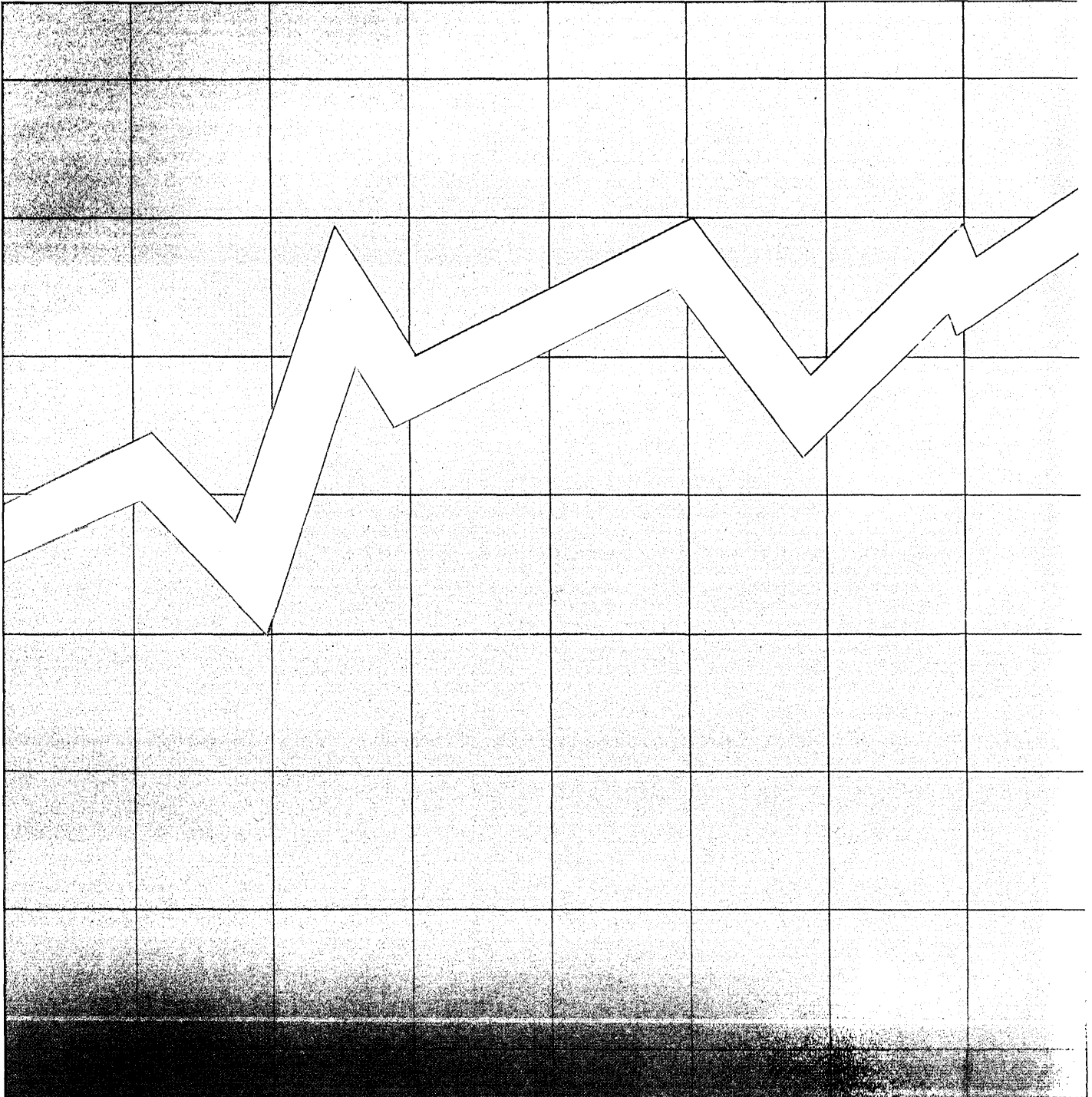

Lowber, senior marketing analyst with Yankee Group, a consulting firm in Boston.

"The supermini group is clearly the high end of the mini market, machines with 32 bits and large address space," agrees Bill Rosser, vice president for small computer systems at the consulting firm Gartner Group Inc., Stamford, Conn. "As for a bus architecture, most already have one."

"I say it's a 32-bit machine with a 32-bit cpu, a 32-bit memory, and a 32-bit path in between," claims Brad Smith, associate director of research for Dataquest's Small Computer Industry Service in San Jose.

Ken Bosomworth, president of International Resource Development Inc., Norwalk, Conn., dissents. "The term is something we try to avoid," he says. "The first IBM 360 was a multi-user, 32-bit machine, so just adopting 32 bits doesn't help. The class has simply lost its identity," he complains.

There's no controversy among the users; they don't judge by bits. "Our Data General MV/10000 supermini provides the computational speed we need for animation, geometric modeling, and finite element modeling," says John Kolb, manager of operations at the Center for Interactive Computer Graphics at Rensselaer Poly-

technic Institute in Troy, N.Y. "Animation requires 24 frames per second, and each frame can take from 30 minutes to two hours of computer time. On our previous minicomputer it took up to eight hours per frame. With a mainframe, meanwhile, you get all those channels to connect different devices, but they are not necessarily geared for computational speed."

Thus, the unifying theme for supermini hardware seems to be a true 32-bit data path. The main players in this market are mostly the old favorites like IBM, Digital Equipment Corp., Data General, Prime, Wang, and a few others. As for the market's activity, the unifying theme is



ILLUSTRATION BY ANDREA BARUFFI



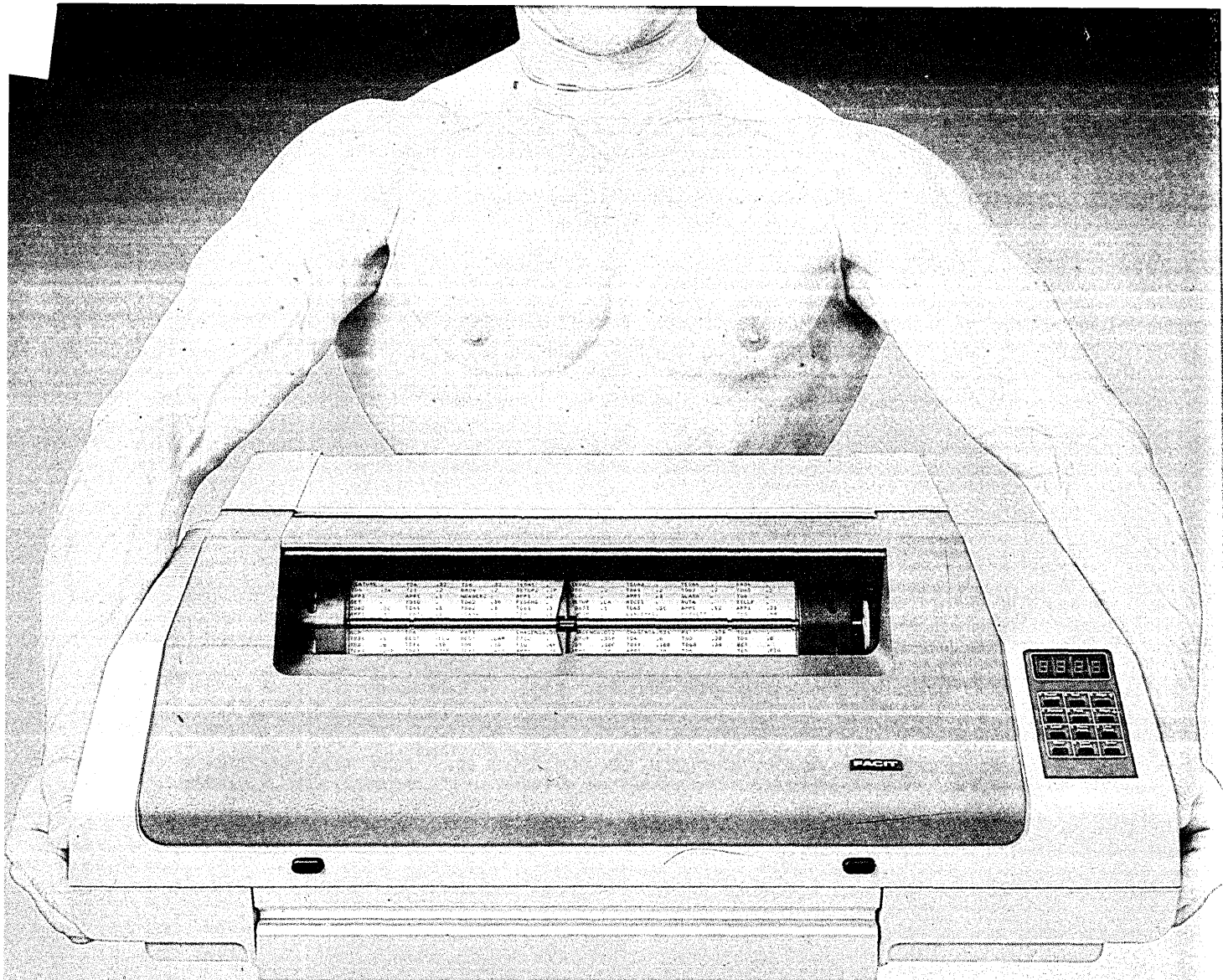

# ADD THE HEAVYWEIGHT TO YOUR SYSTEM POWER

You'll immediately notice the difference with the Facit 4570 Matrix Printer.

Just try to lift it! And its 92 lbs (42 kg) speak for its ruggedness. Built for professional heavy-duty operations round the clock. Featuring Facit's unique Stored Force Flexhammer Printhead with all-perfect, non-deteriorating printouts throughout its average 1,000,000,000 character service life!

Facit 4570 has all the essential qualities that defines it as your central printer for large-volume printouts. As well as the handling of printouts from several wordprocessing workstations. At a speed of 250

CPS draft or 80 CPS NLQ printing.

Integrated in your word- and dataprocessing systems, its software intelligence and printing capability will convince you of its competitive edge.

Italic, bold and elongated characters with 16 different fonts, monospaced or proportional, are easily selected from the keypad or host computer. Equipped with Facit's Cut Sheet Feeder, the Facit 4570 can be manually or automatically fed from two magazines.

So when performance and reliability are vital parts of your system building, Facit 4570 Matrix Printer will add more punch to your own product.

## FACIT

Head Office: P.O. Box 54, S-17222 Sundbyberg, Sweden. Phone: (8)282720.

USA: Nine Executive Park Drive, P.O. Box 334, MERRIMACK, NH 03054.

Phone: (603)424-8000.

CIRCLE 66 ON READER CARD

## Despite differences in definitions, the unifying theme for superminis seems to be a true 32-bit data path.

summed up by Rosser at the Gartner Group. "We are seeing extensions toward both the higher and lower ends of the product lines," he notes. "Vendors want a consistent architecture from the top to the bottom so that customers can start at the low end and migrate upward. The key is a low entry price."

Adds Smith at Dataquest, "They [the minis] have been going downward from a system average of about \$200,000 to provide systems to migrate from, and to fend off the supermicros—the 68000 guys, who have in the past hit the low end of the business real hard."

At the high end, Smith says, "the vendors have been moving upward to get better profit margins, and because there has been somewhat of a performance gap between the \$500,000 range and the \$2,000,000 range, they have been moving to fill it."

### IBM BUCKS SUPERMINI TREND

IBM has bucked the supermini trend by displaying more movement up than down. A low-end Model 3 for the 4361 was unveiled last September, joining models 4 and 5. The 4361 can support up to 32 (optionally 40) workstations. A Model 3 with 2MB of internal memory is \$56,500. The base price for a Model 5 is \$180,000.

At the high end, IBM has the System/38, to which it added high-end models 20 and 40 (joining models 4, 6, and 8) last September. A System/38 can optionally support 128 local workstations. The three older models supported from 1MB to 8MB of internal memory, while the new Model 40 supports 16MB and the Model 20 supports 8MB. A Model 20 with 6MB and a disk unit costs \$175,000, while a Model 40 with 12MB costs \$250,000. The Model 40 has a minimum instruction cycle time of 67 nanoseconds.

IBM's low end is bare, the analysts note. "The window of opportunity for non-IBM vendors is still open because IBM does not have an across-the-board solution under one operating system," says Yankee's Lowber. "At the moment, the System/36 [a 16-bit machine] is a patch between the 4300 line and the PC. But IBM's long-range strategy is to supply such a solution, and we will be seeing lower-end 4361s and desktop 4361s in the future," he predicts.

But you won't find any uncovered flanks in the VAX line from DEC. There are 16 members of the DEC VAX product line; the newest and largest is the VAX 8600, announced last October. The machine supports 32MB of internal memory and 512 communications lines, and has a cpu cycle

time of 80 nanoseconds. Prices for the 8600 start at \$576,000. The smallest VAX is the MicroVAX I, a desk-side 32-bit micro with VAX compatibility. It can support 2.5MB of internal memory and four users. The price of a basic unit with no hard disk is \$9,995.

For the ultra-high end of the market, DEC also has the VAXcluster, which allows 16 high-end VAX superminis to be combined into one computing entity, capable of supporting 160GB of on-line storage.

The VAX line, of course, also includes the VAX 11/780, a machine commonly used as the standard for comparison in the supermini field. It supports up to 100 users and 32MB of internal storage, and has a cpu cycle time of 200 nanoseconds. The price starts at \$150,000.

But while IBM and DEC have, between them, the lion's share of the supermini market, all eyes seem to be on a wild-card newcomer, AT&T Information Systems, with its 3B supermini line. Unveiled about one year ago was the 3B20s, which can support 12MB of internal memory and 128 users, with a base price of \$230,000. The 3B20A is the same machine with an extra processor, boasting 1.8 times the throughput of the 3B20s and supporting 24MB and 128 users. It starts at \$330,000. There is also the 3B5 for office systems with up to 60 users, starting at \$57,000, and the 3B2/300 desktop for up to 18 users, starting at \$9,950. The marketing literature stresses hardware reliability and AT&T's Unix operating system.

"The 3B20, which came out in 1984, has the same performance as the DEC VAX 11/780, which came out in 1977," complains Brad Smith at Dataquest. "They have been successful in selling to [divested] Bell operating companies, but not outside that market," he claims.

"I think they're dead in the water," agrees Lowber at the Yankee Group. "I don't think they've sold anything to any new accounts. Their price is off the wall—out of the ballpark, actually above the VAX 11/780. And there's no software. Nothing. I look for a major change in 1985, unless they want to just die," he said.

Although AT&T-IS will not give out names of users, a 3B system was uncovered outside a Bell operating company, in the Department of Anesthesiology of the University of Texas Health Science Center at San Antonio. "When we limited ourselves to Unix there weren't too many vendors," recalls Philip Helsel, research instructor. The department's 3B2/300 (acquired for office automation) is fully loaded with 18 ports, but AT&T-IS recommends there be no more than seven or eight users on-line at a time, he notes. "The AT&T people have been

very helpful," he says. "A guy from Bell Labs came down to talk to us."

### AT&T-IS DENIES RUMORS

Elsewhere, persistent rumors are encountered that AT&T-IS would start OEMing DEC VAX 8600s (or, alternately, Amdahl mainframes) but an AT&T-IS spokesman denies everything. A DEC spokesman says only, "It would not be appropriate for us to comment."

Among established vendors is Data General with its MV product line: the MV/4000, MV/6000, MV/8000, and MV/10000. The 4000 supports 8MB of internal memory and 64 users; the 6000 supports 8MB and 96 users; the 8000 supports 8MB and 128 users, and the 10000 supports 16MB and 192 users, and has a machine cycle time of 140 nanoseconds. An eight-user small cluster version of the MV/4000 starts at \$38,400.

At Prime Computer Inc., Natick, Mass., the supermini market is represented by the five-member Prime 50 series, ranging from the office-sized 2250 with 800K internal memory and 8 users, to the new 9955, which supports 16MB and 255 users, and has an "effective memory access time" of 58 nanoseconds. Starting prices range from \$30,000 for a 2250 to \$351,000 for a 9955.

Wang Labs has the Wang vs product line. In December Wang shored up its midrange product line with the Wang vs 65, which supports up to 4MB of internal memory and a maximum of 30 users, with the cpu and memory costing \$19,000. At the bottom of the line is Wang's vs 15, supporting a maximum of 10 users, 2MB of internal memory, and a cpu price of \$13,500. Above the new vs 65 there's the vs 85, which handles up to 4MB and 64 users, and has a cpu price of \$64,000. The vs 100 supports 1MB to 8MB and 128 users and has a cpu price of \$85,000, while the vs 300 supports from 4MB to 16MB and 255 users, and has a cpu price of \$170,000.

Gould Inc.'s Computer Systems Division of Fort Lauderdale, Fla., has the Concept 32 line, including the 32/27, 32/67, 32/87, and the new 32/97 with a cycle time of 97 nanoseconds. Honeywell has the DPS6 line with six members, from the desktop 6/10 in the \$5,000 to \$15,000 range, to the 6/95 with 128 ports and a bus cycle time of 300 nanoseconds, in the \$100,000 to \$400,000 range.

Hewlett-Packard offers the HP3000, which breaks down into the systems 39, 42, 48, or 68. The System 39 supports up to 3MB of internal memory and 92 terminals, and has a 105-nanosecond micro-instruction cycle time, and a cpu price of \$33,200.

## "The window of opportunity is still open because IBM does not have an across-the-board solution."

The System 68 is called a "distributed mainframe" and supports up to 8MB of internal memory, has a 75 nanosecond micro-instruction cycle time, and a cpu price of \$186,000.

"Micros, like the 68020, true 32-bit micros, will be coming out in systems later this year," notes Brad Smith at Dataquest, "but almost all those systems will be running Unix. The traditional supermini vendors have strong operating systems—operating systems that are more sophisticated than Unix and have 10 to 15 years of existing applications written for them. The buyers would have to rewrite their software to move from, say, a VAX to a Unix machine, and that would eat up any savings."

"Unix is not a full-scale operating system," adds Lowber at the Yankee Group. "The current version doesn't even have virtual memory or demand paging. The traditional vendors have a tremendous advantage with their operating systems at the moment, but Unix will eventually come up to speed, and then those vendors without a large installed base for their proprietary operating systems will be in trouble."

### PROGRAM EASE WITH WANG VS

The consensus among users is that the operating system advantage is not a trivial point. "The main reason we went with the Wang vs was the ease of programming," says Richard Raybould, director of data processing in the State of Utah's Department of Administrative Services in Salt Lake City. "With one inexperienced person working for a month, we were able to convert an application that took six people a year and a half to write under IBM CICS."

"We did a statistical study and found that we had eight to 12 times the productivity rate for program development on our WANG VS, although the design work takes the same amount of time," says Keith Fogleman, program manager for Input Output Computer Services Inc. in Washington, D.C., which provides the computer services for the Federal Aviation Administration.

Dataquest's Brad Smith also perceives that Unix might give its vendors a "product differentiation" problem. "The traditional mini companies also offer Unix,

so what is the uniqueness of the new supermini cpus that will keep them alive?" he asks. "They will probably end up selling to second- and third-tier customers, and DEC and the others will sell to Fortune 50 or Fortune 500 customers."

There is a new trend afoot in the supermini area and it has to do with the reduced instruction set computer (RISC). As 1985 goes into its second quarter there is much talk of vendors coming out with 32-bit Unix machines based on RISC.

"I expect to see a RISC machine from DEC by mid-1985, and also some product activity from Hewlett-Packard and IBM this year," says Rosser at the Gartner Group. "The price/performance benefits of RISC can be an improvement of 33% or better, although there are more benefits in solving some types of problems than others," he says.

One relative newcomer in the supermini field that embodies both the Unix and the RISC trend is Pyramid Technology Corp., Mountain View, Calif., with its 90X RISC Unix-based supermini. The 90X ranges in price from \$120,000 to \$350,000.

"Our machine was based on RISC ideas, but there are some differences, because in the real world you have to support floating point arithmetic and an operating system," says Robert Ragen-Kelley, co-founder and vice president of architecture and planning at Pyramid. A supermini might have 300 to 500 machine language instructions, while the Pyramid machine has about 100, and a RISC research machine in a college lab might have as few as 30.

"The idea behind RISC is that most operations are performed on data in registers avoiding memory fetches, and that each operation is done in one cycle, or in as few as possible," Ragen-Kelley says. It also allows the maker to use less, and simpler, hardware.

"Unix is written in a high-level language so it's easy to port," Ragen-Kelley claims. "Anyone coming out with a new machine will, in almost every case, end up using Unix. It is just no longer possible to spend the money to write your own operating system, or to get people to convert to it."

Unix and RISC aside, the future for superminis as a class looks rosy. "Superminis are taking over the roles of 16-bit classical minis," says Rosser at the Gartner Group. "The classical minis are going to be lost between the supermicros and the low-end superminis. There is going to be no middle ground left for them," he warns. ©

Lamont Wood is a free-lance writer based in San Antonio, Texas.

### DATA ENCRYPTION... FOR YOUR EYES ONLY

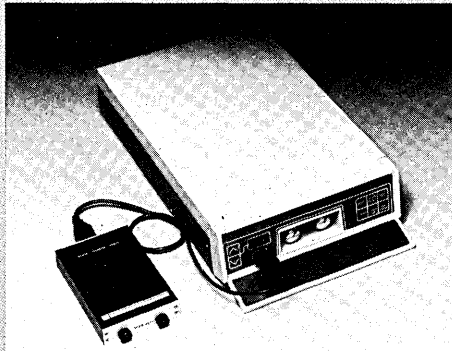

TCC introduces the DES based Cipher X 5000 data encryption system designed to meet FED-STD-1027. The user friendly Cipher X 5000 features a flexible, highly secure key management system and is ideally suited for dedicated and dial-up, point to point and multidrop computer networks, as well as FAX systems.

The Cipher X 5000 ensures that your information is For Your Eyes Only. At TCC, providing COMMUNICATIONS SECURITY SOLUTIONS is our business.



Technical Communications Corporation  
100 Domino Drive, Concord, Massachusetts 01742 USA  
Telephone: (617) 862-6035 Cable: TECOM Telex: 923407



# BLACKOUT

We reserved this space to tell you how you can quickly and easily pinpoint the source of your power problems by using the Liebert 3600A PLDM® but we had a blackout. Please call (800) 538-1770, or in California (916) 381-2730 for a copy of what we were going to tell you on this page before the lights went out.

**Automated solutions have been devised for virtually every phase of police work.**

# THE BINARY BADGE

by Philipp Harper

No one knows precisely what the market is for high-tech devices that aid the police in their efforts to make the streets safe. It is generally agreed, however, that the police are more automated than the felons that they are pursuing.

Little more than a decade ago, records management was virtually the only law enforcement function that had been automated, and then only by the largest agencies. Today, computerized record-keeping is commonplace at all levels. Even medium-sized departments are exploring such esoteric applications as computer aided dispatch and automated crime and fingerprint analysis.

In the greater context of computer use by municipal and state governments, law enforcement ranks behind only financial management in terms of funds invested.

An official with the International Association of Chiefs of Police in Washington, D.C., asserts that it is not unusual for an individual county in the United States to encompass as many as 15 separate law enforcement agencies. Perhaps the most reliable estimate of the gross market is contained in the *Uniform Crime Report* published annually by the FBI. The most recent report, covering 1983, contains voluntary crime reports from nearly 16,000 city, county, and state law enforcement agencies.

The Criminal Justice Information System Clearinghouse, a Sacramento, Calif.-based organization funded by the U.S. Justice Department, keeps track of roughly 1,000 separate law enforcement computer systems in this country. CJIS Director Al Lammers says most of the systems on file with the clearinghouse are dependent on mainframes and generally come under the auspices of some central processing department.

The evolving prominence of the microcomputer in law enforcement—a trend in virtually all vertical markets—is sure to hasten the decentralization of the

data processing function noted by Kenneth Kraemer, a University of California at Irvine professor who specializes in computer use by municipal government.

A decade ago, Kraemer says, "On average, cities with populations of over 50,000—and counties of over 100,000—all had more than one mainframe or mini, and that second machine was used by the police. If anything, it's gotten more decentralized, and there are more computer installations in police departments and everywhere. The departmental machine is a reality."

A reality, perhaps, but commonplace? Apparently not, at least according to Steve Haynes of the International Association of Chiefs of Police. "This truly is a virgin market," says Haynes, who heads the IACP's data processing section.

## SYSTEMS FOR ALL PHASES

Though hard numbers indicative of total computer usage by the law enforcement community are not easily determined, automated solutions have been devised for virtually every phase of police work, from the arrest on the street through to incarceration of the suspect in the city or county jail.

Out on the frontlines, uniformed officers on patrol must no longer depend on radio-voice communication as their sole link to headquarters. Far more efficient, albeit expensive, use of police radio channels is possible with sophisticated mobile crts.

Contemporary mobile car units include features that just a few years ago would have been found only in advanced office systems. For example, the KDT 480, the latest mobile crt from Motorola, adjusts automatically to changes in ambient light, displays up to 480 characters, permits users to perform simple graphics functions, and boasts a detachable keyboard.

The allure of the mobile crt is simple. "You can have many more discussions digitally than you can by voice," claims Ed Hurley, an executive with Hadron Inc., a Vienna, Va., firm that puts together a system designed to augment the KDT 480.

The capability of the Hadron system provides insight into the power many officers now have on hand. One function of the GMS 50, which is marketed exclusively by Motorola, is to serve as an interface between mobile units and state databases.

The time savings made possible with such a system are substantial, but then so are the costs. Mobile crts, which typically cost in the neighborhood of \$5,000 each, usually can be afforded only by larger departments. This may be changing, however.

"We're looking at commercially made handheld computers as a cost-effective way of achieving this mobile data function," says one California-based vendor of mobile radio equipment. He adds that a "64K-type box," priced below \$1,000, probably would be suitable for police use.

While the widespread deployment of mobile crts in the law enforcement community may be a thing of the future, the use of computers to carry out a variety of centralized, headquarters-based functions is firmly entrenched. Moreover, because the microcomputer can deliver substantial power at a relatively low cost, it is a phenomenon of grass roots as well as metropolitan law enforcement.

While record-keeping is undoubtedly the most common back-office application, developments in the areas of computer aided dispatch, crime-pattern analysis, and fingerprint analysis provide a glimpse of the profession's future shape.

Computer aided dispatch "turns the communications room into a paperless system," says Charlie Moss, a Hadron Inc. senior programmer who helped design its computer aided dispatch system. The Hadron system provides a good example of the capabilities now available with computer aided dispatch.

Telephone operators enter calls into the system as they're received, inputting such pertinent details as call type and location. Based on their type, calls are assigned a priority as they enter the dispatching queue, with the most important appearing at the top of the queue by default.

LETTER QUALITY  
AND  
COLOR GRAPHIC  
PRINTER  
JDL-750

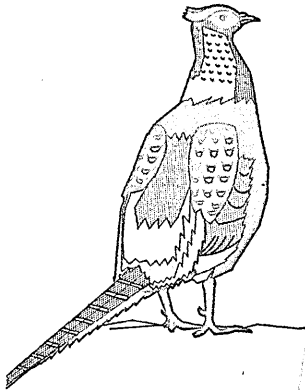

JDL INC

...the three concerns. This article uses  
sputtering source that uses this system.

The target area beneath the wafer position is 200mm  
and 250mm in diameter for a 125mm wafer; both target si  
up to 2.5mm thick. The target is metal-bonded to a wa  
through which a bath of cooling water flows. The magnet is  
plate, exposed. This simplifies changing the target without  
cooling water connection.

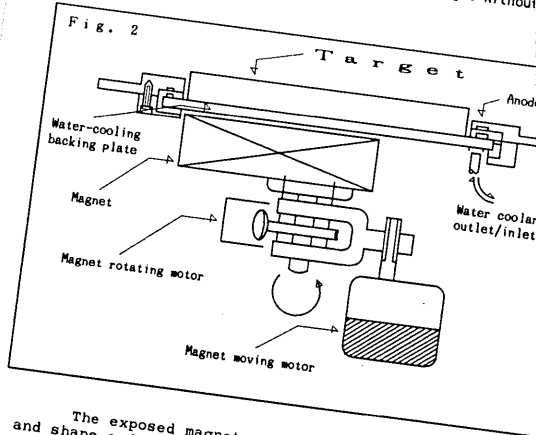

The exposed magnet position allows for greater fr  
and shape and, since the magnet is not near the cooli  
water path is not subject to rust. The target uses thi  
magnetic field technology patented by Smith to raise th  
of the target in the path of the magnetic field that fic

To All District Managers:

Congratulations, for the first six months of this y  
have exceeded projected by a healthy margin.

With the exception of an expected dip in March, mont  
continuing to increase. Given our current growth rat  
potential, we now expect to exceed sales of \$1,500,00  
year end.

The bar graph below dramatically indicates our reven  
and the improvement over projected sales. The pie  
revenue generated by district.

% Revenue (by district)

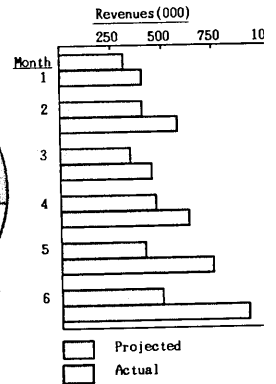
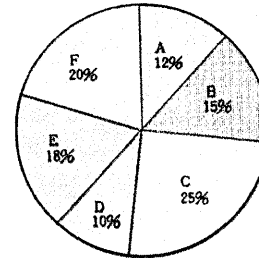

# Call for the print samples that make our competition pale.

What OEM's are saying. OEM's who have seen these print samples for themselves call our graphics CAD-quality. The kind that reproduces the finest detail with superb accuracy and registration. The JDL-750's color graphics are so vivid, images seem to jump off the page. Add to that letter quality printing, and font versatility that surpass fully-formed character printers. Now you know why we're the perfect match for OA and CAD workstations.

What JDL is doing. The JDL-750 brings the best of Japanese printer design and

manufacturing together with American OEM marketing and custom engineering. This gives JDL, Inc. the flexibility and responsiveness necessary to deliver printers that meet your requirements and schedules.

You be the judge. If your workstations need exceptional color graphics, letter quality, font versatility, reliability and value that can't be matched by any competing technology, call us for print samples and product specs.

One look and we're sure you'll call us again... for an evaluation unit.

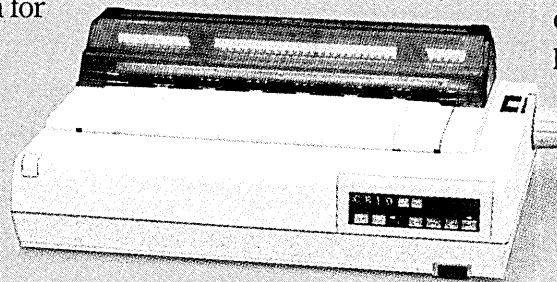

(805) 495-3451

JDL  
INCORPORATED

2801 Townsgate Rd., Suite #104, Westlake Village, CA 91361

CIRCLE 69 ON READER CARD





```

(system) UNIFY SYSTEM
17 SEP 1984 - 18:01
System Menu

1. System Maintenance          9. Data Base Test Driver
2. Schema Listing             10. MENU Screen Menu
3. Create Data Base           11. MENU Report Menu
4. SCRM Menu                  12. Reconfigure Data Base
5. ENTER Screen Registration  13. Write Data Base Backup
6. SQL - Query/IM Language    14. Read Data Base Backup
7. SQL Screen Registration    15. Data Base Maintenance Menu
8. Listing Processor
SELECTION: 0
  
```

```

(student) UNIFY SYSTEM
(1) INQUIRE 25 Aug 1985 - 18:45
Student Registration Form

Invoice Number: (450)

Last Name: Gordon          First Name: Richard
Company: Silicon Design Labs
         5550 Industrial Way
         Basking Ridge NJ 07000
         (201) 555-9400
Student's phone number (if different): (201) 555-5421

Class code (sawwy): DP6965      Subject: C Programming
Class fee: 995.00                Class date: 8/1/85
Deposit date: 8/15/85            Deposit amount ($): 100.00
Payment date: 8/25/85            Payment amount ($): 895.00
  
```

```

(student) UNIFY SYSTEM
(1) INQUIRE 25 Aug 1985 - 18:45
Student Registration Form

Current: 1

REPORT TO: SCREEN PRINT FILE FILENAME
1. Student Registration Listing (r) (.) (.)-listing
2. Student Billing (r) (.)
3. Billing Summary (r)

REPORT (1)
  
```

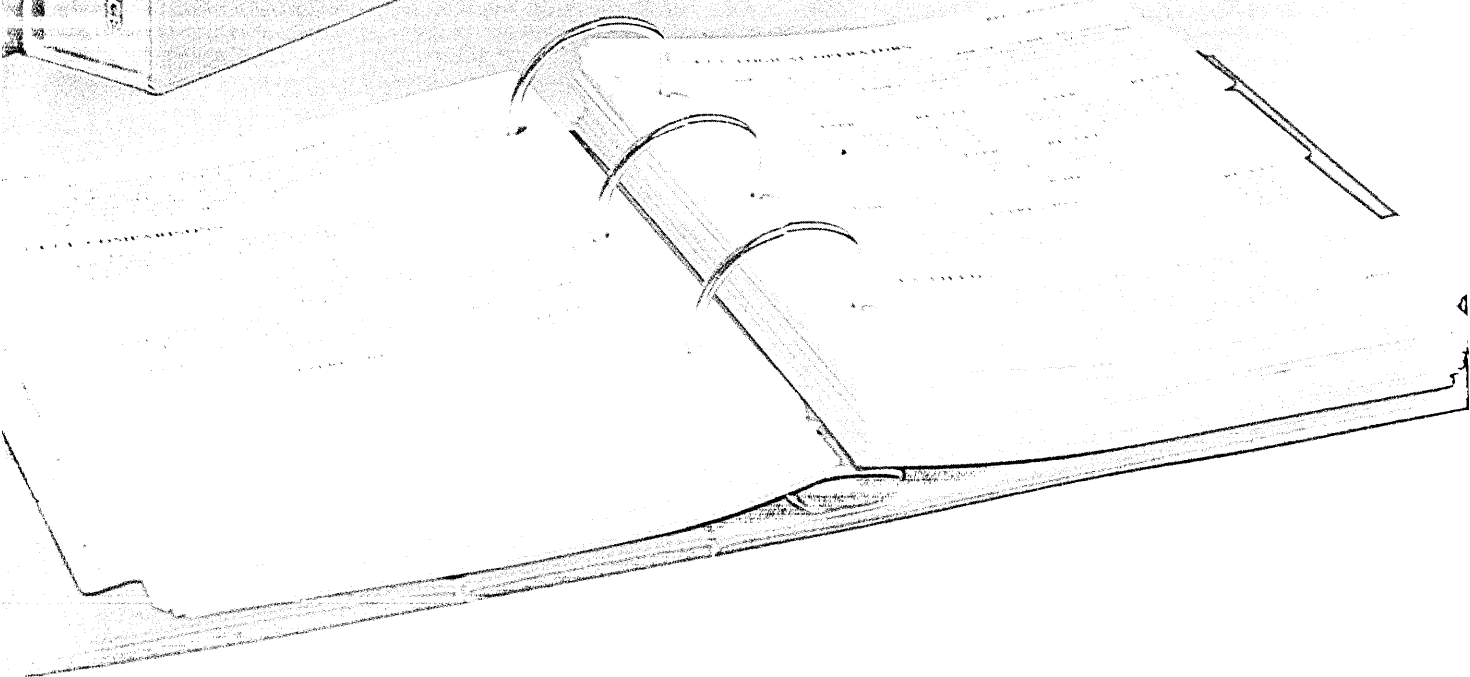

\*UNIX is a trademark of AT&T Bell Laboratories.  
 UNIFY is a trademark of Unify Corporation.  
 Copyright © 1984, Unify Corporation, Lake Oswego, OR 97034

# UNIFY. THE MIGHTY EASY DBMS.

UNIFY isn't only the fastest and most powerful of all UNIX\*-based data base management systems—it's also one of the simplest to use. Which is why some 75 percent of those who see our manuals and buy a DBMS, buy UNIFY.

UNIFY guides the nonprogrammer through data base development with minimal steps, comprehensive menus, on-line HELP, elementary Query By Forms capability, and clear documentation.

UNIFY expedites applications development for users of all skill levels with features like PAINT, for effortless forms design; SQL, the powerful, English-like query language; and a menu-handler that lets you quickly compile screens, queries and reports into menus customized to each user.

And for the skilled programmer, UNIFY offers the most extensive host language interface, for limitless flexibility when you need it.

All of which makes it mighty easy to see why UNIFY has been selected by more computer manufacturers than any other UNIX-based DBMS.

**Judge for yourself.** Send for our demo kit—disks, tutorial and reference manuals, all for only \$150—that shows you how to build virtually any application. Contact UNIFY, 4000 Kruse Way Place, Lake Oswego, OR 97034, 503/635-6265.

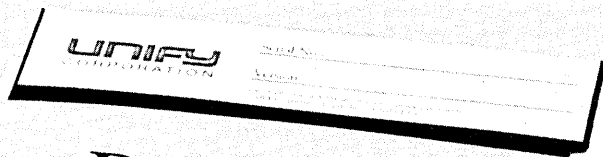

**RELATIONAL  
DATA BASE  
MANAGEMENT  
SYSTEM**

**UNIFY®**

**THE PREFERRED DBMS.**

CIRCLE 70 ON READER CARD

## The use of computers in headquarters functions is firmly entrenched.

### TRACKING POLICE UNITS

The dispatchers are also able to determine, with just a glance at their screen, the location and status of all police units across the covered geographic area. As if that information alone were not enough, the system decides for the dispatcher which unit should be assigned to which call. Additionally, response time is logged, and dispatchers are alerted when a given call has not been answered within a certain time period.

Traditional manual dispatch systems involve filling out cards by the call takers, who pass the cards manually to the dispatchers. Dispatchers must work with a stack of paper instead of a single computer screen.

The Hadron system, which requires 3MB of main memory, is designed to run with a variety of Hewlett-Packard mini-computers, from the 42 series on up. The view package incorporated by the HP 2626 terminal permits windowing so more than one aspect of the dispatch function can be handled simultaneously on a single terminal. Software licensing alone for the system costs \$75,000.

According to Terry Gill, a marketing executive with Wismer & Becker, a Sacramento, Calif., turnkey systems house, "What makes a really useful computer aided dispatch system is the ability to mix other technologies with it." Wismer & Becker sells a range of computer aided dispatch and other law enforcement packages designed to run on HP minis and Tandem mainframes. The systems cost anywhere from \$200,000 to \$500,000.

When an agency is spending that kind of money for that kind of technology, Gill says, "they usually want to add other things." The current trend, he continues, is to use the computer aided dispatch system's backup cpu for other applications.

Two applications in particular—crime and fingerprint analysis—promise to have the most dramatic impact on law enforcement efforts to control American crime.

Systems exist that deal with crime before and after the fact. Crime-pattern analysis measures a given situation, or the behavior of a given individual, and by comparing it with established patterns, attempts to detect the potential for criminal activity.

It is possible to analyze the back end of the criminal process as well. For example, Hadron's Investigation Management Information System (IMIS) is designed to aid future investigations by analyzing the manner in which past crimes have been solved. Cases are even assigned a "solubil-

ity factor." The system can cost up to \$15,000, depending on the options and hardware selected.

Of even more immediate impact are the fingerprint analysis systems that have been acquired by a handful of the larger law enforcement agencies. The acknowledged leader in the field is NEC, the electronics conglomerate based in Tokyo. NEC fingerprint-analysis systems are used in this country by the State of Alaska and the San Francisco police. Earlier this year, the company announced the sale of a \$24 million system to the State of California.

Installed last March, the NEC system in San Francisco has already produced dramatic results. Joe Phillips, who distributes the system for NEC in this country, recounts that on the first night of trial operation, the system correctly identified prints that enabled San Francisco police to solve three homicides, each at least 10 years old.

In the year prior to installation of the system, a total of 52 latent prints taken from crime scenes were positively identified using manual search and comparison techniques. The number of positive identifications rose to 1,000 during the first nine months the new technology was in use.

### PRINT IDS MADE IN 1.3 MSECS

The system, which cost San Francisco some \$2.4 million, compares search prints—whether latents or those on a standard 10-print card—against a database containing the 3 million individual prints of 300,000 persons arrested sometime in the past in San Francisco. Search prints are optically mapped, and their distinguishing features then translated into mathematical designations. Special pipeline processors can compare a search print to a single database print in only 1.3 milliseconds. Each finger in the database is assigned a score based on its similarity to the search print and, Phillips explains, "the highest score bubbles to the top and that's your most likely suspect." Multiple pipeline processors can be brought into play to speed up comparisons with large databases.

"It's crazy," Phillips exaggerates, "but you can't commit a crime twice in San Francisco anymore."

Not every city can afford to be on automation's leading edge, however. Happily, computer solutions also are available to the administrators of smaller municipal budgets as well.

The IACP's Haynes points out that a modest turnkey system used to maintain general records can be purchased for as little as \$2,500. He concedes, though, that it generally costs a small agency anywhere

from \$5,000 to \$10,000 for the requisite system, which might consist of "a couple of floppies or a small fixed-disk cpu, a terminal, and a printer."

At this level the cost of hardware is not the real problem, however. "It's a software-dependent market, and that's been the real issue," Haynes says. "I can go out and buy a dozen pcs of different makes and find good financial software to run on them. But if I buy a dozen pcs of different makes and try to find law enforcement software, that's a different story."

Chicago-based Diamond Systems Inc. is a good example of a software house that moved quickly to meet the needs of medium- to small-sized law enforcement users. Diamond started in the market about three years ago when it customized a records-management package for a single Illinois police department, and now sells some 37 different law enforcement programs off the shelf. Applications range from personnel training and automobile fleet management to crime case inventory and animal licensing. Of the company's \$750,000 in annual sales, roughly 75% is in the law enforcement market.

"Today, police departments are really inundated with records, and they have to have some way to manage them," says Diamond Systems' president Roger Wayman. He cites a police department in one small Midwestern town that maintained its records on 500,000 Rolodex cards. Diamond Systems has sold its software to about 50 police departments around the Midwest.

Though the IACP regularly holds data processing seminars around the country, and the CJIS clearinghouse can show some departments how operations of similar size have automated, many smaller departments find they must go it alone. "They just jump in and try it," says the University of California's Kraemer. "For them, that's the way they're going to have to do it."

Just how far automation will go in the law enforcement community remains to be seen.

"If anything," says Donald F. Norris, senior research associate at the Center for Applied Urban Research at the University of Nebraska, "it's getting more and more difficult to finance anything in municipal government, and the things that are going by the board most rapidly are capital items. If you don't have the money to pay police and fire department salaries, you're sure not going to buy them computers." ©

Philipp Harper is a free-lance writer based in San Diego.

ADDITIONAL INFORMATION

FUJITSU 1035D MODEM 224

INTERFACE				TEST				MODE				TEST							
DTR	DSR	CI	RTS	CTS	CD	TD	RD	HS	ERR	TST	TK	ORG	LS	DL	AL	RDL	ST		
○	○	○	○	○	○	○	○	○	○	○	○	○	○	○	○	○	○		
								DT				ANS				HS			

The keypad does not need to be used for normal operation. It is only used for setting the mode and addressing numbers of operation.

When the power is turned on, the display shows the mode and addressing numbers of operation. The mode is set to "MODE" and the addressing numbers are "0000".

© FUJITSU LIMITED 1985

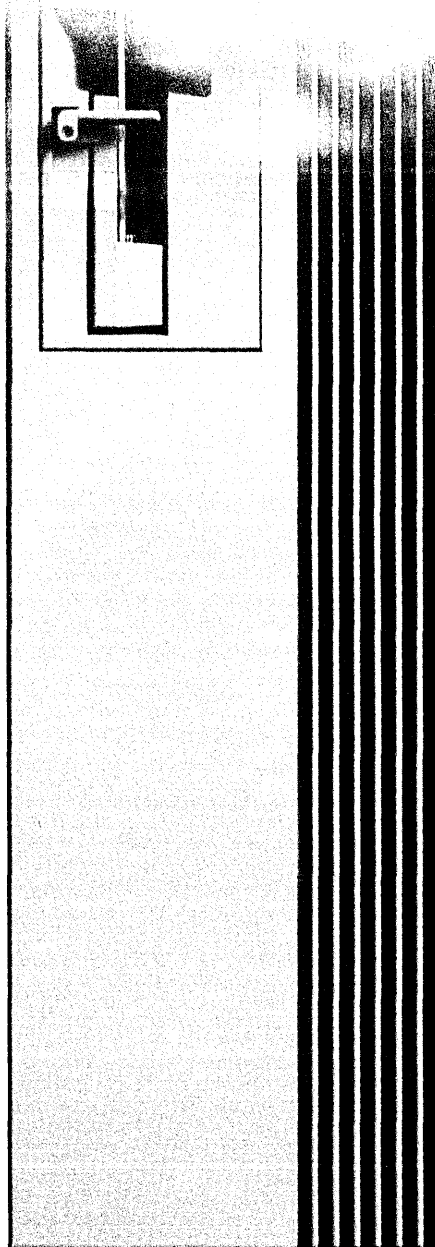
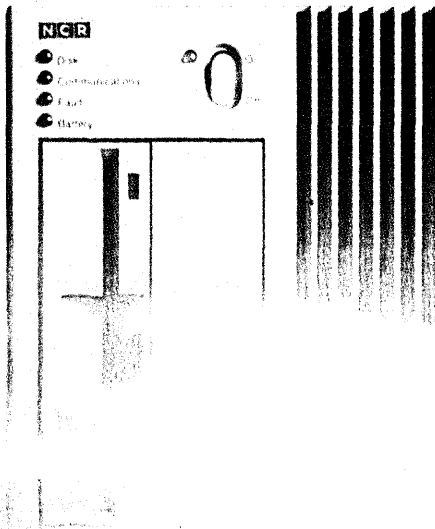

# THE MORE YOU KNOW ABOUT UNIX,\* THE TALLER THE TOWER XP STANDS.

The engineers at NCR are now convinced that UNIX is the best operating system in the industry.

Of course, to convince these reliability fanatics, UNIX had to endure thousands of hours of grueling tests. But that's simply the price any component must pay to get into an NCR product.

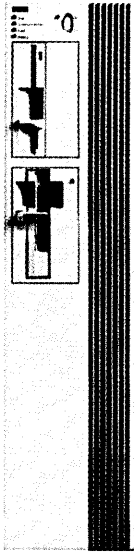

And it's a better UNIX for the experience.

The NCR-enhanced UNIX in the Tower XP is the first UNIX of true, commercial reliability.

It virtually never PANICs. Consequently, neither do your customers.

So that this UNIX might be all things to all users, we employed the Tower XP's menu builder to create the five faces of UNIX. A remarkable case of multiple menu personalities. One for each of five user levels, from sophisticated user to data duffer.

And our UNIX speaks a language for each of five programmer types: Business BASIC, Pascal, Fortran, C, and Cobol.

Team this powerful operating system with the Tower XP's other prodigious features; consistent error logging, extensive remote and in-service diagnostics, Automatic Power Failure Recovery, and more, and you've got a monumental mixture. Capped by NCR's towering commitment to OEMs.

The more you know about Tower XP, the better NCR looks.

**TOWER XP.  
BUILT FOR SYSTEMS BUILDERS  
BY NIT-PICKING FANATICS.**



OEM Systems Division

**CIRCLE 72 ON READER CARD**

NCR Corporation, U.S. Data Processing Group, OEM Systems Division, USG-1, Dayton, Ohio 45479. Nationwide (800) CALL NCR. In Ohio (513) 445-2190. In Canada (800) 268-3966.  
\*UNIX is a registered trademark of AT&T.



# ON-LINE:

# OFF-LINE:

## It's a terminal

## It's an IBM compatible PC



## COPAM'S T-310 PC SERVER

The T-310 PC Server terminal is specially designed to enhance the efficient use of IBM PC, PC XT or PC AT system software and hardware resources. The T-310 works both on-line—as a diskless terminal—and off-line—as a personal computer in its own right.

The COPAM T-310 was designed for people who want to substantially upgrade their IBM PCs (or compatible systems) without making an equally substantial investment. Using advanced local area network technology, the T-310 can be linked to one or more personal computers, thereby eliminating the need to double up on costly peripherals. Resources are shared and utilized more efficiently than previously thought possible.

To get an idea of the T-310's potential, consider the following features:

### Features summary:

- Microprocessor Intel 8088, 4.77 MHz
- Memory 448K RAM, 16K ROM
- Display Adapter TTL mono and RGB color support
- Keyboard Full size, 83 keys, detachable
- Size 310 x 400 x 50 mm
- Ports Parallel and serial, optional
- Expansion box For add-ons, optional

### Network specifications:

- Transfer rate 1.2 million bits per second
- Bus contention CSMA/CD
- Cable RS-422 two-wire, twisted
- Stations Up to 127
- Total system length 4,000 feet
- Other features File lock/unlock, security logon, electronic mail, and more

For more information or OEM prices, contact:

## COPAM ELECTRONICS CORP.

P.O. Box 48-501, Taipei  
No. 19, Lane 3, San Ming Road, Taipei, Taiwan R.O.C.  
Tel: (02) 762-0125/8, 760-2250/4  
Tlx: 13345 COPELEC 26186 MONSHINE

CIRCLE 73 ON READER CARD

## A handful of astute oems are selling to AT&T Information Systems.

# FOR WHOM THE BABY BELL TOLLS

### by Claiborne Cordle

When a Federal judge carved up the Bell System he brought into being a totally unregulated billion-dollar monolith that was initially nicknamed Baby Bell. Today that entity is called AT&T Information Systems, and it is serving as the oem for computer systems products supplied by dozens of other companies. While AT&T-IS has talked at length about its var programs, it has been less than forthcoming about its oem relationships. What is it like to sell to AT&T-IS?

The picture that is emerging makes for mouth-watering reading for software and hardware suppliers.

Control Data Corp.'s multiyear agreement with AT&T-IS to supply peripherals for the 3B product line is valued at about \$540 million. Announced last May, it is one of the largest contracts in CDC's history, and possibly in the history of the oem peripherals industry.

On the software side, Relational Technology Inc. of Berkeley, Calif., made AT&T-IS its biggest customer when it signed a multimillion dollar agreement in November 1983 to supply its Ingres database management system. Similarly, Palo Alto-based Relational Database Systems Inc. reports that the initial commitment under its agreement to supply Informix, File-It!, and C-Isam database software was for more than \$250,000 worth of products—a minimum royalty commitment that RDS president Roger Sippl says already has been met.

Basically, supplier relationships with AT&T-IS can be divided into two categories: products that AT&T-IS acquires, puts its logo on, and then sells as its own product (like Ingres, which is known as AT&T-IS Ingres, or like CDC peripherals, which are incorporated into AT&T-IS machines at the factory), and products that are colabeled (like Informix, which also carries the AT&T-IS logo, but which includes in smaller let-

ters on the manual, "By Relational Database Systems Inc."); and products from third-party vendors, which AT&T-IS either publishes as its own software or lists in catalogs as packages that are alleged to run on their equipment.

The first category implies substantial long-term formal commitments from AT&T-IS and includes a few major suppliers; the second category is intended more to stimulate development of third-party products for the AT&T-IS computers. Except for those cases where AT&T-IS publishes the software, no formal contracts are made. This category includes more than 2,000 companies who participate in AT&T-IS's Independent Software Vendor program.

Although AT&T-IS is turning increasingly to outside suppliers, especially for software, there are some products it prefers to develop in-house. Many of the horizontal utilities, workbenches, and tool kits that are used to facilitate development come out of AT&T-IS's own Unix shop, according to Rick Morris, director of sales and customer support for AT&T-IS's computer systems division. But the overall emphasis, he says, is on outside software. "How many spreadsheets can be written? Do we need to do that? Or is the market being adequately served by the software houses? In many cases our answer to that last question is 'yes,'" Morris says.

### KNOWN PRODUCTS WANTED

Because AT&T-IS wants products that are recognized in the marketplace, RDS and other software suppliers are not concerned that it will one day replace their systems with its own. "They've always been very strong in software development, and you have to believe that there's a lot of database software that was developed within Bell Labs," Sippl acknowledges. But right now, he says, they're interested in product name recognition to help sell their computers.

AT&T-IS is more cautious where hard-

ware is concerned. "You see a lot of people start up and a lot of people get out of it, so certainly anything that is strategic to our hardware product, I think, will continue to be designed and manufactured by us," Morris says. He adds, however, "We are not hung up on designing and building everything. I guess what isn't generally known is that in the past at AT&T the percentage of our sales that actually represented outside purchases was substantial. The feeling that we designed and built everything in-house was not true. In the telephone analogy, we designed and built those things that were in the talking path, but we did that to ensure compatibility with the existing network, and to ensure the quality and reliability of the talking path. An awful lot of the rest of the stuff in that marketplace was, in fact, material that we purchased from other people," Morris contends.

One factor that encourages AT&T-IS and other major hardware manufacturers to turn to outside suppliers for specific hardware components like peripherals is the high cost of producing them in-house. So says Bob Koecheler, oem large account manager (AT&T-IS) for Control Data Corp. "The life cycle of our products is very short, and what you find is that people can't afford the ante to the poker game, so to speak—the R&D to get into it. A good example is Hewlett-Packard, which right now is starting to sell its peripherals oem because their own consumption can't justify the program. And look at IBM, which is buying a significant number of their peripherals on the outside market now. IBM isn't even building them anymore. What it comes down to is just economies of scale. No one customer, including Big Blue, has enough volume to justify a program," Koecheler explains.

If you're interested in selling computer products to AT&T-IS, you might try contacting them directly. You might make initial contact with any of 50 different peo-

## "We are not hung up on designing and building everything ourselves."

ple within the Morristown, N.J.-based AT&T-IS, and eventually you'd wind up discussing your product or proposal with the appropriate product management organization, Morris says.

The product management organizations are broken down into sizes of machines in order to relate to specific markets. "If you were a potential software supplier and you wanted to say, for example, 'Hey, I've got a great database manager and would like to market it through you,' we would bring you into the software product management group, which is related to the Unix group. If it was hardware, you would talk perhaps to the head of the product management staff for the 3B line," Morris says.

That's one way to go about it. Another approach, used successfully by RDS, is to entice AT&T-IS to come to you. "When you're dealing with companies of that size—an AT&T-IS or an IBM or a Northern Telecom—you try to get their attention," Sippl advises. "You try to make them knowledgeable of your products. You advertise. You do public relations things. You go to trade shows. You give demonstrations. Whenever you get a phone call from anyone in that company, you try to find out whether it's an end user who just happens to need something for a particular job, or whether it's a strategic planner who's doing an evaluation of your product for potential resale. You do research and you try to find people's names, and try to get demonstration copies to the right people, and you try to line up sales calls for demonstrations. But what it comes down to is you do all of those things and then either you're chosen or you're not. There's nothing really direct you can do with regard to whether they call you up or they don't," according to Sippl.

### PRODUCTS NOTICED BY AT&T

You can be sure that AT&T-IS will contact a company whose software or hardware product has attracted their attention, Morris says. In some cases they will have researched and even tested your product prior to contacting you. It's not unusual for large manufacturers to buy a product anonymously in order to study it. But Sippl says that AT&T-IS was much more direct with RDS, calling early on and explaining up front that they were interested in looking at RDS products for potential resale.

Of course, in most instances, AT&T-IS will choose not to purchase the product, but they might recommend it to one of their vars and suggest that the var purchase the product for use in his or her marketplace. But let's assume that your product is

of interest to AT&T-IS. What criteria do they use then in evaluating you as a potential supplier?

At the top of the list is quality and product reliability, especially for hardware products, Morris says. Suppliers support that assertion and praise AT&T-IS's quality assurance depth. "When AT&T-IS announces and begins delivering a device, it works," Koecheler says. "We have a five-step phase review process where the product must pass each phase before going on to the next one." AT&T-IS expects that kind of quality control, he says.

It also helps if you have a long-standing relationship with AT&T-IS. Control Data has been working with AT&T since the mid-1970s, a fact that no doubt accounts in part for their current position as the largest supplier of hardware for the 3B computers. "With established companies like Control Data, with whom we've had business relationships for years," says Morris, "AT&T-IS can simply go to them and say, 'We're looking for the following kinds of functionality and reliability in this product in these quantities at about this kind of cost.'"

That doesn't mean that they look only at big firms with a long history in the marketplace, Morris is quick to add. "A lot of what we do is to look at startups that seem to have a product that offers a differential advantage, that when we pair it with ours the result is something that serves the market better, or in a way that it is not presently being served. Believe me, we deal with companies that are very large and some that are very small. Size is not necessarily a criterion," Morris insists.

Relational Technology Inc. and Relational Database Systems are both young and relatively small companies that have grown rapidly. RTI, for example, started four years ago and went from \$250,000 in sales its first year to \$1 million its second, to \$3 million its third, to over \$8 million last year. RDS has sales that will exceed \$5 million this year, and has been profitable for about 11 consecutive quarters, company president Sippl says. That kind of financial stability is important to AT&T-IS because it indicates the company is likely to be around for awhile and support will be available for the products, says Peter Tierney, RTI's vice president of marketing.

Koecheler, too, says that a certain stick-to-itiveness is mandatory. By this he means not only the ability to support the design requirements AT&T-IS places on a vendor, but also the ability to be here tomorrow. "If you look at the marketplace right now, there seems to be a tremendous amount of fallout from very very small to very large suppliers—STC being the most

notable recent example," Koecheler observes.

He also points out that stability is essential because AT&T-IS is looking for long-term partnership-type relationships with its suppliers, and seeks out those companies whose strategies are comparable to its own. "They are not looking to shop for the low price on a product; they're looking to develop relationships, to develop rapport, because of the technical expertise and services that the vendor must supply. It isn't purely dollars and cents that gets the sale. What they talk about is the 'vendor partnership' relationship. That's a generic term within AT&T-IS, and what it really says is that 'we get into bed with vendors and they become in essence an extension of our factory,'" Koecheler suggests.

### NEED A PLAN WITH PRODUCTS

The key to a successful supplier relationship with AT&T-IS is to have not just a product but a plan, an attitude toward the marketplace that fits well with AT&T-IS's own market outlook and methods of conducting business.

Control Data and AT&T-IS complement each other because both are large, conservative organizations that don't move exceedingly fast, Koecheler says. RDS's strategy meshes well with AT&T-IS's strategy of offering software for both Unix and MS/DOS. And when the strategies are mutually rewarding, AT&T-IS doesn't hesitate in making a major commitment. Almost 100% of RDS products made for AT&T-IS machines will be sold through AT&T-IS next year, Sippl says. And as of today, every single 3B that comes out of AT&T-IS's factory has a Control Data product built into it, according to Koecheler.

Perhaps the main reason that AT&T-IS favors these products from these particular companies is that they are proven market leaders. Morris asks of would-be AT&T-IS suppliers, "Have they demonstrated, as in the case of a CDC, market leadership over a period of time, showing that their product is well accepted and well supported?"

More often than not, AT&T-IS's chosen suppliers already have proven themselves in relationships with other big-name computer manufacturers. RTI, for example, sells Ingres directly on Digital Equipment Corp.'s VAX, for which it has more than 700 installations. RTI also sells it directly on IBM-compatible Amdahl systems, and on Pyramid systems. The company also oems Ingres to Burroughs, NCR, and Sun Microsystems, among others. And Koecheler claims that every single domestic computer manufacturer buys peripherals from Con-



**"I invest my time in  
high technology.  
I invest my money in  
U.S. Savings Bonds."**

William L. Rasmussen  
Honeywell, Inc.

William L. Rasmussen, one of the developers of the ring laser gyro, says: "I've tried many forms of investment and I'm satisfied I can't do better than U.S. Savings Bonds."

Just look at the facts. New competitive-rate U.S. Savings Bonds are the answer to sensible savings without risk. Today's Bonds pay higher market-based interest rates—the sky's the limit. And a guaranteed minimum return protects your investment. Bonds are exempt from state and local taxes, so the effective yield is even higher.

Best of all, Bonds are easy to buy—wherever you bank, or through the Payroll Savings Plan where you work. No fees or commissions. And no worries. So save time and money. Buy Bonds.

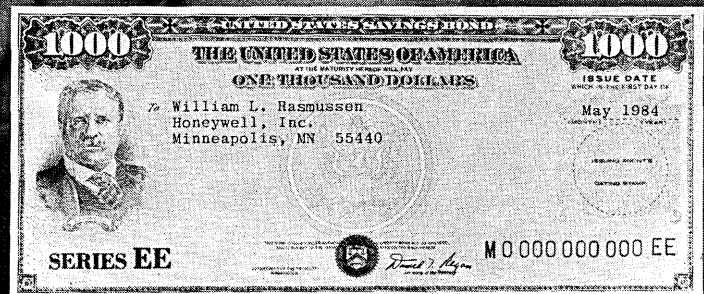

Take  
stock  
in America.



A public service of this publication.



**“What it comes down to is that you are either chosen by AT&T-IS or you are not.”**

trol Data, including DEC, Data General, Hewlett-Packard, Texas Instruments, Prime, Wang, ICL, and now, of course, AT&T-IS.

Clearly, to become a major supplier for AT&T-IS is not an overnight phenomenon. You must develop a multiyear strategy that is consistent with that of AT&T-IS, and position yourself as the market leader in your chosen field of expertise. Furthermore, it's not easy to stay on top, even for a company as solid as Control Data, Koecheler cautions. As a percentage, CDC's share of the oem disk market is decreasing, as emphasis shifts to low-end equipment. Nevertheless, Koecheler boasts, “the closest competitor is less than one third our size.”

“But long term,” he continues, “to sustain the relationship with AT&T-IS I need to have the right product at the right price at the right time, and that is terribly difficult. I've got people who do market analysis and I can project, but one of the biggest pitfalls in this business is reading your data wrong. One of the four or five parameters just doesn't match, and you end up with a flop on your hands. Your costs to maintain a technology lead are just immense.”

AT&T-IS usually purchases hardware outright and the agreement typically is for specific products in specific quantities over a specific number of years. In most cases, the hardware is incorporated at the factory, and end users don't have the faintest idea that anyone other than AT&T-IS manufactured the product.

Software also is supplied for the most part according to standard software oem agreements. “RDS's agreement, for example, is very similar to your standard software manufacturer licensing software to a hardware manufacturer,” says Sippl, “where the hardware manufacturer takes it on as if it's their product. The hardware manufacturer gets serial numbers assigned to them; they manufacture the products, they manufacture the manuals, they put it in their warehouse, they ship it, and send us royalty statements. It's not an unusual contract; it's very similar to the contracts we have with probably 40 other hardware manufacturers/oems.”

As in most oem-vendor relationships, the suppliers provide training and support to AT&T-IS, which in turn provides its customers with support and service for the products it acquires. “We prepare a master copy of the product and a master copy of the documentation. They take it from there,” Tierney of RTI says.

For the most part, such relationships have gotten off to starts that both partners are happy with, and suppliers view

the early problems they have faced as the inevitable consequences of AT&T-IS's size and inexperience in the computer marketplace.

Both RDS and RTI ended up putting together the documentation for the first batch of their product, for example, despite the fact that their contracts relegate that responsibility to AT&T-IS. “It was just a matter of time efficiency,” Sippl says. “As they were getting up to speed on manufacturing things, we were more capable of manufacturing certain parts. They wanted to get a thousand or so copies in their warehouse by a certain date.”

With RTI, Tierney says, “AT&T-IS basically said, ‘Gee, would you produce the first typeset quality documentation for us and we'll take it from there?’ They didn't have documentation procedures in place. So as we were building the documentation, they were rebuilding their policies and procedures regarding what it should look like, how it should be formatted, etc. Those are the types of things that are frustrating. On the other hand, they're almost unavoidable because they simply haven't done those things before.”

**WHAT AND WHERE ARE THEY?**

More general problems associated with the inexperience of AT&T-IS include an insufficiently developed tactical sense of where the company is going, Tierney adds. This makes it difficult for a supplier to anticipate things. “As those things get put in place, it will be a lot easier to deal with them because we'll know what to anticipate in terms of what their integration testing looks like, what the time frame for certification testing is, what the time frame is for documentation releases, how long it will take them to turn around a single reel of tape into floppy disk for release on the 3B2. Lead times. They don't know what they are, and we don't know what they are,” he says.

In addition, forecasting by AT&T-IS could stand improvement, and this means the ability to know what products they need. “When you deal in those kinds of volumes, significant shifts in demand can disrupt our factory immensely, and on occasion that has happened,” Koecheler says.

The ironic problem inherent within the massive AT&T-IS is a difficulty in communications, an area that the premiere communications company should have mastered. “I find that I have to resell the same product over and over again,” Koecheler complains, “where if there were something internal to AT&T-IS that could function as central procurement, I could

probably be more effective.”

Sippl also cautions other companies—small ones in particular—to consider carefully what it means in terms of resources to deal with the giant. “A small company that is going to pursue business with AT&T-IS has to psychologically be ready for the fact that it's a large organization, and that means you're going to have to deal with a lot of people. And those people can only communicate with each other so well,” he says.

Such problems are primarily the domain of the major players—those suppliers whose resources are closely tied to and influenced by AT&T-IS's every move in the computer industry. While the stakes are nowhere near as high, much smaller companies can cash in on the giant's market presence by participating in its Independent Software Vendor program. Consider the software developer who typically does not deal in hardware at all, and who may market his software on his own to vars or end users, or who may also sell or license that software to AT&T-IS.

“The ISV program is not something you sign up for or sign a contract for,” explains Dan Lankford, manager of software services for AT&T-IS's computer systems division. “We have over 2,000 companies participating in one way or another. The important word in the ISV program is ‘independent.’ Our objective is to encourage a bunch of independent businessmen to support our computers, and to give them aid in doing that,” he says.

**3 FORMS OF AID OFFERED**

That aid takes three forms. The first is development support. Development systems that include 3B computers are made available at a discount to software vendors, who also have access to formal technical training and general technical support.

The second component of the ISV program is software publishing, through which AT&T-IS attempts to identify “those third-party-developed software applications that are most consistent with or important to our strategy,” Lankford says. AT&T-IS arranges to publish them as its packages, for distribution through its own channels. “It's important to understand that we will publish only a small percentage of the total number of applications that will be available in the marketplace for our computers,” Lankford stresses. Those are identified through a software screening form sent to any vendor who requests one. If AT&T-IS is interested in the package, the vendor will be asked to submit a copy for evaluation. The program is analyzed in

# YOUR BRAINS. OUR GUTS.



You know your marketplace. We know computers.

The ITT XTRA™ Personal Computer has the guts for your custom applications.

The best engineered PC in the industry. Complete IBM compatibility in a smaller package, at lower cost. Full expandability for custom applications. The best serviceability. All supported by a \$20 billion worldwide telecommunications company committed to profitable partnerships with its resellers.

Examine the ITT XTRA and ask us to demonstrate our claims. Your specific application knowledge can help us both

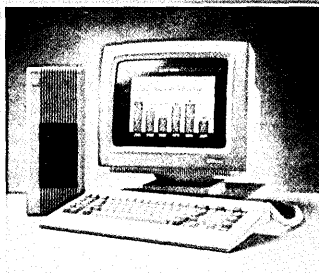

tailor a profitable system for a specific market. For both large and small VARs.

We have expansion options to fit your need. Our integrated graphics adapter supports both monochrome and color monitors plus memory expansion to 640K. In one card slot, IBM 3270 PC and 3278/79 terminal emulation. Voice recognition, digitization, storage and playback. Plus PC compatible options of your choice. So if you're interested, we're interested. Give us a call today at 408-945-8950. It may be the smartest thing you'll ever do. It's certainly the gutsiest.

#### ITT Information Systems

2041 Lundy Avenue, San Jose, CA 95131

Please send me more information on the ITT VAR Program.

Name \_\_\_\_\_  
 Title \_\_\_\_\_  
 Company \_\_\_\_\_  
 Address \_\_\_\_\_  
 City \_\_\_\_\_  
 State \_\_\_\_\_ Zip \_\_\_\_\_  
 Phone \_\_\_\_\_

**ITT**  
 PERSONAL COMPUTERS

## HELPING AMERICA WORK SMART.

© 1985, ITT Systems, Inc.

IBM is a registered trademark of International Business Machines.  
 IBM Selectric is a registered trademark of International Business Machines.

CIRCLE 75 ON READER CARD



# The light inside Hitachi's Laser Beam Printer

Hitachi's SL-1000 is more than an answer. It's more like a revolution because it just about eliminates the bottleneck in producing hard copy, releasing the full potential of office computers, work-processing systems, and high capacity filing systems of your product line.

Try speed. Twelve pages per minute — that's if your system can transmit a page of data in less than 5 seconds! Operation is also quick because it's so easy. Single-action cassette insertion, double cassettes and space-saving one-side paper handling let anyone get the most out of

this printer without any special skills.

Try print quality. Just examine Hitachi's quality for yourself by looking at ill. (1). Quality speaks for itself — up to  $400 \times 400$  dots per inch. That's far beyond what a dot matrix printer can even dream of. An optical scanning system with built-in facet error correction, an automatic toner concentration controller and thermal fixing are the unseen advanced extras that result in the impressive print quality.

### The nitty gritty: reliability

Speed, high capacity, excellent print quality and

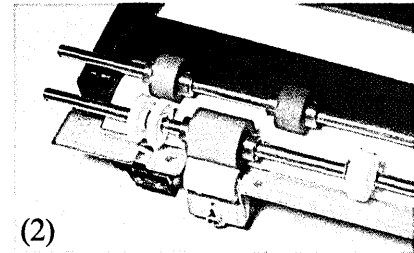

(2)

easy operation can mean much less if you waste time with downtime. Look at ill. (2). What you see is Hitachi's special clawless mechanism. Since only a single sheet of

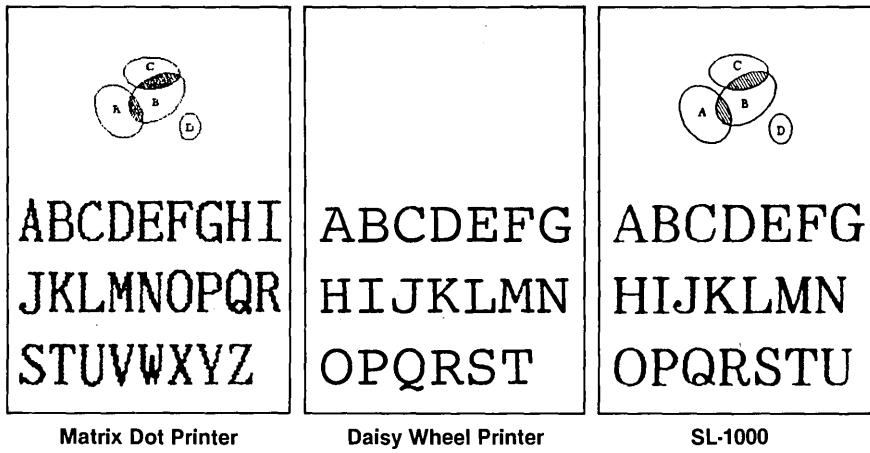

(1)

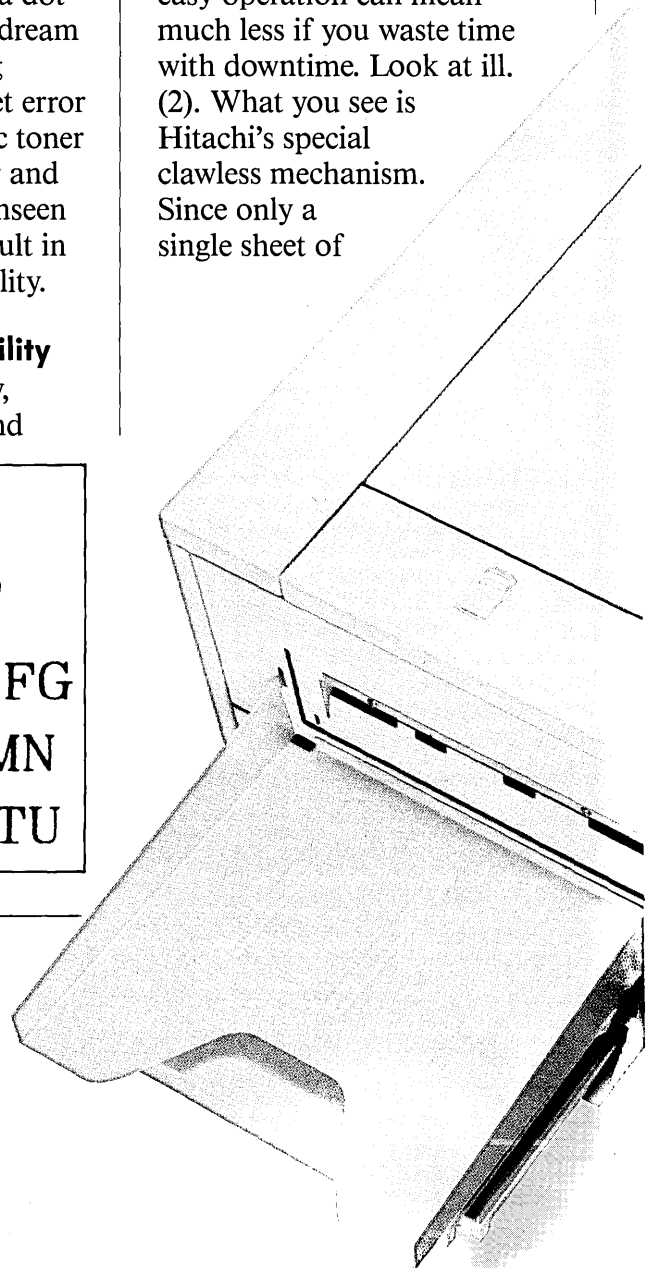

paper can be fed through, the major cause of paper jam has been cleverly eliminated. So you can offer an MCBJ of only 1 jam for 5,000 sheets!

And you can promise over 25,000 sheets, on the average, before our laser beam printer benefits from any maintenance (MCBPM: 25,000 sheets).

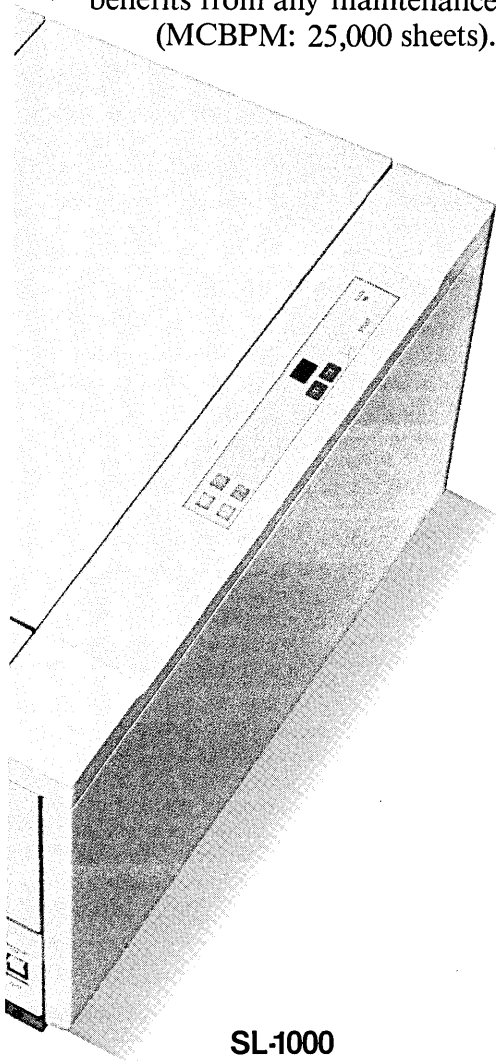

SL-1000

### The light inside

Here is another fact. Weigh it. Mull it over. Compare. Our laser will last over 1 million sheets.

Don't be surprised. After all, we are an experienced OEM supplier and make our own semiconductor lasers so we know a thing or two about them. The laser inside our printer, that crucial inner light, has reliability that is absolutely second to none.

### It's none of our business

We are not here to tell you how to present the SL-1000. If you want to offer rapid copy of CAD or CAM designs or quiet

telex messages (our printer is quite quiet) or wish to hook the printer to LAN or computers and word processors, that's for you to decide.

Our business is to provide your line with state-of-the-art print quality, smooth swift speeds, easy operation and reliability that's not just a word but a year-in, year-out operating reality. For that important competitive edge, here is the desktop LBP of choice for you to put your own label on.

The light inside Hitachi's laser beam printer brings data to printed life and can point to a new peak in sales.

OEM

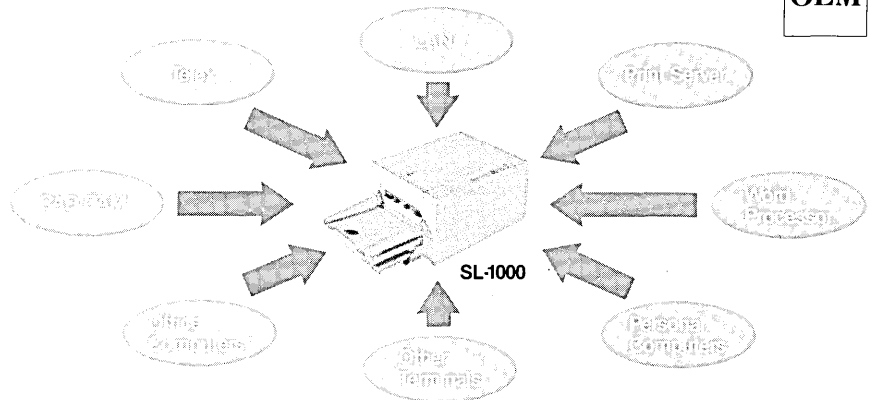

Hitachi America, Ltd.  
Industrial Components Sales & Service Division  
50 Prospect Avenue, Tarrytown, N.Y. 10591-4698,  
Tel: (914) 332-5800

CIRCLE 76 ON READER CARD

# FOR SALE!

Like-new products!

*\$1,255.00 LESS than HP's list price!*

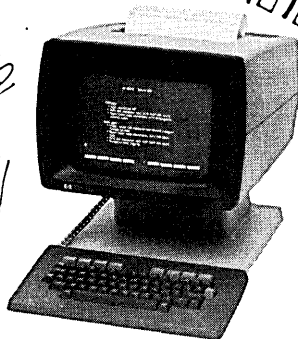

## HP 2621B/050 DISPLAY TERMINAL

Asynchronous display terminal. 110-9600 baud; can display 1920 characters. 2 page memory. Includes Option 050: Integral Printer. 30 Day Warranty.

**\$1,650.00**

Immediate Delivery

Quantity Discounts

Financing Plans Available

All items subject to prior sale.

### HP 2621B DISPLAY TERMINAL

30 Day Warranty **\$895.00**

### HP 2621A INTERACTIVE DISPLAY TERMINAL

30 Day Warranty **\$650.00**

### HP 2621P INTERACTIVE DISPLAY TERMINAL

30 Day Warranty **\$995.00**

Terminals from DEC, LSI, Televideo and others are also immediately available!

**GENSTAR**

**REI Sales Company**

**(800) 225-1008 (800) 227-8409**

In Mass. (617) 938-0900

In Calif. (818) 887-4000

### YOUR PRICES ARE GREAT! TELL ME MORE NOW!

- Call me QUICKLY at \_\_\_\_\_
- Send me a complete catalog on your sale items.
- Send me an equipment rental catalog.

NAME \_\_\_\_\_ TITLE \_\_\_\_\_

ORGANIZATION \_\_\_\_\_

ADDRESS \_\_\_\_\_ MAIL STOP \_\_\_\_\_

CITY/STATE/ZIP \_\_\_\_\_ PHONE \_\_\_\_\_

Phone the numbers above or complete this coupon and mail to: Genstar REI Sales Company, 6307 De Soto Ave., Suite J, Woodland Hills, CA 91367.

D31585

terms of its functionality, its market relevance, and most important, its relationship to AT&T-IS's strategy as a computer vendor, says Lankford.

"If we decide to proceed, then we engage in a business contract negotiation with the ISV," Lankford continues, "Each one of these negotiations is different, depending on the nature of the software, who supports it, about product updates, source code escrow, and all the other factors involved in software publishing. It's generally on a royalty basis, but there are a billion possibilities, including our outright purchase of all rights to the application."

The third element of the AT&T-IS ISV program is catalog publishing. If your product is not chosen for publishing as an AT&T-IS product, you may elect to have it included in one of the AT&T-IS catalogs. The soon-to-be-published AT&T-IS Unix System V catalog will list applications that have been developed by both AT&T-IS and software vendors to run the Unix System V operating system on any computer. A second catalog—the AT&T-IS Computer Software catalog—will list applications that have been tested by AT&T-IS and verified to run on its computers. The first issue includes more than 200 packages that have been ported to the 3Bs from third-party sources.

Whether you are a major supplier or one of the thousands of smaller ISVs, there are a number of advantages to joining forces with AT&T-IS—always assuming, of course, that it will be successful in the computer marketplace. Obviously, Sippl notes, "The more computers they sell, the more of our software they're likely to sell." That means more revenue and maybe three or four times the number of copies of RDS software out in the marketplace. "That doesn't mean our revenue doubles, because we're not getting as much per copy by going through a hardware manufacturer as we would through a distributor or dealer," says Sippl. "But when we started this company we intended to sell software to as high a link in the chain of distribution as possible. It's important to us to be the highest-volume selling database system in the Unix marketplace," Sippl says.

Another benefit for big suppliers is the promise of future business with AT&T-IS. "There are some things we're doing that we unfortunately can't talk about yet," Sippl says in reference to joint projects under way with AT&T. Tierney, too, says RTI anticipates a lot of follow-on business.

Overall, though, the biggest advantage for both major suppliers and ISVs alike is simply ubiquity, Morris says. The presence of AT&T-IS in the North American continent, says Morris, gives it access to the marketplace that others in the computer business don't have, especially in terms of the sheer numbers of people representing the products. ©

Claiborne J. Cordle is a free-lance writer based in Charlottesville, Va.

CIRCLE 77 ON READER CARD

PACIFIC  BELL<sup>SM</sup>  
*presents*  
**TEXPO '85**  
*featuring*  
**T1 CARRIER AND FIBER OPTICS**

# Your one-stop shopping exposition for voice and data information age services

**April 3rd, 4th, 5th**  
**Anaheim Hilton and Towers**  
**Anaheim, California**

**You'll discover total communications solutions for your business at TEXPO '85.**

- Over 75 terminal equipment providers will be on hand to discuss new technologies compatible with Pacific Bell's Network of Services.
- Digital PBX's, Multiplexers, Conferencing and Test equipment, — all the equipment that

interfaces with T1 Carrier or Fiber Optics will be displayed in one place, so you can make informed buying decisions.

- Seminars by industry leaders help you make the most of today's changing telecommunications environment.

**Make your exposition reservations early.**  
 Tickets are \$10 each or \$25 for five.

**For tickets call**  
**1 800 824-4842** (in CA)  
**1 800 228-9193** (outside CA)

**Welcome to the Pacific Bell Network of Services**

*The Pacific Bell Network of Services is designed to improve your productivity by giving you the ability to manage an ever-increasing wealth of information. Quickly. Accurately. And economically.*

*We've spent over \$2 billion dollars in each of the last 4 years to expand and upgrade our digital switching and other new technologies. The result is a highly sophisticated, highly intelligent network that can meet any voice, data or video communication need you might have.*

*Think of the Pacific Bell Network of Services as a valuable business tool. A tool that comes with a vast and exciting array of services. All of which can be tailored to fit the way you do business. Now. And in the years ahead.*

*as a valuable business tool, communications products and exact way you do business.*



**We're here to help make your business better.**

**PACIFIC  BELL<sup>SM</sup>**

A Pacific Telesis Company

# **ACCESS INDIGE**

**INTRODUCING CONDUCTOR.**

**End-user access  
to production data,  
with full control  
and security.**

# ! QUESTION?

Today — end-users need greater access to data. And MIS needs better control. To solve both problems, TSI introduces CONDUCTOR.

CONDUCTOR lets end-users get the data they need. CONDUCTOR selects, manipulates and delivers data to any end-user environment. Without programming. And CONDUCTOR gives MIS more control

than ever over quality and integrity, with a new degree of security.

While others have tried to solve the end-user problem, they've only addressed a small part. CONDUCTOR goes for the big picture. So remarkably different, there's virtually nothing else like it. Find out about TSI's CONDUCTOR today. And help eliminate access indigestion.

## TSI International

**DB** a company of  
The Dun & Bradstreet Corporation

For the facts on CONDUCTOR, call 1-800-227-3800, Ext. 7005 or write 187 Danbury Road, Wilton, Connecticut 06897.



# HOW TO SOLVE THE PROBLEMS PCs CREATE IN TWO WORDS.



## Back-Up™

It's all you have to say when one of your PCs goes down. We specialize in servicing business PCs. Particularly IBM-PCs. We also service your mixed brands of peripherals, too. Our service is fast, flexible and economical. We use a range of service options to design a program that's right for your company. Fixed fee. Per-call. And our unique flexible fee, which can save you up to 70% over traditional maintenance contracts.

But no matter which options you choose, Back-Up gives you centralized support. So calling one number brings service to your company's PCs. Anywhere across the country.

Back-Up is just one of the ways we're using proven technology to solve computer maintenance problems worldwide. Call 1-800-346-6789 (in Minnesota 612/292-2209). Outside the U.S., call your local Control Data office. Wherever you are. Whenever you need us.

 CONTROL DATA

# HARDWARE

## OFF-LINES

Slowly but surely systems integrators -- looking for more megabytes, lower drive cost, and faster access times -- are pushing disk drive vendors for a new generation of product. That impetus is leading disk makers to intelligent, system-level interfaces that integrate controller functions into drives, permit simplified peripheral designs and higher data integrity rates, and allow better manufacturing yields.

It seems that right now three or four device-level and system-level intelligent interfaces are in the running for selection, with no one standard really taking a firm hold as yet. That may change. Some industry analysts say a consensus is emerging this year and that the market is leaning toward the Small Computer Systems Interface (SCSI) standard, sometimes irreverently referred to as "Scuzzi."

A few drive makers are already supporting SCSI, notably Quantum Corp. of Milpitas, Calif., and Priam Corp. in San Jose. These vendors have taken a liking to SCSI's similarity to the only current system-level drive standard of any kind, the Shugart Associates Systems Interface (SASI). With Quantum's verbal commitment to the SCSI, it will introduce this fall the Q200, a half-high, 5¼-inch Winchester drive featuring an on-board controller pegged to the Scuzzi interface.

In an apparent effort to sell more Personal Computer 5s to oems and system integrators, NCR has put together Inter-actTV, a video disk system

that combines its pc with a laser disk player, allowing for the simultaneous display of video disk images and computer-generated text and graphics, while offering dual-channel voice and music. NCR sees applications in the areas of sales, promotion, training, and information delivery.

But who will supply all these specialized video disks to industry and the retail trade? The video disk market is essentially dead, so few firms appear likely to create new video programs for the medium. One answer is to convert video tape media to laser disks, at a cost of approximately \$1,800 a shot.

But if this product is to enter new markets, it stands to reason that new films for new applications will have to be produced. According to Vern Yates, vp of the personal computer division, NCR will attempt to woo oems to do just that. Yates adds, however, that the company initially expects sales for this system to be sluggish.

That isn't surprising, considering the \$8,700 price tag for the turnkey system, which Yates says might contain "patentable technology" in the area of its laser disk control and interface module. With or without patents, \$8,700 is a lot of money for a system that depends on a technology that nobody wants. Indeed, the question is not whether sales will be sluggish, but whether there will be sales at all. In an unrelated move, NCR plans on laying off 230 assembly workers at its Clemson, S.C., plant where the PC4 is manufactured. Production will be consolidated in Augsburg, West Germany.

## PROTOCOL CONVERTER/CONTROLLER

The HyDra II-X is a 32-port direct channel attach protocol converter/controller for IBM mainframes. The unit is a byte multiplexor device providing 3278/79 emulation for pcs and ASCII terminals, and 3287, 1403, and 3211 emulation for ASCII printers.

The unit requires no 3705 or 3725 front-end processor, 3272/74 communications controller, 3270 PC board, or remote software. Pcs and ASCII terminals

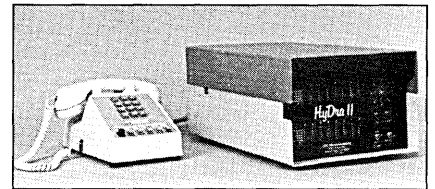

attached to the product look like local 3278/79s to the mainframe host even when attached remotely through a modem for dial-up and lease line applications.

In dp shops running the Airline Control Program, IBM's interactive reservation system software, the HyDra II can be used to let an IBM PC/XT replace the standard 3215 system console. According to the vendor, the product is capable of emulating the 3215 on any ASCII terminal or PC. The HyDra II-X sells for \$14,000. DIVERSIFIED DATA RESOURCES INC., San Rafael, Calif.

**FOR DATA CIRCLE 301 ON READER CARD**

## FOOT MOUSE

Footmouse is a foot-operated cursor control for microcomputers. The device is being offered to users as an alternative to cursor keys. It is targeted primarily for office workers.

The foot mouse is compatible with the IBM PC. Models for the Apple IIe, Macintosh, IBM PC/XT, PC/AT, Compaq, and RS232C terminals will be available later this spring. The product will run all existing software, including MicroPro's WordStar and Lotus 1-2-3, without modi-

## HARDWARE



fication, because it works by interfacing the keyboard to the computer's cpu unit and emulating the keyboard's cursor functions. The device plugs in between the keyboard and the computer and it doesn't interrupt normal cursor functioning, the vendor says. It doesn't require an expansion board or extra software. VERS-ATRON CORP., Healdsburg, Calif.

**FOR DATA CIRCLE 302 ON READER CARD**

### SNA/SDLC GATEWAY

The oem/SNA Gateway and ComCard Communications Card convert the IBM PC or equivalent into a gateway to an SNA network. The product line consists of hardware and software elements designed with a building block approach. The hardware is installed as features on the expansion bus on an IBM PC, PC/XT, PC/AT, or compatible. Multiple gateway products may be combined to work along with the vendor's dedicated network server.

The gateway simultaneously connects other pcs, printers, and other peripherals to the SNA through the use of any local area network, resulting in a system that emulates an IBM 3274 cluster controller with attached 3278 display stations and 3287 printers. The software provides standard session layer interfaces, including MS/NET, PC/LAN, NETBIOS, and a subset of CCITT X.215 session layer functions.

Also provided are built-in programming facilities, configuration and utility support, an IBM display station, and printer emulators supporting logical units Type 1, 2, and 3. The ComCard Communications Card is a 80188-based

system that includes a serial communications channel with an RS232C interface that supports the SNA/SDLC protocol at speeds up to 9600Kbps. The card interfaces with the I/O channel of the PC, PC/XT, and PC/AT. The vendor's NetServer system supports multiple ComCards, LAN interface cards, and future network server functions. The system provides 14 IBM PC card slots with one slot allocated as the bus master. Pricing for oem quantities of 250 is \$1,000 for the ComCard and \$2,200 for the NetServer with eight slots. The oem/SNA Gateway software for an eight-station configuration is priced at \$600. CALIFORNIA NETWORK SYSTEMS, Milpitas, Calif.

**FOR DATA CIRCLE 304 ON READER CARD**

### EMULATES VT-220

The Zephyr DD-220 is an alphanumeric terminal that fully emulates Digital

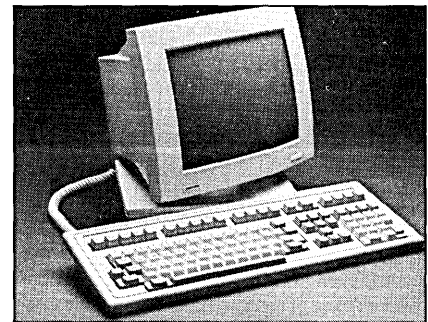

Equipment Corp.'s vt-220 terminal. According to the vendor, the keyboard is "identical key-for-key with the DEC VT-220."

The 105-key, detached, DIN standard keyboard has an 18-key accounting style pad, and 15 of the 20 function keys are programmable. It also has a 14-inch, lockable tilt-and-swivel monitor. There is a choice of either P-31 green or P-134 amber phosphor display. A screen saver blanks the display after 12 to 15 minutes of inactivity.

The terminal features five character fonts: ASCII, United Kingdom national set, DEC special graphics, multinational characters, and a downloadable soft character font. An 80- or 132-column by 25-line display with bidirectional smooth scrolling can be formatted on the screen. The unit features blinking, bold, underline, normal or reverse video, double high/double wide, and blank attributes on a character-by-character basis.

There are two standard communication ports on the unit, an RS232C/RS423 or 20mA current loop, and a buffered RS232C interface. In addition to emulating the DEC VT-220, the terminal has DEC VT-100 and VT-52 capabilities. The Zephyr DD-220 sells for \$850. ZENTEC CORP., San Jose, Calif.

**FOR DATA CIRCLE 303 ON READER CARD**

## HARDWARE SPOTLIGHT

### DEPARTMENT LEVEL DP

The vs 65 is a midrange system in the vs series of computers designed for Integrated Information Processing, the vendor's strategy to integrate data processing, communications, and office automation.

Highlights of the system include a new central processor using parallel architecture, a high-speed cache memory, and an enhanced bus processor. The system has up to 4MB of main memory and can support up to 30 users. It has the ability to communicate with other vs systems and with host mainframes in a distributed network. The product also supports Wang Office, providing an integrated set of network-based applications on Wang systems.

The vendor has designed a new 32-bit vs cpu with 200-nanosecond instruction time and a full 32-bit data path. It offloads I/O processing to an 80286 microprocessor. A variety of Wang systems networking transports allow users to transfer files among Wang and non-Wang systems while also providing network management and control. Many protocols, including tty, asynchronous, synchronous, and bisynchronous, SNA/SDLC, and X.25, allow the unit to communicate with a host mainframe.

The system can be configured to support up to 2.6GB of disk storage, nine-track or cartridge tape systems, and 48 ports for workstations and peripherals. Remote diagnostics are standard with the



system. It provides file management facilities and a choice of programming languages for commercial, business, and scientific applications. The product supports Wang's PACE (professional application creation environment), a fourth generation relational database management system. The operating system is common to the entire vs product line.

A vs 65 package configuration consisting of the cpu with 1MB of main memory, a 5.25-inch 360KB disk drive, remote diagnostics, and the operating system; a 147MB internal fixed disk; two-port disk controller; four 4230-vs workstations; and a 76MB removable disk sells for \$54,000. The basic cpu is priced at \$19,000. WANG LABORATORIES INC., Lowell, Mass.

**FOR DATA CIRCLE 300 ON READER CARD**

**T**hey're keeping RCA Cylix a secret because they don't want their competition to hear about our value-added data communications network. They know that control of fast, accurate data communications is vital to keeping ahead of the pack. And they're delegating the details to us because we assure them better control.

We achieve this control by keeping ahead of the latest technology changes, and maintaining a close relationship with all major carriers. At our central switching facility, back-up equipment assures maximum uptime. And, our Customer Resource Teams stand ready around the clock to address customer

needs quickly, before valuable time and data are lost.

The RCA Cylix on-line network offers satellite-based, end-to-end management of your synchronous data communications. Plus, a continuing array of new services, including dial-in asynchronous, to make sure your network is no less than top notch. The result is single-vendor simplicity with no capital investment, available throughout the U.S. and Canada.

To find out more about why RCA Cylix is the best kept secret in data communications, send the coupon or call, 901-761-1177 fast. Before your competition hears about us.

Please send me your free booklet, "The Best Kept Secrets In Data Communications."

Name \_\_\_\_\_

Title \_\_\_\_\_

Company \_\_\_\_\_

Address \_\_\_\_\_

City \_\_\_\_\_ State \_\_\_\_\_

Zip \_\_\_\_\_ Phone \_\_\_\_\_

Protocols currently used (including lookalikes)

IBM 3270 Bisynch

Burroughs Poll/Select  Asynch

SDLC  X.25 Other \_\_\_\_\_

How many of your sites are 300+ miles from your host computer? \_\_\_\_\_

Type of Network:  Start-up  Existing

**RCA** Cylix Communications Network

Dept. MC  
800 Ridge Lake Boulevard  
Memphis, TN 38119

DA2

CIRCLE 55 ON READER CARD

*Why key DP/MIS managers are keeping RCA Cylix a secret.*



## HARDWARE

### CONSOLIDATES COMPUTING

The 580/Multiple Domain Feature (580/MDF) is a hardware feature for the vendor's 580 series of general-purpose computers, which allows consolidation of multiple computing environments into a single processing complex.

The product enables multiple system control programs to operate concurrently on an Amdahl 580 processor. The vendor says that domains (isolated, secure operating environments) allow the user to avoid the costs and limitations of owning and operating separate processing complexes. In addition, the unit can eliminate the need for production systems separate from test or conversion systems.

According to the vendor, the feature helps users improve the efficiency of their data processing resource. Domains can be used to test new versions of system control programs, subsystems, and new or changed applications without separate processing complexes. It aids the conversion process and allows the consolidation of nonhomogenous environments into one processor. The 580/MDF currently supports two domains on all 580 Series uniprocessors and two domains on either or both sides of the 580 Series multiprocessors operating in partitioned mode. MVS/370, MVS/XA, and VM/SP HPO are the system control programs that can be operated concurrently in any combination of domains. The 580/MDF can be leased for \$6,000 per month with an initial charge of \$20,000. AMDAHL CORP., Sunnyvale, Calif.

**FOR DATA CIRCLE 305 ON READER CARD**

### COLOR AND GRAPHICS

The TeleColor-PC and TeleColor-XT are compatible with the IBM PC and PC/XT with added color and graphics capabilities. According to the vendor, users get the advantage of color at prices in the monochrome range.

The PC is a dual floppy system and the XT-compatible unit features a 20MB hard disk. Both units come standard as integrated packages including disk drives, monitor, keyboard, printer, and communications ports, as well as a built-in RGB color monitor.

The vendor says these products are completely compatible with the color and graphics applications written for the IBM color/graphics display. The standard 16-color selection in text mode along with four-color palette selection in graph mode are supported. Standard features on both units include the 8088 microprocessor, 256KB of RAM, an adjustable 12-inch screen, and built-in serial and parallel ports.

For software, the vendor supplies a PC/DOS-compatible operating system, interpretive GW/BASIC, and an applica-

tions software package containing word processing, spreadsheet, and file management programs. The Telecolor-PC sells for \$3,000 and the TeleColor-XT lists for \$4,600. TELEVIDEO SYSTEMS INC., San Jose, Calif.

**FOR DATA CIRCLE 306 ON READER CARD**

### UPS FOR MINIS

The AP-100 series of uninterruptible power systems (UPS) is specifically designed for minicomputers. The series consists of three models that operate on single-phase, 120-volt current for 3, 5, and 10 KVA power ratings.

The units have a single rotary switch control with microprocessor diagnostic displays. The series was designed for a variety of applications including financial services, inventory control, process control, medical applications, aerospace, and all computer operations requiring constant on-line capabilities and data storage.

These products serve both as a power conditioner and backup protection against outages. The built-in batteries of the AP-100 provide instantaneous power in case of a utility power loss or reduction. At full load the batteries will provide power for up to 10 minutes, and for a longer period if the power usage is lower. The series is designed to fit into a small computer room or in the dp shop. It is compact and quiet with maintenance-free, sealed batteries. Single unit user prices are \$8,000, \$10,000, and \$15,000 for the 3, 5, and 10 KVA models respectively. EMERSON ELECTRIC CO., Industrial Controls Division, Santa Ana, Calif.

**FOR DATA CIRCLE 307 ON READER CARD**

### HIGH-END PDP-11

The PDP-11/84 is a high-end model in the vendors PDP-11 minicomputer product line. It is available to oems in two varia-

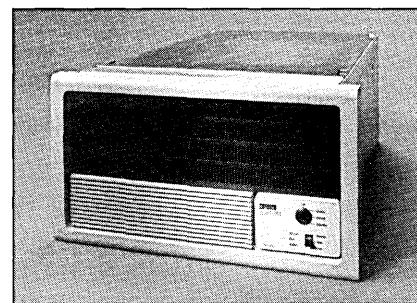

tions: a rack mount processor and a kernel subsystem for freestanding configurations. It provides PDP-11/70-class performance and total hardware and software compatibility with the Unibus PDP-11 line at less cost than the PDP-11/70.

The cpu is the vendor's 15MHZ J-11 microprocessor chip set. The new cpu features the full PDP-11 instruction set including extended and floating point in-

structions, memory management, dual register set, 22-bit addressing, separate instruction and data (I&D) space, and three operating modes. It includes a 2KB EEROM, an 8KB direct-mapped cache, and a 32KB bootstrap/diagnostic ROM.

Both product variations come with a minimum 1MB of memory and have space for system expansion. The unit will support the full range of PDP-11 operating systems and Unibus peripherals. The rack mount version starts at \$16,000. The subsystem kernel sells for \$20,000. Quantity discounts are available. DIGITAL EQUIPMENT CORP., Maynard, Mass.

**FOR DATA CIRCLE 308 ON READER CARD**

### BUSINESS SYSTEM

The Tower XP is a multi-user business system incorporating the Unix System V operating system. According to the vendor, the product has several features that give it up to a 50% performance edge

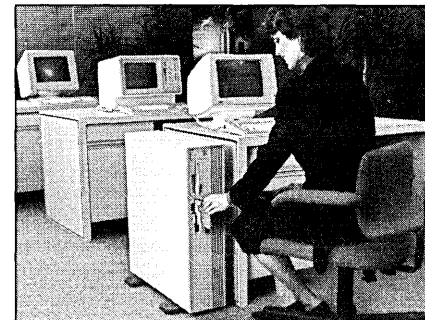

over its Tower 1632 with approximately 15% difference in price. The added performance characteristics include the use of the 68010 microprocessor, the incorporation of Unix System V with selected Berkeley 4.2 utilities and vendor utilities (such as menus), the use of a serial I/O controller with an on-board 68010 processor, an on-board 128KB RAM, and an on-board Unix tty subsystem, and the utilization of a new processor memory controller designed to incorporate the central processor, as well as 4KB page registers and 2KB on-board cache memory.

The product can operate as a complete standalone dp system as well as in a distributed dp environment. It can support up to 16 users and comes in a standard configuration of 1MB of memory, 46MB of disk storage, and 45MB cartridge tape drive. The unit can be expanded to 8MB of error-correcting memory and 260MB of unformatted disk storage. The model 1632 can be upgraded with an upgrade kit. With the processor, 1MB of RAM, a 1MB disk, 46MB fixed disk, 45MB cartridge tape drive, eight serial ports, one parallel port, and the Tower operating system, the Tower XP costs \$19,500. NCR CORP., Dayton, Ohio.

**FOR DATA CIRCLE 310 ON READER CARD**

**—by Robert Crutchfield**





# THE 7800 IS THE ONE WITH THE CHANGEABLE PERSONALITY.

On the left, the IBM® 3180. On the right, the CIE-7800. On the left, a personality that will never change. It's IBM 3270 or *nothing*.

But with the CIE-7800, it's IBM 3270 or DEC VT100® or HP 2622A or IBM 3275/3276-2. At a touch of a key, the CIE-7800 keyboard and display can alternate between personalities.

Something else the IBM 3180 won't let you do is switch from one *use* to another on the same terminal. A 3180 keyboard designed for data entry is for data entry, period.

But the CIE-7800, with its "soft" reconfigurable keyboard, can be used for data entry, or as a typewriter, or even for APL applications. So you can relocate or move 7800s from department to department.

There's also the convenience of a screen printer port on the 7800 for printing right where you sit. You don't have to make a run for hard copy the way you do with IBM.

And besides weighing nearly two times less and being far more compact, the 7800 costs less than the IBM.

The inexpensive, versatile, lightweight, personality changeable CIE-7800. It

should be enough to make even a dyed-in-the-blue IBM user change his mind.

To learn more, just call toll free 1-800-854-5959. In California, call 1-800-432-3687. In Europe, phone Geneva, Switzerland at (022) 29-8384.

 **CIE Systems**  
A C.I.T.O.H. ELECTRONICS COMPANY  
DISTRIBUTED SYSTEMS DIVISION

\* IBM is a Registered Trademark of International Business Machines Corp. DEC and DEC VT100 are Registered Trademarks of Digital Equipment Corp.

© 1984 CIE Systems, Inc.



# GOING ON

## UNIX SYSTEM V. FROM AT&T. ON TOP

Is your company's computing system an unmanageable muddle of isolated workstations and departmental computers?

You need a flexible means to integrate your system and get it under control. UNIX System V from AT&T.

It's another reason why good business decisions are based on UNIX System V.

UNIX System V can help you regain control of your company's system. Its flexibility lets you organize and expand your computing system for maximum efficiency.

And it protects your investment in hardware and software.

**More freedom. More control.**

UNIX System V is virtually hardware independent. It gives you the freedom to combine equipment from a variety of vendors. Even if the machines are of different generations.

You won't waste money rewriting software every time a new computer is added on. UNIX System V is easily adapted to a wide range of computers. From micros to mainframes. Including AT&T's range of 3B Computers.

Don't worry about your stand-alone personal computers running on

MS-DOS\* AT&T's PC Interface allows you to integrate your current machines into your system without costly disruptive change.

And, our COMMKIT™ Software links UNIX System V to the major networking protocols for data communications between computers based on UNIX System V and those that are not.

UNIX System V can support a number of users doing varied tasks at the same time. All sharing a central processing unit and peripherals. All benefiting from a larger base of information. All working as a manageable whole. All contributing to bottom-line cost savings because equipment and computing

# RETURN TO THE BOTTOM LINE.

costs come down while your output and productivity go up.

## A standard that's here to stay.

UNIX System V is backed by the full resources of AT&T. We're committed to seeing that it does the best possible job for your company—now and in the future.

All future software releases will be upwardly compatible. And designed to solve your business needs.

Our Independent Software Vendor Support Program will meet the demands of business with a complete line of high-quality applications software. Rest assured that your choice of a computing system based on UNIX System V is a smart, safe one.

To learn how UNIX System V can help you regain control of your computing system, send for our free brochure, "UNIX Software."

**UNIX System V. From AT&T.**  
**From now on, consider it standard.**

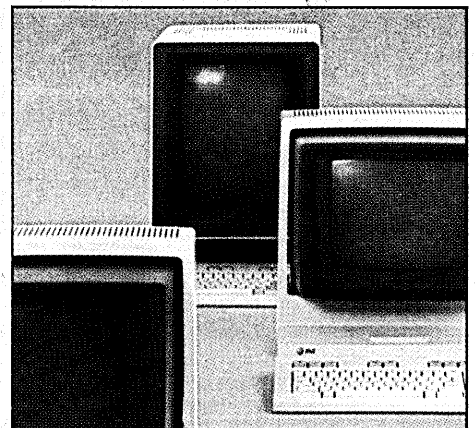

Please send me "UNIX Software." DA-0315-EF  
Mail to: AT&T, P.O. Box 967,  
Madison Square Station, N.Y., N.Y. 10159

Name \_\_\_\_\_  
Title \_\_\_\_\_  
Department \_\_\_\_\_  
Company \_\_\_\_\_  
Address \_\_\_\_\_  
City \_\_\_\_\_ State \_\_\_\_\_ Zip \_\_\_\_\_  
Phone \_\_\_\_\_

UNIX™ System Licensee  Yes  No  Don't know

# Test Your Microcomputer IQ\*

1. Name a totally integrated software package that was rated #1 by *Software Digest*. \_\_\_\_\_
2. Where can you buy an IBM PC XT or AT, AND have it installed, AND get on-site warranty for it? \_\_\_\_\_
3. Who will educate IC personnel or end-users at their site or yours? \_\_\_\_\_
4. What provides virtually any type of PC communications capability — from simple TTY to 3278/79 emulation? \_\_\_\_\_
5. What provides a micro software facility that allows you to customize a system to your specific requirements? \_\_\_\_\_
6. Who are the premier micro consultants to the *Fortune* 1350 companies? \_\_\_\_\_
7. Who has made the word hot-line obsolete, by staffing a full-service support center with computer professionals? \_\_\_\_\_
8. What is the easiest way for an IC manager to satisfy the many end-user needs in the organization? \_\_\_\_\_
9. What company's evolutionary approach to software and service (also demonstrated by NOMAD, now NOMAD2, the premier 4GL/DBMS) ensures that they'll be a major force in the micro marketplace for years to come? \_\_\_\_\_
10. Name the companies that can provide all of the above? \_\_\_\_\_

\*(Turn Page Upside Down for Answers)

1. DunsPlus Software 2. From DunsPlus 3. The DunsPlus Education Staff  
4. DunsPlus's Communications Utilities 5. The DunsPlus Tool Kit 6. DunsPlus's Professional Consulting Staff 7. The DunsPlus Support Center 8. Call DunsPlus at 800-DNB-PLUS 9. Dun & Bradstreet, the parent company of DunsPlus 10. DunsPlus

If you answered all of the above correctly, you've already solved most of the problems facing you. If not, give us a call at 800-DNB-PLUS, or write us at 187 Danbury Road, Wilton, Connecticut 06897.

**DunsPlus:**  
**An Innovation In**  
**End-User Computing**  
**From Dun & Bradstreet**

DunsPlus

**DB** a company of  
The Dun & Bradstreet Corporation

IBM is a registered trademark of International Business Machines Corporation. DunsPlus is a trademark of DunsPlus, a company of The Dun & Bradstreet Corporation. NOMAD2 is a trademark of D&B Computing Services.

CIRCLE 57 ON READER CARD

# SOFTWARE AND SERVICES

## UPDATES

The fanfare associated with activities at Edwards Air Force Base, Calif. -- most significantly the recent space shuttle landings -- was absent the day an F-15 fighter touched down on the Mojave Desert floor after becoming the first aircraft to fly a series of simulations using a mission-critical system programmed in Ada, formerly known as the MIL-STD-1815A computer language. The test flight represented the first live use of digital flight controls, and included a series of longitudinal strikes and 360-degree rolls at speeds of Mach 1.2.

In another test, a Northrop Corp. F-20 Tigershark fighter tested an operational mission computer programmed in Ada. "We have taken Ada past the development phase and placed it into an operational mission computer," says Bob Lopez, manager of Northrop's Aircraft Division in Hawthorne, Calif. "In this flight, over 20,000 lines of Ada code operated the military standard computer."

By no means did these tests prove Ada could fly the aircraft. Nor will on-board computers programmed in Ada replace pilots and flight crews in the near future.

So does Ada have the right stuff? Numerous vendors with an investment in Ada certainly hope so. One optimistic industry estimate puts the Ada market in 1986 at \$1 billion. And with the number of vendors manufacturing Ada products -- such as compilers and applications running on minis and mainframes, and on-board avionics systems -- one vendor predicts the billion dollar mark could be

reached on Ada research expenditures alone.

Another driving force pushing Ada at the Pentagon is the top military brass and their civilian counterparts who are Ada supporters. Though these individuals don't exactly walk around with blank checks, they wield a tremendous amount of lobbying power when it comes to getting what they perceive is good for the nation's defense. And part of getting what you want in Washington these days is paying at least some sort of lip service to the whopping Federal budget deficit. In that connection, the Department of Defense estimates that when Ada becomes fully operational in 1987 it will result in a total cost savings to the government of \$24 billion over a 15-year period.

Once the language is proven in mission-critical applications -- its first mandated use -- the DOD hopes to foster its growth in other military and commercial applications as compilers become available. To test the reliability of these compilers, the government initiated the Ada Compiler Validation Capability test, which became mandatory for DOD use last December.

Does Ada still have you a little confused? Perhaps Charles Bassine, an internationally recognized computer authority can help. He defines Ada as "something you need only know the name of to be an expert in computing. Useful in sentences like, 'We had better develop an Ada awareness.'" And if the DOD expects Ada to be fully operational by 1987, critics say it will have to move beyond the awareness stage.

## ON-LINE MS/DOS HELP

Maxam puts a condensed version of the MS/DOS or PC/DOS manual into memory so that help on using any MS/DOS command is always available. The on-line help provides instant reference to DOS commands, thus eliminating the need for users to consult a manual. The product provides help for each parameter of every DOS command and is context sensitive so that it opens automatically to the command being entered. Since it is RAM-resident, users can access the program in one keystroke and it can be used while in sessions with other applications packages. It is compatible with the IBM PC, PC XT, PC AT, and compatibles using MS/DOS or PC/DOS Version 2.0 or higher. The product consists of 32KB of resident code, so the computer should have at least 128KB of RAM. Maxam costs \$50. MAXAMEDIA CORP., Denver.

**FOR DATA CIRCLE 326 READER CARD**

## INTEGRATES MODULES

The Professional Solution fully integrates the vendor's database management system (ADABAS), the dictionary (Predict), and the fourth generation language (Natural). The product allows users to download, manipulate, then upload data while maintaining the proper level of security, control, and resource management. In addition, Super Natural, an extension of Natural, provides a production reporting capability whereby the user's inquiry can be loaded into a production stream, thus freeing up MIS personnel for more mainstream dp activities. Users may also have access to public or private libraries to retrieve, store, and modify transactions.

Other features include multiple output options to allow users to view information from a terminal or personal computer. User-defined files allow users to create files from existing reports or user-entered data. Data integrity, backup, restart, and recovery options provide consistent DBMS procedures across all data accessed. The Professional Solution is marketed as an extension to ADABAS,

## SOFTWARE AND SERVICES

Natural, and COM-LETE. This option is priced at \$15,000 for DOS/VSE; \$20,000 for VM/CMS and OS/VSI; and \$25,000 for MVS. SOFTWARE AG, Reston, Va.

**FOR DATA CIRCLE 327 ON READER CARD**

### IMPROVES WRITING

RightWriter is an automatic document proofreader for the IBM PC. It uses artificial intelligence to analyze documents for errors in grammar, usage, punctuation, style, and spelling. The software works in conjunction with WordStar and other word processors, requiring only one additional command.

Functions include the ability to flag errors of grammar, style, usage, spelling, and punctuation. Comments are inserted directly in the document to indicate potential areas for improvement. For example, "accounted for by the fact" is replaced with "caused by."

It uses over 1,500 rules and a 30,000-word dictionary to make decisions. The software calculates the reading grade level of the document using the Department of Defense standard and produces an overall critique of the document. It recommends alternatives but never decides, thus the final decision is up to the user. RightWriter requires 96KB of RAM and two disk drives. It costs \$75. DECISIONWARE INC., Longboat Key, Fla.

**FOR DATA CIRCLE 328 ON READER CARD**

### TWO-HOUR DELIVERY

Western Union and DHL Worldwide Courier Express initiated the Express Document service providing two-hour and overnight delivery of documents generated on Western Union's EasyLink electronic communications service. It is said to bridge the gap between electronic mail and overnight delivery.

It delivers reports and other data communications within two hours to 30 major U.S. cities, and overnight to more than 25,000 communities. The service provides letter-quality hardcopy on a personal computer over Western Union's

Easylink or by DHL messenger.

The vendors say the two-hour service will be extended to many other U.S. cities throughout the coming year. The service is also a standard Easylink delivery option. The Express Document service will be priced at \$20 for two-hour delivery and \$8 for overnight service. WESTERN UNION EASYLINK, Upper Saddle River, N.J.

**FOR DATA CIRCLE 329 ON READER CARD**

### EVALUATES FORTRAN

SFUN/Library is a resource of subprograms for evaluating special functions in FORTRAN programming. It offers a selection of user-callable subroutines and functions for use in FORTRAN program development. The software is designed to reduce programming time by allowing users to select complete, fully tested routines rather than writing them. It has routines for evaluating gamma functions, Bessel functions, exponential integrals, error functions, trigonometric and hyperbolic functions, and others. The system features independent single- and double-precision versions of routines. Both versions may be employed in the same program, allowing flexibility in problem solving, and assuring verifiable results through cross-checking. Many functions also have complex argument versions. SFUN/Library is available for the DEC and VAX computers under TOPS 10/20 and VMS. The software is priced at \$1,400 for the initial year, renewable at \$900. Universities are eligible for substantial discounts. IMSL, Houston.

**FOR DATA CIRCLE 330 ON READER CARD**

### PROJECT MANAGEMENT

The Total Project Manager is a personal computer-based project and resource management package, offering on-screen graphics and enabling users to plan and control the project. The software features resource management that is fully integrated with project management functions. It manages an unlimited resource

pool, subject only to memory and disk space, and, according to the vendor, enables managers to plan projects that allow for the management of resources. Users can create what-if scenarios to plan for unexpected situations. It also allocates resources for multiple projects. With the package, users can measure the progress of the project against the original plan.

The software employs the basic planning techniques of critical path method and uses Gantt and PERT (program evaluation and review technique) charts for enhanced visual emphasis. Data combined in a project can be transferred to programs that accept DIF (Data Interchange Format) files, such as Lotus 1-2-3, Symphony, and VisiCalc. It supports the MicroSoft mouse. The software runs on the IBM PC, PC XT, and PC AT with 384KB of RAM and two double-sided disk drives or a disk drive and hard disk configuration. The Harvard Total Project Manager costs \$500. HARVARD SOFTWARE INC., Littleton, Mass.

**FOR DATA CIRCLE 331 ON READER CARD**

### MODEM SOFTWARE

SoftCall is a menu-driven communication software package designed specifically for the vendor's Model 4000 modem, which is used with microcomputers in small business or home applications. The program explains itself as it is used, and help is always available through one keystroke that produces brief explanations of all prompts and menu items on the screen. With the software, there are no option switches to set. It enhances the Model 4000 modem with a variety of features, including a call history log that keeps a record of the time, date, duration, telephone number, and baud rate of all data calls made and received.

The software can store and automatically dial up to 30 telephone numbers, each including its own set of communication instructions and automatic log-on sequences. For automatic log-on, the program stores manually entered sequences, including queries and responses, for automatic use whenever subsequent calls are made to that number. It enables a personal computer to transmit and receive information with a remote source by using XON/XOFF or XMODEM protocols. A remote operations feature allows users to place both the Model 4000 modem and the pc in the auto-answer mode. This feature allows remote callers to leave messages stored in a special message file, or to have access to the pc's files by entering the correct password. The SoftCall communications package retails for \$80. The Model 4000 modem sells for \$500. AT&T CONSUMER PRODUCTS, Parsippany, N.J.

**FOR DATA CIRCLE 332 ON READER CARD**

## SOFTWARE SPOTLIGHT

### FREEFORM DATABASE

Workbase uses a time series database structure, freeing users from preformatted screens. It integrates data with tables, text, statistical analysis, and graphics.

The software enables users to organize and retrieve numerical data and it can hold the equivalent of 100 or more spreadsheets. The product performs free-formatting of tables within a text document; time series statistical analysis and forecasting; multicolor graphs and charts of time series data printed from databases; and integrates data, tables, text, and charts.

Users can combine and automate different tasks, transfer data and text to other software packages, or use text and data generated by other packages with the software's command-driven format. Access to many large mainframe databases is accomplished with the Vendor's Data Baskets product. Workbase runs on MS/DOS and IBM PCs and compatibles with 128KB of memory, and on CP/M machines with 64KB. Workbase costs \$900. Color graphics capability is available for an additional \$400. LAWRENCE INFORMATION SYSTEMS INC., Croton-on-Hudson, N.Y.

**FOR DATA CIRCLE 325 ON READER CARD**

# TODAY'S ACCESS CODE TO TOMORROW'S TECHNOLOGY.

## **NCC '85 – THE "LEADING EDGE" CONFERENCE.**

Come to the 1985 National Computer Conference, July 15-18 at McCormick Place and McCormick Place West, Chicago, Illinois.

Experience first-hand the future of information technology. Exchange information and ideas at the Early Bird Reception and Pioneer Day. Explore the more than 700 exhibits featuring over 300 different products and services. Attend the 84 Technical Sessions and 24 Professional Development Seminars. And don't miss our Keynote speaker, Admiral B.R. Inman, President and CEO of Microelectronics and Computer

Technology Corporation of Austin, Texas.

### **TOMORROW'S TECHNOLOGY IS JUST A PHONE CALL AWAY.**

NCC '85 is the industry's most significant event and is recognized as the key forum for new product introductions.

Don't miss this opportunity to be on the "Leading Edge" of information technology — plan to attend NCC '85!

**CALL TOLL-FREE 800-NCC-1985  
AND REGISTER TODAY!  
(Or fill out the coupon below.)**

CIRCLE 58 ON READER CARD



### **1985 National Computer Conference**

**Yes!** I want to attend NCC '85. Please send me a registration form today!

Name \_\_\_\_\_

Title \_\_\_\_\_

Company \_\_\_\_\_

Address \_\_\_\_\_

City, State, Zip \_\_\_\_\_

**Mail to: NCC '85 • 1899 Preston White Dr. • Reston, VA 22091  
OR CALL TOLL-FREE 800-NCC-1985 AND REGISTER TODAY!**



## SOFTWARE AND SERVICES

### SAS VERSION 5

Version 5 of the SAS System of software products provides increased interactivity for all products in the SAS system, with many procedures rewritten for efficiency and portability.

Enhancements to the base SAS software include the Display Manager System, a full-screen editing facility that allows users to interact with all parts of an SAS job. The display manager includes an on-line help facility, scrollable log and print screens, user-definable function key settings, and automatic execution of a command list.

Base SAS software also provides enhanced dataset management, including a new procedure for comparing SAS datasets. Among the statistical features are procedures for survival analysis and categorical data modeling and a statement for repeated measure analysis.

New features in SAS/GRAPH software allow users to create customized graphs and more easily manage graphic output. Users can manipulate graphs on one screen, define multiple axes, and customize picture selection menus for graphics presentations. Users can also view graphs before transferring them to the vendor's REPLAY/CICS software interactively, and submit graphs to CICS/VS in a batch job.

SAS/FSP has been enhanced with an expanded help command, full-screen editor, user-definable function key settings for all procedures, and a catalog for storing FSP screens. The FSCALC procedure features improved memory utilization, simultaneous viewing of multiple spreadsheets and SAS jobs, and user control over spreadsheets within an SAS job.

Enhancements to SAS/OR, the system's project management tool, allow users to put time constraints on each project activity and additional constraints on resource availability. PROC GANTT monitors the progress of projects. It can be used to produce line printer output by default for high-resolution color graphics.

The IMS-DL/1 interface to IBM DL/1 databases includes enhanced security and help features. A new security kit allows an SAS installation to examine all DL/1 region controller parameters before a job is executed. The exit can also be used to interface with security packages, such as RACF, for increased flexibility.

The vendor's economics software, ETS, for forecasting, modeling, and financial reporting, provides a procedure for fitting polynomial distributed lag models, and Holt-Winters forecasting method. Version 5 is available to current SAS System users at no additional fee. The system runs in batch and interactively under OS, TSO, DOS/VSE, SXX, and ICCF on IBM 370/30xx/43xx and compatible ma-

chines. It also runs under VMS on Digital Equipment Corp.'s VAX computers. The software also supports Data General's Eclipse MV series under AOS/VS and the Prime Computer's 50 series under PRIMOS. First year license fees for corporate customers in the United States are \$8,000 for base SAS software, \$6,000 for SAS/GRAPH, \$2,000 for SAS/REPLAY-CICS, \$5,000 for SAS/FSP, \$5,000 for SAS/OR, \$4,000 for SAS/IMS-DL/1, and \$4,000 for SAS/ETS. SAS INSTITUTE INC., Cray, N.C.

**FOR DATA CIRCLE 333 ON READER CARD**

### NEGOTIATION AID

The Art of Negotiating is an interactive negotiation training software package for the IBM PC and compatibles. It helps a user think through any type of negotiation that may be encountered.

The product, based on a book of the same name, is divided into nine sections that take the user through the steps of an actual negotiation, which the user specifies at the outset of the program. It helps users clarify and expand their thinking about how to negotiate. It encourages users to think objectively about both sides by going through the issues step by step and point by point.

The program can print out any section of the preparation or the entire negotiation. The software is intended for mid- to upper-level managers, for small business owners, and professionals. The Art of Negotiating requires 256KB RAM and costs \$500. EXPERIENCE IN SOFTWARE, Berkeley, Calif.

**FOR DATA CIRCLE 334 ON READER CARD**

### PRESENTATION SOFTWARE

Plot 10 is an interactive, raster-oriented package for automating the creation and production of color presentation graphics. The computer aided presentation software (TeknicAP) supports users in many professions and industries with the tools to create technical and business presentations.

It is organized into a series of fully integrated modules, which can be used in any order or combination. It provides the tools to enhance presentations with illustrations and presentation graphics fonts, and to combine numerous elements into a single picture. Graphic decision-making is simplified through a series of system-wide defaults, any of which can be overridden.

Interaction with the system is through a series of menus and prompts, with graphic input via joydisk, keyboard cursor keys, thumbwheels, or a graphics tablet. The software can be used by casual users since it requires no memorization of complex commands or procedures. The product is compatible with the Tektronix 4107, 4109, and 4115B terminals and the

4120 workstation series and the vendor's 4691, 4692, and 4695 color graphics copiers. Plot 10 TeknicAP sells for \$2,000. TEKTRONIX INC., Beaverton, Ore.

**FOR DATA CIRCLE 335 ON READER CARD**

### ELECTRONIC DELIVERY

The ZapMail two-hour electronic transmission service will now be available to companies. The equipment will enable users to establish intracompany networks and to avail themselves of the entire Federal Express ZapMail network, putting



them within two hours of the nation's business population.

According to the vendor, cost for a ZapMailer on their premises is minimal. There are neither equipment leasing fees nor telephone bills because the units are directly linked to the vendor's own communication network. Charges are based solely on a per-page basis (subject to a minimum charge), with discounts available based on service agreements. For example, there is a minimum charge of \$200 per month per terminal for a user with one to nine ZapMailers on a one-year agreement, which breaks out to 95 cents a page. A three-year contract with more than 100 terminals has a \$75 minimum monthly charge per terminal with a per-page price of 70 cents. If documents are sent to a Federal Express office, not an on-site unit, \$10 delivery is charged.

The device scans, sends, and prints high-quality copies of documents on plain bond paper. The terminal is menu driven and prompts the user on how to send the document. It also captures billing information. Documents are reproduced either at another ZapMail unit in the recipient company or at a Federal Express office with delivery by a courier to the recipient. The product can also be used as a local copier. FEDERAL EXPRESS CORP., Memphis.

**FOR DATA CIRCLE 336 ON READER CARD**

—Robert J. Crutchfield

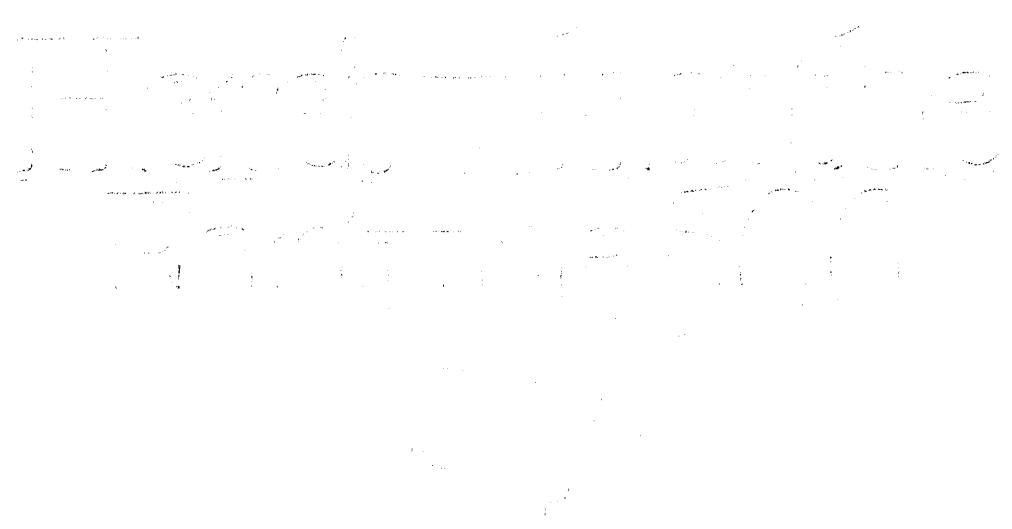
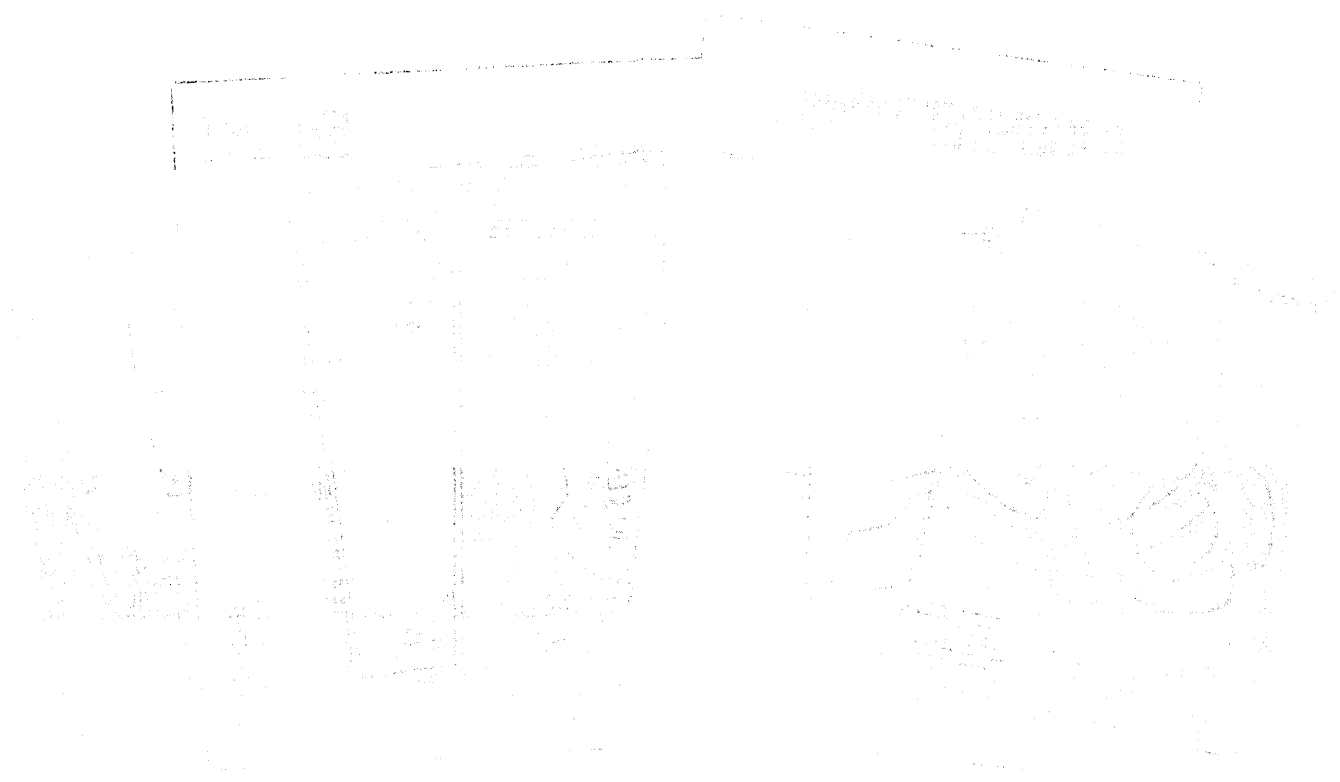

## Datamation reaches 489 companies in the Fortune 500. Check for yourself.

- ✓ 1. Exxon
- ✓ 2. General Motors
- ✓ 3. Mobil
- ✓ 4. Ford Motor
- ✓ 5. International Business Machines
- ✓ 6. Texaco
- ✓ 7. E.I. du Pont de Nemours
- ✓ 8. Standard Oil (Indiana)
- ✓ 9. Standard Oil of California
- ✓ 10. General Electric
- ✓ 11. Gulf Oil
- ✓ 12. Atlantic Richfield
- ✓ 13. Shell Oil
- ✓ 14. Occidental Petroleum
- ✓ 15. U.S. Steel
- ✓ 16. Phillips Petroleum
- ✓ 17. Sun
- ✓ 18. United Technologies
- ✓ 19. Tenneco
- ✓ 20. ITT
- ✓ 21. Chrysler
- ✓ 22. Procter & Gamble
- ✓ 23. R.J. Reynolds Industries
- ✓ 24. Getty Oil
- ✓ 25. Standard Oil (Ohio)
- ✓ 26. AT&T Technologies
- ✓ 27. Boeing
- ✓ 28. Dow Chemical
- ✓ 29. Allied
- ✓ 30. Eastman Kodak
- ✓ 31. Unocal
- ✓ 32. Goodyear Tire & Rubber
- ✓ 33. Dart & Kraft
- ✓ 34. Westinghouse Electric
- ✓ 35. Philip Morris
- ✓ 36. Beatrice Foods
- ✓ 37. Union Carbide
- ✓ 38. Xerox
- ✓ 39. Amerada Hess
- ✓ 40. Union Pacific
- ✓ 41. General Foods
- ✓ 42. McDonnell Douglas
- ✓ 43. Rockwell International
- ✓ 44. PepsiCo
- ✓ 45. Ashland Oil
- ✓ 46. General Dynamics
- ✓ 47. Minnesota Mining & Manufacturing
- ✓ 48. Coca-Cola
- ✓ 49. Consolidated Foods
- ✓ 50. Lockheed
- ✓ 51. Georgia-Pacific
- ✓ 52. Monsanto
- ✓ 53. W.R. Grace
- ✓ 54. Signal Companies
- ✓ 55. Anheuser-Busch
- ✓ 56. Nabisco Brands
- ✓ 57. Johnson & Johnson
- ✓ 58. Coastal
- ✓ 59. Raytheon
- ✓ 60. Honeywell
- ✓ 61. Charter
- ✓ 62. General Mills
- ✓ 63. TRW
- ✓ 64. Caterpillar Tractor
- ✓ 65. Aluminum Co. of America
- ✓ 66. Sperry
- ✓ 67. Gulf & Western Industries
- ✓ 68. Continental Group
- ✓ 69. Bethlehem Steel
- ✓ 70. Weyerhaeuser
- ✓ 71. Ralston Purina
- ✓ 72. Colgate-Palmolive
- ✓ 73. American Home Products
- ✓ 74. Litton Industries
- ✓ 75. Hewlett-Packard
- ✓ 76. Control Data
- ✓ 77. Texas Instruments
- ✓ 78. LTV
- ✓ 79. American Brands
- ✓ 80. International Paper
- ✓ 81. Motorola
- ✓ 82. Burroughs
- ✓ 83. Archer-Daniels-Midland
- ✓ 84. Digital Equipment
- ✓ 85. Borden
- ✓ 86. Champion International
- ✓ 87. Armco
- ✓ 88. Esmark
- ✓ 89. Diamond Shamrock
- ✓ 90. CPC International
- ✓ 91. Time Inc.
- ✓ 92. Deere
- ✓ 93. Bristol-Myers
- ✓ 94. Martin Marietta
- ✓ 95. Firestone Tire & Rubber
- ✓ 96. IC Industries
- ✓ 97. North American Philips
- ✓ 98. Agway
- ✓ 99. Pfizer
- ✓ 100. H.J. Heinz
- ✓ 101. NCR
- ✓ 102. Pillsbury
- ✓ 103. PPG Industries
- ✓ 104. International Harvester
- ✓ 105. American Motors
- ✓ 106. Borg-Warner
- ✓ 107. American Cyanamid
- ✓ 108. Kerr-McGee
- ✓ 109. United Brands
- ✓ 110. FMC
- ✓ 111. Emerson Electric
- ✓ 112. Dresser Industries
- ✓ 113. Boise Cascade
- ✓ 114. Warner Communications
- ✓ 115. Owens-Illinois
- ✓ 116. Carnation
- ✓ 117. American Can
- ✓ 118. Reynolds Metals
- ✓ 119. Campbell Soup
- ✓ 120. Kimberly-Clark
- ✓ 121. Land O'Lakes
- ✓ 122. Celanese
- ✓ 123. Northrop
- ✓ 124. Merck
- ✓ 125. B.F. Goodrich
- ✓ 126. SmithKline Beckman
- ✓ 127. Inland Steel
- ✓ 128. Warner-Lambert
- ✓ 129. Combustion Engineering
- ✓ 130. Eli Lilly
- ✓ 131. Avon Products
- ✓ 132. National Intergroup
- ✓ 133. Burlington Industries
- ✓ 134. Textron
- ✓ 135. Teledyne
- ✓ 136. Norton Simon
- ✓ 137. Abbott Laboratories
- ✓ 138. Eaton
- ✓ 139. Dana
- ✓ 140. Kaiser Aluminum & Chemical
- ✓ 141. St. Regis
- ✓ 142. Owens-Corning Fiberglas
- ✓ 143. Levi Strauss
- ✓ 144. Crown Zellerbach
- ✓ 145. Republic Steel
- ✓ 146. Quaker Oats
- ✓ 147. Whirlpool
- ✓ 148. Hercules
- ✓ 149. Mead
- ✓ 150. Interco
- ✓ 151. Penn Central
- ✓ 152. Swift Independent
- ✓ 153. Tosco
- ✓ 154. Times Mirror
- ✓ 155. Singer
- ✓ 156. Scott Paper
- ✓ 157. Murphy Oil
- ✓ 158. Kellogg
- ✓ 159. Revlon
- ✓ 160. Allegheny International
- ✓ 161. Kidde
- ✓ 162. ConAgra
- ✓ 163. Pennzoil
- ✓ 164. AMAX
- ✓ 165. Ingersoll-Rand
- ✓ 166. National Distillers & Chemical
- ✓ 167. Grumman
- ✓ 168. General Tire & Rubber
- ✓ 169. Gillette
- ✓ 170. American Standard
- ✓ 171. Wilson Foods
- ✓ 172. Williams Companies
- ✓ 173. Fruehauf
- ✓ 174. Engelhard
- ✓ 175. McGraw-Edison
- ✓ 176. American Petrofina
- ✓ 177. Mapco
- ✓ 178. White Consolidated Industries
- ✓ 179. Avco
- ✓ 180. Uniroyal
- ✓ 181. Jim Walter
- ✓ 182. Ujohn
- ✓ 183. Northwest Industries
- ✓ 184. Sherwin-Williams
- ✓ 185. Olin
- ✓ 186. J.P. Stevens
- ✓ 187. Ogden
- ✓ 188. Sterling Drug
- ✓ 189. Rohm & Haas
- ✓ 190. Cooper Industries
- ✓ 191. Baxter Travenol Laboratories
- ✓ 192. Baker International
- ✓ 193. SCM
- ✓ 194. Schering-Plough
- ✓ 195. Squibb
- ✓ 196. Superior Oil
- ✓ 197. Ethyl
- ✓ 198. Gould
- ✓ 199. Manville
- ✓ 200. Central Soya
- ✓ 201. Harris
- ✓ 202. Hershey Foods
- ✓ 203. Gannett
- ✓ 204. Union Camp
- ✓ 205. Emhart
- ✓ 206. Chesebrough-Pond's
- ✓ 207. A.E. Staley Manufacturing
- ✓ 208. Crown Central Petroleum
- ✓ 209. James River Corp. of Virginia
- ✓ 210. National Can
- ✓ 211. Pitney Bowes
- ✓ 212. Air Products & Chemicals
- ✓ 213. American Hoechst
- ✓ 214. Hammermill Paper
- ✓ 215. U.S. Gypsum
- ✓ 216. Cummins Engine
- ✓ 217. Corning Glass Works
- ✓ 218. Tribune
- ✓ 219. Colt Industries
- ✓ 220. General Signal
- ✓ 221. Koppers
- ✓ 222. Great Northern Nekoosa
- ✓ 223. Lever Brothers
- ✓ 224. Cabot
- ✓ 225. Pacific Resources
- ✓ 226. R.R. Donnelley & Sons
- ✓ 227. Wang Laboratories
- ✓ 228. AMP
- ✓ 229. Asarco
- ✓ 230. Alumax
- ✓ 231. Morton Thiokol
- ✓ 232. Westvaco
- ✓ 233. Joseph E. Seagram & Sons
- ✓ 234. Knight-Ridder Newspapers
- ✓ 235. Marmon Group
- ✓ 236. Lear Siegler
- ✓ 237. International Minerals & Chemical
- ✓ 238. Gold Kist
- ✓ 239. NL Industries
- ✓ 240. Armstrong World Industries
- ✓ 241. Geo. A. Hormel
- ✓ 242. PACCAR
- ✓ 243. Farmers' Union Central Exchange
- ✓ 244. Anderson Clayton
- ✓ 245. Witco Chemical
- ✓ 246. Zenith Radio
- ✓ 247. Mid-America Dairymen
- ✓ 248. Mattel
- ✓ 249. Stauffer Chemical
- ✓ 250. Monfort of Colorado
- ✓ 251. Johnson Controls
- ✓ 252. Mobay Chemical
- ✓ 253. Allis-Chalmers
- ✓ 254. Crown Cork & Seal
- ✓ 255. McGraw-Hill
- ✓ 256. Polaroid
- ✓ 257. Louisiana Land & Exploration
- ✓ 258. Blue Bell
- ✓ 259. Mack Trucks
- ✓ 260. Brunswick
- ✓ 261. National Semiconductor
- ✓ 262. West Point-Pepperell
- ✓ 263. Tektronix
- ✓ 264. Amstar
- ✓ 265. Black & Decker Manufacturing
- ✓ 266. Libbey-Owens-Ford
- ✓ 267. Hughes Tool
- ✓ 268. G. Heileman Brewing
- ✓ 269. Square D
- ✓ 270. National Gypsum
- ✓ 271. Norton
- ✓ 272. Intel
- ✓ 273. Becton Dickinson
- ✓ 274. International Multifoods
- ✓ 275. Federal Co.
- ✓ 276. Richardson-Vicks
- ✓ 277. Miles Laboratories
- ✓ 278. Adolph Coors
- ✓ 279. Louisiana-Pacific
- ✓ 280. VF
- ✓ 281. New York Times
- ✓ 282. BOC
- ✓ 283. U.S. Industries
- ✓ 284. Trane
- ✓ 285. BASF Wyandotte
- ✓ 286. Masco
- ✓ 287. Willamette Industries
- ✓ 288. CertainTeed
- ✓ 289. Parker Hannifin
- ✓ 290. Cyclops
- ✓ 291. Perkin-Elmer
- ✓ 292. Dover
- ✓ 293. Thomas J. Lipton
- ✓ 294. Crane
- ✓ 295. NVF
- ✓ 296. G.D. Searle
- ✓ 297. Chromalloy American
- ✓ 298. Stanley Works
- ✓ 299. Apple Computer
- ✓ 300. Phelps Dodge
- ✓ 301. Pennwalt
- ✓ 302. General Instrument

- ✓ 303. AMF
- ✓ 304. Hartmarx
- 305. Mitchell Energy & Development
- ✓ 306. Tyler
- ✓ 307. Cameron Iron Works
- ✓ 308. Ex-Cell-O
- ✓ 309. Hanson Industries
- ✓ 310. Timken
- ✓ 311. National Service Industries
- ✓ 312. General Cinema
- ✓ 313. Lone Star Industries
- ✓ 314. Clorox
- ✓ 315. Ball
- ✓ 316. Potlatch
- ✓ 317. Pundtatch
- ✓ 318. EG&G
- ✓ 319. Quaker State Oil Refining
- ✓ 320. Springs Industries
- ✓ 321. Fairchild Industries
- ✓ 322. Storage Technology
- ✓ 323. Washington Post
- 324. Lafarge
- ✓ 325. Cluett Peabody
- ✓ 326. Dow Jones
- ✓ 327. Clark Equipment
- ✓ 328. CF Industries
- ✓ 329. Fleetwood Enterprises
- ✓ 330. A.O. Smith
- ✓ 331. Harsco
- ✓ 332. Interlake
- ✓ 333. Dean Foods
- ✓ 334. Tecumseh Products
- ✓ 335. Data General
- ✓ 336. Brockway
- ✓ 337. CBI Industries
- ✓ 338. E-Systems
- ✓ 339. Vulcan Materials
- ✓ 340. Household Manufacturing
- ✓ 341. Avery International
- ✓ 342. Rexnord
- ✓ 343. Lubrizol
- ✓ 344. Outboard Marine
- ✓ 345. Todd Shipyards
- ✓ 346. Freeport-McMoRan
- ✓ 347. Fort Howard Paper
- ✓ 348. National Cooperative Refinery Assoc.
- ✓ 349. Anchor Hocking
- ✓ 350. Amdahl
- ✓ 351. Hoover Universal
- ✓ 352. Wheeling-Pittsburgh Steel
- ✓ 353. Kane-Miller
- ✓ 354. Champion Spark Plug
- ✓ 355. Dow Corning
- ✓ 356. Capital Cities Communications
- 357. Inspiration Resources
- ✓ 358. Varian Associates
- ✓ 359. National Starch & Chemical
- ✓ 360. Midland-Ross
- ✓ 361. Magic Chef
- ✓ 362. Reichhold Chemicals
- ✓ 363. Federal-Mogul
- ✓ 364. Sun Chemical
- ✓ 365. McCormick
- ✓ 366. Scovill
- ✓ 367. Fuqua Industries
- ✓ 368. NI Industries
- ✓ 369. American Greetings
- ✓ 370. Newmont Mining
- ✓ 371. Dayco
- ✓ 372. Gerber Products
- ✓ 373. Bemis
- ✓ 374. GAF
- ✓ 375. Smith International
- ✓ 376. Pabst Brewing
- ✓ 377. Frederick & Herrud
- ✓ 378. Collins & Aikman
- ✓ 379. Bell & Howell
- ✓ 380. Southwest Forest Industries
- ✓ 381. Insilco
- ✓ 382. Badische
- ✓ 383. Sonoco Products
- ✓ 384. Economics Laboratory
- ✓ 385. Big Three Industries
- ✓ 386. Figgie International Holdings
- ✓ 387. Hoover
- ✓ 388. Interstate Bakeries
- ✓ 389. Nalco Chemical
- ✓ 390. Joy Manufacturing
- ✓ 391. Stone Container
- ✓ 392. Harcourt Brace Jovanovich
- ✓ 393. Mohasco
- ✓ 394. Genesco
- ✓ 395. M/A-Com
- ✓ 396. Kaiser Steel
- ✓ 397. Scott & Fetzer
- ✓ 398. Idle Wild Foods
- ✓ 399. Dennison
- ✓ 400. Deluxe Check Printers
- ✓ 401. Ferro
- ✓ 402. MEI
- ✓ 403. Briggs & Stratton
- ✓ 404. Sybron
- ✓ 405. Sheller-Globe
- ✓ 406. Brown-Forman Distillers
- ✓ 407. Tyson Foods
- ✓ 408. Arvin Industries
- ✓ 409. Maytag
- ✓ 410. Coleco Industries
- ✓ 411. Armstrong Rubber
- ✓ 412. M. Lowenstein
- ✓ 413. Raychem
- ✓ 414. Wm. Wrigley Jr.
- ✓ 415. Sanders Associates
- ✓ 416. ACF Industries
- ✓ 417. Gulfstream Aerospace
- ✓ 418. Handy & Harman
- ✓ 419. Tyco Laboratories
- ✓ 420. Consolidated Papers
- ✓ 421. Kellwood
- ✓ 422. Smithfield Foods
- ✓ 423. Federal Paper Board
- ✓ 424. Bausch & Lomb
- ✓ 425. Rohr Industries
- ✓ 426. Nashua
- ✓ 427. AM International
- ✓ 428. Echlin
- ✓ 429. A.H. Robins
- ✓ 430. Michigan Milk Producers Association
- ✓ 431. Dexter
- ✓ 432. Dr Pepper
- ✓ 433. Cincinnati Milacron
- ✓ 434. Bucyrus-Erie
- ✓ 435. Fieldcrest Mills
- ✓ 436. H.H. Robertson
- ✓ 437. Westmoreland Coal
- ✓ 438. Bangor Punta
- ✓ 439. Nucor
- ✓ 440. Datapoint
- ✓ 441. Shaklee
- ✓ 442. Foxboro
- ✓ 443. Eagle-Picher Industries
- ✓ 444. Stokely-Van Camp
- ✓ 445. Cessna Aircraft
- 446. Flowers Industries
- ✓ 447. Sun-Diamond Growers of California
- ✓ 448. Universal Foods
- ✓ 449. Georgia Kraft
- ✓ 450. Oxford Industries
- ✓ 451. Prime Computer
- ✓ 452. Revere Copper & Brass
- ✓ 453. Media General
- ✓ 454. ROLM
- ✓ 455. Illinois Tool Works
- ✓ 456. Warnaco
- ✓ 457. Easco
- ✓ 458. Amsted Industries
- ✓ 459. Royal Crown Companies
- ✓ 460. American Bakeries
- ✓ 461. Savannah Foods & Industries
- 462. Roper
- ✓ 463. Coachmen Industries
- ✓ 464. United Merchants & Manufacturers
- ✓ 465. Trinity Industries
- ✓ 466. Rorer Group
- ✓ 467. Palm Beach
- ✓ 468. Guardian Industries
- ✓ 469. Ceco
- ✓ 470. International Flavors & Fragrances
- ✓ 471. Liquid Air
- ✓ 472. Cooper Tire & Rubber
- ✓ 473. Phillips-Van Heusen
- ✓ 474. Snap-on Tools
- ✓ 475. Worthington Industries
- ✓ 476. Cooper Labs
- ✓ 477. Prentice-Hall
- ✓ 478. Ametek
- ✓ 479. Meredith
- 480. Wisconsin Dairies Cooperative
- ✓ 481. Peabody International
- ✓ 482. Dorsey
- ✓ 483. Diebold
- 484. Holly
- ✓ 485. Harte-Hanks Communications
- ✓ 486. Bairnco
- ✓ 487. Rubbermaid
- ✓ 488. Hillenbrand Industries
- ✓ 489. Macmillan
- ✓ 490. Harvey Hubbell
- ✓ 491. Pittway
- ✓ 492. Oak Industries
- 493. H.B. Fuller
- ✓ 494. Sealed Power
- ✓ 495. Tracor
- ✓ 496. Moore McCormack Resources
- ✓ 497. Hyster
- ✓ 498. Riegel Textile
- ✓ 499. Masonite
- ✓ 500. Tandem Computers

The Fortune 500. If you sell almost any kind of computer product or service, they buy the lion's share.

You need to get to their corporate management. Their DP management. Their senior technical people. And twice each month, *Datamation* reaches more of these powerful people than any other computer publication.

They depend on *Datamation's* unequalled reputation for editorial quality. They look to *Datamation* to analyze and sort out the market. And then they buy.

*Datamation* is also the #1 publication with the Fortune Service 500: the largest utilities, commercial banks, financial, retailing, life insurance, transportation, and service companies.

And more than 20 independent surveys agree *Datamation* is also the best read.

So, instead of watering down your advertising dollars in publications that claim they'll get you into the Fortune 500, put your money in the one that really does: *Datamation*.

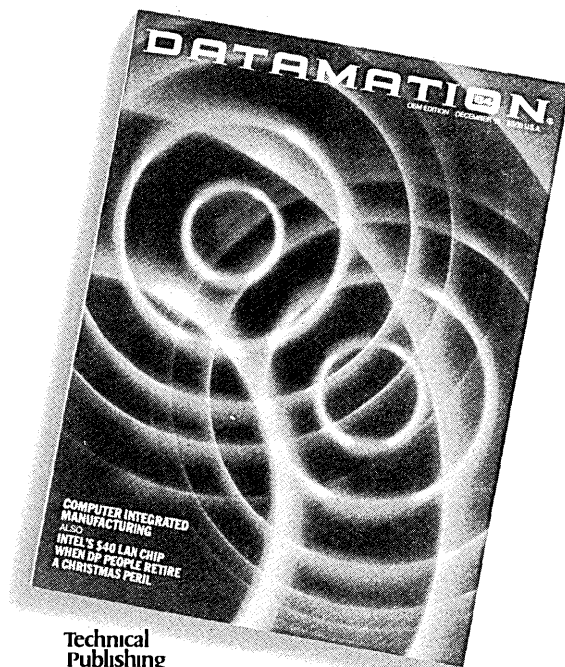

Technical  
Publishing

IBM a company of  
The Dun & Bradstreet Corporation

# The Marketplace... BUY, SELL, LEASE

## ADVERTISERS' INDEX

BUY, SELL, LEASE

R's Data Services ..... 156

## SAVE BIG BUCKS ON BIG PRINTER

Go ahead. Compare prices on the new, factory warranted Centronics Line Writer 400. Now, at an indecent **\$5100**, you can get 400 lines per minute of ultra reliability, whisper-quiet 62 dBA cabinet, paper basket and 64-characters.

Call the West's leading full service OEM printer distributor.

9155-B Alabama Avenue  
Chatsworth, CA 91311

R's DATA SERVICES



Good 'til  
APRIL  
30  
LW 600 "Big Buck"  
Sale Ends 3/31/85.

In California  
1-800-325-0701  
(818) 700-8766

CIRCLE 500 ON READER CARD

Ever wish  
you could start  
your day over?

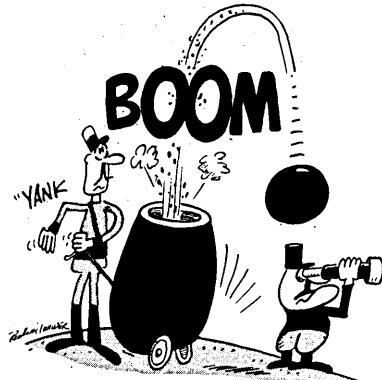

Well, now you can!

Buy U.S. Savings Bonds  
and Get Your Future  
off to a Good Start!



Perform a  
death-defying act.

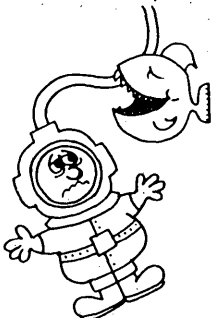

Have your  
blood pressure checked.

Give Heart Fund  
American Heart Association

"A little space."

— WILLIAM BLAKE  
*Songs of Innocence*

"At little cost."

— KATHY MONAGHAN

Call me or Shirley Stirling  
for more details about the  
DATAMATION Marketplace  
at (800) 223-0743.

Back a Fighter



Payroll Savings for education ...and that's no CROCK!

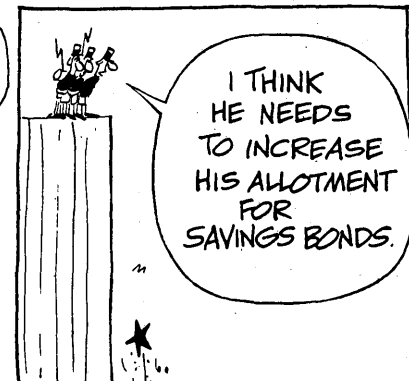
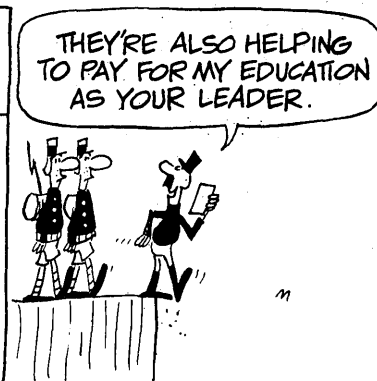

U.S. SAVINGS BONDS DIVISION  
DEPARTMENT OF THE TREASURY

# ON THE JOB

## TELECOMMUNICATIONS IS TOPS...

Employment recruiters will be hot on the trail of telecommunications specialists this year. The demand for these experts is expected to double or even triple in 1985, according to Halbrecht Associates' forecast of executive demand. Particularly popular will be those specialists with combined voice/data expertise.

"Demand for senior telecommunications executives shows no signs of abating. In fact, at this time [that demand] practically dominates the job market in information services," claims Herb Halbrecht, president of the Stamford, Conn.-based executive search firm. Projections

for the first half of 1985 show the demand for middle- and senior-level information services executives will continue to escalate rapidly. This can be attributed to a number of factors, explains Halbrecht. Many banks and financial services companies are expanding their telecommunications systems and thus need to expand their staffs. But there is "a relatively small talent pool for good people to manage and develop these systems," he notes.

The popularity of corporate mergers and acquisitions also contributes to the demand for telecommunications professionals, Halbrecht says. When two companies merge, they often wish to integrate their communications systems. At

the very least, acquired companies need good telecom links to their new corporate headquarters.

Halbrecht also forecasts a relatively strong demand for AI specialists. Software companies and consulting firms are searching for experts in the field, especially in the expert systems area.

It's easier to establish new telecommunications systems than it is to find competent telecom managers. Executive search firm Korn/Ferry International, headquartered in New York and Los Angeles, stresses that when a company's technology is managed correctly, big bucks are saved. This explains the need for top-notch managers and the manag-

## ADVERTISING OFFICES

### Advertising Sales Manager:

**William J. McGuire**  
New York, NY 10022  
875 Third Ave.  
(212) 605-9715

### Marketing Services Manager:

**Kathleen A. Murray**  
New York, NY 10022  
875 Third Ave.  
(212) 605-9723

### Eastern District Managers:

**Francie Bolger, John M. Gleason**  
New York, NY 10022  
875 Third Ave.  
(212) 605-9400

### New England District Managers:

**Jack Orth, John M. Gleason**  
Newton, MA 02159  
181 Wells Ave.  
(617) 964-3730

### Mid-Atlantic District Mgr.:

**Patricia Joseph**  
Plymouth Meeting, PA 19462  
Plymouth Plaza, Suite 201  
(215) 825-4410

### Southern District Managers:

**Michael W. Andrea**  
4 Executive Park Drive N.E.  
Suite 1205  
Atlanta, GA 30329  
(404) 633-5112

### Warren A. Tibbetts

West Palm Beach, FL 33406  
7621 West Lake Dr., Lake Clark Shores  
(305) 964-6298

### Southwest District Mgr.:

**Randall A. Clark**  
1700 Eastgate Drive  
Suite 103  
Garland, Texas 75041  
(214) 270-6461

### Midwest District Mgr.:

**Joseph P. Gleason**  
Chicago, IL 60601  
3 Illinois Center Building, 303 East Wacker Dr.  
(312) 938-2926

### Western District Managers:

**William M. Wilshire**  
Irvine, CA 92715  
2061 Business Center Dr., Suite 111  
(714) 476-2511

### Robert J. Rielly

Los Angeles, CA 90035  
1801 S. La Cienega Blvd.  
(213) 559-5111

### James E. Filiatrault, Janet Engelbrecht

Mountain View, CA 94043  
2680 Bayshore Frontage Rd., Suite 401  
(415) 965-8222

### U.K., Scandinavia, Netherlands

Director - European Operations  
**Martin Sutcliffe, Robert Saidel**  
Technical Publishing Co.  
130 Jermyn Street, London, SW1 4UJ, England  
Tel: (44 1) 839-3916, Telex: 914911 TECPUB G

### France, Belgium, Luxembourg, Spain

**Vivien James**  
Technical Publishing Co.  
130 Jermyn Street, London, SW1 4UJ, England  
Tel: (44 1) 839-3916, Telex: 914911 TECPUB G

### Germany, Austria, E. Europe

**Martin Noble**  
Technical Publishing Company  
6000 Frankfurt 1  
Steinweg 7, W. Germany  
Tel: (49 69) 28-80-63, Telex: W. Germany 4170039  
TECP D

### Italy:

**Luigi Rancati**  
Rancati Advertising  
San Felice Torre 5  
20090 Segrate, Milano, Italy  
Tel: 2-7531445, Telex: 311010

### Switzerland:

**P. J. Ruckstuhl**  
ALAS AG  
Business-Centre  
Schoegrund 1  
CH 6343 Rotkreuz, Switzerland  
Tel: (42) 642964, Telex: 864958

### Japan:

**Hiroshi Sato**  
IRM, Inc.  
Rosei Building, 4, 1-Chone,  
Higashi-Avabu, Minatoku  
Tokyo, Japan  
Tel: (03) 583-1161, Telex: 242-2588 IRMTOKJ

### John K. Abely, President

**Robert L. Dickson**, Exec. Vice President  
**Edwin V. Burkholder**, Senior Vice President/  
Technology

**Walter M. Harrington**, Vice President/Finance  
and Administration

## Technical Publishing

**TB** a company of  
The Dun & Bradstreet Corporation



## ON THE JOB

ers' demands for top dollar (over six figures), according to the Korn/Ferry report.

The telecommunications field is relatively young and the demand for competent managers who can keep up with the technological advances in this field is just beginning to jell, according to John L. Sullivan Jr., one of Korn/Ferry's partners and telecommunications management experts. In the past, the best technicians were promoted to telecommunications managers, tipping the man-

agement-telecom job scales in favor of technically oriented people. While the technology end of their jobs was managed well, the business end was not. The technicians couldn't handle the managerial problems that came with the territory.

Now companies are hiring telecommunications managers who can balance the scales. They are trained to deal with all aspects of the management position. "It's imperative that telecommunications managers have the capability to talk the language of business as well as

the language of telecommunications," says Sullivan.

### BUT LET'S NOT STOP THERE

While telecom executives will be in great demand, other high-tech specialists that companies will be recruiting heavily in '85 include computer programmers, systems analysts, and electronics engineers. In fact, a 20% increase over 1984 levels of demand to fill these positions is expected in 1985, according to a survey of over 900 U.S. employers by Fox-Morris Personnel Consultants, Philadelphia.

Companies will be recruiting heavily for computer experts and engineers with two to six years of experience. These professionals are prime candidates because of their "combination of knowledge and reasonable salary expectations." Electrical engineers will enjoy a particularly prosperous year in '85, thanks in part to President Reagan. Fox-Morris president Sanford L. Fox states that continued interest in the U.S. national defense and an increase in its sophistication will create more jobs for telecommunications, systems, weaponry, and aerospace engineers.

Mechanical, industrial, and design engineers can also look forward to greater job opportunities in the fields of computer aided design and computer aided manufacturing, robotics, research and development, quality assurance, and consumer products, according to the firm's projections.

CompuSearch, the data processing division of Management Recruiters International Inc. (MRI), Cleveland, also conducted a poll on the dp hiring outlook for '85. According to its findings, 35.8% of the 438 companies interviewed said they would increase their staff size, while 57.3% would maintain their '84 employee level. Only 6.6% responded that there would be a decrease in their current staff size.

According to MRI president Alan Schonberg, the poll results "show that the country, on the whole, is experiencing continued optimism among its businesses and industries."

Speaking of optimism, here are some projected 1985 median U.S. salaries for positions in the information services field, as reported in the Fox-Morris 1985 Professional Job/Salary Forecast Survey: corporate data processing/MIS directors—\$69,800; electrical/electronic engineers (two to six years' experience)—\$34,700; EDP internal auditors (two to six years' experience)—\$33,250; computer systems analysts (two to six years' experience)—\$32,600; electrical engineering graduates (BSEE)—\$27,700; computer science graduates (BSCS)—\$24,700.

—Mary Ann Hariton

# Datamation has started publishing classified information.

For 26 years *Datamation* has been the number 1 way to reach top information processing professionals. And now it's also one of the best ways to hire them. Because when we increased our frequency to 24 issues a year, we also increased the size of our recruitment section. Offering expanded editorial, as well as the latest listings. For complete information, call Kathy Monaghan or Shirley Stirling at 1-800-223-0743.

In NY, 212-605-9732/33.

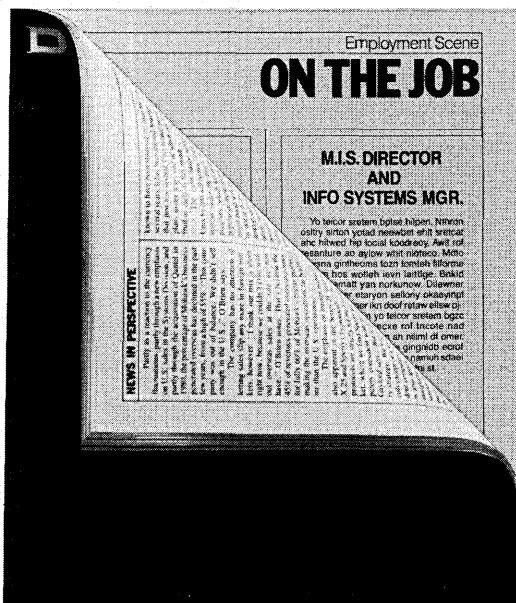

Technical  
Publishing  
A Division of  
McGraw-Hill

# THE ASIAN COMPUTER MARKET IS EXPLODING

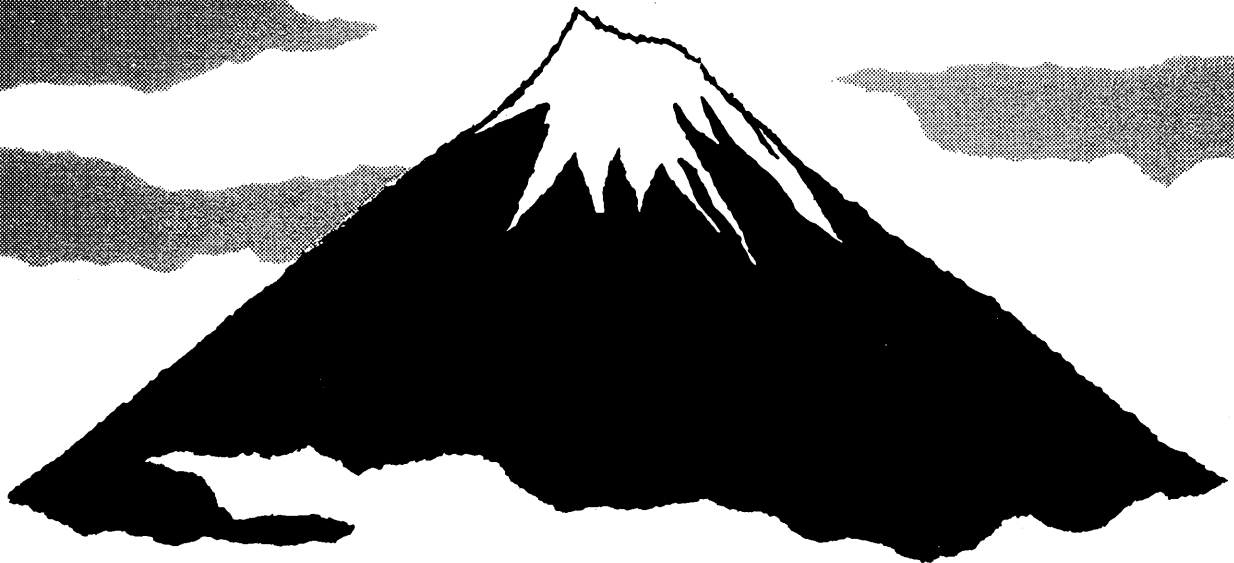

## COMDEX™ IN JAPAN

March 26-28, 1985

Harumi Exhibition Center, Tokyo

**For independent sellers and marketers of computer-related products in Asia.**

COMDEX in JAPAN is a new kind of computer show for Asia. It is the only trade show in Japan and other Asian countries dedicated to the special requirements of those who market and sell computer-related products through the fast-growing independent distribution channel.

That's the COMDEX formula, which has already proven itself to be hugely successful in the United States and Europe.

**Plan NOW to exhibit or attend.**

**For further information: In the U.S. 617-449-6600 • In Tokyo: 03-271-0246**

Presented by



THE  
INTERFACE  
GROUP, Inc.

300 First Avenue, Needham, Massachusetts, USA 02194

Offices In: Los Angeles, CA San Francisco, CA Washington, DC Amsterdam, The Netherlands Tokyo, Japan



**SOME OF THE  
GREATEST THINGS IN AMERICA  
NEVER CHANGE.**

**SOME DO.**

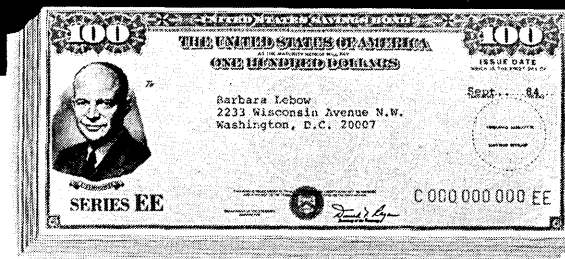

U.S. Savings Bonds now pay like money market accounts! At the current rate—10.94%—you could double your money in less than seven years.

Just hold your Bonds five years or more and get the new higher variable rates. Plus, you get a guaranteed return. That means you can earn a lot more—but never less than 7½%. That's the kind of change anyone can appreciate.

But some of the best things about Savings Bonds haven't changed. They're still as safe as ever. They're still exempt from state and local income taxes. And since Bonds cost as little as \$25,

**U.S. Savings Bonds. Now paying 10.94%.**

they're as affordable as ever. Or easier still, through the Payroll Savings Plan where you work. Today, more than 5.5 million Americans are saving the easy way—through Payroll Savings. Isn't it time you joined them? That's a sure way to appreciate how much Bonds have changed for the better.

For your free booklet, write: "50 Q&A," U.S. Savings Bonds Division, Washington, DC 20226.

**U.S. SAVINGS BONDS**  
*Paying Better Than Ever*

Variable rates apply to Bonds purchased on and after 11/1/82 and held at least 5 years. Bonds purchased before 11/1/82 earn variable rates when held beyond 10/31/87. Bonds held less than 5 years earn lower interest.

A public service of this publication.

DESIGNERS, MANUFACTURERS, SYSTEM INTEGRATORS:

# Before you buy, buy the new BUS BUYERS GUIDES

New Summer '84 Editions Now on Sale

The latest editions of the Bus Buyers Guide are your most complete, most up-to-date reference on bus-compatible microcomputer hardware products. Each Buyers Guide gives you the who, where, when and how of buying products for each bus architecture.

Organized in an easy-to-use format, the Buyers Guides list manufacturers, models, specifications, prices and features. They put data for thousands of products at your fingertips *before you buy*.

Make the vital connection with bus-compatible hardware with the new Bus Buyers Guides...covering IBM PC, Multibus\*, STD BUS, Q-bus\*, VMEbus and S-100 Bus.

Each Buyers Guide is just \$39.95...with special saving on quantity orders. Visa and MasterCard accepted.

To order your copies of the new Bus Buyers Guides call us toll-free at 1-800-843-8747.

- All New Summer '84 Editions. Completely revised and updated.
- Finding the right compatible component is fast and easy.
- Models, prices, specifications, features and delivery data presented for side-by-side comparison.

## CONTROL ENGINEERING Microcomputer Interface Group

FORMERLY IRONOAK COMPANY  
1301 S. Grove Avenue, P.O. Box 1030  
Barrington, IL 60010 • 312-381-1840



Technical Publishing

**EB** a company of The Dun & Bradstreet Corporation

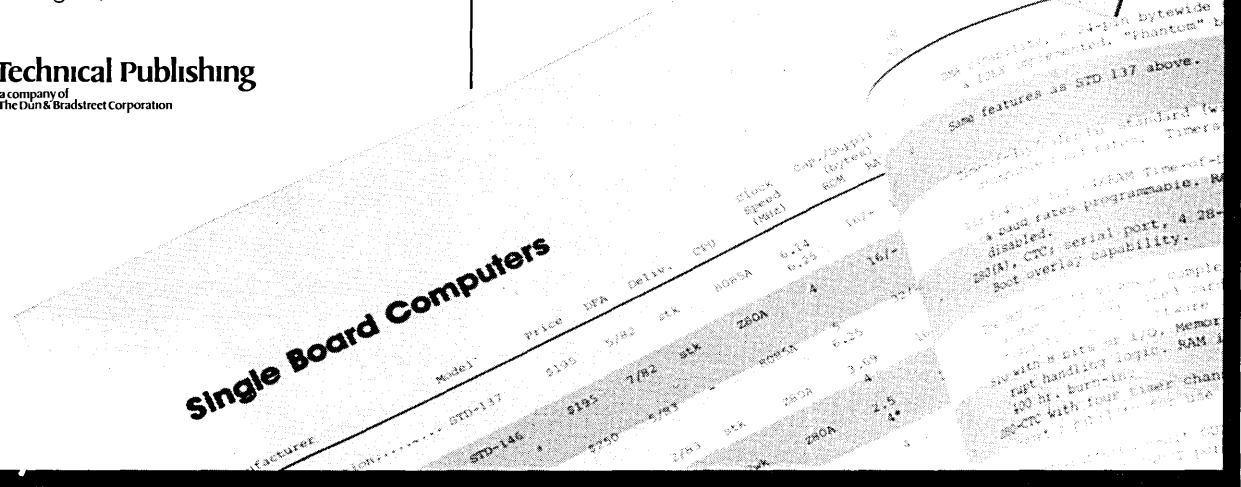
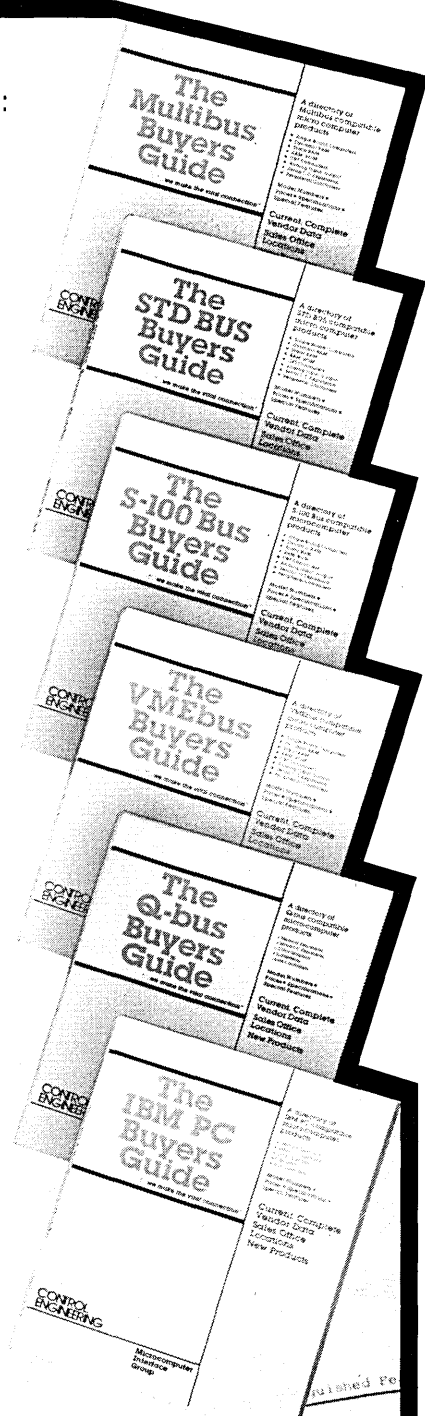

# A SIMPLE LESSON IN ECONOMICS FOR ANYONE WHO BELIEVES ADVERTISING RAISES PRICES.

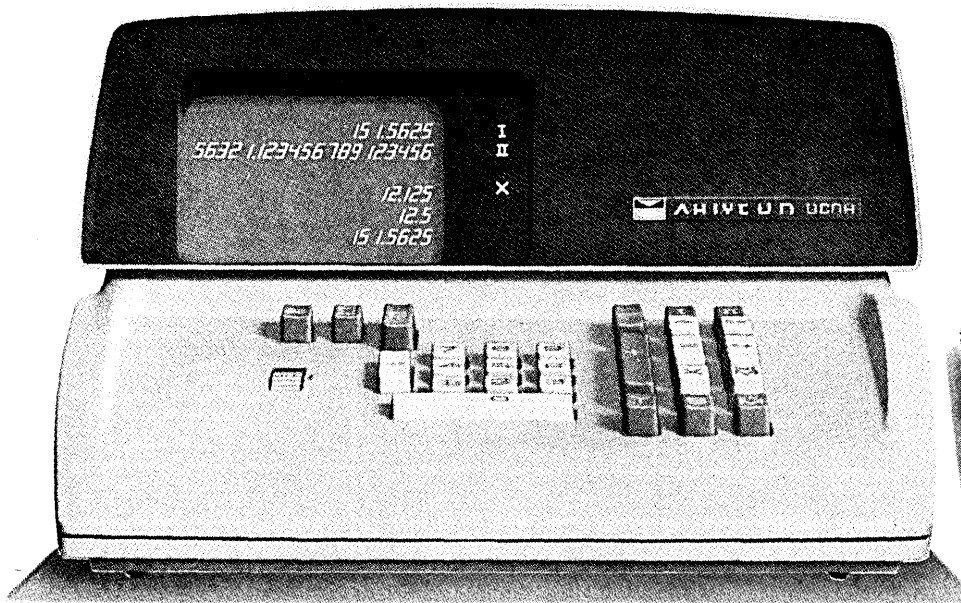

1965 Calculator — Over \$2,000.00



1984 Calculator — Under \$10.00

In the beginning there was the calculator.

It was a new idea. It had never been advertised. And it cost a fortune.

Then the people who sold calculators started to advertise them. That was hardly a new idea. But it, too, cost a fortune.

Now, you might think all that expensive advertising would drive the price of a calculator to incalculable heights.

But no. What happened was exactly the opposite.

It doesn't make sense. How can something as costly as advertising end up saving you money?

It's really quite simple. Advertising spreads news. When it spread the news of the calculator, people started to buy.

As more calculators were sold, more were produced. As more were produced, the cost of producing them came down. And because advertising creates competition, their quality and sophistication went up.

So today, using an electronic calculator is almost cheaper than counting on your fingers. And advertising helped make it happen — just as it has for countless other products.

In fact, with a little effort you could probably figure out precisely how much money advertising has saved you over the years.

But don't try it without a calculator.

**ADVERTISING.**  
**ANOTHER WORD FOR FREEDOM OF CHOICE.**  
American Association of Advertising Agencies

# READERS' FORUM

## THE OOGAH SYNDROME

You can still find rubber-bulb horns in bicycle stores, and larger ones in trendy souvenir shops on Fisherman's Wharf. Squeeze one and it makes a remembered sound: "Oogah-oogah-oogah!" Some years ago I began calling whatever happened to be the fashionable idiocy of our trade at the time—Ada, I'd guess—an "oogah" project. There have been a couple of dozen in our wild and wonderful industry since we hit the front pages in early 1946. Lately there have been so many they are beginning to overlap, and I notice adjacent technologies such as aerospace are beginning to produce them as well, not to mention whole oogah disciplines (you should pardon the expression) like genetic engineering and organ transplants.

An oogah idea is one that generates enthusiasm, then publicity, then venture capital, and in its most virulent stage, sweeps its entire trade with unreasoning and unsupportable vigor. As results and profits fail to appear, the financial community wolves begin to harry the bewildered stragglers, and the professors and the symposium organizers peel off to promote the next excitement.

Some of these enthusiasms leave a residue of useful stuff behind them; intellectual and even practical flotsam, so to speak. I think of the file management software that memorializes the management information systems craze of the early '70s. And some are encapsulated, and endure in a small community of gurus and disciples—APL, for instance. But most of them fade away, or are forgotten as a new wave of wild-eyed youngsters and hungry academics storm down the mountainside with the latest word.

The fifth generation idea is already fading in Japan, while it's in full flower in the United States and just blossoming in Europe. Lewis Carroll described the Japanese situation perfectly: "...it vanished quite slowly, beginning with the end of the tail, and ending with the grin, which remained some time after the rest of it had gone." No one seems to know exactly what the phrase fifth generation means, or meant. Some things that were certainly included were good but not new, like expert systems, which came out of Los Alamos before mainframes and which have been familiar to the general public for years as chess programs. Some things were claimed as successes that still have

years of development to go, such as voice recognition. And some things were so poorly described you couldn't tell whether there would ever be any substance to them, knowledge processing for instance.

One reason the concept faded in Japan was that the artificial intelligence community, largely professor based until then, swarmed all over it here, and was urged on by the venture capital wolf pack. The dignified bureaucrats at the Japanese ministries, having gotten their mileage out of a very small investment, withdrew with obvious relief from the California carnival. In fact, it is a worldwide carnival; Carnegie-Mellon and Edinburgh leaped into the maelstrom almost as quickly as Stanford.

But in this story I really want to comment on something more general, not just to hammer an initial nail or two into the coffins now under construction for the FGP and AI. Why do the oogah projects flourish and can we do anything to dampen them down to a sensible level? Make no mistake, we need and should enjoy the excitement of new ideas—Gene Amdahl's wafer scale integration, Grace Hopper's fully transparent supernetworks. What we don't need is the hoopla, the unquestioning acceptance, the horrid scramble for Texas-size money and red Ferraris we've seen in the last decade. I remember wistfully when Ken Olsen, asked by *Fortune* what he planned to do with his sixties wealth, said he would buy a second canoe! And we don't need the wolfish glee with which the security analysts tear up the Trilogies and even the PC Jrs when the going gets sticky.

Some of it is endemic to the American way of life—Wall Street, *Time* and *Newsweek*, Hollywood and tv. Call it vigor if you like it, greed if you don't; it transforms dull old department stores into Bloomingdales, and leisurely crosscountry skiing into a superhype industry. The Japanese have their own version: an enthusiasm for novelty that produces three-tier golf driving ranges in the heart of Tokyo. The Europeans, among whom my wife and I comfortably live, marvel at both countries but emulate neither (Switzerland has just turned down direct-from-satellite television because "the present legal basis for satellite broadcasting [is] too uncertain.")

The key, it seems to me, is the trade press. I use the term broadly—I don't mean just DATAMATION and *Electronic News*, but *Business Week* and the *Harvard Business Review* as well. These are trade papers to the business community, which our computer community overlaps. The general press pretty much takes its lead from the specialist media and, nowadays at least, with amazing rapidity. We couldn't influence them directly if we tried, but if the trade journals do a better job, the man in the street (assuming there is one left since everybody seems to have





## READERS' FORUM

way can be implemented within the already existing general purpose environment. Failing that, they can always be implemented on a larger model of the same computer family.

Unfortunately, this assumption is no longer (and probably never has been) valid. As computing has expanded, applications demanding stringent performance requirements have been regularly computerized. For example, high-speed, real-time process control of functions such as electric power distribution, vehicle autopilots, nuclear reactors, and seismic exploration are currently being digitally processed by computers rather than through the use of the direct analog feedback equipment of earlier times. These kinds of applications demand exemplary speed and reliability.

In such situations, the use of general purpose computers becomes less than ideal. Though suitable for solving a wide range of problems, the available general purpose hardware and associated operating software families represent a series of compromises. To efficiently support a spectrum of requirements, highly optimized execution of a single type of application is sacrificed. In the real-time arena, this sacrifice is intolerable. Performance requirements for stringent process control applications regularly exceed the capabilities available from general purpose computing systems.

Two distinct requirements continually compete in today's real-time processing control: powerful development tools/capabilities versus low execution (i.e., run time) overhead. In the first case, real-time analysts and programmers are the same as all other analysts and programmers preparing data processing applications. They need good design tools, full-screen editors, compilers, and link editors that are fast and provide accurate diagnostics, and low-overhead debugging utilities. In the second case, however, real-timers desperately need highly optimized execution code as well as exceedingly fast operating software (e.g., operating systems, I/O drivers, error handlers) and hardware. Since development support and production execution are compromised on general purpose computers, a new malady has occurred in recent years: real-timers' schizophrenia.

Depending on the phase of a project, real-timers demand better and expanded development tools. Alternatively, usually later in a project, they also demand smaller and faster operating environments. The emotion embedded in these demands is significant. Computer vendors need ear plugs to withstand the volume whenever they meet with their real-time process control customers. And yet, whatever products the vendors provide in response to their customers' requests, the generality used to support both development and production execution within the same environment inevitably presents another compromise that starts the schizophrenia all over again.

The solution to real-timers schizophrenia is to break with our currently ingrained assumption that all off-the-shelf computers need to be general purpose. The rationale for this approach is firmly rooted in the late 1950s environment of expensive hardware. In the mid-1980s, software is the costly item. Hardware, by comparison, is cheap.

What we need now is a family of computers that are compatible yet optimized for different purposes. Most members of the family would be general purpose. At least one member, however, would be optimized for real-time process control. Other members could be optimized for such tasks as program development and number crunching.

Real-time optimizations would include modifications to both hardware and operating software primarily to enhance execution time performance. Program development processors, on the other hand, would be tuned for ease of programmer and analyst use plus flexibility (e.g., Unix operating system, virtual address hardware). Number crunchers would come equipped with such units as floating point accelerators and back-end array processors.



For the first time ever, anywhere, the collective genius that has brought about the worldwide software revolution will come together to sell product, share ideas and join forces in the international software marketplace.

**The first international software marketplace.**  
More than 42 countries will be present to buy and sell.

**The first international software import/export conference.**

Internationally renowned specialists will lecture on software importing/exporting.

**It all takes place June 3, 4 and 5, 1985 in Montreal, Canada** for the world community of software producers, distributors and buyers.



**Montreal International Software Market**

Tel.: (514) 288-8811  
Telex: 055-62495



**Montreal International Software Market**

300 Léo-Pariseau, Suite 1919  
P.O. Box 1119, Place du Parc  
Montreal, Quebec, Canada H2W 2P4

Please send me more information on MIM 85, in English , in French . I intend to attend as a participant , an exhibitor .

Name \_\_\_\_\_

Title \_\_\_\_\_

Company \_\_\_\_\_

Address \_\_\_\_\_

City \_\_\_\_\_

Country \_\_\_\_\_ Postal Code \_\_\_\_\_

Telephone \_\_\_\_\_ Telex \_\_\_\_\_

I am a software producer , buyer , distributor , manufacturer .

Types of product \_\_\_\_\_

**For fast convenient phone registration or exhibit space booking call: (514) 288-8811**

**Visitors, we honor**



Please print

C-USA-001-DM

CIRCLE 62 ON READER CARD

MARCH 15, 1985 165

# Get Ahead of the Gang



Face it. We could all use a little concrete advice now and then.

Whether you're making a monumental decision like a career change, or a more routine one like an oil change, the free Consumer Information Catalog can make it easier.

The Catalog is published quarterly by the Consumer Information Center of the U.S. General Services Administration to bring you the latest on government programs and a mountain of other information that you can use.

The Catalog lists more than 200 government booklets to help you... start a business, find a job, plan your retirement, repair your home, or carve out a nutrition and exercise program to improve your profile. And many of these booklets are free.

So order your Catalog today. Any way you look at it, you'll be head and shoulders above the crowd.

Just send your name and address on a postcard to:

**Consumer Information Center  
Dept. MR  
Pueblo, Colorado 81009**

A public service of this publication and the Consumer Information Center of the U.S. General Services Administration



## READERS' FORUM

As with current computer families, implicit in this enhanced computer series is the ability of software developed and tested on one machine to execute on any member of the family. Of particular interest is the ability to transport programs from general purpose family members to those that are specialized: real-time, number cruncher, etc. Communications between specialized and general purpose machines should also be well developed to allow such procedures as remote debugging and program preparation on one machine with downloading to another.

The advantages of this approach are several. First, a highly advanced software development tool set can be used on one machine even though it inhibits the responsiveness needed for real-time process control or number crunching execution. Similarly, a highly optimized production execution environment can be used on a processor without the need to retain extensive, high-overhead software development capabilities.

Second, a processor's production operating environment (hardware and software) could be safely and easily tuned for application-unique performance and functionality without affecting other members of the family. Adapting some family members for unfriendly operating conditions (e.g., temperature, humidity, vibration) could also be more widely done.

Third, the apparent disadvantage of two (or more) differing hardware implementations is turned into a plus. Components that are replicated on production execution machines solely because they were required on the development processor need no longer be retained. For businesses producing many copies of a production environment from a single development point, this represents a significant manufacturing cost as well as potential price reduction.

Fourth and finally, real-timers' schizophrenia will be eliminated. The facilities used during development would be (optionally) distinct from the run-time environment. Critical real-time production execution will no longer be burdened. Software development can, on the other hand, be optimized on processors equipped with the best utilities and tools. At last, vendors will be able to provide the computing community with general purpose and appropriately specialized computing all at the same time.

—David A. Feinberg  
Seattle, Washington

## AI YI YI

The following can be attributed to a novice system with an ignorance base and an unnatural language interface, programmed to produce Artificial Humor (AH).

AI, AI!

Of a planning aid using AI,  
A customer said, with a sai,  
"If they think we know whai  
We decide what to trai,  
There's no chance that their product will flai."

HAI! ALAI!

After giving a robot AI,  
An inventor rushed out the next dai.  
With a tear in his ai,  
He gave a sad crai,  
"I've made a machine that can lai!"

—Anonymous

If you'd like to share your opinions, gripes, or experiences with other readers, send them to the Forum Editor, DATAMATION, 875 Third Ave., New York, NY 10022. We welcome essays, poems, humorous pieces, or short stories.

# Solving the #2 Computer Security Problem

**The #1 problem, of course, is making DP users and senior management recognize the importance of information security...and the risks of not having it.**

**The #2 problem is "making security happen." And that's where Computer Security Institute can help you now.**

We can show you exactly how to do it, using training programs we've been developing and refining since 1974. We teach the basics, and we teach you how to get the job done today in practical, cost-effective terms. As a membership organization, we have a great advantage—a direct line to our constituency of 3,000 practitioners. They let us know what they need, and we develop our courses accordingly. No wonder we lead the world in computer security training. In 1985 we'll train over 2,000 people. Let us put our experience to work for you.

<b>1985 WORKSHOP PROGRAM (March-June)</b>				
	New York	Washington	Chicago	Houston
Workshop for the Newly Appointed Data Security Officer (3 days)	April 15-17	June 3-5		
Security in the Electronic Office: Micros, Word Processors, and Workstations (2 days)	April 18-19	June 6-7		
Establishing a Computer Security Program (3 days)		March 11-13	April 29-May 1	
An Introduction to Communications Security (2 days)		March 14-15	May 2-3	
Planning an EDP Disaster Recovery Program (3 days)				March 25-27
Risk Analysis Techniques (2 days)				March 28-29
Building Security Awareness—A One-Day Briefing Session		*Saturday March 16	Thursday, May 2	

## WHAT OTHERS SAY ABOUT CSI

**"Provides the best concentration of computer security information available."**—Ray Evans, Planning & Security Analyst, R. J. Reynolds Industries, Inc.

**"Clearly the leader in all aspects of disseminating computer security information."**—James Duffy, Vice President, Peoples Savings Bank, Bridgeport, CT.

**"Unbiased, no axe to grind, objective."**—William E. Clark, Manager, MIS Administrative Services, Air Products & Chemicals, Inc.

**"Excellent, nothing better. Knowledgeable authority on state-of-the-art issues and practices."**—John Mason, Manager, System Security, Guaranty Trust Co. of Canada

## IN-HOUSE TRAINING

Explore the benefits of CSI's in-house training programs. Convenient and cost-effective...they eliminate travel, hotel, and meal costs. Tuition can be reduced as much as 40%, and there's minimal disruption of work schedules. In-house programs can involve key management and corporate security personnel who might not otherwise attend a computer security seminar.

## 1985 CONFERENCES

- ★ **Micro Security '85**  
at the 4th Annual IBM Users Computer Security Workshop July 15-17, 1985, Washington, DC
- ★ **The 12th Annual Computer Security Conference and Exhibition**  
November 4-7, 1985  
Hyatt Regency O'Hare, Chicago

## FOR MORE INFORMATION

Return to Computer Security Institute  
★ Dept. DM5M ★ 43 Boston Post Road  
★ Northborough, MA 01532 ★ (617) 845-5050

Send me more information on the following:

- Workshop for the New Data Security Officer
- Security in the Electronic Office
- Establishing a Computer Security Program
- Introduction to Communications Security
- EDP Disaster Recovery Planning
- Risk Analysis Techniques
- Building Security Awareness
- Micro Security '85
- 12th Annual Computer Security Conference
- In-House Training

Name \_\_\_\_\_

Title \_\_\_\_\_

Organization \_\_\_\_\_

Address \_\_\_\_\_ M/S \_\_\_\_\_

City \_\_\_\_\_ State \_\_\_\_\_ Zip \_\_\_\_\_

Starting in this issue...  
A New Service for Datamation Subscribers!



# Datamation Instant Response Service

Now you can get product information direct from the advertiser—just by making one easy phone call.

- It's easy...it's fast!
- Call day or night—7 days a week!
- There's an 800 number to serve you!
- One call satisfies all your inquiries... or call as often as you like!

As an additional service, some of our leading advertisers have agreed to provide you with information such as product specifications, availability, and local dealer sources *right on the phone*. Or you can arrange for a follow-up call from the advertiser's technical department or to have a sales representative call.

Advertisers providing additional information are highlighted in the advertisers' index alongside this ad.

### Here's how to use Datamation Instant Response Service

1. Select the products advertised which you would like more information about and write the 3 digit inquiry numbers in the spaces provided in step 6B.
  2. Turn to your mailing label on the front cover of this issue and identify your seven digit personal ID number in the middle of the top line. Write this number in the space below (6A).  
For example: 12111(6670806)W05 4 3026
  3. Now you are ready to start. Use a touch-tone telephone and call 1-800-632-7780 and wait for voice instructions.
  4. When asked for your subscriber number, enter "345678506#".
  5. Next, you will be asked for your mailing label ID number. This is the 7 digit number you copied below. Be sure to enter a "#" after the number.
  6. DIRS will then ask for your inquiries. Respond by entering the inquiry numbers you wrote below and again, follow each number with a "#" sign. Answer questions with a "9" for YES (the number "9" has a "Y" on it), and a "6" for NO (the "6" has an "N" on it).
- 6A. Mailing Label ID number #
- 6B. 1. #    4. #    7. #    10. #  
 2. #    5. #    8. #    11. #  
 3. #    6. #    9. #    12. #
7. End the session on voice instruction. You can be assured that your inquiry will be handled promptly.

To call Datamation Instant Response Service,  
7 days a week, 24 hours...

1-800-632-7780

## ADVERTISING INDEX

Circle		Page
44	AST Research Inc.	80-81
—	AT&T Information Systems	36
—	AT&T Information Systems	146-147
40	Ansul	88
31	Ashton-Tate	64-65
28	Beehive	61
29	Berol USA	62
42	Boeing Computer Services	113
52	BUS Guides	161
56	CIES/DSD	145
61	Cambridge Systems	164
—	Codex Corp.	115
—	Comdex Japan	159
—	Comdex Winter	136
—	Compaq Computer Corp.	125
48	Computer Associates	126-127
45	Computer Corp. of America	118
63	Computer Security Inst.	167
30	Control Data Corp.	63
60	Control Data Corp.	140
73	*Copam Electronics Corp.	136-16
6	Cullinet Software	4
11	Cullinet Software	12
26	D & B Computing Services	45
14	Dataproducts	19
21	Decision Data Computer Corp.	37
—	Digital Equipment Corp.	10-11
57	DunsPlus (Div D & B Computing)	148
27	Elgar Corp.	59
66	*Facit AB	136-4
71	*Fujitsu America, Inc.	136-13
17	General Optronics Corp.	26
65	*General Power Systems	136-1
1	Genicom Corp.	CV2
77	*Genstar REI Sales Co.	136-24
76	*Hitachi	136-22/23
22	Honeywell Information Systems	38-39
—	Hughes Aircraft Co.	67
2	Hyatt Hotels Corp.	CV3
—	IBM Corp.	24-25
75	*ITT Information Systems	136-21
36	Information Builders, Inc.	79
5	Infotron	2
69	*JDL	136-9
68	*Liebert Instrument Group	136-7
62	MIM'85-Montreal Int'l Software Market	165
18	Mathematica, Inc.	28-29
46	Maxell Corp. of America	123
20	McCormack & Dodge	35
23	The Mega Group	43
3	Micom Systems	CV4
8	NBI, Inc.	6-7
58	NCC '85	151
72	*NCR Corp.	136-14/15
49	Network Systems Corp.	131
7	Nixdorf Computer	5
34	Nynex	69
24	On-Line Software Int'l	44
38	Oxford Software Corp.	85
4	Perkin-Elmer Corp.	1
13	Prime Computer	16-17
10	Qume	9
500	**R's Data Services	156
55	RCA Cylis	143
15	Racal-Milgo	20-21
35	Rolm Corp.	72-73
—	SAS Institute Inc.	49-56
25	SDI Support Systems	44
51	Software AG	134-135
32	Software Corp. of America	57
—	Source EDP	33
—	Sperry Corp.	89-104
50	Stratus Computer	133
54	TSI International	138-139
67	*Technical Communications	136-6
37	Tektronix Inc.	116-117
39	TeleVideo Systems Inc.	87
12	Texas Instruments	15
53	Texpo '85 (Pacific Bell)	137
9	Texwipe Co.	8
70	*Unify Corp.	136-10/11
—	Wang	47
—	Wang	109-111

\*OEM Edition  
\*\*Marketplace

# GRACIOUSLY HYATT.

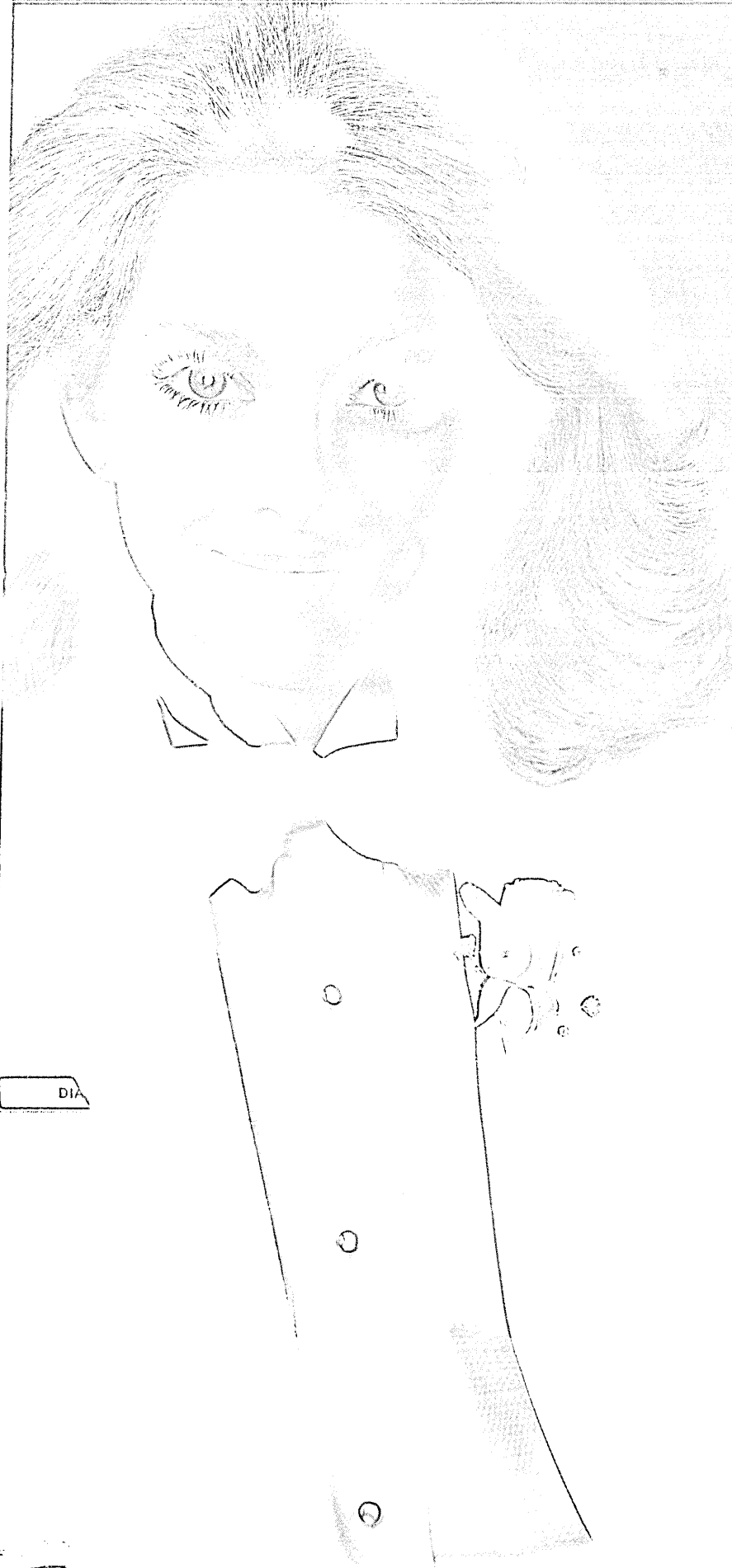

The smile that greets you at our front desk is worth a thousand words. It says we enjoy our guests and we love our work. It says we understand the special needs of business travelers like no one else in the world.

The Hyatt attitude is unmitigable. From our charming concierges, who can make an unfamiliar city feel more accommodating. To our energetic bellmen, who help with all the things you don't have time to do. To our friendly people at the front desk, who handle your messages and requests with cheerfulness and warmth.

A little something extra from us can help make your trip a success. A gracious touch of Hyatt.

Don't you **WISH YOU WERE HERE®**

## FORT WORTH

*The spirit of the West in historic Fort Worth*

## LONG BEACH

*Hyatt Regency is steps away from the ocean, the Queen Mary and business district*

## OAKLAND CITY CENTER

*Part of the downtown business hub, Hyatt Regency is convenient to all parts of the Bay Area*

## WEST HOLLYWOOD

*Hyatt on Sunset is minutes from Beverly Hills, Restaurant Row and all major studios*

## WEST HOUSTON

*Located on Interstate 10 in the new energy and business district of Houston*

**HYATT  HOTELS**

*For reservations, call your travel planner or 800.228.9000. ©1984 Hyatt Hotels Corp.*

**CIRCLE 2 ON READER CARD**



# Our IBM Protocol Converter is not the same under the skin!

Work on its channels.  
Flow to the IBM System Channel.

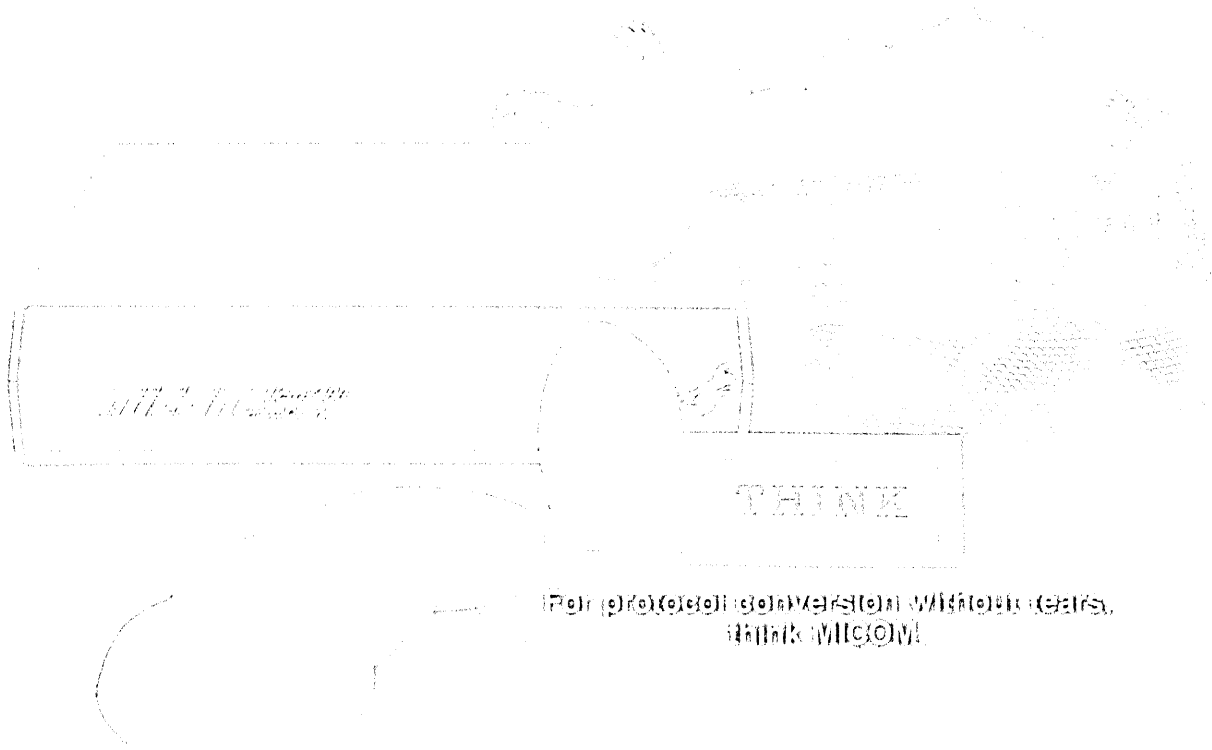

IBM Systems, Inc. 2245 Woodloch Drive, Champaign, IL 61813 Telephone: (312) 339-4200 Telex: 184-2000  
 Regional Sales Offices Atlanta GA (404) 525-2222 Boston MA (617) 252-3000 Chicago IL (312) 298-2000  
 Dallas TX (214) 343-2222 San Francisco CA (415) 354-2222 St. Louis MO (314) 477-2222 Toronto ON (416) 763-2222  
 Washington DC (202) 462-2222 Wichita KS (316) 262-2222 Worldwide Headquarters Armonk NY (914) 490-2222  
 1977 Representative Offices 2411 (312) 339-4200