

EDN®

PC graphics packages ease programming tasks

VLSI chip helps implement factory networks

Phase-locked-loop ICs

EDN's technical-article database index

ELECTRONIC TECHNOLOGY FOR ENGINEERS AND ENGINEERING MANAGERS

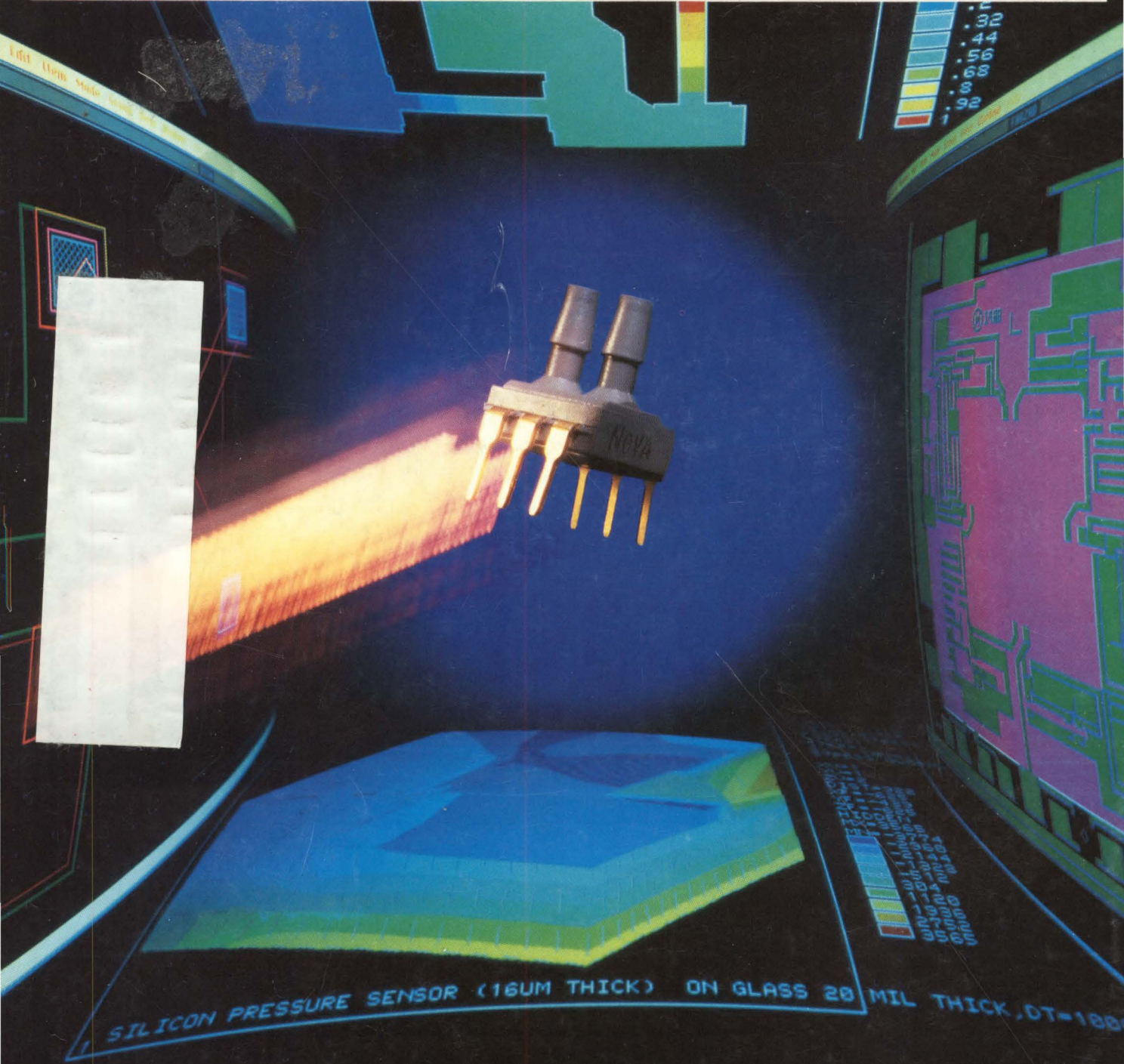

Pressure-sensor design simplified by CAD/CAE

we never stop asking

“What if...”

TDR Yesterday



TDR Today

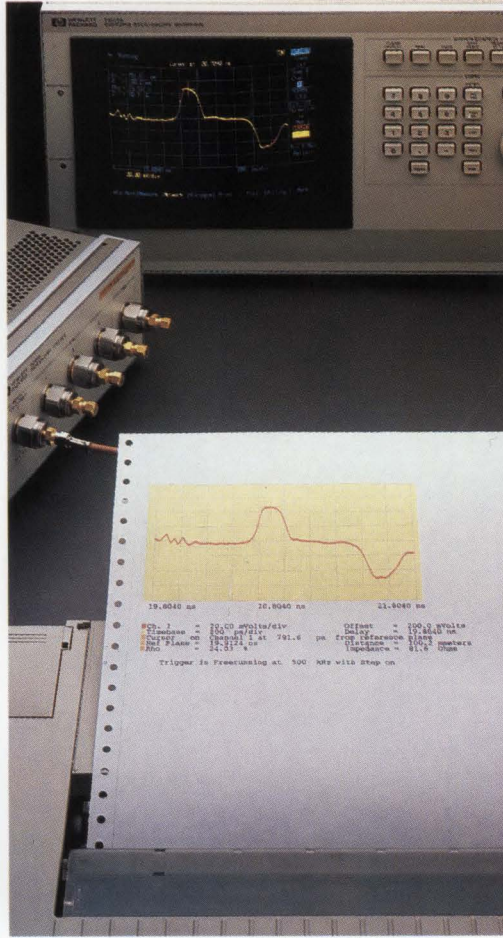

The HP 54120T: precise TDR measurements never before possible.

Throw away the calculators and slide rules. Toss out the CRT camera, the pencils and the scratch paper. Enter an unprecedented realm of TDR measurement that is powerful, fast, accurate, and easy to use. The HP 54120T Digitizing Oscilloscope and TDR with 20 GHz bandwidth and 10 ps resolution will make your life a lot easier.

Match bandwidth to system requirements.

The software we developed for the HP 54120T enables you to accurately match bandwidth to the speed of the device under test. Normalization* then corrects for reflections and imperfections caused by connectors and cables. You measure the device—not the connecting hardware—for error-free readings.

In addition, the HP 54120T features unmatched speed and convenience. HP Auto-Scale gets waveforms to the screen

quickly, automatic measurements produce test results fast, English-like commands via HP-IB make programming easy, time and voltage markers customize measurement parameters, hardcopy documentation is available at the push of a button. And there are numerous other features we simply can't get into a single ad.

Call HP today!
1-800-752-0900, Ext. F215.

Application notes are yours for the asking. They include "Improving TDR Network Analysis," "TDR Fundamentals," and other technical data. You'll see for yourself what the HP 54120T can do for your design, characterization and test applications.

**Normalization is accomplished using the Stanford Bracewell Transform. The Bracewell Transform is under license from Stanford University.*

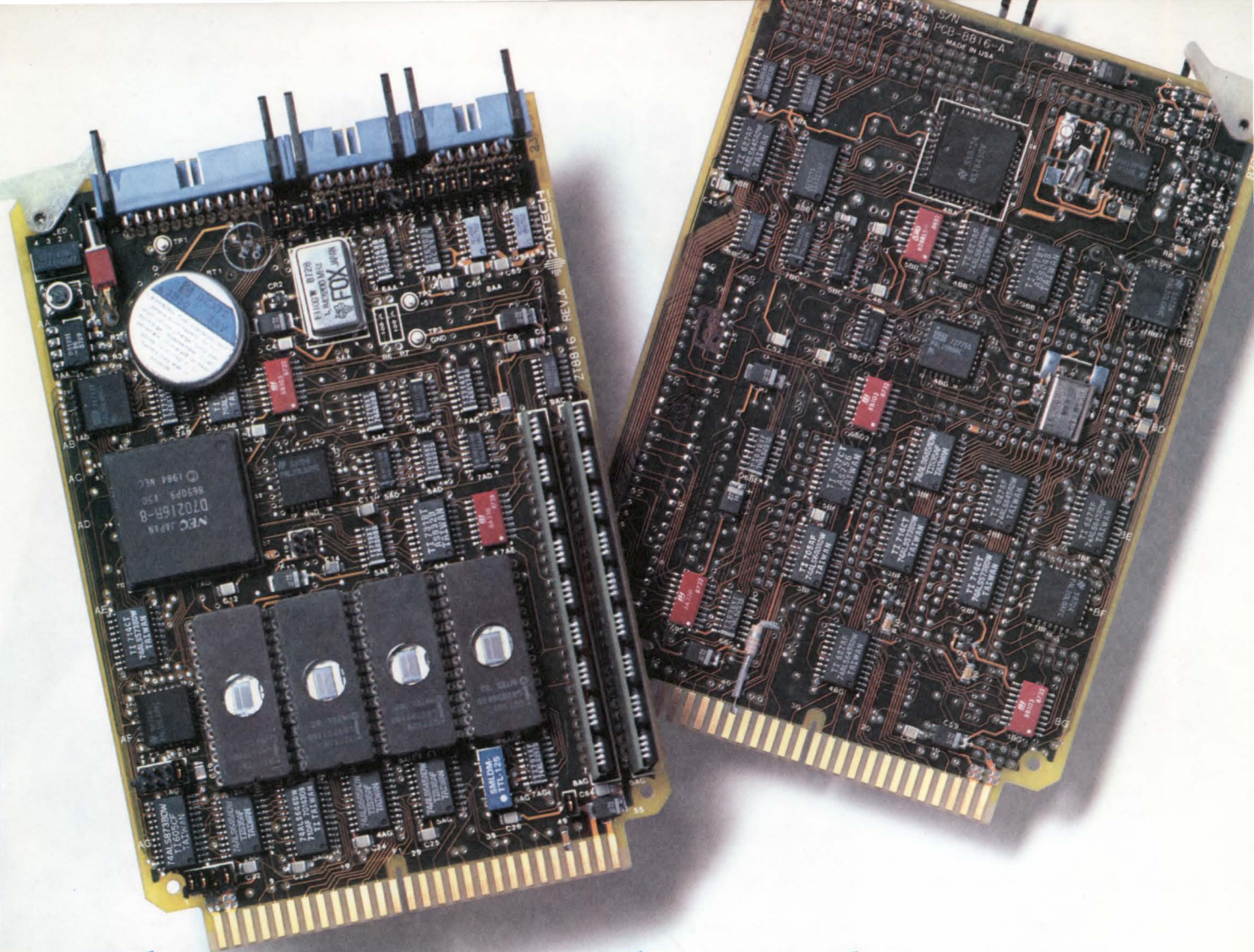

There are two sides to this story...

Side One:

Highly integrated 16-bit industrial computer

Ziatech's NEC V50-based single board computer, the ZT 8816, packages the features of several STD boards into a unique, dual-sided surface-mount design. The ZT 8816 tackles demanding industrial applications with a 16-bit data bus, an 832K on-board memory capacity, a real-time battery-backed clock, AC/DC power-fail protection, DMA controller, an interrupt controller, two serial channels, and three counter-timers.

For the rest of the story...

Free Technical Brochure

Call today for the ZT 8816 Technical Data Sheet and the 24-page STD DOS Technical Brochure. With more information on what the ZT 8816 can do for your industrial application, you may start seeing the Ziatech side of the story.

(805) 541-0488

Side Two:

IBM AT-compatible industrial computer

The ZT 8816 is more than just the most advanced STD Bus computer hardware on the market today. It is designed to operate PC DOS or ROM-based user programs such as the VRTX multitasking kernel. Development tools are available to provide a large range of target system software architectures. STD DOS V50 on the ZT 8816 delivers IBM AT performance and compatibility with optional networking, EGA video, disk and bubble memory subsystems, multiprocessing, and a device driver library. Ziatech's exclusive Virtual System Console supports easy development through a host PC by transparent resource sharing.



3433 Roberto Court
San Luis Obispo, California 93401 USA
ITT Telex 4992316
FAX (805) 541-5088
Telephone (805) 541-0488



WHY VTC? ASK THE VME CONSORTIUM.

"For a bunch of companies that don't always agree on everything, we sure were unanimous on VTC."

The VME Consortium needed an economical, yet highly functional VME bus interface chip, to minimize design time . . . and to help raise the VME standard to higher levels.

"We looked at the leading suppliers," said Joe Ramunni, consortium chairman (and president of Mizar), "and VTC came out on top. Their CMOS standard-cell ASIC approach gave us the high drive capability we needed, optimized for bus interfacing. And, it proved much more cost-effective, with higher performance, than gate array technology."

The VME Consortium is made up of such firms as Plessey Microsystems, Omnibyte Corporation, Mizar Inc., Ironics Inc., Heurikon Corporation, Matrix Corporation, and Clearpoint Inc., among others. What did they look for in a supplier?

"We needed a credible business partner," said Ramunni, "with a proven track record, who could provide a turnkey package . . . both design and fab. A supplier that could produce in quantity, and provide technical support to the market at large.

"We also needed a firm with an international marketing structure, because we expect this chip to be the de facto standard worldwide.

"But, we needed *people* we could work with, too. VTC had the right 'comfort factor'."

Jack Regula, consortium technical director (and VP-R&D, Ironics) added: "Our requirements for high speed, high gate-count, low power consumption, and VME bus drive capability were all met well with VTC's 1-micron CMOS standard cell library. And we were extremely impressed with VTC's facilities, its people, and its customer list."

In the future, the VME bus chip (VIC) will become a standard cell within VTC's CMOS library, to allow customers to further customize the chip.

Shouldn't you be getting to know VTC, too? You'll be in good company when you do. Call or write us today, and we'll send you our short-form product catalog, which describes our product offerings in linear signal processing, high-speed CMOS logic, mass storage ICs, bipolar ASIC, and CMOS ASIC.

VTC Incorporated, 2401 East 86th Street, Bloomington, MN 55420. (In Minnesota, 612/851-5200.) Telex 857113.

CALL 1-800-VTC-VLSI



Joseph Ramunni, chairman (left), and Jack Regula, technical director, VME Technology Consortium.

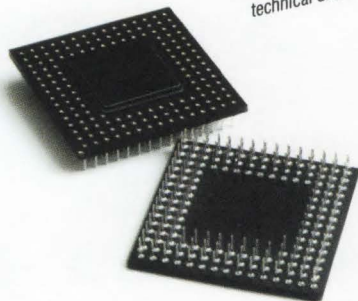

VTC Incorporated
Performance, Pure & Simple™

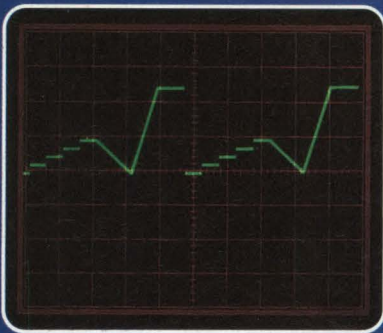

Vibration analysis with stop and hold.

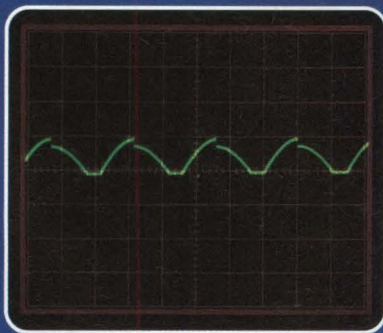

Complex waveforms for servo drives.

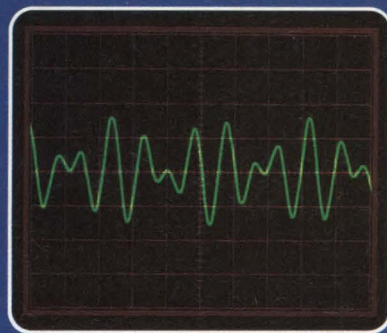

Dual tones for telephone testing.



EKG and hemodynamic waveforms.



Radar/sonar envelope simulation.

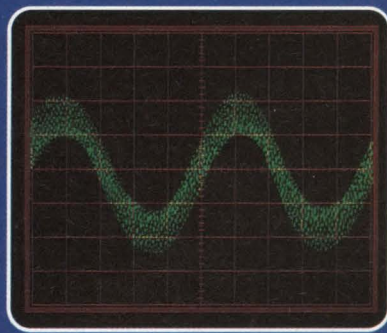

Noise added to any waveform.

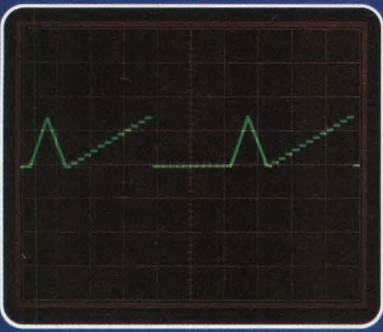

A/D, amplifier development and calibration.

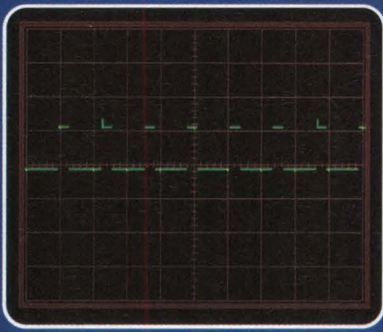

Digital testing and troubleshooting.

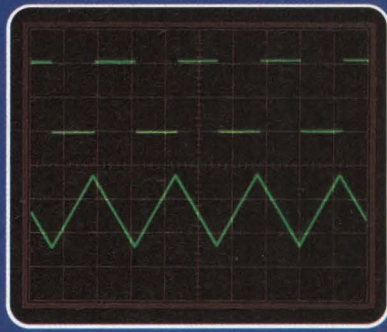

Standard waves at the push of a button.

We've been making waves for 25 years. Now it's your turn.

A quarter-century ago, Wavetek brought you the first waveforms produced by a solid-state function generator. Now our Model 75 Arbitrary Waveform/Function Generator puts you in control.

Model 75 lets you generate waveforms without entering x/y coordinates. Thumbtack and rubberband modes allow easy development and editing of any waveform. There are also nine standard functions which you can use at the push of a button.



Waveforms are stored in nonvolatile memory, with more than 4,000 vertical points and 8,000 horizontal points of resolution. They can be played back at any rate, up to 500ns per point.

By linking two or more Model 75's together, you can superimpose waveforms to introduce phase displacement or other special effects. And at the low price of \$2295, you might want to buy several.

For literature or to arrange an amazing demonstration, call or write Wavetek San Diego, Inc., P.O. Box 85265, San Diego, CA 92138. Phone (619) 279-2200; TWX (910) 335-2007.

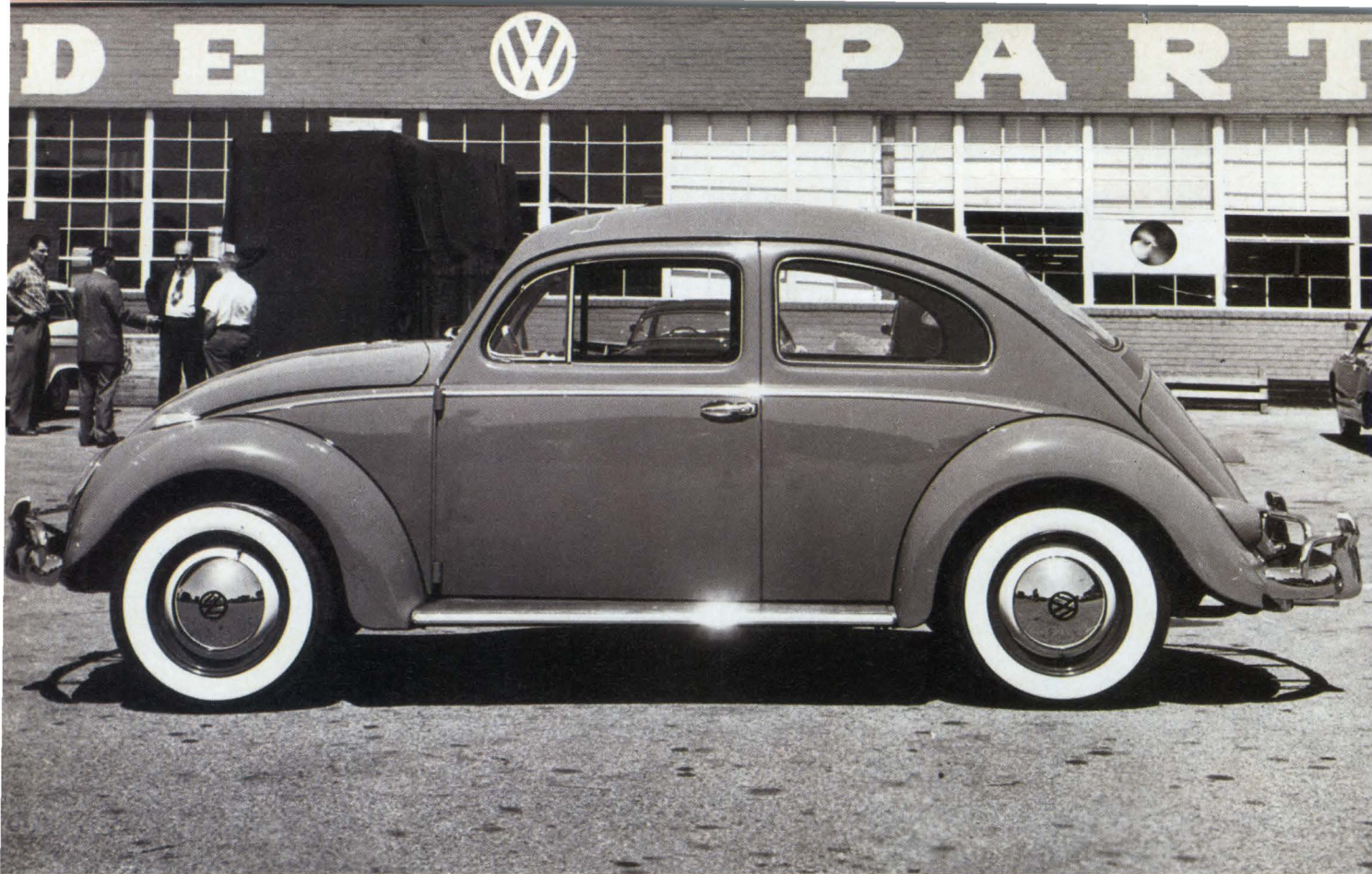

The Bettman Archive Inc.

Making something very small can be truly revolutionary.

At first people scoffed. Some laughed out loud. But the people's car set a new size standard for an entire industry.

Sizes are still shrinking in the micro-miniature world of cable and connector technology at

Precision Interconnect. We're designing the critical link between man and machine. These complete interconnect systems, usually using 38 AWG conductors, can be terminated to standard connectors with flex-strain reliefs or contain active devices within custom-molded housings.

To make these cable systems increasingly smaller, lighter, more rugged, and more comfortable to use without compromising signal fidelity, flex-life, or reliability is a continuing challenge presented to us by manufacturers of leading-edge medical equipment around the world.

Our expertise, increasing with each unique problem we

solve, ensures that reliability is designed in, built in, and tested. So we can solve big problems. With small, but revolutionary, innovations.



**PRECISION
INTERCONNECT**

16640 S.W. 72nd Avenue, Portland, OR 97224
(503) 620-9400

Offices in San Francisco, Boston,
Wilmington and Düsseldorf

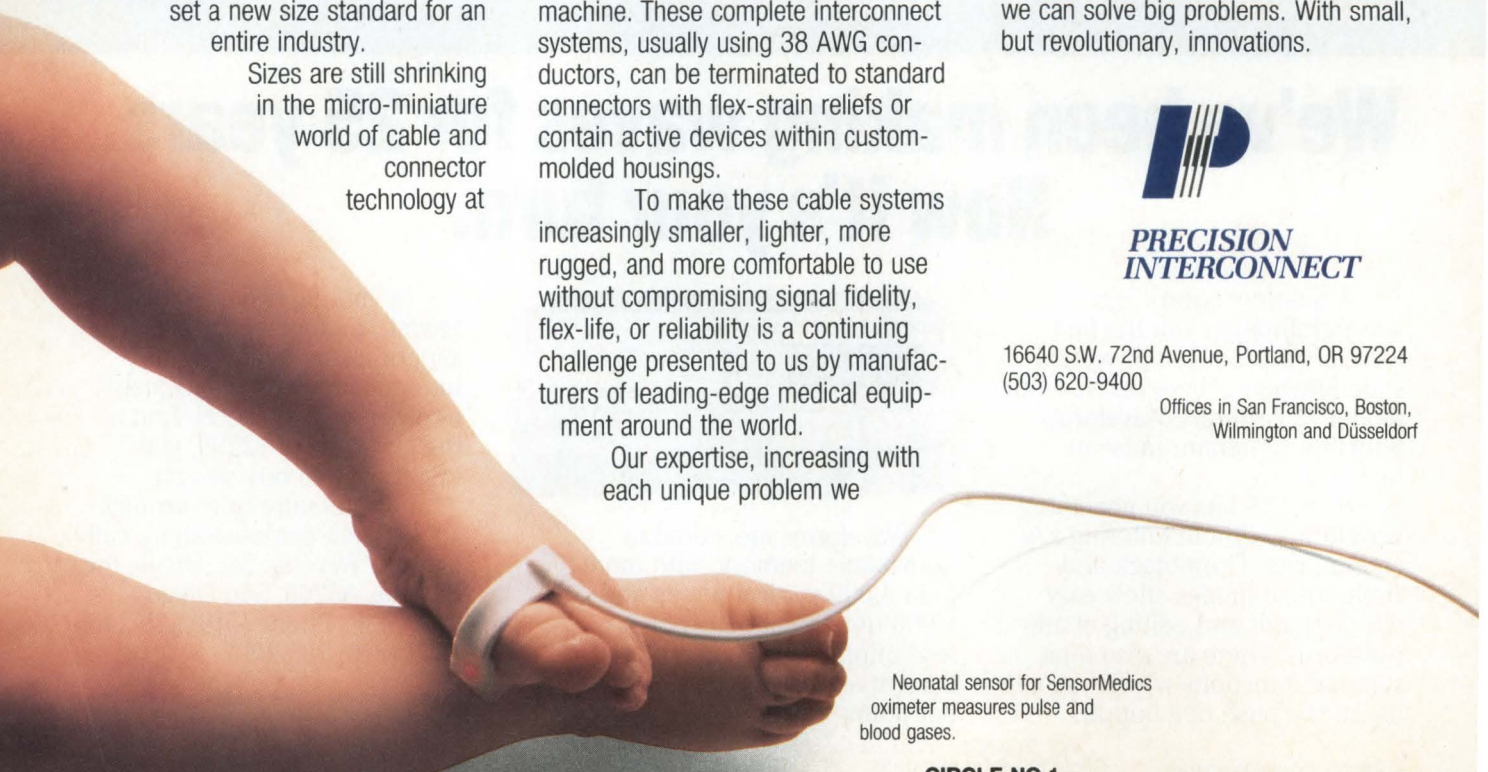

Neonatal sensor for SensorMedics
oximeter measures pulse and
blood gases.

CIRCLE NO 1



On the cover: Pressure sensors and transducers are achieving high marks for performance, thanks in part to device manufacturers using CAD/CAE techniques. See pg 106. (Photo courtesy Nova Sensors)

SPECIAL REPORT

Pressure sensors and transducers

106

By employing CAD/CAE and new fabrication technologies, pressure sensor and transducer manufacturers have been able to improve product performance without exacting any price penalties. In the silicon-based sensor area, in fact, prices are actually going down as performance figures improve—a combination that opens up a host of new applications.—*Tom Ormond, Senior Editor*

DESIGN FEATURES

CAE software uses algorithms instead of schematics

125

Drawing logic schematics isn't the only way to create ASIC designs. You can also use algorithms to automatically generate the net list for your hardware design—and you can do so in about one-tenth of the time that it often takes to complete a schematic.—*Jay R Southard, Algorithmic Systems Corp*

Single VLSI chip helps you implement EPA factory networks

145

The Enhanced Performance Architecture (EPA), a subset of the MAP specification, allows networks to provide fast, noise-immune communication over short distances. By applying a single VLSI chip that implements most of the EPA functions in silicon, you can speed your network's response time without a huge software-development effort.—*Rhonda Alexis Dirvin and Anne-Marie Larkin, Motorola Inc*

Static system design exploits low-power CMOS features

159

Static CMOS architectures let you customize a design for optimum performance and minimum power dissipation. Capitalizing on the characteristics of CMOS means addressing clock-frequency control before starting the initial design process.—*Walter J Niewierski, Harris Semiconductor*

EDN Technical-Article Database Index

171

EDN's semiannual database index lists articles published from November 1987 to April 1988 in EDN, EDN News, Electronic Design, Electronics, Electronic Products, Computer Design, and ESD.

Continued on page 7



VBPA ABP



EDN® (ISSN 0012-7515) is published 40 times a year (biweekly with 1 additional issue a month, except for July which has 3 additional issues) by Cahners Publishing Company, A Division of Reed Publishing USA, 275 Washington Street, Newton, MA 02158-1630. Terrence M McDermott, President; Frank Sibley, Electronics/Computer Group Vice President; Jerry D Neth, Vice President/Publishing Operations; J J Walsh, Financial Vice President/Magazine Division; Thomas J Dellamaria, Vice President/Production and Manufacturing. Circulation records are maintained at Cahners Publishing Company, 44 Cook Street, Denver, CO 80206-5800. Telephone: (303) 388-4511. Second-class postage paid at Denver, CO 80206-5800 and additional mailing offices. POSTMASTER: Send address corrections to EDN® at the Denver address. EDN® copyright 1988 by Reed Publishing USA; Saul Goldweitz, Chairman; Ronald G Segel, President and Chief Executive Officer; Robert L Krakoff, Executive Vice President; William M Platt, Senior Vice President. Annual subscription rates for nonqualified people: USA, \$100/year; Canada/Mexico, \$115/year; Europe air mail, \$135/year; all other nations, \$135/year for surface mail and \$210/year for air mail. Except for special issues where price changes are indicated, single copies of regular issues are available for \$6, \$8, and \$10 (USA, Canada/Mexico, and foreign). Please address all subscription mail to Eric Schmierer, 44 Cook Street, Denver, CO 80206-5800.

Fluke breaks the old mold.



The Fluke 37. A bold new shape emerges with more features for the money than any other bench DMM. Period.

Dollar for dollar, the new Fluke 37 is unbeatable. In addition to its breakthrough design — with built-in handle and storage compartment — it has all the high-performance features of the world's best, most reliable 3½ digit DMMs.

Autoranging, to eliminate guesswork. Audible Continuity, so you don't have to look at the display. An exclusive analog and digital display, for the best view of the signal being measured. Superior EMI shielding. And user-friendly features like auto self-test, auto battery test and auto-polarity. All this, *plus* a two-year warranty.

And, how many other \$249 bench meters give you these features? Min-Max recording, for monitoring signals. 38 components dedicated exclusively to input protection. Relative mode, to help you calculate changes in readings. And Fluke's patented Touch Hold, to give you an extra set of hands when you're taking critical measurements.

None. Not at \$249. Not at *any* price. For your nearest distributor or a free brochure, call toll-free *anytime* 1-800-44-FLUKE, Ext. 33.

FROM THE WORLD LEADER
IN DIGITAL MULTIMETERS.



FLUKE 37

\$249*
0.1% basic dc accuracy
Analog/Digital Display
Volts, Ohms, Amps, Diode Test
30 kHz AC bandwidth
Fused 10A Range
Integral handle, storage compartment
2-year warranty

*Suggested U. S. list price, effective January 1, 1988.



John Fluke Mfg. Co., Inc. P. O. Box C9090, M/S 250C, Everett, WA 98206. Sales (206) 356-5400, Other: (206) 347-6100
© Copyright 1988 John Fluke Mfg. Co., Inc. All rights reserved. Ad No 0181-F37



Third-party graphics-software packages for IBM PCs and compatible computers can ease your software-writing chores (pg 55).

TECHNOLOGY UPDATE

Third-party PC graphics packages streamline your programming tasks 55

Attention-grabbing, colorful graphics can dramatically enhance the software you write, regardless of whether you're developing it for your company's internal use or for customers.—*Margery S Conner, Regional Editor*

Limited selection of monolithic PLL ICs suffices for current applications 65

Monolithic phase-locked-loop (PLL) circuits provide an elegant way to achieve frequency demodulation or digital selection of frequency.—*Tarlton Fleming, Associate Editor*

PRODUCT UPDATE

Video and system controller IC 83
Data logger 86
Industrial IBM PC/AT-compatible system 88
Digital scope 90
Modular 1500W power system 92

DESIGN IDEAS

Transistor powers low-dropout regulator 205
8031 routines expand address space 205
555 timer turns beep into warble or chirp 209
Single-chip μ P controls resolver 209
Thermistor measures respiration rate 214

Continued on page 9

EDN magazine now offers Express Request, a convenient way to retrieve product information by phone. See the Reader Service Card in the front for details on how to use this free service.



Cahners Publishing Company, A Division of Reed Publishing USA Specialized Business Magazines for Building & Construction Manufacturing Foodservice & Lodging Electronics & Computers Interior Design Printing Publishing Industrial Research & Technology Health Care and Entertainment. Specialized Consumer Magazines: American Baby and Modern Bride.

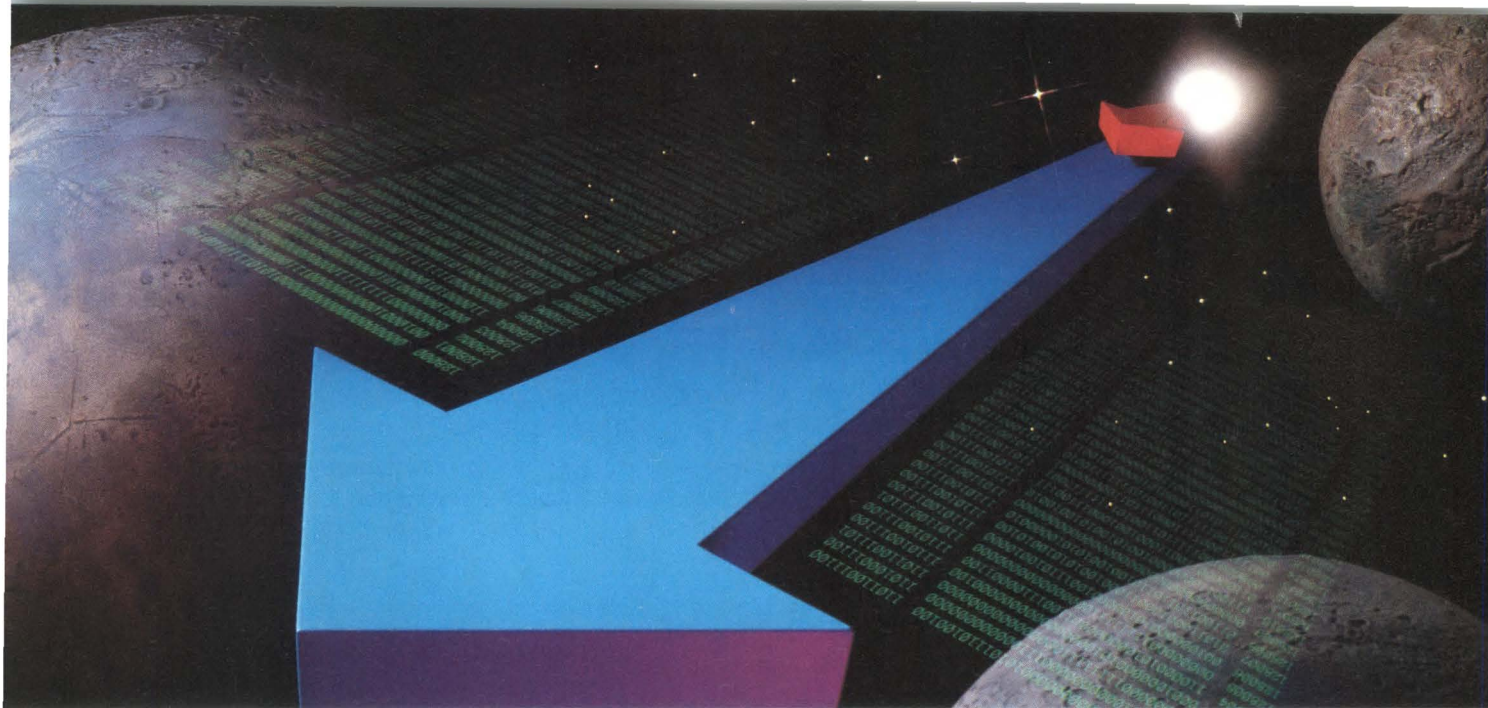

128 TIMES THE MEMORY DEPTH AND LIGHT-YEARS AHEAD OF THE COMPETITION.

Only the Tek DAS9200 with its new 92A90D acquisition module gives you a memory depth of 128K bits-per-channel—128 times the depth provided by the most popular alternatives.

No wonder it alone lets you see so much, so easily, for so many complex applications.

■ **Better-than-ever multiprocessor support.**

Now get the depth of overlapping data you need for debugging designs involving processors like

the 68030, 88100, and 80386—up to six at a time.

■ **Timestamping without penalty.** For correlating multiprocessor interactions, the 92A90D lets you place a 44-bit timestamp value on every transaction stored—at no cost to your 128K memory depth.

■ **Selective data suppression.** To help you analyze 131,072 90-channel bus

cycles in one acquisition, Tek provides high-resolution color, highlighting, address symbols, and your choice of tailorable display formats.

You can choose an overview of subroutine activity or program branches, a full assembly listing, or a format that shows every bus transaction in order.

To find out more about the Tek DAS9200 Digital

Analysis System, the most powerful problem-solver around, contact your Tek representative, or call **1-800-245-2036.**

In Oregon, 231-1220.



Tektronix
COMMITTED TO EXCELLENCE

Circle 128 for sales contact

Circle 127 for literature

VP/Publisher
Peter D Coley

VP/Associate Publisher/Editorial Director
Roy Forsberg

Editor
Jonathan Titus

Managing Editor
John S Haystead

Assistant Managing Editor
Joan Morrow

Special Projects
Gary Legg

Home Office Editorial Staff
275 Washington St, Newton, MA 02158
(617) 964-3030

Tom Ormond, *Senior Editor*
Deborah Asbrand, *Associate Editor*
Joanne Clay, *Associate Editor*
Tarlton Fleming, *Associate Editor*
John A Gallant, *Associate Editor*
Clare Mansfield, *Associate Editor*
Michael C Markowitz, *Associate Editor*
Dave Pryce, *Associate Editor*
Cynthia B Rettig, *Associate Editor*
Charles Small, *Associate Editor*
Dan Strassberg, *Associate Editor*
Chris Terry, *Associate Editor*
Valerie Lauzon, *Staff Editor*
Helen McElwee, *Staff Editor*
Julie Anne Schofield, *Staff Editor*
Steven Paul, *Senior Production Editor*

Editorial Field Offices

Margery S Conner, *Regional Editor*
Los Osos, CA: (805) 528-0833

Doug Conner, *Regional Editor*
Los Osos, CA: (805) 528-0865

Steven H Leibson, *Regional Editor*
Boulder, CO: (303) 494-2233

J D Mosley, *Regional Editor*
Arlington, TX: (817) 465-4961

Richard A Quinnett, *Regional Editor*
San Jose, CA: (408) 296-0868

David Shear, *Regional Editor*
San Jose, CA: (408) 997-5452

Maury Wright, *Regional Editor*
San Diego, CA: (619) 748-6785

Peter Harold, *European Editor*
0603-630782
(St Francis House, Queens Rd,
Norwich, Norfolk NR1 3PN, UK)

Contributing Editors
Robert Pease, Bob Peterson,
Don Powers, Bill Travis

Editorial Services
Kathy Leonard, *Office Manager*
Loretta Curcio, Nancy Weiland,

Art Staff
Kathleen Ruhl, *Senior Art Director*
Ken Racicot, *Associate Art Director*
Chin-Soo Chung, *Staff Artist*
Cathy Filipski, *Staff Artist*

Production/Manufacturing Staff
William Tomaselli, *Production Supervisor*
Donna Pono, *Production Manager*
Danielle M Biviano, *Production Assistant*
Linda Lepordo, *Production Assistant*
Diane Malone, *Composition*

Graphics Director
Norman Graf

VP/Production/Manufacturing
Wayne Hulitzky

Director of Production/Manufacturing
John R Sanders

Business Director
Deborah Virtue

Marketing Communications
Janice Molinari, *Director*
Anne Foley, *Promotion Manager*
Sara Morris, *Promotion Assistant*

EDITORIAL 49

Establishing a tariff that funds US R&D efforts might be a suitable alternative to mandating artificially high semiconductor prices.

NEW PRODUCTS

Integrated Circuits	222
Components & Power Supplies	231
Computers and Peripherals	237
Test & Measurement Instruments	243
CAE & Software Development Tools	246

PROFESSIONAL ISSUES 255

Milt Scovill's long and winding road.—*Deborah Asbrand, Associate Editor*

LOOKING AHEAD 267

Surveys quiz CASE users and vendors . . . PC-board ATE market to reach \$1.1B by '93.

DEPARTMENTS

News Breaks	21
News Breaks International	24
Signals & Noise	31
Calendar	42
Readers' Choice	96
Literature	254
Business/Corporate Staff	259
Career Opportunities	260
Advertisers Index	266

Odds are 50-50
your perfect ASIC is a
perfect dud the first time
you plug it in.



That's why Mentor Graphics lets you combine ASIC and board circuitry in a single simulation.

Trouble in ASIC paradise.

The big day has arrived.

Your first gate array is back from the foundry. With high expectations, you plug it into your board and power up.

It doesn't work.

Don't feel alone. Over 50% of ASICs aren't operational when first installed in their target system. Even though 95% pass their foundry tests with flying colors.

An immediate solution.

Mentor Graphics shifts these even odds heavily in your favor with our QuickSim™ logic simulator, which lets you simulate both your ASIC and board circuitry in a single run.

With QuickSim, you not only track the internal operations of your ASIC circuitry, but also its transactions with the system at large. If there's a problem, you see precisely where it's located, either inside or outside your ASIC. All in a single, interactive simulation environment, where you can view and graphically "probe" the circuitry created by our NETED™ schematic editor.

Check out our libraries.

Library support is an ideal benchmark to gauge the true worth of an electronic design automation system. The more diverse and plenti-

ful the component modeling libraries, the greater the design capability. It's as simple as that.

By this simple, yet decisive measure, Mentor Graphics brings you unequaled design capability. While other EDA vendors scurry to produce their own ASIC libraries (with little guarantee of accuracy), more ASIC vendors put their libraries on Mentor Graphics workstations than any other. And in most cases, we're the first workstation supported, which means you have the first shot at exploiting new chip technologies.

With Mentor Graphics, you get a breadth of LSI and VLSI component models, both hardware and software based. All of which can be mixed with ASICs in a single simulation that cuts your run time to an absolute minimum.

To be continued.

So much for the present. We're already developing new EDA tools for systems design that will extend to every dimension of electronic product development. From high-level systems descriptions to CASE. It's what our customers expect. It's what we'll deliver.

It's all part of a vision unique to Mentor Graphics, the leader in electronic design automation. Let us show you where this vision can take you.

Call us toll-free for an overview brochure and the number of your nearest sales office.

Phone 1-800-547-7390
(in Oregon call 284-7357).



Mentor Graphics®

Your ideas. Our experience.

How the fa

Our new 75ns PAL[®] device is fast enough to prove that standard logic shouldn't set the standard anymore.

It's also fast enough to finally let today's new microprocessors run at the speeds for which they were designed—breathtaking.

Raising your standard.

How fast would you like your standard logic?

How about faster than any TTL logic around? Even FAST[™] or AS? You've got it with the 75ns PAL device.

And the fact that you can config-

ure it yourself means you can get exactly what you want.

If you want to redesign something, you change the PAL device. Not the board.

Not only is this the fastest way to get high speed logic, it's also the most practical. One 75ns PAL device replaces two to six standard TTL devices.

Which cuts down on board size.

And cuts down chances for a device failure.

75ns PAL Device vs. FAST & AS				
SSI/MSI		FAST	AS	75ns PAL Device
Combinatorial				
74138	tPD	8.0	10.0	7.5
Decoder				
74151	tPD	11.0	15.0	7.5
Mux				
Register/Latch				
74374	tCO	10.0	9.0	6.5
Octal Register				
74373	tPD	8.0	6.0	7.5
Octal Latch	tLEO	13.0	11.5	7.5
Counters				
74161	tS	5.5	8.0	7.0
Four bit Ctr	tCO	11.0	13.5	6.5
74269/869	tS	2.5	5.0	7.0
Eight bit Ctr	tCO	10.0	11.0	6.5

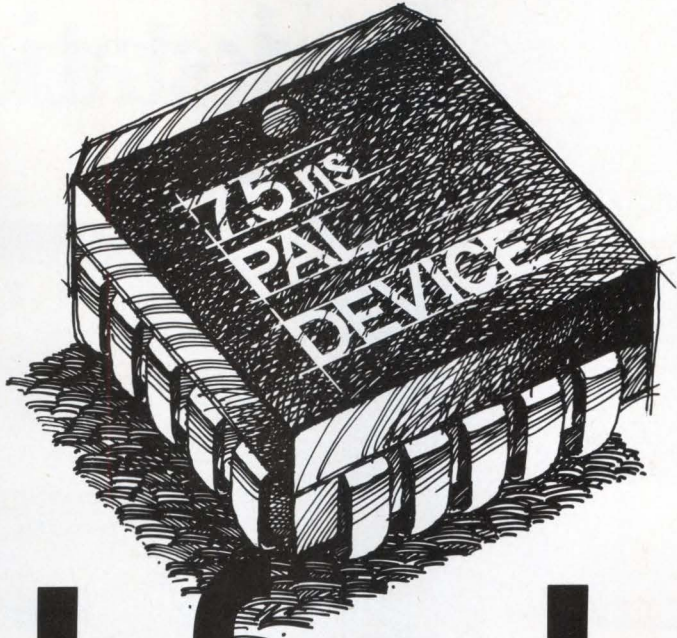

st get faster.

What to give the microprocessor that has everything.

We suggest the first PAL device that can keep up with it.

The 7.5ns PAL device runs at 74 Mhz. It can deliver the speed the new high performance microprocessors need.

Processors like the 29K, the 386 and the 68030.

This PAL device delivers 25% more speed than any other PAL device.

We even have the fastest 22V10.

Our 15ns 22V10 runs at 50Mhz. That's 10ns faster than anyone else on the market. And it lets you run at twice the rate of the new 25Mhz microprocessors.

We've been shipping 20 pin 10ns

PAL devices for eighteen months. And now you can get the new 24 pin 10ns PAL device as well.

There's plenty of service and support to get and keep your project moving. And all our fast PAL devices are available in volume when you need them. Now, for example.

For all the facts about our fast PAL devices, drop us a line. Or call us at (800) 222-9323.

Because you can never be too fast.

Advanced Micro Devices 
Monolithic Memories 

901 Thompson Place, P.O. Box 3453, Sunnyvale, CA 94088.

PAL is a registered trademark of Advanced Micro Devices, Inc. FAST is a trademark of National Semiconductor Corporation. ©1988 Advanced Micro Devices, Inc.

High performance workstations.

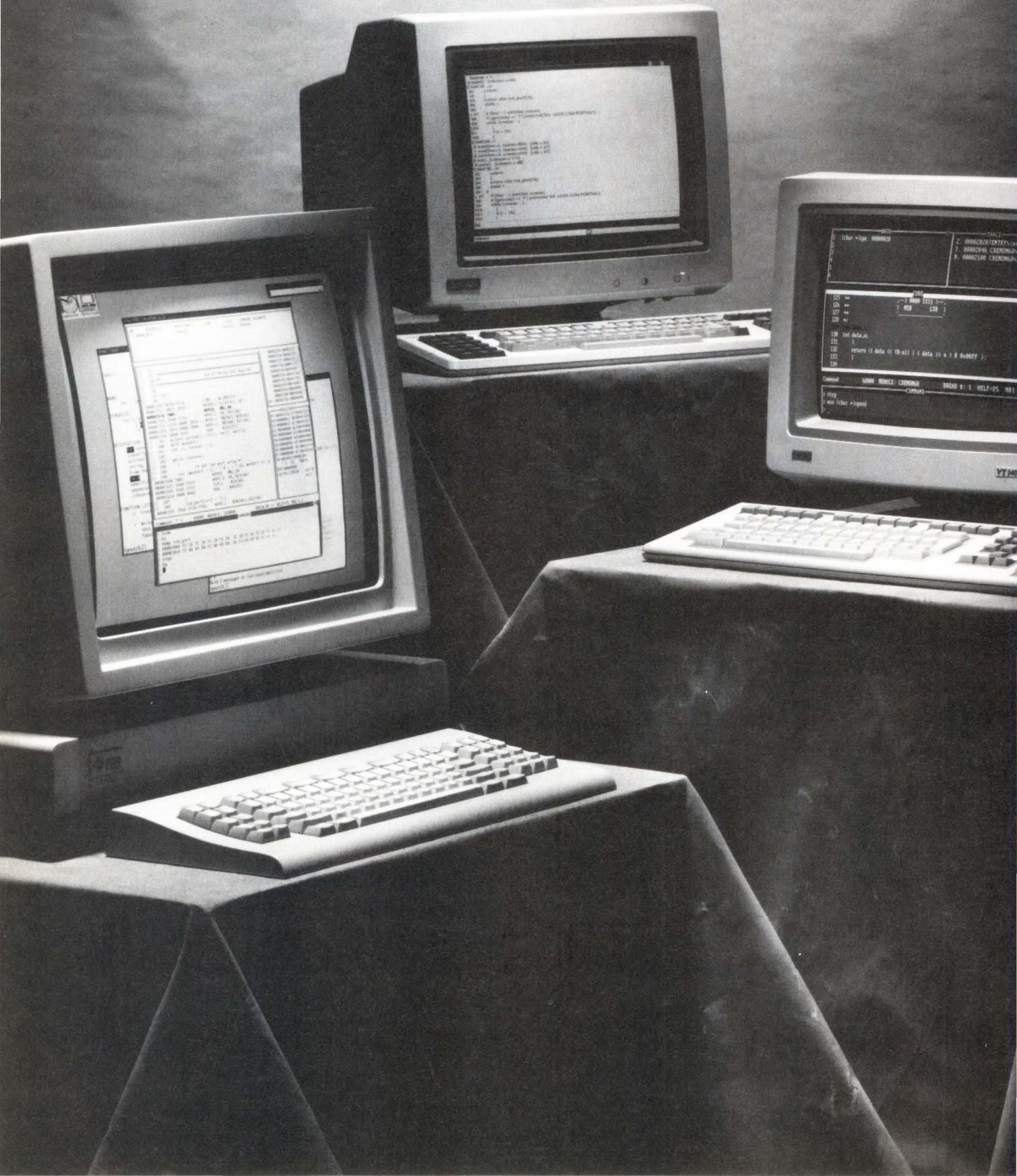

The highest performance development tools.

Now you can build a high performance development environment around the engineering workstation you already own. And get your embedded microprocessor designs completed more quickly and with less effort than ever before.

Your Sun, Apollo or DEC workstation has the processing power and high resolution graphics. Applied Microsystems adds the debuggers, utility software and excellent emulation you need to complete your system. Only Applied Microsystems can make all of these pieces work together seamlessly.



Our ES 1800 Series of emulators provide the most powerful transparent emulation system available anywhere.

in a closely coupled development environment. What's more, VALIDATE is supported by a rich library of linkers, loaders, compilers and assemblers.

Add the real-time, transparent emulation capabilities of our ES

you the largest overlay memory capability in the industry.

Make your workstation work even harder.

Get full value from your investment in engineering workstations.

Applied Microsystems can turn your workstation into the heart of a high performance microprocessor development environment.

To find out more, write Applied Microsystems Corporation, P.O. Box 97002, Redmond, Washington, USA 98073-9702. Or call

(800) 426-3925, in Washington call (206) 882-2000.

In Europe contact Applied Microsystems Corporation Ltd., Chiltern Court, High Street, Wendover, Aylesbury, Bucks, HP22 6EP, United Kingdom. Call 44-(0)-296-625462.

UNIX is a registered trademark of AT&T. AMC-228



Applied
Microsystems
Corporation

Operating Environment Host Operating System	Microprocessors/ Microcontrollers	Software Utilities Languages Tools	Emulation Link	Debuggers
VAX MicroVAX Apollo Sun PC PC XT PC AT PC Compatibles	Intel: 8048 family, 8051 family 8080, 8085, 8086/8, 80186/188 and 80286 Motorola: 68HC11, 6800/2/8, 6809/9E, 68000/08/10 and 68020 Zilog: Z80, Z80H, MK 3880/4 and Z8001/2 NSC: NSC 800 Hitachi: 64180	C Compilers Pascal Assemblers FORTRAN Linkers PL/M Locators Assembler Jovial ADA (VERDIX)	ES 1800 (16 & 32-bit) EC 7000 (8-bit microcontrollers) EM Series and EL 800 (8-bit microprocessors)	VALIDATE and other soft- ware products for source and symbolic debugging

We offer debug and development tools with a difference: they are integrated solutions for virtually any development environment.

Source or symbolic debugging for Intel, Motorola, and Zilog. Plus the best emulation.

The VALIDATE family of source and symbolic debuggers and host control software has been specifically tailored by Applied Microsystems to work with our emulators

1800 Series of 16-bit and 32-bit emulators, and you have the most powerful emulation system anywhere. The high speed SCSI interface option lets you upload and download files more than twenty times faster than with RS 232. Our Advanced Event Monitor System lets you precisely control emulation with logical statements of system conditions. The ES 1800 also gives

CIRCLE NO 6

**"Listen, the future of
this product line is rid-
ing on my next design
automation decision.
Not to mention my job."**

**"I hear you. So tell me
more and let's figure
out how HP can help
you make some of
those decisions."**



"Well, first, we're feeling enormous pressure to get products out faster. The key is designs that'll go through manufacturing the first time. If we're going to stay competitive, we've got to tackle the overall product development process—and it starts right here in design."

Look, HP's gone through the same thing. Our own divisions deal with the same problem daily. We came up with a solution called DesignCenter. It combines our electronic design automation tools with the rest of the process to produce a high degree of manufacturability right from the start—in design."

"That's exactly what we need. A single data path from design right on through production and out the door. If we could somehow combine electronic design with microprocessor development and mechanical engineering and tie it into manufacturing and test, we'd be a lot happier. Are you saying HP can do that for us now?"

"We're not there 100% yet. Nobody is. But that's the whole idea behind our DesignCenter. Right now, we've got the broadest set of EDA tools there is. Match them up with the HP test and measurement tools you've used for years, and you'll be way ahead of the game."

"We've always counted on HP test equipment. But how does that relate to your EDA tools?"

"We were able to bridge the gap between design and prototype test. Now you can create higher quality tests—faster, too—by transferring data directly between our logic analyzers and simulation. And the design and layout tie directly into HP board test systems."

"That's terrific. But testing is only one part of the process. We're making decisions on everything from ASICs and PLDs to microwave hybrids to multi-layer PCBs. And they all have different parts and technologies. I'll tell you, it's impossible to keep up."

"We agree, it's a big problem. But that's the reason we have digital, analog, and microwave CAE tools for design, simulation, and layout. We even support it all with information management to handle the tough tradeoffs your team has to make in choosing between all the technologies and complex interactions."

"There's one thing that's always a concern. We've got systems in here from some of your competitors. If we go with HP, can you fit into our existing environment?"

"Absolutely. Using either off-the-shelf or customized interfaces, we'll help you integrate HP tools into your existing systems. And, since HP supports EDIF and IGES standards, you'll have the flexibility you need down the road."

"Speaking of standards, tell me about your platforms."

"Well, HP is among the industry leaders in standardization because the marketplace is demanding it. Our family of workstations and servers supports UNIX and networking standards. They thrive in a multi-vendor environment, making it easier to get your job done right the first time. That's the bottom line these days."

"I get the feeling you understand that we're interested in a lot more than just tools. I mean, you seem to be talking about more than hardware and software."

"I am. HP is totally committed to this idea of getting more correct-by-design products through your plant. We are talking about a lot more than the tools. We'll sit down with you and help create a system that meets your needs... not ours or somebody else's. And I mean we'll get right down to solving problems and training your people. That's what we do better than anyone else."

"I want to keep talking about this whole thing. And I want to include some other engineers, too. What are you doing next Wednesday?"

"I've got a feeling I'll be back here."

"Right."

"Name a time."

The dialogue continues...

More and more project managers are talking to HP about EDA tools and DesignCenter. Start a dialogue today. Call toll free. Ask for information on HP Electronic Design Automation and bridging the gap from design to prototype test: 1-800-752-0900, Ext. C215.

we never stop asking

What if...

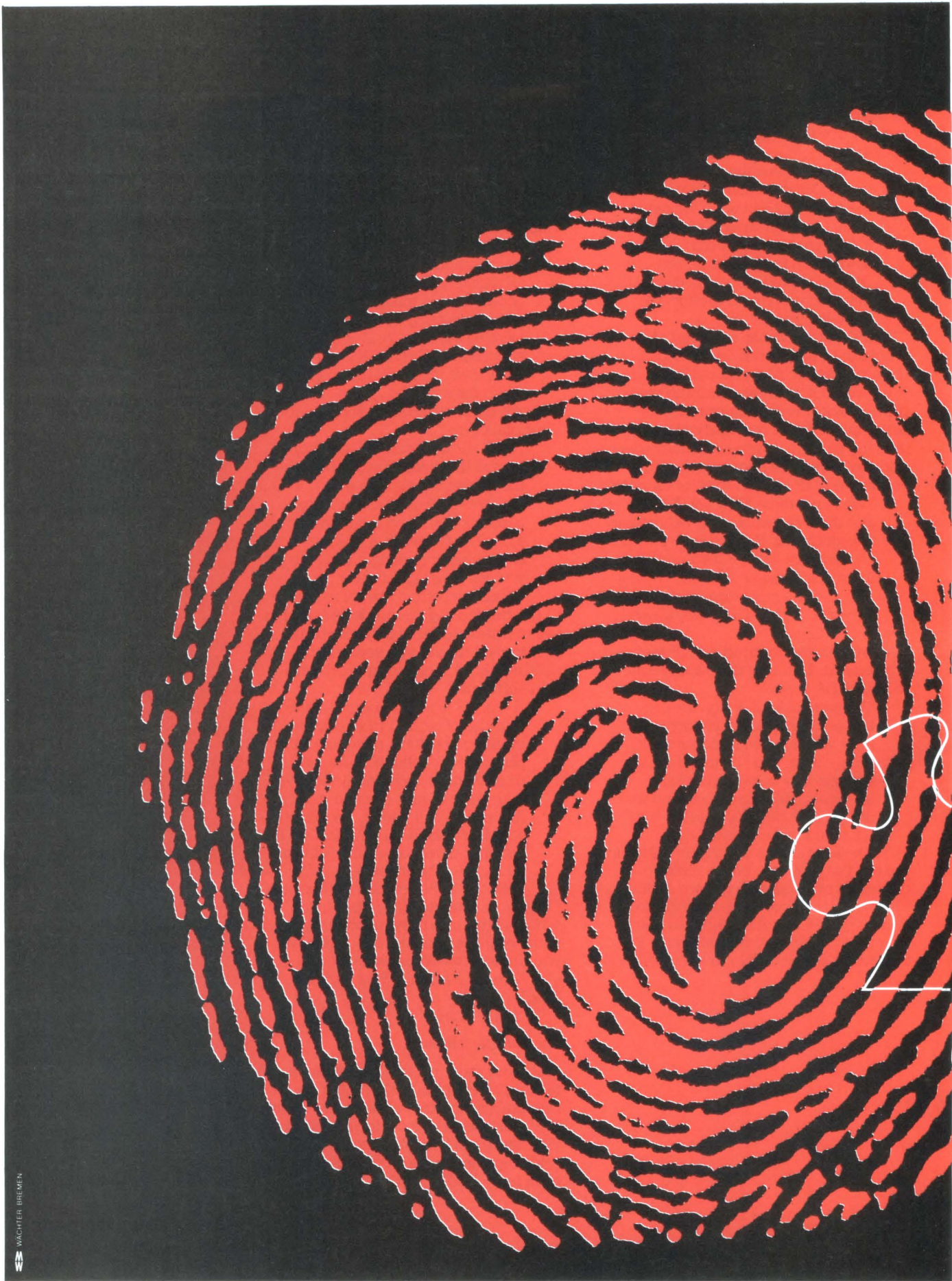

WÄCHTER BREMEN
M

HARTING/Austria, Vienna, Tel. 0222-68 68 18-0 · HARTING/Belgium, Relegem, Tel. 02-465.42.40 · HARTING/France, Fontenay-sous-Bois Cedex, Tel. (1) 487 706 26
HARTING/Great Britain, Biggin Hill, Tel. (09 59) 71411 · HARTING/Italy, Pioltello (Milan), Tel. 02-92100 847 · HARTING/Japan, Yokohama, Tel. 045-931.5718

SOME THINGS CAN'T BE COPIED.

That's something we at HARTING learned long ago. For instance, our engineers and designers invested years of hard work to develop our "HARTING Industrial HAN® Connector." Their goal was to get every little detail just perfect so that state-of-the-art production processes and high-tech robots could be used to produce the definitive connector.

Well, our HAN® Connectors were a big success worldwide – and they still are. Of course, it didn't take long before similar connectors with similar names hit the market. But the original HAN® still hasn't been equalled.

Because it's unique – just like your fingerprints. After all, it's the only one produced in completely automated high-tech production facilities. Each individual component part is made of

the very best material available. And each part has to go through a

whole series

of quality-control stations.

That's how we manage to make sure that every HAN® Industrial Connector that leaves our plant is

absolutely perfect. And the millions of our connectors in use throughout the world today are proof of this unprecedented reliability.

World headquarters:

HARTING ELEKTRONIK GmbH

P. O. Box 1140 · D-4992 Espelkamp

West Germany

☎ (05772) 47-1 · ☎ 9 72310-11 he d

**CONNECT UP WITH QUALITY –
WITH HARTING.**



HARTING/Netherlands, AM Etten-Leur, Tel. 01-608-35400 · HARTING/Norway, Oslo, Tel. 02-64 75 90 · HARTING/Sweden, Spanga, Tel. (08) 7 6179 80 · HARTING/Switzerland, Schwerzenbach, Tel. 01-8 25 51 51 · HARTING/USA, Chicago, Tel. (312) 519-77 00

How to crack 386 protected mode.

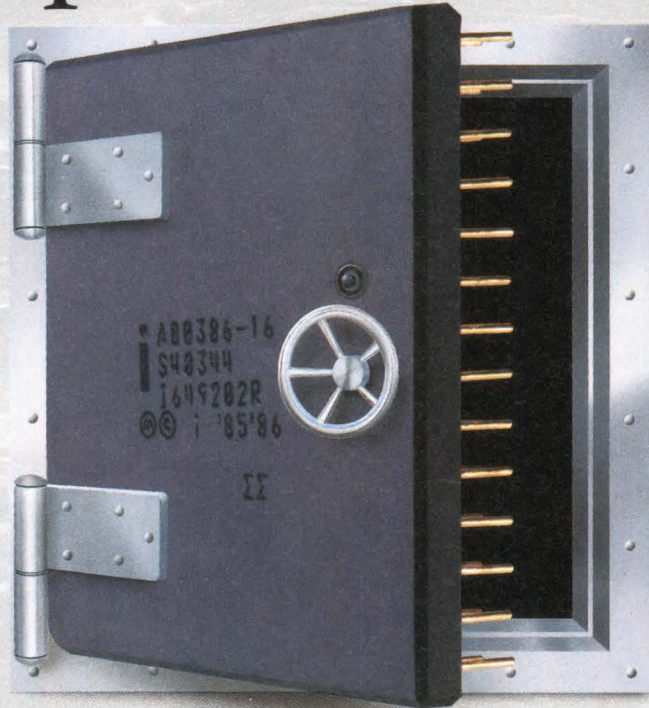

Unlock selectors and descriptor tables. Break open task state segments (TSS) and call gates. Microtek's In-Circuit-Emulator (MICE) cracks 80386 protected mode with real-time, non-intrusive emulation to 20 MHz.

MICE unravels all the intricacies of the 80386, so you harness its full potential. Internal registers, including GDT and IDT base values are all directly accessible. And MICE also provides decoded access to all selector and descriptor bits, like privilege level, segment type and page accessed bits.

Use MICE as a stand-alone device, or integrate it into your development environment. MICE easily interfaces with the IBM® PC/XT/AT, VAX®, Apollo® and Sun® computers.

And the 80386 emulation system is just one of our many embedded software development tools.

Our Software Analysis Workstation (SAW) delivers hardware-based, real-time software analysis in a source code environment. For source code development, our Microtec® Research products provide you

with C and Pascal cross-compilers, cross-assemblers and debuggers for many popular microprocessors.

And MicroCASE™ backs all of its products with solid applications support, both at the local and factory level.

Microtek enjoys a long track record of being first to market with quality support for many major microprocessors. We were the first alternative for 80386 emulation. We're first to provide non-proprietary support for 80386 protected mode.* And you can count on the same support in the future.

For more information and product literature on our full line of MICE, call us at (408) 253-5933.

Crack 80386 protected mode, and open the door to exciting design possibilities—with the best 80386 emulation system now available. From MicroCASE.



**Micro
CASE**

Formerly Northwest Instrument Systems, Inc.

P.O. Box 1309 • Beaverton, OR 97075

*Without the use of a proprietary "bond-out" chip.

IBM is a registered trademark of International Business Machines. VAX is a trademark of Digital Equipment Corporation. Apollo is a trademark of Apollo Computer, Inc. Sun is a trademark of Sun Micro Systems.

Processors supported by Microtek: 80386, 80286, 80186, 80188, 8086, 8088, 68020, 68010, 68008, 68000, 6809, 6809E, 6502, Z80, NSC800, 8085, 8032, 8051, 8031, 8344, 8048, 8049, 8050, Z8, SUPER 8, 68HC11, 64180, 80515.

Circle No. 73 for demonstration

Circle No. 72 for literature

NEWS BREAKS

EDITED BY JOANNE CLAY

8-BIT HALF-FLASH ADC INCLUDES TRUE SAMPLE/HOLD AMPLIFIER

The LTC1099 from Linear Technology Corp (Milpitas, CA, (800) 637-5545) is a half-flash 8-bit A/D converter that converts in 2.5 μ sec typ. A true sample/hold amplifier is included on the chip; it allows the ADC to convert 5V p-p signals at as much as 167 kHz, or signals with slew rates as high as 20V/ μ sec. The LTC1099 is pin compatible with the AD7820 and the ADC0820; these older devices can complete the A/D conversion in 1.5 μ sec, but have pseudo-S/H amplifiers that can accept signals with a maximum slew rate of 0.1V/ μ sec or a bandwidth limit of 7 kHz. (To acquire signals with higher frequencies, these older devices require an external S/H amplifier, which is usually expensive.) The LTC1099 costs \$8 (100).—David Shear

EVALUATION MODULE PROVIDES INTERFACE TO CONSUMER ELECTRONIC BUS

The SEM-200 Smarthome evaluation module from CyberLynx (Boulder, CO, (303) 444-7733) provides easy access to the Consumer Electronic Bus (CEBus) currently being developed as a standard under the sponsorship of the EIA. The CEBus is a low-cost, multimedia LAN designed to interconnect appliances, audiovisual equipment, and other household devices. The \$450 SEM-200 acts as a network node and LAN analyzer that monitors network traffic. You can connect a PC or a dumb terminal to the unit's RS-232C interface to observe activity on the CEBus network. The module provides digital inputs and relay outputs that allow you to add CEBus capability to a wide range of product prototypes. CyberLynx and Texas Instruments (Dallas, TX) are jointly developing a line of interface ICs for the CEBus.—Steven H Leibson

PC/AT GPIB INTERFACE OFFERS 1-MHz DMA TRANSFERS

If you have an IBM PC/AT or compatible computer, you can use the AT-GPIB expansion card from National Instruments (Austin, TX, (515) 250-9119) to speed your IEEE-488 communications. This \$495 interface lets your 80386- or 80286-based computer communicate with as many as 13 instruments at data-transfer speeds reaching 1M byte/sec. Bidirectional FIFO buffers let the device read at 1M byte/sec, write at 700k bytes/sec, and execute GPIB commands at 320k bytes/sec. The AT-GPIB comes with the NI-488 software package, which includes BASICA, Quick BASIC, and a binary MS-DOS device driver with more than 30 IEEE-488 functions. The board can use one of 11 selectable lines to interrupt the host PC.—J D Mosley

ANALOG MEASUREMENT MODULE OFFERS 50-kHz THROUGHPUT

For applications requiring 16-bit A/D conversions, you can select the AMM2 Master Analog Measurement Module from Keithley Instruments (Cleveland, OH, (216) 248-0400) for 50-kHz data transfer. The \$1155 module offers 16 single-ended or eight differential analog inputs, a crystal-controlled oscillator for jitter-free FFT analysis, and an external trigger. The AMM2 provides programmable operating parameters that let you control gain and configure inputs. The unit automatically performs internal calibration when used with the manufacturer's Soft500 and Quick500 data-acquisition software.—J D Mosley

MICROCOM NETWORKING PROTOCOL INCLUDED ON MODEM CHIP SET

Sierra Semiconductor (San Jose, CA, (408) 263-9300) is changing the program of its SCL1011 modem processor: The new version, the SCL1013, will implement the Microcom Networking Protocol (MNP). This protocol has been used for many years to provide error-free communications in the banking industry. The MNP is a data-

NEWS BREAKS

communications protocol for full-duplex, error-free communication over ordinary voice-grade telephone lines. Software-communication packages use similar techniques, but these tend to be machine dependent. MNP exists in firmware within the modem, so any computer or terminal can be used. The protocol includes a data-compression algorithm that provides an effective data rate as high as 2900 bps with a 2400-bps modem. The SC11013 modem processor and the SC11006 modem analog peripheral together cost \$33.50 (25,000). You'll also need some extra components such as a RAM, a USART, and some logic circuits; you can obtain all the necessary parts for \$7.50. In effect, you'll be able to build a modem that implements the MNP for less than \$11 over the cost of producing a standard 2400-bps modem.—David Shear

GRAPHICS CHIP AND MATH COPROCESSOR INCREASE DRAWING SPEED

The TMS34020—the latest version of the TMS34010 graphics processor from Texas Instruments (Dallas, TX, (800) 232-3200 ext 700)—can make use of the company's new TMS34082 floating-point coprocessor to accelerate graphics functions such as coordinate transformations. In addition, the 34020 has 25% more microcoded graphics primitives, so it can render the primitives faster than can software-based primitives. All 34010 object code is upwardly compatible with the 34020. The 34010 has a 32-bit internal and a 16-bit external data bus; the 34020 has an internal and an external 32-bit data bus. The 34020 runs at from three to 20 times the speed of the 34010. Samples of both the 34020 graphics processor and the 34082 math coprocessor will be available in the fourth quarter of 1988 at \$500 each; production quantities will be available in the first quarter of 1989. You can expect to see the price of the 34020 drop by an order of magnitude within the next 18 months.—Margery S Conner

INTERFACE UNIT CONVERTS SCSI TO ETHERNET

The Nodem allows you to connect your personal computer to Ethernet via your computer's SCSI port. The unit is completely external; it doesn't use your computer's expansion slots, and it has its own wall-mounted power supply. You adapt the unit to your system configuration by using software supplied with the unit. The Nodem works with IBM PCs and compatibles, the IBM PS/2, and the Apple Macintosh. It's transparent to AppleTalk.

The units are made by Adaptek (Milpitas, CA, (408) 945-8600), but will be marketed primarily by LAN-system suppliers and value-added resellers. The standard Ethernet version will cost approximately \$545; the Cheapernet and twisted-pair versions will sell for about \$595. The units will be available with software for Macintosh systems in September; software for IBM systems will be available in early 1989.—Richard A Quinnell

MULTITASKING, RESIDENT BASIC COMPILERS TARGET EMBEDDED SYSTEMS

The MTBasic compilers from Softaid Inc (Columbia, MD, (301) 964-8455) provide multi-tasking Basic and a kernel operating system for diskless, embedded-processor systems employing the Zilog Z80 or Z280, the Hitachi 64180, or the Intel 8088 μ Ps. The compilers reside in a ROM on the target system and offer a conventional programming environment similar to that provided by compilers running on personal computers. The vendor supplies source code for each compiler, allowing you to tailor features of the language for your specific application. Each compiler costs \$6500.—Steven H Leibson

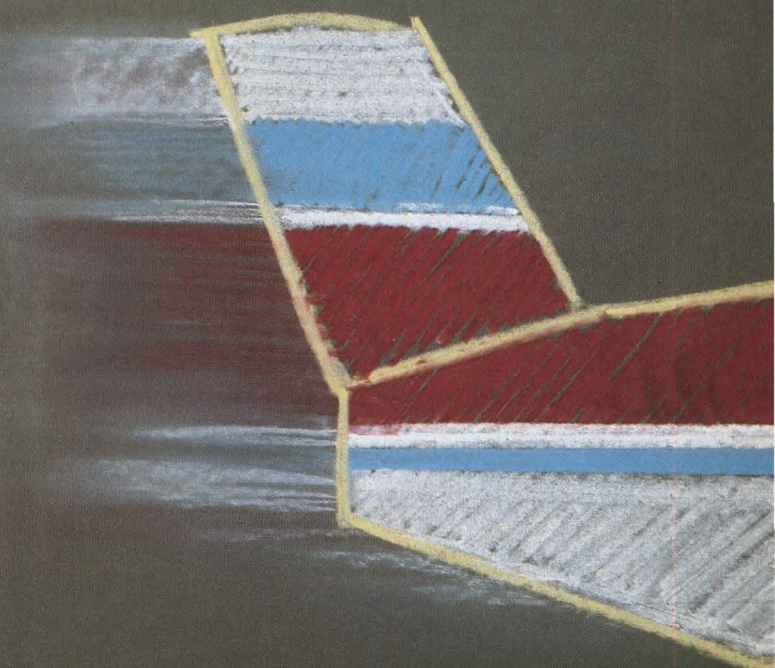
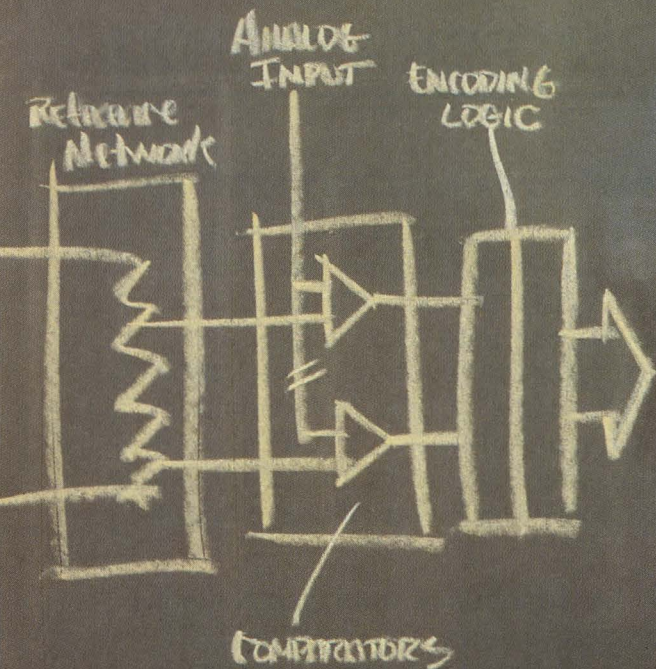

THE COMPETITION IS STILL TALKING ABOUT THEIR 10-BIT FLASH ADC

WE'RE SHIPPING OURS

That's right — shipping. For years there's been a lot of talk about monolithic 10-bit ADCs. The talk is over. The TDC1020 is a reality. The world's first monolithic 10-bit flash ADC is available from TRW LSI Products.

And the best news is the performance. It's going to be hard to beat. This truly state-of-the-art flash converter guarantees 10-bit resolution at a 20MSPS conversion rate over both commercial and military temperature ranges. Packaged in a 64-pin DIP, its outstanding features include TTL interface, overflow flag, selectable output formats and guaranteed no missing codes. All you need is a standard $\pm 5V$ power supply and a challenging application.

The TDC1020 can help your equipment achieve the kind of performance

that you've been dreaming about for years. But beyond performance, the TDC1020 in your system will be a real cost and space saver too.

So stop listening to all the talk about 10-bit ADCs. The TDC1020 is here. *Now!* Try it in your medical imaging, broadcast video, military, process control equipment or any other demanding application.

Call for a full data sheet, pricing and immediate technical assistance. Production quantities are available right now from TRW LSI Products and our national distributors — Hall-Mark and Hamilton/Avnet.

**TRW LSI Products —
Bringing the worlds of Data
Acquisition and DSP together.**

TRW LSI Products Inc.
P.O. Box 2472
La Jolla, CA 92038
619.457.1000

In Europe, phone:
TRW LSI Products Inc.
Munich, 089.7103.124;
Paris, 1.69.82.92.41;
Guildford (U.K.), 0483.302364

In the Orient, phone:
Hong Kong, 3.880629;
Tokyo, 3.487.0386, 3.461.5311;
Taipei, 751.2062;
Seoul, 2.553.0901

TRW Inc. 1988 — 712A02887



TRW LSI Products Inc.

NEWS BREAKS: INTERNATIONAL

ADA COMPILERS MAKE TRANSPUTERS SUITABLE FOR MILITARY SYSTEMS

If you're using Inmos Transputers in embedded systems for military contracts, you'll probably be required to write the system software in the Ada programming language. Two compilers being developed by Alsys SA (La Celle Saint-Cloud, France, TLX 697569; in the US: Waltham, MA, (617) 890-0030) can help. The compilers generate code for any of the Inmos 16- and 32-bit integer Transputers or the IMS-T800 floating-point Transputer. One is a cross-compiler that runs on DEC VAX computers under VMS; the other is a host compiler that runs under MS-DOS on IBM PCs and compatibles to which you've added a T800-based add-in card. For a medium-sized VAX, the cross-compiler is expected to sell for around Fr 250,000. The PC-based host compiler will probably cost around Fr 50,000.

Although these compilers won't be available until the middle of 1989, you can start software development now by using one of the company's currently available VAX-based validated Ada compilers. Because all the company's Ada compilers share a common-root front-end and intermediate code, the software you write with one of the available compilers will recompile to Transputer code when run through the Transputer's Ada compiler. To meet military-hardware requirements, Inmos (Bristol, UK, TLX 444723; in the US: Colorado Springs, CO, (719) 630-4000) plans to introduce a version of the T800 Transputer that's qualified to MIL-STD-883C during the first quarter of 1989. The company will follow that product with military versions of the 16- and 32-bit integer Transputers later the same year.—Peter Harold

SIEMENS AND AMD AGREE TO DEVELOP PIN-COMPATIBLE ISDN CHIP SET

Siemens Components (Munich, Germany, TLX 521000; in US: Santa Clara, CA, (408) 980-4500) and Advanced Micro Devices (Sunnyvale, CA, (408) 732-2400) have agreed to jointly develop and supply ICs for the telecommunications and data-communications industry, with emphasis on an ISDN chip set. You will be able to obtain pin-compatible devices from both companies, selecting from a set of 15 devices (13 Siemens chips and two AMD chips) that are based on a common architecture. PSB2110 ISDN terminal adapter circuit, PEB2085 ISDN subscriber-access controller, and the Am79C401 integrated data-protocol controller. The companies will begin by offering each other's parts; then they'll exchange manufacturing technology to build a true alternate-source capability for the entire set of devices.—Richard A Quinnell

TOSHIBA FORMS TUNNEL JUNCTION FROM SUPERCONDUCTOR MATERIAL

According to reports in the Japanese press, Toshiba Corp has created a thin-film technology for high-temperature superconducting material that may make commercial superconducting computer chips possible. The company has successfully combined lead and yttrium-based superconductor material, forming a tunnel junction. The firm used this procedure to make a prototype, and confirmed that the device's voltage could be used in on/off switching functions. These results reportedly represent the first time anyone has confirmed such a function in a superconducting device.—Joanne Clay

How to Beat EMI/RFI Once and For All!

With high performance TDK EMI/RFI components



EMI/RFI Suppression Filters

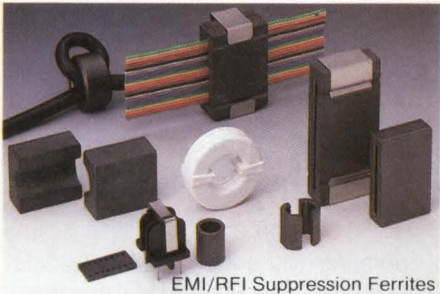

EMI/RFI Suppression Ferrites



UL Recognized (CSA, VDE, SEV, SEMKO, BS)
Ceramic Capacitors

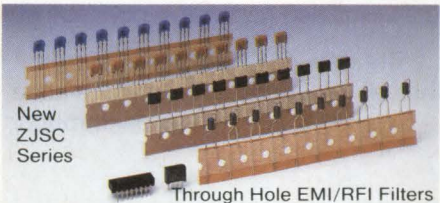

New ZJSC Series
Through Hole EMI/RFI Filters

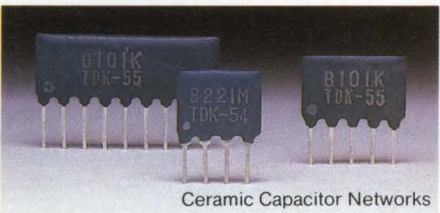

Ceramic Capacitor Networks

With recent advances in digitization and integration, electronic circuits require a higher degree of reliability than ever before. Advanced circuits and devices now have to overcome expanding EMI environments and the tighter international EMI/RFI standards enforced by the FCC, CISPR, and DIN. TDK technology can help.

Our expertise in ferrite and other materials technology has produced an outstanding line of noise-beating components, all manufactured according to integrated production processes. We offer every kind of EMI/RFI filter imaginable—from power source filters to through hole filters—to combat noise from the low to high frequency range.

Our products include ferrite cores, amorphous magnetic materials, ceramic capacitors, varistors, radio wave absorbent materials, and electromagnetic shielding materials. All carry the TDK guarantee of reliability, and are suitable for a variety of applications, including advanced computers, automobile electronics, and OA and FA equipment.

And with TDK, you get more than noise-combatant components. You also get our full support services, whether it's a matter of constructing an electromagnetic wave anechoic chamber, or devising the right measurements.

GEL is at your service. CEL, TDK's Component Engineering Laboratory in Torrance, CA, can assist you by custom designing and test manufacturing TDK EMI/RFI Components to meet your specific requirements. Call (213) 530-9397.

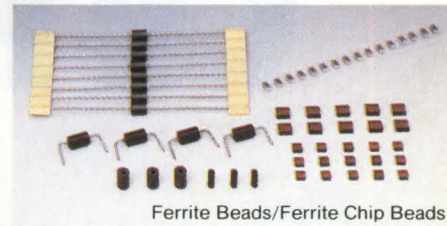

Ferrite Beads/Ferrite Chip Beads

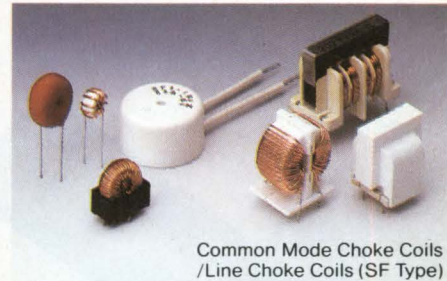

Common Mode Choke Coils / Line Choke Coils (SF Type)

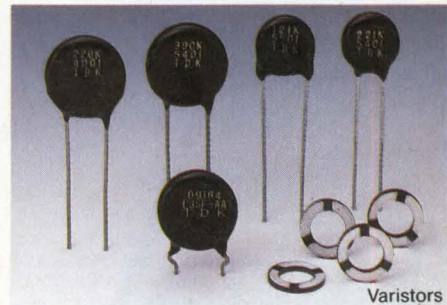

Varistors

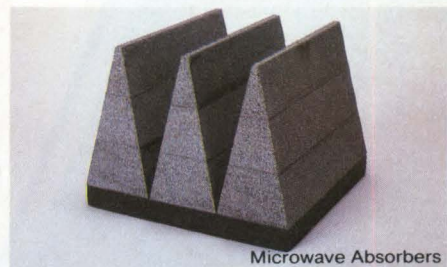

Microwave Absorbers

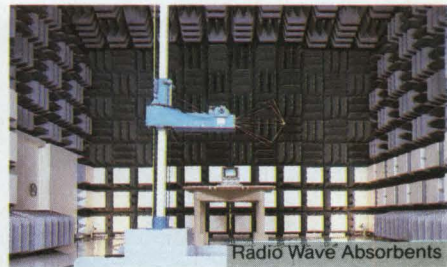

Radio Wave Absorbents

TDK Electromagnetic Compatibility Technology — At Your Service!



TDK CORPORATION OF AMERICA HEAD OFFICE 1600 Feehanville Drive, Mount Prospect, IL 60056, U.S.A. Phone: (312) 803-6100 CHICAGO REGIONAL OFFICE Phone: (312) 803-6100 INDIANAPOLIS REGIONAL OFFICE Phone: (317) 872-0370 NEW YORK REGIONAL OFFICE Phone: (516) 625-0100 LOS ANGELES REGIONAL OFFICE Phone: (213) 539-6631 DETROIT DISTRICT OFFICE Phone: (313) 353-9393 NEW JERSEY DISTRICT OFFICE Phone: (201) 736-0023 HUNTSVILLE DISTRICT OFFICE Phone: (205) 539-4551 GREENSBORO DISTRICT OFFICE Phone: (919) 292-0012 DALLAS DISTRICT OFFICE Phone: (214) 506-9800 SAN FRANCISCO DISTRICT OFFICE Phone: (408) 437-9585 **TDK CORPORATION**, TOKYO, JAPAN.

rugged plug-in amplifiers

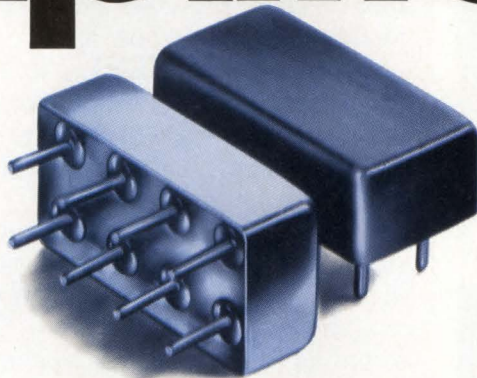

0.5 to 1000/MHz from \$13⁹⁵ (5 to 24 qty)

Tough enough to meet full MIL-specs, capable of operating over a wide -55° to $+100^{\circ}\text{C}$ temperature range, in a rugged package... that's Mini-Circuits' new MAN-amplifier series. The MAN-amplifier's tiny package (only 0.4 by 0.8 by 0.25 in.) requires about the same pc board area as a TO-8 and can take tougher punishment with leads that won't break off. Models are unconditionally stable and available covering frequency ranges 0.5 to 500MHz and 0.5 to 1000MHz, and NF as low as 2.8dB.

Prices start at only \$13.95, **including** screening, thermal shock -55°C to $+100^{\circ}\text{C}$, fine and gross leak, and burn-in for 96 hours at 100°C under normal operating voltage and current.

Internally the MAN amplifiers consist of two stages, including coupling capacitors. A designer's delight, with all components self-contained. Just connect to a dc supply voltage and get up to 28dB gain with +9dBm output.

The new MAN-amplifier series...
another Mini-Circuits' price/performance breakthrough.

MODEL	FREQ. RANGE (MHz) f_L to f_H	GAIN dB min flatness ^{††}	MAX. OUT/PWR [†] dBm	NF dB (typ)	DC PWR 12V, mA	PRICE \$ ea. (5-24)
MAN-1	0.5-500	28 1.0	8	4.5	60	13.95
MAN-2	0.5-1000	19 1.5	7	6.0	85	15.95
MAN-1LN	0.5-500	28 1.0	8	2.8	60	15.95
◇MAN-1HLN	10-500	10 0.8	15	3.7	70	15.95

^{††}Midband $10f_L$ to $f_{U/2}$, $\pm 0.5\text{dB}$ [†]1dB Gain Compression ◇Case Height 0.3 In.
Max input power (no damage) +15dBm; VSWR in/out 1.8:1 max.

finding new ways ...
setting higher standards

Mini-Circuits

A Division of Scientific Components Corporation
P.O. Box 350166, Brooklyn, New York 11235-0003 (718) 934-4500
Fax (718) 332-4661 Domestic and International Telexes: 6852844 or 620156

CIRCLE NO 114

C118 REV. B



tough attenuators

one-piece design defies rough handling from **\$14⁹⁵** (1-49)

- Each unit undergoes high-impact shock test
- Unexcelled temperature stability, .002 dB/°C
- 2W max. input power (SMA is 0.5W)
- BNC, SMA and N models (TNC, consult factory)
- Immediate delivery, one-year guarantee
- **50 ohms, dB values,**
1, 2, 3, 4, 5, 6, 7, 8, 9, 10, 12, 15, 20, 30, and 40
- **75 ohms dB values,** 3, 6, 10, 15, 20 BNC only
- **Price** (1-49 qty.)
CAT (BNC) \$14.95 SAT (SMA) \$17.95
NAT (N) \$19.95

*Freq. (MHz)	Atten. Tol. (Typ.)	Atten. Change. (Typ.) over Freq. Range		VSWR (Max.)	
		DC-1000	1000-1500	DC-1000 MHz	1000-1500 MHz
DC-1500 MHz	±0.3	0.6	0.8	1.3	1.5

*DC-1000 MHz (all 75 ohm or 30 dB models) DC-500 MHz (all 40 dB models)

Model Availability

SAT (SMA) CAT (BNC) NAT (N)

Model no. = a series suffix and dash number of attenuation.

Example: CAT-3 is CAT series, 3 dB attenuation.

Precision 50 ohm terminations only \$7.95 (1-24)
DC to 2 GHz, 0.25W power rating, VSWR less than 1.1
BNC (model BTRM-50), TNC (consult factory)
SMA (model STRM-50), N (model NTRM-50)

finding new ways ...
setting higher standards

Mini-Circuits

A Division of Scientific Components Corporation

P.O. Box 350166, Brooklyn, New York 11235-0003 (718) 934-4500

Fax (718) 332-4661 Domestic and International Telexes: 6852844 or 620156

C 92 REV. D

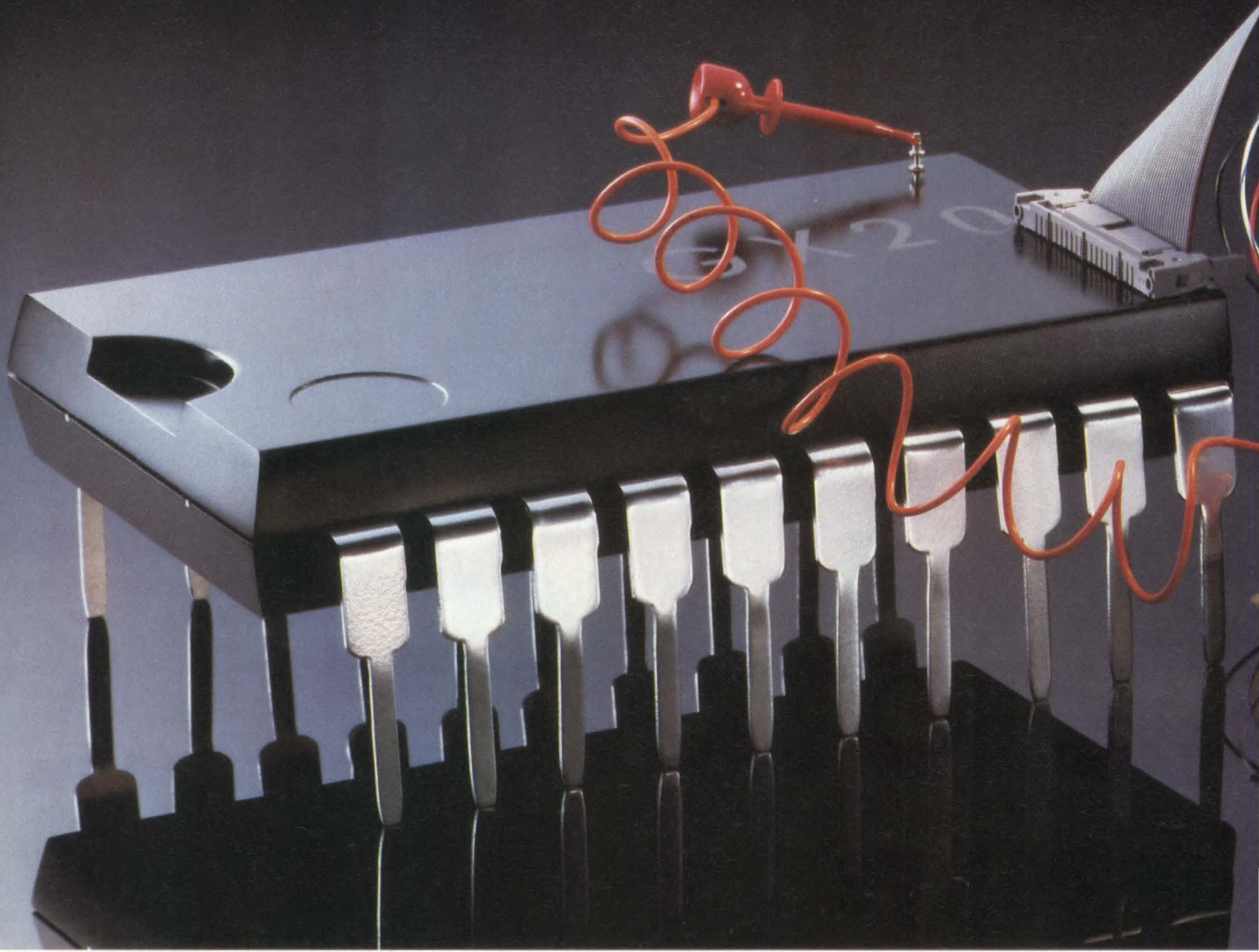

You wouldn't do this with your Analog VLSI devices.

You'll have to if you go to most ATE companies for a solution to today's sophisticated "system silicon" testing problems. Because all you'll get is a make-shift tester. And that means resigning yourself to man-months of custom hardware work integrating analog and digital instrumentation. And putting up with the long hours of low-level software development that go with custom solutions. Worse, you can expect these delays to cut your chances of getting your product to market on time.

Teradyne now has a simple answer to this complex testing problem. The A500 Analog VLSI Test System. It's the first of a new generation of systems specifically for AVLSI "system silicon" devices. A test system that can help you cut critical product development time by months or even years.

One Test System, Once and for All

With AVLSI devices you won't get fast design feedback, unless you test individual components—the

"building blocks" of system silicon. And you won't comply with customer and industry requirements if you don't do complete "system" functional testing. With conventional test systems it means two of everything. Two testers, two test programs, two insertions, two data bases. And more than twice the time to get to market.

The A500 allows you to do it all with one system. So there's only one system to program. One insertion to make for both component and functional testing. And only one data base to work with. Which means significantly less time to market.

Vector Bus II™: the Great Integrator

The heart of the A500 is Teradyne's unique Vector Bus II architecture. It integrates analog and digital VLSI test capability at the system level. Which means you won't have to build special applications hardware for every new device you design. Vector Bus II eliminates that costly custom-work bottleneck

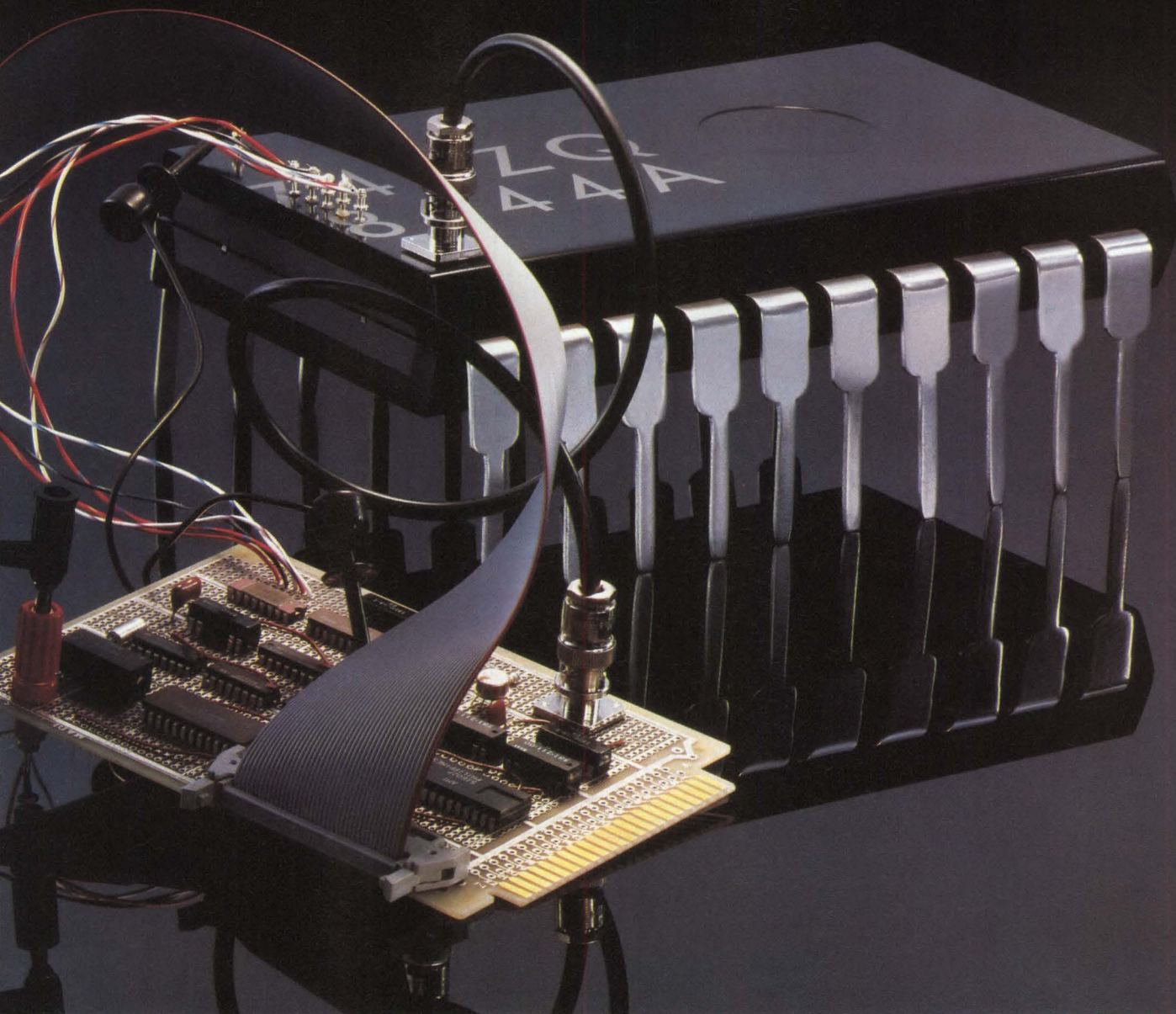

Why accept it in an Analog VLSI Test System?

with such features as TimeMaster™ Synchronization, Mixed-Signal Event Control, and MultiSource Data Mixing.

A Picture's Worth a Thousand Keystrokes

The A500 also revolutionizes program development. Our IMAGE™ (Interactive Menu-Assisted Graphics Environment) software gives you graphics programming as powerful as device designers' CAD/CAE tools. Using a mouse to control multiple windows, pop-up menus and software "power tools," you move ideas rapidly from mind to screen. And much faster to market.

Teradyne's new A500 is the only test system with the features you need to win the race for Analog VLSI market opportunities. To find out more, call Beth Sulak at (617) 482-2700, ext. 2746. Or call your nearest Teradyne sales office or write: Teradyne, Inc., 321 Harrison Avenue, Boston, MA 02118.



TERADYNE

We measure quality.

Digitally Programmable Delay Generator

AD9500

FEATURES

- 10ps Delay Resolution
- 2.5ns to +100µs Full Scale Range
- Differential Inputs
- Separate Trigger and Reset Inputs
- 310mW Power Dissipation

APPLICATIONS

- ATE
- Pulse Deskewing
- Phase Correction
- High Stability Timing Circuits
- Waveform Generators

PRODUCT DESCRIPTION

The AD9500 is a digitally programmable delay generator which includes virtually all the circuits needed for generating time delays for digital pulses. It provides 256 programmed delays in a user-specified full scale range which can be varied from more than 100µs to as little as 2.5ns. On the latter scale, it can resolve increments as small as 10 picoseconds.

Its output is delayed from the input by a time which is directly proportional to the 8-bit digital input code. Using groups of AD9500 devices is an excellent way to adjust signal timing skews and delays in various system applications.

Differential TRIGGER and RESET control inputs are designed primarily for ECL signal levels but will also function with analog and TTL levels. An on-board ECL reference midpoint allows both to be driven by either single-ended or differential ECL circuits.

Two temperature ranges and three packages are available. For industrial temperatures of -25°C to +85°C, order the AD9500BP or the AD9500BQ. The "P" suffix indicates a 28-pin PLCC; the "Q" designates a 24-pin ceramic "skinny" DIP with 0.3" package width. For extended temperatures of -55°C to +125°C, order the AD9500TE (28-pin LCC) or AD9500TQ (24-pin "skinny" DIP).

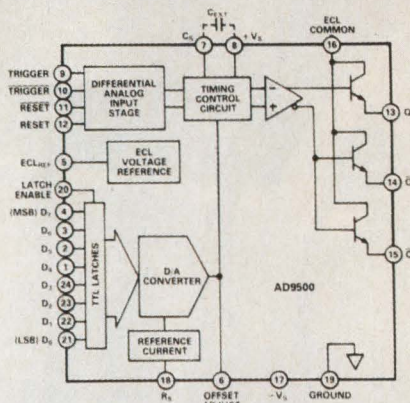

AD9500 Functional Block Diagram

PRODUCT HIGHLIGHTS

1. The AD9500 delay generator is an extremely versatile but remarkable, easy-to-use timing device. A few basic configurations can be expanded and extended into multiple applications.
2. Accurate control of pulse timing is critical for all digital electronic systems, and many systems require that delays be controlled digitally. Until now, the majority of systems using that technique used discrete LSI devices which may consume up to one watt or more of power. The AD9500 performs the same function with 300mW of power.
3. Like a high speed counter, the AD9500 can be programmed with a binary digital word. This makes the unit a variable delay device, in effect, a digital-to-time converter (DTC). The digital input word scales the time reference of the AD9500 in essentially the same way a digital word scales voltage or current references in a DAC.

TO SAVE HOURS IN DIGITAL TIMING DESIGN, SPEND A FEW MINUTES ON THIS PAGE.



If you can't afford to spend hours designing and testing your own time delay circuits, then take a few minutes to learn about our new AD9500 monolithic time delay generator. It combines all the

functions you need to generate time delays for digital pulses on a single chip, so all you have to do is specify and order.

This unique, one-part solution also helps conserve board space and power, since the AD9500 is available in skinny 24-pin DIP or 28-pin LCC or PLCC packages, and dissipates only 310mW.

But its small size and low power consumption don't mean low performance. The AD9500 allows you to use an 8-bit TTL control word to select any one of 256 delay increments in a full-scale range of 100µs to 2.5ns. At the low end, you can resolve delays to 10ps.

And the AD9500 comes in the standard industrial temperature range of -25°C to +85°C, or an extended range of -55°C to +125°C.

In addition, the AD9500 is ECL compatible and usable with analog as well as TTL input levels. These features make it ideal for adjusting cable delays in multichannel ATE systems, or phase correction and timing generation in radar/ECM.

The AD9500 is not only quick to help you with your designs, it's quick to save you money, too. Prices start at \$16.00 each (in 100s).

With the AD9500, you won't have to waste another minute on time delay generation. So don't delay - call your nearest Analog Devices sales office, or our applications engineers at (919) 668-9511 soon.



Analog Devices, Inc., One Technology Way, P. O. Box 9106, Norwood, MA 02062-9106; Headquarters: (617) 329-4700; California: (714) 641-9391, (619) 268-4621, (408) 559-2037; Colorado: (719) 590-9952; Maryland: (301) 992-1994; Ohio: (614) 764-8795; Pennsylvania: (215) 643-7790; Texas: (214) 231-5094; Washington: (206) 251-9550; Austria: (222) 885504; Belgium: (3) 237 1672; Denmark: (2) 845800; France: (1) 4687-34-11; Holland: (1620) 81500; Israel: (052) 911415; Italy: (2) 6883831, (2) 6883832, (2) 6883833; Japan: (3) 263-6826; Sweden: (8) 282740; Switzerland: (22) 31 57 60; United Kingdom: (932) 232222; West Germany: (89) 570050

SIGNALS & NOISE

EE seeks source of basic, general-purpose algorithms

The company I work for designs medical test equipment, and most of our work involves 8-bit microprocessors in embedded-control applications. We use IBM PCs and compatibles as development tools, and there is plenty of software for that environment. However, there is no source that I can find for writing the fundamental algorithms that we take for granted in a high-level language. What I'm very anxious to find are sources for algorithms in general terms that can solve the problems we often encounter.

For instance, floating-point routines, sine, cosine, tangent, square root, graphics, and ASCII-to-binary routines are becoming much more important to our needs. Where can the fundamental algorithms be found to implement these functions?

The ideal solution for me would be

a reference book (or books) that described at a flowchart level how to code these algorithms independently of a specific processor. This method allows the designer to pick the best hardware solution without depending on the availability of some special-purpose software that is written for only one μ P.

In the accompanying table, I've listed some of the particular needs that I've run across; it's a wish list of mysteries I'd love to see revealed.

If you could suggest some places

to look or publications that answer some of these questions, I'd appreciate it very much. I think this need is shared by a great many engineers. Perhaps someday your magazine could publish the solutions to these algorithms in generic format.

Alan Clark
Dynatech Nevada
Carson City, NV

(*Ed Note: We'd like to enlist the readers' help on this one. If you know of any sources for the algo-*

FUNCTION	DESCRIPTION
FLOATING POINT	ADD, SUBTRACT, MULTIPLY, DIVIDE
TRIGONOMETRY	SINE, COSINE, TANGENT
SQUARE ROOT	INTEGER AND FLOATING-POINT SOLUTIONS
INTEGER TO FLOATING	CONVERSION
FLOATING TO INTEGER	CONVERSION
GRAPHICS	HOW TO MODEL A BIT-MAPPED PLANE; ROUTINES FOR DRAWING A LINE BETWEEN TWO POINTS; CIRCLES AND OTHER SHAPES
ASCII TO INTEGER	CONVERT ASCII STRING TO SIGNED/UNSIGNED INTEGER
INTEGER TO ASCII	CONVERT INTEGER TO SIGNED/UNSIGNED ASCII STRING

HIGH FREQUENCY low cost

The IH-150 is a small, lightweight, accurate non-contact current sensor for measurements up to 150 amps dc or ac peak, from dc to 200 kHz.

These Hall-effect units provide complete isolation, and do not impose a serious load on the measured circuit.

Request complete technical data today.

CURRENT SENSOR

Reads dc to 200 kHz

Features:

- High Frequency
- Reads dc to 200 kHz
- Low Cost
- Mounts on PC Board or Bulkhead
- Made in the U.S.A.



Model IH-150
Non-contact Current Sensor

F.W. BELL

6120 Hanging Moss Rd. Orlando FL 32807
Phone: 407-878-6900 TWX: 810-853-3115
FAX: 407-677-5765

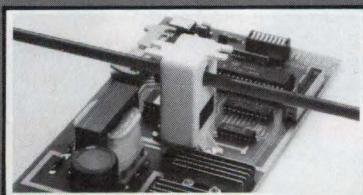

Board-mountable



Bulkhead-mountable

SIGNALS & NOISE

rhythms Alan is seeking, please send the information to the Signals & Noise Editor, EDN, 275 Washington St, Newton, MA 02158. We'll publish the information in this column in a future issue.)

Fault-critical applications need bugless processors

Steven H Leibson's article "Fault-tolerant design spans terrestrial and space applications" (EDN, April 28, 1988, pg 180)—while naturally, in the space available, is able to offer only superficial treatment of this important subject—is particularly timely with regard to Intel's announcement of its 80376 microprocessor for embedded applications.

Embedded processors, especially high-end 32-bit machines, are primarily intended for fault-critical applications such as those outlined in Steve's article. To use a processor in

a fault-critical application, one must have a high level of confidence in that processor's integrity—its freedom from undocumented faults that can lead to abnormal behavior. The 80386, upon which the 80376 is based, however, is becoming notorious for its number of errors, and Intel's *Stepping Information* (essentially a bug list showing possible ways to work around those bugs) is now at Revision D, and possibly even at Revision E. Is this an architecture one can have confidence in for a critical application?

That question leads me to a crucial point that Steve doesn't mention in his article: the problems of common-mode faults and the question of software in redundant systems.

The inexperienced may be tempted to think that redundancy is a potential panacea, but that's not so. Suppose that you construct a dual-redundant system, using the same processor and the same soft-

ware in each channel. If that processor contains a fault that causes the system to crash for some combination of data and instructions, both channels will fail simultaneously.

What is needed is a processor that has been proven to contain no bugs, and that behaves in a predictable manner for such cases as illegal op codes. Such a processor would not, of course, protect against erroneous (but legal) software operations, but it would remove at least one level of uncertainty from the design of fault-critical systems. Such a processor is already commercially available: It has a RISC architecture, 32-bit data, predictable behavior, and an architecture that has been mathematically verified to be correct. I refer, of course, to the MAS-1908 Viper, which is available from Marconi and supported by Assurance Systems. Unfortunately, in the US this device seems to suffer from the NIH ("not invented here") syn-

You Don't Need a Thousand Words When You Have a Picture Like This!

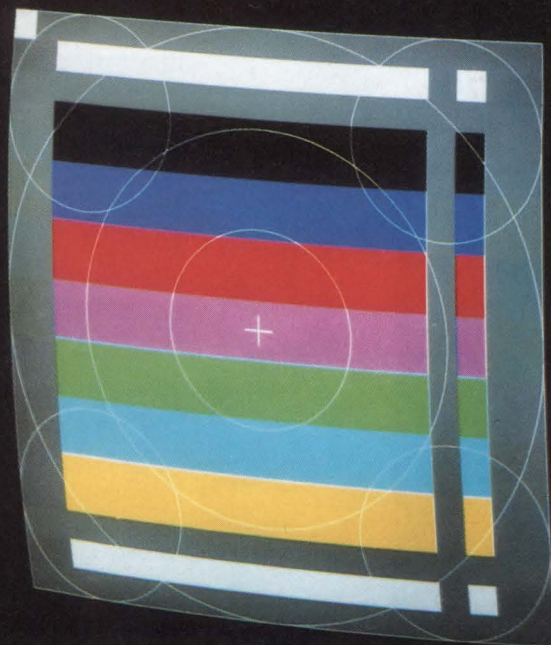

Unretouched photograph

*3.5 NS max. rise & fall time measured at CRT cathode.

The image quality demonstrated here is required by your customers... and will be appreciated! They expect THE BEST from original equipment manufacturers. You can provide it! While other video monitor vendors claim, "about 100 + MHz" video bandwidth,* Video Monitors, Inc. provides it! While other vendors claim, "full gray-scale color capability," VMI delivers it!

And if your customers or you need semi-custom or custom designs, VMI can provide this service. These are just a few of the reasons why Video Monitors, Inc. should be your supplier of very high resolution monitors.

Video Monitors Inc

3935 North White Avenue
Eau Claire, Wisconsin 54703
(715) 834-7785

A Subsidiary of DOTRONIX, INC.



Large Image Area



Ergonomic Design



State-of-the-Art Technology



A COMPLETE LIST OF SWITCHING POWER SUPPLY COMPANIES LARGER THAN ASTEC.

We've sold over 14 million switching power supplies in the past 10 years. More than any company. Anywhere. Not to mention largest market share. So says a recent industry study.*

Yet some people still draw a blank when they hear the name Astec.

Until now.

Your Standards Will Never be the Same.

The long list of Astec standard power supplies comes from proven OEM designs that have put us in our place atop the market.

Ranging from 30 to 1500 watts, our standards give you power to be your best. Without the costs and delays of designing your own.

And with our large local stock and quick distribution, most models are only hours away—thanks to our manufacturing capabilities that can turn out 4 million power supplies a year. Each undergoing tough computer testing and 100% burn-in to ensure over 200,000 hour MTBF.

Get a Taste of Foreign Customs.

When you need switching power supplies, Astec's overseas operation keeps costs down and quality up.

So all you supply is the need. And we'll supply the power. Exactly what you want.

Which won't be a problem, since our U.S. headquarters provides sales, engineering and service

around the nation.

To learn more about The Real Power or to locate the distributor nearest you, call Astec now: 800-7AS-TEC7, ext. 11. Or write: Astec USA, 2880 San Tomas Expressway, Santa Clara, CA 95051; (408) 748-1200.

We look good on paper. And better in your designs.

*Study done by Venture Development Corporation.



ASTEC
The Real Power

Now in
AMORPHOUS
Materials!

MAG ALWAYS



For tighter cross-regulation and higher efficiency in your switching power supplies.

Coilcraft's new mag amp toroids are the low-cost way to precisely regulate multiple output switched mode power supplies.

Compared to conventional linear or switching regulators, mag amp control increases efficiency, simplifies circuit design, lowers EMI, and improves reliability—especially at higher output levels.

And only Coilcraft can give you mag amps off the shelf at truly affordable prices.

Start with our handy **Mag Amp Experimenter's Kit**. It contains 6 styles of 1 and 5 amp coils (2 each) with volt-time products from 42 to 372 V- μ sec. To order Kit P206 (\$100) or for more information, call 312/639-6400.

Coilcraft

Dept. D, 1102 Silver Lake Rd.,
Cary, IL 60013 312/639-6400

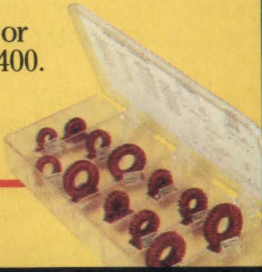

SIGNALS & NOISE

drome, so I and others will have to continue to ensure our safe descent into Logan Airport at night, in a thunderstorm, by the unproven (but not disproven) power of prayer.

Cris Whetton
President
Assurance Systems
Levittown, PA

Resistor would solve discharge-current problem

The Schmitt-trigger switch-debounce circuit appearing in the Design Idea "Switch debouncer uses few parts" (EDN, February 18, 1988, pg 244) will ultimately be unreliable, because excessive discharge current from the 4.7- μ F capacitor will damage the switch contacts (S1). This problem would be even more troublesome should the designer choose a switch designed for low-current switching (an appropriate choice for the type of circuit shown). A 220 Ω resistor in series with the switch would solve the problem and leave the circuit's performance essentially unaffected.

Rod Deakin
Director of Engineering Services
Arix Corp
San Jose, CA

(Ed Note: In fact, the circuit contains a number of problems. The author is submitting a corrected version of the Design Idea; it'll appear in a future issue of EDN.)

Omission

Part 5 of the Decade 90 Series (EDN, April 28, 1988, pg 180) neglected to mention the location of Fail-Safe Technology Corp, a consulting firm specializing in reliable-system design. The company is based in Los Angeles, CA.

WRITE IN

Send your letters to the Signals and Noise Editor, 275 Washington St, Newton, MA 02158. We welcome all comments, pro or con. All letters must be signed, but we will withhold your name upon request. We reserve the right to edit letters for space and clarity.

Programmable IC Filters Easy To Design With Improved Performance

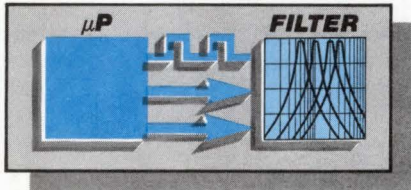

Filters are basic building blocks required in many systems applications. Most are built using discrete op amps, resistors, capacitors and inductors. This approach works for precision applications, but requires manual tuning of the elements. Once designed, these filters cannot be changed easily.

An alternate approach has been available for some time where the analog signal is sampled. This makes it tuneable with a clock. The circuit can be efficiently integrated on-chip using switched capacitor filter technology. This approach has been successful when used for application specific filters, however, for general-purpose filter applications it has its shortcomings: (1) the devices are difficult to use and require lots of external support circuitry; (2) very little software exists to help with the design process; (3) the devices typically exhibit excessive noise characteristics and change in value of programmed center frequency or selectivity (Q); (4) the devices only handle up to 20kHz center frequency. Users have had to be very knowledgeable about sampled filters to successfully build one.

A new family of general purpose dual 2nd order programmable filters from Maxim, the MAX260-268, provide some solutions that can be used for precision applications over a wide frequency range.

Microprocessor or Pin-Programmable

Under microprocessor control the MAX260/261/262 filters can be programmed for center frequency (f_0 - 6-bits) and selectivity (Q - 7-bits). Filter characteristics can be reprogrammed in milliseconds. If μP control is not desired, pin programmed versions of

the MAX263/264/265/266 provide hard-wired control. The MAX265 and 266 resistor programmed filters provide infinite Q and center frequency resolution for precisely tuned notches and applications which require fine Q control. The MAX267/268 dedicated bandpass filters round out the family.

In addition to the MAX260 programmable filters, Maxim offers the DC-accurate, "zero offset" MAX280 filter in an 8-pin package. And, for continuous non-switched filtering applications, including anti-aliasing, the MAX270 family of digitally programmed RC active filters will be introduced later in 1988.

Programming the Filter from a PC

Complex nth order filters can be designed effortlessly in minutes with a MAX260-268 and Maxim's powerful software. This software reduces hours of searching through filter textbooks and performing hand calculations to a few simple keystrokes. It is PC-based, menu-driven and easy to use. A designer need only specify the basic parameters: type of filter (highpass, lowpass, bandpass, notch or allpass), and the frequency response. The 6-color graphics routine then plots the simulated frequency response of the composite complex filter, so it can be examined on the computer screen to optimize its performance for desired results before you build it. For development work, the filters can even be programmed by connecting them to a PC's printer port without requiring μP programming or adjustments.

Improved Performance

Center frequencies of the MAX260 family range from .01Hz to 140kHz. This extends bandwidth up to six times higher than previous switched capacitor filters. 100 μV Wideband RMS noise represents less than 1/2 LSB in a precision 12-bit system. The MAX260-268 4th order and MAX280 5th order filters are three to four times quieter than

(Please see Programmable Filters on back)

Replace Two DG211's With The MAX333

A quad Single Pole Double Throw (4 x SPDT) analog switch from Maxim can now replace two DG303s, two IH5043s, or a DG211 plus DG212—at a lower price per channel than any of the alternatives.

The MAX333 is specifically designed for large volume applications such as disk drives, environmental controls and telecom.

At \$2.37 (1000-up), the cost per channel for the MAX333CPP-2 is less than \$0.60!

Four Switches in One

A single pole double throw (SPDT) switch is really two switches that are operated by a single command. When one of the switches is turned on (closed), the other switch is simultaneously turned off (opened). An SPDT analog switch is therefore ideal for switching between two input signals.

The MAX333 quad SPDT switch has four distinct SPDT switches on a single chip. Previously, the best a designer could get was two SPDT switches in a package.

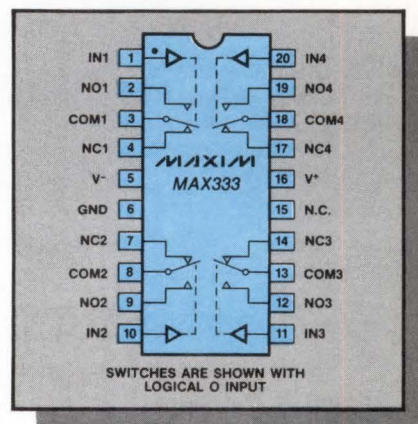

Guaranteed +12V Operation

In addition to dual supply operation guaranteed over a $\pm 5V$ to $\pm 18V$, the MAX333 can operate with just one supply where ground serves as the negative supply. Single supply operation is guaranteed for supplies ranging from +10V to +30V. Electrical specs for

(Please see Replace Two DG211's on back)

Maxim's Family of Filter Products

Part No.	Frequency Range	Prog. Interface	Price*
Dual 2nd Order—Universal Filters			
MAX260	0.01Hz to 7.5kHz	Microprocessor	\$6.50
MAX261	0.40Hz to 57.0kHz	Microprocessor	6.50
MAX262	1.0Hz to 140.0kHz	Microprocessor	7.50
MAX263	0.4Hz to 57.0kHz	Pin Strap	6.50
MAX264	1.0Hz to 140.0kHz	Pin Strap	7.50
MAX265	0.4Hz to 57.0kHz	Resistor and Pin Strap	6.50
MAX266	1.0Hz to 140.0kHz	Resistor and Pin Strap	7.50
Dual 2nd Order—Bandpass Filters			
MAX267	0.4Hz to 57.0kHz	Pin Strap	6.50
MAX268	1.0Hz to 140.0kHz	Pin Strap	7.00
Dual 2nd Order—Lowpass RC Filter			
MAX270	1.0Hz to 25.0kHz	Pin Strap or Microprocessor	5.00
5th Order Lowpass Filter—Zero DC Offset			
MAX280	0.1Hz to 20.0kHz		3.55
Universal 2nd Order Filter			
MF10	0.1Hz to 30.0kHz	Resistor	1.70

* 1000-up.

filters like the MF-10. Dynamic Range is in excess of 88dB!

1% clock-to- f_0 ratio accuracy and only 5ppm/°C variance in center frequency and gain are guaranteed over the full military temperature range.

No External Components—Minimum Size

The MAX260 filters eliminate up to 8 resistors needed to program previous filters. All filters are available in DIPs and 0.3" wide SOIC surface mount packages at no extra cost.

Ease of Design

A sample bandpass filter with the following desired parameters:

Center frequency (f_0)	= 15.6kHz
Pass bandwidth	= 15.6kHz
Stop bandwidth	= 46.8kHz
Max. passband ripple	= 1.0dB
Min. stopband attenuation	= 20dB

Using the filter software, the order (number of poles), f_0 , Q and number of sections is determined. The software generates the digital coefficients required by the filter, 'N.' The values of 'N' are listed in Figure 1, as well as the chosen clocks and mode selection.

In this example, two 2nd order filter sections are required. This can be implemented using one MAX262.

Both halves of the filter operate in Mode 1 (Fig. 2) and use the same clock source, which is switched from 1MHz to 2MHz and 3MHz, resulting in center frequencies of 15.6kHz, 31.3kHz and 47.0kHz, respectively (Fig. 3).

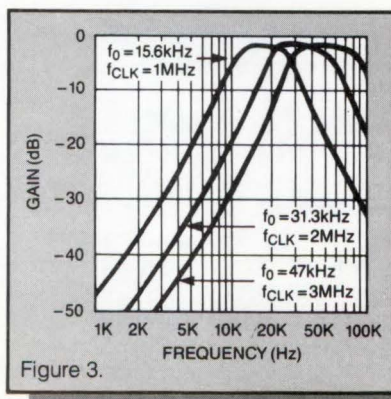
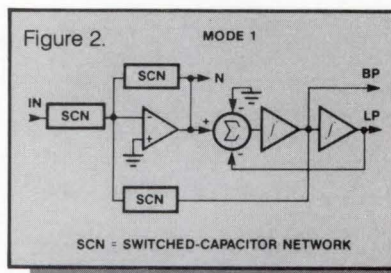
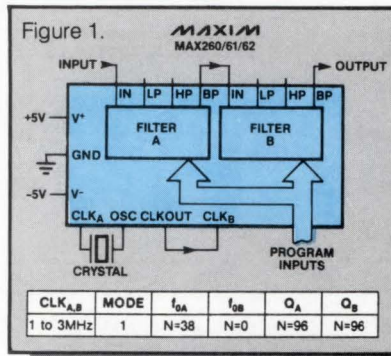

12V operation are shown on the data sheet as well as the specs for typical analog supplies of $\pm 15V$. The MAX333 does not require a separate +5V logic supply for either single or dual supplies and is completely TTL/CMOS logic compatible.

Only 2 mW Power Dissipation

The MAX333 requires only 130 μA positive supply current and 10 μA negative supply current. Its analog signal range includes both the positive and negative supplies. ON resistance is 140 ohms and ON leakage only 0.2nA. OFF leakage is 0.02nA with a turn off time of just 50ns.

The MAX333 makes a useful flying capacitor multiplexer that multiplexes two channels differentially, removing any common mode signal present. Line rejection in industrial applications benefits from such an arrangement because the circuit can reject line interference and present the signal conditioning amplifier with an improved signal to noise ratio.

In telecommunications, the switching between different banks of channels is more cost effective with a MAX333. Not only is the cost per channel lower, but the device requires less board space than the alternatives—especially if the surface mount (SOIC) package is used.

In disk drive circuits the MAX333 enables multiplatter or disk read/write amplifier circuits to be switched into a common data separator/servo control circuit.

The MAX333 complements Maxim's broad line of proprietary analog switches and multiplexers. Maxim supplies both industry standard analog switches (DG200, DG300, IH5040, and IH5140 families) and 'improved' proprietary devices such as the low power, high speed MAX331/332, an upgrade of the popular DG201/202.

★ **FREE** ★

Filter Booklet

(CIRCLE 10)

Analog Switch Book

(CIRCLE 11)

Comprehensive descriptions and application information on Maxim's analog switch and filter devices.

For immediate applications assistance, call (408) 737-7600 or write Maxim Integrated Products, 120 San Gabriel Dr., Sunnyvale, California 94086.

we never stop asking

"What if..."



HP humbly introduces
the highest performance
multimeter in the world.

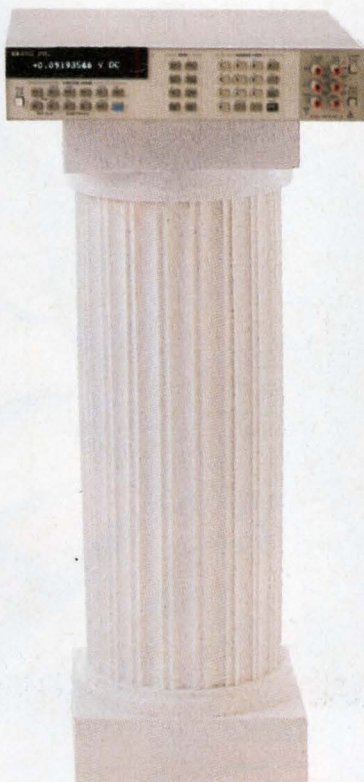

100,000 readings per second and Cal Lab accuracy.

Lots of people claim they have the best multimeter, but we're just going to let the specs do the talking. You'll see we've created a multimeter that doesn't present you with a bunch of trade-offs—you can have speed *and* accuracy.

- 100,000 readings per second at 4½ digit resolution. If you need 5½ digit resolution, you'll get it at 50,000 readings per second.
- Remarkable throughput rate—change a function and change a range, take

a measurement and output to the bus 200 to 300 times per second.

- Calibration standard accuracy and 8½ digits.
- Modest price: \$5,900.00*

To get complete technical specifications before you order an HP 3458A DMM for your system, call 1-800-752-0900, Dept. A215.

*U.S. List Price
©1988 Hewlett-Packard Co. 0901802/EDN

 **HEWLETT
PACKARD**

Save nanoseconds on logic.

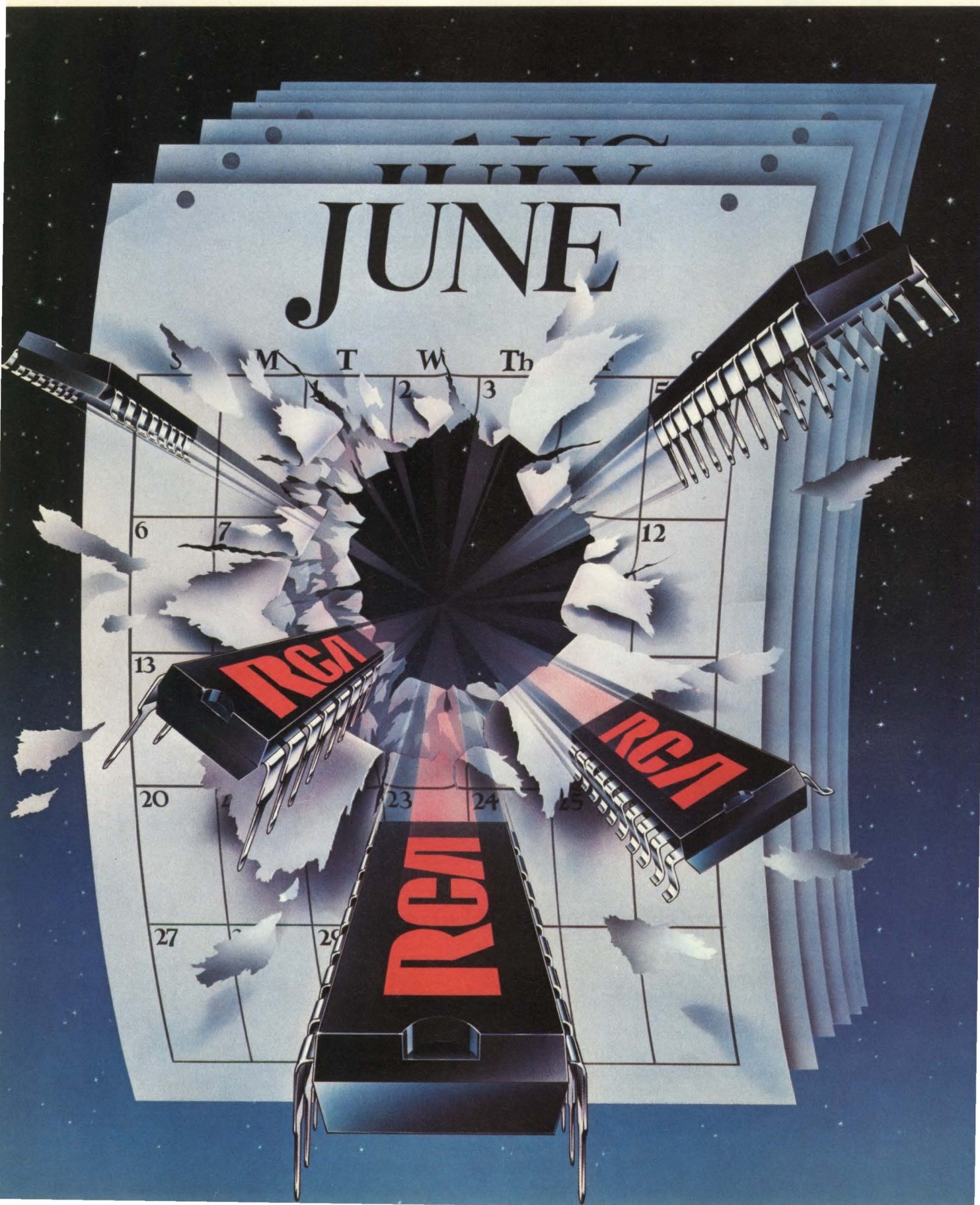

And months on design.

Logic Automation's model cell library now contains all RCA Advanced CMOS Logic circuits. Any other approach to logic design is a waste of time.

You know the advantages of CMOS, such as low power dissipation, high noise immunity and wide operating temperature range.

And you probably know that AC/ACT logic adds a new dimension to CMOS: advanced speed.

But you may not know that this faster logic can now be designed-in much faster.

System-level AC/ACT simulations.

RCA AC/ACT is the first advanced-speed CMOS logic to have all its circuits (more than 100 and growing rapidly) available as SmartModels[†] in Logic Automation's library.

These sophisticated behavioral-level models don't need the computing power of a mainframe. So you can use them on just about any popular engineering workstation.

But what really sets SmartModels apart is their technique of Knowledge-Based Design Verification. Each model has been worked on by engineers and systems designers who know the design problems you're most likely to encounter when using parts from the AC/ACT library.

If any of these errors does occur, it is immediately pinpointed. You get the exact time, location and nature of the problem.

All circuits are checked for timing (including setup, hold, frequency and pulse width), and usage (specific checks for each device).

The result is far less prototyping. Which means savings of months. And thousands of dollars.

A new world of design possibilities.

RCA AC/ACT gives you the speed of FAST.*

But power dissipation and idling power are small fractions of FAST ICs.

So, for example, you can design a computer that doesn't have a cooling system. Or a sealed system to prevent dust problems. Or dramatically reduce your system's size.

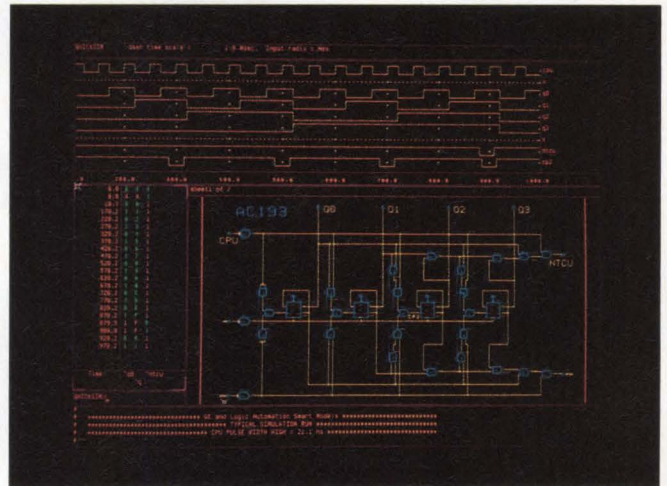

System-level simulations eliminate the need for prototypes, saving time and money.

In addition, AC/ACT gives you latch-up and ESD protection. All this at FAST prices.

And these circuits are available in Military/Aerospace versions for the most demanding applications.

Start saving time on both logic and design right now, by calling toll-free 800-443-7364, ext. 29.

Or contact your local GE Solid State sales office or distributor.

In Europe, call: Brussels, (02)246-21-11; Paris, (1) 39-46-57-99; London, (276) 68-59-11; Milano, (2) 82-291; Munich, (089) 63813-0; Stockholm (08) 793-9500.

[†]SmartModel is a registered trademark of Logic Automation, Incorporated.

*FAST is a trademark of National Semiconductor Corporation.

General Electric Company, U.S.A.

LOGIC
AUTOMATION



GE Solid State

OKI DSP CMOS



True 22-bit Floating Point – 100ns cycle

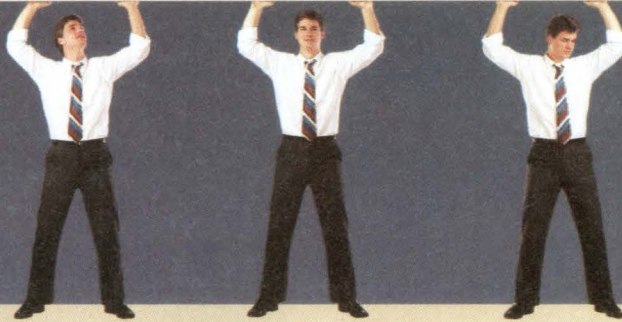

New OKI 699210 – Internal memory doubled

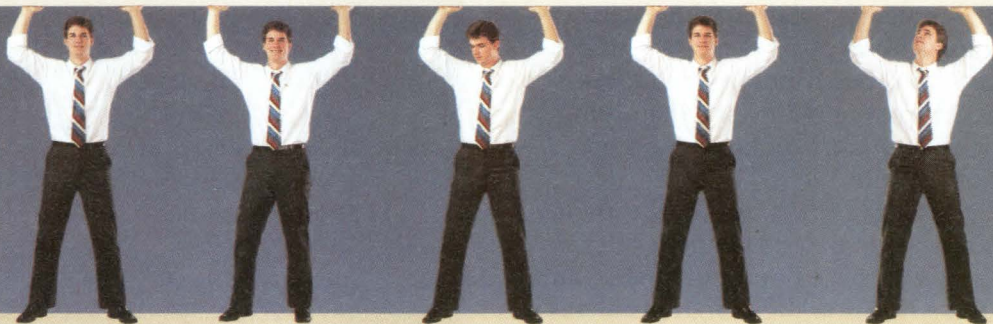

Solid PC-based Development Support – High-level assembler

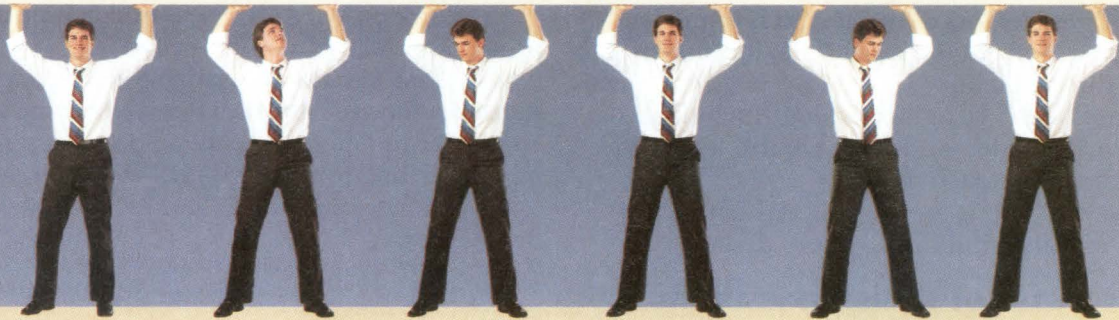

OKI System Technologies for Customer Solutions



The OKI DSP 22-bit Floating Point flexibility, on a single CMOS chip.

- + Expanded on-board RAM and ROM
- + Powerful instruction expansion
- + High-speed cycle times
- + Unique application ease.

OKI gives you a big lift in Digital Signal Processing. With the fastest-growing family of CMOS devices and high-level support tools on the market today. Only OKI now offers *true* floating point CMOS DSP solutions, because we target our system technologies to customer needs.

The OKI DSP chips.

Now joining our widely-applied 6992 DSP: the new *code-compatible* OKI 699210, setting new benchmarks in both price and performance. A 1.5 micron CMOS design, the new 210 significantly expands your DSP capabilities—at a significantly lower cost.

We built in twice as much internal memory: 512 × 22-bit words of data RAM; 2K × 32-bit words of instruction ROM. 210 instructions have been expanded to include a power-down mode, save and recover modes, as well as the ability to inhibit post-normalization. Plus programmable wait states for interfacing with slow memory.

Both single-chip DSPs, 6992 and 210, can be configured for floating point format, fixed data format or logical data format. Both offer 100ns instruction cycle times. And any code written for the 6992 can be run on the 210.

The OKI DSP support.

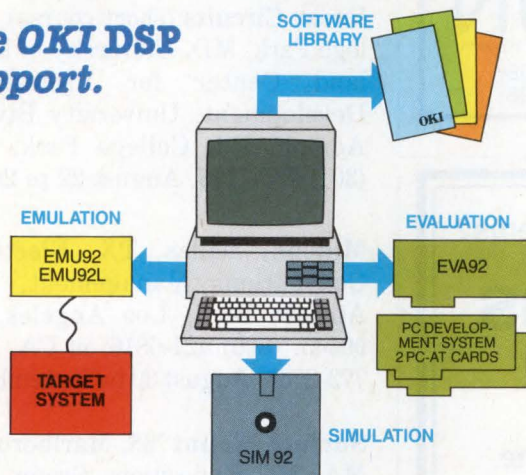

All our device-family innovations are enhanced by OKI's complete family of DSP support tools. These cover every development and programming function involved in any DSP design effort. Quickly, simply and cost-effectively.

Your total development process is PC-based, using OKI's own DSP hardware and software tools. Plus you can assemble in high-level mnemonics, with our Intermediate Language Assembler. Makes programming easier since the pipeline is invisible, while still producing very efficient code.

We've made debugging easier too. With SIM92/210 software for simulation, and the EVA92/210 board for evaluation. To handle emulation, we can supply an ICE for realtime development. Or use our special PC-AT cards. The first is a digital card for ICE-less emulation. The other provides 12-bit ADC-DAC conversion, with programmable sampling rates and anti-aliasing filter.

It's all here: high-level math processors plus a high-level development process. True DSP solutions, simplified by the industry's most committed system technologies.

OKI DSP — Set yourself up!



Please send complete DSP technical data package for:

- OKI 6992 — 22-bit Floating Point CMOS DSP.
- OKI 699210 — 22-bit Floating Point CMOS DSP.
- Call me. I have immediate requirements.

Tel: (____) _____

Name/Title _____

Company _____

EDN080488

Please clip coupon to business card or letterhead and return to:
DSP Customer Service, OKI Semiconductor,
650 N. Mary Avenue, Sunnyvale, CA 94086. (408) 720-1900.

OKI

SEMICONDUCTOR

CIRCLE NO 50

NEW!

ThermaPro-V Technology for the Major DC and Patriot DC fans.



Introducing Major DC and Patriot DC with optional ThermaPro-V Technology. High pressure capabilities for computer and telecommunications applications, combined with ThermaPro-V, make Major DC and Patriot DC a design engineer's answer to complex cooling problems.

Comair Rotron's Major DC and Patriot DC with patented feathered edge blades offer wide voltage input and extended performance ranges. Simplified circuits, increased options, quiet ball bearing operation and an all metal venturi are now available in a single fan for multiple use.

ThermaPro-V Technology, Voltage Regulated, Programmable, and Thermally Speed Controlled.

Comair Rotron. The First Name in Forced Convection Cooling Technology.

**Therma
Pro-V**
FORCED CONVECTION
COOLING TECHNOLOGY

For literature only call 800-367-2662. In NYS
and for product or technical assistance call our
application Engineering Dept. at (914) 246-3615.

COMAIR ROTRON

a KLI company

12 North Street Sawyer Industrial Park, Saugerties, N.Y. 12477-1096
Telephone: (914) 246-3615 TWX 910-333-7572 Telex: 551496

CIRCLE NO 18

Tight Schedule? Complex Project? Tough Problems?

Add MicroDimensions to Your Team

Let MicroDimensions assist you — with complete hardware and software development services.

- We can help you with part of a project you prefer not to handle — or all of the job from start to finish
- Hardware design facilities include a complete electronic design lab including CAD design tools & PC layout
- Software development capability in a wide range of languages, environments, including VAX/VMS, and the 68xxx family
- System integration services include system design, prototyping, assembly and testing
- Our specialties include VME, MAP, communications, and process control. We have extensive servo experience
- We are proud of our proven record of performance — on schedule, within budget
- A prestigious client list including many Fortune 100 companies

For a corporate brochure contact Bruce R. Knox, President



MicroDimensions, Inc.

7345 Production Drive
Mentor (Cleveland), Ohio 44060
Phone: (216) 974-8070 • FAX: (216) 974-1648

CIRCLE NO 19

CALENDAR

International Conference on Handheld Computing, Corvallis, OR. Eric Gakstatter, ICHC, 301 NE Byron Pl, Corvallis, OR 97330. (503) 752-5456. August 4 to 6.

CASE Benchmarks: A Product Comparison Seminar, Atlanta, GA. Digital Consulting Inc, 6 Windsor St, Andover, MA 01810. (617) 470-3870. August 10 to 12.

Microwave Circuit Design I: Linear Circuits (short course), College Park, MD. University of Maryland Center for Professional Development, University Blvd at Adelphi Rd, College Park, MD. (301) 985-7195. August 15 to 19.

Microwave Circuit Design II: Non-linear Circuits (short course), College Park, MD. University of Maryland Center for Professional Development, University Blvd at Adelphi Rd, College Park, MD. (301) 985-7195. August 22 to 26.

Midcon, Dallas, TX. Electronic Conventions Management, 8110 Airport Blvd, Los Angeles, CA 90045. (800) 421-6816; in CA, (213) 772-2965. August 30 to September 1.

Surface Mount '88, Marlborough, MA. MG Expositions Group, 1050 Commonwealth Ave, Boston, MA 02215. (800) 223-7126; in MA, (617) 232-3976. August 30 to September 1.

Modern Electronic Packaging (seminar), Santa Clara, CA. Technology Seminars, Box 487, Luther-ville, MD 21093. (301) 269-4102. September 7 to 9.

International Test Conference, Washington, DC. Doris Thomas, ITC, Box 264, Mount Freedom, NJ 07970. (201) 267-7120. September 12 to 14.

Worst-Case Circuit Analysis (seminar), Boston, MA. Design and Evaluation, 1000 White Horse Rd, Suite

AMPLIFIERS

**BREAKTHROUGHS IN POWER,
SPEED AND
VOLTAGE ...**

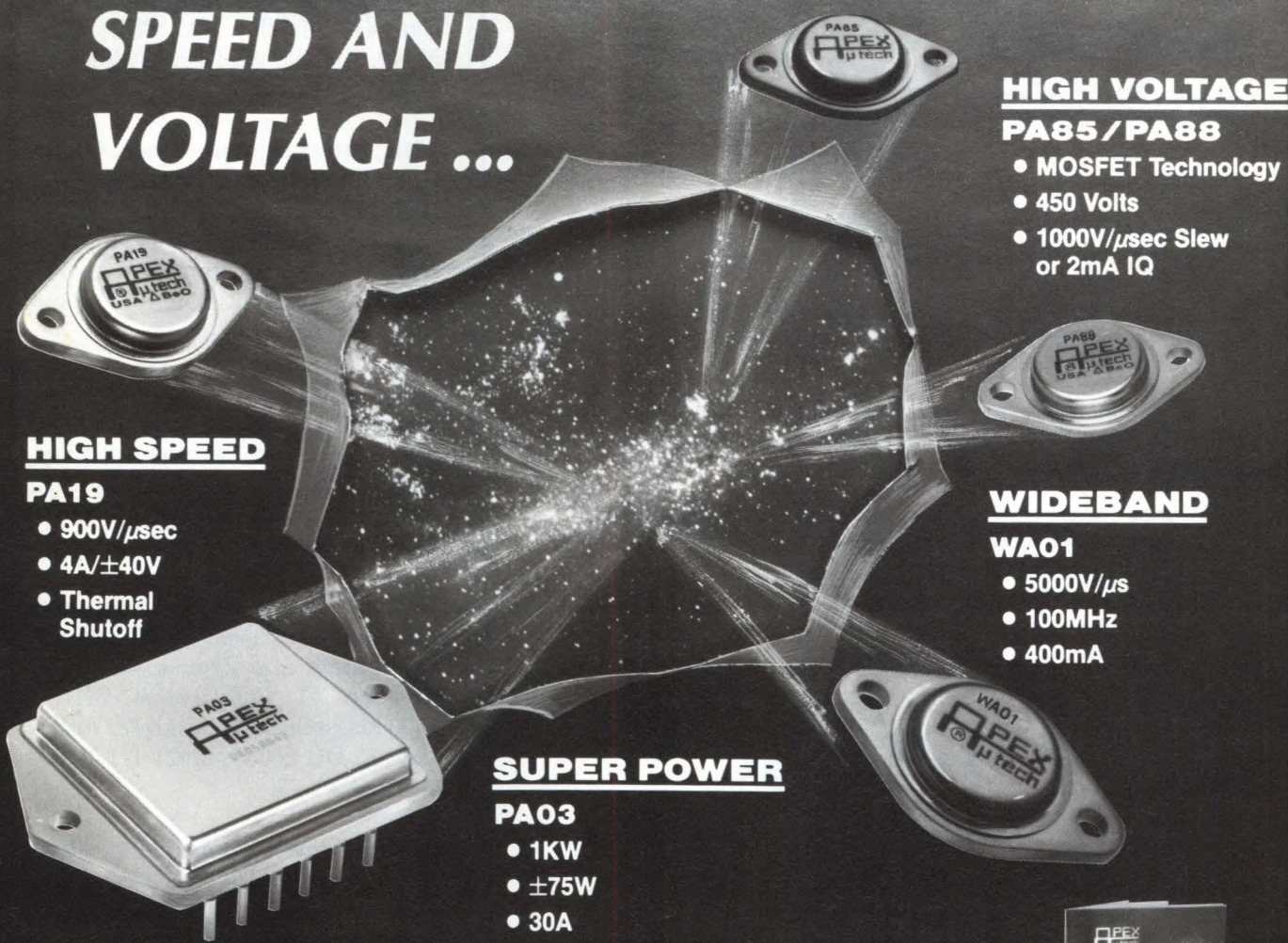

HIGH SPEED

PA19

- 900V/ μ sec
- 4A/ \pm 40V
- Thermal Shutoff

HIGH VOLTAGE PA85/PA88

- MOSFET Technology
- 450 Volts
- 1000V/ μ sec Slew or 2mA IQ

WIDEBAND

WA01

- 5000V/ μ s
- 100MHz
- 400mA

SUPER POWER

PA03

- 1KW
- \pm 75W
- 30A

**For more information, call our Application Hotline...
(800) 421-1865**

or ask for our **NEW**
AMPLIFIER HANDBOOK!
...176 pages of data and applications
information on 23 models.

Describes 65 choices
including military versions
and high-performance
gradeouts.



APEX[®]
 μ tech

DEDICATED TO EXCELLENCE

APEX MICROTECHNOLOGY CORP. • 5980 N. Shannon Rd. • Tucson, AZ 85741 USA • (602) 742-8600
BELGIQUE (02) 219.58.62 - CANADA (416) 821-7800 - DEUTSCHLAND (BRD) (06152) 61081 - FRANCE (1) 69.07.08.24
ISRAEL (03) 923 3257 - ITALIA (02) 6131341 - NEDERLANDEN 01620-81600 - NIPPON (03) 244-3511 - NORGE (2)500650
ÖSTERREICH (1) 505-15-22-0 - SCHWEIZ (042) 41 24 41 - SVERIGE (08) 795 9650 - TAIWAN (02) 5361157 - UK 08446 8781

CIRCLE NO 51

Low Current High Isolation Auto Insertion Opto-Isolators

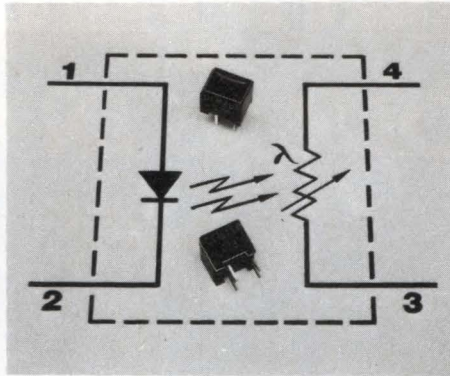

The new CLM400 series of opto-isolators with 2000 volt isolation and drive currents of 1ma. are packaged in a pin based lead design package for rapid auto insertion in PCB's. Low "ON" resistances of 250 ohms at 1ma. are available. Noiseless switching and automatic gain control for audio circuits are readily accomplished, at low cost and with high performance.

For the optimum solution to each of your individual "light" problems, call 914-664-6602 or FAX 914-664-6449 or write Clairex®, 560 South Third Avenue, Mount Vernon, New York 10550.

CLAIREX ELECTRONICS

A Division of Clairex Corporation

CIRCLE NO 20

UNIVERSAL PROM/PAL*/MICRO PROGRAMMER

U.S. prices From **\$995.00***

- EPROMS TO 1 MEG
- EPROM SIMULATION
- SET PROGRAMS
- 20-24 PIN PLD/EPLD
- BIPOLAR PROMs
- SINGLE CHIP MICROS
- RS-232/PC DRIVEN OR STAND-ALONE

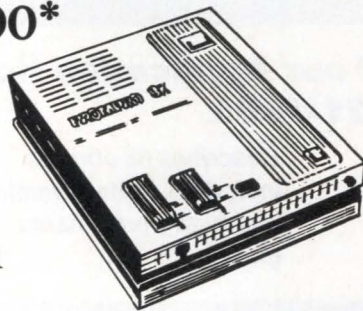

1-800-331-PROM

(305) 974-0967 Telex 383142 Fax (305) 974-8531

From a Name You Can Trust

LOGICAL DEVICES INC.

Represented In 18 Countries

1201 N.W. 65th Place, Fort Lauderdale, FL 33309

*Some devices require optional Adaptors - PAL is a Trademark of Monolithic Memories Inc.

CIRCLE NO 21

CALENDAR

304, Voorhees, NJ 08043. (609) 770-0800. September 12 to 14.

C Programming Workshop (short course), Seattle, WA. SSC, Box 55549, Seattle, WA 98155. (206) 527-3385. September 12 to 15.

12th International Fiber Optic Communications and Local Area Networks Exposition, Atlanta, GA. Information Gatekeepers, 214 Harvard Ave, Boston, MA 02134. (800) 323-1088; in MA, (617) 232-3111. September 12 to 16.

Connector and Interconnection Technology Symposium, Dallas, TX. Electronic Connector Study Group, 104 Wilmot Rd, Suite 201, Deerfield, IL 60015. (312) 940-8800. October 3 to 5.

IEEE International Conference on Computer Design: VLSI in Computers and Processors, Port Chester, NY. Gail Clanton, IEEE, 1730 Massachusetts Ave NW, Washington, DC 20036. (202) 371-1013. October 3 to 5.

Autotestcon, Minneapolis, MN. Steve Palmer, Unisys, 3333 Pilot Knob Rd, Eagan, MN 55121. (612) 456-2349. October 4 to 6.

Buscon/88 East, New York, NY. Conference Management Corp, 200 Connecticut Ave, Norwalk, CT 06856. (203) 852-0500. October 4 to 6.

Electronic Imaging Conference East, Boston, MA. MG Expositions Group, 1050 Commonwealth Ave, Boston, MA 02215. (800) 223-7126; in MA, (617) 232-3976. October 4 to 6.

Power Electronics East, New York, NY. Conference Management Corp, 200 Connecticut Ave, Norwalk, CT 06856. (203) 852-0500. October 4 to 6.

SIEMENS

Announcing a 27 Billion Dollar backer for your Siemens ASIC team.

Siemens, a proven winner in electronics with \$27 billion in sales, just entered the U.S. ASIC market. And our team is geared for the ASIC circuit.

With our first effort, we've combined ECL and CML technology in one gate array family. This means you can now design-in the ideal combination of super ECL speed with economical, high-density CML performance on one chip...everytime. You no longer must compromise the speed you need for the power you don't. In addition, speed/power programming, as well as I/Os designed for both ECL 10K/100K and TTL interfaces give you the flexibility you need.

And that's just the start. Coming down the home stretch are more Siemens entries...1.5/1.2 micron CMOS standard cells and 1.2/1.0 micron CMOS sea of gates arrays. Use our sea of gates CMOS family for quick turn logic and memory on one chip or design your high-performance, cell-based ASICs utilizing the common

ADVANCELL™ ASIC library and guarantee yourself compatible second sources.

The Siemens ASIC team's responsive service and technical innovation provides you with the winning edge.

For more information on how to put your design into high gear write to Siemens Components, Inc., ASIC Marketing, 2191 Laurelwood Road, Santa Clara, California 95054. Or call ASIC Marketing at 408/980-4568, and see for yourself how Siemens is making the difference on the ASIC circuit.

**Siemens...
your partner for the future.**

© 1988 Siemens Components, Inc.
ADVANCELL is a trademark of Siemens AG, or
licensed from Toshiba or General Electric Co., USA
in certain countries. CG/2000-460 WLM 795

CIRCLE NO 52



In the time it takes other graphics engines to draw a few lines...

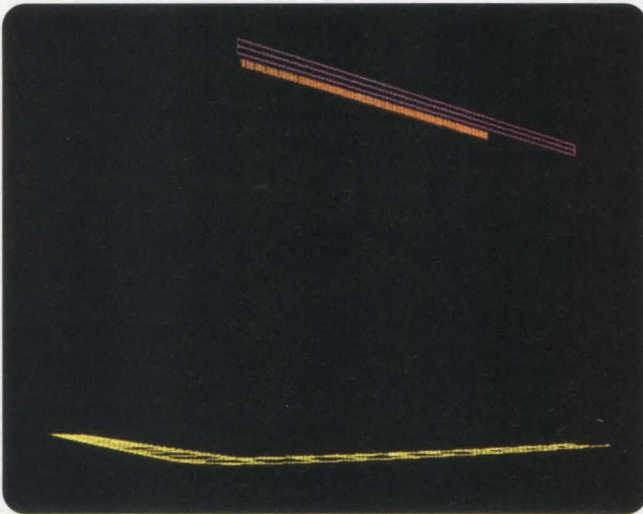

Texas Instruments TMS 34010 (2%)

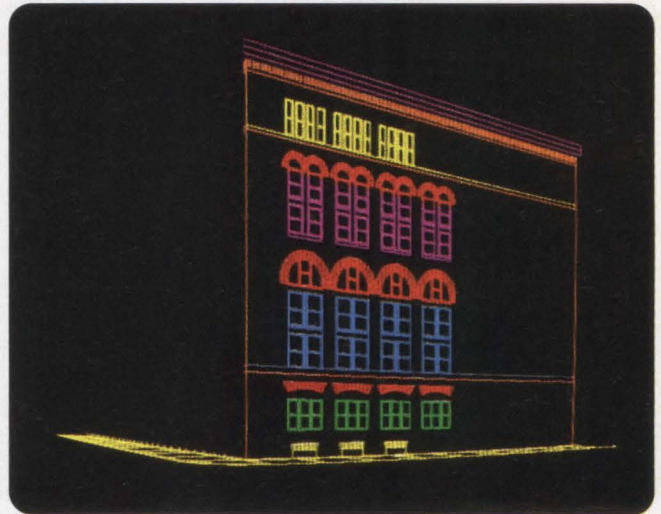

AMD Am95C60 (17%)

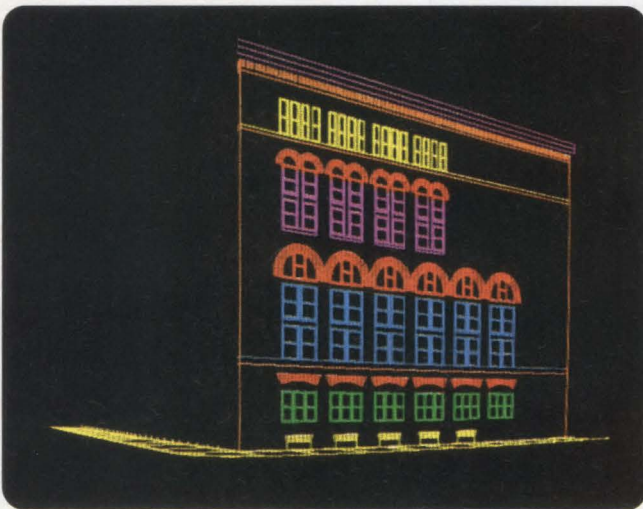

Hitachi HD63484 (20%)

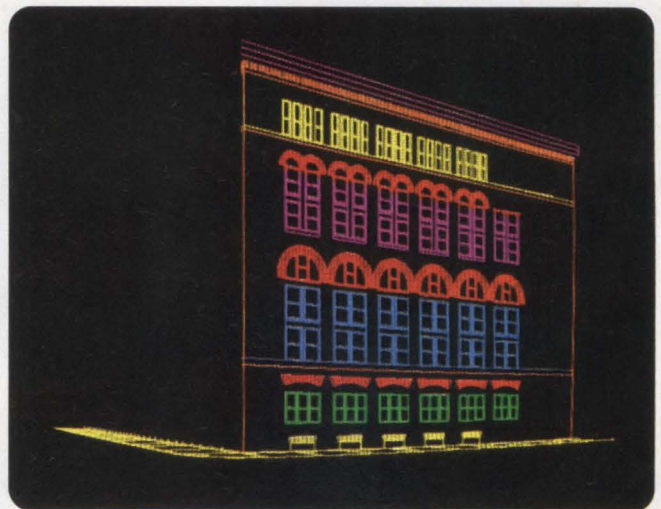

Intel 82786 (25%)

*GeoCad perspective drawing courtesy of Rudolph Horowitz and Associates, Architects.
Simulated performance based on maximum patterned line-drawing rates in an eight-bit color system with a resolution of 1024 by 768.
Of course, performance ultimately depends on system elements like memory speed.*

ours gives you the whole picture.

THE FIRST FULLY PROGRAMMABLE GRAPHICS PROCESSOR WITH ON-CHIP ACCELERATION

You can have the fastest calculations in the world but if your system's graphics are slow, your system is slow. National's latest addition to its Advanced Graphics Chip Set — the DP8500 Raster Graphics Processor (RGP) — is the fastest graphics engine on the market.

This 20-Mhz CMOS chip features a bus cycle time of 100 nanoseconds on back-to-back vector and block operations.

It gives you blazing speed in line drawing, BitBLT, fills, polygons, character drawing, and windowing — regardless of the number of bit planes. It also controls screen refresh.

COMPLETE FLEXIBILITY

The RGP gives you the programmability of a general-purpose processor, so you can optimize your system for specific applications. Or differentiate it from your competitors through proprietary algorithms.

The RGP, with our DP8511 BitBLT processing unit, is also the only

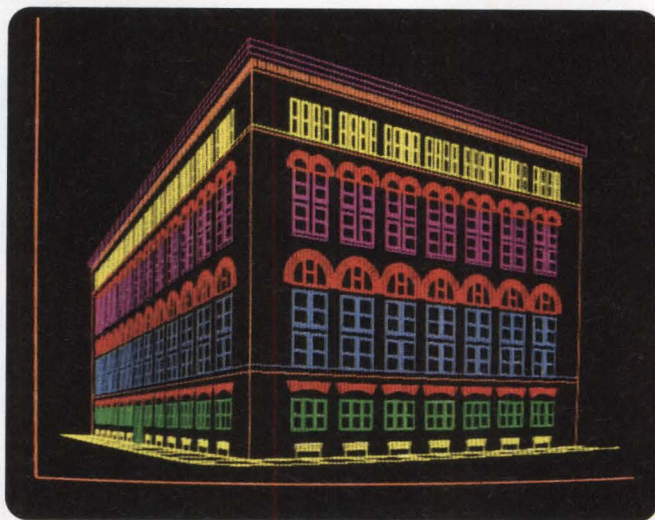

National DP8500 Raster Graphics Processor

graphics solution that effectively allows you to select either planar or pixel-oriented operation on-the-fly. So you no longer have to lock yourself into one architecture or the other.

The RGP handles the very highest-resolution CRTs and printers, including laser printers. And it supports any type of memory.

It also gives you the right "hooks" and the right architecture for moving into 3D and solids modeling applications.

A COMPLETE SET OF CHIPS

Our Advanced Graphics Chip Set also includes

- two BitBLT processing units
- four video clock generators
- four video shift registers
- three video RAM controllers
- a growing list of video DACs

They're all part of National's unique modular approach — the only approach that addresses the complete graphics pipeline. And the only one with the performance and flexibility you need to carry you into the 1990s.

COMPLETE SUPPORT

We offer a wide range of software tools — including assembler, debugger, librarian, linker, software

utilities, graphics kernel packages, and a C compiler package.

Nova Graphics International is providing full support for graphics software standards, including GKS and CGI.

Check it all out for yourself with the DP850EB demo/evaluation board for only \$1495. Buy the board and we'll include a coupon good for ten free RGPs on your first order of 100 or more.

To order today, call National Semiconductor at (408) 721-5404. Or for a copy of our system-level comparison brochure, circle the reader service number.

 **National Semiconductor**

Why high performance designers are so excited about the new PLD 7C330 State Machine:

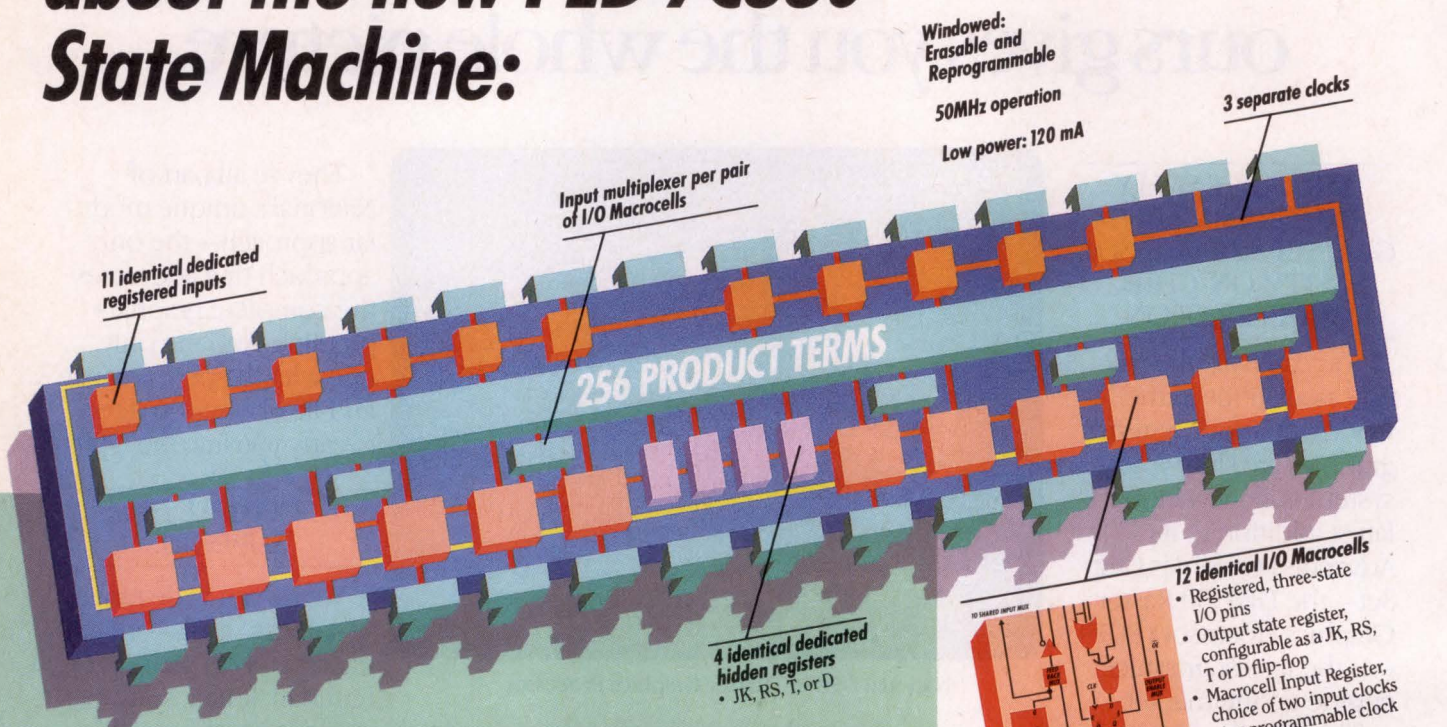

As state machines go, this one goes the fastest. With the highest functional density available.

A system that lets you design state machines that can execute control sequences at a full 50MHz without even breathing hard.

High performance designers are excited by the extensive features, led by the richness of 256 product terms.

By this part's ability to deliver twice the performance and density of previous generation PLDs, with about half the power.

By the ease of programming, using popular programming languages and machines.

And by the ability to design the highest performance state machines, with 1000 to 1500 gate functionality, using reprogrammable PLD technology.

See for yourself. Get our Preview Kit.

Our Preview Kit, with demo floppy and technical paper, even includes application ideas, like our step-by-step design example showing you how to create a 16 x 4 programmable multiplexer using a single CY7C330.

You'll also get the databook that has the information you need on this great part, and on ALL our high performance parts.

CMOS high speed SRAM.
CMOS high speed PROM.
CMOS high speed PLD.
CMOS high speed Logic.

PLD 7C330 Preview Kit and DataBook. Yours free, for a toll-free call.

DataBook Hotline:
1-800-952-6300

Ask for Dept. C43
(32) 2-672-2220 In Europe
(416) 475-3922 In Canada

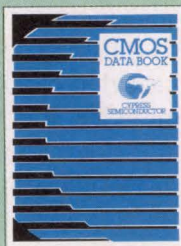

CYPRESS
SEMICONDUCTOR

EDITORIAL

Spend it here



A guest editorial in the June 21st *Wall Street Journal* describes the causes of today's memory-chip shortages and defends the 1986 semiconductor pact between Japan and the US. According to the author, the Japanese priced dynamic-RAM chips below cost in the early 1980s in order to drive US manufacturers out of the DRAM business. Thus, they aimed to secure the world's semiconductor markets for the Japanese manufacturers. It's true that dumping products into a market can force out domestic suppliers—as many US DRAM manufacturers found out. However, the semiconductor pact took an illogical and shortsighted approach that continues to hurt US semiconductor suppliers and consumers.

In essence, the pact forces Japanese suppliers to charge a "fair" price for their DRAM chips. However, by raising prices to artificially high levels, we give foreign manufacturers extra profit, and we fund their research. The pact gives US industries some time to regroup, but that time is hard to put a price on. As an alternative to the pact, the US could impose a tariff, but according to the *Journal's* contributor, a tariff would result in immediate shortages—although the author doesn't explain why. Also, multinational companies could circumvent any tariff by purchasing low-cost DRAMs in overseas markets where tariffs don't exist.

In most cases, tariffs are counterproductive—companies use them as a shield against foreign competitors. After all, if the government forces up the price for a commodity, there's no incentive for domestic companies to increase manufacturing productivity or take any other measures to compete against low-cost foreign imports. But a short-term tariff on imported semiconductors just might work. If semiconductor prices must go up, I'd rather have the extra money stay in the US than go to fund Japanese researchers' next DRAM breakthrough.

So, let's eliminate the "fair" prices and let the Japanese and others charge what the market will bear. Then let's have the US government impose a tariff on every foreign DRAM that enters the US, whether it's in a tube of chips or in a telephone manufactured in Hong Kong. We'll set the tariff at \$1 per chip.

The funds collected from the tariff will go to an industry-research group such as Sematech and to US university labs working on semiconductor research. However, a semiconductor-tariff law must have a few restrictions. First, no one will be permitted to license or transfer any of the tariff-funded research information or process technology to a foreign-owned or -dominated company. Second, the tariff will diminish to zero over the next two years, and it won't be reimposed. If we detect dumping again, however, a tariff will go into effect again. To get the ball rolling, I'll contribute \$1 for every foreign-made DRAM chip in my PC—even though I bought them before the dumping started. Just tell me where to send the check.

Jon Titus
Editor

No one can solve but we solve

Everyone thought gate arrays would be a great solution to their semi-custom design needs. Then they designed one and discovered that "semi-custom" translated into "expensive," "time consuming" and "risky."

PGAs let you spot system problems before they become a real headache. No more risking large sums of money and time

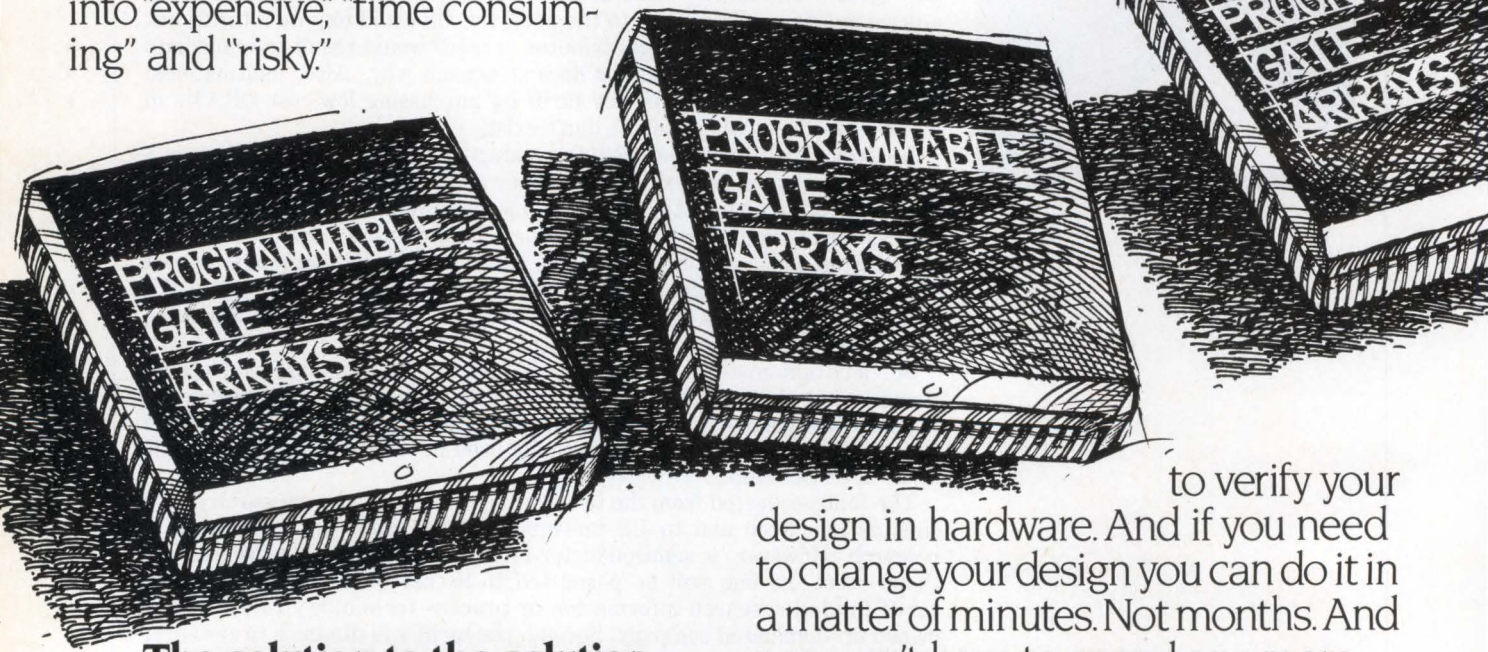

The solution to the solution.

Meet the Logic Cell™ Array—the first Programmable Gate Array. It's a high density CMOS chip of unmatched technology that's user programmable where it's easiest for you to program—in software.

Your development cycle is cut to a week or two instead of six months. So you can get your product to market that much sooner.

to verify your design in hardware. And if you need to change your design you can do it in a matter of minutes. Not months. And you won't have to spend any more money.

9000 ways to get ahead of schedule.

The Am2000 series has densities from 1000 to 2000 usable gates and the Am3000 series has densities from 2000 to 9000 usable gates. With those densities (we'll have even higher densities later), you need fewer parts to get the same functions as

ve the problem, d the solution.

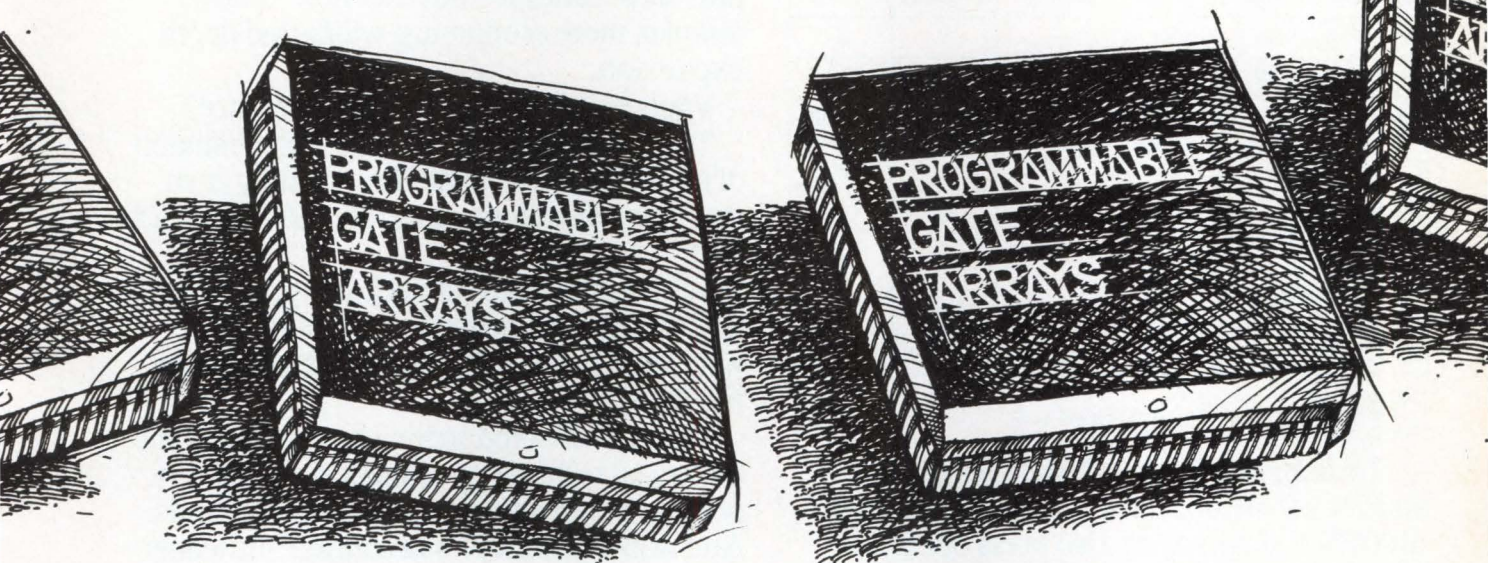

EPLDs or discrete logic.

There is no other PGA technology available today. And over 5000 designers are already using it.

Even getting started is easy.

Your investment is minimal. You don't have to finance months of NRE. You can get started for the price of a PC (which you probably already have) and some software.

PGAs are the epitome of the just-in-time product. They are the only gate arrays stocked in production quantities at your distributor. And they're programmable instantly. Which means you can go from design to production as fast as you need to.

Even overnight.

See for yourself.

Contact us for a free diskette that gives you a detailed product overview, an interactive session where you can plug in your own design criteria and find out how PGAs can help your design. Part of the PGA development software is included so you can get started saving time and money right away.

Just call (800) 222-9323. Or drop us a line.

Advanced Micro Devices 

901 Thompson Place, P.O. Box 3453, Sunnyvale, CA 94088.

© 1988 Advanced Micro Devices, Inc. Logic Cell is a trademark of Xilinx, Inc.

Launch your design with the FIFOs that came in first.

You can't think FIFOs without thinking of the Winning Team first—SGS-THOMSON Microelectronics. We launched the standards our competitors continue to follow.

	MK4505	MK45264/5	MK4503	MK4501
Organization	1K x 5	64 x 5 x 2	2K x 9	512 x 9
Cycle Time	40 MHz	13.3 MHz	12.5 MHz	12.5 MHz
Access Time Range	15-25ns	55-70ns	65-200ns	65-200ns
Depth Expandable	x	—	x	x
Width Expandable	x	x	x	x
Packaging	300 mil 24/20 Pin DIP	300 mil 24 Pin DIP	600 mil 28 Pin DIP	600 mil 28 Pin DIP 32 PLCC
Status Flag	E, F	E, F	E	E
E, Empty. F, Full. HF Half Full. AF, Almost Full. AE, Almost Empty.	HF, AF	AF	F	F
	AE	AE	HF	
Availability	***	*	***	**

* Sampling now

** Off the shelf—4 wks. depending on package and speed

*** Off the shelf—8 wks. depending on package and speed

The industry standard 512 x 9 MK4501 and 2K x 9 MK4503 use a CMOS RAM-based BiPORT™ architecture: two ports operate at fully independent data rates and provide simultaneous read/write capability.

With blazing 15ns access speed and 40MHz serial I/O rates, the 1K x 5 MK4505

puts FIFOs on the fast track. The MK4505 is also the first FIFO to support two independent, asynchronous free-running clock inputs with a full complement of status flags, eliminating the need for extra registers and buffers. Plus, you can get all that speed and performance in an ultrathin space-saving 300 mil DIP. The SGS-THOMSON Master and Slave concept—another first—allows simpler, more economical width and depth expansion.

Want bidirectional FIFO performance?

Try the MK45264/5, a unique combination of two FIFOs on a single chip, for fully asynchronous operation...again an SGS-THOMSON first.

With surface mount packaging, commercial and military grade devices, it's easy to see why SGS-THOMSON is the industry leader in FIFOs.

We have the production capability and the advanced technology to meet your delivery, pricing, performance and quality demands. And SGS-THOMSON will continue its leadership with FIFOs of higher density, faster speed and innovative architectures.

BiPORT is a trademark of SGS-THOMSON Microelectronics.

© 1988 Copyright SGS-THOMSON Microelectronics

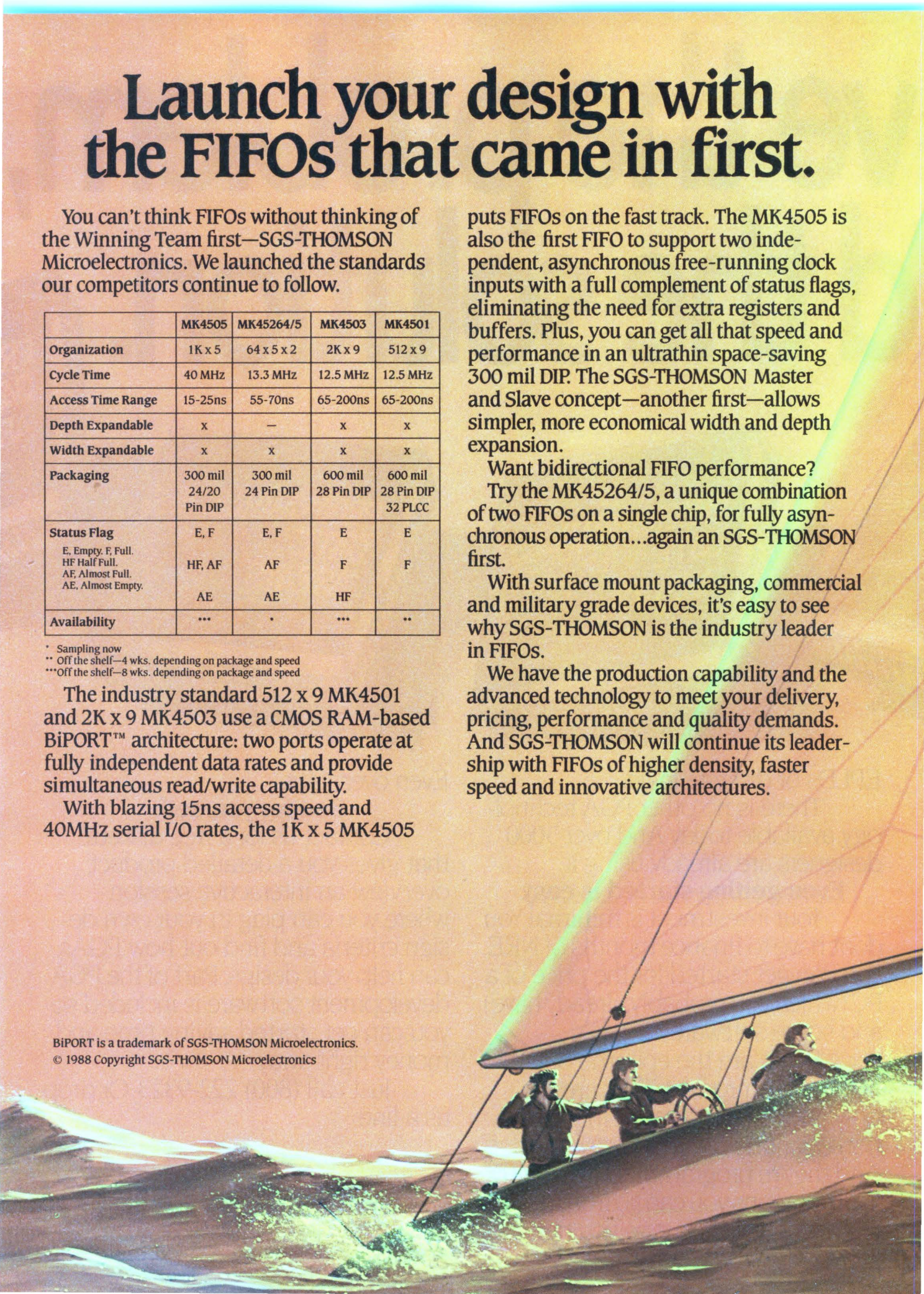

Join the Winning Team.

FREE MEMORY DATA BOOK

If second best isn't good enough for you, send for the facts that prove we're the FIFO leader. You'll find them in our free Memory data book. For your copy call 602/867-6259 or write SGS-THOMSON Microelectronics, 1000 E. Bell Road, Phoenix, AZ 85022.



SGS-THOMSON
MICROELECTRONICS

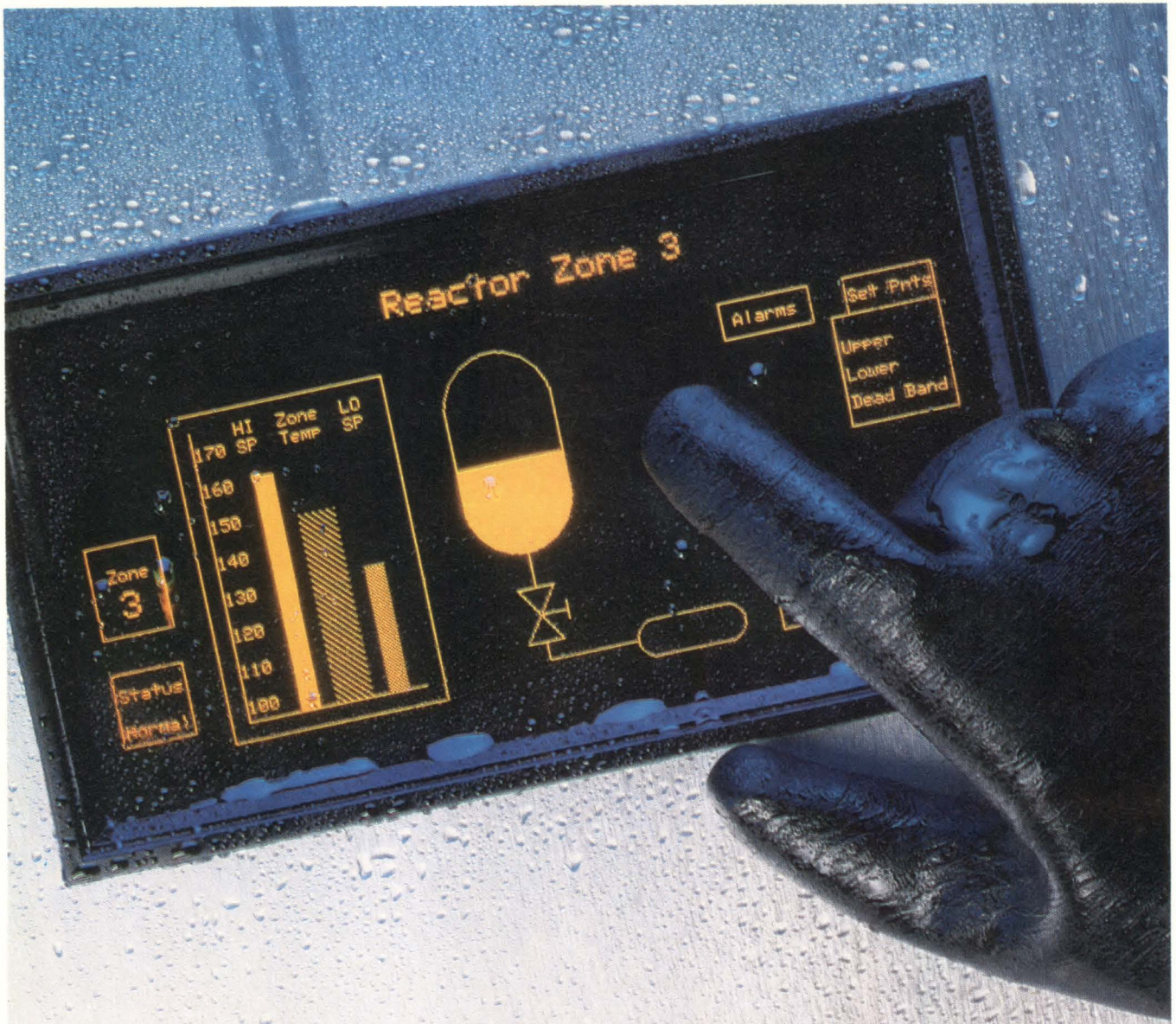

DEECO SEALTOUCH® DISPLAY SYSTEM. SEALS IN PERFORMANCE. SEALS OUT DIRT AND MOISTURE.

If there's one thing you don't need, it's dirt and moisture seeping into your display system and disrupting its performance. The DeeCO SealTouch display system is the best solution for your most demanding industrial applications.

Designed especially for harsh environments, SealTouch delivers consistently reliable performance under the most threatening conditions.

The SealTouch display system is a 3-part module consisting of flat-panel display and sealed I-R Touch panel, mounted on a controller card with VT100 text emulation and extensive drawing graphics. All within an absolute minimum footprint.

Easy-to-use touch software, pop-up menus and convenient button draw routines make SealTouch easy to design-in and simple to use. The system's programmable touch sensitivity allows you to easily implement protection against annoying false triggers. What's more, the SealTouch infra-red beam diagnostics continuously monitor system performance, assuring you of consistent reliability.

Don't take chances with any other display system. Call or write for full product information. Let SealTouch seal in performance for your design. And seal out dirt and moisture.

DEECO®

Digital Electronics Corporation, 31047 Genstar Road, Hayward, CA 94544-7831 (415) 471-4700

SealTouch and DeeCO are registered trademarks of Digital Electronics Corporation.

TECHNOLOGY UPDATE

Third-party PC graphics packages streamline your programming tasks

Margery S Conner,
Regional Editor

Attention-grabbing, colorful graphics can dramatically enhance the software you write, regardless of whether you're developing it for your company's internal use or for customers. When you're writing software for IBM PCs and compatible computers, however, you'll find that addressing the PC's graphics hardware is a difficult task. To lighten your programming chores, consider using third-party graphics-software packages.

Third-party graphics packages for PCs come in varying degrees of complexity. Many are simply libraries of graphics subroutines that you'd otherwise have to write yourself. These packages range from general-purpose libraries (often called graphics toolkits), to libraries of specialized scientific subroutines. Other third-party packages include a graphics editor that helps you develop your display format in a hurry, and a complex graphics platform that offers a complete graphics-programming environment. By taking advantage of any these packages, you can develop graphics displays faster and for a wider variety of display adapters than you could on your own.

Until recently, most C and Pascal compilers for the IBM PC provided minimal support for color graphics displays. Third-party packages have filled that graphics void. However, since EGA and VGA adapters—with their relatively high resolution—have become commonplace, the compiler vendors have beefed up the graphics libraries available with their compilers.

Borland International (Scotts Val-



Although the Halo '88 graphics library explicitly supports only 2-D renderings, you can develop 3-D renderings with it. Mega CADD (Seattle, WA) used Halo '88 as the graphics library for its Mega CADD 3D, a CAD software package.

ley, CA), for example, which sells two of the most popular versions of C and Pascal, now also offers the Borland Graphics Interface (BGI). BGI is a common graphics interface: Whether you're programming in Borland's Turbo C or Turbo Pascal, the graphics library is the same. A further advantage of using BGI is that if you're developing software for resale, you don't have to pay a royalty fee, as you do when you use most of the third-party packages for that purpose.

Keep in mind, however, that BGI is essentially just a library of primitives, which are the basic graphics commands, such as the commands to draw a point, line, circle, and polygon, and the commands to fill a circle and a polygon. Third-party graphics packages not only offer more-elaborate graphics commands, but also give you the option of programming in coordinates other than Cartesian ones. (Cartesian coordi-

nates are specific to a particular display.)

Toolkits complement compilers

If your compiler already includes a good amount of graphics support, the complexity of your application's graphics will determine whether you'll need to lay out the extra money for a third-party graphics package. Chuck Batterman, graphics manager for Borland, explains: "If you don't need the high-level windowing and world coordinates supplied in the third-party packages, then BGI will do the job for you. And if you do need the more exotic graphics, then you can get your feet wet with the BGI and know that the third-party system is a reasonable investment." In other words, if you don't know whether you need a third-party package, you can find out by using the graphics supplied with your compiler to create a prototype of your display.

MICRO-LOGIC II.™

The CAE tool with a 10,000-gate digital simulator for your PC.

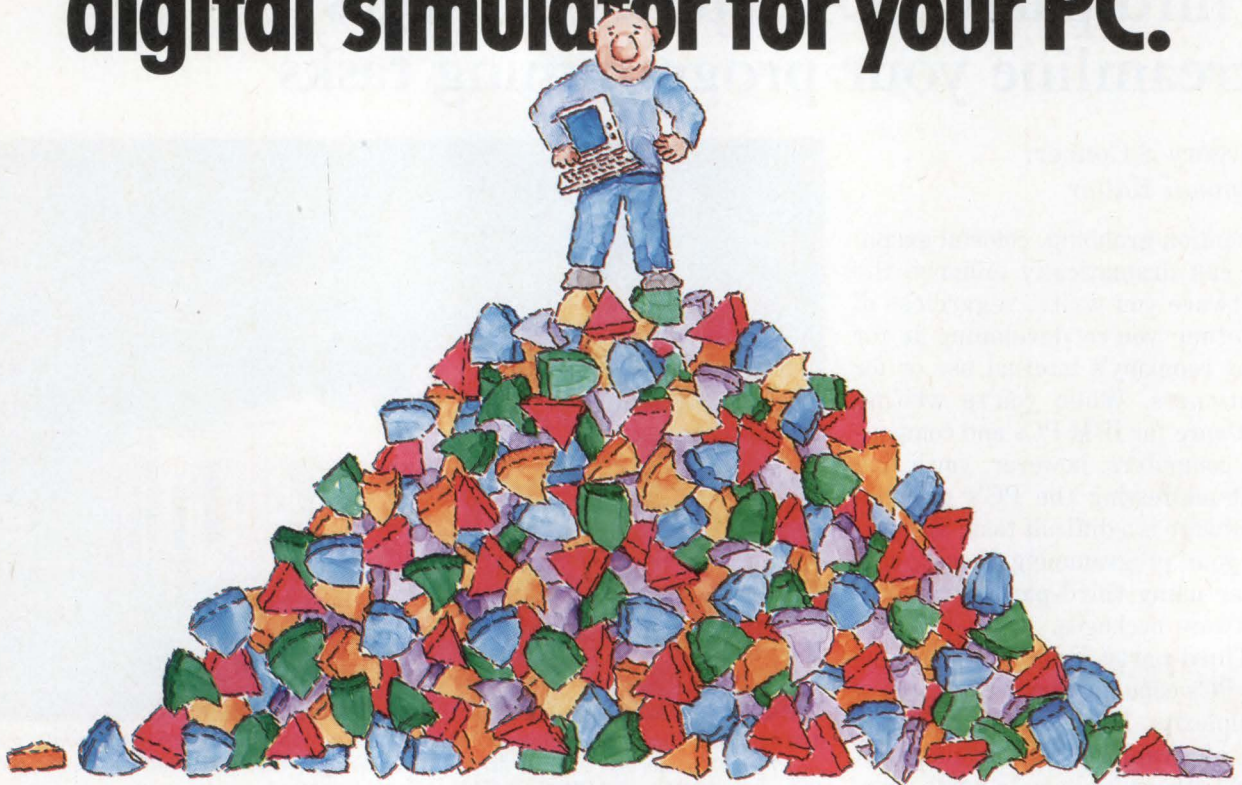

Spectrum Software's MICRO-LOGIC II® puts you on top of the most complex logic design problems. With a powerful total capacity of 10,000 gates, MICRO-LOGIC II helps engineers tackle tough design and simulation problems right at their PCs.

MICRO-LOGIC II, which is based on our original MICRO-LOGIC software, is a field-proven, second-generation program. It has a high-speed event-driven simulator which is significantly faster than the earlier version.

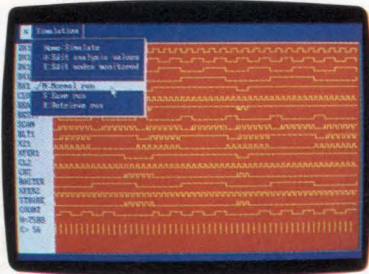

Timing Simulator

The program provides you with a top-notch interactive drawing and analysis environment. You can create logic diagrams of up to 64 pages with ease. The software features a sophisticated schematic editor with pan and zoom capabilities.

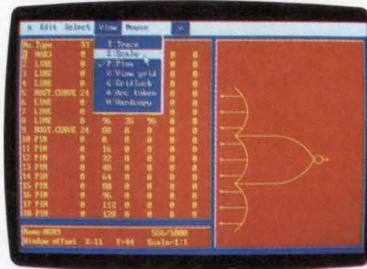

Shape Editor

A 200-type library of standard parts is at your fingertips. And for a new high in flexibility, a built-in shape editor lets you create unique or custom shapes.

MICRO-LOGIC II is available for the IBM® PC. It is CGA, EGA, and Hercules® compatible and costs only \$895 complete. An evaluation version is available for \$100. Call or write today for our free brochure and demo disk. We'd like to put you in touch with a top digital solution.

- Total capacity of 10,000 gates
- Integrated schematic editor
- Fast assembly language routines
- Standard parts library of 200 types
- Event-driven timing simulator

- Built-in shape editor
- Multiple delay models
- Printer and plotter hard copy

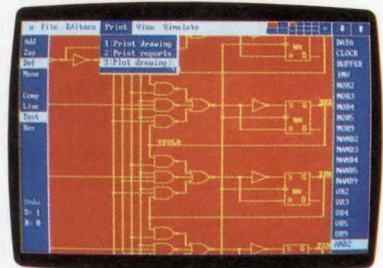

Schematic Editor

Spectrum

1021 S. Wolfe Road, Dept. E
Sunnyvale, CA 94087
(408) 738-4387

MICRO-LOGIC II is a registered trademark of Spectrum Software.

Hercules is a registered trademark of Hercules Computer Technology

IBM is a registered trademark of International Business Machines, Inc.

TECHNOLOGY UPDATE

Halo '88 from Media Cybernetics, for example, gives you the choice of specifying graphics positions in Cartesian, world, or normalized world coordinates. Unlike Cartesian coordinates, world coordinates are not specific to a particular display. Normalized world coordinates are world coordinates expressed as a number between zero and one.

World coordinates are useful when your software may have to run on a variety of graphics boards, because display coordinates vary from one board to another. If you use Cartesian coordinates, you must know the resolution of each supported graphics device, and your software won't be device independent. With Halo '88's implementation of world coordinates, you specify the resolution of the graphics, and Halo '88 maps the coordinates in your program to the device coordinates of your display adapter.

Because the compilers' graphics libraries have graphics drivers that access the EGA and VGA boards directly through the hardware, they are not device independent. Device independence allows a graphics program developed for one board—say, a nonintelligent EGA—to run on another board, such as an intelligent graphics-coprocessor-based board. When you use a device-independent program, you can specify your system's board at run time, and the program will then automatically send the correct level of information to that board. For the EGA, for example, the software must calculate the position of each pixel; for a board based on Texas Instruments' (Houston, TX) TMS34010, the software only needs to send the graphics primitives.

Third-party packages support a wide range of EGA and VGA boards that offer resolutions beyond the

IBM standard, as well as boards with graphics coprocessors. Halo '88, for example, supports 144 different display adapters.

Also keep in mind that the graphics libraries supplied with compilers don't support a wide range of hard-copy output devices, but third-party packages commonly support a plethora of plotters and printers.

Port software from OS/2

A third-party graphics package that provides for portability between MS-DOS and the forthcoming OS/2 is crucial for you if your software will have to run under both operating systems. The Graphics Development Toolkit (GDT) from Graphics Software Systems is available in both OS/2 and MS-DOS versions, and their source code is compatible. GDT also supports IBM's new 8514/A intelligent display adapter. Because IBM hasn't re-

REPRESENTATIVE THIRD-PARTY GRAPHICS PACKAGES FOR IBM PCs AND COMPATIBLES

MANUFACTURER	PACKAGE	LANGUAGE BINDINGS								PRICE	NOTES
		MICROSOFT C	TURBO C	LATTICE C	TURBO PASCAL	RYAN-MCFARLAN FORTRAN	LAHEY FORTRAN	IBM ASSEMBLER	MICROSOFT ASSEMBLER		
COURSEWARE APPLICATIONS INC	DRAWBRIDGE	•	•		•					\$129	GRAPHICS EDITOR DETERMINES, COORDINATES, AND GENERATES CALLS FROM POSITION OF MOUSE: METAWINDOW VERSION IS \$49
ITHACA SOFTWARE INC	HOOPS	•							•	\$575	ORGANIZES PRIMITIVES INTO SEGMENTS IN HIERARCHICAL DATABASE; ALSO RUNS ON SUN, DEC, AND MACINTOSH SYSTEMS
GRAPHICS SOFTWARE SYSTEMS INC	GRAPHICS DEVELOPMENT TOOLKIT	•		•	•	•	•	•	•	\$495	SOFTWARE THAT USES MS-DOS VERSION IS PORTABLE TO OS/2
METAGRAPHS SOFTWARE CORP	METAWINDOW	•	•	•	•	•	•	•	•	\$195	HAS DOS-RESIDENT DRIVER: BINDING-SPECIFIC VERSION FOR C COMPILERS IS \$95
	METAWINDOW/PLUS	•		•					•	\$275	LINKABLE LIBRARY: GENERATES .EXE FILE
	METAWINDOW/PREMIUM	•		•					•	\$495	LINKABLE LIBRARY WORKS WITH INTELLIGENT COPROCESSOR-BASED BOARDS
MEDIA CYBERNETICS INC	HALO '88	•	•	•	•	•			•	\$325	
SCIENTIFIC ENDEAVORS CORP	GRAPHIC	•	•	•						\$395	MATH FUNCTIONS AND BASIC GRAPHICS PRIMITIVES

TECHNOLOGY UPDATE

leased much information about this board's hardware, writing to it through an interface such as the GDT's is the best way at present to ensure that your software will run on the board.

Virtually all graphics toolkits must appeal to two different kinds of customers: the programmer who uses the graphics features only in programs for his or her company's internal use, and the programmer who uses the packages to develop a software-based product. Meta-graphics lets you choose from three versions of its graphics package. The standard Metawindow package costs \$195 and supports a wide variety of compilers for C, Pascal, and Fortran. The company also offers a version for \$95 that supports either Microsoft C, Turbo C, or Turbo Pascal. Both these packages have DOS-resident drivers. Every time you run the program, you must first load the graphics driver into memory. (The driver can also be deleted from memory from the DOS level.) These programs are best for personal use or internal company use.

For \$275, you can obtain Metawindow/Plus, which includes a linkable graphics library; your application program links in only the graphics functions it actually uses, and it consists of a single .EXE file. Further, the code for Metawindow/Plus is more compact than that of the DOS-resident driver version. The Plus version also supports display adapters with resolutions higher than those of the standard EGA and VGA boards. The \$495 Metawindow/Premium is also linkable, and it supports display adapters that have onboard graphics coprocessors, such as the Genesis 1280 from National Design (Austin, TX), which is based on TI's TMS34010.

Down-and-dirty math library

If you're developing software that will display graphs of specialized math functions rather than using more general-purpose graphic elements, such as windows, consider

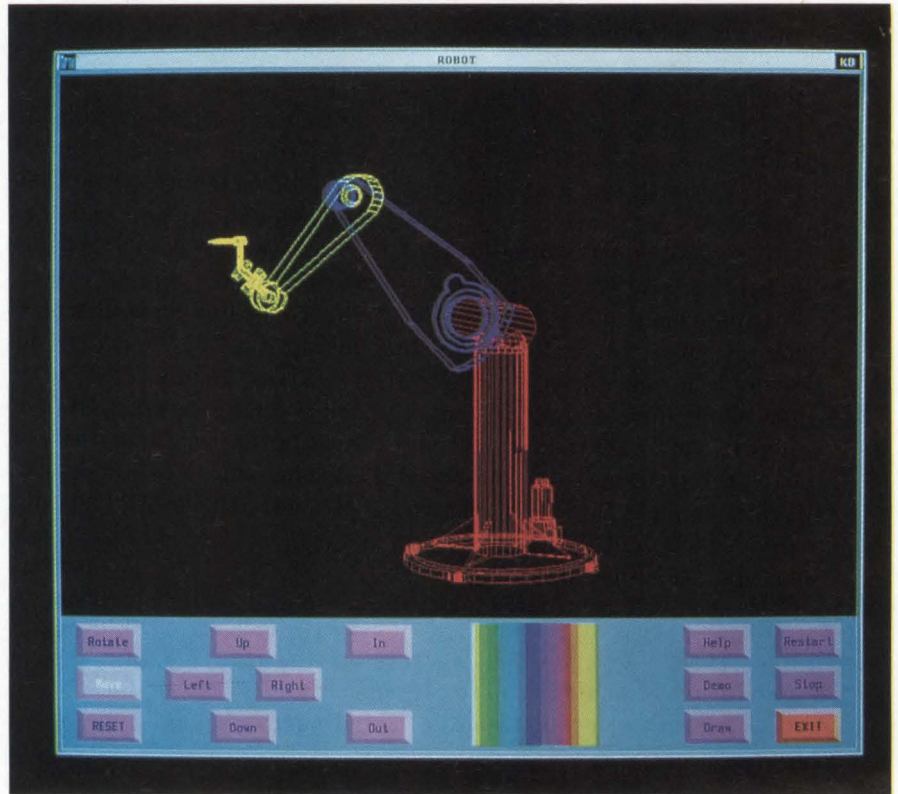

Fig 1—This robot comprises elements stored in four segments: the base, the upper arm, the lower arm, and the torch. Because of the hierarchical relationship among the elements, a command to rotate the base will cause the arms and the torch to rotate along with it. The robot was developed at Cornell University with the Hoops graphics package.

using Graphic from Scientific Endeavors. Its \$395 price includes source code. The software performs all the calculations for a high-resolution Tektronix format of 4096×3120 pixels and shrinks it down to suit the lower-resolution EGA/VGA format. It stores the higher-resolution display on disk. Because most printers, even inexpensive ones, have higher resolution than the VGA's 640×480 pixels, you can print out a high-resolution hard copy of your math functions.

Because the functions are computation-intensive, it's best to use the Graphic package with a math coprocessor. For example, a 6-MHz PC/AT without a math coprocessor takes about 90 seconds to complete a typical plot with 600 trigonometric function calls; with a math coprocessor, it takes under 10 seconds.

With any of these graphics libraries, you still have to figure out the coordinates at which you want graphical elements such as windows

and icons to appear. This task can quickly become tedious unless you use a package such as Courseware Applications Inc's Drawbridge, a graphics editor that lets you position the elements on the screen with a pointing device such as a mouse. Once you've determined the placement of the elements, Drawbridge determines all of the coordinates and generates the library calls needed to display them. Drawbridge does not contain the subroutines themselves; instead, it acts in conjunction with a graphics library. It currently supports the Microsoft C, Turbo Pascal, and Turbo C libraries (\$129 each), and the Metawindow package (\$49).

If your graphics needs are complex—that is, if you require lots of transformations and 3-D manipulations—you may be able to justify using a graphics platform such as Hoops from Ithaca Software Inc. Hoops supports 2-D and 3-D rendering as well as hidden-line removal

LOW ESR & MORE.

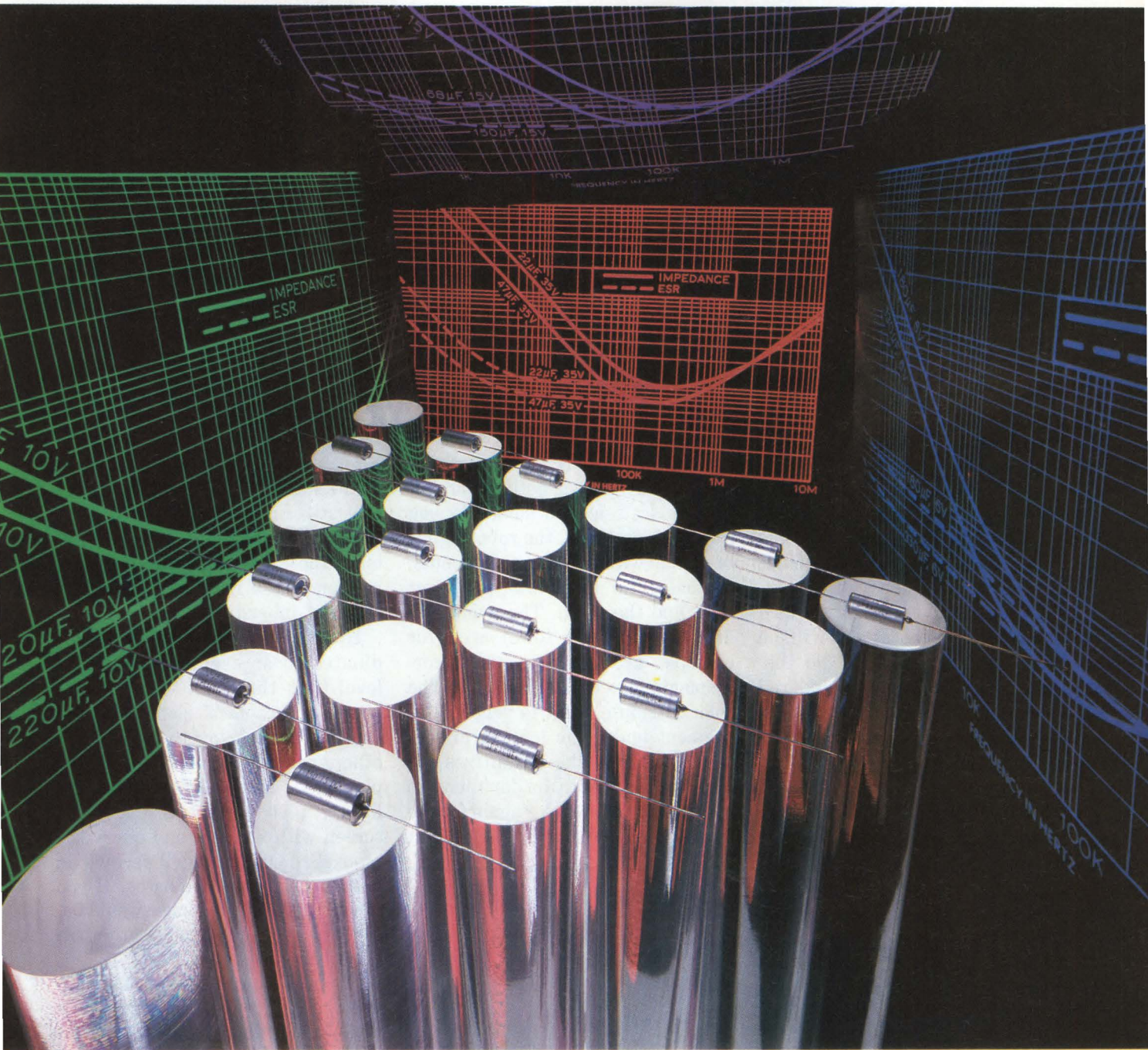

4SW-4129R2

SPRAGUE TANTALUMS MEET MANY SMPS NEEDS.

Sprague Type 550D Solid-Electrolyte Tantalum[®] Capacitors, designed for use in power supply filters at frequencies to 100 kHz, feature extremely low ESR and high ripple current capability. Maximum ESR for a 300 µF, 6 VDC unit is only 0.045Ω at 100 kHz. Additional advantages include small size, long life, exceptional capacitance stability and hermetic sealing to withstand severe environments. Capacitance values: 5.6 to 330 µF. Voltage ratings: 50 to 6 WVDC. Write for Engineering Bulletin 3548 to Technical Literature Service, Sprague Electric Co., P.O. Box 9102, Mansfield, MA 02048-9102.



CIRCLE NO 59

UPDATE

and shading from multiple light sources.

Most graphics libraries are procedural; they comprise many detailed, explicit drawing instructions, but have no structure that relates the various elements of the display. Hoops stores the display's graphical elements in a hierarchical database. The software lets you manipulate the display by creating the graphical elements and defining the relationships between the elements. Once you've established the relationships between the elements, you can modify the image (change the perspective, say) with just a single command.

The database's basic units are segments, or named places in the database where you can store related primitives. You create a graphics element by grouping the primitives that describe the element into a segment. Then you use declarative commands to define which elements in the database will be displayed, where they'll be displayed, and how they'll be rendered (in other words, what attributes they'll have, such as color or pattern).

The primitives in a segment are drawn according to the attributes set within the segment. Because the

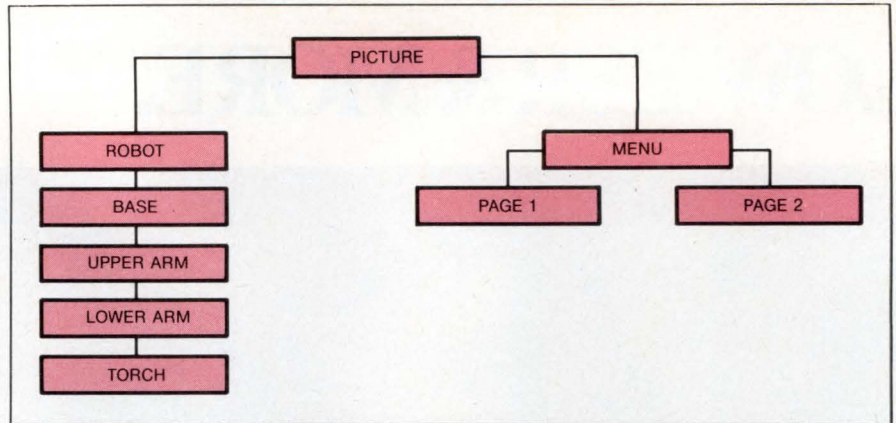

Fig 2—This tree illustrates the hierarchical relationship among the segments of the robot in Fig 1. Any attributes, such as color or pattern, that are set for a segment can be inherited by the segment below it.

segments are related hierarchically, if a segment doesn't specifically set the attribute, it inherits the attribute setting from the segment that precedes it in the hierarchy.

The robot in Fig 1 provides an illustration of this characteristic. The display shows both the robot itself and a selection menu. As you can see from Fig 2, the robot figure breaks down into four components: the base, the upper arm, the lower arm, and the torch. The primitives used to draw the lower arm, for example, are stored segments corresponding to that component. The color attribute is set to yellow. The segment under the lower-arm segment contains the primitives for drawing the torch. You don't have to specify the yellow color again for the torch, because it will inherit that

attribute from the lower-arm segment.

Note that the robot is 3-dimensional, and the menu and icons on the screen need only two dimensions. If you just set the z axis to zero, any movement or manipulation of the menu portion of the display will still involve the z axis, even though it's set to zero. You can eliminate the z axis for just the menu portion of the database; any lower segment inherits the absence of z.

Hoops defines an element's coordinates on an even more abstract level than the toolkits do: Hoops gives the graphical element's position in relationship to the scene's other graphical elements. For example, under a conventional graphics library, if you point to a spot on the screen with a mouse and query the mouse's position, you'll receive an answer in x-y-z coordinates. If you query Hoops, its response would be, say, "on the torch tip," or "the bottom of the lower arm."

For a small program—a few hundred lines of code—Hoops may be a little faster than a toolkit such as GDT, Halo '88, or Metawindow, but you probably wouldn't want to spend the time learning to program in the Hoops environment. For programs of 1000 to 1 million lines, however, Hoops gives you a big advantage over a toolkit. **EDN**

For more information . . .

For more information on the graphics packages discussed in this article, contact the following manufacturers directly, circle the appropriate numbers on the Information Retrieval Service card, or use EDN's Express Request service.

Courseware Applications Inc
475 Devonshire Dr
Champaign, IL 61820
(217) 359-1878
Circle No 705

Ithaca Software Inc
The Clinton House
Ithaca, NY 14850
(607) 273-3690
Circle No 706

Graphics Software Systems Inc
9590 SW Gemini Dr
Beaverton, OR 97005
(503) 641-2200
TLX 4994839
Circle No 707

Media Cybernetics Inc
8484 Georgia Ave, Suite 200
Silver Spring, MD 20910
(301) 495-3305
Circle No 708

Metagraphics Software Corp
269 Mount Hermon Rd
Scotts Valley, CA 95066
(408) 438-1550
Circle No 709

Scientific Endeavors Corp
Route 4, Box 79
Kingston, TN 37763
(615) 376-4146
Circle No 710

Article Interest Quotient
(Circle One)

High 518 Medium 519 Low 520

Microprocessor Support Made Simple

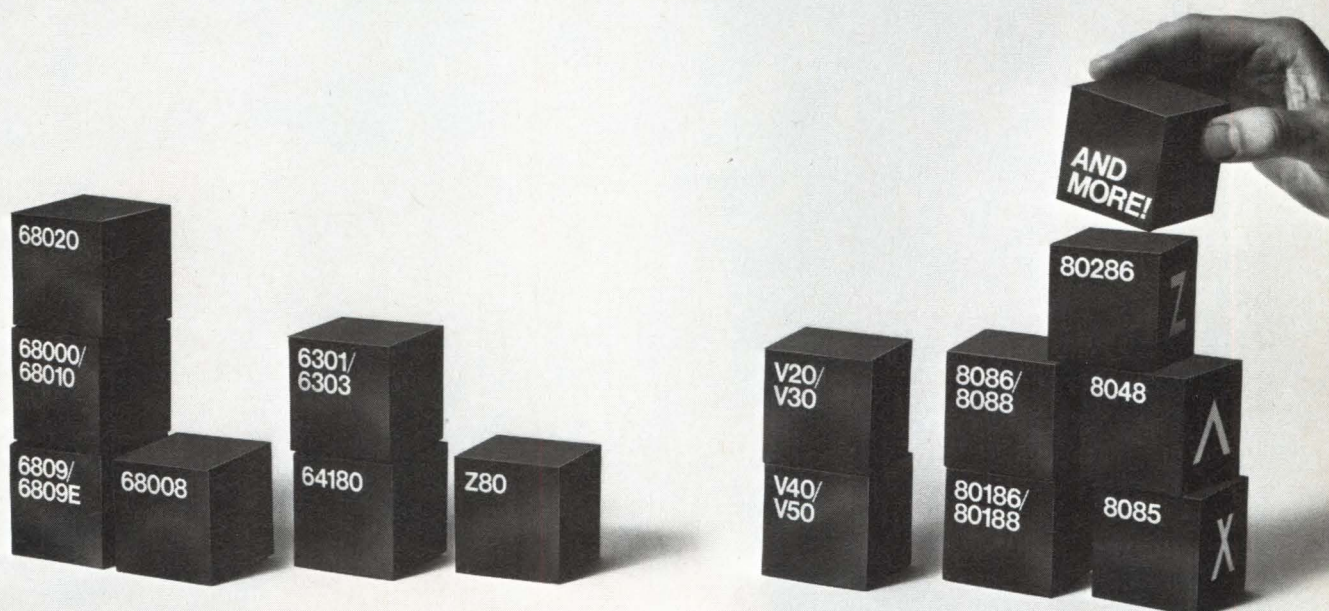

Now, ZAX simplifies microprocessor design, integration and testing with their advanced line of ERX- and ICD-series emulators. You simply tell us the processor that drives your design and we tailor a development system especially for your environment, including full software support.

Our ERX-series emulators provide over 80 debugging commands, with 256,000 hardware breakpoints, real-time performance analysis, high-level language debug and trace analysis of program execution while you emulate in real-time. And they interface directly to your personal computer (AT-class) to provide you with a complete host development station and emulation manager. This consolidated approach utilizes industry-standard equipment and eliminates the use of a proprietary dedicated chassis.

ZAX established the benchmark for standalone emulation tools when they introduced their versatile line of ICD-series emulators. Completely flexible, ICD-series emulators can be interfaced to either a simple terminal or host computer (from pc to mainframe) depending on your requirements. This makes them ideal for both in-house development and on-site testing.

Simplify support for your microprocessor development projects with the help of ZAX! Call today to arrange a product demonstration or write for complete details about our product line. Call us TOLL FREE at 800-421-0982 (in California phone 800-233-9817) or write to ZAX CORPORATION, 2572 White Road, Irvine, CA 92714.

In Europe, call United Kingdom: 0628 476 741, West Germany: 02162-3798-0, France: (03) 956-8142, Italy: (02) 688-2141.

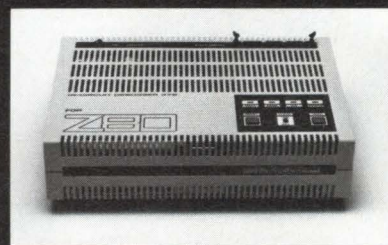

ZAX
Zax Corporation



Now you can mold the silicon to fit the logic. Not the other way around.

**PROGRAM OUR
GENERIC ARRAY LOGIC
ANYWAY YOU WANT.
REPROGRAM ANYTIME
YOU WANT**

These new GAL[®] devices emulate the full range of PAL[®] architectures with 100 percent socket compatibility. They can even be configured to all the in-between architectures — like a 16R1 or 20R7.

You can also change architectures during the design process. And when your design is complete, you can move functions from pin to pin to simplify your board layout. You can even make changes during manufacturing — without huge penalties.

The one-device-does-all approach not only gives you unlimited design freedom, it also reduces parts counts and inventories and decreases your system costs.

REAL TESTABILITY

The first PLDs to use electrically erasable CMOS technology, GAL devices are instantly erasable and reprogrammable. (No time-consuming trips to the UV lamp.) And we guarantee 100 erase/write cycles.

This makes them ideal for prototyping and for pattern changes or

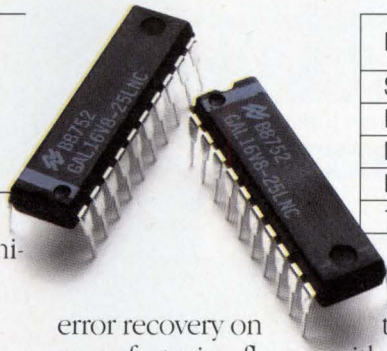

error recovery on the manufacturing floor — with no waiting or waste.

More important, it allows us to program and erase each device many times during manufacturing to directly test all characteristics, including AC, DC and functionality. As a result, we can assure you 100 percent programming and functional yields without any board rework.

REAL REDUCTIONS IN POWER

Another advantage of CMOS technology is that these new devices are just as fast as bipolar but consume less than half the power — as little as 45 mA active and 25 mA standby.

And because they consume less power, you'll have fewer cooling problems and a much more reliable system.

REAL SOFTWARE SUPPORT

GAL devices are fully supported by industry-standard development

Device Type	ECL PAL	TTL PAL	EECMOS GAL [®]
Speed	fastest	fast	fast
Power	highest	high	low
Density	low	medium	high
Programmability	OTP	OTP	100%
100% Testability	no	no	yes

tools, including ABEL[®], CUPL[™], and PLAN[™]. You don't need any sophisticated or expensive upgrades.

And you don't need any special programming hardware either. Almost all hardware manufacturers support GAL parts on existing models.

So get real design freedom. These new devices are like putty in your hands.

Call National — for information on GALs or any other type of PLD. We're the only manufacturer that offers three different technologies — ECL, TTL, and EECMOS.

For a free copy of our new programmable logic brochure, call your local National sales engineer, authorized distributor, or National Semiconductor, MS23/200, P.O. Box 58090, Santa Clara, CA 95052-8090, 1-800-252-4488, ext. 733.

 **National
Semiconductor**

©1988 National Semiconductor Corporation

PLAN is a trademark of National Semiconductor Corp. GAL is a registered trademark of Lattice Semiconductor Corporation. PAL is a registered trademark of Advanced Micro Devices (Monolithic Memories Inc.) ABEL is a registered trademark of Data I/O Corp. And CUPL is a registered trademark of Assisted Technologies Inc.

DRAMATIC!

**Now...Highest speeds AND production...
60/70/80ns 1Mb AND 256K DRAMS...**

Exclusively from NMB Semiconductor - the high speed DRAM specialist - we've broken the speed barrier with FutureFast™ 256K and 1Mb DRAMS...first with access times of 60/70/80ns. This means designers can now have true "0" wait state systems without using complex, expensive cache memory techniques.

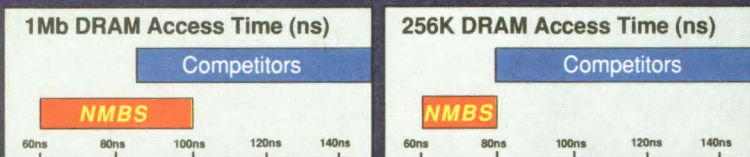

We've broken the delivery barrier too. NMBS offers much higher volume production than our competitors. These dramatic advances are made possible in the most advanced CMOS/VLSI plant in the world optimized for volume production of high speed DRAMS. With computerized operation and robot control in Class 1 ultra-clean rooms. Plus state-of-the-art design, processing and testing.

Product Line Summary				
Series*	Access Time	Organization	Package**	Availability
AAA2800 256K	60/70/80 (ns)	256Kx1	P-DIP	Production
			PLCC	Production
			C-DIP	Production
AAA1M100 1Mb	100/120 (ns)	256Kx4 1Mbx1	P-DIP	Production
			SOJ	Production
			ZIP	Production
AAA1M200 1Mb	60/70/80 (ns)	256Kx4 1Mbx1	P-DIP	2Q88
			SOJ	2Q88
			ZIP	2Q88

* All Series available in Static Column and Page Modes. ** SIMM'S and SIPS available for each series.

Available in the packages and organizations designers want for high performance projects.

More good news. We're now shipping qualification samples of our new 1Mb DRAM.

So for complete specs, evaluation units, quantity prices and delivery call NMBS - the high speed DRAM specialists - today. Prove to yourself that with FutureFast™ DRAMS, your future is now.

NMB | NMB TECHNOLOGIES
INCORPORATED

SEMICONDUCTOR DIVISION

9730 Independence Ave. • Chatsworth, CA 91311
Tel: 818/341-3355, FAX: 818/341-8207, TLX: 651340

FUTUREFAST™

...IS NOW.

CIRCLE NO 66



Limited selection of monolithic PLL ICs suffices for current applications

Tarlton Fleming,
Associate Editor

Monolithic phase-locked-loop (PLL) circuits provide an elegant way to achieve frequency demodulation or digital selection of frequency. As a result, PLL ICs have become vital components in modern TVs, car radios, frequency-shift-keyed (FSK) systems, and disk-drive electronics. You might expect, then, to find a robust market for PLL circuits.

Currently, though, domestic IC companies offer a sparse selection of new PLL devices. This lack of activity is surprising when you consider the extensive applications support that was once available to an engineer intent on designing a phase-locked loop into his system. It's doubly surprising when you consider the current emphasis on designing discrete-component PLL circuits for frequency-agile, military-RF systems. The truth is that much PLL work has moved offshore, along with the design and manufacture of certain high-volume, PLL-based products—car radios, for instance. Fortunately, enough applications remain in the US to support a continuing demand for domestically produced PLL ICs.

A PLL is a small servo system in which negative feedback forces the frequency of a voltage-controlled oscillator (VCO) equal to that of the applied signal, f_{IN} (Fig 1). This action causes the PLL to sense and track the f_{IN} frequency, thereby reconstructing f_{IN} and removing noise in the process (which is a form of filtering).

If you monitor the VCO's input instead of its output, the PLL will function as a frequency-sensing device suitable for FM detection or

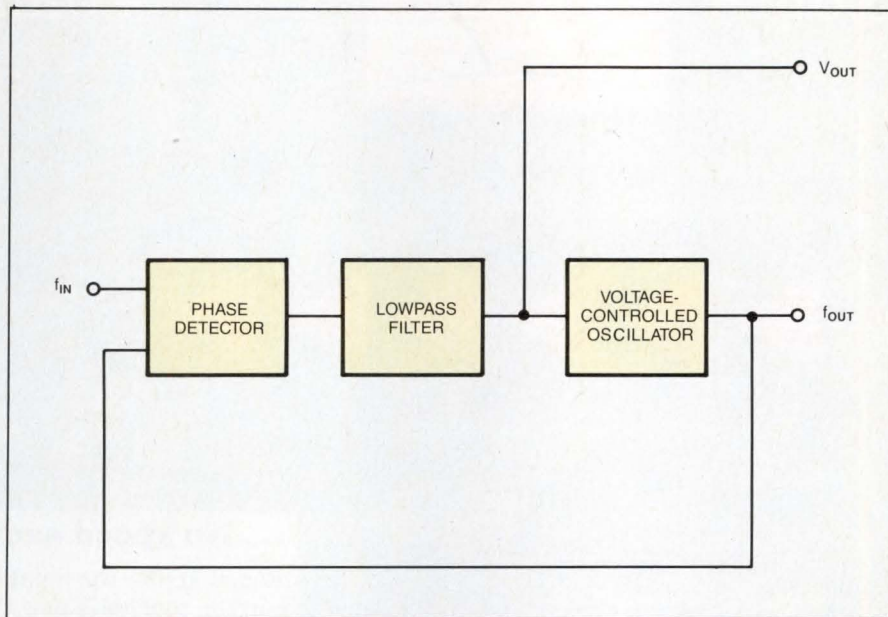

Fig 1—The basic phase-locked-loop circuit is a small servo system. The voltage output is proportional to frequency, and the frequency output is a noise-free equivalent of f_{IN} .

FSK demodulation. These two configurations (taking the PLL's output from the VCO's input or its output) account for most applications. If you add a divide-by-M counter at the input and a divide-by-N counter within the loop, at the VCO output, the PLL can also produce a digitally selectable frequency, $f_{IN}(N/M)$.

Many low-frequency applications (approximately 1 MHz and below) use the industry-standard CMOS PLL, whose generic part number is 4046. Manufacturers of this type include GE/RCA, Motorola, National Semiconductor, and Signetics. The Motorola MC14046BCP is a representative part: It costs \$0.93 in quantities of 100.

The 4046 devices include two types of digital phase detectors on chip. (Most other PLLs feature one type, not both.) Your 4046 application determines whether a type I or type II phase detector is most ap-

propriate, and you then make external connections for including that detector in the loop.

Type I vs II phase

The type I phase detector is simply an XOR gate. The output signal, after passing through an external lowpass filter, produces a linear ramp in which the amplitude is proportional to the phase (0 to 180°) between f_{IN} and the onboard VCO signal. The ramp reverses and repeats when the PLL is out of lock, forming a sawtooth waveform. The type I phase detector provides the widest lock range (the f_{IN} range for which the loop will remain locked) for input signals with a duty cycle of 50%. When the loop is locked at the VCO's free-running frequency, the phase detector generates a dc level at half the ramp amplitude—equivalent to a 90° phase difference.

If nonzero phase in the locked condition is unacceptable, you can

OP-07 PERFORMANCE AT 1/6TH THE POWER

3.6mA

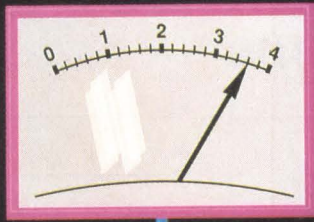

4.0mA

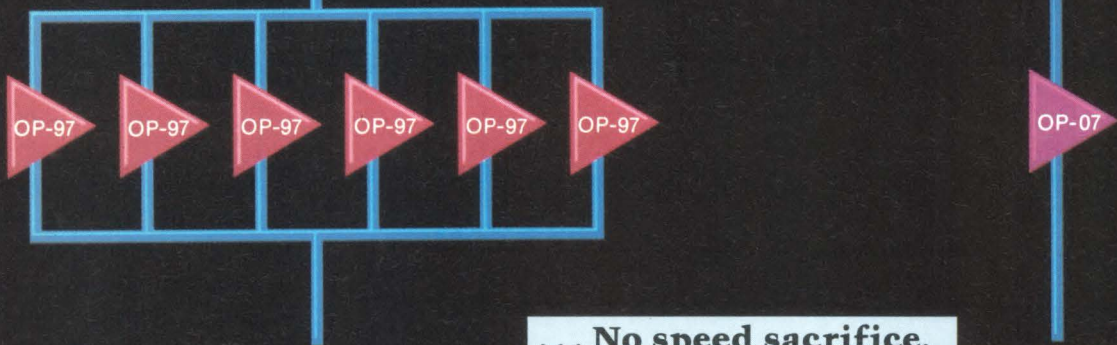
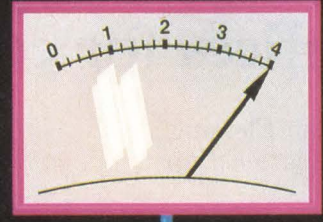

... No speed sacrifice.

And at 1/20th the input bias current, too! PMI's new OP-97 beats even JFET op amps at +125°C! OP-97 drops directly into existing OP-07 sockets immediately saving power and delivering greater accuracy.

Check the specs for yourself:

	OP-97	OP-07	
V _{OS}	25	25	μV Max
TCV _{OS}	0.6	0.6	μV/°C Max
A _{VO}	300	300	V/mV Min
I _B @ 25°C	±100	±2,000	pA Max
I _B @ 125°C	±250	±4,000	pA Max
I _{SY} @ ±15V	600	4,000	μA Max

If it's precision you need, PMI wrote the book. Circle the reader service number or call 1-800-843-1515.

Precision Monolithics Inc.
A Bourns Company
Santa Clara, California, USA
408-727-9222

ATLANTA: (404) 263-7995, ALTAMONTE SPRINGS: (407) 260-9780,
BLOOMFIELD: (203) 242-1014, BOSTON: (617) 794-0926, CHICAGO: (312) 250-0808,
DALLAS: (214) 341-1742, DENVER: (303) 792-9595, DETROIT: (313) 227-2190,
HOUSTON: (713) 481-6460, LOS ANGELES: (818) 886-8881, MILPITAS: (408) 942-8060,
ORANGE COUNTY: (714) 637-9602, PHILADELPHIA: (215) 853-1070,
SCOTTSDALE: (602) 941-1946



The precision solution.

CIRCLE NO 67

TECHNOLOGY UPDATE

use the type II (edge-controlled) phase detector, which ignores waveform duty cycles by operating on the two input signals' positive-going digital edges. While in the locked condition, the phase detector allows no phase difference between the VCO and f_{IN} signals. The type II detector provides a large capture range (the range of f_{IN} for which an unlocked PLL can achieve the locked condition) that is independent of the external filter's time constant.

When unlocked, the detector produces a high or low dc level according to the relative frequency values for f_{IN} and the VCO signal (vs the ac output of a type I detector). This circuit, also known as a phase-frequency detector, was an important advance in the development of PLLs at the time of its introduction.

Exar and Signetics are noted for their PLL product lines. Exar's XR-210, for example, suits FSK applications and includes a VCO, an XOR-gate phase detector, and a voltage comparator. The device operates with a 5V supply over frequencies of 0.5 Hz to 20 MHz. Housed in a 16-pin ceramic DIP, an XR-210CN sells for \$2.78 (100).

The more-complex XR-2211, second-sourced by Raytheon, also fits data-communications tasks such as tone decoding and FSK demodulation. The 2211 has an analog-multiplier-type phase detector (Gilbert cell) that subtracts the two input signals. It provides outputs for lock detection and FSK demodulation, and it operates from 0.01 Hz to 300 kHz. Exar's version costs \$2.89 (100).

For applications that require temperature stability, Exar's precision XR-2212 PLL operates from 0.01 Hz to 300 kHz and exhibits a 20-ppm/°C temperature coefficient of the VCO frequency. The XR-2212 comes in a 16-pin DIP and costs \$2.88 (100).

Signetics uses a bipolar process in its high-frequency NE568 design in which the f_T for the npn transistors

exceeds 6 GHz. The result is a 150-MHz PLL suitable for incorporation in satellite receivers, fiber-optic video links, and VHF-range FSK demodulators.

Realizing that proper pc-board and component layout is essential at high frequencies, Signetics includes an evaluation circuit with the NE568's data sheet, as well as a pc-board pattern and parts list. According to the manufacturer, with a good layout and surface-mount capacitors, the device demodulates $\pm 10\%$ deviations from a 70-MHz IF and exhibits a linearity error of less than 4%. An NE568N comes in a 20-pin DIP, draws 60 mA from a 5V supply, and costs \$1.79 (100).

Digital vs analog PLLs

Although overwhelmingly digital, most PLL ICs are called analog PLLs because their VCO input is an analog error voltage. The SN74LS297 from Texas Instruments, however, is all digital. The device has a counter and increment/decrement circuit in place of the conventional lowpass filter and VCO. To program the counter, you use a 4-bit digital word, which corresponds to setting the filter time constant in an analog PLL circuit. (Both types of adjustments tradeoff

loop bandwidth and phase jitter.) The SN74LS297's operating-frequency range is dc to 50 MHz. A 16-pin, plastic-DIP version costs \$11.69 (100).

Unlike the discrete-IC PLLs discussed so far, Sierra Semiconductor's PLL34M exists only as a CMOS cell in the vendor's semicustom-ASIC library. This standard-cell PLL circuit operates at 30 MHz (or as high as 60 MHz, with tweaking by the manufacturer). It includes a phase detector, I/O drivers, and a bandgap reference for setting the VCO frequency. The chip area is 3224 mils². By combining the PLL34M with other cells in the library—you have a choice of 250 digital, 50 analog, and 20 EEPROM cells—you can configure an ASIC suitable for use as a data separator in disk drives, for example. You can buy a PLL34M, plus 500 logic gates, enclosed in a 44-pin surface-mount package for \$3.50 (100,000).

Prescalers offer alternatives

Siemens combines its PLLs with appropriate prescaling circuits to produce ICs capable of handling the high frequencies involved in digital channel selection in TVs and radios. These products are partial PLLs because they operate in conjunction

For more information . . .

For more information on the PLL products discussed in this article, contact the following manufacturers directly, circle the appropriate numbers on the Information Retrieval Service card, or use EDN's Express Request service.

Exar Corp
2222 Qume Dr
San Jose, CA 95131
(408) 732-7970
Circle No 712

Motorola Semiconductor Products Inc
3501 Ed Bluestein Blvd
Austin, TX 78721
(602) 244-6900
Circle No 713

Siemens Components Inc
2191 Laurelwood Rd
Santa Clara, CA 95054
(408) 980-4500
Circle No 714

Sierra Semiconductor Corp
2075 N Capitol Ave
San Jose, CA 95132
(408) 263-9300
Circle No 715

Signetics Corp
Box 3409
Sunnyvale, CA 94088
(408) 991-2000
Circle No 716

Texas Instruments
Box 225012
Dallas, TX 75265
(214) 995-6611
Circle No 717

High Class Low Pass

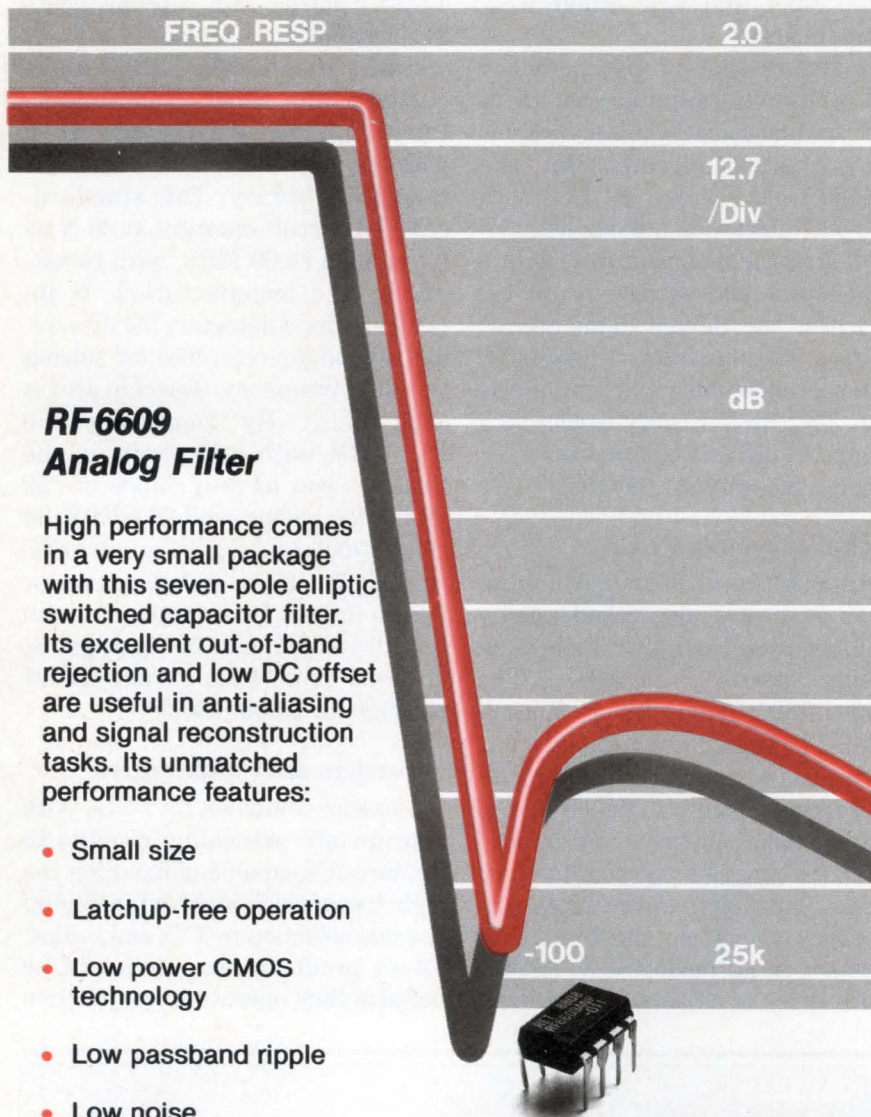

RF6609 Analog Filter

High performance comes in a very small package with this seven-pole elliptic switched capacitor filter. Its excellent out-of-band rejection and low DC offset are useful in anti-aliasing and signal reconstruction tasks. Its unmatched performance features:

- Small size
- Latchup-free operation
- Low power CMOS technology
- Low passband ripple
- Low noise

The RF6609 analog filter is suitable for use in telecommunications, biomedical, or instrumentation applications. Its small size fits easily into portable devices.

Check our specs and you will see that this 8-pin DIP filter meets your compact low pass needs.

EG&G Reticon's high quality products are supported by technical expertise. Questions? Contact a sales office.

Western Region	408 245-2060
So. California	714 583-2250
Central Region	312 640-7785
Eastern Region	617 745-7400
Japan	0423 33-8111
England	0734 788666
West Germany	089 92692-666

EG&G RETICON
WHERE VISION AND TECHNOLOGY MEET
345 Potrero Avenue Sunnyvale, California 94086-4197

CIRCLE NO 22

UPDATE

with an external tuning chip that contains the VCO. Model SDA 3202-2, for instance, includes an RF amplifier, a phase-frequency detector, and a serial-data μ P interface. Counter circuits on the chip can scale signal frequencies as high as 1.3 GHz. The phase detector then compares the result with a 7.8125-kHz reference (obtained from an on-board oscillator divider and an external crystal). In an 18-pin DIP, the device draws 55 mA from a 5V supply. It's priced at \$4.63 (100).

Siemens uses the same approach in its SDA 2121, a device that helps provide digital tuning in AM and FM radio receivers. The CMOS chip can accept a VCO input as high as 35 MHz (AM) or 150 MHz (FM). It comes in a 20-pin DIP and costs \$5.14 (100).

Similarly, the TBB 200 is a CMOS PLL circuit optimized for use in μ P-controlled mobile telephones and radios. When added to an external VCO tuner and prescaler, the chip forms a compact system suitable for use in circuits operating above 900 MHz. The TBB 200 comes in a 14-pin DIP and costs \$5.61 (100). **EDN**

Article Interest Quotient
(Circle One)
High 512 Medium 513 Low 514

S A M S U N G

NOW

Number I

CMOS
Programmable
Logic in
Volume

*Now Samsung
brings low
power within
everybody's
reach.*

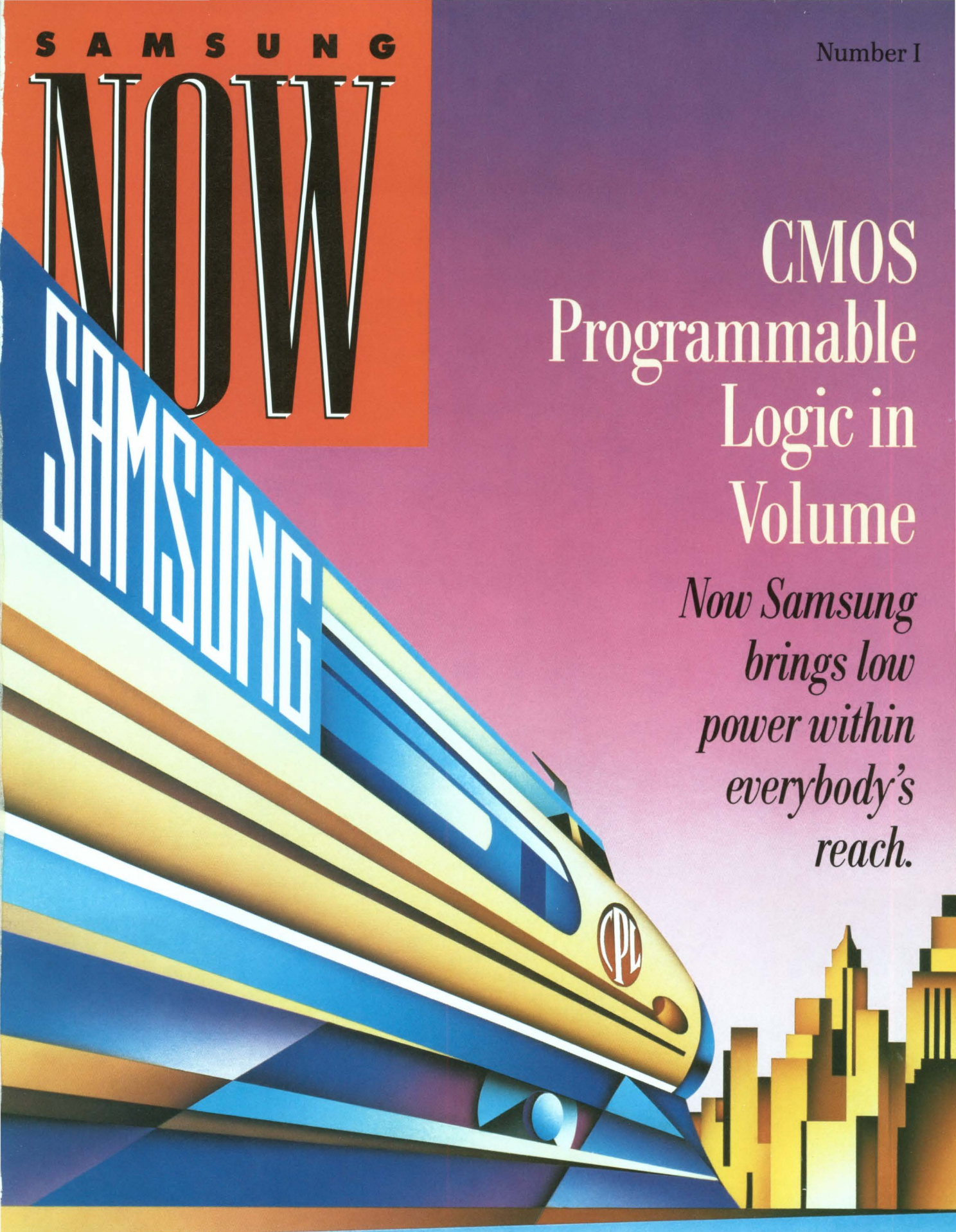

We Introduce an Exceptionally Reliable New EEPROM in CMOS
Blazing Speed from a DRAM Controller □ 400 MOSFETs Superb in Ruggedness.

CMOS PROGRAMMABLE LOGIC

INTRODUCING CPL™ Samsung Moves

Harnessing our manufacturing strength, we become the first to produce this demanding technology in volume.

Since the beginning, Samsung Semiconductor has been known for its manufacturing expertise.

Samsung's commitment to CMOS technology is also long-standing.

Today, our new CPL (CMOS Programmable Logic) product line draws on both of those strengths.

It is a product line at the cutting edge of technology, and we are uniquely positioned to manufacture it—and manufacture it in volume.

What the introduction of CPL means is that, for the first time, there is a viable low-power alternative to bipolar PALs.[®]

It's viable both because we are offering CPL in volume. And because we're making it affordable—comparable in cost to bipolar parts.

In short, we're taking CMOS Programmable Logic, once and for all, out of its high-priced niche. To make low power a reality. And make com-

pact systems more feasible than ever.

What will CPL do for you as a designer?

It will let you cut your power consumption 70% by directly replacing the bipolar PALs in your existing design. With no new development tools. And with no redesign.

In new designs, you'll have a head start on reducing power consumption.

And there's another critical advantage. Unlike bipolar PALs, Samsung's UV-

erasable CPL devices are reprogrammable. Which means that we're in a position to ship 100% tested parts. We subject every CPL device, in fact, to programming, AC, and functional testing.

CPL—low in power, 100% tested, and produced in volume by a manufacturing giant—is here to stay. Request a databook and samples today, and get started with this winning technology now. ■

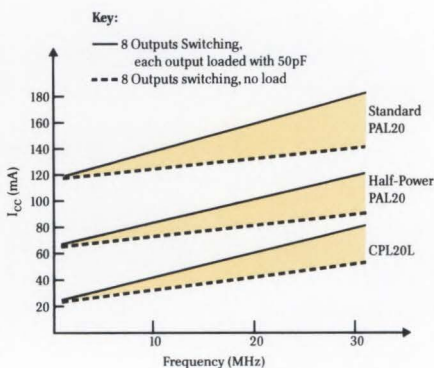

CPL reduces power dissipation up to 70% compared to bipolar PALs.

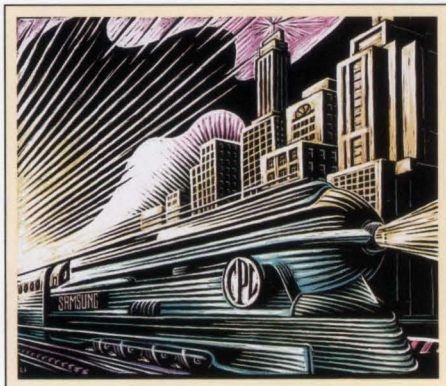

Samsung: A leader in CMOS
 Samsung Semiconductor is among the world's leaders in manufacturing products that use leading-edge CMOS processes. Our 6-inch wafer-fabrication lines are some of the most advanced in existence. Our technology has evolved from 2.5 micron to 0.8 micron in just four years. And, we have invested more than \$600 million in new-product development. Throughout our growth, we have continued to manufacture products that meet the very highest quality standards.

The CPL Parts

CPL 20	CPL 24
CPL16L8	CPL20L10
CPL16R4	CPL20L8
CPL16R6	CPL20R4
CPL16R8	CPL20R6
	CPL20R8

Speed options: 25 nsecs, 35 nsecs.
 Power options (I_{cc} max.) 45 mA, 70 mA

TURN

to coupon on back page to request free CPL samples and data book.



To The Forefront.

You can develop a CPL design with existing tools. Or you can use our Starter Kit and start prototyping immediately.

Developing new, low-power designs with Samsung CPL is easy. And to make it that much easier, we're offering a low-priced CPL Starter Kit.

The Starter Kit includes a software package developed by Personal CAD Systems and based on CUPL™, the most powerful high-level language for designing programmable logic. And it also includes samples of Samsung CPL20 and CPL24 devices, which are supported by the Starter Kit.

Since CPL devices are reprogrammable, this means the Starter Kit includes everything you'll need to prototype and debug your design.

And you'll be doing that in short order. The CUPL software runs on any IBM PC/XT/AT or compatible system, and it lets you choose from a variety of options for entering your design—including truth tables; state diagrams and ASM flow charts (for describing sequential designs); and high-level equations.

CUPL power tools provide logic minimization, available in three

algorithms for improved optimization; DeMorganization (helpful when negating complex expressions); and simulation, to help you verify your design.

Comprehensive documentation

includes a logic "template" file for design ease; a fuse map and expanded product-term information; a chip diagram illustrating pin assignments; and a symbol table of all variables. In addition to the CUPL software,



Samsung's CPL Starter Kit includes:

- CPL20 and CPL24 samples.
- A CPL data book.
- A manual for the CUPL software.
- A Programmable Logic User Guide (PLUG) diskette, which lets you browse interactively through the workings of programmable logic.
- "My First PAL Design," a booklet that leads you step by step through programmable logic design.

At just \$220, Samsung's CPL Starter Kit is a bargain. Request ordering information today and get started designing—in low power. ■■■

TURN

to coupon on back
page to request
information on the
CPL Starter Kit.



ADVANCED CMOS LOGIC FAMILY

125 Parts

that are Exceptionally Fast and Very Available.

The entire Samsung AHCT CMOS advanced logic family is in stock, available, ready, and waiting to be shipped—right now. All fast, all very very cool.

KS74AHCT Parts

Gates and Inverters

00	08	20	51
01	09	21	58
02	10	22	86
03	11	27	132
04	12	30	133
05	14	32	266

Buffers and Line Drivers

125	241	367	467
126	244	368	468*
210	365	465*	540
240	366	466	541

Flip-Flops

73	173	534	823
74	174	564	824*
76	175	574	825*
78	273	670	826*
107	374	794	
109	377	821*	
112	399	822*	

Latches

75*	533	841*	845
77*	563	842*	846
259	573	843*	
373	793	844*	

Transceivers/Registered Transceivers

242*	643	651	664
243*	645	652	665*
245	646	658*	
640	648	659*	

Counters

160	168	192	590*
161	169	193	591*
162	190	390*	592
163	191	393	593*

Decoders/Encoders

42	139	154	238
138	148	155	239

Multivibrators

121*	123*	423*	
------	------	------	--

Logic Level Converters

4049	4050*		
------	-------	--	--

Multiplexers

151	158	257	353
153	251	258	
157	253	352	

Shift Registers

164	194	299	596*
165	195	595	597
166			

Arithmetic Circuits

181	518	522	684*
182*	519	679	686*
183	520*	680	688
280	521	682	689*

All parts are available in plastic DIP. For SOIC availability, contact the factory.

*Available by end of 1988.

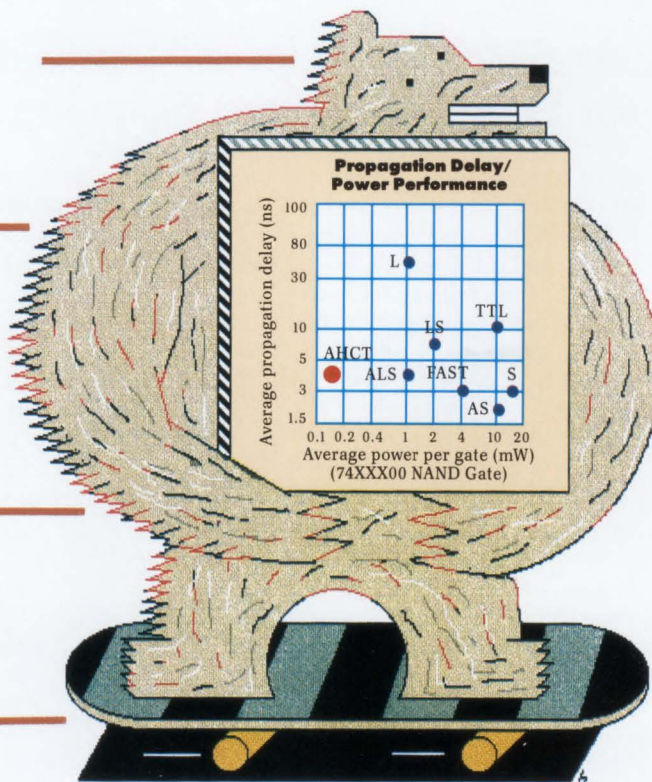
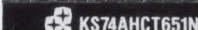
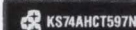

W

hen you look at both speed and power, you see that Samsung's AHCT family is, simply, unsurpassed.

And unlike other advanced logic families, these are parts that are available today, from stock.

All 157* of the AHCT CMOS logic family parts are direct plug-in replacements for ALS and FAST™—parts that provide the most comprehensive selection of standard logic functions

available. Which means that no matter which ALS or FAST part you're using, you can replace it with an AHCT CMOS part—and cut your power-right away.

The entire family has a successful three-year production history behind it. And the parts are competitively priced—in fact you'll pay no more than you would for ALS.

We have free samples available

for you today. Or, as an additional way to learn just how good these parts are, use the coupon at the back of this insert to request information on our AHCT toolbox. It keeps 100 of the most popular advanced CMOS logic device types at your fingertips, whenever you need them. ■

*Of the 157 parts in the family, 125 are available from stock today; the remaining 32 will be available by the end of 1988.

TURN
to coupon on back page to request free AHCT family samples, data book, and toolbox information.

DRAM CONTROLLER

Our new 1- and 4-meg DRAM Controller is also a system accelerator. It can give you

80ns Performance
from 120ns DRAMs.

Our new 1- and 4-meg DRAM Controller does so much for system speed that we've named it *The Accelerator*.

If you're a designer attracted to speed, you're going to want to design it in.

The KS84C21/22 DRAM Controller supports interleaving, and it supports the fastest access modes of the newest DRAMs.

It radically reduces parts count and engineering effort compared to PAL-based designs and interfaces to all major microprocessors.

But above all, it effectively increases the speed of your memory array—giving you performance exceeding 80ns from 120ns DRAMs.* Which



means if you want speed, you won't have to drive up costs by using expensive DRAMs, and you won't have to go to SRAMs either.

The Accelerator is available in two

versions. One has an externally programmable register, for prototyping and moderate-volume applications. The other version is the first and only mask-programmed DRAM controller ever developed anywhere, and it eliminates still more logic parts.

To make it easier to get started with The Accelerator, we've made up a sample kit.

Request yours today and start designing-in speed!

Samsung's DRAM Controller.

Part	RAMs Supported	Package
KS84C21-25CL	256K, 1 MB	68-pin PLCC
KS84C22-25CL	256K, 1 MB, 4 MB	84-pin PLCC

*System dependent.

TURN

to coupon on back page to request free DRAM controller sample kit and specifications.



Samsung: Building on our leadership in DRAMs
As one of the world's leading producers of DRAMs, Samsung Semiconductor has been able to compete in one of the most demanding technologies of all. And we will continue to do so as our 4- and even 16-megabit products emerge. We're making additional use of this manufacturing know-how to deliver an extremely broad range of semiconductor products that are remarkable for their high performance, their cost-effectiveness, and their reliability.

 KS84C21-25CL

EEPROMS

Our CMOS 64K EEPROM Is an Entirely New Breed.



Feature by feature it's as good or better. But besides using less power, it also consumes less money.

When you stack it up against the leading competitors, our new CMOS 64K EEPROM is, in a word, better.

It uses less power (100 μ A vs. 150 μ A standby current, 30 mA vs. 50 mA active current). It's exceptionally fast.

And it's available at much lower cost.

The part is available in volume right now.

In reliability, it's superb—far more reliable than requirements call for. In 1000 hours of testing in the key areas of endurance, WHTS, HOPL, and WHOPL—with industry-standard testing procedures—there were *zero*

failures experienced.

We think what all this means is that our new CMOS 64K EEPROM is simply the most sensible choice on the market.

But don't take our word for it. Request our reliability report, data sheet, and samples today. Then compare it for yourself. 

Product Specification	Samsung 28C64 8K x 8 CMOS EEPROM	Leading Competitor's 64K CMOS EEPROM
ISB (standby current)	100 μ A	150 μ A
ICC (active current)	30 mA	50 mA
TAA (address access time)	200 ns	200 ns
TRC (read cycle time)	200 ns	200 ns
TWC (write cycle time)	2-5 ms/byte	2-5 ms/byte
VCC	5V \pm 10%	5V \pm 10%
Page mode	Yes	Yes
Endurance (write cycle)	10,000	10,000
Data retention	10 years	10 years
Packaging	DIP, PLCC	DIP, PLCC

The KM28C64/65 at a glance.

8K x 8 CMOS EEPROM ■ 28-pin JEDEC byte-wide memory pinout (DIP, PLCC) ■ Single 5V \pm 10% Vcc supply ■ Performance: 200/250ns ■ Current: standby (max) 100 μ A; active (max) 30mA ■ 32 byte page write: 5ms ■ 4-cell bridge for enhanced reliability ■ Write completion indicator: Data polling, Rdy/busy (for KM28C65) ■ Endurance 10,000 cycles ■ Data retention 10 years



TURN

to coupon on back page to request free EEPROM samples, reliability report and data book

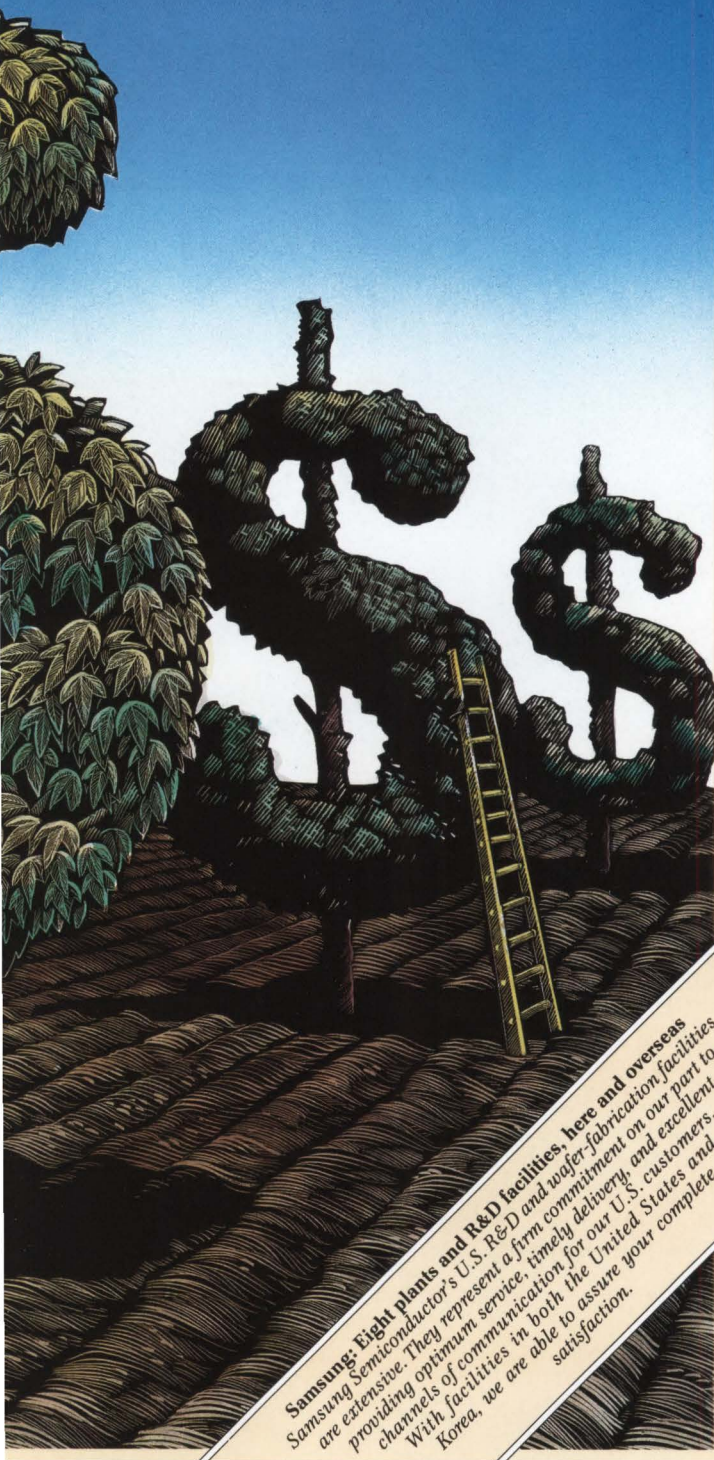

Samsung: Eight plants and R&D facilities, here and overseas are extensive. They represent a firm commitment on our part to providing optimum service, timely delivery, and excellent channels of communication for our U.S. customers. With facilities in both the United States and Korea, we are able to assure your complete satisfaction.

EEPROMS

The Most Reliable Battery-Backed SRAMs Aren't SRAMs at All.



They're EEPROMs from Samsung.

Since EEPROMs don't require batteries to retain data during power loss, they are, of course, inherently more reliable than devices that do—such as SRAMs.

Because of the relative costs, however, it wouldn't occur to most designers to use an EEPROM where conventional thinking calls for an SRAM—even *with* the improvement in reliability that there'd be.

But those relative costs are changing.

Today, SRAMs cost more than they once did. And Samsung's EEPROMs, in fact, now compare favorably in price.

Which means that if you want reliability, there's every reason to start using these EEPROMs—and making your next battery-backed SRAMs, Samsung EEPROMs.

There are, of course, additional applications at which we excel. Our entire EEPROM family—including our new 64K CMOS part—is also superbly suited to rugged applications such as communications, instrumentation, robotics, and industrial control.

All Samsung EEPROMs are guaranteed to provide endurance in excess of 10,000 write cycles and data retention of 10 years. And they meet or surpass all other industry standards for performance, reliability, and quality.

Most important of all, our EEPROMs are available in large quantities *from stock*—so you avoid escalating lead times as well as high prices.

EEPROM performance, reliability, and availability—all at low cost. To start taking advantage of them, request samples, a data sheet, and a reliability report today.

Samsung CMOS and NMOS EEPROMs.

Part Type	Organization	Speed	Features	Technology	Pinout	Availability
KM28C64P	8K x 8	200,250	Data Polling, 32-byte Page Mode, Low Power, 5ms (max) write time	CMOS	28 pin	From Stock
KM28C65P	8K x 8	200,250	Data Polling, 32-byte Page Mode, Low Power, 5ms (max) write time	CMOS	28 pin	From Stock
KM2816AP	2K x 8	250,300,350	10ms (max) write time	NMOS	24 pin	From Stock
KM2817AP	2K x 8	250,300,350	Ready/Busy, 10ms (max) write time	NMOS	28 pin	From Stock

In linear, what Samsung gives you can be stated easily.

MORE.

A DATA CONVERTER THAT DOES MORE.



Samsung's new KSV3110 data converter is a technological feat that we're rather proud of.

On a single chip, it offers independent 8-bit flash A/D and 10-bit D/A functions. And with an operating range of DC to 20MHz, it's faster than any other part available that does both. Also unique, it gives

you an auxiliary circuit, which can be used to do impedance matching within the chip.

What's good about having all this on one chip, of course, is that it saves you real estate and money—and also cuts power drain. And, at the same time, boosts system reliability.

In short, the KSV3110 doesn't just do more. It does *way* more.

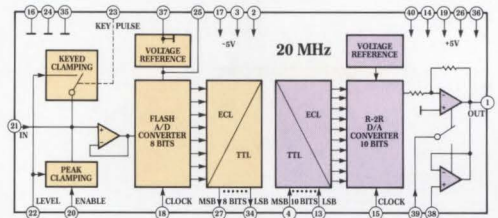

TURN

to coupon on back page to request linear data books and specifications.



Samsung's 3110 Series Combination A/D-D/A Converters.

Part Type	Resolution		Linearity		Conversion Speed	Industry Part
	A/D	D/A	A/D	D/A		
KSV3110N-10	8 bits	10 bits	±1/2 LSB	±1/2 LSB	20 MSPS	
KSV3110N-9	8 bits	10 bits	±1/2 LSB	±1 LSB	20 MSPS	
KSV3110N-8	8 bits	10 bits	±1/2 LSB	±2 LSB	20 MSPS	
KSV3110N-7	8 bits	10 bits	±1/2 LSB	±4 LSB	20 MSPS	
KSV3100AN-8	8 bits	10 bits	±1/2 LSB	±2 LSB	20 MSPS	UVC3101
KSV3100AN-7	8 bits	10 bits	±1/2 LSB	±4 LSB	20 MSPS	UVC3101

VOLUME LEADERSHIP IN CONVENTIONAL A/D AND D/A...



As a company that does remarkable things in the manufacturing arena, Samsung is in a superb position to produce high-quality conventional data converters cost effectively and in volume.

And that's just what we do.

Which means that if you use data converters in large quantities, you simply won't find anyone it makes better sense to do business with.

Samsung: Some of the world's most advanced fabrication lines Among our fabrication lines, a particular showpiece is our new Class 1.0" wafer facility in Kihong, Korea, dedicated to DRAM technology and set to open in October of this year. It utilizes advanced stepper technology and automated manufacturing and is among the largest in the world.

The Samsung A/D and D/A Lines.

Part Type	Resolution		Linearity		Conversion Speed	Industry Part
	A/D	D/A	A/D	D/A		
KSV3208N	8 bits		±1/2 LSB		20 MSPS	
KAD0820ACN	8 bits		±1/2 LSB		1.5 μsec	ADC0820BCN
KAD0820AIN	8 bits		±1/2 LSB		1.5 μsec	ADC0820BCJ
KAD0820BCN	8 bits		±1 LSB		1.5 μsec	ADC0820CCN
KAD0820BIN	8 bits		±1 LSB		1.5 μsec	ADC0820CCJ
KAD0808IN	8 bits		±1/2 LSB		100 μsec	ADC0808CCN
KAD0809IN	8 bits		±1 LSB		100 μsec	ADC0809CCN
KDA0800CN		8 bits		±1/2 LSB	*100 nsec	DAC0800LCN
KDA0801CN		8 bits		±1 LSB	*100 nsec	DAC0801LCN
KDA0802CN		8 bits		±1/4 LSB	*100 nsec	DAC0802LCN
KDA0806CN		8 bits		±2 LSB	*150 nsec	DAC0806LCN
KDA0807CN		8 bits		±1 LSB	*150 nsec	DAC0807LCN
KDA0808CN		8 bits		±1/2 LSB	*150 nsec	DAC0808LCN
KS7126CN	3-1/2 digit		±1/2 LSB		333 msec	TSC7126
KS25C02		CMOS 8-bit successive approx. register				DM2502
KS25C03		CMOS 8-bit successive approx. register				DM2503
KS25C04		CMOS 12-bit successive approx. register				DM2504

*Settling Time

AND IN OP AMPS, REGULATORS, COMPARATORS, TIMERS, AND MORE.



Across the entire spectrum of high-volume linear devices, in fact, Samsung—being a manufacturing leader—offers a combination of reliability and competitiveness in price that has given these devices tremendous acceptance in the marketplace.

It's a market we're strongly committed to, and we have more than 250 industry-standard ICs available for immediate delivery now.

If by chance you *aren't* buying linear devices from Samsung, it will make sense for you to look into us.

SOLUTIONS TAILORED TO SPECIFIC HIGH-VOLUME NEEDS. FOR THOSE WHO SIMPLY NEED MORE.



A particular specialty that Samsung offers in linear is in the area of specific, rather simple solutions tailored to certain very high-volume applications.

We have developed devices for use in such high-volume areas as telephones, car stereo, and household appliances—among many others.

If you have a need for a high-volume, tailored linear device on this order, we may have the device you need—and if we don't, we'd like to talk about making

it for you.

Our line of simple speech synthesis chips—designed for use primarily in electronic toys and answering machines—is one particular example of the kind of low-cost solution we can offer.

To learn about others, please contact us.

Our Speech Synthesizers.

Part	Function	Application
KS5901A	Voice synthesizer (external ROM)	Sound information answering machines
KS5902XX	Voice synthesizer (internal ROM)	Toys; simple sound generation
KS5911	Voice recording and reproducing (talking back type)	Talk-back answering machines
KS5912XX	Natural sound generation	Toys; natural sound effect

Major Linear ICs

Regulators

3T Positive

KA78TXXCF	3 Amp
KA78TXXCT	3 Amp
LM317T	1.5 Amp
MC78XXCT	1 Amp
MC78MXXCT	0.5 Amp
MC78LXXACZ	0.1 Amp
LM723CN	0.1 Amp

3T Negative

KA337T	1.5 Amp
MC79XXCT	1 Amp
MC79MXXCT	0.5 Amp
MC79LXXACZ	0.1 Amp

Switching

KA78S40CN	KA3524N
-----------	---------

REF Voltage

KA431CZ (TL431CLP)	KA336Z-2.5,5
KA431N (TL431CP)	KA385Z-1.2

Comparators

KA319N (LM319N)	LM2903N
KA361N (LM361N)	LM311N*
KA710CN (LM710N)	LM3302N
KS374N (TLC374N)	LM339N/AN*
LM2901N	LM393N/AN*

Op Amplifiers

KA301N/AN (LM301N)*	LM348N*
KA733CN (LM733CN)	LM358N/AN*
KA9256 (POWER AMP)	LM741CN*
KF351N (LF351N)	MC1458N*
LM2902N	MC3303N
LM2904N	MC3403N*
LM324N/AN*	MC4558N*

Telecommunication ICs

KA2410N	Tone Ringer
KA2411N	Tone Ringer
KA2418N	Tone Ringer/bridge diode
KA2412FN	Speech Network
KA2413N	DTMF
KS5808N	DTMF (MK5089)
KS5805AN	Pulse (MK50992)
KS5805BN	Pulse (MK50993)
KS55820N	DTMF/Pulse
KT3040J	CODEC Filter
KT5116J	CODEC
LM567N*	Tone Decoder
LM567LN	Tone Decoder (Low Power)
KS5812N	Quad UART

Timers

KS555N (CMOS)*	NE555CN*
KS555HN (CMOS)*	NE556CN*
KS556N (CMOS)*	NE558CN

RS-232 Interfaces

MC1488N*	MC1489/AN*
----------	------------

Audio ICs

LM386N	0.5 Watt Power Amp
KA2201N	1.2 Watt Power Amp
KA2206	2.3 Watt Dual Power Amp
KA22062	4.6 Watt Dual Power Amp
KA2210	5.8 Watt Dual Power Amp
KA22101	23 Watt Power Amp
KA2243	AM/FM IF & DET
KA22441	FM IF & DET
KA22495	FM Front End
KA2263	FM MPX

45 other audio ICs available

Video ICs

KA2914A	Color TV VIF/SIF
KA2153	NTSC Chroma & Deflection
KA6101	Video R.G.B. Interface
KA6102	Video R.G.B. Interface

40 other video ICs available

Others

KA2580AN (UDN2580AN)	
KA2588AN (UDN2588AN)	
KA2651N (UCN5815AN)	
KA2615	LED/Lamp Driver
KA2616	LED/Lamp Driver
KA2284	5 Dot LED Meter Driver
KA2286	5 Dot LED Meter Driver
KA2288	7 Dot LED Meter Driver
KA2181	Infrared Amp
KA8301	Motor Driver IC
KS5803AN	Infrared Transmitter
MC3361N	FM IF Amp

*Also available in surface mount package (SOIC)

TRANSISTORS

We Launch a New 1500 volt Power Transistor

**With over 500 transistors,
Samsung is among the world's
largest producers.
Our 1500-volt parts break
ground even for us.**

As a producer of transistors, Samsung sits squarely among the very largest in the world.

There is virtually no transistor need we can't fill—with a high-quality part, and at an advantageous price.

Our entire line of more than 500 transistors, in fact, is in full production and available from stock.

You can order anything from our list *now*, and get immediate delivery.

At present, we are introducing state-of-the-art, 1500-volt power transistors—transistors so difficult to produce that only one other company makes them.

We also provide 100 types of SOT-23s, ideal for both hybrid and surface-mount applications, plus TIP Series, MJE Series, and TO-92 transistors.

Many are listed here, but for a complete list of Samsung transistors, please turn to the back of this issue and request it.



**The new 1500-volt
transistors at a glance.**

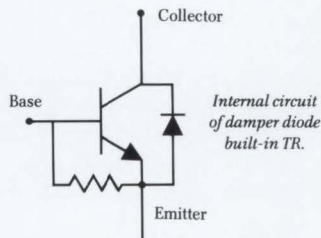

Designed for high-voltage switching systems and industrial motor controls, the eight new Samsung 1500-volt power transistors utilize the TO-3PF fully isolated plastic package.

TURN

to coupon on back
page to request complete
list of Samsung
transistors and data
book.



Transistors From Samsung

1500-Volt Power TR

2.5 amps KSD5010*	5 amps KSD5012*	6 amps KSD5013*
KSD5014	KSD5016	KSD5017

3.5 amps KSD5011*
KSD5015

*Damper diode built-in transistor

SOT-23

BCX70G	MMBT4403	MMBTA43
BCX71G	MMBT5087	MMBTA55
MMBR5179	MMBT5088	MMBTA56
MMBT2222A	MMBT5089	MMBTA63
MMBT2484	MMBT5401	MMBTA64
MMBT2907A	MMBT5550	MMBTA70
MMBT3904	MMBT6428	MMBTA92
MMBT3906	MMBTA05	MMBTA93
MMBT4123	MMBTA06	MMBTH10
MMBT4124	MMBTA13	MMBTH17
MMBT4125	MMBTA14	MMBTH24
MMBT4126	MMBTA20	
MMBT4401	MMBTA42	

66 other types also available.

TIP SERIES

TIP29 Family	TIP106	TIP140F
TIP30 Family	TIP107	TIP140T
TIP31 Family	TIP110	TIP141F
TIP32 Family	TIP111	TIP141T
TIP41 Family	TIP112	TIP142F
TIP42 Family	TIP115	TIP142T
TIP47	TIP116	TIP145F
TIP48	TIP117	TIP145T
TIP59	TIP120	TIP146F
TIP50	TIP121	TIP146T
TIP100	TIP122	TIP147F
TIP101	TIP125	TIP147T
TIP102	TIP126	
TIP105	TIP127	

MJE SERIES

MJE170	MJE210	MJE800
MJE171	MJE340	MJE801
MJE172	MJE350	MJE802
MJE180	MJE700	MJE803
MJE181	MJE701	MJE2955T
MJE182	MJE702	MJE3055T
MJE200	MJE703	

TO-92

2N3904	2N5210	MPSA42
2N3906	2N5400	MPSA43
2N4123	2N5401	MPSA55
2N4124	2N5550	MPSA56
2N4125	2N5551	MPSA70
2N4126	2N6427	MPSA92
2N4400	2N6428	MPSA93
2N4401	2N6515	MPSH10
2N4402	2N6517	MPSH17
2N4403	2N6520	MPSH20
2N5086	MPSA05	MPSH24
2N5087	MPSA06	PN2222A
2N5088	MPSA14	PN2907A
2N5089	MPSA20	

200 other types also available.

Samsung: One of the world's largest corporations. Samsung Semiconductor is here to stay. Last year, the Samsung Group enjoyed revenues of \$24 billion, which would put us in 15th place on the list of the Forbes 500. We have the resources to make things happen technologically, and we have the strength to be a partner in whom you may have absolute confidence.

MOSFETS

THE WORD IS Rugged

Power MOSFETs just don't come any more rugged than ours.

E

xhaustive testing has proven Samsung's line of over 400 industry-standard power MOSFETs to be unsurpassed anywhere in ruggedness. They've been shown to withstand 2J at 500V, and in addition, each part has been screened to MIL-STD-750 specifications.

Our recently published ruggedness application note thoroughly documents the superior ruggedness of these parts, and we invite you to complete the coupon at the back of this insert to request a copy. We'll rush it to you.

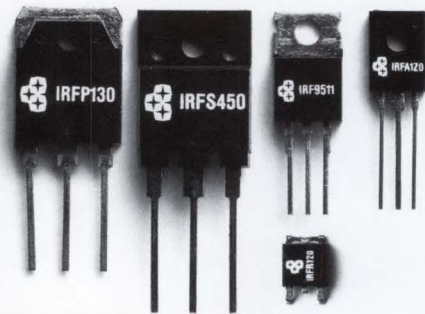

The single MOSFET that does the job of two.

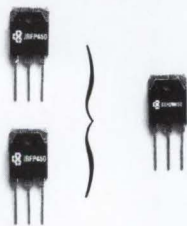

Samsung's SSH20N50 - available only from us - improves reliability, simplifies assembly, and minimizes mounting hardware, because it's a direct replacement for two IRFP450's. There's less to go wrong, and less to mount.

TURN
to coupon on back page to request MOSFET samples and ruggedness application note.

In the past several months, our MOSFETs have been qualified at an exceptionally large number of major accounts. We continue to offer the entire line with competitive pricing.

Samsung MOSFETs directly replace parts from IR and Motorola.® And since they are one of the broadest lines on the market, you can get just about anything you need. Both N and P channel parts are available, as are a variety of packages - including lead-formed TO-220s, state-of-the-art TO-247 FULL PACK and DPAK.

What more could you ask?

Samsung Power MOSFETs

TO-247 Full Pack N-Channel Types	IRF430	SSM4N50
	IRF431	SSM20N50
	IRF432	SSM4N45
	IRF433	SSM20N45
	IRF440	SSM5N40
	IRF441	SSM25N40
	IRF442	SSM5N35
	IRF443	SSM25N35
	IRF450	SSM7N20
	IRF451	SSM8N20
	IRF452	SSM7N18
	IRF453	SSM8N18
	SSM3N70	SSM7N15
	SSM4N70	SSM8N15
	SSM6N70	SSM7N12
TO-3P Package N-Channel Types	SSM10N70	SSM8N12
	SSM4N60	SSM12N10
	SSM6N60	SSM10N10
	SSM8N60	SSM12N08
	SSM15N60	SSM10N08
	SSM4N55	SSM12N06
	SSM6N55	SSM10N06
	SSM8N55	SSM12N05
	SSM15N55	SSM10N05
	IRFP120	IRFP922
	IRFP121	IRFP923
	IRFP122	IRFP924
	IRFP123	IRFP925
	IRFP130	IRFP926
	IRFP131	IRFP927
	IRFP132	IRFP928
	IRFP133	IRFP929
	IRFP140	IRFP930
	IRFP141	IRFP931
	IRFP142	IRFP932
	IRFP143	IRFP933
	IRFP150	IRFP934
	IRFP151	IRFP935
	IRFP152	IRFP936
	IRFP153	IRFP937
	IRFP220	IRFP938
	IRFP221	IRFP939
	IRFP222	IRFP940
	IRFP223	IRFP941
	IRFP230	IRFP942
	IRFP231	IRFP943
	IRFP232	IRFP944
	IRFP233	IRFP945
	IRFP240	IRFP946
	IRFP241	IRFP947
	IRFP242	IRFP948
	IRFP243	IRFP949
	IRFP250	IRFP950
	IRFP251	IRFP951
	IRFP252	IRFP952
	IRFP253	IRFP953
	IRFP320	IRFP954
	IRFP321	IRFP955
	IRFP322	IRFP956
	IRFP323	IRFP957
	IRFP330	IRFP958
	IRFP331	IRFP959
	IRFP332	IRFP960
	IRFP333	IRFP961
	IRFP340	IRFP962
	IRFP341	IRFP963
	IRFP342	IRFP964
	IRFP343	IRFP965
	IRFP350	IRFP966
	IRFP351	IRFP967
	IRFP352	IRFP968
	IRFP420	IRFP969
	IRFP421	IRFP970
TO-220 Package N-Channel Types	IRF510	IRF741
	IRF511	IRF742
	IRF512	IRF743
	IRF513	IRF820
	IRF520	IRF821
	IRF521	IRF822
	IRF522	IRF823
	IRF523	IRF830
	IRF530	IRF831
	IRF531	IRF832
	IRF532	IRF833
	IRF533	IRF840
	IRF540	IRF841
	IRF541	IRF842
	IRF542	IRF843
	IRF543	SSP3N70
	IRF610	SSP4N70
	IRF611	SSP4N60
	IRF612	SSP6N70
	IRF613	SSP6N60
	IRF620	SSP6N55
	IRF621	SSP4N60
	IRF622	SSP4N55
	IRF623	SSP4N50
	IRF630	SSP4N45
	IRF631	SSP5N40
	IRF632	SSP5N35
	IRF633	SSP7N20
	IRF640	SSP8N20
	IRF641	SSP7N18
	IRF642	SSP8N18
	IRF643	SSP7N15
	IRF710	SSP8N15
	IRF711	SSP7N12
	IRF712	SSP8N12
	IRF713	SSP12N10
	IRF720	SSP10N10
	IRF721	SSP12N08
	IRF722	SSP10N08
	IRF723	SSP12N06
	IRF730	SSP4N06
	IRF731	SSP10N06
	IRF732	SSP12N05
	IRF733	SSP10N05
	IRF740	
TO-3 Package N-Channel Types	IRF120	IRF242
	IRF121	IRF243
	IRF122	IRF250
	IRF123	IRF251
	IRF130	IRF252
	IRF131	IRF253
	IRF132	IRF320
	IRF133	IRF321
	IRF140	IRF322
	IRF141	IRF323
	IRF142	IRF330
	IRF143	IRF331
	IRF150	IRF332
	IRF151	IRF333
	IRF152	IRF340
	IRF153	IRF341
	IRF220	IRF342
	IRF221	IRF343
	IRF222	IRF350
	IRF223	IRF351
	IRF230	IRF352
	IRF231	IRF353
	IRF232	IRF420
	IRF233	IRF421
	IRF240	IRF422
	IRF241	IRF423
TO-220 Package P-Channel Types	IRF9510	IRF9610
	IRF9511	IRF9611
	IRF9512	IRF9612
	IRF9513	IRF9613
	IRF9520	IRF9620
	IRF9521	IRF9621
	IRF9522	IRF9622
	IRF9523	IRF9623
	IRF9530	IRF9630
	IRF9531	IRF9631
	IRF9532	IRF9632
	IRF9533	IRF9633
	IRF9540	IRF9640
	IRF9541	IRF9641
	IRF9542	IRF9642
	IRF9543	IRF9643
TO-126 Package N-Channel Types	IRFA120	IRFA123

DRAMS

1Mb DRAMs!



They're in CMOS, they're fast, and they lead the ranks of a formidable family of DRAM products.

As the latest DRAM addition to our line of leadership memory products, Samsung now offers several 1-megabit DRAMs. Thanks to our internally developed CMOS technology, they are low in power consumption, offer extremely fast access

times, and as our reliability report shows, are highly reliable.

Part Type	Organ.	Features	Speeds	Packages	Avail.
KM41C1000	1M x 1	Fast Page mode	100,120	DIP,ZIP,SOJ	Now
KM41C1001	1M x 1	Nibble mode	100,120	DIP,ZIP,SOJ	2Q '89
KM41C1002	1M x 1	Static Column mode	100,120	DIP,ZIP,SOJ	3Q '88*
KM44C256	256K x 4	Fast Page mode	100,120	DIP,ZIP,SOJ	3Q '88
KM44C258	256K x 4	Static Column mode	100,120	DIP,ZIP,SOJ	3Q '89
KM41256	256K x 1	Page mode	120,150	DIP,ZIP,PLCC	Now
KM41257	256 x 1	Nibble mode	120,150	DIP,ZIP,PLCC	Now
KM41464	64K x 4	Page mode	120,150	DIP,ZIP,PLCC	Now
KM4164	64K x 1	Page mode	120,150	DIP	Now

*Samples available now.

We offer our complete DRAM line in all industry-standard packages.

Please contact us today for reliability reports and data sheets.

To receive data and/or samples

of Samsung products, simply check the items you want and return this coupon to Product Marketing Dept., Samsung Semiconductor Inc., 3725 No. First St., San Jose, CA 95134-1708. Or call this number:

1-800-423-8624

1-800-669-5400 (inside California) or 408-434-5400

Name _____

Company _____ Title _____

Address _____

City _____ State _____ Zip _____

Telephone (_____) _____

<input type="checkbox"/> CMOS Programmable Logic	<input type="checkbox"/> Samples <input type="checkbox"/> Data book	<input type="checkbox"/> Information on CPL Starter Kit	Part type _____
<input type="checkbox"/> Advanced CMOS logic family	<input type="checkbox"/> Samples <input type="checkbox"/> Data book	<input type="checkbox"/> Information on AHCT toolbox	_____
<input type="checkbox"/> DRAM controller	<input type="checkbox"/> Sample kit	<input type="checkbox"/> Specifications	_____
<input type="checkbox"/> 64K CMOS EEPROMs	<input type="checkbox"/> Samples	<input type="checkbox"/> Reliability report	_____
<input type="checkbox"/> EEPROMs	<input type="checkbox"/> Samples	<input type="checkbox"/> Data book	_____
<input type="checkbox"/> Linear devices	<input type="checkbox"/> Data converter data book <input type="checkbox"/> Linear IC data book	<input type="checkbox"/> Speech synthesizer spec sheet	_____
<input type="checkbox"/> Transistors	<input type="checkbox"/> Data book	<input type="checkbox"/> Complete list of Samsung transistors	_____
<input type="checkbox"/> MOSFETs	<input type="checkbox"/> Samples	<input type="checkbox"/> Ruggedness application note	_____
<input type="checkbox"/> DRAMs	<input type="checkbox"/> Data sheets	<input type="checkbox"/> Reliability report	_____

EDN





THE LARGEST AND MOST PRESTIGIOUS OEM ELECTRONICS EXPOSITION IN TEXAS IS EVEN BETTER THIS YEAR!

Check these reasons and discover why you REALLY can't afford to miss Midcon/88

- ★ **Midcon/88 is New.** New exhibits, new programs, new learning experiences
- ★ **New Opportunities.** The chance to meet face-to-face with the leading designers and manufacturers of the newest and most advanced electronics products.
- ★ **New Technical Program.** Leading experts discuss the latest technological breakthroughs and advancements. Sure to help you grow professionally and be more valuable to your firm.
- ★ **New Solutions to Technical Problems.** Meet with design engineers who offer new solutions through new technology and products.

**ADD IT ALL UP!!!
YOU REALLY CAN'T AFFORD TO MISS MIDCON/88**



COMPLIMENTARY REGISTRATION

2 -90121

- ZX IEEE Member
 ZY ERA Member
 ZZ Other Affiliation _____

CIRCLE APPLICABLE BOXES CARD MUST BE FILLED OUT COMPLETELY

BA	Computers
BB	Communications
BC	Military/Aerospace
BD	Automotive
BE	Electronic Components, Devices
BF	Business Equipment
BG	Medical
BH	Consumer/Entertainment
BI	Consulting/Education
BJ	Other

AA	Systems Design
AB	Circuit Design
AC	Packaging, Prototype Design
AD	Production/Fabrication
AE	Research/Development
AF	Purchasing
AG	Engineering Management
AH	Administration, Management
AI	Testing, QC/QA
AJ	Consulting, Education
AK	Other
AL	CAD/CAE Tools, Systems
AM	Computer Software
AN	Electronic Components
AO	Electro-Mechanical Components
AP	Production Equipment, Machinery
AQ	Production Supplies, Materials
AR	Consulting Services
AS	Fabrication Services
AT	Test, Inspection, Measurement Instr.
AU	Testing Systems
AV	Other

Please PRINT as you want shown on badge

Name _____
FIRST OR INITIALS LAST

Position • Telephone _____ • _____
AREA CODE NUMBER

Company/Organization _____

Business Address _____
DEPT OR M/S

City, State, Zip Code _____
STATE ZIP CODE

To receive your badge in advance, complete this card and mail to arrive by **August 12, 1988**. After **August 12**, bring completed card with you to Midcon for free admittance. Card must be filled out completely. **Persons under 18 years of age not admitted.**

To register complete this form and mail to: Registration Control Systems, 2368 Eastman Ave., Suite 11, Ventura, CA 93003-

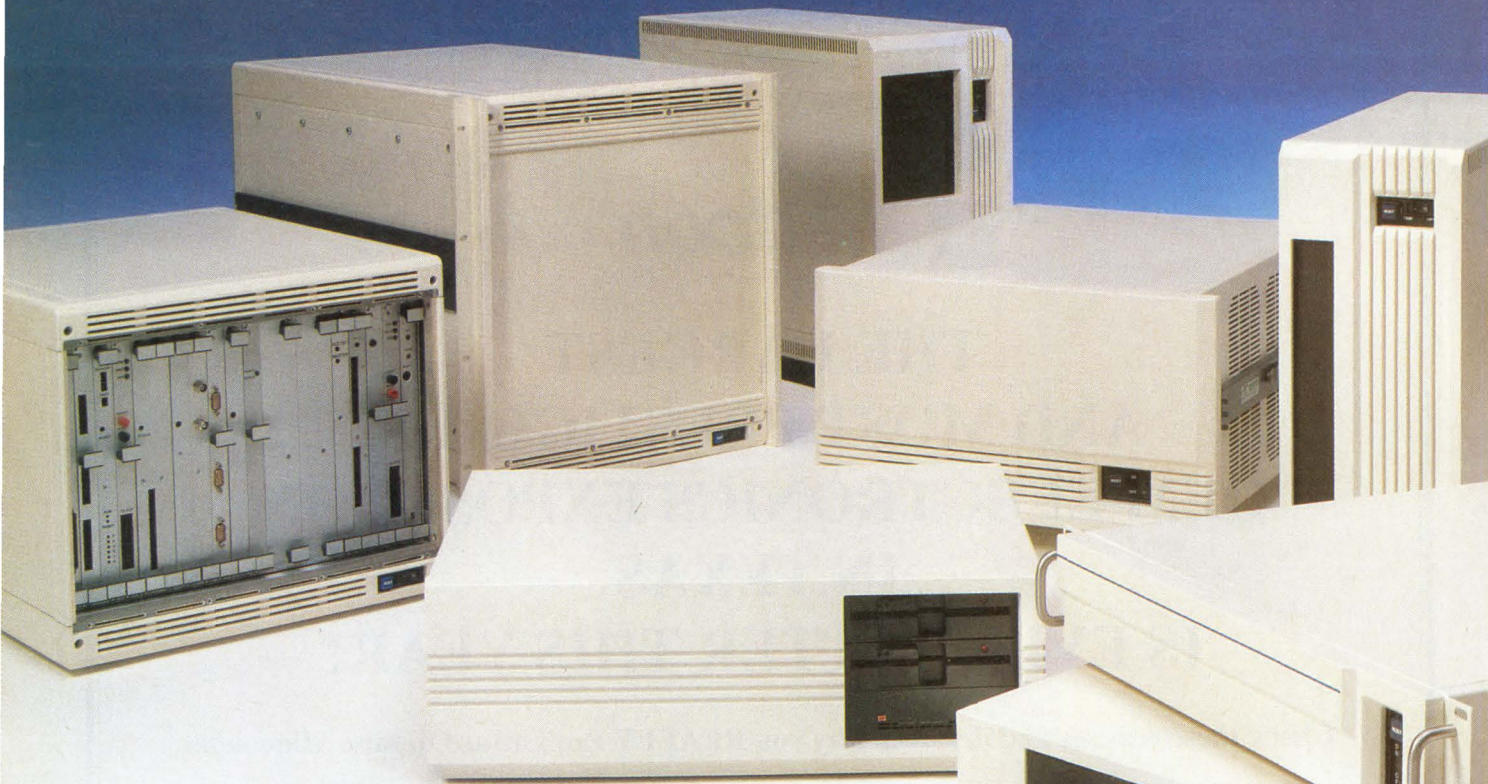

Packaging Makes the Difference

If you want your system to look its very best, look to Electronic Solutions.

The first thing you'll find is that the beauty we add to your board level system is a lot more than skin deep. It will look better, sell better, and work better in an Electronic Solutions enclosure, for a lot of reasons:

Engineered Cooling for maximum performance from the new, high-density cards.

Built from Experience: We've been the enclosure experts since board-level systems began.

Safety and EMI/RFI Approvals by UL, CSA, TUV(IEC380) and the FCC.



Off the Shelf or Built to Order: From simple needs like paint and labeling to complete reshaping for the most unusual requirements—we do it all. Most of the time we have a big head start.

See how packaging can make the big difference to your system. Give us a call today on our toll-free numbers.

Huge Selection of Complete Enclosures

Multibus I

Tabletop 4, 7, 10, 12, 15 slots
3 1/2" Rack 4 slots
7" Rack 7, 10 slots
10 1/2" Rack 12, 15 slots
DeskMate 7, 10, 12, 15 slots

VME

Tabletop 3, 5, 6, 7, 12, 20, 32, 40 slots
3 1/2" Rack 3 slots
7" Rack 5, 7 slots
10 1/2" Rack 12 slots
14" Rack 12, 20, 32, 40 slots
DeskMate 5, 7, 12 slots

Multibus II

Tabletop 6, 7, 12, 20 slots
7" Rack 7 slots
14" Rack 12, 20 slots

REQUESTED INFORMATION
PLEASE DELIVER IMMEDIATELY

TO: _____
COMPANY: _____
FAX: _____

Electronic Solutions
FACTSHEET

Series 10
VERTICAL ENCLOSURE

Want the latest data in a hurry? Nothing is faster than Electronic Solutions' new "FAX the FACTS" program. Call our "800" number and give us the information you need from us. We'll FAX it to you immediately.



Electronic Solutions
UNIT OF ZERO CORPORATION

6790 Flanders Drive, San Diego, CA 92121
(619) 452-9333 Telex 11(TWX); 910-335-1169

Call Toll Free: (800)854-7086
In Calif: **(800)772-7086**

CIRCLE NO 68

Video and system controller IC promises low-cost 16/32-bit color computers

Used in conjunction with the company's 68070 μ P, the 66470 video and system controller IC allows you to build a complete 16/32-bit processing and color display system, using as few as 10 ICs. You can also utilize the device with other 68000-family μ Ps. The 66470 incorporates a dynamic RAM controller for video/system RAM, display control logic, a pixel accelerator, and an interface for an optional graphics coprocessor. Its system-controller functions include reset frequencing, address decoding, interrupt, DTACK generation logic, and a watchdog timer.

The dynamic RAM controller supports dynamic RAMs with capacities as high as 1M bit, and the address decoding provides chip selects for as much as 1.5M bytes of video/system RAM, 0.5M bytes of ROM, and 1k byte of peripheral I/O space. You can configure as much as 1M byte of the RAM as video memory, containing 4- or 8-bit pixels to provide 768 \times 560-pixel 16-color, or 384 \times 280-pixel 256-color displays, respectively. Lower screen resolutions are also possible. You can program the video start address anywhere within the 1M byte of video RAM; each screen pixel occupies either a nibble or a byte in memory, thus simplifying the fetching of pixel information for modification by the system's CPU or the 66470's pixel accelerator. You can configure the video RAM for logical or physical screen modes and generate either full screens or screens with a programmable border color.

The video-display logic provides a digital output for use with an external D/A converter or color look-up table. The display timing is compatible with European, Japanese, and US standards for TV and Teletext.

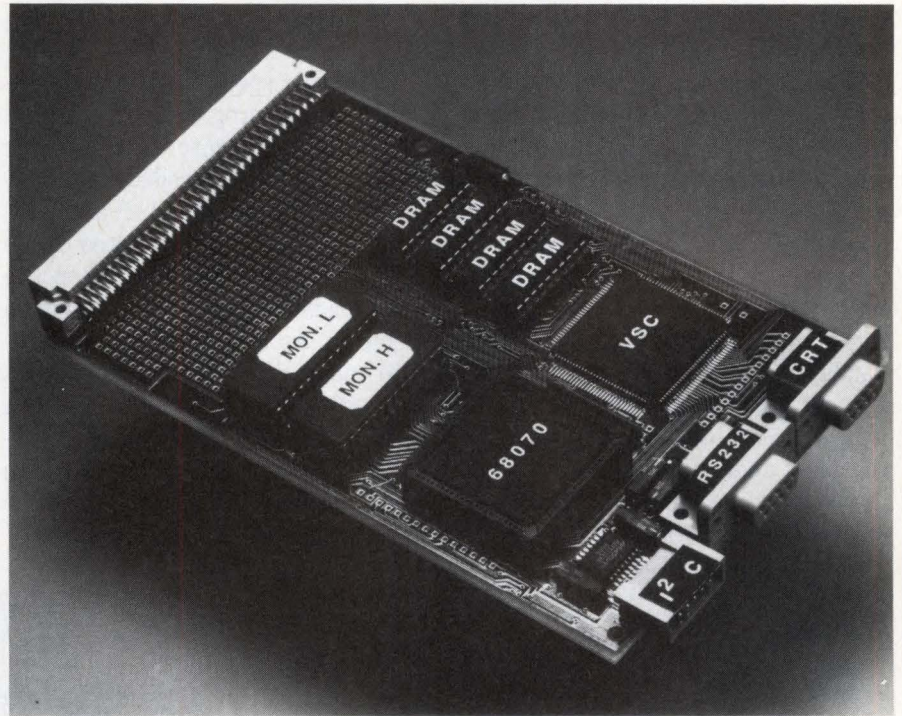

Using the 68070/66470 chip set, this single-Eurocard board contains all the components required to implement a 16/32-bit color computer, and still has room to spare.

You can synchronize the 66470 with a TV signal or with another 66470, and a RAM-control mechanism allows you to operate the video RAM as a frame grabber.

Associated with the video RAM are two areas of memory that contain instructions to control the display. The first of these, designated the image control area (ICA), is accessed before the start of each frame—that is, during the display's vertical retrace period. The second area, designated the dynamic control area (DCA), contains as much as 64 bytes of information for each horizontal line in the display. The instructions in the dynamic control area for a particular display line are fetched and executed during the horizontal retrace period that precedes the display of that line.

The ICA/DCA instruction list in-

cludes instructions to reload the video start address, generate a processor interrupt, and change the border color. You can also include instructions to control a back-end processor that's connected to the video output port. The ability to change the video start address on a frame-by-frame or line-by-line basis allows you to achieve a variety of special effects, including horizontal and vertical smooth scrolling, or division of the screen into a number of horizontal subscreens.

To manipulate individual pixels in the image, you can use the 66470's on-chip pixel accelerator rather than the system CPU. This accelerator can perform pixel operations in a single instruction cycle that would take several instruction cycles if you performed them using the 68000's instruction set. Operations that the

PRODUCT UPDATE

pixel accelerator can perform include copying source pixels to destination pixels, exchanging source and destination pixels, transferring source pixels to destination pixels with an associated color change to the current foreground or background color, changing pixels to the current foreground or background color according to a bit-map, and testing pixel color.

You can make most of these operations conditional on whether or not the source pixel's color coincides with the currently defined transparent color. Other pixel accelerator operations, which can execute concurrently with some of the operations described above, include horizontal zooming or shrinking of the display by a factor of 2, transparency test inversion, and a range of logical operations on the result of the pixel operation.

The pixel accelerator doesn't operate as a coprocessor that needs to

take control of the CPU's address and data bus. Instead, you use the CPU to set up the required pixel operation in the pixel accelerator, then use the CPU to move data to and from registers in the pixel accelerator. The pixel accelerator is automatically triggered to perform the pixel operation when the CPU writes data to the appropriate register.

To further speed image manipulation, you can program the pixel accelerator to operate with implicit addressing. In this mode, the appropriate register in the pixel accelerator is automatically connected to the dynamic RAM's data bus when the CPU reads or writes data from or to memory. As a result, you can execute many pixel operations with a single 68000 move instruction. In addition to controlling the pixel accelerator from the system's main CPU, you can also control it via the 66470's coprocessor interface.

The 66470 is a CMOS part that operates from a single 5V supply and draws a maximum operating supply current of 65 mA at a clock frequency of 30 MHz. It is packaged in a 124-pin quad flatpack, surface-mount package. Initial samples of the 66470 have been implemented in a gate array and are available at a cost of around \$50 (100). The company expects that full custom parts with enhanced functionality will be available in 1989 at a cost of around \$25 (100), but that a high-volume price for the 68070/66470 chip set will be around \$30 by 1991.

—Peter Harold

Philips, Components Division,
5600 AM Eindhoven, The Netherlands.
Phone (040) 757189. TLX 51573.

Circle No 726

Signetics Corp, 811 E Arques
Ave, Sunnyvale, CA 94088. Phone
(408) 991-4571.

Circle No 727



ARIES
ELECTRONICS, INC.

Headers, Sockets, Jumpers, DIP Switches, .025 Sq. Stix, etc.

P.O. Box 130
Frenchtown, NJ 08825
Telephone (201) 996-6841
Telex 6974615
FAX 201-996-3891



8 and 10 Pins
.200 centers.



8, 14, 16, 18, 20 Pins
.300 centers.



22 Pin
.400 centers.

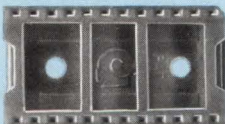

8, 10, 14, 16, 18, 22,
24, 28, 32, 34,
36, 38, 40, 48 Pins
.600 centers.

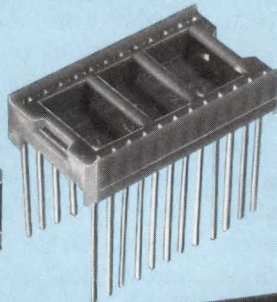

a complete line!

DIP SOCKETS

either solder
tail or wire
wrap pins

Available in
many non-
standard sizes!

Along with precision molding,
high stand-off, no solder
wicking... you get Aries
bifurcated contacts with firm
spring grip and superior
electrical contact with either
flat or round leads.

See EEM Vol. C, pgs. 1185-1190



EIA - 530 TO RS - 232 CONVERTER

- Supports 10 Category 1 & 3 Category II circuits
- Full EIA - 530 compliance
- DTE & DCE models
- Meets Mil-Std-188-114 Type 2
- Up to 1 MBS data rate
- Doubles as RS-422 converter

1-800-835-3298

(516)423-3232

TXW510-226-0449

TELEBYTE
TECHNOLOGY, INC.

270 E. Pulaski Road Greenlawn, NY 11740 A Public Company

MIGHTY MICRO8

Big 8-bit performance. Tiny 18-pin package. Miniscule price.

Introducing the smallest Z8 microcontroller yet, the high-performance Micro8™ (Z86C08). Just imagine what you'll be able to do with all this capability, packed into a DRAM-sized chip. For what amounts to pocket change.

Mighty strong performance

First of all, the Micro8 features the high-end Z8 architecture. Then there's 128 bytes of RAM, two counter/timers, two single-supply analog comparators, and low power consumption. Not to mention all the advantages of Superintegration™ and CMOS technology.

Mighty powerful protection

The Micro8 may be tiny, but it's as bullet-proof as they come. You get brown-out protect and a watchdog timer, for instance. You get an operating range of 3-5.5V. And you get CMOS I/O levels and hysteresis for noise protection.

Mighty impressive bit bang for your buck

The Micro8 gives everything you want in an 8-bit microcontroller. In the smallest package you've ever seen. For about a buck and a half. Plus you're working with the familiar software and proven performance of the Z8 Family. And it's all backed by Zilog's solid reputation for quality and reliability.

You really ought to see for yourself just what the mighty Micro8 can mean to your design application. Why wait? Contact your local Zilog sales office or your authorized distributor today. Zilog, Inc., 210 Hacienda Avenue, Campbell, CA 95008, (408) 370-8000.

The Z8 Family: Still setting the standards.

From the first, the Z8 microcomputer has been one of the industry's finest examples of simplicity and elegance. The most sophisticated microcontroller family continues to grow.

Today, there is Z8 support for every phase of your system development, from prototyping to full production. Along with devices you know and trust, there are new parts with an increasing number of options and features for your design. Recently, the Z8 is found in such diverse uses as fans, puppy door controllers, induction hot plates, and high-performance hard disk controllers, printers, and local area networks (LAN).

Since demand for Z8 products, and their importance to the industry continues to increase, we are developing new members of the Family. The Super8™ is now clearly established as the high-end Z8, and the Micro8 can be expected to have as much an impact on low-end Z8 applications. Among the other new Z8 Family members you should be keeping an eye on are:

- ▶ Z86C91 High-performance CMOS ROMless microcontroller
- ▶ Z86C10 Low cost 28-pin CMOS, has 22 I/O lines and 4K bytes of on board
- ▶ Z86C21 8K ROM Z8, has 32 I/O lines, 2 levels of security

Right product. Right price. Right away. **Zilog**

ZILOG SALES OFFICES: CA (408) 370-8120, (714) 838-7800, (818) 707-2160, CO (303) 494-2905, FL (813) 585-2533, GA (404) 923-8500, IL (312) 885-8080, MA (617) 273-4222, MN (612) 831-7611, NJ (201) 288-3737, OH (216) 447-1480, PA (215) 653-0230, TX (214) 231-9090, CANADA Toronto (416) 673-0634, ENGLAND Maidenhead (44) (628) 39200, W. GERMANY Munich (49) (89) 67-2045, JAPAN Tokyo (81) (3) 587-0528, HONG KONG Kowloon (852) (3) 723-8979, R.O.C.: Taiwan (886) (2) 731-2420, U.S. AND CANADA DISTRIBUTORS: Anthem Electric, Bell Indus., Hall-Mark Elec., JAN Devices, Inc., Lionex Corp., Schwebel Elec., Western Microtech., CANADA Future Elec., SEMAD.

Data logger acts as system analyzer in both benchtop and field environments

If your embedded-control application includes the 6800 or 68000 family, consider using the Step-120 Mobile Incident Logger (MIL). Although it's geared specifically for the automotive industry, the unit offers a combination of features that also make it suitable for use as a system analyzer in both benchtop and field environments.

The MIL requires an IBM PC or compatible computer to act as a host for data transfer and for initialization. Once initialized, however, the unit operates independently of the host and doesn't need to remain connected to it. Nonvolatile RAM in the unit retains the setup conditions and the acquired data, so you can use the data logger to collect data in the field as well as on the test bench.

The unit records three types of data: processor-bus data, RAM variables, and external events. You can specify match (or comparison) words for each data type, using the match words for triggering and for data filtering. When filtering, the unit stores only those samples that meet the match-word conditions. The data logger can store 32k samples, which you can configure as a single-sample memory or as four 8k-sample memories for repeated sample runs.

The bus section of the unit monitors the behavior of the processor. The unit will record a 16-bit address bus, an 8-bit data bus, and a 3-bit status bus. (You can upgrade these bus widths to 24 bits, 16 bits, and 8 bits, respectively.) In addition, you can have the unit monitor a series of RAM addresses that you've defined. The data logger then records any transactions at those addresses.

A special feature of the unit is its code-coverage mapper. This mapper



This multipurpose instrument functions as a data logger, logic-state analyzer, and chart recorder. Together with a host computer, the Step-120 Mobile Incident Logger offers a versatile tool for embedded-control applications.

records all addresses within a 64k-address range that have been accessed by a particular type of bus cycle. You can use this feature to verify that test programs completely exercise your code. You can also use it to identify frequently used sections of code, highlighting areas where improvements in code efficiency would have the greatest impact.

The data logger has four analog channels and eight event channels. The analog inputs have a selectable range of 0 to 5V or 0 to 20V; they offer 8-bit A/D resolution. The event channels work at logic voltages, but can tolerate as much as 125V continuously.

When you've collected your data, you must use the host computer to retrieve it. Once the host contains the data, you can access that data in a variety of ways. You can view the complete data record with the data

types interleaved chronologically, or you can examine only one or two data types. You can plot the analog data as a function of time. And you can view the bus activity as disassembled code or as source code from some C compilers.

The unit operates from dc power with a 9 to 16V input range, which reflects the instrument's automotive orientation. Its operating-temperature range is -25 to $+65^{\circ}\text{C}$, and it tolerates vibration and mechanical shock. Without a host, the data logger costs \$14,900 and is available for delivery within 30 days ARO.

—Richard A Quinnell

Step Engineering, 661 E Arques Ave, Sunnyvale, CA 94088. Phone (408) 733-7837.

Circle No 728

IGBTs. The ^{latest} comparisons.

Compare Power

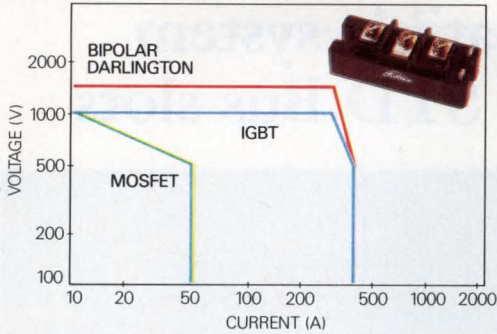

Compare Speed

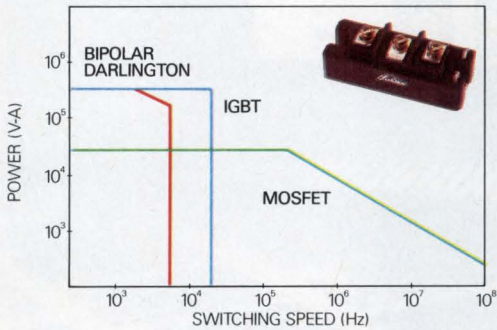

Compare Selection

IGBT (Insulated Gate Bipolar Transistor) Selection Guide

CIRCUIT	SYMBOL	V _{CES} (V)	MAXIMUM RATING											
			COLLECTOR CURRENT I _c (A)											
			8	15	25	50	75	100	150	200	300	400		
	BS	500		GT15H101†	GT25H101†	GT50G101† (400V)								
		1000	GT8N101†*	GT15N101†	MG25N1BS1	MG50N1BS1	MG75N1BS1*	MG100N1BS1						
	US	500										MG300H1US1	MG400H1US1	
		600										MG300J1US1*	MG400J1US1*	
		1000										MG200N1US1*	MG300N1US1*	
		1200										MG200Q1US1*	MG300Q1US1*	MG400Q1US1*
	YS	500			MG25H2YS1	MG50H2YS1	MG75H2YS1	MG100H2YS1	MG150H2YS1	MG200H2YS1				
		600					MG75J2YS1*	MG100J2YS1*	MG150J2YS1*	MG200J2YS1*				
		1000			MG15N2YS1	MG25N2YS1	MG50N2YS1	MG75N2YS1	MG100N2YS1	MG150N2YS1*				
		1200			MG25Q2YS1*	MG50Q2YS1*	MG75Q2YS1*	MG100Q2YS1*	MG150Q2YS1*	MG200Q2YS1*				
		1400			MG25S2YS1*									
	JS	1000			MG25N1JS1									
	ZS	500				MG50H1ZS1								
		1000				MG25N1ZS1								
	ES	500		MG15H6ES1*										
		1000	MG8N6ES1*	MG15N6ES1*										

†Non Isolated Type TO-3P *Under Development

The choice is now obvious when you require both power and switching speed in your power systems. Insulated Gate Bipolar Transistors (IGBTs) offer both.

Similar to Bipolar, IGBTs have high conductivity with faster switching speeds ($t_f = 0.5\mu\text{s}$ typ). And like MOSFETs, IGBTs have high input impedance/high speed with lower on-resistance (as low as $8\text{m}\Omega$).

So now, for applications like low-noise inverters and servo-motor drives, there really isn't any reason to compromise. The solution you've been looking for is available: IGBT. The performance combination that doesn't make you give up one thing to get another.

Leading the way, again, this time with the broadest line of IGBTs anywhere in the world. Toshiba.

TOSHIBA AMERICA, INC.
Semiconductor Products Division



TOSHIBA AMERICA, INC., Semiconductor Products Division Headquarters, 9775 Toledo Way, Irvine, CA 92718 • (714) 455-2000. Regional Sales Offices: Western Region, (714) 455-2000; Central Region, (312) 945-1500; Northeastern Region, (617) 272-4352; Southeastern Region, (404) 368-0203.

Distributed by: Marshall Industries, Cronin Electronics, General Components, Inc., Goolid Electronics, ITT/Multicomponents • RAE Electronics (Canada only), Image Electronics, Ital Electronics, JACO Electronics, Repron Electronics, Sterling Electronics and Western Microtechnology.

SPD-88-003

Industrial IBM PC/AT-compatible system employs an 80386 μ P and 23 STD Bus slots

Targeting industrial-control applications, the STD Busmaster-386 system couples a 16-, 20-, or 25-MHz 80386 μ P to the STD Bus. Compatible with the IBM PC/AT and MS-DOS, the system provides 23 STD Bus slots. It also includes a watchdog timer and an individual interrupt acknowledge/disable function.

The system operates in high-vibration and electrically noisy environments, and works over a 0 to 70°C temperature range. The company packages the system in an anodized-aluminum card cage that you can mount in an EIA-standard 19-in. rack or a NEMA-rated box.

To couple the 80386 to the STD Bus, the designers partitioned the system into two functional and physical sections. The 80386 μ P resides on a PC/AT card that hosts as much as 16M bytes of 32-bit dynamic RAM and an optional 80387 math coprocessor. The board plugs into a passive 3-slot PC/AT-compatible mother board that is positioned in the upper portion of the card cage.

A second PC/AT-compatible board includes a video controller that is EGA, CGA, and Hercules compatible. The multifunction card includes two serial ports, a parallel port, a dual-floppy-disk-drive controller, and a SCSI host adapter. The company offers an optional ST-506 Winchester controller or LAN-controller board for the third slot. In addition, you can integrate the board of your choice in the system.

The lower portion of the card cage houses the 23 STD Bus slots and a 24th slot that interfaces the PC/AT bus to the STD Bus. A plug-in board acts as the interface between the

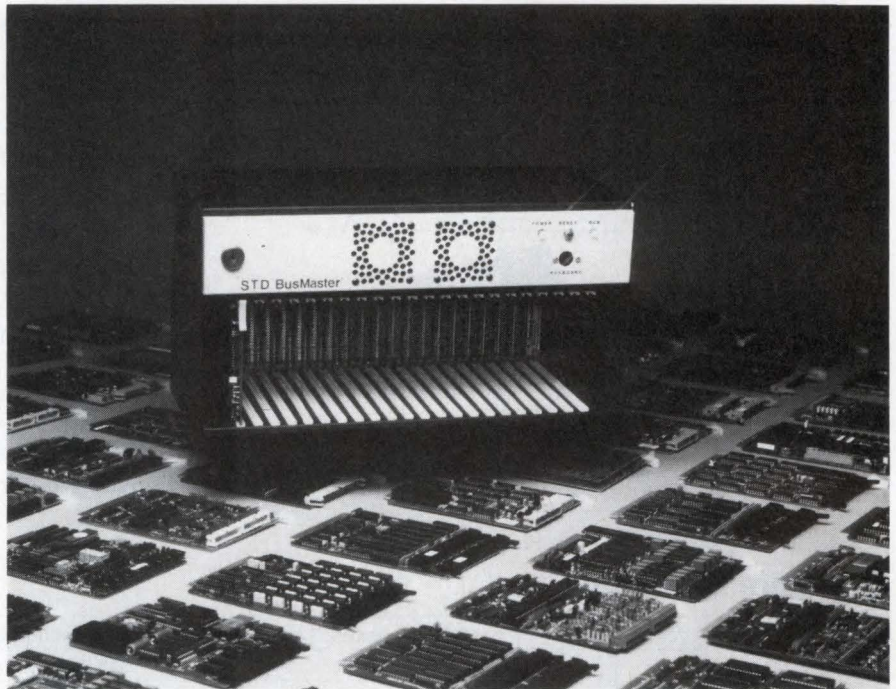

An 80386 μ P and a 23-slot STD Bus card cage suit the STD Busmaster-386 system for industrial applications that require more computational power than typical STD Bus CPU cards offer.

two buses. The 24th slot employs a DIN connector. The 80386 can address 128k bytes of 8-bit STD Bus memory and 504 contiguous 8-bit I/O locations.

The STD Bus operates as if a 4-, 6-, or 8-MHz Z80 were the CPU. The bus-interface card passes wait states, generated by STD Bus cards, directly to the 80386. The CPU automatically inserts wait states on memory and I/O accesses to the STD Bus to emulate a Z80. You can select the STD Bus's clock frequency to be the CPU clock frequency divided by 2 or 4, or you can select it to be 7.16 or 3.58 MHz.

Eight 3-slot groups generate individually vectored interrupts that you can separately enable and disable. You can enable or disable the watchdog timer with software. You

can program timeout selection to 0.25 or 1.0 sec. The system's brown-out reset activates a system reset when the V_{CC} drops below 5 or 10% (the percentage is software selectable) of the nominal inputs.

The company offers models for MS-DOS version 3.3; Unix-386 System V; Xenix System V; and QNX, a real-time version of Unix. The company will offer 8088- and 80286-based systems and a system with only eight STD Bus slots. A 16-MHz model with no DRAM installed, a 23-slot card cage, and MS-DOS costs \$3995. Delivery, stock to 90 days.—*Maury Wright*

Computer Dynamics Sales, 107 S Main St, Greer, SC 29651. Phone (803) 877-8700.

Circle No 731

THE THRILL OF DESIGNING A/D SUPPORT CIRCUITRY ENDS IN A FLASH.

The thrill of designing voltage references, input buffers, timing, and adjustment circuitry is gone. We do it for you. And in hybrid packages smaller than you'd expect for flash converters alone.

Consider these three "pop-in" converters. Our 8-bit HS1068 flash A/D samples at 20MHz minimum, has no spurious or missing codes, aperture jitter of only 60ps, and true 1/2 LSB 8-bit 47dB signal-to-noise ratio. Our 8-bit SP1070 samples at 25MHz minimum and requires only 1W of power. And our dual-flash SP1072 provides the performance of two SP1070s while saving you considerable real estate.

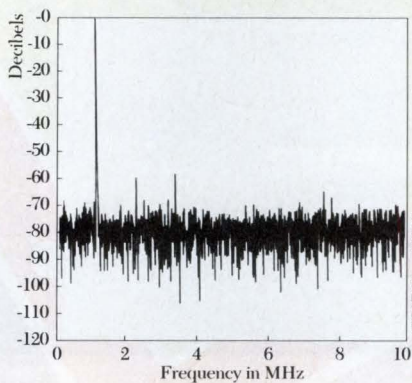

FFT of HS1068 Flash Converter,
Fin = 1.123MHz, Fsample = 20MHz

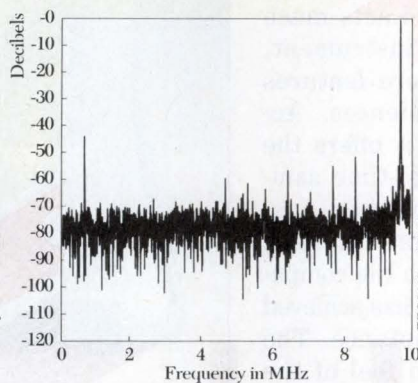

FFT of HS1068 Flash Converter,
Fin = 9.678MHz, Fsample = 20MHz

Naturally, we test each device to ensure maintenance of SNR as input frequencies climb. They'll be distortion-free in your

hypersensitive DSP applications.

And, we are the only company you can rely on to deliver full MIL-STD-1772 and MIL-STD-883C, self-contained, hybrid flash converters off the shelf. For data sheets, or a copy of our 382-page 1988 catalog, write SIPEX Corporation, Six Fortune Drive, Billerica, MA 01821, or call 1-800-272-1772. In Massachusetts call (617) 663-7811.

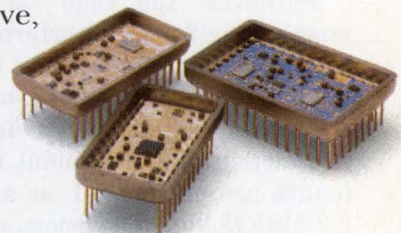

Sipex Corporation
Hybrid Systems Division

SIGNAL PROCESSING EXCELLENCE

Digital scope simultaneously captures data from two sources at 500M samples/sec

When Tektronix engineers set out to design the Model 2440 digital-storage oscilloscope, the company was concerned, of course, with performance and price. But equally important was ease of use; using the scope had to feel natural to people accustomed to using high-performance analog scopes. The result is a product that looks and acts much like a familiar analog instrument, yet provides many more features and operating conveniences. According to Tektronix, it offers the industry's highest real-time sampling rate—500M samples/sec.

The instrument's predecessor, the Model 2430A, which the company will continue to sell, has achieved a high degree of acceptance. The 2440 has the look and feel of the 2430A, but its 300-MHz vertical bandwidth improves on the earlier model's bandwidth by a factor of 2; its ability to take 500M samples/sec betters its predecessor's ability by a factor of 5; and its greatest sweep speed (2 nsec/div in equivalent-time-sampling mode) is faster by a factor of 2.5. (In real-time sampling mode, the 2440's 100-nsec/div max sweep speed is 5 times that of the 2430A.)

Moreover, the 2440 sacrifices none of the 2430A's performance. The simultaneous sampling of two inputs, 8-bit resolution, 2-mV/div max sensitivity (200 μ V/div in average mode), and 1024-point record length are unchanged, as are the 6.3 \times 13 \times 18.9-in. dimensions and the 24-lb weight. Furthermore, the cost of the 2440 is only 29% more than that of the 2430A.

Its conveniences include auto setup that automatically configures the sensitivity and sweep speed to let you see the waveform at the input you select in the mode of your

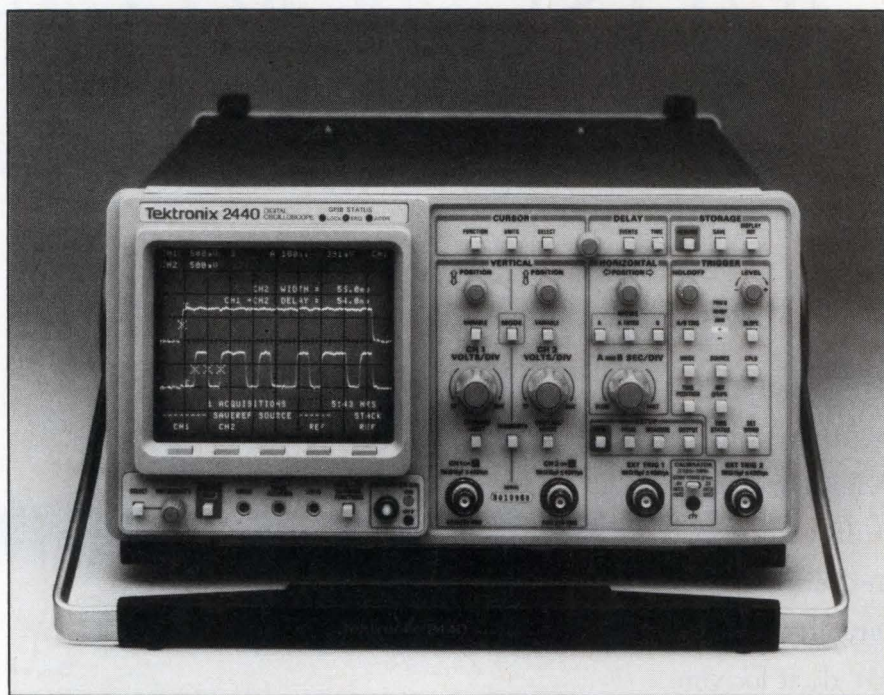

The front panel of the 2440 digital-storage oscilloscope intentionally resembles those of high-performance analog scopes, because market research has indicated that users want scopes whose operation is intuitive to them.

choice. Auto pass/fail testing allows you to define a waveform envelope. You can then operate the scope unattended, and if any waveform falls outside your predefined envelope, the scope will store it and record the time at which it occurred. An auto-measure mode can, among other things, provide a numeric display of 20 parameters of a captured waveform.

The scope's dual timebases provide many display modes. For example, you can delay the A or B sweeps by a number of B-trigger events that you select (2^{16} max). You can also supply your own sampling clock with a frequency from 1 to 100 MHz. A glitch-capture feature enables the scope to recognize pulses that are 2 nsec wide at the 50% amplitude points (at any sweep speed—with 85% probability). Ex-

cept at the highest sweep speed, such pulses could fall between samples.

Among the unit's interfacing features is an IEEE-488 port that can send waveforms, cursor measurements, and instrument configuration to a company HC 100 color pen plotter, an HP 7400 Series plotter, or an HP Think-Jet printer. A rear-panel output also provides an analog representation of the channel-2 waveform. The price of the 2440 is \$11,500, and the 2430A costs \$8900.

—Dan Strassberg

Tektronix Inc, Box 1700, Beaverton, OR 97075. Phone (800) 426-2200.

Circle No 725



When You Want Fast 1 Mb EPROMs.

Mitsubishi delivers with a family of 150ns, CMOS 1 megabit UV EPROMs. Available now. And, for applications requiring even higher performance, 120ns versions are on the way.

Now, you can combine the advantages of fast access times and low power CMOS operation in the organizations and pin-outs you need.

There's a 128K x 8 that's pin-compatible with 1 Mb mask ROMs for easy conversion when you reach high volume production. Another device offers the JEDEC-standard pin-out allowing easy upgrade from lower density EPROMs. Plus, there's a 64K x 16, ideal for applications requiring wider data paths. And, they're all available in 150ns speeds. From Mitsubishi.

When You Want Cost-Effective Packaging Options.

If you want all the advantages of Mitsubishi EPROMs, but don't need to reprogram, Mitsubishi's 1Mb, 200ns CMOS OTP ROMs provide cost-effective alternatives for volume production.

And, for maximum flexibility, Mitsubishi's 1 Mb OTP ROMs are available in PDIP and PLCC packages, with SOP available soon.

For fast EPROMs, or cost-effective packaging options, call or write: Mitsubishi Electronics America, Inc., Semiconductor Division, 1050 East Arques Avenue, Sunnyvale, CA 94086. (408) 730-5900.

MITSUBISHI EPROMs

	Density	Organization	Part No.	Access Time (ns)					Package (CERDIP)	
				100	120	150	170	200		250
CMOS	128K	16K x 8	M5M27C128K			■		■	■	28 pin
	256K	32K x 8	M5M27C256K			■	■		■	28 pin
	512K	64K x 8	M5M27C512AK	■	■	■				28 pin
	1 Mb	128K x 8 64K x 16	M5M27C100K/M5M27C101K M5M27C102K			■		■	■	32 pin 40 pin
NMOS	64K	8K x 8	M5L2764K						■	28 pin
	128K	16K x 8	M5L27128K						■	28 pin
	256K	32K x 8	M5L27256K						■	28 pin
	512K	64K x 8	M5L27512K					■	■	28 pin

MITSUBISHI OTP ROMs

	Density	Organization	Part No.	Access Time (ns)		Package Options
				200	250	
CMOS	256K	32K x 8	M5M27C256	■		28 pin PDIP and SOP
	1 Mb	128K x 8	M5M27C100	■		32 pin PDIP, PLCC and SOP
	1 Mb	128K x 8	M5M27C101	■		32 pin PDIP, PLCC and SOP
	1 Mb	64K x 16	M5M27C102	■		40 pin PDIP and 44 pin PLCC
NMOS	64K	8K x 8	M5M2764		■	28 pin PDIP
	128K	16K x 8	M5M27128		■	28 pin PDIP
	256K	32K x 8	M5M27256		■	28 pin PDIP and SOP
	512K	64K x 8	M5M27512		■	28 pin PDIP and SOP

Products subject to availability.

CIRCLE NO 74

Quality Through Commitment.



Regional Offices:
NORTHWEST, Sunnyvale, CA (408) 730-5900
SOUTHWEST, Torrance, CA (213) 515-3993

SOUTH CENTRAL, Carrollton, TX (214) 484-1919
NORTHERN, Minnetonka, MN (612) 938-7779
NORTH CENTRAL, Mt. Prospect, IL (312) 298-9223

NEW ENGLAND, Woburn, MA (617) 938-1220
MID-ATLANTIC, Piscataway, NJ (201) 981-1001
SOUTH ATLANTIC, Norcross, GA (404) 662-0813

SOUTHEAST, Boca Raton, FL (305) 487-7747
CANADA, St. Laurent, Quebec, (514) 337-6046.

NEW 2400 BPS CCITT V.22 BIS SINGLE-CHIP MODEM

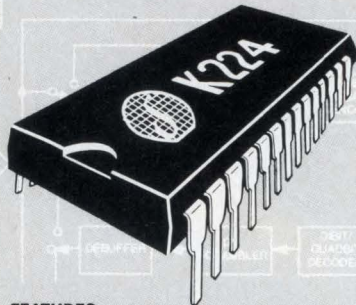

FEATURES:

- One-chip multi-mode modem IC for V.22 bis/V.22/V.21 and Bell 212A/103 applications
- FSK (300 BPS), DPSK (600, 1200 BPS), or QAM (2400 BPS) encoding
- All modem functions included in a single chip
- Integrated DSP for high performance adaptive equalization receive capability
- Fully compatible with SSI K212, K221, and K222 1-chip modems
- Interfaces directly with standard microprocessors (8048, 80C51 typical)
- Single +12V or +5V supply
- CMOS technology for low power consumption (120mW @ 5V)

Silicon Systems now offers the industry's most highly integrated modem IC—the SSI K224. It is a single-chip modem IC that provides all the functions needed to construct a V.22 bis compatible modem, capable of 2400 BPS full-duplex operation over dial-up lines. The SSI K224 offers excellent performance and a high level of functional integration in a single 28 pin DIP. This device meets world-wide standards and supports all modes of operation, allowing both synchronous and asynchronous communication.

The SSI K224 is ideal for use in either free-standing or integral system modem products such as lap-tops, PC's and portable terminals, or wherever full-duplex 2400 BPS data communications over the 2-wire switched telephone network is desired.

The SSI K224 is pin and software compatible with the SSI K212, K221, and SSI K222 single-chip modem IC's, allowing system upgrades with a single component change.

For more information on the SSI K224 and the complete SSI K-Series modem IC family, contact: **Silicon Systems**, 14351 Myford Road, Tustin, CA 92680. Phone: (714) 731-7110, Ext. 575.

silicon systems
INNOVATORS IN INTEGRATION

PRODUCT UPDATE

Modular 1500W power system suits fault-tolerant designs

By using the 29D Series modular power supplies with the company's Powersystem enclosures, you can implement 2-, 4-, or 6-supply fault-tolerant subsystems. The supplies' power ratings range from 225 to 300W. A 6-supply fault-tolerant subsystem can provide 1500W. When used in parallel, the supplies feature automatic load sharing. The family of products targets applications in telecommunications, data communications, and computer systems.

To implement a fault-tolerant subsystem, you simply connect one more supply than you need. For example, six 300W supplies actually provide 1800W in parallel, but only provide 1500W when a supply fails. The company offers isolation diodes for failed supplies, and the enclosures allow for "hot plug-in"—in other words, they let you replace a supply without taking the system off line.

The supplies provide five isolated floating outputs with voltages ranging from 5 to 24V dc. The first output supplies 5V and 30 or 40A. Outputs 2 through 5 offer combinations of 5, 12, 15, and 24V.

The supplies meet all domestic and international safety standards. They require 110 or 220V ac input power, which is field selectable. You can adjust the first four outputs to $\pm 5\%$ of the nominal output voltage. The fifth output tracks the first output. The supplies' line regulation is $\pm 0.2\%$ on all outputs. The first four outputs provide $\pm 0.2\%$ load regulation. The semiregulated fifth output features a $\pm 5\%$ load regulation. A step-load change or a 25% shift in rated maximum load causes an output change of less than 3%. The output recovers to within 1% in less than 400 μ sec.

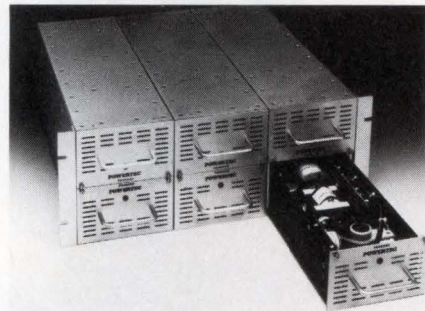

Six modular power supplies in parallel implement a 1500W fault-tolerant subsystem when mounted in the Powersystem enclosure. The enclosure offers "hot plug-in" capability; that is, it lets you replace a supply without taking the system off line.

To create fault-tolerant subsystems, you can connect the supplies in parallel. You can parallel the first output of a supply only with the first output of another supply. However, you can parallel outputs 2 through 4 within the same supply or with outputs from other supplies—as long as the outputs have equal voltages and polarities. When connected in parallel, outputs 1 through 4 share current proportionally within $\pm 10\%$ of each output's 50°C current rating (for forced-air cooling). You can't use the fifth output for parallel connections.

The enclosures are 7 in. high and 17½ in. deep, and the widths vary: The 2-, 4-, and 6-supply units are 5.7, 11.3, and 19 in. wide, respectively. A supply with isolation diodes and outputs of 5V/30A, 12V/3.75A, 12V/2.25A, 24V/3A, and 12V/2.25A costs \$508 (25). The enclosures range from \$158 (25) for a 2-supply unit to \$484 (25) for a 6-supply unit. Both the supplies and the enclosures are available from stock.—**Maury Wright**

Bonar Powertec, 20550 Nordhoff St, Chatsworth, CA 91311. Phone (818) 882-0004. TLX 277483.

Circle No 730

LET THIS NEW MODEM CHIP MAKE LIFE EASY FOR YOU

The Only 5-Volt, 2400 BPS, 1-Chip Modem For Low-Power Applications

If modem chips have a place in your company's products, here's how a new low-power single-chip modem from Silicon Systems can make life easier for everyone.

Now your product designers can put this new 1-chip 2400 BPS modem into their designs and replace three or more old-style modem IC's. The K224L draws less than 120 mW from a single 5-volt supply, eliminating the need for additional power supplies and making integration of the modem function possible in lap-tops, portable terminals, and other battery-operated applications.

Your marketing department will be happy to know that this single chip fully supports all the world-wide operating modes—V.22 bis, V.22, V.21, and Bell 212A/103. They'll like the competitive edge that state-of-the-art single-chip modem technology can give to your company's products.

And, of course, your management team can only be proud of an engineering and marketing group that has the good sense to make the most of such innovative components that enhance the features of your products, reduce costs, and boost company sales.

Call Now!

(714) 731-7110, Ext. 3575

For more information on the new Silicon Systems 73K224L, or any of SSI's fully compatible K-Series 1-chip modems, contact: **Silicon Systems**, 14351 Myford Road, Tustin, CA 92680.

silicon systems[™]
INNOVATORS IN INTEGRATION

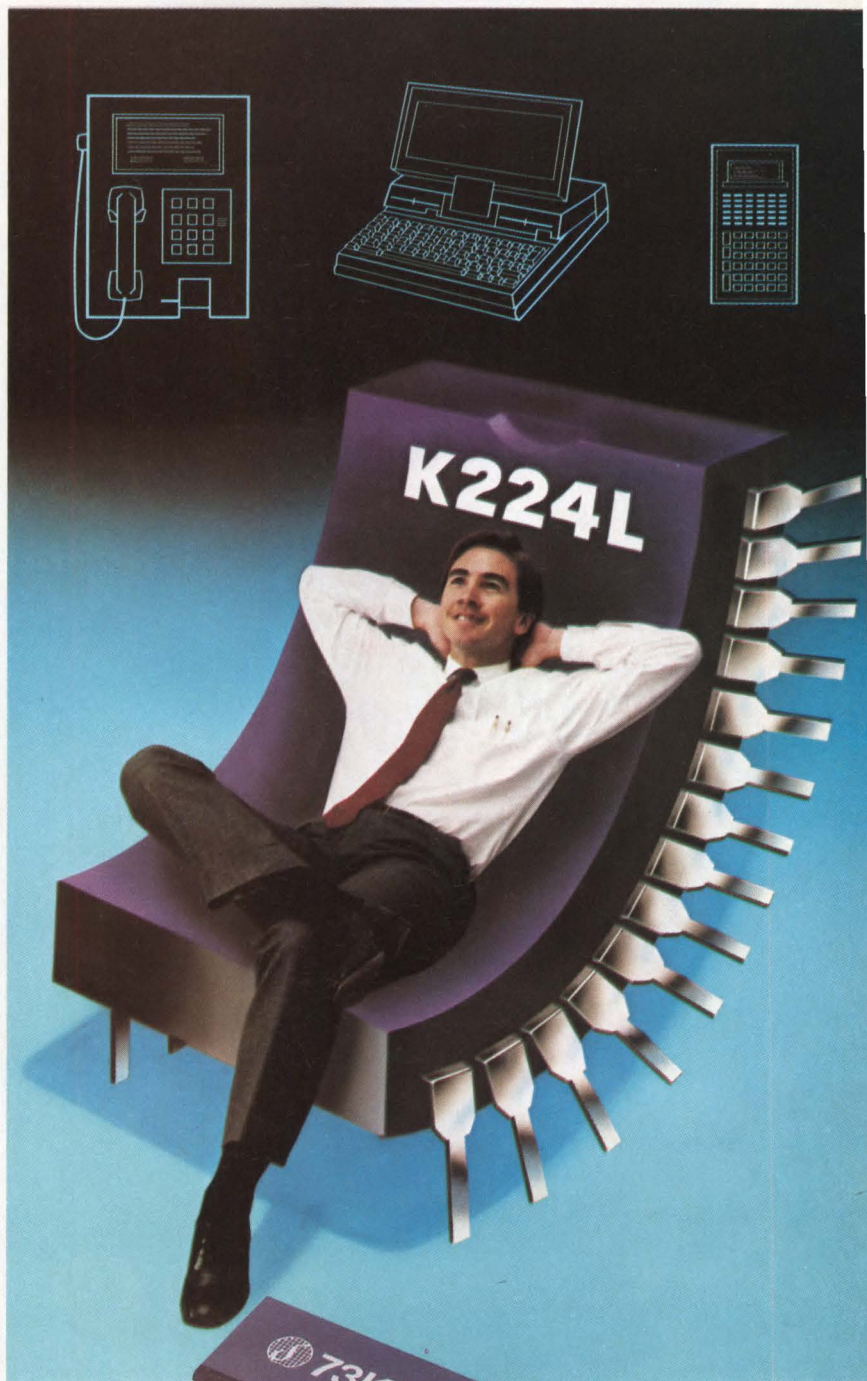

"Where we design to your applications."



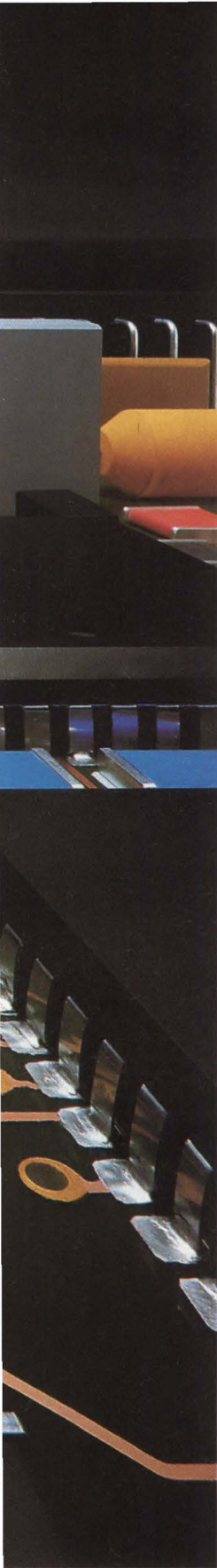

**If you want to increase
the value of your PWB real estate,
Du Pont can help
you do it.**

With VACREL® photopolymer film solder mask. The material that enables you to reliably encapsulate dense circuitry and tent via holes, permitting more electrical functions in less PWB real estate; to let you create higher density PWBs than ever before.

Instead of placing vias and components on separate areas of the board, you simply design vias under the components. And because VACREL tents the vias, solder stays only in the places where you want it; you avoid bridging, shorts, and contamination. It's also easier to clean under components.

In addition, you use less solder, minimizing assembly weight, because you're only covering connections. Hole-filling defects are also avoided. The bottom line is VACREL can increase assembly yields and cut manufacturing costs per function allowing you to get the most from your PWB real estate.

If you want more value out of your PWB real estate, ask for VACREL photopolymer film solder mask. It's the right material for PWB designs. Just call Du Pont at **1-800-237-4357**. Or write: Du Pont Company, Room G-51176, Wilmington, DE 19898.

DuPont Electronics
Share the power of our resources.



READERS' CHOICE

Of all the new products covered in EDN's **May 12, 1988**, issue, the ones reprinted here generated the most reader requests for additional information. If you missed them the first time, find out what makes them special: Just circle the appropriate numbers on the Information Retrieval Service card, refer to the indicated pages in our **May 12, 1988**, issue, or use EDN's Express Request service.



◀ RACK-MOUNT PC/AT

The QPC-7000 IBM PC/AT-compatible computer meets EIA standards for mounting in a standard 19-in. rack (pg 244).

Qualogy Inc.
Circle No 603

TURBO C DEBUGGER

The A-COM debugger is a full-screen, source-level debugger for use with Borland International's (Scotts Valley, CA) Turbo C programming tools (pg 276).

A-Com.
Circle No 605



▲ 3¾-DIGIT DMM

The DM79 can provide 10 times the resolution supplied by 3½-digit meters on many measurements (pg 258).

Beckman Industrial Corp.
Circle No 604

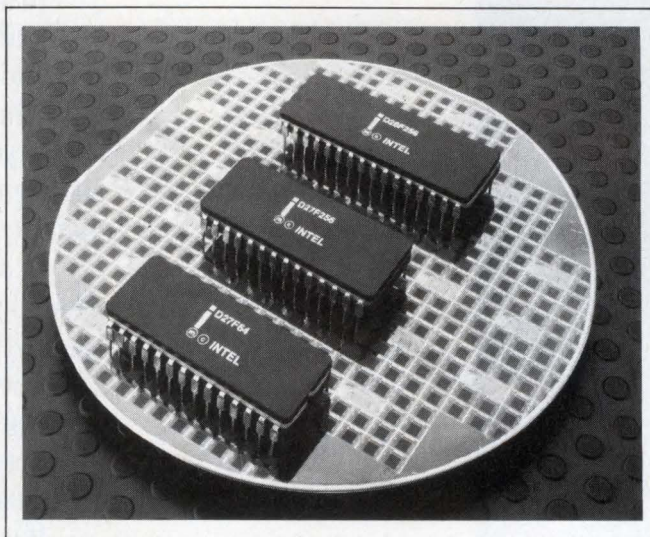

▲ CMOS EPROMs

The 27F64 and 28F256 flash memories are 64k-bit and 256k-bit devices, respectively, that feature in-circuit electrical erasing and reprogramming (pg 88).

Intel Corp.
Circle No 601

5-YEAR BATTERY

The Model PS-1242 is a 12V, sealed lead-acid battery. It's maintenance free, rechargeable, usable in any position, and suitable for both standby and deep-cycle applications (pg 243).

Power-Sonic Corp.
Circle No 602

Circle No. 76 for Tektronix

EDN August 4, 1988

NEW 500 MEGASAMPLES/SEC 300 MHz DIGITAL PORTABLE

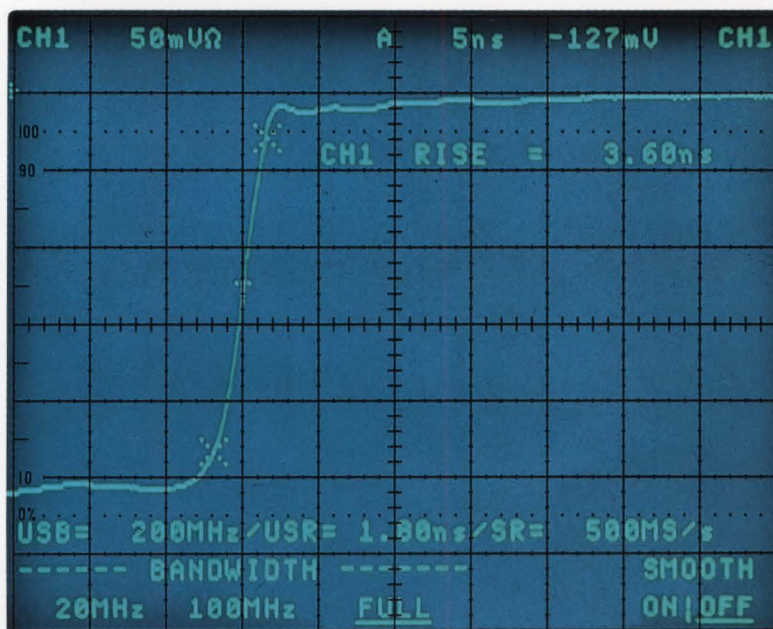

**TEK
PUSHES
THE
LIMIT...**

AT THE PUSH OF A BUTTON.

AUTO SETUP

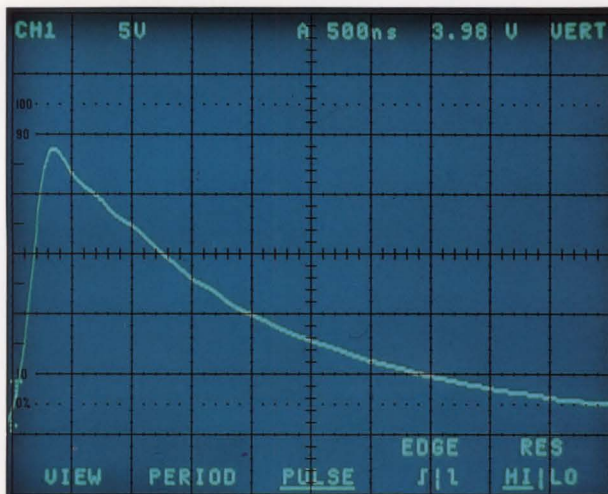

AUTO PASS/FAIL

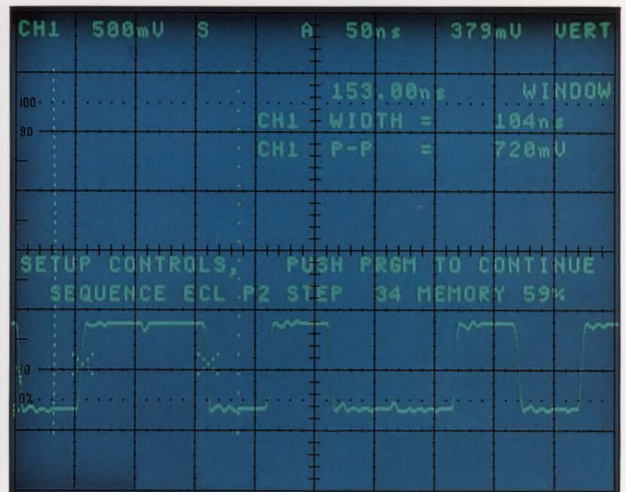
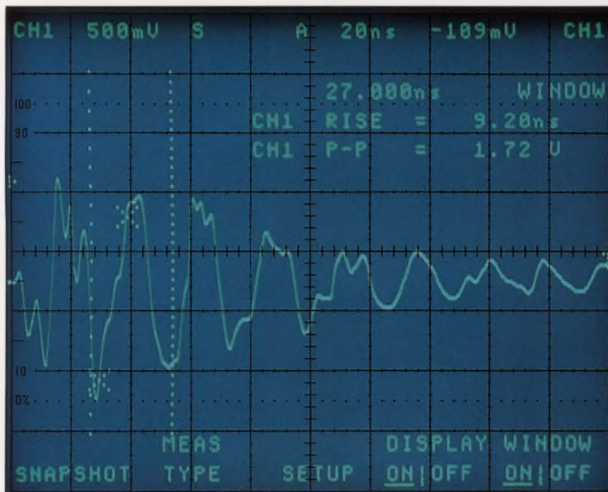
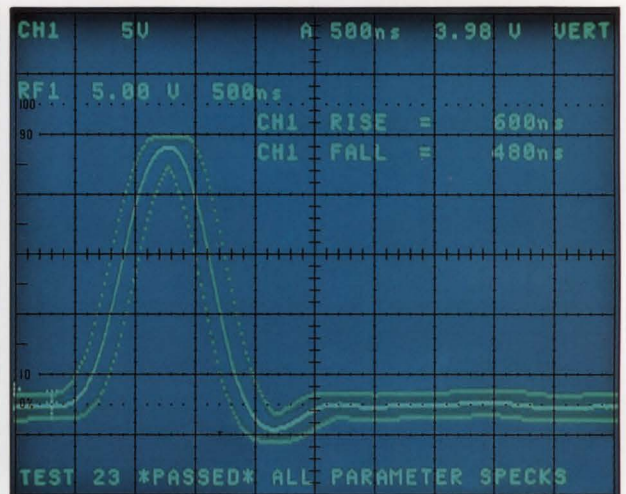

AUTO MEASURE

AUTO SEQUENCE

ONLY FROM TEK.

The new Tek 2440 Digital Oscilloscope is the only portable offering a 500 MS/s sampling rate—on two channels simultaneously.

Capture signals competitors can't.

You can digitize, store and process single-shot phenomena to 200 MHz and repetitive signals to 300 MHz. At the touch of a button.

This is a scope built for solving tough problems fast.

Complete confidence in results.

Exclusive Tek digital features let you capture glitches as short as 2 ns with continuous sampling; automatically catch intermittent failures in babysitting applications; and see waveform changes virtually as they occur thanks to the high update rate.

With the 2440's 500 MS/s sample rate, 8-bit vertical resolution, and 0.0015% crystal-controlled timebase accuracy, you'll have complete confidence in the accuracy of your waveform data. You'll know what you're seeing is what's actually happening in your circuit.

The 300 MHz 2440 and 2432, along with the 150 MHz 2430A, drive like the scopes you're used to. They feature a familiar front panel and simple, one-level menus.

Built-in automation simplifies operation even more. The scopes set up at the touch of a button. And you can characterize waveforms instantly: press another button and read out your choices from 21 different measurements.

On the design bench, the 2400 DSOs are effective standalone test systems. Full GPIB programmability, pass/fail testing and time-saving measurement sequencer make them equally powerful system components. With off-the-shelf software you can fully automate measurements and extend waveform analysis.

Don't settle for less. Get the total performance package only Tek delivers, feature for feature, spec for spec.

A digital family you already know how to use.

Powerful system components.



WHEN THE MEASUREMENT COUNTS, COUNT ON TEK.

**The standard
of excellence
in portable
scopes.**

No matter what you measure, Tek measures best.

Analog or digital, standalone or automated, no other portables match Tek 2400 Series Oscilloscopes for sheer breadth of line, range of performance and wide choice of options.

Their proven reliability and built-in versatility are a result of Tek's dedication to superior waveform acquisition tailored to individual needs.

**Answers
at the touch
of a button.**

Six four-channel analog oscilloscopes combine pushbutton simplicity and leading-edge performance. They bring unprecedented efficiency to your design lab, production line or field service site.

The top-of-the-line 2467 with Tek's patented microchannel plate CRT even makes single-shot pulses to 350 MHz visible—at the touch of a button.

A complete range of options further extend each scope's capabilities.

Scope for scope, feature for feature, Tek has the best solution for your measurement needs.

Ask your Tek representative for a demonstration. With the 2440 joining the family, there's an even better selection—in sample rate, performance and price. For more information, please return the reply card or call Tek direct:
1-800-426-2200.

**Call Tek
for details.**



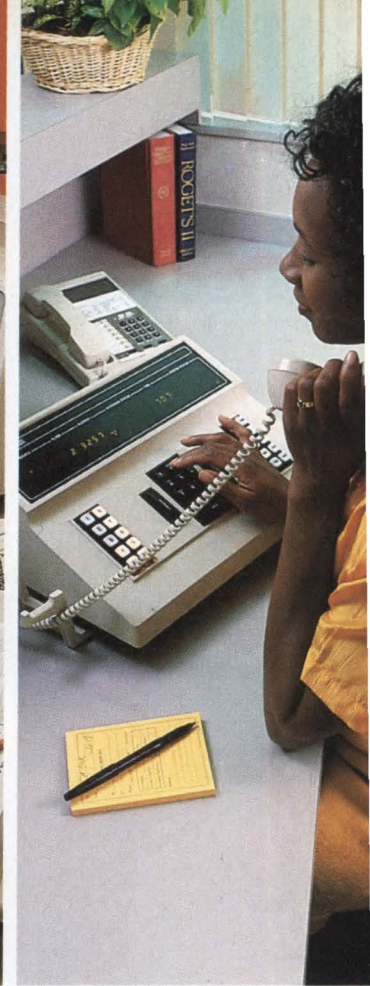
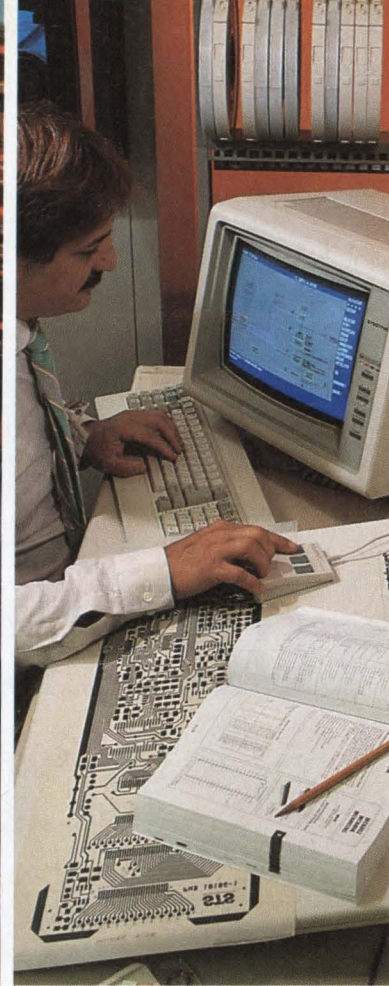

Our networks give more for less... less space, less time, less cost.

Mepco/Centralab thick-film networks save space and design time in all of your circuits — computer, communications, military, automotive, industrial control and instrumentation.

Choose from our broad range of highly integrated standards — cost-effective conformal networks, EMI/RFI networks, ECL terminators, MIL-R-83401 networks, capacitor banks, and more. We can also custom-design a space-saving unit to meet your requirements, including MIL designs.

With quality-designed Mepco/Centralab networks, you get the extra advantage of ordering just one part instead of many discrete components. So you simplify your purchasing, handling, stocking and assembly operations. And, since you only have to install a single part that's 100% pre-assembled and tested, you automatically improve your system's electrical and mechanical performance, and its overall reliability.

Look into space-saving, time-saving Mepco/Centralab networks for your commercial, industrial and military-grade products. They're your assurance of high reliability, plus just-in-time delivery and competitive pricing.

Ask for our catalogs. Write to Mepco/Centralab — the active leader in passive components.

Mail to: Mepco/Centralab
Attn: Corp. Advertising
2001 W. Blue Heron Blvd.
Riviera Beach, FL 33404.

Please send me the following:

- Leaded Resistor/Capacitor Data Book
- Surface-Mount Device Catalog
- Please have a sales representative call

Name/Title _____
Firm/Dept./Div. _____
Address/MS _____
City/State/Zip _____ Phone () _____

EDN080488

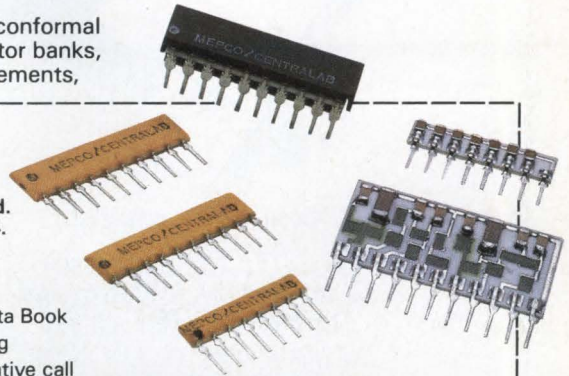

MEPCO/CENTRALAB
A DIVISION OF NORTH AMERICAN PHILIPS CORPORATION





FDDI.

From deskwork to network.

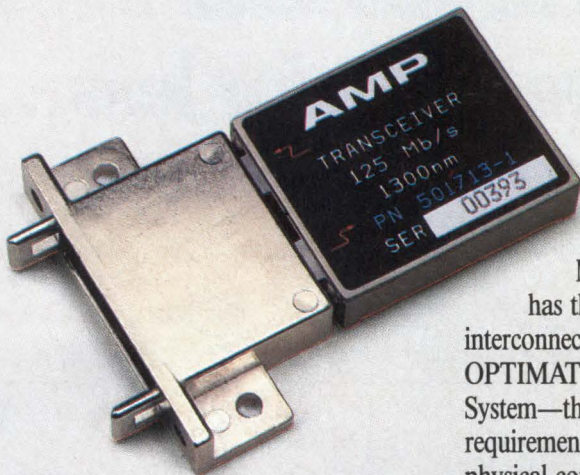

Good news for networks!

The X3T9.5 Task Group, under the procedures of ANSI Accredited Standards Committee X3, has reaffirmed approval of the Media Interface Connector (MIC) for the proposed FDDI (Fiber Distributed Data Interface) Physical Layer Medium Dependent (PMD) document.

More good news! AMP has the complete fiber optic interconnection system—the AMP OPTIMATE Fixed Shroud Duplex System—that meets all FDDI PMD requirements. And includes all the physical components you need to make your fiber optic network a reality.

Of special note: the transceiver—the first of its kind—is capable of operating at data rates up to 125 Mb/s. Available in standard or raised (+5v) ECL logic, it gives you a compact, board-mount data link in a single 24-pin module. Reliable duplex mating

and electro-optic conversion are now easier than ever.

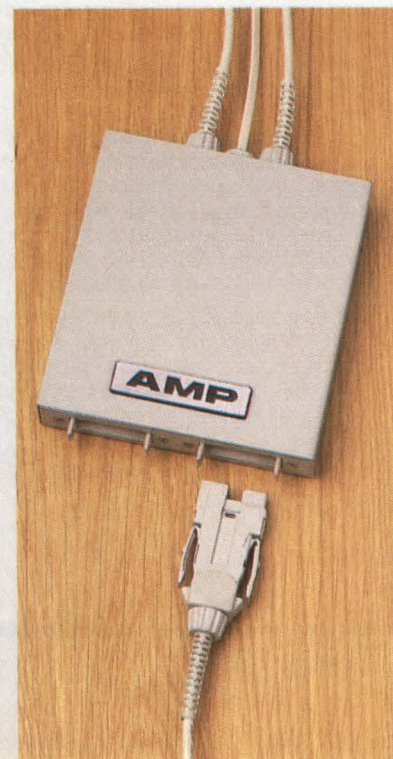

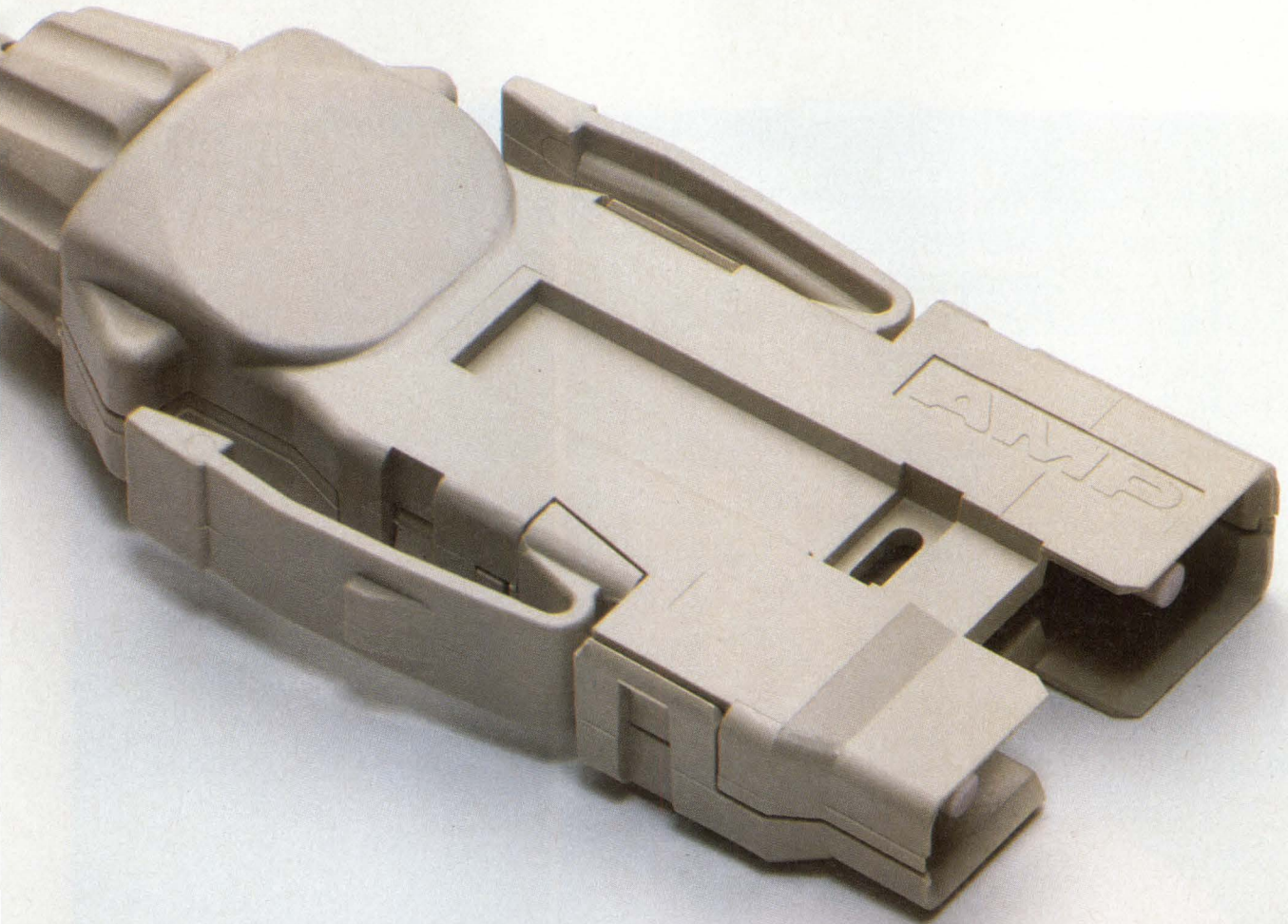

All system components, in fact, are easy to install and reconfigure. Our field termination kit makes short work of attaching duplex connectors to fiber cable. And because all interconnections use a floating interface, you get consistent, low-loss mating (0.6 dB typical) throughout.

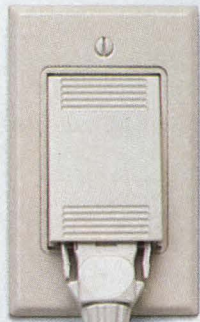

You can also order complete, custom-built cable assemblies from us. Either way, you'll have the assured compatibility that comes from dealing with only one supplier for all your FDDI interconnection components. A supplier whose capability

in fiber optic technology is everything you'd expect from the world's largest connector company.

For technical literature and more information, call 1-800-522-6752. AMP Incorporated, Harrisburg, PA 17105-3608.

CIRCLE NO 77

AMP Interconnecting ideas

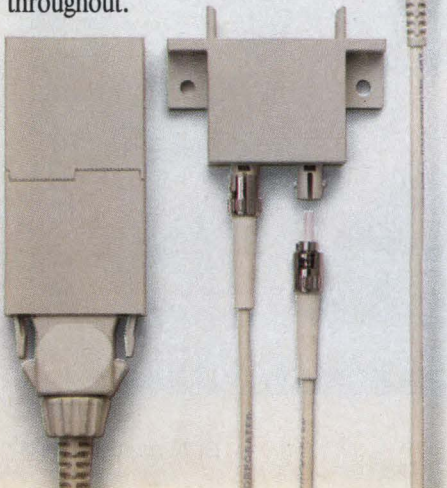

By employing CAD/CAE and new fabrication technologies, pressure sensor and transducer manufacturers have been able to improve product performance without exacting any price penalties. In the silicon-based sensor area, in fact, prices are actually going down as performance figures improve—a combination that opens up a host of new applications.

Pressure sensor and transducer manufacturers are offering less expensive, yet more capable, devices through the use of a largely automatic micro-machining process of producing silicon wafers. (Photo courtesy Micro Switch)

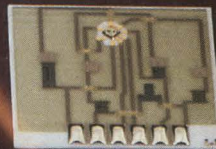

Pressure sensors and transducers

Tom Ormond, *Senior Editor*

Improved performance at a lower cost is the ultimate goal of any product designer. When it comes to strain-gauge-type pressure sensors and transducers, manufacturers have achieved this goal and made the devices practicable for numerous applications in the automotive, medical, and military fields. In addition, advances in device-fabrication and -packaging techniques allow today's pressure sensors and transducers—including devices based on older piezoelectric and linear-variable-differential-transformer (LVDT) techniques—to easily handle the harshest industrial environments. Manufacturers are also integrating more electronics into the device package, which makes it easier for users to apply the sensors and transducers.

Amplifiers represent one type of integration. Although most of today's transducers generate usable unamplified outputs, you can get products that offer logic-level output signals while operating from low voltage supplies. Transducer manufacturers also include integral electronics that address thermal-related problems. Just about every transducer available today includes temperature-compensation circuitry, which allows the units to provide very accurate output readings in environments involving significant temperature variations. On the other hand, some manufacturers also offer uncompensated products for those users working in a benign environment, who don't want to pay for something they don't need.

Three of the most popular sensor technologies are strain-gauge (piezoresistive), LVDT, and piezoelectric. Nowadays, you'll find that most of the newsworthy

technological developments concern strain-gauge types of sensors. These devices typically use one of three sensing elements: an unbonded metallic-filament strain gauge, a bonded metallic-foil strain gauge, or a bonded piezoresistive (semiconductor) gauge. Regardless of element technology, however, strain-gauge sensors and transducers find their way into diverse applications.

Solid-state sensors—where the action's at

Gulton Industries' GMS110 Series of pellicloid thin-film strain-gauge transducers, for instance, fit demanding military as well as aerospace applications. Packaged in a welded, hermetically sealed housing, the solid-state devices are available in versions that measure full-scale absolute or gauge pressures of 15 to 5000 psi.

The sensors consist of a thin-film circuit deposited on a micromachined silicon diaphragm. Pressure across the diaphragm produces strain in the metal-film sensing elements, causing slight changes in their resistances. These sensing elements are configured as a 4-arm, fully active strain-gauge bridge with integral trimming resistors. The fabrication process places the compensation resistors close to the sensing elements to minimize thermal shift in the span and zero parameters: 0.005% full-scale output (FSO)/°F max.

The GMS110 Series operates from 10V dc; the transducer output is 2.5 mV/V min. Repeatability and hysteresis are 0.05% FSO max, and nonlinearity equals $\pm 0.25\%$ max. The overall operating range spans -320 to $+350^\circ\text{F}$; the compensated range is -65 to $+250^\circ\text{F}$. The transducers cost \$1050.

Strain-gauge-type transducers find their way into diverse applications.

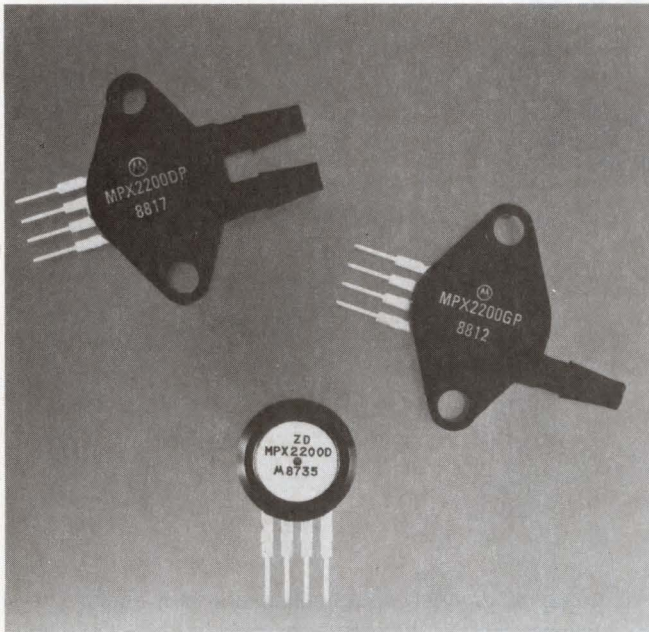

Featuring 0.2-mV/kPa sensitivity, Motorola's MPX2000 Series temperature-compensated transducers spec $\pm 0.05\%$ full-scale linearity over -40 to $+125^\circ\text{C}$.

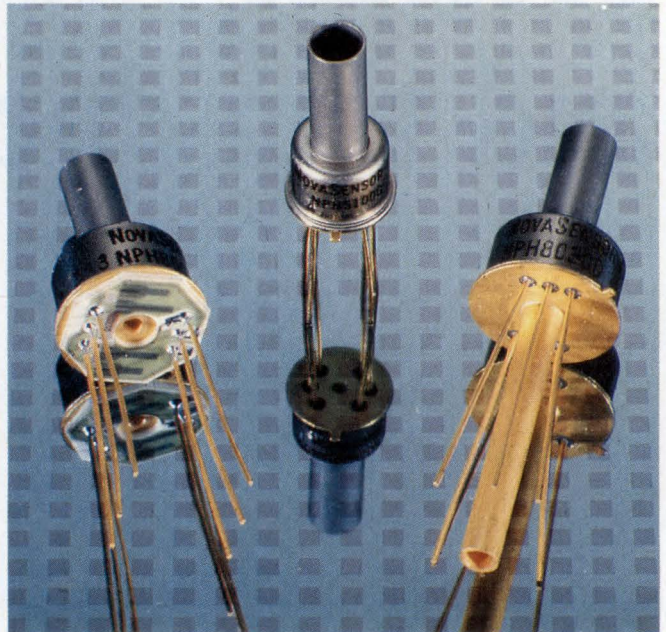

Offering 1- and 2-psi FS measurement ranges, NPH sensors from NovaSensor feature maximum nonlinearity and hysteresis errors of ± 0.2 and $\pm 0.5\%$, respectively.

Designed to provide absolute-pressure measurements in low-pressure applications, NPH Series sensors from NovaSensor are available in 0- to 7-kPa (approximately 0 to 1 psi) and 0- to 15-kPa versions (approximately 0 to 2 psi). The 0- to 7-kPa unit provides an unamplified output voltage of 75 mV. In OEM quantities, NPH sensors cost \$12. NovaSensor attributes its ability to achieve such a price/performance ratio to CAD-analysis and advanced-silicon-etching (micromachining) techniques (see box, "Computer-based techniques facilitate sensor design").

The NPH Series specifies respective nonlinearity and hysteresis errors of $\pm 0.2\%$ and $\pm 0.05\%$ max. Thermal hysteresis is less than $\pm 0.25\%$ FSO, and thermal error is 1% max over the 0 to 70°C compensated operating-temperature range. The sensors are also available in uncompensated versions, as are models that provide differential-pressure readings. All models are compatible with noncorrosive gas and moist-air media. A pressure port with an outside diameter of $\frac{3}{16}$ in. is standard, but similar tubes or vent holes for either TO-5 or TO-8 packages are available to satisfy specific OEM requirements.

Endevco's strain-gauge Model 8515B is a rugged, miniature transducer designed for applications requiring surface-pressure measurements. It utilizes a sculp-

tured, piezoresistive pressure-sensing diaphragm and readily mounts on curved surfaces without affecting laminar-air or hot-gas flow. For a flush fit, you can recess the transducer and lead wires into the mounting surface. The transducer includes a protective screen to protect against particle impingement.

The \$495 transducer is available in full-scale versions of 15 psia (pounds per square in. absolute) (Model 8515B-15) and 50 psia (Model 8515B-50). The 0.03×0.25 -in. case contains hybrid temperature-compensation circuitry that stabilizes operation over the -65 to $+250^\circ\text{F}$ temperature range. Full-scale output measures 300 mV. For the 8515B-50 and 8515B-15 versions, sensitivity is 6 ± 2 mV/psi and 20 ± 6.7 psi, respectively. Combined nonlinearity (hysteresis, nonrepeatability, and nonlinearity) equals 0.5% FSO. Thermal zero shift measures 4% max.

SCC Series strain-gauge transducers from Sensym are designed for cost-sensitive applications where precise accuracy over a wide temperature range is not a critical design consideration. Typical applications include pneumatic controls, automotive diagnostics, medical equipment, and environmental controls. Each member of the series costs \$9.90 and features an IC sensor element housed in a single-in-line package. You have a choice of three devices with full-scale pressure

Computer-based techniques facilitate sensor design

Thanks to CAD and micromachining techniques, the latest generation of silicon sensors are sophisticated devices with performance levels far exceeding those found in older-technology chips. Chips with onboard, laser-trimmed calibration and temperature-compensation resistors, for example, are now available in high volume. You can also buy extremely low-pressure sensor chips—less than 1 psi full scale—in large quantities. Today, maximum sensor output nonlinearity is routinely 0.25%.

All these achievements require the most elaborate design, analysis, and manufacturing automation tools and techniques available. Finite element modeling (FEM) programs, for instance, are mechanical-analysis tools that designers can use to predict the operation and performance of complex 3-dimensional shapes such as sensors. Such tools allow designers to calculate and optimize the sensitivity, nonlinearity, resonant frequency, and damping coefficients of new sensor structures before making commitments to expensive tooling.

In addition, FEM programs enable designers to predict the difficult, but important, interactions between the chip and the package. High-performance, high-speed computer workstations, and programs such as ANSYS, make it possible to obtain highly accurate results. By reducing the development time

and experimental tooling and materials costs, modeling significantly reduces sensor cost. In effect, a designer can build, test, and optimize a sensor on the computer before any investment in actual hardware takes place.

Circuit-analysis software performs a function similar to that of FEM. According to the application requirements, the computer will integrate the sensor's electrical performance with that of the signal-conditioning circuitry. Designers can, for example, test active correction coefficients and temperature coefficients before actually building a sensor. And, they can use feedback from such computer testing to modify the required chip and circuit specifications to increase performance or decrease cost.

Test, calibration, and trim procedures also have become more sophisticated as the complexity of sensor chips increases. For advanced sensor systems, designers must use computers and modeling to obtain cost-effective solutions for electrical-design, manufacturing, test, calibration, and final-trim specifications.

As users demand sensors with higher accuracy specifications, the need for precision and long-term stability in semiconductor diffused or implanted resistors becomes crucial. Silicon process modeling can predict process variations. These predictions provide input on device specifications and distributions in these specifications before fabrication

of the first chips begins. Sensor designers can use these same models to evaluate new processing concepts for improvements in product yield, long-term stability, and device reliability.

After defining and modeling device specifications, designers must convert their engineering concepts into hard tooling. Again, computer-design systems are essential. Computer-graphics terminals can quickly and accurately digitize the various mask levels necessary to fabricate silicon-based sensors. These systems can also rapidly implement design modifications to speed up development schedules.

Computer-aided test systems complete the computer-aided design/analysis process. During the release of early-production-run sensors, computer-aided test systems provide designers with immediate feedback on device performance and correlate this information with design goals. Computer-aided test systems also give engineering and manufacturing groups continuous, online, up-to-date, readily available information on yield and on the distribution of crucial specifications for mature sensors already in production.

Acknowledgment

EDN would like to thank Kurt Peterson and F Pourahmadi of NovaSensor for their invaluable assistance in supplying background information for this box.

Transducers are available for applications where low cost is more critical than is precise accuracy over a wide temperature range.



Housed in convenient, low-cost single-in-line packages, Sensym's SCC Series sensors are designed for applications where precise accuracy is not a prime system consideration.

ranges of 5, 15, and 30 psig (pounds per square in. gauge). All units feature internal temperature compensation for operation over 0 to 50°C. Although optimized for this temperature range, SCC sensors do operate from -40 to +125°C. The guaranteed span-temperature error is less than 0.75% FSO, and the combined linearity, hysteresis, and repeatability error is less than 0.5% FSO.

IC Sensors' Models 151 and 154 are solid-state strain-gauge devices that utilize a 316 stainless-steel housing to provide compatibility with most harsh media. The devices are available in gauge-, sealed-gauge-, and absolute-pressure versions that handle full-scale readings of 5 to 300 psi. Static accuracy is $\pm 0.25\%$, and the operating range spans -10 to +80°C.

Model 154 includes integral laser-trimmed resistors that provide calibration and temperature compensation over the 0 to 50°C range. When the sensor is drawing a 1.5-mA supply current, the nominal output span is 100 mV. For the Model 151, you must provide compensation by using three external resistors (the manufacturer supplies the correct resistance values). Again, for a 1.5-mA supply current, the nominal output span equals 100 mV. The zero-pressure output equals ± 1 mV, and the zero and span temperature coefficients correspond to $\pm 1\%$. The sensors cost \$60 (OEM qty); delivery is stock to 60 days ARO.

Motorola's MPX2200 silicon, piezoresistive pressure



Compatible with various liquid and gas media, PT11 sensors from Revere feature a full-scale measurement capability ranging from 100 to 10,000 psi.

sensors each contain, on-chip, a monolithic shear-stress strain gauge, diffused thermistors, and a thin-film resistor network. The pressure sensors are laser trimmed and therefore provide span and offset calibration as well as temperature compensation over -40 to +125°C.

The MPX2200 Series costs \$10 in quantities of 50,000 and is available in either basic-element packages for absolute- and differential-pressure measurements or in ported packages for measuring differential, absolute, gauge, gauge-vacuum, gauge-axial, and gauge-axial-vacuum pressure. Over the 0- to 30-psi (0 to 200 kPa) absolute- and differential-pressure ranges, the sensors' 0- to 40-mV analog output is extremely linear. At 25°C, the linearity equals $\pm 0.1\%$ FSO typ and $\pm 0.25\%$ FSO max. The sensitivity is 0.2 mV/kPa, and the typical zero-pressure offset is ± 0.05 mV. Temperature effects

on hysteresis, full-scale span, and offset are $\pm 0.5\%$ FS, $\pm 0.5\%$ FS, and ± 0.5 mV, respectively.

Micro Switch's 14PC Series are also piezoresistive, strain-gauge types residing on a silicon chip, but these sensors feature four piezoresistors, an integral sensing diaphragm, and are enclosed in miniature, wave-solder-compatible packages. Internally, an elastomer O-ring surrounds the pressure-sensitive diaphragm, leaving it exposed to pressure media applied through the ports, which are ultrasonically welded in place. You can select seal material to fit specific application requirements.

The series is available in both gauge- and differential-measurement versions with full-scale pressure ranges of 5, 10, and 15 psi. Repeatability and hysteresis accuracy translates to $\pm 0.75\%$ FSO. Linearity is 0.5% full scale. The sensors operate from 10V dc supplies and dissipate 20 mW. Their full-scale output, when operating from a 10V dc supply, equals 250 mV. The price is \$10.24 (500).

Handling harsh environments

Model 1224 pressure transducers from Foxboro/ICT boast a proprietary 316 stainless-steel/oil-media interface that isolates the solid-state piezoresistive sensing element from excessive shock and vibration. The units' 0- to 100-mV output has a $\pm 0.02\%$ repeatability spec. Available in both gauge-pressure and absolute-pressure versions that cover full-scale pressure ranges from 15 psig/psia to 5000 psig, the sensors cost \$135. Standard devices have $\pm 0.5\%$ FSO max static accuracy; $\pm 0.25\%$ is available as an option. Maximum thermal error is $\pm 2\%$ FSO over the -20 to $+180^\circ\text{F}$ compensated temperature-operating range. The devices are designed specifically to accommodate rugged operating conditions and come with a 3-year warranty.

Revere's PT11 pressure sensor finds use as a primary control component in hydraulic systems, air-conditioning systems, engine monitoring, refrigeration units,

compressors, and industrial-control systems. The seven models that make up the line feature full-scale measurement ranges spanning 100 to 10,000 psi. The average combined error for any unit equals $\pm 0.05\%$.

The 100-psi sensor is constructed of 2024-T351 aluminum; the 250-, 500-, 1000-, 3000-, 5000-, and 10,000-psi devices are constructed of #17-4 PH stainless steel. The minimum burst-pressure limit for all models is greater than 500% of range, and the safe-overrange limit is 200% of full scale. The supply voltage can be 12V ac or dc. The full-scale output is 2 mV/V $\pm 20\%$, and the operating range covers -40 to $+150^\circ\text{F}$. Prices range from \$40 to \$57, depending on quantity.

The TJE high-precision, wet/wet differential-pressure transducer, available from Sensotec, is engineered for pressure ranges of 50 to 500 psi. The bidirectional device sells for \$950, specs 0.1% full-scale accuracy, and

Designed for applications requiring surface-pressure measurements, Endevo's Model 8515B transducer features hybrid temperature-compensation circuitry for stable operation over -54 to $+121^\circ\text{C}$.

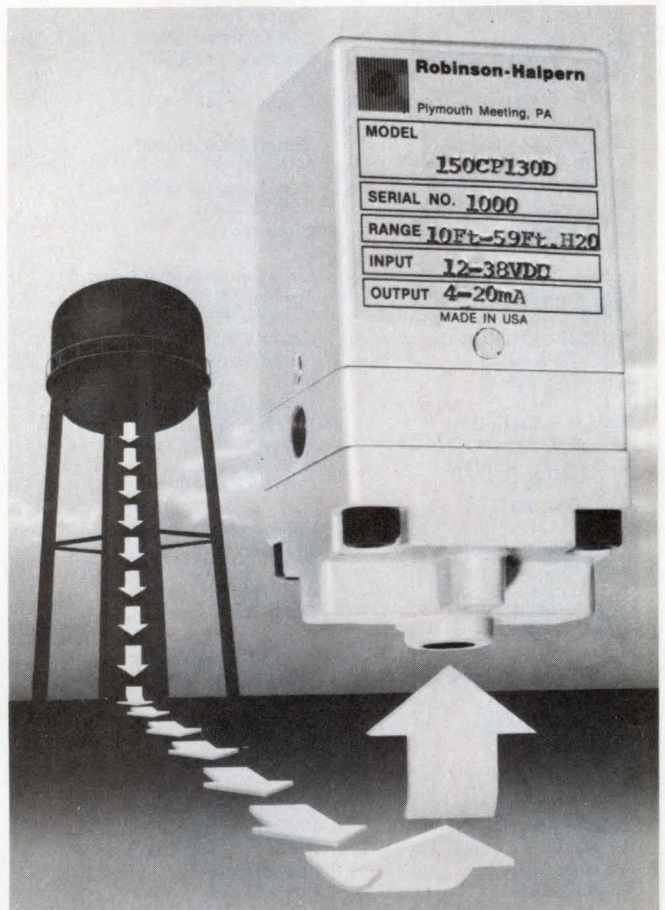

Offering full control of variable-speed pump motors, the 150B and 150C transducers from Robinson-Halpern are designed to solve measurement and control problems in sprinkler-system water tanks.

Transducers with low power consumption and logic-level electrical outputs are ideal for remote or portable applications.

is designed to accommodate fluid or gas media in both ports. Features such as stainless-steel construction and built-in overload protection provide a high degree of durability in harsh industrial environments. The bonded-foil, strain-gauge-type Model TJE employs a 10V dc supply to produce a standard 2-mV/V output; a 4- to 20-mA output is optional. The operating range extends from -65 to +250°F. Zero-offset and span temperature effects are both 0.25%/°F.

Viatran's 22 Series strain-gauge-type transducers are available with either a mV/V output (Model 122,

\$479) or 1 to 6V dc output (Model 222, \$525). The use of military-grade components makes possible a -60 to +250°F operating range. The units are available in versions with full-scale pressure-measurement capabilities of 50 to 10,000 psig and psia. All feature an accuracy of better than ±0.4% FSO.

The transducers are compensated for an operating range of 70 to 170°F. Temperature effects on span and zero are ±2% max. Model 122 operates from a 10V ac/dc supply voltage, whereas Model 222 operates from either 12 or 28V dc. The full-scale output for the 122

Manufacturers of pressure sensors and transducers

For more information on pressure sensors and transducers such as those discussed in this article, contact the following manufacturers directly, circle the appropriate numbers on the Information Retrieval Service card, or use EDN's Express Request service.

Advanced Kinetics Inc
1231 Victoria
Costa Mesa, CA 92627
(714) 646-7165
Circle No 650

Ametek
Controls Div
860 Pennsylvania Blvd
Feasterville, PA 19047
(215) 355-6900
Circle No 651

Bailey Controls Co
29801 Euclid Ave
Wickliffe, OH 44092
(216) 585-8500
Circle No 652

Barber-Colman Co
Box 2940
Loves Park, IL 61132
(815) 877-0241
Circle No 653

Barksdale Controls
Box 58843
Los Angeles, CA 90058
(213) 589-6181
Circle No 654

BLH Electronics Inc
75 Shawmut Rd
Canton, MA 02021
(617) 821-2000
Circle No 655

Robert Bosch Corp
2800 S 25th Ave
Broadview, IL 60153
(312) 681-5000
Circle No 656

Bourns Inc
1200 Columbia Ave
Riverside, CA 92507
(714) 781-5071
Circle No 657

Bristol Babcock Inc
40 Bristol St
Waterbury, CT 06708
(203) 575-3000
Circle No 658

Columbia Research Labs
MacDade & Bullens
Woodlyn, PA 19094
(215) 872-3900
Circle No 659

Computer Instrument Corp
100 Madison Ave
Hempstead, NY 11550
(516) 483-8200
Circle No 660

Consolidated Controls Corp
15 Durant Ave
Bethel, CT 06801
(203) 743-6721
Circle No 661

Data Instruments Inc
100 Discovery Way
Acton, MA 01720
(617) 264-9550
TLX 200081
Circle No 662

D-J Instruments Inc
18 Republic Rd
North Billerica, MA 01862
(617) 667-5301
Circle No 663

Dynisco
10 Oceana Way
Norwood, MA 02062
(617) 769-6600
Circle No 664

Endevco
30700 Rancho Viejo Rd
San Juan Capistrano, CA 92675
(714) 493-8181
TWX 20081
Circle No 665

Entran Devices Inc
10 Washington Ave
Fairfield, NJ 07006
(201) 227-1002
Circle No 666

Foxboro Co
38 Neponset Ave
Foxboro, MA 02035
(617) 543-8750
Circle No 667

Foxboro/ICT Inc
199 River Oaks Parkway
San Jose, CA 95134
(408) 432-1010
FAX (408) 432-1860
Circle No 668

Furnas Electric Co
1000 McKee St
Batavia, IL 60510
(312) 879-6000
Circle No 669

Genisco Technology Corp
650 Easy St
Simi Valley, CA 93065
(805) 581-3985
Circle No 670

Gulton Industries
Servonic Div
1644 Whittier Ave
Costa Mesa, CA 92627
(714) 642-2400
TWX 910-596-1352
Circle No 671

IC Sensors Inc
1700 McCarthy Blvd
Milpitas, CA 95035
(408) 432-1800
TLX 350066
Circle No 672

Kaman Instrumentation Corp
1500 Garden of the Gods Rd
Colorado Springs, CO 80933
(303) 599-1500
TLX 452412
Circle No 673

Kavlico Corp
14501 Los Angeles Ave
Moorpark, CA 93021
(805) 532-2000
Circle No 674

Kulite Semiconductor Products
1 Willow Tree Rd
Leonia, NJ 07605
(201) 945-3000
Circle No 675

Measurement Systems Inc
523 West Ave
Norwalk, CT 06854
(203) 838-5561
Circle No 676

Micro Switch
Div of Honeywell
11 W Spring St
Freeport, IL 61032
(815) 235-6600
Circle No 677

varies from 1 to 2 mV/V. Long-term stability equals $\pm 0.25\%$ max for six months, and repeatability is better than $\pm 0.1\%$ FSO. The units will mount in any position and have proof- and burst-pressure specs of 1.5 and 5 times rated pressure, respectively.

The SA devices from Data Instruments are designed to work in applications demanding a rugged, reliable transducer. The units' design isolates the pressure measurand from the electronic hybrid circuitry, allowing the transducers to accommodate media such as oil, gas, saline solutions, blood, hydraulic fluids, alcohol,

freon, ammonia, acids, and gasoline. Full-scale pressure ranges extend from 15 to 50 psia and 100 to 5000 psis (pounds per square in. sealed gauge). Each device is computer-trimmed for calibration and temperature compensation to ensure unit-to-unit interchangeability of $\pm 1\%$. The transducers' 5V output precludes the need for external amplification. Accuracy (including the effects of nonlinearity, hysteresis, and repeatability) is within $\pm 1\%$ of span. Long-term stability measures $\pm 1\%$ FSO over one year.

The SA transducers function from supply voltages in

Midwest Components Inc

1981 Port City Blvd
Muskegon, MI 49443
(616) 777-2602
Circle No 678

MKS Instruments Inc

6 Shattuck Rd
Andover, MA 01810
(617) 975-2350
TWX 910-240-8005
Circle No 679

Motorola Semiconductor Products

Box 20912
Phoenix, AZ 85036
(602) 244-6900
Circle No 680

NovaSensor

1055 Mission Ct
Fremont, CA 94539
(415) 490-9100
TLX 990010
Circle No 681

Paine Corp

2401 S Bayview St
Seattle, WA 98144
(206) 329-8600
Circle No 682

PCB Piezotronics Inc

3425 Walden Ave
Depew, NY 14043
(716) 684-0001
TWX 710-263-1371
Circle No 683

Piezo Electric Products Inc

212 Durham Ave
Metuchen, NJ 08840
(201) 548-2800
Circle No 684

Revere Corp of America

Box 56
Wallingford, CT 06492
(203) 269-7701
TLX 844387
Circle No 685

Robinson-Halpren Co

1 Apollo Rd
Plymouth Meeting, PA 19462
(215) 825-9200
TWX 510-660-8637
Circle No 686

Schaevitz Engineering

Route 130 & Union Ave
Pennsauken, NJ 08110
(609) 662-8000
TWX 710-892-0714
Circle No 687

Sensotec Inc

1200 Chesapeake Ave
Columbus, OH 43212
(614) 486-7723
Circle No 688

Sensym Inc

1255 Reamwood Ave
Sunnyvale, CA 94089
(408) 744-1500
TLX 176376
Circle No 689

Setra Systems Inc

45 Nagog Park
Acton, MA 01720
(617) 263-1400
Circle No 690

Siemens Components Inc

Special Products Div
186 Wood Ave S
Iselin, NJ 08830
(201) 321-3400
Circle No 691

Thermometrics Inc

808 Hwy 1
Edison, NJ 08817
(201) 287-2870
TLX 844387
Circle No 692

Trans Metrics Inc

5325 Naimon Parkway
Solon, OH 44139
(216) 248-2229
TWX 810-427-2059
Circle No 693

Transducer Systems Inc

Box 341
Kulpsville, PA 19443
(215) 256-4611
Circle No 694

Transducers Inc

14030 Bolsa Lane
Cerritos, CA 90701
(714) 739-1991
Circle No 695

Transducers & Systems Inc

Twin Lakes Rd
North Branford, CA 06471
(203) 481-5721
Circle No 696

Unimeasure Inc

7055 NW Grandview Dr
Corvallis, OR 97330
(503) 757-3158
Circle No 697

Vernitron Corp

Vernitech Div
300 Marcus Blvd
Deer Park, NY 11729
(526) 586-5100
Circle No 698

Viatran Corp

300 Industrial Dr
Grand Island, NY 14072
(716) 773-1700
TWX 710-260-1353
Circle No 699

West Coast Research Corp

Box 25061
Los Angeles, CA 90025
(213) 478-8833
Circle No 700

Yellow Springs Instrument Co Inc

Box 279
Yellow Springs, OH 45387
(513) 767-7241
Circle No 701

Stainless-steel construction and built-in overload protection provide a high degree of durability in harsh industrial environments.

the 9 to 20V dc range. Although the units have a 30 to 185°F compensated operating-temperature range, they will function from -67 to +257°F. Thermal effects on span and zero-offset voltages are $\pm 1\%$. All units include reverse-polarity and RFI protection as standard features. They cost \$209.

Foil-gauge units satisfy low-power needs

Boasting a current consumption of only 1 mA, Trans Metrics' P21L transducers are well-suited to applications where low power consumption is a primary design consideration. In addition, the units provide a 0 to 5V output from 5V dc supplies. They employ foil strain gauges bonded to the nonwetted side of a machined stainless-steel diaphragm-type sensor. There is no contact between the measured fluids and the electrical circuits, so the transducers accommodate any corrosive fluid that does not attack stainless steel.

Relative-, absolute-, compound-, vacuum-, and differential-pressure types are available in full-scale measurement ranges of 15 through 15,000 psi. All models cost \$395. The transducers will operate over the -30 to +180°F range and are compensated for operation from 0 to 160°F. Zero-balance and nonrepeatability-error specifications are $\pm 2\%$ FSO and 0.2% FSO, respectively. The static error band (including nonlinearity, hysteresis, and nonrepeatability) measures $\pm 1\%$ FSO for models below 150 psi and $\pm 0.5\%$ FSO for all others.

The signal-conditioning circuitry consists of a low dropout regulator, a voltage doubler, a negative-voltage converter, and an amplifier. Because of the nega-

tive-voltage converter, P21L transducers provide an output of 0V at zero pressure, thereby eliminating the need to trim out any voltage offset. The signal-conditioning circuitry also contains field-adjustable zero-balance and span potentiometers. These adjustments are located behind weather-tight plugs.

The Model PA194SH from West Coast Research is a micropower transducer ideal for use in salt water, corrosive fluids, and hostile environments. Capable of working in a submerged condition, it operates from approximately 1 mW and provides a full-scale output of 1V or higher. High sensitivity is a key feature of the PA194SH. At 600 ft of water, for example, it is capable of resolving 1 part in 72,000 (0.0014%). Output nonlinearity is less than 0.05%. The unit is available with an output converter or transmitter to yield either BCD, 4- to 20-mA, 0 to 5V, or other control-signal outputs. The submersible version costs \$1250; a reduced-sensitivity version (1 part in 24,000) is available for \$850.

Medical uses—no problem for foil units

The PPS-1 from Thermometrics costs only \$76 and is designed for invasive use in measuring pressure at selected anatomical sites, and, more specifically, for use in thermal-dilution catheters and wedge-pressure catheters. It does accommodate noninvasive applications, too, however. The sensor features a distal tip mount, which attaches to a catheter tube. The silicone rubber diaphragm is at the front face of the sensor, and the

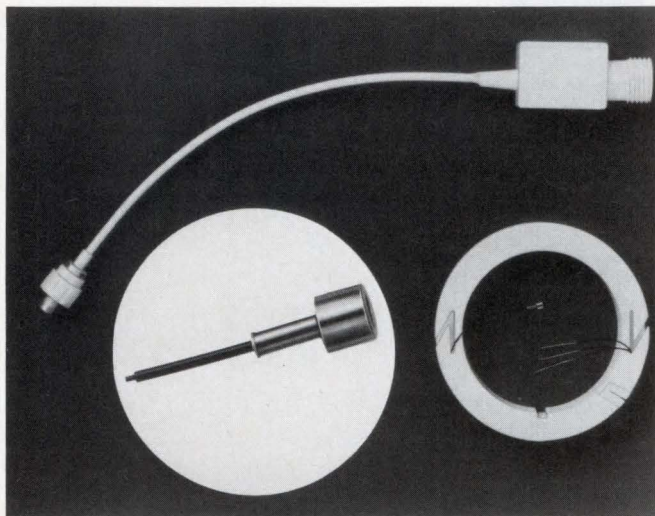

Developed for laboratory and biomedical use, PPS-1 sensors from Thermometrics monitor changes in both pressure and temperature.

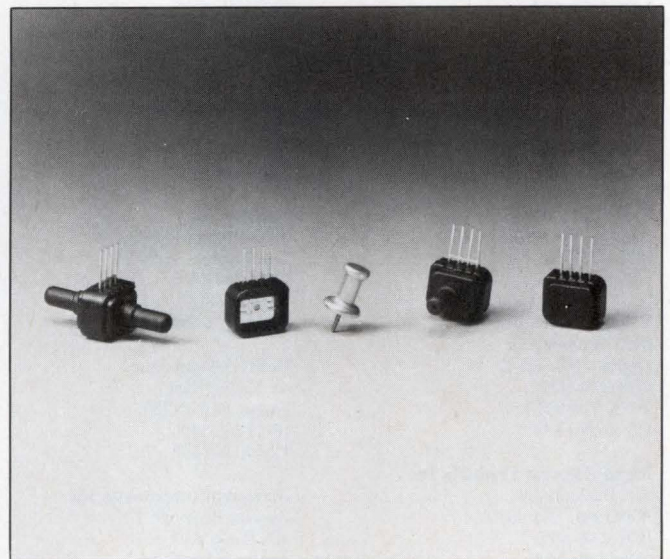

Offering wet/wet media compatibility, Micro Switch's 14PC Series is assembled using a TAB (tape automated bonding) process and elastomer O-ring seals.

the beat goes on....



... WITH SENSYM AT THE HEART.

Pressure Sensors

Sensym offers the industry's broadest line of solid state pressure sensors. For example, the new SCX series pressure sensors offer:

- Guaranteed precision over temperature: 1% max!
- Calibrated zero: 300 μ V max!
- 26 models. From 0-1 psi up to 0-100 psi
- \$15 each in 100 piece quantities

Solid-State Accelerometers

Sensym offers the latest in micromachined semiconductor accelerometers. They're available in ranges from 2 g's to 200 g's.

And, for only \$57 each in single piece quantities.

Visit us at the Sensors Expo
Booth #814

Sensym

Sensor Handbook

F R E E

The new 1988 handbook features over 200 pages of the latest product and application information on:

- Solid State Accelerometers
- Silicon Pressure Sensors
- Media Isolated Transducers
- Ultra Low Pressure Series (10" H₂O Full Scale)
- Sensor Modules

Call us today for your free copy.

1255 Reamwood Avenue • Sunnyvale, CA 94089

• Tel.: |408| 744-1500

Transformer-based transducers have long operational life and feature excellent resolution.

rear section serves as a shank that attaches to the catheter. Three wires and an atmospheric vent tube extend from the shank.

The sensor measures pressures over the range of -30 to $+300$ mm of mercury (Hg), and it operates over the range of 15 to 45°C . Overpressure capability extends from -100 to $+1200$ mm. The sensor operates from 5 to 10V dc supply voltages. Sensitivity at 25°C equals 5 to 10 mV/V/mm Hg . Zero balance is ± 75 mm Hg, and the combined linearity and hysteresis error equals ± 2 mm Hg. The zero-drift spec (over time and temperature) measures $0.3\text{ mm Hg}/^{\circ}\text{C}$ max and $3\text{ mm Hg}/24$ hours, respectively.

The number and variety of available strain-gauge transducers attests to their popularity. Nonetheless, other technologies still command a piece of the market. LDVT transducers represent one such technology. Compared with strain-gauge types of sensors, LVDT transducers rely on a transformer coil for the sensing element. Such transducers are unaffected by mechanical strain, making them extremely reliable.

LVDT transducers find an industrial home

Robinson-Halpern's Models 150B and 150C pressure transducers feature a wide zero- and span-adjustment capability that makes them well-suited to solving pressure-measurement and -control problems in auxiliary water tanks such as those used for sprinkler systems. The $\$325$ units can provide precise liquid-level measurement in elevated tanks or water towers even if the instrumentation is located at ground level. Using only a small portion of their pressure-range capability, they maintain full control of variable-speed pump motors. Users can compress the transducers' span from 100 to

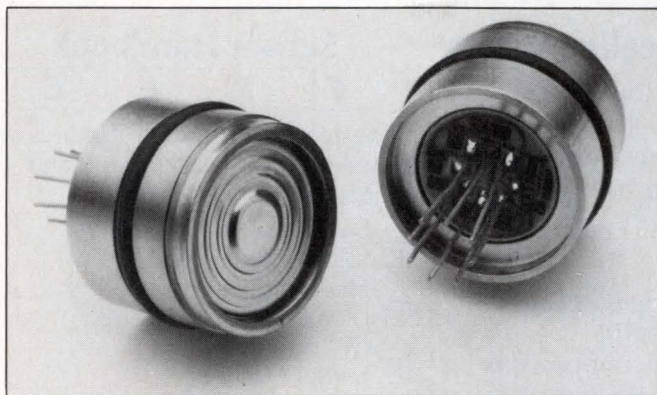

Combining varied media compatibility with low cost, Model 151 and 154 sensors from IC Sensors measure full-scale pressures from 5 to 300 psi with $\pm 0.25\%$ accuracy.

15% of the rated range, and suppress the zero-offset voltage by as much as 85% . Zero and span controls are externally accessible.

Models 150B and 150C measure the pressure of liquid or gas media in gauge, differential, or absolute units. They are available in nine versions featuring full-scale capabilities of 1.5 to 300 psi; accuracy is $\pm 0.5\%$ of the user-calibrated range. The devices operate over the -40 to $+176^{\circ}\text{F}$ range, and they are temperature-compensated over the 25 to 150°F range. Their cast-aluminum housing has a NEMA-1 rating. An internal regulator, which features polarity-reversal protection, allows the devices to operate from unregulated power sources.

The P-3061, a member of the P-3000 Series from Schaevitz, has a low-pressure-measurement-range capability. It is available in gauge- and differential-pressure versions capable of measuring 0 to 2 in. of water to 100 psi. The transducer operates from an unregulated 10 to 32V dc supply, consumes only 1.2 mA, and provides a 0 to 5V dc output. The P-3061's total static error is less than $\pm 0.5\%$ of its full-range output (FRO); a $\pm 0.25\%$ FRO spec is available as an option. The operating range extends from -40 to $+175^{\circ}\text{F}$. The cost is $\$300$.

Kaman Instrumentation Corp also employs inductive technology in its pressure-sensor offerings. The KP-1911 high-temperature pressure-measuring system is an integrated transducer system that operates at temperatures of 1100°F . It includes a pressure sensor/transducer (with $50,000$ -psi capability), cabling, and signal-conditioning circuitry. The cabling has two sections joined by a transition connector—a metal-sheathed high-temperature section, and a flexible twisted-pair section that connects to the system's electronics.

The sensor can operate in media such as liquid sodium, steam, plastics, and petrochemicals. The system output is an analog voltage directly proportional to the applied static or dynamic pressure. The sensor uses internal impedance variations to measure static and dynamic absolute pressure. Gauge- and differential-pressure-measurement versions are also available. The gauge sensor has a vent that provides an atmospheric reference, and the differential sensor includes a tube that allows you to provide a dry-gas reference pressure.

The KP-1911's housing is alloy 718; the cable sheath is alloy 600. The patented 2-coil sensor design in essence cancels temperature effects and provides a compensated operating range of -100 to $+1000^{\circ}\text{F}$. Each sys-

If you think HP board testers aren't affordable, think again.

we never stop asking

What if...



If you want a complete board tester that meets your needs at a price you'll like, consider the new HP 3065ST.

It's surprisingly affordable, with many standard features not found on other board testers under \$100,000.

You get multi-user capability without the headaches of foreground/background systems. Automatically generated 6-wire analog measurement. Analog functional testing. A vector application rate of 2.5 MHz. A high-speed digital library with more than 4,500 devices. 81 megabytes of mass storage. And more. *All standard.*

There's also complete software and fixture compatibility across the HP 3065 family. So you can start small and easily expand as you grow.

And like all HP board testers, the HP 3065ST is

available with HP's exclusive 99% Guaranteed Uptime program.*

Call HP for your free videotape!
1-800-752-0900, ext. J215.

For a free videotape on the HP board test family, or more information, call today.



**HEWLETT
PACKARD**

CIRCLE NO 71

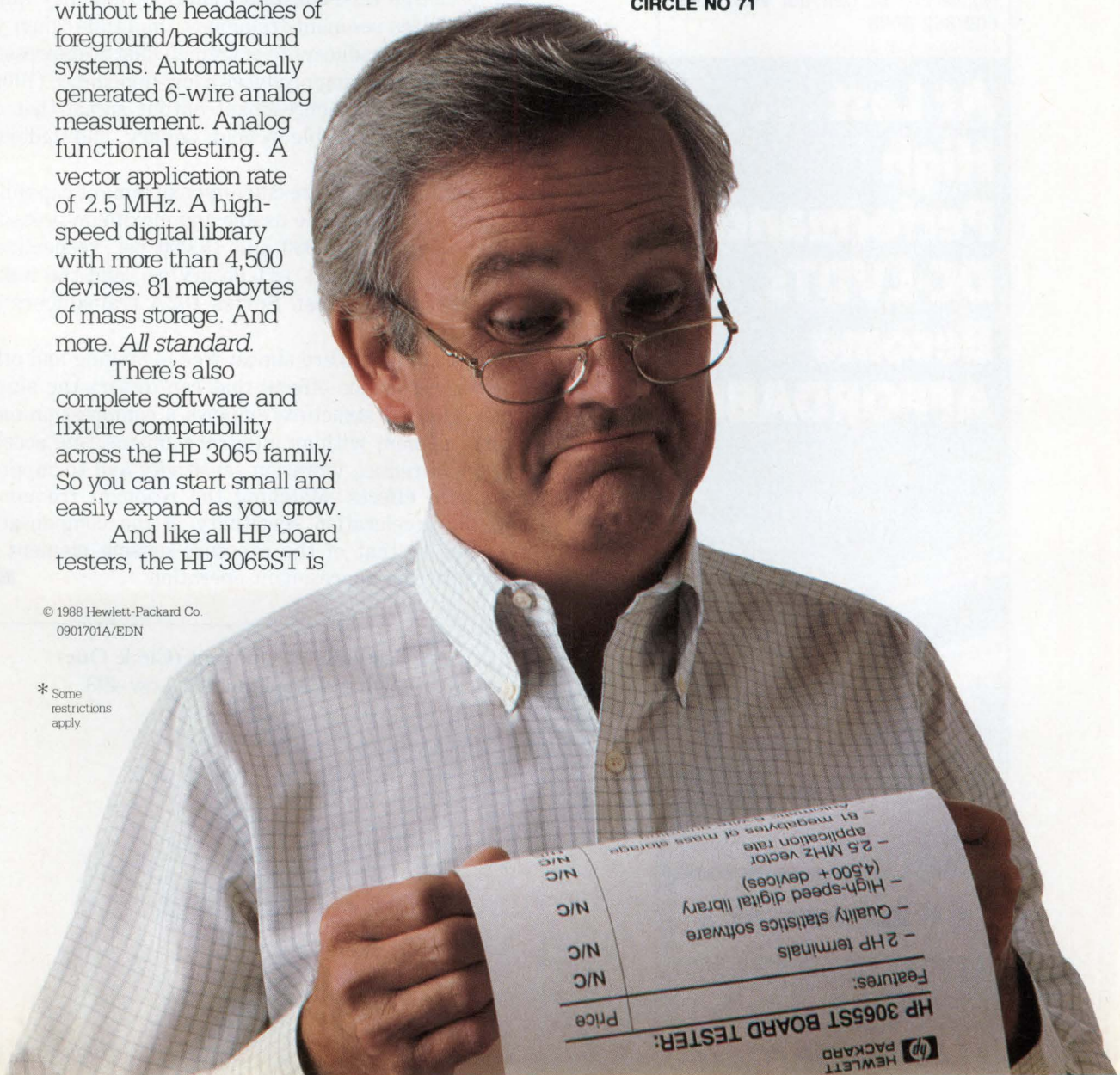

© 1988 Hewlett-Packard Co.
0901701A/EDN

* Some restrictions apply.

HEWLETT
PACKARD

HP 3065ST BOARD TESTER:

Price	N/C	N/C	N/C
2 HP terminals			
Quality statistics software			
High-speed digital library (4,500+ devices)			
2.5 MHz vector application rate			
81 megabytes of mass storage			

Features:



DISPLACEMENT

This DC-operated linear displacement sensor incorporates unique monolithic circuitry and ratio-metric design for accurate, repeatable measurements — at very affordable prices.

With an operating temperature range of +32° to +160°F and linearity at 0.25% full range, our DC-LVDT operates efficiently in tough environments.

Measuring DISPLACEMENT, PRESSURE, ACCELERATION, FORCE/WEIGHT, SLOPE/TILT, or VELOCITY? For nearly half a century, we've demonstrated our commitment to sensor technology with products for a variety of measurement applications.

For complete information on the DC-LVDT, write Schaevitz, U.S. Route 130 & Union Avenue, Pennsauken, NJ 08110 or call our **Hot Line: 609/662-8008.**

Grid Scale: 3/8" x 3/8"

At Last . . . High Performance DC-LVDTs Become AFFORDABLE



schaevitz

The Name in Sensor Technology

tem has user-adjustable zero and gain controls. Prices start at \$4340.

Although nowhere near as popular or prevalent as strain-gauge or LDVT transducers, piezoelectric transducers still deserve a mention. Advances in crystal technology have made possible piezoelectric transducers that measure high-pressure amplitudes and also produce high outputs at low-pressure levels.

Piezoelectric sensors have clean outputs

The Series 102A from PCB Piezotronics serves as a good example. This line of seven high-frequency pressure transducers differs in sensitivity, full-scale ranges, and discharge time-constant values. Frequency tailoring minimizes resonant-frequency amplitude when you subject the transducers to extremely fast step-pressure inputs. This tailoring produces a low-impedance (100Ω), high-voltage (5V) nonresonant output signal that can drive long coaxial cable in field, factory, and underwater environments.

The transducers' pressure-measurement capability ranges to 5000 psi. The usable and maximum pressure-rating specs are 10,000 and 15,000 psi, respectively. The sensitivity equals 1±0.05 mV/psi, and the resolution measures 0.1 psi. Series 102A transducers are priced at \$460.

The transducers are almost free of ringing and other internal resonance effects that can distort the signal. Their internal structure employs a compression-mode quartz element with an integral compensating accelerometer to reduce vibration sensitivity and to suppress resonance effects. Matching the resonant frequency, and the acceleration sensitivity of the compensating element, to that of the pressure-sensing element accounts for the nonresonant operation.

EDN

Article Interest Quotient (Circle One)
High 491 Medium 492 Low 493

we never stop asking

"What if..."



HP's perfect balance between price and performance in logic analysis.

The balance is called value! And nobody can put more value on your bench than HP. With the HP 1650A and HP 1651A, you get powerful capabilities at prices that keep the bottom line where you like it—low.

HP Logic Analyzers: the extra measure.

The exceptional value stems from HP's proprietary "logic-analyzer-on-a-chip" technology which integrates state analysis, timing analysis and acquisition memory on a single IC. You get features like 25MHz state/100MHz transitional timing on all channels and two independent analyzers in a single instrument.

If your application is digital hardware, or if you're working with popular 8-bit μ Ps, choose our 32-channel HP 1651A at only \$3,900.

For your 8-, 16-, or 32-bit μ P development applications, choose the 80-channel HP 1650A analyzer at only \$7,800. It offers full support for most popular μ Ps including the Motorola 68020 and the Intel 80386.

Both analyzers are capable of cross-domain triggering which lets you simultaneously capture and display state and timing information with time correlation for powerful cause/effect problem solving. Each has a built-in disc drive for storage of setups and measurements. And additional software tools to make your measurement tasks easier.

**Call HP for your free video!
1-800-752-0900, Ext. 215V**

Get a hands-on feel for our HP 1650A and HP 1651A logic analyzers with our demo video and literature. They're free!

You'll see how we balanced price and performance—perfectly.



hp HEWLETT
PACKARD

There's an easier way to



make sure it's rugged.

Order GE/RCA Rugged MOSFETs, the only ones with an "R" on the label. Because the wrong device can ruin your creation.

Two years ago an independent testing company compared GE Ruggedized MOSFETs with all leading competitive units. The results were even better than we expected.

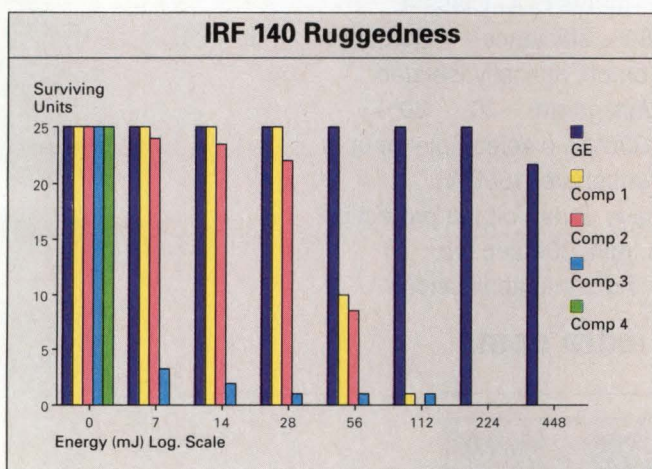

In this test conducted by Associated Testing Laboratories, Inc., the ruggedness of 25 GE IRF-series MOSFETs was compared with 25 devices from each of four competitors. As you can see, the GE parts significantly outperformed the others.

Today, the situation is different.

Because our MOSFETs are more than *twice as rugged* as they were then. Yet our ruggedized MOSFETs cost no more than competitors' standard MOSFETs.

A powerful combination.

We've achieved this by combining the rugged technology of GE products with the outstanding manufacturing, quality control and cost-effectiveness of RCA power MOSFETs. So we can bring you the best line

of rugged PowerFETs in the industry.

And the benefits are considerable.

Why you need Rugged FETs.

Our Rugged MOSFETs are fast. But they're not fragile.

They're designed, tested and *guaranteed* to withstand a specified level of circuit-induced electrical stress in breakdown avalanche mode.

When you design with our Rugged devices, you can eliminate zener diodes, snubbers and other costly circuitry.

So you save money. And by simplifying your design, you improve system reliability.

Just as important, these devices give you a margin of error.

Because you can never be sure when your system will be subjected to voltages beyond what you expected.

And if you're designing for applications that routinely have to handle surges and transient voltages, these devices are perfect.

A wide selection of drop-ins.

We have more than 200 parts in distributor stock. And they're drop-in replacements for virtually any N-channel devices.

So why take chances, when you can improve your system performance and reliability at no added cost?

For more information, contact your local GE Solid State sales office or distributor. Or call toll-free 800-443-7364, extension 28.

In Europe, call: Brussels, (02) 246-21-11; Paris, (1) 39-46-57-99; London, (276) 68-59-11; Milano, (2) 82-291; Munich, (089) 63813-0; Stockholm (08) 793-9500.



GE Solid State

GE/RCA/Intersil Semiconductors
Three great brands. One leading-edge company.

New 150KHz switcher. 4.3 inches high. 50 to 1500 Watts. SELV. And loaded.

- 8mm primary-secondary and 4mm primary-ground spacings for a SELV (Safety Extra Low Voltage) power supply per IEC 380/VDE 0806. UL recognized, CSA certified. VDE/IEC certified by TÜV Rheinland.
- On-board dual-choke filter meets FCC Class A.
- MIL STD 810D certified. ■ 75-80% efficiency. ■ Soft start.
 - Power on LED. ■ Remote on/off, optically isolated.
 - Remote error sensing. ■ Voltage adj +10, -30%.
- Overvoltage protection. ■ 115/230V a-c selectable input.
 - 300V d-c input. ■ Current share (1500W).
- The 300W and 1500W models have undervoltage protection.
 - Holding time: 20msec. min, 30msec typ.
- Supplied fully enclosed for industrial applications.

All built-in. No extra cost.*

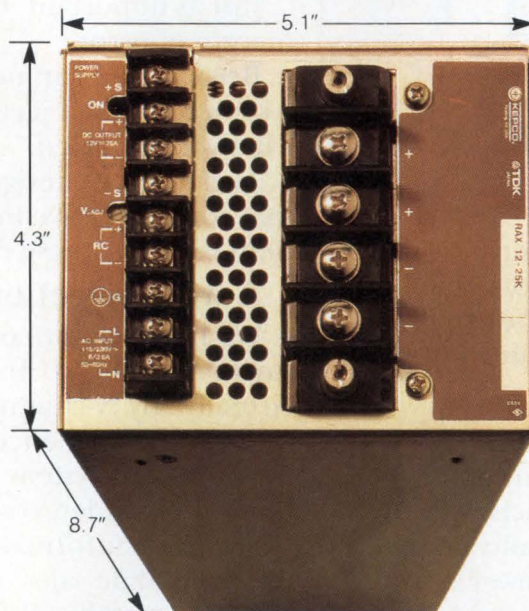

Shown:
300-Watt Model
RAX 12-25K
(Output 12V/25A).

***Price complete:**
50W — \$199
100W — \$289
175W — \$380
300W — \$520
1500W — \$1450
Quantity discounts available.

**24 MODELS OF HEAVY DUTY, INDUSTRIAL GRADE,
FET-BASED SWITCHING POWER SUPPLIES
KEPCO/TDK SERIES RAX**



Call or write Dept. KAF-12, KEPCO, INC., 131-38 Sanford Ave., Flushing, NY 11352 USA • (718) 461-7000 • TWX #710 582 2631 • FAX (718) 767-1102

CAE software uses algorithms instead of schematics

Drawing logic schematics isn't the only way to create ASIC designs. You can also use algorithms to automatically generate the net list for your hardware design—and you can do so in about one-tenth of the time that it often takes to complete a schematic.

Jay R Southard, *Algorithmic Systems Corp*

Using algorithms to design your hardware can simplify and clarify the design process as well as reduce by as much as 90% the amount of time and money you spend on it. Although engineers customarily associate schematic design with hardware and algorithmic design with software, this need not always be the case. Hardware and software are really just media for implementing your design. Schematics and algorithms, on the other hand, are design methods.

The Ascyn synthesizer transforms your algorithm directly into an ASIC foundry's net list. It also simulates designs, determines clock rates, and automatically generates test vectors. The package, written in LISP, is an artificial-intelligence logic synthesizer that can run on VAXs and personal computers.

Using this synthesizer, you can program your de-

sign's algorithm and then either compile it for a simulation run, or synthesize a net list for a specific ASIC foundry's process. After the software generates a net list, the ASIC foundry can tell you how much the circuit will cost to make.

The synthesizer is neither a schematic-capture package nor a silicon compiler. Silicon compilers work by converting high-level schematic specifications into ASIC layouts. The synthesizer, on the other hand, translates algorithms directly into net lists. How the manufacturer lays out the hardware devices is irrelevant to the algorithmic synthesizer's operation.

The algorithmic synthesizer isn't great for every type of design. Designs larger than 10 pages of Ascyn code probably won't fit in 10,000-gate gate arrays, which are generally the largest available. Moreover, any synthesized ASIC will of course be faster than the corresponding algorithm running on a standard computer, but it's unlikely to be more than 50 times faster at best.

Synthesized designs can be larger and slower than carefully crafted, schematic designs. At the 1000-gate level, the average synthesizer-generated ASIC is about 10% larger than the best schematic implementation of the same function. However, at about 2000 gates and above, the algorithmic synthesizer is better than schematic capture at minimizing chip size because a synthesizer looks over the entire IC and finds shareable resources.

You can't make a general, quantified comparison of

Algorithmic design typically costs one-tenth as much as schematic design.

the speed of an algorithmically designed ASIC with the speed of a schematically designed ASIC. Rather you must evaluate them on a case-by-case basis.

Three key traits characterize synthesizer

The synthesizer's ability to transform algorithms into net lists stems from three key characteristics of the package: its frequent use of master-slave registers, its method of assigning operators to operations, and the way it implements Boolean functions.

Although the master-slave register plays only a minor part in schematic designs, it's fundamental to algorithmic designs. If you write in any computer language:

$$B := B+A$$

what you really mean is:

- Sample the values of variables on the right-hand side of the assignment operator.
- Perform the indicated operation (in this case an addition).
- Hold the resulting value.
- Update the values of the variable on the left-hand side of the assignment operator with the held results.

This sequence defines exactly what a master-slave register does.

The synthesizer's master-slave registers have three inputs: data (word-wide), latch enable (a single-bit signal), and clock. If the latch-enable signal is 0, then the register retains its stored value; if it's 1, then the register gets updated in accordance with the data input, the clock, and the master-slave rules. In **Figs 1, 2, and 3**, the master-slave registers are boxes with parallel data inputs and a latch-enable single-bit signal. The clock line is implicit.

Operators vs operations

The synthesizer's second key characteristic is its method of assigning operations to operators. For the purposes of this article, operations are the primitive elements of an algorithm. They are the instructions that apply to specific variables at specific times. In contrast, operators are the primitive elements of a schematic. They represent the objects that are eventually connected together to make an integrated circuit. Good logic design involves the art of packing the required operations into the least expensive, highest-performance set of operators.

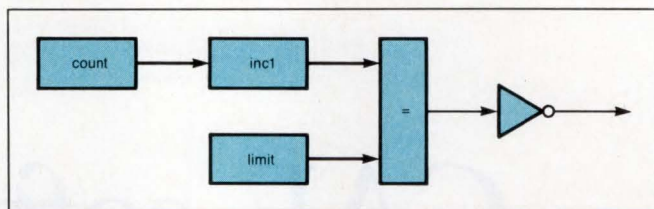

Fig 1—The algorithmic logic synthesizer transforms a simple limit-checking code fragment into this circuit.

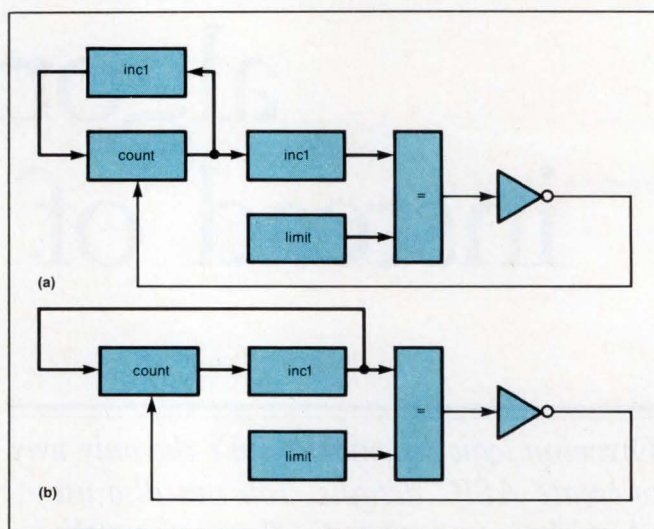

Fig 2—The synthesizer automatically condenses the redundant operations in (a) into a single operator in (b).

Using the synthesizer, you can try various design options. You can, for example, write a series of operations either sequentially or in parallel. Thus you can write two lines of operations sequentially:

$$A := A-1 \quad B := B+A$$

or in parallel:

```
(par
  A := A-1
  B := B+A)
```

The parallel construction includes two operations in a single cycle. The synthesizer can implement the sequential operations with only a single physical operator that can alternately add or subtract (such as an ALU), but not do both at the same time. The parallel version, on the other hand, needs two physical operators to execute both operations simultaneously: It's faster but it requires more hardware.

In some cases, the synthesizer only has to assign a

separate operator to each operation. For instance, consider this small fragment of code in Fortran:

```
.NOT. (LIMIT .EQ. (COUNT + 1))
```

The corresponding piece of Ascyn code is:

```
(not (= limit (incl count)))
```

Working under the assumption that these operations must execute in one clock cycle, the synthesizer transforms this algorithm into the circuit in **Fig 1** (the program can generate schematics of this sort at any point in the design cycle). The thick lines in **Fig 1** highlight word-wide data paths; the thin line is an unregistered, single Boolean signal (a "wire" variable in the Ascyn language). For this simple algorithm, every operation has its own operator.

Now consider a slightly larger piece of code:

```
(if (not (= limit (incl count))) (setn-word count
    (incl count)))
```

According to the rules of the Ascyn language, the synthesized hardware must execute these operations in one clock cycle. The hardware must therefore perform two "incl" operations in parallel. **Fig 2a** meets this requirement by including two "incl" operators, but that solution is very inefficient.

The synthesizer solves the problem by recognizing that both "incl" operations increment the same variable ("count"); it then synthesizes by applying its fan-out rule and generates the circuit in **Fig 2b**.

To see how the synthesizer would handle a slightly more complicated design, consider the following set of operations that must be sequential (**Program 1**):

```
(setn-word A (- (+ A B) D)) (setn-bit BOOL
    (= LIMIT (- C D)))
```

If you designed the circuit so that each step is performed separately, you would create the configuration in **Fig 3a**. The synthesizer, however, recognizes that because these operations are sequential and not parallel, they can share operators (**Fig 3b**). This streamlined circuit substitutes a multiplexer and a little more control wiring for a subtractor—a good tradeoff.

Note the control box in **Fig 3a**. Normally, a hardware designer designs everything in the data path except the code for the control section (the data path includes all

the registers and arithmetic operators through which data is processed). Programmers later specify the control code so that the data path executes the higher-level algorithm desired at the time. In contrast, the synthesizer automatically generates all code for the data path, including the control code.

When you want to estimate an ASIC's performance, algorithmic design facilitates identifying the critical path, which is difficult to do from schematics. In the **Fig 3** designs, for example, the critical path depends on the control code. With one control code, the critical path might flow from A and B through the +, MUX, -, and = operators all the way to BOOL. With another control code, the critical path might only flow through the +, MUX, and - operators (**Program 1**, in fact, defines this path). Thus you can easily determine the critical path if you look at the algorithm; but if you just look at the schematic, the critical path is obscure.

To further illustrate this point, consider that a second algorithm exists that generates the same data path as the previous algorithm but not the same control section:

```
(set n - word A (- C D))
(set n - bit BOOL (=(+ A B)D)LIMIT))
```

It's possible to determine the different critical paths by

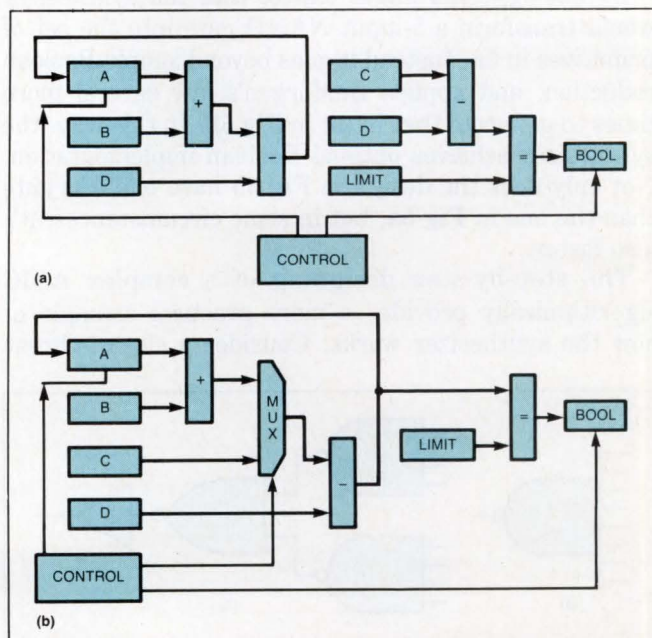

Fig 3—The synthesizer maximizes the use of expensive operators, such as the subtractor in (a) by employing a multiplexer for sequential operations (b).

A synthesized ASIC is not likely to be much more than 50 times faster than the same algorithm running on a standard computer.

analyzing the algorithms, but not if you look at the schematics—which are identical.

The third key element of the Ascyn synthesizer is its Boolean implementation, which differs from the more common Boolean reduction. Most Boolean reductions produce sets of sum-of-products expressions. By DeMorgan's law, these expressions can be realized as 2-level NAND-NAND implementations. But NAND-NAND implementations are not always practical. Consider the high fan-in NAND gate in Fig 4a. Such high fan-in gates pose two problems: They are slow, and they're not available in gate arrays. In fact, if you do find an 8-input NAND-gate entry in your foundry's cell library, it's almost certain to be a macro that expands into the primitive cells in Fig 4b.

In many cases, the particular high fan-in gate that you need is neither a primitive nor a macro available in a given foundry's library. If you were using normal design methods, you would use the next highest size available and simply tie off some of the inputs. In comparison, if the Ascyn synthesizer can't find exactly the right size in the cell library, it generates from primitives the size needed. To do this, the synthesizer uses a series of rules that transforms and minimizes gates. For example, if an 8-input NAND gate does not exist, the synthesizer generates the circuit in Fig 4b.

By analogy, you might expect that the synthesizer would transform a 5-input NAND gate into the set of primitives in 5a. Instead it goes beyond simple Boolean reduction, and applies DeMorgan's law several more times to generate the circuit in Fig 5b. In this way, the synthesizer achieves optimal Boolean implementation. Not only does the design in Fig 5b have one less gate than the one in Fig 5a, but in some circumstances, it's also faster.

The step-by-step designing of a complex ASIC algorithmically provides a more practical example of how the synthesizer works. Consider a closest-threat

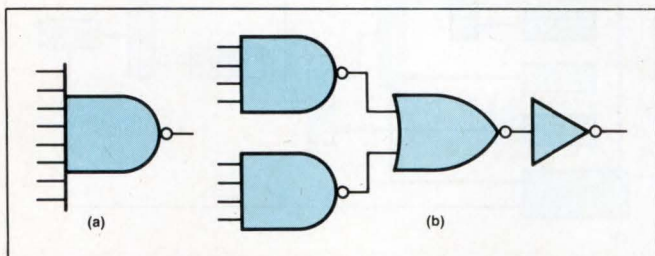

Fig 4—Simple Boolean reducers often produce results that require high fan-in NAND gates (a). In actuality, such gates in a foundry's cell library are macros that expand to the circuit in (b).

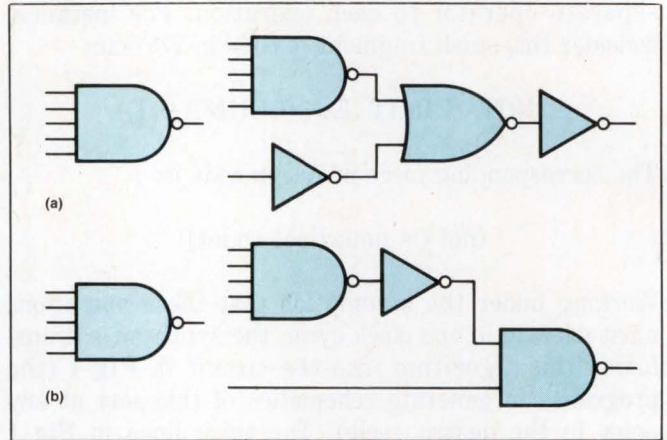

Fig 5—The synthesizer develops the exact-sized gate required. Although (a) is one possible expansion of a 5-input NAND gate, the synthesizer repeatedly applies DeMorgan's law to achieve an even simpler circuit (b).

alert subsystem. The system monitors a scanning device (such as a radar or video detector) and then determines and reports the object nearest to a selected set of X,Y coordinates. First, a master processor specifies a set of X,Y coordinates. The ASIC then checks these coordinates against the next frame of data from the scanning device and all subsequent frames until the master selects a new set of coordinates. When the ASIC detects a new closest threat, it alerts the master processor, which then can obtain the current closest object's X,Y location (the alert signal remains high until the next such interrogation) (Fig 6).

The closest-threat alert subsystem executes algorithms to perform five tasks:

- Input coordinates from the master processor.
- Output coordinates and alarm the master processor.
- Process the pixel data from the scanner.
- Compute the distance from detected objects to the coordinates supplied by the master processor.
- Update the closest threat and alert the master processor if necessary.

Before deciding that an ASIC is the best way to implement the closest-threat subsystem, you must first determine the throughput requirements of the subsystem. The distance calculation seems to be the most critical; the other algorithms seem much less computationally complex. The scanning device scans 256 lines of 256 points each. A frame consists of a framing bit followed by 65,536 data bits. A data bit of 1 indicates that an object exists at the point then being scanned in the frame.

If X_L and Y_L are the X and Y values of the coordinates selected by the master processor, then the distance from X_L, Y_L to any (X, Y) coordinate is:

$$\sqrt{(X-X_L)^2 + (Y-Y_L)^2}.$$

This simple formula is very computationally intensive however. The following algorithm approximates $\sqrt{a^2+b^2}$ without recourse to squaring or square roots:

$$g = \text{MAXIMUM} \begin{cases} |a| \\ |b| \end{cases}$$

$$l = \text{MINIMUM} \begin{cases} |a| \\ |b| \end{cases}$$

$$c = \frac{7}{8}g + \frac{1}{2}l$$

$$\text{APPROXIMATE SQUARE ROOT} = \text{MAXIMUM} \begin{cases} c \\ g \end{cases}$$

The subsystem must process 65,536 bits (or pixels) per frame. The number of frames per second depends on the scanning device; the device in this example displays 60 frames per second (a typical number). The subsystem must therefore have a throughput rate of about 4M pixels/sec or better.

Standard μ P won't work

You can rule out using a standard μ P. The fast magnitude-approximation algorithm needs about 20 instructions. At a clock rate of 16 MHz, and assuming 4 cycles per instruction (both are optimistic estimates), an advanced standard μ P can do no better than 0.2M distance computations per second.

You could try other algorithms. For example, you could buffer a frame's worth of data and perform a spiral search. Or, rather than use an approximation, you could note that $(d+1)^2 = d^2 + 2d + 1$, and compute successive values of distance recursively from the beginning of a scan. Using the synthesizer, you can evaluate both the advantages and disadvantages of these two algorithms.

Another hardware option to consider is a programmable logic device (PLD). Unfortunately, the arithmetic required for this application immediately disqualifies

standard PLDs because the carry action of multibit arithmetic implements poorly as a sum-of-products Boolean function.

Yet another possibility is to use a ROM. The distance calculation is completely combinational—it doesn't require saving any data from one input to the next. Because the X and Y inputs are 8 bits each, the resulting distance may be as large as 360, thus requiring 9 bits. This magnitude implies a 64k \times 9-bit ROM, which is hardly a standard size. Even if you did have such a part, you would still need some auxiliary logic to implement the other, system-oriented, parts of the problem (eg, comparison against current minimum, alerting the master processor).

Code implements distance calculation

The code in Listing 1 implements only the distance calculations and does not include any I/O functions. The first line names the ASIC as "mag," and declares the default integer word size to be 9 bits wide. The next section, starting with the keyword "def," declares the types of the variables—in this case "input," "output," and "wire" ("wire" variables are unregistered, single-value Boolean variables).

The last section, starting with "always," defines the algorithm. The keyword "always" starts an endless loop that executes everything that follows continuously. The Ascyn language uses a prefix notation, so that ($\geq x \text{ xl}$) denotes a conditional test that is true if x is greater than or equal to xl, and is false otherwise. Therefore, when the first three program lines following the "always" says:

```
(if ( $\geq x \text{ xl}$ ) (set-word dx (- x xl))
  (set-word dx (- xl x )))
```

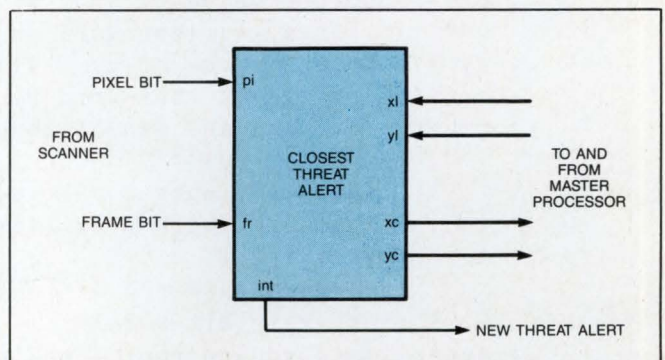

Fig 6—The closest-threat alert subsystem processes a high-speed bit stream from a scanning device and gives a master processor the coordinates of the closest object.

Three key characteristics of the synthesizer give it the ability to transform algorithms into net lists.

this code fragment means that if x is greater than or equal to x_l , then dx is assigned the value $x - x_l$; otherwise, dx is assigned the value $x_l - x$. In other words, this code fragment guarantees that dx is the positive difference between x and x_l . (Comments start with a “;” and continue to the end of the line.)

The second program line treats dy similarly. The next program section finds the minimum and maximum of dx and dy . In this case, if dx is greater than or equal to dy , the code does two things in parallel: It assigns the value of dx to g , and it assigns the value of dy to l . The parallel action is exactly the opposite when dy is greater than dx .

The next section creates the approximation c according to the algorithm. The operator \gg is a right-shift command and can take several options, including an option for the number of bits to shift. Note that $\%8 = 1 - \frac{1}{2}$. Finally, the program selects the maximum of g or c to be the d output.

In order to submit this program to the synthesizer and discover how fast the algorithm will run, you obviously must choose a foundry's cell library. For the closest-threat subsystem, several are available. This

example uses the California Devices Inc (CDI) 2- μ m double-level metal-cell library.

To estimate the maximum frequency, the synthesizer analyzes the critical path, taking fan-out capacitive loading into account. This estimate stops short of actually converting the net list into a physical layout and calculating the speed based on the chip's geometry—that's the task of the foundry. The package's simulator estimates that the ASIC's maximum clock frequency will be 4.57 MHz.

Further, this algorithm consumes 742 physical cells of a CDI gate-array chip. The cell count indicates how expensive production is going to be. The average gate-array chip comprises 2,000 of these cells, and the foundry makes up to 10,000-gate chips available (chips with more gates cost more of course).

These manufacturing specifications do not apply to other foundries. To see how large this design will be (and how much it will cost and how fast it will run) using other foundries' gate arrays or standard cells, you must resynthesize the algorithm using their libraries.

In this case the CDI chip is an acceptable size. If it weren't but you only needed a 10% improvement, you

LISTING 1—BASIC DISTANCE-CALCULATION ALGORITHM

```
(system mag 9
  (def
    (x input word *) (xl input word *) (dx wire word *)
    (y input word *) (yl input word *) (dy wire word *)
    (g wire word *) (l wire word *)
    (c wire word *) (d output word *)
  )

  (always
; dx = absolute value of (x - xl)
    (if (>= x xl) (set-word dx (- x xl)) (set-word dx (- xl x)))
; dy = absolute value of (y - yl)
    (if (>= y yl) (set-word dy (- y yl)) (set-word dy (- yl y)))
; g and l are max and min of absolute values
    (if (>= dx dy)
      (par (set-word g dx) (set-word l dy))
      (par (set-word g dy) (set-word l dx)))
; c = 7/8 g + 1/2 l
    (set-word c (+ (>> l) ; 1/2 l +
                  (- g (>> g bit-0 3))) ; 7/8 g
; approximate square root = max of g , c
    (if (>= c g) (set-word d c) (set-word d g))
  )
)
```

might try altering the fan-out ratio. However a 10% change often isn't sufficient, and you must consider more radical measures.

Pipelining shortens critical paths

One possible measure is pipelining. It gives you a larger design but a shorter critical path. Yet pipelining also changes the chip's operation because the outputs are delayed some number of cycles behind their associated inputs. The rest of the system must be able to accommodate this latency.

You have the option of pipelining the distance calculation. This sort of pipelining is very easy to effect. Just designate some of the variables to be "saved" variables rather than as unregistered ("wire") variables. Selecting variables *l* and *g* is a good choice because they are roughly in the middle of the algorithm (**Listing 2**). Thus pipelining here yields the greatest improvement in performance for the least cost. The first pipeline stage calculates *l* and *g* from *dx* and *dy*. The second stage uses *l* and *g* to calculate *c* and *d*. Except for the declarations of the type of variables, the code is unchanged from **Listing 1**.

Selecting the same foundry's library as before, and

resynthesizing, yields a chip that runs at 7.72 MHz instead of 4.57 MHz. However, the chip now consumes 842 physical cells instead of 742. So far, this result is exactly as you would expect: You've traded time for space. You could make more pipeline stages. For example, *dx* and *dy* could be pipeline registers—so could *c*. Each time you add a pipeline stage, you should improve the throughput at the expense of increased chip area.

One of the primary advantages of an ASIC over standard parts is that you can achieve exactly the right I/O configuration as well as exactly the right computation on a system-by-system basis. Depending on the processor bus to which you are connecting, the data bus could, for example, be bidirectional. If you are using one of the Intel processors, you might find that the address and data buses were multiplexed. A standard chip that does not meet the processor's interface requirements requires extra chips for the interface. On the other hand, you can change the I/O algorithm to accommodate such processor-bus variations.

The processor needs to be able to load the ASIC with new values of *xl* and *yl* (**Listing 3**). In specifying I/O, for example, you can assign some of the processor's

Text continued on pg 134

LISTING 2—DISTANCE ALGORITHM WITH PIPELINING

```
(system mag 9
  (def
    (x input word *) (xl input word *) (dx wire word *)
    (y input word *) (yl input word *) (dy wire word *)
    (g saved word *) (l saved word *) ;pipeline registers
    (c wire word *) (d output word *)
  )
  (always
; dx = absolute value of (x - xl)
    (if (>= x xl) (set-word dx (- x xl)) (set-word dx (- xl x)))
; dy = absolute value of (y - yl)
    (if (>= y yl) (set-word dy (- y yl)) (set-word dy (- yl y)))
; g and l are max and min of absolute values
    (if (>= dx dy)
      (par (setn-word g dx) (setn-word l dy))
      (par (setn-word g dy) (setn-word l dx)))
; c = 7/8 g + 1/2 l
    (set-word c (+ (>> l) ; 1/2 l +
                  (- g (>> g bit-0 3))) ; 7/8 g)
; approximate square root = max of g , c
    (if (>= c g) (set-word d c) (set-word d g))
  ))
```

LISTING 3—MEMORY-MAPPED I/O TO CUSTOMIZE ASIC FOR A μ P

;The processor expects to receive an interrupt when the closest threat changes.

```
(system com 9
  (def
    (ad-hi input word 8 0 *) ; The inputs are only
    (ad-lo input word 8 0 *) ; 8 bits wide,
    (do input word 8 0 *) ; When used in a 9-bit operations, msb will be 0
    (di tri-state word *)
  ; di will be hi-impedence unless explicitly set during a clock cycle
  (rd input bit *)
  (wr input bit *)
  (xc saved word *)
  (yc saved word *)
  (dc saved word *) ; saved value of current distance
  (intfl saved bit *) ; generate an interrupt if the newly calculated
  (int output bit *) ; distance chages from the old value of dc
  (xl saved word *)
  (yl saved word *)
  (y saved word *)
  (x saved word *)
  (fr input bit *)
  (pi input bit *)
  (restart saved bit *)) ; hold until next
  (always
    (set-bit int intfl) ; int is always the same as interrupt flag
    (if wr
      (if (reduce and ad-hi) ; ad-hi all ones
        (par (set-bit restart bit-1) ; resync calculation
              (if (bit-lsb ad-lo)
                (setn-word yl do) ; odd -> set new yl
                (setn-word xl do)))) ; even -> set new xl
      (if rd
        (if (reduce and ad-hi) ; ad-hi all ones
          (par (setn-bit intfl bit-0) ; clear pending interrupt
                (if (bit-lsb ad-lo)
                  (set-word di yc) ; odd -> send current yc
                  (set-word di xc)))) ; even -> send current xc
        ;*****
        ; now input frame sync and manage x and y counters,
        (if fr
          (par (setn-word x 0) (setn-word y 0)
                (if restart
                  (par (setn-bit restart bit-0) ; clear pending restart
                        (setn-word dc 511)))) ; and set dc to max.
          (if (bit-msb y) () ; too many rows - wait for frame sync
            (if (bit-msb x)
              (par (setn-word x 0) (setn-word
```

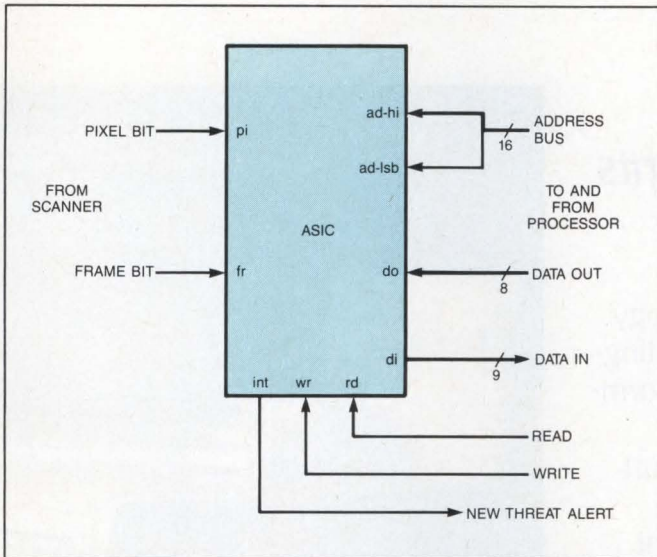

Fig 7—Adding data and address buses to the ASIC customizes it for a particular μP .

memory-address locations to the ASIC. If the processor writes to an even address in the $FFXX_{HEX}$ block, it loads a new x_l value, and similarly loads a new y_l value if the address is odd.

If the processor reads an even address in the $FFXX_{HEX}$ block, the chip will output the closest threat's x coordinate for the duration of the read signal. If the address is odd, the chip outputs the y_l coordinate, and the processor generates the "Read" and "Write" signals, which the chip then inputs.

The chip maintains the x and y values; these values are derived from the framing bit ("fr") that comes from the scanning device. Fig 7 reflects these modifications in the initial closest-threat-alert diagram. When synthesized, the completed chip uses 1342 gates and operates at 4 MHz.

EDN

Author's biography

Jay R Southard is the president of Algorithmic Systems Corp (Braintree, MA). Previously he worked for MetaLogic, MIT's Lincoln Lab, Draper Labs, and General Instruments. Jay received a BA from Grinnell College and an MSEE from Stanford. He belongs to the IEEE.

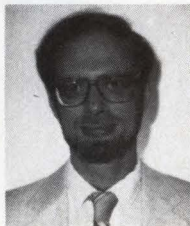

Article Interest Quotient (Circle One)
High 497 Medium 498 Low 499

Be An Author!

When you write for EDN, you earn professional recognition. And you earn \$75 per published magazine page.

EDN publishes how-to design application information that is read by more than 137,300 electronics engineers and engineering managers worldwide. That's an audience that could belong to you.

If you have an appropriate article idea, send your proposal and outline to: John Haystead, 275 Washington Street, Newton, MA 02158-1630.

For a FREE EDN Writer's Guide—which includes tips on how to write for EDN and other technical publications—please circle number 800 on the Information Retrieval Service Card.

EDN

First in Readership among Design Engineers and Engineering Managers in Electronics.

The 32-bit floating point processor

Expert support complements leading-edge technology.

NEC is the front-runner in DSP technology. The proof? Our μ PD77230 32-bit Floating Point Processor with 13.4-MFLOPS performance is now in mass production.

And we back it with enhanced support services. To speed your programming, we offer a complete set of development tools and an EPROM version. DSP applications specialists are waiting to give you expert advice and the latest application notes at our worldwide network of support centers.

For a faster, easier design-in, call NEC. We'll give you leading-edge DSP technology and support to match.

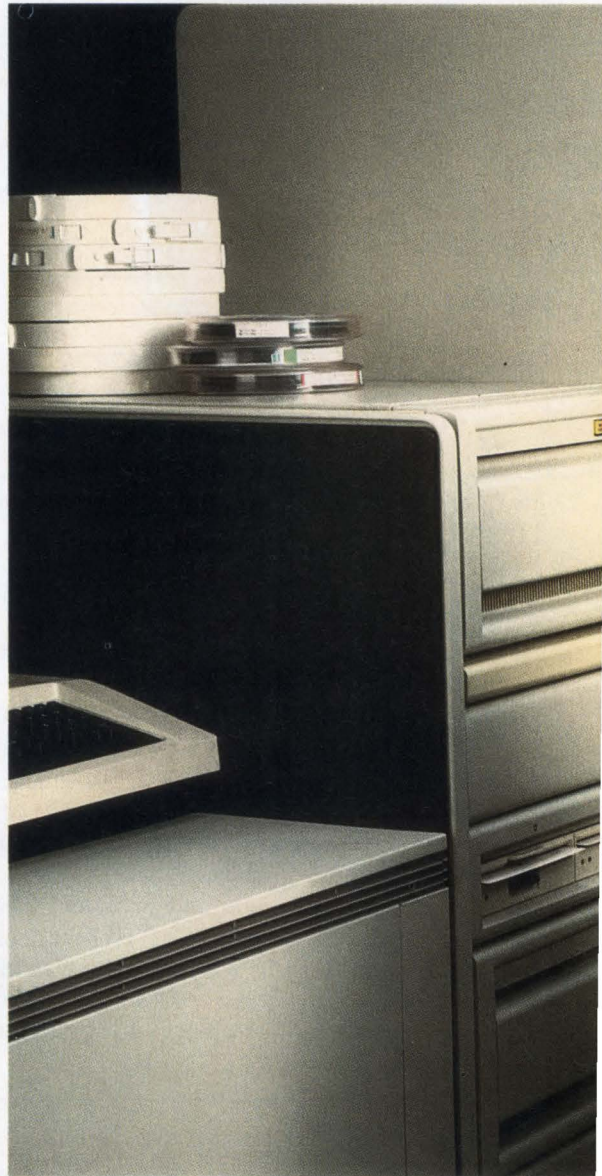
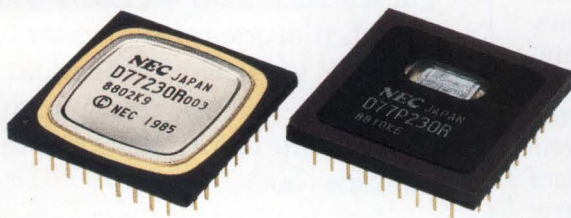

For fast answers, call us at:

USA Tel: 1-800-632-3531. TWX: 910-379-6985. Sweden Tel: 08-732-8200. Telex: 13839.
W. Germany Tel: 0211-650302. Telex: 8589960. France Tel: 1-3946-9617. Telex: 699499.
The Netherlands Tel: 040-445-845. Telex: 51923. Italy Tel: 02-6709108. Telex: 315355.

from the DSP pioneer.



*Junko Sunaga
Application Engineer
Semiconductor Application
Engineering Division.*

CIRCLE NO 63

AD744

FEATURES

Fast Settling:

500ns to 0.01% for 10V Step
1.5 μ s to 0.0025% for 10V Step

Slew Rate: 75V/ μ s

Total Harmonic Distortion (THD): 0.0003%

**>1000pF Capacitive Load Drive Capability with
10V/ μ s Slew Rate**

Input Offset Voltage: 0.25mV max

Input Offset Drift: 3 μ V/ $^{\circ}$ C max

Open Loop Gain: 250V/mV min

Noise: 4 μ V p-p max, 0.1Hz to 10Hz

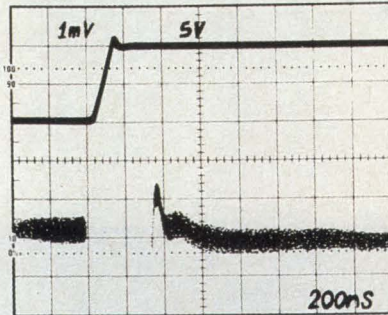

AD744 Settling Characteristics 0 to +10V Step

PRODUCT DESCRIPTION

The AD744 makes a breakthrough in the high speed BiFET market by offering guaranteed maximum settling to 0.01% in 750ns. It also offers the excellent dc characteristics of the AD711 BiFET family with enhanced slew rate, bandwidth and load driving capability.

The single-pole response of the AD744 provides fast settling: 500ns to 0.01% typically, and 750ns maximum. This feature, combined with high dc precision, makes the AD744 suitable for use as a buffer amplifier for 12-, 14- and 16-bit DACs and ADCs. Furthermore, the AD744's low total harmonic distortion (THD) level of 0.0003%, low noise and gain bandwidth product of 13MHz make it an ideal amplifier for demanding audio applications. It is also an excellent choice for high speed instrumentation amplifiers and for use in active filters.

The AD744 offers optional custom compensation for additional design flexibility. This external compensation allows the AD744 to drive capacitive loads up to 2000pF and greater with full stability, making the AD744 outstanding for use as a coaxial cable driver. Alternatively, external decompensation may be used to increase the gain bandwidth of the AD744 to over 200MHz at high gains. This makes the AD744 ideal for use as an ac preamp in digital signal processing (DSP) front ends.

PRODUCT HIGHLIGHTS

1. The AD744 offers exceptional dynamic response. It settles to 0.01% in 500ns and has a 100% tested minimum slew rate of 50V/ μ s.
2. The combination of Analog Devices' advanced processing technology, laser wafer drift trimming and well-matched ion-implanted JFETs provide outstanding dc precision. Input offset voltage, input bias current and input offset current are specified in the warmed-up condition and are 100% tested.
3. The AD744 has a guaranteed and tested maximum voltage noise of 4 μ V p-p, 0.1 to 10Hz.
4. The AD744 is a high speed BiFET op amp that offers excellent performance at competitive prices.

**THIS PAGE SETTLES
THE QUESTION OF WHO MAKES
THE FASTEST SETTLING BiFET.**

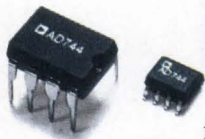

A lot of companies say they have fast-settling, high-performance BiFET amps. But our AD744 settles to 0.01% in 500ns and to 0.0025% in 1.5 μ s—making it the world's fastest-settling, highest-performance BiFET.

This superior settling, combined with excellent dc performance, makes the AD744 unbeatable for active filters, and for buffering DACs and ADCs up to 16 bits.

The AD744, with a total harmonic distortion of just 0.0003%, low noise, a clean pulse response, and a gain bandwidth product of up to 200MHz, is also ideal for digital signal processing and audio applications.

If you work in communications, you'll appreciate the AD744's ability to drive loads greater than 2000pF with full stability. And you'll also appreciate the fact that the AD744 can drive a 1000pF

cap load while maintaining a slew rate of 10V/ μ s.

The AD744 isn't our only outstanding BiFET, either. The AD711 single, AD712 dual, and soon the AD713 quad, settle in 1 μ s with the same high resolution as the AD744. If low power with precision is critical, try our AD548 single or AD648 dual.

Whichever BiFET your application requires, you'll find our products deliver excellent performance at an excellent price. For example, the AD744 starts at only \$2.25; the AD711 at \$.80; and the AD548 at \$.75 (100s).

If you'd like to see more proof on why we can say we make the best BiFETs, call Applications Engineering at (617) 935-5565, ext. 2628 or 2629. Or write to Analog Devices, P. O. Box 9106, Norwood, MA 02062-9106.



Analog Devices, Inc., One Technology Way, P. O. Box 9106, Norwood, MA 02062-9106; Headquarters: (617) 329-4700; California: (714) 641-9391, (619) 268-4621, (408) 559-2037; Colorado: (719) 590-9952; Maryland: (301) 992-1994; Ohio: (614) 764-8795; Pennsylvania: (215) 643-7790; Texas: (214) 231-5094; Washington: (206) 251-9550; Austria: (222) 885504; Belgium: (3) 237 1672; Denmark: (2) 845800; France: (1) 4687-34-11; Holland: (1620) 81500; Israel: (052) 911415; Italy: (2) 6883831, (2) 6883832, (2) 6883833; Japan: (3) 263-6826; Sweden: (8) 282740; Switzerland: (22) 31 57 60; United Kingdom: (932) 232222; West Germany: (89) 570050

we never stop asking

"What if..."

\$0.000034
per Hz

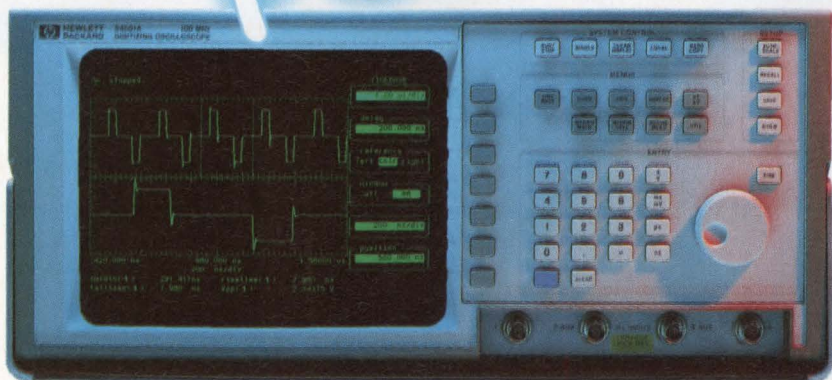

Introducing 100MHz performance for \$3465 in a general purpose digitizing oscilloscope.

- Instant Hardcopy Output
- Full Programmability
- Automatic Measurements
- Pushbutton Automatic Set-up
- Advanced Logic Triggering
- Easy to Use

The new HP 54501A Digitizing Oscilloscope is, without a doubt, the general purpose digitizing oscilloscope you've been waiting for. It does what most analog scopes will do and it provides additional performance capabilities found in the most expensive digitizing oscilloscopes.

Compare at twice the price.

The combination of low price, high performance and a full set of features makes the HP 54501A the best scope available, even when compared feature-for-feature to competitive scopes costing up to twice as much.

An intuitive operating interface makes the HP 54501A extremely easy to work with. And it's packed with features that make set-ups and measurements a snap—including

HP Auto Scale, dual timebase windowing and four separate set-up memories.

You get versatile, programmable 100MHz measurement capability. Plus there are passive probes and a new TV/video pod among a wide selection of accessories that make your job even easier.

Call for a free video and a discount.
1-800-752-0900, Ext. K215.

Free Video: to see the HP 54501A in action, ask for our free application demo video that provides all the details.

\$800 Discount: for a limited time, get an \$800 Discount when you buy an HP 54501A/HP 8116 Pulse Generator combination. Ask for details when you call.





AREA SALES OFFICES: **CENTRAL AREA**, Toshiba America, Inc., (312) 945-1500; **EASTERN AREA**, Toshiba America, Inc., (617) 272-4352; **NORTHWESTERN AREA**, Toshiba America, Inc., (408) 737-9844; **SOUTHWESTERN REGION**, Toshiba America, Inc., (714) 455-2000; **SOUTH CENTRAL REGION**, Toshiba America, Inc., (214) 480-0470; **SOUTHEASTERN REGION**, Toshiba America, Inc., (404) 368-0203; **MAJOR ACCOUNT OFFICE**, Fishkill, New York, Toshiba America, Inc., (914) 896-6500; **BOCA RATON, FLORIDA**, Toshiba America, Inc., (305) 394-3004. **REPRESENTATIVE OFFICES:** **ALABAMA**, Montgomery Marketing, Inc., (205) 830-0498; **ARIZONA**, Summit Sales, (602) 998-4850; **ARKANSAS**, MIL-REP Associates, (512) 346-6331; **CALIFORNIA** (Northern) Elreco, Inc., (415) 962-0660; **CALIFORNIA** (L.A. & Orange County) Bager Electronics, Inc., (818) 712-0011, (714) 957-3367, (San Diego County) Eagle Technical Sales, (619) 743-6550; **COLORADO**, Straube Associates Mountain States, Inc., (303) 426-0890; **CONNECTICUT**, Datcom, Inc., (203) 288-7005; **FLORIDA**, Sales Engineering Concepts, (813) 823-6221, (305) 426-4601, (305) 682-4800; **GEORGIA**, Montgomery Marketing, Inc., (404) 447-6124; **IDAHO**, Components West, (509) 922-2412; **ILLINOIS**, Carlson Electronic Sales, (312) 956-8240, R.W. Kunz, (314) 966-4977; **INDIANA**, Leslie M. DeVoe Company, (317) 842-3245; **IOWA**, Carlson Electronics, (319) 377-6341; **KANSAS**, D.L.E. Electronics, (316) 744-1229; **KENTUCKY**, Leslie M. DeVoe Company, (317) 842-3245; **LOUISIANA**, MIL-REP Associates, (713) 444-2557; **MAINE**, Datcom, Inc., (617) 891-4600; **MASSACHUSETTS**, Datcom, Inc., (617) 891-4600; **MICHIGAN**, Action Components Sales, (313) 349-3940; **MINNESOTA**, Electric Component Sales, (612) 933-2594; **MISSISSIPPI**, Montgomery Marketing, Inc., (205) 830-0498; **MISSOURI**, D.L.E. Electronics, (316) 744-1229, R.W. Kunz, (314) 966-4977; **MONTANA**, Components West, (206) 885-5880;

Remember, Toshiba Is Producing The World's Broadest Line Of High Density Non-Volatile Memory.

Only Toshiba volume production can give you the non-volatiles you need – in the leading edge densities you want.

For high reliability, low

cost and automatic insertion capability, select OTPs in densities to 1 Mb. Choose from a wide selection in EPROMs, including one of the fastest 1 Mb available.

And in ROMs, you can get up to 4 Mb in CMOS today.

Nobody else offers you so many options in high density non-volatile memories with the production capabilities to deliver in volume.

Why deal with a herd of suppliers to get all the non-volatiles you want.

Just remember

Toshiba, the heavyweight in non-volatiles.



Toshiba. The Power in Non-Volatile Memories.

TOSHIBA AMERICA, INC.

PART NO.	ORG.	PROCESS	PART NO.	ORG.	PROCESS
EPROM			ONE TIME PROGRAMMABLE		
TMM2764AD~	8KX8	NMOS	TMM24128AF	16KX8	NMOS
TMM2764ADI	8KX8	NMOS	TMM24256BP	32KX8	NMOS
TMM27128AD~	16KX8	NMOS	TMM24256BF	32KX8	NMOS
TMM27128ADI	16KX8	NMOS	TC54256AP	32KX8	CMOS
TMM27256BD~	32KX8	NMOS	TC54256AF	32KX8	CMOS
TMM27256BDI	32KX8	NMOS	TMM24512AP	64KX8	NMOS
TC57256AD	32KX8	CMOS	TMM24512AF	64KX8	NMOS
TMM27512AD~	64KX8	NMOS	TC541000P	128KX8	CMOS
TMM27512ADI	64KX8	NMOS	TC541001P	128KX8	CMOS
TC571000D	128KX8	CMOS	ROM		
TC571001D	128KX8	CMOS	TC53257P	32KX8	CMOS
TC571024D	64KX16	CMOS	TC53257F	32KX8	CMOS
ONE TIME PROGRAMMABLE			TC531000AP/AF	128KX8	CMOS
TMM2464AP	8KX8	NMOS	TC531001AP	128KX8	CMOS
TMM2464AF	8KX8	NMOS	TC534000P	512KX8	CMOS
TMM24128AP	16KX8	NMOS			

~ = +/-10%V_{CC} AVAILABLE

NEVADA, Elrepro, Inc., (415) 962-0660; NEBRASKA, D.L.E. Electronics, (316) 744-1229; NEW ENGLAND, Datcom, Inc., (617) 891-4600; NEW HAMPSHIRE, Datcom, Inc., (617) 891-4600; NEW JERSEY, Nexus-Technology, (201) 947-0151; NEW MEXICO, Summit Sales, (602) 998-4850; NEW YORK, Nexus Technology, (201) 947-0151; Pi-tronics, (315) 455-7346; NORTH CAROLINA/SOUTH CAROLINA, Montgomery Marketing, Inc., (919) 467-6319; NORTH DAKOTA/SOUTH DAKOTA, Electric Component Sales, (612) 933-2594; OHIO, Steffen & Associates, (216) 461-8333; (419) 884-2313, (513) 293-3145; OKLAHOMA, MIL-REP Associates, (214) 644-6731; OREGON, Components West, (503) 684-1671; PENNSYLVANIA, Nexus Technology, (215) 675-9600, Steffen & Associates, (412) 276-7366; RHODE ISLAND, Datcom, Inc., (617) 891-4600; TENNESSEE, Montgomery Marketing, Inc., (205) 830-0498; TEXAS, MIL-REP Associates, (512) 346-6331, (713) 444-2557, (214) 644-6731; UTAH, Straube Associates Mountain States, Inc., (801) 263-2640; VERMONT, Datcom, Inc., (617) 891-4600; WEST VIRGINIA, Steffen & Associates, (419) 884-2313; WASHINGTON, Components West, (206) 885-5880, (509) 922-2412; WISCONSIN, Carlson Electronics, (414) 476-2790, Electric Component Sales, (612) 933-2594; WYOMING, Straube Associates Mountain States, Inc., (303) 426-0890; CANADA, BRITISH COLUMBIA, Components West, (206) 885-5880; ONTARIO, Electro Source, Inc., (416) 675-4490, (613) 592-3214; QUEBEC, Electro Source, Inc., (514) 630-7486.

Our ASIC line-up is only half the story.



When it comes to delivery of high-quality, reliable ASICs, S-MOS wrote the book.

We did it in collaboration with our manufacturing affiliate, Seiko Epson. With 18 years of CMOS experience, Seiko Epson is one of the world's most advanced CMOS IC manufacturers.

Through Seiko Epson's high-yield manufacturing technology, we ship millions of ASIC units a month, and

with a reject rate of less than .0001%. That's our quality story.

Now we've added a new chapter on design. At our advanced R&D design facility, engineers from S-MOS and Seiko Epson are developing new software to simplify circuit design, simulation and the creation of new megacells for our extensive cell library.

Of course, you can still take advantage of our established design

tools because S-MOS supports such workstations as Daisy, Mentor, Calma and PC-based systems using FutureNet, OrCAD and ViewLogic.

Our proprietary LADS simulator will speed up the design process. The S-MOS engineering team will support you from concept to production.

If you are looking for an ASIC program that can make your designs best sellers, call us. (408) 922-0200.



CMOS Gate Arrays

- Up to 38,550 available gates
- SLA8000 (800 ps)*, 1.2μ drawn, 1.0μ Leff.
- SLA7000 (1.0 ns)*, 1.5μ drawn, 1.2μ Leff.
- SLA6000 (1.8 ns)*, 2.0μ drawn, 1.5μ Leff.
- SLA700B High Drive Output
- SLA100L Low Voltage

CMOS Standard Cells

- Complexities to 16K gates**
- SSC1000 (1.4 ns)*, 1.8μ drawn, 1.4μ Leff.
- Fully migratable from S-MOS gate arrays
- RAM and ROM blocks available

Compiled Cell Custom

- The Alternative to Full Custom*
- 1.8μ CMOS process
- Can utilize dissimilar cell geometries
- 3-button approach to custom design
- Currently over 300 fully characterized cells
- Fast 14-week implementation time
- Timing-driven TANCELL® place-and-route software

TANCELL is a registered trademark of Tangent Systems.

*Typical propagation delay of 2-input NAND gate driving 2 internal loads with 1mm of interconnect.

**Maximum gate utilization depends on amount of interconnect used.

CIRCLE NO 81



S-MOS SYSTEMS, INC.
2460 North First Street
San Jose, CA 95131-1002

Remember when cramming more into less space was fun and games? Now it's your job.

Streamline with our SLICs: BORSHT functions on one chip.

Back then it was phone booths and Volkswagens. Today it's line cards in PBXs, key systems, switching units and more.

Different cases, same principle: success demands getting more from available space. Taking efficiency to the extreme.

That demands our solid-state SLICs. Their robust Dielectric Isolation processing makes "hot plug-up" latch-up a thing of the past.

Six years ago, designers began eliminating bulky discrete components, using our monolithic SLICs to increase system reliability and decrease costs.

Today — 5 million parts later — you'll find our SLIC

solutions working around the globe, flexible enough to comply with the telecom world's ever evolving standards.

Here're more numbers: HC-5504, HC-5504B, HC-5502A, HC-5502B; voltages: +5, +12, -48 (long lines), -24 (short lines); temperatures: -40°C to +85°C; packages: DIPs and PLCCs.

Because Harris SLICs are customer-defined, you're not locked into an architecture that could lock you out of the future.

Decide your own course in line card design...call us! In U.S. phone 1-800-4-HARRIS, Ext. 1420. In Canada: 1-800-344-2444, Ext. 1420.



The Bettmann Archive

IN SPACE-SAVING SLICs,
THE NAME IS
HARRIS

Harris Semiconductor: Analog - CMOS Digital
Gallium Arsenide - Semicustom - Custom



March, 1959: A college "stuffing team" crams 20 people into one phone booth and claims a world record.

©1988, Harris Corporation

"Fads come and go...Harris SLICs are here to stay!"



Single VLSI chip helps you implement EPA factory networks

The Enhanced Performance Architecture (EPA), a subset of the MAP specification, allows networks to provide fast, noise-immune communication over short distances. By applying a single VLSI chip that implements most of the EPA functions in silicon, you can speed your network's response time without a huge software-development effort.

Rhonda Alexis Dirvin and Anne-Marie Larkin
Motorola Inc

If you're building or extending a factory network that includes intelligence, programmable controllers, and systems that must respond quickly to their controlling computer, you'll find the Manufacturing Automation Protocol (MAP) too slow for your purposes. To let machines or sensors send status information and command acknowledgment to their controlling computer quickly, you can implement the Enhanced Performance Architecture (EPA), a streamlined version of the MAP specification that takes into account the networking requirements of the workstations, PCs, and intelligent machines in a factory environment—requirements that are vastly different from those of large computers.

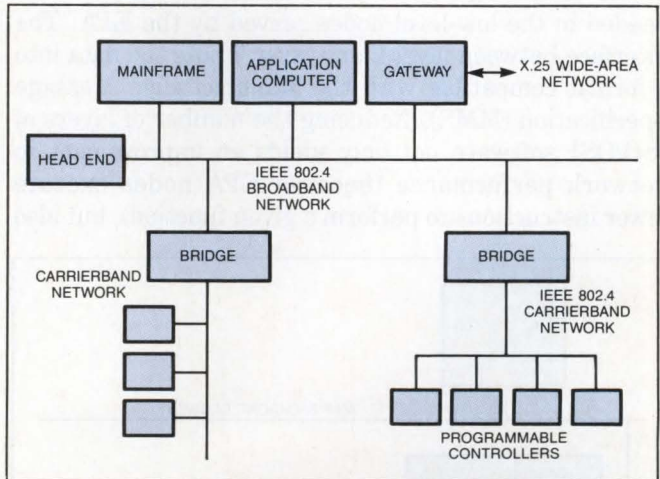

Fig 1—A broadband network connects the major nodes of a MAP system, which uses all seven layers of the ISO/OSI model. Local carrierband networks connect the smaller computers to sensors and intelligent machines that require high performance and short response times.

The EPA, created by the SP-72 committee of the Instrument Society of America (ISA) and the MAP Enhanced Performance Architecture Task Group, accommodates a wide variety of machines by dividing the total network into a hierarchy of subnetworks, each of which could meet a different set of performance requirements (Fig 1). The Process Industries Special Interest Group also played an important part in pressing for and helping to define the EPA.

The initial MAP specification concentrated on creating a backbone network in the factory to provide

The Enhanced Performance Architecture provides a high-performance, low-cost link between process-control stations and a MAP network.

communication among the large computers at the administrative level. This type of communication did not need to be especially fast; several seconds might elapse between file transfers, for instance. On the lower level of the factory, however, machines such as numerical controllers and robots need to perform information transfers at much shorter intervals (tenths of milliseconds, in some cases). At present, it's not possible to obtain this high performance if all communications must pass through the full seven layers of the OSI protocol, which the MAP uses. Further, it takes significant memory and horsepower to run all seven layers. If your task is merely to provide a network for the low-cost machines at the factory's lower level, you probably won't be able to justify the expense of all that memory and horsepower.

The EPA solves that problem by specifying only layers 1 and 2, an interface, and layer 7. The remaining layers (3 through 6) perform functions that are not needed in the low-level nodes served by the EPA. The interface between layer 2 and layer 7 puts the data into a format compatible with the Manufacturing Message Specification (MMS). Reducing the number of layers of ISO/OSI software not only yields an improvement in network performance (because EPA nodes execute fewer instructions to perform a given function), but also

reduces software-design costs, because the system designer has fewer layers to deal with.

For one thing, the specifying bodies chose broadband technology as the physical layer for the backbone of the MAP, because it can operate over long distances (miles) and because it has high noise immunity. EPA subnetworks, on the other hand, operate only over distances of 500 to 1000 ft; they could therefore use either carrierband or baseband technology in the physical layer. Both of these technologies are far less expensive than broadband technology.

Today's broadband modems cost from \$700 to \$1500 and require a head-end remodulator (one per network), which sells for around \$10,000. Carrierband modems cost from \$400 to \$600 and require no head-end remodulator. This price comparison does not take into consideration the fact that carrierband technology will soon be available in silicon form—a fact that will drop the carrierband price to approximately \$100 per node. Carrierband technology also lets you save on space, because you'll probably need only one board instead of two to accommodate the hardware. The primary reason to choose carrierband over broadband, therefore, is economic.

When considering alternatives to broadband technology, the specifying bodies preferred carrierband over baseband for several reasons, including cost: Carrierband is somewhat less expensive than baseband. More important, however, is that carrierband has much better noise immunity, because it frequency-modulates a constant-amplitude carrier signal instead of amplitude-modulating a constant-frequency signal, as the baseband technique does. Its higher noise immunity makes carrierband more suitable for use in an electrically noisy factory environment.

EPA subnetworks contain a variety of node types

The Enhanced Performance Architecture embraces several different types of stations that fulfill different purposes; the types include Mini-MAP, MAP/EPA, and router nodes (Fig 2). Mini-MAP nodes can communicate only with each other and with MAP/EPA nodes over the subnetwork, using the 3-layer EPA architecture. Direct communications of this type are easy and efficient. The MAP/EPA node is also a carrierband device, but it contains facilities for converting data from 3-layer format to 7-layer format and vice versa.

All the communications between a Mini-MAP node and a backbone node take place via a MAP/EPA node and a router. The MAP/EPA node performs all of the

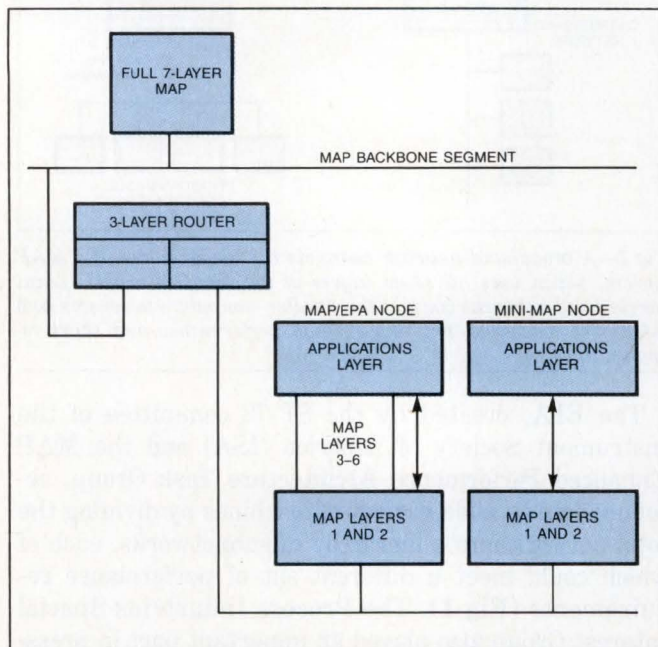

Fig 2—Mini-MAP nodes serve small machines and programmable controllers. They communicate with backbone nodes via MAP/EPA nodes and a router.

conversions between the 3-layer EPA architecture and the 7-layer MAP architecture. The router is a 3-layer device that can segment data frames to ensure that they conform to the maximum size limitations, both on the backbone side and on the EPA-segment side. It also contains both broadband hardware that connects to the backbone network, and carrierband hardware that connects to the EPA segment (subnetwork). Routers' frame-segmenting capability is the reason that the specifying bodies preferred routers over bridges or gateways as the links between the backbone and EPA segments. Bridges are too simple and can only filter addresses; gateways, which perform full protocol conversion, are more complex and more expensive than is necessary for the MAP/EPA link.

Redundancy maintains network integrity

A subnetwork may contain multiple MAP/EPA nodes, both to provide redundancy and to improve performance. If one of the MAP/EPA nodes fails, another one can perform the same functions; it thus prevents the subnetwork from being isolated from the backbone. If you expect to have a substantial amount of network traffic between the subnetwork and the MAP back-

bone, you should consider providing more than one MAP/EPA node in order to maintain acceptable levels of performance. Indeed, the MAP specification requires that a subnetwork contain at least two MAP/EPA nodes before it can be classified as an EPA segment.

EPA functions allow very simple nodes

One function that was not in the original MAP specification but was added to the EPA is the IEEE 802.2 Logical Link Control (LLC) type 3 Acknowledged Connectionless Service. This function allows EPA station A to ask station B a simple question, such as "What is your temperature?" While station A still holds the token, station B can respond immediately with a simple answer (for example, "58°C"). This function can achieve response times of around 5 μ sec, because station B doesn't have to obtain the token and then establish a new communication link.

By using the LLC type 3 feature, you can greatly reduce the cost of attaching simple devices to an EPA segment of the network. Temperature and pressure sensors, for example, do not need to participate in the token-passing ring; they only have to be able to respond properly when they're sent an LLC type 3 request

ISO/OSI model specifies seven layers

The MAP specification is based on the International Standards Organization's Open Systems Interconnect (ISO/OSI) model primarily because the ISO/OSI model already has widespread international support. Now the US federal government, too, has chosen the ISO/OSI model for the new networking procurements described in the Government Open Systems Interconnection Profile (GOSIP) document.

The ISO/OSI model breaks the communications task into seven sections, or layers. Each layer has a duty to perform or a service that it must provide to the layer immediately above it. ISO specifies what services must be

provided, but it doesn't specify the manner of implementing them. **Table A** shows the name and function of each layer of the

ISO/OSI model. Immediately above layer 7 are any user application programs, which are not part of the ISO/OSI model.

TABLE A—THE SEVEN LAYERS OF THE ISO/OSI MODEL

NAME	FUNCTION
LAYER 7—APPLICATION	PROVIDES ALL SERVICES THAT ARE DIRECTLY COMPREHENSIBLE TO APPLICATION PROGRAMS
LAYER 6—PRESENTATION	TRANSFORMS DATA TO AND FROM NEGOTIATED STANDARDIZED FORMATS
LAYER 5—SESSION	SYNCHRONIZES AND MANAGES DIALOGUES
LAYER 4—TRANSPORT	PROVIDES TRANSPARENT RELIABLE DATA TRANSFER FROM END NODE TO END NODE
LAYER 3—NETWORK	PERFORMS MESSAGE ROUTING FOR DATA TRANSFER BETWEEN NODES
LAYER 2—DATA LINK	MANAGES ORDERED ACCESS TO THE MEDIUM AND DETECTS ERRORS INVOLVED IN THIS PROCESS
LAYER 1—PHYSICAL	ELECTRICALLY ENCODES AND PHYSICALLY TRANSFERS DATA OVER THE MEDIUM

EPA networks use carrierband technology as the medium because it's less expensive than broadband and has better noise immunity than baseband.

TABLE 1—LLC TYPE 3 PRIMITIVES PROVIDED BY THE MC68824

ACKNOWLEDGED CONNECTIONLESS DATA-UNIT TRANSMISSION SERVICE

PRIMITIVE	DESCRIPTION
L_DATA_ACK.request	USED TO SEND A DATA UNIT WITH ACKNOWLEDGMENT TO ANOTHER NODE
L_DATA_ACK.indication	USED TO INDICATE THE RECEPTION OF A NON-NULL, NONDUPLICATE LSDU FROM A REMOTE DATA-LINK NODE
L_DATA_ACK_STATUS.indication	USED TO INDICATE WHETHER THE PREVIOUS LSDU TRANSMISSION REQUEST WAS SUCCESSFUL

ACKNOWLEDGED CONNECTIONLESS DATA-UNIT EXCHANGE SERVICE

PRIMITIVE	DESCRIPTION
L_REPLY.request	USED TO REQUEST AN ACKNOWLEDGED CONNECTIONLESS DATA-UNIT EXCHANGE
L_REPLY.indication	USED TO INDICATE RECEPTION OF AN RWR FRAME
L_REPLY_STATUS.indication	USED TO CONFIRM RWR FRAMES

REPLY DATA-UNIT PREPARATION

PRIMITIVE	DESCRIPTION
L_REPLY_UPDATE.request	USED TO INDICATE THE NEED TO UPDATE A RESPONSE
L_REPLY_UPDATE_STATUS.indication	USED TO CONFIRM THAT A RESPONSE WAS UPDATED

frame. Very simple hardware can provide them with this ability; the node can consist merely of an enhanced token-bus-controller chip, a carrierband chip, some memory to hold the response, and some mechanism for updating the memory as required.

VLSI chip embodies the EPA functions

To meet the requirements for low cost and high performance that are driving the development of the EPA, you can apply a device such as the MC68824 token-bus controller (TBC), which implements the EPA functions in silicon. Motorola recently enhanced the chip so that it now implements both the Media Access Control (MAC) portion of the IEEE 802.4 standard and the Receiver portion of the IEEE 802.2 LLC type 3 Acknowledged Connectionless Service (Table 1 summarizes the latter).

These services provide a means, at the data-link level, of sending a message from one node to another and of receiving an acknowledgment message without establishing a separate data-link connection. This feature yields the very fast response time that the applications require. In addition, the MC68824 provides two

separate methods of bridging: hierarchical and IBM-defined source routing. The chip allows the user to choose between powerful address mechanisms that permit group-address recognition and multidrop operation.

Some of the MC68824's enhancements include a reduced-data-structure mode for increased performance, a FIFO option for increased reliability, and a bus-analyzer mode that lets you run the TBC as a powerful protocol analyzer. The chip can now perform serial data transfers over the network at speeds ranging from 10k to 12.5M bps, and it can accommodate system clock rates from 10 to 16.67 MHz.

The MC68824 functions as an intelligent peripheral device to a host microprocessor. The TBC is a full MC68000 bus master; it has on-chip DMA facilities for managing tables and frame buffers located in shared memory, and these DMA facilities transfer data frames to and from a shared memory with minimal intervention from the host μ P. A fully linked buffer-management scheme allows the queuing of frames during transmission and reception. You can configure the TBC bus interface to handle both 8-bit and 16-bit

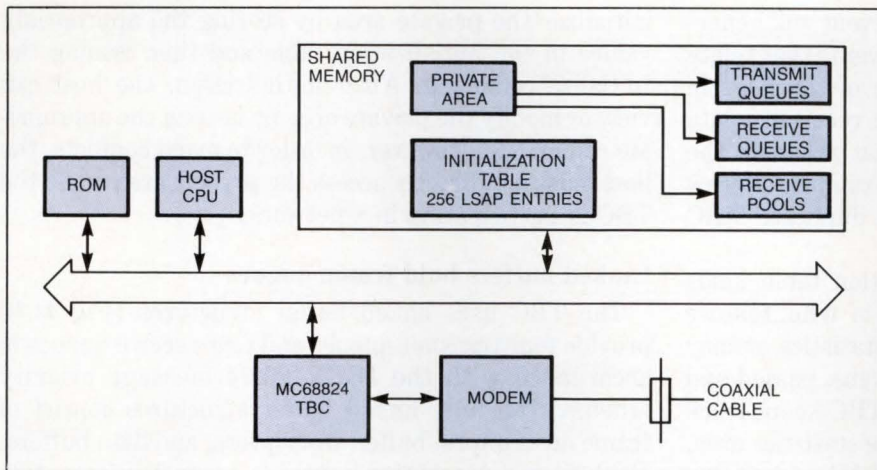

Fig 3—An EPA node consists of an enhanced TBC, a host CPU, memory shared by the host and the TBC, and a modem. The node can be very simple, because it needs to implement only the lower three layers of the ISO/OSI model.

data transfers in either Motorola/DEC or Intel/IBM data formats. Fig 3 shows the MC68824 in a typical intelligent system environment.

EPA is one of chip's three operational modes

The MC68824 has three main operational modes: the TBC mode, the EPA mode, and the bus-analyzer mode. In the TBC mode, which is the default mode, the MC68824 provides a full MAC implementation as well as support for LLC types 1 and 3. Running the TBC in its default mode allows the host μ P to perform the LLC functions (or equivalent functions) in software.

In the EPA mode, the MC68824 performs the receiver functions of the Acknowledged Connectionless Service of the LLC sublayer, as well as operating normally when it receives a nonrequest-with-response frame. The receiver portion of LLC type 3 is the most time-critical, and it performs much better when implemented on chip.

To use the EPA mode, the host must set a bit in the initialization table, and must also add an LSAP (Link Service Access Point) table to the end of the initialization table. This table has an entry for each of the 128 possible individual LSAPs and one for each of the 128 group LSAPs. Each LSAP entry contains user information as well as LSAP status information (such as whether or not the LSAP is active). For each active LSAP, the host prepares a response and puts the pointer to the response in the corresponding entry of the LSAP table. The host also updates the response when necessary.

When a receiving station running in EPA mode finds a Request with Response (RWR) encoded in the frame control of an incoming frame, the station looks at the corresponding LSAP entry in the LSAP table. If the

RWR frame requests data, the receiving station will return the data that the LSAP entry points to, provided that the LSAP is active. If the LSAP is not active, the station returns a NACK. If the RWR frame does not request data, the station merely returns an ACK (if it has received the frame correctly) or a NACK (if it has received the frame incorrectly).

In the bus-analyzer mode, the MC68824 is not part of the logical ring, but it receives all frames. This feature makes the TBC an ideal chip for use in a protocol-analyzer application. In this mode, the TBC time-stamps all frames, so it can measure the elapsed time between network events.

Host, TBC communicate through shared memory

The TBC also makes use of a simpler data structure. The MC68824 and the host communicate with each other through shared memory. This shared memory comprises two tables and some buffer structures that store received frames or frames awaiting transmission. The two tables are called the initialization table and the private area.

The initialization table contains the initial parameters that the host loads into the private area by giving the Initialize command at power-up or after a reset. The table also holds the command-parameter area, the interrupt status words, some statistics, and, if the TBC is running in the EPA mode, an LSAP table.

The command-parameter area has two main uses: The host employs it mainly to pass parameters to the TBC in conjunction with a command, and the TBC uses it to return parameters to the host in response to a command. The TBC continuously updates two Interrupt Status Words (ISWs) to indicate status changes. Flags in the ISW, filtered by an interrupt status mask,

You can now obtain a single VLSI chip that implements most of the EPA functions, as well as standard token-bus-controller functions, in silicon.

determine whether or not a particular event will generate an interrupt. ISW1 keeps track of events that relate to the local system. For example, one of the flags in ISW1 informs the host that the TBC has received a data frame. ISW2 keeps track of events that relate to the network. One of the flags in ISW2, for example, informs the host that the TBC has detected a duplicate MAC address on the network.

The statistics area of the initialization table holds network statistics, such as "number of who_follows events." The host may collect all the statistics or may disable the collection of two items (Tokens_passed and Number_of_tokens_heard). Also, the TBC keeps track of various types of modem errors in the statistics area.

The private area contains mainly MAC operational parameters and statistics; therefore, the TBC uses it primarily as an extra storage area. Hi_Priority-Token_Hold Timer, for example, is a MAC operational timer that you can specify in the private area if you use the priority option. IEEE 802.4 specifies this and many other timers. Among the MAC statistics kept in the private area is the Last Token_Rotation_Time, which is the observed time measured from token arrival to token arrival.

The private area also holds the pointers to the various buffer structures used for receiving and transmitting data frames. After power-up or reset, the host

initializes the private area by storing the appropriate values in the initialization table and then issuing the Initialize command. After initialization, the host can view or modify the private area by issuing the appropriate commands. However, in order to avoid conflicts, the host must not directly access the private area while the TBC is participating in a network.

Linked buffers hold frame queues

The TBC uses linked buffer structures (Fig 4) to provide four transmit queues and four receive queues in accordance with the IEEE 802.4 message-priority scheme. The fully linked buffer structures consist of frame descriptors, buffer descriptors, and data buffers. Each frame descriptor contains control information pertaining to a frame sent or received, plus links to the next frame descriptor and to the buffer descriptor. The buffer descriptor contains the data buffer's attributes, such as the user-specified offset, which points directly to the data in the data buffer. This feature is useful for appending upper-layer protocol headers without moving the data. Each buffer descriptor also contains links to the next buffer descriptor (if there is one) and to the data buffer. Finally, the data buffers contain the actual data.

This linking scheme makes it easy for the host's software to build data frames: The scheme lets each

MAP uses IEEE 802.4 token-bus protocol

At the physical and data-link layers, the MAP uses the token-passing bus protocol specified by IEEE standard 802.4. The protocol was chosen because it's deterministic; that is, the maximum allowable time for any station to access the medium is known. A token bus is also very flexible, because its topology allows you to add stations to or delete them from the network without disrupting network operations. The token-bus protocol also clearly defines error-related functions such as recovery from lost or multiple tokens, token-passing failures, inoperative

transmitters or receivers, and duplicate station addresses.

A token is a specific bit sequence in the frame-control portion of the frame. When a station holds the token, it has the right to transmit. When that station has finished transmitting all of its frames, or when the timer that tracks the station's maximum token-holding time (which is specified by the user) has timed out, the station passes the token to the station having the next lower address. This process continues until the station with the lowest address passes the token back to the sta-

tion with the highest address.

The station that holds the token periodically polls stations that are connected to the bus (but are not currently part of the logical ring) to see if any station wishes to join the logical ring. If a new station does wish to join the ring, the sending station patches the new station into the ring as its logical successor. For example, if the sending station, A, receives a valid reply from station E, station A patches station E into the ring by making E (instead of B) the logical successor to A.

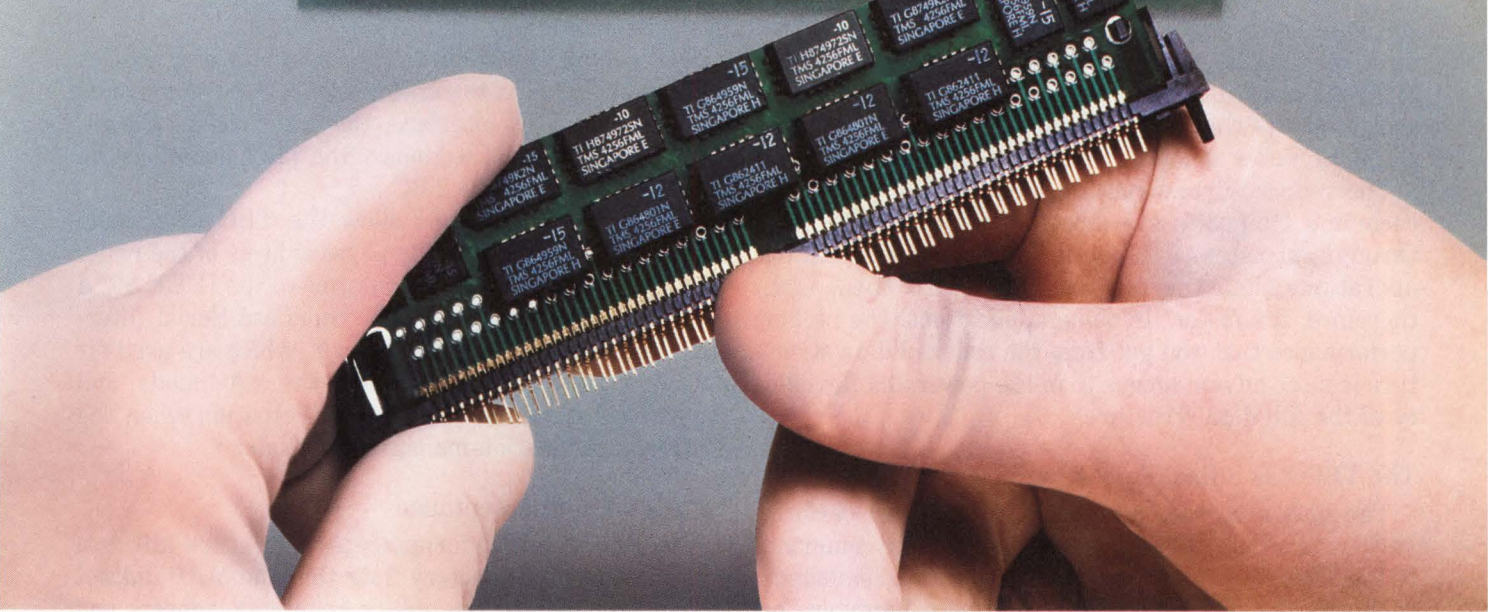
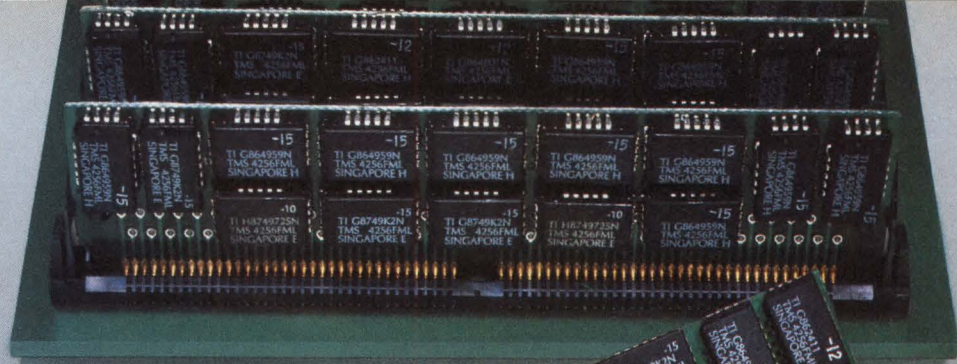

Our new ultra high density SIMM socket is a perfect fit for your new chip. Row after row.

We listened to what you want...
in products and service

Our new ultra high density .050" SIMM socket fits the next-generation in-line memory modules like they were made for each other. They were.

With zero insertion force, proven contact design, and high-temperature plastics, our new SIMM sockets meet all your requirements.

The Texas Instruments investment in leading-edge products pays off when you're trying to get your design to market faster. And our experience in semiconductor and interconnect technology enables TI to be early to market with products like high density SIMM sockets that mate with the latest in-line memory modules.

Our new line offers the features you expect, with some extras TI thinks you deserve, like detailed engineering data, local field sales engineers to help with design solutions, fast sample delivery, and state-of-the-art manufacturing capabilities under statistical process control. Our ship-to-stock program from TI plants worldwide will complement your just-in-time manufacturing.

TI is a perfect fit—in quality high density products and service. Give us a call.

CIRCLE NO 83



TEXAS INSTRUMENTS

Texas Instruments Incorporated
P.O. Box 809065
Dallas, Texas 75380-9065

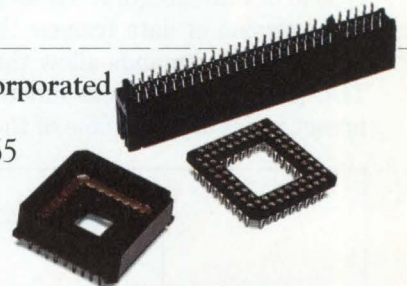

Get to know our new Ultra High Density family. Send for free samples and data on the new .050" SIMM socket or call us at 1-617 699-5242.

My application is: _____

EDN080488

NAME _____

TITLE _____

COMPANY _____

ADDRESS _____

CITY _____ STATE _____ ZIP _____

AREA CODE _____ TELEPHONE _____ EXT. _____

34-8132
©1988 TI

MSU023ED800
Offer expires December 31, 1988

Providing a subnetwork with multiple MAP/EPA nodes not only yields higher performance, but prevents malfunctions from isolating the subnetwork.

software layer append the header information to the data by simply changing a pointer or offset. The MC68824 can also run in a reduced-data-structure mode that combines the frame descriptor, buffer descriptor, and data buffer as one structure.

The reduced-data-structure mode is well suited for receiving frames in systems that require very high throughput rates, because it requires fewer linking operations than the full data structure does, and, therefore, it's faster. In some applications, the higher performance that you get from the reduced data structure is more advantageous than the power and flexibility of the full data structure.

The TBC has a flexible command set

The host processor commands the TBC to perform various functions by writing the appropriate command to the TBC command register. Initialization commands configure the TBC for operation after a hardware or software reset. These commands include Reset, Offline, Load Initialization Table Function Code, Initialize, and Idle. Idle causes the TBC to join the ring.

Mode commands set or clear various modes of TBC operation; the Set/Clear In_Ring_Desired command is typical of this category. Three commands pertain to the transmission of data frames: Start, Stop, and Restart. Parameter commands allow the host to modify or read TBC parameters such as function codes, the pad-timer-preset register, and some of the parameters that reside

in the private area.

Test commands allow the host to run diagnostics while the TBC is in the off-line state; these commands test the host/TBC interface, the transmitter, the receiver, and the serial sections of the TBC, as well as the internal sections of the TBC.

Finally, two commands allow the TBC to provide management services to the physical layer of the node. The TBC's serial interface conforms to the IEEE 802.4 Standard Serial Interface. The Standard Serial Interface specifies a set of 10 I/O signals, which are used for data transfer when the TBC is in the MAC mode, and for passing station-management information when the TBC is in the station-management mode.

EPA is gaining acceptance

The Enhanced Performance Architecture fulfills a requirement of the factory floor that the MAP did not previously address: the ability to provide sensors and intelligent machines with a low-cost, high-performance link to the MAP network. However, the fast response times that the EPA requires were initially very difficult to achieve. The EPA is only now starting to gain acceptance because of the emergence of devices such as the MC68824 Enhanced TBC.

EDN

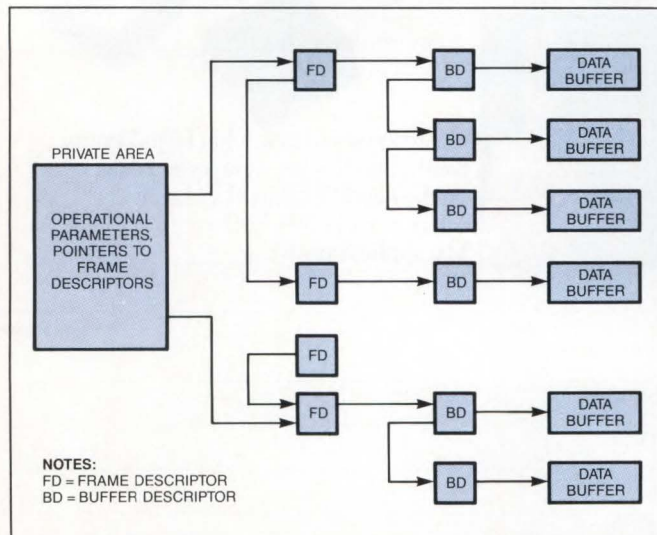
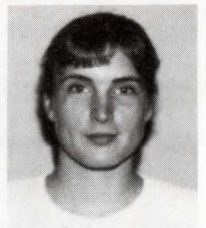

Fig 4—The shared memory holds frame descriptors (FDs), buffer descriptors (BDs), and data buffers. The private area holds operational parameters and pointers to the first FD of each message to be queued.

Authors' biographies

Rhonda Alexis Dirvin is LAN VLSI program manager at the Microprocessor Products Group, 68000 Operations, of Motorola Inc (Austin, TX). She holds a BSEE from Cornell University and is a member of the IEEE.



Anne-Marie Larkin is currently applications manager for data-communications and networking products at the Microprocessor Products Group, 68000 Operations, of Motorola Inc (Austin, TX). She received a BSEE from the University of Tennessee.



Article Interest Quotient (Circle One)
High 488 Medium 489 Low 490

**When it comes
to ASICs,
you need more
than technology
that works.**

You need a partne



Partnership that works.

In today's highly competitive marketplace, it takes more than technology and tools to meet your ASIC needs. It takes a long-term partner you can count on. One who's ready to help you turn your hot idea into an even hotter new product.

At Fujitsu Microelectronics, we believe that the only way we can achieve our goals is to help you achieve yours. So we've committed our technical, financial and human resources to providing you with the ASIC technology, tools and trust you need to meet your objectives. From design support through volume production of your advanced VLSI ICs. The heart of your new products.

When you shake hands with Fujitsu, you get more than just a business deal. You get the industry's most experienced volume producer of ASIC devices as a working partner.

We become an extension of your ASIC design team, providing you with a nationwide network of field application and technical resource engineers, ready to offer local technical support on both products and tools.

You also get ASIC sales and marketing support to help you smooth out all the administrative wrinkles.

Plus coast-to-coast technical resource centers, fully equipped with easy-to-use design tools. And local training and twenty-four hour design facilities, so you can work whenever inspiration strikes.

All supporting the most advanced process and manufacturing technologies in the industry, including CMOS, ECL, BiCMOS and LSTTL.

All of which is structured for the fast design input-to-prototype turnaround, design security and timely delivery of volume production you need to get to market faster.

It all adds up to a partnership that works. Which, after all, is everything an ASIC partner should be.



FUJITSU

FUJITSU MICROELECTRONICS, INC.

Everything an ASIC partner should be.

3545 North First Street, San Jose, CA 95134-1804 (408) 922-9000

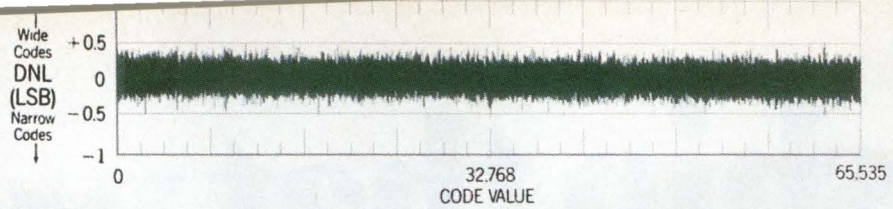

Shows ± 0.7 LSB code width variation from ideal (definitely no missed codes)
CS5016 16-BIT DIFFERENTIAL NONLINEARITY AT 16 μ SEC CONVERSION TIME

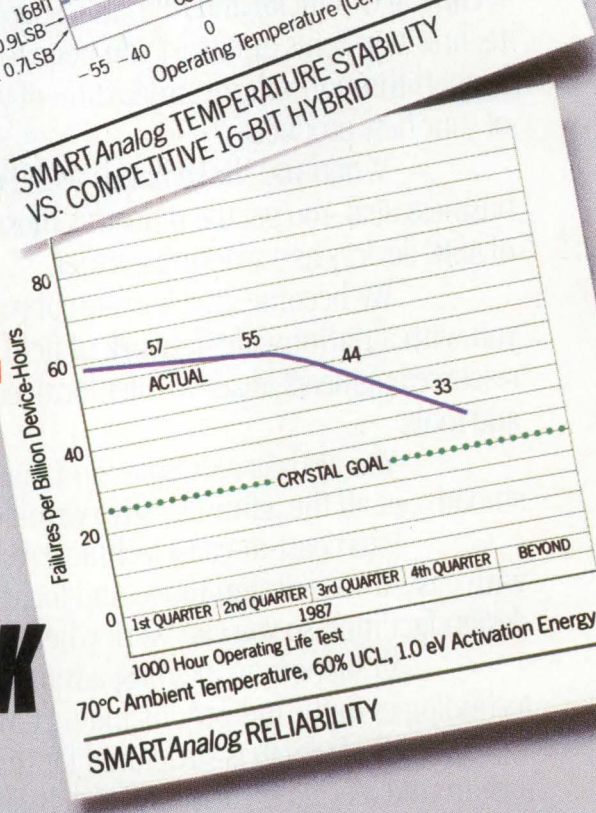
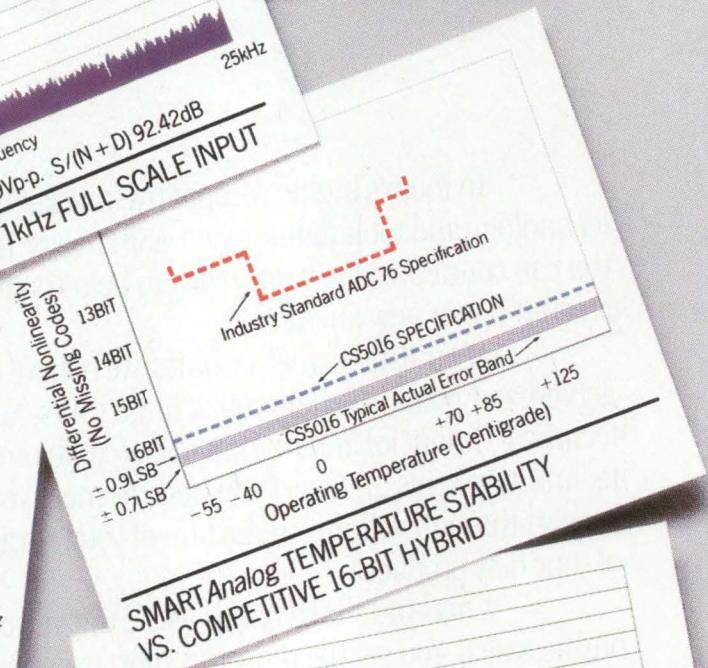
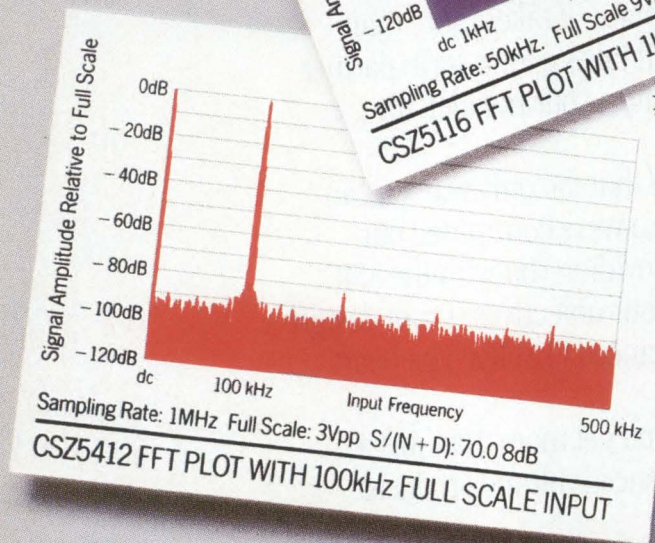
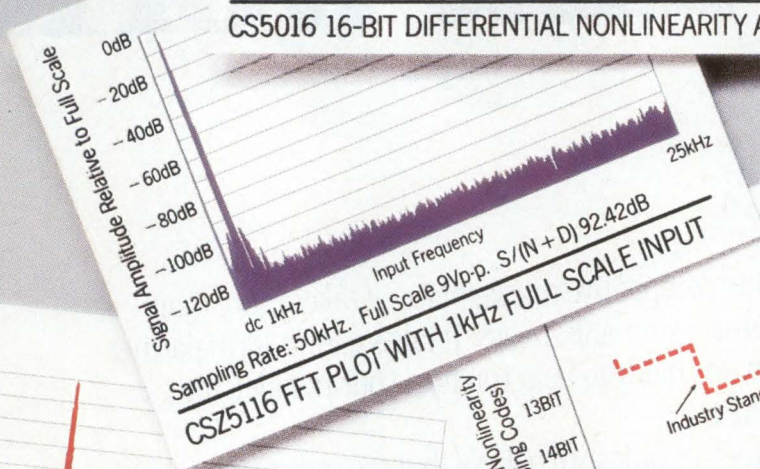

**OUR 12-TO 16-BIT
 CMOS A/D
 CONVERTERS LOOK
 GREAT ON PAPER.**

**AND ARE THE WORLD'S
 BEST IN ACTION.**

Anyone can promise the world's best performance from monolithic CMOS A/D converters. Only Crystal can prove it.

Get your hands on the evaluation board of a Crystal SMARTAnalog™ device and you'll believe the breakthrough performance the plots on the opposite page promise.

Dynamic performance really is 92 dB SNR over a 25 kHz bandwidth, or 70 dB over 500 kHz.

Differential Non-Linearity of 16 bits with no missing codes is so outstanding we've published a DNL plot no one else dares to.

Stability over temperature is dramatically better than the competition across the entire military range.

Our reliability far surpasses the alternatives, with less than 33 failures per billion operating hours (FITs).

What the plots don't show, you already know: monolithic A/D converters using CMOS technology mean lower design and assembly costs, higher reliability,

DEVICE	STATIC-TESTED ADCs				DYNAMIC FFT-TESTED ADCs				
	CS5016	CS5014	CS5012	CS7820	CS25412	CS25316	CS25116	CS25114	CS25112
Resolution	16	14	12	8	12	16	16	14	12
Conversion Time (μsec)	16	14	7	1.3	1.25	16	14	7	
Throughput Speed (KHz)	50	56	100		1000	20	50	56	100
Static Specifications:									
Linearity Error (% FS, max)	+/- .0015	+/- .003	+/- .012	+/- .2	+/- .01				
No Missing Codes (Bits)	16	14	12	8	12	16	16	14	12
Dynamic Specifications									
THD (%)					.02	.007	.001	.003	.008
S/(N+D) (dB)					70	84	92	83	73
Power Dissipation (mW)	120	120	120	40	700	220	120	120	120
On-Chip Sample and Hold	YES	YES	YES	YES	YES	YES	YES	YES	YES

The proof behind the promise: monolithic CMOS performance that beats even hybrids.

bility, lower power consumption, easier manufacturing and faster deliveries than hybrid or discrete designs can manage.

And our SMARTAnalog devices are the first with self-calibration at any time/temperature. Which ensures accuracy throughout their operating lives, correcting for gain, offset and even linearity errors. Automatically.

If that weren't enough, Crystal's SMARTAnalog line is the first line of 12- to 16-bit A/D converters with the converter, track/hold, digital interface, calibration circuitry and timing all on a single chip. So you can forget designing, building and characterizing discrete

devices while trying to correlate component specifications with system requirements.

Prove to yourself how our revolutionary SMARTAnalog technology makes hybrids a very expensive proposition, indeed. Call 512-445-7222 today for your very own 12-, 14- or 16-bit evaluation board. Or ask for a demonstration at your facility.

Either way, you'll know why seeing a SMARTAnalog converter in action makes our promises on the opposite page seem flat by comparison.

CRYSTAL
SEMICONDUCTOR CORPORATION
P.O. Box 17847, Austin, TX 78760

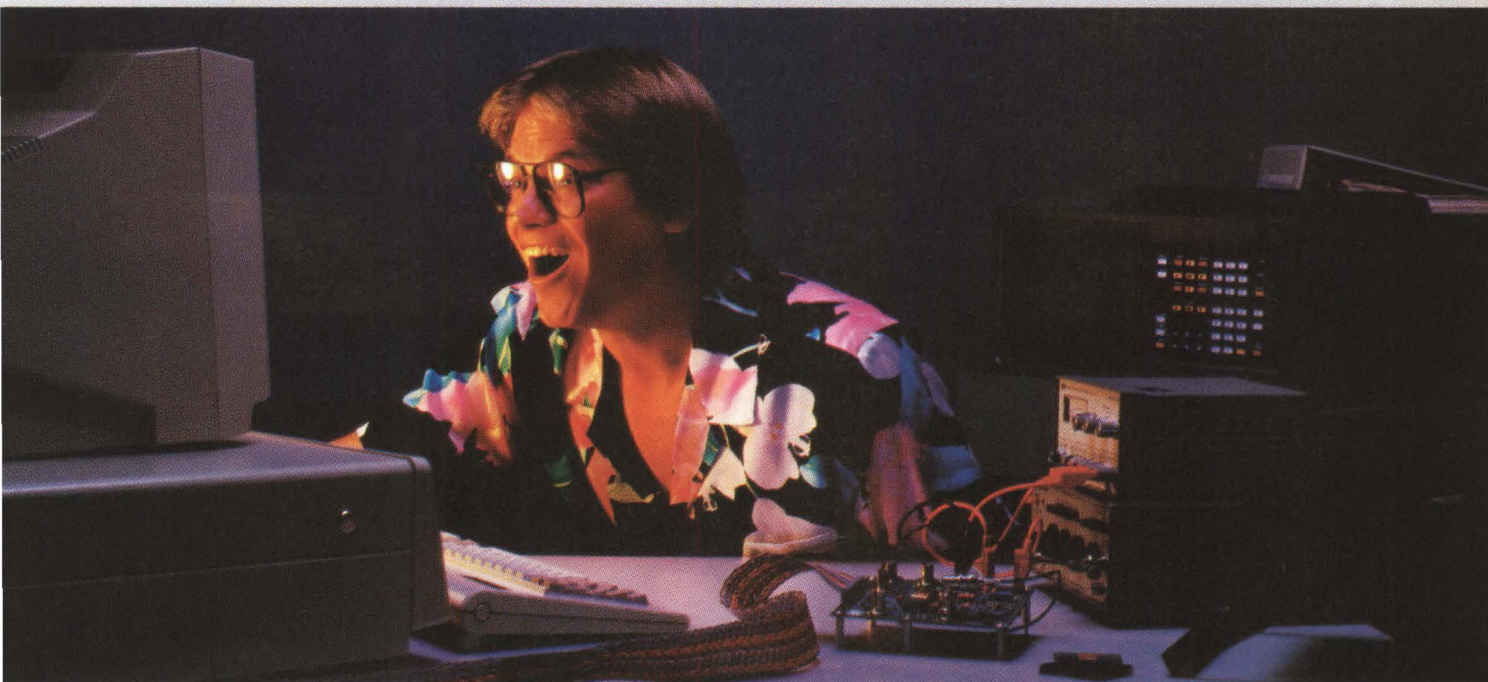

512-445-7222: CALL TODAY

World's Fastest CMOS

20ns Multipliers & 25ns MACs

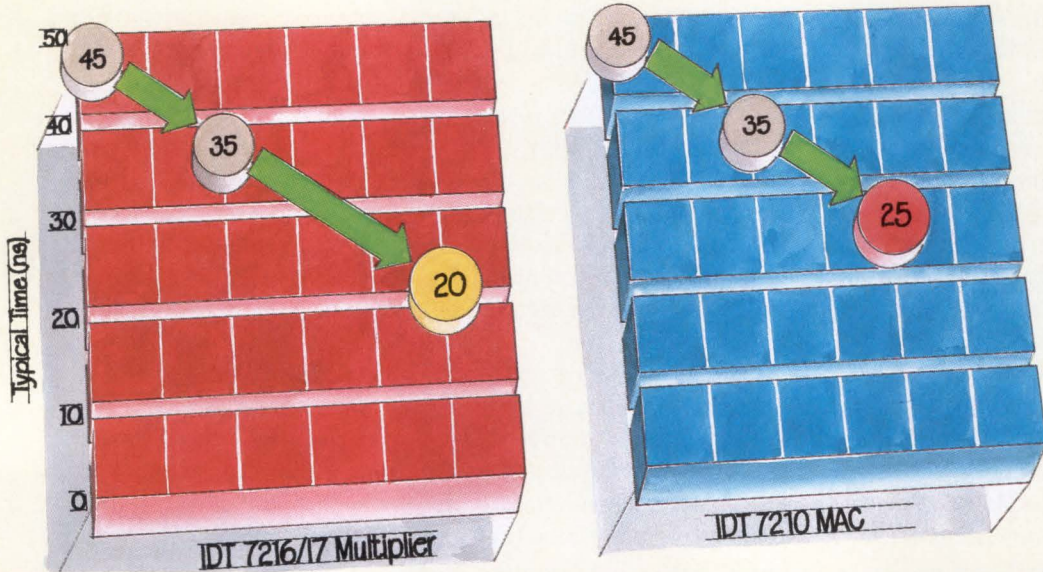

Why use someone else's multipliers and MACs when you can have the world's fastest? Now! From IDT!

Use the IDT7216 and IDT7217 Multipliers and IDT7210 MAC to improve the speed of your system.

43% faster. The IDT7216 and IDT7217 multipliers run at an incredible 20ns. And the IDT7210 MAC speeds along at a fast 25ns. These x16 DSP building blocks from IDT combine low-power CMOS with ultra fast speeds.

Industry standard. All are designed to drop-in and replace the industry standard, slower multipliers/MACs. So upgrading your design is easy.

MIL-STD-883 compliant. IDT is the recognized leader in providing high-performance CMOS to the military.

Packages. Available now in 68-pin PGAs, PLCCs and LCCs.

Applications. Ideal for fast, real time DSP applications such as Radar/sonar Image processing and Telecom.

The ultimate performance for floating point coprocessors.

If you're looking for a high-performance coprocessor, the IDT721264 and IDT721265 coprocessor chipset is the winner! It runs at a blazing 33 Mflops and a cool 500mW. And a single multiplier does a 1K Radix 2 FFT in 1.8ms.

Higher speed, 1/10th the power. Upgrading any system based on the WTL1264/1265 will bring you higher speed at 1/10 the power. Same pinout. Same software.

Low profile package. Our cooler CMOS allows us to offer this chipset in a 144-pin PGA (no heat sink needed).

Applications. Radar/sonar Medical Image processing and CAD/CAM, to name a few.

Ask for your FREE Data Book!

Everything you want to know about the world's fastest DSP logic is in our new, 1800 page **1988 DATABOOK**. Call your local IDT representative or **(408) 492-8225** and ask for your FREE copy.

The DATABOOK also contains complete information on our CMOS Static RAMs • specialty memory products such as FIFOs and DUAL-PORTS • ultra-fast RISC processors and bit-slice ALUs • EDC • Data Conversion products • ECL Interface products • TTL logic.

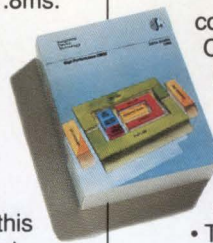

COMING SOON!

IDT'S
NEW ADVANCED DSP
BUILDING BLOCKS

CALL (408) 492-8366

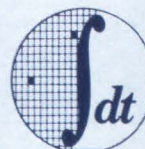

Integrated
Device Technology

3236 Scott Blvd.
Santa Clara, CA 95054-3090
(408) 492-8366
FAX: 408 727-2328

Static-system design exploits low-power CMOS

Static CMOS architectures let you customize a design for optimum performance and minimum power dissipation. Capitalizing on the characteristics of CMOS means addressing clock-frequency control before starting the initial design process.

Walter J Niewierski, *Harris Semiconductor*

As every engineer knows, CMOS μ P's combine low power with high performance: A CMOS μ P's power dissipation is directly related to its frequency of operation. Reducing the operating frequency from 16 MHz, say, to 1 MHz, allows the power-supply current to drop proportionately. An NMOS or bipolar μ P's supply current, on the other hand, remains the same regardless of how you manipulate a system's throughput-rate spec.

An NMOS system can be bulky

The benefits of CMOS vs NMOS are readily apparent when you compare datasheet operating specifications. An NMOS 80286 μ P, for example, has a typical power-dissipation spec of 3W ($I_{IC}=600$ mA at 5.25V). In contrast, a CMOS 80C286 μ P, when running at a clock rate of 16 MHz, has a maximum operating current of 260 mA.

Operating power also has a ripple effect through a

system design. Usually you have to add NMOS memory and NMOS or bipolar peripherals to support an NMOS device. Depending on the size of your system, power requirements may be 25 to 30W, and you may well have to specify a larger and heavier 50W power supply to accommodate future expansion.

You also have to account for the fact that temperatures within an NMOS system can rise significantly. It's not unusual for the temperature of an NMOS or bipolar die to rise 40 to 60°C during operation, and fans and heat sinks are necessary to compensate for this increase. Oftentimes, the system also requires an air filter for the fan. Obviously, you have to design an enclosure large enough to hold all of this equipment—fans, bulky power supplies, and heat sinks.

Because CMOS devices dissipate less power, you can specify smaller power supplies. Lower power dissipation also means that the system will run at a lower ambient temperature. Heat sinks and fans are unnecessary, and vents can be shut to ensure a clean operating environment. Sealed enclosures can also be smaller and lighter.

For these reasons, many NMOS- and bipolar-device architectures are now available in CMOS. Furthermore, CMOS technology is amenable to static-circuit design, and NMOS is not. Static circuits allow you to customize your design to balance speed requirements and power considerations.

Static ICs run on any clock frequency from dc to the maximum circuit operating specification. In a dynamic circuit, if the clock frequency falls below a manufacturer-specified minimum, the circuit can lose or alter data,

Static circuits run on any frequency from dc to the maximum circuit operating specification.

and thus the memory cells require refreshing at a certain rate to maintain valid data. You can put a static μP in a standby mode simply by stopping the clock signals, and even if you stop the external clock indefinitely, the device will retain data. When you reinitiate the CPU clock signal, the system starts up where it left off.

The ability to stop the clock also allows you to perform single-step operations during system development. This valuable method of debugging allows you to inspect the system bus and other functions for proper operation by manually stepping through the clock cycles. Single-stepping—and therefore the elimination of real-time data transfers—can simplify debugging significantly.

By taking advantage of opportunities to manipulate the system clock during your initial design, you can mix and match standby, low-frequency, and high-frequency

operations to achieve the most performance for the least power. You can design a μP system that allows the software executive routine to power down the entire system or just portions of the system not in use (certain I/O sections, for example, or file-maintenance areas).

A clock controller eases design

To ease the implementation of static-operating modes in CMOS systems, clock controllers are available for various μPs . Fig 1 illustrates a CMOS system configuration using a Harris 82C85 static clock controller to interface directly to the maximum-mode status lines (\overline{S}_2 , \overline{S}_1 , and \overline{S}_0) of either a Harris 80C86 or 80C88 μP . The three control lines ($\overline{S}_2/\text{Stop}$, \overline{S}_1 , and \overline{S}_0) on the 82C85 let you control the operation of the system clock with 80C86/80C88 software. Essentially, the μP controls the clock by issuing a Halt instruction in software.

The status lines of the 80C86/80C88 identify the type

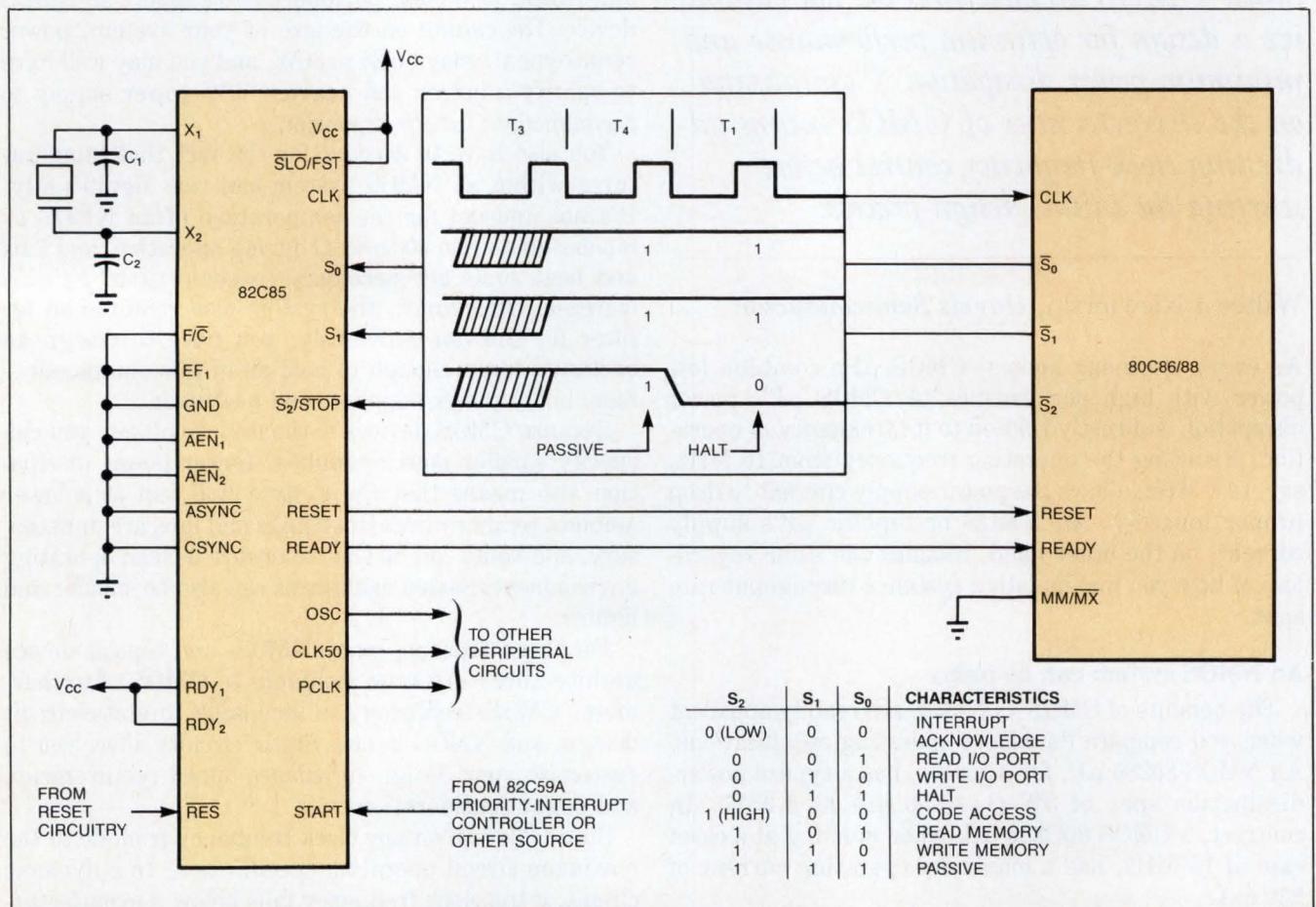

Fig 1—The 82C85 clock controller interfaces directly to an 80C86 or 80C88 CPU operating in the maximum mode. When the controller detects a Halt instruction, it stops the clock.

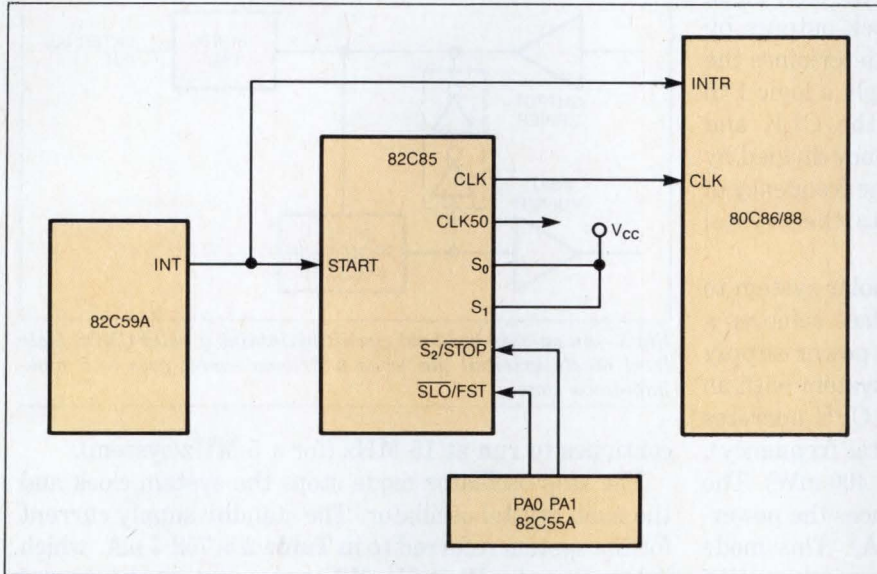

Fig 2—A CMOS peripheral such as the 82C55 can control a clock controller's stop, start, and slow or fast operations.

of bus cycle that the CPU is starting to execute, and are accessible only during maximum-mode operation. Typically, a bus controller uses these status lines to decode the current bus-cycle status of the CPU. Fig 1's truth table shows the status lines for different bus transactions. When operating in the maximum mode, the CPU places the \overline{S}_2 , \overline{S}_1 , and \overline{S}_0 lines in a 111 state followed by a 011 state to indicate a Halt instruction. The control lines on the 82C85 automatically decode this state sequence to halt the system clock.

You can use a peripheral such as a programmable interface (in this case, the 82C55A) to stop the clock by using the \overline{S}_2 /Stop line as a stand-alone Stop command (Fig 2). You must tie the \overline{S}_0 and \overline{S}_1 pins of the 82C85 to V_{CC} to emulate a logic 111 state before applying a logic 0 to the \overline{S}_2 /Stop line to stop the clock. To place the 82C85 clock controller in a stop-oscillator mode, you tie the $\overline{F}/\overline{C}$ line low. In this mode, the 82C85 stops the clock synchronously whenever it detects a Halt instruction. Regardless of whether the controller is operating in the fast or slow mode, it will decode a Halt instruction. Table 1 compares the four operating modes of the 82C85.

Stop the clock!

The 82C85 also offers another way of stopping the system clock. The start-input line on the 82C85 provides independent clock control. A level-triggered active-high input overrides any stop condition. You can control the start-input line, for example, by using an 82C59A priority-interrupt controller (Fig 2). The INT

OPERATING MODE	DESCRIPTION	POWER LEVEL	PERFORMANCE
STOP-OSCILLATOR	ALL SYSTEM CLOCKS AND MAIN CLOCK OSCILLATOR ARE STOPPED.	MAXIMUM SAVINGS	SLOWEST RESPONSE DUE TO OSCILLATOR-RESTART TIME
STOP-CLOCK	SYSTEM CPU AND PERIPHERAL CLOCKS ARE STOPPED, BUT MAIN CLOCK OSCILLATOR CONTINUES TO RUN AT RATED FREQUENCY.	REDUCED SYSTEM POWER	FAST RESTART; NO OSCILLATOR-RESTART TIME
SLOW	SYSTEM CPU CLOCKS ARE SLOWED WHILE PERIPHERAL CLOCK AND MAIN CLOCK OSCILLATOR RUN AT RATED FREQUENCY.	POWER DISSIPATION SLIGHTLY HIGHER THAN STOP-CLOCK MODE	CONTINUOUS OPERATION AT LOW FREQUENCY
FAST	ALL CLOCKS AND OSCILLATORS RUN AT RATED FREQUENCY.	HIGHEST POWER	FASTEST RESPONSE

output pin of the 82C59A connects directly to the start-input pin of the 82C85 and the INTR pin of the 80C86/80C88 μ P. An external event (such as a key depression) can produce an 82C59A interrupt request, which causes the 82C85 to start the system clock.

If your system must operate continuously but power

During the initial design of a static CMOS system, the designer should anticipate circumstances in which the system can be stopped or run more slowly.

consumption is a concern, you can utilize the slow mode on the clock controller to divide the clock outputs by 256. The 82C85 has a $\overline{\text{SLO}}/\text{FST}$ pin that determines the speed of the system clock. When you apply a logic 1 to the $\overline{\text{SLO}}/\text{FST}$ pin, the frequency of the CLK and CLK50 outputs equals the crystal frequency divided by 3. A logic 0 on the $\overline{\text{SLO}}/\text{FST}$ pin makes the frequency of the CLK and CLK50 outputs equal to the crystal frequency divided by 256.

If you are converting an NMOS or bipolar system to CMOS technology, each device you replace achieves a power savings. **Table 2** shows typical power-supply currents for devices in an 80C88-based system with an 82C85 static clock controller. When the CPU operates at 5 MHz (that is, with a 15-MHz crystal frequency), the total system draws 72 mA (less than 400 mW). The slow mode (20-kHz CPU frequency) reduces the power-supply current by a factor of 3 (24 mA). This mode maintains continuous operation yet gives you the option to switch the system to full speed at any time.

The two stop modes offer the alternative of fast clock turn-on or minimum power dissipation. In the stop-clock mode, the main system oscillator continues to run and permits full-speed operation to resume within three CPU clock cycles (600 nsec at 5 MHz) after the fast mode is reinitiated. The main crystal oscillator

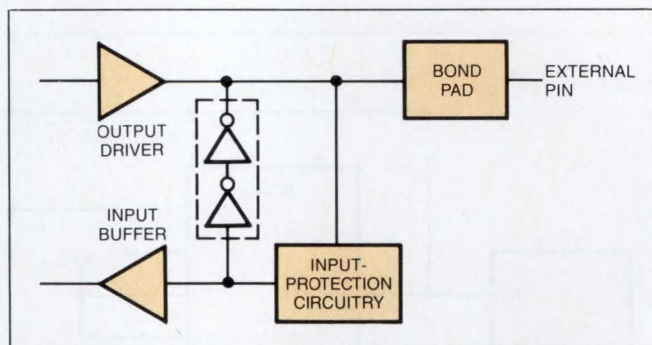

Fig 3—An on-chip bus-hold circuit maintains a valid CMOS logic level on its external pin when a driving source goes to a high-impedance state.

continues to run at 15 MHz (for a 5-MHz system).

The stop-oscillator mode stops the system clock and the main crystal oscillator. The standby supply current for the system referred to in **Table 2** is 752.7 μA , which is less than 4 mW at 5V. When you restart the crystal oscillator, the frequency and amplitude can vary significantly. After the amplitude reaches a specified amplitude, the 82C85 counts 8192 oscillator cycles to ensure crystal stabilization. The stabilization time guarantees that the clock outputs turn on within the specification limits and with the proper phase relationship.

The choice of operating modes depends upon system

TABLE 2—SYSTEM CURRENT DRAIN WITH AN 82C85 CLOCK CONTROLLER

TYPICAL-SYSTEM DEVICES	MODES			
	STOP-OSCILLATOR	STOP-CLOCK	SLOW	FAST
82C85	24.4 μA	14.1 mA	16.9 mA	24.7 mA
80C88	106.6 μA	106.6 μA	173.0 μA	23.8 mA
82C82	1.0 μA	1.0 μA	6.5 μA	1.7 mA
82C86	1.0 μA	1.0 μA	14.0 μA	1.4 mA
82C88	3.8 μA	3.8 μA	14.3 μA	3.5 mA
82C52	1.0 μA	1.0 μA	72.0 μA	151.2 μA
82C54	1.0 μA	3.5 μA	915.0 μA	943.0 μA
82C55A	1.0 μA	1.0 μA	1.2 μA	3.2 μA
82C59A	509.0 μA	509.0 μA	520.0 μA	580.0 μA
HD-6406	4.97 mA	4.97 mA	5.09 mA	5.12 mA
74HCXX PLUS OTHER ICs	90.0 μA	90.0 μA	110.0 μA	2.9 mA
HM-6516	1.9 μA	1.9 μA	132.0 μA	820.0 μA
HM-6616	12.0 μA	12.0 μA	52.5 μA	6.3 mA
TOTAL WITH 6406	5.72 mA	19.8 mA	24.0 mA	71.9 mA
TOTAL WITHOUT 6406	752.7 μA	—	—	—
CPU FREQUENCY	dc	dc	20 kHz	5 MHz
CRYSTAL FREQUENCY	dc	15 MHz	15 MHz	15 MHz

High Powered Response



The ICE pacesetter that drives 15X faster than existing systems.



Rev-up your emulation performance. Do it faster and better than ever before. The SA98 from Sophia combines the flexibility to go from 8- to 32-bit microprocessors, and is fully compatible with IBM's PC/AT or XT. The SA98 is setting the pace as the price/performance leader.

Parallel Interface

Get a real speed boost over traditional RS-232 type interface with Sophia's unique parallel interface. You'll gain an 8X improvement in down load time. Optimize portability between IBM PC/AT, XT, or compatibles with Sophia's MS-DOS software drivers.

Unmatched Performance

Sophia's proprietary Direct Access Controller doesn't sidetrack ICE performance. It cuts through the curves others have to follow. The SA98, at high-speed, down loads to the target memory. Makes memory and data I/O modifications during program execution. Has full symbolic debugging. And you can view and augment trigger and trace conditions on-the-fly.

Dual Processor Emulation

Used in tandem, two SA98's emulate two separate 8- or 16-bit microprocessors simultaneously on a single host. Set your independent debug triggers, and

emulation. The split screen feature displays code execution for each . . . independently.

Get Your Hands on the SA98

Experience the SA98 in action. Drive away with the real performance leader. You've got to see it to believe it.

Call Toll-Free Today

1-800-824-9294 (U.S.)

1-800-824-6706 (CA)

Sophia systems.

Dedicated to MDS/ICE Support

U.S. & European Headquarters: Sophia Systems, 3337 Kifer Road, Santa Clara, CA 95051 (408) 733-1571
Corporate Headquarters: Sophia Systems Co., Ltd., NS Bldg. 8F, 2-4-1 Nishishinjuku, Shinjuku-ku, Tokyo 160 03-348-7000
©1988 Sophia Systems. Sophia Systems is a registered trademark of Sophia Systems Co., Ltd.
ICE is a registered trademark of Intel Corporation. MDS is a registered trademark of Mohawk Data Science Corporation.
IBM PC/AT and XT are registered trademarks of International Business Machines Corporation.

Clock control is the key to designing a minimum-power system.

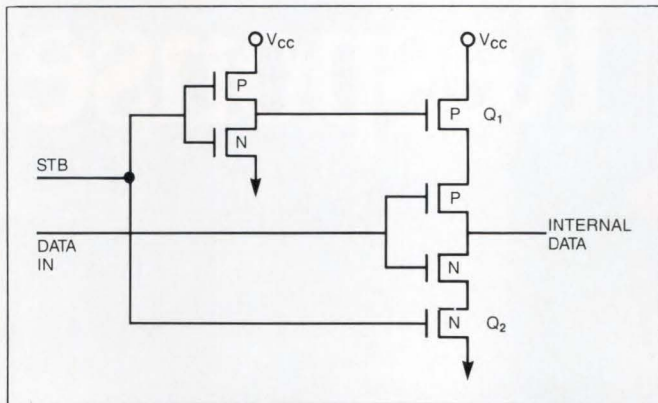

Fig 4—In CMOS devices with gated inputs, a low logic level on the STB line turns the Q_1 and Q_2 FETs off so that a transition on the data-input line doesn't draw power-supply current.

priorities. The stop-clock mode delivers the fastest response and return from standby operation, but does so at the expense of higher power dissipation than the stop-oscillator mode. The stop-oscillator mode minimizes power dissipation, but has a longer response time.

Although clock control is key to low-power performance in a static CMOS system, there are other factors of which you should be aware. For example, when the input-voltage level on a CMOS device approaches the minimum V_{IH} (high-level voltage) or maximum V_{IL} (low-level voltage), the p- and n-channel FETs can partially turn on. This condition produces a low-resistance path between V_{CC} and GND and results in excessive power-supply current. Therefore, you must tie all CMOS inputs to V_{CC} or GND in some manner when they are not in use.

Pull-up/down resistors are the most common method of ensuring CMOS input-voltage-level specifications. The resistors maintain valid CMOS voltage levels when a driving source is in a floating high-impedance state. This technique, however, suffers from some disadvantages. First, extra resistors are necessary, which increases both board real estate and cost. Second, the circuit's power dissipation increases because the driving source must supply extra current to the resistors. Needless to say, if you can avoid using pull-up/down resistors, you can improve overall system performance.

Fig 3 shows the bus-hold circuitry that the 80C86, 80C88, 82C55A, and 80C286 devices include to eliminate the need for pull-up/down resistors. When no driving source is present or when a driving source is in a floating high-impedance state, the on-chip circuitry maintains a valid CMOS logic level on specific inputs.

The circuit will maintain this valid CMOS level until an external source overdrives the affected input. The external device must source or sink approximately 400 μA to overdrive the input. Because the bus-hold circuits are active, their current requirements are similar to the leakage currents for an active device: The circuit typically draws less than 10 μA when it isn't switching. This current is in contrast to the current drawn through a 10k- Ω pull-up resistor: 500 μA when the logic level is low.

Excessive current drain can also result when the input circuitry of a CMOS device responds to voltage transitions unrelated to its operation. A typical system has bus transceivers and latches attached to the system bus. The input circuitry of these devices undergoes many signal transitions unrelated to the functional operation of the devices themselves. These unrelated voltage transitions switch the input circuitry of a CMOS device, causing an increase in power dissipation. In addition, if the system bus experiences a high-impedance state (a floating condition), it could result in an indeterminate logic state internal to an attached CMOS device.

You can eliminate excessive current drain due to unrelated input transitions by using bus transceivers and latches with gated inputs. The Harris Series 82C8X bus transceivers and latches (such as the 82C82/83/86/87) let you gate their data inputs when not in use (**Fig 4**). When the strobe line (STB) is in a active-low state, the upper p-channel FET (Q_1) and the lower n-channel FET (Q_2) turn off. This action removes V_{CC} from the input circuitry so that no supply current flows to GND during unrelated input transitions and the circuit doesn't respond to floating inputs. **EDN**

Author's biography

Walter J Niewierski is a marketing manager at Harris's Semiconductor Product Div in Melbourne, FL. He previously worked for Ford Motor Co and Burroughs Corp before joining Harris eight years ago. Walt has a BSEE from the University of Michigan and enjoys coaching little-league baseball in his spare time.



Article Interest Quotient (Circle One)
High 494 Medium 495 Low 496

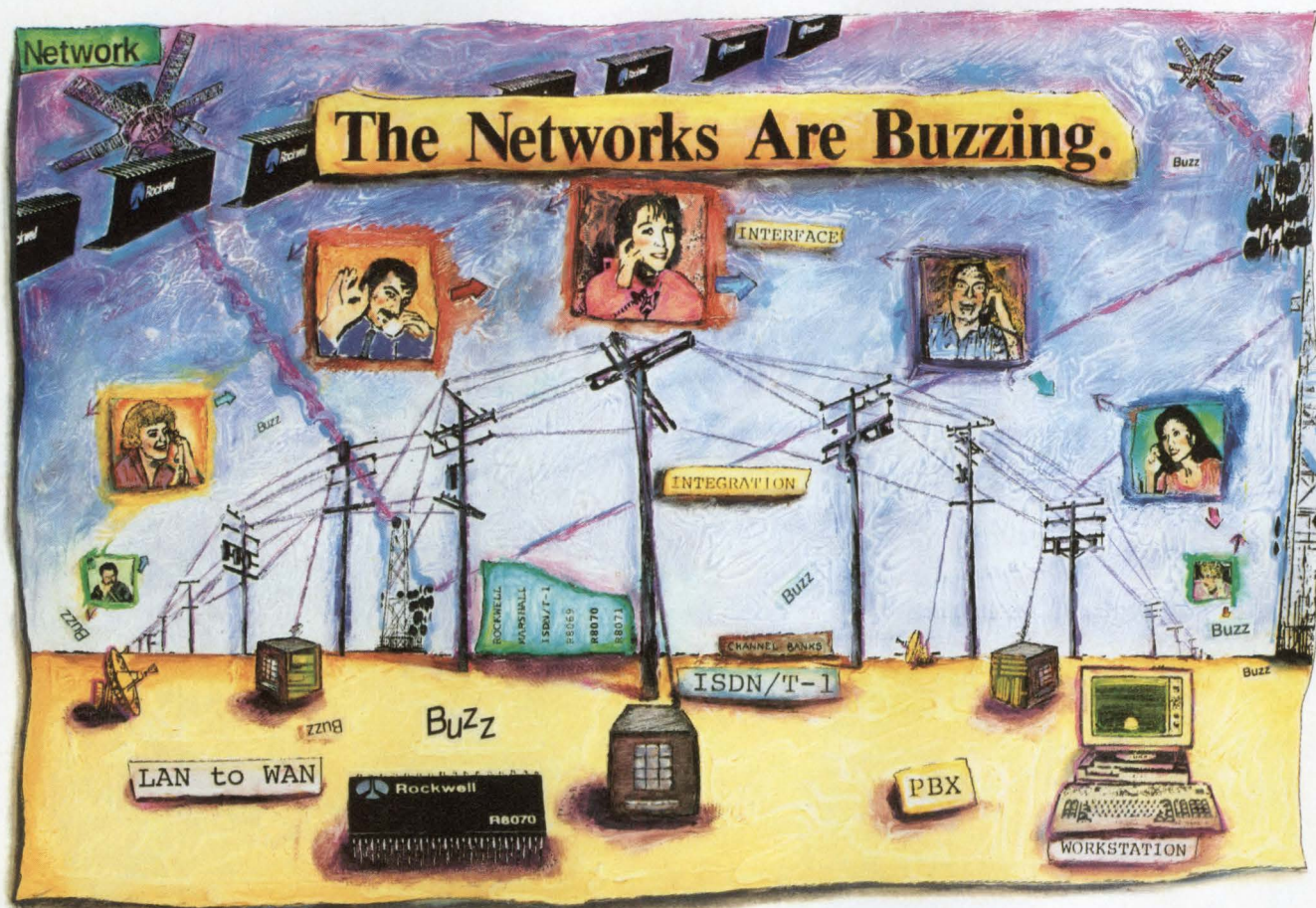

Get in on the excitement with Marshall and Rockwell ISDN Technologies.

Like the R8070 T-1 PCM-30 Transceiver, which incorporates CMOS technology and is capable of processing digital signals that meet the requirements for D4, extended superframe and PCM-30 formats. Or Rockwell's latest ISDN offerings, the R8069 Line Interface Unit and the R8071 DMI Link Layer Controller.

Get your products to market quicker. Connect to public or private ISDN networks worldwide. Develop ISDN PRI capability over T-1 or PCM-30 lines. Build a T-1 interface rapidly, with considerable space and component savings. And take advantage of applications that include workstation to PBX, PBX to computer, host to host, and LAN to WAN. Or design your own.

With Rockwell ISDN Technologies, all you need to meet your networking needs.

And all from Marshall. Tomorrow, if you want. So to get in on the excitement there's only one thing to do.

Give Marshall a buzz today.

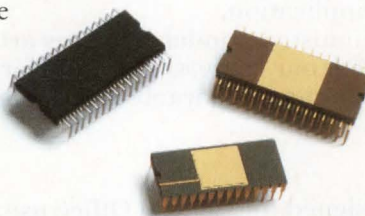

Marshall

(* Authorized Locations)
AL Huntsville (205) 881-9235*
AZ Phoenix (602) 496-0290*
 Tucson (602) 790-5687*
CA Irvine (714) 859-5050*
 Los Angeles (818) 407-4100*
 Sacramento (916) 635-9700*
 San Diego (619) 578-9600*

San Francisco (408) 942-4600*
CO Denver (303) 451-8383*
CT Connecticut (203) 265-3822*
FL Ft. Lauderdale (305) 977-4880*
 Orlando (407) 767-8585*
 Tampa (813) 576-1399*
GA Atlanta (404) 923-5750*

IL Chicago (312) 490-0155*
IN Indianapolis (317) 297-0483*
KS Kansas City (913) 492-3121*
 Wichita (316) 264-6333*
MA Boston (617) 658-0810*
MD Maryland (301) 840-9450*
MI Michigan (313) 525-5850*

MN Minneapolis (612) 559-2211*
MO St. Louis (314) 291-4650*
NC Raleigh (919) 878-9882*
NJ N. New Jersey (201) 882-0320*
 Philadelphia (609) 234-9100*
NY Binghamton (607) 798-1611*
 Long Island (516) 273-2424*

Rochester (716) 235-7620*
OH Cleveland (216) 248-1788*
 Dayton (513) 898-4480*
 Westerville (614) 891-7580*
OR Portland (503) 644-5050*
PA Pittsburgh (412) 963-0441*
 TX Austin (512) 837-1991*

Brownsville (512) 542-4589*
 Dallas (214) 233-5200*
 El Paso (915) 593-0706*
 Houston (713) 895-9200*
 San Antonio (512) 734-5100*
UT Salt Lake City (801) 485-1551*
WA Seattle (206) 747-9100*
WI Wisconsin (414) 797-8400*

SLIC ICs.

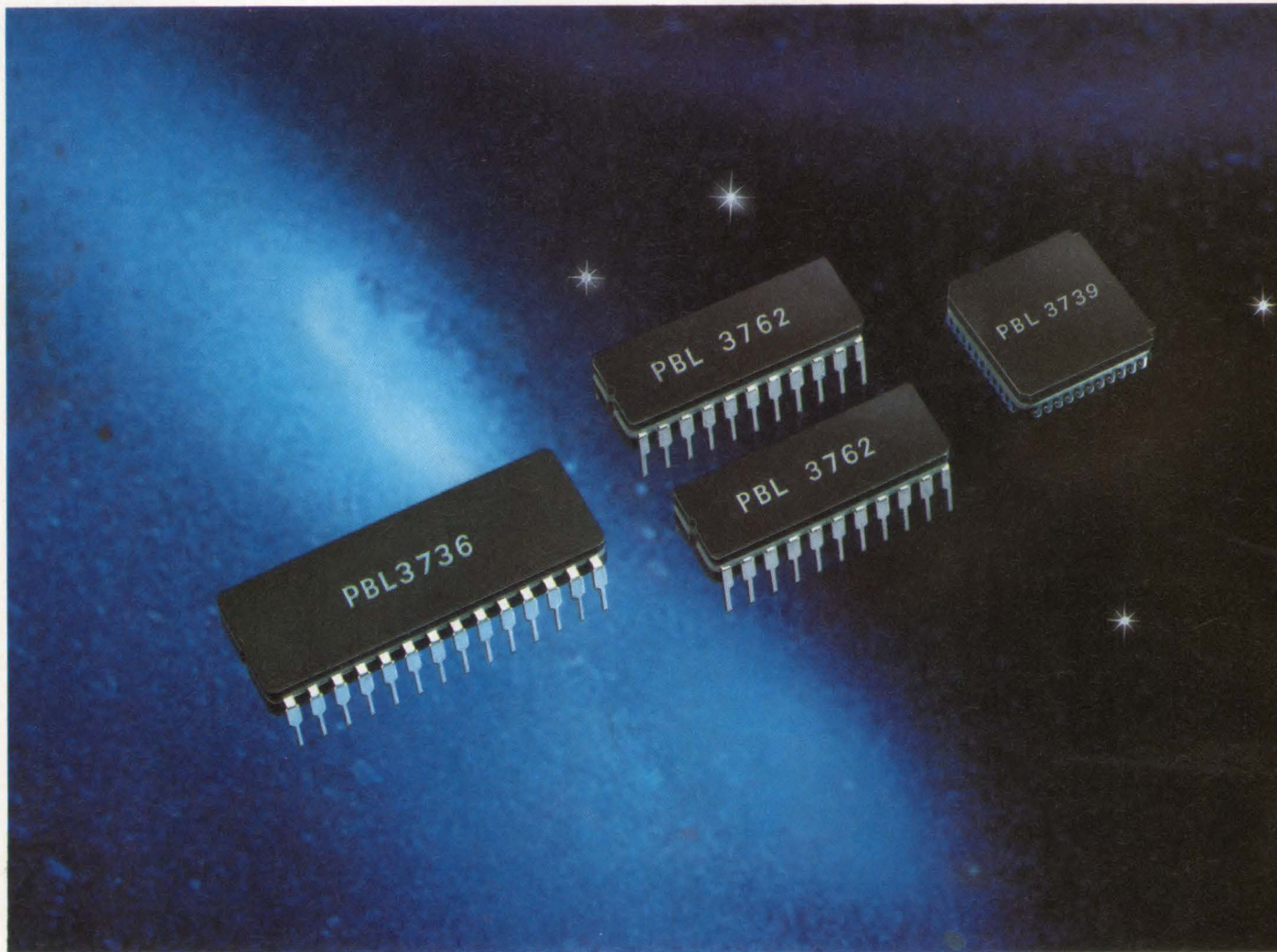

Choose RIFA for the world's leading family of Subscriber Line Interface Circuits. First in the field with monolithic SLIC production, we now offer the widest selection, to suit every application.

Many of our industry-standard devices are now second-sourced; our leadership in bipolar production techniques guarantees space-age reliability.

PBL 3736.

Originally designed for Central Office use, also recommended for high-quality PABX applications. Full-line interfacing in compact CERDIP package. On-board voltage switching regulator cuts power dissipation and the need for special heat sinking. Features include polarity reversal and a digital interface for efficient operating parameter control.

PBL 3762.

High-performance, resistive-feed SLIC designed for PABX. Excellent longitudinal-to-metallic balance, 63dB min, 70dB typical, meets FCC requirements easily. Special -40°C version for outdoor use, eg in Subscriber Loop Carrier Systems.

PBL 3739.

Special version of PBL 3736 designed for very high density PABX line cards. Built-in switching voltage regulation, very low heat dissipation, in 44-pin J-lead Quad CERPAC for surface mounting.

Call up RIFA and discover the fullest set of data, longest experience and genuine design partnership.

We're in the lead

RIFA Inc.

403 International Pkwy
Richardson, TX 75085-3904
Telephone (214) 480-8300
Telefax (214) 680-1059

ERICSSON 

RIFA is a member of the Ericsson Group

1988

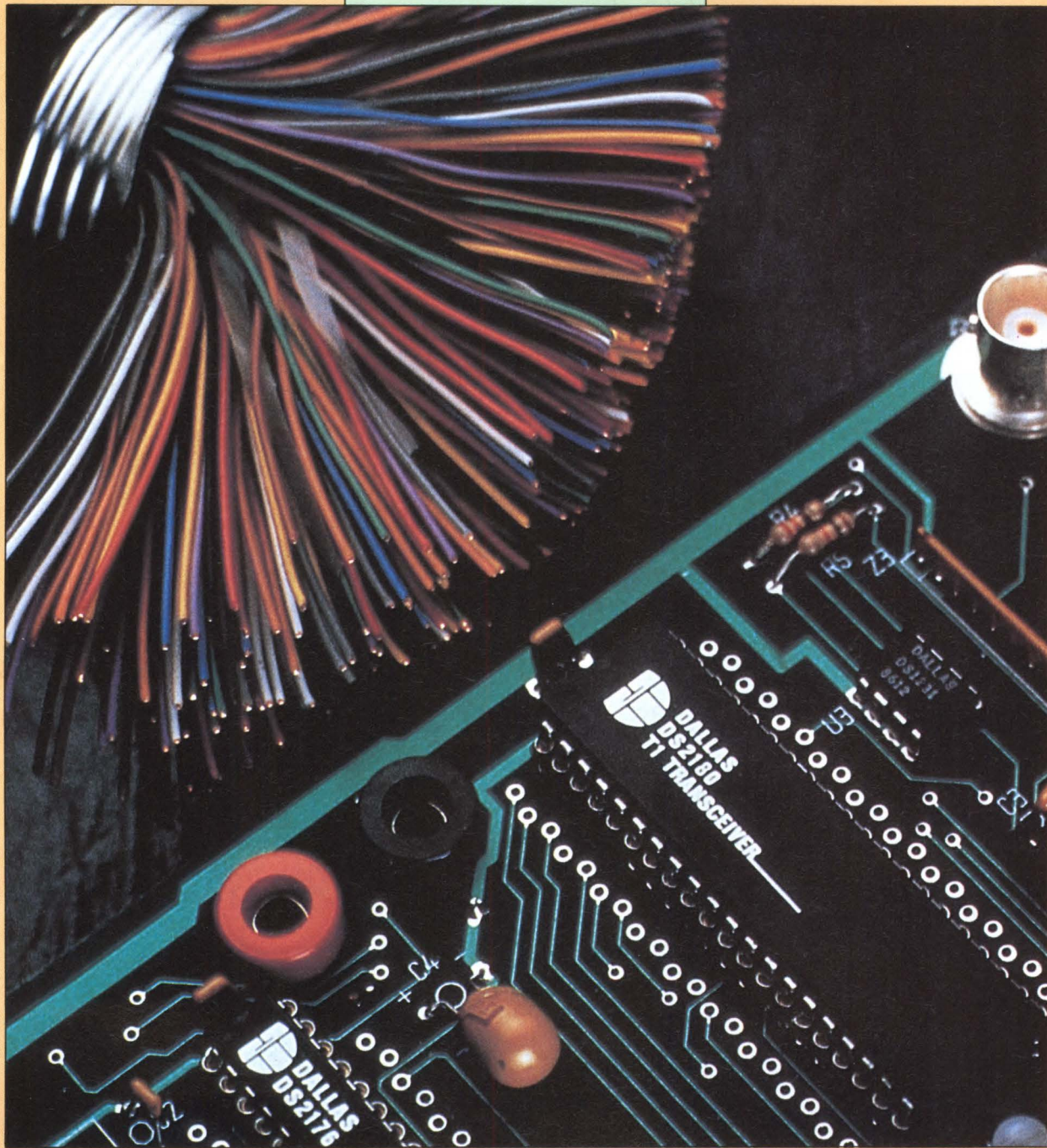

Technical-Article Database Index

(November 1987 through April 1988)

Including EDN, EDN News, Electronic Design,
Electronics, Electronic Products, Computer Design, and
ESD

With compliments from EDN

To use this database . . .

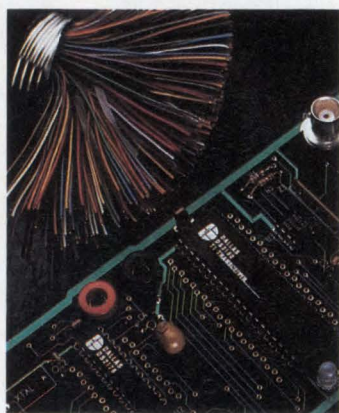

(Photo courtesy Dallas Semiconductor)

. . . Look for the topic of interest in the keyword index. If your topic isn't one of the keywords, try a related, but less specific, topic. Then go to the appropriate page in the database and scan the article titles, which are listed alphabetically within each keyword category. Information provided in each listing includes article title, author, company, magazine name, issue date, starting page number, and article length.

For more information on the articles listed, please contact each magazine directly.

EDN
Cahners Building
275 Washington St
Newton, MA 02158
(617) 964-3030

EDN News
Cahners Building
275 Washington St
Newton, MA 02158
(617) 964-3030

Computer Design
119 Russell St
Littleton, MA 01460
(617) 486-9501

Electronic Design
10 Holland Dr
Hasbrouck Heights, NJ 07604
(201) 393-6052

Electronic Products
645 Stewart Ave
Garden City, NY 11530
(516) 227-1300

Electronics
1221 Avenue of the Americas
New York, NY 10020
(212) 512-2000

ESD
1900 W Park Dr
Westborough, MA 01581
(617) 898-3210

EDN's Technical Article Database Index is now available on floppy disk. See the order form on pg 202.

1988

Technical-Article Database Index

(November 1987 through April 1988)

Keyword Index

Advertising	174	Digital multimeters (DMMs)	183	Network architecture/design/design standards (nonlocal)	193
Amplifiers	174	Digital signal processing	183	Networking ICs	193
Analog switches	174	Digital voltmeters (DVMs)	183	Office automation	193
Arithmetic chips/circuits	174	Discrete components, other	183	Op amps	193
Artificial intelligence	174	Disk controllers	183	Optical storage	193
Audio	174	Disk-drive testers/testing	183	Optoelectronics	194
Automatic test equipment/techniques	174	Display drivers	183	Oscillators	194
Batteries	174	Displays	183	Oscilloscopes	194
Board-level computers	174	Distributed processing	183	Parallel processing	194
CMOS logic	174	Engineering workstations	184	Parametric/functional testing	194
CMOS technology	174	Fiber optics	184	Personal computers	194
Cache memory	174	Filter circuits	184	Plotters	194
Capacitors	174	Floppy-disk drives	184	Power converters	194
Clock circuits	174	Frequency synthesizers/synthesis/measurement	184	Power semiconductors	194
Communications ICs	174	Function generators/generation	184	Power supplies	194
Comparators	174	GPIO instruments	184	Printed circuits	194
Computer applications	179	GaAs technology	184	Printed-circuit processing	194
Computer firmware	179	Gate arrays	184	Printers	194
Computer languages/compiler/interpreters	179	Graphics boards	184	Process control	194
Computer operating systems/system software	179	Graphics circuits	184	Processors, special-purpose (array, front-end, etc)	194
Computer software, application generator	179	Graphics systems	184	Production testing techniques	194
Computer software, communications/networking	179	Hardware/interconnection, other	184	Production/manufacturing/testing, other	199
Computer software, design applications	179	Heat sinks/cooling devices	184	Programming	199
Computer software, graphics	179	Imports/exports	184	Prototyping boards/systems	199
Computer software, other	179	In-circuit emulators/emulation	184	Relays	199
Computer software, performance measurement	179	Industrial electronics	189	Resistors	199
Computer software, production test	179	Instrument interface systems	189	Rigid-disk drives	199
Computer software, program development	179	Instrumentation amps	189	S/H circuits	199
Computer subsystems/peripherals, other	179	Instrumentation/design aids & services/measurement, other	189	Semicustom/custom ICs	199
Computer systems/system design, other	179	Integrated circuits/semiconductor devices/circuit design, other	189	Sensors/transducers	199
Computer-aided design/engineering (CAD/CAE)	180	Interconnection systems	189	Signal sources/generation	199
Computer-aided manufacturing/testing (CAM/CAT)	180	Linear circuits	189	Simulators/simulation	199
Conferences/conventions/shows	180	Local-area network architecture/design/design standards	189	Software documentation	200
Connectors	180	Logic analyzers/analysis	189	Standards	200
Consumer electronics	180	Logic arrays/systems	189	Substrates	200
Corporate appointments/developments/strategies	180	Mainframe computers	189	Surface-mounting devices/techniques	200
Crystals/crystal oscillators	180	Marketing/markets/pricing	190	Switches	200
Data acquisition systems/techniques	183	Memory controllers	190	Technology/research, other	200
Data communications systems/techniques	183	Memory devices	190	Telecommunications	200
Data converters	183	Microcomputer buses/interfaces	190	Temperature measurement	200
Data processing	183	Microcomputers	190	Terminals	200
Desktop computers	183	Microprocessor buses	190	Test fixtures/probes	200
Development systems	183	Microprocessor support chips	190	Timer ICs/circuits	200
		Microprocessors	193	Touch-screen devices	200
		Military electronics	193	Transmitters/receivers	200
		Minicomputers	193	Video	200
		Modems	193	Vision systems	200
		Motor control circuits	193	Voltage converters	200
		Motors/motor controllers	193	Voltage references	200
		Multiprocessing	193	Waveform analyzers/analysis	200
		Multiuser computer systems	193	Wire/cable	200
		Network analyzers/analysis	193		

EDN TECHNICAL-ARTICLE DATABASE

A

Advertising

Advertiser Product Database—May-October 1987. *Staff*; *EDN NEWS*, 12/87, pg 36, 1.5 pgs.
Selective growth and new DRAM cells share the IEDM spotlight. *Cole, Bernard C, Managing Editor*; *Electronics*, 11/26/87, pg 109, 2 pgs.

Amplifiers

Cut noise in isolated circuits with variable-carrier amplifier. *Burt, Rod, Burr-Brown*; *Electronic Design*, 04/14/88, pg 101, 3.5 pgs.
High-speed buffers help solve problems in circuit applications. *Underwood, Bob, Maxim Integrated Products*; *EDN*, 01/21/88, pg 137, 5.5 pgs.
Isolation amplifiers break ground loops and achieve high CMRR. *Fleming, Tarlton, Associate Editor*; *EDN*, 12/24/87, pg 97, 5.5 pgs.
Micropower op amp offers simplicity and versatility. *Rahim, Zahid, Signetics*; *EDN*, 01/07/88, pg 181, 7 pgs.
Simple techniques help you conquer op-amp instability. *Siegel, Barry L, Elantec*; *EDN*, 03/31/88, pg 181, 8 pgs.
Transimpedance amps: fast yet accurate. *Palmer, Wyn, Analog Devices*; *Electronics*, 01/07/88, pg 151, 4 pgs.
Use of transimpedance amplifiers minimizes design tradeoffs. *Hansford, Alan, Analog Devices*; *EDN*, 11/26/87, pg 205, 7.5 pgs.

Analog switches

Eliminate the guesswork in analog-switch error analysis. *Moore, Stephen, Siliconix*; *EDN*, 11/26/87, pg 219, 7 pgs.

Arithmetic chips/circuits

Building-block chips are busy widening DSP horizons. *Leonard, Milt, Senior Editor*; *Electronic Design*, 03/31/88, pg 68, 7.5 pgs.
Floating-point milestone: Single-chip processors. *Lineback, J Robert, Managing Editor*; *Electronics*, 03/17/88, pg 77, 1 pg.
Newest floating-point processors blur architectural distinctions. *Wilson, Ron, Senior Editor*; *Computer Design*, 04/15/88, pg 32, 6 pgs.

Artificial intelligence

Digital signal processing and AI inherent in consumer electronics. *Staff*; *Electronic Design*, 01/07/88, pg 144, 2 pgs.

Audio

Analog filtering: top gun for audio. *Ambrose, John, Exar*; *ESD*, 01/88, pg 97, 3.5 pgs.

Automatic test equipment/techniques

Design for testability creates better products at lower cost—Decade 90 Part 3. *Leibson, Steven H, Regional Editor*; *EDN*, 03/31/88, pg 135, 8.5 pgs.
Military ATE: capability up, tester inventory down. *Novellino, John, Associate Editor*; *Electronic Design*, 01/21/88, pg 68, 8 pgs.
Pioneering engineers begin to adopt board-level automatic test generation. *Strassberg, Dan, Associate Editor*; *EDN*, 03/17/88, pg 57, 7.67 pgs.

B

Batteries

Focus on rechargeable batteries: Economic portable power. *Grossman, Morris, Senior Editor*; *Electronic Design*, 03/03/88, pg 118, 6.5 pgs.

Board-level computers

Big RISC boxes bust out all over. *Vaughan, Jack, Managing Editor*; *ESD*, 04/88, pg 24, 1 pg.
Board vendors turn to systems approach. *Wilson, Dave, Editor*; *ESD*, 04/88, pg 17, 2 pgs.
DSP card fits IBM PC. *Bridges, Jim, Communications Automation & Control*; *EDN NEWS*, 03/88, pg 1, 1 pg.
Fax-board makers carve out niches. *Harbert, Tammi, Senior Editor*; *EDN NEWS*, 04/88, pg 12, 1 pg.
Interface turns Mac II into GPIB controller. *DeSantis, Tom, IOtech*; *EDN NEWS*, 04/88, pg 29, 1 pg.
Low-cost, rugged commercial computers fit military needs. *Conner, Margery S, Regional Editor*; *EDN*, 12/24/87, pg 151, 7.5 pgs.
Plug-in boards let your personal computer perform parallel-processing tasks. *Mosley, J D, Regional Editor*; *EDN*, 02/04/88, pg 89, 5 pgs.
STE Bus vies for share of US STD Bus domain. *Harold, Peter, European Editor*; *EDN NEWS*, 04/88, pg 1, 1 pg.

C

CMOS logic

AC/ACT logic supplies the glue for bus interface. *Funk, Richard E, GE Solid State*; *Electronic Design*, 04/14/88, pg 121, 5 pgs.
CMOS VLSI sets the direction for new ICs. *Wilson, Ron, Senior Editor*; *Computer Design*, 12/87, pg 79, 9 pgs.
Chip sets for PC/AT compatibles support faster μ Ps and shrink board size. *Conner, Margery S, Regional Editor*; *EDN*, 11/12/87, pg 79, 4 pgs.
Controversy, user doubts continue to embroil advanced CMOS logic. *Wilson, Ron, Senior Editor*; *Computer Design*, 03/01/88, pg 24, 2 pgs.
Managing power makes CMOS logic systems shine. *Curtis, Rick, Texas Instruments*; *Electronic Products*, 03/15/88, pg 30, 6 pgs.
Understand CMOS flash ADCs to apply them effectively. *Demler, Michael J, Datel*; *EDN*, 01/21/88, pg 127, 6.5 pgs.

CMOS technology

Is BiCMOS the next technology driver. *Cole, Bernard C, Managing Editor*; *Electronics*, 02/04/88, pg 55, 3 pgs.
Jedec simplifies selection of BiMOS, CMOS gate arrays. *LaBuda, Virgil P, Motorola*; *Electronic Design*, 03/17/88, pg 107, 8 pgs.
Overcome testing hurdles posed by new CMOS logic. *Pino, Dave, Hall, William, National Semiconductor*; *Electronic Design*, 01/21/88, pg 109, 4 pgs.
Understand CMOS flash ADCs to apply them effectively. *Demler, Michael J, Datel*; *EDN*, 01/21/88, pg 127, 6.5 pgs.

Cache memory

Cache controllers flare memory bottleneck. *Bursky, Dave, Executive Editor*; *Leonard, Milt, Senior Editor*; *Electronic Design*, 03/31/88, pg 25, 5 pgs.
Cache tag RAMs hasten main memory response. *Leonard, Milt, Senior Editor*; *Electronic Design*, 03/03/88, pg 19, 3.5 pgs.

Capacitors

Capacitors chip in for surface-mounting and switching supplies. *Bianco-mano, Vincent, Technology Editor*; *Electronic Design*, 03/88, pg 25, 5 pgs.
Special Report: A big cast of SMD passives hits center stage. *Shreff, Jesse, Contributing Editor*; *Electronics*, 02/04/88, pg 103, 6 pgs.

Clock circuits

Interface a real-time clock chip to the IBM PC or Apple II. *Khan, Adnan, GE Solid State*; *Alexander, Mark, GE/Intersil*; *EDN*, 11/12/87, pg 209, 7 pgs.

Communications ICs

Boost fast modem throughput by analyzing dial-up lines. *Berger, Bill, Rockwell International*; *Electronic Design*, 11/12/87, pg 113, 3.5 pgs.
Data-compression chip eases document-processing design. *Silver, David, Kofax Image Product*; *Williamson, James, Advanced Micro Devices*; *Computer Design*, 11/15/87, pg 101, 3 pgs.
Dial-up modem chip sets get smaller, faster. *Chester, Michael, Southwestern Editor*; *Electronic Products*, 01/15/88, pg 22, 6 pgs.
ISDN data must conform to analog telecom networks. *Hardwick, Steve, Siemens Components*; *Electronic Design*, 11/12/87, pg 105, 3.5 pgs.
Interface the ISDN to your PC with a voice/data board. *Gulick, Dale, Crowe, Charlie, Advanced Micro Devices*; *Electronic Design*, 12/10/87, pg 85, 4 pgs.
LAN chip makers grapple in a turbulent market. *Cole, Bernard C, Managing Editor*; *Electronics*, 04/14/88, pg 87, 3 pgs.
MAPcon takes on factory network configuration. *Iversen, Wesley R, Industrial & Consumer Editor*; *Electronics*, 04/14/88, pg 95, 2 pgs.
Mainframe network chips ease big interfacing blues. *Cormier, Denny, Senior Technical Editor*; *ESD*, 01/88, pg 17, 2 pgs.
Mimic's next challenge: Slashing production costs. *Naegele, Tobias, Military/Aerospace Editor*; *Electronics*, 11/26/87, pg 121, 3 pgs.
New choice in crossbar switching: the IC. *Lineback, J R, Managing Editor*; *Electronics*, 01/21/88, pg 32, 1 pg.
Processor and communication ICs. *Mokhoff, Nicolas, Senior Editor*; *Electronic Design*, 02/18/88, pg 83, 8.5 pgs.
Software changes smart modem to smart scope. *Alunkal, John, Codex*; *Holley, Paul, Holley*; *Electronic Design*, 12/10/87, pg 99, 4.5 pgs.
StarLAN transceiver makes easy connections for office PC. *Paetau, Jens, Exar*; *Electronic Design*, 02/04/88, pg 79, 6 pgs.
Telecomm ICs offer improved functions for telephone- and PABX-system designs. *Pryce, Dave, Associate Editor*; *EDN*, 01/07/88, pg 55, 5.33 pgs.

Comparators

Analog comparators achieve high speeds, but application challenges remain. *Shear, David, Regional Editor*; *EDN*, 01/07/88, pg 75, 5.5 pgs.
CMOS comparators surpass bipolar devices. *Andrews, Peter, Granahan*,

One if by land...



Official U.S. Army photograph

Two if by sea...

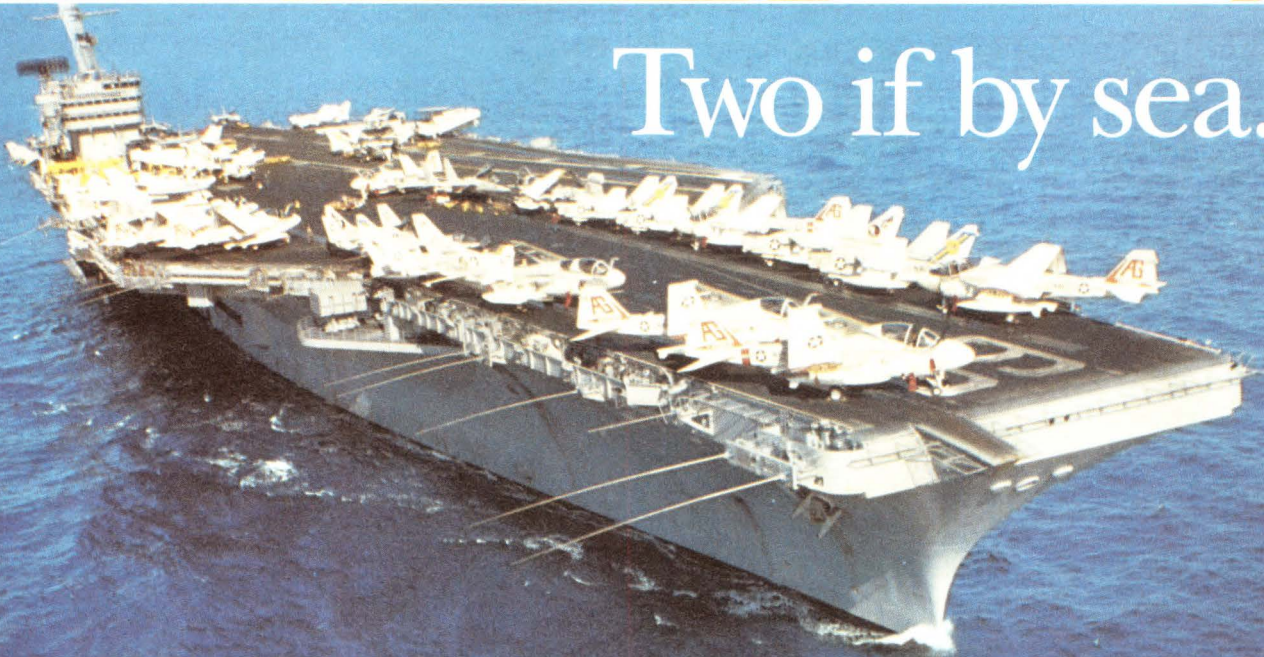

Official U.S. Navy photograph

Three if by air...



All from GE.

The combined forces of GE, Intersil and RCA—now #1 in High-Rel CMOS, and a leader in linear and power—give you a powerful ally for all your military needs.

There's more to choosing a military semiconductor supplier than finding the right parts. You need a technological partner who is as committed to the business as you are. A partner with the experience, expertise and production capabilities to serve this demanding market.

more than 1.5 million ASICs last year. We offer rad-hard and non-rad-hard, Class S and Class B ASICs.

With decades of military experience, fully-equipped design centers worldwide, and software that is exceptionally easy-to-use, we can help you translate your ideas into silicon *fast*. With first-time success of virtually 100%.

You can use our new silicon compiler technology to create designs that are heavily bus-structured, with ROMs, RAMs, PLAs and ALUs right in them.

Or choose from dozens of fully-characterized cells to design ASICs to more than 10,000

gates. With die sizes up to 150,000 mil². Our range of ASIC technologies is impressive, including bulk silicon from 1.5 micron to 7 micron; 1.5 micron silicon-on-sapphire; single- and double-level metal.

All supported by a team of experienced, dedicated High-Rel designers and engineers.

LOGIC

RCA invented CMOS. And

RCA Class S and Class B CMOS logic has long been the first choice for military and aerospace systems. For both rad-hard and non-rad-hard applications.

The CD 4000 series, introduced over 18 years ago, includes hundreds of devices proven in dozens of successful tactical programs.

We increased speed tenfold with the 54HC/HCT family, which now includes more than 250 types and is fully compliant to 883B Rev. C.

We tripled the speed again with our 54 AC/ACT series, matching bipolar ALS in speed. These devices can be used to replace LS and ALS circuits at only a small fraction of the power consumption.

And our newest line, now being introduced, is 54 HCS/HCTS.

The "S" indicates that this family is made on sapphire substrate.

HCS/HCTS is just like HC/HCT except for two important advantages: the speed of AC/ACT; and radiation hardness (over 200K Rads, screened to Class S).

Representative GE Solid State Credentials

Satellite, Aerospace 10⁵ and 10⁶ RAD Levels

Atmosphere Explorer	Sat Com Nimbus	Imp Satellites IUE	Galileo Voyager I & II	SICBM MILSTAR
7 OP	Helios	VELA	Lightweight Receiver	GPS
HEAO	DMSP	Vega I & II	IUS	COBE
Space Shuttle	Oscar-6	Geosat	GOES	SDI
ITOS	Pioneer-F	AMPTE	INSAT	DSCS
B-Sat	ATS	TIROS		LANDSAT

Tactical Military Programs

Tow Cobra	ARC-164	Multi-Role Combat Air	M-56	GEMNS
Tenley	PRC-85	AN-TPN-19	XM-70	GATOR
S-3A Aircraft	Stinger	AN-ASQ-119	ADAM	KG84A
Lans Program	Captor	Arctic Beacon	FMU-112B	KG84C
TD-1065 Communication	Manpack	AWACS	FMU-117B	STU II
Vinson	Skiru	MK 46	Ptarmigan	STU III
Airs	AN/ALE 139	NYVO	TICM	KGV 10
ARC-150	DMD/PLARS	B155	Sparrow	Copperhead
	Parkhill		SINGARS	Hellfire

That's why you should take a close look at what the merger of three great brands—GE, RCA and Intersil—means to you.

ASICs

GE Solid State is a leading supplier of High-Rel ASICs.

Many ASIC companies concentrate only on front-end design. We're strong in design, but equally strong in volume production. In fact, we shipped



INTERSIL

Intersil's commitment to the military market goes back to 1974.

Today, Intersil can offer you more than 300 JAN QPL and 883B, Rev. C devices, including analog switches, multiplexers, JFETs, voltage converters, power-supply-management ICs, UARTs, EPROMs, timers and data acquisition products.

Plus one of the world's broadest lines of analog-to-digital and digital-to-analog converters and extremely sophisticated DSP devices.

There are currently more than 10,000 active Intersil customer source-control drawings on file.

RAD-HARD CMOS/SOS

If you're designing aerospace or strategic military systems, CMOS/SOS should be your choice. That's because the sapphire substrate gives you totally isolated n and p devices, for high speed and outstanding radiation hardness.

The advantages of CMOS/SOS are available in rad-hard ASICs, RAMs and HCS/HCTS logic. CMOS/SOS devices are the key to the success of major

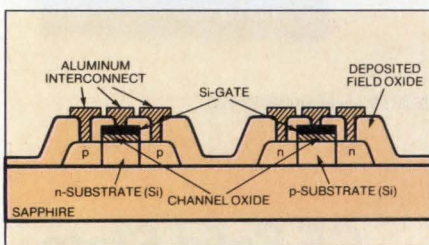

CMOS/SOS structure uses sapphire substrate to insulate the n- and p-transistors from each other. This structure is highly resistant to transient radiation, total-dose radiation, and single-event upsets.

military programs like Milstar and

Minuteman small ICBM. CMOS/SOS is virtually latch-up free under transient radiation.

It has extremely high tolerance to single event upset (SEU) caused by radiation. For example, SRAMs typically have SEU of 2×10^9 errors/bit/day. SOS offers a very high total dose tolerance: all the way from 100K Rads to "MEGARAD" dosage.

We know, because we invented SOS.

1750A PROCESSOR

When Rockwell needed super-reliable, proven, rad-hard components for their 1750A processor (used in the new small ICBMs), they turned to us.

We responded with the ASIC that did the job: the MIL-STD 1750A embedded processor.

The processor has speed >700 KOPS (dais mix). The CPU uses six LSI logic chips implemented with our standard cells.

RAMs

We're delivering rad-hard 16K SRAMs, screened to Class S, in high volume.

These 16Kx1 RAMs are latch-up free; with SEU of 2×10^{10} errors/bit/day; transient upset rate $>10^{10}$ Rads/second; and total dose tolerance >100 K Rads (Si). Access time is 80 ns typical at 25°C (post-Rad access time is 150 ns).

Our 4Kx1 and 1Kx4 rad-hard SRAMs are being qualified to

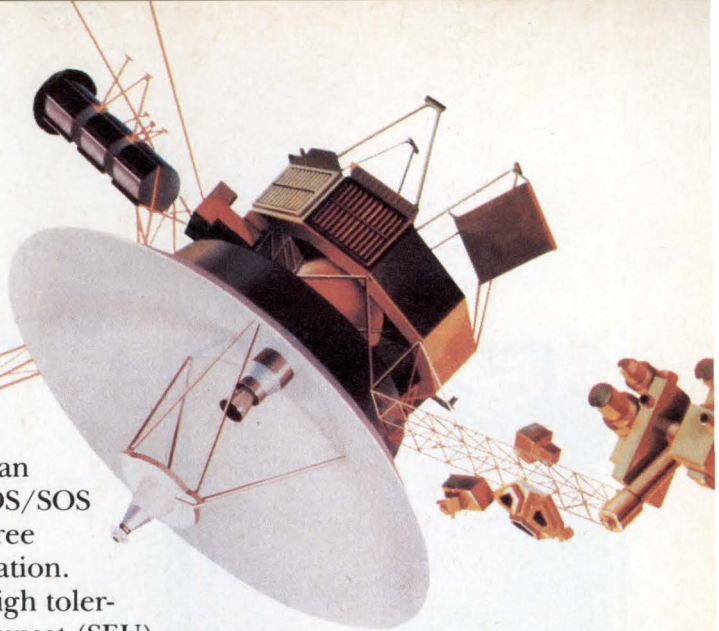

M38510 Class S.

Also, we offer 64K (8Kx8) and 256K (32Kx8) non-rad-hard high-rel SRAMs.

POWER

We're among the leaders in high-rel power, with more than 200 QPL Bipolar and MOSFET devices.

We invented the logic-level high-rel MOSFET, which has a 5-volt gate drive.

Another invention of ours, the IGT, achieves a 10:1 improvement in on-state resistance over conventional power MOSFETs when operating in the 400-to-500 volt range.

And we now offer Rugged MOSFETs, which can withstand high levels of avalanche energy.

GE Solid State has been awarded more engineering development contracts for rad-hard MOS than any other semiconductor supplier.

GE Solid State has the only DESC approved MOVs in the industry. And we can screen any of our 248 GE-MOV® Varistors to your high-rel requirement.

MANUFACTURING

Except for GE-MOVs, which are made in Dundalk, Ireland, all GE Solid State wafers are fab-

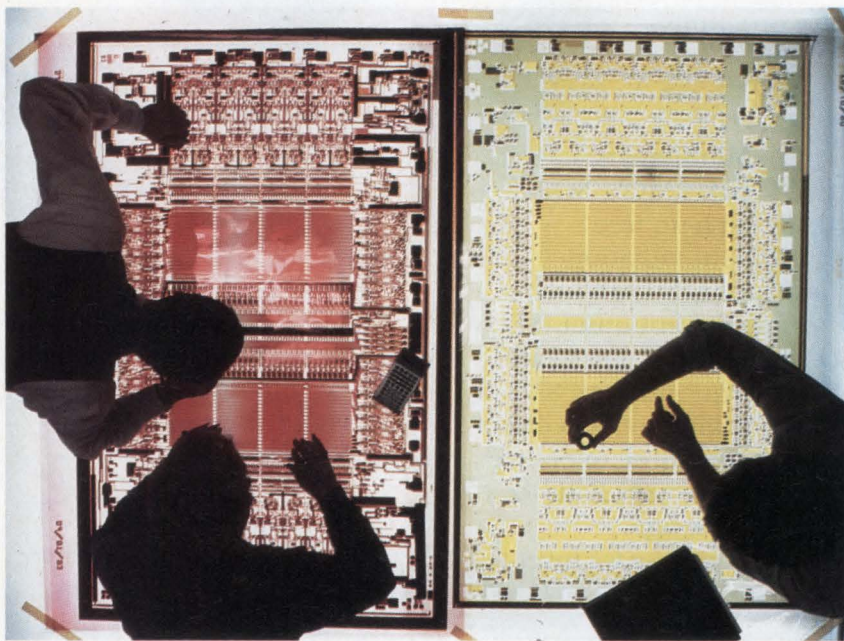

ricated in the U.S.A.

Our main high-rel plant is in Findlay, Ohio. One of the world's most efficient front ends, Findlay boasts a state-of-the-art high volume wafer fab plus complete military/aerospace assembly and test facilities, JAN certified to Class S.

Findlay turns out more high-rel CMOS devices than any other plant in the world... about 5 million per year. 1.5 micron devices are now being produced, with 1.25 and sub-micron capabilities planned for the near future. Findlay uses a Class 10 wafer processing area.

More important than the advanced equipment used at

Findlay is a stable, very experienced work force that has been engaged in high-rel IC production for two decades.

The Intersil plant in Santa Clara, California, is also certified for JAN 38510 CMOS and bipolar production. High-rel power discretes are fabricated and assembled at our very efficient Mountaintop, PA, plant.

PACKAGING

Our hermetically-sealed packages provide a protective environment for our high-rel chips.

You can choose from ceramic dual-in-line, ceramic flat packs,

leadless chip carriers and pin-grid arrays in a variety of lead finishes.

We provide packages with up to 132 terminals or more. And we have sizes for chips as large as 400x400 mils.

YOUR STRATEGIC PARTNER

This is only a sample of what the combined forces of GE, RCA and Intersil—the new GE Solid State—can offer you. For example, our line includes CMOS bipolar and BiMOS linears; CMOS micros and peripherals; and an Emulating and Programmable Chip set that can be used to implement new architectures or to emulate existing ones.

Why not partner with the world's premier high-rel CMOS supplier? Call for a copy of our High-Reliability Capabilities brochure. 800-443-7364, extension 26.

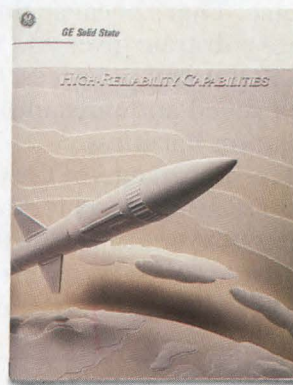

In Europe, call: Brussels, (02) 246-21-11; Paris, (1) 39-46-57-99; London, (276) 68-59-11; Milano, (2) 82-291; Munich, (089) 63813-0; Stockholm (08) 793-9500.



GE Solid State

GE/RCA/Intersil Semiconductors

Three great brands. One leading-edge company.

EDN TECHNICAL-ARTICLE DATABASE

Mark, Texas Instruments; EDN NEWS, 01/88, pg 24, 1.5 pgs.
Precision comparators ease oscillator and data-converter design. Dutra, John, Harvey, Barry, Elantec; EDN, 02/18/88, pg 219, 9 pgs.

Computer applications

RISC systems to lead the way in computation-intensive design jobs. Staff; Electronic Design, 01/07/88, pg 78, 2 pgs.
When are MFLOPS really MFLOPS. Aseo, Joseph, West Coast Technical Editor; ESD, 03/88, pg 38, 5 pgs.

Computer firmware

Chip sets for PC/AT compatibles support faster μ Ps and shrink board size. Conner, Margery S, Regional Editor; EDN, 11/12/87, pg 79, 4 pgs.

Computer languages/compilers/interpreters

Bare Machine Ada solves real-time problems. Seymour, Burch, Gould; Computer Design, 03/01/88, pg 58, 5 pgs.
C compilers team up with other development tools to ease system design. Falk, Howard, Contributing Editor; Computer Design, 04/15/88, pg 44, 4 pgs.
C interpreters and incremental compilers function as interactive development tools. Terry, Chris, Associate Editor; EDN, 01/21/88, pg 57, 3.33 pgs.
Coding languages to change little as libraries offer reusable code. Staff; Electronic Design, 01/07/88, pg 96, 1 pg.
Combine forth with other tools for rapid software development. Payne, W H, Sandia Laboratories; Electronic Design, 01/21/88, pg 103, 4 pgs.
Digital signal processing: Chips are here, but software isn't. McLeod, Jonah, Managing Editor; Electronics, 03/31/88, pg 57, 3 pgs.
Languages coupled with fast processors for high throughput. Aseo, Joseph, West Coast Technical Editor; ESD, 02/88, pg 26, 1 pg.
Novel architecture backs high-level languages. Case, Brian, Olson, Tim, Advanced Micro Devices; Electronic Products, 02/15/88, pg 35, 5 pgs.
Object-oriented languages reorient programming techniques. Wilson, Ron, Senior Editor; Computer Design, 11/01/87, pg 52, 6 pgs.
Optimize supercomputer code with vectorizing compilers. Dodson, David S, et al, Convex Computer; Electronic Design, 03/03/88, pg 79, 6 pgs.
Raise programmer productivity with C-language extension. Murrin, Ken, Software Consultant; Electronic Design, 02/18/88, pg 113, 4 pgs.
Run a computer flight simulator with a modified Ada. Seymour, Burch, Gould; Electronic Design, 01/21/88, pg 97, 3.5 pgs.
Software opens door to MS-DOS applications for non-PCs. Falk, Howard, Contributing Editor; Computer Design, 01/15/88, pg 22, 2.5 pgs.
To assure software success, choose a suitable language. Schindler, Max, Software Editor; Electronic Design, 03/31/88, pg 113, 10.5 pgs.

Computer operating systems/system software

CAE/CAD suppliers catch some sun. Collett, Ronald E, Senior Technical Editor; ESD, 03/88, pg 30, 1 pg.
Developers target Unix and Ada with real-time kernels. Falk, Howard, Contributing Editor; Computer Design, 04/01/88, pg 55, 11.5 pgs.
First tron microprocessor gets Japan into the 32-bit fray. Lineback, J R, Managing Editor; Electronics, 01/21/88, pg 31, 1 pg.
Instruction-set architecture prepares systems for 1990s. Bursky, Dave, Executive Editor; Electronic Design, 02/04/88, pg 33, 5.5 pgs.
Is the U.S. headed for a fall by rushing toward unix standards. Young, Jeremy, Managing Editor; Electronics, 02/04/88, pg 31, 1 pg.
Onboard kernels for VME Bus boards. Travis, Bill, Contributing Writer; EDN NEWS, 12/87, pg 1, 1 pg.
Real time calls the VMEbus. Wilson, Dave, Editor; ESD, 12/87, pg 26, 1 pg.
Real-time operating systems. Small, Charles H, Associate Editor; EDN, 01/07/88, pg 115, 17.5 pgs.
Satisfactory operating systems for workstations remain elusive. Staff; Electronic Design, 01/07/88, pg 98, 1 pg.
Sleight of hand makes MS-DOS multitasking. Aseo, Joseph, West Coast Technical Editor; ESD, 12/87, pg 47, 3 pgs.
Software opens door to MS-DOS applications for non-PCs. Falk, Howard, Contributing Editor; Computer Design, 01/15/88, pg 22, 2.5 pgs.
Supercomputer software: The floodgates are opening. Young, Jeremy, Managing Editor; Electronics, 03/03/88, pg 75, 3 pgs.
Toward faster and portable real-time operating systems. Schindler, Max, Software Editor; Electronic Design, 01/21/88, pg 31, 5 pgs.
UNIX and 386 find perfect match. Aseo, Joseph, West Coast Technical Editor; ESD, 04/88, pg 30, 1 pg.
Unix licensees up in arms over the Sun-AT&T deal. McLeod, Jonah, Managing Editor; Electronics, 01/21/88, pg 33, 1 pg.
Until OS/2 comes along. Clarke, Robert M, Contributing Writer; ESD, 04/88, pg 77, 3 pgs.
Update: 80386 operating systems. Myrvagnes, Rodney, Associate Editor; Electronic Products, 02/01/88, pg 18, 1.5 pgs.
When are MFLOPS really MFLOPS. Aseo, Joseph, West Coast Technical Editor; ESD, 03/88, pg 38, 5 pgs.

Windowlike user interfaces link systems and applications. Williams, Tom, Western Managing Editor; Computer Design, 04/01/88, pg 34, 6 pgs.

Computer software, application generator

Automatic programming could boost productivity threefold. Staff; Electronic Design, 01/07/88, pg 94, 1 pg.

Computer software, communications/networking

Networking software. Wright, Maury, Regional Editor; EDN, 03/03/88, pg 103, 7 pgs.

Computer software, design applications

Advanced tools finally start to automate software design. Schindler, Max, Software Editor; Electronic Design, 11/27/87, pg 61, 7.5 pgs.
Autorouters debut in PC-based CAE arena. Harbert, Tammi, Senior Editor/News; EDN NEWS, 01/88, pg 8, 3 pgs.
CASE tools. Terry, Chris, Associate Editor; EDN, 04/28/88, pg 111, 7.5 pgs.
CASE tools emerge to handle real-time systems. Falk, Howard, Contributing Editor; Computer Design, 01/01/88, pg 53, 14 pgs.
CASE tools square off to analyze a real-time system. Schindler, Max, Software Editor; Electronic Design, 04/28/88, pg 103, 10 pgs.
Evaluate model types before simulating logic circuits. Moffat, Kent, Carter, Don, Mentor Graphics; EDN, 03/17/88, pg 187, 5.5 pgs.
New software tools run IBM PC software on a variety of 32-bit μ Ps. Cushman, Robert H, Special Features Editor; EDN, 02/18/88, pg 93, 3.83 pgs.
PLD-design software meets the challenge of multiple-device PLD applications. Small, Charles H, Associate Editor; EDN, 02/18/88, pg 61, 4 pgs.

Simple worksheet predicts attenuation of digital signals. Doyle, Greg J, Control Data; Electronic Design, 03/31/88, pg 93, 4 pgs.

Software lets you design first, pick PLD later. Warrington, Gene, Minc; EDN NEWS, 03/88, pg 10, 1 pg.

Software will level the road for parallel processing. Staff; Electronic Design, 01/07/88, pg 100, 1 pg.

Spice extensions dynamically model thermal properties. Filseth, Eric, Analog Design Tools; Jachowski, Mike, Precision Monolithics; EDN, 04/14/88, pg 169, 10 pgs.

Timing reports: real-time CASE systems emerge. Aseo, Joseph, West Coast Technical Editor; ESD, 01/88, pg 20, 1 pg.

Computer software, graphics

AI beeps up gray-scale correlation. Silver, William M, Schatz, David, Cognex; ESD, 03/88, pg 89, 3 pgs.

Computer-supported graphics ease software specifications. Schindler, Max, Software Editor; Electronic Design, 03/03/88, pg 87, 9 pgs.

Estimating kernels from amplitude spectra. Krukar, Richard, University of New Mexico; ESD, 12/87, pg 35, 2 pgs.

Image restoration techniques. Wilson, Scott R, University of New Mexico; ESD, 12/87, pg 39, 3 pgs.

Interactive image processing using X windows. Rasure, John, et al, University of New Mexico; ESD, 12/87, pg 32, 2 pgs.

Windowlike user interfaces link systems and applications. Williams, Tom, Western Managing Editor; Computer Design, 04/01/88, pg 34, 6 pgs.

Computer software, other

Supercomputer software: The floodgates are opening. Young, Jeremy, Managing Editor; Electronics, 03/03/88, pg 75, 3 pgs.

Computer software, performance measurement

Digital signal-synthesis tools model real-world environments. Kafadar, Karen, Hewlett-Packard; EDN, 11/12/87, pg 239, 7.5 pgs.

Computer software, production test

Pioneering engineers begin to adopt board-level automatic test generation. Strassberg, Dan, Associate Editor; EDN, 03/17/88, pg 57, 7.67 pgs.

Computer software, program development

Customer training and reverse engineering promise to escalate the acceptance of CASE. Terry, Chris, Associate Editor; EDN, 03/17/88, pg 73, 4 pgs.

Program-generation tools for PCs ease IEEE-488 system integration. Harold, Peter, European Editor; EDN, 04/14/88, pg 71, 6.33 pgs.

Computer subsystems/peripherals, other

A new look at analyzing peripheral performance. Hospodor, Andy, I/O XEL; Computer Design, 03/15/88, pg 94, 4 pgs.

Alternative computer architectures reduce bottlenecks. Hess, James W, Ohmeda; EDN, 11/12/87, pg 271, 8 pgs.

Input technologies extend the scope of user involvement. Williams, Tom, Western Managing Editor; Computer Design, 03/01/88, pg 41, 9.5 pgs.

Computer systems/system design, other

For cost/performance, partition RISC system on bus parameters. Cates,

EDN TECHNICAL-ARTICLE DATABASE

- Ron, VLSI Technology; *Electronic Design*, 11/12/87, pg 121, 6 pgs.
RISC systems to lead the way in computation-intensive design jobs.
Staff; *Electronic Design*, 01/07/88, pg 78, 2 pgs.
- Computer-aided design/engineering (CAD/CAE)**
ASIC verification: Chasing a moving target. McLeod, Jonah, Managing Editor; *Electronics*, 11/26/87, pg 79, 3 pgs.
Automating test vectors cuts chip development time. Lukanc, Jeffrey A, et al, VTC; *Electronic Design*, 11/27/87, pg 73, 3.5 pgs.
Autorouters debut in PC-based CAE arena. Harbert, Tammi, Senior Editor/News; *EDN NEWS*, 01/88, pg 8, 3 pgs.
CAE: On a continuum between known techniques, new challenges. Staff; *Electronic Design*, 01/07/88, pg 72, 2 pgs.
CASE tools. Terry, Chris, Associate Editor; *EDN*, 04/28/88, pg 111, 7.5 pgs.
Create linear ASIC macros without Spice nightmares. Orgain, Cheryl, Analog Design Tools; *Electronic Design*, 12/10/87, pg 77, 3 pgs.
Customer training and reverse engineering promise to escalate the acceptance of CASE. Terry, Chris, Associate Editor; *EDN*, 03/17/88, pg 73, 4 pgs.
Design tools advance to keep pace with system complexity. Goering, Richard, Senior Editor; *Computer Design*, 12/87, pg 103, 8 pgs.
Developing CAE tools target top-down design of complex systems—Decade 90 Part 2. Leibson, Steven H, Regional Editor; *EDN*, 03/17/88, pg 131, 7 pgs.
EDIF translators begin to open up CAE/CAD systems. Goering, Richard, Senior Editor; *Computer Design*, 12/87, pg 30, 1.5 pgs.
Improved autorouting makes old algorithm do new tricks. Mazzullo, Tony, ECAD; *Electronic Design*, 04/28/88, pg 83, 3.5 pgs.
Keep pc boards reliable with thermal-analysis tools. LaBonte, Mike, et al, Valid Logic Systems; *Electronic Design*, 04/28/88, pg 79, 4 pgs.
Laying out mixed chips takes IBM days, not weeks. Naegele, Tobias, Military/Aerospace Editor; *Electronics*, 02/18/88, pg 76, 1 pg.
Logic simulation on personal computers: Friend or foe. Milne, Bob, Senior Editor; *Electronic Design*, 03/03/88, pg 50, 9 pgs.
Modeling strategies simplify board-level simulation. Goering, Richard, Senior Editor; *Computer Design*, 03/01/88, pg 29, 4.5 pgs.
Routing your way through pc-board design tools. Milne, Bob, Senior Editor; *Electronic Design*, 04/28/88, pg 58, 10.5 pgs.
Silicon compilers still struggling toward widespread acceptance. Andrews, Warren, Contributing Editor; *Computer Design*, 02/15/88, pg 37, 6 pgs.
Simulate analog circuit boards without Spice's shortcomings. Walsh, Kevin, Electrical Engineering Software; *Electronic Design*, 02/04/88, pg 75, 4 pgs.
Simulation accelerators address throughput issues. Goering, Richard, Senior Editor; *Computer Design*, 03/15/88, pg 42, 5 pgs.
Simulation puts zip into circuit board design. Spadaro, Joseph J, Associate Editor; *Electronic Products*, 04/01/88, pg 34, 8 pgs.
Software for translating CAE simulation into test vectors. Chester, Michael, Southwestern Editor; *Electronic Products*, 02/15/88, pg 13, 3 pgs.
Solutions begin to surface for linking board design and test. DeSena, Art, ADS Associates; *Computer Design*, 03/01/88, pg 34, 5 pgs.
Speed DSP simulation, design with CAE-library function blocks. Grossman, Robert M, DSP & CAE Consultant; *Electronic Design*, 04/28/88, pg 92, 4 pgs.
Speed digital filter design with smart multiplier chip model. Johnson, Tony, Logic Automation; Schnettler, Tim, Texas Instruments; *Electronic Design*, 04/28/88, pg 97, 5 pgs.
Spice extensions dynamically model thermal properties. Filseth, Eric, Analog Design Tools; Jachowski, Mike, Precision Monolithics; *EDN*, 04/14/88, pg 169, 10 pgs.
Will 386-based PCs ignite a desktop CAE explosion. Bassak, Gil, Managing Editor; *Electronic Design*, 02/04/88, pg 62, 7.5 pgs.
Worst-case timing analysis ensures board reliability. Rizzatti, Lauro, Wasilewski, Mary, Teradyne; *Computer Design*, 11/15/87, pg 90, 6 pgs.
- Computer-aided manufacturing/testing (CAM/CAT)**
Solutions begin to surface for linking board design and test. DeSena, Art, ADS Associates; *Computer Design*, 03/01/88, pg 34, 5 pgs.
- Conferences/conventions/shows**
A torrent of future products at the solid state conference. Cole, Bernard C, Managing Editor; *Electronics*, 02/18/88, pg 67, 1 pg.
Board vendors turn to systems approach. Wilson, Dave, Editor; *ESD*, 04/88, pg 17, 2 pgs.
Buscon spotlights ASICs, standards and partnerships. Lieberman, David, Senior Editor; *Computer Design*, 04/01/88, pg 21, 4 pgs.
Buscon/88 West rings in a new year. Lieberman, David, Senior Editor; Mayer, John H, Senior Associate Editor; *Computer Design*, 02/15/88, pg 128, 2 pgs.
Complexity, specialization, and speed high-light ISSCC. Cormier, Denny, Senior Technical Editor; *ESD*, 02/88, pg 23, 2 pgs.
Electro/88. Strassberg, Dan, Associate Editor; *Computer Design*, 02/15/88, pg 128, 5 pgs.
- Evolutionary advances and some surprises revealed at ISSCC. Wilson, Ron, Senior Editor; *Computer Design*, 02/01/88, pg 21, 1 pg.
ICCAD: Logic synthesis and parallel processing. Phillips, Barry W, Technology Editor; *Electronic Design*, 11/12/87, pg 33, 2.5 pgs.
IEDM technical program to air key advances. Leonard, Milt, Senior Editor; *Electronic Design*, 11/27/87, pg 35, 3 pgs.
ISSCC announcements promise strong impact on system design. Wilson, Ron, Senior Editor; *Computer Design*, 04/01/88, pg 29, 2.5 pgs.
Largest-ever Electro adds software to its showcase of electronics technology. Fleming, Tarlton, Associate Editor; *EDN*, 04/14/88, pg 87, 3 pgs.
Look for hot developments in every area at the ISSCC. Cole, Bernard C, Managing Editor; *Electronics*, 12/17/87, pg 103, 2 pgs.
Marching toward automation and higher throughput. Chin, Spencer, Associate Editor; *Electronic Products*, 02/01/88, pg 16, 1.5 pgs.
Nepeon highlights the dominant role tape-automated bonding is taking. Lyman, Jerry, Packaging/Production Editor; *Electronics*, 02/18/88, pg 104, 2 pgs.
PCs, ASICs, solar cells, and microwave chips light up Wescon program. Biancomano, Vince, Technology Editor; *Electronic Design*, 11/12/87, pg 85, 3 pgs.
System integration comes to the Macintosh II. Wilson, Andrew, Executive Editor; *ESD*, 03/88, pg 28, 1 pg.
Wescon/87. Strassberg, Dan, Associate Editor; *EDN*, 11/12/87, pg 139, 3.5 pgs.
- Connectors**
Fiber-optic connectors come down in price. O'Connell, Patricia, Managing Editor; *EDN NEWS*, 02/88, pg 23, 2 pgs.
Materials and hardware. Ormond, Tom, Senior Editor; *EDN*, 02/18/88, pg 149, 11 pgs.
Specialty cabling creates versatile and streamlined network systems. Graeber, George C, Crouch, Ronald A, Brand-Rex; *Electronics*, 02/04/88, pg 119, 4 pgs.
Surface-mounting connectors seek brighter day. Chin, Spencer, Associate Editor; *Electronic Products*, 02/01/88, pg 31, 4.5 pgs.
- Consumer electronics**
Consumer. Staff; *Electronics*, 01/07/88, pg 84, 2 pgs.
Digital audio tape gets closer in U.S. Iversen, Wesley R, Industrial & Consumer; *Electronics*, 12/17/87, pg 32, 1 pg.
In Las Vegas, the action's in three-inch CDs. Iversen, Wesley R, News Bureau—Chicago; *Electronics*, 01/21/88, pg 33, 1 pg.
Integration will turn the wheels of automotive electronic design. Staff; *Electronic Design*, 01/07/88, pg 142, 2 pgs.
Military and commercial applications demand tailored high-reliability ICs. Martin, Steven L, Contributing Editor; *Computer Design*, 01/15/88, pg 37, 5 pgs.
- Corporate appointments/development/strategies**
Betting the company on a high-priced plant. Waller, Larry, News Bureau—Los Angeles; *Electronics*, 04/28/88, pg 95, 1 pg.
Can U.S. chip profits pay for a new generation of fabs. Lineback, J R, Managing Editor; *Electronics*, 02/18/88, pg 81, 2 pgs.
Executive outlook: crash isn't changing plans—yet. Staff; *Electronics*, 12/17/87, pg 91, 6 pgs.
Has Silicon Valley lost its zing. Young, Jeremy, Managing Editor; *Electronics*, 11/12/87, pg 127, 3 pgs.
Intel's ambitious game plan in embedded chips. Cole, Bernard C, Managing Editor; *Electronics*, 04/14/88, pg 97, 4 pgs.
Intergraph will hawk Clipper to all comers. Curran, Lawrence, Managing Editor; *Electronics*, 11/12/87, pg 88, 2.5 pgs.
Motorola confirms RISC effort as pressure on 68000 builds. Lineback, J R, News Bureau—Dallas; *Electronics*, 12/17/87, pg 31, 1 pg.
Selling to the military: Is it about to get easier. Naegele, Tobias, Military/Aerospace Editor; *Electronics*, 03/31/88, pg 83, 3 pgs.
Sematech aims to put fab in operation by this summer. Lineback, J R, Managing Editor; Naegele, Tobias, Military/Aerospace Editor; *Electronics*, 01/21/88, pg 34, 0.5 pgs.
TI finds a new way to predict package reliability. Lyman, Jerry, Packaging/Production Editor; *Electronics*, 03/31/88, pg 87, 2 pgs.
Transforming a risky startup into a solid supercomputer company. Manuel, Tom, Managing Editor; *Electronics*, 03/03/88, pg 62, 2 pgs.
Users backing Motorola's 88000 chip band together and join the RISC battle. Manuel, Tom, Managing Editor; McLeod, Jonah, Managing Editor; *Electronics*, 04/14/88, pg 31, 1 pg.
- Crystals/crystal oscillators**
Design method yields low-noise, wide-range crystal oscillators. Hillstrom, Tim L, Hewlett-Packard; *EDN*, 03/17/88, pg 141, 5 pgs.

The Blues always help you see things more clearly.

If you've been singing for higher contrast Liquid Crystal Displays, Seiko Instruments has some happy news for you.

Thanks to the unique blue characters on their LCD modules, seeing what's on the screen is easier than ever.

Another big advantage of getting the blues from Seiko is their extremely wide viewing angle. The widest available for small LCDs. So your customers can read the screen from positions that are comfortable to them. Little extras that mean a lot when it comes to making a design decision.

If all this sounds good, there's one more feature that'll be music to your ears. Plug-in compatibility.

Simply drop in the new modules wherever you were using Seiko's parallel interface, TN

type modules. Making a visible improvement in your products easy. Quick. And free of retooling costs.

And, with a variety of these easy-to-read modules ranging from 1x16 to 4x40, Seiko's bound to have what you need.

Call Seiko Instruments today at (213) 517-7770 and ask about their LCDs with the blue characters. It'll give you, and your customers, a whole new outlook on your products.

Seiko Instruments, USA, Inc.
Electronic Components
Division

2990 West Lomita Blvd.
Torrance, CA 90505
(213) 517-7770
FAX (213) 517-7792



Seiko Instruments

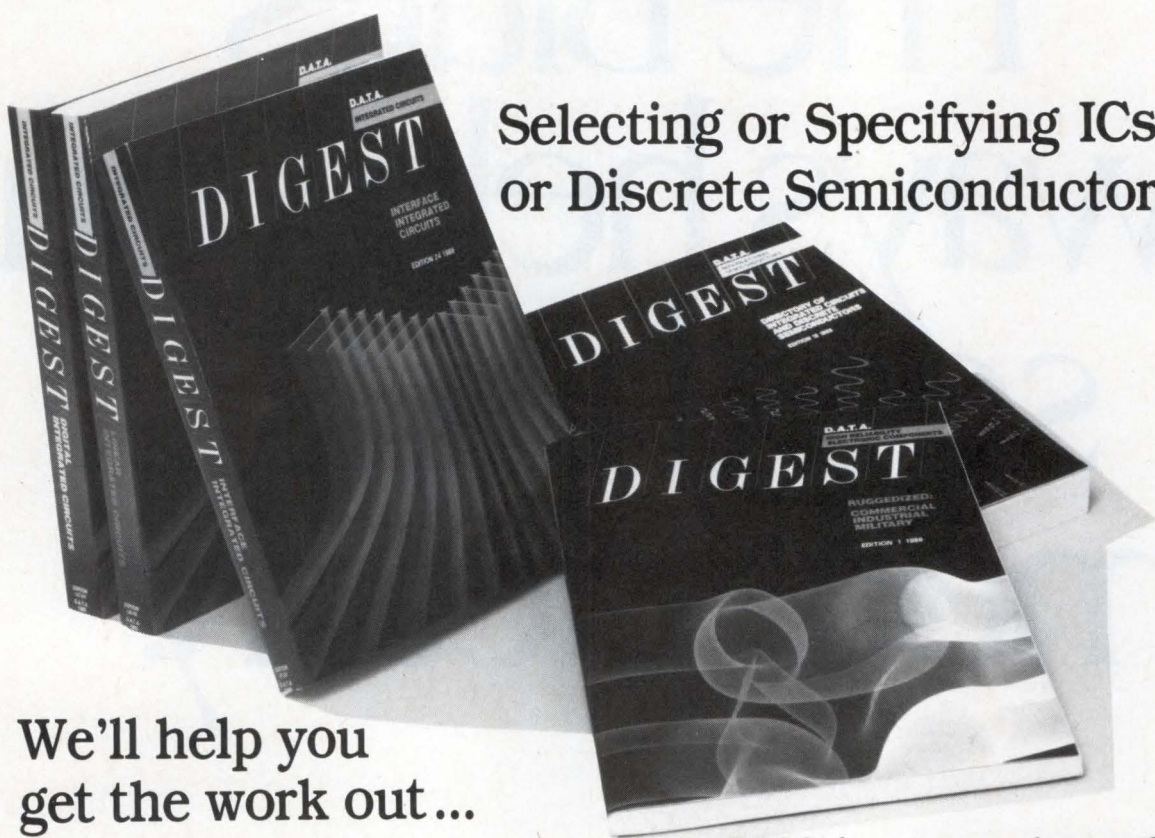

Selecting or Specifying ICs or Discrete Semiconductors?

We'll help you
get the work out...

without the workout.

If you spend time working with IC or Discrete semiconductors, you should get to know our DIGESTs. Because they can make your work go a whole lot easier.

Quickly compare electrical specs, packages, pinouts; find alternate sources or replacement information; or go directly from generic or part numbers to technical and manufacturer data. All at your fingertips...your own personal library at your desk.

Involved with MIL SPEC or Hi-Rel components? Our Hi-Rel/Military Digest can lighten your load. Simplified cross-referencing and a user-friendly format eliminate time-wasting searches through QPL's, MIL-STD 1562,

DESC drawings and manufacturer catalogs. Searches that previously took hours can be done in minutes.

And to keep up with the latest technology, the DIGESTs feature optional Updates, automatically sent to you either quarterly or semi-annually.

We offer the DIGESTs separately, discount them in quantity, and, of course, all DIGESTs carry our 30-day moneyback guarantee. We also lease our database on magnetic tape.

To find out more about how the DIGESTs can simplify your workload, call our toll-free numbers.

The D.A.T.A. DIGESTs: getting out the work doesn't have to be a workout anymore.

the DIGESTs™

where semiconductor selection begins

EDN TECHNICAL-ARTICLE DATABASE

D

Data acquisition systems/techniques

Boost fast modem throughput by analyzing dial-up lines. *Berger, Bill, Rockwell International; Electronic Design, 11/12/87, pg 113, 3.5 pgs.*
Build an ISDN interface for VMEbus workstations. *Komaneky, Mark, et al, AT&T Bell Laboratories; Electronic Design, 04/14/88, pg 129, 4 pgs.*
Communications. *Staff; Electronics, 01/07/88, pg 75, 2.5 pgs.*
Computers are on the verge of the open-systems era. *Manuel, Tom, Managing Editor; Gosch, John, News Bureau—Frankfort; Electronics, 04/14/88, pg 68, 2 pgs.*
From systems to standards, the pace quickens in networking. *Runyon, Stan, Managing Editor; Electronics, 04/14/88, pg 67, 1.5 pgs.*
Software changes smart modem to smart scope. *Alunkal, John, Codex; Holley, Paul, Holley; Electronic Design, 12/10/87, pg 99, 4.5 pgs.*
The race to interconnect computer networks is on. *Curran, Lawrence, Managing Editor; Electronics, 04/14/88, pg 70, 3 pgs.*
Wide-area nets explode as standards emerge. *Shandle, Jack, New Products Editor; Electronics, 04/14/88, pg 75, 3 pgs.*

Data communications systems/techniques

Boost fast modem throughput by analyzing dial-up lines. *Berger, Bill, Rockwell International; Electronic Design, 11/12/87, pg 113, 3.5 pgs.*
Build an ISDN interface for VMEbus workstations. *Komaneky, Mark, et al, AT&T Bell Laboratories; Electronic Design, 04/14/88, pg 129, 4 pgs.*
Communications. *Staff; Electronics, 01/07/88, pg 75, 2.5 pgs.*
Computers are on the verge of the open-systems era. *Manuel, Tom, Managing Editor; Gosch, John, News Bureau—Frankfort; Electronics, 04/14/88, pg 68, 2 pgs.*
From systems to standards, the pace quickens in networking. *Runyon, Stan, Managing Editor; Electronics, 04/14/88, pg 67, 1.5 pgs.*
Software changes smart modem to smart scope. *Alunkal, John, Codex; Holley, Paul, Holley; Electronic Design, 12/10/87, pg 99, 4.5 pgs.*
The race to interconnect computer networks is on. *Curran, Lawrence, Managing Editor; Electronics, 04/14/88, pg 70, 3 pgs.*
Wide-area nets explode as standards emerge. *Shandle, Jack, New Products Editor; Electronics, 04/14/88, pg 75, 3 pgs.*

Data converters

A-D and D-A converters to leap in resolution and speed. *Staff; Electronic Design, 01/07/88, pg 106, 1 pg.*
CD-player design requires an accurate 16-bit D/A converter. *Highton, Frederick J, Burr-Brown; EDN, 11/12/87, pg 225, 5.5 pgs.*
Converters digitize signals for DSP. *Malone, Bob, Sylvan, John, Analog Devices; EDN NEWS, 01/88, pg 24, 1 pg.*
Data capture matches flash converter speeds. *Lechner, Alexander, et al, Siemens Components; Electronic Design, 03/31/88, pg 101, 6 pgs.*
For A/D converter specs, read between the lines. *Colotti, James J, Eaton; Electronic Products, 04/15/88, pg 53, 5.5 pgs.*
Improve converter resolution with μ P tracking techniques. *Carlson, Brian, Hootman, Joe, University of North Dakota; Electronic Design, 02/04/88, pg 97, 4.5 pgs.*
Make programmable sine oscillator from quad DAC chip. *Wong, James, Precision Monolithics; Electronic Design, 02/04/88, pg 103, 3.5 pgs.*
Mixed process technologies drive D-A converters to higher performance. *Mayer, John H, Senior Associate Editor; Computer Design, 03/01/88, pg 63, 4 pgs.*
One-chip ADCs reach 2 GHz; others hit 18-bit accuracy. *Runyon, Stan, Special Projects Editor; Electronics, 02/18/88, pg 77, 1 pg.*
Programmable-delay ICs control system timing. *Hilton, Craven, Barrow, Jeff, Analog Devices; EDN, 02/18/88, pg 209, 7.5 pgs.*
S/H amp-ADC matrimony provides accurate sampling. *Little, Al, Burnett, Bob, Harris; EDN, 02/04/88, pg 153, 12 pgs.*
Special Report: High-resolution arrives for ADC chips and hybrids. *Riezenman, Mike, Contributing Editor; Electronics, 01/07/88, pg 133, 6 pgs.*
Understand CMOS flash ADCs to apply them effectively. *Demler, Michael J, Datel; EDN, 01/21/88, pg 127, 6.5 pgs.*

Data processing

Data processing. *Staff; Electronics, 01/07/88, pg 65, 4 pgs.*

Desktop computers

PS/2 products proliferate. *Lewis, Sasha, Northwestern Editor; Tuck, Barbara, Associate Editor; Electronic Products, 12/15/87, pg 15, 1.5 pgs.*

Development systems

Development systems evolve toward integrated, host-independent solutions. *Falk, Howard, Contributing Editor; Computer Design, 04/01/88, pg 44, 6 pgs.*
PC-based emulators gain performance edge. *Goering, Richard, Senior Editor; Computer Design, 02/01/88, pg 26, 2 pgs.*

Digital multimeters (DMMs)

DMM adopts varied guises. *Jessen, Kenneth, Hewlett-Packard; EDN NEWS, 02/88, pg 1, 1 pg.*
High-performance DMMs and calibrators bring standards-lab specs to the benchtop. *Strassberg, Dan, Associate Editor; EDN, 02/04/88, pg 57, 6.5 pgs.*
The system DMM becomes a far more powerful tool. *Berg, Rex A, Hewlett-Packard; Electronics, 03/17/88, pg 123, 4 pgs.*

Digital signal processing

A potpourri of DSP. *Bond, John, Technology Communications; ESD, 01/88, pg 67, 6 pgs.*
Analog filtering: top gun for audio. *Ambrose, John, Exar; ESD, 01/88, pg 97, 3.5 pgs.*
Building-block chips are busy widening DSP horizons. *Leonard, Milt, Senior Editor; Electronic Design, 03/31/88, pg 68, 7.5 pgs.*
DSP chip speeds VME transfer. *Cooper, John, Ironics; ESD, 03/88, pg 47, 3 pgs.*
DSP's big conference enters the real world of products. *Young, Jeremy, Managing Editor; Electronics, 03/31/88, pg 63, 1.5 pgs.*
DSPs finally find floating point. *Taylor, David, et al, Zoran; ESD, 01/88, pg 81, 3.5 pgs.*
Digital filtering: the right stuff for video. *Williams, Bob, Ampex; Prater, Jim, NCR Microelectronics; ESD, 01/88, pg 91, 3.5 pgs.*
Digital signal processing: Chips are here, but software isn't. *McLeod, Jonah, Managing Editor; Electronics, 03/31/88, pg 57, 3 pgs.*
FFT-based filter design boosts radar system's prowess. *Cox, Roger, United Technologies Microelectronics; Electronic Design, 03/31/88, pg 81, 4 pgs.*
FFT-specific chips crunch frequency-domain data. *Cormier, Denny, Senior Technical Editor; ESD, 12/87, pg 20, 1 pg.*
Novel DSP boards break through speed bottlenecks. *Phillips, Barry W, Technology Editor; Electronic Design, 02/18/88, pg 132, 13 pgs.*
Selection method steers designers to best DSP solution. *Daly, Alexander, E-Systems; Computer Design, 03/01/88, pg 53, 5 pgs.*
Speed DSP simulation, design with CAE-library function blocks. *Grossman, Robert M, DSP & CAE Consultant; Electronic Design, 04/28/88, pg 92, 4 pgs.*
Speed digital filter design with smart multiplier chip model. *Johnson, Tony, Logic Automation; Schnettler, Tim, Texas Instruments; Electronic Design, 04/28/88, pg 97, 5 pgs.*
The next century's DSP chips promise gigaflops throughput. *Staff; Electronic Design, 01/07/88, pg 118, 1 pg.*

Digital voltmeters (DVMs)

Transform your IBM PC into a 6 1/2-digit voltmeter. *Haigh, Geoffrey, Analog Devices; Electronic Design, 02/18/88, pg 119, 4 pgs.*

Discrete components, other

A different touch: force-sensing resistors. *Yaniger, Stuart, Intertek Electronics; EDN NEWS, 03/88, pg 8, 1 pg.*
Components. *Staff; Electronics, 01/07/88, pg 98, 3 pgs.*

Disk controllers

Building tomorrow's disk controller today. *Reynolds, Jim, Randall, Dave, Andromeda Systems; Electronic Products, 12/15/87, pg 47, 3.5 pgs.*
Multifunction chip steers hard disk drives. *Holm, Robert E, Intel; ESD, 04/88, pg 67, 5 pgs.*

Disk-drive testers/testing

2M-byte diskettes need special tests for quality control. *Hartke, Jerome L, Media Sciences; EDN, 03/03/88, pg 127, 6 pgs.*

Display drivers

High-resolution LCD panels change demands on driver electronics. *Fenger, Carl, Muhlemann, Kurt, Philips/Faselec; EDN, 04/14/88, pg 157, 5 pgs.*
Innovations in monolithic display drivers improve flat-panel cost/performance ratios. *Wiegand, Jim, Associate Editor; EDN, 02/04/88, pg 75, 3.67 pgs.*
Take care when choosing controllers for flat-panel displays. *McManus, Colin, Digital Electronics; EDN, 04/28/88, pg 209, 8 pgs.*

Displays

Building cheaper active-matrix LCDs. *Iversen, Wesley R, News Bureau—Chicago; Electronics, 01/21/88, pg 38, 0.5 pgs.*
Color flat-panel displays strut their stuff at SID. *Bursky, Dave, Executive Editor; Electronic Design, 04/23/88, pg 22, 4 pgs.*
Electroluminescent panels move to center stage. *Van Stroth, Rolland W, Planar Systems; Electronic Products, 03/01/88, pg 64, 4.5 pgs.*
Flat panels shine in autos, test, and portables. *Wilson, Andrew, Executive Editor; ESD, 02/88, pg 32, 1 pg.*

Distributed processing

Distributed processing provides low-cost acceleration. *Goering, Richard, Senior Editor; Computer Design, 04/01/88, pg 32, 2 pgs.*

EDN TECHNICAL-ARTICLE DATABASE

E

Engineering workstations

- Portable workstations to take on functions of desktop computing. *Staff; Electronic Design, 01/07/88, pg 82, 1 pg.*
- Supercomputing gives workstations a shot. *Ohr, Stephan, Executive Editor; Till, Johna, Associate Editor; Electronic Design, 04/14/88, pg 39, 3 pgs.*
- Will 386-based PCs ignite a desktop CAE explosion. *Bassak, Gil, Managing Editor; Electronic Design, 02/04/88, pg 62, 7.5 pgs.*

F

Fiber optics

- Fiber-optic connectors come down in price. *O'Connell, Patricia, Managing Editor; EDN NEWS, 02/88, pg 23, 2 pgs.*
- Fiber-optic sensor systems move to new markets. *Coco, Donna, Staff Editor; EDN NEWS, 01/88, pg 10, 2 pgs.*
- Fiber-optic transmitters and receivers enhance data-link performance. *Ormond, Tom, Senior Editor; EDN, 03/31/88, pg 57, 5 pgs.*

Filter circuits

- Digitally programmable 1-chip filters yield lower-cost data-acquisition systems. *Fleming, Tarlton, Associate Editor; EDN, 03/17/88, pg 83, 4.67 pgs.*

Floppy-disk drives

- 2M-byte diskettes need special tests for quality control. *Hartke, Jerome L, Media Sciences; EDN, 03/03/88, pg 127, 6 pgs.*

Frequency synthesizers/synthesis/measurement

- Digital signal-synthesis tools model real-world environments. *Kafadar, Karen, Hewlett-Packard; EDN, 11/12/87, pg 239, 7.5 pgs.*
- Digitize analog functions using simple procedures. *Ellis, George, Industrial Drives; EDN, 03/31/88, pg 153, 5 pgs.*

Function generators/generation

- Function generators for all seasons. *Yates, Warren, Associate Editor; Electronic Products, 12/15/87, pg 42, 4 pgs.*
- Signal generators will boost speed and expand versatility. *Staff; Electronic Design, 01/07/88, pg 138, 1 pg.*

G

GPIB instruments

- Personal computer-based instrument control: a tale of two buses. *Nowlin, William C, Canik, Robert, National Instruments; ESD, 01/88, pg 30, 4.5 pgs.*

GaAs technology

- Designing with GaAs logic. *Cates, Ron, Vitesse Semiconductor; ESD, 03/88, pg 63, 4 pgs.*
- Exclusive-OR inputs give you many uses for GaAs flip-flop. *Deierling, Carl, GigaBit Logic; Electronic Design, 12/10/87, pg 59, 4.5 pgs.*
- GaAs ICs begin to make inroads into silicon territory. *Andrews, Warren, Contributing Editor; Computer Design, 02/01/88, pg 37, 6 pgs.*
- Gallium arsenide digital ICs complement ECL families in high-speed applications. *Gallant, John, Associate Editor; EDN, 03/03/88, pg 79, 6 pgs.*
- Rockwell's design used for 8-bit GaAs processor. *Waller, Larry, News Bureau—Los Angeles; Electronics, 02/18/88, pg 74, 1 pg.*
- Will ASICs propel GaAs out of its niche. *Waller, Larry, News Bureau—Los Angeles; Electronics, 02/18/88, pg 40, 0.5 pgs.*

Gate arrays

- Programmable array serves as a controller for dynamic RAMs. *Waugh, Thomas, Xilinx; EDN, 02/18/88, pg 169, 6.5 pgs.*

Graphics boards

- Video and graphics—The twain shall meet. *Lawcewicz, Tad, Wang, Robert, Imagraph; ESD, 04/88, pg 55, 2.5 pgs.*
- What's new—an electronic imaging '87 review. *Wilson, Andrew, Executive Editor; ESD, 12/87, pg 17, 2 pgs.*

Graphics circuits

- Chip set combo transforms images at low cost. *Mannix, Charles, Ives; ESD, 12/87, pg 54, 4 pgs.*
- Data-compression chip eases document-processing design. *Silver, David, Kofax Image Product; Williamson, James, Advanced Micro Devices; Computer Design, 11/15/87, pg 101, 3 pgs.*

- Graphics chips forge high-res boards for PCs, workstations. *Mokhoff, Nicolas, Senior Editor; Electronic Design, 03/17/88, pg 62, 10 pgs.*
- Graphics pipeline merges off-the-shelf and semicustom ICs. *Wilson, Ron, Senior Editor; Computer Design, 12/87, pg 25, 2 pgs.*
- Picking the right computer graphics chip. *Myrvuagnes, Rodney, Associate Editor; Electronic Products, 11/15/87, pg 26, 8.5 pgs.*
- Specialized processors aim at graphics, imaging jobs. *Cole, Bernard C, Managing Editor; Electronics, 02/18/88, pg 73, 1 pg.*
- VGA chip sets. *Mosley, J D, Regional Editor; EDN, 03/17/88, pg 119, 6.5 pgs.*
- VGA chips offer design opportunities and latest IBM compatibility. *Williams, Tom, Western Managing Editor; Computer Design, 11/15/87, pg 50, 2.5 pgs.*

Graphics systems

- 3D PC graphics. *Macdonald, Sarah, Matrox; ESD, 02/88, pg 53, 3.5 pgs.*
- AI beefs up gray-scale correlation. *Silver, William M, Schatz, David, Cognex; ESD, 03/88, pg 89, 3 pgs.*
- Design a graphics board for an IBM personal computer. *Grimes, Jack, Shankman, Richard, Intel; Electronic Design, 03/17/88, pg 87, 6.5 pgs.*
- Focusing on image enhancement. *Dawson, Ben, Imaging Technology; ESD, 03/88, pg 83, 3 pgs.*
- Graphics supercomputers tackle real-time visualization. *Williams, Tom, Western Managing Editor; Computer Design, 03/15/88, pg 21, 2.5 pgs.*
- Graphics visualization is a real eye opener. *Manuel, Tom, Managing Editor; Electronics, 03/17/88, pg 91, 2 pgs.*
- In search of a PC video bus standard. *Wilson, Andrew, Executive Editor; ESD, 03/88, pg 26, 1 pg.*
- Interactive image processing using X windows. *Rasure, John, et al, University of New Mexico; ESD, 12/87, pg 32, 2 pgs.*
- Landscape generation: a changing perspective. *Chen, Yin-Pao, Simulator Systems; ESD, 02/88, pg 44, 4 pgs.*
- Lasers and liquid crystals project large images quickly. *Stepner, David, Greyhawk Systems; ESD, 01/88, pg 47, 3 pgs.*
- Manage design trade-offs in high-end graphics board. *Whitton, Mary C, Sun Microsystems; et al, Electronic Design, 03/17/88, pg 77, 7 pgs.*
- Putting your PC in pictures. *Masraff, Anthony, Omnicomp Graphics; ESD, 03/88, pg 101, 2 pgs.*
- Stereoscopic 3D imaging. *Weissman, M A, Microscience; ESD, 04/88, pg 59, 4 pgs.*
- Video and graphics—The twain shall meet. *Lawcewicz, Tad, Wang, Robert, Imagraph; ESD, 04/88, pg 55, 2.5 pgs.*
- What color is color. *Wilson, Andrew, Executive Editor; ESD, 01/88, pg 38, 4.5 pgs.*
- Windows for workstations: A menu for multitasking. *Alexander, Tom, University of Washington; et al, ESD, 03/88, pg 74, 4.5 pgs.*

H

Hardware/interconnection, other

- Interconnection bottlenecks will dominate future VLSI designs. *Staff; Electronic Design, 01/07/88, pg 104, 2 pgs.*

Heat sinks/cooling devices

- Cooling devices take the heat from SMDs. *Strassberg, Dan, Associate Editor; EDN, 12/10/87, pg 97, 8.5 pgs.*
- Cooling high-speed ECL conventionally. *Gupta, Omkarnath R, Gupta Packaging Technologies; Edmundson, Neil, Fairchild Semiconductor; Electronic Products, 11/15/87, pg 44, 4.5 pgs.*
- Materials and hardware. *Ormond, Tom, Senior Editor; EDN, 02/18/88, pg 149, 11 pgs.*

I

Imports/exports

- France. *Staff; Electronics, 01/21/88, pg 74, 4 pgs.*
- Italy. *Staff; Electronics, 01/21/88, pg 78, 3 pgs.*
- Japan. *Staff; Electronics, 01/21/88, pg 61, 5 pgs.*
- Overseas market report. *Staff; Electronics, 01/21/88, pg 59, 2 pgs.*
- United Kingdom. *Staff; Electronics, 01/21/88, pg 70, 4 pgs.*
- West Germany. *Staff; Electronics, 01/21/88, pg 66, 4 pgs.*

In-circuit emulators/emulation

- Focus on in-circuit emulators. *Novellino, John, Associate Editor; Electronic Design, 11/12/87, pg 139, 5 pgs.*
- HLL cross compilers speed 1-chip- μ C software development. *Leibson, Steven H, Regional Editor; EDN, 12/24/87, pg 127, 9 pgs.*
- In-circuit emulators ease development of hardware for 80386-based applications. *Strassberg, Dan, Associate Editor; EDN, 03/03/88, pg 69,*

Satisfy everyone with Toko's new ultra-compact universal input switchers.

Try us for size! Toko's new MOSFET power supplies are the smallest switchers in their class—with power densities to 2.45 watts per cubic inch and 15, 30 and 50-watt models that stand a miniature 1" high.

Toko satisfies your need for smaller size without sacrificing power. Utilizing our broad experience in inductor technology, we engineered these new power supplies with MOSFET switching circuits and switching frequencies over 100kHz.

Additionally, our state-of-the-art "wireless" copper thin film transformer design helps achieve lower switching noise, greater efficiency, and eliminates the chances of an open winding or a short.

To ensure reliability, Toko features 105°C electrolytic capacitors and 20% derating of all components.

SERIES	AC INPUT VOLTAGE	RATED POWER	# OUTPUTS	INCHES		
				H	L	W
MK	85-132	150W	1	3.8	6.7	2.4
MW	85-264	15W	3	1.0	4.3	2.4
MW	85-264	30W	3	1.0	5.9	2.4
MW	85-132/	50W	3	1.0	6.1	3.7
MW	170-264*	100W	4	1.6	7.8	4.4

- Universal 85-264V. Input on MW15 and 30
 - 80% Efficiency
 - FCC Class B
 - Designed to Meet UL & CSA
 - Thin, Eurocard, Flex Power Method
- *Jumper selectable.

Best of all, Toko offers these power supplies at prices so low that they compete with larger, conventional supplies. Our two-year warranty backs our commitment to high performance.

More power and less space...at the right price. You really can satisfy everyone with Toko's new switchers. For complete details, contact **Toko America, 1250 Feehanville Drive, Mt. Prospect, IL 60056 (312) 297-0070, FAX (GIII): (312) 699-7864**

TOKO
TOKO AMERICA, INC.

*Your strategic partner...
for all the right reasons.*

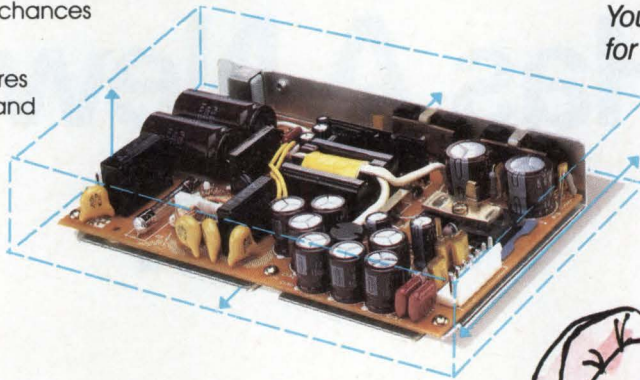

Toko's MW50, stands only 1" high. It's 85% smaller in total volume than Computer Product's PHB-719.



**MORE
POWER!**

**LESS
SPACE!**

**Total Contract
Electronic
Manufacturing
Has A New
Name:**

**PHILIPS
CIRCUIT
ASSEMBLIES**

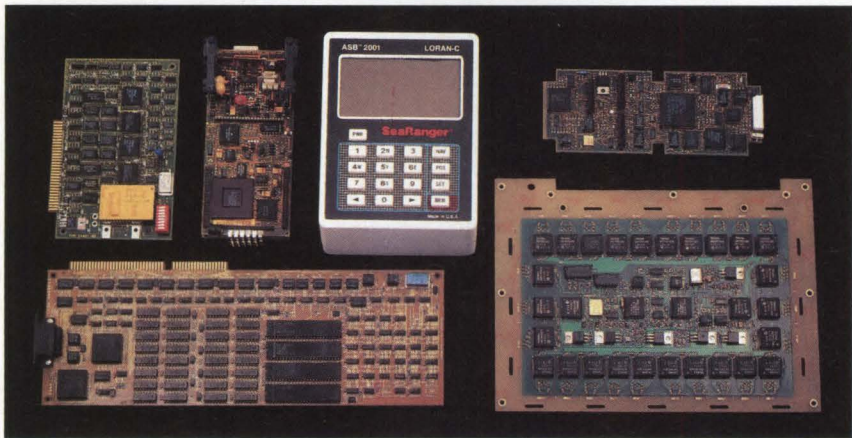
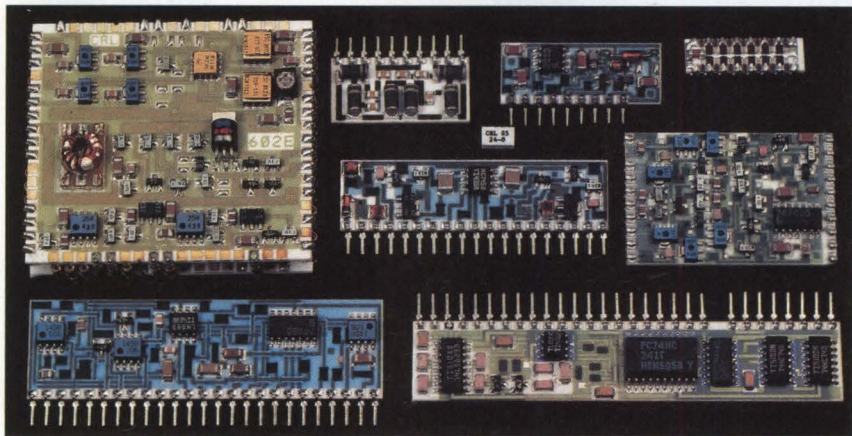
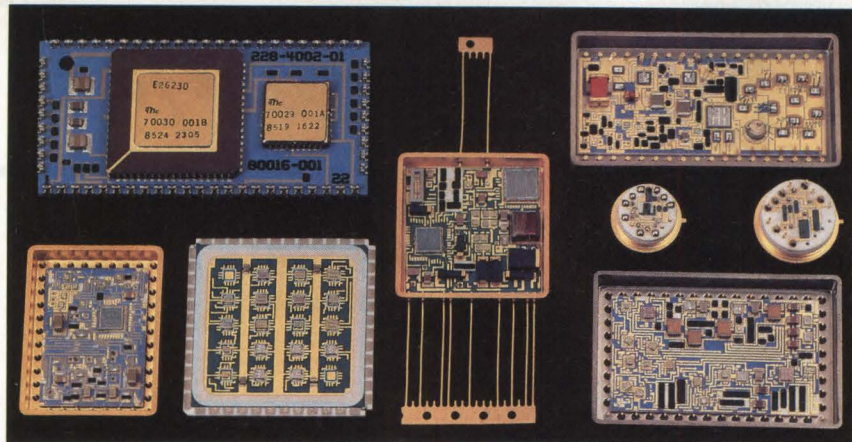

State-of-the-art Materials Management

Philips Circuit Assemblies achieves planned throughput and meets critical JIT delivery schedules by using a proven MRPII (Manufacturing Resource Planning) program. This provides total material control and tracking through the entire manufacturing process.

Engineering Support

The Philips Circuit Assemblies engineering team can work with you from the outset of your project to answer key questions about layout, placement and testing. We optimize your designs for peak manufacturing efficiency and performance. And provide size reductions at the lowest cost.

Quality Control

The Total Quality Control (TQC) program at Philips Circuit Assemblies is based on building products right the first time. All employees receive ongoing training aimed at developing their skills to meet Philips' high standards of quality workmanship.

In addition, SPC (Statistical Process Control) systems monitor, plot and analyze trends in manufacturing variables to prevent problems before they occur.

Full-service Test and Repair

Philips Circuit Assemblies performs in-circuit, functional, burn-in and stress testing. Custom-designed hardware/software are provided through our experienced test engineers. Test engineers and technicians offer worst-case analysis and recommendations for improving circuit performance.

At the 26,000 square-foot Custom Repair Center, electronic and electromechanical diagnostic and repair functions are performed on in-warranty, out-of-warranty and third-party circuit card assemblies or finished products.

Flexible Automated Assembly Systems

Through Philips Circuit Assemblies you can upgrade your own assembly line with renowned Philips MCM Modular Placement Systems. Philips Placement Systems are the world's standard for flexible, cost-effective automation of SMT circuit assembly.

Far East SMT Production

In Singapore, Philips Circuit Assemblies' sister company, SMT Circuit Assembly, provides contract assembly services and leading-edge technology to support your manufacturing operations in the Pacific Basin.

Worldwide Components Purchasing

The international procurement leverage of Philips assures you greater economy and availability of materials from established suppliers around the world.

Nothing even comes close to the total electronic manufacturing services from Philips Circuit Assemblies. To put Philips Circuit Assemblies to work for you, call 1-800-522-7752 (in Wisconsin, 414/785-6359). To receive our Capabilities Catalog, write to: Philips Circuit Assemblies, Corporate Advertising, 2001 W. Blue Heron Blvd., Riviera Beach, FL 33404.

You've known us for years as Mepco/Centralab Circuit Systems, North American Philips SMD® Technology Center, and Interconics — building networks, custom printed circuits and ceramic hybrid circuits, and providing surface-mount, through-hole and mixed-technology assembly services.

Now, we've joined together as a fast-growing division of North American Philips Corporation:

Philips Circuit Assemblies

It's easy to say. And it says a lot.

Philips Circuit Assemblies offers America's broadest range of contract electronic manufacturing and packaging capabilities — to help reduce the time to bring your products to market. Immediate services available to you are: computer aided design, engineering,

worldwide purchasing, manufacturing assembly and test. Philips' capital investments, production efficiencies and world class quality will meet all of your requirements.

Broad-line Assembly Technologies

Philips Circuit Assemblies can meet your technology needs from commercial to high-reliability military applications. Capabilities include through-hole and surface-mount circuit assembly, surface-mount ceramic assembly, as well as chip-and-wire assembly and custom networks. Computer-controlled automatic placement machines, plus infrared and vapor-phase reflow systems and state-of-the-art wave soldering, provide optimum manufacturing flexibility and efficiency.

PHILIPS CIRCUIT ASSEMBLIES

Mendelson Electronics Inc.

1-800-422-3525

CONTROL YOUR HOME OR BUSINESS FROM YOUR IBM*PC OR PC/AT COMPATIBLE

This card is what you need to TURN ON & OFF lights, machinery, and other electrical or electronic equipment.

IBM PC* DATA ACQUISITION AND CONTROL ADAPTER & DISTRIBUTION PANEL provides the capability to control and monitor processes within a sensor base system.

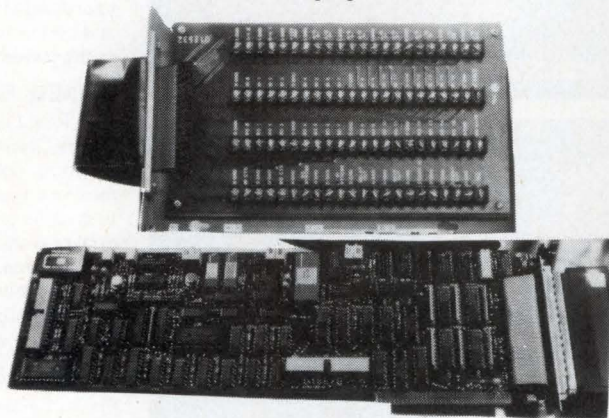

IBM PC* DATA ACQUISITION AND CONTROL ADAPTER provides an easy to use interface for accessing the ANALOG and DIGITAL I/O. Integrates analog, binary and time/counter devices on a single adapter card.

THIS IS AN ORIGINAL IBM* PRODUCT !!!

Up to four IBM DATA ACQUISITION AND CONTROL ADAPTERS can be attached to an individual PC or AT Compatible.

*** The Adapter has:**

- Four analog input channels (12-bit resolution)
- Two analog output channels (12-bit resolution)
- 16-channel digital input port
- 16-channel digital output port
- Programmable sampling rates provided by a 32-bit timer
- Event counter, programmable rate generator, or programmable time delay provided by a 16-bit user timer/counter

*** The Distribution Panel has:**

- Screw terminals provided to attach devices to the distribution panel
- Multiple grounds for twisted pair terminations
- Shielded construction to minimize noise interference

*** USES**

Chromatography, Electrochemistry, Energy management, Electronic testing, Process control, Data logging, Robotics. Some parameters commonly monitored or controlled include: Pressure, Flow, Displacement, Voltage, Light intensity, Rotational speed.

Some instruments or devices that may utilize the Adapter are: Chromatographs, Spectrophotometers, Pressure gauges, Relay controls, Thermocouples, Gas analyzers, Humidity sensors, Valve actuators, Level gauges, Load cells, Conductivity cells, pH Meters.

*** TECHNICAL DATA**

ANALOG INPUT: The analog input functions of the adapter operate in either programmed or interrupting mode. The analog input functions provide 12-bit relative accuracy.

RESOLUTION - 12 bits
INPUT CHANNELS- four differential

INPUT MODES-	unipolar or bipolar, user-selectable
INPUT RANGES:	
unipolar	0 TO ± 10 volts, user-selectable
bipolar	± 5 and ± 10 volts user-selectable
OUTPUT MODE:	
unipolar	straight binary
bipolar	offset binary
INPUT IMPEDANCE	>100 megohms with 100 picofarads
INPUT CURRENT	limited to less than ± 4 mA
INPUT VOLTAGE:	
Normal mode	± 30 volts maximum, without damage, power on or power off
Common mode	± 11 volts maximum
COMMON MODE	
Rejection ratio	72 db
Integral linearity error	± 1 LSB maximum
DIFFERENTIAL Linearity	
Error	± ½ LSB maximum
Stability	± 5 ppm/degrees C of FSR (max)
GAIN:	
Error	± 0.1% between ranges (max) any range adjustable to 0
Stability	± 32 ppm/degrees C of FSR (max)
OFFSET:	
Error	adjustable to 0
Unipolar stability	± 24 ppm/degrees C of FSR (max)
Bipolar stability	± 24 ppm/degrees C of FSR (max)
MONOTONICITY	0 to 50 degrees C
THROUGHPUT to memory	15,000 conversions/second min

The analog output functions of the adapter operate in programmed I/O mode. The analog output functions provide 12-bit relative accuracy.

RESOLUTION	12-bits
Number of output channels	2
OUTPUT modes	unipolar or bipolar, user-selectable
OUTPUT ranges:	
Unipolar	0 to ± 10 volts, user-selectable
Bipolar	± 5 and ± 10 volts, user-selectable
INPUT CODE:	
Unipolar	straight binary
Bipolar	offset binary
OUTPUT Current	+ 5 milliamps, min. with normal loading and protection from damage with the output shorted to common.
OUTPUT impedance	2 ohm, max
CAPACITIVE loading	0.5 microfarads, max
GAIN:	
Error	0.1 between ranges (max.), any range adjustable to 0
Stability	± ppm/degrees C of FSR(max)
OFFSET:	
Error unipolar	± 325 millivolt max, adjustable to 0
Error bipolar	± 8 ppm/degrees C of FSR (max)
Unipolar stability	± 24 ppm/degrees C or FSR (max)
Bipolar stability	0 to 50 degrees C
MONOTONICITY	10 microseconds max. to within 0.1% FSR for a 10 volt step with 1000 of load
SETTLING TIME	Protected for short to common ± 1% of FSR max
PROTECTION	
OVERSHOOT	
THROUGHPUT	
from memory	25,000 conversion/second

OUR LOW! LOW! PRICE FOR BOTH UNITS



\$195

PER SET

Shipping & Handling \$6.50

INCLUDES TURBO PASCAL DEMO SOFTWARE W/SOURCE CODES, ADDRESSES, ANALOG & BINARY INPUT & OUTPUT MODULES

IBM* DATA ACQUISITION AND CONTROL ADAPTER #6451502 ORIGINAL COST \$1275
IBM* ADAPTER DISTRIBUTION PANEL #6451504 ORIGINAL COST \$245

MENDELSON'S ADVANCED DEMO IN TURBO PASCAL AVAILABLE FOR \$25

Part No. #200-108 Demo Turbo

Mendelson Electronic Co., Inc.

STORE HOURS 8:30 - 5:00 Monday thru Saturday.
*IBM PC/XT is a registered trademark of IBM corp.
TERMS: MasterCard/Visa/Discover Card, Check or Money order (checks allow two weeks for clearance), C.O.D. add additional \$3.00. Ohio residents add 6% State Tax.
Above shipping/handling are rates for UPS ground in Continental U.S. only
340 East First Street Dayton, Ohio 45402 513/461-3525
1-800-422-3525



FAX 513/461-3391

20% Restocking Fee on Non-Defective Returns

EDN TECHNICAL-ARTICLE DATABASE

3.33 pgs.

Modular emulator yields real-time data. *Pasternack, Irene, Applied Microsystems; EDN NEWS, 02/88, pg 14, 1.5 pgs.*

Industrial electronics

Industrial. *Staff; Electronics, 01/07/88, pg 86, 2 pgs.*

Instrument interface systems

Computer cards won't replace traditional instruments. *Staff; Electronic Design, 01/07/88, pg 132, 2 pgs.*

Interface turns Mac II into GPIB controller. *DeSantis, Tom, IOTech; EDN NEWS, 04/88, pg 29, 1 pg.*

Instrumentation amps

Instrumentation amps begin to challenge op amps. *Graeme, Jerald, Burr-Brown; Electronics, 04/28/88, pg 125, 4 pgs.*

Instrumentation/design aids & services/measurement, other

Personal computer-based instrument control: a tale of two buses. *Noulin, William C, Canik, Robert, National Instruments; ESD, 01/88, pg 30, 4.5 pgs.*

Quality will be the dominant force in future circuit designs. *Staff; Electronic Design, 01/07/88, pg 150, 2 pgs.*

Test & measurement. *Staff; Electronics, 01/07/88, pg 77, 3 pgs.*

Testing will become an integral part of the design process. *Staff; Electronic Design, 01/07/88, pg 134, 1 pg.*

Versatility is a necessity for tomorrow's test instruments. *Staff; Electronic Design, 01/07/88, pg 136, 1 pg.*

Integrated circuits/semiconductor devices/circuit design, other

Opportunity knocks for new optocouplers. *Jamison, Richard, et al, Hewlett-Packard; Electronic Products, 11/01/87, pg 57, 4 pgs.*

Programmable-delay ICs control system timing. *Hilton, Craven, Barrow, Jeff, Analog Devices; EDN, 02/18/88, pg 209, 7.5 pgs.*

RISCy business. *Harbert, Tammi, Senior Editor/News; EDN NEWS, 12/87, pg 1, 1.5 pgs.*

Semiconductors. *Staff; Electronics, 01/07/88, pg 92, 4 pgs.*

Token-bus-controller interface must resolve family disparities. *Polansky, Paul, Motorola; EDN, 03/17/88, pg 167, 9.5 pgs.*

Interconnection systems

Molded circuits require attention to new design techniques. *Williams, John, ICI Electronics; EDN, 01/21/88, pg 161, 5 pgs.*

New package technology supports soaring IC and system complexity—Decade 90 Part 4. *Leibson, Steven H, Regional Editor; EDN, 04/14/88, pg 141, 8 pgs.*

VLSI and VHSIC designs push improved backplane development. *Mayer, John H, Associate Editor; Computer Design, 01/01/88, pg 84, 5 pgs.*

L

Linear circuits

Analog ICs. *Goodenough, Frank, Senior Editor; Electronic Design, 02/18/88, pg 63, 5 pgs.*

Analog arrays will boast dedicated structures such as 12-bit ADCs. *Staff; Electronic Design, 01/07/88, pg 108, 1 pg.*

Analog's major move to new markets. *Currant, Lawrence, Managing Editor; Electronics, 12/17/87, pg 79, 2 pgs.*

Create linear ASIC macros without Spice nightmares. *Orgain, Cheryl, Analog Design Tools; Electronic Design, 12/10/87, pg 77, 3 pgs.*

Evolution, not revolution, marks most future linear IC advances. *Staff; Electronic Design, 01/07/88, pg 110, 1 pg.*

Linear semicustom shifts into high gear. *Collett, Ron, Senior Technical Editor; ESD, 12/87, pg 63, 4.5 pgs.*

These chips are breaking the linear bottleneck. *Currant, Lawrence, Managing Editor; Electronics, 12/17/87, pg 61, 4 pgs.*

To avoid compromise, consider insulation resistance. *Kirsop, Doug, Keithley Instruments; Electronic Design, 02/18/88, pg 125, 3.5 pgs.*

Video op amp, line-driver IC builds high-frequency circuits. *Salerno, Carmine, Wittlinger, Hal, GE/RCA Solid State; Electronic Design, 02/04/88, pg 107, 4 pgs.*

Local-area network architecture/design/design standards

An EtherStar is born. *Chiang, Al, Fujitsu Microelectronics; ESD, 03/88, pg 52, 4.5 pgs.*

Bitbus gains support for building low-cost serial links. *Andrews, Warren, Contributing Editor; Computer Design, 02/15/88, pg 23, 2.5 pgs.*

Custom logic helps clear LAN traffic bottlenecks. *Hammer, Claire, et al, Texas Instruments; Electronic Design, 01/21/88, pg 119, 4 pgs.*

Ethernet moves to twisted-pair for easier access. *Aseo, Joseph, West Coast Technical Editor; ESD, 03/88, pg 32, 1.5 pgs.*

FDDI and integrated packaging cast new light on future of fiberoptics. *Barron, Janet J, Associate Editor; Computer Design, 01/15/88, pg*

46, 5 pgs.

Fiber optics: a winning technology for LANs. *Southard, Robert K, AMP; Electronics, 02/04/88, pg 111, 4 pgs.*

Japanese beat the pack with optical MAP. *Cohen, Charles L, News Bureau—Tokyo; Iversen, Wesley R, Industrial & Consumer Editor; Electronics, 02/18/88, pg 32, 0.5 pgs.*

LAN chip makers grapple in a turbulent market. *Cole, Bernard C, Managing Editor; Electronics, 04/14/88, pg 87, 3 pgs.*

Networking unties OS development knot. *McCreary, Dan, ETA Systems; ESD, 02/88, pg 61, 4.5 pgs.*

System-level constraints dictate real network throughput. *Viallet, Fabian, Gespac; Computer Design, 01/15/88, pg 79, 4.5 pgs.*

The LAN war pits IBM's token ring vs. the world. *McLeod, Jonah, Managing Editor; Electronics, 04/14/88, pg 80, 2.5 pgs.*

Work-station vendors factor in connectivity. *Runyon, Stan, Managing Editor; Electronics, 04/14/88, pg 83, 2 pgs.*

Logic analyzers/analysis

Building big systems takes hardware logic analyzers. *Boyce, Doug, Tektronix; Electronics, 03/17/88, pg 131, 3.5 pgs.*

Consider logic analyzers for more than μ P applications. *Conner, Doug, Regional Editor; EDN, 12/24/87, pg 55, 9.5 pgs.*

Focus on logic analyzers. *Milne, Bob, Senior Editor; Electronic Design, 11/27/87, pg 101, 6 pgs.*

Proper glitch capture requires knowledge of logic-analyzer limits. *Schweitzer, Wolfgang, Kontron Messtechnik; EDN, 01/07/88, pg 157, 5 pgs.*

Logic arrays/systems

A programmable gate array: Can it be true. *Collett, Ronald E, Senior Technical Editor; ESD, 04/88, pg 28, 1 pg.*

A walk through a state-machine architecture. *Lytle, Craig, Kopec, Stan, Altera; ESD, 04/88, pg 45, 5 pgs.*

Architectural and process enhancements deliver faster, more flexible PLDs. *Andrews, Warren, Contributing Editor; Computer Design, 01/01/88, pg 31, 7 pgs.*

Clocking subsystems pace high-performance logic. *Shuhami, Jacob, Draper, Don, Intergraph Advanced Processor; Computer Design, 11/01/87, pg 95, 4.5 pgs.*

Everything you always wanted to know about designing a 100,000-gate ASIC. *Rau, Jerry, Daspit, Tom, LSI Logic; ESD, 02/88, pg 36, 4 pgs.*

Exclusive-OR inputs give you many uses for GaAs flip-flop. *Deierling, Carl, GigaBit Logic; Electronic Design, 12/10/87, pg 59, 4.5 pgs.*

Integrated PLDs support Multibus II bus arbitration. *Khu, Arthur, Advanced Micro Devices; EDN, 01/07/88, pg 165, 7 pgs.*

Mastering PLD test aspects eases PLD system testing. *Durwood, Brian H, Data I/O; O'Donnell, Gary, National Semiconductor; Electronic Design, 02/18/88, pg 103, 5 pgs.*

New gate array gets more density with antifuses. *Cole, Bernard C, Managing Editor; Electronics, 02/18/88, pg 75, 1 pg.*

PLD architectures vie for larger share of CPU support logic. *Wilson, Ron, Senior Editor; Computer Design, 11/01/87, pg 37, 4 pgs.*

PLD design system picks chips, partitions logic. *Collett, Ronald E, Senior Technical Editor; ESD, 02/88, pg 34, 1 pg.*

PLD testing: why, when and how. *Durwood, Brian H, Data I/O; Computer Design, 04/01/88, pg 71, 5 pgs.*

PLDs: On the road to state-machine design. *Collett, Ronald E, Senior Technical Editor; ESD, 04/88, pg 34, 6.5 pgs.*

Standard logic families will be cooler, faster, easier to use. *Staff; Electronic Design, 01/07/88, pg 120, 1 pg.*

Update: High-density PLDs. *Lewis, Sasha, Northwestern Editor; Electronic Products, 01/15/88, pg 14, 2 pgs.*

M

Mainframe computers

Cray's new Y-MP will face a more powerful rival-from Cray. *Iversen, Wesley R, Industrial & Consumer Editor; Electronics, 02/18/88, pg 31, 1.5 pgs.*

Graphics supercomputers tackle real-time visualization. *Williams, Tom, Western Managing Editor; Computer Design, 03/15/88, pg 21, 2.5 pgs.*

Japan focuses on simple but fast single-processor supercomputers. *Cohen, Charles L, News Bureau—Tokyo; Electronics, 03/03/88, pg 57, 2 pgs.*

New architectures give supercomputers power to mirror reality. *Bond, John, Contributing Editor; Computer Design, 03/15/88, pg 67, 11 pgs.*

Supercomputers: The proliferation begins. *Manuel, Tom, Managing Editor; Electronics, 03/03/88, pg 51, 6 pgs.*

Supercomputing gives workstations a shot. *Ohr, Stephan, Executive Editor; Till, Johna, Associate Editor; Electronic Design, 04/14/88, pg 39, 3 pgs.*

EDN TECHNICAL-ARTICLE DATABASE

Marketing/markets/pricing

Analog's major move to new markets. *Curran, Lawrence, Managing Editor; Electronics, 12/17/87, pg 79, 2 pgs.*
Communications. *Staff; Electronics, 01/07/88, pg 75, 2.5 pgs.*
Components. *Staff; Electronics, 01/07/88, pg 98, 3 pgs.*
Consumer. *Staff; Electronics, 01/07/88, pg 84, 2 pgs.*
Data processing. *Staff; Electronics, 01/07/88, pg 65, 4 pgs.*
France. *Staff; Electronics, 01/21/88, pg 74, 4 pgs.*
Industrial. *Staff; Electronics, 01/07/88, pg 86, 2 pgs.*
Italy. *Staff; Electronics, 01/21/88, pg 78, 3 pgs.*
Japan. *Staff; Electronics, 01/21/88, pg 61, 5 pgs.*
Military & government. *Staff; Electronics, 01/07/88, pg 88, 1.5 pgs.*
Overseas market report. *Staff; Electronics, 01/21/88, pg 59, 2 pgs.*
Pushing for continued growth in 1988. *Staff; Electronics, 01/07/88, pg 63, 2 pgs.*
Semiconductors. *Staff; Electronics, 01/07/88, pg 92, 4 pgs.*
Test & measurement. *Staff; Electronics, 01/07/88, pg 77, 3 pgs.*
United Kingdom. *Staff; Electronics, 01/21/88, pg 70, 4 pgs.*
West Germany. *Staff; Electronics, 01/21/88, pg 66, 4 pgs.*

Memory controllers

Cache tag RAM chips boost speed and simplify design. *Wyland, David C, Integrated Device Technology; Computer Design, 11/01/87, pg 85, 6 pgs.*

Memory devices

1M-bit video RAMs offer speed for high-resolution graphics displays. *Conner, Margery S, Regional Editor; EDN, 03/31/88, pg 79, 4.67 pgs.*
A new memory technology is about to hit the market. *Weber, Samuel, Executive Editor; Electronics, 02/18/88, pg 91, 3.5 pgs.*
BiCMOS SRAM tops ECL memories. *Hochstedler, Charles, National Semiconductor; Electronic Products, 03/01/88, pg 32, 5.5 pgs.*
Cache chips score 32-bit MMU hits. *Cormier, Denny, Senior Technical Editor; ESD, 03/88, pg 21, 2 pgs.*
Cache controllers flare memory bottleneck. *Bursky, Dave, Executive Editor; Leonard, Milt, Senior Editor; Electronic Design, 03/31/88, pg 25, 5 pgs.*
Cache tag RAM chips boost speed and simplify design. *Wyland, David C, Integrated Device Technology; Computer Design, 11/01/87, pg 85, 6 pgs.*
Cache-memory systems benefit from on-chip solutions. *Shear, David, Regional Editor; EDN, 12/10/87, pg 245, 10 pgs.*
Calculate the MTBF of EEPROMs with on-chip error correction. *Sweetman, David, Seeq Technology; Electronic Design, 02/04/88, pg 95, 2 pgs.*
EEPROMs compete for UV-EPROM sockets. *Lewis, Sasha, Northwestern Editor; Electronic Products, 12/01/87, pg 36, 4.5 pgs.*
EEPROMs move toward higher densities, speeds. *Harbert, Tammi, Senior Editor/News; EDN NEWS, 02/88, pg 8, 2 pgs.*
Five blazing fast CMOS SRAMs are coming. *Cole, Bernard C, Managing Editor; Electronics, 02/18/88, pg 69, 1.5 pgs.*
Flash EEPROM approaches EPROM density. *Rauh, Gary, Villott, Mike, Seeq Technology; EDN NEWS, 04/88, pg 36, 1 pg.*
Handle the ninth parity bit efficiently with 8-bit EEPROMs. *Barry, Joe, CTS Fabri-Tek; Electronic Design, 02/04/88, pg 89, 3 pgs.*
High-density flash EEPROMs are about to burst on the memory market. *Lineback, J Robert, Managing Editor; Electronics, 03/03/88, pg 47, 1.5 pgs.*
Intel close to production with a 4-MBIT EPROM. *Cole, Bernard C, Managing Editor; Electronics, 02/18/88, pg 72, 1 pg.*
Memories gain in smarts, density, and speed as feature sizes shrink. *Staff; Electronic Design, 01/07/88, pg 126, 1 pg.*
Memory ICs. *Bursky, Dave, Executive Editor; Electronic Design, 02/18/88, pg 71, 7.5 pgs.*
New challenger: the ferroelectric ram. *Iversen, Wesley R, Industrial & Consumer Editor; Electronics, 02/04/88, pg 32, 0.5 pgs.*
RAM and ROM find a home on semicustom ICs. *Steinle, Adrienne L, NCR Microelectronics; Electronic Products, 12/01/87, pg 43, 3 pgs.*
Specialty DRAMs accelerate video system performance. *Cormier, Denny, Senior Technical Editor; ESD, 04/88, pg 22, 1 pg.*
System architecture dominates design of no-wait-state cache. *Flynn, James K, Mera, Narciso, AT&T Microelectronics; EDN, 03/17/88, pg 155, 6 pgs.*
The flag's up for the 4-Mbit DRAM derby. *Chester, Michael, Southwestern Editor; Electronic Products, 01/01/88, pg 15, 1.5 pgs.*
The next wave: 16-MBIT drams from Japan. *Cole, Bernard C, Managing Editor; Electronics, 02/18/88, pg 68, 1.5 pgs.*
These ECL-compatible SRAMs combine bipolar and CMOS. *Cole, Bernard C, Managing Editor; Electronics, 02/18/88, pg 71, 1 pg.*
Wide electrical PROMs stride into 1-bit terrain. *Leonard, Milt, Senior Editor; Electronic Design, 12/10/87, pg 29, 3 pgs.*

Microcomputer buses/interfaces

BiCMOS gate arrays promise new wave of bus-driving solutions. *Andrews, Warren, Contributing Editor; Computer Design, 03/01/88,*

pg 19, 3 pgs.

Bitbus gains support for building low-cost serial links. *Andrews, Warren, Contributing Editor; Computer Design, 02/15/88, pg 23, 2.5 pgs.*
Buscon spotlights ASICs, standards and partnerships. *Lieberman, David, Senior Editor; Computer Design, 04/01/88, pg 21, 4 pgs.*
DSP chip speeds VME transfer. *Cooper, John, Ironics; ESD, 03/88, pg 47, 3 pgs.*
Expansion buses give systems room to grow. *Lieberman, Dave, Senior Editor; Computer Design, 03/15/88, pg 52, 6 pgs.*
IPI-3 subsystems meet future data storage needs. *Coulter, Bob, Intellistor; Computer Design, 01/15/88, pg 87, 4 pgs.*
Metastable-free arbitrator coordinates processors. *Siddique, Naseer, Dike, Charles, Signetics; Electronic Design, 04/14/88, pg 107, 5 pgs.*
One-chip VMEbus interface builds compact graphics board. *Willy, John, Rivoire III, Charles, SBE; Electronic Design, 03/17/88, pg 97, 4 pgs.*
Personal computer-based instrument control: a tale of two buses. *Nowlin, William C, Canik, Robert, National Instruments; ESD, 01/88, pg 30, 4.5 pgs.*
Pooling the resources of different computing systems. *Vukovic, Philip M, Larsen, Larry L, Bit 3 Computer; Electronic Products, 12/15/87, pg 37, 4 pgs.*
SCSI rivalry heats up as new controller chips vie. *McLeod, Jonah, Managing Editor; Electronics, 03/31/88, pg 79, 1 pg.*
STE Bus: ready to break into U.S. market. *Mayer, John, Senior Associate Editor; Computer Design, 03/15/88, pg 27, 1.5 pgs.*
STE Bus vies for share of US STD Bus domain. *Harold, Peter, European Editor; EDN NEWS, 04/88, pg 1, 1 pg.*
Serial link increases microcomputer analog output. *Artusi, Daniel, Motorola; Electronic Design, 03/03/88, pg 105, 3 pgs.*
Serial techniques expand your options for μ C peripherals. *Naufel, Naji, Motorola; EDN, 02/18/88, pg 199, 6 pgs.*
Simple circuitry connects plug-in cards to NuBus. *Harvey, Audrey, National Instruments; Electronic Design, 02/18/88, pg 97, 4 pgs.*
To boost bus bandwidth, match processor and memory timing. *Miller, Lloyd, Harris Semiconductor; Electronic Design, 03/31/88, pg 107, 4.5 pgs.*
VMEbus and Multibus II mature for multiprocessing applications. *Lieberman, David, Senior Editor; Computer Design, 11/01/87, pg 25, 7 pgs.*
What's holding up the PS/2 clones. *Manuel, Tom, Managing Editor; Electronics, 04/14/88, pg 32, 1 pg.*

Microcomputers

Computer performance still climbing at unrelenting pace. *Lieberman, David, Senior Editor; Computer Design, 12/87, pg 37, 8 pgs.*
For cost/performance, partition RISC system on bus parameters. *Cates, Ron, VLSI Technology; Electronic Design, 11/12/87, pg 121, 6 pgs.*
Languages coupled with fast processors for high throughput. *Aseo, Joseph, West Coast Technical Editor; ESD, 02/88, pg 26, 1 pg.*
Macintosh II: a new breed of PC for the engineer. *Wolfe, Ron, National Instruments; Electronic Products, 02/15/88, pg 22, 5.5 pgs.*
Macintosh II: expansion boards begin to emerge. *Yates, Warren, Associate Editor; Electronic Products, 02/15/88, pg 30, 4 pgs.*
Mainframe performance on a chip will challenge large machines. *Staff; Electronic Design, 01/07/88, pg 128, 1 pg.*

Microprocessor buses

Designers seek new approaches to open I/O bottlenecks. *Wilson, Ron, Senior Editor; Computer Design, 01/15/88, pg 57, 12.5 pgs.*
Onboard kernels for VME Bus boards. *Travis, Bill, Contributing Writer; EDN NEWS, 12/87, pg 1, 1 pg.*
VME source list points the way. *Staff; Electronic Products, 03/15/88, pg 38, 5 pgs.*

Microprocessor support chips

CPU-equipped peripheral chips force partitioning decisions. *Wilson, Ron, Senior Editor; Computer Design, 11/15/87, pg 22, 2.5 pgs.*
Chip sets for PC/AT compatibles support faster μ Ps and shrink board size. *Conner, Margery S, Regional Editor; EDN, 11/12/87, pg 79, 4 pgs.*
Database accelerator targets micro channel bus. *Kamath, Govind, Advanced Micro Devices; ESD, 02/88, pg 71, 4.5 pgs.*
Designers seek new approaches to open I/O bottlenecks. *Wilson, Ron, Senior Editor; Computer Design, 01/15/88, pg 57, 12.5 pgs.*
More chips join VME barrage. *Wilson, Dave, Editor; ESD, 03/88, pg 24, 1 pg.*
Newest floating-point processors blur architectural distinctions. *Wilson, Ron, Senior Editor; Computer Design, 04/15/88, pg 32, 6 pgs.*
PS/2-compatible chips make clone building a snap. *Cormier, Denny, Senior Technical Editor; ESD, 02/88, pg 28, 1 pg.*
Token-bus-controller interface must resolve family disparities. *Polansky, Paul, Motorola; EDN, 03/17/88, pg 167, 9.5 pgs.*
What's holding up the PS/2 clones. *Manuel, Tom, Managing Editor; Electronics, 04/14/88, pg 32, 1 pg.*

Because you're thinking fast...

you need responsive suppliers as well as fast parts. Comlinear is tuned in. With high quality, high-speed products. Assistance from R&D-level applications engineers to help develop your ideas quicker. Sales and distribution that get you what you need fast. Quality product documentation with guaranteed specs so you don't waste time. In your business, time is everything. Count on us for the speed you need.

What could you do with a 12ns settling op amp that has instantaneous output clamping and 1ns overload recovery?

Plenty.

With clamping performance like this—plus an 80MHz bandwidth and 12ns settling time to 0.05%—the new CLC501 Clamping Op Amp is the residue amplifier you've been searching for in subranging A/D applications.

Its 1ns overload recovery makes it the op amp you've wanted for resolving small signals ordinarily lost following large, saturating signals in radar, optical communications, and line testing applications.

User-settable output clamping means it's the only high-speed op amp that gives you a simple yet flexible solution for protecting downstream circuits.

And its 50MHz clamping input bandwidth opens up new design possibilities. Such as modulating a square wave to produce pulse amplitude modulation. When there's a new concept in op amps, there's no telling where the applications end.

Call today for details on the op amp designed to tickle your imagination.

CIRCLE NO 95

 **Comlinear Corporation**
Solutions with speed

4800 Wheaton Drive
Fort Collins, Colorado 80525
(303) 226-0500

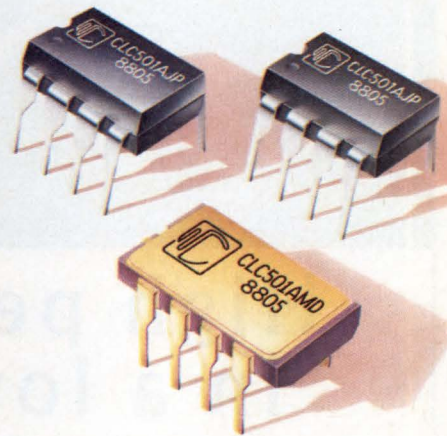

Our new name is
Ericsson Components AB

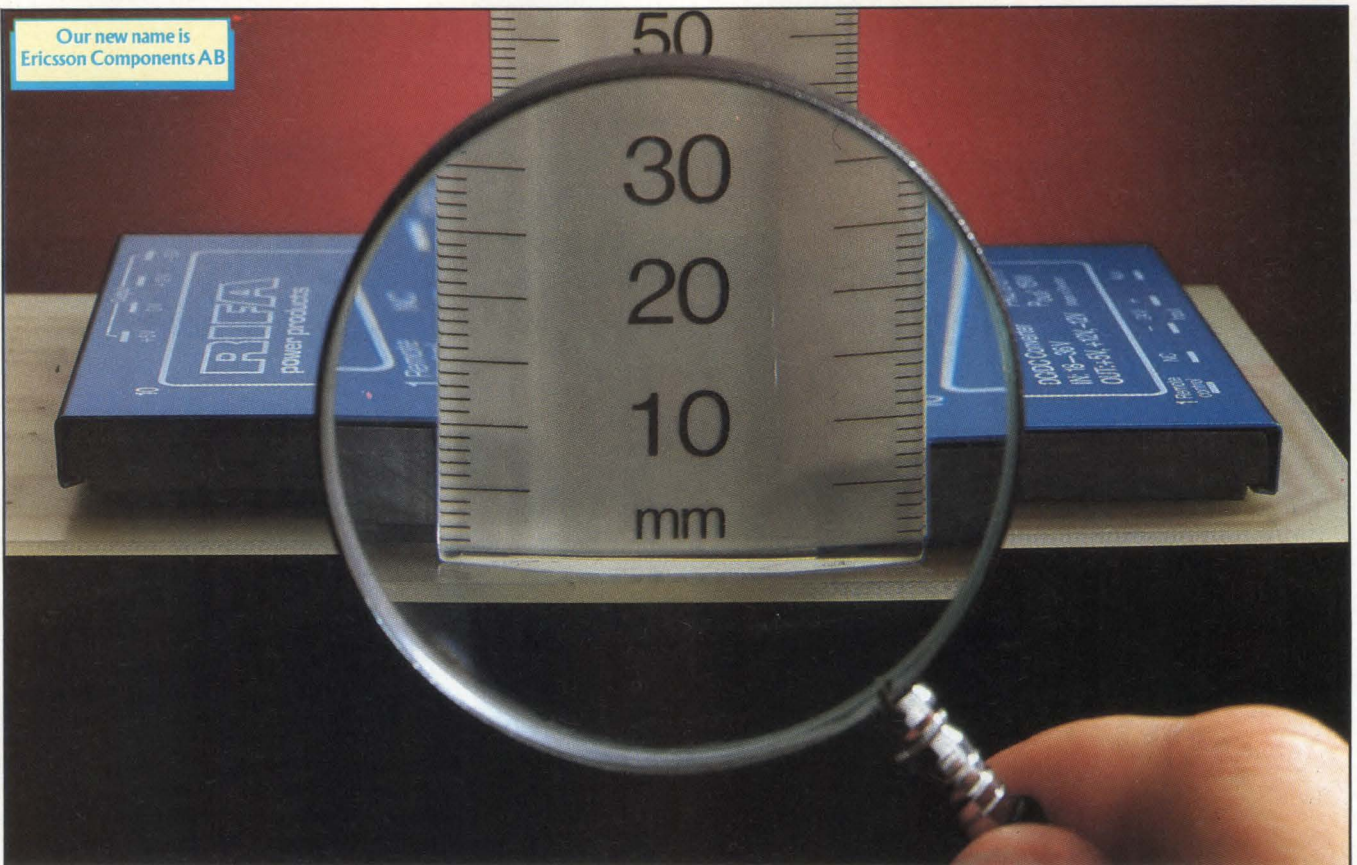

High performance power, in a low profile package

Ericsson's new triple output, 15 Watt DC/DC converter is only 8.5mm high with In-Card™ mounting!

When you need high performance and a low profile in a DC/DC converter, Ericsson's new 15W PKC series has the answer.

The PKC's advanced mechanical design offers two mounting options. Using conventional "On-Card" pcb mounting results in a height of 0.42" (10.7mm).

Where profile is critical our In-Card™ mounting provides the unique capability of recessing the supply into the pcb providing a height of 0.33" (8.5mm)!

Allowing inputs of 24V (18-36V) and 48V (36-72V) the PKC series provides 5, 12 and 15V dc outputs in single, dual and triple output configurations. A high reliability magnetic feed back loop ensures that all outputs are regulated to within 2.5%. Each model is fully isolated to 500V dc and all outputs are overvoltage protected.

Advanced technology, including the use of highly automated surface mount manufacturing and 300kHz switching frequency results in the PKC's exceptional MTBF of over 200 years.

SMD components are assembled onto a thick film ceramic substrate to give excellent thermal characteristics. As a result, efficiency is 85% and the unit operates without derating over the temperature range of -45°C to +85°C!



The PKC takes up no more pcb space than a credit card.

No extra components, filters or heatsinks are required to meet VDE, FCC or CISPR regulations with respect to RFI specifications or high temperature environments.

Paralleling units for higher output requirements or redundancy configurations is easily accomplished by a simple connection.

To find out more about the world's most advanced 15W DC/DC converter, contact Ericsson today.

ERICSSON 

Choose from On-Card or In-Card™ mounting.

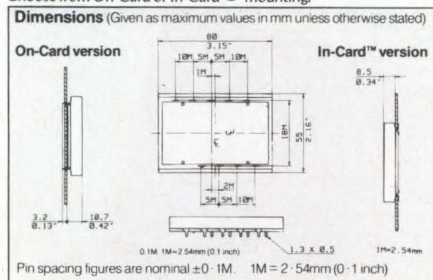

RIFA Inc.
PO Box 853904, RICHARDSON,
TEXAS 75085-3904 USA
Tel: 214 480-8300 Fax: 214 680-1059
Telex: 735389 ERICS RCHN

Ericsson Components AB
Power Products, S-16481 KISTA-STOCKHOLM,
SWEDEN
Tel: +46 8 757 5000 Fax: +46 8 757 48 84
Telex: 109 48 POWER I S

EDN TECHNICAL-ARTICLE DATABASE

Microprocessors

- 16-bit microcontrollers tune-up for real-time embedded control tasks. *Leonard, Milt, Senior Editor; Electronic Design, 03/88, pg 13, 7 pgs.*
- 32-bit micros: From RISC to TRON. *Myrvaagnes, Rodney, Associate Editor; Electronic Products, 04/01/88, pg 47, 3.5 pgs.*
- 8-bit microcontrollers specialize for embedded control applications. *Bond, John, Contributing Editor; Computer Design, 11/15/87, pg 26, 6 pgs.*
- Choosing a RISC chip: What drives customers. *McLeod, Jonah, Managing Editor; Electronics, 04/28/88, pg 85, 2 pgs.*
- Choosing a microprocessor: Designers take many paths to the best solution. *Wilson, Ron, Senior Editor; Computer Design, 02/15/88, pg 59, 11 pgs.*
- Designers' buying guide. *Staff; Computer Design, 02/15/88, pg 77, 39 pgs.*
- Designers seek new approaches to open I/O bottlenecks. *Wilson, Ron, Senior Editor; Computer Design, 01/15/88, pg 57, 12.5 pgs.*
- EDN's 14th annual μ P/ μ C chip directory. *Cushman, Robert H, Special Features Editor; EDN, 11/26/87, pg 101, 44 pgs.*
- Enhanced microcontroller chips. *Gallant, John, Associate Editor; EDN, 01/21/88, pg 113, 8.5 pgs.*
- First tron microprocessor gets Japan into the 32-bit fray. *Lineback, J R, Managing Editor; Electronics, 01/21/88, pg 31, 1 pg.*
- Improve converter resolution with μ P tracking techniques. *Carlson, Brian, Hootman, Joe, University of North Dakota; Electronic Design, 02/04/88, pg 97, 4.5 pgs.*
- Intergraph will hawk Clipper to all comers. *Curran, Lawrence, Managing Editor; Electronics, 11/12/87, pg 88, 2.5 pgs.*
- MIPS gathers backers for RISC. *Lewis, Sasha, Northwestern Editor; Electronic Products, 01/01/88, pg 19, 1.5 pgs.*
- Microcontrollers learn arithmetic. *Myrvaagnes, Rodney, Associate Editor; Electronic Products, 01/01/88, pg 34, 5 pgs.*
- Motorola confirms RISC effort as pressure on 68000 builds. *Lineback, J R, News Bureau—Dallas; Electronics, 12/17/87, pg 31, 1 pg.*
- Motorola's bombshell—a RISC chip this spring. *Runyon, Stan, Special Projects Editor; Electronics, 02/18/88, pg 83, 2 pgs.*
- Processor's on-chip EEPROM helps control motors. *Hassan, Zaheer, Sierra Semiconductor; Electronic Design, 11/12/87, pg 133, 3 pgs.*
- RISC processor enters the race of real-time computing. *Wilson, Ron, Senior Editor; Computer Design, 12/87, pg 23, 1.5 pgs.*
- RISC slugfest: Is marketing more important than performance. *Cole, Bernard C, Managing Editor; Electronics, 04/28/88, pg 63, 6 pgs.*
- RISCy business. *Harbert, Tammi, Senior Editor/News; EDN NEWS, 12/87, pg 1, 1.5 pgs.*
- Rebuild a military processor to test itself for faults. *Karakotsios, Ken, Silicon Compiler Systems; Marcks, Jeff, General Dynamics; Electronic Design, 01/21/88, pg 87, 4.5 pgs.*
- Rockwell's design used for 8-bit GaAs processor. *Waller, Larry, News Bureau—Los Angeles; Electronics, 02/18/88, pg 74, 1 pg.*
- Single-chip μ Cs solve problems in pattern generation. *Ghormley, Chris, ITT Federal Electric; EDN, 03/03/88, pg 139, 5 pgs.*
- The embedded processor breaks out of its niche. *Cole, Bernard C, Managing Editor; Electronics, 03/17/88, pg 61, 3 pgs.*

Military electronics

- Battlefield 2000: electromagnetic guns and fiber-optic guided robots. *Staff; Electronic Design, 01/07/88, pg 146, 2 pgs.*
- Distributed control and localized processing power will shape avionics. *Staff; Electronic Design, 01/07/88, pg 148, 2 pgs.*
- Military & government. *Staff; Electronics, 01/07/88, pg 88, 1.5 pgs.*
- Military ATE: capability up, tester inventory down. *Novellino, John, Associate Editor; Electronic Design, 01/21/88, pg 68, 8 pgs.*
- Military and commercial applications demand tailored high-reliability ICs. *Martin, Steven L, Contributing Editor; Computer Design, 01/15/88, pg 37, 5 pgs.*
- Reaching for the stars. *Wilson, Dave, Editor; ESD, 01/88, pg 22, 1 pg.*
- Rebuild a military processor to test itself for faults. *Karakotsios, Ken, Silicon Compiler Systems; Marcks, Jeff, General Dynamics; Electronic Design, 01/21/88, pg 87, 4.5 pgs.*
- Selling to the military: Is it about to get easier. *Naegle, Tobias, Military/Aerospace Editor; Electronics, 03/31/88, pg 83, 3 pgs.*

Minicomputers

- Computer performance still climbing at unrelenting pace. *Lieberman, David, Senior Editor; Computer Design, 12/87, pg 37, 8 pgs.*
- For cost/performance, partition RISC system on bus parameters. *Cates, Ron, VLSI Technology; Electronic Design, 11/12/87, pg 121, 6 pgs.*
- Minisupercomputers to take over superminicomputer domain. *Staff; Electronic Design, 01/07/88, pg 80, 1 pg.*

Modems

- Dial-up modem chip sets get smaller, faster. *Chester, Michael, Southwestern Editor; Electronic Products, 01/15/88, pg 22, 6 pgs.*
- Single-IC modems. *Gallant, John, Associate Editor; EDN, 04/14/88, pg 119, 12 pgs.*
- Software changes smart modem to smart scope. *Alunkal, John, Codex; Holley, Paul, Holley; Electronic Design, 12/10/87, pg 99, 4.5 pgs.*

Motor control circuits

- Monolithic stepper-motor drivers achieve higher power levels and greater versatility. *Harold, Peter, European Editor; EDN, 01/21/88, pg 69, 8 pgs.*
- Motor modeling simplifies design of control systems. *de Sa e Silva, Claudio, Unitrode; EDN, 03/31/88, pg 169, 5 pgs.*
- Motor-control ICs extend performance levels of stepper and brushless dc motors. *Pryce, Dave, Associate Editor; EDN, 11/26/87, pg 61, 6 pgs.*
- Motor-control semiconductors drive motor revolution. *Goodenough, Frank, Senior Editor; Electronic Design, 04/14/88, pg 78, 11 pgs.*

Motors/motor controllers

- Monolithic stepper-motor drivers achieve higher power levels and greater versatility. *Harold, Peter, European Editor; EDN, 01/21/88, pg 69, 8 pgs.*
- Motor modeling simplifies design of control systems. *de Sa e Silva, Claudio, Unitrode; EDN, 03/31/88, pg 169, 5 pgs.*
- Motor-control semiconductors drive motor revolution. *Goodenough, Frank, Senior Editor; Electronic Design, 04/14/88, pg 78, 11 pgs.*

Multiprocessing

- VMEbus and Multibus II mature for multiprocessing applications. *Lieberman, David, Senior Editor; Computer Design, 11/01/87, pg 25, 7 pgs.*

Multiuser computer systems

- Computer performance still climbing at unrelenting pace. *Lieberman, David, Senior Editor; Computer Design, 12/87, pg 37, 8 pgs.*
- System-level strategy attacks key multiuser bottlenecks. *Seery, Jim, et al, AT&T; Computer Design, 01/01/88, pg 77, 6 pgs.*

N

Network analyzers/analysis

- Equivalent circuits model subtle traits of advanced CMOS ICs. *Dike, Charles, Signetics; EDN, 04/14/88, pg 189, 9 pgs.*

Network architecture/design/design standards (nonlocal)

- Computers are on the verge of the open-systems era. *Manuel, Tom, Managing Editor; Gosch, John, News Bureau—Frankfort; Electronics, 04/14/88, pg 68, 2 pgs.*
- From systems to standards, the pace quickens in networking. *Runyon, Stan, Managing Editor; Electronics, 04/14/88, pg 67, 1.5 pgs.*
- Networked systems change the way of software creation. *Staff; Electronic Design, 01/07/88, pg 92, 2 pgs.*
- The race to interconnect computer networks is on. *Curran, Lawrence, Managing Editor; Electronics, 04/14/88, pg 70, 3 pgs.*
- Wide-area nets explode as standards emerge. *Shandle, Jack, New Products Editor; Electronics, 04/14/88, pg 75, 3 pgs.*

Networking ICs

- LAN chip makers grapple in a turbulent market. *Cole, Bernard C, Managing Editor; Electronics, 04/14/88, pg 87, 3 pgs.*
- MAPcon takes on factory network configuration. *Iversen, Wesley R, Industrial & Consumer Editor; Electronics, 04/14/88, pg 95, 2 pgs.*
- Mainframe network chips ease big interfacing blues. *Cormier, Denny, Senior Technical Editor; ESD, 01/88, pg 17, 2 pgs.*

O

Office automation

- Office automation strives to juggle competing demands. *Lieberman, David, Senior Editor; Computer Design, 11/15/87, pg 69, 9 pgs.*

Op amps

- Micropower op amp offers simplicity and versatility. *Rahim, Zahid, Signetics; EDN, 01/07/88, pg 181, 7 pgs.*
- Monolithic op amp sets sights on video applications. *Mathews, Brian D, Bye, Daniel L, Harris; Electronic Products, 04/15/88, pg 34, 4.5 pgs.*
- Op amps extend their limits. *Spadaro, Joseph J, Associate Editor; Electronic Products, 01/01/88, pg 27, 3.5 pgs.*
- Simple techniques help you conquer op-amp instability. *Siegel, Barry L, Elantec; EDN, 03/31/88, pg 181, 8 pgs.*
- Transimpedance amps: fast yet accurate. *Palmer, Wyn, Analog Devices; Electronics, 01/07/88, pg 151, 4 pgs.*
- Use op amps to design optical position-sensing circuitry. *Graeme, Jerald, Burr-Brown; EDN, 11/26/87, pg 229, 7.5 pgs.*

Optical storage

- Erasable optical disks move out of labs. *Aseo, Joseph, West Coast Techni-*

EDN TECHNICAL-ARTICLE DATABASE

cal Editor; *ESD*, 04/88, pg 26, 1 pg.
It's showdown time in interactive video. *Manuel, Tom, Managing Editor; Electronics*, 11/26/87, pg 92, 3 pgs.
Peripherals and memory systems chase computer price/performance. *Williams, Tom, Western Managing Editor; Computer Design*, 12/87, pg 57, 8.5 pgs.

Optoelectronics

Advances in speed and voltage ratings enhance applications for optocouplers. *Pryce, Dave, Associate Editor; EDN*, 04/28/88, pg 75, 5 pgs.
Fiber optics: a winning technology for LANs. *Southard, Robert K, AMP; Electronics*, 02/04/88, pg 111, 4 pgs.
Fiber-optic photoelectric sensors gain in performance, popularity. *Chin, Spencer, Associate Editor; Electronic Products*, 04/01/88, pg 28, 2.5 pgs.
Fiber-optic sensor systems move to new markets. *Coco, Donna, Staff Editor; EDN NEWS*, 01/88, pg 10, 2 pgs.
Fiber-optic transmitters and receivers enhance data-link performance. *Ormond, Tom, Senior Editor; EDN*, 03/31/88, pg 57, 5 pgs.
In search of surface-mount optocouplers. *Coco, Donna, Staff Editor; EDN NEWS*, 04/88, pg 3, 1 pg.

Oscillators

Make programmable sine oscillator from quad DAC chip. *Wong, James, Precision Monolithics; Electronic Design*, 02/04/88, pg 103, 3.5 pgs.

Oscilloscopes

PC-based scopes encroach on stand-alone devices' turf. *Harbert, Tammi, Senior Editor/News; EDN NEWS*, 03/88, pg 12, 1 pg.
Productivity enhancements drive 100-MHz analog scope designs. *Mayer, John H, Associate Editor; Computer Design*, 01/15/88, pg 94, 4 pgs.
Special Report: Digital scopes are set to challenge analog units. *Riezenman, Mike, Contributing Editor; Electronics*, 03/17/88, pg 107, 6 pgs.

P

Parallel processing

Parallel processors deal with cost, programming trade-offs. *Wilson, Ron, Senior Editor; Computer Design*, 11/15/87, pg 20, 2 pgs.
Plug-in boards let your personal computer perform parallel-processing tasks. *Mosley, J D, Regional Editor; EDN*, 02/04/88, pg 89, 5 pgs.
Software will level the road for parallel processing. *Staff; Electronic Design*, 01/07/88, pg 100, 1 pg.

Parametric/functional testing

Dynamic testing describes behavior of high-frequency ADCs. *Blom, Eric D, Sipex; EDN*, 04/14/88, pg 215, 8 pgs.

Personal computers

Cloning IBM's PS/2 is just the beginning. *Runyon, Stan, Special Projects; Electronics*, 02/04/88, pg 34, 0.5 pgs.
PC-based scopes encroach on stand-alone devices' turf. *Harbert, Tammi, Senior Editor/News; EDN NEWS*, 03/88, pg 12, 1 pg.
Plug-in boards let your personal computer perform parallel-processing tasks. *Mosley, J D, Regional Editor; EDN*, 02/04/88, pg 89, 5 pgs.

Plotters

Multipen plotters keep pace with CAD advancements. *Mayer, John H, Senior Associate Editor; Computer Design*, 03/15/88, pg 100, 4.5 pgs.

Power converters

DC/DC converters adapt to the needs of low-power circuits. *Sherman, Len, Maxim Integrated Products; EDN*, 01/07/88, pg 145, 7 pgs.
Growing array of 1-chip dc/dc converters provides power for diverse applications. *Pryce, Dave, Associate Editor; EDN*, 02/18/88, pg 73, 5 pgs.
Mini dc/dc supplies simplify redundancy in parallel systems. *Thorsell, Lars, Rifa Power Products; EDN*, 04/28/88, pg 225, 6.5 pgs.
New dc/dc converters meet system design needs. *Mayer, John H, Associate Editor; Computer Design*, 11/01/87, pg 104, 5.5 pgs.
System designer's guide to modular dc/dc converters. *Hartman, William D, Computer Products/Stevens-Arnold; Electronic Products*, 03/01/88, pg 41, 4.5 pgs.
The shrinking dc/dc converter. *Yates, Warren, Associate Editor; Electronic Products*, 11/15/87, pg 39, 3.5 pgs.

Power semiconductors

Power ICs will adapt operation to changing real-world conditions. *Staff; Electronic Design*, 01/07/88, pg 112, 1 pg.
Power MOS transistors span wide current and voltage range. *Goed-nough, Frank, Senior Editor; Electronic Design*, 03/88, pg 35, 3 pgs.
Power MOSFET makes low-cost, low-dropout voltage regulator. *Hughes, Richard S, U.S. Naval Weapons Center; Electronic Design*, 01/21/88, pg 115, 2 pgs.
Smart power: Changing the face of power control. *Fury, Art, Power Integrations; Electronics*, 04/28/88, pg 135, 4 pgs.

Smart power goes off-the-shelf. *Waller, Larry, News Bureau—Los Angeles; Electronics*, 12/17/87, pg 33, 0.5 pgs.
Smart-power ICs. *Pryce, Dave, Associate Editor; EDN*, 03/31/88, pg 113, 12 pgs.

Power supplies

Beware the low power factor of switch-mode power supplies. *Hansen, Arthur G, Electronic Products*, 03/01/88, pg 47, 3 pgs.
Converter makers meet reliability challenge. *Miller, George D, Editor; EDN NEWS*, 03/88, pg 22, 1.5 pgs.
External power supplies fit many applications. *Newhouse, John, Ault; Electronic Products*, 03/01/88, pg 58, 2.5 pgs.
Focus on laboratory power supplies. *Maliniak, David, Senior New Products Editor; Electronic Design*, 01/21/88, pg 131, 7.5 pgs.
For battery-backed supplies use low-drop regulators. *Antoniazzi, Paolo, Wolfsgruber, Arturo, SGS Microelectronics SpA; Electronic Design*, 11/27/87, pg 97, 3 pgs.
Galvanically isolated switching supplies provide high power—Part 2. *Williams, Jim, Linear Technology; EDN*, 11/26/87, pg 191, 8 pgs.
Linear regulated supplies live on. *Yates, Warren, Associate Editor; Electronic Products*, 03/01/88, pg 51, 3 pgs.
Power MOSFET makes low-cost, low-dropout voltage regulator. *Hughes, Richard S, U.S. Naval Weapons Center; Electronic Design*, 01/21/88, pg 115, 2 pgs.
Powering VMEbus systems. *Yates, Warren, Associate Editor; Electronic Products*, 01/15/88, pg 29, 4 pgs.
Regulator IC speeds design of switching power supplies—Part 1. *Williams, Jim, Linear Technology; EDN*, 11/12/87, pg 193, 7 pgs.
Special Report: Less is more with the latest switching supplies. *Heftman, Gene, Contributing Editor; Electronics*, 04/28/88, pg 113, 5 pgs.
Switcher power densities change filter-capacitor needs. *Maxwell, John, AVX; EDN*, 11/12/87, pg 257, 3 pgs.
Switching power supplies move into low-power applications. *Mayer, John H, Senior Associate Editor; Computer Design*, 04/01/88, pg 78, 4 pgs.
Switching supplies: changing with the times. *Bassett, John, Computer Products; Electronics*, 01/07/88, pg 145, 4 pgs.

Printed circuits

Improved autorouting makes old algorithm do new tricks. *Mazzullo, Tony, ECAD; Electronic Design*, 04/28/88, pg 83, 3.5 pgs.
Materials and hardware. *Ormond, Tom, Senior Editor; EDN*, 02/18/88, pg 149, 11 pgs.
Molded circuits require attention to new design techniques. *Williams, John, ICI Electronics; EDN*, 01/21/88, pg 161, 5 pgs.
PC boards hot-wired for faster, more flexible service. *Biancomano, Vincent, Components/Packaging Editor; Electronic Design*, 02/18/88, pg 29, 4.5 pgs.
Routing your way through pc-board design tools. *Milne, Bob, Senior Editor; Electronic Design*, 04/28/88, pg 58, 10.5 pgs.
Simulation puts zip into circuit board design. *Spadaro, Joseph J, Associate Editor; Electronic Products*, 04/01/88, pg 34, 8 pgs.
Surface-mounted parts make a pass at both sides. *Biancomano, Vincent, Technology Editor; Electronic Design*, 01/07/88, pg 33, 3 pgs.

Printed-circuit processing

Materials and hardware. *Ormond, Tom, Senior Editor; EDN*, 02/18/88, pg 149, 11 pgs.
SMT changes test fixturing. *Harbert, Tammi, Senior Editor/News; EDN NEWS*, 12/87, pg 24, 1.5 pgs.

Printers

Focus on ink-jet printers: Lower prices and better printheads perk them up. *Grossman, Morris, Senior Editor; Electronic Design*, 04/14/88, pg 145, 6 pgs.
Hard-copy output moving to 3D, personal, low-cost color images. *Staff; Electronic Design*, 01/07/88, pg 88, 1 pg.
Microcapsule approach spurs filmless imaging. *Wilson, Andrew, Executive Editor; ESD*, 02/88, pg 30, 1 pg.
Printers show their colors as performance and reliability improve. *Bond, John, Contributing Editor; Computer Design*, 01/01/88, pg 43, 6 pgs.
Raster printers profit from available technologies to suit diverse uses. *Wright, Maury, Regional Editor; EDN*, 01/07/88, pg 87, 5.33 pgs.

Process control

Advanced ICs portend radical changes in system design—Decade 90 Part 1. *Leibson, Steven H, Regional Editor; EDN*, 03/03/88, pg 115, 5.5 pgs.

Processors, special-purpose (array, front-end, etc)

DSP card fits IBM PC. *Bridges, Jim, Communications Automation & Control; EDN NEWS*, 03/88, pg 1, 1 pg.

Production testing techniques

Fault-tolerant design spans terrestrial and space applications—Decade 90 Part 5. *Leibson, Steven H, Regional Editor; EDN*, 04/28/88, pg 181, 7 pgs.

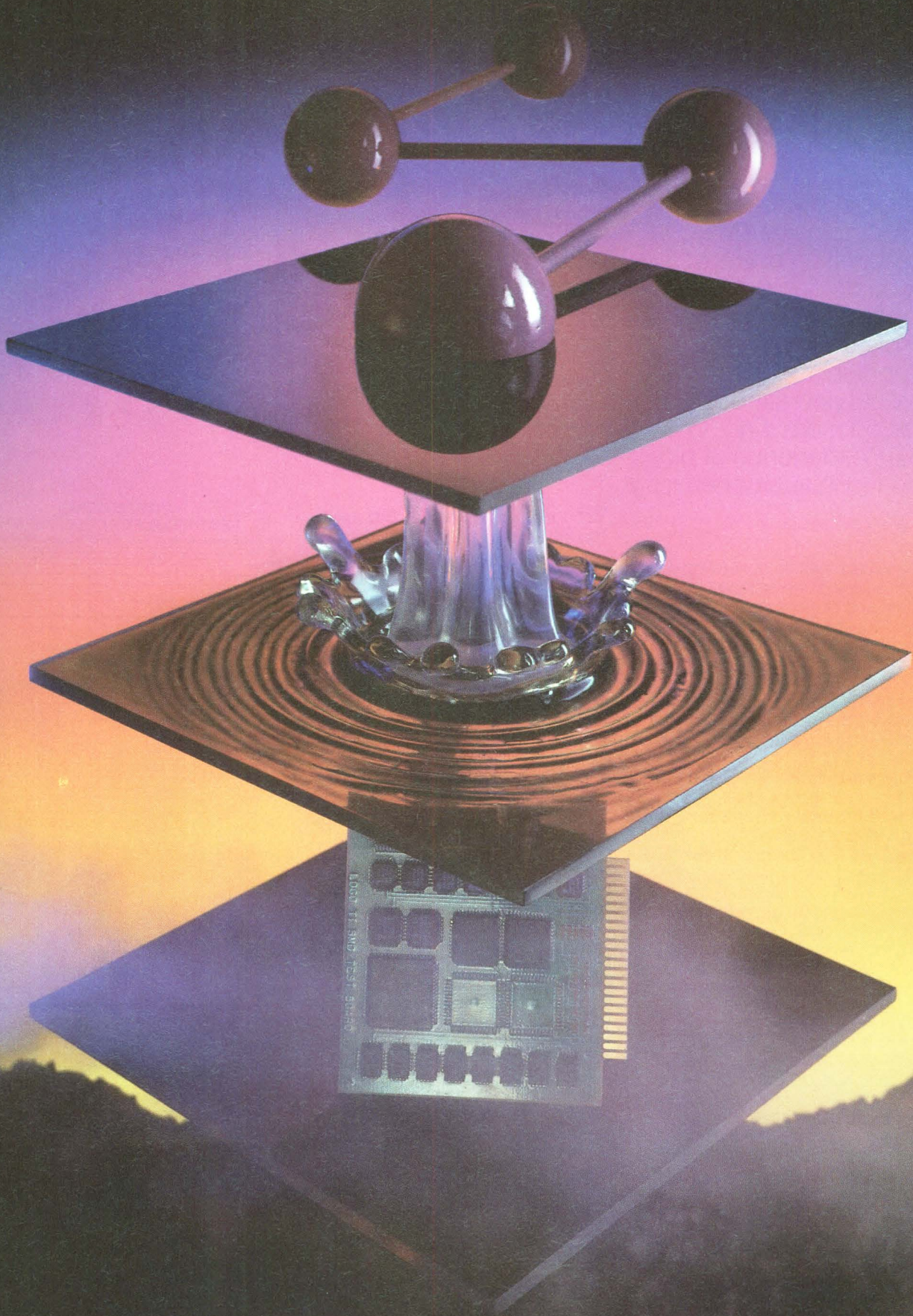

**Discover
Fluoronics Resources**

Fluorinert™ Liquids—products that power Fluoronics Resources.

*Fluoronics Resources:

An exclusive 3M combination of innovative products backed by research and development, manufacturing expertise, technical data and service assistance built on more than 35 years' experience of pioneering in fluorochemistry.



3M has had a whole generation of experience in the development, manufacture and refinement of perfluorinated liquids. We first introduced these versatile liquids to electronics design, testing and production professionals in the fifties. Since then, Fluorinert Liquids have become the mainstays in electronic cooling, high reliability testing and vapor phase soldering.

Fluorinert Liquids, used as a direct contact heat transfer medium, offer a range of physical properties that make them particularly suitable for electronic uses. They are non-polar and exhibit no solvent action. They are colorless, low in toxicity, non-flammable and offer exceptionally high dielectric strength plus thermal and chemical stability. Most important, they have almost no chemical reactivity and they evaporate without leaving a residue on parts.

Buy the numbers

Our FC™ numbers — FC-40, FC-70, FC-77, etc. — are used to identify Fluorinert Liquids that offer certain physical characteristics to meet specific application needs. These FC numbers are solely 3M designations for various fluorochemical products.

Fluorinert Liquids are being used cost-effectively in cooling, high reliability testing and vapor phase soldering operations. When you are interested in applying these versatile liquids in your own production, 3M can provide an abundance of technical information and support.

Technical assistance: the main benefit of Fluoronics Resources

3M offers prompt assistance to help you solve many production and testing problems. We provide comprehensive technical recommendations for specific fluids. We consult with you on the proper application equipment and help you evaluate production methods and results. Our service bulletins bring you up to date on the most recent advances in vapor phase soldering and high reliability testing. Ask us about 3M's audiovisual materials and on-site application training seminars.

Discover Fluorinert™ Liquids' heat transfer capability

What are your needs? A precise degree of temperature control? Fast, uniform heat transfer? High dielectric strength? Fluorinert Liquids offer the broad range of physical characteristics required in most applications.

Fluorinert Liquids are an effective direct contact heat transfer medium whether used in a liquid or vapor state. Their unique properties enable you to use them in contact with sensitive components and substrates.

Major differences between the various products in the Fluorinert Liquids family can be seen in their boiling points. These can range from 56°C to 253°C. Should you need products with intermediate boiling temperatures, the 3M staff will work with you to fashion a product especially for your needs. It's an example of how 3M's Fluoronics Resources provide you with "customized" service to solve special problems.

COMPARATIVE HEAT TRANSFER COEFFICIENTS

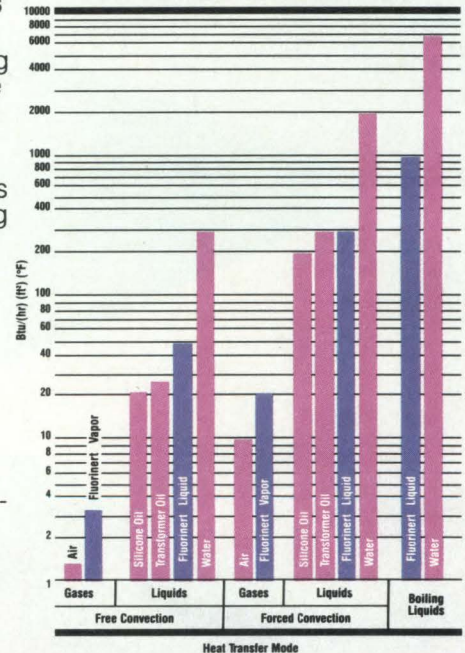

Fluorinert™ Liquids achieve accurate high reliability testing

It's a small world you work in. Where time ticks in nanoseconds and dimension is measured in Angstrom units. And as circuitry becomes more complex, a greater demand is placed on testing capability — not only in speed, but in higher reliability and accuracy.

Fluorinert Liquids meet those requirements by providing a controlled temperature environment and a high degree of electrical protection. They offer maximum compatibility between

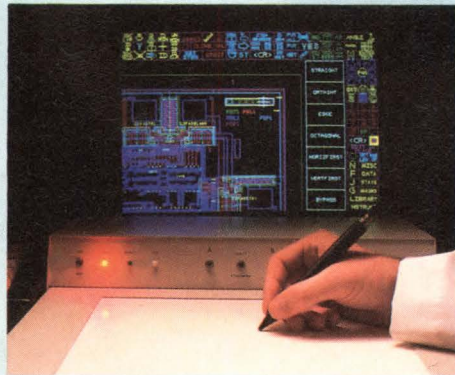
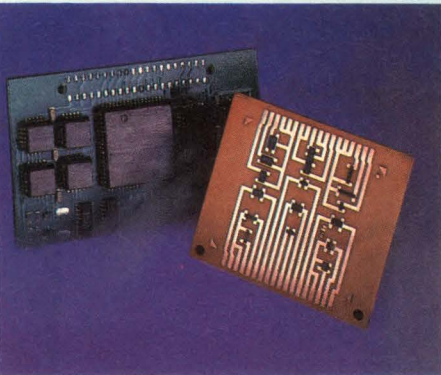

the heat transfer medium and the device under test. Fluorinert Liquids reduce testing costs by reducing testing time substantially. They do this by rapidly reaching test temperature and providing precise and uniform temperature control. You'll minimize the number of faulty units by detecting defects before they become rejects.

These liquids provide cost-effective tests such as gross leak, thermal shock, liquid burn-in, ceramic crack detection, electrical environmental, temperature calibration and failure analysis/short detection.

Fluorinert Liquids are specified in the MIL-STD's for thermal shock and gross leak testing.

THERMAL SHOCK TEST CONDITIONS

Military Standard 883-1011			Military Approved Fluorinert Liquids	
Test Condition	Hot Test Step 1	Cold Test Step 2	Hot Test Step 1	Cold Test Step 2
A	100°C	-0°C	Water, FC-40	Water, FC-40, FC-77
B	125°C	-55°C	FC-40, FC-70, FC-5311	FC-77
C	150°C	-65°C	FC-40, FC-70, FC-5311	FC-77
D	200°C	-65°C	FC-70, FC-5311	FC-77
E	150°C	-195°C	FC-40, FC-70, FC-5311	Liq. N ₂
F	200°C	-195°C	FC-70, FC-5311	Liq. N ₂

GROSS LEAK TEST CONDITIONS

Military Standards	Military Approved Fluorinert Liquids		
	Indicator Fluids	Detector Fluids	Absorption Fluids
MIL-STD 883-1014	FC-40, FC-43	FC-72, FC-84	Do not apply
MIL-STD 750-1071	FC-40, FC-43	FC-72, FC-84	FC-43, FC-75, FC-77
MIL-STD 202-112	FC-40, FC-43	FC-72, FC-84	Do not apply

Discover higher yields in vapor phase soldering

Fluorinert Liquids have been the industry's fluid of choice since the vapor phase reflow soldering (VPS) process was introduced in 1975. There are a number of good reasons for this universal acceptance. VPS with Fluorinert Liquids produces highly reliable solder joints. The system reduces reject rates, increases production, and lowers production costs. With Fluorinert Liquids, you can be assured that your products will never be exposed to a temperature higher than the selected liquid's boiling point. (See above)

You'll avoid those problems usually associated with other systems — shadowing, uneven heating, and overheating. The liquids are non-flammable. Their low surface tension helps them evaporate quickly from the work pieces without leaving a residue.

VPS with Fluorinert Liquids is especially suited for boards with high mass or complex geometries. The liquid vapors completely surround the assembly and penetrate remote recesses to heat all surfaces evenly. The vapors are 15 to 20 times heavier than air so they can be contained easily within the work area. The system offers an oxygen-free, non-corrosive environment to minimize rejects from oxidation contamination.

Some typical applications using Fluorinert Liquids in VPS include surface mounted leaded or leadless components, through-hole leads and wire-wrap pins, lead frame attachment, reflow of electroplated solder or tin and miscellaneous metal joining.

VPS SELECTION GUIDE

Fluorinert Liquid	Boiling Point	Typical Solders
FC-43	174°C/345°F	70 Sn/18 Pb/12 In 100 In 58 Sn/42 In 58 Bi/42 Sn
FC-70, FC-5311 FC-5312	215°C/419°F	63 Sn/37 Pb 60 Sn/40 Pb 62 Sn/36 Pb/2 Ag
FC-71	253°C/487°F	100 Sn 95 Sn/5 Ag 60 Pb/40 Sn

Discover the unique cooling benefits of Fluorinert™ Liquids

As the package size decreases, your need for more efficient heat dissipation increases in proportion: 3M Fluorinert Liquids are very efficient as a direct contact heat transfer medium, with the added advantage of having the high dielectric characteristics needed to meet stringent demands of the diversified electronics industry. We offer 11 liquids with boiling points that range from 56°C to 253°C.

These stable liquids allow you to maximize power density and miniaturize your package. Yet they reduce failure rates and increase reliability.

Fluorinert Liquids are used in such demanding applications as:

- Radar transmitters • Power supplies
- High voltage transformers • Lasers
- Radar klystrons • Computer modules
- Computer memories • Fuel cells

Typical properties of Fluorinert Liquids used in cooling are:

Fluorinert Liquid FC-77 (English Units)	Liquid		Vapor
	Room Temp. (77°F)	Boiling Point (207°F)	Boiling Point 207°F @/ATM
Density lb./ft. ³	111	100	0.85
Thermal Conductivity Btu/(hr) (ft. ²) (°F/ft)	0.037	0.033	0.008
Specific Heat Btu/(lb.) (°F)	0.25	0.28	0.23
Viscosity c.p.	1.42	0.46	0.02
Coefficient of Thermal Expansion ft. ³ /(ft. ³) (°F)	0.0008	0.0009	0.0015

Discover heating/curing with Fluorinert™ Liquids

Because they maintain their vapor temperature with absolute precision, Fluorinert Liquids can be used in many heating and/or curing operations. They serve as heat transfer media in solder mask and polymer thick film applications and for polymer processing. The non-corrosive vapors will not support oxidation. Ideal where solvent flash-off is a problem.

Discover Fluoronics Resources

3M presents a unique short course in the use of Fluorinert™ Liquids for the electronics industry.

3M is now offering a series of "Applied Fluoronics" tapes demonstrating how Fluorinert Liquids are used in a number of applications. See first hand how these remarkable products can improve overall electronic production.

Three cassettes are available:

1. "Applied Fluoronics: High Reliability Testing"
2. "Applied Fluoronics: Vapor Phase Soldering"
3. "Applied Fluoronics: Direct Contact Cooling"

These informative VHS format tapes are available to qualified personnel in the electronics industry. Specify which cassette(s) you would like to view.

Write on your company letterhead, describing your general interest. Mail to: Fluoronics Resources, Industrial Chemical Products Division/3M, Building 223-6SE-04, 3M Center, St. Paul, MN 55144-1000.

For technical information or assistance on High Reliability Testing and Cooling, call 612/733-6282; for Vapor Condensation Heating assistance, call 612/733-7424.



3M

EDN TECHNICAL-ARTICLE DATABASE

Production/manufacturing/testing, other

- Mastering PLD test aspects eases PLD system testing. *Durwood, Brian H, Data I/O; O'Donnell, Gary, National Semiconductor; Electronic Design, 02/18/88, pg 103, 5 pgs.*
- PLD testing: why, when and how. *Durwood, Brian H, Data I/O; Computer Design, 04/01/88, pg 71, 5 pgs.*

Programming

- Modula-2's design simplifies programming and compilation. *Anderson, Brian, Vancouver Community College; EDN, 03/03/88, pg 147, 11.5 pgs.*
- Moving PC-based debugging to real time. *McLeod, Jonah, Managing Editor; Electronics, 02/04/88, pg 42, 1 pg.*
- Software development parallels computer hardware advances. *Schindler, Max, Software Editor; Electronic Design, 02/04/88, pg 115, 9 pgs.*
- Software lets you design first, pick PLD later. *Warrington, Gene, Minc; EDN NEWS, 03/88, pg 10, 1 pg.*

Prototyping boards/systems

- Slash memory-array size with silicon circuit board. *Hyden, Lloyd, Data I/O; Sharp, Steve, Mosaic Systems; Electronic Design, 04/28/88, pg 87, 4.5 pgs.*

R

Relays

- Packaging enhancements highlight solid-state relays. *Chin, Spencer, Associate Editor; Electronic Products, 12/01/87, pg 49, 3 pgs.*

Resistors

- A different touch: force-sensing resistors. *Yaniger, Stuart, Interlink Electronics; EDN NEWS, 03/88, pg 8, 1 pg.*
- Focus on surface-mounted resistors. *Maliniak, David, Senior New Products Editor; Electronic Design, 04/28/88, pg 113, 6.5 pgs.*
- Special Report: A big cast of SMD passives hits center stage. *Shereff, Jesse, Contributing Editor; Electronics, 02/04/88, pg 103, 6 pgs.*

Rigid-disk drives

- Adding drives to increase reliability. *Aseo, Joseph, West Coast Technical Editor; ESD, 12/87, pg 22, 1 pg.*
- Drive makers meet demand for 3 1/2-in. products. *Miller, George D, Editor; EDN NEWS, 12/87, pg 10, 1.5 pgs.*
- IPI-3 subsystems meet future data storage needs. *Coulter, Bob, Intellistor; Computer Design, 01/15/88, pg 87, 4 pgs.*
- In Las Vegas, the action's in three-inch CDs. *Iversen, Wesley R, News Bureau—Chicago; Electronics, 01/21/88, pg 33, 1 pg.*
- Magnetic and optical devices to quench data-storage quest. *Staff; Electronic Design, 01/07/88, pg 86, 1 pg.*
- Multifunction chip steers hard disk drives. *Holm, Robert E, Intel; ESD, 04/88, pg 67, 5 pgs.*
- Peripherals and memory systems chase computer price/performance. *Williams, Tom, Western Managing Editor; Computer Design, 12/87, pg 57, 8.5 pgs.*
- SCSI drive stores 1.5G bytes. *Kent, Tom, Micropolis; EDN NEWS, 12/87, pg 14, 1 pg.*
- Winchester drive reliability tracks capacity and performance gains. *Williams, Tom, Western Managing Editor; Computer Design, 02/01/88, pg 49, 5 pgs.*

S

S/H circuits

- S/H amp-ADC matrimony provides accurate sampling. *Little, Al, Burnett, Bob, Harris; EDN, 02/04/88, pg 153, 12 pgs.*

Semicustom/custom ICs

- A GaAs gate array layout tests ASIC chips up to 800 MHz. *Davenport, William, et al, TriQuint Semiconductor; Electronic Design, 01/21/88, pg 93, 3 pgs.*
- ASIC design environment produces analog/digital ICs. *Goering, Richard, Senior Editor; Computer Design, 11/01/87, pg 48, 1.5 pgs.*
- ASIC simulators. *Conner, Margery S, Regional Editor; EDN, 02/04/88, pg 119, 8.5 pgs.*
- ASIC verification: Chasing a moving target. *McLeod, Jonah, Managing Editor; Electronics, 11/26/87, pg 79, 3 pgs.*
- Analog ASICs undersell discrete designs. *Crolla, Paul, Micro Linear; Electronic Products, 11/01/87, pg 50, 4.5 pgs.*
- Analog arrays will boast dedicated structures such as 12-bit ADCs. *Staff; Electronic Design, 01/07/88, pg 108, 1 pg.*
- Arrays with 100,000 gates shrink systems to silicon. *Collett, Ronald E, Senior Technical Editor; ESD, 01/88, pg 26, 1.5 pgs.*

- BiCMOS arrays combine density, speed, and power. *Phillips, Barry W, Technology Editor; Electronic Design, 03/17/88, pg 25, 6.5 pgs.*

- BiCMOS gate arrays promise new wave of bus-driving solutions. *Andrews, Warren, Contributing Editor; Computer Design, 03/01/88, pg 19, 3 pgs.*

- Build mixed-mode semicustom ICs by specifying standard devices. *Goodenough, Frank, Senior Editor; Electronic Design, 02/18/88, pg 41, 4.5 pgs.*

- Build new ASIC arrays while profiting from old ones. *Blumberg, Rick, SGS-Thomson Microelectric; Electronic Design, 03/17/88, pg 117, 4 pgs.*

- Consider the tradeoffs when evaluating linear-semicustom ICs. *Moore, Bruce, Raytheon Semiconductor; Ritmanich, Will, Consultant; EDN, 02/04/88, pg 135, 7 pgs.*

- Create linear ASIC macros without Spice nightmares. *Orgain, Cheryl, Analog Design Tools; Electronic Design, 12/10/87, pg 77, 3 pgs.*

- Designers' buying guide. *Staff; Computer Design, 04/15/88, pg 77, 54 pgs.*
- Designers contend with an explosion in ASICs. *Andrews, Warren, Contributing Editor; Computer Design, 04/15/88, pg 57, 12 pgs.*

- Everything you always wanted to know about designing a 100,000-gate ASIC. *Rau, Jerry, Daspit, Tom, LSI Logic; ESD, 02/88, pg 36, 4 pgs.*
- Gate arrays' big problem: They take too long to build. *Cole, Bernard C, Managing Editor; Electronics, 11/12/87, pg 69, 3 pgs.*

- Graphics pipeline merges off-the-shelf and semicustom ICs. *Wilson, Ron, Senior Editor; Computer Design, 12/87, pg 25, 2 pgs.*

- Improve differential amplifier's linearity and dynamic range. *Bray, Derek, Analog Design Tools; Electronic Design, 03/03/88, pg 99, 4.5 pgs.*

- Jedec simplifies selection of BiMOS, CMOS gate arrays. *LaBuda, Virgil P, Motorola; Electronic Design, 03/17/88, pg 107, 8 pgs.*

- Linear semicustom shifts into high gear. *Collett, Ron, Senior Technical Editor; ESD, 12/87, pg 63, 4.5 pgs.*

- Next-generation digital ASICs to carry out system-level designs. *Staff; Electronic Design, 01/07/88, pg 116, 1 pg.*

- RAM and ROM find a home on semicustom ICs. *Steinle, Adrienne L, NCR Microelectronics; Electronic Products, 12/01/87, pg 43, 3 pgs.*

- Silicon compilers still struggling toward widespread acceptance. *Andrews, Warren, Contributing Editor; Computer Design, 02/15/88, pg 37, 6 pgs.*

- Slash memory-array size with silicon circuit board. *Hyden, Lloyd, Data I/O; Sharp, Steve, Mosaic Systems; Electronic Design, 04/28/88, pg 87, 4.5 pgs.*

Sensors/transducers

- A different touch: force-sensing resistors. *Yaniger, Stuart, Interlink Electronics; EDN NEWS, 03/88, pg 8, 1 pg.*

- Fiber-optic photoelectric sensors gain in performance, popularity. *Chin, Spencer, Associate Editor; Electronic Products, 04/01/88, pg 28, 2.5 pgs.*

- Fiber-optic sensor systems move to new markets. *Coco, Donna, Staff Editor; EDN NEWS, 01/88, pg 10, 2 pgs.*

- Silicon microstructures let manufacturers implement a variety of sensors on chip. *Mosley, J D, Regional Editor; EDN, 11/26/87, pg 75, 5.33 pgs.*

Signal sources/generation

- "Predistortion" improves digital synthesizer accuracy. *Lowitz, Greg, Armitano, Robert, Hewlett-Packard; Electronic Design, 03/31/88, pg 85, 4.5 pgs.*

Simulators/simulation

- A full range of solutions emerge to handle mixed-mode simulation. *Goering, Richard, Senior Editor; Computer Design, 02/01/88, pg 57, 9 pgs.*

- Circuit simulators conquer new domains. *Gabay, Jonathan, Contributing Editor; Computer Design, 11/15/87, pg 39, 5 pgs.*

- Logic simulation on personal computers: Friend or foe. *Milne, Bob, Senior Editor; Electronic Design, 03/03/88, pg 50, 9 pgs.*

- Modeling strategies simplify board-level simulation. *Goering, Richard, Senior Editor; Computer Design, 03/01/88, pg 29, 4.5 pgs.*

- Modeling the mixed-mode mesh. *Collett, Ron, Senior Technical Editor; ESD, 01/88, pg 55, 4.5 pgs.*

- Simulate analog circuit boards without Spice's shortcomings. *Walsh, Kevin, Electrical Engineering Software; Electronic Design, 02/04/88, pg 75, 4 pgs.*

- Simulate any size circuit with object-oriented modules. *Newburger, Bruce, The Whitewater Group; Electronic Design, 03/03/88, pg 75, 3.5 pgs.*

- Simulate the interface between analog and digital circuits. *Sarin, Harish, et al, Daisy Systems; Electronic Design, 03/03/88, pg 63, 5 pgs.*

- Simulation accelerators address throughput issues. *Goering, Richard, Senior Editor; Computer Design, 03/15/88, pg 42, 5 pgs.*

- Simulation puts zip into circuit board design. *Spadaro, Joseph J, Associate Editor; Electronic Products, 04/01/88, pg 34, 8 pgs.*

- Speed DSP simulation, design with CAE-library function blocks. *Grossman, Robert M, DSP & CAE Consultant; Electronic Design, 04/28/88, pg 92, 4 pgs.*

EDN TECHNICAL-ARTICLE DATABASE

Software documentation

Debuggers help you perfect high-level and real-time code. *Small, Charles H, Associate Editor; EDN, 12/10/87, pg 153, 13 pgs.*

Standards

Acronyms from A/D to ZTAT. *Staff; Electronic Products, 11/01/87, pg 65, 11 pgs.*

After three years, a VHSIC chip standard. *Iversen, Wesley R, Industrial & Consumer Editor; Electronics, 04/14/88, pg 33, 0.5 pgs.*

Is the U.S. headed for a fall by rushing toward unix standards. *Young, Jeremy, Managing Editor; Electronics, 02/04/88, pg 31, 1 pg.*

Substrates

Molded circuits require attention to new design techniques. *Williams, John, ICI Electronics; EDN, 01/21/88, pg 161, 5 pgs.*

PC boards hot-wired for faster, more flexible service. *Biancomano, Vincent, Components/Packaging Editor; Electronic Design, 02/18/88, pg 29, 4.5 pgs.*

Surface-mounting devices/techniques

Capacitors chip in for surface-mounting and switching supplies. *Biancomano, Vincent, Technology Editor; Electronic Design, 03/88, pg 25, 5 pgs.*

Focus on surface-mounted resistors. *Maliniak, David, Senior New Products Editor; Electronic Design, 04/28/88, pg 113, 6.5 pgs.*

In search of surface-mount optocouplers. *Coco, Donna, Staff Editor; EDN NEWS, 04/88, pg 3, 1 pg.*

SMT changes test fixturing. *Harbert, Tammi, Senior Editor/News; EDN NEWS, 12/87, pg 24, 1.5 pgs.*

Special Report: A big cast of SMD passives hits center stage. *Shereff, Jesse, Contributing Editor; Electronics, 02/04/88, pg 103, 6 pgs.*

Surface mounting keeps calculators competitive. *Pettit, Tom, Hewlett-Packard; Electronic Products, 12/15/87, pg 52, 4 pgs.*

Surface-mount passives are coming on strong. *Mattera, Lucinda, Special Projects Editor; Electronics, 02/04/88, pg 99, 1 pg.*

Surface-mounted parts make a pass at both sides. *Biancomano, Vincent, Technology Editor; Electronic Design, 01/07/88, pg 33, 3 pgs.*

Switches

To manage fast switching jobs, look to silicone elastomers. *Stern, Harry, Conductive Rubber Technology; Electronic Design, 03/17/88, pg 123, 4.5 pgs.*

T

Technology/research, other

Acronyms from A/D to ZTAT. *Staff; Electronic Products, 11/01/87, pg 65, 11 pgs.*

Fiber-optic engineering networks distribute tasks globally. *Staff; Electronic Design, 01/07/88, pg 34, 1 pg.*

Superconductors warm up, meeting no resistance in system design. *Staff; Electronic Design, 01/07/88, pg 74, 2 pgs.*

Where system speed is paramount, ECL technology will remain king. *Staff; Electronic Design, 01/07/88, pg 124, 1 pg.*

Will 1988 see a 92 K superconductor IC. *Waller, Larry, News Bureau—Los Angeles; Electronics, 01/07/88, pg 32, 0.5 pgs.*

Telecommunications

Communications. *Staff; Electronics, 01/07/88, pg 75, 2.5 pgs.*

Heed local norms when designing telecomm interfaces. *Dash, Glen, Dash, Straus & Goodhue; EDN, 02/04/88, pg 175, 9 pgs.*

ISDN data must conform to analog telecomm networks. *Hardwick, Steve, Siemens Components; Electronic Design, 11/12/87, pg 105, 3.5 pgs.*

ISDN wends its way toward reality. *Barron, Janet J, Associate Editor; Computer Design, 02/15/88, pg 46, 5 pgs.*

Interface the ISDN to your PC with a voice/data board. *Gulick, Dale, Crowe, Charlie, Advanced Micro Devices; Electronic Design, 12/10/87, pg 85, 4 pgs.*

Manage PABX conference calls with a single chip. *Nguyen, Chinh, Pariani, Angelo, SGS-Thomson Microelectronics; Electronic Design, 04/14/88, pg 137, 4 pgs.*

Programmable communications platforms speed time-to-market. *Barron, Janet, Associate Editor; Computer Design, 11/15/87, pg 61, 2 pgs.*

Temperature measurement

Keep pc boards reliable with thermal-analysis tools. *LaBonte, Mike, et al, Valid Logic Systems; Electronic Design, 04/28/88, pg 79, 4 pgs.*

Terminals

Diskless PC terminals for the desktop and factory floor. *Myrvaganes, Rodney, Associate Editor; Electronic Products, 02/15/88, pg 15, 1.5 pgs.*

Test fixtures/probes

SMT changes test fixturing. *Harbert, Tammi, Senior Editor/News; EDN*

NEWS, 12/87, pg 24, 1.5 pgs.

Timer ICs/circuits

Expand or shrink clock cycles to the system's needs. *Purvis, Rick, Yee, Jenny, Advanced Micro Devices; Electronic Design, 11/27/87, pg 93, 3 pgs.*

Touch-screen devices

Acoustic touch technology adds a new input dimension. *Platshon, Mark, Elographics; Computer Design, 03/15/88, pg 89, 5 pgs.*

Transmitters/receivers

Fiber-optic transmitters and receivers enhance data-link performance. *Ormond, Tom, Senior Editor; EDN, 03/31/88, pg 57, 5 pgs.*

V

Video

Digital filtering: the right stuff for video. *Williams, Bob, Ampex; Prater, Jim, NCR Microelectronics; ESD, 01/88, pg 91, 3.5 pgs.*

Vision systems

A slew of standards for camera systems. *Amorese, Philip, Bloomfield, John, Datacube; ESD, 03/88, pg 94, 3.5 pgs.*

Landscape generation: a changing perspective. *Chen, Yin-Pao, Simulator Systems; ESD, 02/88, pg 44, 4 pgs.*

Sophisticated hardware and software beget efficient machine-vision systems. *Mosley, J D, Regional Editor; EDN, 04/28/88, pg 55, 6.33 pgs.*

What's new—an electronic imaging '87 review. *Wilson, Andrew, Executive Editor; ESD, 12/87, pg 17, 2 pgs.*

Voltage converters

New dc-dc converters meet system design needs. *Mayer, John H, Associate Editor; Computer Design, 11/01/87, pg 104, 5.5 pgs.*

The shrinking dc/dc converter. *Yates, Warren, Associate Editor; Electronic Products, 11/15/87, pg 39, 3.5 pgs.*

Voltage references

Selection criteria assist in choice of optimum reference. *Knapp, Ron, Maxim Integrated Products; EDN, 02/18/88, pg 183, 9 pgs.*

Stable reference IC simplifies the design of analog systems. *Thompson, Bill, Analog Devices; EDN, 01/21/88, pg 147, 7.5 pgs.*

W

Waveform analyzers/analysis

Make accurate measurements on video IC systems. *Mathews, Brian D, Harris Semiconductor; Electronic Design, 03/03/88, pg 109, 2.5 pgs.*

Wire/cable

Specialty cabling creates versatile and streamlined network systems. *Graeber, George C, Crouch, Ronald A, Brand-Rex; Electronics, 02/04/88, pg 119, 4 pgs.*

The Application Servers

Build your application with Mizar's new generation
of 32-bit microcomputers.

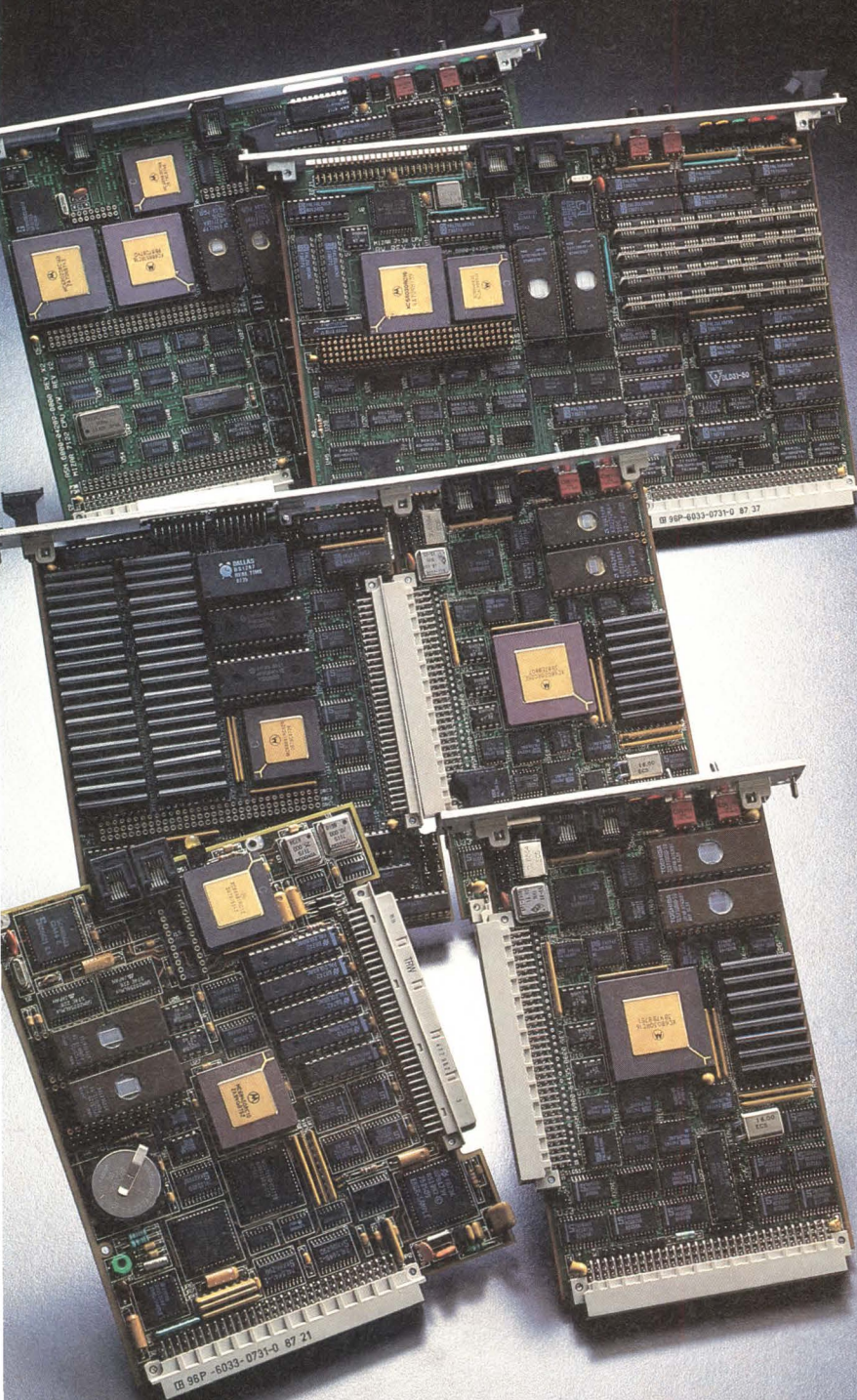

Mizar. The shortest distance between concept and reality.

MIZAR

1419 Dunn Drive • Carrollton, TX 75006 • (214) 446-2664

CIRCLE NO 126

New standards of VME performance.

Mizar presents a new line of microprocessors for VME-based applications. With powerful Motorola 68020 and 68030 CPUs at up to 30 MHz, and the latest in memory interface and surface mount technology, Mizar provides the performance and functionality your application demands.

Platforms for every application.

Mizar designed its new processors with the application developer in mind. Mizar's single-height processors are not only excellent computing engines, but through Mizar's MXbus™, become uniquely configurable to meet specific I/O, memory and processing needs. MZ 8100 Series single-height processors can be transformed into double-height solutions with complete single-board functionality and performance. Similarly, the MZ 7100 Series of double-height processors provide all you expect from a single board computer, and can be tailored with easy-to-use plug-in modules. With either solution, you can start development today.

Superior memory handling.

Mizar's engineers have reduced critical wait-states to zero at 16.7, 20 and 25 MHz in many cases. To enhance multiprocessor system performance, Mizar's new on-card memory arbitration logic frees the CPU during time-consuming memory operations across the VMEbus, allowing concurrent local processing. And for more demanding applications, Mizar's 68030 based MZ 7130 even includes cache options.

Your application demands the latest in 32-bit VME technology. Call Mizar.

1-800-635-0200

Ask for extension 140

EDN's Technical Article Database Index is Now on Floppy Disk!

Now you can utilize EDN magazine's Technical Article Database Index right on your computer screen. When used with your IBM PC or compatible computer, this new floppy-based index gives you all the benefits of our printed index . . . and more:

- Fast computer searches and sorts
- AND and OR capabilities to precisely specify your search criteria
- Printout of search results

The index lists articles printed in EDN, EDN NEWS, Electronic Design, Electronics, Electronic Products, Computer Design, and ESD. Two installments are available—covering articles published from May to October, 1987, and from November 1987 to April 1988.

EDN'S index is compatible with most popular programs, including 1-2-3 from Lotus, MailMerge from MicroPro International, and dBASE from Ashton-Tate. It also works with Buttonware, Inc.'s PC-File+, a "shareware" database manager that you can order from us.*

Our Technical Article Database Index on your computer will mean added convenience for you. Order your copy today.

*EDN provides fully functional copies of PC-File+ for a nominal reproduction fee. Receipt of PC-File+ does not constitute ownership, which must be purchased from Buttonware for \$69.95 if you continue to use the program, but merely the right to evaluate the program's capabilities. EDN assumes no responsibility for the programs operation.

PC-File+ runs on IBM PCs and compatible computers and requires 384k bytes of memory, two double-sided floppy disk drives or one double-sided floppy drive and a hard disk, an 80-column display, and MS-DOS or PC-DOS version 2.0 or later.

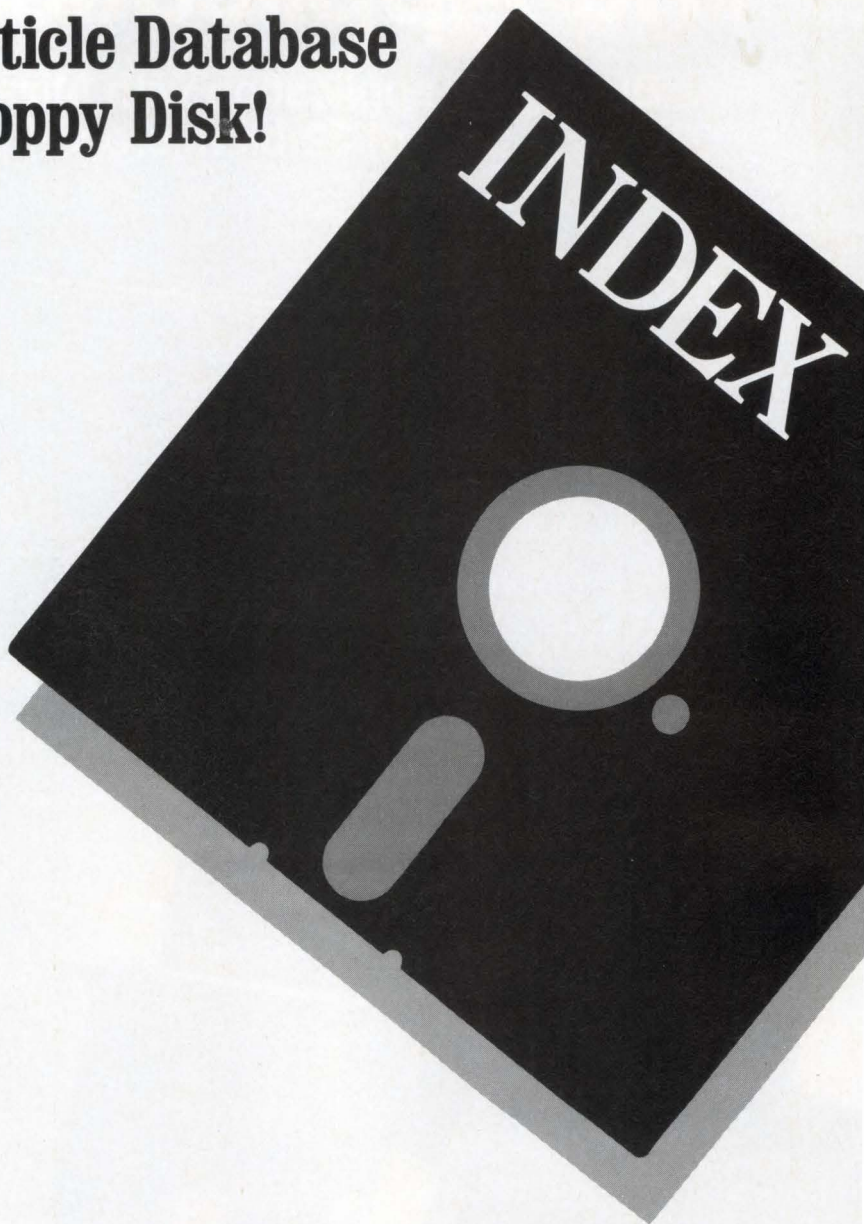

ORDER FORM

EDN's Technical Article Database Index on IBM PC DSDD floppy disc

Installment 1 (May 1987–October 1987)	_____ copies at \$19.95 = _____ (\$21.95 for non-US)
Installment 2 (November 1987–April 1988)	_____ copies at \$19.95 = _____ (\$21.95 for non-US)
PC-File+ database software (3 disks) (Available only in US, Canada, and England)	_____ copies at \$14.95 = _____ (\$16.95 for non-US)
	TOTAL _____

Check or money order made out to EDN Reprints must accompany each check. No COD. Massachusetts residents add 5% sales tax. Foreign checks must be drawn on a US Bank, issued in US currency.

Send to:
Technical Article Database Index
EDN Magazine
Cahners Building
275 Washington Street
Newton, MA 02158-1630

Please Print clearly.
This is your mailing label.

NAME

TITLE

COMPANY

ADDRESS

CITY STATE ZIP

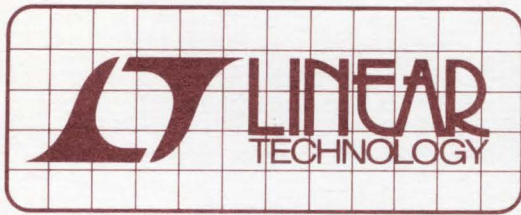

DESIGN NOTES

Number 13 in a series from Linear Technology Corporation

August, 1988

Closed Loop Control with the LTC1090 Series of Data Acquisition Systems

Guy Hoover
William Rempfer

Introduction

The use of microprocessors in process control loops is quite common. A processor based control loop requires special design considerations as compared to traditional analog loops. Often a single centrally located processor will be used to control several remotely located processes. The outputs of the remote process sensors can be digitized at the sensor location and then be transmitted to the central processor. Unfortunately, transmitting digital signals typically requires one wire for each bit of resolution and requires expensive cabling. Alternatively, the sensor output can be transmitted as an analog signal to the central processor area for digitization. However, transmitting analog signals over distances can introduce errors because of noise and voltage drops in the wires.

The solution to these control loop problems can be found in the LTC1090 series of data acquisition systems. As can be seen in the schematic of Figure 2, ten bits of data can be digitized remotely and sent to the processor with only three wires plus ground. The single supply capability and the low DC current drain (1mA typ.) also simplify remote location. The LTC1090 series provides the user with blocks of 1, 2, 6 or 8 10-bit channels which can be chosen according to how many sensors are located in each remote site.

The LTC1090 series is ideally suited for such process control loop applications as position control, temperature control, container filling and tension control.

Circuit Description

The circuit of Figure 2 is a container filling control loop which has a resolution of .03 pounds with a 30 pound full scale. It

was designed to implement an automatic filling station for the model train shown in Figure 1. When S1 is closed the MC68HC05 processor reads the LTC1092. If the weight is below the preprogrammed limit in the processor then the motor drive line which controls the pump is turned on. The LTC1092 is continually read by the processor as the truck is filled, until the limit is reached. The motor drive line is then shut off. The limit may be derived in a number of ways. A fixed limit will result in filling to an absolute weight, while relative or tare weight filling can be implemented when the measured empty weight is used in the calculation of the limit. Code for this application is available upon request from Linear Technology Corporation.

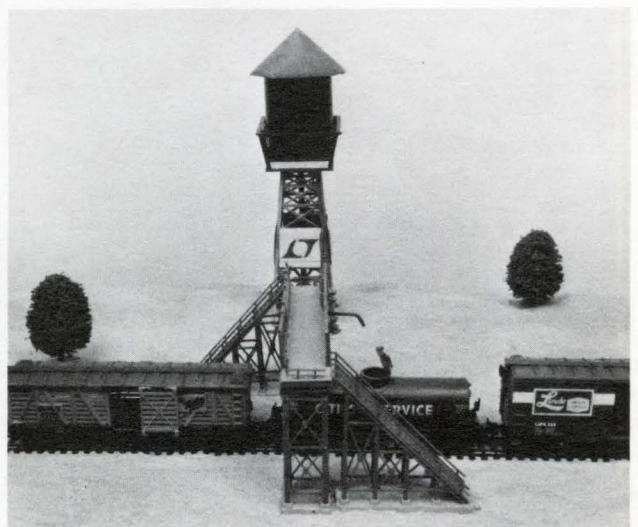

Figure 1. A Typical Application. Automatic Filling at a Railroad Siding.

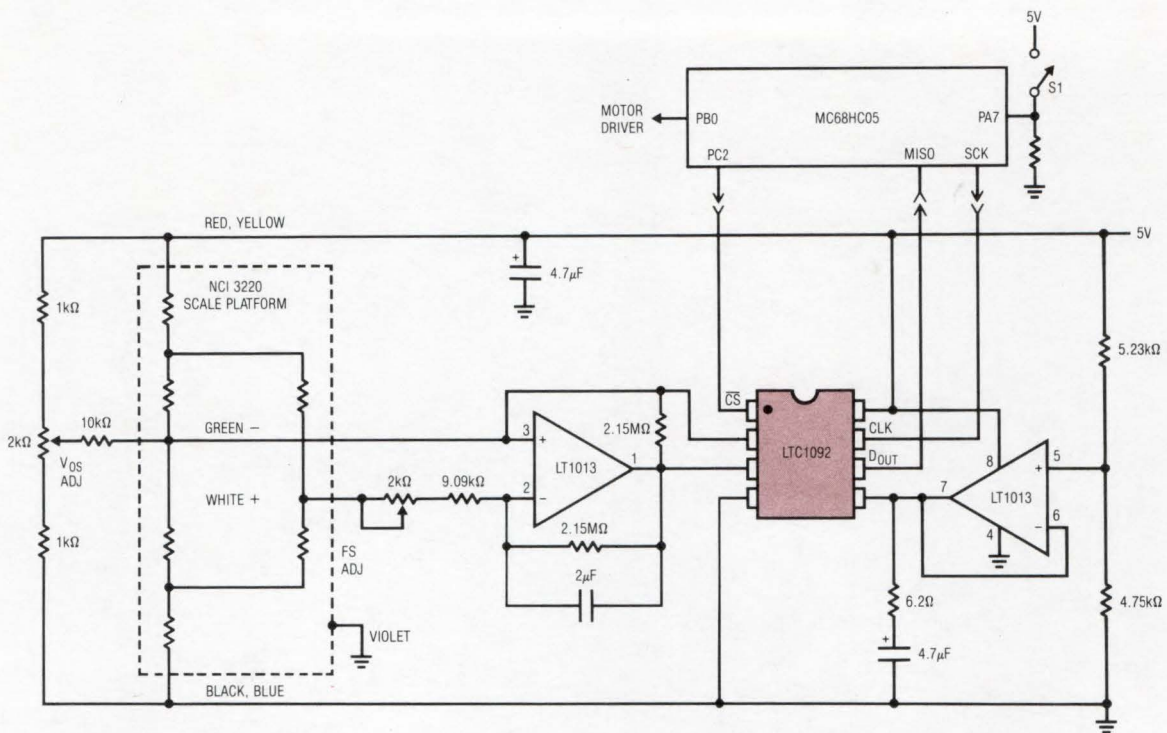

Figure 2. This Circuit Determines Small Weight Changes, Permitting Accurate Filling. Using the Appropriate Transducer, Containers may Range from Perfume Bottles to Railroad Cars.

The NCI 3220 strain gauge used in this circuit has a linearity specification of .04% which makes it a good match for the .05% linearity of the LTC1092. However, the offset and full scale of the strain gauge are only guaranteed to 10% so trims are required. The circuit is run ratiometrically so an absolute reference is not required. The strain gauge output is amplified by one-half of an LT1013 with the other half being used to buffer the resistor divider that is used for the LTC1092's V_{REF} pin. Only one op amp is necessary to amplify the strain gauge output because of the differential inputs of the LTC1092. The 2.15MΩ resistor from pin 1 to 3 of the LT1013 is to balance the load on the strain gauge bridge. With the strain gauge zeroed, both inputs on the LTC1092 are at about 2.5V. As weight is added, the output of the LT1013 into the minus input of the LTC1092 swings toward ground. At the 30 pound full scale, the output of the LT1013 is about 100mV above ground which results in a total swing of about 2.4V. The 2μF mylar capacitor filters the LT1013 output eliminating the effects of vibration caused by filling the train car. (As the train car nears the full point, vibration induced noise can cause the processor to stop the filling too soon.) It is important that the processor monitors the filling process in a timely fashion to prevent overflow. The setup shown relied on a slow fill rate to solve the last problem but with the processor in the loop it is possible to give the fill algorithm some

intelligence so that it would run at a high speed to begin with and then run at a slower speed at some preset limit until the final limit is reached.

To calibrate the circuit, offset is first adjusted with no weight on the platform. Next, a known weight near full scale is used to adjust the gain. Once calibrated, variations in the supply voltage within the voltage limits of the LTC1092 should not cause additional errors.

Summary

The LTC1090 series is well suited for use in closed loop control systems. Their low supply current and serial interface make them easy to locate remotely. With a total unadjusted error of .05% over temperature the LTC1090 series is a good match to a wide variety of sensors. The differential inputs of the LTC1090 series can also simplify circuit design while a choice of 1, 2, 6 or 8 inputs gives the user just the level of complexity that is needed.

For LTC1090 Series literature call 800-637-5545. For help with an application call (408) 432-1900, Ext. 361.

DESIGN IDEAS

EDITED BY CHARLES H SMALL

Transistor powers low-dropout regulator

James E Dekis

Maxim Integrated Products, Sunnyvale, CA
and Terry Blake

Motorola, Schaumburg, IL

The monolithic regulator chip in Fig 1, combined with an external pnp transistor, forms a very-low-dropout regulator. The composite regulator can supply several hundred milliamps at 5V from an input as low as 5.3V. Such low-dropout performance suits battery-powered applications, because it extends the useful life of batteries having sloping discharge curves, such as sealed lead-acid and lithium batteries.

The monolithic regulator derives its supply current from the base circuit of the external pnp transistor. The feedback-resistor ratio sets the output voltage:

$$V_{OUT} = 1.3V \times (R_1 + R_2) / R_1.$$

If the output-voltage feedback to the chip's V_{SET} input is below the bandgap-reference voltage (1.3V), the supply current into V_{IN} (the pnp transistor's base current) increases. The transistor multiplies this base current by β and delivers it to the load. The circuit's quiescent current is a function of the transistor's β and load current.

When there's no load, the quiescent current is typically 10 μ A. For larger load currents, the quiescent current is simply the load current divided by the transistor's β . The regulator chip can sink 40 mA max. When you enable the chip's shut-down input, the circuit consumes 6 μ A typ. R_4 supplies current to the chip under no-load conditions.

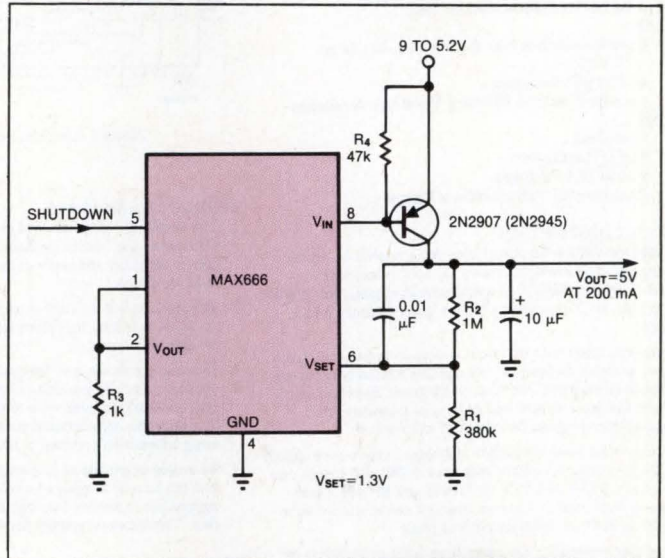

Fig 1—A monolithic regulator chip driving a dummy load sets the base current of an external, series-pass pnp transistor; the result is a very-low-dropout regulator for batteries whose output voltage droops under load.

R_3 can limit the transistor's base current. The chip's V_{OUT} pin will try to raise its voltage level to that of the V_{IN} pin when the output voltage of the chip is low. Reducing R_3 has the effect of supplying larger base currents to the external transistor.

You can substitute a 2N2945 for the 2N2907 shown in Fig 1. With this substitution, the circuit will supply a 5V, 100-mA max output from a 5.1V input. **EDN**

To Vote For This Design, Circle No 750

8031 routines expand address space

Robert J Ryan

Robert Merrill Inc, Tukwila, WA

This Design Idea corrects a problem with the Design Idea "Add two 16-bit pointers to the 8031 μ P" (EDN, April 28, 1988, pg 238), by Noor Singh Khalsa. Khalsa uses the μ P's P2 port indirectly to form the upper byte, or page, of a 16-bit address; he maintains the page

addresses in μ P registers and writes the appropriate page address to P2 just prior to moving data to or from the page.

Problems arise when you attempt to use this scheme in both your main routine and a subroutine that uses a different page. Obviously, the subroutine must save the page address being used by the main routine and restore that address to P2 before returning control to

High Performance Monolithic Resolver-to-Digital Converters

2S80/2S81

FEATURES

Monolithic Tracking R/D Converters
 Ratiometric Conversion
 High Maximum Tracking Rate (260 rps at 12 Bits)
 Natural Binary Digital Word Output
 Accurate Velocity Output (1% Linearity typ)
 Low Power Consumption (300mW typ)
 Dynamic Performance Set by User

2S80:

User-Selectable Resolution (10, 12, 14 or 16 Bits)

40-Pin DIP Package

Commercial and Military Versions Available

2S81:

Low Cost

12-Bit Resolution

28-Pin DIP Package

Commercial Temperature Range

PRODUCT DESCRIPTION

The 2S80 and 2S81 are monolithic tracking resolver-to-digital converters manufactured on Analog Devices' proprietary BiMOS II process. BiMOS II combines high-density, low-power CMOS logic and high-accuracy bipolar linear circuitry on the same chip.

A ratiometric conversion technique is used to output continuous position data with no delay. It also provides immunity to changes in absolute signal levels, tolerance to harmonic distortion on the reference and input signals, and high noise immunity when using long leads between the converter and resolver.

The output data word is supplied in 2 bytes in three-state digital form on either 16 output data lines (2S80) or 8 output data lines (2S81). BYTE SELECT, INHIBIT and ENABLE pins allow easy data transfer. External counters can be connected to the 2S80 or 2S81 for counting cycle or pitch.

The reference frequency can range from 50Hz to 20,000Hz for the 2S80 and from 400Hz to 20,000Hz for the 2S81.

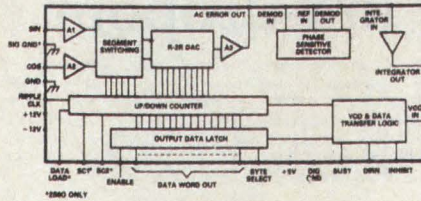

2S80/81 Functional Block Diagram

PRODUCT HIGHLIGHTS

1. The monolithic 2S80 and 2S81 are one-chip solutions that offer lower cost, smaller package size, higher reliability, greater flexibility and easier design-in than either hybrid or in-house designs.
2. The resolution of the 2S80 is user-set via two control pins to 10, 12, 14 or 16 bits. This allows selection of optimum resolution for each application.
3. Dynamic performance is determined by the user. Bandwidth, maximum tracking rate and velocity scaling are established with low-cost, preferred-value external resistors and capacitors. The values for these external components are easily calculated using information provided in the data sheet.
4. An analog output signal proportional to velocity is provided that can be used in place of a velocity transducer in many applications to provide loop stabilization and velocity feedback data. This signal is typically linear to one percent.

TO CLOSE THE BOOK ON ALL OTHER R/D DESIGNS, TURN TO THIS PAGE.



Instead of spending time designing custom R/D converters, or spending money on expensive purchased solutions, spend a few minutes and learn about our new 2S80 and 2S81, the world's first and only monolithic R/D converters. They are the only R/Ds to offer all the advantages of monolithic devices, including small size, low power and high reliability, along with high performance at a low cost.

The 2S80 is available in both commercial and military temperature range versions, and in three accuracy grades (± 8 , ± 4 and ± 2 arc minutes, each ± 1 LSB).

The 2S81 operates over the standard commercial temperature range of 0° to 70°C and features accuracy of ± 30 arc minutes

± 1 LSB, making it ideal for a wide variety of commercial and industrial applications.

All these high performance features are available without a high price tag. The 2S80 starts at only \$89.10 in 100s, while the 2S81, at \$70.00 in 100s, is the lowest priced R/D converter you can buy. And both the 2S80 and 2S81 are in stock now for immediate delivery.

To find out how the 2S80 and 2S81 are rewriting the book on R/D converters, call Ian Bruce at (617) 461-3210. Or write to Analog Devices, P.O. Box 9106, Norwood, MA 02062-9106.



Analog Devices, Inc., One Technology Way, P.O. Box 9106, Norwood, MA 02062-9106; Headquarters: (617) 329-4700; California: (714) 641-9391, (619) 268-4621, (408) 559-2037; Colorado: (719) 590-9952; Maryland: (301) 992-1994; Ohio: (614) 764-8795; Pennsylvania: (215) 643-7790; Texas: (214) 231-5094; Washington: (206) 251-9550; Austria: (222) 885504; Belgium: (3) 237 1672; Denmark: (2) 845800; France: (1) 4687-34-11; Holland: (1620) 81500; Israel: (052) 911415; Italy: (2) 6883831, (2) 6883832, (2) 6883833; Japan: (3) 263-6826; Sweden: (8) 282740; Switzerland: (22) 31 57 60; United Kingdom: (932) 232222; West Germany: (89) 570050

DESIGN IDEAS

the main routine. The problem is that the μ P stores P2's output in a special-function register (SFR). Executing a simple read or stack push from P2 gives your subroutine the contents of P2 only when your program runs in an in-circuit emulator. In a target system, however, read and stack-push commands input the byte

on P2's pins and don't input the contents of its SFR. Only read-modify-write commands that have the SFR as a destination access P2's SFR directly when your program runs in your target system.

Figs 1a and **1b** show two subroutine-entry stubs that use read-modify-write instructions, DJNZ and JBC, to

```

(a)
SUB1:  PUSH   ACC           ;START SUBROUTINE
      CLR    A
LOOP:  INC    A
      DJNZ   P2,LOOP
      MOV    P2,A           ;RESTORE P2 (OPTIONAL)
      PUSH   ACC
      .
      .
      .
      POP    P2           ;RESTORE P2 LATCH
      POP    ACC
      RET

(b)
SUB2:  PUSH   ACC           ;START SUBROUTINE
      MOV    A,#0FFH
      JBC   P2.0,BIT1      ;BIT 0 OF P2 LATCH SET? Y-BIT1
      CLR    ACC.0
BIT1:  JBC   P2.1,BIT2      ;BIT 1 OF P2 LATCH SET? Y-BIT2
      CLR    ACC.1
BIT2:  JBC   P2.2,BIT3      ;BIT 2 OF P2 LATCH SET? Y-BIT3
      CLR
      .
      .
      .
      MOV    P2,A           ;RESTORE P2 (OPTIONAL)
      PUSH   ACC           ;SAVE CONTENTS OF P2 LATCH
      .
      .
      .
      POP    P2           ;RESTORE P2 LATCH
      POP    ACC
      RET

      MOV    P2RAM,#VALUE  ;LOAD RAM IMAGE WITH DESIRED VALUE
      MOV    P2,P2RAM      ;COPY RAM IMAGE TO P2 LATCH
      .
      .
      .
;***** SUBROUTINE *****
      PUSH   P2RAM         ;SAVE RAM IMAGE OF P2
      .
      .
      .
      POP    P2RAM        ;RESTORE RAM IMAGE OF P2
      MOV    P2,P2RAM      ;RESTORE P2 LATCH
      RET

(c)

```

Fig 1—These three routines allow you to use an 8031's P2 special-function register to indirectly address pages of external memory in both your main routine and subroutines. The first routine (a) uses few instructions, but its execution time depends on P2's contents. The second routine (b) is faster but uses up more memory. The third routine (c) maintains a RAM image of P2's special-function register.



Novasensor accomplishes a deep sea rescue.

Place: Silicon Valley. *Date:* June 25th.
Situation: a high-tech SCUBA manufacturer, racing to beat a production deadline on a new dive computer, discovers its silicon pressure sensor is flawed. All options appear disastrous. A new vendor, Novasensor, is contacted.

Friday: design brainstormed.
Saturday: prototype fabricated.
Sunday: hybrid electronics designed.
Monday: manufacture begun.
Wednesday: testing initiated. *Saturday:* (4th of July) 100 laser-trimmed sensors delivered. Mission accomplished.

We go to any length or depth to rescue a customer in distress. Our state-of-the-art technology, experience and manufacturing resources offer the best performance and price. The Novasensor product family includes ultra-stable pressure sensors (.3 to 10,000 psi), acceleration sensors (1 to 100g), and the world's most advanced microstructures. We offer a growing number of standard products as well. To find out the depth of our expertise contact: Novasensor, 1055 Mission Court, Fremont, CA 94539. (415) 490-9100.



**NOVA
SENSOR**

Your partner in
product innovation.

DESIGN IDEAS

determine the contents of P2's SFR. Fig 1a's program uses few instructions, but the execution time depends on the SFR's contents; its loop can execute 255 times if P2's SFR holds FF_{HEX}. Fig 1b's program executes more quickly, but is not very memory efficient.

Fig 1c shows an alternative scheme that employs a RAM image of P2. Every time you write a page address to P2, you also update the byte P2RAM directly. Subroutines can then push the contents of P2RAM onto

the stack upon entry and restore the calling routine's page address to P2RAM and P2 upon exit. Note that you must always update P2RAM before updating P2 to ensure that the scheme in Fig 1c operates properly during interrupts.

EDN

To Vote For This Design, Circle No 746

555 timer turns beep into warble or chirp

R E McCain
Avalon Products, Fremont, CA

The simple circuit in Fig 1 transforms the steady beep of an audible-signal device such as a Mallory Sonalert into a distinctive warble or chirp. The value of C₂ determines just what tone color you'll get. With the 1- μ F value shown, the circuit produces a warble similar to the ring tone of an inexpensive, non-Bell phone. A 10- μ F value produces a chirp similar to a truck's back-up alarm. One elaboration of this circuit would be to use the second section of a 556 timer to drive a piezoelectric transducer instead of a Sonalert; that modification would vary the tone's pitch as well as the chirp rate.

EDN

To Vote For This Design, Circle No 748

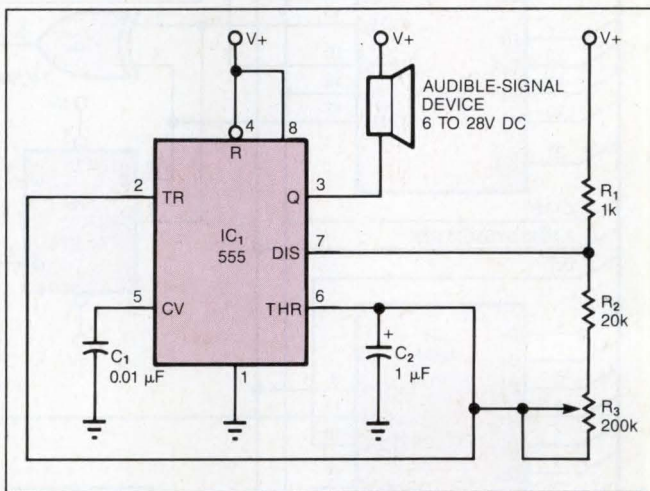

Fig 1—Adding a 555 timer to your audible-signal device's circuit will transform its plain-Jane beep into a distinctive warble or chirp.

Single-chip μ P controls resolver

Tadeusz Jarosinski
FMiK ERA, Warsaw, Poland

Without the aid of external circuitry, a single-chip μ P can't handle all the overhead associated with controlling a resolver. The 8253 programmable-interval-timer

chips—IC₁ and IC₂ in Fig 1a—along with a handful of logic devices, provide sufficient speed and resolution for many applications.

The circuit in Fig 1 lowers the single-chip μ P's overhead because the μ P only needs to respond to the INT signal from the motor controller, load the 8253

DESIGN IDEAS

programmable-interval timers with the appropriate divisors, and enable the timers via the START line. Normally, counter 0 of IC₁ divides the system clock (CLK) by 8. But if the single-chip μ P reloads this counter for exactly one period with 16 or for two

periods with 4, the drive circuit will subtract one clock pulse, or add one clock pulse, respectively (Fig 1b). (The single-chip μ P must reload the counter with 8 immediately.) Adding or subtracting clock pulses has the effect of shifting the resolver's phase in $\pm 4\text{-}\mu\text{sec}$

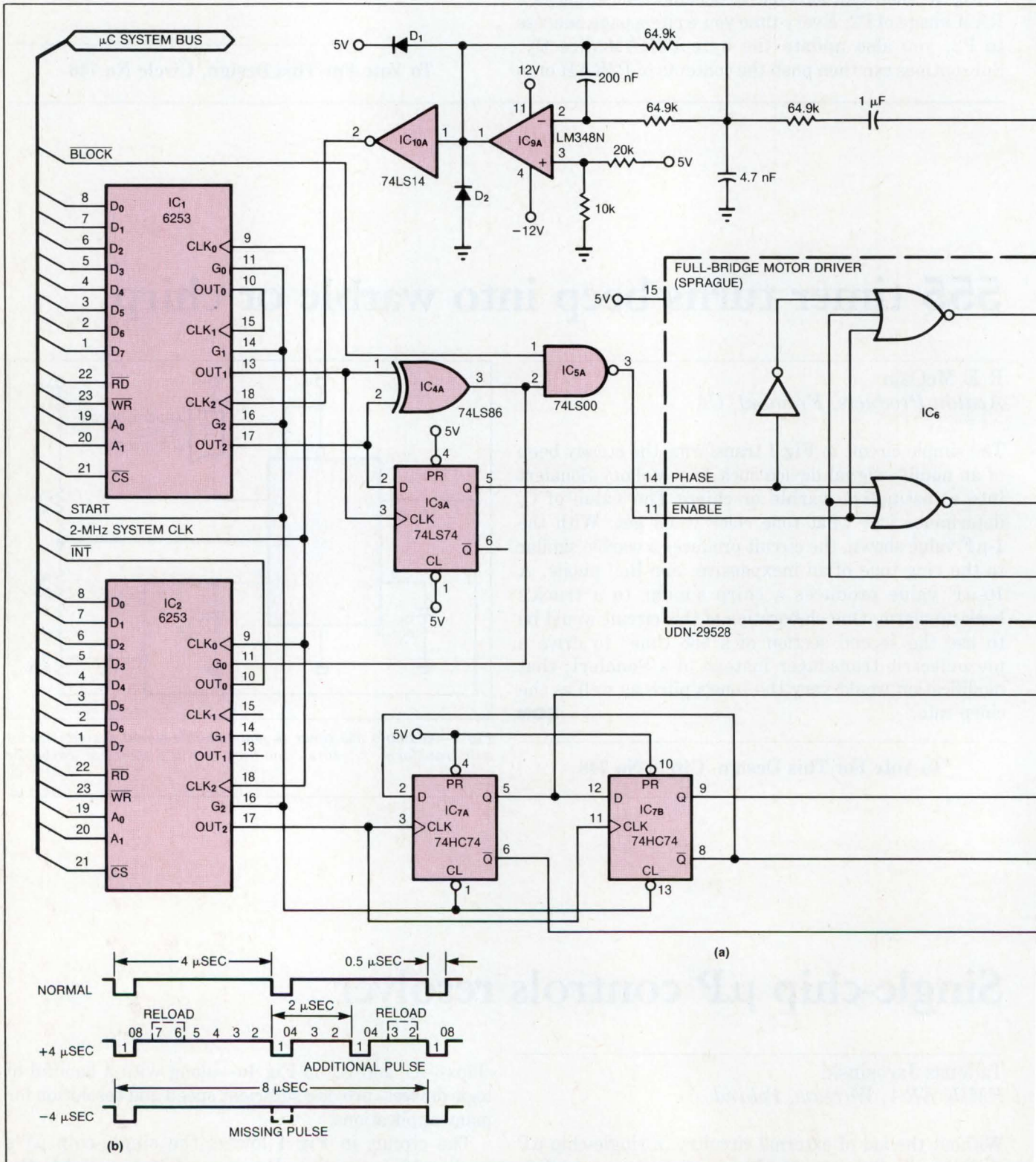

Fig 1—A single-chip μ P can control a resolver's phase in 4- μ sec increments with the aid of external programmable counters and logic.

DESIGN IDEAS

increments.

The feedback-control portion of this design begins with the feedback signal, or error, from the resolver's rotor winding. IC₉ and IC₁₀ filter this signal to a pure sinusoid and then turn it into a square wave. The phase

of this square wave, with respect to the stator-drive signal, corresponds to the rotor's position. Counter 2 in IC₁ divides this square wave by 8 (mode 3). XOR gate IC_{4A} compares the divided-feedback square wave with the rotor-drive signal from counters 0 and 1 of IC₁

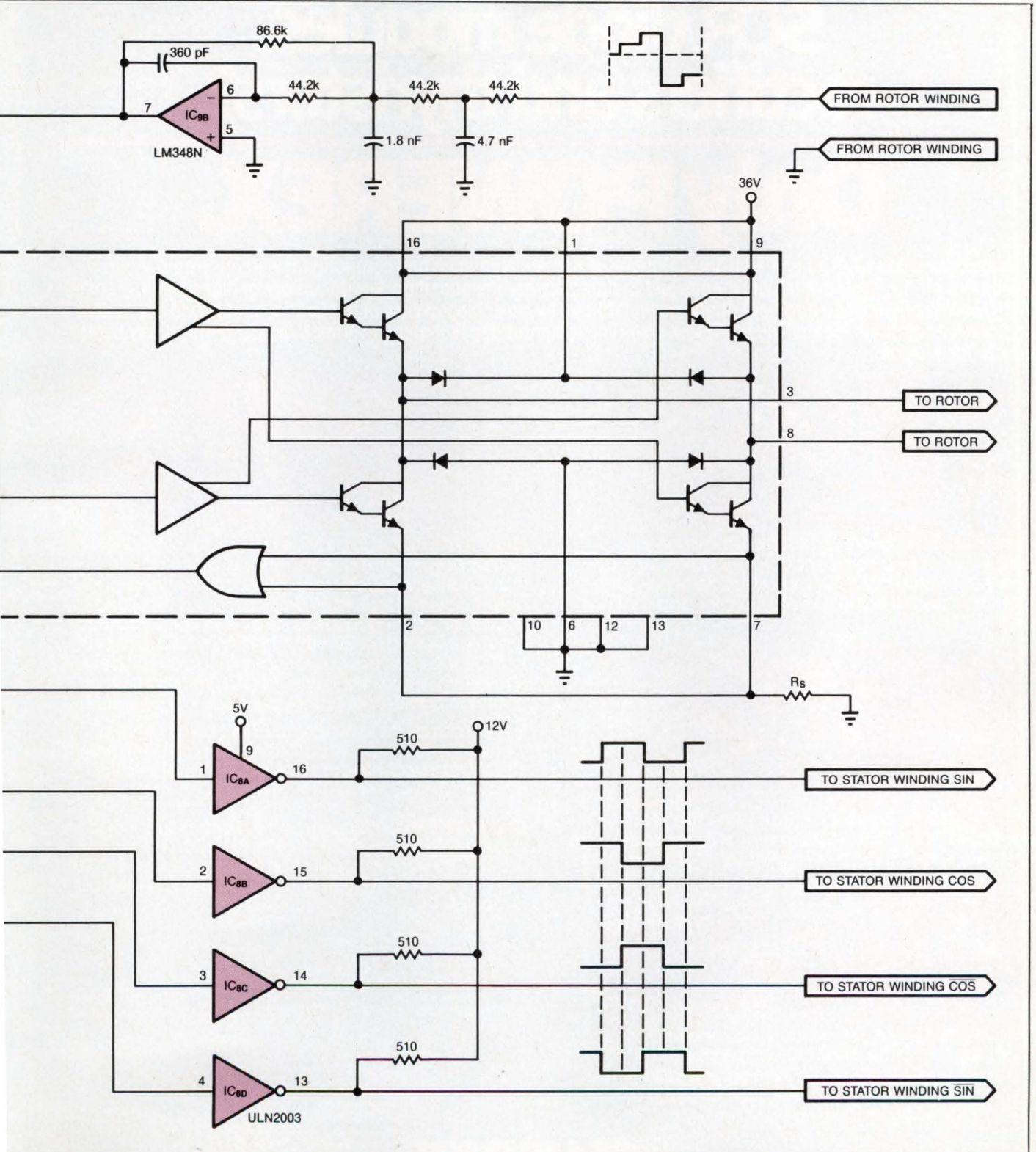

Who offers you the broadest line of power semiconductors... Darlington, FETMOD,™ MOSBIP,™ SCR/diode modules, rectifiers and thyristors?

Only POWEREX.

Powerex gives you what no one else does. Our one-source convenience and compatibility eliminate multi-source doubt. Our off-the-shelf availability means just-in-time delivery, instead of back-order delays or high inventory costs. We'll provide engineer-to-engineer phone conversations for an unbiased view of application needs and alternative component solutions. Best of all, POWEREX gives you leading-edge technology, rather than last-generation obsolescence. Take a look.

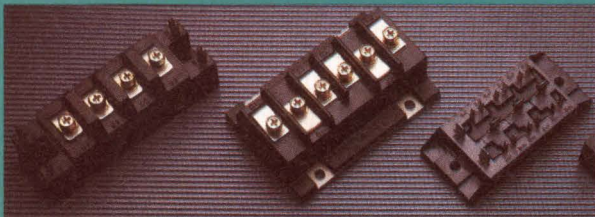

Only POWEREX offers you such a broad line of advanced power semiconductor modules, including next generation FETMOD and cascade or cascode MOSBIP, rated at 8-300 A, 50-1,000 V for applications up to 100 kHz.



Only POWEREX offers you a complete line of low-power triacs and SCRs as part of the broadest line of power semiconductors available.

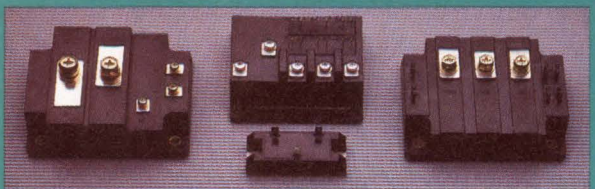

Only POWEREX offers you more advanced Darlington modules, including Application Specific (ASM™) modules: Single device, Phase-Leg, H-Bridge, Three Phase, Chopper and Common Emitter, 5-600 A, with $V_{CEV(SUS)}$ from 200 to 1400 V.



Only POWEREX can provide a modular solution for all the key power components from logic interface devices, input rectifiers and DC regulating components to the output power stage. POWEREX now offers the world's widest array of input power stage thyristor and diode modules. Ratings of 20-800 A, with V_{DRM}/V_{RRM} from 400 to 3000 V. Circuit configurations include Single device, Phase-Leg, Three Phase Bridge and Center Tap in common cathode or common anode configuration.

Recent additions to the product line are a family of Center Tap fast recovery diodes rated at 20-100 A up to 1200 V, a new compact 150 A/1600 V Dual thyristor module, and a new 1200 V/300 A GTO thyristor module.

Only POWEREX offers you all this. For product literature, call POWEREX at 1-800-451-1415, Ext. 300. (In New York, 315-457-9334.) For application assistance, call 412-925-7272, or write POWEREX, Inc., Hillis Street, Youngwood, PA 15697.

POWEREX

Joint Venture Corporation of Westinghouse, GE and Mitsubishi.

CIRCLE NO 101

DESIGN IDEAS

(whose phase the single-chip μP can alter in $\pm 4\text{-}\mu\text{sec}$ increments). Therefore, when the $\overline{\text{BLOCK}}$ signal is active high, $\text{IC}_{5\text{A}}$ impresses the error-signal-modulated drive signal upon the motor-drive IC's Enable pin (IC_6). The width of this drive signal, in turn, determines the resolver's current.

The D flip-flop, $\text{IC}_{3\text{A}}$, monitors the error signal's direction (positive or negative) and controls the drive IC's PHASE input. Note that counter 0 of IC_2 can trigger the single-chip μP 's interrupt line. This counter triggers an interrupt if the error signal exceeds the allowable maximum by monitoring the output of $\text{IC}_{4\text{A}}$. A positive transition from $\text{IC}_{4\text{A}}$ starts the counter. Therefore, any error signal that lasts for less than half of the counter's period does not result in an interrupt.

The controller circuit's 2.5-kHz stator-drive signals result from IC_2 's dividing the system clock by 200 (in mode 3). IC_7 and IC_8 develop the sine and cosine drive signals for the resolver's two stators.

The listing in Fig 2 is for a 12-MHz 8031 single-chip μP . The major software problem to be solved is that of

synchronizing the reloading of the counter with 4 at the instant that IC_1 's counter 0 holds 7 or 6 (reloading with 16 is not as time critical as reloading with 4 is). The program achieves this synchronization by waiting exactly 6 μsec (until counter 0 of IC_1 contains 3 or 2) before beginning to reload the counter with 8. The 2-MHz resolver system clock is derived from the single-chip μP 's 12-MHz clock; therefore, the loading of the counter and the resolver will remain synchronized (that is, the START signal ensures that the counters and flip-flops will start together), because this program ensures that two 2- μsec periods will elapse.

To synchronize the stator and rotor signals with an external event such as the closure of a limit switch, the μP must first set the $\overline{\text{BLOCK}}$ line, then incrementally shift the phase of IC_1 's counter 1, and then read back the count of IC_2 's counter 0 to measure the phase difference between IC_1 's counters 1 and 2. **EDN**

To Vote For This Design, Circle No 749

```

00F8      U1      EQU      0FSH      ; CS FROM UPPER 8 BITS
0003      MODE    EQU      3         ; 8253 MODE CONTROL WORD
0000      CNT0    EQU      0         ; COUNTER 0

;
; MACHINE
; CYCLES
0000 C0A8      PHASE:  PUSH    IE      ; SAVE STATE OF ER BIT
0002 C2AF      CLR      EA         ; DISABLE INTERRUPTS
0004 7583F8    MOV      DPH,#U1    ; SELECT U1 MODE RE9
0007 758203    MOV      DPL,#MODE ;
000A E4        CLR      A         ;
000B F0        MOVX     @DPTR,A    ; SC1,SC0 := 00
000C 758200    MOV      DPL,#CNT0 ; 2 LATCH CNT0
000F E0        MOVX     A,@DPTR   ; 2 SELECT CNT0 (U1)
0010 20E202    JB       ACC.2,V74  ; 2 READ CNT0
0013 00        NOP                     ; 1 JUMP, IF 7, 6, 5, 4
0014 00        NOP                     ; 1
0015 30E101    V74:   JNB     ACC.1,V54 ; 2 ADJUST 4 (2  $\mu\text{SEC}/0.5 \mu\text{SEC}$ )
0018 00        NOP                     ; 1 JUMP, IF 5, 4
0019 00        V54:   NOP                     ; 1 adjust 2 (1  $\mu\text{SEC}/0.5 \mu\text{SEC}$ )
001A 00        NOP                     ; 1
001B 500C      JNC     MIN4US        ; 2 - 4  $\mu\text{SEC}$  FOR NC
001D 7404      MOV      R,#4         ; 1 4 x 0.5  $\mu\text{SEC}$  = 2 -  $\mu\text{SEC}$  PERIOD
001F F0        MOVX     @DPTR,A    ; 2 7 OR 6 IN CNT0 NOW
0020 00        JOIN:   NOP                     ; 1
0021 00        NOP                     ; 1
0022 00        NOP                     ; 1 2 PERIODS ELAPSE
0023 7408      MOV      A,#8         ; 1 RETURN TO 4- $\mu\text{SEC}$  PERIOD
0025 F0        MOVX     @DPTR,A    ; 2 3 OR 2 IN CNT0 NOW
0026 D0A8      POP      IE         ; RESTORE EA
0028 22        RET

0029 7410      MIN4US: MOV     A,#16    ; 1 16 x 0.5  $\mu\text{SEC}$  = 8- $\mu\text{SEC}$  PERIOD
002B F0        MOVX     @DPTR,A    ; 2 7 OR 6 IN CNT0 NOW
002C 80F2      SJMP    JOIN         ; 2 WAIT FOR 8- $\mu\text{SEC}$  PERIOD

0000      END

```

Fig 2—This program allows a 12-MHz 8031 single-chip μP to control the circuit in Fig 1.

Thermistor measures respiration rate

Ricardo Jimenez-G
San Diego State University, Calxico, CA

The circuit in **Fig 1** uses a thermistor (R_{TH}) that measures respiration rate when placed near a subject's

nostril. The thermistor responds to the relatively high temperature of exhaled air. The circuit measures respiration rates between 10 and 50 breaths/sec; above and below these limits, it sounds an alarm. To measure these low-frequency phenomena, the circuit uses the

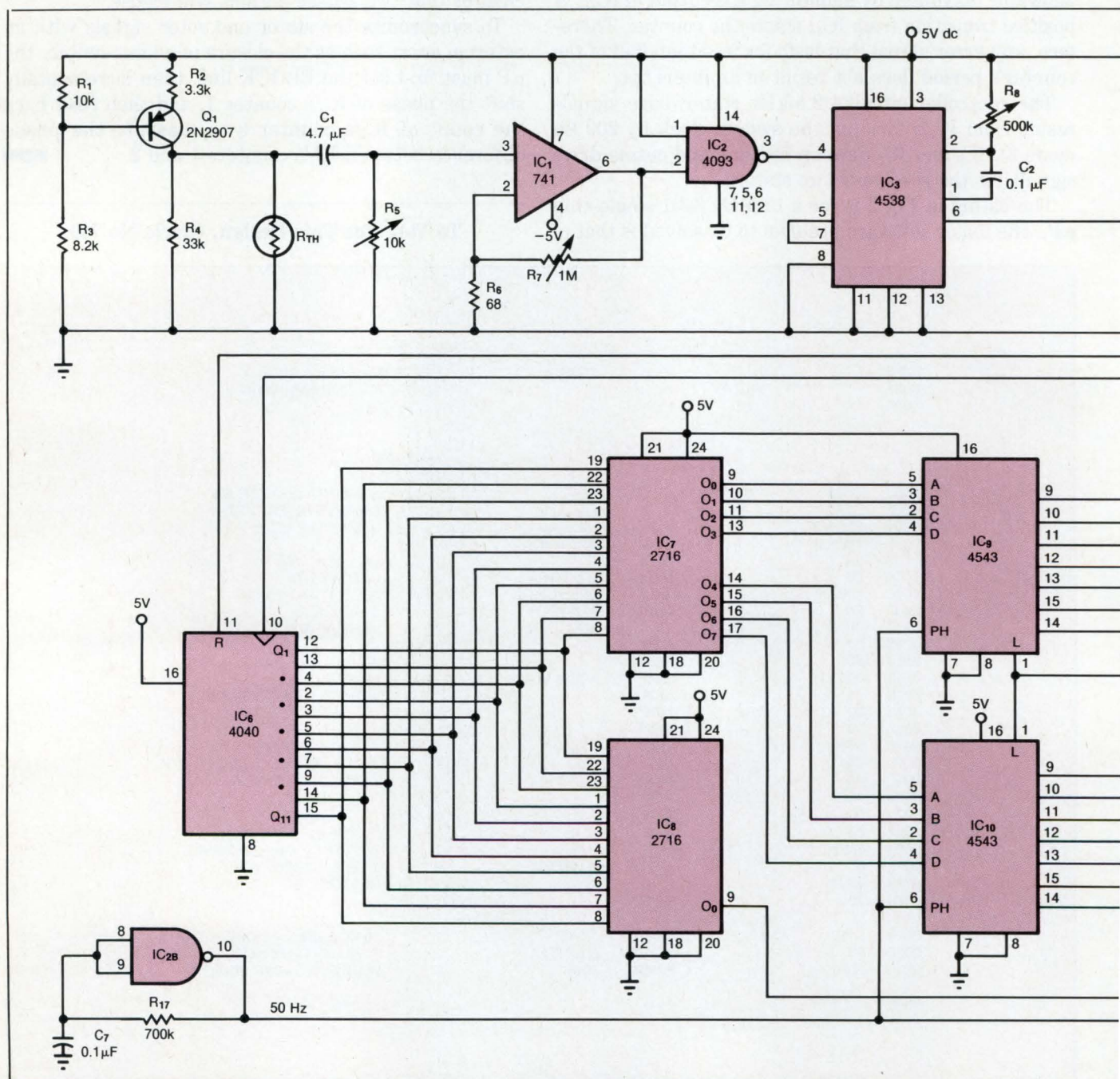
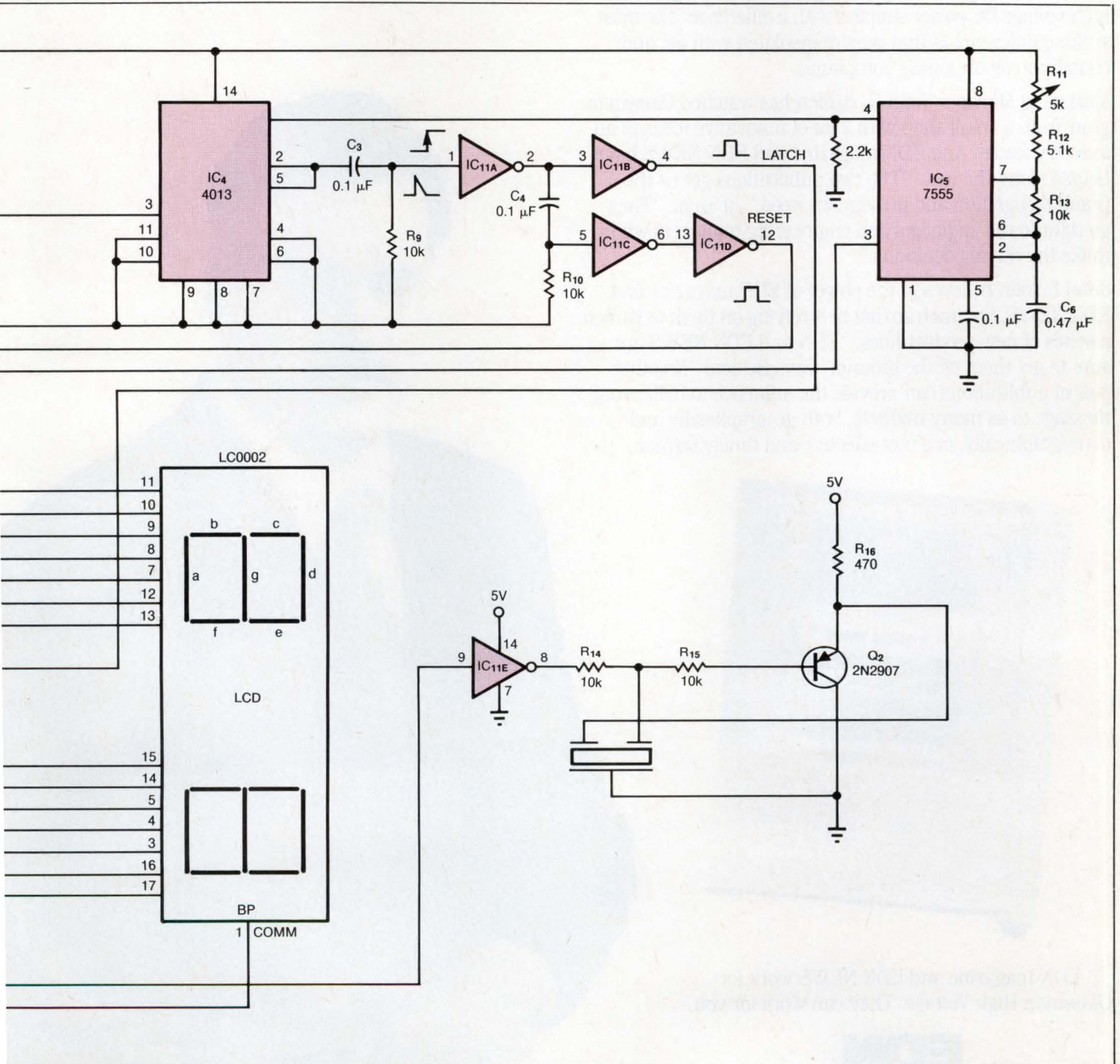

Fig 1—This circuit uses a thermistor placed near a subject's nostril to measure respiration rate. The EPROMs translate the respiration period into rate.

DESIGN IDEAS

respiration signal to gate a higher-frequency multivibrator on and off. A counter totals the multivibrator's output, and a combination of EPROMs and BCD- to 7-segment decoders drives an LCD. Fig 2 shows the programs for the two EPROMs, IC₇ and IC₈.

Q₁ and its associated circuitry compose a constant-current generator that linearizes the response of thermistor R_{TH} (Fenwal UUT43J1). R₄ is the equivalent resistance of the thermistor at 25°C. The constant current is



"I COUNT ON **EDN MAGAZINE** AND **EDN NEWS** TO CREATE WORLDWIDE BRAND AWARENESS FOR OUR POWER SUPPLIES."

John R. Belden
Marketing Manager
Glassman High Voltage, Inc.

Glassman High Voltage designs and manufactures high-voltage DC power supplies with a difference. The most striking difference is that they're insulated with air, and contain no oil or potting compound.

Marketing Manager John R. Belden has watched Glassman grow from a small shop with a lot of innovative ideas to an industry leader. And EDN magazine and EDN NEWS have helped along the way. "The two publications get us the brand recognition and prestige we need," he says. "They go right to the engineers and engineering managers who make the buying decisions."

John Belden believes in the power of EDN magazine and EDN NEWS. So much so that he's relying on them to launch a series of new product lines. "EDN and EDN NEWS are sure to get them off the ground," says Belden. "No other pair of publications can provide the influence to deliver our message to as many markets, both geographically and demographically, in a cost-effective and timely fashion."



EDN magazine and EDN NEWS work for Glassman High Voltage. They can work for you.

EDN

Where Advertising Works

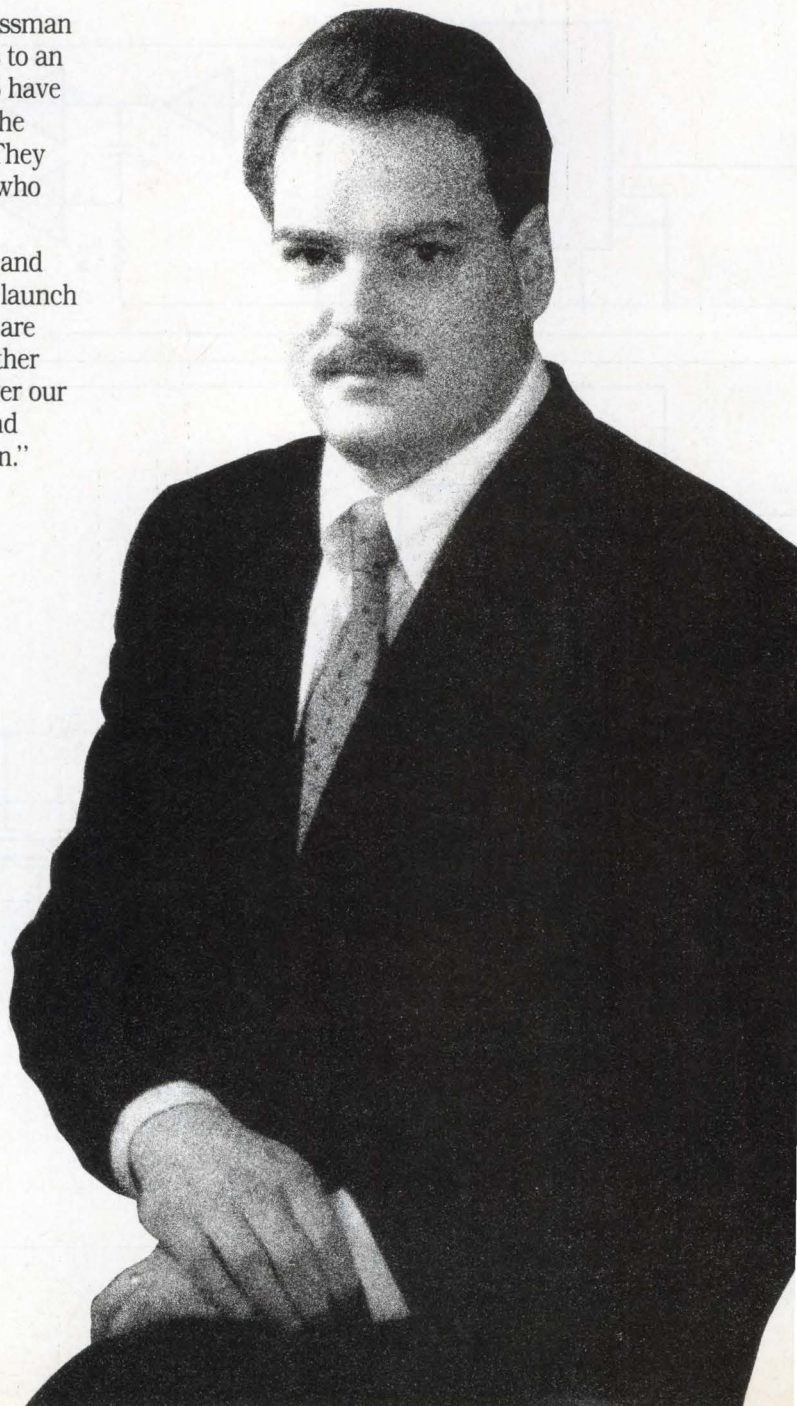

DESIGN IDEAS

$$I_C = (V_{CC} - V_b - 0.7) / R_2$$

$$I_C = 0.62 \text{ mA.}$$

The resistance across the thermistor, therefore, equals this constant current multiplied by the parallel combination of R_4 and the thermistor. C_1 blocks dc levels from IC_1 , which amplifies voltage changes arising from changes in thermistor resistance. Potentiometer R_7 adjusts IC_2 's gain.

IC_2 , a Schmitt trigger, triggers IC_3 , which is a one-shot having a period of approximately 0.2 sec ($T = R_8 \times C_2$). The one-shot, in turn, gates on IC_5 , a

multivibrator operating at 10 Hz, via flip-flop IC_4 . The multivibrator drives IC_6 , a 12-stage counter. IC_7 through IC_{10} form a latched decoder for the counter's output. The EPROMs, IC_7 and IC_8 , convert the respiration period measured by the counter into respiration rate or trigger the out-of-range alarm, whichever is appropriate. IC_{11} 's inverter gates reset the counter and latch the display drivers. **EDN**

To Vote For This Design, Circle No 747

HEX ADDRESS	HEX DATA	HEX ADDRESS	HEX DATA	HEX ADDRESS	HEX DATA
A	60	3A	10	A	1
B	55	3B	10	B	1
C	50	3C	10	C	1
D	46	3D	10	D	1
E	43	3E	10	E	1
F	40	3F	10	F	1
10	38	40	09	10	1
11	35	41	09	11	1
12	33	42	09	12	1
13	32	43	09	13	1
14	30	44	09	14	1
15	29	45	09	15	1
16	27	46	09	16	1
17	26	47	08	17	1
18	25	48	08	18	1
19	24	49	08	19	1
1A	23	4A	08	1A	1
1B	22	4B	08	1B	1
1C	21	4C	08	1C	1
1D	21	4D	08	1D	1
1E	20	4E	08	1E	1
1F	19	4F	08	1F	1
20	19	50	08		
21	18	51	07		
22	18	52	07		
23	17	53	07		
24	17	54	07		
25	16	55	07		
26	16	56	07		
27	15	57	07		
28	15	58	07		
29	15	59	07		
2A	14	5A	07		
2B	14	5B	07		
2C	14	5C	07		
2D	13	5D	06		
2E	13	5E	06		
2F	13	5F	06		
30	13	60	06		
31	12	61	06		
32	12	62	06		
33	12	63	06		
34	12	64	06		
35	11				
37	11				
38	11				
39	11				

Fig 2—These EPROM programs for IC_7 (a) and IC_8 (b) effect the period-rate translations.

DESIGN IDEAS

Design Entry Blank

\$100 Cash Award for all entries selected by editors. An additional \$100 Cash Award for the winning design of each issue, determined by vote of readers. Additional \$1500 Cash Award for annual Grand Prize Design, selected among biweekly winners by vote of editors.

To: Design Ideas Editor, EDN Magazine
Cahners Publishing Co
275 Washington St, Newton, MA 02158

I hereby submit my Design Ideas entry.

Name _____

Title _____ Phone _____

Company _____

Division (if any) _____

Street _____

City _____ State _____ Zip _____

Design Title _____

Home Address _____

Social Security Number _____

(Must accompany all Design Ideas submitted by US authors)

Entry blank must accompany all entries. Design entered must be submitted exclusively to EDN, must not be patented, and must have no patent pending. Design must be original with author(s), must not have been previously published (limited-distribution house organs excepted), and must have been constructed and tested.

Exclusive publishing rights remain with Cahners Publishing Co unless entry is returned to author or editor gives written permission for publication elsewhere.

In submitting my entry, I agree to abide by the rules of the Design Ideas Program.

Signed _____

Date _____

ISSUE WINNER

The winning Design Idea for the May 12, 1988, issue is entitled "Counter controls its own clock frequency," submitted by Shantha Fernando of the Arthur C Clarke Centre (Moratuwa, Sri Lanka).

Your vote determines this issue's winner. All designs published win \$100 cash. All issue winners receive an additional \$100 and become eligible for the annual \$1500 Grand Prize. **Vote now**, by circling the appropriate number on the reader inquiry card.

MUNICH, 8-12 NOVEMBER:

WHERE THE CREATIVE SPARKS FLY.

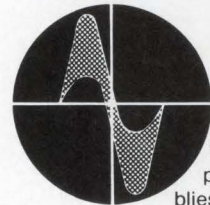

electronica is the world's largest trade fair for electronic components and assemblies. Here state-of-the-art

technology is on display, and developments, trends, methods and solutions are showcased in a comprehensive, precise, clear and up-to-the-minute style.

13th International Conference on Microelectronics
7-8 November 1988

4th International Macroelectronics Conference
9-10 November 1988

Technical Sessions on Sensory Analysis and Engineering
9-10 November 1988

Symposium on Quality Assurance in the Field of Electronics
11 November 1988



electronica 88[®]

Information:

Kallman Associates, 5 Maple Court,
Ridgewood, NJ 07450,
Tel. (201) 652-7070,
Telex 264 715 gdw d ur

MESSE MÜNCHEN
INTERNATIONAL

CIRCLE NO 41

EDN August 4, 1988



value-packed
filters **\$995**
 from

dc to 3GHz

- less than 1dB insertion loss over entire passband
- greater than 40dB stopband rejection
- 5 section, 30dB per octave roll-off
- VSWR less than 1.7 (typ)
- over 100 models, immediate delivery
- meets MIL-STD-202
- rugged hermetically sealed package (0.4 x 0.8 x 0.4 in.)
- BNC, Type N, SMA available

finding new ways ...
 setting higher standards

Mini-Circuits

A Division of Scientific Components Corporation
 P.O. Box 350166, Brooklyn, New York 11235-0003 (718) 934-4500
 Fax (718) 332-4661 Domestic and International Telexes: 6852844 or 620156

LOW PASS	Model	*LP-	10.7	21.4	30	50	70	100	150	200	300	450	550	600	750	850	1000
Min. Pass Band (MHz) DC to			10.7	22	32	48	60	98	140	190	270	400	520	580	700	780	900
Max. 20dB Stop Frequency (MHz)			19	32	47	70	90	147	210	290	410	580	750	840	1000	1100	1340

Prices (ea.): P \$9.95 (6-49), B \$24.95 (1-49), N \$27.95 (1-49), S \$26.95 (1-49)

HIGH PASS	Model	*HP-	50	100	150	200	250	300	400	500	600	700	800	900	1000
Pass Band (MHz)	start, max.		41	90	133	185	225	290	395	500	600	700	780	910	1000
	end, min.		200	400	600	800	1200	1200	1600	1600	1600	1800	2000	2100	2200
Min. 20dB Stop Frequency (MHz)			26	55	95	116	150	190	290	365	460	520	570	660	720

Prices (ea.): P \$12.95 (6-49), B \$27.95 (1-49), N \$30.95 (1-49), S \$29.95 (1-49)

*Prefix P for pins, B for BNC, N for Type N, S for SMA *example: PLP-10.7*

C105 REV.D

Digital
has
it
now.

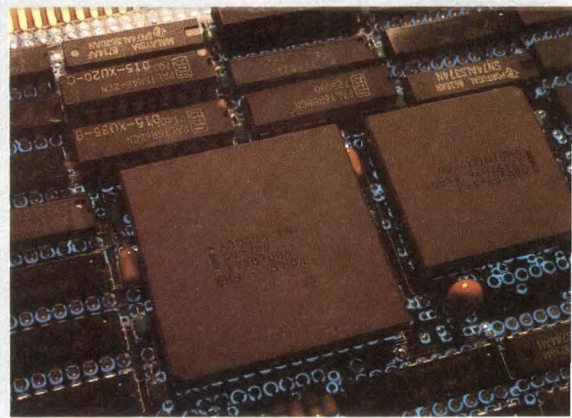

Scientific Calculations is one of the leading suppliers of printed circuit board design software to Fortune 500 companies: telecommunications, aerospace, automotive and computers.

According to Stephen W. Testa, Scientific Calculations Vice President of Sales, "We do business in an 'on-line' manner - we license the SCICARDS® System design software and provide automatic, easily implemented upgrades every 9 to 12 months. Only one computer company provides the kind of architecture, know-how and support we need to operate that way: Digital."

"Digital's VAX™ architecture allows us to bring our software to the customer in the most cost-effective manner. The marketplace is calling for VAX-based solutions, because design engineers need the mainframe power on their desks that MicroVAX™ and VAXstation™ workstations provide. And because of DECnet™ networking software, our product works in a multivendor environment. This

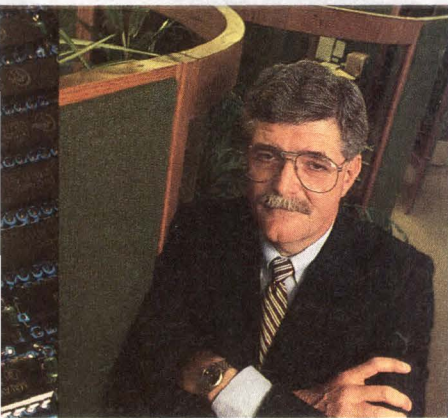

"An architecture Scientific Calculations uses to provide leading edge design software to the world's leading electronics firms."

integration lets customers move data through different parts of their organizations easily."

"Working with Digital also allows us to be backward and forward compatible. So our customers can keep current with technology cost effectively, improving time-to-market, without rewriting their applications."

"We can say to our customers, 'Everything from design to the manufacture of printed circuit boards is available from Scientific Calculations.' And Digital is the common thread."

To learn how Digital can give you a competitive advantage, write:
Digital Equipment Corporation, 200 Baker Avenue, W., Concord,
MA 01742. Or call your local Digital sales office.

digital™

©Digital Equipment Corporation, 1988.
The Digital logo, VAX, MicroVAX, VAXstation and DECnet are trademarks of Digital Equipment Corporation.
SCICARDS is a registered trademark of Scientific Calculations, a division of Harris Corporation.

NEW PRODUCTS

INTEGRATED CIRCUITS

Signetics 1 Mbit DRAM Dual Ported Controllers 74F1764 and 74F1765



RAM CONTROLLERS

- Work with 40-nsec dynamic RAMs
- Dual-ported, 1M-bit capability

The 74F1764 and 74F1765 1M-bit dynamic RAM controllers offer synchronous single- and dual-port operation at 100 MHz. They provide arbitration, signal timing, and refresh address generation for 40-nsec dynamic RAMs. The 74F1764 differs from the 74F1765 only in the addition of an on-chip input address latch—a useful feature for systems that employ unlatched or multiplexed address and data buses. Other features include the ability to address as much as 4M-bits of memory via external address multiplexing and a separate refresh clock that supports adjustable refresh timing. 48-pin DIP, \$11; PLCC, \$11.75 (1000).

Signetics Corp, Box 3409, Sunnyvale, CA 94088. Phone (408) 991-2000.

Circle No 351

RESONANT CONTROL IC

- Uses frequency-modulation control scheme
- Operates to 3 MHz

Intended for resonant-mode power-supply control applications, the UC3860 features a frequency-modulated, fixed on-time control scheme. A precision 5V reference and a high-gain error amplifier controls a variable-frequency oscillator that operates to 3 MHz. The IC generates

temperature-stable pulses as short as 200 nsec, and contains two totem-pole outputs for driving the gates of power MOSFETs. Each output, which you can program to run alternately or in parallel, is capable of providing 2A current pulses. The chip also provides programmable control for soft start, undervoltage lockout, and fault management. MIL-STD-883 devices will be available in a 24-pin DIP or a 28-pin LCC in December 1988. A sample-pack containing a UC3860N, a multilevel pc board, a UC3611 Schottky-diode array, and descriptive material is available for \$15.

Unitrode Integrated Circuits, 7 Continental Blvd, Merrimack, NH 03054. Phone (603) 424-2410.

Circle No 352

MODEM IC

- Suitable for use in mobile radio systems
- Interfaces to a μP

The FX429 single-chip 1200-baud fast frequency-shift keying modem is targeted for use in trunked radio systems. It conforms to the UK's MPT1317/1327 Band-III trunked radio-protocol specification, but you can use it in other radio- or cable-based data-link applications. The device operates in full-duplex mode at 1200 baud. While transmitting data, you can program the device to automatically generate and transmit preamble bit-reversals for link synchronization, and a 2-byte checksum for the transmitted data. You can disable the checksum function to

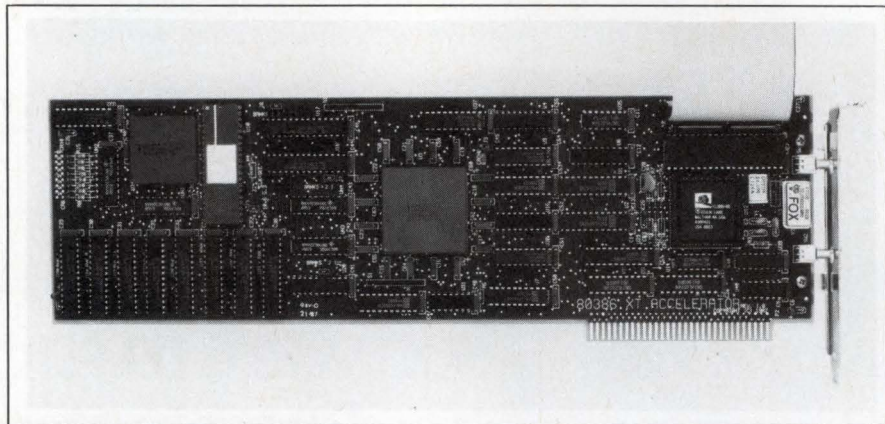

CUSTOM VLSI CHIP

- 80386 clock rates to 20 MHz
- 8088 clock rates to 10 MHz

The EL386-88 processor/converter chip is a high-speed CMOS IC that translates the control signals and 32-bit transfer sequences of an 80386 μP into the equivalent signals and 8-bit transfer sequences of an 8088 μP . To the 80386, the EL386-88 appears as a 32-bit memory or as a peripheral device operating at a 16- to 20-MHz 80386 clock rate. To the 8-bit circuitry on the system's mother board, the EL386-88 appears as an 8-bit 8088 operating at its own

clock rate. The two μP clocks can be completely asynchronous, allowing the 80386 to run at a full 20 MHz, yet address peripherals designed for 4.77-MHz 8088 IBM PC data rates. The EL386-88, which increases operating speed as much as 10 times that of the 8088-based PC, automatically converts 32-bit transfer requests into multiple 8-bit transfers. The IC performs all the translation without any software changes. \$50 (1000).

Edsun Laboratories Inc, 9 Spring St, Waltham, MA 02154. Phone (617) 647-9300. TLX 853664.

Circle No 353

Your imagination.

It's limited only by practical considerations. Materials. Technologies. Costs. That's why coming to Fall Design can make a crucial difference.

You'll expand your knowledge — and save time, too. Because Fall Design puts you in touch with more technical experts, and more new products than you could evaluate in months at your office.

You can further increase your expertise with courses at the ASME-sponsored Conference.

Spend a day at Fall Design and you'll come away stimulated. Refreshed. Equipped with the information you need to fuel your imagination. So that you can turn design projects into successful products.

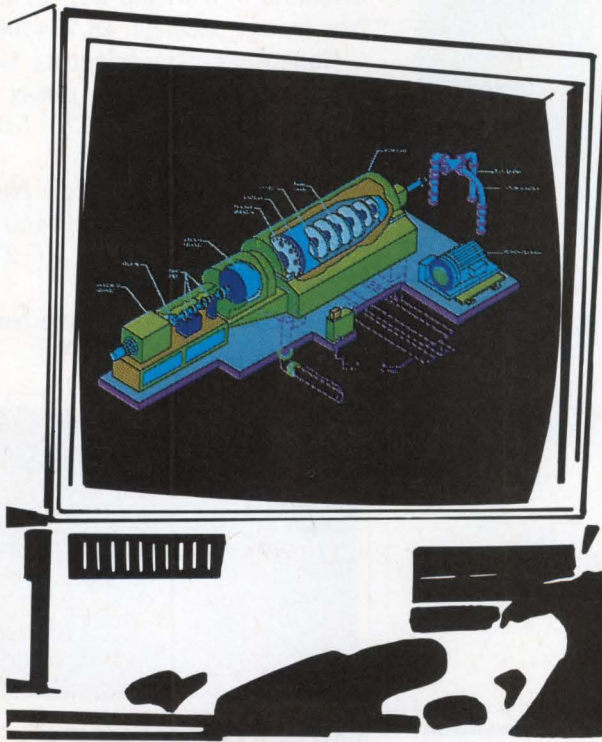

Fall
Design
Engineering
Show & Conference™

October 11-13, 1988
Jacob K. Javits Convention Center
New York, New York

FREE Show admission with this coupon!
Save \$20 by sending in this coupon. You'll get your Show credentials by mail.

NAME _____
COMPANY _____
ADDRESS _____
CITY _____ STATE _____ ZIP _____
TITLE _____
Mail to: Fall Design
Engineering Show & Conference™
P.O. Box 597
Chester, NY 10918

64 ANTI-ALIAS CHANNELS

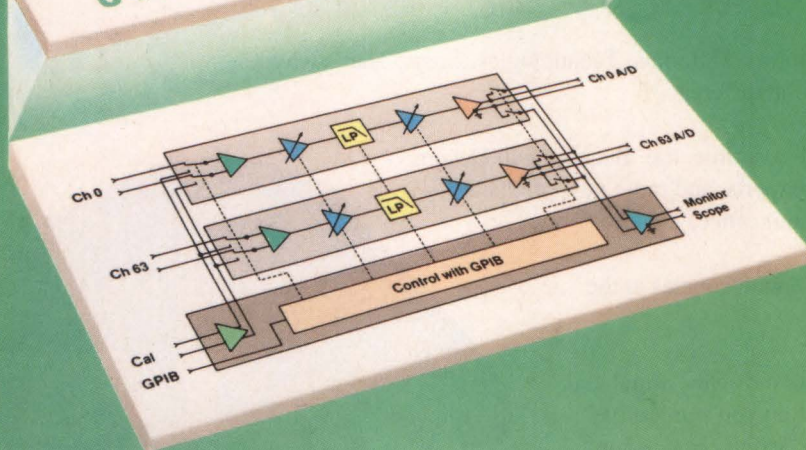

**64 anti-alias
filter channels.
80 dB/octave.
0.1Hz to 10.23 kHz.
1° phase match.
Pre and post gain.
Differential input.
Calibration input.
Output monitor.
All in 7"
mainframe.**

Only With System Friendly

Just one of hundreds of programmable hardware building block configurations possible with our operating system. Just one of hundreds of exclusive possibilities that make Precision 6000 truly System Friendly now and easy to update in the future. Call (607) 277-3550 for brochure. Or write.



PRECISION FILTERS, INC.

240 Cherry Street, Ithaca, New York 14850

CIRCLE NO 27

DID YOU KNOW?

EDN is distributed
at every major
electronics/computer show in the
U.S., France, and Germany.

EDN

INTEGRATED CIRCUITS

allow continuous data transmission. In receive mode, the device detects the 16-bit Sync (control channel frame synchronization) or Synt (traffic channel frame synchronization) word that's in front of the data packet. You can also program it to error-check the data, using the transmitted checksum. The FX429 has an on-chip clock oscillator that accepts a 4.032-MHz crystal or external clock input and an 8-bit μ P-compatible control/data interface. Its 1.008-MHz output drives peripheral circuitry. Fabricated in CMOS, the device operates from a 5V supply and draws a typical supply current of 5 mA when active. It is available in a 24-pin DIP or a surface-mount package. £6.78 (1000).

Consumer Microcircuits Ltd, 1 Wheaton Rd, Witham, Essex CM8 3TD, UK. Phone (0376) 513833. TLX 99382.

Circle No 354

Mx-Com Inc, 4800 Bethania Station Rd, Winston-Salem, NC 27105. Phone (919) 744-5050.

Circle No 355

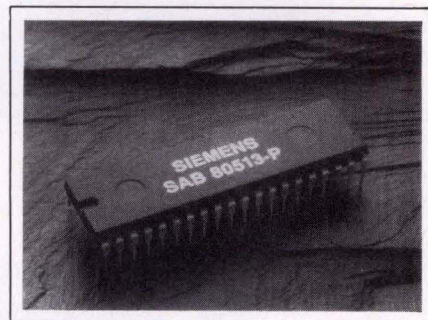

NMOS CONTROLLER

- 8-bit circuitry
- Includes on-chip ROM

Fabricated in NMOS, the SAB 80513 8-bit, single-chip microcontroller contains 16k bytes of mask-programmable ROM. The 80513 maintains all features of the 8051 family architecture. The controller is a low-cost upgrade for designers using the SAB 8052, particularly CMOS 16k-byte ROM users whose system doesn't need the low power

INTEGRATED CIRCUITS

consumption of CMOS. In addition to the ROM, the SAB 80513 contains 256 bytes of RAM, four 8-bit ports, an interrupt structure with six vectors and two programmable priority levels, a serial channel, and oscillator and clock circuitry. The SAB 80513 comes in a 40-pin DIP and a 44-pin PLCC in both 12- and 16-MHz versions. \$4.10 to \$4.55 (100,000).

Siemens Components, 186 Wood Ave S, Iselin, NJ 08830. Phone (201) 321-3400.

Circle No 356

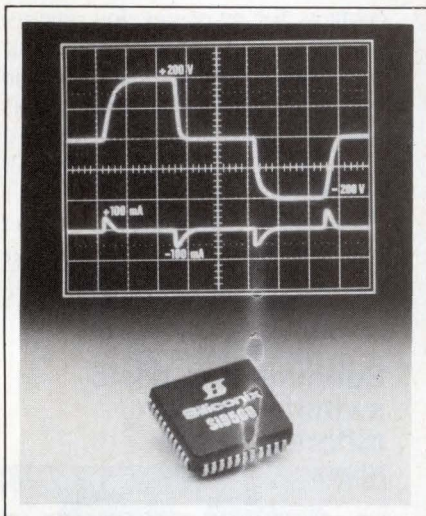

SYMMETRIC ROW DRIVER

- For AC-TFEL displays
- Data-transfer rate to 4 MHz

According to the manufacturer, the Si9560 is the first monolithic symmetric row driver to meet the requirements for ac thin-film electroluminescent (AC-TFEL) displays. Replacing two chips with one, the Si9560's symmetric drive scheme significantly reduces the differential aging effects that cause latent imaging in AC-TFEL displays, and nearly doubles the lifetime of EL displays. A front-end logic interface accepts 10.8 to 15V serial inputs and transfers data at rates to 4 MHz. Thirty-four 230V push-pull outputs on each driver provides a sink and source capability of greater than 100 mA. Although specifically designed for AC-TFEL displays, the high-

voltage, high-current outputs of the Si9560 can also drive large-area matrix vacuum-fluorescent and plasma displays. The IC is also useful for driving capacitive elements in ink-jet printers. \$25 (100), \$5 (OEM qty, available in September).

Siliconix Inc, 2201 Laurelwood Rd, Santa Clara, CA 95054. Phone (408) 988-8000.

Circle No 357

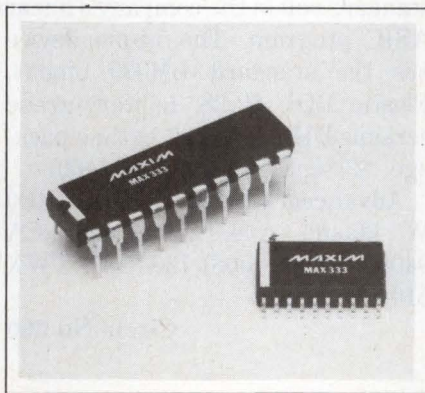

QUAD ANALOG SWITCH

- Contains four spdt switches
- Low On/Off leakage current

Designed for switching functions that require four spdt analog switches, the MAX333 operates from either single or dual supplies. Dual-supply operation ranges from ± 5 to ± 18 V. Where ground serves as the negative source, single-supply operation ranges from 10 to 30V. The device does not require a separate 5V logic supply and is TTL/CMOS compatible. The monolithic IC can switch signals to the supply rails. At a supply voltage of ± 15 V, the MAX333 consumes 130 μ A from the positive supply and 10 μ A from the negative supply. The on-resistance is 140 Ω , and the on-leakage is 0.2 nA. The off-leakage is 0.02 nA, and the turn-off time is 50 nsec. The device has break-before-make switching action. 20-pin plastic DIP \$2.95; 20-pin military-grade ceramic DIP \$7.90, (100).

Maxim Integrated Products, 120 San Gabriel Dr, Sunnyvale, CA 94086. Phone (408) 737-7600.

Circle No 358

Because you're thinking fast... count on us for the speed you need.

Now, 19ns settling op amps that survive saturations and shorts...

Comlinear's two new high-speed op amps bring you built-in protection against saturation. Plus simple short-circuit protection. That means easy solutions for fast input and output amplifiers in systems where signal level or load can't be controlled.

use as little as 57mW...

Our new 170MHz CLC205 offers fast dynamic performance and power consumption down to 57mW (with ± 5 V supplies). A settling time of 24ns to 0.05% is complemented by the drive performance of a ± 12 V output swing and ± 50 mA output current.

or drive up to ± 100 mA.

For higher drive, call for our 180MHz CLC206 which will drive up to ± 100 mA and settle in just 19ns (to 0.1%). It is coupled with a high slew rate of 3400V/ μ s and delivers a large-signal bandwidth of 70MHz at 20V_{pp}.

Both of these new op amps give you saturation and short-circuit protection plus *tested and guaranteed performance at half the price of other high-speed amps*. Now you can be safe at high speed.

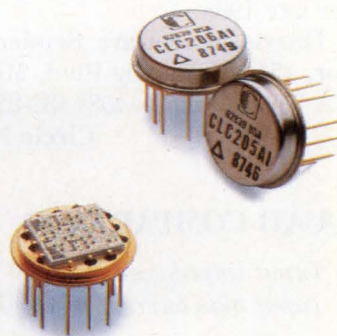

Comlinear Corporation
Solutions with speed

4800 Wheaton Drive
Fort Collins, Colorado 80525
(303) 226-0500

CIRCLE NO 28

INTEGRATED CIRCUITS

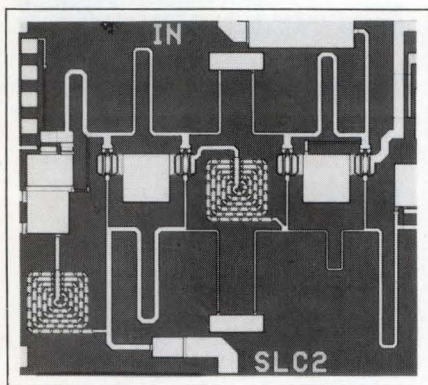

GaAs MMIC

- 6- to 18-GHz bandwidth
- 5-dB small-signal gain

Designed for electronic-warfare applications, the HMM-11820 MMIC (monolithic microwave integrated circuit) has a small-signal gain of 5 dB over the bandwidth of 6 to 18 GHz. The chip consumes 35 mA of current and has an output power of 12 dBm at 1 dB of gain compression. The chip's VSWR is more than 2:1 at both the input and output, and the noise figure is 5.5 dB typ. The device includes dc blocking at the RF input and output, and an on-chip source bias resistor. Using a distributed topology, the chip contains four 200- μ m MESFETs and all necessary capacitors, coils, and resistors. Standard wafer qualification exceeds MIL-STD-883C. \$99 (1000). Production quantities are scheduled for late 1988.

Harris Microwave Semiconductor, 1530 McCarthy Blvd, Milpitas, CA 95035. Phone (408) 433-2222.

Circle No 359

QUAD COMPARATOR

- Input impedance is $10^{12}\Omega$
- Input bias current of 10 pA

An improved version of the industry standard LM339, the ALD-4302 CMOS quad comparator features an input impedance of $10^{12}\Omega$, an input bias current of 10 pA, and a TTL-input response time of 120 nsec. The comparator can sink an output current of 60 mA, yet requires only a 150- μ A supply current for each

comparator. The device works from a nominal 5V supply, but will work with any single supply from 3 to 12V, or from a dual supply of 1.5 to 6V. Other features include an input voltage range that includes ground, and outputs that can sink or source current. You can use the outputs in a wired-OR connection without pull-up resistors, or in a push-pull configuration with 2 mA of sourcing current. The ALD-4302 is also a standard cell in the company's linear ASIC program. The 14-pin device has the standard LM339 pinout. Plastic DIP, \$2.28; military-grade ceramic DIP, \$4; small-outline package, \$2.80; die form, \$2.28 (100).

Advanced Linear Devices, 1030 W Maude Ave, Sunnyvale, CA 94086. Phone (408) 720-8737. TWX 510-100-6588.

Circle No 360

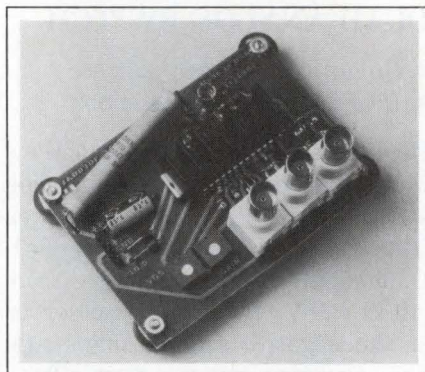

DISPLAY DRIVER

- 50V output into 6-pF load
- Operates at 175 MHz

Based on the company's QuickChip ASIC technology, the TKDD10P CRT (Z-axis) display driver can drive a 6-pF load with 50V p-p at 175 MHz. According to the company, it is the only monolithic IC capable of this performance. You can add an external impedance-matching network to extend the performance to 200 MHz. Two input connections allow either a single-ended or a differential input drive. The inputs accept RS-343 signals of ± 0.714 mV p-p. By means of a 5-k Ω potentiometer, you can vary the gain linearly

Miniature basic switches provide versatility

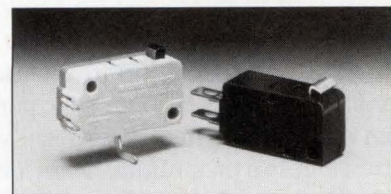

The V Series of miniature, basic switches has a variety of low-cost solutions for your applications. The V7 product is a cost effective design that features printed wiring board terminals which reduce installation costs. The V10 product serves as an effective option for on-off/off-on applications and its non-snap design is interchangeable with other industry standard products.

Other features include special contacts for switching low energy circuits, and power handling capabilities of up to 25 amps. Some versions feature an operating force as low as 10 grams. The standard temperature tolerance range is -20° to +180° F (-4° to +85° C).

For more information, contact MICRO SWITCH, The Sensor Consultants at 815-235-6600.

Subminiature basic switches fit many different needs

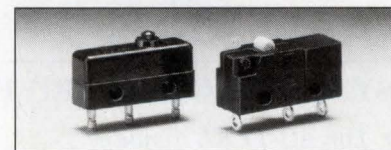

The 9SM, a newer addition to the sub-miniature SM Series, was developed for applications requiring less precise switching characteristics. These miniature switches are cost-effective, durable, and adaptable to a variety of different auxiliary or integral actuators.

The precision 11SM is a light weight switch and can be made with silver projection contacts for low energy circuit applications, providing a cost effective alternative to gold contacts.

The standard temperature range is -65° to +180° F (-54° to +85° C). Certain versions are rated for logic level switching and handle power loads of up to 11A -1/4 HP 125 VAC.

For more information, contact MICRO SWITCH, The Sensor Consultants at 815-235-6600.

CIRCLE NO 29

Seven money saving ideas.

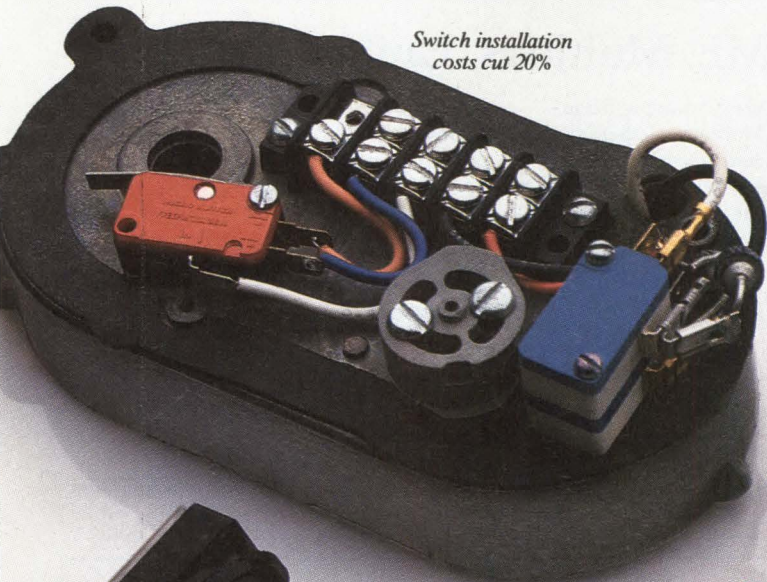

Switch installation costs cut 20%

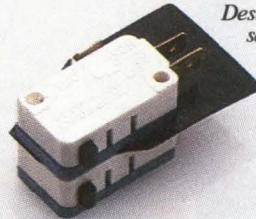

Design concept saves 20%

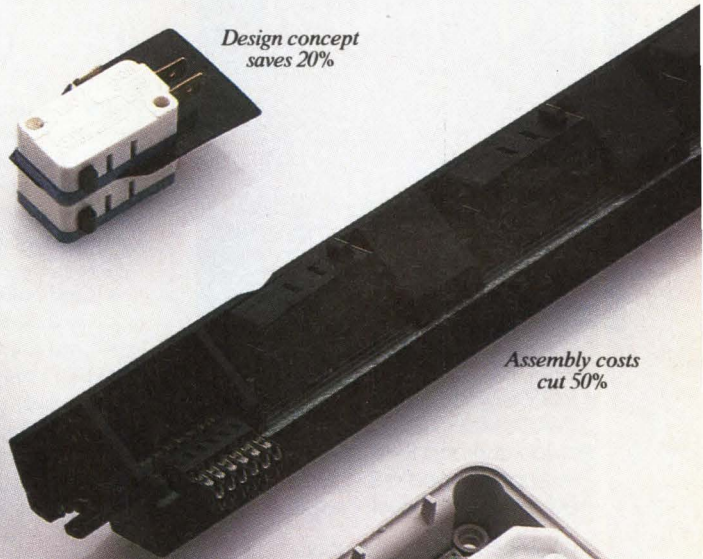

Assembly costs cut 50%



Total product costs cut 10%



Assembly costs cut 40%

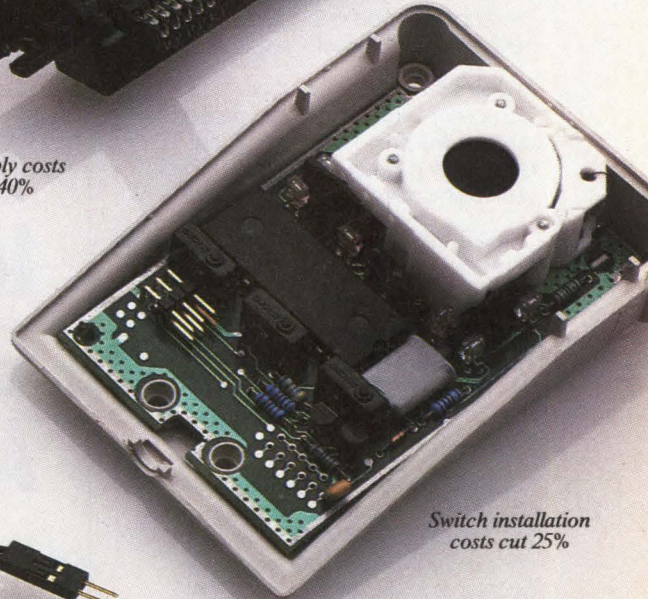

Switch installation costs cut 25%



Assembly costs cut 15%

Take the long black strip of switches for example. It was the result of working together with a gaming machine manufacturer who needed to lower the cost of their product.

In addition to supplying less expensive basic switches that didn't compromise quality, we modified the switch terminals. Then we mounted the switches on a PC board, attached them to a connector, and assembled it all in a plastic housing. The result? A MICRO SWITCH idea designed to cut the

customer's assembly costs in half.

Each one of the basic switch ideas you see here has a money saving story of its own. To find out what they are, or for other ways we can work with you to reduce your total costs, ask for our new brochure. Call us at 815-235-6600. Or write MICRO SWITCH, Freeport, IL 61032. CIRCLE NO 107



V7

The start of many money saving ideas.

Together, we can find the answers.

MICRO SWITCH
a Honeywell Division

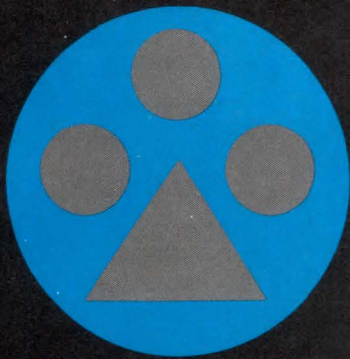

INTROL

CROSS DEVELOPMENT SYSTEMS

- INTROL-C Cross-Compilers
 - INTROL-Modula-2 Cross-Compilers
 - INTROL-Macro Cross-Assemblers
- Provide cost and time efficiency in development and debugging of embedded microprocessor systems

All compiler systems include:
Compiler • Cross-assembler • Support utilities • Runtime library, including multi-tasking executive • Linker • One year maintenance • User's manual, etc.

TARGETS SUPPORTED:
6301/03 • 6801/03 • 6804 • 6805 • 6809
• 68HC-11 • 68000/08/10/12 • 32000/
32/81/82 • 68020/030/881/851

AVAILABLE FOR FOLLOWING HOSTS:
VAX & MicroVAX; Apollo; SUN; Hewlett-Packard; Gould PowerNode; Macintosh; IBM-PC, XT, AT and compatibles

INTROL CROSS-DEVELOPMENT SYSTEMS are proven, accepted, and will save you time, money, effort with your development. All INTROL products are backed by full technical support. CALL or WRITE for facts NOW:



INTROL

CORPORATION

647 W. Virginia St., Milwaukee, WI 53204
414/276-2937 FAX: 414/276-7026
Quality Software Since 1979

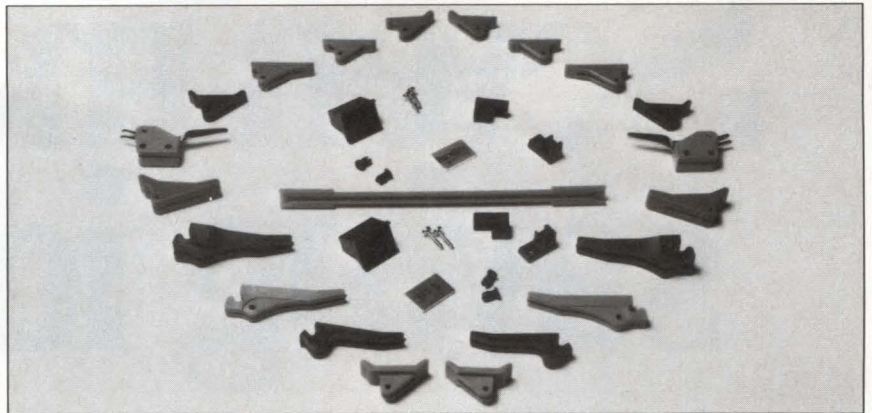

VME, Multibus, Unibus, or...

Philips Components is a leading manufacturer of VME, Multibus, Unibus, and other component hardware. We offer piece parts, kits, or assembled front panels, brackets, and hardware. Available components include:

- Card guides
- Card ejectors
- Card pullers
- DEC* compatible hex and quad brackets
- VME front panel hardware
- Sun Micro computer board ejectors

In addition, our parts can be custom stamped or screened to your needs. To order or to receive a free copy of our catalog call us today at:

PHILLIPS COMPONENTS INC.

23141 La Cadena Dr., Suite P
Laguna Hills, CA 92653
Phone: 714-855-4263
FAX: 714-583-9337

*Digital Equipment Corporation

CIRCLE NO 31

Turn Good Ideas Into Good Articles

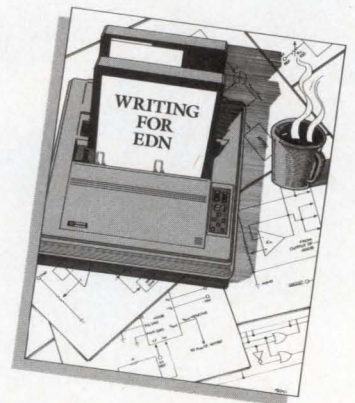

With EDN's FREE Writer's Guide!

Would you like to get paid for sharing your clever engineering ideas and methods with your professional colleagues? If so, then send for EDN's new FREE writer's guide and learn how.

You don't need the skills and experience of a professional writer. And you don't need to know publishing jargon. All you do need are a little perseverance, your engineering skills, and the ability to communicate your ideas clearly.

Our new writer's guide takes the mystery and intimidation out of writing for a publication. It shows you how to write for EDN using skills you already have. Plus, it takes you step-by-step through the editorial procedures necessary to turn your ideas into polished, professional articles.

Get your FREE copy of EDN's writer's guide by circling number 800 on the Information Retrieval Service Card or by calling Sharon Gildea at (617) 964-3030.

INTEGRATED CIRCUITS

from 0 to 80. The TKDD10P operates from a $\pm 10V$ power supply and comes in a 24-pin power-tab package that features low thermal impedance. \$35 (1000).

Tektronix Inc, Integrated Circuits Div, Box 14928, Portland, OR 97214. Phone (800) 835-9433, ext 100.

Circle No 361

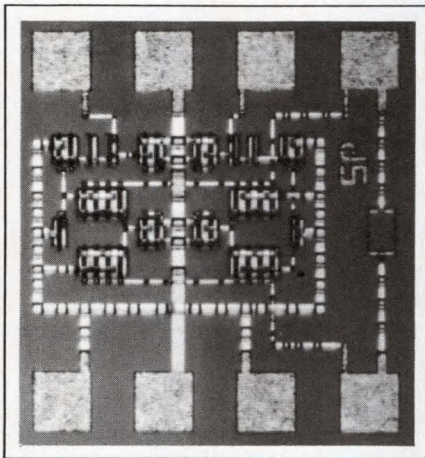

PHASE SPLITTER

- Operates from 10 MHz to 3 GHz
- 2-dB typical insertion loss

Fabricated in GaAs, the APS30010 is an active 180° phase splitter that operates to 3.5 GHz and features a single-port insertion loss of 2.0 dB typ. The chip has an amplitude balance of 0.3 dB, a phase balance of 1.0°, and a reverse isolation of 30 dB. Other features include an isolation of 20 dB min between ports, a noise figure of 12 dB, a 3-dBm compression level, and a third-order intercept point of 8 dBm. The input return loss is 20 dB typ, and the output return loss is 12 dB typ. Die form, \$43.50; 8-pin flatpack, \$65 (1000). Delivery, four to eight weeks ARO.

Anadigics Inc, 35 Technology Dr, Warren, NJ 07060. Phone (201) 668-5000. TWX 510-600-5741.

Circle No 362

PHILIPS

130 SERIES SWITCHING BIPOLAR TRANSISTORS YOUR ONLY ALTERNATIVE TO SWITCHMODE III*

An alternative: Philips new switching bipolar transistors are the only alternative to Switchmode III by Motorola. Philips transistors are extremely rugged, have 1000 V/40 ns capabilities, and meet all Switchmode III requirements. Three series are immediately available. BUT131 (5 amps), BUW132 (8 amps) and BUW133 (15 amps).

An improvement: Philips Statistical Process Control and advanced production techniques deliver a consistent, high-quality product, batch after batch. So you can produce a product that performs like the prototype.

Put us to the test. Send for free samples to replace the Motorola Switchmode III you're now using. We'll also include product specifications, a product cross-reference chart, and an application note.

Amperex®

DISCRETE SEMICONDUCTOR PRODUCTS GROUP

PHILIPS



Amperex Electronic Company, a Division of North American Philips Corporation
George Washington Highway, Smithfield, RI 02917, (401) 232-0500
In Canada: Philips Electronics Ltd., 601 Milner Ave.,
Scarborough, Ontario M1B 1M8, (416) 292-5161

*Switchmode III is a registered trademark of Motorola, Inc.

CIRCLE NO 32

Be An Author!

When you write for EDN, you earn professional recognition. And you earn \$75 per published magazine page.

EDN publishes how-to design application information that is read by more than 137,300 electronics engineers and engineering managers worldwide. That's an audience that could belong to you.

If you have an appropriate article idea, send your proposal and outline to: John Haystead, 275 Washington Street, Newton, MA 02158-1630.

For a FREE EDN Writer's Guide—which includes tips on how to write for EDN and other technical publications—please circle number 800 on the Information Retrieval Service Card.

First in Readership among Design Engineers and Engineering Managers in Electronics.



“A career as an EDN editor offers you great variety and flexibility.”

EDN Editor David Shear

Just over a year ago, David Shear held an engineering position much like yours. Today, as an EDN editor, he is extending his engineering experience.

David is enthusiastic about his new career: “I’m acquiring a broader understanding of engineering than was possible as an engineer and the work is more varied. Also, the writing challenges me to translate my knowledge and experience into useful information for our readers.”

He also enjoys the recognition and visibility that come with being an EDN editor. As David says, “I cover developments, breakthroughs, new technologies, and product introductions across the entire spectrum of electronics.

I’m at the forefront.”

You too can turn your electrical or electronic engineering background into an exciting opportunity with EDN. All you need are a B.S. in electrical engineering, at least two years of design experience, and an ability to write clearly. Salaries are commensurate with engineering experience.

If you’re interested, please call Toll Free 1-800-521-1127 x733 and ask for Michelle Clarke in Human Resources.

Or send your resume to her at Human Resources Dept., 275 Washington Street, Newton, MA 02158-1630.

David Shear is glad he did. You will be too.

EDN

NEW PRODUCTS

COMPONENTS & POWER SUPPLIES

DC/DC CONVERTERS

- Available in single- and multiple-output versions
- Powers as many as four disk drives

Operating from 48V inputs, these dc/dc converters can output as much as 350W. Housed in packages measuring 9×5×2.5 in., they feature a high-efficiency flux-gate switching post regulator, monocoque construction to optimize heat transfer, a current-fed inverter topology, and surface-mount technology. The open-frame converters are available in either single- (DC) or multiple-output (DCX) versions. The single-output models output from 5 to 48V at currents in the 5.5 to 30A range. The main output of some multi-output models can deliver as much as 50A of tightly regulated (1% for line and load changes) 5V power. In addition, multiple output versions fea-

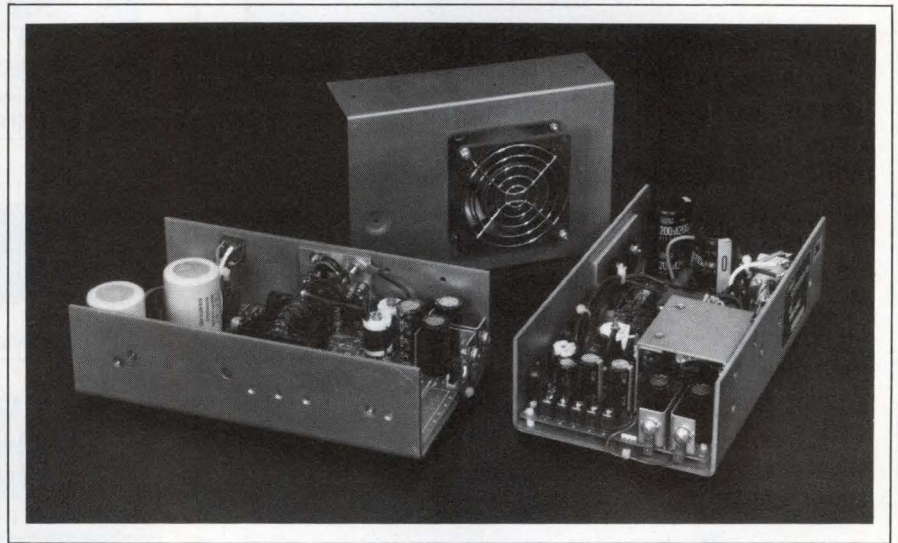

ture two post-regulated mag-amp outputs and one low-power, 3-terminal regulated output. The 12V outputs have a peak current rating of 12A, enabling them to power as many as four disk drives. You can expand units to include isolation diodes and modified current-sharing

for redundancy. Optional remote inhibit and dc power fail are available, as are cover/fan assemblies. \$470 (100).

Todd Products Corp, 50 Emjay Blvd, Brentwood, NY 11717. Phone (516) 231-3366. TWX 510-227-4905.

Circle No 365

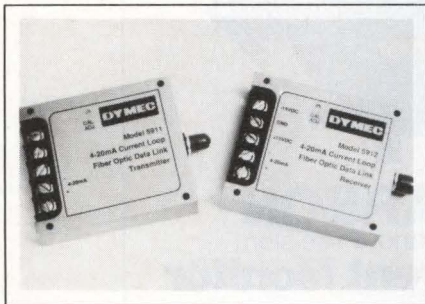

CURRENT LOOP

- 3200-ft transmission distance capability
- Solves isolation problems

This 4- to 20-mA current-loop transmission system solves problems with erratic signals due to ground loops by using fiber-optic technology to isolate the loop and to ensure that it floats with respect to system ground. The loop has a 3200-ft transmission distance capability. The Model 5911 link transmitter accepts the current input and converts it to light. The transmitter is cur-

rent-loop powered and requires no external power. The Model 5912 receiver accepts the optical signal and outputs a 4- to 20-mA output. The transmitter and receiver are housed in 2×3-in. aluminum blocks with mounting holes in the four corners. Terminal strips are provided for electrical (signal and power) inputs. Transmitter, \$268; receiver, \$343 (25).

Dymec Inc, 8 Lowell Ave, Winchester, MA 01890. Phone (800) 225-1511; in MA, (617) 729-7870.

Circle No 366

REED RELAYS

- Design can withstand surface-mounting processes
- Offer a 10-VA max switching capability

Available with gull-wing or J-hook terminals, JS2 reed relays are designed specifically for surface-

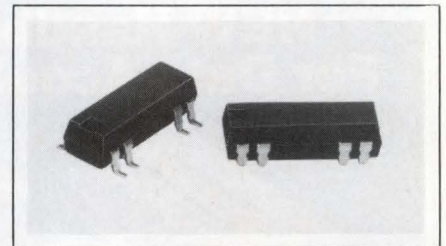

mount applications. The units have a maximum switching capacity of 10W or 10 VA. Maximum voltage and current-switching ratings for the spst NO reed switch equal 100V and 0.5A, respectively. The switch will carry 1A max. Standard continuous-duty coil voltages are 5, 12, 15, and 24V dc. Initial dielectric strength is 250V dc min between open contacts and 500V dc min between the relays' coil and contacts. \$3.39 (500). Delivery, stock to 10 weeks ARO.

Potter & Brumfield Inc, 200 S Richland Creek Dr, Princeton, IN 47671. Phone (812) 386-2257.

Circle No 367

RGB

Cables & Assemblies

- Small diameter 75 OHM miniature coax cable extruded in colors
- Combines RGB and sync functions in one compact PVC jacketed cable
- Eliminates sleeving and tie wraps
- Available in 3, 4 and 5 conductor styles
- UL recognized

Contact us with your requirements:

Atronix

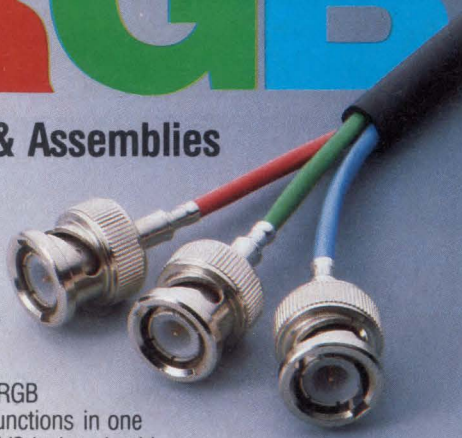

Atronix, Incorporated
780 Boston Rd., Billerica, MA 01821
617-663-5100 Fax 617-667-3888



CIRCLE NO 33

V SERIES SWITCHING POWER SUPPLIES

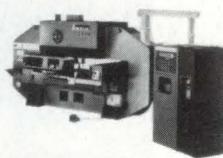
Engineered and Manufactured by Perfectionists!

 Simulations by SPICE	 Stability by HP/VENABLE	  
 Sheet Metal by AMADA	 Auto Insert by UNIVERSAL	
 Testing by ZEHNTL	 Burn In by CENTIGRADE	 Service by PHILLIPS

Call Toll Free 1-800-523-2332

Deltron inc. P.O. BOX 1369 ■ WISSAHICKON AVENUE, NORTH WALES, PA 19454
PHONE 215-699-9261 TWX 510/661-8061

CIRCLE NO 34

FREE THIRD EDITION NEW Handbook For Data Acquisition

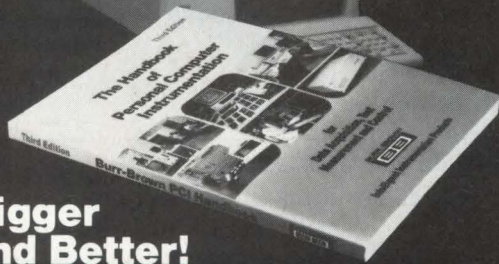

Bigger and Better!

Our newly expanded *Handbook of Personal Computer Instrumentation for Data Acquisition, Test, Measurement, and Control* contains more than ever before. It has everything you've ever wanted to know, and much more. Almost 300 pages include:

- A tutorial
- A chapter on available software
- An applications section
- System configuration guides
- Example programs
- Technical specifications

This \$15 value is FREE for the asking. Write on your company's letterhead to:

The New PCI Handbook, Burr-Brown Corp.
Intelligent Instrumentation
1141 West Grant Rd., #131, Tucson, Arizona 85705



CIRCLE NO 35

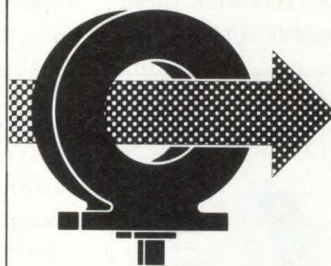

PEARSON

Wide Band, Precision
Current Monitor

With a Pearson current monitor and an oscilloscope you can make precise amplitude and waveshape measurement of ac and pulse currents from milliamperes to kiloamperes. Currents can be measured in any conductor or beam of charged particles, including those at very high voltage levels.

A typical model gives an amplitude accuracy of +1%, -0%, 20 nanosecond rise time, droop of 0.5% per millisecond, and a 3 db bandwidth of 1 Hz to 35 MHz.

Contact us and we will send you engineering data.

PEARSON ELECTRONICS, INC.

1860 Embarcadero Road
Palo Alto, Calif. 94303, U.S.A.
Telephone (415) 494-6444
Telex 171-412 · FAX (415) 494-6716

CIRCLE NO 36

COMPONENTS & POWER SUPPLIES



TRANSCEIVER

- Provides an Ethernet connection to a coaxial cable
- Conforms to Ethernet IEEE-802.3 specifications

The ANC-15 thin-net transceiver provides an Ethernet connection to a coaxial cable. It conforms to Ethernet/IEEE-802.3 transceiver specifications and 10M-bps Ethernet CSMA/CD operational requirements. The unit has an integrated BNC-type T-connector that facilitates the network connection. Two integral LEDs serve as SQE

(heartbeat) and power indicators. The ANC-15 is housed in a compact aluminum die-cast package. \$240.

American Network Connections Inc., 462 Oakmead Pkwy, Sunnyvale, CA 94086. Phone (408) 737-1511.

Circle No 368

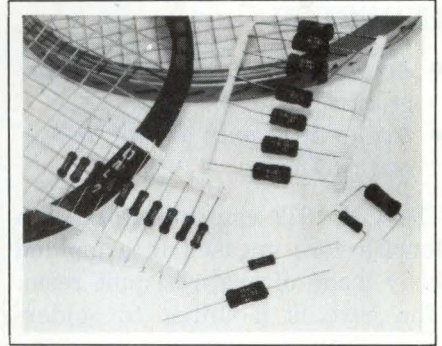

LINE CHOKES

- Feature UL recognition
- Employ high-saturation core material

The RL1283 and RL1284 Series compact power-line chokes are UL-recognized devices. The axial-lead units employ high-saturation core material, which allows them to accommodate high current levels. The chokes are available with inductance values ranging from 3.9 to 100,000 μ H. Saturation-current values range from 81 mA to 15.5A. The series includes almost 100 standard

values, and nonstandard values are available. The chokes are available on tape and reel to accommodate auto-insertion equipment, or with their leads preformed to user specifications. The operating range spans -55 to $+125^{\circ}\text{C}$. All units are supplied with insulated sleeves. MIL-STD-27D devices are also available. \$0.50 (10,000). Delivery, stock to eight weeks ARO.

Renco Electronics Inc., 60 Jefryn Blvd E, Deer Park, NY 11729. Phone (516) 586-5566.

Circle No 369

POWER-LOK CONNECTION SYSTEMS

POWER AMPEATER CONTACTS

13 Ampere Continuous
20 Ampere Intermittant at 125°C

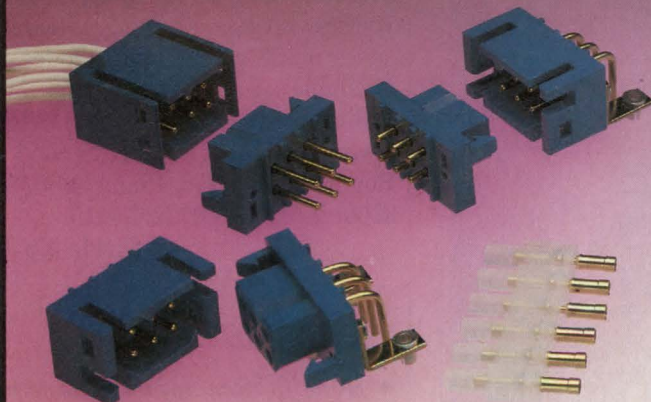

POWER SOURCE TO PRINTED BOARD BUS with Minimum Heat generated at contact connection surfaces due to unique design of LARGE SURFACE AREA contact mating system.

CONTACTS: Removable, machined of solid copper alloy. Male contact lengths can be varied to permit sequential mating to eliminate initial power overload. **PLATING:** Gold or palladium alloy. **TERMINATIONS:** Crimp and solder type 14AWG (2.5mm^2) wire maximum. Printed board mount straight or 90° angled, mother-daughter board or board to board sandwich connection systems. **INSULATORS:** Polyester glass-filled; twelve contact variants, 3 through 24 contacts with rows of one, two and three contacts. **POLARIZATION:** Connector bodies keyed for alignment and correct coupling. **SHROUDS:** Male contacts protected with plastic shrouds. **LOCKING SYSTEM:** POWER-LOK system, easy to lock and unlock. **CABLE ADAPTORS:** Strain reliefs. **MOUNTING:** Panel and printed boards. **WORKING TEMPERATURE:** -55°C to $+125^{\circ}\text{C}$. **CRIMPING TOOLS:** Manual and automatic.



POSITRONIC INDUSTRIES, INC.

423 No. Campbell Av. • Springfield, Mo. 65806
Tel. 417-866-2322 • 800-641-4054 • Telex 436445 • Fax 417-866-4115

CIRCLE NO 37

INDUCTOR

- Accommodates reflow soldering processes
- Available in bulk or tape-and-reel packaging

The CM 1812 chip inductor has a ferrite core encased in a molded body made of heat-resistant resin. The core is mounted to solder-

coated metal terminals, which attach to pc boards. The unit can accommodate reflow soldering processes and requires no special handling. It is available in values ranging from 0.18 to 1000 μ H, and minimum Q specs at 50. From 0.18 to 8.2 μ H, the standard tolerance equals $\pm 20\%$; above 8.2 μ H, the standard tolerance equals $\pm 10\%$.

The unit is available in bulk or tape-and-reel type packaging. From \$0.25.

ICS Manufacturing Inc, 11661 Martens River Circle, Fountain Valley, CA 92708. Phone (800) 642-2645; in CA, (800) 247-7864.

Circle No 370

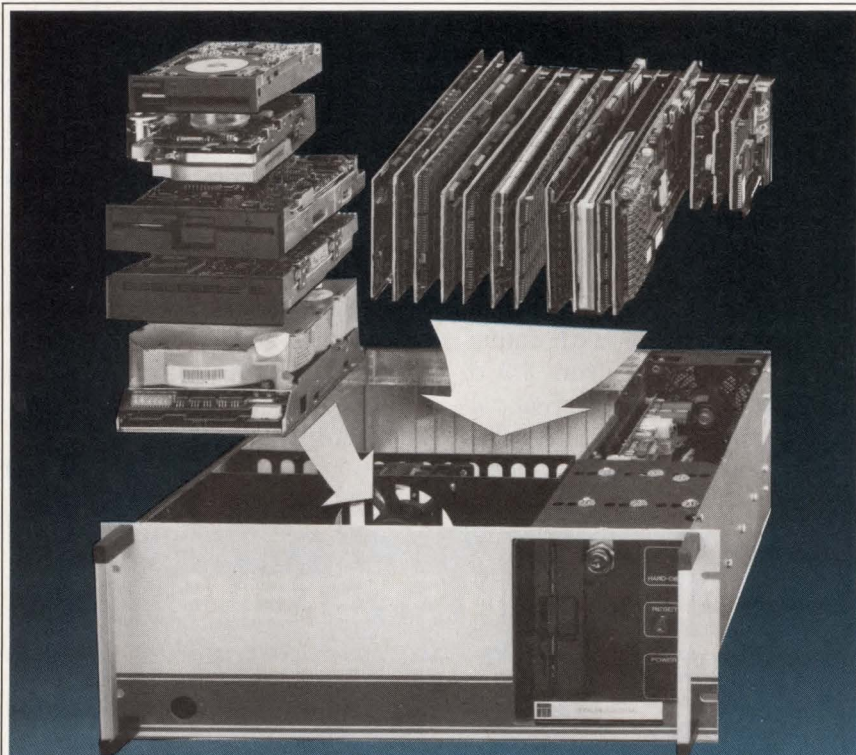

GET MORE SPACE FOR YOUR BOARDS

With TMI's Model 3014
BIG PC!

- **LARGE CAPACITY:** Room for as many as **14** full-size PC Bus plug-in CPUs and applications cards, **5** half-height disks.
- **RELIABLE:** Uses four-layer passive backplanes with microdipoles for low-noise operation. Industrial grade construction throughout.
- **VERSATILE:** Models available to house XT®, AT® or 386 compatible PC Bus CPUs and applications cards.

If you need more space in a PC Bus computer to hold cards and memory devices, here's the answer. Standard rack mount, only 22 inches deep and 7 inches high, with a 225 watt power supply. The 3014 is designed to let you add memory, CPU and applications power to meet any requirements.

We can satisfy your complete PC Bus computer requirements. For more details, contact your nearest TMI sales office or our Houston headquarters.



TEXAS MICROSYSTEMS
INCORPORATED

10618 Rockley Road • Houston, Texas 77099
(713) 933-8050

1-800-627-8700

Designers and manufacturers of *quality*
computers for more than a decade

©1988, Texas Microsystems Incorporated

CIRCLE NO 38

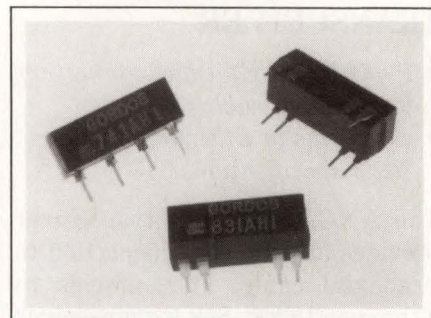

REED RELAYS

- Feature a 1-billion cycle operating life
- Available in SIP and DIP housings

These miniature mercury-wetted reed relays can switch 50W for a minimum of 1 billion cycles. Operating from a 5V supply, they consume only 125 mW. Offered in either SIPs or DIPs, the spst NO relays spec a maximum switching capability of 500V dc and 1A. Release time, over a 0- to 250-kHz frequency range, specs at 1.5 msec. The relays are available with 5, 12, or 24V dc coil-voltage ratings. Contact resistance specs at 50 m Ω . Clamp diodes are available as an option. \$4.65 (500). Delivery, stock to six weeks ARO.

Gordos Corp, 1000 N Second St, Rogers, AR 72756. Phone (800) 643-3500; in AR, (501) 526-4415.

Circle No 371

TRIMPOTS

- Have 15-turn adjustment screws
- Surface-mount devices

TS6 and TS63 Series 0.25-in. square surface-mount multiturn cermet trimmers with nominal values $\geq 100\Omega$ feature a typical temperature coefficient of ± 50 ppm/ $^{\circ}$ C

(± 100 ppm/ $^{\circ}\text{C}$ maximum) over their operating temperature range of -55 to $+155^{\circ}\text{C}$. Their typical contact resistance variation is 2% of their nominal value or 2Ω , and their end resistance is typically 1Ω . The TS6 version meets military specifications. The trimmers have a 15-turn mechanical rotation, and a clutch mechanism that prevents damage if you overrotate them. Four variants, with different adjustment screw and contact positions, are available. The trimmers are available in E3 Series values between 10Ω and $2.2\text{ M}\Omega$. The standard resistance value tolerance is $\pm 10\%$, and $\pm 5\%$ tolerance

trimmers are available on request. Their power rating is 0.25W at 85°C . TS6 Series, $\$0.95$; TS63 Series, $\$0.73$ (1000).

Sfernice, 199 blvd de la Madeleine, 06021 Nice Cedex, France. Phone 93446262. TLX 470261.

Circle No 372

Ohmtek, 2160 Liberty Dr, Niagara Falls, NY 14304. Phone (716) 283-4025. TWX 710-524-1653.

Circle No 373

POWER SUPPLIES

- Provide as many as four outputs
- UL, CSA, and VDE approved

Low-profile (under 1 in.) ESPO22A 25W switching power supplies offer as many as four outputs that are 5 and 12V dc, and ± 5 and $\pm 12\text{V}$ dc. Available models offer dual 90-130/180-260V ac jumper-selectable in-

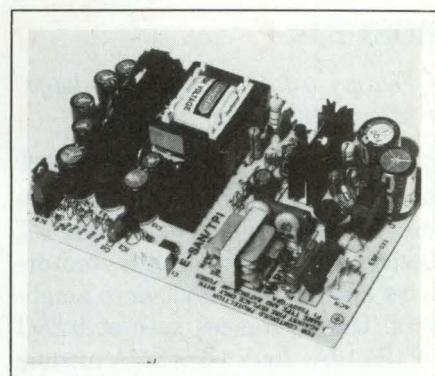

puts; a universal 90 to 260V ac input is available as an option. All models feature 0.1% line regulation. Load regulation specs at 0.5% on the main 5V output and 0.2% on all auxiliary outputs. Ripple and noise equals 1% typ. The operating range spans 0 to 50°C , and the MTBF specs at 60,000 hours. All models are UL, CSA, and VDE approved. From $\$52$ (100).

Total Power International Inc., 418 Bridge St, Lowell, MA 01850. Phone (617) 453-7272. TLX 948617.

Circle No 374

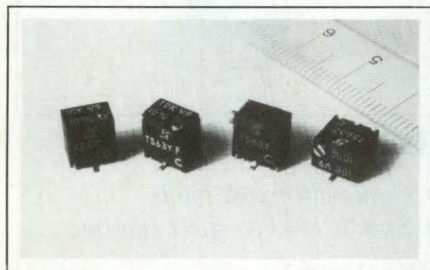

HIGH DENS-D

15 through 104 poles
Sub-D Connectors

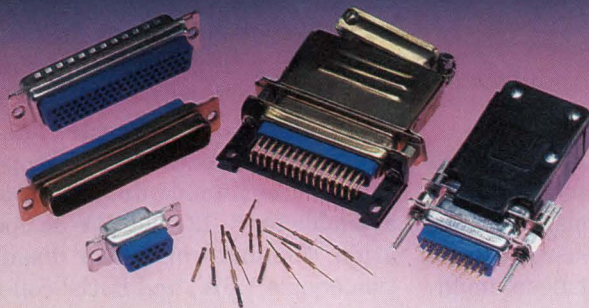

76% CONTACT DENSITY INCREASE: Qualified to MIL-C-24308 and U.L. recognized. **CONTACTS:** Removable, machined copper alloy, gold over nickel, 5 amp. "closed entry" female, MIL-C-39029. **TERMINATIONS:** Crimp, solder, printed board, straight or 90° . **INSULATOR:** Polyester glass, U.L. 94 V0, 6 variants of 15, 26, 44, 62, 78 and 104 poles. **SHELLS:** Steel or brass with tin plate (dimpled); zinc or cadmium plate with dichromate seal, stainless steel, passivated. **MOUNTING:** Panel and printed board. **COUPLING:** Jackscrews and slide lock system. **HOODS:** Metal, plastic. EMI/RFI.



POSITRONIC INDUSTRIES, INC.

432 N. CAMPBELL AVE. · SPRINGFIELD, MO 65806
TEL. 417-866-2322-800-641-4054-TELEX 436445-FAX 417-866-4115

CIRCLE NO 39

DUAL-PORT

Space Saver/Cost Saver
Sub-D Connectors

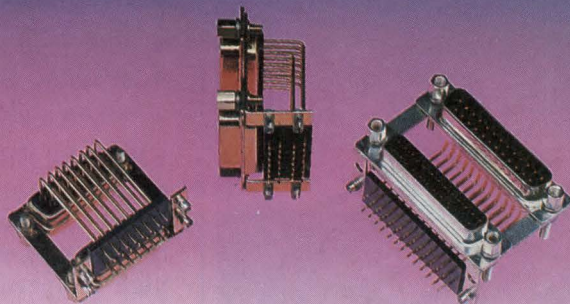

DUAL-PORT VARIANTS: 9, 15, 25, 29, 37 and 50 poles, male or female. **FULLY OR PARTIALLY POPULATED CONNECTORS:** Contacts selectively positioned to order. RS 232, RS 449. **MOUNTING:** Rapid insert Push-on fastener, fixed to panel and printed board in one maneuver. **CONTACTS:** Male, machined brass alloy; female, machined high tensile phosphor bronze, gold over nickel, 5 amp. **INSULATOR:** Nylon resin. **SHELLS:** Steel or brass, tin plated (dimpled); zinc or cadmium plate with dichromate seal. **COUPLING:** Jackscrews and slide lock system. **NORMS:** Conforms to MIL-C-24308 and IEC 807-2, U.L. recognized.



POSITRONIC INDUSTRIES, INC.

432 N. CAMPBELL AVE. · SPRINGFIELD, MO 65806
TEL. 417-866-2322-800-641-4054-TELEX 436445-FAX 417-866-4115

CIRCLE NO 40

MOSFETs

- Feature a fully isolated package
- Mount directly to heat sinks

CPX200 Series H-Bridge HEXFET modules are designed to replace four TO-220-type power MOSFET devices in power supplies, motor-drive applications, and servo amplifiers. On-resistances spec at 0.28Ω for the 10A, 250V CPX234A module and 0.85Ω for the 5.8A, 500V CPX254A device. Both are housed in a 9-pin SIP and feature an electrically isolated base that allows you to mount the units directly to heat sinks or a chassis with only two screws or a body clip. Available options include zener-protected gates to eliminate overvoltage gate stressing, a Kelvin-connected source, and HEXSense lower switches for onboard current sensing. CPX234A, \$10.82; CPX254A, \$10.99 (1000). Delivery, four to six weeks.

International Rectifier, 233 Kansas St, El Segundo, CA 90245. Phone (213) 607-8939.

Circle No 375

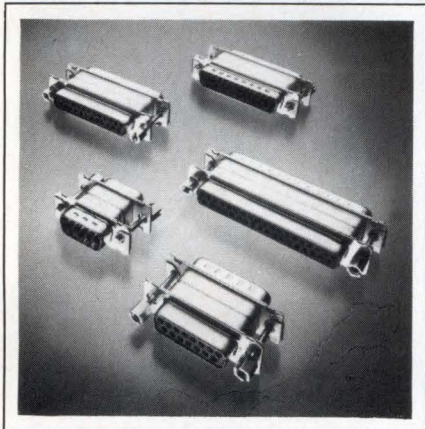

SUPPRESSORS

- Pass transient voltages to ground within 5 nsec
- Available in 9-, 15-, 25-, and 37-position versions

Data Line Protectors provide compact, reliable defense against data-line transient voltages that can damage computers and peripherals.

These subminiature D-type protectors are a connectorized package of silicon avalanche diodes and pass any transient voltage exceeding 25V to ground in less than 5 nsec. The maximum surge power equals 2000W, and the maximum peak current measures 75A. The protectors simply plug in between the port needing protection and the appropriate cable assembly. Standard units are available in 9-, 15-, 25-, and 37-position versions. You can specify the units to protect either all or selectively loaded pins. \$30 (1000). Delivery, 10 weeks ARO.

AMP Inc, Box 3608, Harrisburg, PA 17105. Phone (717) 564-0100.

Circle No 376

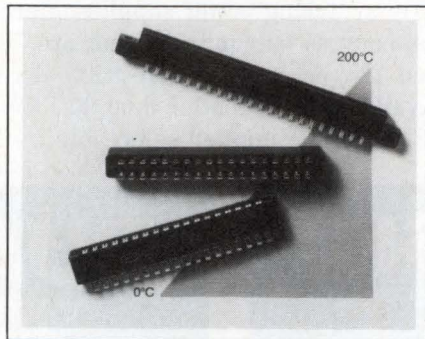

CARD CONNECTORS

- Withstand 200°C temperature
- Available in a variety of termination styles

EB7D and EB8 dual-row edgeboard connectors are designed for high-temperature applications, including component burn-in ovens. A special high-temperature thermoset molding compound for the body and beryllium-copper material for the contacts helps them withstand 200°C operating temperatures. The connectors are available in a variety of terminations, including dip-solder, solder-eyelet, and card-extender styles. EB7D units are available with 6, 10, 12, 15, 18, 22, 36, and 43 contacts per row; EB8 connectors offer a choice of 6, 10, 12, 15, 18, 22, 24, or 25 contacts per side. EB8 connector with dual rows of 22/24 contact positions and card-extender

terminations, \$4.80 (1000). Delivery, four to six weeks ARO.

Dale Electronics Inc, Dept 860, Box 609, Columbus NE 68601. Phone (605) 665-9301.

Circle No 377

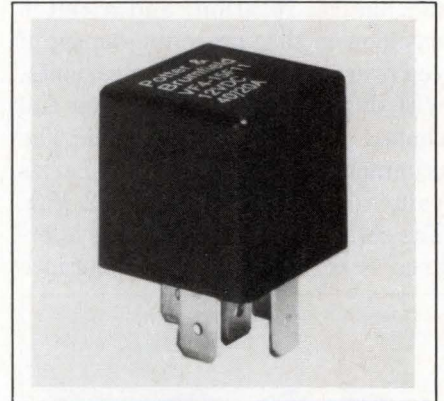

RELAYS

- Can switch 40A loads
- Spec a 100,000 cycle lifetime

VF4 Series electromechanical relays provide a 40A switching capability in a package measuring approximately 1 in.³ The units are available in pc-board or socket-mount versions. The relays feature silver contacts and are available in spst NO and spdt contact configurations. Voltage-dependent maximum switching power capability ranges from 50 to 500W for dc loads and 900 VA for ac loads. The expected life, at 40A resistive, specs at 100,000 operations. Continuous-duty coils are available for 6, 12, and 24V dc operation. Nominal coil-power dissipation equals 1.6W, and initial coil-to-contact breakdown voltage equals 500V dc. Standard VF4 relays are equipped with a black plastic dust cover. Weatherproof enclosures and cases, with integral mounting brackets, are available as options. \$1.33 (10,000) for an spst version. Delivery, stock to 10 weeks ARO.

Potter & Brumfield Inc, 200 S Richland Creek Dr, Princeton, IN 47671. Phone (812) 386-2272.

Circle No 378

NEW PRODUCTS

COMPUTERS & PERIPHERALS

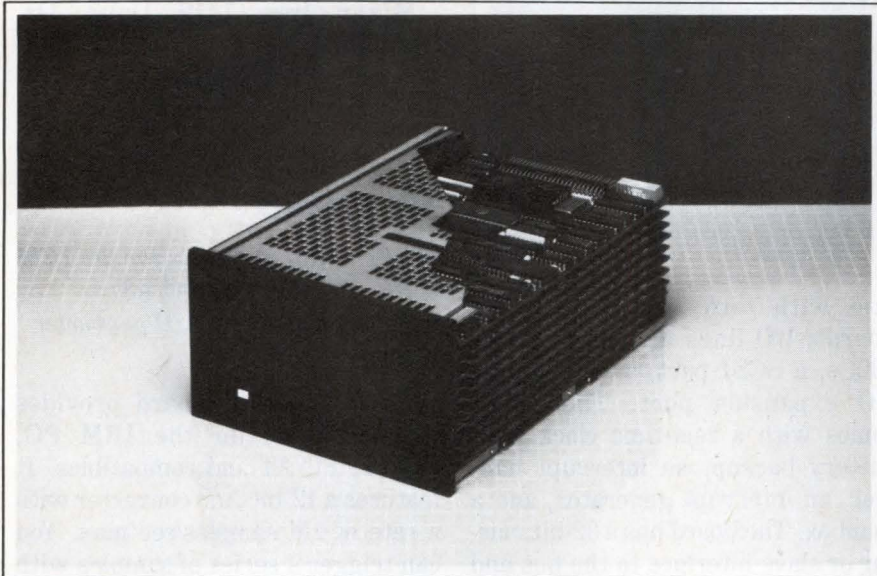

RAM DISKS

- Come in full- and half-height 5¼-in. form factors
- SCSI-compatible units have access time of ½ msec

The RAMstor family of RAM disks provides full- and half-height 5¼-in. form factors. Their SCSI ports can sustain a 5M-byte/sec transfer rate. The disks feature an average access time of less than ½ msec. This figure includes overhead for processing the SCSI commands. The full-height Model 5150 comes with 8M- to 80M-byte storage. The half-

height Model 4150 comes with 8M- to 32M-byte capacities. You can upgrade each model in 8M-byte increments. A processor performs disk emulation, diagnostics, and error correction. It can do single-bit and multiple-bit error detection. An optional internal battery backs up 32M bytes of memory for as long as two hours. The unrecoverable data-error rate equals 1 in 10⁵ power-on hours. The 8M-byte model, \$6895.

Western Automation, 1700 N 55th St, Boulder, CO 80301. Phone (303) 449-6400. TWX 710-111-1401.

Circle No 380

MEMORY BOARD

- Provides 512k to 16M bytes of RAM
- Operates with version 4.0 of LIM/EMS specification

The JustRAM/AT16 memory expansion board for the IBM PC/AT and compatibles contains 512k to 16M bytes of RAM, depending on the configuration. The board operates with version 4.0 of the Lotus/Intel/MicroSoft Expanded Memory Specification (LIM/EMS). With three boards you can get a 32M-byte expanded memory and 16M-byte extended memory. The board oper-

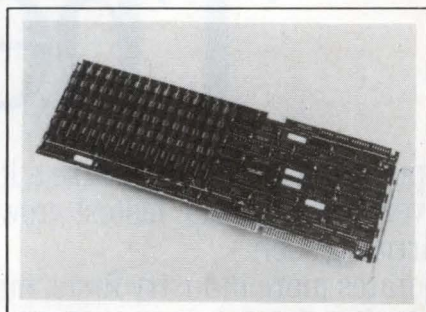

ates at 10 MHz with zero wait state and at 12 MHz with one wait state. In addition, it features switch-selectable starting addresses on 128k-byte boundaries from 0 to 16M bytes. An EMS 4.0 driver and diagnostics are standard. When operat-

ing at the 16M-byte capacity, the board requires 15W. The board comes with a 5-year warranty. The 2M-byte version, \$1888; the 16M-byte version, \$11,097.

Monolithic Systems Corp, 84 Inverness Circle E, Englewood, CO 80112. Phone (303) 790-7400. TLX 221126.

Circle No 381

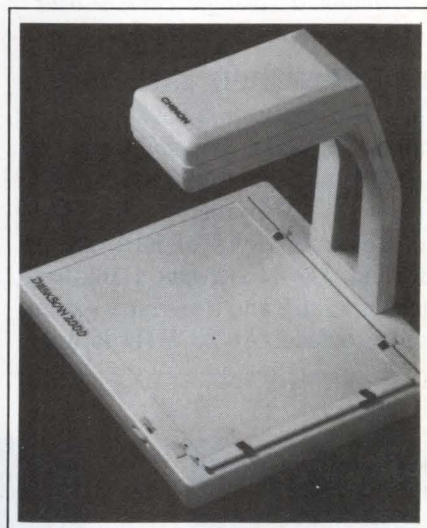

IMAGE SCANNER

- Has 100- to 200-dot/in. resolution in ambient light
- Offers optional optical-character-recognition software

The Deskscan 2000 image scanner performs overhead scanning in ambient light conditions. The user-selectable resolution ranges from 100 to 200 dots/in. The unit weighs less than 6 lbs and consumes 15W. It provides an RS-232C with 19,200-baud communications and a bidirectional parallel interface. A configuration that includes cabling and a utility disk costs \$659. For a turnkey publishing system, with PC Paintbrush+ software for an IBM PC, PC/XT, or PC/AT with at least 384k bytes of memory, the price is \$695. A package with FrontPage Personal Publisher, PC Paintbrush+, TopDOS Version 3.0, and Haba

Finder software costs \$795. Optional optical-character-recognition software is available for an additional \$895.

Chinon America Inc, 6374 Arizona Circle, Los Angeles, CA 90045. Phone (213) 216-7611. FAX 213-216-7646.

Circle No 382

CPU BOARD

- Features a 68030 μ P that runs up to 30 MHz
- Provides a 4M-byte DRAM and a 16k-byte cache memory

The MZ7130 CPU board for the VME Bus features a 68030 μ P that runs to 30 MHz. It provides a 4M-byte, dual-ported dynamic RAM with up to 2M bytes of static RAM and up to 1M byte of EPROM. In addition, the board has a 16k-byte cache memory and a memory expansion interface. At 25 MHz it oper-

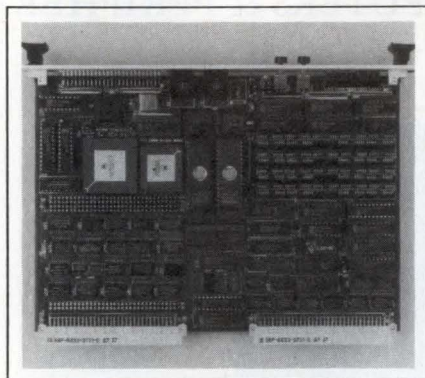

ates with zero wait states. The board's I/O lines include two RS-232Cs, a SCSI port, and a parallel I/O expansion port. The board comes with a real-time clock with battery backup, an interrupt handler, an interrupt generator, and a mailbox. The board has a 32-bit master or slave interface to the bus and a system controller with four levels of arbitration. The board provides sockets for an optional 68881 or 68882 floating-point coprocessor. The software development packages

include Ready System's VRTX32, Wind River System's VxWorks, and Microware's System OS-9. \$5995.

Mizar Inc, 1419 Dunn Dr, Carrollton, TX 75006. Phone (214) 446-2664. TWX 510-600-4272.

Circle No 383

A/D BOARD

- Offers four channels for the IBM PC, PC/XT, and PC/AT
- Features a 12-bit A/D converter sampling at 1 MHz

The DAS-50 A/D board provides four channels for the IBM PC, PC/XT, PC/AT and compatibles. It features a 12-bit A/D converter with a rate of 1M samples/sec max. You can trigger a series of samples with software commands, an external trigger, or a voltage level input. The board comes with a 1M-word onboard buffer memory. It employs 16 consecutive locations in the I/O



The First

When you're looking for input on raster plotters, take a look at some major CalComp output. Twenty-four different versions from the fastest growing raster family in the world. (With more family members arriving soon.)

Every raster plotter incorporates more industry firsts, more choices. From simple, colorful business graphics to the complexity of super-dense integrated circuit design, mapping, etc.

The 5800 and 5700, our color and black-and-white electrostatic plotters, deliver speed, superior resolution, multiple configurations and A to E size plots.

For CAD graphics, PlotMaster™ produces quick-check "A" size presentation-quality color.

Or plug ColorMaster® into your PC and through CalCompatibility, you can run the most popular business presentation graphics software.

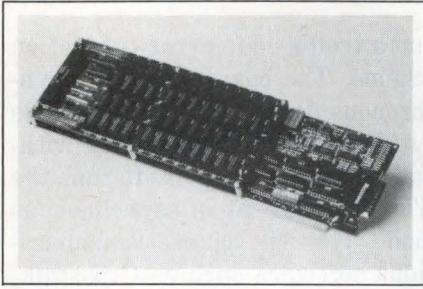

DSP WORKSTATION

- Has a 20-MHz 80386 μ P and an 80387 coprocessor
- Provides a 42M-byte hard disk

The DSP Workstation computing system employs a 20-MHz 80386 μ P and a 20-MHz 80387 coprocessor. The system uses a DSP and an acquisition board based on AT&T's WE DSP32 chip and an 8-kHz codec. The system contains a 42M-byte hard-disk drive with an average access time of 28 msec; a 44M-byte tape backup; a 1.2M-byte 5¼-in. floppy-disk drive; a choice of an additional 360k- or a 720k-byte 5¼-in. floppy-disk drive; a Keytronics 101 keyboard; an NEC GB-1 EGA card; an NEC Multisync II high-resolution color monitor; a 2M-byte static RAM; and Hypersignal-Workstation DSP software. This software lets you acquire real-time data at 150 kHz to a RAM disk and at 70 kHz continuously using an

optional Data Translation 2821 or 2823 acquisition board. \$9995.

Hyperception Inc, 9550 Skillman St, LB 125, Dallas, TX 75243. Phone (214) 343-8525.

Circle No 385

address space that you can start at any base address. It has five software-programmable, unipolar or bipolar input ranges: 0 to 5V, 0 to 10V, $\pm 2.5V$, $\pm 5V$, or $\pm 10V$. The linear-error figure specs at 1 LSB max. There are no missing codes over the full input range. A pop-up display controls the board with such features as diagnostics, memory checking, and on-line help screens. The 256k-word version, \$1999; the 1M-word version, \$2449.

MetraByte Corp, 440 Myles Standish Blvd, Taunton, MA 02780. Phone (617) 880-3000. TLX 503989.

Circle No 384

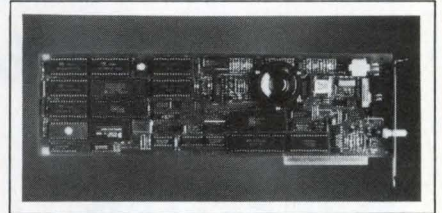

V.32 MODEM

- Provides full-duplex operation at 9600 bps
- Has a port adapter for synchronous communications

The Sync-Up V.32 IBM PC modem board conforms to the CCITT V.32 standard. It permits full-duplex operation at 9600 bps through the use of an echo-cancellation technique

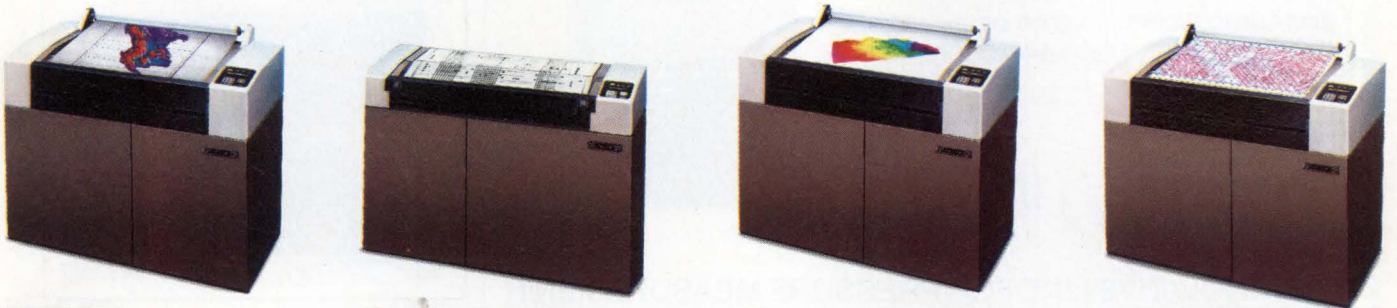

Family.

The first family? You bet. First in high-resolution 400 DPI color. First in pin-point accuracy with electronic registration. First in embedded controllers to save space. First with convenient ROM pack firmware. First with flexibility of over 2,000 line and area fill colors. And too many more firsts to talk about here.

There's also a national 800 helpline, 425 trained service persons, 46 service centers nationwide, 32 international field offices, and on-site service. And a single supply source.

Don't be the last to learn about the first family. Call 1-800-CALCOMP or write CALCOMP, P.O. Box 3250, Anaheim, CA 92803. In Canada, call (416) 635-9010.

We draw on
your imagination.™



A Lockheed Company

**This
TRONIC
LINE
sensor family
serves 80%
of your
pressure
applications.**



For details on the complete line of WIKA transmitters and transducers... write or Call TOLL FREE 1-800-645-0606

WIKA

TRONIC LINE

THE INNOVATIVE LINE FOR PRESSURE MEASUREMENT

WIKA Instrument Corporation • One Corporate Drive, P.O. Box 11247, Hauppauge, New York 11788
Phone: 1-800-645-0606 in NY: 1-516-435-0606, Telex: 967732, Telefax: 1-516-435-0713

CIRCLE NO 43

DID YOU KNOW?

Half of all EDN's
articles are staff-written.

EDN

COMPUTERS & PERIPHERALS

and a trellis-code error-correction scheme. The board features a synchronous port adapter that permits synchronous communications without a separate adapter. It runs the AT command set in asynchronous mode. This lets you use communications software such as Crosstalk, Smartcom, and MirrorII. In the synchronous mode, a Sync-Up synchronous autodialing language supports both Bisync and SDLC protocols. The board is compatible with third-party IBM 3270 and 3770 terminal emulation packages. Other features include call-progress monitoring, answer and line disconnect, an onboard speaker with volume control, and built-in diagnostics. From \$1295.

Universal Data Systems, 5000
Bradford Dr, Huntsville, AL 35805.
Phone (205) 721-8000. TLX 752602.

Circle No 386

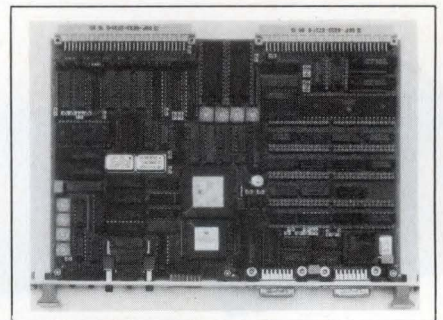

CPU CARD

- Employs a 68020 μ P and 68881 math coprocessor
- Provides FIFO registers for message passing

The vendor of the PG2050 32-bit computer board offers either a stand-alone, single-board computer or a CPU card for VME Bus systems. The board runs a 68020 μ P and 68881 math coprocessor at 16 MHz. The sockets feature a 1M-byte max, 150-nsec, 16-bit, dual-ported static RAM. The 32-bit local memory provides a 4M-byte EPROM or a 2M-byte, zero-wait-state, static RAM and a 2M-byte EPROM. The board employs a 16-byte FIFO reg-

COMPUTERS & PERIPHERALS

ister for message passing. The board offers three serial I/O ports: two are front-panel asynchronous RS-232Cs and the third provides either a synchronous/asynchronous RS-232C or an RS-485 interface to the board's two P2 connectors. In addition, the board features two 8-bit parallel I/Os, six programmable timers, and a real-time clock calendar. Gld 6000.

Philips, Industrial & Electro-acoustic Systems Div, 5600 MD Eindhoven, The Netherlands. Phone (040) 788620. TLX 35000.

Circle No 387

Philips Electronic Instruments Inc, 85 McKee Dr, Mahwah, NJ 07430. Phone (201) 529-3800.

Circle No 388

VGA BOARD

- Provides a 800×600-pixel mode on IBM PCs
- Displays 132 text columns with a 256k-byte memory

The AST-VGA Plus VGA-adaptor board for the IBM PC, PC/XT, PC/AT, and compatibles offers several graphics resolution modes. One mode provides 640×480-pixel resolution and can display 256 colors simultaneously. You can use the 800×600-pixel resolution mode with 16 simultaneously displayed colors for CAD/CAM and desktop publishing applications. In monochrome text mode, the board provides 720×400-pixel resolution with a 9×16 dot-matrix box. It displays 132 columns of text and features a 256k-byte graphics memory, but you can get up to 512k bytes. The ¾-size board is compatible with EGA, CGA, MDA, and HGC (Hercules Graphic Card) graphic standards. The board runs with the IBM 8503-, 8512-, 8513-, and 8514-compatible displays and with NEC Multisync monitors. \$599.

AST Research Inc, 2121 Alton Ave, Irvine, CA 92714. Phone (714) 863-9991. FAX 714-863-9478.

Circle No 389

PHILIPS FETS WON'T GIVE YOU FITS.

For the surface-mounted FETS that fit your application, go right to the source: Philips/AmpereX. You'll find J FETS, MOS FETS and D MOS FETS in both P and N channel. In SOT-23, SOT-89, and SOT-143 for dual gate devices. All built to the tough quality control standards Philips is famous for. Find out how you can get all the FETS you need with fewer FITS. Call today for a free brochure: (401) 232-0500. AmpereX, George Washington Highway, Smithfield RI 02917

In Canada: Philips Electronics Ltd., 601 Milner Ave. Scarborough, Ontario M1B 1M8, (416) 292-5161.

PHILIPS: THE SOURCE FOR ALL YOUR SMD NEEDS.

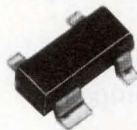

AmpereX[®]
A NORTH AMERICAN PHILIPS COMPANY

SMD
TECHNOLOGY

CIRCLE NO 44

DID YOU KNOW?

EDN serves
electronic engineers and
engineering managers in more than
100 countries worldwide.

EDN

"EDN MAGAZINE'S PRODUCT MART SECTION IS HELPING US BECOME A LEADER IN OUR MARKETPLACE."

Raymond J. Schnorr
Vice President of Marketing
ACCEL Technologies

As Vice President of Marketing, Ray Schnorr is responsible for marketing ACCEL Technologies' affordable, professional software that meets the design needs of electrical engineers. He operates on a fixed budget and demands results. "When it comes to buying media, I'm interested in two things: performance and price. With EDN's Product Mart section, I pull high-volume sales leads and meet my budget," says Schnorr.

In nineteen months, ACCEL has sold 5000 software packages to 3000 sites. "Our 1/9-page Product Mart ads in EDN magazine are allowing us to reach our target audience." And Schnorr sees more for EDN and ACCEL. "We have significant growth plans for ACCEL, and running bigger ads in EDN will be part of the strategy to get there.

"The power and prestige of EDN is helping us grow into a leading design software company."

Great Designs Start With Tango-Schematic. Just \$495.
Designs quickly come to life with Tango-Schematic's easy-to-use drawing editor and extensive component libraries. Features four line types, four text sizes, repeat and block functions, unique built-in word processor. Includes DRG, BOM, Wire List, Net List output and crop plots, prints, or laserprints. The perfect front end to our popular TangoPCB and TangoRoute board design systems.
TangoPCB and TangoRoute board design systems.
For IBM PC/XT/AT/PS/2. Just \$495. Full-function Demo Package. \$10. Order toll-free 800-435-7801. VISA/MC. Thirty-day money back guarantee.
ACCEL Technologies, 7558 Trade St., San Diego, CA 92121
Orlando, FL, U.S.A. contact: EDN Technology (Australia)
Phone: 61-02-34-0499 FAX: 61-02-35-8771
CIRCLE NO 347

Glide Through PCB Design.
TangoPCB Create the toughest board designs with powerful layout software that's a snap to use. Function rich TangoPCB supports eight layers, 1 mil grid, OrCAD* or Schema* redlist input, print/plot/photoplot output, and more.
TangoRoute Get impressive completion rates and remarkable speed with TangoRoute, a four layer, eleven pass autorouter. **Just \$495 each.**
For IBM PC/XT/AT/PS/2. Compare features and you'll buy Tango. Or try Full-Function Demo Package, just \$10.
Order toll-free 800-435-7801. VISA/MC. Thirty-day money back guarantee.
ACCEL Technologies, 7558 Trade St., San Diego, CA 92121
CIRCLE NO 348

PCB 'DEPENDABLE' ICP QUARTZ ACCELEROMETERS
SOLVE DECAPITULATED PROBLEMS
BANG/SET (EEPROM MULTIPROGRAMMERS)
MINIPONT A FULL RANGE OF CONNECTORS & SOCKETS
Kestelink Technology, Inc.
Glide Through PCB Design. TangoPCB
TangoRoute

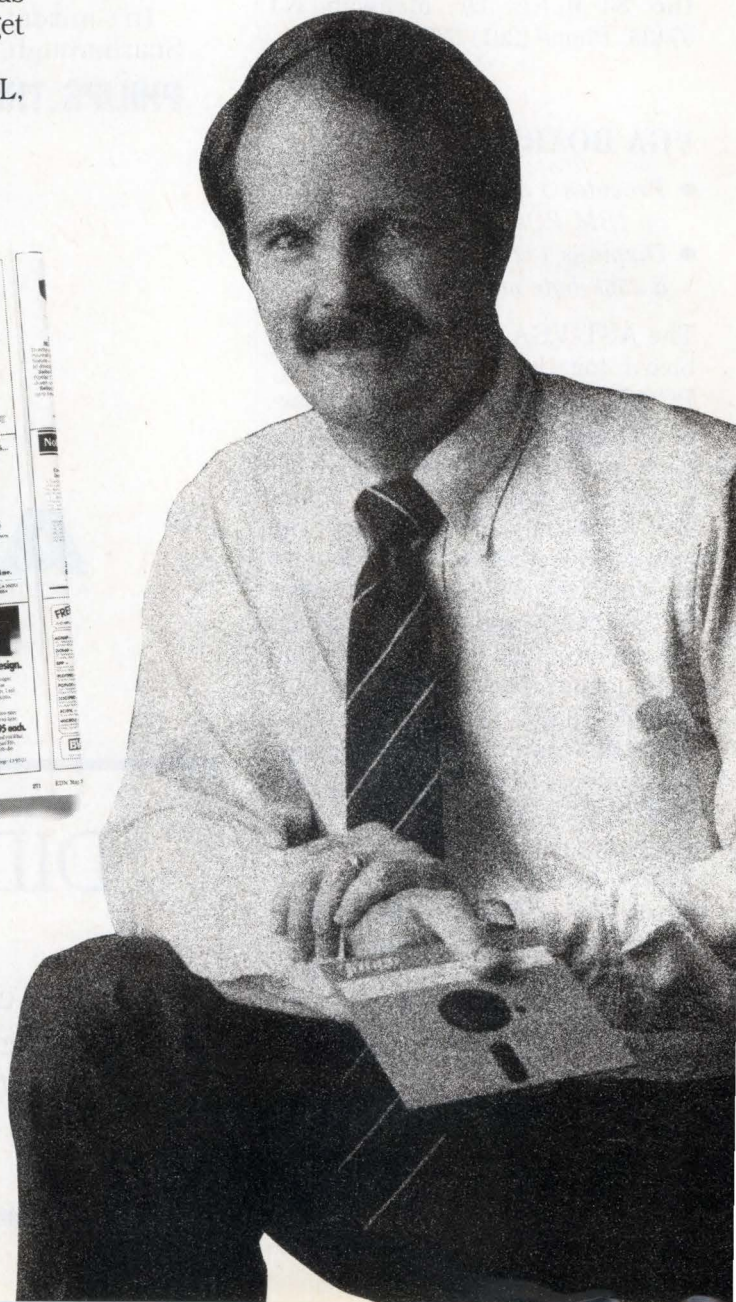

EDN magazine works for
ACCEL Technologies. It can work for you.

EDN

Where Advertising Works

NEW PRODUCTS

TEST & MEASUREMENT INSTRUMENTS

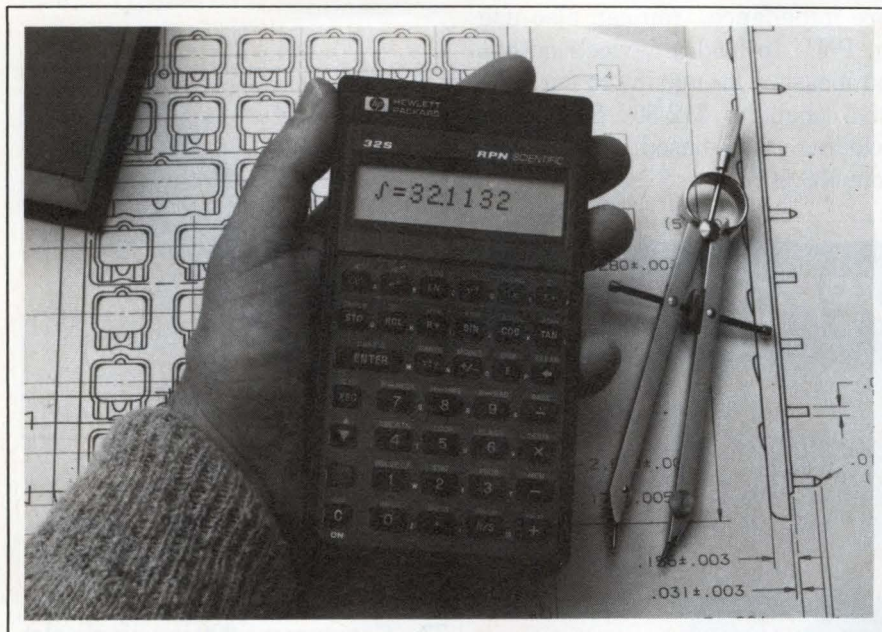

CALCULATOR

- Solves equations repeatedly without re-entry
- Uses loops, tests, and flags to make logical decisions

When you need to solve an equation for more than one variable, the HP-32S, RPN (reverse-Polish-notation) scientific calculator for engineering professionals saves you from having to enter an equation repeatedly. Instead of rewriting the equation to isolate the dependent variable, you simply set it equal to zero and supply values for all of the

independent variables. The calculator performs numeric integration and manipulates complex numbers; it allows keystroke programming of equations for which you need repetitive solutions. The unit's 4-level stack and 27 storage registers, as well as its ability to execute program loops, to perform tests, and to use flags allow you to use it for solving problems that require logical decisions. \$69.95

Hewlett-Packard Co, 19310 Pruneridge Ave, Cupertino, CA 95014. Phone local office.

Circle No 395

LOGIC ANALYZER

- Provides 32 25-MHz clock-rate channels
- Offers disassembler support for 13 μ Ps

The K25 logic analyzer provides 32 channels with a 1k-word-deep capture memory for each channel. It operates with internal or external clocks at rates to 25 MHz and provides four levels of triggering with restart capability as well as event and delay counting. Disassembler

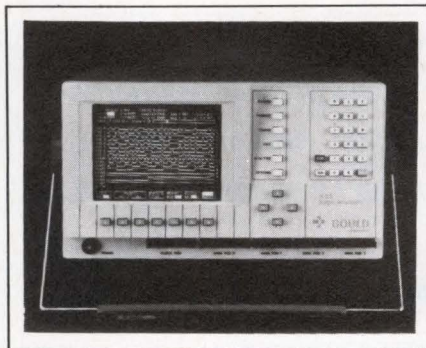

packages support the following 8- and 16-bit μ Ps: Z80, 6800, 8085, 8031, 8051, 8086, 8088, 68000,

64180, 8048, and 8049. In timing mode, you can display any 17 channels; you can expand the display as much as 16 times; and you can search for any word. In list mode, you can group 32 channels and assign them a single label. You can choose among five formats for the list-mode display. The unit includes IEEE-488, RS-232C, and Centronics interfaces; it stores data and setup information in battery-backed RAM. \$2995. Delivery, 60 days ARO.

Gould Inc, 3631 Perkins Ave, Cleveland, OH 44114. Phone (800) 538-9320. TLX 196113.

Circle No 396



MEASURING UNIT

- Adds parameter measurement to ASIC-verification tester
- Verifies continuity and measures impedance

The Parametric Measuring Unit (PMU) provides an option to the vendor's STM 5200 ASIC-verification test system. Basically, the PMU is a bipolar dc source-and-measurement subsystem that can force voltage onto one or more device pins and measure the current that flows through the pin(s); or force current through a pin and measure the voltage that appears at the pin. To prevent damage to the device under test, you can separately program the forcing quantity and

the maximum permissible values of the measured quantity. If application of the programmed forcing voltage or current causes the measured quantity to exceed its programmed limits, the unit will not allow application of the full requested forcing quantity. The voltage range is -3 to $9.995V$ with a 4.88-mV resolution. The unit can force and measure cur-

rents from 150 pA to 100 mA in six ranges. Among other things, these capabilities permit you to use the PMU to verify continuity and measure impedance. You can also use the PMU to load a device's output and measure its maximum current-drive capability. $\$12,500$. STM 5200, including 80386-based workstation, from $\$39,500$.

Cadic Inc., 1725 SW 167th Pl, Beaverton, OR 97006. Phone (503) 645-2222. TLX 887936.

Circle No 397

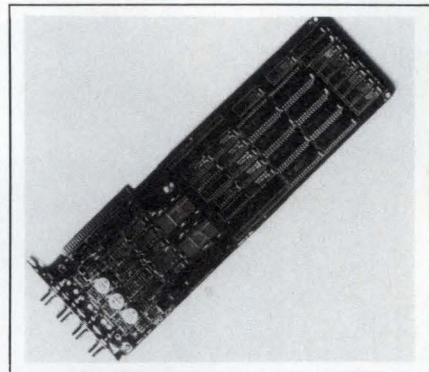

PC-BASED SCOPE

- Can acquire $40M$ samples/sec
- Stores $256k$ samples in onboard RAM

The Compuscope 220 is a single-slot board for the IBM PC bus. It allows the computer to function as a 20-MHz -bandwidth oscilloscope that simultaneously samples two analog waveforms at any of seven full-scale sensitivities from 0.1 to $10V$. The board allows you to independently select the sweep rate for each channel—you can set the rate from 10 nsec to 10 sec/div . The maximum acquisition speed and acquisition-memory depth on channels A and B, respectively, are $40M$ and $20M$ samples/sec and $256k$ and $128k$ bytes. The unit stores acquired data on board—not in the computer's memory. It allows mid-, pre-, and post-triggering initiated by either channel, an external source, or a keyboard command. The software supplied performs addition, subtraction, multiplication, division, integration, and differentiation of waveforms. It also performs FFTs and curve fitting, and allows you to use the board as a digital voltmeter or a frequency counter. $\$1995$.

Gage Applied Sciences Inc., 5905 St-François Rd, Montreal, Quebec, Canada H4S 1B6. Phone (514) 337-6893. FAX (514) 337-8411.

Circle No 398

FAMILY SUPPORT

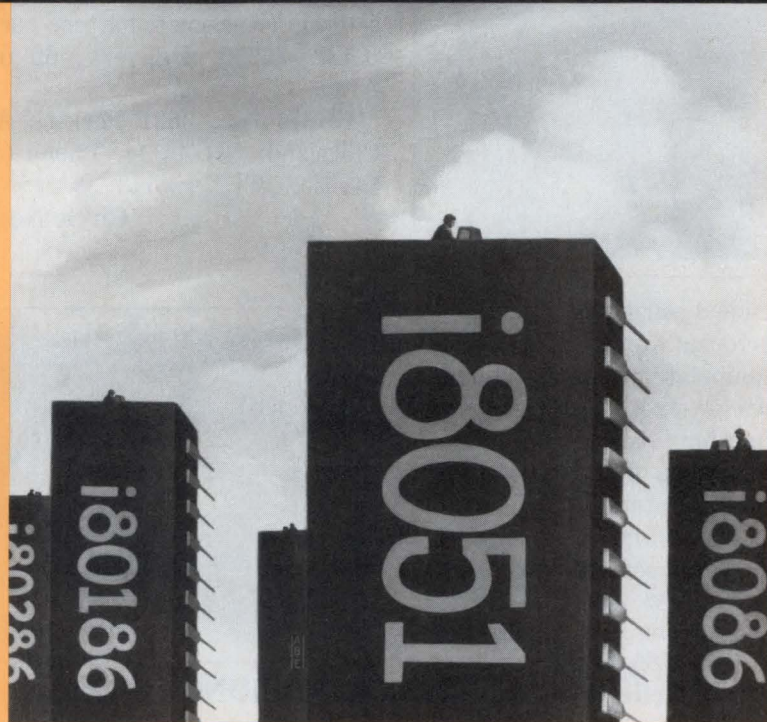

While many Intel architectures are alternate-sourced by other manufacturers, no one knows them better, or supports them better, than Intel.

Truest real-time emulation. Optimized languages. Common interfaces. Simpler operation. Single-point support for both silicon and tools. And support for new components months ahead of secondary tool suppliers.

Intel Development Tools. The Short, Sure Path To Success.

For your free Intel development tools catalog call:

ARROW/KIERULFF at 1-800-777-ARROW

New Toll-Free Number

PLD PROGRAMMER

- Connects to PC via parallel printer port
- Incorporates 23 universal pin drivers

The PLD-1100 programmer connects to an IBM PC or compatible computer through a parallel printer port. The unit, which utilizes 23 identical universal pin drivers capable of producing 0 to 25V in 100-mV steps and delivering peak currents as large as 5A, can handle nearly all programmable logic devices in 20- and 24-pin DIPs without hardware modifications or the use of personality modules. The vendor distributes device-library updates on MS-DOS-format disks. An internal μ P automatically calibrates the unit, performs a number of self tests, and executes diagnostic routines. A full-screen editor allows you to edit device fuse maps, and the vector sets the programmer uses for device testing. \$798.

BP Microsystems, 10681 Had-dington, Suite 190, Houston, TX 77043. Phone (800) 225-2102; in TX (713) 461-9430. TLX 1561477.

Circle No 399



6 1/2-DIGIT DMM CARD

- Makes 250 measurements/sec
- Measures 5 quantities

The DMM20 6 1/2-digit multimeter on a card plugs into the vendor's PC-based modular automatic-test systems. Depending on the resolution you program, the meter will make from 0.25 to 250 measurements/sec. Quantities measured include dc and

ac (true rms) voltage and current, resistance (2- or 4-wire), and the rms value of a voltage or current consisting of dc plus superimposed ac. On its most sensitive ranges, the unit can resolve 100 nV and 100 $\mu\Omega$; on its least sensitive ranges, it can measure 300V rms, 500V dc, and 20 m Ω . For dc measurements on the 2V range, the error is less than

0.001% of reading plus 20 counts for 24 hours after calibration at $\pm 1^\circ\text{C}$ of calibration temperature. The unit specs ac-measurement accuracy from 20 Hz to 100 kHz: \$2500. Delivery, 90 days ARO.

Summation Inc, 11335 NE 122nd Way, Kirkland, WA 98034. Phone (206) 823-8688. TLX 152219.

Circle No 400

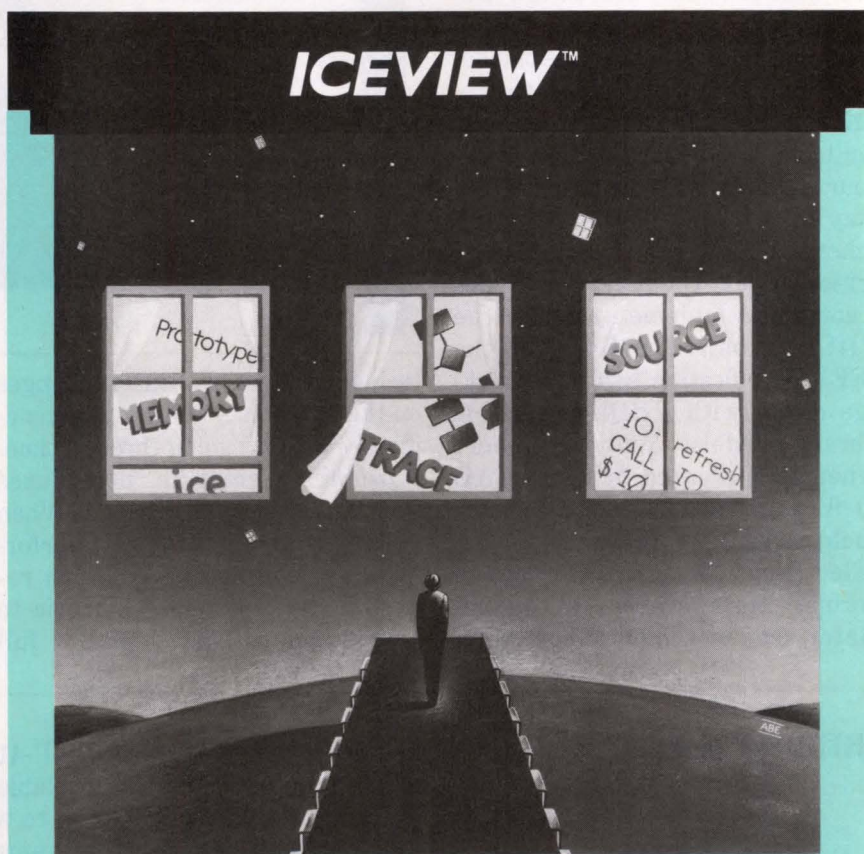

For more than a decade Intel has made the world's most powerful emulator technology easy to use.

Now there's ICEVIEW.™ More than an advanced human interface with windows and menus, ICEVIEW is the latest example of Intel's commitment to keep application development simple. Available now in I²ICE™ for the 8086/186/286.

Intel Development Tools. The Short, Sure Path To Success.

ICEVIEW and I²ICE are trademarks of Intel Corp.

For your free Intel development tools catalog call:

ARROW/KIERULFF at 1-800-777-ARROW
New Toll-Free Number

NEW PRODUCTS

CAE & SOFTWARE DEVELOPMENT TOOLS

DESIGN VERIFIER

- Simulator lets you perform real-time "what if?" analysis
- Accepts input in VHDL format and shows results of changes

The VantageSpreadsheet lets you use VHDL (VLSI Hardware Description Language) statements to create a schematic, simulate the design's operation, and display the results in real time. You can select multiple windows for displaying your definitions. You can also display all or part of the resulting schematic and see waveforms at critical nodes. The package includes a complete implementation of the VHDL standard defined in the IEEE specification 1076. The package comes with VHDL-compatible library models. You can import schematics created by other CAE tools that use existing standards such as Unix, VHDL, and EDIF (Electronic Design Interchange Format). However, because the simulator uses incremental compiling

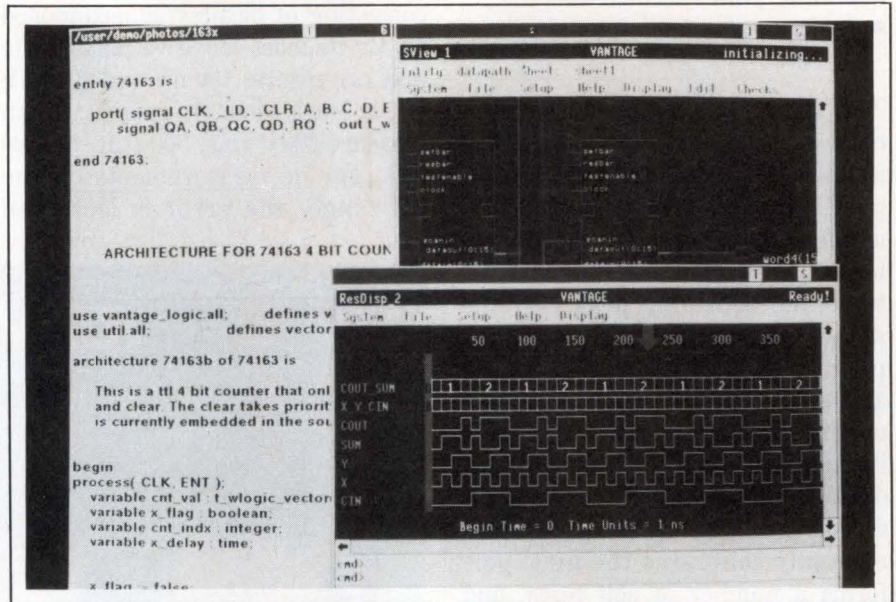

techniques, you can make changes on-the-fly and see the results immediately without going through time-consuming, start-up procedures such as net-list extractions. When you're satisfied with the performance of the design, you can re-export the modified schematic to your standard CAE tools for full

processing. The program runs on Apollo Domain workstations and costs \$30,000 to \$60,000, depending on the host's configuration.

Vantage Analysis Systems Inc,
428-40 Christy St, Suite 201, Fremont, CA 94538. Phone (415) 659-0901. FAX (415) 659-0129.

Circle No 405

IEEE-488 SOFTWARE

- Uses command set of the HP-41 scientific calculator
- Has 15-digit precision

The Eli-488 program runs on the IBM PC, PC/XT, PC/AT and compatibles. It provides engineers and scientists with calculation and control facilities that are completely compatible with the HP-41 scientific calculator. The program can use an 8087/80287 math coprocessor, if you have one in your system, and provides 15-digit precision for all calculations. If you have a National Instruments GPIB-PC interface board, you can control as many as 30 IEEE-488-based instruments. The program also includes additional functions to control I/O ports such as digital I/O boards, relay boards,

and ADCs and DACs. All HP-41 user-solution libraries are available on disk; they give you access to a range of fully debugged programs that were originally written for the HP-41. \$295.

Eclipse Logic Inc, Box 2003, Huntington Park, CA 90255. Phone (213) 569-6020.

Circle No 406

DSP DESIGN TOOL

- Lets you generate, analyze, and test a DSP design
- Provides an interface to board-level DSP products

The Monarch menu-driven, DSP design tool provides a user interface with pull-down menus and on-screen help. The Design module lets you design and analyze FIR, IIR,

and Pole-zero filters with user-specified architecture and time- or frequency-domain properties. The View module lets you perform an FFT on specified files and display the result as 2- or 3-dimensional plots. The Siglab module lets you generate and analyze a wide variety of test signals and systems without leaving the main program. An applications window provides access to applications programs such as the TMS320 package. Finally, the OS Shell module lets you perform standard PC-DOS file-management operations without leaving the program. Basic Monarch package, \$399.

The Athena Group Inc, 3424 NW 31st St, Gainesville, FL 32605. Phone (904) 371-2567.

Circle No 407

REAL-TIME KERNEL

- Functions as an OS for an embedded 8051 controller system
- Performs task-timing and synchronization functions

The AVR51 real-time executive functions as an operating system in a multitasking system based on the Intel 8051 μ P family. The executive provides pre-emptive scheduling for as many as eight tasks with four priority levels, three tiers of interrupt support, as many as 32 mailboxes for intertask communications, and two types of system timing services: interval timing and elapsed-time tracking. The executive provides interfaces to high-level languages such as Pascal or C; with a macroassembler you can write routines to link hardware to the executive. It comes in a relocatable object form. You can write your application programs with a cross-assembler (such as AVMAC51, which runs on the IBM PC, PC/XT, PC/AT and compatibles) and then link them to the executive for downloading to the target system. \$995.

Avocet Systems Inc, 120 Union St, Rockport, ME 04856. Phone (207) 236-9055.

Circle No 408

DETAILS MANAGER

- Shows how low-level detail meets high-level requirements
- Helps you meet DoD STD 2167A and other standards

The RTrace CASE tool tracks and reports how low-level details correspond to high-level requirements in any development project. It reports and lists all requirements and their associated allocation components; components that have no requirements allocated; and requirements for which no components have been allocated. The trace reports show the relationships between requirements and the associations between high-level requirements and the low-level system components that satisfy them. You can generate a

report at any stage of the development and get a picture of the architecture or allocation. The program lets you trace requirements compliance under DoD-STD-2167A, but you can adapt it to any life-cycle methodology and use it for any development project that must meet a set of requirements and document compliances. The program runs on a

VAX/VMS system (Version 4.6 or higher) that has a 4M-byte memory and that has at least 60,000 free blocks on the disk storage. Prices start at \$30,000 for a single MicroVax 2000.

Nastec Corp, 24681 Northwestern Hwy, Southfield, MI 48075. Phone (313) 353-3300.

Circle No 409

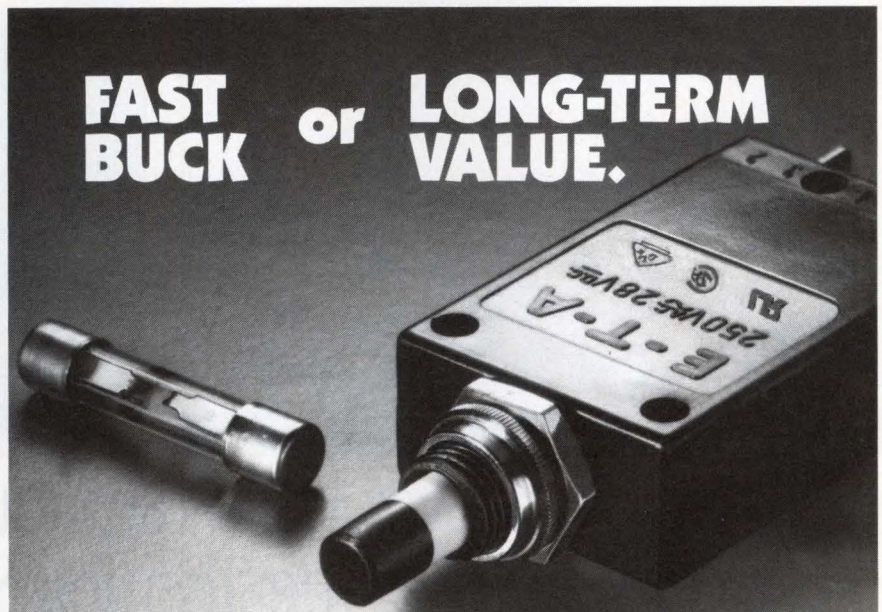

FAST BUCK or LONG-TERM VALUE.

If your only concern is initial cost, then fuses cost less than E-T-A circuit breakers. But beyond initial cost, there's reality. Fuses *blow* and can drive up your cost of warranties, service, replacement, even product liability.

E-T-A circuit breakers, on the other hand, add value to your product. Yet they can lower costs while providing superior circuit protection and better performance characteristics than fuses. For example, they're trip-free, foolproof, 100% tested for quality, and approved for use, worldwide.

So, forget the fast buck. Instead, go for the long-term value of E-T-A circuit breakers. Call today or circle the number below for specification details.



E-T-A[®]
CIRCUIT BREAKERS GROUP
 setting the pace for circuit protection

7400 N. CRONAME RD., CHICAGO, IL 60648 Tel. (312) 647-8303 FAX: (312) 647-7494

© 1988 E-T-A Circuit Breakers

CIRCLE NO 47

Module type No. TLX-1181-G3B



When your eyes need high quality displays, you need the Toshiba ST LCD.

Once again Toshiba has made a breakthrough in display quality. Clear and beautiful displays are achieved with the ST LCD. The LCD for the new age. And for your eyes. Now, by employing a new operating mode, this module provides excellent readability from a viewing angle perpendicular to the LCD panel. This was difficult to achieve with conventional LCDs. The aim was to make our LCD easier on the eyes. We succeeded with the ST LCD. Just another improvement in the man-to-machine interface by Toshiba.

ST LCD Module Specifications

Model name	Number of dots	Dot pitch (mm)	Outline dimensions (mm)	Recommended controller	Built-in EL module
TLX-1181	640 × 400	0.35 × 0.35	276 × 168 × 12	T7779	TLX-1181-EO
TLX-1181-G3B	640 × 400	0.35 × 0.35	276 × 168 × 12	T7779	★
TLX-561	640 × 200	0.35 × 0.49	275 × 126 × 14	T7779	TLX-562-EO
TLX-1342-G3B	640 × 200	0.35 × 0.49	275 × 126 × 14	T7779	★
TLX-932	640 × 200	0.375 × 0.375	293 × 97.6 × 14	T7779	—
TLX-1241	480 × 128	0.48 × 0.48	277 × 86 × 14	T7779	—
TLX-1301V	240 × 128	0.70 × 0.70	241 × 125.3 × 12	(T6963C)	—
TLX-1013	160 × 128	0.60 × 0.60	129 × 104.5 × 14	(T6963C)	TLX-1013-EO
TLX-711A	240 × 64	0.53 × 0.53	180 × 65 × 12	(T6963C)	TLX-711A-EO
TLX-1021	120 × 64	0.48 × 0.60	85 × 70 × 20	(T6963C)	TLX-1021-EO
TLX-1391	128 × 128	0.43 × 0.43	85 × 100 × 14	(T6963C)	TLX-1391-EO
TLX-341AK	128 × 128	0.45 × 0.45	93.2 × 86.6 × 12	T6963C	—
TLX-761	640 × 64	0.38 × 0.42	320 × 47 × 14	T6963C	—

(): Built-in controller, ★: B-ST, built-in EL module

In Touch with Tomorrow
TOSHIBA

Toshiba America, Inc., Chicago Office: 1101A Lake Cook Rd., Deerfield, IL 60015 Tel: 312-945-1500 Western Area Office: 2021 The Alameda, Suite 220, San Jose, CA 95126
 Tel: 408-244-4070 Eastern Area Office: 25 Mall Road, 5th Floor, Burlington, MA 01803 Tel: 617-272-4352

EDN PRODUCT MART

This advertising is for new and current products.

Please circle Reader Service number
for additional information from manufacturers.

UNIPRO™ UNIVERSAL PROGRAMMER AND MEMORY/TTL IC TESTER FOR PC/XT/AT

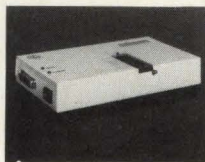

E(E)PROM (16K-1MB)
PAL (20 & 24 pins)
BIPOLAR
8741/42/48/49/50 CPU
87(C)51/44 CPU
DYNAMIC/STATIC RAM &
TTL TESTER
Option: 4 Socket Adaptor
only \$585 complete

Other products available. Individual programmers for E(E) PROM (up to 1MB), PAL, BIPOLAR, 8748 series, 8751 series, Memory/TTL Tester, and gang programmers with 4, 8, and 16 sockets. Also industrial quality EPROM Eraser with timer and safety switch is available. (erases 30 of 28 pin eeproms at a time) OEM & Distributor welcome. 10% educational discount

473 Sapena Ct. #24
Santa Clara, CA 95054
Tel) 408-727-6995
FAX) 408-727-6996

XELTEK

VISA
M/C
AMEX

CIRCLE NO 325

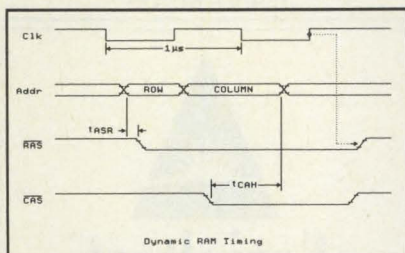

TIMING DIAGRAM SOFTWARE

Design Aid:
Quickly draw and edit waveforms.
Documentation Tool:
Easily label waveform drawings.

IBM PC with mouse required.

To order Timing Diagram, send check or money
order for \$149 to:

CEDRUS

10980 S. W. 81st, Tigard, OR 97223 (503) 620-2510

CIRCLE NO 326



GANG/SET (E)EPROM MULTIPROGRAMMERS™

Model 135-E: \$995⁰⁰

- BYTEK's 135 is a SET Programmer, GANG Duplicator, & UNIVERSAL Device Programmer.
- Programs virtually all 24, 28, & 32-pin (E)EPROMs.
- RAM expandable to 2MegaByte.
- Optional support for 40-pin EPROMs, Bipolar PROMs, 40-pin Micros, & (E)PLD/GAL/FPLA Devices.
- **18-Month FREE WARRANTY and also 12-Month FREE DEVICE UPDATES.**

1-800-523-1565

In Florida: 1-407-994-3520

BYTEK BYTEK Corporation
508 N.W. 77th St., Boca Raton, FL 33487
FAX: (407) 994-3615 Telex: 4998369 BYTEK

* (U.S. Prices only)

CIRCLE NO 327



your PCB
projects will stay

Well-connected

Caddy integration means one environment for Schematic Capture, PCB Layout, Autorouting, Auto-ARTGEN to plotters and Gerber, 2D assembly drawings and 3D packaging design...all on your PC...all well-connected. Call Now!

Caddy Corporation
3401 Algonquin, Suite 340
Rolling Meadows, IL 60008
(312) 394-7755 or 1-800-223-3911

CADDY

CIRCLE NO 328



REMOTELY LOCATE YOUR COMPUTER MONITOR

Your computer's monitor can now be located up to 1000 feet from your computer with SCREEN SENDER™. Works with any TTL monitor, color or monochrome. The Transmitter connects to your computer's monitor port and the Repeater can be located up to 1000 feet away using multi-paired cable. Repeaters can be daisy chained for connecting multiple monitors to one computer. Great for factory automation, public displays, training environments, and remote monitoring. Transmitter and Repeater pair is only \$495.00. Call today for more information.

Communications
 Specialties, Inc.

TEL (516) 499-0907

FAX (516) 499-0321

CIRCLE NO 329



900W SERVO AMPLIFIER IC

Features: 33KHz PWM frequency • Protection against output short circuit, over-heating and over-voltage • Adjustable current limit • No external heatsink or forced air-cooling is required for most duty cycles even at the maximum output rating of $\pm 90V$ at $\pm 10Amps$ • The unit contains a complete DC velocity servo with tach/computed back EMF • Supply voltage can be any value from 20 to 90 volts • Price is \$249.95 each • PWM input and STD card dual axis amplifiers and units up to 60A/150V also avail.

ADVANCED MOTION CONTROLS

15921 Haynes St., Van Nuys, CA 91406
(818) 989-4480

CIRCLE NO 330

To advertise in Product Mart, call Joanne Dorian, 212/463-6415

Analog Circuit Simulation

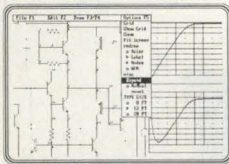

NEW
IS_SPICE/386
\$386.00

Runs on 386 PC's in protected mode with DOS 3.1 & up. Uses 287, 387 or W1167 coprocessor

- **IS_SPICE, \$95.00:** Performs AC, DC and Transient analysis; runs on all 80?86 PC's in real mode.
- **PRE_SPICE, \$200.00:** Adds Monte Carlo Analysis, Sweeps, Optimization, libraries and algebraic parameter evaluation.
- **Intu_Scope, \$250:** A graphics post processor works like a digital oscilloscope. Easy to use with all the waveform operations you will ever need.
- **SPICE_NET, \$295:** Schematic entry for any SPICE simulator. Automatically makes a SPICE net list and places Intu_Scope waveforms on your schematic.
- **30Day Money Back Guarantee**

intusoft

(213) 833-0710

P.O. Box 6607
San Pedro, CA
90734-6607

CIRCLE NO 331



MIL QUALITY / LOW PRICE CONNECTORS

Our JCM connectors deliver the same MIL-SPEC quality as SMA-types, without charging you for expensive materials and military paperwork. The JCM line offers commercial versions of SMA/SMB/SMC RF plugs, jacks, adapters, test jacks, cable sets and PC-mount cable terminations in popular sizes and types. Get MIL-C-39012 performance without the MIL price.

Call **800/247-8343** for a free JCM catalog. (In MN: 507/835-6222)

EF JOHNSON COMPONENTS

CIRCLE NO 332



1 line x 24 Character INTELLIGENT Display System

Instant information on problems, machine or process status as it happens... or is about to happen. In plain English. NEMA 4X SS bezel. Model W424-1X5D.

List price only \$880.00

(Also available, NEMA 12 bezel at \$690.00)

CHERRY

CHERRY ELECTRICAL PRODUCTS
3600 Sunset Avenue • Waukegan, IL 60087 • 312-360-3500 • FAX: 312-360-3566

CIRCLE NO 333

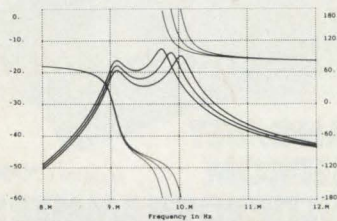

ANALOG CIRCUIT ANALYSIS ECA-2

Introducing ECA-2 for the Macintosh. ECA-2 2.31 includes more models, increased graphics capabilities, and expanded documentation.

- AC, DC, Transient
- Fourier, Temperature
- Worst-case, Monte-Carlo
- Full, nonlinear simulator
- Interactive or batch
- SPICE compatible models
- Twice as fast as SPICE
- Over 500 nodes
- Sine, Pulse, PWL, SFFM and Exponential generators
- Money back guarantee

EC-Ace, a subset of ECA-2, \$145

ECA-2 IBM PC or Mac \$675

Call 313-663-8810 For **FREE DEMO** disk



Tatum Labs, Inc

1478 Mark Twain Court, Ann Arbor, MI 48103

CIRCLE NO 334



Serialtest™
Serial data analysis on your PC. Source and monitor modes; data-scope and breakout box; ASCII and EBCDIC; trigger processing, live data display, adjustable buffer size. Custom cabling included.

800 562-8378

Advanced Computer Consulting, Inc.
700 Harris Street, Suite 101
Charlottesville, Virginia 22901

CIRCLE NO 335

Join Forces

Combine your larger ads with EDN Product Mart ads for a total marketing program.

EDN Product Mart

CIRCLE NO 336

CY525 3rd generation STEPPER MOTOR CONTROLLER

most intelligent controller offers linear ramping, 10,000 steps/sec, unlimited stepping, change rate on the fly, read position on the fly, and much more.

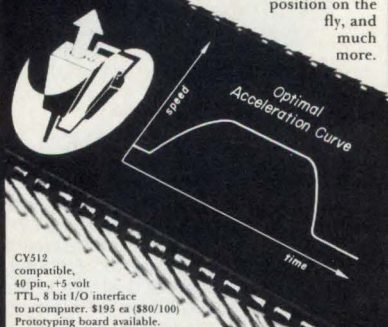

CY512 compatible, 40 pin, +5 volt TTL, 8 bit I/O interface to computer. \$195 ea (\$30/100) Prototyping board available.

Cybernetic Micro Systems
P.O. Box 3000, San Gregorio, CA 94074
(415) 776-3000 Telex: 171-135 attn: Cybernetic

CIRCLE NO 337

"D" SIZE PLOTTER

\$2295.00
RETAIL

\$1695.00
INTRODUCTORY
OFFER

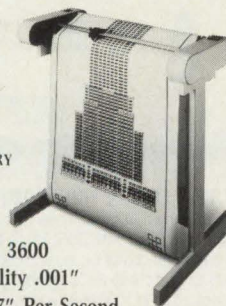

- Model PC 3600
- Repeatability .001"
- Speed at 7" Per Second
- Vacuum Paper Hold Down
- High Resolution Circles: Suitable for PCB Artwork

(415) 490-8380 **ZERICON**

STEVENSON BUSINESS PARK
BOX 1669 • FREMONT, CA 94538

CIRCLE NO 338

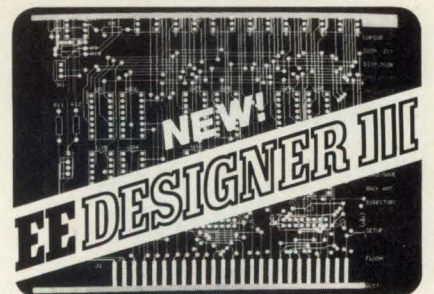

CAE/CAD Integrated Software Package
for IBM PC/XT/AT/PS2

Weigh Cost Against Performance

When you balance cost and performance, EE Designer III gives you more features per dollar than any other electronic design software package. You get full-featured PCB layout plus schematic capture, analog/digital circuit simulation, support for EMS memory, 45 degree autorouting, and full postprocessing functions. EE Designer packages start at \$995.

30 day money back guarantee. Full purchase price refunded if not completely satisfied. Call 1-800-553-1177 today to order your package. Bank cards welcome.

VISIONICS CORPORATION 343 Gibraltar Drive
Sunnyvale, CA 94089

CIRCLE NO 339

To advertise in Product Mart, call Joanne Dorian, 212/463-6415

NO WAITING FOR COMPLETE, LOW PRICED, CHIP COMPONENT KITS

CC-1 Capacitor Kit contains 365 pieces, 5 ea. of every 10% value from 1pf to .33µf. CR-1 Resistor Kit contains 1540 pieces; 10 ea. of every 5% value from 10Ω to 10MΩ. Sizes are 0805 and 1206. Each kit is ONLY \$49.95 and available for immediate One Day Delivery!

Order by toll-free phone, FAX, or mail. We accept VISA, MC, AMEX, COD orders, or company P.O.'s with approved credit. Call for free detailed brochure.



COMMUNICATIONS SPECIALISTS, INC.
426 West Tall Avenue • Orange, CA 92665-4296
Local (714) 998-3021 • FAX (714) 974-3420

Entire U.S.A. 1-800-854-0547

CIRCLE NO 340

EPROM PROGRAMMER \$349

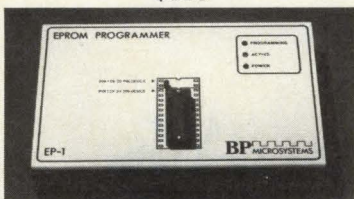

THE EP-1's a GREAT VALUE & HERE'S WHY:

- READS, PROGRAMS, COPIES OVER 300 EPROMS AND EEPROMS FROM 29 MANUFACTURERS INCLUDING 2716-27513, 2804-28256, 27011
- READS & WRITES INTEL, MOTOROLA, STRAIGHT HEX AND BINARY
- OPTIONAL HEADS PROGRAM INTEL 874X, 8751, 87C51, 8755
- MENU-DRIVEN CHIP SELECTION BY MFG & P/N; NO MODULES
- FAST, SLOW, QUICK PULSE PROGRAMMING ALGORITHMS
- SPLITS FILES BY BASE ADDRESS AND ODD/EVEN (16&32 BIT)
- ALL INTELLIGENCE IN UNIT; Z80 MICROPROCESSOR BASED
- 5, 12.5, 21, 25 VOLT PROGRAMMING FOR CMOS AND A SUFFIX PARTS
- FREE PC-DOS SOFTWARE
- FREE PC-DOS SOFTWARE
- GOLD TEXTOL ZIF SOCKET
- SAME DAY SHIPMENT
- ONE YEAR WARRANTY
- MONEY-BACK GUARANTEE
- RS232 TO ANY COMPUTER
- 8 BAUD RATES TO 38,400
- GENERATES, CHECKS CHECKSUMS
- TWO FREE FIRMWARE UPDATES
- UV ERASERS FROM \$34.95

CALL TODAY FOR MORE INFORMATION

BP MICROSYSTEMS

800/225-2102 713/461-9430 TELEX 1561477
10681 HADDINGTON #190 HOUSTON, TX 77043

CIRCLE NO 343

SCHEMA II Schematic Capture

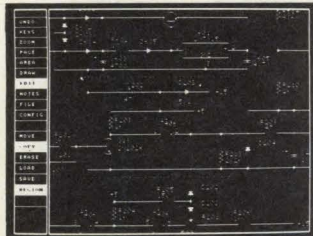

FREE Demo Disk: 1-800-553-9119

SCHEMA's success is the talk of the CAE industry and thousands of satisfied SCHEMA owners know why. Incredible speed, ease of use, and power have made SCHEMA a best-selling schematic capture program for engineering professionals the world over.

Now, SCHEMA II is available. SCHEMA II sells for \$495 and supports most common IBM PC/XT/AT configurations. Please call today for a free SCHEMA II demo disk.



OMATION

In Texas Call (214) 231-5167

CIRCLE NO 346



CROSS-16 META ASSEMBLER

- Table based 8/16 bit cross-assembler.
- Uses manufacturer's assembly mnemonics.
- Tables & Example Source files are included for ALL of the following processor families:

1802	3870	64180	6502
65816	6801	6805	6809
6811	68000	7000	8048
8051	8085	8086	8096
COP800	SUPER8	Z8	Z80

- Users may modify or create new tables for additional processors.
- Produces listing, symbol table, and 8/16 bit binary, Intel and Motorola hexcode.
- 5" DSDD for PC/MS-DOS 2.0 or greater.

\$99.95 US \$139.95 CDN

- Portable C sourcecode is available.

Worldwide shipping (AIRMAIL) & handling included. Credit Card orders (\$139.95 CDN) please specify: Card number, name on card and expiry date.



Universal Cross-Assemblers

P.O. Box 384, Bedford, N.S.
Canada B4A 2X3

CIRCLE NO 341

RUGGED STAINLESS STEEL P21 L TYPE PRESSURE TRANSDUCERS

- 0-5 V output
- 5 V input (4-26 V capable)
- 0-3 thru 0-15,000 psi
- three terminal



From \$251 (Qty. of 1)

LOW VOLTAGE — LOW CURRENT
One mA ideal for battery and solar operation



5325 Naiman Pkwy.
Solon, Ohio 44139

PH. 216/248-2229 / TWX 810-427-2059 / FAX 216/248-7780

CIRCLE NO 344

QUARTZ 'RELIABLE' ICP* PRESSURE SENSORS



Made in U.S.A.

Adapted for test measurement or continuous monitoring in tough environments - rugged, solid state pressure sensors simplify your dynamic measurement task and lower your cost per channel. For full information, call or write us today.

*Integrated Circuit Piezoelectric

PCB PIEZOTRONICS, INC.
3425 Walden Avenue
Depew, NY 14043-2495
716-684-0001



CIRCLE NO 347

FREE CATALOG



- Test Adapters (Socketed LCC/PLCC/PGA)
- Test Clips (Surfaced Mounted SOIC/PLCC)
- 150 Types of Prototyping Board Adapters
- 125 Types of Programming Socket Converters
- Many Types of Emulator Pod Converters
- PGA/PLCC Extraction/Insertion Tools
- And Much, Much More...



Emulation Technology, inc.

STATE OF THE ART VLSI and SURFACE MOUNT ACCESSORIES

2368-B Walsh Ave. • Bldg. D • Santa Clara, CA 95051
TEL: (408) 982-0660 • FAX: (408) 982-0664

CIRCLE NO 342

6809 Single Board Computer

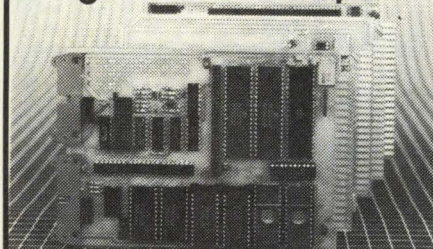

6809 MPU, 2 serial ports, 4 parallel ports, RAM, EPROM, real-time clock, watchdog timer, 44-pin 4.5" x 6.5" PCB
EXPANSION MODULES: RAM, EPROM, CMOS RAM/battery, analog I/O, serial I/O, parallel I/O, counter/timer, IEEE-488, EPROM programmer, floppy disks, cassette, breadboard, keyboard/display.



Wintek Corp.
1801 South Street
Lafayette, IN 47904
800-742-6809

CIRCLE NO 345

PADS SUPERROUTER™

Simply the Best Autorouter Available

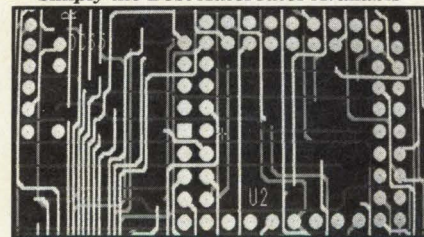

PADS-SUPERROUTER is a Ripup and Reroute Autorouter that works around the clock, and completes up to 100% of the connections on your board. Upon completion, the results are optimized for high quantity manufacturing. (All this is done unattended, while you are performing other tasks!)

100% Autorouting!

Call for a No-cost Evaluation Package
508/486-8929 (Inside MA)
1-800-255-7814 (Outside MA)



119 Russell Street
Littleton, MA 01460

CIRCLE NO 348

To advertise in Product Mart, call Joanne Dorian, 212/463-6415

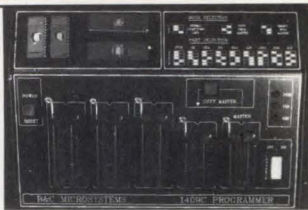

UNIVERSAL E(E)PROM PROGRAMMER \$495 (Kits from \$165)

- No personality modules; Menu driven device selection.
- Built-in Eraser/Timer option (\$50); Conductive foam pad.
- Direct technical support; Full 1 year warranty.
- Stand alone duplication & verify (27XX parts).
- Quick pulse algorithm (27256 under 60 sec).
- 27xx to 1 Mbit; 25xx; 68xx; CMOS; EEPROMS.
- 8741,-2,-4,-8,-8H,-9,-9H,-51,-CS1,-52,-55, 9761 & more.
- IBM-PC, Apple, CPM or Unix driver; Autobaud RS232.
- Offset/split Hex, Binary, Intel & Motorola 8,16,32 bit.
- Manual with complete schematics.

VISA MC AMEX Call today for datasheets !!

B&C MICROSYSTEMS

355 WEST OLIVE AVE. SUNNYVALE, CA 94086
PH: (408) 730-5511 FAX: (408) 730-5521 TELEX: 984185

CIRCLE NO 349

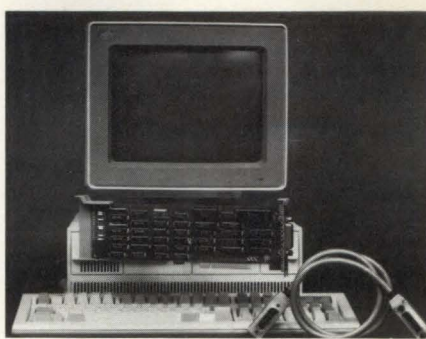

IEEE-488 (GP-IB, HP-IB) FOR THE IBM PERSONAL SYSTEM/2™

- Control instruments, plotters, and printers.
- Supports BASIC, C, FORTRAN and Pascal.
- High speed DMA and shared interrupts.
- Software library. Risk free guarantee.



Capital Equipment Corp.
99 South Bedford St.
Burlington, MA. 01803

Call today (617) 273-1818

CIRCLE NO 350

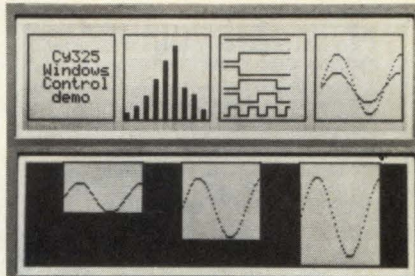

LCD WINDOWS CONTROLLER

The CY325 supports LCDs up to 128x240 pixels (16x40 char) with easy-to-use high-level commands and Parallel or Serial interface to host computer. The 256 built-in windows (or make your own) support window-relative text, graphics, plotting, bargraphs, waveforms, scroll/wrap/clip, etc. Read from an A/D and Write into Window! Separate text and graphic planes can be written or erased in any window. Eight pins support a variety of functions (soft-keys, waveforms) or can be used for GP I/O. Icons or special fonts can be user defined. Giant character mode, etc. Save months of design time with the CY325. \$75 CMOS \$20/1000s.



Cybernetic Micro Systems Inc.

P.O. Box 3000 • San Gregorio, CA 94074 • USA
Phone: (415) 726-3000 • Telex: 910-350-5842

CIRCLE NO 751

HIGH PRESSURE TRANSDUCER

Custom ranges from 200 - 5000 lbs.

- Stainless steel
- Strain gage
- NEMA 4 option
- 4-20 mA or 0-5 VDC output

Call free
800-323-7115
In PA 800-323-7114



Robinson-Halpern COMPANY

A Subsidiary of Teleflex Incorporated (USA)

CIRCLE NO 752

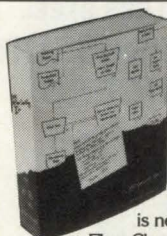

Flow Charting II+ The New Plus for Fast Flowcharting

FLOW CHARTING is new! It's now

Flow Charting II+, with more speed + more functions + more printing options;

- 10 text fonts; 26 shapes; • Line mode can stop at a shape; • Backspace key can erase a line to its origin; • Free text entry anywhere, or select auto-centering; • Vertical or horizontal printing; one chart or multiple charts.

Used by Fairchild, Bechtel and more than 500 other major corporations. Edit quickly and accurately - even major edits - with Flow Charting II+, the Specialist.

See your retail store or call:

PATTON & PATTON
Software Corporation

1-800-525-0082, Outside California
408-629-5376, California/International

CIRCLE NO 753

A Lot For A Little

Reach 137,000 specifiers of electronics components, equipment, and systems for only \$780.

◆ EDN Product Mart

CIRCLE NO 754

Tango™ Sets The Pace!

Tango's ease-of-use, rich functionality and crisp output have brought tens of thousands of boards to life, quickly and affordably.



Start-to-finish design tools include:

- Tango-Schematic** With Library Manager, \$495
- Tango-PCB** 1 mil Grid, 9 Layers, Gerber Output, \$495
- Tango-Route** Autoroutes 90+% Fast!, \$495
- Tango-Tools** 8 Money-Saving Utilities, \$295

Let's discuss your design needs Toll-Free, or order a full function Evaluation Pkg, just \$10. VISA/MC.

800 433-7801 619/695-2000 Satisfaction guaranteed.

ACCEL Technologies, 7358 Trade St., San Diego, CA 92121

CIRCLE NO 755

SYNCHRONOUS/ASYNCHRONOUS RS-422, RS-485, RS-232, CURRENT LOOP

SYNCHRONOUS COMMUNICATION

- 1 Mbaud data transfer rate
- DMA facility
- Byte sync, SDLC, HDLC
- RS-422, RS-485, RS-232

ASYNCHRONOUS COMMUNICATION

- Single/dual port option
- Selectable interrupt
- Address selectable
- Current Loop, RS-422, RS-485, RS-232



QUA TECH INCORPORATED

Leaders in Communication Technology

TOLL FREE: 1-800-553-1170
478 E. Exchange St. Akron, Ohio 44304
(216)434-3154 TLX:5101012726 FAX:(216)434-1409

CIRCLE NO 757

To advertise in Product Mart, call Joanne Dorian, 212/463-6415



MOUSE-TRAK
The Stationary Alternative
For Precision and Comfort!

This new space saving input device emulates both Microsoft and Mouse Systems RS-232 mice. With MOUSE-TRAK you can watch your screen and not your mouse running off your desk.

With a single connection to your computer, no power supply or mouse pad is necessary.

MOUSE-TRAK's ergonomic design with soft wrist pad puts complete control of cursor and input at your fingertips.

Special features include speed control, allowing the user to toggle the resolution with a 4:1 ratio. User definable input keys offers added versatility and comfort.

Pricing - \$139.00 - \$179.00

For further information:

ITAC SYSTEMS, INC.

3121 Benton Drive, Garland, Texas 75042 U.S.A.
1-800-533-4822 Fax 214-494-4159

CIRCLE NO 758

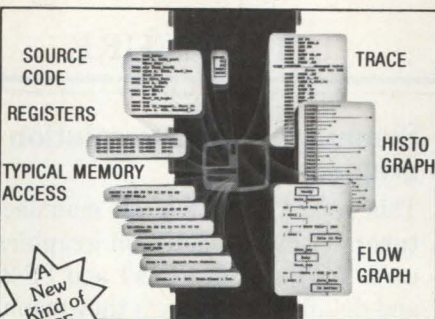

dICE-51 only \$595

8051 Debugger with In-Circuit-Element

The CY-8051 in-circuit element replaces the 8051 and communicates with your IBM-PC over COM1. The powerful dynamic user interface provides source code and symbolic debugging with easy access to all 8051 spaces. Live keyboard, Global Symbol Monitor, 'C' support. Histogram generated during reduced speed execution. Lowest cost, most powerful 8051 design support. Mil spec and CMOS versions available.



Cybernetic Micro Systems, Inc.

Box 3000 • San Gregorio, CA 94074 • USA
(415) 728-3000 • Telex: 910-350-5842

CIRCLE NO 759

E & H Field Probes

\$495

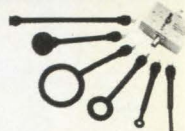

EDN "Readers Choice" (6/25/87)

Makes finding E & H Field emissions easy!

Use with any o-scope or spectrum analyzer. Set includes three H and two E field probes, extension handle, case, documentation, two year warranty. Pre-amp with battery charger, optional. Call, write to order or for brochure.

1-800-253-3761

PO Box 1546 Austin, TX 78767



CIRCLE NO 760

Want
Attention From
137,000
Engineering
Specifiers?

Place your ad in
EDN Product Mart.

CIRCLE NO 761

WINPOINT
A FULL RANGE OF
CONNECTORS & SOCKET

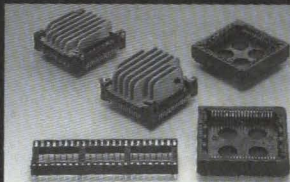

IC SOCKETS-8, 14, 16, 18, 20, 22,
24, 28, 40, 42, 48 contact
LCC SOCKET-68 contact
PLCC SOCKET-28, 32, 44, 52, 68,
84 contact series



Winpoint Electronic Corp.

P.O. Box 89-80, Taipei, Taiwan, R.O.C. Office: No. 47,
Chi-Wei St., San Chung City, Taipei, Taiwan, R.O.C.
Tel: (02) 966-0208, 984-0209
Telex: 34227 WINPOINT Fax: 886-2-9838555

CIRCLE NO 762

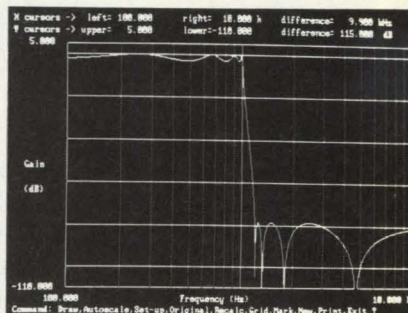

AFD - ADVANCED ACTIVE FILTER DESIGN SOFTWARE

Version 3.1 designs Lowpass, Highpass, Bandpass, Bandstop and Allpass filters with Butterworth, Chebyshev, elliptic and Bessel response
• Calculates values and sensitivities for MFB, VCVS, biquad, state variable, National MF-10 and Reticon circuits • Interactive graphics for group or phase delay, gain, phase, impulse and step response of the complete filter or individual section • Combine filters for system design/analysis • Modify circuits to observe effects • For IBM PC, XT, AT, PS/2 (\$725)

**** FREE DEMO DISK AVAILABLE ****

FILE CONVERSION FOR SPICE, TOUCHSTONE & NETOPT AVAILABLE

RLM Research

P.O. Box 3630, Boulder, CO 80307-3630 (303) 499-7566

CIRCLE NO 763

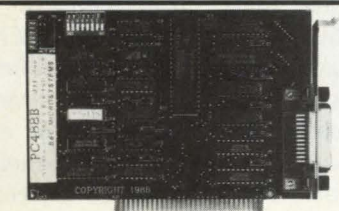

PC488B \$445

IEEE-488 INTERFACE CARD WITH BUILT-IN BUS ANALYZER

- GPBASIC package complements IBM/Microsoft BASIC interpreter and compiler to create a programming environment similar to HP desktop computers.
- Additional libraries of over 20 high level 488 dedicated functions for C, Pascal or Fortran available (\$30).
- Powerful menu-driven bus analyzer, which can run in the foreground or in the background while 488 programs or commands are executed, features program stepping, break points and real time bus data capture (4k circular buffer).
- Instant toggling between foreground and Analyzer screen.
- Complete Talker/Listener/Controller capability.
- Dipswitch selectable Base Address, IRQ, DMA

VISA MC AMEX Call today for datasheet!!

B&C MICROSYSTEMS

355 West Olive Ave, Sunnyvale, CA 94086
PH: (408)730-5511 FAX: (408)730-5521 TELEX: 984185

CIRCLE NO 764



Schematic and PCB Software

Create and revise schematics and PCBs quickly and simply with **HiWIRE-Plus** and your IBM PC. Use symbols from HiWIRE-Plus's extensive library, modify them, or create your own quickly and painlessly. Netlist, bill-of-materials, and design-checking utilities are included. **HiWIRE-Plus** is \$895 and comes with a thirty-day money-back guarantee.

Wintek Corp.

1801 South St., Lafayette, IN 47904
(800) 742-6809 or (317) 742-8428

CIRCLE NO 765

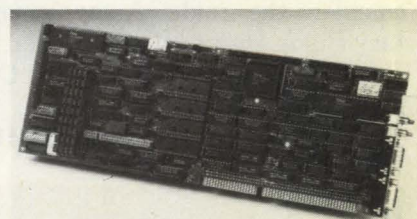

Z80,000™ AT-BUS SBC (ATZ80K)

Zilog's new Z320™ 32-bit pipelined CPU/MMU/CACHE unit is the heart of this PC-AT™ coprocessor, passive-backplane master, or stand-alone SBC. Get 2 to 5 MIPS performance at 10 MHz with 1M or 4M 32-bit burst-mode no-wait-state RAM, 4 32-pin EPROM/EEPROM sockets for up to 512K 32-bit burst-mode no-wait-state non-volatile storage, 2 RS-232 ports, 24 I/O lines, 3 16-bit counter/timers, an 8-bit DIP switch, and an SBX connector. Debugger, assembler, and C available.

Call or write for more information.

Single Board Solutions, Inc.

20045 Stevens Creek Blvd., Cupertino, CA 95014
(408) 253-0250

Z80,000 & Z320 are trademarks of Zilog
PC-AT is a trademark of IBM

CIRCLE NO 766

To advertise in Product Mart, call Joanne Dorian, 212/463-6415

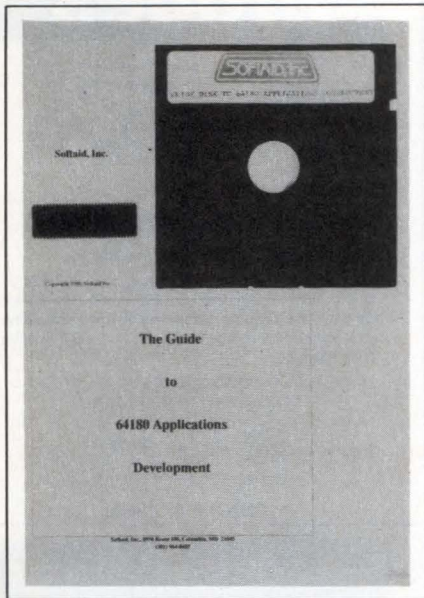

Data book delineates applications development

The *Guide to 64180 Applications Development* gives instructions for programming the 64180 microprocessor. Its inclusion of benchmarks comparing the 64180 with other processors helps you select an appropriate CPU. It tells you how to use the μ P's peripherals such as UARTs, timers, and the memory management unit, and it provides schematics and code segments that are useful in most applications. A description of hardware- and software-development environments, and a listing of support products complete the guide. A supplementary Guide Disk is also available.

Softaid Inc., 8930 Route 108, Columbia, MD 21045.

Circle No 415

Folder features timers and relays

This 8-pg publication details the vendor's line of timing controls consisting of time-delay relays and timers. The booklet provides a selection chart for time-delay relays and a timer selection guide. It also includes specifications, photographs, and diagrams.

Timeco Inc., Box 8036, Huntington, WV 25705.

Circle No 416

Summary of high-resolution graphics cards

This report identifies all manufacturers of high-resolution graphics cards for the IBM PC/AT and PS/2, and details the products they manufacture. It features a market summary, a product-evaluation scheme, and definitions of the terms used to describe the cards. This 1988 report is three times longer than the 1987 edition. \$250.

Jon Peddie Associates, 6201 Asocot Dr, Oakland, CA 94611.

INQUIRE DIRECT

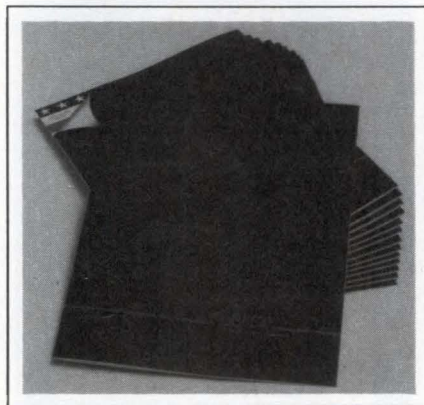

Booklet presents UPSs

This 28-pg illustrated brochure depicts the vendor's complete line of FerrUPS and microFerrUPS uninterruptible power systems. It provides application examples, technical and engineering specifications, information about performance and pricing, and available services and options.

Best Power Technology Inc., Box 280, Necedah, WI 54646.

Circle No 417

Periodical deals with information management

FYI, a magazine for information management, publishes information about the company in a feature-news format that covers developments, trends, and case studies. It aims at an audience of executives in information technology; individuals who use high-technology systems, equipment, and components; and

company employees. Articles in a recent issue focus on planning strategic information networks; computerized weather forecasting; a new μ P for laptop computers; fail-safe radios for emergency communications, and computerized flight simulation.

FYI, Harris Corp MS-24, 1025 W NASA Blvd, Melbourne, FL 32919.

Circle No 418

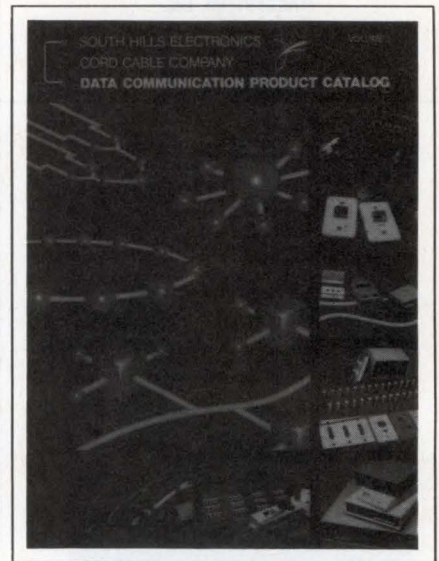

Catalog focuses on enhanced customer service

The vendor's 152-pg catalog calls attention to its enlarged customer-service sections located at three separate distribution centers in Pittsburgh, PA; Rochester, MN; and Los Angeles, CA. The publication is divided into nine parts covering coaxial and multiconductor cables, cabling systems, patch panels, cabinets, connectors, cables, converters, modems, multiplexers, power equipment, switches, and other related products for installing, expanding, or modifying computer communications systems. Specific sections on local-area networking offer coax, twinax, Ethernet, cabling system, twisted-pair, and multimode fiber-optic systems.

South Hills Electronics, 760 Beechnut Dr, Pittsburgh, PA 15205.

Circle No 419

Milt Scovill's long and winding road

Deborah Asbrand, *Associate Editor*

Although Milt Scovill left Pacific Northwest Bell 13 years ago, the old Bell system's presence is never far away. Vestiges of what was once the world's largest company are scattered through the office that Scovill built adjacent to his Seattle, WA, home. Along a window ledge sits a row of glass insulators. Collectors items now, they

once perched atop the telephone poles that remain the most visible signs of the vast Bell network. A bookshelf holds early versions of the cordless telephone and the first personal paging system, or "beeper." And mounted on the wall by the door is an old bronze plaque, a genuine Bell artifact that bears the phone company's motto: "No job is

so important, no service so urgent, that we can't take time to perform our jobs safely."

In these days of fast-track careers and the pursuit of engineering as a stepping stone to marketing or management, the slow and careful immersion into engineering that the Bell system offered Scovill is long gone. So is the system itself, which

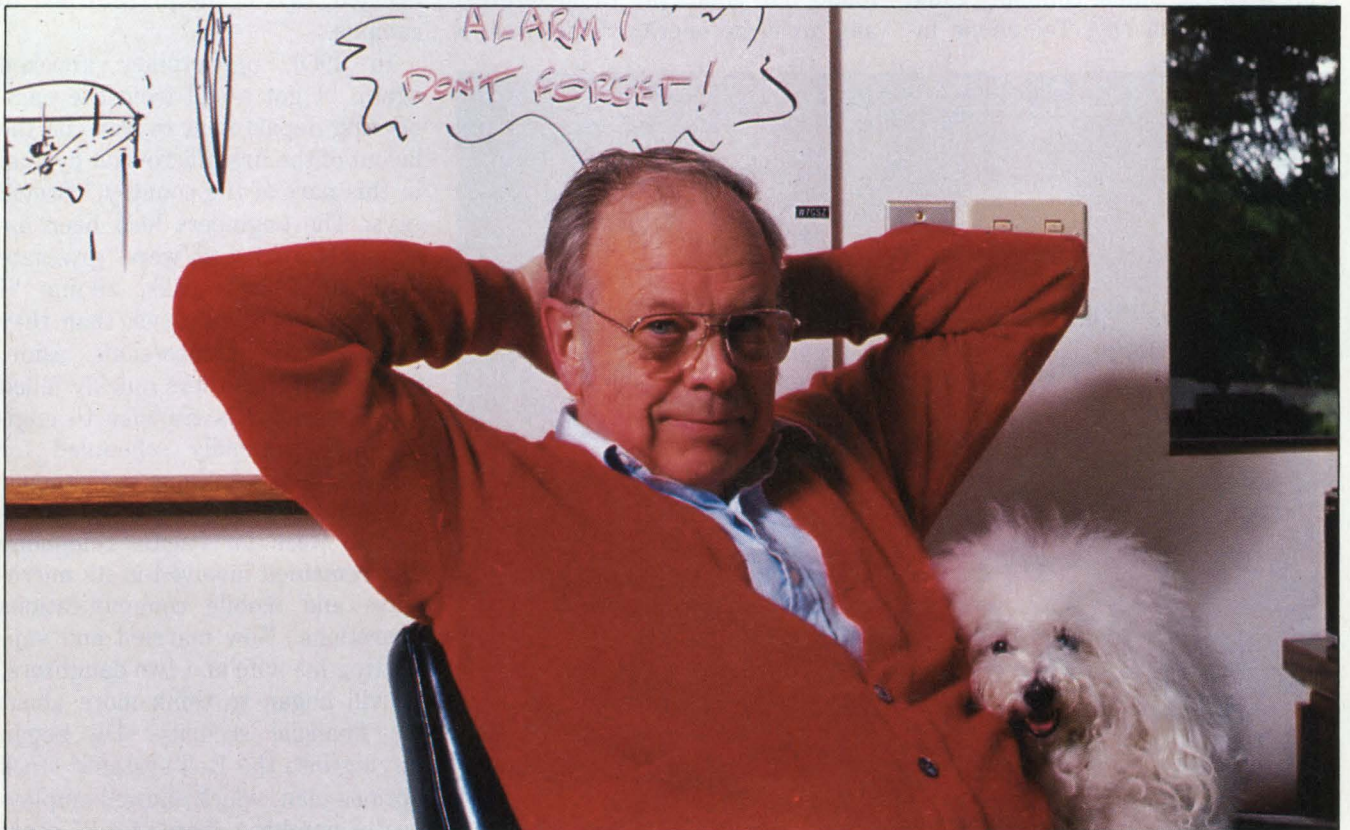

Milt Scovill parlayed an interest in radio communications and a job as a messenger boy into an engineering career. For the next 33 years, he doggedly remained an engineer first, an employee second. Now a successful consultant at age 66, he devotes all his working hours to the engineering he loves.

was his nurturer, his teacher, and, eventually, his adversary. Throughout his 33-year career at Pacific Northwest Bell, Scovill doggedly refused to acquire the notorious "Bell-shaped head" or to acquiesce to policies that he believed compromised his engineering designs. Retired from the company since 1975, he attributes his ability to command \$140/hour consulting fees to the richness of his engineering experience during his long and stormy Bell career.

Ever since Pacific Telephone and Telegraph opened its Northwest operations in the 1890s, Seattle has been Bell country. Scovill's family lived across the street from Pacific Telephone's north garage, where the company's installers would go each day to sign out a truck and begin their rounds. His first association with the phone company came when he was a boy. Telephone in-

stallers paid him 25 cents to crawl beneath porches and thread the thick phone wires through holes drilled in the wooden slats.

Radio fascinated Scovill when he was a teenager, and his acquisition of amateur and commercial radio operator's licenses led to future associations with Bell that were more interesting and profitable. When he graduated from high school in 1939, Scovill, like most Seattlites, filled out a job application for the phone company. Within a short time, Pacific Telephone hired him as a messenger. For a while, he took engineering classes at the University of Washington by day and worked for the phone company at night.

After a hitch in the Navy during World War II, Scovill returned to Seattle and to his job at the phone company. When Pacific Telephone found out about his radio interest and his radio operator's licenses, it

relieved Scovill of his message-shuttling duties and transferred him to a job maintaining mobile-telephone equipment. Shortly after that, Scovill moved to the main training center, where he conducted FCC-license training classes.

The start of a career

Scovill and Pacific Telephone quickly developed a mutual liking. The company's efforts to devise new means of communication fired his imagination, and the young man's interest and enthusiasm made him an ideal training candidate. "Opportunities kept popping up for me one after the other," he remembers. "The company put me on a rotational training program. It was an excellent program, the best learning vehicle you could find." College learning paled by comparison, he decided, and he never returned to campus.

In 1950, opportunity knocked again. "I got a call from the engineering department to work on the layout of the first microwave system in this part of the country," Scovill says. The engineers he'd been assigned to work with were "graduate engineers," he recalls, adding "I was more of a maverick than they were." First impressions aside, Scovill and the others quickly jelled into a team. His transfer to engineering, originally scheduled for just six weeks, became permanent.

Throughout the 1950s he continued to work for Pacific Telephone and remained involved in its microwave and mobile communications operations. Now married and supporting his wife and two daughters, Scovill began to think more about his financial security. He began buying into the Bell systems' stock options plan, which allowed employees to purchase shares for 85 cents on the dollar and without the assistance of a broker. "It was generous, and it was an excellent deal," he says. "Dividends were solid as a rock. You couldn't lose."

Over time, though, Scovill began



“Opportunities kept popping up for me one after the other. The company put me on a rotational training program. It was an excellent program, the best learning vehicle you could find.”

to realize that the stock options actually carried a much higher price. It was common knowledge that Western Electric—AT&T's manufacturing arm—supplied all the parts that Pacific Telephone and the other Bell operating companies used. Stamped onto each Bell product were the words "Made by Western Electric." Scovill found some Western Electric products to be of the highest quality and the best purchase for his engineering designs. Western Electric's cable, for example, was among the best. "They could spin cable like you wouldn't believe, and build good, rugged black telephones," Scovill says. Other products, however, were less reliable, and for these items, he turned to other vendors.

The road not taken

Scovill wasn't naive. He knew that the Bell system's profits didn't come from the local-service fees that the company charged consumers. The real moneymakers were long-distance service and Western Electric. What he didn't know was how far Bell employees would go to defend the policy of purchasing only Western Electric equipment once they qualified for the company's stock plan, which gave them a financial stake in the company's prosperity. He also underestimated the amount of antipathy that his actions would arouse.

Word spread about Scovill's purchases, and at times life became difficult for him. A Pacific Telephone manager once buttonholed Scovill at a party and chastised him for appearing not to understand "how this game is played." Then, after several years of satisfaction with Scovill's performance in the microwave department, Pacific Telephone transferred him to another department. A dyed-in-the-wool company man became Scovill's new supervisor. The company's message was unmistakable: His new manager would show him how to be a true company employee.

Although he was transferred back to the microwave department two years later, Scovill's days at Bell remained "turbulent," he says. He continued to protest the mandatory Western Electric purchases. "I was under a tremendous amount of pressure." He wasn't a lone voice, however: He always had the support of his staff and his supervisor. When he's asked why he remained with the company, answers elude Scovill at first, but then he sums up his decision to stay in one word: "Stubbornness."

After hearing descriptions of the 1950's-era, 24-channel vacuum-tube radios used by Washington's state-police patrol, Scovill accepted the patrol's invitation to redesign the system and postponed his other plans. "It made all the old adrenaline run again."

Indeed, Scovill turned down opportunities that others might have seized. The most tempting one came in 1958 from Bill Farinon, an engineering colleague who worked for a microwave component company. Farinon planned to start his own microwave company in the Silicon Valley area, and he was recruiting engineers to join him. He put in a call to Scovill, who turned him down. "I had just dug the hole for the foundation to this house, and Bill said 'Well, fill it in and get down here,'" Scovill recounts with a smile. His Seattle roots, however, run deep. He's a third-generation Seattlite; his grandfather was born there in 1861. Leaving, he decided, was out of the question. Undoubtedly, it was a similar resoluteness that kept him at Bell.

But in 1975, when Scovill was manager of the microwave department at Pacific Northwest Bell (the name that Pacific Telephone took on in 1965), he finally tired of the conflict. For the first time in 33 years, he laid plans that didn't include Pacific Northwest Bell. At 53, he planned to retire and finance a venture of his own, using his healthy pension to tide him over. "I had every intention of never having anything to do with the telephone business again," he says adamantly. His great love is flying, and the object of that passion for the past 25 years has been the C-2 Colonial Skimmer amphibian aircraft that he houses at Paine Field. As his first post-retirement project, he intended to manufacture and market an electronic aircraft checklist that he'd devised over the years.

A new career

A true engineer, Scovill can't resist the lure of a problem that needs solving. So when Washington's state-police patrol approached him shortly after his retirement about consulting on a microwave project, he politely explained that he was going to market his avionics device—but he kept one ear cocked. The state patrol planned to abandon its antiquated radio system in favor of a microwave system that would more efficiently link its dispatchers with its fleet of patrol cars. The patrol invited Scovill to redesign the system on a consulting basis. After hearing descriptions of the 1950s-era, 24-channel vacuum-tube radios the patrol used, Scovill caved in. "When I saw what they wanted me to do, it made all the old adrenaline run again."

Shortly after Scovill took on the state-patrol project, Oregon Public Broadcasting called to seek his services for a microwave project it had tried and failed twice to implement. Scovill paused. He hadn't planned on making consulting a second career, but he relished working on his own terms. Even more satisfying

HIGH PROGRAMMING
YIELDS

**EPROM
PROM
PLD**
(LOGIC)



LOW PROGRAMMING
COSTS



PC-Remote Programmers

- All EPROM's up to 40 pin!
- P275127 seconds per device!
- No limit on RAM size!

Our Programmer range includes:

- 3000 PC based to megabit EPROMs
- 4000 Gang EPROM/EEPROM Copiers
- 5000 Editing/Remote Set EPROM
- 1011 Bipolar PLD (logic)
- 1012 Bipolar PROM/EPROM
- 1013 Set/Gang EPROM (up to 8 x 32 pin)
- 1014 EPLD & CMOS PLD
- 1015 Set/Gang EPROM (up to 8 x 40 pin)
- & Elan's Universe 1000 (full universal)
- (World's 1st Intel flash EPROM approval)

Options cover single chip micros, PLCC, IBM/VAX remote and Elan Logic compilers.

Ask for our Demo disks.

In Europe:	F (014) 8632828
GB (0293) 510448	I (02) 6120041
A (0222) 835646	I (02) 2440012
B (02) 2416460	IRL (01) 501845
CH (01) 7414644	NL (01720) 43221
D (089) 780420	P (01) 549011
E (01) 4054213	S (0589) 14111

Elan Digital Systems
2162 North Main Street,
Walnut Creek,
CA. 94596
Tel: (415) 932-0882
Tel: (800) 541-ELAN



was the fact that he could make a lot of money at it. "I started getting serious about it when my daily income from consulting was rapidly approaching my monthly pension check. I began to think maybe this wasn't a bad business to be in."

The final chapter in the relationship between Scovill and the telephone company came in 1980, when happenstance brought Scovill to the attention of two lawyers working on the Justice department's antitrust case against AT&T. The department's lawyers needed assistance in wading through the piles of technical documents associated with the case. They hired Scovill as an expert witness to decipher some of the technical material as well as AT&T's explanation of it. As he reviewed the documents, Scovill became irate. "I began to get madder and madder at the chicanery that was being played by AT&T," he says. In the spring of 1981, Scovill flew to Washington DC and recounted for the trial record the ramifications of the Bell system's parts procurement from Western Electric. His former supervisor at Pacific Northwest Bell also received a subpoena. In 1982, Judge Harold Greene ended the Bell era by ruling that the monopoly be dismantled.

Scovill's tumultuous days are behind him, and so is the corporate scene. His office now is a second-story aerie that overlooks Seattle's Lake Washington. From the room's picture window, he points out the big-leaf maples, cedars, and hawthorns. Atop his L-shaped desk are a pair of binoculars for bird watching, and a ham radio. There's also a 1917 edition of Audel's *Easy Lessons in Wireless Telegraphy* in mint condition.

Scovill, now 66, continues to handle about four consulting projects at a time—few enough to allow him to play hooky occasionally and take his aircraft for a spin. Retirement, though, is not something he considers. "I can see now that even though I'd like to do more flying, I'll never

The final chapter in Scovill's relationship with the telephone company came in 1980, when Justice department lawyers hired him as an expert witness to decipher some of the technical material involved in the department's antitrust case against AT&T.

totally retire. If I didn't enjoy what I was doing and feel that I was of value to my clients, I wouldn't do it." Not one to spend time looking back, he's unsentimental about the passing of the Bell era and the breakup of AT&T.

The 5x5-ft topographical map mounted on one of Scovill's office walls bears mute testimony to his past and present relationship with the now-defunct Bell system. Scovill had bought the map from Pacific Northwest Bell when it sold its older office furniture and other equipment after relocating to new headquarters. The map once hung in the engineering department where Scovill worked, and neat black lines on the map's surface trace the labyrinthine pattern of the company's microwave facilities throughout the northwest.

Undaunted by the magnitude of his former employer's presence, Scovill has added to the map since he acquired it. In addition to the original lines, he's plotted a second set of lines that represent his own, post-Bell microwave projects. The added lines are fewer in number than the original, but they're marked just as boldly. **EDN**

Article Interest Quotient
(Circle One)

High 515 Medium 516 Low 517

EDN's CHARTER

EDN is written for professionals in the electronics industry who design, or manage the design of, products ranging from circuits to systems.

EDN provides accurate, detailed, and useful information about new technologies, products, and design techniques.

EDN covers new and developing technologies to inform its readers of practical design matters that will be of concern to them at once or in the near future.

EDN covers new products

- that are immediately or imminently available for purchase
- that have technical data specified in enough detail to permit practical application
- for which accurate price information is available.

EDN provides specific "how to" design information that our readers can use immediately. From time to time, EDN's technical editors undertake special "hands-on" projects that demonstrate our commitment to readers' needs for useful information.

EDN is written by engineers for engineers.

EDN

275 Washington St
Newton, MA 02158
(617) 964-3030

Peter D Coley
VP/Publisher
Newton, MA 02158
(617) 964-3030; Telex 940573
Ora Dunbar, Assistant/Sales Coordinator

Deborah Virtue
Business Director
Newton, MA 02158
(617) 964-3030

Mark J Holdreith
Advertising Sales Director
Newton, MA 02158
(617) 964-3030
Heather McElkenny, Assistant

NEW ENGLAND
John Bartlett, Regional Manager
Chris Platt, Regional Manager
199 Wells Ave
Newton, MA 02159
(617) 964-3730

STAMFORD 06904
George Isbell, Regional Manager
8 Stamford Forum, Box 10277
(203) 328-2580

NEW YORK, NY 10011
Daniel J Rowland, Regional Manager
249 West 17th St
New York, NY 10011
(212) 463-6419

PHILADELPHIA AREA
Steve Farkas, Regional Manager
487 Devon Park Dr, Suite 206
Wayne, PA 19087
(215) 293-1212

CHICAGO AREA
Clayton Ryder, Regional Manager
Randolph D King, Regional Manager
Cahners Plaza
1350 E Touhy Ave, Box 5080
Des Plaines, IL 60017
(312) 635-8800

DENVER 80206
John Huff, Regional Manager
44 Cook St
(303) 388-4511

DALLAS 75243
Don Ward, Regional Manager
9330 LBJ Freeway, Suite 1060
(214) 644-3683

SAN JOSE 95128
Walt Patstone, Regional Manager
Bill Klanke, Regional Manager
Philip J Branon, Regional Manager
James W Graham, Regional Manager
3031 Tish Way, Suite 100
(408) 243-8838

LOS ANGELES 90064
Charles J Stillman, Jr
Regional Manager
12233 W Olympic Blvd
(213) 826-5818

ORANGE COUNTY/SAN DIEGO 92715
Jim McErlan, Regional Manager
18818 Teller Ave, Suite 170
Irvine, CA
(714) 851-9422

PORTLAND, OREGON 97221
Pat Dakin, Regional Manager
Walt Patstone, Regional Manager
1750 SW Skyline Blvd, Box 6
(503) 297-3382

UNITED KINGDOM/BENELUX
Jan Dawson, Regional Manager
27 Paul St
London EC2A 4JU UK
44 01-628 7030
Telex: 914911; FAX: 01-628 5984

SCANDINAVIA
Stuart Smith
27 Paul St
London EC2A 4JU UK
01-628 7030
Telex: 914911; FAX: 01-628 5984

FRANCE/ITALY/SPAIN
Alasdair Melville
27 Paul St
London EC2A 4JU UK
01-628 7030
Telex: 914911; FAX: 01-628 5984

WEST GERMANY/SWITZERLAND/AUSTRIA
Wolfgang Richter
Sudring 53
7240 Horb/Neckar
West Germany
49-7451-7828; Telex: 765450

EASTERN BLOC
Uwe Kretzschmar
27 Paul St
London EC2A 4JU UK
01-628 7030
Telex: 914911; FAX: 01-628 5984

FAR EAST
Ed Schrader, General Manager
18818 Teller Ave, Suite 170
Irvine, CA 92715
(714) 851-9422; Telex: 183653

HONG KONG
John Byrne & Associates Ltd.
1613 Hutchison House
10 HGarcourt Road
Central Hong Kong
Tel: 5-265474
Tlx: 61708 WEDIN HX
Fax: 5-8106781

JAPAN
Kaoru Hara
Dynaco International Inc
Suite 1003, Sun-Palace Shinjuku
8-12-1 Nishishinjuku, Shinjuku-ku
Tokyo 160, Japan
Tel: (03) 366-8301
Telex: J2322609 DYNACO

KOREA
Kim Kyong-Hae, BK International
Won Chang Bldg, 3rd Floor 26-3
Yoido-dong, Youngdungpo-ku
Seoul 150, Korea
Tel: 785-6665; FAX: 784-1915
Telex: K32487 BIZKOR

**SINGAPORE/MALAYSIA/INDONESIA/THAILAND/
THE PHILIPPINES/AUSTRALIA/NEW ZEALAND**
Asia Pacific Media House PTE Ltd
Peter Cheong
100 Beach Rd
#24-03 Shaw Tower
Singapore 0718
Tel: 2915354; Telex: RS 50026 MESPLY

TAIWAN
Acteam International Marketing Corp
6F, No 43, Lane 13
Kwang Fu South Rd
Mailing Box 18-91
Taipei, Taiwan ROC
760-6209 or 760-6210
Telex: 29809; FAX: (02) 7604784

PRODUCT MART
Joanne Dorian, Manager
249 West 17th St
New York, NY 10011
(212) 463-6415

CAREER OPPORTUNITIES/CAREER NEWS
Roberta Renard, National Sales Manager
(201) 228-8602
Janet O Penn, Eastern Sales Manager
(201) 228-8610
103 Eisenhower Parkway
Roseland, NJ 07068

Ellen Sherwood, Western Sales Manager
12233 West Olympic Blvd
Los Angeles, CA 90064
(213) 826-5818

Maria Cubas, Production Assistant
(201) 228-8608

Susan M Campanella, Advertising/Contracts Coordinator
Nan Coulter, Advertising/Contracts Coordinator
(617) 964-3030

**William Platt, Sr, Vice President, Reed Publishing USA
Cahners Magazine Division**
Terry McDermott, President, Cahners Publishing Co
Frank Sibley, Group Vice President, Electronics/Computers
Tom Dellamaria, VP/Production & Manufacturing

Circulation
Denver, CO: (303) 388-4511
Sherri Gronli, Group Manager
Eric Schmierer, Manager

Reprints of EDN articles are available on a custom printing basis at reasonable prices in quantities of 500 or more. For an exact quote, contact Joanne R Westphal, Cahners Reprint Service, Cahners Plaza, 1350 E Touhy Ave, Box 5080, Des Plaines, IL 60018. Phone (312) 635-8800.

CAREER OPPORTUNITIES

1988 Editorial Calendar and Planning Guide

EDN

Issue Date	Recruitment Deadline	Editorial Emphasis	EDN News
Sept. 1	Aug. 11	Instruments, Op Amps, Computers & Peripherals	
Sept. 15	Aug. 25	Data Acquisition, Data Communications, Digital ICs	Closing: Sept. 1 Mailing: Sept. 22
Sept. 29	Sept. 8	DSP, Graphics, Optoelectronics	
Oct. 13	Sept. 22	Test & Measurement Special Issue, Instruments, Computers & Peripherals	Closing: Sept. 29 Mailing: Oct. 20
Oct. 27	Oct. 6	CAE, Computers & Peripherals, Integrated Circuits, Wescon '88 Show Preview	
Nov. 10	Oct. 20	Programmable Logic Devices, Integrated Circuits, Test & Measurements, Wescon '88 Show Issue	Closing: Oct. 27 Mailing: Nov. 17
Nov. 24	Nov. 3	Microprocessor Technology Directory Graphics, CAE	

Call today for information:

East Coast: Janet O. Penn (201) 228-8610
 West Coast: Ellen Sherwood (213) 826-5818
 National: Roberta Renard (201) 228-8602

Engineers

Systems Service Engineers Hightstown, NJ

GE Government Services has immediate opportunities for experienced professionals (degrees preferred) in the field of Systems Engineering including:

- Power
- Guidance navigation and attitude control
- Data management/digital systems
- Component specification
- Test and verification
- Ground and in orbit operations
- Communications (eg K-Band, S-Band, TDRSS Links)

GE Government Services offers an excellent salary and a comprehensive benefits package as well as significant opportunities for continued professional growth. Please forward your resume with salary requirements to: Barry Robinson, GE GOVERNMENT SERVICES, Rt. 38, Bldg. 201-2, Cherry Hill, NJ 08358. Equal Opportunity Employer.



GE Government Services

Equal Opportunity Employer

OPPORTUNITIES IN DATA COMMUNICATIONS

We're Computrol, a division of MODCOMP, an AEG Company, and a recognized leader at the forefront of the data communications industry. Those who join our team enjoy concept-through-completion responsibilities and a stimulating environment that encourages and rewards creativity. Our continued growth has created several outstanding career opportunities as follows.

ANALOG, RF & FIBER OPTIC ENGINEERS

You will be responsible for the analysis and design of RF, analog and fiber optic circuits, sub-assemblies and systems for state of the art ISO/OSI and IEEE data communications, modems and systems. These positions require a BSEE and a minimum of 4 years related experience in at least one of the following areas:

- Design of fiber optic receivers, transmitters, modems and sub-systems for up to 100 MB/S.
- Design of carrierband and broadband modems for up to 400 MHz
- Design of RF sub-assemblies such as filters, mixers

Familiarity with digital design is a definite plus.

We offer a salary fully commensurate with your experience and an outstanding benefits package. To apply, please send your resume and salary history to: **K.L. Hunziker, Personnel Manager, COMPUTROL, 239 Ethan Allen Highway, Dept. E, Ridgefield, CT 06877-6297.**

COMPUTROL

Division of MODCOMP

Equal Opportunity Employer M/F

An AEG Company



Electronic Product Manager

Bussmann Division, Cooper Industries, a leading producer of circuit protection devices and connector products, has a career opportunity for a Product Manager, reporting to the Division's Electronic Marketing Manager.

Your major responsibilities will include the management of new product development for OEM applications in the electronics industry. You will be working closely with Sales, Engineering, and Manufacturing to develop concepts into successful products that will assure the company's continued dominance as a supplier of electronic components. Other responsibilities include assisting the Electronic Marketing Manager in strategic and tactical planning, technical support of the Application Engineering and Field Sales efforts, new product introduction and product line maintenance.

The qualified candidate will have successfully worked in an electronic circuit design/development environment for an electronic product manufacturer. Expertise in overcurrent and overvoltage components and related circuit design is a definite plus, as is a familiarity with electronic assembly techniques. A BSEE degree or equivalent required.

If you're right for the job, we have an excellent starting salary, comprehensive benefits, and growth opportunities waiting for you. Please submit your resume and salary history to: **Manager, Employee Relations; BUSSMANN; Cooper Industries; P.O. Box 14460; St. Louis, MO 63178.**

Equal Opportunity Employer M/F/H



BUSSMANN

The Intel Influence

Intel New Mexico opens its second fab in 10 months.

We started out with a goal and a commitment: To lead the way in microelectronic technology. The result: An unprecedented market demand for our latest generation microprocessor family and ground floor opportunities in Fab 9, a state-of-the-art facility which will house 4 different fab modules. Last year, Fab 9.1 began producing the revolutionary 80386 microprocessor. This year, we're starting Fab 9.2 with an even more advanced technology.

PRODUCT/YIELD ENGINEERING

Engineers & Managers

- Process Control - Contamination reduction responsibilities over entire class 10 clean room. Requires complete familiarity with analysis techniques, particle detectors and counters. Will develop and maintain process control monitors; understanding of SPC a plus.
- E-Test and Pre-Sort/Sort - Testing and characterization. Evaluation of new tester and related hardware to bring up test capabilities. High level software language knowledge required.
- Gas Pad - Responsible for gas delivery system (cylinder to equipment) and resulting yield. Requires high theoretical gas knowledge and safety standards - contamination control and gas monitoring systems.

BS/MS or equivalent and 3+ years experience required for above positions.

Technicians

- E-Test and Pre-Sort/Sort - Assist in testing and characterization, also assist in evaluation of testers and related hardware; high level software knowledge a plus.
- Gas Pad - Responsible for gas delivery system (cylinder to equipment). Safety standards - requires contamination control and monitoring of all gases.
- Low Yield Analysis - Assist Analytical and LYA Engineers in improving yields. Requires knowledge of SEM, spectroscopy and fab processes.

AA or equivalent and 3+ years experience required for above 3 positions.

PHOTO/ETCH

Process/Equipment Engineers & Managers

- Photo and Etch - Equipment experience at 1.2 to submicron levels.
- Defect Reduction - Lithography and/or etch experience required.

BS/MS or equivalent and 3+ years experience required for above positions.

Process/Equipment Technicians

- Photo and Etch - Requires equipment and/or process experience with an AA or equivalent and 4+ years.

AUTOMATION

Senior Programmer Analysts

- COMETS Program Management - Will implement and enhance VAX based information system. May supervise other Programmers if candidate possesses demonstrated management skills. BS/MS or equivalent and 6+ years experience.

DIFFUSION/THIN FILMS/IMPLANT

Process/Equipment Engineers & Managers

- Diffusion - Furnace experience required. Thermco knowledge desirable.
- Thin Films - Films and metals experience required.
- Vacuum/Implant - Establish and improve in thin films and implant equipment reliability to meet process goals. Requires knowledge in sputtering and tungsten silicide deposition.
- Particle Contamination - Familiarity with RCA cleans, CVs and contamination in diffusion and oxidation.
- Spin-on-Glass - Responsibility for advanced SOG process.

BS/MS or equivalent and 3+ years experience required for above positions.

Process/Equipment Technicians

- All areas of Diffusion/Thin Films/Vacuum and Implant - Responsibilities in diffusion, thin films and vacuum/implant equipment, process development: poly/nit/HTO, metals deposition, tungsten silicide. Requires an AA or equivalent and 4+ years experience in equipment and/or process.

Albuquerque... a city with a colorful past and high tech future. This dynamic metropolitan area offers clean skies, moderate cost of living, an unspoiled environment and an entire spectrum of cultural and educational opportunities. For the outdoor enthusiast, our year-round recreational activities include backpacking in the Rocky Mountains, skiing in alpine areas, water skiing in our clear lakes and four-wheeling in the high desert.

We welcome your interest in Intel...please send your resume to: Intel Staffing, Dept. N257, 4100 Sara Road, Rio Rancho, NM 87124.

Equal Opportunity Employer
M/F/H

The Intel logo is rendered in a large, bold, lowercase sans-serif font. The letters are thick and closely spaced. A registered trademark symbol (®) is located at the top right of the letter 'l'. The logo is positioned in the bottom right corner of the advertisement, overlapping the text area.

What if ... your career path led to clean air, gorgeous scenery, river rafting, sailing, nature walks and a great house you could afford?

You'd be working at Hewlett-Packard in the Pacific Northwest.

Living and working in the Pacific Northwest can be summed up in one word: Opportunity. We have first-rate schools and colleges, a reasonable cost of living, plus every recreational, sports and cultural activity imaginable.

Product Marketing Engineer

Our Lake Stevens Instrument Division in Everett, Washington is looking for a Product Marketing Engineer. Our products include HP's very successful line of low frequency swept and FFT signal analyzers, including the HP3561A, HP3562A and the new HP35660A.

You will research and understand customer applications and market trends; develop, recommend and implement marketing programs; and provide a liaison with R&D, manufacturing and the field sales organization.

Your qualifications will include a BS plus 3 years' experience in electronic engineering or a related scientific discipline; a strong business or marketing background; and a solid foundation in signal analysis tools and techniques. Proven, successful communication skills, excellent judgment and creativity are also required.

We offer you the path to unlimited career possibilities. And a truly outstanding way of life.

So take a new perspective on your career, look to Hewlett-Packard. We pay competitively and have excellent benefits. Please send your resume and salary history to: **Personnel, Dept. ED, Hewlett-Packard, Lake Stevens Instrument Division, 8600 Soper Hill Road, Everett, WA 98205-1298.**

Hewlett-Packard Company is an Equal Opportunity/Affirmative Action Employer.

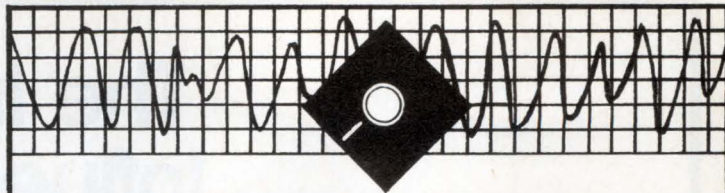

ENGINEERING: Systems Engineer: 5-7 years experience in product development. Position requires strong design skills in analog and digital, video experience preferred. Must be familiar with microprocessor based real time control applications. Regulatory affairs experience a plus. CAD/EDA experience required.

ENGINEERING: Software design engineer: minimum 3 years experience in product development of microprocessor controlled real time applications (8 bit environments). Assembly required, C a plus. Send resume to:

HTSTM
EXCELLENCE BY DESIGN.

HTS
90 Inverness Circle East
Englewood, CO 80112

INCREASE YOUR PROFITS

TAI staff has extensive experience and a successful track record in promoting and selling products and firms to the military, communications, automobile, nuclear and industrial markets.

If you are in business or if you are only in the "idea stage", we can help! We will:

- **Develop your Business Plan**
- **Structure your Quality Assurance Program to meet MIL-I-45208A and MIL-Q-9858A**
- **Develop your Brochure**
- **Assist in locating and securing financing**
- **Promote your Products Nationally and Internationally**
- **Assist in Developing and Implementing Sound Business/Management Practices throughout your firm**

Send information about your type of business and the type of help you need, with a self addressed envelope to:

VP, Marketing Dept.

Tech for Adv

P.O. Box 171253
Kansas City, KS 66117

The Right Job. The Right Place. Right Now.



It's the right job with Philips Ultrasound, impacting the technology of medical imaging. We supply the advanced resources and fine minds to draw from. You supply the desire to make a difference, related experience, and required skills.

The right place is Orange County in Southern California, with its wealth of recreational resources, cultural advantages, and centers of learning. Throw in year-round sun, beaches, mountains, desert, and room to create the kind of lifestyle that's right for you.

The time is right now. Consider the following opportunities.

Senior Project Engineers — These positions emphasize the system aspects of product development and require knowledge and experience in all areas of product design, including digital, analog, software, and packaging. Prior experience with relatively large systems in communications, radar, sonar, or similar applications is required. Candidates should have a BSEE and 10 years design experience with some project level responsibility. High speed digital design and systems development experience necessary.

Principal Engineers — Responsibilities include taking design from feasibility to production for either Front End or Back End Systems Development. A BSEE and 5 years experience including high speed digital design, programmable logic and some analog design background required. Systems integration background is highly desirable.

Senior Engineer — Candidate will design, document, test and release to production circuit board assemblies and provide support to manufacturing and field on products designed. A BSEE and 5 years design experience in low noise RF analog signal processing required as well as a background in high speed digital design.

Mechanical Engineering Supervisor — The selected candidate will supervise engineers and designers in mechanical development activity. Individual will also be responsible for technical analysis and design as well as administrative supervisory activities. The ideal Supervisor will have 10 years experience in electro-mechanical product design (packaging & mechanisms) and 5 years similar supervisory experience. A BSME is preferred.

Applied Physicist — We are seeking an Engineer who will be responsible for acoustic power and other water tank measurement activities. These measurements are used to insure compliance of our new products with strict FDA requirements as well as confirmation of system performance. A BS or MS in Physics or Electrical Engineering and a good experimental background are required.

Along with stimulating challenges and a way of life that's second to none, we offer an excellent compensation and benefits package. Apply yourself. Send your resume along with salary history to **Human Resources, Philips Ultrasound, 2722 South Fairview Street, Santa Ana, CA 92704**. Principals only, please.

PHILIPS ULTRASOUND

An Equal Opportunity Employer M/F/H/V.

EDN Databank

Professional Profile

Announcing a new placement service for professional engineers!

To help you advance your career. Placement Services, Ltd. has formed the EDN Databank. What is the Databank? It is a computerized system of matching qualified candidates with positions that meet the applicant's professional needs and desires. What are the advantages of this new service?

- It's absolutely free. There are no fees or charges.

- The computer never forgets. When your type of job comes up, it remembers you're qualified.
- Service is nationwide. You'll be considered for openings across the U.S. by PSL and it's affiliated offices.
- Your identity is protected. Your resume is carefully screened to be sure it will not be sent to your company or parent organization.

- Your background and career objectives will periodically be reviewed with you by a PSL professional placement person

We hope you're happy in your current position. At the same time, chances are there is an ideal job you'd prefer if you knew about it.

That's why it makes sense for you to register with the EDN Databank. To do so, just mail the completed form below, along with a copy of your resume, to: Placement Services, Ltd., Inc

IDENTITY

Name _____ Parent Company _____
 Home Address: _____ Your division or subsidiary: _____
 City _____ State: _____ Zip: _____ Location (City, State) _____
 Home Phone (include area code): _____ Business Phone if O.K. to use: _____

PRESENT OR MOST RECENT EMPLOYER

EDUCATION

Degrees (List)

Major Field	GPA	Year Degree Earned	College or University

POSITION DESIRED

EXPERIENCE

Present or Most Recent Position _____ From: _____ To: _____ Title: _____

Duties and Accomplishments: _____ Industry of Current Employer: _____

 Reason for Change: _____

PREVIOUS POSITION:

Job Title: _____
 Employer: _____ From: _____ To: _____ City: _____ State: _____
 Division: _____ Type of Industry: _____ Salary: _____
 Duties and Accomplishments: _____

COMPENSATION/PERSONAL INFORMATION

Years Experience	Base Salary	Commission	Bonus	Total Compensation	Asking Compensation	Min. Compensation		
Date Available	I Will Travel			I own my home. How long? _____		I rent my home/apt. <input type="checkbox"/>		
<input type="checkbox"/> Employed	<input type="checkbox"/> Self-Employed	<input type="checkbox"/> Unemployed	<input type="checkbox"/> Light	<input type="checkbox"/> Moderate	<input type="checkbox"/> Heavy	<input type="checkbox"/> Married	<input type="checkbox"/> Single	Height _____ Weight _____
Level of Security Clearance		<input type="checkbox"/> U.S. Citizen	<input type="checkbox"/> Non-U.S. Citizen	My identity may be released to: <input type="checkbox"/> Any employer			<input type="checkbox"/> All but present employer	
<input type="checkbox"/> WILL RELOCATE		<input type="checkbox"/> WILL NOT RELOCATE		<input type="checkbox"/> OTHER _____				

EDN Databank

A DIVISION OF PLACEMENT SERVICES LTD., INC.

265 S. Main Street, Akron, OH 44308 216/762-0279

MOS/VLSI OPPORTUNITIES

**To Meet The Sharp Upswing In Demand For Circuits,
We Have Excellent Career Opportunities At All Levels
At Our Suburban, Long Island Headquarters!**

Standard Microsystems Corporation is a leading developer and manufacturer of advanced MOS/VLSI circuits for computer peripheral, communications, semicustom and full custom applications. High levels of funding in new product and semiconductor development in the past three years as well as an on-going emphasis on world-wide business development have positioned Standard Microsystems at the forefront of our rapidly growing markets. We are seeking highly qualified individuals for the following positions:

MANAGEMENT

- **Director of Computer-Aided Engineering**
- **Manager of Product Engineering**
- **Area Sales Manager** (San Jose based—11 state territory)

ENGINEERING

- **VLSI (ASIC) Design Engineers**
- **Product Engineers**
- **Field Applications Engineers**
(San Jose, Europe, or Far East)
- **CAE Engineers**
- **Test Engineers**
- **Process Engineers**
- **Failure Analysis Engineers**

You must have the appropriate educational background with a strong academic record (a master's degree is preferred) plus significant achievements in the area in which you are interested.

Standard Microsystems, one of the most successful and stable companies in the industry, offers excellent salaries, a full range of insurance coverages, financial benefits programs such as tax deferred stock purchase and profit sharing, bonus, and stock options plans; comprehensive relocation assistance; advancement opportunities; a progressive, employee-oriented work environment; and job security. You and your family will also appreciate our desirable Suffolk County, Long Island location, approximately 50 miles from New York City and all its advantages while close to the finest beaches and boating plus educational institutions in the country. To apply, please send your confidential resume, including your salary history and the area of your interest to: **A. P. Solowey, Manager, Recruitment, Dept. D, Standard Microsystems Corporation, 350 Kennedy Drive, Hauppauge, New York 11788.** SMC is an equal opportunity employer m/f.

**STANDARD MICROSYSTEMS
CORPORATION**

**The One To Watch—
In The Place To Be**

ADVERTISERS INDEX

ACCEL Technologies Inc	252	Linear Technology Corp	203-204	Toshiba America Inc/Semiconductor Div	87
Advanced Computer Consulting Inc	250	Logical Devices Inc	44	Toshiba Corp	248
Advanced Micro Devices	12-13, 50-51	3M Fluoronics	195-198	Transmetrics	251
Advanced Motion Controls	249	Marshall	165	TRW/LSI Products Inc	23
AMP	104-105	Maxim Integrated Products	35-36	Universal Cross—Assemblers	251
Amperex Electronic Corp*	229, 241	Mendelson Electronics	188	Video Monitors Inc	32
Analog Devices Inc	30, 136, 206	Mentor Graphics Corp	10-11	Visionics Corp	250
Apex Microtechnology Corp	43	Mepco/Centralab	103	VTC Inc	2
Applied Microsystems Corp	14-15	Micro Dimensions Inc	42	Wavetek San Diego Inc	3
Aries Electronics Inc	84	MicroCASE*	20	Wika Corp	240
Arrow Electronics	244, 245	Microswitch	226, 227	Winpoint Electronic Corp	253
Astec	33	Midcon	81	Wintek Corp	251, 253
Atronix	232	Mini-Circuits Laboratories	26-27, 219, 268	Xeltek	249
B&C Microsystems	252, 253	Mitsubishi	91	Zax Corp	61
BP Microsystems	251	Mizar Inc	201	Zericon	250
Burr-Brown Corp	232	National Semiconductor Corp	46-47, 62-63	Ziatech Corp	1
Bytek Corp	249	NEC Corp	134-135	Zilog Inc	85
CAD Software	251	NMB Semiconductor Corp	64		
CADdy Corp	249	Nova Sensor	208	Recruitment Advertising 260-265	
Calcomp	238-239	OKI Semiconductor	40-41	Computrol	
Capital Equipment Corp	252	Omaton Inc	251	GE Government Services	
Cedrus	249	Patton & Patton	252	Hewlett-Packard	
Cherry Electrical Products Inc	250	PCB Piezotronics Co	251	HTS	
Clairex Electronics	44	Pearson Electronics	232	Intel	
Coilcraft	34	Philips Circuit Assemblies	186-187	Phillips Ultrasound	
Comair Rotron Inc	42	Philips Components**	20	Technology for Advancement	
Comlinear Corp	191, 225	Philips Elcoma Div**	154-155, 216		
Communication Specialists	251	Philips T&M**	45, 153	*Advertiser in US edition	
Communications Specialties Inc	249	Phillips Components Inc	228	**Advertiser in International edition	
Crystal Semiconductor	156-157	Positronic Industries Inc	233, 235		
Cybernetic Micro Systems	250, 252, 253	Powerex Inc	212		
Cypress Semiconductor	48	Precision Filters Inc	224		
Data Inc	182	Precision Interconnect	4		
Data I/O Corp/Futurenet Div	C4	Precision Monolithics Inc	66		
Deltron Inc	232	Qua Tech Inc	252		
Digital Electronics Corp	54	RLM Research	253		
Digital Equipment Corp*	220-221	Robinson-Halpern	252		
Du Pont Co Vacrel	94-95	Samsung Semiconductor	69-80		
EF Johnson Co	250	Schaevitz Engineering	118		
EG&G Reticon	68	Seiko Instruments	181		
Elan Digital Systems	258	SenSym	115		
Electro-Mechanics	253	SGS-Thomson Microelectronics*	52-53		
Electronic Solutions	82	Siemens AG**	220-221, 242		
Electronica	218	Siemens AG Karlsruhe**	52-53		
Emulation Technology Inc	251	Siemens Components Inc*	45		
Ericsson Components	166, 192	Silicon Systems Inc	92, 93		
E-T-A Circuit Breakers	247	Single Board Solutions	253		
Fujitsu Microelectronics Inc*	153-155	Sipex Corp-Hybrid Systems	89		
F W Bell Inc	31	S-MOS Systems	142-143		
GE Solid State	38-39, 122-123, 175-178	Sophia Systems Inc	163		
Harris Semiconductor Products	144	Spectrum Software	56		
Harting Electronics**	18-19	Sprague Electric Co	59		
Hewlett-Packard Co	C2, 16-17, 37, 117, 119-121, 137-139	Tatum Labs	250		
Integrated Device Technology Inc	158	TDK Corp of America	25		
Intel/Arrow Electronics	244, 245	TEAC Corp**	6		
International Rectifier	C3	Tektronix Inc	8, 97-100, 101-102		
Intrac Corp	228	Telebyte Technology Inc	84		
Intusoft	250	Teradyne Inc	28-29		
Itac Systems Inc	253	Texas Instruments Inc	151		
John Fluke Manufacturing Co Inc	6	Texas Microsystems Inc	234		
Kepeco Inc	124	Toko America Inc	185		

This index is provided as an additional service. The publisher does not assume any liability for errors or omissions.

LOOKING AHEAD

EDITED BY CYNTHIA B RETTIG

Surveys quiz CASE users and vendors

What do CASE-tool users want? And what do vendors think they ought to want? Strategic Focus, a consulting firm based in Milpitas, CA, interviewed 400 CASE-tool users and some of the sellers of those tools. It found that users think the tools often lack some very highly desirable features. They said that the majority of individual packages doesn't address the entire range of requirements for developing software from beginning to end. Users also wanted to see more interfaces between tools. And they wanted better integration of various tools needed throughout the development cycle, including a uniform interface to database management systems.

Learning how to use CASE tools takes too long, some users said. Others pointed out that the initial costs are high enough to require some kind of formal justification to superiors prior to purchase and a great deal of pressure to produce afterward. Users would also like better means for measuring productivity when using CASE packages. Because most of the CASE-tool companies are relatively small, support for customers at remote sites is generally very weak.

On the positive side, users identified the five top reasons why they turn to CASE tools in the first place. Of those polled, 37% said they use these tools to track the users' requirements throughout the entire development period. And 35% found that when using CASE tools, they can communicate better with end users. Among the other benefits derived from using CASE tools were improved quality of the final products, reusable software modules, and reduction in the time required

HOW USERS RATE CASE TOOLS

LIFE CYCLE PHASE	SATISFIED (%)	DISSATISFIED (%)
STRATEGIC PLANNING	30	70
ANALYSIS	65	35
DESIGN	70	30
PROTOTYPING	66	34
CODE GENERATION	50	50
DEBUGGING	54	46
PERFORMANCE TUNING	37	63
SYSTEM BUILDING	50	50
OPERATION/MAINTENANCE	50	50
DOCUMENTATION	61	39
REVERSE ENGINEERING	0	100
PROJECT MANAGEMENT	50	50
CONFIGURATION MANAGEMENT	46	54
SOURCE CODE CONTROL	50	50

(SOURCE: STRATEGIC FOCUS)

to complete a given project.

When Strategic Focus surveyed the vendors themselves, it found them fairly aware of the relative importance of various features and services that will be keys to their success in the next few years. They said they considered customer education and support very significant. They also believe that it's good to include in the packages ways to measure improved productivity. Building and maintaining a strong

direct sales force and establishing a strong company image are also critical. Strategic Focus sees a major shakedown coming in the CASE-tool marketplace, and it predicts that, of the more than 55 CASE vendors currently vying for market share in the US, it's very possible that only a third of them will still be around in 1991.

PC-board ATE market to reach \$1.1B by '93

Market Intelligence Research Company (Mountain View, CA) estimates that the world market for automatic test equipment (ATE) available on printed-circuit boards and subassemblies will reach \$1.1 billion by 1993. MIRC expects that the fastest growing area of the market over the next few years will be the segment that makes and sells defect analyzers for manufactured goods. This segment should grow at a compound annual growth rate of 24%. Although functional-testing

products has recently lost market share, the market researchers predict that there will be renewed interest in those functional-testing products in the near future.

MIRC characterizes the pc-board ATE market as highly competitive. It discerns a trend toward combining and generally upgrading the types of boards currently available. These types include bareboard, in-circuit, and performance boards, as well as functional devices and defect analyzers for manufacturers' goods.

RF transformers

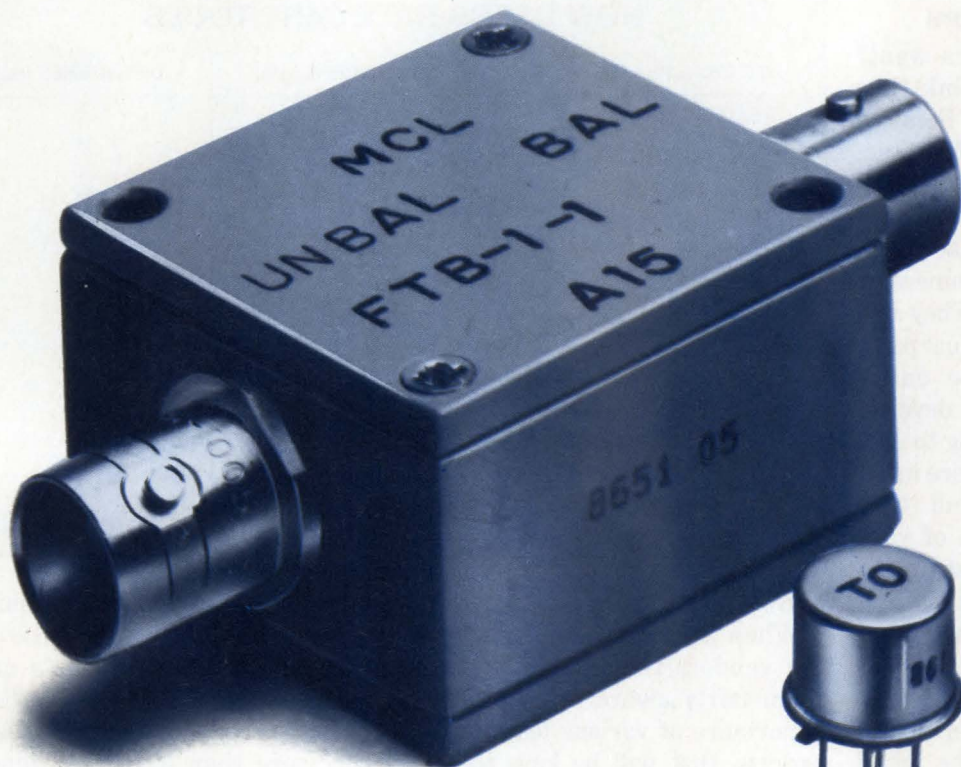

3 KHz-800 MHz
over 50 off-the-shelf models
from \$2⁹⁵

Choose impedance ratios from 1:1 up to 36:1, connector or pin versions (plastic or metal case built to meet MIL-T-21038 and MIL-T-55631 requirements*). Fast risetime and low droop for pulse applications; up to 1000M ohms (insulation resistance) and up to 1000V (dielectric withstanding voltage). Available for immediate delivery with one-year guarantee.

Call or write for 64-page catalog or see our catalog in EBG, EEM, Gold Book or Microwaves Directory.

*units are not QPL listed

finding new ways...
setting higher standards

**Mini-Circuits**

A Division of Scientific Components Corporation
P.O. Box 350166, Brooklyn, New York 11235-0003 (718) 934-4500
Domestic and International Telexes: 6852844 or 620156

C71 Rev. A

CIRCLE NO 108

THE REVOLUTION REACHES THE BRIDGE.

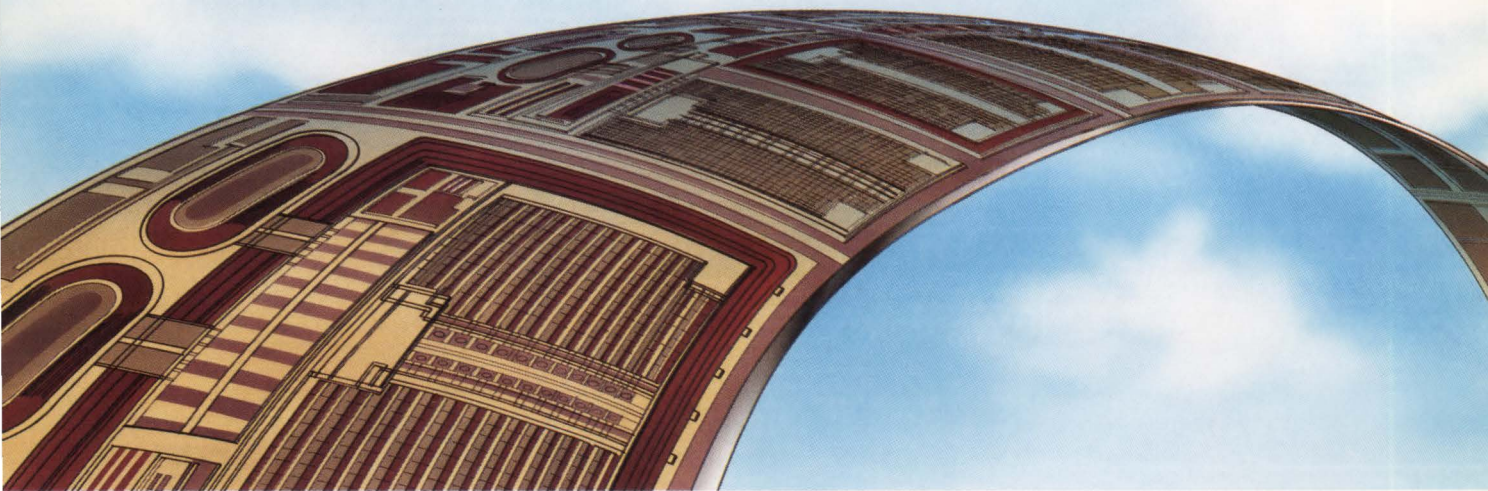

Introducing the IR2110 high-voltage, bridge driver.

The high side and the low side.

Without the down side.

It works off-line, any-

where worldwide. Inputs are LSTTL and CMOS compatible. With two independently controlled outputs to drive upper/lower HEXFET® and IGBT power supply and motor control circuits.

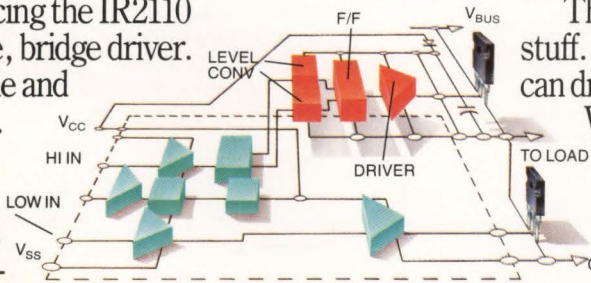

This is powerful stuff. Each output can drive up to 2A.

With its dv/dt immunity making it almost inde-

structible. All at frequencies well above 1MHz!

Of course you won't be needing transformers, optical isolation or 60% of your drive components.

That's the beauty and simplicity of this 500V bridge driver. Just add a

diode, a resistor, a capacitor and the design's complete.

The IR Revolution has reached the bridge. The bridge between control and power.

Cross over. Call us at (213) 607-8899 and ask about the IR2110 Bridge Driver.

IR2110

INTERNATIONAL RECTIFIER
233 Kansas Street, El Segundo, CA 90245

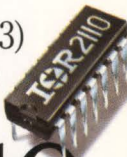

LOGIC SYNTHESIS

PALS
EPLDs
LCAS
Gate Arrays
FPLAS

LOGIC SYNTHESIS GIVES YOU MORE DESIGN CHOICES.

FutureDesigner™ gives you more choices than any other design entry software—choices in how you enter your design, in target technologies, and in design output. And only FutureDesigner uses logic synthesis to automatically turn your input choices into your output choices, optimizing and streamlining your design for the technology you select.

CHOOSE THE DESIGN ENTRY METHOD.

Only FutureDesigner lets you describe your design in the easiest, fastest, most natural way. You can enter some functions structurally, using DASH schematics. Others can be described behaviorally with any combination of truth tables, state diagrams, or high-level logic equations. Interactive verification and design rule checking help you catch errors up front, as you design.

CHOOSE THE TARGET TECHNOLOGY.

FutureDesigner is technology independent. After you've described your



Choose the platform: FutureDesigner runs on 80386 and 80286 machines, IBM® personal computers, and the Sun-3 Series.

design, you can choose any mix of TTLs, PLDs, LCAs, gate arrays, or other ASIC devices for implementation. It's also easy to migrate designs from one technology to another—for example, from TTL to PLD, PLD to LCA, or PLD to gate array.

CHOOSE THE OUTPUT FORMAT. With more than 100 DASH-Partners providing a broad range of comple-

mentary products and services, FutureDesigner's industry-standard format is accepted virtually everywhere. When you design with FutureDesigner, you'll have more choices in technologies, CAE systems, foundries, and service bureaus.

CHOOSE FUTUREDESIGNER WITH LOGIC SYNTHESIS.

With its unique logic synthesis capabilities, FutureDesigner reduces and factors your design, eliminating redundancy and improving efficiency. It optimizes for the particular technology you've selected, making the necessary speed/size trade-offs. Then it generates the schematics, net lists, or JEDEC files for programming PLDs. Automatically.

Call us today for more information. Find out why FutureDesigner is the design entry software of choice.

1-800-247-5700
Ext. 129

FutureNet

A Division of Data I/O Corporation

Data I/O Corporation 10525 Willows Road N.E., P.O. Box 97046, Redmond, WA 98073-9746, U.S.A. (206) 881-6444/Telex 15-2167
Data I/O Canada 6725 Airport Road, Suite 302, Mississauga, Ontario L4V 1V2 (416) 678-0761
Data I/O Europe World Trade Center, Strawinskylaan 633, 1077 XX Amsterdam, The Netherlands +31 (0)20 6622866/Telex 16616 DATIO NL
Data I/O Japan Sumitomoseimei Higashishinbashi Bldg., 8F, 2-1-7, Higashi-Shinbashi, Minato-ku, Tokyo 105, Japan
(03) 432-6991/Telex 2522885 DATAIO J

©1988 Data I/O Corporation

CIRCLE NO 110