

June 9, 1994

NEW PRODUCT INTRO

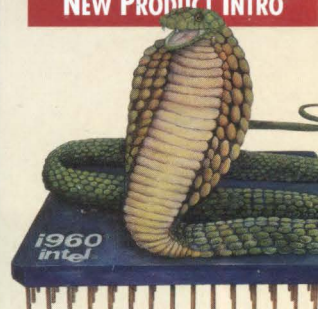

Clock doubling strikes the i960 μ P pg 17

TECHNOLOGY UPDATE

Ignore packaging effects at your peril pg 47

DESIGN FEATURES

Windows NT brings uniformity and low cost to EDA pg 162

Technique eases design of high-order PLLs pg 172

Good design enables hot insertion of power supplies pg 184

DSPx:

- ▶ The show pg 58
- ▶ The products pg 62

Design Ideas pg 139

Hands On! pg 225

EDA consumer advocate speaks out pg 228

EDN[®]

THE DESIGN MAGAZINE OF THE ELECTRONICS INDUSTRY



**EDN's
1994 DSP
Chip
Directory**
pg 75

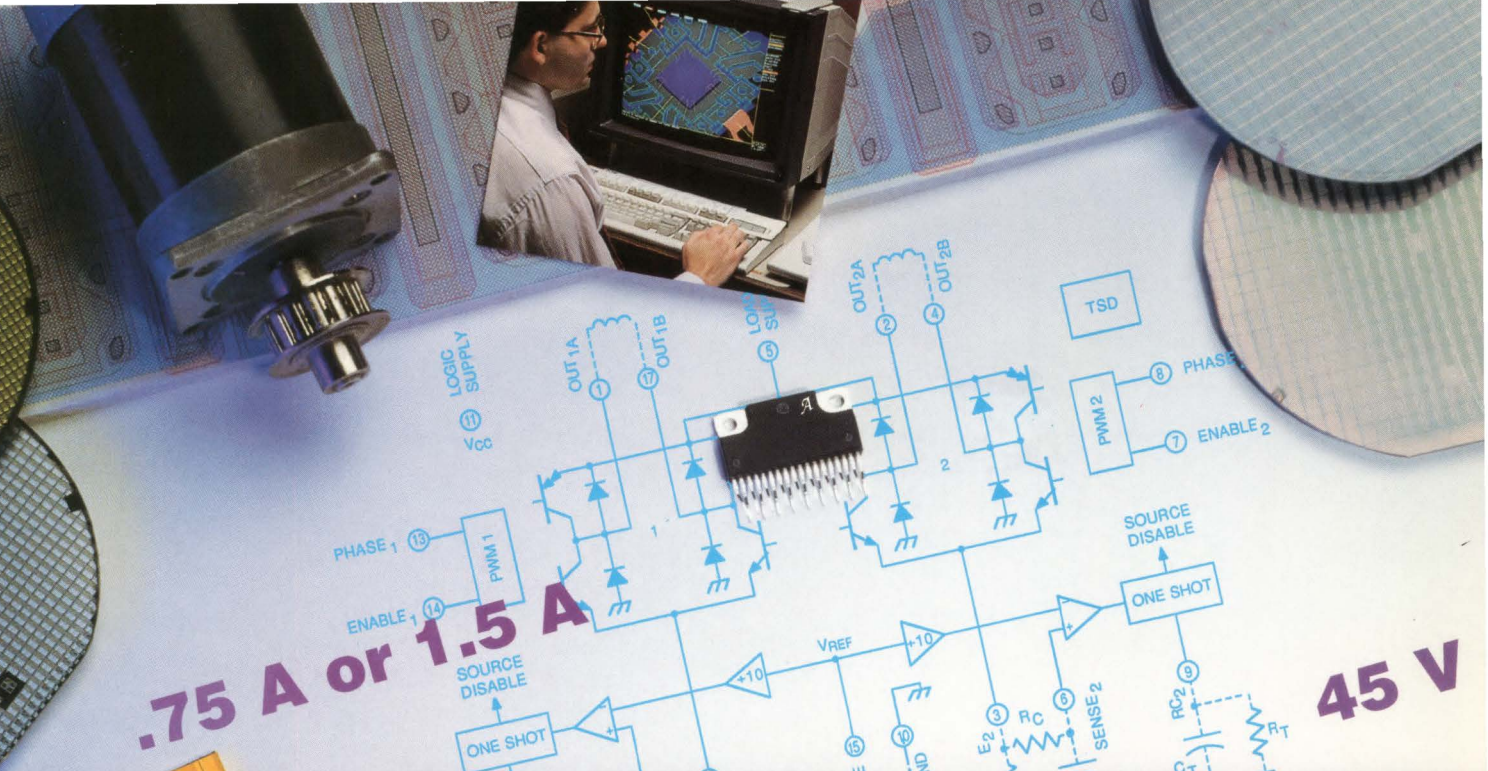

.75 A or 1.5 A

45 V

THE POWER TO DRIVE 2 WINDINGS WITH ONE IC
2916, 2917, & 2918 Dual Full-Bridge PWM Motor Drivers

FEATURES

- For Bipolar Stepper Motors or For Two DC Motors
- $\pm .75$ A or ± 1.5 A Continuous Output Current
- 45 V Output Sustaining Voltage
- Internal PWM Current Control
- Internal Clamp Diodes
- Internal Thermal Shutdown

Circuitry Elegantly Engineered To Meet Your System Requirements

Containing two full bridges, the Allegro's 2916, 2917, & 2918 motor drivers are designed to drive both windings of a bipolar stepper motor or bidirectionally control two dc motors. Each bridge is capable of sustaining

45 V and includes internal pulse-width modulation (PWM) control of the output current to $\pm .75$ A (2916) or ± 1.5 A (2917, 2918). Current is determined by the user's selection of a reference voltage and sensing resistor. Included on chip are ground clamp and flyback diodes for protection against inductive transients. Internally generated delays prevent cross-over currents when switching current direction. Thermal protection circuitry disables the outputs if the chip temperature exceeds safe operating limits.

Designed For Manufacturability

Allegro's ICs are "designed-for-manufacturability" under stringent standards of Total-Quality. Design/Production teams, under our

PACE (Product And Cycle-time Excellence) program, work closely with our customers to meet their time-to-market and quality/reliability objectives.

Headquartered in Worcester, Massachusetts, Allegro operates two Wafer-fabrication plants as well as assembly/test facilities. Design centers are located worldwide, sharing common cell libraries and design tools.

Take A Test-Drive... Call For Samples

Samples are available now. Just give us a call at 1•508•ALLEGRO and we'll have our Sample Pack in the mail to you the same day. After all, the measure of our success can only be *your total satisfaction.*

THE PACE QUICKENS



Formerly Sprague Semiconductor Group

CALL 1 • 508 • ALLEGRO
 115 Northeast Cutoff, Worcester, Massachusetts 01615
 CIRCLE NO. 29

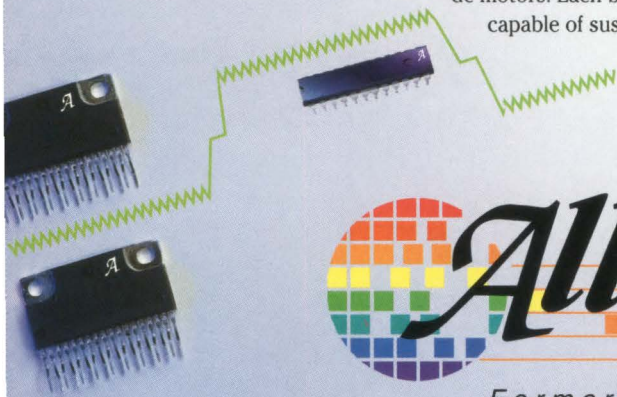
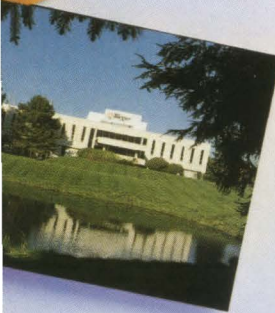
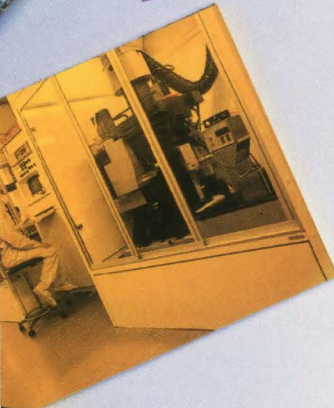

PERFORMANCE YOU CAN MEASURE

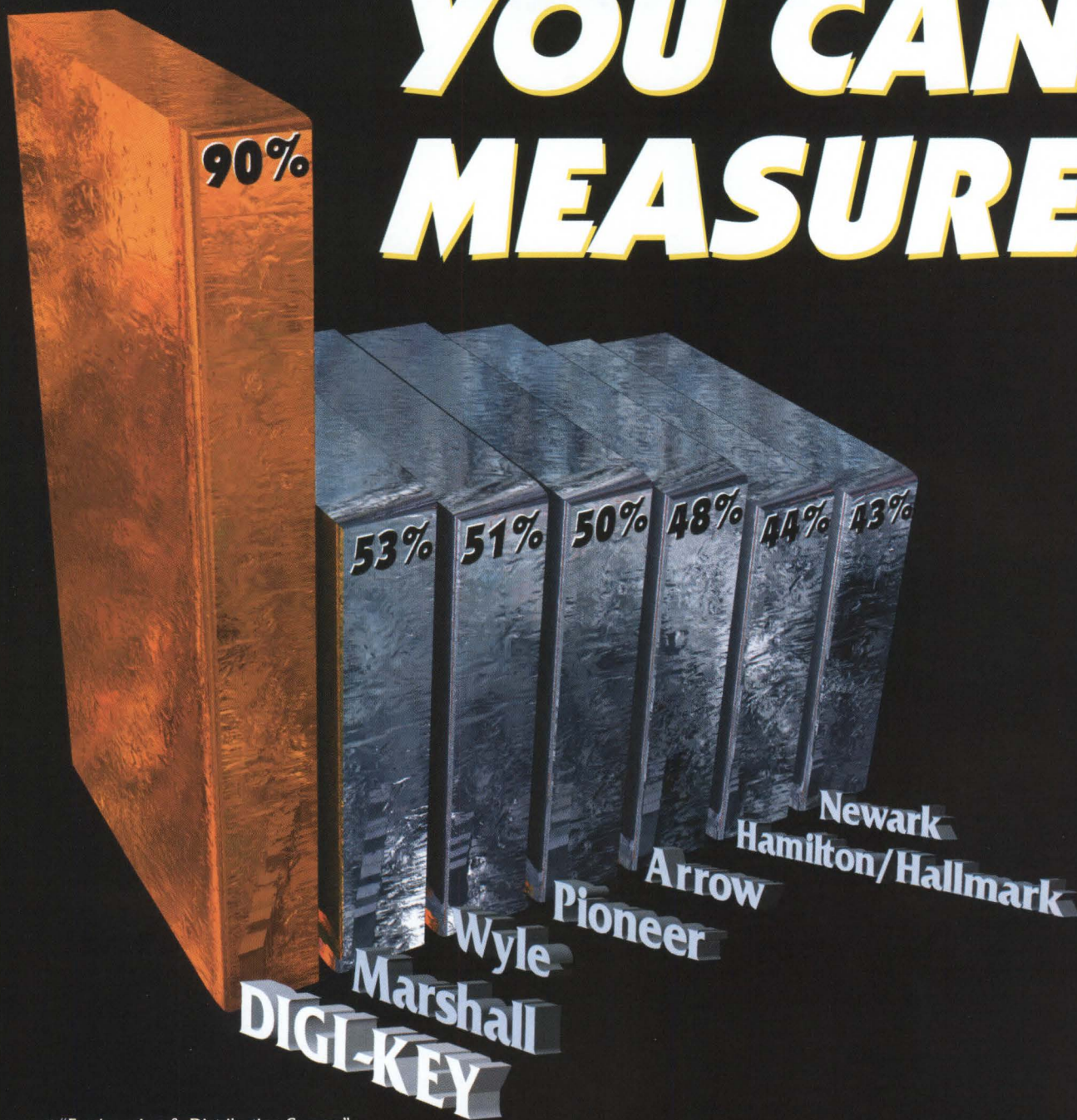

In a recent "Engineering & Distribution Survey" conducted by *Electronic Engineering Times*, engineering managers were asked to evaluate distributors they have done business with/are most familiar with on a wide range of criteria related to customer service and technical support. The bars above reflect the percentage of each distributor's customers that rated their distributor as excellent (6 & 5 responses) on a 6 point scale where 6=excellent and 1=poor in terms of OVERALL PERFORMANCE.

Note: Since the bases varied for each distributor, direct comparisons should not be made.

DIGI-KEY is a registered trademark of Digi-Key Corporation and is in no way affiliated with the other distributors evaluated in the survey or listed in this advertisement.

Put These Numbers to Work for You!

Digi-Key
CORPORATION

Quality Electronic Components, Superior Service

1-800-344-4539

701 Brooks Ave. South, Thief River Falls, MN 56701

Fax: 218-681-3380

CIRCLE NO. 64

This Settles It.

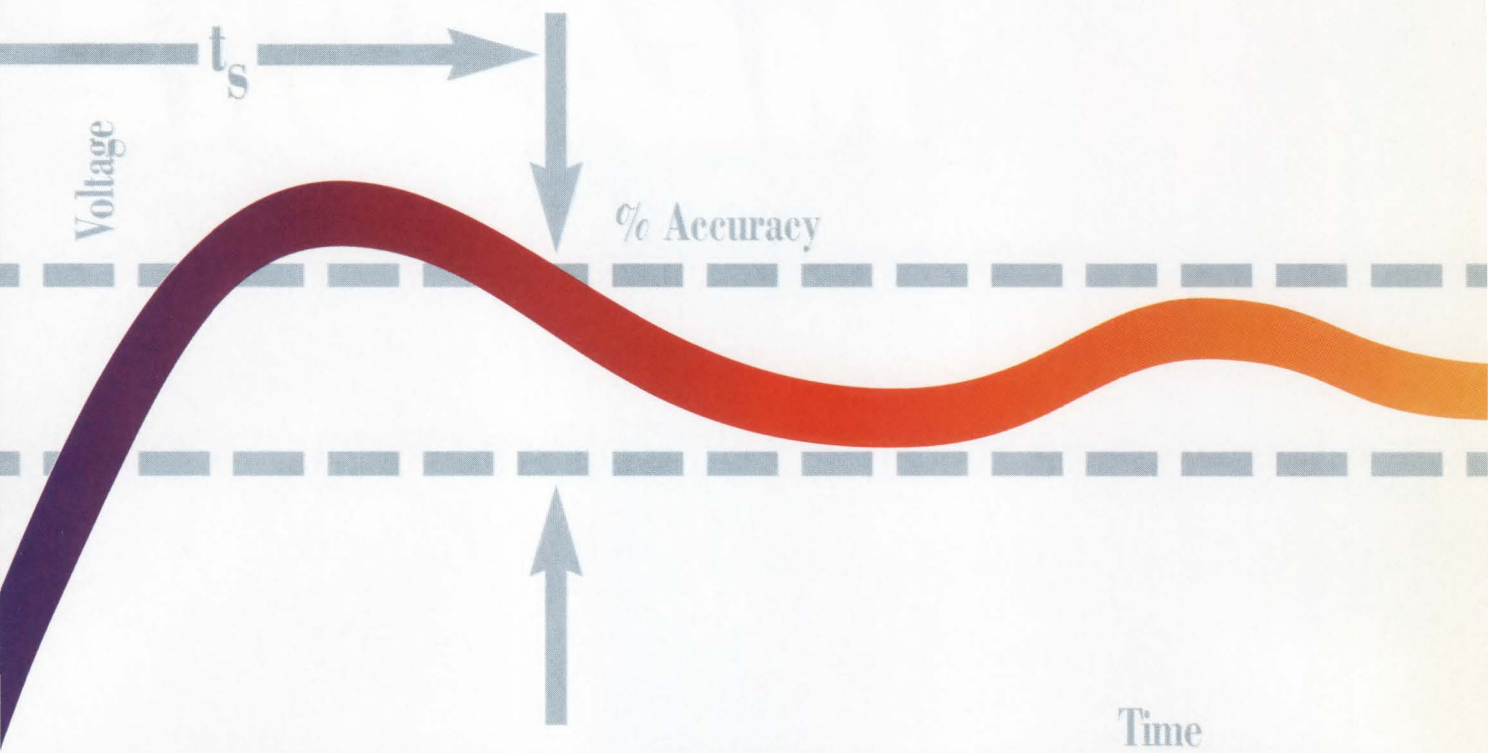

Avoid Inaccurate Data – Use DAQ Boards with the NI-PGIA™

You told us you wanted data acquisition (DAQ) boards that deliver full accuracy at any gain and at any multichannel sampling rate. So we developed the NI-PGIA – the custom instrumentation amplifier for our high-performance DAQ boards.

Using a DAQ board with the NI-PGIA – such as the AT-MIO-16F-5 – you can measure your signals without the settling time inaccuracies that commonly plague plug-in DAQ boards. Boards with the NI-PGIA can settle to 12 bits in 2 μ s and to 16 bits in less than 40 μ s, even when sampling multiple channels

at high gains. That's more than five times faster than boards with the best off-the-shelf programmable gain instrumentation amplifiers!

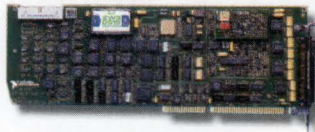

Call for a FREE catalog, which has complete specifications on National Instruments DAQ products. Also, ask for our application note, "Is Your Data

Inaccurate Due To Instrumentation Amplifier Settling Time?"



**NATIONAL
INSTRUMENTS®**
The Software is the Instrument®

(800) 433-3488
(U.S. and Canada)



6504 Bridge Point Parkway • Austin, TX 78730-5039 • Tel: (512) 794-0100 • 95 (800) 010 0793 (Mexico) • Fax: (512) 794-8411

Branch Offices: Australia 03 879 9422 • Austria 0662 435986 • Belgium 02 757 00 20 • Canada 519 622 9310 • Denmark 45 76 26 00 • Finland 90 527 2321 • France 1 48 65 33 70 • Germany 089 714 50 93
Italy 02 48301892 • Japan 03 3788 1921 • Netherlands 03480 33466 • Norway 32 848400 • Spain 91 640 0085 • Sweden 08 730 49 70 • Switzerland 056 27 00 20 • U.K. 0635 523545

© Copyright 1994 National Instruments Corporation. All rights reserved. Product and company names listed are trademarks or trade names of their respective companies.

CIRCLE NO. 82

GaAs SWITCHES

DC-2GHz Immediate Delivery from **\$2³⁰**
(1000 qty.)

Finally! A line of SPDT absorptive, reflective and transfer switches that appeals to your technical side, and business side as well! It's Mini-Circuits GaAs switches...providing outstanding performance features such as very high isolation (up to 60dB), superfast 3nsec switching speed and excellent compatibility with surface mount soldering techniques. Additionally, the entire series is built extremely tough and is immediately available from stock with a 1 week shipment guarantee. At only \$2.95 (qty.10), this top-of-the-line value is priced with your bottom line in mind! To order, call or Fax Mini-Circuits with your requirements today.

Mini-Circuits...we're redefining what VALUE is all about!

Model No.	Freq. (GHz)	Insertion Loss ① dB (max.)	1dB Comp. ① dBm (typ.)	In-Out Iso. ① dB (typ.)	Price \$ea. (qty.10)
MSW-2-20 (Reflective)	DC-2.0	1.0	+24	34	2.95
MSWA-2-20 (Absorptive)	DC-2.0	1.3	+27	40	3.45
MSWT-4-20 (Transfer)	DC-2.0	1.8 TX ② 2.0 FX ③	+28 TX ② +27 FX ③	30	3.95

① Midband, 500-1000MHz ② Transmit ③ Receive

All Units: SOIC 8pin Package



Actual Size

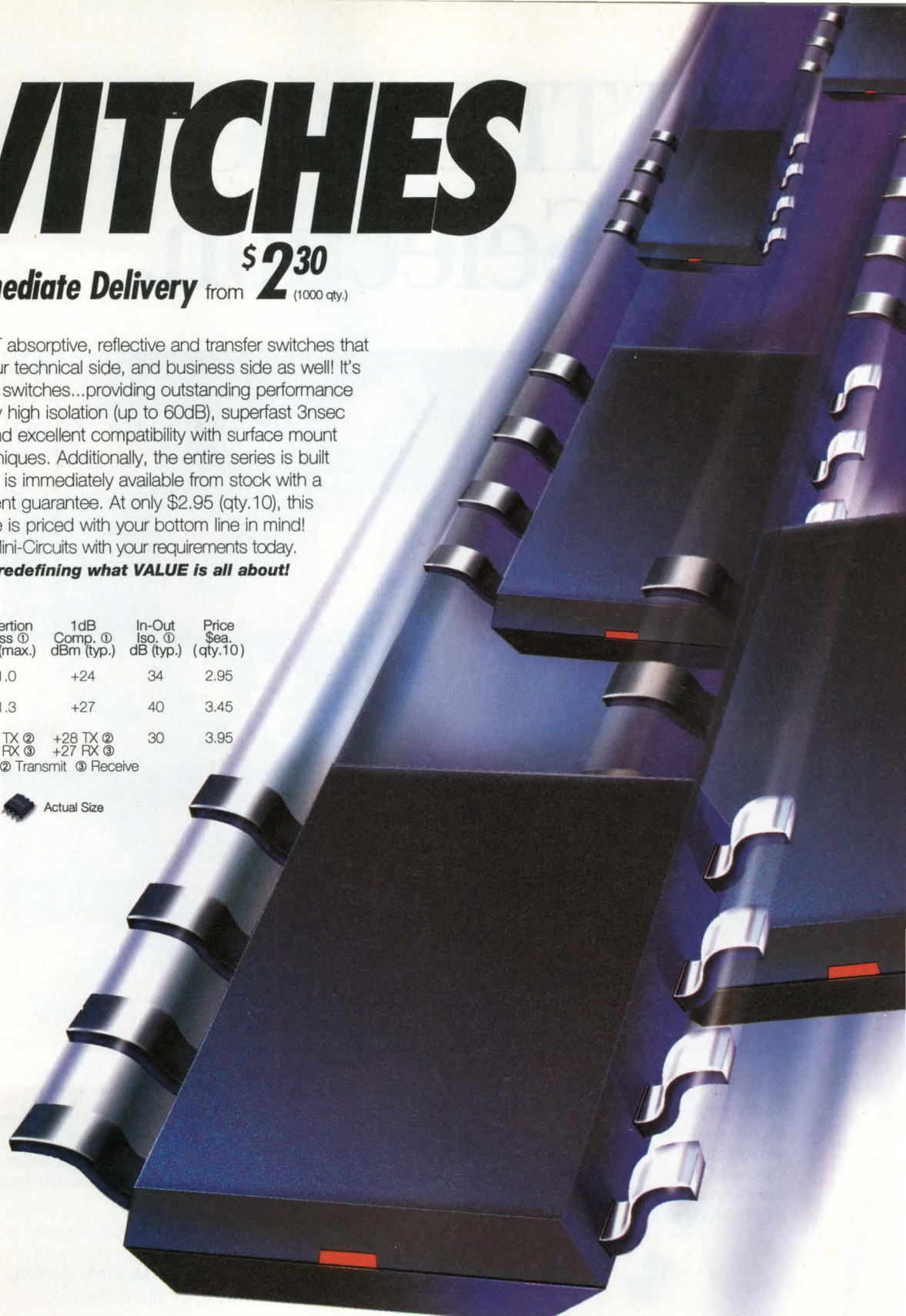
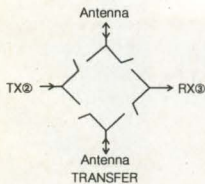
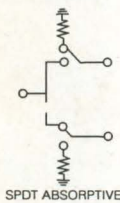
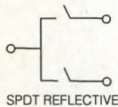

Mini-Circuits®

P.O. Box 350166, Brooklyn, New York 11235-0003 (718) 934-4500 Fax (718)332-4661

For detailed specs on all Mini-Circuits products refer to • THOMAS REGISTER Vol. 23 • MICROWAVES PRODUCTS DIRECTORY • EEM • MINI-CIRCUITS' 740- pg. HANDBOOK.

CUSTOM PRODUCT NEEDS...Let Our Experience Work For You.

F 174 Rev Orig

CIRCLE NO. 157

EDN June 9, 1994 • 3

LITTLE FOOT, Big Selection.

<p>Si9925DY Dual N-Channel</p>  <p>20 V, 50 mΩ</p>	<p>Si9940DY Dual N-Channel</p>  <p>50 V, 50 mΩ</p>	<p>Si9958DY Complementary N-&P-Ch</p>  <p>N-Ch: 20V, 100 mΩ P-Ch: -20V, 100 mΩ</p>	<p>Si9410DY Single N-Channel</p>  <p>30 V, 30 mΩ</p>	<p>Si9928DY Complementary N-&P-Ch</p>  <p>N-Ch: 20V, 50 mΩ P-Ch: -20V, 110 mΩ</p>
<p>Si9952DY Complementary N-&P-Ch</p>  <p>N-Ch: 25 V, 100 mΩ P-Ch: -25 V, 250 mΩ</p>	<p>Si9959DY Dual N-Channel</p>  <p>50V, 300mΩ</p>	<p>Si9400DY Single P-Channel</p>  <p>-20V, 250 mΩ</p>	<p>Si9433DY Single P-Channel</p>  <p>20V, 65 mΩ</p>	<p>Si9956DY Dual N-Channel</p>  <p>20V, 100 mΩ</p>
<p>Si9948DY Dual P-Channel</p>  <p>-60 V, 280 mΩ</p>	<p>Si9430DY Single P-Channel</p>  <p>-20 V, 50 mΩ</p>	<p>Si9407DY Single P-Channel</p>  <p>-60V, 150 mΩ</p>	<p>Si9936DY Dual N-Channel</p>  <p>30V, 50 mΩ</p>	<p>Si9939DY Complementary N-&P-Ch</p>  <p>N-Ch: 30V, 50 mΩ P-Ch: -30V, 100 mΩ</p>
<p>Si9953DY Dual P-Channel</p>  <p>-20V, 250 mΩ</p>	<p>Si9947DY Dual P-Channel</p>  <p>-20V, 100 mΩ</p>	<p>Si9435DY Single P-Channel</p>  <p>-30V, 55 mΩ</p>	<p>Si9405DY Single P-Channel</p>  <p>-20V, 100 mΩ</p>	<p>Si9955DY Dual N-Channel</p>  <p>50V, 130 mΩ</p>
<p>Si9943DY Complementary N-&P-Ch</p>  <p>N-Ch: 20V, 125 mΩ P-Ch: -20V, 160 mΩ</p>	<p>Si9945DY Dual N-Channel</p>  <p>60 V, 100 mΩ</p>	<p>Si9942DY Complementary N-&P-Ch</p>  <p>N-Ch: 20 V, 125 mΩ P-Ch: -20 V, 200 mΩ</p>	<p>Si9933DY Dual P-Channel</p>  <p>-20V, 110 mΩ</p>	<p>Si9434DY Single P-Channel</p>  <p>-12V, 40 mΩ</p>

Try these specs on for size. Nothing fits your design for low on-resistance load switching, power conversion, and motor control like the original LITTLE FOOT® power MOSFETs.

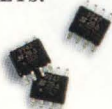

Lower on-resistance and more choice than ever.

Whether your system runs at 2.7, 3.3, 5 V, or more, there's a LITTLE FOOT product that can help it run cooler and more efficiently. You'll notice the difference Siliconix proprietary technologies make, like p-channel devices with a maximum 40-mΩ on-resistance – even at 4.5 V!

Walk a mile in our shoes.

You can't beat experience when it comes to quality and service. We've shipped over 150 million devices in three years with less than 1 ppm AOK.

If the shoe fits, contact your local TEMIC sales office. Or call 1-800-554-5565, ext. 928, for more information.

Siliconix
A Member of the TEMIC Group

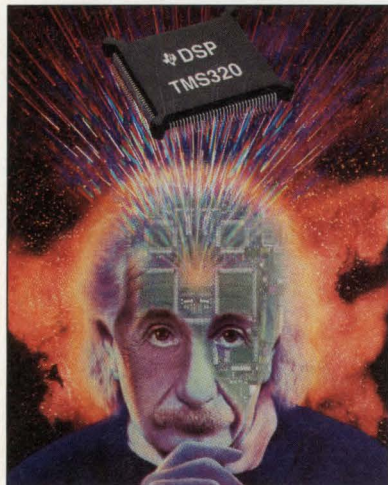

On the cover: If you're thinking about designing with DSPs, look no further. Our annual DSP directory, which begins on pg 75, gives you a head start on the evaluation process. (Cover photo courtesy Texas Instruments; design, Dennis Full; Albert Einstein photo courtesy The Roger Richman Agency Inc, Beverly Hill, CA, which is the licensing agency for The Hebrew University of Jerusalem, the beneficiary of the estate of Albert Einstein.)

THE DESIGN MAGAZINE OF THE ELECTRONICS INDUSTRY

SPECIAL REPORT

EDN's 1994 DSP Chip Directory

75

Our annual DSP directory covers 22 chips, providing a run-down of architectural, performance and pricing information—*Compiled by James P Leonard, Associate Editor*

SHOW PREVIEW

DSP^x 94 helps introduce DSP into your designs

58

This year's DSP^x conference divides sessions into three groups, tutorials, product presentations, and advanced application sessions.—*Steven H Leibson, Editor-in-Chief*

DSP^x Products

62

DESIGN FEATURES

Windows NT brings uniformity and low cost to EDA

162

The Windows NT operating environment is a major advancement in the continuing evolution of operating systems and their associated graphical user interfaces.—*Bill Fuchs, Simucad*

Technique eases design of high-order PLLs

172

Maintaining stability in high-order PLLs can be a chore. Two design programs can assist you in designing stable types 2 and 3, third-order PLLs.—*Fred Salvatti, White Sands Missile Range*

Continued on page 7

EDN® (ISSN 0012-7515, GST Reg. #123397457, IPM #0280844) is published 38 times per year, bi-weekly with one additional issue per month, by Cahners Publishing Company, A Division of Reed Publishing USA, 275 Washington Street, Newton, MA 02158-1630. Robert L. Krakoff, Chairman and Chief Executive Officer; Timothy C. O'Brien, Executive Vice President/Finance and Administration; Michael Wisner, Senior Vice President/General Manager, Boston Division; Michael Wisner, Vice President/Publishing Director. Circulation records are maintained at Cahners Publishing Company, 8773 South Ridgeline Blvd., Highlands Ranch, CO 80126-2329, Telephone (303) 470-4445. Second-class postage paid at Highlands Ranch, CO 80126-2329 and additional mailing offices. **POSTMASTER: Send address changes to EDN®, PO Box 7500, Highlands Ranch, CO 80126-7500.** EDN® copyright 1994 by Reed Publishing USA. Rates for non-qualified subscriptions, including all issues: US, \$140.00 one year, \$238.00 two year; Canada, \$209.00 one year, \$355.00 two year (includes 7% GST, GST# 123397457); Mexico, \$195.00 one year, \$332.00 two year; Foreign surface \$245.00 one year, \$417.00 two year; Foreign air expedited surcharge add \$152.00 one year, \$304.00 two year. Except for special issues where price changes are indicated, single copies are available for \$10.00 US and \$15.00 foreign. Please address all subscription mail to EDN®, 8773 South Ridgeline Blvd., Highlands Ranch, CO 80126-2329. EDN® is a registered trademark of Reed Properties Inc., used under license.

(Printed in USA)

What Is The #1 Reason To Choose Us For Optoelectronics?

#1 In Surface Mount Performance And Selection.

We offer an unbeatable variety of surface mount products, including TOP-LED[™]s, SIDE-LED[™]s and BOTTOM-LED[™]s, as well as our unique MULTI-LED[™]s which let you electrically change the display color. All feature an industry-standard footprint, SMT soldering compatibility, and pick-and-place ease of handling. *Call and ask for Lit. SKU #OPT009.*

CIRCLE NO. 131

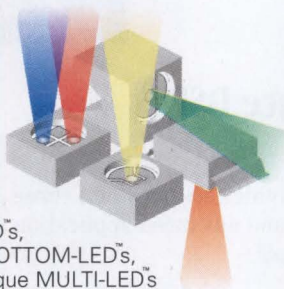

#1 Provider Of The Industry's Highest Board Density Optocouplers.

Nobody offers more innovative optocouplers than Siemens. We're first in DIP packages for Dual and Quads. First in SO-8 packages for single, dual and PCMCIA-compatible packages. And the first with a 2-channel (dual) surface mount in one package (SO-8), which doubles your board density and saves significant board space. *Call and ask for Lit. SKU #OPT007.*

CIRCLE NO. 132



#1 Linear Optocoupler.

Our commitment to R&D has resulted in innovations like the IL300 family, as well as SIDE-LED[™] right-angle SMT emitters and detectors for office automation and consumer applications. *Call and ask for Lit. SKU #OPT007.*

CIRCLE NO. 133



MOST Flexible Optoelectronics Solutions In The World.

Our Application Specific Intelligent Displays[®] let you create your own semicustom display. And we'll deliver it in about 14 weeks, for about what you'd pay for a standard part. One example is our SCDV 554X, the first multicharacter 5x5 dot matrix vertical format display. *Call and ask for Lit. SKU #OPT005.*

CIRCLE NO. 134

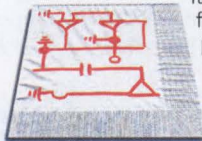

Announcing Our Latest Reason.

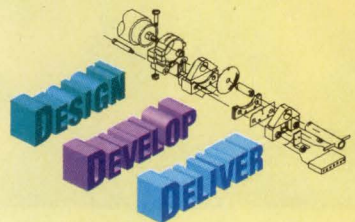

#1 In Custom Design Flexibility And Affordability.

If your application calls for a unique product design or specific performance requirements, Siemens Custom Optoelectronics Products offers the Custom Engineering Support, Packaging Capabilities and Hybrid Module Expertise to help you develop exactly the right part for the job.

Our engineers are experts in evaluating customer requirements and proposing solutions which can reduce the size and costs of your designs. We can even fabricate products from a variety of hybrid modules, for unequalled flexibility in your design. And we back all our products with on-site field support for added convenience and security. *Call and ask for Lit. SKU #OPT008.*

CIRCLE NO. 135

You Decide.

From simple standard designs to complex custom applications, the most advanced Optoelectronics solutions begin with Siemens.

We've become one of the world's largest suppliers of optoelectronics by helping our customers develop the right product, then get their

product to market fast. With the flexibility to create your own unique solution, or choose from a large variety of standard products.

And we continue to offer the package selection, Just-In-Time delivery, and ease-of-design you need to succeed.

Whatever your #1 reason might be for choosing an Optoelectronics supplier, Siemens is the #1 company to call.

1-800-77-SIEMENS

Call Today, And Ask For Extension 3.

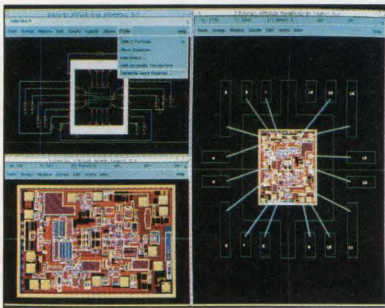

Design for packaging is not yet a standard part of CAD tools. Fortunately, vendors are developing the needed tools (pg 47).

DESIGN FEATURES

Good design enables hot insertion of power supplies

184

Hot insertion of power supplies offers many advantages, but it can cause lots of problems unless you prepare for it in your design.

—Mikhail Grabois, *Ascom Timeplex Inc*

TECHNOLOGY UPDATE

Ignore packaging effects at your peril

47

Your high-speed ASIC design looked great in simulation and matched all its test vectors. So why didn't it work when you plugged it in a board? Maybe you didn't account for packaging effects.

—Richard A Quinnell, *Technical Editor*

DESIGN IDEAS

PC and DSP μ P interrupt each other	139
Autocalibrator nulls dc offsets	139
Low-cost MOSFET quashes power resistor	140
Spice plots noise figure	142
Passive components cancel phase errors	147
PLDs substitute for obsolete latches	149
PC printer port controls frequency divider	150
Printer-port data appears as bar on PC screen	152
Simple ADC is surprisingly accurate	154
Precision clamp recover in nanoseconds	154
Software Shorts	156

New Instrumentation Amp in an Op Amp Package

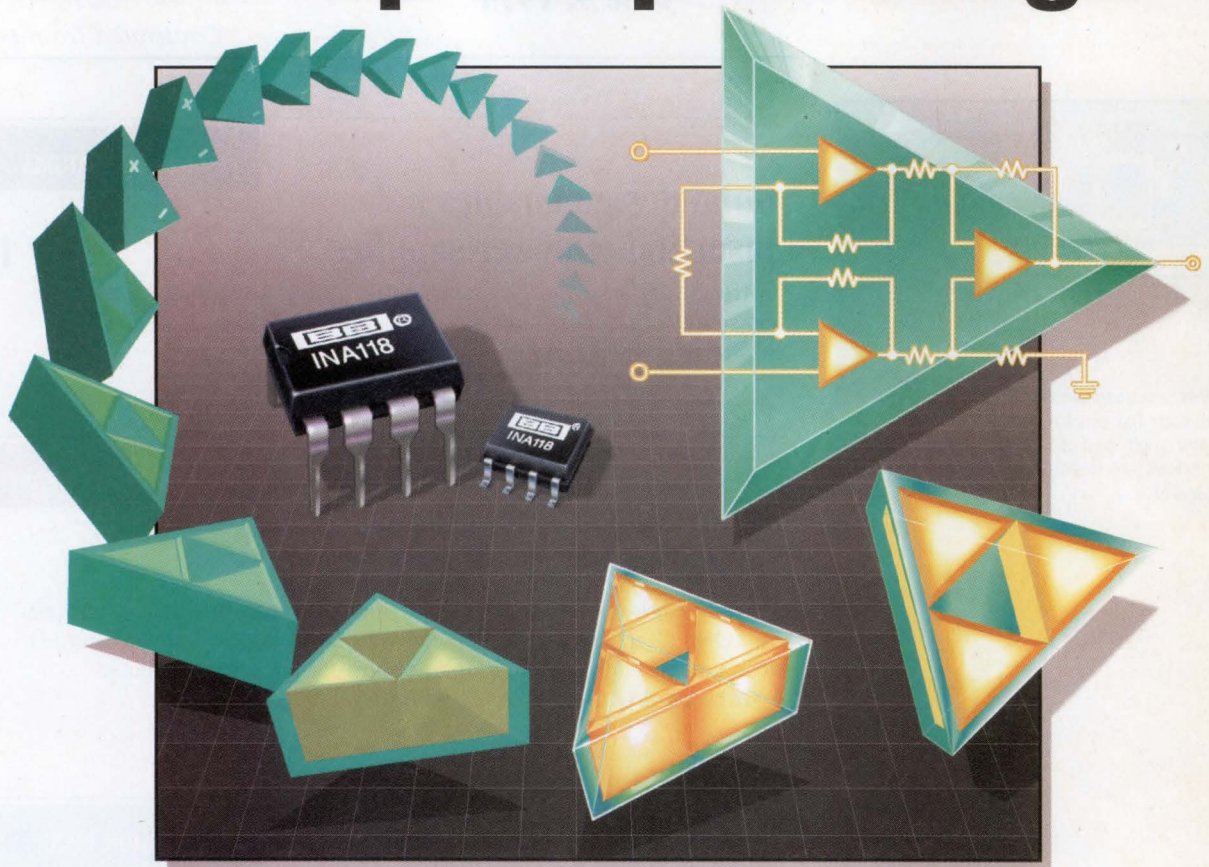

Simple Solution

INA118 is your best choice—you get a true three op amp instrumentation amplifier in a standard op amp package. It gives you outstanding precision at low power and low price. **INA118** is perfect for portable instruments, thermocouple amplification, medical instrumentation, and data acquisition designs. It's simply your best choice at the best price!

Power Miser

INA118 is a power miser! It operates with power supplies from $\pm 1.35\text{V}$ to $\pm 18\text{V}$ —single-supply down to 2.7V . Quiescent current is only $350\mu\text{A}$ —it's ideal for battery operated systems and other low power applications. And, internal input protection withstands up to $\pm 40\text{V}$ without damage.

Money Saver

INA118 delivers the highest accuracy and outperforms the competition for a lower price. At $\$3.25$ (in 1000s), it's a better solution than any other "make" or "buy" amp out there. You get the best for less.

INA118 key specifications

- Low offset voltage $50\mu\text{V}$ max
- Low offset voltage drift $0.5\mu\text{V}/^\circ\text{C}$ max
- Wide bandwidth 70kHz at $G=100$
- Low quiescent current $350\mu\text{A}$
- Power supply $\pm 1.35\text{V}$ to $\pm 18\text{V}$
- High common-mode rejection 110dB
- Input overvoltage protection $\pm 40\text{V}$
- Packages 8-pin plastic DIP, SO-8, dice
- From **\\$3.25** in 1000s

Get One FREE!

Get your FREE sample, data sheet, and *Instrumentation Amplifiers* guide by calling **1-800-548-6132**.

Or, contact your local sales representative for more information.



Home Office

275 Washington St, Newton, MA 02158
 EDN Bulletin Board: (617) 558-4241
 MCI: EDNBOS
 Phone (617) 558-plus 4-digit extension below
 Fax (617) 558-4470

To send a message to an EDN editor via Internet, add "@MCIMAIL.COM" to his or her MCI address.

Publisher

Jeffrey Patterson -4454

Editor-in-Chief

Steven H Leibson -4214

Managing Editor

Joan Morrow Lynch -4215

Gary Legg, *Senior Technical Editor* -4404
 Charles Small, *Senior Technical Editor* -4556
 MCI: EDNSMALL

Dan Strassberg, *Senior Technical Editor* -4205
 MCI: EDNSTRASSBERG

John A Gallant, *Technical Editor* -4666
 Frances T Granville, *Senior Associate Editor* -4344
 James P Leonard, *Senior Associate Editor* -4324
 Gillian A Caulfield,

Manager of Art and Editorial Production -4263
 Patricia Shaughnessy, *Production Editor* -4206
 Ken Racicot, *Senior Art Director* -4708
 Chinsoo Chung, *Associate Art Director* -4446

Brian Kerridge, *Senior Technical Editor*
 22 Mill Rd, Loddon
 Norwich, NR14 6DR, UK
 (508) 528435; fax (508) 528430
 MCI: EDNKERRIDGE

Doug Conner, *Technical Editor*
 Atascadero, CA: (805) 461-9669
 fax: (805) 461-9640; MCI: EDNDCONNER

Markus Levy, *Technical Editor*
 Citrus Heights, CA: (916) 725-4485
 MCI: EDNLEVY

Richard A Quinell, *Technical Editor*
 Aptos, CA: (408) 685-8028
 MCI: EDNQIINNELL

David Shear, *Technical Editor*
 Corvallis, OR: (503) 754-9310
 MCI: EDNSHEAR

Anne Watson Swager, *Technical Editor*
 Wynnwood, PA: (215) 645-0544
 MCI: EDNSWAGER

EDN Asia, Mike Markowitz, *Editor*
 Cahners Asia Ltd
 19th Floor, Centre Point
 181-185 Gloucester Rd, Wanchai, Hong Kong
 Phone (852) 838-2666; fax (852) 575-1690

Contributing Technical Editors

Robert Pease, Don Powers, Dave Pryce, Bill Travis

Assistant to Editor-in-Chief

Kathy Leonard -4405

Editorial Services

Helen Benedict, *Senior Secretary* -4681

Marketing & Business Director

Deborah Virtue -4779

Marketing Communications

Jean Graham, *Promotion Specialist* -4698

Director of Creative Services

Norm Graf, -4293

Production

Andrew Jantz, *Group Manager* -4372
 Karen Banks, *Production Manager* -4441
 Alice Dorsey, *Production Associate* -4601

EDN Products

301 Gibraltar Dr, Box 650
 Morris Plains, NJ 07950
 Phone (201) 292-5100; fax (201) 292-0783

Group Publisher

Terry McCoy, Jr

Associate Publisher

Steven P Wirth, (201) 292-5100, ext 380

Editorial Director

Richard Cunningham, (702) 648-2470

Editor-in-Chief

Bruce Bennett, (201) 292-5100, ext 390

Managing Editor

Jen Brinkman, (201) 292-5100, ext 330

Production Manager

Sheila Rodgers, (201) 292-5100, ext 287

Customer Service Manager

Tara Poli, (201) 292-5100, ext 318

Design Director

John M Angelini

Art Director

Beverly Blake



June 9, 1994

Continued from page 7

EDITORIAL

**Technological proof of innocence,
Part 2**

43

Technological proof of innocence, Part 2: the case for smart cards.
—Steven H Leibson, *Editor-in-Chief*

COLUMNIST

The Verilog/VHDL wars are ending

228

A watershed event took place recently in the ASIC/EDA/
field-programmable gate-array industry.—John Cooley, *EDA
consumer advocate*

NEW PRODUCTS

Embedded Systems	189
Electronic Design Automation	190
Integrated Circuits	193
Test & Measurement	200
Computers & Peripherals	203
Power Sources	208
Components	210

DEPARTMENTS

Inside EDN	13
News Breaks	17
Signals & Noise	29
Ask EDN	34
Literature	212
Career Opportunities	221
Business Staff	224
Hands On!	225
EDN's International Advertisers Index	227

SIEMENS

Superior Solutions Down the Line

If you want to take the lead in information technology, it pays to work with a partner who has the widest range of solutions. Starting with line cards – we are the only vendor that can offer analog and digital solutions with optimized DSP macros.

In digital communications, we offer an impressive array of devices in silicon and gallium arsenide for voice,



text, data and images. These are the building blocks of modern telecommunications – from digital featurephones to complete ISDN switching systems. Our ESCC8 8-channel serial controller for data communication, for example, is second to none in performance.

And in pursuit of excellence throughout information technology, we have set the pace in mobile communications, too. With VLSI solutions and custom chipsets, we meet GSM 900 and DECT standards. And, as you would expect, our experienced teams are a match for any challenge in radio frequency engineering.

More information by fax
49-911-3 00 12 38, quoting HL 9117

**Global PartnerChip
for Systems on Silicon.
Siemens**

CIRCLE NO. 187



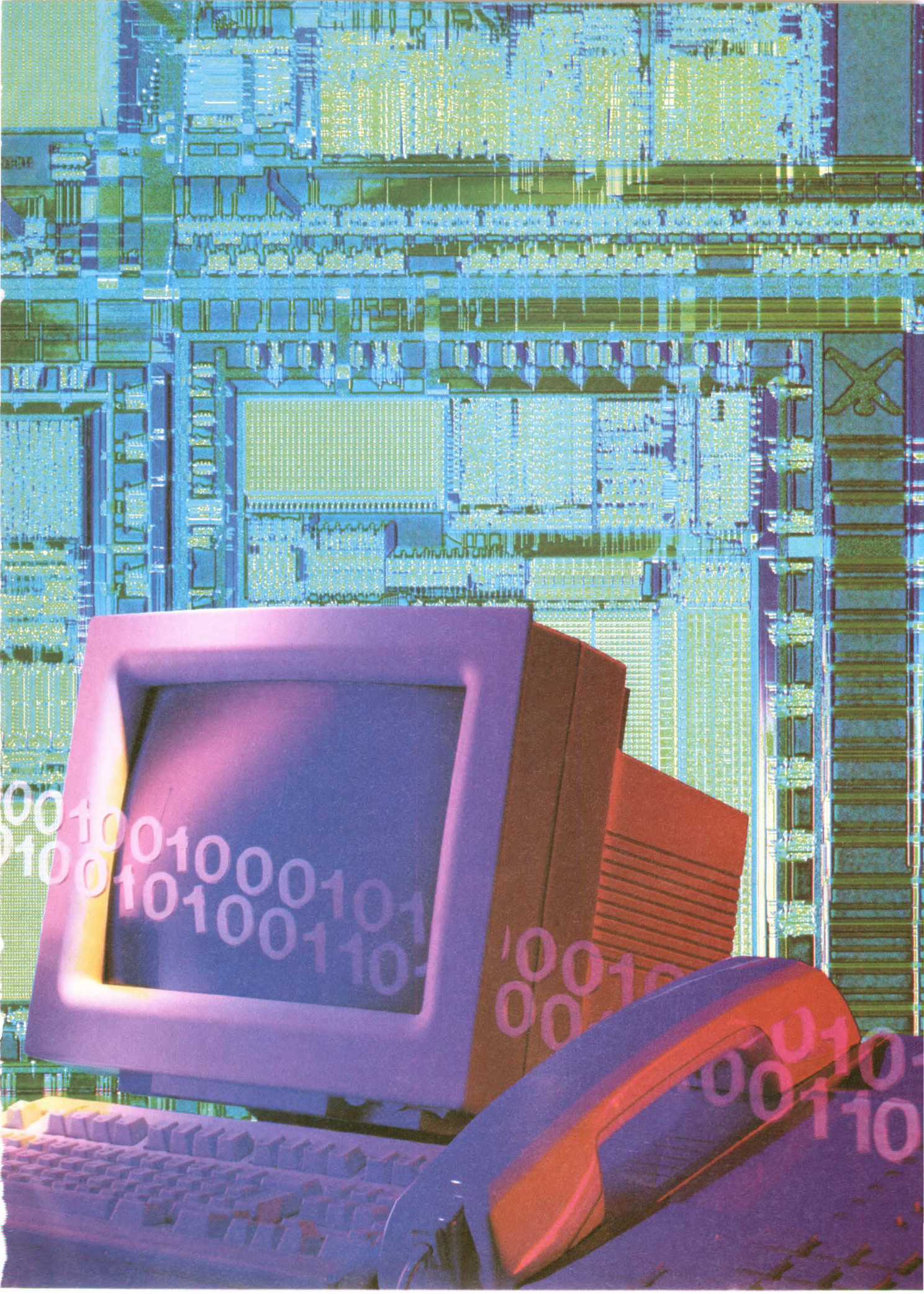

001001000101
010010100110

0010
0010

0010
0110

CPLDs

WITH KICK



Pin for pin Atmel's CPLDs are the most powerful programmable logic on any stage. They're real show stoppers.

The ATV750 is equal to two 22V10s in one 24-pin package. The ATV2500 has 2,500 gates neatly packed into 40 pins.

Both offer you new levels in predictable, uncompromised performance. Atmel's cell design eliminates the need to steal critical product terms, yet it still provides 17 per macrocell. All this with 100 percent connectivity.

No strings attached - 7.5 ns

propagation delay for the ATV750 and 12 ns for the ATV2500, that's it. No change from one application to the next. Use one product term or a dozen, your timing never misses a beat.

You already know how to use them. You probably own the tools. Because these new CPLDs use the same standard off-the-shelf hardware and software you've always used.

So upgrade with us and we'll give you the most kick per pin. But, don't wait 'til the fat lady sings, 'cause she ain't in this show.



Call: 800-365-3375 Ext. 494

Atmel Corporation Headquarters: 2125 O'Neil Drive, San Jose, CA 95131 (408) 441-0311, FAX (408) 436-4300. © Copyright 1994 Atmel Corp.

CIRCLE NO. 32

The DSP and Analog Special Issue

You've got a two ways to access the wealth of DSP and analog-related material that we've amassed for this special issue. Way #1: Read and keep this handy issue. Way #2: Log on to the free EDN bulletin-board system (BBS).

Start with our cover story—EDN's 1994 DSP Chip Directory (pg 75). You'll find all you need to know about 22 digital signal processors and their families: detailed architectural and performance data and pricing information on everything from 16-bit fixed-point chips to 32-bit floating-point devices. In addition, Technical Editors Charles Small and Anne Swager gathered DSP- and analog-specific Design Ideas for this issue. See that special section beginning on pg 139.

Our coverage of the DSP^x show will benefit new and experienced DSP users alike. Read about the design-oriented sessions and introductions of innovative products beginning on pg 58.

If you haven't had a chance to check out our free BBS, now would be the perfect time. It contains quite a bit of freeware and shareware for DSP and Spice, in addition to related material, on three subsections of the BBS under the Main System Menu.

The first place to look is the BBS's repository for Design Ideas, the /DI_SIG Special Interest Group. All of the post-

ings on the /DI_SIG are freeware, available for only the price of a phone call. Among the 220 Design Ideas posted on this SIG you will find 20 related to DSP and 37 related to Spice.

Next visit the /DSP Special Interest Group. Of the 140 postings on the /DSP SIG, most are freeware. The posted files contain specialized math routines for many different DSP μ Ps as well as software for implementing functions such as a software modem. The /DSP SIG also contains development tools for DSP μ Ps such as monitors, simulators, assemblers, and linkers.

Analog engineers will be able to find Spice models for components ranging from the mundane (metal-oxide varistors) to the exotic (solar arrays). The /SPICE SIG also contains 16- and 32-bit versions of Spice compiled for operating systems such as OS/2, Windows 3.X, and Windows NT, among others. These versions of Spice are generally shareware programs. You may try out shareware programs for free, paying a modest "registration" fee only if you like the program.

To delve into the EDN Readers' BBS, first study its hierarchy. One layer down from Main System Menu are the Special Interest Groups. Attached to each SIG is a single chain of messages. Optionally, each message can have a single file attached to it. Generally these files are compressed ZIPfiles that may contain, in compressed, concatenated

form, entire suites of files and their directories.

To log on and register, call (617) 558-4241, 1200/2400 8,N,1 (9600 baud, (617) 558-4580). To check out the Design Ideas SIG, for example, from the Main System Menu, enter *ss/DI_SIG*. Best bet: When you get to a SIG's main menu, turn on your communications program's screen-capture or log-file feature and then enter *rlb*. This command will give you a directory of everything posted on the SIG.

Or do a keyword search. To perform a keyword search for DSP-related Design Ideas on the /DI_SIG, for example, enter *rkdsp*. Again, having your screen-capture feature enabled during a search is a good idea. Once you find and read a message describing a file you want, the BBS will offer you the chance to download the attached file using one of a variety of common protocols. If you do not have PKware's outstanding example of shareware, PKUNZIP, with which to uncompress your downloaded file, you can pick up a copy from the BBS's /util SIG. Versions are available for PCs, MACs, and Unix computers. Happy hunting.

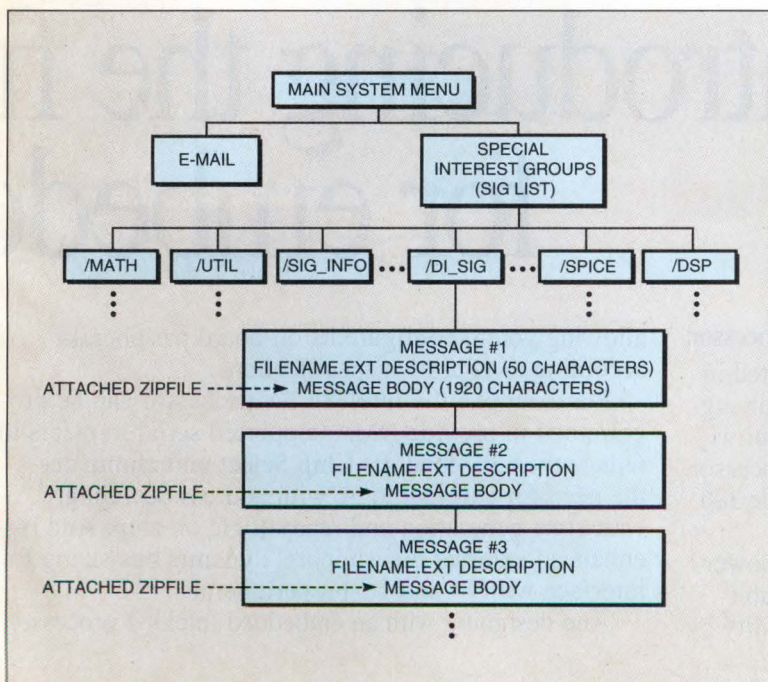

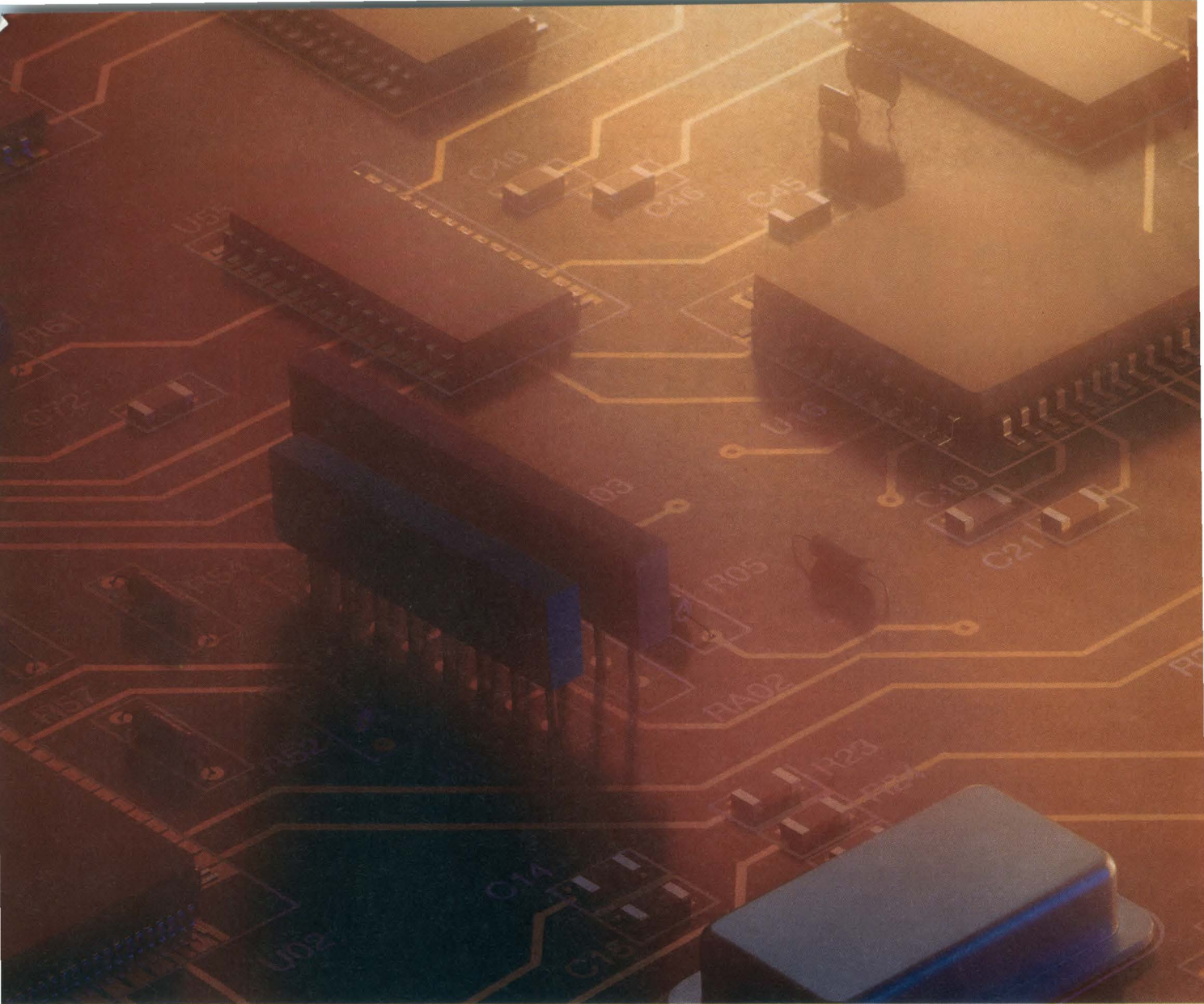

Introducing the first for embedded



The embedded Intel386™ EX processor:

We asked you what you wanted in an embedded processor, and your suggestions truly hit home. The result is the embedded Intel386™ EX processor. The first and only PC-compatible 386 that's optimized for embedded designs.

The integrated Intel386 EX processor offers power management and low-voltage operation for portable applications. It also increases your design flexibility by

allowing you to configure its on-board peripherals according to your own specifications.

For example, the Intel386 EX processor can be programmed to provide DMA-supported serial transfers to reduce the CPU load. Its Chip Select unit eliminates the need for external logic with address decoding, wait-state generation and ready-logic on chip. And its enhanced external bus supports dynamic bus sizing to interface with 8- and 16-bit peripherals.

And designing with an embedded Intel386 processor

© 1994 Intel Corporation. *Third-party trademarks are the property of their respective owners.

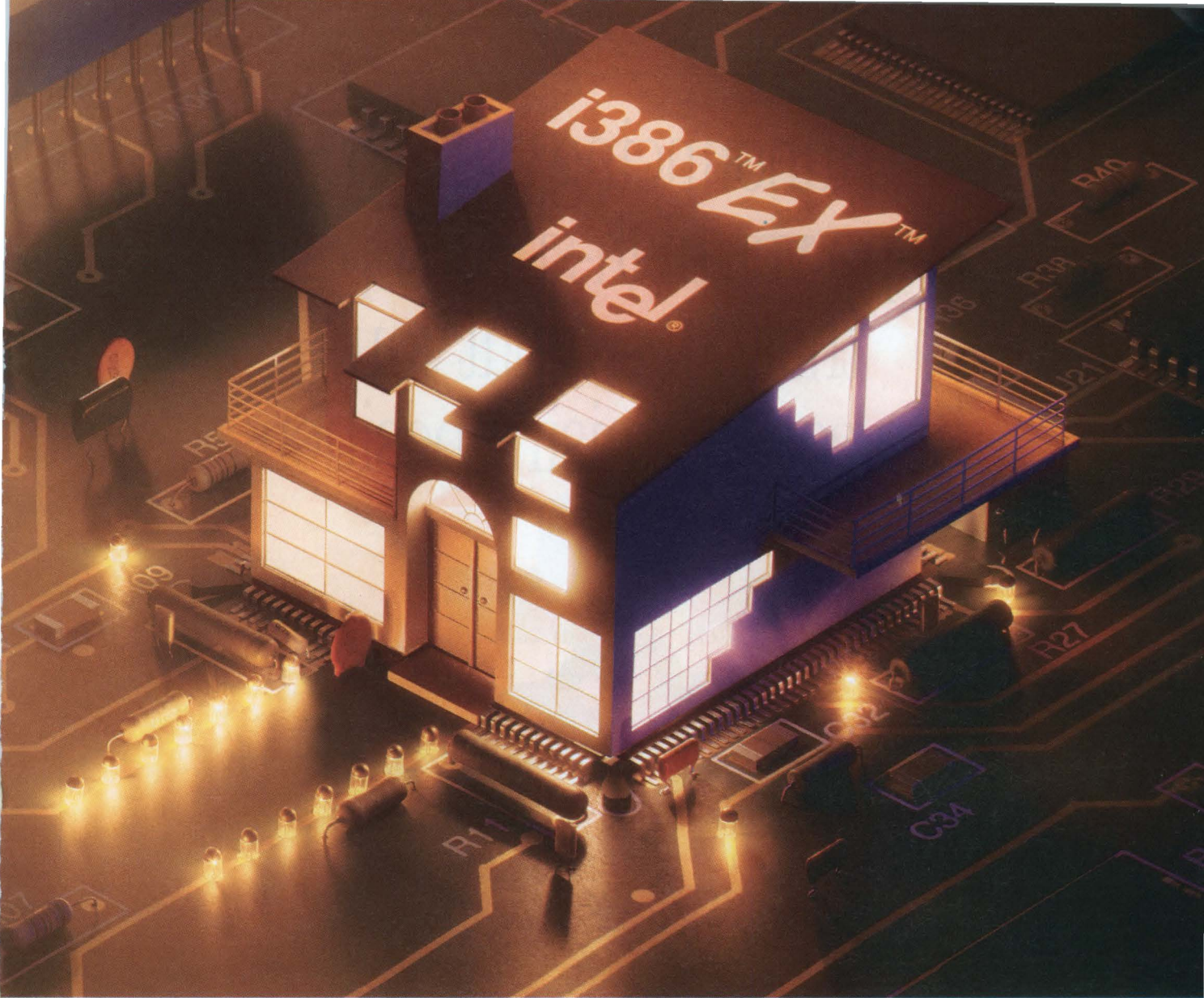

Best 386 custom built applications.

couldn't be easier. The off-the-shelf tools and support of the PC architecture will allow you to get your designs out more quickly, and differentiate them with familiar interfaces like DOS and Windows*.

Dial the FaxBack* service at 1-800-628-2283, cat. #2312 to get additional information about the embedded Intel386 EX processor. Or contact your distributor to receive Intel386 EX processor

Embedded Intel386™ EX Processor Block Diagram

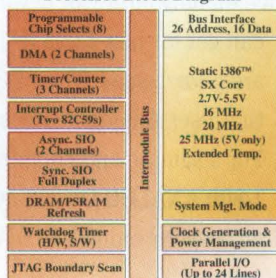

samples or to get current pricing of Intel386 SX and DX processors.

Move into an embedded Intel386 EX processor. Because when you want a solution that's optimized for embedded, nobody else is even in the neighborhood.



Announcing the first low-power, high-speed op amp that doesn't put you in a compromising position.

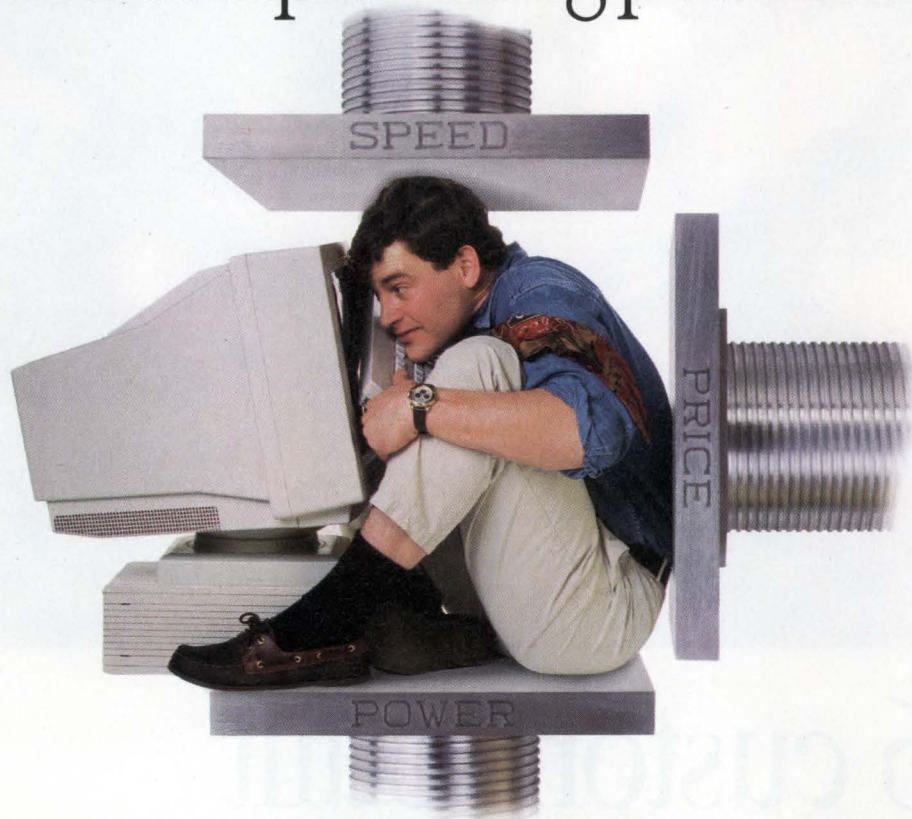

Analog Devices' new AD8001: 800 MHz. 50 mW. \$2.75 (1000s).

Finally, an op amp that delivers the uncompromising performance you need for your video, imaging or communications applications, without imposing speed/power/price trade-offs. At 800 MHz, our new AD8001 gives you more than *twice* the bandwidth-at equal power-than any other amplifier. Add exceptional differential gain and phase performance on only 50 mW of power, and you've got the best performance you



Specification	AD8001	CLC406	HFA1105	OPA623
-3dB BW, G=+1, (MHz)	800	160	300	340
Peaking, G=+2, (dB/MHz)	.1/100	.2/25	.12/75	.2/100
Slew Rate (V/μsec)	1200	1500	1100	2100
Diff Gain/Phase (%°)	.01/.025	.02/.025	.02/.02	.12/.05
Supply Current (mA, Max)	5.5	6.7	6	4.5

can get for just \$2.75 in 1000s. What's more, our min/max ac specs are *guaranteed*. The AD8001 is the first in a new series of amplifiers that uses Analog Devices' revolutionary XFCB™ fabrication process. For a sample and complete technical information, call us today at **1-800-ANALOG-D** (262-5643) and press "2" or fax your request to 617-821-4273.



Analog Devices, Inc., Three Technology Way, P.O. Box 9106, Norwood, MA 02062-9106. Distribution, offices and application support available worldwide.

EDITED BY FRAN GRANVILLE

Cache and clock doubling boost i960 μ P performance 2x

Intel has borrowed two speedup techniques from its immensely successful 386/486 μ P family—clock doubling and on-chip cache—to more than double the performance of the company's third-generation i960 RISC μ Ps. Code-named the "Cobra" series and officially designated the "J" series, the new i960 μ P family members retain pin-for-pin and code compatibility with earlier members of the family and provide substantially faster execution than the earlier units.

The Cobra series comprises the 80L960JA, 80L960JF, 80960JF, and 80960JD. Each μ P is available in two or more speeds. The first two μ Ps, with the "L" designation in the part number, are 33-MHz, 3.3V processors. The 3.3V processors use 60% less power than the i960's "K" series processors. All processors in the "J" series have a low-power power-down mode and employ active power management, which switches off unused processor blocks on an instruction-by-instruction basis.

The 80L960JA has a 2-kbyte instruc-

tion cache and a 1-kbyte data cache, and the other three J-series processors have 4-kbyte instruction caches and 2-kbyte data caches. The midrange family member, the 80960JF, runs on 5V at 40 MHz, and the fastest of the Cobra series, the 80960JD, employs clock doubling to run at 50 MHz, while its external bus runs at 25 MHz. In addition, the Cobra i960 series employs a modular core that lends itself to custom versions. Intel will consider making custom parts based on the i960 core for key large-volume customers.

At the same time, Intel is introducing a 2-pass profiling compiler said to increase processor performance by an average of 25 to 30%. In the first pass, the profiling compiler puts timers and probes into code to identify the code segments that are consuming the most execution time. During the second pass, the compiler uses the first-pass

timing information to optimize key code segments through optimization techniques such as code unrolling. Some early users of this approach have realized speed improvements of as much as 300%.

Samples of the 80960JF and 80L960JA will be available in September. Samples of the 80960JD will be available in December. Production volumes of all J-series μ Ps will be available in 1995. Prices are as follows: 80L960JA16: \$16.60, 80960JF16: \$24.90, 80L960JF16: \$27.40, 80960JD32: \$29.45.—by Steven H Leibson

Intel Corp, Chandler, AZ, (800) 628-8686.

Circle No. 471

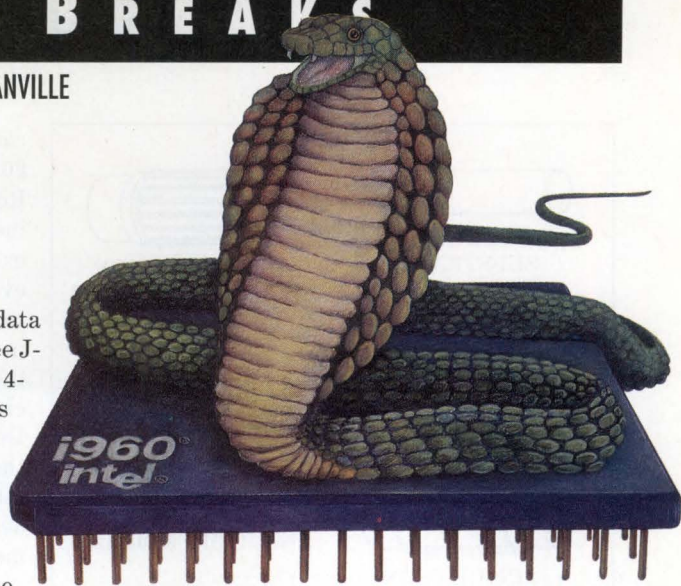

Experimental micromotor measures 1.4×15 mm

Matsushita Research Institute Tokyo Inc has successfully fabricated an experimental, electrostatic wobble motor using a concentric "buildup," or additive, process that more closely resembles pc-board or IC manufacturing than conventional motor assembly. Researchers elsewhere have developed wobble motors using silicon micromachining or conventional machining. Matsushita's experimental fabrication process creates a wobble motor whose size falls somewhere between motors built from these other processes. The completed micromotor is 15 mm long and 1.4 mm in diameter. It operates from 350V pulses and rotates as fast as 140 rpm with an applied excitation of 14k pulses/sec.

The fabrication process for the prototype motor starts with a machined

ceramic rotor shaft (a). The hollow shaft has an outer diameter of 1 mm, an inner diameter of 0.12 mm, and is 15 mm long. RF magnetron sputtering adds a rotor electrode to the shaft (b). During sputtering, machinery in the sputtering chamber rotates the motor shaft to achieve a uniform electrode layer around the rotor shaft's circumference. In a similar manner, RF magnetron sputtering then adds a 0.004-mm SiTiO_3 insulating layer to electrically separate the motor's stator and rotor electrodes during the motor's operation (c).

Adding a polyimide sacrificial layer, the next step, (d), is the key to eliminating mechanical assembly steps. The dip-coated sacrificial layer provides a mechanical spacer that separates the motor's rotor and stator during manufacturing. Later, one of the final assembly steps dissolves the sacrificial layer leaving a 2-piece motor assembly. Researchers at Matsushita admit that achieving uniformity with the dip-coat-

ing process is tough and state that this manufacturing step requires more development.

A second dip-coating step then adds a layer of photoresist polymer to the rotor assembly. Special rotating imaging equipment patterns the ground and stator electrodes onto the photoresist, and conventional etching leaves patterns behind for the electrodes. Electroless plating forms the 1- μ m-thick stator electrodes in depressions left in the photoresist layer after etching (e). The prototype motor has 16 stator poles.

After plating, the remaining photoresist is dissolved, and conventional wire bonding adds drive wires to each stator electrode (f). Then a resin coating fills in between the electrodes and a second coating, using a different resin, encompasses the overall stator. Finally, an ultrasonically assisted etching step completes the motor fabrication by dissolving the sacrificial layer and leaving behind an 11- μ m gap be-

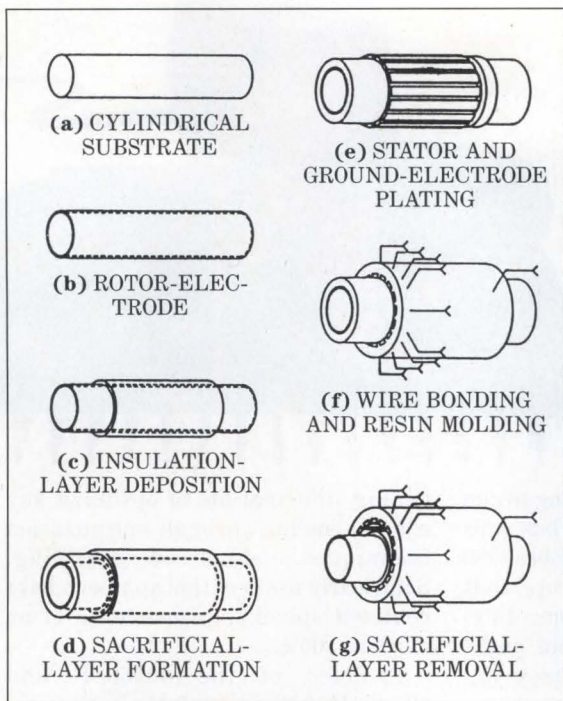

Steps in the wobble motor's fabrication

tween the motor's rotor and stator (g). Although calculations predicted that the motor would rotate at 160 rpm with an excitation of 2k pulses/sec, the fabri-

cated motor achieves only 30 rpm at that pulse rate. Rotation rate does seem to increase linearly with the excitation pulse rate, however. Researchers conjecture that residual stresses in the stator resin deformed the stator after the sacrificial layer was removed. Deformation would degrade the accuracy of the rotor-stator gap and could account for the drop in mechanical efficiency.

(Research on this wobble motor was performed under the management of Japan's Micromachine Center as part of the Research and Development of Micromachine Technology project supported by NEDO, the New Energy and Industrial Technology Development Organization.)

—by Steven H Leibson

Matsushita Electric Industrial Co, Tokyo, Japan, 81-3-3459-9736.

Circle No. 472

ATM ICs proliferate at telecomm trade shows

Components and products for asynchronous-transfer-mode (ATM) data links were a major component of two recent communications trade shows, SuperComm '94 (New Orleans) and Network/Interop '94 (Las Vegas). The product announcements at these shows included a number of second-generation ATM ICs that reflect recent additions to the ATM specifications. Devices from AT&T Microelectronics, Fujitsu, LSI Logic, and PMC-Sierra head the list of new devices.

AT&T Microelectronics introduced its T7652 ATM Layer Interface (ALI) chip at Network/Interop. The \$35 (10,000) device handles ATM-layer functions, such as policing and virtual-channel translation for broadband switching equipment. Working with AT&T's T7650 self-routing switch, the ALI chip allows creation of ATM switches and hubs capable of handling 1000 virtual channels at sustained rates of 320 Mbps.

Fujitsu introduced its second-genera-

tion ATM chip set for network-interface cards. The set comprises the MB86680 switch-routing element (\$86), the MB86686 adaptation-layer controller (\$105), the MB86683 network-termination controller (\$60), and the MB86689 address-translation controller (\$47). The devices are pin-compatible with their first-generation counterparts but include enhancements reflecting additions to the ATM specifications. The enhancements include circuits to manage flow control, network congestion, and traffic-statistics gathering.

LSI Logic introduced the ATMizer-LX and -BX, both standard products based on the company's programmable ATM ASIC cores. The devices employ a RISC processor to handle segmentation-and-reassembly (SAR) and ATM-layer operations at data rates to 155 Mbps. The LX series (\$79 to \$129) devices serve the needs of network-interface cards for a variety of computer buses. The BX series (\$175) devices are intended for backbone hub and router applications.

PMC-Sierra announced its STEL/AR chip set for broadband-transmission interfaces and switching subsystems.

The devices work with PMC's earlier SUNI ATM physical-layer products and are aimed at Synchronous Optical Network (SONET) and STS-3/12 broadband line cards. Prices range from \$121 to \$336 (5000).

In addition to chip introductions, several manufacturers announced collaborative agreements to develop ICs for bringing ATM to desktop computers. Fujitsu is working with Olicom A/S (Denmark) and Cray Communications (UK) to develop ICs for ATM LANs and LAN-to-WAN (wide-area-network) links. LSI Logic will work with Integrated Telecom Technology (IgT) (Gaithersburg, MD) to combine the ATMizer with IgT's SONET framer in a single IC.—by Richard A Quinnell

AT&T Microelectronics, Allentown, PA, (800) 372-2447, Dept P21.

Circle No. 473

Fujitsu Microelectronics, San Jose, CA, (800) 642-7616.

Circle No. 474

LSI Logic, Milpitas, CA, (800) 451-2742.

Circle No. 475

PMC-Sierra, Burnaby, BC, Canada, (604) 668-7300.

Circle No. 476

Build 0.8- μ m gate arrays in a day

With its QYH500 family of laser-programmable gate arrays, Chip Express can provide packaged ASIC prototypes parts in one day. These laser-programmable devices combine the performance and density of traditional gate arrays with the fast turnaround of field-programmable gate arrays. The family offers 20,000 to 45,000 total gates, up to 300 programmable I/Os, 460-MHz toggle rates, and less-than-300-psec NAND gate delays. The fast turnaround results from the company's patented laser-based disconnect system and its QuICk place-and-route software. The software take inputs from industry-standard design tools and generates a cut list for a laser-based micromachine. With up to 10,000 bursts/sec, a 45,000-gate device that requires up to 15 million cuts takes approximately 2 hours to customize. The company ships packaged and tested units from the factory as quickly as one day after receipt of a customer's netlist.—by Anne Watson Swager

Chip Express, Santa Clara, CA, (408) 988-2445.

Circle No. 477

DESIGN COMPLEX PLDs WITHOUT LEAVING YOUR SYSTEM BEHIND

PLSyn is the most advanced desktop programmable logic synthesis system available. Part of the **Design Center** family of products, it offers device-independent logic synthesis fully integrated with a mixed-signal design environment.

DESIGN YOUR SYSTEM...

PLSyn lets you concentrate on your system, not on the PLDs. It is the only desktop system that allows you to design and simulate a system containing programmable logic, discrete digital, and analog parts all on the same schematic. You can describe your logic using a powerful synthesis language, logic symbols, or a combination of both. Programmable logic is automatically compiled and simulated with the rest of your system—even if it includes analog! You no longer need to piece together separate programmable logic, discrete logic, and analog simulations to be sure your system will work.

...THEN CHOOSE THE PARTS

When logic design is complete, PLSyn helps you find the best parts to use. You define your own goals for price, speed, and power consumption. PLSyn does the rest. It searches a library of over 4,000 devices, including the new large complex PLDs from AMD and others. PLSyn can even automatically partition your design into several different types of parts to meet your design goals. Whether you are new to programmable logic, or an experienced PLD user, the **Design Center's** PLSyn is your most productive programmable logic design system. Call today for more information!



SCHEMATIC CAPTURE



MIXED-SIGNAL SIMULATION

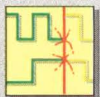

DIGITAL SIMULATION



ANALOG SIMULATION



SIGNAL INTEGRITY



PROGRAMMABLE LOGIC SYNTHESIS

Design Center and PSpice are registered trademarks of MicroSim Corporation. All other trademarks are the property of their respective owners.

• CIRCLE NO. 150 FOR IBM

• CIRCLE NO. 152 FOR SPARCSTATION



MicroSim Corporation

Providing the Best in Desktop EDA

20 FAIRBANKS • IRVINE, CA 92718 • USA
(714) 770-3022 • (800) 245-3022
FAX: (714) 455-0554 • BBS: (714) 830-1550

ICs emulate fader potentiometers

Using dual current-feedback input stages that drive a pair of multipliers, Linear Technology's LT1251 and LT1256 provide for easy gain adjustment of signals from dc to 40 MHz. A single 0 to 2.5V-dc input voltage linearly fades the output signal between the two inputs. Internal control circuits set the gain of the multipliers and keeps the gain constant with temperature. The patent-pending architecture results in gain-control accuracy that's typically $\pm 1\%$ and a maximum of $\pm 3\%$. The current-feedback architecture of the amplifiers results in a bandwidth of 40 MHz for gains from 1 to 10, and typical distortion of 0.001% when the gain is 100%. Other specifications include a low 2.5 mV of control feedthrough, 40 mA of output current, supply range of $\pm 2.5V$ to $\pm 15V$, and 13 mA of supply current. Differential gain and phase are 0.1% and 0.1°, respectively. The 1251 has circuitry optimizing it for fader applications; the LT1256 is optimized for gain control. A 14-pin DIP version costs \$5.76 (1000); SOICs, \$6.06.

—by Anne Watson Swager

Linear Technology Corp, Milpitas, CA, (408) 432-1900. **Circle No. 478**

IF ICs aim for flexibility

A line of general-purpose intermediate-frequency (IF) ICs from AT&T Microelectronics are flexible, programmable, integrated alternatives to discrete components for digital-cellular and other digital-communications systems. The 5V ICs comprise a 150- to 450-MHz quadrature modulator (the W2009), a 100-MHz programmable AGC amplifier (the W1466), and two quadrature demodulators (the 45- to 86-MHz W1452 and 10- to 86-MHz W1575) with integrated AGC. The AGC amplifier in the receiver products feature digitally controlled gain steps of 3 dB. With accurate programmable gain up to 69 dB and total gain over 75 dB, you can use the quadrature-demodulator circuits for both the base station and the terminal. Wide (8-MHz) I/Q bandwidths suit narrowband-voice or wideband requirements using QPSK,

GMSK, DQPSK, or QAM modulation. The ICs also feature a power-down capability. Prices range from \$2.50 to \$4.50.—by Anne Watson Swager

AT&T Microelectronics, Allentown, PA, (800) 372-2447. **Circle No. 479**

Isolated thermocouple-measurement system costs \$64/point

Looking much like the vendor's Daq-Book units that add data-acquisition capabilities to notebook PCs, the MultiScan/1200 makes isolated measurements on up to 744 type J, K, T, E, R, S, B, or N thermocouples at speeds as high as 147 channels/sec, with resolution as fine as 0.1°C, errors as low as $\pm 0.5^\circ\text{C}$, and a cost as small as \$64/point. The unit connects to both notebook and desktop PCs; it includes IEEE-488 and RS-232C/RS-422 interfaces. The base unit, which houses 24 channels, controls up to 15 daisy-chained expansion chassis, each accommodating two 24-channel, screw-terminal-input scanning boards.

The unit's 16-bit, 20k-sample/sec successive-approximation ADC is ohmically isolated from ground. Relays whose rated life is 10^8 operations connect the signals to the ADC. The inputs withstand 250V peak between channels and from any channel to the output or ground. You can choose scanning boards of two types: One accepts the listed thermocouples and ac and dc voltages from ± 100 mV to $\pm 10V$ full scale. The other accepts ac and dc voltages between ± 250 mV and 250V full scale. With either board, you can program gain individually on each channel.

There are three measurement modes. To reduce ac-line-related artifacts, the ADC spaces 32 readings over a line cycle. The unit can also integrate over 2, 4, 8, 16, or 32 line cycles. In the multichannel scanning mode, the ADC

can take single readings on each channel (up to 147 channels/sec) or can remain connected to individual channels long enough to acquire and average 2 to 32 readings. In the high-speed burst mode, the ADC acquires single-channel data as fast as 20k samples/sec. The unit performs $y=mx+b$ offset and gain scaling using separate coefficients for each channel. It can monitor inputs for alarm conditions. When it detects an out-of-limits input, it can report the alarm and increase its scanning rate. The unit, which includes a real-time clock, stores readings in 256 kbytes of RAM. You can expand the RAM to 8 Mbytes by plugging in SIMMs.

Two MS-Windows-based applications accompany the unit. One allows quick configuration of the operating parameters; the other permits a 32-

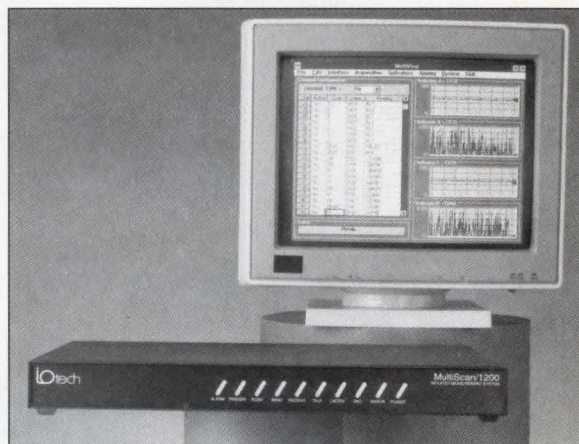

A 16.75×12×1.75-in. unit houses a 24-channel version of IOtech's MultiScan/1200 isolated thermocouple data-acquisition subsystem, complete with screw-terminal inputs and cold-junction compensation. Expansion chassis of the same size house 48 channels. Up to 15 of them daisy-chain to the main unit.

channel display. Drivers are also available for several third-party data-acquisition packages. The base unit costs \$1495. Both types of 24-channel scanning boards cost \$995 each. Expansion chassis also cost \$995 each. Thus, a 744-channel system costs \$64/point, a 24-channel system costs \$104/point, and additional points in any system that has an expansion chassis with an open slot cost \$41 each. Delivery is four to six weeks ARO.

—by Dan Strassberg

IOtech Inc, Cleveland, OH, (216) 439-4091. **Circle No. 480**

Honey *I shrunk the disk!*

Make *Flash* happen today with DiskOnChip™ !
Single chip Flash Disk is on the market now !

DiskOnChip™ is a miniature with a large capacity. It stores up to 16 MByte of data in a standard integrated circuit package.

DiskOnChip™ is easily integrated into your system. EUROM designed it to replace the BIOS and provide complete disk and BIOS functionality from the BIOS socket.

No software drivers or hardware changes are needed to incorporate EUROM's technology.

DiskOnChip™ frees a PCMCIA slot for essential communication cards.

- 100% DOS compatible and fully bootable
- Pin to pin compatible replacement for system BIOS chip
- Embedded Flash File System software
- Single chip solution for space and weight savings
- Single 5 volt supply
- Low power consumption
- Non-volatile storage

Call or fax:

EUROM
FlashWare
Solutions

● **Headquarters: EUROM FlashWare Solutions Ltd.**
Atidim Industrial Park Bldg. 1, P.O.B 58032, Tel Aviv 61580, Israel
Tel: +972-3-490 920 Fax: +972-3-490 922

● **USA Office: EUROM FlashWare Solutions Inc.**
4655 Old Ironsides Drive, Suite 200, Santa Clara, CA 95054
Tel: 408-748-9995 Fax: 408-748-8408

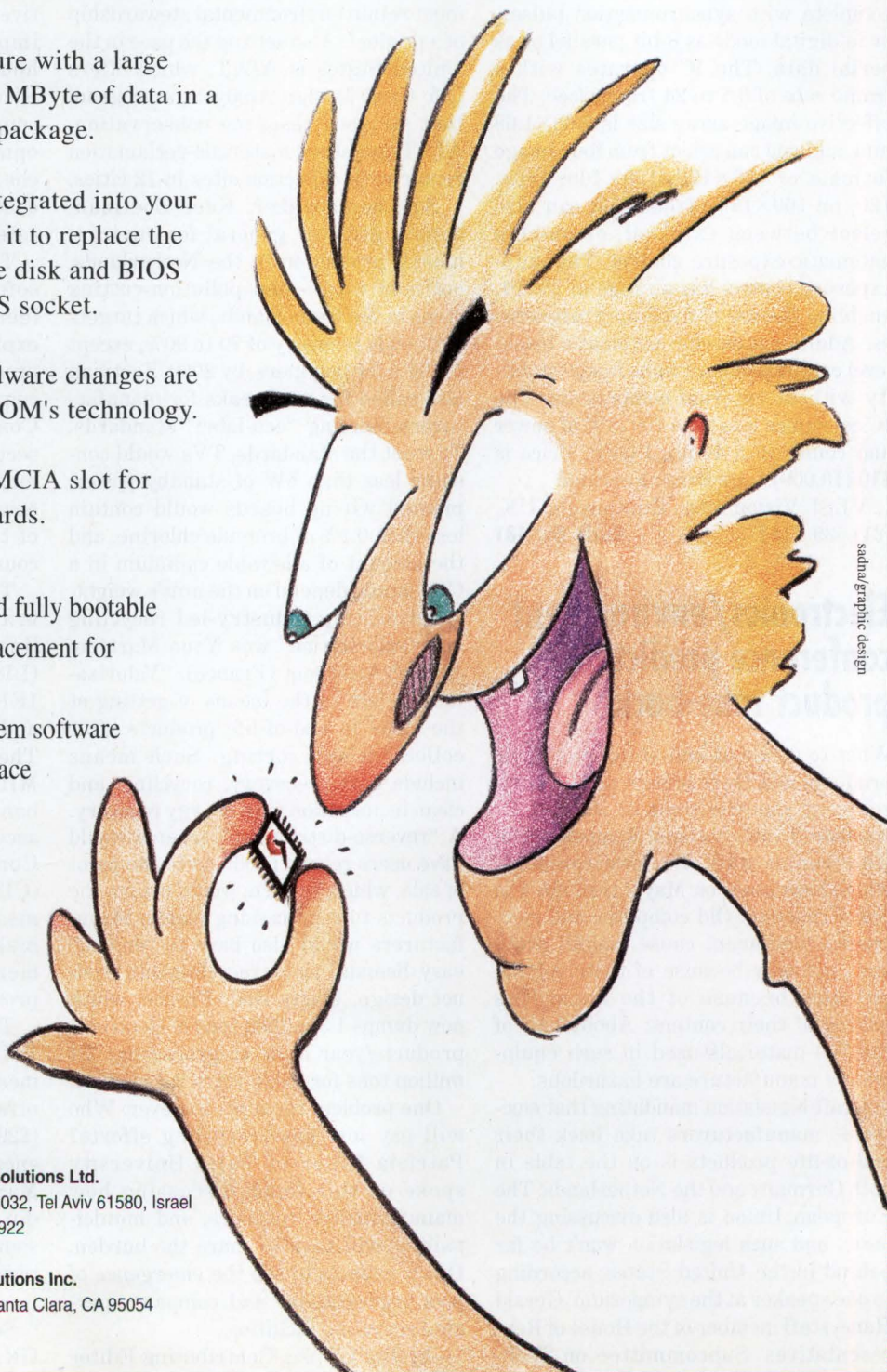

sadun/graphic design

Camera IC digitizes images on chip

The ASIS-1070 CMOS IC from VLSI Vision integrates a 160×160-pixel photodiode image-sensor array with enough active circuitry to produce an automatic-exposure camera. You can select video output in analog mode, complete with synchronization pulses, or in digital mode as 8-bit parallel or as serial data. The IC operates with a frame rate of 0.5 to 24 frames/sec. The effective image-array size is 1.68×1.68 mm, and you can select from four image formats of 120×120, 120×160, 160×120, or 160×160 pixels. You can also select between external, or on-chip automatic-exposure control. The auto-exposure control has a range of 2000:1, enabling the use of fixed-aperture lenses. Additional on-chip automatic black-level calibration maintains image stability without external components. The IC consumes less than 100 mW of power and comes in a 44-pin PQFP. Price is \$10 (10,000).—by Brian Kerridge

VLSI Vision Ltd, Edinburgh, UK.
(31) 539-7111. **Circle No. 481**

Electronics/environment conference predicts product take-back

What to do about end-of-life electronic products and their effects on the environment was the topic of the IEEE-sponsored International Symposium on Electronics and the Environment, which took place on May 2 through 4 in San Francisco. Old computer and electronics equipment cause landfill problems not only because of their volume but also because of the hazardous nature of their content: About half of the 700 materials used in such equipment's manufacture are hazardous.

Draft legislation mandating that electronic manufacturers take back their end-of-life products is on the table in both Germany and the Netherlands. The European Union is also discussing the issue, and such legislation won't be far behind in the United States, according to one speaker at the symposium, Gerald Hane, staff member of the House of Representatives' Subcommittee on Tech-

nology, Environment, and Aviation.

US computer manufacturers with plants in Europe, such as Digital Equipment Corp, Hewlett-Packard, IBM, and Xerox, are already planning for such laws. For example, Lutz Kaiser of IBM Deutschland, outlined IBM's ecological product strategy, including extensive product recycling and possible "function leasing," in which a manufacturer must retain environmental stewardship of a product. Also setting the pace in the United States is AT&T, which offers Life Cycle Design Analysis, a program that stresses resource conservation. AT&T operates a materials-reclamation center with collection sites in 12 cities.

Another speaker, Kees Zoetman, deputy director general for environmental protection in the Netherlands, outlined waste- and pollution-cutting steps in the Netherlands, which targets materials recovery of 70 to 90%, except for 30% for polymers, by 2000. Zoetman also called for tax breaks for manufacturers meeting "eco-label" standards. To meet the standards, TVs would consume less than 5W of standby power, printed wiring boards would contain less than 0.1% of bromide chlorine, and the amount of allowable cadmium in a CRT would depend on the unit's weight.

Advocating industry-led recycling and "valorization" was Yvon Marty of Alcatel-Alsthom (France). "Valorization" refers to the means of getting at the value in end-of-life products after collection and sorting. Such means include parts recovery, recycling, and clean incineration with energy recovery. A "reverse-distribution" scheme would have users return products to the point of sale, which, in turn, would return the products to reprocessing plants. Manufacturers would also have to "embed" easy dismantling for recycling into product design, Marty said. France, which now dumps 1.3 million tons of electronic products/year aims at processing 2.1 million tons for value retrieval by 2004.

One problem remains, however: Who will pay for these recycling efforts? Patricia Dillon of Tufts University spoke on this topic, discussing how manufacturers, retailers, and municipalities will have to share the burden. Dillon expects to see the emergence of pool organizations and company-operated recycling facilities.

—by Jim Lippke, Contributing Editor

Comprehensive test package anticipates EMC Directive

A combination of software and two test instruments helps you identify tests required by Europe's electromagnetic-compatibility (EMC) directive relative to your product and to perform important parts of those tests in-house. The package from Seaward Electronics allows you to perform pre-compliance tests during product development or before formal test-house checks. It also lets you "self-certify" compliance, depending upon product category.

The Expert Consultant MS Windows software (£495) part of the package identifies routes to compliance and explains standards appropriate to your product. The software also helps you to compile EMC test plans, or "Technical Construction Files." The diagnostic section of the software details test-and-measurement methods and explains how to interpret test results. A section of the software covers EMC-problem countermeasures.

The Sceptre test instrument (£1980) is a spectrum analyzer with a built-in line-impedance-stabilizing network (LISN). Sceptre links to a PC via an IEEE-488 bus interface for control and for display and analysis of data. The analyzer has a 150-kHz to 450-MHz input frequency, and has preset bandwidth and detection settings in accordance with International Special Committee on Radio Interference (CISPR) requirements. The analyzer measures conducted emissions and makes relative radiated measurements using antennae or near-field probes.

The EMC directive also specifies EMI-susceptibility requirements. To meet those requirements, the company offers the Mace test instrument (£2980), which simulates line interference and produces ESD to test EMI. Mace performs programmable voltage-dip testing to prEN50093, fast transient testing to IEC 801-4, and ESD testing to IEC 801-2.

—by Brian Kerridge

Seaward Electronics Ltd, Peterlee, UK. (91) 586-3511. **Circle No. 482**

HARRIS HYPERFAST DIODES: FASTEST RECOVERY ON TWO LEGS.

Nobody beats Harris diodes when it comes to recovery time. Our HYPERFAST diodes are twice as fast as ULTRAFAST. And all Harris diodes give you low forward voltage drop, low leakage, and exceptionally soft recovery, which can cut design costs. And they come in a full range of current ratings, single and dual configuration, with nine popular package types. It's enough to make Harris your one-stop source for diodes. Want to get the jump on your competition? Give us a call.

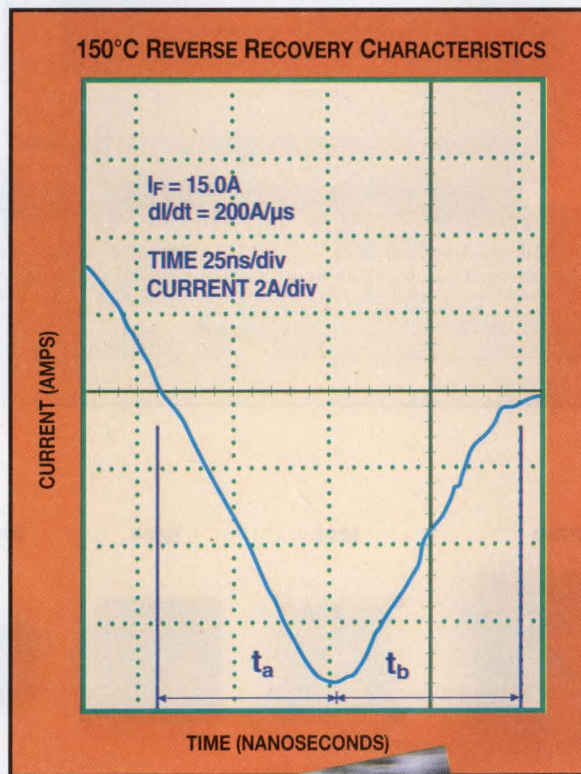

Features

- Low leakage
- Low forward voltage drop
- Blocking voltage: 100V-1200V
- Exceptionally soft recovery characteristics
- Dual configurations available
- Nine package types, including low profile

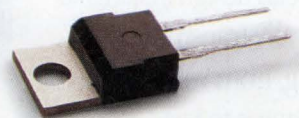

Fastest recovery. Softest landing.
HYPERFAST – the only way to fly.



Try our AnswerFAX service!

For a line card, call 407-724-3818 and request document #523268.
Or call 1-800-4-HARRIS, ext. 7228.



With today's technology, you can digitize just about anything.

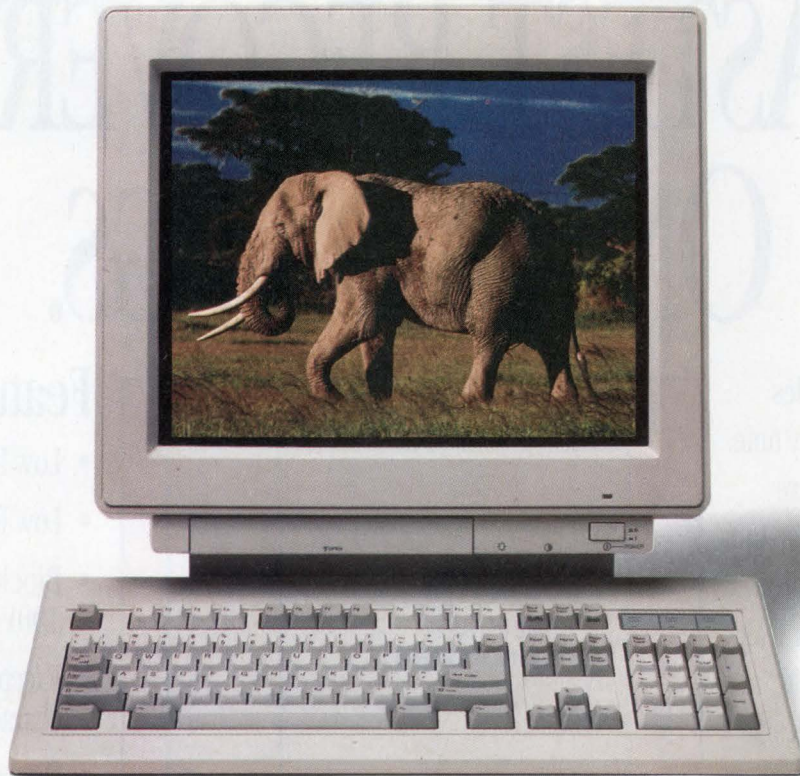

With Motorola's ISDN U-Interface Transceiver II you can design systems to digitally transmit anything, from voice to video to images to text.

That's no small feat.

But the big news is

value. Now in its second generation, the MC145572 U-Interface Transceiver II has been enhanced to do much more — for far less — than any other device of its kind.

Stands head and shoulders above the rest.

The MC145572 sets the industry standard for ISDN, with superior transmission performance, on-chip capabilities

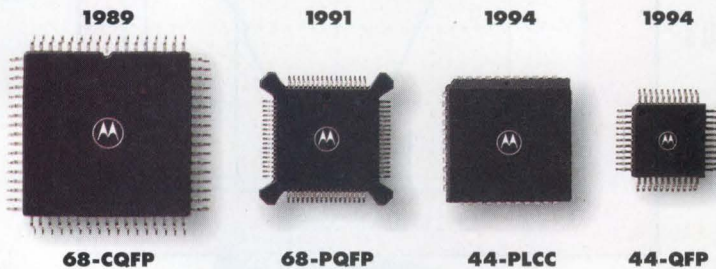

It gets better every time. Motorola's second-generation MC145572 U-Interface Transceiver II features a smaller die size, fewer pins, fewer external components, greater transmission performance, and more digital interface functionality than ever before.

like full maintenance operations, automatic embedded operations channel mode, six programmable timeslot assigners, serial or parallel control interfaces, and much more. All at a maximum power dissipation of 300 mW and 250 mW typical. All this in a 44-QFP or 44-PLCC package. It conforms fully to ANSI T1.601 and ETSI standards for ISDN U basic access interface transceivers.

Evolved from years of ISDN experience.

Motorola's commitment to ISDN U Transceiver technology

That's pretty neat, but with ISDN, we can send it over twisted pair.



goes back to 1989 when we introduced the MC145472. Based on this experience, we've developed the next generation of ISDN U Transceivers and we'll also be introducing the next generation S/T transceiver in the fourth quarter of 1994. Like the MC145572, the MC145574 S/T Interface Transceiver II is a low-power, small-package IC with unparalleled capabilities.

Want a closer look?

Just send in the coupon for a complete package of technical documentation on Motorola ISDN transceivers and information on how you can order an MC145572 evaluation kit.

639 EDN 060994

Show me more.
Send me the complete package of technical information on Motorola ISDN transceivers.

Name _____
Title _____
Company _____
Address _____
City _____ State _____ Zip _____
Phone _____ FAX _____

Copy and fax toll-free to 1-800-492-9384 or copy and mail to:
Motorola, 616 West 24th Street, Tempe, AZ 85282



Coming through loud and clear.



MOTOROLA

*MOS Digital-Analog Integrated
Circuits Division*

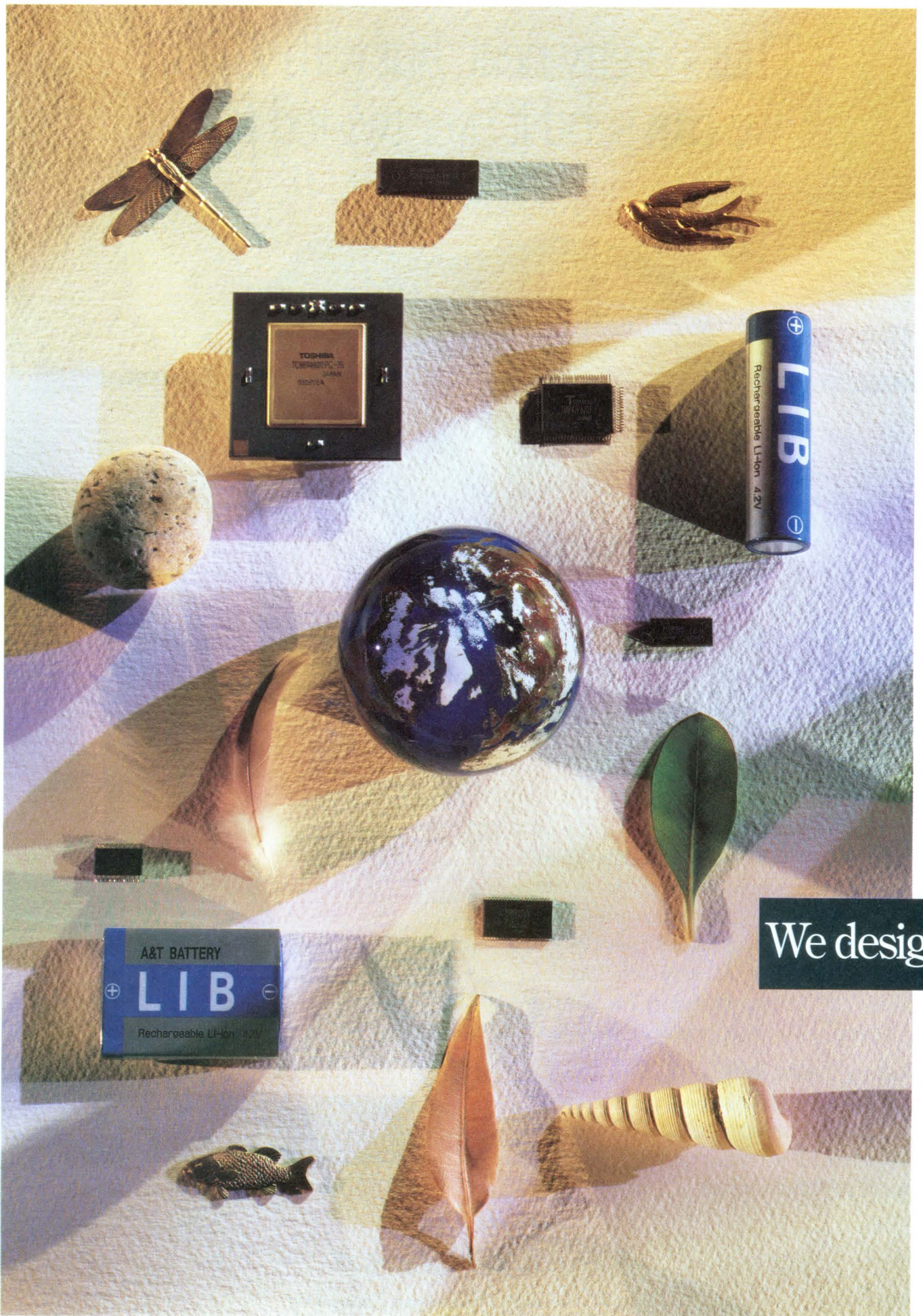

We design

At Toshiba, we believe that great power is best used sparingly.

That's what guides our approach to environmentally-friendly component design. And it's the reason our wide line of Green PC parts is helping ensure that worldwide energy demand doesn't become worldwide energy crisis.

Of course, we aren't alone.

System makers worldwide are routinely designing features like automatic power-

down, sleep modes, and low power displays into their new products — without affecting cost or performance.

It's a move that's expected to reduce desktop power consumption by 60%, while saving PC users over \$2 billion a year.

And a move that's made possible thanks to many of our low-power components.

Like Toshiba's 3.3 volt DRAM, for example, available in 4Mb, 1Mb x 16 and self-refresh versions.

monitor tubes, that save power while extending operating life.

A new, more power-efficient 3-watt LCD display, for brilliant VGA color in power-stingy notebooks and subnotebooks.

Microcontrollers that operate at just 2.7 volts.

Rechargeable Lithium Ion batteries, that deliver twice as much portable power — without dangerous heavy metals.

As well as 3.3 volt versions of 0.5 micron

ASICs, 20ns cache SRAMs, VHC logic and memory cards.

And a broad line of other energy-saving components.

That's our environmental impact statement. And more and more, it's the kind of responsible engineering that will be demanded in every electronic design.

At Toshiba, we're ready for that demand.

With over a century's worth of experience in cutting-edge R&D. An international network of service and support. And manufacturing experience that spans the globe.

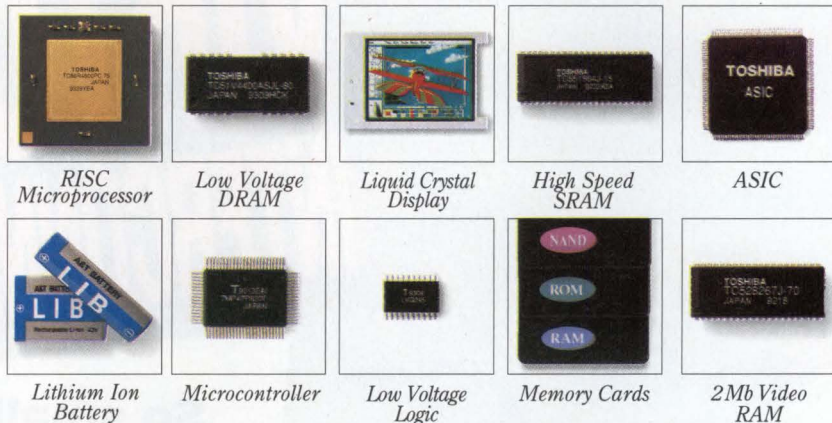

components for the most important system of all.

Our new 64-bit RISC microprocessor, based on 3.3 volt technology.

Low magnetic radiation, ozone-safe computer display

For more information on any of our low-power products, just call 1-800-879-4963.

And save your energy for something big.

In Touch with Tomorrow
TOSHIBA

TOSHIBA AMERICA ELECTRONIC COMPONENTS, INC.

Please call me, Circle No. 98 Send more information, Circle No. 99

LCD graphic created with Publisher's Paintbrush™ by Z-Soft Corporation.
©1994 Toshiba America Electronic Components, Inc.

GRP-93-109

SAMTEC VIRTUAL INTERCONNECTS

(actual size)

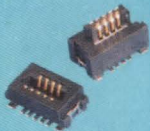

**So small
they're virtually
invisible.**

Samtec 1mm and .050" pitch surface mount and micro interconnects provide high-speed, low-impedance connections in minimal space. In fact, if you couldn't see them, you would hardly know they were there. Just the way interconnects should be.

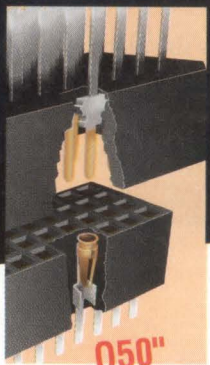

**.050"
FOUR ROW**

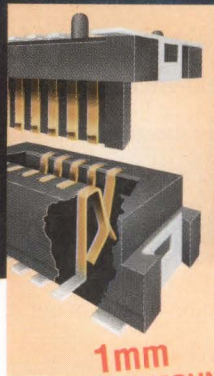

**1mm
SURFACE MOUNT**



**.050"
SURFACE MOUNT**

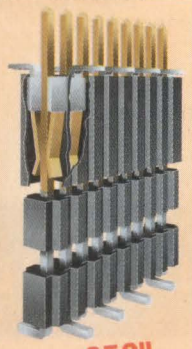

**.050"
SKYSCRAPER**



Get the big story on Samtec's Full-Line of small interconnects.
Call 1-800-SAMTEC-9



samtec

IS SUDDEN SOLUTIONS

New Albany, Indiana USA • Cumbernauld, Scotland UK • Singapore
SAMTEC, INC. • P.O. Box 1147 • New Albany, IN 47151-1147 USA • Phone 812-944-6733 • Fax 812-948-5047

Connecting physics, convergence, and EEs

I am not in a position to comment on "Step-by-step procedures help you solve Spice convergence problems" (EDN, March 3, 1994, pg 121), except that, in my experience, I've found convergence problems are often a warning that there may be a flaw in your approach to a problem.

Spice is a linearized program that frequently depends on the less stable of device parameters, which is something I (as physicist and electrical engineer) learned early on—but that engineers without a thorough physics background may not pick up. EEs must carefully classify parameters for elements of circuits or systems and must use an approach that avoids obvious pitfalls.

When Kirchhoff developed his laws he was aware that network properties must be developed in terms of both input and output parameters as well as two parameter types, which are now sometimes called across and through. Voltage, because it represents a difference (such as in height), can be called an across (or covariant) variable, whereas current, which is flow-variable, can be called a contravariant variable. Relations must be developed in these terms.

These ideas are key to what is called in physics "dimensional analysis," which is a subject electrical engineering typically neglects. When these principles are applied to the active devices used with Spice, it's immediately evident that the diode equation is of far greater importance than beta for bipolars or mu for triode tubes. When the linear simultaneous equations for a 2-port are rewritten in terms of the diode equations, a simpler and more meaningful

approach results—and it just may be free of many convergence problems. Keats A Pullen Jr
Kingsville, MD

Design needs warning label

The circuit in "Off-line power supply requires few parts" (Design Ideas, February 17, 1994, pg 55) provides no isolation from the ac line! It can seriously harm (or kill) unsuspecting users who may inadvertently bridge a number of points in the circuit (except ground) to the neutral of the ac line or any ground-point or surface.

This problem isn't new; it surfaces with surprising regularity. Because the circuit is low cost and unsophisticated, it's likely to be attractive to those with little knowledge of the hazards inherent in such a design. Similar circuits, using the reactance of a capacitor to drop the line voltage to low levels, are commonly used in low-cost battery-charging circuitry. They have the same isolation problems as the published circuit.

Safety agencies would only accept this type of circuitry if it were isolated from the user by high-reliability interlocks and the presence of barriers to prevent the user from coming into contact with any portion of the circuit. They consider all portions of such circuitry to be live.

Arthur E Michael, Editor
International Product Safety News
Middletown, CT

Senior Technical Editor Charles Small responds: This problem is common to any off-line switcher that is nonisolated, as most "cheapy" versions are. Note that *Design Ideas* are just ideas—not complete solutions that comply with UL, VDE, or CSA standards.

Just add a few resistors...and voilà

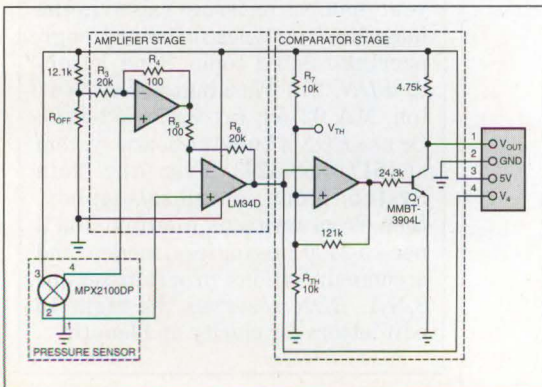

Fig 1 in "Simple pressure switches comprise transducers, comparators, and op amps" (EDN, April 14, 1994, pg 117) needs a few resistor names added. We neglected to label R_3 , R_4 , R_5 , R_6 , and R_7 in the schematic. Here is the correct version of Fig 1.

AVAILABLE IN DIE FORM

Dual Amplifier Doubles the Output *Not* the Cost



The Apex PA26 puts two 2.5A rated power amplifiers on a single die, in a single package. That saves valuable real estate. Priced at \$5.⁷⁵ in 100s or \$3.⁴⁵ in 10,000s, the PA26 is also extremely affordable. That's real value for the money.

Audio & Small Motor Applications

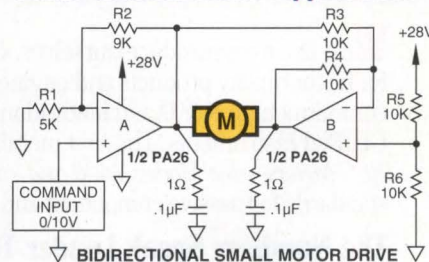

BIDIRECTIONAL SMALL MOTOR DRIVE

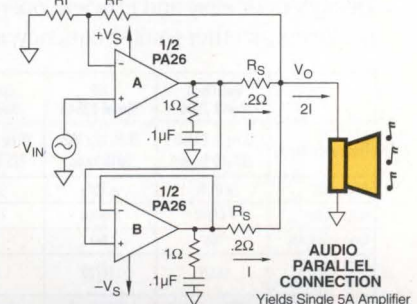

AUDIO PARALLEL CONNECTION
Yields Single 5A Amplifier

PRODUCT SPECIFICATIONS

Part #	V _{SS}	I _O	V _{CM} ¹	V _{SAT}	PKG	\$/100s
PA26	5V-40V	2.5A x 2	-V _S -3V	1.8V @ 1.0A	SIP ²	\$5.75
PA25	5V-40V	2.5A x 2	-V _S -3V	3V @ 2.5A	TO-3 ³	\$19.75
PA21	5V-40V	2.5A x 2	-V _S -3V	3V @ 2.5A	TO-3 ³	\$23.95
PA21M ³	5V-40V	2.0A x 2	-V _S -3V	3.5V @ 2A	TO-3 ³	\$65.90

¹ Common mode range includes negative supply

² The TO-3 is a hermetic package; the SIP is a non-hermetic package

³ "M" designates hi-rel military grade



APEX MICROTECHNOLOGY CORPORATION
5980 N. Shannon Road, Tucson, AZ 85741
For Product Information or Apps Assistance Call
1-800-862-1015 or FAX (602) 888-3329
Deutschsprachig 0130 81 3599

AUSTRALIA/N.Z. (08) 277 3288
BELGIUM/LUX (323) 458 3033
CANADA (613) 592 9540
DENMARK (45) 52 24 4888
DEUTSCHLAND (6172) 5113
ESPAÑA (1) 530 4121
FRANCE (1) 69 07 08 24
ISRAEL (3) 9345171
ITALIA (2) 6640 0153
INDIA (212) 339836
NEDERLAND (10) 451 9533
NORGE (2) 50 06 50
ÖSTERREICH 505 15 220
REP. S. AFRICA (021) 23 4943
SCHWEIZ (0049) (6172) 5113
SVERIGE (8) 795 9650
TURKIYE (1) 337 2245
U.K. (844) 278781

CIRCLE NO. 138 IN U.S.
CIRCLE NO. 139 IN EUROPE



Introducing The Next Generation of RLC Meters

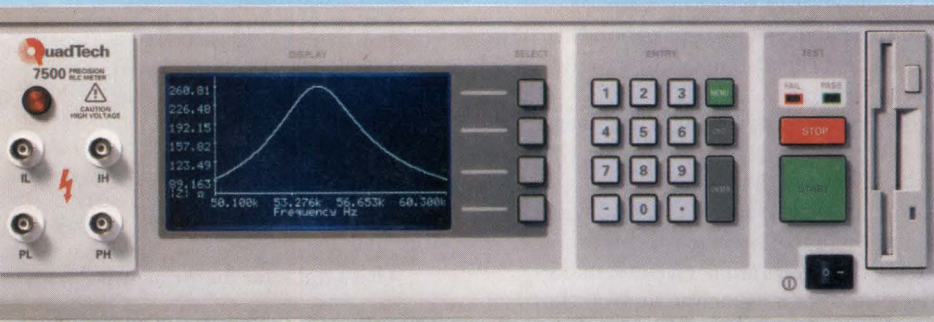

We'd like to reintroduce ourselves. Combine the reputation of General Radio for quality products and engineering excellence; with renewed commitment to R & D and innovation, the result—QuadTech, formerly GenRad Instruments. The first members of QuadTech's new family of RLC Meters—the Models 7400 and 7500—set new performance standards for passive component and materials testing.

The Numbers Speak Louder Than Words.

Designed for easy and efficient operation, the QuadTech 7500 outperforms all other multi-frequency, automatic RLC meters. Test component parameters in the 10 Hz to 2 MHz range with $\pm 0.01\%$ accuracy over a broad range of test conditions. Add an intuitive user interface, internal storage for 50 test setups, a swept parameter display (e.g., Q or ESR vs. frequency), a unique automatic accuracy function that elimi-

nates the need for complex calculations—and much more. You'll agree that QuadTech sets the standard by which all other RLC meters are measured.

And all QuadTech products are backed by our **45-day money-back guarantee** and **life-time warranty**. Call one of our Technical Sales Engineers today, at 1-800-722-1330 to discuss your testing requirements.



RLC BRIDGES MEGOHMMETERS MILLIOHMMETERS HIPOT DECADES & STANDARDS

CIRCLE NO. 136

Ghost theorist offers harmonics insight

"The right μP simplifies using induction motors to propel electric cars" (EDN, March 31, 1994, pg 48) reminds me of an encounter I had in the late 1960s with a research team that designed a 50-Hz, 3-kW power supply using solid-state devices.

Back then, because of a power shortage, the power-line frequency drift was so great in mainland China that a television signal could not withstand it and therefore needed a stabilized power supply for TV-broadcasting equipment.

The design was based on a theory (unfortunately I cannot recall its author) that when a frequency synthesizer generates a series of pulses, the output waveform resembles the following:

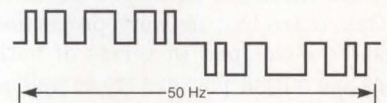

With proper timing, number of pulses, and correct width, the theorist claimed that the highest harmonic is the 7th. Comparing this idea with the article in EDN, the older method has the advantage of a definable harmonic, which may reduce the risk of EMI and cause less iron loss in the motor (the filtering isn't free), and results in a greatly simplified circuit (clock and counters). Obviously the method is appropriate in different power and frequency applications.

Robert Shiyang Gao
Vicon Industries Inc
Melville, NY

Call Toll Free
1-800-722-1330
TEL: 1-508-779-8300
FAX: 1-508-779-3222

Sound off

"Signals & Noise" lets you express your opinions on issues raised in the magazine's articles or on any engineering-related topic. Send letters to EDN, 275 Washington St, Newton, MA 02158; fax (617) 558-4470. Or use EDN's bulletin-board system at (617) 558-4241: From the Main System Menu, enter ss/soappbox, then W to write us a letter. You'll need a 2400-bps (or less) modem and a communications program set for 8,N,1. EDN reserves the right to edit letters for clarity and length.



SPARKS OF GENIUS.

Small wonders, you could call them. Abbott's SM family of surface mount DC to DC converters are the most reliable very high density power supplies available today. Guaranteed to operate without derating over the full-Mil temperature range from -55° to 100°C. And delivering up to 280 Watts at better than 50 Watts per cubic inch, in an industry standard footprint.

Rugged durability is just the beginning. Inside their tough exteriors is a constant frequency topology that minimizes ripple and makes filtering a breeze. The exclusive use of commercially available, fully derated components eliminates the risk of underperforming on specs —

or stretched out or missed deliveries. Plus full overvoltage and over temperature protection with (n + 1) paralleling for designing in redundancy and backup. Even a companion filter module and an input transient suppressor, to make your designs simpler and more compact.

For all this ingenuity, delivery is quite predictable. Get the whole family off-the-shelf. With 50, 100 or 200 Watt outputs. Single or dual output configuration. For inputs ranging from 28 to 270 VDC.

Talent recognizes genius, they say. In that case, call Abbott to try out the SM family. And prepare to be impressed.

MODEL	SM100S	SMH50	SM100D	SMF200	SM1275
SPEC	SM200S	SMH100	SM200D		
PRODUCT DESCRIPTION	SINGLE OUTPUT	HALF-SIZE SINGLE OUTPUT	DUAL OUTPUT	HALF-SIZED EMI FILTER	HALF-SIZED TRANSIENT SUPPRESSOR
PEAK POWER IN WATTS	100 / 280	50 / 100	100 / 200	375	300
INPUT VOLTAGE (VDC)	16-50 and 200-400				MIL-STD-1275A MIL-STD-704A
OUTPUT VOLTAGE (VDC)	2, 3, 3, 5, 5.2, 12, 15, 24, 28		±5, ±12, ±15	—	—

abbott
when reliability is imperative®

CIRCLE NO. 196

Welcome to
engineering in the '90s.

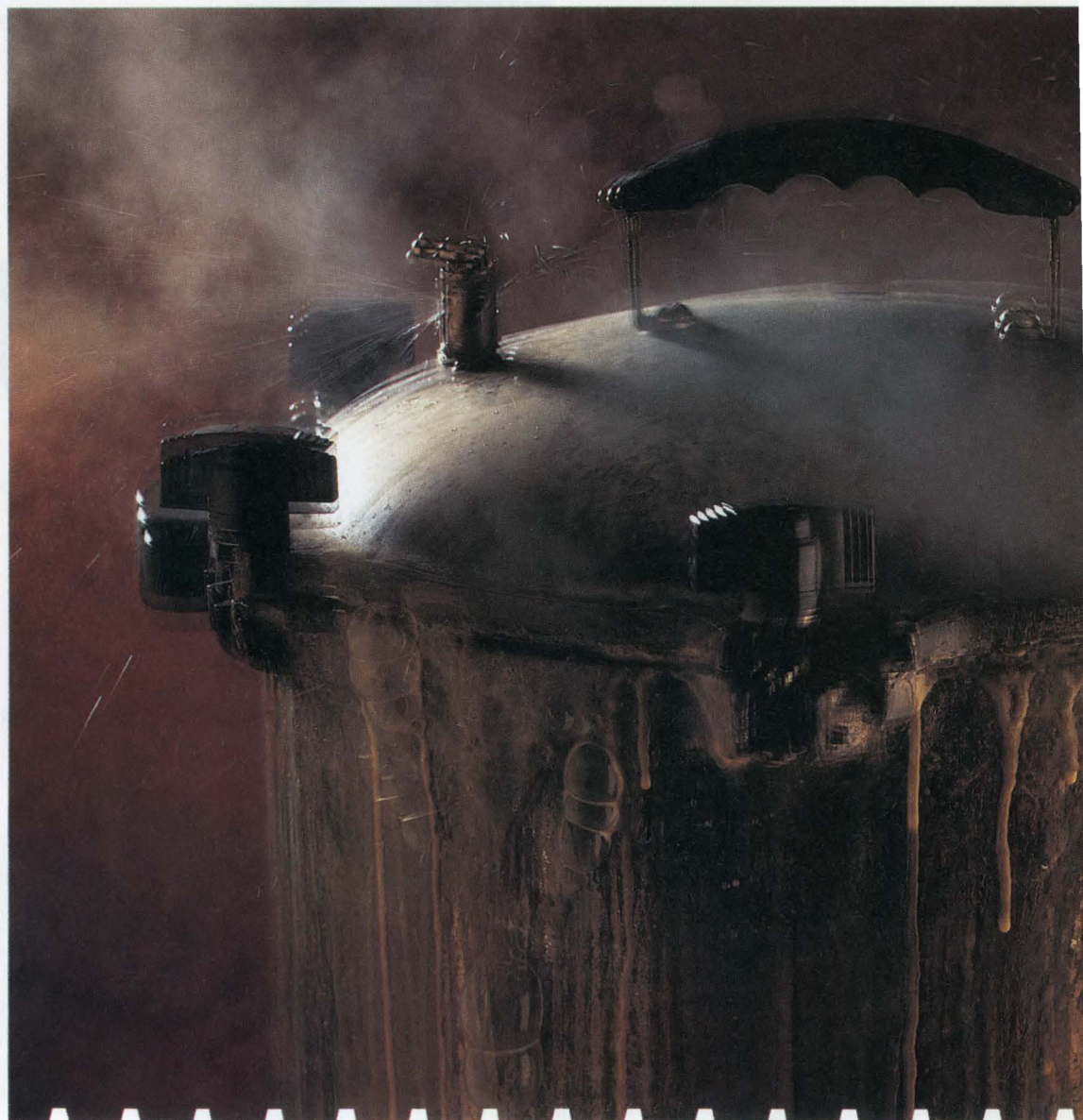

Everything needs to be done yesterday.

Only smaller and using less power. But with twice as many features. For the same money as last year's model.

And if it turns out other-

wise, you'll hear about it.

Look, we can't claim to alleviate all your problems, no one can.

But we'll tell you this. There's no one better to have in the stew with you

than Xilinx®.

First of all, no one is pushing the technology faster or farther.

As the leader, that's our job. And while it's not cheap, it is worth it.

Our product line now includes over 350 different versions—low power, high density, high speed, special packaging like TQFPs—you name it.

So you have more choices to work with. And our software is now so powerful, there's no corner of our parts you can't get to, work on, and make better.

Which, by the way, is exactly what we're constantly doing to our software.

Then there are our new EPLDs, with more speed, predictability, features, and just plain usability than EPLDs have ever offered.

Allowing you to integrate more devices, faster, and deliver a smaller, cleaner, more efficient design—for less money.

Finally, our FPGAs have never offered more density or more speed.

And nothing will get you to market faster.

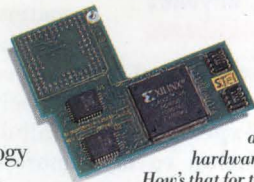

Stanford Telecom chose our XC4005 to build a custom signal processor and got operational hardware in less than 5 weeks. How's that for taking the pressure off?

Literally months faster than a conventional gate array. Nothing is more forgiving in the design process, either.

There's no penalty for changes, and you can program our parts at your desk, or even reprogram them in the system. All in less time than it takes to figure out why your supposedly non-recurring engineering costs keep recurring.

One more reason why the cost of going with us is a lot lower than you think.

Well, that about covers it. To learn more about how we can help you get a better handle on your next project, talk to your Xilinx representative, or call our 24-hour literature hotline at 800-231-3386.

Then you better get back to work before somebody blows a gasket.

 **XILINX®**
The Programmable
Logic Company.™

©1993 Xilinx, Inc., 2100 Logic Drive, San Jose, CA 95124. Europe, 44 (932) 349401; Japan, 81 (3) 297-9191; Asia, 852 (3) 721-0900.

Xilinx is a registered trademark, and The Programmable Logic Company is a service mark of Xilinx, Inc. All other trademarks or registered trademarks are the property of their respective holders.

Creative design advice, anyone?

I am bumping up against my level of ignorance, but I hope that you can offer some technical expertise to point out an easy solution to my problem.

I need to be able to continuously determine the position of an object moving past a given point at a variable speed. The positioning of the object must be accurate to approximately 250 places per inch; any solution must be capable of being installed in a device 0.5 mm thick.

A slow 4-/8-bit microcontroller can be used to store data and perform calculations; any solution must be low-cost, easy-to-make and install, and reliable. I hope you or your readers can help.

*Robert Daggar, President
Creative Associates Ltd
Reston, VA*

Senior Technical Editor Charles Small responds: Without more specific information about this application, a recommendation would be tough. Possible choices include laser, LED, ultrasonic, capacitive, mechanical, magnetic, and Hall-effect sensors (and perhaps even more types I don't even know of). To figure the best type of sensor for your application, you'd need to list the medium through which the measurement is to be made, the material that the sensed object is made from, the distance between the sensor and the sensed object, and the size of the spot that is available for measurement. The requirement that the fixture be <0.2 in. thick is rather puzzling. To help solve your dilemma, write back with specific information when it becomes available.

Open forum for design advice

I am conducting an in-depth analysis of an LTC1043 application (refer-

ence Linear Technology's 1990 Linear Databook—LT1057/1058 Data Sheet (pgs 2-243, example "Analog Divider")), as I'd like to incorporate it into a middle-range production plan (hundreds of devices per year). The problem is that the linearity error of such a circuit is quite high (approximately $\pm 0.6\%$ FS and more), whereas its specular version (LTC1043 Data Sheet (pgs 11-23, example "Analog Multiplier")) exhibits a satisfactory error of $< \pm 0.04\%$ FS worst case.

I unsuccessfully spent a lot of time trying to understand the reason for this. I've put a request in to Linear Tech for help, but before I give up on the idea of using such a divider, I'd also like to request the advice of EDN readers.

*Paolo Zambusi
R&D Management
Società Italiana Controlli
e Collaudi Srl
Selvazzana Dentro, Italia*

10,000 systems

to test.

Only two days

to do it.

**Use National's SCAN™
Bridge. Or cancel your
plans for the weekend.**

National's SCAN Bridge technology enhances the testability of computing and communications systems. So you can improve manufacturability, shorten time to market, and lower product costs. All within a normal work week. SCAN Bridge is the first system test device to deliver 1149.1 signals across the backplane. When used with test programs from major ATPG suppliers, our silicon supports complete, system-level testability. For information and samples, call 1-800-NAT-SEMI, Ext. 301. Then start improving your yields — without yielding to overtime.

IEEE
1149.1

**National
Semiconductor**

EDN BBS user scans for PCI-chip info

An EDN reader logged-on to our electronic BBS (bulletin-board system) to request contact information for PLX Technology, which makes PCI chip sets, as well as references for other companies that make PCI chip sets for interfacing general-purpose hardware—specifically a general-purpose PCI interface chip in which the interface acts as a master as well as slave device on PCI.

Senior Technical Editor Gary Legg responds: You can reach PLX Technology (Mountain View, CA) at (415) 960-0448. PLX has a chip that provides an interface between the PCI bus and an i960 processor. For a more general-purpose interface chip, try Applied Micro Circuits Corp (San Diego, CA) at (619) 450-9333. AMCC has been working on a chip that will serve as an interface

between the PCI bus and virtually any microprocessor; it will probably be available by the cover date of this issue.

Search for long-lost interface card

Years ago, my company purchased a μ ANALYST 2000 system from North West Instrument Systems Inc of Beaverton, OR. This system is a logic analyzer operating at 100-MHz timing and 10-MHz state. It comprises an electronics box having the usual connecting pods on one side and an interface to a PC for display and control on the other. The system initially worked well but was packed away for a while during a company move. We now wish to use the system again but find that the special interface card that fitted into a PC is missing. We are seeking a replacement

for the missing interface card but have been unsuccessful in locating North West Instruments; we suspect that the company has moved or has ceased operating. Maybe your readers could help locate either the company or the interface card.

*Roger A Munt
Senior Design Engineer
August Systems Ltd
Crawley, West Sussex, UK*

Fruitless search for title in France

In *EDN Hands On!* (March 3, 1994, pg 173), Charles Small reviewed a book entitled *Microcontroller Technology, Data Acquisition and Process Control with the M68HC11 Microcontroller* by Frederick Driscoll, Robert Coughlin, and Robert Villanucci. I have searched—without success—to locate this book, which

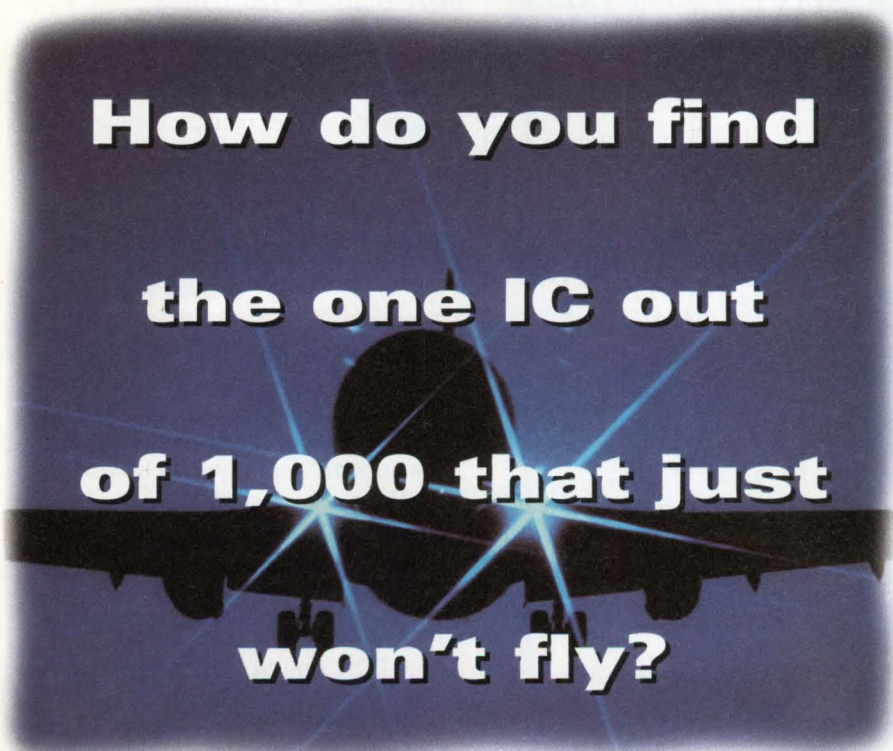

**How do you find
the one IC out
of 1,000 that just
won't fly?**

**Use National's
SCAN™ Bridge.
Or you're grounded.**

National's SCAN Bridge technology identifies faults and isolates them down to the component level. That can save you hours of costly down time, thousands of parts in inventory, and millions in expensive training and equipment. Your efficiency will soar with our growing portfolio of IEEE-compliant boundary scan devices that — along with test programs from major ATPG suppliers — support complete, system-level testability. For information and samples, call 1-800-NAT-SEMI, Ext. 301. Before you take off on your next design.



**National
Semiconductor**

SCAN is a trademark of National Semiconductor. ©1994 National Semiconductor Corporation. NORTH AMERICA: P.O. Box 7643, Mt. Prospect, IL 60056-7643 (Tel: 1-800-628-7364, ext. 301, Fax: 1-800-888-5113) All rights reserved.

New PEEL'N SHIELD™ EMI gaskets lower installed cost!

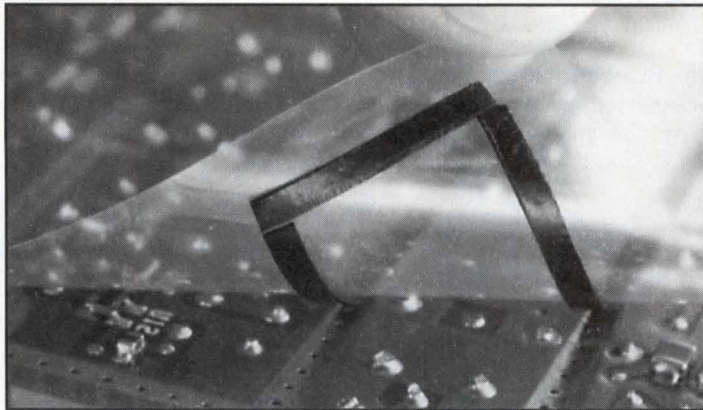

W.L. Gore & Associates, Inc.'s new PEEL'N SHIELD gasket assemblies (patent pending) significantly reduce your installed costs while providing excellent EMI/RFI shielding. PEEL'N SHIELD gaskets use removable release and carrier sheets for easy alignment and fast installation. These soft and pliable EMI gaskets, made of high performance GORE-SHIELD™ expanded PTFE material, offer 100dB shielding through 18 GHz. They lower installed cost on your PCBs (populated or unpopulated), castings, or covers and can be positioned to tight tolerances. Automated production also makes PEEL'N SHIELD EMI gaskets extremely cost effective for routine or unique applications. Call now for more information:



1-800-231-4364

W.L. Gore & Associates, Inc. P.O. Box 1220, Elkton, MD 21922
GORE-SHIELD and PEEL'N SHIELD are trademarks of W.L. Gore & Associates, Inc.

CIRCLE NO. 92

Piher's New Cermet Trimmers... From Our Shelf To Your Product

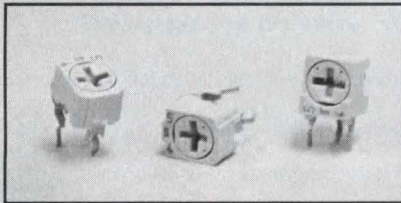

Piher's new highly compact cermet trimmers are ideal for applications where space is restricted and component size is critical; their nominal body size is only 1/4" in all

dimensions. And, they are available directly from stock.

You can order these trimmers in either horizontal or vertical adjustment in an ohmic range of 100Ω to 1MΩ, on tape for automatic insertion, or in bulk. Contact us if you would like to have samples, product literature or more information.

ISO 9001
Reg. 08/100/903773

PIHER

A MEGGITT ELECTRONICS Co.

903 Feehanville Drive
Mt. Prospect, IL 60056
Telephone: 708/390-6680
Toll-Free: 800/323-6693
Facsimile: 708/390-9866

CIRCLE NO. 137

Ask EDN

Macmillan Publishing Co publishes under the Merrill imprint. Any advice?

*Guy Lemoine, Technical Director
ELBO Electronique
Ste Elbo, Courmangoux, France*

Contact Macmillan's overseas distributor, which is located in the UK, and refer to ISBN 0-02-330555-X for the text and 0-02-330556-8 for the solution manual:

International Book Distributors
Campus 400, Maylands Ave
Hemel, Hempstead
Herts HP2 7EZ, UK
(44) 442-881900
fax (44) 442-882277.

Seeking CCITT documentation

I am writing a C program in MS-DOS to convert a text file to a CCITT T.4 fax format file to send a fax with a fax/data modem.

Where can I find a copy of the CCITT T.4 standard? Also, where can I buy the C routines to convert a text file to CCITT T.4 fax standard or TIFF Group 3 for fax?

*Keith Chow
Eliwell Spa
Pieve D'Alpago (BL), Italy*

For CCITT information, contact the ITU:

International Telecommunications Union (ITU)
Place des Nations
CH-1211 Geneva 20
Switzerland.

New or used will do

For some time now, I've been searching for a copy of *The PLL Synthesizer Cookbook* by Harold Kinley (Tab Books, Blue Ridge Summit, PA). Perhaps an EDN reader would be willing to sell me a used copy.

*Frank Lewon III
7614 Marion Ct
Saint Louis, MO 63143*

Ask EDN solves nagging design problems and provides the answers to difficult questions. Address your letters to Ask EDN, 275 Washington St, Newton, MA 02458; fax (617) 558-4470; MCI: EDNPRIME.

PACK & STACK

IBM COMPATIBLE INDUSTRIAL RACKMOUNT COMPUTERS

Choose From DTI's Selection Of PENTIUM™,
80486™, 80386™ or 80286 Single Board Computers.
Bus Architectures Available Include ISA, EISA & PCI Local Bus

With Diversified Technology's 19" Rackmountable Computers, you can custom configure a complete industrial system that is tailored for your application. "Pack" it with modules chosen from DTI's selection of passive backplanes, CPU cards, hard & floppy drives, as well as power supplies. Combine the "packed" rackmount with DTI's rackmountable components and "Stack" it to create a complete Industrial Computer Solution. DTI's selection of rackmount components includes: monitor enclosures, printer drawers, video/keyboard switches, keyboards w/drawer and various sizes of slides. Each DTI Rackmount Computer is UL & FCC Recognized and comes with a full one year warranty. Let DTI help you to "Pack & Stack" quickly and easily. Call for more information on DTI's rackmount family.

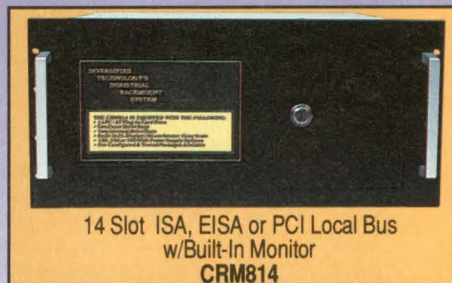
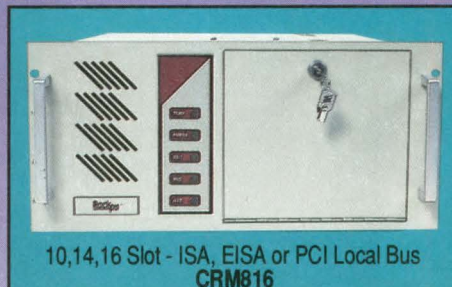
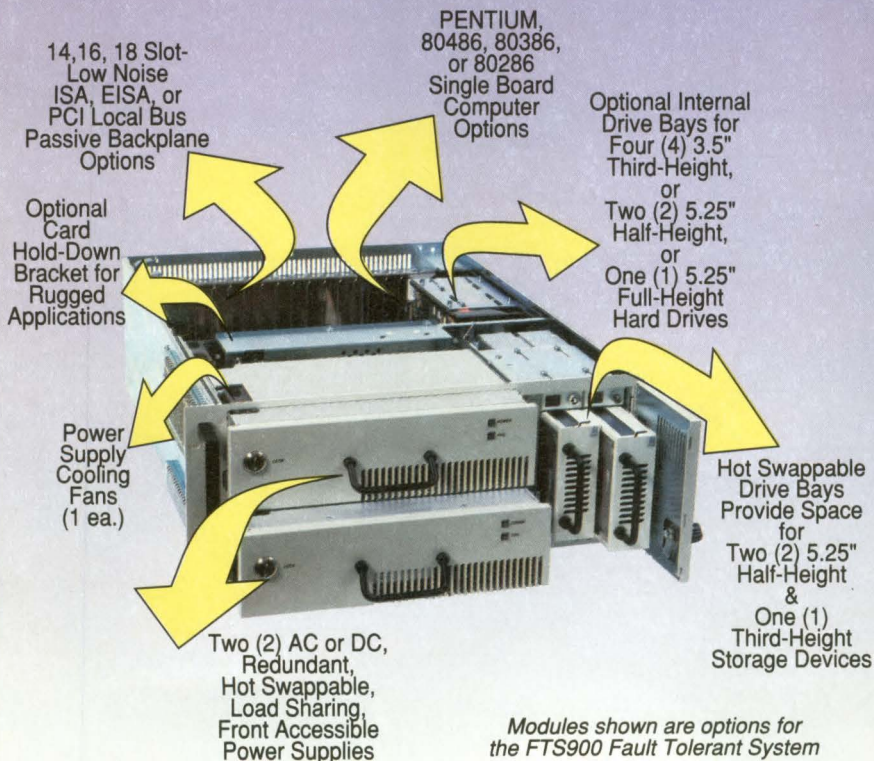

Call us toll free for orders and information

1-800-443-2667

U.S.A. - (601) 856-4121 Fax (601) 856-2888

Outside U.S.A. - (201) 891-8718/Fax (201) 891-9629

All products as noted throughout are trademarks of their respective holders.
The Intel Inside Logo is a trademark of Intel Corporation.

* also available in black

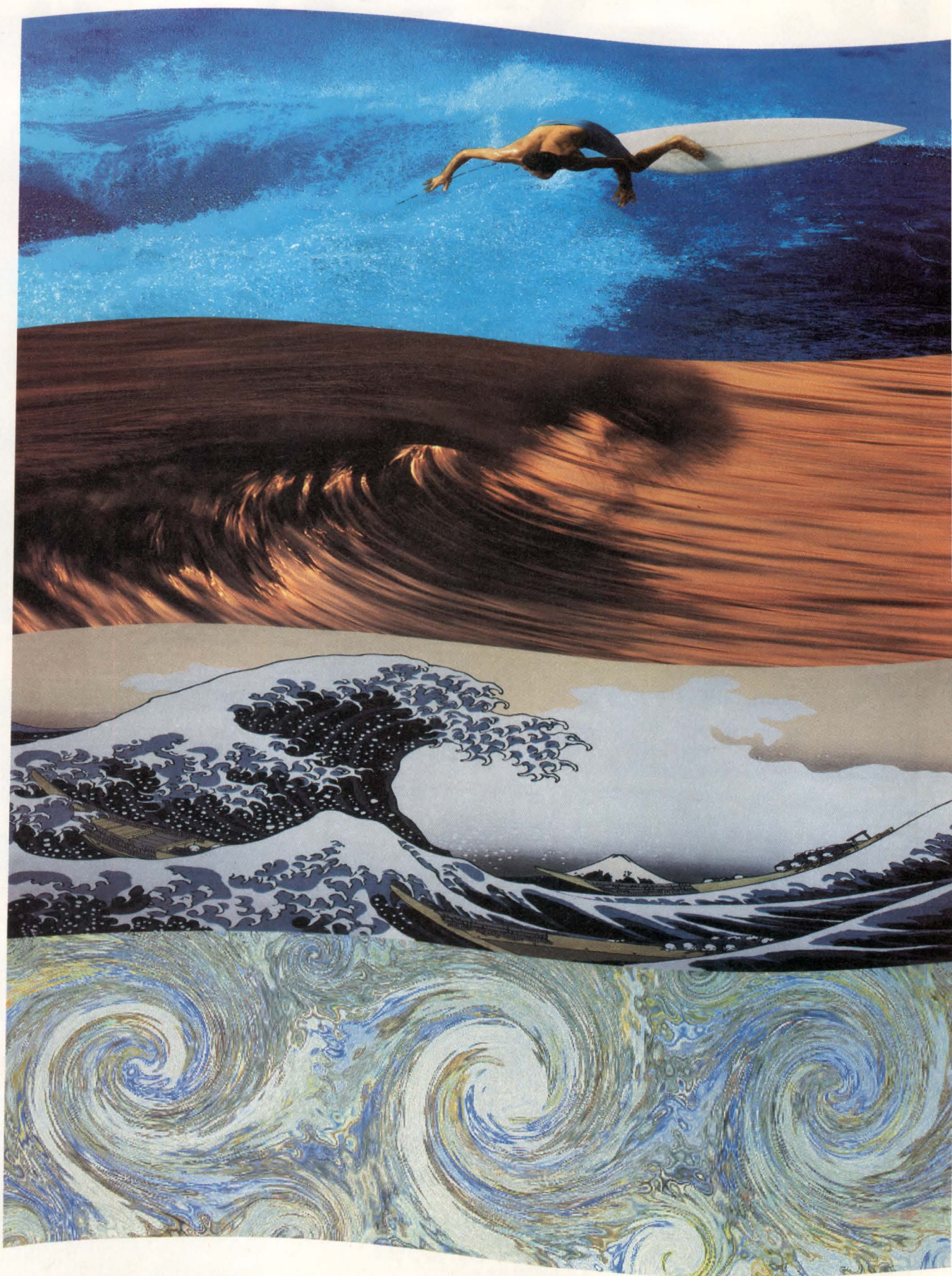

NOT THE SAME OLD WAVE

The LM3886T ~ Typical total harmonic distortion and noise (THD + N) of 0.03% from 20Hz to 20KHz at the rated output power of 60 Watts (continuous average) ~ Signal-to-noise ratio >95 dB (minimum) with a noise floor of 2.0 microvolts ~ Mute function eliminates transients at power-up and power-down ~ Thermal shutdown ~ Rugged enough to withstand overvoltages, undervoltages and current limiting conditions ~ Dynamic SOA provides the highest level of reliability ~ Call 1-800-NAT-SEMI, Ext. 295 for a free product sample kit and ordering information.



© 1994 National Semiconductor Corporation, NORTH AMERICA: P.O. Box 7643, Mt. Prospect, IL 60056-7643 (Tel: 1-800-628-7364, Ext. 295 Fax: 1-800-888-5113. All rights reserved.

THE WORLD'S

BEST SOUNDING
60
Watt
MONOLITHIC

AUDIO
AMP

FAST Track to *FAST* SCSI

90's Challenges. The 90's demand higher levels of performance and faster delivery than ever. Time-to-market, technological demands, and changing user needs make fast, simple SCSI seem as elusive as the horizon. To stay ahead in these challenging times, you need products you can count on, with proven ability to deliver the quality and reliability your customers require.

90's Products. After over a decade of industry leadership, NCR is still working hard to meet your needs and the challenges of the 90's. The NCR 53C90 family of SCSI Controllers is constantly evolving, implementing and offering state-of-the-art products. For example, the NCR 53C90 family supports multiple bus architectures, advanced SCSI-2 commands, fast SCSI data transfers and provides our exclusive TolerANT[®] SCSI driver and receiver technology, for reliable data transfers in every SCSI system.

90's Solutions. The SCSI challenges of the 90's can't be solved with silicon alone. NCR quality and service provide you with the competitive edge that can make your industry leading designs a reality. Whether you require SCSI-1 or fast SCSI-2, in any system architecture, NCR has the product to meet your needs today. You can count on us to keep you on the fast track with the right technology, at the right price, at the right time for all your SCSI requirements.

The NCR 53C90 Family

*Proven Performance
for the 90's and
Beyond*

CIRCLE NO. 153



NCR SCSI: Real Products, Real Solutions, Real Fast!

SCSI	FAST SCSI*	
53C90A	53CF90A	<i>Single-bus architecture; SCSI sequences controlled by hardware state machine to minimize host intervention</i>
53C90B	53CF90B	<i>Adds pass-through parity for increased system reliability</i>
53C94	53CF94	<i>Adds split-bus architecture for more flexibility</i>
53C96	53CF96	<i>Adds support for differential transfers</i>

*NCR Fast SCSI devices transfer SCSI data at 10 MB/s synchronous or 7 MB/s asynchronous

*For more information about
NCR SCSI products
and a free poster,
call 1-800-334-5454.*



Technological proof of innocence: Part 2

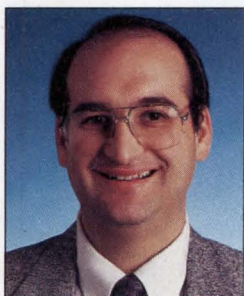

In my last editorial, I recounted an experience I'd had with an improperly issued parking ticket and suggested that bar-coded license plates and scanners might be a better way to track vehicles than handwritten paper tickets. This time, I want to finish this line of thought by recounting a story of an improper credit-card charge and making a case for smart cards.

I admit that I was unconvinced by the smart-card advocates until late last year. Then, I became a convert. I purchased some tires from a well-known retailer and charged them to my account. Two nearly equal charges appeared on my next credit-card bill. It took me two months to get this matter cleared up. The next month, the company billed me for interest on the unpaid fictitious charge. That charge took another month to clear up.

As with the undeserved parking ticket, it's almost impossible to prove you didn't charge something. You must force the credit provider to admit that it cannot produce a duly-authorized charge receipt. However, if this retailer used smart cards, it would be a simple matter to drop by the local retail store and pop my card into a reader to prove that the purchase never took place. Better yet, I could pop the card into a home reader and transmit the necessary information (encrypted, of course) to the company's billing office by phone.

Only when I can keep secure, duplicate records can I be safe from billing errors of this sort. Credit cards with magnetic stripes simply cannot store enough information to serve this need. The ever-rising spiral of technological advancement doesn't always simplify my life. However, this time, it would have.

Steven H Leibson
Editor-in-Chief



Jesse H. Neal
Editorial Achievement Award
1990 Certificate, Best Editorial
1990 Certificate, Best Series
1987, 1981 (2), 1978 (2),
1977, 1976, 1975

American Society of
Business Press Editors Award
1991, 1990, 1988, 1983, 1981

*Note: This is the latest in a series of articles on C-Quad engineering. C-Quad (or C⁴) stands for the **convergence of computer, consumer, and communications technologies.***

Send me your comments via fax at (617) 558-4470, or on the EDN Bulletin Board System at (617) 558-4241, 300/1200/2400 8,N,1. From the Main System Menu, enter ss/soapbox and select W to write us a letter.



THE FACT THAT WE MAKE

500 DIFFERENT AMPLIFIERS

PROBABLY DOESN'T MEAN MUCH.

UNLESS, OF COURSE, YOU NEED EXACTLY

THE RIGHT AMPLIFIER AT EXACTLY

THE RIGHT PRICE TO MAKE

THE BIGGEST DESIGN OF YOUR CAREER

WORK EXACTLY THE WAY YOU WANT.

NOBODY DOES AMPLIFIERS LIKE ANALOG DEVICES

Your design specs are tight. Not to mention your cost target and time to market window. So

The dual OP295 is the industry's highest accuracy, lowest power true rail-to-rail amplifier for single-supply applications.



you call the company that not only has the industry's broadest line of high performance op amps, but also the absolute best part in every category. High speed, precision, low noise, instrumentation, single supply and low power. Drop-in solutions and robust designs. And all at competitive prices. Which sounds pretty good in these days of shrinking boards and shrinking budgets.

With a combination of high output current, excellent AC performance, and unlimited cap load drive, the low cost AD817 is ideal for demanding video applications.



The high speed, low power AD817 offers 50 MHz unity gain bandwidth, 350-V/ μ s slew rate and needs only 7.0mA supply current. The AD620 is the first

monolithic instrumentation amp that outperforms traditional discrete designs using three op amps and associated resistors, yet costs less. The OP295 single supply, dual op amp is the industry's highest accuracy, lowest power true rail-to-rail amp. The amazing AD8001 delivers 800 MHz bandwidth on only 50mW of power.

The AD620 high-accuracy instrumentation amplifier provides gain from 1 to 1,000 and replaces discrete designs with less overall error, board space and cost.



So you get performance and value. Plus our worldwide manufacturing capabilities, technical documentation, applications engineering support and problem solving. Put another way, exactly the right amplifier at exactly the right price so your design works exactly the way you want. Please call 1-800-ANALOGD (262-5643) for more information.



Analog. Digital. Solutions.

3pF SCSI Gives Your Bus a Lift

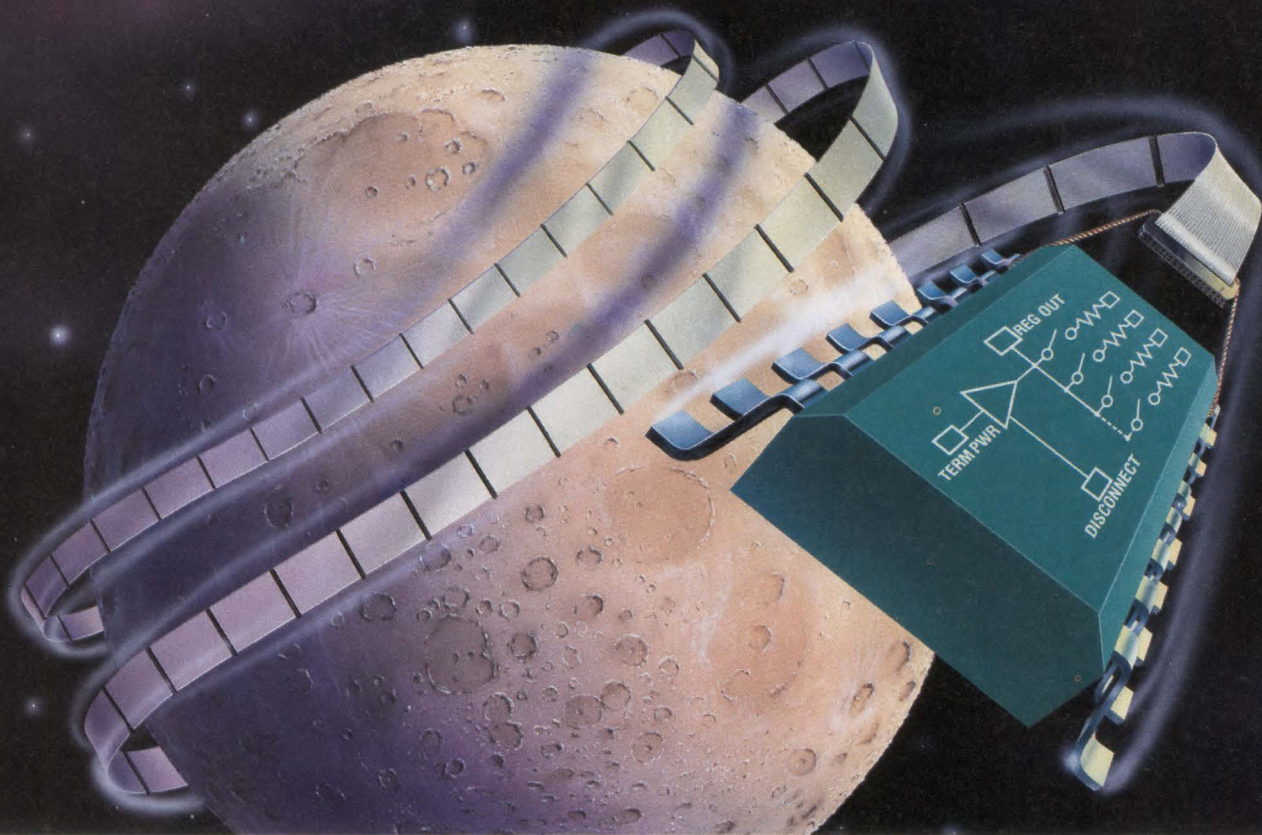

Lighten your bus and take your designs to a new level of speed with Unitrode's UC5613 nine line SCSI active terminator. With the lowest capacitance available today, your designs will have hotswap ability, and a high transfer rate. The UC5613 will launch your CD Rom and computer peripheral designs with confidence and greater speed.

Call, FAX, or write us today for free samples and application information.

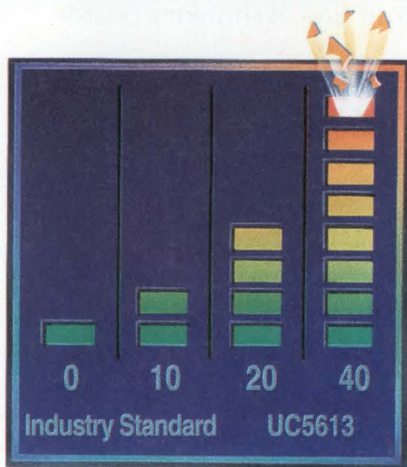

Megatransfer Rate

The UC5613 Advantages

- ◆ 3pF Channel capacitance during disconnect
- ◆ Meets SCSI hot plugging capability
- ◆ +400mA Sinking current for active negation
- ◆ Custom power packages are utilized to allow normal operation at full power (1.2 watts)
- ◆ 0.7V Dropout voltage regulator
- ◆ Logic command disconnects all termination lines
- ◆ 100µA Supply current in disconnect mode



TEL: (603) 429-8610

FAX: (603) 424-3460

7 Continental Boulevard, Merrimack, NH 03054

CIRCLE NO. 111

Ignore packaging effects at your peril

RICHARD A QUINNELL, Technical Editor



Your high-speed ASIC design looked great in simulation and matched all its test vectors. So why didn't it work when you plugged it in a board? Maybe you didn't account for packaging effects.

There are hundreds of package types available for housing your IC design. Even though system or budget constraints eliminate some options, you have plenty of opportunity to make package-related decisions throughout the IC design process. You may need that flexibility. At today's signal rates, the electrical behavior of the packaging can undermine an otherwise-sound IC design unless you make those decisions carefully.

A confluence of several factors is forcing designers for the first time to consider packaging effects. For one, system clock speeds are pushing past 100 MHz to meet the demands for more CPU power and greater networking data rates. Along with the increased clock speeds are coming faster edge rates, now dropping below 1 nsec.

Together, these two increases bring the spectral content of digital signals into the realm where the package's inductance and parasitic capacitance can create a significant noise problem. Lead inductance translates into ground bounce. Mutual inductance and lead-to-lead capacitance provide paths for coupling signals into adjacent lines. Further, the impedance changes that occur at bond-wire junctions, along the lead frame, and at pin posts cause reflections. The reflections are internal to the package; you cannot observe or accommodate them during system debug. You must design for them.

These noise sources degrade system performance because they add to the time for a signal to stabilize before being clocked by the next stage. With

ever-increasing clock frequencies, that additional delay combines with shrinking cycle times to reduce timing margins. Adding a few hundred picoseconds to those margins may make the difference between a manufacturable product and one that must be handcrafted to work.

Another factor forcing an interest in packaging effects is the reduced operating voltage toward which circuit design is migrating. Although logic thresholds have remained relatively constant with the lowered operating voltage, noise margins have been slashed. As a result, the formerly negligible effects of packaging have doubled in importance.

A third factor is the ongoing trend toward larger circuits, with larger packages. As processors move from 16- and 32-bit widths with multiplexed address and data toward 64-bit widths with separate address and data paths, I/O pin count has quadrupled. Hand in hand with the larger package styles

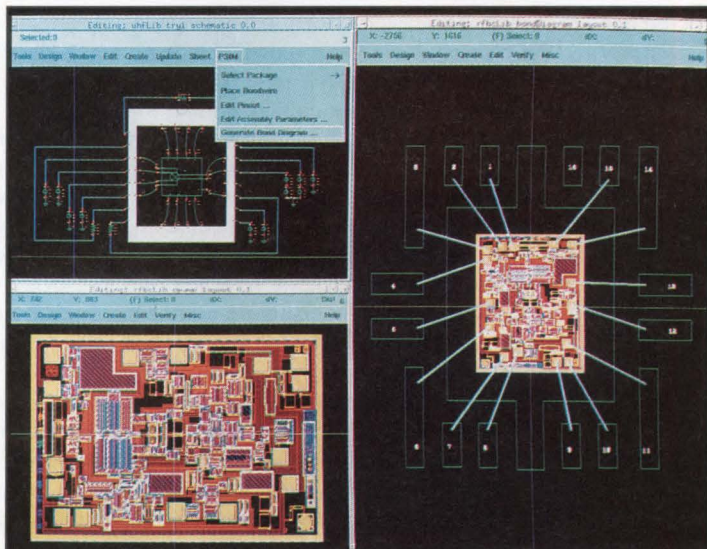

Design for packaging is not yet a standard part of CAD tools. Fortunately, vendors are developing the needed tools. The addition Harris Semiconductor is developing for its Fastrack CAD tool, for example, aids in package selection, assists in bond-wire placement, and automatically includes package Spice models in your simulations.

HIGH-PERFORMANCE PACKAGING

have come longer chip-to-pin leads and closer lead spacing. The longer leads add inductance and propagation delay. The tighter spacing increases the coupling between signal leads, increasing noise.

Many designers have run afoul of the most prominent packaging effect: ground bounce. In brief, ground bounce is the temporary shift in ground (and V_{cc}) an IC sees inside a package because of an L di/dt drop in the power lead caused when an output driver switches and draws a surge of current. That shift slows the effective rise time of the output signal by temporarily lowering the voltage swing the circuit can achieve. The shift also biases the outgoing signal relative to an IC with a stable ground, possibly causing false triggering.

Ground bounce posed a significant problem in standard logic 5 years ago (Ref 1), forcing the development of new designs for I/O-driver circuits (Refs 2 and 3) to reduce the effect. Still, the problem has not vanished; it has merely been partly contained. ASIC designers still must treat ground bounce as a serious threat to their circuits' operation.

You can take several steps to reduce

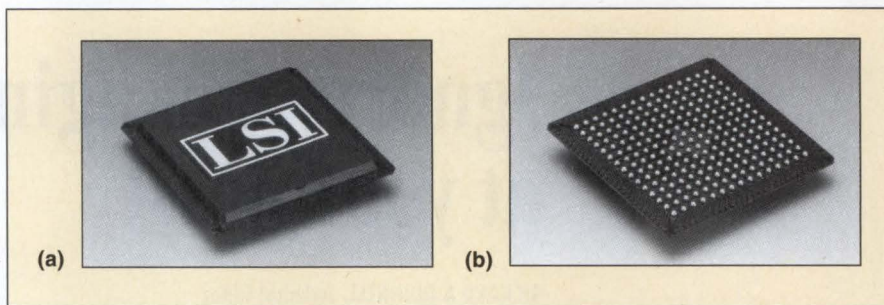

The plastic ball grid array brings traces from the IC to vias on the substrate's top surface (a), then back to a solder-ball grid on the bottom (b). The trace pattern is such that two adjacent I/O pads on the IC can connect to traces differing by 0.5 in. in length, a potential source of skew. (Photo courtesy LSI Logic)

ground bounce when you design with packaging in mind. The most obvious step is to select a small package. By using the smallest package into which your IC can fit, you eliminate unnecessary lead inductance. You can also choose a package type that offers low lead inductance. A survey of package offerings (Ref 4) shows that lead inductance for package types can range from less than 1 nH to 12 nH. If you're stuck with a package in the higher range, you can provide multiple power and ground pins to reduce the total lead inductance.

You also have design options within

the package. The method you use to attach the IC die to the lead frame affects the overall inductance that causes ground bounce. You can choose between a rim-connected IC and an array-connected IC. In an array-connected IC, the chip's I/O bond pads are scattered throughout the device. By bumping the pads and attaching the die to the lead frame in a flip-chip configuration, you minimize the inductance of the IC's metal-layer traces and can achieve short runs within the lead frame. A rim-attached device, with all I/O pads on the die's perimeter, is less costly, however, and may be a forced choice.

Even so, you have attachment choices. A bumped die with a rim-attached bonded lead frame, for example, produces a much lower inductance than does a traditional wire-bond attachment. If cost constrains you to use wire bonds anyway, you can reduce inductance on power and ground leads by using multiple bond wires in parallel from the lead frame to the die. To use this approach, though, you must remember to design-in extra bond pads on the die, even if the wires go to the same lead.

Don't think that, once you've addressed ground-bounce, you're done. Crosstalk, reflections, and skew are also becoming significant packaging effects in high-performance designs. Crosstalk, for example, increases with signal frequency. It stems from mutual inductance and parasitic lead-to-lead capacitance in the lead frame, both being aggravated by the trend toward larger packages and finer lead pitches.

Longer-lead packages also mean that

LOOKING AHEAD

The need to include packaging effects in IC design is only beginning to become widespread. As a result, few tools are available to automate the effort of including package effects in simulation. Awareness of packaging's importance is growing, however, and the CAD community is starting to respond.

One design-for-packaging tool under development comes from Harris Semiconductor. Faced with a need to account for packaging in its wireless communications-IC designs, Harris is modifying its Fastrack design software to incorporate packaging automatically. The enhancements provide designers with the characteristics of more than 400 packages. They allow quick initial estimates of packaging effects to facilitate package selection and to provide detailed models for final Spice simulations. The software carries the package characteristics throughout the design process, including preparation of bonding diagrams for final manufacture.

Another indication of packaging's growing importance is the creation of an IEEE Conference on Electrical Performance of Electronic Packaging. The conference, now in its third year, has grown tremendously in popularity, drawing both academic and industry experts in package design and circuit modeling. The 1994 conference will take place in Monterey, CA, November 2 to 4. Call (602) 621-3054 for information.

Although it will be painful for early adopters, accounting for package characteristics during design will slowly become a normal part of design. And, as with logic simulation, we'll come to wonder how we ever got anything to work without it.

SONY

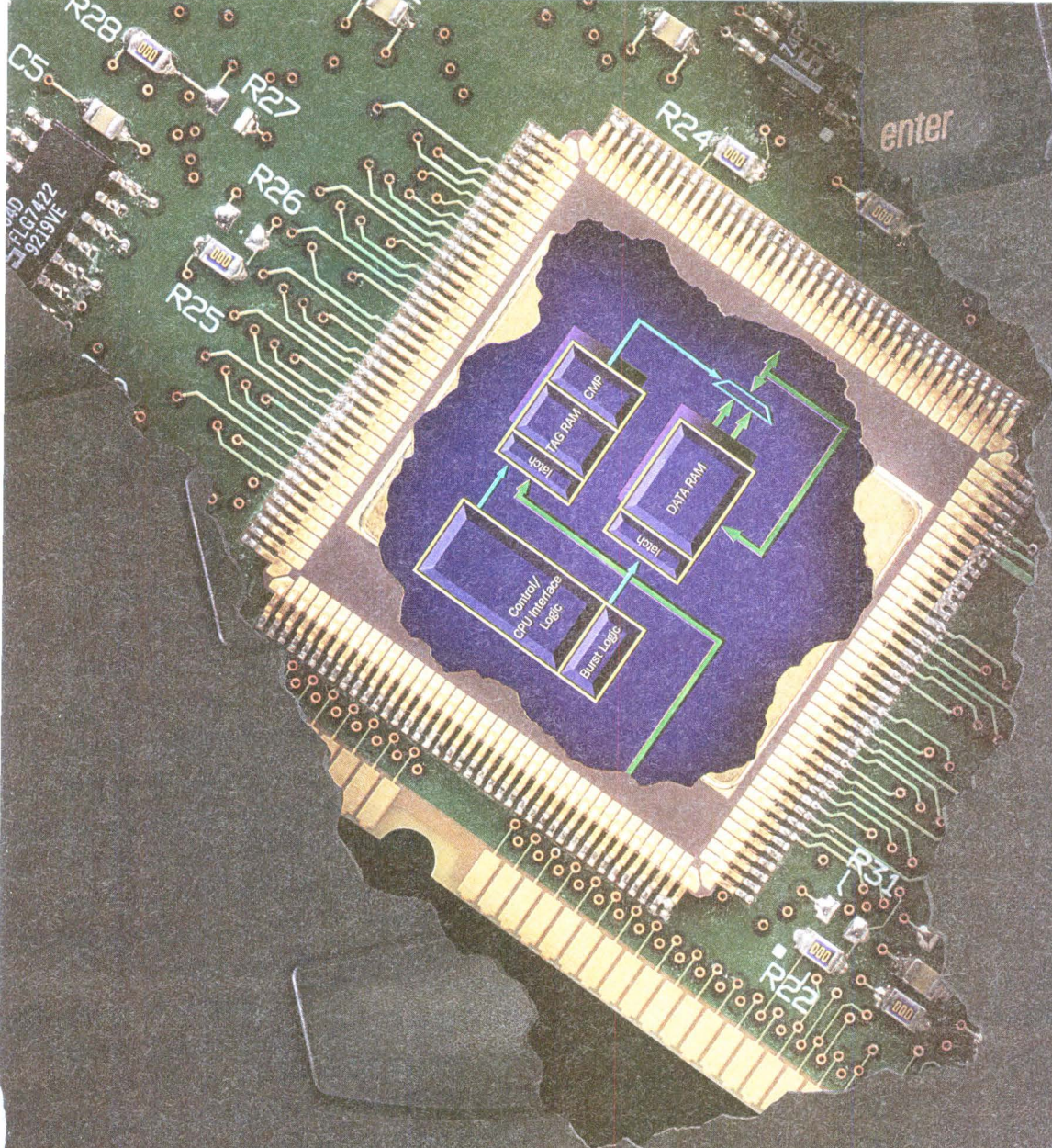

INTRODUCING THE GREAT SONY CACHE ADVANCE.

Now for the first time, high-speed data RAM, tag RAM and control logic — a complete, integrated cache subsystem — on a single chip.

Think of it as pure gold — cache-in-the-bank.

Sony Cache is based on our new Memory-intensive ASIC, or MASIC™ technology.

With it, we can quickly turn new cache chips for the latest processors and keep memory from becoming a system bottleneck.

The first two 256KB Sony Cache chips (CXK784862Q-33/50) are available now for 486SX/DX/DX2 processors and a wide variety of chip sets. They deliver unheard-of performance for mobile PCs, yet take only about one-quarter the power and space of the modules they replace.

Call 1-800-336-SONY for your cache advance.

Sony. We make the chips. You make the history.

© 1994 Sony Electronics Inc. Reproduction in whole or in part without written permission is prohibited. All rights reserved. Sony and MASIC are trademarks of Sony.

HIGH-PERFORMANCE PACKAGING

reflections, caused by impedance changes from lead frame to I/O pin, can return just as circuits with sub-nanosecond rise times are crossing the switching threshold. Further, the package elements can form an RLC circuit that can ring like a bell following a high-speed transition, increasing circuit settling time. A package choice that can reduce this problem is one that allows multiple lead-frame planes for creating transmission-line leads.

Lead length also affects the signal's propagation delay from die to board. Variations in path length through the lead frame can thus introduce skew that is invisible to pc-board-layout-based timing-simulation tools. That skew is not insignificant. A large pin-grid array, for example, can have as much as a 2-in. difference between its shortest and longest die-to-pin runs. With propagation speeds within the package running 6 to 8 in./nsec, that difference can result in a length-induced skew of more than 250 psec at each end of the signal run. With a cycle time of 10 nsec or less, that half-nanosecond may be fatal.

Design early for packaging

IC designers have traditionally ignored package-induced crosstalk, reflections, and skew effects, leaving



Packages exhibit vastly different electrical characteristics, so choose carefully. The pin-grid array, for instance, has wide pin-to-pin variations in on-chip delays. The QFP has more consistent lead lengths, but has a greater lead inductance. (Photo courtesy Logic Devices)

them to packaging engineers. Yet, to catch and declaw these success-killers, your best opportunities occur during circuit design and simulation—the earlier in your design cycle, the better.

For example, when creating the initial floor plan for an IC's layout, you would typically arrange circuit elements to minimize on-chip timing

delays. Your decisions, however, may place I/O signals where they might aggravate the package-induced delays. Remember, too, the effect that I/O assignments have on pc-board routing. If you don't pay attention, you could easily lose more in the packaging and board delays than you gain on the die.

You may also find that you're better off cutting your circuit in two. By placing critical signals in an IC with a small package and the rest of your design in the large package, you can reduce the packaging's impact on those critical signals. You may even be able to save money by replacing one high-cost package with two cheaper ones.

To determine the impact of all these packaging effects on your design, you need to know the package's electrical characteristics. Many package providers, unfortunately, give only typical values or upper limits for package inductance and capacitance. When ranges are available, they often refer equally to all package leads. Neither offering proves adequate for simulating critical signals. Ideally, your package supplier can provide lead inductance, capacitance, and die-to-board propagation-delay data for each pin or lead in the package. If the supplier doesn't have this information, however, you may have to char-

FOR FREE INFORMATION...

The following companies contributed their expertise in packaging technology to the creation of this article. For free information on their packaging capabilities, circle the appropriate numbers on the postage-paid Information Retrieval Service card or use EDN's Express Request service. When you contact any of the following manufacturers directly, please let them know you read about their products in EDN.

Harris Semiconductor
Melbourne, FL
(800) 442-7747
Circle No. 364

IBM Microelectronics
Hopewell Junction, NY
(914) 894-2121
Circle No. 365

Intel Corp
Chandler, AZ
(602) 554-8080
Circle No. 366

Logic Devices Inc
Sunnyvale, CA
(408) 737-3300
Circle No. 367

LSI Logic
Milpitas, CA
(408) 433-8000
Circle No. 368

Micro Linear
San Jose, CA
(408) 433-5200
Circle No. 369

Motorola Inc
Phoenix, AZ
(602) 952-3000
Circle No. 370

Quality Semiconductor
Santa Clara, CA
(408) 986-1700
Circle No. 371

Synergy Semiconductor
Santa Clara, CA
(408) 730-1313
Circle No. 372

VOTE . . .

Please also use the Information Retrieval Service card to rate this article (circle one):

High Interest 592
Medium Interest 593
Low Interest 594

Super Circle Number

For more information on the packaging capabilities of all of the vendors listed in this box, you need only circle one number on the postage-paid reader service card.

Circle No. 373

Reliable power— the whole idea behind our linears.



Condor's International Plus® linear power supplies offer price, performance and full agency approvals.



We have the combination you've been looking for—quality, reliability, value and complete agency approvals, including UL1950 without D3 deviation, IEC950 and VDE0871 Level B EMI. Condor has more approved linears in stock than anyone in the industry (including more than 30 models in IEC medical configuration). International Plus linears feature:

- 115 models (single- and multi-output)
- 7 power levels (3 to 288W)
- Worldwide AC input ranges
- OVP on all 5V outputs
- Hermetically sealed power transistors
- MTBF 200,000+ hrs. per Mil Hndbk 217E
- 2-hour burn-in with cycling (8 hours on

medical versions)

- Computerized testing (data sheets furnished)
- 3-year warranty—longest in the industry
- 30-day FREE evaluation (call for samples)

For world-class reliability and performance with great pricing and quick turnaround, call Condor—the leader in linear D.C. power supplies.

WORLD CLASS RELIABILITY
CONDOR

Condor D.C. Power Supplies, Inc. • 2311 Statham Parkway, Oxnard, CA 93033 • (805) 486-4565 • 1-800-235-5929 (outside CA)
FAX (805) 487-8911 • Send for our catalog, or see us in EEM.

CIRCLE NO. 199

EDN June 9, 1994 • 51

HIGH-PERFORMANCE PACKAGING

acterize the package yourself (Ref 5).

Armed with that information, you can begin to simulate the package's effect on your system. Typically, you know the timing of critical signals and the I/O structure you're using early in the design cycle. By using an I/O-cell model driving the LRC circuit representing the package, you can make a preliminary estimate of the package's impact on signal integrity. This provides you with the opportunity to make I/O-pin assignments that help protect critical signals.

Take care in simulations

Later in the design, you can run a full-chip simulation, including the packaging effects. Many IC simulators can't directly account for package effects, however, and you need to be careful in setting up the simulation. One common source of error is that simulators extract a circuit's parasitic capacitance to an ideal ground. To account for ground bounce, then, you

must insert an inductor in the simulation model between the chip ground and node zero.

Another common error is to analyze signal integrity in the packaged IC using the fastest possible signals, yet set system timing constraints assuming the slowest possible signals. A simulation that fails under those conditions may prompt an unnecessary redesign. Make sure that your assumptions are consistent.

Admittedly, considering the package's electrical characteristics during IC design is more work. Worse, most design-automation tools force you to add manually the information needed to reflect those characteristics in your simulation, because electronic databases of package characteristics are almost nonexistent. And you may need to characterize your package yourself. Increasingly, though, it's worth the effort. With packaging effects accounted for, your final simulation should provide confidence that your IC design

works not only alone, but also when plugged into a board. EDN

References

1. Shear, David, "EDN's advanced CMOS logic ground-bounce tests," *EDN*, March 2, 1989, pg 88.
2. Quinnell, Richard A, "Bus-driver ICs," *EDN*, February 3, 1992, pg 78.
3. Shear, David, "EDN ground-bounce tests revisited," *EDN*, April 15, 1993, pg 120.
4. Pivin, David P, "Pick the right package for your next ASIC design," *EDN*, February 3, 1994, pg 91.
5. Diamond, Scott, Jeff Kennedy, and Bo Janko, "Characterization of high-speed interconnects," "Proceedings of the Technical Program," NEPCON West, 1994, pg 986.

You can reach Technical Editor Richard A Quinnell at (408) 685-0504, fax (408) 685-0504*.

Article Interest Quotient
(Circle One)

High 592 Medium 593 Low 594

D70 Series

LINEAR ACTIVE DIP FILTERS for Anti-Alias Applications

- Data Acquisition
 - Noise Elimination
 - Signal Reconstruction



Small Size - High Performance - Low Cost

- Compact 8-pin (4-pole) and 14-pin (6 & 8-pole) Dual In-line Packages reduce board-space requirements.
- No clocks, extra components, or adjustments needed reducing your engineering and manufacturing time.
- 14 bit (-90 dB) resolution for precision performance.
- Economically priced for a high-quality, cost-effective filter solution.

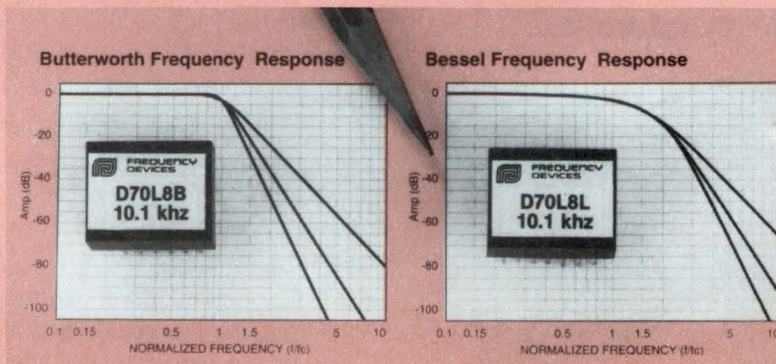

FREQUENCY DEVICES™

25 Locust Street • Haverhill, MA 01830
FAX (508) 521-1839

Call Us Today at
(508) 374-0761

What's the brightest news in A/D price and performance in 1994?



TI's new TLC2543 12-bit A/D converter at \$5.25*.



The TLC2543 from Texas Instruments sets a new price/performance point in the marketplace. Its power dissipation is only 5 mW typical. That's 50 percent lower than most 12-bit A/D converters, at about half the cost.

The right stuff. With the TLC2543 you get an on-board 14-channel multiplexer that offers 11 analog-input channels and three self-test channels. This 12-bit A/D converter has a 10- μ s maximum conversion time and sample and hold. Plus a system clock and 8-bit control register. And an end of conversion flag makes it easy to interface with microprocessors and DSPs.

TLC2543 Features

- 12-bit resolution A/D converter
- 10- μ s maximum conversion time
- Low power consumption — 5 mW (typ), 13 mW (max)
- Power-down mode — 125 μ W
- Standard serial interface
- On-chip system clock
- 11 analog-input channels
- Available in 20-pin SOIC, DIP or PLCC packages

Where you need it. Use the TLC2543 in automotive, instrumentation and a broad range of industrial applications, including motor control, robotics, numerically controlled machine tools and data logging.

Easy migration. Its pinout is compatible with the TLC543 8-bit and TLC1543 10-bit A/D converters from

TI. So upgrades are easily achieved with only minor software adjustments.

Convert today. Get 12-bit A/D performance at a 10-bit price. To find out how easy it is, just return the reply card today. Or call us at **1-800-477-8924, ext. 3473.**

New Members of TI's A/D Family

Device	Supply Voltage	Input/Output	Conversion Speed (Max)	Resolution
TLC2543	5.0 V	11 ch/serial	10 μ s	12 bits
TLV1549	3.3 V	1 ch/serial	21 μ s	10 bits
TLC1549	5.0 V	1 ch/serial	21 μ s	10 bits
TLV1543	3.3 V	11 ch/serial	21 μ s	10 bits
TLC1541/43	5.0 V	11 ch/serial	21 μ s	10 bits
TLC1550	5.0 V	1 ch/parallel	6 μ s	10 bits
TLC1225	5.0 V	1 ch/parallel	12 μ s	12 + sign

The TLC2543 in 3.3-V and shrink small-outline versions is on the horizon.

EXTENDING YOUR REACH WITH TOTAL INTEGRATION™

 **TEXAS
INSTRUMENTS**

New Wave Memories

Very Fast SRAMs offer 6ns speed





For workstation designers, Fast SRAMs are just as important as speedy CPUs.

Even the speediest RISC microprocessor can't boost performance without equivalent cache speed.

NEC's Very Fast SRAMs maximize RISC CPU potential. We offer a broad line of 256K and 1M devices. Implemented with our advanced 0.5-micron BiCMOS technology, they're specifically designed for secondary cache operations in high-end workstations.

Our selection includes 5V and 3.3V versions at both the 256K and 1M densities. The standard package is an SOJ. TSOP is available as an option for 64K x 16/18 devices (μ PD461016/18).

256K

μ PD46258	32K x 8	6,7,8ns (5V) 9,10,12ns (3.3V)
μ PD46259	32K x 9	

1M

μ PD461008	128K x 8	8,10ns (5V) 10,12ns (3.3V)
μ PD461009	128K x 9	
μ PD461016	64K x 16	10,12ns (3.3V)
μ PD461018	64K x 18	

For applications that demand pure CMOS, we also offer a wide choice of 1M and 4M Fast SRAMs.

1M

μ PD431008	128K x 8	15, 17, 20ns
μ PD431009	128K x 9	
μ PD431016	64K x 16	

4M

μ PD434004	1M x 4	20, 25ns
μ PD434008	512K x 8	

New wave memories are designed to improve the flow of information throughout your system. For SRAMs fast enough to keep up with your RISC CPU, call NEC today.

From the leader in memory technology

For fast answers, call us at: USA Tel:1-800-366-9782. Fax:1-800-729-9288.
Germany Tel:0211-650302. Fax:0211-6503490. The Netherlands Tel:040-445-845. Fax:040-444-580. Sweden Tel:08-753-6020. Fax:08-755-3506. France Tel:1-3067-5800. Fax:1-3946-3663. Spain Tel:1-504-2787. Fax:1-504-2860. Italy Tel:02-6709108. Fax:02-66981329.
UK Tel:0908-691133. Fax:0908-670290. Ireland Tel:01-6794200. Fax:01-6794081.
Hong Kong Tel:886-9318. Fax:886-9022. Taiwan Tel:02-719-2377. Fax:02-719-5951.
Korea Tel:02-551-0450. Fax:02-551-0451. Singapore Tel:253-8311. Fax:250-3583.
Australia Tel:03-8878012. Fax:03-8878014. Japan Tel:03-3454-1111. Fax:03-3798-6059.

NEC

CIRCLE NO. 80

DSP^x 94

helps introduce DSP into your designs

Steven H Leibson, *Editor-in-Chief*

Reflecting the growing presence of DSP in all types of product design, this year's DSP^x conference delivers a broad range of design-oriented sessions. The sessions are split into three series (100, 200, and 300) to reflect the varying needs of the design and development community. Sessions from all three levels will occur each day of the conference.

The 100 series sessions are introductory and are designed to help the new DSP user. The 200 series sessions

are moderated panels. Each panel contains four to eight company representatives who will compare and contrast their company's products in 10-minute presentations. Independent experts will moderate these panels.

The 300 series sessions are for people looking for more advanced information. These sessions focus on technical applications of DSP and may include case studies or design examples. The **box**, "DSP^x '94 conference program" provides a complete list of the three sessions.

On Monday, June 13, companies will have the opportunity to introduce new DSP products in a special session focused just on products. In addition, more than 70 exhibitors will be displaying their latest DSP products in the DSP^x exposition. For a sampling of DSP-related products at DSP^x, turn to pg. 62 for product reviews. Because Moscone Center is in downtown San Francisco, parking may seem somewhat daunting. The map will help you find a place to park.

You might also consider taking Caltrain ((800) 660-4287 in California) to the San Francisco Terminal, which is only a few blocks from the Moscone Center.

EDN

DSP^x '94 CONFERENCE PROGRAM

Monday, June 13

8:30-10:3	101	Introduction to DSP
	203	Digital Cellular Solutions
10:15-11:45		New Product Introductions
11:45-1:15	102	Start-up and Algorithms
	206	System-Level Graphical Tools
2:15-3:45	205	Multimedia Platforms
	308	New and Emerging Speech Coding Standards
4:00-5:30	309	Audio Engineering Society Roundtable

Tuesday, June 14

8:30-10:30	204	Video, Graphics, and Image Processing
	306	Speech Recognition/Synthesis
11:00-12:30	202	Mobile Communications
	302	Wireless
1:30-3:00	301	PC-Based Multimedia
	303	Speech Coding
3:30-5:30	103	DSP Case Studies
	201	Signal Analysis Software

Wednesday, June 15

8:30-10:30	210	High-Level System Design
	304	Digital Telephony
11:00-12:30	104	Symbolic Computation
	208	Data Acquisition, A/D and D/A Converters
1:30-3:30	207	Parallel DSP Architectures
	305	Advanced Topics in Signal/Spectral Analysis
4:00-5:30	209	Development Tools
	307	Embedded Control Systems

Article Interest Quotient (Circle One)
High 586 Medium 587 Low 588



DSP^x '94 EXHIBITOR LIST (PARTIAL)

3L Limited	DSPnet	NEC Electronics Inc
AT&T Microelectronics	Datacube Inc	National Instruments
Adaptive Solutions Inc	EDN Magazine	Pentek Inc
Advanced Computing	ESL	Rational Software Corp
Alacron Inc	Forward Concepts Co	Scientific Computing & Automation
Analog Devices Inc	Giga Operations	Signalogic
Analogical Systems	HNC Inc	Signum Systems
Ariel Corp	Harris Semiconductor	Silicon Systems Inc
Athena Group	Hyperception	Sonitech International Inc
Atlanta Signal Processors	IBM Mwave	Spectron Micro Systems
Audio Engineering Society	IEEE Signal Processing Society	Spectrum Signal Processing Inc
Bittware Research Systems	Ixthos	Star Semiconductor
Butterfly DSP	Image & Signal Processing Inc	Tartan Inc
CADIS Software Ltd	Integrated Motions	Texas Instruments
CSPI	Intelligent Systems International	Texas Memory Systems
Comdisco Systems, A business unit of Cadence Design Systems Inc	Loughborough Sound Images Ltd	Transtech Parallel Systems
Communication Automation & Control Inc	MW Media	Traquair Data Systems
Computer Design	Macrochip Research	Vocal Technologies Ltd
Domain Technology	The Math Works Inc	White Mountain DSP
DSP Group Inc	Mentor Graphics	Wintriss Corp
DSP Research	Mercury Computer Systems	Wireless Design & Development
DSP Software Engineering	Mizar Inc	Wolfram Research
	Momentum Data Systems	Zola Technologies
	Motorola, SPS	

DON'T GET ZAPPED!



Make the Intelligent Choice by Knowing

Can the IC latch up if hit with ESD?

This is critical. An ESD event may cause the ESD structure to latch, in which case the IC would stop functioning and use up to 1A of current until system power is recycled. In severe cases, the IC could burn up, rendering the serial port useless.

What is the ESD voltage rating and test method?

Different test methods yield different voltage ratings. Maxim specifies its high ESD RS-232 ICs using the Human Body Model and IEC 801-2 (Contact and Air Gap Discharge).

What were the test results over the complete ESD protection range?

ESD protection structures are dynamic in nature—different mechanisms operate at different voltages. Therefore, a device that survives a $\pm 10\text{kV}$ Human Body Model (HBM) ESD pulse may not survive a $\pm 5\text{kV}$ HBM ESD pulse. Maxim tests ESD over the entire voltage range in 200V increments.

For applications assistance,
call 1-800-998-8800

Differences Between IEC 801-2 and the Human Body Model

The main difference between the two ESD standards is the peak current. A device zapped using IEC 801-2 must absorb over five times more peak current for the same voltage, compared to the Human Body Model:

VOLTAGE (kV)	PEAK CURRENT	
	IEC 801-2 (A)	HUMAN BODY MODEL (A)
2	7.5	1.33
4	15.0	2.67
6	22.5	4.00
8	30.0	5.33
10	37.5	6.67

SELECT THE RIGHT HIGH ESD RS-232 IC. ⚡

the Facts About ESD Protection

Does the ESD protection affect normal operation?

In normal operation, an improperly designed ESD structure could trigger, causing latchup. For RS-232 ICs, a slew rate of less than 3V/μs indicates that the device may be susceptible to latchup.

Are there any special precautions that must be taken to use the IC?

Some bipolar ICs may need expensive, low-ESR capacitors, or a low-impedance AC ground path to function. It's best to know what you're getting into beforehand.



Select the Rugged, ±15kV ESD, +5V RS-232 IC for Your Design

MAXIM PART	Tx/Rx	ESD*			LATCHUP FREE	CAPACITORS (μF)	DATA RATE (kbps)	PRICE†
		HUMAN BODY MODEL	IEC801-2					
			CONTACT DISCHARGE	AIR GAP DISCHARGE				
MAX202E	2/2	±15kV	±8kV	±15kV	YES	0.1	120	\$1.85
MAX232E	2/2	±15kV	±8kV	±15kV	YES	1.0	120	\$1.85
MAX211E	4/5	±15kV	±8kV	±15kV	YES	0.1	120	\$3.62
MAX213E	4/5	±15kV	±8kV	±15kV	YES	0.1	120	\$3.62
MAX241E	4/5	±15kV	±8kV	±15kV	YES	1.0	120	\$3.62

*ESD testing done on all RS-232 I/O pins using Human Body Model waveform and IEC 801-2 waveform.

†Price is 1000 piece recommended resale.



FREE Interface Design Guide—Sent Within 24 Hours!
Includes: Data Sheets and Cards for Free Samples

CALL TOLL FREE 1-800-998-8800
For a Design Guide or Free Sample

MasterCard® and Visa® are accepted for Evaluation Kits or small quantity orders.



Distributed by Arrow, Bell, Digi-Key, Elmo, Hamilton Hallmark, and Nu Horizons. Authorized Maxim Representatives: AL, M-Squared, Inc. AZ, Techni Source Inc. CA, Mesa, Pro Associates, Inc., Infinity Sales, Inc. CO, Component Sales CT, Comp Rep Associates DE, TAI Corporation FL, Sales Engineering Concepts GA, M-Squared, Inc. ID, E.S. Chase IL, Heartland Technical Marketing Inc. IN, Technology Marketing Group IA, JR Sales Engineering, Inc. KS, Delltron LA, BP Sales MD, Micro-Comp, Inc. MA, Comp Rep Associates MI, Micro Tech Sales MN, Mel Foster Technical Sales, Inc. MS, M-Squared, Inc. MO, Delltron MT, E.S. Chase NE, Delltron NV (Reno, Tahoe area only) Pro Associates, Inc. NH, Comp Rep Associates NJ, Parallax, TAI Corporation NM, Techni Source Inc. NY, Parallax, Reagan/Compar NC, M-Squared, Inc. OH, Lyons Corporation OK, BP Sales OR, E.S. Chase PA (Pittsburgh area) Lyons Corporation, (Philadelphia area) TAI Corporation SC, M-Squared, Inc. TN, M-Squared, Inc. TX, BP Sales UT, Luscombe Engineering Co. VA, Micro-Comp, Inc. WA, E.S. Chase WI, Heartland Technical Marketing, Inc. Distributed in Canada by Arrow. Authorized Maxim Representative in Canada: Tech Trek.

Austria, Allmos Electronics Belgium, Master Chips Denmark, Exatec A/S Finland, Yleiselektronikka Oy, France, Maxim France, France/Distributors: Maxim France, ASAP Germany, Maxim GmbH Germany/Distributors: Maxim GmbH, Spezial Electronic KG Ireland, FMG Electronics Italy, Consystem S.r.l., Italy/Distributor: Esco Italiana Electronics Supply Netherlands, Koning En Hartman Norway, Odin Electronics A/S Poland, Uniproduct, Ltd. Portugal, ADM Electronics, S.A. Spain, ADM Electronics S.A. Sweden, Egevo AB Switzerland, Laser & Electronic Equip. Turkey, Interec (U.S.A.) U.K. Maxim Integrated Products (U.K.), Ltd., U.K./Distributors, Maxim Integrated Products (U.K.), Ltd., 2001 Electronic Components, HB Electronic

Maxim is a registered trademark of Maxim Integrated Products. © 1994 Maxim Integrated Products

DSP^x CHIPS



SHARC (μ P) attack. The ADSP-21060 SHARC DSP μ P combines a 32-bit, 40-MIPS, floating-point ADSP-21020 DSP processor core with a dual-ported, 4-Mbit SRAM; a 10-channel, 40-MHz DMA controller; two 40-Mbps serial ports; and six 240-Mbyte/sec interprocessor link ports. The processor core incorporates an ALU, a multiplier, and a shifter and can perform 120 Mflops (peak) and sustain 80 Mflops. On-chip hooks allow "glueless" multiprocessor configurations. \$296 (1000). **Analog Devices Inc**, Norwood, MA. (617) 329-4700.

Circle No. 438

Wireless DSP μ P runs on 2.7V. Designed with AT&T's DSP1600 core, the DSP1611 DSP μ P provides as much as 54 MIPS of processing power and can run on supply voltages as low as 2.7V. On-chip memory comprises 12k words of dual-ported RAM and 2k words of ROM. You can download a program on the fly to the DSP's system RAM through its integral JTAG port. Three power-management modes drop the processor's power dissipation in stages down to less than 50 μ A (in stop mode). The device is pin-compatible with the company's DSP1618 and DSP1617 μ Ps and includes on-chip, full-speed emulation hardware. A JTAG-based development system aids single-processor or multiprocessor software development. \$85 (1000). **AT&T Microelectronics**, Allentown, PA. (800) 372-2447.

Circle No. 439



DSP μ P powers down three ways.

Designed for applications where power is at a premium, the 33-MIPS ADSP-2171 DSP μ P features three power-down modes that can drop the chip's power requirements to $\frac{1}{2}$ mW. For example, the μ P requires only 28 mW and 3.3 MIPS to execute the GSM (European digital cellular) speech-coding algorithm. The ADSP-2171 is part of and is code-compatible with the 16-bit, fixed-point ADSP-21xx family, but it has an enhanced architecture including bit-manipulation instructions and an "Xop-squared" instruction. On-chip memory includes 2k words of 24-bit program/data memory, 2k words of 16-bit data memory, and an optional block of program ROM (8k 24-bit words). \$25 (1000). **Analog Devices Inc**, Norwood, MA. (617) 329-4700.

Circle No. 441

"Pro-sumer" ADC. The AD1877, a 16-bit delta-sigma ADC, features a 92-dB signal-to-noise ratio (typ) and a 90-dB signal-to-(distortion plus noise) ratio (typ). The IC runs on 5V and draws only 100 μ W in power-down mode. It has two single-ended analog inputs and a serial digital output. The input section employs autocalibration to correct any dc offsets. Because the ADC employs a delta-sigma modulator to digitize the analog input, the digitized output is inherently monotonic. Digitizing sample rates range from 235 Hz to 97.64 kHz. \$10 (1000). **Analog Devices Inc**, Norwood, MA. (617) 329-4700.

Circle No. 440

DSP^x SOFTWARE & DEVELOPMENT TOOLS

Signal processing and analysis for Unix. Vipre (visual processing environment) is a signal-acquisition and -analysis package for Unix workstations. Standard features include time-, amplitude-, and frequency-domain analysis during both real-time data acquisition and playback of previously recorded data. \$7900. **Engineering, Scientific, and Industrial Computing**, Carlisle, MA. (508) 369-8499. **Circle No. 442**

RF library. This library of block functions adds RF circuits including nonlinear amplifiers, switches, couplers, A/D converters, and mixers to the company's Signal Processing WorkSystem. \$5000. **Alta Group** (formerly Comdisco Systems), Foster City, CA. (415) 574-5800. **Circle No. 443**

WORLD'S LOWEST POWER 5V 12-BIT DACs

VOUT DAC Draws Only 300µA (max) From Single +5V Supply!

Designed for portable and battery-powered applications, the new serial MAX538/MAX539 comes in a tiny 8-pin SOIC package, and cuts supply current by 3 times over the closest competition. In addition, it's the first +5V-powered VOUT DAC to provide true 12-bit $\pm 1/2$ LSB linearity.

SERIAL INTERFACE & 8-PIN SO SAVE SPACE

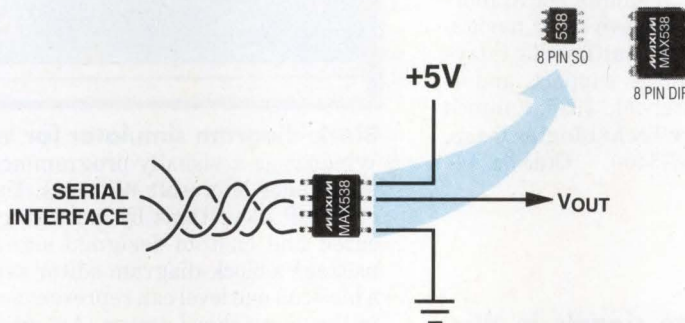

- ◆ Serial Interface Saves μ P Pins
- ◆ SPI™, QSPI™, μ Wire™ Compatible
- ◆ Rail-to-Rail Output Amplifier
- ◆ Internal Reference Version (MAX531)
- ◆ Guaranteed Monotonic Over Temp
- ◆ Priced from only \$4.85*
- ◆ Parallel Version Available (MAX530)

CUT POWER, IMPROVE ACCURACY

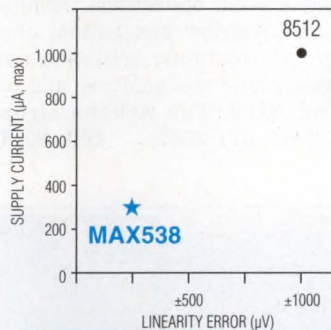

FREE D/A Converter Design Guide—Sent Within 24 Hours!
Includes: Data Sheets and Cards for Free Samples

CALL TOLL FREE 1-800-998-8800 ext. 6444

For a Design Guide or Free Sample

MasterCard® and Visa® are accepted for Evaluation Kits or small quantity orders.



MAXIM



Maxim Integrated Products, 120 San Gabriel Drive, Sunnyvale, CA 94086, (408) 737-7600, FAX(408) 737-7194.

Distributed by Arrow, Bell, Digi-Key, Elmo, Hamilton Hallmark, and Nu Horizons. Authorized Maxim Representatives: **AL**, M-Squared, Inc. **AZ**, Techni Source Inc. **CA**, Mesa, Pro Associates, Inc., Infinity Sales, Inc. **CO**, Component Sales **CT**, Comp Rep Associates **DE**, TAI Corporation **FL**, Sales Engineering Concepts **GA**, M-Squared, Inc. **ID**, E.S. Chase **IL**, Heartland Technical Marketing Inc. **IN**, Technology Marketing Group **IA**, JR Sales Engineering, Inc. **KS**, Delltron **LA**, BP Sales **MD**, Micro-Comp, Inc. **MA**, Comp Rep Associates **MI**, Micro Tech Sales **MN**, Mel Foster Technical Sales, Inc. **MS**, M-Squared, Inc. **MO**, Delltron **MT**, E.S. Chase **NE**, Delltron **NV** (Reno, Tahoe area only) Pro Associates, Inc. **NH**, Comp Rep Associates **NJ**, Parallax, TAI Corporation **NM**, Techni Source Inc. **NY**, Parallax, Reagan/Compar **NC**, M-Squared, Inc. **OH**, Lyons Corporation **OK**, BP Sales **OR**, E.S. Chase **PA** (Pittsburgh area) Lyons Corporation, (Philadelphia area) TAI Corporation **SC**, M-Squared, Inc. **TN**, M-Squared, Inc. **TX**, BP Sales **UT**, Luscombe Engineering Co. **VA**, Micro-Comp, Inc. **WA**, E.S. Chase **WI**, Heartland Technical Marketing, Inc.

Distributed in Canada by Arrow. Authorized Maxim Representative in Canada: **Tech Trek.**

Austria, Allmos Electronics **Belgium**, Master Chips **Denmark**, Exatec A/S **Finland**, Yleiselektronikka Oy, **France**, Maxim France, *France/Distributors*: Maxim France, ASAP **Germany**, Maxim GmbH *Germany/Distributors*: Maxim GmbH, Spezial Electronic KG **Ireland**, FMG Electronics **Italy**, Consystem S.r.l., *Italy/Distributor*: Esco Italiana Electronics Supply **Netherlands**, Koning En Hartman **Norway**, Odin Electronics A/S **Poland**, Unipro, Ltd. **Portugal**, ADM Electronics, S.A. **Spain**, ADM Electronics S.A. **Sweden**, Egevo AB **Switzerland**, Laser & Electronic Equip. **Turkey**, Interex (U.S.A.) **U.K.** Maxim Integrated Products (U.K.), Ltd., *U.K./Distributors*, Maxim Integrated Products (U.K.), Ltd., 2001 Electronic Components, HB Electronic

Maxim is a registered trademark of Maxim Integrated Products. © 1994 Maxim Integrated Products

CIRCLE NO. 78



Data acquisition and control for Windows.

Labtech Notebook release 8.0 and Labtech Control release 5.0 are new versions of data-acquisition and -control software products that run under Microsoft Windows. Newly supported features include global parameter changes across an unlimited number of I/O channels, data streaming to 1 MHz under Windows DMA, hierarchical icon grouping, drill-down layer navigation, extensive on-line help, multimedia (plays .WAV files) and bit-map image support, and 4-level security. Labtech Notebook, \$995; Labtech Control, \$1995. **Laboratory Technologies Corp.**, Wilmington, MA. (508) 657-5400. **Circle No. 444**

Generate and analyze signals in Windows.

Siglab for Windows allows you to perform "what-if" experiments with simulated signals and systems. The software package runs under Microsoft Windows and includes more than 140 mathematical and system operations including Fourier transforms, window generation, phase and group delay, convolutions, arithmetic and complex arithmetic, statistical analysis, and program flow control. \$199. **The Athena Group**, Gainesville, FL. (904) 371-2567. **Circle No. 446**

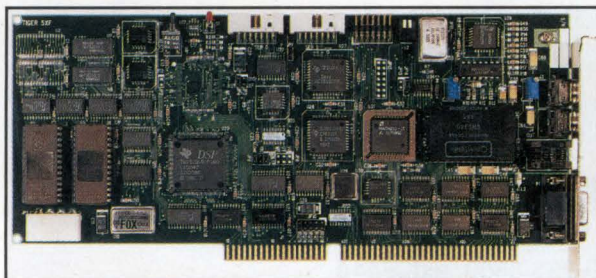

ICs for TMS320C40 and 'C5x. The Tiger C40 emulator for Windows and the Tiger C5x emulator for DOS and Windows are scan-based emulators for systems based on the TMS320C40 and TMS320C5x DSP μ Ps, respectively. The target system runs at full execution speed during emulation. The 10-ft emulator cable allows considerable distance between target and host systems. You can debug in C source code, assembly language, or mixed modes. The Tiger C40 emulator supports debugging of multiprocessor systems. You can also get a complete TMS320C5x development system, the Tiger 5XF. Tiger C40 or Tiger C5x emulator, \$3995; Tiger 5XF development system, \$3995 to \$6995. **DSP Research**, Sunnyvale, CA. (408) 773-1042.

Circle No. 448

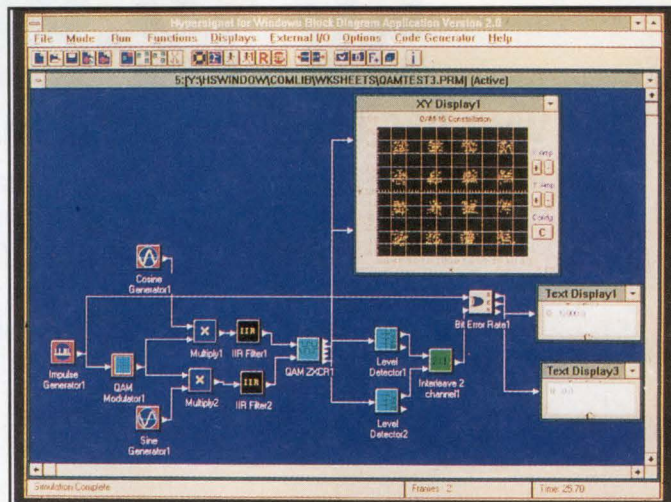

Block-diagram simulator for Windows. Hypersignal for Windows is a visually programmed simulation package running under Microsoft Windows. You can create and test various DSP algorithms by arranging and connecting prefabricated and custom-designed signal-processing blocks. The package's block-diagram editor supports hierarchical design; a block on one level can represent several blocks at a lower level in the hierarchical design. An optional C source-code generator emits code for selected DSP μ Ps. An advanced transmission library adds a comprehensive set of blocks for radio, wireline, and fiber-optic transmission systems. Hypersignal for Windows, \$1495 to \$7995; Advanced Transmission Library, \$1495. **Hyperception**, Dallas, TX. (214) 343-8525. **Circle No. 445**

Turnkey development platform.

The MX31 developer's kit is a turnkey package of hardware and software for embedded DSP development. The hardware system consists of an enclosure, power supply, and the company's TMS320C31-based motherboard, which accepts a variety of daughtercards. These daughter cards add memory, analog and digital I/O, and motion control. The software component of the development kit includes a C compiler and the Boss source-code debugger/development environment. \$2495. **Integrated Motions Inc.**, Berkeley, CA. (510) 527-5810. **Circle No. 447**

Remote Ethernet debugger for TMS320C40.

You can remotely debug TMS320C40 programs over the Ethernet from a Sun workstation with the Remote Ethernet Debug System (REDS) for the company's CV line of 'C40-based VME boards. Implementation employs remote procedure calls in a client/server arrangement, allowing coexistence with other Ethernet communications. \$8500. **Spectrum Signal Processing Inc.**, Burnaby, BC, Canada. (604) 421-5422.

Circle No. 449



BEST 10-BIT SERIAL ADC FOR LOW-POWER DESIGNS – \$2.95†

MAX192 Defines "Best":

- ◆ **Best in Completeness:**
 - 10-Bit ADC with On-Chip
 - Voltage Reference
 - Track/Hold
 - 8-Channel Mux
- ◆ **Best in Low-Power:**
 - Single +5V Supply
 - 2 μ A Shutdown Current
 - 100 μ A Operating Current
 - (1 ksp/s, includes voltage reference!)
- ◆ **Best in Performance:**
 - 133ksp/s Throughput
 - Guaranteed No Missing Codes
- ◆ **Best in Saving Space:**
 - Small 20-Pin SSOP/SO/DIP Packages
 - Microwire™, SPI™, QSPI™, TMS320-Compatible Serial Interface

Best Choice to Monitor Supplies, Temperatures, Batteries, and Sensors...

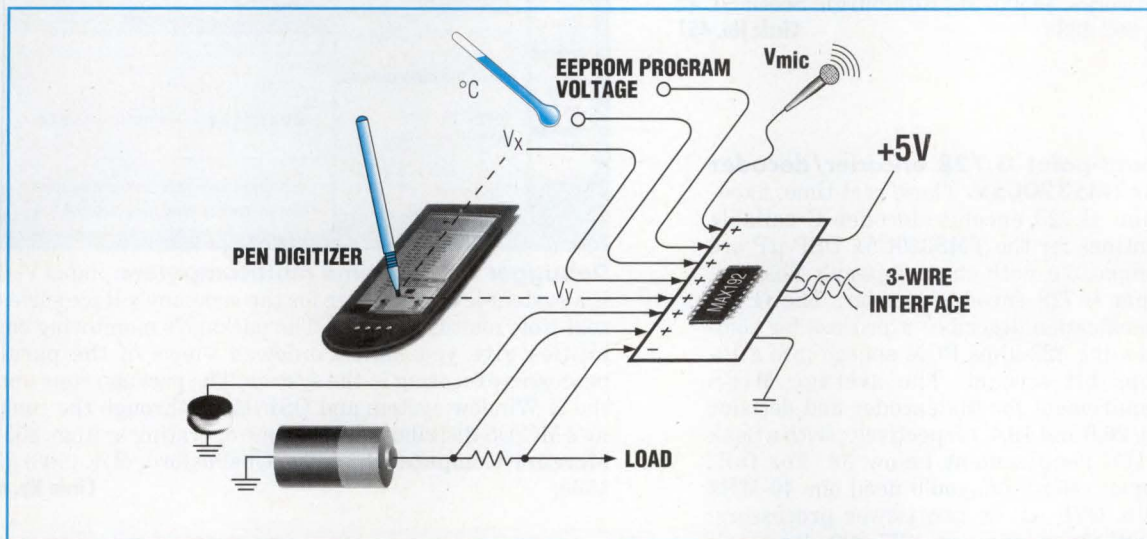

Eight analog inputs are independently programmable for differential or single-ended, unipolar or bipolar signals via the serial interface.



FREE A/D Converter Design Guide—Sent Within 24 Hours!
Includes: Data Sheets and Cards for Free Samples

CALL TOLL FREE 1-800-722-8266
For a Design Guide or Free Sample

MasterCard® and Visa® are accepted for Evaluation Kits or small quantity orders.

MAXIM



Distributed by Arrow, Bell, Digi-Key, Elmo, Hamilton Hallmark, and Nu Horizons. Authorized Maxim Representatives: AL, M-Squared, Inc. AZ, Techni Source Inc. CA, Mesa, Pro Associates, Inc., Infinity Sales, Inc. CO, Component Sales CT, Comp Rep Associates DE, TAI Corporation FL, Sales Engineering Concepts GA, M-Squared, Inc. ID, E.S. Chase IL, Heartland Technical Marketing Inc. IN, Technology Marketing Group IA, JR Sales Engineering, Inc. KS, Delltron LA, BP Sales MD, Micro-Comp, Inc. MA, Comp Rep Associates MI, Micro Tech Sales MN, Mel Foster Technical Sales, Inc. MS, M-Squared, Inc. MO, Delltron MT, E.S. Chase NE, Delltron NV (Reno, Tahoe area only) Pro Associates, Inc. NH, Comp Rep Associates NJ, Parallax, TAI Corporation NM, Techni Source Inc. NY, Parallax, Reagan/Compar NC, M-Squared, Inc. OH, Lyons Corporation OK, BP Sales OR, E.S. Chase PA (Pittsburgh area) Lyons Corporation, (Philadelphia area) TAI Corporation SC, M-Squared, Inc. TN, M-Squared, Inc. TX, BP Sales UT, Luscombe Engineering Co. VA, Micro-Comp, Inc. WA, E.S. Chase WI, Heartland Technical Marketing, Inc.
Distributed in Canada by Arrow. Authorized Maxim Representative in Canada: Tech Trek.

Austria, Allmos Electronics Belgium, Master Chips Denmark, Exatec A/S Finland, Yleiselektronikka Oy, France, Maxim France, France/Distributors: Maxim France, ASAP Germany, Maxim GmbH Germany/Distributors: Maxim GmbH, Spezial Electronic KG Ireland, FMG Electronics Italy, Consystem S.r.l., Italy/Distributor: Esco Italiana Electronics Supply Netherlands, Koning En Hartman Norway, Odin Electronics A/S Poland, Unipro, Ltd. Portugal, ADM Electronics, S.A. Spain, ADM Electronics S.A. Sweden, Egevo AB Switzerland, Laser & Electronic Equip. Turkey, Interex (U.S.A.) U.K. Maxim Integrated Products (U.K.), Ltd., U.K./Distributors, Maxim Integrated Products (U.K.), Ltd., 2001 Electronic Components, HB Electronic
†FOB USA direct resale for 25,000-pieces Maxim is a registered trademark of Maxim Integrated Products. © 1994 Maxim Integrated
™ SPI and QSPI are trademarks of Motorola, Microwire is a trademark of National Semiconductor.



Fixed-point optimizer speeds hardware design. The Fixed-Point Optimizer works with the company's Hardware Design System to accelerate hardware design by automatically determining the optimum fixed-point attributes for a behavioral algorithm or architectural design. The optimizer works for any design including time-varying, multirate, and nonlinear sys-

tems. This tool allows you to start designing a system using floating-point blocks. It then automatically replaces floating-point blocks with fixed-point blocks where possible, thus reducing overall system cost while maximizing dynamic range and avoiding arithmetic overflow. \$20,000. **Alta Group** (formerly Comdisco Systems), Foster City, CA. (415) 574-5800. **Circle No. 450**

Parallel C for the TMS320C40. This latest version (1.1) of the company's parallel C compiler for TMS320C40 systems adds access to low-level DMA, timer, interrupt, and CPU registers; global file services (any task on any processor has access to host I/O); flood filling of processor networks (topology independent); and a worm utility for exploiting 'C40 networks. \$4500. **3L**, Edinburgh, Scotland. 44 31 662 4333. **Circle No. 451**

Fixed-point G.728 encoder/decoder for TMS320C5x. These real-time, fixed-point G.728 encoder/decoder C-callable routines for the TMS320C5x DSP μ P are compatible with the company's floating-point G.728 encoder/decoder. The G.728 specification describes a process for compressing 128-kbps PCM speech into a 16-kbps bit stream. The average MIPS requirement for the encoder and decoder are 26.6 and 19.4, respectively, with a peak MIPS requirement below 38. For full-duplex operation, you'll need one 40-MHz 'C5x DSP μ P or two slower processors. North American price, \$75,000 plus royalties. **DSP Software Engineering**, Bedford, MA. (617) 275-3733. **Circle No. 452**

Development kit for Windows multimedia. Develop multimedia applications for 24-bit DSP56000 DSP μ Ps and Microsoft Windows including voice and data communications and high-quality audio with the PC Media system. The kit supports SPOX-based Windows API calls. SPOX is the DSP kernel from Spectron Microsystems (Goleta, CA). Initially, the kit's software library includes routines for audio synthesis, fax and data modems, a full-duplex speakerphone, MPEG audio, general MIDI, speech compression, text-to-speech conversion, and a telephone answering machine. The kit also includes a developer's board, reference design schematics, demo software, an assembler/linker, and a C compiler. \$7500. **Motorola Inc**, Austin, TX. (800) 441-2447. **Circle No. 454**

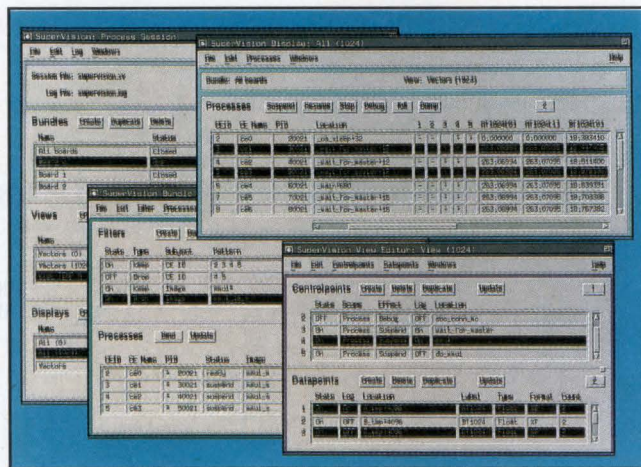

Debugger for real-time multicomputers. SuperVision is a system-level debugger for the company's Race series of real-time multicomputers. The package's monitoring capabilities give you multiwindowed views of the parallel processes executing in the system. The package runs under the X Window system and OSF/Motif through the company's MC/OS distributed, real-time operating system. \$5500. **Mercury Computer Systems**, Chelmsford, MA. (508) 256-1300. **Circle No. 453**

Signal-processing routines for TMS-320C3x/C40. DSPLib is a library of signal-processing routines for the Texas Instruments TMS320C3x and 'C40 DSP μ Ps. You provide the glue in the form of C source code to link these callable routines into a DSP program. Functions in the library include FFTs; infinite- and finite-impulse-response filters; convolution; correlation; windowing; Gaussian white-noise generation; and matrix multiplication. The library can implement a 100-coefficient finite-impulse-response filter in 548 μ sec on a 40-MHz 'C40 DSP μ P. \$750. **Spectrum Signal Processing Inc**, Burnaby, BC, Canada. (604) 421-5422. **Circle No. 455**



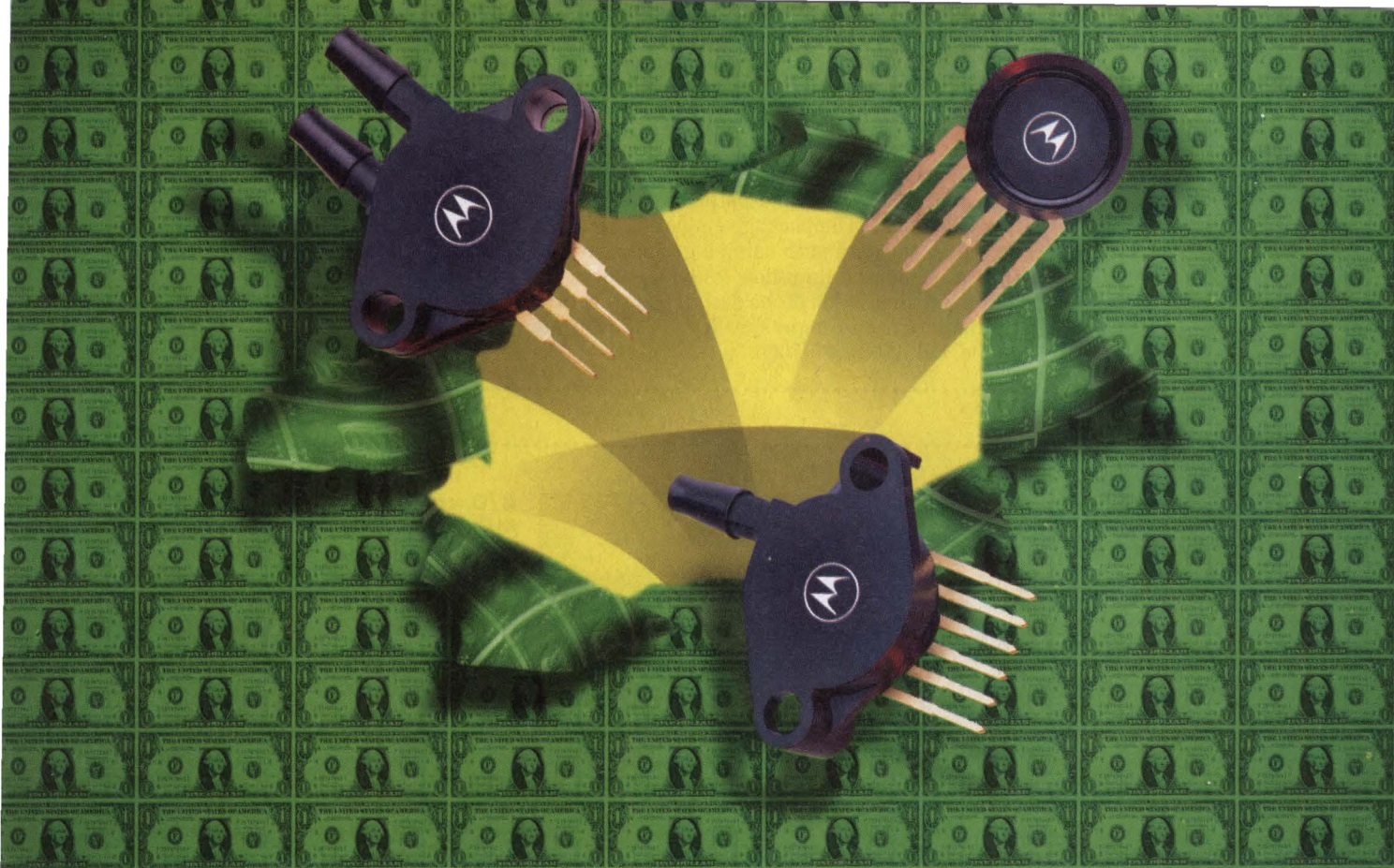

Price Breakthrough!

Motorola continues price reductions on many Pressure Sensors.

We kicked off 1994 by promising you new, lower prices on our high-quality, high-performance Pressure Sensors. Read on and you'll see we're keeping our word.

Here's Proof!

Earlier this year, we made available an uncompensated sensor for under \$5; a high impedance, temperature compensated sensor for under \$9; a signal conditioned sensor for under \$10; and a temperature sensor for under 14¢—each in a quantity of 5K. *Now* we're offering many of our MPX2000 temperature compensated and calibrated sensors at an average price of \$10* and under, also in quantities of 5K.

A Wide Range of Sensors

Motorola's large portfolio of silicon Pressure Sensors includes devices for differential, absolute or gauge pressure measurements. They're available as the basic sensing element—with temperature compensation and calibration, or with full signal conditioning circuitry included to interface directly to A to D microprocessor or microcontroller-based systems.

Motorola Pressure Sensors feature a patented strain gauge design. The higher sensitivity and excellent long-term repeatability of some of our newest units make them ideally suited for such applications as altimeters, pneumatic controls and robotics, liquid level measurement, manifold vacuum control, and HVAC systems.

Contacting Us Now Makes Sense!

By now, you should be sold on Motorola Pressure Sensors. Especially when we remind you we're selling them at new, lower prices. Contact your local sales office for the latest pricing information. And for technical

information on our complete family of Pressure Sensors, including our MPX2000 and MPX5000 series, return the coupon below, call 1-800-441-2447, or write Motorola Semiconductor Products, Inc., Literature Distribution Center, P.O. Box 20912, Phoenix, AZ 85036. Request Pressure Sensor Data Book #DL200/D, Rev. 1.

* Pricing is in US dollars for US delivery only. For complete terms and conditions, contact your local Motorola sales representative.



MOTOROLA

Motorola and  are registered trademarks of Motorola Inc.

To: Motorola Semiconductor Products Inc., P.O.Box 20912, Phoenix, AZ 85036

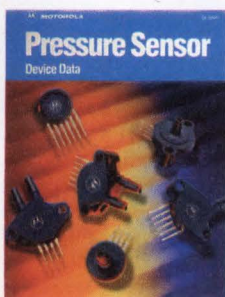

Please send me Pressure Sensor Data Book #DL200D, Rev. 1.

632EDN060994

Name

Title

Company

Address

City State Zip

Call Me ()



Design DSP data paths directly. DSP Blocks adds the ability to design custom DSP ASIC data paths for the company's DSP Station design environment. The package employs 22 parameterizable generators to create the data path using a graphic design approach. It also generates a behavioral data-flow language description, which allows fast fixed-point simulation of the design and structural VHDL code for VHDL simulation and logic synthesis. \$15,000. **Mentor Graphics**, Wilsonville, OR. (503) 685-7000. **Circle No. 456**

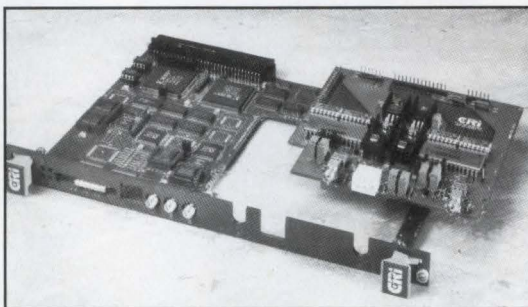

A/D card samples 14 bits at 40 MHz. The Nimble A/D board for VME and VSB bus systems offers one or two A/D channels with 10- to 14-bit resolution and sample maximum rates of 5 to 40 MHz. The board actually consists of a VME motherboard and five daughterboards of varying ability. The mother board has image-processing capabilities including frame synchronization and pixel selection. The A/D cards offer single-ended or low-noise differential front ends. A 12-bit, 10M-sample/sec system costs \$5700. **Catalina Research Inc.**, Colorado Springs, CO. (719) 637-0880. **Circle No. 457**

Highly modular, parallel-processing DSP system. Mix four ADSP2101 DSP μ Ps, 4 Mbytes of RAM, and two FPGAs, place them on a 2.4x3.65-in. circuit board, and you have a powerful, reconfigurable DSP module capable of performing video-rate processing. Three carrier boards of varying speeds for the PC VASA bus each have four connectors. Each connector accommodates four stacked processing modules for a maximum of 16 modules per carrier and a total of 48 DSP μ Ps. DSPMOD processing modules, \$500 to \$2000; carrier cards and development software, \$2000 to \$3500. **Giga Operations Corp.**, Berkeley, CA. (510) 528-8438. **Circle No. 458**

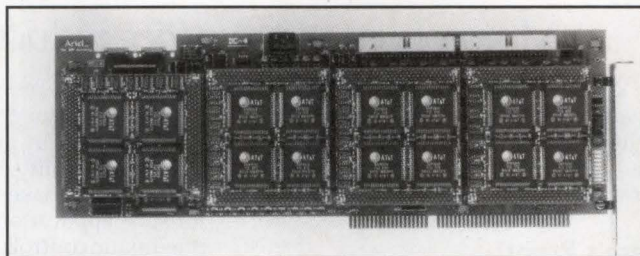

Floating-point DSP for PC/104 bus. Based on AT&T's 50-MHz DSP32C DSP μ P, the PC5-DO board brings floating-point DSP to the PC/104 bus. The board also incorporates 512 kbytes of SRAM. In addition to the 8- or 16-bit PC/104 interface, the board has a 25-Mbps serial port for high-speed data transfers to and from the processor. A separate 32-bit, 100-Mbyte/sec mezzanine connector provides an expansion port for the DSP32C's address/data bus. \$1395. **Communication Automation & Control Inc.**, Allentown, PA. (215) 776-6669. **Circle No. 459**

ISA card mounts 16 DSP3210 DSP μ Ps. The TeraDON PC ISA bus card has four sites for 4-processor DON-4D daughter cards for a total of 16 processors. Each DON-4D incorporates four AT&T DSP3210 DSP μ Ps and as much as 256 Mbytes of DRAM. Software support for this system includes AT&T's VCOS real-time multitasking operating system and a set of multimedia and telephony software modules including fax, modem, text-to-speech conversion, speech recognition, MPEG/P*64 audio compression, and still image compression. A 4-processor version, \$3995; 16-processor version, \$9995. **Ariel Corp.**, Highland Park, NJ. (908) 249-2900. **Circle No. 460**

Digital I/O board brings DSP to control applications. This 32-channel digital I/O board adapts DSP μ Ps for control applications. The DSP communicates with the board via the company's DSP-Link interface. \$1045. **Spectrum Signal Processing Inc.**, Burnaby, BC, Canada. (604) 421-1764. **Circle No. 461**



POWER-ONE

LINEAR POWER SUPPLIES

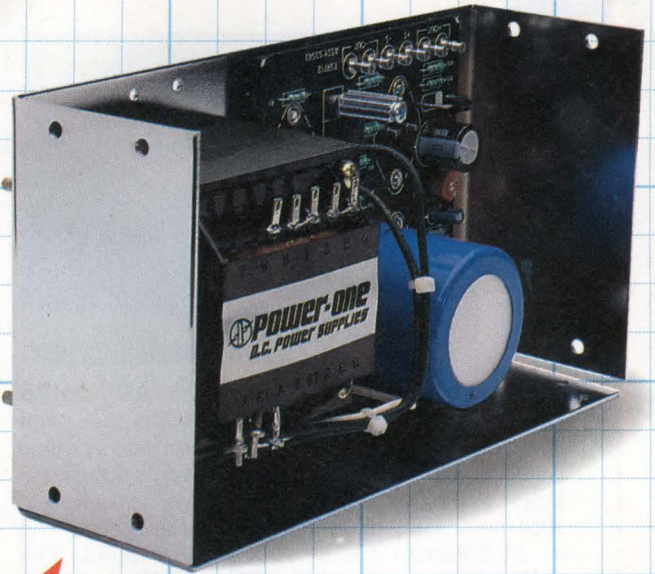

WHY AXIS = Reasons To Call Power-One Today!

The Shortest Path To Your Power Solutions

5mV PK-PK Noise and Ripple

0.1% Line/Load Regulation

.05 mA Leakage Current

1,000,000 Hours Typical MTBF

Over 100 Models In Stock At Over 250 Distributor Locations

Over 6,000,000 Power-One Linears Produced



740 Calle Plano, Camarillo, CA 93012-8543
Phone: (805) 987-8741 • FAX: (805) 388-0476

X AXIS = Power-One Linear Features

DSP^x
BOARDS

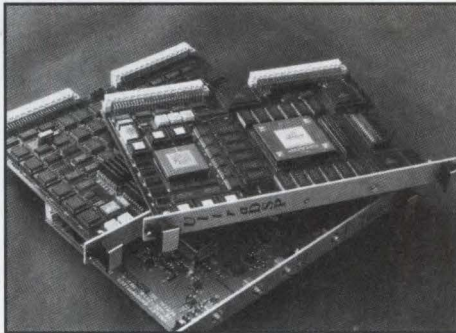

Ultra board series exploits 400-MIPS LH9124 DSP. The Ultra board family gives you three board-level building blocks to create systems based on the Sharp LH9124, a 24-bit, 400-MIPS DSP μ P. This processor can perform a windowed, 1024-point FFT in 93 μ sec, about the same speed as 20 TMS320C40s or 11 i860 processors. The DSP mounts on the UltraDSP, a VME processor board. An onboard DSP32C DSP μ P acts as a supervisory controller. The UltraADC is a 10-bit, 40-MHz A/D-converter board that communicates with the UltraDSP through dedicated pins on the VMEbus' P2 connector. This board also incorporates a 12-bit D/A converter for waveform generation. The third member of the Ultra family, the UltraBUF, is a 24-bit \times 1M-word memory card that supports data-acquisition and waveform-generation rates to 40 Mbytes/sec. UltraDSP, \$21,000; UltraADC, \$5500; UltraBUF, \$6500. **Valley Technologies Inc**, Tamaqua, PA. (717) 668-3737.

Circle No. 463

200-Mflops VME board carries five TMS320C31s. The AP65 DSP signal processor achieves 200 Mflops by ganging five 40-MHz TMS320C31 DSP μ Ps. The board also includes 16 Mbytes of global memory. The processors are arranged in a master/slave configuration, but all processors act as computational peers. The master processor controls the board's I/O ports, which include an 80-Mbyte/sec FIFO port, a 960-kbps serial port, an RS-232C port, and a 20-Mbyte/sec SCSI-2 port. \$13,200. **Analogic Corp**, Peabody, MA. (508) 977-3000.

Circle No. 465

Put two or four 'C40s on VME. The Spirit-40 VME and Quad-40 VME place two or four 40- or 50-MHz TMS320C40 DSP μ Ps on a VME board, respectively. Both boards provide local memory for each processor and global memory for interprocessor communications. Both boards also accommodate as much as 4 Mbytes of local SRAM per processor and 4 Mbytes of global SRAM. Each board has six 20-Mbyte/sec ASM-C processor communications ports on the front panel for board-to-board communications and two 50-Mbyte/sec ASM-M ports for memory expansion. Spirit-40 VME, \$8995; Quad-40 VME, \$9995. **Sonitech International Inc**, Wellesley, MA. (617) 235-6824.

Circle No. 466

VME multiprocessor card employs Quick-Ring. With eight Intel i860 μ Ps arranged in four processing pairs, the Supercard-4SLX delivers 640 MFLOPS. Multiple boards communicate via 182-Mbyte/sec QuickRing interfaces and reach an aggregate transfer rate of 1.28 Gbytes/sec when fully configured as a 16-board system. Each processing element can have as much as 16 Mbytes of local DRAM. A 5-port crossbar switch links the four processing elements on the board with the VMEbus. \$29,000. **CSPI**, Billerica, MA. (508) 663-7598.

Circle No. 462

Image processing for 'C40 systems. You can convert existing TMS320C40 DSP systems into image processing systems with the IPI-40 VME board. The board can capture frames from as many as four multiplexed NTSC or PAL video sources. It performs real-time 8×8 , 2-dimensional convolution and RGB pseudocolor processing. The IPI-40 communicates with 'C40 systems via one of the 'C40's 20-Mbyte/sec comm ports. The HETVIO, a complete image-processing system that combines the features of the IPI-40 with a TMS320C40, a 1-Mbyte VRAM frame store, and 4 Mbytes of DRAM, is also available for ISA, VME, and SBus systems. IPI, \$3850 (\$5050 with convolution); HETVIO, \$6750. **Traquair Data Systems**, Ithaca, NY. (607) 272-4417.

Circle No. 464

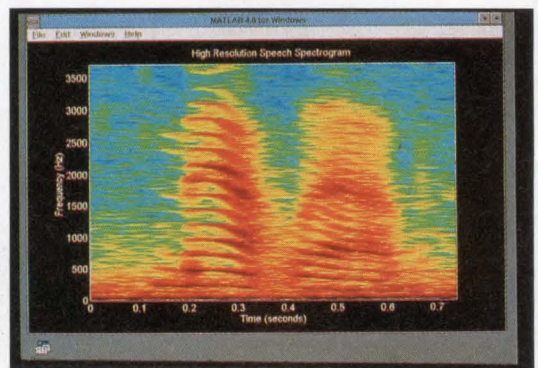

Software for filter design and spectral analysis. Signal Processing Toolbox 3.0 software for signal analysis and DSP algorithm development includes an expanded, spectral-analysis suite and advanced design techniques for FIR and IIR filters. New features in the upgrade include parametric modeling routines for time-series analysis; graphical objects with automatic plotting; and specialized design and analysis functions for communications, multi-rate, speech-processing, and real-time embedded applications. **The MathWorks Inc**, Natick, MA. (508) 653-1415.

Circle No. 467

THE UNIVERSAL DEVICE PROGRAMMER FOR ALL PACKAGE TYPES.

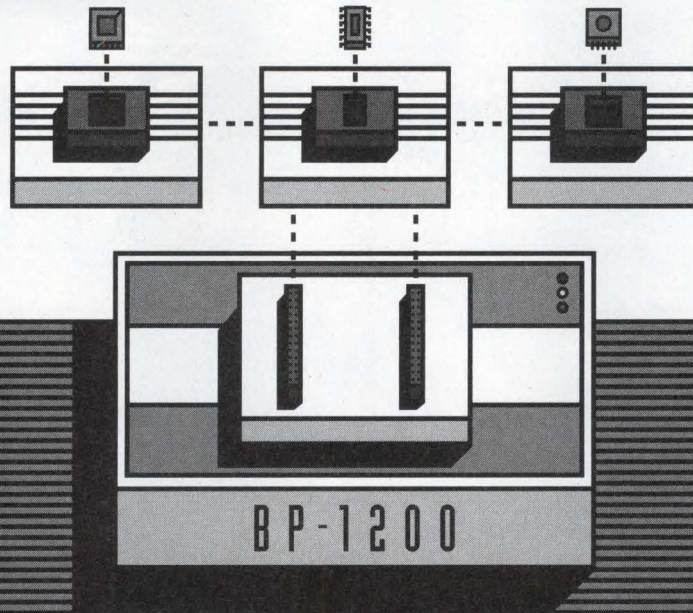

The BP-1200 universal device programmer leads the industry in package types supported, programming speed, ease of use, and reliability. With prices starting at \$2495, free software updates, and a three year limited warranty,* the BP-1200 is simply the best choice for those seeking the biggest bang for the buck!

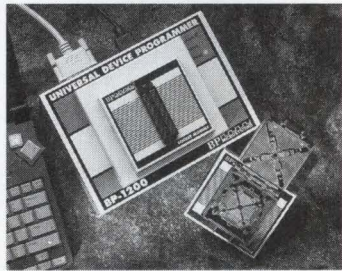

The BP-1200's ability to program virtually every programmable device, including the fastest and largest EPROMs, microcontrollers and memories, gives you the freedom to choose the ideal parts for your next design. The BP-1200 also supports all package types. Our complete line of interchangeable programming sockets supports DIP, LCC, PGA, PLCC, QFP, SOIC and PLCC devices directly.

The BP-1200 is the first programmer that programs vector tests devices with up to 240 pins. If you don't need 240 pin support yet, you can start with as little as 32 pin DIP support and upgrade in the field (to 48, 84, 144 or 240 pins) when you need to do so.

The BP-1200 is the fastest universal programmer on the market. Since the BP-1200 connects directly to your PC's printer port, you can program parts in seconds, not minutes. The BP-1200 reads files directly from your hard disk or network, so you won't waste time copying files to a floppy disk or waiting on a serial download.

The BP-1200's high speed, high yields and optional Advanced Feature Software make it ideal for production use, whether you are doing medium volume manual programming or very high volume autohandler production.

Call today for more information about the BP-1200 and a free demonstration disk!

DEVICE SUPPORT INCLUDES:

- Altera 7000 series
- AMD MACH parts
- Intel 32M bit flash EPROM
- Intel FX740 and FX780 FPGAs
- Lattice pLSI and ispLSI devices
- Microchip PIC microcontrollers
- Motorola 68HC705 and 68HC711 families
- over 3400 devices from over 66 manufacturers

BP MICROSYSTEMS

BP Microsystems, Inc. • Houston, TX

1-800-225-2105

*Only on BP-1200s purchased in the U.S. after September 15, 1993. Some restrictions and exclusions apply. Features and specifications subject to change without notice. Call for details.

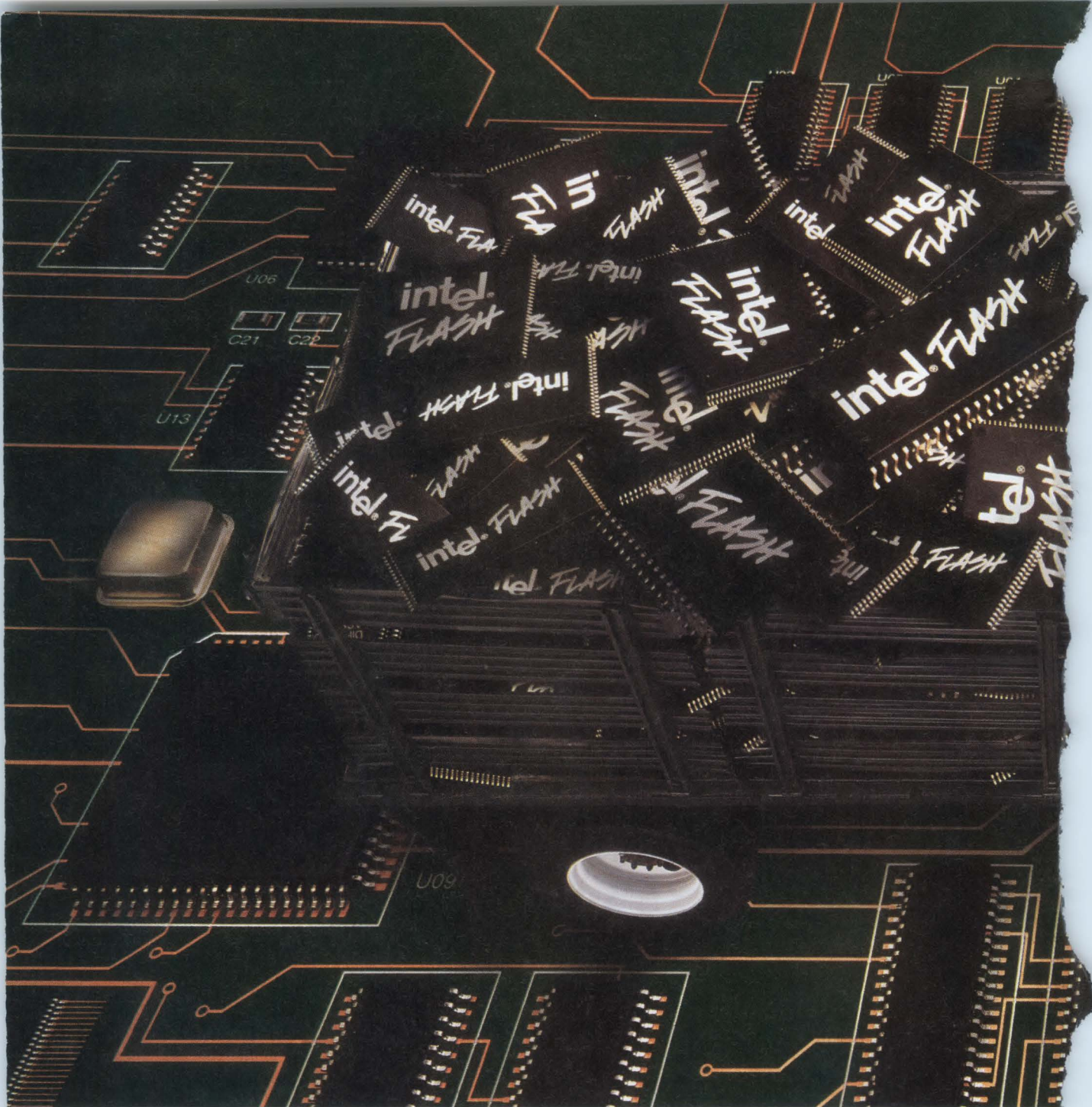

We not only have a ton of these

Intel Flash Memory is shipping in high gear. Our factory capacity is up. Our prices are coming down. And we're leading the industry in flash technology.

The shortage is over. With three flash factories now on line, Intel can support both your immediate and long-term needs. In fact, our sub-micron process

Intel Flash Memory Factory Output



in each factory allows us to provide multiple sources for our flash products to ensure delivery.

What's more, our new capacity is so huge, we can outsupply all other flash manufacturers. Combined!

Intel Flash Component Pricing Trend*

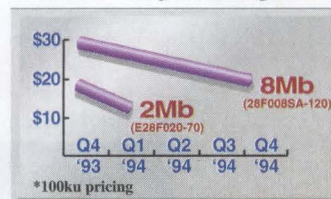

We're also growing the market by driving down flash prices, making Intel Flash

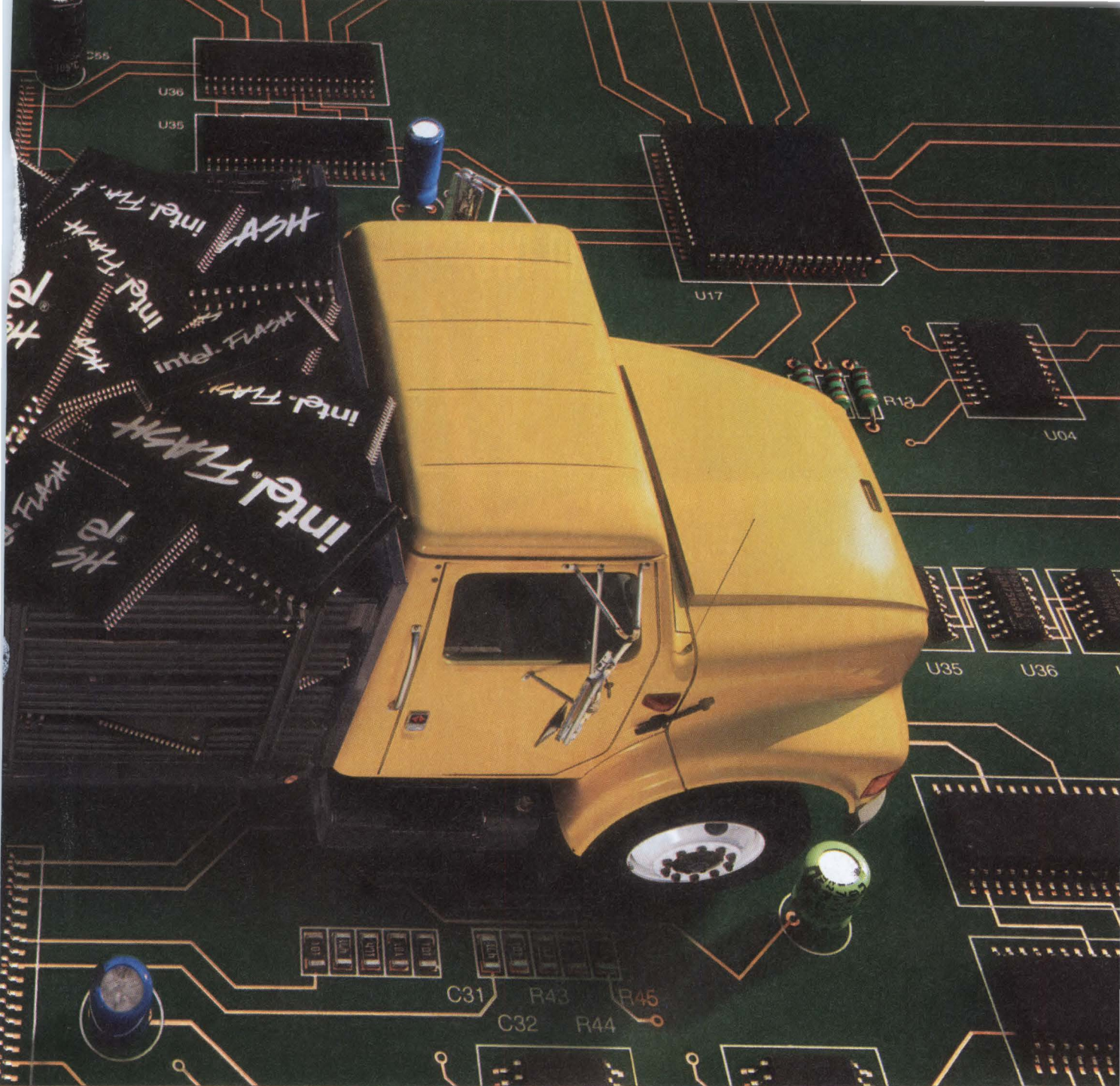

but now you'll also save a ton.

Memory a viable option for virtually any new design. In fact, since Q4 '93, we've dropped prices by as much as 31 percent. And by the end of the year, the volume price for our 120ns, 8Mb FlashFile™ devices will be as low as \$20.

This is an opportune time to get the design wheels rolling, too. Because you can now purchase one hundred 8Mb devices for just \$25 each.

With chips from 256Kb to 32Mb, to PCMCIA Flash Cards and ATA Flash Drives, Intel also gives you

by far the broadest, most technologically advanced line of flash products in the industry.

So if you're ready to load up on flash memory, call 1-800-879-4683, ext. 101 for complete information. Because Intel is more than ready to deliver.

intel®

As a Rule, Four Points of Contact Are Better Than Two.



2,5mm
SPOX® IDT
System

With 4 points of contact instead of the usual two, Molex's new 2,5mm SPOX (spring box) IDT terminals provide unmatched reliability in wire-to-board terminations.

The SPOX IDT system features a crimped metal strain relief for secure connections without secondary clamps. Insulation Displacement Technology (IDT) allows mass termination without wire stripping, lowering your total applied costs. Optional staggered PC tails prevent shorting and facilitate circuit tracing.

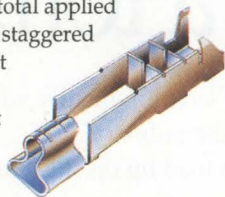

Introducing the 2,5mm SPOX® IDT System, With Four Points of Contact, for Unmatched Reliability.

Environmentally tested (72 thermal cycles without failure), the UL-Recognized, CSA-Approved Molex 2,5mm system gives you superior reliability where miniaturization has restricted your design space for connectors.

Intermateable with the crimp SPOX system, the Molex design permits unique combinations to accommodate board space and height restrictions. Molex's SPOX also comes

with four optional colors to help in production and field servicing.

The new 2,5mm SPOX lowers your applied costs, through Molex's semi-automated application tooling for high volume assembly. For maximum cost-effectiveness, a direct board-in version allows you to build an off-line harness that solders directly to the board, eliminating the need for a header.

Providing unique 4-point contact reliability, design flexibility and lower total applied costs, Molex's SPOX IDT system will give you a leg (or two) up on the competition.



Bringing People & Technology Together, WorldwideSM

Corporate Headquarters: 2222 Wellington Ct., Lisle, IL 60532 U.S.A., Tel: (708)969-4550 • European Headquarters: Munich, Germany, Tel: 49-89-413092-0
Far East North Headquarters: Tokyo, Japan, Tel: 81-427-21-5539 • Far East South Headquarters: Jurong Town, Singapore, Tel: 65-660-8555

EDN's

DSP-CHIP

1994

DIRECTORY

Compiled and edited by James P Leonard, Senior Associate Editor

The 1994 EDN DSP-Chip Directory is a keeper: Not only have we revised and updated last year's chip specs, but we've also added new entries, including Zoran's 16-bit fixed-point ZR38000, the Texas Instruments' 32-bit MVP, and Analog Devices' SHARC, a 32-bit floating-point DSP.

The 16-bit fixed-point devices continue to dominate low-cost applications. As new variations of each DSP μ P hit the market, each family fills a greater variety of applications. The largest markets for these 16-bit speedsters include telecommunications, digital cellular telephones, and disk drives.

Floating-point DSPs are being designed in by the cluster. Often you'll see products that, instead of having just a couple of DSPs within, have many. For a number of years, designers generally thought floating-point DSPs would be used for prototyping fixed-point DSP-based products. Even though floating-point devices are easier to use, most developers aren't opting to use them as a crutch. As a result, floating-point devices end up in applications where the three most important design criteria are performance, performance, and performance.

Designing with DSPs continues to get easier. You can now buy world-class software-development tools. And in many cases, you don't even need to write the code—you can just buy the algorithms premade. For example, TI has created the TMS320 Software Cooperative, which offers a collection of algorithm data sheets. You select the algorithm you want by paging through the packet.

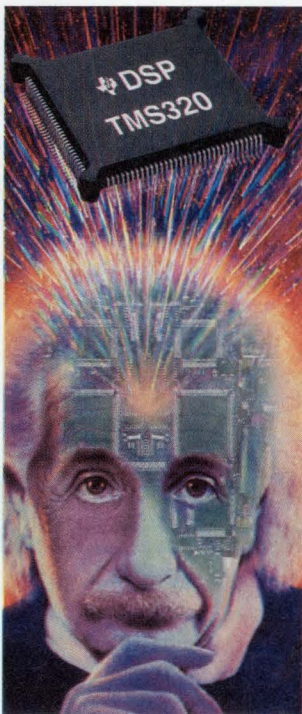

Getting a DSP-based board to work with Microsoft's Windows is also getting easier. In conjunction with DSP real-time operating-system (RTOS) vendors, Microsoft is busy creating a standard method for applications to call for DSP functions. Any DSP-based board that works within the guidelines of the standard can be plugged into the PC and used with any application.

Another year of above-average growth for DSPs hasn't been affected by a marketing myth that superfast CISC or RISC μ Ps will begin to replace DSPs. In many cases, the replacement trend is working the other way. The supremely fast DSP is using surplus cycles to replace slower microcontrollers.

As you flip through the following pages, you'll find a comprehensive listing of the major DSP chips, ranging from stripped-down, 16-bit, fixed-point processors to full-blown, 32-bit floating-point processors.

Each chip family has its own page full of architectural information and a quick run-down of variations, peripherals, and price/packaging information. If your time's limited, check out the handy reference tables in the upper-right corner of each page—we've noted important feature and performance specs in an easy-to-read format. Keep a copy of the directory as a reference for your design work throughout the coming year. **EDN**

—Additional reporting by Contributing Editors Ray Weiss and David Shear

Article Interest Quotient (Circle One)
High 583 Medium 584 Low 585

Text continued on pg 76

DSP-Chip Directory Index

Supplier	DSP chip	Type	Page	Circle No.
Analog Devices	ADSP-2100 Family	16-bit fixed-point	79	484
	ADSP-21020	32-bit floating-point	80	485
	ADSP-2106x	32-bit floating-point	83	486
AT&T	ADSP16xx	16-bit fixed-point	84	487
	ADSP32C/3210	32-bit floating-point	95	488
DSP Group, Semiconductor Division	Oak/Pine Core	16-bit fixed-point	96	489
Motorola	DSP56156/166	16-bit fixed-point	99	490
	DSP56001/2/4	24-bit fixed-point	100	491
	DSP96002	32-bit floating-point	105	492
NEC	μ PD77C25	16-bit fixed-point	106	493
	μ PD77017	16-bit fixed-point	109	494
	μ PD77220	24-bit fixed-point	110	495
SGS-Thomson	ST18 Family	16-bit fixed-point	113	496
Star Semiconductor	SPROC-1x00 Family	24-bit multiprocessor	114	497
Texas Instruments	TMS320C1x	16-bit fixed-point	117	498, 499
	TMS320C2x	16-bit fixed-point	120	500
	TMS320C3x	32-bit floating-point	123	501
	TMS320C4x	32-bit floating-point	124	502
	TMS320C5x	16-bit fixed-point	126	503
	TMS320C80	32-bit multiprocessor	131	504
Zilog	Z89Cxx	16-bit fixed-point	132	505
Zoran Corp	ZR38000	16-bit fixed-point	135	506

Key to abbreviations in schematics

AB —combined program-and-data address bus	DMAAB —DMA address bus	cations port
ACC —accumulator	DMADB —DMA data bus	PRAB —peripheral address bus
ADC/DAC —analog-to-digital and digital-to-analog converters	DMAC —DMA controller	PRDB —peripheral data bus
ADDR GEN —address generator	FP —floating point	REG —register
ALU —arithmetic logic unit	FX —fixed point	REGB —register bus
BIT MANIP —bit manipulation	GDB —global data bus	SIO —serial I/O
BS —barrel shifter	HOST INTER —host interface	TIM —timer
CDB —control data bus	IDB —instruction data bus	XAB —external address bus
CM —cache memory	INT —external interrupt	XDB —external data bus
CPUB —CPU bus	MAC —multiply/accumulate	XDAB —external data address bus
DAB —data address bus	MULT —multiplier	XDDB —external data data bus
DB —combined program-and-data data bus	PAB —program address bus	XIOAB —external I/O address bus
DDB —data data bus	PDB —program data bus	XIODB —external I/O data bus
DM —memory for data only	P/DM —program and data memory	XPAB —external program address bus
	PIO —parallel I/O	XPDB —external program data bus
	PM —memory for program only	
	PPCP —parallel processor communi-	

Plans are set for future talks.

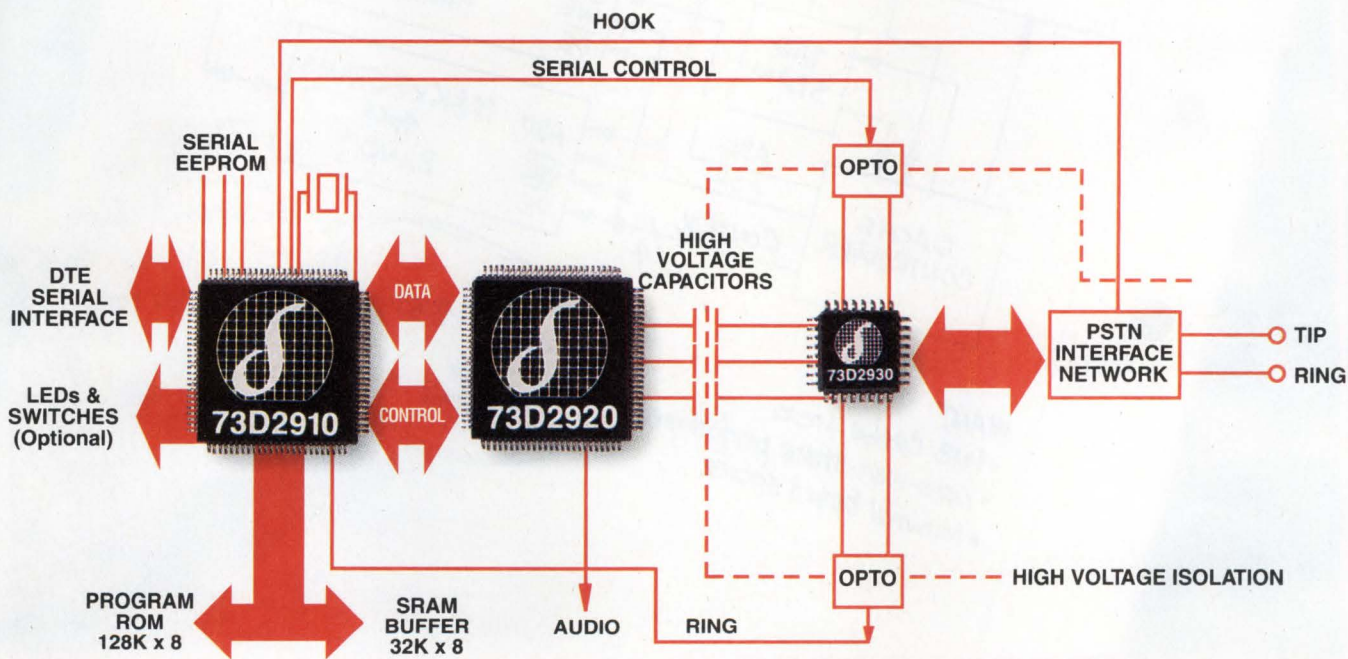

These are plans you can act on now. Or when you're ready. They involve our new, and dare we say, breakthrough ultra low power 2950 Data/Fax Modem IC with optional speech compression capability.

Our 2950T version features TrueSpeech™ audio compression adopted by Microsoft® for voice-capable PCs, and brings that capability to laptops, notebooks, PDAs and other low power hosts.

So now embedded voice files can accompany modem/fax transmissions and answering machine functions from portables without taxing storage space. To wit,

a one-minute voice file that used to eat up 900 kilobytes now needs just 60 kB.

Even if your design isn't yet of such vocal proportions, you'd be wise to consider our 2950 data/fax solution. It saves you cost, design space and transmission time while offering silicon "transformerless" DAA operation. Plus, it runs on ultra low power for both 3.3V and 5V worlds. It offers both QFP and TQFP packaging. And it's universally customizable. It does everything but speak like the 2950T.

Which is exactly why you should be talking with us. Call and we'll send you

literature package CPD-16 and, if you'd like, we'll tell you how to contact your nearest Silicon Systems representative. 1-800-624-8999, ext. 151.

Silicon Systems, Inc.
Communications Products Division
14351 Myford Road, Tustin, CA 92680
Ph (714) 573-6000 Fax (714) 573-6906



CACHE PROBLEM SOLVED.

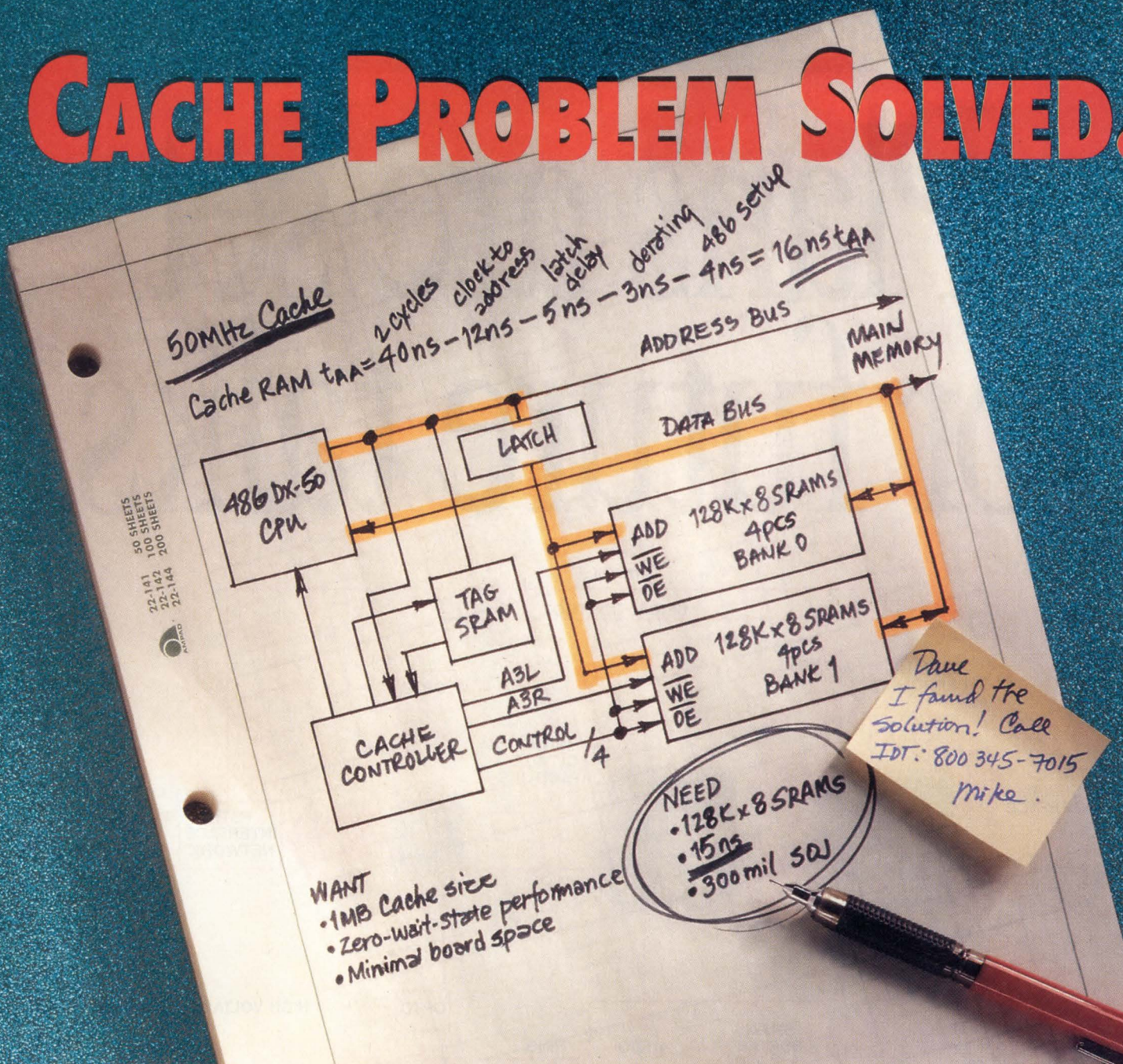

We'll provide the 15ns 128K x 8 300mil SOJ SRAMs for your first board!

IDT is the only 1Mb SRAM vendor to offer 15ns, 300mil SOJ SRAMs in volume, now. IDT's leading CMOS technology provides the performance and manufacturability to make the IDT71024 the ideal 1Mb SRAM for your design. Available in 300mil SOJ and 400mil SOJ/DIP packages, our 128K x 8 SRAM is the ideal solution for both high-density board designs and performance upgrades of existing systems. Interested? Call us or FAX in the coupon today to get technical data, application briefs, and details on our free 300mil SOJ 1Mb SRAM offer.

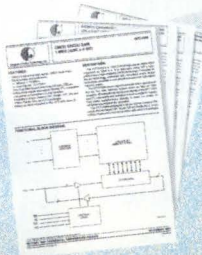

NAME _____

TITLE _____

COMPANY _____

ADDRESS _____

CITY () _____ STATE _____ ZIP _____

PHONE () _____

FAX _____

E-MAIL _____

(800) 345-7015
FAX: 408-492-8674
ASK FOR KIT CODE 8101



**Integrated Device
 Technology, Inc.**

Analog Devices ADSP-2100 Family

OVERVIEW The 2100 family combines 16-bit math processing with zero-overhead looping. The first chip, the DSP-2100, has no on-chip program or data memory. Instead, it has two external buses—one each for program and data—and an on-chip cache of 16 instruction words. Later chips, such as the ADSP-2171, add on-chip memory. The ADSP-2171 has 8k-word program ROM, 2k-word program RAM, and 2k-word data memory. Executing from this on-chip memory, the CPU can deliver single-cycle execution. It has two address generators (X, Y) and two buses: program and data. While executing out of on-chip cache, the two buses feed the X and Y data values for each MAC cycle. The program bus is free for MAC use when the CPU executes out of program ROM, which has a direct connection to the program sequencer and instruction decoder.

The later chips with on-chip memory have a single external, 24-bit bus for a simpler configuration and a larger address space. AD engineers also added peripherals to simplify processing and reduce chip counts. The peripherals include a 16-bit autoreloading timer, two serial ports, 8-/16-bit host/parallel port, and DMA controller, as well as a 16-bit sigma-delta ADC and a 16-bit DAC for audio-band applications.

16-bit fixed-point DSP

ADSP-2171

- ▶ 24-bit instruction word, 14-bit data word
- ▶ 2k×14-bit data RAM
- ▶ 4k×24-bit program RAM
- ▶ 8k×24-bit program ROM
- ▶ 8-/16-bit parallel/host interface
- ▶ 2 serial I/O ports
- ▶ 1 16-bit interval timer
- ▶ 3 external interrupts
- ▶ 8k PM ROM, 2k PM RAM, 2k DM RAM
- ▶ 3 power-down modes
- ▶ 33-MHz operation (16.67-MHz external clock)
- ▶ 30-nsec ADD, NOP, MPY, MAC
- ▶ 1-cycle external memory R/W
- ▶ Multiple wait states
- ▶ Register shadowing for fast context switch
- ▶ Zero-overhead instruction loops
- ▶ 3-cycle interrupt latency
- ▶ Serial I/O to 13-MHz rate
- ▶ Supports up to 8 simultaneous circular buffers

VENDOR CONTACTS

Analog Devices Inc, Norwood, MA, (617) 329-4700. **Circle No. 484**
Application Hot Line: (617) 461-3672.
DSP BBS: (617) 461-4258 (N,8,1).

ARCHITECTURE

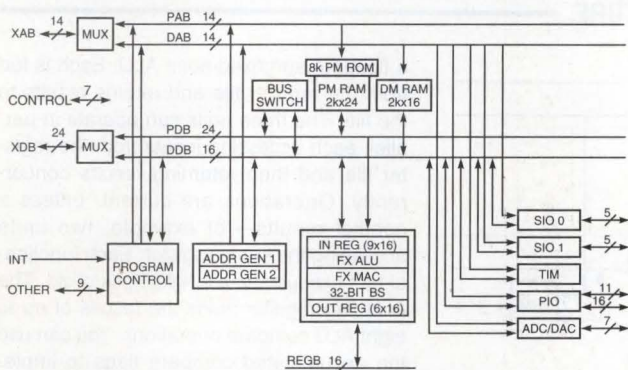

The ADSP-2100 family's CPU handles general processing needs and delivers single-cycle instruction execution when executing tight DSP algorithms from on-chip memory. Analog Devices designers opted for a wide 24-bit instruction word to minimize instruction decoding and speed execution, while utilizing complex instruction formats. Data words are 16 bits. The difference in code and data word sizes requires a Harvard architecture with two separate memory spaces. But Harvard architectures with separate memory spaces are typical for most DSPs; they enable instruction fetches to occur in parallel with single-cycle MAC operations. In the ADSP-2100's case, the different memory sizes can complicate external-memory design.

For DSP processing, the ADSP-2100 architecture treats both these spaces—program and data—as two data spaces: the X and Y memories supply variables and constants for a series expansion. Thus, program memory can be used as a data memory to hold constants for MAC processing. Code can execute multiple operations per clock cycle; the MAC, ALU, and barrel shifter are separate units and can execute in parallel.

When running at full speed, the DSP can execute an instruction per cycle out of on-chip memory. When doing a MAC operation, the X and Y data are accessed from the off-chip memory (ADSP-2100) or from on-chip program ROM and data RAM. A DO UNTIL command sets up a sequence of instructions for repeat operations. The hardware has built-in automatic loop control and addressing for MAC processing. The ADSP2100 delivers single-cycle MAC execution, executing from on-chip memory or from an on-chip cache in DSPs without on-chip memory.

The ADSP-2100 instruction set is surprisingly sophisticated for a stripped-down DSP processor. Most instructions, for example, are conditional: The hardware checks a specified condition first and then executes the core instruction if the condition is true. This tactic compacts

code by eliminating the need for separate tests (branches) before doing specific work.

Address generators—Two address generators that access X and Y memory data. Zero-overhead looping: each generator supports up to four loops with three registers each, which define the end, length, and access address. Each generator handles modulo addressing (circular). One generator, DG1, provides bit-reversed addressing (for data only).

VARIATIONS

ADSP-2100/A—A stripped-down version with no on-chip memory or peripherals. Accesses main memory through 14-bit addressing and 24-bit data/program buses. Has hardware wait states.

ADSP-2101/02—2k×24-bit programmable RAM/ROM; 1024×16-bit data RAM, timer, two serial I/Os.

ADSP-2103—3.3V part; has 2k×24-bit programmable RAM, 1024×16-bit data RAM, timer, two serial I/Os.

ADSP-2161/2—8k×24-bit programmable ROM, 0.5k×16-bit RAM, timer, two serial I/Os. 5 and 3V parts; 16.7- and 10-MHz clocks.

ADSP-2163/4—4k×24-bit programmable ROM, 0.5k×16-bit RAM, timer, two serial ports, 10 and 16.7-MHz, 3 and 5V parts.

ADSP-2165/6—12k×24-bit programmable ROM, 1k×24-bit programmable RAM, 4k×16-bit data RAM, timer, two serial I/Os. 10/13/16.67/20-MHz clocks.

ADSP-2171—8k×24-bit programmable ROM, 2k×16-bit programmable RAM, 2-kbyte data RAM, two serial I/O ports, 33 MIPS from 1/2 clock.

ADSP-2111—8k×24-bit programmable ROM, 2k×24-bit programmable RAM, 2-kbyte data RAM, two serial I/O ports, 20-MHz clock, host port.

ADSP-21mps51—2k×24-bit programmable ROM/RAM, 2k×24-bit programmable ROM, 1k×16-bit data RAM. Power-down modes, 16-bit timer, two serial I/Os, 13-MHz clock; 144-pin PGA, 100-pin PQFP.

Part No.	Clock (MHz)	Mode	Max power (mA at 5V)	Pins, package	Price (1000)
ADSP-2105	13.8	Run Idle	70	68-pin PLCC	\$9.90
ADSP-2101	20	Run Idle	70 14.4	80-pin PQFP 68-pin PLCC	\$31
ADSP-2103	10	Run Idle	13 4	68-pin PLCC	\$31
ADSP-21msp5X	13	Run Idle	54 13.4	100-pin PQFP	\$45
ADSP-2105	13.8	Run Idle	64 14	68-lead PLCC	\$9.90
ADSP-2171	33	Run	N/S	128-lead TQFP/PQFP	\$62

SUPPORT

HARDWARE Evaluation boards are available for most ADSP processors. ICEs are available for hardware target debugging.

SOFTWARE Analog Devices supplies an ANSI C compiler and an assembler, linker, and interactive simulator.

Analog Devices ADSP-21020

OVERVIEW Introduced in 1990, the ADSP-21020 is the first member of Analog Devices' high-performance, floating-point DSP family. A descendent of the earlier ADSP-2100 processors, the ADSP-21020 has the processing throughput of 16-bit fixed-point DSPs while moving up to 32-bit floating-point processing. The ADSP-21020 meets IEEE-754 floating-point standards and, as with earlier AD chips, takes advantage of a large instruction word to encode multiple operations per instruction and speed hardware decoding.

Designed for high-speed DSP, CPU execution is optimized for executing instructions from an on-chip instruction cache. The chip features zero-overhead looping and automatic addressing for X and Y memories. It features a Harvard architecture with separate buses for code and data. The buses do not multiplex address information with data or code.

The ADSP-21020 and ADSP-2100 families use program memory as one of the data memories needed for series evaluation. The program bus and memory provide the X data-memory values, which combine with the Y data-memory values for MAC and ALU operations. Although they target high-throughput math processing, AD's DSP processors also have surprisingly sophisticated CPU features. For example, most

32-bit floating-point DSP

ADSP-21020

- ▶ 48-bit instruction, 32/40-bit data words
- ▶ 80-bit MAC accumulator
- ▶ 3-stage pipeline, 63 instructions
- ▶ 32x48-bit instruction cache
- ▶ 10-port, 32x40-bit register file (16 registers/set, 2 sets)
- ▶ 6-level loop stack
- ▶ 24-bit program, 32-bit data address spaces, memory buses
- ▶ Modulo, bit-reversed address
- ▶ 5 external interrupts
- ▶ 33-MHz clock
- ▶ 1 instruction/cycle (pipelined)
- ▶ 1-cycle MPY (32-bit floating or fixed point)
- ▶ 6-cycle DIV (32-bit FP)
- ▶ 2-cycle branch delay
- ▶ Zero-overhead loops
- ▶ 4-cycle max interrupt latency
- ▶ On-chip emulation via JTAG port

instructions have conditional execution: They use a preliminary condition test and, if true, then execute the main instruction.

VENDOR CONTACTS

Analog Devices Inc, Norwood, MA, (617) 329-4700. **Circle No. 485**

Application Hot Line: (617) 461-3672.

DSP BBS: (617) 461-4258 (N,8,1).

ARCHITECTURE

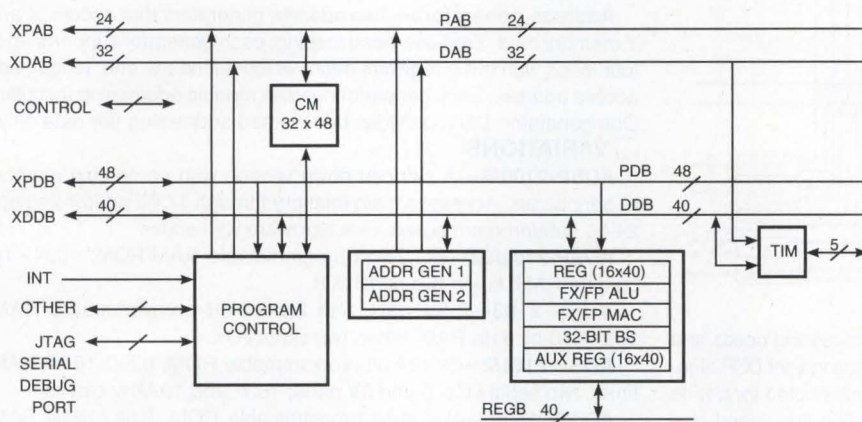

The ADSP-21020 delivers single-cycle, pipelined 80-bit MAC operations. It has a hybrid DSP organization. Like the earlier ADSP-2100 16-bit DSPs, the 21020 has no on-chip program or data memory. Instead, it has a 32-word cache memory to hold inner-loop instructions. The chip also has two external buses: one for instructions (48 bits) and one for data (32 bits). Like the 2100, the 32-bit 21020 achieves single-cycle MAC execution by executing the inner-loop instructions from its on-chip cache and bringing in the coefficients and data from external memory.

Unlike the early DSP designs, the ADSP-21020 is not a minimal-register, accumulator-based design. Operations center around a 32x40-bit, multiported register file that holds multiple accumulators and registers. For fast context switching, two 16-register segments shadow the file. The register file serves as the link between the two main buses and the three computational units. The buses pump data into the register file, which unloads to supply input data to the computational units. Ten ports link the computational units and the data and program buses to the register file.

The ADSP-21020's three computational units comprise a floating-point multiplier and fixed-point accumulator, a 32-bit barrel shifter, and

a floating- and fixed-point ALU. Each is fed from the register file and returns results to the file. The three units can operate in parallel, each accessing inputs from the register file and then returning results concurrently. Operations are current, unless a conflict results—for example, two units accessing the same register. Each functional unit executes in a single clock cycle. The ALU flag register holds the results of up to eight ALU compare operations. You can use the accumulated compare flags to implement 2D and 3D graphical clipping operations.

Hardware automatically handles address generation for the X and Y data needed for each MAC cycle. The hardware has two

address generators to access the X, Y memory data. Each address generator supports up to four loops with three registers each, which define the end, length, and access address. Each generator handles modulo addressing (circular). One generator, DAG1, provides bit-reversed addressing (data only) for FFT calculations.

Addressing modes—Direct and indirect addressing; must use indirect for off-chip memory access.

Fast context switching—Shadow registers for major registers enable fast context switching for interrupts. The PC stack is 20 levels deep. The program sequencer's count and loop stacks are six levels deep and support six levels of interrupt nesting.

Numeric representations—IEEE-754 32-bit single-precision floating point (23-bit data, 8-bit exponent, and sign bit) and a 40-bit extended IEEE format for additional accuracy (32-bit data, 8-bit exponent, and sign bit). Can also use 32-bit fixed-point formats, fractional, and integer (2's-complement or unsigned).

Part no.	Clock (MHz)	Mode	Max power (mA at 5V)	Pins, package	Price (1000)
ADSP-21020	33	Run Idle	500 150	223-pin PGA	\$159

SUPPORT

HARDWARE Analog Devices sells a full-speed ICE and an evaluation board. Third-party tools are also available; contact the company for references.

SOFTWARE Analog Devices provides a tool set that includes an ANSI C compiler, C compiler with numerical C extensions for math and floating-point applications, source-level debugger, assembler/linker, simulator, application libraries, and PROM splitter. Third-party tools include the Spox real-time OS, filter-design packages, and a graphical application-development package.

If you've got a head for VIDEO,

Push the limits of video technology with our full family of affordable ICs.

Get a head start on those hot new video products.



Choose Raytheon Semiconductor. We've combined the video technology and innovation that earned TRW an Emmy with Raytheon Semiconductor's own video design expertise and manufacturing capacity. That means no compromises between leading-edge performance and true affordability.

With highly-integrated analog and digital circuitry, you get a complete solution for all your video needs.

With just one call, you're set. Because for all of today's exciting applications, our full and growing family of video ICs gives you better designs at a lower cost.



have we got a line FOR YOU

PART	PRODUCT	DESC.	FEATURES
TMC 22071 Genlocking video digitizer	NTSC/ PAL	8 bit	10 to 15 MSPS/ sec
TMC 22x5x Digital video decoders	3-line comb filter	8 and 10 bits	10 to 18 Mhz
TMC 22080 Digital video mixer	RGB/ YCbCr/ CI	9 bit Alpha channel	36 Mhz
TMC 22x9x Digital video encoders	NTSC/ PAL	10 bit	10 to 18 Mhz

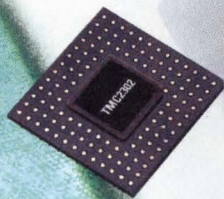

Your design partner for broadcast, video communication, desktop video, imaging and display ICs.

At every step of your design, we'll be there with our video experience and innovation. We'll even customize ICs to meet your exact need.



Call now and learn more about our advanced family of video products.

To make amazing headway in video, simply call 1-800-722-7074.

Raytheon

Raytheon Semiconductor Division

CIRCLE NO. 96



Proof?

VP8200

TRW

Positive!

Why fret over development test? Think positive. Prove your results beyond the shadow of a doubt with the TRW VP8000 Wideband Signal and Test System.

The key is deep memory. The TRW VP8000 has up to 64 megabytes of it. With high-speed capture and generation in both analog and digital. This lets you soak up more real-world signal. In more detail. In less time. With less retesting.

This assures that you catch problems in the lab. Not in production.

The TRW VP8000 proves to be a positive in other ways, too. A single workstation-based system, it replaces stacks of test and measurement devices. Integrating the accessibility of computers with the power of instrumentation. Delivering such doubtless benefits as fast test set-up... a smooth upgrade path... portability... and affordability.

So, don't just prove results the usual way – improve. Give us a call at **1-800-354-6195.**

And let us prove how the TRW VP8000 will erase all your doubts about development test.

The TRW VP8000 – there's no doubt about it.



Analog Devices SHARC (ADSP-2106x)

OVERVIEW Unlike other top-end DSP chips, the ADSP-2106x's CPU actually executes using only on-chip memory for a range of application code—it has 512-kbyte on-chip SRAM. Built on the ADSP-21020 32-bit DSP CPU, the ADSP-2106x integrates an I/O controller with the CPU to offload I/O. This DSP chip has six communication links, which enable designers to create DSP multiprocessor meshes; two high-speed serial ports and a host/parallel port that provides a direct interface to off-chip memory, peripherals, and a host processor; and bus arbitration for up to six ADSP-2106x chips in a multiprocessor cluster.

The core DSP CPU, the ADSP-21020 CPU, has a 48-bit instruction word and a 32-bit data word, although it handles double precision, 64-bit floating-point arithmetic. The wide instruction word minimizes instruction-decode overhead and speeds execution. Similar to Analog Devices' earlier 16-bit DSP processors, the 32-bit DSP core has a small, on-chip cache to hold the last x instructions for fast, inner-loop execution.

32-bit floating-point DSP

ADSP-2106x

- ▶ 48-bit instruction word
- ▶ 32/40-bit IEEE floating-point words
- ▶ 512-kbyte on-chip, dual-access memory
- ▶ I/O controller
- ▶ Host/parallel port
- ▶ Glueless, scalable, multiprocessing support
- ▶ 6 comm ports, 2 serial ports
- ▶ On-chip-emulation mode, JTAG support
- ▶ 33-, 40-MHz clock (25-nsec cycle)
- ▶ 120-Mflops peak performance
- ▶ Parallel ALU and MAC, 1-cycle execution
- ▶ 240-Mbyte/sec max comm port rate
- ▶ Max 40-Mbps serial I/O
- ▶ 3-cycle max interrupt latency
- ▶ 1k complex FFT in 0.46 msec
- ▶ 53M Whetstones/sec; 83k Drystones/sec

VENDOR CONTACTS

Analog Devices Inc, Norwood, MA, (617) 329-4700; (800) 262-5643.
Applications Assistance Line, (617) 461-3672.
Computer Bulletin Board, (617) 461-4258. **Circle No. 486**

ARCHITECTURE

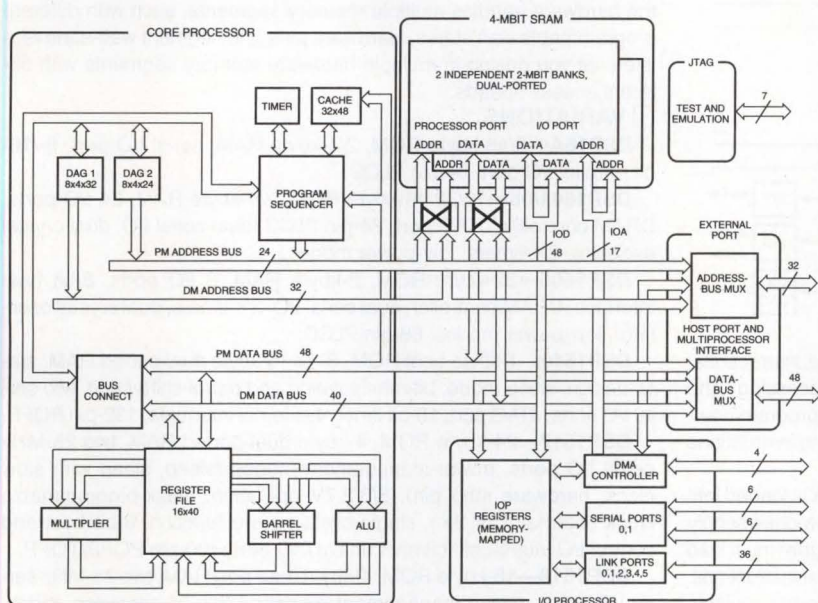

SHARC is an advanced replay of the earlier ADSP-21020 32-bit DSP chip, but it moves 32-bit DSP processing to a new level of capability. SHARC fields a large 512-kbyte on-chip memory organized into two banks of dual-ported RAM. This on-chip RAM holds large chunks of critical code and delivers sustained single-cycle memory accesses. This large memory is fed, in turn, by an independent I/O controller that offloads reads and writes between off- and on-chip memory; the I/O controller executes in parallel with the chip's DSP core CPU, although delays are possible when they contend for the same data. The CPU, I/O controller, and peripherals interconnect through a multibus-crossbar-interconnection unit that allows flexible, nonintrusive transfers between these units. To reduce bottlenecks, the crossbar permits data and instruction fetches from external or internal memory, cache, and I/O from off- or on-chip peripherals all in a single cycle.

Following in the footsteps of the pioneering SGS-Thomson Transputer and TI's C40, the SHARC provides special communication links or ports. Fed through the I/O controller, these ports enable designers to create meshes of DSP processors (each processor in the mesh is defined by point-to-point connections between DSP ports). The on-chip I/O controller sets up, runs, and responds to these ports. Transfers pass through the I/O ports to and from internal memory. The I/O

controller separates these transfers from mainstream DSP processing.

SHARC builds on the ADSP-21020 DSP CPU. The instruction set is upwardly compatible with the 21020s. The ADSP-2106x runs up to 40 MHz and can execute parallel floating-point ALU and multiplication computations in one 25-nsec cycle. The CPU has three arithmetic engines: an ALU, a multiplier, and a barrel shifter. Their operations center around a 10-port register file that transfers or receives operands from the computational units and memory in a single cycle. Arithmetic operations include y/x and $1/x$. Two independent data-address generators support zero-overhead addressing (includes indirect), as well as modulo and bit-reverse address generation.

I/O controller—To maximize data movement, SHARC includes an I/O controller that executes I/O transfers in parallel with CPU execution. The controller manages 10 DMA channels, transferring data between internal memory and external peripheral devices and the host, serial, and link ports. All DMA controller operations are zero-overhead data transfers that generally do not interrupt or delay core thread execution. The synchronous serial ports can deliver transfer rates up to 40 Mbps; the six communication ports move data in 4-bit nibbles, transferring up to 1 byte/clock cycle. With six links operating simultaneously, there is a max throughput of 240 Mbytes/sec.

External interfaces—SHARC has a parallel port that serves as a direct interface to off-chip memory, peripherals, or a host processor. Up to six ADSP-2106x chips can share this bus with a common system-host processor; the bus implementation includes bus arbitration. The ADSP-2106x supports page-mode DRAM and fast SRAM external memory. It can access up to 4G words of external memory. For a 40-MHz clock, (25-nsec cycle) the chip requires a 15-nsec access time for zero-wait-state memory. The special host interface supports both 16- and 32-bit microprocessors, as well as system buses such as ISA and PCI. This host is treated like a memory-mapped device, with direct writes or read to internal memory.

Part no.	Clock (MHz)	Mode	Max power (mA at 5V)	Pins, Package	Price
ADSP-21060 (512 kbytes)	33, 40	Run Idle	720 50	240-pin PQFP	\$296
ADSP-21062 (256 kbytes)	33, 40	Run Idle	680 50	240-pin PQFP	\$196

SUPPORT

HARDWARE Analog Devices sells an ICE, which is a full-speed, nonintrusive, JTAG-based hardware tool that uses the ADSP-2106x built-in debugging capability. It runs under Microsoft Windows and supports debugging for multiple processor systems. Also available is the EZ-LAB Development System, a PC plug-in card for multiple 2106x processors.

SOFTWARE Analog Devices supplies a C compiler that has full support for Numerical C, which extends C with vector- and matrix-processing capabilities for signal processing. Other tools include an assembler/linker, a simulator, application libraries, a PROM splitter, and a C source-level debugger.

AT&T DSP16xx

OVERVIEW The DSP16 has a core MAC unit, multiple on-chip memories, a small instruction cache, dual data-address generators, and multiple buses to move data in parallel. The DSP16 features a 16-bit external bus, three 16-bit internal buses, an 8-kbyte program/coefficient ROM block, a 1-kbyte data RAM block, and a small instruction cache. It loads 15 inner-loop instructions in the cache and then repeatedly executes them by pumping data and coefficients from the ROM and RAM blocks to the MAC execution unit. The chip also has a 16-bit host I/O port and a serial I/O port. Later versions add a bit-manipulation unit with a 16-bit barrel shifter, a second serial I/O port, and more peripherals; they also have a JTAG test/emulation port for chip test and in-circuit debugging.

VENDOR CONTACTS

AT&T Microelectronics, Allentown, PA, (800) 372-2447. **Circle No. 487**
BBS: (610) 712-4444, V.22bis, up to 2400 bps; (610) 712-1440, V.32bis, up to 14,400 bps (N,8,1).

16-bit fixed-point DSP

DSP1617

- ▶ 8-stage pipeline, 46 instructions
- ▶ 4 36-bit accumulators; 4 alternate 16-bit regs
- ▶ 15-instruction cache
- ▶ 24-kbyte ROM (secure option)
- ▶ 3 buses: X, Y internal data
- ▶ 4-kbyte dual-ported RAM
- ▶ MAC unit with two 36-bit accumulators
- ▶ Bit-manipulation unit
- ▶ ROM, RAM address generators
- ▶ 2 64-kbyte address spaces
- ▶ 8-bit parallel I/O, two serial I/Os
- ▶ 2 external interrupts
- ▶ 38/40/50-MHz clock (1 cycle=1 clock), static design
- ▶ 5-cycle reg-to-mem ADD
- ▶ 1-cycle MPY, ACCUM (pipelined)
- ▶ No DIV instruction
- ▶ 2-cycle mem W; 1- to 2-cycle R
- ▶ Dual RAM access; 1-cycle penalty for accessing same bank
- ▶ Programmable wait states for each address-space segment
- ▶ 20/25-Mbps max for serial I/O
- ▶ 8-cycle interrupt latency
- ▶ ISRs and cache ops not interruptible; max cache-op latency is 1905 instr

ARCHITECTURE

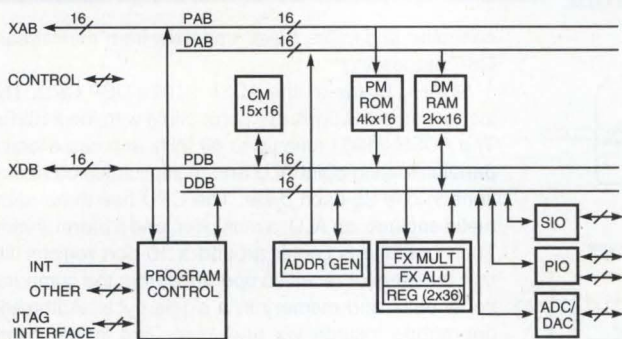

The 16-bit DSP16 uses three internal buses to move instructions, coefficients, and data in parallel for high-throughput processing. The DSP CPU defines two 64k-word address spaces, one for program/coefficients and one for data. The X memory space holds both instructions and coefficients; the Y memory space holds data.

For fast inner-loop processing, an inner-loop code block is loaded into a 15-word instruction cache, and the on-chip X and Y memories supply the coefficients and data to drive MAC execution. The program must load the cache and execute the cached instructions via special instructions. The Y RAM is dual-ported, has eight banks, and supports multiple accesses. Accesses to the same bank, however, cause a 1-cycle delay. The DSP1610 and later versions have only one RAM block that holds both X coefficients and Y data, which can be accessed simultaneously.

The DSP has two address-generation units: the XAAU ROM address arithmetic unit and the YAAU RAM address arithmetic unit. These units have their own internal adders and registers to hold address values and offsets. The XAAU has a 12-bit adder, 12-bit static offset register, and four 16-bit pointer registers—the PC, program-return, program-interrupt, and table-pointer registers. The YAAU has eight static registers and an adder. In the original DSP16, the static registers were nine bits; in later processors, they are 16-bit registers. The XAAU and YAAU registers are accessible to programmers—you can use them for loading and storing.

The main execution unit is the DAU (data arithmetic unit), which has a 16x16-bit multiplier and a 36-bit adder with two accumulators. The multiplier and adder operate in parallel, and multiplier inputs and outputs are registered. A full MAC execution is pipelined. In the first stage, the registered inputs drive the multiplier, which outputs a 32-bit result into a holding register. The MAC can shift the multiply result before running it through the 36-bit ALU/shifter and into one of the accumulators. The DSP16 CPU uses fixed-point, 2's-complement arithmetic throughout. The bit-manipulation unit has a 36-bit barrel shifter, two 36-bit accumulators, and four general-purpose 16-bit registers.

The DSP CPU supports two memory spaces: a program/coefficient

space and a data space. These address spaces are segmented, and the hardware handles multiple memory segments, each with different programmable wait states. Hardware pins and segment wait-state registers let you design-in multiple hardware memory segments with different access speeds.

VARIATIONS

DSP16A—8/48-kbyte ROM, 2/4-kbyte RAM, serial I/O port, 8-/16-bit parallel I/O port, 84-pin PLCC.

DSP1604/06—16/32/48-kbyte ROM, 2/4-kbyte RAM, 24 I/O ports, DRAM controller, JTAG port, 84-pin PLCC, dual serial I/O, dual crystal oscillator, 2x timers, low-power modes.

DSP1605—32-kbyte ROM, 2-kbyte RAM, 8 I/O ports, 8-bit host interface, DRAM controller, dual serial I/O, 2x timers, dual crystal oscillator, low-power modes, 68-pin PLCC.

DSP1610—1-kbyte boot ROM, 8- or 16-kbyte dual-ported RAM, static design, sleep mode, bit-manipulation and barrel-shifter unit, two serial I/O ports, JTAG port, 16-bit timer, 4 external interrupts, 132-pin PQFP.

DSP1617—24-kbyte ROM, 4-kbyte dual-ported RAM, two 25-MHz serial I/O ports, power-management modes (sleep, sleep with slow clock, hardware stop pin), 5/3/2.7V operation, mask-programmable clock (internal 1 or 2x), single-cycle square function, 8-bit host and control I/O interfaces, bit/shift unit, JTAG port, 100-pin PQFP/TQFP.

DSP1618—16-kbyte ROM, 4-kbyte dual-port RAM, two 25-MHz serial I/O ports, power-management modes, 5/3/2.7V operation, mask-programmable clock (internal 1 or 2x), single-cycle square function, 8-bit host and control I/O interfaces, bit/shift unit, JTAG port, 100-pin PQFP/TQFP.

DSP1616X30—24-kbyte ROM, 4-kbyte dual-ported RAM, two 25-MHz serial I/O ports, power-management modes, 5/3/2.7V operation, mask-programmable clock (internal 1 or 2x), single-cycle square function, 8-bit host and control I/O interfaces, bit/shift unit, JTAG port, 100-pin PQFP/TQFP.

Part no.	Clock (MHz)	Mode	Max power (mA at 5V)	Pins, package	Price (10,000)
DSP1604/06	33	Run Sleep	100	84-pin PLCC	\$15 to \$20
DSP1605	33	Run Sleep	100	68-pin PLCC	\$13.25
DSP1610	40	Run	130	132-pin PQFP	\$63
DSP1617	50 30	Run Sleep SW stop	75 36 μ A (2.7V) 28.6 μ A (2.7V)	100-pin PQFP	\$42.60
DSP1616X30	50	Run Sleep SW stop	50 (2.7V) 33 μ A (2.7V) 28.6 μ A (2.7V)	100-pin PQFP 100-pin TQFP	\$27.40
DSP1618	50 30	Run Sleep SW stop	75 36 μ A (2.7V) 26 μ A (2.7V)	100-pin PQFP 100-pin PQFP 100-pin TQFP	\$55

SUPPORT

HARDWARE AT&T supplies a hardware-development system with an ICE pod. Evaluation and demo boards are also available.

SOFTWARE AT&T sells software-development tools including a C compiler, assembler/linker, debugger, simulator, and application library.

There are many areas where our function generator will surpass your expectations.

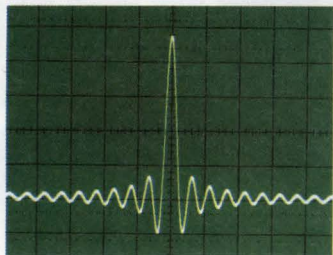

A built-in 12-bit, 40 MSample/sec, 16K deep arbitrary waveform generator easily handles your custom waveform needs.

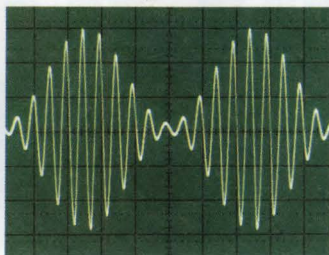

Internal AM, FM, FSK and burst modulation eliminate your need for a second modulation source.

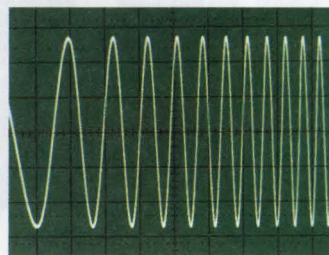

Both linear and log sweeps are built in, making filter and amplifier testing quick and easy.

And one where it falls short.



The HP 33120A 15 MHz synthesized function/arb generator: Within budget, without compromise.

In the world of function generators, price and performance have always been synonymous. So it's understandable you'd expect to pay more for the measure of confidence you get with a synthesized signal source that delivers stable, accurate signals test after test. Or, for the flexibility to generate complex waveforms with arbitrary waveform capability.

You'd probably also expect to pay a premium for the convenience of built-in sweep and modulation functions. And to have both HP-IB and RS-232 interfaces standard.

Fact is, you can always get high performance with the high price to

match. Or, order the HP 33120A fully loaded function/arb generator and get something totally unexpected. A price you can afford.

Call HP DIRECT at 1-800-452-4844*, Ext. 7819 to talk to an HP engineer about your function generator needs.

Want to speak to someone about the HP 33120A function/arb generator features, its complementary BenchLink/Arb software, or your application needs? Calling HP DIRECT is the fast, easy way to get all your questions answered — with no obligation to order.

You see, HP DIRECT is your direct line to information and solutions for HP basic test instruments. With one simple call, you can get product

specifications or any technical literature you need to make the right decision. Or, for one-on-one technical support, you can speak to an engineer who has

first-hand experience with HP products.

And, of course,

if you're ready to order, we can help you do that, too.

So give us a call. And discover how much more you get from HP today.

* In Canada, call 1-800-387-3867, Dept. 476

There is a better way.



THE HOTTEST NEW WAY TO DESIGN COOL ELECTRONICS.

ICEPAK.



Don't let your cool packaging design get burned by slow, outmoded thermal design methods. Now there's a hot alternative. Icepak. The new thermal design software from Fluid Dynamics International.

FAST RESULTS.

No matter what kind of electronic packaging you're designing, nor what kind of thermal design experience you may have.

Eliminate hot spots to optimize thermal performance even while reducing enclosure sizes. With Icepak, you beat the heat of shortened design cycles and ever-increasing cost pressures.

QUICK LEARNING CURVE. Problem set-up and results generation are fast. You get the short turn-around time you need to keep up with design changes.

INTELLIGENT GRAPHICAL INTERFACE. Icepak is a radical departure from any design methods or software. This

object-based tool combines an intelligent graphical user interface with a modern software architecture.

A FULLY INTEGRATED SOLUTION. Icepak includes an interactive model-builder, powerful automatic mesh generation, an accurate solver, and the most sophisticated post-processing and 3D graphical visualization capabilities you've ever seen. Nothing else comes even close. And nothing else is easier to use.

FROM THE LEADER: FDI. All this is just what you'd expect from FDI... the leader in FEA based CFD software for over 10 years. For more information about Icepak, or to arrange a demonstration, call or fax today. Make your next hot design the coolest one yet.

icepak

Fast, Easy Thermal Design.

©1994, Fluid Dynamics International. All rights reserved. Icepak is a trademark of Fluid Dynamics International.



Fluid Dynamics International, 500 Davis Street, Suite 600, Evanston Illinois 60201, 708.491.0200, Fax: 708.869.6495

86 • EDN June 9, 1994

CIRCLE NO. 70

AMPLIFIERS

NOBODY DOES AMPLIFIERS LIKE ANALOG DEVICES

IN THIS ISSUE

Whatever your application, ADI has the ideal amplifier for you. And they're available from national distributors and local sales offices nearby. In this issue you'll find our newest amplifiers, with performance and prices to meet the most demanding applications.

High-Speed

High-speed amplifiers for video, high-definition imaging and graphics, office equipment, communications systems, and test and measurement instrumentation.

Precision

From the inventors of the OP-07 come new circuits that combine superior ac/dc specifications, high common-mode rejection, and low gain error.

Single-Supply

If you're designing 3 V or 5 V systems, you need amplifiers specifically designed and tested for low-voltage applications. Choose from the industry's largest selection of true single-supply amplifiers.

Low-Noise

For medical imaging systems or advanced audio equipment, ADI has a low-noise, low-distortion amplifier to fit your needs, at a price you can afford.

Instrumentation Amps

Why build your own instrumentation amplifier when ADI has a full selection ready to go, all with high accuracy and prices to beat discrete designs.

Free Spice Disk

The industry's best SPICE models covering over 392 devices are yours for the asking. The diskette includes macro-models of amplifiers, references, multipliers, analog switches, and more.

Applications Information

Our team is on your team. For assistance call on our factory or field applications engineers. With over twenty-five years of analog experience, we're here to help. 1-800-ANALOG-D.

LEADERS IN HIGH SPEED

FASTEST AMP ON 50 mW

Introducing the industry's fastest op amp on 50 mW. The new AD8001 800-MHz unity-gain monolithic amplifier uses just 5 mA of supply current. It can process high-speed video signals in HDTV equipment, professional cameras and graphics workstations. Video-specific parameters include 0.1 dB gain flatness to 100 MHz, 0.01% differential gain, 0.025° differential phase ($G = +2$, $R_L = 150 \Omega$).

Other specifications include 1,200 V/ μ s slew rate and 10 ns settling of 2 V steps to within 0.1%. A single AD8001 can provide 70 mA of output current and drive up to six back-terminated (75 Ω load) cable lines. Full power bandwidth is 125 MHz with 5 V p-p signal swings. The AD8001's worst harmonic component at 20 MHz is -60 dB, and voltage noise

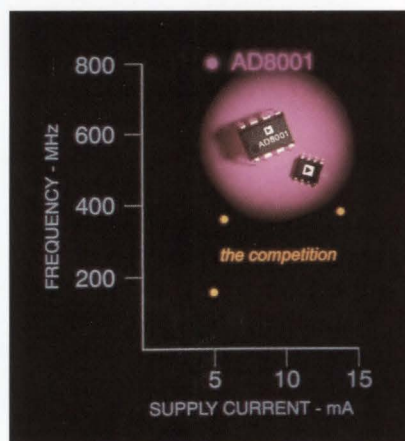

at 10 kHz is only 2 nV/ $\sqrt{\text{Hz}}$.

The AD8001 is packaged in an 8-pin plastic DIP or SO-8 and operates from -40°C to +85°C. Military grades will be available with operation from -55°C to +125°C. Prices begin at \$2.75 in 1,000s.

CIRCLE 1

LOW-POWER 110-MHz BUFFER RUNS COOL

The 110-MHz BUF04 slews at 3,000 V/ μ s and consumes only 6.9 mA. At ± 5 V, you can reduce power to one-third with full ± 15 V performance. Closed-loop design provides low offset and great gain accuracy, and ± 10 V signals settle to within 0.1% in 60 ns. Best of all, the BUF04 is packaged in low-profile SO-8 and 8-pin DIPs.

Applications include a/d converter buffering, video cable driving, pulse detection, pro-audio d/a converters, and more. The BUF04 operates from

BUF04 KEY SPECS

Parameter	Min	Typ	Max	Units
GBW		110		MHz
Slew Rate	2,000	3,000		V/ μ s
Supply Current		6.9	8.5	mA
Voltage Noise Density	4			nV/ $\sqrt{\text{Hz}}$
Offset Voltage	0.3	1		mV
Gain Linearity		0.005		%

Prices, from \$3.71 in 1,000s.

1 Specifications with ± 15 V supply operation

± 5 V to ± 15 V supplies over temperatures from -40°C to +125°C.

CIRCLE 2

WIDE BAND OP AMPS FOR VIDEO, IMAGING, AND COMMUNICATIONS

These new high-speed op amps provide optimal price/performance in a wide range of video-speed applications. They excel at driving heavy capacitive loads. Some are specified for operation on single +3 V to +5 V supplies, others use common ± 5 V and ± 15 V dual supplies.

AMPS WITH LOW $\Delta G/\Delta \theta$

If you need high output drive, try the AD811. It's a high-performance video amplifier with superb video specs to preserve signal fidelity in high-definition TV systems. The AD811 delivers high output drive of 100 mA for efficient line driving. It's specified over a wide power supply range of ± 4.5 V to ± 18 V and uses just 16.5 mA of power supply current.

Other family members include the AD810 and AD812, ideal for broadcast-quality applications. The AD810 is a low-power version that consumes just 6.8 mA in normal mode, while a DISABLE feature further reduces power to only 2.1 mA. The versatile and low-cost dual AD812, runs on a single +3 V or +5 V supply, or from ± 5 V or ± 15 V supplies. Package options include 8-pin plastic DIPs, 16- and 20-pin SOICs, 8-pin Cerdips, or 20-pin LCCs.

CIRCLE 3

TRIPLE VIDEO AMP WITH FAST DISABLE

The triple AD813 packs three current-feedback op amps, each with its own independent 80 ns disable function. It offers unprecedented gain flatness for high-quality computer video and broadcast video gear. Operation is from either single +3 V to +5 V, or ± 5 V to ± 15 V supplies. Supply current is a low 3.5 mA (+3 V) and it delivers 100 MHz of unity gain (-3 dB) bandwidth.

For video muxing, CCD-based equipment, and RGB line driver applications, nothing matches the AD813. It operates from -40°C to $+85^\circ\text{C}$ and comes in small 14-pin DIP or narrow body SOIC packages.

CIRCLE 4

LOW-COST, GENERAL-PURPOSE AMPLIFIERS

The AD817 is optimized for applications that require unity-gain stable operation. Its counterpart, the AD818 is tailored for gains of magnitude equal to or greater than +2 or -1 . The AD818, with low differential phase and gain errors, is great for video cameras and pro video equipment. As an ADC buffer or line driver, the AD817 excels with its combination of high output current and unlimited capacitive load drive.

CIRCLE 5

HIGH-SPEED FET-INPUT

The AD843 and AD845 FET-input op amps combine excellent ac and dc performance with low power consumption. The dc performance of these unity-gain stable op amps is perfect for high-speed data acquisition systems. Their low input bias current and offset voltage can reduce errors in high-speed active filters, integrators, peak detectors, and current-to-voltage converter circuits.

Dynamic performance is equally impressive. They have low total harmonic distortion for high-speed sample/hold circuits, ADCs, and DSP front-end circuits. They also have industry-standard pinouts and can upgrade system performance. Both op amps operate from ± 15 volt supplies with five performance grades specified over commercial, extended, and military temperature ranges.

CIRCLE 6

VIDEO LINE DRIVING MADE EASIER

The figure below depicts a video line driver circuit and provides a list of recommended products with associated resistor values. When using a current feedback op amp for U1, closed-loop bandwidth largely depends on the value of the feedback resistor R_F .

Attenuation of the circuit's open-loop response, especially when driving a load value $< 250 \Omega$, will also affect its bandwidth. Gain resistance (R_G) is typically set for stable operation at $G = 2$. Low values of R_G and R_F will minimize the circuit's feedback time constant and nonlinear behavior. The use of 1% metal-film resistors ensures the widest possible 0.1 dB bandwidth. To achieve even wider bandwidths, you can reduce the magnitude of R_F , but you run the risk of increasing signal peaking. Use maximum supply voltages and limit amplifier loads to minimize signal distortion.

With the exception of the AD8001, which operates from ± 5 V supplies, the products in the chart below are characterized with ± 15 V supplies. Bandwidth is a measure of gain flatness at 0.1 dB.

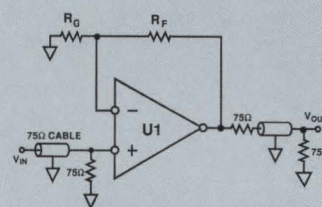

MODEL	0.1dB BW (MHz)	ΔG (%)	$\Delta \phi$ ($^\circ$)	R_F/R_G (Ω)
AD8001	110	0.01	0.025	750
AD811	35	0.01	0.01	649
AD812	40	0.05	0.02	715
AD813	50	0.03	0.06	681
AD818	55	0.005	0.045	1,000

FOR INFORMATION

HIGH SPEED QUAD WITH PRECISION

The OP467, with four fast op amps in one package, has the fastest slew rate (170 V/ μ s) and settling time (≤ 200 ns to 0.01%) among quads. In multi-channel systems, it can save space, reduce power and cost, and increase reliability. It's unity-gain stable and can drive high-capacitance loads up to 1,600 pF.

Besides its speed, it offers a low 200 μ V offset. Use the OP467 in high-speed instrumentation and test equipment, high-speed detectors, laser scanners, sonar arrays, and other applications that need speed, accuracy, and a wide ± 5 to ± 15 V operating range. It's housed in 14-pin plastic DIP, cerdip, 16-lead SOL, and 20-contact LCC surface-mount packages.

CIRCLE 7

IMPROVED EL2020

The ADEL2020, a superior second source, will improve performance with less power drain and lower cost. Low differential gain and phase errors make it ideal for low-power video applications. The ADEL2020 is available in either plastic DIP or SOIC packages specified over the -40°C to $+85^{\circ}\text{C}$ industrial temperature range.

CIRCLE 8

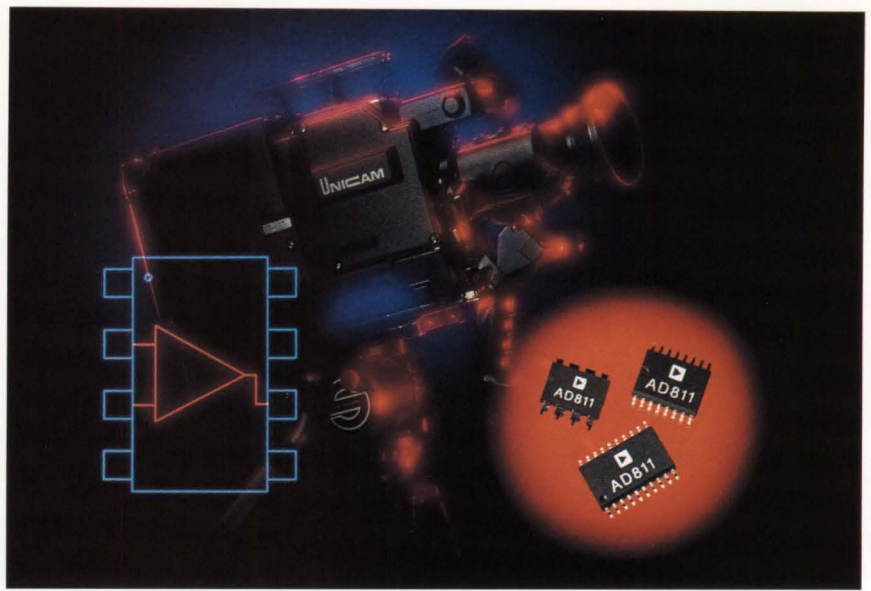

AN AMPLIFIER WITH A DIFFERENCE

The AD830 wideband amplifier rejects high-frequency common-mode voltage noise in differential line receiver applications. It handles differential signals, system grounds, and low-distortion high-frequency amplification. With $> \pm 50$ mA full-output-current drive, it's useful for driving heavy loads. And its output clamping is great for driving ADCs.

Other benefits include balanced impedance inputs, symmetrical circuit behavior for gain of either +1 or -1, and low sensitivity to source resistance.

The AD830 uses ± 15 V and ± 5 V supplies, but its special offsetting capability allows it to perform with single supplies from +10 to +30 V. Packages include 8-pin plastic miniDIP, cerdip, and SOIC. **CIRCLE 9**

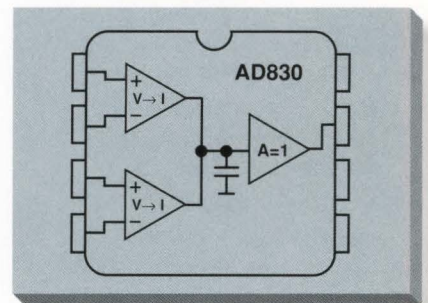

MODEL	AD810	AD811	AD812	AD813	AD817	AD818	AD843	AD845	OP467	AD830	UNITS
Channels	Single	Single	Dual	Triple	Single	Single	Single	Single	Quad	Single	
Supply Voltages	$\pm 5, \pm 15$	$\pm 5, \pm 15$	+3 to ± 15	+3 to ± 15	+5 to ± 15	+5 to ± 15	± 15	± 15	$\pm 5, \pm 15$	$\pm 5, \pm 15$	Volts
Feedback	Current	Current	Current	Current	Voltage	Voltage	Voltage	Voltage	Voltage	Voltage	
BW, 0.1 dB ($G=+2$)	30	35	40	50	16	55	—	—	—	15	MHz
BW, -3 dB ($G=+1$)	80	140	145	125	50	130 (+2)	34	16	28	100	MHz
Slew Rate	1,000	2,500	1,600	450	350	500	250	100	170	530	V/ μ s
Settling Time (0.01%)	125	65	40 (0.1%)	40 (0.1%)	70	80	135	350	200	35 (0.1%)	ns
Δ Gain Error	0.02	0.01	0.02	0.03	0.04	0.005	0.025	0.04	—	0.05	%
Δ Phase Error	0.04	0.01	0.02	0.06	0.08	0.045	0.025	0.02	—	0.08	$^{\circ}$
V_n (10 kHz)	2.9 (1 kHz)	1.9 (1 kHz)	3.5	3.5	15	10	19	18	6 (1 kHz)	27	nV/ $\sqrt{\text{Hz}}$
Max V_{OS}	6	3	5	5	2	2	2	1.5	0.5	± 3	mV
Min Output Current	40	100 (typ)	40	50	50	50	50	50 (typ)	50 (typ)	± 50	mA
Max Supply Current	8	18	5.5	5.5	7.5	7.5	13	12	10	14.5	mA
Prices in 1,000s	\$2.08	\$2.85	\$2.48	\$3.74	\$1.52	\$1.69	\$3.70	\$2.76	\$4.86	\$2.42	USD
	CIRCLE 3	CIRCLE 3	CIRCLE 3	CIRCLE 4	CIRCLE 5	CIRCLE 5	CIRCLE 6	CIRCLE 6	CIRCLE 7	CIRCLE 9	

1 . 8 0 0 . 2 6 2 . 5 6 4 3

LOW-POWER PRECISION FAMILY

When your design demands precision and low power, nothing beats the OP97 family. The OP97 (single) OP297 (dual) and OP497 (quad) are great for designs that need very low bias currents.

The OP97 family is ideal for sample-and-hold circuits, peak detectors, and logarithmic amplifier designs that exhibit low leakage current. Thermocouples, strain gages and other industrial equipment need the OP97's accuracy over wide temperature ranges. Unlike conventional FET-input op amps, these ICs use a unique current cancellation circuit to keep bias current low over the entire temperature range.

The family combines low power consumption with guaranteed accuracy. Maximum voltage offset at 25°C is only 50 µV (with only 0.5 µV/°C drift) and bias current is 100 pA. Minimum open-loop gain is 2 kV/mV. Combined, these specs can eliminate the need for offset trims and additional gain stages.

Battery and low-powered systems will benefit from the OP97 family's low supply current: 625 µA (max) per channel. Wide supply voltages range from ±2 V to ±20 V. Packaging options include 8- and 14-pin DIPs and cerdips, 8- and 16-pin SOICs, and 20-contact LCCs.

CIRCLE 10

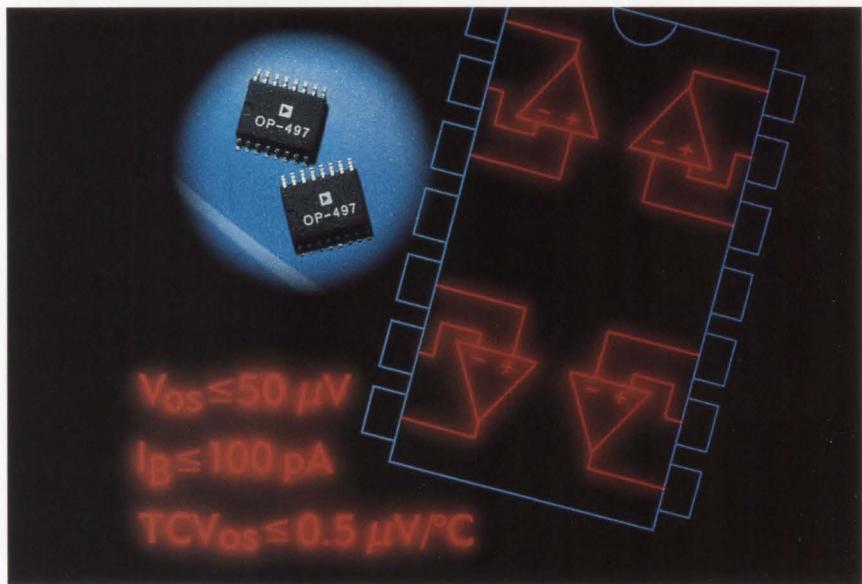

WHAT'S BETTER THAN THE OP-07?

The OP177 is today's industry standard for ultrahigh precision. Maximum offset voltage is only 10 µV, with less than 0.1 µV/°C V_{OS} drift, eliminating external V_{OS} trimming and increasing system accuracy over temperature. Other guaranteed specifications include minimum 130 dB CMRR and 120 dB PSRR.

This low-noise, bipolar-input op amp is a good alternative to chopper-stabilized amplifiers. The OP177 provides chopper-type performance without high noise, low frequency chopper spikes, external capacitors, and limiting common-mode input voltage

range. The OP177 is available in 8-pin plastic, cerdip and SO-8 packages. Cerdip and 20-lead LCC devices are guaranteed over extended and military temperature ranges.

CIRCLE 11

DUALS AND QUADS TOO

The dual OP200 and quad OP400 offer great performance over temperature and use very little power. For example, the OP200's input offset voltage is typically 25 µV with only 0.2 µV/°C drift from -55°C to +125°C. Its supply current (per amplifier) is a scant 570 µA. Industry standard DIP, SOL and LCC packages are available.

CIRCLE 12

MODEL	OP97	OP297	OP497	OP177	OP200	OP400	UNITS
Channels	Single	Dual	Quad	Single	Dual	Quad	
Offset Voltage (V_{OS})	25	50	50	10	75	150	µV, max
V_{OS} Drift	0.6	0.6	0.5	0.1	0.5	1.2	µV/°C, max
Offset Current (I_{OS})	0.1	0.1	0.1	1	1	1	nA, max
Input Bias Current	±0.1	±0.1	0.1	1.5	2	3	nA, max
Voltage Noise @ 1kHz	14	17	15	(118)	11	18	nV/√Hz (nV _{RMS})
Current Noise	20	20	20	(8)	400	600	fA/√Hz (pA _{RMS})
CMRR	132	120	120	130	120	120	dB, min
PSRR	132	120	120	120	-	-	dB, min
Input Voltage Range	±14	±14	±14	±13.5	±13	±13	V
Bandwidth (G=+1)	900	500	500	600	500	500	kHz
Supply Current	600	625	625	2,000	725	725	µA, max
Prices in 1,000s	\$1.00	\$2.50	\$4.04	\$0.95	\$2.48	\$4.50	USD
	CIRCLE 10	CIRCLE 10	CIRCLE 10	CIRCLE 11	CIRCLE 12	CIRCLE 12	

SINGLE-SUPPLY AMPLIFIERS DELIVER TOP PERFORMANCE AT LOW COST. INDUSTRY'S BROADEST PRODUCT LINE

Nobody has a broader product portfolio of single-supply amplifiers for low-power and battery-powered gear. These are just a few of the products we've recently introduced.

LOW-COST DUALS AND QUADS OUTPERFORM CMOS AMPS

The dual OP292 and quad OP492 single-supply op amps are low in cost and outperform comparably priced CMOS devices. These 4 MHz, 4 V/ μ s amplifiers combine the qualities of complementary bipolar—low noise, precision and output drive capability—with the low cost of CMOS devices. With +5 V supplies, the OP292 guarantees 2.4 mV maximum (500 μ V typ) offset over our new H_{OT} temperature range (-40°C to +125°C), at no additional cost.

Unlike competitive ICs, the inputs of these amplifiers can swing well below ground with output swings to ground. The OP292 and OP492 draw less than 1.4 mA per channel, excellent for multichannel battery-powered applications. Both amps feature low voltage and current noise: 15 nV/ $\sqrt{\text{Hz}}$ and 0.7 pA/ $\sqrt{\text{Hz}}$, and channel separation (at 1 kHz) is 100 dB.

Applications that can take advantage of the OP292 and OP492 include disk drives, mobile phones, multichannel industrial and servo control systems, modems, fax machines, pagers, and power supply monitoring circuits. Packaging options include 8- and 14-pin plastic DIPs or surface-mount narrow-body SOICs. USD prices for the OP292 and OP492 start at \$1.32 and \$2.16, respectively.

CIRCLE 13

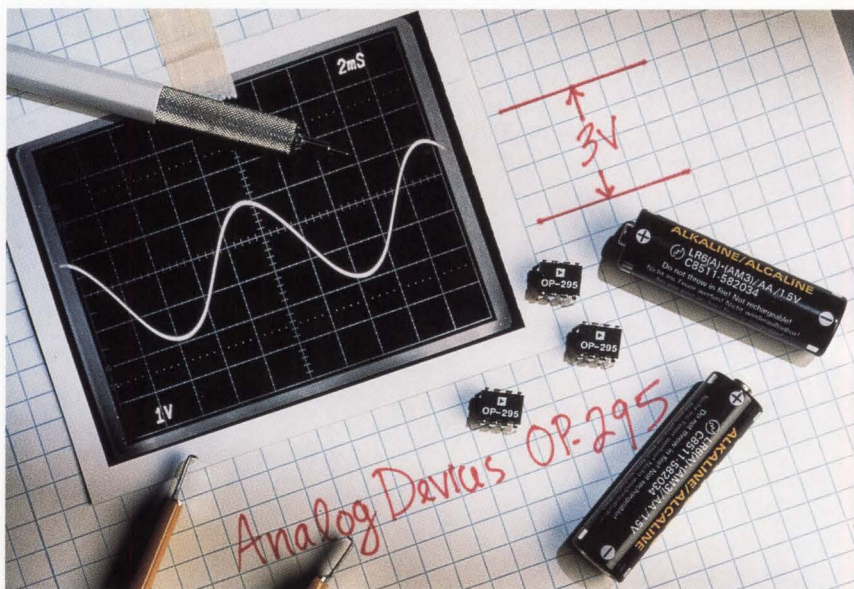

3-V TO 30-V RAIL-TO-RAIL

The dual OP295 and quad OP495 3-V single-supply op amps are the industry's highest accuracy, lowest power true rail-to-rail amplifiers. Their low 30 μ V offset, combined with a high gain of 1,000 V/mV, makes them ideal for portable instrumentation. On a 3 V supply, they drive a 10 k Ω load from 2.90 V to within only 2 mV of ground—perfect for process and motor control circuitry.

For driving coax cable, large FETs, or other capacitive loads, the OP295 and OP495 offer stability with loads up to 300 pF. They can supply over ± 25 mA to the load on ± 15 V supplies (± 18 mA at +5 V), with a typical gain-bandwidth product of 75 kHz.

The OP295 uses less power than CMOS chips, gives exceptionally low voltage offset drift (typically 1 μ V/ $^{\circ}$ C), and requires only 50% of the quiescent current of the closest competitive product.

The OP295 and OP495 are specified from -40°C to +125°C and packaged in plastic DIPs and SOICs. Die are also available. USD prices in 1,000s begin at \$1.98 and \$3.56, respectively.

CIRCLE 14

HIGH PRECISION AT +5 V

The OP113, OP213 and OP413 are single, dual and quad single-supply precision amplifiers. Operating from +5 V to ± 15 V, these op amps feature low noise (4.7 nV/ $\sqrt{\text{Hz}}$), 3.5 MHz bandwidth, 75 μ V offset voltage, and drift of just 0.2 μ V/ $^{\circ}$ C. Applications include automotive, process control, portable instruments, and pressure/strain gages. Packaging options range from 8-lead SOIC and plastic DIP to 16-lead SOL packages. USD prices in 1,000s begin at \$1.47 (single), \$2.21 (dual) and \$4.92 (quad).

CIRCLE 15

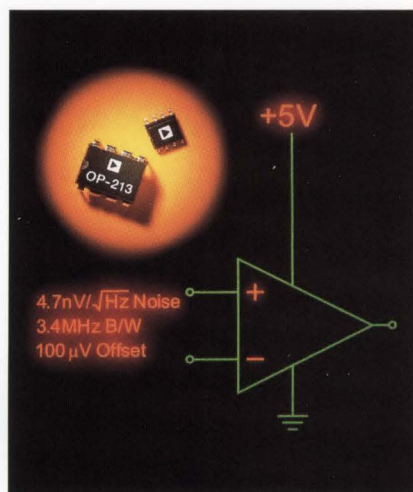

1 . 8 0 0 . 2 6 2 . 5 6 4 3

SINGLE-SUPPLY FET

The AD820 (single) and AD822 (dual) are precision, low-power, FET-input op amps that operate from a single +3 to +36 V range, or with dual supplies from ± 1.5 to ± 18 V. Their outputs swing from rail to rail (within 10 mV) and their inputs can swing 0.2 V below ground. The JFET input stage maintains low bias current (≤ 10 pA at 25°C, B grade), with offsets as low as 900 μ V max over temperature (-40°C to $+85^\circ\text{C}$) and 25 $\text{nV}/\sqrt{\text{Hz}}$ noise at 10 Hz.

Though the quiescent current drain is only 620 μ A, both the AD820 and AD822 will drive loads of up to 15 mA and 350 pF. They both have a unity gain bandwidth of 1.8 MHz and 3 V/ μ s slew rate. A 3-volt version is optimized for low-power operation from -40°C to $+85^\circ\text{C}$ at no extra cost. The AD820 and AD822 are available in 8-pin plastic DIPs and SOICs.

CIRCLE 16

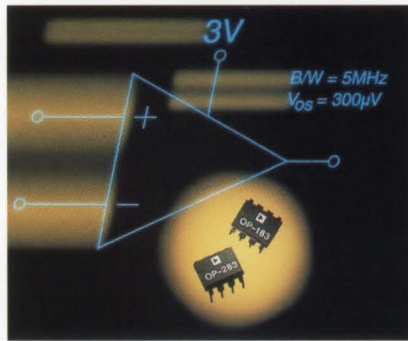

INDUSTRY'S FASTEST 3 V SINGLE-SUPPLY AMP

If your 3 V system needs a gain bandwidth product greater than 1 MHz, select the OP183 or OP283. They combine 5 MHz bandwidth with low noise for use in low voltage applications, such as ADC buffering, filtering, servo control and audio for portable computers.

These two amps are thoroughly specified for +3 V, +5 V and ± 15 V supply operation. Unlike competing

3 V devices that specify only typical performance characteristics, the OP183 and OP283 guarantee low offset, high gain, and input and output ranges that include ground. Noise is typically a low 10 $\text{nV}/\sqrt{\text{Hz}}$, and both amplifiers can sink and source 25 mA—even with a 3 V supply.

Both devices are specified from -40°C to $+85^\circ\text{C}$ and are available in 8-lead plastic DIPs and SO-8 packages. Prices for the OP183 and OP283 (in 1,000s): \$1.42 and \$2.15, respectively.

CIRCLE 17

SINGLE-SUPPLY INSTRUMENTATION AMPLIFIERS FEATURE SINGLE-SUPPLY, HIGH ACCURACY, LOW COST

When accuracy, space and cost are your concern, one of these three in-amps will provide the lowest cost solution—especially when compared with the time to design and implement an equivalent circuit.

SINGLE SUPPLY IN-AMP

Specified for operation from +5 to ± 15 volts, the AMP04 precision in-amp packs accuracy in a small SO-8 footprint for those difficult single-supply designs. The AMP04 can eliminate the need for a separate gain stage to isolate low-level differential signals from high-level common-mode signals. Gain is easily programmable from 1 to 1,000 with a single resistor.

The AMP04 has an input offset current of 1 nA for direct connection to strain gages and high-impedance transducers. Guaranteed max specs include 3 $\mu\text{V}/^\circ\text{C}$ offset drift, 150 μV offset voltage, and 0.005% gain non-

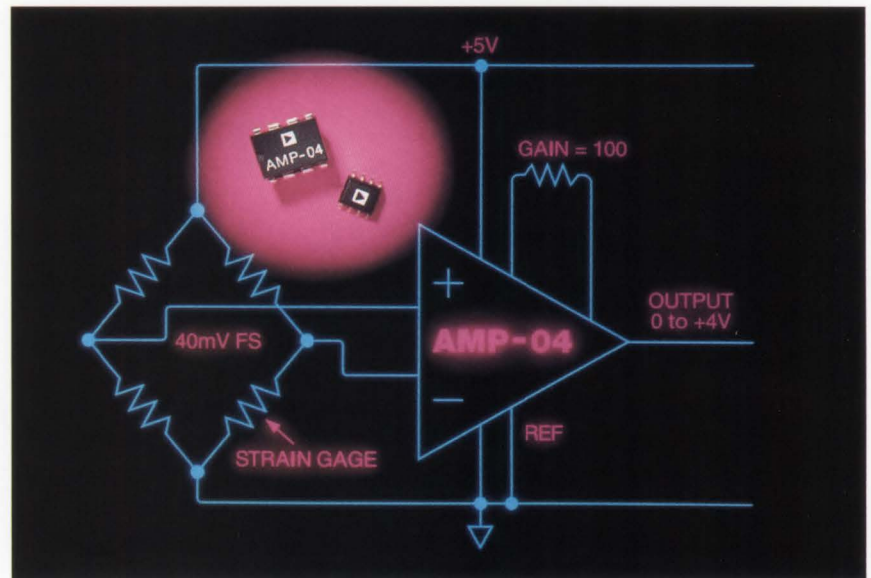

linearity, while requiring only 700 μ A of supply current. A unique feature of the AMP04 is that it doesn't exhibit common-mode swing limiting at high gain, unlike "triple-amp" designs (see sidebar).

The AMP04 precision in-amp is specified for operation from -40°C to $+85^\circ\text{C}$. Package options include an 8-pin plastic DIP, 8-pin SOIC, or 8-pin cerdip. USD prices (in 1,000s) begin at \$4.55. **CIRCLE 18**

F O R I N F O R M A T I O N

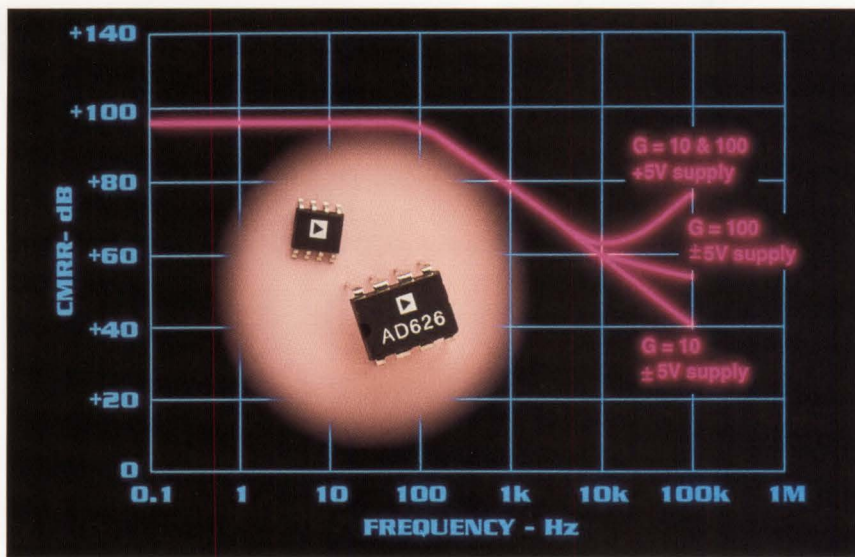

EXTEND COMMON-MODE SWING LIMITATIONS AT HIGH GAIN

In traditional three op amp in-amp designs, common-mode voltage (CMV) range is limited at high gain. For example, the in-amp circuit below (Figure A) is designed for a gain of 1001 with a CMV of 10 volts, but there's a problem. Amplifier B must swing to 15.01 volts in order for the circuit's output to swing to 10.01 volts. Operating from a +15 V supply, an op amp cannot handle this swing range. The output will saturate before reaching the supply rails.

The single-chip AMP04 in Figure B, operating at the same common-mode conditions, does not exhibit this limitation. None of its internal nodes reach signal levels that are high enough to cause amplifier saturation. In addition, the AMP04 maintains a gain accuracy of 0.5%, provides high input impedance (4×10^9), and features 105 dB of CMRR at a gain of 1,000.

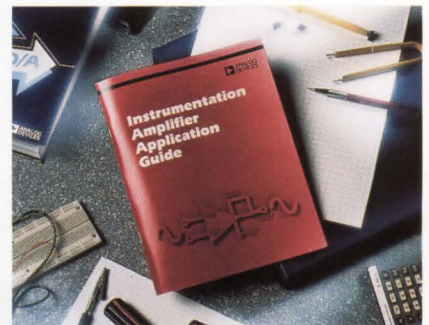

Instrumentation Amplifier Guide

CIRCLE 21

LOW-COST IN-AMP REPLACES DISCRETE DESIGNS

The AD620 high-accuracy in-amp replaces discrete designs with less overall error, lower power use, and reduced board space. It allows for gains from 1 to 1,000 set by a single external resistor. Noise is low ($0.28 \mu\text{V p-p}$, 0.1 to 10 Hz and $9 \text{ nV}/\sqrt{\text{Hz}}$ at 1 kHz); bandwidth is 120 kHz ($G = 100$). With guaranteed-maximum $50 \mu\text{V}$ voltage offset, $0.6 \mu\text{V}/^\circ\text{C}$ drift, 1 nA input bias current, and 40 ppm nonlinearity—and minimum 93 dB CMR ($G = 10$)—it's ideal for weigh scales, transducer interfaces and ECG circuits. The supply range is a wide $\pm 2.3 \text{ V}$ to $\pm 18 \text{ V}$, at 1.3 mA (maximum). Prices in 1,000s begin at \$3.27 USD.

CIRCLE 19

SINGLE-SUPPLY DIFFERENTIAL AMP

The AD626 is a single-supply, low-power differential amplifier with on-chip gains of 10 and 100 V/V (externally set). Its supply range is +2.4 to +10 V single, ± 1.2 to $\pm 6 \text{ V}$ dual, drawing less than $290 \mu\text{A}$ of current. Uses include current sensing and sensor interfacing, especially in battery and portable applications. Its common mode range, $6 (V_s - 1 \text{ V})$, exceeds the supply; for +5 volt supply, CMR = 90 dB and the output range is +30 V to +4.7 V (minimum). Its inputs are overload protected (50 V continuous), and the internal attenuation network includes RFI filters. Prices (1,000s) start at \$2.85 USD.

CIRCLE 20

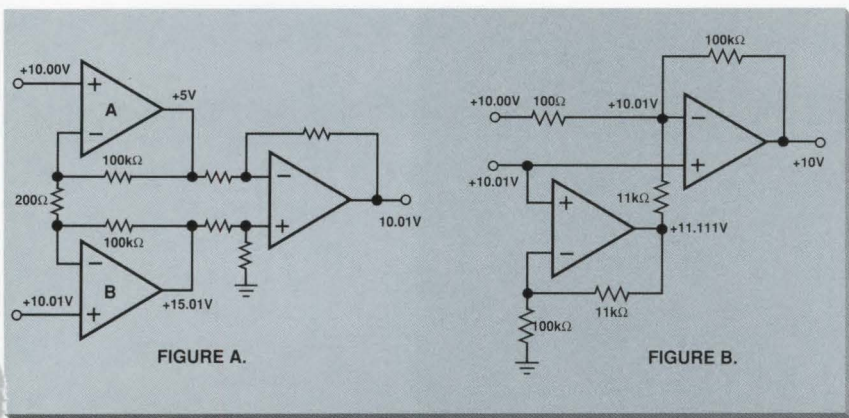

FIGURE A.

FIGURE B.

1 . 8 0 0 . 2 6 2 . 5 6 4 3

LOWEST NOISE & DISTORTION AMPS

The AD797 features the industry's lowest voltage noise and distortion. It's an excellent choice for use in audio pre-amplifiers, FFT and spectrum analyzers, and IR and ultrasound imaging: $V_n = 0.9 \text{ nV}/\sqrt{\text{Hz}}$ and remains flat over the full 8 MHz bandwidth (Gain = 10) at 1 kHz. Total harmonic distortion is -120 dB at 20 kHz. Settling time is 800 ns to 16-bit accuracy.

Many dc specifications are guaranteed, including a maximum 60 μV voltage offset with 0.6 $\mu\text{V}/^\circ\text{C}$ drift, 300 nA (200 nA typical) input offset current, and 2 μA input bias current. The AD797 features a fast 20 V/ μs slew rate and a gain-bandwidth product of 110 MHz (Gain = 1,000). Full-power bandwidth is 280 kHz at 20 V_{p-p}. Output current drive is typically 50 mA, permitting the use of low-value gain-setting resistors to curb resistor noise.

AD797 operates from ± 5 to ± 15 V supplies over the -40°C to $+85^\circ\text{C}$ industrial and -55°C to $+125^\circ\text{C}$ military temperature ranges. Packages include 8-pin plastic DIP, SOIC and cerdip. Prices start at \$3.36 (1,000s).

CIRCLE 22

LOW-POWER AUDIO AMPS COMBINE ADVANTAGES OF JFET & BIPOLAR CHIPS

The single OP176 and dual OP275 op amps feature a patented input circuit (combining both JFET and bipolar technologies) that offers new levels of performance to audio, instrumentation and consumer applications. The result is an op amp that offers the traditional benefits of bipolar amps (low

distortion and voltage noise) with the advantages of JFETs (high slew rates, and wide dynamic range) at one third the power of the NE5532.

The OP275 features 0.0006% total harmonic distortion plus noise and 6 $\text{nV}/\sqrt{\text{Hz}}$ voltage noise density. Input offset voltage is guaranteed at $<1 \text{ mV}$ allowing the OP275 to be used in dc coupled or summing applications without adding noisy offset adjustment circuitry. Dynamic characteristics include 22 V/ μs slew rate and 9 MHz gain-bandwidth product. In addition, the OP275 uses less than 5 mA of supply current, even with ± 22 volt supplies.

For professional audio console designs, the small SO-8 package combined with the low power can save many square inches of board space and many watts of power, resulting in cooler operation and greater density.

Its companion, the OP176 has the same attributes with greater output swing and output short-circuit protection, at much lower power than NE5534, plus it's stable at unity gain.

Both the OP176 and OP275 are specified over the -40°C to $+85^\circ\text{C}$ extended industrial temperature range and are available in 8-pin plastic DIP or SOIC packages. The SOIC package is offered in 2,500 piece spools for high volume handling. Prices for the OP176 and OP275 begin at \$.88 and \$1.08, respectively in 1,000s.

CIRCLE 23



FREE SPICE DISK CONTAINS OVER 350 MODELS

ADSpice puts the power to predict amplifier behavior in your PC. This free disk contains the most innovative and comprehensive library of SPICE models ever. It contains over 350 complete models, including hundreds of high-speed and precision op amps, CMOS analog switches, variable-gain amplifiers, and video-difference amplifiers.

This valuable tool uncovers design problems before you breadboard by simulating real-world transient and ac electrical conditions. Critical performance models such as noise, bandwidth, and phase response are included. Don't miss this free offer, available on either 3-1/2" or 5-1/4" IBM PC-compatible disks.

Circle 24 (3-1/2")

Circle 25 (5-1/4")

MODEL	AD797	OP176	OP275	Units
Channels	Single	Single	Dual	
GBW	110	10	9	MHz
Slew Rate	20	25	22	V/ μs
Supply Current	10.5	2.5	5	mA, max
THD + N	(98)	0.001	0.0006	(dB) %
Offset Voltage	0.8	1	1	mV, max
V _{OUT} Swing	± 13	± 13.5	± 13.5	V
Price in 1,000s	\$3.36	\$0.88	\$1.08	USD
	CIRCLE 22	CIRCLE 23	CIRCLE 23	

WORLDWIDE HEADQUARTERS

Analog Devices, Inc.
P.O. Box 9106
Norwood, MA 02062-9106, U.S.A
Tel: (800) 262-5643
Fax: (617) 326-8703

Printed in U.S.A.

 **ANALOG
DEVICES**

AT&T DSP32C/3210

OVERVIEW Introduced in 1984, AT&T's DSP32 was one of the first general-purpose 32-bit floating-point DSP processors. It has a fair-
straightforward, microprocessor-like architecture. It delivers peak
single-cycle (pipelined) instruction execution and has a 1-cycle MAC
unit. The DSP32 was later upgraded to CMOS, called the DSP32C,
which was then followed by the DSP3210, a cost-reduced DSP32C for
telecommunications and multimedia applications.

The DSP32C features a main bus, program ROM, three RAM blocks,
and three functional units. These functional units are the data arithmetic
unit with 32-bit floating-point multiplier and adder; a control arithmetic unit
with a 16-/24-bit ALU; and a serial I/O peripheral. The DSP32 architecture
gets its speed from the use of high-speed on-chip memories that enable
the CPU to perform multiple sequential accesses within a single cycle. The
CPU has three pipeline stages. Each stage takes two external clocks but
uses four sequential time-slot clocks for multiple sequential operations in a
single cycle. Thus the CPU can handle up to four memory accesses per
cycle: an instruction fetch, two operand (X,Y) fetches, and a memory write.

The later DSP3210 reduces motherboard design-in costs by direct-
supporting standard μ P buses such as the 680x0 and 80x86 buses.
It also has an on-chip DRAM controller. The DSP3210 has two on-chip
RAM blocks, which can hold data or code, and a small boot ROM. AT&T

32-bit floating-point DSP

DSP3210

- ▶ 68 instruction, 3-stage pipeline
- ▶ Two 4-kbyte RAM blocks
- ▶ 1-kbyte boot ROM
- ▶ 32-bit barrel shifter
- ▶ 32-bit address space; big/little-endian addressing
- ▶ External memory bus: 32-bit addr, 32-bit data; bus adapted to 680x0 and 80x86 bus systems
- ▶ Serial I/O port, 2 DMA channels
- ▶ 32-bit timer
- ▶ 2 ext intr
- ▶ 55/66.7-MHz clock (2 clocks/cycle)
- ▶ 4 X clocks per cycle
- ▶ Multiple operations/cycle using phased X clocks
- ▶ 1-cycle MAC, ADD (pipelined)
- ▶ 660-nsec floating-point DIV
- ▶ Up to 2 external memory R/W accesses/cycle
- ▶ 4-word external-memory burst
- ▶ Wait states=cycle/4
- ▶ 180-nsec intr latency (3 cycles)

designed the VCOS Visible Cache Operating System in conjunction with the DSP3210. The operating system helps cut costs by letting the DSP3210 use motherboard main memory for caching instructions and data and for external storage instead of having the DSP rely on more-expensive on-chip RAM/ROM or external SRAM.

□ **VENDOR CONTACTS** AT&T Microelectronics, Allentown, PA, (800) 372-2447. **BBS:** (610) 712-4444, V.22bis, up to 2400 bps; and (610) 712-1440, V.32bis, up to 14,400 bps (N,8,1). **Circle No. 488**

ARCHITECTURE

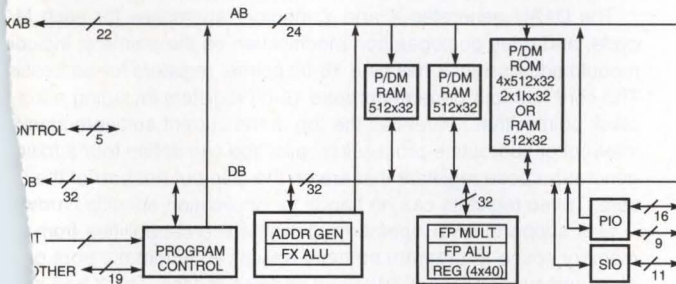

one of the first 32-bit floating-point DSPs, the DSP32 has a register-
based architecture that centers on a set of general-purpose registers.
It also has a dedicated MAC unit with four built-in 40-bit accumulators
that does a MAC operation in a single instruction cycle. The DSP32 has
a simple architecture: Rather than use multiple buses to move the
instructions and data needed for a single cycle, it has a single internal
bus that can handle up to four sequential operations per cycle. The
CPU can access three 2-kbyte RAM blocks (or two RAM blocks and 4
kbytes of ROM) and drives two core functional units. The first functional
unit is the data arithmetic unit (DAU), which has the floating-point mul-
tiplier and adder and four 40-bit accumulators. The second unit is the
control arithmetic unit (CAU), which has an integer ALU and 22 24-bit
addressing registers that handle both program and data addressing.
The DSP32 family members have a high-speed internal bus that can handle
up to four operations/instruction cycle. The CAU can generate up to four
accesses/cycle, one for each phase or state of an instruction cycle. The
bus is pipelined; it has a 4-stage pipeline for a MAC cycle. Thus, the results
of a MAC cycle initiated by instruction 1 will be available when instruc-
tion 5 starts its first cycle; that is, the fifth cycle from the start of the MAC
instruction. The CAU runs in parallel with the DAU; it executes addressing
operations as well as control, data-move, and integer ALU operations.

The latest DSP32 version, the DSP3210, is a cost-reduced DSP32C.
The DSP3210's on-chip RAM has been reduced to two 4-kbyte RAM
blocks supplemented by a 1-kbyte boot ROM. The DSP32C's DMA
controller has been eliminated and replaced by a serial DMA controller
for CPU data moves. The DSP3210 also has full 32-bit external
memory addressing: The external bus has a 32-bit address, and the
on-chip bus has 32-bit—rather than 24-bit—address registers. For low-power
operation, both the DSP3210 and the DSP3207 run at 3.0V.

The DSP3210 is tailored for multimedia, telecommunications,
and graphics applications. Instead of relying on on-chip memory,
the DSP3210 can use low-cost, external DRAM to hold code and
data. It can share the motherboard's system memory instead of
requiring its own expensive SRAM. AT&T's VCOS operating system
has been designed for DSP3210 applications. A minimal OS,
the kernel is only 400 bytes. The VCOS kernel resides in on-chip mem-
ory along with critical instructions and data. The OS uses external
system memory to cache pending code and data. The DSP3210
interfaces directly to standard ISA and MCA buses without external
logic.

Addressing modes—Immediate, memory direct, register direct,
register indirect, bit reversed (special case of register indirect), PC re-
lative. Indexing is available as are postincrement and decrement
options for register-indirect addressing.

Special instructions—DO next *k* instructions; DO LOCK, signals
interlocked bus, DO BLOCK, signals quad word transfer; conditional incre-
ment/decrement; conditional ALU operations; compare; conversion to
IEEE format; go-to loop with counter, and create a seed (reciprocal of *Y*).

DMA controller—Supplies two DMA channels (input and output) for
moving data between memory and the serial I/O buffer. The DMA con-
troller can access internal and external memory. It uses cycle stealing
to move data and does not disturb the CPU's execution thread. The
controller has its own set of control registers and can move single or
multiple data frames. The controller can be restricted to request DMA
cycles only when the DSP processor has ownership of the shared exter-
nal bus. This strategy ensures that DMA operations won't incur the
overhead of bus-master requests.

Part no.	Clock (MHz)	Mode	Max power (mA at 5V)	Pins, package	Price (10,000)
DSP32C	40	Run	180	133-pin PGA	\$70
	50	Run	225	164-pin PQFP	\$57
DSP3210	55	Run	220	132-pin PQFP	\$44
		Wait	86		
		Run	285		
	Wait	103			
DSP3207	40	Run	150 (3V)	132-pin PQFP	N/S
		Wait	6 (3V)		
	66/55	Gated-clock	0.6 (3V)		
		Run	282/220		
	Wait	26/22			

SUPPORT

SOFTWARE AT&T supplies a development board and an ICE.
Third-party vendor tools include an HP ICE. Contact AT&T for refer-

□ **SOFTWARE** AT&T sells development tools including a C com-
piler, assembler/linker, simulator, the VCOS operating system, and a
library of multimedia functions.

DSP Group Oak/Pine

OVERVIEW DSP Group developed its own 16-bit DSP core architecture, called the Oak/Pine DSP, and licenses it to developers. Using one of the cores as a base, you can tailor your own DSP ASIC. Oak is DSP Group's second-generation 16-bit DSP core, following the Pine DSP core currently available at a number of ASIC vendors. Oak/Pine DSP processors are standard cells that are available in the ASIC libraries from many vendors. The cores use double-metal CMOS technology. Pine is available in 1.0-, 0.8-, and 0.6- μ m processes; Oak is available in a 0.6- μ m process. Pine and Oak both have built-in power-management features to cut power dissipation, including 3V parts to reduce power consumption further.

In high volume, Oak/Pine-based ASICs can cost less than \$10 each. Both DSPs have been designed for ASIC development. They have an inner-core architecture and an expandable outer layer. Thus, engineers can make do with the minimal core or expand the architecture for higher processing efficiencies by adding more memory, peripherals, interrupt logic, and custom logic sections. Pine has two data buses and one program bus, two RAM data blocks for X, Y memory, an address generator, and a MAC unit. Oak expands on Pine by adding a barrel shifter, a bit-

16-bit fixed-point DSP ASIC cor

OAK DSP CORE

- ▶ 4-stage pipeline, 70 instructions
- ▶ 4 36-bit accumulators
- ▶ 9 16-bit general-purpose regs (4 optional user-defined regs)
- ▶ 2 2k data-RAM blocks, expandable to 64k
- ▶ ROM expandable to 64k
- ▶ 16x16-bit MPY, to 36-bit ALU
- ▶ 64k-word data, prog addr spaces
- ▶ Bit field operations
- ▶ Shadow reg/context switching
- ▶ 36-bit barrel shifter
- ▶ Viterbi accelerator
- ▶ On-chip emulation
- ▶ 4 external interrupts
- ▶ 80-MHz clock (2 per cycle)
- ▶ Static design, 3V operation
- ▶ Single-cycle MAC instruction
- ▶ Exponent evaluation in 1 cycle
- ▶ Divide step instruction
- ▶ Zero-overhead data addressing
- ▶ Program looping (4-level block repeat)
- ▶ Instruction repeat
- ▶ Software stack
- ▶ Wait-state support
- ▶ 2-cycle max interrupt latency
- ▶ Double-precision support

manipulation unit, two more accumulators, software stack, download architecture, on-chip emulation, and an expanded instruction set.

VENDOR CONTACT

DSP Group Inc, Santa Clara, CA, (408) 986-4315. **Circle No. 4**

ARCHITECTURE

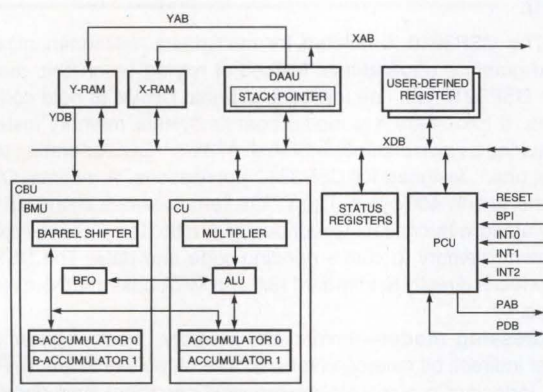

Oak has a double-level architecture: system and core. At the system level, the chip consists of a 16-bit Oak DSP core with links to on-chip program ROM, data RAM, and a bus-interface unit. At the core level, Oak is a compact DSP design with an X, Y data RAM block, data-arithmetic-address-generation unit (DAAU), a computational unit (CU) comprising a MAC unit, ALU with two 36-bit accumulators, and a bit-manipulation unit (BMU). The BMU adds a 36-bit barrel shifter and two additional 36-bit accumulators. The core also includes a software stack, program-control unit, four optional general-purpose registers, six interrupts, and a special on-chip-emulation module (OCEM), which provides trace and breakpoint capabilities for real-time debugging.

Oak's MAC unit has two 16-bit input registers; it takes in two 16-bit numbers, signed or unsigned, and delivers a 32-bit 2's-complement product in one cycle. The product is then sign-extended to 36 bits through a 4-bit extension nibble. The ALU performs arithmetic/logical operations on the data operands and functions such as normalization, step division, and rounding. The Oak's BMU has a 36-bit barrel shifter, a bit-field-operations unit (BFO), and two additional 36-bit accumulators with access to the accumulators of the CU. The accumulators can rapidly switch context between the two sets of accumulators, including the shadow registers. The accumulators can also evaluate 36-bit exponents.

Three main buses feed the DSP. At each cycle, they move X and Y memory data to the MAC unit from core X and Y data RAMs; the PCU fetches a new instruction from on-chip, external program ROM or RAM. The X data bus also serves as the main CPU data bus by linking the two data RAMs,

status register, program-control unit, and a set of general-purpose registers.

The DAAU generates X and Y memory addresses for each MAC cycle, and does postoperation modification on the pointers, including modulo addressing. It has nine 16-bit pointer registers for addressing. The core has four general-purpose 16-bit registers including a top-stack pointer that references the top of the current software stack interrupt or subroutine-processing calls. You can define four additional general-purpose registers that are on the chip but not part of the core. These registers can be handy for application-specific hardware.

Oak supports DMA operation, downloading capabilities from memory space to program memory space, an automatic boot procedure, and support for two 64k-word address spaces: The X and Y space and the program space. The X RAM space can be in both internal and external memory; the Y RAM space is in core internal memory only. The X and Y memories can be expanded internally in the to 2k words, and the X memory expands externally to 62k words. Off-core program memory can expand to 64k words. Oak has a built-in 16-bit loop counter, which can repeat an instruction or block of instructions up to 64k times. A repeat instruction can be nested in a loop with up to four levels of block nesting. Pine is a subset of Oak and has all the architectural features of Oak except for the BMU. A hardware stack replaces the software stack; the optional general-purpose registers expand to 8. Pine's instruction set is also a subset of Oak's.

Addressing modes—direct, register indirect, relative, and indirect.

Special instructions—conditional subroutine call/return from subroutine, repeat next/block instructions, division step, compare, square, accumulate/subtract previous product, move data/program memory, modify accumulator conditionally, support for double-precision calculations, bit-field operations, exponent evaluation, context switching, min/max calculation, and automatic boot.

Part	Clock (MHz)	Mode	Max power (mA) at 5V	Price
Oak Core	80	Run	16 (3.3V)	N/S
		Slow	1 (3.3V)	
		Stop	10 fA	
Pine Core	50	Run	30 (5V)	N/S
		Slow	5 (5V)	
		Stop	10 fA	
	33	Run	14 (3.3V)	N/S
		Slow	1 (3.3V)	
		Stop	10 fA	

SUPPORT

HARDWARE DSP Group supplies an ICE board and evaluation/development board and on-chip-emulation capabilities; the company also sells a bond-out chip for emulation and debugging.

SOFTWARE Software tools for Oak include an assembler, loader, simulator and debugger, a C compiler, and the ASS assembler, which enables users to map their customized logic into the target hardware. All tools run under MS-Windows.

2 CHANNEL VIDEO MIXER/FADER

GT4123A

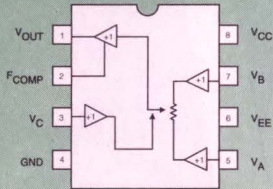

$$V_{OUT} = V_C \times V_A + (1 - V_C) \times V_B$$

- Excellent Video & Control Performance
- 25 MHz 0.1dB BW; 75 dB Isolation @ 5MHz; 0.02% dg, 0.02° dp
- 4 ns Control Delay; 1% Control Linearity
- \$5.55 in 100 unit quantities

UNITY GAIN VIDEO BUFFER WITH POWER-DOWN

GB4600

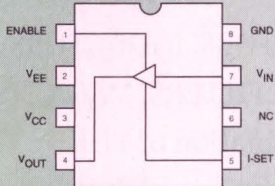

- 100 MHz 0.1 dB BW Driving 27 pF
- 0.02% dg, 0.02° dp
- Disabled Power Only 160 μW
- \$2.42 in 100 unit quantities

DC RESTORED VIDEO AMPLIFIER

GB4551

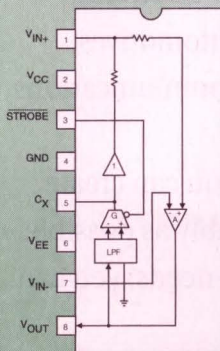

- ±1 mV DC Restore Uses Integration For Accuracy
- 0.03% dg, 0.03° dp, 30 MHz BW
- Space-Saving SIP Needs Only 2 External Capacitors
- \$5.13 in 100 unit quantities

NOISE-TOLERANT VIDEO SYNC SEPARATORS

GS1881

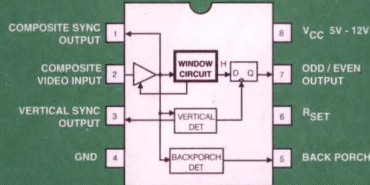

- Window Circuit For Noise Immunity, Fast Recovery
- Excellent Specs & Temperature Stability (±1 ns)
- Replaces LM1881 With Improved Performance
- Industrial Temperature Range Available
- \$2.35 in 100 unit quantities

GS4881

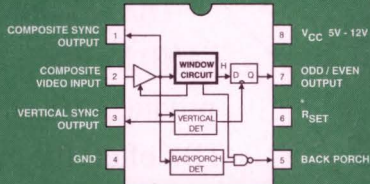

- All the Features of the GS1881 Plus
- Constant Rate, Noise Immune Back Porch Pulse
- Replaces LM1881 For New Designs
- Industrial Temperature Range Available
- \$2.50 in 100 unit quantities

GS4981

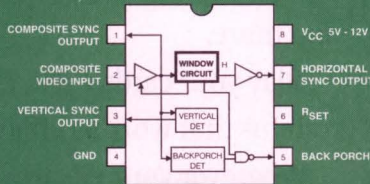

- All the Features of the GS4881 Plus
- Horizontal Sync Output in Place of ODD/EVEN
- H-Sync Output has Superior Noise Immunity
- Industrial Temperature Range Available
- \$2.60 in 100 unit quantities

FULLY BUFFERED SUB-10ns SWITCH

GY4102A

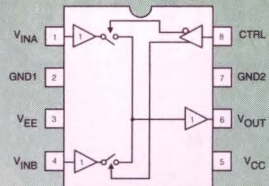

$$V_{OUT} = CTRL \times V_{INA} + CTRL \times V_{INB}$$

- Sub 10ns Switching @ 100 MHz 0.1 dB BW
- Ultra Low Switching Transients (25mV/3ns)
- Outstanding Video Specs (0.02% dg, 0.01° dp)
- \$5.23 in 100 unit quantities

4 x 1 VIDEO MUX

GX4314L

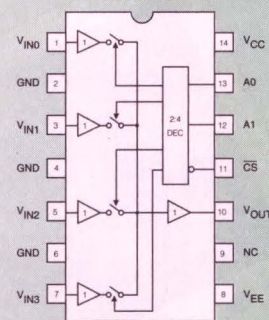

- Low Offset (±7 mV) Buffered Signal Path
- Excellent Video Specifications (0.01% dg, 0.01° dp)
- 80 dB Isolation @ 100 MHz; 100 MHz - 1.0 dB BW
- \$6.24 in 100 unit quantities

VIDEO AMPLIFIER WITH SYNC TIP CLAMP

GB4550A

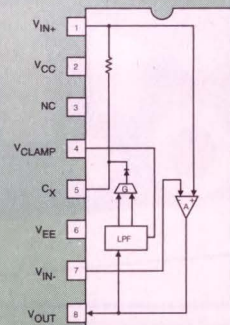

- Restores Sync Tip to VCLAMP ±7 mV
- 0.03% dg, 0.03° dp, 30 MHz BW
- \$4.60 in 100 unit quantities

For Literature or Samples call (800) 263-9353* ext. 282
Get instant Fax literature at (905) 940-5515 access code 1212

* In Canada call (905) 632-2999 ext. 282.

GENNUM CORPORATION P.O. Box 489, Stn. A, Burlington, Ontario, Canada L7R 3Y3

Tel (905) 632-2996 Fax (905) 632-2055

WITH TDK YOU'LL ALWAYS HAVE THE WINNING HAND.



CERAMIC CAPACITORS, INDUCTORS, TRANSFORMERS, EMI FILTERS, MAGNETS AND MORE - any combination of TDK products will always give you a royal flush.

TDK offers the most complete selection of advanced electronic components, specially suited for your strictest surface mount technology requirements. We're your one-stop shop for passive electronic components used in applications for: automotives, consumer electronics, computers, telecommunications and more.

Play your cards right, and with TDK you can create systems that work as effectively and reliably as possible.

Whatever your electronic component needs, you can bet TDK has the answer.

ELECTRONIC COMPONENTS DIVISION

- DIRECT/OEM
- DISTRIBUTION
- FACTORY AUTOMATION



SEE US AT THE ELECTRO SHOW
BOOTH # 4534

TDK CORPORATION OF AMERICA 1600 Feehanville Drive, Mount Prospect, IL 60056, USA Phone: 708-803-6100 INDIANAPOLIS Phone: 317-872-0370 NEW YORK Phone: 908-494-0100 SAN FRANCISCO Phone: 408-437-9585 LOS ANGELES Phone: 310-539-6631 DETROIT Phone: 313-462-1210 BOSTON Phone: 508-624-4262 HUNTSVILLE Phone: 205-464-0222 GREENSBORO Phone: 910-292-0012 DALLAS Phone: 214-506-9800
CEL, TDK's Component Engineering Laboratory in Torrance, CA, can custom design and test manufacture TDK EMI/RFI suppression components to meet your specific requirements. For more information, call (213)530-9397. TDK CORPORATION Tokyo, Japan

Motorola DSP56100 Family

OVERVIEW Targeting digital-cellular and communications applications, Motorola engineers created the 16-bit DSP56100 family of DSP chips, which are downsized versions of the 24-bit fixed-point DSP56000. The DSP56100 builds on the basic DSP56000 architecture, adding a codec for D/A and A/D voice conversions for digital-cellular and voice communications. The DSP56156 suits the European cellular standards; the DSP56166 suits the emerging American and Japanese VSELP standards. To reduce silicon, the DSP56100 has two on-chip RAMs: 4 kbytes of program RAM and 4 kbytes of X memory SRAM. A program bus and X data memory bus serve these memories; each has an address and a data bus. Another bus, the global data bus, links the address-generator registers to external memory, peripherals, and a bit-manipulation functional unit. The chip's external bus is 16 bits.

A single-cycle (2-clock) MAC unit serves as the core for DSP processing. It has four 16-bit registers that hold MAC inputs and two 40-bit registers for accumulating results. You can repeat instructions or blocks of code for inner-loop processing. X values can be supplied from an on-chip X memory. The CPU can access memory with no penalty but requires fast SRAM. The DSP56100's address generator can deliver two addresses per instruction cycle. The address generator supports linear, modulo, and bit-reversed carry addressing. It has three sets of

16-bit fixed-point DSP

DSP56156

- ▶ 3-stage pipeline, 89 instructions
- ▶ 4-kbyte program RAM or 24-kbyte program ROM and 4-kbyte RAM
- ▶ 2 128-kbyte address spaces
- ▶ External bus: 16-bit address, data MAC: 4 16-bit input regs, 2 40-bit accumulators
- ▶ 1 address generator with 12 address regs
- ▶ Register-bit manipulation
- ▶ 14-bit sigma-delta codec
- ▶ 2 serial I/O ports
- ▶ On-chip ICE support (4 pins)
- ▶ 4 external interrupts, 8-bit host port
- ▶ 40/60 MHz (2 clocks/cycle), PLL
- ▶ 1-cycle most instr, NOP (pipelined)
- ▶ 1-cycle MAC (no pipeline)
- ▶ Address generator calculates 2 addr/cycle
- ▶ 21.6- μ sec A/D conversion
- ▶ 1-cycle ext-mem R/W
- ▶ 2- to 3-cycle branch penalty
- ▶ Zero-overhead loops (DO, repeat)
- ▶ Indirect, modulo, bit-reversed addressing
- ▶ Stop instruction halts clock
- ▶ 161-nsec max interrupt latency

four registers that serve as address, offset, and ALU modification registers.

VENDOR CONTACTS

Motorola Inc, DSP Div, Austin, TX, (512) 891-2030. **Circle No. 490**
DSP Helpline: (512) 891-3230. **BBS:** (512) 891-3771, 9600 (N,8,1).

ARCHITECTURE

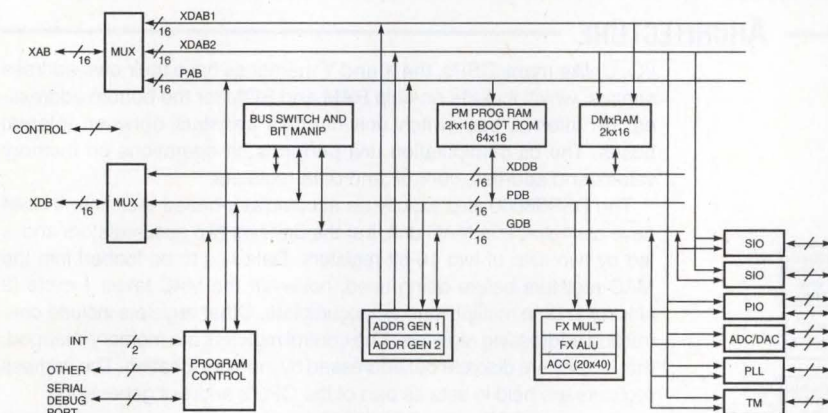

Motorola's DSP56100 DSP processors are true 16-bit machines derived from the earlier DSP56000 family of 24-bit DSP chips. Designed for embedded-telecommunications applications, the DSP56100 delivers single-cycle MAC operation and offers hardware support for sum of products and vector processing. Like the DSP56000, the 56156/166 is partly an accumulator-based architecture and partly a register-based machine. The core MAC unit is accumulator-based (with two sets of two 16-bit input registers to hold incoming variables and coefficients) and two 40-bit accumulators to accumulate results. However, the address generator has 12 16-bit registers for sophisticated addressing and holding interim data values.

The 16-bit DSP architecture has three internal buses: a program address and data bus set, an X address and data bus set, and a global data bus. Processing centers around on-chip RAM and ROM. The DSP56156 has 4-kbyte program RAM and 4-kbyte X-memory data RAM as well as a 128-byte boot ROM. The 56166 has 4-kbyte program RAM, 8-kbyte X-memory data RAM, and a 128-byte boot ROM. For inner-loop MAC-type processing, first the code must be loaded into the program RAM. The X and Y data are fetched each cycle from X memory and external memory. Single-cycle inner-loop execution is possible as long as the code stays in the cache while external memory and the X-memory RAM furnish the MAC coefficients and variables for each cycle.

With a 60-MHz external clock and a 30-MHz basic pipeline cycle, a

CPU memory fetch must take <33 nsec for single-cycle execution. The MAC unit has four input registers; these registers must be loaded on a previous cycle for the current MAC execution to complete in a single cycle. You can load a MAC input register in a MAC cycle that uses other registers.

The 16-bit external bus addresses two 64-kbyte address spaces—program and X memory. For MAC processing, portions of the X-memory space furnish the Y-memory values. The DSP56100 has two data-memory address buses—the XAB1 and XAB2—that fetch data from the X-memory RAM and from the external memory for Y-memory values. The processor also has an 8-bit host interface to link to a host processor and up to 25 I/O pins.

The DSP56100 DSPs have a stripped-down DSP56000 address generator with 16-bit (rather than 24-bit) paths and registers. Instead of the two address generators of the DSP56000 with two sets of ALUs and registers, the 16-bit DSP has only one address generator. However, the generator logic is fast enough to handle two address calculations per pipeline cycle. The address generator follows the DSP56000 family architecture and has address, offset, and modification registers that can be used for addressing as well as holding interim data. The address-generator registers are accessible via the global data bus.

Addressing modes—Register direct, address-register indirect (postincrement/decrement by 1 or offset indexed by offset). Special: immediate, short jump, absolute or I/O short address, implicit.

Debugging—The on-chip emulator port lets external hardware set breakpoints, single-step the CPU, and read/modify memory or registers. You can configure the chip to run with external RAM for development.

Part no.	Clock (MHz)	Mode	Max power (mA at 5V)	Pins, package	Price (1000)
DSP56156	60/40	Run Stop Wait	N/S N/S N/S	112-pin CQFP	\$46.10/ \$44.30
DSP56166	60	Run Stop Wait	100 11 0.4	112-pin CQFP	\$51.21

SUPPORT

HARDWARE Motorola fields the Application Development System with ICE operation using the DSP's on-chip emulation features. Third-party tools are also available; contact Motorola for references.

SOFTWARE Motorola supplies a Gnu C compiler and debugger, assembler/linker, and simulator. Third-party vendors supply data-acquisition and filter-design packages as well as operating-systems software. Contact Motorola for references.

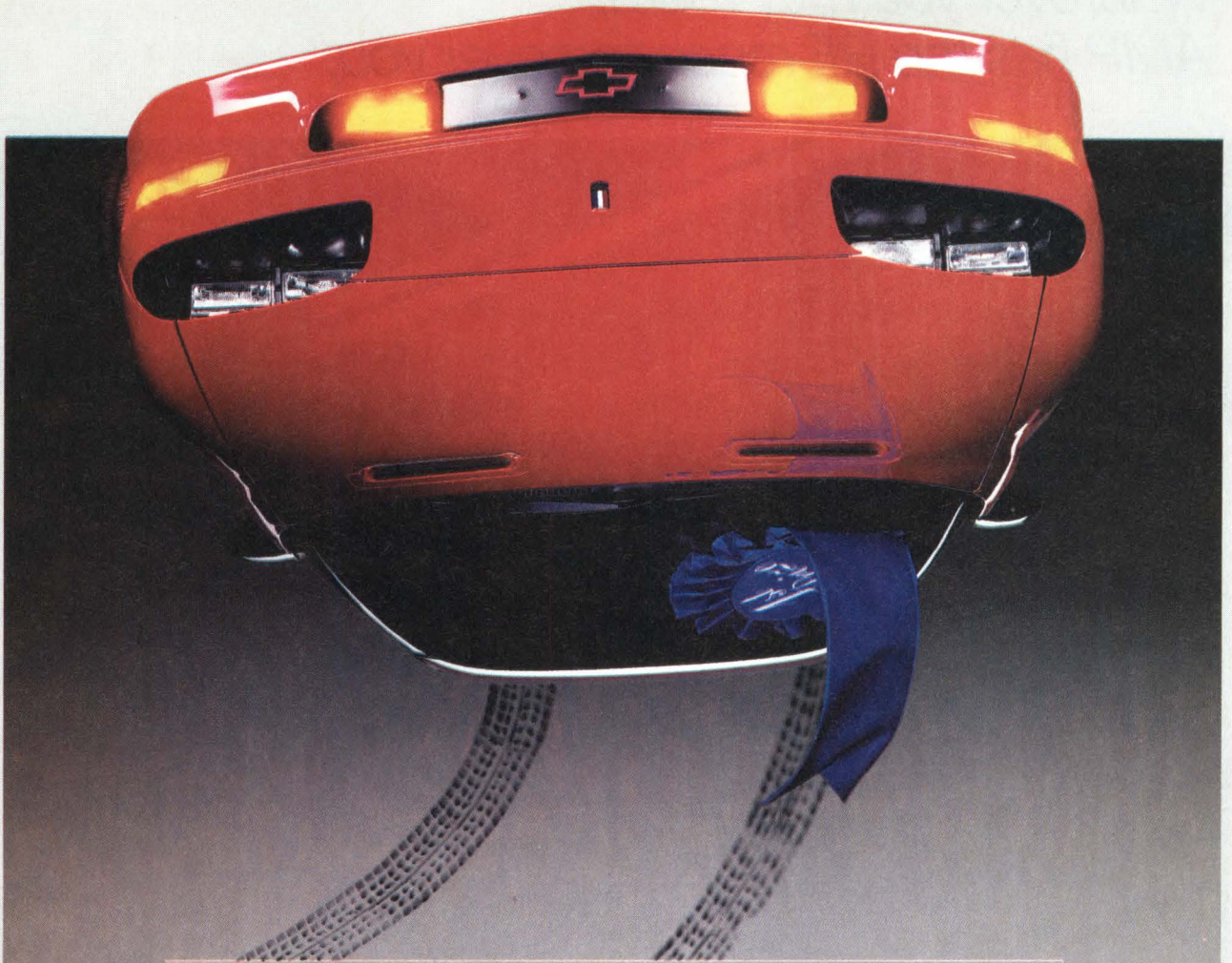

A DESIGN CONTEST FOR ENGINEERS WHO SEE THINGS DIFFERENTLY.

If conventional thinking drives you up the wall,
order the Philips DS-750 development tool kit.

It helps you dream up great designs using our
8-bit 8XC750 microcontroller. Including the
design that could win you a hot new Camaro!

For the low price of just **\$4750** (plus
shipping), the Philips DS-750 gives you all the
hardware, software and documentation
needed to quickly build, emulate and
debug 8-bit designs using our 8XC750.

The 8XC750 is our powerful, low-cost
entry into the full family of Philips 80C51
microcontrollers.



© Philips Electronics North America Corporation, 1994

Together, they give you winning designs.
Which is why you
should be sure to

enter the exciting Philips
Dream Machine Design Contest. Just submit
a design to us using the 8XC750 or any
Philips 80C51 microcontroller derivatives by
September 30, 1994. If it turns our judges on
their heads, you could win the Camaro or a
color or monochrome laptop computer.

So turn it up. Use your credit card to order
the DS-750 today. We'll also send you more infor-
mation on this incredible design contest:

1-800-447-1500, ext. 1120 DN



Co-sponsored by EDN

Wherever you may roam,
AMP has the RF reach to cover you.

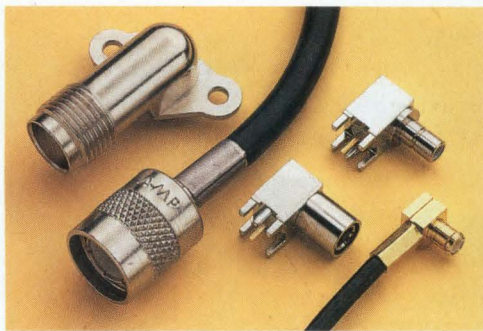

Cellular specials—including our conductive black finish versions for antenna mounts: nice to look at (non-glare), with no compromise in performance.

With its 4GHz top end, our latest RF addition is at home in a range of products, from instrumentation to cellular phones.

It's a wide, wide spectrum out there, and some of the terrain can be downright challenging. So it's good to know AMP can deliver the uncompromising RF performance you want, with just the options you want.

We've got capacity to support fast-growing segments like cellular—with the developmental depth to come up with a unique, highly conductive black finish that offers big-time aesthetic appeal with no sacrifice in electrical properties. Our latest entry in this area: our micro-miniature, 4GHz board-mount system with the lowest mated profile (0.140") of any connector using standard RG cables. Just the kind of innovation that makes your life easier. And just the kind of engineering we love to do.

No matter where you're working in RF—from DC to 50GHz—

we've got answers you're looking for. In a

wide selection of commercial and fully qualified Mil versions. In a range of solidly consistent characteristic impedances. With all the choices you could ask for in materials, finishes, and mounting options. And we now offer custom and semi-custom high-speed coax and transmission cable assemblies, simplifying one of the trickier aspects of RF design.

And of course this comes with significant productivity gains—faster termination, simplified production, and easier fieldwork, with tooling second to none. It all adds up to good reason for giving us a call.

AMP is a trademark.

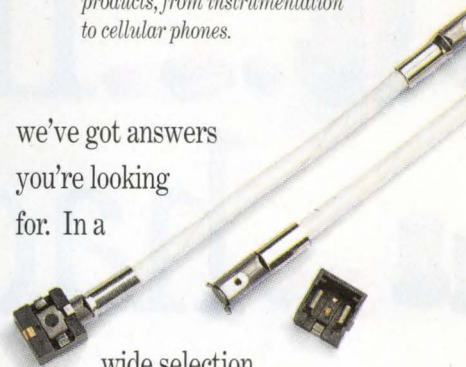

For literature, or the name of your nearby AMP Distributor, call our Product Information Center at 1-800-522-6752 (fax 717-986-7575). AMP, Harrisburg, PA 17105-3608. In Canada, call 905-470-4425.

AMP



If you
had just
one idea,
we'd make
just one
capacitor.

On the surface, nobody gives you a wider or more reliable choice of surface mount aluminum electrolytic and tantalum chip capacitors than Nichicon.

Fifteen series, designed to help you cut costs and speed assembly time. Each, designed to help you match the operating performance and delivery dates you want to your product needs.

Call your Nichicon representative or distributor for your free Product Catalog. It's an idea you can live with.

AN ISO 9000 CERTIFIED COMPANY
SURFACE MOUNT CAPACITORS from

nichicon[®]
The capacitor choice.
(708) 843-7500. FAX (708) 843-2798.

Motorola DSP96002

OVERVIEW Motorola's 32-bit DSP96002 has found a home in high-end DSP and military sockets. Its external buses allow designers to cobble together multiprocessor systems. Basically a 32-bit floating-point extension of the 24-bit fixed-point DSP56000, the DSP96002 has five major internal buses to speed multiple-operation processing. These buses include the DSP56000's program, X-memory, and Y-memory bus sets and the global data bus. The DSP96002 has a DMA bus that supports two DMA channels. An on-chip DMA controller moves data without CPU assistance. The DSP96002 also has two 32-bit external bus systems. These buses can access or share external memory or link multiple DSP96002s in a multiprocessor configuration.

The floating-point processor presents a programming model nearly identical to that of the earlier 24-bit DSP56000 fixed-point processor. Motorola engineers extended the instruction set with floating-point instructions and extended the registers (including addressing registers) from 16 to 32 bits. The DSP floating-point data unit is built around a register file of 10 96-bit registers. The data ALU includes a separate floating-point/integer adder; format-converter logic for front-ending the register fills; and cascaded logic, divide, and square root/multiplier units. These units support integer operations as well as floating-point operations with 11-bit exponents and 32-bit mantissas. The DSP96002

32-bit floating-point DSP

DSP96002

- ▶ 9-stage pipeline, 133 instructions
- ▶ Reg file: 10 96-bit regs, 24 32-bit address registers
- ▶ 96-bit accumulator, IEEE 754
- ▶ 2 2-kbyte RAM blocks
- ▶ 4-kbyte programmable RAM
- ▶ 2 preprogrammed data ROMs
- ▶ 5 internal 32-bit buses
- ▶ 2 external 32-bit memory buses
- ▶ 1 to 3 selectable address spaces
- ▶ 2 DMA channels, 1 serial port
- ▶ On-chip ICE support
- ▶ 3 external interrupts
- ▶ 33/40-MHz clock (2 clocks/cycle)
- ▶ Address generator calculates 2 addr/cycle
- ▶ 1-cycle MAC, instruction execution
- ▶ 200-nsec FP DIV (60 MHz)
- ▶ Parallel ALU, bit-logic, MAC ops
- ▶ Zero-overhead loops
- ▶ 1- to 3-cycle branch penalty
- ▶ Indirect, modulo, bit-reversed addressing
- ▶ 1-cycle off-chip fetch
- ▶ STOP instr halts clock
- ▶ 6-instruction max interrupt latency

meets the IEEE standards for single- and double-precision floating-point representations.

VENDOR CONTACT Motorola Inc, DSP Div, Austin, TX, (512) 891-2030. **DSP BBS:** (512) 891-3771, 8N1, to 9600 bps. **Circle No. 492**

ARCHITECTURE

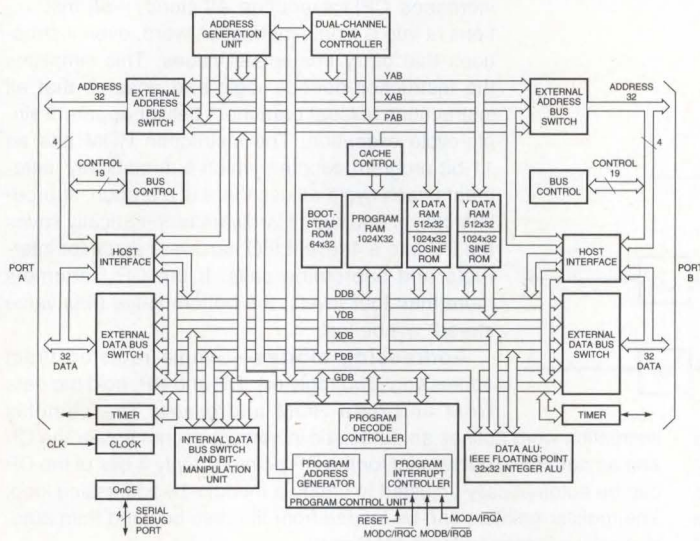

The DSP96002 is a third-generation, 32-bit floating-point DSP processor. It has a complex, performance-oriented architecture. Features include on-chip program, X, and Y memories; five internal buses for concurrent processing; and a register-based (rather than accumulator-based) architecture. Additionally, the DSP96002 has two 32-bit external-memory interfaces with separate address and data buses. These external interfaces have built-in multimaster capability. Another DSP96002 or a host processor can use a bus request to take over the bus and use it to access shared external memory or the DSP96002's internal memory.

The DSP96002 is a 32-bit floating-point extension of the 24-bit fixed-point DSP56000 architecture. It has the same internal bus sets: address and data buses for program, X memory, and Y memory. It also has two logical buses: the global data bus (from the DSP56000) for transferring address and local data, and the DMA bus for moving data without disrupting the DSP CPU's instruction thread. The DSP96002 has a 3-stage pipeline.

Unlike the DSP56000, the DSP96002 has on-chip program memory—

4 kbytes of static RAM. It also has a boot ROM. Like the DSP56000, it has X and Y RAM and ROM blocks to supply the coefficients and variables for sum-of-product MAC calculations. MAC operations take input data from a 10-register (96-bit-wide), multiported register file. So although MAC operations are not pipelined, the X, Y data accesses must be pipelined to pump data into the register file before the downstream MAC operation uses the data. The data ALU block includes multiply, add, logic, divide, and square-root units. The adder unit can operate in parallel with the logic, divide, square-root, and multiplier units. The adder has a parallel adder and subtractor (handles both add and subtract for FFT calculations) and a barrel shifter and normalizer. It produces a 32-bit value or an IEEE single-precision (24-bit mantissa) value.

The DSP96002 has basically the same address-generation unit as the earlier DSP56000. This unit consists of two address generators that can operate concurrently. The generators each have three sets of four 32-bit registers: address (address pointers), offset (offset values), and modify registers. These registers are loaded and accessed via the global data bus. The DSP96002 has a flexible architecture; many typically hard-wired features are available as programmable options that you can set up via control registers. For example, the DSP chip supports a mix of address spaces ranging from a single unified address space to one that has separate 32-bit spaces for X, Y, and program memory.

Addressing modes—Register direct, address-register indirect (postincrement/decrement by 1 or offset, indexed by offset). Special modes: immediate, short jump, absolute/I/O short address, implicit.

Debugging—The on-chip emulator port lets external hardware set breakpoints, single-step the CPU, and read/modify memory or registers. You can configure the chip to run with external RAM for development.

Special instructions—DO/End DO, repeat, bit test and change, compare, graphics compare, divide iteration, jump if bit clear/set, jump to sub-routine conditionally, conditional ALU operation, move program memory.

Part no.	Clock (MHz)	Mode	Max power (mA at 5V)	Pins, package	Price (1000)
DSP96002	33.3/40	Run Wait Stop	300 (typ) 10 (typ) 0.1 (typ)	223-pin PGA	\$143.90/ \$172.70

SUPPORT

HARDWARE Motorola sells the Applications Development Module for evaluating and debugging the DSP96002. The module uses the processor's on-chip emulation support for ICE-like debugging. Some third-party tools are available; contact Motorola for references.

SOFTWARE Motorola supplies a Gnu C compiler and tools and an assembler/linker, librarian, application library, and behavioral simulator. Third-party tools include C and Ada compilers, graphical development systems, filter-design software, and real-time operating systems. Contact Motorola for references.

NEC μ PD77C25

OVERVIEW The μ PD77C25 is NEC's second 16-bit fixed-point DSP chip, following the μ PD7720. The C25 is a CMOS part that doubles performance but is pin- and upward-code-compatible with the older chip. Both DSPs have an accumulator-based architecture and run from on-chip program and data memory. The C25 has 2048 24-bit instruction words and two data blocks to hold MAC inputs—512 bytes of data RAM and 2048 bytes of data ROM. Program and data ROM are also available as EPROM or OTP memory. The μ PD77C25 handles pipelined, single-cycle MAC operations with a 16×16 -bit multiply and a 16-bit accumulator.

The μ PD77C25 can run in stand-alone mode or in conjunction with a host processor. It has an 8-bit parallel I/O host port for exchanging data or DSP status with a host processor. This port can interface with standard μ C buses such as the 8080, 8085, and 8086 and can handle 8-bit or double-buffered 16-bit data transfers. The μ PD77C25 also has two serial ports, which can interface to serial peripherals such as ADCs, DACs, codecs, and other μ PD77C25 DSPs. You can configure the serial ports for single- or double-byte transfers.

16-bit fixed-point DSP

μ PD77C25

- ▶ 24-bit instruction, 16-bit data
- ▶ 4 instruction types, 98 instructions
- ▶ 2 16-bit accumulators
- ▶ $2k \times 24$ -bit program ROM/EPROM/OTP
- ▶ 2-kbyte data ROM/EPROM/OTP
- ▶ 512-byte data RAM
- ▶ 16-bit ALU/accumulator
- ▶ 2 internal data buses
- ▶ 4-level hardware stack
- ▶ 2 serial 8-bit I/O ports
- ▶ 2 I/O pins, 1 external interrupt
- ▶ 8/10-MHz clock
- ▶ All instructions 1 word
- ▶ 1-cycle MAC, MPY-SUB (pipelined)
- ▶ 16×16 -bit MPY, 31-bit result
- ▶ 122-nsec ADD; 100-nsec NOP
- ▶ Auto increment/decrement for data-RAM pointer
- ▶ Auto increment for data-ROM pointer
- ▶ DMA support for 8-bit parallel I/O port
- ▶ 4-MHz serial I/O
- ▶ 2-cycle max interrupt latency

VENDOR CONTACT

NEC Electronics Inc, Mountain View, CA, (800) 366-9782.

Circle No. 493

ARCHITECTURE

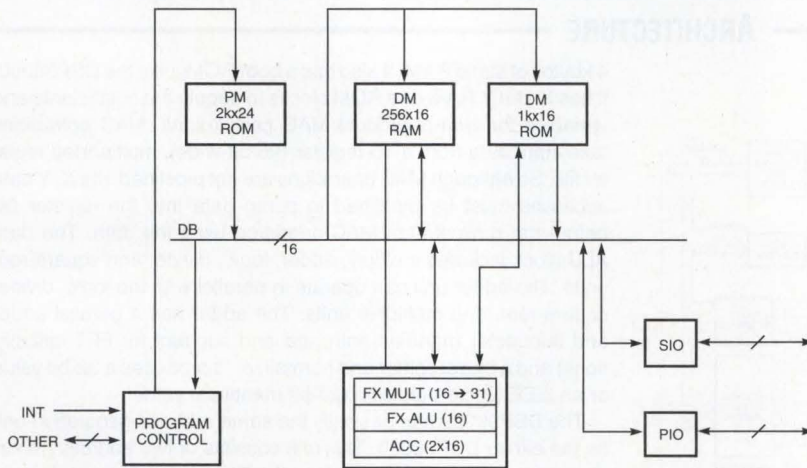

The μ PD77C25 is a classical accumulator-based architecture built around a pipelined MAC core. It has three on-chip memories: one program and one data ROM/EPROM/OTP-memory block and a data-RAM block. The CPU can fetch two values per cycle to fill the multiplier input registers while getting the next instruction. The DSP has one 16-bit data bus that links to all memories and peripherals. For MAC data fetches, the RAM bypasses the data bus and directly feeds one of the MAC inputs. The data bus feeds the other MAC input, which passes data from the data ROM/EPROM/OTP-memory block.

The MAC unit is pipelined; the multiplier and accumulator-adder run in parallel. A multiply-accumulate takes two clock cycles: one for the 16-bit multiply and another for the product to be added to the accumulated result. The multiplier produces a 31-bit signed word, which is held in two 16-bit registers. The 16-bit-wide adder circuit has two 16-bit accumulators; you can keep two 16-bit running sums or a 32-bit sum that takes two passes through the adder. The multiplier is registered; each input is loaded into a register before passing through the unit's Booth multiplier. The resulting products are also registered. The accumulator ALU has two accumulators; an input from one accumulator can shift on its way to the ALU.

The μ PD77C25 has a 24-bit instruction word and a 16-bit data word. The wider instruction word increases CPU execution efficiency—all instructions fit into a single instruction word, even instructions that carry immediate values. This simplifies the instruction-decode logic and ensures that all instructions (except branches) deliver apparent single-cycle execution. The instruction ROM has an 11-bit program counter, which automatically increments each cycle unless there is a branch, subroutine call, or interrupt. Hardware automatically saves the PC into a 4-level LIFO hardware stack for interrupts and subroutine calls. If the CPU attempts more than four levels, the bottom value (first value stored) will be lost.

Addressing modes—Simple register-direct addressing. Two registers, DP and RP, hold the data RAM and data ROM addresses. The complex instruction word defines an automatic increment/decrement for the DP and an automatic decrement for the RP pointers. Only 4 bits of the DP can be automatically adjusted to create a modulo-16 addressing loop. The register pointers can be loaded from the data bus and then automatically adjusted for each MAC cycle.

Numeric representations—The multiplier multiplies the 2's-complement of two 16-bit data words. The result is 30 bits of data and 1 sign bit and is left justified with a 0 LSB. The 16-bit accumulators require two passes for a 31-bit accumulate.

Special instructions—Accumulator decrement/increment, 8-bit exchange, 1's-complement the accumulator (no divide instruction).

Part no.	Clock (MHz)	Max power (mA at 5V)	Pins, package	Price (10,000)
μ PD77C25	8	50	44-lead PLCC	\$12.90
	8	50	28-pin PDIP	\$8.70
	8	50	28-pin SOP	\$12.00
	10	50	28-pin DIP	\$10.20
μ PD77C25	8	60	28-pin PDIP (OTP version)	\$56.20
	8	60	28-pin PDIP (EPROM version)	\$101.55

SUPPORT

HARDWARE An evaluation board, EVAKIT-77C25, is available from NEC. It can also function as a limited ICE by plugging directly into the target-system DSP socket. The evaluation board with an adapter also plugs into standard PROM burners to program versions with EPROM or OTP memory.

SOFTWARE No C compiler is available for the 77C20. NEC supplies an assembler-linker-loader package, and a third-party simulator is also available.

AVAILABLE FROM STOCK!
Universal Input & Unity Power Factor

VI-HAM™

Harmonic Attenuator Module

- Up to 600 Watts of Output Power
- Booster Versions Available
- Meets IEC 555
- High Efficiency
- Module Enable and Power OK
- Size: 4.6"L x 2.4"W x 0.5"H

The pressure is on to wring more and more usable power from a standard AC outlet—safely and economically—and to pack the necessary power processing capability into ever smaller spaces.

Solution: the VI-HAM Harmonic Attenuator Module. This component-level front end—in the industry standard package—provides unity power factor for line powered systems anywhere in the world. Vicor DC-DC converters and VI-HAM modules together create a universal input, off-line switching power supply for systems requiring from hundreds of watts to kilowatts of total power, with any number of outputs, from 1 to 95 VDC.

Use VI-HAM modules with Vicor VI-26X (full size) or VI-J6X MiniMod™ DC-DC converters in booster expandable arrays to satisfy a wide range of power demands. And when your system has to meet international standards for EMI/RFI emissions, choose the Vicor filter that fits your need.

Build new flexibility into *your* power system designs with the VI-HAM module. Call today for details.

Left: no power factor correction
Right: power factor correction with the VI-HAM

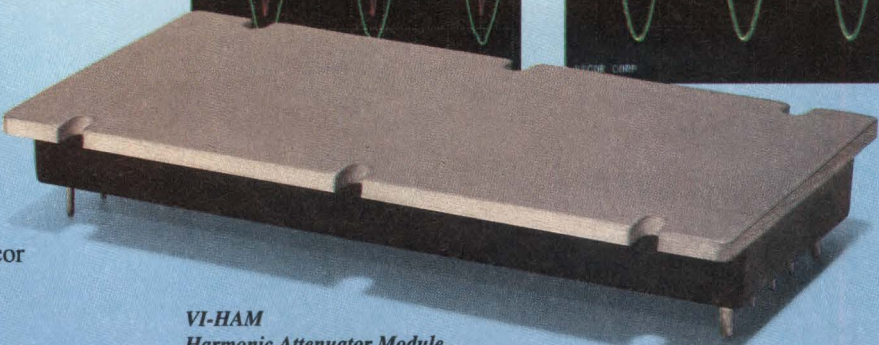
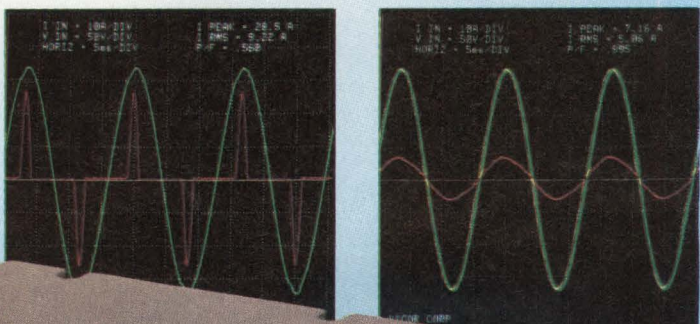

VI-HAM
Harmonic Attenuator Module

Component Solutions For Your Power System

Vicor Corporation, 23 Frontage Road, Andover, MA 01810 (508) 470-2900 or (800) 735-6200

Vicor GmbH • Germany • Tel: +49-89-329-2763 • Fax: +49-89-329-2767 Vicor Far East • Taiwan • Tel: +886-2-9188240 • Fax: +886-2-9132982

CIRCLE NO. 192



SEND A CLEAR MESSAGE!

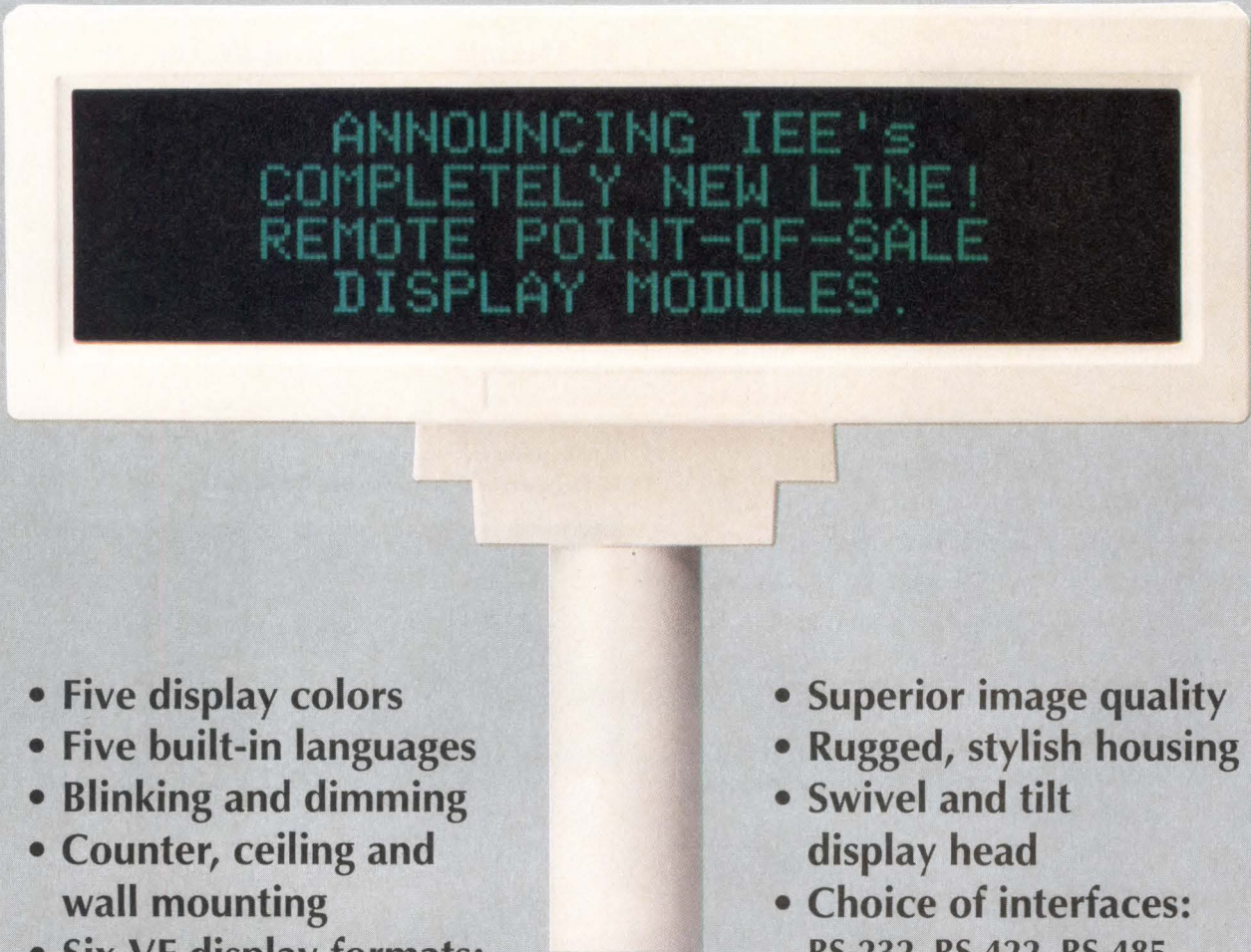

ANNOUNCING IEE's
COMPLETELY NEW LINE!
REMOTE POINT-OF-SALE
DISPLAY MODULES.

- Five display colors
- Five built-in languages
- Blinking and dimming
- Counter, ceiling and wall mounting
- Six VF display formats:
2x20 9mm, 4x20 9mm, 2x20 11.3mm, 2x16 11mm, 1x20 13mm, 1x16 11.5mm
- Superior image quality
- Rugged, stylish housing
- Swivel and tilt display head
- Choice of interfaces:
RS-232, RS-422, RS-485



Industrial Electronic Engineers, Inc.
7740 Lemona Avenue, Van Nuys, CA 91409-9234
Tel 818-787-0311 Ext. 418 • Fax 818-901-9046

NEC μ PD77017

OVERVIEW Introduced this year, NEC's μ PD77017 targets 16-bit digital-cellular, voice, and fax-modem applications. The 16-bit fixed-point processor is the most recent of the NEC DSP offerings. It has many of the features of third-generation DSP architectures such as separate on-chip X and Y data RAMs, each with its own address generator and two sets of four address-pointer and index registers. The core execution unit consists of three 40-bit functional units—a multiplier, ALU, and barrel shifter. The μ PD77017 has a set of eight 40-bit, general-purpose register/accumulators and three internal buses to minimize conflicts when moving multiple data in a single cycle. The DSP delivers apparent single-cycle (pipelined) instruction execution. The MAC unit is pipelined as well and takes one cycle.

The μ PD77017 has 16-bit data words, 32-bit instruction words, and 12k words in on-chip code ROM and 256 words of on-chip code RAM. It has dual external-memory ports—one for 16-bit data and one for 32-bit programs—with two distinct 16k-word address spaces for data. Memory read/write accesses can take a single cycle, although instruction pipelining may require an extra cycle for some instructions. An on-chip wait-state generator lets the processor run with slower, less-expensive memory. Like many of NEC's DSPs, the 77017 has an 8-bit host I/O port, which enables a host μ P to exchange data with the DSP.

16-bit fixed-point DSP

μ PD77017

- ▶ 3V operation
- ▶ 32-bit instruction, 16-bit data
- ▶ 3-stage pipeline, 81 instructions
- ▶ 8 40-bit reg/accumulators
- ▶ 40-bit MPY, ALU, barrel shifter
- ▶ 2 2-kbyte data-RAM blocks
- ▶ 12k \times 32-bit program ROM
- ▶ 256 \times 32-bit program RAM
- ▶ 3 internal buses
- ▶ 1 external-memory bus
- ▶ 15-level hardware stack
- ▶ 2 serial I/O ports
- ▶ 8-bit host I/O port with DMA
- ▶ 4 external interrupts, 5-pin JTAG
- ▶ 33/16.5/8.25/4.125-MHz clock (2 clocks/cycle)
- ▶ 1-cycle pipelined execution
- ▶ 1-cycle MAC
- ▶ Zero-overhead nested looping; program-loop control, data address generators
- ▶ Data: modulo, bit-reversed addressing; auto increment/decrement
- ▶ 4-level loop stack
- ▶ 2-cycle interrupt latency; repeat takes 2+n cycles
- ▶ DC to 16-Mbps serial I/O
- ▶ Power-down mode
- ▶ Built-in PLL

VENDOR CONTACT

NEC Electronics Inc, Mountain View, CA, (800) 366-9782.

Circle No. 494

ARCHITECTURE

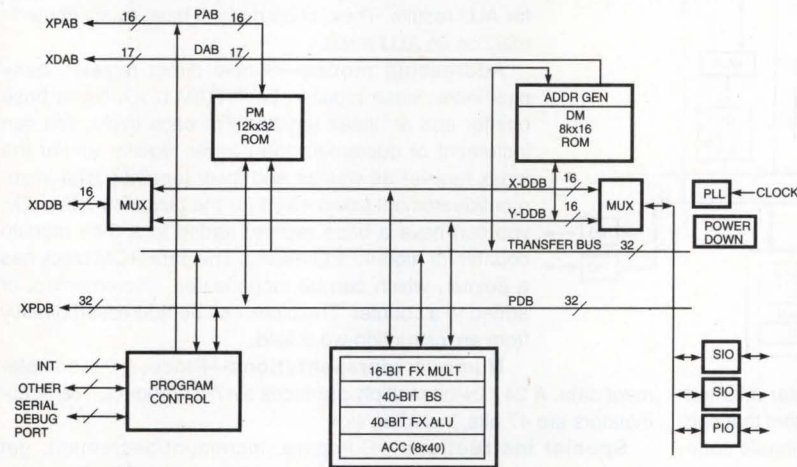

A third-generation DSP processor, the 16-bit fixed-point μ PD77017 combines a number of architectural features to ensure fast, single-cycle MAC execution. These features include three internal buses for X data, Y data, and transfer buses; separate X and Y memories, each with its own dedicated address generator; a MAC unit; and eight general-purpose 40-bit register/accumulators. The 77017 is a 16-bit processor with a wider 32-bit instruction word to minimize instruction-decoding logic and increase code efficiency.

The 77017 neatly partitions into two major processor sections and a peripheral set. The main sections are the data unit and the program unit. The data unit contains the X and Y memory units, each of which has an address unit, register file, and MAC-execution unit. The program unit contains the instruction-address unit with built-in loop control, interrupt-control logic, 12k words of program memory, and instruction-decode/control logic. A main bus, the transfer bus, links the two main units. Each main unit connects to an external data-memory interface: 14-bit addresses and data for the data unit.

The data unit's MAC has three 40-bit parallel subunits: a multiplier/ALU, an ALU, and a barrel shifter. Unlike many DSP implementations, the MAC subunits do not have dedicated input and output registers. Instead, the MAC is tightly integrated with a set of eight

general-purpose registers. The X, Y, and transfer buses push data into the general register set; the general register set provides the data to drive the individual MAC subunits, which can execute concurrently. In effect, the general register set, which is basically a multiport register file, serves as the interchange that links the data side of the processor to the execution side. The basic MAC operation executes in a single clock cycle.

Two 2-kbyte ROM data-memory banks supply the X and Y data components for each MAC cycle. Each bank has its own address generator with a set of four address-pointer registers, supplemented by four index registers and a modulo register. A special bit-reverse circuit handles bit-reversed addressing for each bank. On the program side, the DSP has a 12k-word (32-bit) instruction ROM and 256-word instruction RAM. The RAM has to be directly loaded under program control. To speed instruction execution, the DSP has a 15-level hardware PC stack that pushes and pops the PC for interrupts and subroutine calls and returns. Additionally, the DSP hardware supports automatic looping with a 4-level loop stack that lets code nest so it can loop under hardware control.

The X and Y address units each have two sets of four 16-bit registers, which serve as address pointers and modification registers. Each unit also has an index-register link to the main data bus. Through this bus, code can load and modify the pointer and modification registers. Each unit also has a modulo register for modulo index addressing.

Addressing modes—Direct, register, addressing, immediate. Hardware supports modulo and bit-reversed addressing for each data memory.

Special instructions—Conditional operations (minimize jumps), multiply-subtract, 1-bit shift-multiply-add, 16-bit multiply-add, increment/decrement, clip, exponent, absolute value, register-indirect subroutine call, register-indirect jump, loop, repeat, loop pop.

Part no.	Clock (MHz)	Mode	Max power (mA at 3V)	Pins, package	Price (10,000)
μ PD77017	33	Run	170	100-pin TQFP	\$32

SUPPORT

HARDWARE NEC supplies a PC-based plug-in development board that offers in-circuit emulation using the 77017's on-chip emulation features. The board plugs into the PC/AT bus and links to the target board via a 6-pin connector that connects to the 77017's on-chip ICE logic.

SOFTWARE NEC has MS-Windows-based development tools that include a simulator, relocatable assembler, librarian, linker, and a viewer for displaying error and assembly listings. (A C compiler will be available soon.)

NEC μ PD77220

OVERVIEW Introduced in 1986, the 24-bit fixed-point DSP μ PD77220 fits between NEC's 16- and 32-bit architectures. It is a second cousin to the 16-bit DSPs and a reduced version of the 32-bit μ PD77240. The instruction set and coding resemble that of the 16-bit DSPs; the register-based architecture reflects that of the later 32-bit DSP. And like its older 32-bit brother, the 77220 has provisions for a close coupling with a host processor as well as the capability to use external memory for both data and code.

The μ PD77220 has a complex architecture. In the NEC tradition, it uses an instruction word that is wider than its data word—32-bit instructions and 24-bit data. It has a single, 24-bit main data bus with hardware bypasses to ensure parallel data accesses for feeding the core MAC unit. The MAC unit has a parallel 47-bit multiplier and 47-bit ALU. The ALU has eight general-purpose register/accumulators. These registers can be used to accumulate results or as holders for interim program values. The data RAM and ROM blocks have their own built-in address generators and pointer registers to speed processing. An 8-level hardware stack automatically holds PC values for interrupts and subroutine calls. The hardware has two PSWs (program

24-bit fixed-point DSP

μ PD77220

- ▶ 32-bit instruction, 24-bit data
- ▶ 3-stage pipeline, 51 instructions
- ▶ 8 47-bit accumulators
- ▶ 2k \times 24-bit program ROM/EPROM
- ▶ 2 768-byte data RAM blocks
- ▶ 3-kbyte data ROM block
- ▶ 16-bit host port (slave mode)
- ▶ External-memory interface: 13-bit address, 32-bit data
- ▶ 4 I/O pins, 2 external interrupts
- ▶ 8/10-MHz clock (2 clocks/cycle)
- ▶ All instructions 32-bit words
- ▶ 100-nsec ADD, NOP (10 MHz)
- ▶ 1-cycle MAC, MPY-SUB (pipelined)
- ▶ 10-bit loop counter
- ▶ Data pointers: autoincrement/decrement, base+pointer, modulo addressing
- ▶ 8-level hardware stack
- ▶ 4-MHz max serial I/O
- ▶ 3-cycle max interrupt latency

status words), which can be dynamically selected by a bit in each instruction.

VENDOR CONTACT

NEC Electronics Inc, Mountain View, CA, (800) 366-9782.

Circle No. 495

ARCHITECTURE

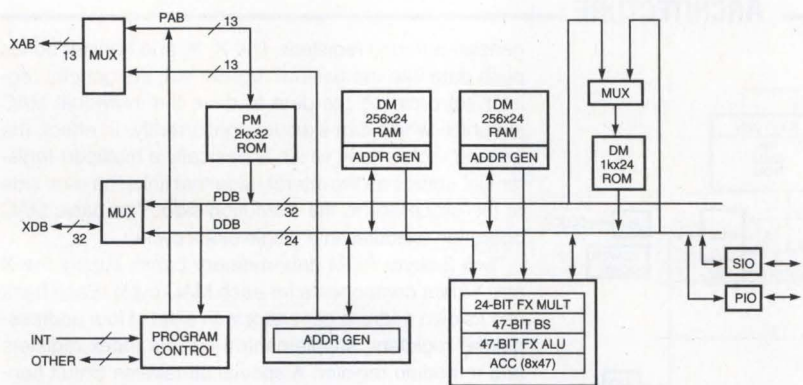

two 4-bit PSWs (program status words) that hold the flags for ALU results. Thus, code doesn't have to act immediately on an ALU result.

Addressing modes—Simple direct register, base plus index, base register. Each RAM block has a base pointer and an index register. For each cycle, you can increment or decrement the pointer register and/or the index register as well as add them together. The increment/decrement takes effect for the next instruction. Or, you can have a base register added to a 9-bit modulo counter for modulo addressing. The data ROM block has a pointer, which can be incremented, decremented, or added to a counter. The block can be addressed directly from an instruction-word field.

Numeric representations—Process 2's-complement data. A 24 \times 24-bit multiply produces a 47-bit product. The accumulators are 47 bits, including sign.

Special instructions—Compare, increment/decrement, get absolute value, multiply and subtract, multiply-logical/shift. No divide instruction.

PERIPHERALS

Slave mode—The 77220 has two hard-wired modes: slave mode and master mode. In slave mode, the DSP is slaved to a host processor. This mode maintains a 16-bit data port through an internal register. The host can write to this register or read from it. The DSP can transfer data between this register and RAM or any internal register. The host processor cannot take command of the slaved DSP CPU; it can only send or receive data through the port. In slave mode, the DSP can drive a general-purpose set of I/O pins and a limited external memory. The I/O pins comprise two output pins and two input pins. The 8-bit external-memory interface has a 13-bit address bus. Up to 8 kbytes of external memory can be used for data storage.

Master mode—In master mode, the DSP has no provision for direct interfacing to a host processor. Instead, the CPU supports up to 8 kbytes of 32-bit-wide external memory; 4 kbytes can be data, 4 kbytes code.

Part no.	Clock (MHz)	Max power (mA at 5V)	Pins, package	Price (10,000)
μ PD77220L	8 10	200 200	68-lead PLCC	\$32 \$38
μ PD77220R	8 10	200 200	68-pin PGA	\$52 \$55

NEC's 24-bit, fixed-point μ PD77220 DSP has a register-oriented architecture with eight general-purpose register/accumulators that can hold values or accumulate results. Complex instructions enable code to operate on these registers for addressing or arithmetic/logical operations. The core of the processor consists of three RAM and ROM data blocks that feed a registered multiplier and ALU units each cycle. A MAC operation takes two cycles—one for the multiply and one for accumulating the multiplication result.

The 77220 takes a hard-wired approach to accessing and moving data to the DSP multiplier and ALU. It has a single 24-bit data bus that links all the major elements together. For fast MAC processing, the bus is bypassed with hard-wired paths to move data in parallel. Each of the data RAM and ROM blocks has its own attached address-generator logic. The two 768-byte data RAMs have a base pointer and index register that are directed by fields in each instruction word. The data ROM has an address register and a modulo counter; it can also be addressed directly from the instruction word.

The 77220 has a built-in 10-bit loop counter, which can be loaded, read, and decremented. When the counter decrements past 0, it generates a borrow, which causes the hardware to substitute a NOP for the next instruction. A decrement that passes through 0 will skip the jump instruction, typically a jump that loops back to the top of the block; this skip will fall through and terminate the loop.

The DSP has an 8-level hardware stack that pushes the PC on a LIFO basis for interrupts and subroutine calls. On returns, the PC values are popped off the stack into the PC. The hardware also maintains

SUPPORT

HARDWARE NEC supplies an evaluation board with 8-kbyte external program memory, 8-kbyte external data memory, and an 8-kHz analog front end. A stand-alone emulator is also available.

SOFTWARE NEC has a relocatable assembler/linker/loader package for the 77220. It also has a window-oriented simulator for analyzing code and timing.

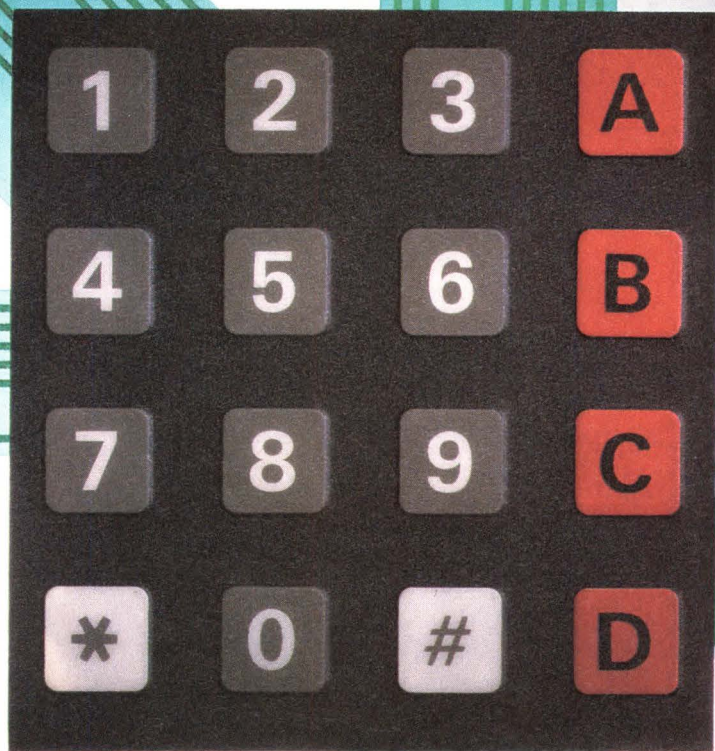

The components that control the switch control it all.

The performance of sophisticated electronic equipment may ultimately be judged by something as small, and seemingly insignificant, as the membrane switch that controls it. So the quality of your switch components is critical.

3M membrane switch laminating adhesives and spacers give you the long-lasting, high performance you need to assemble a reliable switch. A switch that can stand up to millions of actuations in a wide variety of stressful environments.

If you're not using 3M components, it's time to make a switch. For our free brochure write: 3M Identification and Converter Systems Division, 3M Center Bldg. 220-7W-03, St. Paul, MN 55144-1000. Or call: 800-223-7427; 3M Canada Inc., PO Box 5757, London, Ontario N6A 4T1, 519/452 6025; 3M Puerto Rico, Puerto Rico Industrial Park, PO Box 100, Carolina, PR 00986-0100, 809/750 3000.

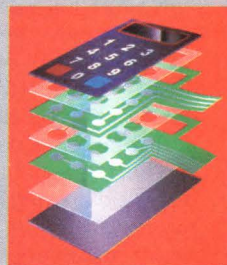

Some Delays Can't Be Avoided.

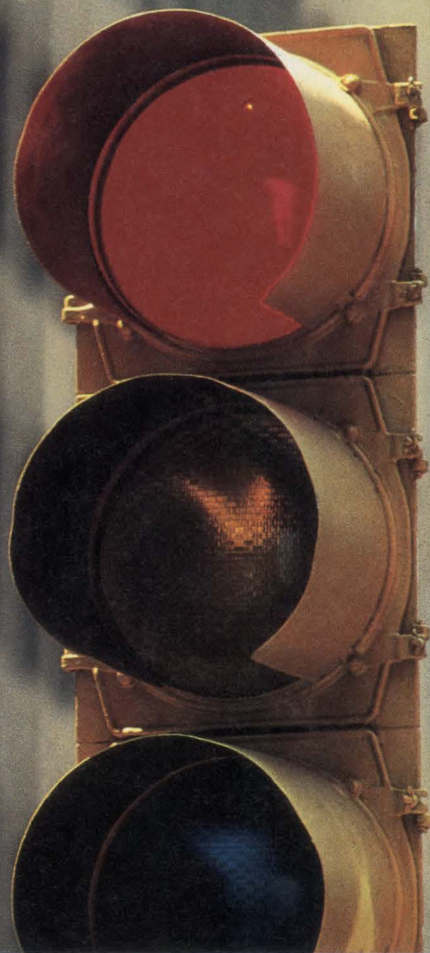

Some Can.



No one likes delays. System engineers especially. That's why we invented a logic switch so fast it 'disappears' in your system. Its 250 ps propagation delay is *at least* 10 times faster than standard logic devices. So you can say good-bye to logic-induced performance penalties for good.

This high-end technology has swiftly grown into our QuickSwitch® product family. Offering pin-for-pin replacements for bus switches, high-speed buffers and transceivers, and mux/demux devices.

QuickSwitch products deliver delay-free 5V-to-3V signal conversion making them ideal for emerging

Pentium-based PCs as well as laptops and PDAs. They also have the hot-plug (live insertion) capability plus a low 5-ohm "On" resistance. They add no power dissipation, no ground bounce, and require no directional control.

QuickSwitch devices come in SOIC, QSOP, and now QVSOP™ as well as standard DIP packages. Call today for the popular *QuickSwitch Product Handbook* chock full of innovative, customer-inspired applications. 1-800-609-3669. Or Fax 408/496-0773.

Avoid delay. We did.



Quality Semiconductor, Inc.

QuickSwitch is a registered trademark of Quality Semiconductor, Inc. Q and QVSOP are trademarks of Quality Semiconductor, Inc.

SGS-Thomson ST18 Family

OVERVIEW The ST18950 is a general-purpose, programmable 16-bit, fixed-point DSP core. The ST18950 can be embedded as a megafunction in a gate array or cell-based device that has a 0.5- μ m library containing RAM, ROM, and PLAs. By simply adding optional peripherals (IT controller, DMA controller, bus-switch control unit, etc) and memory for data and instruction, you can customize a powerful application-specific digital-signal processor (ASDSP) around the ST18950 DSP core. A key to the ST18950's performance is its high degree of parallelism, which allows the ST18950 to simultaneously perform multicyle functions along with other processors.

The ST18950's built-in 0.5- μ m, triple-level-metal CMOS technology includes an arithmetic data-calculation unit (DCU), a program-control unit (PCU), and an address-calculation unit (ACU). The chip has up to 64k \times 16-bit (program) and 128k \times 16-bit (data) memory. An emulation and test unit (ETU) helps you implement and test ASDSPs built around the ST18950.

VENDOR CONTACT

SGS-Thomson Microelectronics Inc., Phoenix, AZ, (602) 867-6100.

Circle No. 496

16-bit fixed-point DSP

ST18950

- ▶ 40 MIPS/25-nsec instruction-cycle time
- ▶ Harvard architecture
- ▶ 2 64k \times 16-bit data memories
- ▶ 64k \times 16-bit program memory
- ▶ 16 \times 16-bit parallel multiplier
- ▶ 40-bit barrel shifter unit
- ▶ 40-bit ALU (40-bit math operations)
- ▶ 2 40-bit extended precision accumulators
- ▶ Fractional and integer arithmetic (for floating-point)
- ▶ Bit manipulation
- ▶ Immediate and computed branches and subroutines
- ▶ No overhead nested hardware loops
- ▶ 1 interrupt pin and interface to interrupt-controller peripheral
- ▶ Bootstrap loading
- ▶ Stack in data memory
- ▶ 2 address-calculation units with modulo and bit-reverse capability
- ▶ General-purpose 8-bit I/O port
- ▶ Dedicated hardware for emulation and test; IEEE 1149.1 (JTAG) compatible
- ▶ Coprocessor interface and coprocessor-dedicated instructions
- ▶ Operation to dc
- ▶ Single 3.3V power supply
- ▶ Low-power standby mode

ARCHITECTURE

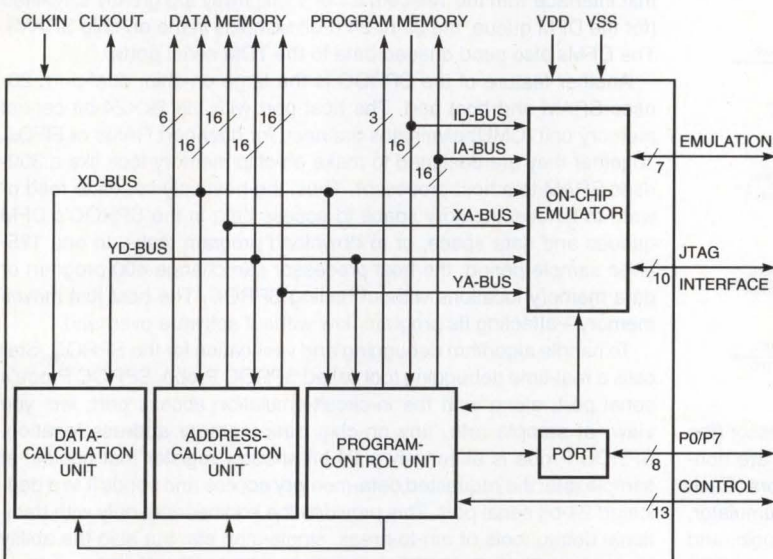

The SGS-Thomson ST18950 DSP architecture has four main components: a data-calculation unit (DCU), address-calculation unit (ACU), program-control unit (PCU), and emulation-and-test unit (ETU). These units are organized in a Harvard architecture around three bidirectional 16-bit buses—two for data (XD/YD) and one for instruction (ID); each bus is dedicated to a unidirectional 16-bit address bus (XA/YA/IA). Data memory (RAM and ROM) and registers map on to the external data buses (XD/YD and XA/YA). Access to program RAM and ROM is via the instruction bus (ID/IA); data and instruction buses share the same bus-control interface (RD/WR/BS).

Depending on the calculation mode, the ST18950 DCU computes operands, which can be 16- or 32-bit, signed or unsigned. The chip includes a 16 \times 16-bit parallel multiplier to implement MAC-based functions (1 cycle/MAC). A 40-bit arithmetic-and-logic unit (ALU) implements a range of functions, with an 8-bit extension for arithmetic operations. The ST18950 has a 40-bit barrel-shifter unit and a bit-manipulation unit that handles MCU (master-controller-unit) processing through bit operations. Both 16/32-bit fractional

(signed/unsigned) and 16/32-bit integer (signed/unsigned) word formats are available.

The ST18950 ACU generates an address for each of the two identical data memories and updates them at each instruction, allowing execution of instructions and performing up to two register-to-memory moves in one cycle. The ST18950 implements various addressing modes: direct, indirect-linear, indirect-modulo, indirect-bit-reverse (all with postincrement), indirect-indexed, and immediate.

The ST18950 PCU updates the program counter (PC) according to the current instruction and/or internal and external events. It performs program-address generation, instruction fetch and decoding, exception processing, and hardware loop control. By default, the PC increments by 1.

The chip's ETU contains three independent parts that share the same external interface: an emulation part, core-scan registers (CSR), and a test part (for production-test purposes). Access to these units is via dedicated I/O pins, which allow the ETU to interface with an outside JTAG TAP controller or function as primary access to the final ASDSP chip—according to the IEEE 1149.1 JTAG standard.

An 8-bit general-purpose parallel port (P0 to P7) can be configured (input or output). A test condition is attached to each bit to test external events; chip control is via interface pins related to interrupt, low-power mode, reset, and miscellaneous functions.

VARIATIONS

ST18932—40-MHz DSP-core megacell for application-specific processors. Includes 384-byte X RAM, 256-byte Y RAM, no program ROM, MAC unit, 10/13-MHz clock, boundary-scan on-chip emulation.

ST18933—40-MHz, ST18 DSP with 8-kbyte data RAM, 16-kbyte data ROM, 64-kbyte program ROM, 3 serial I/Os, 8-bit host port, 160-pin PQFP.

Part no.	Clock (MHz)	Mode	Max power (mA at 5V)	Pins, package	Price
ST18933	40	Run	80	150-pin PQFP	\$26(10,000)

SUPPORT

HARDWARE SGS Thomson offers a JTAG pc board with a graphic windowed high-level source debugger for ASDSP emulation.

SOFTWARE A C compiler, a simulator, and an assembler/linker that run on PC/Sun systems are available, as well as a Synopsys VHDL model.

Star Semiconductor SPROC-1x00 Family

24-bit multiprocessor DSP

OVERVIEW Star Semiconductor's SPROC-1400 has a unique architecture, with up to four 24-bit general signal processors (GSPs) that work independently or in unison. The GSPs deliver a sustained 40-MIPS throughput. The SPROC has four data-flow managers (DFMs), on-chip DMA units, and 2kx24-bit 20-nsec SRAM for program and data. SPROC also has an in-circuit emulation access port with real-time probe capabilities. An extensive family of macros provides an easy-to-use software-development environment. Developers can currently work in Assembly language and, in the future, XDL.

VENDOR CONTACTS

Star Semiconductor Corp., San Jose, CA, (408) 526-2160; fax (408) 526-2165
Circle No. 497
BBS (408) 526-2180, 1200 to 2400 bps; (408) 526-2179, 4800 to 14,400 bps (N,8,1).

SPROC-1400

- ▶ 4 24-bit processors/chip
- ▶ CPUs time-share memory, buses
- ▶ 5 time slots/cycle, 61 instructions
- ▶ CPUs execute from same program memory
- ▶ Break/loader program ROM
- ▶ 2 3-kbyte RAM blocks; data, prog
- ▶ 24-bit instr, data, trigger buses
- ▶ 24-bit MPY; 56-bit result
- ▶ 8/16/24-bit parallel port with watchdog timer
- ▶ Serial I/O; 2 inputs, 2 outputs
- ▶ Access and probe ports
- ▶ 35/50-MHz clock (5 clocks/cycle)
- ▶ Static CMOS design
- ▶ Each CPU uses different time slots to access memory
- ▶ Most instructions: 1 cycle
- ▶ 3-cycle MAC; other operations in parallel with MAC
- ▶ Data-address generator
- ▶ Parallel MAC unit, ALU in CPU
- ▶ Slave and master modes (pin-settable)
- ▶ Hardware/software wait states for external memory
- ▶ I/O takes fifth slot in data access

ARCHITECTURE

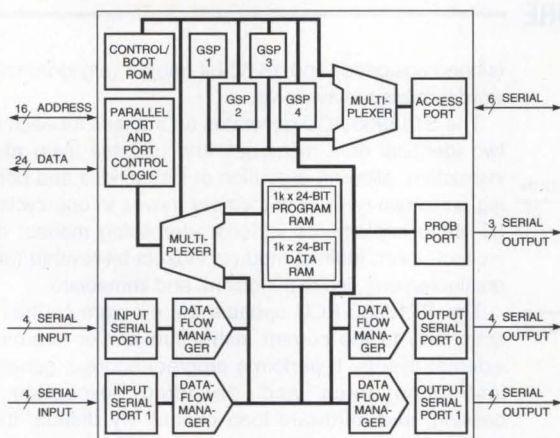

The SPROC architecture has up to four GSPs on one processor (the -1400 has four GSPs; the -1200 has two). SPROC's GSPs are non-pipelined, register-to-register, Harvard-architecture processors. Each GSP has its own 24-bit ALU, 24-bit MAC unit with 56-bit accumulator, data/program address-generation logic, instruction decode logic, and status flag register. To avoid memory or bus contention, each GSP works within a fixed time slot or state. The five states include fetch, decode, read, execute and flag-update. GSP memory or external bus access occurs only during the fetch (program op-code fetch) and read (data memory read/write) states. The SPROC has four GSPs and an I/O that request access to memory every five states. Therefore, GSP1 fetches while GSP2 is in decode state, and GSP3 is reading or writing to data memory. In addition, each GSP is autonomous from the next, allowing processing of four data types at four sample rates, concurrently and without software overhead.

SPROC/2: The data-flow managers work with time-division-multiplex (TDM) serial ports to maintain and queue input and output sampled data. These on-chip data queues can be any length (to 255 sam-

ples deep). For example, to eliminate interrupt overhead, applications that interface with the Telecom E1 or T1 highway are greatly simplified (for the DFM queue, the 32 or 24 8-bit samples in the on-chip SRAM). The DFMs also send queued data to the TDM serial ports.

Another feature of the SPROC is the large on-chip, dual-port, 20-nsec SRAM and host port. The host port with the 2kx24-bit central memory unit (CMU) eliminates the need for dual-port RAMs or FIFOs. Together they are designed to make on-chip memory look like a 300-nsec SRAM to a host processor. Thus, the host only needs to read or write to its own memory space to access data in the SPROC's DFM queues and data space, or to download program tasks. In one 125-μsec sample period, the host processor can change 400 program or data memory locations without halting SPROC. The host just moves memory—affecting its program flow without software overhead.

To handle algorithm debugging and verification for the SPROC, Star sells a real-time debugging tool called SPROC Probe. SPROC Probe's serial port, along with the in-circuit-emulation access port, lets you view, at sample rate, any on-chip data-memory address location. SPROC Probe is effectively a 24-bit shadow register that copies, at sample rate, the requested data-memory access and sends it to a dedicated 24-bit serial port. This provides the engineer not only with traditional debug tools of run-to-break, single-step etc, but also the ability to change a system variable in real time and see its effect.

Addressing modes—direct, register, indexed.

Numeric representation—24-bit integer, 24-bit Q22 fixed-point.

Memory access—10-bit program-address bus, 16-bit data-access bus.

Special instructions—multiply-accumulate, load parallel-port register from external address (master mode only).

Part no.	Clock (MHz)	Max power (mA at 5V)	Pins, package	Price (500)
SPROC-1400	50	480	144-pin MQFP	\$96.29
	35	340	144-pin PQFP	\$84.44
SPROC-1200	50	300	84-lead PLCC	\$45.33
SPROC-1210	50	300	84-lead PLCC	\$50.37

SUPPORT

HARDWARE Star Semiconductor's development system is PC-based and communicates through a serial port to the SPROCbox interface unit. SPROCbox connects to a low-cost SPROC development evaluation board with I/O plug-and-go functions, such as an 80C51 host microcontroller card and a 48-kHz stereo A/D and D/A converter. The SPROC development system and the development-evaluation board use the SPROCbox to interface to the access port on the SPROC DSP, which provides ICE-like debug and run-time emulation capabilities. A PC/AT plug-in board is available from a third-party supplier.

SOFTWARE Star Semiconductor sells a complete development environment for writing and debugging assembly-language routines as well as an extensive library of turnkey macros. The macros can be linked with user-generated code in text-editor or graphical-schematic packages. Also included in the development software is a scheduler and the tools required to link and schedule a DSP design. SPROC Micro Interface, another utility, takes advantage of SPROC's memory-mapping capability; it provides all the software hooks for the host to download and read any variable within the SPROC environment using C syntax (.H file structure).

**EDI Memory
Data Book '94
Now Available!**

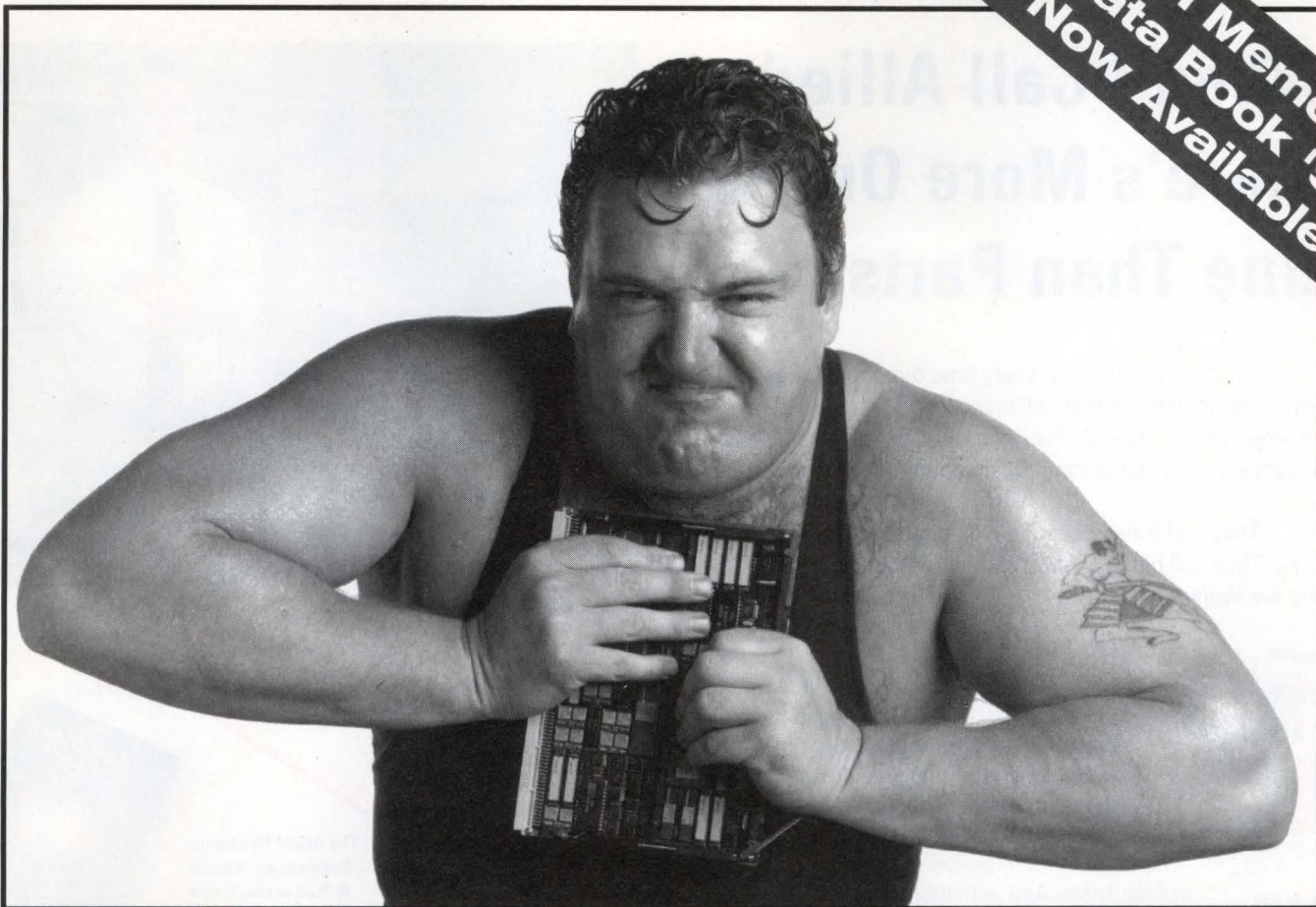

NOW THERE'S AN EASIER WAY TO SQUEEZE MORE MEMORY ON TO YOUR BOARD

EDI's new range of wide memory devices provide a more practical way to add muscle to microprocessor system performance, while reducing size and weight.

Packing a powerful punch, high speed (down to 12ns) Static RAMs benefit from ultra high density vertical ZIP and SIMM packaging and wide data widths, up to 32 bits.

There's no need to wrestle with tough decisions either, because they are available in plastic packaging for commercial and industrial use.

Commercial and Industrial Grade SRAM Modules

High Density Vertical Package Styles

Organization	Part No.	Speed (ns)	Package Style
64Kx32	EDI8F3265C*	12	64 pin ZIP/SIMM
128Kx32	EDI8F32128C*	12	64 pin ZIP/SIMM
256Kx32	EDI8F32256C*	12	64 pin ZIP/SIMM
256Kx32	EDI8F32257C*	17	64 pin ZIP
32Kx24	EDI8F2432C	15	56 pin ZIP
64Kx24	EDI8F2464C	15	56 pin ZIP
128Kx24	EDI8F24128C	20	60 pin ZIP

Surface Mount Package Styles

Organization	Part No.	Speed (ns)	Package Style
256Kx8	EDI8F8257C*	70	32 pin SOIC
2x512Kx8	EDI9F81025C	55	36 pin SOIC

*JEDEC Pinout

HIGH PERFORMANCE MEMORY MODULES

1-800-800-SRAM (XT.219)

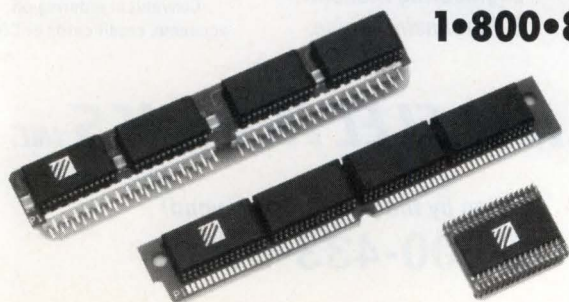

ELECTRONIC DESIGNS INC.

One Research Drive • Westborough, MA 01581 USA
Tel: 508-366-5151 • Fax: 508-836-4850
Tech Hot Line: 800-400-3349

Electronic Designs Europe Ltd.

Shelley House, The Avenue • Lightwater, Surrey GU18 5RF
United Kingdom • 0276 472637 • FAX: 0276 473748

CIRCLE NO. 158

EDN June 9, 1994 • 115

"When I Call Allied, There's More On The Line Than Parts."

At Allied Electronics, every time our phone rings, we know there's more riding on that call than just parts. That caller is putting his project on the line. Or his reputation. Or, if it's a start-up company, he may be putting the company's future on the line.

They call Allied because we understand what's at stake. They call because they expect results.
And we deliver.

ALLIED IS DIFFERENT

For over 65 years, we've earned the confidence of engineers by being more than simply the best catalog in the industry. Our special Allied brand of personal service means our customers get what they've come to expect and more. Like the engineer who wasn't sure what kind of connector he needed to finish his prototype. The local Allied sales office and our product manager figured it out and the next morning the connector was on the engineer's desk. Our customers know that we become a part of their team. And with more than 80 local Allied offices, **we're there when our customers need us because we realize there's a person at the end of the line.**



Same day
shipment



NEW!

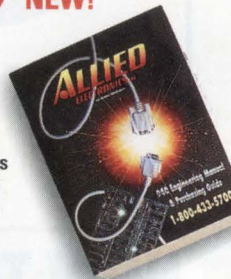

The Allied Electronics
Engineering Manual
& Purchasing Guide

MORE THAN A CATALOG

Our catalog is called an Engineering Manual and Purchasing Guide for a reason. The drawings, specifications and tables give more useful information to working engineers than just lists of part names and numbers that you see in other catalogs. And beyond the limits of the printed page, each of our service representatives has on-line access to our own and Avnet warehouses with inventory worth hundreds of millions of dollars.



**Expect the best.
Call today for your free
Engineering Manual
& Purchasing Guide.**

Convenient ordering on
accounts, credit cards or COD



More than 80 local offices

ALLIED ELECTRONICS INC.

AN AVNET COMPANY

**Going by the book...And beyond!
1-800-433-5700**

Texas Instruments TMS320C1x Family

OVERVIEW Introduced in 1982, TI's TMS320C10 has some limitations, but they reflect the constraints of many early μ Cs and μ Ps: The CPU is accumulator-based, and the architecture relies on shared resources, such as buses and memories, rather than implementing multiple sets to speed processing. The modified Harvard architecture separates program and data accesses, yet allows transfers between code and data spaces to share resources. Initially, on-chip memories were small, and the C10 had a limited off-chip addressing range (12 bits).

The TMS320C10 incorporates a single-cycle multiplier, 16-bit barrel shifter, DSP-specific instruction set, and 4-level hardware stack. The C10 now has a large base of experienced designers, a large collection of application code, and a range of applications. The chip requires careful assembly-language programming, but costs have dropped to the point that C10s are competitive with many μ P and μ Cs. In volume, C10s cost <\$3 a piece.

TI has expanded the C10 family with object-code-compatible DSPs with expanded memory and peripheral sets. Memory for the later chips has ballooned—512-byte RAM and 8-kbyte ROM from the C10's 288-byte RAM and 3-kbyte ROM. Some versions provide OTP memory for development and prototyping.

16-bit fixed-point DSP

TMS320C14

- ▶ 16-bit instruction, data
- ▶ 59-instruction, 3-stage pipeline
- ▶ 2 16-bit registers, 32-bit accumulator
- ▶ 512-byte RAM
- ▶ 4-kbyte ROM/EPROM/OTP
- ▶ 2 sets 16-bit internal buses
- ▶ 4k-word address space
- ▶ 16-bit (L) barrel shifter
- ▶ 3 capture/compare timers
- ▶ 1 serial I/O port, 16 I/O pins
- ▶ 2 external interrupts
- ▶ 20/25/35-MHz clock
- ▶ 4-cycle instruction; 114-nsec cycles at 35 MHz
- ▶ Combined shift/ALU cycle
- ▶ 1-cycle multiplier
- ▶ 8-cycle MAC instruction
- ▶ 4-cycle instruction with memory R/W
- ▶ Watchdog timer
- ▶ 7-cycle max interrupt latency
- ▶ 4-level instruction stack

VENDOR CONTACTS

Texas Instruments Inc, Dallas, TX, (800) 336-5236. **Circle No. 498**
TMS320 Technical Hot Line: (713) 274-2320.

TMS320 BBS: (713) 274-2323 (N,8,1).

Microchip Technology Inc, Chandler, AZ, (602) 786-7200 (second source for the TMS320C10, C14, and E14). **Circle No. 499**

ARCHITECTURE

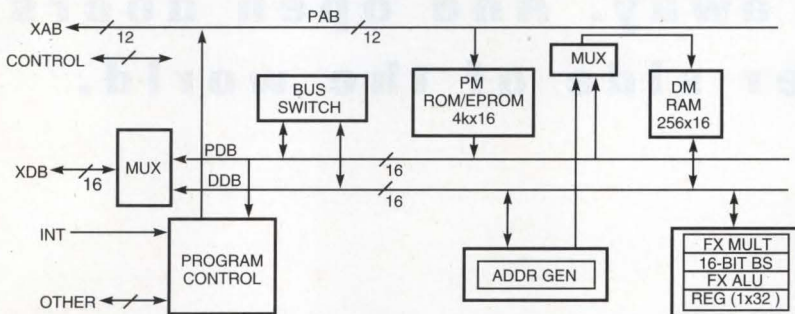

A basic DSP engine, TI's TMS320C10's Harvard architecture separates program and data—each has its own bus and memory. Like many early μ Cs, the C10 is accumulator-based; the accumulator, however, is 32 bits wide for double-precision, 2's-complement arithmetic. A fast, single-cycle multiplier or 16-bit barrel shifter in parallel with the multiplier feeds the accumulator. A MAC operation takes two cycles and two instructions—first the multiply and then the add instruction. Addressing for the MAC data values is not automatic; a basic MAC pass requires code to specifically address, fetch, and operate on each set of X, Y data values.

The TMS320C10 has a single data bus. For each MAC operation, code must load the multiplier's T register with one data value, then move the second data value to the multiplier before starting the multiply. The DSP chip has two 16-bit auxiliary registers to hold temporary values and has one 32-bit accumulator.

The MAC's 16-bit shifter in parallel with the 16-bit multiplier feed into a 32-bit ALU that handles both 16- and 32-bit operations. The accumulator feeds back to the ALU to keep a running accumulation. Going forward, the accumulator feeds a simple shifter (shifts 0, 1, or 4 bits over) that, in turn, links to the data bus.

Code fetch and decoding is handled in a logic section that has its own program bus and memory. This section has a 4-deep stack that holds PC values for interrupts or subroutine branches. Data in the program ROM or EPROM can be transferred to the data RAM and used as constants for MAC series expansion.

Addressing modes—Direct addressing: 7 bits in instruction concatenate with 1-bit data-page pointer for accessing data RAM (128 words each page). Indirect addressing: Uses 8 bits from one of two auxiliary registers to address data RAM. Immediate addressing: Uses data in instruction.

Parallel I/O ports—You can use the 16-bit external data bus as an I/O port to connect external peripherals such as A/D or D/A converters.

Separate I/O select signals let you use up to eight separate I/O ports on the bus.

Event manager—The C14 event manager adds a compare and capture subsystem to supplement the C14's two 16-bit timer/counters. The subsystem has six 16-bit compare and six 16-bit capture registers. Compare-register values are compared with the running timers; on a match, the subsystem generates an interrupt or an external signal. A high-precision PWM mode adds 2 bits of additional resolution for PWM outputs (resolution is 40 nsec at 25.6 MHz). The subsystem can capture events; changes in one of six input lines trigger logic to set the timer/counter value into a capture register. The subsystem has a FIFO stack that can buffer up to four capture values for four capture registers.

Companding hardware—On the C17, this hardware compands (compresses and expands) data for serial or parallel mode. It handles both the A and μ -Law forms, which meet American, Japanese, or European standards.

VARIATIONS

TMS320C10—288-byte RAM, 3-kbyte ROM, 16-bit parallel I/O port, 40-pin DIP, 44-pin PLCC.

TMS320C14—512-byte RAM, 8-kbyte ROM/EPROM, 16 I/O lines, 1 serial I/O port, 2 timers, 16-bit watchdog timer, 1 baud-rate-generation timer, 68-pin PLCC.

TMS320C15—512-byte RAM, 8-kbyte ROM/EPROM; 40-pin DIP, 44-pin PLCC, 44-pin ceramic leaded chip carrier.

TMS320C16—512-byte RAM, 16-kbyte ROM, 64-pin QFP.

TMS320C17—512-byte RAM, 8-kbyte ROM/EPROM/OTP, 2 serial I/O ports, 1 timer, 8/16-bit asynchronous coprocessor port; 40-pin DIP, 44-pin PLCC. 5 and 3V parts.

Part no.	Clock (MHz)	Max power (mA at 5V)	Pins, package	Price (1000)
TMS320C10	25.6	94.4	68-pin PLCC	\$4
TMS320C14	25.6	50	44-pin PLCC	\$8.40
TMS320C15	25.6 14.4	85 50 (3.3V)	68-pin PLCC 68-pin PLCC	\$5.80 \$5.30
TMS320C16	35 25.6	100 65 (3.3V)	64-pin QFP 64-pin QFP	\$6.30 \$6.30
TMS320C17	20 14.4	300 22.7 (3.3V)	44-pin CLCC 44-pin PLCC	\$5.30 (10,000) \$5.30 (10,000)

SUPPORT

HARDWARE An ICE and evaluation modules are available from TI. Many third-party vendors sell hardware development tools for the C1x; contact TI for references.

SOFTWARE TI furnishes a development tool kit with an assembler/linker, simulator, and application library. Many third-party tools are also available; contact TI for references.

**It will unlock your car door
from 50 feet away. And open doors
on the other side of the world.**

Today's wireless products, like remote keyless entry systems, are ingenious combinations of highly miniaturized, high-performance components. And while we don't manufacture or package these systems, they're an excellent example of what talented engineers can design using Murata

components. As a leader in important surface mount technologies, Murata's manufacturing facilities in the United States, South America, Europe, Japan and elsewhere in Asia supply our customers with one of the broadest lines of superior components in the industry – including SAW



filters and resonators, EMI filters, thin-film inductors, ceramic resonators, chip capacitors, microwave-related products and custom circuit modules. As you begin designing your next wireless product, let us play a small part in making it the sort of success that will open doors

for you all over the world. Our combined efforts will make the chances of that success anything but remote. For more information, call **1-800-831-9172, ext. 118.**



**A small part
in your success**

Texas Instruments TMS320C2x Family

OVERVIEW Introduced in 1986, the TMS320C2x is TI's second-generation 16-bit, fixed-point DSP. The C2x follows the C1x's accumulator-based architecture, but TI used increasing silicon densities to raise processor performance and make the chip easier to program and design in. TI engineers worked out the earlier C10's limitations: External memory addressing is 16 bits (64k words each for data and code); they added 24 new instructions, including a repeat instruction (with automatic data-address increments for MAC operations) and expanded on-chip RAM to include two 512-byte data blocks for X and Y memories supplemented by 64 bytes of RAM. Program ROM is 16 kbytes, and DMA simplifies external access to internal memory. A 16-bit ALU with a set of 8 auxiliary registers parallels MAC operations. The TMS320C2x is source-code compatible with the earlier 16-bit fixed-point C1x DSPs.

VENDOR CONTACTS

Texas Instruments Inc, Dallas, TX, (800) 336-5236. Circle No. 500

16-bit fixed-point DSP

TMS320C28

- ▶ 133 instructions, 3-stage pipeline
- ▶ 8 auxiliary regs
- ▶ 2 544-byte data RAM blocks
- ▶ 64-byte data RAM
- ▶ 16-kbyte program ROM
- ▶ 2 64k-word address spaces
- ▶ 16-bit multiplexed external bus
- ▶ External bus access to internal memory via DMA
- ▶ 8-deep interrupt stack
- ▶ 16-bit timer, 3 external interrupts
- ▶ 50-MHz clock (cycle=clock/4)
- ▶ 1-cycle instruction execution (pipelined)
- ▶ 1-cycle MPY, MAC (pipelined)
- ▶ Data block move
- ▶ Zero-overhead instruction repeat
- ▶ Bit-reversed addressing
- ▶ Hardware wait-state generator
- ▶ Parallel MPY, ALU operations
- ▶ Power-down, idle modes
- ▶ 8-cycle max interrupt latency

TMS320 Technical Hot Line: (713) 274-2320.

TMS320 BBS: (713) 274-2323 (N,8,1).

ARCHITECTURE

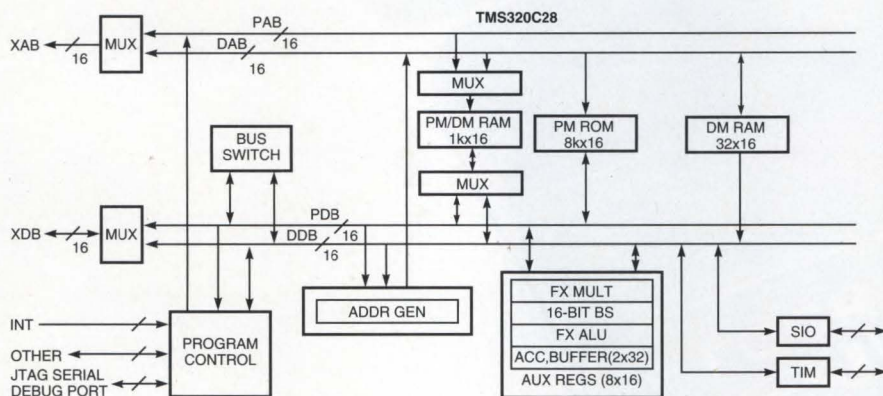

The TMS320C2x is TI's second-generation DSP family. Compatible (to a degree) with the first-generation C10, the C20 processors still rely on a multiplier-accumulator combination. However, TI designers supplemented those resources with a parallel 16-bit ALU having eight auxiliary registers. The TMS320C2x runs a basic MAC cycle in two cycles—one to multiply and one to accumulate. The MAC instruction does a multiply on current variables and an accumulate using the last cycle's accumulated value. The chip can access two data (or program) RAMs in a single cycle to feed the multiply for a MAC cycle. However, unlike later DSPs, C2x code must explicitly handle data addressing for the next MAC cycle unless the MAC instruction is a repeated instruction. In that case, the data and program/data block addresses are automatically incremented.

The C2x has a modified Harvard architecture and maintains two separate memory and bus systems, one each for data and program code. On-chip program accesses do not interfere with DSP data manipulation. Code and data share a common external memory bus; each has its own 64k-word address space. A C2x can address up to 128k words of external memory, with a pin differentiating between the data and program address spaces. With a fast enough external memory, a C2x delivers single-cycle (pipelined) instruction execution by accessing instructions or one of the data values from external memory. However, you can use slower memory to cut costs; the C2x hardware generates memory wait states to stretch out access times.

With the C2x, you don't have to write code loops to repeat key instructions. TI added a repeat-instruction capability, and you can repeat an instruction up to 255x. Also, the 8-level hardware stack automatically extends into memory, thus enabling code to deal

with deep subroutine and interrupt nesting.

Addressing modes—Direct, indirect, and immediate addressing. Can use the auxiliary registers to hold indirect pointers as well as to index the address. Indirect address registers can be postincremented/decremented to minimize addressing overhead. Indirect-addressing options include bit-reversal addressing.

External DMA access—External devices can take control of the C2x's internal buses and read/write the on-chip memories. When the HOLDA signal pulls down, the C2x processor halts, opening memory to external access.

Special instructions—Load T (multiply) register and accumulate previous product; load T register, accumulate previous product,

and move data; multiply and accumulate; multiply and accumulate previous product; square and accumulate; square and subtract previous product; call subroutine indirect; block move (used with repeat instruction, program to data, data to data memory); table R/W; test bit (in memory); repeat.

VARIATIONS

TMS320C25—40/50-MHz, 1088-byte RAM, 8-kbyte ROM/EPROM, serial I/O port, 68-pin PGA/PLCC.

TMS320C26—50-MHz, three 1-kbyte data/program RAM blocks, 64-byte data RAM, 512-byte boot ROM, timer, serial I/O port, 68-pin PLCC. Multiprocessor support.

TMS320C28—40-MHz, 512-byte data RAM, 512-byte data/program RAM, 64-byte data RAM, 16-kbyte ROM, timer, serial I/O port, 68-pin PLCC or 80-pin PQFP. Power-down mode.

TEC320C25A—60-MHz application-specific processor (ASP) that combines a C25 and a gate array with 15k usable gates, 8-kbyte program ROM, 1088-byte data RAM, and 1-kbyte RAM. 100/144-pin SQFP.

Part no.	Clock (MHz)	Mode	Max power (mA at 5V)	Pins, package	Price (1000)
TMS320C25	50	Run Idle	185 100	68-pin PLCC	\$11.60
TMS320C26	50	Run Idle	220 100	68-pin PLCC	\$10.50
TMS320C28	40	Run Power-down	185 100	80-pin QFP 68-pin PLCC	\$12.60

SUPPORT

HARDWARE TI provides a software development board and evaluation boards that use the built-in emulation logic in the C2x. Third-party tools are also available; contact TI for information.

SOFTWARE TI supplies a C compiler, source-level debugger, assembler/linker, simulator, and application library. Third-party tools are also available.



WELCOME TO THE SUBMICRON WORLD OF COMPASS DESIGN

One million gates. Four million transistors.
All in 0.35μ technology.

Sound like the future? Hardly. That's the kind of design that companies worldwide are achieving with COMPASS' new generation of IC design tools.

Only COMPASS provides a seamless graphical specification and synthesis environment that integrates logic design, physical design, libraries and library development tools. Others make this claim but it's no secret they built their product line by acquiring technologies to fill in design "holes."

COMPASS tools were built from the top down. You get everything you need from one company, at one time. And all COMPASS tools are designed to work with the foundry of your choice.

Say good-bye to yesterday's mix-and-match design tools, endless hours of integration and empty promises. Say hello to tightly integrated tools that speed you from concept through synthesis, layout, verification and silicon. Break through today's design barriers - into the future of submicron design.

Call 1-800-433-4880 for more information on COMPASS design tools.

The shape of things to come.

COMPASS
Design Automation 

CIRCLE NO. 36

Synthesis to Silicon

COMPASS Design Automation,
1865 Lundy Avenue, San Jose, CA 95131
© 1994 COMPASS Design Automation, Inc.
The COMPASS logo is a registered trademark
of COMPASS Design Automation, Inc.

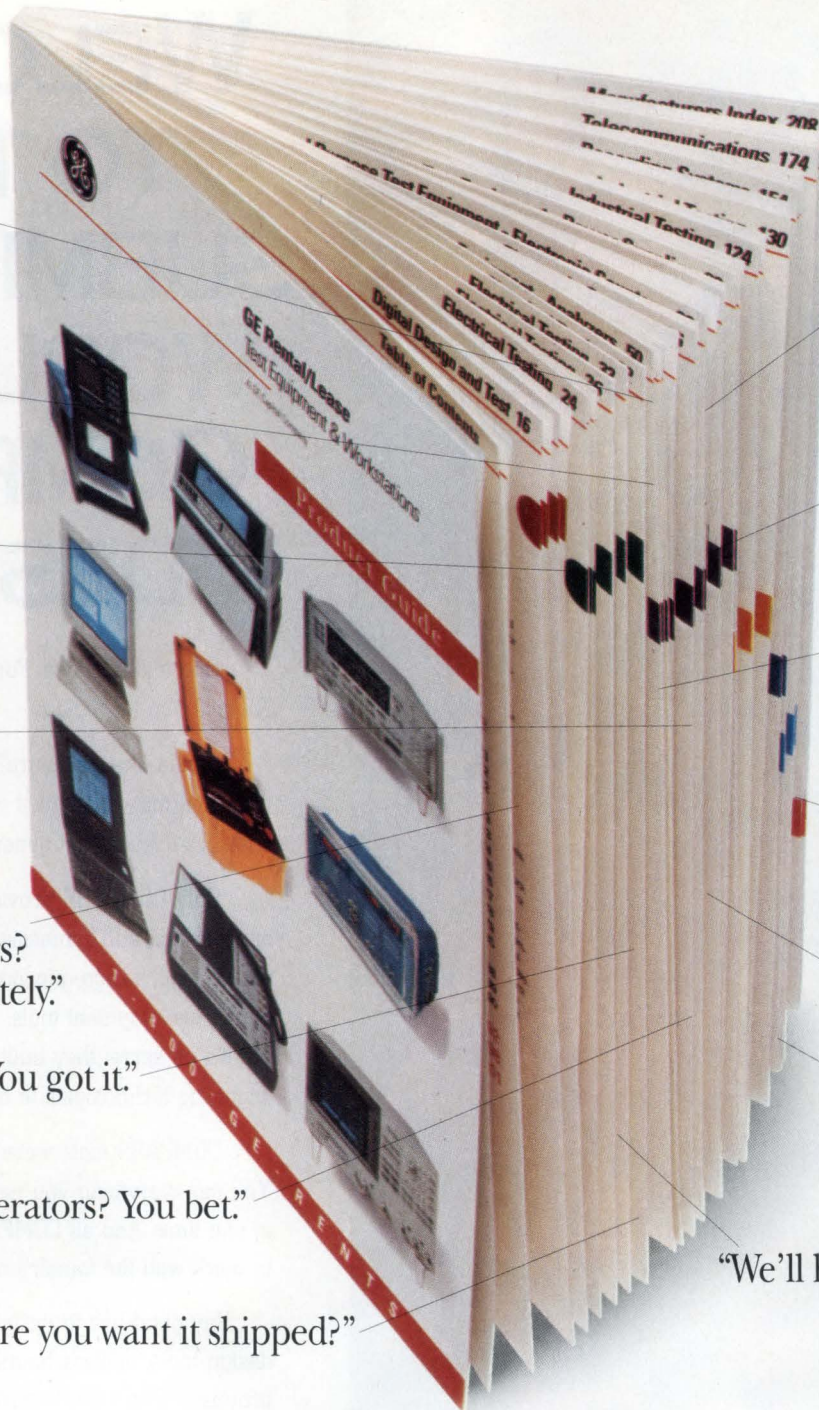

"Four signal generators? No problem."

"Spectrum analyzers? We've got 'em."

"Done deal."

"Oscilloscopes? You betcha."

"You'll have 'em tomorrow."

"All the leading brands."

"Network analyzers? Sure."

"Recorders? Right away."

"Logic analyzers? Absolutely."

"No problem."

"You got it."

"Environmental chambers? Yes."

"Surge generators? You bet."

"We'll have 'em there."

"Where you want it shipped?"

Need test equipment?

When you need test equipment for a critical job, GE Rental/Lease comes through for you. Looking for a spectrum analyzer to measure 40 GHz with a resolution bandwidth of 3 Hz? How about a thermal array recorder with up to 32 channels?

We've got more than 120,000 pieces of name-brand test equip-

ment and workstations to choose from. Available for overnight delivery to almost anywhere in the U.S. and Canada. Our seasoned technical experts and ISO 9002 registration help assure you'll get the equipment and support you need.

Get the full picture in the new GE Rental/Lease catalog. Keep the

equipment you need right at your fingertips. Call 1-800-GE-RENTS for your **free catalog** today.



GE Rental/Lease
Test Equipment & Workstations

Texas Instruments TMS320C3x Family

OVERVIEW TI's third-generation DSP, the TMS320C3x, is a 32-bit processor that integrates a Von Neumann microprocessor architecture with a high-performance, 32-bit, floating-point DSP MAC core. On the microprocessor side, the C3x supports a single 24-bit address space. On the DSP side, the C3x processor performs single-cycle MAC processing; the processor gets the next instruction while accessing two data values for the current instruction's MAC cycle. Two address generators automatically update X, Y memory addresses for inner-loop processing.

The C3x architecture uses multiple memories and bus paths for parallel data and instruction accessing as well as processing. The C3x supports two complete external memory or I/O buses; has three bus sets—program, data1, and data2—and a DMA bus to provide access to on-chip memories; and holds four memories—a 64-word cache, two 1k-word RAM blocks, and one 4k-word ROM block. The inner-core CPU is a complex of five sub-buses interconnecting a multiplier, 32-bit barrel shifter and ALU, and multiple accumulators. Instead of confining MAC operations to an accumulator-based structure, the C3x relies on a multiported register file, which holds 8 extended-precision registers, 8 auxiliary registers, 2 index and 12 control registers.

VENDOR CONTACTS

Texas Instruments Inc, Dallas, TX, (800) 336-5236. Circle No. 501

32-bit floating-point DSP

TMS320C31/LC31

- ▶ 32-bit data, instruction
- ▶ 4-stage pipeline, 113 instructions
- ▶ Multiport reg file: 8 40-bit extended-precision regs, 2 index, 8 indirect address regs
- ▶ 32-bit barrel shifter/ALU
- ▶ 256-byte program cache, 16-kbyte ROM
- ▶ 2 4-kbyte data RAM blocks
- ▶ Floating-point/integer multiplier, ALU
- ▶ 32-bit barrel shifter
- ▶ Two address generators
- ▶ 3 address/data bus sets: program, data1, data2
- ▶ 24-bit address space
- ▶ 2 16-bit timers, serial I/O
- ▶ 4 external interrupts
- ▶ 27/33/40-MHz clock (2 clocks=1 cycle)
- ▶ Zero-overhead looping
- ▶ Single-cycle branches
- ▶ 2- and 3-operand instructions
- ▶ 1-cycle MPY, ALU operations
- ▶ 24-bit integer operations; 32-bit floating-point operations
- ▶ 40-bit floating-point MPY
- ▶ Code-block-repeat instruction
- ▶ DMA controller
- ▶ 200- μ sec max interrupt response
- ▶ Serial scan, test/debug interface
- ▶ LC31: 2 user-programmable power-down modes

TMS320 Technical Hot Line: (713) 274-2320.

TMS320 BBS: (713) 274-2323 (N,8,1).

ARCHITECTURE

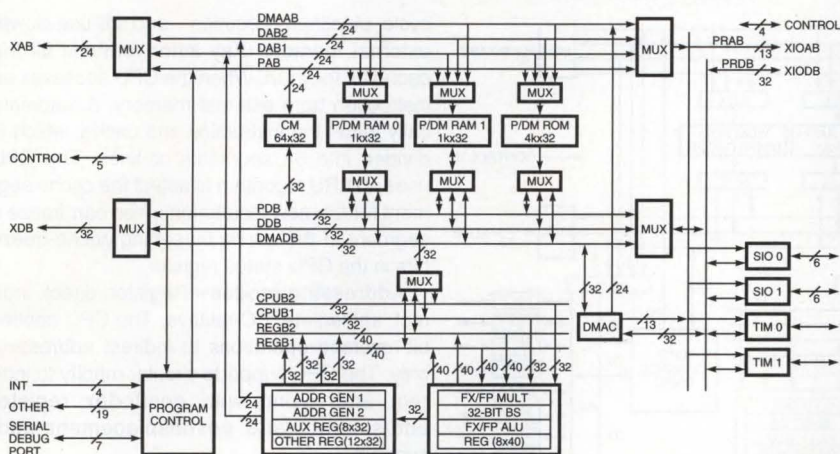

and two register buses that move data between internal core registers. These registers and access data feed into an integer/floating-point multiplier and a parallel 32-bit barrel shifter/ALU. Results are stored in extended-precision or auxiliary registers that hold the values. Two address generators in the subsystem generate the addresses to access the memory/access subsystem's data memories. The major core registers—extended-precision registers (40 bits), auxiliary registers, and key-control registers—are held in a central multiported register file.

The third C3x subsystem, the I/O subsystem, comprises a single-channel DMA controller and a collection of peripherals interlinked with the peripheral address and data bus set. The DMA controller uses the memory/access subsystem's DMA bus to access on-chip memory. The memory/access subsystem buses pass through a multiplexer and link to the peripheral bus, which serves the DMA controller and peripherals. The peripheral bus links to the second external bus with a 13-bit address bus and 32-bit data bus.

The 32-bit floating-point TMS320C3x is a complex DSP processor; it relies heavily on multiple buses, multiple memories, and register files to deliver parallel, high-throughput processing. It supports a single 16-Mbyte address space and has two external bus systems, a primary bus and expansion bus. (The C31 has only the primary bus.)

Three subsystems make up the TMS320C3x DSP: the memory/access, central core, and I/O subsystems. The memory/access subsystem builds around four major buses that link the central core and I/O subsystems and multiplex into the two external buses. The four buses—the program address/data buses, two data address/data1+data2, and DMA address/data buses—enable programs to access the next instruction and two data values simultaneously and transfer data to or from the I/O subsystem in one cycle. The data buses share a single address bus; they make two sequential RAM accesses in a single cycle. An on-chip cache automatically loads as instructions are accessed and holds up to 64 instructions. The two 4-kbyte RAM blocks hold parameters and constants for sum-of-products MAC processing, and a large ROM can hold code or coefficients for MAC processing.

The two data buses, which a single data-address bus serves, feed the C3x central-core subsystem. A minisystem in its own right, the central core has its own set of buses to move data and results; two CPU buses move data to and from the memory and access the subsystem

Addressing modes—Register, direct, indirect, short immediate, long immediate, PC relative, pre- and postindex add/subtract, automatic circular, and bit-reversed addressing. The hardware has a memory-based stack.

Special instructions—Repeat code block, repeat an instruction, standard/delayed branches (standard empties pipe; delayed waits 3 cycles before changing PC), interlocked access instructions for multiprocessing (load/store integer or FP value and signal interlocked), computed GOTOs (dynamic subroutine calls). You can specify instructions to execute in parallel.

Part no.	Clock (MHz)	Max power (mA at 5V)	Pins, package	Price (10,000)
TMS320C30	27	500	181-pin PGA (3V, 208-pin PQFP)	\$126 (3V, \$53.20)
	33	600		\$135 (3V, \$57)
	40	730		\$155.70 (3V, \$65.60)
TMS320C31 (TMS320LC31)	27	260	132-pin PQFP	\$33.30
	33	325		\$38
	40	390		\$41.80

SUPPORT

HARDWARE TI supplies a full-speed ICE and an evaluation module. Third-party vendors have hardware tools for the C3x; contact TI for references. HP has an ICE for the C30.

SOFTWARE TI sells a tool set that includes a C and C++ compiler, assembler/linker, source-level debugger, code profiler, simulator, and application library. Third-party tools: C and Ada compilers, an OS (Spox), filter-design packages, and advanced graphical design tools.

Texas Instruments TMS320C4x Family

OVERVIEW The TMS320C40 is the top TI floating-point DSP. As a DSP engine, the C40 has enough internal buses and on-chip memories to deliver single-cycle execution while walking through X, Y memories for a series of MAC operations. A cache speeds inner-loop processing using slower, cheaper external memories.

The C40 is more than just a fast, floating-point DSP chip—it provides a new level of parallel processing. TI engineers added six independent communications ports for point-to-point links to other C40 processors. The ports are backed with a sophisticated DMA subsystem that has its own internal buses. The C40 is popular for multiprocessor applications and is making a dent in the multiprocessing market previously dominated by the SGS-Thomson Transputer, which has point-to-point serial communications links.

TI engineers also added on-chip, scan-based emulation-control capability accessible via a JTAG test port. External hardware can use the JTAG port to control the processor as well as to set and to monitor registers or memory. You can also string multiple C40s on a JTAG circuit for parallel debugging. One processor breakpoint can halt execution in an array of C40s, and you can single-step them all in lock step.

32-bit floating-point DSP

TMS320C40

- ▶ Multiport reg file: 12 40-bit, 8 auxiliary, and 12 control regs
- ▶ 4-stage pipeline, 135 instructions
- ▶ 512-byte program cache
- ▶ 2 4-kbyte dual-access RAM blocks
- ▶ Boot-loader ROM
- ▶ 2 external buses: 31-bit address, 32-bit data
- ▶ 6/12-channel DMA controller
- ▶ 6 8-bit comm ports
- ▶ 2 timers, 4 external interrupts
- ▶ JTAG test/debug interface
- ▶ 80/60/50/40-MHz clock (2 clocks=1 cycle)
- ▶ 1-cycle pipelined execution for most instructions
- ▶ 1-cycle IEEE floating-point conversion, branch, calls, returns
- ▶ 6 operations/cycle: 2 accesses, FP MPY, FP ALU, branch, DMA
- ▶ External bus: 160 Mbytes/sec max
- ▶ 29 Mbyte/sec max per comm port
- ▶ Circular, bit-reversal addressing
- ▶ Automatic loop and DMA addressing
- ▶ 12-cycle max interrupt latency

VENDOR CONTACTS

Texas Instruments Inc, Dallas, TX, (800) 336-5236. **Circle No. 502**
TMS320 Technical Hot Line: (713) 274-2320.
TMS320 BBS: (713) 274-2323 (N,8,1).

ARCHITECTURE

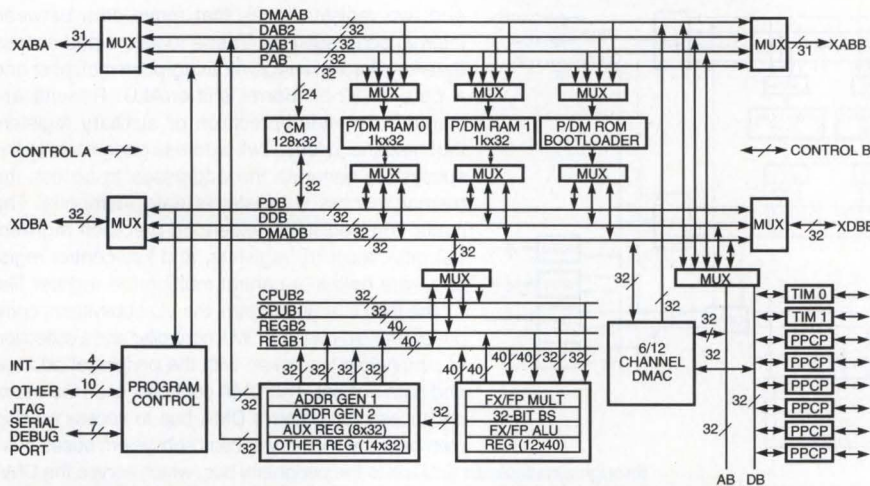

cycle, pipelined execution—and still use slower external memory. Key inner routines fill the cache as they run. When the CPU accesses an instruction from external memory, it automatically loads the instruction into cache, which is divided into 32 segments or lines. The CPU uses an LRU algorithm to select the cache segment for the new instructions. You can freeze a segment in the cache by setting cache-freeze bits in the CPU status register.

Addressing modes—Register, direct, indirect, immediate, PC-relative. The CPU applies bit-reversed operations to indirect addressing only. The CPU supports circular modify to indirect addressing with postindex register add/subtract and postdisplacement add/subtract.

Memory maps—The C40 has a 4G-word address space for program and data. External memory for program and data are accessed via the local or global external buses. Bus usage is not fixed, but assigned by the application. Local and global buses have different memory-block assignments within each memory space. I/O can also use the external buses.

Numeric representation—The C40 supports TI's 40-bit extended floating-point format. However, TI built in a 1-cycle instruction that extends the TI format to the IEEE format. The C40 supports

- 16-bit short signed and unsigned integer
- 32-bit signed and unsigned integer
- short floating point: 4-bit exponent, sign bit, 11-bit fraction
- single-precision floating point: 8-bit exponent, sign bit, 23-bit fraction
- extended precision floating point: 8-bit exponent, sign bit, 31-bit fraction.

Repeat modes—The C40 can repeat a single instruction or a block of code with zero-overhead looping control. Launching a block repeat requires 4-cycle overhead; block repeats are nestable.

The TMS320C40 has come a long way from the accumulator-based TMS320C10 that TI introduced in 1982. The C40, introduced in 1991, is built around a 5-port register file; and rather than time-sharing a single bus system, it features separate buses for program and two data fetches. Additionally, the C40 has three separate functional units: the FPU multiplier, ALU, and barrel shifter for parallel operations.

To maintain high throughput for math-intensive processing, the C40 has two independent bus systems for accessing separate external memories. These buses can be linked to the internal program and data buses. A small, 128-word cache holds inner-loop code for fast processing. To minimize instruction-fetch overhead, instructions and code blocks in the cache can be repeated with the help of automatic code control and X, Y data addressing.

TI engineers equipped the C40 with six independent communications ports for point-to-point communications with networks of C40s and peripherals. These ports free the external memory buses for program or data accesses. A sophisticated DMA subsystem with its own address and data buses moves data between the communication ports and memory without altering the CPU's sequential threads. Such data movements do not load down the DSP processor with servicing overhead, although some data contention for memory may slow CPU execution.

The C40's 128-word cache enables the processor to deliver single-

HARDWARE Development system includes scan-based emulation via the C40's JTAG test port. TI sells a C40 evaluation board with four processors that works with a number of host platforms. Third-party tools are also available; contact TI for a list of vendors.

SOFTWARE Tools include a C compiler, Ada and C++ compilers, source-level debugger for parallel debugging, assembler/linker, and simulator. TI also has an application library. Third-party support includes the Spox, Parallel C, Virtuoso, and Helios operating systems.

Part no.	Clock (MHz)	Max power (mA at 5V)	Pins, package	Price (10,000)
TMS320C40	40	680	325-pin PGA	\$178.20
	50	850		\$198
	60	1020		Sampling
	80	1360		this quarter

SUPPORT

SINGLE-DEVICE **5V TO 3.3V** POWER

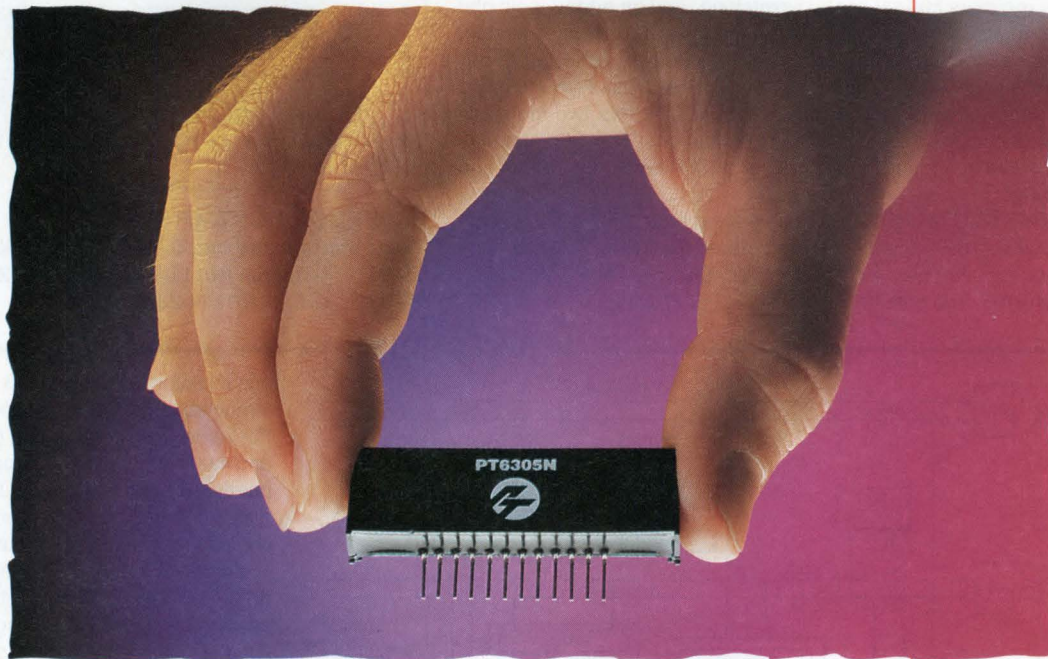

...THAT PLUGS RIGHT IN.



Now, from the innovator in integrated switching regulators, comes a new series of high-performance 5V to 3.3V, 3 Amp, 12-Pin, single in-line products. The new Power Trends PT6305 family lets you easily solve the problem of integrating low power 3.3V logic integrated circuits into existing 5V systems, *without redesigning the power supply.*

And, because the PT6305 Series has an extremely low profile of .36" x 2.00" x .60" (H),

it's ready to meet your needs *and* conserve board space. Vertical, horizontal and surface mount versions are available.

The PT6305 features a high operating frequency of 650KHz, for state-of-the-art power density and 85% efficiency. The device supports a wide input range of 4.5 to 10V with good line and load regulation. Over-temperature and short circuit protection are built in.

If you're ready for a space-saving on-board power converter that you can plug right in, *call Power Trends for a sample today!*
1-800-531-5782.



POWER TRENDS®

1101 North Raddant Road, Batavia, IL 60510 • (708) 406-0900 • Fax (708) 406-0901

CIRCLE NO. 85

EDN June 9, 1994 • 125

Texas Instruments TMS320C5x Family

OVERVIEW Introduced in 1989, the TMS320C5x is TI's highest performance 16-bit fixed-point DSP. TI designers enhanced the C2x for more efficient operation, higher-throughput processing, and embedded applications. A static CMOS design, the C5x runs at up to 80 MHz for the 5V version and to 50 MHz for the 3.3V device. Processor throughput is double that of the earlier TMS320C2x; the instruction cycle is 25 nsec for pipelined execution. The C5x has gained instructions for controller applications, major registers have shadow registers for fast context switching, and an added logic unit handles logical bit operations. Depending on the device version, C5x features include up to 20-kbyte program/data RAM, up to 32-kbyte ROM, a standard serial port, a time-division-multiplexed (TDM) serial port, and a 16-bit timer. The C5x has two indirectly addressed circular buffers for DSP applications. The C5x also has a JTAG serial scan port for chip text and ICE-like debug control and monitoring.

The TMS320C52 DSP CPU is also offered as an application-specific-processor (ASP) core for a TI gate array, the TEC320C52. It combines 10k usable gates for special logic, 8k words of ROM, and 2k words of RAM. The gate array runs at 57.1 or 80 MHz.

16-bit fixed-point DSP

TMS320C53

- ▶ 3 MPY regs, 8 aux regs, 11 shadow regs
- ▶ 32-bit accumulator, buffer
- ▶ 2 1-kbyte data/prog RAM blocks, 64-byte data RAM, 6-kbyte data/prog RAM
- ▶ 32-kbyte program ROM
- ▶ 16-bit external bus
- ▶ 3 128-kbyte spaces for data, program, I/O
- ▶ 8-level PC stack
- ▶ 16-bit timer, 4 ext intr
- ▶ 2 serial I/O ports (1 TDM)
- ▶ JTAG-port emulator control
- ▶ 40/57/80-MHz clock (div-by-1 PLL)
- ▶ 1-cycle instr execution (pipelined)
- ▶ Single-cycle MPY
- ▶ Parallel ALU, MPY, logic operations
- ▶ Parallel op-code and 2-data fetch
- ▶ 1-2-cycle read/write to ext memory
- ▶ 32-bit accum buffer for comparisons, 64-bit shifts
- ▶ Software wait-state generator for memory; up to 7 states
- ▶ Serial I/O up to 20 bps
- ▶ 5, 3.3V parts

VENDOR CONTACTS

Texas Instruments Inc, Dallas, TX, (800) 336-5236. **Circle No. 503**
TMS320 Technical Hot Line: (713) 274-2320.
TMS320 BBS: (713) 274-2323 (N,8,1).

ARCHITECTURE

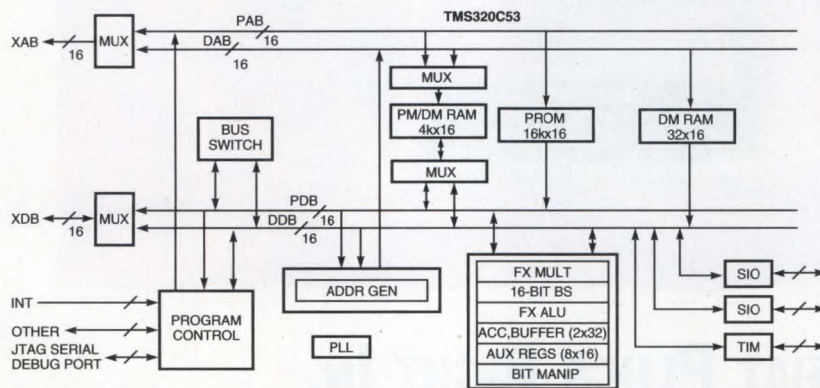

The TMS320C5x is both an accumulator-based, 16-bit fixed-point DSP and a register-based processor. It has a fixed MAC circuit with a registered, 16x16-bit multiplier loading a 32-bit product register. The product register, in turn, feeds a 32-bit accumulator. The C5x also has two parallel functional units feeding off the data bus: an independent ALU with a register file of eight auxiliary registers and a bit-logic processing unit. A multiply takes one cycle, as does an accumulate. The basic MAC cycle involves setting a value into a temporary register, fetching a second value, multiplying into a holder register, and accumulating the result in the next cycle. Like most DSPs, the C5x has a Harvard architecture with separate program and memory buses.

To improve C25 performance, TI engineers streamlined the hardware implementation, extended the instruction set, and moved to a smaller CMOS process. The C5x delivers double the performance of the earlier C2x. Additionally, the C5x has larger on-chip memories: up to 32 kbytes of program ROM, a 2112-byte data RAM that can also store code, and up to 18 kbytes of RAM for storing data or code. The CPU can read the 2112-byte data RAM to retrieve two values for the next MAC cycle. Data in the multiplier register can be preloaded before passing into the 32-bit ALU for the accumulator cycle.

For embedded applications, TI engineers added fast context switching and bit-level operations. To minimize the overhead for saving the CPU state or context on an interrupt, the C5x has a 1-deep shadow register stack for the major registers (accumulator,

accumulator buffer, product reg, status regs, three temporary regs, index reg, and auxiliary compare reg). For control applications that need bit manipulation, TI engineers added a parallel logic unit (PLU) that runs in parallel with the MAC and ALU circuits. The PLU operations can set, clear, test, or toggle multiple bits in a control/status register or data-memory location.

Power-down mode—Minimizes power by shutting down the CPU (IDLE1 instr) or the CPU and the peripherals (IDLE2). Pulling down an external pin (HOLD*) can also force the chip into power-down mode. An interrupt brings the chip up to normal run conditions.

Addressing modes—Direct, indirect, immediate, dedicated register, memory-mapped register. The processor supports automatic circular buffer addressing for two buffers.

Special instructions—Block repeat, load T (multiply) register and accumulate previous product; load T register, accumulate previous product, and move data; multiply and accumulate; multiply and accumulate previous product; square and accumulate; square and subtract previous product; call subroutine indirect; block move (use with repeat instr and prog to data, data to data memory); table R/W; test bit in memory; repeat.

VARIATIONS

TMS320C50—20-kbyte prog/data RAM, 4-kbyte ROM, 2 serial ports, 1 timer, 132-pin PQFP.

TMS320C51—4-kbyte prog/data RAM, 16-kbyte ROM, 2 serial ports, 1 timer, 132-pin PQFP/100-pin TQFP.

TMS320C52—2-kbyte prog/data RAM, 8-kbyte ROM, 1 serial port, 1 timer, 100-pin PQFP/TQFP.

TMS320C53—8-kbyte prog/data RAM, 32-kbyte ROM, 2 serial ports, 1 timer, 132-pin PQFP/100-pin TQFP.

Part no.	Clock (MHz)	Max power (mA at 5V and 40 MHz)			Price		
		Run	Idle-1	Idle-2	40-MHz	57-MHz	80-MHz
TMS320C50	40/57/80	100	10	0.005	\$55	\$60	\$66
TMS320C51	40/57/80	100	10	0.005	\$24	\$27	\$33
TMS320C52	40/57/80	100	10	0.005	\$16	\$19	\$23
TMS320C53	40/57/80	100	10	0.005	\$37	\$42	\$51

SUPPORT

HARDWARE TI supplies a DSP starter kit, an evaluation module and an emulator based on the C5x's built-in emulation logic. Third-party tools are also available.

SOFTWARE TI supplies a C compiler, source-level C/assembler debugger, assembler/linker, simulator, profiler, and application library. Third-party tools are also available.

With TI and 1394, a single, real-time I/O is close at hand.

An unprecedented universal I/O solution connects portables, desktops, peripherals and consumer devices as never before. It's the proposed IEEE 1394 High-Performance Serial Bus. And it offers real-time data transfer for multimedia capabilities via low-cost interface. In fact, *Byte* magazine named 1394 "the most significant new technology" of the fall COMDEX '93 show.

Now available, the first fully compliant 1394 chipset from TI.

We're providing breakthrough silicon in this emerging interface standard. And we are the first to offer a physical-layer chip (TSB11C01) and a link-layer chip (TSB12C01). Combined, they give you a full-chipset solution.

1394 Serial Bus Features

- Real-time data transfer for video and audio applications
- 100 Mbits/s data rates today; 200 and 400 Mbits/s in future
- Live insertion and "plug and play" ability
- Branch and daisy-chain support
- No need for active termination
 - Allows for bandwidth allocation
- Single connector for all applications
 - Compliant with proposed 1394 standard

Fewer ports, faster data rates.

This leading-edge technology allows you to eliminate current I/O solutions such as SCSI, IDE and RS-232. With TI's complete 1394 chipset, you have the capability of designing in one common interface for all applications, such as HDD and CD-ROM, digital cameras and printers.

Inventing the future: You, Texas Instruments and 1394. New possibilities are what the 1394 standard is all about. For complete information, simply return the reply card or call **1-800-477-8924, ext. 3474.**

EXTENDING YOUR REACH WITH TOTAL INTEGRATION™

 **TEXAS
INSTRUMENTS**

VIEWLOGIC PRO SERIES™

The world's most powerful
Windows-based design tools

starting from
\$1,995

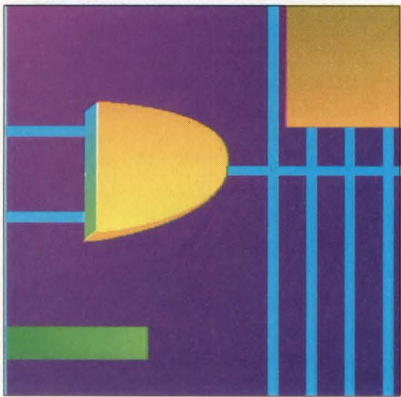

PROcapture™

EDN Reader's Choice Survey rated Viewlogic tools as the best schematic entry solution. \$1,995

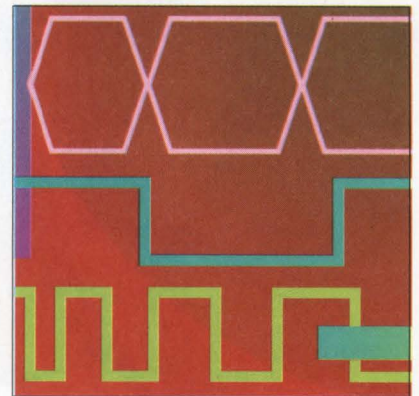

PROsim™

28-state, high-performance timing simulation. \$4,995

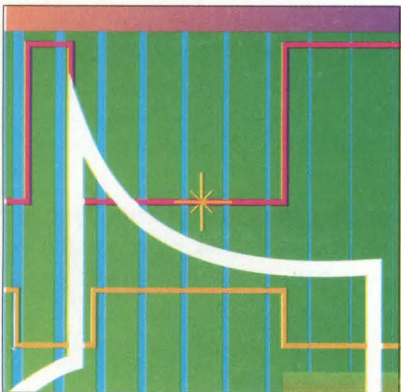

PROanalog™

Windows-based analog design and SPICE simulation. From \$2,995

```
if  
(reset="1")  
then Load  
# "00000"
```

PROvhdl™/PROsynthesis™

VHDL, simulation and synthesis for FPGA and CPLD design. From \$1,995

VIEWlogic

PRO Series

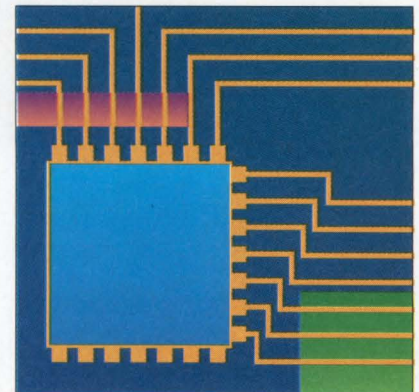

PROdeveloper™/PROchip™

For complete PLD, FPGA and systems design including design entry, verification and place and route. From \$9,995

CALL 1-800-USE-VIEW NOW FOR A FREE DEMO DISK

© 1993 Viewlogic Systems, Inc. All trademarks and registered trademarks are the property of their respective owners.

Texas Instruments TMS320C80

OVERVIEW The TI Multimedia Video Processor (MVP) delivers 2-BOPS (billion-operations/sec) performance and integrates four DSP CPUs and a 32-bit RISC CPU with a fast crossbar memory (50 kbytes), supplemented with I/O and video controllers. MVP's processing suits a range of real-time applications, such as video compression/decompression, telecommunications, image recognition, multimedia presentation, and audio. With the MVP, system designers no longer have to gang multiple DSPs to achieve billion-operation performance. And MVP is cost-effective: its four DSPs and 32-bit RISC fit on a single chip. Each processor has its own memory but can access the others' memories.

Following the TMS340, its graphics-processor predecessor, MVP handles bit/pixel addressing and processing. MVP has a video controller (VC) that supports two video channels and an on-chip I/O controller; its transfer controller accesses ROM, SRAM, VRAM, and DRAM. MVP does have processing limitations, however, such as per-processor memory resources and a 400-Mbyte/sec external bus bandwidth.

32-bit multiprocessor DSP

TMS320C80

- ▶ 4 million transistors, 0.6- μ m CMOS
- ▶ 4 32-bit DSP CPUs: 64-bit instruction word, 2-kbyte instruction cache (CBM)
- ▶ 32-bit RISC CPU: 4-kbyte instruction cache (CBM), 4-kbyte data cache (CBM), 64-bit FPU (IEEE 754)
- ▶ On-chip crossbar memory (CBM): 25 2-kbyte RAM blocks with 5 2-kbyte blocks/CPU
- ▶ Transfer controller: 32-bit address, 64-bit data external buses with DRAM address multiplexing
- ▶ Video controller
- ▶ 42-, 50-MHz cycle rate (84/100-MHz crystal input)
- ▶ 2 billion operations/sec (BOPS)
- ▶ 4 DSP CPUs (1-cycle MAC)
- ▶ 1-cycle RISC CPU execution
- ▶ CBM: 4.2-Gbyte/sec peak rate, to 15 accesses/cycle, to 3 accesses/cycle/DSP, round-robin access priority, pipelined
- ▶ 400-Mbyte/sec peak off-chip transfer rate (50-MHz cycle rate)
- ▶ Big- or little-endian operation

VENDOR CONTACT Texas Instruments Inc, Semiconductor Group, Houston, TX. (800) 477-8924, ext 4500. **Circle No. 504**

ARCHITECTURE

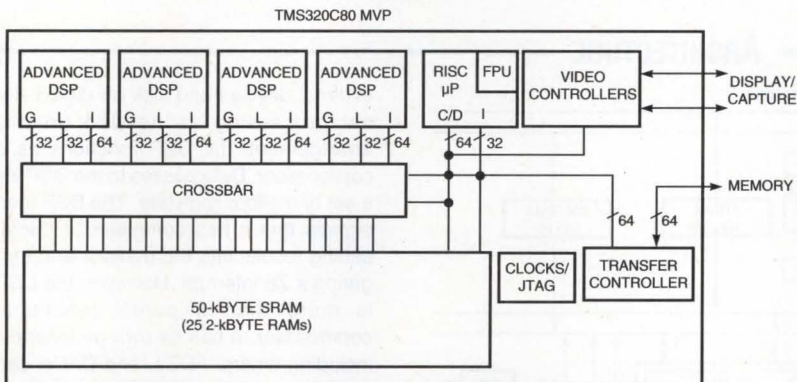

MVP integrates, on a single chip, four DSP CPUs and a 32-bit RISC CPU with a fast crossbar memory (50 kbytes) and memory and video controllers. MVP processes multiple tasks in parallel (each assigned to a specific processor), collectively delivering high processing throughput.

MVP's five processors (four parallel DSP chips and a 32-bit RISC chip with its own FPU) execute independently and concurrently. A high-speed, on-chip crossbar connects the CPUs with 25 2-kbyte blocks of dedicated SRAM, which provides cache and RAM for each CPU. Any processor can access any of 16 SRAM blocks, although 5 blocks are dedicated to each CPU. The crossbar handles up to 15 simultaneous RAM accesses/clock cycle: 3 per DSP processor; 2 for the 32-bit RISC master processor; and 1 for the transfer controller. Peak crossbar bandwidth is 4.2 Gbytes/sec. Memory-mapped control registers handle both transfer and video controllers; the chip has a separate 32-bit data path between the MP (master processor), TC (transfer controller), and VC (video controller), which enables the MP to set register values.

The MVP has high processor throughput: each CPU can execute from its own crossbar-memory instruction cache—2 kbytes for the DSPs and 4 kbytes for the RISC CPU. The RISC CPU also has 4 kbytes of crossbar-memory data cache. The DSP processors access data from their dedicated SRAM blocks through the crossbar memory. Executing from crossbar instruction caches, the CPUs achieve apparent single-cycle execution.

The DSP CPUs have a 64-bit instruction word with three major subfields for controlling the data unit (with a 32-bit ALU and 16-bit multiplier) and each of two independent address units in each single-cycle instruction. Each address unit has a 32-bit data path to the crossbar. Three zero-overhead loop controllers support nested looping. The 32-bit ALU can split into two 16-bit ALUs or four 8-bit ALUs; the multiplier performs one 16 \times 16 multiply or two 8 \times 8 multiplies. Additional hardware supports bit field and pixel processing.

The 32-bit RISC CPU has an integrated 64-bit floating-point unit (FPU) that shares a common 31 \times 32-bit register file with integer processing. A register scoreboard flags registers that are waiting on loads from memory or from the FPU to keep operations in order

without unnecessary waiting.

The MP FPU incorporates a single-precision FP multiplier and a double-precision FP adder. It also supports vector processing with built-in vector operations and four accumulators to hold interim vector results. Both the CPU main integer path and the FPU units are pipelined. The CPU has a 3-stage pipeline. A single-precision multiply or double-precision addition normally takes four cycles to complete but are pipelined, so they can start every cycle. Divides, square root, and double-precision multiplies cycle to complete. The integer unit triggers FPU operations, which then proceed independently. Vector instructions can start a multiply, add, and load or store every cycle, yielding a peak performance of 100 Mflops.

The MVP is more than just a collection of CPUs and memory; it has its own on-chip I/O and memory controller, the TC, which provides an adaptive memory interface with automatic byte alignment, as well as both linear and X, Y (frame buffer) addressing. It supports DRAM, VRAM, and SRAM and also has a video controller to minimize design for video applications. This controller supports two video frames (all video timing signals). It also has a special serial-register-transfer (SRT) controller for controlling VRAM frame memories by the TC.

Part no.	Clock	Max power	Package	Price
TMS320C80	50 MHz	7.5W	305-pin CPGA	\$400 (10,000)

SUPPORT

HARDWARE MVP supports multiple processor breakpoints: one CPU can breakpoint and halt execution of all CPUs on the chip. TI sells a parallel-processing ICE (XDS5210) that handles debugging of multiple MVP chips. Loughborough Sound Images Ltd (Loughborough, Leicestershire, UK) sells a MVP hardware-development system.

SOFTWARE TI sells a tool set that includes an assembler/linker, a C compiler, a simulator, a parallel debugger, and an application library. The debugger includes the Master Processor Debugger and multiple DSP debuggers. The Parallel Debug Manager handles and coordinates the individual CPU debuggers. TI fields a multitasking executive that runs on the RISC CPU, interfaces to a host CPU, and issues commands to MVP's DSP CPUs.

Zilog Z89C00 Family

OVERVIEW Zilog, a μ P pioneer, added DSP chips and DSP-enhanced μ Cs to its line to handle math-intensive processing for voice, video, and disk-control applications. Starting with the Z89C00, Zilog offers a 10-MIPS, 16-bit, fixed-point DSP. The Z89C00 is an accumulator-based processor built around a MAC core, which includes a 16×16 -bit multiplier, 24-bit product register, and 24-bit accumulator. The Z89C00 executes MACs in one cycle. Two on-chip RAM blocks hold X and Y data; two internal buses for program and data speed processing. The MAC core can access two operands/cycle because the two RAM blocks can directly load the MAC input-holding register each cycle.

Zilog uses the Z89C00 DSP as a core engine for embedded applications; Zilog engineers integrated the DSP with a standard Z8 8-bit μ C. The two processors run concurrently and use a mailbox to pass data back and forth. Typically, the Z8 drives processing; it acts as an application host and initiates DSP processing as needed. When the DSP engine finishes a processing function, it can trigger a Z8 interrupt to notify the controller of pending processing. The Z8/DSP combination has been tailored for applications including disk-drive control and tapeless answering machines. Zilog has also expanded the Z89C00 engine with a variety of peripherals. A low-cost version, the Z89321,

16-bit fixed-point DSP

Z89C00

- ▶ 2-stage pipeline, 30 instructions
- ▶ 16-bit program, data buses
- ▶ 24-bit MPY/ACCUM, accumulate register
- ▶ 8-kbyte ROM; 2 512-byte RAM blocks
- ▶ 16-bit external memory bus, I/O bus
- ▶ 64k-word external address space
- ▶ 6-level hardware stack
- ▶ 2 output, 2 input pins
- ▶ 3 external interrupts
- ▶ 10-MHz clock, static design
- ▶ 1-cycle MAC, MPY, ACCUM
- ▶ 15-cycle DIV
- ▶ 1-cycle external-memory R/W (adds cycle to instruction execution)
- ▶ Zero-overhead looping for MAC addressing; auto-increment
- ▶ 2 to 256 modulo addressing
- ▶ 2 input pins for conditional branch test
- ▶ 8-cycle max interrupt latency

has an on-chip codec interface for voice, audio, and digital-cellular applications.

VENDOR CONTACTS

Zilog Inc, Campbell, CA, (408) 370-8000.

Circle No. 505

Product Support BBS: (408) 437-8024 (N,8,1).

ARCHITECTURE

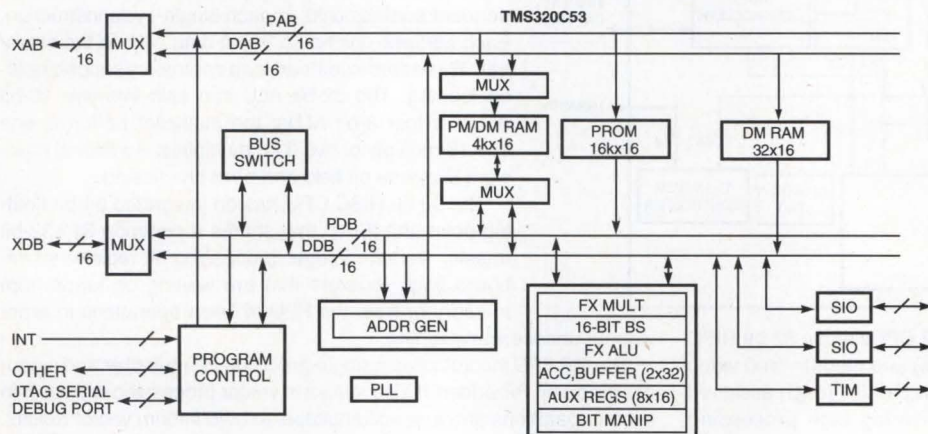

The Z89C00 has a compact, accumulator-based DSP architecture and a single-cycle MAC unit. Two RAM blocks hold program coefficients and data, which feed into the MAC's input registers each cycle. Results land in a product register and 24-bit accumulator each cycle.

The DSP processor runs from an 8-kbyte program ROM, which external program memory supplements. Two internal bus sets—a program address/data bus set and a data address/data set—prevent program thread execution from interfering with cycle-by-cycle MAC processing. The RAM blocks feed directly into the MAC input registers, thus eliminating the need for a second data-bus set. RAM block addressing automatically increments or decrements the address, which eliminates the need for data-address-generation code for each MAC cycle. Modulo addressing options include modulo 2 to 256 processing loops.

The basic DSP chip has two external buses: an external program bus and an I/O bus; external data must come in on the I/O bus. An external-memory R/W takes one cycle. Running code from external memory takes one additional cycle for each instruction—the data is read in one cycle but is not available for processing until the next instruction cycle.

Zilog designers integrated the DSP engine with a Z8 μ C and added peripherals for both processors so that the Z8 can control and monitor

external devices and kick off digital signal processing as needed. In this arrangement, the DSP functions as a coprocessor. Data passes to the DSP via a set of mailbox registers. The DSP then signals that it has completed a chore, setting results into the mailbox and triggering a Z8 interrupt. However, the DSP is more than a purely functional coprocessor. It has its own peripherals, including timers, ADCs, and DACs; can time its processing; and can take in, process, and return analog data.

Halt pin—If pulled high with the clock, the halt pin will stop DSP CPU trace and start executing NOPs. Halts CPU until it gets an interrupt.

Addressing modes—Direct (to 512 RAM words), indirect (to RAM or ROM with pointer regs), immediate, short-form direct (uses 16-bit data registers in RAM), external peripheral addressing (1 cycle, treats peripheral as a reg).

Special instructions—Absolute value of accumulator, increment/decrement accumulator, compare register to accumulator, multiply and add, multiply and subtract, push and pop system stack.

VARIATIONS

Z89C00—10-MHz DSP core with two 512-byte RAM blocks, 8-kbyte ROM.

Z89320—Low-cost version; has one 16-bit external bus, 10-MHz clock; 40-pin DIP, 44-lead PLCC.

Z89321—320 with a codec interface (20 MIPS).

Part no.	Clock (MHz)	Mode	Max power (mA at 5V)	Pins, package	Price
Z89C00	10	Run Standby	60 5.5	68-pin PLCC	\$5 (50,000)
Z89320	10	Run Standby	60 5.5	40-pin DIP 44-pin PLCC	\$2.50 (100,000)

SUPPORT

HARDWARE Zilog sells an evaluation board and ICE for the Z89C00, as well as for the combined Z8/Z89 chips.

SOFTWARE Zilog fields a C compiler, assembler/linker, simulator, source-level debugger, and application libraries. It also has a TMS320-to-Z89C00 assembly-code translator.

Visit us at DSPx '94
Booth #426 June 13-15
San Francisco, California

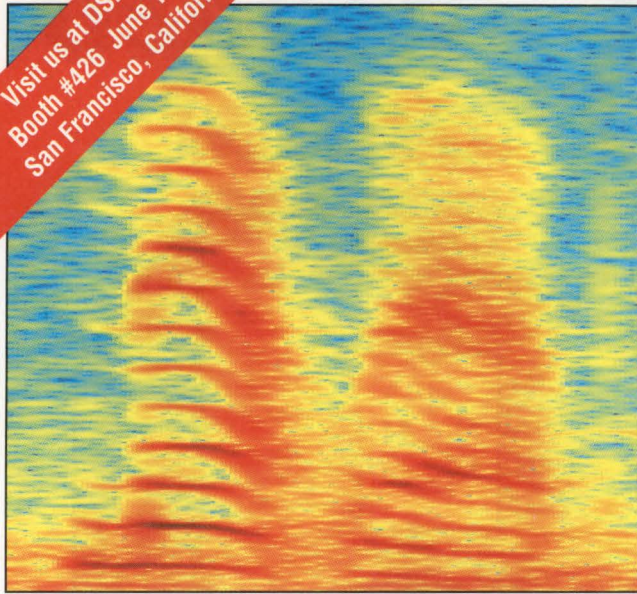

MATLAB simplifies analysis and algorithm development with integrated modeling, design and graphical tools. This spectrogram shows how a speech signal varies with time and frequency.

Speak the language of signal processing with MATLAB.[®]

The MATLAB Signal Processing Toolbox is a powerful interactive environment for signal analysis, algorithm development, and DSP design.

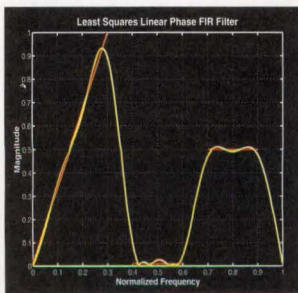

Leading-edge filter design tools make it easy to design filters to fit any specification.

Because its matrix language is ideal for vector processing and data analysis, MATLAB helps you solve the widest range of signal processing problems.

Signal processing power

The Signal Processing Toolbox gives you an unrivaled ability to filter, model, and analyze signals and time-series data. Powerful functions let you perform FFTs, spectral estimation, and filter design in a single step, and display the results automatically.

Without writing a single line of C or Fortran, you can easily explore, create, and apply the innovative signal processing tools that let you keep up with—and advance—the leading edge.

Rapid algorithm development

You create DSP algorithms in MATLAB just as you would write them mathematically. As a result, you can rapidly validate your designs long before you commit to a full implementation.

Your work always draws upon world-class tools, whether you rely on classical methods or invent state-of-the-art technology.

MATLAB brings a foundation of over 500 math, scientific, and engineering functions to your desktop. Each function is tuned for maximum efficiency and numeric reliability. So you always get immediate, accurate results.

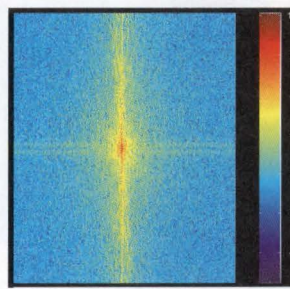

Visualization of a 2-D FFT. Efficient FFT algorithms form the basis for powerful spectral analysis and estimation functions.

Expand your DSP vocabulary

With the high-level MATLAB language, it's easy to modify the source code for any toolbox function, and add your own. Or combine signal processing with other toolboxes to design custom solutions to complex problems.

Powerful GUI tools let you build intuitive applications that look like pre-packaged software, but address your specific design and analysis needs.

MATLAB

Picture the Power

Signal Processing Toolbox

- Complete tools for filter design, analysis, and implementation
- FFT, DCT, cepstrum, chirp-z, Hilbert, and other transforms
- Spectrum estimation and statistical signal processing
- Signal and linear system models
- Specialized design tools for embedded real-time, multi-rate, and communications systems
- Integrated with application toolboxes, including:
 - Image Processing
 - System Identification
 - Hi-Spec[™]
 - Neural Networks
 - Optimization

The Ultimate Technical Computing Environment[™]

MATLAB is an extensible, interactive Technical Computing Environment that seamlessly integrates computation, visualization, and modeling, on PCs, workstations, and supercomputers. You will find it wherever people speak the language of signal processing.

For a free technical brief that will show you the signal processing power of MATLAB, call us today.

508-653-1415

The
**MATH
WORKS**
Inc.

24 Prime Park Way/ Natick, MA 01760
Tel: 508/653-1415 Fax: 508/653-6284

Email: info@mathworks.com

Mosaic: <http://www.mathworks.com>

The MathWorks is represented in the following countries:
Australia: +61-2-922-6311 • Brazil: +55-11-816-3144
France: +33-1-45-34-23-91 • Germany: +49-89-995-9010
India: +91-80-2-260-260 • Israel: +972-3-561-5151
Italy: +39-11-24-85-332 • Japan: +81-3-5978-5410
Portugal: +34-3-415-49-04 • Scandinavia: +46-8-15-30-22
Spain: +34-3-415-49-04 • South Korea: +82-2-517-1257
Switzerland: +41-31-998-44-11 • Taiwan: +886-2-501-8787
For Belgium, Luxembourg, The Netherlands, United Kingdom and Republic of Ireland call Cambridge Control, Ltd: +44-223-423-200 or Rapid Data, Ltd: +44-903-821-266

MATLAB is a registered trademark of The MathWorks, Inc.

Play with Our Video Building Blocks!

EL4581C Video Sync Separator

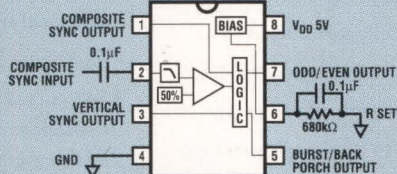

- Precision 50% Slicing
- Low Power CMOS (1.5 mA Max)
- \$2.67 in 1,000's P-DIP

EL4083C Current Mode 4-Quadrant Multiplier

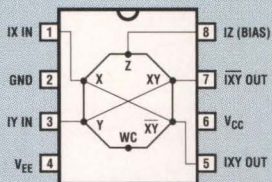

- 200 MHz Bandwidth
- THD < 0.1% @ 10 MHz
- \$6.90 in 1,000's P-DIP

EL4583C Video Sync Separator

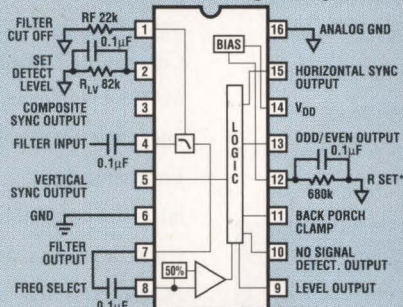

- *Note: R SET must be a 1% resistor
- Adjustable Filter & H-sync Output
 - Precision 50% Slicing
 - \$3.76 in 1,000's P-DIP

EL4441/EL4442 Multiplexed-Input Video Amps

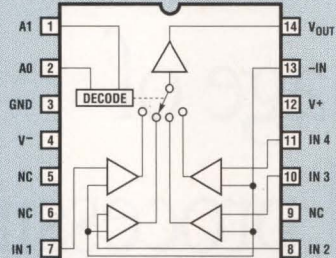

- 8 ns Switching Time
- 0.02%/0.02° Diff Gain/Phase
- \$4.71 in 1,000's P-DIP

EL4584 Genlock

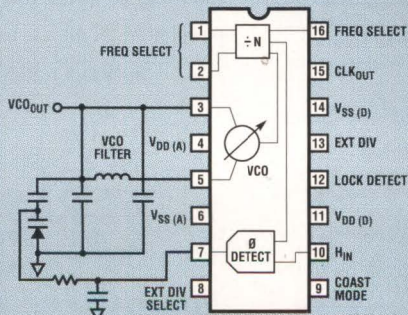

- Selectable 8-Preset Frequencies
- Precision Phase-Locked Loop
- \$4.71 in 1,000's P-DIP

EL4451C Wideband Variable-Gain Amp

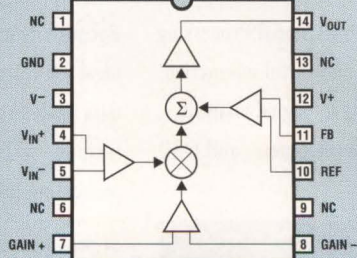

- 80 MHz Bandwidth
- Calibrated Linear Gain Control
- \$3.33 in 1,000's P-DIP

élantec
ANALOG INTEGRATED CIRCUITS

FOR SAMPLES CALL (800) 333-6314 ext 311
For Literature Only - ext 234

ELANTEC, INC. ■ 1996 Tarob Court ■ Milpitas, CA 95035 ■ (408) 945-1323 ■ (800) 333-6314 ■ FAX (408) 945-9305

Authorized Distributors: Marshall Industries ■ Nu Horizons ■ Insight Electronics

CIRCLE NO. 124

Zoran ZR38000

OVERVIEW Zoran's ZR38000 is one of the few DSP-chip architectures developed for a specific application class and in tandem with a technology user, Dolby Laboratories. The ZR38000 is aimed at applications in multimedia audio and video, but the company is developing multiple application-specific DSP chips (ASDSPs) based on the original ZR38000. These variations include 6- and 2-channel Dolby AC-3 audio decoders and a 2-channel MPEG-1 audio decoder. A reduced-ROM ZR38000 variation substitutes 1k×32-bit code RAM and 1.5k×20-bit coefficient ROM.

The ZR38000 borrows heavily from RISC technology but simultaneously incorporates a number of standard DSP features. Zoran takes advantage of a 32-bit wide-word instruction to streamline processing but relies on a 20-bit data word for better-than-16-bit resolution. Like RISC and other processors, the ZR38000 is a load/store, register-oriented architecture that lends itself to straightforward coding. The ZR38000 incorporates 8k words of 32-bit program ROM with 2k 20-bit data RAM for data. It delivers a 40-nsec MAC, a 0.88-msec 1024-point complex FFT, 160-nsec Radix-2 FFT Butterfly.

16-bit fixed-point DSP

ZR38000

- ▶ 32-bit instruction, 20-bit data words, 34 instruction
- ▶ 3-stage pipeline
- ▶ 16-bit instruction cache
- ▶ 8k×32-bit code ROM
- ▶ 2k×20-bit data RAM
- ▶ 20×20-bit multiplier
- ▶ 48-bit ALU
- ▶ 8 20-bit data register file (3 reads, 2 writes/cycle)
- ▶ 25 20-bit address register file
- ▶ 48-bit barrel shifter
- ▶ 20-bit (1M-word) address space
- ▶ 25-MHz crystal oscillator
- ▶ PLL, 2× internal clock (50 MHz)
- ▶ 25 MIPS peak
- ▶ 4-cycle Radix-2 Butterfly inner loop
- ▶ 877-μsec 1024-point, Radix-3 complex FFT
- ▶ 20-bit precision (120-dB range)
- ▶ 2-cycle, 20-bit normalization
- ▶ Modulo, FFT bit-reversal addressing
- ▶ 2 data address generators
- ▶ Zero-overhead looping

VENDOR CONTACT

Zoran Corp., Santa Clara, CA. (408) 986-1314.

Circle No. 506

ARCHITECTURE

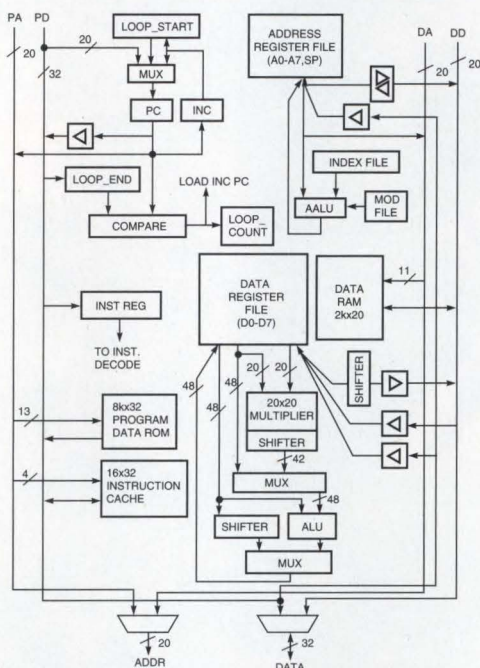

Zoran's ZR38000 integrates high-speed RISC design techniques with DSP-specific hardware features. To minimize decoding and instruction overhead, Zoran relies on a 32-bit instruction word. However, to minimize costs and provide sufficient math resolution, the ZR38000 has a 20-bit data word with a 1M-word address space. The DSP chip can hold up to 8k 32-bit instruction words and 32 kbytes of code in ROM (or RAM in some versions); it also has a 2k×20-bit data RAM.

Similar to Analog Devices DSPs, the ZR38000 has a small, on-chip instruction cache. Its 16×32-bit cache holds the last sixteen instruction words executed. Running from the cache, the CPU can start an instruction every cycle; it has a short, 3-stage pipeline, with instruction fetch, instruction decode, and execute stages. The hardware uses a RISC-like delayed branch: the delayed-branch instruction will execute the next two instructions before it takes a branch.

Similar to most DSPs, the ZR38000 architecture supports multiple operations per instruction cycle. For MAC class cycles, it can generate two data addresses per cycle, as well as fetch the next instruction. For

dual data addressing, the chip has two data address generators and has an 8×80-bit address register file. Using a basic 50-MHz internal clock (up from 25 MHz), the hardware can access its on-chip RAM twice during a single, 40-nsec cycle. Thus, the processor can make do with a single data RAM, even for dual-access MAC operations. The hardware supports FFT bit reversal and modulo addressing for DSP processing. It incorporates zero-overhead looping, with up to four stacked loops (as long as they have separate end addresses).

An address register file (ARF) expands addressing capabilities: It incorporates a 20-bit stack pointer and eight address sets. Each address set consists of three registers: a 20-bit address, a 20-bit index, and a 20-bit modulus register. The hardware supplies a range of addressing options, including direct and indirect addressing (both with increment/decrement), indexed, bit-reversed, or circular modulus options. For table walking, you can postincrement/decrement by one or by an index value. You can also use the ARF registers as general registers or for I/O.

Arithmetic operations center on a multiport register file. This file can handle up to three reads and two writes per cycle, enabling the hardware to read data for the next operation while returning results for the current operation. The register file has eight 20-bit registers. Two of the registers are extended to 48 bits to support 48-bit accumulation (40-bit data, 8-bit overflow). The hardware incorporates a 48-bit ALU, a 20×20-bit multiplier, and step division. Some instructions integrate multiple operations to perform common DSP functions.

The ZR38000 supports a 20-bit, 1M-word, unified program/data address space. The chip has 20-bit external address bus and a 32-bit external data bus. Internally, the chip builds on a dual bus system with a 20-bit data address bus and data bus set, and a 20-bit program address bus and 32-bit data bus set. The hardware feeds the external address bus by multiplexing the internal program and data address buses. Similarly, the external data bus links through a bidirectional multiplexer to the 32-bit program data bus and 20-bit data bus. The ZR38000 supplies six serial I/O ports that suit multimedia applications.

Special instructions—Absolute Value, Butterfly Primitive (multiplies 2 registers, stores registers, and intermediate sum), Compare, Compare Absolute, Delayed Branch (executes next two instructions before branch), Increment/Decrement, Divide Iteration (bit step), Loop, Multiply-and-Add/Sub, Move Max/Min (moves max/min value from array), Normalize (also for max mantissa), and Repeat Instruction.

Part no.	Clock	Max power (5V)	Package	Price
ZR38000	25 MHz	300 mA	128-pin PQFP	\$42 (1000)

SUPPORT

HARDWARE Zoran sells a ZR38000 development board. PC-AT ISA-bus compatible, the board can be dropped into a standard PC-AT (and above). It comes with 128k×32-bit, 24.5-MHz, zero-wait-state external memory. It has an interface to external analog systems.

SOFTWARE Zoran supplies a software-development tool set, which runs on MS-Windows 3.1 on a 386- or 486-based PC. The tools include an assembler/linker, a simulator, and a debugger. Zoran has developed MPEG-1 utilities for decompression/compression (32-, 44.1-, 48-kHz sampling rates; 32- to 48-kbps compressed bit rates).



SAMSUNG
WORLD'S
First
16
MEG
DRAM

You're designing a Pentium- or Power PC-based system and you know it needs synchronous SRAM cache to generate the performance it ought to have.

But synchronous SRAM cache is so expensive that using it is prohibitive.

That's exactly the problem these

new Samsung SRAMs solve. We've used an innovative pipelined burst design to produce a part we can sell for about half the cost of conventional burst SRAMs. But which gives you approximately 99% of the performance that they do.

As you can see, we consider it

heady stuff—we look on it as a revolutionary development.

And because it actually does make performance affordable—and makes synchronous cache available to designers of even highly cost-constrained systems—we think you'll probably agree.

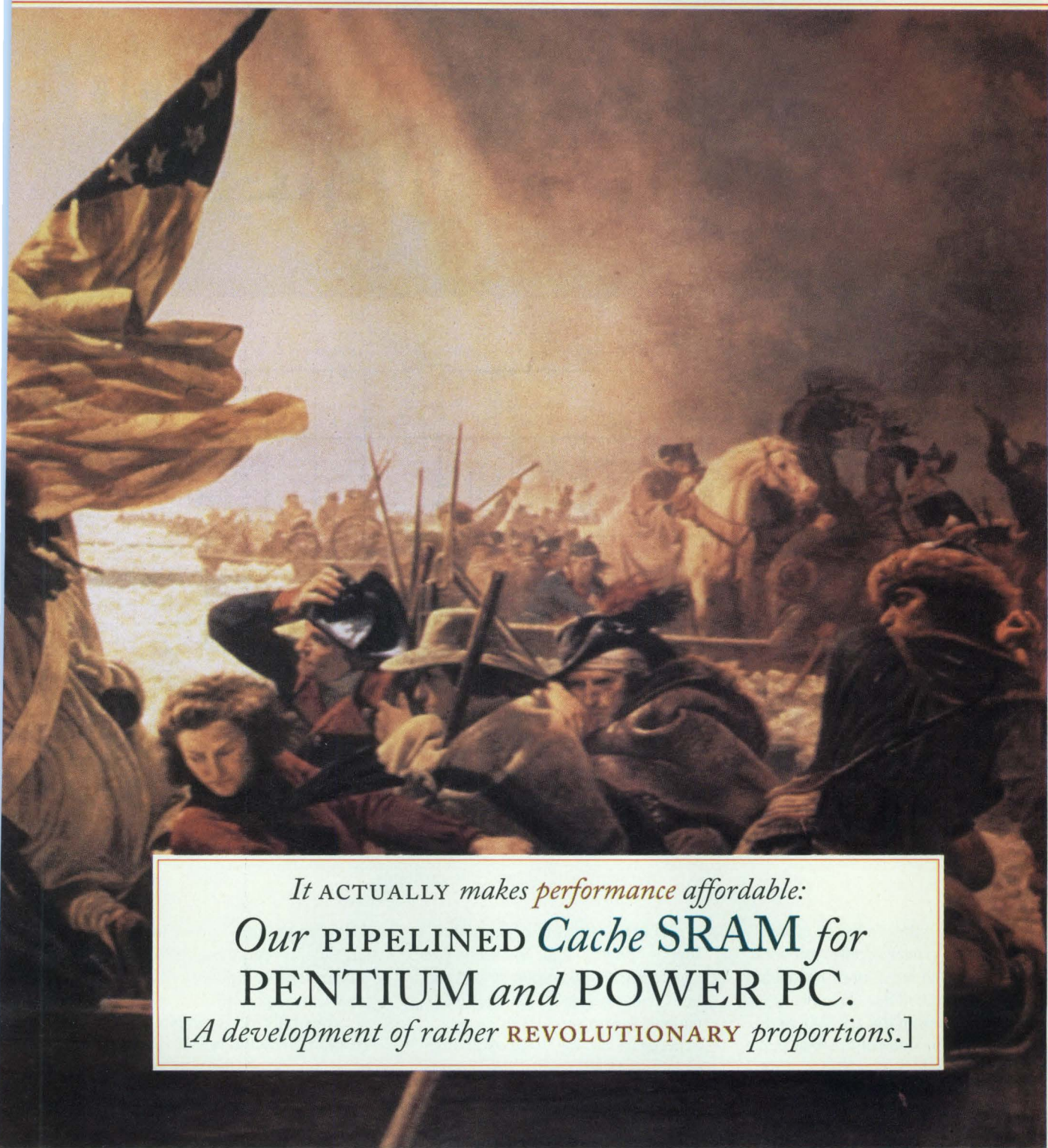

It ACTUALLY makes performance affordable:
**Our PIPELINED Cache SRAM for
PENTIUM and POWER PC.**
*[A development of rather **REVOLUTIONARY** proportions.]*

This revolutionary design was developed collaboratively with major systems developers. It has already met with wide acclaim throughout the industry, and is second-sourced. It will support 3.3 volt systems up to 75 MHz, and is available in speeds of 7, 8, and 9ns.

For Samsung, the pipelined burst cache SRAM is just one of many notable achievements in memory—in a program that sails forward with remarkable success.

For information on designing it in, please call 1-800-446-2760 or 408-954-7229 today. Or write to

SRAM Marketing, Samsung Semiconductor Inc., 3655 North First Street, San Jose, CA 95134.



SEMICONDUCTOR

A Generation AHEAD.

PC and DSP μ P interrupt each other

Jerzy R Chrzaszcz, Institute of Computer Science, Warsaw, Poland



Efficient synchronization and communication between a PC bus and an add-on board is important for virtually all applications—but is essential to DSP boards such as those that use the TMS320C25. A bidirectional register mapped in I/O space at the DSP side and decoded in I/O channels at the PC side provides this efficiency and is simple and flexible. **Listing 1** describes control logic for such a register encapsulated in a low-cost GAL20V8 that allows for polled and interrupt-driven service. When enabled, the register generates DSP-to-PC or PC-to-DSP interrupts on data reads or writes. Jumpers or the control register can set four interrupt enables. To allow for polled service at the PC side, additional flags indicate register reads and writes executed by the DSP μ P.

The design's interface to the PC bus requires eight locations. (This design doesn't include the decoding functions.) Because a 320C25 distinguishes only 16 I/O ports, the design uses four address lines for decoding at the DSP side. Separate flags are set when the DSP μ P writes and reads data to and from the register. The flags clear when the PC resets and whenever the PC reads data from an I/O location designated as the status register. You can easily modify addresses by editing the "refine" statements in the source file. (You also have to make the appropriate changes in the simulation input file to generate valid test vectors.) For ISA compatibility, the "irq86" interrupt-request line needs an open-collector buffer. The **listing** posted on the *EDN* bulletin-board system includes a simulation file. (DI #1439) **EDN**

To Vote For This Design, Circle No. 340

Listing 1—GAL20V8 interrupt controller for ISA add-on board with 320C25

```

Pin 1      = a0      ; /* 320C25 address lines */
Pin 2      = a1      ; /* . */
Pin 3      = a2      ; /* . */
Pin 4      = a3      ; /* . */
Pin 5      = !is     ; /* 320C25 i/o space select */
Pin 6      = !we     ; /* 320C25 write enable */
Pin 7      = !strb   ; /* 320C25 strobe */

Pin 8      = !rd86   ; /* enable 80x86 interrupt on read */
Pin 9      = !wr86   ; /* enable 80x86 interrupt on write */
Pin 10     = !rd25   ; /* enable 320C25 interrupt on read */
Pin 11     = !wr25   ; /* enable 320C25 interrupt on write */
Pin 23     = reset   ; /* reset from bus connector */

Pin 18     = sa0     ; /* host system address lines */
Pin 19     = sa1     ; /* . */
Pin 20     = sa2     ; /* . */
Pin 21     = !hit    ; /* base address decoded on [sa9..sa3] */
Pin 13     = !ior    ; /* data read strobe */
Pin 14     = !iow    ; /* data write strobe */

Pin 22     = !irq25  ; /* 320C25 interrupt request */
Pin 15     = irq86   ; /* 80x86 interrupt request */
Pin 16     = rdflag  ; /* data read flag for 80x86 */
Pin 17     = wrflag  ; /* data write flag for 80x86 */

$define ISA_DATA 0
$define ISA_STAT 2
$define DSP_DATA 0

field isa_adr = [sa2..sa0];
isa_hit = hit & isa_adr: 0;
isa_rd  = isa_hit & ior;
isa_wr  = isa_hit & iow;
staTrd = hit & isa_adr: 2 & ior;

field dsp_adr = [a3..a0];
dsp_hit = dsp_adr: 0;
dsp_rd  = dsp_hit & strb & is & !we;
dsp_wr  = dsp_hit & strb & is & we;

rdflag  = dsp_rd # rdflag & !reset & !stard;
wrflag  = dsp_wr # wrflag & !reset & !stard;
irq86   = rd86 & rdflag # wr86 & wrflag;
irq25   = rd25 & isa_rd # wr25 & isa_wr;

```

Autocalibrator nulls dc offsets

Doug Mercer and Steve Ruscak, Analog Devices, Wilmington, MA

Three inexpensive ICs in **Fig 1**'s autocalibration circuit correct for both the ADC's offset errors and systematic dc offsets that accumulate before the converter input. An RS flip-flop, a counter, and a low-cost DAC combine to provide the requisite offset correction voltage. When configured in unipolar mode, IC₁, a 12-bit 1.25-Msamples/sec ADC, has a maximum dc offset of ± 9 LSBs, which this autocalibration circuit can reduce to less than $\frac{1}{2}$ LSB.

IC₁ provides an out-of-range (OTR) signal that indicates when the analog input has exceeded positive or negative full scale. This OTR output drives the reset input of IC_{2B}. IC_{2B} and IC_{2C} form an RS flip-flop. The set input to the flip-flop is an external pulse, STRT_CAL, which initiates the calibration sequence. The width of this pulse must

exceed one conversion period for proper circuit operation.

When you apply a STRT_CAL to the circuit, a 74HC393 configured as an 8-bit counter (IC₃) resets to zero. Simultaneously, the Q output of the RS flip-flop goes low, allowing an inverted copy of the ADC's sample clock (ENCODE) to gate through IC_{2A}. IC_{2D} inverts the ENCODE pulse such that the counter clocks at the same time as the beginning of conversion. At this point, the analog input of IC₁, AIN1, must be at its zero-level or negative full scale. The current at the IOUTA' node is equal to

$$I_{OUT A'} = -\left(\frac{D}{256}\right) * \left(\frac{REF_OUT}{R_1}\right) + \left(\frac{REF_OUT}{R_2}\right),$$

where D is the digital input code to IC₄'s DAC. When D equals 0, the current at IOUTA' equals approximately 0.5 mA. The resultant correction voltage that the circuit applies to the AIN2 input of IC₁ approximately equals $IOUTA' \times R_3$, or approximately 25 mV. As the ADC performs subsequent conversions, the counter increments by one count, which in turn decreases the voltage at AIN2. Conversions continue until the OTR pin toggles high, indicating that the AIN1 voltage has been level-shifted 1/2 LSB below negative full scale. Simultaneously, the Q output of the RS flip-flop goes high, which prevents further ENCODE pulses from incrementing the counter. At the maximum count of 255, the voltage at AIN2 is approximately equal to -25 mV. With IC₁'s full-scale input range of 5V p-p, each LSB equals 1.22 mV, which corresponds to a maximum correction range of ± 20 LSBs. (DI #1444) EDN

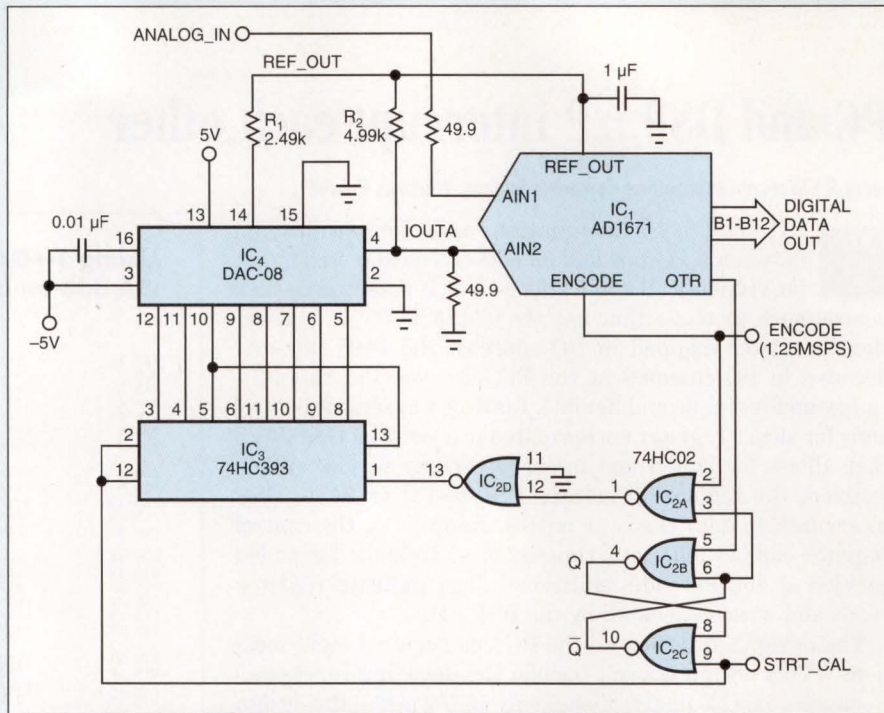

Fig 1—Three inexpensive ICs—an RS flip-flop, a counter, and a low-cost DAC—combine to provide an offset correction voltage for IC₁'s ADC, which reduces the uncalibrated offset error from ± 9 LSBs to less than 1/2 LSB.

To Vote For This Design, Circle No. 341

Low-cost MOSFET quashes power resistor

Christophe Basso, European Synchrotron Radiation Facility, Grenoble, France

At power-on, off-line power supplies use a resistor to provide start-up current for the PWM IC, current that is necessary to start driving the power switch. After a few periods, an auxiliary winding delivers a sufficient voltage to power the

IC. Unfortunately, the start-up resistor dissipates heat and raises the power supply's overall temperature. Manufacturers have recently introduced high-voltage MOSFETs to replace the power resistors. Wired as current sources, these

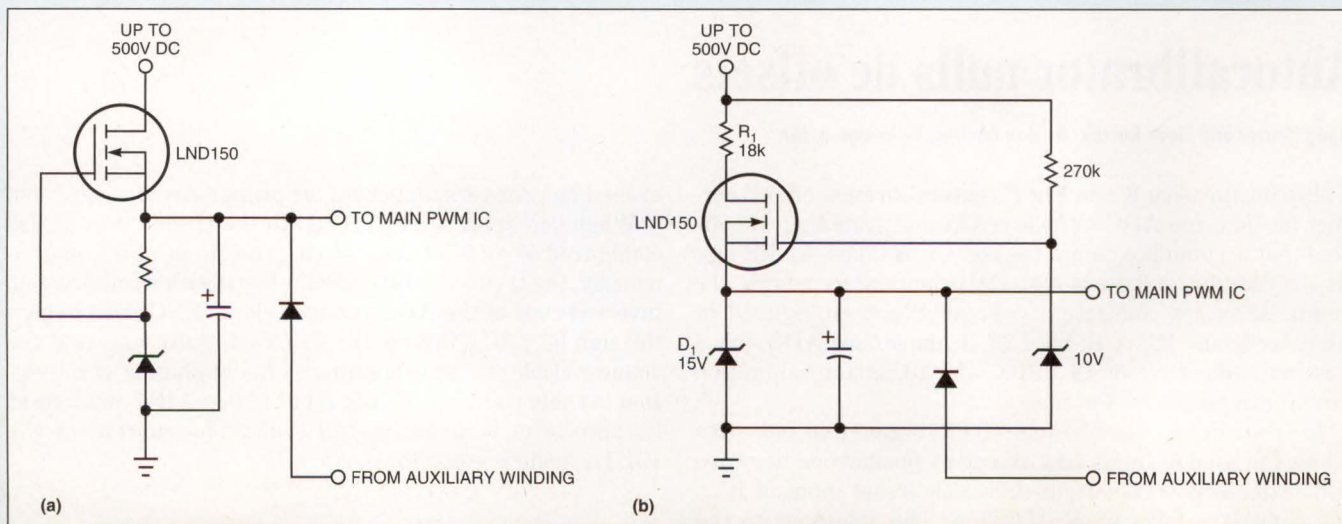

Fig 1—Built-in current sources allow some new MOSFETs to supply a few hundred microamps of start-up current (a). Some minor modifications to the circuit (b) provide much higher start-up currents of a few milliamps.



9-36 Volts 18-72 Volts DC/DC Converters

Unipolar, Bipolar and Triple Outputs!

Meet the challenge of designing complex distributed power architectures in telecommunication, marine, portable instrument, and MPP computer applications. DATEL's new line of wide-input-range DC/DC converters are the cost-effective solution ... requiring the least amount of space ... and the smallest number of devices.

Call today for details on DATEL's complete line of DC/DC converters.

- 3, 10 and 20 Watt Outputs
- Fully Regulated/Isolated
- High Efficiencies (to 82% min.)
- Extended Temperature (-25 to +105°C)
- UL/CSA/IEC Certified
- Full EMI Testing Available
- 100% Burn-in @ Full Load
- Custom Designs for OEM's
- Very Low Cost

Unipolar Models	V _{in} Range (Volts)	V _{out} (Volts)	I _{out} (mA)	R/N (mV, p-p)	Efficiency (Min.)	Case	Price (100's)	Bipolar Models	V _{in} Range (Volts)	V _{out} (Volts)	I _{out} (mA)	R/N (mV, p-p)	Efficiency (Min.)	Case	Price (100's)
UWR-3.3/4850-D12	9-36	3.3	4850	75	74%	C4	\$76	BWR-5/1700-D12	9-36	±5	±1700	100	82%	C4	\$76
UWR-5/4000-D12	9-36	5	4000	100	80%	C4	\$76	BWR-12/830-D12	9-36	±12	±830	100	81%	C4	\$76
UWR-12/1650-D12	9-36	12	1650	100	81%	C4	\$76	BWR-15/670-D12	9-36	±15	±670	100	81%	C4	\$76
UWR-15/1300-D12	9-36	15	1300	100	82%	C4	\$76	BWR-5/250-D48	18-72	±5	±250	120	73%	C1	\$45
UWR-5/500-D48	18-72	5	500	120	75%	C1	\$45	BWR-12/125-D48	18-72	±12	±125	150	80%	C1	\$45
UWR-12/250-D48	18-72	12	250	150	76%	C1	\$45	BWR-15/100-D48	18-72	±15	±100	150	80%	C1	\$45
UWR-15/200-D48	18-72	15	200	150	76%	C1	\$45	BWR-5/700-D48	18-72	±5	±700	100	76%	C2	\$66
UWR-3.3/1800-D48	18-72	3.3	1800	75	72%	C2	\$66	BWR-12/415-D48	18-72	±12	±415	75	79%	C2	\$66
UWR-5/1800-D48	18-72	5	1800	75	77%	C2	\$66	BWR-15/330-D48	18-72	±15	±330	75	79%	C2	\$66
UWR-12/750-D48	18-72	12	750	75	80%	C2	\$66	BWR-5/1700-D48	18-72	±5	±1700	100	81%	C4	\$76
UWR-15/600-D48	18-72	15	600	75	80%	C2	\$66	BWR-12/830-D48	18-72	±12	±830	85	81%	C4	\$76
UWR-3.3/4850-D48	18-72	3.3	4850	100	78%	C4	\$76	BWR-15/670-D48	18-72	±15	±670	85	82%	C4	\$76
UWR-5/4000-D48	18-72	5	4000	100	80%	C4	\$76	Triple Models							
UWR-12/1650-D48	18-72	12	1650	100	81%	C4	\$76	TWR-5/1200-12/250-D48	18-72	5/±12	1200/250	75/175	81%	C4	\$76
UWR-15/1300-D48	18-72	15	1300	100	82%	C4	\$76	TWR-5/1500-12/250-D48	18-72	5/±12	1500/250	75/175	79%	C4	\$76
Case Dimensions: C1 - 1.25" L x 0.80" W x 0.43" H C2 - 2.00" L x 1.00" W x 0.375" H								TWR-5/1800-12/200-D48	18-72	5/±12	1800/200	75/175	81%	C4	\$76
C4 - 2.00" L x 2.00" W x 0.45" H								TWR-5/1000-15/250-D48	18-72	5/±15	1000/250	75/175	79%	C4	\$76
								TWR-5/1500-15/250-D48	18-72	5/±15	1500/250	75/175	81%	C4	\$76
								TWR-5/1800-15/150-D48	18-72	5/±15	1800/150	75/175	80%	C4	\$76

DATEL, Inc., 11 Cabot Boulevard, Mansfield, MA 02048 Tel: (508) 339-3000
FAX: (508) 339-6356. For immediate assistance 800-233-2765.

DATEL
INNOVATION and EXCELLENCE

MOSFETs provide the few hundred microamps necessary to start the IC. **Fig 1a** shows a circuit based on the new Super-tex (Sunnyvale, CA) LND150. Unfortunately, this configuration isn't sufficient for a main IC that requires start-up current of a few milliamps. For example, this current source cannot start a half-bridge power MOSFET driven by an International Rectifier (El Segundo, CA) IR2110 in off-line fluorescent ballast applications.

A circuit that provides higher current (**Fig 1b**) still uses the LND150, but this time as a high-voltage switch. At power-on, the LND150's positive V_{GS} allows the current to flow through R_1 . The source potential starts to rise, authorizing the PWM IC to oscillate. The auxiliary winding

begins to deliver voltage and forces the MOSFET's source voltage to rise until D_1 reaches its voltage limit. When the dc rail exceeds the 10V gate voltage, the V_{GS} becomes negative and soon stops MOSFET conduction, thus freeing R_1 from dissipating any heat. The heat dissipated by the resistor thus falls to zero, avoiding all the nuisance caused by excessive heat in the circuit and leading to better overall efficiency. A further enhancement to this circuit would be to lock the MOSFET gate to ground, thus inhibiting all oscillations when the auxiliary power supply disappears, such as when the tube is broken in ballast applications. (DI #1442) **EDN**

To Vote For This Design, Circle No. 342

Spice plots noise figure

Michael A Wyatt, SSAVD Honeywell Inc, Clearwater, FL

The waveform-manipulation capabilities of modern Spice-based simulators, such as MicroSim Corp's PSpice, make it easy to plot complex functions, such as noise figure. The traditional definition of "noise figure" is "the amount of signal-to-noise degradation a circuit causes." Another definition is "the total-output-noise power divided by the output-noise power due to the source impedance, expressed in decibels." Spice computes the total-output-noise voltage, e_{onoise} , as the root-sum-square voltage of all network noise sources referenced to the output, which corresponds to the equation

$$e_{\text{onoise}} = \sqrt{\sum_1^k [(e_{n1} \cdot G_1)^2 + (e_{n2} \cdot G_2)^2 + \dots + (e_{nk} \cdot G_k)^2]} \quad (1)$$

where e_{nk} is the kth noise contributor and G_k is the associated kth gain. Spice also computes the equivalent input noise e_{inoise} , which would produce the same output noise voltage with a noise-free amplifier as

$$e_{\text{inoise}} = e_{\text{onoise}} / G_{\text{amp}} \quad (2)$$

where G_{amp} is the amplifier gain. Because noise power is proportional to noise voltage squared, you can replace e_{inoise} with $e_{\text{inoise}} \times G_{\text{amp}}$ to compute noise figure for equal input and output impedances as

$$\text{Noise Figure} = 10 \cdot \log \left[\frac{(e_{\text{inoise}})^2}{4kTR_{\text{source}}} \right] \quad (3)$$

where k is Boltzmann's constant (1.38×10^{-23} J/K) and T is temperature in Kelvin (298K at room temperature).

Consider the RF amplifier in **Fig 1a**. Spice computes the total root-sum-square output noise voltage and references it to the input source V_{in} . Spice can then use this noise voltage V_{inoise} with **Eq 3** to display noise figure. For example, entering the equation into PSpice's Probe feature produces **Fig 1b**, a graph of the RF amplifier's noise figure vs frequency. This convenient display is typical of RF semiconductor manufac-

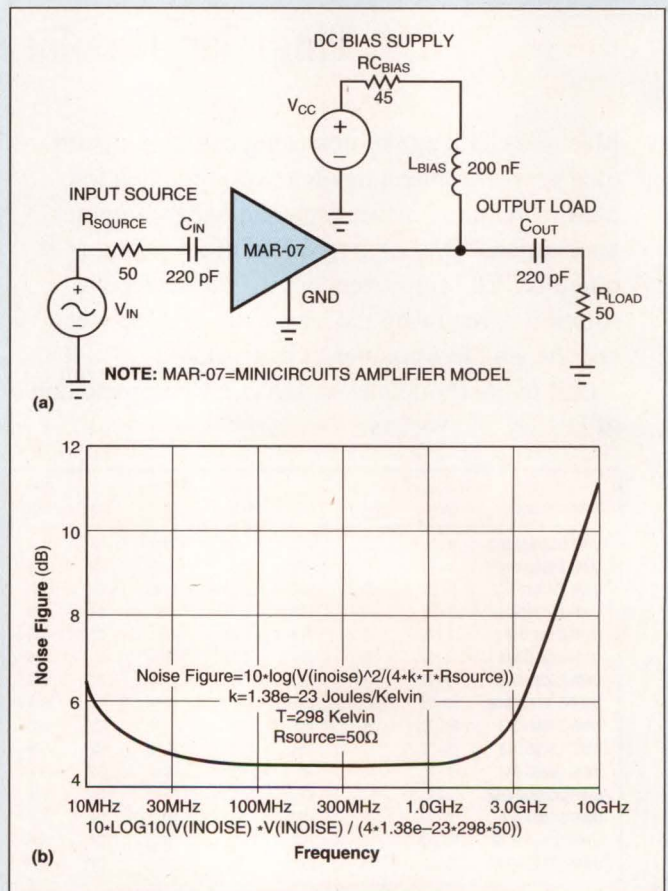
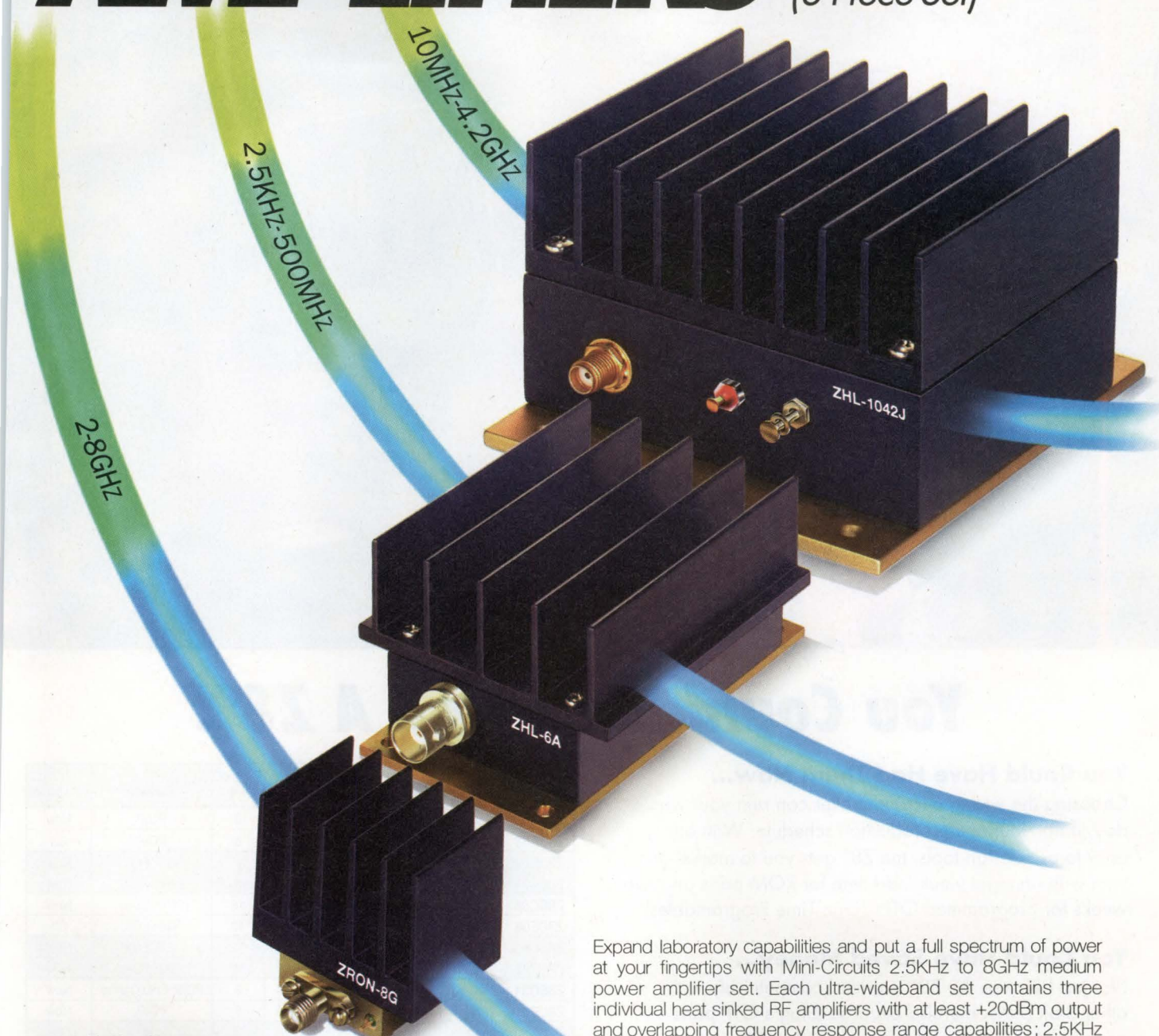

Fig 1—Equations for noise figure and PSpice's Probe feature can plot an RF amplifier's noise figure (a) vs frequency (b).

turers' data sheets, and you can use it to investigate circuit, bias point, and component influences on noise figure. (DI #1440) **EDN**

To Vote For This Design, Circle No. 343

2.5KHz to 8GHz AMPLIFIERS (3 Piece Set)



\$1095 (Set of 3 1-9 qty.)
only **+20dBm Power Output, 20dB Gain**

Model :	Freq. (MHz)	Gain (dB)	Power Output, dBm @ 1dB Compression	DC Power Volt	Current mA	Conn. Type	Indiv. Price (\$)
ZHL-6A	.0025-500	21	+23	+24	350	BNC	199
ZHL-1042J	10-4200	25	+20	+15	330	SMA	495
ZRON-8G	2000-8000	20	+20	+15	310	SMA	495

Set of 3 Amplifiers # KZHL-318: \$1095 (1-9 qty.)

Expand laboratory capabilities and put a full spectrum of power at your fingertips with Mini-Circuits 2.5KHz to 8GHz medium power amplifier set. Each ultra-wideband set contains three individual heat sunked RF amplifiers with at least +20dBm output and overlapping frequency response range capabilities; 2.5KHz to 500MHz, 10MHz to 4.2GHz and 2GHz to 8GHz. Applications for these amplifiers include increasing the signal levels to power meters, spectrum analyzers, frequency counters and network analyzers as well as boosting signal generator outputs.

You can buy these amplifiers individually at Mini-Circuits already low prices, or own the full spectrum set for the money saving price of only \$1095 (1-9 qty.) ! To order from stock with a guarantee to ship within one week, call Mini-Circuits today !

Mini-Circuits...we're redefining what VALUE is all about!

Mini-Circuits®

P.O. Box 350166, Brooklyn, New York 11235-0003 (718) 934-4500 Fax (718)332-4661

For detailed specs on all Mini-Circuits products refer to • THOMAS REGISTER Vol. 23 • MICROWAVES PRODUCTS DIRECTORY • EEM • MINI-CIRCUITS' 740- pg. HANDBOOK.

CUSTOM PRODUCT NEEDS...Let Our Experience Work For You.

CIRCLE NO. 122

F 176 Rev Orig



You Could Have Had A Z8®!

You Could Have Had Them Now...

Choosing the wrong microcontroller can ruin your whole day, if not your entire production schedule. With our easy to use design tools, the Z8® gets you to market on time with an eight week lead time for ROM parts and two weeks for programmed OTPs (One Time Programables).

You Could Have Saved Money...

Not just because the Z8® is priced competitively with other 8-bit parts, but also because Zilog's OTP parts are priced low enough to change code while in the early stages of production — even relatively large volumes can be affordable for running production during mask ROM development.

You Could Have Had A Full Range Of Options...

The Z8® family provides a full range of OTP and mask ROM parts and package sizes. You can also select from features that include watchdog timers, analog comparators, counter timers, power-on reset and I/O modes.

Don't take chances, take the Z8® from Zilog.

	Type	Pins	ROM Bytes	RAM Bytes	I/O	Speed MHz	Package	Available
Z86C03	Masked	18	512	60	14	8	PDIP	Now
Z86E03	OTP	18	512	60	14	8	PDIP	Q3
Z86C04	Masked	18	1K	144	14	8	PDIP, SOIC	Now
Z86E04	OTP	18	1K	144	14	8	PDIP, SOIC	Now
Z86C06	Masked	18	1K	144	14	12	PDIP, SOIC	Now
Z86E06	OTP	18	1K	144	14	12	PDIP, SOIC	Q3
Z86C08	Masked	18	2K	144	14	12	PDIP, SOIC	Now
Z86E08	OTP	18	2K	144	14	12	PDIP, SOIC	Now
Z86C31	Masked	28	2K	256	24	8	PDIP, Chip Carrier	Now
Z86E31	OTP	28	2K	256	24	8	PDIP	Now
Z86C30	Masked	28	4K	256	24	12	PDIP	Now
Z86E30	OTP	28	4K	256	24	12	PDIP	Now
Z86C40	Masked	40/44	4K	256	32	12	PDIP, PLCC, QFP	Now
Z86E40	OTP	40/44	4K	256	32	12	PDIP, PLCC, QFP	Now

Contact your nearest Zilog sales office or authorized distributor to find out how you can have a Z8®.



210 E. Hacienda Avenue
Campbell, CA 95008-6600
(800) 662-9826 – within the U.S.
(408) 370-8000
FAX (408) 370-8056



DESIGN NOTES

C-Load™ Op Amps Tame Instabilities – Design Note 83

Richard Markell, George Feliz and William Jett

Introduction

By taking advantage of advances in process technology and innovative circuit design, Linear Technology Corporation has developed a series of C-Load op amps which are tolerant of capacitive loading, including the ultimate, amplifiers which are stable with any capacitive load. These amplifiers span a range of bandwidths from 1MHz to 140MHz. They are suited for a wide range of applications from coaxial cable drivers to capacitive transducer exciters.

The Problem

The cause of the capacitive load stability problem in most amplifiers is the pole formed by the load capacitance and the open-loop output impedance of the amplifier. This output pole increases the phase lag around the loop which reduces the phase margin of the amplifier. If the phase lag is great enough the amplifier will oscillate.

External networks can be used to improve the amplifier's stability with a capacitive load but have serious drawbacks. For instance, most designers are familiar with the use of a series resistor R_S between the load and the amplifier output. The optimum value of R_S depends on the load capacitance, so this approach isn't useful for ill-defined loads. Further disadvantages of the external approach include reduced output swing and drive current, and increased component count.

An Example

Figure 1 shows an example of a competitor's medium speed device which is sensitive to capacitive loading. When 50pF is paralleled with a 5k Ω load, the response exhibits considerable ringing. With a 75pF load the device oscillates. By comparison, the transient responses of the 50MHz LT1360 voltage feedback amplifier (Figure 2) shows the improvement in stability achieved in the latest generation of C-Load op amps. In fact the LT1360 maintains a stable transient response for any capacitive load.

C-Load is a trademark of Linear Technology Corporation

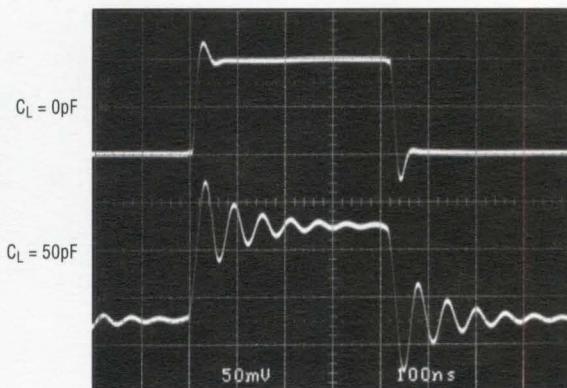

$V_S = \pm 15V$ $R_L = 5k$
 $A_V = 1$

DN83 • F01

Figure 1. Medium Speed Non-LTC Op Amps

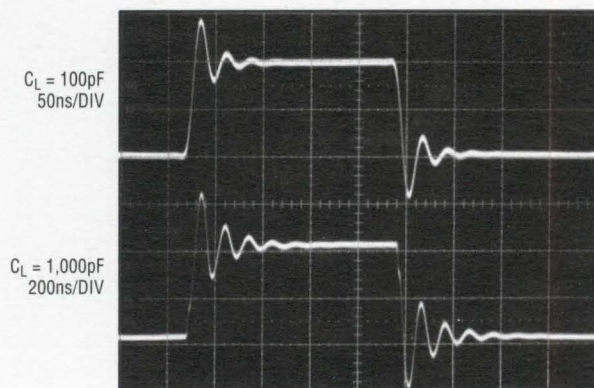

$V_{IN} = 100mV_{p-p}$ $A_V = 1$
 $V_S = \pm 15V$ $R_L = 5k$

DN83 • F02

Figure 2. LT1360

The Solution

LTC's new family of voltage feedback amplifiers adjusts the frequency response of the op amp to maintain adequate phase margin regardless of the capacitive load thus, the amplifiers cannot oscillate. These C-Load amplifiers are great in systems where the load is not fixed or is ill-defined. Examples include driving coaxial cables that

may or may not be terminated, driving twisted-pair transmission lines, and buffering the inputs of sampling A/D converters that present time varying impedances.

Table 1 lists LTC's *unconditionally stable* voltage feedback C-Load amplifiers. Table 2 lists other voltage feedback C-Load amplifiers that are stable with loads up to 10,000pF. Figure 3 shows overshoot as a function of capacitive load being driven for a wide variety of LTC op amps. Note that the unconditionally stable amplifiers (LT1355, LT1358 and LT1363) have the greatest overshoot for $C_L = 10nF$. Overshoot actually declines as C_L is increased beyond 10nF.

Table 1. Unity-Gain Stable C-Load Amplifiers Stable with All Capacitive Loads

Singles	Duals	Quads	GBW (MHz)	I _s /Amp (mA)
LT1200	LT1201	LT1202	11	1
LT1220	—	—	45	8
LT1224	LT1208	LT1209	45	7
LT1354	LT1355	LT1356	12	1
LT1357	LT1358	LT1359	25	2
LT1360	LT1361	LT1362	50	4
LT1363	LT1364	LT1365	70	6

Table 2. Unity-Gain Stable C-Load Amplifiers Stable with $C_L \leq 10,000pF$

Singles	Duals	Quads	GBW (MHz)	I _s /Amp (mA)
LT1012	—	—	0.6	0.4
—	LT1112	LT1114	0.65	0.32
LT1097	—	—	0.7	0.35
—	LT1457	—	2	1.6

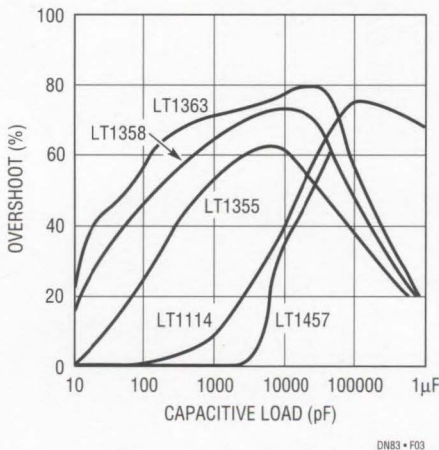

Figure 3. Overshoot vs Capacitive Load

All LTC op amps with adjustable bandwidth can be stabilized for a range of capacitive loads. The bandwidth of current feedback amplifiers is set by the external feedback resistor. Graphs which allow selection of the proper feedback resistor for C_L values to 10,000pF appear in the data sheets of most LTC current feedback amplifiers. As an example, Figure 4 shows the LT1206, a 60MHz current feedback amplifier with 250mA output current, driving loads of 1000pF and 10,000pF while remaining stable.

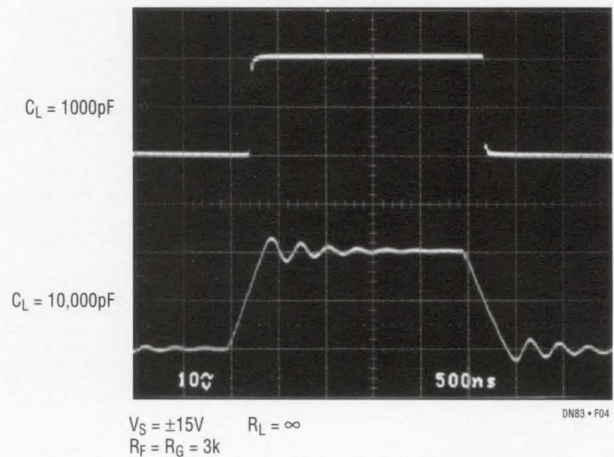

Figure 4. LT1206

Conclusions

Linear Technology has developed families of medium and high speed amplifiers which are much easier to apply than their predecessors. Stable operation with capacitive loads can be achieved without critical external components or loss of output drive. Amplifiers which are stable with any capacitive load are ideal for applications where the load is not well defined. These amplifiers can simplify even low frequency designs by insuring stability under all conditions of loading. For more information on C-Load op amps see the February 1994 issue of *Linear Technology Magazine*.

For literature on our Operational Amplifiers, call **1-800-4-LINEAR**. For applications help, call (408) 432-1900, Ext. 456

Passive components cancel phase errors

Stan Bleszynski, Applied Micro Electronics Ltd, Dublin, Ireland

The circuit in **Fig 1** aims to achieve a constant, frequency-independent delay filter with a very flat amplitude characteristic that is insensitive to input impedance and load resistance. The addition of C_1 and L_1 cancels the nonlinear, third-order term in the formula relating the output phase angle (ϕ) to the frequency (f):

$$\phi = 2 \cdot a \tan \left[\frac{f/f_0}{1 - (f/f_0)^2} \right] \quad (1)$$

First choose R , L , and C such that

$$f_0 = \frac{R}{2\pi L} = \frac{1}{2\pi RC} \quad (2)$$

where R is the effective resistance and equal to

$$R = \frac{r \cdot R_0}{r + 2 \cdot R_0} \quad (3)$$

By choosing C_1 and L_1 such that

$$f_1 = \frac{1}{2\pi\sqrt{LC_1}} = \frac{1}{2\pi\sqrt{CL_1}} = f_0\sqrt{3}, \quad (4)$$

$$C_1 = \frac{L}{3R^2}, \quad (5)$$

and

$$L_1 = \frac{R^2 C}{3}. \quad (6)$$

the third-order term in the expansion series of **Eq 1** vanishes, leaving only the first-order (linear) term and the fifth- and high-order terms such that

$$\phi = 2(f/f_0) + 0(f/f_0)^5. \quad (7)$$

The time delay (t) between the input and the output is, therefore, expressed by the approximate formula

$$2\pi t = d\phi/df = 2/f_0 = \frac{2L}{R} = \text{constant}, \quad (8)$$

which has an error on the order of 1%, even at frequencies as high as $F_0/2$. Of course, it's normal first to choose R , L , and C to get the required t and then calculate proper values for C_1 and L_1 .

Two more things worth noting about this circuit are

a. The filter exhibits frequency-independent delay and gain, regardless of the load resistance (r). The

load resistance affects the attenuation factor (k) as follows:

$$k = \frac{r}{r + R_0} \quad (9)$$

b. Input impedance is purely resistive and equal to

$$R_0(r + R_0)/(r + 2R_0), \quad (10)$$

which facilitates cascading the filter.

The following values produce a time delay of 50 nsec: $R_0=150\Omega$, $L=3.3\mu\text{H}$, $L_1=1\mu\text{H}$, $C=150\text{pF}$, $C_1=47\text{pF}$, $r=3\text{k}\Omega$, $f_0=7.2\text{MHz}$. As **Fig 1** shows, you can connect the output of the filter to a differential amplifier with the gain of 1.05 ($1/k$) to compensate for the attenuation factor k . (DI #1441)

EDN

To Vote For This Design, Circle No. 344

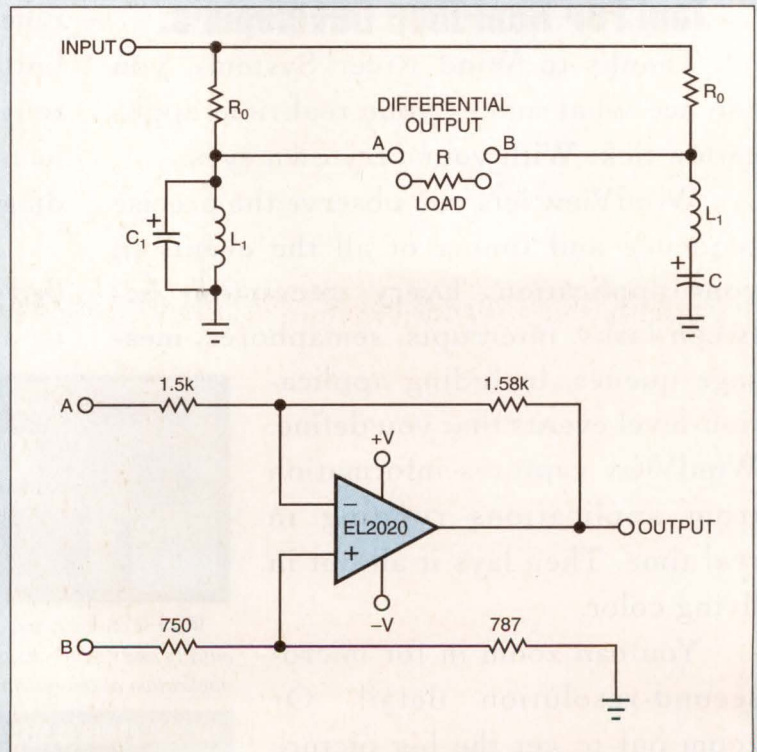

Fig 1—The addition of C_1 and L_1 to this delay filter cancels nonlinear phase-error terms.

Want A Similar View Of Your Embedded Real-Time Applications?



WindView™—The First Visual Analysis Tool For Real-Time Developers.

Thanks to Wind River Systems, you can see what makes your real-time application tick. With your very own eyes.

WindView lets you observe the precise sequence and timing of all the events in your application. Every interaction between tasks, interrupts, semaphores, message queues, including application-level events that you define. WindView captures information from applications running in real time. Then lays it all out in living color.

You can zoom in for micro-second-resolution detail. Or zoom out to get the big picture

on your software's execution. You'll see race conditions, deadlocks, performance bottlenecks and missed deadlines—those tough real-time problems that delay projects by days, weeks, even months—and diagnose them in a matter of minutes.

We call it a logic analyzer for embedded software. But WindView, by any name, is a visible breakthrough for real-time

development. And a truly ingenious addition to the WindPower Tools for VxWorks®. To try WindView for yourself, call us



and we'll send you our free demo. After all, seeing is believing. 1-800-677-1586.

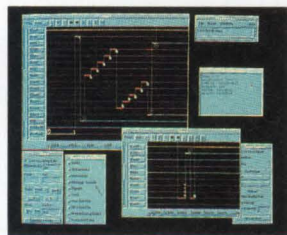

With WindView, you can quickly and easily visualize an application at the system level.

THE REAL POWER IN REAL TIME.



**WIND
RIVER
SYSTEMS**

PLDs substitute for obsolete latches

John R Stauber, Picker International Inc, Highland Heights, OH

The 22V10 series of PLDs in 24DIP300 or 28PLCC packages can substitute both physically and functionally for the now-discontinued 74ALS844 and 74ALS880 latches. Beware, however, that some early PLCC versions of the 22V10 *do not* have compatible pinouts. **Listings 1** and **2** contain the PLDASM source code for 22V10s that emulate the 74AS/ALS844 and 74AS/ALS880, respectively.

Determine whether your application can tolerate the performance differences between the PLDs and the AS/ALS originals. Pay particular attention to the I_{OH} source and I_{OL} sink capability your application requires. 22V10s source and

sink only -3.2 and $+16$ mA compared with the ALS873/880's -2.6 and $+24$ mA and the AS873/880's -15 and $+48$ mA. Thus, these PLDs may not be a viable solution if your application drives a bus or a heavy load. Also, select the appropriate speed grade of the PLD, again depending on your application's requirements. The ZIPfile attached to **EDN BBS /DI_SIG #1430** contains the writeup and listings—including simulation specifications. (DI #1430) EDN

To Vote For This Design, Circle No. 345

Listing 1—74AS/ALS844 PLD emulation

```
TITLE 74AS/ALS844 Emulator
PATTERN ???
REVISION A
AUTHOR Stauber
COMPANY Picker International
DATE 02/28/94

CHIP _74ALS844 PAL22V10

PIN 1 /OC ; INPUT
PIN 2 /D1 ; INPUT
PIN 3 /D2 ; INPUT
PIN 4 /D3 ; INPUT
PIN 5 /D4 ; INPUT
PIN 6 /D5 ; INPUT
PIN 7 /D6 ; INPUT
PIN 8 /D7 ; INPUT
PIN 9 /D8 ; INPUT
PIN 10 /D9 ; INPUT
PIN 11 /CLR ; INPUT
PIN 12 GND ;
PIN 13 C ; INPUT
PIN 14 /PRE ; INPUT
PIN 15 Q9 COMBINATORIAL ; OUTPUT
PIN 16 Q8 COMBINATORIAL ; OUTPUT
PIN 17 Q7 COMBINATORIAL ; OUTPUT
PIN 18 Q6 COMBINATORIAL ; OUTPUT
PIN 19 Q5 COMBINATORIAL ; OUTPUT
PIN 20 Q4 COMBINATORIAL ; OUTPUT
PIN 21 Q3 COMBINATORIAL ; OUTPUT
PIN 22 Q2 COMBINATORIAL ; OUTPUT
PIN 23 Q1 COMBINATORIAL ; OUTPUT
PIN 24 VCC
```

EQUATIONS

MINIMIZE_OFF

```
Q1 = D1 * C * /CLR ; Transparent when C high.
+ D1 * Q1 * /C * /CLR ; Latch data when C low.
+ D1 * Q1 * PRE * /CLR ; Overlap pterm to prevent glitch.
Q1.TRST = OC ; Output forced high when /PRE low.
; Output three-stated when /OC high.

Q2 = D2 * C * /CLR ;
+ D2 * Q2 * /C * /CLR ;
+ D2 * Q2 * PRE * /CLR ;
Q2.TRST = OC ;

Q3 = D3 * C * /CLR ;
+ D3 * Q3 * /C * /CLR ;
+ D3 * Q3 * PRE * /CLR ;
Q3.TRST = OC ;

Q4 = D4 * C * /CLR ;
+ D4 * Q4 * /C * /CLR ;
+ D4 * Q4 * PRE * /CLR ;
Q4.TRST = OC ;

Q5 = D5 * C * /CLR ;
+ D5 * Q5 * /C * /CLR ;
+ D5 * Q5 * PRE * /CLR ;
Q5.TRST = OC ;

Q6 = D6 * C * /CLR ;
+ D6 * Q6 * /C * /CLR ;
+ D6 * Q6 * PRE * /CLR ;
Q6.TRST = OC ;

Q7 = D7 * C * /CLR ;
+ D7 * Q7 * /C * /CLR ;
+ D7 * Q7 * PRE * /CLR ;
Q7.TRST = OC ;

Q8 = D8 * C * /CLR ;
+ D8 * Q8 * /C * /CLR ;
+ D8 * Q8 * PRE * /CLR ;
Q8.TRST = OC ;

Q9 = D9 * C * /CLR ;
+ D9 * Q9 * /C * /CLR ;
+ D9 * Q9 * PRE * /CLR ;
Q9.TRST = OC ;
```

Listing 2—74AS/ALS880 PLD emulation

```
TITLE 74AS/ALS880 Emulator
PATTERN ???
REVISION A
AUTHOR Stauber
COMPANY Picker International
DATE 02/28/94

CHIP _74ALS880 PAL22V10

PIN 1 /PRE1 ; INPUT
PIN 2 /OC1 ; INPUT
PIN 3 D11 ; INPUT
PIN 4 D21 ; INPUT
PIN 5 D31 ; INPUT
PIN 6 D41 ; INPUT
PIN 7 D12 ; INPUT
PIN 8 D22 ; INPUT
PIN 9 D32 ; INPUT
PIN 10 D42 ; INPUT
PIN 11 /OC2 ; INPUT
PIN 12 GND ;
PIN 13 /PRE2 ; INPUT
PIN 14 C2 ; INPUT
PIN 15 /Q42 COMBINATORIAL ; OUTPUT
PIN 16 /Q32 COMBINATORIAL ; OUTPUT
PIN 17 /Q22 COMBINATORIAL ; OUTPUT
PIN 18 /Q12 COMBINATORIAL ; OUTPUT
PIN 19 /Q41 COMBINATORIAL ; OUTPUT
PIN 20 /Q31 COMBINATORIAL ; OUTPUT
PIN 21 /Q21 COMBINATORIAL ; OUTPUT
PIN 22 /Q11 COMBINATORIAL ; OUTPUT
PIN 23 C1 ; INPUT
PIN 24 VCC
```

EQUATIONS

MINIMIZE_OFF

```
Q11 = D11 * C1 * /PRE1 ; Transparent when C1 high.
+ D11 * Q11 * /C1 * /PRE1 ; Latch data when C1 low.
+ D11 * Q11 * PRE1 * /PRE1 ; Overlap pterm to prevent glitch.
Q11.TRST = OC1 ; Output forced high when /PRE1 low.
; Output three-stated when /OC1 high.

Q21 = D21 * C1 * /PRE1 ;
+ D21 * Q21 * /C1 * /PRE1 ;
+ D21 * Q21 * PRE1 * /PRE1 ;
Q21.TRST = OC1 ;

Q31 = D31 * C1 * /PRE1 ;
+ D31 * Q31 * /C1 * /PRE1 ;
+ D31 * Q31 * PRE1 * /PRE1 ;
Q31.TRST = OC1 ;

Q41 = D41 * C1 * /PRE1 ;
+ D41 * Q41 * /C1 * /PRE1 ;
+ D41 * Q41 * PRE1 * /PRE1 ;
Q41.TRST = OC1 ;

Q12 = D12 * C2 * /PRE2 ; Transparent when C2 high.
+ D12 * Q12 * /C2 * /PRE2 ; Latch data when C2 low.
+ D12 * Q12 * PRE2 * /PRE2 ; Overlap pterm to prevent glitch.
Q12.TRST = OC2 ; Output forced low when /PRE2 low.
; Output is three-stated when /OC2 high.

Q22 = D22 * C2 * /PRE2 ;
+ D22 * Q22 * /C2 * /PRE2 ;
+ D22 * Q22 * PRE2 * /PRE2 ;
Q22.TRST = OC2 ;

Q32 = D32 * C2 * /PRE2 ;
+ D32 * Q32 * /C2 * /PRE2 ;
+ D32 * Q32 * PRE2 * /PRE2 ;
Q32.TRST = OC2 ;

Q42 = D42 * C2 * /PRE2 ;
+ D42 * Q42 * /C2 * /PRE2 ;
+ D42 * Q42 * PRE2 * /PRE2 ;
Q42.TRST = OC2 ;
```

PC printer port controls frequency divider

Bogdan Manolescu, Microelectronica, Bucharest, Romania

BBS In Fig 1's circuit, two cascaded synchronous presettable binary counters, IC₁ and IC₂, can derive signals having a frequency of f_{CLK}/N . In the circuit, a simple oscillator generates f_{CLK} ; however, you can substitute any triggerable source.

An IBM PC supplies the binary-coded integer divisor N (N=255 max) via eight pins of its printer port. Two additional control lines (pins 1 and 14 of the printer port) provide start and reset functions. The signal that starts the oscillator (COM=0) also enables the first counter, IC₁.

The counters, wired to count down, activate the overflow output of IC₂ when the counters reach zero. The overflow signal then enables the counters' parallel loading of the integer divisor N. The Turbo C++ program in Listing 1 controls the frequency dividers' operation.

(DI #1431)



Listing 1—Frequency-divider control program

```
#include <stdio.h>
#include <conio.h>
#include <dos.h>
#include <ctype.h>

#define OUT_PORT 0x378 /* printer output port address */
#define CTRL_PORT 0x37A /* printer control port address */

int main(void)
{
    int n; char c;
    for (;;) {
        clrscr();
        printf("Input the divisor (between 1 and 255): ");
        scanf("%d", &n);
        printf("\nStart ? (y/n)");
        if (tolower(getch())=='y') {
            outportb(OUT_PORT,n); //send out divisor
            outportb(CTRL_PORT,0x02); //start oscillator and enable counter1
            printf("\n\n\!Stop with any key...\n\n\!ESC to exit...");
            c=getch();
            if (c==0x1b) break;
            outportb(CTRL_PORT,0x01); //reset the counters
            delay(1);
            outportb(CTRL_PORT,0x03);
            delay(1);
        }
    }
    return 0;
}
```

To Vote For This Design, Circle No. 346

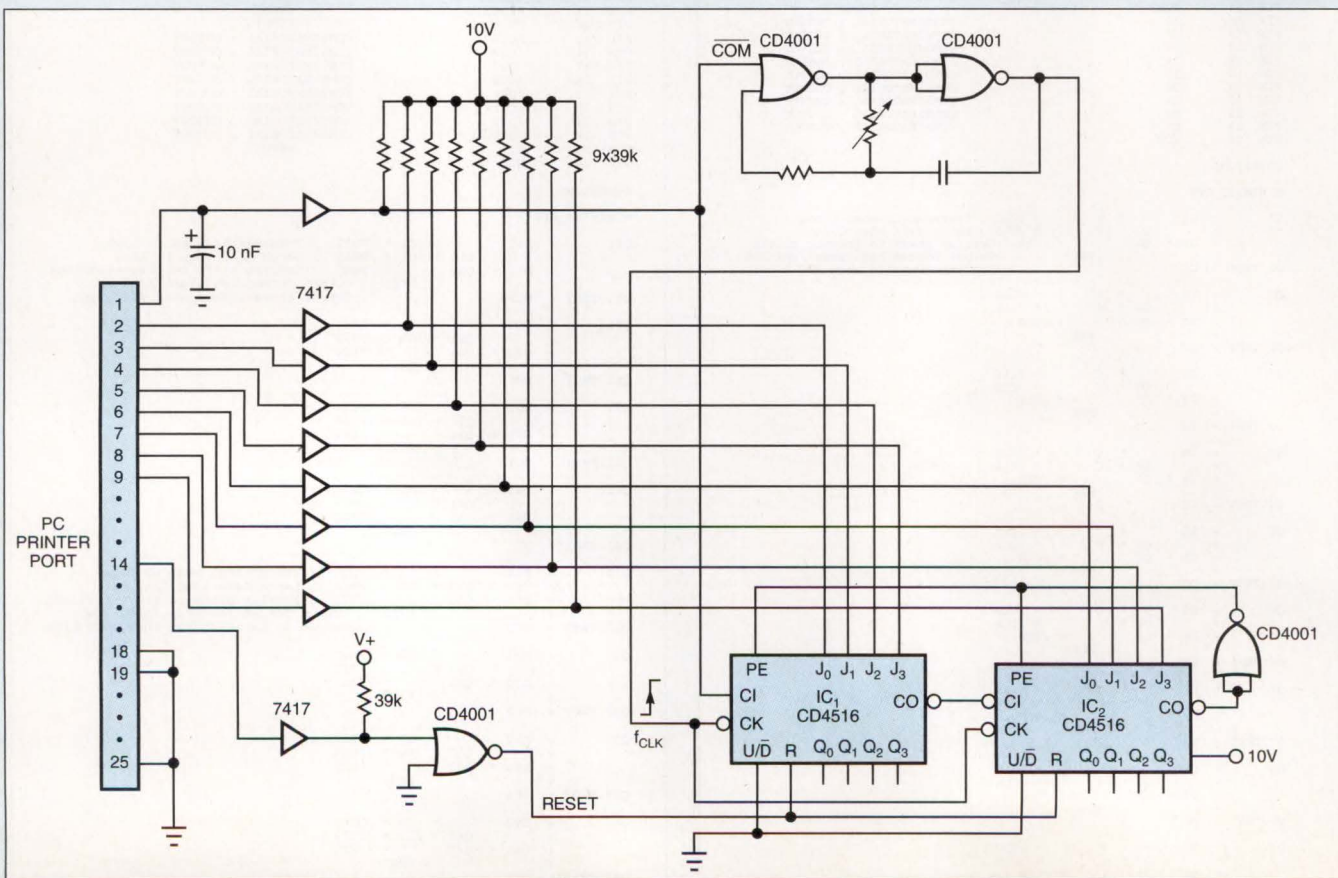
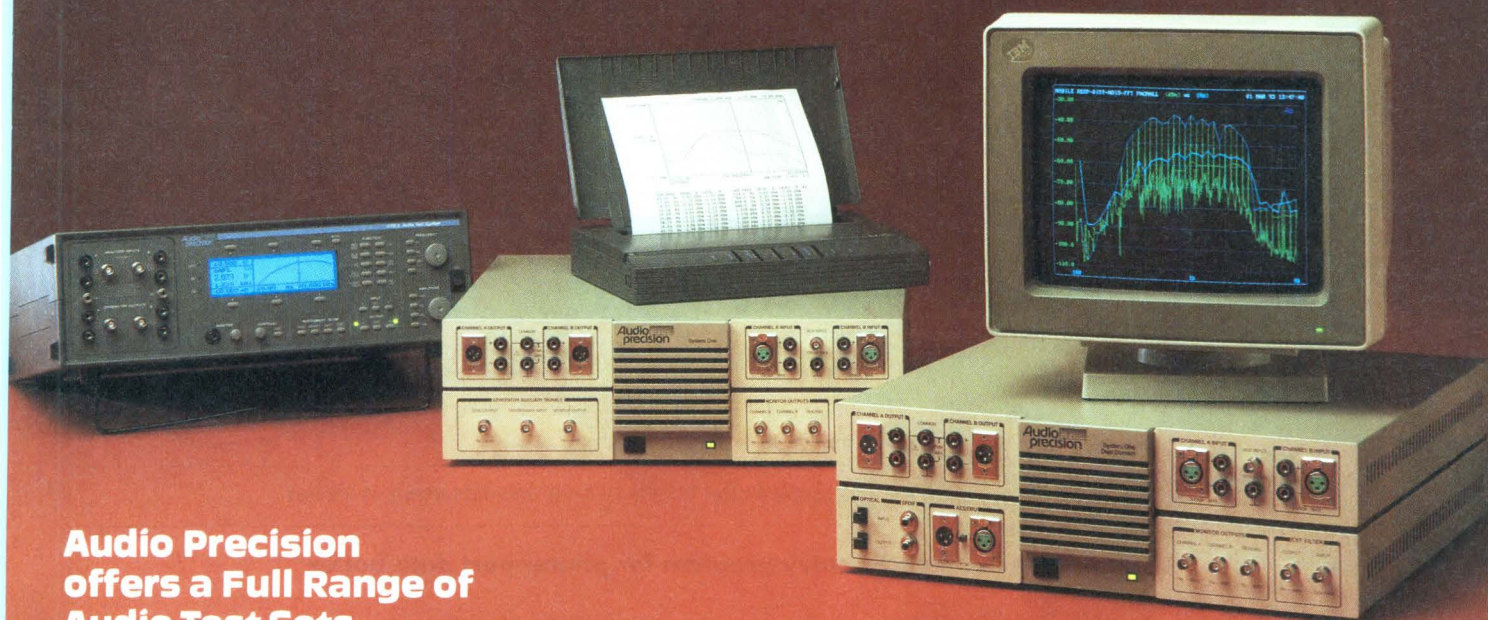

Fig 1—An IBM PC supplies a binary-coded integer divisor circuit to this circuit's pair of synchronous, presettable binary counters.

FAST FASTER FASTTEST

High Speed Audio Frequency Testing



Audio Precision offers a Full Range of Audio Test Sets ...

FAST

ATS-1 is a competitively priced audio test set featuring front panel and GPIB programmable operation as well as higher performance and speed than the typical audio testers it replaces. Both Audio Precision and HP 8903B GPIB command sets are supported. A sample suite of 43 measurements¹ takes only 33 seconds. The dual channel ATS-1 is at home in production floor environments thanks to its rugged fan-cooled enclosure and front or rear mount modular connector panels.

FASTER

System One automated integrated audio test sets measure distortion, frequency, phase, wideband or selective noise, and crosstalk in production test environments benefiting from high speed and performance. System One can make a sample suite of 43 measurements¹ in 21 seconds. Optional spectrum analysis and digital domain signal generation and analysis capabilities make it the one-stop audio test system. Available both in GPIB and PC controlled versions, System One is today's recognized standard in audio testing.

FASTTEST

System One DSP versions test any audio channel in the *fastest* possible time. With DSP power, **FASTTEST** completes the 43 measurement² example above in 2 seconds! System One **FASTTEST** technology generates and analyzes special multi-sine wave test signals. These wideband signals provide complete frequency response, distortion and noise measurements from a single stimulus acquisition.

Audio precision

P.O. Box 2209
Beaverton, OR 97075-3070
(503) 627-0832 (800) 231-7350
FAX: (503) 641-8906

¹Sample suite of GPIB programmed audio measurements included 1) noise measurement (20Hz-22kHz bandpass).

²31 point single tone frequency response sweep over 20Hz-22kHz range, and 3) 11 point distortion sweep over 20Hz-22kHz range.

³**FASTTEST** uses multi-tone stimulus and analysis to make the same measurements listed above.

INTERNATIONAL DISTRIBUTORS: **Australia:** IRT Electronics Pty. Ltd., Tel: 2 439 3744 **Austria:** ELSINCO GmbH, Tel: (222) 815 04 00 **Belgium:** Trans European Music NV, Tel: 2/466 5010 **Brazil:** INTERWAVE LTDA, Tel: (21) 325-9221 **Bulgaria:** ELSINCO, h.e. Strelbishte, Tel: 92 581 698 **Canada:** GERRAUDIO Distribution, Tel: (416) 696-2779 **China, Hong Kong:** A C E (Int'l) Co. Ltd., Tel: 424-0387 **Czech Republic:** ELSINCO Praha spol. s r.o., Tel: (2) 4702 1 451, 452 **Denmark:** npp Elektronik aps, Tel: 86 57 15 11 **Finland:** Genelec OY, Tel: 77 13311 **France:** ETS Mesureur, Tel: (1) 45 83 86 41 **Germany:** RTW GmbH, Tel: 221 70913-0 **Greece:** KEM Electronics O.E., Tel: 01-6478514/5 **Hungary:** ELSINCO KFT, Tel: (1) 112 4854 **India:** HINDITRON Services PVTY, Tel: 22 836-4560 **Israel:** Dan-EI Technologies, Ltd., Tel: 3-544-1485 **Italy:** Audio Link s.p.a., Tel: 0521/648723 **Japan:** TOYO Corporation, Tel: 3 (5698) 6800 **Korea:** B&P International Co., Ltd., Tel: 2 546-1457 **Malaysia:** Test Measurement & Engineering Sdn. Bhd., Tel: 3 734 1017 **Netherlands:** TM Audio B.V., Tel: (0) 30 414070 **New Zealand:** Audio & Video Wholesalers, Tel: 7 847-3414 **Norway:** Lydconsult, Tel: 9 19 03 81 **Poland:** ELSINCO Polska sp. z o.o., Tel: (22) 39 69 79 **Portugal:** Acutron Electroacustica LDA, Tel: 1 9414087 / 9420862 **Singapore:** TME Systems Pte Ltd., Tel: 298-2608 **Slovakia:** ELSINCO Bratislava spol. s r.o., Tel: (7) 784 165 **South Africa:** SOUND FUSION, Tel: 11 477-1315 **Spain:** Telco Electronics, S. A., Tel: 1 531-7101 **Sweden:** Tai & Ton Elektronik AB, Tel: 31 80 36 20 **Switzerland:** Dr. W.A. Gunther AG, Tel: 1 910 41 41 **Taiwan:** ACESONIC Int'l Co., Ltd., Tel: 2 719 2388 **United Kingdom:** SSE Marketing Ltd., Tel: 71 387-1262

CIRCLE NO. 33

Printer-port data appears as bar on PC screen

Yongping Xia, EBT Inc, Torrance, CA

BBS Using the circuit in Fig 1, a PC's printer port can accept 8-bit parallel data. The 74HC241 in the circuit is a data buffer as well as a high/low nibble selector. The Borland C program in Listing 1 reads the high and low nibbles, reforming the 8-bit data and converting them to a vertical bar on the PC's screen. Moreover, the program can compare the input data with preset high and low limits, sending the results of this comparison back out through the printer port. You can obtain a copy of the listing from **EDN BBS/DI_SIG #1432**. Because the printer port powers the IC, the circuit requires no external power. (DI #1432)

EDN

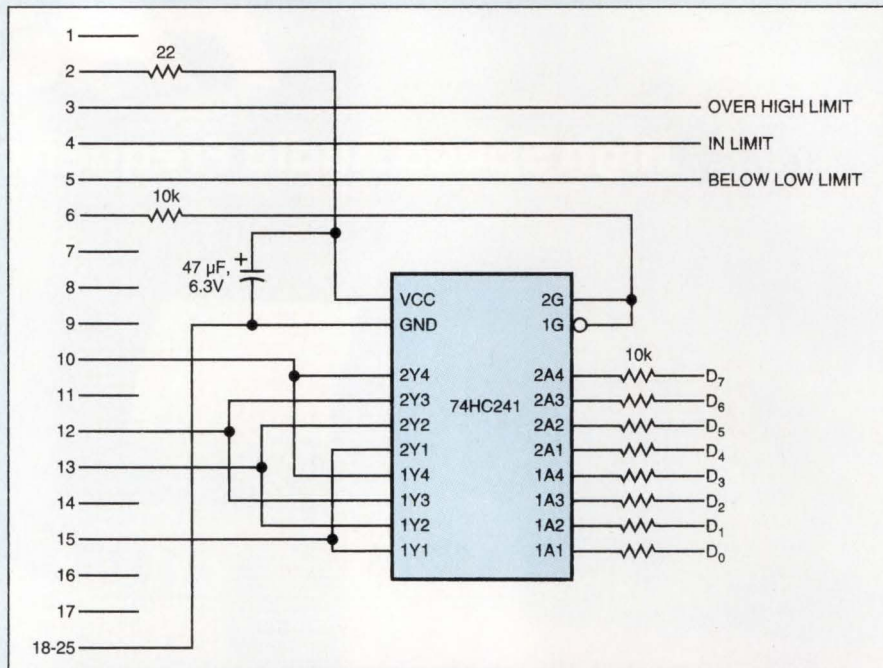

To Vote For This Design, Circle No. 347

Fig 1—This simple buffer breaks up 8-bit data into a pair of nibbles.

Listing—Command-and-display program for printer-port data buffer

```
#include <graphics.h>
#include <stdlib.h>
#include <stdio.h>
#include <conio.h>
#include <dos.h>
#include <bios.h>

#define POWER_ON 0x01
#define LOW_4BIT 0xef
#define HIGH_4BIT 0x10
#define CLEAN_OUT 0xf1
#define OVER_LIMIT 0x02
#define IN_LIMIT 0x04
#define BELOW_LIMIT 0x08
#define HIGH 0x90 /* high limit */
#define LOW 0x70 /* low limit */

typedef unsigned int WORD;

int data, out_port, in_port, out=0;
char msg[80];

main()
{
    find_port();
    init_graph();
    init_screen();
    do {
        out |= LOW_4BIT;
        outportb(out_port, out); /* set port to read low nibble */
        data=(inport(in_port)/8)&0xf; /* read low nibble */
        out |= HIGH_4BIT;
        outportb(out_port, out); /* set port to read high nibble */
        data*=(inport(in_port)*2)&0xf0; /* combine high and low nibbles */
        out |= CLEAN_OUT;
        outportb(out_port, out); /* clean comparason output */
        if (data>HIGH)
        {
            out|=OVER_LIMIT;
            outportb(out_port, out); /* send out over-limit output */
        }
        else if (data<LOW)
        {
            out |= BELOW_LIMIT;
            outportb(out_port, out); /* send out below-limit output */
        }
        else
        {
            out |= IN_LIMIT;
            outportb(out_port, out); /* send out in-limit output */
        }
        setviewport(0, 0, 639, 479, 1);
        setfillstyle(1, RED);
        bar(70, 30, 85, 286-HIGH); /* display over-limit bar */
        setfillstyle(1, GREEN);
        bar(70, 286-HIGH, 85, 286-LOW); /* display in-limit bar */
        setfillstyle(1, RED);
        bar(70, 286-LOW, 85, 286); /* display below-limit bar */
        line(70, 286-data, 85, 286-data); /* display data mark */
        line(70, 285-data, 85, 285-data);

        setviewport(68, 320, 95, 340, 1);
        clearviewport();
        sprintf(msg, "%d", data);
        outtext(msg); /* show data on screen */
        delay(100); /* quit if any key hit */
    } while (!kbhit());
    clean_up();
    return 0;
}

init_screen() /* initialize display screen */
{
    setbkcolor(BLUE);
    setcolor(WHITE);
    line(2,2,637,2);
    line(5,4,634,4);
    line(2,2,2,477);
    line(5,4,5,475);
    line(2,477,637,477);
    line(634,5,634,475);
    line(637,2,637,477);
    line(5,350,634,350);
    setviewport(450, 440, 630, 460, 1);
    sprintf(msg, "press any key to quit");
    outtext(msg);
    setviewport(0, 0, 639, 479, 1);
    return 0;
}

init_graph() /* initialize graphic mode */
{
    int gdriver = DETECT, gmode, errorcode;
    initgraph(&gdriver, &gmode, "");
    errorcode = graphresult();
    if (errorcode != grOk)
    {
        printf("Graphics error: %s\n", grapherrormsg(errorcode));
        printf("Press any key to halt:");
        getch();
        exit(1);
    }
    return 0;
}

find_port() /* find printer port's address */
{
    out_port=*(WORD far *)MK_FP(0x0040,8);
    in_port=out_port+1;
    out |=POWER_ON;
    outportb(out_port, out); /* power on */
    delay(1000);
    return 0;
}

clean_up() /* close graphic mode */
{
    closegraph();
    return 0;
}
```

How to Get a Benchful of Signals Without a Bench Full of Generators.

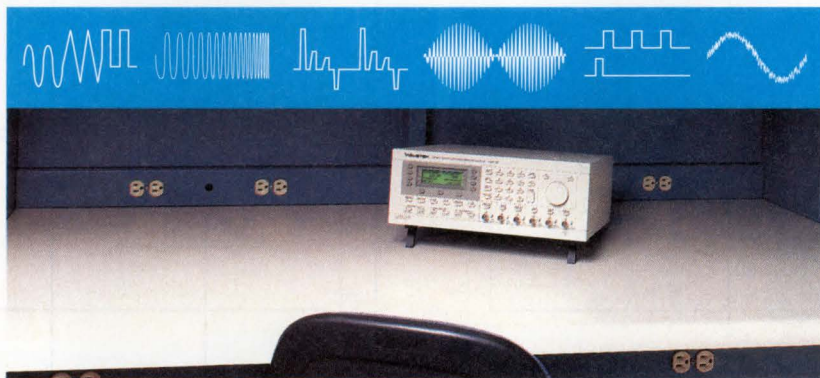

Gone are the days of scouring the lab for function-specific generators.

At a price that's less than many single-purpose generators, Wavetek's new Model 395 does the job of seven different signal sources and does every job extremely well.

In an instant you can choose from a host of signals, from clean sine

waves up to 40 MHz to complex pulse trains and arbitrary waveforms. When you use Model 395 as a pulse generator, for example, you can individually control the amplitudes, widths, and rise and fall times for up to ten pulses in a train. On-screen help makes

signal selection easier than ever.

You can create many signals that might otherwise require hooking

together two, three or more generators. With gating, looping, linking, signal summing, and complete arbitrary waveform capability, our universal signal source can produce just about any waveform you can conceive. You can even store any setup for later use – for recall at the

touch of a button!

So come to the source for all your signal needs. Call Wavetek today at **1-800-223-9885**, and get all the details on the new Model 395 universal signal source.

**Take your choice:
function generator,
sweep generator,
pulse generator,
modulator,
trigger generator,
noise generator,
arb, and all of
the above.**



The Universal Signal Source.

U.S.A.:(619)279-2200 / U.K.:(603)404824 / Germany:(089)96 09 49-0 / Hong Kong:(852)865-1903

©1993 Wavetek Corporation

CIRCLE NO. 113

WAVETEK

Simple ADC is surprisingly accurate

Mike Walne, Farnell Instruments, Wetherby, West Yorkshire, UK

The reference voltage in **Fig 1a**'s simple rail-to-rail PWM ADC is the only critical component. The input-voltage range extends from ground to the power rail which also acts as the reference. The circuit is essentially a variation on the classic dual-slope integrator, the slopes being proportional to V_{IN} and $V_{REF} - V_{IN}$. The circuit works well in μP -based systems that have the spare capacity to perform the mark/space measurement and the necessary calculations.

Assuming that there is no loading, the output voltage is a square wave with amplitude equal to V_{REF} and a mean equal to V_{IN} . Provided that the period is much greater than the dig-

ital transition times, the principal source of error is the input offset voltage of the op amp. The accuracy is at least 9 bits (and more likely 12) over the full operating-input and supply-voltage range with no trims. Working with a higher supply rail yields better accuracy. You can increase resolution by lengthening the time for the mark and period.

You can also use the circuit to measure the ratio of two resistors R_U and R_L as in **Fig 1b**. The mark/space ratio is then independent of V_{REF} and equal to R_L/R_U . (DI #1443) **EDN**

To Vote For This Design, Circle No. 348

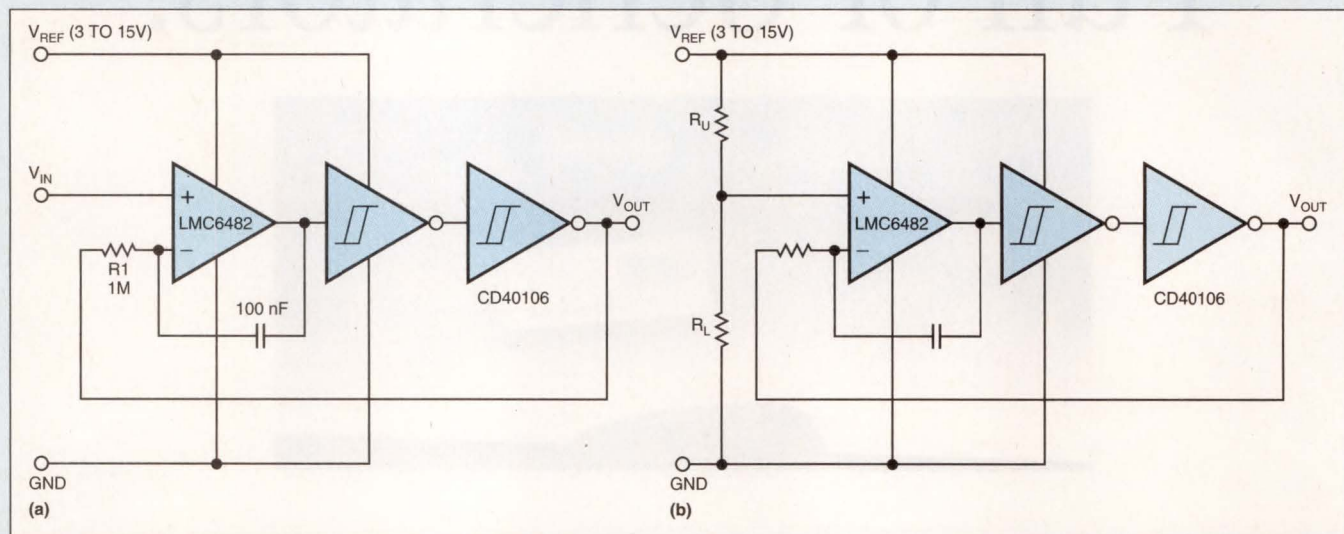

Fig 1—This simple ADC's output (a) is a PWM signal with a mark/period ratio equal to V_{REF}/V_{IN} . The circuit variation in (b) measures the ratio of R_L and R_U .

Precision clamp recovers in nanoseconds

Steven D Roach, Kaman Instrumentation, Colorado Springs, CO

High-speed ADCs sometimes place very strict limits on their allowable input-voltage range, limits that generally require the use of input clamps. Some applications require very temperature-stable clamps that don't interfere with the speed of a 50-MHz amplifier. **Fig 1** shows one such circuit that clamps positive-going voltages to 1.25V at 10 mA, and you can easily adapt it for negative-going voltages and different voltage and current levels. Recovery from the clamped state occurs in about 1 nsec.

This circuit improves on the conventional diode clamp in three major areas. First, the clamping voltage drifts at only a fraction of the -2 mV/C figure of a simple diode clamp. For even lower drift, you can replace the transistors with a monolithic matched pair. Second, by using the emitter of a transistor as the clamping element, the circuit easily obtains a low clamping impedance over a very wide range of frequen-

cies. Third, Q_1 recovers from the clamped state much faster than does a PN junction diode because there is no excess charge storage.

The op amp in the reference-circuit servo controls Q_2 to establish 1.25V at the emitter while carrying exactly 10 mA. The circuit also applies the base voltage of Q_2 to Q_1 . Assuming reasonable matching of the transistors, Q_1 clamps V_{OUT} at exactly 1.25V when the clamp reaches 10 mA. This occurs when V_{IN} reaches 2V. (Transistor base currents are assumed negligible in this analysis.) The 47-pF capacitors reduce the clamping impedance of Q_1 at high frequencies.

You can easily modify the clamping voltage and current by changing V_{CLAMP} and R_{BIAS} . The circuit can clamp negative-going voltages using NPN transistors in place of Q_1 and Q_2 and changing the supply-voltage polarity. You can combine NPN- and PNP-based clamping circuits for precision clamp-

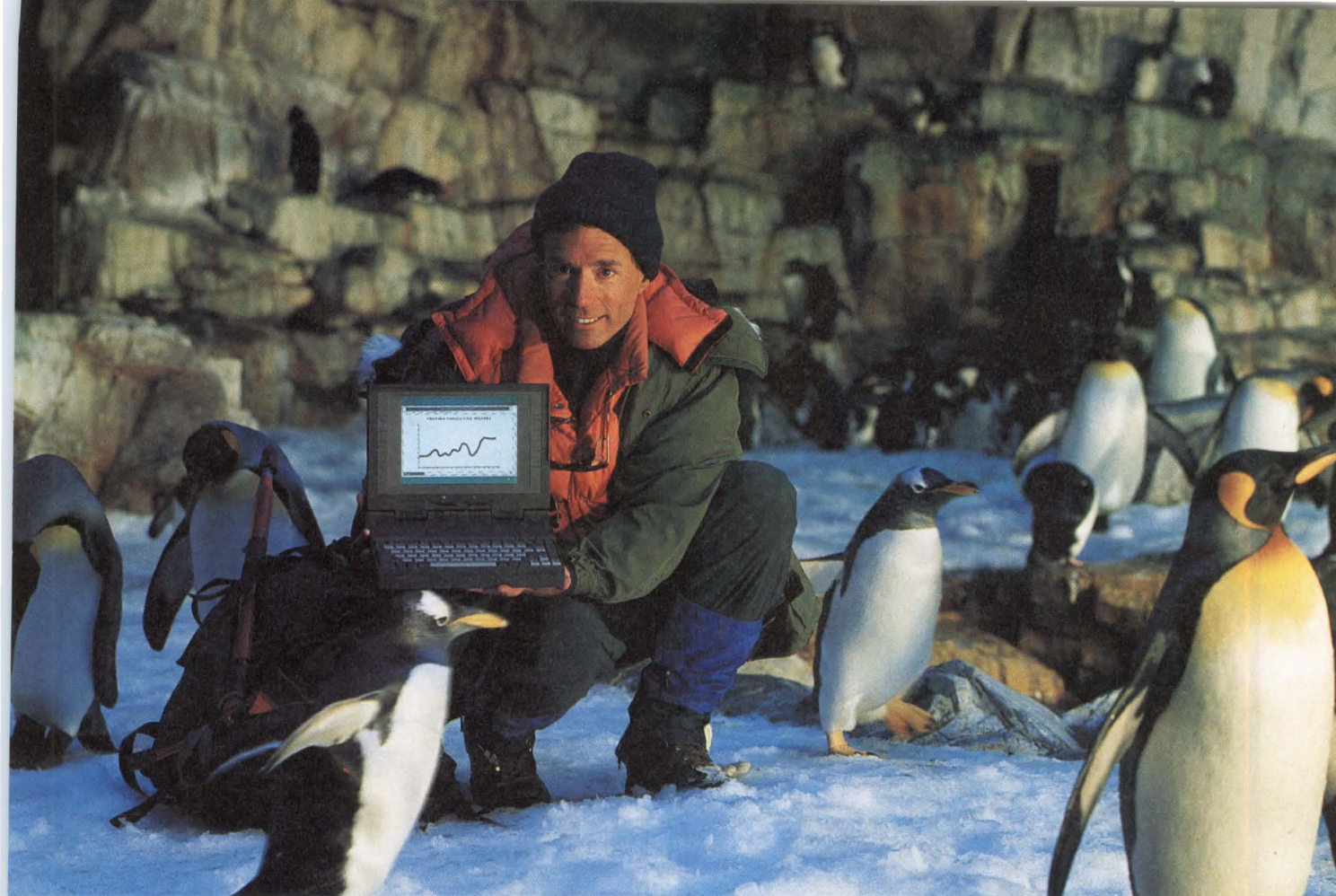

If you were 4,000 miles from spare parts, what 2mm connector would you spec?

For 2mm, trust 3M. Now available in convenient tape-and-reel packaging.

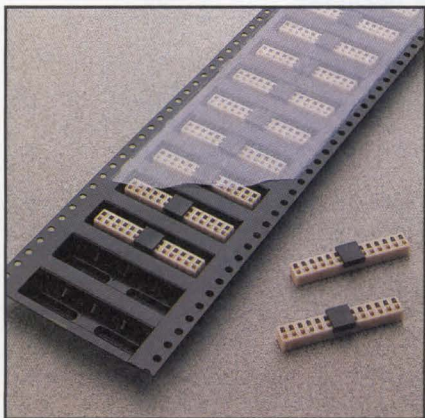

When it comes to reliability, 3M's 2mm connectors are second to none. They're tough enough to withstand the high-temp rigors of infrared and vapor phase soldering — without warping or blistering. They're compatible with vacuum pick-and-place equipment, providing precise placement every time. And, they possess the same 3M quality construction and durability that hallmarks every one of our products.

All of which means that they'll provide years of trouble-free service to the people who depend on your products day and night, even if that night lasts for months at a time.

Of course, those same qualities also mean you'll enjoy fewer manufacturing

problems, especially when you take advantage of our tape-and-reel packaging.

3M offers a full line of 2mm connectors, as well as custom engineering support. No matter what you need, we can build it. In fact, you could go to the ends of the Earth and not find a better, more reliable connector, or a more responsive supplier.

So, if failure leaves you cold, call 1-800-354-1919 and we'll send you more information on some of the hottest 2mm connectors around. 3M Electronic Products Division, 6801 River Place Boulevard, Austin, Texas, 78726-9000.



DELIVERY

In Crystals and Oscillators.

Delivery means responsiveness and peace of mind. You can be confident you'll get what you need when you need it. With Ecliptek crystals and oscillators.

Uncompromising quality standards and wide selection you can count on. Plus competitive prices to keep you within budget.

We put crystals and oscillators in a whole new light. See EEM 1993/94 for technical details. Or call 714-433-1200.



The Crystal and Oscillator Specialists

CIRCLE NO. 69

156 • EDN June 9, 1994

EDN-DESIGN IDEAS

ing in both directions. When using this circuit, be sure to consider the emitter breakdown voltage of Q_1 . (DI #1445) **EDN**

To Vote For This Design, Circle No. 349

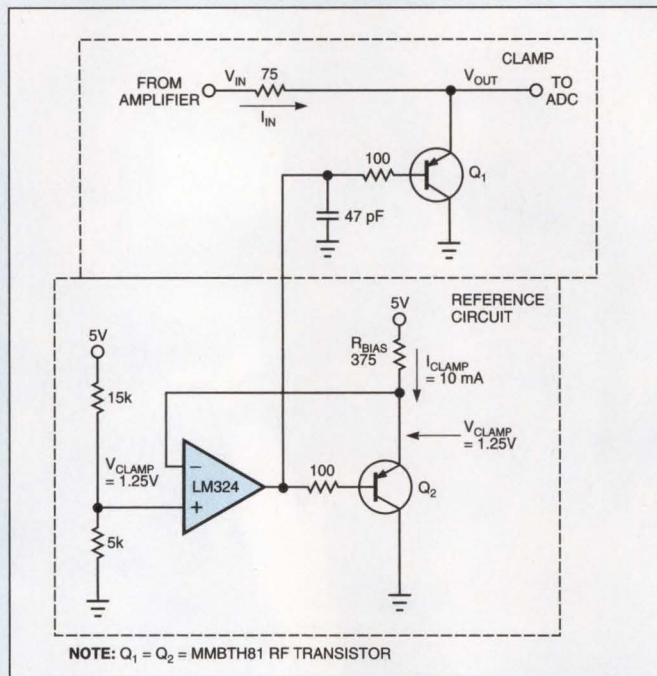

Fig 1—Compared with conventional diode clamps, this precision clamp circuit has lower drift, provides lower impedance over a wide range of frequencies, and, most important, recovers in nanoseconds.

SOFTWARE SHORTS

Switches simulate chopper

Brian A Freese, Storage Technology Corp
Louisville, CO

Just two switches in the pSpice subcircuit in **EDN BBS/DI_SIG #1409** simulate a chopper circuit. You can modulate positive, negative, or mixed-polarity waveforms.

To Vote For This Design, Circle No. 436

C routine straightens out PC printer-port inputs

William Grill, Riverhead Systems, Littleton, CO

The C routine in **EDN BBS/DI_SIG #1411** allows you to take advantage of the speed of your PC's parallel printer port to input data.

To Vote For This Design, Circle No. 437

These Software Shorts listings are too long to reproduce here. You can obtain the listings from the Design Idea Special Interest Group on *EDN's* bulletin-board system: (617) 558-4241, 310/1210/2410 8,N,1. From Main Menu, enter ss/DI_SIG, then rknnnn, where nnnn is the file referenced above.

Our Power Module is Dual... theirs is only single output!

- **Low Cost DC-DC Converters**
Single Outputs \$104 / Dual Outputs \$149
- **Dual Isolated Outputs**
28 Standard Models / Special Voltages Available
- **Wide Input Voltage**
Four Series / 18-380 VDC Input
- **Parallel Operation**
*Fixed Frequency 100kHz
True Redundancy Operation*
- **100 Watts**



Patent Pending

The availability of DUAL ISOLATED OUTPUTS creates cost and space savings in many applications.

Fully safeguarded for over voltage, over temperature and continuous short circuit protection, these FIXED Hi-Frequency units minimize technical problems.

With output voltages from 3.3VDC to 100VDC, four distinct input ranges and the choice of single or dual outputs plus the capability of Parallel Operation, as standard features, your circuit designs can be optimized.

Assembled in the U.S.A. with PICO quality components, these hi density units allow the most stringent mechanical, electrical and environmental requirements.

FAX or call today for immediate engineering assistance, product information or FREE catalog.

PICO Electronics, Inc.

453 N. MacQuesten Pkwy., Mt. Vernon, N.Y. 10552

Call Toll Free

800-431-1064

in New York Phone 914-699-5514

FAX 914-699-5565

HIGH POWER FACTOR

Custom Switching Power Supplies

- for ● Engineering work stations
- Computer main frames
- Computer peripheral equipment
- Business equipment
- Telecommunications
- etc.



- High power factor 0.99
- Design, manufacturing in Japan
- Repair center in U.S.A.

FDK also specializes in DC-DC converters, hybrid ICs, memory cards, ferrite cores, lithium batteries, stepper motors, optical isolators, etc.

FDK Your Best Strategic Partner
FDK AMERICA, INC.

A Division of Fuji Electrochemical Co., Ltd.
San Jose Office: 3099 North First Street, San Jose, CA 95134, U.S.A.
TEL: 408-432-8331 FAX: 408-435-7478

Dallas TEL: 214-650-7742 FAX: 214-650-7792
Boston TEL: 617-487-3198 FAX: 617-487-3199

CIRCLE NO. 144

A NONTRADITIONAL APPROACH TO EMI



EDN's DESIGNER'S GUIDE TO ELECTROMAGNETIC COMPATIBILITY can help alleviate any electromagnetic interference problems you may encounter. With more than fifty years of collective experience under their belts, Daryl Gerke and Bill Kimmel focus on practical insights and ideas about EMI to help you identify, prevent, and solve your EMI problems as you design your equipment. Topics include: noise and interference, EMI regulations, power disturbances, circuit boards, grounding, and troubleshooting. 88 pages.

Please send me _____ copies of EDN's DESIGNER'S GUIDE TO ELECTROMAGNETIC COMPATIBILITY @ \$19.95.

Sales tax (orders shipped to these states must include applicable sales tax: CA, CT, MA, NJ, NY)

Shipping: \$3.50/copy

Total _____

CALL TOLL FREE (800) 523-9654 (FAX 708-390-2779) to order. Or fill out this coupon and mail it to: Cahners Reprint Services, 1350 E. Touhy, Des Plaines, IL 60018

My check is enclosed payable to Cahners Reprint Services

Charge my credit card: Master Card Visa Amex

CREDIT CARD # _____ EXPIRATION DATE _____ SIGNATURE _____

NAME _____ COMPANY _____

ADDRESS _____

CITY _____ STATE _____ ZIP _____ PHONE _____

EDN-DESIGN IDEAS

Design Entry Blank

\$100 Cash Award for all published entries selected by editors. An additional \$100 Cash Award for the winning design of each issue, determined by vote of readers. Additional \$1500 Cash Award for annual Grand Prize Design, selected among biweekly winners by vote of editors.

To: Design Ideas Editor, EDN Magazine
Cahners Publishing Co
275 Washington St, Newton, MA 02158

I hereby submit my Design Ideas entry.

Name _____

Title _____ Phone _____

Company _____

Division (if any) _____

Street _____

City _____ State _____

Country _____ Zip _____

Design Title _____

Home Address _____

Social Security Number _____
(US authors only)

Entry blank must accompany all entries.

Design entered must be submitted exclusively to EDN, must not be patented, and must have no patent pending. Design must be original with author(s), must not have been previously published (limited-distribution house organs excepted), and must have been constructed and tested. Fully annotate all circuit diagrams. Please submit software listings and all other computer-readable documentation on a 5¼-in. IBM PC disk in plain ASCII.

Exclusive publishing rights remain with Cahners Publishing Co unless entry is returned to author, or editor gives written permission for publication elsewhere.

In submitting my entry, I agree to abide by the rules of the Design Ideas Program.

Signed _____
Date _____

Your vote determines this issue's winner. All designs published win \$100 cash. All issue winners receive an additional \$100 and become eligible for the annual \$1500 Grand Prize. **Vote now**, by circling the appropriate number on the reader inquiry card.

How to use our bulletin board



This icon identifies those Design Ideas that have computer-readable material posted on EDN's bulletin-board system (BBS). Call our free BBS at (617) 558-4241 (310/1210/2410 8,N,1). Not every Design Idea has downloadable material, but each one does have a BBS number printed at the end of it. If you'd like to comment on any Design Idea, include the number in the subject field of your message.

Avoid future shock: Transvidiate* with XTK™

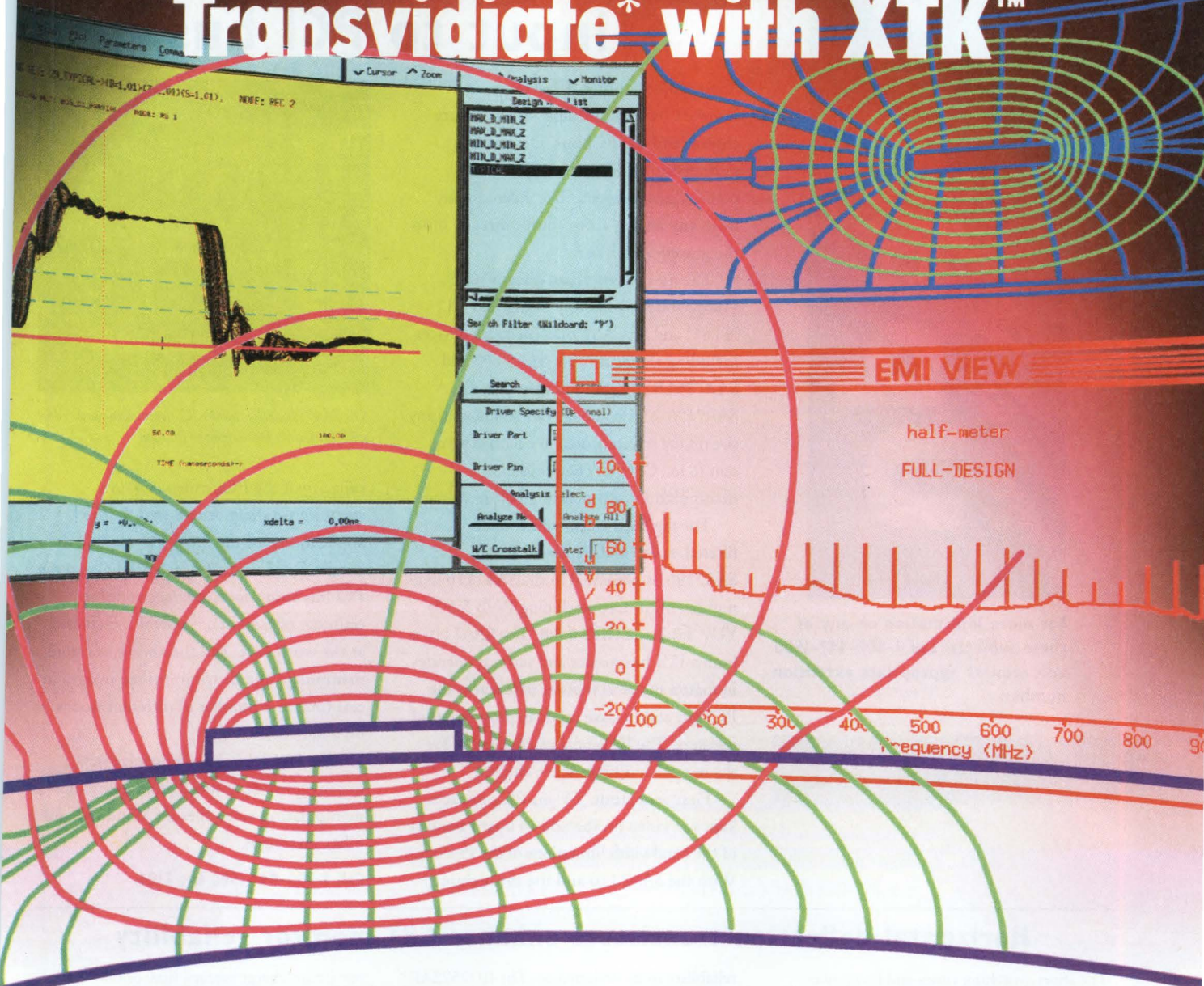

Identify signal distortions before they occur.

If the rigors of high performance design have you caught up in repetitive prototyping, break away with XTK (Crosstalk Tool Kit) from Quad Design. Simply stated, XTK is the most powerful and comprehensive signal integrity tool money can buy. It speeds your design cycle by pinpointing signal quality problems and predicting the effects of signal distortions prior to prototyping.

XTK automatically extracts topology and electrical parameters from PCB and MCM layout systems, allowing rapid and accurate simulation of lossy transmission line and crosstalk effects for entire digital systems. This, in addition to its speed and accuracy, makes XTK an essential element in increasing the quality of your high performance designs while decreasing product debug time.

For an even greater impact on your design cycle, XTK will soon be augmented by QUIET™ the industry's first integrated EMI tool kit. QUIET will not-so-quietly predict radiated noise from PCBs.

Avoid future shock by transvidiating with XTK. Call Quad Design at (805) 988-8250 and we'll send you a brochure on our whole fleet of predictive tools. 1385 Del Norte Road, Camarillo, California 93010... FAX (805) 988-8259.

CIRCLE NO. 154



SEE US AT DAC BOOTH NUMBER 735



* *transvidiate* (trans vid'è at') vt. *-a ted, -a ting* [TRANS (L. across, over) + VID (L. videre, to see) + -IATE]] **1.** to bridge the present and future by knowing all signal distortion effects of your digital circuit design before they happen **2.** to avoid future design mistakes while the design is still a vision **3.** to exist in the future presently — *trans-vid'i-a'tion* n.

For more information on any of these subjects: call 1-800-447-1500 and request appropriate extension number.

All Philips Semiconductors plants worldwide are ISO 9000 certified

New DTV chip links video input to PCI bus

A new video capture IC serves as an interface between Philips' video capture chipset and the PCI bus. Designed in partnership with Intel, the SAA7116 permits instantaneous live video display from any analog video source directly onto the graphics monitor.

The new IC interfaces directly with Philips' extensive family of digital PAL, NTSC and SECAM video decoder devices including the SAA7196, SAA7110 and SAA7151B. By combining it with the SAA7196, a video image can be scaled to any size on the screen, stored in a hard drive or sent to the CPU for compression, manipulation or processing before storage.

The digitized video, which can be filtered, scaled and translated by the SAA7196, is presented to the SAA7116 in a number of formats, including RGB 5:5:5, YUV 4:2:2 and RGB 8:8:8. The SAA7116 is both a PCI bus master and slave. It operates in master mode to transfer data across the PCI bus and in slave mode to program local registers. The IC generates I²C control for the rest of the Philips video chipset.

First generation TV-on-PC products kept the video on the add-in board because of the bandwidth limitations of the ISA bus. With the SAA7116 and the throughput

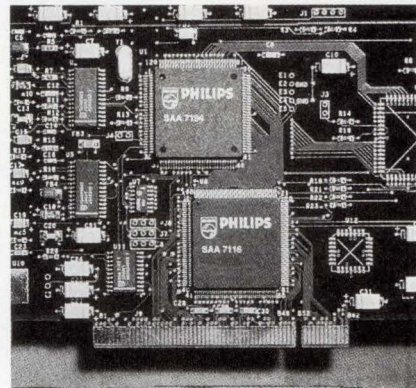

The SAA7116 video capture IC, designed in partnership with Intel, links video input to PCI bus.

capacity of the PCI, video can now stream onto the motherboard. Future applications for the SAA7116 include the possibility of sending video straight from the PCI bus onto a local area network for training, education or general information at the workplace, and the ability to create, manipulate and distribute video images in real time to a number of different nodes on a network.

The SAA7116 is an impressive step towards providing speed and facility in manipulating video files on Windows and other platforms.

Call 1-800-447-1500 Ext 1126

Horizontal deflection transistors enhance CRT monitor reliability

The short switching times and low power losses achieved by Philips Semiconductors' two high-speed high-voltage npn power transistors significantly reduce power dissipation in the horizontal deflection circuits of CRT monitors. A narrow gain spread between transistors, resulting from carefully controlled diffusion processes, together with 100% testing of their RBSOA (reverse bias safe operating area) simplify the analysis of worst-case operating and fault conditions, allowing maximum circuit

reliability to be designed-in. The BU2522AF and BU2527AF are targeted for use in 14- to 17-inch high-resolution monitors operating at horizontal scan rates up to 64 kHz.

The transistors are 1500 V devices designed to operate at mean collector currents between 5 and 7 A. Their DC maximum and peak collector current ratings are 10 A and 25 A respectively for the BU2522AF and 12 A and 30 A for the BU2527AF. When switching a mean current of 6 A in a 64 kHz horizontal deflection circuit, both transistors show a

maximum charge storage time of only 2.0 μ s, and maximum collector turn-off fall times are 0.25 μ s for the BU2522AF and 0.20 μ s for the BU2527AF. These very short switching times are major contributors to the low power dissipation and high reliability achievable.

The transistors are housed in SOT199 plastic power packages with electrically-isolated seating planes which eliminate the need for thermally-conductive washers between transistor and heat sink.

Call 1-800-447-1500 Ext 5015

First low-voltage IC for economic NiCd and NiMH battery management

A new low-cost LV-HCMOS battery management IC, the 74LV4799, is the first of its kind to be designed for operation from supply voltages between 0.9 and 6 V so that it can be used with one to four rechargeable NiCd or NiMH cells. Intended for 'intelligent' batteries and applications with integrated batteries, the low-power device is ideal for use in domestic appliances, personal care products, cordless tools, personal communications, data handling and many other consumer applications.

An on-chip oscillator, driver and up/down counter maintain a highly accurate log of the battery status and the charge, self-discharge and discharge times. The IC features automatic switchover to trickle charge at the end of the charge time, and can be adjusted to support

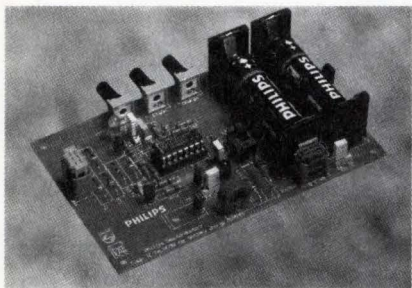

A demonstration board is available for evaluating the 74LV4799's performance in various battery charging applications and with different battery types. Virtually all types of rechargeable batteries. Typical charging time is between four and 16 hours.

Battery status indication includes an LED output for charge/battery full indication and a 'nearly empty' output for driving an LED or buzzer. The energy remaining can be detected by using the serial scan output, which represents the status of the internal counter. Built-in power-on reset initiates the IC when the battery is used for the first time or if it is disconnected. For maximum flexibility, the power-on sense input accepts input frequencies from DC to 100 kHz and voltages up to 10 V. The 74LV4799 is supplied in a 16-pin DIL package or in an SO minipack for surface mounting.

Call 1-800-447-1500 Ext 1127

Low power IS-54 chipset speeds time-to-market

Philips Semiconductors has introduced a low power, highly integrated chipset that meets the IS-54 TDMA (Time Division Multiple Access) North American digital cellular standard. The four-chip set provides designers with a complete radio solution for portable cellular handsets.

The dramatic growth in cellular phone usage has led service providers to convert a portion of their analog channels to a digital format. TDMA allows multiple users to share one channel at the same time, and the IS-54 digital standard provides for an analog link to satisfy those areas that do not endorse the TDMA standard. Dual mode operation requires higher integration and performance than other standards, and the new integrated chipset meets the challenges.

Incoming and outgoing signals are routed from chip to chip with minimum use of power while optimizing connectivity. The four chips are the SA601 RF front end, the SA637 digital IF receiver, the SA7025 dual

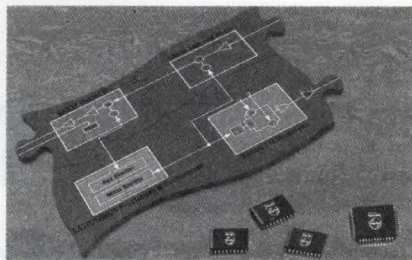

The new Philips chipset simplifies the design and implementation of the IS-54 standard.

frequency fractional-N synthesizer and the SA900 I/Q transmit modulator.

The new chipset offers a number of advantages to the cellular phone manufacturer. By using a low power chipset, designed from the start to work together, engineers can quickly create a phone that will be less expensive, offer longer talk time with fewer batteries, and still meet the exacting requirements of the IS-54 standard.

Call 1-800-447-1500 Ext 1125

Low-voltage low-power frequency synthesizers for mobile communication systems

Three new dual-frequency synthesizer ICs offer the lowest power dissipations per synthesizer currently available, offering operation at supply voltages as low as 2.7 V. Between them, these devices cover the frequency range 50 MHz to over 2 GHz, with each device being optimized for use in particular mobile phone systems.

The UMA1015M serves CT1/CT1+ cordless and AMPS/(E)TACS/NMT analog cellular systems, the UMA1018M serves GSM and the UMA1020M DCS1800 and DECT systems. The UMA1020M is the only dual synthesizer in the world to offer over 2 GHz synthesis from a 2.7 V supply. All three synthesizers are also suitable for a wide range of other RF frequency synthesis applications.

All the synthesizers feature two independent frequency synthesis loops, direct drive to a voltage-controlled oscillator, and auxiliary output ports for control of other handset functions. With current consumption of

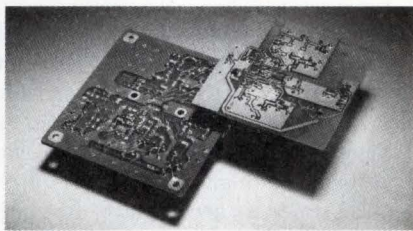

New dual-frequency synthesizer ICs mean that Philips now provides low-voltage low-power solutions to RF frequency synthesis in handsets for all the latest mobile phone systems.

typically only 10 mA, power-down modes which reduce standby power consumption to just 20 μ A, plus high-speed on/off switching capabilities, these ICs can effectively increase time between battery charges in hand-portable telephones.

The synthesizers are programmed via a high-speed, serial interface, allowing the user to control the main and reference dividers, charge-pump operating mode, auxiliary control outputs and power-down modes. The devices are fabricated in Philips' QUBiC BiCMOS process to achieve the necessary combination of high speed and low power consumption.

Call 1-800-447-1500 Ext 1124



PHILIPS

Windows NT brings uniformity and low cost to EDA

Bill Fuchs, Simucad

The Windows NT operating environment is a major advancement in the continuing evolution of operating systems and their associated graphical user interfaces.

Windows NT provides a level of integration between operating systems (OSs) and graphical user interfaces (GUIs) the computer industry has never seen before in high-performance systems. Although Apple's Macintosh operating system includes many powerful user-interface features, it lacks the performance high-end users require. Windows NT and NT-based products are about to revolutionize the computer industry, especially engineering software.

The reason for this revolution is simple: Windows NT is very much like Unix—but without most of Unix's problems. Until now, engineers have had to use Unix for high-level design tasks. But, although Unix is available for most high-performance computers, Unix versions are usually unique to each computer. Versions of Unix include Apple Computer's AUX, Digital Equipment's Ultrix, Hewlett-Packard's HP-UX, IBM's AIX, and Sun Microsystems' SUN-OS and Solaris. Xenix and numerous other System V-based Unix variants are available for X86-based PCs. Unix proponents once touted the variety of Unix offerings as its greatest strength. But today, the multitude of versions is one of Unix's most significant handicaps. This situation is particularly true for software developers—especially those software developers who support multiple computer brands.

A clear example of Unix's weakness occurred a few years ago when Mentor Graphics decided to support additional workstations along with the Apollo, upon which the company's orig-

inal Idea system ran. After a lengthy decision, Mentor took a few years to port its products to Sun workstations. Furthermore, Mentor delayed introducing many of its more powerful software products on Sun workstations for more than another year. The result was devastating for Mentor, its shareholders, its stock value, and most important, its loyal customers. It is impossible to determine whether the differences between the Unix OSs and their associated GUIs were the sole cause of the problems at Mentor. Nonetheless, assuming that these differences were responsible for some of the difficulties is reasonable.

For developers who support many computer brands, the nightmare consists of having to maintain a workstation and all of the related, specialized peripherals required to support software development for each hardware system. The following equipment is required to construct a complete software-development environment for a single software developer using a workstation:

- A computer with adequate performance

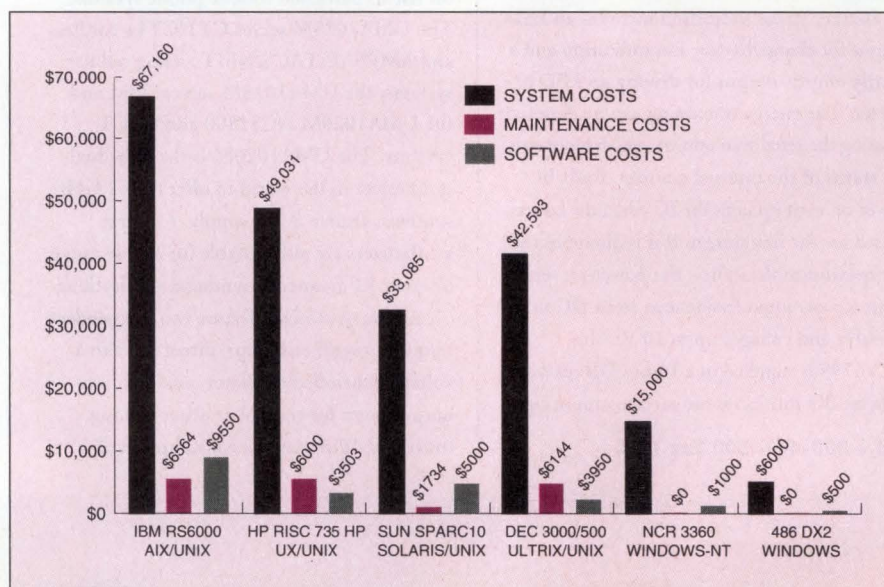

Fig 1—The real cost of a software-development environment includes hardware-system costs, maintenance costs, and software costs.

Look who's running with the pack.



Compaq has joined Duracell in leading the charge for the advancement of standard sized rechargeable batteries for portable computers.

We're not merely keeping the pace. We're setting it. In fact, standard sized DURACELL® Nickel-Metal Hydride Rechargeable Batteries last up to 40% longer than ordinary nickel cadmium batteries. And for the new Compaq Contura Aero subnotebooks, that means as much as four to six hours of battery life with the DURACELL DR19 and DR31.

The DR19 and DR31 are two in a family of four standard sized DURACELL Rechargeable Batteries designed for a wide variety of portable computers. This way, retailers can carry fewer battery sizes, while consumers enjoy longer battery life and the convenience of worldwide availability.

The race to mass market is on. And Duracell is working harder to keep your portable computers running longer.

DURACELL®
RECHARGEABLE BATTERIES

WINDOWS NT SOFTWARE DEVELOPMENT

- Enough hard-disk capacity for Unix, X (the X Window System), Motif, the system development kit (SDK), and other related development tools and quality-assurance tests
- A CD-ROM drive to load the OS, X, and Motif
- A high-density tape drive to load and offload applications and files
- DAT to handle system backups
- Additional network utilities and system memory to test large-design capacity (required for simulator development)
- Assorted application software such as the Motif SDK, editors, debugging tools, and networking software.

The price for a typical Sun Sparcstation 10 that can handle a task of this scope is about \$40,000, not including the application software. The problem is that software developers need a complete configuration for each computer they target for development. If developers choose to support DEC, HP, IBM, and Sun, their development environment could easily cost several hundred thousand dollars, considering the cost of hardware, software, and annual maintenance fees associated with workstations. However, these costs are *not* the most significant limitation to developing under Unix.

Unix's real costs

The real costs associated with developing Unix applications are the time and resources to port software—particularly graphical software—to each architecture's version of Motif, Unix, and X. In addition, whenever you upgrade one of these software modules to a new version, it may create compatibility problems with previous versions (Fig 1). The time and resources to coordinate the elements of this development environment directly translate into the extremely high purchase price of Unix-based applications (especially the price of electronic-design-automation (EDA) software). This effort also directly relates to the delay in getting new products, new releases, and updates to market on time.

This problem does not exist with Windows NT running X86

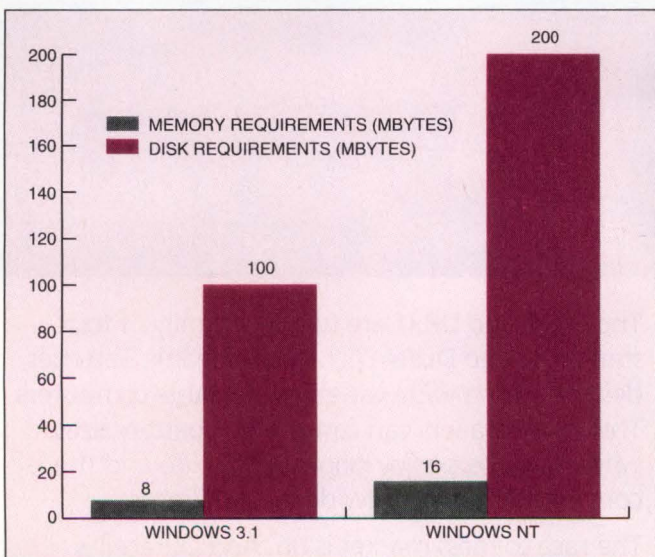

Fig 2—Windows NT turns out not to be the memory hog that some predicted.

PCs. All PCs run the same version of Windows NT, just as they do DOS and Windows. This similarity means that developers require only one X86 system and its related peripherals to develop under Windows NT. The completed programs run on every X86 PC without recompiling for each brand of hardware. This attribute is an extremely important one of Windows NT, not only from the software developers' perspective, but also from the users' perspective. With a common OS and GUI, users no longer are limited to a specific brand of hardware to obtain the software tools they want.

The workstations that run Windows NT, such as DEC's Alpha and MIPS R4000/4400, require recompilation of each application's source code. This recompilation occurs because the architectures of the workstations are different from those of the X86-based systems. Although recompilation is necessary, changes to the source code will probably be insignificant, provided that the workstation designers learn from their experiences with Unix and design their hardware to run the standard version of Windows NT.

A clear example of Unix's limitation in this area occurred when Simucad engineers tried to bring up Sun's new Solaris OS on a Sparc 10. Simucad has hundreds of man-years of experience working with various OSs and hardware configurations, but nothing prepared them for this experience.

When Simucad upgraded its Sparc 10, Sun notified Simucad that it had to install Solaris, and that Solaris was compatible with SUN-OS. Simucad's unique development environment, itself built under SUN-OS, should have been easy to port to Solaris. The company has significant in-house expertise and a great deal of knowledge about Sun's products.

Despite that expertise, bringing the development environment up to operational speed took more than five weeks. Sun provided very little assistance, and nobody knew how great a level of incompatibility exists between the two OSs. An even more obvious indication of the software problem was that Simucad engineers were working on the same computer as they had previously worked on. They anticipated having a working version of the company's product under Solaris in approximately four months.

In contrast, using Windows NT provided significant time-saving. Because NT is so new, Simucad had only around four man-years of experience with it vs 30 man-years with Windows and DOS. However, working with a new DEC Alpha system and a MIPS R4000, engineers not only brought up the development environment, but also built a working version of the product—in one day. The product port took 3 hours for the R4000 and 2 hours for the Alpha.

Designing high-performance software to operate in a computer-independent way presents many difficulties. Windows NT will help eliminate most of these concerns. When Simucad embarked on porting the Silos III simulation environment to Microsoft Windows 3.0, Simucad expected to encounter a great deal of difficulty in maintaining the performance advantages it had gained over the last few years.

About three months into the development, a working pre-alpha version of the product, although primitive, was functioning. Simucad's development engineer followed Microsoft's development guidelines for Windows and used the appropriate Windows calls and system tasks,

assuring a smooth-running, easily upgradable program.

One of the most interesting results of the initial development effort was an overall improvement in performance over DOS. But, perhaps more important, the final product is much easier to learn and to use than previous versions. Simucad focused on building not only a menu-based system but also a highly intuitive GUI. This interface entailed designing and implementing a system that goes beyond menus, scroll bars, dialog boxes, and mice. It required developing a common-sense GUI—a difficult task for a complex simulation environment.

Most GUIs for complex simulators require the user to memorize many abstract command strings, particularly for some of the more advanced debugging features. In addition, popular simulators, such as Verilog, also require programming knowledge for the more sophisticated aspects. Simucad engineers incorporated these features while staying within the programming guidelines for Windows.

Simucad tested its methods by distributing 100 beta-test versions of a new simulation environment without a single piece of supporting documentation. The results were astonishing. Every one of the 100 beta-test sites was able to use the simulator without difficulty by using their experience with other Windows-based tools. The only questions users asked were how to use the product's advanced debugging features. Simucad then included an on-line, context-sensitive help system, answering many of the users' questions. The Windows SDK supports adapting an intuitive GUI under Windows and Windows NT.

By following the structure of Microsoft's portable coding guidelines, the port from Windows 3.0 to Windows 3.1 was virtually effortless, and Simucad completed the development effort to port to the beta version of Windows NT in less than two months.

Developing under Windows NT offered many similarities to developing under Windows 3.0 and 3.1, but it also required many of the unique development strategies necessary when developing under Unix. Windows NT provides true preemptive multitasking, much as Unix does.

This multitasking requires a developer to consider how multiple versions of the application software can run and display results concurrently. This concurrency is of particular concern when a developer is building a simulation environment that must contend with many files of varying length and complexity from the execution of a process or multiple processes. In a multitasking environment, the developer must contend with numerous files directly related to each other for each simulation process and the potential for multiple simulation processes to execute concurrently. Only a sophisticated OS can handle this problem, and Windows NT proved capable of the task.

The development under Windows NT was similar in many ways to the development under Windows 3.0. Other developers told Simucad's developers that they would pay a severe performance penalty because Windows NT is slow, that painting and graphical refresh speeds are slower than those of Windows 3.1, and that Windows NT requires even more memory and disk space than does Windows 3.1, which some regard as a memory hog (Fig 2). Developers also warned Simucad that the beta version of Windows NT is replete with bugs.

As with any software under development, Windows NT

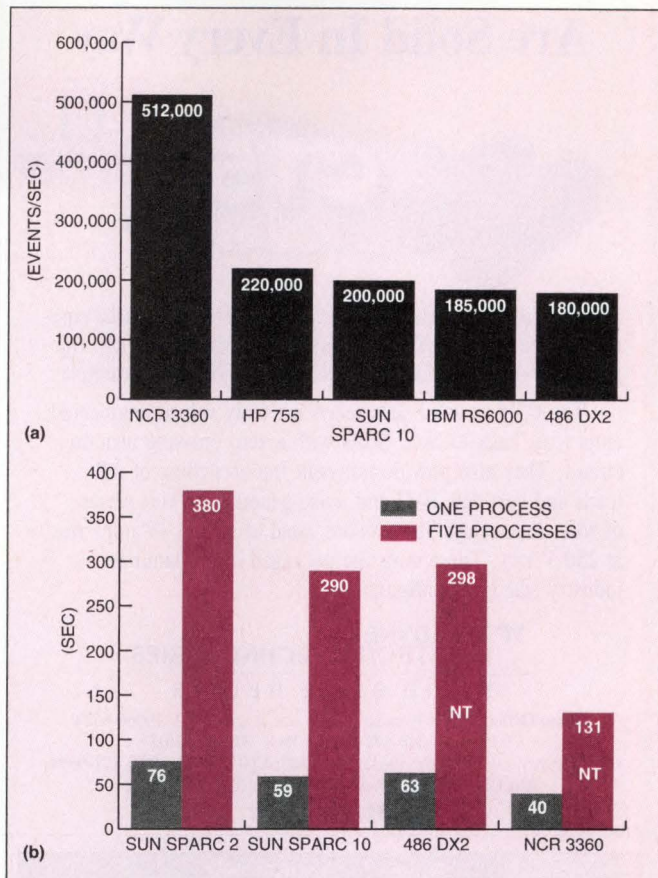

Fig 3—These software-performance results (a) and the multitasking-performance results (b) are early indicators of the performance you can expect from high-performance Pentium-based PCs.

had bugs. However, Microsoft responded promptly with fixes and work-arounds. In one case, the development engineer reported a problem to Microsoft on Friday afternoon and received a Federal Express package with a new floppy disk containing the bug fix on Monday morning.

The prediction of performance penalties under Windows NT was pure fiction. In fact, using Microsoft's C compiler (which is currently a beta version and which the Windows NT SDK includes), Simucad's Silos III simulator running under Windows NT realized a 15% performance improvement over the Windows 3.1 version running on the same computer. The company expects that with a final version of the C compiler and with some custom optimization of critical routines, the improvement could be around 35%.

When users consider such features as preemptive multitasking, multithreading, and true networking, along with this type of performance improvement, Windows NT seems a clear upgrade path. However, when you combine Windows NT with a high-performance PC, such as an NCR 3360 (dual 60-MHz Pentium μ Ps) and sufficient system memory and storage, you can have a system equal to or better in performance than any workstation.

To validate Windows NT's potential, Simucad uses its own hardware-performance test to determine system performance. The test comprises a string of devices in a chain that, when simulated with Silos III, provides a consistent measure

SOLID STATE IS OUR BUSINESS

Our Solid State Relays Are Solid In Every Way



25 years of solid state relay experience—commercial/industrial experience since 1968. All of our products contain that know-how. Our price/performance ratios are better than ever. Here is an example:

The C-15 ac solid state relays are truly valued engineered, employing back-to-back SCRs with a zero crossing turn on circuit. They also provide transient free switching of AC loads and very low EMI and noise generation. This series of solid state relays has versions rated at 10 and 25 amps rms at 250 V rms. These units are packaged in the familiar industry standard configuration.

**TELEDYNE
ELECTRONIC TECHNOLOGIES**
SOLID STATE RELAYS

Home Office, 12964 Panama Street, Los Angeles, CA 90066-6534

Telephone: 310-577-3825 • FAX: 310-574-2015

OVERSEAS: GERMANY: (0611) 7636-143; ENGLAND: (081) 571-9596;
BELGIUM: (02) 717-52-52; JAPAN: (03) 3797-6956.

CIRCLE NO. 107

Buyer in Trouble #99

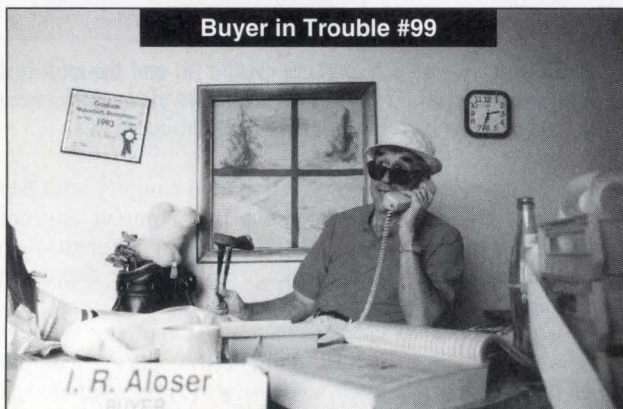

Losing the Golf War

"Rocky. This new catalog's not only got transformers, it's got golf balls guaranteed to go 400 yards. Don't scream, Rocky. I didn't know Prem had a new catalog.

But think about it, Rocky, 400 yards...

(CLICK!) Rocky?? Hello...Hello...

I really shoulda called Prem.

You oughta call Prem!"



Where Quality Really Counts!

For Prem's new catalog or additional product information, call or write

Prem Magnetics, Inc.,

3521 North Chapel Hill Road, McHenry, IL 60050.

Phone: 815-385-2700. FAX: 815-385-8578.

CIRCLE NO. 86

EDN-DESIGN FEATURE

WINDOWS NT SOFTWARE DEVELOPMENT

in events/second. This measurement is useful because it provides an accurate benchmark of raw hardware performance. The best rating previously generated was 220,000 events/sec on an HP PA-RISC series 755 tested in HP's porting lab. In contrast, the NCR 3360 delivered a rating of 512,000 events/sec, more than twice that of the highest rated workstation—and that was with a program compiled without full optimization (Fig 3).

One of the more significant benefits of Windows NT is that it does not require a systems expert to install and maintain. On the other hand, Unix's complexity dictates that an expert in Motif, Unix, and X install and maintain the utilities and assures that system upgrades (new releases) are compatible with existing utilities and application software. Windows NT's consistency and guaranteed compatibility between the OS and the GUI ensure relatively easy installation and smooth operation of Windows NT-based software.

Another benefit of Windows NT is that, like Windows, it provides device independence. Microsoft and hardware vendors support peripherals, such as hard drives, tape drives, modems, networking hardware, multimedia systems, and printers. If you have ever tried to get a nonstandard printer or peripheral to run under Unix, you know the value of this often overlooked benefit.

Windows NT has the necessary OS attributes for superior EDA-application performance. It provides all the benefits that make Unix so popular but differs from Unix in one key area: It combines the GUI with the OS without variance and without compromise. This benefit, although arguable, provides the finest level of compatibility and consistency available. In short, Windows NT is an operating environment, and Unix is an OS.

The combination of Windows NT and Pentium create a highly desirable paradigm for high-performance EDA. Because developing software under Windows NT is far less complex, less resource-restrictive, and less costly than it is to develop under Unix, the price of EDA software for Windows NT should be less than the equivalent software for Unix. Furthermore, the X86-based PC's ever-increasing capacity and performance continue to make it an even more attractive computer for which to target EDA tools. This attraction is true for both software developers and users alike.

The X86 PC requires much less overhead and maintenance than its Unix-based workstation counterparts and benefits from reduced start-up costs. Nonetheless, users will move to Windows NT in large numbers only when qualified EDA software products are available at reasonable prices. Therefore, users must demand high-quality, price-sensitive Windows NT-based EDA software from their EDA tool suppliers. **EDN**

Author's biography

Bill Fuchs is president and CEO of Simucad in Union City, CA. Bill has been with Simucad for six years. His job includes "everything but writing the code," he says. Fuchs enjoys playing basketball and restoring automobiles in his spare time.

Article Interest Quotient (Circle One)
High 598 Medium 599 Low 600



You're in good company with UL as your ISO 9000 Registrar.



Nearly 50,000 companies know us for the comprehensive safety certification, testing and inspection services we provide for their products. Now they — as well as many other companies — are also choosing UL for ISO 9000 quality registration for the same reasons.

At UL we provide the most thorough ISO 9000 registration service in the industry. Our experienced auditors work closely with you to make sure the process runs smoothly. Plus, UL's method of regular assessments eliminates the need for costly, full reassessments.

If your plans include business in domestic and international markets, come to the company that's known and respected throughout the world. We have numerous reciprocal international agreements. In fact, a single assessment with UL can provide you with multiple worldwide registrations.

So for prompt, thorough ISO 9000 registration services with the added value of the UL name and broad global acceptance, you're in good company with UL. For more information please call us at (516) 271-6200, ext. 22615.

Underwriters Laboratories Inc.®

We thank those UL clients who have granted UL permission to use their trade names and trademarks solely for the purpose of this advertisement.

8 lbs. of GORE high reliability

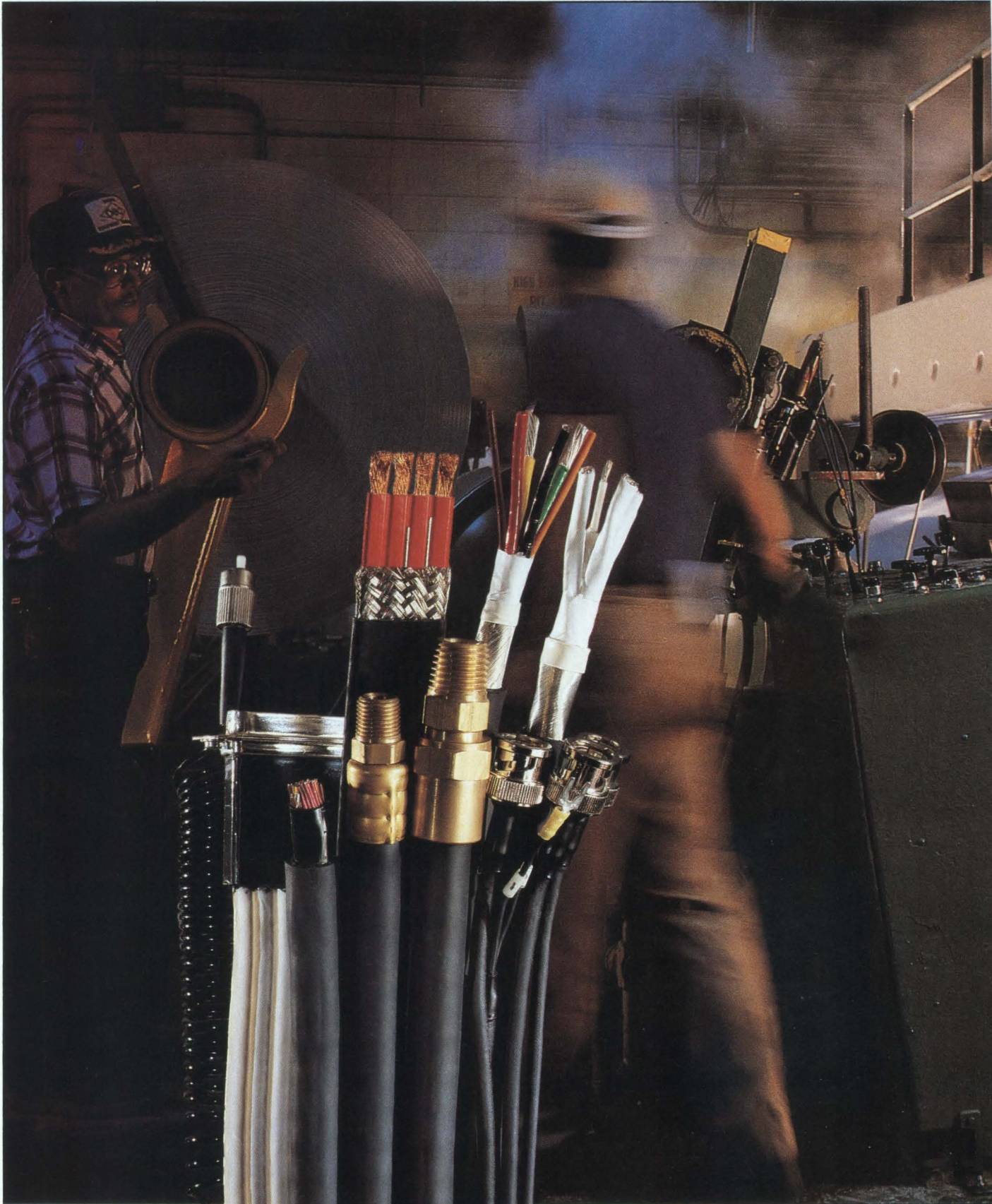

© 1993 W.L. Gore & Associates, Inc.

GORE is a trademark of
W.L. Gore & Associates, Inc.

AccuRay and Smart Platform are
trademarks of ABB.

**High reliability industrial cables from
Gore are available in podded, ribbon,
round, fiber optic or customized
packages.**

cables, 15 tons more production

A small part in big savings

Manufacturers around the world rely on ABB automation technology like this AccuRay® Smart Platform™ used in the paper industry. The Smart Platform™ must continually scan thousands of miles of paper as it is being produced. The electronic cabling in this field-proven ABB technology must reliably perform in heat, moisture and chemicals of harsh industrial environments. That's why ABB chose high-flex life cables from W. L. Gore & Associates, Inc.

Reliability through innovation

GORE offers design and material innovations for even the most demanding electronic cabling applications. Our high-flex single-axis cables eliminate the need for flex tracks while dramatically increasing flex cycles to over 10 million. By podding hydraulic, pneumatic, electrical and fiber optic lines, we can provide multi-functional systems that maximize savings. Rugged, high-flex GORE cables and assemblies are ideal for a multitude of automated functions. From machine tools and servo motors to resolvers, controls, vision and more.

Less downtime, better signals

The long term performance of GORE cable and assemblies directly reduces your downtime and overall maintenance costs. In one application ABB equipment using GORE cables allowed downtime to be cut in half, resulting in an additional 15 tons of paper production per week. At the same time you get the highest signal fidelity possible, ensuring smooth operation of all system electronics.

GORE offers innovative, high reliability signal management products for Industrial Electronics, Computer, Telecom, ATE, Microwave, Medical Equipment and many other markets. For more information or an evaluation sample of GORE high reliability interconnects call:

1-800-531-6064



Reliably Performing!

DIGITAL MEDICAL MICROWAVE INDUSTRIAL

W.L. Gore & Associates, Inc.

7811 Burselson-Manor Road • Manor, Texas 78653 • Fax: (512) 276-7614

Introducing the
Downsized 16-meg DRAM.
[At 300 mils, it's lost WIDTH.]

At 300 mils, our new 16-meg DRAM is, in a word, *svelte*. Especially when you compare it to the rather *fat* 400-mil part which has been the only way you could get a 16-meg.

And—size being size—the thin 300-mil gives you an advantage nothing

else does. It lets you put more into the same amount of space.

If you're a *Then.* *Now.* manufacturer of high-end workstations, mainframes, and supercomputers, you'll have the

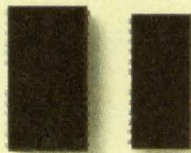

potential to increase your number of memory chips—and therefore your memory—by as much as 33 percent. Compared to what you get with the 400-mil part.

Samsung is among the first suppliers in the world to complete the 300-mil 16-meg. Partly because the



before

after



part's lead-on-chip construction—which is what makes it so much smaller than the now-standard part—is extremely difficult to manufacture. And building it marks one more in a long line of significant achievements in memory for Samsung.

We offer the 300-mil in both 5.0

and 3.3 volt. And if you build systems that benefit from a maximum of memory, you're probably going to want to take advantage of it—and all the width it lets *you* lose.

For more information, please call 1-800-446-2760 or 408-954-7229

today. Or write to DRAM Marketing, Samsung Semiconductor CA 95134.



SEMICONDUCTOR

A Generation AHEAD.

Technique eases design of high-order PLLs

Fred Salvatti, White Sands Missile Range

Maintaining stability in high-order PLLs can be a chore. Two design programs can assist you in designing stable types 2 and 3, third-order PLLs.

Designers are using PLLs in a variety of applications, including clock distribution. Because distributing high-frequency clocks (above 33 MHz) on a pc board can cause RF problems, such as clock skew and crosstalk, designers are instead placing PLLs wherever a high-frequency clock is needed and distributing a low-frequency clock to the PLLs on the motherboard. The PLLs multiply the frequency of the low-frequency clock to generate localized high-frequency clocks, avoiding the problems of high-frequency distribution.

To determine the stability of a PLL, you can use a stability-factor (SF) parameter (Ref 5). The SF replaces tables and charts with an intuitive measure of stability and simplifies the design of a second-order PLL. SF is a dimensionless quantity that equals the number of damped natural-frequency cycles/system time constant. The more cycles/time constant, the longer time required for the PLL to reach a steady-state value. SF applies to higher-order systems, such as types 2 and 3, third-order PLLs.

BBS The software listings in this article are available on EDN's computer bulletin-board system. Phone (617) 558-4241 with modem settings 300/1200/2400 8,N,1. Access /freeware SIG and specify /rlead option followed by /keyword search for "MS #681."

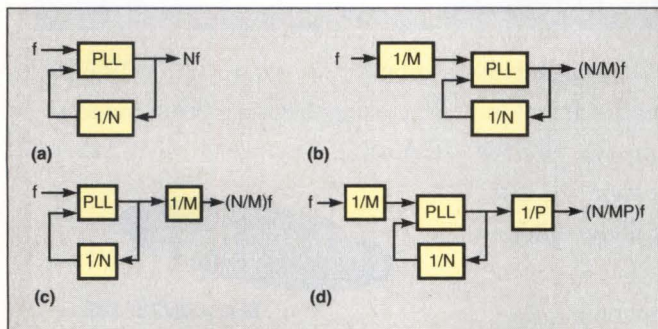

Fig 1—You can accomplish frequency multiplication by means of a PLL using one of four popular methods.

Fig 1 shows the basic methods for synthesizing a high-frequency clock from a low-frequency clock. Fig 1a shows the simplest method for multiplying by an integer. To multiply a frequency by a rational number, you must use the methods in Fig 1b or c. Because the bandwidth of the PLL should be smaller than the PLL's reference-input frequency to obtain good noise filtering and sideband suppression, designers prefer the method in Fig 1c. In cases in which method Fig 1c is not practical due to VCO range limits, the method in Fig 1d provides an alternative by lowering the input-reference frequency by 1/M.

High-order PLLs often find use in frequency-synthesis applications. The number of poles at the origin in the open-loop transfer function determines the type of the loop. The type also determines the steady-state tracking error. Because phase is the time integral of frequency, a frequency step produces a phase ramp, and a frequency ramp produces a constant phase acceleration. A Type 2 PLL tracks a reference frequency ramp with a constant phase error.

You can convert a Type 2, second-order PLL to a Type 2, third-order PLL by adding a single-pole RC filter to the out-

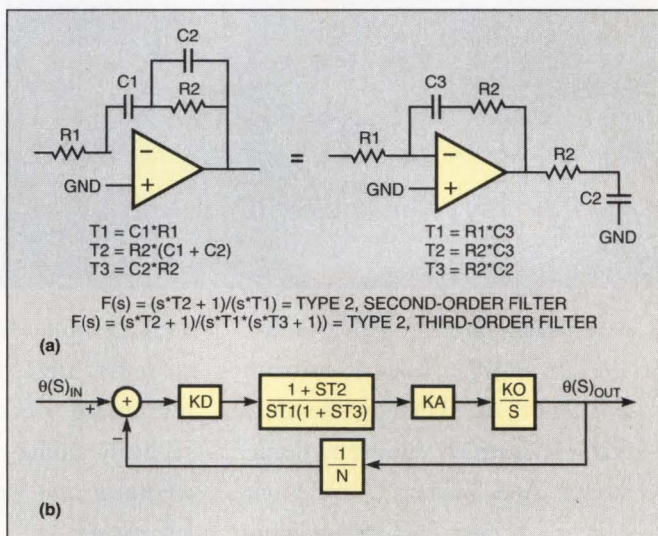
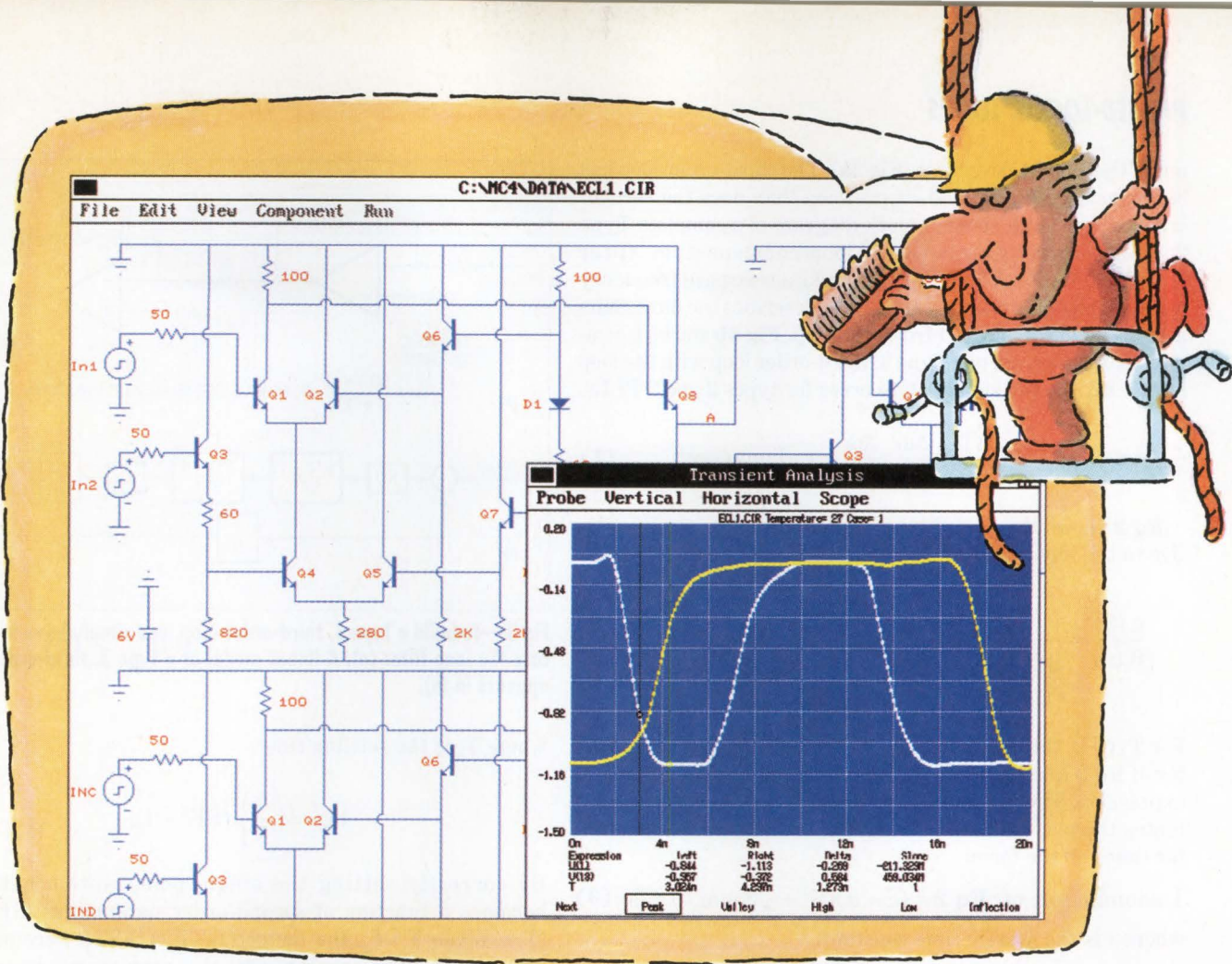

Fig 2—To convert a Type 2, second-order loop to a Type 2, third-order loop, you add another pole to the loop filter. (a) shows two methods of building the loop filter; (b) shows a block diagram of the linear model.



INTRODUCING MICRO-CAP IV.™ MORE SPICE. MORE SPEED. MORE CIRCUIT.

PC-based circuit analysis just became faster. More powerful. And a lot easier. Because MICRO-CAP IV is here. And it continues a 12-year tradition of setting CAE price/performance standards.

Put our 386/486 MICRO-CAP IV to work, and you'll quickly streamline circuit creation, simulation and edit-simulate cycles — on circuits as large as 10,000 nodes. In fact, even our 286 version delivers a quantum leap upward in speed. Because, for one thing, MICRO-CAP IV ends SPICE-file-related slowdowns; it reads, writes and analyzes SPICE text files and MC4 schematic files. It also features fully integrated schematic and text editors. Plus an interactive graphical interface — windows, pull-down menus, mouse support, on-line HELP and documentation — that boosts speed even higher.

Now sample MICRO-CAP IV power. It comes, for example,

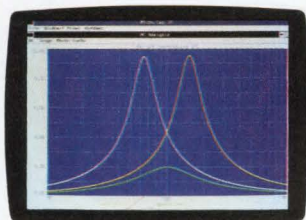

AC Analysis

from SPICE 2G.6 models plus extensions. Comprehensive analog behavioral modeling capabilities. A massive model library. Instant feedback plotting from real-time waveform displays. Direct schematic waveform probing. Support for both Super and Extended VGA.

And the best is still less. At \$2495, MICRO-CAP outperforms comparable PC-based analog simulators — even those \$5000+ packages — with power to spare. Further, it's available for Macintosh as well as for IBM PCs. Write or call for a brochure and demo disk. And experience firsthand added SPICE and higher speed — on larger circuits.

spectrum

1021 S. Wolfe Road
Sunnyvale, CA 94086
(408) 738-4387 FAX (408) 738-4702

PHASED-LOCKED LOOPS

put of the loop's active filter (**Fig 2a**). The third-order loop has better noise and sideband suppression than does the second-order loop. **Fig 2b** shows a block diagram of a complete Type 2, third-order loop with a loop-compensation filter $(1+ST_2)/(1+ST_3)$. A Type 3 PLL tracks a reference frequency ramp without any phase error. **Fig 3a** describes the filter characteristics of a Type 3, third-order loop. **Fig 3b** shows a complete block diagram of a Type 3, third-order loop with the loop filters. **Eq 1** is the steady-state error for types 2 and 3 PLLs.

$$e_{ss}(t) = \frac{\Delta\omega / \Delta T}{K_a} + \frac{\Delta\omega}{K_v} ; \frac{\Delta\omega}{\Delta T} = \text{radians/sec}^2. \quad (1)$$

Eq 2 shows the transfer function of the phase error relative to the input phase:

$$\frac{\epsilon(s)}{\theta_i(s)} = \frac{S^3 + S^2 \frac{1}{T_3}}{S^3 + S^2 \frac{1}{T_3} + S \frac{K_D K_A K_O T_2}{N T_1 T_3} + \frac{K_D K_A K_O}{N T_1 T_3}}. \quad (2)$$

For Type 2, third-order PLLs, you can factor the denominator of **Eq 2** into the products of a single pole and a quadratic expression. The complex pole-pair closest to the origin dominates the performance of the loop. The factored denominator takes on the form:

$$\text{Denominator of Eq 2} = (S + \alpha)(S^2 + \frac{2}{\tau}S + \omega_n^2) = 0, \quad (3)$$

where τ is the system time constant.

$$T_s = 2\pi\tau, \quad (4)$$

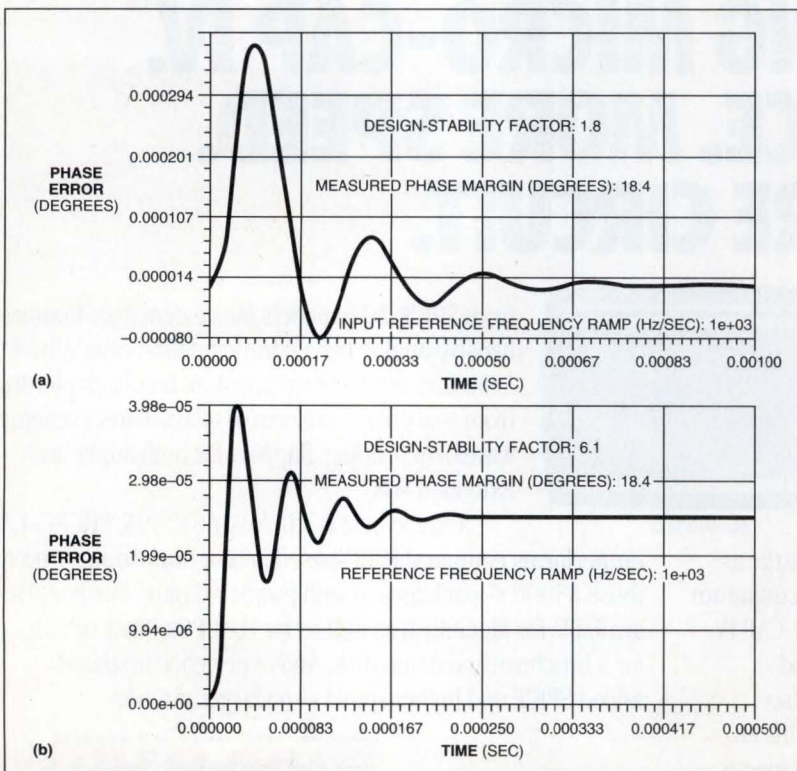

Fig 4—a shows the constant acceleration transient response of a Type 3, third-order PLL having a stability factor (SF) of 1.8. b shows the same response for a Type 2, third-order PLL having an SF of 6.1.

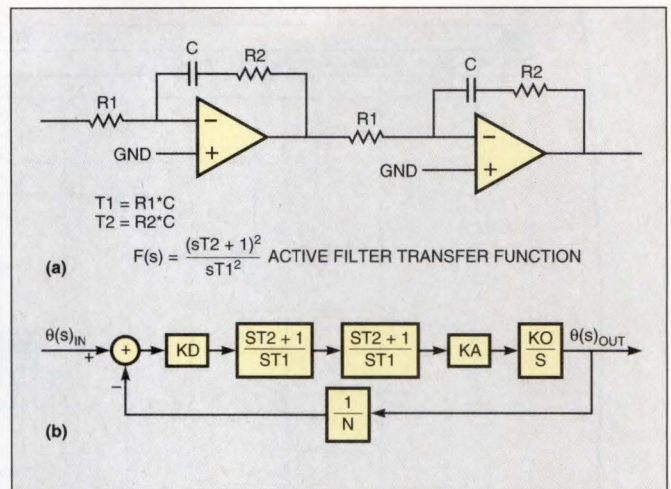

Fig 3—To build a Type 3, third-order loop, you simply have to duplicate the loop filter (a). A linear model of a Type 3, third-order loop appears in (b).

where T_s is the settling time.

$$\omega_n^2 = \left(\frac{1}{\tau}\right)^2 (SF^2 + 1). \quad (5)$$

By correctly setting the single pole, system behavior becomes a function of second-order parameters (SF) and (T_s). When $T_2 > T_3$, the factor $(1+sT_2)/(1+ST_3)$ becomes a phase-lead compensator, and the maximum phase lead occurs at

$$\omega_{0db} = \sqrt{\frac{1}{T_2 T_3}}. \quad (6a)$$

The design goal is to make the 0-dB crossover frequency of the open-loop Type 2, third-order transfer function identical to the frequency in **Eq 6a**. To ensure second-order dominance, impose the following restriction:

$$\alpha = 5 \times \omega_n. \quad (6b)$$

Equating coefficients in **Eq 3** and substituting **Eq 4** and **Eq 5**, you can arrange **Eq 6a** to be:

$$\omega_{0db} = 5 \frac{\sqrt{(SF^2 + 1)}}{T_s \sqrt{\frac{T_2}{T_3}}}. \quad (7)$$

You can determine the stability of higher-order systems by examining the phase margin. **Eq 8** from **Refs 1 and 2** gives the phase margin, given a phase-lead compensator of $(1+sT_2)/(1+ST_3)$.

$$\frac{T_2}{T_3} = \left[\frac{\cos \Phi}{(1 - \sin \Phi)} \right]^2, \quad (8)$$

where Φ = phase margin.

In addition, **Eq 9** relates the SF and the damping factor.

$$SF = \sqrt{\frac{1}{\zeta^2} - 1}, \quad (9)$$

where ζ is the second-order system-damping factor.

For second-order systems, **Eq 10** shows that the phase margin is a function of the damping factor or SF (**Ref 3**).

$$\Phi = \frac{\pi}{2} - \arctan \sqrt{\frac{1}{2} \sqrt{\left(1 + \frac{(SF^2 + 1)^2}{4}\right)} - \frac{1}{2}} \quad (10)$$

Using the relationships from **Eq 3 to 10**, you can solve for T_1 , T_2 , and T_3 for any given SF and T_s . A design program is available that accepts SF, T_s , and other PLL parameters as inputs. (See **box**, "How to get a copy of the programs.") The program then selects the required values for resistors and capacitors that produce PLL performance corresponding to SF and T_s .

The transfer function of the phase error relative to the input phase in **Fig 3b** is:

$$\frac{\epsilon(S)}{\theta_i(s)} = \frac{S^3}{S^3 + S^2 \frac{T_2 K_D K_A K_0}{NT_1^2} + S \frac{K_D K_A K_0 2T_2}{NT_1^2} + \frac{K_D K_A K_0}{NT_1^2}} \quad (11)$$

Again, factoring the denominator into the product of a single- and complex-pole pair yields:

$$\text{Denominator of Eq 11} = (S + \alpha)(S^2 + \frac{2}{T}S + \omega_n^2) = 0. \quad (12)$$

Ref 4 shows that the open-loop, 0-dB crossover frequency is:

$$\omega_{0db} = \frac{K_D K_A K_0 T_2^2}{NT_1^2}. \quad (13)$$

To solve for T_1 and T_2 , set the single-pole frequency to five times the value of the second-order natural frequency. Then, equate coefficients in **Eq 12** and substitute **Eqs 4 and 5**. A program is available to design a Type 3, third-order PLL using SF, T_s , and other PLL parameters.

Stability differs for PLLs

Generally, a Type 3 system is less stable than a Type 2 system because Type 3 PLLs have three integrators in the loop and Type 2 PLLs have only two. **Figs 4 and 5** show how the stability factor and phase margin affect Type 2 and Type 3 PLL behavior in the time domain. **Fig 4a** shows the time response for a Type 3, third-order filter, where SF=1.8 and the phase margin=18.4°. The loop is stable, but it takes an SF=6 to produce the same phase margin in a Type 2, third-order loop. **Fig 4b** shows the same time response for a Type 2, third-order loop under the same conditions.

Fig 5 shows that the Type 3, third-order loop is less stable than the Type 2, third-order loop.

HOW TO GET A COPY OF THE PROGRAMS

You can obtain a copy of the PLL programs mentioned in this article. A DOS PLL program on a 5¼-in., 1.2-Mbyte floppy disk contains the design of a Type 2, third-order PLL and costs \$29.95. Another 5¼-in., 1.2-Mbyte floppy disk contains a DOS program to design a Type 3, third-order PLL and costs \$39.95, plus shipping and handling. Send your orders to Fred Salvatti, 4644 Larkspur Court, El Paso, TX 79924 or phone (505) 676-5889. You must include payment with your purchase order. A demonstration program is available on EDN's bulletin board posted at MS681Z.ZIP on the /freeware Special Interest Group.

In **Fig 5a**, the Type 3, third-order loop becomes unstable when SF=2.7. The phase margin is 206°. **Fig 5b** shows that a Type 2, third-order loop is stable for the same SF and has a phase margin of 38°.

Tune the loop for the desired bandwidth

Recall that SF is the number of cycles/system time constant and T_s in **Eq 4** is a function of the system time constant. If you keep T_s constant and increase the number of cycles/time constant, you increase system bandwidth. Similarly, if you keep SF constant and increase T_s , then you decrease the system bandwidth.

Figs 6 and 7 show how you can decrease the rise time without increasing the bandwidth. Figure **6b** shows the open-loop performance when SF=2 and $T_s=0.0028$ sec. **Fig 6a** shows the corresponding rise time of approximately 0.00047 sec. **Figs 7a and b** show that by increasing SF to 2.7 and increasing T_s

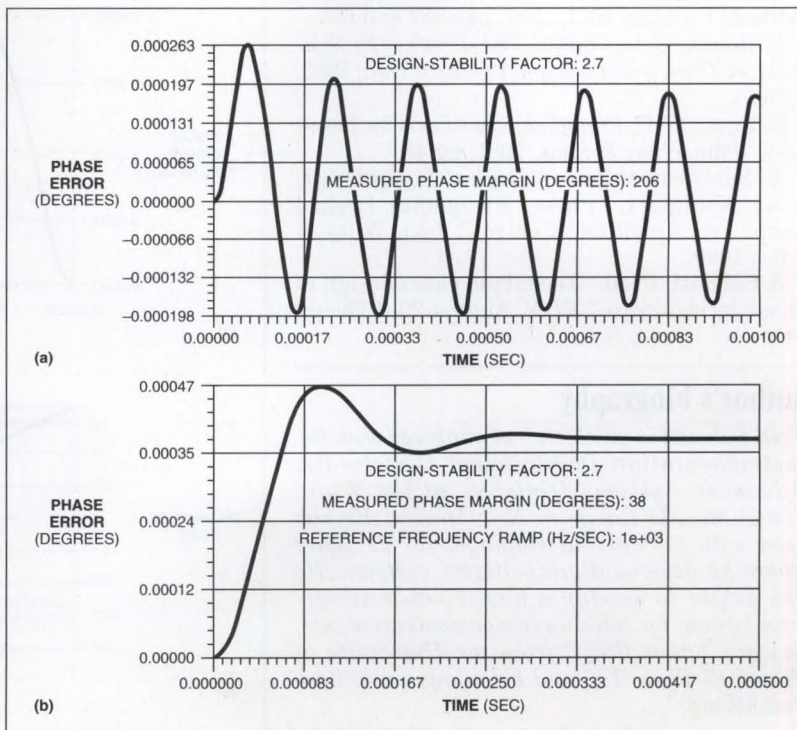

Fig 5—For a 2.7 SF, a Type 3, third-order PLL (a) is less stable (phase margin=206°) than a Type 2, third-order PLL (b) (phase margin=38°).

PHASED-LOCKED LOOPS

to 0.0045 sec, the rise time decreases to approximately 0.00037 sec. The bandwidth remains constant at 1.56 kHz. The figures also show that the damped oscillations die out after 0.00187 sec in both cases. The SF and T_s design parameters only approximate system performance; actual behavior may not be the same. However, using the design programs, SF and T_s let you quickly adjust to the desired performance.

Type 3 PLLs can be more difficult to design than Type 2 PLLs because they tend to be more unstable. However, the Type 3, third-order design program simplifies the design task. Using the program, you enter known or measured loop parameters, and the program computes and displays the component values to meet your requirements. Actual components, whose values only approximate the computed values, may cause the PLL to behave slightly different from what you expect. The program allows you to enter actual values, so that you can observe the transient and frequency response under actual conditions. Using this feature, you can observe the effects of component tolerances on loop stability. In addition, you can design even higher-order PLLs, such as fifth- and seventh-order loops, using the design program. EDN

References

1. Kou, B, *Automatic Control Systems*, Fifth Edition, Prentice Hall, 1987, pgs 652 and 655.
2. Rohde, U L, *Digital PLL Frequency Synthesizer Theory and Design*, Prentice Hall, 1983, pg 36.
3. Egan, W F, *Frequency Synthesis by Phase Lock*, John Wiley & Sons, 1981, pg 46
4. *Synchronization in Digital Communications*, Volume 1, "Phase, Frequency-Locked Loops and Amplitude Control," John Wiley & Sons, 1990.
5. Salvatti, Fred, "Technique eases design of phase-locked loops," *EDN*, August 20, 1990, pg 141.

Author's biography

Fred Salvatti is an electrical engineer with the Instrumentation Development Directorate, Advanced Systems Division, at the White Sands Missile Range in New Mexico. He has been with his current employer for 28 years where he designs digital-control systems. He has helped to develop a film-to-video conversion system for making image measurements. Salvatti has a BSEE from the University of Texas, El Paso, TX, and he enjoys computers and hiking.

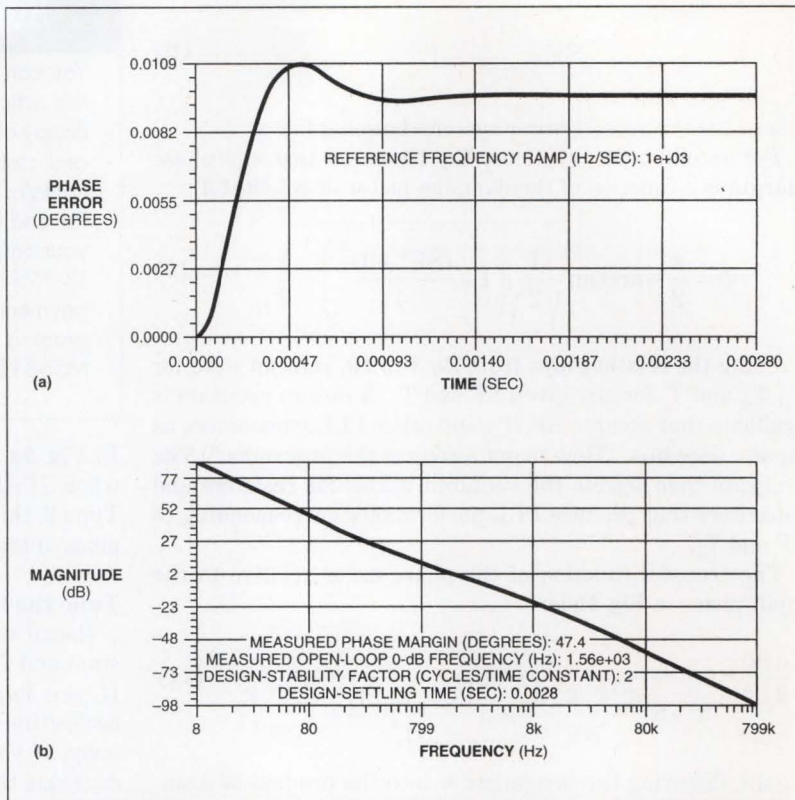

Fig 6—This design of a Type 2, third-order PLL employs an SF of 2 and a settling time (T_s) of 0.0028. The rise time is 0.00047 sec (a), and the open-loop 0-dB frequency is 1.56 kHz (b).

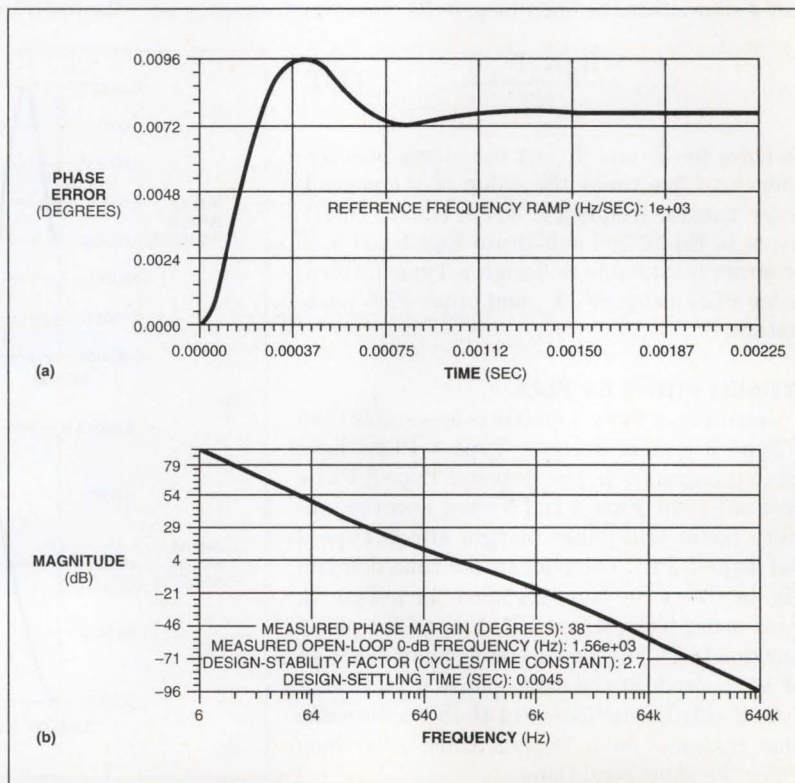
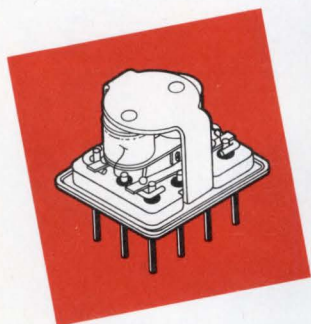

Fig 7—By changing the SF to 2.7 and the settling time (T_s) to 0.0045 sec, you can maintain the same bandwidth as Fig 6 and decrease the rise time to 0.00037 sec.

Article Interest Quotient (Circle One)
High 589 Medium 590 Low 591

THE HIGH PERFORMANCE GIGAHERTZ RELAY



- RF Switching up to 4 GHz
- Magnetic latching cuts power drain
- Convenient Centrigrid® package
- Aerospace and commercial versions

The TO-5 family of relays are great performers in RF switching applications. They are inherently that way. Low inter-contact capacitance. Low insertion loss. Up through 500 MHz. No problem.

But then you wanted them for even higher frequencies. You wanted gigahertz performance, and not just 1 GHz, but 3 or 4. That took some serious doing. But our combination of experience and innovation was equal

to the task. We married over three decades of TO-5 and Centrigrid® technology with some new techniques we developed to enhance the RF characteristics. The results? The gigahertz Centrigrid® relay (RF 170). We were able to extend the relay's performance from the MHz range to the GHz range. And handle RF switching functions all the way up to 4 GHz. The RF 170 has higher isolation across contacts and across poles over the frequency range.

The high performance gigahertz Centrigrid® relay (RF 170) will handle your toughest switching assignments, especially when power drain is critical. For price, delivery, and more technical information, call **1-800-284-7007** or Fax us at 1-213-779-9161.



TELEDYNE RELAYS
Innovations In Switching Technology

Home Office: 12525 Daphne Avenue, Hawthorne, CA 90250 • Telephone: 213-777-0077 • Fax: 213-779-9161

Overseas: GERMANY, (0611) 7636-143; ENGLAND, (081) 571-9596, BELGIUM, (02) 717-52-52; JAPAN, (03) 3797-6956

A NONTRADITIONAL APPROACH TO EMI



Misconceptions about EMI? *EDN's DESIGNER'S GUIDE TO ELECTROMAGNETIC COMPATIBILITY* can help alleviate any electromagnetic interference problems you may encounter. With more than fifty years of collective experience under their belts, Daryl Gerke and Bill Kimmel focus on practical insights and ideas about EMI to help you identify, prevent, and solve your EMI problems as you design your equipment.

Topics include: noise and interference, EMI regulations, power disturbances, circuit boards, grounding, and troubleshooting. 88 pages.

CALL TOLL FREE (800) 523-9654 (FAX 708-390-2779) to order.

Or fill out this coupon and mail it to:
Cahners Reprint Services
 1350 E. Touhy
 Des Plaines, IL 60018

My check is enclosed payable to Cahners Reprint Services

Charge my credit card:

Master Card Visa Amex

CREDIT CARD # _____ EXPIRATION DATE _____

SIGNATURE _____ PHONE _____

NAME _____

COMPANY _____

ADDRESS _____

Total _____ CITY _____ STATE _____ ZIP _____

Please send me _____ copies of *EDN's DESIGNER'S GUIDE TO ELECTROMAGNETIC COMPATIBILITY* @ \$19.95.

Sales tax (orders shipped to these states must include applicable sales tax: CA, CT, MA, NJ, NY) _____

Shipping: \$3.50/copy

The Smaller, The Better. Ultra Miniature SMD Crystal Clock Oscillators from Raltron.



CO4810
 Height: 2.0 mm

CO2300
 Height: 2.3 mm

- SMD miniature package
- High stability/reliability
- 3.3V version for battery applications

Frequency Range:
 1.8432 to 67 MHz

Frequency Stability:
 ± 50, ±100 ppm
 (-10° to 70° C)

Dimensions:
 (CO4810 / CO4910)
 7.5 mm length
 5.0 mm width
 2.0 mm height

CO4910
 Height: 2.0 mm

Call or fax your specs to:

RALTRON
ELECTRONICS CORP.

2315 NW 107 AVENUE
 MIAMI, FLORIDA 33172 U.S.A.
 FAX (305) 594-3973
 TELEX 441588 RALSEN
 (305) 593-6033

ONLY RALTRON HAS IT ALL.
 Crystals / Crystal Oscillators
 Crystal Filters / Ceramic Resonators

DUMB TERMINALS ... for smart engineers

**Better Ergonomic Features,
 Better Configurability.**

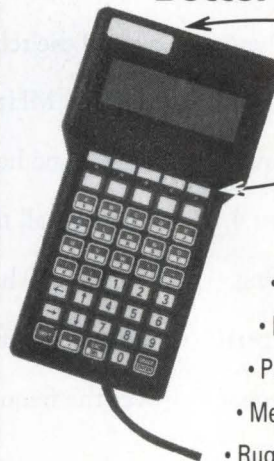

**FREE Logo and
 Top Key Customizing**

- Every key configurable
- More hardware options
- Multi-drop interface available
- More powerful command set
- Programmable indicator LEDs
- Metal snap-dome keys for crisp feel
- Rugged, attractive, comfortable case

QSI
 CORPORATION

QSI Corporation
 2212 South West Temple #46
 Salt Lake City, UT 84115-2648 • USA
 Phone 801-466-8770 (Fax 801-466-8792)

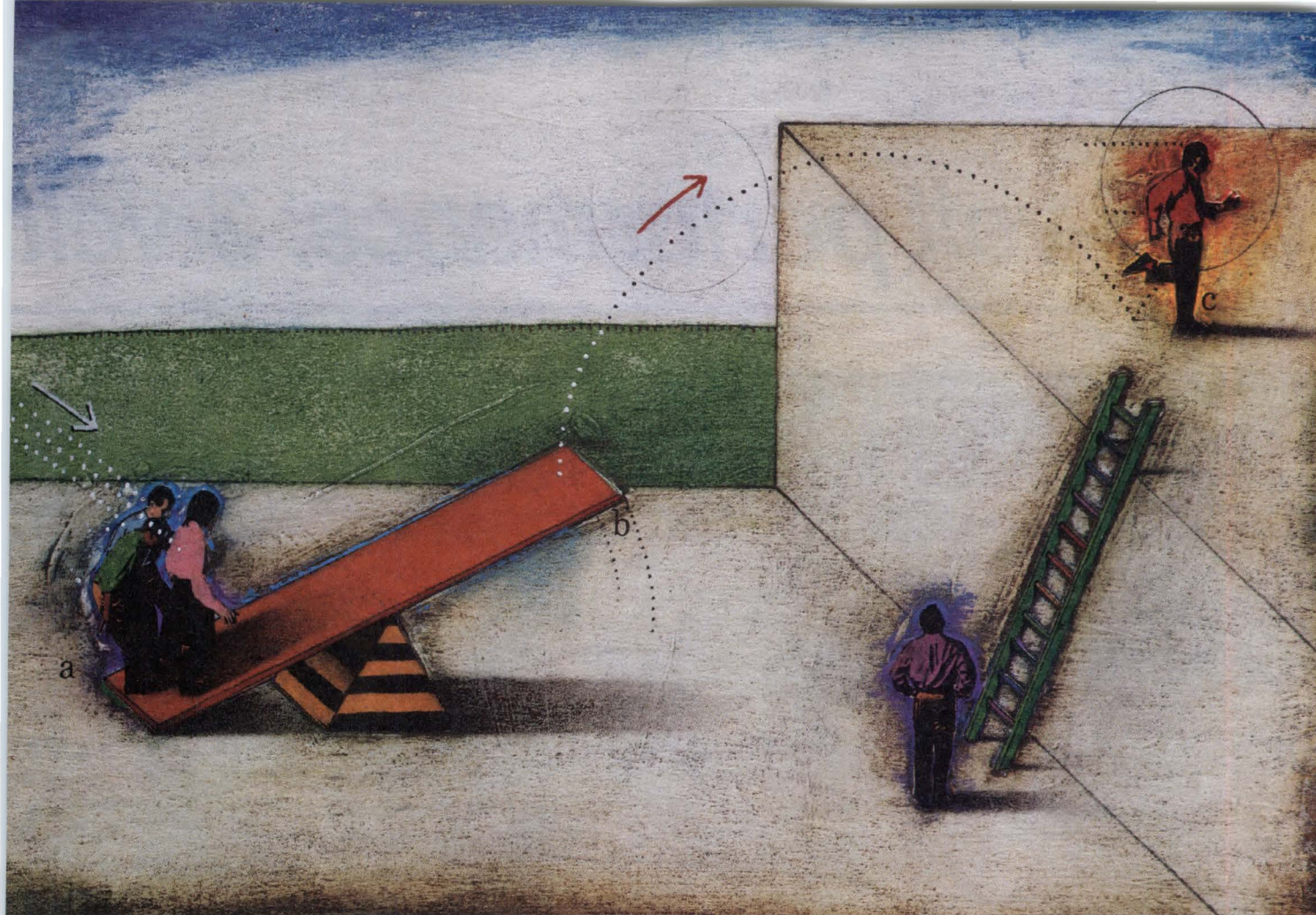

With the TMS320 Software Cooperative, it's easy to get a jump on your competition.

Now, beating your competition to market with a DSP-differentiated product isn't such a stretch. Just turn to the new TMS320 Software Cooperative. We've brought together information on more than 100 off-the-shelf, third-party-developed digital signal processing (DSP) algorithms for many of the applications you may be working on (or thinking about).

Once installed, these easy-to-use algorithms are C callable. And they help cut cycle time while allowing you



DSP Algorithms

- Speech Recognition
- MPEG Audio
- V.32 bis Modem
- V.17 Fax
- Text-to-Speech
- G.728 Speech Compression
- Run-Time Support Libraries
- And Many More

to differentiate your product instead of writing generic code for DSP functions. What's more, you'll deal directly with the third-party vendors who test, license and maintain the algorithms. Meaning you save time and product life-cycle costs.

To learn how you can get the jump on your competition and receive a FREE TMS320 Software Cooperative kit, which includes an index and data sheets on the algorithms, simply call **1-800-477-8924, ext. 3552.**

EXTENDING YOUR REACH WITH TOTAL INTEGRATION™

 **TEXAS
INSTRUMENTS**

5-volt performance. 3-volt

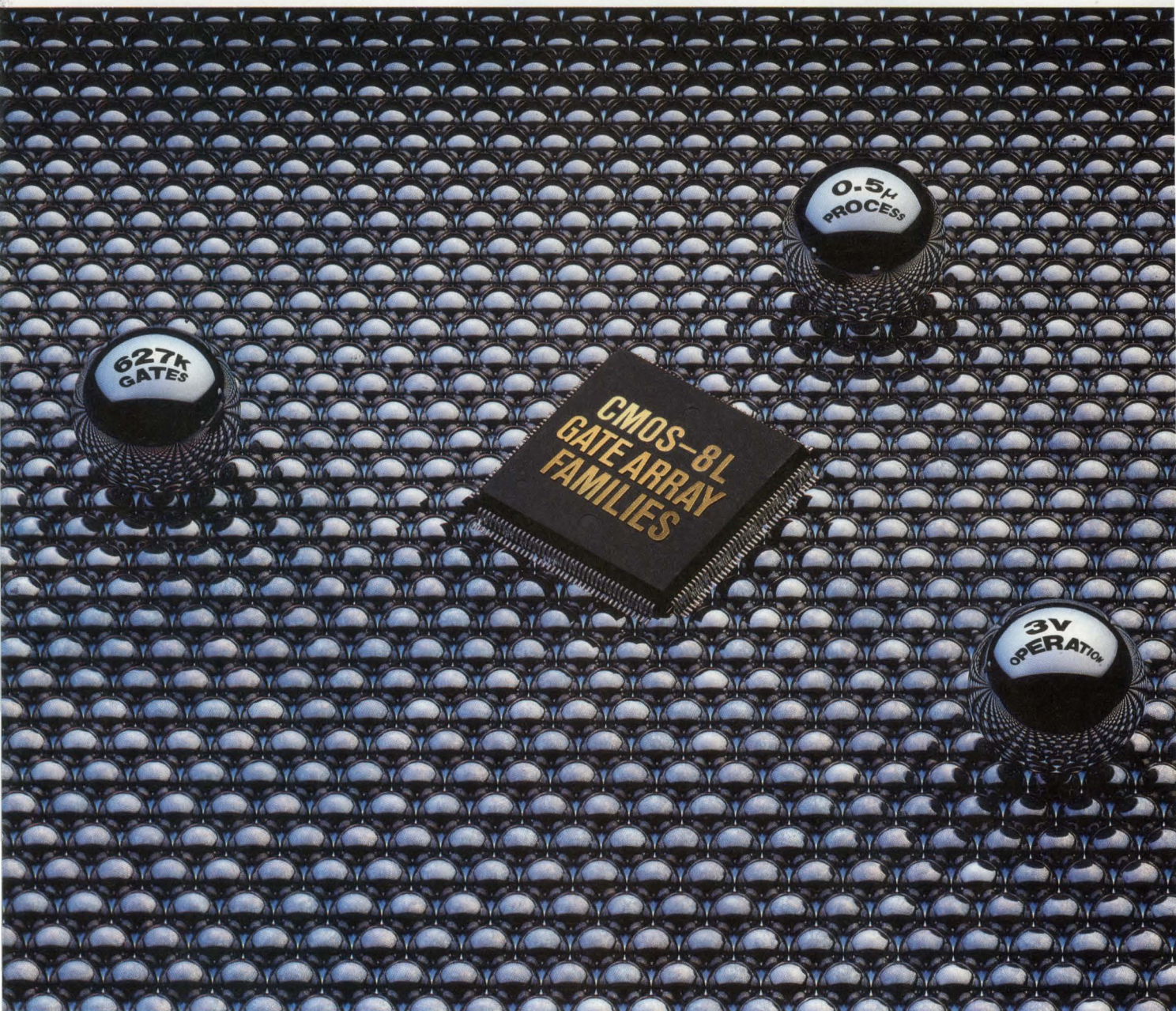

For fast answers, call us at: USA Tel:1-800-366-9782. Fax:1-800-729-9288. Germany Tel:0211-650302. Fax:0211-6503490. The Netherlands Tel:040-445-845. Fax:040-444-580. Sweden Tel:08-753-6020. Fax:08-755-3506. France Tel:1-3067-5800. Fax:1-3946-3663. Spain Tel:1-504-2787. Fax:1-504-2860. Italy Tel:02-6709108. Fax:02-66981329. UK Tel:0908-691133. Fax:0908-670290. Ireland Tel:01-6794200. Fax:01-6794081. Hong Kong Tel:886-9318. Fax:886-9022. Taiwan Tel:02-719-2377. Fax:02-719-5951. Korea Tel:02-551-0450. Fax:02-551-0451. Singapore Tel:253-8311. Fax:250-3583. Australia Tel:03-8878012. Fax:03-8878014. Japan Tel:03-3454-1111. Fax:03-3798-6059.

operation.

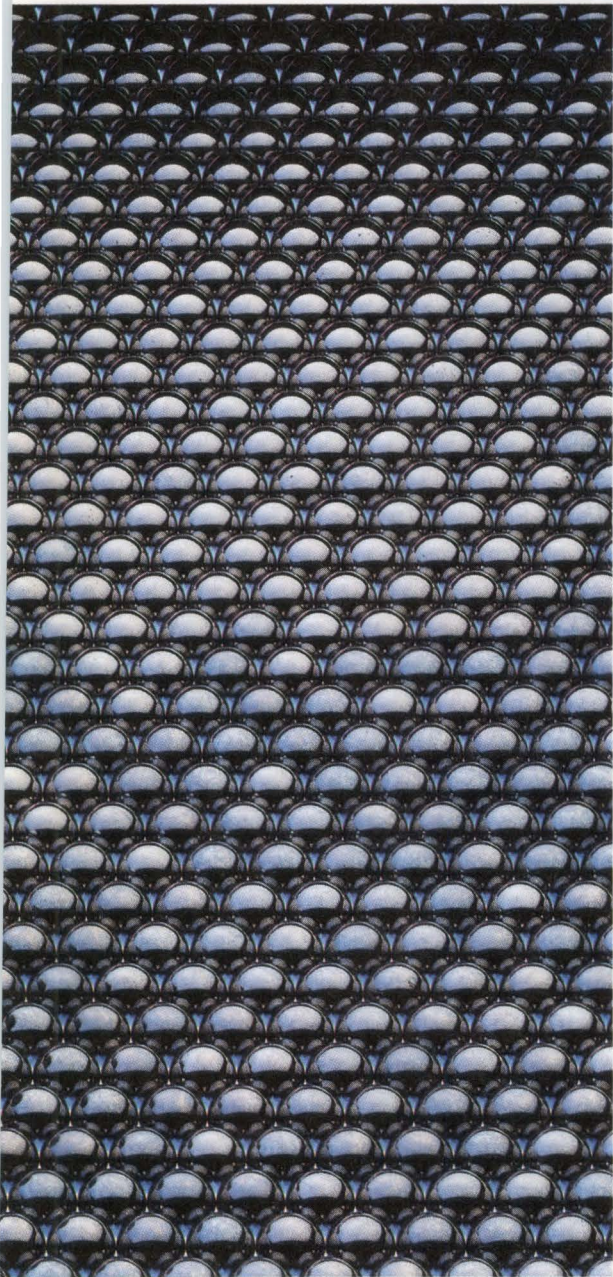

Higher performance with lower power consumption. That's what designers need for tomorrow's high-end products. And that's precisely what you get from NEC's new 0.5-micron gate array families.

Our CMOS-8L and CMOS-8LCX families give you 3-volt operation to reduce power consumption, resolve heat and noise problems, and lower packaging costs. Far from sacrificing performance to achieve these benefits, they also offer a wide range of high-end features for portable products, workstations, and multi-processing enterprise systems.

Our new gate arrays give you a loaded speed of 198 picoseconds*, high integration with up to 627K raw gates, and low power dissipation of 1.24 μ W/MHz/cell. CMOS-8LCX incorporates CrossCheck[®] embedded test technology. Other premium-performance features include:

- Compiled RAM with Built-in Self Test (BIST).
- PLL, GTL and clock tree synthesis.
- Combination TAB/QFP packaging.
- 5-volt interface.
- SCAN and JTAG test alternatives.
- OpenCAD[®] Design System support.

NEC's CMOS-8L and CMOS-8LCX gate array families provide a competitive edge in tomorrow's markets by reducing power consumption without sacrificing performance. For more information on our high-end 3-volt ASICs, call NEC today.

* F/O=2, W/L=0.5mm

CrossCheck is a registered trademark of CrossCheck Technology Inc.

OpenCAD is a registered trademark of NEC Electronics Inc.

Good design enables hot insertion of power supplies

Mikhail Grabois, Ascom Timeplex Inc

Hot insertion of power supplies offers many advantages, but it can cause lots of problems unless you prepare for it in your design.

By providing for "hot," or "live," insertion of power supplies, you can improve system serviceability, reliability, and availability. But these improvements don't come without a price; they require extra design effort to select the right connectors, prevent contact damage, avoid system-bus glitches, and balance power distribution.

Start with the connector

One of the first things to consider is the power-supply connector, which you can attach to the supply in one of three ways—with cables, with short wires, or directly to the supply's pc board. Each approach has its advantages and disadvantages.

If you use cables to attach connectors to a power supply and its load, you can remove the supply with part of the cabling in case the supply needs to be replaced. This approach somewhat improves serviceability but lowers overall reliability.

In the second approach, you can attach connectors to the power supply terminals by a set of short wires and then mechanically attach the body of the connector to the supply. Then it's possible simply to insert the power supply into the system rack and engage a connector on the backplane. A set of wires on the backplane runs from the connectors to the load. Because "connectorized" versions of power supplies are uncommon, this approach offers the advantage of using an off-the-shelf power supply with minor modifications. Disadvantages include the need for additional space and the increased cost of repackaging.

In a custom design, you can attach

connectors directly to a power supply's pc board. This approach provides the most compact design and the highest reliability. If you select the correct connectors, this way provides the lowest cost for adding connectors. Note, though, that pc-board connectors cannot handle a significant amount of current, so you have to take special precautions in your design.

Don't neglect path resistance

When you use power connectors with only a few contacts, it's not difficult to select the rating and the number of contacts to accommodate any deviation in current-path resistance. However, if large numbers of pins have low current capacity, as is the case with board-mounted connectors, then path resistances become a real concern.

The current in each connector pin or contact is inversely proportional to the resistance of the path (and not the contact itself). In a way, that's good news, because contact resis-

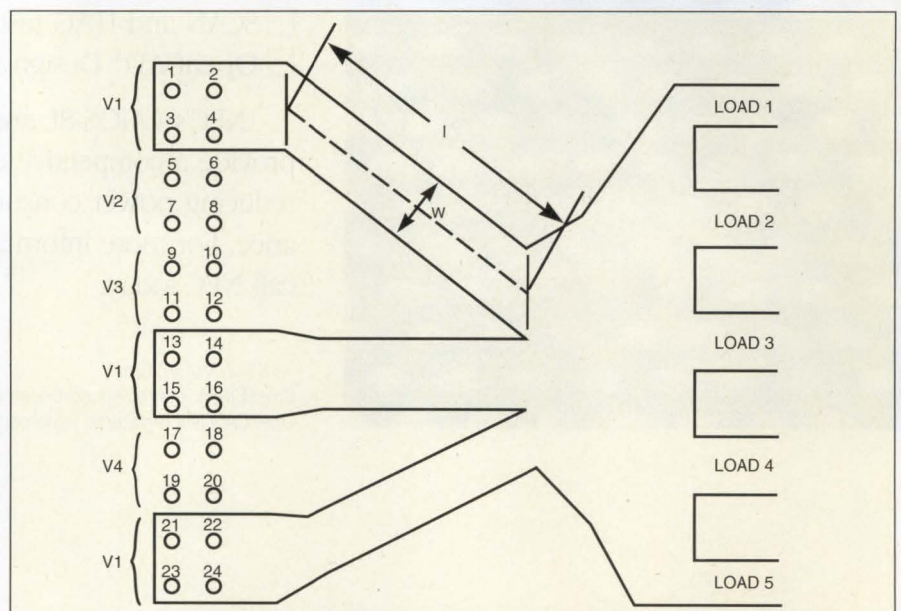
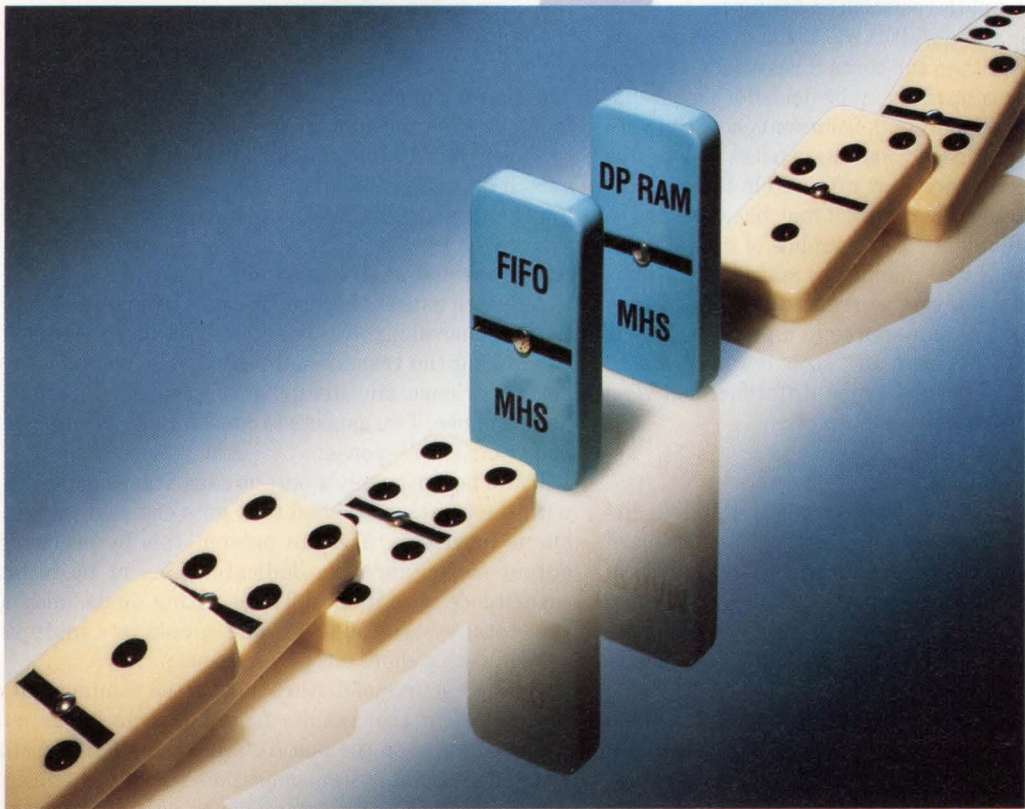

Fig 1—If contact resistances on a power supply's connector pins differ only a little, you can equalize path resistances by ensuring that pc-board traces have a significantly higher resistance and that all traces have the same length-to-width ratio.

FIFOs and DP RAMs from MATRA MHS : Introducing new smart memories that stand up to the competition.



IDT is a registered trademark.

Our FIFOs and Dual Port RAMs offer pin-to-pin compatibility with the competition, plus extra performance at no extra cost :

- Power consumption up to 10 times lower than the nearest competitor,
- Thin Quad Flat Packs (10 x 10 x 1.4 mm),
- your choice of ceramic or plastic packages,
- surface mount or through hole design,
- direct replacement for IDT® sockets.

Thoroughly proven designs meet today's most demanding quality standards, including ISO 9001.

FIFOs and Dual Port RAMs from MATRA MHS. Don't fall for anything less than the best !

Call us today at :
1-800-554-5565, ext. 921

Device	Format	Capacity	Access time	Power (µA)
FIFO	9	512, 1K, 2K, 4K, 8K, 16K	25ns - 55ns	10 - 100
DP RAM	8 or 16	1K, 2K, 4K, 8K,	25ns - 55ns	10 - 50

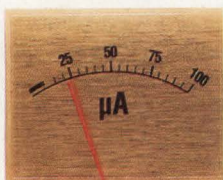

TEMIC

A Company of AEG and Deutsche Aerospace
within the Daimler-Benz Group

CIRCLE NO. 75

Members of the TEMIC Semiconductor Division : Telefunken Semiconductors, Siliconix, Matra MHS, Dialog Semiconductor

TEMIC Sales Offices

FRANCE : Tel. (33) 1-30 60 71 08 - GERMANY : Tel. (49) 7131 67-0 - ITALY : Tel. (39) 2-332 121

SCANDINAVIA : Tel. (46) 8-733-0090 - UNITED KINGDOM : Tel. (44) 344-485757

HONG KONG : Tel. (852) 378-9789 - JAPAN : Tel. (81) 3-5562-3321

USA : 2201 Laurelwood Road, Santa Clara, CA 95056 - Tel. (408) 970-58 58 - Fax : (408) 748-04 39

POWER SUPPLIES

tance is harder to control than any other part of the circuit. Some connectors—for example, the multirow pin-and-socket type—have distinct resistance differences that result from contact-length differences. You can control the resistances of individual contact circuits by providing separate runs, with individual wires or traces, that connect to a common bus. If differences in contact resistances aren't very obvious, it is sufficient to equalize all path resistances (using traces with the same length and the same width) and to make those resistances sufficiently higher than the contact resistance (**Fig 1**).

Often, pc boards have copper layers or fields for power distribution. In such cases, the currents from connector contacts take the shortest paths to the load, and these paths may be different for different contacts and may differ from the geometrical shape of the conductor. Therefore, it may be necessary to isolate the paths for individual pins or groups of pins (**Fig 2**).

An engineer who generates the design specification for a power supply must also address current distribution over connector contacts. The current source in a power supply is usually a single point (a device lead), so it is important to minimize or compensate for resistance difference between the source point and the connector contacts.

Guard against contact arcing

The issue of contact arcing is always a concern in live-circuit replacement, but it is much more critical for pc-board connectors with small contacts. Arcing results either from high voltage breaking the air gap between contacts during contact engagement or disengagement or from an interruption of the high current in low-voltage circuits. You should try to minimize the effects of both factors.

Limiting the available current minimizes the effect of high voltage, which is present on the contacts carrying the input ac power to the power supply. During contact engagement, the input current—called "inrush current" in this situa-

tion—results from the charging of the power supply's input capacitance. The duration of charging is usually less than 30 to 50 msec, and after this transitional period, any input-current increase is not critical because the contacts are fully engaged and do not produce arcing. The power supply's specified maximum inrush current should not exceed 10A. During contact disengagement, the fully charged input capacitance limits the input current.

Limiting the current can also minimize the effect of high current at low voltage—the usual output of the power supply. The power supply's output current should be significantly lower by the time contact disengagement occurs. To achieve this, you can disable the outputs in advance by the manual switch or, better, by an early disengagement of a connector pin that is shorter than the power-output pins.

Avoid power-bus disturbances

A design aspect that is critical to live power-supply insertion or removal involves the conditions on the common output bus during the transitional period. The common bus should not experience any disturbances that could affect system performance. Two aspects to consider are output capacitance and transient response.

If the power supply's output capacitance comes in contact with the common bus before it gets charged, sagging of the bus is inevitable. You can prevent this by precharging the output capacitance via dedicated pins or by isolating the capacitance with diodes. The isolating diodes may also prevent total system failure if one supply in a multiple-supply system gets a short circuit on its output.

Another source of disturbance on the common bus is a current transient that results from a change in the number of power supplies on the bus. To avoid this kind of disturbance, which may affect system operation, specify and design power supplies with a transient response adequate for the worst-

case current-amplitude change and the maximum speed of the change.

In one situation, however, proper transient response is inadequate. If you yank an on-line power supply from a live system, no power supply can compensate for the change. Only the disabling of the output before removing the unit can do the job. EDN

Author's biography

Mikhail ("Mike") Grabois is a staff engineer at Ascom Timeplex Inc, Woodcliff Lake, NJ, where he is responsible for the design of power systems and high-speed backplanes and also addresses thermal and electromagnetic-compatibility performance issues. He has a BSEE from the Moscow Institute of Railway Engineering and an MSEE from New York University, New York. His leisure activities include theater, music, soccer, and skiing.

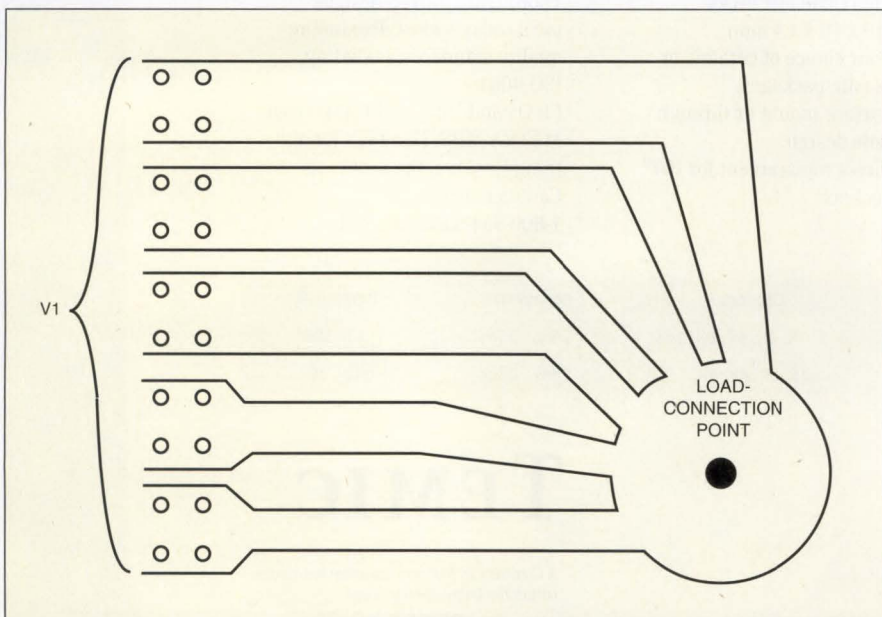
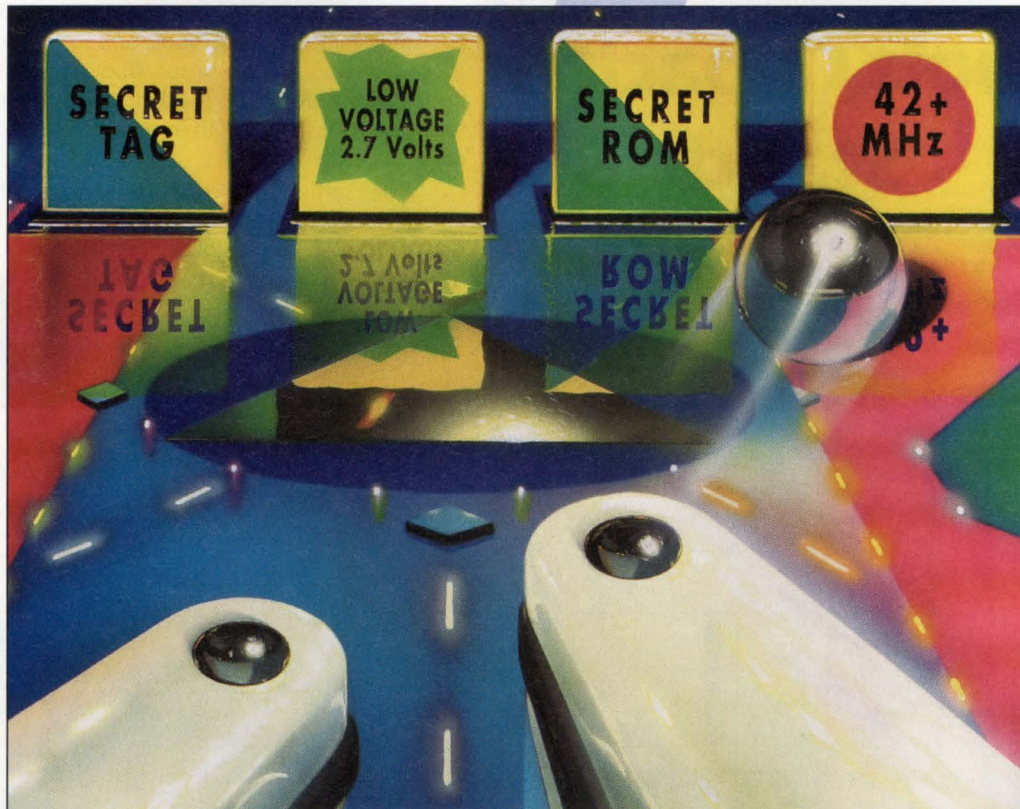

Fig 2—For proper power distribution when the same voltage appears on multiple connector pins, isolate and equalize current paths. Otherwise, current from the contacts takes the shortest paths to the load.

Article Interest Quotient (Circle One)
High 595 Medium 596 Low 597

The 80C51 family from MATRA MHS : Why shoot for anything less than the best ?



Intel® is a registered trademark.

When it comes to performance, our Intel® licensed 8-bit microcontrollers can help you win big...

No wonder we supply millions of 80C51-family microcontrollers to the world's most demanding customers every month. We've taken a popular performer and given it impressive new powers.

- 42 MHz (and faster!) clock speed,
- low supply voltage (2.7 V) that gives you the design lead in portable applications,
- powerful program encryption and hardware locks that protect your competitive edge,
- software-readable secret tags for user ID and terminal applications,
- 1.0 & 1.4 mm thin packages for PCMCIA applications,
- a wide range of thin surface mount packages and probed dice,
- ROM size from 4K to 32K (80C51/52/154/154 D),
- commercial, industrial, automotive, military and even radiation-tolerant space grades available,
- quality you depend on (ISO 9001).

The MHS 80C51 microcontroller family. Because in this game, you play to win.

For more, call us today at :
1-800-554-5565, ext. 922

TEMIC

A Company of AEG and Deutsche Aerospace
within the Daimler-Benz Group

Members of the TEMIC Semiconductor Division : Telefunken Semiconductors, Siliconix, Matra MHS, Dialog Semiconductor

TEMIC Sales Offices

FRANCE : Tel. (33) 1-30 60 71 08 - GERMANY : Tel. (49) 7131 67-0 - ITALY : Tel. (39) 2-332 121

SCANDINAVIA : Tel. (46) 8-733-0090 - UNITED KINGDOM : Tel. (44) 344-485757

HONG KONG : Tel. (852) 378-9789 - JAPAN : Tel. (81) 3-5562-3321

USA : 2201 Laurelwood Road, Santa Clara, CA 95056 - Tel. (408) 748-93 62 - Fax : (408) 748-04 39

When You Need Service, Illinois Capacitor Stands Tall.

The best capacitors with the best service and support... that's what Illinois Capacitor is all about.

IC starts by helping you choose the right capacitor to fit your application and budget.

You'll save labor too, with IC's value-added services, which include epoxy end sealing, tape and reel/ammo pack, cut leads, and selection to special capacitor tolerances. Whatever your needs, your order will be filled with 100% burn-in tested capacitors to assure dependability and save you QC time.

Don't settle for just capacitors. Demand the industry's best quality capacitors and service. Call your local IC distributor or IC. Do it today!

Ask for **FREE**
Capacitor Engineering Guide.



ic[®]
ILLINOIS CAPACITOR, INC.

3757 West Touhy Avenue, Lincolnwood, IL 60645
(708) 675-1760 • Fax: (708) 673-2850



Emulator verifies code that controls flash memory

With its ability to accept and retain data without power, flash memory is ideal for many embedded systems and is finding use in many applications. But flash memory is not without its troubles. You must ensure that your code controls flash memory properly, and flash memory can perform only a limited number of write cycles.

Until now, it was difficult to verify that your code was indeed using the flash memory correctly. FlashICE from Grammar Engine aims at

alleviating the problems of using flash memory. It emulates the operation of the Advanced Micro Devices Am29Fxxx family of 5V flash memories. FlashICE helps you with three main types of tests. First, it allows you to verify that you are correctly controlling the flash memory. The FlashICE works only with flash memo-

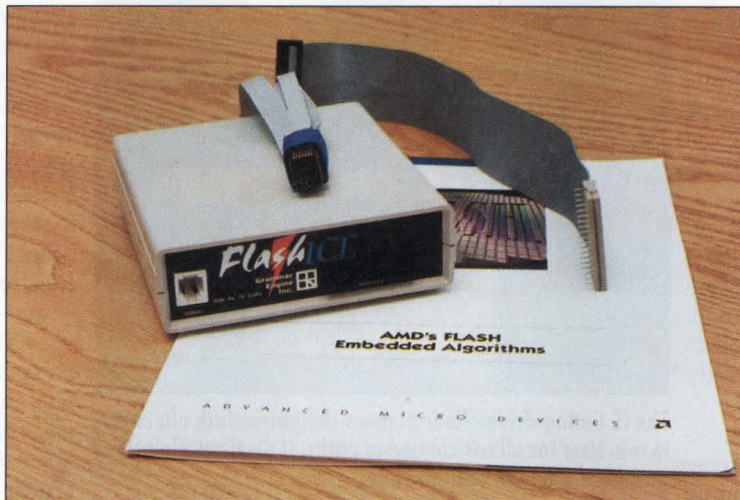

You can verify your flash-memory control code with Grammar Engine's FlashICE flash-memory emulator.

ry that uses an embedded algorithm. Your software must send the appropriate series of bytes to the flash memory, and then the memory takes over to perform the actual operation. The FlashICE verifies that you are sending the correct series of bytes.

The second test profiles sector write and erase cycles. Some applica-

tions require you to level the wear on the flash memory because logging data to the same memory location quickly wears out flash memory. But, storing data throughout the flash memory lengthens the memory's life. The FlashICE logs write/erase cycles to ensure that your wear-leveling algorithm is accessing all sectors equally.

The third test is a simulation of errors. You can force a flash-memory error and then verify that your software properly handles the error.

The FlashICE flash-memory emulator connects to a target, much as a ROM emulator does. Functionally, the emulator looks just like the flash memory, and you can use it like any ROM emulator for code development. \$2995.

—David Shear

Grammar Engine Inc, Westerville, OH. (614) 899-7878. **Circle No. 304**

Image-processing module is based on TMS320C40 DSP

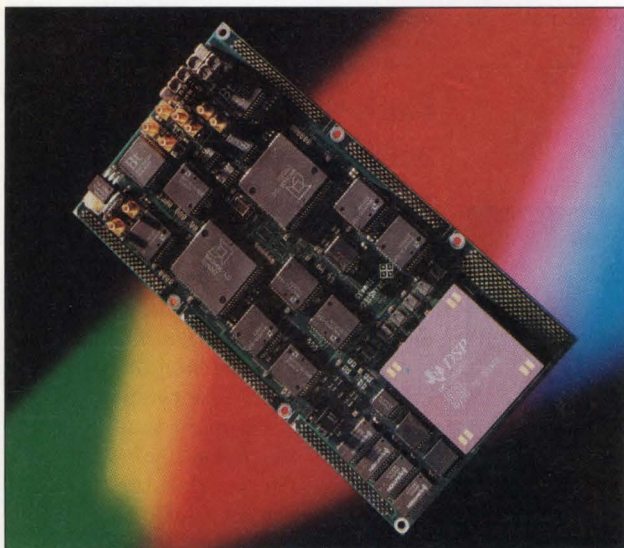

The TDM435 image-processing module includes two 1024×1024-pixel frame buffers.

The TDM435 image-processing module incorporates a programmable-resolution 8-bit monochrome frame grabber with two 1024×1024-bit video-RAM (VRAM) frame buffers, 4 Mbytes of zero-wait-state local memory, and a programmable-resolution RGB graphics-display section with a 4-bit overlay plane.

The high-resolution, TMS320C40-based module captures full-frame CCIR- and RS170-standard video, as well as high-resolution-camera video. Its architecture allows for simultaneous capture, display, and access by the C40 to the same block of VRAM.

The TDM435 comes with a graphics and capture-control library that facilitates display setup, window management, draw and fill operations, look-up-table control, and image-acquisition control, including live capture to a window.

The module is based on the TIM-40 specification and connects to global memory on a mother board, such as the TDMB410 PC, which can accept up to four TIM-40 modules. The TDM435 costs \$7000.—David Shear

Transtech, Ithaca, NY. (607) 257-6502.

Circle No. 305

Board-level design moves beyond place and route

Not that long ago, pc-board design was mostly a matter of finding a placement that let you efficiently route a design. As circuit speeds increased, clock-distribution lines and other critical signals started needing special attention during layout to meet timing and signal-integrity requirements. The typical practice was to start with a placement you hoped would avoid signal-integrity problems; then, after routing signals, you tried to mop up whatever signal-integrity problems were left.

Today, circuit speeds are moving even higher, and the interconnection problem is mushrooming to include not just a few but many of the signals on high-speed pc boards and multichip modules.

To work with demanding high-speed board designs, Interconnectix is launching its interconnection-synthesis technology product, IS. The tool takes the interconnection requirements, including netlist, timing, and signal purity, and synthesizes a physical implementation to meet those requirements. Instead of iteratively modifying a physical design to meet timing and signal-integrity requirements, the tool attempts to find a workable design before going into layout.

The tool comprises four major mod-



The IS timing-driven floor planner computes slack allocation in real time for all critical timing paths. It displays violations graphically and in tabular form.

ules: a hierarchical timing and thermal-driven floor planner, a physical-analysis engine, a spreadsheet-based rules engine, and a synthesizer with an intelligent router.

You start by capturing your design either in schematic or hardware-description-language form and then compiling the design into a netlist. The tool accepts netlists in a variety of standard formats and accepts timing constraints in the Standard Delay Format (SDF) file. Next, you specify rules using a spreadsheet for elements or groups of elements within the design. Timing and signal-purity rules can include setup-and-hold-time specifications; path- or

net-based time delay; skew management; and maximum allowable crosstalk, overshoot, undershoot, and ringback constraints.

Once you provide a netlist, design constraints, and models, you are ready to develop a physical design. The timing-driven hierarchical floor planner lets you create and physically arrange functional groups. It automatically generates net topology, termination strategy, and power-density management to simplify floor planning. As you develop a floor plan, timing-path estimates and slack-time allocation help you track interconnection timing

problems and whether the floor plan works.

After you develop a workable floor plan, you can put the intelligent router to work. The synthesis-and-router module makes routing decisions based on manufacturing-design rules and on the electrical constraints you specify. Synthesis continues until the tool creates an implementable physical representation that satisfies the electrical description.

IS runs on Unix workstations and is available now. A fully configured system costs \$170,000.—**Doug Conner**

Interconnectix, Portland, OR. (503) 684-6641. Circle No. 306

Mixed-signal simulator accepts analog behavioral language

The Continuum mixed-signal-simulation tool ties the QuickSim II digital simulator with the AccuSim II analog simulator using a simulation-backplane approach. AccuSim II integrates Anacad's Eldo simulator with Mentor Graphics' Spice simulator. The simulator accepts HDL-A, Anacad's proprietary VHDL-based analog behavioral language. Continuum will be available in July and costs \$65,000.

Mentor Graphics, Wilsonville, OR. (503) 685-8000. Circle No. 307

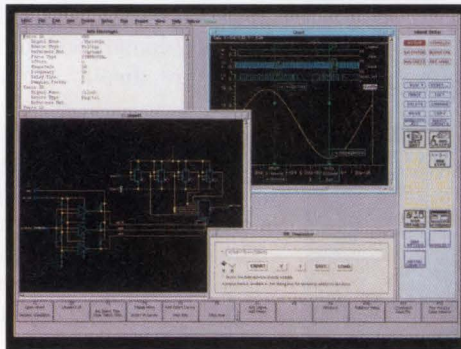

The Continuum mixed-signal simulator accepts analog behavioral language.

Fault-simulation accelerator offers interactive fault tracing

The Paradigm Super Fault XP includes an interactive fault tracer that lets you view the path of a fault through a design during simulation. The information is useful in determining where a fault was blocked. The company claims the accelerator is more than 20 times faster than the fastest software fault simulator. The accelerator provides fault simulation for 64,000 to 4 million gates. Prices start at \$79,900.

Zycad Corp, Fremont, CA. (510) 623-4400. Circle No. 308

Clip and Save!



No.	Product	Series	Type	Samples	Typical Circuit
1	Solid Chip Suppressor	NZ	1608		
			2012		
			3216		
			4516		
2	Inductor	NW	5750		
			2520		
3	Common Mode Choke	M	520		
			530		
		CZ	5745		
			TZ	5745	
4	Leadless Power Inductor	P•IZ	9x7x5		
			12x10x6		
		P•IL	9x7x5		
			12x10x6		
5	3-Terminal Noise Suppressor	E-T	4525		
6	3-Terminal Chip Capacitor	E-C	3216		

Project
1000
Tue

Call
re.

Whether you're working with camcorders, cellular phones or electronics notebooks, signal lines or power lines, normal mode or common mode, TOKIN EMC components provide exceptional functionality that can boost your PC boards to a powerful new performance level.

TOKIN

Tokin Corporation

International Sales Department
Sumitomo Seimei Sendai Chuo Bldg., 4-6-1, Chuo, Aoba-ku,
Sendai 980, Japan
Phone: 022-211-1281 Fax: 022-211-0975
Korea Representative Office
#602, Champs-Elysees Bldg., 889-5, Daechi-Dong, Kangnam-gu,
Seoul, Korea
Phone: (2) 569-2582 ~ 5 Fax: (2) 544-7087

Tokin America Inc.

155 Nicholson Lane, San Jose, California 95134, U.S.A.
Phone: 408-432-8020 Fax: 408-434-0375
Chicago Branch
9935 Capitol Drive, Wheeling, Illinois 60090, U.S.A.
Phone: 708-215-8802 Fax: 708-215-8804

Tokin Electronics (HK) Ltd.

Unit 705-707, Chiwan Tower, Park Lane Square, 1 Kimberly Rd.,
Tsimshatsui, Kowloon, Hong Kong
Phone: 730-0028 Fax: 375-2508
Taiwan Liaison Office
Phone: (02) 7728852 Fax: (02) 7114260
Singapore Branch
Phone: 2237076 Fax: 2236093, 2278772
Shanghai Liaison Office
Phone: 21-433-4488 Ext. 80809 Fax: 21-433-3265 Ext. 80809

Tokin Europe GmbH

Knorrstr. 142, 80937 München, Germany
Phone: 089-311 10 66 Fax: 089-311 35 84

ABSOLUTE VALUE



SRS DEMO DIRECT
2 Day Delivery, No Obligation
CALL (408)744-9040

High performance LCR meters from SRS. Absolutely lowest price. Starting at \$995.

Value. It means getting your money's worth.

For passive component measurement, the new standards in value are the SR720/715 LCR meters from SRS. Meters that offer significant advantages in performance and price.

Performance like .05% basic accuracy, 100 kHz test frequency, and fast measurement rates up to 20 per second. Features like a built in Kelvin fixture, averaging, binning and limits, stored setups, and quick calibration. With the standard RS232 and optional GPIB and Handler interfaces, the SR720/715 solves your incoming inspection and automated test needs. All for a price well below what you'd expect.

The SR720/SR715. Absolute values in a complex world. Call **(408)744-9040** today for more information about the SRS advantage.

SR720

\$1995

- 0.05% basic accuracy
- 100 Hz to 100 kHz measurement frequency
- Two 5 digit displays for simultaneous readout of major and minor parameters.
- Auto, R+Q, L+Q, C+D, C+R, Series and Parallel measurement modes
- 100 mV to 1.0 V test signals
- Internal and External Bias
- Binning and Limits for production testing and component inspection.
- RS232 interface
- GPIB and Handler interface (optional)

SR715

\$995

- Same as SR720 except:
- 0.2% basic accuracy
 - 100 Hz to 10 kHz measurement frequency
-



STANFORD RESEARCH SYSTEMS

1290 D Reamwood Avenue, Sunnyvale, CA 94089 TEL (408)744-9040 FAX 4087449049

CMOS logic series lets you mix 3 and 5V devices

The Crossvolt logic series from National Semiconductor comprises five CMOS families, which enable designers to mix 3 and 5V devices in a system. The families provide standard bus interfaces, which address the need for 3V devices to operate with 5V devices.

The LVX-X dual-supply translating transceivers operate from 3.3 and 5V supplies. The family suits 3V CPUs, which must interface to 5V buses and traditional 5V components. Two of the LVX-X devices offer configurable I/O translation on the fly for PCMCIA (Personal Computer Memory Card International Association) PC card slots. The devices enable a laptop computer to support a 3.3 or a 5V PCMCIA card. The translating receivers in a QSOP cost \$2 (1000).

The LCX low-voltage octal and 16-bit buffers and transceivers provide 5V-tolerant inputs and outputs. The \$2 (1000) devices enable complete 3V or

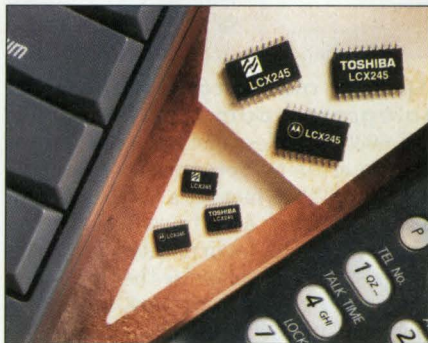

A joint agreement involving Toshiba, National Semiconductor, and Motorola has produced a family of 3V CMOS buffers and transceivers with 5V-tolerant inputs and outputs.

both 3 and 5V operation in one design. The LCX family is the result of National Semiconductor's joint-development partnership with Toshiba and Motorola.

The LVX 10-bit low-impedance bus

switches provide a high-speed bidirectional interface between buses with mixed voltages, 3V CPUs, and low-cost 5V dynamic RAMs. The 250-psec bus switches feature a current drain of 3 μ A. Price is \$2 in a QSOP (1000).

The LVX low-voltage gates, multiplexers, and octal transceivers have 5V tolerant inputs. The devices feature low power and noise for portable laptop or personal-digital-assistant applications. Toshiba provides an alternate source for the devices. Prices for the LVX family range from \$0.92 for a flip-flop to \$1.62 for an octal transceiver (1000).

Introduced last year, the LVQ Quiet devices suit only 3.3V applications that do not require interfacing with 5V devices. An LVQ device in a QSOP costs \$1.25 (1000).—**John Gallant**

National Semiconductor, Santa Clara, CA. (800) 272-9959.

Circle No. 309

DIGITAL SIGNAL PROCESSING DATA ACQUISITION SIGNAL ANALYSIS

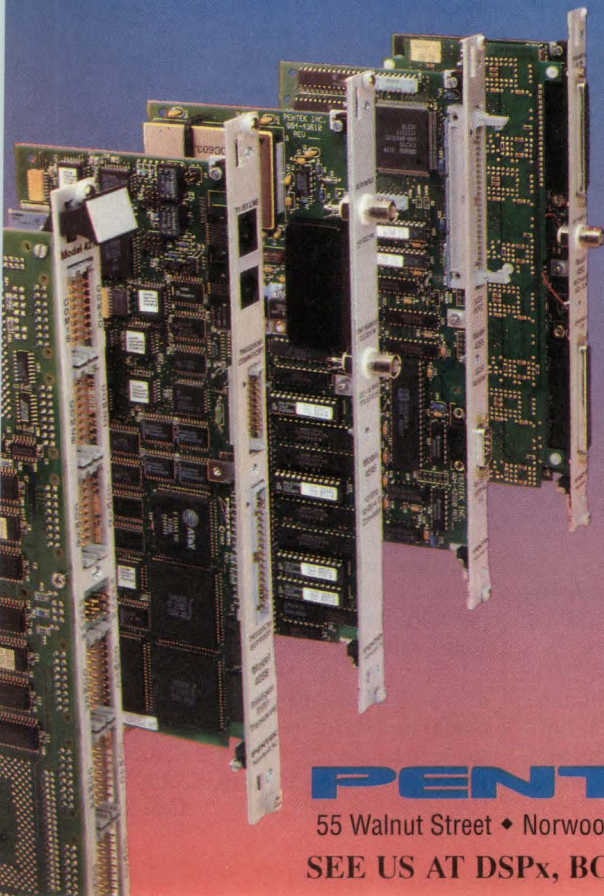

If you need solutions to real-world problems in

- Multichannel spectrum analysis
- Real-time image processing
- Noise and vibration analysis
- On-line monitoring
- Process control
- Acoustics
- Digital audio
- Sonar or radar

contact the DSP experts at Pentek.
You'll be glad you did.

**When it comes to DSP...
Pentek has the whole solution**

PENTEK

Innovative DSP systems

55 Walnut Street • Norwood, NJ 07648 • Tel: 201-767-7100 • Fax: 201-767-3994 • BBS: 201-767-8733

SEE US AT DSPx, BOOTH No. 714

© 1994 Pentek, Inc.

CIRCLE NO. 93

INTEGRATED CIRCUITS

FREE INFO, FREE POSTAGE

Use our postage-paid reader-service cards to get more information on any of these products.

Spindle motor controller/driver integrates output drivers. The ML6035 brushless motor controller uses a zero-crossing rotor-position sensing technique that monitors the back EMF from the motor coils to control commutation. The IC incorporates six drive transistors that comprise the three complementary output drivers needed to power 3-phase brushless dc motors' windings. Each output can drive 1A at 1 Ω . The 5V IC draws 6 mA, and a serial bus minimizes the number of external control pins. In a 32-pin thin QFP, \$6.95 (1000). **Micro Linear Corp.**, San Jose, CA. (408) 433-5200. **Circle No. 375**

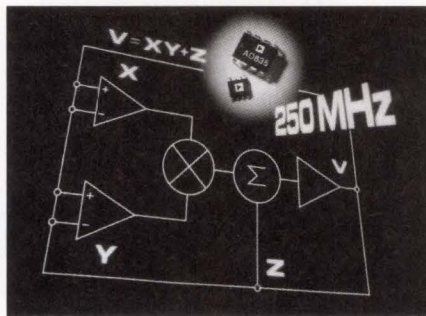

Four-quadrant multiplier has 250-MHz bandwidth. The dc-coupled, voltage-output AD835 has a small-signal rise time of 1 nsec; full-scale $\pm 1V$ rise and fall times are 2.5 nsec with 150 Ω loads. Settling time to within 0.1% of full scale is typically 17 nsec. Typical noise is 44 nV/ $\sqrt{\text{Hz}}$. The IC requires few external components; its X and Y differential multiplication and Z summing inputs are high-impedance nodes that don't require signal conditioning. The low-impedance outputs don't need additional buffering to drive $\pm 2.5V$ into 50 Ω loads. With $\pm 5V$ supplies, the multiplier operates from -40 to +85°C. In 8-pin DIPs and SOICs, \$7.95 (1000). **Analog Devices Inc.**, Wilmington, MA. (617) 937-1428. **Circle No. 376**

RS-485 transceiver consumes 300 μA max. The low-power SP485 half-duplex transceiver, the first in a family of RS-485 devices, uses BiCMOS technology and meets the standard's requirements up to 5 Mbps. A half-duplex arrangement and a wide common-mode input range allow you to use the part in multipoint data-transmis-

sion networks. In 8-pin DIPs and SOICs, \$1.10 (1000). **Sipex Corp.**, Billerica, MA. (508) 667-8700. **Circle No. 377**

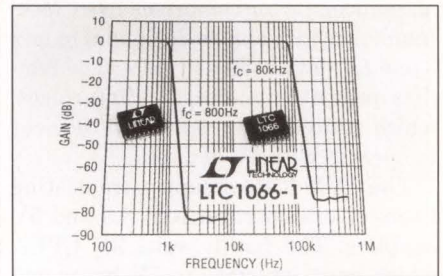

Lowpass filter has 14-bit dc-gain linearity. The LTC1066-1 is an 8th-order, pin-selectable elliptic or linear-phase filter with a clock-tunable cutoff frequency of 10 Hz to 100 kHz. An internal servo loop and precision op amp produce dc performance of 14-bit gain linearity and 1.5-mV offset over temperature. The filter IC's S/N ratio is 92 dB. Passband ripple is ± 0.15 dB, and an 80-dB stopband attenuation occurs at 2.3 \times the cutoff frequency. \$16.94 (1000). **Linear Technology Corp.**, Milpitas, CA. (408) 432-1900. **Circle No. 378**

Linear regulators each provide two voltage levels. The CS-8167, -8147, and -8157 feature an array of logic-control functions, low-quiescent sleep modes, and output voltage levels of 9, 10, and 12V, respectively. The tolerance on these primary outputs is $\pm 2.5\%$, and output current is 500 mA. Each device also has a 5V $\pm 5\%$ secondary output that can source 70 mA. A CMOS enable pin puts the regulators into sleep mode, which reduces quiescent current to 70 μA . The devices can survive load dumps of 60V and reverse-polarity transients of -50V minimum. They feature short-circuit and thermal-runaway protection. In 5-lead TO-200 packages, \$1.10 (10,000). **Cherry Semiconductor Corp.**, East Greenwich, RI. (401) 885-3600. **Circle No. 379**

Read-channel IC set handles 64-Mbps data. The 2-chip Disk Reader set includes the PCA1151 pulse qualifier and equalizer and the PCA1161 data separator in 44- and 52-pin packages. The pair provides servo burst capture, 64-region zone switching, write compensation, and a 1.7 ENDEC for data rates as fast as 64 Mbps. The set offers five power-down modes and shifts from sleep to full-power mode in 2 μsec . Evaluation set, \$25. **GEC Plessey Semiconductors**, Scotts Valley, CA. (408) 438-2900. **Circle No. 380**

HTBasic

SCIENTIFIC BASIC

HTBasic can transform your PC into a powerful engineering workstation. You get a language with all the attributes of Rocky Mountain BASIC at a fraction of the cost.

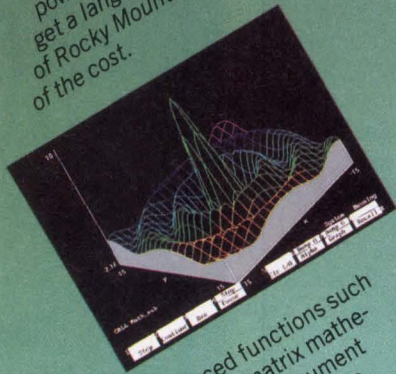

HTBasic has advanced functions such as: complex arithmetic, matrix mathematics, and sophisticated instrument control. Our 32-bit-compiled routines boost high-speed calculations. And a full library of precompiled subroutines for FFTs, curvefitting, and waveform analysis speeds your development.

With HTBasic, your PC is compatible with the HP9000 Series 200/300. Our transfer utility even allows you to port your current BASIC programs to your PC and run them with little or no changes. You get all the capabilities needed for complex applications without sacrificing DOS compatibility.

HTBasic: the ideal scientific language for all technical users. Find out more today.



TransEra

Engineering Excellence for 15 Years™

3707 N. Canyon Road • Provo, UT 84604
(801) 224-6550 • Fax (801) 224-0355

Your clock has the jitters? We can help!

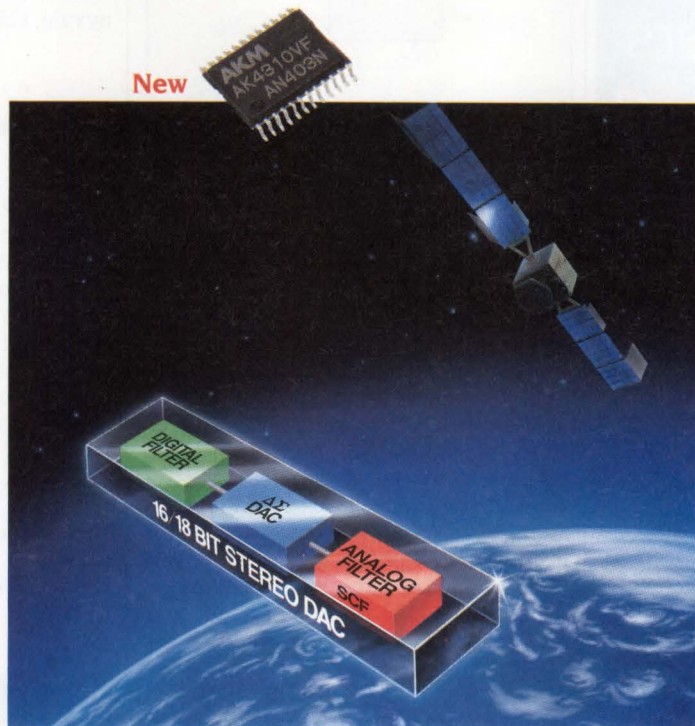

AKM's Stereo DACs don't mind a little jitter. Or even a lot! Up to 100ns is no problem. AKM's unique architecture provides high tolerance to clock jitter, ideal monotonicity and low distortion—all without trimming. Choose AKM's low cost, easy-to-use DAC products for any application—digital CATVs, satellite receivers, digital audio systems, digital music keyboards, digital sound recording systems, CD players, etc. AKM delivers—price, performance, quality.

DAC Product Family

Device	# of bits	DR	S/N	THD + N	Special Features	Voltage
New AK4310	16	92dB	92dB	0.005%	<ul style="list-style-type: none"> • High tolerance to clock jitter • On chip buffer 	3 ~ 5.5V
AK4316	16	90dB	90dB	0.01%	<ul style="list-style-type: none"> • High tolerance to clock jitter 	+ 5V
AK4318	18	97dB	97dB	0.0025%	<ul style="list-style-type: none"> • High tolerance to clock jitter • De-emphasis control circuit • Soft mute function 	+ 5V
AK4313	18	93dB	93dB	0.004%	<ul style="list-style-type: none"> • High tolerance to clock jitter • De-emphasis control circuit • Soft mute function • Low voltage 	2.7 ~ 4.0V

For more information, please contact:

USA——2055 Gateway Place, Suite 415, San Jose, CA 95110 Phone: (408) 436-8580/Fax: (408) 436-7591
EUROPE——Avenue Louise 326, Bte 056, 1050 Brussels, Belgium Phone: (32) 2-649-7831 /Fax: (32) 2-640-1809



Asahi Kasei Microsystems

TS Bldg., 24-10, Yoyogi 1-chome, Shibuya-ku, Tokyo 151, Japan

CIRCLE NO. 198

PICO

ULTRA-MINIATURE

Surface Mount Audio Transformers

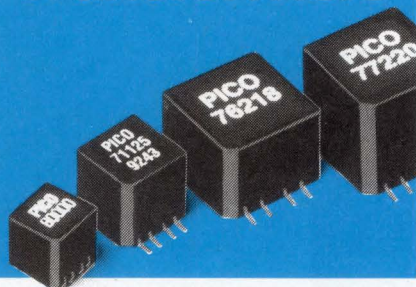

Low Profile
.2" Ht.

- Manufactured and tested to MIL-T-27
- Frequency range 20 Hz to 250 KHz
- Available from 100 milliwatts to 3 watts
- Impedance from 20 ohms to 100 K ohms
- Operating temperature -55°C to +130°C
- Low profile .2" ht.

PICO surface mount units utilize materials and methods to withstand extreme temperature (220°C) of vapor phase, I.R., and other reflow procedures without degradation of electrical or mechanical characteristics.

Delivery—
stock to one week

See EEM
or send direct
for Free PICO Catalog.

Call toll free **800-431-1064**
in NY call **914-699-5514**
FAX **914-699-5565**

PICO Electronics, Inc.

453 N. MacQuesten Pkwy., Mt. Vernon, N.Y. 10552

CIRCLE NO. 147

EDN-NEW PRODUCTS

INTEGRATED CIRCUITS

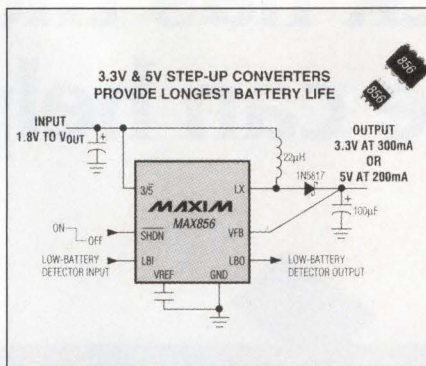

Converters boost two cells to 3.3 or 5V. The MAX856 to 859 family current-limited, step-up dc/dc converters combine efficiency, low-quietest current, and very low shutdown current. For example, the MAX856 draws 25 μ A, and its efficiency exceeds 85% when delivering 5V at 50 mA from a 2.5V input. Shutdown current is 1 μ A maximum. The 856 and 857 deliver 100 mA at 5V; the 858 and 859 deliver 25 mA. The 856 and 858 have a pin-selectable 3.3 or 5V output. Two resistors fix the adjustable output of the 857 and 859 from 2.7 to 6V. A low-battery detector is built in. In 8-pin packages, from \$1.60 (1000). **Maxim Integrated Products**, Sunnyvale, CA. (408) 737-7600, ext 6087. **Circle No. 381**

Devices implement SONET/SDH standard. Three new devices for implementing SONET are the Level 3 Mapper, which maps DS-3 or E-3 line signals into the SONET/SDH format; the advanced DS-3/STS-1 receiver/transmitter, which provides a single-chip line interface for DS-3 and STS-1; and the M13E, which multiplexes and demultiplexes 28 DS-1 signals into a DS-3 signal. Level 3 Mapper provides SONET or SDH mapping for both North American DS-3 lines at 45 Mbps and European E-3 lines at 34 Mbps. The receiver/transmitter performs the transmit and receive line-interface function required for STS-1 and DS-3 signal transmission. Level 3 Mapper, \$182; receiver/transmitter, \$45; M13E, \$211 (1000). **Transwitch Corp**, Shelton, CT. (203) 929-8810. **Circle No. 382**

Frequency synthesizers integrate fractional-N division. The SA7025 and SA8025 integrate a high-frequency prescaler with a fractional-N, phase-locked-loop synthesizer on a single chip. The devices meet the fast switching requirements of IS-54 cellular and Japanese digital-cellular and cordless standards. The SA7025 provides cover-

age to 1 GHz; the SA8025 handles coverage to 2 GHz. A high-speed, 3-wire serial interface handles programming and channel selection. An adaptive filter with a programmable speed-up mode uses two filter designs with different charge-pump currents. In 20-pin SSOPs, SA7025, \$6.50; SA8025, \$8 (1000). **Philips Semiconductors**, Sunnyvale, CA. (800) 447-1500, ext 3012. **Circle No. 383**

Instrumentation amp consumes 350 μ A. The INA118 operates with dual power supplies from ± 1.35 to ± 18 V and single supplies down to 2.7V. The 3-op-amp, current-feedback architecture provides wide bandwidth at gains to 10,000. For example, the bandwidth is 500 kHz at a gain of 10. A single resistor sets the gain from 1 to 10,000. The IC protects its inputs up to ± 40 V with or without power applied. Other key specs include 50- μ V offset voltage and 0.5 μ V/°C offset drift, 5-nA input bias current (all maximum), and 110-dB minimum CMRR. Operating temperature range for the 8-pin DIPs or SOICs is -40 to +85°C. \$3.25 (1000). **Burr-Brown Corp**, Tucson, AZ. (800) 548-6132. **Circle No. 384**

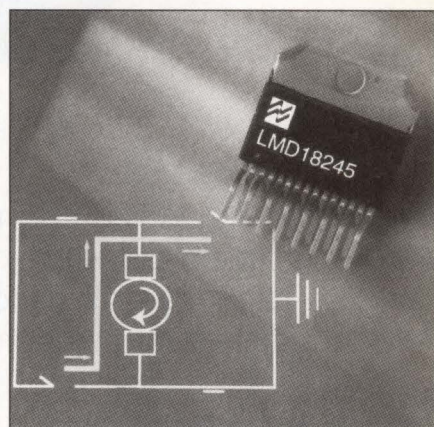

3A motor driver uses PWM. The LMD18245 55V H-bridge driver controls motor velocity directly through a pulse-width modulator, unlike linear controllers, which require two external power amps. The IC also features a 4-bit DAC for digital current control. In response to logic-level signals at the DAC's input, the IC uses a fixed off-time control scheme to regulate motor velocity; it does so by switching the bridge on and off at a variable high frequency, which controls the current to the motor. $R_{DS(ON)}$ per switch is 0.3 Ω . Protection features include thermal shutdown, current limit, and undervoltage lockout. \$8.45

P-CAD HELPED PUT TRIMBLE ON THE MAP.

You're never lost when you carry the SCOUT GPS™ global positioning system from Trimble Navigation. P-CAD helped Trimble's design engineers find what they were searching for – the world's most productive PCB design software. Trimble used P-CAD software to navigate through the design process, cutting time to market and positioning their new product as a market leader. P-CAD PCB design tools enjoy some unique positioning of their own, consistently ranking first in pins-per-hour benchmark surveys among independent service bureaus. In fact, compared to other PC-based systems, P-CAD software helps designers do their work in as little as half the time. Take P-CAD Master Designer™ for example. It includes enhanced auto-dimensioning so designers can document

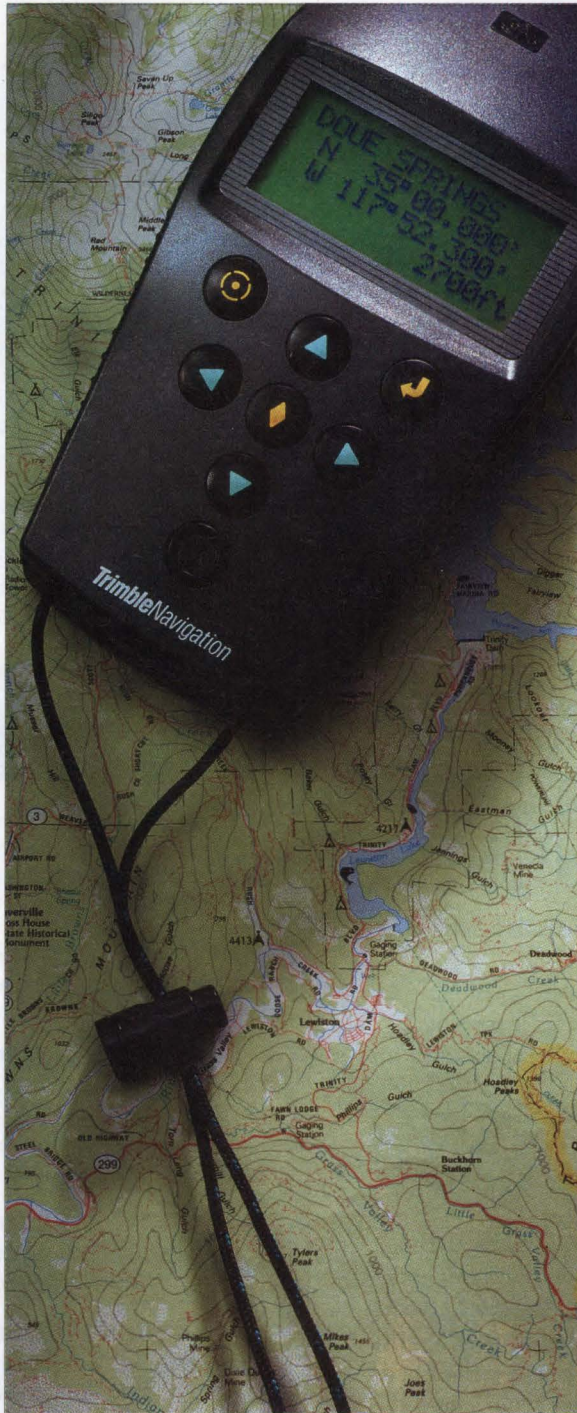

their work without mastering a separate mechanical CAD system. P-CAD offers a complete line of software tools for DOS, Windows™ and UNIX® platforms starting for as little as \$1,995. For the name of your nearest P-CAD reseller, call us toll-free. We'll tell you how you could win a free SCOUT GPS. And to help you map out your own winning design strategy, we'll send you a free copy of our booklet, "P-CAD – Productivity Across the Board." In today's competitive world, you could be lost without it.

(800) P-CAD-844

*More Productivity —
Across The Board*

p-cad®
From ALTIUM, An IBM Company

EDN-NEW PRODUCTS

INTEGRATED CIRCUITS

(1000) in 15-lead TO-220 packages. **National Semiconductor**, Santa Clara, CA. (408) 721-6937. **Circle No. 385**

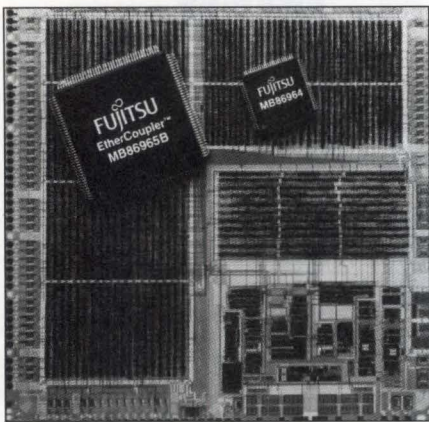

Ethernet controllers match diverse system needs. The MB86964 and MB86965B Ethernet controller ICs include onboard 10BaseT transceivers, Manchester codecs, and transmit/receive filters. The MB86964 comes in a 100-pin shrink quad flat pack and offers a generic interface, suiting it for embedded applications. The 160-pin MB86965B offers an ISA interface and

includes a full-duplex Ethernet interface. It suits add-in-card applications. MB86964, \$15.25; MB86965B, \$16.65 (10,000). **Fujitsu Microelectronics Inc.**, San Jose, CA. (800) 642-7616.

Circle No. 386

Logic devices operate at 3V.

PEEL18CV8L is a 3V programmable electrically erasable logic (PEEL) device. The devices typically draw 5 mA from a 3V supply. PEELs provide $\frac{1}{8}$ to $\frac{1}{10}$ the power of traditional bipolar devices. Compared with a GAL device's five macrocells, the PEELs provide seven additional macrocell configurations, for a total of 12. \$1 (10,000). **American Microsystems Inc.**, Pocatello, ID. (208) 234-6668. **Circle No. 387**

RAMDAC operates at 135 MHz.

The W30C491 is a RAMDAC that can operate at 135 MHz. It supports multi-window displays and independent access to 16.8 million colors for each window. The RAMDAC can be used in XGA, Microsoft Windows, Targa, and Hi-Color GUIs. The chip offers eight software-selectable true-color modes of

15, 16, 18, or 24 bits. It also offers true-color bypass for direct D/A input access and an 8-bit pseudo-color mode. Integrated on the device are three 256x8-bit color lookup tables and three 8-bit D/A converters. 135-MHz version, \$15.97. **IC Works Inc.**, San Jose, CA. (408) 922-0202. **Circle No. 388**

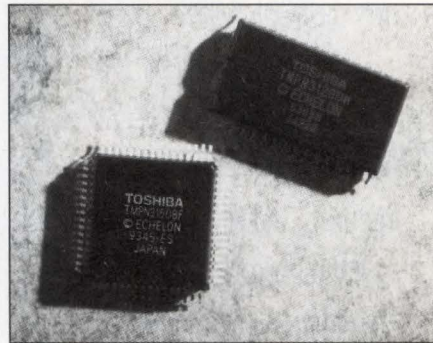

Neuron chips use Lontalk protocol.

The TMPN3150BF and TMPN3120BM are second-generation Neuron chips for use in Echelon Corp's Lonworks control network. The VLSI devices communicate with each other using the Lontalk protocol. Both chips contain 512 bytes of EEPROM for node

NTC H-UNIT THERMISTORS ...IN A RUSH.

This rugged thermistor can be in your hands for testing quickly if you call us today.

Therm-O-Disc's hermetically sealed thermistors, in a standard diode package, are perfect for all types of temperature compensation and sensing applications up to 315° C.

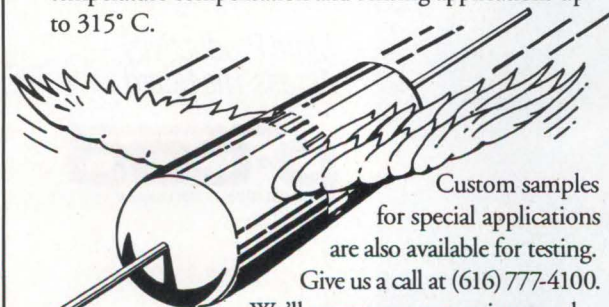

Custom samples for special applications are also available for testing. Give us a call at (616) 777-4100. We'll answer your questions, and send you a sample . . . in a rush.

THERMODISC

MIDWEST COMPONENTS PRODUCT GROUP

P.O. Box 3303, Muskegon, Michigan 49443
(616) 777-4100 FAX (616) 773-4214

Virtuoso™

Giving you the time to design in real-time.

Virtuoso delivers! Ported from 8bit microcontrollers to parallel processing systems with thousands of 32bit DSPs. Ease of use, superfast performance, high reliability and value for money. Includes source code, 12 months support and maintenance. Ask for full details and availability.

Virtuoso Nano

The fastest and smallest multi-tasking kernel for DSPs. Process switching and services in < 1 microsecond. Stdio. Network wide messages.

Virtuoso Micro

A high level but small preemptive real-time kernel with fully distributed semantics for transparent parallel programming. An industries' first with built-in cross development capability in C on any target! With task level debugger, tracing monitor, stdio, etc. Free license for use under DOS.

Virtuoso Classico

A seamless integration of Virtuoso Nano and Micro. A must for parallel processing systems. The real-time O.S. that really works for DSPs.

Virtuoso Modulo 0, I, II, III, IV, V, VI

A wide range of optimized libraries and support tools for DSP (> 1000 functions, stdio, PC graphics, plotting, heap allocation, loader, etc.)

Worldwide distributed, our open distribution policy welcomes new representatives and Value Added Resellers. Join the Virtuoso concept now!

Intelligent Systems International. Tel. (+32).16.62.15.85.

Fax (+32).16.62.15.84. e-mail: virtuoso@bix.com

EDN-NEW PRODUCTS

INTEGRATED CIRCUITS

addressing and configuration data. Each chip contains a unique 48-bit serial identification number that the application program can read for network configuration or product serialization. The chips have an operating current of 16 mA and a sleep mode of 15 μ A. Either device, \$5 (10,000). **Toshiba America Electronic Components Inc.**, Irvine, CA. (714) 455-2000.

Circle No. 389

Cache SRAMs feature 7-nsec access time. Five application-specific cache SRAM modules are available for the Intel Pentium μ P and the IBM/Motorola PowerPC μ P. The MCMs (multichip modules) feature clock to level-two cache array access times as fast as 7 nsec. Three of the new modules are customer-configurable as 64k \times 72, 128k \times 36, or 256 \times 18 bits. Two additional SRAMs are available in fixed 32k \times 72-bit configurations. The MCM SRAMs are designed for small skew and low noise, and a small form factor reduces line lengths. All of the MCMs run from a 5V supply. \$400 for a 4-Mbit device. **Micromodule Systems** Cupertino, CA. (408) 864-7437. Circle No. 390

GaAs SP4T switch has wide bandwidth. The GSWA-4-30DR GaAs SP4T switch has a dc to 3000-MHz bandwidth. The device comes in a 28-pin PLCC package that has strain-relief J-leads. Other features include 25-nsec

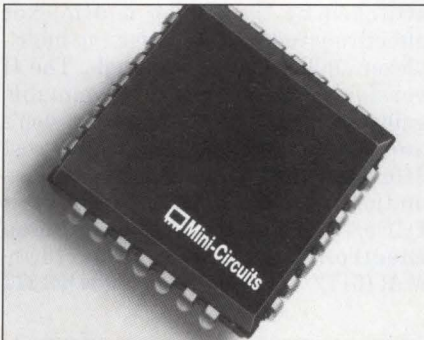

switching time; 0.9-dB insertion loss; 30- to 40-dB isolation; and 50 Ω RF ports. The switch can be used as an antenna switch in a 2-way radio receiver or as a filter or local oscillator selector. \$19.95. **Mini-Circuits**, Brooklyn, NY. (718) 934-4500. Circle No. 391

PLD pair offers low power. Two complex programmable logic devices are available in 44-pin PLCCs, ceramic

leadless chip carriers, or ceramic leaded chip carrier packages. The ATV2500B offers a propagation delay of 12 nsec and typical pin-to-pin delays of 10 nsec. The low-power ATV2500BL offers 2-mA standby current. The devices contain 24 flexible macrocells that each have 17 product terms, which are globally connected by a single AND/OR matrix. Each macrocell has two flip-flops that can be configured as either D- or T-types. \$19.75 (100). **Atmel Corp.**, San Jose, CA. (408) 441-0311. Circle No. 392

Logic device combines CMOS and EPROMs. The PEEL22CV8 is a 24-pin replacement for the GAL20V8. The programmable electrically erasable logic (PEEL) device combines CMOS and EPROM technologies. CMOS PLDs replace bipolar devices and the erasability provides an alternative to conventional PLDs and GALs. The PEELs also have a faster erase time than GALs by a factor of 10. The device provides independent output enables and two additional input pins. \$0.60 to \$3. **American Microsystems Inc.**, Pocatello, ID. (208) 234-6668. Circle No. 393



Go Configure

Spectrum's expertise goes beyond boards to encompass all phases of engineering—from specification, design and pre-production testing to volume manufacturing.

Off-the-shelf products provide leverage for designing custom solutions for your DSP application.

Custom DSP Products

If you have a specific DSP application, we'll help configure a specific DSP solution. With support from design specification through manufacturing.

From a DSP board-level company featuring ISO 9002 Quality System registration. And a staff of experts from a

variety of DSP backgrounds.

All so you'll get quick time-to-market and low-cost OEM boards for PC, VME or proprietary platforms.

So before you configure, call **1-800-663-8986**, for the finest DSP hardware, development systems and experienced technical support in the industry.



CIRCLE NO. 28

TEST & MEASUREMENT

Graphical tool builds custom data-acquisition applications. With Visual Designer V2.0, function blocks selected from a menu appear on the screen as icons that you link to establish data flow. The latest version (\$595 until July 31) adds 14 blocks, including one for serial-communication, which extends control to RS-232C/422/485 devices; the tool previously supported only ISA-bus boards. Other new blocks include a DDE client block that lets the software receive data from other Windows applications (the earlier version allowed sending of data only), an X-Y plot block, and a load block that lets you run other Windows programs without leaving Visual Designer. **Intelligent Instrumentation**, Tucson, AZ. (602) 623-9801. **Circle No. 320**



Digital IC-test systems suit evaluation and production testing. The HP 83000 F240i and F330i (240 and 330 MHz, external test head, from \$3300/pin) are for prototype evaluation and analysis of defective ICs (complex RISC and CISC μ Ps, peripheral and support chips, and telecommunications devices, for example). The F80t and F120t (80 and 120 MHz, integral test head, from \$4100/pin) are for high-volume production testing. The systems, which can change waveforms and timing on the fly, accommodate as many as 512 pins now and can expand to as many as 1024 in the future. Pattern memory stores 4M vectors. The 80- and 120-MHz systems' overall timing accuracy is ± 300 psec. Shipments will begin this fall. **Hewlett-Packard Co.**, Santa Clara, CA. (800) 452-4844. **Circle No. 321**

1M-sample/sec ADC boards have an amplifier per channel. The WIN-30PGH and PGL boards operate even faster than 1M-sample/sec ADC boards whose several channels share a programmable-gain amplifier. Using an amplifier per channel does away with the need to wait for amplifier settling. Moreover, the higher level of the signals

FREE INFO, FREE POSTAGE

Use our postage-paid reader-service cards to get more information on any of these products.

switched by the analog multiplexer effectively reduces the noise the multiplexer adds to low-level signals. The H version's software-programmable gains are 1, 2, 4, and 8; the L version's are 1, 10, 100, and 1000. The boards cost \$1625 each, and both provide 12-bit resolution, two 12-bit DACs, two 16-bit DACs, and 24 digital I/O lines. **United Electronic Industries**, Watertown, MA. (617) 24-1155. **Circle No. 322**

100M-sample/sec, 4-channel DSO boasts 2M-sample/channel memory. The VC-7124 offers a bandwidth of 150 MHz. It acquires data in both real-time and random-repetitive-sampling modes. At its fastest real-time sampling rate, it can acquire 20-msec records. You can also partition the acquisition memories to store many shorter records in quick succession (2000 1k-sample records, for example). In addition to the deep internal memories, the scope accepts PCMCIA cards that store as much as 4 Mbytes. The scope, which performs Go/No-Go testing, includes a built-in printer, an RS-232C port, and an IEEE-488 port. \$12,500. **Hitachi Denshi America Ltd.**, Torrance, CA. (310) 328-6116. **Circle No. 323**

Economical DSOs bring back the advantages of analog-scope displays without the drawbacks. The 54600B series of benchtop DSOs incorporate a second-generation custom waveform-processor IC that produces vector-enhanced displays, which indicate slew rate the way analog-scope displays do: Brighter traces denote more slowly changing signals; dimmer traces indicate signals that are changing more rapidly. The scopes' 1.5M-pixel/sec display rate allows refreshing the display 60 times/sec, even when 12 waveforms are on the screen. The 54600B series includes 2- and 4-channel units whose bandwidths range from 100 to 500 MHz and whose prices range from \$2495 to \$4995. **Hewlett-Packard Co.**, Santa Clara, CA. (800) 452-4844. **Circle No. 324**

Electronic books provide on-line reference on thermodynamics, circuits, and differential equations. A series of electronic books works with

the vendor's MathCad technical calculation software. Each book provides examples of problems, taking you through the process of breaking down the equation and interpreting the results. You can change numbers and watch the effect on solutions. The circuits and thermodynamics books cost \$49 each; the differential-equation book costs \$99. **Mathsoft Inc.**, Cambridge MA. (617) 577-1017. **Circle No. 325**

Extender simplifies troubleshooting of PCMCIA cards. Model EXT-6800 plugs into PCMCIA sockets and accepts Type I and II PCMCIA cards. A right-angle socket on the extender provides access to both sides of the card under test. In addition, the extender provides access to all bus signals. A jumper on the extender lets you monitor the current drawn by the card under test from the 5V supply. \$190. **Advanced Electronic Systems**, Lake Forest, CA. (714) 855-7271. **Circle No. 326**

Software tailors HP 48 calculators for EEs' use. Even if you aren't familiar with the HP 48, you can use EE-Pro the first time you try it. The package includes on-line text help, a menu-navigation system with which you can quickly reach routines or reference data, and a key for setting the menu-scrolling speed. The package, which requires 5 kbytes of free calculator memory, comes on a plug-in expansion card for the 48GX and is fully compatible with the 48SX. \$109.95, including a 330-pg user guide. **Sparcom Corp.**, Corvallis, OR. (503) 757-8416. **Circle No. 327**

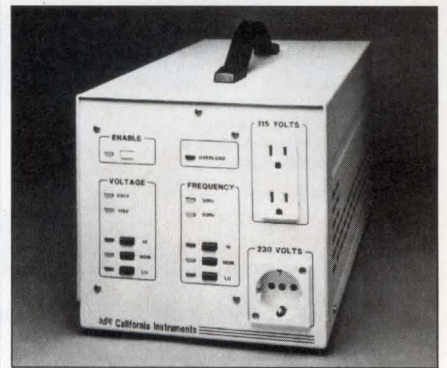

Portable unit supplies 1.3 kVA continuously at 50 and 60 Hz and five voltages for product testing. The fully isolated 1251WP produces 100, 115, 220, 230, or 240V ac with low distortion. It reliably starts loads whose inrush current is as much as 100A peak. You can select any voltage-

frequency combination. Two of the 29-lb. units mount side-by-side in an 8.75-in. space in an EIA rack. From \$2850. **California Instruments Corp.**, San Diego, CA. (619) 279-8620. **Circle No. 328**

Software uses graphics to simplify data-acquisition-system setup.

Fast-Daq uses National Instruments' LabView graphical instrumentation software and AT-MIO-16 series or Lab-PC+ data-acquisition boards. The \$849 package helps you install boards, set switches, connect signals, and select sampling rates. Once the equipment is set up, the package automatically collects, stores, and displays the data. It lets you customize the displays or recall and display data recorded earlier. **Fast-Daq Engineering**, Maitland, FL. (800) 732-7832. **Circle No. 329**

Vendor bundles instrument-control library software with ISA-bus IEEE-488.2 interface card. With the 82335B, you can use routines from a standard I/O library or the vendor's SICL (Standard Instrument Control Library). SICL works with any Win-

dows or DOS PC and with C, C++, Basic (including Visual Basic), and Pascal. Both libraries accompany the board, which, until September 30, costs \$295. **Hewlett-Packard Co.**, Santa Clara, CA. (800) 452-4844. **Circle No. 330**

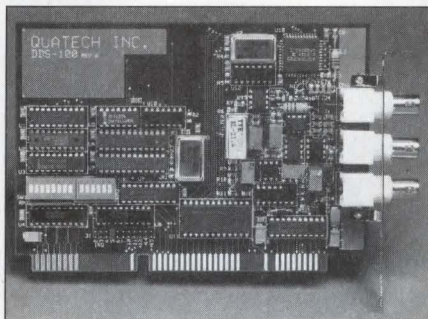

ISA-bus board uses 32-bit direct-digital synthesis to create 20-Hz to 20-MHz sine waves. The DDS-100 produces TTL-compatible square waves at the same frequency as its sine waves. With appropriate software, such as the Windows application packaged with it, the board can produce FSK, AM, QAM, and phase-modulated outputs and output bursts. It can also do frequency hopping and create frequen-

cy sweeps. A phase-modulation register lets you use software to control the output phase. \$495. **Quatech Inc.**, Akron, OH. (216) 434-3154. **Circle No. 331**

Memory of 4-channel, 60-MHz analog/digital scope expands to 128k samples/channel. The 2216's standard memory depth is 16k samples/channel, but you can expand it to 128k. The scope, which offers a parallel printer port and is fully programmable via RS-232C and IEEE-488 ports, also functions as an analog instrument. The maximum real-time acquisition rate in DSO mode is 20M samples/sec. In the random repetitive sampling mode, the scope allows pretrigger viewing to 100% of its memory depth. The unit makes 15 types of automated measurements and permits cursor measurements of voltage, time, and frequency. \$3995; expanded memory, \$1290. **Tektronix Inc.**, Beaverton, OR. (800) 426-2200. **Circle No. 332**

Handheld DMMs tailor features and prices to user needs. Depending on which model you select, the

Dale® Touch Panel Systems

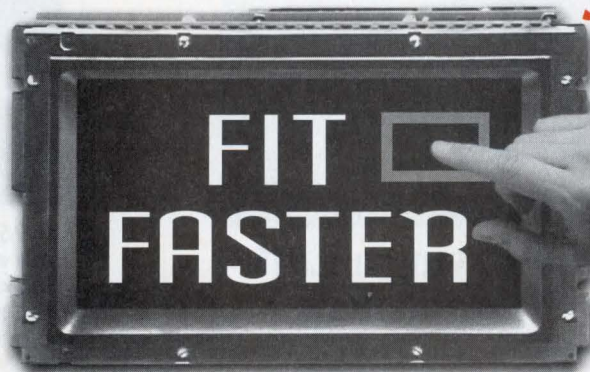

On Sharp®, Planar®, Hitachi® and other LCD and EL Displays

Dale® infrared panels make it easy to complete your plans for information center displays, interactive video, process control and a variety of other tactile-activated systems. Key to our growing design acceptance is a slender profile which, on average, adds less than 1 inch to overall unit depth and requires no adapters to fit many widely-used LCD and EL displays. We can also supply touch panels integrated with Dale gas plasma displays and complete with drive electronics and controllers.



Dale touch software supports mouse emulation for both Windows® and DOS® platforms making integration a snap. That's the key to Dale touch panels—they're quick to integrate so you can be quick to market.

For complete details, design assistance or compatibility chart phone 402-563-6506. For literature only, fax 1-800-835-4272 today. Dale Electronics, Inc., 1122 23rd Street, Columbus, Nebraska 68601-3647.

EDN-NEW PRODUCTS

TEST & MEASUREMENT

971A, 972A, 973A, and 974A offer 3½- or 4½-digit resolution. All models measure ac and dc voltage, current, frequency, and resistance and perform diode and continuity tests. Two models have true rms ac and ac+dc ranges. Two models measure capacitance and provide dual digital readouts. \$195 to \$370. **Hewlett-Packard Co**, Santa Clara, CA. (800) 452-4844. **Circle No. 333**

\$495 data-acquisition package runs under Macintosh System 7.

Igor Pro V2.0 can acquire and display data in real time. User-defined buttons and displays let you use the "System 7 savvy" application to build custom control panels. The package, which you can operate interactively by pointing and clicking or by issuing commands, can also execute programs that you create. Upgrades from earlier versions cost \$200. **Wavemetrics Inc**, Lake Oswego, OR. (503) 620-3001. **Circle No. 334**

Test probes with switchable 10× attenuators add functions to Fluke ScopeMeters. The fully insulated 6033, a \$125 kit of two probes (a red one

and a gray one), and the 6035, a \$95 individual probe, offer switchable ×1 and ×10 attenuation. The probes, which withstand 360V rms and are rated to operate to 200 MHz, terminate in insulated BNC connectors. **ITT Pomona Electronics**, Pomona, CA. (909) 469-2900. **Circle No. 335**

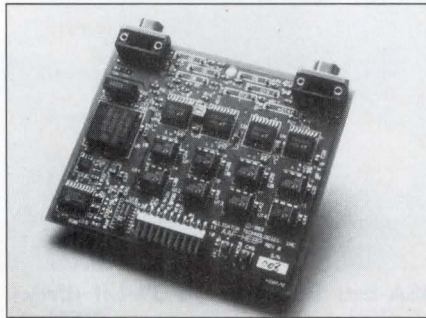

8-channel antialiasing filter programs from 1 Hz to 50 kHz via RS-232C. Unlike other switched-capacitor active filter boards, the \$3995 AAF-HE8P does not plug into a standard bus. You can, however, daisy-chain 16 of the boards and control them from one RS-232C port. The boards have 5-pole Butterworth response with ±0.2-dB typ

passband ripple to 0.8 f_c. Channels are phase-matched within ±0.5° typ. The boards require 7.5V at 175 mA, -7.5V at 185 mA, and 5V at 40 mA. **Alligator Technologies**, Costa Mesa, CA. (714) 850-9984. **Circle No. 336**

\$79.95 handheld tester checks Ethernet cabling. The DXB65 separates into remote and master sections that you can use independently to test installed wiring or rejoin for bench testing of patch cords. **L-com Inc**, North Andover, MA. (508) 682-6936. **Circle No. 337**

VXibus ARB now accommodates 512k-point memory. With a \$595 128k-point memory option or a \$1995 512k-point option, the \$4995 SCPI-compatible model 1395 can store long waveforms or multiple shorter ones. (Segments can be as short as five points.) With these options, the vendor has redesigned the waveform-management system to keep programming tasks from proliferating. **Wavetek Corp**, San Diego, CA. (619) 279-2200. **Circle No. 338**

Buyer in Trouble #111

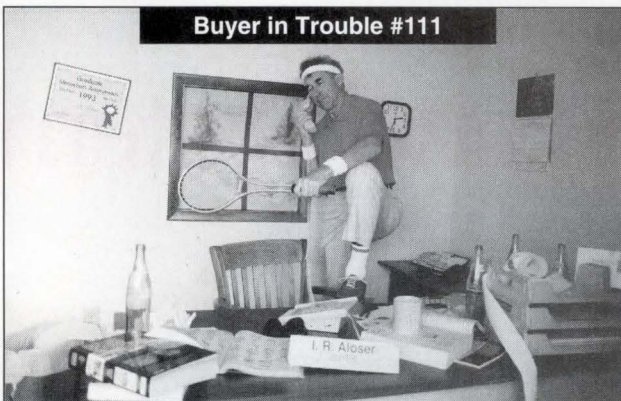

"I Didn't Mind Paying a Little Extra for Transformers

But my boss freaked out. In quantity, a little extra adds up to a lot extra and if you go to a distributor... it's like the national debt! He threatened to cancel my tennis club membership!

I really shoulda called Prem.

You oughta call Prem!"



Where Quality Really Counts!

For Prem's new catalog or additional product information, call or write Prem Magnetics, Inc.
3521 North Chapel Hill Road, McHenry, IL 60050.
Phone: 815-385-2700. FAX: 815-385-8578.



\$995 5.7538.37531.5-in., 1.7-lb unit adds data acquisition to notebook PCs. The DAQPad-1200 works with any PC that has a parallel printer port; it transfers data faster when connected to an enhanced parallel port (EPP). The unit receives power from an ac adapter or from a \$295 battery pack from which it operates for nine to 12 hours. There are eight single-ended analog inputs (four channels differential), two 12-bit DACs, 24 lines of TTL I/O, and three 16-bit counter timers. Speed of the 12-bit ADC is 100k samples/sec; the unit includes a 2k-sample FIFO ADC buffer. A programmable-gain amplifier boosts signal levels from one to 100 times in seven steps. **National Instruments Corp**, Austin, TX. (512) 794-0100. **Circle No. 339**

PCMCIA disk drives compete for storage-capacity championship

The PCMCIA disk drive with the highest storage capacity is

- Intégral's 170-Mbyte Viper
- Maxtor's 131-Mbyte MobileMax
- MiniStor's 260-Mbyte More MB
- All of the above.

The correct answer could be "d," but it's hard to tell for sure. All three companies have laid claim to "highest capacity" honors, and each claim may actually be valid. Qualifiers attached to the claims explain the apparent contradictions.

First, Intégral announced shipment of its 170-Mbyte Viper drive. Then, MiniStor announced availability of its 130-Mbyte More MB drive with an onboard compression utility that doubles capacity to 260 Mbytes. (You can disable compression if you wish.) Finally, Maxtor claimed its 131-Mbyte MobileMax is the highest capacity PCMCIA disk drive in volume production. So, depending on how many drives you need (and when) and how you feel about data compression, any one of the drives might be the most capacious available to suit your needs.

Shock tolerance also figures in the marketers' claims. Intégral says its drives can withstand a 750g nonoperating shock, MiniStor claims 900g shock tolerance, and Maxtor claims 600g tolerance. MiniStor also provides a storage and transport pouch, called the Pocket Socket, that boosts shock tolerance to 1200g. Operating shock tolerance for the drives ranges from 80g (Maxtor MobileMax, z axis) to 100g (Integral Viper, 2-msec linear pulse) to 120g (MobileMax, x and y axes) to 200g (MiniStor More MB, measurement method unspecified). Unfortunately, no standard exists for measuring disk drives' shock tolerance (see "Small rugged disk drives take (fairly) hard knocks," *EDN*, November 11, 1993, pg 41).

Other manufacturer-supplied specifications reveal few major differences in the disk drives. Power consumption varies the most, with MiniStor and Maxtor having an advantage during operation and with Integral edging out

MiniStor during standby and sleep. Some of the best specs for typical power consumption are

- Active—0.6W, Maxtor
- Read/write/seek—1.25W, MiniStor
- Standby—45 mW, Intégral and Ministor
- Sleep—25mW, Intégral.

Average seek time is 15 msec for the Intégral and MiniStor drives, 19 msec for the Maxtor drive. Start-up time, important in portable devices that power-down disk drives that aren't being accessed, is 1.5 sec for Intégral and Maxtor, 2.5 sec for MiniStor.

Prices for the small disk drives are remarkably similar: \$499 each.

—Gary Legg

Intégral Peripherals, Boulder, CO.
(303) 449-8009. **Circle No. 301**

Maxtor Corp, San Jose, CA. (408) 432-1700. **Circle No. 302**

MiniStor Peripherals Corp, San Jose, CA. (408) 943-0165. **Circle No. 303**



PCMCIA disk drives are increasing their storage capacity. With built-in data compression, the More MB drive from MiniStor can hold 260 Mbytes.

Get SMART[™]

REGULATORS

Enable...Reset...Watchdog

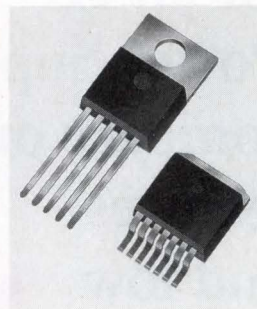

Cherry Semiconductor SMART Regulators, give you clean, tightly-regulated supply lines, sophisticated micro-processor monitoring & control, and energy conservation capabilities all in one IC!

Available in a range of efficient power packages, simply select the best combination of logic functions for your application:

- **Get ENABLE** to control your system actuators as needed.
- **Get RESET** for your micro-processor during low voltage conditions.
- **Get WATCHDOG** protection against microprocessor misexecutions.

Call 1-800-272-3601 for your FREE Smart Regulator[™] Selection Guide!

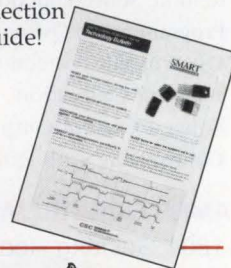

CHERRY SEMICONDUCTOR

Cherry Semiconductor Corporation
2000 South County Trail, East Greenwich, RI
401 885-3600

CIRCLE NO. 146

Before you spend more than double for an HP Power Supply, compare our features and low prices!

3 YEAR WARRANTY



22 models to choose from with different voltage/current combinations to meet all your application requirements.

- GPIB Interface Standard
- Voltage/Current Programming and Readback via LCD Panel
- Power-Off Memory
- Voltage and Current Step-up/Step down Function
- Output Enable/Disable
- Superior Line/Load Regulation
- Remote Sense Function
- Programmable Overvoltage and Overcurrent Protection
- Software Calibration
- Voltage/Current Outputs Controllable with External Voltage

AMERICAN RELIANCE INC.

11801 Goldring Road, Arcadia, CA 91006
Fax: 818-358-3838

1-800-654-9838

CIRCLE NO. 87

EDN-NEW PRODUCTS
COMPUTERS & PERIPHERALS

FREE INFO, FREE POSTAGE

Use our postage-paid reader-service cards to get more information on any of these products.

Video moves to HP workstations.

The PowerVideo 700 series of EISA-bus cards puts full-size, full-motion, true-color video on Hewlett-Packard 9000 Series 700 workstations. The cards let you display, digitize, compress, and store video and take advantage of optional analog input. Optional software tools, which work with HP's Mpower 2.0 collaborative multimedia software product, help you develop video-enabled applications. Prices for the cards, with various options and configurations, range from \$2995 to \$4995. **Parallax Graphics Inc**, Santa Clara, CA. (408) 727-2220. **Circle No. 418**

ISA-bus DSP card targets multimedia and telephony.

TeraDON, an ISA-bus card, uses as many as 16 AT&T DSP3210 floating-point signal processors to provide peak performance of 533 MFLOPS. Available software for the card includes ready-to-run multimedia and telephony modules for incorporating fax capabilities, modems, text-to-speech conversion, speech recognition, audio compression, and still-image compression. The card runs AT&T's VCOS multimedia operating system. With four processors, \$3995; with 16 processors, \$9995. **Ariel Corp**, Highland Park, NJ. (908) 249-2900. **Circle No. 419**

Removable-cartridge disk drive stores 270 Mbytes.

The SyDOS 270MB series of removable-cartridge disk drives stores 270 Mbytes and provides 13.5-msec average seek times. The 3.5-in. drives are also compatible with 105-Mbyte cartridges. \$500 to \$700; cartridges, <\$100. **SyDOS**, Boca Raton, FL. (407) 998-5400. **Circle No. 420**

200-Mbyte drive accommodates earlier SyQuest cartridges.

The 5.25-in. SQ5200C removable-cartridge disk drive stores 200 Mbytes and is compatible with earlier 44- and 88-Mbyte SyQuest cartridges. The drive has a SCSI II interface and an average access time of 18 msec. MTBF is 100,000 hours. Drive and cartridge,

from \$599; cartridge only, \$99 to \$109. **SyQuest Technology**, Fremont, CA. (510) 226-4000. **Circle No. 421**

Flat-panel computer has 14-in. color LCD.

The DisplayPac-Vista combines a 14-in., 262,000-color TFT LCD with a 486DX-based computer and a resistive touchscreen. The package fits in a 12.5x15.5x4.5-in. metal, open-frame panel mount, and a 19-in. rack-mount version is also available. From \$7435 (OEM). **Computer Dynamics**, Greer, SC. (803) 877-8700. **Circle No. 422**

Workstation features 70-MHz MicroSPARC II.

The micro COMPstation, based on a 70-MHz MicroSPARC II processor, provides performance estimated at 50 SPECint92 and 43 SPECfp92. It's available with 16 to 256 Mbytes of memory, three SBus slots, and Solaris 1.1.1B software. Available color monitors range from 14- to 20-in. versions. From \$5000. **Tatung Science & Technology Inc**, Milpitas, CA. (800) 659-5902. **Circle No. 423**



Cursor controller works in harsh environments.

DuraPoint, a ruggedized cursor controller, works in harsh environments, including wet areas and outdoor installations. The device is environmentally sealed and completely immersible. It's also resistant to shock, vibration, and most cleaning solutions. The controller is available in stand-alone and panel versions. \$279. **Interlink Electronics**, Camarillo, CA. (805) 484-8855. **Circle No. 424**



PKA series 25-40 watt DC/DC converters. The de-facto standard setter



PKC series 15-18 watt DC/DC converters with up to three regulated outputs. 10.5mm height

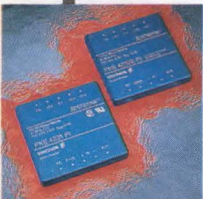

PKE series 25-40 watt, low profile DC/DC converters. A follow up on the PKA series with 10.7mm height, 1500 V isolation and 48/60 V input



MacroDens™ 3-7 watt DC/DC converters. The first of their kind for automatic placement.



PI, 2PKV and 7PKV series 0.3-7 watt DC/DC converters

World class ideas matched to world class manufacturing have made us The Power in Telecommunications

It's taken just 10 years for Ericsson to become the undisputed world leader in DC/DC component power for the telecommunications industry.

When we launched the concept of component power in 1983, it took a little explaining. No-one had ever seen compact, lightweight, high reliability DC/DC converters like the 25-40 watt PKA series before.

But they soon caught on.

Further innovations followed, including the credit card sized PKC, a miniature 15 watt device with up to three regulated outputs. And most recently we introduced the PKE, a low profile 25-40 watt version of the PKA, with extended input/output isolation.

But what may not have been so obvious to our customers has been the massive investment in R&D and manufacturing automation which has made these great concepts viable as high quality commercial products. It's an investment which has led to a world class automated factory, and UL recognition and CSA certification for our products. In addition our operations are ISO 9001 certified - a guarantee for professionalism and a reliable source.

Simply call us for more information, and to ensure that we keep you informed of forthcoming innovations in power.



Ericsson Components AB is an ISO 9001 certified supplier since 1991

Sweden: Stockholm, Tel: +46-8-721 6356 Fax: +46-8-721 7001
Denmark: København, Tel: +45-33 88 31 01 Fax: +45-33 88 31 05
Finland: Helsinki, Tel: +358-0-299 4098 Fax: +358-0-299 4188
France: Guyancourt, Tel: +33-1-30 64 85 00 Fax: +33-1-30 64 11 46
Germany: Neu-Isenburg, Tel: +49-6102-20 05 0 Fax: +49-6102-20 05 33
Great Britain: Swindon, Tel: +44-793-48 83 00 Fax: +44-793-48 83 01
Hong Kong: Hong Kong, Tel: +852-950 2388 Fax: +852-590 9550
Italy: Milano, Tel: +39-2-55 21 26 16 Fax: +39-2-39 00 04 02
Norway: Billingstad, Tel: +47-66 84 19 05 Fax: +47-66 84 19 09
United States: Richardson, TX, Tel: +1-214-997-6561 Fax: +1-214-680-1059

ERICSSON 

EDN-NEW PRODUCTS

COMPUTERS & PERIPHERALS

Quad-speed CD-ROM drive has fast access. The Teac Super Quad, a quad-speed CD-ROM drive, provides data transfers of 600 kbytes/sec and an access time of 195 msec. The drive supports CD-ROM XA (extended architecture), has multisession photo-CD capability, and complies with MPC Level II. It has a 5.25x1-in. form factor. \$399. **Teac America Inc.**, Montebello, CA. (213) 726-0303. **Circle No. 425**

Color flat-panel display serves SPARCstations. A flat-panel display subsystem, comprising of the C5020 color active-matrix TFT display and the S20VGA frame buffer, makes a compact monitor for Sun workstations. The 9.4-in. (diagonal), 640x480-pixel screen displays 256 colors from a palette of 16.8 million; refresh rate is 60 Hz. The S20VGA is register-compatible with Sun's CG3 driver. \$4295. **Integrax Inc.**, Newbury Park, CA. (800) 300-8288. **Circle No. 426**

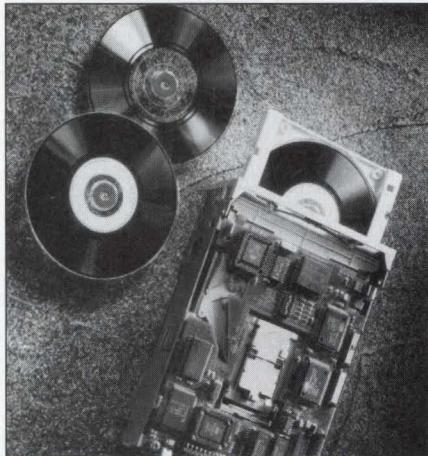

Magneto-optical drive stores 230 Mbytes. The LB3230 magneto-optical disk drive stores 230 Mbytes on a 3.5-in. magneto-optical cartridge and has an average seek time of 28 msec. It also handles erasable optical-read-only-memory (OROM) and partial-ROM media and is compatible with 128-Mbyte cartridges. Burst-transfer rates

are 4 Mbytes/sec; streaming data-transfer rates range from 920 kbytes/sec (zone 0) to 1.47 Mbytes/sec (zone 9). \$800. **LaserByte Corp.**, Sunnyvale, CA. (408) 734-9200. **Circle No. 427**

Graphics accelerators work on PCI bus. The GE 64 PCI and the Prostar 64 PCI graphics-accelerator cards provide a choice of performance levels for the PCI bus. Each card has 64-bit bandwidth and 32-bit bus transfers; the GE 64 delivers 16.8 million colors to 1024x768-pixel displays, and the Prostar 64 provides 65,536 colors at that resolution. The \$229 GE 64 uses S3 Vision 864 accelerator chip; the \$189 Prostar 64 uses Cirrus Logic's 5434 chip. **Actix Systems Inc.**, Santa Clara, CA. (408) 986-1625. **Circle No. 428**

MPEG compression software runs on Windows. XingCD software provides full-screen MPEG-I compression

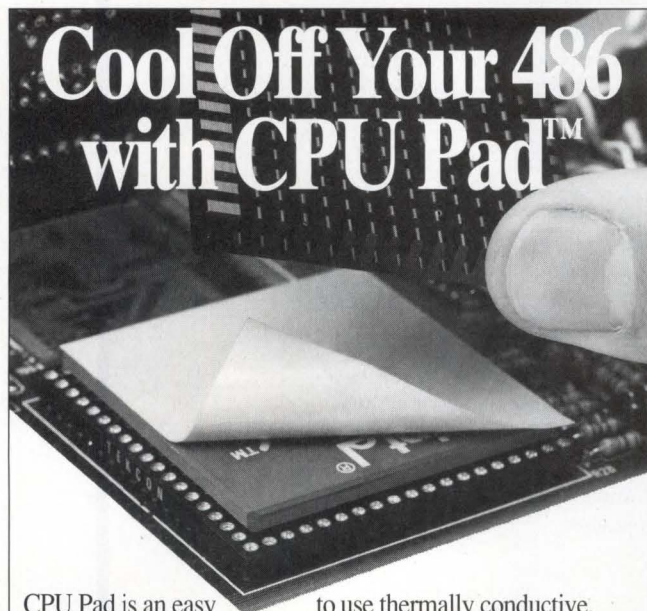

Cool Off Your 486 with CPU Pad™

CPU Pad is an easy to use thermally conductive, electrically insulating, double coated tape used to mount a heat sink on top of a heat generating component such as the central processing unit on a PC board. CPU Pad bonds the sink to the PGA with light mounting pressure, replacing clips and thermal compound. Thermal impedance is 0.34 °C/in² Watt.

For a complete Sil-Pad Design Guide Call Toll Free: 1-(800) 347-4572.

THE BERGQUIST COMPANY

5300 Edina Industrial Blvd., Minneapolis, MN • Tel: (612) 835-2322 • Fax: (612) 835-4156

AFFORDABLE Thin Film Chip Resistors? Look at the Specifications:

- **affordable** thin film precision & stability
- 0.1% & 0.5% R-value tolerance **standard**
- ± 25 to 100 ppm/°C TCR
- 0402, 0603, and 0805 package size
- E-24 to E-96 series in stock
- **thin film performance at thick film prices!**

Manufacturer

SSM
THIN FILM TECHNOLOGY

Susumu Co., Ltd.
14 Umamawashi-Cho, Kamitoba
Minami - Ku, Kyoto, Japan 601
075 671-7371, Fax 075 671-7374

North America Sales Agent

Thin Film Technology
1980 Commerce Drive
N. Mankato, MN 56003
507 625-8445, Fax-3523

TFT
Thin Film Technology

EDN-NEW PRODUCTS

COMPUTERS & PERIPHERALS

for Windows applications without MPEG hardware. It produces MPEG video streams from TGA, AVI, or BMP formats; it handles 352×240-, 320×240-, and 160×120-pixel images. \$995. **King Technology Inc.**, San Jose, CA. (800) 294-6448. **Circle No. 429**

Large color display suits demanding applications. The PrecisionColor Display/21 monitor puts 16.7 million colors in sharp edge-to-edge focus on a 21-in. screen. Its multiple-frequency capability allows configuration from 1024×768 to 1360×1024 pixels. Dot pitch is 0.28 mm. \$2499. **Radius Inc.**, San Jose, CA. (800) 227-2795. **Circle No. 430**

SCSI kits handle multimedia. Six new 16-bit SCSI host-adaptor kits offer a variety of hardware and software options for multimedia CD-ROM applications. Versions are available with and without a floppy-disk controller; with and without CorelSCSI software; and with and without drivers for Windows NT, OS/2, Novell NetWare, and SCO Unix. From \$140 (100). **Rancho Technology Inc.**, Rancho Cucamonga, CA. (909) 987-3966. **Circle No. 431**

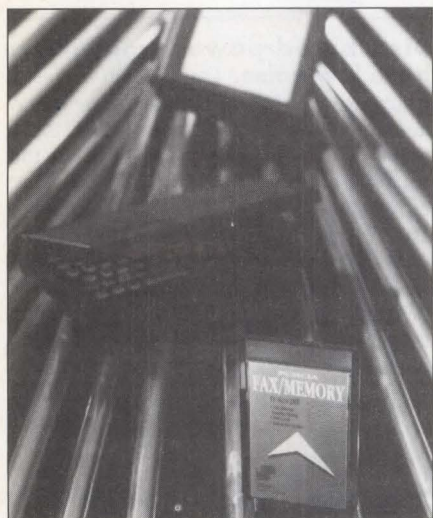

PCMCIA card combines fax and memory. A Type II PCMCIA card combining memory and a fax helps overcome the limitations of low-memory, single-slot, portable computers. The Hayes-compatible modem has full-duplex communication at 2400 bps plus fax operation at 9600 bps. The card is

available with 2 Mbytes of flash memory for \$349 or with 4 Mbytes for \$449. **Smart Modular Technologies**, Fremont, CA. (510) 623-1231. **Circle No. 432**

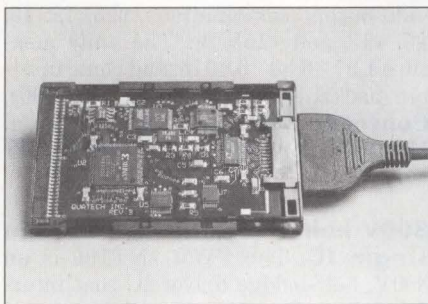

PCMCIA card holds RS-232C adapter. The SSP-100 packs a single-channel RS-232C asynchronous serial adapter in a PCMCIA card. The Type II card includes a 16550 UART and complies with release 2.1 of the PCMCIA standard. You can assign any COM port, interrupt level, and I/O address. \$229. **Quatech Inc.**, Akron, OH. (216) 434-3154. **Circle No. 433**

PCI local bus gets Ethernet controller. A new Ethernet adapter for the PCI bus has an independent 10-MHz serial clock and a PCI system clock that operates at speeds up to 33 MHz with no wait states. The card provides full support for 10BaseT, 10Base2, and 10Base5 connection in all popular network operating systems and supports IEEE 802.3, ANSI 8802-3, and Ethernet standards. A sleep mode reduces power consumption for battery-powered applications. \$399. **CNet Technology Inc.**, San Jose, CA. (408) 954-8000. **Circle No. 434**

Graphics card has PCI and VL versions. The WindowsVGA 64 graphics card, available in versions for the PCI and VL buses, provides 16.8 million colors on 1024×768-pixel displays. The DRAM-based card is based on Cirrus Logic's CL-GD5434 graphical-user-interface chip and has a 64-bit memory interface. The card is available with 1 Mbyte of memory (upgradable, via sockets, to 2 Mbytes) or with 2 Mbytes (upgradable to 4 Mbytes). 1-Mbyte version, \$199; 2-Mbyte version, \$289. **Genoa Systems Corp.**, San Jose, CA. (408) 432-9090. **Circle No. 435**

PICO

Free
136 pg.
catalog

SURFACE MOUNT & PLUG-IN TRANSFORMERS & INDUCTORS

DC-DC CONVERTERS

- Surface Mount • PC Board Mount
- Low Profile • Single and Dual Output
- Isolated • Industrial to Military
- up to 1000 Volts

AC-DC POWER SUPPLIES

- Linear • Switchers • Open Frame
- Low Profile • Up to 200 Watts

New HIGH POWER DC-DC CONVERTERS

- New Isolated **DUAL** Outputs
- Wide Input Voltage Range
- Regulated 100 Watts

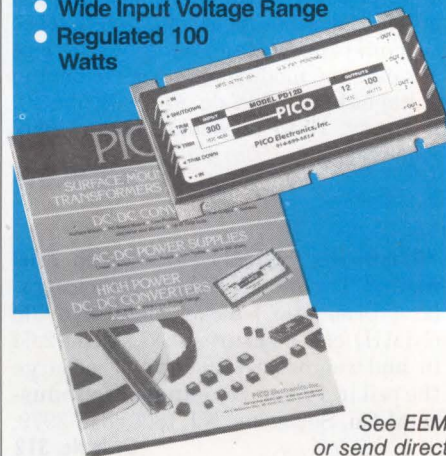

See EEM
or send direct
for Free PICO Catalog.
Call toll free **800-431-1064**
in NY call **914-699-5514**
FAX **914-699-5565**

PICO Electronics, Inc.

453 N. MacQuesten Pkwy., Mt. Vernon, N.Y. 10552
CIRCLE NO. 147

POWER SOURCES

Switching power supplies meet military specifications. A line of MIL-SPEC universal-input switching supplies includes input filtering that meets MIL-STD-461C. The units comply with MIL-STD-454 and MIL-STD-2000. Units are available from 25W to 300W in single-, dual-, triple-, and quad-output versions. The units have a 3-year warranty. \$845 to \$2100 in small quantities. **Logitek Inc.**, Ronkonkoma, NY. (516) 467-4200. **Circle No. 310**

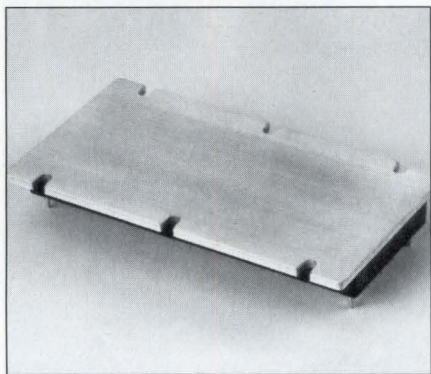

Current sources supply constant current from batteries. The BatMod current-source modules run off batteries and deliver a programmable output current. The units measure 4.6×2.4×0.5 in. and handle currents up to 40A at 100V dc. One analog port controls the output-current level, and another controls the point at which the module switches from constant-current to constant-voltage mode. You can arrange the modules in series to handle voltages up to 500V dc. \$150 (OEM qty). Delivery, 10 to 12 weeks. **Vicor Corp.**, Andover, MA. (508) 470-2900. **Circle No. 311**

"Prismatic" NiMH cell stores 760 mAh. The model HHF80T rectangular ("prismatic") nickel metal-hydride (NiMH) cell measures 0.67×0.24×2.64 in. and weighs 0.88 oz. You can recharge the cell in 1 hour. \$8. **Panasonic Industrial Co.**, Secaucus, NJ. (800) 848-3979. **Circle No. 312**

DIP-sized converter has ultra-high 8000V pk isolation. The 100VFI series of DIP-sized single- and dual-output 1.5W dc/dc converters feature 8000V pk (4000V steady-state) input-output isolation. Eighteen models

FREE INFO, FREE POSTAGE

Use our postage-paid reader-service cards to get more information on any of these products.

operate from 5, 12, or 15V dc and provide output combinations of 5, 12, 15, ±5, ±12, and ±15V dc. The units measure 1.27×0.80×0.40 in. and come in 24-pin packages. \$25.90 to \$27.30 (100). **Conversion Devices Inc.**, Brockton, MA. (508) 559-0880. **Circle No. 313**

800V half-bridge driver comes in single IC. The PWR-INT100 is an 800V, half-bridge driver IC that interfaces between 5V control logic and MOSFETs driving high-voltage, 2-hp, brushless dc motors at rates up to 50 kHz. The IC incorporates a lockout for full-bridge implementations that prevents both high- and low-side transistors from turning on simultaneously. The drivers sink 300 mA and source 150 mA. \$1.76 (1000). **Power Integrations Inc.**, Mountain View, CA. (415) 960-3572. **Circle No. 314**

Hybrid converters meet military specifications. The 2680 series of 30W hybrid dc/dc converters operates from 28V-dc sources. The units exhibit MIL-STD-704 or -1275 surge characteristics and have MIL-STD-461 EMI filtering. The converters come in single-, double-, and triple-output models. They measure 0.495×1.34×2.12 in. Operating temperatures are from -55 to +115°C. \$1014 (10). **Modular Devices Inc.**, Shirley, NY. (516) 345-3100. **Circle No. 315**

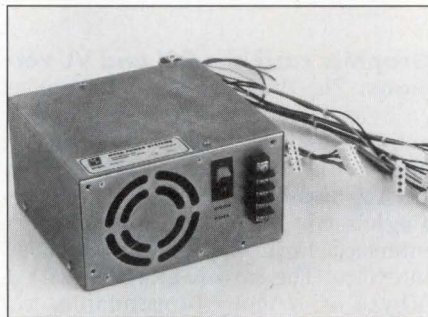

IBM PC AT-type supplies operate from 12, 24, or 48V dc. A line of IBM PC AT-type supplies operates from 12, 24, or 48V dc inputs and handles 100, 125, or 240W, respectively.

Input-output isolation is 500V dc. The supplies have short-circuit protection with automatic recovery. Operating temperature is 0 to 50°C. \$187 (1000); delivery from stock. **Mesa Power Systems**, Escondido, CA. (619) 489-8162. **Circle No. 316**

SIP regulator lowers 5 to 3.3V dc. The PT6305N 5 to 3.3V regulator comes in a 12-pin SIP. The IC handles 3A at 85% efficiency max. It tolerates a 4.5 to 10.0V input-voltage range and has over-temperature and short-circuit protection. The unit measures 0.36×2×0.60 in. \$19.90 (100); delivery, two to four weeks. **Power Trends Inc.**, Batavia, IL. (800) 531-5782. **Circle No. 317**



Distributed-power converters have low noise. The PM900 series of ultra-low-noise, high-accuracy 5W dc/dc converters operate from 5, 12, 24, and 48V dc. The single- and dual-output units measure 2×2×0.42 in. Output ripple for single-ended units measures 10 mV p-p max, 6 mV p-p max for dual-ended. The units meet VDE 0871 Level B EMI requirements. Line and load regulation spec ±0.02%, and transient response is 20 μsec for 100% load steps. \$50 (OEM qty). **Computer Products Inc.**, South Boston, MA. (617) 464-6656. **Circle No. 318**

Regulators supply 7.5A at 3.3V with 600-mV dropout. The LDO family of 3-terminal regulators handles 1.5, 3, 5, and 7.5A. The regulators come in fixed (3-pin) and adjustable (5-pin) 3.3, 5, and 12V versions. Dropout voltage is 600 mV max. 3-pin models, \$1.93 to \$4.40 (100); 5-pin models, \$2.14 to \$5 (100). **Micrel Semiconductor**, San Jose, CA. (408) 944-0800. **Circle No. 319**



Interpoint's MIL-STD-883 dc-dc converters: Recognized for outstanding performance.

On Space Station Freedom, the Patriot Missile, European Fighter Aircraft and thousands of critical applications, Interpoint dc-dc converters are the ones designers choose first. However you measure performance, Interpoint commands the field.

Interpoint is recognized for broadest selection. From fully qualified SMD parts to low-cost solutions, from 5 to 285 watts. Interpoint has a solution for almost every power need.

Interpoint is recognized for innovation. Our 20-year history of breakthroughs includes the first 70 W/in³ board-mountable dc-dc converters.

Interpoint is recognized for reliability. Our power supplies have logged more than 1,000,000 field hours per failure.

Our new, fully compliant MSA Series offers 5 watts of power in a case just 0.27" high. The MSA also meets MIL-STD-704A input voltages (up to 80V surges) with 5, 12, and 15 Vdc outputs.

For your **FREE HI-REL DESIGN FIELD KIT**, with Guides to selecting and using dc-dc converters in HI-REL systems, call:

NEW!
The 5-watt
MSA Series
now meets
MIL-STD-883

1-800-822-8782

In Europe, call:
Interpoint U.K. (0252) 815511
Interpoint France (1) 34-28-54-55

HI-REL DC-DC Converters for Every Power Level

Series	V in	V out	Outputs	Power
MSA	16 to 40	5,12,15	1 or 2	5 W
MHF+	16 to 40	5,12,15	1 or 2	15 W
MTR	16 to 40	5,12,15	1, 2, or 3	30 W
MFL	16 to 40 80 to 160 160 to 400	5,12,15,28	1 or 2	65 W*
MFLHP	19 to 40	5,12,15	1 or 2	100 W*

* Multiple units current share

interpoint

ADTEK

HIGH SPEED EISA BUS INTERFACE CARDS

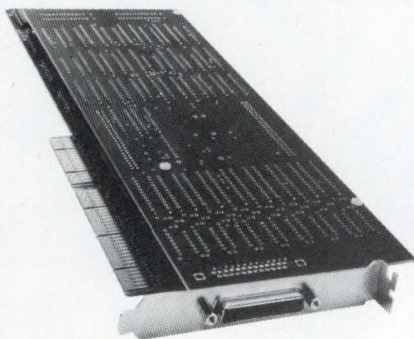

12 BIT A/D

- 8 Ch @ 333 Khz/Ch
- 4 Ch @ 2.0 Mhz/Ch
- 2 Ch @ 5.0 Mhz/Ch
- 1 Ch @ 10 Mhz/Ch

DIGITAL I/O

- High Speed 16/32 Bits

Providing sustained transfer rates over 20 megabytes per second direct to extended memory.

FRANCE

DiPsi Industrie
TEL: (33) 1 497902111
FAX: (33) 1 40860661

ENGLAND

LaPlace Instruments
TEL: 0692 500777
FAX: 0692 406177

SWEDEN

System
TEL: 4613 11 01 40
FAX: 4613 14 05 30

AUSTRALIA

Electro Optics
TEL: (02) 654 1873
FAX: (02) 654 1539

OTHER COUNTRIES

Silicon Valley
Technologies
TEL: (33) 92 91 05 58
FAX: (33) 92 91 02 93

ANALOG DIGITAL TECHNOLOGY

31324 Via Colinas, #106
Westlake Village, CA 91362
(818) 597-1578 • Fax (818) 597-8211

EDN-NEW PRODUCTS

COMPONENTS

FREE INFO, FREE POSTAGE

Use our postage-paid reader-service cards to get more information on any of these products.

Manual volume control stifles Mallory Sonaalerts. You can fit a manual volume control in the field to classic Mallory screw-neck Sonaalerts. The control provides 14-dB attenuation of the Sonaalert's ear-piercing, high-frequency shriek. Once you adjust the control, you can lock its setting in place. The control adds 1/4 in. to the height of the Sonaalert. \$0.59 (100). **North American Capacitor Co.**, Arlington Heights, IL. (708) 577-8505. **Circle No. 350**

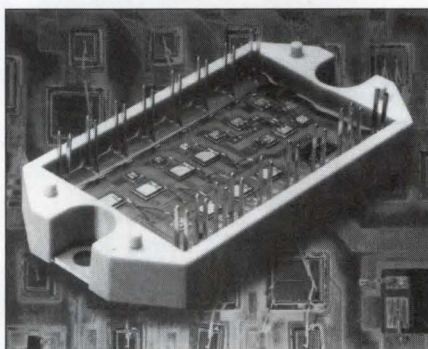

Inverter stage integrates all power components for 1-hp motor drive. The MHPM7A15A60 hybrid power module integrates a 3-phase input rectifier bridge, a 3-phase output inverter, a brake transistor-diode, an optional current-sense resistor, and a temperature sensor on its insulated metal substrate (IMS). The 600V, 15A module drives 1-hp (750W) or smaller motors to bring intelligent motor control down to office equipment and household appliances. The output inverter uses matched IGBTs and free-wheel diodes. Other features include access to both positive and negative dc bus and a single-phase ac-input option. \$50 (100). **Motorola Semiconductor Products Sector**, Phoenix, AZ. (602) 244-3103. **Circle No. 351**

PIN diode switches 1 kW at low frequencies. Normally confined to very high frequencies, the UM2100 series of PIN diodes can switch 1 kW at frequencies as low as 500 kHz. The diodes' capacitance and series resistance are flat enough so that you can use the diodes as switching elements in the 2- to 30-MHz band. A forward bias of 50 mA max obtains an IP3 of 60 dBm at 300 kHz with 1W per tone. Voltage

range of the devices is 0 to 1000V max. \$18 to \$46. **Microsemi Corp.**, Watertown, MA. (617) 926-0404. **Circle No. 352**

Gilbert Cell transistor-array IC suits double-balanced RF-mixer and amplifier applications up to 2.5 GHz. The HFA3101 Gilbert Cell transistor array replaces discrete, expensive GaAs ICs and is a pin-for-pin replacement for the NEC UPA101. The IC's f_T is 10 GHz, and collector-cutoff current, I_{CBO} , specs 10 nA. The device's gain-bandwidth product is 5 GHz, and its noise figure is 2.5 dB. Spice models and RF scattering parameters are available. \$2.66 (1000). **Harris Semiconductor**, Melbourne, FL. (800) 442-7747, ext 7223. **Circle No. 353**

Liquid-cooled thermal planes suck heat out of closed chassis. Liquid-cooled thermal planes come in standard configurations for SEM or VME systems or as custom units. The thermal planes can be as thin as 0.070 in. Each side of the plane has a 0.09°C/W thermal resistance. The planes feature brazed cooling fins and a 150-psi working pressure. \$500 to \$1000, depending on design and volume. **Lytron Inc.**, Woburn, MA. (617) 933-7300. **Circle No. 354**

Low-value, surface-mount chip resistors incorporate solid metal strips. The WSL series of low-value, surface-mount chip resistors have resistance values from 0.01 to 1Ω. These 2512-size units dissipate 1W max. Resistance tolerance is ±1%, and temperature coefficient is ±75 ppm/°C. \$0.38 (10,000); delivery, six weeks. **Dale Electronics Inc.**, Columbus, NE. (402) 563-6506. **Circle No. 355**

NTC thermistor-probe assemblies suit medical applications. A line of medical thermistor-probe assemblies include digital thermometers that feature tight tolerances over the medical temperature range of 32 to 43°C. Respiratory probes sense airflow through respirators; kidney-dialysis probes monitor blood flow through dialysis machines. Esophageal probes measure fluid flow in the body, and thermal-dilution probes go into heart catheters. Blood-flow-analysis probes suit intravenous use. \$1 for disposable units, \$5 for reusable units. **Fenwal Electronics Inc.**, Milford, MA. (508) 478-6000. **Circle No. 356**

LED assemblies directly replace wedge-based incandescent lamps.

An LED assembly consisting of a cluster of emitters, a lens, a protection diode, a limiting resistor, and a wedge-type base can directly replace common wedge-based incandescent lamps. The LED assemblies last 10 times longer than do the lamps they replace and consume 50% of the lamps' power. Versions of the assemblies accept power from 5 to 120V ac or dc, 50 to 400 Hz. Viewing angle is 160° (spherical). Eight colors are standard. A 28V-dc, red assembly costs \$2.89 (1000). Samples are available. **Ledtronics Inc.**, Torrance, CA. (310) 534-1505. **Circle No. 357**

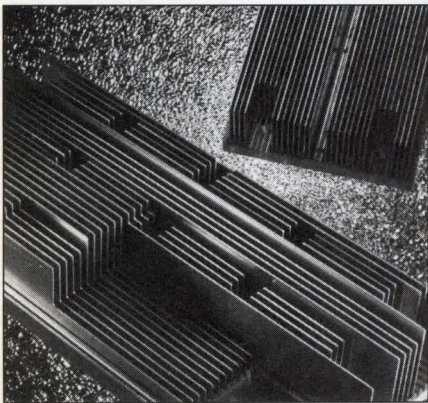

Heat sinks's bonded fins remove heat two to three times faster than extruded fins do.

The Series 4200 heat sinks feature cooling fins bonded to an aluminum heat spreader. This construction method permits 300% more cooling area than do extruding fins. The series comes in 24 variations of width and fin spacing. Widths range from 1.25 to 17 in. The highest fin count is 66 fins. A 2.4×2.4×2.5-in. heat sink having 16 bonded fins costs \$10.20 (100); delivery is three to four weeks ARO. **Aavid Engineering Inc.**, Laconia, NH. (603) 528-3400. **Circle No. 358**

Surface-mount coupler measures 0.31×0.31×0.2 in. The LRDC-10-1 broadband coupler's insertion loss measures 1 dB typ. Its directivity is 30 dB typ, and VSWR is 1.2 typ. The insertion loss has 4.5σ repeatability. Standard operating temperature range is -55 to +100°C. \$15.95. **Mini-Circuits**, Brooklyn, NY. (718) 934-4500. **Circle No. 359**

Keyboard switches migrate into other applications. The FSM J series of pushbutton switches began life as "tactile" switches mass-produced for

low-cost keyboards. But they are now available for other consumer application that require a positive feel from less than 0.02 in. of actuation travel. The switches use a silver-plated dome-shaped spring contact rated at 100,000 cycles/minute. \$0.235 (5000). **Augat Inc.**, Attleboro Falls, MA. (508) 699-7646. **Circle No. 360**

Curly plastic pigtail bundles cables. Kurly-tie brand cable wraps contract into a tight curl—somewhat smaller than a conventional phone cord—when not in use. Their inherent curl allows you to secure large or small cable bundles permanently during assembly or temporarily during test. The cable wraps come in 16 colors. The wraps are rubbery and do not slip. \$1.49 to \$12.95. Trial pack of all 16 colors, \$8.50 (plus \$2 shipping); sample, \$1. **SuperVid Supply**, Stone Mountain, GA. (404) 413-8624. **Circle No. 361**

Tiny black-and-white TV camera comes on a single chip. The V-007's camera IC measures 0.55×0.42 in. A complete camera assembly in an aluminum case and bearing a 4-mm lens measures 1.37 in. square. The IC has a 312×287-pixel image-sensor array. Pixel size is 19.6×16 μm. Automatic exposure range is 40,000:1, and AGC is adjustable to -10 dB. The camera is sensitive into the infrared. A demo unit operates from a 9V battery and plugs directly into any type of monitor. \$249. **Marshall Electronics Inc.**, Culver City, CA. (310) 390-6608. **Circle No. 362**



Tiny surface-mount bead quashes EMI/RFI. The ICB-0603's inductance measures 120Ω at 100 MHz. The EMI/RFI-suppressing device measures 0.8×1.6 mm and carries 200 mA max. Devices come in 2000-item reels. \$0.108 (100,000); delivery, eight weeks. **Associated Components Technology**, Garden Grove, CA. (714) 636-2645. **Circle No. 363**

Embedded PC

"The new megatel PC/+v offers on-board VGA in a small rugged form factor."



PCI/+v

On-board Features Include:

- 16 MHz V-40 CPU
- 640KByte User DRAM
- On-Board VGA Video/LCD display controller
- Power Consumption under 2 watts, +5 volt only operation
- 3 RS-232 Serial Ports
- Floppy, SCSI, Keyboard Ports
- Parallel, Printer Port
- PC Compatible BIOS
- Real Time Clock
- Only 4" x 6" (100 x 160mm)
- ISA and PC/104 Bus Options

For a list of our International Distributors, please contact our head office at:

megatel computer corp.

125 Wendell Ave.

Weston, Ont. M9N 3K9 Canada

Fax: (416) 245-6505

(416) 245-2953

ECC

EMBEDDED COMPUTER CONFERENCE
& EXPOSITION

JUNE 8-10, 1994

SANTA CLARA CONVENTION CENTER
SANTA CLARA, CA.

megatel®

CIRCLE NO. 88

EDN June 9, 1994 ■ 211

Handbook on compliance labeling. *The Essential, No Nonsense Guide to Compliance Labeling: Compliance Labeling for the Electronics and Telecommunications Industries* explains how to install label printing systems to meet industry-specific or customer-mandated bar-code label specifications. This 14-pg pamphlet discusses why labeling standards are necessary and how you design and implement a successful labeling program. **Zebra Technologies Corp**, Vernon Hills, IL.

Circle No. 394

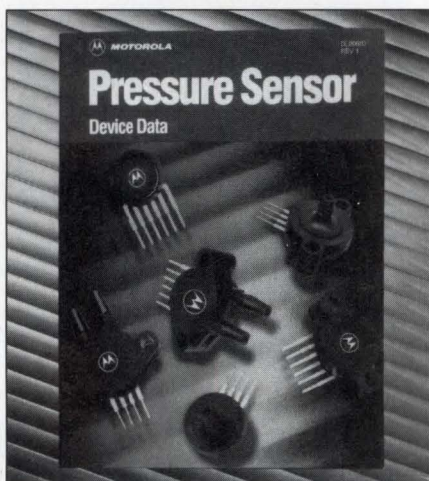

Data book details silicon pressure sensors. The *Pressure sensor device data book* offers extensive information on Motorola's integrated μ P-compatible pressure sensors. The book covers specifications for individual devices, descriptions of interface circuitry, package outline drawings, and information for handling and mounting the devices. **Motorola Inc**, Phoenix, AZ.

Circle No. 395

Data on cables. A 4-color, 2-pg data sheet features the Super CAT line of cables, which is designed for higher-performance systems such as ATM. **Helix/HiTemp Cables Inc**, Franklin, MA.

Circle No. 396

Supplier directory for the fiber-optics industry. The *Worldwide Fiberoptic Suppliers Directory for 1994-1995* lists companies, products, and contacts for the fiber-optics industry. The directory also lists more than 1300 suppliers in over 36 countries and includes contacts and products manufactured. \$60 plus \$5 if shipped outside the US. **KMI Corp**, Newport, RI.

Circle No. 397

212 • EDN June 9, 1994

Paper addresses dangers in electronic equipment. *Powerline Disturbances and Electronic Systems* presents an analysis of powerline disturbances and describes unexpected dangers to electronic equipment that conventional surge-control devices can't handle. **Zero Surge Inc**, Frenchtown, NJ.

Circle No. 398

Free Spice newsletter. *Intusoft Newsletter* covers topics related to the Spice circuit-simulation program. The newsletter includes regular features, such as the Intusoft Modeling Corner, a column about Spice modeling. **Intusoft** San Pedro, CA.

Circle No. 399

Book explains obstacles of circuit simulation. *Inside SPICE: Overcoming the Obstacles of Circuit Simulation* demonstrates how to get accurate, high-quality simulation results by learning to overcome common causes of error and simulation failures. The 208-pg book addresses the problems that engineers most commonly encounter while using Spice or any Spice-like simulator program. Topics covered include: the stumbling blocks of nonconvergence, numeric integration instabilities, and time-step control errors. \$50. **RCG Research Inc**, Indianapolis, IN.

Circle No. 400

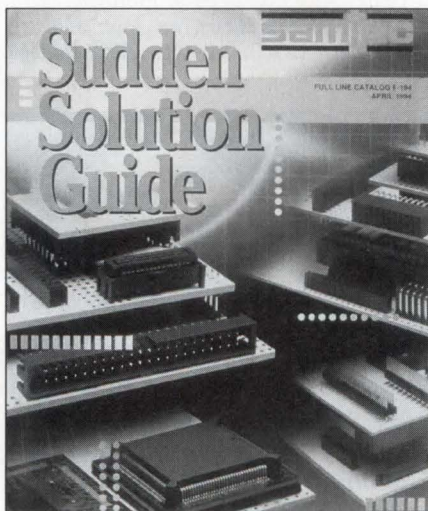

Catalog of connectors. Catalog F-194 details 0.100-in.-pitch board-to-board interconnects, micro and surface-mount connectors, IC-to-board sockets and adapters, and IDC cable assemblies. An applications section gives information on the design of sock-

ets and adapters for advanced IC packages. **Samtec Inc**, New Albany, IN.

Circle No. 401

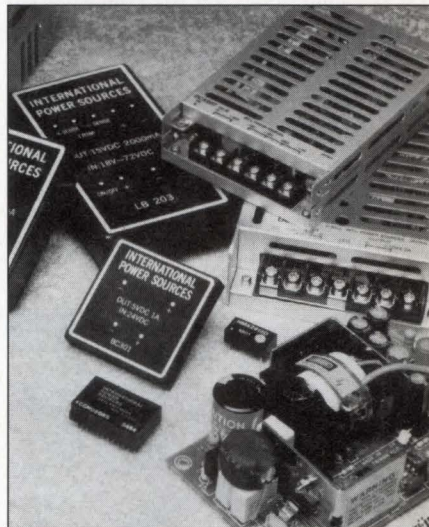

Catalog describes switching power supplies and converters. In 64 pgs, this catalog covers ac/dc switching power supplies from 15 to 650W and dc/dc converters from 1 to 650W. New products include surface-mount, wide-input-range, and high-isolation dc/dc converters. The catalog also contains detailed specifications, features, and performance graphs. **International Power Sources Inc**, Ashland, MA.

Circle No. 402

Paper describes voice-over-data technologies. This 5-pg paper details the features of the MultiModem PCS, including the voice-and-data mode that enables you to talk to the person on the other end of the modem link when sending data. The paper also compares the various voice-over-data technologies on the market. **Multi-Tech Systems Inc**, Mounds View, MN.

Circle No. 403

Guide to selectors. The *RF Selector Guide and Cross Reference for 1994* outlines RF product offerings and incorporates new categories such as RF integrated circuits. The guide also includes package outline information and a listing of application literature. **Motorola**, Phoenix, AZ.

Circle No. 404

Brochure describes stainless-steel enclosures. This brochure and selection guide assist enclosure specifiers

who require stainless steel for their applications. The brochure explains new programs designed to cut lead times for modified enclosures. **Hoffman Engineering Co**, Anoka, MN.

Circle No. 405

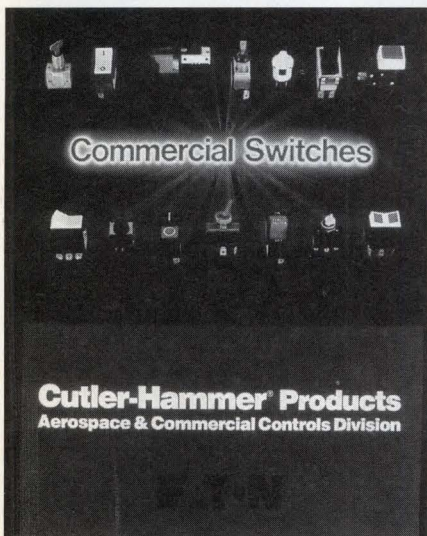

Commercial switches catalog. Catalog No. NC-168 details switches for commercial and industrial applications. Each product section includes a brief description and a selection table to simplify the search and selection process. **Eaton Corp**, Milwaukee, WI.

Circle No. 406

Brochure features datacomm/telecomm products. This free brochure describes cabinet racks, open relay racks, and a broad selection of compatible accessories for the datacomm/telecomm markets. **Bud Industries Inc**, Willoughby, OH

Circle No. 407

Catalog features membrane switches for custom applications. This 4-color, 8-pg catalog contains photos, features, mounting dimensions, technical information, specifications, options, and components of membrane switching systems for custom applications. **EAO Switch Corp**, Milford, CT.

Circle No. 408

List of CD-ROM programs. This 2-pg sheet describes the various CD-ROMs available from PC-SIG. The list includes the *PC-SIG Library CD-ROM, 13th ed*, which contains thousands of

fully functional shareware programs as well as spreadsheets, databases, word processors, and graphics programs. *The PC-SIG World of Windows CD-ROM* contains over 350 of the best Windows shareware programs available. **PC-SIG**, Sunnyvale, CA.

Circle No. 409

Catalog details family of plug-in integrated switching regulators.

Providing specifications, photos, and schematics on each power module, this 32-pg catalog covers a line of integrated switching regulators and converters. A section on product operation, applications, and special considerations is also included. **Power Trends**, Batavia, IL.

Circle No. 410

Specs on RF and microwave components. This 93-pg catalog incorporates detailed specifications and outline drawings on a variety of passive components in the dc to 18-GHz frequency range. Commercial, industrial, and military components such as fixed and tunable filters, attenuators, switches, and switching and control subsystems are also covered. **Trilithic**, Indianapolis, IN.

Circle No. 411

Hardware and Windows packages covered in handbook. This free 320-pg catalog highlights lines of data-acquisition and imaging products and programming tools. It details the DT VEE visual-programming language for data acquisition; the Global Lab Image family of imaging software tools; VB-EZ data-acquisition and high-speed plotting custom controls for Visual Basic; DataAcq-EZ and Vision-EZ low-cost data-acquisition and imaging packages; and the Fidelity series of high-accuracy frame grabbers. The handbook provides technical tutorials and examples of products to use as aids in choosing a product. **Data Translation**, Marlboro, MA.

Circle No. 412

Features of fiber-optic connectors and adapters. This 132-pg catalog describes a line of fiber-optic connectors and adapters in addition to cable assemblies, termination tooling, fiber-optic switches, and premise-wiring products. It also provides a glossary and a section describing connector-termination procedures and the tooling required. **Molex Inc**, Lisle, IL.

Circle No. 413

Catalog details EMI/RFI services and products. "Solving Fabrication Problems" is a 100-pg catalog providing technical data materials from suppliers of electrical insulation, pressure-sensitive tapes, gasket materials, and EMI/RFI shielding. **Fabrico Div, Electrical Insulation Suppliers Inc**, Atlanta, GA.

Circle No. 414

Hardware catalog. A 200-pg catalog describes a line of electronic hardware and includes specifications for circuit-board spacers, captive panel screws and retainers, standoffs, chassis and cabinet handles, shoulder screws, and many other items. **RAF Electronic Hardware**, Seymour, CT.

Circle No. 415

Application selector guide for wire-tacking adhesives. This guide highlights an extensive line of high-performance adhesive compounds for tacking wires and attaching components to printed wiring boards. **Master Bond Inc**, Hackensack, NJ.

Circle No. 416

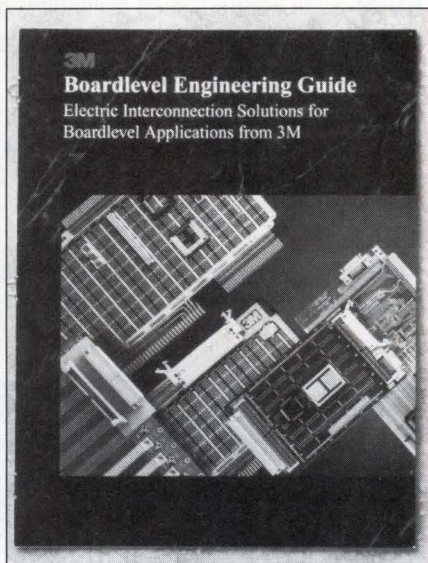

Guide available for interconnect products. This 8-pg brochure helps designers select the appropriate board-level interconnect product for I/O board stacking, IC socketing, and board-to-backplane applications. It includes photographs and specs on a line of sockets, headers, and high-density stacking connectors. Tables help you match the header and socket based on board-spacing requirements, pin or lead counts, contact quantities, and pitch. **3M**, Austin, TX.

Circle No. 417

Speed PLUS Op Amps... More Than High Speed!

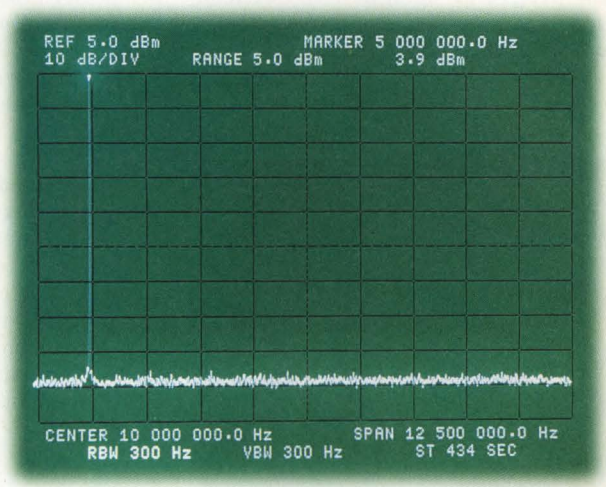
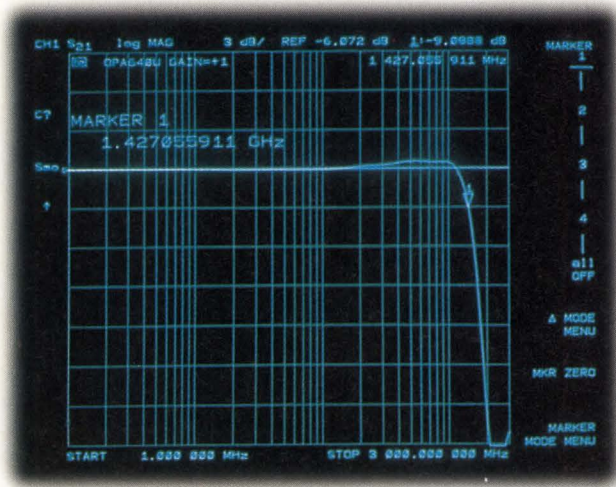

Six wideband op amps give you the speed you'll need for tomorrow's faster designs, *PLUS* key specs to optimize your most demanding applications. Our new *SpeedPlus* op amps make your future faster.

FREE SAMPLES! Speed into the future... now! For a few samples, call **1-800-548-6132**. And, ask for a free copy of our *Operational Amplifiers* guide. Or, contact your local sales representative for immediate assistance.

OPA640 is the world's highest bandwidth op amp. Its speed and dynamic performance make it your best choice for critical communications and test equipment applications.

OPA643 is stable in gains of five or greater and delivers high slew rate and low noise. It's purely perfect for all preamp applications.

OPA641 is stable in gains of two or greater and features a fully symmetrical differential input and fast 12-bit settling. Try it for RF and imaging designs.

OPA644's current feedback design gives you very high open loop transimpedance with high slew rate and superior differential gain/phase performance.

OPA642 gives you high speed with very low distortion and noise, the right combination for high resolution imaging and preamp applications.

OPA646's speed and low power simplify and improve a wide range of portable, imaging, communications, and similar signal processing applications.

Model	Gain BW	Settling (0.01%)	V_N (nV/√Hz)	Slew Rate (5MHz, $R_L=100\Omega$)	Low Harmonics	Features
OPA640	1.3GHz at G=1	22ns	3.0	350V/μs	-82dBc	Unity Gain Stable
OPA641	1.8GHz at G=2	22ns	3.0	700V/μs	-80dBc	Stable $G \geq 2$
OPA642	450MHz at G=1	13ns	2.3	250V/μs	-95dBc	$A_{OL} = 95dB$
OPA643	1.5GHz at G=5	21ns	2.0	1000V/μs	-90dBc	Stable $G \geq 5$
OPA644	500MHz at G=1	18ns	1.9	2500V/μs	-85dBc	Diff Gain/Phase errors; 0.008%/0.009°
OPA646	650MHz at G=1	15ns	8	180V/μs	-82dBc	Low Power, 55mW

Pricing starts at \$5.95 in 100s. All models available in 8-pin DIP, SOIC, and ceramic packages.

CIRCLE NO. 164



Burr-Brown Corp. P.O. Box 11400, Tucson, AZ 85734

EDN

PRODUCT MART

This advertising is for new and current products.

Please circle Reader Service number for additional information from manufacturers.

ROM-IT

EPROM EMULATION SYSTEM



The Most Flexible EPROM Emulator You Can Get Today

- Emulates up to eight 4-Megabit EPROMs through one standard serial port.
- Downloads 2-Megabit programs in less than 23 seconds
- Examine and modify individual bytes or blocks.
- Accepts Intel Hex, Motorola S-Record and Binary files.
- Software available for IBM PC and compatibles.
- Base 27256 EPROM System \$395.00. Other configurations available.

Incredible Technologies, Inc.
Visa, Mastercard and American Express Accepted

Order Now - It's Easy
Call (708)870-7027 Or Fax (708)870-0120
For More Information

CIRCLE NO. 241

68HC16 683xx

BACKGROUND MODE DEBUGGER



- C Source Level Debugger.
- Fast Downloads over PC-ISA Bus.
- Windows 3.1 Interface.
- Source level support for most assemblers.
- In-depth high level support for HiWare, Intermetrics, Introl, Microtec Research, Sierra and SDS.

\$1495
BDM with C Debugger!

SLD available at \$995.
Call for a Free Demo Disk.
(408) 866-1820

US Pricing Only
NOHAU CORPORATION

51 E. Campbell Avenue
Campbell, CA 95008
Fax (408) 378-7869

CIRCLE NO. 244

EXPRESS

Best Value in the World for POLYIMIDE & FR4
1 to 5 DAY TURN
1 to 12 Layers
PRINTED CIRCUIT PROTOTYPES

2 PIECE PRICES FOR FR4 .062 Th.

LAYERS	1	2	3&4	5&6	7&8
15	\$233	\$292	\$639	\$787	\$935
30	264	330	724	891	1059
60	311	389	853	1049	1137
90	358	448	980	1207	1434
120	385	486	1044	1311	1559

5 PIECES x 1.34
10 PIECES x 1.67

5 DAY PRICES ABOVE
UL LISTED

EXTRAS	CAPABILITIES	DISCOUNTS
Photo Plotting	Buried & Blind Vias	5%
Testing	Polyimide Multilayer	10%
Gold Contacts - \$50	Full Body Gold	
25% - Below 8 Mil Hole	Carbon Paste	
Below 15 Mil Hole	Tin nickel burn-in boards	
SMOBC & LPI - \$50	SMT-SMOBC	
	Up to 22 layers	
	Impedance control boards	

FOR MORE INFORMATION CALL OR FAX
Ken Bahl ■ 1108 W. Evelyn Ave., Sunnyvale, CA 94086
Phone (408)735-7137 FAX (408)735-1408 Modem (408)735-9842

CIRCLE NO. 248

Intelligent Data Acquisition

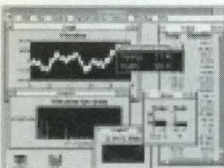

DAPwindows™, the new, easy way to develop high performance data acquisition applications under Windows, lets you implement your data acquisition application on a **Data Acquisition Processor™** board without Windows programming.

- Every Microstar Laboratories™ Data Acquisition Processor, from the entry level DAP 800™ to the 486-based DAP 3200e™, has its own processor on board to handle the time-critical parts of an application.
- In measuring or controlling a real-time process, computing power has to be there when it is needed. If it isn't, readings are lost and results are corrupted. With a DAP, an application has the computing power it needs when it needs it—free from the multitasking delays and resource demands of Windows. And with DAPwindows there's no Windows programming.

Call us about your project; ask for a FREE demo diskette.
206-453-2345 / fax 206-453-3199

MICROSTAR LABORATORIES™
2265 116th Avenue NE, Bellevue, WA 98004

CIRCLE NO. 262

UNIVERSAL/GANG PROGRAMMERS



FLEX-700
32 pin from \$645
40 pin from \$845
48 pin from \$945

ALL-03A \$595

IC Manufacturer approved & under \$1000

- Supports Altera 7xxx, MACH 435, Xilinx, Intel FX7xx, nearly all FPGA/CPLD/PLD...
- Support EPROM, 28/29F FLASH, Serial PROM, PSD4XX/5XX, Intel/Motorola/TI/NEC/Hitachi MPU/DSP devices.
- Test 74/40/45 series, DRAM(SIP/SIMM), and SRAM.
- Parallel port connection to PC option.
- Free software updates via BBS.

Tribal Microsystems Inc.
44388 S. GRIMMER BLVD., FREMONT, CA 94538
Tel: (510) 623-8859
Fax: (510) 623-9925

CIRCLE NO. 263

Low Cost Miniature Controllers



Save time. Save money.

Our wide range of C-programmable miniature controllers are ideal for control applications, data acquisition, and test and measurement. Compact and low in price (the Little PLC™ above is 2"x3" and \$195), these controllers are programmed with our easy-to-use Dynamic C™ development system. Our controllers feature digital I/O, ADCs and DACs, relays and solenoid drivers, RS232 and RS485 serial ports, battery-backed memory and time/date clock, LCDs, keypads, enclosures and more!

1724 Picasso Ave.
Davis, CA 95616
24-Hour AutoFax 916.753.0618. Call 916.757.3737
from your FAX. 916.753.5141 FAX

ZWORLD
ENGINEERING

CIRCLE NO. 256

ANALYZER-EMULATOR



UniLab 8620

- PC Based, Zero-Wait-State Operation
- Non-Stop Analysis: Define & Refine Triggers & View Multiple Traces On-The-Fly
- Source Level & Symbolic Debug
- Built-In EPROM Programmer
- Same Base Unit Supports Most 8-bit μ Cs & μ Ps, including 8051, 68HC05, 68HC11, Z80, 80C196, 6502, 8085, etc.

1-800-729-7700

Tel: 415-327-8800
Fax: 415-327-9881

ORION
INSTRUMENTS

180 Independence Dr., Menlo Park, CA 94025 U.S.A.

CIRCLE NO. 274

GET *DS*Speed!



TMS320C5X 40 MIPS DSP
TMS320C2X 12.5 MIPS DSP

In-Circuit Emulators

Featuring:

- TI compatible HLL Debugger
- 4K deep real-time trace buffer
- Zero wait-state overlay memory
- Multiple hardware breakpoints



1-800-240-0355
FAX 214-578-2761

CIRCLE NO. 275

Device Programmer \$44995

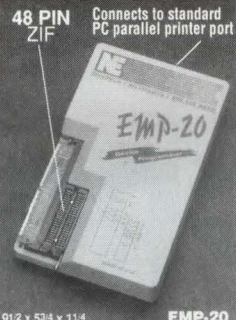

91/2 x 53/4 x 11/4

EMP-20

- Easy to use software, on-line help, full screen editor
- FREE software upgrades available via BBS
- Demo SW via BBS (EM20DEMO.EXE)
- Made in USA
- Technical Support by phone
- 30 day Money Back Guarantee
- 1 year Warranty
- Fast Programming
27C010A, 23 seconds
28C020, 34 seconds
27C040, 95 seconds
- Requires PC with 512K & parallel printer port

FOR MORE INFORMATION CALL

NEEDHAM'S ELECTRONICS, INC.

4539 Orange Grove Ave.
Sacramento, CA 95841
(Monday-Friday, 8 am-5 pm PST)

(916) 924-8037

BBS (916) 972-8042

FAX (916) 972-9960

MasterCard C.O.D.

CIRCLE NO. 259

VME to Encore HSD Data Link/Emulation

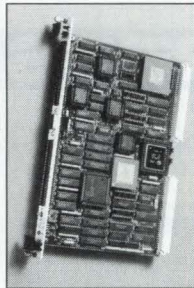

Using our VMEHSD[®] card and file transfer software, files can be moved between a VME system and an Encore computer HSDII board. The

VMEHSD also emulates the HSDII; whereby, the VMEHSD can drive a HSDII compatible peripheral device. Test Program and UNIX drivers available for Motorola, Sun & SGI. This product provides an excellent data acquisition, monitoring or testing tool.

APPLIED DATA SCIENCES, INC.

P.O. Box 814209
Dallas, TX 75381-4209
(214) 243-0113
FAX (214) 243-0217

CIRCLE NO. 233

New *TURBO C30II* Realtime DSP Development System

Shown with user application daughter board

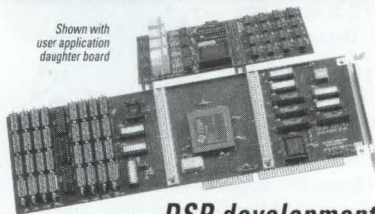

DSP development environment using TI's TMS320C30 floating point DSP.

FEATURES

- TI software compatible
- 2MB dual access memory
- 4.2MB/sec data transfer
- Daughter board interface
- Up to 8MB RAM
- 33/40 MHz speed
- Prototyping daughter board
- Low cost C30I available

From \$1595

WINTRISS ENGINEERING CORPORATION
6342 Ferris Square, San Diego, CA 92121
800-733-8089

CIRCLE NO. 267

RELIABILITY PREDICTION SOFTWARE

ARE YOUR PRODUCTS RELIABLE?

The RelCalc 2 Software Package automates the reliability prediction procedure of MIL-HDBK-217, or Bellcore, allowing quick and easy reliability analysis of electronic products on your PC. Say goodbye to tedious, time consuming, and error prone manual methods!

- NEW UPDATE! VERSION 3.1 now available.
- User friendly: pop-up menus, hypertext help.
- Very easy to learn and use; quick data entry.
- Part library for rapid recall of part data.
- Global editing functions for what-if? trials.
- Reports which clearly organize results.
- Save time & money as you design for quality.
- Try our Demo Package today for \$25.

T-Cubed Systems, 31220 La Baya Drive, Suite 110, Westlake Village, CA 91362
CALL: (818) 991-0057 FAX: (818) 991-1281

CIRCLE NO. 252

TCP/IP & SNMP NETWORKING PROTOCOLS

Add them to your System Designs with:
FUSION Developer's Kit

- ▼ FUSION TCP/IP protocol suite
- ▼ FUSION SNMP agent MIB 2 + Ver.2
- ▼ Flexible architecture - C source code
- ▼ Used in hundreds of process control, embedded systems, and end-user designs
- ▼ Full support, training, consulting and porting services

For More Information Call
(800) 541-9508

(805) 484-2128 • Fax (805) 484-3929

Pacific Softworks

CIRCLE NO. 273

168-PIN DIMM SOCKET PLACES MORE MEMORY IN LESS SPACE

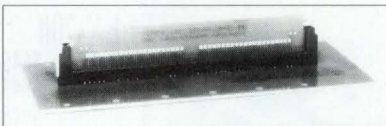

Hirose Electric offers a new 168-position, small outline DIMM (dual in-line memory module) double-density socket connector. DIMMs will accommodate today's 4- and 16-Mbit DRAMs — important for handheld personal computers, game products, medical equipment and factory automation equipment. The new DIMMs are also suitable for the future 64- and 256-Mbit generation. The largest configuration for a DIMM which a DIMM socket can support is 512-Mbyte of memory using a 256-Mbit DRAM. The Hirose SX4 socket connector has 1.27mm pitch (0.050").

For further information on the SX4, contact Hirose Electric (U.S.A.), Inc., 2688 Westhills Court, Simi Valley, CA 93065-6235. (805) 522-7958 or FAX (805) 522-3217. For instant fax catalog information: 1-800-879-8071. Ask for #5018.

CIRCLE NO. 271

Talk Is Cheap, Even Digitally.SM

MODEL: VP1410

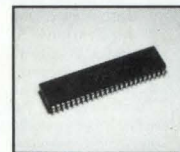

- QuikVoice™ technology
- Plays up to 10 messages stored in external EPROM
- 10 direct-trigger pins
- CVSD encoding
- 3 - 6V single supply
- DIP or surface-mount
- Low cost

Let your product speak for itself!

Our QuikVoice family of digital voice boards and IC chips give your product the competitive edge by letting them talk in real voice. Imagine how much more "user friendly" your product will become! Conventional voice technology requires high tooling cost and long turn-around time, while QuikVoice technology allows you to create a voice EPROM in just minutes with low-cost in-house equipment! Change messages easily or customize messages for each of your customers!

ELETECH ELECTRONICS, INC.
16019 Kaplan Ave, Industry, CA 91744 (818) 333-6394

CIRCLE NO. 237

In-Circuit Emulators

Development tools for the most demanding

8051
80196
80186
HPC +
Z8
8085
DSP's

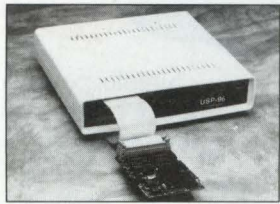

- Unparalleled features
- HLL debugger with locals support
- External unit, no plug-in cards !!!
- High speed download (64k in 12 sec)
- Banking support for > 64KB operation

see the difference - free 2 week trial

SIGNUM SYSTEMS

Mountain View, CA / Thousand Oaks, CA.
(415)903-2220 (805) 371-4608

CIRCLE NO. 250

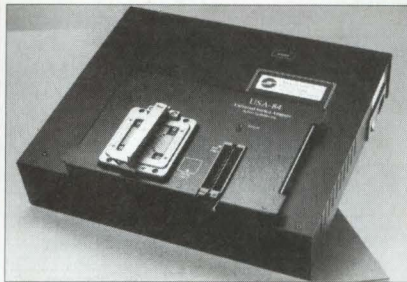

PILOT-U84 Universal Programmer

#1 in New Device Support & Expandability

Altera 7064,7128,7160,7192 in 84-, 100- and 160-pin packages
Xilinx 1765D,17128 etc Intel FLEX, 87C196 KC.KDJR.MC etc.
Moto 68HC711, 68HC705, WSI PSD-3XX,-4XX,-5XX.PAC.SAM
Atmel 29C040, ATF22V10 etc. AMD MACH435, 29F040, etc
Lattice pLSI-1000,2000,-3000, Microchip PIC micros
All packages to 256-pin: PLCC.PGA.QFP.TQFP.TSOP.SOIC
800-627-2456 FAX:(408) 736-2503, Sunnyvale, CA.

CIRCLE NO. 232

Thermal Analysis

of
Systems
Boards
Components

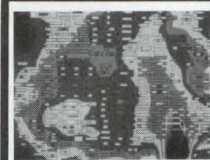

- Analyzes all types of Electronic Boards, Cardcages, Cabinets, ASICs, MCMs, and Many More.
- Concurrent Thermal Analysis
- 3-D Modeling, High Accuracy
- Failure Analysis Enhancement
- Interfaces with Mentor, Cadence, Pads Valid, P-Cad, Cadstar, Tango, Orcad ...
- Available on PC and Unix (Sun & HP)

The BETAsoft Series

Dynamic Soft Analysis, Inc.

Tel (412) 683-0161 Fax: (412) 683-3641

CIRCLE NO. 257

PERFECTLY configured



Series 3120 switch/breaker combination now has three options for more versatility and cost-efficient design engineering opportunities: traditional industrial two-button push ON/push OFF control, standard commercial rocker switch configuration, or press-to-reset only.



E-T-A CIRCUIT BREAKERS

7400 North Croname Road Niles, Illinois 60714-3982
Ph: 708-647-8303 Fax: 708-647-7494

236 Markham Road Markham, Ontario L3R 3K8
Ph: 416-475-5886 Fax: 416-475-5889

CIRCLE NO. 265

You Don't Have
To Burn Your
Devices Like This!



LOGICAL



Has a Full
Range of
High Quality
Universal & Gang
(EEPROMS, FLASH, PLD,
& MICRO CONTROLLER)
Programmable

LOGICAL DEVICES, INC.

TEL: (305) 428-6868
FAX: (305) 428-1811



1 800 331-7766 Ext: 103

CIRCLE NO. 243

PROTECT YOUR ICs



Organize and protect all your ICs from physical and electrical damage in our family of versatile **component storage albums**. They're the perfect solution for storing, archiving and transporting your library of IC Masters, MODS, REVS, Samples and Spares - EPROMS, ASICs, PALS, DIPS, SIPS. At your desk, bench, workstation or in the field, our **inexpensive** albums keep your expensive ICs at hand, unzapped, unbent, uncrushed, uncracked and clean.

- MIL spec. ESD Protection
- Dust-Tight
- Crushproof Construction
- Snap-Closed

100% Unqualified Satisfaction Guaranteed

iTOI P.O. Box 59, Newton, MA 02161
ENTERPRISES TEL: (617) 332-1010 FAX: (617) 332-2173

CIRCLE NO. 240



Oyster's new catalogue and data sheets contain detailed information on a wide range of hand-held terminals. The terminals interface with a spectrum of microprocessor-controlled equipment in a variety of applications. The literature specifies terminal use, and a special chart allows a choice of specification to suit your requirements. So for the essential hand-held reference, it's got to be Oyster.



Every hand-held terminal you'll ever need.

UK Office: Oyster Terminals, Tel: 44 633 214147
Fair oak House, Church Road, Newport, Gwent NP9 7EJ
US Office: Escom, Tel: 714-361-1961
701 Calle Amable, San Clemente, CA 92673, USA

CIRCLE NO. 245

ICE FOR THE 2105 DSP

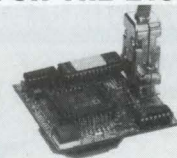

- Low cost in circuit emulator for the 2105 DSP comes with DOS user software.
- VGA color display allows viewing and editing target memory and registers.
- Pull-downs, menus, and soft keys are used in the mouse driven user interface.
- Your assembled files may be loaded, emulated, debugged, and printed with optional symbolic displays.
- Software breakpoints, step, trace, move, fill, and other functions are available.

Independent Digital Consulting, Inc.
Box 1868, Akron, Ohio 44309
Phone 216-753-0777 Fax 216-753-0772

CIRCLE NO. 260

LARGE SCREEN

First In A Family Of Larger Display Operator Interfaces

- 8 Lines by 24 Character or 16 Lines by 32 Characters (selectable)
- VT-100 Compatible (ANSI 3.64)
- User Programmable Keypad
- 20, 30, 32 or 45 Key Keypad
- Readily Customized to Suit Your Application
- RS-232 or RS-422 Interface
- Full line of Terminals Available



Two Technologies
419 Sargon Way
Horsham, PA 19044
Tel: (215) 441-5305
Fax: (215) 441-0423

CIRCLE NO. 261

Powerful PLD and CPLD design: \$1995

ABEL™, the industry-standard universal PLD design tool, now gives you more power for less:

- New StateCAD™ graphical entry option lets you draw state machines
- VHDL - Direct™ for full VHDL design entry and synthesis
- New fitter support includes AMD® MACH, Altera® MAX, and Lattice® pLSI devices

To order call **1-800-3-DataIO EXT. 602**
(1-800-332-8246)



CIRCLE NO. 236



Simple, personal
device programming

- Chiplab™ makes device selection and programming fast and easy with its Windows™-like user interface
- Extensive on-line help
- Programs more than 2000 PLDs, PROMs, EPROMs, EEPROMs, and MCUs
- \$895 (32-pin version) or \$1495 (48-pin version)

To order call:
Authorized Distributors
JDR Microdevices 1-800-538-5000
Promark Technology West 1-800-227-3345
or call:
Data I/O Corporation 1-800-332-8246 Ext. 901

DATA I/O

CIRCLE NO. 264



*Schematic
Capture
for
Windows
and
Macintosh®*

DESIGNWORKS™

The universal schematic capture front-end is now available for Windows. DesignWorks™ for Windows has all the same workstation functionality as its Macintosh counterpart, including full hierarchy with unlimited levels, automatic gate packaging and comprehensive symbol libraries. DesignWorks is built to work with PCB, FPGA, ASIC, and SPICE packages from any vendor. Custom netlist/report generation, back annotation, EDIF schematic support and a custom programming interface free your designs from being locked into one layout package or one simulator.

CALL (800) 444-9064 FOR YOUR FREE DEMO!
CAPILANO COMPUTING
(604) 522-6200 Fax (604) 522-3972

CIRCLE NO. 234

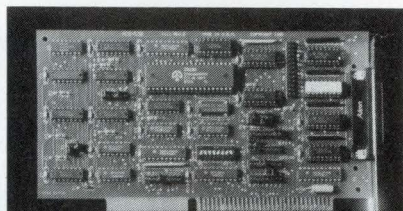

ACB-530

- Two channels of Sync/Async Communications using 8530 SCC
- DMA supports data rate greater than 1 million bps (Bits Per Second)
- Supports X.25, SDLC, BISYNC and HDLC protocols
- Standard "XT" and Extended "AT" IRQ's available (2,3,4,5,7,10,11,12,15)
- Selectable DMA Channel (0,1,2 or 3)
- RS-530/422/485 Interface (other ACB versions available)
- Developers Toolkit Available
- Part #4111



SEALEVEL SYSTEMS INC.
P.O. Box 830
Liberty, SC 29657
(803) 843-4343

CIRCLE NO. 249

Combine your
Product Mart ads in
EDN Magazine and
Products Editions
for
*higher impact
and a
lower rate!*

CIRCLE NO. 279

MIXED-MODE CIRCUIT SIMULATION

NEW RELEASE 2.7

Integrated, powerful, easy to use
TopSPICE

True Analog/Digital/Behavioral
Mixed-Mode Circuit Simulator for PC

from
\$159

- Complete SPICE analog simulator with extended syntax.
 - Fully integrated event-driven logic simulator.
- Analog Behavioral modeling using arbitrary equations, Laplace transforms and look-up tables. • Analog and digital model libraries. • Monte Carlo analysis.
 - Graphical post-processor. • Schematic entry.



P.O. Box 10358
Canoga Park, CA 91309, (818) 347-9203

Call or write for
FREE DEMO disk
800-272-0674
Fax (818) 347-9240

CIRCLE NO. 246

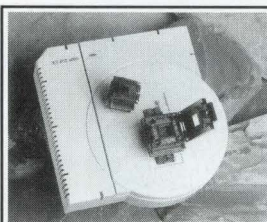

*10% off
all
adapters
ordered
with
programmer*

PC-based Programmer for over 1800 Devices

- ✓ Program CMOS, PLDs, FPGAs, bipolar and MCUs
- ✓ Semiconductor manufacturer approved algorithms
 - ✓ Over 400 adapters available from stock
- ✓ Immediate device list updates via BBS 408-982-9044
 - ✓ Ask about our trade-in discount offer
 - ✓ Same day delivery



EMULATION TECHNOLOGY, INC.
800.995.4381

CIRCLE NO. 269

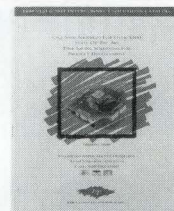

*#1 in
Adapter
Solutions
for over
10 years*

FREE 1994 Interconnect Solutions Catalog

- ✓ Over 3,500 devices for one-stop-shopping
- ✓ 120 "Off-the-shelf" items available for overnight delivery
 - ✓ Unlimited application consulting
- ✓ Time saving solutions for product development
 - ✓ Ask about our custom designs
- ✓ Leading edge technology -- over 500 PQFP solutions



EMULATION TECHNOLOGY, INC.
800.995.4381

CIRCLE NO. 270

Total Silicon Capability from **stag** microsystems



- Wide ranging device support from the smallest PROM to the most complex FPGA
- PC-based EPROM programmer to full blown Universals (and everything in-between) from \$395
- Hand held battery portables
- Production gang programmers
- Turn-key board programming systems

Stag Microsystems, Inc
Tel: 408 988-1118 Fax: 408 988-1232



CIRCLE NO. 266

SOIC TO DIP

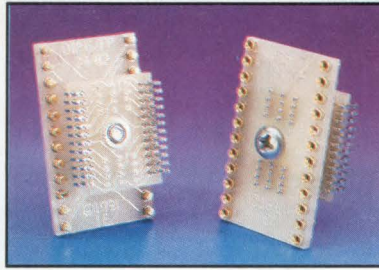

WITH DIP/SOIC PACKAGE CONVERTER

- Convert surface mounted SOIC pattern to DIP.
- Solder to SOIC Land Pattern.
- Then plug DIP IC into DIP socket.
- DIP pins are gold plated machined pins.
- Multiple sizes available

IRONWOOD ELECTRONICS
P.O. BOX 21151, ST. PAUL, MN 55121
(612) 431-7025; FAX (612) 432-8616

CIRCLE NO. 242

Smart TekMeter from Tektronix



The new TekMeter integrates the usability of a digital multimeter with the waveform display of an oscilloscope in a compact, easy-to-use, two pound battery-operated package. TekMeter has 25Ms/sec digitizer(s) automatic setup, spike detect and cursors. Prices for TekMeters range from \$859 to \$1,259. For more information, call Tektronix at 800-426-2200 or your local distributor.

CIRCLE NO. 253

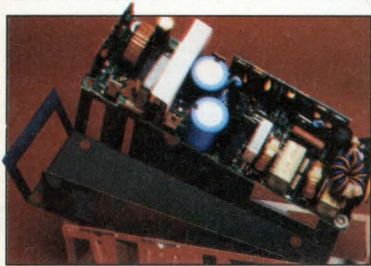

High Performance Lexan® FR700 Film For Barrier Insulation

- UL94 V-0 rated at .010" • High heat resistance of 275°F • Excellent dielectric strength • Easy fabrication—sharp folds, intricate die-cut shapes • Competitively priced
- Call for free information: (800) 451-3147

Ext. 3102



GE Plastics
Structured Products

© Registered Trademark of GE.

CIRCLE NO. 238

PCMCIA (No Soap-on-a-Rope)



CH1827 PHONE INTERFACE

- Eliminates external DAA's — Fits Type II
- Works with all modem chip sets — V.32bis, V.TURBO
- Isolation included
- FCC Part 68 approvable
- Free Application Notes

Your Source for Modem Components



Tel: 408-752-5000
Fax: 408-752-5004

Cermetek Microelectronics, Inc.
1308 Borregas Ave. • Sunnyvale, CA 94089

CIRCLE NO. 235

8051 68HC11 COP8 68HC05



iceMASTER™ In-Circuit Emulators From \$851

- Easy to learn & use
- Windowed interface—user configurable
- Real-time and non-intrusive
- Source level debug
- Support for structures, arrays, unions and pointers
- Trace buffer with advanced searching capabilities.
- Fast serial (RS-232) link to any PC, even laptops.
- Broad support of derivative devices/interchangeable probe cards
- Rental and 10-day trials available.
- Call today for free demo disk

(800) 638-2423

New DSB0C320
8xL51Fx
8xC575



Phone: (602) 926-0797
Fax (602) 926-1198

MetaLink Europe GmbH
Telefon: (08091) 2046
TeleFax (08091) 2386

CIRCLE NO. 276

4-Color Product Mart Ads Are Available in EDN Magazine and Products Editions!

For an additional \$340, you can run your Product Mart Ad in color. For more information, call Joanne Dorian at (212) 463-6415.

CIRCLE NO. 280

DECISION IS YOURS!

as to who gives you the best value?
5 Day Turn For FR4

QUANTITY	2	5	10	QUANTITY	2	5	10
15	\$186	\$245	\$310	15	\$715	\$950	\$1175
30	210	280	352	30	795	1040	1350
60	248	330	415	60	890	1190	1425
90	285	380	486	90	995	1355	1710
120	305	415	519	120	1048	1480	1860
15	\$230	\$310	\$389	15	\$840	\$1125	\$1395
30	264	350	441	30	950	1275	1595
60	312	415	520	60	1025	1495	1875
90	358	475	597	90	1290	1725	2150
120	388	515	649	120	1405	1875	2325

- SERVICES**
- Same day Prototype
 - Hi-Volume Production Runs
 - Instant Quotes
 - Complete CAD/DFM Service
 - Deep Tank Gold & Palladium
 - 24 Hour Modems
 - Gerber/AutoCad/HPGL/P-CAD
 - SMT & Thru Hole Assembly
 - Stencil

EXTRAS
• Photoplotting
• Gold \$50.00 • Testing



CALL US TODAY AT
408-748-9600

CIRCLE NO. 231

MICROPROCESSOR EMULATORS

Zax provides a comprehensive series of real-time emulation support for Motorola, Intel, NEC, Zilog, and Hitachi microprocessors. Some of the highlighted features include source-level debug, real-time trace, and performance analysis.

Call now for more information:

(800) 421-0982
(714) 474-1170 (Inside CA)
(714) 474-0159 (Fax)

ZAXTEK

42 Corporate Park Irvine, CA 92714

CIRCLE NO. 255

The GPIB Chip

Turbo
charged GPIB

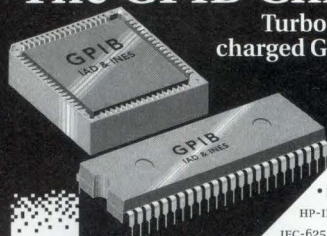

ines
Microelectronics

Ines Inc.
10012 England Ave.
Phone: 303-779-8354
FAX: 303-779-6336

- IEEE-488.2, HP-IB, GPIB, IEC-625 and SCPI
- Controller, Talker and Listener chips
- 100% pin and software compatible with NEC 7210C and TMS 9914 • 2 X 256 Byte FIFO buffer for complex SCPI strings and High-Speed Transfer • DMA STATE MACHINE for "last byte handling" and "handshake hold off" • Synchronous C-Mos design, Full Custom Chip • IEEE-488.2 device driver software
- Integrated GPIB bus driver (75160 and 75162)
- Integrated Fiber Optic Controller (optional)

CIRCLE NO. 239

MULTIPIN CABLE CONNECTORS OPTIONAL SIGNAL & POWER MODULES

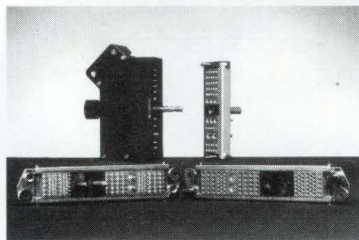

L Series cable connectors modular building block system provides optional signal, 15-50 amp power, as well as, 50 & 75 OHM coax and 8,000 volt high voltage modules. Black polycarbonate housings provide jack screw assisted durable enclosures.

L Series connectors use the Hypertac® Hyperboloid, low force contact which offers high cycle life, immunity to shock and vibration, and contact resistance in the .4 to 2.5 milliohm range. FOR ADDITIONAL INFORMATION, CONTACT:

HYPERTRONICS CORPORATION
16 Brent Drive, Hudson, MA 01749
(800) 225-9228 or (508) 568-0451
FAX: (508) 568-0680

CIRCLE NO. 272

IMAGINE IF YOUR PRODUCT COULD TALK!

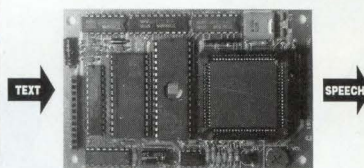

V8600 text-to-speech synthesizer

- Converts plain ASCII text into speech ("talking printer")
- Requires only a single 5V supply and speaker
- Unlimited vocabulary—no custom recording necessary
- Programmable pitch, rate, tone, volume, etc.
- Text, character, phonetic, tone and PCM modes
- Microprocessor, serial and printer interfaces
- Use in telecom, robotics, monitoring systems, etc.
- Less than \$100 in OEM quantities
- ISA, PC/104 and stand-alone versions available

FREE V8600 DATA BOOK
USA Ph: 206 355-3800 Fax: 355-1098
UK/Europe Ph: +4481 539 0285

RC SYSTEMS
INCORPORATED

RC Systems, Inc. • 1609 England Avenue • Everett, WA 98203 USA

CIRCLE NO. 268

A Complete Line of Development Boards, Programmers and In-Circuit Emulators

NEW...NEW...NEW...NEW...

DS-186 – In-Circuit Emulator for
80C186/8/XL/EA/EB/EC, V40/50
8086/8 and other μ Cs

*** **NEW ADDRESS IN THE USA** ***

Call today for your
free demo and
software update

Toll Free: 1-800-833-4084

CEIBO 7 EDGESTONE CT.
FLORISSANT, MO 63033
TEL: 314-830-4084
FAX: 314-830-4083

CIRCLE NO. 258

R&M Prediction and FMECA

SOFTWARE

PSI software is designed to fit your commercial and military needs for analysis of electronic, electrical, or mechanical equipment of any complexity.

PSI's entire product line is packed with powerful features, such as, pull-down menus and pop-up windows, user-friendly interface, a visible in-tended assembly tree, and superior report outputs.

- Reliability • Industrial • Automotive
- Parts Count • Mechanical
- System Reliability • Maintainability
- FMECA • Process FMEA

Call 1-800-779-0202, Code 013343
to receive a direct FAX



PSI POWERTRONIC SYSTEMS, INC.
13700 Chef Menteur Hwy
New Orleans, LA 70129
504-254-0383 FAX 504-254-0393

CIRCLE NO. 247

Find out how you
can break through
the clutter to get big
results for a small
price, by placing a
4-color ad in
EDN Product Mart.
Call Joanne Dorian
at (212) 463-6415
for details.

CIRCLE NO. 281

486 Single Board Computers & Rack Mounts

**3 YEAR
WARRANTY**

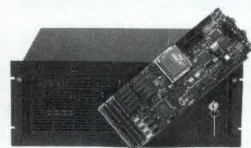

14 Slot 486DX2-50 4MB 120MB HD .. \$2,295
486SX-25 Single Board Computer \$ 575
486DX-33 Single Board Computer \$ 775

ORDER DESK 1-800-777-4875

US LOGIC Made In U.S.A.
7004 Convoy Court, San Diego, CA 92111
(619) 467-1100 • FAX (619) 467-1011

The Intel Inside Logo is a registered trademark of Intel Corporation.
3 year warranty applies to Falcon-II Single Board Computer.

CIRCLE NO. 254

REMOVE HARDWARE LOCKS

**PROTECT YOUR INVESTMENT!
MAINTAIN PRODUCTIVITY!**
Software utility that allows for
the removal of hardware locks.

Available for most major
CAD/CAM and PCB
software programs

Easy - Simple - Guaranteed

Programs start at \$99.00 U.S.

Visa and Mastercard Welcome
Call or Fax for more Information

SafeSoft Systems Inc. Phone (204) 669-4639
201-1111 Munroe Ave. Winnipeg, Mb. R2K 3Z5 FAX (204) 668-3566
Canada

CIRCLE NO. 251

RS-232/GPIB-488 SOLUTIONS FOR INSTRUMENTATION PROGRAM STORAGE & TRANSFER NEEDS



The Easi-Disk Simplifies Your Data Acquisition
Transfer, and Retrieval Needs Completely

- IBM/MS-DOS PC Compatible
- RS-232, GPIB-488, 8-Bit Parallel, RS-485, RS-422, plus
- Host or Manual Controls
- Remote Polling
- 3 1/2" and 5 1/4" Floppy Disks or Removable RAM
- Stand-Alone, Rackmount or "Built-In" OEM
- 110VAC, 220VAC, 6VDC, 12VDC, or Battery Operation
- Stand-Alone Price is \$795, Controller Card Price is \$495, in Singles with Quantity Discounts

Also, ADPI offers New "ONE FOR ALL" Portable Optical Disk and Tape Drives on DOS, Macintosh, SCO-UNIX, OS/2, PICK, Peer to Peer LANs, and Novell LANs via Parallel & SCSI ports.

ANALOG & DIGITAL PERIPHERALS, INC.
P.O. BOX 499
TROY, OHIO 45373
PHONE 513/339-2241
FAX 513/339-0070



CIRCLE NO. 230

EDN-CAREER OPPORTUNITIES

MARKETING MANAGER

Audio Products & Applications

Our Audio Products Division is growing. Computer & consumer electronic manufacturers like the low price of our WaveDectm and WaveFrontm components.

Our team needs a technically experienced manager to continue our success and growth.

Responsibilities will include the design and definition of IC audio products into PC products/boards and computer systems boards. Experience in computer based products must be based on Intel or Motorola microprocessors. Design background must be consumer oriented product experience, PC industry experience a must. Superb communication skills are needed to develop new business, strategic partnership development, and technology acquisition and license contract negotiations. Experience in contracting outside sources for design and assembly is needed. Multimedia design personal computing experience required. Strong leadership skills are needed to lead a team of product marketing engineers and application engineers and to manage the day to day activities. You must have 7-10 years experience in a similar environment. A BSEE required; MSEE preferred. Your background must include project management. We are a fast growing manufacturer of semiconductor products focusing on the design & marketing of mixed signal integrated circuits and cost effective components for multimedia sound and video applications, frequency timing generators for personal computers, engineering work stations and power management solutions. THE POSITION IS STATIONED IN OUR VALLEY FORGE, PA FACILITY. Please respond in complete confidence with salary history and requirements to: Director of Audio Products Division, INTEGRATED CIRCUIT SYSTEMS, INC., 1271 Parkmoor Ave., San Jose, CA 95126. FAX — (408) 925-9460. Equal Opportunity Employer.

EDN-PROFESSIONAL SERVICES

USE YOUR FAX TO
FIND COMPETITIVE
COMPONENTS & PRODUCTS
PRICES IN JUST ONE
BUSINESS DAY
PHONE# 610-667-9170 • FAX# 9165

A SMALL AD
HERE COULD
ATTRACT
A LOT OF
ATTENTION

THE WORLD IS WATCHING WHAT WE DO IN SAN DIEGO.

The new generation in digital television has triggered a revolution in telecommunications. At the forefront of this revolution is General Instrument Corporation, the world's largest supplier of access control, scrambling and descrambling equipment used by cable and satellite television programs, such as CNN, HBO, superstations and sports channels. We are a leader in the next generation of multi-channel



digital and television technology High Definition Television (HDTV) and an integral part of the "Grand Alliance," which is combining technologies to become the U.S. broadcast standard for HDTV.

We have career opportunities for qualified professionals with the vision to enhance our future... and change the way the world sees itself.

SYSTEMS ENGINEERS

Will design, test and integrate advanced digital communications systems for satellite, cable and broadcast TV. Requires an MSEE plus at least 5 years' experience in the following areas: communication system design, data communication protocols, telephony and networks, encryption and access control, digital signal processing, digital video compression, system integration or system level validation. (CODE PMN)

FIRMWARE ENGINEERS

Will design, develop and integrate embedded real-time code for complex video scrambling/compression systems. Requires a BSEE with experience in firmware design and microprocessor/controller real-time programming. Familiarity with communication theory and firmware test development is a plus. (CODE JPN)

DIGITAL DESIGN ENGINEERS

Will design a variety of digital compression boards and perform signal processing developmental tasks encompassing field programmable gate arrays and microprocessor-based systems. Duties will also include system integration/test and involvement from product conception to production. Requires a BSEE (MSEE desirable) and 3+ years' experience, along with strong skills in UNIX, Viewlogic and FPGA (XILINX, ACTEL, MAX). (CODE LTN)

DESIGN ANALYSIS ENGINEER

Requires a BSEE/MSEE and 5-7 years' experience. Knowledge and experience writing firmware on 6805, 6502, TMS7000, 680xx, 80x86 or 8051 family microprocessors, hardware knowledge including high-speed microprocessors, discrete logic, custom devices and serial communications, and ability to write "C" language software also required. Excellent analyt-

ical and verbal/written communication skills are a must. RF, analog design or VLSI/gate array experience; familiarity with data communications systems, protocols or cryptography; and design analysis experience preferred. (CODE ESN)

ANALOG/RF DESIGN ENGINEERS

Will design analog/RF circuits and systems for video/audio hardware. Detail design includes op-amp, transistor circuits, oscillators, A/D, D/A, filters, PLL and amplifiers. Requires analog/RF design experience (DC thru UHF); MSEE and video/audio circuit design a plus. (CODE HSN)

TEST ENGINEERS

Will develop test strategy and dedicated equipment used in production of complex consumer audio/video gear, and work from design phase through production start to optimize product design-for-test, test equipment design and product quality. Requires BSEE with 3-7 years' experience designing and/or programming dedicated test equipment and associated products. Exposure to Boundary-Scan, NTSC/PAL testing and DFT is highly desirable. Openings exist in hardware and firmware; must have skills in both. (CODE MMN)

PRODUCT DEVELOPMENT ENGINEERS

Will design sophisticated products for DigiCipher-II video systems. Positions are available for Project, Lead and Design Engineers. All products encompass a broad range of technologies including digital demodulation, error correction, video and audio decompression, advanced GUI, and DES-based access control. Transmission is via MPEG-2 compatible packet bit stream. Requires BSEE (minimum) with 4+ years' experience in analog/digital hardware design, hardware/firmware integration and communications systems. (CODE BDN)

The world is watching what we do. Be part of this new wave of technology. Send your resume, including salary history/requirements, referencing appropriate code to: Human Resources, General Instrument Corp., 6262 Lusk Blvd., San Diego, CA 92121. On-site gym. Smoke-free facility. EOE. Principals only. No entry-level positions available at this time.

GI General Instrument



DIFFERENCE IS POWER.

At Dell, we've made a business of being different. Of doing the unexpected. That's why we were the industry's first direct marketer. First to offer on-site service. First to introduce written guarantees for service, compatibility, and response time. And the very last to follow the crowd.

We recognize difference for what it is: empowerment. So, if taking a different path is something you're comfortable with, come make a difference at Dell.

We're taking resumes for the following positions:

SOFTWARE ENGINEERS

Software design engineer, SCSI device driver expert with 5+ years programming experience, 2 years experience writing SCSI disk device drivers for NetWare®. Knowledge of PC architecture, C, and assembly required.

Software design engineer, SQL database performance expert with 7+ years programming experience with expertise in transaction systems. Must have C language experience.

HARDWARE ENGINEERS

PC hardware logic designers, with 3 years experience with Intel® microprocessors. Responsible for designing/debugging complex PCs for high-volume production. Prefer BSEE.

MECHANICAL ENGINEERS

3 years experience in the design and testing of PC enclosures for high-volume production; working knowledge of 3D solid modeling, software, Pro/Engineering, plastics, sheet metal parts, and thermal/shock testing principles.

PC MONITOR ENGINEERS

Board-level designer/analysis experience for PC monitors. Prefer BSEE with 5+ years in the PC industry, working knowledge of analog components, digital video, audio, and DSP technologies.

PORTABLES TEST ENGINEER

EE degree required with 4-5 years experience in PC development and debugging. Demonstrated experience with portable system development including familiarity with analog power management issues. Will oversee process improvements and test development in Portables Test group; train both technicians and engineers on new developments in the industry; and interface from the beginning of a development project with the development team.

MULTIMEDIA ENGINEER

Bachelor's Degree or equivalent with 5+ years PC industry experience required. Board-level design and analysis experience for PC system or subsystems, and engineering experience with full-motion digital video (DVI, MPEG, INDEO, H.261, etc.) a must.

DIAGNOSTIC DEVELOPMENT ENGINEERS

Intel 80X86/Pentium™ system architecture knowledge, and strong high-level and assembly language programming skills required. 5-7 years programming experience in product development or R&D environment and BSEE/CS or equivalent experience required.

PROJECT PLANNERS

Responsible, detail-oriented individual with 5+ years experience in PC industry in a developmental environment. Must have project management experience to include scheduling, cost control, and inventory control.

PROJECT MANAGER

Experience managing complex projects and tasks of products through their life cycles. Experience with people and business management, marketing/sales activities, and profit/loss required.

PRODUCT MARKETING MANAGER

BS/BA or equivalent with 5-7 years experience in product management or related field. Good knowledge required of server markets, current server vendor offerings, and array technology.

PRODUCT MARKETING MANAGER

BA/BS or equivalent with 5-7 years experience in product management or related field. Business planning knowledge, preferably with experience in P&L approach to product planning. Knowledge of high-end server markets and new technologies required. Experience with planning or sustaining mainstream server systems, from product concept through End of Life. Must have excellent understanding of customer requirements and ability to collect requirements.

ADDITIONAL OPPORTUNITIES

Additional opportunities are available for BIOS Programmers, Test Engineers, and Component Engineers.

An industry leader in the technology field, Dell is a strong, stable FORTUNE 500® company rapidly approaching \$3 billion in sales. For more information, mail or fax your resume to:

DELL

™ Dell Computer Corporation
Staffing Department, OCR522
9505 Arboretum Boulevard
Austin, TX 78759-7299

Where Difference Works. **FAX: 512 728-3330**

Copyright 1994 Dell Computer Corporation. All rights reserved. Intel is a registered trademark, and Pentium is a trademark of Intel Corporation. NetWare is a registered trademark of Novell, Inc. FORTUNE 500 is a registered trademark of The Time Inc. Magazine Company. Dell cannot be responsible for errors in typography.

EDN-CAREER OPPORTUNITIES

Electronics Engineering Technology Instructor needed. Requirements include B.S.E.E. or B.S.E.T. degree; three years recent industrial experience in PLCs, process and motor controls, digital, analog, microprocessors. Knowledge of Assembly, C, Visual Basic, MS Dos, Windows, Schema/Tango, CADs, Spreadsheet. Understand and support the unique role of a community or technical college. An Isothermal Community College application form, resume and cover letter must be received by June 15, 1995. Contact Mrs. Martha Blackwell, Isothermal Community College, P.O. Box 804, Spindale, NC 28160.

IOWA MIDWEST

MIDWEST OPENINGS

RF DESIGN ENGINEERS

MSEE/BSEE. Experience levels to 10+ years. RF/Microwave circuit design. HF to 3.0 GHz. Areas of interest are: receivers, transmitters, power amplifiers, frequency synthesizers, modulation/demodulation, spread spectrum, DSP implementation of radio functions. Multiple openings with several of my Midwest client companies.

DON GALLAGHER, MSEE

Gallagher & Brei Associates
1145 Linn Ridge Rd., Mount Vernon, IA 52314
(319) 895-8042 • Fax (319) 895-6455

To place an ad call
Jackie Daniels
1-800-603-4859

Without Tears™

Learn DSP
and Put your
Knowledge to
work
immediately!

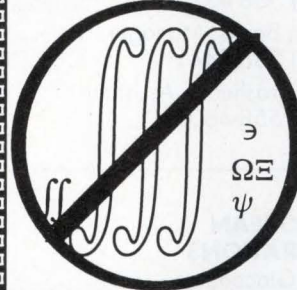

Coming to a
Place Near You

Boston San Jose
Salt Lake City
Washington D.C.
Toronto Austin
Scottsdale, AZ

Call Z Domain Technologies, Inc.
(800)-967-5034
(404)-587-4812

Call 9-5 EST. Ask for
brochure.

Our 2-Day Advanced
Course is ready. Call for
more info

By Taking This
3-Day Course
You will really
learn DSP.
Guaranteed!

PRODUCT DEVELOPMENT DESIGN TEAM

PC Notebook

Rapidly growing PC company is seeking key contributors for their new design team. This is an excellent opportunity to make a real industry impact. Specialists are needed in the following disciplines:

BIOS Firmware
Systems Engineering
Hardware Engineering
Power Management Engineering
Architecture
Program Management
Product Management

For further information call or connect to FCO's BBS for full details.

f-o-r-t-u-n-e®
Personnel Consultants of Orlando

2500 Maitland Center Parkway, Ste. 107, Maitland FL 32751

Voice (407) 875-0833 FAX (407) 875-1975 BBS (407) 875-1028, (407) 875-1623

EDN reaches an audited circulation of 163,000 professionals, assuring 100% qualified inquiries for specialized technical jobs.

Why not let EDN's Career Opportunities help you hire the qualified engineering professionals you need!

If I can be of assistance in helping you with your recruitment advertising, please call:

Jackie Daniels at
1-800-603-4859

EDN Headquarters
275 Washington St
Newton, MA 02158
Fax: (617) 558-4470

Publisher

Jeffrey Patterson
(617) 558-4454
Maria McGrath, Assistant
(617) 558-4346

Advertising Sales Director

Paul Rothkopf
(617) 558-4651

Marketing/ Business Director

Deborah Virtue
(617) 558-4779

Promotion

Jean Graham
(617) 558-4698

Production Staff

Andrew A Jantz,
Group Manager
(617) 558-4372
Karen Banks, Manager
(617) 558-4441
Kelly Brashears, Assistant
(617) 558-4601

Contracts

Muriel Murphy,
(617) 558-4451

Circulation: Denver, CO

Denise Garcia,
(303) 398-7694

Custom Publishing Services

Patricia Tyler, Director
(617) 558-4526
fax: (617) 558-4470

Reprints of EDN articles are available on a custom printing basis at reasonable prices in quantities of 500 or more. For a quote, phone Ellen Sandram, Cahners Reprint Service at (708) 390-2773.

NEW ENGLAND

Chris Platt
Tel: (617) 964-3730
Fax: (617) 332-7128

NEW YORK/NEW JERSEY AND MID/SOUTH ATLANTIC

Diane Driscoll
Tel: (203) 326-5161
Fax: (203) 326-5160

IL, IN, KY, OH, TN, TX, OK, FL, SC

JoAnn Cannon
Tel: (708) 635-8800
Fax: (708) 635-0929

IL, MI, MN, NE, IA, KS, ND, SD, WI, MO, AL, AR, GA, MS, CANADA

Jack Johnson
Tel: (708) 635-8800
Fax: (708) 390-2815

ARIZONA

Donnie Jones Adams
Tel: (408) 243-8838
Fax: (408) 243-2144

COLORADO/ WASHINGTON/ OREGON

Frank Granzeier
Tel: (408) 243-8838
Fax: (408) 243-2144

ORANGE/RIVERSIDE/ SAN DIEGO COUNTIES LOS ANGELES/ SOUTHERN CA, NV

Susan N Green
Tel: (714) 851-9422
Fax: (714) 752-6867

NORTHERN CA/ SILICON VALLEY

James W Graham
Frank Granzeier
Donnie Jones Adams
Tel: (408) 243-8838
Fax: (408) 243-2144

EUROPEAN OPERATIONS

Tully Giacomazzi,
Managing Director
Tel: 49 89 769 02 391
Fax: 49 89 769 02 144

UK

John Waddell
Tel: 44-81-312-4696
Fax: 44-81-312-1078

NORWAY, SWEDEN, FINLAND

Roland Nihlmar,
Lars Grunberger
Tel: 46 8616 0760
Fax: 46 8616 0777

DENMARK

Aase Kisborg
Tel: 45 33 14 9888
Fax: 4533149288

GERMANY-NIELSEN 4/ BAVARIA

Margarethe Munchmeier
Tel: (49-89) 22 20 15
Fax: (49-89) 299 160

SPAIN

Luis S Giner
Tel: 343-894-43-26
Fax: 343-894-88-37

AUSTRIA

Sven Kollensperger
Tel: 43-732-79-34-55
Fax: 43-732-79-34-58

ISRAEL

Asa Talbar
Tel: 972-35-223-621
Fax: 972-3-524-2177

ITALY

Roberto Laureri
Tel: 39-2-236-2500
Fax: 39-2-236-4411

SWITZERLAND

Roswitha N Briand
Tel: 41-1-261-4690
Fax: 41-1-251-45-42

NETHERLANDS/ BELGIUM/NORTHWEST GERMANY (NIELSEN 1, 2, 5, 6, 7)

Albert Ticheler
Tel: 31-40-41-37-27
Fax: 31-40-42-04-30

CENTRAL/ SOUTHWEST GERMANY (NIELSEN 3A, 3B)

Renate Munk
Tel: (49) (6272) 2345
Fax: (49) (6272) 2167

FRANCE

Alain Faure
Tel: 33-1-4629-4629
Fax: 33-1-4093-0337

HONG KONG

Adonis Mak
Tel: 852-838-2666
Fax: 852 575 1690/
852 575 1967

JAPAN

Kaoru Hara
Tel: (81-3) 3389-1822
Fax: (81-3) 3389-1761

KOREA

Jeong-gwon Seo
Tel: 82-2-752-4392
Fax: 82-2-752-4394

SINGAPORE/ MALAYSIA

Hoo Siew Sai
Tel: 65-738-0122
Fax: 65-738-2108

AUSTRALIA

Alexandra Harris-Pearson
Tel: 61-2-299-5677
Fax: 61-2-299-6178

TAIWAN

Parson Lee, John Shih
Tel: 886-2-7114833
Fax: 886-2-7415110

PRODUCT MART

Joanne Dorian
Tel: (212) 463-6415
Fax: (212) 463-6404

INFO CARDS/ LITERATURE LINK

Melissa Bachman
Tel: (617) 558-4282
Fax: (617) 558-4328

RECRUITMENT

Jacqueline Daniels
Tel: (617) 558-4488
Fax: (617) 630-3925

TELEMARKETING SALES

Judy Telander
Tel: (310) 826-5818
Fax: (310) 207-1067

Direct Mail Service:
(708) 390-2361

Cahners Magazine Division

Robert Krakoff,
President, CEO,
Cahners Publishing

Michael Wisner,
Senior VP/General Mgr,
Boston Div

Tom Dellamaria,
Senior VP/Production &
Manufacturing

User-interface design book tells all

The response to my article on prototyping user interfaces (Ref 1) shows that a great many *EDN* readers really care about how users interact with their products. As a visit to a suitable technical library will quickly reveal, there is much you can read about human-factors engineering and interaction between people and computers. These subjects are controversial, too, so no single book or article provides a comprehensive view of the field. That said, if your human-factors library allows room for only one volume, you should seriously consider making it *Developing User Interfaces* by Deborah Hix and H Rex Hartson (ISBN 0-471-57813-4), a 391-pg trade paperback priced at \$34.95.

For the most part, this eminently readable book succeeds in remaining objective. It covers such topics as styles of interaction and the iterative process of developing, evaluating, and refining a user interface. Each chapter provides a reference list. Most chapters also include exercises for the reader and possible solutions. The chapter on development tools avoids presenting a long list of products; it focuses instead on how to evaluate and select tools. Considering how rapidly new and revised tools emerge and that books continue to be available for long periods, this approach is probably the only sensible one.

I did find several chapters to be downright depressing, though. These are the ones on user-action notation (UAN). As an alternative to using vague and verbose prose to describe the operation of user interfaces, especially graphical ones, the authors offer us the UAN shorthand. As an example, in UAN the tilde (~) character denotes a

mouse movement. Being able to communicate easily how a graphical interface works has undeniable advantages, and using text-based notation to convey such information unambiguously seems like a good idea—at first. But a few minutes of reading about UAN made me wonder whether a problem so complex might be too tricky to even try solving.

Yes, it's worth knowing whether a function name will be highlighted as soon as I push down on a mouse button or whether the highlighting won't come on until I lift my finger off the button. And, yes, a text-based description of the interface operation might fail to differentiate between the two conditions. Nevertheless, I can't help thinking that the authors' cure is worse than the disease.

My feelings of frustration were heightened when I realized that the notation, which is supposedly based on the ubiquitous ASCII character set, uses several unique non-ASCII characters—an upside-down capital A and a double solid line that ends in arrows—in addition to superscripts and subscripts. These special characters make it impossible to use a standard text printer to reproduce UAN files. Moreover, if human-factors specialists can devise such an arcane and inscrutable notation, you have to wonder whether they believe that human factors are important to everybody *except* people who do human-factors work.

Nevertheless, the book is comprehensive, and most of it is informative and useful. It should prove worthwhile to any engineer seriously interested in creating products that real people can use. No book is perfect, and the UAN chapters should

not deter you from purchasing this one.—**Dan Strassberg**

John Wiley & Sons Inc, New York, NY. (908) 469-4400. Circle No. 469



Reference

1. Strassberg, Dan, "User-interface prototypes help you design products real people can operate," *EDN*, March 3, 1994, pg 51.

New version improves CubiCalc's fuzzy-development features

Late last year, HyperLogic released CubiCalc Version 2.0, although I had been working with a beta version since midsummer. I reviewed CubiCalc 1.2 in the March/April 1992 issue of *PCAI* and expanded on that review in the March 1992 issue of the *Huntington Technical Brief*. This article discusses only version 2.0 features and only those I consider to be key to how I use fuzzy logic.

The addition for which I am most grateful is the support of matrices. The matrices are currently constrained to three dimensions with a maximum dimension size of 4000. The program provides a collection of operations, including matrix addition, subtraction, copying, inversion, transposition, and scaling, as well as diagonal-matrix initialization and several more that are a bit esoteric. The on-line help and readme file document all these matrices, although the current manual does not.

HyperLogic also has continued to strengthen the expression language, which processes data applied to and received from the rule base and simulates a controlled system in a feedback simulation. In some ways, the expression language is looking increasingly C-like. For example, the new version adds the C short-form operations +=, -=, *=, and /=. The software also now supports looping, using *while* as the keyword, and it supports random access to binary input files (with data in IEEE-standard, floating-point, 32- or 64-bit format).

HyperLogic has also improved the setting of fuzzy-variable values and added a terse-rule syntax for rules with antecedents connected with AND operators. For example, you can represent the rule with a traditional syntax

```
if E_X is SM_POS and
    DELTA_X is LRG_NEG then
    DRIVE is MED_POS;
```

as:

```
E_X SM_POS, DELTA_X LRG_NEG:
    DRIVE MED_POS;
```

The software supports multiple rule consequences; one rule can now specify actions for more than one output. CubiCalc includes two new fuzzy-related functions. **active_rules(...)** and **membership(...).active_rules** return the number of rules governing a specified output function that has fired.

The **membership** function is more interesting to me. It is called in the form:

```
var = membership(
    variable_name,
    adjective_name,
    crisp_input);
```

Given a fuzzy variable **variable_name**, one of its adjectives **adjective_name**, and a crisp-input value **crisp_input** returns the degree to which **adjective_name** contains **crisp_input**. You can use this feature, for example, to perform specialized fuzzy inference not using the provided defuzzification, as when combining the strengths of rule firings using a weighted average.

Version 2.0 also provides several new inference methods (and I am glad to see that the documentation separates combination and defuzzification of operations). As in earlier versions, you can choose between "scale via product" (often called "max-dot") and "scale via maximum" (often called "max-min"). In addition, you can now combine data via maximum or via sum. Both are forms of output-function combinations: The maximum method creates a resultant function by taking the pointwise maximum value of the functions being combined, and the sum method takes the pointwise sum.

The software also allows for a consequence indicated by multiple rule triggers to be counted only once or the number of times it was triggered. Two defuzzification options, centroid and maximum, are available, and the manual provides a good discussion of all inference methods.

HyperLogic has also provided three

new plots: activation, resultant, and decision surface. The activation plot shows the degree to which each of the adjectives for a given variable is active. The resultant plot shows the output fuzzy-set waveform with a marker indicating the defuzzified output. The decision-surface plot is the only one that CubiCalc does not generate at runtime. It plots three variables in an X, Y, Z coordinate system.

Although, typically, these variables are fuzzy, X and Y are inputs, and Z is an output, CubiCalc does not require this restriction: Any of the three can be fuzzy or crisp and can be inputs, outputs, or internal variables. To control viewing angle, the decision-surface window has three graphic thumbwheels to rotate the plot about the three possible axes. An optional but valuable feature of the decision-surface plot is the display of orthogonal slices at a specified coordinate pair through the X and Y input spaces.

The software also provides for color plots, making it easier to distinguish between the traces in the x-y scatter plot, available in this and earlier versions. In addition, this version supports execution tracing. Running a simulation with tracing enabled causes the status bar to show the phase and line number of each instruction as it executes. Further, if the editor window containing the currently executing expression is open, CubiCalc highlights each executable line as it is processed.

I am also grateful for CubiCalc's adherence to the part of the Windows specification that designates Ctrl-x, Ctrl-c, and Ctrl-v for Cut, Copy, and Paste, respectively. This feature facilitates projects with a lot of cuts and pastes and makes the keyboard version of these operations both more convenient and more Macintosh-like.

The runtime-compile (RTC) option continues to be available in Version 2.0. RTC allows you to compile a designed fuzzy system as a number of library functions that you can then link with Borland or Microsoft C for execution on a PC. The RTC fuzzy engine is also available as C source code that you can compile for non-PC targets.

Given all these improvements to CubiCalc, I list the following not as shortcomings of the current version (as I did the lack of matrices in Version 1.2), but as improvements worthy of a next generation.

First, the terse-command entry is an improvement, but I would also like to see a graphical-matrix-rule entry and presentation.

Second, I would like to see HyperLogic continue to strengthen CubiCalc's expression language, including the addition of user-generated functions and a textual in-line means of declaring variables, especially non-fuzzy variables.

Third, I would also very much like to see CubiCalc treat the characteristics of fuzzy values (CubiCalc's "adjectives") as variables available to the expression language, thus allowing such functional control as shifting, scaling, and hedging. Such capability is necessary in the design of adaptive and self-organizing systems, of which we shall see an increasing number.

Fourth, I would enjoy seeing CubiCalc support Sugeno inference, which replaces output fuzzy sets with functions of inputs.

A final "would-be-nice" feature is the ability to have multiple rule bases defined within a single simulation. CubiCalc can currently do this with multiple instantiations communicating through Windows, but a self-contained solution is preferable.

But, in general, Version 2.0 is a positive and significant refinement of an already-good fuzzy-simulation tool. It is apparent that HyperLogic developers put much thought into which features to add. The tool is easy to use and has considerable power. I often "throw together" a simulation on CubiCalc just to test the concept and feasibility of a new system.

In most ways, I consider CubiCalc to be not merely a contender but the front-runner in the fuzzy-development-tool market. It is also satisfying to know that while other fuzzy-tool vendors are struggling, HyperLogic remains strong.

CubiCalc runs under Windows 3.1. Its base price is \$495 and \$795 with the RTC option. Source code for the RTC engine is \$995.

Bottom line: This is an excellent fuzzy-development tool—the one I most often use and recommend.—**David I Brubaker**
HyperLogic Corp, Escondido, CA.
(619) 746-2765. **Circle No. 470**

David I Brubaker is president of Huntington Advanced Technology (Menlo Park, CA) and a frequent contributor to EDN.

EDN-INTERNATIONAL ADVERTISERS INDEX

Company	Page	Circle	Company	Page	Circle	Company	Page	Circle
ADPI	220	230	International Rectifier Corp	C3	74	Signum Systems	217	250
AMP Inc	102-103*	48	Interpoint	209	67	Silicon Systems	77	105
Abbott Electronics Inc	31	196	Ironwood Electronics	219	242	Siliconix	4	
Accutrace	219	231	Linear Technology Corp	138	156	Sony Semiconductor	49	16
Adtek	210	89		145-146		Sony Semiconductor Europe	6*	188
Advin Systems	217	232	Logical Devices	217	243	Spectrum Signal Processing	199	28
Allegro MicroSystems	C2	29	Loughborough Sound Images Limited	12*	186	Spectrum Software	173	125
Allied Electronics	116	30	Macrochip Research	216	275	Stag Microsystems Inc	219	266
American Reliance Inc	204	87	Mathworks Inc	133	9	Stanford Research Systems Inc	192	189
Analog Devices Inc	16*	31	Matra Harris	185	75	T-Cubed	216	252
	44-45	197		187	76	TDK Corp	98	47
	87-94		Maxim Integrated Products	60-61	77	Tektronix Inc	219	253
Apex Microtechnology Corp	29	138-139		63	78	Teledyne Electronic Technologies	166	107
Applied Data Sciences Inc	216	233		65	79	Teledyne Relays	177	190
Asahi Kasei Microsystems Co Ltd	195	198	Megatel Corp	211	88	Texas Instruments	53-55	
Atmel	12	32	Mesago Messe & Kongress GmbH	101*	17		70 A-J	
Audio Precision	151	33	Metalink Corp	219	276		127-129	117
BP Microsystems Inc	71	163	MicroSim Corp	19	150-152		179-181	108
Berquist Co	206	34	Microstar Labs	215	262	Thermo Disc Inc	198	118
Burr-Brown Corp	8	164	Mini-Circuits	3	157	Thin Film Technology Corp	206	109
CEIBO	220	258		143	122	3M	155	38
Capilano Computing Systems	218	234	Molex	74	123		111	106
Cermetek	219	235	Motorola Semiconductor Products	67		Tokin Corp	191	37
Cherry Semiconductor	203	146		24-25*		Toshiba America Electronics Components	26-27	98-99
Compass Design Automation	121	36	Murata Electronics	118-119	19	Toshiba Electronics	158*	
Condor Inc	51	199	NCR Corp	42	153		159*	191
Cypress Semiconductor	C4		NEC Corp	56-57	80	TransEra Corp	194	149
Dale Electronics	201	39		182-183	81	Tribal Microsystems	215	263
Data I/O Corp	218	236	National Instruments	2	82	Two Technology	218	261
		264	National Semiconductor	34-37		US Logic	220	254
Datel Inc	141	49		35-36		Underwriters Laboratory	167	155
Digi-Key Corp	1	64	Needham's Electronics	40-41		Unitrode Integrated Circuits	46	111
Diversified Technology	39	65	Nichicon	216	259	Vicor Corp	107	192
Duracell Corp	163	159	Nohau Corp	104	83	Viewlogic Systems Inc	130	112
Dynamic Soft Analysis, Inc	217	257	Orion Instruments	216	274	W L Gore & Associates Inc	38	92
E-T-A Circuit Breakers	217	265	Oyster Terminals	217	245		168-169	193
ESL Inc	82	84	P-CAD	196 A-B		Wavetek	153	113
EUROM Flash Ware Solutions Ltd	21	66		197	115	Wind River Systems	148	114
Ecliptek Corp	156	69	Pacific Softworks	216	273	Wintriss Engineering	216	267
Elantec	134	124	Pentek Inc	193	93	Xilinx Inc	32-33	194
Electronic Designs Inc	115	158	Penzar Development	218	246	Zaxtek	219	255
Eletech Electronics	216	237	Philips Semiconductors	160-161*	40-44	Zilog Inc	144	162
Emulation Technology	218	269	Philips Semiconductors North America	101		Zworld Engineering	215	256
		270	Pico Electronics	157	94			
Ericson Components	205	185		196	147			
FDK America	158	144	Piher International	207	147			
Fluid Dynamics International	86	70	Power One	38	137			
Frequency Devices Inc	52	200	Power Trends Inc	69	116			
GE Plastics	219	238	Powertronic Systems Inc	125	85			
GE Rental/Lease	122	71	Prem Magnetics	220	247			
Gennum Corp	97	2		166	86			
Harris Semiconductor	23*	3	QSI Corp	202	91			
Hewlett-Packard	23*		Quad Design	178	148			
	24-25*	161	QuadTech Inc	159	154			
	85*	72	Quality Semiconductor Inc	30*	136			
Hirose Electric	216	271	RC Systems	112	110			
Hypertronics Corp	220	272	Raltron Electronics	220	268			
IEE	108	103-104	Raytheon Corp	178	95			
INES GmbH	220	239	Safe Soft Systems	81	96			
ITOI Enterprises	217	240	Samsung Semiconductor Inc	220	251			
Illinois Capacitor	188	73		136-137	102			
Incredible Technology	215	241	Samtec Inc	170-171	97			
Independent Digital Consulting	217	260	Sealevel Systems	28	27			
Integrated Device Technology Inc	78		Siemens AG	218	249			
Intel Corp	14-15*	4	Siemens Components Inc	10-11*	187			
	72-73*	121		6*	131-135			
Intelligent Systems International	198	145	Sierra Circuits	110A-D				
				215	248			

Recruitment Advertising 221

*Advertiser in European edition

This index is provided as an additional service. The publisher does not assume any liability for errors or omissions.

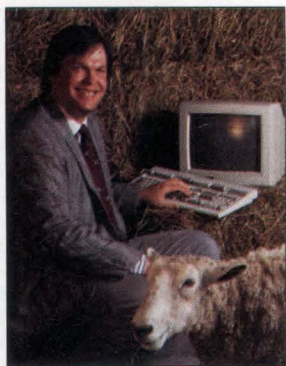

**JOHN COOLEY, EDA
CONSUMER ADVOCATE
& FOUNDER OF ESNUG**

Whoa! The Verilog / VHDL wars are ending!

Toward the end of the movie "The Wizard of Oz," a scene shows Dorothy finally getting to meet what she believes is the Wizard of Oz. What she sees is an incredibly large human head floating between two columns of fire and smoke. As she meekly converses with this angry apparition, her dog, Toto, manages to expose a man standing behind a nearby curtain. The man appears to be operating some sort of control room. When Dorothy notices this man, he tells her, "Pay no attention to that man behind the curtain!"



Real-life elements similar to Dorothy's experience dramatically unfolded at the Open Verilog International '94 (OVI) conference in March. Among all the usual technical discussions—such as what to include in the IEEE 1364 push, EDA-vendor announcements (such as that Cadence had just sold its 10,000th copy of Verilog-XL), and the hubbub of a very busy exhibit hall with lots of curious customers—a watershed event in the ASIC/EDA/field-programmable gate-array industry was taking place.

It was neither the fact that this year's OVI had 35 exhibitors compared with last year's 24 nor the fact that this year's OVI had 493 attendees compared with last year's 390; it was what was happening behind the scenes that was of real interest.

The hot gossip at OVI was

that two EDA companies, Synopsys and ViewLogic, which had until the conference been very adamant—almost militant—VHDL proponents, were in a bidding war for Chronologics, a company that specializes in high-speed Verilog simulation. When asked about the rumor, all three EDA vendors gave the usual reply: "Pay no attention to that man behind the curtain!"

To muddy the waters further, in the middle of the "8 CEOs and Two Other Bigwigs" panel (on how many ways one can use the word "paradigm" in a sleepy discussion on 1-million-gate ASICs), Alain Hanover, CEO of ViewLogic, quoted "purchased" market research indicating that VHDL would soon kick Verilog's derriere. (ViewLogic eventually won the bidding war for Chronologics. When asked later why he quoted such "statistics" in the middle of a Verilog conference, Hanover said, "We knew that the rumor had gotten out, but we didn't want to tip our hand.")

Why is this such a watershed event? Big companies buy little companies all the time, you say. But it's not which company won the bid for Chronologics that's important; it's which companies were doing the bidding. What their actions signify is that the disastrous Verilog/VHDL wars are ending! The additional fact that Mentor dropped a pretty piece of change buying a pricey lunch for all the OVI attendees and was quite active in the technical forum also backs this assertion. The ever-demure CEO of Cadence, Joe Costello, says of this development, "Hell, we thought it was a bankrupt strategy to take sides in the Verilog/VHDL wars five years ago. Sell the customer the HDL [hardware-description language] he asks for, and you have a happy customer. Force him to go to an HDL he doesn't want, and you get an unhappy customer."

In this case, Costello couldn't have said it better. Now that ViewLogic has joined the "language-neutral" club by offering *both* Verilog and VHDL, it's only a matter of time before Synopsys and Mentor do the same.

John Cooley, an EDA consumer advocate and founder of the out-law E-mail Synopsys Users Group (ESNUG), lives on the Holliston Poor Farm in Massachusetts. He raises sheep and is an EDA- and ASIC-design instructor and project-in-crisis consultant. He can be reached at "jcooley@world.std.com" or at (508) 429-4357.

Power-full tiny inverter.

Or how to shrink a 1hp, 3-phase motor control inverter to fit your pocket...book.

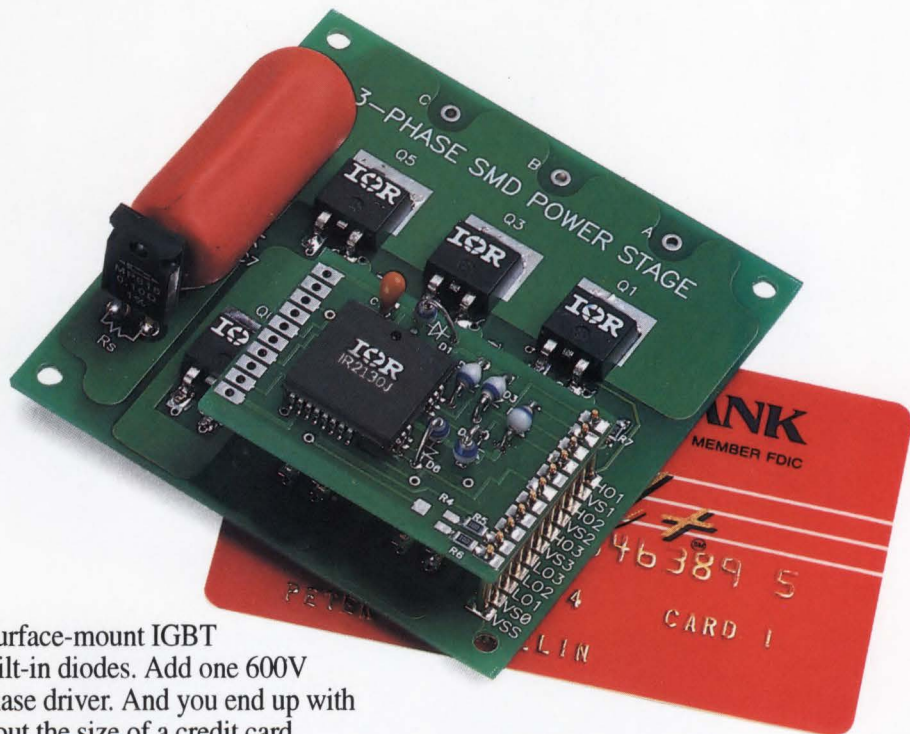

Take six IR surface-mount IGBT CoPacks with built-in diodes. Add one 600V IR2130J three-phase driver. And you end up with a 1hp inverter about the size of a credit card.

The lower part count, size and weight reductions bring added value to your end product. Your customers benefit from the pass-along savings. And you gain the competitive edge.

Thanks to the most compatible line of power devices ever. Value-priced to save you money. In stock to save you delivery time. Send for our data "Shrink Pak." Quicker yet, call. 1-800-245-5549.

You'll see how small your inverters can get.

Available now at key IR distributors.

This motor control inverter is 3" x 3" sq. and features six SMD-220 surface-mount CoPack UltraFast IGBTs driven by a single 600-volt, 3-phase driver (IR2130J) with current-sensing.

IOR International Rectifier

WORLD HEADQUARTERS: 233 KANSAS ST., EL SEGUNDO, CA 90245, USA 310-322-3331, FAX 310-322-3332, TELEX 66-4464. EUROPEAN HEADQUARTERS: HURST GREEN, OXTED, SURREY RH8 9BB, ENGLAND, (0883) 713215, FAX (0883) 714234

CIRCLE NO. 74

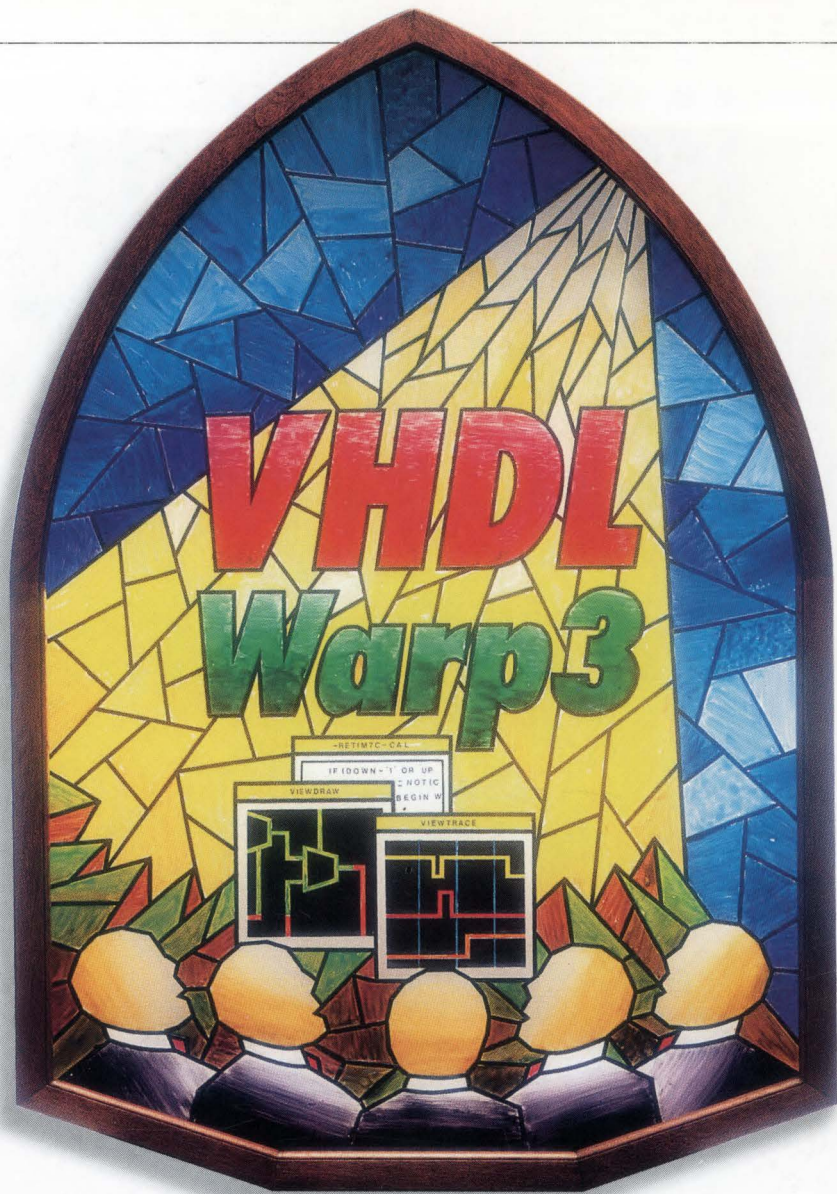

Here's a revelation for everyone designing with CPLDs and FPGAs.

Warp3™ is the easiest way into VHDL and the fastest design path for high-density programmable logic: from creation through optimization. *Warp3* is based on ViewLogic's™ highest-end Powerview™ and Workview Plus™ graphical environment for Sun and PC platforms. Now you can reevaluate designs in minutes—not hours—

**GET THE POWER
AND THE GLORY.**

**AND BRING A MORE ENLIGHTENED
APPROACH TO PROGRAMMABLE LOGIC.**

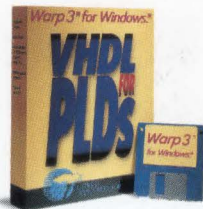

with automatic place and route and fitting. Enjoy full timing simulation, mixed mode design entry and schematic capture. Designs can be targeted to Cypress's UltraLogic™ family of high-performance pASIC380 FPGAs and high-density FLASH370 CPLDs, or to alternate devices without modification. Try it for yourself. And see the light. **For a comprehensive brochure and free demo disk, call 1-800-858-1810*, Dept. C4H.**

*In Europe, fax requests to the above Dept. at (32) 2-652-1504 or call (32) 2-652-0270. In Asia, fax requests to the above Dept. at 1-415-940-4337. All trademarks are of their respective companies © 1994 Cypress Semiconductor, 3901 North First Street, San Jose, CA 95134 Phone 1-408-943-2600.

ULTRA
L O G I C

