

# Electronic Design 12

VOL. 15 NO.

THE MAGAZINE OF ESSENTIAL NEWS, PRODUCTS AND TECHNOLOGY

JUNE 7, 1967

**Tune in with varactor diodes.** With tuning ratios running higher than twenty-to-one and Q better than 300, tiny voltage-variable capacitors replace bulky ganged

air-variables. Electronic tuning — even remote — is possible from the broadcast band all the way up to uhf. For a look at the specs and some tuner designs, see p. 116.



# SEE MORE! DO MORE! WITH THE NEW GO-ANYWHERE hp 180A OSCILLOSCOPE!

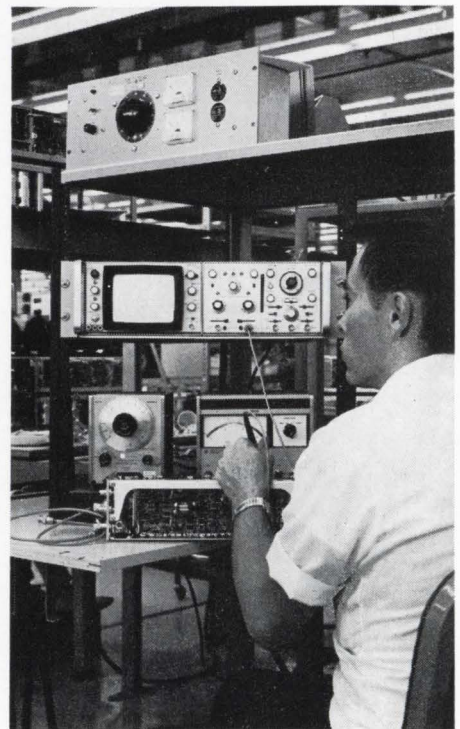
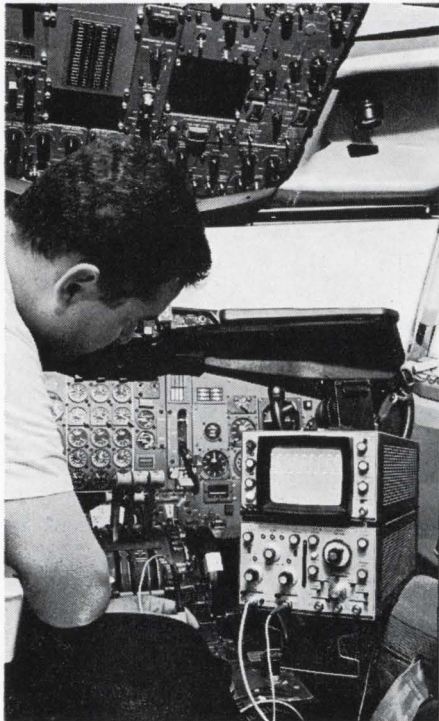

*Weighs only 30 pounds! Specified Performance at  $-28^{\circ}\text{C}$  to  $+65^{\circ}\text{C}$ !  
50 MHz at 5 mv/cm! 8x10 cm CRT! All-solid-state!*

You can see more, do more with this high-frequency (50 MHz) 30-pound oscilloscope that goes anywhere—field, laboratory, or production line! Designed with aircraft-type frame construction for maximum ruggedness and minimum weight, this scope will give you specified performance at  $-28^{\circ}\text{C}$  to  $+65^{\circ}\text{C}$ , 95% relative humidity to  $40^{\circ}\text{C}$ , and up to 15,000 feet! Built to withstand rigors of field and mobile use, the hp Model 180A Oscilloscope also is designed to give big picture CRT, plug-in versatility and step-ahead all-solid-state performance. These features add up to *more total performance, more usability than any other scope on the market!*

Mainframe and plug-ins of the hp 180A are all-solid-state. Mainframe is the first with power supplies specifically designed for solid-state circuitry—gives you full performance benefits from solid-state devices in all present and future plug-ins. New horizontal amplifier has wide bandwidth with X10 magnification to provide linear 5 nsec/cm sweeps, giving you greater resolution of high frequency signals and fast pulses.

The dual channel 50 MHz at 5 mv/cm vertical amplifier has low-drift FET input stages for accurate DC measurement . . . plus quick, 15-second warm-up. Vertical attenuation, which sets vertical deflection factor, is ahead of the amplifier. This prevents trace jump as you change ranges; bandwidth is maintained on all ranges even when verniers are used.

Time base plug-ins offer new easy-to-use delayed sweep for examining complex waveforms in detail. Tunnel diode triggering circuits lock-in waveforms to beyond 90 MHz. Exclusive hp mixed sweep feature combines display of first portion of trace at normal sweep speeds, and simultaneously expands

trailing portion of trace at faster delayed sweep speed to allow magnified examination.

Accurate measurements are easier to read and view on the new hp 180A scope, because a new design breakthrough offers a compact 17-inch long, high-frequency 8 x 10 cm CRT with extra-large picture area—30% to 100% larger than any other high-frequency scope! With the black internal graticule, calibrated in centimeters, the bright trace, and a 12 kv accelerating potential, you get sharp, crisp traces for accurate resolution of waveform details—even at 5 nsec/cm sweeps.

Call your nearest hp field representative for full specifications and a demonstration of how you can see more, do more with this new versatile, go-anywhere hp Model 180A Oscilloscope. Or, write to Hewlett-Packard, Palo Alto, California, 94304. Tel (415) 326-7000; Europe: 54 Route des Acacias, Geneva. Price: hp Model 180A Oscilloscope, \$825.00; hp Model 180AR (rack) Oscilloscope, \$900.00; hp Model 1801A Dual Channel Vertical Amplifier, \$650.00; hp Model 1820A Time Base, \$475.00; hp Model 1821A Time Base and Delay Generator, \$800.00.

106C

**HEWLETT**  **PACKARD**  
An extra measure of performance



RF OUTPUT  
 $Z_0 = 50 \text{ OHMS}$

1026 STANDARD-SIGNAL GENERATOR  
GENERAL RADIO COMPANY  
CONCORD MASSACHUSETTS USA  
SERIAL 106

## RF output: 1/2 watt

We've used an ordinary pilot lamp to prove a point: Our new Type 1026 Standard-Signal Generator puts out lots of power —  $\frac{1}{2}$  watt into 50 ohms, 10 volts behind 50 ohms (5 volts when modulated). It also puts out as little as 0.1  $\mu\text{V}$  and anything in between these limits.

The 1026 also has true single-dial tuning over its entire 9.5- to 500-MHz frequency range. There is no output trimmer control to adjust every time you change frequency. Output of the 1026 is *automatically* leveled; you can change frequency within a range or even switch ranges and maintain output level within  $\pm 0.2$  dB to 110 MHz and within  $\pm 0.5$  dB to 500 MHz. The carrier is leveled whether modulated or unmodulated. Amplitude modulation up to 95% can be imposed on the carrier from an internal, highly stable 1-kHz oscillator or from an external audio source. There are also provisions for external modulation to 1.5 MHz and for pulse modulation.

Other specifications are as much as an order of magnitude better than those of

any other signal generator you can buy. For example, envelope distortion is less than 1% for 1-kHz, 50% modulation; incidental fm accompanying this a-m is less than 1 ppm, peak; residual fm is less than 0.05 ppm, peak; residual a-m is at least 70 dB below carrier level in CW, internal 1 kHz, and external audio modes.

This instrument is made to order for a-m receiver testing, and its high-level output makes it most suitable for antenna-pattern and impedance measurements, receiver overload and cross-modulation tests, and measurements of large insertion losses. The ease of operation and outstanding performance of the 1026 in the most critical applications must be experienced to be appreciated.

For complete information or a demonstration of the 1026, write General Radio Company, W. Concord, Massachusetts 01781; telephone (617) 369-4400; TWX (710) 347-1051.

ON READER-SERVICE CARD CIRCLE 2

GENERAL RADIO

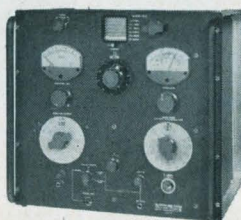

Type 1026 Standard-Signal Generator, \$6500 in U. S. A.

DATA SYSTEMS

PULSE  
INSTRUMENTATION

NEW Model 111

# NANO **2** SECOND

VARIABLE RISE PULSE GENERATOR with  
PRECISION DC BASELINE OFFSET... 4 Hz to 40 MHz  
rep. rates... single or double pulse...  $\pm 5v$  output... narrow  
pulses to 5 nanosec. ■ Fully controllable fast pulses for  
exact waveform simulation...worst case testing ■ Precision  
dc baseline offset control for off-ground logic simulation  
...noise susceptibility analysis ■ Ultra high rep. rates for  
high speed circuit development ■ Auxiliary dc output for  
test biasing ■ Double pulses to 25 MHz (simulates 50 MHz)  
for flip-flop resolution checks...



Model 111  
Pulse Generator

Write for Technical Data.

Datapulse is the leading producer of solid state pulse instrumentation.  
48 technical sales offices and 7 field service centers in 18 countries.

**DATAPULSE**®

DATAPULSE/Division of Datapulse Inc./10150 Jefferson Blvd., Culver City, Calif. 90230/(213) 871-0410, 836-6100/TWX: 910-340-6766/Cable DATAPULSE  
DATAPULSE • NESCO INSTRUMENTS • DE MORNAY-BONARDI • KRS INSTRUMENTS

ON READER-SERVICE CARD CIRCLE 3

# Electronic Design 12

VOL. 15 NO.

THE MAGAZINE OF ESSENTIAL NEWS, PRODUCTS AND TECHNOLOGY

JUNE 7, 1967

---

## NEWS

- 13 News Scope
- 17 **Radar mapper measures severity of storms**  
Raindrop echoes on PPI scope may help pilots to avoid dangerous weather.
- 20 **Lunar success will come in a small package**  
A radar landing system more sensitive than Surveyor's to guide men to Moon.
- 24 **Army reports critical components 'gap'**  
Top scientist complains that DOD does not tell industry its needs directly.
- 29 Washington Report
- 36 **Loudness analyzer imitates the ear's response**  
Instrument based on theory of human hearing designed by Hewlett-Packard.
- 48 Letters
- 51 **Editorial: Whom do the car makers think they are kidding?**

---

## TECHNOLOGY

- 54 **Use a good switching transistor model** in computer analyses of circuits. Over-complex models waste computer time; oversimple ones give inaccurate results.
- 62 **Decapsulate components undamaged** for reject analysis or recovery. Mechanical, thermal or chemical stripping methods are compared.
- 66 **Design a high-voltage pulse generator** with a tape-wound toroidal core that is operated by a transistorized core driver circuit.
- 72 **Select varactors for voltage tuning** with the aid of three nomograms that give design data directly from the varactor spec sheets.
- 78 **Photocell and lamp automate testing** of subminiature modules. This unique design approach combines economy and excellent performance.
- 83 **Addenda to Electronic Design's 1967 Semiconductor Directory.**
- 86 **Cut copper costs: use aluminum strip** as a conductor. A simple nomogram gives the aluminum equivalent for the round copper wire in your designs.
- 90 Ideas for Design
- 102 NASA Tech Briefs

---

## PRODUCTS

- 116 **Cover Feature: Hyperabrupt junction** gives varactors 20:1 tuning ratio, Q to 300.
- |                      |                          |
|----------------------|--------------------------|
| 120 Semiconductors   | 148 Materials            |
| 124 Microelectronics | 156 Microwaves           |
| 128 Components       | 164 Production Equipment |
| 140 Test Equipment   | 166 Systems              |

---

## Departments

- |                       |                         |
|-----------------------|-------------------------|
| 108 Book Reviews      | 184 New Literature      |
| 180 Design Aids       | 190 Advertisers' Index  |
| 182 Application Notes | 193 Designer's Datebook |

---

**ELECTRONIC DESIGN** is published biweekly by Hayden Publishing Company, Inc., 850 Third Avenue, New York, N. Y. 10022. James S. Mulholland, Jr., President. Printed at Poole Bros., Inc., Chicago, Ill. Controlled-circulation postage paid at Chicago, Ill., and New York, N. Y. Application to mail at controlled postage rates pending in St. Louis, Mo. Copyright © 1967, Hayden Publishing Company, Inc. 62,529 copies this issue.

# Will a bargain bypass/filter capacitor jeopardize your entire system?

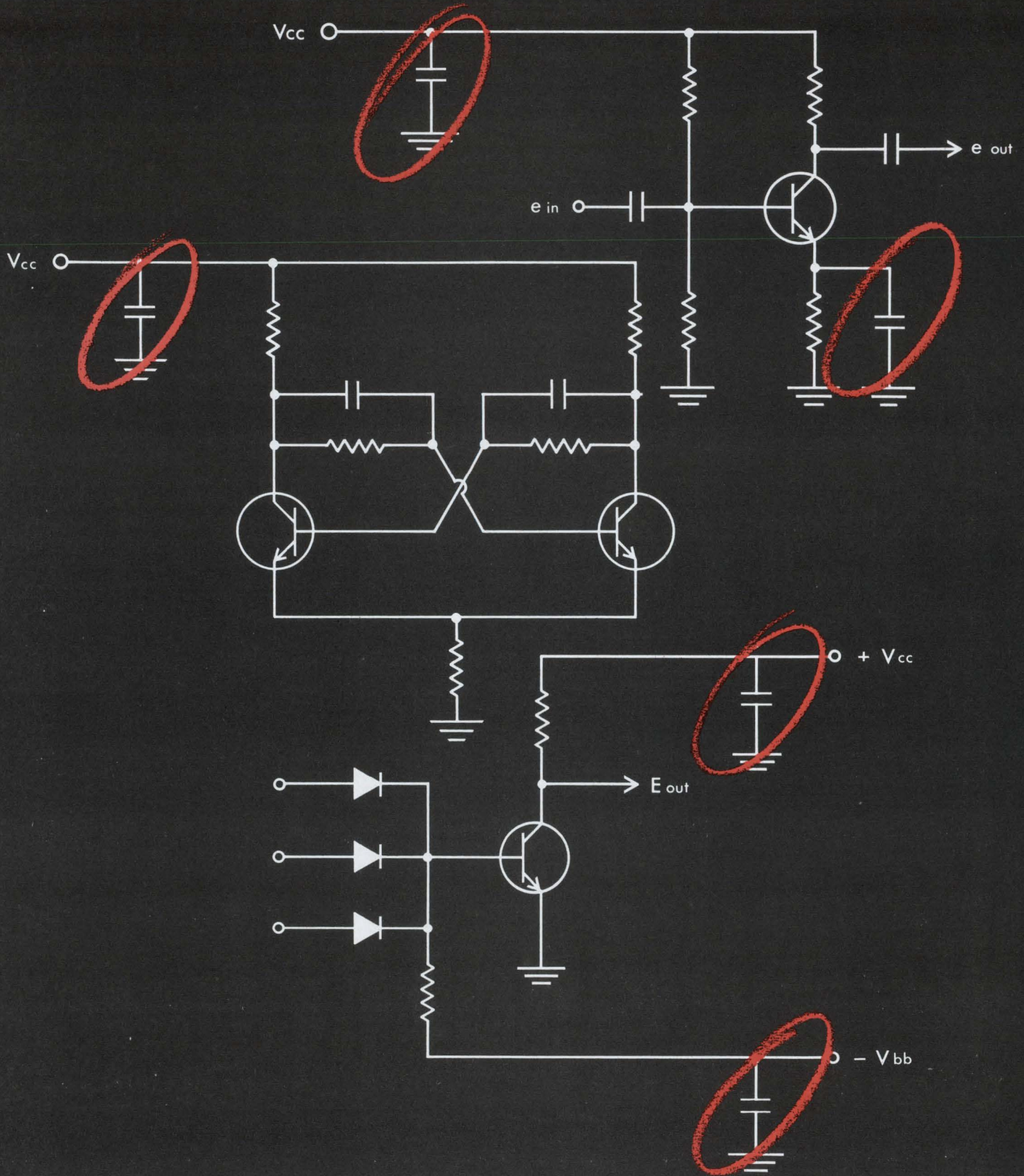

# Specify CORNING® Glass-K Capacitors ... for confidence

Considering the finality of bypass failure, anything less than the reliability of glass is false economy.

CORNING Glass-K Capacitors guarantee that reliability in two case sizes.

Get 1000 to 51,000 pf in .250" x .100", and 21,000 to 100,000 pf in .250" x .140".

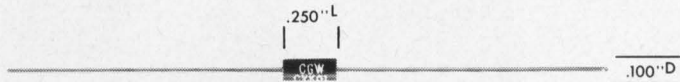

Specify CORNING Glass-K Capacitors when you need:

- bulk capacitance in minimum case size
- the total design flexibility of three stability characteristics, T, U, and V
- capacitor A to track capacitor B with the positive retraceability of glass
- minimum power attenuation and phase error with CORNING Glass-K Capacitors' low power factor
- tight end of life design with the guaranteed low capacitance change of CORNING Glass-K Capacitors
- adaptability to cordwood, printed circuit, and point-to-point packaging.

Get all this in a competitively priced unit that gives  $\Delta C$  with life as tight as 2%, IR greater than 100,000 megohms, D.F. as low as 1%, and standard item delivery of two weeks or less.

Tell us what you want a bypass/filter capacitor to do, and we'll tell you which CORNING Glass-K Capacitor will give you the confidence you need.

For complete data, write to: Corning Glass Works, Electronic Products Division, 3909 Electronics Drive, Raleigh, N. C.

**CORNING**  
ELECTRONICS

# 600 ounce-inches torque

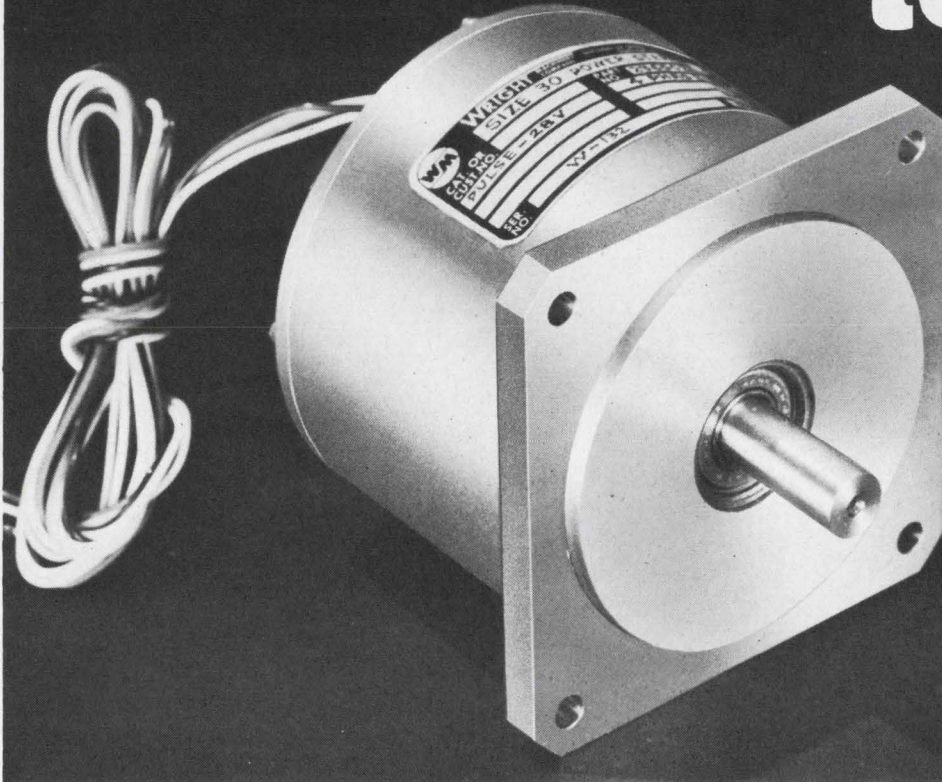

now  
available  
in 15°  
step  
angles

*Powerful, permanent magnet stepper motors by Wright Division of Sperry Rand open whole new fields of application for steppers. For the first time, designers are offered a line of stepper motors for the direct drive of all types of mechanical systems. With the high torque (up to 600 ounce-inches) and wide step angle (15°) of these motors, you can replace clutches, ratchets, gearheads, belts and cams with high speed electrical drives.*

15° Step Angle Power Steppers

SIZE	20 S	20 L	25 S	25 L	34 S	34 L	40
Outside Diameter, inches	2.000	2.000	2.500	2.500	3.390	3.390	4.000
Length, inches	1¾	2¾	1¾	2¼	2¾	4¼	4¾
Rotor Moment of Inertia, oz.-in <sup>2</sup>	.18	.36	.73	1.50	4.10	8.2	12.8
Volts Per Phase	28	28	28	28	28	28	28
Current Per Phase, amps	.40	.65	1.14	1.85	3.2	5.2	4.8
Input Power Per Phase, watts	11.5	18	32	52	90	145	135
Stall Torque, oz.-in.	15	30	60	120	220	450	600
Max. Controlled Stepping Rate, steps/sec.	250	250	250	250	200	200	150

## Applications

Tape drive, carriage, valve, belt, paper, azimuth, hydraulic, position, printer, screw, elevation, worm, digital, meter, instrument, set point, and similar drives.

## Speed

150 - 250 steps per second controlled.

## Low Power

Requires half the power of other devices. Benefits: simplicity, smaller size, lighter weight, lower cost, longer life.

Design engineers are invited to write or telephone for details. Comparison will show you that on applications where digital rotation is needed, this new Wright concept in steppers offers substantial advantages.

**WRIGHT**   
Division of Sperry Rand Corporation

Durham, North Carolina ■ Telephone 919-682-8161 ■ TWX 919-682-8931

ON READER-SERVICE CARD CIRCLE 5



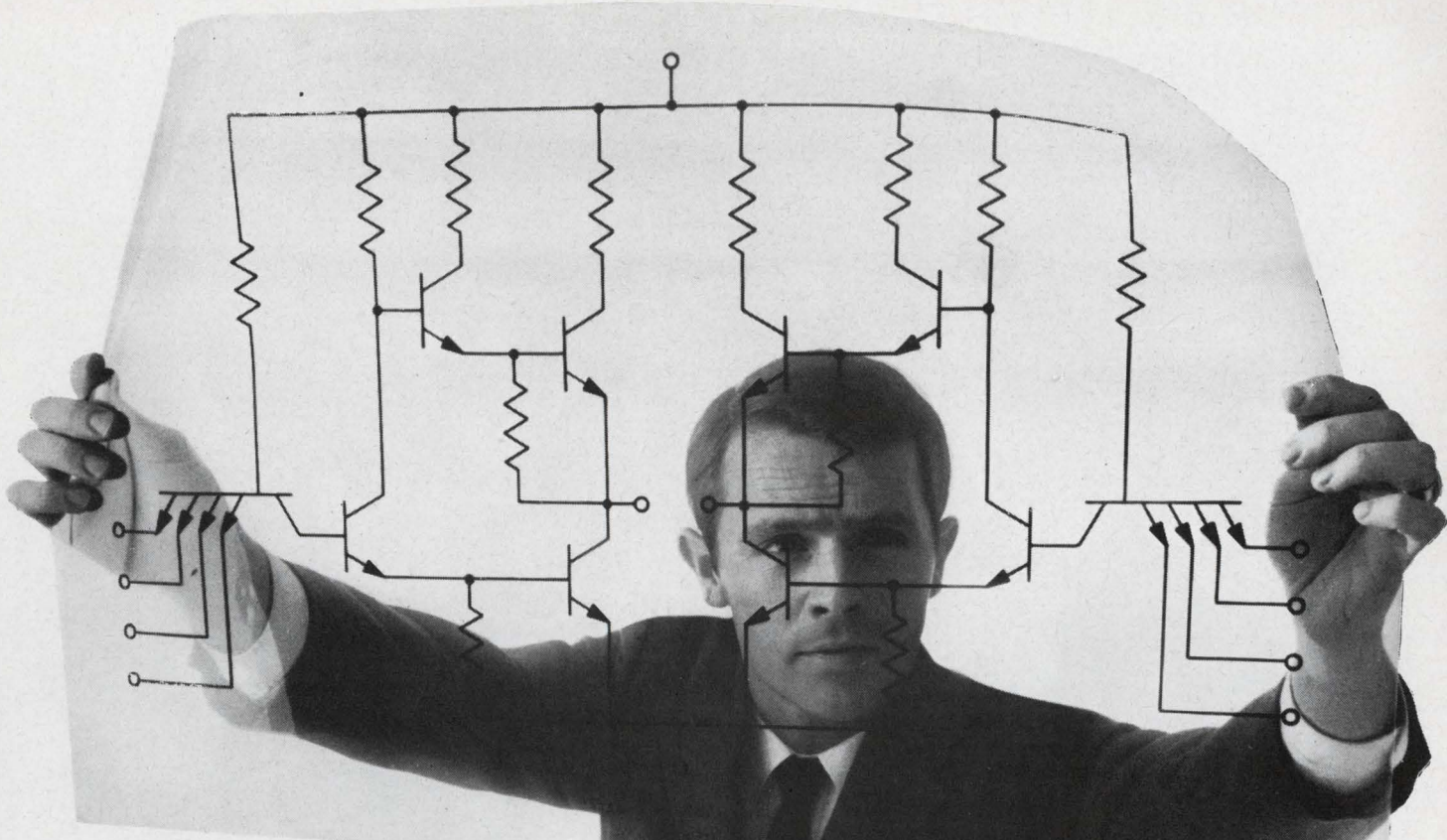

**Now Westinghouse has a pin-for-pin replacement for the industry-accepted TTL.**

**But don't think of us only as a second source.**

There's a very good reason why you should make Westinghouse TTL your *first* source.

Because this is the TTL line that is available now.

It's a direct mechanical and electrical replacement for the industry-accepted SUHL II. And all circuits are available in industry-standard dual-in-line and flat packages.

They include: 6G260 Single 8-input NAND/NOR Gate, 6G241 Dual 4-input NAND/NOR Gate, 6G221 Quadruple 2-input NAND/NOR Gate, 6G210 Dual Expandable OR/NAND Gate, 6G250 Quadruple Expandable OR/NAND Gate, 6G130 Dual 4-input Driver, 6G270 Dual OR Expander, 6F251 AND input JK Flip-Flop, 6F261 OR input JK Flip-Flop.

In fact, it makes good sense to make Westinghouse first choice for all your IC's. Because our goal is to help keep your products competitive now and into the 1970's.

For evaluation quantities, contact your Westinghouse Electronic salesman. Or phone Westinghouse at (301) 796-3666. Or write Westinghouse Molecular Electronics Division, Box 7377, Elkridge, Maryland 21227.

You can be sure if it's Westinghouse



J-09142



ONE POUND NET  
**TRANSISTORS**  
**EN 2369A**

**FAIRCHILD**  
SEMICONDUCTOR

# Get them by the pound.

There are 712 epoxy TO-5's to a pound; 1,516 epoxy TO-18's. Armed with this basic knowledge you are now ready to assimilate a few more facts about Fairchild epoxy devices.

**Full line:** We have epoxy PNP's, epoxy NPN's, epoxy FET's, epoxy anythings.

**Metal-can performance:** Our new EN epoxy transistors are equivalents of their metal-can counterparts, up to 70°C. (For example, an epoxy EN 2369A is the equivalent of a metal-can 2N 2369A.)

**Fast delivery:** We make more silicon epoxy devices than all the rest of the industry put together. (We can ship 2 to 3 tons per week — 5,000,000 devices to be exact.)

**Low Prices:** Our low epoxy prices are even lower now, while our special one pound discounts are in effect.

**Call a Fairchild Distributor:** Ask him to deliver a pound of your favorite transistors. And don't forget to redeem your coupon.



25¢

This coupon is good  
for 25¢ at your neighborhood  
Fairchild Distributor on purchase  
of one pound of Fairchild  
epoxy transistors.



ONE POUND NET  
TRANSISTORS  
EN 2369A



25¢

**FAIRCHILD**  
SEMICONDUCTOR

A Division of Fairchild Camera and  
Instrument Corporation ■ 313 Fairchild Drive,  
Mountain View, California 94040,  
(415) 962-5011 ■ TWX: 910-379-6435



25¢



25¢

# Now from Sprague!

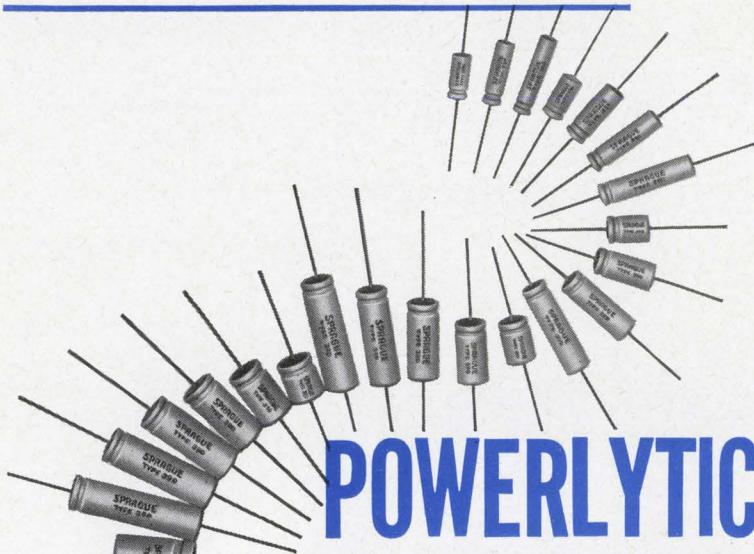

## POWERLYTIC® CAPACITORS IN 42 CASE SIZES...

for maximum capacitance in minimum space!



### Type 36D Cylindrical Case

Designed specifically for space economy, in applications such as computer power supplies, industrial controls, high gain amplifiers, etc. Case sizes from  $1\frac{3}{8}'' \times 2\frac{1}{8}''$  to  $3'' \times 5\frac{5}{8}''$ . Improved temperature capabilities—may now be operated at 85 C. Low equivalent series resistance, low leakage current, excellent shelf life, high ripple current capability. Superior seal employs molded cover with recessed rubber gasket. Reliable safety vents. Solder lug or tapped terminals. Standard ratings from 3 to 450 VDC, capacitance values to 270,000  $\mu$ F.

### Type 39D Tubular Case

Smaller companion to proven 36D capacitor, possessing same outstanding performance. Case sizes from  $\frac{1}{2}'' \times 1\frac{1}{8}''$  to  $1'' \times 3\frac{3}{8}''$ . Designed for operation at temperatures up to 85 C. Unique construction—anode and cathode terminals are welded—no riveted or pressure connections—prevents open circuits, even in microvolt signal range. Improved molded phenolic end seals contribute to unusually long life (expectancy, 10 years or more). Low effective series resistance, low leakage current. Standard ratings include capacitance values to 18,000  $\mu$ F, voltages from 3 to 450 VDC.

For complete technical data on Type 36D or Type 39D Powerlytic Capacitors, write for Engineering Bulletins 3431B and 3415, respectively, to Technical Literature Service, Sprague Electric Co., 347 Marshall Street, North Adams, Mass. 01247.

Popular ratings are now available for fast delivery from your Sprague Industrial Distributor.

### SPRAGUE COMPONENTS

CAPACITORS  
TRANSISTORS  
RESISTORS  
INTEGRATED CIRCUITS  
THIN-FILM MICROCIRCUITS  
450-5131R2

PULSE TRANSFORMERS  
INTERFERENCE FILTERS  
PULSE-FORMING NETWORKS  
TOROIDAL INDUCTORS  
ELECTRIC WAVE FILTERS

CERAMIC-BASE PRINTED NETWORKS  
PACKAGED COMPONENT ASSEMBLIES  
BOBBIN and TAPE WOUND MAGNETIC CORES  
SILICON RECTIFIER GATE CONTROLS  
FUNCTIONAL DIGITAL CIRCUITS



'Sprague' and '®' are registered trademarks of the Sprague Electric Co.

ON READER-SERVICE CARD CIRCLE 8

# News

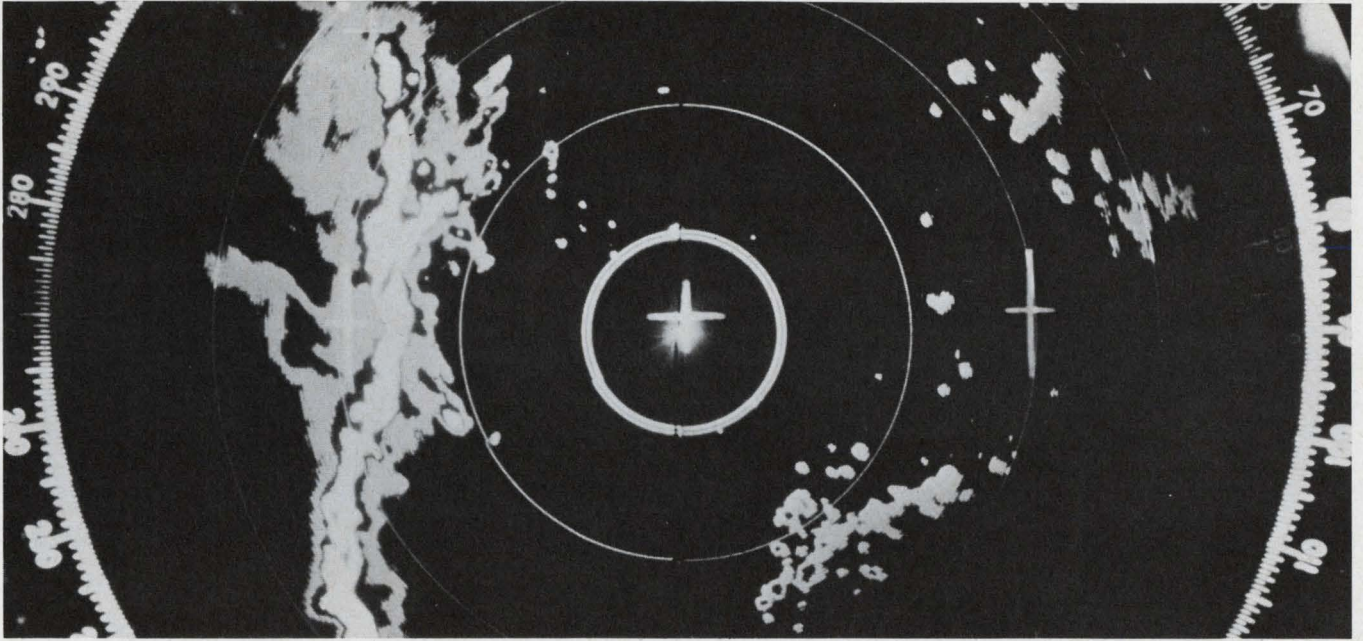

**New weather radar system** enables intensity of storms to be read directly off a scope face.

With its aid, pilots may be able to fly a safe path through bad-weather hazards. Page 17



**Communications gap** between the Pentagon and component manufacturers assailed by Army's chief scientist. Page 24



**Loudness analyzer** based on theory of hearing. Page 36

## Also in this section:

**Lunar landing will be controlled** by hypersensitive radar system. Page 20

**Matched cores yield** combined DRO/NDRO memory stacks. Page 40

**News Scope**, Page 13 . . . **Washington Report**, Page 29 . . . **Editorial**, Page 51

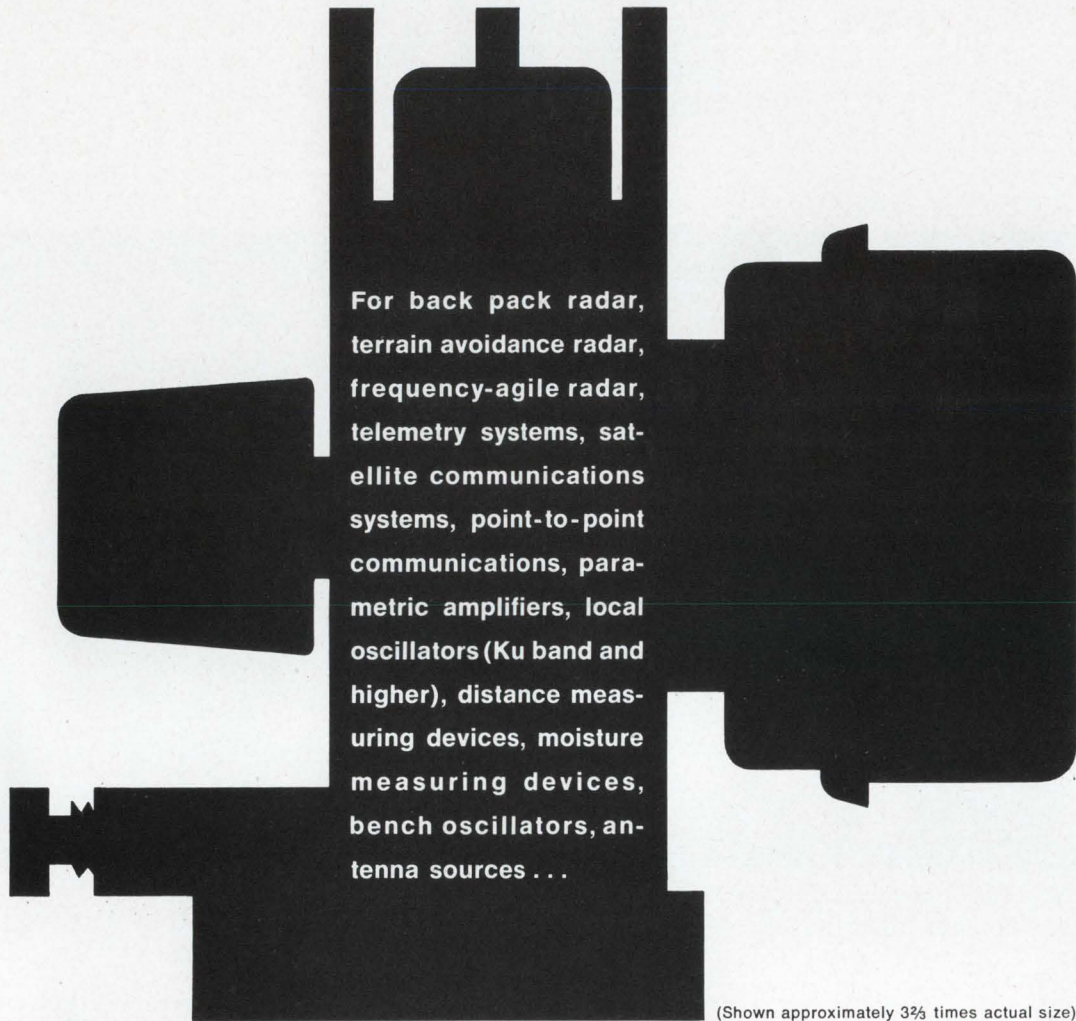

For back pack radar, terrain avoidance radar, frequency-agile radar, telemetry systems, satellite communications systems, point-to-point communications, parametric amplifiers, local oscillators (Ku band and higher), distance measuring devices, moisture measuring devices, bench oscillators, antenna sources . . .

(Shown approximately 3 $\frac{1}{2}$  times actual size)

## A new family of reflex klystrons with an exclusive design flexibility which will save you development time and money.

For the first time, you can choose the combination of parameters you need within these limits:

<b>Frequency range:</b>	<b>10 to 35 GHz</b>
<b>Output power (min):</b>	<b>20 mW to 1.5 W</b>
<b>Beam Voltage (max):</b>	<b>150 to 900 Vdc</b>
<b>Electronic tuning:</b>	<b>45 to 200 MHz</b>
<b>Mechanical tuning:</b>	<b>Up to 2000 MHz</b>

Warranty: 5000 hours. Efficiency: 1 to 2% at low beam voltage; up to 4% at high beam voltage. Weight: approximately 4 ounces. Size: 1 $\frac{3}{4}$  inches cubed. Excellent power and frequency stability. Delivery: 30 to 60 days (usual).

■ For complete information on this versatile line of reflex klystrons, write the Palo Alto Tube Division, 611 Hansen Way, Palo Alto, California. In Europe: Varian A.G., Zug, Switzerland. In Canada: Varian Associates of Canada, Ltd., Georgetown, Ontario, Canada.



ON READER-SERVICE CARD CIRCLE 9

## Industry ponders tariff cuts, riots, war threats

Recent international developments have unsettled the U.S. electronics industry:

- The Kennedy Round of tariff agreements, which reduce or eliminate import duties on an estimated 60,000 items, may spur foreign sales by American electronics manufacturers, some corporate spokesmen believe. They say, however, that it is too early yet to draft plans because the Government has not spelled out the details of the accord reached last month in Geneva. On the other hand, others say, the cuts may lead to increased importation of foreign products, particularly of such consumer items as TV sets and phonographs.

- The cold shoulder given to Britain's efforts to enter the European Economic Community (Common Market) may prompt U.S. firms with operations in the United Kingdom to consider establishing facilities directly in the Common Market countries as the only way to increase their sales in Europe.

- Pro-Communist riots in Hong Kong threaten companies like Fairchild Semiconductor, which have invested heavily in plants in low-cost-labor areas in order to derive maximum profits.

- The confrontation between Israel and the Arab states may lead to an embargo on exports of electronic products to the Middle East.

Most problematical is the tariff situation. According to a representative of the Electronic Industries' Association, the EIA is "trying desperately to get some definite word on what is affected" by the latest General Agreement on Tariffs and Trade worked out by most of the world's great trading nations.

Unofficially, the EIA speculates

that there may have been a blanket agreement on electronic components, since the industry had pressed for renegotiation of all tariffs on them. However, it has not been divulged whether this recommendation was accepted as a package.

Nor are companies with extensive overseas operations, like Radio Corp. of America or International Telephone and Telegraph, willing to comment officially yet.

The importance of the cuts cannot be overestimated. If they were sizable enough, a U.S. company's foreign plants could even export components to the United States to compete with its own domestic products.

### Phased array antenna updates older systems

RCA has announced an antenna system that can convert conventional monopulse radar into a phased array. The conversion adds electronic beam steering to parabolic

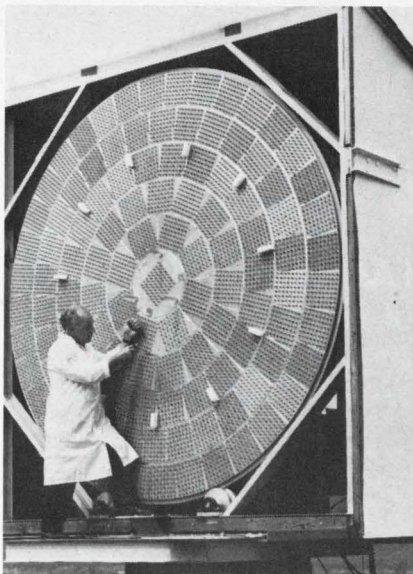

From monopulse to phased array

antennas but retains their hemispheric coverage and simplicity.

Engineers at RCA's Missile and Surface Radar Div., Moorestown, N. J., say that the new array performs as well as a conventional phased array costing 50 times as much.

RCA reports that their development will be put to use in testing and evaluating advanced weapons for the U.S. Navy's Poseidon missile system.

The 10-foot-diameter prototype antenna is said to be able to improve space communications and offers possibilities for use in anti-ballistic missile radars.

The phase shifters of the antenna can steer the beam 5 degrees in any direction from the array axis, providing a 10° cone of electronic scan.

### ICs finding wider use in consumer products

The race to incorporate integrated circuits into electronic products for the home continues as Philco-Ford Corp. and Radio Corp. of America announce several additions to their product lines.

Philco-Ford is introducing three new units: a color television set with ICs in the picture amplifier circuits; a stereo console that is said to provide sensitive FM reception by means of an IC in the FM limiter stage; and a dual-purpose push-button remote-control transmitter containing an IC that can order various modes of automatic record-changing in a phonograph and turn a TV set on and off.

RCA has developed an integrated-circuit preamplifier which is carried under the belly of a ceramic cartridge. The unit gives performance as good as that of more expensive magnetic cartridges, and enables a ceramic cartridge to be used with low-impedance transistor amplifiers.

The IC contains a dual Darling-ton array, which operates over a wide range of impedances. Input and output load impedances are therefore not critical.

### Engineer salaries continue to climb

The salary of the median engineer—a man with about 12 years' experience—was 14.5% higher in 1966 than two years earlier. This

is revealed in a new report, *Professional Income of Engineers 1966-67*, issued by the Engineering Commission of the Engineers' Joint Council. The report interprets the rise as a direct result of the shortage of engineering graduates, which has been growing more acute over the last few years.

Striking evidence of the demand for recent graduates is the relatively greater increase in the professional income of those with three years' experience or less. Their median salary rose by one-half to two per cent more than the average. The report points out that most older engineers, however, had chalked up actual gains of \$1,100 to \$1,300 over 1964, compared with about \$900 for the younger group. As in the past the survey disclosed that engineers in supervisory positions can expect to earn substantially higher incomes than those in non-supervisory jobs.

Copies of the report may be ordered in advance of publication at \$5.00 each, prepaid, from Engineers' Joint Council, Dept. P, 345 E. 47 St., New York, N. Y. 10017.

## Memory bank enhances TV studio transmission

A spokesman for CBS laboratories says it has improved the quality of television transmitted live from broadcast studios through the introduction of a new electronic image enhancer.

Basically, the new device is said to compare and increase the contrast of points on the picture, both horizontally and vertically. Since the improvement is in the studio equipment, it should produce sharper monochrome and color reception in the home without additional expense to the viewer.

The key element is reported to be a pair of ultrasonic delay lines acting as a short-term memory bank. The unit retains picture information long enough to compare every point with all of the points surrounding it. The contrast of these points is then emphasized; simultaneously, noise is eliminated.

R. H. McMann, vice-president of television engineering for CBS Laboratories, commented: "Until now, this detailed technique has required the use of computers, as was done with photos relayed from the moon."

Several versions of the image enhancer, designed to operate with color and monochrome cameras and film chains, are now being made available to TV broadcast stations, McMann said.

## Weather Bureau expands disaster warning system

The Commerce Department's Environmental Science Services Administration (Weather Bureau) has announced that this year it will take its first major steps toward improving the nationwide Natural Disaster Warning system.

The system is designed to improve warnings of such natural hazards as hurricanes, floods, seismic sea waves and solar disturbances.

Dr. Robert N. White, ESSA Administrator, said that in 1967 the bureau will buy new detection devices, expand its communications networks and initiate river forecast services, to give residents of 25 states earlier warning of impending natural disasters.

ESSA will establish or complete teletypewriter networks in 16 states, making information available to the press, radio and television in 789 communities for the first time. ESSA also plans to buy eight high-powered weather surveillance radars, and equipment for displaying radar-received data for later installation at about 25 ESSA Weather Bureau offices.

Other plans are for an intensified research program leading to better prediction and warning of tornadoes and other severe storms.

## FAA trails airlines' use of radar transponders

A program to equip airliners with transponders that would obviate much of the routine conversation between pilots and flight controllers should be 70% complete by 1970, the Air Transport Association predicts. At the same time, however, only 30% of the Federal Aviation Agency's air traffic control facilities will

be ready with equipment that enables full use to be made of the information transmitted from the airliners.

The joint airline-FAA program involves comprehensive use of so-called secondary radar, in which a ground station interrogates an aircraft's transponder. The replies are decoded on the ground and displayed on a scope so that the controller can better monitor aircraft in the vicinity.

The new equipment will permit the aircraft to transmit, and the ground station to decode and display alphanumerically, the identity and altitude of each equipped aircraft.

At present, flight controllers can sort radar targets functionally—ascending, descending, proceeding in level flight—by assigning reply codes which are displayed in symbolic form on the radar scope. The controller can also request the pilot to identify the target produced on the scope by pushing a button in the aircraft that makes his target momentarily grow larger and brighter.

Nearly all airliners and air traffic control stations use the basic system today. The alphanumeric display capability will be added in the next few years. The difference between the basic and the advanced systems lies in the number of codes: 64 for the former, 4096 for the latter.

## Stevens to open center for study of cryogenics

What is believed to be the first U.S. center for the study of cryogenics is scheduled to be opened July 1 at Stevens Institute of Technology, Hoboken, N. J.

One of the problems in cryogenics research has been the piecemeal nature of much of it while there has been no academic center to coordinate it.

The new center will have two objectives, according to Dr. Jess H. Davis, who heads the Stevens Institute. "First, it will help meet the pressing need for scientists and engineers who have substantial training and experience in this developing science. Second, it will conduct basic research which seeks to extend man's knowledge of cryogenics into areas as yet unexplored."



# THE CONNECTOR THING

A periodical periodical, designed quite frankly to further the sale of Microdot Inc. connectors and cables. Published entirely in the interest of profit.



# HAPPY 1/2 NEW YEAR

Last December 31 our crass commercialism made us forget to wish you a happy gala in this journal. But now we'll make it up to you, with the celebration you didn't expect...

**WELCOME TO LATTER '67 FROM MICRODOT!** Grab a gal or a half-gallon, give half a toot on your pizzazz maker, and join us at least halfheartedly in making whoopee. We're sure your 1967 calendar is pretty grubby by now, with all sorts of notations you'd rather forget... so to help you get off to a clean start in 1967 1/2.

**GET YOUR 1967.5 CONNECTOR GIRL CALENDAR!** Actually, we wanted to make a calendar showing our six beautiful major connector lines; however, some D.O.M. in the Sales Dept. insisted you'd rather have girls. So we've set up this contest where you get both the girls and the connector information. Sneaky.

**MATCH OUR MATCHLESS CONNECTORS** July through December are represented by Mary through Patricia, otherwise known as the Connector Girls. That's on the calendar. In this ad they're shown representing the six major Microdot connector lines. To get your superb 1967.5 calendar, merely match the letters under the girls with the paragraph number describing the connector each girl illustrates. Read carefully. Careless readers may be punished by being sent a calendar that shows the products.

**1.**  When you want economical, microminiature pin and socket connections, this one is the ticket. The contact spring member has been eliminated through a breathing helical spring principle. The name is Twist/Con, and its construction permits high-density packaging of contacts on 0.050" centers—up to 420 contacts per square inch. Can you imagine 420 contacts on a postage stamp square? That's dense!

**2.**  Our special atmosphere controlled furnaces for high reliability parts make it a cinch to produce the highest quality line of hermetic seal connectors. To meet MIL-C-26482 (Rev. B) we offer high pressure units with both push-pull and bayonet connections. Hi temp and High pressure units are also available to meet MIL-C-26500, threaded or bayonet and with feed-thru adapters. For those concerned with MIL-C-5015, there are also special cryogenic, hi temp and high pressure models.

**3.**  Ultraminiature is the word for this connector line. How ultra? Like 5/32" outside diameter and 3/8" to 7/16" long, depending on your selection from seven configurations. Lepra/Con gets that small because it uses the Twist/Con (see above) closed-entry, tubular-type, gold contacts and helically wound phosphor-bronze pins. Screw-on and slide-on versions in entire line.

**4.**  Microdot's standard line of coax connectors comes in so many configurations that you'll find selection is a ball. You can, for instance, get Neoprene or silicone bend relief caps—in colors—and knurled or hex nuts, gold plating, slide or screw type, hermetically sealed bulkhead type, etc., etc., and so forth. But get the catalog and see for yourself the hundreds of variations. Oh yes. For the contest, this paragraph describes "standard coaxial connectors".

**5.**  This line is the greatest in high density, cylindrical, multi-pin connectors. It combines exclusive Posilock ruggedness in push-pull lock coupling with unique Posiseal multiple-silicon rings for sealing. Fingertip operation. No mismatching even in "blind" conditions. Meets MIL-C-38300A (USAF) for altitude—that's the MARC 53. The brand-new rear insertable version, MARC 53 RMD, is revolutionary—field assembly without special insertion or extraction tools. The subminiature lightweight version, the MARC 43, conforms to MIL-C-26482 and it's economical as can be. Neither of the MARC's requires heat to terminate conductors to contacts.

**6.**  Look, Ma, **both hands**. All you need for any of these coax connectors besides your hands are standard Microdot crimping tools, a bargain. With Microcrimp, you can forget soldering, burning, and miscrimping. Also, Microdot's "snap-lock" feature lets you quickly snap the connector into a bulkhead or mounting block afterwards.



## MICRODOT INC.



### Attention: Coupon for Connector Girl Calendar

MICRODOT INC.  
220 Pasadena Avenue, South Pasadena, California 91030

Dear Sirs:

- Send your 1967 1/2 Connector Catalog.
- Send me a Microdot Rep.
- Send me anything, if it's free.

Here's my matchup below. Send me my groovey 1967.5 Connector Girl Calendar. Hurry! It's almost the 1/2 New Year.

- |   |   |
|---|---|
| A | 1 |
| B | 2 |
| C | 3 |
| D | 4 |
| E | 5 |
| F | 6 |

(Connect letters and numbers with a pencil line.)

Name \_\_\_\_\_ Title \_\_\_\_\_

Firm \_\_\_\_\_

Address \_\_\_\_\_

City \_\_\_\_\_ State \_\_\_\_\_ Zip \_\_\_\_\_

Telephone \_\_\_\_\_

Offer void where taxed or restricted, and expires June 30, 1967.

ON READER-SERVICE CARD CIRCLE 10

# Sorensen modular power supplies

**$3\frac{5}{16}'' \times 3\frac{7}{8}'' \times 7''$ ,  $\pm 0.005\%$  regulation**

**\$89<sup>00</sup>**

## any questions?

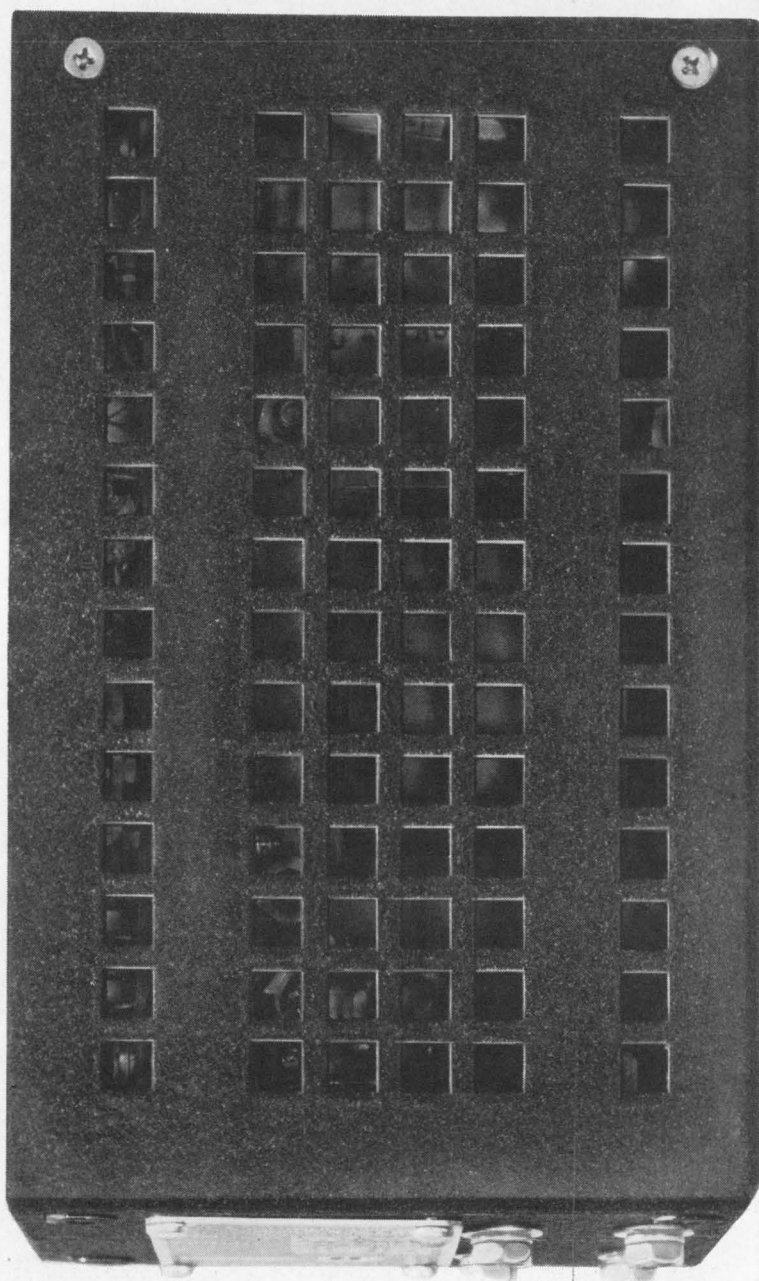

Model QSA48-.4 Power Supply, shown actual size, illustrates the compactness of the Sorensen QSA Series. New off-the-shelf models cover the range to 150 volts.

All silicon transistor design—convection cooled—operating temperatures up to 71°C.

Requires no external heat sink—mount in any position.

Lowest ripple of any modular supplies—300  $\mu\text{V}$  rms.

Best voltage regulation— $\pm 0.005\%$  line and load combined.

Lowest prices—\$89 to \$149.

Overload and short circuit protection.

20  $\mu\text{s}$  response time—no turn-on/turn-off overshoots.

Three sizes in each voltage range depending on power level—all are rack mountable with optional 3½" rack adapter.

Remote sensing and remote programming—capable of series/parallel operation.

Any further questions? For QSA details or for other standard/custom DC power supplies, AC line regulators or frequency changers contact your local Sorensen representative or: Raytheon Company, Sorensen Operation, Richards Avenue, Norwalk, Connecticut 06856. Tel: 203-838-6571

**RAYTHEON**

# Radar mapper measures severity of storms

## Contoured image of raindrops on PPI scope may help define squall cells for aircraft pilots

Richard N. Einhorn  
News Editor

Modern fliers, seeking to avoid the potentially devastating turbulence of thunderstorms, rely on radars that give a fair indication of where the storms are but less than perfect information about their violence. A new device being tested by the United States Weather Bureau may go a long way toward overcoming this deficiency.

It processes the radar video so that a weather observer can see at a glance the intensity of precipitation in six graded levels, from very light to extreme.

### Device installed on ground

The device would be installed at radar-equipped weather stations, and observers would describe the precipitation content from examination of a plan-position indicator (PPI) scope. In the event of severe storms, the Weather Bureau observers could make a special report to airport flight controllers by teletype or telephone. Some day a repeater link might permit direct transmission of the PPI image to aircraft control centers, although this is not

currently planned.

Present weather radar, using conventional techniques, permits a ground observer to look out 200 miles or so and see the weather as it is occurring. The radar displays give a maplike view (PPI) or a vertical cross-section (range-height indication—RHI) of the precipitation.

Radar also presents intensity information, but it is not displayed well, and is difficult to extract.

One of the greatest problems is that the radar echo comes from thousands of raindrops, which act as scatterers as well as absorbers and attenuators. This scattering produces violent fluctuation in amplitude on the radar scope, so that the operator has to average out the targets. In turn, this leads to subjective judgments of intensity. Measurements vary from observer to observer, because the top of the pulse dances violently up and down, and he has nothing better than eyeball technique for arriving at the average level of the peaks.

The key element of the new intensity-measuring system is a video-integrating processor, conceived by Dr. Roger M. Lhermitte of the

National Severe Storms Laboratory, Norman, Okla., and refined by Lhermitte, Kenneth H. Shreeve of the Weather Bureau in Washington, D. C., and Robert J. Erdahl. The device, which is being tested at Washington National Airport, integrates and averages the raw video signals from the radar receiver and displays the precipitation targets in a scheme resembling an elevation contour map, with all targets of the same intensity level represented in the same manner.

The six intensities displayed are graded in ascending order of severity. Thus, level 1 means very light precipitation, 2 light, 3 moderate, 4 heavy, 5 very heavy and 6 extreme. The scheme of representation is gray, bright, black, gray, bright, black, in that order. Absence of precipitation also appears black.

Since the signals are automatically sorted into intensity levels, the observer's task is vastly simplified. He merely reads the intensity level off the radar scope, and he need define only the spatial coverage of the targets. Needless, to say, measurements are far less subjective.

### Any level can be zeroed in

While repetition of the gray-bright-black scheme may lead to

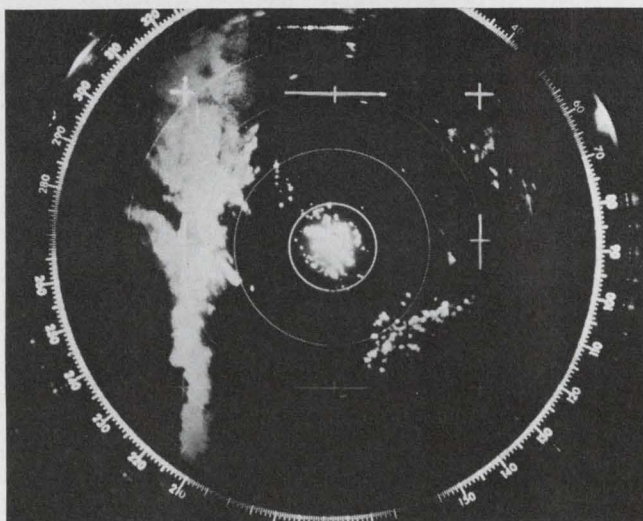

Integrating weather radar video signals produces the improved display shown at right. Use of three analog



voltage levels produces gray-bright-black image instead of ragged black-and-white one at left.

**(radar mapper, continued)**

some ambiguity, this can be resolved by viewing the front panel of the video-integrating processor, which has six lamps that indicate the six intensity levels. To zero in on a squall line of, say, level 5 (very heavy precipitation), the operator pushes button No. 5. This selects another display mode, in which level-5 targets turn bright and everything else becomes black. Now every pinpoint stands out, and the operator can make an accurate report of the location of the storm.

The device under test could become the prototype for systems to be installed at all weather radar stations around the United States. If the test series is successful—and preliminary results are said to be promising—a production contract may be awarded by this fall. However, it might be a few years before an entire network can be equipped.

It works as follows. The weather radar (typically, a Raytheon WSR-57 with a 12-foot parabolic antenna) rotates at 3 rpm and radiates in a 2° conical beam at 2.8 GHz. S-band radar was chosen because the energy can penetrate the clouds. Both PPI and RHI displays are used, but only one at a time.

The radar set contains a logarithmic receiver with 70-dB dynamic range. The video output of the receiver is applied directly to the video-integrating processor, where it is amplified, and the video gated on and off. The gated portion of the video is applied to a chain of 115

identical RC integrators, each handling a one-mile range bin, so that a total range between 10 and 125 nautical miles is covered.

The RC integrators are switched on and off synchronously with the radar, starting with the first range bin. At the end of 12.34  $\mu$ s (the interval required for a radar pulse to travel 1 nautical mile and return), a digital shift register turns on the next range bin. This goes on until all 115 have been turned on in sequence.

**Operation is in real time**

At the same time that information is being fed into the integrators, it is also being read out. Thus, operation occurs in real time. However, the readout consists of the new information together with information left over from the previous 18 pulses. There is general integration of the signal for one mile. Addition and subtraction occur at different fixed rates, and the 18 pulses are not equally weighted: the more recent, the greater the weight.

The result is a 115-tooth sawtooth pattern that corresponds to one composite radar pulse return. Each peak is an rms value of the return for one mile, taking into account the previous 18 pulses.

The composite is read out bin by bin at the same time that each bin is updated. The signal is coupled to a buffer amplifier, then it is applied to six level sensors. These are essentially integrated-circuit operational amplifiers which act as threshold detectors.

The level sensors are adjusted to predetermined levels. The output follows a hysteresis loop and goes from saturation in one direction to saturation in the other. Regenerative feedback is used to achieve rapid switching.

The outputs of all six level detectors are routed to a set of coincidence gates which picks out the level corresponding to the highest intensity. This, in turn, feeds the encoder, which produces adjustable dc levels of 0, 1.5 or 3 volts, corresponding to black, bright or gray on the display.

The output of the coincidence gates drives the encoder, which in turn drives the normal radar displays. The encoder also provides outputs to the light drivers and the level selection circuits. In addition, it could drive circuits for a different encoding scheme (e.g., binary-coded decimal) for use with a digital computer to make a permanent record of weather data.

**Integrated circuits used**

Integrated circuits comprise about 50 percent of the video-integrating processor; the other half are discrete solid-state components. The manufactured unit would be similar to the one under test.

In the patent application filed by Lhermitte, Shreeve and Erdahl, mention is made of possible application to sonar as well as radar. The three-level displays could also be upgraded to four or more levels, depending on the complexity of the circuits used. ■ ■

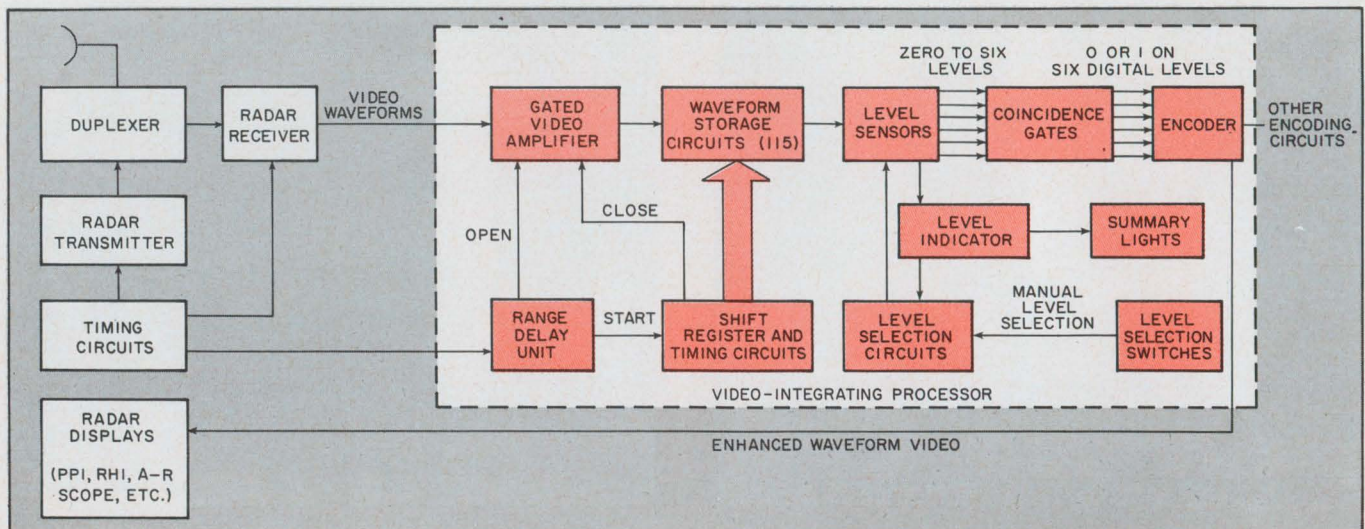

Video-integrating processor contains 115 RC integrators, each corresponding to 1-mile range storage bins.

# NEW DVM

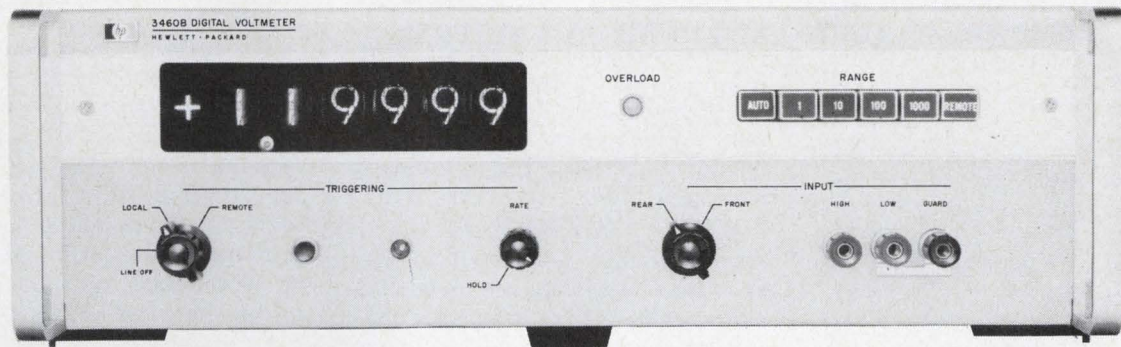

## Dual Technique for 0.004% Accuracy

*hp 3460B Integrating/Potentiometric Voltmeter Has High Accuracy...  $>10^{10}\Omega$  Input Resistance... Systems Compatibility*

The new hp 3460B Digital Voltmeter is a dual-technique instrument that combines the best features of an integrating voltmeter with those of a potentiometric voltmeter—to give an accuracy of 0.004% of reading, superimposed noise immunity of integrating DVM's and a high common mode rejection of 160 dB at dc.

You get up to 15 readings per second with five full digits and 20% overranging indicated by a sixth digit. Polarity selection is automatic. The 3460B has 10  $\mu\text{V}$  sensitivity. Four ranges are selectable by pushbuttons on the front panel, or, range selection can be automatic or remote.

Floating and guarded input connectors are on both the front and back of the instrument. Input resistance is  $>10^{10}\Omega$  at balance on 1 V and 10 V ranges (minimum 10 M $\Omega$ ), and a constant 10 M $\Omega$  on 100 V and 1000 V ranges.

*Programmability.*—hp 3460B is designed for

fully automatic operation in a digital data acquisition system. A four-line BCD output (1-2-4-8) on the back of the instrument contains 6 digits of data, polarity, decimal location and overload information. Voltage range and two integration periods can be selected by external circuit closure to ground.

Get the full story on the new dual-technique hp 3460B Digital Voltmeter from your nearest hp field engineer. Or, write to Hewlett-Packard, Palo Alto, California 94304, Tel. (415) 326-7000. Europe: 54 Route des Acacias, Geneva. Price: hp Model 3460B, \$3600.00.

097/13

**HEWLETT**  **PACKARD**  
An extra measure of quality

ON READER-SERVICE CARD CIRCLE 12

# Lunar success will come in a small package

## 1.85-cubic-foot radar system, more sensitive than that on Surveyor, to guide LEM to Moon's surface

**Ronald Gechman**  
West Coast Editor

Many billions of dollars' worth of engineering effort, the fate of two astronauts, the prestige of the nation will depend for fulfillment one day on 1.85 cubic feet of electronic circuitry.

The critical package is a radar landing system. It will guide a two-man lunar excursion module (LEM) to a gentle touchdown on the Moon. With it, the astronauts will be able to measure their velocity of descent down to about 5 feet with an accuracy of  $\pm 1.4$  per cent. Without it, they might easily crash to the surface and be killed.

The LEM terminal guidance radar system is being developed by the Ryan Aeronautical Co., of San Diego, Calif. In one major respect, it is like the radar soft-landing system developed by Ryan for the successful Surveyor mooncraft. But improvements in the LEM system's performance make for some significant differences.

Both systems use a three-beam cw Doppler radar to obtain velocity information and an FM/cw radar to measure altitude. The differences are these:

- The LEM system makes substantial use of integrated circuits and uses varactor multipliers in place of Surveyor's klystrons.

- The LEM consumes less power—125 watts, against Surveyor's 590.

- The LEM's landing-error range of 1.4 per cent compares with 5.0 per cent in Surveyor's system.

Ryan envisions the operation of its system this way:

A three-man lunar exploration team has been shot aloft from Cape Kennedy by a giant Saturn rocket. The astronauts are now in an elliptical orbit around the Moon, some 50,000 feet above its surface. Two astronauts crawl from the main spacecraft into the accompanying LEM vehicle and cut free into space. While traveling at 5500 feet a second, they ignite their retro engine,

slip from orbit and begin to drop toward the surface of the Moon.

The LEM guidance computer has the craft under control from information supplied to it by an Inertial Measuring Unit (IMU). At 40,000 feet the radar range sensor begins supplying altitude information to the guidance computer and display equipment. At 25,000 feet the velocity sensor takes over from the IMU to complete the LEM's descent.

### Three radars used

Three Doppler velocity beams and a single altimeter beam radiate from the LEM. The three radar returns show a Doppler frequency shift proportional to the spacecraft's velocity along each beam axis. These returns completely define the spacecraft's velocity.

The horizontal components of velocity align the thrust axis continuously with the velocity vector during the approach to the lunar surface. Detection of the Doppler frequency on each velocity sensor beam is accomplished by heterodyning the received energy with a portion of the transmitted energy.

The attitude of the LEM varies from near parallelism of the thrust axis to the lunar surface during initial descent to alignment with the local vertical at touchdown. To keep the landing radar beams in contact with the surface, a two-position planar array antenna is used. The astronauts switch the antenna to the second position as they maneuver the LEM nose upward, until the spacecraft is fully vertical, about 200 feet from the Moon's surface, and its legs are set to touch down.

### Noise problems eliminated

The low-level signal returns are amplified to a convenient signal level for processing by the frequency trackers. The tracker rapidly sweeps the band of expected Doppler frequencies to acquire and track the center of the Doppler power spectrum. This tracking technique allows spurious signals to be



Electronics portion of LEM landing radar system together with aluminum-coated planar array antenna weighs 32.7 pounds.



One good tune  
deserves another,  
and another,  
and another,  
and another,  
and another,  
and another,  
and another.

Case styles in *Tuning Varactors* are not your only choice. Microwave Associates' silicon epitaxial voltage variable capacitance diodes range in capacitance from 1 to 100 pF, range in voltage from 15 to 150V, with figures of merit (Q) to 400 and higher.

But let's talk about your choice of case styles. We have channel mounted chips that go directly on substrates, all the standard glass and ceramic styles including pills and tab leads, and, on the other extreme, molded encapsulations.

Name your C, name your V, name your Q and name your case style.  
All told, the line is the broadest in the industry.  
More than 1,000 combinations available.  
Write.

#### **MICROWAVE ASSOCIATES**

Burlington, Massachusetts Offices: Burlington, Mass.; 9911 Inglewood Ave., Inglewood, Cal.  
Hyde House, Edgware Rd., London NW9, England.  
Subsidiary: Microwave Associates, Ltd., Luton, Beds, England.



(LEM radar, *continued*)

rejected from the true Doppler or range signals.

Smooth operation is provided through zero velocity on each velocity component, so that the control system can null the lateral components of velocity. As the LEM touches down, the lateral velocity components must be zero, or the craft will skid along the lunar surface and risk tipping over.

The single altimeter beam continuously measures the slant range from the spacecraft to the lunar surface. The single FM/cw radar return is heterodyned with a sample of the transmitted signal, and the frequency difference establishes the slant range to the lunar surface.

Ryan is to build 27 prototype LEM landing systems under contract to the Radio Corp. of America. RCA is responsible for integrating the major electronic subsystems into the lunar spacecraft module. Five prototype and system test models have already been delivered,

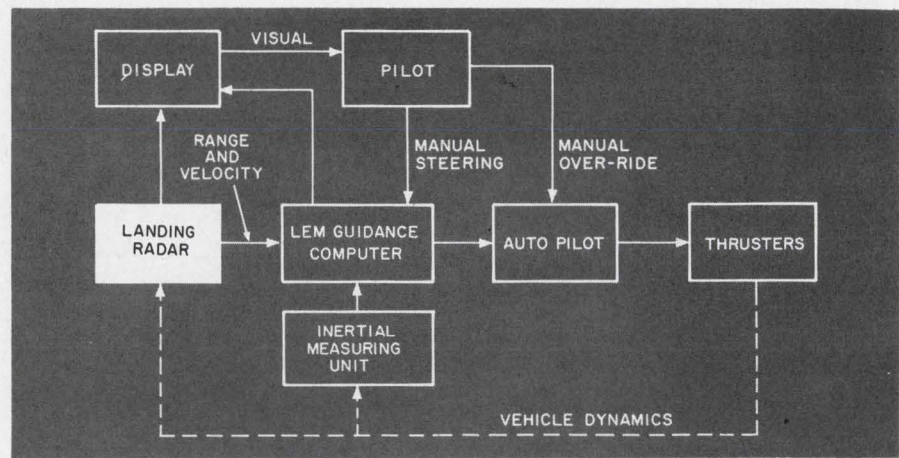

**LEM computer** controls spacecraft descent with data input from inertial guidance unit above 40,000 feet, and from landing radar at lower altitudes.

along with the first flight unit.

The different mission requirements of the LEM and Surveyor have contributed, in part, to the differences in the two landing systems. Surveyor is a relatively light craft, intended only for photographing and sensing the environment of the lunar surface. The Radar Altimeter Doppler Velocity Sensor that Ryan built for Survey-

or, under contract to the Hughes Aircraft Co., has done its job well. But the guidance requirements are more stringent when human lives are involved, as they are in the LEM mission.

The use of varactor multipliers in LEM necessitated lowering the radar transmitter frequency to 10.5 GHz from the 13.3 used in Surveyor. When the LEM radar was de-

## Comparison of space landing radars

Function	Surveyor landing radar	LEM landing radar
No. of beams and modulation Velocity Altimeter	3, cw 1, FM/cw	3, cw 1, FM/cw
Operating range Velocity radar Altimeter radar Spacecraft attitude Spacecraft velocity	14-50,000 feet 14-40,000 feet $\pm 45^\circ$ at max. altitude 1-3000 ft/s	5-25,000 feet 10-40,000 feet $\pm 20^\circ$ at max. altitude 1-4000 ft/s
Velocity accuracy Mean error Noise	rms* of 2% and 1 ft/s 0.5% $\pm 0.5$ ft/s	$\pm 1\%$ $\pm 0.5$ ft/s $\pm 1\%$ $\pm 1$ ft/s
Range accuracy 10-2500 feet 2500-40,000 feet	rms* of 5% and 4 feet rms* of 5% and 30 feet	$\pm 1.4\%$ $\pm 5$ feet $\pm 1.4\%$ $\pm 15$ feet
Radar transmitters Type Power Velocity sensor Altimeter Frequency Velocity sensor Altimeter	Klystrons  8 watts 0.4 watt  13.3 GHz 12.9 GHz	Varactor multipliers  0.2 watt 0.1 watt  10.5 GHz 9.6 GHz
Antenna aperture	4 square feet	3.3 square feet
Weight	33.7 pounds	32.7 pounds
Power consumption	590 watts	125 watts
Operating time (deep space)	5 minutes	25 minutes

\*rms — Root sum square



signed, varactor multipliers had not yet been developed to operate reliably at high frequencies.

Visual displays have also been added, to provide the crew with the lateral and vertical components of velocity in feet per second and slant-range altitude in feet above the lunar surface. Should the automatic landing system malfunction, the crew commander can take over and manually land the craft with the aid of these displays.

Dr. L. E. Matson, manager of space systems analysis at RCA, says that various types of sensors were considered to provide guidance information for the LEM. One plan involved the use of a monopulse terrain-avoidance system and another the use of a laser radar.

The multibeam Doppler radar was chosen, he said, because it permits day or night landings, does not depend on prelocated landing aids, allows unmanned landings, and supplies data directly to displays for manual control.

The cw Doppler radar was selected for the velocity sensor because it is the simplest of all types, has the highest potential accuracy and affords the highest signal-to-noise ratio for a given transmitted power and antenna aperture at high altitudes and high velocity.

The FM/cw altimeter was chosen because it is well suited for a 10- to 40,000-foot operating range. With the use of solid-state, frequency-multiplier transmitters, the deviation rate and hence the accuracy, can be controlled to close tolerances.

### Beyond the Moon

For missions beyond the Moon, many new landing-guidance concepts are being considered, according to Thomas Lund, senior project engineer for Ryan. The radar may be called on to determine the local vertical, surface roughness and slope at the landing site.

Lund predicts that the weight, volume and power consumption of future radars will be reduced significantly, as more microelectronic circuitry is used. He believes that the volume of future landing radars could be reduced by 80 per cent, the weight by two-thirds, the power consumption by over a half, and the parts count by a factor of better than 2. ■ ■

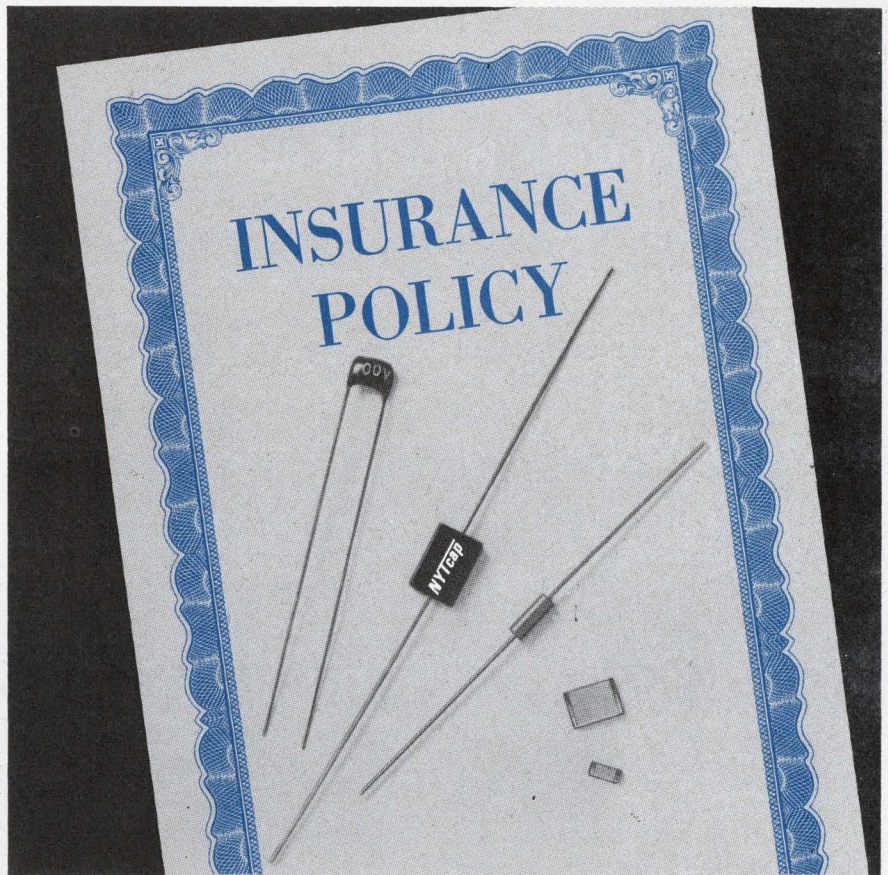

## No small print

The Nytronics name on the package is all the insurance you need, to know your sub-miniaturized ceramic capacitors represent the highest standards of quality, stability, and capacitance-to-size-ratio. Available in four complete lines:

**NYT-CHIP** — An ultra-stable chip capacitor with tinned terminals, 0.170" x 0.065" x 0.070", with capacitance range of 4.7 pf through 220 pf, and 0.280" x 0.195" x 0.070" for 270 pf to 4700 pf. Temperature coefficient does not exceed  $\pm 40$  ppm/ $^{\circ}$ C over a temperature range of  $-55^{\circ}$ C to  $+125^{\circ}$ C. Working voltage 200 volts D.C.

**NYT-CAP** — An ultra high stability ceramic capacitor series packaged in a miniature molded epoxy tubular package 0.1" diameter by 0.250" in length, with capacitance range of 4.7 pf to 220 pf. The remainder of series in miniature, molded epoxy case 0.350" long by 0.250" wide by 0.1", with a range of 270 pf to 4700 pf. Temperature coefficient does not exceed  $\pm 40$  ppm/ $^{\circ}$ C over a temperature range of  $-55^{\circ}$ C to  $+125^{\circ}$ C. Working voltages 200 D.C.

**DECI-CAP** — A subminiature ceramic capacitor with an epoxy molded envelope 0.100" diameter by 0.250" long, axial leads, with capacitance range 4.7 pf to 27,000 pf, tolerance  $\pm 10\%$ . Unit designed to meet MIL-C-11015.

**HY-CAP** — Offers extremely high capacitance range .01 mfd. to 2.5 mfd. in  $\pm 20\%$  tolerance. Voltage 100 WVDC, no derating to  $125^{\circ}$ C. Designed to meet MIL-C-11015.

Write or call for more information. In addition to ceramic capacitors, our inventory of other standardized high quality components includes inductors, delay lines, and resistors.



# NYTRONICS®

*...for Precision Electronic Components*

550 Springfield Ave., Berkeley Heights, N.J. 07922 ■ (201) 464-9300 ■ TWX: 710-984-7977

ON READER-SERVICE CARD CIRCLE 14

# Army reports a critical components 'gap'

## Chief scientist says Defense Dept. loses 'years' by not informing industry directly of its needs

The Defense Dept. is failing to communicate its needs directly to the electronic components industry, and, as a result, is losing "precious years" in developing advanced devices for systems, according to the Army's Chief Scientist.

The scientist, Dr. Marvin R. Lasser, acknowledged that Government and industry had expanded their contacts through increasing briefings by the military.

"Unfortunately, however," he added, "these briefings are designed primarily to communicate with systems and equipment people."

Addressing the recent Electronic Components Conference in Washington, Dr. Lasser reported that "at best, the related demands on the components industry have had to work their way down from the equipment and systems levels and have not, in general, come directly to the components people from the military services."

As a result, Dr. Lasser declared, "we lose precious years in the process. The early conceptual work that

must be done in components to meet these future system needs often gets started too late."

Six systems areas, according to Dr. Lasser, account for more than 95 per cent of the Army's electronic expenditures: communications, automatic data processing, avionics, electronic warfare, combat surveillance and night vision, and target acquisition. The systems in these categories, Dr. Lasser went on, need components in these broad areas: extension of the spectrum, improved sensors, miniaturization, improved power sources, better display techniques, high-power electromagnetic generation, precision signal processing and reliability (see Fig. 1).

Referring to Army communications as an example, Dr. Lasser cited a critical need for increased miniaturization and improved power sources because of a growing demand for more functions from a radio set.

In avionics, he said, important programs in terrain-avoidance require operations in the millimeter-

or submillimeter-wave regions. With the increasing electronic equipment carried in modern aircraft, miniaturization is a must, Dr. Lasser said.

In electronic warfare, combat surveillance and night vision, and target acquisition, the scientist called for vastly improved sensors and, again, improved capabilities in the submillimeter and optical spectrum.

The components that can satisfy these needs, Dr. Lasser indicated, lie in these specific areas: electron tubes, batteries and fuel cells, microelectronics, electronic materials, quantum electronics, semiconductor devices, frequency control and passive parts (see Fig. 2.)

### Laser improvements sought

For example, extension of the spectrum through quantum electronics may be accomplished by laser techniques. If the systems are to be successful, however, new components will be required, including better reflection mirrors and windows, transmission optics for lenses, beam splitters, optical films, amplifiers, detectors, modulators, pulsers and Q-spoiling devices, Dr. Lasser said.

Particularly needed, he went on, are safety measures for prevention of retinal burns by lasers in laboratory and field applications, such as in range-finders.

An observer who looks directly into the beam of present laser range-finders, the scientist said, may receive retinal burns at up to 18 kilometers.

Dr. Lasser suggested that safe design options would involve lasers operating at wavelengths where "transmission through the ocular medium is low."

At wavelengths in the infrared, he continued, "there is need for efficient lasers which emit within atmospheric windows, and where fast, efficient solid-state detectors could be made available." A whole series of new components are needed, he observed, if the military is to develop lasers that operate reliably outside of the visible spec-

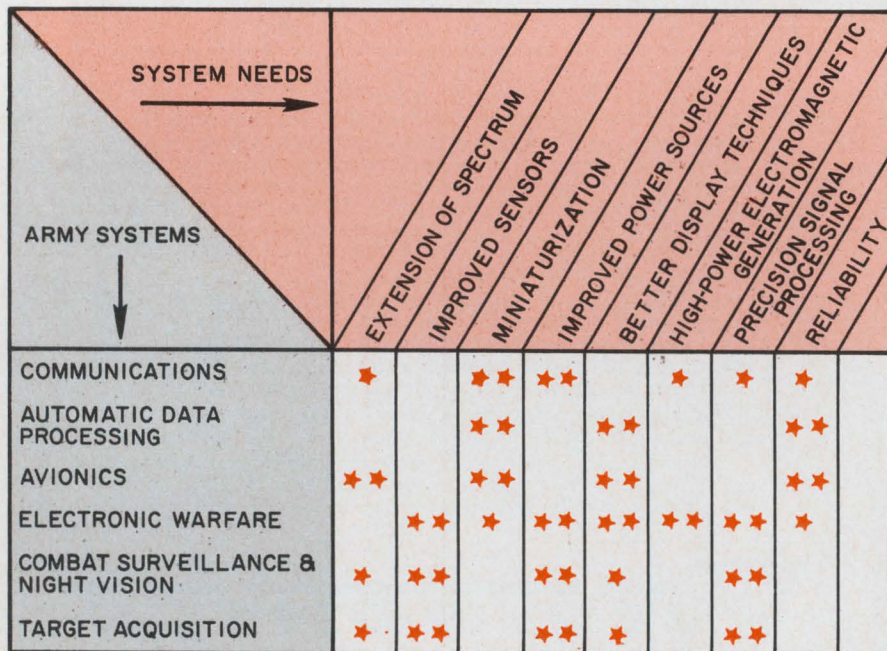

1. The Army's systems needs can be broken down into six broad mission areas, listed at left. Stars denote areas where components are needed, and double stars indicate critical needs.

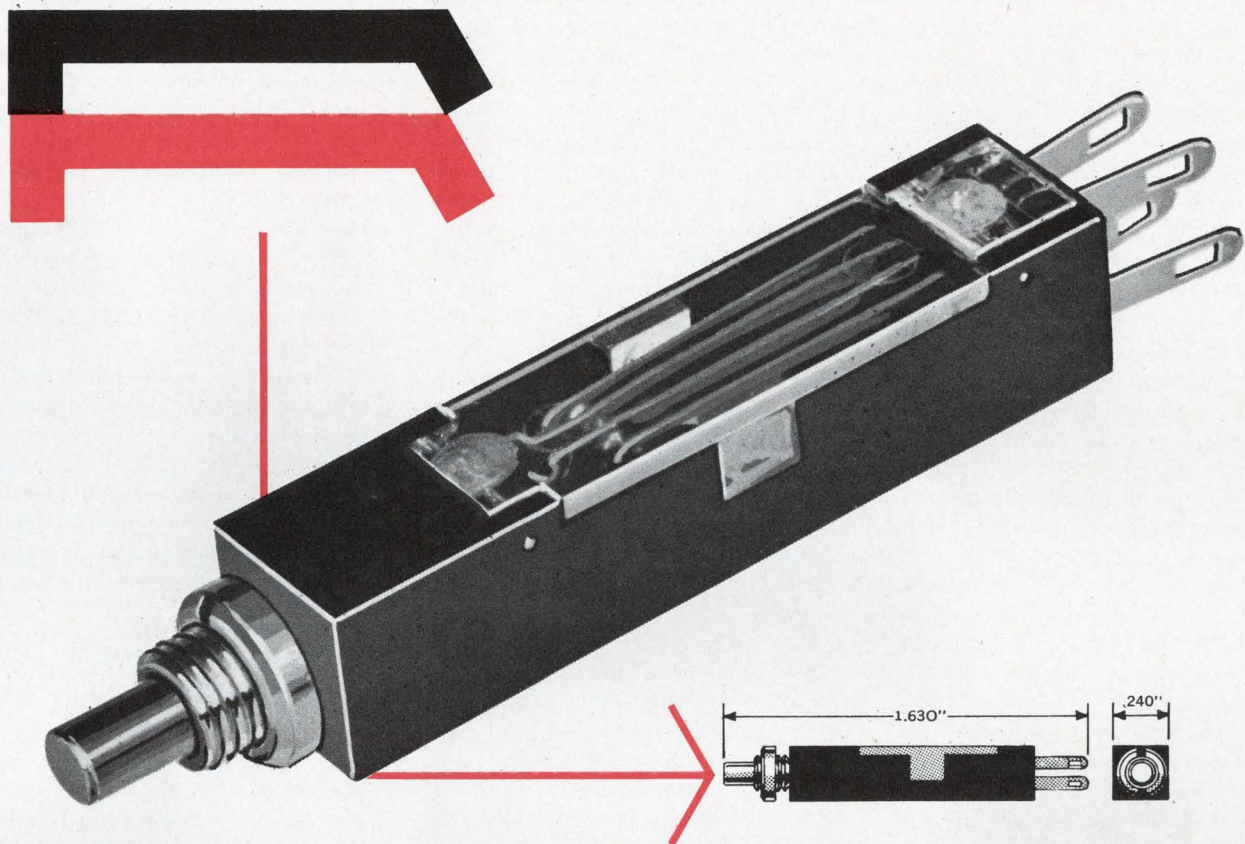

## ROWAN'S NEW **PS SWITCH**...

is a momentary action, two-circuit switch with a maximum contact rating of 500 milliamps, 50 volts AC or DC, and featuring:

1. Sub-miniature size measuring 1.63" x 0.24".
2. High density, modular pack of four switches (8 circuits) per 1/2 square inch.
3. Very long life, repeatedly tested in excess of 5,000,000 electrical operations.
4. Very low resistance—very low voltage drop.
5. Extremely low bounce.

The PS Switch is standard with either two N/O, two N/C, or one N/O and one N/C contacts. Weighing 2.2 grams, it is mounted in a 0.166" panel hole by means of either circular, hex or knurled nut. Square or round buttons are offered in any of five colors.



*For more information, call or write*

**THE ROWAN CONTROLLER COMPANY**

OCEANPORT, NEW JERSEY 07757

ON READER-SERVICE CARD CIRCLE 15

(Army's components, continued)

trum.

Turning to frequency control technology, Dr. Lasser said the prime problems here were miniaturization and generation of "absolutely stable precision oscillator frequencies."

The Army would like to eliminate the power-consuming crystal ovens now needed to maintain stability of the quartz reference oscillators in tactical communications systems—particularly manpack, vehicular and SSB sets, Dr. Lasser said.

This frequency stabilization could be accomplished by compensated quartz crystal oscillators instead of ovens.

These compensated oscillators are now being used to meet the stiff 3/4-ppm frequency stability requirement of the new 30-MHz sets.

"What we need now is a 1/4-ppm stability for the next generation of 76-MHz sets," Dr. Lasser said.

Furthermore, he noted, the present sets require precise frequency calibration every six months, whereas the requirement for the new 76-MHz sets calls for no recalibration for the six-year life of the equipment. At present, the scientist observed, many thousands of sets in the field must undergo periodic recalibration.

Another goal, he said, is to reduce the present aging rate of the quartz crystal itself by a factor of 20—from  $1 \times 10^{-8}$  per week to  $5 \times 10^{-10}$  per week.

Other oscillator components—such as varactors, thermistors, Zeners, resistors, capacitors—must have 12 times their current stabilities, Dr. Lasser said.

In passive components, Dr. Lasser said, cheaper, smaller, improved filters will be required to facilitate improvements in the Army's all-digital, tactical communications system (RADA).

RADA is the new tactical communications system to be used by all Army units below the division level.

For example, the filter assembly in the present RADA system receiver operates at 68 MHz and consists of eight crystals and associate parts that filter digital pulse information. What is needed, according to the scientist, is a much smaller package—perhaps by using a single crystal wafer with multiple tuned elements, and with acoustical couplings between these elements. The Army has already applied the single-wafer technique to a 10-MHz filter with good performance, Dr. Lasser reported.

Also needed in large quantities for receiver front-ends are lightweight, wide-band filters in the 100-to-500-MHz regions, with good

bandwidth control. The Army is currently using semiconductor piezoelectric transducers deposited on quartz substrates. The quartz is driven to oscillate at a higher overtone of its fundamental frequency.

Future electronic systems, according to Dr. Lasser, will require greater use of fixed electro-acoustic and variable magneto-acoustic delay lines in the microwave region.

And he pointed to the need for improved low-loss transducers for delay lines and for polycrystalline oxides with better acoustical properties, possibly achieved through introduction of oriented ferroelectric fibers.

The Army recognizes that it needs far more manageable and versatile phased-array antennas, according to Dr. Lasser. However, there are serious obstacles at present to development of such arrays for practical manpack, vehicular and airborne surveillance equipment, he noted.

**New materials needed**

The scientist called for small, low-loss reciprocal microwave phase shifters with low power needs. These, he explained, will require new ferromagnetic materials with better reproducibility and improved temperature stability.

He also pointed to the need for translating bulky designs of phase shifters and their related microwave circuitry—circulators, isolators, filters, etc.—into compatible, microminiature stripline configurations at greatly reduced cost.

Finally, he observed, even the simplest of portable systems today require capacitors that weigh several pounds. One technique the Army is considering to cut the weight, he said, is the use of very-fine-particle, ultra-pure ceramics, incorporated in a polymer film or highly densified in a monolithic structure, to achieve low-loss capacitors suitable for high-speed charging and discharging.

"Recent market statistics show that the total electronic component market has risen to the \$6-billion-to-\$7-billion level—a substantial segment of the total \$20-billion U.S. electronic industry," Dr. Lasser said. "Since the DOD represents 40 per cent of this market, it makes considerable sense for the Government to make itself heard more." ■■

SYSTEM NEEDS	COMPONENT TECHNOLOGIES							
	ELECTRON TUBES	BATTERIES/FUEL CELLS	MICROELECTRONICS	ELECTRONIC MATERIALS	QUANTUM ELECTRONICS	SEMICONDUCTOR DEVICES	FREQUENCY CONTROL	PASSIVE PARTS
EXTENSION OF SPECTRUM	*			*	*	*		*
IMPROVED SENSORS	*				*	*		
MINIATURIZATION		*	*	*		*	*	
IMPROVED POWER SOURCES		*		*				
BETTER DISPLAY TECHNIQUES	*		*	*	*	*		
HIGH POWER ELECTROMAGNETIC GENERATION	*			*	*			
PRECISION SIGNAL PROCESSING				*	*		*	*
RELIABILITY			*		*		*	*

2. Eight areas where Army systems need components are listed at left. Stars denote specific component needs.

# Replace 80% of all FET types with one!

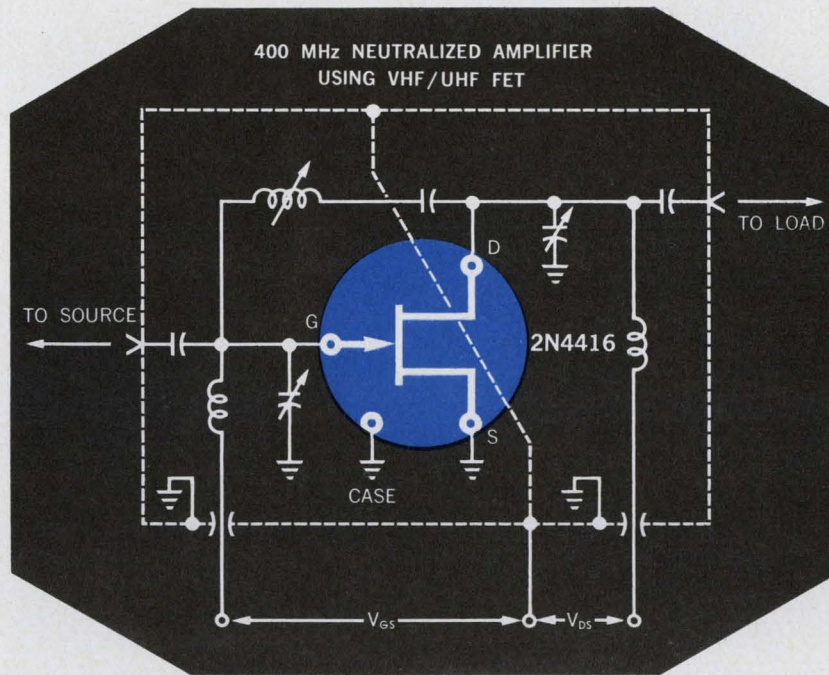

**Here's how:** Buy the Union Carbide 2N4416 universal FET in quantity, and you can select transistors over the entire frequency range covered by 80% of all field effect types. The 2N4416 is specified below as a VHF/UHF amplifier. However, from any class lot of this device you can select (1) general purpose, low noise, high gain amplifiers from D.C. to 900 MHz, or (2) ultra low noise devices for low frequency applications. This device is also available in a ribbon lead ceramic package (.138" dia.) as the low capacitance 2N4417. Use for TV tuners, FM sets, IF strips, mixers, oscillators, or even switches. Write for complete specifications.

CHARACTERISTICS Small Signal, Common Source @ 25°C	2N4416 TO-72	Frequency
Forward Transconductance RE ( $Y_{fe}$ ) (min.)	4000 $\mu$ mhos	400 MHz
Input Capacitance, $C_{iss}$ (max.)	4.0 pf	1.0 MHz
Output Capacitance, $C_{oss}$ (max.)	2.0 pf	1.0 MHz
Reverse Transfer Capacitance, $C_{rss}$ (max.)	0.8 pf	1.0 MHz
Spot Noise Figure (Neutralized), NF (max.)	4.0 dB	400 MHz
Spot Noise Figure, NF (max.) (Neutralized)	2.0 dB	100 MHz
Power Gain, $G_{ps}$ (min.) (Neutralized)	10.0 dB	400 MHz

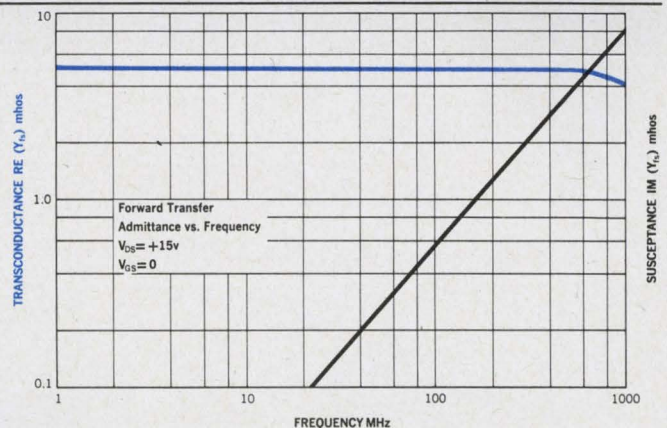

**ELECTRONICS**

Semiconductor Department / 365 Middlefield Road, Mountain View, California 94040 / Telephone: (415) 961-3300 / TWX: 910-379-6942

ON READER-SERVICE CARD CIRCLE 16

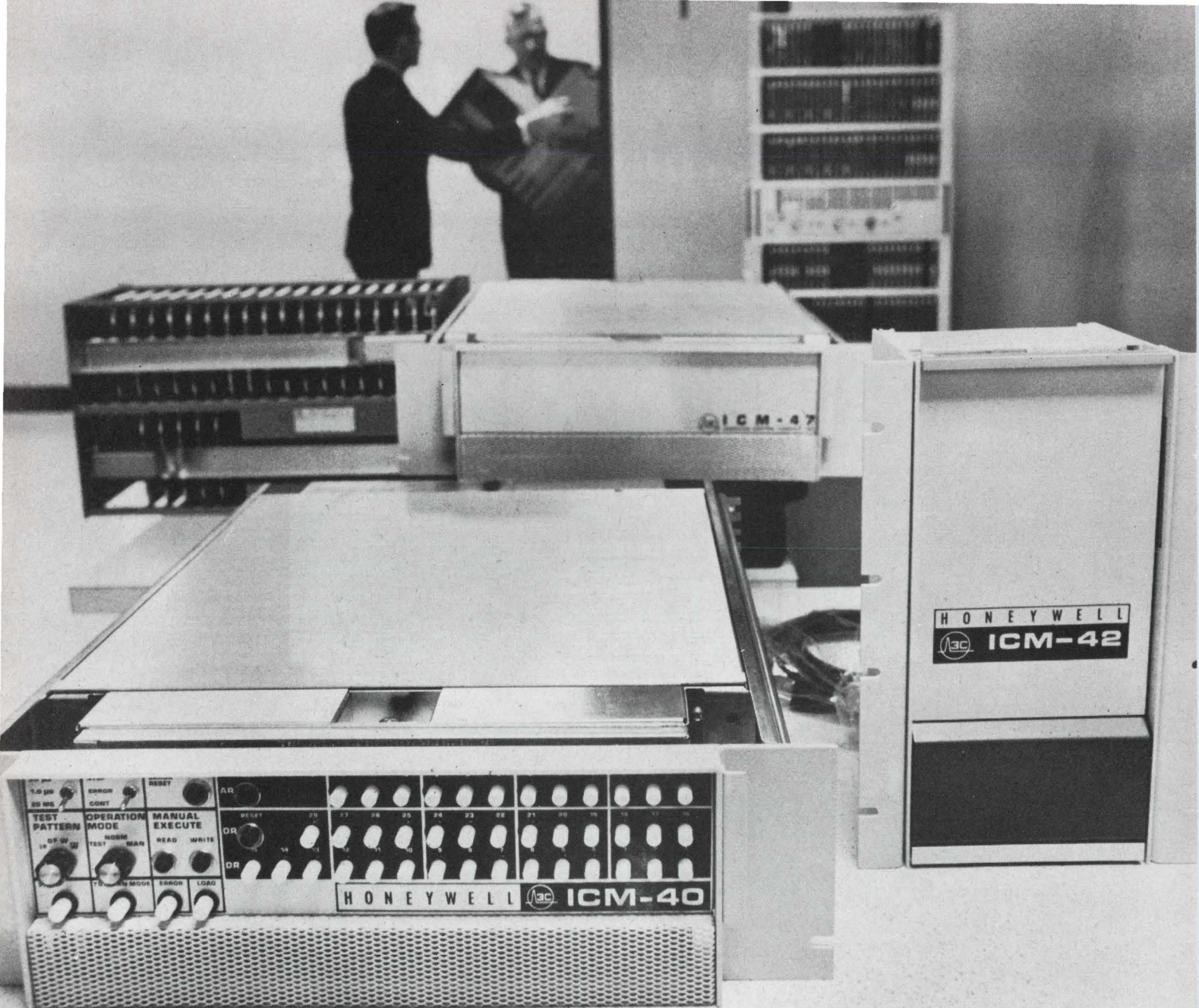

Eight years' experience . . .

**. . . make our I/C  
 $\mu$ -STORE memory systems  
a sound solution to your  
digital design problems**

In eight years we've delivered hundreds of core memory systems — over 1,100 still operational. We've also delivered over a hundred I/C  $\mu$ -STORE core memories, like the ICM-40 and ICM-47. (These sub-microsecond memories are the result of more than three years' research and development in I/C technology.)

If you've drawn a block marked "core memory" recently, let us show you  $\mu$ -STORE speeds, capacities, and capabilities . . . you'll find our eight years' experience has helped produce a series of standard products designed to meet your memory needs. Write for our new brochure. It sums up all the facts. Honeywell, Computer Control Division, Old Connecticut Path, Framingham, Massachusetts 01701.

# Honeywell

 **COMPUTER CONTROL  
DIVISION**

Laser range finder: R&D model



## Equipment lag in Vietnam

Much of the sophisticated electronic equipment designed in the last few years to aid American troops in combat is still in some phase of R&D and not in wide use on the battlefield in Vietnam, a random check by ELECTRONIC DESIGN indicates. The equipment includes mortar-emplacement detectors, night-vision devices and counter-intrusion alarms, also called "people detectors."

"Sure, we've got modern techniques for determining where Vietcong mortar shells are coming from," a field-grade officer at Army Materiel Command headquarters commented when queried. "A man jumps into the crater with a protractor and a book of tables and figures it out just about the way we did it in World War II."

R&D agencies and contractors have been putting out such a stream of press releases about sophisticated new equipment that the public is inclined to believe that GIs in Vietnam are well supplied with it.

"Yes, we've got some new electronic counter-mortar stuff over there," the Army materiel officer explained. "About as much as we have the new portable front-line radars and fully automated aerial photo-processing equipment. Maybe a piece or two, if any, where we'd like to have dozens or hundreds; maybe one item in a division where some day there will be one in every platoon; maybe a prototype for evaluation."

This, some Congressmen have been saying in recent weeks, is what Defense Secretary Robert S. McNamara means when he says that the dollar demands of Vietnam fighting are postponing "marginal modernization" in the armed services. Some in the Government equate "marginal" items with "gadgets" until the equipment is proved by time. However, one member of the House defense appropriations subcommittee, Melvin Laird (R-Wis.), calls the McNamara postponement a putting off of

# Washington Report

S. DAVID PURSGLOVE,  
WASHINGTON EDITOR

"regular modernization" of the military.

At a recent closed hearing, McNamara told Congressmen that night-vision devices, people detectors and ground-fire-detection equipment for aircraft were needed so urgently that Project PROVOST (Priority Research and Development Objectives for Vietnam Operations Support), announced last year, had been completely revamped. Rather than wait for new R&D funds available after July 1 in the fiscal 1968 budget, the Defense Secretary asked for a supplemental allocation of \$135 million to push the development of the equipment.

The Army's Chief of Staff, Gen. Harold K. Johnson, has confirmed that much equipment popularly thought to be operational is still in some phase of R&D. The admission was drawn from him in hearings by Rep. Robert L. Sikes (D-Fla.). Sikes asked him to describe new equipment in use or under development "as a result of the lessons learned in Vietnam."

General Johnson reluctantly responded to the prodding. He replied:

"I can give you a general picture. For example, we are looking at sensors, electronic and infrared. We are looking at different types of small mines to cope with infiltration. We are doing a lot of experimenting with different lighting systems, both infrared and direct light, so we can improve our night operations. A good deal of research is going into that. In this area we are moving out. This is the type of thing that we are doing."

## Agriculture satellite not dead

The Agriculture Dept. has awarded a contract to Purdue University to study ways "to identify vegetation, animals and soils by remote-sensing equipment in satellites." The award is the first official sign in many months that the department's planned space program is not dead.

In March, 1966, the department announced that

# Washington Report

CONTINUED

it would use satellite sensing equipment to make large-area surveys of agricultural conditions and land use. Secretary Orville L. Freeman indicated that the department had awarded a contract to NASA to make studies, but he did not specify the amount nor what the space agency would do.

For months there was no further word on the program. When the 1968 Federal budget was announced last January, *ELECTRONIC DESIGN* asked Presidential Science Adviser Donald Hornig about funds for the agriculture satellite. Hornig replied that he was unfamiliar with the agriculture program and proceeded to discuss a similar Interior Dept. program with EROS satellites (*Washington Report*, May 10, p. 29). An Agriculture Dept. information officer was unable to give any information on the program last March on the first anniversary of the announcement. He assumed it was dead.

The Purdue contract is valued at \$246,000 and is designed to correlate information gathered from aircraft flying over known vegetation with information from other remote sensors.

## U.S. pressing systems approach

The White House is renewing its insistence that Federal agencies and their contractors use the systems approach to problems wherever possible. The Administration began the push 18 months ago when the Budget Bureau ordered Government planning five years in advance under its Program Planning and Budgeting System. For his latest reminder to agencies and contractors, President Johnson chose his special assistant, Joseph Califano, who addressed the Washington chapter of Sigma Delta Chi, the journalism fraternity. Califano, who has replaced Bill D. Moyers as the President's No. 1 assistant, spoke on "The Politics of Innovation and the Revolution in Government Management."

After 20 minutes of describing the R&D systems approach to high-speed rail transit, jumbo jets, eight-lane turnpikes and education and welfare programs, Califano said: "I have attempted to describe the way President Johnson would like the Government to approach problem-solving and decision-making."

But up to the time Califano spoke, at least,

Federal agencies were apparently running far behind White House hopes. A university team studying the Government's use of the systems approach found many agencies unchanged in their views. The study is continuing.

The chief investigator for the study sees a battle shaping up between R&D concerns that are well-staffed with systems analysts and universities that are similarly endowed.

"If agencies are really going to try to adopt systems analysis and apply it to their operations," he contends, "there will be quite a bidding battle for the work."

## The human factor analyzed

One of the first questions a military service board asks when a new weapon or item of equipment is proposed is: "Can it be maintained?" The ease or difficulty of maintenance and the cost are key values in the cost-effectiveness picture, which may determine whether or not the item will be developed and procured. The life of components and costs and availability of replacements can be cranked into the formula. But so far the services have not been able to come up with figures to represent the most important consideration, the human factor.

The Air Force for some time has tried various routes to the answer, all without notable success. The Rome Air Development Center is asking R&D concerns, especially those that are engineering oriented, for suggestions. The center is expected to issue a formal invitation to bidders shortly on a contract to quantify the influence that the human factor has on the maintainability of equipment and weapons.

## One-shot torpedoes considered

The Navy may simplify—and thereby expand—the manufacture of its torpedoes. The Naval Ordnance Systems Command is considering adopting torpedoes designed for one-time use rather than for reuse. Some officials in the Defense Dept. contend that the Navy's continued preference for the reusable torpedo is rooted in tradition. The Navy counters that it's better to have a primary vehicle that can be refitted several times for training purposes.

However, the Navy is checking the one-shot weapon. An Ordnance Command officer admits that the lower cost and greater reliability of such a torpedo are attractive. But he points out that, for training, many more torpedoes would have to be procured than the Navy now buys.



# Everyone knows that to make a Triac to control 720 watts you have to use an expensive press-fit package

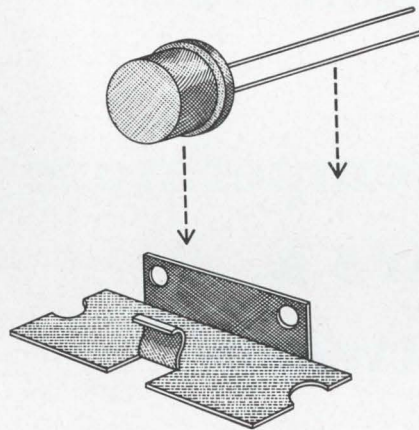

## Well, everyone is wrong!

**RCA designed the low-cost two-lead 40485  
TO-5 package to control 720 watts when used  
with an associated heat spreader!**

The 40485 Triac is designed for 120V line operation for the phase control of ac loads in applications such as light dimming, universal and induction motor control, and heater control. *It sells for only \$1.50\**. The 40486 Triac can control 1440 watts, 240V line operation, *and it sells for only \$1.98\**.

Both new Triacs are delivered in hermetically sealed, all-welded, tin-plated modified TO-5 packages which offer the advantage of small size where space restrictions are a primary consideration. And because they are tin-plated, they can be soldered directly to a heat spreader as illustrated. This allows the use of mass produced, pre-

punched parts, and batch soldering techniques, and simplifies mechanical mounting and heat sinking. The process is a simple one. RCA salesmen are ready to demonstrate in your own office just how easy it is.

So save the money you'd spend for a comparable press fit unit, and take advantage of the small size and superior performance of RCA 40485 and 40486 Triacs. Your RCA Field Representative can give you all the information, including delivery. For additional technical data, write RCA Commercial Engineering, Section RG6-1, Harrison, N.J. 07029. See your RCA Distributor for his price and delivery. *\*Prices in quantities of 1,000 up*



**RCA Electronic Components and Devices**

**The Most Trusted Name in Electronics**

ON READER-SERVICE CARD CIRCLE 18

Would you believe  
the new  
"VY"  
Thin Line  
Porcelain Capacitors,  
featuring a  
-100 ppm/°C temperature  
coefficient, have a  
mean-time-between-  
failure rate of  
6,000,000 hours?

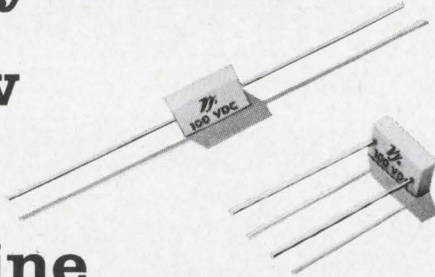

■ Ten million unit hours of testing "VY" Thin Line Capacitors at accelerated conditions — equal to 50 million unit hours at rated conditions — bear this out. Their proven, low failure rate is .016% per 1000 hours, at a 90% confidence level.

Users of negative T.C. capacitors gain positive features: three space-saving case sizes and two lead configurations, ratings to 500 VDC, plus the stability and low-losses a porcelain dielectric guarantees.

Thinking more positively about these negative T.C. capacitors? Then write for Data Sheet P 18 — and be more sure.

"VY" Thin Line also available with  $0 \pm 25$  ppm/°C T.C.)

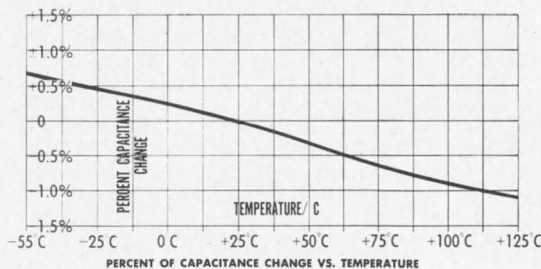

**Vitramon**

VITRAMON, INCORPORATED  
BOX 544  
BRIDGEPORT, CONN. 06601

In Greater Europe Contact:  
VITRAMON EUROPE  
Wooburn Green, Bucks, England

ON READER-SERVICE CARD CIRCLE 19

NEWS

## Back-pack generator for battlefield use

A "man-pack" thermoelectric generator that can deliver 300 watts of power, has an eight-hour fuel supply and can operate on kerosene, jet fuel or diesel fuel is currently being evaluated for Marine Corps field use.

The 35-pound solid-state power unit is said to provide instant, silent and long-term power for communications equipment and other field gear.

Developed by 3M Co., the generator is expected to take the place of engine generators in forward battle areas, according to the maker.

It measures 2 cubic feet and can be transported on a Marine Corps packboard, strapped to the back of a soldier.

In the thermoelectric generator, a series of pellets of semiconductor material are connected by copper straps. Electricity is produced when a temperature gradient is maintained across the length of the pellets, heating one end and cooling the other.

Earlier models required bottled propane gas but the new model is designed specifically to run on fuel readily available in the field, it was pointed out. ■ ■



Portable thermoelectric generator weighs 35 pounds, with fuel.

ON READER-SERVICE CARD CIRCLE 20

- 7 STANDARD single, dual, and triple units, including units with concentric shaft and vernier operation.

---

- 16 STANDARD resistance values from 50 ohms to 5 meg.

---

- 2 STANDARD tolerances 10% and 20%.

---

- 5 STANDARD resistance tapers.

---

- 18 STANDARD electrical tap options.

---

- 46 STANDARD shaft lengths from 3/8" to 6.0".

---

- 3 STANDARD shaft endings.

---

- 9 STANDARD variations of bushings.

---

- 4 STANDARD locating lug options.

---

- 4 STANDARD switch options with single and double pole.

# Allen-Bradley offers a 1,000,001 standard variations of Type J Potentiometers



Allen-Bradley Type J  
hot molded variable resistors  
rated 2.25 watts @ 70°C

These *standard* variations in the Allen-Bradley Type J hot molded potentiometer line eliminate the need for a "special" control. When you include the numerous special resistance values and tapers in which the Type J can be supplied, the variations become virtually infinite.

Yet, all of these Type J variable resistors have one thing in common—each and every one is made by the same A-B hot molding process—your guarantee of "tops" in quality. The solid hot molded resistance track assures extremely long life—exceeding well beyond 100,000 complete operations on accelerated tests with less than 10% resistance change. Control is always smooth and free from the sudden turn-to-turn resistance changes of wire-

wound units. And being essentially noninductive, Type J controls can be used at the higher frequencies—where wire-wound units are totally impractical.

Let Allen-Bradley Type J variable resistors be the answer to your special requirements—it's almost certain there's a "standard" unit in the Type J line. And you *know* you're obtaining the ultimate in reliability and performance. For more complete information on Allen-Bradley Type J potentiometers, please write for Technical Bulletin 5200: Allen-Bradley Co., 222 W. Greenfield Ave., Milwaukee, Wis. 53204. In Canada: Allen-Bradley Canada Limited. Export Office: 630 Third Ave., New York, N.Y., U.S.A. 10017.



**ALLEN - BRADLEY**  
QUALITY ELECTRONIC COMPONENTS

Printed circuit board from General Radio Type 1680 Automatic Capacitance Bridge showing use of A-B Type CB ¼ watt fixed resistors and Type F ¼ watt adjustable resistors.

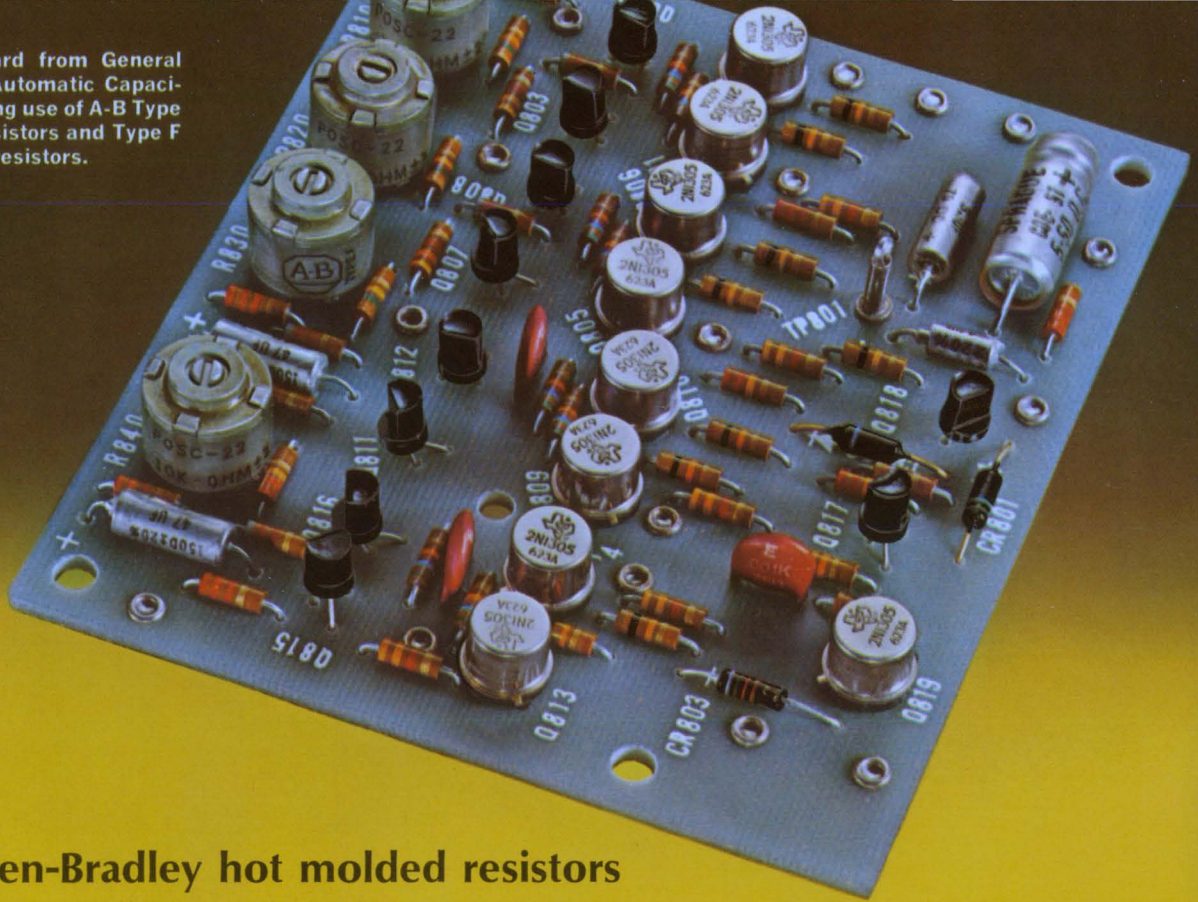

"we use Allen-Bradley hot molded resistors because their consistent, stable characteristics—month to month and lot to lot—ensure repeatable measurements by our instruments." GENERAL RADIO CO.



General Radio Type 1680 Bridge automatically measures capacitance and loss simultaneously, generates coded digital output data, and displays measured values in about one-half second. The basic accuracy is  $\pm 0.1\%$  and the range is from 0.01 pF to 1000  $\mu\text{F}$ .



**Type F variable resistor** with pin type terminals for mounting directly on printed wiring boards. Rated ¼ watt at 70°C. Total resistance values from 100 ohms to 5 megohms. Shown actual size.

**A-B hot molded fixed resistors** are available in all standard resistance values and tolerances, plus values above and below standard limits. Shown actual size.



Just as surely as automatic equipment saves its users' money when it is in operating condition, it is virtually worthless when failure of a component has made the entire device inoperative. To insure the reliable and accurate performance of their new automatic capacitance bridge, General Radio designers selected Allen-Bradley hot molded fixed and variable resistors.

Allen-Bradley resistors are made by a hot molding process using completely automatic machines developed by Allen-Bradley. This results in such precise uniformity from one resistor to the next—year in and year out—that long term resistor performance can be accurately predicted. Furthermore, there is no known instance of catastrophic failure of an Allen-Bradley hot molded resistor.

The same manufacturing technique is used with the Type F variable resistors. Their solid hot molded resistance track assures smooth control from the very beginning and which improves with use—and are completely devoid of the abrupt changes to be expected of wire-wound controls. In addition, A-B variable resistors are essentially noninductive, permitting their use at frequencies far beyond range of wire-wound units.

For more complete information on the full line of Allen-Bradley quality electronic components, please write for Publication 6024: Allen-Bradley Co., 222 W. Greenfield Ave., Milwaukee, Wis. 53204. In Canada: Allen-Bradley Canada Limited. Export Office: 630 Third Ave., New York, N. Y., U.S.A. 10017.



**ALLEN - BRADLEY**  
QUALITY ELECTRONIC COMPONENTS

## 28-volt IC logic to be used in aircraft

A monolithic integrated-logic-circuit family designed specifically for aircraft applications has been announced by Boeing Co.'s Microelectronics Laboratory in Seattle.

Aircraft require numerous simple logic systems to drive lamps, bells, horns, relays and solenoids, all of which operate from the aircraft's 28-volt dc power bus. The most common of these systems are visual displays for the crew, indicating the status of wing flaps and slats of the landing gear, of the air conditioning and of many other systems. Currently, most of these functions are performed by relays. Some newer aircraft have logic systems built up from discrete solid-state components.

The basic prototype unit of the 28-volt logic family is a special version of a DTL NAND gate.

Features which distinguish this logic family from conventional microcircuits, according to a Boeing spokesman, are 28-volt operating voltage, ability to withstand 80-volt transients of 50-ms duration, a dc noise margin of about 9 volts, an ac noise margin greater than 90 volts for transients shorter than two  $\mu$ s and the ability to sink 100 mA when used as a lamp driver.

The circuit is made in monolithic form by use of the standard double-diffused npn structure on a p-type substrate. Low saturation voltage—1 volt at 100 mA—in the output transistor is achieved by means of a buried-layer collector and interdigitated base-emitter structure.

Each member of the logic family can be built from one master slice by using different intraconnection masks.

Large component areas are used to provide the power capability in both the bias and load elements. The accompanying large parasitic capacitances are acceptable because of the low speed requirement of the circuit. The prototype circuits are packaged in a Philco 1/4-inch-by-3/8 inch flat pack, with gold-plated Kovar base cover and leads. ■ ■

# New Dual-Tracking DC Power Modules from ERA



## Ultra-Compact, High Temperature

Drive operational amplifiers, IC's and other devices requiring dual-tracking DC with ERA's value-engineered, fully repairable DV series Transpacs.® Two independent power sources provide continuously adjustable and proportional outputs,  $\pm 12$  VDC through  $\pm 15$  VDC, reducing variations in operational amplifier performance resulting from power supply changes. Special design assures precise reliable performance under most severe conditions.

### SPECIFICATIONS

<b>Input:</b> 105-125 VAC, 50-400 cps	<b>Transient response:</b> Less than 50 microseconds
<b>Voltage output:</b> $\pm 12$ through 15 VDC, Dual	<b>Operating temperature:</b> $-20^{\circ}\text{C}$ to $+71^{\circ}\text{C}$
<b>Current rating:</b> See table	<b>Temperature coefficient:</b> 0.02% per degree C
<b>Ripple:</b> Less than 800 microvolts, RMS	<b>Heat sinking:</b> Internal, convection cooled
<b>Line, load regulation:</b> Less than 0.05%, full line or load change	

### STANDARD MODELS

Output Voltage VDC	Current 71° C	Size WxDxH (Inches)	Weight (lbs.)	Model	Price
+ (12-15) - (12-15)	0-60 ma 0-60 ma	2¼ x 3 <sup>15</sup> / <sub>32</sub> x 3¾	1.2	DV60	\$96.00
+ (12-15) - (12-15)	0-500 ma 0-500 ma	3 <sup>3</sup> / <sub>16</sub> x 4 x 5 <sup>1</sup> / <sub>8</sub>	2.8	DV500	\$149.00
+ (12-15) - (12-15)	0-1 amp 0-1 amp	4 x 4¾ x 6¼	3.9	DV1000	\$189.00

Write for Catalog # 151



### ELECTRONIC RESEARCH ASSOCIATES, INC.

Dept. ED-6, 67 Sand Park Road, Cedar Grove, N. J. 07009 (201) 239-3000

Subsidiaries: ERA Electric Co. • ERA Acoustics Corp. • ERA Dynamics Corp. • ERA Pacific, Inc.

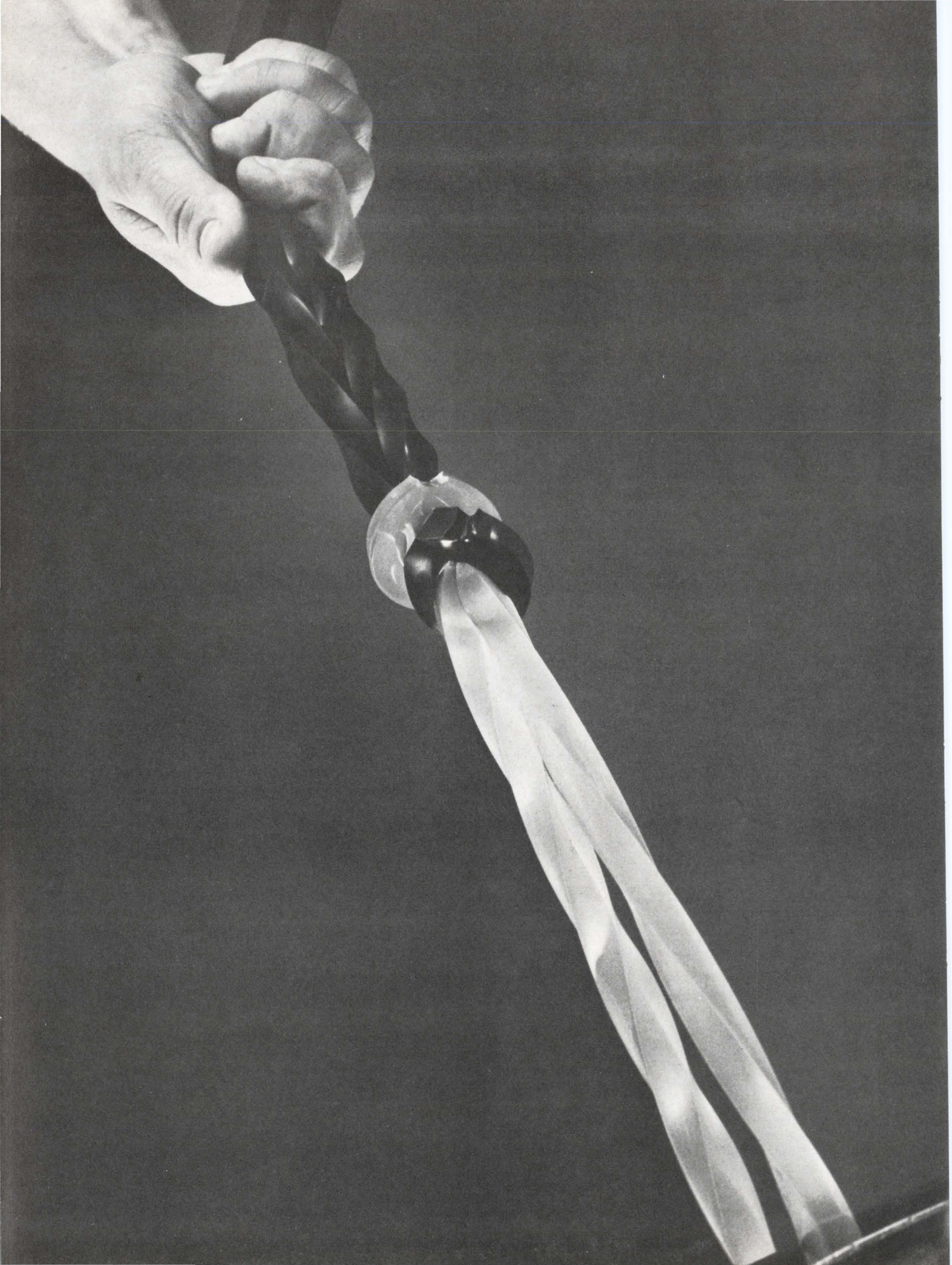

# **T**est these new high-strength silicone resins before you specify!

Send for a cured sample of Sylgard® 186 or Sylgard® 187 silicone resin and test your own strength! These resins are *tough . . . flexible . . .* and highly tear resistant, even after being knicked.

Yet, they cure without danger of exothermic damage to delicate electronic parts . . . without damage due to stresses caused by shrinkage during cure. They are ideally suited for encapsulating, potting, filling, coating and embedding.

Sylgard 186 resin is transparent while Sylgard 187 resin is black. Both cure at room temperature . . . provide deep section cure . . . and have a service temperature range from -65 to 250 C with no post cure.

We will be happy to send you a sample of either Sylgard 186 or 187 silicone resin; plus complete technical data on both.

For the name of the Dow Corning representative in your area, write to: Dept. 3918, Electronic Products Division, Dow Corning Corporation, Midland, Michigan 48640.

**DOW CORNING**

*We're a materials producer exclusively. Let us tailor a material to your need.*

Circle No. 851

# Loudness analyzer imitates the ear's response

## Instrument based on theory of human hearing designed by Hewlett-Packard's German facility

An instrument that closely simulates the complex response characteristics of the human ear has been designed by engineers at Hewlett-Packard's facility in Böblingen, West Germany.

The instrument, called a loudness analyzer (8051A), presents two displays to the user. One is the intensity within each of 20 frequency bands from 0 to 14 kHz, presented on a CRT display that is broken into 20 strips. The second is a meter which shows the total intensity of the sound, or the integration under the curve covering all twenty bands.

The new instrument, priced at \$5000, was introduced at Mesucora 67, the European measurements and controls meeting held in Paris, April 14-21.

The design was based on studies of human sound perception, according to Peter Kohl, project leader at the Böblingen plant. Different approaches have been taken to sound analysis, but the internationally ac-

cepted method of Zwicker was used in this case. Hearing does not occur at sharp, discrete frequencies, according to this theory, but breaks into about 24 bands in the 0-to-14-kHz range. Twenty bands are used, each covering 1/3 octave, in the H-P instrument, Kohl said, so standard band-pass filters could be used.

The sensitivity of the ear is not the same within each band, so that different weighting factors are assigned to each. These weights are distributed in a complex pattern from low to high frequencies, and from soft to loud sounds, so that ordinary sound-level meters are unable to give very accurate readings in terms of true human perception.

The ear does not hear pure frequencies. Its response will peak at the sound frequency exciting it, but there will be a "skirt" toward higher frequencies. Thus if a slightly higher pitch were sounded at the same time at low intensity the ear would not detect it at all. The inten-

sity of the second sound must exceed the response "skirt" of the louder first sound. This characteristic is implemented by means of blanking in the H-P analyzer. The dashed vertical curves in the diagram represent the blanking skirts for the various bands.

The CRT-chart display can be used in various modes. It can store instantaneous or maximum signals to aid analysis, and also can plot records on an X-Y recorder. A sharp hand-clap, for example, will shift amplitude up in a couple of bands, but cause very little shift at any other frequencies.

The scale used on the CRT display is in sones, which is a measure of the ear's response. Sound intensity can be measured on the basis of actual sound pressure in phons, a logarithmic scale covering the ear's total dynamic range in 130 dB. Unfortunately, this scale doesn't correspond to the ear's perception of loudness. For example, a 200-Hz tone at a sound pressure level of 63 dB will sound equal in loudness to a 40-dB signal at 1 kHz. Therefore a new scale has been developed which assigns a value of 1 sone to each of these sounds.

Such instruments are used in noise control in factories or city locations, in studies of aircraft or machine performance, and in such areas as physiological research. ■ ■

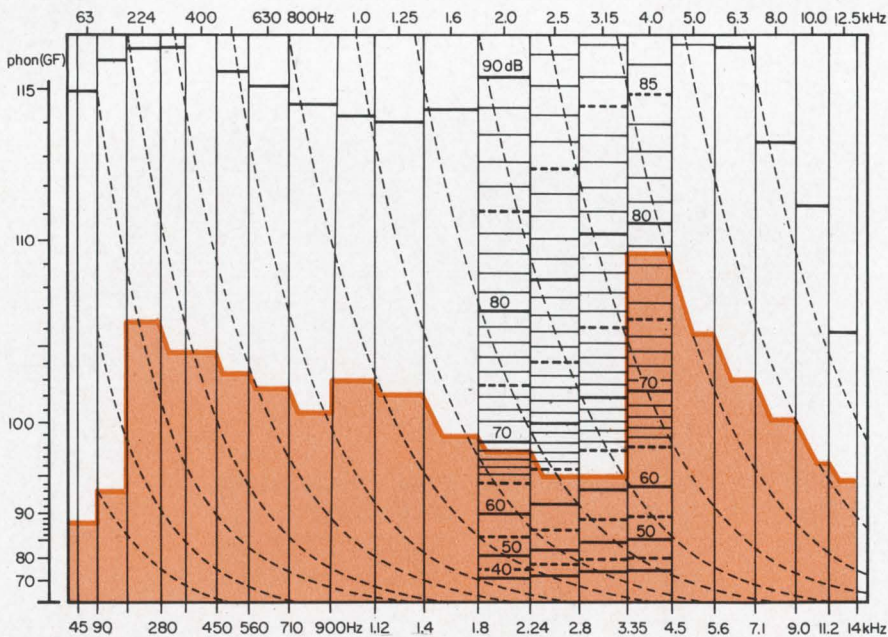

**Simplified Zwicker diagram** is similar to the display presented to the user of the loudness analyzer. Shaded region, representing a complex sound pattern, is integrated to provide an absolute sound intensity reading in sones on an adjacent meter. Note the curved vertical lines which define the threshold which sounds in higher frequency bands must exceed to be perceived as separate.



**Peter Kohl, project leader** at Hewlett-Packard's plant in Böblingen, West Germany, adjusts the loudness analyzer he helped design.



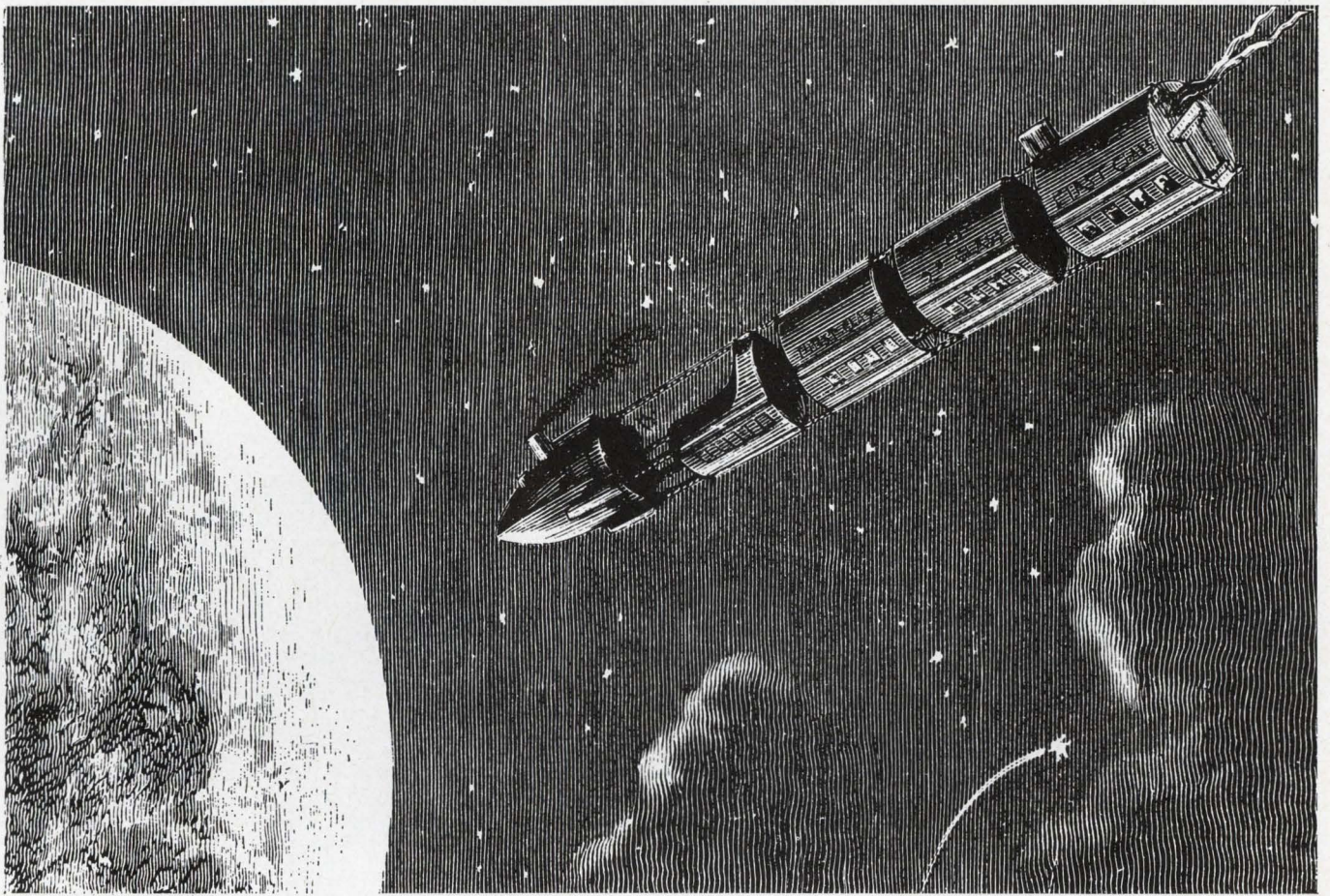

## “Way out deliveries do take longer”

... unless you order from a local distributor. A case in point, the distributors listed below stock Dow Corning electronic materials. That means you can usually place an order by phone and get delivery in an hour or so. The “way out” deliveries may take a day.

And to help you speed your orders, there's a new Dow Corning Electronic Materials Selection Guide. It covers the distributor-stocked Dow Corning line of potting, encapsulating, embedding and coating materials as well as silicone dielectric fluids which provide added protection and reliability to your electronic products.

For your copy of the Selection Guide, contact your local Electronic Materials Distributor or, write: Dept. 3930, Electronic Materials Dept., Dow Corning Corp., Midland, Mich., 48640.

**DOW CORNING**

### ELECTRONIC MATERIALS DISTRIBUTORS

**Allied Radio Corporation**  
Chicago, Illinois

**K. R. Anderson Company**  
Mountain View, California

**Atlas Packing & Rubber Company**  
Seattle, Washington

**Brownell, Incorporated**  
New York, N.Y.; Cambridge, Mass.;  
Orlando, Fla.; Hapeville, Ga.;  
Memphis, Tenn.; Charlotte, N.C.

**Cramer Electronics, Incorporated**  
Newton, Mass.; Hamden, Conn.;  
Fort Lauderdale, Fla.

**Electrical Insulation Sales Company**  
North Bergen, New Jersey

**Ensko Distributing Corporation**  
St. Louis, Mo.; Prairie Village, Kan.

**Harrison Equipment Company, Incorporated**  
Houston, Texas

**Magnuson Associates**  
Chicago, Ill.; St. Paul, Minn.

**Pyttronic Industries, Incorporated**  
Baltimore, Md.; Warrington,  
Harrisburg, Penn.

**E. V. Roberts & Associates, Incorporated**  
Culver City, Palo Alto, San Diego, Calif.;  
Scottsdale, Ariz.

**Sheridan Sales Company**  
Cincinnati, Dayton, Ohio;  
St. Louis, Mo.; Southfield, Mich.

**Specialized Products Company**  
Dallas, Texas

**Summit Distributors, Incorporated**  
Buffalo, New York

**Waco Electronics, Incorporated**  
Albuquerque, N. M.; Denver, Colo.

ON READER-SERVICE CARD CIRCLE 23

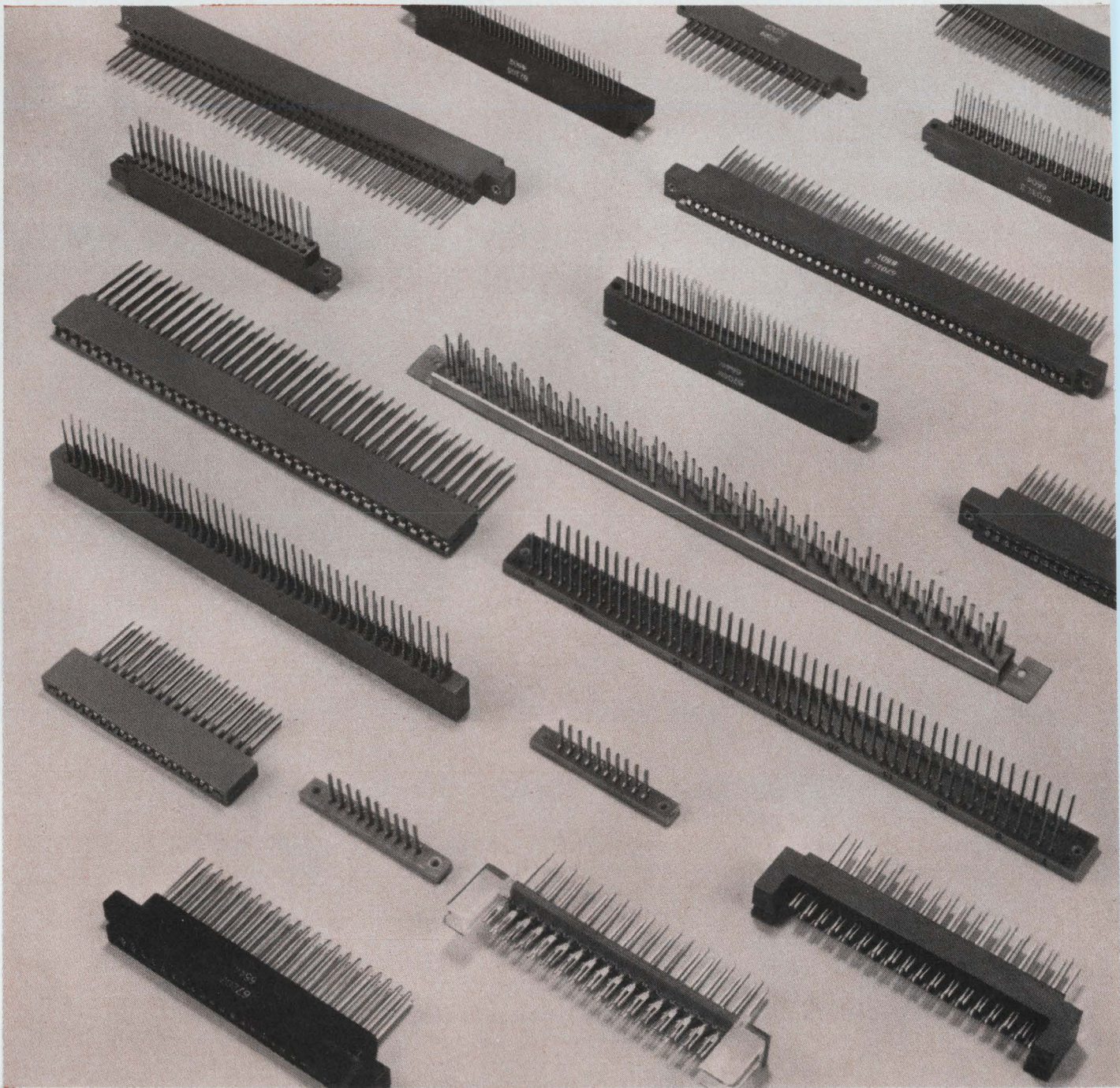

**Associated  
TERMI-POINT<sup>★</sup>  
products  
keep you  
posted...  
25 different  
ways!**

Here are 25 of our latest associated TERMI-POINT products for your high-density wiring applications. They all feature AMP's unique post, designed especially for TERMI-POINT clips and tooling, yet they're compatible with other point-to-point connection methods.

Here's the easy solution to those finicky wiring jobs on miniature connectors and tedious interconnections on densely packed equipment. With these products you can forget about burnt insulation, burnt fingers, bulky tools, and special training of wiring personnel. From lightweight hand tools to fully automatic machines, TERMI-POINT tooling is matched to these products for foolproof operation and utmost reliability.

This new technique is the culmination of AMP's continuing research into advanced wiring technology, yet it is based on the solderless pressure connection principle which the company began developing a

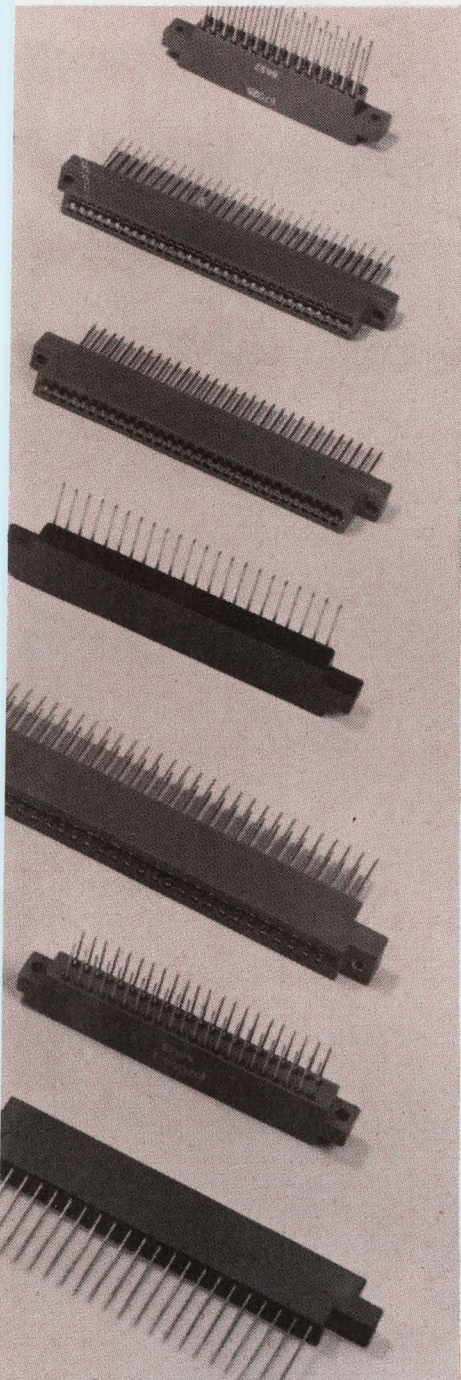

Lightweight hand tool applies bulk wire and strip terminals for limited volume production.

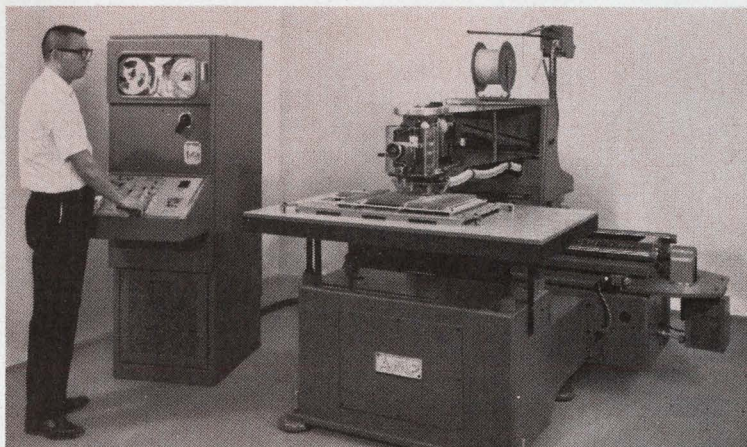

Tape-programmed TERMI-POINT Automatic Wiring Machine routes and fully terminates a 10" lead in less than four seconds.

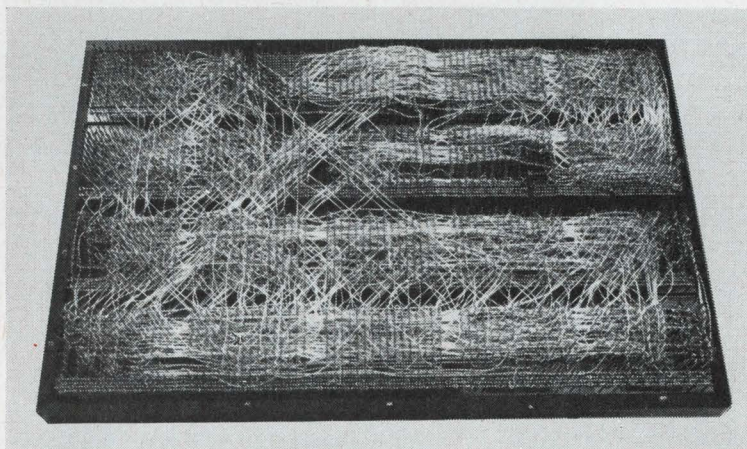

Panels pre-wired at AMP's Harrisburg facilities give you the benefits of automated production without requiring capital investment.

quarter century ago. Today, in communications, data processing, military electronics and related fields, TERMI-POINT products provide flexibility, speed, and applied cost savings that are unequalled in the industry. And this will be true in generations of new products under development for the future.

Now's a good time to find out about this modern technique, and its matched tooling and product line. Write today. We'll see that you get the whole story, posthaste.

\*Trademark of AMP INCORPORATED

**AMP**  
**INCORPORATED**  
 Harrisburg, Pennsylvania

A-MP\* products and engineering assistance are available through subsidiary companies in:  
 Australia • Canada • England • France • Holland • Italy • Japan • Mexico • Spain • West Germany

ON READER-SERVICE CARD CIRCLE 24

# NEW EG&G SILICON DIFFUSED PHOTODIODE

- HIGH QUANTUM EFFICIENCY
- WIDE SPECTRAL RANGE • FAST RESPONSE TIME • LOW NOISE

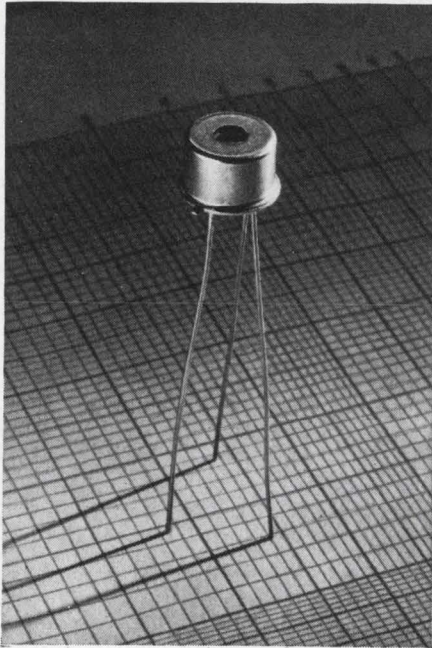

**SGD-100 PHOTODIODE**

The SGD-100 Photodiode — successor to the popular SD-100 — offers greater sensitivity and lower noise characteristics. Embodying EG&G's improved diffused guard ring design, the SGD-100 has a wide spectral range with an unusually high response in the "blue" region, fast response time and high quantum efficiency. The photodiodes are hermetically sealed in a TO-5 package.

Sensitivity . . . . .  $0.5 \mu\text{A}/\mu\text{W}$  at 0.9 microns  
(70% quantum efficiency)

Spectral Range . . . . . 0.35 to 1.13 microns

Capacitance . . . . . 7 picofarads at 90v

Rise Time . . . . . 4 nanoseconds

Leakage . . . . .  $0.2 \mu\text{A}$  at 90v

NEP ( $0.9\mu, 10^3, 1$ ) . . . . .  $7.9 \times 10^{-13}$  watts

Linearity of Response . . . . . over 7 decades

Applications include CW, pulsed light and laser detection and measurement, star tracking, optical navigation, communication and guidance, and range-finding systems. The new SGD-100, also available in calibrated versions, is in quantity production for fast delivery at low price.

For information, write: EG&G Inc., 166 Brookline Avenue, Boston, Massachusetts 02215. Telephone: 617-267-9700. TWX: 617-262-9317.



ON READER-SERVICE CARD CIRCLE 26

## Matched cores yield DRO / NDRO memory

Problems of incompatibility which forced memory manufacturers to separate destructive and nondestructive memories into different packages have been overcome by at least one company.

Bob Johnson, manager of the Military Matrix Dept. of Electronic Memories in Hawthorne, Calif., said the company has developed a destructive read-out (DRO) and alterable nondestructive read-out (NDRO) in one memory stack. The stack is an engineering prototype developed for Lockheed for use in a spacecraft vehicle.

The stack contains 256 words, each 44 bits long. The NDRO portion uses the first 36 bits and consists of a toroidal core threaded by four wires, one each for the *X*, *Y*, *sense* and *inhibit* functions. The alterable NDRO portion uses the remaining 8 bits and consists of a multiaperture transfluxor (Shmoo) core also threaded by four wires, one each for the *X*, *Y*, *sense* and *clear/inhibit* functions.

The stack is built to withstand severe environments and has a cycle time of 1.8 microseconds. Johnson explained that this is considered fast for severe-environment memories. Memories built for industrial and commercial use, on the other hand, operate at a microsecond or less.

The DRO/alterable NDRO combi-

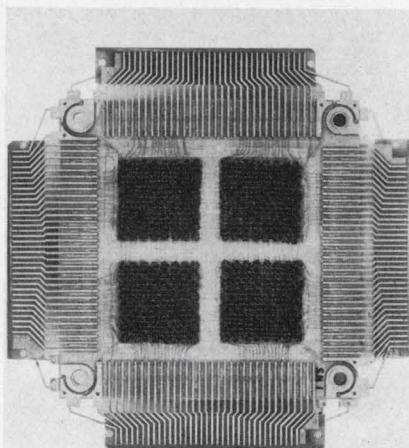

Array detail of  $256 \times 8$  transfluxor array for first DRO/alterable NDRO core memory stack.

nation was made possible by the discovery of a way to use one drive and one sensing system for both types of memory core. This was the result of developing a toroidal core and a Shmoo transfluxor with nearly identical electrical characteristics and of using an all-metal board construction that quickly dissipates heat, so that the mutual thermal tolerances of the toroidal core and Shmoo transfluxor are not exceeded. A conventional PC board could be used, Johnson said, by decreasing the speed in order to reduce internal heating.

Computers which have both DRO scratch-pad and NDRO memories typically use two systems, such as a rope memory and core memory. Each system requires entirely different selection and drive circuitry, because different toroidal cores normally vary so widely from one another in electrical characteristics. They also have different amplitudes and speeds which affect memory timing, and different outputs and temperatures for certain drive characteristics.

The all-metal construction, Johnson said, permits any two cores in the stack to operate with a temperature difference of no more than  $5^\circ\text{C}$  under average conditions and  $10^\circ\text{C}$  under worst-case conditions. This provides reliable core operation over the wide temperature range often found in spacecraft applications. The operating temperature range is  $-55^\circ$  to  $+100^\circ\text{C}$ .

Johnson listed the advantages of the new stack as reduced system complexity, power consumption, physical size and weight, and increased reliability. The prototype stack measures 3 inches square by 1 inch thick.

The Lockheed prototype memory was extremely difficult and costly to construct, according to the company, mainly because of problems in stringing the Shmoo cores. Applications of the DRO/NDRO memory are limited at present to satellites, missiles and re-entry vehicles, he explained. There are no plans to market a commercial version. ■ ■

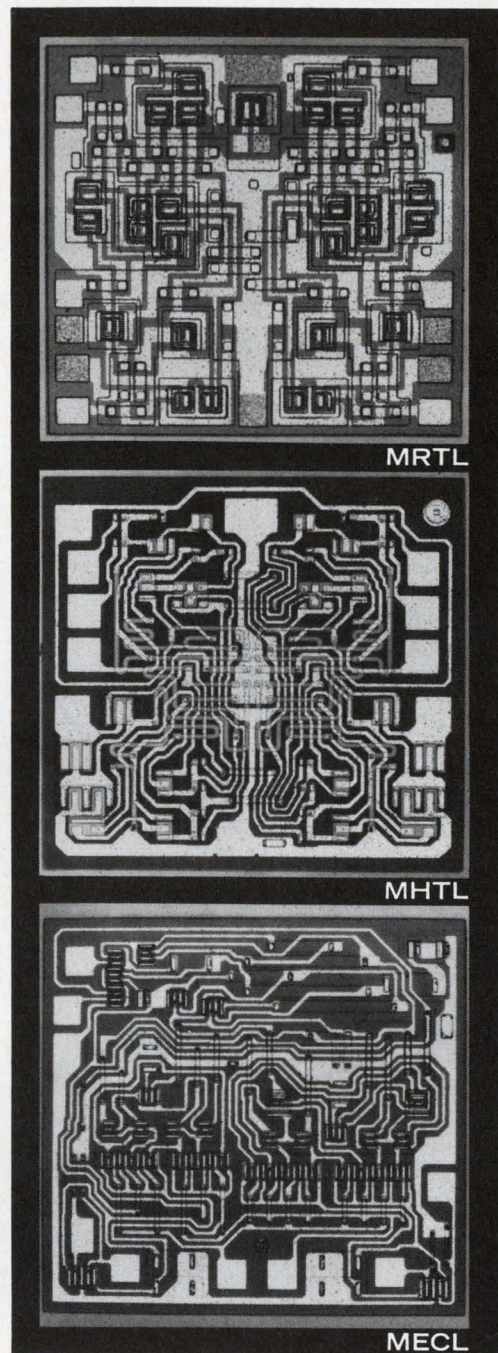
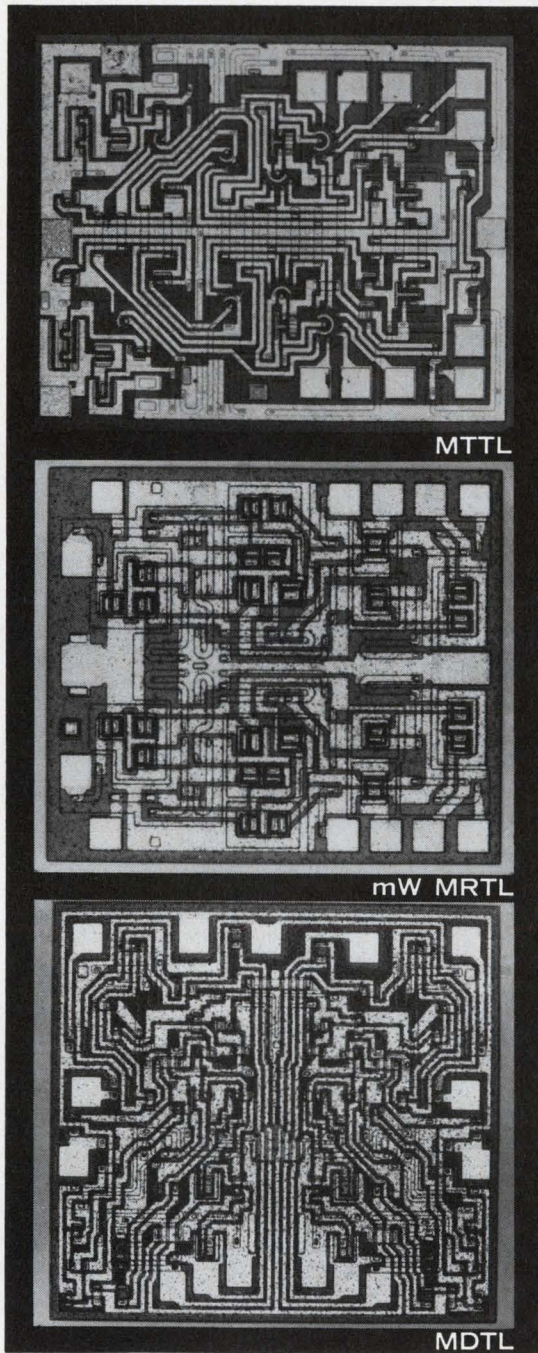

... digital integrated circuits

# Only Motorola Makes them All!

(And More Linear Circuits, Too).

Send for a free copy of our new  
integrated circuits full-line brochure.

MOTOROLA SEMICONDUCTOR PRODUCTS INC. / P. O. BOX 955 / PHOENIX, ARIZONA 85001

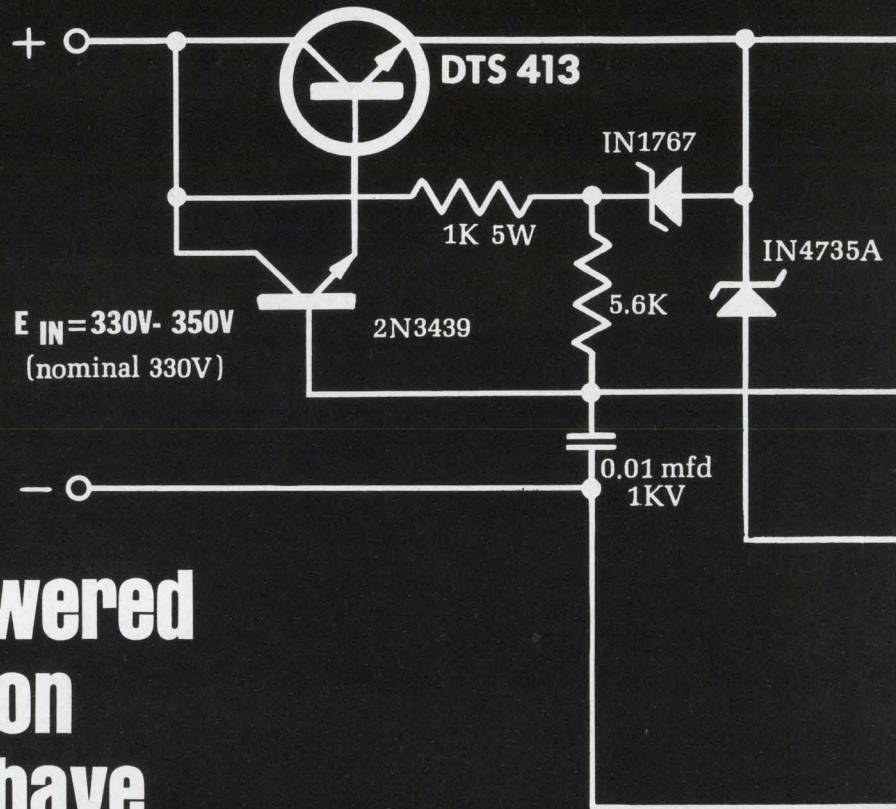

## High-powered regulation doesn't have to carry a high-powered price!

The simple DC regulator shown supplies 290 volts to a load of 50 to 600 milliamperes. Regulation is better than  $\pm .05$  percent with an input voltage variation of 15%. Delco high voltage silicon makes this possible with just one series transistor—the DTS-413—priced at just \$3.95 each in 1000-and-up quantities.

This circuit also can be scaled to the capabilities of any of the other cost saving Delco DTS transistors, including the new DTS-424 and DTS-425. And no matter which Delco high voltage transistor you use, reduction of weight, size, and component cost is part of the bargain. Circuit complexity and number of components are reduced and so assembly costs go down, too. And fewer components mean higher reliability.

Right now, Delco silicon power transistors are adding these benefits in such high energy circuits as: DC-DC converters, ultrasonic power supplies, VLF class C amplifiers, off-line class A audio output and magnetic CRT deflection (several major TV manufacturers use them in big screen horizontal and vertical sweep circuits).

How soon can you get Delco silicon power transistors? How soon do you need them? With our experience and new plant facilities, samples or production quantities can be shipped promptly. Call one of our distributors or a Delco sales office now.

For full details on the DC regulator circuit, ask for application note number 38.

# Application of Delco high voltage silicon power transistors: a DC voltage regulator.

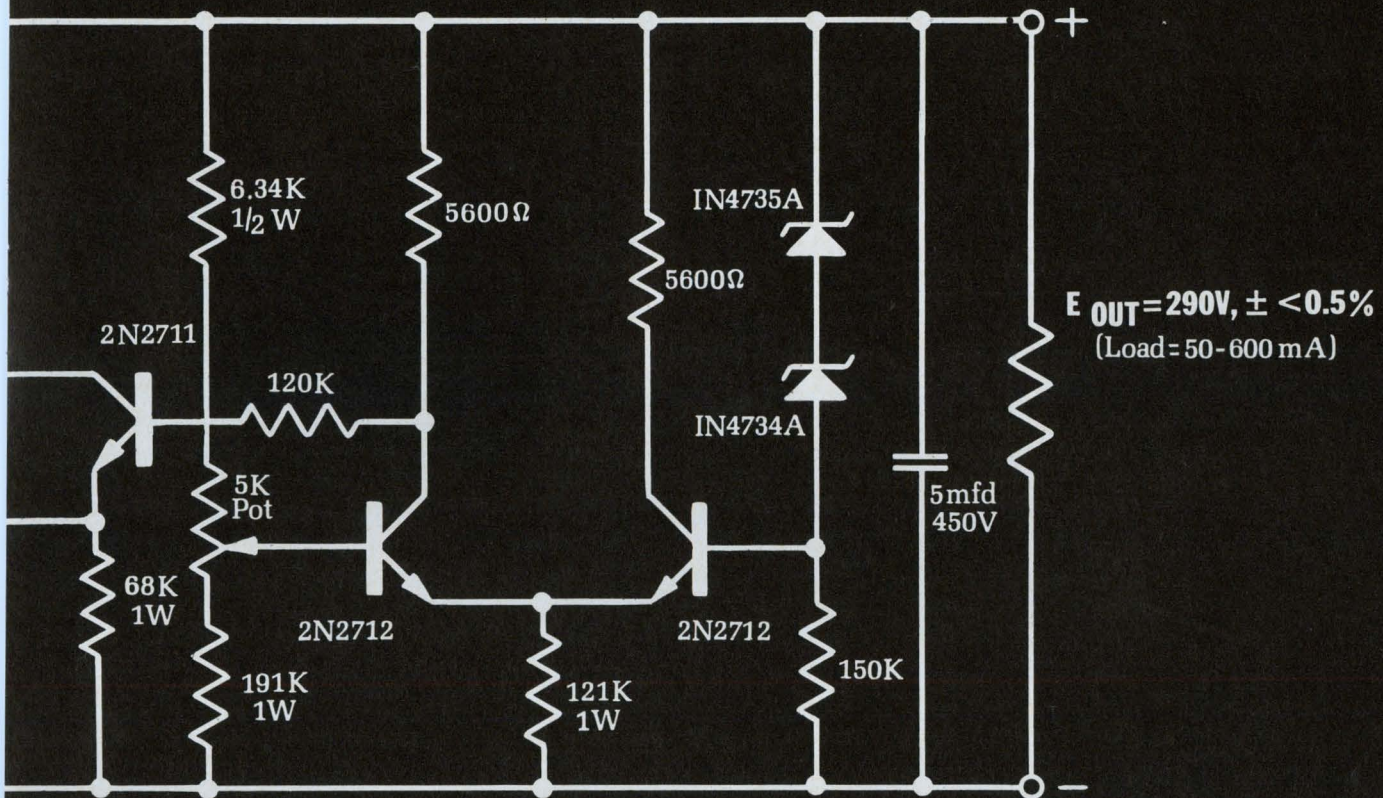

TYPE	V <sub>CEX</sub>	V <sub>CEO</sub> (sus) min.	I <sub>c</sub> max.	h <sub>FE</sub> min. V <sub>CE</sub> =5 V @ I <sub>c</sub>	P <sub>D</sub> max.	PRICE 1000-and-up QUANTITIES
DTS-413	400V	325V	2.0A	15 @ 1.0A	75W	\$3.95
DTS-423	400V	325V	3.5A	10 @ 2.5A	100W	\$4.95
DTS-424	700V	350V	3.5A	10 @ 2.5A	100W	\$7.00
DTS-425	700V	400V	3.5A	10 @ 2.5A	100W	\$10.00
DTS-430	400V	300V	5.0A	10 @ 3.5A	125W	\$17.49
DTS-431	400V	325V	5.0A	10 @ 3.5A	125W	\$25.00

NPN silicon transistors packaged in solid copper TO-3 case.

Field Sales Offices: Union, New Jersey\* 07083 Box 1018 Chestnut Station (201) 687-3770; Detroit, Michigan 48202 57 Harper Avenue (313) 873-6560; Santa Monica, Calif.\* 90401 726 Santa Monica Blvd. (213) 393-1465; Syracuse, New York 13203 1054 James Street (315) 472-2668; Chicago, Illinois\* 60656 5151 N. Harlem Avenue (312) 775-5411; General Sales Office: 700 E. Firmin, Kokomo, Ind. 46901 (317) 459-2175

\*Office includes field lab and resident engineer for applications assistance.

**DELCO RADIO**  
DIVISION OF GENERAL MOTORS • KOKOMO, INDIANA

ON READER-SERVICE CARD CIRCLE 28

# What will be your future identity?

If your talents seek recognition beyond group levels, if you have a need to contribute as an individual, now's the time to explore the potentials at Omni Spectra, Inc., truly a growth organization.

We want engineers who are ready for an early assumption of responsibilities and the accompanying early recognition.

Immediate openings in engineering, sales, and manufacturing. Areas of special interest include:

- Application of semiconductors to microwave circuits.
- Microwave component and sub-system development.
- Advanced microwave connector design.
- Application engineering.
- Prototype production engineering.
- High reliability and environmental testing.

Liberal paid employee benefits, plus progressive salary administration program. An equal opportunity employer. Call collect, or send resume to Personnel Manager, Omni Spectra, Inc., 19800 W. 8 Mile Road, Southfield, Michigan 48075. Phone (313) 444-8890.



Our all-new facility now under construction at Farmington, Michigan, in rolling country just northwest of Detroit. Only ½ hour to University of Michigan, ½ hour to downtown Detroit. The gateway to fishing, hunting, camping, skiing in America's Water-Winter Wonderland.

**Omni**  
**Spectra, Inc.**

ON CAREER INQUIRY FORM, PAGE 109, CIRCLE 904

## Microwave show has practical theme

Techniques and applications of the microwave art rather than theoretical treatises are the theme of Microwave Exposition/67 at New York's Coliseum. More than 80 companies are exhibiting at the event, which runs from June 6 through 8.

Manfred Meisels, editor of the magazine *MicroWaves*, which is a sponsor of the exposition, described the papers and exhibits as timely and directly useful to designers.

"For example," he said, "practical measurements of laser power, radiance, frequency, stability, harmonics, coherence, etc., have never before been presented at a meeting. And here we go into a discussion of the techniques and instruments that are available."

A demonstration of actual laser measurements and operating equipment is being coordinated by Lawrence Waszak and Ted Schultz of the TRG Div. of Control Data Corp.

Another highlight is a how-to-do-it demonstration of holography by the Conduccion Corp. Showgoers will be able to see a demonstrator "who actually makes a laser hologram and plays it back," Meisels said. The approach, he added, will be: "Here's the laser and here's the mirror and you use this kind of lens, and you can't use this kind of laser." Both transmission and reflection holograms will be dealt with.

With an eye on the increasing acceptance and application of microwave transistors at frequencies around 3 GHz, Texas Instruments, Inc., is sponsoring a seminar on the selection and use of these devices and of microwave integrated circuits. This will include discussion of the S-parameter measurement technique, which relates input to output of such parameters as voltage, current and impedance and is more and more used to characterize microwave transistors. Expressing the transfer functions of the black-box elements together with the fixed components in a circuit gives better insight into the operation of the circuit as a whole.

Tektronix is holding a seminar on the use of the spectrum analyzer. It will deal with "how to make all the measurements—pulse, cw, FM, fre-

quency, pulse modulation and envelope shape, side lobes," Meisels said. The seminar will include practical demonstrations not only of these techniques but also of dual-beam spectrum analysis, antenna pattern measurements, swept oscillator linearity and video spectra.

Antenna requirements will be the subject of a two-part panel discussion. Experts in the field will examine both phased arrays and optical and broad-band antennas.

### Users are included

The rarefied atmosphere of technical discussion and demonstrations has not shut out the everyday user, however. A panel of spokesmen for the airlines, railroads, chemical industry, and CATV will discuss the latest applications of microwave communications. Many railroads, for example, still rely on the telegrapher. Southern Railroad, however, has introduced a microwave system that covers 4000 miles of track. Voice, telemetry, data and facsimile transmission accommodate every need from switching cars to handling the company's payroll.

Other topics to be covered in the papers at the exposition include:

"Design of anechoic chambers" (Emerson and Cuming)

"Application of Schottky-barrier diodes" (Sylvania Semiconductor)

"Two-probe swept-vswr measurements" (AMP, Inc.)

"Practical antenna measurements" (Scientific-Atlanta)

"Intelligent use of ferrite devices" (Melabs)

"Choosing and using low-noise TWTs" (Watkins-Johnson)

"Measuring microwave noise" (Airborne Instruments Laboratory)

"Which road to receiver protection?" (Microwave Associates)

Panel discussions will include: "The future of Microwave Tubes," "Getting the Most from Coax Connectors" and "Techniques in Microwave Marketing."

The exposition is to be an annual event. Next year, the scene will shift to the West Coast. The meeting is scheduled for early June in San Francisco. ■ ■



# Name your failure rate

this  
G-E  
sealed  
relay  
will give  
it to you

But you have to let us establish:

- level of confidence
- operating conditions
- what constitutes a failure

By varying these conditions, we can give you any failure rate you want.

Doesn't make sense, does it? You're supposed to set the conditions. Not us.

That's why we don't establish failure rates till you give us application information.

If we did, we'd hurt you. And us.

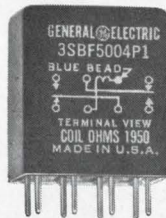

You, because you might buy the wrong relay.

Us, because we might hurt our reputation and lose you—a valued customer.

Want realistic failure rate data and the best relay for your next project? Con-

tact your G-E Electronic Components Sales Engineer. Or for latest catalog information, write General Electric Company, Section 792-40, Schenectady, New York 12305.

**GENERAL**  **ELECTRIC**

ON READER-SERVICE CARD CIRCLE 30

# Semiconductor Report



NEW POWER CONTROL PRODUCTS AND IDEAS FROM MOTOROLA

## 800 mA SCR (RMS) TURNS ON MANY LOW-COST, HIGH-VOLUME APPLICATIONS

With prices pegged below 40¢ in volume quantities, the new 2N5060-63,800 mA SCR series is sure to be a hit with the designer of low-current, low-voltage power control circuitry.

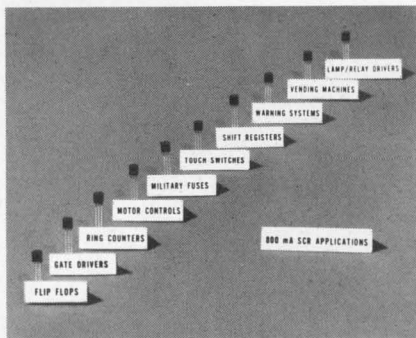

Housed in the miniature Unibloc\* plastic package, these 30 to 150-volt units can be plugged into existing TO-18 pin circles without lead crossing.

Only 200  $\mu$ A of current triggers them into conduction, too — making them ideal for low-level sensing and triggering circuits.

Applications in low-power consumer / industrial / military designs are limitless: military fuzes (squib firing and safety circuits), flame detectors, automatic warning systems, lamp and relay drivers, tiny motor controls, sensing, detecting and processing control circuits, vending machines, burglar alarms, touch switches, ring counters, shift registers, flip flops, gate drivers for larger SCR's, ad infinitum . . . !

And exclusive Annular† construction affords reliable operation over a wide  $-65^{\circ}$  to  $+125^{\circ}$ C operating temperature range. Other features include 6-ampere peak surge current rating, and 1.7-volt forward on voltage @ 1A peak.

Quantity availability of the "big little" series is immediate!

R. S. No. 161

## PULL THE TRIGGER ON COSTLY THYRISTOR DESIGNS WITH 3 NEW FIRING DEVICES

Look what happens to your consumer / industrial thyristor power control circuitry when you design in a new Motorola Unibloc plastic trigger — you get: symmetrical switch-

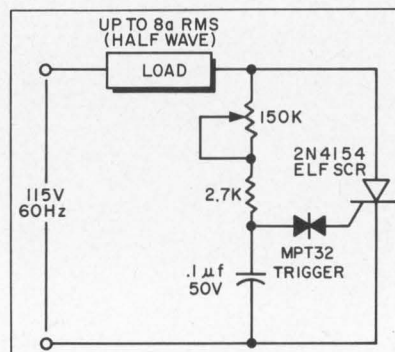

ing characteristics . . . low 50  $\mu$ A (max) switching current which reduces trigger capacitor size . . . and larger, 10-volt (typ) switch-back voltage which furnishes higher energy pulses to gate and gives faster turn-on, lower switching losses and more reliable SCR operation.

How can you best use them . . . at below-25¢ volume prices?

Tie the MPT-28, -32, -36 series together with any of the more than 270 different thyristors now available from the industry's broadest, up-to-35-ampere thyristor line including these 8-ampere Motorola units: new 50-400 volt TRIACS, 50 to 600-volt Thermopad\* plastic

SCR's and the ever-popular, hermetic, 25 to 400-volt Elf\* devices (see circuit).

Try a Motorola thyristor / trigger combination today!

R. S. No. 162

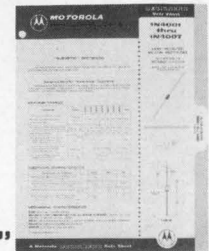

## NO "GUESSES" WITH NEW RECTIFIER SPEC

Undefined areas on either side of the old JEDEC rectifier-derating-curve method — often filled by confusing performance claims and promises by many manufacturers — have been eliminated with publication of the new Surmetic\* rectifier Designers Data Sheet\*.

Incorporating the new JEDEC method of defining a diode's capability in terms of lead length and temperature, the design aid shows the low-cost Surmetic to be capable of far more than its former, nominal 1-ampere-at-75°C rating. In fact, at 80°C, with leads clipped close to the body, it can easily handle over 2.5 amperes, resistive or inductive load!

Besides affording invaluable information on output current-temperature conditions, the Data Sheet provides a clear picture on both typical and maximum  $v_F$  vs  $i_F$ , surge ratings followed by full  $V_{RM}$ ,  $v_F$  at various junction temperatures, plus 10 other important, first-time device specs which permit the design of most circuits entirely from the information presented. Send for a copy now! Motorola Semiconductor Products Inc., Box 955, Phoenix, Arizona 85001. R. S. No. 163

\*Trademark of Motorola Inc.

†Annular Semiconductors are Patented by Motorola Inc.



**MOTOROLA Semiconductors**

*- where the priceless ingredient is care!*

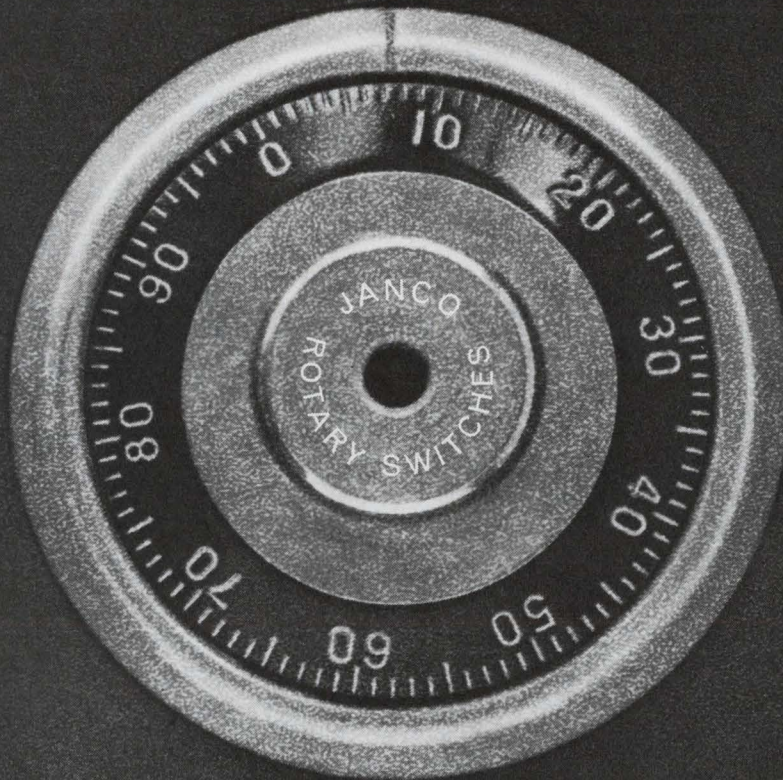

## WHAT IS THE RIGHT COMBINATION FOR YOU?

Janco Corporation's ability to build a quality, totally enclosed rotary switch stems from a concern to offer you the right combination.

It is this philosophy which permeates Janco's products, management, and customer relations. It is a credo which states that we owe the best combination of talents and materials to you and ourselves, and the end result is peace of mind for both of us. Peace of mind in knowing that the product we built, and you bought, will consistently perform to your requirements.

The right combination starts with the right materials... top quality materials. All Janco rotary switches are

insulated with glass filled alkyd for superior mechanical and electrical characteristics. Current conduction is handled by Beryllium copper and solid silver alloy contacts.

The finest materials in the world and the finest manufacturing techniques and equipment are worthless without the added combination of quality control... tight quality control. Janco has that control because all manufacturing steps are performed within its own plant. Tooling, investment casting, die stamping, component machining, plating and furnace brazing are all performed at Janco by specialists.

Another important ingredient that makes up the right combination for you, is customer service. Janco's data processing center keeps tabs on your order from development to delivery... on time delivery. A technically oriented rotary switch specialist is located in your area to service your requirements.

Remember, Janco builds a quality rotary switch... a switch that might cost a little more than the one you used yesterday, but it is the cost of quality that takes the problems out of tomorrow and gives the builder and the buyer peace of mind. Now, isn't that the right combination for you?

**JANCO**  
CORPORATION  
3111 Winona Avenue

ON READER-SERVICE CARD CIRCLE 32

**P&B DRY REED  
CLIP FILE**

**A dry reed  
relay makes this  
memory circuit  
do double duty...  
*faster,  
cheaper, longer***

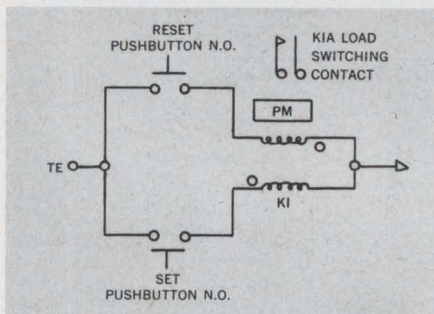

This double-duty circuit provides (1) memory and (2) switching from low level to 50 watts. Specify an inexpensive P&B dry reed relay and get high speed (in the low millisecond range), extremely long life (20 million operations) and compact size. Metal enclosures provide electrical shielding as well as physical protection for the coils and capsules.

**Full line—up to  
5 reeds per module**

JR standard size and JRM miniature reed relays are available in assemblies of 1 to 5 switches. Both sizes come in a complete range of coil voltages and various combinations of Forms A, B and C contact arrangement.

**Capsule seals are  
stress-protected**

Bobbin flange extensions support the terminal pins, providing stress protection of the capsule seals.

Send for a catalog giving complete specifications. Contact your local P&B representative or the factory direct for complete information.

P&B Dry Reed Relays are now available from authorized electronic parts distributors.



**POTTER & BRUMFIELD**  
Division of American Machine & Foundry Co.  
Princeton, Indiana 47570

ON READER-SERVICE CARD CIRCLE 33

# Letters

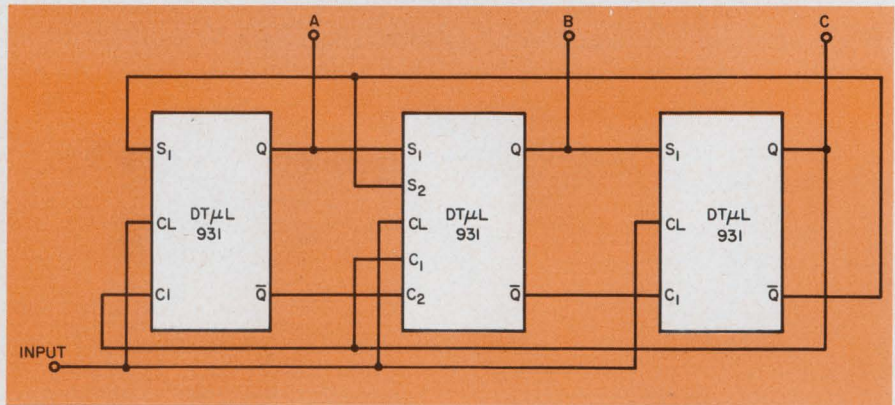

1. 'Moebius' counter will not lock up in subsequence.

## Three-phase generator may lock in subsequence

Sir:

The circuit shown on p. 106 of the April 12 issue of ELECTRONIC DESIGN [ED 8], "Generation of 3-phase square waves simplified," has a serious flaw and illustrates a problem commonly encountered in logic design. The circuit essentially consists of three dc flip-flops and associated gating, and can thus assume eight distinct states. Only six of these states are used in normal sequence, and careful examination will show that the remaining two states (A, B, C all high, or A, B, C all low) are possible and can form a two-state subsequence in which each output merely repeats the input clock.

The availability of circuits such as the Fairchild DTμL 931, which is a J-K flip-flop with two set gates and two clear gates, makes it possi-

ble to implement a three-bit "Möbius" counter (Fig. 1) in three packages which will not lock up in a subsequence. Another circuit (Fig. 2) can also be made with the same three flip-flops; it resembles the "Möbius" counter but follows a different procedure in escaping from the unused states. Both these circuits differ from the circuit in question in that they require an input clock at six times the output frequency, but they have the advantage that the clock need not have a 50-percent duty cycle.

Howard Hamer  
Leader, Engineers  
Paul Holtzman  
Associate Engineer

Astro Electronic Div.  
Radio Corp. of America  
Princeton, N. J

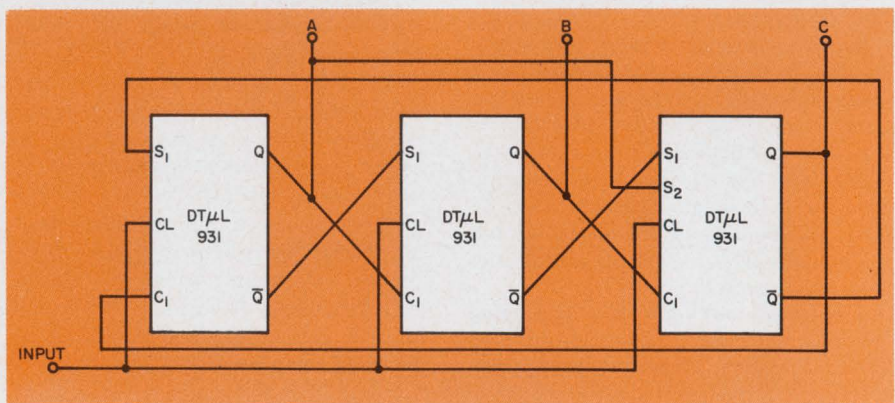

2. Twisted-ring counter also escapes unused states.



# NEW SHIELD-KON™ SHIELDED WIRE CONNECTOR

PAT. PENDING



ONE-PIECE WOBBLE ACTION CONNECTOR GATHERS AND LOCKS ALL STRANDS



Quick, Easy Insertion  
inner sleeve wobbles as braid  
and ground wire are inserted



Absolute Visual Inspection



Grounds from Front or Back



Easy Color-Coded Size Selection

● LOWERS INSTALLED COSTS ● RAISES RELIABILITY

## Shure-Stake<sup>®</sup> Tool and Unique Shield-Kon<sup>®</sup> Connector Combine To Achieve New Degree of Connection Reliability

The floating inner sleeve uniformly distributes the braid within the connector as shielded wire is inserted into connector. One squeeze of the T&B Shure-Stake hand tool and a noise-free, high-quality connection is completed. A qualified operator can't make a faulty crimp. More than a million dollars in Shure-Stake tooling research gives you T&B connector reliability.



See other side for more details

FIRST CLASS  
PERMIT NO. 2016  
ELIZABETH,  
NEW JERSEY

### BUSINESS REPLY MAIL

NO POSTAGE NECESSARY IF MAILED IN THE UNITED STATES

POSTAGE WILL BE PAID BY

The Thomas & Betts Co., Incorporated  
36 Butler Street  
Elizabeth, New Jersey 07207



400.5



# HARD INNER AND SOFT OUTER SLEEVES GIVE "TWO PIECE" RELIABILITY IN ONE CONNECTOR

Completely new and different connector design advances the reliability of shielded wire connectors. The "wobble-action" of the hard inner sleeve allows it to move when the shielded cable is inserted. The hard inner sleeve also protects the dielectric. The soft outer sleeve provides an excellent compression material. One squeeze of the T&B Shure-Stake Hand Tool and a noise-free, high-quality connection is completed, which meets the performance specifications of MIL-F-21608B. Equally important, these connectors reduce costs because of increased speed in installation.

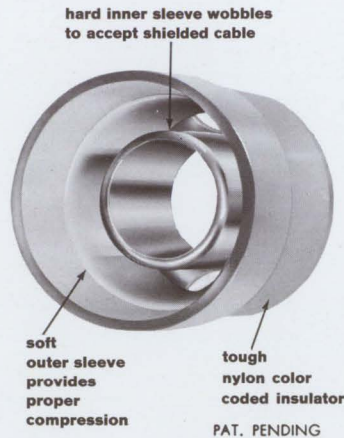

## NOW -- A SINGLE HAND TOOL ACCOMMODATES ALL GSW CONNECTORS



WT-440  
PATENTED

Snap-in dies now make it practical for a single tool to install different sizes of connectors. This light weight, aluminum hand tool features the Shure-Stake technique. Qualified operators can't make a faulty crimp — the tool will **not** release the connector until the compression stroke is properly completed.

### SELECTION TABLE FOR GSW SERIES SHIELD-KON™ CONNECTOR

CONNECTOR CAT. NO.	MAX. DIA. INNER DIELECTRIC	COLOR	COAXIAL CABLE
GSW-90	.053	Red	RG178A/U, RG178B/U, RG196/U
GSW-100	.058	Yellow	RG161/U
GSW-110	.075	Blue	RG174/U, RG179A/U, RG179B/U RG187/U, RG188/U
GSW-120	.096	Green	RG122/U
GSW-130	.120	Black	RG58/U, RG58A/U, RG58B/U, RG58C/U RG141/U, RG141A/U, RG180/U, RG180A/U RG195/U
GSW-150	.130	Green	RG55/U, RG55A/U, RG55B/U, RG142/U, RG142A/U, RG223/U
GSW-160	.151	Red	RG59/U, RG59A/U, RG59B/U RG62/U, RG62A/U, RG62B/U RG124/U, RG140/U, RG210/U
GSW-180	.170	Blue	RG71/U, RG71A/U, RG71B/U, RG108/U
GSW-200	.202	Yellow	RG54A/U, RG126/U, RG143/U, RG143A/U

SOLD COAST-TO-COAST THROUGH AUTHORIZED T & B DISTRIBUTORS

I am interested in learning how Shield-Kon™ connectors can reduce costs and improve reliability.

- Please send me Publication 400.1.
  - Please have a T&B sales specialist call for appointment.
- My interest is: immediate  future  general .

NAME ..... TITLE .....

COMPANY ..... DEPT. ....

ADDRESS ..... PHONE .....

CITY ..... STATE ..... ZIP .....

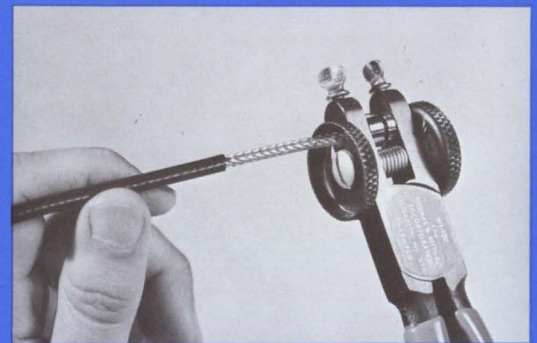

### EASY STRIPPING

Insert — lock — squeeze — open — you have cleanly stripped shielded cable the modern way with T & B WT-700 STRIPPING TOOL.

PATENTED

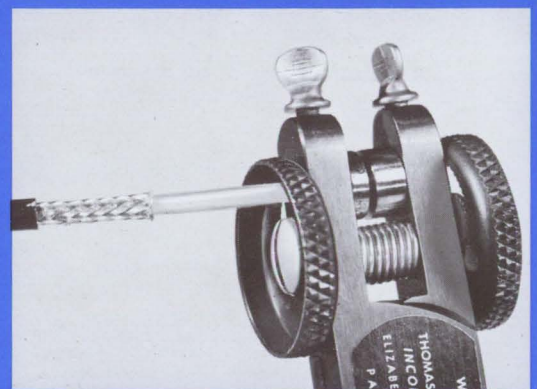

THE THOMAS & BETTS COMPANY, INC.  
36 Butler Street • Elizabeth, N. J. 07207  
In Canada, Thomas & Betts Ltd. • Iberville, P.Q.



**THOMAS & BETTS**

### British research solves cps-to-Hz conundrum

Sir:

Further to the brilliant nomograph published in your April 1 issue to convert Hz to cps [Letters column, ED 7, p. 37], we tentatively offer this formula for the conversion of cycles per second into hertz:

$$F = f \left[ \frac{\cosh f \sqrt{1 - \tanh^2 f}}{\sin^2(\epsilon^{-\pi f}) + \cos^2(\epsilon^{-\pi f})} \right],$$

where:

$F$  = frequency in Hz,  
 $f$  = frequency in cps.

Extensive experimental verification of the law on which this equation is based is on record. Prospects seem good that present large-scale research efforts will further clarify and simplify the problem.

Han de Mann

Dynamics Group  
 The Plessey Co., Ltd.  
 Ilford, England

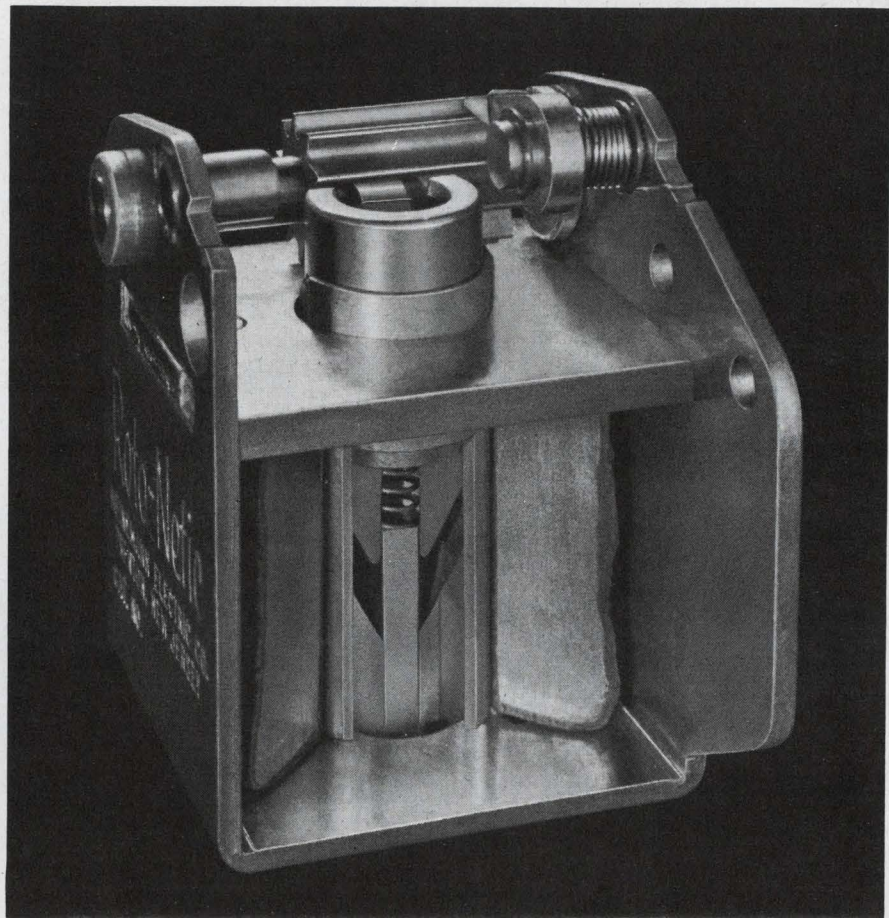

**Nobody ever built a stepping motor this way before.**

### Accuracy is our policy

In "Make a filter out of an oscillator," ED 10, May 10, 1967, pp. 56-58, a printer's error garbled Eq. 8 on p. 57. It should read:

$$\lim_{A \rightarrow \infty} (e_3/e_1) = -(1/RCs).$$

In the Idea for Design, "Spst switch reverses PM dc motor rotation," ED 9, April 26, 1967, p. 245, a jumper was omitted between the collectors of Q2 and Q4 in the schematic. The corrected schematic is published below:

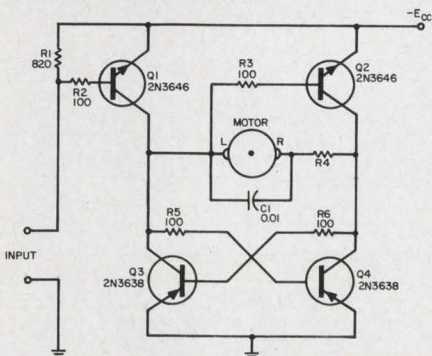

### Or sold one for so little.\*

A stepping motor has always been a rotary motor that steps. With all the design and manufacturing difficulties that implies. Precision bearings, dynamic balance, and the like. Incremental rotation calls for detents, springs, balls. Or magnetic braking. Then there's the axial thrust problem. Not surprisingly, you pay a lot of money for a rotary motor that steps.

Our picture shows a stepping motor that is not a rotary motor. It's a solenoid in disguise. A spring-loaded armature actuates a ratchet and pawl mechanism. Mechanically, that's all there is to it.

But functionally, there's a great deal more. For example, there's a double-ended shaft that lets you choose the direction of output rotation. An output torque of 0.1 inch-pounds. A ten-step star wheel (very handy for decade functions). A standard stepping speed of 600 steps/min.

There's still more, but we'll save it until you ask—either for Bulletin 701, which is free, or for a sample motor, which costs ten dollars. If you'd like the sample, please let us know whether you want the 12 VDC or 115 VAC model. Heinemann Electric Company, 2616 Brunswick Pike, Trenton, N.J. 08602.



\*\$8, to OEM's, in quantities of 100 to 499.



**HEINEMANN**

ON READER-SERVICE CARD CIRCLE 35

# TRW TRANSISTORS announces another member of the Gigahertz family

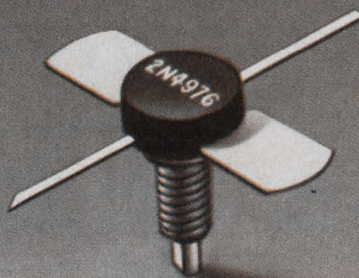
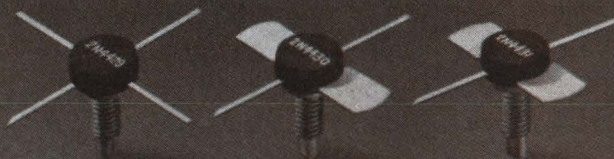

1 Watt  
**2 GHz**

8-32

## 1 Watt output ... 5dB gain!

TRW again breaks the Gigahertz barrier with this new 2 GHz addition to the TRW family of Ultra High Frequency transistors! They are the finest broadband transistors you can buy—the only power transistors capable of GHz operation in simple, straight through circuits.

As doublers or triplers these transistors will reach 3 GHz with cool efficiency. In the 600 to 700 MHz range their gain and efficiency are phenomenal!

And you get this remarkable performance from a 28 volt power source, 1 Watt output, 5 dB gain!

Contact any TRW distributor or TRW Semiconductors Inc., 14520 Aviation Blvd., Lawndale, Calif. 90260. Phone: 213-679-4561. TWX: 910-325-6206. *TRW Semiconductors is a subsidiary of TRW INC.*

# TRW

ON READER-SERVICE CARD CIRCLE 36



**Co-Publishers**

James S. Mulholland, Jr.  
Robert E. Ahrens Dorf

**Editorial Director**

Edward E. Grazda

**Editor**

Howard Bierman

**Managing Editor**

Robert C. Haavind

**Technical Editors**

Jeffrey N. Bairstow  
Peter N. Budzilovich  
Maria Dekany  
Roger K. Field

**News Editors**

Ralph Dobriner, Chief  
Richard N. Einhorn

**East Coast Editor**

Neil Sclater

**West Coast Editor**

Ron Gechman

**Copy Editor**

Peter Beales

**New Products Editors**

David H. Surgan  
Daniel R. Butterly

**Washington Editor**

S. David Pursglove

**Editorial Production**

Dollie S. Viebig  
Karen L. Sherman

**Art Director**

Clifford M. Gardiner

**Art Assistant**

William Kelly

**Technical Illustrators**

Cheh Nam Low  
William Alvarez  
Sheila F. Ward

**Production Manager**

Thomas V. Sedita

**Asst. Production Manager**

Helen De Polo

**Production Assistants**

Bernard Wolinsky  
Robert B. Lichtig

**Circulation Manager**

Nancy L. Merritt

**Reader Service**

Diane Mandell

**EDITORIAL**

## Whom do the car makers think they are kidding?

There has been considerable static in the last half year about the imminent rebirth of the electric car. Ford has announced the development of a sodium-sulphur cell that could power an electric vehicle. General Motors has reported that a modified Corvair, packed with silver-zinc cells, attained speeds of 80 miles an hour. Sound promising?

Ford ballyhooed the battery without ballyhooing the fact that it must be heated to 500°F before it can power even an electric toothbrush. Imagine tooling around town alongside batteries that contain gallons of boiling sodium and molten sulphur!

General Motors noted only casually that the silver-zinc batteries in its experimental Corvair were not now competitive with the gasoline engine. Well, they cost only about \$14,000. And they can be recycled a little over a hundred times!

Who's kidding whom? The auto makers are making a big production of their electric cars in the press without the inconvenience of planning any production of the cars themselves. Their announcements, one must conclude, are intended to convey more image-building weight than chassis weight.

For years the Big Three in Detroit have put their big money into flashy annual body-style changes. As insurance, they have doled out dribs and drabs to investigate alternative power sources—just in case some audacious innovator should get the notion he might like to compete.

The potential for the electric car is still promising, many authorities feel, particularly since it offers hope of alleviating the growing pollution of air over the nation's major cities. And it's just possible that the innovators could beat the auto manufacturers at their own game. After all, battery power is the legitimate concern of the electronics industry.

The first steps have already been taken. Westinghouse is marketing a two-motor electric town car. General Electric is testing an electric prototype in Florida. General Dynamics' General Atomic Div. is developing a rechargeable air-zinc battery. Gulton Industries has made a rechargeable, high-charge-density lithium battery.

Will mass production of automobiles emerge from the electronics industry? In an age of increasing diversification, that might not be as far-fetched as it sounds.

ROGER KENNETH FIELD

# Tektronix Type 1S1

## DC-to-1 GHz

### Sampling Plug-in Unit

for your  oscilloscope  
that accepts letter and  
1-series plug-ins

Here's a new dc-1 GHz sampling unit with operation practically as simple as conventional plug-ins—as you can see by the front panel of the sampling plug-in. You need no pretriggers or external delay lines—the 1S1 unit has internal triggering with a built-in delay line.

Many other features add to the capabilities and operating ease of the Type 1S1, such as: A tunnel-diode trigger circuit that insures stable triggering through 1 GHz • A single control to select the sweep rate and magnify the display up to X100 when desired • Direct readout of the sweep rate even when magnified • A dc-offset control that permits observation of millivolt signals in the presence of up to  $\pm 1$  volt input levels • Less than 1 mV noise in the display, with a smoothing control for further reduction • Output signals available at the front panel for driving chart recorders—and for powering an auxiliary time domain reflectometer pulser unit.

#### BASIC CHARACTERISTICS

RISETIME  $\leq 0.35$  ns. SENSITIVITY from 2 mV/cm through 200 mV/cm, in 7 steps. DYNAMIC RANGE  $\pm 2$  V. Safe overload is  $\pm 5$  V. DC OFFSET range is greater than  $\pm 1$  V. SWEEP RATES from 100 ps/cm to 50  $\mu$ s/cm, with  $\pm 3\%$  accuracy normal or magnified. SAMPLES/CM continuously variable. TRIGGERING ac-coupled,  $\pm$  internal,  $\pm$  external, and free run. DISPLAY MODES are repetitive, single display, manual scan, or external scan. VERTICAL OUTPUT is 200 mV per displayed cm through 10 k. HORIZONTAL OUTPUT is 1 V per displayed cm through 10 k.

Type 1S1 Sampling Plug-In Unit . . . . . \$1100  
Type 281 TDR Pulser Unit . . . . . \$95

U.S. Sales Prices, f.o.b. Beaverton, Oregon

For a demonstration,  
call your Tektronix field engineer.

## Tektronix, Inc.

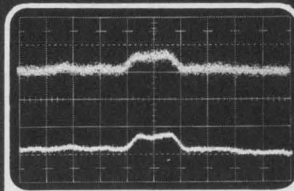

**Tangential Noise**  
Display of a 1 mV, 2 ns wide pulse, externally triggered. Upper waveform is unsmoothed, the lower is smoothed.  
2 mV/cm—1 ns/cm

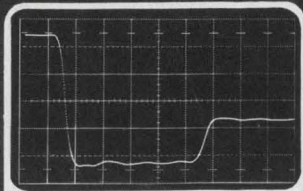

**Time Domain Reflectometry (TDR)**  
Display (with 281 Pulser) of 50  $\Omega$  system, with transition to a 25  $\Omega$  system. Any portion of the display can be expanded vertically and horizontally for more detailed analysis.  
100 mV/cm—5 ns/cm

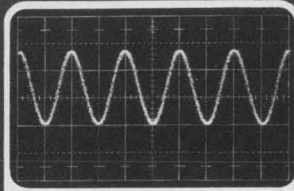

**Triggering At 1 GHz**  
Display of a 1 GHz sine wave internally triggered  
100 mV/cm—0.5 ns/cm

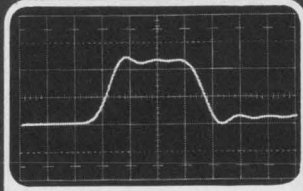

**Pulse Triggering**  
Display of a 50 mV, 2 ns wide pulse, internally triggered.  
20 mV/cm—0.5 ns/cm

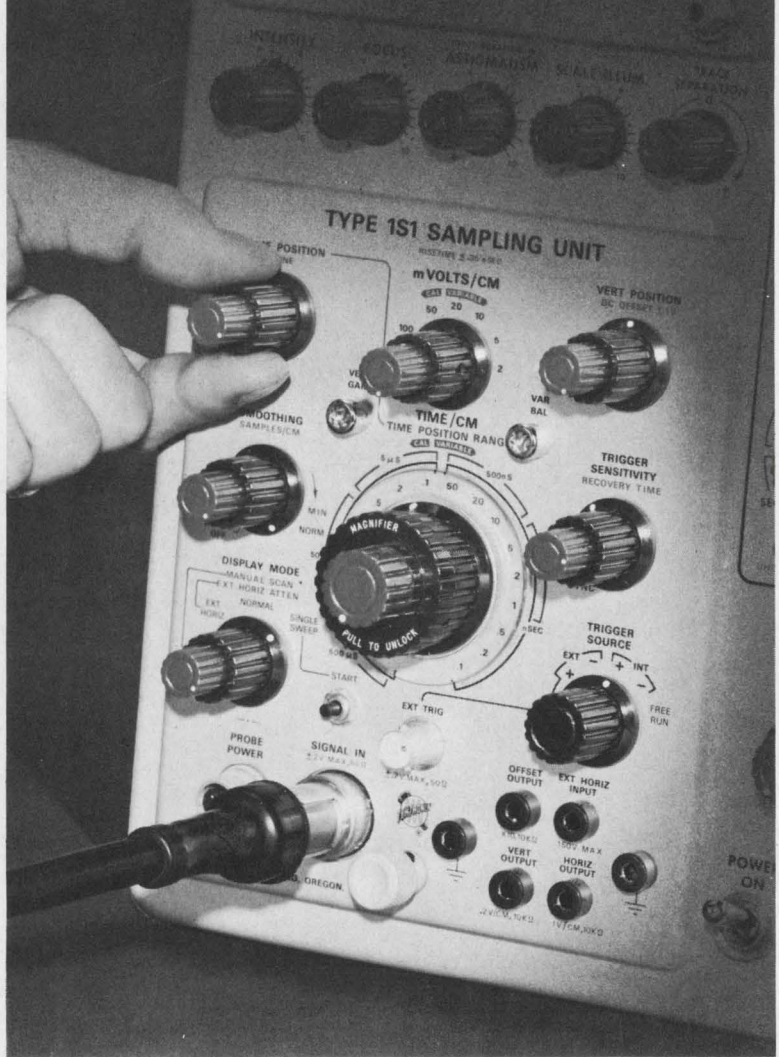

# Technology

1.3250E 01	1.01135E 00
1.3500E 01	9.94709E-01
1.3750E 01	9.77753E-01
1.4000E 01	9.61233E-01
1.4250E 01	9.45833E-01
1.4500E 01	9.32156E-01
1.4750E 01	9.20694E-01

The choice of a good semiconductor model and assignment of proper numerical values

to model parameters are keys to success in computer-aided analysis of a circuit. Page 54

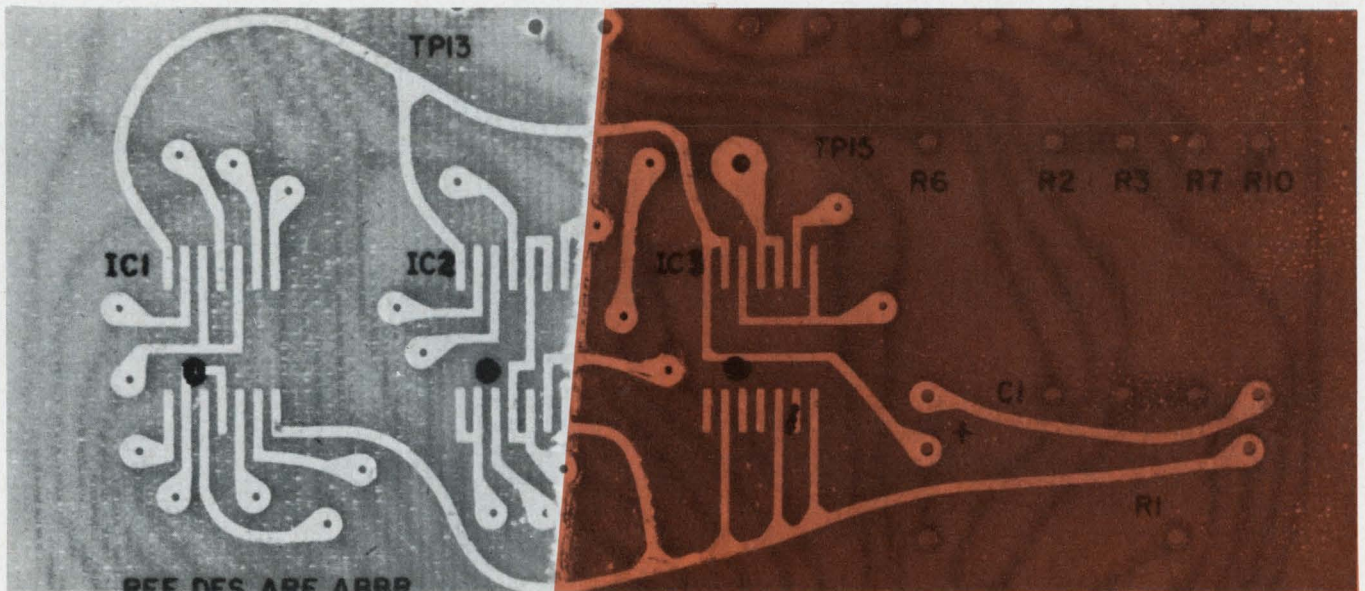

Removing the cured plastic encapsulant from components without damaging them can be

done by 3 methods: mechanical, thermal or chemical. The three are compared on p. 62

## Also in this section:

Varactor selection for voltage tuning is simplified by three nomograms. Page 72

Addenda to ELECTRONIC DESIGN's 1967 Semiconductor Directory. Page 83

Copper costs may be cut by the use of aluminum strip for conductors. Page 86

# Use a good switching transistor model

in computer analyses of circuits. Overcomplex models waste computer time; oversimple ones give inaccurate results.

## *Part 1 of a three-part series*

For all its advantages, the computer analysis of a circuit can be no better than the data that are fed into it. Poor models or improperly assigned values yield inaccurate results. In fact, once a circuit analysis program is running on a computer and the designer has developed the skill to use it, the choice of semiconductor models and the procedures for finding numerical values for the models' parameters are the main stumbling blocks to applying the program.

Whether the designer performs the computer analysis himself or has it done by a service organization, he needs to understand the semiconductor

***“... the computer analysis of a circuit can be no better than the data that are fed into it.”***

models and the methods of deriving numerical values. This series aims to fill that need.

### **How device characteristics are obtained**

Transistor or diode characteristics can be obtained in two different ways, depending on how the computer calculations of circuit behavior are being used. Either measurements from actual devices can be used or appropriate characteristics may be assumed.

If it is desired to simulate a particular diode or transistor that is on hand, its performance can be measured and the device constants to be used by the computer can be derived from those measured characteristics. This is done, for example, when characterizing “typical” values for devices or for component parts of an integrated circuit.<sup>1</sup>

If it is desired to simulate a transistor or diode

that has certain assumed characteristics, the assumed characteristics are used to derive the constants. They are used for worst-case or statistical analyses of limit circuits, because normally no transistor or diode that combines all the desired characteristics is available. Assumed limit characteristics are generally obtained from extrapolations of the limit characteristics given on the specification sheets. Alternatively, use may be made of the measured characteristics of several different devices of the same type, each of which is the “limit” for a particular performance characteristic such as  $h_{FE}$ ,  $f_T$ ,  $C_{ob}$ .

Assumed characteristics are also used in parameter variation analyses, where the variation of circuit performance with device parameters is under investigation. A third use for assumed characteristics is to predict the performance of a circuit with hypothetical transistor or diode parameters, to determine whether it is worth attempting to build it. Yet another use is to “try out” a device when its specification sheet with assumed characteristics is available but the actual device is not.

References to the characteristics or measured characteristics of a transistor or diode can hereaf-

***“Beware of data-sheet curves that are artistically attractive but cannot be read to a precision of a few millivolts.”***

ter be taken to mean either the measured or the assumed characteristics, whichever is appropriate to the use that is being made of the computer analysis.

The parameters of a real switching transistor or real diode vary as functions of voltage, current, and temperature. Modeling is most accurate when the device characteristics are measured under conditions of voltage, current and junction temperature similar to those under which the device is expected to operate. Storage time, for example,

---

**Nathan O. Sokal**, President, **Joseph J. Sierakowski**, Senior Engineer, Design Automation, Inc., Lexington, Mass., and **Jonathan J. Sirota**, Vice-President, Memory Technology, Inc., Waltham, Mass.

should be measured at the intended operating temperature with approximately the intended values of base turn-on and turn-off and collector currents flowing. Similarly, when the equations given later are used, all conditions for a given device should be consistent. The gain and junction voltages specified and used, for instance, should be ones that are valid for the temperature specified. Thus a low-temperature value of gain should not be used with a high-temperature value of junction voltage.

The nonlinear transistor and diode models discussed can simulate the devices' dc characteristics more accurately than the characteristic curve given in many manufacturers' data sheets. Beware of data-sheet curves that are artistically attractive but cannot be read to a precision of a few millivolts.

### The calculated- and measured-parameter gap

Sometimes calculated constants are not numerically identical to values measured experimentally, particularly for constants that are difficult to measure, are defined in several ways, or vary significantly over the operating range, such as  $R_{BB}$  and  $F_n$ , the base ohmic series resistance<sup>2</sup> and the normal-mode intrinsic gain-bandwidth product, respectively. There are a number of reasons for this.

***"The device parameter used by the computer is a mathematical abstraction of complex voltage-current-time relationships inside the device."***

The experimental measurement frequently yields a value that depends strongly on the method of measurement. The device parameter used by the computer is a mathematical abstraction of complex voltage-current-time relationships inside the device. The experimental method also assumes a mathematical abstraction yielding a single number to describe complex relationships, but the measurement technique may depend on a different abstraction from that used by the computer. Furthermore, the constants are given values such that the specified characteristics of the device are matched by the mathematical effect of all the constants working together in the equations used by the computer. Values of parameters are chosen to compensate for variations in a "constant" over the device's voltage and current operating range so that a good numerical match is obtained; e.g., a slight increase in  $R_{BB}$  and  $R_{EE}$  can be used to match the effect of an increase in the "constant"  $M_E$  at high current,<sup>3</sup> although the model equations

assume that  $M_E$  is independent of current.

### Which switching transistor model?

The nonlinear Ebers-Moll models<sup>4,5</sup> that are used in *NET-1 Network Analysis Program*<sup>6</sup> have been selected for specific examples of nonlinear models for these reasons:

- NET-1 is a reliable, mature program that can be run on five different, popular IBM computers (7040/44, 7090/94, and the 360/65 with 7094 emulator).

- The models used by NET-1 are a good compromise between complexity (for accurate simulation) and simplicity (for reasonable computing speed and size of memory, and for comprehension and manipulation by the user).

- The models used by NET-1 are complete enough for most of the numerical-value assignment methods described to be adapted easily to the nonlinear and linear models used by other programs.

The model descriptions are taken from the NET-1 manual of Malmberg, Cornwell and Hofer.<sup>7</sup>

The transistor and diode models used in NET-1 cover both small-signal linear and large-signal nonlinear operation. They account for both ac and dc components. Small-signal parameters are varied automatically as functions of the operating currents and voltages. The transistor model covers all four modes of operation: off, active normal, active inverted, and saturated; the diode model covers both on and off modes. Thirty-one constants are used to provide accurate modeling of transistor behavior, including nonlinearities and most departures from the ideal. Ten constants model diode behavior. The transistor model and its constants are explained so that the user will know how the constants influence device behavior and how to manipulate them to change device characteristics in any way desired.

***"... the user will know how the constants influence device behavior and how to manipulate them to change device characteristics in any way desired."***

The transistor model used is the universally accepted Ebers-Moll model<sup>8,9</sup> with additions. All commonly used models are either mathematically equivalent<sup>10</sup> to the Ebers-Moll model (e.g., the Linvill model<sup>11</sup> and the Beaufoy-Sparkes model<sup>12</sup>) or are less accurate ones which result from simplifications aimed at making manual calculation feasible (e.g., the various simplified "charge-control" models).<sup>13,14,15</sup> The limitations of manual calculation, however, are irrelevant to high-speed computer calculation, so the full Ebers-Moll

## Table: Transistor constants

Symbol	Brief description	Sign	Usual units
$R_{BB}$	Base ohmic series resistance	+	Kilohms
$R_{EE}$	Emitter ohmic series resistance	+	Kilohms
$R_{CC}$	Collector ohmic series resistance	+	Kilohms
$R_E$	Emitter-base junction ohmic leakage resistance	+	Kilohms
$R_C$	Collector-base junction ohmic leakage resistance	+	Kilohms
$I_{ES}$	Emitter-base diode saturation current at the operating junction temperature	+	Milliamperes
$I_{CS}$	Collector-base diode saturation current at the operating junction temperature	+	Milliamperes
$M_E$	Emission constant for emitter-base diode	+	Dimensionless
$M_C$	Emission constant for collector-base diode	+	Dimensionless
$T$	Junction absolute temperature	+	Degrees Kelvin
$B_N$	Peak normal-mode current gain	+	Dimensionless
$A_1$	Normal-mode gain curve shape constant	+ (in NET-1)	Dimensionless
$A_2$	Normal-mode gain curve shape constant	+ or -	Volts <sup>-1</sup>
$A_3$	Normal-mode gain curve shape constant	+ or -	Volts <sup>-2</sup>
$A_4$	Normal-mode gain curve shape constant	+ or -	Volts <sup>-3</sup>
$B_I$	Peak inverted-mode current gain	+	Dimensionless
$B_1$	Inverted-mode gain curve shape constant	+ (in NET-1)	Dimensionless
$B_2$	Inverted-mode gain curve shape constant	+ or -	Volts <sup>-1</sup>
$B_3$	Inverted-mode gain curve shape constant	+ or -	Volts <sup>-2</sup>
$B_4$	Inverted-mode gain curve shape constant	+ or -	Volts <sup>-3</sup>
$*V_{ZE}$	Emitter-base junction contact potential	+	Volts
$*N_E$	Emitter-base junction grading constant	+	Dimensionless
$*D_1$	Emitter-base transition capacitance proportionality constant	+	_____
$*D_2$	Collector-base transition capacitance proportionality constant	+	_____
$*V_{ZC}$	Collector-base junction contact potential	+	Volts
$*N_C$	Collector-base junction grading constant	+	Dimensionless
$*F_n$	Normal-mode intrinsic gain-bandwidth product	+	Gigahertz
$*F_i$	Inverted-mode intrinsic gain-bandwidth product	+	Gigahertz

\*Not used in dc steady-state calculations.

model is used with the following additions:

- The  $M$  (sometimes called  $\eta$  or  $\lambda$ ) emission constant<sup>16</sup> accounts for departures from the  $q/kT$  exponent in the junction forward-conductance characteristic,  $I = I_s(\epsilon^{qv/MkT} - 1)$ .

- The emitter and collector transition and diffusion capacitances are always considered, with junctions biased either off or on. This partly accounts for the apparent  $f_T$  decrease and storage time-constant increase at low currents when those junctions are forward biased. Both phenomena are experimentally observed.

- Transition capacitances vary with junction voltages, and diffusion capacitances are proportional to junction emitted currents.

- Emitter, base, and collector bulk and contact resistances and base spreading resistance are always accounted for, adding components to the intrinsic junction voltages.

- Emitter and collector junction ohmic leakages are always accounted for.

- Both the normal and the inverted current gains can be made functions of the transistor currents.

**“... the designer ... needs to understand the semiconductor models and the methods of deriving numerical values.”**

Junction breakdown, base-narrowing, conductivity modulation and automatic change of junction temperature as a result of power dissipation are not included in the NET-1 model.

### The transistor equivalent circuit

A transistor is represented by the lumped-parameter T equivalent circuit shown in the figure. A pnp transistor is used for illustration; an identical model, with  $v_1$  and  $v_2$  changed in polarity,

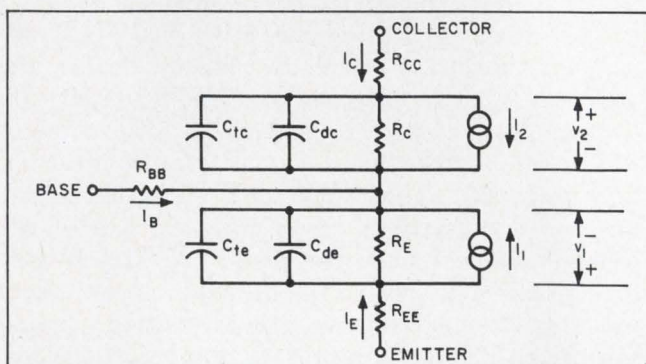

This pnp equivalent circuit can be used for a npn simply by changing the polarity of  $v_1$  and  $v_2$ , the emitter-base and collector-base voltages, respectively.

ty, is used for npn transistors. (Junction voltage polarities are so defined that a positive number signifies forward bias for both npn and pnp. Similarly, current into a transistor terminal is defined as positive.)  $v_1$  and  $v_2$  are the emitter-base and collector-base junction voltages, respectively.

The transistor resistances used are:

$R_{BB}$ —the base spreading, bulk, and contact resistance;

$R_{EE}$ —the emitter bulk and contact resistance;

$R_{CC}$ —the collector bulk and contact resistance;

$R_E$ —the emitter-base junction ohmic leakage resistance;

$R_C$ —the collector-base junction ohmic leakage resistance.

### Transistor current generators

Current generators  $I_1$  and  $I_2$  are across the emitter-base and collector-base junctions, respectively. Both  $I_1$  and  $I_2$  are the sums of two currents:

$$I_1 = I_{EF} - \alpha_I I_{CF}, \quad (1)$$

$$I_2 = I_{CF} - \alpha_N I_{EF}, \quad (2)$$

where:

$$I_{EF} = [I_{ES}/(1 - \alpha_N \alpha_I)] [\epsilon^{qv_1/M_E kT} - 1], \quad (3)$$

$$I_{CF} = [I_{CS}/(1 - \alpha_N \alpha_I)] [\epsilon^{qv_2/M_C kT} - 1]. \quad (4)$$

$I_{EF}$  and  $I_{CF}$  are the currents emitted from the emitter and collector, respectively.  $\alpha_N I_{EF}$  is that portion of the current emitted from the emitter that is collected by the collector.  $\alpha_I I_{CF}$  is that portion of the current emitted from the collector that is collected by the emitter.

Also in Eqs. 1 through 4:

$\alpha_N$  = common-base normal-mode dc current gain,

$\alpha_I$  = common-base inverted-mode dc current gain,

$I_{ES}$  = emitter-base diode saturation current,

$I_{CS}$  = collector-base diode saturation current,

$q$  = electron charge,

$k$  = Boltzmann's constant,

$T$  = junction absolute temperature (in °K),

$M_E$  = emission constant for emitter-base diode (the factor by which the junction voltage and the emitter dynamic resistance are larger than the ideal values given by  $qv_1/kT$ ),

$M_C$  = emission constant for collector-base diode (similar to above).

The emitter dynamic resistance at a particular forward-bias operating point is often of interest and can be found from Eq. 3:

$$r_e = \partial v_1 / \partial I_E$$

$$\approx M_E (kT/q) \frac{1}{I_{EF} + [I_{EF}/(1 - \alpha_N \alpha_I)]}$$

$$\approx M_E (kT/q) (1/I_E)$$

$$= 0.0257 M_E / I_E \text{ at } 25^\circ\text{C.}$$

In the inverted mode the emitter-base junction is reverse biased and the collector-base junction is forward biased. Thus the emitter and the collector are interchanged with respect to the normal-mode connections. (Both junctions of the transistor are assumed to be at the same temperature.)

### Transistor current gains

For ease of specification and use, the common-emitter dc current gains,  $\beta_N$  and  $\beta_I$ , can be specified instead of the common-base current gains,  $\alpha_N$  and  $\alpha_I$ . The relations between  $\alpha$  and  $\beta$  are:

$$\alpha_N = \beta_N / (\beta_N + 1), \quad (5)$$

$$\alpha_I = \beta_I / (\beta_I + 1). \quad (6)$$

The current gains,  $\beta_N$  and  $\beta_I$ , can be fitted well as functions of the logarithms of the emitter currents. This can be verified by observing that typically a semilogarithmic plot of  $\beta_N$  (linear scale) vs  $I_E = I_C [1 + (1/\beta_N)]$  (logarithmic scale) is almost a straight line over a range of  $I_E$  of some two to three orders of magnitude. The junction voltages  $v_1$  and  $v_2$  are proportional to the logarithms of these currents (Eqs. 3 and 4). These voltages can therefore be used as the independent variables, just as well as the logarithms of the currents can, for fitting the variation of  $\beta$  with current. Moreover,  $v_1$  and  $v_2$  are convenient for computational purposes because their values are already known and stored as a result of calculating the circuit voltages.

The variation of  $\beta_N$  and  $\beta_I$  with current can thus be modeled as:

$$\beta_N = B_N (A_1 + A_2 v_1 + A_3 v_1^2 + A_4 v_1^3), \quad (7)$$

$$\beta_I = B_I (B_1 + B_2 v_2 + B_3 v_2^2 + B_4 v_2^3). \quad (8)$$

In Eqs. 7 and 8 the functions inside the parentheses are shaped functions which can be made to have peak values of unity for convenient normalization, if desired.  $B_N$  and  $B_I$  then specify the peak magnitudes of the current-gain curves.

***“The limitations of manual calculation, however, are irrelevant to high-speed computer calculation.”***

To ignore the shape function and have a constant value of  $\beta_N$ , not dependent on current, the user can simply set  $A_1 = 1.0$ ,  $A_2 = A_3 = A_4 = 0$ , and  $B_N =$  the desired constant value of  $\beta_N$ . The same can be done for  $\beta_I$  and its constants,  $B_1, B_2, B_3, B_4, B_I$ .

### Transistor transition capacitances

The emitter-base transition capacitance,  $C_{te}$ , is a function of the emitter-base junction voltage,  $v_1$ :

$$C_{te} = D_1 / (V_{ZE} - v_1)^{N_E}, \quad (9)$$

where:

$D_1 =$  proportionality constant,

$V_{ZE} =$  emitter-base junction contact potential (a positive number),

$N_E =$  emitter-base junction grading constant,

$v_1 =$  reverse bias (a negative number).

The collector-base transition capacitance,  $C_{tc}$ , is a function of the emitter-base junction voltage,  $v_2$ :

$$C_{tc} = D_2 / (V_{ZC} - v_2)^{N_C}, \quad (10)$$

where:

$D_2 =$  proportionality constant,

$V_{ZC} =$  collector-base junction contact potential (a positive number),

$N_C =$  collector-base junction grading constant,

$v_2 =$  reverse bias (a negative number).

### Transistor diffusion capacitances

$C_{de}$  and  $C_{dc}$  are the emitter-base and collector-base diffusion capacitances, respectively. They are small-signal capacitances that are functions of the junction currents.

The emitter-base diffusion capacitance,  $C_{de}$ , is a function of the current emitted by the emitter,  $I_{EF}$ :  $C_{de} = q \{ I_{EF} + [I_{ES} / (1 - \alpha_N \alpha_I)] \} / 2\pi M_E k T F_n$ , (11) where  $F_n$  is the normal-mode gain-bandwidth product of the intrinsic transistor. This is the gain-bandwidth product that would be measured if it were possible to eliminate the transition capacitances and the extrinsic and stray resistances and capacitances.

The transistor frequency response (or switching time) is determined primarily by the 3-dB frequency (or time constant) of the diffusion capacitance and the junction dynamic resistance. Both these parameters vary with junction current but their product (time constant) is a constant:

$$r_e C_{de} = 1 / 2\pi F_n.$$

The collector-base diffusion capacitance,  $C_{dc}$ , is a function of the current emitted by the collector,  $I_{CF}$ :

$$C_{dc} = q \{ I_{CF} + [I_{CS} / (1 - \alpha_N \alpha_I)] \} / 2\pi M_C k T F_i, \quad (12)$$

where  $F_i$  is the inverted-mode gain-bandwidth product of the intrinsic transistor.

The effective gain-bandwidth products are smaller than the intrinsic values because the diffusion capacitances are paralleled by transition capacitances. Effective gain-bandwidth product is inversely proportional to the total of diffusion plus transition capacitance. The shunting effects are most severe at low currents, where the diffusion capacitances are small; they are less so at high currents, where the diffusion capacitances are large compared with the transition capacitances. In the low-current region, the effective gain-bandwidth product will be proportional to emitted current, as is shown if Eq. 11 is solved for  $F_n$ . This is because the diffusion capacitance is



small, and the transition capacitance—and hence total capacitance—is virtually constant.

Table 1 summarizes all the transistor constants used in the preceding equations. Any self-consistent set of units can be used: e.g., kilohms, picofarads, milliamperes, volts, nanoseconds, gigahertz; or ohms, farads, amperes, volts, seconds, hertz; or ohms, microfarads, amperes, volts, microseconds, megahertz. The messages printed by NET-1 are based on the first set.

### Special features and limitations of the models

NET-1 contains several special features in the use of the transistor and diode models that are helpful to the engineer. It also has restrictions which must be understood.

NET-1 calculates the absolute temperature,  $T$ , in degrees Kelvin, when the user specifies temperature in degrees Celsius (formerly called centigrade) as the parameter TEMP. NET-1 does not, however, automatically vary junction temperature with device dissipation, nor does it vary junction saturation currents as a function of junction temperature. Thus the user must specify a junction temperature that takes account of the expected junction heating, and must specify a saturation current appropriate to the chosen temperature. Each device can have its temperature specified independently of all others; both junctions of a transistor are assumed to be at the temperature that is specified.

NET-1 automatically calculates  $D_1$  and  $D_2$  in the transition capacitance formulas for the tran-

***“Thus the user must specify a junction temperature that takes account of the expected junction heating, and must specify a saturation current appropriate to the chosen temperature.”***

sistor model (Eqs. 9 and 10), if the user specifies measured values, called  $C_{me}$  and  $C_{mc}$ , respectively, at test voltages called  $V_{TE}$  and  $V_{TC}$ , respectively.

In evaluating the gains  $\beta_N$  and  $\beta_I$  as functions of current (Eqs. 7 and 8), NET-1 automatically limits the values of  $v_1$  or  $v_2$  inserted in the equations to between zero and a constant  $A$ . If  $v_1$  or  $v_2$  is negative, it will be assumed to be zero for Eqs. 7 and 8; if  $v_1$  or  $v_2$  is greater than  $A$ , it will be assumed to be  $A$ . This allows the gain to be made constant for currents greater than some desired value corresponding to junction voltage  $A$ .

The coefficients  $A_1$ - $A_4$  and  $B_1$ - $B_4$  must be so chosen that  $\beta$  is never allowed to be negative at any value of current that the computer may encounter during calculation. Otherwise  $\beta$  variation

may cause the computer to halt without any diagnostic printout.

***“The NET-1 program checks the device operation in both dc and transient analyses.”***

In addition to the electrical constants discussed, NET-1 permits specification of five additional constants for the transistor, and three for the diode, for the maximum voltage, current, and power ratings of the devices. These are  $V_{CE}$ ,  $V_{BE}$ ,  $V_{CB}$ ,  $I_C$  and  $P$  for the transistor, and  $I_F$ ,  $V_R$  and  $P$  for the diode. The NET-1 program checks the device operation in both dc and transient analyses to see if any of the maximum ratings is approached in dc analyses, or if any voltage or current rating is exceeded in transient analyses. A message appears in the computer printout if any of these conditions occurs.

How numerical values are assigned to the transistor model and how to detect and correct inaccuracies in the input data will be covered in Part 2 of this article, in the next issue. Part 3, in the following issue, describes model construction and the assignment of numerical values for diodes. ■ ■

### References:

1. Philip Spiegel, “Design a Better Integrated Circuit,” *ELECTRONIC DESIGN*, XV, No. 4 (Feb. 15, 1967), 78-81.
2. P. Spiegel, “Transistor Base Resistance and Its Effect on High-Speed Switching,” *Solid State Design*, VI, No. 12 (Dec., 1965), 15-18.
3. G. C. Ebner and P. E. Gray, “Static V-I Relationships in Transistors at High Injection Levels,” *IEEE Trans. on Electron Devices*, Vol. ED-13, No. 10 (Oct., 1966), 692-700.
4. J. J. Ebers and J. L. Moll, “Large-Signal Behavior of Junction Transistors,” *Proc. IRE*, XLII, Dec., 1954, 1761-1772.
5. J. L. Moll, “Large-Signal Transient Response of Junction Transistors,” *ibid.*, 1773-1784.
6. A. F. Malmberg, F. L. Cornwell and F. N. Hofer, *NET-1 Network Analysis Program, 7090/94 Version* (LA 3119) (Los Alamos, N. M.: Los Alamos Scientific Laboratory, 1964).
7. *Ibid.*
8. Ebers and Moll, *op. cit.*
9. Moll, *op. cit.*
10. D. J. Hamilton, F. A. Lindholm and J. A. Narud, “Comparison of Large-Signal Models for Junction Transistors,” *Proc. IEEE*, LII, March, 1964, 239-248.
11. J. Linvill, “Lumped Models of Transistors and Diodes,” *Proc. IRE*, XLVI, June, 1958, 1141-1152.
12. R. Beaufoy and J. J. Sparkes, “The Junction Transistor as a Charge-Controlled Device,” *ATE Jour.*, XIII, Oct., 1957, 310-327.
13. J. F. Cleary (ed.), *Transistor Manual* (7th ed.; Syracuse, N. Y.: General Electric Co., 1964), chap. 6.
14. *Motorola Switching Transistor Handbook* (1st ed.; Phoenix, Ariz.: Motorola Semiconductor Products Div., Inc.), chap. 5.
15. J. A. Ekiss and C. D. Simmons, “Junction Transistor Transient Response Characterization,” Part I, *The Solid State Jour.*, II, Jan., 1961, 17-24; and Part II, *ibid.*, Feb., 1961, 24-29.
16. R. L. Pritchard, “Advances in the Understanding of the P-N Junction Triode,” *Proc. IRE*, XLVI, June, 1958, 1130-1141.

# 23 new TTL circuits from TI

Series 54/74 features three levels of speed and power dissipation

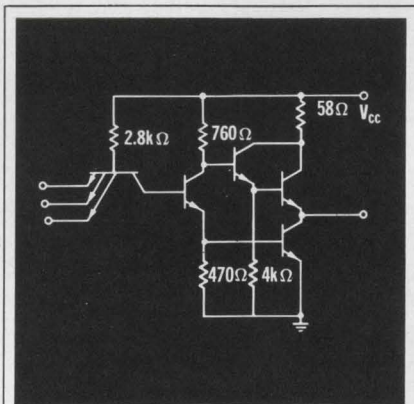

Typical Characteristics	Gate	Flip Flop
Propagation delay	6 nsec	17 nsec
Power dissipation	22 mW	80 mW
Noise immunity	1 V	1 V
Fan-out		
Standard loads	12	12
High-speed loads	10	10

## 16 Series 54H/74H high speed circuits feature 6 nsec propagation delay

This line offers the highest speed available in saturated logic... six nanoseconds per gate. Applications include critical portions of digital systems such as high speed computation and data processing sections.

Series 54H/74H circuits may also be combined with standard and low-power TTL circuits in a single system... giving you the advantage of speed where it is required while keeping system power consumption low.

Sixteen circuit functions include AND gates as well as NAND so you can design simpler less costly systems.

Circle 210 for data sheets.

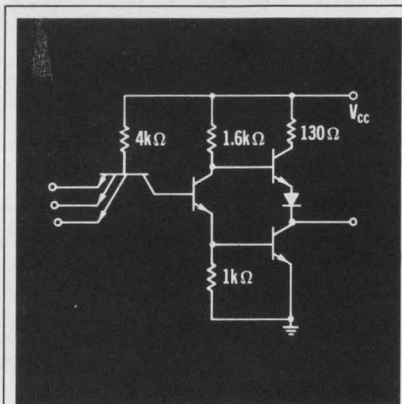

Typical Characteristics	Gate	Flip Flop
Propagation delay	13 nsec	40 nsec
Power dissipation	10 mW	60 mW
Noise immunity	1 V	1 V
Fan-out	10	10

## 27 standard Series 54/74 circuits include 3 new devices for added versatility

Standard Series 54/74 integrated circuits offer a combination of speed and power dissipation best suited for most applications. When used with the new high-speed and low-power circuits, they provide today's system designer with unprecedented flexibility... in selecting speed and power requirements.

Twenty-seven circuits are offered in the standard line, including many complex-function devices that perform up to forty gate functions. These complex-function circuits enable you to cut costs while simplifying system design and improving reliability.

Circle 211 for data sheets.

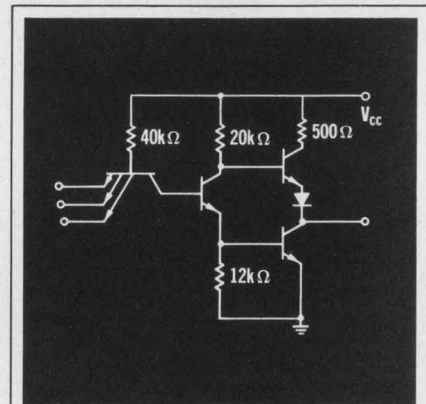

Typical Characteristics	Gate	Flip Flop
Propagation delay	33 nsec	47 nsec
Power dissipation	1 mW	3.8 mW
Noise immunity	1 V	1 V
Fan-out		
Standard loads	1	1
Lower-power loads	10	10

## New series 54L low-power circuits feature 1 mW per gate power drain

This line of four circuits features power requirements less than one-tenth that of standard circuits... yet speeds are approximately twice as fast as other circuits with similar power dissipation.

TI's Series 54L/74L circuits are specifically designed for space systems, avionic systems and other applications where power consumption and heat dissipation are critical. They may be combined with standard and high-speed Series 54/74 circuits to provide almost any desired speed/power dissipation combination the system designer requires.

Circle 212 for data sheets.

**New standard-line additions reduce cost, improve performance of systems using Series 54/74 TTL**

With three speed ranges, three power dissipation levels, two lead arrangements, two packages, and two temperature ranges, TI's Series 54/74 family of 47 TTL integrated circuits is industry's most versatile and complete logic line. All circuits use the same 5 Volt supply voltage and all use the same familiar TTL design rules.

Here are three new additions to the standard line that open the way to further cost reductions and improvements in performance.

**SN7475 quadruple bistable latch replaces four flip flops**

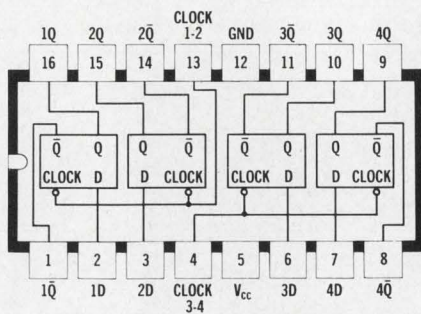

This specialized circuit was designed for readout tube applications. When used with the SN7490 decade counter and the SN7441 decoder/driver, the SN7475 will enable you to realize substantial savings in overall system costs.

This latest addition to TI's growing group of complex-function circuits features a propagation delay of 30 nanoseconds. Power dissipation is 40 milliwatts per latch.

Circle 213 for data sheet.

**SN5401 NAND gate features open collector output for "Wire-OR" logic**

This circuit enables designers to employ the economical "Wire-OR" logic function to simplify system designs. With the open collector output, the "collector-OR" function is built-in, permitting outputs to be connected directly.

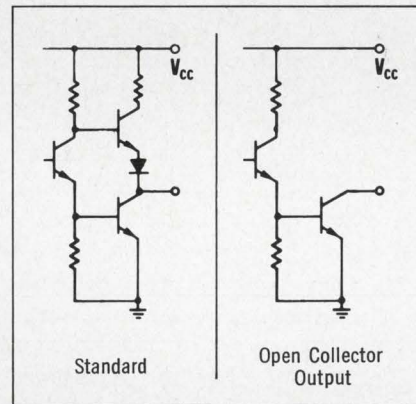

Before this circuit was developed, "Wire-OR" logic could only be used with DTL and RTL circuits. Now system designers can take advantage of this simplification and still benefit from the speed, economy and noise immunity of TTL.

Circle 214 for data sheet.

**SN5402 NOR gate reduces package count and propagation delays**

Here is a quadruple 2 input NOR gate that performs the "Not-OR" logic function directly. It eliminates the need for three or four NAND gates, making possible a 100 percent speed improvement as well as a 67 percent reduction in gate count.

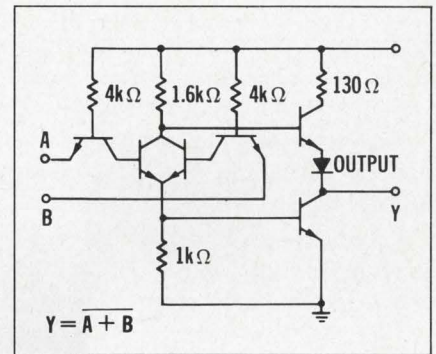

Designers may use the SN5402 with other Series 54/74 circuits... including complex-function types... to reduce overall system costs significantly below that possible with any other logic types.

Circle 215 for data sheet.

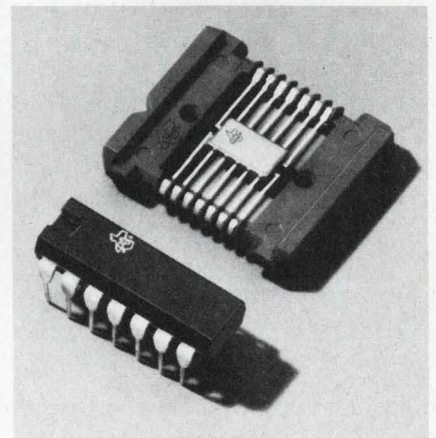

No other high-performance IC family is as complete, versatile and economical as Series 54/74 TTL from Texas Instruments. For more information, contact your nearest TI field sales engineer or authorized distributor, or write P. O. Box 5012, Dallas, Texas 75222.



**TEXAS INSTRUMENTS**  
INCORPORATED

# Decapsulate components undamaged

for reject analysis or recovery. Mechanical, thermal and chemical stripping methods are compared.

The engineer every so often faces the need to remove cured plastic encapsulants<sup>1</sup> from components and assemblies. This he has to do without difficulty or damage to the system. Removal or stripping may be required for several reasons:

- Reject analysis to determine the cause of failure.
- Recovery or repair of experimental devices, expensive components or systems.
- Analysis of a particular circuit or subsystem.

The thermosetting plastics most commonly used for packaging electronic components are of the epoxy or urethane type. They are specifically designed as a protective environment against shock, humidity, temperature, chemicals and corrosion. Their reliability, low cost and easy application have brought them into wide use.

Dissolving thermoplastic materials (polystyrene, vinyl, acrylic) by the application of heat or solvents has long been feasible and, in most cases, simple. Their softening point occurs at a relatively low 115° to 235°F and they are soluble in such common solvents as toluene, xylene, MEK (methyl-ethyl-ketone) and chlorinated compounds. Experience has shown, however, that the removal of cured thermosetting plastics or resins without harming the component is less easy.

There are three methods that can be applied to the removal of all epoxies and urethanes: mechanical, thermal and chemical stripping.

## Mechanical and thermal stripping of limited use

Mechanical removal may be accomplished by cutting, chipping, sanding or blasting the plastic material. Small parts are difficult to handle, and the fact that epoxies and urethanes are tough and abrasion-resistant makes the probability of damage high. Although the technique is not the most desirable from the standpoint of component recovery, it can be used to strip encapsulants (both solid and foams) and thin coatings from components of a sufficiently sturdy configuration.

Thermal stripping is more effective, but its applications are limited by the high temperature

required (700° to 1000°F) and the long exposure necessary (1 to 3 days). Together these will destroy temperature-sensitive components and adversely affect solders and materials used in the components' construction. In some glass-metal systems, though, thermal removal of encapsulants is feasible, since the components can withstand the temperature and exposure needed to degrade almost completely the encapsulating materials, which may then simply be flushed away.

## Chemical strippers show best results

Chemical stripping is the most useful for the successful removal of encapsulating materials. A wide variety of inorganic chemicals (nitric acid, sulfuric acid, sodium hydroxide) and organic chemicals (formic and acetic acid, methylene chloride and other chlorinated solvents, dimethyl sulfoxide, oxygenated solvents, esters and blends) are available to the engineer off the shelf.\*

The ideal chemical for removing cured epoxy and urethanes should have the following basic characteristics:

- It must completely remove cured plastic.
- It must do the job in a relatively short time; under 24 hours is preferable.
- It should not destroy or adversely affect electronic components or materials of construction; removal must be selective.
- It must be reasonably safe to use.

No one stripping solution is ideal for all applications. Several chemicals and proprietary blends have proven to be widely effective, however. Among the best are:

*Methylene chloride* and mixtures work well on room-cured epoxy systems but generally have little or no effect on most heat-cured epoxy systems. Although they will swell or soften some urethanes, they will not cause complete disintegration. Softened urethane can be removed by mechanical or thermal means, but this may prove

\*The U.S. Government has sponsored specialized projects in the chemical removal of thermosets. Report TM-1121 covers the comparative testing of seven epoxy-stripping solutions. The report was prepared by Motorola, Defense Electronics Div., Phoenix, Ariz. Copies are available from Motorola.

Samuel Ringel, President, Dynaloy, Inc., Newark, N. J.

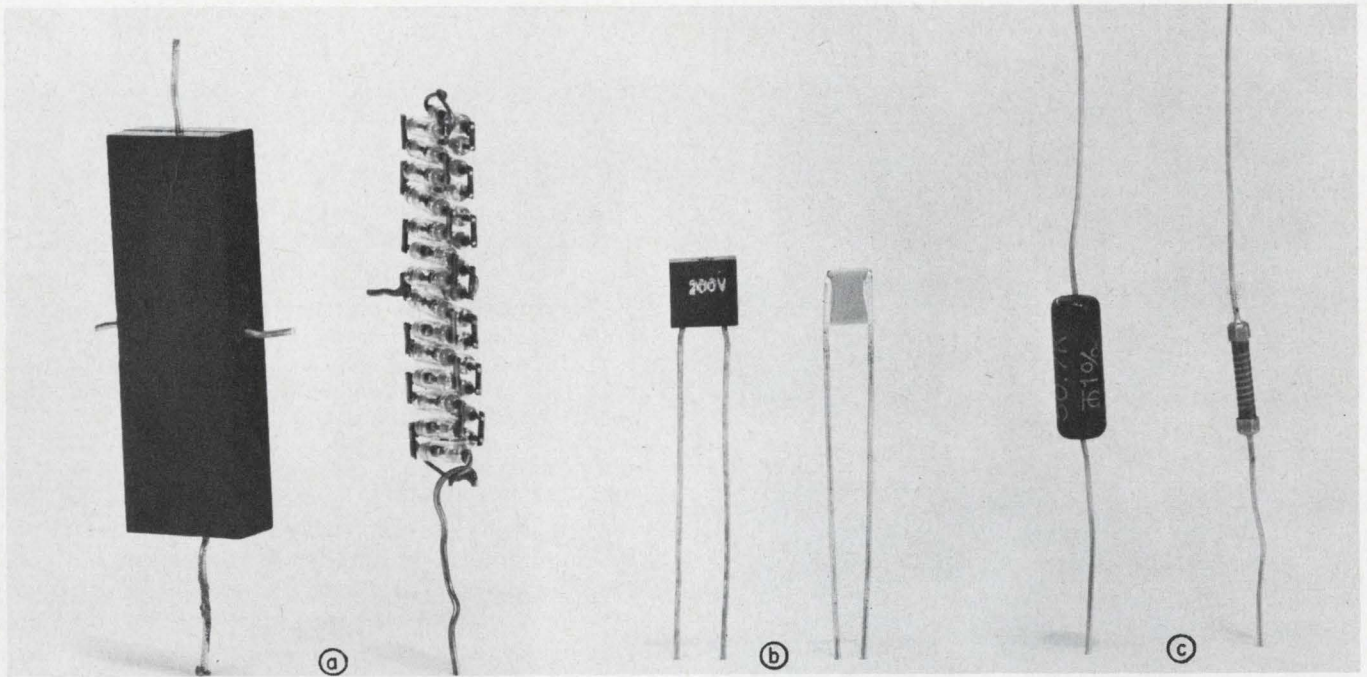

**1. Performance analysis of encapsulated components.** All were immersed in DeCap at 110°C. Glass diode rectifier assembly (a) showed glass breakage due to expansion and contraction of encapsulant and cold solder joints. Materials of construction are glass, plated copper leads, solder, methyl nadic anhydride-cured epoxy. Fra-

gile ceramic capacitor (b) is found to be unaffected by transfer molding. Materials of construction are barium titanate ceramic, tinned copper leads and transfer-molded epoxy. Carbon film resistor (c) showed poor assembly prior to encapsulation. Materials are ceramic core, carbon film, metal leads and heat-cured transfer-molded epoxy.

impractical. If all of the urethane is not softened, only the softened portion can be stripped and the remainder must again be immersed in methylene chloride. Depending on the composition of the urethane and the degree of cure, this cycle may have to be repeated many times. Methylene chloride, which is very volatile, will not affect most metals used in electronic assemblies.

*Formic acid, nitric acid* and mixtures containing strong acids disintegrate many room-temperature- and heat-cured epoxies. They are not selective and tend to corrode conductors and degrade components and insulations. They are also hazardous to the user.

*DeCap*<sup>†</sup> removes most epoxy systems whether heat-cured or room-cured. For maximum effectiveness against heat-cured systems, the solution must be used at about 110°C. DeCap is not selective and will attack most plastics; it is neutral and has no adverse effect on active electronic components or most metals. It will, however, tarnish solders and silver after an 8-hour immersion at 110°C. It will attack many urethane foams, but will only swell certain urethane elastomers. It should be washed away with water or alcohol after use. Figure 1 illustrates removal with DeCap.

*Uresolve*<sup>‡</sup> are highly selective stripping

<sup>†</sup>DeCap, a blend of oxygenated solvents, is a trademark of Dynaloy, Inc., Newark, N. J.

<sup>‡</sup>Uresolve, a blend of reactive components in alcohol, methyl cellosone or polar solvents, is a trademark of Amicon Corp., Cambridge, Mass., and is marketed by Dynaloy, Inc., Newark, N. J.

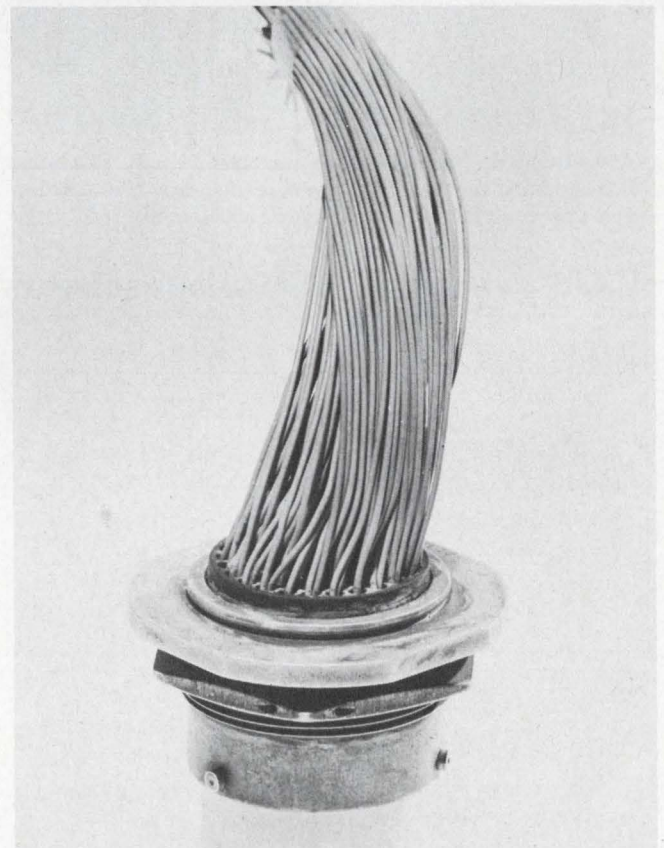

**2. To replace a faulty wire in this cable assembly,** Coast Pro-Seal 794 cured urethane encapsulant was removed with Uresolve. Materials of construction include anodized aluminum shell, neoprene insert, gold-plated connector, copper wire, irradiated polyethylene cable insulation and fluorinated silicone O-ring. The only material affected other than the urethane was the O-ring.

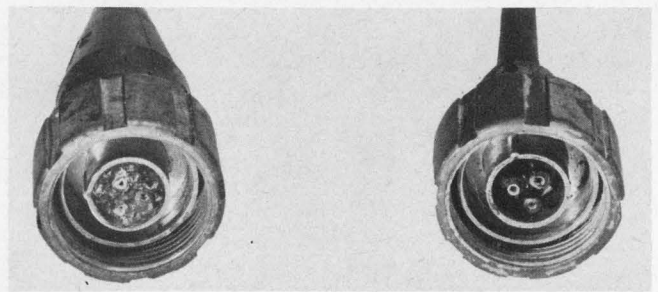
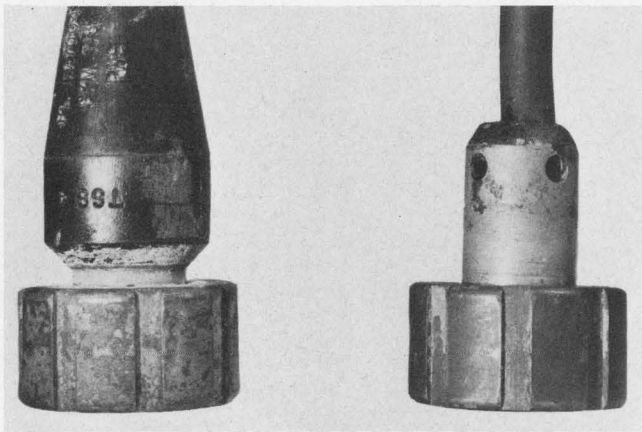

3. To remove cured urethane and reclaim expensive brass connector parts from this power connector (left, both photos), Uresolve was used to remove Products Research Corp. 1538 cable encapsulant. Neoprene cable jacket is unaffected (right, both photos).

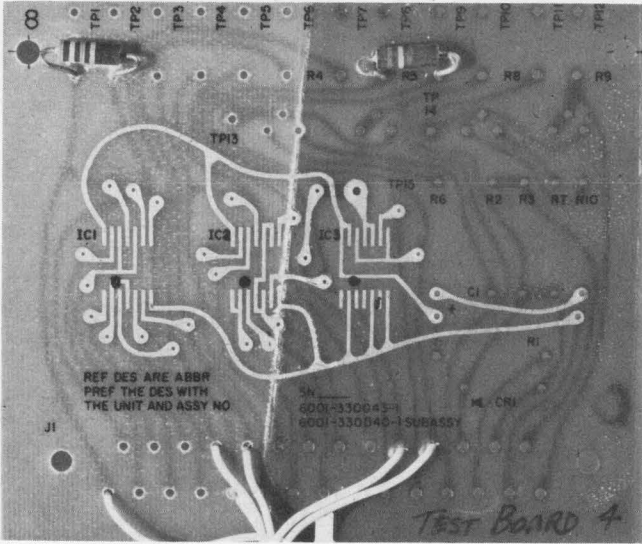

4. Urethane is stripped from this glass-epoxy PC board with a Uresolve gel. The board, the epoxy printing and even the resistor color code are unaffected.

agents. They dissolve most urethane foams, coatings or elastomers and will slowly attack polyesters and diallyl phthalate as well as anhydride-cured epoxies. This reactive solvent is strongly alkaline, and dissolved material must be completely washed away with water or alcohol to prevent corrosion. Despite its basicity, it does not attack aluminum, magnesium or other metals commonly used in electronic assemblies. Figures 2, 3 and 4 show examples of urethane removal.

The table summarizes performance of several stripping solutions on seven epoxy and urethane encapsulants.

#### Manufacturers can recommend best solvent

Although it holds true that effective removal of epoxy or urethane coatings depends largely on the structure of the plastics to be stripped, individual testing is almost prohibitively costly and time-consuming. Many encapsulant manufacturers will conduct tests, however, and supply charts and recommendations.

Epoxy-stripping solutions are available from Dynaloy, Inc., Newark, N. J.; Beck Equipment Co., Cleveland; Emerson and Cuming, Canton, Mass.; Hysol Corp., Olean, N. Y.; Furane Plastics, Los Angeles; and H. V. Hardman Co., Belleville, N. J. In addition, all major suppliers of epoxies or urethane polymers either have a proprietary solution or will recommend a particular blend for their system.

Strippers for cured urethanes are available from Dynaloy, Inc. For partially cured urethane systems, Dow Chemical Corp., Midland, Mich., and Allied Chemical Corp., New York, have blends of methylene chloride. Union Carbide Corp., New York, and Humble Oil Co., New York, supply toluene and other hydrocarbon solvents. In general, all major petrochemical manufacturers furnish solvents that can be used on partially cured urethanes. ■ ■

Table. Performance of various solvents

Solvent	Epoxy			Urethane			
	1	2	3	4	5	6	7
Methylene chloride (23°C)	N	D	N	S	N	S	N
Dimethyl formamide (23°C)	D	D	D	D	S	S	S
Nitric acid (120°C)	D	D	D	-	-	-	-
Formic acid (23°C)	D	D	D	-	-	-	-
DeCap (110°C)	N	N	N	D	S	S	S
Uresolve (23°C)	N	D	N	D	D	D	D

#### Key:

##### Epoxy

1. Bisphenol A (polyamide-cure)
2. Bisphenol A (anhydride-cure)
3. Transfer-molded (amine-cure)

D—Disintegrated  
 S—Swelling or softening but no removal  
 N—Not effective  
 —Not evaluated

##### Urethane

4. Nopco Foam H102N
5. DuPont Adiprene 315
6. Baker Vorite Polycin
7. Products Research 1538

#### Reference:

1. Alex. E. Javitz, "Guidelines to Successful Encapsulation," ELECTRONIC DESIGN, XII, No. 24 (Nov. 23, 1964), 86-87.

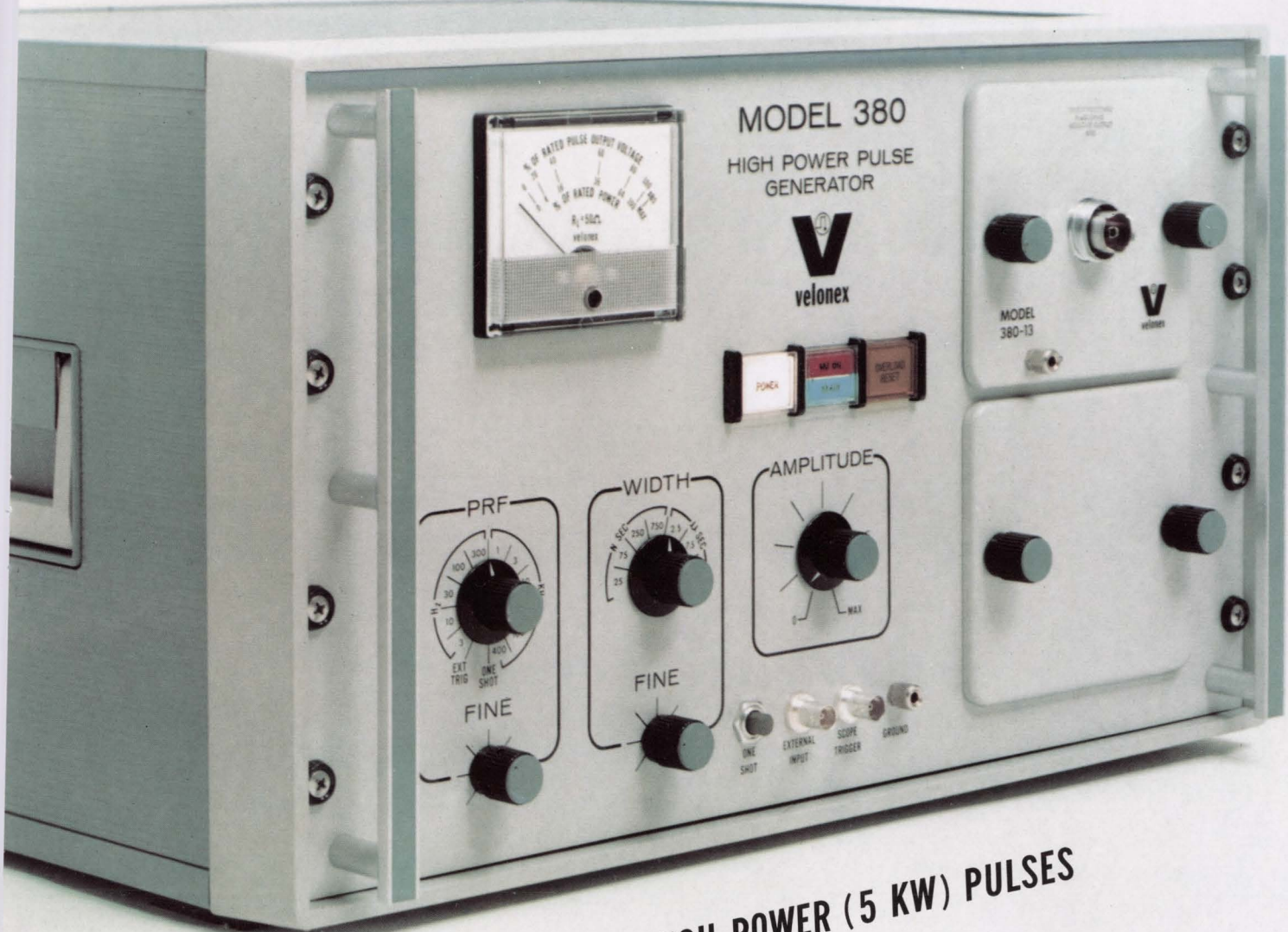

## FAST-RISING (<9 NS) HIGH-POWER (5 KW) PULSES

- FOR NUCLEAR PULSE SIMULATION
- MICROWAVE DIODE DEVELOPMENT
- ULTRASONIC INVESTIGATIONS
- INJECTION LASER DRIVER
- GENERAL PURPOSE LABORATORY INSTRUMENT

Rapid rise time (<9 ns) invades the world of high-power pulses with Velonex's new Model 380. A model of versatility, Model 380 puts pulse powers to 5 KW at your command, gives you continuous variability of pulse widths from 25 ns to 25 μs and repetition rates from single shot to 400,000 pulses per second. It enables you, with accessory plug-ins, to vary rise and fall time to suit your needs, and step up output voltage to 1 KV, or output current to 100 amps. You will find Model 380, with all its capabilities, easier to operate than most low-power pulse generators. Write or phone today for details. Price \$4,500.00



division of Pulse Engineering Inc.

560 Robert Avenue, Santa Clara,  
California 95050 (408) 244-7370  
TWX 910-338-0114

# Design a high-voltage pulse generator

with a tape-wound toroidal core that is operated by a transistorized core driver circuit.

Necessity has proverbially been the mother of invention. Now the need to generate very precise, highly reproducible high-voltage pulses has led to development of a magnetic core driver that uses transistors and a transformer constructed of square-hysteresis-loop material. The following discussion deals with the applicability of the design approach and the requirements of the magnetic core driver, transformer and core switching circuitry to practical high-voltage pulse generators.

The circuit was primarily designed for high-potential testing, but may be used anywhere that high-voltage, high-duty-cycle, accurate pulses are required.

## Transformer operation reviewed

When the primary of the transformer is subjected to voltage  $V_p$ , the magnetic flux must increase according to the relationship:

$$\phi(t) = (1/N_p) \int_0^t V_p(t) dt, \quad (1)$$

where:

$\phi(t)$  = magnetic flux,

$N_p$  = number of turns on the primary winding.

If  $V_p$  is a constant over time  $t$ , then:

$$\phi(t) = [V_p(t)t]/N_p. \quad (2)$$

Therefore secondary voltage  $V_s$  is related to the primary voltage by:

$$V_s = N_s(d\phi/dt) = (N_s/N_p)V_p, \quad (3)$$

where  $N_s$  is the number of secondary turns.

The desirable features for a transformer include low-leakage reactance, close coupling, and a core material that is sharply saturated (see Fig. 1). A tape-wound toroidal core of 50-per-cent nickel-iron alloy is a core material with these features. Examples of commercially available cores of this composition include Orthonal\* and Deltamax.†

A transistor is used to switch the primary

voltage across the primary winding, causing a flux change in the core. Because the applied voltage is a well-defined square wave, the rate of change of flux is a constant. This yields an output pulse that exhibits exceptional flatness with good rise- and fall-time characteristics.

During this flux change, a high-voltage pulse of positive or negative polarity is induced in the secondary winding. When the drive pulse terminates, a reset pulse returns the core to its original flux condition. The flux change that occurs during core reset induces a similar waveform of opposite polarity in the secondary winding. A series-diode limiting circuit eliminates the unwanted voltage level from the output waveform.

## Designing the circuit

A simplified schematic of one possible configuration of a high-voltage pulse generator is illustrated in Fig. 2. In this circuit,  $CR1$  and  $R2$  comprise the series-diode limiting circuit.  $R1$  is a current-limiting resistor. When diode size or speed, or both, are important, the limiting circuit of Fig. 3 can be used. In this case,  $R1$  and  $R2$  maintain safe peak-voltage levels across  $CR1$  and  $CR2$ . Capacitors are occasionally used to secure safe peak voltages during transition times.

For this type of limiting circuit,  $R1$  and  $R2 \leq 0.1 R_{r(min)}$  where  $R_{r(min)}$  is the minimum leakage resistance of the reverse-biased diode. If  $I_B$  is the maximum leakage current at the maximum operating voltage,  $V_B$ , and maximum temperature, then:

$$R_{r(min)} = V_B/I_B. \quad (4)$$

If a load capacity,  $C_L$ , exists, provision has to be made for its effect on the rise and fall times of the output voltage waveform. If it is assumed that the output voltage must reach its maximum value during time  $t$  (see Fig. 4), and for all practical purposes a 100% charge is reached in five RC time constants, then:

$$5 R1 C_L = t \quad (5)$$

and

$$R1 = t/5 C_L. \quad (6)$$

Warren R. Wrenner, Senior Associate Engineer, IBM, Components Division Manufacturing Research Laboratory, Endicott, N. Y.

\*Magnetics, Inc., Butler, Pa.

†The Arnold Engineering Co., Marengo, Ill.



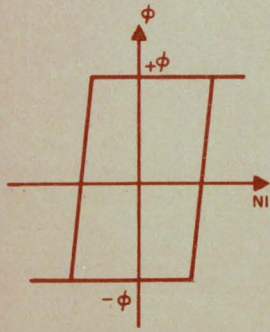

1. Square-loop hysteresis characteristic such as that exhibited by Orthonal or Deltamax constitutes the basic core requirement for the pulse transformer.

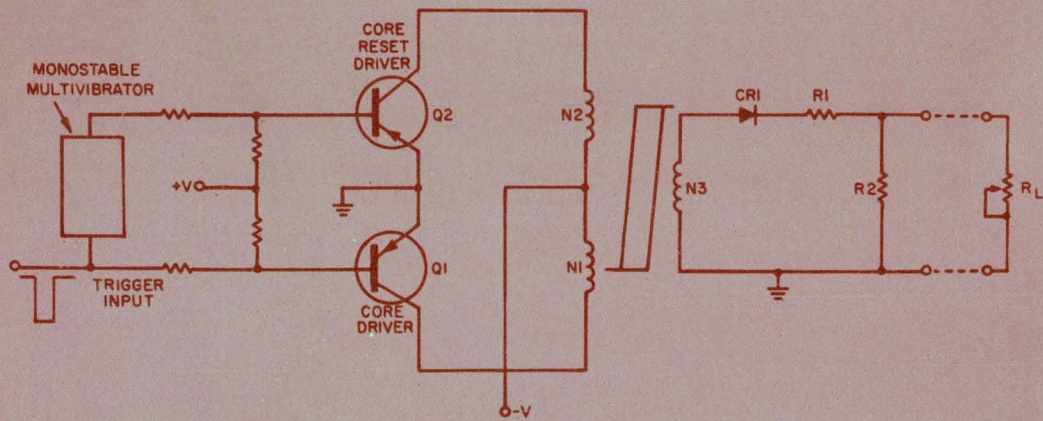

2. High-voltage pulse generator is functionally simple.

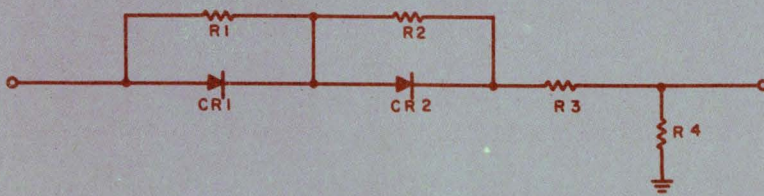

3. Diode limiting of the output amplitude can take many forms. Network shown was chosen for this case.

4. Selection of the series limiting resistor in the presence of a capacitive load is governed by the size of the load capacitor.

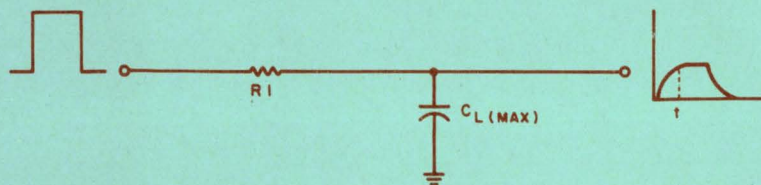

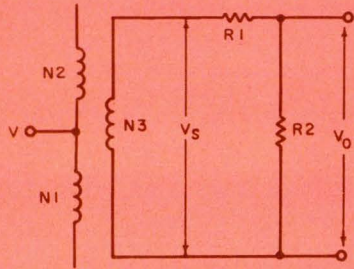

5. Number of secondary turns is determined by the values of R1, R2, and the desired output voltage,  $V_o$ .

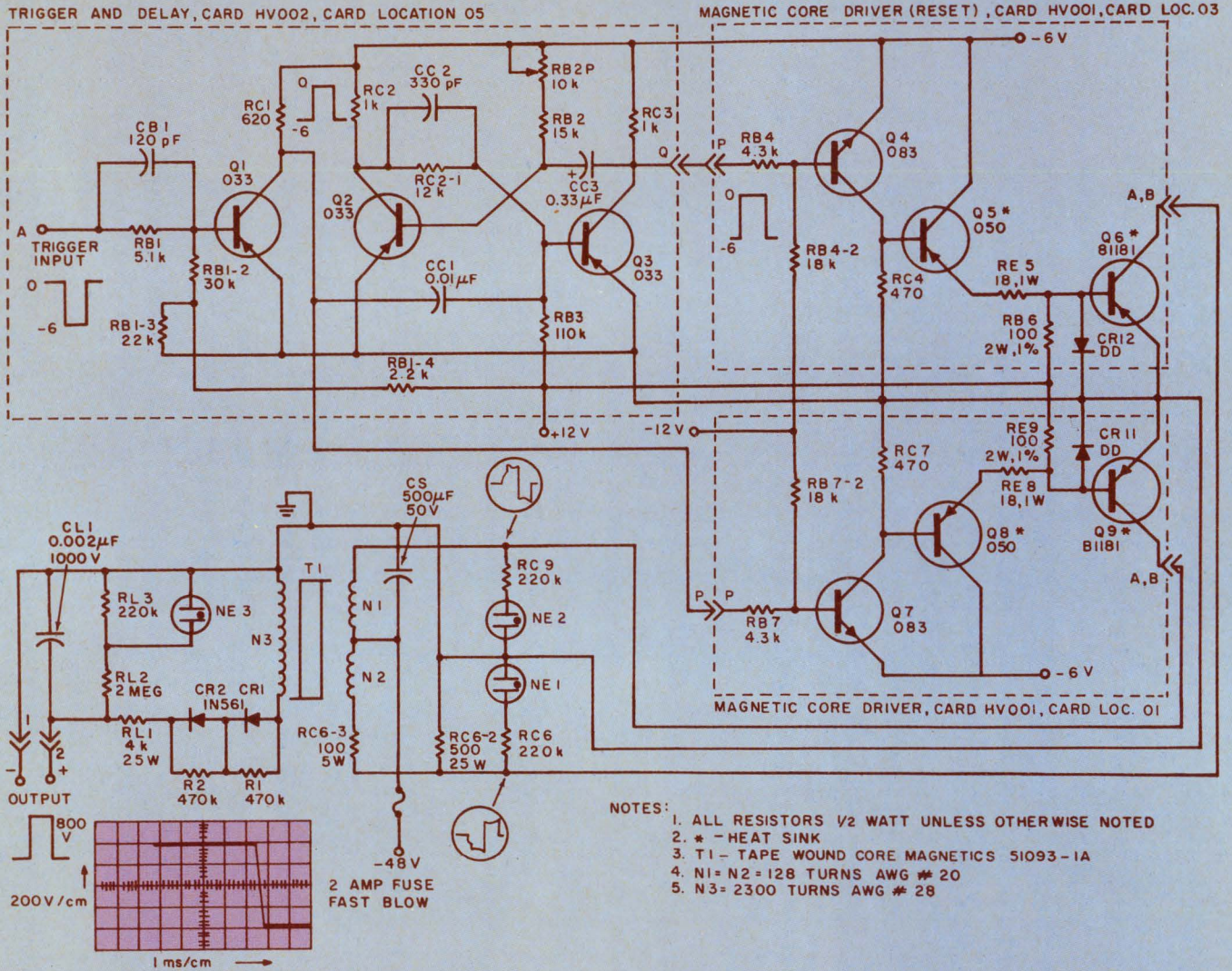

6. 800-volt pulse generator produces accurate clean pulses (see facsimile of the scope photo near the output terminals) of 5 ms duration at 40% duty cycle.

## How to switch the core

The maximum output power,  $P_o$ , is:

$$P_o = V_o^2/R_1, \quad (7)$$

where  $V_o$  is the output voltage. The required input power,  $P_{in}$ , is:

$$P_{in} = P_o/\eta, \quad (8)$$

where  $\eta$  is the transformer efficiency.

The peak collector-to-emitter voltage of the core driver and core reset driver transistors will be equal to twice the primary supply voltage plus the voltage transients that are normally present in this type of circuit. In addition to the voltage requirements, the driver transistor must be capable of handling the current required for maximum power output. The maximum collector current that the core driver must switch, then, is:

$$I_{c(max)} = P_{in}/(V - V_{sat}), \quad (9)$$

where  $V$  is the primary supply voltage and  $V_{sat}$  is the collector-to-emitter saturation voltage for a specific collector current.  $V_{sat}$  is usually negligible when compared with  $V$ . Therefore:

$$I_{c(max)} = P_{in}/V. \quad (10)$$

The required base current,  $I_{BE}$ , for the core driver is:

$$I_{BE} = I_{c(max)}/h_{FE(min)}, \quad (11)$$

where  $h_{FE(min)}$  is the minimum current gain at specified  $I_c$ .

When the core driver is switched on, the flux change is given by:

$$d\phi = (-V/N)dt. \quad (12)$$

If  $t$  is the time in seconds required to bring the core from a state of negative-flux saturation,  $-\phi_m$ , to a state of positive-flux saturation,  $+\phi_m$ , the above expression can be integrated to yield:

$$N = Vt/2B_m A \times 10^{-8}, \quad (13)$$

where:

$N$  = one-half the number of primary turns,

$V$  = primary voltage in volts,

$t$  = maximum pulse duration in seconds,

$B_m$  = maximum flux density in gauss,

$A$  = cross-sectional area of core in  $\text{cm}^2$ .

This equation describes the relationship that exists among core size, supply voltage, primary turns, and pulse duration. Since the core serves as a medium for the transformation of power, its physical properties determine the limit of the pulse duration. The core must have a sufficiently large cross-sectional area to permit the generation of output pulses with the desired time duration without an excessive number of secondary turns. The interwinding capacities increase with the number of turns, and a large capacitance can cause spurious oscillations when the core is excited with a square-wave input.

High power levels can be delivered during pulse time when the core is driven by a low-impedance source. Copper losses can be minimized by choosing the correct wire size on the basis of current-

handling capability and average current levels; however, the ease or difficulty of machine winding can sometimes affect the choice. A wire with a current-carrying capacity of 500 circular-mils per ampere is satisfactory for most pulse generator applications.

The number of secondary turns necessary for  $V_o$  is calculated as follows (see Fig. 5):

$$V_s = 2V[N_3/(N_1+N_2)] \\ = [(R_1+R_2)/R_2]V_o; \quad (14)$$

$$N_3 = (1/2V)(N_1+N_2)[(R_1+R_2)/R_2]V_o. \quad (15)$$

Since secondary voltage,  $V_s$ , is directly related to the primary voltage,  $V$ , the regulation of the primary voltage supply is an important design consideration.

The 800-volt pulse generator shown in Fig. 6 was designed for high-speed, high-potential testing of shorts between adjacent printed-circuit lines. The design objectives required an 800-volt pulse generator capable of supplying 5-ms pulses (see Fig. 6b) at an approximately 40% maximum duty cycle to a constantly varying complex load defined by  $0 \leq R_L \leq \infty$  and  $C_L \leq 0.2 \mu\text{F}$ . The pulse generator detection circuit that provides output signals to indicate high- and low-voltage shorts in printed-circuit networks is omitted from the circuit of Fig. 6.

## Circuit operation in a nutshell

The circuit in Fig. 6 operates in the following manner. Switching stage  $Q_1$ , when triggered by a  $-6$ -volt pulse, drives  $Q_7$  into conduction. The voltage at the emitter of  $Q_7$  is coupled to the input of the core driver,  $Q_9$ , through a current amplifier,  $Q_8$ . Initially, the set and reset core drivers,  $Q_9$  and  $Q_6$ , are biased in the off condition. The core is biased in the negative flux condition by current flowing through winding  $N_2$ .

When  $Q_9$  is switched on, the supply voltage ( $V = -48$  volts) is applied across winding  $N_1$ , and because  $N_1 = N_2$ , the  $d\phi/dt$  induces a voltage of the same magnitude across  $N_2$ . Assuming that  $Q_9$  is completely saturated, the combined voltage across  $N_1$  and  $N_2$ , ( $2V$ ), will appear across the collector-to-emitter of  $Q_6$ .

During the time that  $Q_9$  is on, the magnetic core is driven toward positive-flux saturation and the changing flux in the core induces a voltage in the secondary with a magnitude proportional to the turns ratio.

The maximum pulse width that can be obtained from this circuit is the time required for the core-flux to change from  $-\phi_m$  to  $+\phi_m$ , or slightly greater than 5 milliseconds. At the end of the 5-ms trigger pulse, a single-shot,  $Q_2$  and  $Q_3$ , switches  $Q_6$  on to short out  $RC_6-2$  for 5 milliseconds; during this time, the core bias returns to the negative flux condition. ■ ■

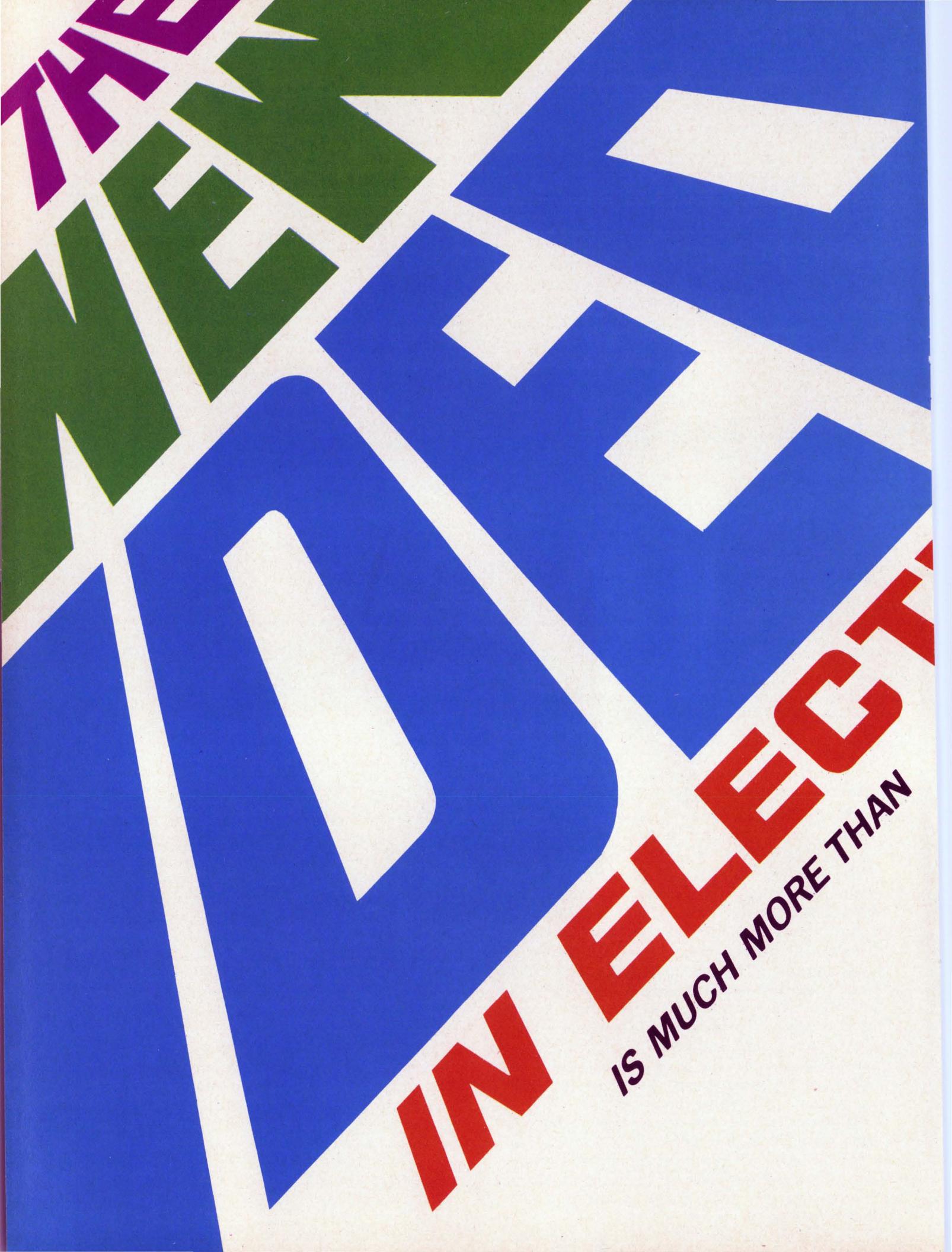

**IN ELECT**  
IS MUCH MORE THAN

# RONICS

THE PRODUCT YOU BUY...

## It's the right electronic component plus circuit specialists trained in finding total circuit solutions for your product problems

Straight talk! General Electric's new idea is the Electronic Components Sales Operation—a team uniquely oriented to the special needs of this growing and changing market.

It's a circuit specialist who can find total circuit solutions for your product problems . . . a specialist who can stay on top of trends in electronics and apply the right combination of technical ideas when you need them.

It's unmatched technical backup assistance plus the widest product range in the world. You name it, and it's available through one man. To mention just a few of the component types he offers:

- silicon controlled rectifiers
- nickel cadmium batteries
- high power klystrons
- specialty a-c, d-c and Hyper-servo\* motors and generators
- germanium and silicon transistors
- film and paper-oil capacitors
- TV camera tubes
- sealed relays
- unijunction transistors
- aluminum electrolytic capacitors
- ignitrons and thyratrons
- voltage regulators
- tunnel and back diodes
- cathode ray tubes
- thermistors and Thyrite\* varistors
- panel meters and meter relays
- transformers
- terminal boards, push buttons, indicating lights

\*Reg. Trademark of General Electric Co.

Put GE's total electronic capability to work today. A call to your Electronic Components Sales Operation office is the way to start. There's one in every major market area.

285-24

ELECTRONIC COMPONENTS SALES OPERATION

**GENERAL**  **ELECTRIC**

ON READER-SERVICE CARD CIRCLE 38

# Select varactors for voltage tuning

with the aid of three nomograms that give design data directly from the varactor spec sheets.

Voltage-controlled resonant circuits for oscillators and filters are commonly designed on the basis of the voltage-dependent capacitance of a reverse-biased varactor diode. Designing them with ordinary varactor-diode data-sheet information can be a tedious cut-and-try process. These three nomograms, however, give circuit design parameters direct from data-sheet information.

The parameters of interest comprise the varactor's operating  $Q$ , the frequency range, and capacitance changes.

The capacitance of a reverse-biased varactor diode is:

$$C_v = C_0 [1 + (V_b/\phi)]^\gamma, \quad (1)$$

where  $V_b$  is the applied reverse-bias voltage,  $C_0$  is the capacitance for zero bias, and  $\phi$  is the junction self-bias voltage. The exponent  $\gamma$  depends on the junction: it is approximately 1/2 for abrupt

**M. Michael Brady**, Research Engineer, Nera A/S, Oslo, Norway.

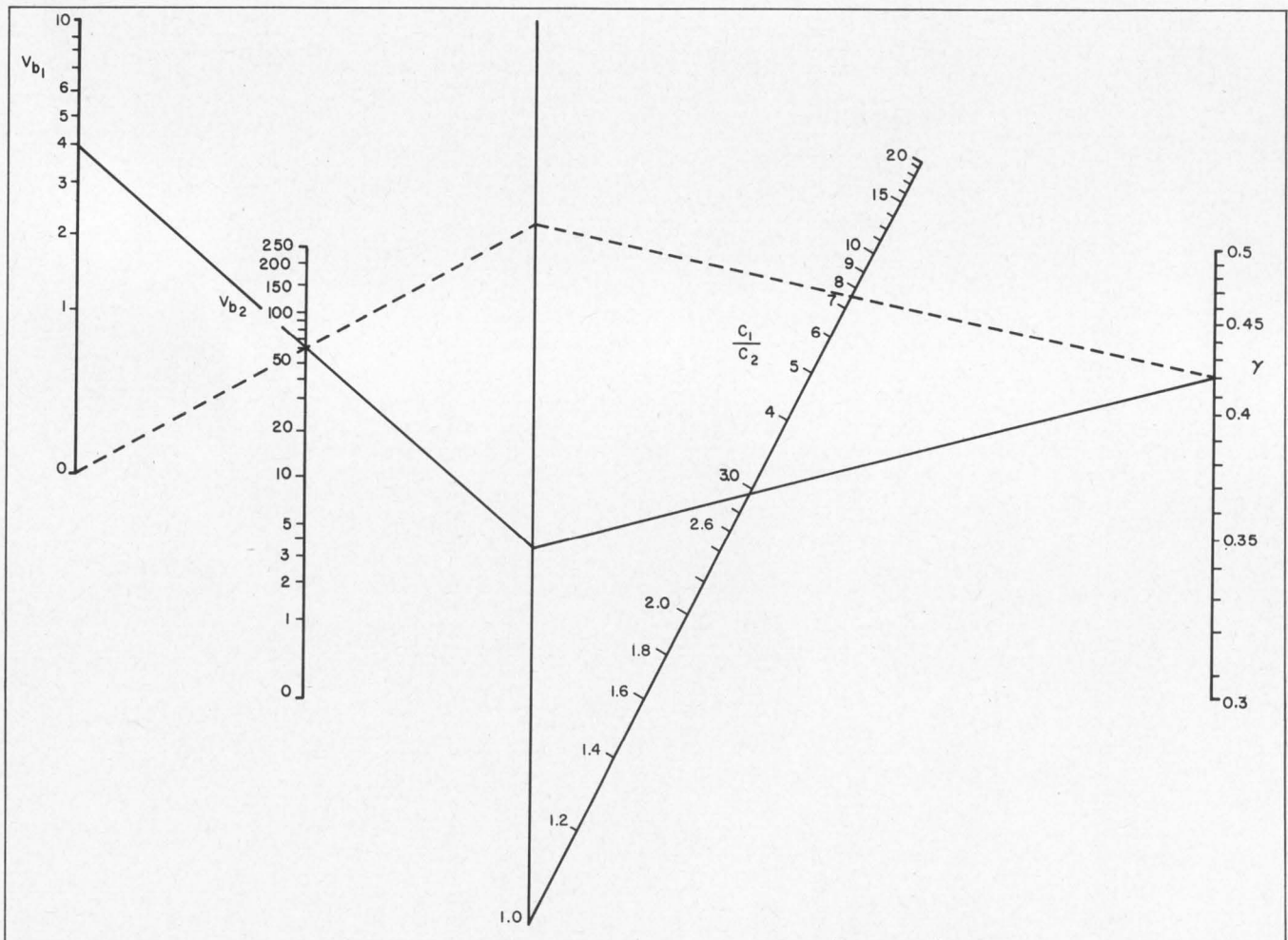

1. Changes in the ratio of capacitances with changes in the bias voltages are found with this nomogram. It also helps to find  $\gamma$ , the exponent in Eq. 1, that characterizes

the junction. The necessary basic information is supplied from the data sheets. The solid and dashed lines represent examples worked out in the text.

junctions, 1/3 for graded junctions, and between 1/3 and 1/2 for diffused junctions. The self-bias voltage,  $\phi$ , is about 0.5 volt for most varactor diodes now in use.

Data sheets usually give a capacitance  $C_1$  at a voltage  $V_{b1}$ , and a capacitance ratio of  $C_1/C_2$  where  $C_2$  is the capacitance at some limiting bias,  $V_{b2}$ , near breakdown. The value of  $\gamma$  is rarely given. To find  $\gamma$  and  $C_1/C_2$  for other voltages, use the nomogram in Fig. 1.

Figure 1 represents Eq. 1 for a self-bias  $\phi$  of 0.5 volt. A typical use of this nomogram would be where a varactor-diode data sheet gives  $V_{b1} = 4$  V,  $V_{b2} = 60$  V, and  $C_1/C_2 = 2.75$ . The problem is to find what the exact value of  $\gamma$  is and what the capacitance ratio is if the lower bias,  $V_{b1}$ , is reduced to the minimum of 0 volts.

From the given voltages and capacitance ratio,  $\gamma$  is 0.42 (see solid lines in Fig. 1). For  $V_{b1} = 0$  V,  $V_{b2} = 60$  V and  $\gamma = 0.42$ , the capacitance ratio,  $C_1/C_2$ , becomes 7.6 (see dashed lines in Fig. 1).

### Find the right Q for the diode

The varactor diode's Q is usually defined and

specified for some fixed frequency,  $f_s$ , and capacitance,  $C_s$  (or bias voltage,  $V_s$ ). In terms of these parameters, the Q at any arbitrary frequency is:

$$Q = Q_s (f_s/f) (C_s/C_v), \quad (2)$$

where  $Q_s$  is the specified Q and  $C_v$  is obtained from Eq. 1 (or Fig. 1).

In varactor-tuned resonant circuits, the minimum Q of the varactor occurs at the minimum frequency  $f_1$ ; any demands on Q must be based on this lowest  $Q_1$  at frequency  $f_1$ . The nomogram in Fig. 2 gives  $Q_1$  directly in terms of the ratio  $C_s/C_1$  and  $f_s/f_1$ , or directly in  $f_1$  for the common specified frequency,  $f_s = 50$  MHz.

For instance, the varactor diode of the previous example may have a Q of 100 at 50 MHz and a  $V_{b1}$  of 4 volts. What is its Q at 20 MHz if  $V_{b1}$  remains unchanged, and what is it if  $V_{b1}$  is changed to zero volts?

For an unchanged  $V_{b1}$ , the ratio of  $C_s$  to  $C_1$  is 1. Since  $Q_s$  is 100 and  $f_1$  is 20 MHz,  $Q_1$  is 250 (see solid lines in Fig. 2).

When  $V_{b1}$  is reduced from 4 to 0 volts, the capacitance ratio,  $C_1/C_2$ , goes up from 2.75 to 7.6

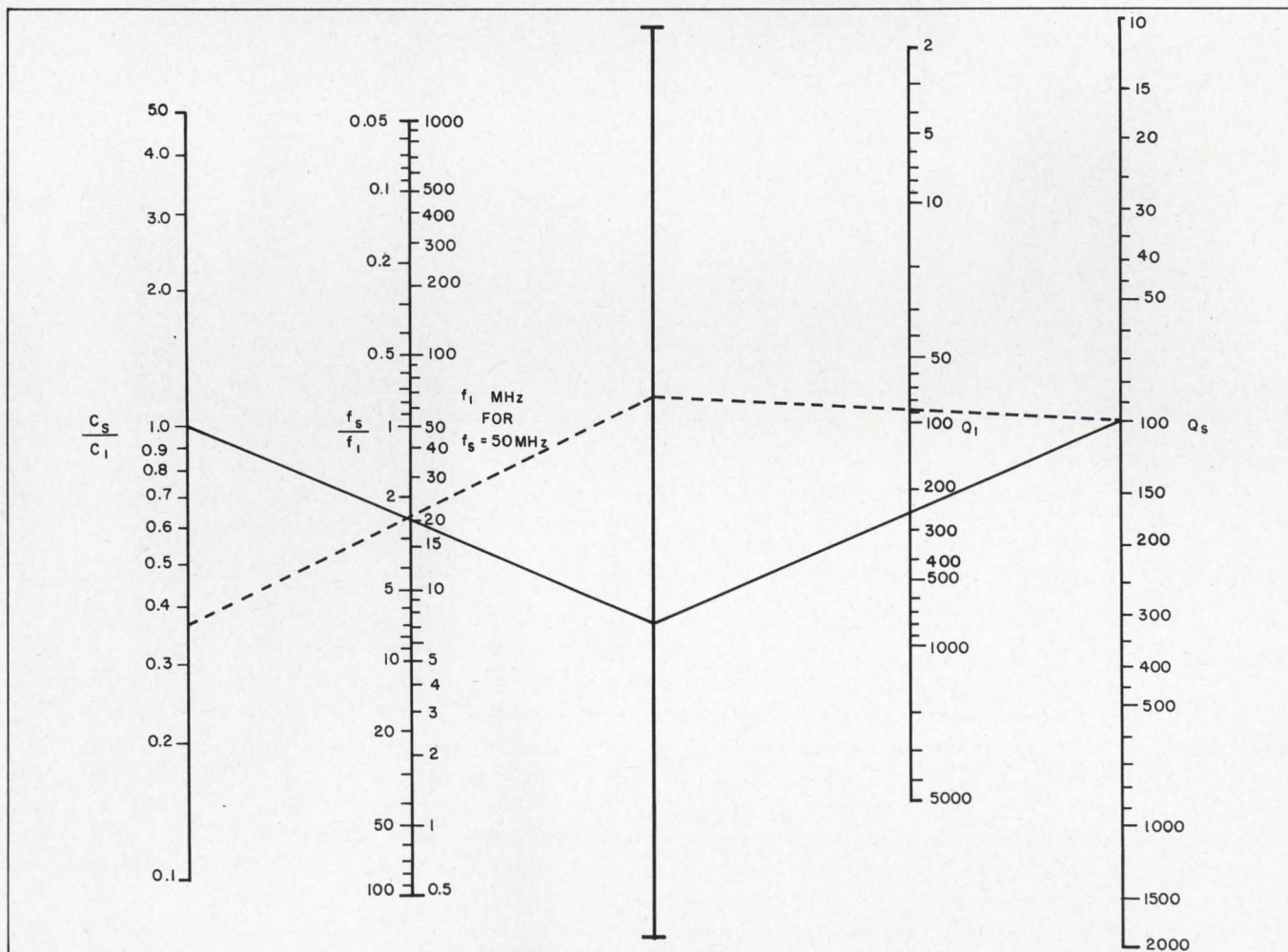

2. The Q of the diode changes with frequency, as the above graph shows. Data sheets usually specify the Q at one frequency only. In terms of the given data, the Q may

be found for any arbitrary frequency. The graph also pinpoints the changes in Q resulting from variations in the bias voltage,  $V_{b1}$ .

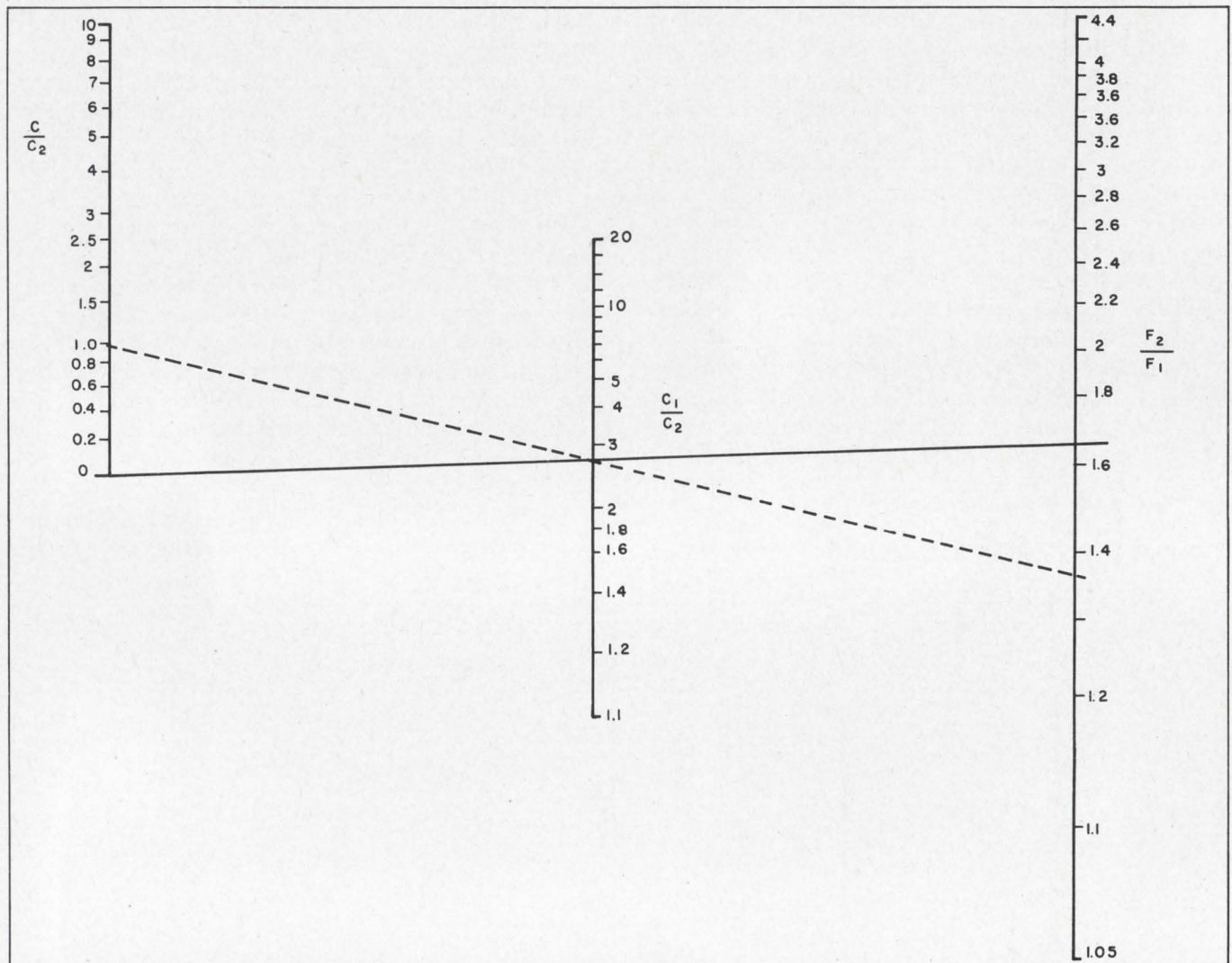

3. Circuit capacitances related to frequency range through the diode's capacitances are shown in this nomogram.

(as in the first example), and  $C_s/C_1$  becomes  $2.75/7.6 = 0.36$ . Again  $Q_s$  is 100,  $f_1$  is 20 MHz and  $C_s/C_1$  is 0.36. Hence  $Q_1$  is found to be 88 (see dashed lines in Fig. 2).

**Frequency range depends on circuit**

The frequency range of the circuit does not depend entirely on the varactor. All varactor-tuned circuits have some capacitance in addition to the  $C_v$  of Eq. 1. A parallel circuit, comprising varactor capacitance  $C_v$  in parallel with circuit capacitance  $C$  (which includes all other capacitances such as stray capacitance, varactor package capacitance, etc.) and a fixed inductance, has a frequency range ratio,  $f_2/f_1$ , of:

$$f_2/f_1 = [(C+C_1)/(C+C_2)]^{1/2}, \quad (3)$$

where  $f_1$  and  $f_2$  are the minimum and maximum resonant frequencies, corresponding to the maximum and minimum varactor capacitances of  $C_1$  and  $C_2$ .

The third nomogram (Fig. 3) relates  $f_2/f_1$  to varactor capacitance ratio,  $C_1/C_2$ , and to the normalized circuit capacitance,  $C/C_2$ . To illustrate the effects of the circuit capacitance, assume that the varactor of the previous two examples is to be used in a parallel resonant circuit. What frequency ratios,  $f_2/f_1$ , are possible when external capacitance  $C$  is assumed to be zero, and when it is assumed to equal the varactor's minimum capacitance,  $C_2$ ?

For  $C/C_2 = 0$  and  $C_1/C_2 = 2.75$ , frequency ratio  $f_2/f_1$  is 1.63 (see solid lines in Fig. 3). When  $C/C_2 = 1.0$ , the same  $C_1/C_2$  will give a frequency ratio of 1.35 (see dashed lines in Fig. 3). ■ ■





# Our military switches are sweeping the country!

Quick now, what's the first thing you think of when you think of Cutler-Hammer military switches?

We thought so: airborne equipment.

Not surprising. We created the first line of switches for airborne use back in the roaring 20's. Today, nearly everything that flies—from helicopters to space vehicles—uses Cutler-Hammer switches.

So what's new? Just that designers are discovering that these same switches work as well in ground support equipment, ship-board electronics, and ordnance as they do in the air.

That's because of the painstaking care we take in design and manufacture. The exhaustive in-process inspection. And our rigorous final testing.

The result? Unquestionable reliability, performance, and long life—under extreme environmental conditions.

On your next project—ground, marine, or airborne—specify Cutler-Hammer military switches. Call your local stocking distributor, or write for new catalog LL-291-K217.

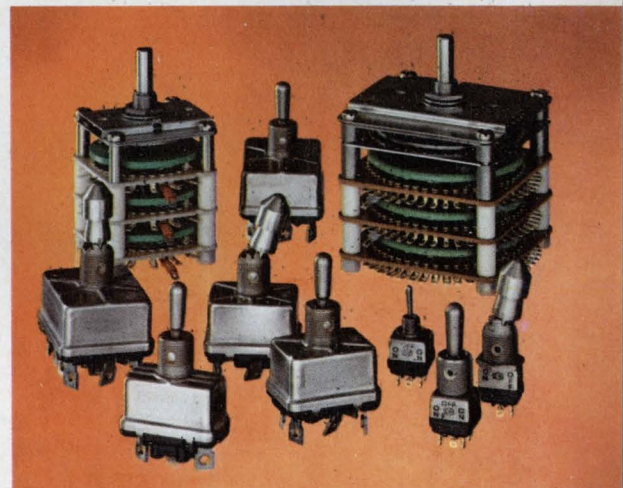

A few of the thousands of military switches available from Cutler-Hammer: miniature, and standard-size positive-action toggle switches (MIL-S-8834), Shallcross rotary switches (MIL-S-3786).

Switch  
to No. 1

More than just switches:  
prompt availability,  
field help, innovation,  
quality assurance too.



**CUTLER-HAMMER**

Milwaukee, Wisconsin 53201

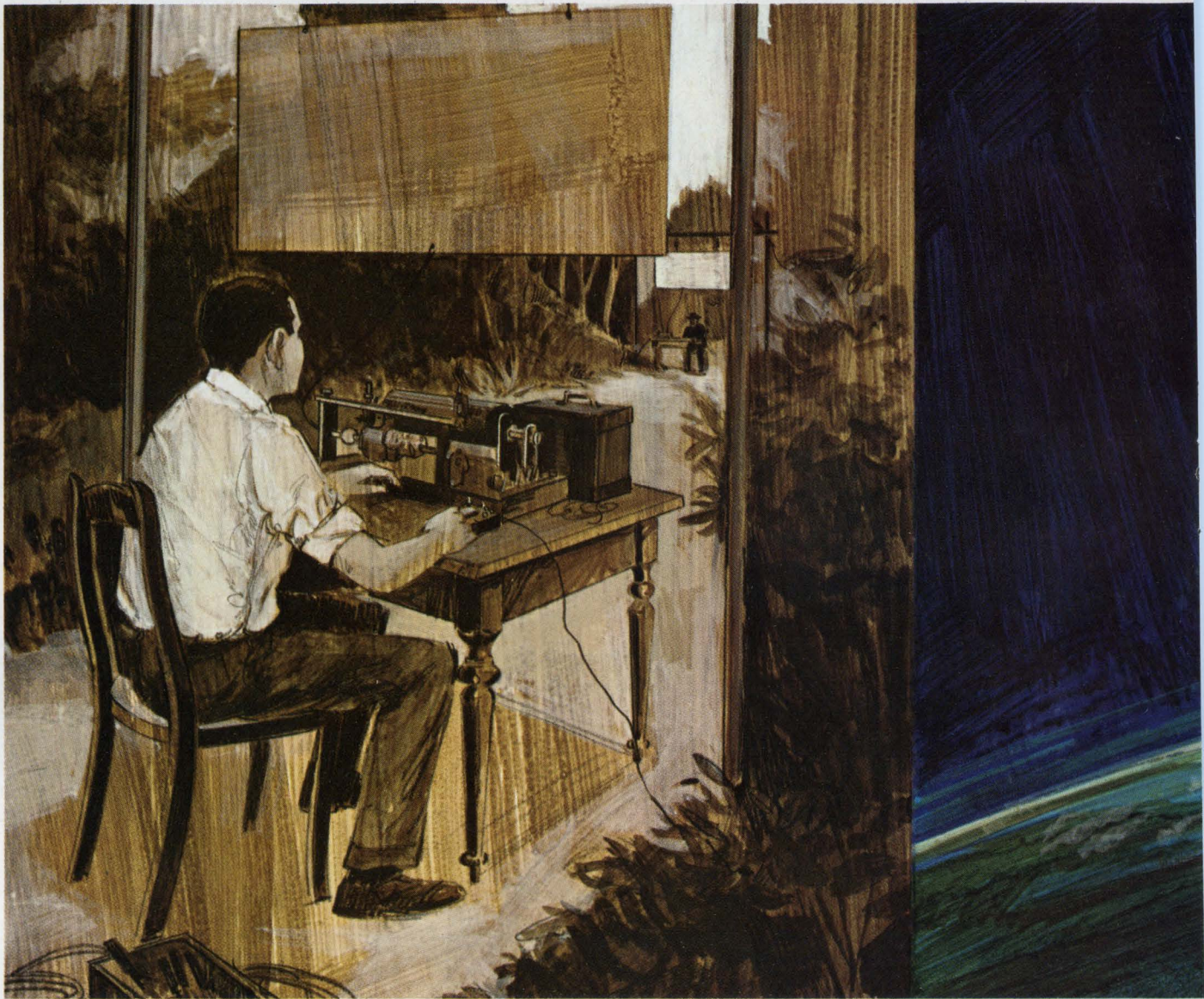

## The Kind of Knowledge that makes progress possible...

On a summery day in 1895, near Bologna, Italy, Guglielmo Marconi worked with wireless telegraphy in pursuit of his childhood dream. Although only 21, Marconi had studied radio wave theories for years, and on this particular day, his efforts began to bear fruit. He established communication between a sending and receiving apparatus.

Marconi's early success earned him the support of the governments of Italy and England. With this aid, he developed bigger and better transmitting equipment. And, as early as 1901, he was sending messages from England to Newfoundland . . . over 2,000 miles away.

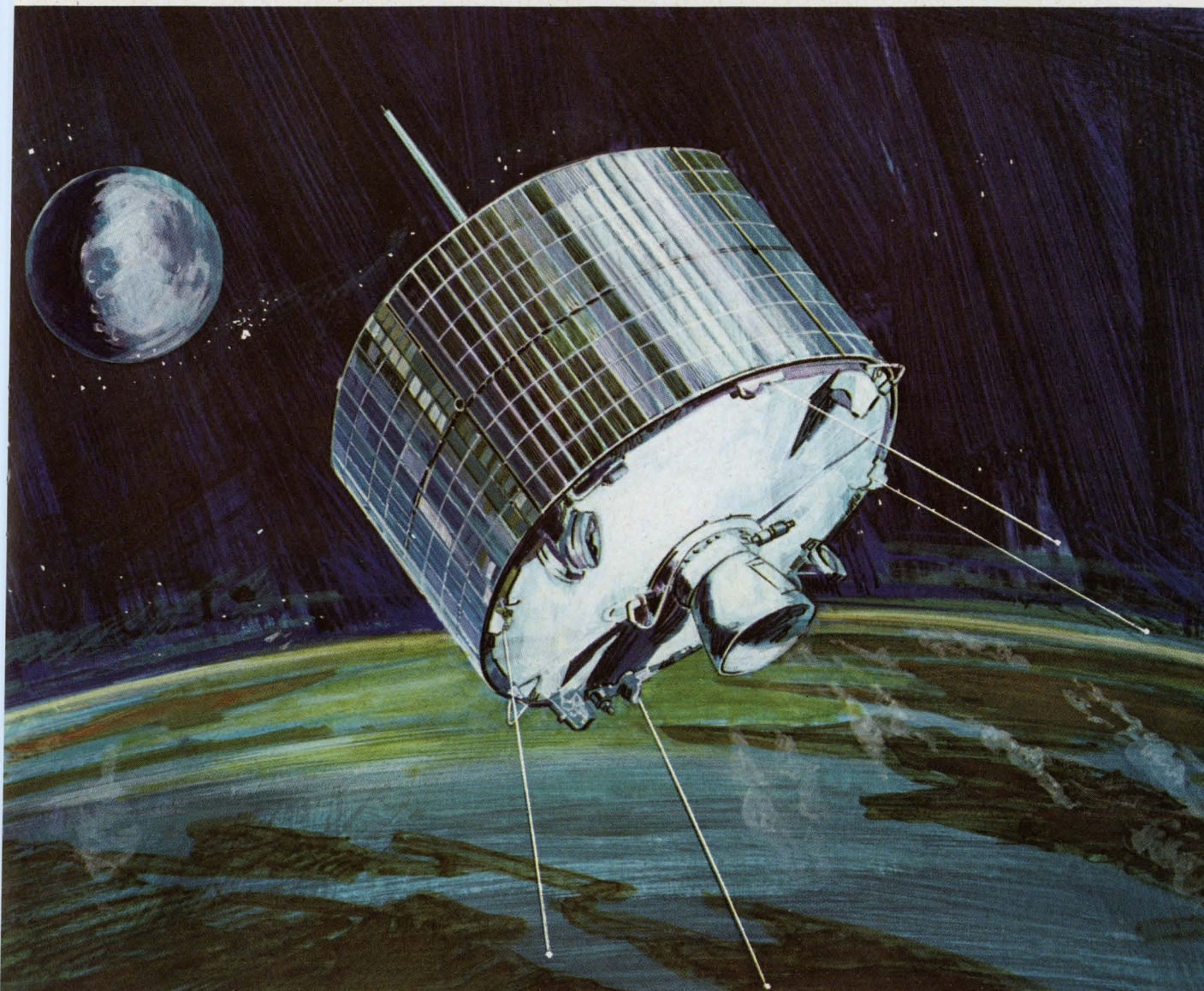

## IS THE KIND OF KNOWLEDGE YOU GET FROM KESTER

Since Marconi's miracle, man has worked on the transmission of radio waves. As a result, smaller equipment has been doing bigger communications jobs. Today, the tiniest transmitters send messages to the earth from the far side of the moon.

The kind of knowledge that has developed the communications field is the kind you get from Kester. Just four years after Marconi's first successful transmission, Kester products and soldering knowledge were at work serving industry.

Today, after 68 years of working with engineers in the technology of solders, fluxes and their applications, Kester stands ready to serve you. Write, phone or wire for specific information.



## KESTER SOLDER COMPANY

A DIVISION OF LITTON INDUSTRIES

4201 Wrightwood Avenue, Chicago, Illinois 60639 • Newark, New Jersey 07105 • Anaheim, California 92805 • Brantford, Ontario, Canada

1899-1967—68 years devoted to production of products of the highest reliability—solders and fluxes

ON READER-SERVICE CARD CIRCLE 40

# Photocell and lamp automate testing of subminiature modules. This unique design approach combines economy and excellent performance.

A large production run of a military electronic system required extensive testing of a subminiature module. One of the more important tests was to measure at what audio input level an output thyatron in the module fired.

Formerly, this test was done manually by slowly varying the audio input voltage to the module until a firing was indicated. This was a slow and inaccurate procedure, since it involved trying to read a varying voltage at the instant of firing and constant manual resetting of the input voltage.

It was decided therefore to automate the whole procedure. The design objectives of the test setup were:

- To create an approximate ramp function of an audio voltage.
- To hold and read the audio voltage at the point of thyatron firing.
- To reset and restart the process.

The first of these objectives was the most taxing problem. For a solution, it was decided to use a dc ramp function as the controller in a variable voltage divider. Figure 1 is a simplified diagram that shows how the desired ac ramp is produced with a Clairex Photomod CLM 5006. Essentially the Photomod is a photocell and an incandescent lamp in a single package.

The ac reference signal is fed into a voltage divider consisting of fixed resistor  $R_F$  and  $R_V$ , which is the photosensitive resistor of the Photomod. A positive-going ramp,  $e_i$ , is fed into the base of an emitter-follower, the output of which drives the lamp of the Photomod. The emitter-follower is required to provide both isolation and current gain. With maximum negative voltage across the Photomod lamp, the resulting illumination reduces the resistance of the photosensitive resistor to a minimum. Therefore, voltage  $e_o$  is at a minimum. As the voltage of the input dc ramp slowly decreases in magnitude,  $e_o$  increases until the dc ramp is at a minimum. Thus, an output ac ramp

has been created that is the inverse of the dc control voltage. If the dc control voltage is stopped at any point, the ac voltage will also stop or "hold."

Figure 2 shows the method used to stop the dc control ramp voltage. A charged condenser,  $C_T$ , is allowed to discharge through a precise resistance,  $R_T$ , forming an approximate positive-going ramp. The voltage across the junction of the resistor and capacitor is fed into a high-gain dc amplifier connected in the noninverting unity-gain configuration. The input impedance of this amplifier approaches infinity. Therefore, if discharging resistor  $R_T$  should be removed from the circuit by a relay contact, the voltage on the capacitor retains its last value. The output voltage of the dc amplifier then holds the voltage input to the emitter-follower constant, stopping any variation in ac output,  $e_o$ .

## Complete system operates automatically

The complete control system is shown in Fig. 3. On receipt of a reset pulse, the timing circuit sends a negative pulse,  $T_1$ , into the base of transistor  $Q1$ . This actuates relay  $K1$ , which in turn charges timing condenser  $C_T$  to  $-V_{ref}$ . As pulse  $T_1$  ends, pulse  $T_2$  is initiated by the timing circuit and relay  $K1$  is released, leaving  $C_T$  charged to  $-V_{ref}$ .

The  $T_2$  pulse, which is longer than  $T_1$ , is fed into the base of transistor  $Q3$ , which together with  $Q2$  forms a logical AND circuit. The base of  $Q2$  is connected to the output of a flip-flop that has been reset, so that the  $Q2$  base is saturated. The  $T_2$  pulse therefore causes relay  $K2$  to become energized, allowing the timing capacitor,  $C_T$ , to start discharging through resistor  $R_T$ . This discharge voltage, a positive-going ramp, is then coupled to the base of emitter-follower  $Q4$  as already described.

The emitter-follower output voltage drives the lamp of the Photomod, thus producing the rising ac ramp, which is fed into the module under test. At some point, the ac ramp fires the thyatron, causing a negative pulse at the plate of the tube.

---

Jerry Lyman, Senior Engineer, Reeves Instrument Div., Dynamics Corp. of America, Garden City, N. Y.

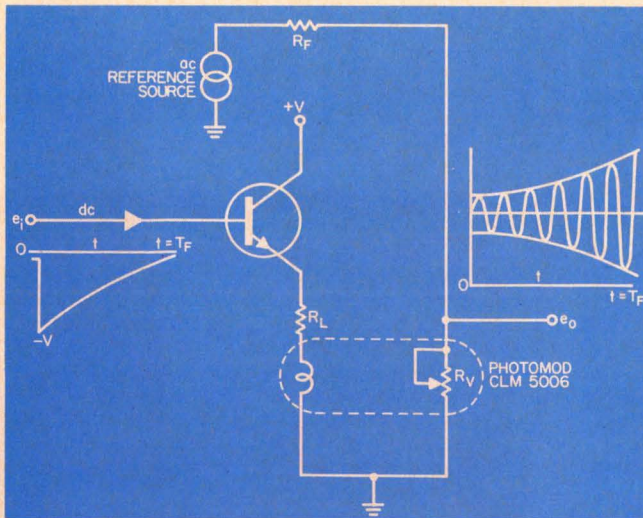

1. Photomod produces ac output ramp that is controlled by the dc input ramp. The emitter-follower stage provides isolation and current gain.

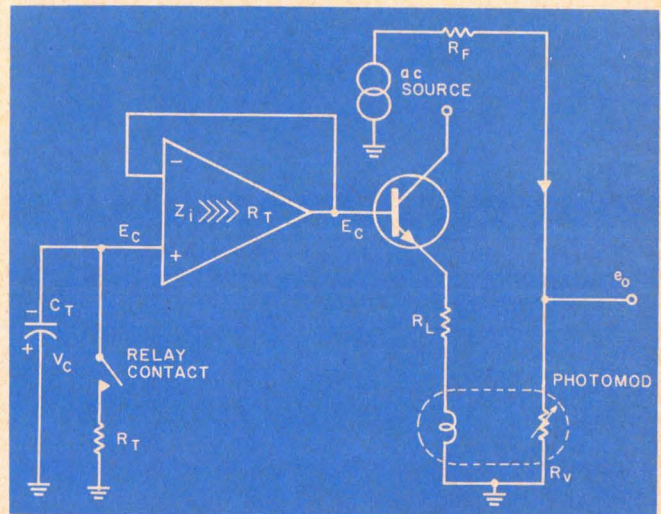

2. Dc ramp is generated when capacitor  $C_T$  discharges through resistor  $R_T$ . The high-gain dc amplifier couples the ramp to the base of the emitter-follower.

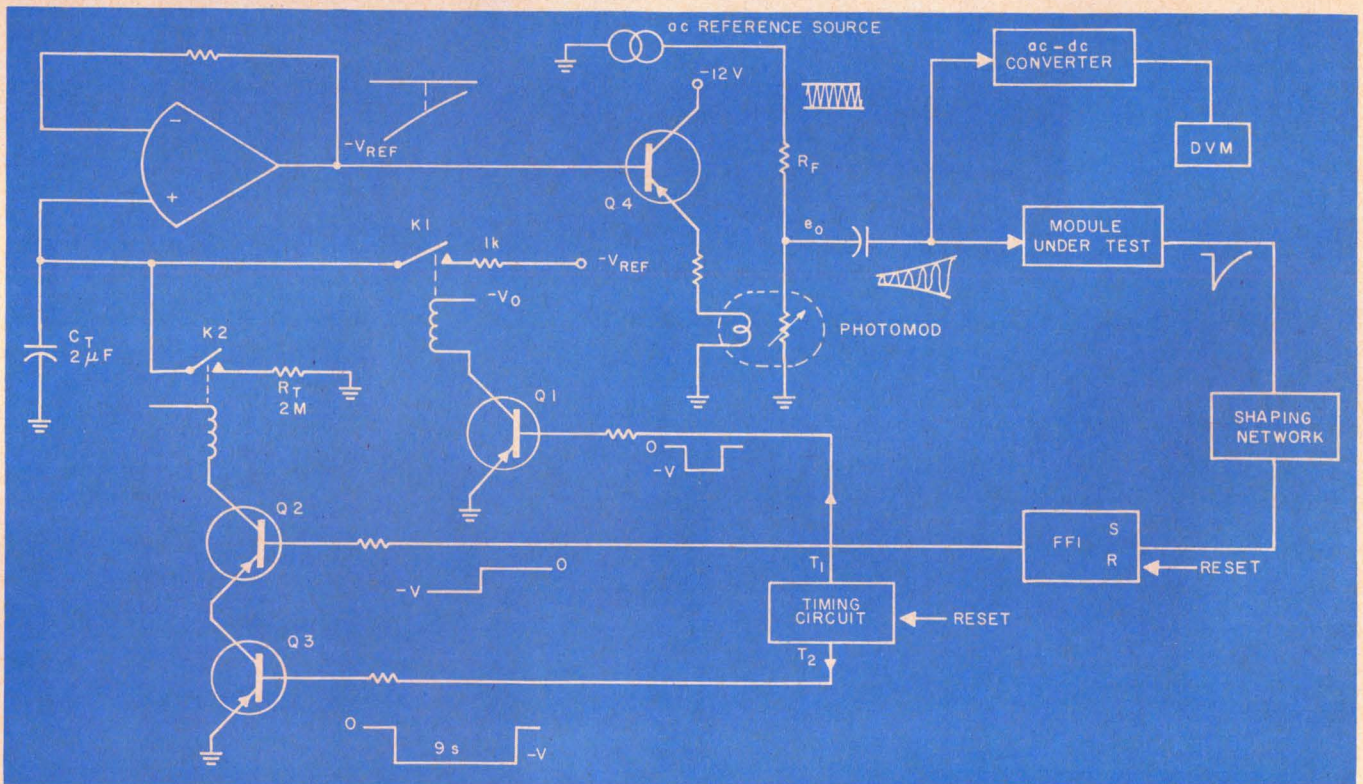

3. Thyatron firing is detected automatically by the system, and the input level at which firing occurs is read

out on a DVM. Resetting the timing circuit and flip-flop then prepares the system for the next test.

This pulse, suitably shaped, changes the state of flip-flop *FF1*. As a result, transistor *Q2* is brought out of saturation, opening *K2*. The result leaves capacitor  $C_T$  charged to its last value and paralleled by an extremely high resistance. This has the effect of "hold."

Since the dc ramp is in a state of "hold," the ac control voltage is also "frozen." This ac voltage is read out on a digital voltmeter, establishing the input firing level of the thyatron. A reset pulse to the timer and the flip-flop then prepares the circuit for another unit.

In the design of this automatic test system, other possibilities for controlling the output voltage were also considered. These included a follow-up electromechanical servo and a form of diode agc. The use of a servo was rejected as too expensive, and the diode agc had the disadvantage of mixing the ac and dc signals. The Photomod, on the other hand, was ideal for the application because it is economical as a component and uses a minimum of hardware. In addition, it affords complete isolation of the control and output signals, and can be reset electronically. ■ ■

# Now there's a "4th generation"



# of plug-in digital counters



The use of IC's in a prize-winning package design gives you more of what you want in a counter, from DC to microwave.



THE 125 MHz MAIN-FRAME ACCEPTS ANY OF THESE PLUG-INS: Model 1104A 0.3-3 GHz Converter; Model 1102A Six-digit Preset; Model 1101A 1GHz Prescaler; or the Model 1103A 50-500 MHz Converter. Available soon: compatible video preamplifier, DVM plug-in and microwave frequency converters.

Look what you get in Monsanto's new Model 1500A plug-in digital counter-timer: Cool, solid reliability of its IC circuits; 125 MHz main-frame range; built-in remote programmability compatible with either passive contact closures or active circuits; increased flexibility, by trigger level control, by overflow and gate indicators, by the ability to accept *any* external time base up through 10 MHz; new package detail which includes a unique lever latch that frees a plug-in with the flip of a finger. With the Model 1500A you get a lot of counter for just \$2,850! (U.S.A. dollars, f.o.b. New Jersey; plug-ins extra)

Monsanto Electronics Technical Center,  
620 Passaic Avenue, West Caldwell, N. J.  
07006. Phone: (201) 228-3800.



ELECTRONIC  
INSTRUMENTS

ON READER-SERVICE CARD CIRCLE 41

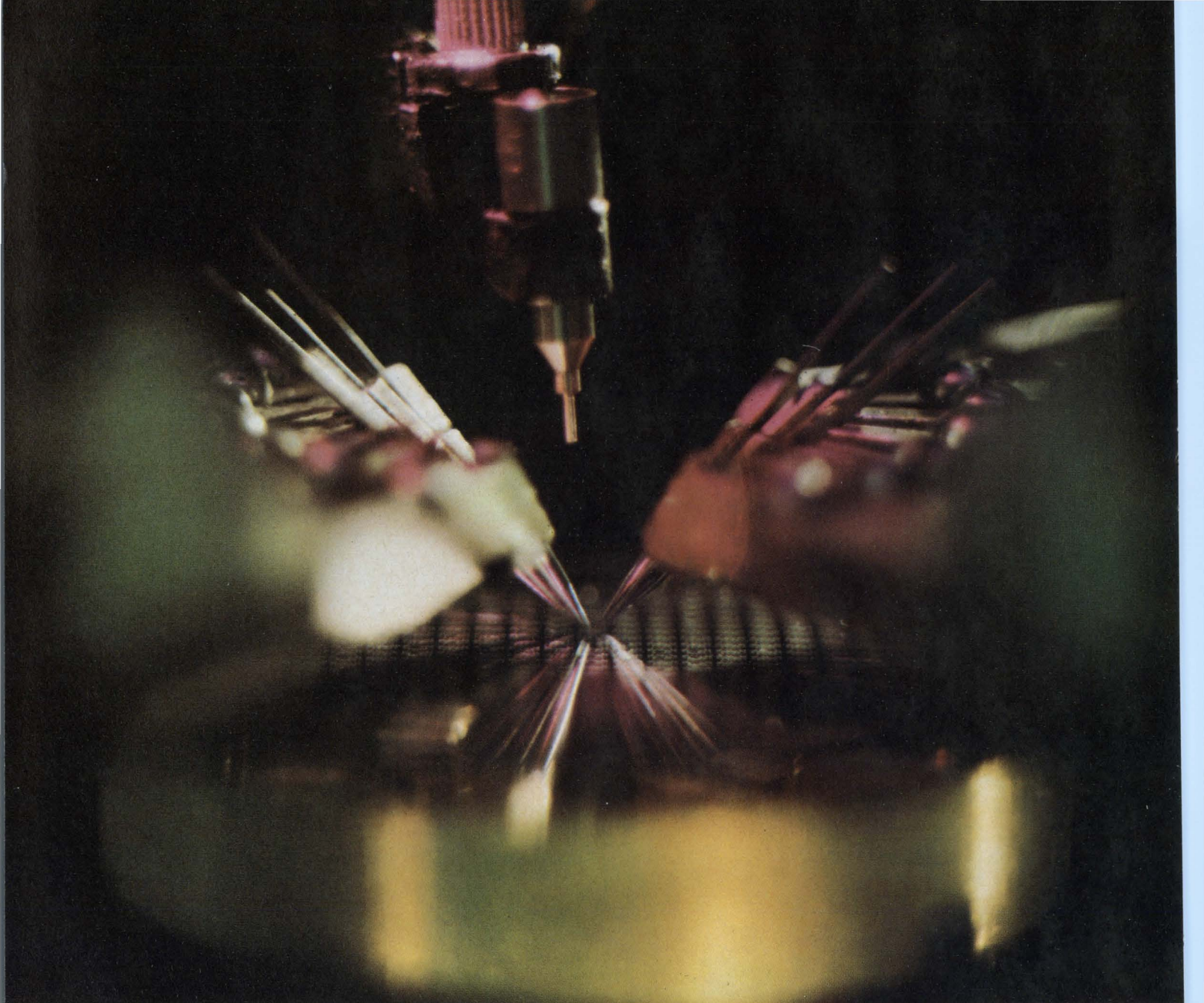

## We cross examine every IC at 14 points... and that's just the beginning.

Early in production, every Sylvania IC is 100% DC tested on our fully automated 14-point probe.

At the end, each Sylvania IC must pass final operational tests in four consecutive, temperature-controlled chambers from  $-55^{\circ}\text{C}$  to  $125^{\circ}\text{C}$ .

And there's no let-up in testing in between. All bonds are air-blasted and mechanically tested prior to package sealing. All packages are baked at  $300^{\circ}\text{C}$  to insure absolute dryness before sealing.

After sealing, all units are aged at  $300^{\circ}\text{C}$  for

60 hours. Then all IC's are temperature cycled from  $-65^{\circ}\text{C}$  to  $200^{\circ}\text{C}$ , centrifuged at 20,000 Gs in the  $Y_1$  plane, and all packages are 100% leak tested for hermetic seal.

These tests are far more comprehensive and thorough than any performed by our competitors. And we minimize errors in the first place with our fixed production process.

Sylvania Semiconductor Division, Electronic Components Group, Woburn, Mass. 01801.

**SYLVANIA**  
SUBSIDIARY OF  
GENERAL TELEPHONE & ELECTRONICS **GTE**



# Addenda to ELECTRONIC DESIGN 1967 Semiconductor Directory (ED 9, April 26, 1967)

The following integrated circuits manufactured by Sprague Electric Co. were omitted from our 1967 Semiconductor Directory. Included are their operating temperature ranges and package descriptions. For full specifications, circle **388** on the Reader-Service Card in this issue.

**Operating temperature ranges**

-55 C to +125 C Series SE, US      +10 C to +55 C Series LU  
 -20 C to +85 C Series SU          +15 C to +70 C Series SP  
 0 C to +70 C Series NE, ST

**Packages** (letter following the type number)

A 14-lead plastic dual in-line      E TO-91  
 B 10-lead flat pack                  G TO-91  
 C TO-85                                  J TO-88  
 D TO-78                                  K TO-100

			Fan-out	Propagation delay (nsec)	Average power (mW)	
DTL	NE106A, NE106J, SE106J	Dual 5-input gate expander	—	—	—	
	SE111J	Dual 4-input high fan-out gate	19	20	34	
	NE112A, NE112J, SE112J	Dual 3-input high fan-out gate	19	20	34	
	NE116A, NE116J, SE116J	Dual 4-input NAND gate	6	25	15	
	NE124A, NE124J, SE124J	RST binary element	7	18 MHz	28	
	NE125A, NE125J, SE125J	J-K binary element	8	12 MHz	40	
	SE155J	Dual 4-input clock/cap. line driver	19	20	34	
	NE156A, NE156J, SE156J	Dual 4-input clock/cap. line driver	19	20	34	
	NE161A, NE161J, SE161J	Monostable multivibrator	4	—	51	
	NE170A, NE170J, SE170J	Triple 3-input NAND gate	6	25	15	
	NE180A, NE180J, SE180J	Quadruple 2-input NAND gate	6	25	15	
	SP616A, ST616A	Dual 4-input expandable NAND gate	5	30	34	
	SP620A, ST620A	J-K binary element	5	5 MHz	28	
	SP629A, ST629A	RST binary element	5	10 MHz	40	
	SP631A, ST631A	Quadruple 2-input gate expander	—	—	—	
	SP659A, ST659A	Dual 3-input buffer/driver	12	25	34	
	SP670A, ST670A	Triple 3-input NAND gate	5	30	15	
	SP680A, ST680A	Quadruple 2-input NAND gate	5	30	15	
	US-720J	Quadruple 2-input NAND gate	6	25	14	
	US-721J	Triple 3-input NAND gate	6	25	14	
	US-727J	Triple 2-input NAND gate	6	25	15	
	US-729J	RST binary element	7	18 MHz	28	
	US-730J	Dual 5-input NAND gate	6	25	15	
	US-731J	Quadruple 2-input gate expander	—	—	—	
	US-732J	12-input gate expander	—	—	—	
	mWRTL	US-0908D, US-0908E	adder	—	120	10
		US-0909D, US-0909E	buffer	—	80	10
US-0910D, US-0910E		dual gate	—	40	4	
US-0911D, US-0911E		gate	—	80	4	
US-0912D, US-0912E		half adder	—	120	8	
US-0913D, US-0913E		register	—	120	15	
US-0921D, US-0921E		gate expander	—	40	0	
TTL		NE416A, NE416J, SE416J	Dual 4-input expandable NAND gate	7	32	9
	NE417A, NE417J, SE417J	Dual 3-input expandable NAND gate	7	35	8	
	NE424A, NE424J, SE424J	Dual AC binary element	7	9 MHz	14	
	NE440A, NE440J, SE440J	Dual exclusive OR gate	7	25	10	
	NE455A, NE455J, SE455J	Dual 4-input power/driver	24	29	12	
	NE480A, NE480J, SE480J	Quad 2-input NAND gate	7	25	9	
	NE806A, NE806J, SE806J	Dual 4-input expander	—	—	—	
	NE808A, NE808J, SE808J	Single 8-input NAND gate	10	13	20	
	NE816A, NE816J, SE816J	Dual 4-input NAND gate	10	13	20	
	NE825A, NE825J, SE825J	Dc clocked J-K binary element	10	20 MHz	70	
	NE826A, NE826J, SE826J	Dual J-K binary element	5	30 MHz	35	
	NE840A, NE840J, SE840J	Dual 4-input exclusive OR gate	10	13	35	
	NE855A, NE855J, SE855J	Dual 4-input power gate	30	13	25	
	NE870A, NE870J, SE870J	Triple 3-input NAND gate	10	13	20	
	NE880A, NE880J, SE880J	Quad 2-input NAND gate	10	13	20	
	SE8416J	Dual 4-input expandable NAND gate	7	35	4.5	

**Operating temperature ranges**

-55 C to +125 C Series SE, US  
 -20 C to +85 C Series SU  
 0 C to +70 C Series NE, ST

+10 C to +55 C  
 +15 C to +70 C

Series LU  
 Series SP

**Packages (letter following the type number)**

A 14-lead plastic dual in-line E TO-91  
 B 10-lead flat pack G TO-91  
 C TO-85 J TO-88  
 D TO-78 K TO-100

			Fan-out	Propagation delay (nsec)	Average power (mW)	
TTL	SE8417J	Dual 3-input expandable NAND gate	7	50	4.5	
	SE8424J	Dual AC binary element	7	9 MHz	9.0	
	SE8440J	Dual exclusive OR gate	7	25	4.5	
	SE8455J	Dual 4-input buffer/driver	20	28	7.0	
	SE8480J	Quad 4-input NAND gate	7	25	3.5	
	SE8806J	Dual 4-input expander	-	-	-	
	SE8808J	Single 8-input NAND gate	10	12	20	
	SE8816J	Dual 4-input NAND gate	10	12	20	
	SE8825J	Dc clocked J-K binary element	10	20 MHz	70	
	SE8826J	Dual J-K binary element	10	30 MHz	35	
	SE8840J	Dual 4-input exclusive OR gate	10	12	25	
	SE8855J	Dual 4-input power gate	26	12	25	
	SE8870J	Triple 3-input NAND gate	10	12	20	
	SE8880J	Quad 2-input NAND gate	10	12	20	
	SP416A, ST416A	Dual 4-input expandable NAND gate	7	40	12	
	SP417A, ST417A	Dual 3-input expandable NAND gate	7	40	12	
	SP424A, ST424A	Dual AC binary element	7	9 MHz	22	
	SP440A, ST440A	Dual exclusive OR gate	7	45	18	
	SP455A, ST455A	Dual 4-input power/driver	24	45	16	
	SP480A, ST480A	Quad 2-input NAND gate	7	40	9.0	
	SP806A, ST806A	Dual 4-input expander	-	-	-	
	SP808A, ST808A	Single 8-input	8	20	25	
	SP816A, ST816A	Dual 4-input NAND gate	8	20	25	
	SP825A, ST825A	Dc clocked J-K binary element	8	20 MHz	135	
	SP826A, ST826A	Dual J-K binary element	4	30 MHz	60	
	SP840A, ST840A	Dual 4-input exclusive OR gate	8	20	30	
	SP855A, ST855A	Dual 4-input power gate	24	20	45	
	SP870A, ST870A	Triple 3-input NAND gate	8	20	25	
	SP880A, ST880A	Quad 2-input NAND gate	8	20	25	
	RCTL	US-0100B	R-S flip-flop/counter/shift reg.	4	-	2
		US-0101B	R-S flip-flop/counter/shift reg.	20	-	3
		US-0102B	6-input NOR/NAND gate	5	-	2
US-0103B		6-input NOR/NAND gate	25	-	2	
US-0104B		Dual 3-input NOR/NAND gate	5	-	2	
US-0104B		Exclusive OR circuit	5	-	3	
US-0106B		Dual 2-input NOR/NAND gate and inv.	25	-	2	
US-0107B		Clock driver circuit	20	-	3	
US-0108B		Single shot multivibrator	5	-	4	
US-0109B		Pulse exclusive OR gate	5	-	6	
US-0110C		R-S flip-flop with dual resets	4	-	2	
US-0111C		R-S flip-flop with dual resets	20	-	3	
US-0112C		Triple 2-input NOR/NAND gate	5	-	2	
US-0113C		Triple 2-input NOR/NAND gate	5	-	2	
US-0114B		4x1x1 input NOR/NAND gate	5	-	2	
US-0115B	4x1x1 input NOR/NAND gate	25	-	2		
Linear Circuits	NE501, SE501	RF/video/pulse amplifier	-	4-40 MHz	25	
	NE505, SE505	Small signal diff. amplifier	-	1 MHz	100	
	NE506, SE506	Operational amplifier	-	500 kHz	180	
	NE518, SE518	Voltage comparator	-	5 MHz	170	
Utililog	LU300K, SU300K	Dual 3-input gate expander	-	-	-	
	LU305K, SU305K	6-input AND gate	10	25	5	
	LU306K, SU306K	Dual 3-input AND gate	10	25	5	
	LU314K, SU314K	7-input NOR gate	17	30	18	
	LU315K, SU315K	Dual 3-input NOR gate	17	30	18	
	LU316K, SU316K	Dual 2-input NOR gate	17	30	18	
	LU320K, SU320K	J-K binary element	17	4 MHz	90	
	LU331K, SU331K	Dual 2-input OR gate	17	30	36	
	LU332K, SU332K	Dual 3-input OR gate	17	30	36	

The following companies should be added to the diode chart:

Company	Products	Company	Products	Company	Products
<b>Parametric Industries, Inc.</b> 63 Swanson Street Winchester, Mass. 01890 Tel.: (617) 729-7333	Varactors PIN diodes	<b>Monsanto Electronics</b> 800 N. Lindbergh Blvd. St. Louis, Mo. 63166 Tel.: (314) 694-2136	Lasers Visible and invisible light emitting diodes and arrays	<b>Victory Engineering</b> P.O. Box 187 Springfield, N.J. Tel.: (201) 379-5900	Varistors

# EMI is out.

# New Bendix filter-connectors are in.

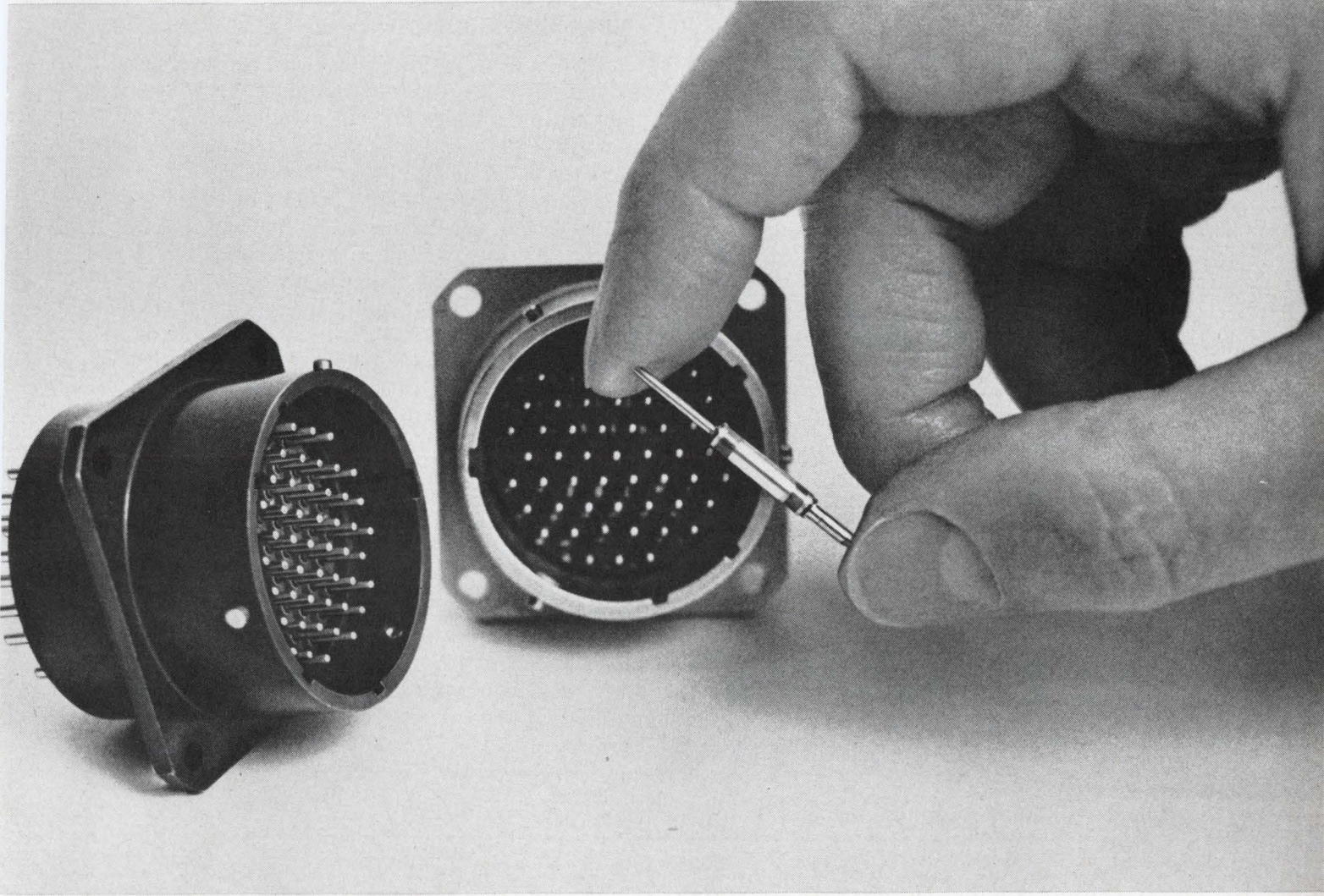

Bendix® filter-connectors can eliminate EMI (electro magnetic interference) better than conventional filtering methods ever could. The filtering action is completely built-in because we've surrounded each individual pin with a miniature ferrite filter.

We don't have to tell you the benefits of making the filter an integral part of the connector. The savings in space, weight and production costs are obvious. A Bendix filter-connector costs about a third less than a filter-box setup with a standard connector. It eliminates two out of three solder joints. There's no need to manufacture, assemble and test extra filter components.

Also, consider what fewer solder joints and a superior

mechanical structure can mean in reliability.

All this adds up to an entirely new concept in filtering. And a new way for you to save money while improving the performance and reliability of today's highly complex electronic equipment.

A great number of models are readily available including types intermatable with the Bendix Pygmy® Series (Mil-C-26482), Bendix JT Pancake Series and Bendix LJT Series. More are on the way. And we'll design filter-connectors to meet your specific requirements. For all the details, just write: The Bendix Corporation, Electrical Components Division, Sidney, N.Y. 13838.

**Bendix** **Electronics**

# Cut copper costs: use aluminum strip

as a conductor. A simple nomogram gives the aluminum equivalent for the round copper wire in your designs.

The use of aluminum strip is one way to overcome the copper shortage. This simple nomogram converts round copper into aluminum strip conductor on the basis of equivalent current-carrying capacities. Depending on application, the final choice of aluminum strip dimensions can be made from a variety of strip width-strip gauge trade-offs. First, consider some virtues of aluminum.

## Pricing is stable, supply plentiful

The price of aluminum is very stable because of the basic abundance of the material. Currently, aluminum conductors are one-third cheaper than copper ones for equivalent ampere capacity. From the designer's viewpoint, aluminum has the advantages of simplified coil design and winding equipment for strip conductors and lower turn-to-turn voltage stress since adjacent strips are right on top of each other rather than many electrical turns away. Aluminum strip also has a lower temperature coefficient and offers a saving in weight of up to 50 per cent over copper wire. On the negative side, the volume conductivity of aluminum is 40 per cent lower than copper.

Aluminum has already proved itself in distribu-

tion transformers, power transformers, alternators, chokes and superconductive coils.

## Nomogram simplifies conversion

The nomogram simplifies the conversion of copper AWG gauges into aluminum strip and vice versa. Any straight line drawn through the AWG number of interest on the center scale will indicate width and gauge (thickness) of a corresponding aluminum strip on the scales to left and right, respectively. For example, to find an aluminum strip with the current-carrying capacity of 12-gauge copper wire, a straight line is pivoted through the 12-gauge point on the center scale. It reveals a number of choices: a 2-inch wide aluminum strip with a gauge of 4 mils, or a 3-inch wide strip of 2.73 mils, etc.

The Table estimates weight where a coil has to be wound. To find the weight in pounds, the width of the aluminum strip as found from the nomogram is multiplied by the figure given for the desired core inside diameter and roll outside diameter. If, on the other hand, weight is the critical factor, the procedure can be reversed. The required weight is divided by the figure given for the appropriate core ID and roll OD, the result is applied to the nomogram, and the necessary aluminum strip gauge is read off. ■ ■

**Fred Meier**, Marketing Manager, Electronic Products, Republic Foil, Inc., Danbury, Conn.

**Table. Factors to estimate coil weights**

Roll OD (inches)	3-inch Core ID*	6-inch Core ID	12-inch Core ID	Roll OD (inches)	3-inch Core ID*	6-inch Core ID	12-inch Core ID
8-1/2	4.7	—	—	17-1/2	22.7	19.37	12.5
9	5.4	2.74	—	18	24.0	20.68	13.7
9-1/2	6.1	4.32	—	18-1/2	25.4	22.63	15.5
10	6.9	4.14	—	19	26.8	23.41	17.0
10-1/2	7.7	4.90	—	19-1/2	28.3	24.83	18.3
11	8.5	5.69	—	20	29.8	26.29	20.0
11-1/2	9.3	6.52	—	20-1/2	31.4	27.79	21.2
12	10.2	7.39	—	21	32.9	29.32	23.0
12-1/2	11.2	8.29	—	21-1/2	34.6	30.89	24.5
13	12.2	9.24	—	22	36.2	32.49	26.2
13-1/2	13.2	10.21	—	23	39.7	35.81	30.0
14	14.2	11.23	—	24	44.3	39.28	33.0
14-1/2	15.3	12.28	—	25	47.0	42.90	37.0
15	16.4	13.37	6.2	27	53.0	51.8	42.5
15-1/2	17.6	14.50	7.4	30	69.0	66.0	54.0
16	18.8	15.66	8.7	35	94.0	92.0	83.0
16-1/2	20.0	16.86	10.0	40	122.0	120.0	112.0
17	21.3	18.09	11.0	45	153.0	152.0	145.0

\*For 4-in. ID core use 3-in. ID column.

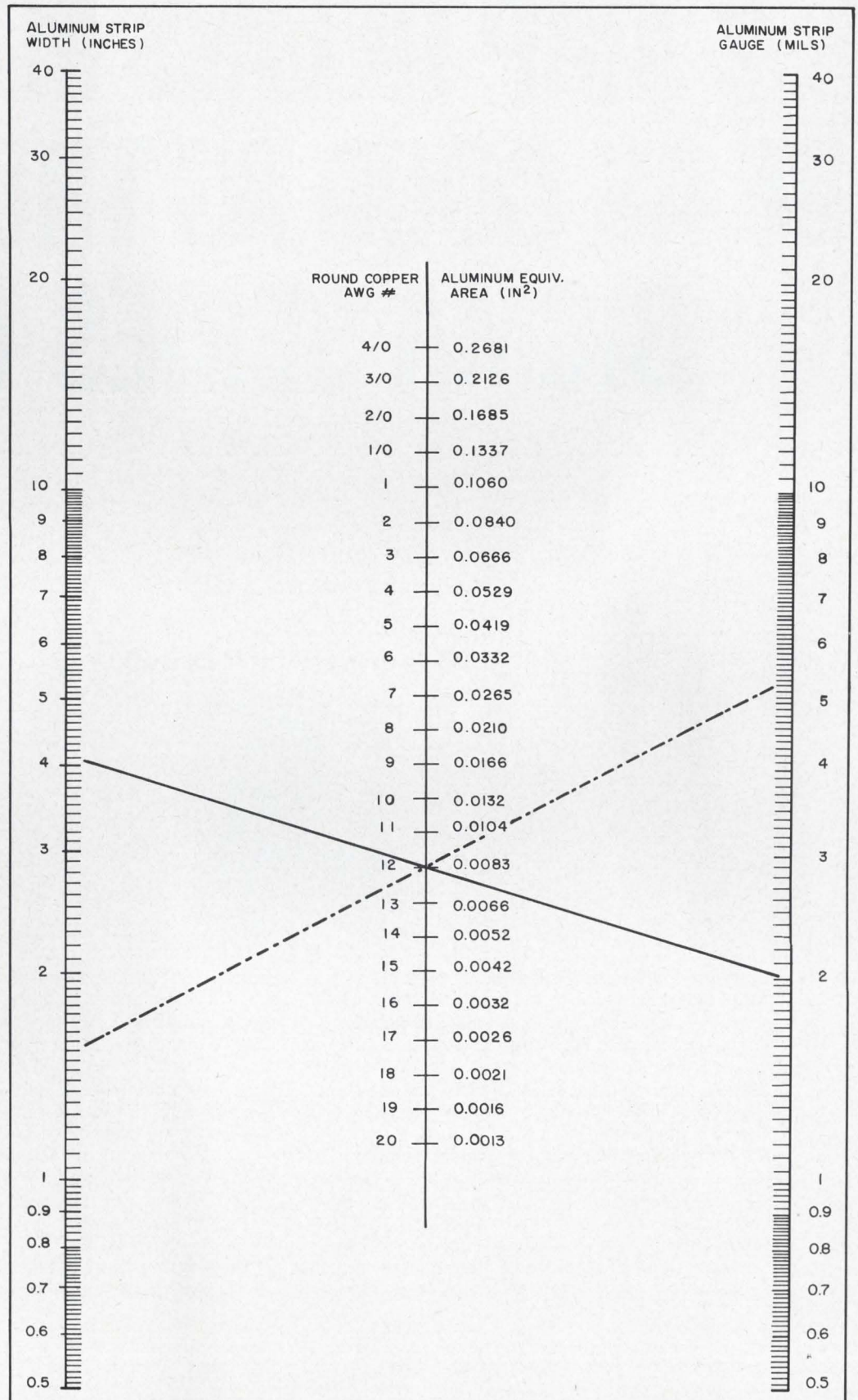

Aluminum strip equivalents for round copper conductors are found by pivoting a straight line through the AWG number of interest. Two equivalents for AWG #12 copper wire are shown above.

# OTHER 2, 4 AND 6 POLE 2 AMP RELAYS MIGHT BE AS GOOD AS THE NEW SIGMA SERIES 62.

If they were built as well.

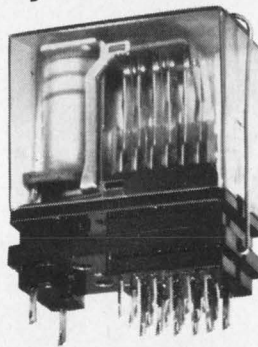

Versatile, miniature Sigma Series 62 general purpose relays outperform their competitive counterparts because they are built better three ways:

**Larger Contacts For Longer Life:** The larger contacts (.093" & .058" dia.) used in the Series 62 assure superior thermal and electrical conductivity and a life expectancy of 1 million operations at rated load.

**Thicker Base For Greater Contact Stability:** The Series 62 base, in the terminal area, is twice as thick as competing types. This provides a much higher degree of mechanical support assuring long-term stability of the stationary contact members.

**More Durable Lifter For Better Contact Action:** The contact actuator of the Series 62 is made of

fabric-filled phenolic rather than paper-based phenolic. It is extremely durable, rigid, and not subject to cracking even after extended use.

**We'd like to give you a new Sigma Series 62**—or any of our other standard relays. Test and compare it against the brand you may now be using. It's the best way we know to prove what we say about Sigma relay performance. Just circle our reader service number on the reader service card. We'll send you the new Sigma relay catalog and a "free relay" request form. Return the form to us and your Sigma representative will see that you get the relay you need.

**Need fast delivery? The Series 62 is available off-the-shelf from your Sigma distributor.**

SIGMA DIVISION  SIGMA INSTRUMENTS INC  
Assured Reliability With Advanced Design / Braintree, Mass. 02185  
Sigma Instruments (Canada) Ltd., P.O. Box 43, Toronto 18

ON READER-SERVICE CARD CIRCLE 44

# SAVE

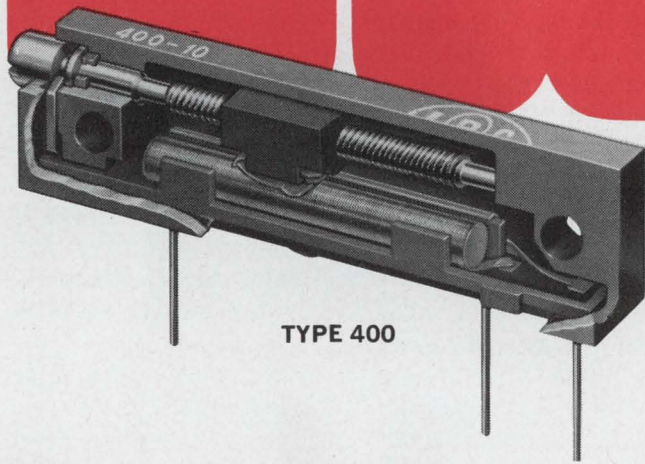

TYPE 400



TYPE 600

## Military quality at industrial prices

### IRC wirewound rectangular trimmers save space and dollars

IRC's CIRCUITRIM potentiometers offer MIL characteristics at the same price as industrial types. Benefit by upgraded performance and reliability for your industrial needs and impressive savings for your MIL applications.

Both series are designed to perform under environmental requirements of MIL-R-27208. Molded diallyl phthalate cases are rugged, light and practical for use in any military or high grade industrial application. A one-piece, corrosion-resistant shaft and specially designed wiper block system isolate electrical elements and assure "set-and-forget" stability.

The 600 series is designed to MIL-Style RT-11 and is offered with staggered P.C. pins or teflon insulated leads. The 400 series is designed to MIL-Style RT-12 with P.C. pins in-line or teflon insulated leads. It is also available in a thin-line version of RT-11 (Type 400-20) with staggered P.C. pins which offer 30% space savings and complete interchangeability on pre-printed boards.

These low-cost MIL-type units are the result of IRC's years of experience in building high-quality trimmers. Samples available

from local sales offices. For prices and data, write: IRC, Inc., 401 N. Broad St., Philadelphia, Pa. 19108.

#### ONLY IRC OFFERS ALL 4 POPULAR STYLES

Wirewound or infinite resolution elements



#### CAPSULE SPECIFICATIONS

	TYPE 400	TYPE 600
MIL STYLE	RT-12*	RT-11
POWER	1 W @ 70°C	1 W @ 70°C
TOLERANCE	± 5%	± 5%
RESISTANCE	10Ω to 50KΩ	10Ω to 50KΩ
TEMPERATURE	-55°C to 150°C	-55°C to 150°C

\*Plus thin-line version of RT-11 (Staggered P.C. pins)



ON READER-SERVICE CARD CIRCLE 45

# A novel integrator results by grounding its capacitor

A conventional integrator uses an operational amplifier with negative feedback applied from the output terminal to the inverting input through a capacitor. It is frequently desirable to use an electronic switch to set and reset the capacitor to some initial condition, and this is made difficult because the capacitor is floating. The circuit described does not have this disadvantage since it has a grounded capacitor among other features.

The figure is a circuit diagram of the integrator. It uses a single grounded capacitor, four equal resistors, and an operational amplifier. The circuit output voltage can easily be shown to be:

$$V_3 = (1/RC) \int_0^t (V_2 - V_1) dt.$$

This equation shows that the circuit will integrate a differential input signal. To do this with a conventional integrator requires two capacitors which further complicates the setting of initial conditions. If terminal 1 is grounded ( $V_1 = 0$ ), the circuit operates as a noninverting integrator. With terminal 2 grounded ( $V_2 = 0$ ) the circuit acts as an inverting integrator. Thus, with single-ended signals it is possible to select a desired output polarity by grounding the appropriate

input terminal. Output polarity selection is possible in the differential case by appropriate connection to the two input terminals.

To illustrate the ease with which capacitor  $C$  can be reset in various modes of operation, two simple electronic switches,  $Q1$  and  $Q2$ , are shown in the figure. Consider the case where  $V_1 = 0$  and  $V_2$  is a positive constant voltage.  $V_3$  will then be a linear sweep with a slope of  $V_2/RC$  volts per second. With  $S$  in position  $a$  the circuit operates in a free-running mode owing to the voltage-sensing switching action of unijunction transistor  $Q1$ . With  $S$  in position  $b$  the sweep can be made to start and stop by application of negative and positive voltages, respectively, to the base of bipolar transistor  $Q_2$ , so that the circuit operates as a triggered sweep.

When  $V_1 = 0$  and  $V_2$  is a positive, variable voltage to be integrated, transistor  $Q2$  can be used to set an initial condition of  $V_3 = 0$  and to reset the integrator when desired.

The simplicity of the switching involved in all those modes of operation is a direct result of capacitor  $C$ 's having one side grounded.

If a low impedance output is required, it is available at the amplifier output, terminal 4, where:

$$V_4 = (2/RC) \int_0^t (V_2 - V_1) dt - V_1.$$

If  $V_1$  is made zero and  $V_2$  is the variable to be integrated, a low impedance voltage source of:

$$V_4 = (2/RC) \int_0^t V_2 dt$$

is available at terminal 4 with the same ease of resetting of  $C$  available as before.

*Gordon J. Deboo, Ames Research Center, NASA, Moffett Field, Calif.*

VOTE FOR 110

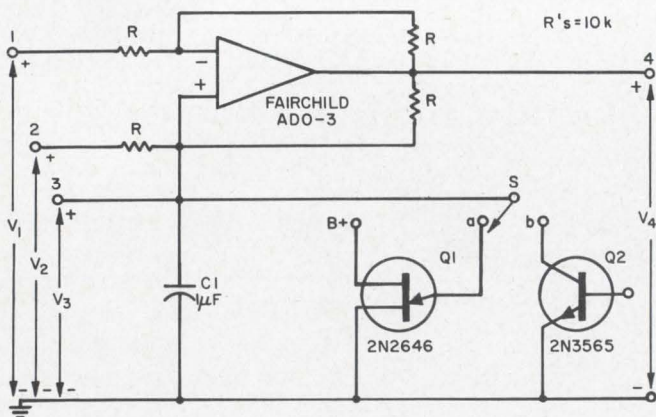

Grounding capacitor  $C$  permits use of a standard integrator circuit in a variety of modes determined by electronic switches  $Q1$  and  $Q2$ .

**VOTE!** Circle the Reader-Service-Card number corresponding to what you think is the best Idea-for-Design in this issue.

**SEND US YOUR IDEAS FOR DESIGN.** Submit your IFD describing a new or important circuit or design technique, the clever use of a new component, or a cost-saving design tip to our Ideas-for-Design editor. If your idea is published, you will receive \$20 and become eligible for an additional \$30 (awarded for the best-of-issue Idea) and the grand prize of \$1000 for the Idea of the Year.

## Standing waves eliminated within antenna elements

Damage caused by excessive vibration is a frequent problem in the operation of multielement vhf antenna arrays. Even moderately light winds may cause standing waves inside the element, and the resulting stresses will lead to metal fatigue and



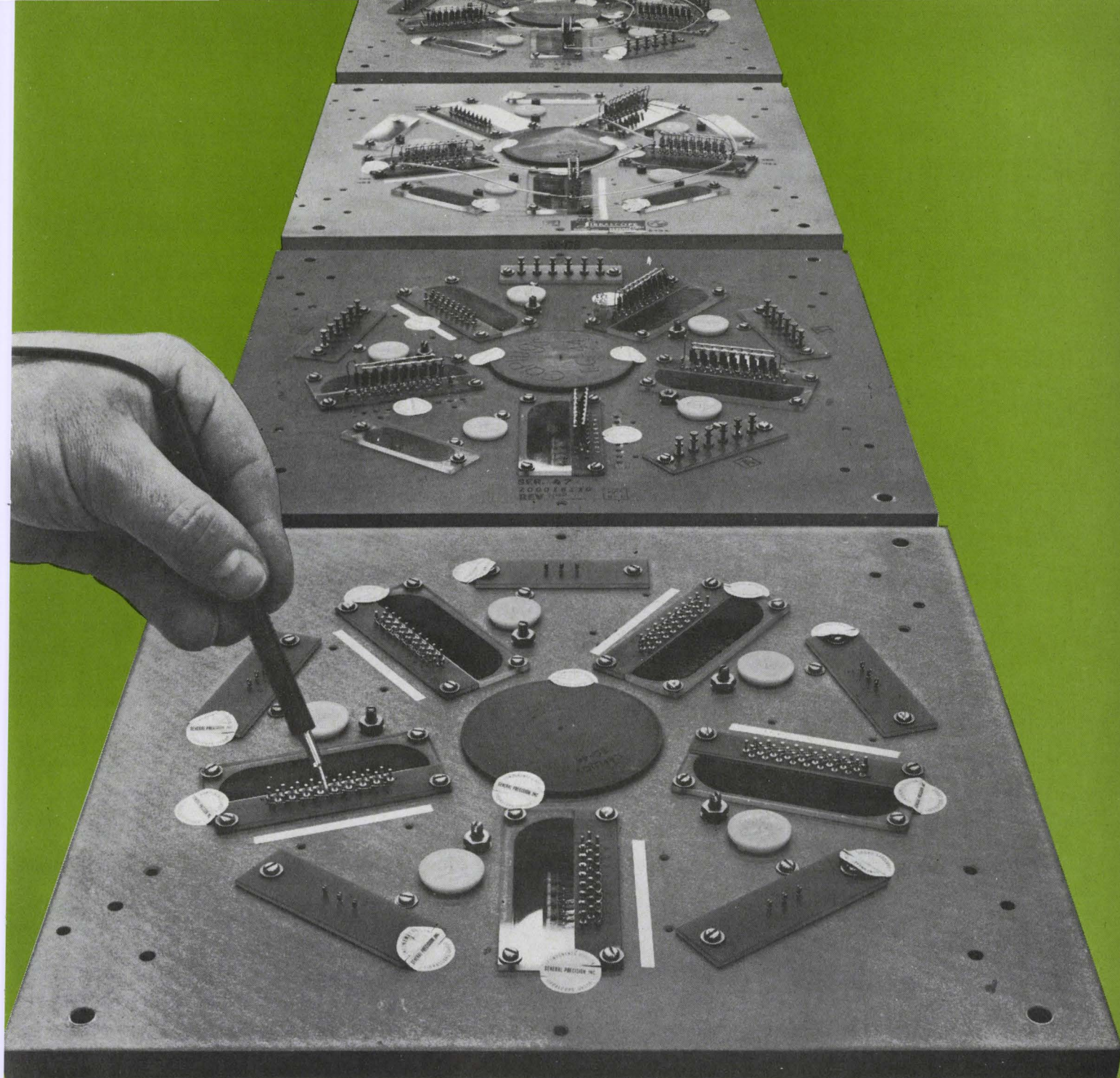

## Fairchild has these fond memories of Librascope

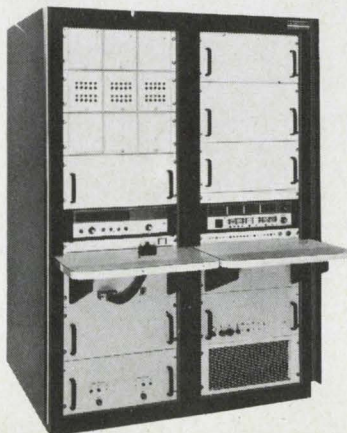

Unlimited programmed testing with flexible test sequencing is one reason why. That's the advanced state-of-the-art job called for by the programming unit of Fairchild's new Series 4000M Automatic Integrated Circuit Testing System. Librascope's Series L100 Disc Memory got the call. Each stores 900 test programs—grouped in sequences of 25—and runs up to 60 per second. The same testing line accepts a variety of devices for high-speed processing. A simple keyboard programs the disc—no accessory hardware needed. And an entire sequence is reprogrammed in minutes. Proven reliability (over 600 L100 units in use) stems from conservative, no-compromise design. Yet the L100 is probably the lowest-cost disc memory on the market.

Thanks for the memory order, Fairchild—reputations are made of this. For the brochure detailing the longest line of discs in memory, write: General Precision, Inc., Librascope Group, Components Division, 808 Western Avenue, Glendale, California 91201.

**GP GENERAL  
PRECISION INC.**  
LIBRASCOPE GROUP

## IDEAS FOR DESIGN

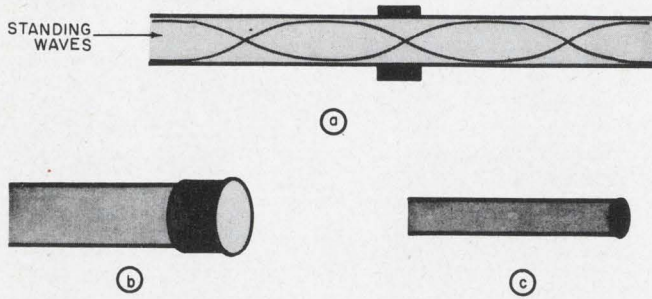

**Standing waves** occurring within hollow vhf antenna elements (a) can be avoided by sealing ends either with a plastic cap (b) or with a small amount of epoxy.

eventual breakage of the elements.

A simple but effective way to counter this "organ pipe" effect is to seal the ends of the hollow elements. Plastic pipe caps have been found effective for large-diameter tubing, while the application of epoxy works quite well for small-diameter tubing. This procedure also serves to exclude moisture and prevent corrosion.

It is well worth while to invest a few dollars to save on maintenance and repair of costly antenna systems.

*Paul A. Moskowitz, Research Engineer, Department of Physics, New York University, New York.*

VOTE FOR 111

## Latching relay and SCR memorize last input pulse

A circuit (see figure) using only one latching relay and an SCR can memorize the last input pulse even with very narrow pulses.

Assuming that the relay contacts are as shown, +28 volts dc will be applied to the SCR through one half of the relay winding. A positive pulse applied to the input will fire the SCR. The relay contacts will transfer from 5 to 6. The SCR will turn off during the relay contact transfer, so that,

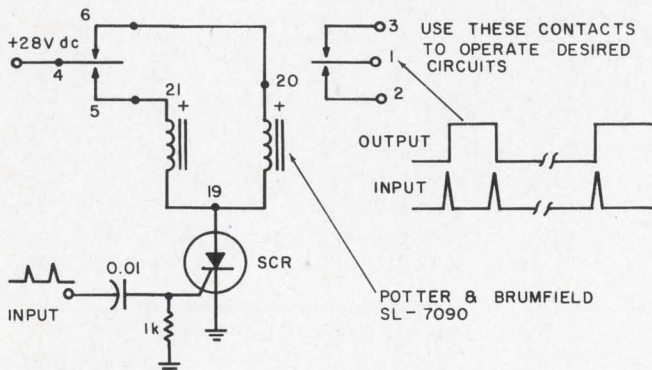

**Electromechanical flip-flop** has high gain and can be operated by very narrow input pulses.

when +28 volts dc is applied to it through the other half of the relay, it will be "open." Thus it will take another positive pulse at the input to return the circuit to its initial state.

This configuration can then be used as a slow flip-flop in a variety of applications. Its speed is limited by the relay operating time. It can be used, for example, to start and stop a clock or a timing device triggered on and off by two successive pulses. Or, it may be used to drive a counter directly.

*Charles C. Diaz, Senior Electronic Engineer, Martin Company, Orlando, Fla.*

VOTE FOR 112

## Simple components make up audible visual alarm

An inexpensive, relayless, audible visual "ring-back" alarm can be built with an alternate-action pushbutton switch and split-screen pilot lights. A separate Mallory Sonalert electronic tone device furnishes the audible signal.

The operation of the alarm circuit is as follows:

Circuit condition	Operation
Normal	1. Contacts are as shown in wiring diagram, alarm light and audible signal off, normal light on.
Alarm	2. Remote, single-pole, double-throw alarm contact switches from normal to alarm position. 3. Normal light goes off, alarm light and audible signal turn on.
Acknowledge	4. Silence pushbutton (alternate action) is depressed, silencing the audible signal.
Return to Normal	5. Alarm condition over; alarm contact returns to normal position. 6. Alarm light off, normal light on, audible signal "ring-back" to announce return to normal.
Normal	7. Silence button is depressed and audible signal turns off. 8. Conditions same as initially. (Operation 1.)

The alarm circuit may be operated on 6-28 V ac/dc or 115 V ac with the proper choice of available component voltages.

One or the other pilot light is always alight,

1967 Catalog

DC Power Supply Modules  
**GUARANTEED  
FOREVER**  
acde electronics inc.

If you'll circle Reader Service #25,  
we'll send you one by return mail.

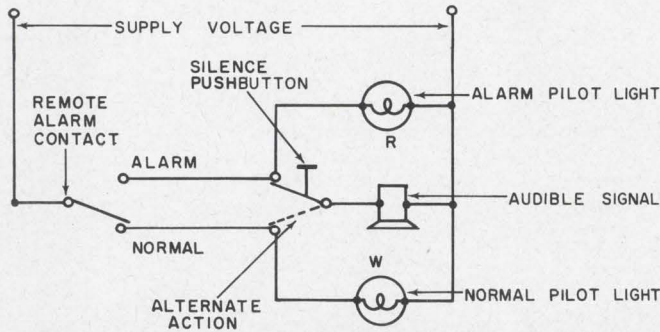

Audible and visual alarm signal will persist until the silence switch is operated and the alarm condition is removed.

thus indirectly indicating a "power on" condition as well as serving as a lamp burnout check.

M. K. Kessie, Design Specialist, Atomics International, Canoga Park, Calif.

VOTE FOR 113

## Phase detector uses single transistor

If two signals of the same amplitude and shape are fed into the base and emitter of a transistor amplifier, the average dc level at the collector indicates the phase between the two signals.

If both signals (Fig. 1) are in phase and of the same amplitude, there is no signal current through the base-emitter junction of the transistor. The dc voltage at the transistor collector remains at zero.

If both signals are sine waves, and one sine wave is displaced in phase, the maximum voltage between them occurs at  $\theta/2$ , where  $\theta$  is the phase shift between the two signals (Fig. 2).

From Fig. 2,  $E_1$  is given by:

$$E_1 = 2 E_{peak} \sin(\theta/2). \quad (1)$$

The phase detector output will look like the

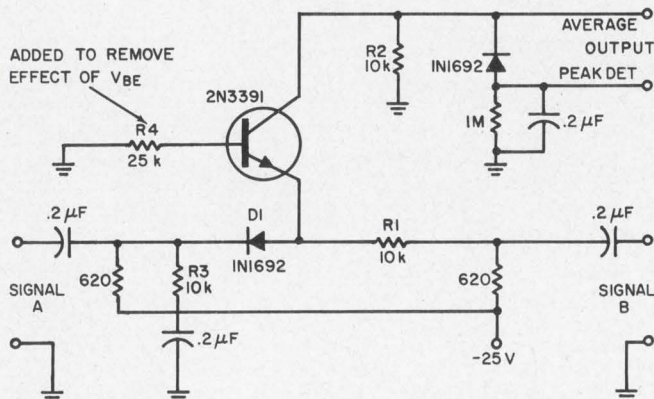

1. Phase shift between two signals A and B applied to the base and the emitter of a transistor results in an output at the collector.

output of a half-wave rectifier because there is current through the base-emitter junction of the transistor during half the time. The average dc voltage from a half-wave rectifier is  $1/\pi$  times the peak value.

The average voltage out of the phase detector is therefore:

$$E_{ave} = - (R2/R1) [(E_1 - V_{BE})/\pi] \quad (2)$$

when  $E_1 \gg V_{BE}$ , and

$$E_{ave} = 0 \text{ when } E_1 < V_{BE}, \quad (3)$$

where  $V_{BE}$  is the base-emitter-junction voltage drop of the transistor.  $E_1$  must be greater than  $V_{BE}$  before collector current starts to flow in the transistor.

Combining Eqs. 1 and 2 gives:

$$E_{ave} = - (R2/R1) [2 E_{peak} \sin(\theta/2) - V_{BE}]/\pi. \quad (4)$$

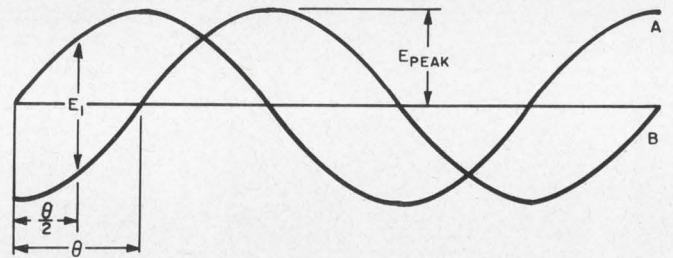

2. Maximum phase shift voltage occurs at  $\theta/2$  where  $\theta$  is the phase shift between the two sine waves.

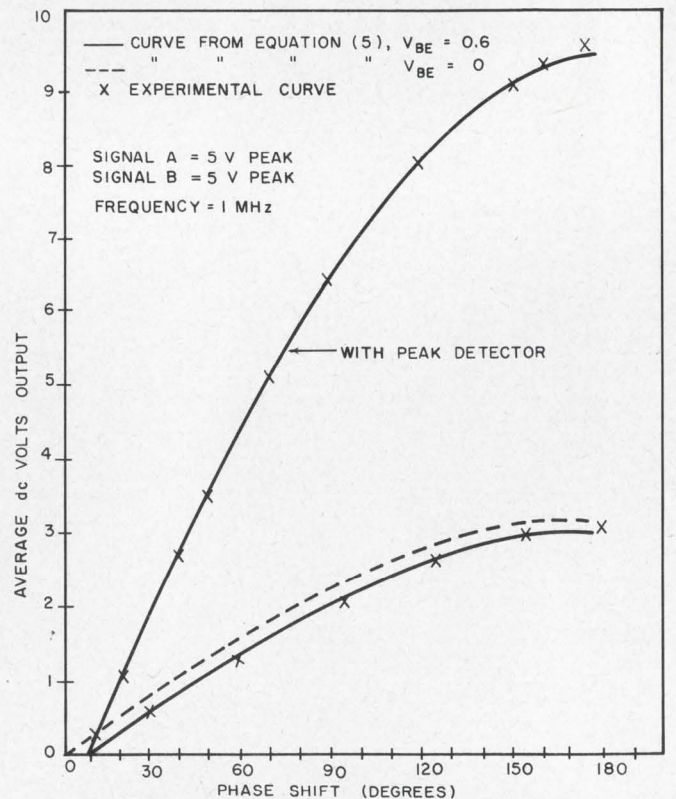

3. Phase shift vs average voltage output shows good agreement between calculated and experimental curves. Value of  $V_{BE}$  shifts the curve by a fixed amount.

PROBE  
AND READ  
IN-CIRCUIT  
MEASUREMENTS



## *RF Vector Impedance Meter with direct readout simplifies testing*

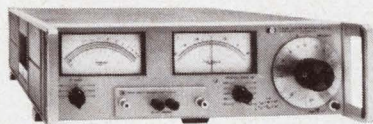

**A COMPANION INSTRUMENT COVERS THE 5 Hz to 500 kHz RANGE**

The Hewlett-Packard 4800A Vector Impedance Meter measures impedance in seconds. It does for AC measurement what the ohmmeter does for DC testing. Just plug it in and read it. Price: \$1,490.00. Complete specifications are yours on request.

The Hewlett-Packard 4815A RF Vector Impedance Meter provides fast, direct reading measurements of impedance and phase angle over the frequency range from 500 kHz to 108 MHz. The convenience of probe measurement and direct readout make the instrument equally useful for laboratory, receiving inspection or production line measurements. The 4815A reads complex impedance over its full frequency range without charts, data interpretation or a slide rule. As a result, it offers fast, accurate evaluation of the complex impedance of both active circuits and components.

The 4815A is an all solid-state integrated vector impedance system that reads out directly in  $Z$  and  $\theta$ . Low-level signal strength minimizes circuit disturbance and prevents overloading the test component. Price: \$2,650.00. For complete specifications, contact your local Hewlett-Packard field engineer or write Hewlett-Packard, Green Pond Road, Rockaway, N. J. 07866.

**HEWLETT**  **PACKARD**  
measuring instruments  
for science and industry

A peak detector can be added to the output of the phase detector and the sensitivity will be increased by a factor of  $\pi$ :

$$E_{ave} = -(R2/R1) [2 E_{peak} \sin(\theta/2) - V_{BE}]. \quad (5)$$

The phase detector as shown will not function over the whole 180° range because some phase shift is necessary before  $E_1$  is greater than  $V_{BE}$ . The first nine degrees are lost when the input signals are 5 volts peak and a silicon transistor with  $V_{BE} = 0.6$  V is used. The first 30 degrees would be lost if the input signals were 1 volt peak.

The phase detector can be used for lower-level

signals if some forward biasing is added to the transistor equal to  $V_{BE}$  (see  $R_4$  in Fig. 1).

$D1$  and  $R3$  were added to make the load impedance for both signals nearly the same.  $D1$  and  $R1$  can be left out with some change in the phase detector sensitivity.

The graph of Fig. 3 shows both experimental and calculated results. The dashed line is a calculated curve for forward biasing equal to  $V_{BE}$ .  $V_{BE}$  was replaced by zero in Eq. 5.

*Rudy Stefenel, Design Engineer, Microwave Laboratory, Hewlett Packard, Palo Alto, Calif.*

VOTE FOR 114

## Power unbalance switch uses integrated circuits

In many industrial control systems, unbalanced loads may make it necessary to shut the system down. Quite often the signals to be sensed are low-amplitude sinusoidal waves derived from current transformers. Conventional circuits used to detect this unbalanced condition are usually sensitive to any phase differences between the two signals, extremely sensitive to any noise spikes present, and asymmetrical—that is, shutdown may occur if signal  $A$  is 20% greater than signal  $B$  but may

not disable the system until signal  $B$  is, for instance, 35% greater than signal  $A$ .

A very satisfactory approach is to use a pair of commercially available integrated-circuit operational amplifiers and differential comparators. The object is to amplify, rectify and then compare the relative magnitudes of the two input signals. The resulting configuration produces a power unbalance switch which is insensitive to the phase differences between the two sense signals, is symmetrical, is relatively insensitive to noise because of extensive filtering, maintains a stable trip point for ambient temperatures ranging from

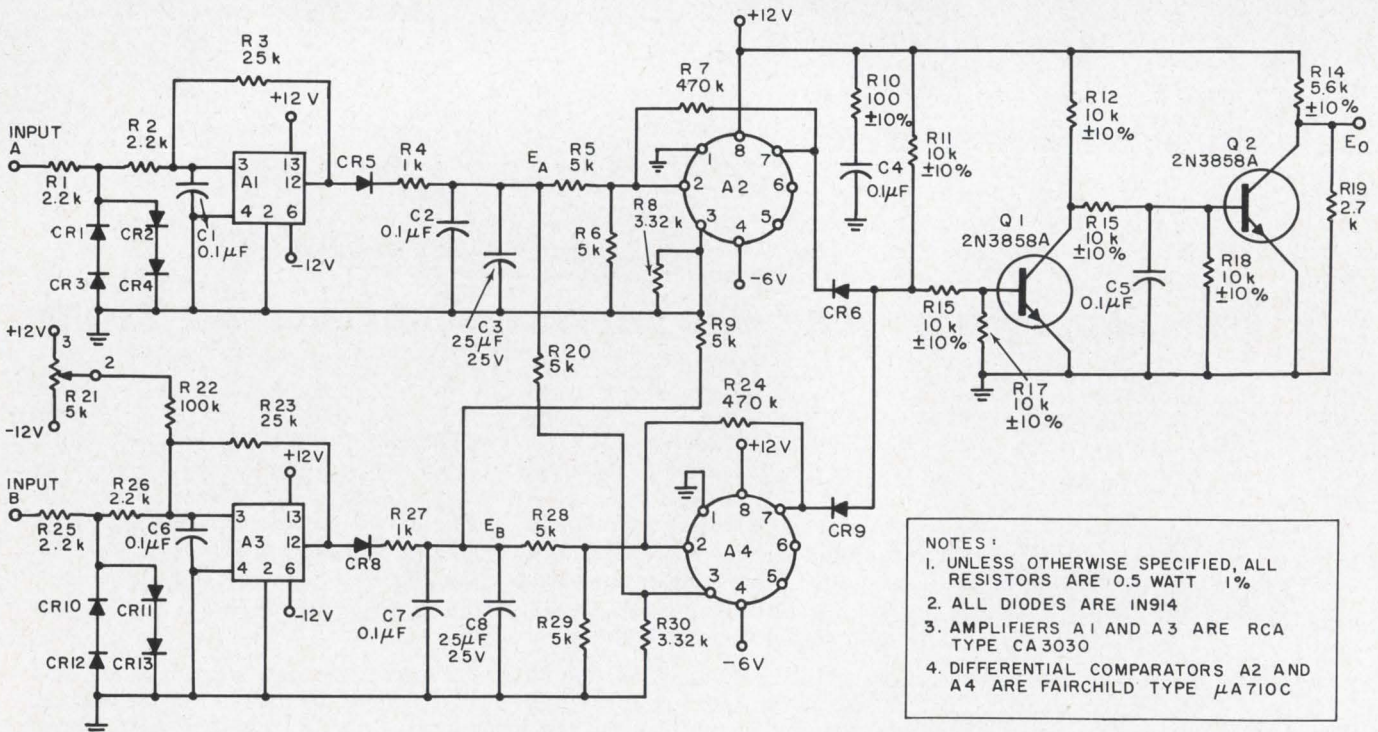

Amplitudes of two sinusoidal signals are compared with the simple circuit above. Output signal,  $E_o$ , is obtained

whenever the voltages at points  $E_A$  and  $E_B$  differ by more than 20%.

Investing in a Sweep Generator with a limited frequency range can be an expensive purchase unless you're positive your requirements won't change 6 months or a year later. To avoid that embarrassing possibility, Telonic's SM-2000 is built for non-obsolescence; it is actually

## 20 SWEEP GENERATORS

in one. The chassis will accept 20 different plug-in oscillators spanning various segments of the spectrum from 20 Hz to 3000 MHz, in an area that just fits your application today, or tomorrow, or in 6 months, or next year. And since it doesn't cost any more than most single-range units, why not be a hero. Order one.



### BASIC SPECIFICATIONS\*

Frequency Range	20 Hz to 3000 MHz
Impedance	50 or 75 ohms
Operating Modes	Sweep, CW, 1 kHz Modulated Sweep or CW
Attenuation	0-60 dB in 1 dB steps
Output (Scope Horizontal)	15 volts P-P (approx.)
Frequency Markers	8 Plug-in and/or Variable
Sweep Width, Sweep Rate, Level Control, and Flatness will depend on the Plug-in Oscillator used.	

\*Complete specifications on the SM-2000 and Plug-in Oscillators, plus an extensive treatment of Sweep Frequency Measurement Applications are covered in Catalog #70. Yours on request.

**Telonic** INSTRUMENTS  
Division of Telonic Industries Inc.

60 N. FIRST AVE., BEECH GROVE, INDIANA 46107, TEL. (317) 787-3231 TWX-810-341-3202

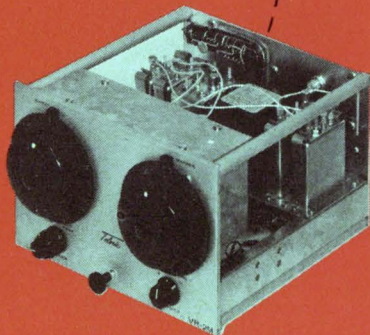

0°C to 60°C, and is relatively inexpensive.

The power unbalance switch shown in the Figure indicates an unbalanced load when the input signals differ by more than 20% ±5% when referred to the larger signal, where the larger signal may range from 200 to 700 mV rms. The circuit was used in an application where the input signals were 300-Hz sinusoidal waves. The same circuit can be used with dc inputs. (Of course, CR5, CR8, C3 and C8 could be removed for such an application.)

Operational amplifiers A1 and A3 amplify the incoming signal so that rectification by CR5 and CR8 is possible. Diodes CR1, CR2, CR3, CR4 and CR10, CR11, CR12 and CR13 protect the operational amplifiers from damage in case of transient

spikes on the input signals. Comparator A2 produces a negative-going pulse (terminal 7) when voltage  $E_B$  is 20% greater than the voltage  $E_A$ . Comparator A4 produces a negative-going pulse (terminal 7) when  $E_A$  is 20% greater than  $E_B$ . CR6 and CR9 form an OR gate which makes  $E_o$  go negative if either A2 or A4 produces a negative going pulse. When  $E_o$  goes negative, the system is automatically shut off.

The switch can be made to trip at any desired differential between the input signals by proper selection of dividers R8, R9 and R20, R30.

George J. Granieri, Research Scientist, Physics and Electronics Dept., American-Standard Products, New Brunswick, N. J.

VOTE FOR 115

## Random-signal generator uses Zener diode

Quite often one needs a source of random signals. Such a source (see Fig. 1a) can be built with a Zener diode. It is well known that Zener diodes are particularly "noisy" components, especially at very low currents. This property, usually considered a shortcoming, is here used to advantage.

In Fig 1a a pnp high-frequency 2N384 transistor is used as a common-emitter amplifier. Its base current is supplied by the Zener diode, the breakdown voltage of which is somewhat lower than the supply voltage, that is, about 20 volts. Potentiometer R1 in series with the emitter enables both the Zener current and the operating point of the transistor to be controlled. In this fashion the "frequency" of the random signals can be set.

An emitter-follower stage, 2N1711, is used to

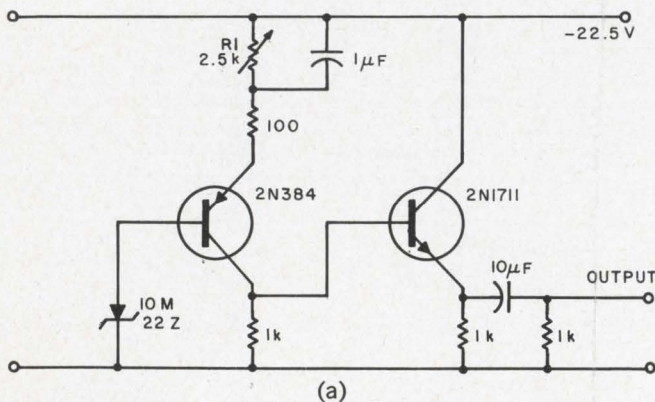

**Random-signal generator** (a) uses Zener diode as a "noise" source. The time base is 5 ms/cm in (b) and 0.1 ms/cm in (c). Output voltage can be set anywhere between 4 and 10 V peak-to-peak.

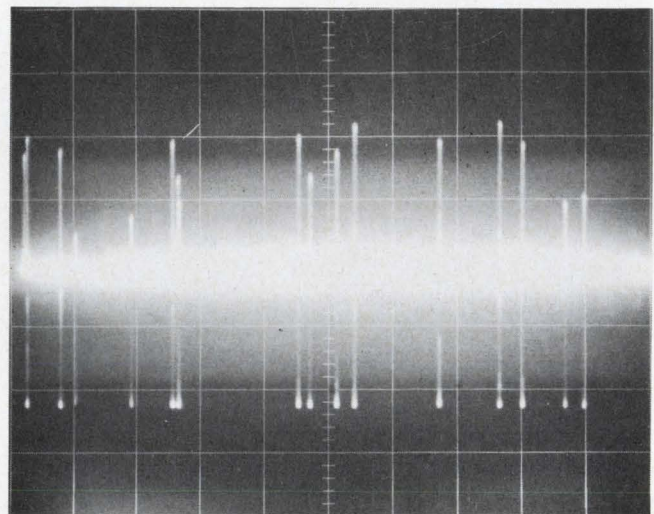

(b)

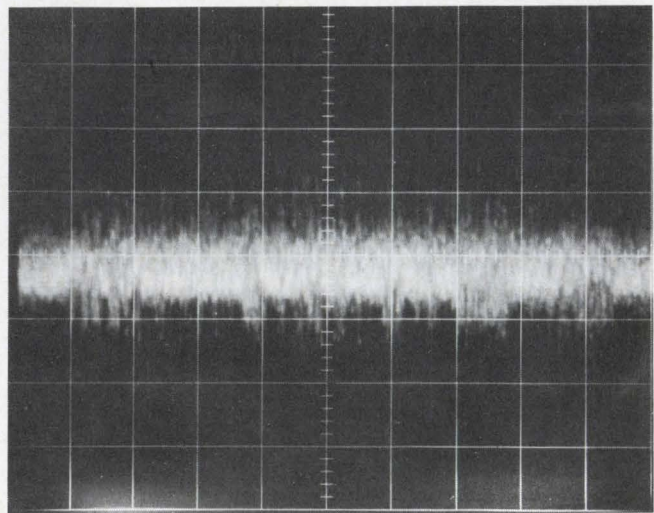

(c)



# NEW LOWER PRICES

## NEW TEST DATA FOR CTS INDESTRUCTIBLE CERMET SEMI-PRECISION RESISTOR NETWORKS

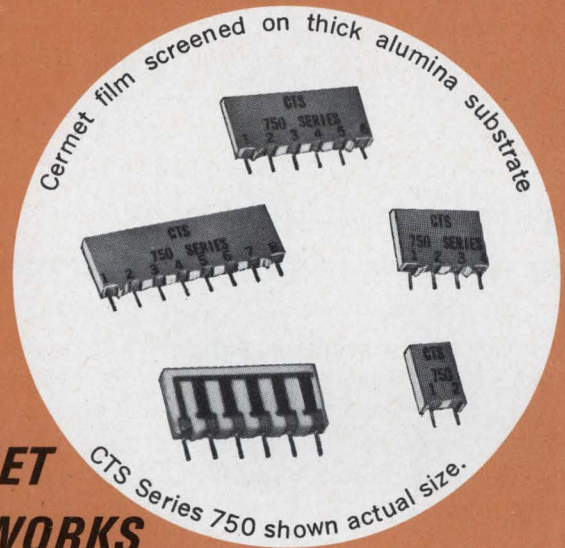

Series 750	2-Pin (1 Resistor)	4-Pin (3 Resistors)	6-Pin (5 Resistors)	8-Pin (7 Resistors)
Total Module Load	0.5 Watts	1.0 Watts	1.5 Watts	2.0 Watts
Approx. 10,000 cost	<del>17¢</del> <del>\$0.92 ea.</del>	<del>18¢</del> <del>\$0.94 ea.</del>	<del>21¢</del> <del>\$0.26 ea.</del>	<del>26¢</del> <del>\$0.31 ea.</del>

STANDARD MODULE SPECIFICATIONS FOR ALL SIZES	
Resistance Range	50 Ω to 100K Ω
Resistive Tolerance	±5.0%
TC	±300 ppm/°C
Load Life: 0.1 W per resistor at 70°C, 1000 hrs. (Over 4,000,000 resistor hours)	±0.40% Δ R max. ±0.20% Δ R av.
Moisture Resistance: .1 rated wattage at 70°C, 90-98% humidity, 1000 hrs.	±0.50% Δ R max. ±0.20% Δ R av.
Insulation Resistance: measured wet after moisture resistance test, 200 VDC	500 meg. Ω
Thermal Shock: 5 cycles, -63°C to +125°C, no load	±0.10% Δ R max. ±0.03% Δ R av.
Short Time Overload: 2.5 times rated voltage, 5 sec.	±0.25% Δ R max. ±0.05% Δ R av.
Low Temperature Exposure: -63°C, 4 hrs.	±0.10% Δ R max. ±0.04% Δ R av.
Terminal Strength: 5 lb. tensile & compression, 30 sec.	±0.10% Δ R max. ±0.03% Δ R av.
Effect of Soldering: 63/37 solder, 246°C, 2 sec.	±0.10% Δ R max. ±0.05% Δ R av.

The data speaks for itself. Examine and judge its value for your application:

Extreme Stability and Reliability
High Power Capability: (Up to 1 watt per resistor)

- Space saving—a single module replaces up to 7 discrete resistors.
- Available in an infinite number of circuit combinations.
- Custom-built to your exact requirement.
- Ideally suited for cost-saving automatic handling.
- Cover coating unaffected by solvents.



founded 1896 Request Cermet Catalog

**CTS**  
**OF BERNE, INC.**  
**BERNE, INDIANA**

SUBSIDIARY OF  
**CTS CORPORATION • ELKHART, INDIANA**

Extra cost options	
Resistance Range	10 to 49 Ω, 101K to 1 meg. Ω
Resistance Spread	Over 10 to 1
Resistive Tolerance	±0.5%, 1%, 2.5%
TC	±150 ppm/°C

obtain low output impedance. This can be further lowered with a Darlington emitter-follower stage. Photographs in Figs. 1b and 1c show the outputs of the circuit.

Roger Damaye, Fontenay aux Roses, Hauts de Seine, France.

VOTE FOR 116

## Precision one-shot uses inexpensive integrated circuits

Building a precision-pulse-width one-shot multivibrator often requires extensive temperature compensation, since the pulse width is dependent on temperature-sensitive timing components. The one-shot shown in the diagram utilizes a  $\mu\text{L914}$  as a crystal oscillator and two  $\mu\text{L923}$ s connected as a counter.

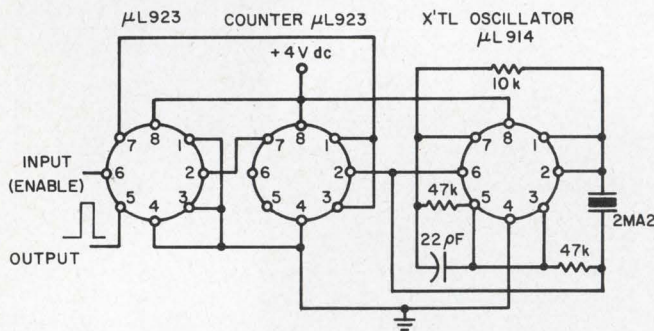

**Precision one-shot** can be built with only three ICs and a few external components.

The triggering signal activates the counter, which tallies the pulses from the crystal oscillator. When the count is finished, the counter is inhibited until another signal is received.

The pulse width is determined by the frequency of the crystal oscillator and the number of cycles counted. A high-precision pulse width can be generated that is relatively insensitive to temperature by judicious selection of oscillator frequency versus count.

Jerry F. Foster, Chief Project Engineer, Wave-tek, San Diego, Calif.

VOTE FOR 117

## Noninverting operational amp has fixed zero offset

A noninverting operational amplifier circuit can be designed to yield a fixed zero input offset with a linear gain characteristic around the output offset point.

This application is useful when coupling a plus

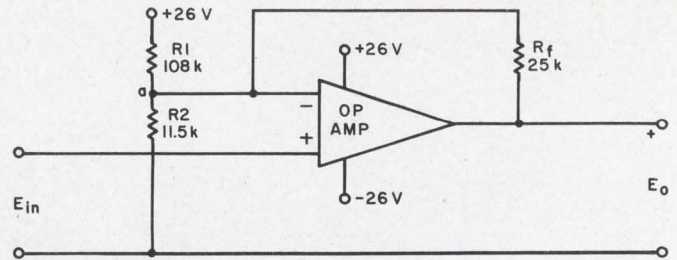

**An operational amplifier** has  $-6\text{-V}$  zero input voltage offset. Component values are calculated from Eqs. 4 and 6.

or minus signal, with respect to supply zero or ground, to a CRT driver amplifier or any differential device with an input centered around some value other than supply zero or ground.

The basic circuit is shown in the figure. The node equation for point  $a$ , on the assumption that  $E_a = E_{in}$ , is:

$$(E_s - E_{in})/R1 - E_{in}/R2 = (E_{in} - E_o)/R_f. \quad (1)$$

From this:

$$E_o = E_{in}(R_f/R1 + R_f/R2 + 1) - (R_f/R1)E_s. \quad (2)$$

If  $E_{in} = 0$ ,  $E_{o1}$  = desired offset voltage, and  $E_s$  = supply voltage ( $+E_s$  for minus offset, and  $-E_s$  for plus offset), then:

$$E_{o1} = -(R_f/R1)E_s, \quad (3)$$

or:

$$R1 = E_s R_f / E_{o1} = E_s / E_{o1} R_f. \quad (4)$$

Substituting Eq. 4 into Eq. 2 gives:

$$E_o = E_{in}(R_f/R2 + 1 + E_{o1}/E_s) + E_{o1}. \quad (5)$$

Solving for  $R2$  yields:

$$R2 = R_f E_{in} / E_o - E_{in}(1 + E_{o1}/E_s) - E_{o1}. \quad (6)$$

Values for  $E_{in}$  and  $E_o$  that are compatible with the desired gain are selected from within the operating range.

To complete the design,  $R1$  is selected and  $R1$  and  $R2$  are calculated from Eqs. 4 and 6.

The values shown in the figure were calculated in this manner to meet these requirements:

- Zero input voltage offset 6 V.
- Gain 3.4.
- Output voltage swing  $\pm 7.5\text{ V}$  around the  $-6\text{-V}$  point.
- Minimum load impedance 220 k $\Omega$ .
- Source impedance 1 k $\Omega$ .
- Supply voltage  $\pm 26\text{ V}$ .

William E. McDonald, Senior Design Engineer, North American Aviation, Inc., Columbus, Ohio.

VOTE FOR 118

## IFD Winner for Mar. 1, 1967

Rudy Stefenel, Design Engineer, Microwave Laboratories, Hewlett-Packard, Palo Alto, Calif. His Idea, "LC oscillator tank circuit built with just one FET," has been voted the \$50 Most Valuable of Issue Award.

**Cast Your Vote for the Best Idea in this Issue.**

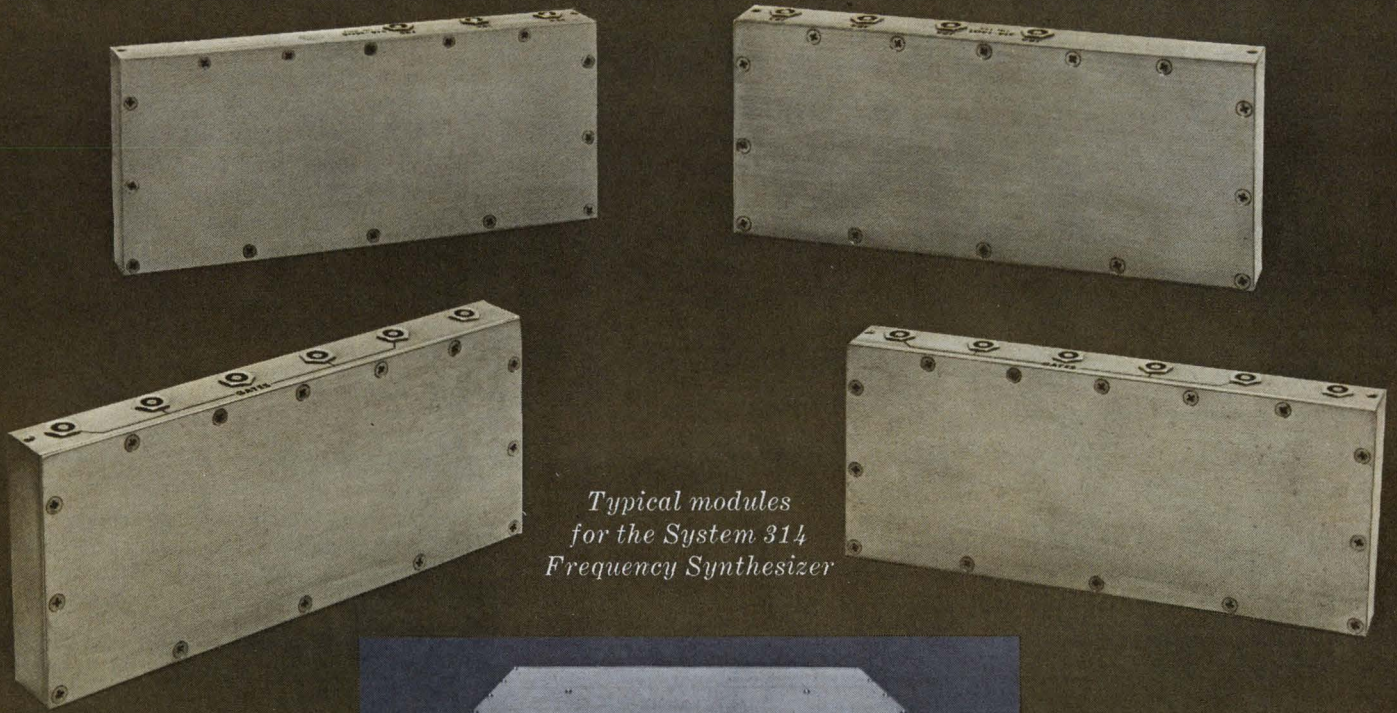

*Typical modules  
for the System 314  
Frequency Synthesizer*

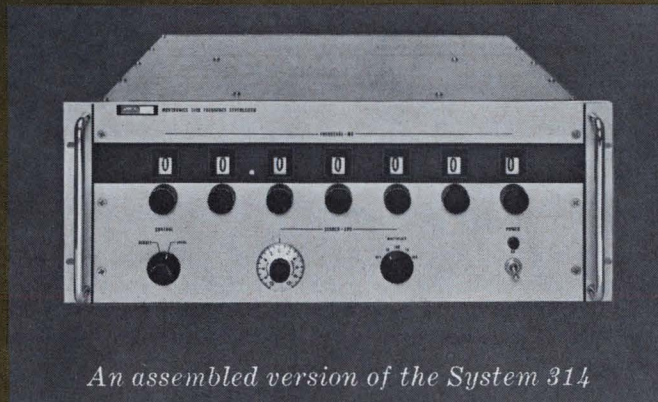

*An assembled version of the System 314*

## The system 314: a sophisticated new modular frequency synthesizer built to satisfy your exact needs today or your updated requirements tomorrow.

Here's something to think about before you buy any frequency synthesizer. No matter how good the product is today, it is quite unlikely that it will meet your exact requirements a year from now or on another program even sooner. That's why Fluke/Montronics designed the modular System 314.

The System 314 is a new frequency synthesizer of exceptional technical sophistication which features a wide choice of output frequency ranges, spurious signals more than 100 db down, digital frequency control, nominal 40 microsecond switching time, and exceptionally low phase noise. But more than all these goodies, we assembled the synthesizer from a family of individual modules containing

the circuit functions of a direct synthesizer.

With this system, a synthesizer may be assembled for a particular test or program. Later the unit can be modified to change output frequency, number of steps, search oscillator capability, or fixed frequencies. Each internal module is a separate entity. It is no longer necessary to purchase a complete laboratory synthesizer to obtain a narrow band of output signals for a specific system requirement. The System 314 makes it easy to optimize both performance and economy.

### **What are your requirements?**

An eight page technical bulletin with complete information on the System 314 is yours for the asking. In it we have also included a short

questionnaire which when completed by you will allow us to tell you exactly what version of the System 314 will do the job for you at the lowest cost. For your copy call your full service Fluke/Montronics Sales Engineer (listed in EEM), or write directly to Mr. Robert Mawson here at the factory.

Montronics, Box 7428, Seattle, Washington. Phone: (206) PR 6-3141. TWX: (910) 449-2850. In Europe, address Fluke International Corporation, Sophialaan 2, The Hague, The Netherlands. Telex 845-31469.





**KEPCO  
POWER SUPPLIES**



## SUPPORT

Kepco publishes volumes of technical data to provide applications support for its power supplies. The exploitation of a regulator's operational capabilities is a new field, enthusiastically supported by Kepco's software.

For a sampling, subscribe to our periodical *The Kepco Power Supply News*, write for your personal copy of the *Handbook* and, if you don't already have one, ask for a copy of our big catalog.

*For complimentary copies of any or all of these technical publications, write on company letterhead to:*

**Publications, Dept. 4B**  
G.P.O. Box 67 • Flushing, N.Y. 11352



ON READER-SERVICE CARD CIRCLE 51

## Check thermocouple during operation

**Problem:** Monitor the electrical continuity and resistance of multiple thermocouple installations without disconnecting them from a data system.

**Solution:** Connect a constant-current source across the input of the millivolt measuring system. As each thermocouple is sampled, the system output voltage is a direct function of the thermocouple loop resistance.

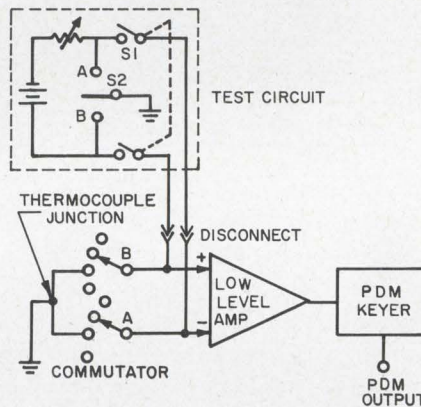

The constant-current source consists of a battery and adjustable resistor. It is connected across the pulse-duration-modulated (PDM) output of the commutator in proper polarity. As each thermocouple loop is sampled by the commutator, the voltage across the loop is proportional to its resistance and the voltage read-out signal is a measure of this resistance.

The current source is adjusted so that the voltage across a known resistance, greater than the resistances to be measured, equals the full scale range of the data system.

A read-out is first taken with *S1* open to confirm the absence of voltages. A read-out with *S1* closed then directly reflects the thermocouple resistances, with the read-out for an open circuit depending on system limiting characteristics. Placing *S2* in the *A* or *B* positions provides a measurement of the resistance of each leg of the thermocouple

circuit if the junction is grounded and the measuring system has differential inputs, as indicated.

The technique was used for periodic monitoring of a large number of very small-gauge thermocouple leads during the assembly and preflight testing of the Project Fire reentry packages.

Typical measured resistances ranged from 20 to 400 ohms. The test circuit was set for 0.1 mA, so that the 50-mV range of the system represented 500 ohms full-scale.

While a PDM system is shown, the technique should be equally usable with pulse amplitude modulation (PAM) or other modulation systems.

*For further information, contact: Technology Utilization Officer, Langley Research Center, Langley Station, Hampton, Va. 23365 (B66-10623).*

## Thin-film detector has very wide range

**Problem:** Develop a broadband power-measuring detector for electromagnetic radiation in the 50-to-30,000-GHz (6-mm-to-10-micron) band.

**Solution:** Use a matched pair of detectors which incorporate thin-film radiation absorbers.

Each of the two detectors in the assembly consists of a thin-film radiation absorber mounted on a dielectric substrate in close thermal contact with a thermistor bolometer element. The detectors are matched electrically and thermally, to compensate for ambient temperature variations when operated in a balanced Wheatstone bridge circuit. In tests on an experimental model, the detector assembly exhibited a responsivity of 240 volts/watt at 70 GHz. The minimum detectable signal was  $10^{-8}$  watt, and it had a dynamic range of 50 dB

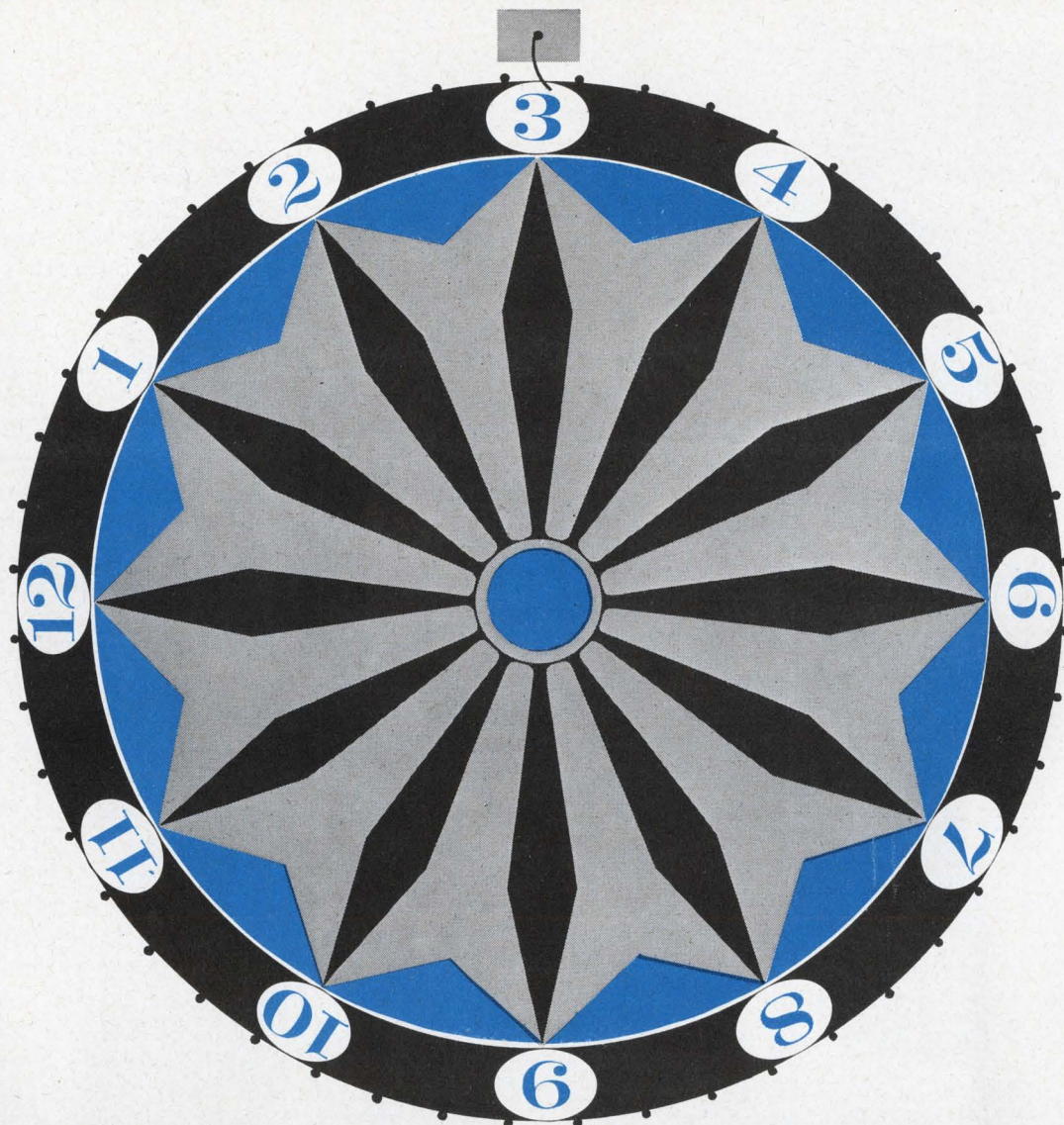

## Take the Chance out of Electromechanical Design Problems



Clifton synchros and rotating components have the priceless ingredient of our long experience in the manufacture of an endless variety of standard and exotic units.

What do you need in the way of accuracy, size, type, temperature, radiation or corrosion resistance, terminals or leads, double ended shafts, tandems or BuWeps types?

We also specialize in the custom design and manufac-

ture of gyro pickoffs, single and multispeed, beryllium, stainless or aluminum housings. (Our units were chosen for the Apollo program.)

Clifton Precision Products, Division of Litton Industries, Clifton Heights, Pa., 215 622-1000.

**CLIFTON**   
DIVISION OF LITTON INDUSTRIES

ON READER-SERVICE CARD CIRCLE 52

# NEED HIGH VOLTAGE CAPACITORS FAST?

... Prompt Delivery -

## NO!

... Immediate Delivery

## YES!



GLASS  
CONTAINERS



METAL CAN  
CONTAINERS



Our list of satisfied "blue chip" customers is growing and growing which necessitated a large expansion of our manufacturing and engineering facilities. Now, we can supply a complete range of voltages from 2,000 to 50,000 volt capacitors from our expanded "stock on hand". Don't take excuses, we'll supply you faster than at any time in our many years in the field—**BETTER PRODUCTION FROM US—BETTER DELIVERY FOR YOU!**

Write for complete list of Standard High Voltage Capacitors in stock—or, send specifications for custom quotations.



## Plastic Capacitors, INC.

2620 N. Clybourn • Chicago 14, Ill.  
DI 8-3735

### NASA TECH BRIEFS

( $10^{-8}$  to  $10^{-8}$  watt). The output voltage was linear with respect to input power.

The detector is effective with either coherent or incoherent radiation.

For further information, contact: Technology Utilization Officer, Electronics Research Center, 575 Technology Square, Cambridge, Mass. 02139 (B66-10581).

## AM receiver uses laser LO

**Problem:** Develop an optical superheterodyne receiver to receive amplitude-modulated video bandwidth signals through the atmosphere.

**Solution:** Couple a laser to a frequency translator, to supply both the incident signal and local oscillator signal in an optical superheterodyne receiver, as shown in Fig. 1.

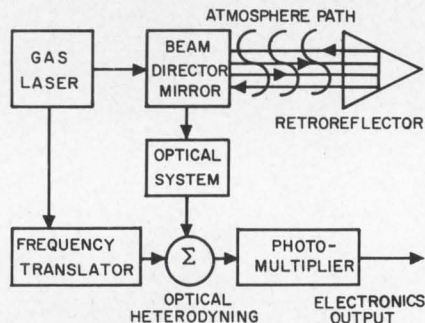

### 1. Optical receiver.

The output of the laser is reflected by mirrors to the beam director, which directs it to the remotely located retroreflector (see Fig. 2). The return rays are

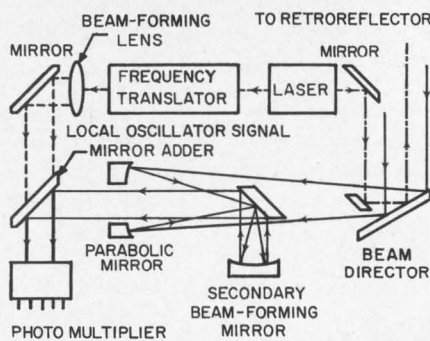

### 2. Mirror system.

reflected by the beam director to the parabolic mirror and then to the secondary beam-forming mirror, that directs the rays through the open center of the parabolic mirror to the mirror adder.

Simultaneously, the local oscillator beam, originating in the laser, is shifted in frequency by the frequency translator to provide a frequency offset. This offset beam is focused by a beam-forming lens into a focus point corresponding to the focus point produced by the secondary mirror.

The collimated return rays are now mixed with the local beam at the mirror adder and the resultant difference beat is detected by the photomultiplier and fed to the electronic output circuitry.

A receiver for a 1-GHz Doppler receiver can be constructed with presently available components. Electro-optic frequency translators in conjunction with wide-band detectors will make it possible to cover 20-GHz Doppler shifts in the future.

This receiver should be useful in scientific propagation experiments, tracking experiments, and communication experiments.

For further information, contact: Technology Utilization Officer, Marshall Space Flight Center, Huntsville, Ala. 35812 (B66-10584).

## 'Signature' of relay allows quick check

**Problem:** Monitor the action of relays without disturbing circuit parameters or degrading relay performance. Normally, relay monitoring has been limited to fully-open- or fully-closed-position indications plus coil-circuit condition. Steady-state or transient-position data cannot

# New Model 3111 Relay by Bourns



{ SMALL  
IN SIZE }



# BIG IN SPECS

The Bourns Model 3111 TRIMPOT® Relay is a high performance, 0.5 amp, Double Pole Double Throw unit that answers the demand for higher reliability and greater miniaturization. It is hermetically sealed in a 1/6 size crystal can, with convenient 0.1" pin spacing.

The Model 3111 has an operating temperature range of -65°C to +125°C. Contact rating is 0.5 ampere resistive at 28 VDC, with a pick-up sensitivity of 130 MW. Operate and release time is 4 milliseconds maximum. Contact bounce is 2 milliseconds maximum. This model also features a self-damping return spring and balanced armature design assuring excellent shock (50G) and vibration (20G) performance. All requirements of MIL-R-5757 are met or exceeded by the Model 3111.

For further data and detailed specifications, contact your nearest Bourns sales office or representative, or write the factory direct.

## Coil Operating Table

Standard Coil Resistance	Nominal Operating Voltage	VOLTAGE ADJUSTED		Drop-out Voltage Min.
		Maximum Pull-In Voltage at +25°C	at +125°C	
70	6.0	3.0	3.9	0.3
280	12.0	6.0	7.8	0.6
1500	26.5	14.0	18.0	1.4

Coil characteristics applicable at +25°C unless otherwise specified. Various terminal types and mounting styles are available adding flexibility to fulfill your design requirements.



BOURNS, INC., TRIMPOT DIVISION • 1200 COLUMBIA AVE., RIVERSIDE, CALIF.  
TELEPHONE (714) 684-1700 • TWX: 910 332-1252 • CABLE: BOURNSINC.

TRIMPOT® AND PRECISION POTENTIOMETERS—RELAYS—MICROCOMPONENTS: TRANSFORMERS, INDUCTORS, RESISTORS AND CAPACITORS

# NOW..

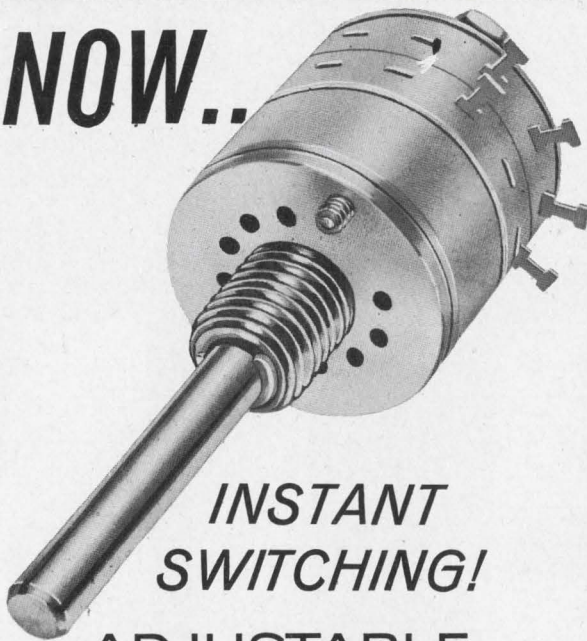

## INSTANT SWITCHING!

### ADJUSTABLE STOPS NOW AVAILABLE IN

# 1/2" ROTARY SWITCHES

**"Off-The-Shelf" shipments for INDUSTRY'S BEST DELIVERY!**

- • from 2 to 12 positions (shorting or non-shorting) available merely by moving external plate!
- • up to 6 poles available on one deck!
- • Instant switching to any desired number of circuit positions!
- • ideal for breadboard setups, laboratory stock, and prototype work—where rapid circuit modification may be desired.

Write for complete engineering information.

# RCL ELECTRONICS, Inc.

General Sales Office:

700 So. 21st Street, Irvington, New Jersey 07111

## NASA TECH BRIEFS

be obtained through current monitoring because the steady-state current depends only on the dc resistance of the coil.

**Solution:** Establish the characteristic signature of a relay by measuring the magnetic flux produced under transient conditions.

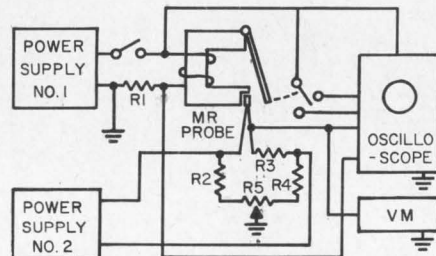

A magnetoresistor is placed in a recess in the contact end of the relay core. This probe is operated by its own power supply and, through a bridge circuit, its reaction to change in relay magnetic flux is indicated on a voltmeter and displayed on an oscilloscope.

Photographing the oscilloscope display makes voltage and current conditions related to time available for determining the characteristic signature of a given relay. Such parameters as contact travel time, time for coil current to reach a steady-state condition, and coil voltage condition afford a clear picture of relay operating characteristics.

Many malfunctions, such as lack of armature movements, friction, welded contacts, and low coil voltage, may be determined from the transient waveforms.

This device permits relay monitoring with a single passive sensor that does not affect relay operation or reliability.

For more details, contact: Technology Utilization Officer, Marshall Space Flight Center, Huntsville, Ala. 35812 (B66-10650).





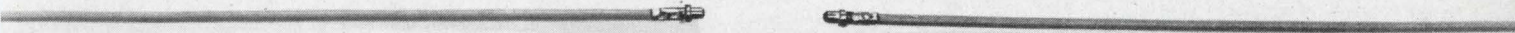

When splicing is taboo, here's the answer.



Crimp Deutsch Rear Release terminals to both wires.



Insert the wires with one expendable tool.



And you've got a Jiffy Junction.<sup>®</sup>

This is the same reliable, high performance contact system used in all Deutsch Rear Release products including terminal junctions, feed-throughs, adaptor junctions, step-downs, grounding junctions, component terminations and electrical connectors.

The Jiffy Junction<sup>®</sup> is designed for use in all applications where splicing is prohibited.

It provides a fast, positive, inexpensive means of connecting wires. Available in wire sizes 12 through 26 A.W.G.; environmental and non-environmental types.

Write us and we'll send you data in a jiffy.

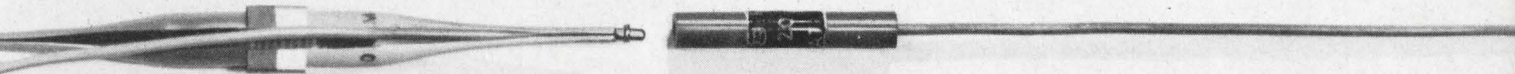

But the beauty of a Jiffy Junction<sup>®</sup> is that it disconnects just as easily.

**DEUTSCH** 

Electronic Components Division, Municipal Airport, Banning, California

**Our leadership position in Time/Frequency Synchronization is creating splendid career opportunities for electronic systems design & development engineers.**

**Experience Requirements:**

A background in successful systems design and development in the fields of airborne radars, IFF, very high frequency omni-range, distance measuring equipment, tactical air navigation, air traffic control system philosophy, command and control systems, tactical data systems and advanced communication systems. Direct experience in communication theory, operations analysis, system design, electronic circuit design, or component research, development and testing.

**Assignment:**

To apply precise time reference in the development of command and control, communication, navigation, and identification systems, as a member of the CNI Systems Department at McDonnell.

**Responsibilities:**

System studies and specifications, program monitoring, vendor liaison and test liaison, circuit design and development, and time/frequency synchronization applications investigations in areas of digital logic precision oscillators, frequency multipliers, frequency discriminators, displays and instrumentation.

**Positions Open:**

**1 Group Engineer:** For this you should have more than five years in operations research and an advanced degree in O. R. or mathematics.

**2 Engineers:** A degree in mathematics or operations research and more than two years experience will qualify you.

**2 Senior Engineers:** Five years experience in avionics packaging for civil aviation and a BSME or BSEE will do nicely.

**4 Senior Group Engineers:** Here you need at least 10 years in systems work (of a consistently complex nature) on such projects as integrated weapon systems or space systems. And you will undoubtedly have a degree in EE, AE, ME, math or physics.

**5 Electronic Engineers:** An EE degree and three years experience.

**4 Engineers:** Apply if you have two years system experience in complex electronic systems and current experience in micro-circuit electronics and a degree in EE, AE, ME, math or physics.

**MCDONNELL DOUGLAS**

Send your resume in confidence to W. R. Wardle, Professional Placement, McDonnell, Box 516, St. Louis, Mo. 63166.

An Equal Opportunity Employer

ON CAREER INQUIRY FORM CIRCLE 901

# Book Reviews

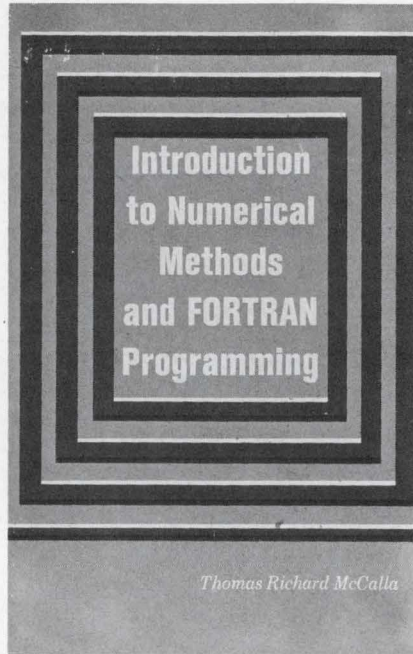

## Numerical methods and programing combined

*Introduction to Numerical Methods and FORTRAN Programming*, Thomas Richard McCalla (John Wiley & Sons, Inc., New York) 359 pp. \$7.95.

For practicing engineers and scientists or graduate students, Lt. Cmdr. McCalla has attempted to combine in a single volume an introductory text on numerical methods and one on computer programing.

An electronic engineer looking for an instructive work on numerical methods will find most of his needs satisfied by this book, despite its lack of emphasis on applications. To the extent that many excellent texts on FORTRAN programing already exist, however, the sections on FORTRAN are probably too short to be of real value to the practicing engineer.

After two introductory chapters the author devotes each of seven chapters to a particular group of numerical methods. Each chapter develops the topic tutorially, giving flow charts and, occasionally, actual FORTRAN IV programs. The chapters are rounded out by a series of exercises with both hand-computation and computer-programing examples. No answers or solutions are

given.

An adequate bibliography, referenced in the text, and an index are included.

—Jeffrey N. Bairstow

## Reticle techniques

*Reticles in Electro-Optical Devices*, Lucien M. Biberman (Pergamon Press, New York), 177 pp. \$7.00.

The optical designer or engineer who wishes to understand and apply reticle techniques to his problem will find this book helpful with specific design. It will give him a general understanding of the subject matter and includes valuable coverage of the important literature, including patents. The text begins with simple reticles for metrology and leads into the more recent applications of data transmission by a beam of light. The use of simple choppers, episcotisters and reticles for modern radiometry is treated in a chapter on radiometric problems. Other chapters cover reticles in error-signal generators, wave-function generators, and optical-tracking techniques. Reticle fabrication from design to etching is described in the last chapter.

## Transistor physics

*Transistor Physics*, K. G. Nichols and E. V. Vernon (Chapman and Hall, London), 332 pp. \$7.25.

This is an introduction to the application of physical theory to the study of semiconductors and transistor devices. While it deals almost exclusively with theoretical aspects, references to experimental work are given. Beginning with a discussion of classical atomic theory and quantum mechanical applications to electron energy levels, the authors accent statistical mechanics (including application of the Fermi-Dirac statistics), equations for drift and diffusion currents, current flow across pn junctions, and pnp transistor theory.

# Free Career Inquiry Service

## Absolutely Confidential

Respond to the career opportunities advertised in this issue. Fill out and send us this handy resume. **Electronic Design** will do the rest – neatly typed copies of this form will be mailed to the companies of your choice, indicated by the circled Career Inquiry Numbers at the bottom of this page.

# 12

<b>Name</b>				<b>Home Phone</b>	
<b>Home Address (Street)</b>			<b>City</b>	<b>State</b>	<b>ZIP Code</b>
<b>Age</b>	<b>U.S. Citizen</b> <input type="checkbox"/> Yes <input type="checkbox"/> No		<b>Security Clearance</b>		
<b>Prime Experience</b>			<b>Secondary Experience</b>		
<b>Desired Salary</b>			<b>Availability Date</b>		
<b>Employment History – present and previous employers</b>					
Company					
City, State					
Dates	to		to		to
Title					
Specialty					
<b>Education – indicate major if degree is not self-explanatory</b>					
Degree					
College					
City, State					
Dates	to		to		to
<b>Additional Training – non-degree, industry, military, etc.</b>					
<b>Professional Societies</b>					
<b>Published Articles</b>					

**Career Inquiry Numbers:**

900   901   902   903   904   905   906   907   908   909  
 910   911   912   913   914   915   916   917   918   919

**ELECTRONIC DESIGN**  
 850 Third Avenue  
 New York, New York 10022

It took Hughes  
engineers 3½ years to  
create the  
SYNCOM  
story.

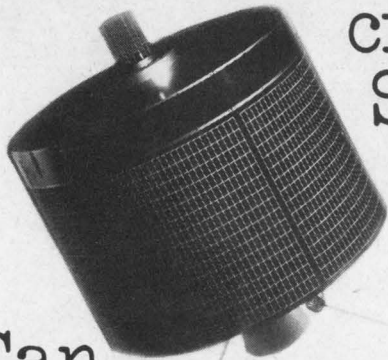

Can  
you write it?

Hughes Field Service and Support is urgently seeking qualified E.E.'s for a dual challenge—to your engineering know-how and to your writing ability. You will be closely associated with the latest and most advanced aerospace projects. As a Systems Writing Engineer, your assignment will be to **communicate** your knowledge of these projects.

The Syncom series is just one example of the magnitude and significance of the projects involved. Other subjects include space vehicles, weapons systems, electronic computers, guided missiles, radar and communications, programmed instructional devices, and systems trainers.

You will research drawings, specifications, and reports; you will interview project engineers and make first-hand examinations and inspections. Then you'll interpret and analyze this data and write engineering publications for use by other engineers on allied projects.

This is a demanding position and an important one. If you wish to rapidly broaden your engineering knowledge and gain systems-oriented technical experience, if you have a B.S.E.E. or a B.S. in Physics—and if you can write—please send your resume at once to: Mr. B. P. Ramstack, Hughes Aircraft Company, P.O. Box 90515, Los Angeles, California 90009. U.S. citizenship required.



## BOOK REVIEWS

### Transistor limitations

*Characteristics and Limitations of Transistors*, R. D. Thornton, D. DeWitt, P. E. Gray and E. R. Chenette (John Wiley & Sons, New York), 180 pp. \$4.50 (clothbound), \$2.65 (paperbound).

The purpose of this volume is to examine the important physical processes that limit the allowable range of voltage, current, temperature and speed of response in transistors. Attention is focused on those transistor limitations that cannot be circumvented by even the most clever circuit designs. A knowledge of the second-order properties of transistors described in this book will help the designer to minimize cost, improve reliability, and advance the state of the art of both circuit and device design.

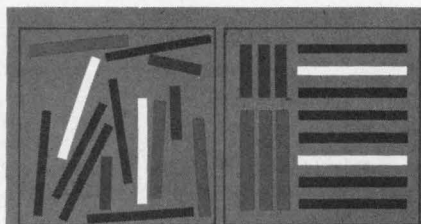

### The Technical Program Manager's Guide to Survival

Melvin Silverman

### Program management

*The Technical Program Manager's Guide to Survival*, Melvin Silverman (John Wiley & Sons, New York), 126 pp. \$6.95.

It is surprising, perhaps, that this concise and precise little volume can be so good when it is a first of its kind. Silverman gives the engineer an excellent guide to planning, carrying out and controlling a technical program—and in doing it he has wasted no words and has avoided involved explanations.

In the early chapters Silverman

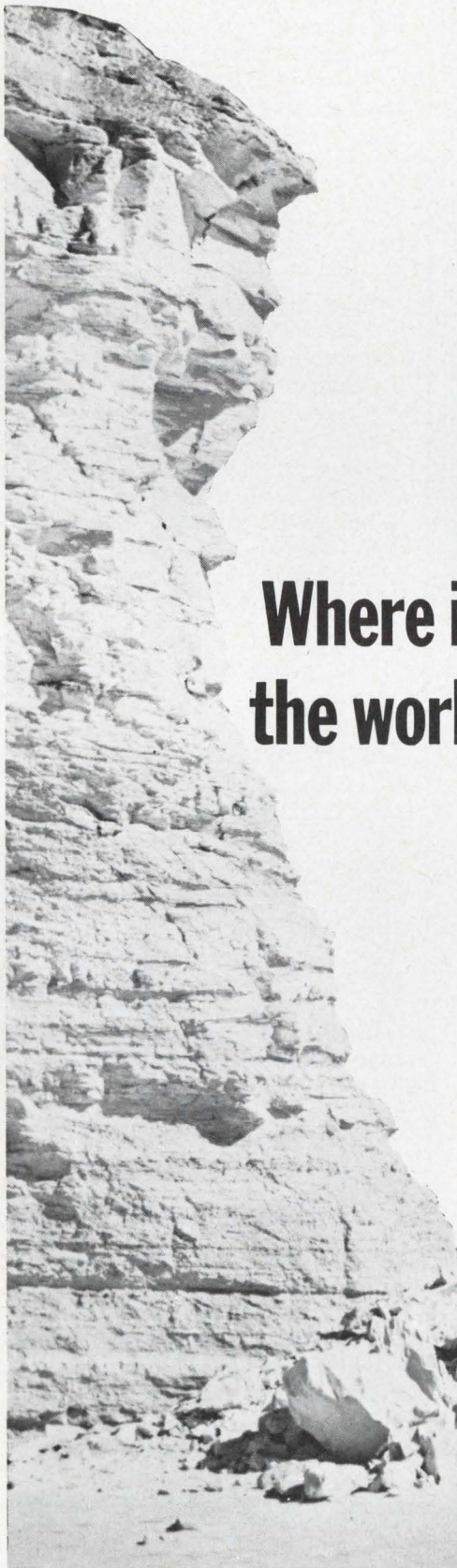

# Where in the world ...but Kansas

**Scenic variety in Kansas is unending. Surprised? Kansas has many surprises to enjoy in the four-season climate. These Monument Rocks are the remains of shale and chalk beds that, at one time, completely filled the Smoky Hill River valley in western Kansas. You'll enjoy our free recording of "Where In The World But Kansas," and it's available by simply mailing us the coupon on this page. We'll appreciate the opportunity to enclose more information about Boeing, Wichita, too.**

**AVIONICS:** Analysis and development of electro-optical sensor systems, long range airborne communications, forward looking infrared systems, ELINT/DF Systems, radar, navigation/guidance systems. Integration design and installation of aircraft electrical/electronic equipment.

**ANTENNA SYSTEMS:** Perform design, performance evaluation, and analysis of antennas, radomes and RF transmission systems, utilizing both digital computer and laboratory test evaluations.

**FLIGHT TEST:** Design airborne instrumentation. Test and analysis related to production or prototype aircraft systems.

**OPERATIONS ANALYSIS:** Develop conceptual missions for future military aircraft. Use advanced mathematical techniques and cost effectiveness methodology to define aircraft systems which satisfy the mission and cost requirements.

**CONTROL DYNAMICS:** Perform servo control analysis; involves analog and digital computer application in development of automatic flight controls. Analysis techniques include both classical and modern control theory

**Inquiries are also invited in other areas of Technical Competence.** Salaries are competitively commensurate with experience and educational background. Travel and moving allowances are paid to newly hired personnel. Boeing is an equal opportunity employer and complies with the provisions of the Civil Rights Act of 1964.

**TELEPHONE COLLECT**  
**Area Code 316, MUrray 7-2239**

Monday through Friday  
8:00 AM to 4:30 PM, CDT

Details of a career with Boeing in your specific area of engineering interest will be promptly provided.

**FREE RECORD OFFER:**  
45 RPM recording of "Where In The World But Kansas" by composer Bill Post and Chorus. Mail coupon below.

GERALD CAYWOOD, DEPT. A7P Boeing Professional Employment Office Wichita, Kansas 67210	
Name	_____
Home Address	_____
City	_____
State	_____ Zip _____

**BOEING**

**Wichita (Kan.) Division 67210**

OTHER DIVISIONS: Commercial Airplane • Missile and Information Systems • Space • Vertol • Also Boeing Scientific Research Laboratories



# DIGITAL LOGIC DESIGN

**ELECTRICAL DESIGN ENGINEER — SENIOR** Design experience including schematic diagram presentation, electrical/electronic components, design installation and related circuit design and analysis for automatic checkout equipment.

**ELECTRICAL DESIGN ENGINEER** Design experience including preparation of schematics and wiring diagrams. Able to work from check-out parameter criteria and evolve check-out equipment circuitry utilizing current state-of-the-art components for electrical check-out equipment design.

**ELECTRICAL DESIGN ENGINEER — JUNIOR** Prefer recent college graduates with industrial design experience involving solid state circuitry and/or logistic presentation to assist in the design of automatic electrical checkout equipment.

BS in E.E. or Physics required for all of the above positions.

Call our Los Angeles Professional Placement representative at (213) 623-1258. Or write Mr. R. C. Birdsall, P. O. Box 504, Sunnyvale, California. An Equal Opportunity Employer.

**LOCKHEED**  
**MISSILES & SPACE COMPANY**  
 A GROUP DIVISION OF LOCKHEED AIRCRAFT CORPORATION

ON CAREER INQUIRY FORM CIRCLE 902

## COMPLETE DC LAB CAPABILITY in two compact measuring systems

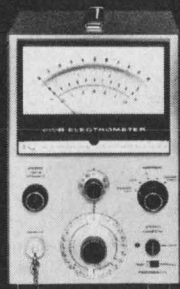

**610B ELECTROMETER**  
*Measures V-I-R-Q*

Electrometer performance with VTVM operating ease. 79 ranges with recorder output.

F. S. Range: 1mv—100v  
 0.3a—10<sup>-14</sup>a  
 100Ω—10<sup>14</sup>Ω  
 10<sup>-9</sup> coul—10<sup>-12</sup> coul

Input Impedance: 10<sup>14</sup> ohms  
 Stability: 200μ v/hr.

**\$565**

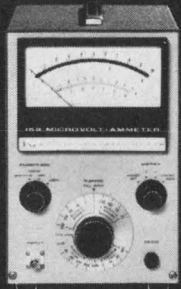

**153 MICROVOLT-AMMETER**  
*Versatile, Sensitive*

Measure from microvolts to a kilovolt. High AC line rejection. Recorder output.

Voltage Range: 5μv to 1000v f.s.  
 Current Range: 5x10<sup>-12</sup> to 0.1 amp. f.s.  
 Input Impedance: 10<sup>7</sup>—10<sup>8</sup> ohms  
 Noise: <0.06μv rms  
 Drift: <2μv/day

**\$550**

Ask your Keithley Engineering Representative for demonstrations and applications brochures.



**KEITHLEY  
 INSTRUMENTS**  
 28775 Aurora Road • Cleveland, Ohio 44139  
 EUROPE: 14 Ave. Villardin, 1009 Pully, Suisse

ON READER-SERVICE CARD CIRCLE 57

## BOOK REVIEWS

gives definitions and deals with engineering and quotations. He then slides neatly into other operations such as contracts, quality control, logistics, productions schedules. His main emphasis, however, is on the difficult problem of securing authority and cooperation from all levels of a company.

In all, this is an excellent book which fulfills its stated purpose. I do take exception to the title in spite of Silverman's neat definition in his preface. Here is a man who tells quite clearly how to carry out the function of a program manager yet starts off with the apologetic "guide to survival" phrase. He is starting, actually, on the chilling assumption that engineers cannot be managers. Must he presume that there exists a deep-rooted fear of failure? And where it doesn't exist, must he instill it?

—A. Doria

## Thermionic data

*Handbook of Thermionic Properties*, V.S. Fomenko (Plenum Press Data Div., New York), 151 pp. \$12.50.

This concise guide is the outcome of extensive research into electronic work functions and Richardson constants of elements and compounds. The original Russian edition published in 1964 was based on data available then; the present English edition incorporates later work done on a widening circle of materials.

The book offers exhaustive information on each element or compound. The sections on borides and carbides of the transition and rare metals, in particular, have been brought up to date in response to the growing interest in the use of these elements as cathode materials.

An entirely new section deals with thermionic properties of aluminides. The handbook constitutes a comprehensive reference for engineers interested in the emission properties of elements and compounds.

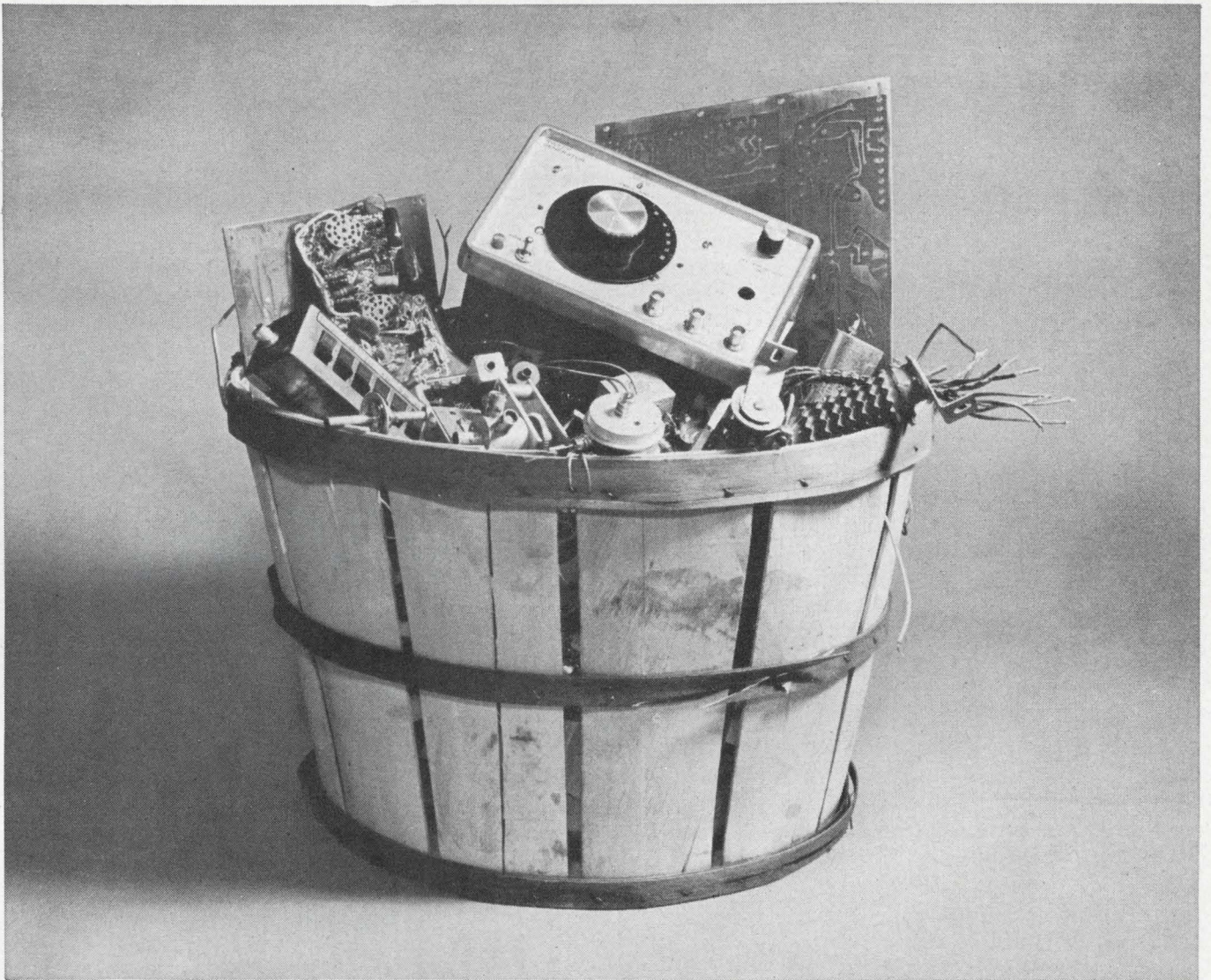

# You order it. We'll build it.

Let's face it. No two jobs are alike. Then why should one instrument be expected to fill the needs of all electronic engineers? Knowing this, we design and engineer all our equipment with utmost flexibility.

Our new VS-80 sweep signal generator is a good example.

Proven equipment design has produced an extremely stable oscillator, which provides an exceptionally accurate CW output as well as wide sweep capabilities.

So far we've described a good, solid state sweep signal generator.

But what raises it above the ordinary is the range of options available.

At your request we can add a switchable, 1 KHZ, 100%, amplitude modulation function, or an additional 0 to 10 db in 1 db step attenuator, or the sweep rate can be changed to 0.1 HZ to 10 HZ. And we've just started. Maybe you need markers to modulate the RF output or external amplitude modulation, or increased RF output.

Remember, we'll build the instrument you need . . . even if your name is Rube Goldberg.

**FREQUENCY RANGE**

1 MHZ to 1200 MHZ

**SWEEP WIDTH**

50 KHZ to 400 MHZ

**FLATNESS**

±0.25 low band,  
±0.50 high band

**OUTPUT**

0.5v rms

**SWEEP RATES**

Manual, 60 cycle, external, variable

**ATTENUATION**

0-70 db in 10 db steps,  
0-10 db vernier

**PRICE**

\$1495.00

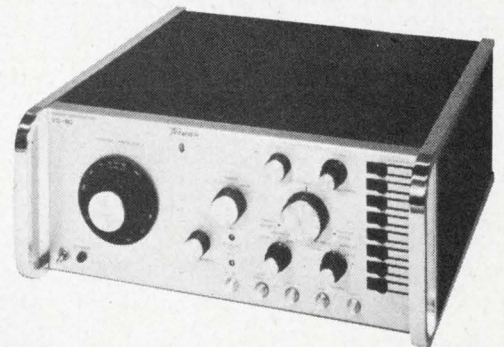

Specialists In Electronic Instrumentation

**Texscan**  
CORPORATION

51 Koweba Lane • Indianapolis, Indiana 46207 • Ph. (317) 632-7351

TURRET ATTENUATORS • TERMINATIONS • IMPEDANCE MATCHING PADS • REFLECTION COEFFICIENT BRIDGES  
ON READER-SERVICE CARD CIRCLE 58

# You can save a lot of troublesome circuit engineering with the AE Series OCS Relay. We've "packaged" most of the programming!

AE's Series OCS Relay is low in cost and no bigger than a pack of king-size cigarettes. But it can save you a lot of engineering time.

This little relay can do the work of a whole battery of solid-state devices. And it won't lose its memory in a power failure or a circuit interruption.

*"Packaged" programming.* The AE Series OCS will follow or initiate a prescribed series of events or cycles at 30 steps per second impulse-controlled—or 65 per second self-interrupted. You can set up any programming sequence on one to eight cams, with as many as 36 on-and-off steps per cam. And each cam, tailored to your specifications, will actuate as many as six contact springs.

Can AE help take the "snags" out of your job? Our engineers are ready to work with you, to find the most practical and economical solution to any circuit-transfer problem.

There's a lot of helpful application information in the 160-page book, "How to Use Rotary Stepping Switches." Just ask your AE representative. Or write Director, Relay Control Equipment Sales, Automatic Electric, Northlake, Illinois 60164.

**AUTOMATIC ELECTRIC**  
SUBSIDIARY OF  
GENERAL TELEPHONE & ELECTRONICS **GT&E**

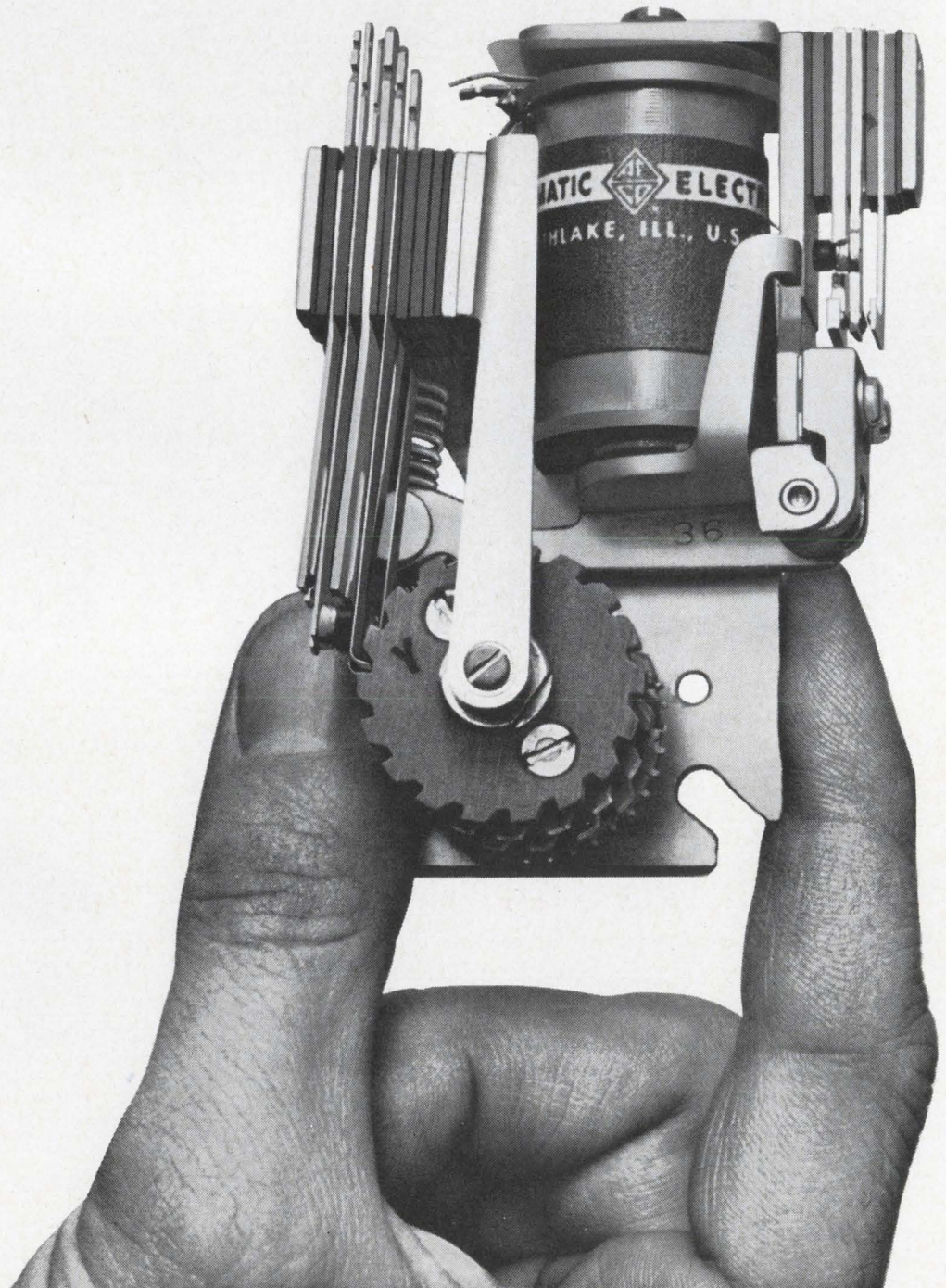

ON READER-SERVICE CARD CIRCLE 59



# Products

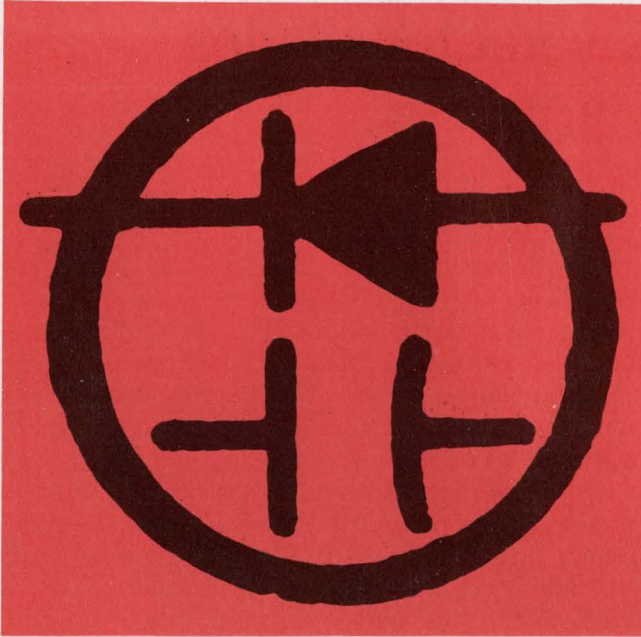

**Tune in with varactor diodes.** Tuning ratios range to twenty-to-one, Qs to 300. Page 116

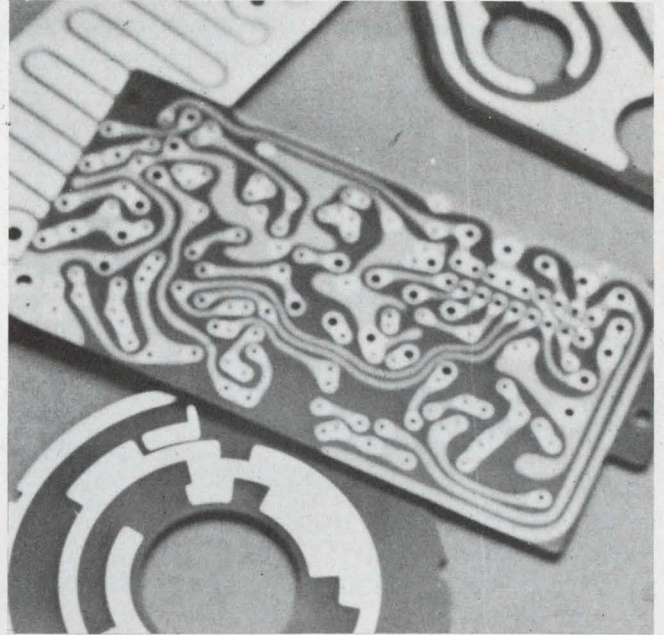

**PC boards use 7-ounce beveled edge copper** to increase load-handling capacity. Page 128

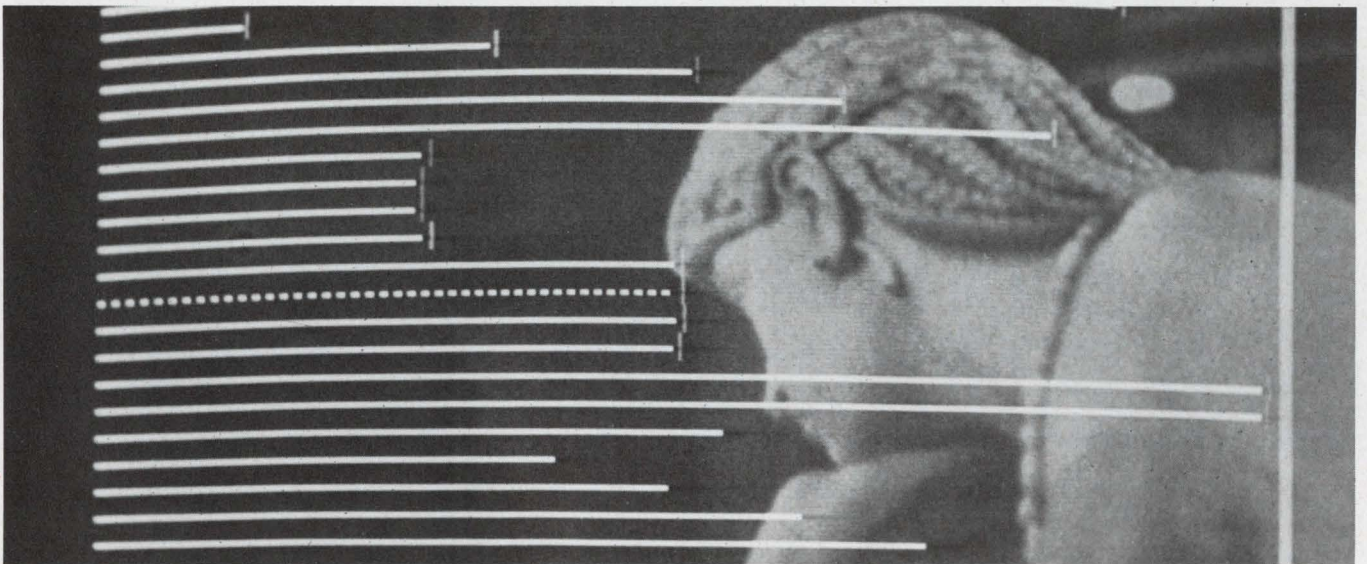

**Display up to 30 channels of data** on any standard closed-circuit TV monitor. The

length of each display bar is proportional to its associated input voltage level. Page 140

## Also in this section:

**Thermoplastic capabilities extended** into the metallic temperature range. Page 150

**Glass capillary tips** provide clean thermocompression bonding of ICs. Page 164

**Design Aids**, Page 180 . . . **Application Notes**, Page 182 . . . **New Literature**, Page 184

# Hyperabrupt junction gives varactor diodes tuning ratios to 20:1, Q to 300

Motorola Semiconductor Products, Inc., 5005 E. McDowell Rd., Phoenix. Phone: (602) 273-6900. P&A: \$5.95 each in evaluation lots; stock.

Voltage-variable capacitors, no larger than a quarter-watt composition resistor, can replace bulky air-variables in tuning applications ranging from the broadcast band all the way to uhf. Motorola Semiconductor, manufacturer of the hyperabrupt junction devices, specifies that their MV1403 varactors have:

- Usable tuning ratio of 10:1 to 15:1 from 2 to 10 volts bias.

- Q of 200 at 1 MHz and 2 volts reverse bias.
- Capacitance of 200 pF  $\pm 20\%$  at 1 volt reverse bias.

Motorola also has a unit, the MV1401, with a tuning ratio ranging from 14:1 to 21:1, Q of 300 and capacitance of 500 pF. The two devices are part of a line of varactors characterized by capacitances of 22 to 500 pF.

Up to now, varactors have not had the capacitance range to cover the broadcast band (a min-to-max ratio of 10-to-1 is needed) together with the high Q needed to preserve the required selectivity. While they had a sufficient range for uhf

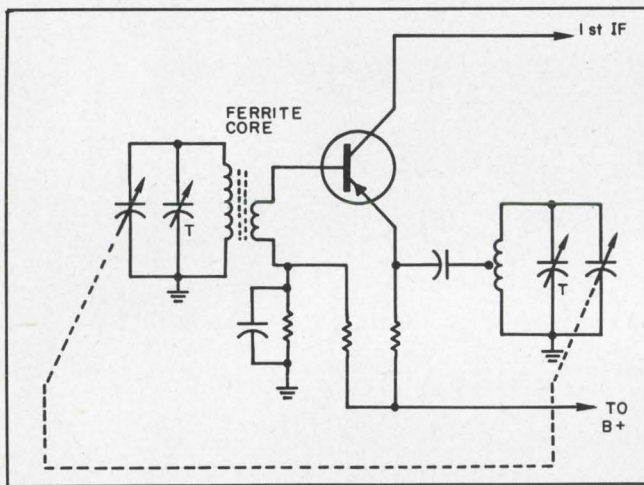

	600 kHz	1000 kHz	1400 kHz
Signal level for 6 dB S+N/N	65 $\mu\text{V}/\text{m}$	60 $\mu\text{V}/\text{m}$	125 $\mu\text{V}/\text{m}$
Signal level for 20 dB S+N/N	250 $\mu\text{V}/\text{m}$	250 $\mu\text{V}/\text{m}$	300 $\mu\text{V}/\text{m}$
Signal level for 50-mW output	575 $\mu\text{V}/\text{m}$	500 $\mu\text{V}/\text{m}$	1000 $\mu\text{V}/\text{m}$
F+2 IF rejection (IF rej. = 36 dB)	41 dB	40 dB	39 dB
Output for 10% dist. RF = 5 mV/m		0.45 mW	

1. **Mechanical tuner covers 518.2 to 1619.3 kHz.** To convert to electronic tuning, the 2-gang capacitor is replaced without altering antenna or oscillator transformers.

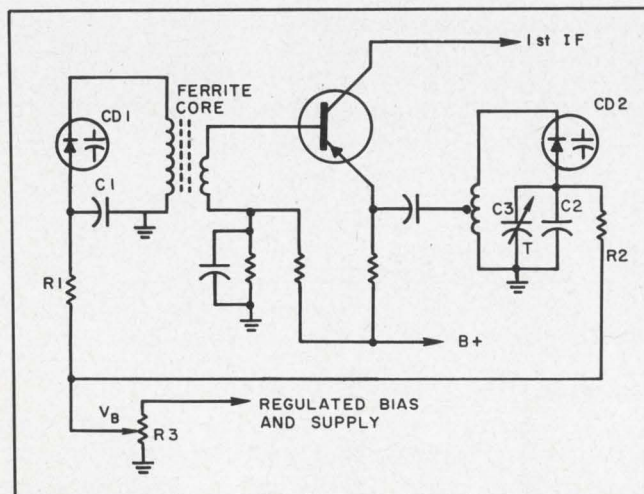

	600 kHz	1000 kHz	1400 kHz
Signal level for 6 dB S+N/N	78 $\mu\text{V}/\text{m}$	106 $\mu\text{V}/\text{m}$	105 $\mu\text{V}/\text{m}$
Signal level for 20 dB S+N/N	240 $\mu\text{V}/\text{m}$	250 $\mu\text{V}/\text{m}$	205 $\mu\text{V}/\text{m}$
Signal level for 50-mW output	700 $\mu\text{V}/\text{m}$	1250 $\mu\text{V}/\text{m}$	700 $\mu\text{V}/\text{m}$
F+2 IF rejection (IF rej. = 33 dB)	40 dB	29 dB	34.5 dB
Output for 10% dist. RF = 5 mV/m		0.36 mW	

2. **Electronic tuner covers 461.4 to 1614.4 kHz.** In antenna circuit, air-variable and trimmer are replaced by CD1, in oscillator circuit by CD2, C2 and trimmer C3.



## These two heat-shrinkables are hungry for tough mil-spec insulation problems.

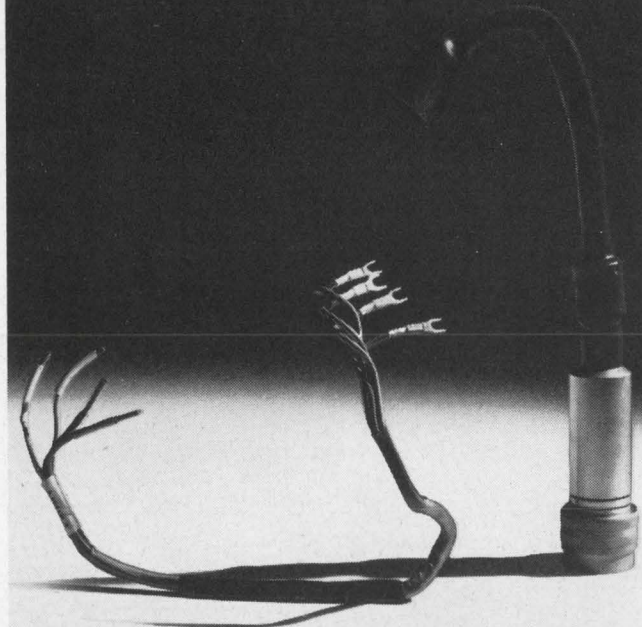

Feed them.

New Insultite® SR-350 eats up shock, strain and vibration like only a semi-rigid, irradiated polyolefin can. It combines superior dielectric characteristics with high structural strength. From 3/64" to 1" I.D.

Insultite FP-301, on the other hand, has a flexible polyolefin appetite that devours mil-spec applications. Quickly. Totally. From 3/64" to 4" I.D.

SR-350 meets classes 3 and 4 of MIL-I-23053A and NASA 276A. FP-301 meets classes 1 and 2.

Both are available in ten standard colors. Write today for free samples. (Specify diameters, please.)



**ELECTRONIZED CHEMICALS  
CORPORATION**

A subsidiary of High Voltage Engineering Corporation  
Burlington, Mass. 01803, Area Code 617-272-2850

E.C.C. heat shrinkables are recognized under UL component file E39100.

ON READER-SERVICE CARD CIRCLE 61

## COVER FEATURE

applications (4-to-1 is needed for the uhf TV band), they fell short in Q. In lower frequencies where they did have high Q, their tuning range was too restricted. And, their small applications potential kept prices high. Motorola now forecasts an OEM quantity price of well below \$1, competitive with air-variables.

To evaluate tuning performance a pair of varactors was substituted for a two-gang tuning capacitor in a consumer transistor AM radio. Before it was converted to electronic tuning, performance tests were made to IEEE Std. 186, "Methods of Testing AM Broadcast Receivers." The tuner and test results are shown in Fig. 1.

In the modified circuit (Fig. 2), tuning diode *CD1* replaces the mechanical tuner and trimmer in the antenna circuit. Tuning diode *CD2*, *C2* and series trimmer *C3* replace the mechanical tuner. The trimmer and *C2* are used to achieve the proper oscillator capacitance throughout the band without modifying the antenna or oscillator coils.

Bias voltage  $V_B$  is obtained from a regulated supply and is varied by the potentiometer *R3*. Decoupling in the antenna circuit is accomplished with bypass capacitor *C1* and with *R1*, which has a value of several hundred kilohms. Decoupling resistor *R2* in the oscillator circuit has the same value as *R1* since both varactors are matched within 2% at 1, 4 and 10 volts of bias for bias vs capacitance. A Zener-regulated bias supply with additional filtering prevents variations due to line fluctuations and changes in supply voltage during periods of high audio output. The peak-to-peak oscillator voltage across the oscillator tank must be held low enough to prevent detuning of the varactor.

After conversion, the receiver was aligned as follows:

- Set *R3* for max bias voltage and adjust oscillator inductor for max output at 1600 kHz (determined by rocking *R3*)
- Adjust the oscillator trimmer for max output at 600 kHz.
- Repeat the procedure until no change is noted in the settings.

Performance is summarized in Fig. 2.

Applications for the new series of hyperabrupt junction varactors might even include remote electronic tuning. The fact that tuning is essentially done with a dc voltage, rather than a rotating shaft, frees the circuit designer from layout limitations. For example, a car radio could be located in the trunk with controls on the dash, or a TV or FM preamplifier could be located at the antenna but tuned inexpensively right at the receiver.

CIRCLE NO. 250

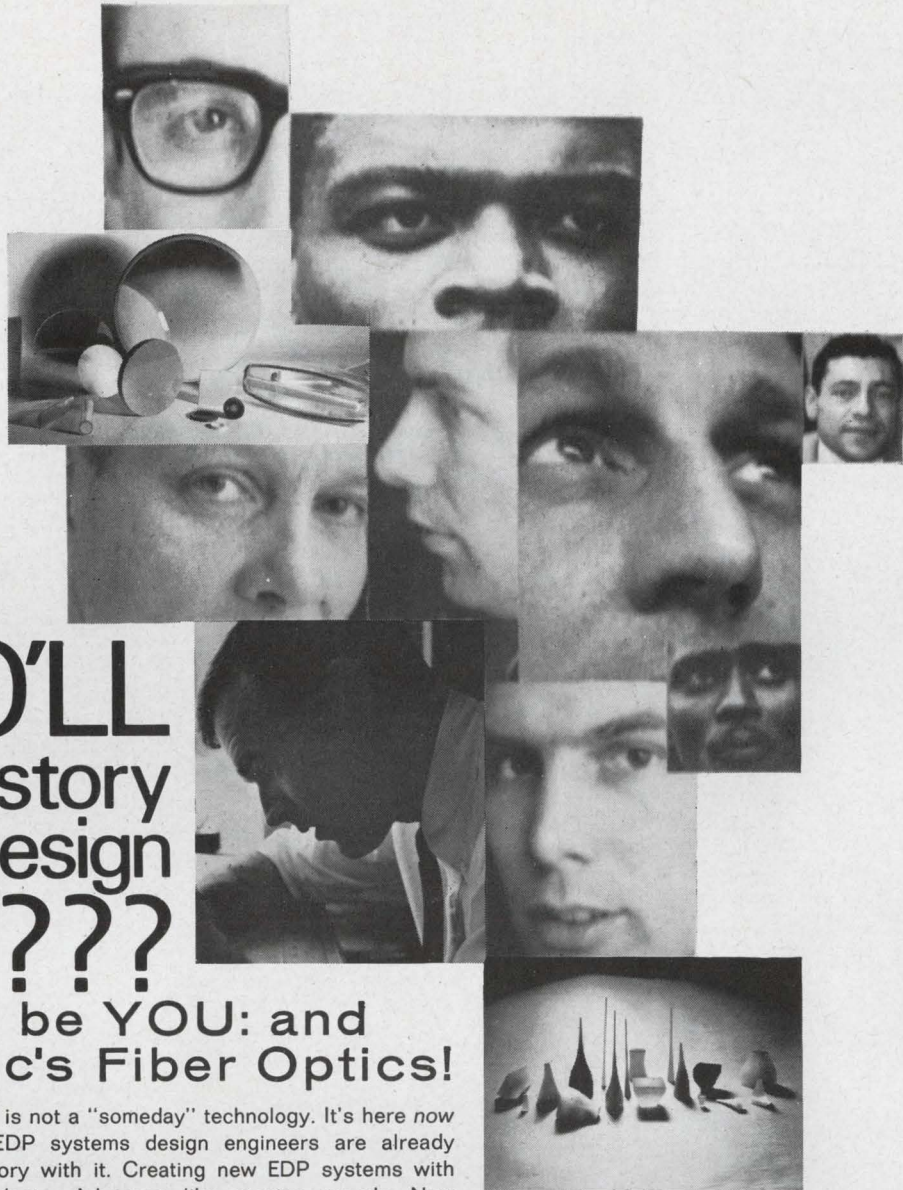

# WHO'LL make history in EDP design ?????

## Could be YOU: and Mosaic's Fiber Optics!

Fiber optics is not a "someday" technology. It's here now . . . and EDP systems design engineers are already making history with it. Creating new EDP systems with superior talents. Advances like greater speeds. New capabilities. Design freedom. Greater reliability and lower costs.

Do you know what happens when you use Mosaic's fiber optic faceplate on a CRT, vidicon, or orthicon tube? Your recording sensitivity is greatly increased (in some cases, as much as 40X) enabling you to compromise on the tube design. With the effect of a zero thickness window, you get improved contrast and resolution, and can take *direct* accurate measurements on the image.

Have you heard about Mosaic's Fiber Optic systems? On new EDP printers, readers, punched tape and card verifiers, keypunch and teletype equipment, they beat heat, wear and friction-prone mechanical systems

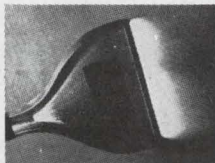

hands-down: with increased reliability, greater efficiency, speeds over 4 times faster and lower cost!

Mosaic's fiber optics can help you make history in EDP design, now . . . a field that leaves you no time for old design notions. Give those specific design problems of yours a hard look, today. Then contact Mosaic Fabrications. We know fiber optics inside-out. We're the largest single source of fiber optics technology, capability, and productivity in the world! Mosaic will work with you to solve your EDP design problems now . . . will help you design and develop, from prototype to production, the specific EDP fiber optic hardware to put you far ahead!

Call or write for descriptive literature, today!



**Mosaic  
Fabrications, Inc**

GALILEO PARK, STURBRIDGE, MASSACHUSETTS 01518, (617) 347-9191

ON READER-SERVICE CARD CIRCLE 62

## UNLIMITED VARIETY

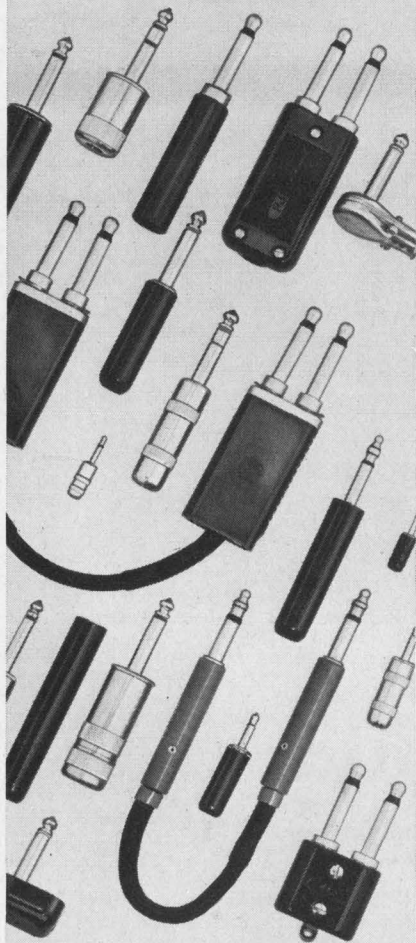

## INCOMPARABLE QUALITY

### SWITCHCRAFT PHONE PLUGS

Why waste time "shopping around" . . . whatever your plug requirement—regardless of size or type, Switchcraft makes it, and makes it better! The one piece tip rod, for instance, is staked into the terminal to assure tightness . . . the tip rod can't fall out! Switchcraft offers you the world's largest selection of phone plugs . . . with solder terminals, screw terminals, cable clamps; .250", .206", .140", .097" finger diameters; shielded handles, or tough plastic handles; single plugs, twin-plugs; 2-conductor or 3-conductor—you name it! Chances are it's a thoroughly proved, field-tested STOCK plug from the incomparable Switchcraft line of plugs.

SEND FOR NEW CATALOG P-202 or see your Switchcraft Authorized Industrial Distributor for immediate delivery at factory prices.

**SWITCHCRAFT**  
INC.

5529 North Elston Ave.  
Chicago, Illinois 60630

ON READER-SERVICE CARD CIRCLE 63

## SEMICONDUCTORS

### Uhf mixer diodes have 14-dB NF

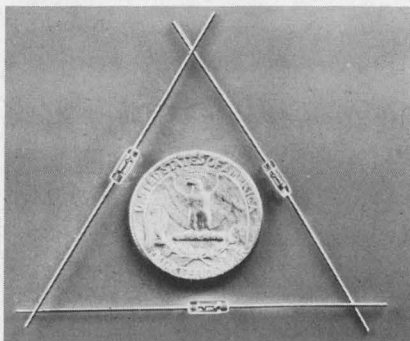

Sarkes Tarzian, Inc., 415 N. College Ave., Bloomington, Ind. Phone: (812) 332-1435. Price: 30¢ (over 10,000).

Uhf mixer diodes of epitaxial material have a noise figure of 14 dB. The diode is glass-encased and measures 0.1 inch diameter and 0.3 inch long and has gold-plated du-met, weldable and solderable leads. The 1N82A and 1N82AG are rated at a PIV of 5 V and a forward current of 15 mA. With performance up to 1 GHz, the mixer is suitable for applications in radio communications, consumer electronics, amateur and test equipment.

CIRCLE NO. 251

### Tiny silicon diodes have PIV to 4 kV

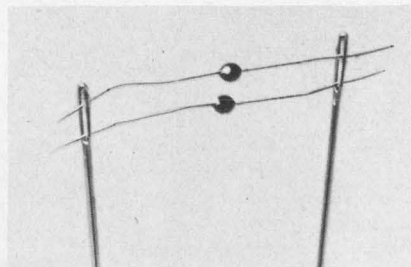

Atlantic Semiconductor, Inc., 905 Mattison Ave., Asbury Park, N. J. Phone: (201) 775-1827.

High-voltage silicon diodes, the NV series, operate with peak inverse voltage ratings from 1000 to 4000 volts. They supply 10-mA maximum continuous forward current with 10-nA maximum reverse current at the rated peak inverse voltage. Maximum capacitance at zero volts is 1 pF. The units measure 0.85 inches in diameter by 0.1 inch long with a lead diameter of 0.1 inch.

CIRCLE NO. 252

### Eight-ampere Triacs in 3 package styles

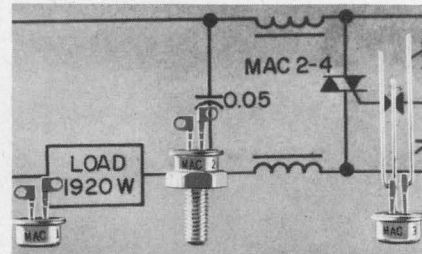

Motorola Semiconductor Products, Inc., P. O. Box 955, Phoenix. Phone: (602) 273-6900. P&A: \$1.60, \$2.20, \$3.50 (100-up); stock.

A series of 8-A Triacs, MAC1, 2 and 3, are designed for large-volume applications such as light dimmers, space heaters, oven and furnace heating controls, street light controls, power supplies, ac static switches, vending machine logic, and speed control for portable tools, fans and air conditioners. A chip design, with a built-in copper slug for added protection, facilitates current spreading while furnishing a high 100-A peak surge current rating. The MAC1 package is the lug terminal type that can be glued or soldered down. The MAC2 is a 7/16-inch stud package and the MAC3 three-leaded package is for PC board mounting. Peak blocking voltages of 50, 200 and 400 V are available.

CIRCLE NO. 253

### Coax package houses RF overlay transistor

RCA Electronic Components and Devices, Harrison, N. J. Phone: (201) 485-3900. P&A; \$90 in evaluation quantities.

RF power overlay transistors operating at 2 GHz have a new coaxial package with low parasitics. The devices should find applications as amplifiers or fundamental frequency oscillators in L- and S-band equipment designs including telemetry, radar, ECM equipment, or as a driver for microwave tubes and varactors. As an amplifier, the TA7003 has 1-watt minimum power output at 2 GHz with 5-dB gain and 30% efficiency. As an oscillator it has 1.5-watt typical power output at 1 GHz. Both modes of operation are specified from a 28-V source.

CIRCLE NO. 254

# In Making Masks for Electronic Components . . . . . . there's no Margin for Error!

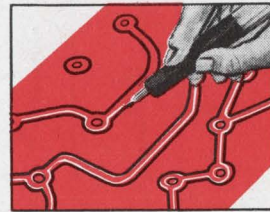

With sharp blade, outline the areas to be masked. Do not cut through the backing sheet. The Ulano Swivel Knife does the job quickly, easily.

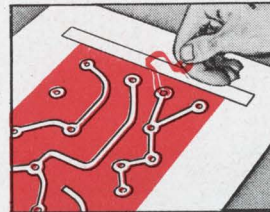

Now carefully peel off the film as outlined leaving a completed photo mask, positive or negative, that corresponds exactly to the desired pattern.

**THAT'S WHY EXPERIENCED DESIGNERS  
AND ENGINEERS ALWAYS INSIST ON...**

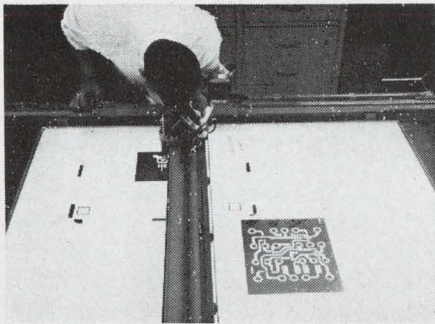

# RUBYLITH<sup>TM</sup>

HAND-CUT MASKING FILM FOR THE GRAPHIC ARTS

**THE KNIFE-CUT, LIGHT-SAFE MASKING FILM  
LAMINATED TO A STABLE POLYESTER BASE**

The most versatile line of hand-cut masking films, including

**.0075—RUBYLITH 75 DR\*    .005 RUBYLITH 5 DR  
.005 AMBERLITH 5 DA**

These new, thick Ulano films provide the positive answers where exact register assumes a critical importance.

*\* Available in sheets only, cut to your specifications.*

*by*

# Ulano<sup>TM</sup>

**ulano**<sup>TM</sup>

610 DEAN STREET, BROOKLYN, N. Y. 11238

NEW YORK • CALIFORNIA • CHICAGO • ZURICH

In Europe: ULANO A. G., Untere Heselbachstrasse 22, Kusnacht 8700, Switzerland

*Write on your letterhead for special electronic test kit (no charge) No. 4127*

ON READER-SERVICE CARD CIRCLE 64

# Low Cost 4 DIGIT

## 400 SERIES

### INTEGRATING DC

# DIGITAL VOLTMETER



**Extended Range Measurements:** Fifth digit over-range.

**Precise Measurements:** With accuracies to 0.05%.

**Input Flexibility:** Four voltage ranges and a micro-current input for measuring in "Engineering Units" (psi, degrees, etc.)

**System Compatibility:** BCD Outputs and Remote Programming.

**High Noise Rejection:** Differential input and integration techniques provide common mode rejection greater than 120 db at 60 Hz.

**Economical:** 3 and 4 digit models range from \$349.50 to \$495.50.

These DVM's are not only **NEW**, they're **AVAILABLE** from Janus representatives from coast to coast!

**CALL OR WRITE FOR A DEMONSTRATION.**



296 NEWTON STREET • WALTHAM • MASSACHUSETTS 02154 • TEL: (617) 891-4700  
ON READER-SERVICE CARD CIRCLE 65

## SEMICONDUCTORS

Power rectifiers rated to 5.5 A, 25 kV

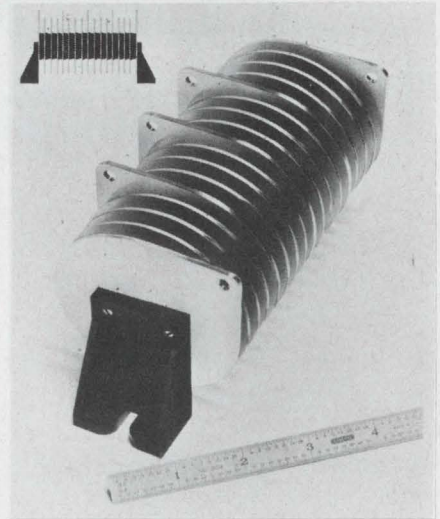

Semtech Corp., 652 Mitchell Rd., Newbury Park, Calif. Phone: (213) 628-5392.

Per leg current ratings to 5.5 A in free air (11 A in forced air or oil) and per leg voltage ratings to 25 kV are featured in Stacpac rectifiers. They need no additional heat sinks and are reportedly capable of being used in applications up to 1,000,000 volts. The units are whisker-free double tungsten stud silicon rectifiers electrically and thermally bonded to aluminum discs which serve as compensation, cooling fins and corona protection. Units are available in stacks, doublers, center-taps, and bridges and vary in length according to PIV.

CIRCLE NO. 255

## GaP diodes emit green at 5600 angstroms

Monsanto Co., 800 N. Lindbergh St., St. Louis, Mo. Phone: (314) 993-1000.

Developmental solid-state diodes which emit green light are produced from gallium phosphide. They emit light at a typical wavelength of about 5600 Å. They exhibit a brightness of from 70 to 200 foot lamberts with a forward current of 70 mA. The new diodes exhibit a long life expectancy and fast switching and will be offered singly or in small-size alphanumeric displays.

CIRCLE NO. 256



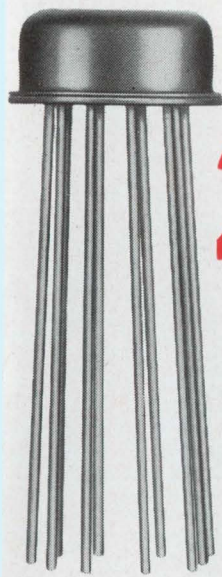

**now you can test  
24 parameters of a  
10-pin microcircuit  
in 2 minutes flat...**

**with this new semi-automatic IC analyzer**

**MICA  
150**

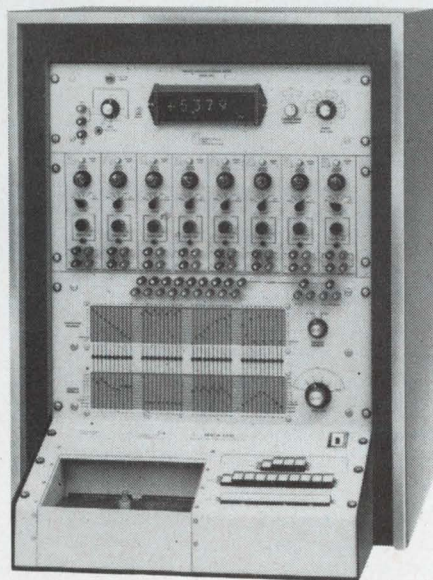

Now even a non-technical operator can speed through comprehensive DC tests on all types of IC packages with from 2 to 40 pins. Test conditions are easily set up on the programming switches of MICA-150 and pushbutton sequencing of the test from pin-to-pin of a device is simple and fast with test results indicated by direct digital readout. On a typical 10-pin, 5-input gate circuit, as many as 24 parameters of the device can be checked within two minutes without changing a single crossbar switch.

For additional information on applications of MICA-150 for DC or high frequency testing, contact W. Leo McBlain, (609) 424-2400

**COMPUTER TEST CORPORATION**

CHERRY HILL,



NEW JERSEY

# The ultimate in Q

## JFD Uniceram capacitors

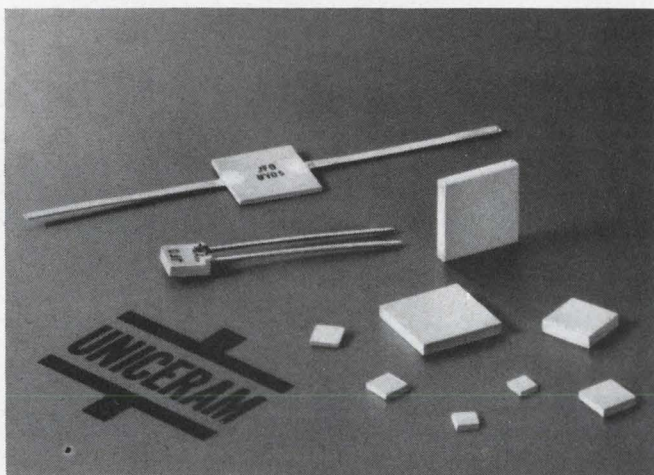

Capacitors shown enlarged 25%

Glass encapsulated or unencapsulated wafer Uniceram monolithic High Q ceramic fixed capacitors—offer a high ratio of capacitance per unit volume. They combine exceptional stability and a guaranteed minimum Q in a smaller size package than competitive units.

Over 1,000 glass encapsulated models, with capacitance values from 0.5 to 3000 pf, provide the ultimate in High Q—proven reliability and stability. All models meet applicable requirements of MIL-C-11272B.

Uniceram High Q capacitors are also available as wafers with metalized edges. These lower-cost units in the same capacitance values offer the same outstanding electrical properties. These wafers, or chips, ideally suited for hybrid integrated circuits, can be soldered directly to printed circuit boards or used as discrete components.

A High K series of encapsulated Uniceram fixed capacitors with up to 1 mfd capacitance is also available.

Write for Catalog UNM 65-2

**JFD** "TODAY'S COMPONENTS BUILT FOR TOMORROW'S CHALLENGES"

JFD ELECTRONICS CO. / COMPONENTS DIVISION 15th Avenue at 62nd Street Brooklyn, N. Y. 11219 / Phone 212-331-1000 • Sales Offices—Arcadia, Calif. Chi., Ill. / Balt., Md. / Saxonville, Mass. / Bklyn., N. Y. / New Hartford, N. Y. Cinn., Ohio / Phila., Pa. / Pitts., Pa. / Paris, France / Azor, Israel

## MICROELECTRONICS

### Printed-circuit socket handles 14-lead ICs

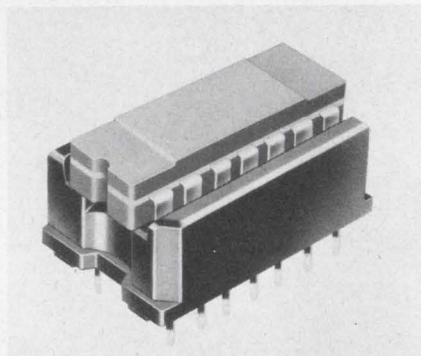

Augat, Inc., 33 Perry, Attleboro, Mass. Phone: (617) 222-2202. P&A: 25¢ to 45¢; 3 to 4 wks.

Low-profile printed-circuit sockets permit packaging on 1/2-inch centers. Mounting configuration is identical to the IC package. The sockets accept packages with flat or round leads. They use wiping-type beryllium copper contacts and are available in diallyl phthalate or black phenolic with gold or tin-plated contacts.

CIRCLE NO. 257

### Test sockets accept 8- and 10-lead TO-5s

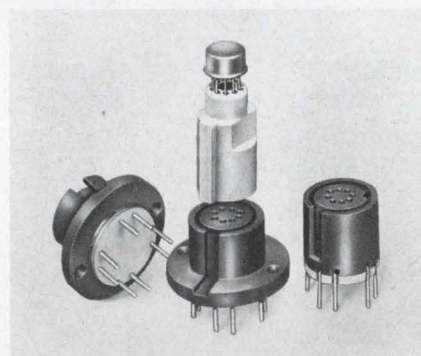

Barnes Development Co., Lansdowne, Pa. Phone: (215) 622-1525. P&A: \$1.50 to \$2.50; stock to 2 wks.

Series MF test sockets accommodate Motorola 8- or 10-lead polysulfone carriers for TO-5 packaged ICs. Lead sizes accepted are 0.016 to 0.024 inch diameter and 21/64 inch maximum length. Molded of polysulfone dielectric for continuous operation from  $-65^{\circ}$  to  $140^{\circ}\text{C}$ , the sockets are available with or without flanges.

CIRCLE NO. 258

# TEST YOUR E.Q.\*

\*EVALUATION QUOTIENT

## in pots and trimmers

Check One of the Three Manufacturers For Each Question and Compare Your Answers with the Correct Answers Below

SPECTROL

Mfr. A

Mfr. B

1. Which manufacturer recently achieved an outstanding breakthrough in trimmer design — introducing the first cermet trimmer with a seamless construction that virtually eliminates leakage problems?

2. Which manufacturer built its reputation as a precision potentiometer and trimmer "spec house" and still welcomes your orders for those tough, hard-to-design specials?

3. Which manufacturer offers the best non-linear function capability to meet those "hairy" pot designs and still provides you with more than 200,000,000 options in its standard line of potentiometers and trimmers?

4. Which manufacturer offers the broadest line of quality precision potentiometers capable of meeting the stringent requirements of MIL-R-12934?

5. Which manufacturer has the newest, most up-to-date facility for the design and manufacture of potentiometers and trimmers?

Give yourself 20 points for each correct answer. A score of 80 or better means a very high E.Q. 60 is average. And below 60 means that you need more information to wisely specify or purchase precision or trimming potentiometers. (In case there's any doubt, the correct answer to all questions is "Spectrol.")

Whether your E.Q. is high or low, if you specify or purchase precision or trimming potentiometers, why not send for Spectrol's Short Form Catalog. We will also include complete information on the industry's first seamless trimmer — our remarkable new cermet — the Model 53.

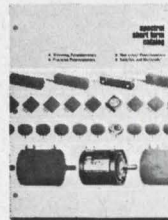

Better Components  
for Better Systems



**SPECTROL ELECTRONICS CORPORATION** 17070 East Gale Avenue City of Industry, California 91745

ON READER-SERVICE CARD CIRCLE 68

## Monolithic audio amp gives one-watt output

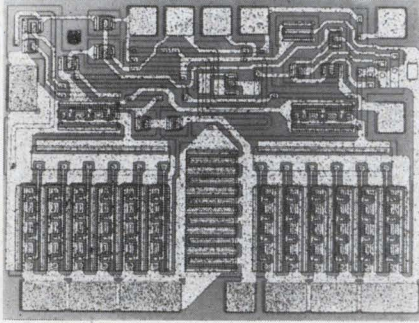

Motorola Semiconductor Products, Inc., P. O. Box 955, Phoenix. Phone: (602) 273-6900. P&A: \$15 (100 to 999); stock.

Motorola's new one-watt audio amplifier, the MC1554G, joins General Electric's (ED 7, Apr. 1, 1967, p. 113) as industry's only monolithic audio amplifier to deliver one watt. The unit offers the one-watt output with a total harmonic distortion of less than 0.4% over a frequency range of 20 Hz to 20 kHz.

The MC1554G is also designed as a general-purpose amplifier for signals with frequencies of up to 300 kHz. The output is delivered to either direct coupled or capacitively coupled loads. Housed in a 10-in, low-profile metal can, the unit has an input impedance of 10 k $\Omega$  and output impedance of 0.2  $\Omega$ . This output impedance is optimized for driving a 16- $\Omega$  load, commonly encountered in audio or servo applications. Voltage gain is adjustable by means of external connections to three gain adjust pins. Through these connections, nominal voltage gains of 9, 18 or 36 may be selected.

Typically, the output voltage changes less than 2 mV across the full -55° to 125°C operating temperature range. The output voltage sensitivity to power supply variations is 40 mV/V. For zero signal input, the drain current is 11 mA dc with a 16-V power supply.

CIRCLE NO. 259

## modular thumbwheel switches by Amperex

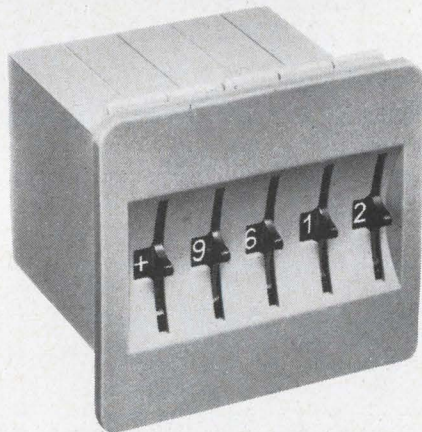
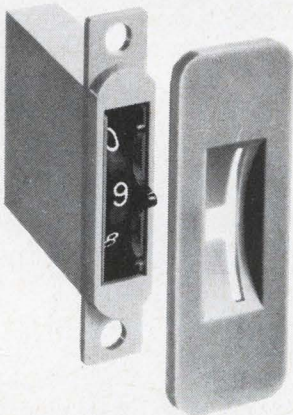

for all single, double and 4-pole applications

### easiest to mount:

Individual switches mount with two screws onto the rear of the panel by means of face-plates available in lengths for one to nine switches in cascade.

### easiest to wire:

Uniquely designed terminals accept solder or wire wrap connections.

### most versatile:

4 independent wipers provide a wide variety of decoding possibilities. The built-in diode gate in decoding switches eliminates mounting external gate and running in extra leads.

#### Outstanding Features

- Binary decoding and coding
- Bronze, nickel plated, glass epoxy, printed circuit board
- Lightweight, modular design

Immediately available, priced from \$3.60 per unit for the single-pole, 10-position decimal switch.

Savings are achieved through availability of multiple face-plates in various lengths to accommodate from one to nine switches in cascade on 1/2 inch centers.

For complete information, write: Amperex Electronic Corporation, Components Division, Hicksville, Long Island, New York 11802.

**Amperex**  
TOMORROW'S THINKING IN TODAY'S PRODUCTS

## MOS-FET analog switch commutates $\pm 10$ V

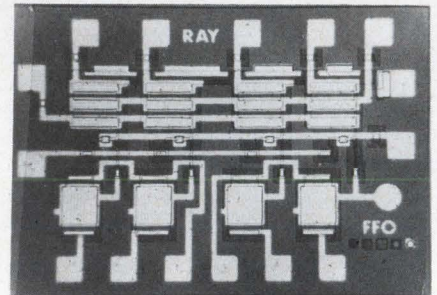

Raytheon Co., Semiconductor Operation, 350 Ellis St., Mountain View, Calif. Phone: (415) 968-9211.

A monolithic MOS-FET analog switch and commutator contains 4 p-channel, enhancement-mode MOS-FET switches on a chip of silicon measuring 0.045 x 0.0062 inches. Each switch is driven by a 3-input NOR gate and is capable of commutating signals up to  $\pm 10$  volts. In most applications a 5-volt swing on the input of the NOR gates will allow commutation through the 4 channels. Typical applications include multiplexing, D-to-A conversion and logical gating. The device is available as a 14-lead flat pack (1/4 x 1/8 inch) with a choice of 2 different lead bonding configurations and 3 voltage levels.

CIRCLE NO. 260



**This Babcock  
10 amp. relay  
also  
switches  
dry circuit  
with the  
same contact set**

Now, your Babcock 10 amp. full size crystal can relay will also switch dry circuit with the same set of contacts. These exclusive universal contacts have greatly simplified your relay stocking requirements. You can order one model to meet a given set of performance parameters without concern for load requirement — *at no cost premium*. Get complete information about this versatile relay, and the entire Babcock line, all with universal contacts.

Write Babcock Relays, Division of Babcock Electronics Corporation, 3501 Harbor Boulevard, Costa Mesa, California 92626; or telephone (714) 540-1234.



The Babcock Model BR7 relay will perform from dry circuit to 10 amps., with universal contacts, and is designed to meet critical aerospace applications.

**SPECIFICATIONS**

**SIZES**  
1.300" h. x 1.075" l. x .515" w  
**WEIGHT:**  
Approx. 1.0 oz.  
**CONTACT ARRANGEMENTS:**  
SPDT and DPDT

**PULL-IN POWER:**  
Low as 80 mw.  
**LIFE:**  
100,000 operations, min.  
**TEMP. RANGE:**  
-65°C to +125°C

**FROM THE BABCOCK FAMILY OF CRYSTAL CAN RELAYS**



**TWICE SIZE  
4PDT**  
dc to 10 Amps.



**FULL SIZE  
DPDT**  
dc to 10 Amps.



**HALF SIZE  
SPDT & DPDT**  
dc to 2 Amps.



**SIXTH SIZE  
SPDT & DPDT**  
dc to 1 Amp.

**WATCH FOR BABCOCK RELAYS ON THE EDN MOBILE DISPLAY — SOON IN YOUR AREA.**

# DC STANDARDS for

- Laboratory
- Production Line
- Field Service . . .

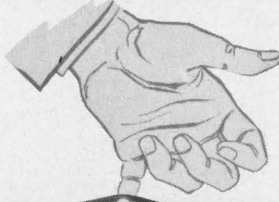

that is ■ portable laboratory calibration equipment designed for field environment ■ operational in 30 sec and ■ traceable to NBS.

All solid state . . . calibration and stability guaranteed for 1 year.

	Model MV-100-N	Model VS1000/007
Absolute Accuracy*	0.01% of reading	0.007% of reading
Output Voltage (fs)	±111.110 mv dc and ±11.1110 vdc	±1111.110 vdc
Stability (8 hrs)	0.001%	0.001%
Output Current	10 ma	10 ma
Weight	8 lbs	20 lbs
Price	\$745	\$1250

\*Calibration Accuracy (Basis for Absolute Accuracy statement): 20 PPM RSS of tolerance of primary calibration system, including 1000 volts.

OTHER FEATURES: Instant operation (30 sec), no zeroing, no balancing, short-circuit and overload protection (automatic recovery). Ideal for production line, laboratory and field service applications; for use as a voltage calibrator/source and a differential voltmeter.

Available for standard rack mounting . . . delivery from stock. Other standard models and ranges available from \$619.

- Instruments available for no charge evaluation. Contact local sales representative or factory direct.



**ELECTRONIC DEVELOPMENT CORPORATION**

423 WEST BROADWAY · BOSTON 27, MASSACHUSETTS  
Tel: 617 268-9696

## COMPONENTS

### PC boards increase load handling capacity

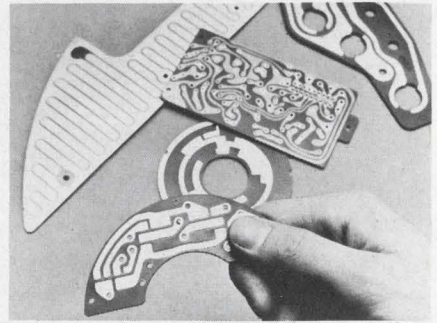

GTI Corp., Dytronics Div., Leesburg, Ind. Phone: (219) 453-3261.

Circuit boards having three times the load handling capacity of present types use copper up to 7 oz in weight. Etched circuits now in use are mainly limited to copper weight of 2 oz for most applications. The additional copper increases load capacity in the same or smaller area. The boards have a beveled copper circuit edge which is desirable for commutator and switching applications because of the better arc resistance and wear characteristics. The boards can be made with copper thicknesses of 0.001 to 0.008 inch and will take 600°F solder for 10 seconds, twice the UL standard.

CIRCLE NO. 261

### Tiny ceramic caps rated at 200 wVdc

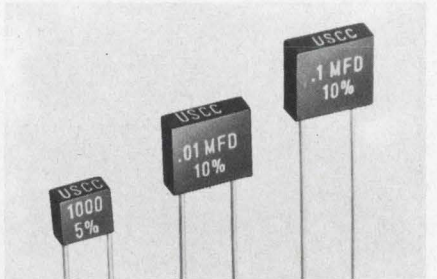

U. S. Capacitor Corp., 2151 N. Lincoln St., Burbank, Calif. Phone: (213) 843-4222.

Miniature ceramic capacitors for 200 wVdc are square epoxy-encased units available in 66 capacitance values from 10 pF to 0.12 μF. Case sizes measure 0.2 x 0.2 x 0.1 inch for 10 pF to 1000 pF and 0.3 x 0.3 x 0.1 inch for 1200 pF to 0.12 μF. The radial-lead unit is designed for PC board applications with 0.02-inch lead spacing.

CIRCLE NO. 262

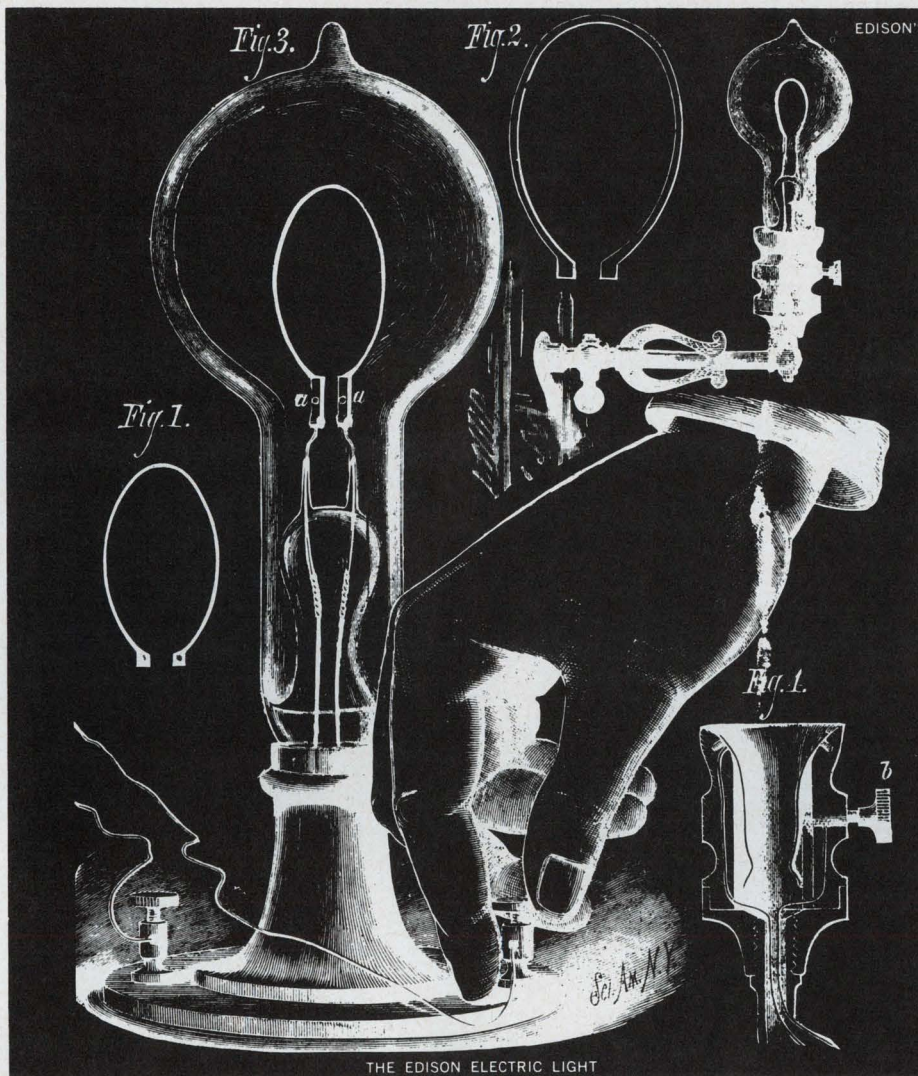

**if you design the best for others...  
you'll want the best for yourself.**

When you know your designs and specifications can be improved, you improve them. You have to.

Insist on the same standards for yourself. Don't put up with poor color TV reception. You know how important it is to aim your antenna. Direct signals produce sharp, clear pictures by reducing "color ghosts", snow, and interference. Directional control also makes it possible to pull in more stations — even from fringe areas. Put this knowledge to work for yourself.

An Alliance Tenna Rotor gives you the directional control you need at your finger tips. It's designed and engineered the way you would do it. And it's easy to install. You can do it yourself, if you wish.

Treat yourself and your family to the kind of Color and B&W TV reception you know you should be getting. See your local dealer or send coupon for information about Alliance Tenna Rotor.

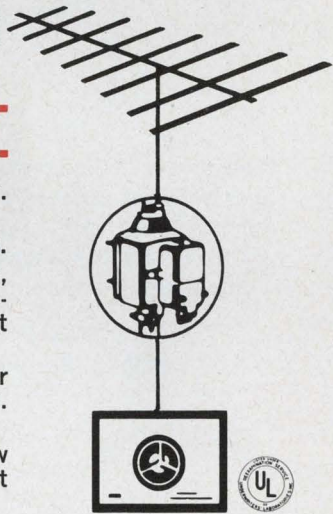

the **ALLIANCE** Manufacturing Company, Inc. Alliance, Ohio 44601

(Subsidiary of Consolidated Electronics Industries Corp.)

MAKER OF GENIE® AUTOMATIC GARAGE DOOR OPENER SYSTEM

**ALLIANCE TENNA ROTOR®**  
"TV'S BETTER COLOR GETTER!"

Send me additional information about Alliance Tenna Rotor and names of nearby dealers.

**The Alliance Manufacturing Co., Inc.**  
Alliance, Ohio

Name \_\_\_\_\_  
Address \_\_\_\_\_  
City and State \_\_\_\_\_ Zip \_\_\_\_\_

ED-7

## Custom connector kit for "do-it-yourselfers"



Star-tronics, Georgetown, Mass.  
Phone: (617) 352-6200. Price: \$5.

A "do-it-yourself" custom strip-line connector assembly kit comes in a plastic see-through case which contains the basic connector body plus alternate flanges, termination pieces, contacts and the insulator. With these elements, the designer can assemble any type of special connector. All parts are machined and plated to ensure easy assembly by press-fitting them together.

CIRCLE NO. 263

## FET-input op-amps for general-purpose use

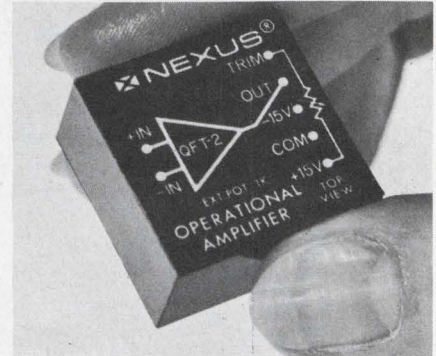

Nexus Research Labs., Inc., 480 Neponset St., Canton, Mass. Phone: (617) 828-9000. P&A: \$45, \$70, \$85; 3 wks.

The QFT-2 series FET-input op-amps provide  $10^{11} \Omega$  differential and common-mode impedances. Typical input bias current is 10 pA, common-mode rejection is 86 dB. A slewing rate of  $10 \text{ V}/\mu\text{s}$  permits the full  $\pm 10\text{-V}$ ,  $\pm 10\text{-mA}$  output to 200 kHz. Three models are available. The QFT-2, QFT-2A and QFT-2B have maximum temperature coefficients of 35, 10 and  $5 \mu\text{V}/^\circ\text{C}$  respectively. Open-loop gain at dc is 150,000 with full rated load.

CIRCLE NO. 264

# Can you

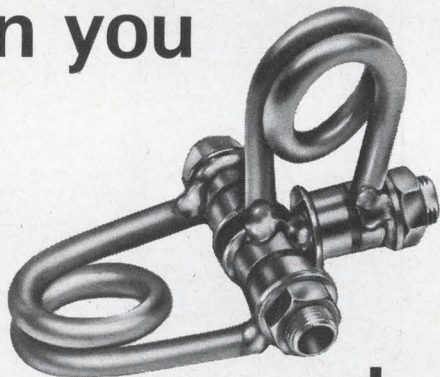

# do this?

These new Johanson glass *capacitors* are designed to bridge the gap between conventional trimmers and high frequency air capacitors. They have high Q—low inductance; they have high RF current characteristics, they can be soldered together with components to simplify circuitry and they are *strong*.

### Models include:



SG11054

**Series II:** High RF voltage *low cost* units with  $Q > 1200$  and TC;  $0 \pm 50$  ppm.



GQ11115

**Johanson GQ11115:** High voltage quartz capacitors which feature 7000 VDC; 2500 V peak RF at 30 mc and current capacity  $> 2$  amps.

### Also available are:

- Tuners and ganged tuners; linear within  $\pm 0.3\%$
- Differential capacitors
- Mil spec capacitors
- Microminiature capacitors .075" diameter and .1-1 pf

Write today for full catalog.

**Johanson MANUFACTURING CORPORATION**

400 Rockaway Valley Road, Boonton, N. J. 07005 (201) 334-2676

Electronic Accuracy Through Mechanical Precision

ON READER-SERVICE CARD CIRCLE 73

## Coax relay has integral connectors

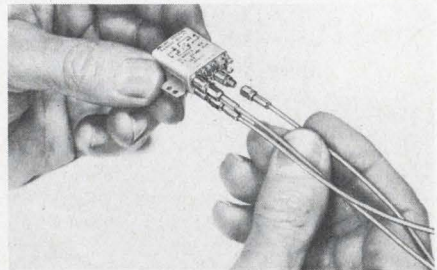

Aemco Div., Mid Tex, Inc., 10 State St., Mankato, Minn. Phone: (507) 388-6286.

Microminiature coaxial relays housed in the standard crystal can offer the convenience of integral connectors. The relay connectors mate with Microdot LEPR/CON connectors. Connecting cables are RG178 or RG196. Other specifications are 100-watt RF switching depending on vswr, dpdt or spdt RF switching with an auxiliary contact.

CIRCLE NO. 265



you get a choice,

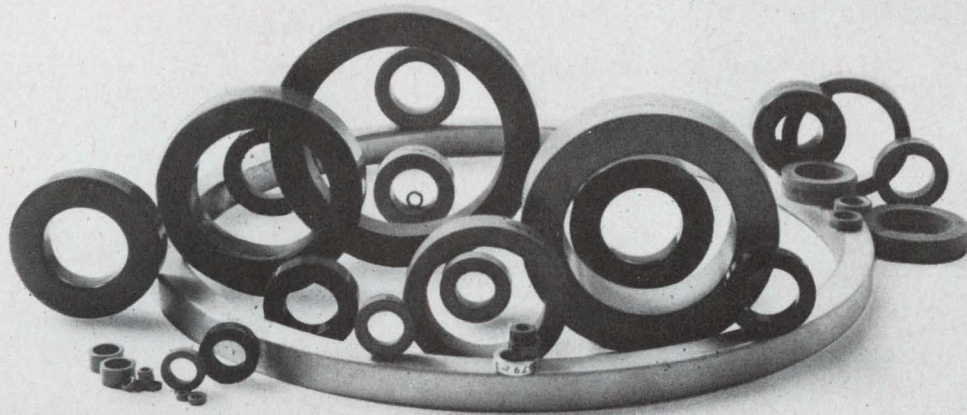

not a challenge



**Most complete line of high quality tape wound cores available from any manufacturer**

Magnetics' selection of tape wound cores encompasses eight material types, in a range of sizes from 0.050" to 12" inside diameter. For frequencies from DC through 500 kc, materials are produced in thicknesses ranging from 1/8 mil through 14 mils. All core sizes are available boxed in phenolic or plastic, aluminum or GVB-coated

aluminum. Magnesil<sup>®</sup>, less sensitive to external stresses, is also available unboxed or epoxy encapsulated.

In addition to offering this broad range of tape wound cores, Magnetics has improved its production of raw materials, using the most advanced testing devices to control quality in metals, winding, annealing, potting compounds, boxing processes and the application of encapsulating

materials. This across-the-board control assures you of getting what you pay for in performance.

If you have an application for tape wound cores, why settle for an approximation of your specifications? With Magnetics, you don't have to "make do"—you get a choice, not a challenge. For further information on our complete line of tape wound cores, write for Catalog TWC-300, Magnetics Inc., Butler, Pennsylvania 16001

**MAGNETICS inc.**  

## Reduce Hybrid Circuits With . . .

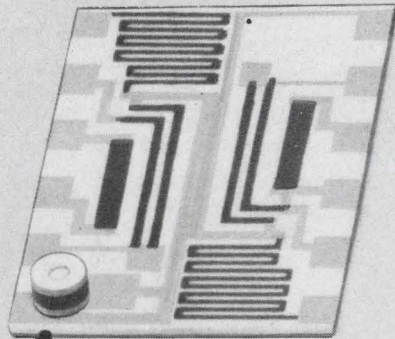

# PYROFILM MICROMINIATURE METAL FILM PELLET RESISTORS

Pyrofilm's microminiature pellets introduce a completely new resistor concept and capability. Pyrofilm's pellet resistors reduce hybrid circuit size and are used in all microcircuit designs including: flat packs, microwave loads and attenuators, temperature compensated transistor circuits, load resistors, and offer

- Lower T.C.
- Better Stability
- Tighter Tolerances
- Solderable Terminals
- Low Voltage Coefficient
- Higher Resistance Values
- Good R.F. Characteristics
- Sizes .100" x .062" to .050" x .030"

Write for detailed  
Pellet Resistor bulletin.

## PYROFILM RESISTOR COMPANY, INC.

3 SADDLE ROAD • CEDAR KNOLLS, N. J.  
(201) JEFFERSON 9-7110

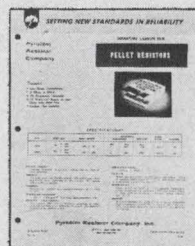

## COMPONENTS

### FET op-amp for D-to-A converters

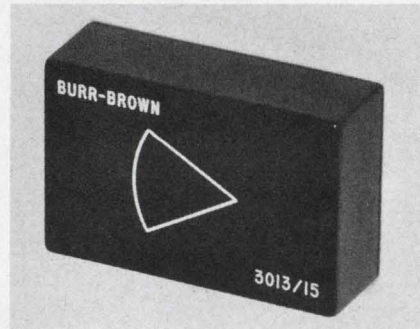

Burr-Brown Research Corp., 6730  
S. Tucson Blvd., Tucson, Ariz.  
Phone: (602) 294-1431. P&A: \$95  
(1 to 9); stock.

A high-speed FET operation amplifier with differential input combines fast settling time (1.5  $\mu$ s) and high input impedance ( $10^{11} \Omega$ ). The unit is useful as a buffer for A/D and D/A converters and solid-state multiplexers. Output is  $\pm 10$  V and  $\pm 20$  mA, input bias current is less than 100 pA, voltage drift is  $\pm 15 \mu$ V/ $^{\circ}$ C, unity gain bandwidth is 10 MHz and slewing rate is 30 V/ $\mu$ s.

CIRCLE NO. 266

### One-inch dc torquer puts out 1.3 oz-inch



Torque Motor Products Div.,  
Aeroflex Labs., Inc., S. Service Rd.,  
Plainview, N. Y. Phone: (516) 694-  
6700.

With a peak torque of 1.3 ounce-inch over an angle of  $\pm 45^{\circ}$ , this 1-oz dc torque motor measures 1 inch OD and 0.35 inch thick. The brushless torquer features a permanently magnetized rotor and a stator winding designed to develop smooth, step-free torque with no mechanical restraints due to friction, motor ripple, or "slot lock" effects.

CIRCLE NO. 267

ON READER-SERVICE CARD CIRCLE 75

# Size problems with UHF/VHF Standard Circulators and Isolators? Use our new NETWORK units.

Size reductions up to 50:1!

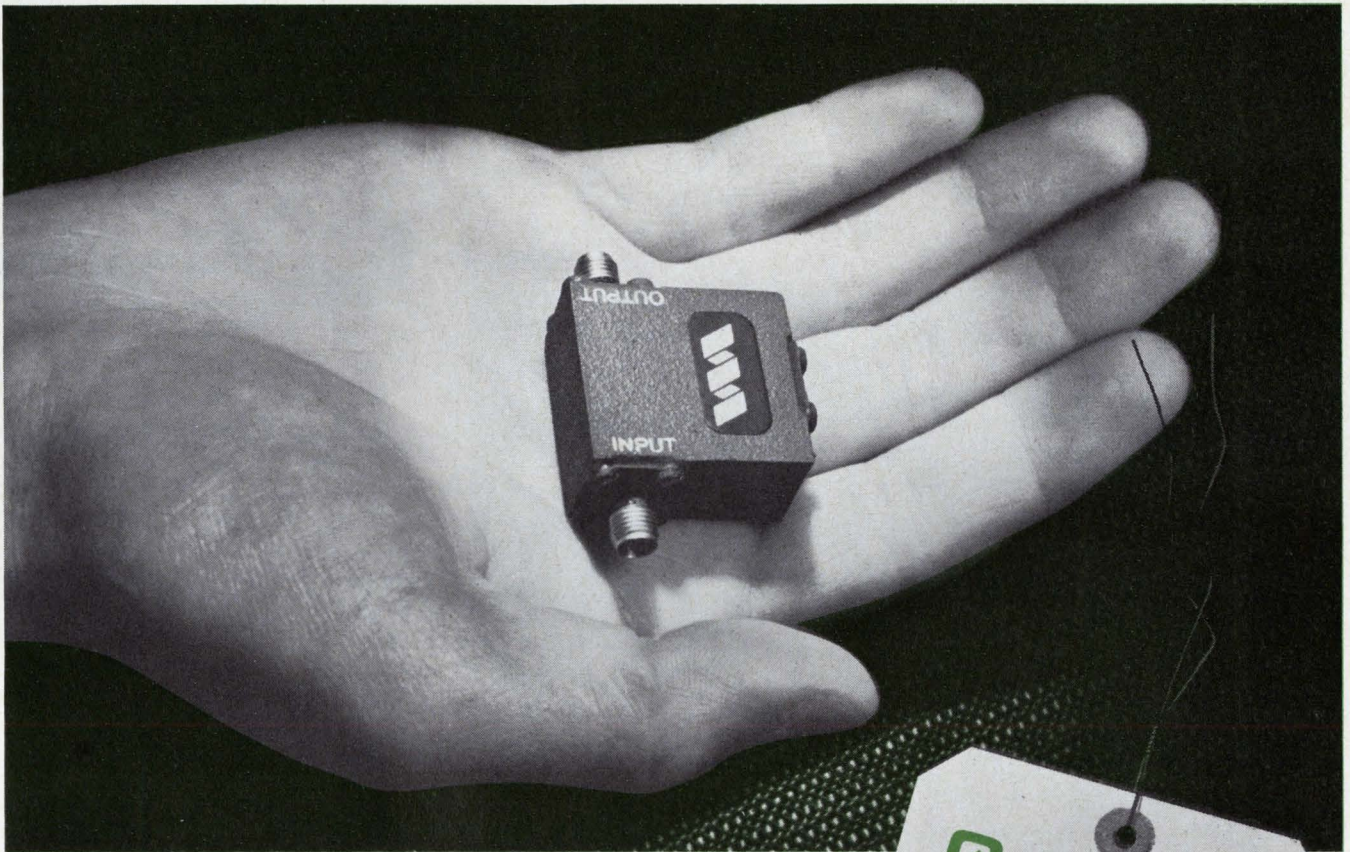

## 50 to 850 MHz

Bandwidth coverage up to 15%

### Applications:

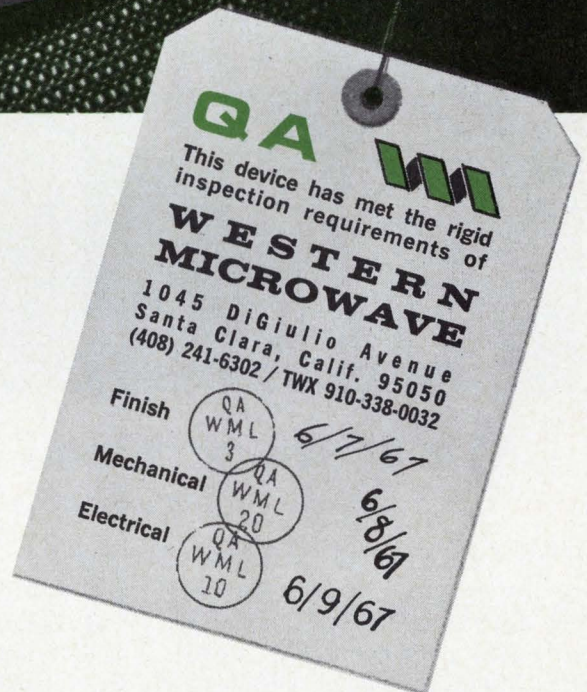
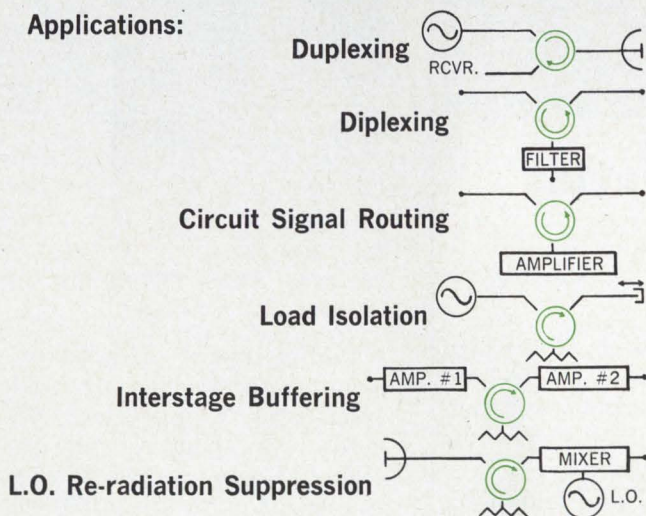

Write or phone for brochure

**WESTERN MICROWAVE LABS., INC.**

1045 DiGiulio Ave./Santa Clara, Calif. 95050

(408) 241-6302/TWX 910-338-0032

ON READER-SERVICE CARD CIRCLE 76

## Tuning fork oscillator shock-mounted

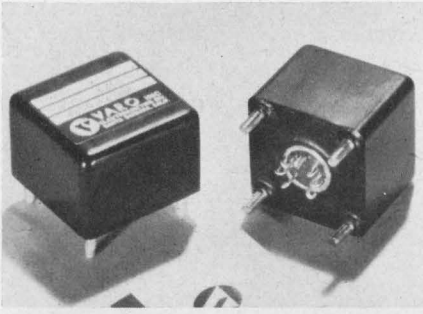

Varo, Electrokinetics Div., 402 E. Gutierrez St., Santa Barbara, Calif. Phone: (805) 963-2055.

For operation from a 12-Vdc source, this tuning fork oscillator is shock-mounted in silicone rubber and hermetically sealed. Frequency range is 800 Hz to 4 kHz with a stability of  $\pm 0.2\%$  to  $\pm 0.005\%$ . Temperature range is from  $-50$  to  $+85^\circ\text{C}$ . Output is 6 V p-p minimum into a 10-k $\Omega$  load.

CIRCLE NO. 268

## Glass thermistor probe used at high pressures

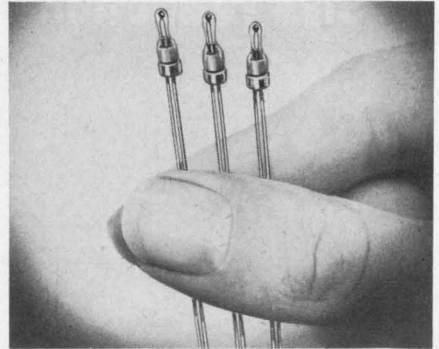

Fenwal Electronics, Inc., 63 Fountain St., Framingham, Mass. Phone: (617) 875-1351.

Glass thermistor probes, fitted with metal mounting seals, are designed to be soldered to a probe housing, bulkhead or metal pipe, with a joint which can withstand up to 15,000 psi. Six probe types are available, with nominal resistances ranging from 100  $\Omega$  to 10 M $\Omega$  at  $25^\circ\text{C}$ . The probes permit direct exposure of the glass-enclosed sensing bead in the medium to be monitored and thus provide faster responses.

CIRCLE NO. 269

**80  
ohms/cm<sup>2</sup>  
gold  
pot  
wire**

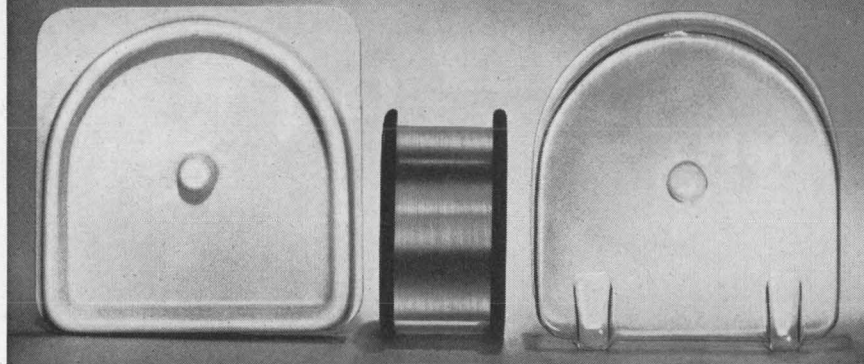

## We've Never Made it Better (neither has anyone else!)

We've been producing the finest quality 80 ohms/cm<sup>2</sup> gold potentiometer alloy since 1958. It is available as round premium grade potentiometer wire as small as .0004". Uniformly heat-treated for maximum linearity and consistency of both specific resistance and TC.

Enamelling is done in our own

plant — to your most exacting specifications.

If your requirements are for high quality, fine potentiometer wire, you should write for a copy of our comprehensive brochure on wire for the potentiometer industry.

Please write on your letterhead; no obligation of course.



7 INTERVALE STREET, WHITE PLAINS, NEW YORK 10606 • (914) 949-4757

ON READER-SERVICE CARD CIRCLE 77

## Digital relays available single-pole, 128 throw

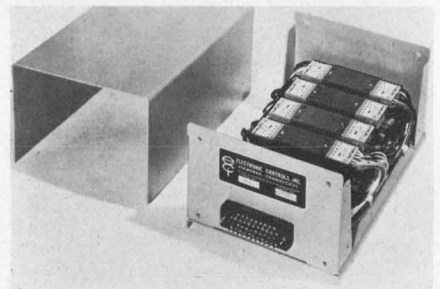

Electronic Controls, Inc., Danbury Rd., Wilton, Conn. Phone: (203) 762-8351. P&A: \$100 (sp32t), \$275 (sp128t); 4 to 6 wks.

Digital relays prepackaged for circuit path selection are available from sp16t to sp128t or dp16t to dp64t. Two standard trees can be connected point to point to route any one of up to 128 inputs to any one of 128 outputs. Trees may be ganged for greater capacity. Available for 6, 12, 24, 48, 110-Vdc or 115-Vac operation, the relay trees are offered in dust covers or hermetically sealed.

CIRCLE NO. 270

# ARNOLD IS

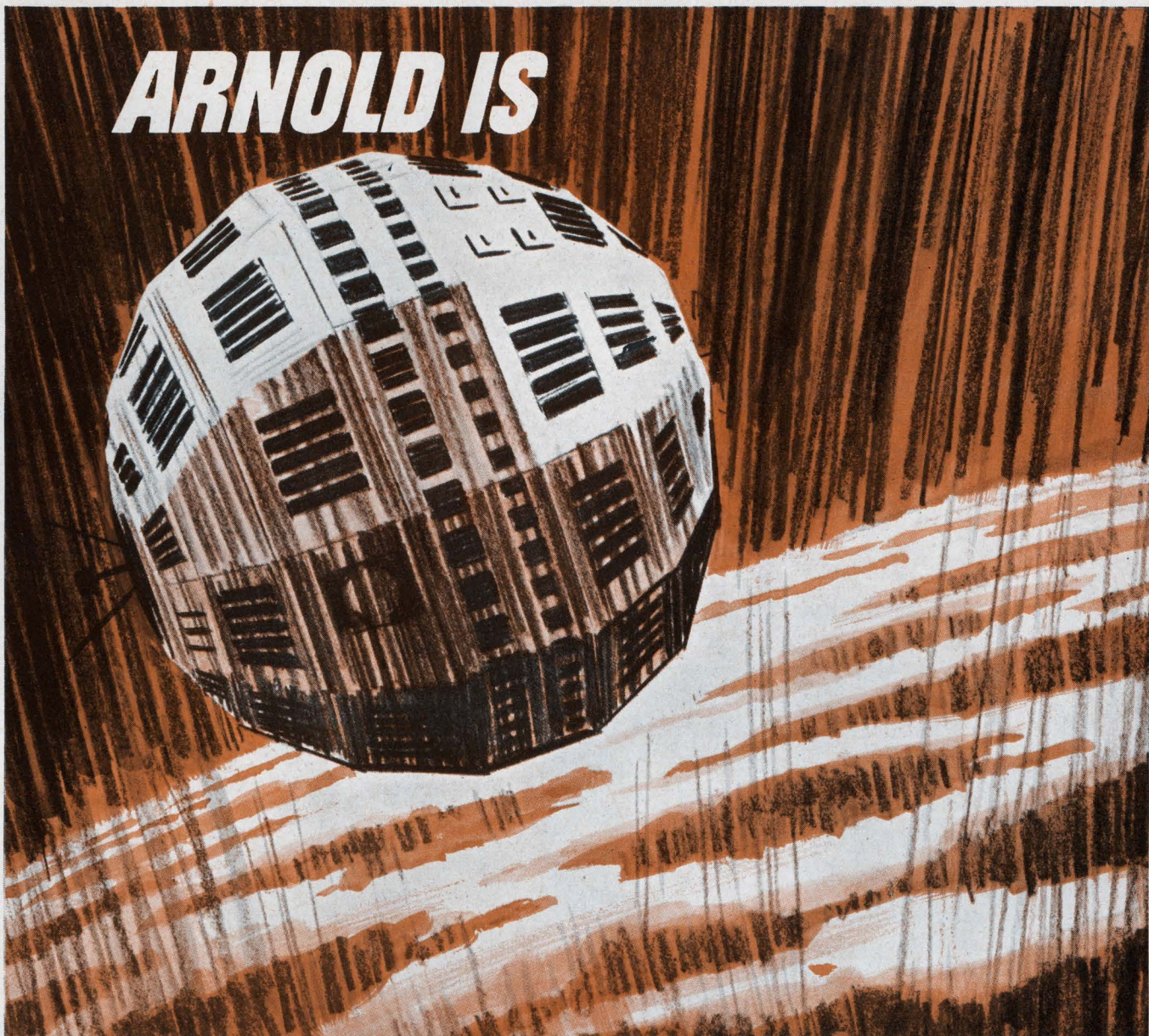

## MPP CORES

From communications satellites to telephone high and low pass filters—from loading coils to inductors and RFI filters, Arnold has total MPP Core capability. With 386 sizes, varieties and electrical parameters available from stock, Arnold is the leading producer of Molybdenum Permalloy Powder Cores.

Available in many toroidal sizes—from 1/4" dia. to 5" dia. in eight standard permeabilities (205, 173, 160, 147, 125, 60, 26 & 14 Mu). Most of these cores can be furnished with a controlled temperature coefficient of inductance. Arnold MPP Cores show best stability to DC magnetization and modulation factor—also least change in core loss with variation in current level.

Arnold is also ■ Permanent Magnets ■ Silectron Cores ■ Tape Wound Cores ■ Bobbin Cores ■ Iron Powder Cores ■ Electrical Alloy Transformer Laminations ■ Transformer Cans and Hardware ■ Magnetic Shielding ■ Special Magnetic Materials.



# ARNOLD

SPECIALISTS in MAGNETIC MATERIALS

THE ARNOLD ENGINEERING COMPANY, Main Office: MARENGO, ILL.  
BRANCH OFFICES and REPRESENTATIVES in PRINCIPAL CITIES

ON READER-SERVICE CARD CIRCLE 78

## How good is Line Electric?

Send for proof.



We could toot our horn and tell you that our prices are the best in the industry. And that we guarantee delivery within six weeks; maybe less, but never more.

And we could tell you that our people are the most knowledgeable and the most courteous in the business.

We could also tell you that our growth speaks for itself: This year's shipments are 80% ahead of last year's and our sales volume has quadrupled in the past six years.

We could tell you all those things and more. But we'd only sound like we're patting ourselves on the back and you probably wouldn't believe us anyway.

So how do we prove how good we are? Send us an order. By the time we're finished, you'll have all the proof you need.

The Line Electric Company/Division of Industrial Timer Corp.,  
Manufacturers of relays and the best service in the business.

Send for 64 page catalog:

305 U.S. Highway 287, Parsippany, N.J. 07054

ON READER-SERVICE CARD CIRCLE 79

## COMPONENTS

### Firing circuit module gates 6 SCRs

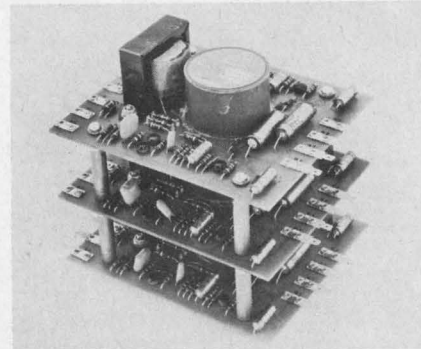

*Crydom Laboratories, 3115 W. Wainier, Santa Ana, Calif. Phone: (714) 540-1390. P&A: under \$135 (large quantity); 2 to 3 wks.*

SCR firing circuit modules are designed to gate 6 SCRs. They are suited for 3-phase full-wave rectification systems where it is necessary to minimize harmonic content and ripple amplitude. Three ac input lines are brought to the terminals and the output is then available for full control of the 6 SCRs. The modules feature "hard firing" (0.5-A, 100-ns rise), good power sensitivity (50  $\mu$ W of control power), 0.7-V negative gate bias and response to dc control signal polarity.

CIRCLE NO. 271

### Ten positions per deck in half-inch rotaries

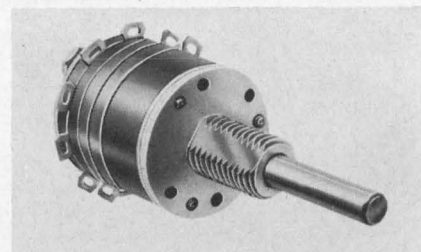

*RCL Electronics, Inc., 700 S. 21st St., Irvington, N. J. Phone: (201) 374-3311.*

Up to 10 active positions per deck, shorting or nonshorting, are available in this line of 1/2-inch rotaries. Up to 9 decks are available. A combination of shorting and nonshorting poles or positions within a pole may be obtained on any one deck. Decks are diallyl phthalate and rotor blades are gold-plated beryllium copper. Contact resistance is 0.004  $\Omega$ .

CIRCLE NO. 272

# The wire that's specially-made for feeding automated wiring systems:

## Brand-Rex Turbowrap<sup>T.M.</sup>

Turbowrap runs like silk in automatic and semi-automatic wiring machines and tools, because it's *unusually uniform*. Foot by foot, and lot by lot — consistent quality in electricals, physicals and mechanicals reduces the chance of jammed or erratic feeding, nicks, strains, cuts or shorts.

And Turbowrap, in a broad choice of insulations and sizes, gives you almost unlimited design freedom. Standard insulations include semi-rigid PVC and PVC/nylon, Teflon FEP and FEP/nylon, Teflon TFE, Kynar and Polysulfone. Sizes as small as #30 AWG, and walls as thin as .004", help you put more wire in less space.

Various Turbowrap types have been expressly engineered for the world's leading manufacturers of computers and business machines. They're one reason why Brand-Rex has chalked up more UL approvals for business machine wire than any other company.

Want to get more out of automated, high-density wiring? Write us for details on Turbowrap.

AMERICAN ENKA CORPORATION

BRAND-REX DIVISION

WILLIMANTIC, CONNECTICUT 06226  
PHONE 203 423-7771

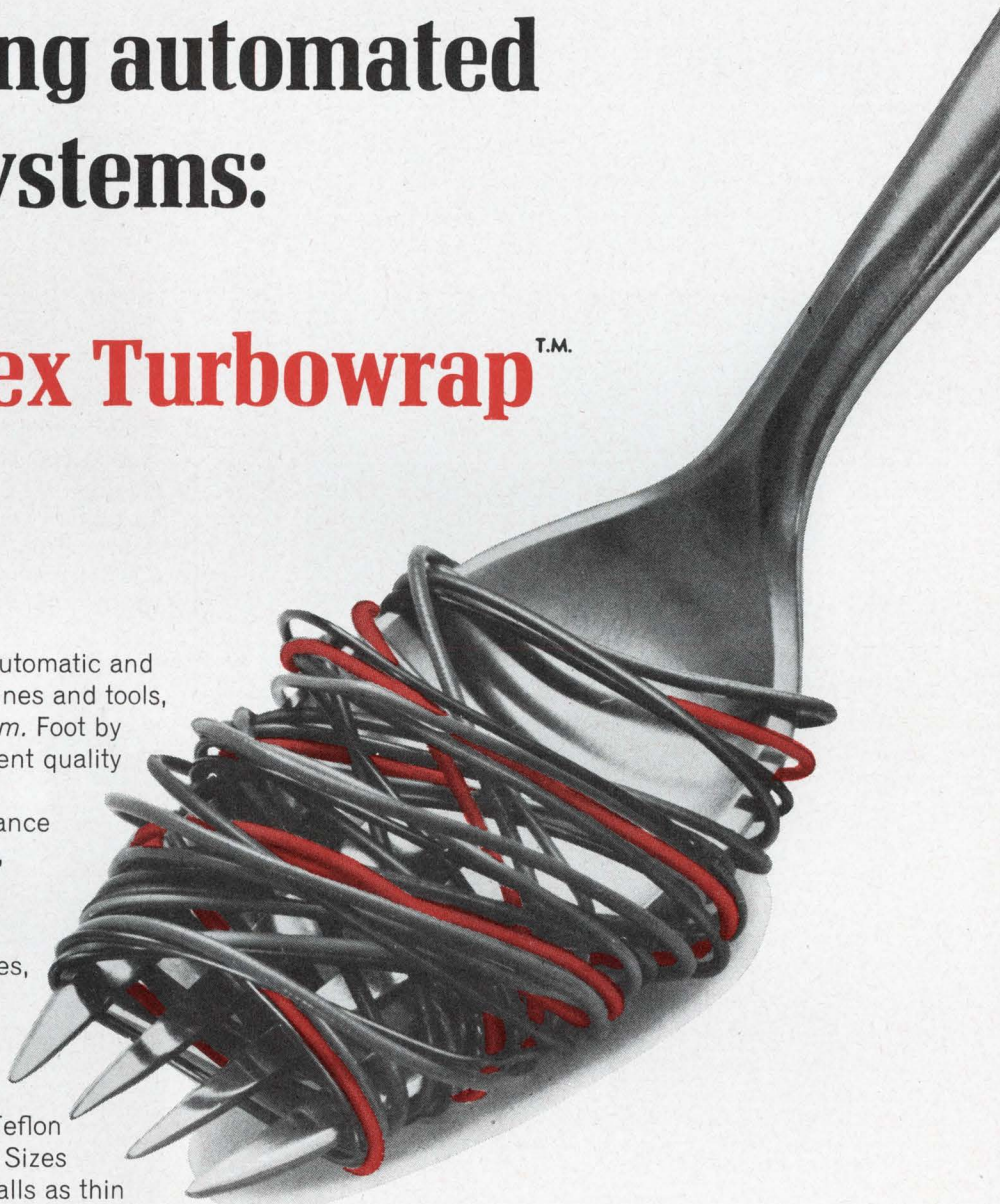

ON READER-SERVICE CARD CIRCLE 80

# Does this look like a digital design problem to you?

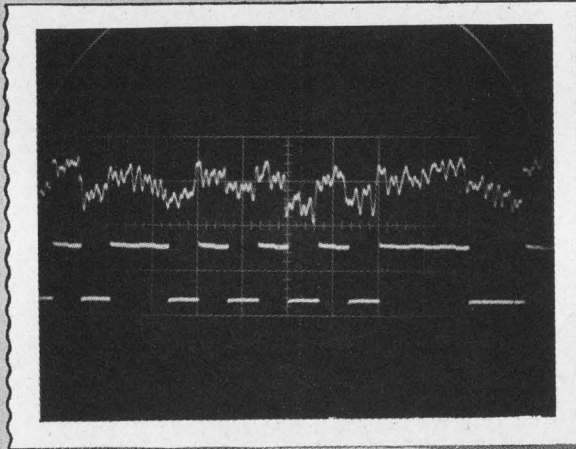

(Actual unretouched photo of DCS Model GPD-6 input/output signals)

Trace A is Digital Data plus Noise at input.

Trace B is Digital Data at output.

**Here's the problem:** Design a bit synchronizer to remove noise and output a clean signal as in Trace B, plus clock (not shown).

**Tough?** Well it takes more than Schmitt triggers, axis crossing detectors, toggles or gates. It's an analog phase-locked loop design problem and we have the solution . . . DCS Models GPS-5 and GPS-6 Bit Synchronizers handle RZ, NRZ-L, NRZ-M, NRZ-S or Bi-Phase-L. The DCS Model GPD-6 handles Apollo and SGLS PSK, too.

We also make PCM Decoms, Synthesizers and data acquisition products. Complete systems specifically to meet your requirements are our specialty.

**Interested?** Call our office nearest you for information and data bulletins on DCS digital products.

Or write directly to:

Dept. ED 6-7, East Liberty Street, Danbury, Conn. 06810  
Telephone: 203-743-9241 TWX 710-456-2596



**DCS DATA-CONTROL SYSTEMS INC.**  
*Instrumentation for Research*

Sales Offices  
Silver Spring, Md., Huntsville, Winter Park, Long Beach, Santa Clara,  
Albuquerque

Copenhagen London Rome Paris Munich Amsterdam

ON READER-SERVICE CARD CIRCLE 81

## COMPONENTS

### Bandpass filters stable from 100 Hz to 20 kHz

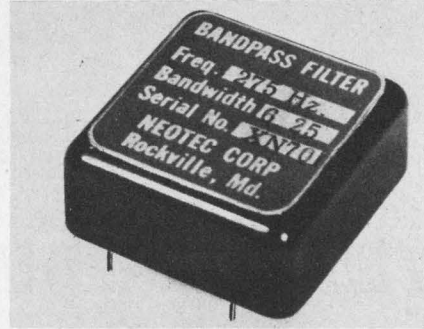

Neotec Corp., Automatic Control Devices Div., 640 Lofstrand Lane, Rockville, Md. Phone: (301) 762-8909. Price: \$140 to \$249.

High-resolution active bandpass filters maintain temperature stability characteristics over the frequency range from 100 Hz to 20 kHz. The filters have a maximum operating range of  $-55^{\circ}\text{C}$  to  $+85^{\circ}\text{C}$  with a center-frequency temperature coefficient of  $\pm 10$  ppm/ $^{\circ}\text{C}$  (between  $-10^{\circ}$  to  $+75^{\circ}\text{C}$ ) and  $\pm 15$  ppm/ $^{\circ}\text{C}$  (between  $-20^{\circ}$  to  $+85^{\circ}\text{C}$ ).

CIRCLE NO. 273

### Feedthrough caps filter broadband RFI



Aerovox Corp., 742 Belleville, New Bedford, Mass. Phone: (617) 994-6661.

To hold effective series inductance to an absolute minimum and filter broadband interference, sub-miniature feedthrough capacitors are engineered for through chassis or through panel mounting. All units are of 3-terminal design where the case serves as the actual ground or common termination. The units are available in five ratings from 100 to 600 Vdc and capacitance ranges from 0.001 to 2  $\mu\text{F}$ .

CIRCLE NO. 274



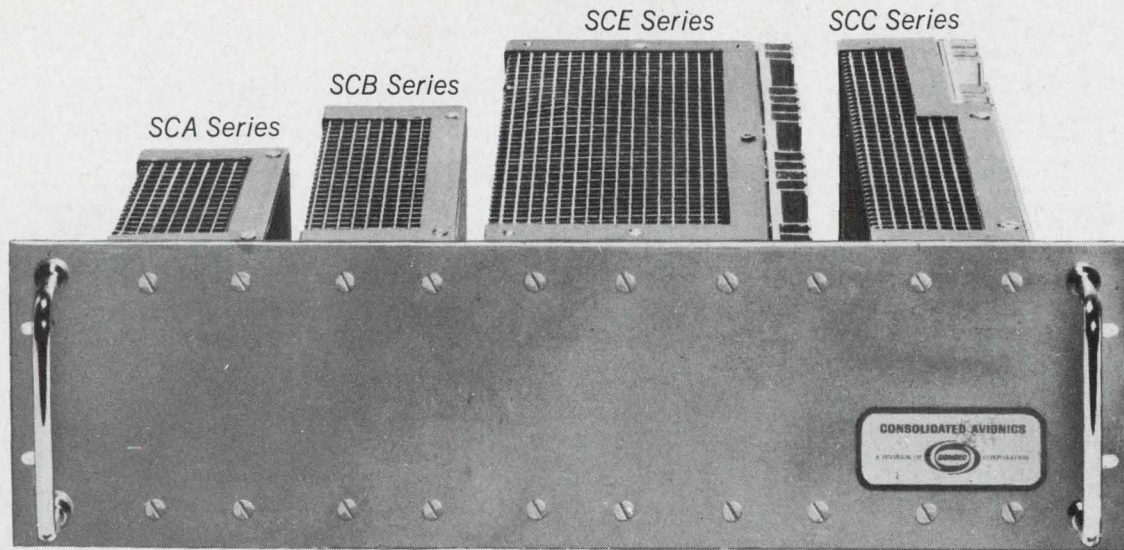

# New Packaging Idea in Systems Power Supplies

*Three Mounting Planes  
And Slim Package Design  
Help You Pack More Power  
In A 19" Rack*

## SPECIFICATIONS

**Input:** 105-125V AC, 47-440 cps  
**Regulation (line and load combined):**  
 $\pm 0.05\%$  or 2 mv, whichever is greater.  
**Ripple:** 1mv rms.  
**Response Time:** 20  $\mu$ secs.  
**Temperature Coefficient:** 0.015%/°C or  
 1.8mv/°C, whichever is greater.  
**Temperature:** 75°C max.

Remote voltage adjustment and remote sensing are standard. Overvoltage protection and metered panels available as options.

You can pack as much as 485 watts into a standard systems rack when you use Con Avionics new SC series of power supplies.

There are 88 modules, in four package sizes, to choose from. You can mount any of the modules on any of three surfaces, including a 3½" panel. A wide variety of rack adapters lets you pick a power supply rack to fit your exact requirements.

The units are self-cooled, saving you precious inches you used to need for heat sinking. They are unconditionally guaranteed for five years. Because they were designed under Worst Case Analysis, they will meet their specifications even under the worst possible combinations of operating conditions.

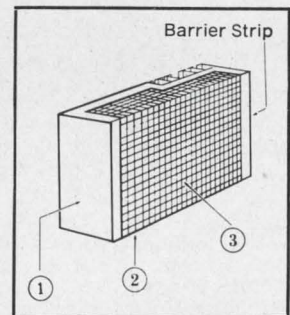

3 Ways To Mount

## CONSOLIDATED AVIONICS

A DIVISION OF  CORPORATION

800 Shames Drive, Westbury, L.I., New York  
 (516) ED 4-8400 TWX: 510-222-6151

WITH **KH** ALL-SILICON  
R-C OSCILLATORS  
**YOU GET MORE  
THAN ADJUSTABLE  
FREQUENCY!**

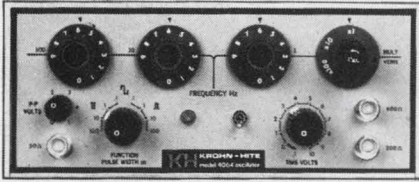

**MODEL 4004**, one of the new K-H all-silicon Variable R-C Oscillators, provides continuously adjustable frequency over the range of 0.001 Hz to 100 kHz. Programmed units also available.

A stable low-distortion signal source is essential for today's complex electronic measurements. You get unsurpassed signal stability and purity in K-H's new line of all-silicon broad band variable R-C Oscillators. Amplitude stability is described, below. Distortion is plotted.

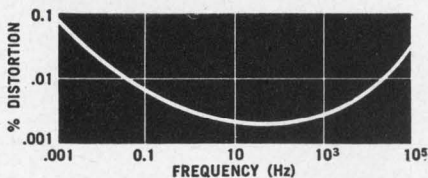

**TYPICAL HARMONIC DISTORTION PLOT** of K-H Series 4000 R-C Variable Frequency Oscillators.

Stability and signal purity are only two examples of the extra value you get from these modern Krohn-Hite electronic instruments. Other values increase user confidence further by providing simpler, faster and lower-cost operation.

**Excellent Amplitude Stability:** 0.01%, cycle-to-cycle; 0.01% per hour.

**Sine- and Square-Wave Outputs:** Pure sine-wave output — no diode-shaped approximations to produce step-function or waveform discontinuities. Square-wave rise and fall times less than 20 nanoseconds.

**Quadrature Outputs:** Sine and cosine outputs remain within  $\pm 1^\circ$  of quadrature. Ideal as driver for polyphase variable power sources or simulators for rotary or linear encoders.

There's more in K-H Data Sheet 4000.

Write for a copy.

**KH KROHN-HITE CORPORATION**  
580 Massachusetts Avenue, Cambridge, Mass. 02139  
Telephone: 617/491-3211

ON READER-SERVICE CARD CIRCLE 83

TEST EQUIPMENT

**Display 30-channel data  
on standard TV monitor**

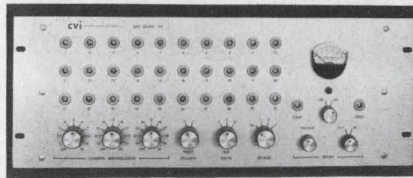

Colorado Video, Inc., Box 928, Boulder, Colo. Phone: (303) 444-3972. P&A: \$4200; 90 days.

A television bar graph generator, reportedly the first of its kind, allows the user to observe up to thirty channels of data on a standard television monitor. Model 120 is used with closed circuit systems to provide a graphic display of 30 separate input signals in the form of a series of horizontal bars, the length of each being proportional to the associated input voltage. Features include selection of black or white bars for display, individual bar identification, expansion of individual decades to fill the entire TV screen, zero suppression, and individual input level controls.

CIRCLE NO. 275

**Decade transformer is  
calibration standard**

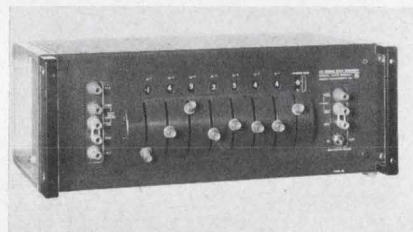

General Radio Co., West Concord, Mass. Phone: (617) 369-4400. Price: \$1100.

A precision decade transformer features resolution of 1 part in  $10^9$  with unambiguous lever-switched horizontal in-line readout. Range is  $-0.1111111$  to  $+1.1111111$  in seven step decades and adjustable  $10^{-8}$  decade. Accuracy is  $\pm 2$  digits in the  $10^{-7}$  decade. Type 1493 is acceptable for calibration by the NBS and can be used as a primary standard for calibration of general-purpose ratio transformers. It can also be used to determine unknown turns ratios and magnitude ratios between similar impedances.

CIRCLE NO. 276

**Digital gaussmeter  
also indicates polarity**



Quantum Electronics Corp., 3120 Crow Canyon Rd., San Ramon, Calif. Phone: (415) 837-5516. Price: \$1500.

An automatic digital gaussmeter provides continuous readout of magnetic fields from 1 to 19,990 gauss. An automatic integration feature provides instant readings with  $\pm 1\%$  accuracy without manual dial settings and range switching. The heart of the new instrument, reportedly the first to apply digital ICs to magnetic field measurement, is a high-frequency sensor with pulse rate directly proportional to magnetic field. The display unit interrogates the sensor, and the number of pulses counted in the time base is read out directly and continuously as gauss.

CIRCLE NO. 277

**Low-noise preamps  
for high-Z sources**



Applied Cybernetics Systems, Inc., 880 Bonifant St., Silver Spring, Md. Phone: (301) 588-4873.

Incorporating FETs, these preamplifiers provide good signal-to-noise ratio for information originating from high-impedance sources such as piezoelectric transducers, capacitor microphones and biomedical sensors. Series LA amplifiers are available in either 20-to-40-dB or 40-to-60-dB gain models with response starting at 2 Hz and ranging up to 2 MHz.

CIRCLE NO. 278

## Dc DVM ranges 1 $\mu$ V to 1 kV

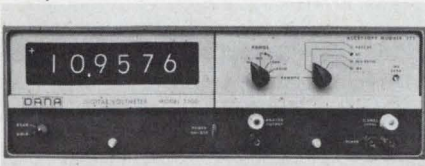

Dana Labs., Inc., 2401 Campus Dr., Irvine, Calif. Phone: (714) 833-1234.

Dc voltages across a dynamic range of 1  $\mu$ V to 1100 V can be measured by this five-digit instrument. A sixth digit overrange preserves accuracy in the range cross-over regions. Five full-scale dc ranges are provided: 110 mV, 1100 mV, 11 V, 110 V and 1100 V. An all-solid-state, null-balance instrument, the unit has a dc voltage accuracy of  $\pm 0.005\%$  of reading and  $\pm 0.0009\%$  of full scale. The mV accuracy is 0.01% of reading and  $\pm 0.02\%$  of full scale on the 100-mV range,  $\pm 0.01\%$  of reading and  $\pm 0.005\%$  of full scale on the 1000-mV range. The value of the least significant digit on the 100-mV range is 1  $\mu$ V, establishing the ultimate resolution. Accuracy as a dc/dc ratiometer is reportedly better than DVM accuracy.

CIRCLE NO. 279

## Nanoamp integrator self-calibrating



Elcor, Div. of Halliburton Co., 2431 Linden Lane, Silver Spring, Md. Phone: (301) 589-6614. P&A: \$1498; 2 to 3 wks.

Two instruments in one, this digital readout integrator is designed to monitor and control experiments involving photomultiplier tubes, Geiger-Mueller tubes, particle accelerators, flow transducers or any device which converts some parameter into a proportional current or voltage. Features include a 12-position sensitivity switch.

CIRCLE NO. 280

# New! -- Ballantine Solid State True RMS Voltmeter

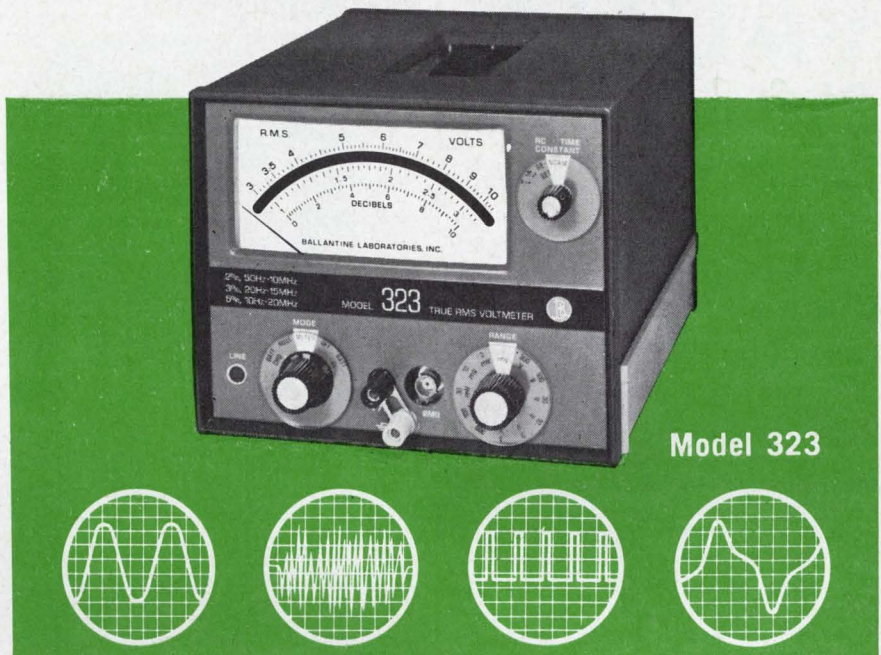

Model 323

## Measures from 10 Hz to 20 MHz regardless of Waveform

Ballantine's new Model 323 is a rugged, all-solid-state voltmeter for True RMS measurements for 10 Hz to 20 MHz . . . and for a wide variety of waveforms. Use it as a completely portable instrument isolated from line effects (due to built-in rechargeable batteries), or plug it into the power line. (Model 323-01 is for use on power line, only.)

### FEATURES:

- ★ Measures True RMS of sine waves, square waves, noise voltages and a range of pulses
- ★ Frequency range of 10 Hz to 20 MHz
- ★ Voltage range of 300  $\mu$ V to 330 V. (As null detector to 70  $\mu$ V)
- ★ Unmatched accuracy: 2% of indication, 50 Hz to 10 MHz; 3% of indication, 20 Hz to 15 MHz; 5% of indication, 10 Hz to 20 MHz. Ballantine's accuracy of 2% means 2% of the actual indication, whether at the top or bottom of a scale
- ★ Operates from built-in rechargeable batteries or line power
- ★ Ideal for recorder applications — DC output of 0.1 to 1.0 V for each range simultaneous with meter reading
- ★ Crest factor: 5 at full scale to 15 at down scale
- ★ Separate isolated signal and case grounds
- ★ Optional 80 dB Attenuator Probe, Model 1301, for operation up to 10,000 V

Prices: Model 323, \$520 (Battery & Line)  
Model 323-01, \$485 (Line only)



**BALLANTINE LABORATORIES INC.**

Boonton, New Jersey

Write for complete technical data today

CHECK WITH BALLANTINE FIRST FOR DC AND AC ELECTRONIC VOLTMETERS/AMMETERS/OHM METERS, REGARDLESS OF YOUR REQUIREMENTS. WE HAVE A LARGE LINE, WITH ADDITIONS EACH YEAR. ALSO AC/DC LINEAR CONVERTERS, AC/DC CALIBRATORS, WIDE BAND AMPLIFIERS, DIRECT-READING CAPACITANCE METERS, AND A LINE OF LABORATORY VOLTAGE STANDARDS FOR 0 TO 1,000 MHZ.

ON READER-SERVICE CARD CIRCLE 84

# NEW! VACTEC Photocell-Lamp Control Module

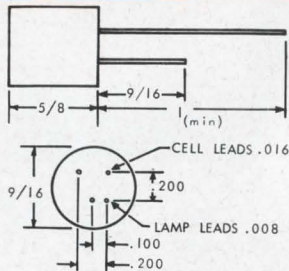
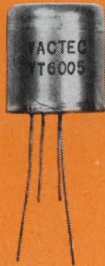

The first of a complete line designed for improved, noiseless volume and tone controls in transistorized amplifiers. Perfect for guitars, organs, musical instruments, radio, TV and the like.

Combines a proven dependable Vactec photocell with an extremely long-life incandescent lamp. Complete low-cost module in a unique epoxy sealed metal enclosure. Leads are spaced on standard .100" centers to simplify circuit board mounting.

Six and 10-volt units now available. Special characteristic designs on request.

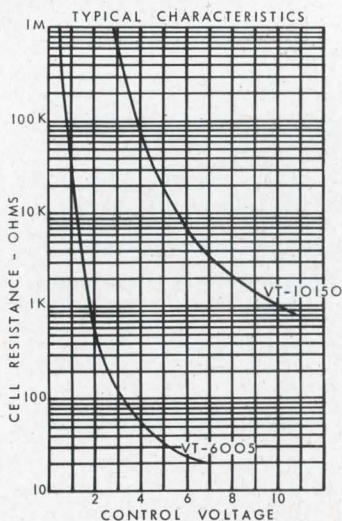

For details, write requesting Bulletin OC-1.

**VACTEC, INC.**  
2423 Northline Ind. Blvd.  
Maryland Hts., Mo. 63042 AC 314, 432-4200  
See Vactec's listing in EBG under "Semiconductors," and in EEM, Sec. 3700.

## TEST EQUIPMENT

### Triggered pulser for bioelectronics



Bioelectric Instruments, Inc., P. O. Box 204, Hastings-on-Hudson, N. Y. Phone: (914) 476-1234. P&A: \$305; 1 month.

This triggered pulse generator features an isolated low-impedance output, a reversible pulse polarity ranging in amplitude from  $0.5 \mu\text{V}$  to 1 V and pulse durations ranging from  $100 \mu\text{s}$  to 200 ms. For dynamic monitoring, the pulse and the signal are mixed at the input of a system so that the pulse and the signal are identically processed. The mixed and processed output is displayed on a scope with the calibration pulse synchronized to the time base. The pulse duration calibrates the time scale, the pulse amplitude calibrates the voltage sensitivity scale, the rise-time characteristic establishes the frequency response of the system and other distortions of the wave shape indicate system nonlinearities.

CIRCLE NO. 281

### Solid-state chronograph counts at high speeds



Electronic Counters, Inc., 235 Jackson St., Englewood, N. J. Phone: (201) 567-5300. P&A: from \$99; stock to 4 wks.

For time interval measurements, this all-silicon instrument has a 1-MHz internal time base with a time base accuracy of 3 parts in  $10^7$  per week. There are 6 decades with Nixie display, giving a resolution of  $1 \mu\text{s}$  with a range of 1 to  $10^6 \mu\text{s}$ . Options include printer output, automatic reset, range switches, preset limit selector and a mechanical register to extend timing range.

CIRCLE NO. 282

### Continuity checks made nondestructively

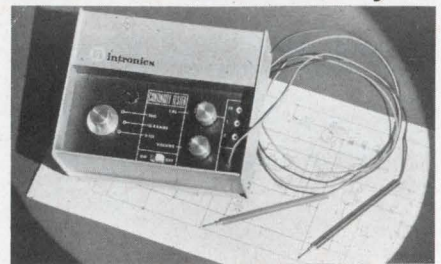

Intronics, Inc., Chapel Bridge Park, 57 Chapel St., Newton, Mass. Phone: (617) 332-7350. P&A: under \$150; stock to 2 wks.

Positive go-no go circuit continuity checks at low and intermediate resistance thresholds are made by this unit without damage to semiconductors. Limiting of both voltage and current from probes prevents damage to solid-state components. Specifications include 3 resistance threshold ranges with separate 10, 1 and  $0.1\text{-}\Omega$  calibration standards built in, and 0.1-V maximum voltage from probes. Maximum power from probes into any circuit resistance is 0.2 mW on the  $10\text{-}\Omega$  range, 0.6 mW on the  $1\text{-}\Omega$  range and 4 mW on the  $0.1\text{-}\Omega$  range.

CIRCLE NO. 283

### Static card reader in small package

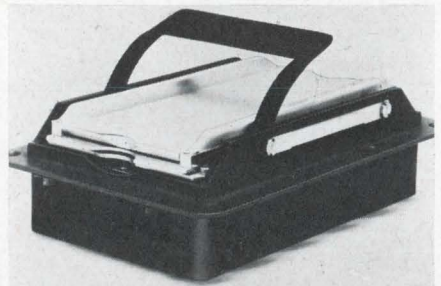

Amp, Inc., Harrisburg, Pa. Phone: (717) 564-0101.

Extending less than 2 inches above the panel, and weighing 6 pounds, this card reader is suited for portable devices. The 540 individual switches, arranged on a  $12 \times 45$  matrix, are available either NO or NC and both terminals of each switch appear on the back panel in the form of solder tabs. The palladium (or gold) plated contacts exhibit less than  $100\text{-m}\Omega$  resistance at 100 mA and feature full wiping.

CIRCLE NO. 284

Report from

**BELL  
LABORATORIES**

# Programming Complex Problems Simply

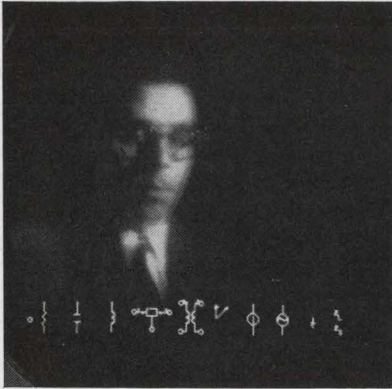

1. A program for GRAPHIC I lets engineer W. H. Ninke draw a circuit diagram on a cathode ray tube, using familiar component symbols.



2. In describing a circuit problem to the computer, he guides nodes (circuit junction points) into place with a light pen.

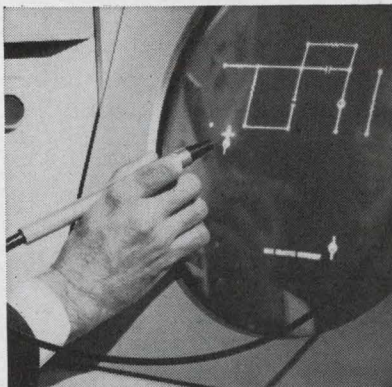

3. He next guides components into place. Where necessary, he can mark certain ones "variable" by placing a slant arrow across each.



4. With a keyboard, which resembles a typewriter, he inserts the values of the various components and the operating conditions of the circuit.

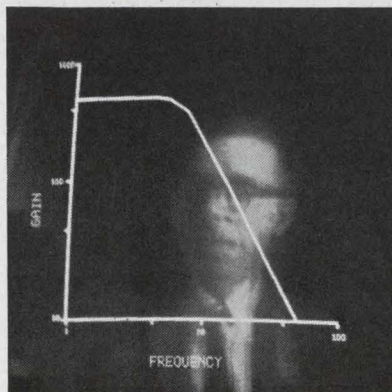

5. He asks the central computer to use this information to calculate and display a curve of gain vs. frequency response for the circuit.

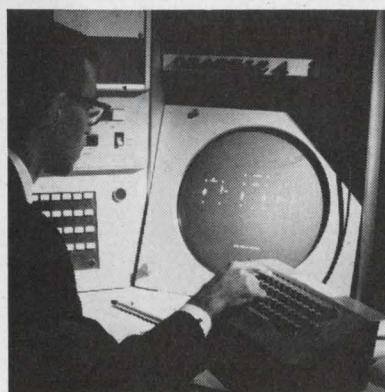

6. Seeing the curve, he may modify the circuit, insert new values for variable components, request the computer to recalculate performance.

Scientists at Bell Telephone Laboratories have improved communications between engineers studying circuits and the computer that helps them. The key is an experimental console on which the engineer works with familiar graphics: component symbols, performance curves, and so on.

The engineer composes a circuit on a cathode-ray tube, inserts component values, makes certain components variable, as required. The display equipment responds immediately to his commands. As he proceeds, the console displays appropriate operating instructions. At his request, the computer calculates and displays circuit performance. He may adjust the variable components or revise the circuit and call for performance calculation again.

This sophisticated tool is not needed in routine circuit design. Its principal use will be where well established, highly automated design procedures do not exist—for example, when investigating effects of temperature, component tolerances, and stray coupling. The "conversational" ability promises to make this hardware-software system a valuable laboratory tool.

The console itself is GRAPHIC I, a man/machine computer terminal developed at Bell Laboratories. It includes a cathode-ray display, a keyboard for inserting letters or numbers, a light pen for selecting and positioning symbols on the tube, and a small display-control computer. Network analysis is handled by a separate large digital computer on a shared-time basis.

The circuit-analysis program is only one of several compiled for GRAPHIC I at Bell Laboratories. Others help generate integrated-circuit masks, design wiring patterns for magnetic-core logic devices, or retrieve documents. A special compiler (program for making programs) has been developed for GRAPHIC I. It is GRIN—for GRaphic INput.

Based on GRAPHIC I, a new generation of graphic terminals will be installed as part of an overall computer facility at Bell Laboratories.



**Bell Telephone Laboratories**  
Research and Development Unit of the Bell System

# Who makes card packaging kits?

## Scanbe does!

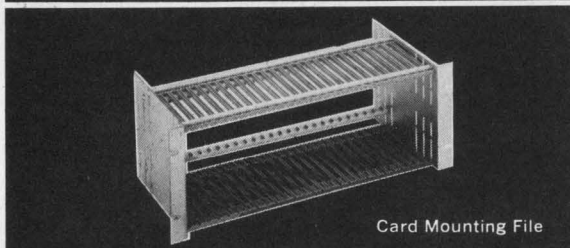

Card Mounting File

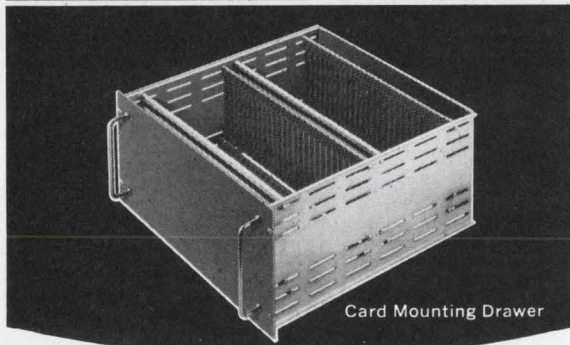

Card Mounting Drawer

Now available in economical kit form, from Scanbe, a new Card-Mate circuit card mounting drawer kit and a new Card-Mate circuit card mounting file which offer these exclusive advantages:

- Easy to assemble into a complete unit
- Card spacing variable in  $\frac{1}{8}$ " increments from .500 min.
- Precision molded nylon and rugged aluminum parts
- Mounts any type connector
- Adjustable to fit most card sizes
- Prices — Drawer Kit from \$80.00 — File Kit \$23.45

Write Scanbe, the specialist for electronic packaging hardware and get our new and complete kit literature.



**SCANBE MANUFACTURING CORP.**  
1161 MONTEREY PASS RD., MONTEREY PARK, CALIF. 91754  
TELEPHONE (213) 264-2300 TWX 910-321-4336  
Distributor Inquiries Invited

ON READER-SERVICE CARD CIRCLE 87

## TEST EQUIPMENT

### Ac power supply for EMI testing

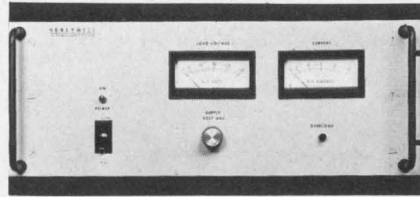

Honeywell, Inc., Test Instruments Div., P. O. Box 391, Annapolis, Md.  
Phone: (301) 263-2661. Price: \$2450.

A regulated ac power supply works with power line test equipment for EMI test systems, or as a standard ac power source for laboratory use. The unit holds the amplitude cycle-to-cycle stability to less than 0.05% variation with an output completely free of dc components. It provides 60-Hz 110-V rms power with extreme amplitude and phase stability characteristics and low total harmonic content. The unit is basically a line corrector, deriving a standard waveform, producing an error signal, and inserting the amplified error signal in series with the ac output to produce a regulated low-distortion output.

CIRCLE NO. 285

### Dc-to-freq converter linear to 0.01%

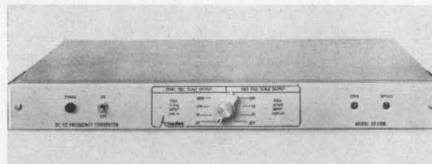

Anadex Instruments, Inc., 7833 Haskell Ave., Van Nuys, Calif.  
Phone: (213) 782-9527. P&A: \$450; 4 wks.

For A-to-D conversion and data logging, this dc-to-frequency converter provides output frequency directly proportional to the input voltage. By means of a range switch, the user selects 4 input voltage ranges from 10 mV to 10 V full scale with a 10-kHz full scale output for each range, or 4 input ranges from 100 mV to 100 V with a 100-kHz output. Front panel offset control provides 0 to 50 kHz output frequency for zero input on any range.

CIRCLE NO. 286

# New Mercury Relay Applications From Adlake

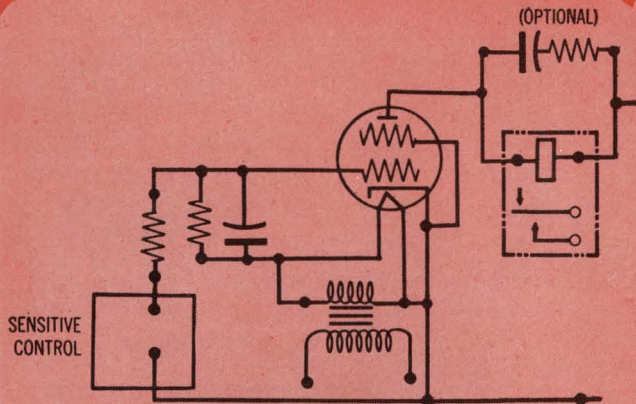

**MERCURY  
DISPLACEMENT  
RELAYS**

## *Small Currents Control "Heavy Duty" Load Relay*

In applications having extremely sensitive controls, this circuit illustrates how very small currents are capable of controlling an Adlake "Heavy Duty" load relay. Resistive loads of 35, 50 or 75 amperes at 120 volts, 60 cycles, are easily met up to 44 operations per minute. 100 ampere loads at the rate of 6 operations per minute.

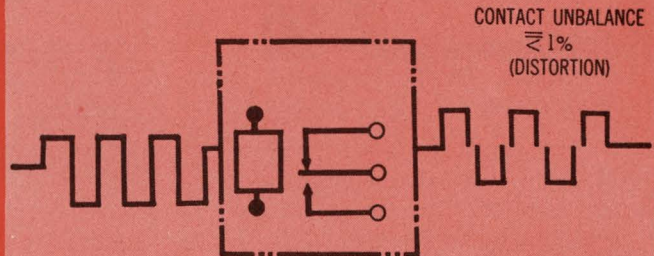

**MERCURY  
WETTED  
CONTACT  
RELAYS**

## *Ideal for Data Transmission or Tele-Typing*

Adlake Polar Relays—Form C—are ideal for data transmission or tele-typewriting where a series of equal length impulses represent an alpha-numeric character or function. Baud rates up to 120 are available with Contact Unbalance—Distortion—of 1% or less including transition. Transition time is normally 200 microseconds or less.

Backed by sound research and disciplined engineering, Adlake applies the industry's broadest line of mercury displacement and mercury wetted relays to the creative solution of design circuit problems. However unique or special your application, Adlake can assist you in developing it. For prompt, personal and knowledgeable attention to your relay needs, contact the one source that is the complete source in the mercury relay field. Contact Adlake today for catalog and further information.



**THE ADAMS & WESTLAKE COMPANY**

Dept. 1067 • Elkhart, Indiana 46514 • Phone (A.C. 219) CO 4-1141

WINDOWS & CURTAIN WALLS • DOORS & ENTRANCES • TRANSPORTATION EQUIPMENT • MERCURY RELAYS • CONTRACT MANUFACTURING

ON READER-SERVICE CARD CIRCLE 88

## PAM-PDM simulator uses 90 crossbars

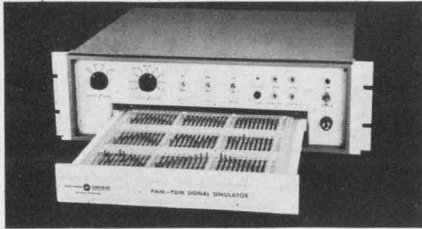

Chrysler Corp., Huntsville Operations, Huntsville, Ala. Phone: (205) 842-4710.

PAM/PDM signal simulators provide time-multiplexed signals for checkout and calibration of telemetry decommutation equipment. The unit has a slide-out drawer which contains 90 crossbar switches for programming. Each of the channel switches can be used to select any one of ten reference voltage levels from 0 to 5 V. This technique eliminates the need for a patch board. Commutation rate is selectable in nine fixed steps from 75 to 3600 pps. Standard frame lengths of 30, 60, 90 or 300 channels are switch-selected.

CIRCLE NO. 287

## Dc supplies regulate current/voltage

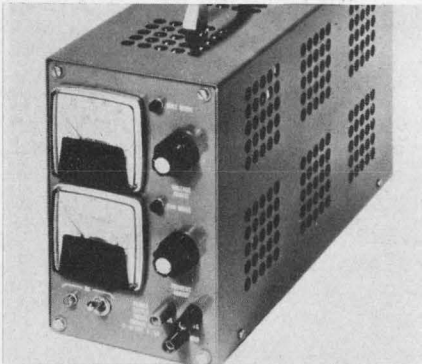

NJE Corp., 20 Boright Ave., Kenilworth, N. J. Phone: (201) 272-6000. Price: \$300.

An all-silicon, high-temperature power supply has the capability for operation in voltage and/or current regulation mode. It has an output of 0 to 20 volts and 0 to 7.5 amps. Voltage regulation for load and line changes is 0.01% or 1 mV respectively, when operated as a voltage regulated power supply. Current regulation is 1 mA/V change in output and 2 mA in constant-current.

CIRCLE NO. 288

## Spectrum analyzers span 1 kHz to 25 MHz

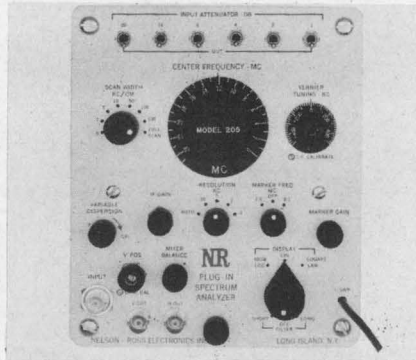

Nelson-Ross Electronics, 5-05 Burns Ave., Hicksville, N. Y. Phone: (516) 433-2730. P&A: \$1400 and \$1500; stock to 30 days.

Wideband video plug-in spectrum analyzers cover 1 kHz to 25 MHz. Model PSA-205 is for use with Tektronix letter series scopes and PSA-235 is for use with Hewlett-Packard 140A/141A scopes. A wide range of calibrated dispersions from 5 kHz to 5 MHz is provided as well as a full scan of 25 MHz. Resolutions of 200 Hz to 20 kHz are automatically programmed with dispersion.

CIRCLE NO. 289

## Ac-to-dc converter has FET input

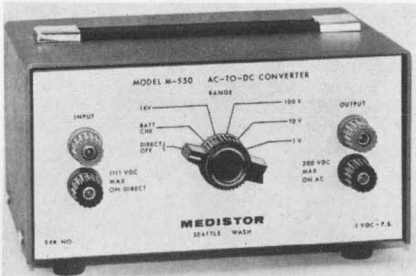

Medistor Instrument Co., 1443 N. Northlake Way, Seattle, Wash. Phone: (206) 633-5145. P&A: \$230; 30 days.

With four ranges from 1 to 1000 volts full scale, this ac/dc converter has input impedance of 1 M on all ranges. The dc output ranges from zero to 1 Vdc with output impedance of 10 k $\Omega$ . The instrument has a rated accuracy of  $\pm 0.25\%$  of reading plus 50  $\mu$ V. Frequency range for rated accuracy is from 50 to 5000 Hz, and accuracy from 5 and 10 kHz is  $\pm 0.4\%$ .

CIRCLE NO. 290

## Decade voltage dividers offer high resolution

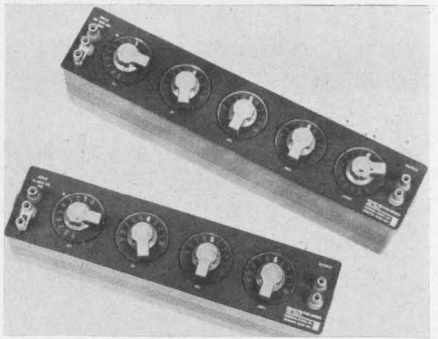

General Radio Co., West Concord, Mass. Phone: (617) 369-4400. Price: \$215 to \$260.

Five resistive decade voltage dividers offer tight tolerances and resolution as high as 1 part in  $10^5$ . Types 1455-A, AH and AL are four-dial units with a ratio range of 0.0001 to 1, and types 1455-B and BH have five dials and a ratio range of 0.00001 to 1. The -H dividers feature high impedance for use with voltages up to 700 V, the 1455-AL is a low-impedance divider useful at low RF. Absolute linearity is better than  $\pm 20$  ppm for the five-dial units for settings of 0.1 to 1 with lower figures for smaller ratios.

CIRCLE NO. 291

## Power supply protects ICs from overshoot

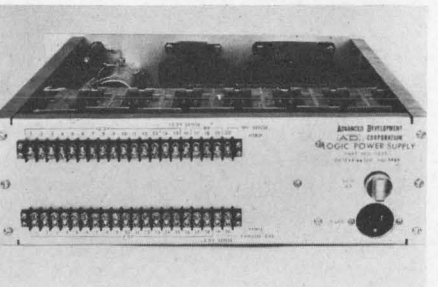

Advanced Development Corp., 2014 West 139th St., Gardena, Calif. Phone: (213) 770-1143.

A system power supply for ICs has zero overvoltage correction response time to protect ICs from any instantaneous overshoot. Response time is effectively zero since no transients or spikes of any duration or magnitude will appear in the output. Model 11535-1 produces 5 Vdc at 0 to 30 A and 2.5 Vdc at 0 to 3 A, and features automatic current limit and reverse voltage protection.

CIRCLE NO. 292



# Voltage Controlled Crystal Oscillators

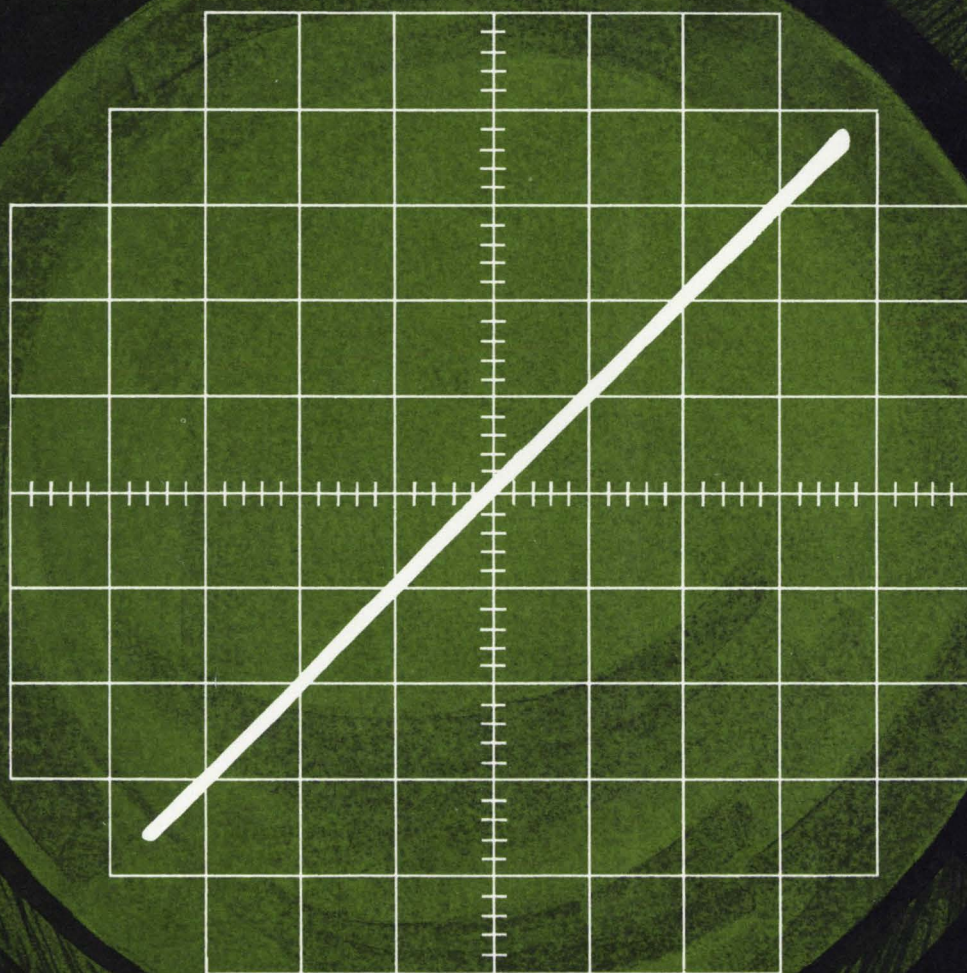

**D** VEXOS  
DAMON

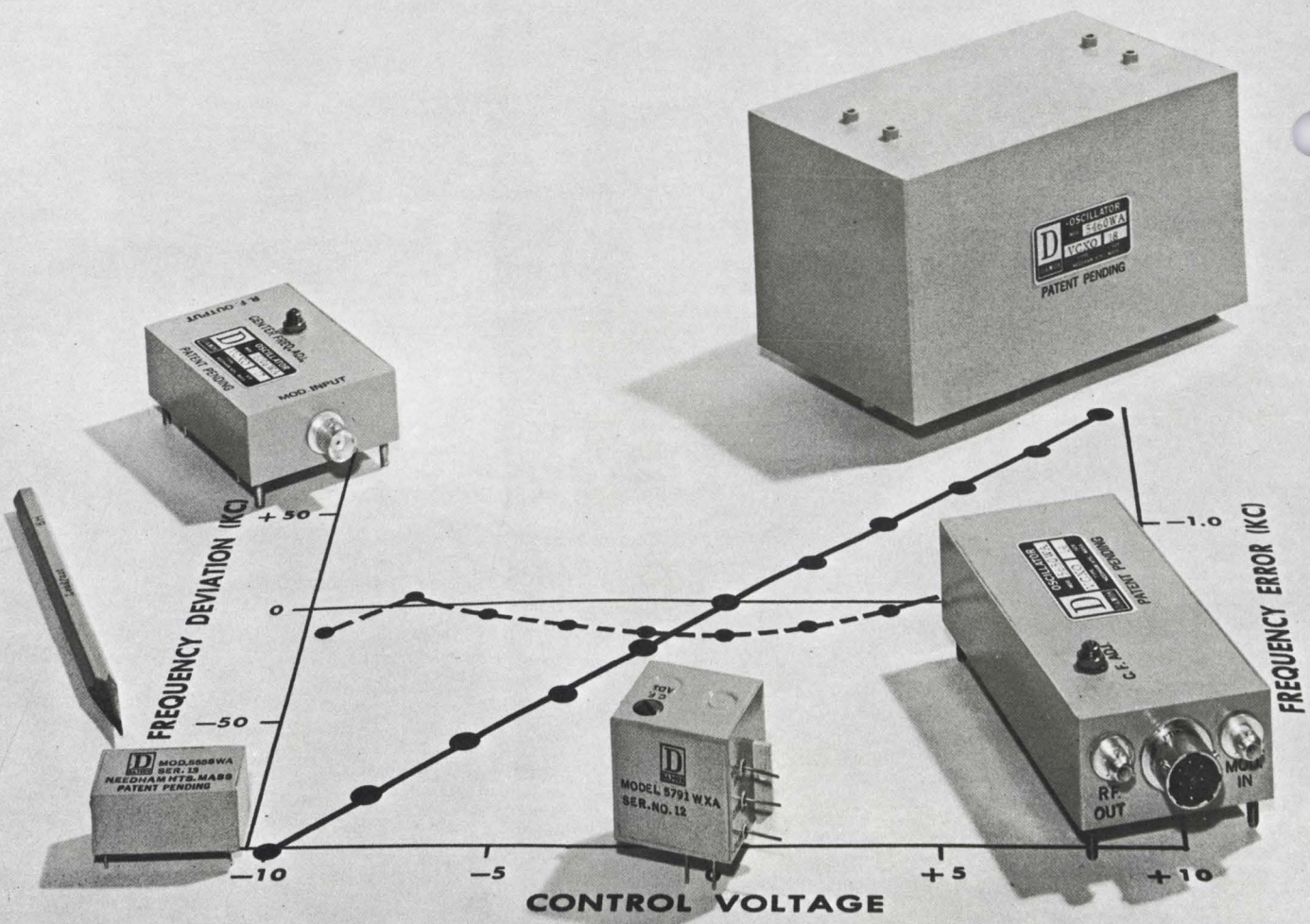
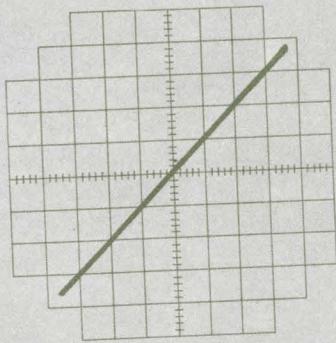

# What is a VCXO?

**DAMON VCXOs** are crystal oscillators with voltage-controlled reactive components that provide variations in output frequency without materially affecting the crystal frequency stability. The accompanying simplified schematic diagram (Figure 1) and performance graphs (Figures 2 and 3) illustrate these concepts. The crystal-stabilized circuit and associated variable reactance diode form the feedback circuit in a series-mode oscillator. The reactance-frequency characteristic of a series-mode crystal oscillator (without modulating circuitry) is shown by the dashed lines in Figure 2. Adding the control elements translates the curve as shown. Adjusting the "DC Bias" sets the center frequency. Variations in control input voltage, adding algebraically to the bias, produce frequency changes above and below the center frequency.

**STABILITY.** The "Q" of Damon VCXO circuits is not significantly degraded by the control circuitry. For example, a typical crystal "Q" is in the order of 50,000 while that of the VCXO (using the same crystal) would be approximately 25,000 (even though the "Q" of the control circuit elements may be about 50). Stability and noise figure of Damon VCXOs are therefore in the same class as many high-performance fixed crystal oscillators.

**LINEARITY.** The Damon VCXO control characteristic closely approximates a straight line (see Figure 3). The dashed curve (note expanded scale) illustrates a typical 40 mc VCXO with peak deviation of  $\pm 100$  kc and less than  $\pm 1.0$  kc departure from perfect linearity. In some applications FM distortion may be more significant than static linearity. FM distortion can approach the static linearity when the FM spectrum is confined within the deviation limits. When modulation rates would add spectrum components outside the peak deviation region, then a VCXO with broader deviation capabilities should be considered. The same considerations apply to those special applications in which control signals are non-sinusoidal (i.e. square-wave, ramp, random, etc.).

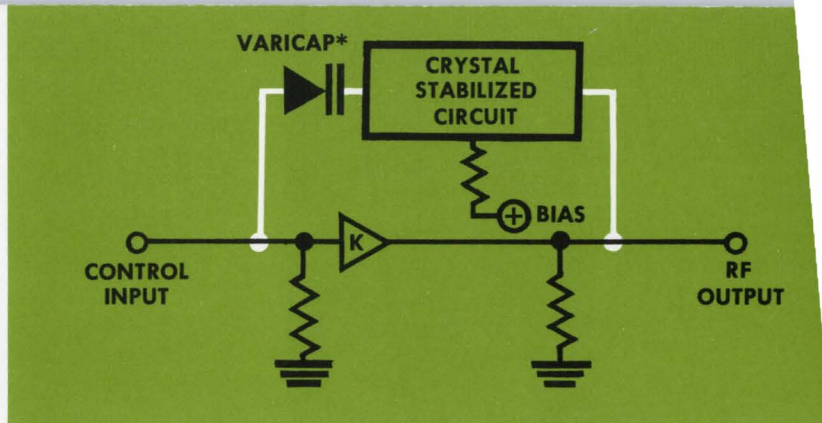

Figure 1 — Simplified Damon VCXO Schematic Diagram

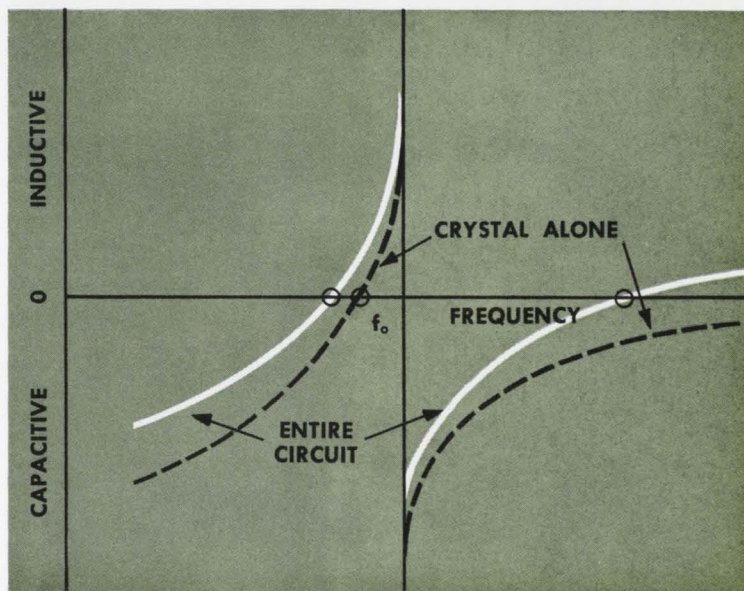

Figure 2 — Reactance-Frequency Plot for Typical Damon VCXO

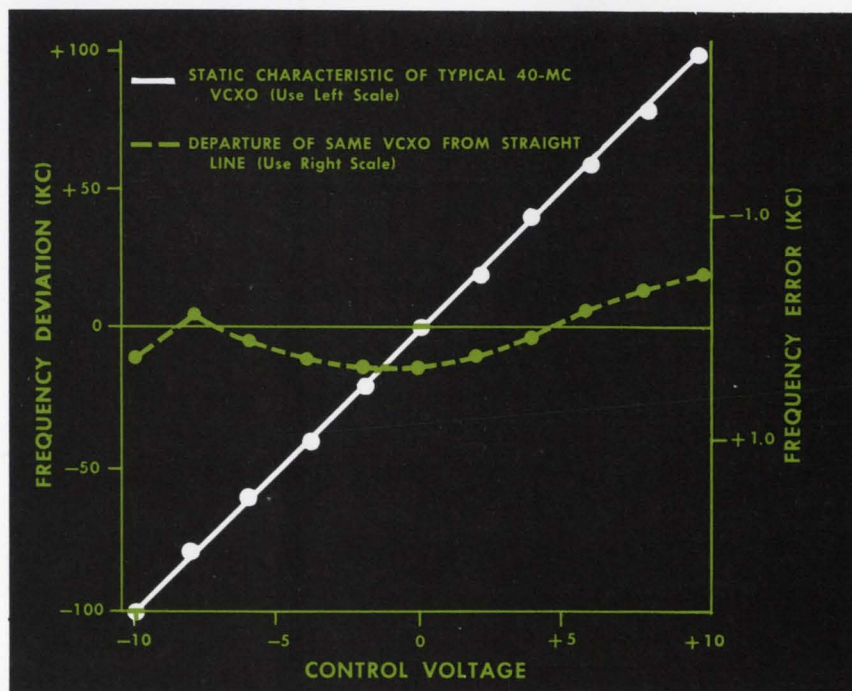

Figure 3 — Typical VCXO Linearity Plot

\* Registered Trademark of TRW Semiconductors, Inc.

# Typical VCXO Applications



## A. VARIABLE FREQUENCY SOURCE

VCXO FM source produces voltage controlled output frequency. Any input signal, such as stepped dc or complex audio, video or pulsed signals may drive the VCXO.



## B. VHF/UHF FM POWER SOURCE

FM power can be achieved at higher frequencies by multiplying and amplifying the VCXO output.

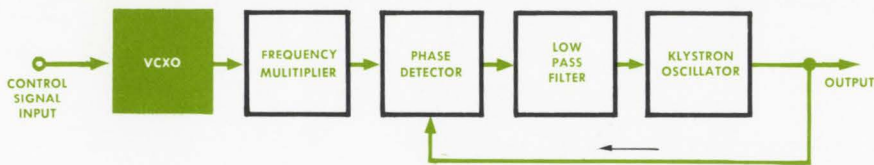

## C. PHASE-LOCKED, CRYSTAL-CONTROLLED MICROWAVE FM SOURCE

FM microwave power with crystal stability uses Low Power Multiplier-Amplifier stages to produce Klystron output frequency. Klystron and VCXO chain feed Phase Detector. Detector output phase-locks klystron. System tracks VCXO control signal.

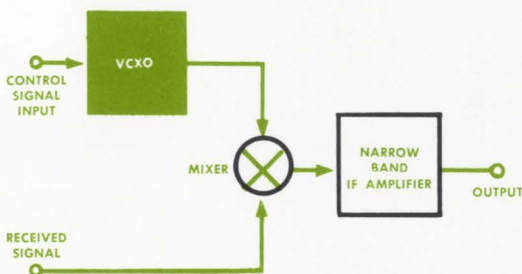

## D. OPEN-LOOP DOPPLER TRACKER

Simple Doppler tracker uses programmed VCXO control signal to establish Doppler correction. VCXO output is combined with received signal in mixer. Narrow Band Crystal Filter passes only the desired sum or difference frequency which is now Doppler corrected.

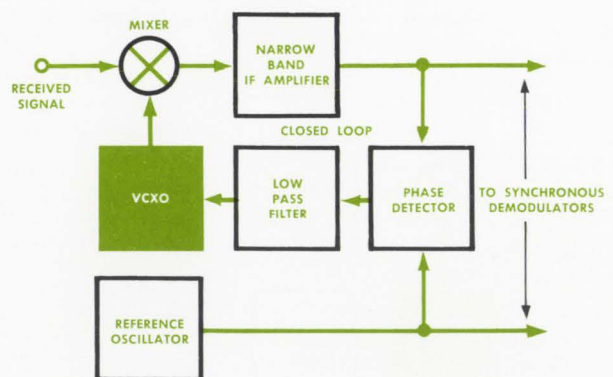

## E. PHASE-LOCKED DOPPLER TRACKER

Automatic Doppler correction or tracking is achieved by VCXO in Closed Loop. Received signal is mixed with VCXO output and fed through Narrow Band Filter to Phase Detector. Reference signal is obtained from Local Oscillator operating at carrier frequency. Low Pass Filter eliminates modulation component, leaving only Doppler effect to control VCXO. VCXO changes frequency to correct for or track Doppler shift.

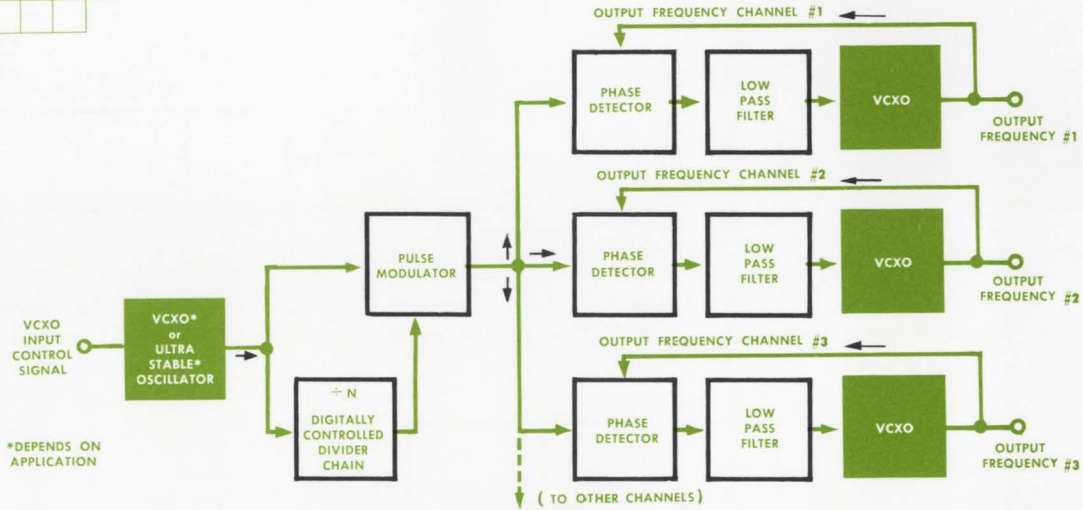
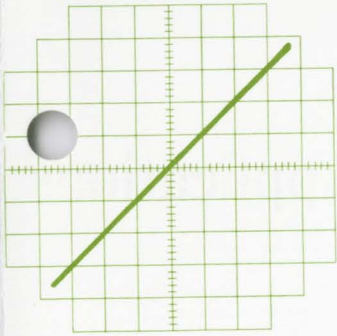

#### F. TYPICAL PHASE-LOCKED FREQUENCY SYNTHESIZER

Phase-locked frequency synthesizer uses either fixed Oscillator or VCXO (for variable output) as basic frequency source. Oscillator output frequency feeds two circuits — Pulse Modulator and Digitally Controlled Divider Chain. Divider output is fed to pulse modulator, to generate a comb spectrum. Modulator output feeds Phase Detectors in Output Frequency Channels. Individual channel VCXOs have center frequencies very near desired pulse modulator output frequency. VCXO output, fed back to associated phase demodulator, is compared to pulse modulator output. DC control signal locks the VCXO to the corresponding pulse modulator output frequency. If basic oscillator is a VCXO, individual channels will track when basic frequency is adjusted.

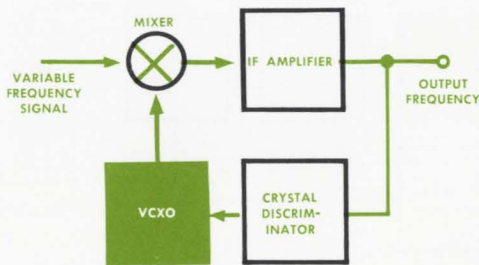

#### G. AUTOMATIC FREQUENCY CONTROL

Automatic frequency control uses VCXO as variable local oscillator to sustain a fixed sum or difference intermediate frequency. The Crystal Discriminator, responding to any variations in output frequency, adjusts VCXO to correct Mixer output.

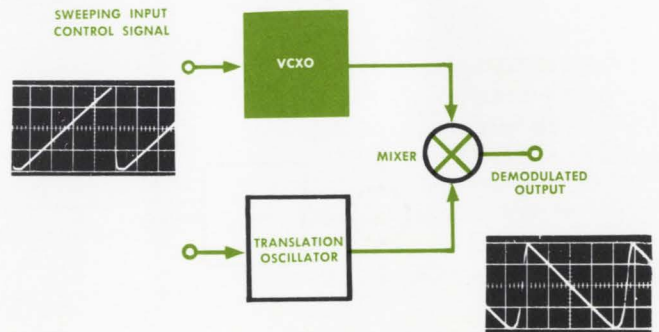

#### H. SWEPT FREQUENCY OSCILLATOR with photos of Input and Output Waveforms

VCXO, driven by sawtooth signal, is mixed with Translation Oscillator to produce desired output frequency. Photos show typical response of 30 mc VCXO. Control Signal — vertical: 2.5v/div; horizontal: 10  $\mu$ sec/div. FM from VCXO — vertical: 20 kc/div; horizontal: 10  $\mu$ sec/div.

The Damon VCXO Characteristic Graph and its accompanying charts provide valuable information to help you specify the correct VCXO for your application. As in any technical specification, the more detailed the information, the better. The enclosed reply card has space for you to spell out your requirements and to indicate any special characteristics.

#### Peak Deviation and Center Frequencies

The Characteristic Graph shows the range of deviation frequencies and center frequencies for which Damon VCXOs may be made. In general, it is desirable to select a center frequency and peak deviation that avoid the regions near the edges of the VCXO Characteristic Graph.

#### Deviation Rate and Waveform

Next determine the deviation rate and characteristics. These include control signal frequency and waveform (sine-wave, square-wave, DC steps, etc.). Please provide rise times where appropriate.

#### Linearity

Linearity should be specified as a percent of peak deviation. If your application appears to involve an output FM spectrum necessitating a broader deviation bandwidth, Damon Engineering will so advise you.

#### Output Power, Package and Environment

Output power and load impedance should be included when possible. Please include data on operating temperature range, shock and vibration, if known. Great flexibility is possible in packaging VCXOs. Extreme miniaturization will increase cost. Generally the volume of a basic VCXO decreases with increasing center frequency. A typical 5-mc VCXO occupies 2.5 cubic inches.

**VCXO Frequency Deviation vs. Center Frequency Graph** (Figure 4) may be used to determine optimum deviation frequency/center frequency combinations for Damon VCXOs. In general, fundamental-mode VCXOs can be packaged in the most compact enclosures. In many cases the customer may wish to purchase a fundamental VCXO and provide his own auxiliary circuitry (multipliers, mixers, etc.). When possible select a VCXO from within the fundamental region. See "Specification Guide."

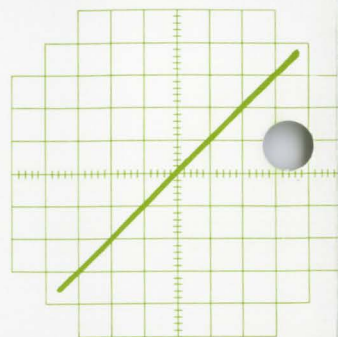

## Specifying the

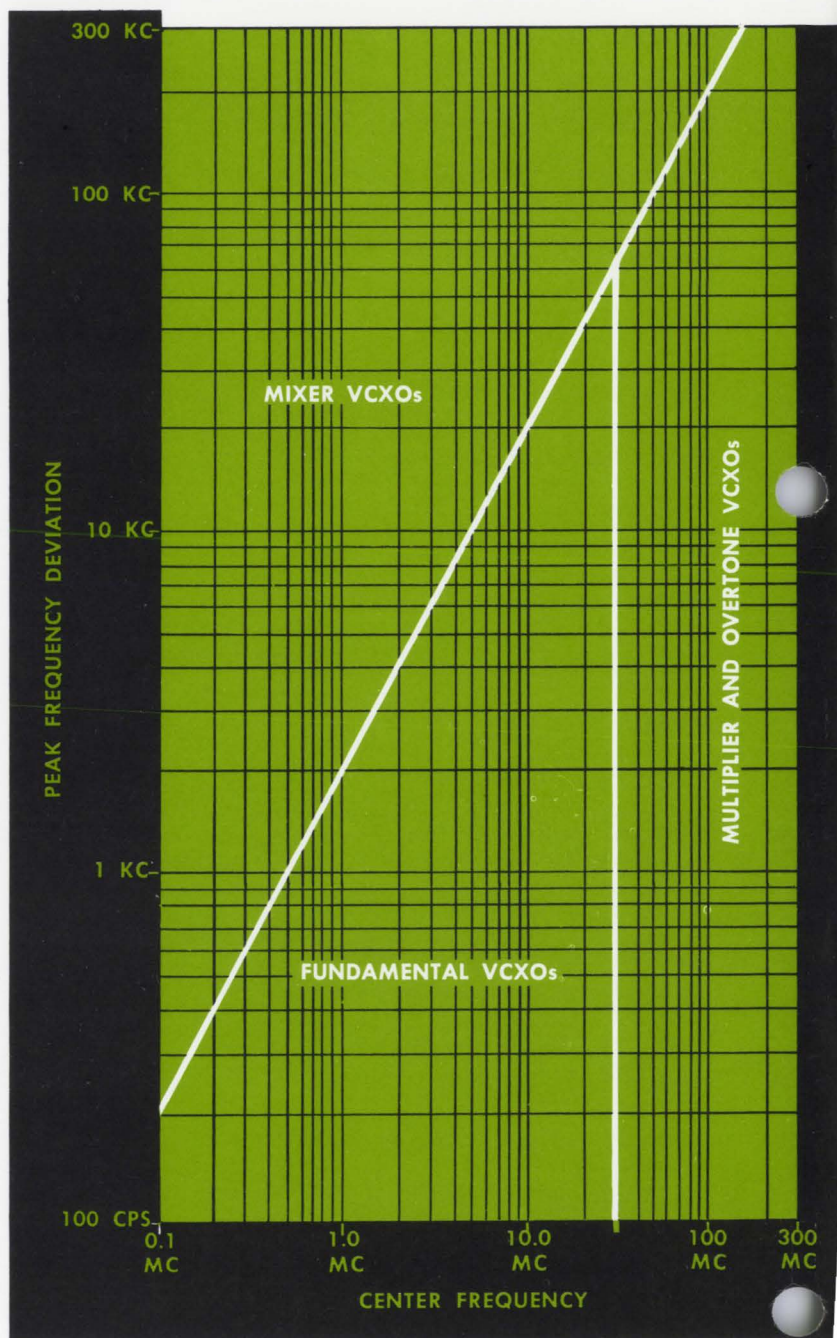

Figure 4 — Characteristic Graph: Peak Frequency Deviation vs. Center Frequency



**TABLE OF TYPICAL VCXO CHARACTERISTICS**

# VCXO

## SPECIFICATION GUIDE

The specifications listed below are indicative of all-silicon solid state VCXOs that can be supplied to your particular requirements. Obviously the limits are not absolute. We invite your inquiry and will be pleased to submit our quotation on prototype or production quantities.

Parameter	Fundamental and Multiplier VCXOs	Mixer and Mixer-Multiplier VCXOs
Center Frequency*	100 kc to 300 mc	100 cps to 300 mc
Frequency Deviation	±0.01% to ±0.25% of C.F.	±10 cps to ±1 mc
Frequency Stability 24 hr. @ 25°C	±1 to ±10 ppm	±0.5% of peak deviation
0 to 65°C (no oven)	±10 to ±50 ppm (see Note 1)	±2% of peak deviation
Linearity (see Note 2)	within 1% of best straight line	within 1% of best straight line
Minimum Deviation Rate	0 (dc)	0 (dc)
Maximum Deviation Rate	0.2% of C.F. (100 kc max.)	10 kc to 100 kc
Mod. Voltage (Typical)	±5 V peak	±5 V peak
Mod. Input Impedance	>50 k ohms	>50 k ohms
Output Power Available	0.5 mw to 20 mw	0.5 mw to 20 mw
Load Impedance	50 ohms to 10 k ohms	50 ohms to 10 k ohms
Power Requirements (Typical)	-25 V ±1 V @ 10-20 ma	-25 V ±1 V @ 30 ma

\* C. F. Manual Adjustment Range ±0.01% ±5% of peak deviation

NOTES: (1) Other temperature ranges available:  
 (a) -20°C to +85°C (no oven): ±0.01%;  
 (b) -20°C to +65°C (ovenized): ±10 ppm.  
 (2) Alternative Specification:  
 Total FM Distortion: 1% maximum (all types).

Item Number	Peak Dev. (± KC)	Center Freq. (MC)	Mod. Sensitivity (KC/V)	VCXO Model No.
1	248	99.062	22.5	5179WXA
2	208	99.750	40.0	5515WXA
3	200	68.000	-20.0	5256WXA
4	100	99.900	14.0	5533WXA
5	100	38.500	-5.0	5091WXA
6	72	60.000	15.0	5548WXA
7	55	77.955	10.0	5312WXA
8	30	24.000	6.0	5359WA
9	30	16.600	6.0	5520WA
10	25	13.000	6.0	5472WA
11	20	19.500	-2.0	5091WB
12	20	10.539	2.0	5209WA
13	15	35.000	11.0	5461WC
14	12.5	19.125	2.5	5270WA
15	10	11.500	1.0	5099WA
16	10	7.000	-2.0	5114WA
17	10	4.700	-2.0	1231WA
18	6.0	10.000	1.2	5524WA
19	5.0	3.250	-2.0	5130WA
20	5.0	0.455	-2.0	5130WB
21	4.5	17.000	1.0	5265WA
22	3.8	0.3456	2.0	5285WA
23	2.0	1.000	0.40	5228WA
24	1.5	28.104	0.20	5244WA
25	1.25	0.500	0.25	5280WA
26	0.5	2.342	0.50	5209WB
27	0.5	0.9595	0.10	5395WYA
28	0.3	2.500	0.075	5607WB
29	0.25	0.1325	0.050	5676WB
30	0.2	7.000	-0.040	5559WA
31	0.2	0.500	0.100	5469WA
32	0.1	6.800	-0.020	5616WB

### Crystal Filters and other Associated DAMON Products

Damon Engineering is the major supplier of crystal-stabilized frequency selective devices and systems. In addition to VCXOs, narrow-band, wide-band crystal filters and discriminators are available. Typical examples are linear phase crystal filters, time domain crystal filters, high efficiency contiguous comb filters and crystal discriminators for high-gain AFC applications. Extremely compact and rugged multi-pole crystal filters with Butterworth, Gaussian, Chebyshev and Bessel attenuation characteristics have been supplied in production quantities.

Damon designed instruments, utilizing the unique characteristics of Damon VCXOs and Crystal Filters, include Real-Time Spectrum Analyzers, Frequency Synthesizers and Frequency Converters.

## DAMON ENGINEERING, INC.



Needham Heights, Mass. 02194 Tel: (617) 449-0800



## Two-channel recorder lightweight, versatile

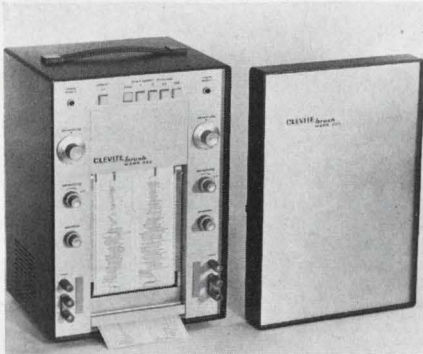

Clevite Corp., Brush Instruments Div., 37th and Perkins, Cleveland. Phone: (216) 361-3315. Price: under \$1704.

Weighing 25 pounds, this 2-channel analog recorder offers servo-restored position feedback pen motion, and pressure ink, rectilinear writing. Frequency response is flat to 100 Hz. Input is differential, balanced-to-ground. Three input terminals are provided for each channel with removable ground strap. Sensitivity is 1 mV per division. Electrical pen limiters prevent damage to the recorder from inadvertent overloading no matter what the attenuator setting, and position feedback pen motors write squarewave.

CIRCLE NO. 293

## Integrating DVM also measures ac, ratio, ohms

Weston Instruments, Inc., 614 Frelinghuysen Ave., Newark, N. J. Phone: (201) 243-4700.

High input impedance and good series mode noise rejection are featured in this integrating DVM. The 0.01% DVM has autorange as a standard feature and ratio, ac and ohms capabilities as optional accessories. Input impedance of 1000 M $\Omega$  on both 1 and 10-volt ranges and a sampling rate up to 10 readings per second are of value in the measurement of signals with high source resistances. A frequency-to-voltage comparator checks the correlation of the output frequency of a voltage-controlled oscillator with the input voltage. A counter then measures the frequency, transferring its digital reading to a buffer storage unit, which operates readout.

CIRCLE NO. 294

## Five-volt supplies power logic modules

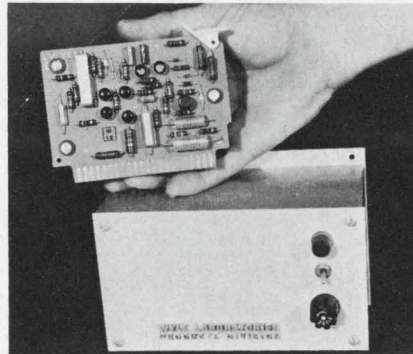

Wyle Products Div., 133 Center St., El Segundo, Calif. Phone: (213) 322-1763.

MPS-5 power regulators can be driven from an 8-Vdc unregulated source to generate +5 Vdc for IC logic circuits. They feature short and overvoltage protection with an automatic voltage cutoff. Output voltage is  $+5 \pm 0.5$  Vdc, adjustable, at 3.5 A. The companion unit MPS-8 is an unregulated dc supply for the power regulators. Input voltage required is 115 V rms  $\pm 10\%$  at 60 Hz. Input current is 200 mA rms for a 2-A load and 500 mA rms for a 5-A load. Output voltage is 8 Vdc at 2 A.

CIRCLE NO. 295

## Low-cost supplies power digital ICs

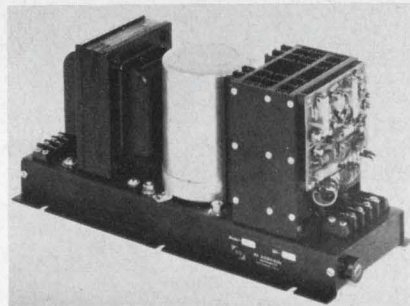

RO Associates, 917 Terminal Way, San Carlos, Calif. Phone: (415) 591-9443. P&A: \$125 and \$139, \$18 (crowbar overvoltage protection); stock to 2 wks.

Designed for digital ICs, models 605 and 610 produce 5 and 10 A respectively with adjustable outputs from 4.5 to 5.5 V. Ripple is less than 1 mV p-p, regulation is 0.25% zero to full load, and  $\pm 0.1\%$  for a  $\pm 10\%$  change in input.

CIRCLE NO. 296

## Hybrid vidicons need only 300 V

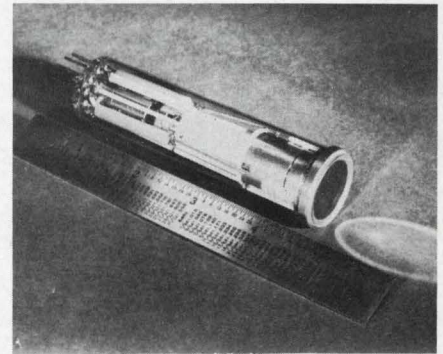

General Electric Co., 1 River Rd., Schenectady, N. Y. Phone: (518) 374-2211.

Lightweight hybrid vidicons utilize magnetic and electrostatic fields in a focus-projection-and-scanning (FPS) mode. Both the magnetic focus and electrostatic deflection fields are superimposed in the same space so that focus and scanning are accomplished simultaneously. The tubes are thus much shorter than usual, with lengths ranging between 4-1/2 and 6 inches.

CIRCLE NO. 297

## Rms volt/ammeter flat from dc to 100 kHz



Greibach Instruments Corp., 315 North Ave., New Rochelle, N. Y. Phone: (914) 633-7900.

Multirange true rms volt/ammeters provide voltage ranges from 30 mV to 1 kV at 1 k $\Omega$ /V and current ranges from 100  $\mu$ A to 10 A without external shunts. Frequency response is essentially flat from dc to 100 kHz on the lower ranges. Accuracy is  $\pm 0.5\%$  of full scale. The transducer used has a flat frequency response from dc to 1 MHz and uses no thermocouples.

CIRCLE NO. 298

# Hitching Post for High-Spirited Electrons...



**JOHNSON'S NEW  
MINIATURE "6-WAY"  
111-200 BINDING POST**

- \* Compact Pre-Assembled Design
- \* Short Front Panel Projection
- \* 5,000 VDC Breakdown

Hold your horses! Look first at Johnson for binding posts . . . for instance, at the #111-200 series designed for compact test equipment applications. Tough, low-loss polyamide body fully insulates stud, provides higher voltage breakdown. Front projection 25/32" max. with thumb nut open . . . only 21/32" closed. Thumb nut is self-captivated . . . cannot work loose. Equipped with single 1/4"-32 nut for fast mounting — no time consuming spacers or mounting hardware required. 6-Way feature permits connection by tip plug, alligator clip to stud, wire wrapped around stud and clamped, wire (max. size #12) through center hole, clamped, and clamped spade lug.

#### ELECTRICAL CHARACTERISTICS:

**Current rating** 15 amps. thumb nut to terminal; five amps. tip jack to terminal.

**Capacitance** to 1/8" panel 3 pf.

**Insulation resistance** greater than 200 megohms after MIL-T-5422B humidity test.

Also available in Series 111-100 (15 amps, 8,000 VDC Breakdown) and Series 111-300 (40 amps, 7,000 VDC Breakdown).

**WRITE NOW FOR FREE SAMPLE  
AND COMPLETE INFORMATION ON  
JOHNSON CONNECTOR LINE**



**E. F. JOHNSON COMPANY**

3356 Tenth Ave. S.W. • Waseca, Minnesota 56093

ON READER-SERVICE CARD CIRCLE 90

## MATERIALS

### Solder-stripped strip cuts contact costs

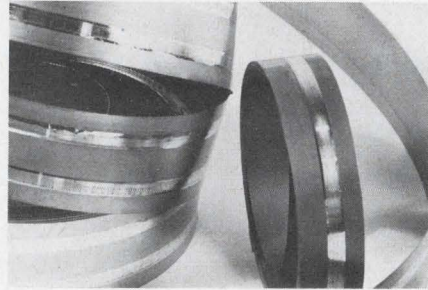

*Sylvania Electric Products, Inc.,  
Parts Div., 12 Second St., Warren,  
Pa. Phone: (814) 723-2000.*

Significant cost savings are claimed by Sylvania through their process of applying solder striping to contact material. Costs are lower because less solder is used and handling time is reduced. When finished contacts are produced from the new material, savings of up to 15% are reported. In the process, solder stripes are applied to beryllium copper strip. Instead of solder coating the entire surface of the new material, single or double solder stripes are applied precisely where they are required. The product is available in coiled form, or as formed contacts for computer connector blocks, PC cards or switches. A tin-silver alloy solder is used for striping. Solder thickness is available up to 0.003 inches and is regulated by skiving (removal of a thin layer). The width is governed by the measurements of the contact. The strip is produced in widths of 0.843 inch (single) or 1.446 inches (double).

CIRCLE NO. 311

### Teflon tubing withstands 500°F

*Zippertubing Co., 1300 S. Broadway,  
Los Angeles. Phone: (213)  
321-3901.*

Teflon zippertubing is resistant to most chemicals, will not melt at temperatures to +500°F, and features zip-on, zip-off jacketing characteristic. This permits different diameter applications as any number of lengths can be quickly zipped together to form the needed ID. The material is resistant to outdoor exposure and has moisture absorption of less than 0.01%.

CIRCLE NO. 312

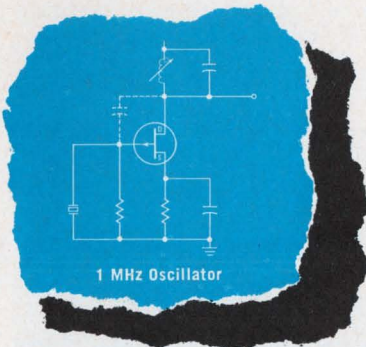

1 MHz Oscillator

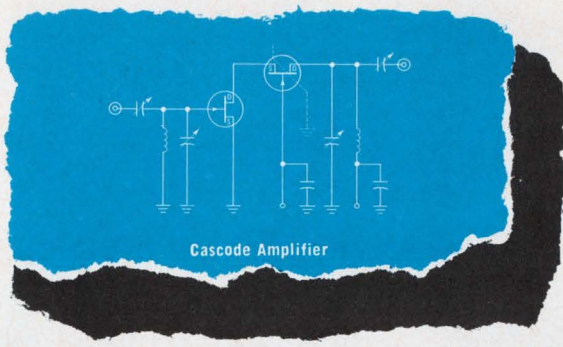

Cascode Amplifier

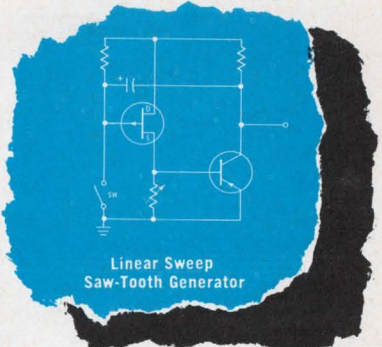

Linear Sweep Saw-Tooth Generator

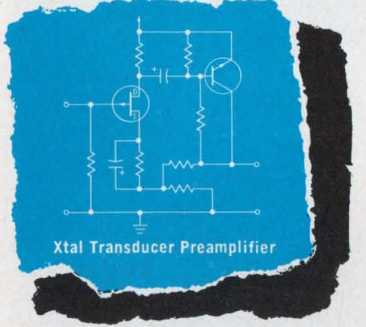

Xtal Transducer Preamplifier

# SILICONIX Epoxy FETs

*(The only thing cheap is the price!)*

Here's just a sampling of the hundreds (thousands?) of ways that FETs can work for you. If price has made you timid, fear no more. Siliconix epoxy FETs give you a new dimension in costing for industrial and commercial applications. What's more, they are available now, *really*, from distributor stocks. Check brief specs below, then check the free offer below that.

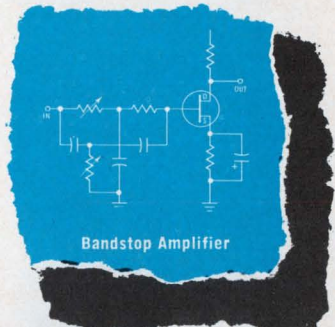

Bandstop Amplifier

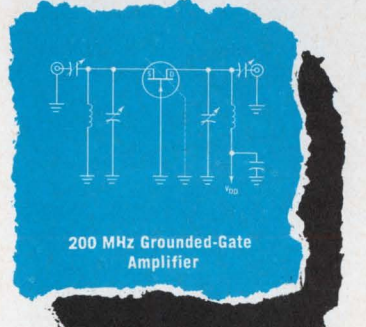

200 MHz Grounded-Gate Amplifier

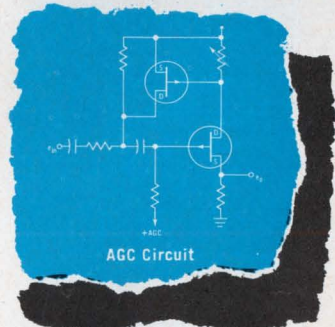

AGC Circuit

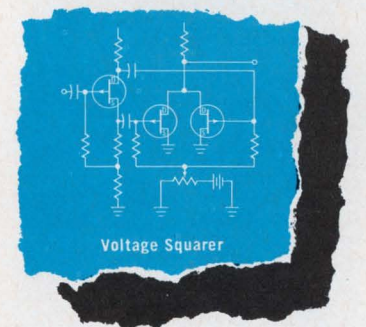

Voltage Squarer

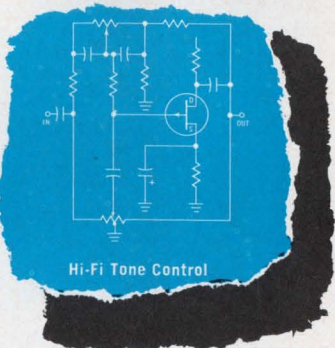

Hi-Fi Tone Control

EPOXY N-CHANNEL JUNCTION FIELD-EFFECT TRANSISTORS									
	E100		E101		E102		E103		Unit
	Min.	Max.	Min.	Max.	Min.	Max.	Min.	Max.	
$I_{GSS} @ 25^{\circ}C$		-0.5		-0.5		-0.5		-0.5	nA
$V_p$	-0.3	-10	-0.3	-1.5	-0.8	-4.0	-2.0	-10	V
$I_{DSS}$	0.2	20	0.2	1.0	0.9	4.5	4.0	20	mA

Siliconix assumes no responsibility for circuits shown, nor does it represent or warrant that they do not infringe any patents.



**FREE: "FET Circuit Ideas,"** a brochure detailing some of the circuits now operating with other Siliconix FETs. 21 circuits in all, some plain, some fancy. All are guaranteed to pique the curiosity and to promote further FET thinking.



**Siliconix incorporated**

1140 W. Evelyn Avenue • Sunnyvale, California 94086  
Phone 245-1000 • Area Code 408 • TWX 408-737-9948

## FRANCHISED DISTRIBUTORS

**ALA.**, HUNTSVILLE, Cramer Electronics, Inc., 536-4493 • **ARIZ.**, PHOENIX, Barnhill Associates, 959-2115 • Sterling Electronics, Inc., 258-4531 • **CALIF.**, HOLLYWOOD, Hollywood Radio & Electronics, 466-3181 • LOS ANGELES, Kieruff Electronics, Inc., 685-5511 • MENLO PARK, Hollywood Radio & Electronics, 322-3431 • MOUNTAIN VIEW, Elmar Electronics, Inc., 961-3611 • OAKLAND, Elmar Electronics, Inc., 834-3311 • RIVERSIDE, Electronic Supply, Inc., 683-8110 • SAN DIEGO, Kieruff Electronics, Inc., 683-8110 • **COLO.**, DENVER, Barnhill Associates, 934-5505 • **CONN.**, HAMDEN, Cramer Electronics, Inc., 288-7771 • **FLA.**, CLEARWATER, Perrott Associates, Inc., 446-2535 • ORLANDO, Perrott Associates, Inc., 275-1132 • WEST PALM BEACH, Perrott Associates, Inc., 585-7761 • **ILL.**, CHICAGO, Semiconductor Specialists, Inc., 662-8860 • **LA.**, BATON ROUGE, Sterling Electronics, Inc., LAFAYETTE, Sterling Electronics, Inc., 234-6331 • NEW ORLEANS, Sterling Electronics, Inc., 522-8726 • **MD.**, HYATTSVILLE, Milgray Electronics, Inc., 864-6330 • **MASS.**, NEWTON, Cramer Electronics, Inc., 969-7700 • **MINN.**, MINNEAPOLIS, Semiconductor Specialists, Inc., 866-3435 • **MISS.**, GULFPORT, Sterling Electronics, Inc., 863-4051 • **MO.**, ST. LOUIS, Semiconductor Specialists, Inc., 521-8866 • **N. J.**, BERGENFIELD, Technical Electronic Distr., Inc., 384-3643 • **N. M.**, ALBUQUERQUE, Barnhill Associates, 265-7766 • Sterling Electronics, Inc., 247-2486 • **N. Y.**, BUFFALO, Summit Distributors, Inc., 884-3450 • NEW YORK CITY, Milgray Electronics, Inc., 989-1600 • SYRACUSE, Eastern Semiconductor Sales, Inc., 455-6641 • **OHIO**, DAYTON, Alpine Industries, Inc., 278-5861 • **OKLA.**, TULSA, Oil Capitol Electronics Corp., 836-2541 • **PA.**, PHILADELPHIA, Simco Electronics, Inc., 229-1880 • **TEX.**, AUSTIN, Sterling Electronics, Inc., 452-0271 • BEAUMONT, Sterling Electronics, Inc., 838-5255 • BRYAN, Sterling Electronics, Inc., 822-1589 • DALLAS, Sterling Electronics, Inc., 357-9131 • LUFKIN, Sterling Electronics, Inc., 634-4222 • HOUSTON, Lenert Company, 225-1465 • Sterling Electronics, Inc., 225-1321 • SAN ANTONIO, Sterling Electronics, Inc., 735-9173 • **WASH.**, SEATTLE, Washington Electronics, Inc., 682-8981  
**CANADA:** MONTREAL, Prelco Electronics, Ltd., 389-8051 • OTTAWA, Wackid Radio, Ltd., 232-3563 • TORONTO, Electro Sonic Supply Company, Ltd., 924-9251

ON READER-SERVICE CARD CIRCLE 91

# NEW!

**DRIVE  
THESE  
ULTRA  
SENSITIVE  
REED  
RELAYS ...**

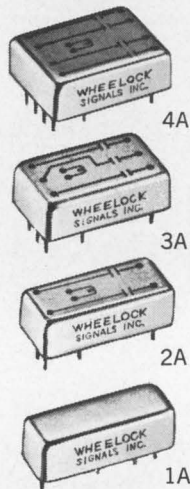

ACTUAL SIZE

**Directly  
from  
YOUR I.C.'s**

Wheelock announces a new generation of reed relays with the 442S Series. They are sensitive enough to be activated with I.C.'s, eliminating expensive driver stages . . . small enough to allow 40 2-pole relays to be mounted on a 4½" x 5½" pcb.

- Operates on 60 milliwatts power
- Contacts Rated at 7 watts
- Occupies 0.05 cubic inches per pole PC board mount

BY *Wheelock* OF COURSE

Contact Wheelock first for any of your relay design problems.

**WHELOCK SIGNALS, INC.**  
273 Branchport Avenue  
Long Branch, New Jersey 07740  
(201) 222-6880

Write for detailed literature on the new 442S Series



## MATERIALS

### Thermoplastic polymer withstands 500°F



3M Co., 2501 Hudson Rd., St. Paul.  
Phone: (612) 733-1804.

A new thermoplastic is capable of long-term service at very high temperatures. The material extends the capabilities of thermoplastics into the metallic range. Polymer 360 is suggested for use as an electrical insulation. Its electrical properties are good throughout a temperature range up to 500°F for long-term service. Good thermal stability, self-extinguishing characteristics, high heat distortion and high cut-through temperatures are also featured.

CIRCLE NO. 313

### Prototype kit for solder-glass sealing

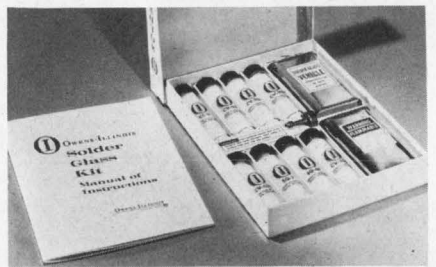

Owens-Illinois, Inc., Industrial & Electronic Products, P. O. Box 1035, Toledo, Ohio. Phone: (419) 242-6543. P&A: \$25; stock.

An R&D kit for solder glass sealing experimentation includes data and materials to experiment on production line sealing of glass, metal and ceramic components. The kit contains samples of eight currently available solder glasses. The glasses are for use where seals of glass-glass, glass-metal, metal-metal, ceramic-glass, ceramic-ceramic, and ceramic-metal are called for. Other uses include film and glaze coatings for glass, ceramic or metals.

CIRCLE NO. 314

ON READER-SERVICE CARD CIRCLE 92

## Conductive silver cement adheres at 400°F

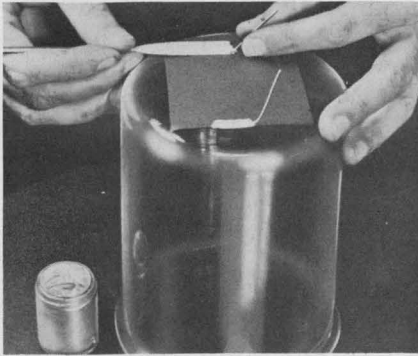

Acheson Colloids Co., 1635 Washington, Pt. Huron, Mich. Phone: (313) 984-4172.

A high-temperature conductive cement contains silver in a thermo-setting resin. It can be used continuously at temperatures to 400°F, and intermittently at higher temperatures. The cement adheres to rigid porous and nonporous materials, including glass, porcelain, ceramics, metal and most plastic surfaces. It may be applied with a spatula, knife and similar tools, or by silk screen for repetitive applications. After application, the cement is cured at 400°F for 30 minutes. Volume resistivity is 0.001  $\Omega$ -cm.

CIRCLE NO. 315

## Glass delay lines store video info for 63 $\mu$ s

Corning Glass Works, Electronic Products Div., 3900 Electronics Dr., Raleigh, N. C. Phone: (919) 828-0511.

Glass delay lines permit the storage of one horizontal sweep line of video information for 63  $\mu$ s. Delayed video information is then presented on CRTs in television cameras and receivers, video tape recorders and in computer displays. The devices are used in vertical aperture correction in color TV cameras, dropout compensation in video tape recorders and digital displays for high-speed computers. The lines operate at frequencies ranging from 2.5 to 40 MHz with 3-dB bandwidths of 2, 4 and 20 MHz available at center frequencies of 4.5, 10 and 25 MHz. The standard 25-MHz unit exhibits a signal-to-noise ratio of 40 dB.

CIRCLE NO. 316



Where trace recording  
is crucial  
B-C Oscillotrons®  
are preferred

In critical situations where reliable, accurate recording of CRT phenomena is vital, Beattie-Coleman Oscillotrons are specified more often than any other 'scope camera.

For use in field test instrumentation, the MII Oscillotron (above) is designed to withstand severe environmental conditions, shock, vibration and dust. Recording ratio is adjustable from 1:1 to 1:0.5. Camera is hinged to swing away at lens as well as at 'scope, permitting camera mount to serve as a shadow box for the CRT. Result: parallax-free adjustments are possible under high ambient light with minimum phosphor excitation. Indicator light gives assurance shutter is open. Records fast transients with either Polaroid or 4x5 sheet film.

Model 565A has 86mm f/1.2 lens for recording nanosecond traces at 1:1 ratio. Other Oscillotrons for 35mm rapid sequence or streak recording. Whatever your needs, from routine lab use to highly critical field tests, we have a model to do the job or will design one for you. Send for brochure.

Coleman Engineering Co Inc., Box 1974, Santa Ana, Calif 92702

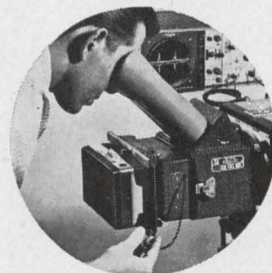

BEATTIE-COLEMAN  
OSCILLOTRON  
'SCOPE CAMERAS

**COLEMAN**

ENGINEERING COMPANY, INC.

ON READER-SERVICE CARD CIRCLE 93

# Miniature Word Indicators solve high-density control panel design problems... AT MINIMUM COST!

MSC Push-To-Relamp and Roto-Tellite® 2-Lamp Word Indicators are compact, highly reliable, low cost answers to close quarter packaging problems. Small size plus optional positioning of mounting brackets permits mounting in the closest proximity to other panel components. Fine craftsmanship and rugged matrix design ideally suit them to aircraft, industrial and commercial control systems. Compare the features and the price. You'll agree!

## SEND FOR COMPLETE CATALOGS

Use the reader service card or write on your letterhead for immediate service. Ask for both catalogs: 2025 and 2026.



### TWO UNIT TYPES LAMP/LEGEND ACCESS FROM THE PANEL FRONT WITHOUT TOOLS

#### ROTO-TELLITE SERIES 6000/7000

Light capsule rotates 180° for easy access to lamps, color filters and legends.



#### PUSH-TO-RELAMP SERIES 4000/5000

Light capsule is unlatched by a push... can then be pulled out and tilted for access to lamps, color filters, legends.

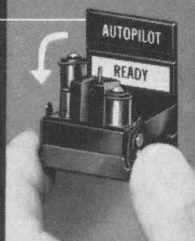

#### OPTIONAL BRACKET PLACEMENT Top/Bottom or sides.



TWO  
DISPLAY  
FACE  
SIZES

FOUR  
LENS  
TYPES

FULL OR  
SPLIT  
DISPLAY

SINGLE OR  
MULTI-UNIT  
MATRIX ASSEMBLIES

# Master MSC Specialties Company



25 Years in Information Display

Master Specialties Company, 1640 Monrovia, Costa Mesa, Calif. 92627  
Telephone (714) 642-2427 • TELEX 6-78433 Offices in Principal Cities.

ON READER-SERVICE CARD CIRCLE 94

## MATERIALS

### Thermal equalizing link for dual TO-18s

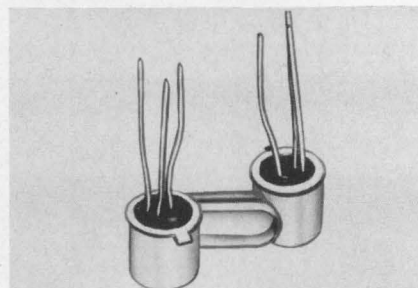

Wakefield Engineering, Inc., Wakefield, Mass. Phone: (617) 937-3460. P&A: \$250/M in large quantities; stock.

In many applications, such as operational amplifiers, it is important to maintain balanced transistors at the same case temperature. At the same time, they must be electrically separated. Type 259 thermal equalizing link holds two TO-18 transistors so they are electrically isolated but have a thermal path. Two cadmium-plated beryllium copper clips are bonded together with a filled epoxy adhesive. This system has a high thermal conductivity with the required dielectric strength. A minimum hipot rating of 500 Vac is obtained.

CIRCLE NO. 317

### Multilayer prepreg resists resin flow

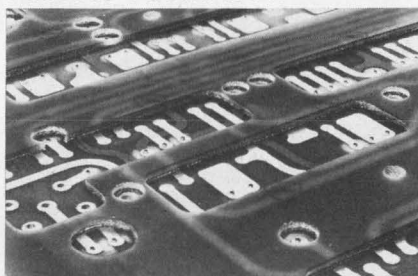

Fortin Laminating Corp., 11921 Sherman Way, N. Hollywood, Calif. Phone: (213) 875-2300. P&A: 90¢ to \$1.25/sq. ft.; stock.

Epoxy-glass prepreg is chemically engineered to resist resin movements at nominal molding pressures. This prepreg reportedly eliminates problems previously related to clearance hole multilayer boards and heat sink laminates where resin flow into the clearance hole or pad area cannot be tolerated. No-Flo can be used in a hot or cold press cycle, with assured dimensional stability.

CIRCLE NO. 318

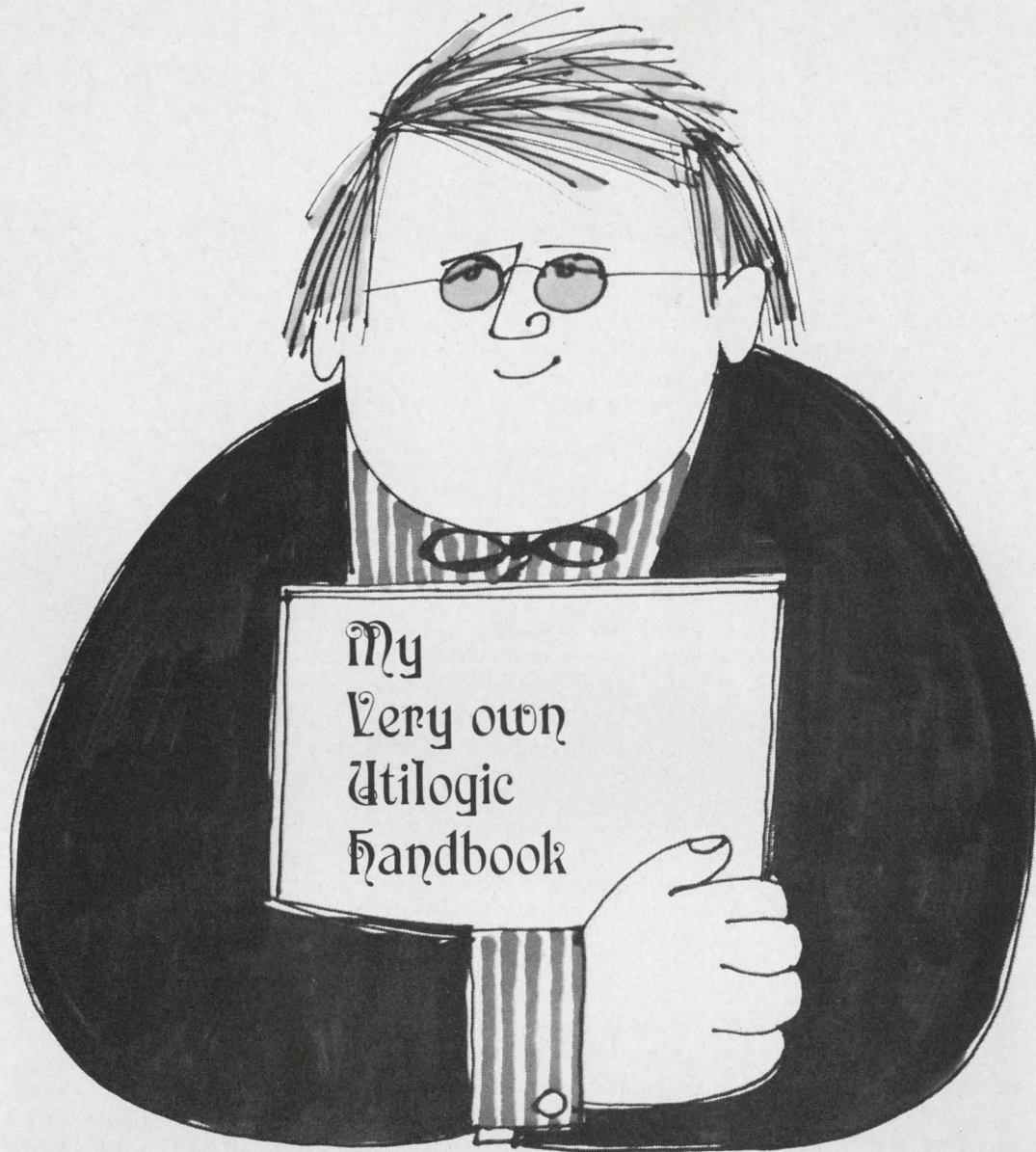

**Since 1 in 10 integrated circuits in use are our own UTILOGIC units, we thought the line deserved its own handbook. It's yours. Free.**

It's the first applications handbook of its kind. Make it your very own. It will give you 32 pages of everything you need to know about using UTILOGIC. Signetics introduced UTILOGIC in 1964: it was the first line designed specifically for the commercial and industrial market. Customers bought them by the millions. No wonder. The UTILOGIC series offers 800 mv minimum noise margins, fan-outs of up to 17 from Gates and J-K Binary and high capacitive drive capability. SU-element operation is guaranteed from  $-20^{\circ}$  to  $+85^{\circ}$  C, and LU-elements from  $+10^{\circ}$  to  $+55^{\circ}$  C. Send for your own UTILOGIC Handbook. Write: Signetics, 811 E. Arques Avenue, Sunnyvale, California 94086.

**SIGNETICS  
INTEGRATED  
CIRCUITS**



A SUBSIDIARY OF CORNING GLASS WORKS

**SIGNETICS SALES OFFICES:** Metropolitan New York (201) 992-3980; Upper New York State (315) 469-1072; Southwestern (214) 231-6344; Western Regional (213) 272-9421; Eastern Regional (617) 245-8200; Mid-Atlantic (609) 858-2864; Southeastern (813) 726-3734; Midwestern Regional (312) 259-8300; Northwestern (408) 738-2710.

**DISTRIBUTORS:** Compar at all locations listed below. Semiconductor Specialists, Inc. (312) 622-8860; Terminal Hudson Electronics (212) 243-5200; Wesco Electronics (213) 684-0880; Wesco Electronics (405) 968-3475.

**DOMESTIC REPRESENTATIVES:** Jack Pyle Company (415) 349-1266. Compar Corporation at the following locations: Alabama (205) 539-8476; Arizona (602) 947-4336; California (203) 245-1172; California (415) 697-6244; Colorado (303) 781-0912; Connecticut (203) 288-9276; Florida (305) 855-3964; Illinois (312) 775-5300; Maryland (301) 484-5400; Massachusetts (617) 969-7140; Michigan (313) 476-5758; Minnesota (612) 922-7011; Missouri (314) 428-5313; New Jersey (609) 429-1526; New Mexico (505) 265-1020; New York (518) 436-8536; New York (607) 723-8743; New York (716) 684-5731; New York (201) 471-6090; North Carolina (919) 724-0750; Ohio (216) 333-4120; Ohio (513) 878-2631; Texas (214) EM 3-1526; Texas (713) 649-5756; Washington (206) 725-7800.

**INTERNATIONAL SALES:** France, Germany, Italy, Belgium, Holland, Luxemburg, Spain—Sovcor Electronique, 11, Chemin de Ronde, Le Vesinet, (S.-&O.) France. United Kingdom, Ireland, Sweden, Denmark, Norway, Switzerland, Austria, Portugal—Electrosil Ltd., Lakeside Estate, Colnbrook-Bypass Slough, Buckinghamshire, Great Britain. Australia—Corning, 1202 Plaza Building, Australia Square, Sydney, N.S.W. 27-4318. Canada—Corning Glass Works of Canada, Ltd., Leaside Plant, Ontario, Canada (416) 421-150. Israel—Optronix, P.O. Box 195, Ramat-Gan, Israel 724-437. Japan—ASAHI Glass Co., Ltd., Corning Products Sales Dept. No. 2, 3-Chome Marunouchi, Chiyoda-ku, Tokyo, Japan.

ON READER-SERVICE CARD CIRCLE 95



It's difficult to make repairs out here ...

...so leading firms use REEVES-HOFFMAN crystals down here

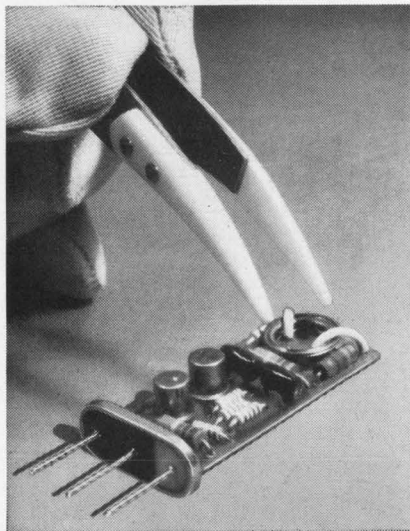

To guard against failure of the crystal "heart"—in outer space, under the sea, and in commercial and consumer applications — leading electronics firms specify Reeves-Hoffman. If reliability is important to you, we invite your inquiry concerning crystals and crystal-controlled filters and oscillators.

(Unit shown: RH 2967 microminature oscillator in RH-13 enclosure, 1.5" x .725" x .317")



400 WEST NORTH STREET, CARLISLE, PENNSYLVANIA 17013

ON READER-SERVICE CARD CIRCLE 96

## MATERIALS

### Alumina tubes made longer and larger

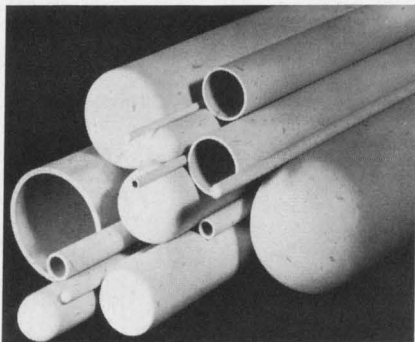

McDanel Refractory Porcelain Co., 510 9th, Beaver Falls, Pa. Phone: (412) 843-8300.

Closed-end and open-end 99.7% alumina tubes are offered in diameters of up to 6 inches and lengths up to 72 inches depending on the diameter. The manufacturer claims that 99.7 is the highest purity impervious alumina tube available. It is impervious and dense, which permits its use at temperatures up to 1900°C. Stable in both oxidizing and reducing atmospheres to melting point, it offers excellent resistance in severe applications. Standard sizes range from IDs of 1/4 to 6 inches and lengths of 48, 60 and 72 inches.

CIRCLE NO. 319

### Ferrous load material for microwave loads

Microwave Filter Co., Box 129, DeWitt Station, Syracuse, N. Y. Phone: (315) 446-0419. P&A: \$6 to \$42/ft; 24 hours.

A microwave load material, Ferrosorb, is intended for use in fabricating coaxial and waveguide loads and other dissipative circuit elements. The material is available in 12-inch-long bars having round, square and waveguide cross-sections. The material is a rigid, readily-machined absorber with high attenuation per unit length (6.25 dB/inch at 1 GHz). It is useful for fabricating coaxial and waveguide terminations and attenuator inserts, back-cavity choke rings and probe isolators. Dielectric dissipation factor is 0.045 from 1 to 10 GHz; dielectric constant is 19.

CIRCLE NO. 320

# LOOKING FOR RELAYS?

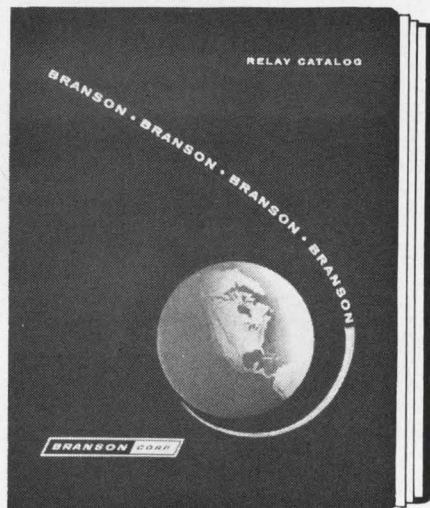

## THIS NEW DESIGNERS CATALOG BY BRANSON INCLUDES:



- TO-87 Flat Pack Relay

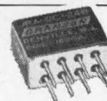

- 1/6 Size Relays  
2 & 4 pole •  
2 pole latching

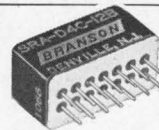

- 1/2 Crystal Can Relays  
2 & 4 pole •  
2 pole latching



- Solid State Time Delay Relays

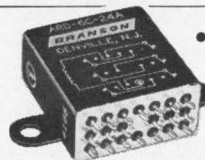

- Crystal Can Relays  
2, 4 & 6 pole

The Branson relay manual is complete with design data, application data, photos, type numbers, environmental, mechanical & electrical specifications.

Relays...  
Our Only Business

Write for your FREE Copy Now . . .

**BRANSON CORP.**

VANDERHOOF AVENUE  
DENVER, NEW JERSEY  
(201) 625-0600

ON READER-SERVICE CARD CIRCLE 97  
ELECTRONIC DESIGN 12, June 7, 1967



## Microwave absorber effective at 25 GHz

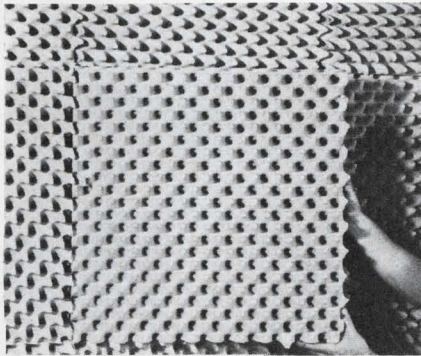

Emerson & Cuming, Inc., Canton, Mass. Phone: (617) 828-3300. P&A: \$10 to \$36/sheet; stock.

Eccosorb CV broadband microwave absorbing materials are for use in anechoic chambers. Because it is electrically tapered, a greater percentage of the energy passes into the material to be dissipated as heat. A smaller proportion of the energy is dissipated by scattering than is the case with flat-wall pyramidal type absorbers. The residual energy reflection is primarily specular and is insensitive to incident angles up to 70°. It is for use in the 25-GHz range.

CIRCLE NO. 321

## Ferroelectric ceramic is ultrasonic transducer

General Electric, Industry Control Dept., Salem, Va. Phone: (703) 389-7011. Price: from \$15 per disc.

A ferroelectric ceramic material, lead metaniobate, is a synthetic crystalline structure used as the element in ultrasonic transducers and probes. It is manufactured in small discs that are polarized to obtain bodies with permanent piezoelectric constants. Sizes and thickness of the discs determine the wave frequency emitted during operations. The ceramic, a brittle, crystalline compound, is polarized by applying a voltage at an elevated temperature. The compound is marketed as a disc 0.25 to 1.25 inches in diameter and as thin as 11 mils. Operating frequencies range from 100 kHz for a 0.5-inch-thick disc to 5.8 MHz.

CIRCLE NO. 322

# NEW

## COMPLETE LINE OF ELECTRONIC ALL SILICON COUNTERS...AS LOW AS \$445.



COUNTER TIMER MODEL CF-500R

If you have a counting application, then you need a counting device. Anadex has a complete new line of counting instruments



VARIABLE TIME BASE COUNTER MODEL CF-501R

for every function: preset counters, counter-timers, bi-directional counters, time interval counters, totalizers, frequency



FREQUENCY COUNTER MODEL CF-503R

counters, and variable time base counters. You have probably looked at other instruments and found they do more than you

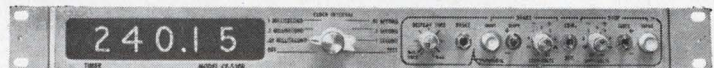

TIME INTERVAL COUNTER MODEL CF-530R

need. And you pay more. It stands to reason that if all you need is an instrument for a specific function, why pay extra dollars



TOTALIZER MODEL DC-500R

for needless frill functions. Anadex counters have in common several unique features: all-silicon solid state, plug-in transis-

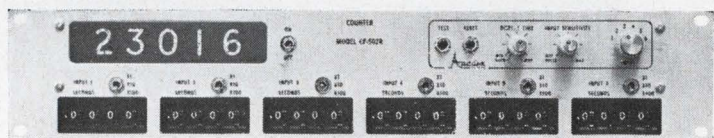

MULTI-CHANNEL VARIABLE TIME BASE COUNTER MODEL CF-502R

tors, 1 3/4" high panel space. If your interest is counting and you are tired of paying for things you don't need, Anadex has the instrument for you... you can count on it! Send for our new counter line catalog today.



RACK OR BENCH MOUNT



... THE NAME YOU CAN COUNT ON

7833 HASKELL AVENUE, VAN NUYS, CALIFORNIA 91406 PHONE 213-873-6620 TWX 213-781-6811

ON READER-SERVICE CARD CIRCLE 98

**PERMACOR<sup>®</sup>**  
 powdered iron cores  
 ...unequalled for  
 design and prompt  
 delivery!

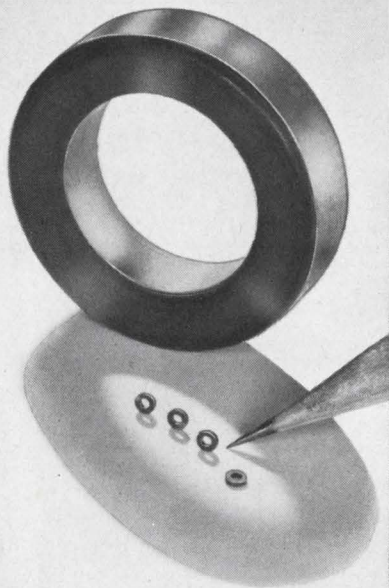

Illustrated: **TOROIDAL IRON CORES**  
 available from 1/8" to 2" O.D.

As the largest maker of iron cores in the world, we offer unequalled production and design facilities for any core design problem. AND, we stock a full line of standard cores at all times.

Need the best in cores . . . Plain, Hollow, Threaded, Insert, Tuning, Cup, and Toroidal Iron Cores, Iron Coil Forms, Sleeves, Flexible Magnetic Shielding, Bobbins and special shapes . . . write and find out why we are unequalled.

**PERMACOR<sup>®</sup>**  
 A Division of Radio Cores, Inc.  
 9540 Tully Ave., Oak Lawn, Ill. 60454  
 Phone: 312-422-3353

ON READER-SERVICE CARD CIRCLE 99  
 156

MICROWAVES

**IF amplifier features  
 low intermodulation**

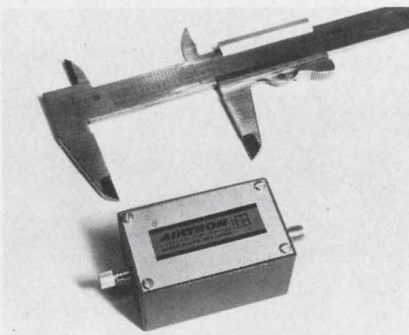

*Airtron Div., Litton Industries, 200 E. Hanover Ave., Morris Plains, N. J. Phone: (201) 539-5500. P&A: \$140 to \$190; 90 days.*

Transistorized IF amplifiers feature low intermodulation, crossmodulation and crossmodulation distortion. They use FETs to achieve crossmodulation of 0.5% and intermodulation spurious response of better than 60 dB. Center frequency is between 60 and 70 MHz and the units can be furnished with bandwidths of up to 20 MHz.

CIRCLE NO. 323

**X-band ssb generator  
 in lightweight package**

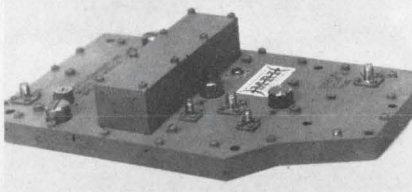

*Micro-Radionics, Inc., 14844 Oxnard St., Van Nuys, Calif. Phone: (213) 786-1760.*

A lightweight Air-strip package houses four basic sections: a mixer, a single-sideband generator, a test signal coupler and a 5-MHz quadrature hybrid section. The entire package weighs 24 ounces. The unit conforms to MIL-E-5400 and features a microphonic level of -150 dBm under extreme vibration conditions. The package is also designed to operate over a temperature range of -54° to +105°C with an MTBF of 8000 hours. All diodes are mounted in accessible holders for quick replaceability.

CIRCLE NO. 324

**Industrial CO<sub>2</sub> laser  
 rated at 50 watts**



*Eimac Div. of Varian, 301 Industrial Way, San Carlos, Calif. Phone: (415) 592-1221. P&A: \$8500; 60 days.*

A CO<sub>2</sub> laser is rated at 40 watts minimum and 50 watts typical output power at 10.6 microns. It has efficiency in excess of 10%. Spatial mode purity allows the IR output beam to be collimated for high-density transmission over large distances, and the 10.6-micron single-frequency output is useful for applications where wide bandwidth cannot be tolerated. The system includes the laser head and associated power supply, with an optional self-contained coolant heat exchanger.

CIRCLE NO. 325

**Pulse oscillator  
 puts out 35 kW**

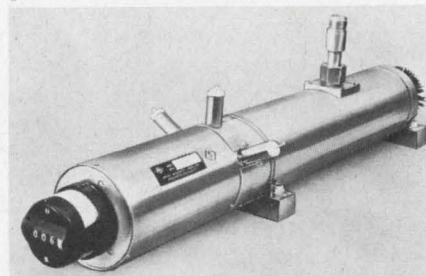

*Applied Microwave Lab, Inc., Andover St., Andover, Mass. Phone: (617) 475-6100.*

Model 5600-352 high-power pulse oscillator has a peak power in excess of 35 kW and a tuning range from 700 to 850 MHz. The oscillator has an input power of -85 kV at 9 A (peak), a pulse width of up to 6 μs and a duty cycle of 0.003 maximum. The over-all length of the unit is approximately 22 inches.

CIRCLE NO. 326

# Tips on cooling off hot transistors

See how circuit designers use IERC heat dissipators to protect semiconductors... improve circuit performance and life.

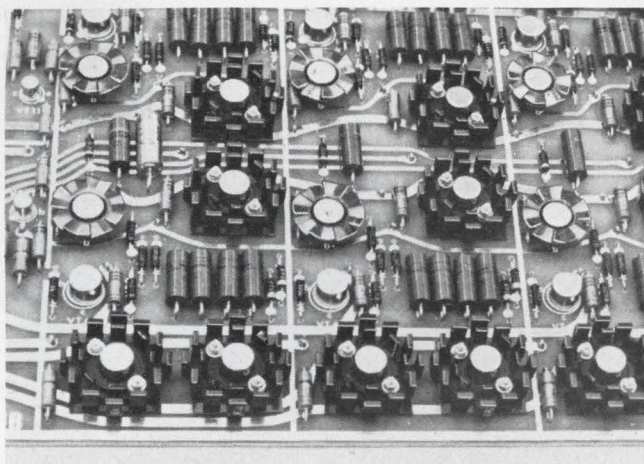

A 2N1837 transistor mounted only to a p-c board with IERC's unique LP dissipator can be operated at 5 watts with a junction temperature of only 153°C. The LP's clamping method makes good thermal contact on both surfaces of the transistor flange, minimizing thermal resistance from transistor to dissipator.

Heat from power transistors or diodes is quickly dissipated with IERC's HP dissipators. Large finger area maximizes efficiency in natural convection or forced air environments. Staggered-finger design which prevents finger surfaces from "looking at each other," radiates heat to the ambient, not back to the dissipator.

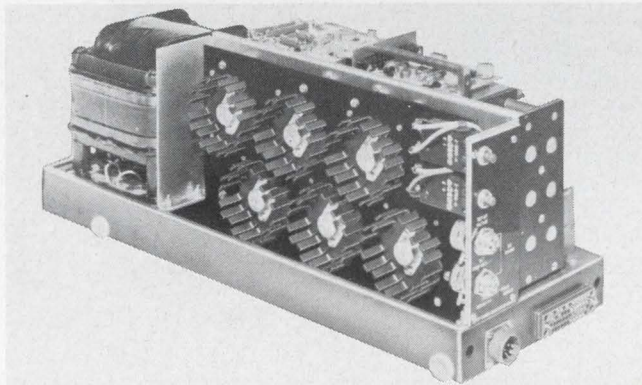

**Send for test reports.** The most thorough test reports in the industry are available on IERC Heat Dissipators. These are multi-page reports complete with graphs showing case and junction temperatures vs. power dissipation for transistors in several mounting conditions. Please indicate which test reports you wish—LP, UP, HP or Therma-Link. On your company letterhead, please.

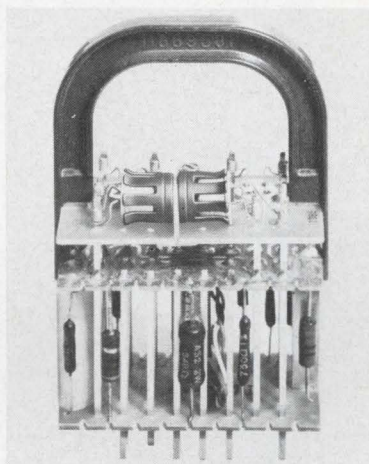

Mounting matched transistors for thermal stability so electrical characteristics stay identical is simple with back-to-back Therma-Link dissipators/retainers. Also used as heat sinks.

Fan-top dissipators increase transistor performance levels, permit use of cheaper transistors. Note how design needs no board space, permits other components to be positioned close by.

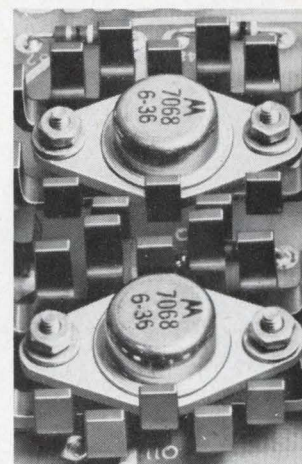
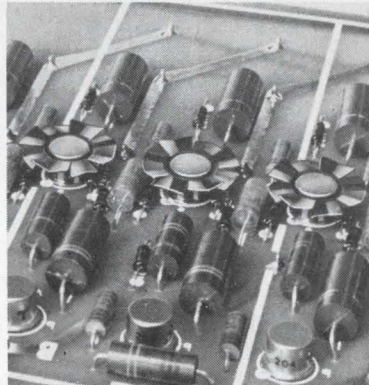

New dissipator for TO-66 transistor uses only 1.7 sq. in. of board space. IERC's unique, staggered-finger design dissipates 9 watts with case temperature of less than 150°C.

Free 8-page catalog gives complete pictorial and ordering data on IERC dissipators, retainers and tube shields, also prices. Send for a copy.

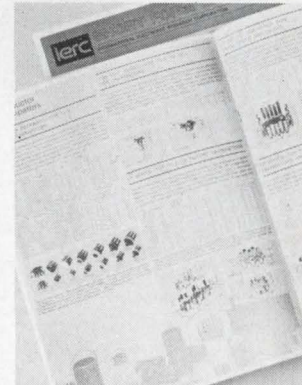

**ierc**  
SEMICONDUCTOR  
HEAT DISSIPATORS

# YTTRIUM AND RARE EARTHS

High purity  
oxides, metals,  
salts  
from the world's  
largest  
ion-exchange  
facility

## APPLICATIONS:

Phosphors  
Electronic Ceramics  
High Temperature  
Refractories  
Ceramic Control  
Materials  
Metallurgy  
Coloring Agents  
Permanent Magnets  
Lasers  
Catalysts  
Glass, Lenses  
Metal Halide Lamps

Like technical data on  
any of the above oxides  
or metals? Write, wire  
or call us about your  
specific interest.

**MICHIGAN  
CHEMICAL  
CORPORATION**



RARE EARTH SALES  
2 North Riverside Plaza  
Chicago, Illinois 60606

Copyright 1967 by Michigan Chemical Corporation RE-67-1

ON READER-SERVICE CARD CIRCLE 101

## MICROWAVES

### Balanced mixers are ultraminiature

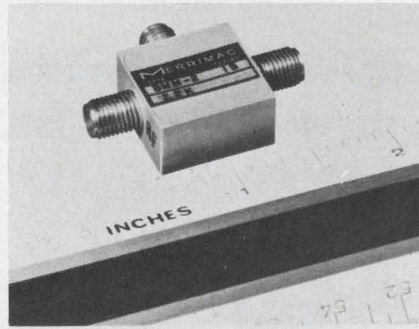

Merrimac Research and Development, Inc., W. Caldwell, N.J. Phone: (201) 371-1616. P&A: \$225; stock to 30 days.

Miniature balanced mixers for microwave applications measure 3/4 by 3/4 by 3/8 inch and weigh less than 1.2 ounce. They are designed for applications in the 1-to-5-GHz frequency range and use quadrature (90°) hybrids in conjunction with hot-carrier diodes. Noise at 1-dB IF is 6.3 dB, isolation is 12 dB, vswr is 1.25 and operating RF bandwidth exceeds 10%.

CIRCLE NO. 327

### Compact YIG filters tunable to 12 GHz



Scientific Atlanta, Inc., Box 13654, Atlanta. Phone: (404) 938-2930.

Electrically tunable YIG band-pass filters are tunable over octave or multioctave ranges to 12 GHz. The filters feature typical insertion loss of less than 2 dB for a two-element filter and less than 5 dB for a four-element unit. Vswr is less than 1.5 in the pass band and the 3-dB bandwidth is optional between 20 and 60 MHz. Several standard models are available for applications between 1 and 12 GHz.

CIRCLE NO. 328

## NOW...

a noted electronics expert and licensed private investigator reveals the secret techniques, devices, circuits, users and suppliers of bugs and anti-bugs!

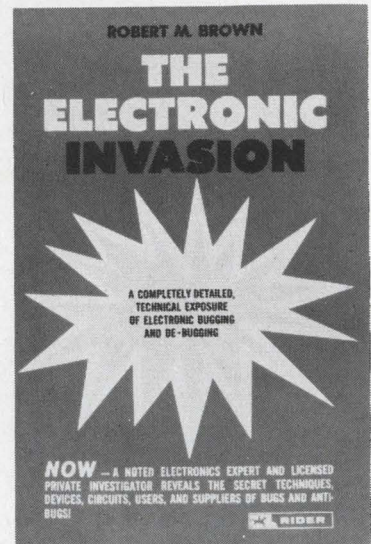

Don't miss this publishing first! You can now have a completely detailed, technical exposure of electronic bugging and de-bugging written by a noted expert—a man who mastered his first working two-wire telephone tap at the age of eleven.

Years of technical developments are explicitly described in fourteen fact-filled chapters: 1—Electronic Snooping—How It Evolved, 2—The Sellers and the Buyers, 3—Bugging the Telephone, 4—Eavesdropping Microphones and Miniature Audio Amplifiers, 5—FM Wireless Microphones and Room Bugs, 6—The Bumper Beepers, 7—The Recording Spies, 8—The Spy Receiver, 9—The Art of Bug Detection, 10—Electronic Bug Detection, 11—The Speech Scramblers, 12—Bugging and De-Bugging Circuits, 13—A Directory—Who Sells the Equipment?, 14—Eavesdropping and the Laws.

Order today—Only \$3.95  
**THE ELECTRONIC INVASION**

Robert M. Brown

184 pp, 5½x8½, fully illustrated, paper

Don't miss this opportunity to inform yourself fully about techniques and developments in this controversial activity and counter-activity.

At your bookseller, or order today for immediate delivery.

**10-DAY FREE EXAMINATION**

John F. Rider Publisher, Inc.  
116 W. 14 St., N.Y., N.Y. 10011

Rush me \_\_\_\_\_ copies of THE ELECTRONIC INVASION @ \$3.95. After ten days' free use I will either remit payment plus a few cents' postage or return the book thereby cancelling any charges.

Name \_\_\_\_\_

Address \_\_\_\_\_

City \_\_\_\_\_ State \_\_\_\_\_ Zip \_\_\_\_\_

Save money! Enclose payment with order and publisher pays all postage charges. Same money-back return privilege.

## Portable ruby laser trims components



Korad Corp., 2520 Colorado Ave., Santa Monica, Calif. Phone: (213) 393-6737. P&A: under \$4000; 30 to 45 days.

A portable ruby laser that sells for less than \$4000 is also available with neodymium-doped glass. It emits at 6943 Å using ruby and at 10,600 Å using glass. The hand-held laser head is 7-1/2 inches long by 2-1/2 inches in diameter. It has a typical output of 1 joule with a 150-to-200- $\mu$ s pulse width. Beam angle (half-angle, half-power) is 4 milliradians with ruby, 3 milliradians with glass.

CIRCLE NO. 329

## Cordwood delay line for telemetry use

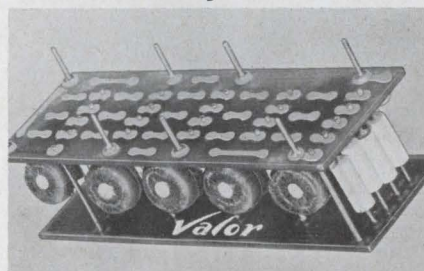

Valor Electronics, Inc., 13214 Crenshaw Blvd., Gardena, Calif. Phone: (213) 321-2280. P&A: under \$50; 6 wks.

This unpotted cordwood-type delay line is designed for use in space telemetry equipment where light weight and small size are requirements. Composed of 20 sections, the delay line is 2 inches long, 5/8 inch high and 0.6 inch wide. Weight is about 10 grams. With a delay time of 2  $\mu$ s, the unit has a rise time of 250 ns and an impedance of 1000  $\Omega$ .

CIRCLE NO. 330

# RESISTOR MAKERS HAVE BEEN TRYING TO PACK ALL THESE SPECS INTO ONE RESISTOR

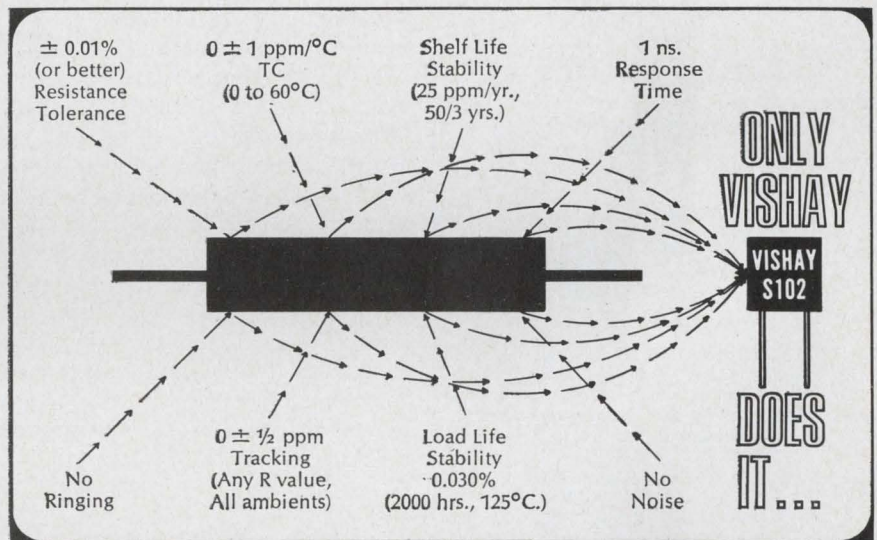

in a practical small size, available in production quantities with fast delivery. And at competitive prices, too!

No wirewound can give you this precision *plus* speed.

No conventional evaporated film can give you this speed *plus* precision and TC.

No other precision resistor gives you all this performance in a small-size unit.

So, why trade off when you don't have to? Simplify your circuit designs, avoid special compensating circuits and get better system performance.

These valuable guides to new thinking in resistor and network performance are free. Write for your copies today.

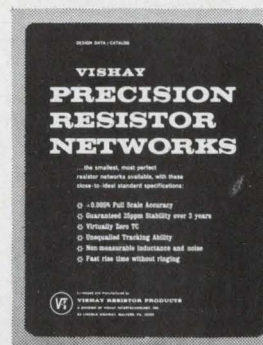
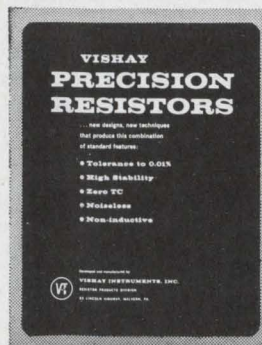

**VISHAY**  
**RESISTOR**  
**PRODUCTS**  
a division of Vishay  
Intertechnology, Inc.  
63 Lincoln Highway  
Malvern, Pa. 19355

ON READER-SERVICE CARD CIRCLE 103

**This is probably the most reliable 1200 lb vibration test system made.**

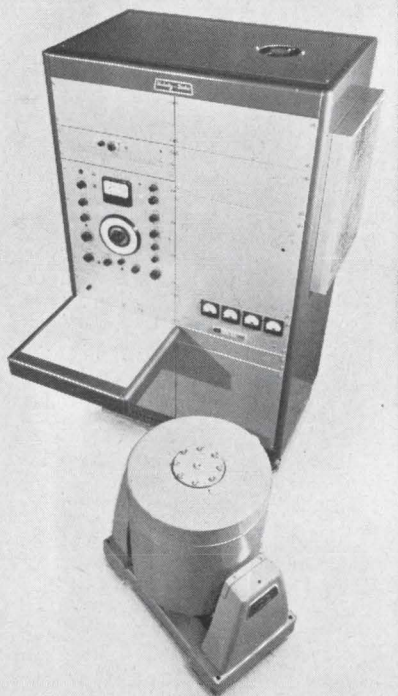

The shaker's moving element and its suspension are warranted for two years — a guarantee unmatched in the industry. System control is "push-button" — simple yet safe. It is thoroughly protected for all overdrive conditions with automatic shutdown circuits. For the complete story on Unholtz-Dickie test equipment, write today.

manufacturers of vibration test systems, advanced instrumentation, accelerometers

**UNHOLTZ-DICKIE CORPORATION**  
3000 Whitney Ave./Hamden, Conn. 06518

ON READER-SERVICE CARD CIRCLE 104

## MICROWAVES

### Microwave switch covers 1 to 18 GHz

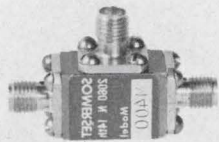

Somerset Radiation Labs., Inc.,  
2060 N. 14th St., Arlington, Va.  
Phone: (703) 525-4255. P&A:  
\$215; 20 days.

Covering 1 to 18 GHz instantaneously, this switch has isolation of over 40 dB above 8 GHz, insertion loss of 0.5 to 2 dB, and power-handling capability of 2 W cw and 100 W peak. The model M400 is suited for service in pulse modulators and shapers, amplitude modulators, T-R switches, limiters, attenuators, automatic gain controls and power levelers. Oxide-passivated silicon pin diodes integrated into a 50-Ω miniature coax line and a bias circuit that overcomes the frequency limitations of conventional blocking capacitors realize the 18:1 bandwidth.

CIRCLE NO. 331

### S-band preamps cut system noise

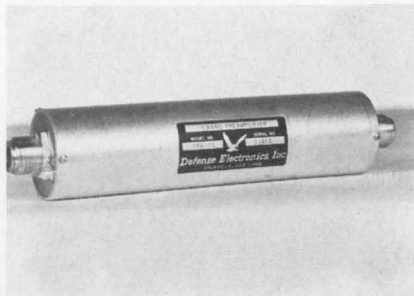

Defense Electronics, Inc., Rockville, Md. Phone: (301) 762-5700.

Solid-state, S-band preamplifiers feature wide dynamic range, a 6-dB noise figure and 20-dB gain with a minimum output of -5 dBm for 1-dB amplitude compression. Designed for use with any S-band telemetry receiver, the TPA-70 reduces over-all system noise figures to approximately 6 dB in place of the 11 to 12 dB previously available without preamps. It has an estimated 340,000 hour MTBF figure.

CIRCLE NO. 332

### Solid-state source gives 2 W at 1 GHz

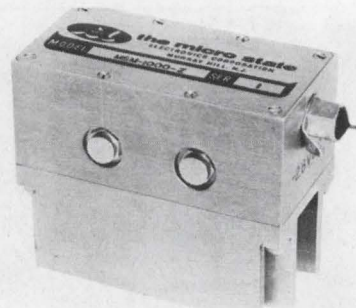

Micro State Electronics Corp., 152 Floral Ave., Murray Hill, N. J. Phone: (201) 464-3000.

A solid-state microwave source produces 2 watts of power in the 1-GHz range. The unit has a mechanical tuning range from 950 to 1080 MHz and a frequency stability of 2 parts per thousand over a temperature range of -30° to +60°C. It converts electrical energy from dc to RF frequencies with an efficiency greater than 30%. Spurious response is -35 dB below the fundamental frequency. The unit operates on a supply of -28 Vdc.

CIRCLE NO. 333

### Solid-state transmitters cover S- and L-band

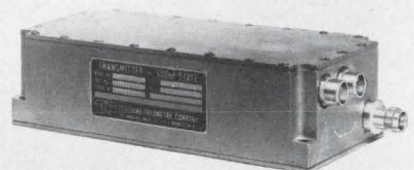

Teledyne Telemetry, 9320 Lincoln Blvd., Los Angeles. Phone: (213) 670-7256. P&A: \$2900; 90 days.

Series TR2200 (S-band) and TR1400 (L-band) transmitters offer RF output power levels from 0.5 to 10 watts. Designed for missile and satellite applications, they conform to IRIG 106-66 and are capable of wideband deviation (to ±10 MHz) and high frequency response (beyond 7 MHz). Free-running RF oscillators make it possible to provide linear wideband modulation (better than 1% linearity to 10 MHz) with frequency response within ±1 dB from dc to over 7 MHz, and deviation sensitivities to 0.4 mV/kHz peak.

CIRCLE NO. 334

# New epoxy transistors

## 2N3605A

Electrically similar to the 2N914.

Price: 20 to 25¢ in volume.

V <sub>CB0</sub> ..... 40V	t <sub>s</sub> ..... 20nsec.
V <sub>EB0</sub> ..... 5V	t <sub>on</sub> ..... 35nsec.
V <sub>CE0</sub> ..... 15V	t <sub>off</sub> ..... 45nsec.
h <sub>FE</sub> ..... 30-120 @ I <sub>C</sub> =10mA; V <sub>CE</sub> =1V	
V <sub>CE(SAT)</sub> ..... 0.25V @ I <sub>C</sub> =10mA; I <sub>B</sub> =1mA	

This is an excellent medium-speed saturated switch for computers and electronic calculators. These transistors offer low storage times and are available in sample quantities now.

## 2N5027

Electrically similar to the 2N2539.

Price: 20 to 25¢ in volume.

V <sub>CB0</sub> ..... 60V	t <sub>d</sub> @ I <sub>C</sub> =150mA... 15nsec.
V <sub>CE0</sub> ..... 30V	t <sub>r</sub> @ I <sub>C</sub> =150mA... 20nsec.
V <sub>CE(SAT)</sub> @ 150mA. 0.45V (max.)	t <sub>s</sub> @ I <sub>C</sub> =150mA... 35nsec.
V <sub>BE(SAT)</sub> @ 150mA. 1.3V(max.)	t <sub>f</sub> @ I <sub>C</sub> =150mA... 25nsec.

This transistor for medium-current, high-speed saturated switching is available in sample quantities as a core driver for computers. Take advantage of its superior h<sub>FE</sub> linearity with current (50 @ 150mA min.).

## 2N4424

Good Beta linearity from 2mA to 100mA.

Price: 25 to 30¢ in volume.

BV <sub>CE0</sub> ..... 40V min.
I <sub>C</sub> ..... 400mA
h <sub>FE</sub> @ 2mA..... 180-540
V <sub>CB0</sub> ..... 40V min.

This general purpose amplifier can add even more epoxy economies to auto radios, TV's, home radios and many other products.

## 2N5029

Electrically similar to the 2N2369.

Price: 20 to 25¢ in volume.

V <sub>CB0</sub> ..... 40V	t <sub>d</sub> @ I <sub>C</sub> =10mA..... 10nsec.
V <sub>CE0</sub> ..... 15V	t <sub>r</sub> @ I <sub>C</sub> =10mA..... 12nsec.
h <sub>FE</sub> @ 10mA. 40-120	t <sub>s</sub> @ I <sub>C</sub> =10mA..... 12nsec.
	t <sub>f</sub> @ I <sub>C</sub> =10mA..... 14nsec.
V <sub>CE(SAT)</sub> @ 10mA..... 0.25V max.	
V <sub>BE(SAT)</sub> @ 10mA..... 0.87V max.	

Now: a high speed saturated switch in an epoxy economy package for computers.

# All with the outstanding moisture resistance of GE's newest epoxy package

That's right. These four new NPN planar passivated silicon transistors are as reliable as the hermetically sealed devices you are using now. Yet they cost less than half as much. The reason is GE's newest innovation in epoxy packaging techniques.

General Electric's new epoxy package is far less moisture sensitive than other plastics; and it will improve performance at higher ambients and junction temperatures.

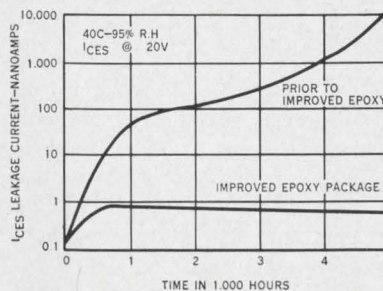

This is just one more example of the total electronic capability you get from General Electric. Call your GE engineer/salesman or authorized distributor for more information. Or write to: General Electric Company, Section 220-51, Schenectady, New York 12305. In Canada: Canadian General Electric, 189 Dufferin St., Toronto, Ontario. Export: Electronic Component Sales, IGE Export Division, 159 Madison Ave., New York, N. Y.

SEMICONDUCTOR PRODUCTS DEPARTMENT

**GENERAL**  **ELECTRIC**

ON READER-SERVICE CARD CIRCLE 109



## "I DON'T MIND PAYING A LITTLE LESS"

With An Airways Businessman's Credit Card He'll Save Even More Money

Being a practical man and a business traveler, this man knows he qualifies for a special Rent-A-Car discount by presenting his AIRWAYS BUSINESSMAN'S CREDIT CARD at any of over 200 AIRWAYS offices. He knows AIRWAYS regular rates are lower than other rent-a-car companies including their 20% corporate discounts. With an AIRWAYS BUSINESSMAN'S CREDIT CARD he knows he'll enjoy even greater savings. He knows AIRWAYS provides 1967 Chevrolets, Buicks, Pontiacs — even Cadillacs. He also knows he'll save time because he simply calls when he arrives at the airport and AIRWAYS will probably arrive before his luggage. We have downtown offices, too. **He knows it — AIRWAYS knows it — now YOU know it.**



Pontiac Le Mans

Send for your free AIRWAYS BUSINESSMAN'S CREDIT CARD now. Write to: Dept. 6ED

AIRWAYS RENT-A-CAR

8405 Pershing Drive  
Plava Del Rey, California 90291



ON READER-SERVICE CARD CIRCLE 105

## Service... Engineering... Experience

MAKE THE **BIG** DIFFERENCE  
BETWEEN A YOKE SPECIALIST  
AND A YOKE SUPPLIER

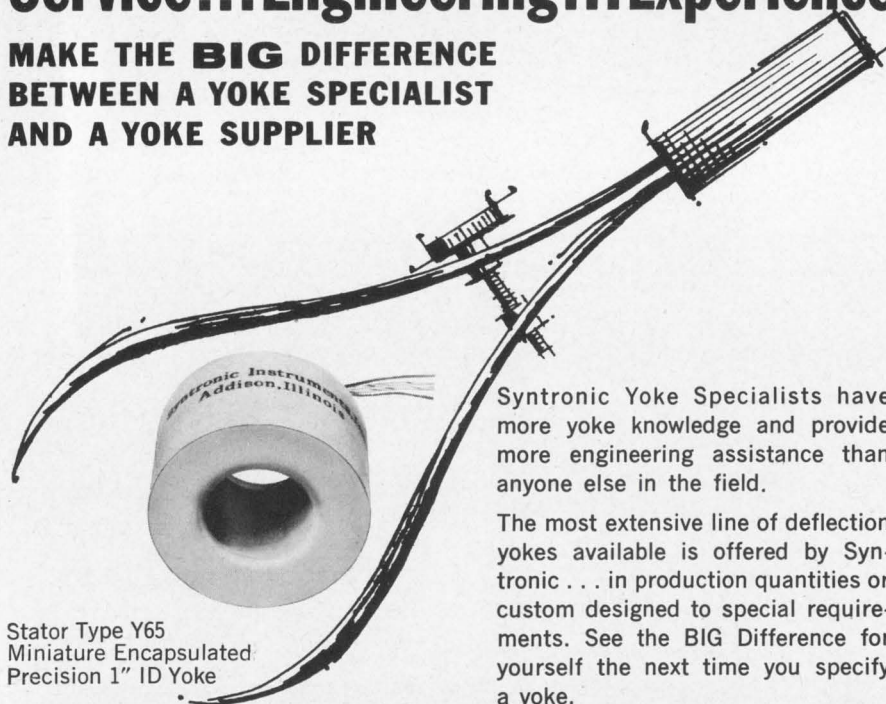

Stator Type Y65  
Miniature Encapsulated  
Precision 1" ID Yoke

Syntronic Yoke Specialists have more yoke knowledge and provide more engineering assistance than anyone else in the field.

The most extensive line of deflection yokes available is offered by Syntronic... in production quantities or custom designed to special requirements. See the **BIG** Difference for yourself the next time you specify a yoke.

**syntronic** INSTRUMENTS, INC.  
100 Industrial Road, Addison, Illinois Phone 312, 543-6444

ON READER-SERVICE CARD CIRCLE 106

## MICROWAVES

### 10-MW YAG laser has rep rate to 50 pps

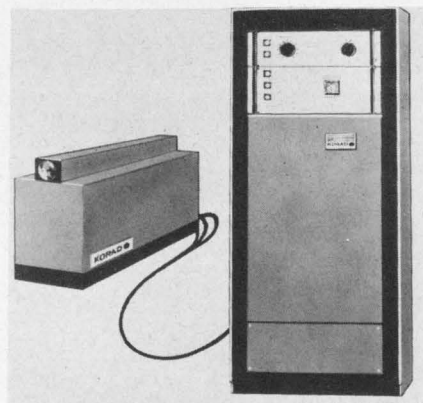

Korad Corp., 2520 Colorado Ave.,  
Santa Monica, Calif. Phone: (213)  
393-6737. P&A: about \$25,000; 90  
days.

A 10-MW yttrium aluminum garnet laser has a repetition rate of up to 50 pulses per second. The neodymium-doped device emits at 1.06 microns, in the IR, with a pulse-width of less than 10 ns, energy output of 100 millijoules per pulse and average power of 5 W. It uses a 5-by-50-mm coreless YAG rod. A closed-cycle liquid system is used.

CIRCLE NO. 335

### Tiny bandpass filters range to 8 GHz



I-Tel, Inc., 10504 Wheatley St.,  
Kensington, Md. Phone: (301) 946-  
1800.

Microminiature bandpass filters, 1/4 inch in diameter and less than 1/2 inch long, are available in center frequencies to 8 GHz. Basically, the filters consist of resonators connected in series between coax connectors. The resonators are suspended in a Teflon dielectric and housed in a gold-anodized aluminum tube. The result is a package small enough for PC boards.

CIRCLE NO. 336



## Pulsed amplifron puts out 3 MW

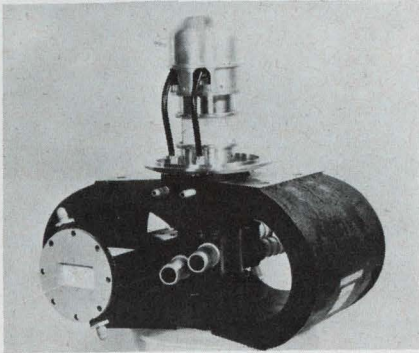

Raytheon Co., Microwave and Power Tube Div., Waltham, Mass. Phone: (617) 899-8400.

A pulsed-type amplifron is capable of power output levels from 0.5 to 3 MW over a range of 5.4 to 5.9 GHz. It is an integral magnet tube with waveguide input and output. In a typical operation, peak power would be 0.5 MW with average power output of 15 kW. With a duty cycle of 0.03 its pulse duration would be 200  $\mu$ s. Peak anode voltage would be 48 to 53 kV, peak anode current, 16 A, and driver peak power, 40 kW.

CIRCLE NO. 337

## Waveguide isolators measure 0.5 inch long



Airtron Div., Litton Industries, Morris Plains, N. J. Phone: (201) 539-5500. P&A: about \$132; 60 days.

Only one-half inch long and weighing 2 ounces, this compact aluminum isolator has a cross-section no larger than a standard UG flange. Isolation is typically 25 dB, insertion loss is 0.2 dB, and vswr is 1.1. For an X-band unit operating over 8.85 to 9.15 GHz, the dimensions are 1.62 in<sup>2</sup> by 0.5 inch long.

CIRCLE NO. 338

# You just figure out what you need in a

# SPRING WIRE

## We'll "draw" the conclusions.

Little Falls Alloys specializes in custom work in non-ferrous spring wire. You name the size, shape, tolerance, temper, alloy and quantity . . . and we draw it that way. In fact, we diamond draw it, to ensure the best possible surface and the highest degree of uniformity.

Little Falls Alloys is particularly known for its ability with Beryllium Copper — age hardenable or pre-tempered "Silvercote"<sup>®</sup> or bare. We are the leader in the development of this wire for commercial use.

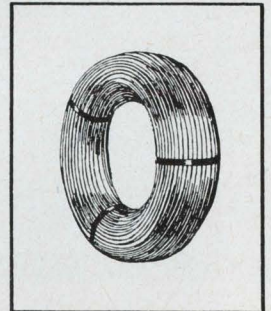

So, whether you want us to meet your specifications or you want engineering help in designing your nonferrous spring wire, come to Little Falls Alloys. It's a great place to be when you have a nonferrous wire requirement to fill.

## beryllium copper

Phosphor Bronze ■ Nickel Silver  
Brass ■ Titanium ■ Zirconium Copper  
Nickel (NASA 270) ■ Beryllium Nickel  
OFHC Copper

### CLOSE TOLERANCES



We meet and certify all standard specifications

**ROUND, FLAT, SQUARE, RECTANGULAR AND SPECIAL SHAPES**

Write for our technical metals catalog

# Little Falls Alloys, Inc.

189 CALDWELL AVE., PATERSON, N. J. 07501 / 201 - 525-1014

ON READER-SERVICE CARD CIRCLE 107

Compare the  
**All-New PAMOTOR  
 Model 4500 with**  
 the miniature  
 axial fan  
 you're now using!

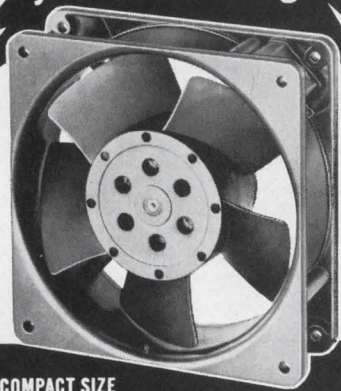

**COMPACT SIZE**

Only 4 1/16" x  
 4 1/16" x 1 1/2".  
 Weighs just 1 1/4  
 lbs. Inter-  
 changeable with  
 similar, less reli-  
 able 4 1/16" fans.

**POWERFUL MOTOR**

Dependable shaded-pole motor operates with low internal heat rise. Efficient inside-out design.

**ALL-METAL CONSTRUCTION**

Precision die cast housing, hub, impellers. Corrosion resistant. Natural heat sink. Warp-free, unlike conventional plastic fans.

**115 CFM WITH LESS  
 THAN 37.5 dB SIL\***

\*Speech Interference Level

- Lubrication-free life in excess of 20,000 operational hours, continuous duty at 55° C.
- Delivers more air at a lower noise level, yet priced under similar conventional plastic fans.
- Model 4500 designed for 117V/50-60 Hz operation. Model 4550 operates at 230V/50-60 Hz.
- Now available for immediate delivery through leading electronic distributors or directly from factory stock.
- Has Underwriters' Laboratories Inc. Yellow Card Component Recognition Number E41168.

Write to  
 PAMOTOR, INC., 312 Seventh St.  
 San Francisco, California 94103.

**PAMOTOR, INC.**

ON READER-SERVICE CARD CIRCLE 121

PRODUCTION EQUIPMENT

**Semiconductor diodes  
 automatically scribed**



*Mechanization Associates, 2622  
 Frontage Rd., Mountain View,  
 Calif. Phone: (213) 967-4262.  
 Price: \$2300.*

A completely automatic scriber for semiconductor diodes accommodates wafers to 2 inches. After dialing in the die size wanted, the operator presses a button and the machine scribes the wafer completely in one direction, rotates 90°, scribes in the other direction, stops and turns itself off. The completely integrated control circuitry controls to an accuracy of 0.0005 inch. The scribing force can be adjusted from 5 to 75 grams.

CIRCLE NO. 339

**IR solder machine  
 bonds multilead packs**

*Federal Tool Engineering Co., 1384  
 Pompton Ave., Cedar Grove, N. J.  
 Phone: (201) 256-5300. P&A: from  
 \$3200; stock.*

An infrared miniature soldering machine solders all leads of a flat-pack simultaneously to a PC board in three seconds or less. An integral IR apparatus provides highly accurate heat focus to make the solder joints, eliminating process contamination and thermal shock damage.

The circuit board is placed into a fixture attached to the X-Y table. A swingaway arm picks up the module from a built-in magazine and carries it to the IR work "chamber". The table then positions the board, and the arm lowers the module onto the board for soldering.

CIRCLE NO. 340

**Microcircuits bonded  
 with glass capillaries**

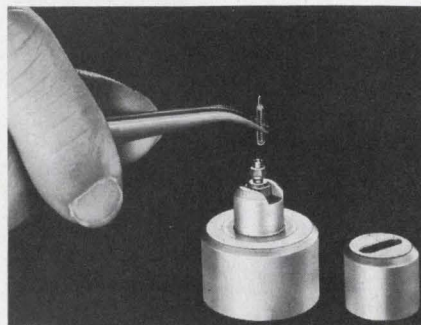

*Specialty Glass Products, Inc., 144  
 Terwood Rd., Willow Grove, Pa.  
 Phone: (215) 659-8400. P&A: (ca-  
 pillaries) \$3.75 to \$5 (500 to 999);  
 stock.*

Bonding capillaries featuring low-cost, easy-to-clean, replaceable glass tips provide fast, effective thermocompression bonding of microcircuits, yet cost much less than conventional metal tips. In addition, the heated glass tips provide better bonding because of the natural smoothness of glass. Unlike metal, the surface of glass is not granular and is completely inert. This eliminates deterioration of the bore and adverse chemical reaction between the tip and the gold bonding wire. Consequently, there is less buildup of gold floss within the tip bore and considerably less plugging. When plugging does occur, the plugged tip is simply removed and replaced with a new heated glass tip in a matter of seconds. Tips are cleaned simply by letting them soak in a solution of aqua regia. Tips are available in various sizes with bores as small as 0.0005 inch in diameter, accurate to ±0.0001 inch. Tip ODs are held to ±0.0005 inch.

CIRCLE NO. 341

**Coil winding machine  
 programmed by tape**

*Coil Winding Equipment Co., Oyster Bay, N. Y. Phone: (516) 922-5660.*

Two sequential operations can be controlled while a third is being performed with this tape-controlled automatic coil winding machine. Turns counting, motor speed control, cutting and cementing, and loading and ejecting the empty bobbin can be controlled by the tape program.

CIRCLE NO. 342

# Comar doesn't shy away from the tough one's



Anyone can handle the easy relay applications, but it takes a company with engineering knowhow, manufacturing superiority and just plain "guts" to take on the tough one's.

The engineers at Comar have an enviable record of rolling up their sleeves and burning the midnight oil to meet stringent relay specifications . . . shock, vibration, miss testing, humidity, special operating characteristics.

The next time someone tells you "it can't be done," call Comar. No miracles, just technical experience and the finest relay test laboratory in the world!



## Comar electric company

3349 Addison Street  
Chicago, Illinois 60618

TELEPHONE TYPE RELAYS • SUBMINIATURE RELAYS •  
RELAY ASSEMBLIES • SOLENOIDS • SOLENOID ASSEMBLIES

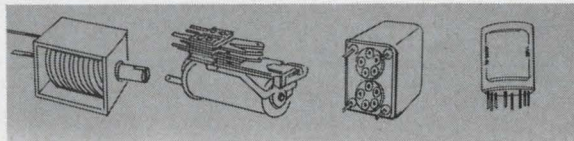

ON READER-SERVICE CARD CIRCLE 122

# LOW PROFILE IC PACKAGING SOCKET

**New**

Directly interchangeable! Exclusive socket configuration, identical to IC package, saves time, simplifies mounting on P C board.

- Permits card stacking on 1/2" centers
- Accepts packages with flat or round leads
- Easy IC insertion with wiping type beryllium copper contacts
- Easy extraction, minimum lead damage—optional extractor tool available
- Available in diallyl phthalate or black phenolic with gold or tin-plated contacts
- Dimensions .79 L x .49 W x .31 H

Request Data Sheet 166.

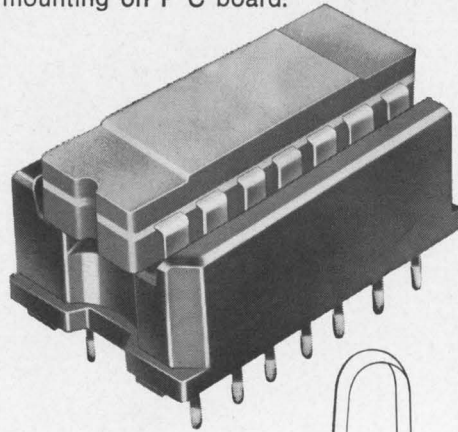

Extractor tool



**AUGAT**

INC. 31 PERRY AVE., ATTLEBORO, MASS. 02703

ON READER-SERVICE CARD CIRCLE 123

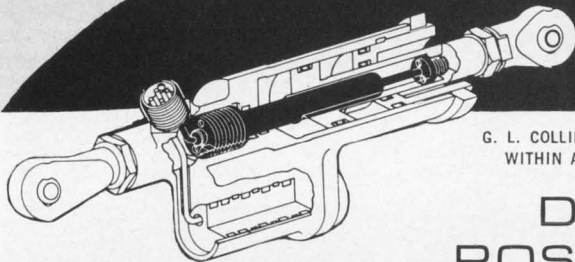

G. L. COLLINS TRANSDUCER  
WITHIN AN ACTUATOR

## D.C. POSITION TRANSDUCER FOR COMPACT INSTALLATION

- G. L. Collins' D. C. Transducer has the engineered capabilities built in
- Internal Mounting offers armored protection and fluid cooling.
- Probe may be separated from transducer body for easy actuator assembly.
- Pressure sealed for operation to 9000 PSI.
- Probe assembly free to rotate with actuator piston.
- Allows zero-backlash probe attachment.
- Electrical windings isolated from hydraulic fluid without the use of seals.
- No remote electronic modules required.
- No precision alignment of probe and transducer body necessary.
- Billion-cycle reliability.
- Controlled manufacturing system perpetuates the same unexcelled accuracy and reliability that have made G. L. Collins transducers FIRST CHOICE among major aerospace control system engineers.

Listed in VSMF, ASCAM and Thomas Microfilm Catalogs



**G. L. COLLINS CORP.**

5875 Obispo Ave., Long Beach, California 90805  
(213) 636-8141 OR 630-3121 • TWX (213) 634-4095

ON READER-SERVICE CARD CIRCLE 124

## SYSTEMS

### Pulse pattern generator for off-line tests



Western Telematic Inc., 5507 Peck Rd., El Monte, Calif. Phone: (213) 442-1862. P&A: \$1192; 4 to 6 wks.

This pulse pattern generator combines a pulse pattern source with a start-stop teleprinter word generator in a single unit. It provides two separate modes of operation. Mode 1 is a pulse pattern generator consisting of a 64-bit frame with all bits and synchronization under user control. Serial output is RZ or NRZ with both outputs presented simultaneously. Mode 2 is a teleprinter mode providing up to an 8-word message in operator-selected bit lengths. Common to both modes is the selection of baud rate, from an internal or external clock, permitting operation to 1 MHz.

CIRCLE NO. 343

### Ferrite core memories store 4096 words, 36 bits

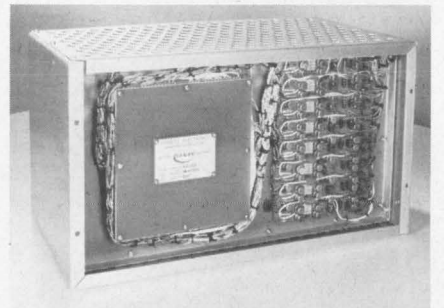

Borders Electronics Mfg. Co., Inc., P. O. Box 517, Pennsauken, N. J. Phone: (609) 665-0226. P&A: from \$1000; 3 wks.

High-reliability ferrite core memories provide storage capacities ranging from 64 to 4096 words and word length from 2 to 36 bits. Access time is 2  $\mu$ s and full-cycle time is as fast as 5  $\mu$ s. The memories consist of input/output data registers, digit drivers, sense amplifiers, current drivers and address switches.

CIRCLE NO. 344

## Core memory system cycles in 0.5 $\mu$ s

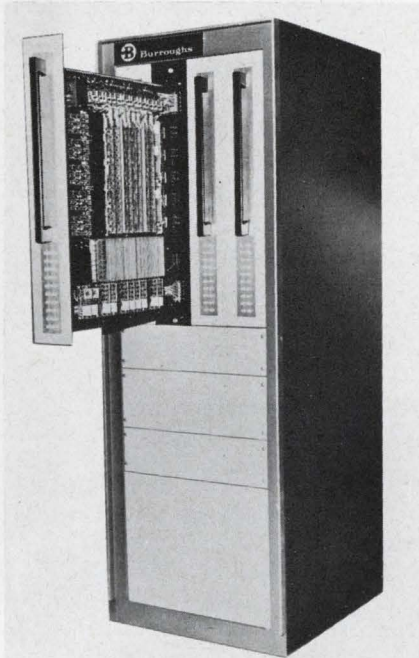

Burroughs, P. O. Box 1226, Plainfield, N. J. Phone: (201) 757-5000.

With cycle time of 0.5  $\mu$ s, these core memory systems are some 20% faster. The systems feature a building block construction where each basic module is either 4092 words or 8192 words by 20 bits. Larger systems can be accommodated by building up the word capacity and bit length in any combination. The 2-1/2D core stack, sense amplifiers, driver circuits and information registers are integral.

CIRCLE NO. 345

## A-to-D converters have low conversion time

Redcor Corp., 7800 Deering Ave., Canoga Park, Calif. Phone: (213) 348-5892. Price: \$1950 (13-bit unit).

Analog-to-digital converter modules over a 22-1/2-ms total conversion time and up to 15-bit accuracy. Model 610 includes a reference power supply and features a choice of eight output logic levels. The 1-1/2-ms per bit speed of the unit is achieved through the use of FET switches. The clock and reference power supply can be slaved to external references.

CIRCLE NO. 346

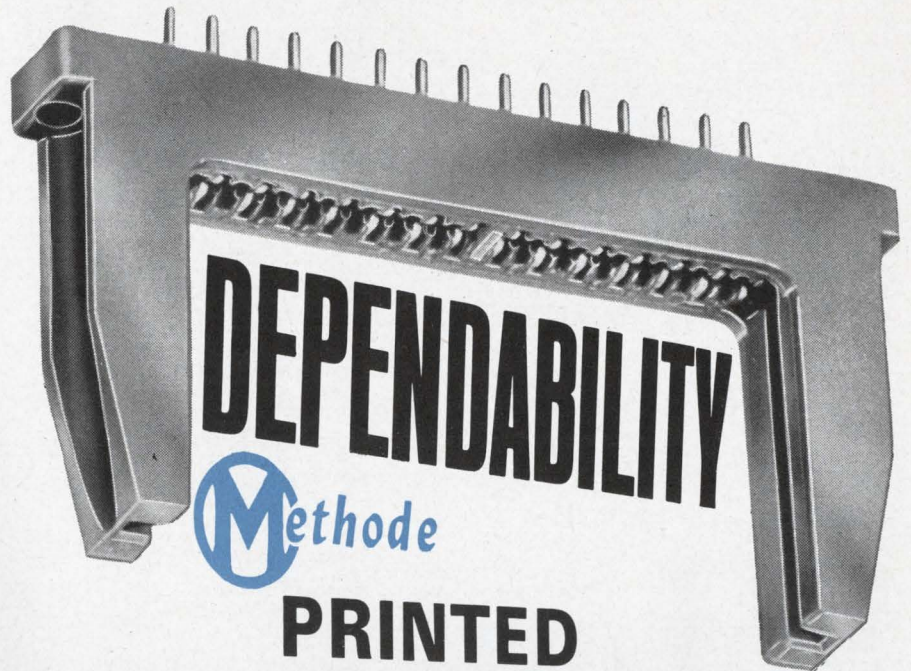

## PRINTED CIRCUIT CONNECTORS

If your design requirements need printed circuit connectors of exceedingly high quality, but your design application is such that you do not need connectors made to military specifications . . . talk to METHODE.

We stock a full line of dependable Reli-acon printed circuit connectors from the largest to the smallest sizes with a variety of contact designs. And all Reli-acon connectors are made to rigid quality standards that give you the reliability you need . . . without paying the premium prices that mil spec. connectors command. However, Methode's MIL-C-21097B fully approved connectors are available to meet your military requirements.



Write for illustrated  
catalog with full  
engineering specifications.

Connector Division

**Methode Electronics, Inc.**  
7447 W. Wilson Avenue  
Chicago, Illinois 60656 • 312/867-9600



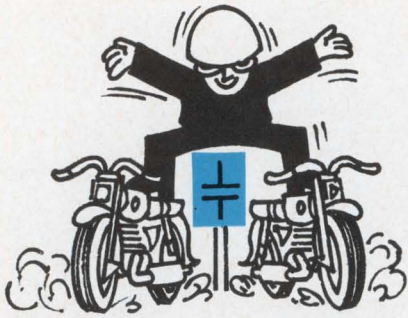

When you need a wide capacitance range and high performance in a small size...

# PAKTRON<sup>®</sup>

MOLDED AND DIPPED CAPACITORS OF MYLAR

are your answer!

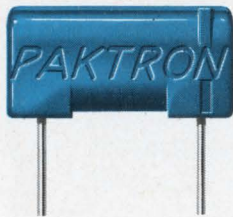

When your capacitor needs require you to think broadly in relation to capacitance and voltage range, then PAKTRON epoxy molded (shown above) and dipped capacitors of MYLAR\* film/foil are your answer. They are designed to provide the widest possible capacitance range and most useful voltage ratings in the smallest practical sizes.

The PAKTRON molded line (shown) offers values through 0.1 mfd. and voltage ratings through 200 WVDC. The dipped line (not shown) provides values through 0.5 mfd. and voltage ratings through 600 WVDC.

Unique PAKTRON construction techniques and high grade epoxy coatings insure stability under severe environmental conditions including shock and vibration.

See for yourself, ask for full details and free samples—no obligation.

\*A DuPont Registered Trademark

"Remember, you're never more than a few feet away from a product of ITW"<sup>®</sup>



ON READER-SERVICE CARD CIRCLE 126

## COMPONENTS

(continued from p. 138)

### Metal film resistors are end-capped

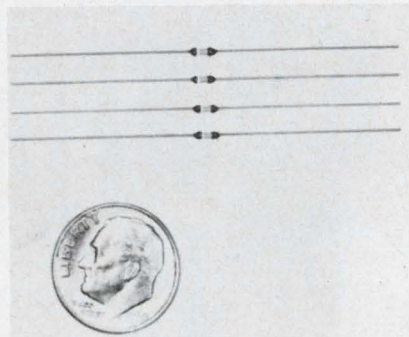

American Components, Inc., 8th Ave. at Harry St., Conshohocken, Pa. Phone: (215) 828-6240. P&A: 59¢ to \$3.51; stock to 3 wks.

Microminiature metal film resistors use end-cap construction to withstand stresses during lead cutting, forming, and soldering. Rated at 50 mW at 100°C and 100 V, the units have body dimensions of 0.04 inch diameter by 0.132 inch long. Resistance range is 25 Ω to 25 kΩ in ±1% tolerance. Temperature coefficients are ±50, ±100 or ±150 ppm/°C.

CIRCLE NO. 347

### Reed relays operate at IC power levels

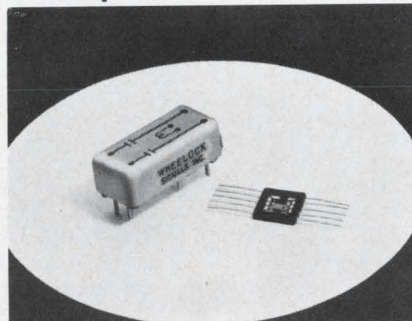

Wheelock Signals, Inc., 273 Branchport Ave., Long Branch, N. J. Phone: (201) 222-6880. P&A: \$5 to \$15; 4 wks.

Sensitive reed relays for high-density switching with ICs require approximately 60 mW of power per pole at rated voltage. This allows them to be driven directly from ICs, without driver stages. Series 442S is available in one- to four-pole models. Contacts are rated at 4 watts.

CIRCLE NO. 348

### Tantalum foil capacitors rated at 125°C

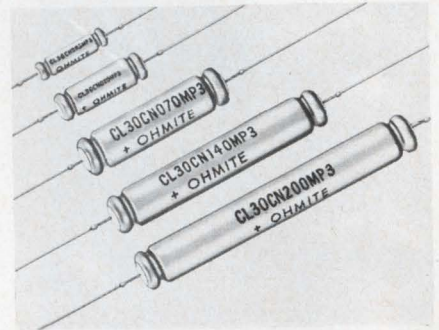

Ohmite Manufacturing Co., 3683 Howard St., Skokie, Ill. Phone: (312) 675-2600.

Plain and etched tantalum foil capacitors rated at 125°C can be supplied in all five case sizes called for in MIL-C-3965 C. Styles CL20 and CL21 are etched foil, uninsulated and insulated, and CL30 and CL31 are plain foil, uninsulated and insulated. The capacitance range for the plain foil units is 0.25 to 160 μF, and 0.5 to 580 μF for the etched foil units.

CIRCLE NO. 349

### Wirewound pots priced at 40¢

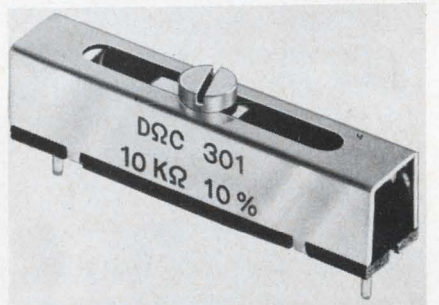

Harry Levinson Co., 1211 E. Denny Way, Seattle, Wash. Phone: (206) 323-5100. P&A: 40¢ (100 lots); stock.

A low-cost wirewound slider potentiometer, the Diplohmatic Type 301 is priced at 40¢ each in quantities of 100. Ten standard ranges from 10 Ω to 10 kΩ are offered. Power dissipation is 0.5 watt, temperature range is -50° to +120°C, tolerance is ±10% and temperature coefficient is 130 ppm/°C. Mounting provision is for PC boards.

CIRCLE NO. 350

# circuit problems?

**Signalite Glow Lamps have solved problems in these areas:**

- Voltage Regulation & References • Photo-Cell Drivers • SCR Triggering
- Timing • Photo Choppers • Oscillators • Indicator Lights • Counters
- Voltage Dividers • Surge Protectors • Logic Circuits • Flip-Flops
- Memory • Switching • Digital Readouts

Signalite glow lamps combine long life, close tolerance and economy, and are manufactured with a broad range of characteristics to meet individual application requirements. For a creative approach to your design problem . . . contact Signalite's Application Engineering Department.



**VOLTAGE REGULATORS BETTER THAN 1% ACCURACY** These subminiature voltage regulators are used in regulated power supplies, as reference sources, photomultiplier regulators, oscilloscope calibrators, etc. They are available in voltages from 82 to 143 V. They are used in multiples as regulators in KV ranges.

**SEE Signalite Application News Vol. 3 No. 2 for TYPICAL APPLICATIONS.**

Reader Service No. 191



**NEON LAMPS WITH TRANSISTORS** The A079 is recommended as an indicator light for transistor circuits, transistorized flip-flops, and other general low voltage operations. The advantages result from the low current and low voltage requirements, the absence of heat generated and extremely long life.

**SEE Signalite Application News Vol. 2 No. 5 for TYPICAL APPLICATIONS.**

Reader Service No. 192

## SIGNALITE APPLICATION NEWS



is used to communicate new and proven techniques and applications of Signalite's neon lamps and gas discharge tubes. Signalite Application News provides a forum for an exchange of ideas to keep the design engineer aware of the versatility of neon lamps and their many applications. Copies are available from your Signalite representative or by contacting Signalite.

Reader Service No. 193



**TRIGGER LAMPS FOR OPERATION OF SCR'S AND TRIACS** The A057B lamp is recommended for use as a triggering device for both SCR'S and TRIACS in motor speed controls and light dimmer circuits. Its properties of stable operation and high current capabilities qualify it for this application.

**See Signalite Application News Vol. 2 No. 4 for TYPICAL APPLICATIONS.**

Reader Service No. 194



**MEMORY SWITCHES** Neon lamps have proven to be an excellent memory switch since they store information and provide visual indication. The properties of neon lamps provide a large differential between breakdown and maintaining voltages, stable electrical characteristics and high "off" resistance (20,000 meg ohms). Other applications include switching, information storage, timing circuitry, etc.

**SEE Signalite Application News Vol. 4 No. 3 for TYPICAL APPLICATIONS.**

Reader Service No. 195

# Signalite

**INCORPORATED**  
NEPTUNE, NEW JERSEY 07753  
(201) 775-2490



SUBSIDIARY OF GENERAL INSTRUMENT

Thought you'd never ask. Mini-Crimp is the registered trademark for a series of crimp-type connectors designed for use with microminiature coaxial and triaxial cable. They feature closed-entry sockets, crimped shield terminations, captivated contacts, internal cable seals, and require no special tools for assembly. We have the whole Mini-Crimp story in one data sheet. Write for it.

 **WAVELABS CO.**  
1925 Euclid Avenue  
San Diego, Calif. 92105

# What's a Mini-Crimp?



ON READER-SERVICE CARD CIRCLE 127

## SMALLEST RELAMPABLE T-1 CONFIGURATIONS

new from Eldema

H-Lites, a new series of Eldema indicator lights, offer the smallest relampable lamp housings and lens caps for the T-1 flange base lamp size.

- Features: both grounded and ungrounded housings. Lamps replaceable from the front. RFI shielding. 5/16" mounting hole for two-

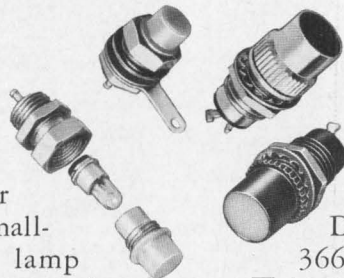

actual size

terminal style; 1/4" for single-terminal style. Designed to MIL-L-3661.

- Available in a variety of lens styles and colors. Waterproof versions available.
- Write for complete data on the H series from Eldema, where innovation is a way of life.

## ELDEMA

A Division of Genisco Technology Corporation  
18435 Susana Road / Compton, California / (213) 774-1850

ON READER-SERVICE CARD CIRCLE 128

## COMPONENTS

### Tiny module performs analog multiplication



*Intronics, Inc., Chapel Bridge Park, 57 Chapel St., Newton, Mass. Phone: (617) 332-7330. P&A: under \$500; 3 to 4 wks.*

A four-quadrant dc voltage multiplier performs multiplication, squaring, division and square rooting without the use of nonlinear or magnetic devices, and without the need for external amplifiers. Specifications include  $\pm 10$ -V differential inputs with common-mode capability, 75-k $\Omega$  minimum input impedance and  $\pm 10$ -V, 5-mA output.

CIRCLE NO. 351

### Form C reed relays standard or miniature

*New Product Engineering, Inc., 812 Manchester, Wabash, Ind. Phone: (219) 563-2191.*

Form C reed relays are offered in standard and miniature sizes. Standard Form C relays are available in single, double, three, four, five, six and eight-pole packages. Rated at 5 VA, they have an initial resistance of 100 m $\Omega$  and an end-of-life resistance of 2  $\Omega$ . Life and reliability at rated load is  $10^7$  operations. Miniature Form C relays are available in single and double-pole packages. Rated at 4 VA, they have an initial resistance of 150 m $\Omega$  and the same end-of-life resistance. Coil voltages for both sizes range from 6 to 48 volts. The Form C relays are available in open or encased construction with PC board mounting or in encased axial-lead designs.

CIRCLE NO. 352



## Photochoppers mount directly on PC boards

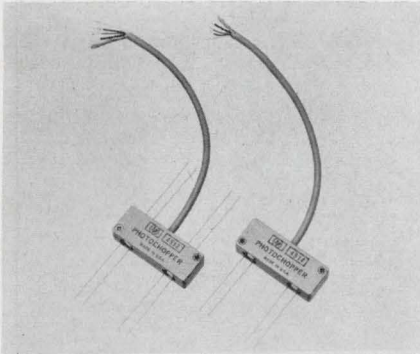

Hewlett-Packard, 1501 Page Mill Rd., Palo Alto, Calif. Phone: (415) 326-7000. P&A: \$21 and \$15.25 (10 to 99); stock.

Low-cost photochoppers with a low-profile die-cast housing less than 1/2 inch thick mount directly on PC boards. Two of the photochoppers are 4-cell units. Each functions as a dual synchronous spdt switch for the simultaneous modulation and demodulation of a dc signal, or the simultaneous modulation of signals on two channels. The input cells of the 4511 photochopper have high impedance whereas the output cells have low impedance, on the order of 10 k $\Omega$ . The 4512 is similar but uses low-impedance cells at the input. The other two units are 2-cell, spdt photomodulators. The 4513 has high-impedance cells and the 4514 uses low-impedance cells.

CIRCLE NO. 353

## Hysteresis motor externally reversible

McLean Engineering Labs., P. O. Box 228, Princeton Junction, N. J. Phone: (609) 799-0100.

With the starting torque approximately the same as the running torque, these motors run at synchronous speed, but are not phase-polarized. The direction of rotation of the shaft is reversible externally. Dual voltage and/or dual speed units are available in rpm of 1200, 1800 and 3600.

CIRCLE NO. 354

# 40% more light output

You get 40% more light output from General Electric's new D2A neon

indicator  
Glow  
Lamp.

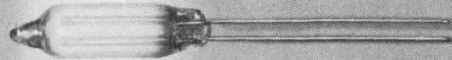

40% more than the C2A lamps you're now using. And 25% more corona coverage. From the same diameter bulb. Without any decrease in life! Unbeatable for legend illumination, display panels, night lights, much more. More information? Write for Glow Bulletin 3-761. For complete Glow lamp line, ask for Glow Bulletin 3-6254. General Electric Co., Miniature Lamp Department, M7-3, Nela Park, Cleveland, Ohio 44112.

GENERAL  ELECTRIC

ON READER-SERVICE CARD CIRCLE 129

# Reed Relay Problems?

A special hi-reliability relay for the Hawk Missile.

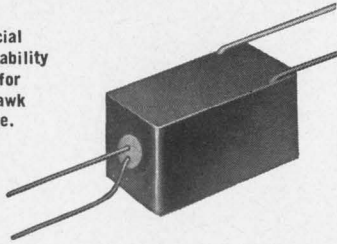

## Can We Solve Your Problem?

**Operating Inputs:** low as 1mA. and 15mW.  
**Standard Coil Voltages:** 6, 12, 24, 32, 48V in stock for immediate delivery.

**Special Voltage or Resistance,** multiple windings for flip flop, memory and crosspoint selection applications — to customer specifications.

**Relay Contacts** in Form A, B, C and latching. Also high vacuum type 5000V Form A.

Write for catalog and prices of our standard line of magnetic reed relays. For special requirements, give complete details for quotation.

# Coto-Coil

**COMPANY INC.**

59 Pavilion Ave.  
Providence, R. I. 02905  
Phone: (401) 941-3355

ON READER-SERVICE CARD CIRCLE 130

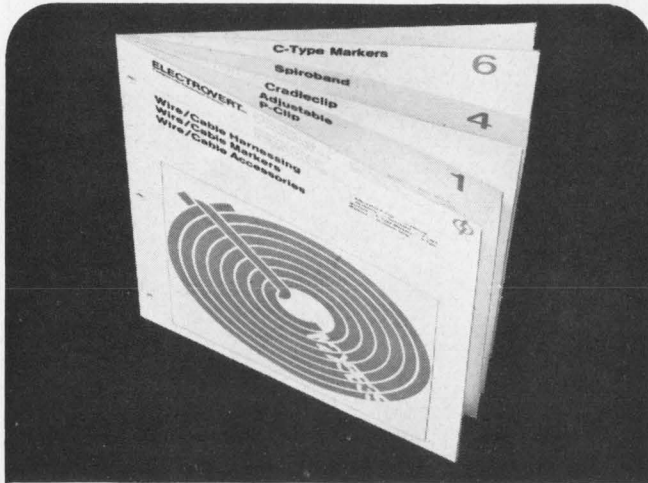

## NEW FREE CATALOG

This easy-to-use catalog contains data on a full line of time, money and inventory saving wire/cable harnessing, marking, and accessory products such as: Adjustable P-Clips; Cable Ties; Cradleclips; Strap-N-Snap Strapping; Spiroband Wrap'round Harnessing; Indestructible Markers; and Snip-N-Fit Grommet Strips. It is designed to help engineers and manufacturers specify and select.

Send for Free Copy.

**ELECTROVERT** INC.  
Components Equipment Division  
86 Hartford Ave., Mt. Vernon, N. Y. 10553  
Milwaukee, Wis. • Burbank, Calif.



SOLD COAST-TO-COAST THROUGH AUTHORIZED DISTRIBUTORS

ON READER-SERVICE CARD CIRCLE 131

## COMPONENTS

### Low contact resistance in tiny binary relay



Data, Inc., 146 Center St., El Segundo, Calif. Phone: (213) 322-0026. P&A: under \$20; 2 wks.

Low contact resistance relays (2.4 mΩ pin-to-pin) offer zero bounce, high speed and the binary characteristic. Solder is eliminated in the contact circuit and contacts are of similar material. A simple drive circuit pulses the relay on and off and establishes a normally off state; the drive pulses are differentiated waveforms, thereby eliminating turn-off transients.

CIRCLE NO. 355

### Multiturn pots in bushing or servo-mount

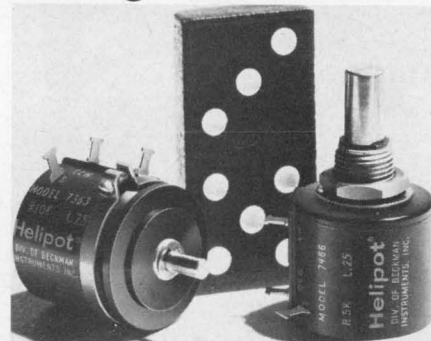

Beckman Instruments, Inc., 2500 Harbor Blvd., Fullerton, Calif. Phone: (714) 871-4848.

Three- and five-turn 7/8-inch diameter pots are available in bushing and servo-mount models, as well as two-gang units. They have 1.5-watt power ratings, ±3% standard resistance tolerance and ±0.25% standard independent linearities in most values. Series 7360 are available in resistance values from 10 Ω to 30 kΩ. Series 7460 values range from 10 Ω to 50 kΩ.

CIRCLE NO. 356

compact, rugged, proven reliable . . .

# THE DIRECTOR

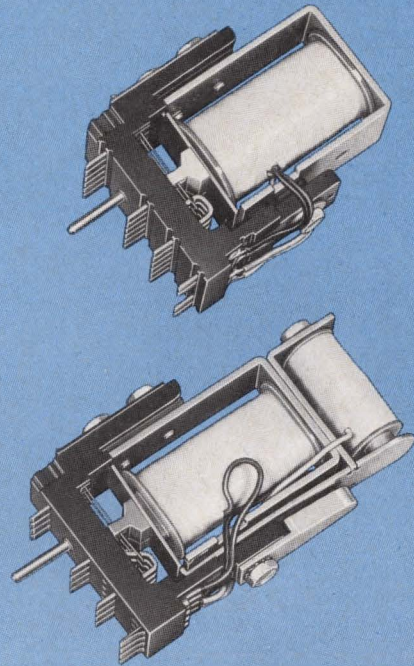
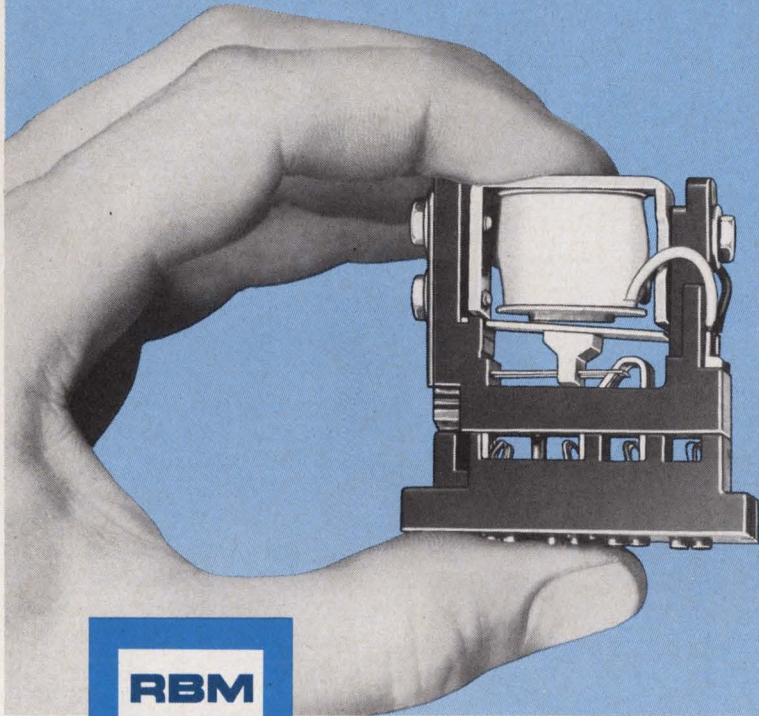

## Type 81 Wire Contact Relays

Meet the "Director" . . . specifically designed to direct or set up circuits in the logic or arithmetic section of computers and business machines. Also proven reliable in similar electronic applications where the contacts of one or more relays must set up a circuit, but are not required to make or break that particular circuit. Type 81 relays are available in four contact forms—4PDT, 4PDT latch, 4PDT long yoke, and 6PDT. When space is limited and reliability a must, you can depend upon the RBM "Director."

### TYPICAL SPECIFICATIONS - 4PDT RELAYS\*

Contact Rating	3 amp. (carry only)
Contact Material (Std.)	Eutectic Alloy—Silver-Copper
Operating Time (Nom.)	5.5 milliseconds max. inc. bounce
Life	200 million operations
Coil Form	Single or Double Winding (Pic & Hold)
Coil Voltage	20 volts D.C. thru 115 volts D.C.
Coil Power	4 watts max.
Breakdown Voltage	1250 volts RMS 60 cycle to frame
Ambient Temperature	50° C
Weight	Approximately 1¾ oz.
Overall dim. (Approx.)	Including plug—2½" x ⅝" x 2"

\* For data on all contact forms, write for bulletin 2000.

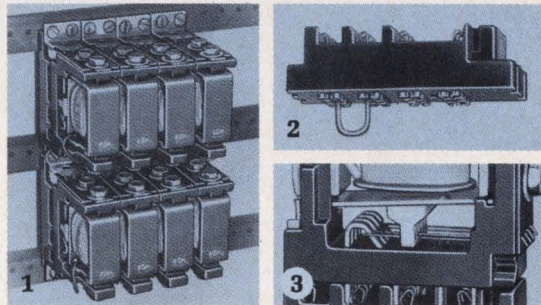

1. Relays can be assembled into groups and rack mounted for fast wiring and easy programming. Requires minimum rack or chassis space.

2. With plug-in connectors "A" relay contacts can be programmed to suit your specific circuit requirements.

3. Standard armature contacts on RBM Type 81 relays consist of two silver alloy wires per pole, providing highly reliable redundant contact surfaces.

**ESSEX**  
WIRE CORPORATION

CONTROLS DIVISION • 131 GODFREY STREET • LOGANSPORT, INDIANA

ON READER-SERVICE CARD CIRCLE 132

# Need a mountain of data on, say, the rumblings of Vesuvius?

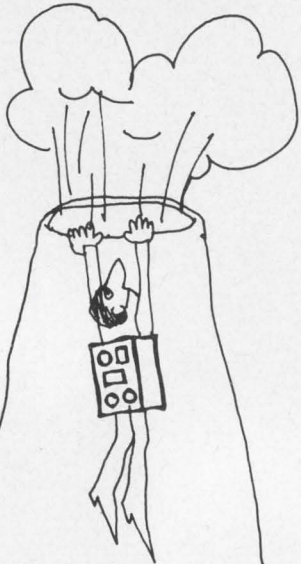

## Lockheed's 28-lb. 417 recorder goes and gets it.

You can't top the 417's portability. Carry it almost anywhere with one hand. Any comparable recorder scales at least 50 lbs. more. And accuracy? The 417 matches even large rack machines.

Durability is another advantage. The 417's dual capstan transport provides precision operation under vibration and in any position.

The 417 operates from its internal battery or from 110/220 volts AC with power consumption as low as 10 watts. Frequency response is 100kc direct, 10kc FM. And it comes in a neat 14" x 15" x 6" package—small enough to fit under an airplane seat. The price is compact, too. Starting at \$7,000.

Next time you're smoking-out data, remember the lightweight 417. For more information, write B. Mayer, Dept. ED-67 Edison, New Jersey.

### LOCKHEED

LOCKHEED ELECTRONICS COMPANY  
A Division of Lockheed Aircraft Corporation

## COMPONENTS

### Panel control knobs push to turn

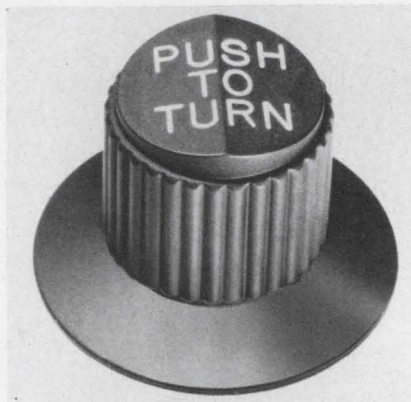

Raytheon Co., Industrial Components Operation, 465 Centre St., Quincy, Mass. Phone: (617) 479-5300.

"Push-to-turn" knobs in the military configuration for electronic equipment give infinite resolution with zero backlash. The knobs are intended for applications in which control settings must be maintained under conditions of shock and vibration. The setting cannot be changed accidentally since the knob must be fully depressed before movement. The knobs are available in 1/4, 1/8 and 3/16-inch shaft sizes.

CIRCLE NO. 357

### Metal-film resistors withstand 300% overload

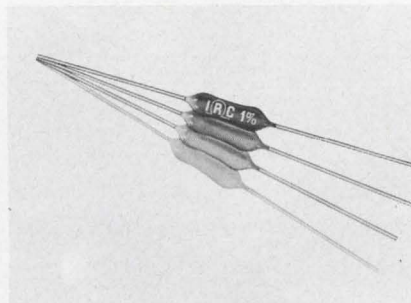

IRC, Inc., 401 N. Broad St., Philadelphia. Phone: (215) 922-8900. P&A: 8¢ (10,000 lots); 2 to 3 wks.

Metal film resistors meeting MIL-R-10509 can be used at up to 300% overload while maintaining a low resistance change. The units are available over a resistance range of 10  $\Omega$  to 1.5 M $\Omega$  with  $\pm 1\%$  initial tolerance; temperature coefficient is  $\pm 100$  ppm/ $^{\circ}$ C.

CIRCLE NO. 358

### Active filters cut off from 5 Hz to 20 kHz



Burr-Brown Research Corp., International Airport Industrial Park, Tucson, Ariz. Phone: (602) 294-1431. P&A: \$175 and \$195; 4 wks.

Encapsulated active filters combine high-gain op-amps and passive elements for low-pass, high-pass, band-pass or band reject applications. Models 5001/29 and 5002/29 are third order low-pass filters with Butterworth and Chebyshev responses. With these units, a pass-band gain of from -6 to +40 dB and a cutoff frequency of from 5 Hz to 20 kHz may be specified. Output is  $\pm 10$  V at  $\pm 10$  mA.

CIRCLE NO. 359

### Tiny vaneaxial fan delivers 6.5 cfm



IMC Magnetics Corp., 570 Main St., Westbury, N. Y. Phone: (516) 334-7070.

Measuring only 1 in<sup>3</sup> and weighing 1 ounce, this tiny vaneaxial fan moves more than 11,000 times its own volume of air each minute. For spot cooling miniaturized equipment, the fan delivers 6.5 cubic feet per minute to cool microcircuits, transistor heat sinks, airborne computers and instrumentation. The unit requires 26 or 115 Vac, 0.28 A.

CIRCLE NO. 360

# SERVO REPEATERS

847A (60 cps)  
770A (400 cps)



- Follow 3 wire synchro data
- Require only 117v power
- Modular construction
- Built-in, solid state amplifier

A versatile line of precision synchro followers for universal industrial and military applications.

WRITE FOR OUR GENERAL CATALOG describing our complete line of Servo Systems, Servo Amplifiers and Servo Testers



ON READER-SERVICE CARD CIRCLE 134

GLOBE

## When a small a.c. motor is too big...

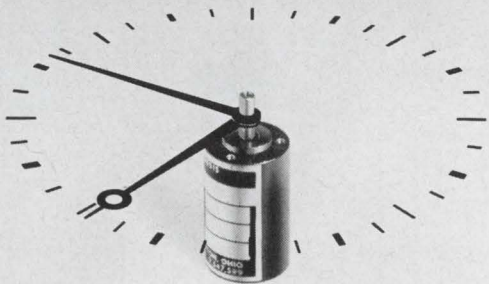

... try Globe's Type CC sub-miniature motor, one of the smallest a.c. hysteresis synchronous motors made. This tiny 2-ounce unit is only 21/32" dia. by 1.34" long. It's used extensively for MIL-spec timers, actuators, and drives requiring compact, exact-speed motors. Voltage is 26 v.a.c., 400 cps, single phase. Both 2- and 4-pole models produce .08 oz. in. sync. torque. Write for Bulletin CC, and ask us about production quantities.

Globe Industries, Inc.  
2275 Stanley Ave., Dayton, Ohio 45404, Tel: 513 222-3741

ON READER-SERVICE CARD CIRCLE 135

ELECTRONIC DESIGN 12, June 7, 1967

$\bar{\mu}$ VL same MicroVersa LOGIC

$\bar{\mu}$ VL same performance

$\bar{\mu}$ VL same reliability

$\bar{\mu}$ VL from Decision Control

$\bar{\mu}$ VL now costs . . .

# 33%

less!\*

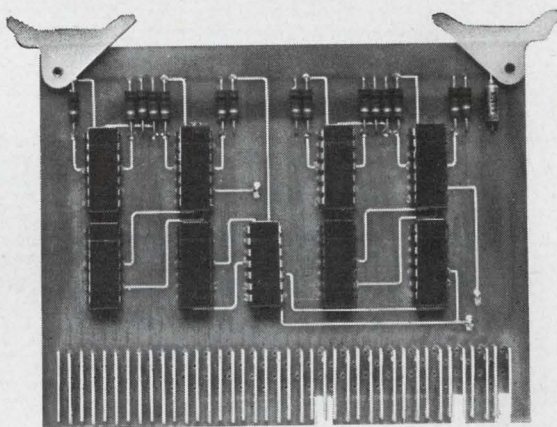

We've reduced MicroVersa LOGIC prices sharply, thanks to lower microcircuit prices. Get the same reliable performance—same proven DTL circuits—5 v. logic levels—plenty of output drive—single power supply—complete mounting hardware available.

If you're building a digital system, build it with MicroVersa LOGIC and really save time and money. We'll show you how—in our  $\bar{\mu}$ VL applications brochure. Send for it today.

\*average module price reduction

**(dci) DECISION CONTROL, INC.**

1590 Monrovia Avenue, Newport Beach, California  
Tel. (714) 646-9371 • TWX (714) 642-1364

ON READER-SERVICE CARD CIRCLE 136

## CABLE ASSEMBLIES FOR ANY APPLICATION...

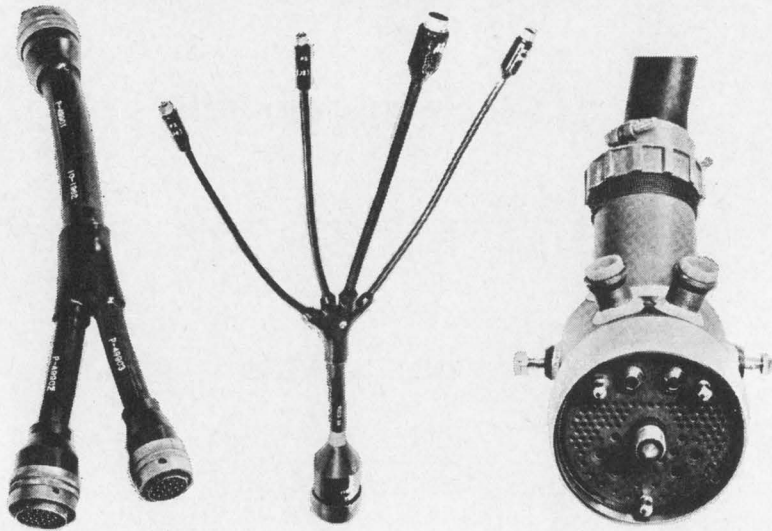

RAPID QUOTATIONS • COMPETITIVE PRICING • PROMPT DELIVERY  
ALLOW US TO SUBMIT OUR QUOTE ON YOUR REQUIREMENTS.

**B&B**

**ELECTRONICS CORP.**

17360 So. Gramercy Place, Gardena, Calif.

Manufacturers of Electronic wire, cable, cable assemblies and custom products.

ON READER-SERVICE CARD CIRCLE 137

# You name the meter. BRAND Ideal has it.

(or we'll make it for you)

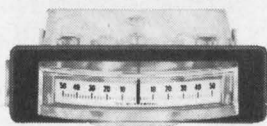
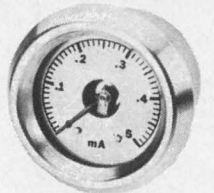
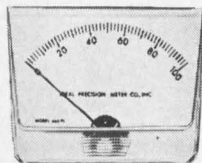
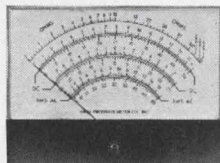

If one concentrates long and hard enough on panel meter development and engineering, one becomes expert.

IDEAL meters are used by all the Military and by leaders in defense and industry. For everything in meters—ruggedized or commercial, custom and stock, 1/2" to 7"—you can count on IDEAL, the proven leader.

Write for free 32-pg. catalog. Ideal Precision Meter Co., Inc., 218 Franklin St., Brooklyn, N.Y. 11222. (212) EVergreen 3-6904.

ON READER-SERVICE CARD CIRCLE 138

## COMPONENTS

### PC connector strips eliminate staking

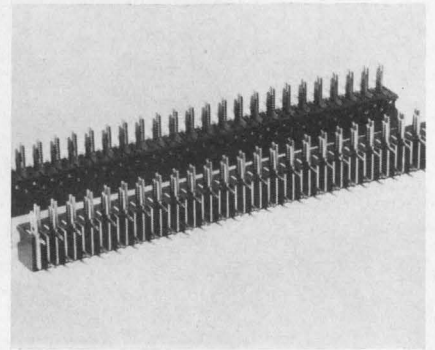

Method Electronics, Inc., Connector Div., 7447 W. Wilson Ave., Chicago. Phone: (312) 265-1417.

Printed-circuit connector strips with split-leg construction enable the board to be snapped directly to the connector, ready for dip soldering operations. Staking operations normally required to hold the strip to the board for soldering are eliminated. The strips provide a rigid, glass-filled diallyl phthalate carrier for both the upper and lower contact rows. Number of contacts can be varied from 3 to 51 depending on need. Contact material is phosphor-bronze, with gold over nickel plating.

CIRCLE NO. 361

### Dpdt slide switch stacks up small

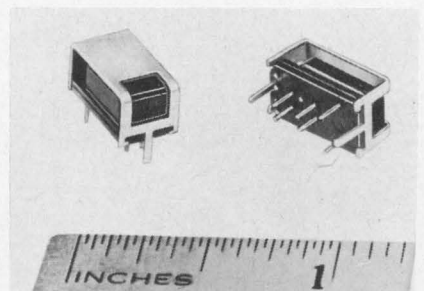

F & F Enterprises, Inc., Chicago Switch Div., 2035 Wabansia Ave., Chicago. Phone: (312) 489-5500.

A dpdt slide switch which measures 0.23 inches high and 0.468 inches long may be actuated by pins, rods, cams or levers within the user's electronics. Features include self-cleaning contacts of either silver, brass, or gold-over-brass for use with plug-in, dip-solder circuit boards or welded integrated circuits. Contact pressure is 25 grams.

CIRCLE NO. 362



**Couch**  
ROTARY  
RELAYS

## Cramped for space?

### Use Couch 1/7-size Relays

Space/weight problem? The new Couch 2X 1/7-size crystal can relay gives you tremendous savings in space and weight. 0.1" grid — plus many outstanding specs — *all in microminiature*. Thoroughly field-proven in electronics and space applications.

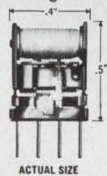

	2X	1X
Size	0.2" x .4" x .5"	same
Terminal Spacing	1/10" grid	same
Rating	0.5 amp @ 30 VDC	same
Coil Operating Power	150 mw	70 mw
Coil Resistance	60 to 4000 ohms	125 to 4000 ohms
Temperature	-65°C to +125°C	same
Vibration	20 G	same
Shock	75 G	same

Meets MIL-R-5757D

Broad choice of terminals, coil resistances, mounting styles. Write for detailed data sheets.

RUGGED ROTARY RELAYS  Dynamically and Statically Balanced

## COUCH ORDNANCE INC.

3 Arlington St., North Quincy, Mass. 02171, Area Code 617, CYPRESS 8-4147 • A subsidiary of S. H. COUCH COMPANY, INC.

ON READER SERVICE CARD CIRCLE 139

## Tiny disc thermistors have speedy response

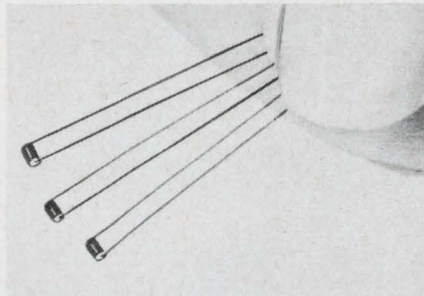

Fenwal Electronics, Inc., 63 Fountain St., Framingham, Mass. Phone: (617) 875-1351.

Miniaturized disc thermistors, providing relatively fast time constants, are designed for use where temperatures do not exceed 150°C, and where the stability and environmental capabilities of glass-coated bead thermistors are not required. Eight types are available with nominal resistance values of from 100 Ω to 200 kΩ at 25°C. Time constants range from 3.5 to 4.5 seconds. The units measure 0.05 inches in diameter and range in thickness from 0.017 to 0.067 inch.

CIRCLE NO. 363

## Shielded transformers mount PC boards

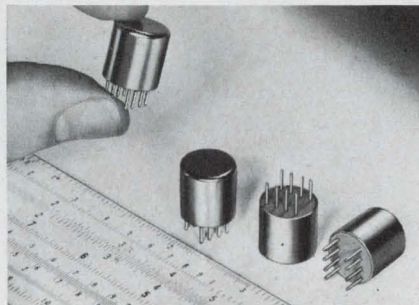

James Electronics, Inc., Components Div., 4050 N. Rockwell, Chicago. Phone: (312) 463-6500. P&A: \$10 to \$18 (over 100); 7 to 9 wks.

Shielded transformers 0.5 inches in diameter by 0.5 inches high have nominal impedances from 100 Ω to 100 kΩ and frequency response from 0.5 Hz to 1 MHz. Common-mode isolation is 75 dB at 20 kHz. Electrostatic shielding is provided for each winding. It reduces capacitance between windings to less than 0.2 pF and circuit isolation in excess of 100 dB is attained.

CIRCLE NO. 364

ON READER-SERVICE CARD CIRCLE 140

Another quality series by Sigmund Cohn Corp.



## LOW RESISTIVITY GOLD ALLOY "POT" WIRE



LR Alloy	Resistivity	Tensile Strength
LR 29*	29Ω/cmft	150,000 PSI
LR 45*	45Ω/cmft	160,000 PSI
LR 65*	65Ω/cmft	160,000 PSI
LR 80	80Ω/cmft	160,000 PSI

\*U.S. Patent #2,944,259

Four noble metal alloys for wire wound Potentiometers have been developed in the Sigmund Cohn laboratories... They are notable for their high Gold content—75% to 80%... Recommended for minimal noise, excellent corrosion resistance and long shelf life.

Write for detailed engineering data



## SIGMUND COHN Corp.

121 South Columbus Avenue  
Mount Vernon, N.Y. 10553

# DACOL's TR26S Digital Magnetic Tape Memory

Can not only replace paper tape, but it's faster, more reliable, and its environmental capability and size open up a whole new design area. Best of all, it only costs \$3000 including I.C. electronics.

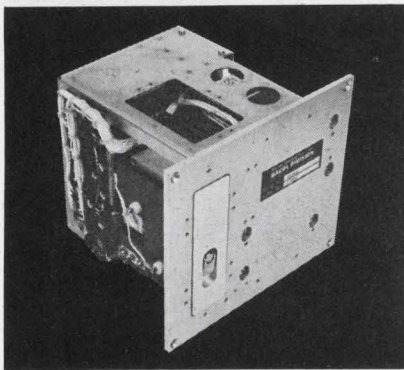

<b>STORAGE MEDIUM</b>	1/2", 7 track, cartridge loaded magnetic tape.
<b>STORAGE CAPACITY</b>	500,000 data bits on 36 feet of tape at a density of 200 characters per inch.
<b>OPERATING MODES</b>	Read, Rewind, Search, Standby.
<b>READING RATE</b>	8400 data bits per second.
<b>POWER REQUIRED</b>	8 watts DC; 30 watts AC.
<b>SIZE</b>	6.5" H x 7.0" W x 6.5" D; Weight, 8 lbs.
<b>TEMPERATURE TAPE PREPARATION</b>	20° to 140°F operating. Magnetic tapes can be generated by computers, DACOL Recorders or paper tape masters utilizing DACOL's Model PMC20 Paper Tape-to-Magnetic Tape Converter.

**WRITE FOR  
COMPLETE SPECIFICATIONS**

**Hersey-Sparling Meter Company**  
**DACOL DIVISION**  
210 W. 131 St. • Los Angeles 90061  
TECHNICAL REPRESENTATIVES  
THROUGHOUT THE FREE WORLD

ON READER-SERVICE CARD CIRCLE 141

## COMPONENTS

### MIL RT24 trimmers in 3 case styles

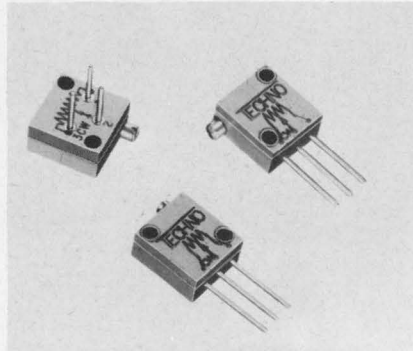

Techno-Components Corp., 7803 Lemon Ave., Van Nuys, Calif. Phone: (213) 781-1642.

Four 3/8-inch-square trimming pots meet RT24 requirements under MIL-R-27208B. Configurations available are PC pins base-mounted, edge-mounted 180° from adjustment shaft and edge-mounted 90° from adjustment shaft. The wire-wound units come in resistance values from 10 Ω to 10 kΩ. All are for 25 adjustment turns with a standard resistance tolerance of 5%.

CIRCLE NO. 365

### Thin cermet trimmer fully sealed

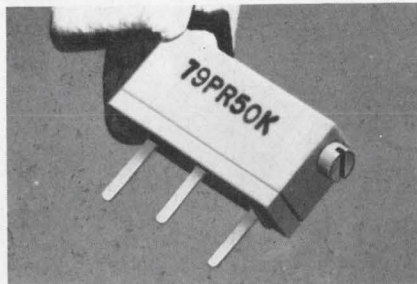

Beckman Instruments, Inc., 2500 Harbor Blvd., Fullerton, Calif. Phone: (714) 871-4848. P&A: \$1.95; stock.

A thin, 3/4-inch-long cermet trimming pot is fully sealed to meet immersion tests of MIL-R-22097C for PC board soldering or solvent cleaning. The 15-turn units have standard resistances from 10 Ω to 2 MΩ ±10%. Power rating is 0.75 watts at 25°C, derating to 0 at 105°C. The cermet element permits setting to within ±0.05% of a required voltage.

CIRCLE NO. 368

### Ac voltage switch all solid-state

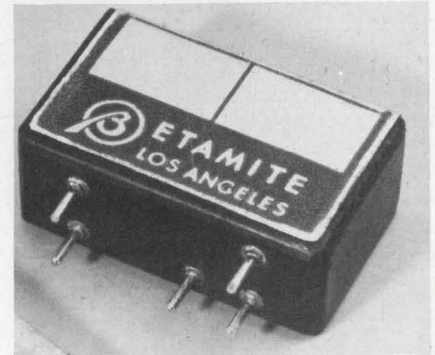

Betamite Electronic Devices, 6321 W. Slauson Ave., Culver City, Calif. Phone: (213) 390-3401.

This normally open voltage switch closes when ac input voltage reaches 30 V rms ±10%, 400 Hz. Maximum input voltage is 45 V rms for 5 ms. The switch is available in a 5- or 7-pin configuration, in 2-pole and 4-pole contact types rated for 2 and 10 A resistive, and a single-pole switch rated for 150 mA. It is not damaged by reversal of dc voltage polarity and has a built-in suppression diode for the relay coil to prevent arc. Dielectric strength meets 100 V rms, ac pins to dc pins.

CIRCLE NO. 367

### Conductive plastic pot has tiny TC

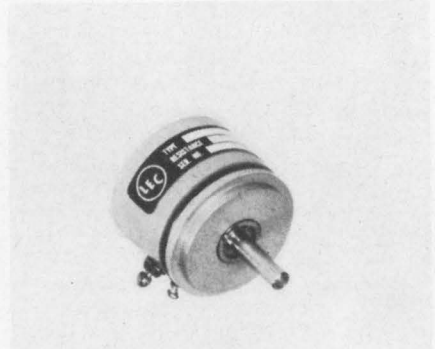

Logan Electronic Corp., 44 Breed St., E. Boston, Mass. Phone: (617) 567-1823.

Conductive plastic potentiometers have a temperature coefficient of 75 ppm/°C, comparable to single-turn wirewounds. The line is available in 12 sizes in standard bushing and servo-mounts and in single or multiple gangs. Resistance range is 1 to 150 kΩ with a tolerance of ±10%.

CIRCLE NO. 366



# Improve Display Capability with Dialco Sub-Miniature ILLUMINATED PUSH BUTTON SWITCHES and matching INDICATOR LIGHTS

Dialco Switches and Indicator Lights provide almost limitless applications—are flexible in arrangement—economical in price—and feature high reliability.

Switches are the silent, momentary type—requiring 24 oz. (approx.) operating force; Contact arrangements are: S.P.S.T., normally open or normally closed; S.P.D.T. two circuit (one normally open, one normally closed). Ratings: 3 amps, 125V A.C.; 3 amps, 30V D.C. (non-inductive).

The switch is completely enclosed and independent of the lamp circuit. The light source is the T-1-3/4 incandescent lamp, available in voltages from 1.35 to 28V. Switches are made for single hole (keyed) mounting in panels up to 3/16" thick and mount from back of panel in 1/2" clearance hole. Switch forms for dry circuits are also available.

Other features include: 1/2" or 3/4" interchangeable caps, round or square, rotatable or non-rotatable, in a choice of 7 color combinations.

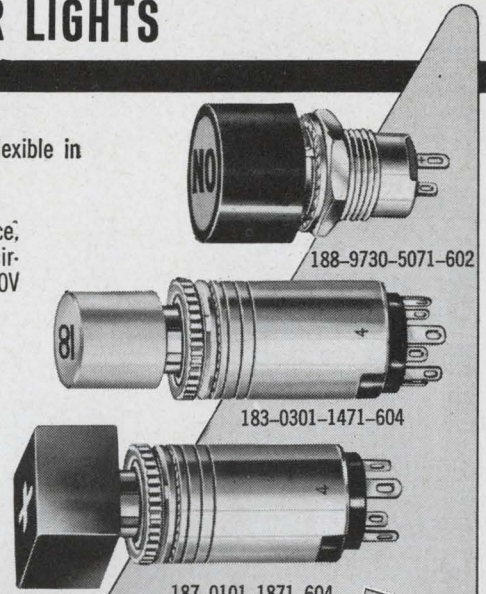

(illus. approx. actual size)



Foremost Manufacturer of Indicator Lights  
**DIALIGHT** CORPORATION

60 STEWART AVE., BROOKLYN, N.Y. 11237 • AREA CODE 212 497-7600

Ask for new 12-page  
Push Button Switch  
catalog. Do it today!



ON READER-SERVICE CARD CIRCLE 142

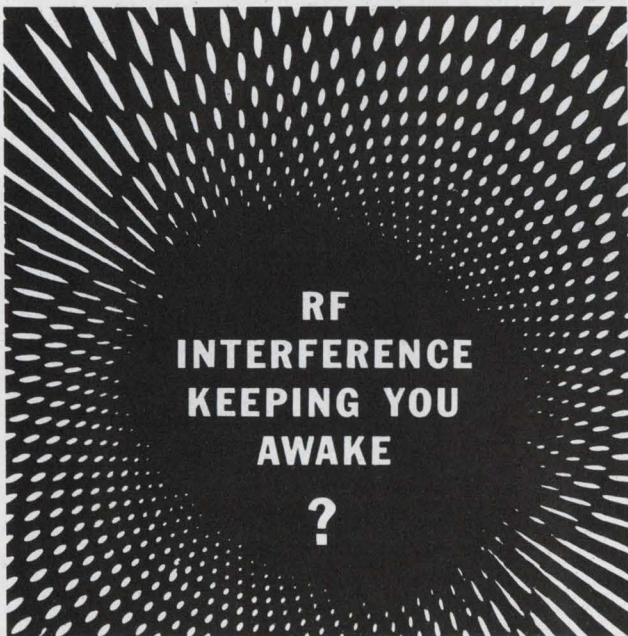

**RF  
INTERFERENCE  
KEEPING YOU  
AWAKE  
?**

Rest easy with reliable Littelfuse RF Interference shielded fuse posts. Wide range of military and commercial applications. Write or phone for information.



**LITTELFUSE**  
DES PLAINES, ILLINOIS

ON READER-SERVICE CARD CIRCLE 143

ELECTRONIC DESIGN 12, June 7, 1967



**FREE CATALOG!  
NEARLY 4,500 BUYS  
FOR INDUSTRY**

**OPTICS! SCIENCE! MATH!  
GIANT 148 PAGES**

Many on-the-job Helps . . . Quality Control Aids! Write for this completely new, 1967 Catalog. New items, new categories, new illustrations. 148 easy-to-read pages packed with hundreds of charts, diagrams, illustrations. A treasure-house of optical and scientific information . . . unusual bargains galore. Optics for industry, research labs, design engineers, experimenters, hobbyists! Instruments for checking, measuring—to speed work, improve quality, cut production costs. We give you facts: what it is—how it works—where it's used.

**Comparators, Magnifiers, Microscopes**

Hard-to-get war surplus bargains—ingenious scientific tools—imported—domestic. Thousands of components: lenses, prisms, wedges, mirrors, mounts, accessories of all descriptions. Dozens of instruments: magnifiers, stereo microscopes, telescopes, binoculars, infrared equipment, photo attachments. Shop by mail. No salesman will call. Use the Catalog of America's greatest Optics—Science—Math Mart. Known for reliability. Mail the coupon below for Catalog "DA."

**EDMUND SCIENTIFIC CO., BARRINGTON, N. J.**

Mail Coupon for FREE Catalog "DA"

EDMUND SCIENTIFIC CO., Barrington, N. J. 08007

Please send FREE Giant 148-page Catalog "DA"

NAME .....

ADDRESS .....

CITY..... STATE..... ZIP.....



ON READER-SERVICE CARD CIRCLE 144

# Design Aids



## Dielectric material charts

Two full-color charts for notebook or wall mounting show the dielectric constant and loss tangent of a host of materials at microwave frequencies. The values for the dielectric constant from 1 to 50 are given on the ordinate, while the values for loss tangent between 0 and 1 are on the abscissa. Each material is located on the chart at its appropriate dielectric constant and loss tangent. The density and heat capabilities of each material are also shown. Over 300 materials are listed. Emerson & Cuming, Inc.

CIRCLE NO. 441

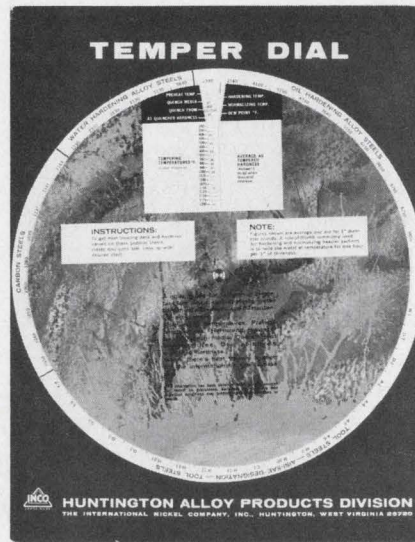

## Heat treating slide rule

An easy-to-use "Temper Dial" shows basic heat-treating data for 46 commonly used steels. All pertinent temperatures, quench data and Rockwell designations are presented. A dial is set at the steel designation desired and the data appears in a slotted opening. A temperature conversion chart is included on the reverse side along with pertinent information on Incoloy 800 and Inconel 600. A comparison of their mechanical properties is given at 100°F intervals from 1000° to 2000°F. Huntington Alloys Div., International Nickel Co., Inc.

CIRCLE NO. 443

memory storage locations. The Arabic numerals, indexing and programming symbols are arranged on the respective disks so that when a combination of programming symbols are made visible by aligning the symbols on the radially extending portions of the disks, the numerals are visible through the window and represent the core memory storage location. If any indexing symbols are included in the program, then the numerals will be accompanied by an appropriate indexer indication. For additional convenience, 85 IBM functions are listed on the reverse side. They include two of the common languages and corresponding machine codes, 30 carriage-control functions, and a sequence of all machine characters with their punch-card and BCD code.

Available for \$6.50 from Hamilton Enterprises, P. O. Box 7380, Phoenix, Ariz.

## IC cross-reference chart

A 6-page pocket-sized conversion chart cross-references Sperry ICs with units from 5 other manufacturers. The guide shows digital RTL and DTL circuits by number, function, type number, temperature range and package. The user simply refers to the basic series number and function of the circuit and reads across to find type numbers available. The chart also includes a schedule of important industry meetings, by date and location, for the remainder of the year. Sperry Semiconductor.

CIRCLE NO. 444

## Decimal equivalent wall chart

Deci-Equiva-Tables cover the common and uncommon fractions used with fine pitch gearing, including the common fractions, 32nds and 64ths. The diametral pitches covered (to 6 places) are 24, 32, 48, 64, 72, 80, 96, 120 and 200. In addition, the tables give the precision spur gear data, formulas, and short-cut "tips on gear meshes." The 11 x 16-inch chart folds to 8-1/2 x 11 inches and is three-hole punched. Timber-Top, Inc.

CIRCLE NO. 445

GENERAL RADIO COMPANY  
engineering department  
**INSTRUMENT NOTES**  
JUNE 1963

USEFUL FORMULAS, TABLES, AND CURVES  
FOR RANDOM NOISE

This collection was originally prepared for use by General Radio people who work with random noise extensively, but do not have all the formulas readily memorized. It has proved so useful that we are making it available to others who may be interested. Separate for additional to this collection will be selected for possible inclusion in subsequent printings.

**SPECTRUM DENSITY**  
Spectrum density in the power per unit bandwidth and in general is a function of frequency. If spectrum density is constant between frequencies  $f_1$  and  $f_2$ :  
 $W = \int_{f_1}^{f_2} W(f) df$  watts/cps  
Where:  $W$  = spectrum density between frequencies  $f_1$  and  $f_2$   
 $P$  = total noise power in frequency band between  $f_1$  and  $f_2$  watts  
 $(f_2 - f_1) = B$  bandwidth over which spectrum density is uniform, cps  
Noise having uniform spectrum density over a specified frequency range is said to be "white" in that range.

**THERMAL NOISE GENERATED IN A RESISTANCE**  
 $e_{n, rms} = \sqrt{4kTRB}$  volts, rms, and  $i_{n, rms} = \sqrt{4kTRB/R}$  amperes, rms  
Where:  $e_n$  = open-circuit thermal noise voltage  
 $i_n$  = short-circuit thermal noise current  
 $k$  = Boltzmann's constant =  $1.38 \times 10^{-23}$  joules/°K  
 $R$  = resistance, ohms  
 $T$  = absolute temperature of resistor, °K  
 $B$  = effective noise bandwidth, cps  
 $(B)_{eff}$  = effective noise bandwidth, Mc (used in formula below)

Available standard-impedance spectrum density  $(W_n)$  from a resistance  $R$  into a matching load  $R_L$  ( $R_L = R$ ) at frequencies where effects of reactance inductance and capacitance are negligible is independent of the magnitude of the voltage  $E_n$  or current  $I_n$  spectrum. The power density transfer from  $R$  to  $R_L$ , considering noise power generated by both resistances, equals  $kT$ , where  $kT$  is the difference in absolute temperatures of the resistors.

At a standard temperature of 293°K (20°C = 68°F):  
 $e_n = 1.27 \times 10^{-16} B^{1/2}$  volts, rms  
For  $R = 50$  ohms and  $(B)_{eff} = 1$  Mc,  $e_n = 0.90$  microvolts  
For  $R = 1$  megohm and  $(B)_{eff} = 30$  cps,  $e_n = 0.50$  microvolts

For other conditions:  
 $e_n = 0.50 \left( \frac{R}{50} \right)^{1/2} \left( \frac{B}{30} \right)^{1/2}$  microvolts, rms  
 $i_n = 0.50 \left( \frac{1}{R} \right)^{1/2} \left( \frac{B}{30} \right)^{1/2}$  microamperes, rms

Noise room temperature, a temperature increase of 10°F produces an increase in noise voltage of about 1%.

**NOISE FROM TEMPERATURE-LIMITED NOISE DIODE**

Low-frequency equivalent circuit

Where:  $e_n$  = open-circuit noise voltage  
 $i_n$  = short-circuit noise current, amperes  
 $R_n$  = noise resistance =  $1.002 \times 10^{11} \omega$  ohms  
 $f_1$  = noise diode current, amperes  
 $(B)_{eff}$  = effective noise bandwidth, cps  
 $(B)_{eff}$  = effective noise bandwidth, Mc (used in formula below)

Conditions:  
1.  $R_n$  must not be so high that current becomes limited by space charge.  
2. Frequency must be low enough to avoid carrier effects and high enough to avoid flicker-noise effects.  
Spectrum density due to shot noise only, in  $R$  equals  $2qI_n R = 3.2 \times 10^{-18} I_n R$  watts/cps.

CIRCLE NO. 442

## Random noise data

Useful formulas, tables and curves for random noise are given in a 6-page fold-out reference chart. Definitions and examples are given as are curves for relative occurrence of amplitude in Gaussian noise, excess noise factor vs source resistance and VTVM calibration. General Radio Co.

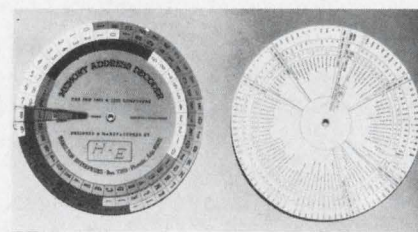

## Programming symbology

A compact slide rule helps 1401 and 1460 IBM computer programmers reduce the time necessary to convert programming symbology into numerical digits. The "Memory Address Decoder" provides fast conversion so that reference to tables and charts is eliminated. One of the circular disks includes a column of symbols designating indexing components of the computer whereas the Arabic numerals represent core



## Is AE's Class B relay outrageously expensive?

Our Class B costs more than \$4.00. Which is pretty steep for some applications. But where you need long-term reliability, you get it with the Class B.

This telephone-type relay will give you at least 400 million operations with unfailing contact reliability.

And, like your telephone, it almost never needs maintenance.

Get all the facts in our Circular 1993. You'll see how the Class B combines good sensitivity with excellent stability. Withstands extreme temperatures. Provides a wide range of practical operate and release timing — a much wider range than possible with smaller relays.

There are *two* armature ratios on the Class B. Long — for fast acting or pulsing. And short — for slow-release and chatter-free AC operation.

This relay has independent twin contacts — to guard against contact failure. A permanent, wear-free back-

stop. Pin-type armature bearings. Plus a sturdy, stable heelpiece.

*New Class B relay features magnetic latching (Series BRM).* When pulsed, remanent magnetism keeps the BRM latched without power consumption until it's restored by a second pulse.

Find out more about the Class B relay, the industry standard for reliability — and outrageously long life. Ask for Circular 1993. Just write to the Director, Relay Control Equipment Sales, Automatic Electric, Northlake, Illinois 60164.

**AUTOMATIC ELECTRIC**  
 SUBSIDIARY OF  
 GENERAL TELEPHONE & ELECTRONICS **GT&E**

ON READER-SERVICE CARD CIRCLE 145

# Application Notes

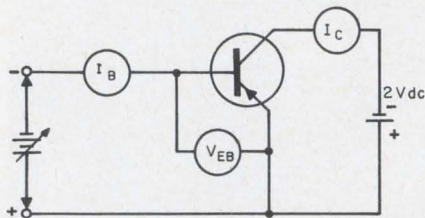

## Ge power transistor tests

This application note provides the user of Ge power transistors with information to enable him to duplicate any standard transistor parameter measurement which appears on the spec sheet. In general, alloy transistors having maximum collector current ratings from 1 to 50 amperes and collector diode ratings from low values to over 100 volts can be measured by the techniques described in this note. Dc parameter measurements can be made easily with accuracy and repeatability. The test circuits involved can be breadboarded or constructed with standard components. Ac parameter measurements such as  $h_{fe}$  (above) beta cut-off,  $f_T$ , rise and fall time, etc., require good quality lab equipment in addition to the basic test circuit to ensure accuracy. The 8-page note details 18 test setups. Delco.

CIRCLE NO. 446

## Impedance measurement

An 11-page application note presents techniques for determining impedance ( $R + jX$ ), referenced to  $50 \Omega$ , in the frequency range from 1 to 1000 MHz with a vector voltmeter. These techniques do not require balancing adjustments or tuning for nulls to find real and imaginary parts of impedances in a range of about 1 to 1000  $\Omega$ . "Measurement of Complex Impedance 1-1000 MHz" describes how a wideband, high-directivity directional coupler is used during measurements of reflection coefficient, from which the complex impedance of transmission-line components is readily derived. This

easy-to-set-up reflectometer method saves much time, particularly for data taken over a wide frequency range. Another technique for frequencies below 100 MHz uses a power splitter to derive a ratio of incident-plus-reflected voltage to incident voltage, from which impedance is derived. The note derives the basic theory, presents practical measurement examples, and discusses accuracy considerations. Hewlett-Packard.

CIRCLE NO. 447

## Arbitrary length counters

In nearly every system which is designed, the need arises for counters to count to some arbitrary length sequence. By trial and error, you can eventually find a logic design which will do the job, but trial and error seldom produces a minimum package count. This note presents a set of rules which will consistently produce a design for a counter of any length sequence with a minimum number of packages, and in which the required fan-in and fan-out of the gates used are minimized. In addition, in applications where the counter designed according to these rules must merely count repetitively rather than start at a predetermined state, no "clear" signal is necessary. After a short count through some of the out-of-sequence states, the counter will automatically go into the desired sequence. Signetics Corp.

CIRCLE NO. 448

## X-ray analysis of glass

Techniques for X-ray emission analysis for composition analysis in glass are described in a 10-page application note. The note includes photos, charts and a discussion of the procedure for iron, aluminum, calcium, magnesium, titanium, potassium, sodium and sulfur analysis. General Electric, X-Ray Dept.

CIRCLE NO. 449

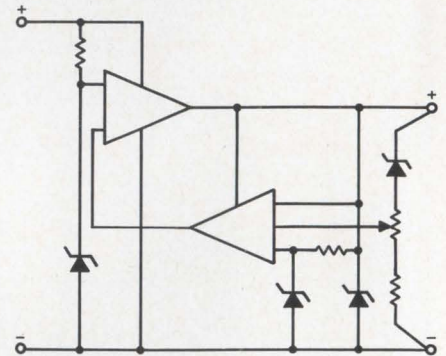

## Regulated supply design

An accurate temperature-stable voltage regulator circuit that provides regulation over a wide range of  $V_{in}$  and  $I$  load can be achieved by combining the WM-110 regulator block with the WC-115 differential amplifier. The circuit is shown above. This 4-page note details the design procedure and performance. Westinghouse, Molecular Electronics Div.

CIRCLE NO. 450

## Small motor applications

Basic design, selection and application information for fractional hp ac induction motors is given in this 28-page booklet. The illustrated publication includes basic engineering formulas for use in applying induction motors, detailed design and application data, performance curves, dimension diagrams, a selection chart and torque and temperature considerations. General Electric Co.

CIRCLE NO. 451

## Magnetic shielding

Magnetic shielding in low-frequency applications is covered with formulas, graphs, diagrams and tables in this 36-page book. Topics include design parameters, choice and comparison of materials, cylindrical, conical, multiple (nested), and wraparound shields, heat treatment and shield evaluation. Westinghouse Electric Corp.

CIRCLE NO. 452

# Philbrick...

## the source for things Analog

Philbrick is the top-value supplier of analog instrumentation components, software, and related accessories for modeling, measuring, manipulating . . . and much else. We offer the widest variety of advanced-technology analog products available . . . and the best in total value — which includes price, plus applications assistance, plus field service, plus stock delivery . . . and Philbrick's 2-year warranty. *Only at Philbrick* can you obtain all six of the analog product types described below.

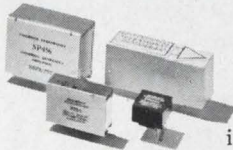

### DISCRETE-COMPONENT OPERATIONAL AMPLIFIERS

Philbrick Operational Amplifiers are, in the simplest terms, high-gain, low-drift amplifiers designed for use in stable feedback loops to provide precise, predictable operations on one or more input signals. In addition to linear applications, a wide variety of nonlinear functions and operations can be performed using them with passive nonlinear elements or with Philbrick Transconductors.

### IC OPERATIONAL AMPLIFIERS

Philbrick MICRO-HYBRID Operational Amplifiers combine the best of two technologies — linear monolithic chip and discrete microminiature components — and offer immunity to overloads, shorts and supply-voltage stresses. They provide superior electrical performance and mounting and assembly advantages. There are no equivalents, particularly in high-reliability applications. Philbrick ISOLITHIC\* Operational Amplifiers are state-of-the-art monolithic amplifiers, superior electrically and mechanically to present monolithic chip amplifiers. \*Trademark.

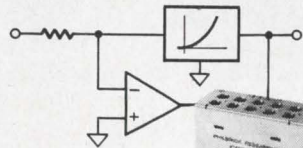
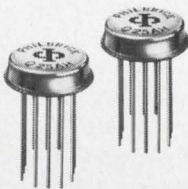

### TRANSCONDUCTORS

Philbrick Transconductors are plug-in analog system components for linearizing or embodying nonlinear functions. These analog network devices include natural continuous function and straight-line approximation (piecewise-linear) types. Philbrick transconductors include networks that accurately exhibit logarithmic, trigonometric, and quadratic behavior.

### REGULATED DC POWER SUPPLIES

Philbrick power supplies are precisely regulated and are essentially noise-free. Typical regulation (including drift) is of the order of 100 PPM, noise and hum less than 1 PPM; and recovery (to within .001%) from a step-change in load is accomplished in microseconds. Philbrick power supplies are available in rack, cabinet, modular, plug-in or built-in models.

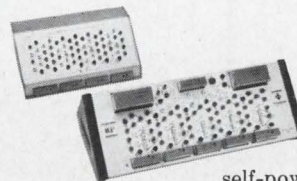

### OPERATIONAL MANIFOLDS

Philbrick operational manifolds offer a new "breadboarding" technique. These all-in-one self-powered analog instruments virtually eliminate wiring problems; components and jumper leads plug into prewired panel jacks. Model MP (with 4 amplifiers) and Model RP (with 5 amplifiers) simplify experimentation, simulation, and instruction in the practical application of feedback techniques, and employ all-silicon solid-state operational amplifiers. Their many uses and habitats include industrial process control, physics and electronic laboratories, educational institutions, as well as in-line analog data processing.

### MODULAR ANALOG COMPUTING INSTRUMENTATION

Philbrick equipment for the implementation of both analog and hybrid computers, simulators and analyzers includes: arbitrary function fitters, universal linear operators, multiplier-dividers and manifolds. Components may be formed into systems by mounting them on Philbrick unique Q3-series modular front panels, chassis, adaptors and accessories. Completely-wired modules for amplification, multiplication, and other analog operations are available individually as self-powered instruments or for integral systems use.



### TECHNICAL SUPPORT SERVICES

For prompt, competent applications engineering advice, call Philbrick in Dedham or one of Philbrick's worldwide Engineering Representatives. Our engineers welcome opportunities to help you apply analog techniques and products in such areas as industrial and scientific instrumentation, process and quality control systems, in-line analog data processing. You are welcome to write to us for technical literature on the product categories of interest. Philbrick Researches, 46 Allied Drive at Route 128, Dedham, Massachusetts 02026

**ELECTRONIC ANALOG COMPUTING EQUIPMENT for MODELLING, MEASURING, MANIPULATING and MUCH ELSE**



**PHILBRICK**

A TELEDYNE COMPANY

ON READER-SERVICE CARD CIRCLE 146

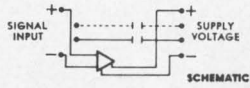

# NOW!

## AN AMPLIFIED REED RELAY WITH CONTROLLED PERFORMANCE

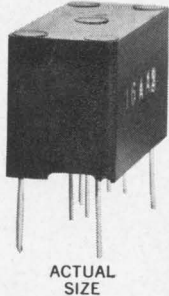

A relay which operates in 1 millisecond; over a 50 to 1 dynamic range; has a life expectancy in excess of  $50 \times 10^6$  operations; and has advanced internal solid-state circuitry and components; integrated into an encapsulated package that defies adverse environments.

Below are a few general applications of our Model 16 Logic and Model 17 Latching Relays.

### TYPICAL APPLICATIONS

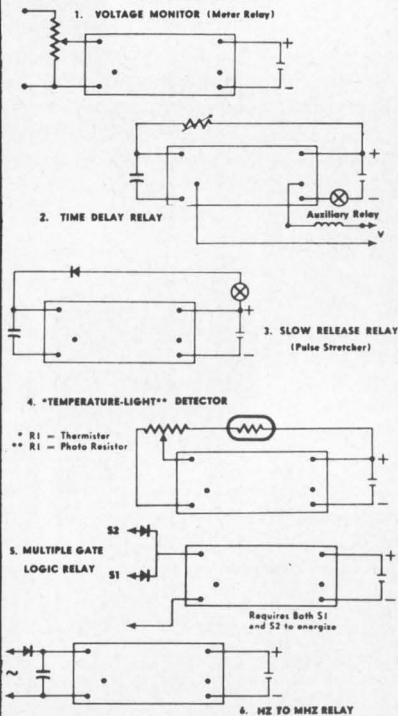

Only \$4.73 in 100 lot quantities. External circuitry can be incorporated into the relay case, on order. Consult us for relay technology to meet individual requirements.

For further information, contact:



**INSTRUMENT CORP.**

531 Front Street  
Manchester, New Hampshire 03102  
(603) 627-1432

ON READER-SERVICE CARD CIRCLE 147

# New Literature



## Servo components brochure

A catalog on components describes 100 different units. Categories include transistorized servo amplifiers, preamps, quadrature rejection circuits, solid-state choppers, modulators, demodulators, resolver buffer amplifiers, amplifier-resolver combinations, isolation amplifiers, summing amplifiers, dc power supplies, signal sensors, signal comparator amplifiers, magnetic amplifiers, and stepper motor driver and logic circuits. Also included in the volume are dc-to-ac modulators, ac-to-dc demodulators, 16-watt and 50-watt 400-Hz servo amplifiers with  $90^\circ$  phase shift, and a series of stepper motor driver and logic electronic packages for permanent magnet, bifilar permanent magnet, and variable reluctance stepper motors. General Precision, Inc.

CIRCLE NO. 453

## Integrated circuits bulletin

A reference source describing the selectivity of dielectrically isolated integrated circuits is available. Schematics, logic diagrams and tables of typical characteristics are presented for the 200, 300 and 500 series DTL logic circuits and op-amps and for several fast-recovery, medium-recovery, and general-purpose diode matrices. Also included are descriptions of the manufacturer's dielectric isolation process, reliability program and IC packaging configurations. Radiation, Inc.

CIRCLE NO. 454



## Electric lamp catalogs

Five catalogs plus a separate index feature listings, application information and simplified format. A 12-page sealed beam catalog lists a line of lamps for automobiles, aircraft, tractors and boats. Filament and base information plus beam patterns and data on heavy-duty lamps is included. The 24-page subminiature catalog lists lamps which are 1/4 inch in diameter and smaller along with complete product descriptions and a guide for selecting the proper type. The miniature lamp catalog covers lamps not shown in the four other catalogs. The glow-lamp catalog contains technical information, application suggestions, description of argon and helium-argon lamps, and a combined listing of indicator and circuit component lamps. General Electric Co., Miniature Lamp Dept.

CIRCLE NO. 455

## Precious metal scrap

Because scrap is an accidental or unplanned product its true worth may not be realized. Details on how to convert metal scrap into dollars are given in this bulletin. It analyzes and explains a recovery program. Precious metal can be recovered from electronic scrap parts of all types, solutions, sludges, residues, ion exchange filters, plated wire and parts. United Refining and Smelting Co.

CIRCLE NO. 456

# MAGNETIC SHIELD REFERENCE GUIDE

SHEET STOCK

TO STOCKED NETIC & CO-NETIC  
MAGNETIC SHIELDING FOIL AND  
SHEETS FOR YOUR FABRICATION

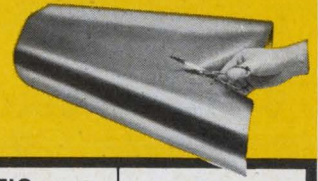

THICKNESS	NETIC S3-6 SHEET WIDTH	CO-NETIC AA SHEET WIDTH	CO-NETIC AA FOIL IN COILS: (Specify length desired)	BLUE NETIC FOIL* IN COILS: (Specify length desired)	Both BLUE NETIC and CO-NETIC AA foils, plain and adhesive backed, can be furnished slit to any desired width, at additional cost— Ask for prices.
.014"	30"	30"	.004" thick x 15" wide	.004" thick x 19 3/8" wide	
.020"	30"	30"	.004" thick x 4" wide	.004" thick x 4" wide	
.025"	24"	30"	.002" thick x 4" wide	*BLUE NETIC foil not available in .002" thick	
.031"	26"	30"	All foil also available adhesive backed. Other widths available to maximum above.		
.049"	26"	30"			
.050"	26"	30"			
.062"	26"	30"			
.095"	26"	30"			

Maximum length is 120".  
Also sold in 15", 30" and 60" lengths.  
After fabrication, shields made from sheet must be heat treated for maximum shielding. No further annealing required.  
Pre-annealed stock also available.

- Non-shock sensitive; requires no periodic annealing
- DELIVERY TIME—normal delivery time on stock widths is 1 to 2 days after receipt of order. For adhesive backed foils, approximately one week, and for foils slit to desired width, approximately 1 to 2 weeks.

Request Short Form Catalog No. 67.



## MAGNETIC SHIELD DIVISION

Perfection Mica Company

1322 N. ELSTON AVENUE • CHICAGO, ILLINOIS 60622

Phone: 312, EV 4-2122 • TWX 910 221-0105

ON READER-SERVICE CARD CIRCLE 148

### INCREASE SOLDERING PRODUCTION 10% TO 40%

with

### LUMA Low Voltage Resistance Solder Tools

for perfect soft or hard,  
"pin-point" or medium  
heavy operations.

Carbon electrodes concentrate instantaneous heat at the solder point. No cold joints.

High capacity power unit, 5 to 2500 watt, (guaranteed for one year) draws current only when actually soldering. No warm-up needed. Permits simultaneous use by multiple operators, thus minimizing capital expenditure.

16 styles of small, light electrode holders balanced for easy, tireless handling. Generate negligible heat for safety from burns or fire hazards. Saving on solder alone can pay for the equipment in a year. The quick-changed carbons provide an average 30,000 contacts each.

Send for complete catalog

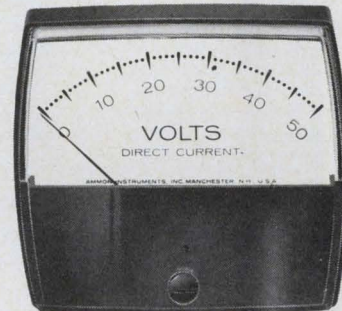
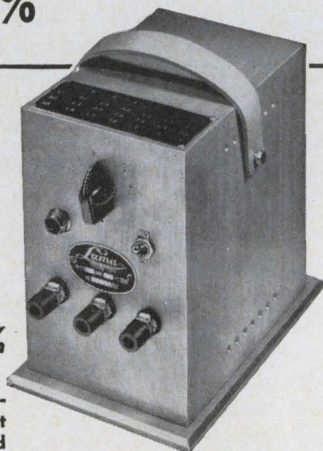

2 1/2 in. AP-2

### Snap-in Dial

2% full scale accuracy,  
self-shielded panel meters

New! Panel meters with plastic bezels give you tailor-made meters at no increase in price. Covers snap off . . . interchangeable dials snap in. High torque mechanism offers 1% linearity, 2% accuracy and sensitivity to 20 ua. Magnetic system is unaffected by external field influences, mounts on any material without interaction. Size: 2 1/2". Choice of colors and finishes. ASA/MIL 3 or 4-stud mount.



THE LUMA ELECTRIC EQUIPMENT CO.  
1629 COINING DRIVE • TOLEDO, OHIO 43612

ON READER-SERVICE CARD CIRCLE 149

ELECTRONIC DESIGN 12, June 7, 1967

## AMMON

AMMON INSTRUMENTS, INC.  
345 Kelley St., Manchester, N.H. 03105

ON READER-SERVICE CARD CIRCLE 150

# WHY SETTLE FOR LESS? GET TOP PERFORMANCE WITH DELTA'S FABULOUS MARK® TEN

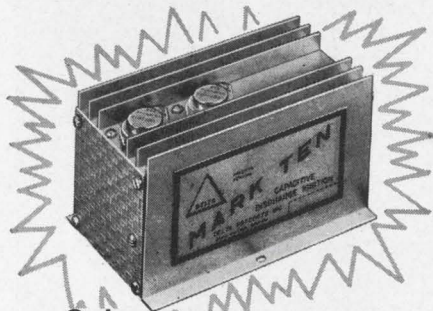

Only  
**\$44.95** CAPACITIVE  
ppd. DISCHARGE  
Deltakit - Only  
\$29.95 ppd. IGNITION SYSTEM

You read about the Mark Ten in the April issue of Popular Mechanics!

Now discover why even Detroit has finally come around. In 4 years of proven performance and reliability, the Mark Ten has set new records of ignition benefits. No wiring. And works on literally any type of gasoline engine. Buy the original, the genuine, the real McCoy — Mark Ten. From Delta. The true electronic solution to a major problem of engine operation.

## READY FOR THESE BENEFITS?

- ▲ Dramatic Increase in Performance and in Fast Acceleration
- ▲ Promotes more Complete Combustion
- ▲ Points and Plugs last 3 to 10 Times Longer
- ▲ Up to 20% Mileage Increase (saves gas)

LITERATURE SENT BY RETURN MAIL  
BETTER YET — ORDER TODAY!

DP 7-9

**DELTA PRODUCTS, INC.**

P.O. Box 1147 ED- Grand Junction, Colo. 81501

Enclosed is \$\_\_\_\_\_. Ship prepaid.  
Please send:  Ship C.O.D.

Mark Tens (Assembled) @ \$44.95  
 Mark Tens (Delta Kit) @ \$29.95

(12 VOLT POSITIVE OR NEGATIVE GROUND ONLY.)

6 Volt: Negative Ground only.  
 12 Volt: Specify  Positive Ground  
 Negative Ground

Car Year \_\_\_\_\_ Make \_\_\_\_\_

Name \_\_\_\_\_

Address \_\_\_\_\_

City/State \_\_\_\_\_ Zip \_\_\_\_\_

ON READER-SERVICE CARD CIRCLE 151

## NEW LITERATURE

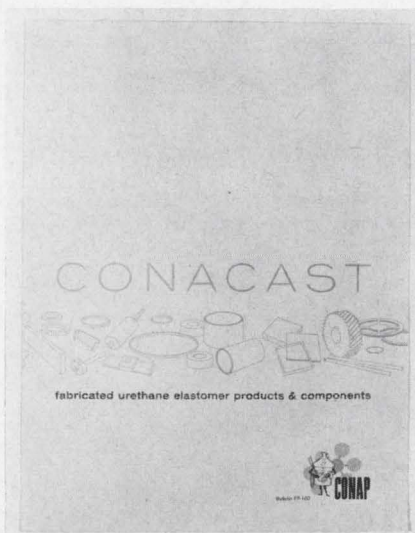

### Fabricated urethane parts

A bulletin describing a service for custom fabrication of urethane elastomer parts has been issued. It contains typical properties of urethane parts and typical applications. Conap, Inc.

CIRCLE NO. 457

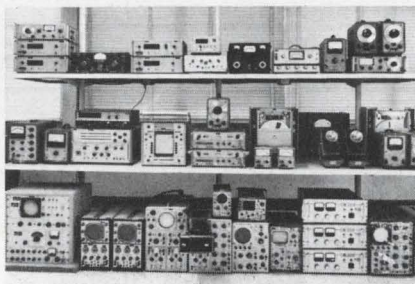

### Equipment for rent

An economical approach to the short-term test equipment requirement with more than 1000 instruments to pick from is covered in this catalog. The brochure describes instruments, terms and prices for varied selections. Insurance and calibration is available. Rental rates include accessories, instruction manuals and maintenance. Continental Leasing Co., Inc.

CIRCLE NO. 458

### Guide to ac motors

This catalog gives dimensional data on a line of ac hysteresis synchronous and induction motors and gearmotors from 5/8-inch diameter to 3-3/4-inch diameter. Units are available for voltages to 200 Vac, 60 and 400 Hz. Globe Industries, Inc.

CIRCLE NO. 459



### Radio electronics catalog

Lafayette's 116-page summer catalog lists major manufacturers' components and introduces a line of vhf communications receivers. Information is given on selection in stereo hi-fi, CB 2-way radio, tape recorders, ham gear, test equipment, radios, TVs and accessories. Lafayette Radio Electronics Corp.

CIRCLE NO. 460

### DTL data package

An 18-page literature package on DTL integrated circuits contains complete DTL product descriptions and consists of individual data sheets as well as composite information. The literature includes logic diagrams, pin arrangements, schematics and application notes. Electrical characteristics and data are supplied for MIL and industrial products in series 930, 932, 933, 944, 945, 946, 948, 949, 950, 951, 961, 962 and 963. Sperry Semiconductor.

CIRCLE NO. 461

### Buyer's guide to PCs

Are you in the market for PC boards? If you're buying, here's how to purchase at the lowest cost, the shortest lead time and the highest reliability. Included in the booklet are hints on price and delivery, production planning, production processing, cost reductions and recommended procurement policies. Lockheed Electronics Co.

CIRCLE NO. 462



# Design Data from Manufacturers

Advertisements of booklets, brochures, catalogs and data sheets. To order use Reader-Service Card.

(Advertisement)

## Adjustable 0-34V, 1.5A Power Supply



Regulation: 0.005% or 1 MV  Ripple: 250  $\mu$ V  
 Output: Adjustable 0-34V, to 1.5A  Completely short circuit proof  Designed to meet environment MIL-E-5272  All silicon semiconductors  Operate to 71°C  Compact 3 $\frac{1}{4}$ " x 3 $\frac{7}{8}$ " x 6 $\frac{7}{8}$ " size  Top quality components & construction  Units operate in series or parallel  Temp. Coef: 0.01%/°C  Response: less than 20  $\mu$ s  MTBF: greater than 100,000 hrs. per MIL HDBK 217  Remote sensing  Universal 3-position mounting  Three year warranty  Only \$88.00 F.O.B. Hackensack, N. J.  Write today.

**Power/Mate Corporation**  
163 Clay St., Hackensack, N. J. 07601  
(201) 343-6294

**171**

## Standard and Precision Ballscrews

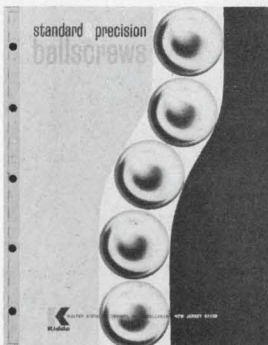

New 8-page folder describes and illustrates advantages and operating principles of Kidde standard and precision ballscrews, including tables listing sizes and operating loads. Technical charts, engineering diagrams, and price schedule for standard ballscrews are also provided.

**Walter Kidde & Company, Inc.**  
675 Main Street  
Belleville, New Jersey 07109

**172**

## Free: 2,500 Plastic Parts Catalog



New from Nylomatic, molders and fabricators of mechanical plastic components, a highly informative 48-page catalog of more than 2,500 standard parts. It can help you save time and money in design, test and production. Advantages of Nylomatic standard parts: no tooling charges, low unit costs, quick delivery, complete range of sizes. Nylomatic standard parts are made of Nylon, Delrin® and other thermoplastic materials. You'll find our new free catalog a real problem solver for designers, send for it today.

**Nylomatic Corporation**  
Dept. P  
Nolan Ave., Morrisville, Pa. 19067

**173**

## Bobbin core design

A 30-page bobbin core catalog provides design formulas, IEEE standards, magnetic materials used and their properties, ceramic and stainless steel bobbin sizes, maximum flux in maxwells and maximum wraps data for each size, proper testing procedures, fabrication and other specifications. The brochure is illustrated with easy-to-use performance and core testing graphs, MKS to CGS units conversion tables and data required for obtaining core characteristics. It has been compiled for the systems design and circuit engineer working on data-processing systems, high-frequency magnetic amplifiers, static inverters, timing circuits, shift registers, ring counters, pulse transformers and static magnetic memory elements. Arnold Engineering Co.

CIRCLE NO. 463

## Stock relay catalog

A 16-page brochure describes and prices the manufacturer's line of 461 relay models. The catalog includes 169 dry reed and mercury-wetted reed relays in miniature, micro-miniature and standard sizes, high-voltage, low-level switching, sensitive, magnetic latching, power, plug-in, printed-circuit and axial-lead types. General-purpose, coaxial, crystal can rotary, telephone and time delay relays in power, low-level switching, sensitive, twin-contact, shock and vibration-resistant, latching, antenna switching, plug-in, hermetically sealed and dust-cover-enclosed types are also described. Magnecraft Electric Co.

CIRCLE NO. 464

## Microwave miniaturization

This 12-page brochure discusses miniature connectors and their use in the coupled line to simplify design. The discussion points out techniques which make it possible for microwave engineers to find the design freedoms enjoyed at low frequencies. Included in the brochure are illustrations of miniature components, performance graphs and application examples. Sage Labs., Inc.

CIRCLE NO. 465

# Design Data from

## Rare earths brochure

Rare-earth applications is the subject of this catalog. The brochure describes the relative abundance of these elements compared with others in the earth's crust. Current and potential applications are discussed for cerium, neodymium, praseodymium, europium, yttrium, lanthanum, samarium and gadolinium. Molybdenum Corp. of America.

CIRCLE NO. 466

## Switch design ideas

A 12-page catalog featuring design ideas for engineers contains a section for miniature electronic switches, remote control relays, readout indicators and pilot lights, ceramic terminal strips, and machined aluminum knobs. Dimensioned drawings and specs are included in the presentation. Alco-switch, Div. of Alco Electronic Products, Inc.

CIRCLE NO. 467

## Crystal components catalog

This brochure describes hermetic, glass-to-metal seal and packaging devices. Crystal enclosures, cold weld and solder seal types, along with a variety of crystal mounts are included. Other products dealt with are window and lens covers for photodiodes and phototransistors, capacitor end seals and pin seals. GTI Corp.

CIRCLE NO. 468

## Radar standards

Minimum performance standards for airborne weather and ground mapping pulsed radar are set forth in this report by the Radio Technical Commission for Aeronautics. The recommended standards were coordinated internationally with the European Organization for Civil Aviation Electronics and an RTCA group. The 40-page document, RTCA DO-134, meets the international standardization needs of users and manufacturers of airborne electronic equipment.

Available for \$2.50 from RTCA Secretariat, 2000 K Street, N. W., Washington, D. C.

## 48 Page Catalog of Lock Nuts



The MacLean-Fogg Lock Nut Company's new catalog No. 880 is the largest such book ever published to deal solely with locking fasteners. Each of the company's wide variety of products is treated comprehensively. The locking principle of each fastener is described. The advantages are stated and materials, finishes, sizes and shapes are covered in detail. Application sketches are given with each product to show how it is used in product assemblies. In addition to data on M-F Products there is a variety of technical information on threaded fasteners including torque-tension data, nut and bolt threads, and a bibliography of reference works on fastening.

### MacLean-Fogg Lock Nut Company

1060 Allanson Road  
Mundelein, Illinois 60060

174

## Laminated and Molded Bus Bars For Power Distribution

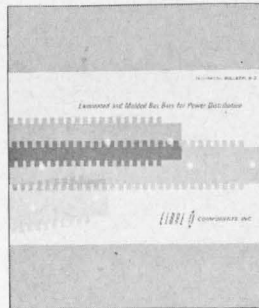

A 16 page Technical Bulletin is now available, describing a new concept in power distribution. Basic mechanical and electrical design principles, along with descriptive pictures and diagrams, are included in this bulletin. These compact buses can replace bulky cable harnesses and repetitive wiring for computer or modular application. This method of construction satisfies the demanding requirements of low inductance and resistance of high speed, solid state systems, while controlling electrical noises.

### Eldre Components, Inc.

1239 University Avenue  
Rochester, New York 14607

175

## Terminal Block Selector

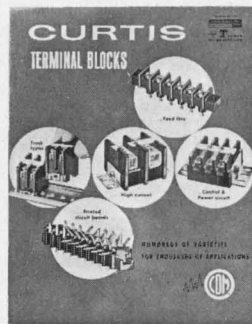

A new 24-page, completely illustrated catalog contains photos, descriptions, ratings, engineering drawings, and prices of the complete line of Curtis terminal blocks. Included are printed circuit, insulated feed-thru, quick disconnect, track type, and high current terminal blocks. Handy selection chart quickly locates the perfect block for your particular requirements. Send today for your free copy.

### Curtis Development & Mfg. Co.

3236 North 33rd Street  
Milwaukee, Wisconsin 53216

176

## Quality Fasteners For All Design Applications



This 8-page catalog provides design data on the complete group of DZUS 1/4-turn self-locking fasteners for standard, high speed and panel applications, as well as universal high strength multiple thread fasteners for high tensile and shear stresses. Dzus stud assemblies, wire forms and receptacles offer an exceptional, wide variety of combinations from stock to fit specific fastening requirements. Diagrams and tables give full details for rapid, unlimited design selection. Condensed Catalog No. S-2 or comprehensive Catalog No. D-3 are available on request.

**Dzus Fastener Co., Inc.**  
Division 32  
425 Union Boulevard  
West Islip, L. I., N. Y. 11795

# 177

## Advertising Representatives

### New York 10022

Robert W. Gascoigne  
Thomas P. Barth  
Samuel M. Deitch  
Richard W. Nielson  
William C. Repetto  
850 Third Avenue  
(212) PLaza 1-5530  
TWX: 867-7866

### Philadelphia

P. O. Box 206  
Merion Station, Pa. 19066  
(215) MO 4-1073

### Boston

Richard Parker  
7 Redstone Lane  
Marblehead, Mass. 01945  
(617) 742-0252

### Chicago 60611

Thomas P. Kavooras  
Berry Conner, Jr.  
720 N. Michigan  
(312) 337-0588

### Cleveland

Robert W. Patrick  
8410 Treetower Drive  
Chagrin Falls, Ohio 44107  
(216) 247-7670

### Los Angeles 90303

Stanley I. Ehrenclou  
Terrence D. Buckley  
W. James Bischof  
2930 W. Imperial Highway  
Inglewood, Calif.  
(213) 757-0183

### San Francisco

Ashley P. Hartman  
175 South San Antonio Rd.  
Ste. 243  
Los Altos, Calif. 94022  
(415) 941-3084

### Southwestern 75206

Tommy L. Wilson  
6200 North Central Expressway  
Dallas, Tex.  
(214) EMerson 1-2311

### London W. 1

Brayton C. Nichols  
44 Conduit Street

### Verviers, Belgium

Andre Jamar  
1, Rue Mallar, 1  
(087) 253.85

### Tokyo

Yoshihiro Takemura  
International Planning  
Service, Inc.  
Room 231 Tokyu-Mita Bldg.  
1, Shiba-Mita Koun-cho  
Minato-ku, Tokyo



## Biddle Portable And Compact Potentiometers



Two complete lines of general purpose voltage or temperature-calibrated potentiometers.

The 605000 series boasts a sensitive multi-reflecting light beam galvanometer which affords excellent resolution.

The 604000 series with pointer type galvanometer includes voltage or temperature-calibrated models, offering many features usually found only in larger portable instruments. Ideal for routine maintenance, trouble-shooting, spot measurement, or production testing.

Request *Bulletins 60-35-1 and 60-36.*

**James G. Biddle Co.**  
Plymouth Meeting, Pa. 19462

# 178

## Selector Chart For Refractory Ware



Free brochure and selector chart describes new line of crystalline oxide refractory and insulating ware for industry and laboratories, featuring high heat resistance, low reactions to chemicals and metals and good mechanical and dielectric strength. Principal materials are: Aluminous Porcelain, Recrystallized Alumina, Thoria, Zirconia, Magnesia. Chart guides selection of insulators, boats, crucibles, tubes, combustion tubes, furnace tubes, pyrometer sheaths, etc. Brochure also covers refractory powders and cements.

**Thermal American Fused Quartz Co.**  
Route 202 & Change Bridge Road  
Montville, N. J. 07045

# 179





## The Complete Engineering Ensemble

The engineering wonders that people like you have accomplished have benefited all mankind. Your basic drawing board tools have also been improved to make your job easier and faster. Prestype, the leading dry transfer alphabet, symbols and borders make it easy to complete a job in quick time and with professional excellence. Our new 74 page catalog illustrates hundreds of lettering faces, borders and symbols that you use everyday.

Depend on Prestype, it's guaranteed.

**Send for it...it's FREE**



**PRESTYPE, INC.**  
136 West 21st Street,  
New York, N.Y. 10011

NAME \_\_\_\_\_

COMPANY \_\_\_\_\_

ADDRESS \_\_\_\_\_

CITY \_\_\_\_\_

STATE \_\_\_\_\_ ZIP \_\_\_\_\_

ON READER-SERVICE CARD CIRCLE 152

# Advertisers' Index

Advertiser	Page
ACDC Electronics Inc.	93
AMP, Incorporated	38, 39
Adams & Westlake Company	145
Airways Rent-a-Car	162
Allen-Bradley Co.	32A-B
Alliance Manufacturing Company, Inc. The	129
American Enka Corporation, Brand-Rex Division	137
Ammon Instruments, Inc.	185
Amperex Electronic Corporation	126
Anadex Instruments, Inc.	155
Arnold Engineering Company, The	135
Augat, Inc.	166
Automatic Electric, A Subsidiary of General Telephone & Electronics	114, 181
B & B Electronics Corp.	176
Babcock Relays, Division of Babcock Electronics Corporation	127
Ballantine Laboratories, Inc.	141
Bell Telephone Laboratories	143
Bendix Corporation, The Electrical Components Division	85
Biddle Co., James G.	189
Bourns, Inc.	105
Branson Corp.	154
CTS of Berne, Inc.	99
Clarostat Mfg. Co., Inc.	117
Clifton, Division of Litton Industries	103
Cohn Corp., Sigmund	177
Coleman Engineering Company, Inc.	151
Collins Corp., G. L.	166
Comar Electric Company	165
Computer Test Corporation	123
Consolidated Avionics, A Division of Condec Corporation	139
Corning Electronics, Division of Corning Glass Works	4, 5
Coto Coil Company, Inc.	172
Couch Ordnance, Inc.	177
Curtis Development & Mfg. Co.	188
Cutler-Hammer	75
Dale Electronics, Inc.	Cover III
Damon Engineering, Inc.	146A-J
Data Control Systems, Inc.	138
Datapulse Instruments Division, Datapulse, Incorporated	2
Decision Control, Inc.	175
Delco Radio, Division of General Motors	42, 43
Delta Products, Inc.	186
Deutsch Electronic Components Division	107
Dialight Corporation	179
Dow Corning Corporation	34, 35, 37
Dzus Fastener Co., Inc.	189
EG&G, Inc.	40
Edmund Scientific Company	179
Eldema, A Division of Genisco Technology Corporation	170
Eldre Components, Inc.	188
Electronic Development Corporation	128
Electronic Research Associates, Inc.	33
Electronized Chemicals Corporation	118
Electrovert, Inc.	172
Fairchild Semiconductor, A Division Fairchild Camera and Instrument Corporation	8, 9
Fluke Mfg. Co., Inc., John	101
General Electric Company	45
General Electric Company, Electronic Components, Sales Operation	70, 71
General Electric Company, Miniature Lamp Department	171
General Electric Company, Semiconductor Products Department	161
General Precision, Librascope Group	91
General Radio	1
Globe Industries, Inc.	175
Grayhill, Inc.	192
Heinemann Electric Company	49
Hersey-Sparling Meter Company	178
Hewlett-Packard	Cover II, 19, 95
Honeywell, Computer Control Division	28
Howell Instruments, Inc.	191
IRC, Inc.	89
ITT Semiconductors, A Division of International Telephone and Telegraph	194
Ideal Precision Meter Co. Inc.	176
Industrial Control Company	175
International Electronic Research Corporation	157
JFD Electronics Co./Components Division	124
Janco Corporation	47
Janus Control Corporation	122
Johanson Manufacturing Corp.	130
Johnson Company, E. F.	148

Advertiser	Page
Keithley Instruments	112
Kepco, Inc.	102
Kester Solder Company	76, 77
Kidde & Company, Inc., Walter	187
Krohn-Hite Corporation	140
Line Electric Company, Division of Industrial Timer Corporation	136
Little Falls Alloys, Inc.	163
Littlefuse	179
Lockheed Electronics Company	174
Luma Electric Equipment Co.	185
MacLean-Fogg Lock Nut Company	188
Magnetic Shield Division, Perfection Mica Company	185
Magnetics, Inc.	131
Master Specialties, Inc.	152
Methode Electronics, Inc.	167
Michigan Chemical Corporation	158
Microdot, Inc.	15
Microwave Associates, Inc.	21
Minco Products, Inc.	193
Monsanto	80, 81
Mosaic Fabrications, Inc.	119
Motorola Semiconductor Products, Inc.	41, 46
Nylomatic Corporation	187
Nytronics, Inc.	23
Paktron Division of Illinois Tool Works, Inc.	168
Pamot, Inc.	164
Perfection Mica Company	185
Philbrick Researches, Inc.	183
Philips Electronic Measuring Instruments	31
Plastic Capacitors, Inc.	104
Potter & Brumfield Division of American Machine & Foundry Company	48
Power/Mate Corp.	187
Prestype Inc.	190
Pyrofilm Resistor Co., Inc.	132
RBM Controls Division	173
RCA Electronic Components and Devices	31, Cover IV
RCL Electronics, Inc.	106
Radio Cores, Inc.	156
Raytheon Company, Sorensen Operation	16
Reeves Hoffman Division of DCA	154
Rider Publisher Inc., John F.	158
Rowan Controller Co., The	25
Scanbe Manufacturing Corp.	144
Secon Metals Corporation	134
Sensitak Instrument Corp.	184
Sigma Instruments, Sigma Instruments, Inc.	88
Signalite, Incorporated	169
Signetics Integrated Circuits, A Subsidiary of Corning Glass Works	153
Siliconix Incorporated	149
Spectrol Electronics Corporation	125
Sprague Electric Company	10
Switchcraft, Inc.	120
Sylvania, Subsidiary of General Telephone & Electronics	82
Syntronic Instruments, Inc.	162
TRW Semiconductors Inc.	50
Tektronix, Inc., Oscilloscopes	52
Telonic Instruments, A Division of Telonic Industries, Inc.	97
Texas Instruments Incorporated, Semiconductors-Components Division	60, 61
Texscan Corporation	113
Thermal American Fused Quartz Co., Inc.	189
Thomas & Betts Co. Incorporated, The 48A-B	121
Ulano	27
Union Carbide Corporation	160
Unholtz-Dickie Corporation	142
Vactec Inc.	12
Varian, Palo Alto Tube Division	65
Velonex, A Division of Pulse Engineering Inc.	32
Vishay Resistor Products, A Division of Vishay Intertechnology, Inc.	159
Vitramon, Incorporated	170
Wavelabs Co.	133
Western Microwave Laboratories, Inc.	7
Westinghouse Molecular Electronics Division	150
Wheelock Signals, Inc.	192
Wood Electric Corporation	192
Wright/Division of Sperry Rand Corporation	6

### Career Advertising:

Boeing Company, The	111
Hughes Aircraft Company	110
Lockheed Missiles & Space Company	112
McDonnell Douglas	108
Omni Spectra, Inc.	44

**HOWELL  
H160 SERIES  
SOLID-STATE  
DIGITAL  
INDICATORS**



**... will measure linear or non-linear signals ... or both with multiple input!**

The H160 Series will monitor, measure and display ... with digital readout in direct engineering terms ... physical processes such as temperature, pressure, flow, voltage, etc., with an accuracy of 0.1% of full scale.

The instruments utilize the null-balance potentiometric principle to measure transducer output signals which are either linear or non-linear. The units follow non-linear functions with multiple, precisely calibrated, straight-line approximations. Non-linear curves of thermocouples, strain gauges or most any other transducer can be accurately followed.

The easy-to-read display sector may include: polarity; numerical readout with decimal point; function such as degrees C, inches Hg, PSI, etc.; out-of-range; and the number of the point being measured. Used with a Howell Multipoint Scanner, input signals may be mixed (linear or non-linear). An example of the Indicator-Scanner System might be a 40-point Scanner with 20 inputs for pressure and 20 inputs for temperature with a single Indicator displaying both sets of data. The data can also be made available in binary-coded decimal or ten-line parallel decimal form at a connector for input to a computer, printer or tape punch.

*Write for detailed brochures.*

**HOWELL INSTRUMENTS  
ALSO OFFERS  
SERVO-DIGITAL INDICATORS,  
DIGITAL DATA SYSTEMS,  
AND A WIDE VARIETY  
OF OTHER INSTRUMENTS  
... CUSTOMIZED  
FOR MANY APPLICATIONS.**

**BH100 and BH186/BH187 Series**

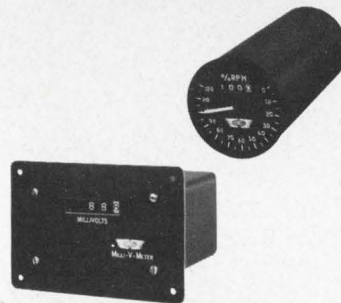

The servo-digital indicators shown above are null-balance instruments utilizing the TA'POT® slidewire. The units are available in various ranges and various direct readouts.

**BH103 Digital Data System**

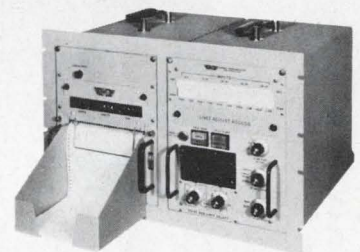

The BH103 incorporates a 100-point Scanner with direct digital readout and prints the data on folded paper. i.e., EVENTS, TEMP °F, TIME.



**HOWELL INSTRUMENTS, INC.**

3479 West Vickery Blvd.

Area Code 817 336-7411 • Fort Worth, Texas 76017

ENGINEERING AND SALES OFFICES IN PRINCIPAL CITIES IN THE UNITED STATES, CANADA, ENGLAND, AUSTRALIA, AND JAPAN

ON READER-SERVICE CARD CIRCLE 153

# simultaneous three-pole operation

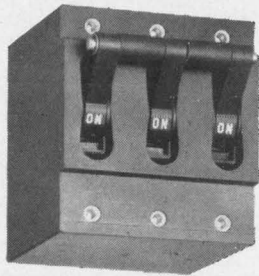

If overload occurs in any one pole, all three open simultaneously. All Wood Electric Three-Pole Magnetic Circuit Breakers are connected internally as well as externally. Instantaneous and Time Delay Types are available in AC and DC with ratings from 1/2 to 50 amps. Write for Thermal and Magnetic Circuit Breaker Catalog.



**WOOD ELECTRIC  
CORPORATION**

244 Broad St., Lynn, Mass. (617) LY 8-5313

ON READER-SERVICE CARD CIRCLE 154

**TOTALLY ENCLOSED ROTARY SWITCHES.  
TEMPERATURE TO 125 C. MULTI-POLE.  
30°, 36°, 45°, 60°, and 90° ANGLE of THROW.  
100,000 OPERATIONS.**

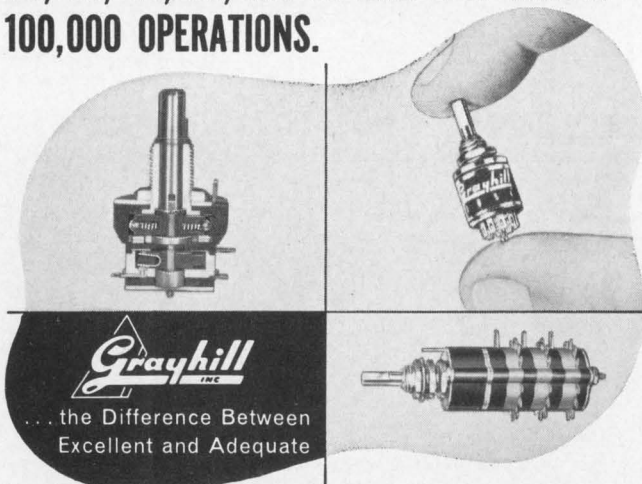

**Grayhill**  
INC.

... the Difference Between  
Excellent and Adequate

**Typical Specifications:**

- Explosion Proof
- Contact Resistance 10 Milliohms
- Make or Break 1/4 Amp. to 15 Amps., 115 VAC Resistive
- 1 to 6 Poles per Deck
- 1 to 12 Decks
- 2 to 12 Positions per Pole

Send for Engineering Catalog G304



565 Hillgrove Avenue  
LaGrange, Illinois 60525  
Area Code 312, Phone 354-1040

"PIONEERS IN MINIATURIZATION"

ON READER-SERVICE CARD CIRCLE 155

## Electronic Design

ELECTRONIC DESIGN's aim is fourfold. It aids progress in the electronics manufacturing industry by promoting good design. It gives the electronic design engineer concepts and ideas that will make his job easier and more productive. The magazine serves as a central source of timely, up-to-the-minute electronics information. And finally it seeks to encourage two-way communication between manufacturer and engineer.

**Want a subscription?** ELECTRONIC DESIGN is circulated free of charge to qualified engineers and engineering management doing design work, supervising design or establishing standards in the United States, Western Europe and the United Kingdom. If you think that you are entitled to a free subscription, use the postfree application form that you will generally find inside the back cover. When it is not included, write to us direct for an application form.

If you are not qualified, you may take out a paid subscription at the following rates: \$25 a year if you live in the U.S.A. or \$35 a year if you live elsewhere. Single copies may be purchased for \$1.50 each.

**If you change your address,** send us an old mailing label and your new address; there is generally a prepaid postcard for this inside the back cover. If you have been receiving ELECTRONIC DESIGN free of charge, you will have to requalify to continue doing so.

**We strive for accuracy.** We take the utmost pains to ensure the highest standard of accuracy throughout the magazine. A single mistake in practical design information can have serious consequences. But to err is human, and for all the care we take, an occasional error slips through. Whenever this occurs, we publish a correction at the earliest opportunity. You will find these corrections printed at the end of the Letters column. If you should spot an error, be sure to let us know. You may save your colleagues heartaches.

**Microfilm copies are available** of complete issues of ELECTRONIC DESIGN that have been published since the beginning of 1961, and of single articles. Complete issues cost 4¢ a page, individual pages cost 50¢ each; shipping and handling charges are extra. The minimum charge is \$3; delivery time runs from 10 days for single pages to five weeks for complete issues. For further details and to place orders, get in touch directly with University Microfilms, Inc., 300 N. Zeeb Road, Ann Arbor, Mich. 48106; telephone (313) 761-4700.

**Want to contact us?** If you have any inquiries about these or other matters, or if you have a manuscript outline or article idea, address your correspondence to:

Howard Bierman, Editor,  
ELECTRONIC DESIGN,  
850 Third Avenue,  
New York, N.Y. 10022.

# Designer's Datebook

JUNE						
S	M	T	W	T	F	S
				1	2	3
4	5	6	7	8	9	10
11	12	13	14	15	16	17
18	19	20	21	22	23	24
25	26	27	28	29	30	

JULY						
S	M	T	W	T	F	S
						1
2	3	4	5	6	7	8
9	10	11	12	13	14	15
16	17	18	19	20	21	22
23	24	25	26	27	28	29

For further information on meetings, use Reader Service card.

## June 19-20

**Microelectronics Symposium** (St. Louis) Sponsor: IEEE; T. F. Murtha, Conductron-Missouri, P. O. Box 426, 2600 N. Third St., St. Charles, Mo. 63301.

CIRCLE NO. 469

## June 25-28

**National Consumer Electronics Show** (New York City) Sponsor: Electronic Industries Assoc.; EIA, 200 Eye St., N.W., Washington, D.C. 20006.

CIRCLE NO. 470

## June 28-30

**Joint Automatic Control Conference** (Philadelphia) Sponsor: IEEE; L. Winner, 152 W. 42 St., New York, N. Y. 10036.

CIRCLE NO. 471

## July 17-19

**Reliability and Maintainability Conference** (Cocoa Beach, Fla.) Sponsor: SAE, AIAA, EIA *et al.*; E. J. Folkman, General Electric Co., Cape Kennedy, Fla. 32920.

CIRCLE NO. 472

## July 18-20

**Electromagnetic Compatibility Symposium** (San Francisco) Sponsor: IEEE; J. S. Hill, P. O. Box 7405, Benjamin Franklin Station, Washington, D. C. 20044.

CIRCLE NO. 473

## July 24-28

**Design Course on Automatic Electronic Test Equipment** (New York City) Sponsor: New York University; D. M. Goodman, N. Y. U. School of Engineering and Science, 401 W. 205 St., New York, N. Y. 10034.

CIRCLE NO. 474

# THERMAL-RIBBON RESISTANCE-TYPE SURFACE TEMPERATURE SENSORS

DESIGNED FOR  
COMMERCIAL — LABORATORY — INDUSTRIAL  
MILITARY AND MISSILE  
APPLICATIONS

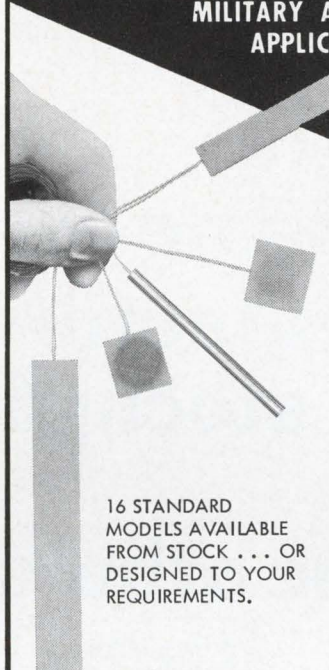

16 STANDARD MODELS AVAILABLE FROM STOCK . . . OR DESIGNED TO YOUR REQUIREMENTS.

**THERMAL-INDICATORS**  
Used with Thermal-Ribbons (left), Resistance Thermometers and Temperature Probes (below). Six models, direct reading from  $-100^{\circ}\text{C}$  to  $+200^{\circ}\text{C}$  or  $-148^{\circ}\text{F}$  to  $+392^{\circ}\text{F}$ .

**TEMPERATURE PROBES, RESISTANCE THERMOMETERS**  
Many tip or stem sensitive stock models for accurate sensing of gas, liquid, solid temperatures in industrial, commercial, laboratory use.

**THERMOFOLIOS**  
Laminated thin-film assemblies, flat or wrap-around, for heating, sensing, or both.

**PRECISION PLATINUM RESISTANCE THERMOMETERS**  
For highly precise measuring or control; long-term stability and accuracy.

**BUTTON-HEATERS**  
Disc shaped units for controlled heat. Available up to 150 watts.

**RESISTANCE TEMPERATURE DETECTORS**  
Rugged sensors for large motors, generators, transformers, etc. Permanently installed by molding or casting into equipment.

## THERMAL-RIBBONS

Thermal-Ribbons provide convenient, fast-response, conversion of surface temperatures to accurate electrical readout for temperature measuring, recording, or control. They have high resistance vs. temperature gradient and high impedance, enabling leads to be switched, spliced, or extended without undue concern about signal error.

Used with Minco Direct Readout Thermal - Indicator (described at right) to accurately measure temperatures from  $-100^{\circ}\text{C}$  to  $+200^{\circ}\text{C}$  ( $-148^{\circ}\text{F}$  to  $+392^{\circ}\text{F}$ ) . . . or with other conventional resistance measuring equipment from  $-200^{\circ}\text{C}$  to  $+260^{\circ}\text{C}$ . Available in both self-adhesive and non-adhesive versions. Time response as low as 0.2 second.

## MINCO PRODUCTS, INC.

740 WASHINGTON AVENUE NORTH — MINNEAPOLIS, MINN. 55401

TELEPHONE: (612) 338-6753

PLEASE SEND INFORMATION ABOUT —

TW X: 910-576-2848

- |   |   |  |
|---|---|--|
| <input type="checkbox"/> Thermal-Ribbons    | <input type="checkbox"/> Thermofoils            | <input type="checkbox"/> Res. Temp. Detectors  |
| <input type="checkbox"/> Thermal-Indicators | <input type="checkbox"/> Precision Thermometers | <input type="checkbox"/> Send Complete Catalog |
| <input type="checkbox"/> Temperature Probes | <input type="checkbox"/> Button-Heaters         | <input type="checkbox"/> Have Rep. Call        |

NAME \_\_\_\_\_

COMPANY \_\_\_\_\_

ADDRESS \_\_\_\_\_

CITY \_\_\_\_\_ STATE \_\_\_\_\_ ZIP \_\_\_\_\_

TELEPHONE \_\_\_\_\_ EXTENSION \_\_\_\_\_

ON READER-SERVICE CARD CIRCLE 156

# **The Predictables.**

**Some computer  
manufacturers  
stockpile diodes.**

**The others order  
from ITT.**

ITT ships any size order, any day you say.  
Any part number, silicon or germanium,  
double plug or DO-7. Make us prove it.  
RFQ: The Predictables.

diodes **ITT**

ITT SEMICONDUCTORS IS A DIVISION OF INTERNATIONAL TELEPHONE AND TELEGRAPH CORPORATION  
FACTORIES IN WEST PALM BEACH, FLORIDA; PALO ALTO, CALIFORNIA; LAWRENCE, MASSACHUSETTS; HARLOW AND FOOTSCRAY, ENGLAND; FREIBURG AND NURENBERG, GERMANY



# Powerfully small!

(15 watts in 1/16 cubic inch)

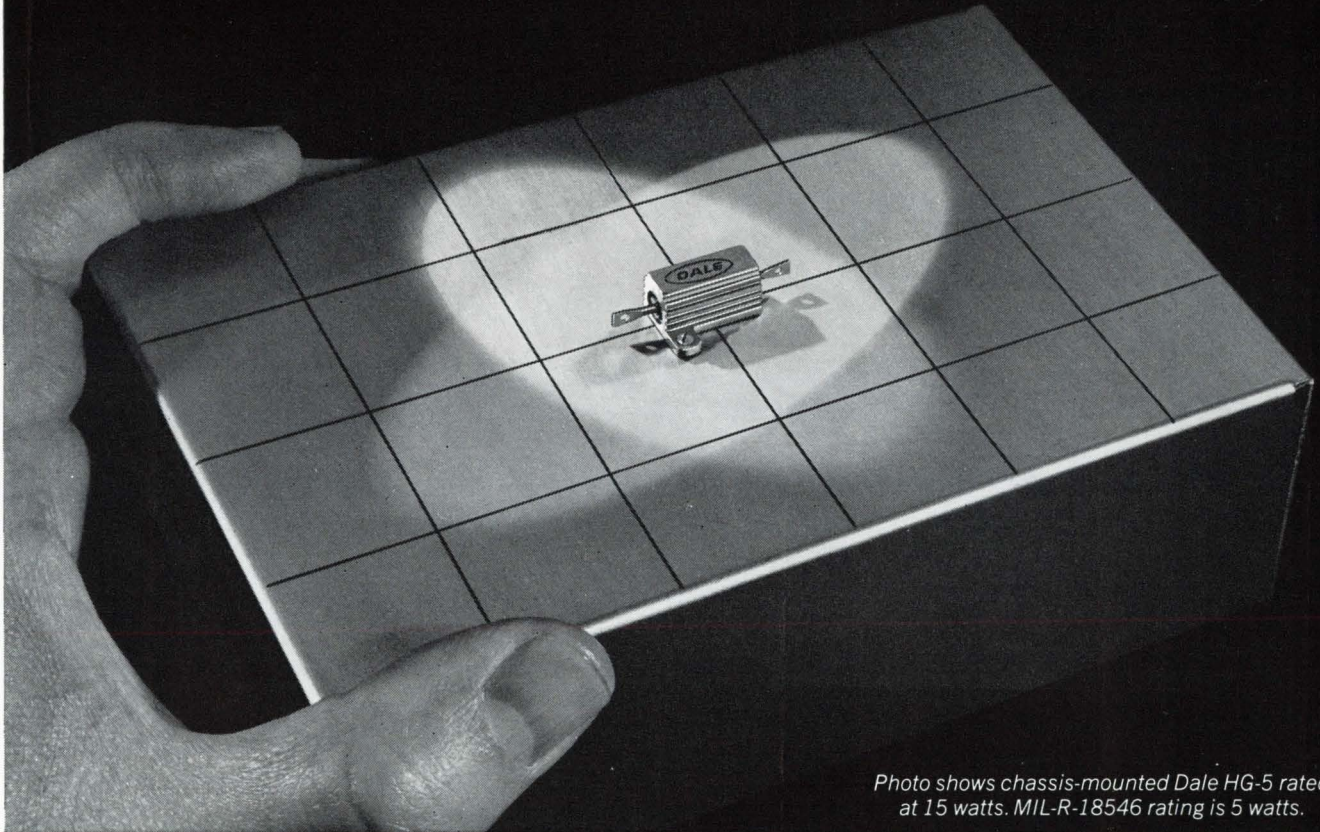

Photo shows chassis-mounted Dale HG-5 rated at 15 watts. MIL-R-18546 rating is 5 watts.



## HG WIREWOUNDS – the right choice for power & stability in minimum size

Load 'em! Dale HG resistors safely handle up to three times their MIL-R-18546 power ratings. Use them to package more power in less space—use them to gain unequalled stability when derated to mil. levels.

This kind of heat dissipation ability is found only in the HG Series. We mold a wirewound BeO core (see chart) inside a special aluminum housing to give you up to 15 watts in a package .600" long; up to 50 watts in a package 1.968" long. *Non-inductive styles, too.* Call on Dale now for your widest choice in meeting precision power requirements.

Core Conductivity at 275° C		BTU-Ft Ft <sup>2</sup> -Hr-°F
	BERYLLIUM OXIDE (BeO) - 64	
	STEEL - 33	
	ALUMINUM OXIDE - 8	
	STEATITE - 1.5	

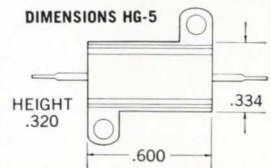

### STANDARD ELECTRICAL SPECIFICATIONS

DALE TYPE	MIL-R-18546 TYPE	POWER RATING* (WATTS)		RESISTANCE RANGE (OHMS)	
		DALE	MIL.	.05%, .1%, .25%	.5%, 1%, 3%
HG-5	RE-60	15	5	1 to 6.5K	.1 to 24.5K
HG-10	RE-65	20	10	1 to 12.7K	.1 to 47.1K
HG-25	RE-70	35	20	.5 to 25.7K	.1 to 95.2K
HG-50	RE-75	50	30	.5 to 73.4K	.1 to 273K

- Operating Temp. Range: -55° C to +275° C
- Temperature Coefficients: ±50 PPM, ±30 PPM, ±20 PPM
- Load Life: ± (1% + .05Ω) Δ R
- Momentary Overload: ± (.25% + .05Ω) Δ R

\*based on chassis mounting

WRITE FOR NEW CATALOG A



**DALE ELECTRONICS, INC.**  
1328 28th Ave., Columbus, Nebraska 68601  
In Canada: Dale Electronics Canada, Ltd.



ON READER-SERVICE CARD CIRCLE 203

# No other RF transistor can offer this performance

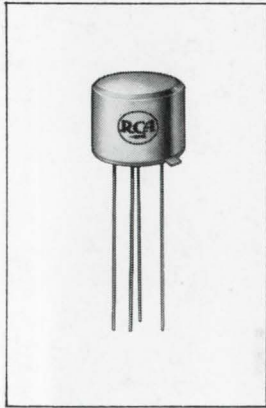

- ✓ **21 dB min. unneutralized power gain at 200 MHz**
- ✓ **3 dB max. NF at 200 MHz**
- ✓ **0.25 pF max. feedback capacitance**
- ✓ **new terminal arrangement for superior high frequency performance**

## at this low price...98¢

2N4935 in quantities of 1,000 and up

RCA 2N4934, 2N4935, and 2N4936 are new silicon npn epitaxial planar transistors expressly designed for low-noise, high-gain rf amplifier service up to 500 MHz. Commercial, military and industrial communications applications include equipment such as mobile and aircraft radio, expendable military equipment, telemetry equipment, amateur radio equipment, wide-band amplifiers, and microwave equipment.

A unique feature of these RF transistors is the new, pace-setting transposed base arrangement and a new internal construction utilizing a solid state shield which provides maximum isolation between terminals. This innovation provides greater stability and more usable gain per stage.

In addition, the exceptionally low feedthrough capacitance reduces oscillator radiation, and the hermetically sealed TO-104 metal case permits operation at higher temperatures and offers long life expectancy. So don't settle for anything less than **top performance** and **top value** in your critical commercial, industrial and military communications applications. For complete information, including price and delivery, see your RCA Field Representative. For additional technical data, write RCA Commercial Engineering, Section **EG-6**, Harrison, N.J. 07029. See your RCA Distributor for his price and delivery.

RCA Electronic Components and Devices



The Most Trusted Name in Electronics

ON READER-SERVICE CARD CIRCLE 204

### ELECTRICAL SPECIFICATIONS

#### high gain bandwidth product

$f_T = 700$  MHz min.

#### high unneutralized power gain

2N4934: 18 dB min. at 200 MHz

2N4935: 21 dB min. at 200 MHz

2N4936: 13 dB min. at 450 MHz

#### low noise figure

2N4934: 3.5 dB max. at 200 MHz

2N4935: 3.0 dB max. at 200 MHz

2N4936: 4.5 dB max. at 450 MHz

#### very low collector-to-base feedback capacitance

$C_{cb} = 0.25$  pF max. at 0.1 to 1 MHz

#### high operating temperature capability

to 200°C

#### PRICE\*

2N4934: 85¢

2N4935: 98¢

2N4936: \$1.15

\*In quantities of 1,000 and up