

Electronic Design 21

FOR ENGINEERS AND ENGINEERING MANAGERS

VOL. 19 NO. 1
OCT. 14, 1971

Tone decoders are easy to build using ICs and phaselock loop techniques. They operate over wide frequency ranges and they are inexpensive, to boot. Areas of application include telemetry, remote control via power lines and low-speed data transmission. For complete design details, see the article beginning on page 66.

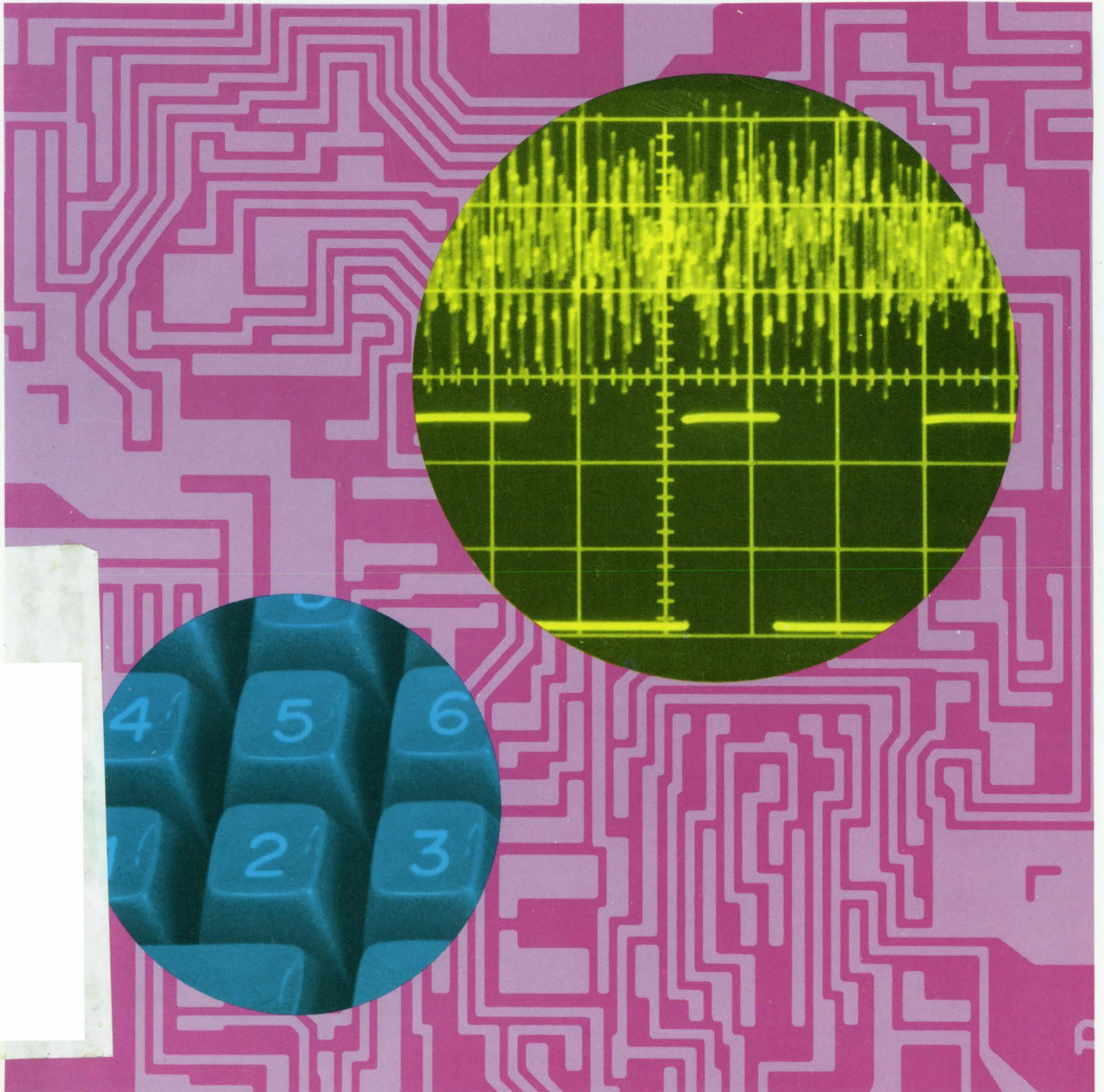

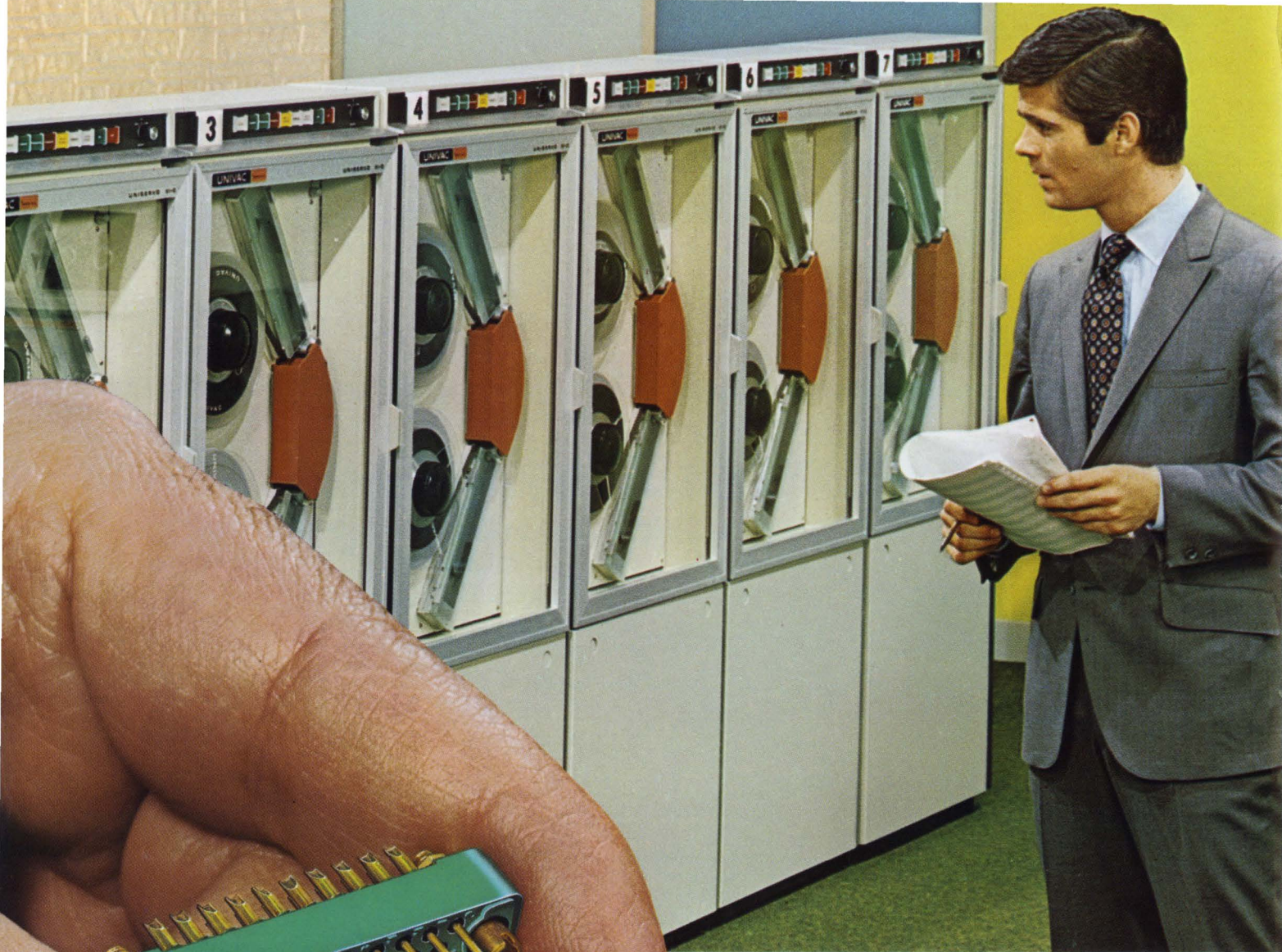

UNIVAC Servo Tape Systems rely on Dale microminiature connectors to provide a precise signal interface between magnetic heads and read/write circuits.

Dale Rack & Panel Connectors read right, write right, priced right

Critical signal transfer applications in UNIVAC Servo Tape Systems are typical of the growing uses for Dale rack and panel connectors. Available in microminiature, subminiature and miniature styles with up to 75 contacts in standard models. All use precision machined phosphor bronze contacts designed to float into easy alignment. Gold over silver plating assures good solderability, low contact resistance. Ask for details today... including Dale's very competitive price.

Phone 605-665-9301 or write for Connector Catalog.

DALE ELECTRONICS, INC.

East Highway 50, Yankton, South Dakota 57078

In Canada: Dale Electronics Canada, Ltd. • A subsidiary of The Lionel Corporation

INFORMATION RETRIEVAL NUMBER 3



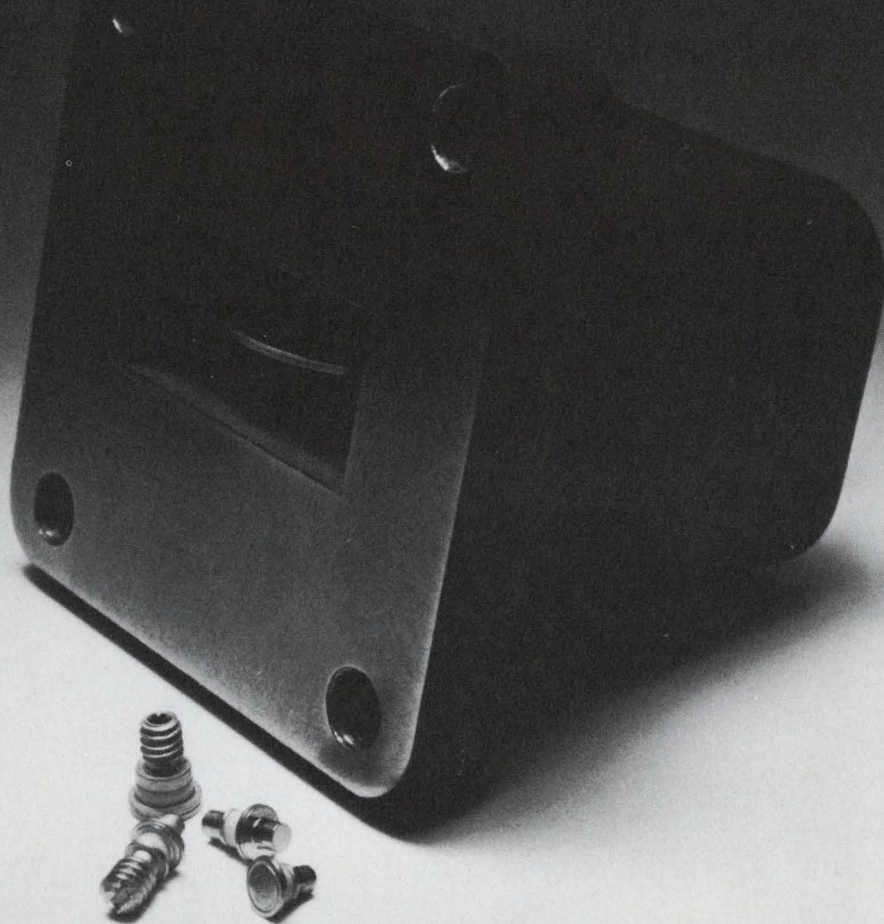

Our IMPATT diodes will uncomplicate your circuits.

We'll show you how in our 32-page guide to IMPATT circuit design. This applications brochure specifically details nine ways to incorporate IMPATTs as the active element in microwave oscillators and amplifiers.

You can use IMPATTs to cut costs and increase performance in applications as diverse as Doppler radar, telecommunications and telemetry. And they're bringing more effective intrusion alarms within the pocketbook of every businessman and homeowner.

But whatever your application, you'll find an HP IMPATT right for your design. We cover the

range from 5 GHz to 14 GHz, with power from 100 mw to over 1½ watts.

Our IMPATT diodes are available in a price range that others can hardly match: 100 mw family, less than \$15; ½ watt family, less than \$50; 1½ watt family, \$75. (100 quantity prices). Start uncomplicating your circuits today and write for our IMPATT application brochure and other information: Hewlett-Packard, Palo Alto, California 94304; Europe: 1217 Meyrin-Geneva, Switzerland.

01107

HEWLETT  PACKARD

Siemens



**No one knows ferrites like a ferrite user.
We produce and use more quality ferrites than anyone.**

Siemens, a world leader in the design and manufacture of sophisticated telecommunications and computer systems, has also become the world's leading producer of linear, memory and microwave ferrites. Ferrites that are performance and reliability engineered to meet our demanding

system requirements.

Siemens pioneered T38 with permeabilities of 10,000, T9 and T10 high-density ferrites for recording heads, SM6 and M6 filter inductors for high packing densities, 12 mil extended temperature cores, plated wire memories and CVB7 microwave material.

Siemens design engineers are ready to assist you in solving your ferrite problems.

Siemens Corporation, 186 Wood Avenue South, Iselin, N.J., 08830. (201) 494-1000. Siemens. A three billion dollar name in quality products. **SIEMENS**



NEWS

- 19 **News Scope**
- 22 **Oil drillers look to electronics** to help them strike it richer with greater safety and fewer personnel.
- 28 **Don't write off the venerable reed relay.** Recent advances have made it faster, tinier and cheaper.
- 30 **Semiconductor laser has twice the efficiency** of previous devices.
- 32 **A mere touch** sets off new burglar alarm.
- 36 **Technology Abroad**
- 41 **Washington Report**

TECHNOLOGY

- 52 **FOCUS on Linear ICs:** A special report on the fiercely competitive world of the linear IC where specs aren't always what they appear to be.
- 66 **Need a tone decoder?** Just modify a phase-locked loop, and you can use low-cost ICs to eliminate tuned circuits and mechanical filters.
- 70 **To use Gunn or Impatt diodes** in the same microwave oscillator structure, you must match a broad range of reactive diode impedances. Here's how.
- 76 **Design active elliptic filters easily from tables.** All you need is passband ripple, stopband rejection and the required frequencies.
- 82 **Want to hire that elusive executive?** You'll have to answer his complaints as a job hunter first, which may mean updating your company's hiring procedure.
- 86 **Ideas for Design**

PRODUCTS

- 95 **Modules & Subassemblies:** Active filter decodes over two octaves.
- 96 **Modules & Subassemblies:** High-density vacuum tube has 64-gun display.
- 112 **ICs & Semiconductors:** Custom design of bipolar ICs can be cheaper and faster.
- 118 Components
- 126 Data Processing
- 132 Instrumentation
- 134 Packaging & Materials
- 137 Microwaves & Lasers
- 152 Product Index

Departments

- 51 **Editorial:** Help
- 7 Letters
- 13 Designer's Calendar
- 140 Evaluation Samples
- 141 Design Aids
- 142 Application Notes
- 143 New Literature
- 146 Bulletin Board
- 150 Advertisers' Index
- 152 Information Retrieval Card

Cover: Designed by Art Director Bill Kelly with special credit to Signetics Corp.

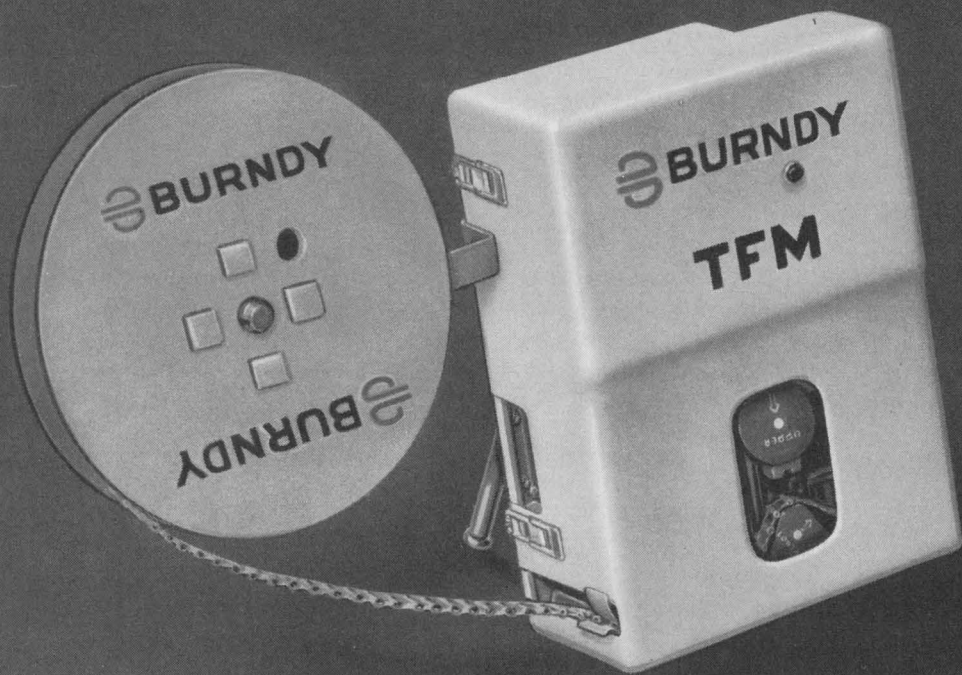

Our little TFM Crimper

No matter what you're using, you can't afford not to use this new Burndy machine for installing terminals and splices on wire sizes 22 to 10. Designed to take all types—vinyl-insulated, nylon-insulated and bare—the TFM does all the work of several competitive machines. And beats all others on the basis of installed cost, ease of use and maintenance.

No die changing. Multi-position die turrets adapt the crimp to all types, all sizes. Just a twist of the

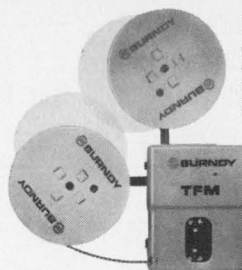

Two-position reel holder allows optimum use of bench space. To operate, just insert the wire and press the foot pedal.

Rear tilt stand is adjustable from 60° to horizontal. Suitcase type handle makes it easy to carry the lightweight TFM to any area.

Vinyl-insulated, nylon-insulated and uninsulated terminals and splices from wire size 22 to 10 are all installed quickly and easily with the TFM.

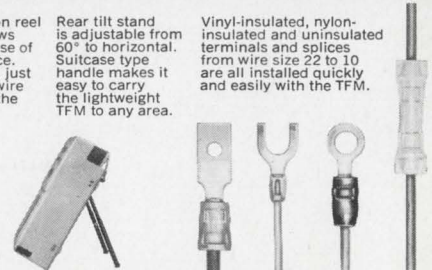

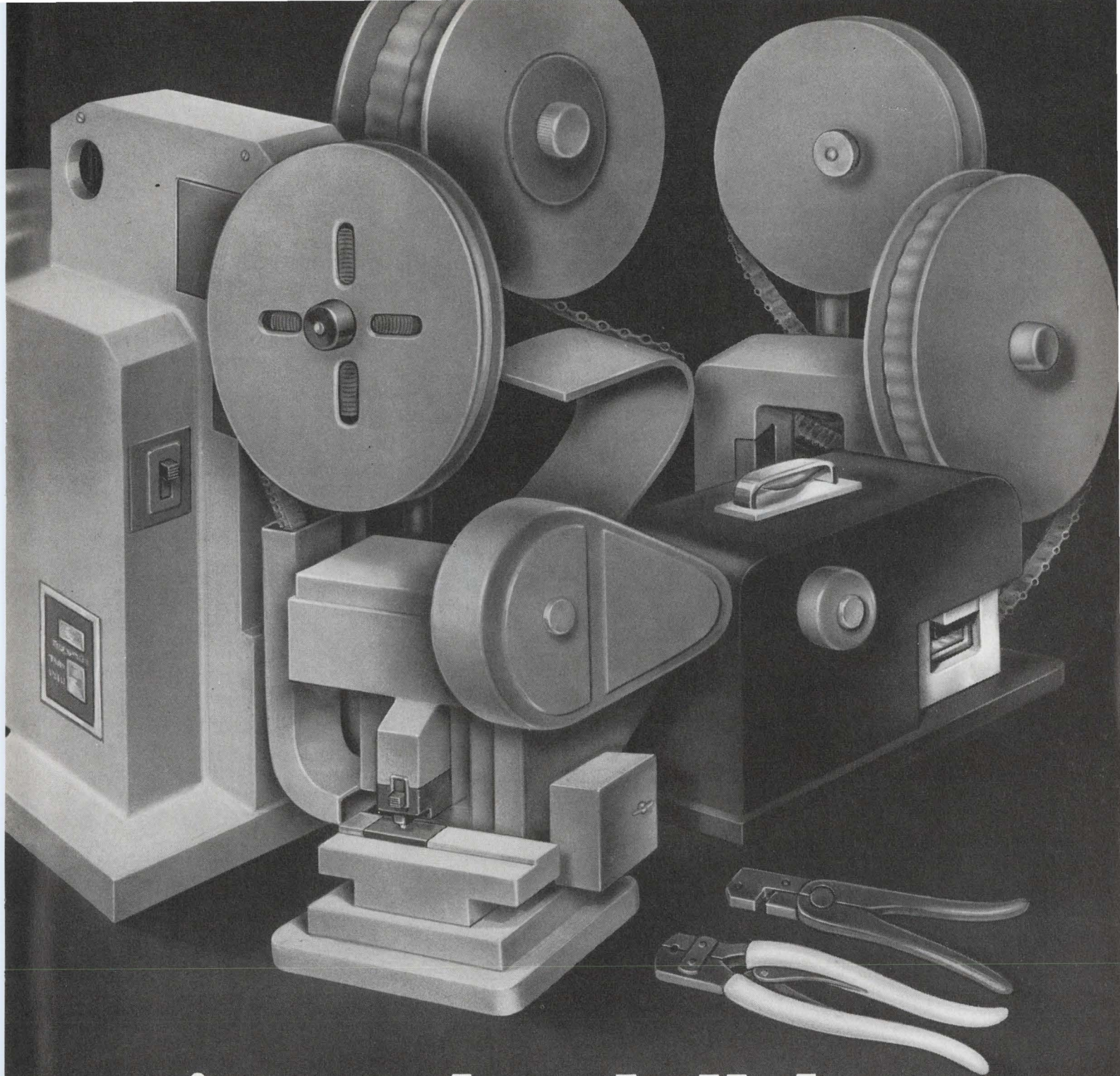

just replaced all these.

wrist rotates the control. In 30 seconds flat, an operator can change reels, terminals and dies.

The TFM offers other important advantages: It's fast. 1500 to 2000 crimps per hour. It's quiet. Powered by air as well as electricity, it cuts the noise by 80% compared with all-electric machines. It's safe. The small opening accepts only wire. A non-glare cover reduces eye fatigue. And because it is lightweight, it can be carried like a suitcase to any bench.

A two-position reel holder adapts to available bench space, and Burndy terminals and splices, mounted on low-cost Mylar, come wound on lightweight, easy-to-handle cardboard reels.

The TFM, available on lease, saves space, inventory and money on all the tooling it replaces.

 **BURNDY**
Norwalk, Connecticut 06856

INFORMATION RETRIEVAL NUMBER 4

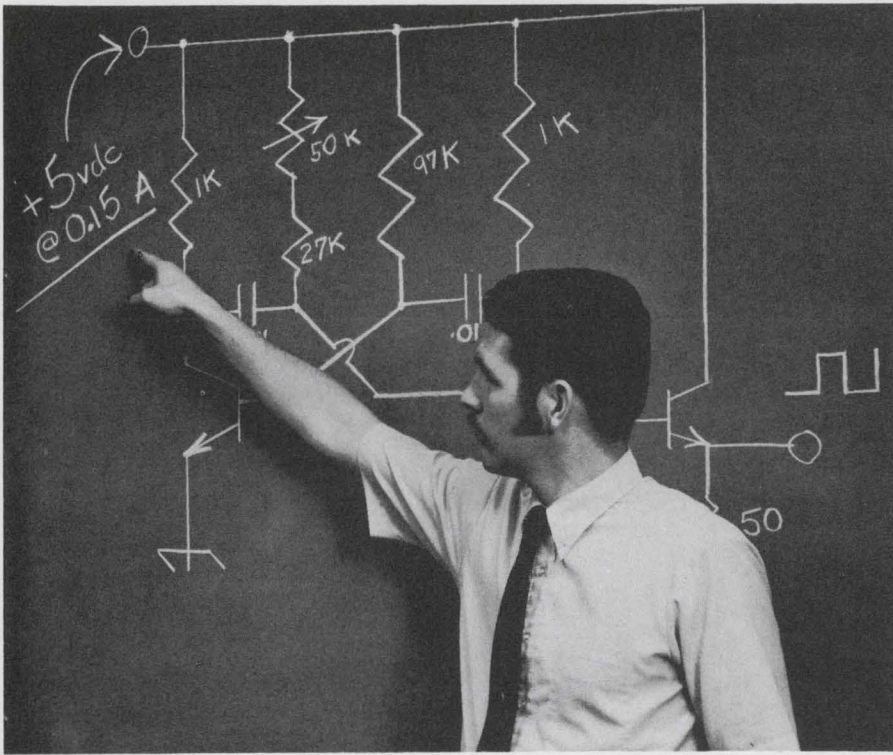

How to Design Your Power Supply for \$83

You get the **complete schematic diagram, and parts list** with operating and installation instructions when you spend \$83 for an Abbott Model "R" power supply. Two years in development, this model represents the latest state of the art in power module design. It features close regulation ($\pm 0.05\%$), low ripple (0.02%), automatic short circuit and complimentary overvoltage protection and continuous operation in a 160°F ambient.

Abbott Engineers followed specific design criteria in engineering these modules. First, the electrical design was carefully engineered to insure that all components operate well within their limits, under "worst case" operating conditions. Second, the thermal design, including case construction, was carefully made to insure that the maximum temperature limits of all components are never exceeded. Then the size and weight of these modules were controlled to a minimum, without sacrificing reliability. Finally these units were thoroughly tested to make certain that all design and performance specifications were met.

So, you can build your own power supply using our schematic diagram if you want to—but we think we can build it more

reliably and for less cost, simply because we have been doing it for ten years. Put our power supply in your system first and try it. Examine its performance. We think you will be pleasantly surprised at the quality, adherence to specifications, and the reliability you find in the Abbott Model "R".

Any output voltage from 5 to 100 volts DC with current from 0.15 to 20 amperes is available. **Many of the popular voltages are carried in stock for immediate delivery.** Please call us for attractive O.E.M. discount prices.

Abbott also manufactures 3,000 other models of power supplies with output voltages from 5.0 to 3,650 volts DC and with output currents from 2 milliamperes to 20 amperes. They are all listed **with prices** in the new Abbott catalog with various inputs:

- 60 A to DC, Hermetically Sealed
- 400 A to DC, Regulated
- 28 VDC to DC, Regulated
- 28 VDC to 400 A , 1 ϕ or 3 ϕ
- 24 VDC to 60 A , 1 ϕ

Please see pages 930 to 949 of your 1970-71 EEM (ELECTRONIC ENGINEERS MASTER Catalog) for complete information on Abbott modules.

Send for our new 68 page FREE catalog.

abbott transistor

LABORATORIES, INCORPORATED

5200 W. Jefferson Blvd./Los Angeles 90016
(213) 936-8185

1224 Anderson Ave./Fort Lee, N.J. 07024
(201) 224-6900

INFORMATION RETRIEVAL NUMBER 7

Publisher

Peter Coley

Editors

Editorial Offices
50 Essex St.
Rochelle Park, N.J. 07662
(201) 843-0550
TWX: 710-990 5071
Cable: Haydenpubs Rochellepark

Editor: George Rostky
Managing Editor: Ralph Dobriner
Managing Editor: Raymond D. Speer
Microelectronics, Steven A. Erenburg
Computers, Raymond D. Speer
Microwaves, Michael J. Riezenman
Circuits, Edward A. Torrero
Special Projects, George Rostky
Management, Richard L. Turmail
Military-Aerospace, John F. Mason
News, Michael P. London
New Products, Roger Allan

Field Offices

Massachusetts
Jim McDermott
P.O. Box 272
Easthampton, Mass. 01027
(413) 527-3632

West Coast

David Kaye
2930 Imperial Highway
Inglewood, Calif. 90303
(213) 757-0183

Washington

Don Byrne
1111 S. Army Navy Drive
Arlington, Va. 22202
(202) 296-8982

Editorial Production

Dollie S. Viebig

Art

Art Director, William Kelly
Richard Luce
Anthony J. Fischetto

Production

Manager, Thomas V. Sedita
Helen De Polo
Kathleen McConkey
Maxine Correal

Circulation

Manager, Nancy L. Merritt

Information Retrieval

Peggy Long

letters

U.S. is in trouble, manufacturer says

I just read your editorial in the Aug. 5 issue ("If We Have to Talk, Let's Make It Positive"). I don't agree with you. We ARE in a bad situation, particularly with regard to foreign imports, and we had better spread the word and get some kind of action. I don't base this on any complicated "balance of trade" figures or a deep study of the economy. I base it on what I see as a small manufacturer (wirewound resistors and reed relays; less than 15 employees).

What do I see? I see a very small profit picture compared with five to 10 years ago. I see no black and white television sets being produced in this country, and very few color sets. I see very few consumer-oriented electronic products being made by American labor.

I cite as one example the fact that my daughter recently purchased a tape deck for her car plus a power supply to run the unit in the house. The tape deck was a Webcor (a good old American make) made in Japan. The power supply was a C & E Electronics (Long Island firm) made in Mexico. By the way her car is a Ford Maverick, made in Canada. I see the steel workers get a 30% increase, not to mention the auto workers, phone workers, construction workers and teamsters, all effective over the next three years. I see that Japanese cars are accounting for 17% of the auto sales in Los Angeles County—more than Chevy or Ford. I see my accounts receivables running 60 to 90 days and sometimes longer. I see my own accounts payable moving up to 45 and 60 days after years of being a 30-day payer. I could go on.

I know this is somewhat disjointed, but I put the facts down as they occurred to me. I believe you will get an idea of the picture

I see. Why did it happen?

I feel that Big Labor and Big Business are at fault (not to mention government). Big Labor demanded too much, and Big Business gave away to Japan and other foreign manufacturers the "simple" products, because they were making fat profits on government contracts. Now, I feel, industries regret their actions, for the Japanese have shown that they can make not only the simple things—and for the most part cheaper, due to low labor cost—but even the most complicated.

I don't know what the answer is. I don't think going around with rose-colored glasses is the solution. I don't think saying that we are a world leader is doing anything but creating a false image. Yes, we are a world leader, but we are slipping fast.

I'm beginning to think that the day of the small manufacturer is on the way out. I consider that a shame, not only because it affects me directly but also because it kills the one thing that helped to build this country to its present level. Perhaps, as many of my fellow manufacturers are doing, I should get into the "service" area; many feel we will become a nation of servicemen, servicing foreign gear. Perhaps I should sell out to a large company and let them worry. But one thing is sure: someone had better do something, and it had better be within the next year.

Howard G. Melick
President

InResCo
503 Adamston Rd.
Brick Town, N. J. 08723

President Nixon's new economic policies may provide a solution to some of Mr. Melick's complaints. However, the letter does raise other intriguing questions—Editor.

Electronic Design welcomes the opinions of its readers on the issues raised in the magazine's editorial columns. Address letters to Managing Editor, Electronic Design, 50 Essex St., Rochelle Park, N. J. 07662. Try to keep letters under 200 words. Letters must be signed. Names will be withheld on request.

A
M
P
E
R
I
T
E

Top Quality
**STILL AT
LOW
PRICE**



Thermostatic DELAY RELAYS

Offer true hermetic sealing...
Assure maximum stability and life.

Delays: 2 to 180 seconds*

Actuated by a heater, they operate on A.C., D.C., or Pulsating Current... Being hermetically sealed, they are not affected by altitude, moisture, or climate changes... **SPST only** — normally open or normally closed... Compensated for ambient temperature changes from -55° to +80°C... Heaters consume approximately 2 W. and may be operated continuously. The units are rugged, explosion-proof, long-lived, and inexpensive!

TYPES: Standard Radio Octal and 9-Pin Miniature.
List Price, \$4.00

***Miniatures Delays:** 2 to 120 seconds.

All Amperite Delay Relays are recognized under component program of Underwriters' Laboratories, Inc. for all voltages up to and including 115V.

PROBLEM? Send for Bulletin No. TR-81.

AMPERITE BALLAST REGULATORS

Hermetically sealed, they are not affected by changes in altitude, ambient temperature (-50° to +70°C.), or humidity... Rugged, light, compact, most inexpensive.

List Price, \$3.00

Write for 4-p. Bulletin No. AB-51.



AMPERITE

600 PALISADE AVE., UNION CITY, N.J. 07087
Telephone: 201 UNion 4-9503
In Canada: Atlas Radio Corp., Ltd.,
50 Wingold Ave., Toronto 10

**Everyone talks
correed reliability,**

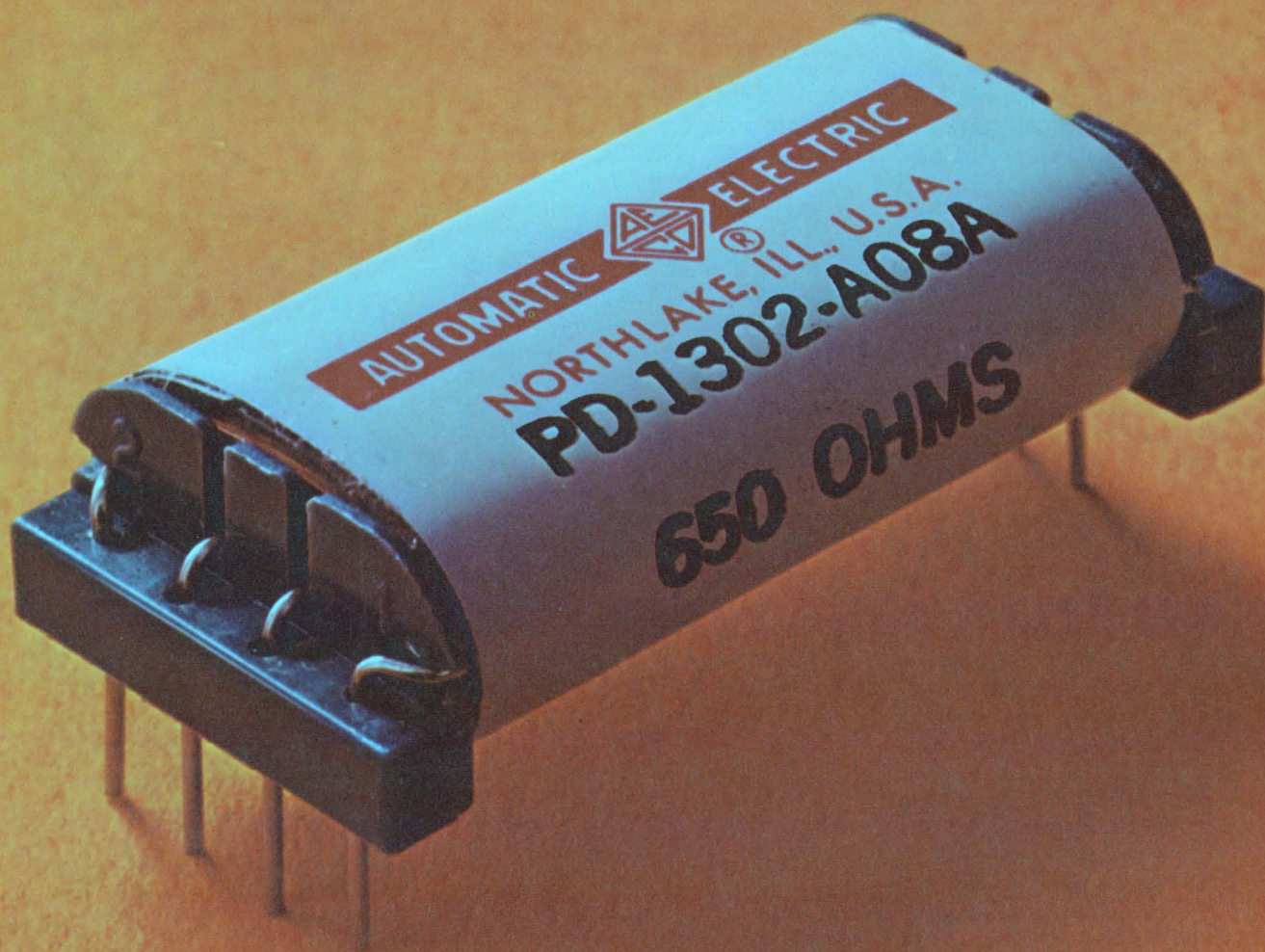

here's the way it looks.

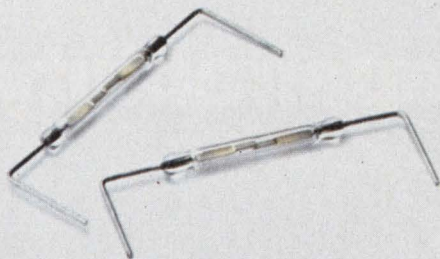

Switches under glass.

The heart of every AE correed is a reed switch consisting of two overlapping blades. For protection, we seal them inside a glass capsule. But only after we pull out all the dirty air and pump in a special, pure atmosphere. That way there's no chance of contact contamination or oxidation. Ever.

Notice our terminals are one piece. A special machine delicately forms them to precision tolerances. It's a lot of work, but one-piece terminals have distinct advantages over the two- and three-piece kind.

For one thing, there's no extra joint so you're always assured of a positive contact. Also, one piece terminals are more reliable when the correed is used to switch low-level analog signals. That's because thermal EMF is reduced to practically zero.

A different kind of bobbin.

Since we go through so much trouble with our correed capsules, we designed a special bobbin to protect them.

It's molded of glass-filled nylon. (You know how plastic chips and cracks.) Moisture and humidity have no effect on this stubborn material. No effect means no malfunctions for you to worry about. No current leakage, either.

Running the full length of the bobbin are a series of slots. They pamper the capsules and keep them from getting damaged or jarred.

And to help you remember which terminal is which, we mold the terminal numbers into the end of the bobbin. You can read them at a glance.

Little things mean a lot.

Reliability means that we pay attention to the little things. Like the tiny pressure rods we use in every miniature correed. They're placed at

each end of the bobbin, across the one-piece terminals. What they do is prevent stresses from being transmitted from the terminals to the reed blades. This keeps the contact gap right on the button. All the time.

The contacts are normally open. To provide them normally closed, we employ another little device—a tiny magnet. It's permanently tucked into a slot next to the reedcapsule. The magnetic action keeps the contacts normally closed.

Coiled by computer.

Once all the parts are secure in the bobbin, we cover them with protective insulation. Around this, we wind the coil. You can be sure the coil winding is correct. It was all figured out for us by computer.

Our next step is to protect the coil. We do that with more protective insulation.

A coat of iron.

On top of the insulation goes a layer of annealed iron. It acts as a magnetic shield and minimizes interaction between coils. Also, it improves the sensitivity of the entire unit. A coat of iron is standard on all AE correeds.

Finally comes super wrap.

To wrap it all up, we use some very special stuff. A layer of mylar laminated material.

It's so tough we guarantee it to withstand all cleaning solvents known to man.



Free Correed Handbook

This 60 page handbook explains advantages and disadvantages of correeds, describes the different types, and tells how to use and test them. To get your free copy, just write John D. Ashby, GTE Automatic Electric, Northlake, Illinois 60164.

GTE AUTOMATIC ELECTRIC

INFORMATION RETRIEVAL NUMBER 9

Dow Corning silicones seal, bond, insulate, cool, encapsulate...

and how's this for repairability?

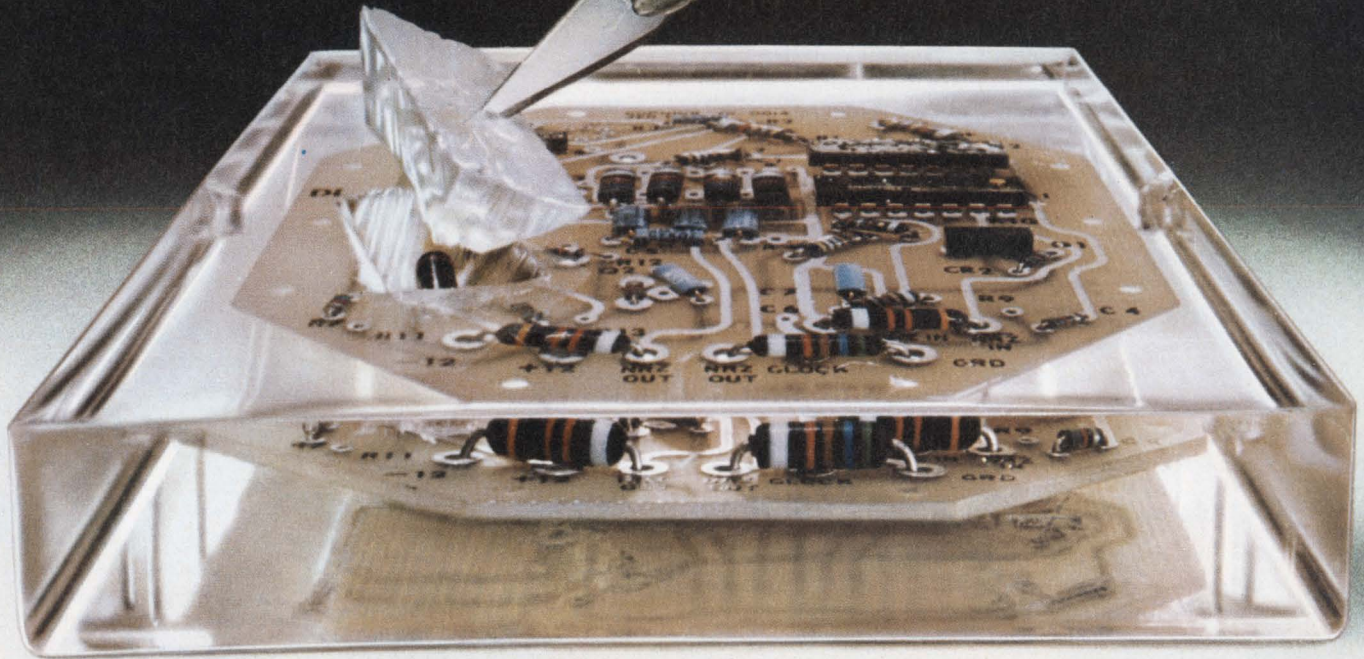

See-through silicone package speeds repair. Encapsulation of microcircuits with a clear resilient Sylgard® brand resin pays off with more than just protection. When circuits are under development, the encapsulant can be cut away to expose components for testing and modification. And, if fast field repair is a factor, defective components are more quickly located and replaced. Voids are merely filled with the silicone resin and protection is again intact. Sylgard resins also eliminate cure shrinkage associated with other encapsulants. They easily meet the most exacting shock, vibration, temperature and moisture resistant requirements. Circle Information Retrieval Number 821.

Silicone materials are unusually versatile. But whether they are used to seal, bond, insulate, impregnate, encapsulate or cool—their one basic function is to protect. And they protect better because of inherent silicone resistance to change—regardless of environment. When electronic equipment must function reliably in hostile atmospheres, look

to silicones from Dow Corning to shut out trouble. Described here are a few ways our materials can ensure the integrity of your designs. Many others are described in our Silicone Electronic Materials brochure available from your Dow Corning distributor. His name appears on the following page. Or write Dept. A-1220, Midland, Michigan 48640.

Electrical / electronic materials from

DOW CORNING

DOW CORNING

Noncorrosive silicone sealants.

For critical electronic insulating requirements on corrosion-sensitive materials. Four noncorrosive, acid-free curing silicone sealants are available from Dow Corning—two are pourable, self-leveling liquids for conformal coatings; the other two are nonslump materials for sealing, mounting and bonding. All are ready to use, cure at room temperature and are serviceable over a wide temperature range. Circle Information Retrieval Number 822.

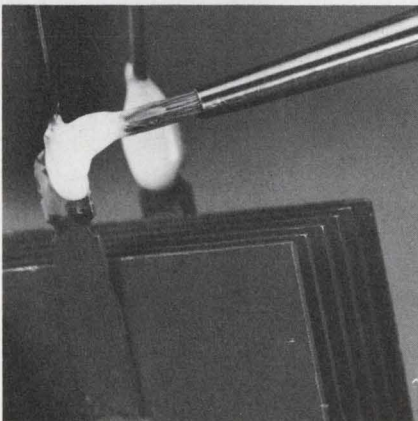

Dissipate heat fast with silicones.

You can use silicone materials to protect from heat, or to get rid of it. A Dow Corning® brand heat sink compound helps cool components such as transistors, diodes and rectifiers by transferring operating heat to heat sink or chassis. Thermal conductivity is effective as high as 200 C with this noncorrosive, metal-oxide filled silicone material. Ask about silicone fluid coolants also. Circle Information Retrieval Number 823.

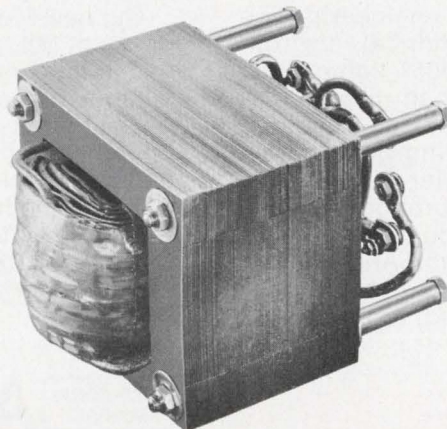

Silicone varnish aids miniaturization.

When operating temperatures of new spacesaving power supplies such as transformers hit the 200 C mark, protection with Dow Corning® brand silicone impregnating varnishes ensures performance. These materials are the most reliable insulating resins available. And they are easy to apply. Stators, chokes, coils, solenoids and other electronic equipment are protected by simply dipping, brushing, flooding or impregnating. Circle Information Retrieval Number 824.

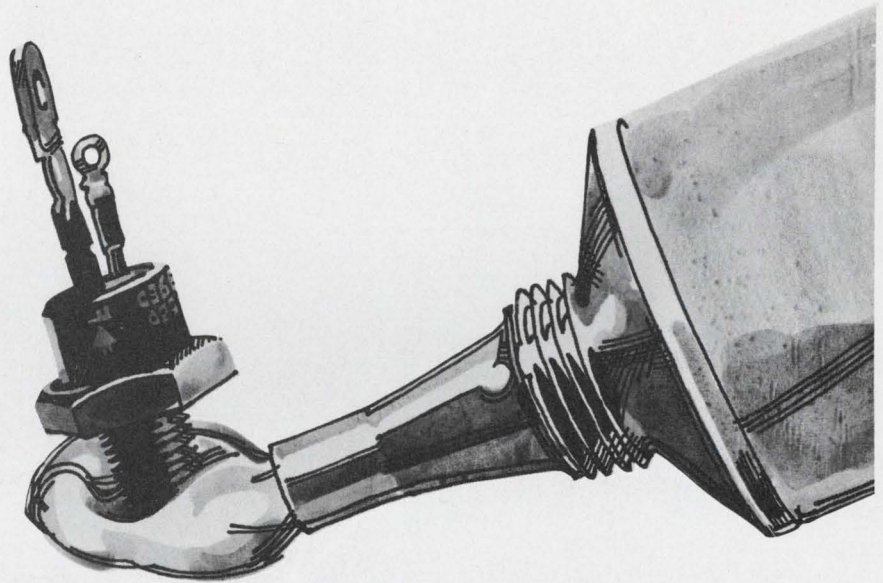

The new Merlin 1[®] connector.

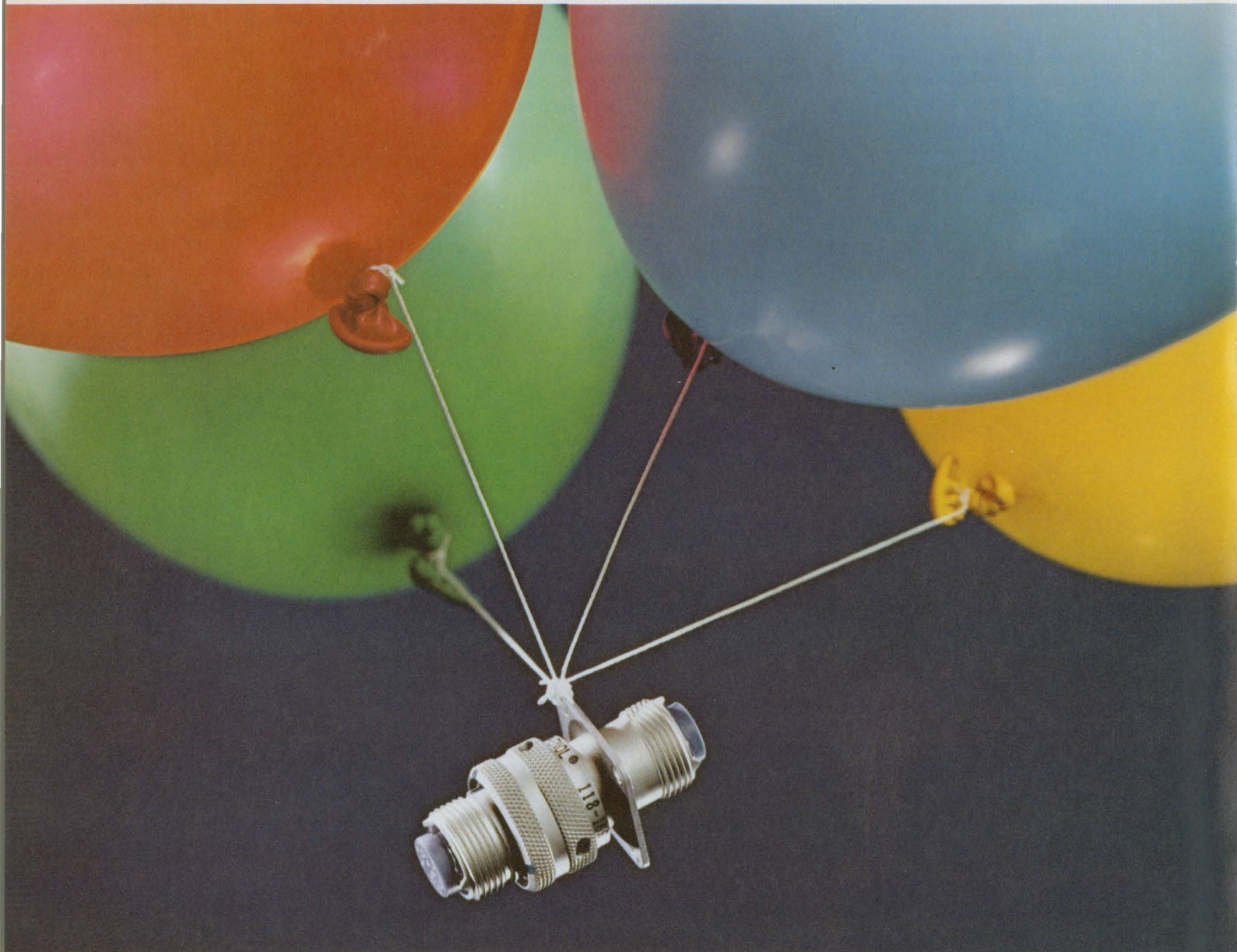

40% lighter than anybody else's.

Through the magic of Amphenol engineering we now bring you a rear-release, cylindrical, environmental connector that is not only 40% lighter than competition, but 1/2-inch shorter than most.

A one-piece thermoplastic retention disc, molded of tough Astrel 360* replaces the individual metal retention clips common in heavier connectors. Therefore, a 61-pin Merlin configuration has one retention disc instead of 61 individual metal clips. The result is a lot less useless weight. And, without all those parts, more reliability.

Adds a little magic to cost-cutting, too.

Our new Merlin exceeds all performance requirements of MIL-C-83723, MIL-C-26482 and NAS-1599 and is fully intermateable and intermountable with all three of these types.

Shell sizes are available in the eight most popular configurations with your choice of straight plug and both wall-mounted or jam-nut receptacles.

To get the full story on the new Merlin 1 connectors, just write or call Steve Kelleher, Amphenol Connector Division, Bunker Ramo Corporation, 2801 S. 25th Avenue, Broadview, Ill. 60153, (312) 261-2000.

*Registered Trade Mark 3M Company.

BUNKER RAMO AMPHENOL

designer's calendar

NOVEMBER 1971

S	M	T	W	T	F	S
	1	2	3	4	5	6
7	8	9	10	11	12	13
14	15	16	17	18	19	20
21	22	23	24	25	26	27
28	29	30				

Nov. 15-18

Fall Joint Computer Conference, (Las Vegas) Sponsors: IEEE, AFIPS, AFIPS Hdqs., 210 Summit Ave., Montvale, N.J. 07645

CIRCLE NO. 416

Nov. 16-19

Conference on Magnetism & Magnetic Materials (Chicago) Sponsors: IEEE, The American Institute of Physics, F.M. Mueller, Argonne National Laboratory, Argonne, Ill. 60439

CIRCLE NO. 417

DECEMBER 1971

S	M	T	W	T	F	S
			1	2	3	4
5	6	7	8	9	10	11
12	13	14	15	16	17	18
19	20	21	22	23	24	25
26	27	28	29	30	31	

Dec. 6-9

Ultrasonics Symposium, (Miami Beach), Sponsor: IEEE, Herbert Matthews, Sperry Rand Research Ctr., Sudbury, Mass. 01776

CIRCLE NO. 418

Dec. 7-9

Vehicle Technology Conference, (Detroit) Sponsor: IEEE, A. E. Marshall, Ford Motor Co., 23400 Michigan Ave., Dearborn, Mich. 01776

CIRCLE NO. 419

DOW CORNING SILICONE PROTECTORS

A full line of silicone encapsulating, insulating, sealing, coating and dielectric materials is available from Dow Corning Distributors at the following warehouse locations:

- ARIZONA**
Phoenix Essex International Inc.—I.W.I. Div. 602-278-8568
- CALIFORNIA**
Berkeley C. D. LaMoree 415-841-0601
Culver City E. V. Roberts & Associates, Inc. 213-870-9561
Los Angeles Essex International Inc.—I.W.I. Div. 213-264-7000
C. D. LaMoree 213-225-5666
Mountain View K. R. Anderson Company, Inc. 415-961-6007
San Diego A. E. Yale Enterprises 714-296-6148
San Francisco Essex International Inc.—I.W.I. Div. 415-626-5351
- COLORADO**
Denver Waco Electronics, Inc. 303-322-7708
- FLORIDA**
Fort Lauderdale Cramer/Florida Inc. 305-947-6517
Orlando Brownell, Inc. 305-424-5634
Electrical Insulation Suppliers, Inc. 305-855-7100
- GEORGIA**
Atlanta Electrical Insulation Suppliers, Inc. 404-355-1651
Hapeville Brownell, Inc. 404-767-9301
- ILLINOIS**
Chicago Prehler Electrical Insulation 312-384-6100
Mt. Prospect Magnuson Electronics, Inc. 312-956-0700
Niles Essex International Inc.* 312-647-0044
- INDIANA**
Fort Wayne Essex International Inc.—I.W.I. Div. 219-742-7441
Hammond Electric Supply Corp. 219-932-8840
- IOWA**
Marion Ensco Distributing Corporation 319-377-6313
- KENTUCKY**
Louisville E & H Electric Supply 502-587-0991
- LOUISIANA**
New Orleans Williamson Distributing Corp. 504-486-5584
Shreveport Williamson Distributing Corp. 318-424-6638
- MARYLAND**
Baltimore Essex International Inc.—I.W.I. Div. 301-644-0140
Pyttronic Industries, Inc. 301-539-6525
- MASSACHUSETTS**
Cambridge Brownell, Inc. 617-864-7500
Newton Cramer Electronic, Inc. 617-969-7700
Peabody Essex International Inc.—I.W.I. Div. 617-531-7100
- MICHIGAN**
Detroit Essex International Inc.* 313-921-6000
Madison Heights McNaughton-McKay Electric 313-399-7500
- MINNESOTA**
St. Paul Magnuson Electronics, Inc. 612-227-8495
- MISSOURI**
Kansas City Essex International Inc.—I.W.I. Div. 816-842-1613
St. Louis Ensco Distributing Corp. 314-542-3935
Essex International Inc.—I.W.I. Div. 314-371-2616
- NEW JERSEY**
Livingston Robert McKeown Co., Inc. 210-992-0700 or 212-267-9264 (NYC)
Moonachie Essex International Inc.—I.W.I. Div. 201-641-4400 or 212-695-7495 (NYC)
North Bergen Electrical Insulation Sales 201-864-2376 or 212-564-6273 (NYC)
- NEW MEXICO**
Albuquerque Waco Electronics, Inc. 505-268-2409
- NEW YORK**
Buffalo Summit Distributors, Inc. 716-884-3450
New York City Brownell, Inc. 212-691-7900 or 212-924-6000
- NORTH CAROLINA**
Charlotte Brownell, Inc. 704-399-9791
Electrical Insulation Suppliers, Inc. 704-392-2306
Essex International Inc.—I.W.I. Div. 704-394-1315
- OHIO**
Cincinnati Cramer/Tri States, Inc. 513-771-6441
Electrical Insulation Suppliers, Inc. 513-771-4073
Sheridan Sales Co. 513-761-5432
Essex International Inc.* 513-771-6500
Cleveland Essex International Inc.* 216-781-2310
Prehler Electrical Insulation 216-267-2650
Columbus McGraw-Edison Co. National Electric Coil Division 614-488-1151
- OKLAHOMA**
Oklahoma City Essex International Inc.—I.W.I. Div. 405-236-5411
- OREGON**
Portland Essex International Inc.—I.W.I. Div. 503-665-0138
C. E. Riggs, Inc. 503-226-3286
- PENNSYLVANIA**
Harrisburg Pyttronic Industries, Inc. 717-233-6591
Montgomeryville Pyttronic Industries, Inc. 215-643-2850
Philadelphia Brownell, Inc. 215-632-3030
Essex International Inc.—I.W.I. Div. 215-236-7100
Prehler Electrical Insulation 215-725-5914
Pittsburgh Essex International Inc.* 412-244-1145
- TENNESSEE**
Memphis Brownell, Inc. 901-323-7693
Electrical Insulation Suppliers, Inc. 901-947-4176
- TEXAS**
Dallas Essex International Inc.—I.W.I. Div. 214-339-8346
Specialized Products Company 214-358-4663
Williamson Distributing Corp. 214-741-5831
Houston Essex International Inc.—I.W.I. Div. 713-227-6358
Williamson Distributing Corp. 713-672-1715
- WASHINGTON**
Seattle Atlas Packing & Rubber Co. 206-623-4697
Essex International Inc.—I.W.I. Div. 206-763-8650
C. E. Riggs, Inc. 206-623-5707
- WISCONSIN**
Milwaukee Essex International Inc.* 414-342-3927
*IMC/I.W.I. Div.

Electrical/electronic materials
from

DOW CORNING

DOW CORNING

A better source for reliable reeds.

If you want the best source for reeds, go to the people who make them for their own equipment. Us. The "Vibrasponder" reeds that we use for thousands of remote control and signaling applications are now for sale.

Features include contactless design, narrow bandwidths, shock and vibration protection, and over 120 standard tones from 67Hz to 3225.8Hz. Specs available from Motorola Component Products Dept., 4545 W. Augusta Blvd., Chicago, Ill. 60651.



MOTOROLA



Unimax Switch CORPORATION

A Riker-Maxson Subsidiary/Ives Road, Wallingford, Conn. 06492

Unimax lighted pushbutton controls offer you the broadest variety of styles in a wider choice of displays, colors, illuminations and actuations. From simple pilot light applications to the most sophisticated split face switch or circuit breaker, you'll find a Unimax LPB to meet your requirements—with Unimax quality and reliability built-in. At competitive prices.

Series 2: A high-rated (5 amps, 250 volts a-c or 28 volts d-c) lighted or unlighted pushbutton switch, available as momentary or alternate action and offering matching indicators. Small in size and price.

Series 5: A versatile two lamp double pole lighted pushbutton switch, momentary or alternate action, that can either transmit or project color in full or split display. High rating. High candlepower. Choice of front panel snap-in or sub panel hard mount. Low price.

Series 9: Highest quality 4 lamp switch meeting the requirements of MIL-S-22885. Single screw mounting, simple front of panel relamping and wide choice of lamp circuits. One to four pole switching. Features and options not available in any other switch.

Series 9C: All the advantages of the Series 9, with the switching mechanism replaced by a hydraulic-magnetic tripping action circuit breaker.

EAO Series 01, 02, 03: Just introduced, these economical products are available in round, square and rectangular styles. Up to three pole switching in momentary or alternate action or as indicators, key lock or mushroom cap models. Ratings and electrical and mechanical performance are uniformly high.

Gentlemen:

I'm impressed. Please have your representative contact me for a demonstration. Please send information on the following LPB lighted pushbutton controls: Series _____

My application: _____

Name _____ Title _____

Company _____

Address _____

City _____ State _____ Zip _____

We have more LPB's going for you than anyone else.

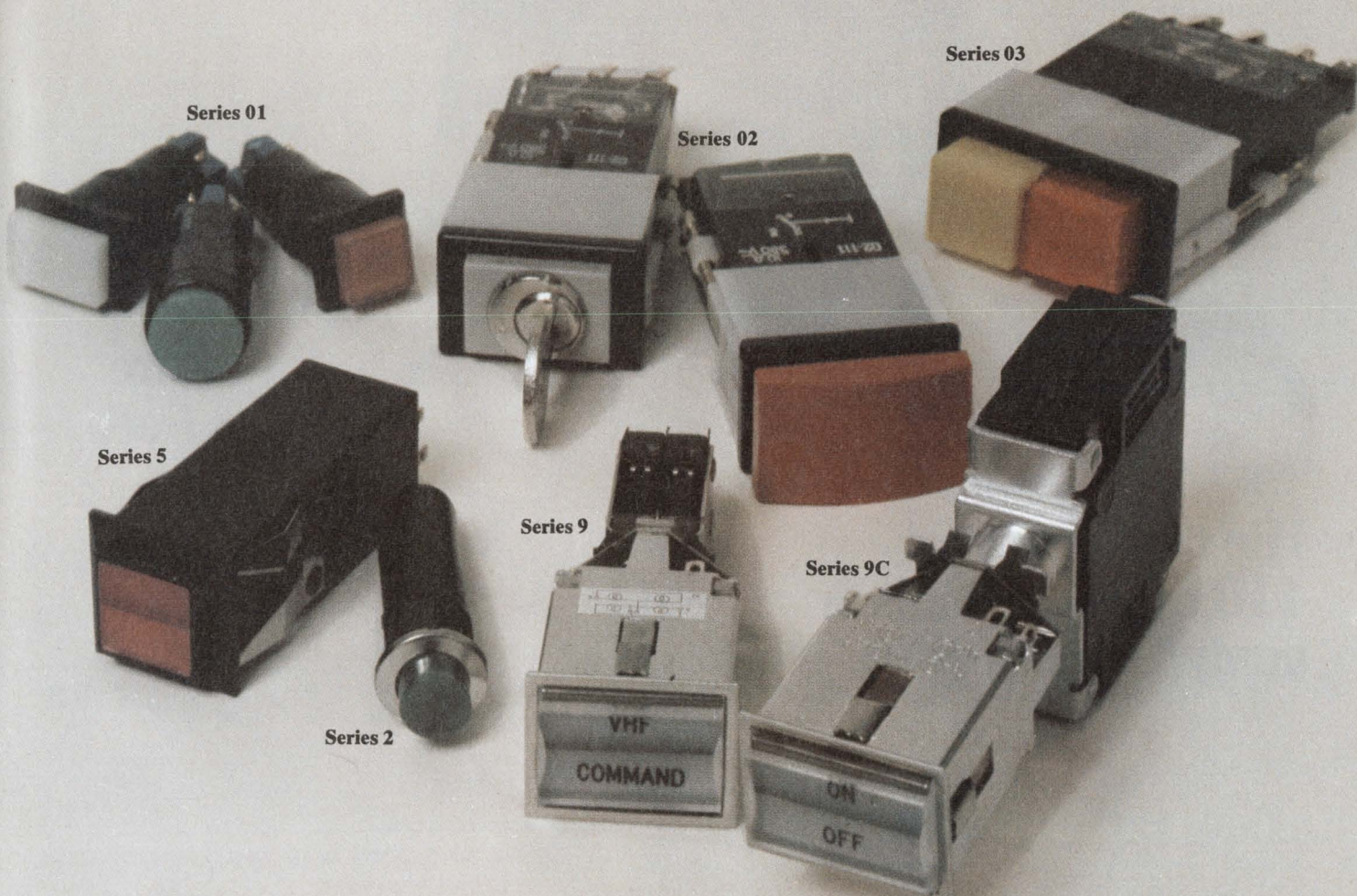

The Signetics Measurement Data 1420 tester can perform go/no-go tests on 95% of all linear integrated circuits sold today. It can test them to manufacturers' and users' specs, under all limits and conditions. (And with the new SMD 450 Manual Programmer, you can change program board limits quickly and easily.)

The 440 transfer function analyzer can generate accurate characteristic curves of gain, common mode rejection, positive power supply sensitivity and negative power supply

sensitivity; for viewing on a scope or x-y plotter.

You can buy the 1420 linear IC bench tester separately—or you can buy both units as a low-cost testing system that will please both your production people and your engineers.

For more information, send for our literature.

Or contact:

Gerry Williams, Signetics Measurement Data, 341 Moffett Boulevard, Mountain View, California 94040. (415) 961-9399 or 961-9384.

Signetics

Measurement Data

The versatile 1420 linear IC bench tester costs \$5,700.



The time-saving 440 transfer function analyzer costs \$980.

All this literature is free.

Gentlemen:
Please send me all this free literature:

1. Transfer function characteristic curves generated by the SMD 440 Transfer Function Analyzer for 709's, 741's, 101's, 201's, 108's, et al.
2. Spec sheets for the 1420, the 440 and the 450.
3. A reprint of an article entitled "The pitfalls of op amp testing."

Name _____ Firm _____

Address _____

City _____ State _____ Zip _____

Signetics Measurement Data, 341 Moffett Blvd., Mountain View, Calif. 94040

A subsidiary of Corning Glass Works

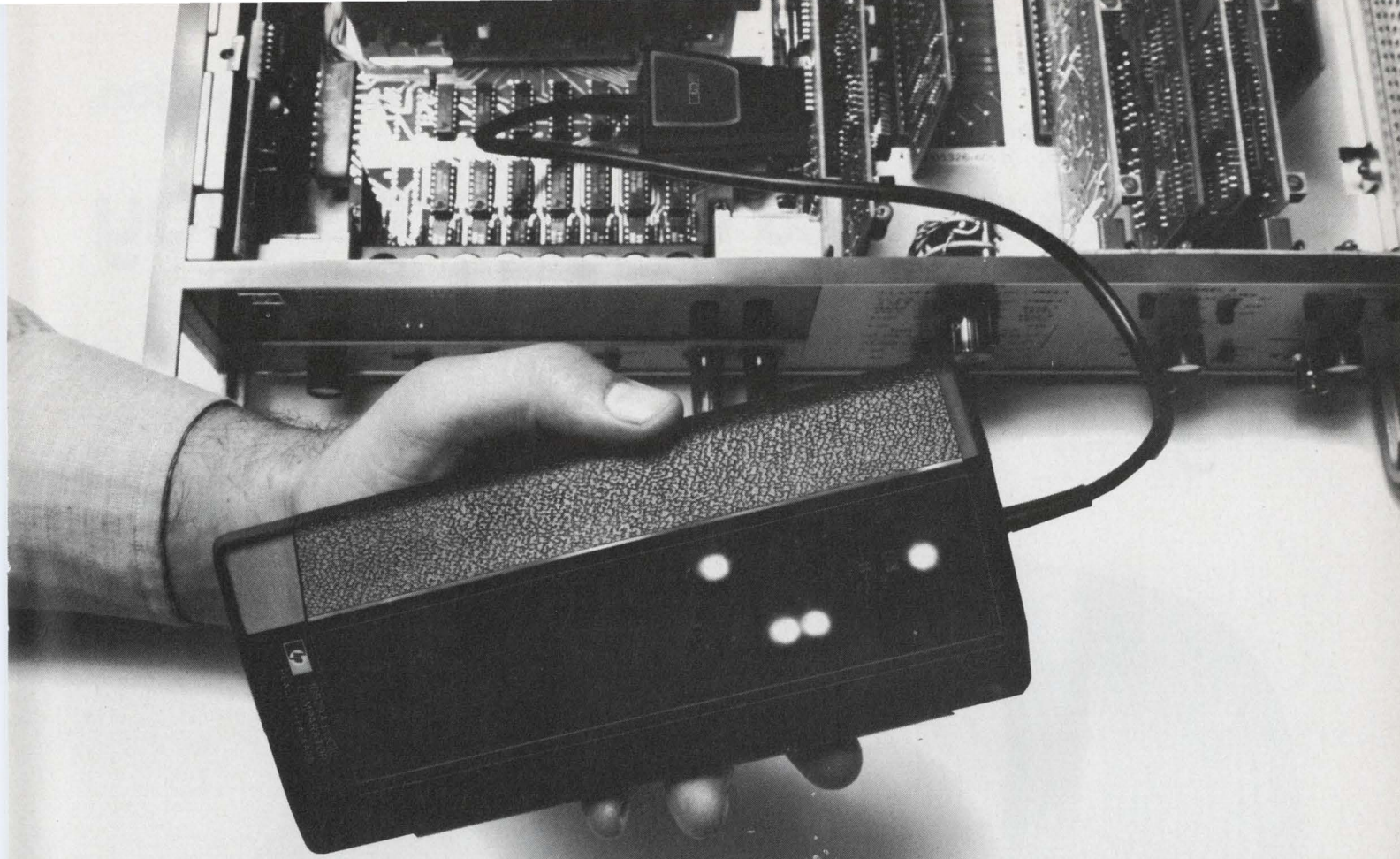

The IC troubleshooters march on.

This one spots a bad IC in 5 seconds or less.

Here comes the latest member of HP's Troubleshooters searching out faulty ICs. Just clip the HP 10529A Logic Comparator onto an in-circuit TTL or DTL IC. If the logic function isn't what it should be, bright red LEDs light up indicating which pins are at fault. A clever comparison scheme uses the circuit's power and input stimulus to do all this. Even dynamic errors as brief as 200 ns are stretched and displayed.

It comes complete with a self-test board, operating manual and all accessories packed in a handy case. It costs only \$295.

We're thinking ahead. Because the case is also designed

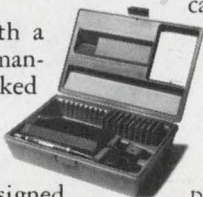

The probe lets you trace pulses through integrated circuits simply by touching a pin. The probe's tip flashes a signal for pulses as narrow as 25 ns, and indicates pulse polarity, pulse trains and logic states. It's almost like having an oscilloscope squeezed into a ball-point pen. \$95.

The clip is a convenient state indicator. It slips over your DTL or TTL package and bright LEDs display the

to hold our other two Troubleshooters — the HP 10525A Logic Probe and the HP 10528 Logic Clip.



static state of all 16 (or 14) pins at a glance. It operates like 16 binary voltmeters. \$125.

You can buy all three as the HP 5010A for \$495, saving you time, aggravation and \$20.

The IC Troubleshooters march on. Wait until you see what we're working on now! Just call your HP field engineer to get your hands on them right away. Or if you want to know more, write Hewlett-Packard, Palo Alto, California 94304; Europe: 1217 Meyrin-Geneva, Switzerland.

HEWLETT  PACKARD

Finally... there's a new and better way to transmit high-speed digital data.

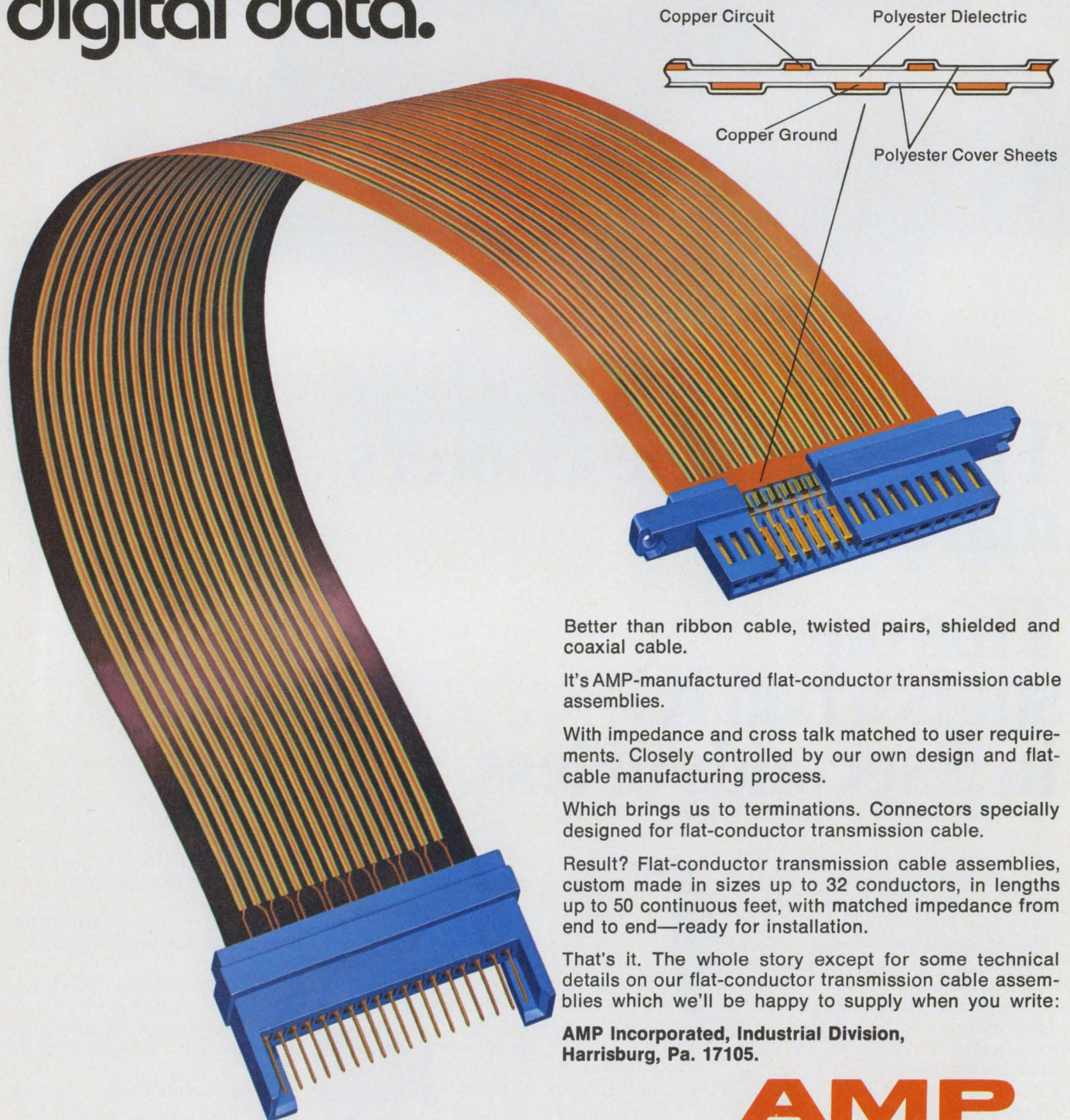

Better than ribbon cable, twisted pairs, shielded and coaxial cable.

It's AMP-manufactured flat-conductor transmission cable assemblies.

With impedance and cross talk matched to user requirements. Closely controlled by our own design and flat-cable manufacturing process.

Which brings us to terminations. Connectors specially designed for flat-conductor transmission cable.

Result? Flat-conductor transmission cable assemblies, custom made in sizes up to 32 conductors, in lengths up to 50 continuous feet, with matched impedance from end to end—ready for installation.

That's it. The whole story except for some technical details on our flat-conductor transmission cable assemblies which we'll be happy to supply when you write:

**AMP Incorporated, Industrial Division,
Harrisburg, Pa. 17105.**

AMP
INCORPORATED

Manufacturing and Direct Sales Facilities in: Australia, Canada, France, Great Britain, Holland, Italy, Japan, Mexico, Puerto Rico, Spain, Sweden, United States and West Germany.

U.S. plans a mass study of antarctic environment

More than 200 scientists and technicians in the United States are cooperating in a research effort to learn more about the Antarctica in the next "several months." They plan to investigate communications, the physics of the upper atmosphere and the habits of natural life on that continent.

Called the United States Antarctic Research Program, it is being sponsored by the National Science Foundation at a cost of \$26-million. The scientists and technicians are from more than 40 colleges and universities, Government agencies and industrial concerns. It is planned to drill 2000 feet into dry valleys about 60 miles west of McMurdo Station, the main U.S. outpost in Antarctica. These valleys remain free of ice and snow for, as yet, unknown reasons.

Gravity, geochemical, geophysical and other studies will be conducted in the valleys. Navy helicopters will conduct geomagnetic studies.

A station will be set up at the base of the Antarctica Peninsula, with a 13-mile-long dipole antenna on the surface, to study the physics of the upper atmosphere.

To decrease the cost of collecting data and to eliminate the hardships in manning isolated scientific outposts, an unmanned geophysical laboratory will be evaluated at McMurdo Station. Developed at Stanford University, the observatory will eventually be instrumented to obtain and transmit data on ionospheric disturbances, the weather, cosmic rays and the earth's magnetism.

At the South Pole, scientists of the Army Cold Regions Research and Engineering Laboratory will sink a thermal pendulum probe through 9,500 feet of ice to the rock surface beneath the icecap. The probe will melt its way down-

ward to provide information on the age of the ice at various levels. The study will also attempt to determine whether the base of the icecap is melting under its own pressure, friction or heat from the earth.

University of Minnesota researchers at McMurdo Station will fasten radio transmitters to seals, as well as use underwater television, to study the activity of these animals.

The presence of global pollutants will be investigated through studies of the effects of chlorinated hydrocarbons, including DDT, in arctic birds. The relatively pure antarctic atmosphere will be measured for traces of lead, copper, iron, aluminum and other metals.

Calculator on a chip available off the shelf

For calculator designers, an off-the-shelf MOS/LSI IC chip, incorporating all the logic and memory for an eight-digit, full-floating-point machine, is now available.

Developed by Texas Instruments of Dallas nearly three months later than it had predicted (see "Calculators Are in Chips; Next: Mini-computers?" ED 4, Feb. 18, 1971, p.21), the chip—designated at TMS-102NC—costs approximately \$20 when purchased in quantities of 10,000 according to the company. The price for a single-quantity order is \$125.

Mostek Corp., also in Dallas, was the first to introduce a one-chip calculator last winter (see "The One-Chip Calculator Is Here, and It's Only the Beginning," ED 4, Feb. 18, 1971, p.34). However, Mostek's was a custom chip, manufactured under an exclusive sales arrangement with the Nippon Calculating Machine Co. of Tokyo for

use in Nippon's line of Basicom calculators.

According to Texas Instruments, there are other differences between its one-chip calculator and the Mostek one, besides the stock availability for the TMS102NC. "Ours has a full-floating-point function and Mostek's didn't," a TI spokesman says. "Because the entire chip circuit was designed with our own programmable logic-array techniques, functional variations can be made by changing a single photomask in the manufacturing process. Mostek's was designed only to be used in Basicom calculators."

The totally programmable TI device consists of a 3520-bit read-only program memory, a 182-bit RAM, a decimal arithmetic logic unit and control, timing and output decoders, all on a 230-by-230-mil chip.

Pacemaker recharging done without surgery

An implanted cardiac pacemaker has a battery that can be recharged by induction of rf energy from outside the body. A circuit in the pacemaker permits checking the internal battery voltage by means of an external electro-magnetic probe.

Developed by scientists at the Weizmann Institute of Science in Rehov, Israel, under the sponsorship of the Electro-Catheter Corp. of Rahway, N.J., the device has been successfully tested on dogs.

Recharging of the batteries is required a minimum of every three months, according to a Weizmann spokesman. On humans, it could be done at an overnight stay in a hospital—this in contrast with present replacement of implanted unit batteries by surgery every 18 months or so.

The new pacemaker has a fixed pulse rate, but both the rate and width are adjustable prior to insertion in the body. Tests to date have used a 72-beat-per-minute pulse with a 1.8-ms width.

The new pacemaker, which uses a nickel-cadmium battery, has a special charging circuit that includes a regulator for keeping internal charging current constant, despite movements or variations in the location of the external transmitter charging coil. The indicat-

ing circuit permits checking of the battery condition with an external probe coil that uses the grid-dip meter principle.

The transmitter, which operates at a few hundred kilohertz, is a small unit that also contains the charging coil. The unit is placed on the patient's chest for charging. A monitoring meter shows attendants whether or not the transmitted power is being accepted by the pacemaker battery.

Upon conclusion of the experiments with animals, the pacemaker will be supplied to cardiologists in the United States for clinical evaluation on humans.

The Electro-Catheter Corp. has an option on a worldwide license for the device.

IC-module plant opened by RCA for color TV

The trend toward all-solid-state color TV sets has accelerated with the opening by RCA of a new production plant in Indianapolis. The \$5-million facility produces ceramic circuit modules for use in the company's XL-100 color TV receivers.

Because the modules lend themselves to a high degree of automation during manufacture, they also are being counted on to help hold the line on TV production costs while raising product performance.

"A prime goal of the new facility," explains Barton Kreuzer, RCA executive vice president for consumer electronics, "is to enhance the competitive position of our consumer electronics manufacturing operations in the United States."

The ceramic modules contain a number of components, including screen-printed resistors and capacitors and miniaturized transistors, encapsulated in resin epoxy on a hard alumina ceramic wafer. Measuring 1.4 x 2 x 1/16 inches, the devices produced are three Kine drivers—interchangeable for each of the three basic colors—and an audio amplifier. These new modules replace larger and less reliable circuits that employ discrete components and vacuum tubes.

The improved reliability comes from the use of the alumina substrate. Made of the same basic material as automobile sparkplugs, the ceramic circuit modules are in-

herently more rugged and durable than vacuum-tube circuits, and they create less heat—a prime cause of failure in electronic equipment.

RCA's vice president for operations, Robert A. Schieber, reports: "We expect, in the not-too-distant future, to be producing color TV sets in which a major portion of the circuitry will be on ceramic modules."

Doubts raised on future of world satcom net

A revolution in communications through the use of satellites? Not in the next 10 years, say two communications engineers in a lengthy technical article in *Astronautics and Aeronautics*.

It would be too costly to develop a worldwide satellite television and telephone network, they suggest. Instead, one of them said in an interview, the big developments in communications in the next decade will occur in the common carriers' use of microwave transmission, in cable TV and in video cassette systems.

Writing in the September issue of the magazine on "The Communication Satellite—A Perspective for the 1970s," the authors—Nathaniel E. Feldman of the Rand Corp. and Charles M. Kelly of the Aerospace Corp.—believe that \$200-million a year in federally financed R&D would be required to develop the high-power satellites and the very-directive antennas needed to cut ground terminal costs. The authors do not see these funds forthcoming.

Existing low-power satellites, they say, cannot make a contribution, because they neither "provide significantly new services nor drastically reduce the costs of existing ones." These satellites are good only for use by broadcasters who can afford the highly expensive ground terminals that are required.

New device controls intravenous feeding

A Columbia University engineer has invented an electronic device that is expected to both lighten the work load of hospital nurses and permit precise control of the

rate of fluid dropped into a patient's veins.

The device—a magnetically activated flowmeter—was developed by Dr. Jordan L. Spencer, a chemical engineering professor at Columbia's School of Engineering and Applied Science.

The current procedure in most hospitals is for nurses to use their wrist watches, as often as every 30 minutes to visually time the drip rate of each bottle of intravenous fluid being administered to a patient.

The electric flowmeter is designed to speedup this procedure. The key element of Dr. Spencer's invention is a tiny metal ball, the size of a pin head, which rests in a small measuring tube. The tube itself is about two-inches long, and set in a magnetic device, which is linked to an electronic counter.

As the intravenous fluid goes through this measuring chamber, the ball is carried forward by the fluid's flow, until it is pulled back into its former position by the magnets. The back- and forth-motion of the ball in the fluid is what is measured electronically, giving nurses a precise measurement of the flow.

Infrared security system offered by Westinghouse

A security system for protecting property against intruders employs an electro-optical transmitter that directs a narrow infrared beam to a receiver 500 feet away. An intruder who interrupts the beam sets off a warning system.

In the security system, developed by Westinghouse Specialty Electronics Div., Pittsburgh, the receiver is adjusted to respond to any beam interruption longer than 0.050 seconds, so it can detect even a fast-running intruder; briefer interruptions by smaller objects, however, such as a bird or a falling leaf are ignored.

A company spokesman says the system operates through adverse weather conditions, such as when visibility is reduced to 20 feet. A single transmitter can be connected to two or more receivers with a beam splitter, and mirrors can be used to turn the beam around corners.

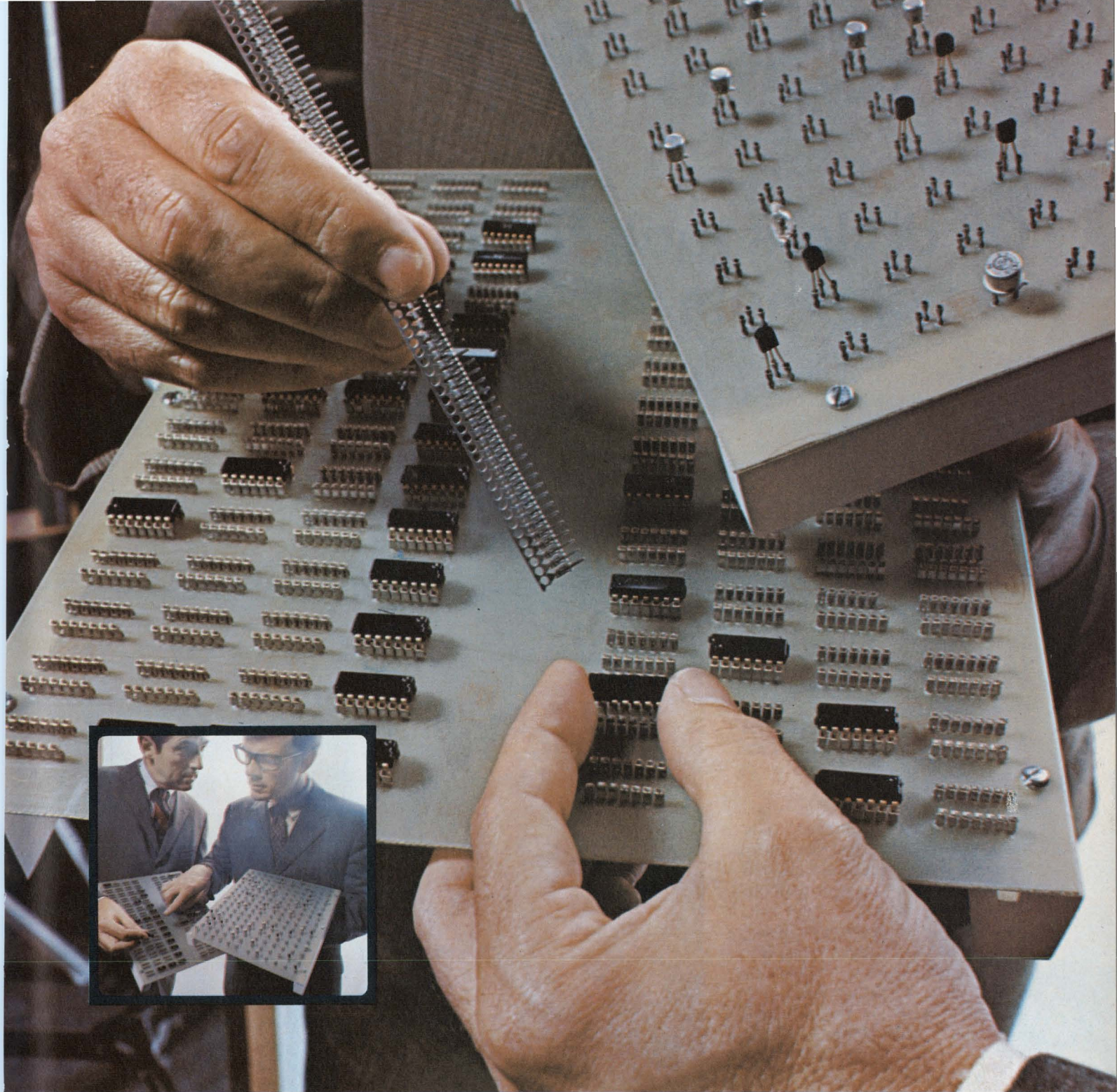

HERE'S A NEW AND BETTER WAY: To make printed circuit board connections. Reliably. At low, low cost. They're Molex Soldercon[®] terminals. Integrated circuit and transistor terminals. Offering the convenience of plug-in I.C.'s and transistors *without* the cost of insulators. They fit directly on the board. And there is equipment available to do the job *automatically*. Fast! Soldercon terminals save time. Money. Speed installation. Make

testing easier, too. And simplify service problems. It's another example of Molex ingenuity . . . in creating components that simplify circuitry. Molex has the know-how and facilities to provide the interconnecting system you need. You can make connections by calling (312) 969-4550. Or write . . . Molex Incorporated, Downers Grove, Illinois 60515.

*... creating components that
simplify circuitry*

Oil drillers look to electronics to help them strike it richer

Until recently oil companies were content to drill well after well on a hit or miss basis. At \$500,000 a throw, they could afford to drill four dry holes, knowing that the fifth, if they were in a productive area, would probably be a strike that would bring in \$10-million.

Now, for a number of reasons that have converged at this time, this cavalier attitude has changed, and drillers are looking with more favor toward controlled drilling with the aid of electronic sensors and computers. The reasons:

- Costs of labor and materials are up.

- Labor is becoming more difficult to find. The work is hard, and the gypsy life-style is losing its appeal.

- Federal and state taxes and restrictions have tightened. Oklahoma, for example, has slapped on so many levies that some oil companies say they'll never drill another well in the state.

- Shallow reserves are nearly depleted in the United States, thus driving drillers deeper on land (the record is now 25,600 feet, with 30,000-foot wells not far off) or to platforms at sea—both costly endeavors requiring much stricter drilling control.

- Ecologists are watching like hawks for blowouts, fires and leaks, both off-shore and on. The days are gone when it was all part of the glamour of oil for a mile of steel pipe to blow out, piling up around the well like stacks of dry spaghetti, while John Wayne frowned and reached for a bullhorn.

“Until three or four years ago, the driller operated by the seat of

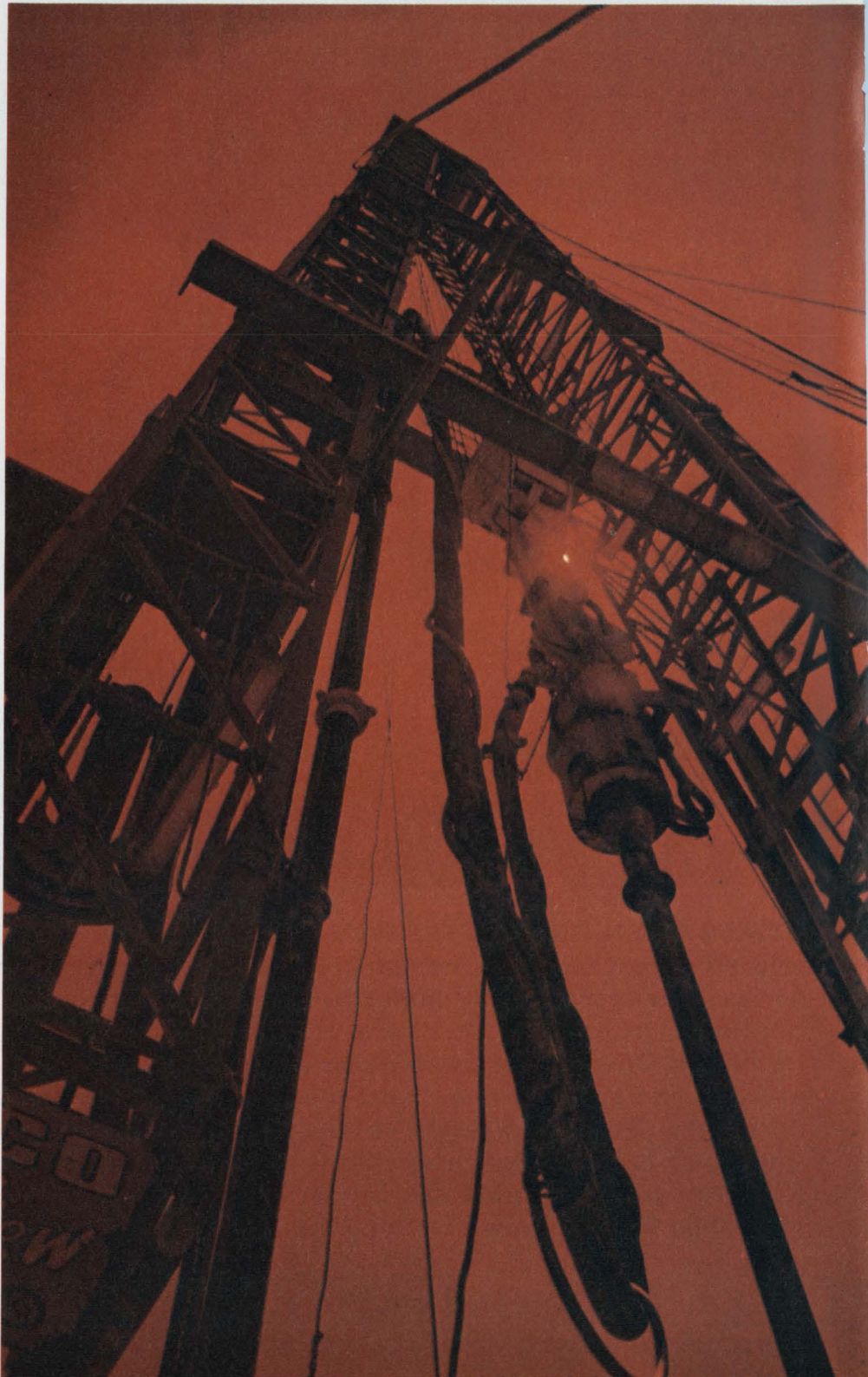

John F. Mason
Industrial Editor

his pants," says F. S. Young Jr., project manager of computerized drilling control for the Baroid Div. of NL Industries, Inc., in Houston, Tex. "All he knew was when he was entering a new rock formation, when he was coming out of it and, roughly, kind of formation.

"He can't afford to do that anymore. He's got to know at all times what's going on at the bottom of that hole, for safety and to cut costs. He's got to be ready to take action or have a system that takes action for him.

"Fortunately, thanks to fallout from research and development for defense and space, we have solid-state devices and minicomputers that are rugged enough and cheap enough to be practical for drilling, and we can help drillers automate their operation."

Baroid is not alone. Nearly a dozen companies are offering electronic drilling aids that range from simple data-acquisition systems to systems that then take that data and run it through a computer that automatically controls the drilling operation.

A variety of devices are being used on the rig—potentiometers, strain gauges, dc generators, binary counters, microswitches, flow transducers, gas detectors and minicomputers. Down the hole, when the drilling has stopped, sensors are lowered, such as gamma-ray detectors and sonic "viewers." Some of these are packaged in sondes 60 feet long and 3-5/8 inches in diameter.

The problem now for companies offering these services is to improve their equipment and to convince the tradition-bound oil man that the equipment can do the job; that it is reliable and that it will cut his risks and costs. According to Baroid, electronic equipment can save a driller up to 15% of his drilling costs.

"We've saved as much as \$1000 a day," Young says. "And, of course, there's no way of putting a figure on how much you save by preventing a blowout."

Ways to 'see' the bottom

The ultimate technique, and the most straightforward way to acquire down-hole data, would be to put sensors, or transducers, at the

bottom of the rotating drill string and to transmit the information up the pipe to the surface. But no sensors presently available will withstand pressures of 25,000 pounds per square inch, heat of 550 F, the tremendous pounding and vibration that goes on at the bit, rotating at 100 rpm, and submersion in mud.

Besides the need for sensors that are rugged enough, no one has figured out how to telemeter the data up a rotating pipe. How



Data from transducers on the rig and from mud tests feeds into Baroid's Applied Drilling Technology van, parked alongside a well in South Texas. A two-man crew gives the driller geological and drilling advice.

do you make electrical connections between each 30-foot or 45-foot pipe? And how do you get enough power down the hole to drive signals up five miles of pipe without too much attenuation?

A number of companies are trying, but no one has announced a solution; nor is anyone willing to discuss progress. Solving this, one electronics company official says, would be like discovering a cure for the common cold—"it would bring in a fortune."

And it would also open the door to complete drilling automation. Until data can be brought up from the hole in real time and fed into a computer, an automatic rig is not feasible.

"Just a couple of sensors down-hole would be a tremendous help," says Ken O. Taylor, Baroid's drilling applications programmer. "A three-mile pipe might be turning at 100 rpm at the surface, but if it's locked down below, the drill might not be turning at all. The false reading this would give could

foul up proper identification of the rock formation below."

A simple tachometer down-hole to tell the correct rotary speed would solve this, Taylor says. Another powerful tool would be a torque meter immediately above the bit. "Someone will develop a down-hole sensor system that will operate on a rotating drill in the next ten years or so," Taylor says.

A spokesman for an electronics supplier who wishes to remain anonymous agrees, but adds: "Who

ever it is, it won't be an established oil company. They are too tradition-bound. Oil companies have good research laboratories. They publish their results in technical journals and then the project dies. Their applications people won't try them."

As for the drillers themselves, the same spokesman says: "Drillers are old-timers who have done their job the traditional way. They've been successful, and they're not about to change what they're doing now.

"The designer has to be extremely careful that the product he shows anyone in the oil business will work."

Since down-hole sensing during drilling is not yet a reality, other techniques have to be used. In general, there are two:

One takes surface measurements exclusively—from machinery on the rig and from material brought up from the hole. This can be done while drilling.

The other approach takes meas-



The rig driller watches a Baroid logging supervisor install and calibrate a hook-load transmitter transducer—a potentiometer similar to those used to measure pressure. Accuracy is ± 500 pounds/250,000 pounds.

urements with sensors lowered into the hole during periods when the pipe has been pulled up to change a wornout bit—or, specifically to make the tests.

View from the top

A good example of the surface technique is the service Baroid provides. It attaches 11 kinds of transducers to key operations on the rig. Every few seconds these transducers obtain information, such as weight applied to the bit, the speed at which the pipe is rotating, the depth of the hole and the amount of mud flowing into the hole and coming out again. (Mud of varying weights is circulated down the hole and back up again to outweigh the upward pressure of the gas or oil in the

formations adjacent to the bore.)

The service also examines chips of the rock formation and the amount of gas that is present—these are both brought up by the circulating mud. All this information is fed into a computer, which calculates some 50 or more conditions at the bottom of the hole.

The computerized units can spot an alarm situation in milliseconds, warn the drilling crew and even shut down the rig.

The growth in sophistication, including closed-loop automation, is shown in the three systems Baroid now provides. Like those offered by other service companies, Baroid's units are housed in vans that can be parked alongside the rig, or on a platform at sea. Two-man crews are on duty around the clock. And when the job is over, the whole setup can be quickly moved to a new well.

Baroid is operating two basic types of instrument systems. The one in use the longest is called an Applied Drilling Technology Unit which receives data from transducers on the rig and from tests made of the mud. Information, some of which passes through an Olivetti calculator, is displayed on dials or on paper logging strips.

More sophisticated is Baroid's Computerized Drilling Control Unit. One of these has been in the field for some months, and an improved unit has just gone out. Both units are completely computerized. One uses a Honeywell 116 and the more advanced a Honeywell 316. Equipped with 30 sensors (11 types), both systems collect and interpret geological information 10 times a second; monitor and analyze well conditions; calculate the best drilling rate and analyze hole problems.

Two actuators allow the computer to control certain operations. "For example," Taylor explains, "when the drill rate gets high and a torque condition sets in, you don't have to worry about twisting off the drill pipe. Within a tenth of a second the computer has taken care of it by reducing the speed."

Besides dials, paper strips and teleprinter readouts, the computerized units provide a data terminal with a CRT display that was built by Video Systems Corp., Pennsauken, N. J. "The unit is expen-

sive, about \$3000," Taylor says, "but you can hook it up to a \$250 television set and have a second, remote readout in another place."

Where work is needed

Among the measurement problems that electronic engineers can help solve, Young says, is a way to get better information on the kind of formation the bit is drilling through three to five miles down. Modulating the mud has been tried without too much success, he says.

A device that would open a tremendous and eager market is something to tell the driller the X,Y,Z position of the bottom of the hole while he is drilling. Now, the pipe must be pulled up and a Rube Goldberg type of apparatus lowered to the bottom of the well. The locator consists of an inclinometer to measure the inclination of the hole, a magnetic compass to measure the direction and a camera to photograph the readings.

Since most wells are drilled at a slant—some as much as 60 degrees—the location is important. Sometimes as many as 30 wells are drilled from one expensive platform at sea. And in California wells are often drilled at a slant from land rigs on the coast to tap oil reserves offshore.

"If a directional gyro could be built into the bit and the data telemetered up the rotating shaft, it would save a lot of time and money," one oil man says. But, again, how do you send electromagnetic signals up a rotating pipe? Oil companies now spend approximately \$40-million a year making directional surveys.

A relatively new company in Houston called The Analysts uses transducers on the rig or platform—and transmits the data to a teleprinter, which produces hard copy and punched paper tape. The tape data is transmitted over radio common carrier and telephone lines to The Analysts' home office, where computer analysis produces a plot of formation porosity and pore pressure as a function of depth. This information is then sent by facsimile transmission to the rig or customer's office at the finish of each bit run, usually once a day.

The Analysts have recently upgraded their system to include a

Belden the Special "Specials" specialist

Here's what to do when cable catalog specs just won't do the job: Dial Area Code 317 ■
Then dial 966-6681 ■ You'll get action ■ From a man who devotes full time to solving
engineered cable problems ■ A Belden specialist that "lives"
with your design parameters from engineering through the
actual production run ■ Cables for underwater-under-
ground devices . . . extra-high voltage and pulse ap-
plications . . . medical instrumentation . . . low-level
signal interference problems . . . unusual environ-
mental conditions . . . he's tackled them all ■

Phone now.

8-5-0

DIAL (317) 966-6681

BELDEN 

... new ideas for moving electrical energy

minicomputer connected to the data-collection system, which processes the data on a foot-by-foot basis, 14 seconds after one foot is drilled.

Meanwhile Com-Drill, Inc., in Oklahoma City is providing well-site monitoring with nine sensors and a computer. Drill-Au-Mation, Inc., in Houston is field-testing a system that computerizes most of the well-drilling functions. It uses Digital Equipment Corp.'s PDP-8-I computer to provide automatic closed-loop control of the bit weight, rotary speed, mud pumps, well-pressure control and mud weight. The system monitors 24 drilling functions.

Martin-Decker Corp. in Santa Ana, Calif., provides a digital-acquisition technique that senses and collects up to eight drilling variables and feeds the measurements into a remote computer, which determines the most economical drilling procedures.

Offering similar services with on-site computers are Petro E,

Inc., of Corpus Christi, Tex.; Smith Tool Co., Compton, Calif., with its FIDO (field-instrumented data optimization) system, and Magobar Operations in Houston, a subsidiary of Dresser Industries.

Automatic Drilling Machines, Inc., in Dallas, offers an automated system that handles the drilling operation with a two-man crew.

View from the bottom

Lowering sensors to the bottom of a well and getting the data up by wire is a totally different operation from logging on the surface. The equipment is different as are the problems. The environment is, of course, brutal, and the sensor package must be designed in an ungainly configuration.

"Many of our sensors are 14 or 15 feet long, but some of them are 60 feet. And because of the pipe diameter, none of them is more than 3-5/8 inches in diameter," says James H. Moran, vice president of engineering of one of the largest

down-hole logging service companies in the world, Schlumberger Well services in Houston.

"One of the primary difficulties we have with equipment is caused by temperature," says Warren Wall of Schlumberger's Engineering Physics Dept. "The scintillation detector and the photomultiplier tube can take up to 150 C, but for more heat we have to put them in a vacuum. This delays the temperature gain inside to provide approximately six hours of operation."

Getting the data up presents a problem because the data rate is limited. "We have a bandwidth of 50 kHz to 100 kHz, but we'd like much more," Wall says.

ICs are another problem.

"We need integrated circuits to operate at 300 C," Wall says, "but the ones available are only rated to 125 C. This means we have to test all the devices.

"Long life is less important than being high-temperature resistant. We think in terms of hundreds of hours rather than thousands."

"We often use ceramic capacitors but they aren't reliable," Wall says. "The lead pulls out of the ceramic sandwich.

"We've had an inordinate amount of trouble with Teflon capacitors. Teflon just doesn't seem to be an ideal capacitor film; it has too many holes or something. We find leakage and total failure.

"Reconstituted mica capacitors have worked out nicely at 260 C for 400 hours or more, which is enough. We don't need long life at these high temperatures."

Printed-circuit boards also cause trouble at 200 C.

"We went to epoxy glass instead of nylons for those high temperatures, but we're now looking at polyamide flat boards," Wall says.

"As for resistors, we have found that metal film is better for us than composition resistors."

In addition Schlumberger has had trouble with the insulation failing in transformers. "We now use Isomica—a reconstituted mica to insulate them," Wall reports.

One design change Schlumberger is considering is to put electronics that won't withstand high temperatures in a Thermos bottle. ■■

Typical sensors used in oil drilling

Transducer	Function	Type
Pit Level	Measures fluid level	Potentiometer (0.1%, 10-turn)
Flow	Measures mud flow in/out of well	Strain gauge (instrumented target)
Pressure	Measures mud pressure	Strain gauge (pressure to electrical current)
Hook-load weight on bit	Measures longitudinal force on bit/weight of hoisting load	Strain gauge (pressure to electrical current and/or potentiometer)
Tachometer	Measures rotational velocity of drill string	DC generator
Gas detection	Determines % of gas in mud	Catalytic
Gas chromatograph	Measures gas stream in mud	Catalytic
Drill-rate computer	Measures computer-bit velocity	Binary counter
Hole depth	Measures depth of hole	Camshaft digital microswitch
Cpm with total cycles printout	Counts cycles per minute of circulating pump	Microswitch integration
Hole fill-up monitor with printout	Measures pumping strokes required to fill hole to displace pipe	Flow transducer with logic circuits

Incredible. A Heinemann circuit breaker in your product could ultimately cost you less than a fuse.

Case in point:

The machine in the picture is a non-impact data printer, the Repco 120.

It was designed at the outset to be more reliable than competitive machines. And sell for a lower price.

Yet it's protected with a Heinemann circuit breaker instead of a fuse.

The breaker costs more, of course.

Or does it?

Consider. Consider the cost of a service call to replace a blown fuse. Perhaps, a fuse that gave up the ghost because of something as harmless as a surge in the power line.

Repco calculated that the cost of one unnecessary service call

would more than pay for the price of the circuit breaker.

And the company got a little bonus in the bargain. The 120 Printer uses our breaker as the main on-off power switch as well as the overload protector.

The breaker in the Repco 120 Printer is our JA model. Its OEM price, in reasonable quantities, is quite reasonable. Not cheaper than a fuse, though.

Just cheaper than a service call.

We'll be glad to send you a copy of our Bulletin 3350, which gives complete data on the JA breaker line. Heinemann Electric Company, 2616 Brunswick Pike, Trenton, N.J. 08602.

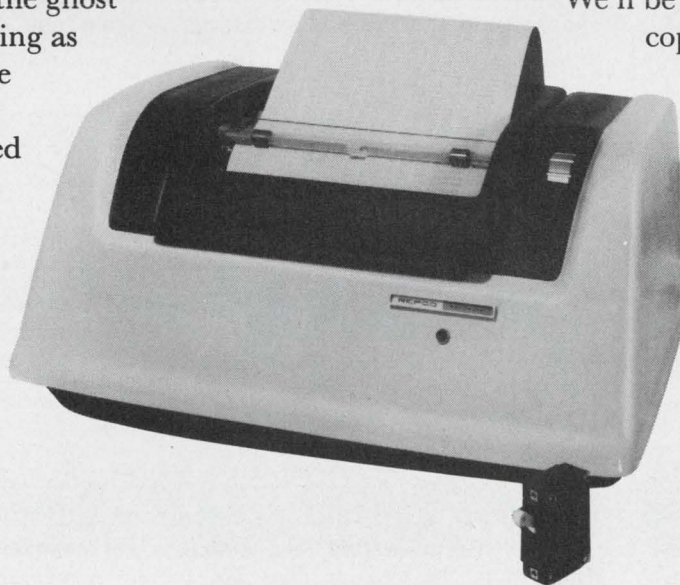

HEINEMANN

INFORMATION RETRIEVAL NUMBER 22

5162

Don't write off the reed relay; It's faster, tinier and cheaper

The reed relay—a venerable device, to be sure—is getting smaller, faster and cheaper as a result of recent advances in engineering and packaging and the introduction of a hybrid device.

Here are some recent developments:

- Mercury-wetted contact relays are faster with less noise.
- Position sensitivity is no longer a limitation of mercury-wetted relays.
- Dry-reed multipole capability, in a variety of form combinations, can be obtained in DIP-sized packages.
- Hybrid relays, with reeds at the input and triacs at the output, combine high reed-relay isolation with the power capacity of a triac.

Mercury relay switches faster

Mercury-wetted contact relays use a hermetically sealed capsule as the basic switching unit. The cap-

sule contains a mercury pool from which a thin film of mercury is maintained on the contacts by capillary action. Contact bounce is eliminated because of the mercury film. This feature is the basic difference between mercury-wetted and dry-reed relays.

A recent advance in capsule construction is the T-shaped hinged armature (Fig. 1), which replaces the conventional cantilever movable element. The capsule, made by C. P. Clare of Chicago, is used in its HGQ relay. The result of this innovation, the company says, is the fastest-switching and lowest-noise mercury-wetted relay available today.

The response time at nominal coil power is less than 950 μ s. This model can be driven to 500 Hz with a minimum of jitter, and contact noise settles to less than 5 μ V in 2 ms.

Transfer action is random, bridging or nonbridging, with transfer time typically less than 100 μ s.

By contrast, the mercury-wetted "industry standard" relay has a response time of 2 ms and switching

speeds of 100 Hz maximum.

C. P. Clare's model HGQ relay sells for about \$5 a pole.

Relay position is no longer limited

A practical limitation in the use of most mercury-wetted relays is their position orientation requirement. Standard relays of this type cannot vary by more than $\pm 30^\circ$ from a vertical position.

But a number of mercury relays on the market today feature position insensitivity. In one type the capsule consists of a standard reed switch with contact surfaces partly wetted. One manufacturer of this relay is Magnecraft of Chicago.

In another development, the capsule construction has been modified (Fig. 2). In this capsule, manufactured by Fifth Dimension of Princeton, N.J., a 3-mg moving contact, resembling a small drill bit, is selectively wetted by—and floats in—a film of mercury within a sealed tube. When a magnetic field is passed through the air gap separating the moving element from one of two stationary con-

Edward A. Torrero
Circuits Editor

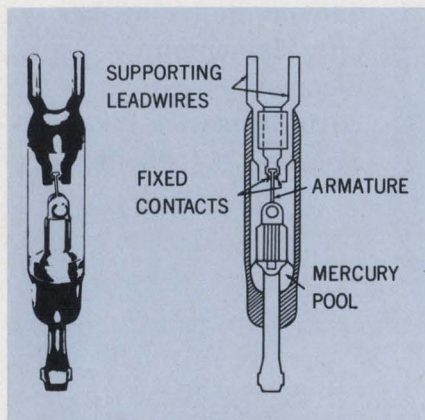

1. The fastest-switching, lowest-noise mercury relay offered today is Clare's HGQ. The improvement results from the use of a hinged armature.

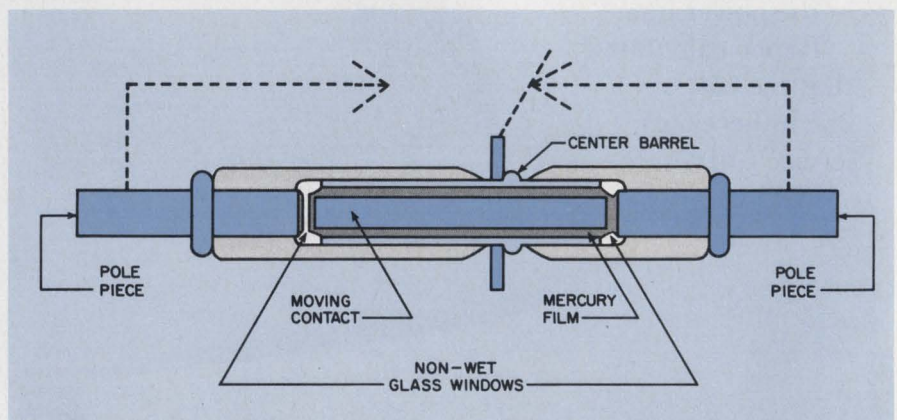

2. This mercury-wetted reed switch is not position-sensitive. Built by Fifth Dimension, the capsule does not contain a mercury pool. Instead, contact surfaces are provided with a thin film of mercury. The design is adaptable to Form C (break-before-make) or Form D (make-before-break).

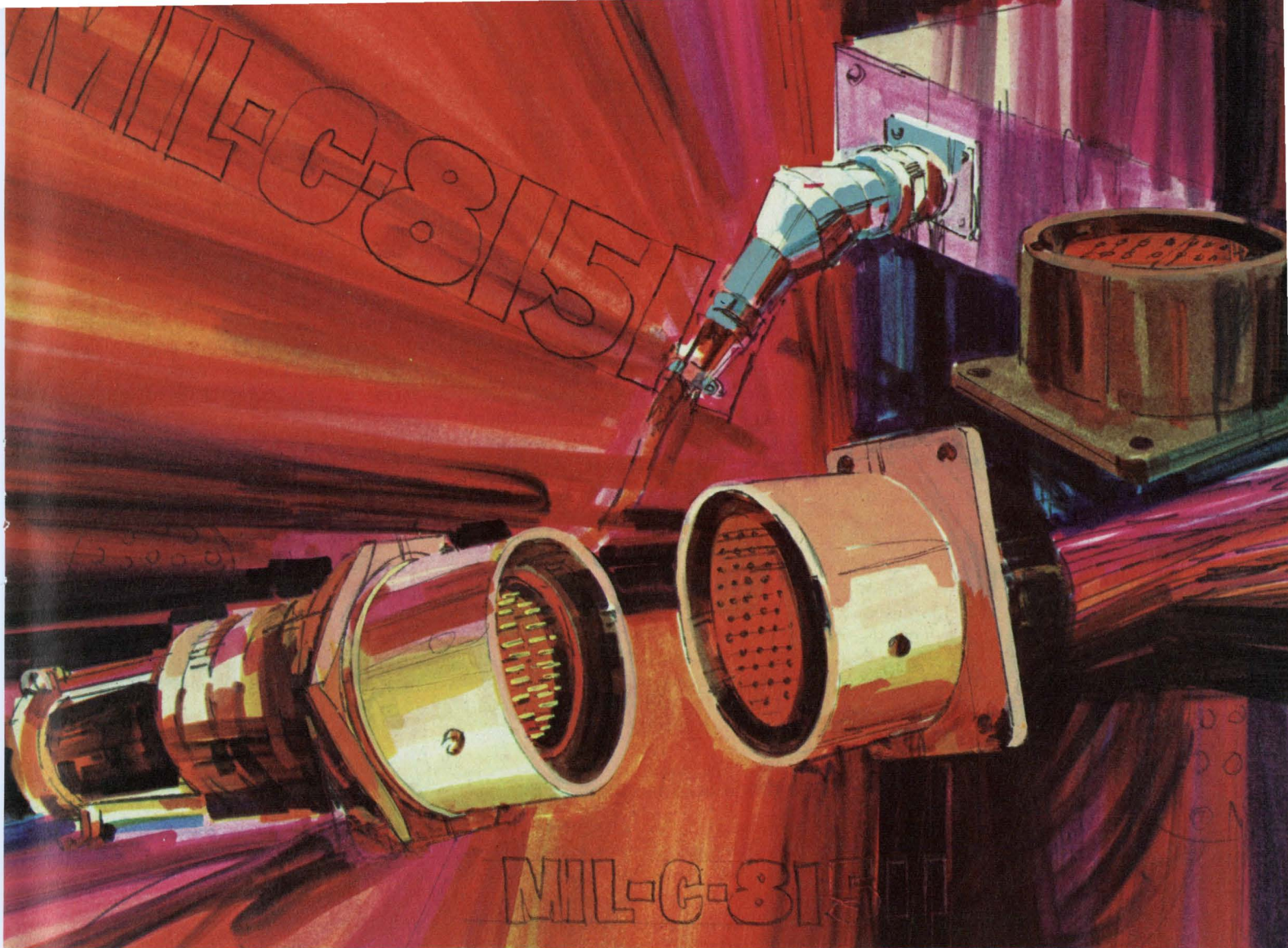

AT CINCH-NULINE WE DON'T REST ON OUR QUALIFICATIONS*



Cinch-Nuline works tirelessly to be sure its MIL-C-81511 connectors exceed the specifications. We are continually improving our material standards, upgrading our manufacturing techniques and inspection procedures. We don't relax—so you can be supplied with an even better connector than you expect!

Maybe that's why our customers are so pleased with the quality record of Cinch-Nuline MIL-C-81511 connectors.

This tri-services approved connector is rapidly becoming the standard for new aerospace programs. If your existing equipment must interface with these new systems, re-designing it to use MIL-C-81511 will solve many problems for you.

For detailed information on these subminiature connectors, contact your nearest Cinch Sales Office, or Cinch-Nuline, a division of TRW Inc., 1015 South Sixth Street, Minneapolis, Minnesota 55415; telephone (612) 339-8301. CN-7160

*Qualified to MIL-C-81511, Revision A on June 30, 1970, to Revision B on July 13, 1970 and to Revision C on March 1, 1971.

CINCH-NULINE

facts, the element glides in the mercury film to close the gap.

No mercury pool is present in the capsule—hence, no position sensitivity. The switch occupies only 0.010 cubic inch and is available in packages with DIP connections for standard mounting. Typical operate times are 1 to 2.5 ms. The contact bounce is eliminated because of the mercury film. The expected life at rated load is about 10^9 operations. The relay sells for about \$10 a pole.

Dry reeds in DIP packages

As for dry reeds in DIP-type packaging, the relay user can obtain Form A (single-pole, single-throw, normally open), Form B (single-pole, single-throw, normally closed) and Form C (single-pole, double-throw) models. A manufacturer of these modules is Grigsby-Barton of Arlington Heights, Ill.

The same relay house also features a line of half DIP-sized modules for edge mounting. Available in this line are the following models: 1 Form A, 1 Form B, 1 Form C and 2 Form A. In a standard DIP module you can get a combination of these forms.

Typical operate times are 500 μ s, with contact bounce not considered. The operate time depends on the coil time constant and the mass of the switch. The contact bounce is a function of operate time, overdrive,

drive method and the type of waveform controlled.

Isolation for these modules is typically 10^{12} ohms at 100 Vdc. A maximum isolation of 10^{15} ohms at the specified dc voltage is available.

In nonstandard DIP-sized packages, Potter & Brumfield of Princeton, Ind., has a line of 2, 4, 6 and 8-pole modules. Any form combination consistent with the number of terminals is available. Typical speeds, with contact bounce included, reach 3.5 ms maximum. The transfer time is under 1 ms.

A hybrid relay with a dry-reed input and triac output is being offered by a number of relay manufacturers, including C. P. Clare, Grigsby-Barton, Potter & Brumfield, and Ohmite.

Contact bounce is eliminated here, even though a dry reed is used. On the first closure of the reed switch, the triac turns ON and stays ON until the hold current falls to essentially zero.

Hybrids accommodate loads

Several types of hybrid relays are made to accommodate various types of loads. In one the reed switch is closed for the first time in 300 μ s after activation. The triac gates ON, and a closed output circuit results. In another type of hybrid, the relay waits for the next zero-voltage point before the triac

turns ON. The delay could be as much as 8.33 ms in 60-Hz lines. In still another model, the relay delays the triac turn-ON until a peak-voltage, or 90°, point is reached at the input. This hybrid is useful for certain reactive loads.

Hybrids are also moving toward DIP packages. Grigsby-Barton is about to come out with two half-DIP-sized packages—one contains the reed relay and the other, the triac circuit. The combined package forms a standard DIP module.

Costs are coming down, too

With the industry trend toward reduced costs, a relay buyer can now get a moderately fast mercury-wetted relay for about \$4.45 a relay in quantities of about 15 k to 20 k. That's a reduction of about 35 cents per relay from an earlier price. The drop is apparently due to lower demand and stiffer competition.

Improved manufacturing techniques are also helping to cut costs. Relay houses are going to automation in adjustment, testing, parts handling and assembly. In some cases relay specs have been loosened to allow for reduced production costs. In quantities of 10 k and above, you can get a DIP-type relay for, typically, \$2. The earlier price was \$2.75. The difference is a result, in part, of the reduction of a shielding spec. ■■

Semiconductor laser efficiency doubled

A new optical-cavity, gallium-arsenide, heterojunction laser has twice the efficiency of previous devices, extends the operating frequency from kilohertz to megahertz and can readily operate at temperatures hot enough to melt conventional metal contacts.

Developed by RCA Laboratories, Princeton, N.J., primarily for infrared (9- μ m) pulse-type, room-temperature applications, the laser diode has an optical waveguide-cavity in the region where conventional devices radiate (see shaded area in the figure). The optical cavity increases the power-conver-

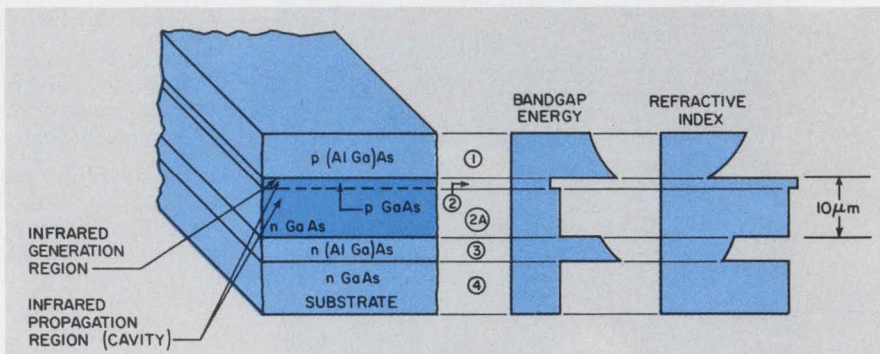

An optical cavity (regions 2 and 2A) improves heterojunction laser performance. Infrared radiation generated in region 2 propagates through 2A to reduce the radiated power density and improve device efficiency.

Take a turn for the better in rotary switches.

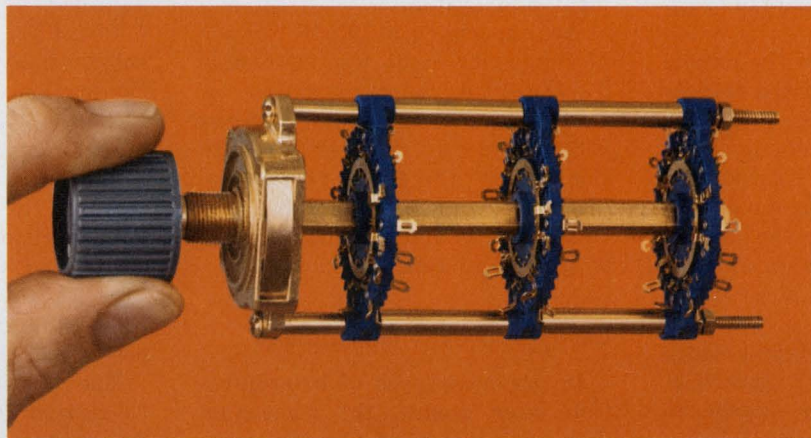

Oak continues to market the broadest line of rotary switches in sizes and configurations to fit your applications.

For example:

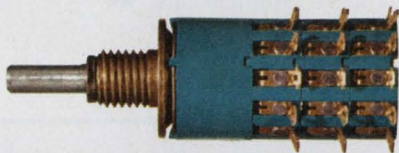

Our 1/2-inch subminiature rotary switch.

Ultra-compact, yet provides superior insulating qualities and dimensional stability in demanding environments at lowest competitive price.

A new 12-position Acorn rotary for printed circuits.

A size-saving design. Crisp, uniform detenting with Oak's patented Unidex™ indexing. Has glass epoxy wafer and tinned PC terminals ready for soldering.

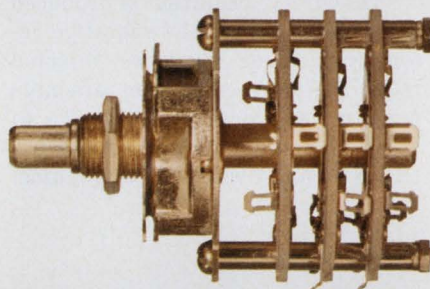

Rotary switches with Unidex indexing, too.

Our F and JKN series. Versatile, economical. And Unidex detent means uniform torque, crisp feel.



And our Multidex® rotary: the almost-universal switch.

Versatile enough to replace 7 old-style rotary designs. Thousands of variations available. With Unidex detent for sure switching time after time. Multidex cuts the cost of engineering design.

There's more.

Miniaturized lever switch: Type 184. Improved dielectric properties plus more clips per stator.



Miniature rotary trim switch. For SPDT trim switching in tight PC-board locations. Long life. Low cost.

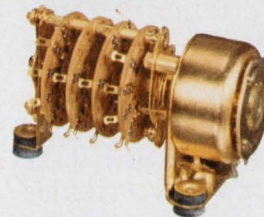

Stepping switches: Compact, lightweight. Subminiature to extra-heavy-duty types. Fast response.

Now: order Moduline™ Switches from your distributor.

Choose from 2-million possible switch combinations. 72-hour delivery. Write for the Moduline Catalog.

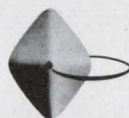

OAK MANUFACTURING CO.

CRYSTAL LAKE, ILLINOIS 60014 · A DIVISION OF OAK ELECTRO/NETICS CORP

Telephone: 815-459-5000

TWX: 910-634-3353

TELEX: 722-447

INFORMATION RETRIEVAL NUMBER 24

sion efficiency (electrical input to light output) from 10% to over 20% at a 3% duty cycle—the highest efficiency so far reported for devices operating at room temperatures, according to Dr. Henry Kressell, who was on the RCA research team that produced the new device.

The cavity lasers work well at temperatures of 100 to 120 C, Kressell reports, in contrast with 75 C for currently available devices.

Another advantage of the optical cavity is a lowering of the threshold currents required to make the diode lase. A semiconductor laser radiates weakly and incoherently on currents below threshold, but when it is pulsed above the threshold, a marked increase in radiant flux occurs at the lasing wavelength.

For previous room-temperature heterojunction diodes, threshold currents ranged from 10,000 to 20,000 A/cm². For the optical cavity device, these threshold currents can be adjusted, by increasing cavity thickness, from 2500 A/cm² to 10,000 A/cm².

The beam spread of the cavity laser radiation is larger than that of the conventional heterojunction unit—namely, 30° vs 20°. However, optics are used in both cases; so

this presents no problem.

The improved characteristics of the diode open new application areas for room-temperature, pulse-type systems that use the 9- μ m invisible, infrared radiation, such as optical data links, line-of-sight multi-channel communications, closed-circuit television and see-in-the-dark illuminators for commercial and military-security equipment and systems.

An experimental 0.7-W version of the cavity diode was introduced by the RCA Solid State Div. of Somerville, N.J., at the recent Electro-Optical Systems Design Conference in New York City. Maximum pulsing frequency for this device is about 1 MHz because of packaging considerations.

Cavity improves performance

In previous types of heterojunction laser diodes, the generation and propagation of the IR radiation occurred only in the junction (region 2 in the figure). With the optical cavity, radiation is produced in the junction by the radiative recombination of electrons injected from the n-type gallium arsenide next to the junction (region 2A in the figure). The junction region (2) is a narrow, leaky waveguide,

while a substantially larger optical cavity is formed by the combination of the junction and the n-type regions (2 plus 2A).

The radiation from the junction excites the higher-order modes in the optical cavity, and radiation occurs from the n-type region (2A) as well. The power density across the total radiating area is thus reduced, and high peak power can be obtained.

Radiation loss is also minimized substantially because the propagation region (2A) is separated from the generation region (2), which absorbs much of its own generated radiation.

While the cavity laser combines good efficiency with good power output and wide operating temperature range, there are tradeoffs, Kressell notes, particularly between power and threshold current levels.

The optical cavities have been fabricated from 1 to 30 μ m, with the wider cavity producing the greater power output. But the threshold current increases as the cavity widens, thereby increasing operating temperatures.

The new device, like other heterojunction lasers, can also be fabricated in arrays, to provide the ultra high-power outputs needed for some applications. ■■

A mere touch sets off new burglar alarm

An anti-intrusion system has been developed for parked aircraft that sets off one or more alarms the instant an unauthorized person so much as touches any part of the plane. The alarm may be a piercing horn, a high-intensity flashing light, or signals sent to a remote alarm monitor in the nearest manned hangar.

Principally for private and corporate aircraft that are often parked for long periods at small, unattended suburban airports, the system was developed by GTE Sylvania's Electronic Systems Group in Mountain View, Calif.

Although Sylvania has no plans to seek other markets at this time, the concept could be modified and

used to build anti-intrusion devices for a number of metal structures, such as trailers, trucks, buses, fence links and even metal boats.

It consists of a sensor module, which includes a battery charger, a ground-cable reel and an alarm device. The module is in a case mounted in the aircraft. The ground-cable reel and the alarm device are mounted in some convenient spot in the protected aircraft.

Once installed, the system is put into operation by making a single connection, the ground cable, and turning the system power switch on. After a three-minute delay to allow the operator to get away from the plane, the protective system is armed. If anyone in contact

with the ground touches the aircraft, the system detects the change in aircraft-to-ground impedance.

The operation of the detection circuitry is basically simple, says Sylvania's Frank Bell, who designed it. The aircraft impedance forms part of the frequency-determining circuit of a relaxation oscillator. When an intruder touches the aircraft skin, the added capacitance causes a frequency shift of 0.1 to 0.2%. The relaxation oscillator output is applied to a counter, and the frequency changes are detected by comparing the times required for two subsequent counts of 16,384 cycles. If the difference exceeds a preset threshold, an alarm is generated. ■■

AiResearch electronic cooling systems are built into the F-14.



We have designed and built complete electronic cooling systems for hundreds of airborne applications — both on board and pod mounted. In fact, a Garrett AiResearch built electronic cooling system is on board the Grumman F-14 air-superiority fighter. □ Whatever your specific airborne electronic cooling requirement, come to Garrett AiResearch for total system optimization.

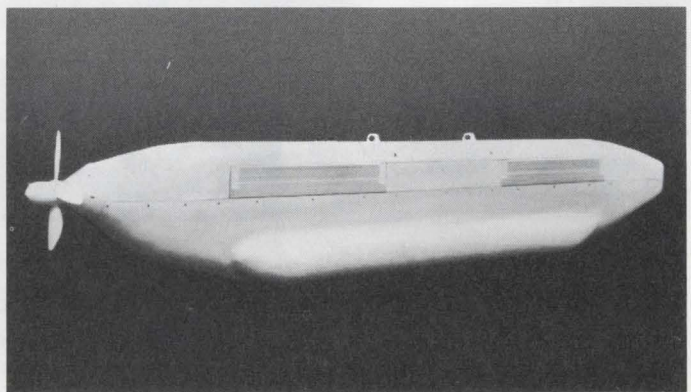

Garrett AiResearch enclosures are also cooling the pod mounted ALQ-76 and ALQ-99 electronic countermeasures systems. The enclosure in the ALQ-99 pod (shown above) for the EA-6B utilizes surface heat exchangers as the ultimate heat sink.

 **AiResearch Manufacturing Co.**
9851 Sepulveda Boulevard, Los Angeles, Calif. 90009
one of The Signal Companies 

Sperry explodes the LED myth

There has been a lot said in recent months about LED's representing the most significant advance in display technology and how they are destined to dominate the digital display market. We feel it's time to explode the myth and set the record straight. So, here's a direct, point-by-point, comparison of Sperry seven segment gas discharge planar displays† vs LED displays.

COST

For the price of a single 1/4" LED digit you can buy three 1/2" or three 1/3" Sperry display digits*. And, in the future, the Sperry displays should continue to be less expensive than LED displays. Gives you something to think about, doesn't it?



SIZE Let the size speak for itself.



READABILITY

Have you tried to read a 1/8" or even a 1/4" LED display at 20'? On the other hand, the Sperry 1/3" display is easy to read at that distance and the 1/2" model can be read at up to 40'. See the difference?



COLOR

With LED's, you have the choice of red, red or red. Not so with Sperry. They come in an eye appealing orange — with amber and red available with filters. If you like red, why pay more for a LED?



APPEARANCE

Which do you prefer — looking at individual red dots on LED devices or at continuous unbroken Sperry figures. The choice is yours.



BRIGHTNESS

Sure you can read LED's indoors, but how about in bright light or direct sunlight? LED's fade fast while Sperry displays stay clearly legible with no appreciable loss in brightness. And, Sperry devices won't poop out when it gets hot!



Sperry advantages don't stop here either. The small Sperry package is only a shade larger than a LED and nearly as thin. Sperry power dissipation is also significantly lower. And, Sperry reliability is so good that they have proven fail-safe in stringent, high performance aircraft applications including the Boeing 747. There are no wire bonds to go bad, either. Don't just take our word for it. Arrange for a comparison demonstration and see for yourself what the difference will mean to your particular application.

For complete technical information on Sperry displays, use this publication's reader service card or phone or write:
Sperry Information Displays Division
P.O. Box 3579, Scottsdale, Arizona 85257
Telephone (602) 947-8371

SPERRY

INFORMATION DISPLAYS

It's a whole new ball game in display devices!

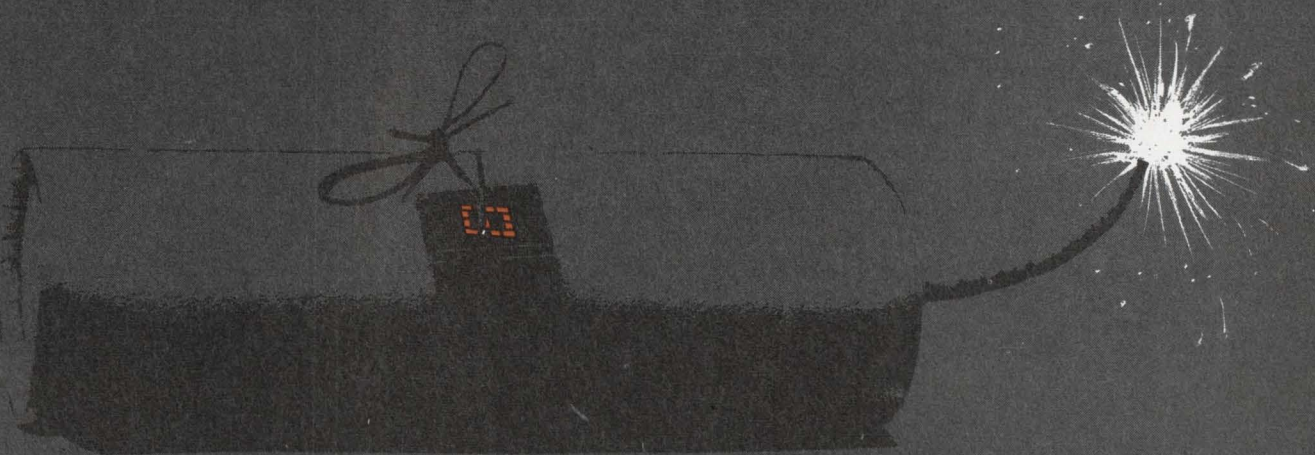

† Patents pending

*based on 1,000 digit quantity, and above. Sperry displays are available in 3 digit, 2 digit, and 1 1/2 (7 segment character and a 1 with + and -) digit models in both 1/3" and 1/2" sizes.

 SPERRY RAND

A year ago we introduced 7 new JCM miniature RF coaxial connectors that "do the job for a fraction of SMA prices."

Here, by popular demand, are 8 more.

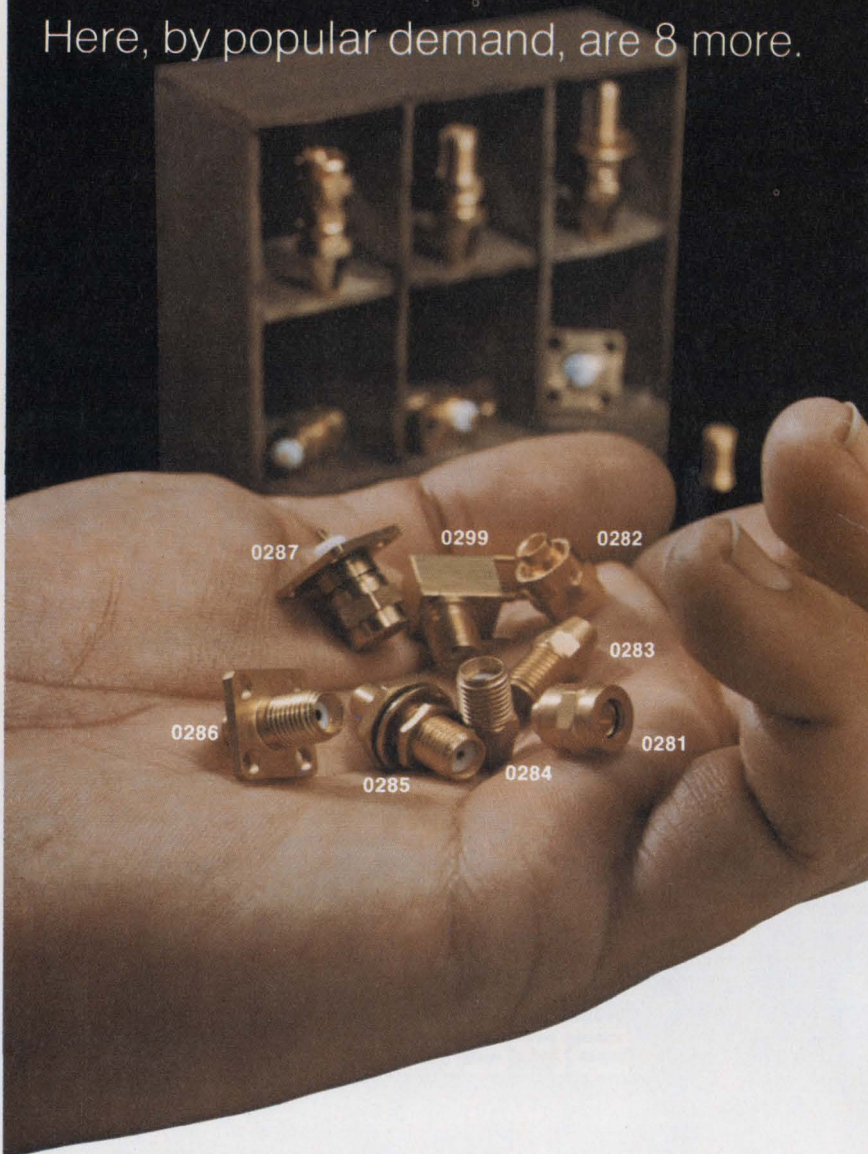

If you don't require all the electrical performance built into SMA type connectors, why pay for it? Up to 3 GHz for flexible cable assembly and even beyond 6 GHz for semi-rigid assembly, our new JCM series gives you the same electrical performance as the far more expensive SMA types. The series includes connectors for both panel and PC mounting. All are interchangeable and intermateable with the standard, expensive SMA connectors. So you can use them without making any changes . . . and without compromising required performance. There are JCM connectors to accept virtually any miniature size cable, so you don't have to stock a big variety. It's worth looking into, isn't it? All it costs is a stamp.

E. F. JOHNSON COMPANY / Waseca, Minnesota 56093

Dept. ED-10

Please check for technical information or test samples of our new low-cost series 142-0200-001 JCM connectors.

- Please send technical information.
- I desire test samples. Please call me at _____

NAME _____

FIRM _____ TITLE _____

ADDRESS _____

CITY _____ STATE _____ ZIP _____



E. F. JOHNSON COMPANY

INFORMATION RETRIEVAL NUMBER 28

technology abroad

What is described as "the world's first in-service telecommunications waveguide system" has been put into operation over a 10-meter route in metropolitan Paris. The waveguide, developed by France's CGE group, is a tube 5 cm in diameter and made of fine, spiraling wire threads. The threads are manufactured with tolerances within several thousandths of a millimeter in a process developed by Cables of Lyon.

CIRCLE NO. 451

A 20-kilobit holographic memory measuring 0.5 mm in diameter has been developed by Hitachi's Central Research Laboratory in Tokyo. It provides storage density of 100 kbit/mm². High density was accomplished by reducing noise and by dispersing the laser beam with a multilayer optical plate, made of thin-film cerium-oxide evaporated through randomly patterned screens on a glass substrate. Light transmitted through this "random phase shifter" plate is recorded in a specially treated transparent gelatin film.

CIRCLE NO. 452

A new conductor, said to be as low-cost and as lightweight as aluminum but as easy to use as copper has been produced by Sieverts Cable Works, a division of Sweden's L. M. Ericsson Co. Called Sinipal, the new wire consists of aluminum electromechanically plated with 0.5 to 1.5 μ m of nickel. The wire has contact properties similar to copper; consequently bi-metal connectors or special cable hardware are not needed. The wire can be easily soldered; tests have demonstrated that connections have less contact resistance and better performance than aluminum under long-term cycle loading. Sinipal is expected to find use in telecommunications, electronic components and electrical wiring.

CIRCLE NO. 453

VCXOs

Get 'em straight from Damon!

Whether you're in a sweat on a VCXO prototype for a tough application – or need a production run in a hurry, you can get 'em straight from Damon. Speedy proficiency in design and production of VCXOs allows Damon to deliver all-silicon solid state devices with linearity to within 1% of best straight line and frequency deviation to $\pm 0.25\%$.

Just glance at the specification guide below for more good news on available characteristics. Computer-assisted designs are available, too. Ask Damon today for a quote on VCXOs tailored to your specifications – and deadlines. Call or write: Damon/Electronics Division, 115 Fourth Ave., Needham, Mass. 02194. Phone: (617) 449-0800.

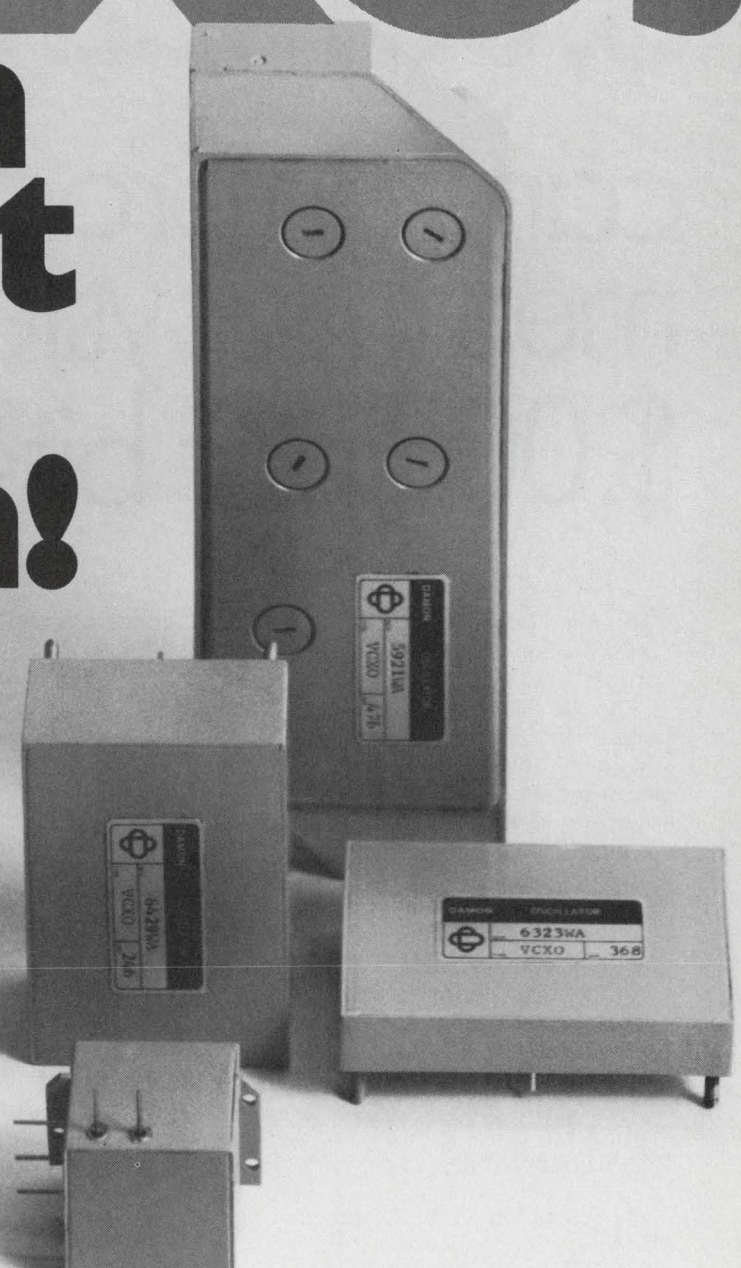

Shown approximately 3/4 size

SPECIFICATION GUIDE*

Parameter	Basic and Multiplier VCXOs	Mixer and Mixer-Multiplier VCXOs
Center Frequency	1 KHz to 300 MHz	100 Hz to 300 MHz
Frequency Deviation	$\pm 0.01\%$ to $\pm 0.25\%$ of C.F.	± 10 Hz to ± 1 MHz
Frequency Stability 24 hr. @ 25°C	± 1 to ± 10 ppm	$\pm 0.5\%$ of peak deviation
0 to 65°C (no oven)	± 10 to ± 50 ppm	$\pm 2\%$ of peak deviation
Linearity	to within 1% of best straight line	to within 1% of best straight line
Minimum Deviation Rate	0 (dc)	0 (dc)
Maximum Deviation Rate	0.2% of C.F. (100 KHz max.)	10 KHz to 100 KHz
Mod. Voltage (Typical)	± 5 V peak	± 5 V peak
Mod. Input Impedance	> 50 K ohms	> 50 K ohms
Output Power Available	0.5 mw to 20 mw	0.5 mw to 20 mw
Load Impedance	50 ohms to 10 K ohms	50 ohms to 10 K ohms
Power Requirements (Typical)	-25 V ± 1 V @ 30 ma	-25 V ± 1 V @ 40-50 ma
C.F. Manual Adjustment Range	$\pm 0.01\%$	$\pm 5\%$ of peak deviation

* Obviously, the limits are not absolute. The interrelationship of parameters for VCXOs are of such a nature as to permit optimization of any one or more characteristics to satisfy customer requirements.



if we can supply memory cores at \$.001 each...

can you produce memory systems at \$.005 per bit?

If you need bulk quantities of cores, we can meet our part of the bargain... at a profit.

And we think you can do the same. In fact, if you use our new 18-mil "low-drive" cores, it's almost a certainty. These devices have very low switching currents... and they don't need a lot of costly electronic support.

If you'd like to cut the cost of your next memory, but not its reliability, contact us for a down-to-earth talk about core quantities and prices... even design. Remember we produce memories too. For quick reaction write
MEMORY PRODUCTS GROUP,
PHILIPS ELCOMA, EINDHOVEN,
THE NETHERLANDS.

In the U.S.A.: Ferroxcube Corporation,
Mt. Marion Rd., Saugerties,
N.Y. 12477; Phone (914) 246-2811,
Twx 510-247-5410.

In Canada: Philips Electron Devices
a division of Philips Electronics
Industries Ltd. 116, Vanderhoof Avenue
TORONTO 17 - Ontario

Test conditions and typical values
at 25°C.

Core type	18PH2*	18PH4	18PH5	18PH6
I_f (mA)	213	425	500	580
I_p (mA)	130	259	305	354
rV_1 (mV)	11	31.4	36	39
wV_z (mV)	1.2	6.8	6.0	6.2
t_p (ns)	230	142	136	123
t_s (ns)	490	290	270	230

*With this core, wired in a 2D configuration and used under asymmetrical drive conditions, read/write switching times of 150/300 ns can be obtained, applying read-, write- and digit currents of about 440, 220 and 110 mA respectively.

Philips designs and produces memories of all kinds... core and non-core. We are sure that, for some time to come, only the core technology will offer the full combination of low price, assured non-volatility of information, realistic system speeds, and 100% component reliability... and be able to prove it.

Philips' advanced production methods can make more memory cores... to highest standards... cheaper... than anybody else. Make us prove it!



electronic components
and materials

PHILIPS

Our R-250 three-speed data recorder you see below has more than enough going for it so it's a standout in any crowd.

As a solo performer, it's a rugged individualist.

But since made to IRIG standards, its character is congenial enough to work compatibly with other components in your system.

(One of the virtues born of its being a member of the large, world-renowned family of TEAC instrumentation products, where synergy is the watchword.)

When put to work by itself or

with other units, in the lab or the field, it provides precise FM recording and reproducing of analog signals from DC to 5kHz at 15 ips.

Its seven-inch reels carry half-inch tape that gives you seven independent record/reproduce data channels.

The eighth channel is an edge-track that takes voiced comments.

While one of the biggest (and best) in our family line, it still weighs in at an easy-to-get-along-with 67 pounds.

Front to back, the R-250 Series is a mere 12", 18" high, 20" wide—

a handsome addition to anyone's measuring instruments system.

Or as a starter of it.

It's not really particular how it's put to use. Or who it works with.

Only *how* it works.

To find out more about how it can work for you, just write or call Ken Williamson, Director of Marketing, Technical Products, TEAC Corporation of America, 7733 Telegraph Road, Montebello, CA 90604. Telephone (213) 726-0303.

He'll give you all the particulars on why there's a good reason to go TEAC.

The particular data recorder that's not particular who it works with.



INFORMATION RETRIEVAL NUMBER 31

(Remote control unit is optional)

Designer's Bonanza!

VVC TUNING

SELECT THE EPICAP* TUNING DIODE THAT'S JUST RIGHT FOR YOUR DESIGN

- Wide package variation, in plastic, ceramic or glass — in TO-92, Mini-L, DO-7, DO-14 and Case 45 outlines.
- Broad capacitance ranges and ratios — with nominal values from 1.0 pF to 550 pF and a selection of maximum working voltages from 12 to 60 volts.
- Very high Q with minimum values guaranteed.
- EXTRA values . . . like a wide variety of abrupt and hyper-abrupt junctions, and hot-carrier diodes for VHF and UHF mixer and detector applications and miscellaneous picosecond switching requirements.

Write for your FREE Designer's Manual today!

This comprehensive new fact-book will show you Q, tuning ratio and nominal capacitance for each device. It will give you working voltages, package types, plus significant series highlights. It also contains detailed data sheets covering all of Motorola's extensive tuning diode lines.

In addition, there's a new cross-reference guide and four enlightening application notes of unusual interest to circuit designers.

To get your copy, write for "Designer's Manual for VVC Tuning Diodes" to Motorola Semiconductor Products Inc., P. O. Box 20912, Phoenix, Arizona 85036.

*Trademark of Motorola Inc.

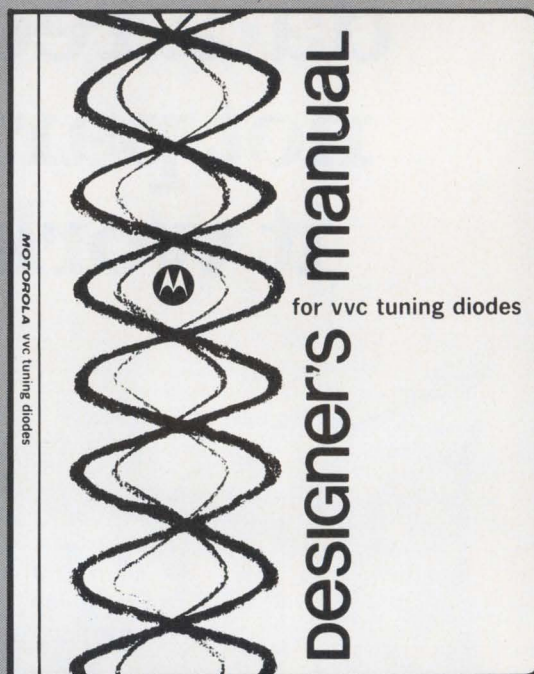

DIODES



MOTOROLA TUNING DIODES

— The Designer's First Choice!

INFORMATION RETRIEVAL NUMBER 32

washington report

DON BYRNE, WASHINGTON BUREAU

FCC kills Telpak-sharing practice

The Federal Communications Commission told common carriers to eliminate the discriminatory provisions of their Telpak-sharing tariffs, a move that may nudge users like the nation's airlines closer to building their own private microwave communications systems. The FCC acted on a July ruling of the U.S. Court of Appeals, which had remanded the sharing provisions to the FCC for further consideration.

Telpak sharing means that users, such as the Government and regulated industries, are eligible for an advantageous rate by sharing bulk private-line communications. Other users are not permitted to share channels.

The airlines have fought both increases in Telpak rates and the elimination of the sharing provisions. Meanwhile John S. Anderson, chairman of Arinc, Inc., the airlines' communications subsidiary, told the FCC under cross-examination that he was confident the money market would be able to furnish sufficient financing to make the airlines' microwave communications project feasible. He said exploratory talks had been held with major lenders, and he added that he assumed enough airlines would be willing to sign 20-year contracts to make the system work. He estimated that Arinc would need about \$50-million a year for five years to build the system.

Court upholds ban on phone company CATV

The U.S. Court of Appeals in New Orleans has upheld a Federal Communications Commission order that bars telephone companies from providing cable-television service in their operating areas, either directly or through subsidiaries. The original FCC order, issued over a year ago, was appealed by six independent (non-Bell system) telephone companies.

In an unrelated case, the Illinois Commerce Commission has assumed jurisdiction over all CATV within the state, saying that under state law CATV is the same as telephone service. The state commission has ordered hearings to formulate rules for CATV operation.

Airlines, FAA launch automated data link communications

The Federal Aviation Administration and the nation's airlines are testing a fully automated data-communications system that may eventually cover all commercial aircraft and routes in this country. The tests are expected to run about six months. Minicomputers and display systems in the aircraft and on the ground will transmit between aircraft and ground stations such data as the location of the aircraft, its altitude, the wind speed and direction and crew messages. The ground stations, in return, will transmit company messages, weather advisories and air-traffic-con-

trol clearances to the aircraft, where they will be printed out in the cockpit, thus relieving the communications workload of the crew and radio congestion.

Tests will be conducted on flights between San Francisco and Los Angeles and between Chicago and New York. Seven remotely controlled, unattended vhf radio facilities will be used in the tests, and additional net stations will be added, as needed, for more coverage. No accurate estimate is available, but airline and FAA officials think purchases could eventually run into hundreds of millions for the computers, display systems and related communications hardware.

Environmentalists threaten Navy's Sanguine

Project Sanguine, the Navy's proposed extremely-low-frequency communications system for submarines, has run afoul of environmentalist thinking in the Senate and may be in for a rough time. Sen. Gaylord Nelson (D-Wis.) is asking the Senate to cut \$5.5-million earmarked for R&D on the project in this year's budget.

Nelson says he wants the money held up until it can be determined what effect the project may have on the environment and whether it will actually work. Communications would be carried out through a huge underground antenna network buried in northern Wisconsin. Nelson says some \$50-million has already been spent on the project, and "we still don't have detailed information on how the environment will be affected."

The Navy is not taking the threat lightly, having seen what environmental concern was able to accomplish with the supersonic transport program.

Capital Capsules: The Bureau of Customs has launched a full-scale investigation into charges that Japanese manufacturers are "dumping" color television tubes in the U.S. at less than their fair market value. Customs noted that in the first half of this year \$2.1 million worth of tubes were imported from Japan. The customs action follows hard on the heels of a recommendation by a Presidential commission investigating future trade policies that the U.S. use the antidumping regulations more vigorously to remedy unfair competition . . . NASA reports that its **Applications Technology Satellite-3 is once again transmitting weather pictures.** The satellite had shut down for about a month because of a locked, improperly phased antenna control system . . . A delegation from California has met in Washington with NASA and Air Force officials in an attempt to have the space-shuttle home port situated at either **Edwards AFB or Vandenberg AFB.** They've cited California's sagging aerospace industry as a good reason for locating the \$10-billion effort there. The delegation estimates that as many as 45,000 jobs may be involved . . . **Boeing has decided to go East for its future in the computer business.** Boeing Computer Services will open an East Coast headquarters at Dover, N.J., in about a week . . . **The Navy has awarded a \$50-million production contract** to the Lockheed Electronics Co. of Plainfield, N.J. The contract award, announced by the Naval Ordnance Systems Command, calls for the manufacture of a number of Mark-86 computerized radar-controlled gunfire systems over the next several years.



**“ESP rectifiers.
They’re new from Unitrode.**

“Typical recovery time is 15 nano-seconds in any circuit. And that’s the fastest available in a power rectifier. Forward voltage drop is as low as .8V at 20A. That’s efficiency. And, as you can see, they’re in extremely compact packages having continuous ratings of 2.5A to 20A in 50V, 75V, 100V and 125V types. And with many thousands of hours of life tests behind them, you can be sure of a state-of-the-art product with demonstrated reliability. Unitrode has the statistical test data to prove it.

“With ESP rectifiers, you can design high current, high frequency power supplies to 500 KHz with very low diode losses and at very low cost. They’re available off-the-shelf in three series. UES 101-4 for 2.5A, UES 201-4 for 6A, and UES 301-4 for 20A applications. Now you know what ESP stands for.”

“You mean Efficiency, Speed and Power.”

“That’s very perceptive of you.”

For fast action, call Sales Engineering collect at (617) 926-0404, Unitrode Corporation, Dept. 10 B, 580 Pleasant Street, Watertown, Mass. 02127.



UNITRODE

a thought about you...

FRUSTRATED

Can't fix it yourself — and can't get anyone else to service it? If the general-purpose mini-computers you use in your OEM application make you feel like this frustrated father, your customers may show an understandable tendency to cry.

To avoid the frustrations which can accompany an OEM purchase, call Cincinnati Milacron. Our service organization is nationwide, but you won't need help very often because our hardware has the kind of built-in reliability that people have come to expect from us.

Call Cincinnati Milacron. We won't let minicomputer problems short-circuit your sales.



minicomputers

**CINCINNATI
MILACRON**

Cincinnati Milacron Company | Cincinnati, Ohio 45209

**Machine Tools
Process Controls
Chemicals
Plastics
Plastics Processing Machinery
Abrasives**



Quality need not be expensive and Rotron[®] can prove it!

Rotron research has spearheaded most of the significant developments in air moving technology... just as Rotron products have set industry standards for quality and performance. Now you can have Rotron leadership at prices competitive with any in the marketplace!

How come? Responding to the challenge of the past decade of inflationary cost increases, Rotron's substantial investment in automated equipment, production

techniques and innovative designs are paying off, enabling us to reduce our production costs and pass these savings on to you.

Have you checked our prices lately?

Rotron's nationwide distributor system of 50 stocking locations provides off-the-shelf delivery of standard units and our network of factory representatives provide on-the-spot technical assistance and service.

Why Settle For Less When The Best Costs No More?

ROTRON INC. Woodstock, N.Y. 12498



914 • 679-2401 □ TWX 510-247-9033

PACIFIC DIVISION Burbank, Calif. 91506 □ 213 • 849-7871 ROTRON N.V. Breda, Netherlands

14639

INFORMATION RETRIEVAL NUMBER 35

The SOLID STATE

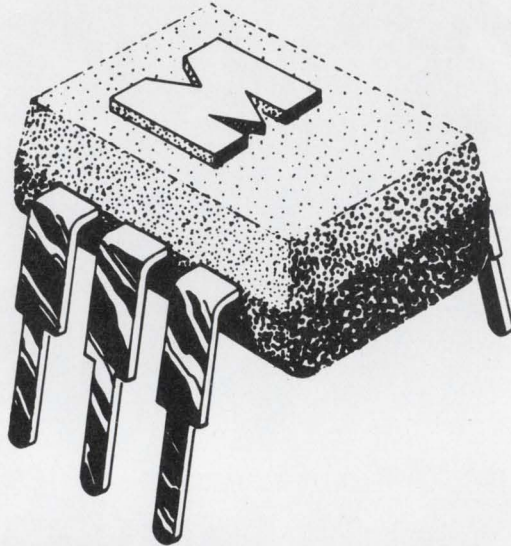

Relays

Monsanto has them
a full line of opto-isolators that couple light emitting diodes to phototransistors, photodiodes, photo SCR's and now to a photo-darlington. All of these units offer the ruggedness and long life associated with solid state devices.

Plus, the new MCA2 photo-darlington relay has the advantage of high gain: an output of 125 mA at a 1 volt contact voltage for a 50 mA coil input current. Transfer ratios of 200% at an input of 10 mA and a VCE of 3 volts are typical.

The MCA2 can be used to replace reed and mercury wetted relays, pulse transformers and in other applications where fast operating time (10 μ s), high contact rating (125mA) and high isolation resistance between coil and contact (10¹¹ ohms) are important.

All this and more comes to you in a convenient plastic dual-in-line package weighing only 0.4 grams.

Monsanto makes them and Monsanto can deliver them.

SOLID STATE RELAYS with the following features:

Detectors: phototransistor
photodiode
photo SCR
photodarlington

Isolation voltage to 25kV

Package styles: axial, 6 lead plastic DIP and hermetic TO-18.

Any of these products can be obtained from Monsanto distributors. Call the one nearest you today:

Elmar Electronics
K-Tronics
Kierulff Electronics (FJR & Schley)
Liberty Electronics
Schweber Electronics
Semiconductor Specialists
Western Radio

Also available through CESCO and Canadian Dynamics.

Or you can call or write Monsanto direct at 10131 Bubb Road, Cupertino, California 95014, (408) 257-2140.

Monsanto

RCA extends triac capabilities again with this exclusive new 80-amp series.

You can hold down design costs for high power lighting and heating controls, welders, induction motors and other applications, because these new triacs simplify circuitry and heat sinking.

And you save on device costs because the triacs utilize the RCA low cost package with compression seal. Available in press-fit and stud pack-

ages. Four modes of gate control add design flexibility. All this means more amps per dollar.

That's why the new 80-amp triac is another example of cost effective simplification from RCA.

Unit prices are \$25 to \$45 in small quantities. Call your RCA Representative or RCA Distributor. For new RCA catalog write RCA Commercial Engineering, Section 57J14/UR12, Harrison, N.J. 07029. International: RCA, Sun-

bury-on-Thames, U.K., or P.O. Box 112, Hong Kong. RCA Limited, St. Anne deBellevue, 810 Quebec, Canada.

	Repetitive Peak Off-State Voltage ^V _{DROM}		
PACKAGE	200 V	400 V	600 V
Press Fit	TA7752	TA7753	TA7754
Stud	TA7755	TA7756	TA7757
Isolated Stud	TA7937	TA7938	TA7939

All types are available with flexible lead attachments.

New RCA Triac controls 80 Amperes

You control design and system cost



RCA Solid State

A Good Thyristor Can Be A

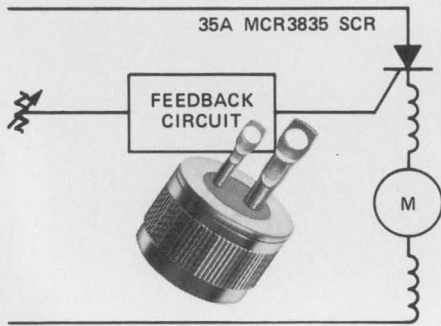

HALF-WAVE CONTROL WITH FEEDBACK — Universal ac/dc; food mixers, blenders, portable tools, floor polishers, and sewing machines.

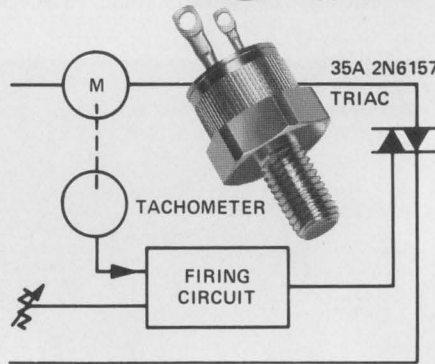

FULL-WAVE CONTROL WITH FEEDBACK — Universal ac/dc with any load, shaded pole or permanent split capacitor with fan/blower load; automatic washers, conveyor belts, air-conditioners, clothes dryers.

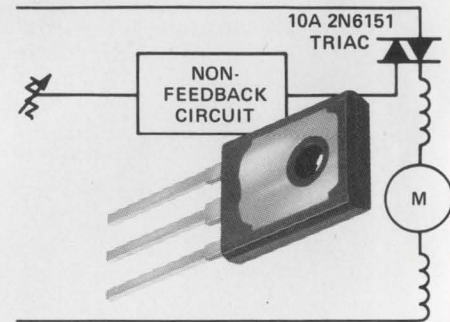

FULL-WAVE CONTROL WITH NON-FEEDBACK — Universal ac/dc, shaded pole, permanent split capacitor; blenders, food mixers, portable tools, floor polishers, sewing machines.

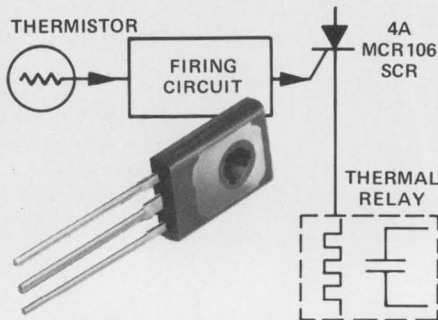

TEMPERATURE CONTROL—Hair dryers, ovens, environmental controls, electric frypans, ranges, heaters and toasters.

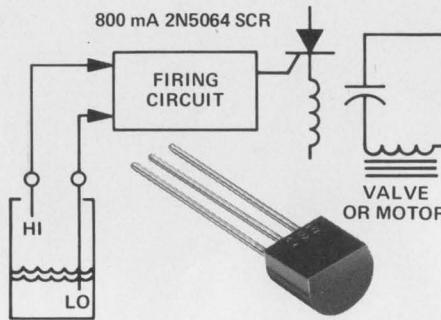

LIQUID LEVEL CONTROL — Industrial applications, dishwashers, automatic washers, humidifiers, dehumidifiers, vending machines, water softeners.

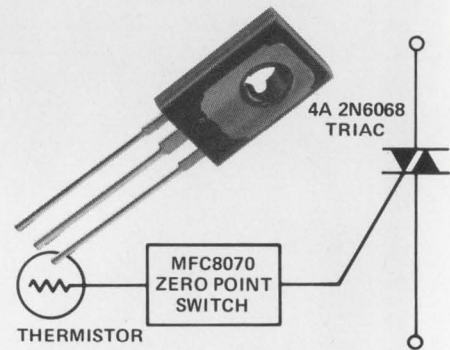

SYNCHRONOUS SWITCHING — Electric blankets, coffeemakers, frypans, ranges, electric heating and water heating.

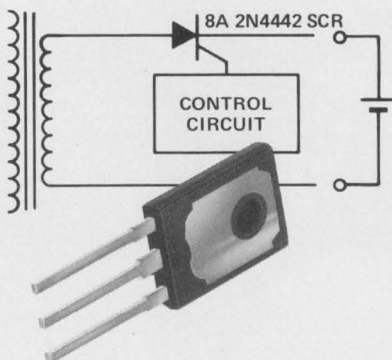

BATTERY CHARGING — Shavers, knives, emergency lighting, toothbrushes, automotive, clothes brushes.

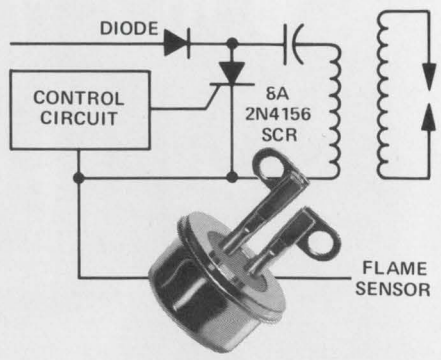

CD PULSE APPLICATIONS — Furnaces, water heaters, automotive/marine ignition, clothes dryers, room heaters.

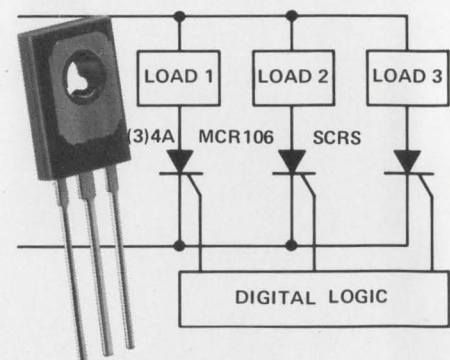

SEQUENCING APPLICATIONS — Vending machines, automotive/aircraft, dishwashers, automatic washers, oven timers.

*Trademark Motorola Inc.

Good Anything

... like the new 2N6068 plastic Triac offering 1,000 watts of full-wave power-handling in heat, light and speed control ... reliably ... at low cost! This Thermopad* device is priced at only 86¢, 100-up, yet offers all these advantages: 4 A/600 V maximum ratings — dual-mode gate firing — 3.5°C/W thermal resistance — and glass-passivated, hermetic die construction for higher voltage yield and the cleanest, most uncontaminated plastic-device junctions you can bet your design on.

... or the popular, industry-standard 8 A 2N4151 metal Elf* SCR that still provides the ultimate in design flexibility and mounting ease combined with rugged compactness and reliability! It's still the smallest of any comparable SCR, still offers six different, hermetic case configurations and is *still* ideal for the value-conscious designer of lamp dimmers, battery chargers, flashers, power supplies and speed controls.

And if you're into lamp and relay drivers, small motor controls, gate drivers for larger thyristors and sensing and detection circuits, you'll want to select one of our 800 mA 2N5060 Unibloc* SCRs, optimized — and priced — for 3 different case temperature applications: 85°, 110° and 125° T_c. They feature sensitive, 200 μA triggering, low-as-30-cent

100-ups and fill out a line of more than 3 dozen economical signal thyristors! Big power requirements? How about a new, 110 A RMS 2N4361 SCR that spells **QUALITY** in the only ways that count: pressure-contact encapsulation ... freedom from thermal fatigue ... guaranteed 100 V/μs dv/dt ... 1,600 A surge protection ... high-temperature (300°C-tested) alloy materials ... hermetic ceramic seals ... all-diffused junctions contoured for longest voltage creepage ... 1,400 V blocking voltage.

There are others — scores of plastic and metal SCRs and Triacs offering you the exact degree of full- or half-wave, stepless power control you want, from 25 to 800 volts in 17 different package styles. Whatever thyristor you want ... in the volume you want ... at the price you can afford ... from the biggest discrete device warehouse you can find!

See your Motorola distributor or write on your company letterhead to P. O. Box 20912, Phoenix, Az. 85036, for your "Guide To Thyristors" — a comprehensive, new look at selection, symbols, characteristics, definitions, uses and cross-referencing of today's thyristors. Motorola thyristors. Great for anything you want!

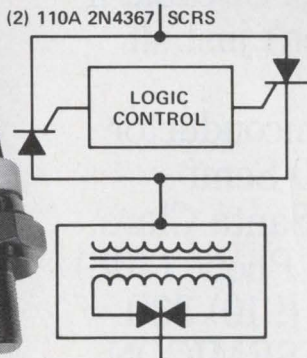
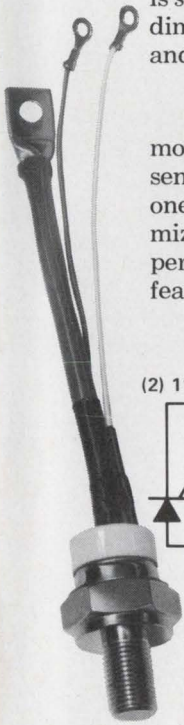

WELDING — Spot welding with automatic cycle determination.

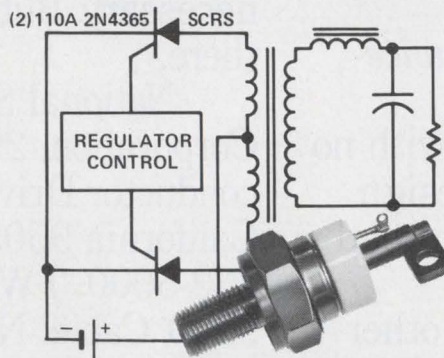

DC-TO-AC CONVERTER — Low-voltage DC to high-voltage AC servos, fluorescent lighting.

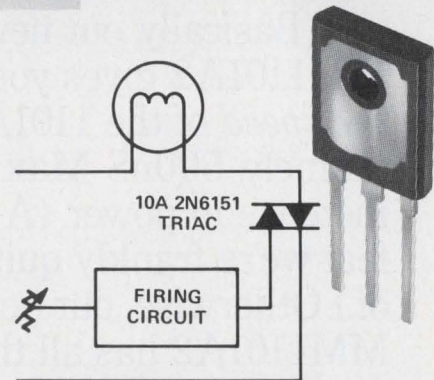

LIGHT DIMMING — For full-on, full-off light control in home, office, business.

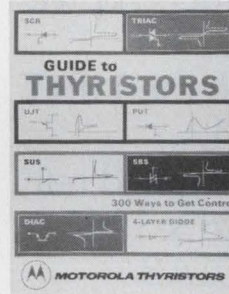

MOTOROLA THYRISTORS
— 300 Ways To Get Control

INFORMATION RETRIEVAL NUMBER 38

Coup de RAM.

When the 1101 random access memory was introduced, we knew it was a winner. So, we second sourced it.

Likewise with the 11011, 1101A and 1101A1.

Now we've designed our very own 256 word x 1 bit RAM, the MM1101A2.

Basically, our new MM1101A2 gives you *twice the speed* of the 1101A1 (namely, 500nS Max.) with no increase in power. (A design feat we're frankly quite proud of.) Otherwise, our new MM1101A2 has all the other features you've grown to know in the 1101 series.

Including the use of silicon gate technology.

So, whether you need a good second source for the 1101, 11011, 1101A and 1101A1, or a good first source for our fast new MM1101A2, just drop us a line. Or give us a call. Or TWX us. Or cable if necessary. But don't just sit there.

National Semiconductor Corporation, 2900 Semiconductor Drive, Santa Clara, California 95051. Phone (408) 732-5000. TWX: (910) 339-9240. Cable: NATSEMICON.

National

editorial

Help

I'm the new editor of *ELECTRONIC DESIGN* and I'm thrilled. But I'm nervous, too. The former editors, Howard Bierman, then Frank Egan, left an awfully tough act to follow.

Every editor wants to improve on the work of his predecessors, but in this case that won't be easy. Before he became editor-publisher of *MicroWaves* and moved that Hayden publication to the head of its field, Bierman left *ELECTRONIC DESIGN* the leading trade magazine in electronics and one of the top professional publications in the world.

He steadfastly refused to bow to other interests, refused to extend *ED*'s coverage to include material that could not help engineers, refused to let *ELECTRONIC DESIGN* slip into those easy ways of doing things. For me, that tradition is an exciting challenge.

It's easy enough to take the reins of a sick magazine and build it. It's a lot harder to take the leading publication and push it further ahead. I'm fortunate in having the finest editorial staff anybody could want—a team of astute men who really know the electronics industry. That's a tremendous start, but I'd like more. I'm not content and neither is anybody else on our staff. Frankly, we'd like your help.

We want *ELECTRONIC DESIGN* to be an integral, indispensable part of your professional life—more so than ever before. But we can't be everywhere. Though we sometimes feel we're keeping the airlines and telephone companies alive, we can't get to talk to each of you. We can't know all your job problems. We'd like to.

Only you can help us do that. You can tell us how *ELECTRONIC DESIGN*'s team can work harder for you. Of course, we'd like to hear you say we're doing a good job. But we're more interested in learning how to do a better job—always.

Tell us your problems. Tell us about manufacturers' specs that befuddle you. Tell us about your product problems, delivery problems, design problems, management problems. We don't kid ourselves into thinking we can lick every problem. We know there's always another behind the first. But we can help. Let us know. Tell us what you like, what you don't like and what you would like.

You can use the space we'll be providing on the Reader Service card. Or you can drop us a note at 50 Essex St., Rochelle Park, N. J. 07662. Or give us a ring at (201) 843-0550. We're listening.

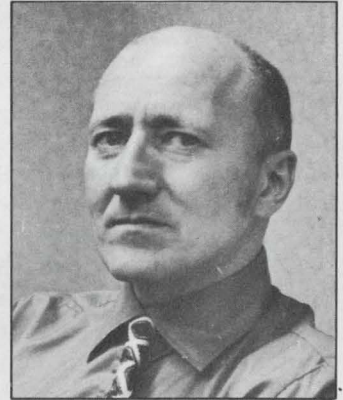

A handwritten signature in dark ink that reads "George Rostky". The signature is fluid and cursive, written in a professional style.

GEORGE ROSTKY
Editor



Focus

on Linear ICs

As suppliers develop newer and better linear ICs (many of them not really linear) to make life easier for engineers, they also refine and polish the ancient art of specs-manship, which tends to make life more difficult. Because linear-IC competition is fierce, specs-manship—the art of concealing deficiencies and highlighting strengths—has become a way of life that's not likely to go away. Engineers must learn to cope with it.

Error sources are many

Tradeoffs are often hidden. Different manufacturers don't often cite the same test conditions for the same spec. And even the same spec sheet may give different conditions for similar specs.

Almost all parameters are functions—nonlinear functions—of temperature. Almost all are nonlinear functions of supply voltage. A single number can never describe a parameter, and qualifications may or may not correspond to conditions in a particular circuit where the IC is to be used.

There's a bewildering array of interdependent specs. For a single amplifier, one vendor gives 27 sets of performance curves. Even these can prove inadequate when they're labeled "typical," a very important adjective.

"Typical" can mean that half the units are better and half are worse. It can mean that half the units meet a spec and half don't. It can even mean, "We once made a device with these specs, and we think we can do it again."

Even the most conservative vendor can't fully characterize production op amps for every possible condition. And all vendors are conservative. All point out that they meet their specs by a wide

margin. No one just squeaks by. Yet spreads between guaranteed and typical values are often wide.

Comparing devices is difficult. Specs can be given for many different conditions. Temperature ranges may differ. Voltage gain can be given with no load, a 2-k Ω load, a 10-k Ω load or an unspecified load. Common-mode rejection may appear with a stated source resistance and source unbalance, or with no statement. Power-supply rejection may be quoted in terms of $\mu\text{V}/\text{V}$, decibels or % fullscale/%. Offset voltage, offset current, and bias current may be stated for a small supply voltage, while output swing is given for a large supply.

No one has optimized every parameter. But vendors have made dramatic improvements in many specs, often sacrificing others. They don't shout about the sacrifices.

Fortunately it's a rare circuit that requires the best of everything. So it can prove fruitful to look at some of the best specs for several different types of linear integrated circuits.

The op amp: daddy of LICs

Because the operational amplifier is the most universal of all linear active circuits, lending itself to the most diverse applications, and because semiconductor manufacturers felt that high-volume production was essential for a monolithic circuit, they integrated the op amp first.

The earliest IC op amps, in 1962 and 1963—Texas Instruments' Series 52, then Fairchild's $\mu\text{A}702$ —were no performance match for discrete-component op amps from leading vendors like George A. Philbrick Researches (now Teledyne Philbrick) or Burr-Brown Research.

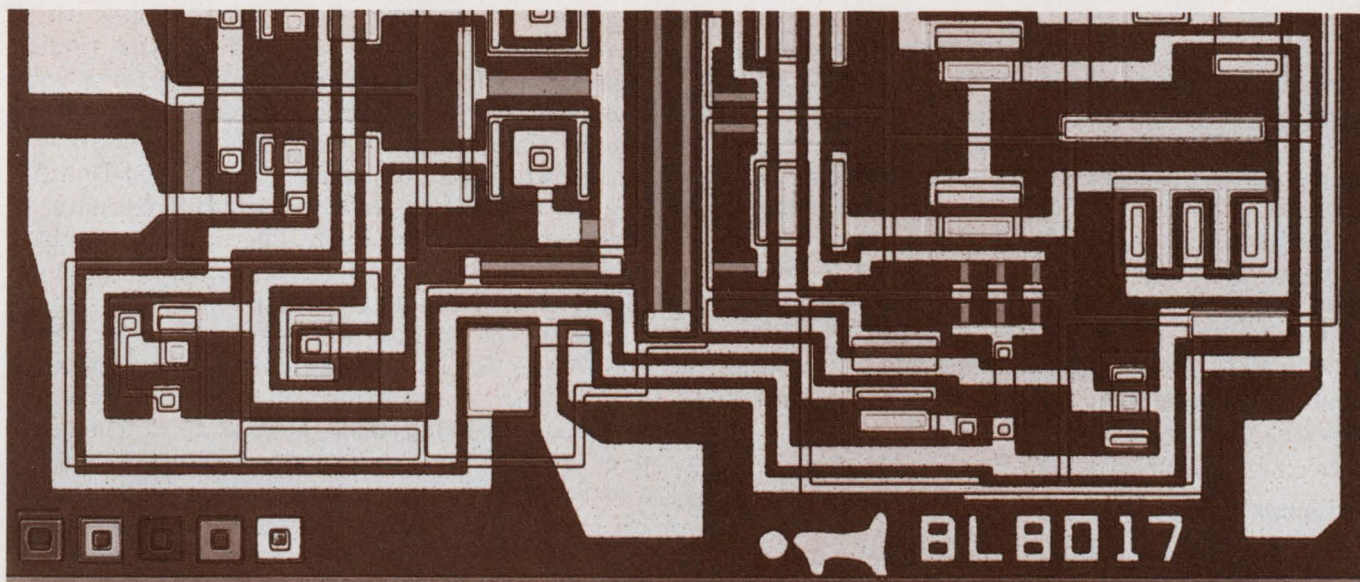

A slew rate of $130 \text{ V}/\mu\text{s}$ can be achieved with Intersil's 8017, an inverting-only op amp requiring several external

components including a bandwidth-control resistor and a feedforward capacitor.

The Series 52 started with two devices, the SN521 dc op amp and the SN522—the same amplifier with emitter-follower output. These circuits, a major technological breakthrough in their day, used two pnps, five npns and six diffused resistors.

Happily, semiconductor manufacturers weren't satisfied with the early efforts of TI and Fairchild. They aimed at the ideal op amp—one with infinite input impedance, bandwidth and gain; zero output impedance, bias, offset and drift; and unconditional stability. Because zero is a small number and infinity is large, no vendor has reached these ultimates.

Early IC op amps were unstable, requiring several external components and careful design to insure stability. Today many op amps require no external compensation. They're internally compensated. But that's a compromise.

If an engineer is very careful with PC layout and circuit design, he can safely push an uncompensated op amp and win higher gain and greater bandwidth. Many vendors, in fact, offer compensated and uncompensated versions of the same amplifier. And often an amplifier requires no compensation unless it's operated with small closed-loop gain.

How fast is it?

So one criterion is compensation—internal or external. Another is slew rate—a favorite arena for specsmanship. It's a function of bandwidth and gain, which depend on compensation and load. And it has little value if there's no spec for settling time to a specified error band.

An unstable amplifier might never settle. Or an amplifier might swing from 0 to 10 V in 100

ns, suggesting a slew rate of $100 \text{ V}/\mu\text{s}$ —which is quick. But that amplifier might continue its swing out to 11 V, then back to 9 V, then up towards 11 V again. It might take many microseconds (or forever) before it settles close to 10 V. If it takes $10 \mu\text{s}$ to settle between 9.99 and 10.01 V, the slew rate of 0.1% is actually $10 \text{ V}/10 \mu\text{s}$, or $1 \text{ V}/\mu\text{s}$.

Manufacturers never specify slew rate this way because the figure is less impressive than the original $100 \text{ V}/\mu\text{s}$. Further, depending on how

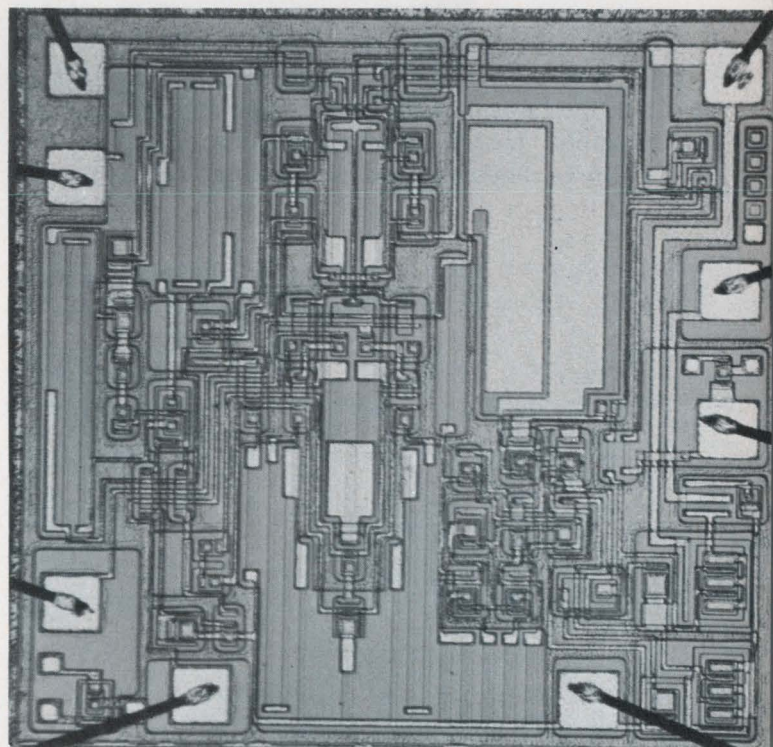

Fast slewing, at $120 \text{ V}/\mu\text{s}$ typical, $100 \text{ V}/\mu\text{s}$ guaranteed, is the big feature of the Harris 2520 op amp, but at a gain of two or three, rather than unity.

a vendor writes his specs, settling time may include slewing time (in which case it's often called acquisition time) or it may not.

The hardest place to get speed is generally at unity gain. But some specs give slew rate at a gain of 10 or 100, which is easier. And some op amps have high slew rate in only one mode—perhaps as inverting amplifiers or voltage followers. And they may not allow differential operation.

Though the highest slew rates come with hybrid and discrete-component modules, very high slew rates are available in monolithic (single stone) op amps, too.

Op amps for speed

National Semiconductor, for example, has just introduced the LM118, with minimum 50 V/ μ s at unity gain and settling to 0.1% in 500 ns. The monolithic op amp has internal frequency compensation, 15-MHz unity-gain bandwidth, and full output (± 13 V at 5 mA) at 1 MHz.

Compared with some other op amps, the LM-118 may not seem speedy. For example, DDC's HVA-23 has minimum unity-gain slew rate of 600 V/ μ s in the inverting mode. Unity-gain bandwidth in that mode is 100 MHz, and full output (10 V at 30 mA) is at 10 MHz.

But the HVA-23 is a multichip, thick-film hybrid on three substrates. Like most high-performance hybrids, this one isn't cheap. DDC doesn't publish large-quantity prices, but the 100-up price is likely to be about 10% less than the 1-to-24 price of \$125. In contrast, National's 100-up price for the LM118 ranges from \$9.95 (for 0 to 70 C) to \$29.95 (for -55 to +125 C).

Even by monolithic standards, the LM118 may not be fastest. But direct comparisons are impossible. Harris Semiconductor's HA-2520, for example, has a typical slew rate of 120 V/ μ s and

a minimum of 100 V/ μ s, with 200-ns typical settling to 0.1%. But these values are for a voltage gain of two—or three—depending on which side of the data sheet one reads.

Bandwidth for full output (± 10 V and 10 mA) is at least 1.5 MHz, and bandwidth for a gain of three is typically 10 MHz. The op amp requires no external compensation for gains of three or higher. In 100-up quantities, it costs \$48.

One of the earliest high-slew op amps, Fairchild's μ A715, has unity-gain slew rate, typically, of 100 V/ μ s in the inverting mode and 18 V/ μ s in the noninverting mode, both at 25 C. The company gives typical unity-gain settling of 300 ns and acquisition time (with 5-V output) of 800 ns, but it doesn't give the error band. At unity gain, the 715 requires external compensation. In 10 to 24, the device costs \$19.25.

At lower prices one can consider two very fast amplifiers with almost identical specs—the Intersil 8017 and the Analog Devices AD505. At the 100-up level, the 8017 costs \$10, and the 505 costs \$12.

These have typical slewing of 130 V/ μ s at unity gain, with typical settling to 0.1% in 1 μ s when a bandwidth-control resistor is 20 k Ω . Intersil quotes unity gain at 10 MHz, typical, with 10-k Ω source and feedback resistances and 20-k Ω bandwidth-control resistor. Analog quotes typical unity gain at 12 MHz, open loop, with a 20-k Ω bandwidth-control resistor. Both quote 2-MHz full-power bandwidth as typical.

These amplifiers are inverting only. They require two external compensation capacitors, an external feedforward capacitor, and, for most applications, an external bandwidth-control resistor.

Op amps for accuracy

Three very important error sources are *bias* (usually the average of the two input currents for zero output voltage, but sometimes the larger one), *offset current* (the difference between the two input currents for zero output voltage) and *offset voltage* (the voltage between the two inputs when equal resistances are in series with each, or the voltage required between the two inputs to obtain zero dc-output voltage). A second-order error source, but an important one, is the offset-voltage drift with temperature.

Many op amps have outstanding bias and offset. The best bias current appears in Intersil's 8500A, which, for -25 to +85 C, offers a maximum of 0.01 pA—a stunning number. But offset voltage is high—20 mV max—and that's at 25 C. The temperature coefficient of V_{os} is 5 mV/ $^{\circ}$ C from -25 to +25 or from +25 to +75 C. The 8500 is a FET-input hybrid. So is the AmpereX AT404, whose 0.05-pA bias level is only slightly higher than that of Intersil's 8500A.

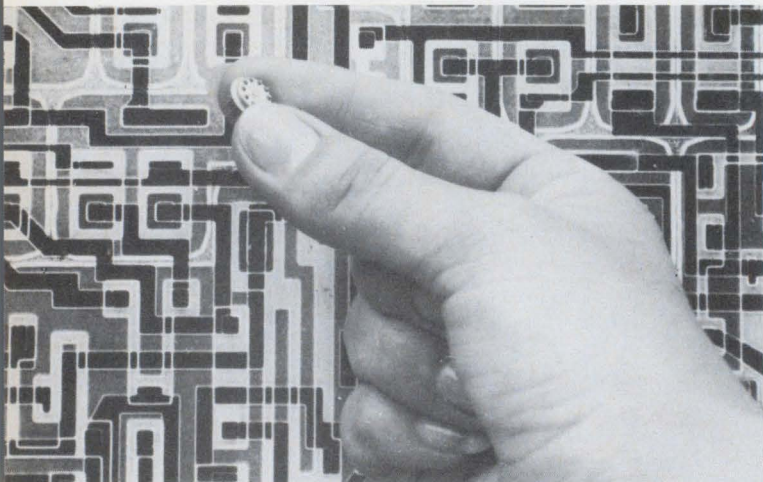

The first monolithic phase-locked loop, part of the Signetics 560 series, lends itself to a wide variety of applications that formerly required inductors.

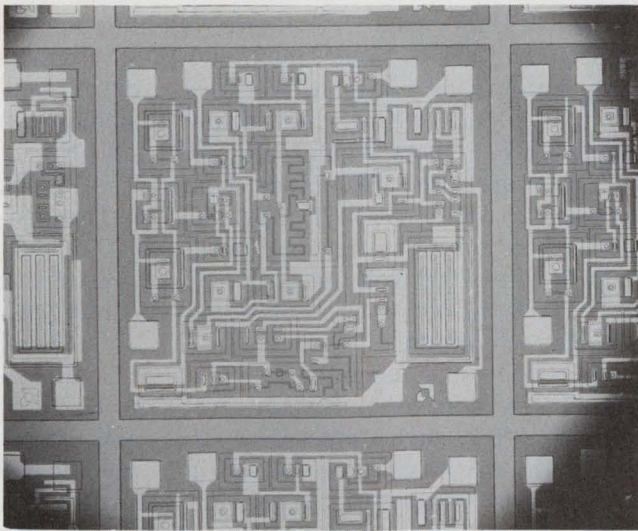

Aimed at a gap between the popular 301, 307, 741, 748 and the superior 308 families, the Advanced Micro Devices Am 1660 op amp offers better performance than the lower achievers and equal performance to some of the superior devices at a compromise price, \$5 in 100-up. Max 25 C bias is 15 nA.

The Analog Devices 520J seems less impressive, with 100-nA typical I_B at 25 C, 25-nA I_{OS} and no specification for V_{OS} . But Analog points out that this device is a true instrumentation amplifier, the first on a single monolithic chip—not merely a general-purpose op amp that can be used for instrumentation. Its adjustable gain (from 1 to 1000) does not depend on external feedback resistors that can add errors.

Input resistance is 2 G Ω , compared with a few megohms or less for most low-bias op amps. And output impedance is a mere 2 ohms, with a gain of 100 at 100 Hz. Common-mode rejection with a 1-k Ω source unbalance ranges from 70 to 106 dB for gains of 1 to 1000 at dc to 100 Hz.

That's respectable performance even in hybrid instrumentation amplifiers. The Zeltex ZA701D1, for example, offers at least 80-dB CMR at a gain of 1000—the latter, however, with no input unbalance. The Zeltex unit has differential input resistance of 500 M Ω .

Precision Monolithics, Inc., gives somewhat different specs for monolithic instrumentation-grade op amps in the SSS725 series. The SSS-725A, for -55 to +125 C, has maximum bias of 70 nA at 25 C, 10 nA at worst-case temperature. The maximum I_{OS} is 1 nA at 25 C, 4 nA at worst temperature, and the maximum V_{OS} is 100 μ V at 25 C, 180 μ V at worst temperature.

While PMI specifies at least 114 dB CMR across the entire temperature range, the company quotes this figure for a source resistance of less than 20 k Ω and cites no source-resistance unbalance. The 25-C input resistance is 0.8 M Ω minimum or 1.8 M Ω , typical.

PMI gives much higher input resistance—at least 230 M Ω at 25 C—in the monoOP-08A. This

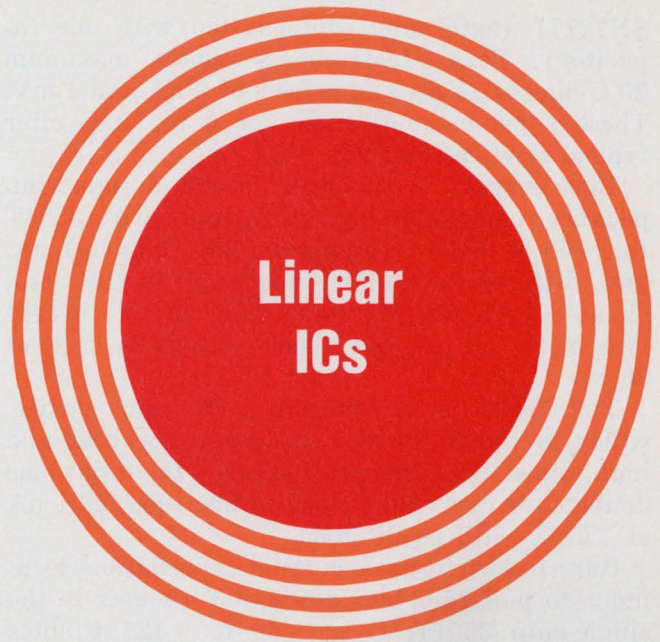

unit, for -55 to +125 C, has worst-temperature bias of 990 pA (barely squeaking under 1 nA) and 330-pA and 1-mV offsets. Both units need external compensation.

Win some, lose some

Amplifiers from other vendors are more impressive on some specs, less on others. Solitron's UC4250, for example, has only 15-nA max bias and 5-nA max offset from -55 to +125 C. But these specs, together with 4-mV max offset and 480- μ W max quiescent dissipation, apply with a 6-V supply. Other vendors tend to give ratings with 15-V supplies. Solitron has dual and triple versions of the UC4250.

For its SN72770 (internally compensated) and

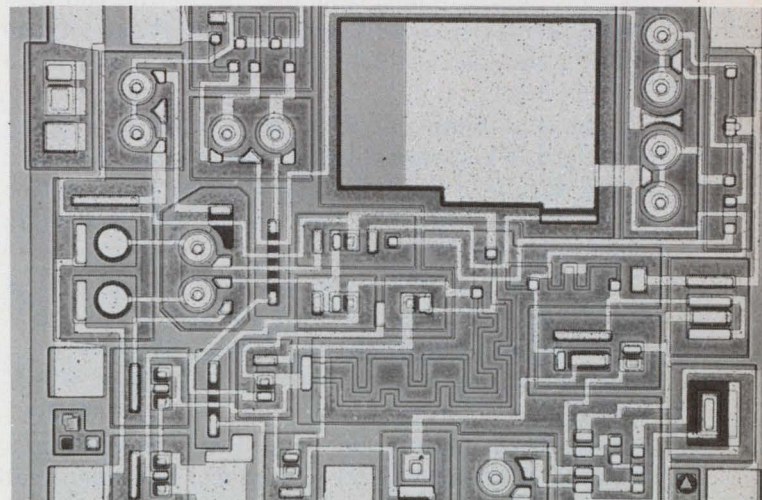

Almost any spec can be optimized by proper choice of set current, supply voltage and load resistance with Fairchild's μ A776 op amp.

SN72771 (externally compensated with one capacitor), Texas Instruments quotes maximum 25 C bias of 15 nA and offsets of 2 nA and 4 mV. These super-beta op amps for 0 to 70 C offer typical slew rates of 2.5 V/ μ s.

Bias current is extremely low and input impedance remarkably high in Burr-Brown's 3503T for -55 to +125 C. Maximum 25-C bias is 1 pA, and differential input impedance is 100 G Ω , shunted by 3 pF. Maximum 25-C offset current is a mere 0.5 pA, but offset voltage is high at 30 mV.

The 3503T is a two-chip FET-input device, which accounts for the extremely low bias and high impedance. Characteristically, the input bias doubles for every 10 C rise, so bias exceeds 1 nA at 125 C—still really good.

Burr-Brown uses a current-cancellation technique to pull 25-C bias down to 3 nA max in the single-chip 3501T. Over -55 to +125 C, bias

Teledyne Philbrick's FET-input 1420, but the 25-C offset voltage is 15 mV max, and the company's data sheet does not give worst-case offset current. It does, however, quote input impedance, a startling 10¹² ohms typical, shunted by 3 pF.

The same input resistance, shunted by 2 pF, appears in Intersil's FET-input 8007M. This amplifier has worst-case bias current at 25 C of only 20 pA, but offset voltage is 20 mV max at 25 C. At 0.5 pA the offset current is superb—but typical, not maximum.

The Harris Semiconductor HA-2700, a dielectrically isolated op amp for -55 to +125 C, doesn't offer such impressive bias and offset specs (50-nA worst-case bias, 5-mV and 30-nA offsets over temperature), but the amplifier has a unity-gain, 25-C slew rate of 10 V/ μ s in the noninverting mode. That's at least twice as high as what's found in the usual low-error amplifier.

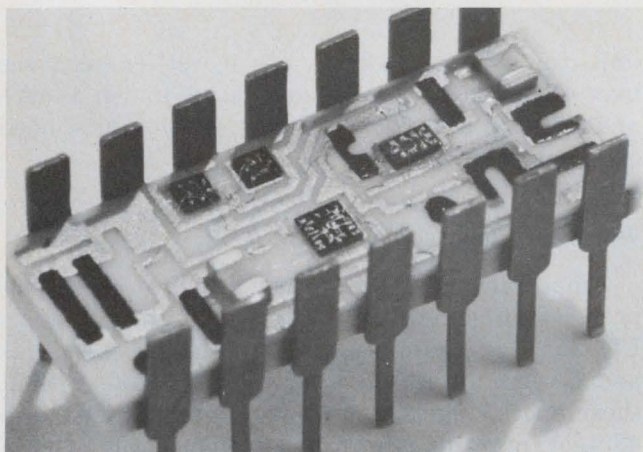

A high-performance instrumentation amplifier, the Zeltex ZA701D1 uses thick-film resistors, a chip capacitor and several chip semiconductors.

changes 0.1 nA/ $^{\circ}$ C. Offset current is 2 nA max at 25 C and changes 0.01 nA/ $^{\circ}$ C. While the currents at 25 C aren't as good as those in the 3503T, the 25-C offset voltage, 2 mV max, is 15 times better.

National Semiconductor has impressive specs for the LM112, and Silicon General has the same specs for its SG118. National offers even better specs in the LM216A, and Silicon General beats them with the SG118A.

Over the full-Mil range, the LM112 and SG118 have worst-case bias of 3 nA and offsets of 3 mV and 400 pA. The LM216A, over -25 to +85 C, has worst-case bias of 100 pA, offsets of 6 mV and 30 pA. The SG118A, over -55 to +125 C, offers 3-nA worst-case bias, 1-mV and 400-pA offsets. Advanced Micro Devices has identical specs in its 108A. And other vendors have similar units with similar specs.

There's a very fine bias, 50 pA max at 25 C, in

Programmed op amps

No single op amp offers the best of everything. But two companies, with entirely different approaches, have just introduced devices to modify that fact. Harris has the HA-2400, an op amp with four digitally selected input channels. And Fairchild has the μ A776, a multipurpose op amp whose specs can be changed over a wide range by proper choice of a single external resistor.

The Harris PRAM (for PRogrammable AMplifier) has typical 100-nA bias, 2-mV and 10-nA offsets, 10-V/ μ s slew rate and 150,000 voltage gain for each channel. A user can use different feedback and input networks for each input channel, then switch the output to deliver any of four responses. For example, he can program four gain or attenuation settings, or four oscillator or filter frequencies. Or he can design a four-channel comparator or an integrator and ramp generator with initial-condition reset. And he can cascade PRAMs to extend the versatility further.

Fairchild's μ A776, at \$3.28 in 100 to 999 lots, costs more than some devices it can replace. But since a user will be able to fill many different sockets with the same device, he may save money in large-volume purchasing of a single IC and in inventory costs as well.

Changing a single "set" current (with one resistor) changes input bias current, offset voltage and current, noise current, gain-bandwidth product, open-loop voltage gain, common-mode and power-supply rejection, quiescent current and slew rate. Many of these parameters change, too, with supply voltage, which can be as low as \pm 1.2 V and as high as \pm 18 V.

An almost identical device, Solitron's OC4250, was introduced more than two years ago — in April 1969. And just a few months ago, Solitron

added the 4252 and 4253, dual and triple versions of the 4250.

Op-amp compromises

Compromises are necessary, even in outstanding op amps. In most cases, vendors offer the same op amp with different packages for different temperature ranges. For the most part, the best specs (those cited here) appear in the device with the widest temperature range, usually -55 to $+125$ C.

In addition some vendors offer "premium" versions—devices screened for one or two selected specs. Most devices have second sources whose printed specs may be identical or close. Virtually all op amps include provision for zeroing the offset voltage with an external potentiometer. The pot, however, alters the offset-voltage temperature drift—sometimes drastically.

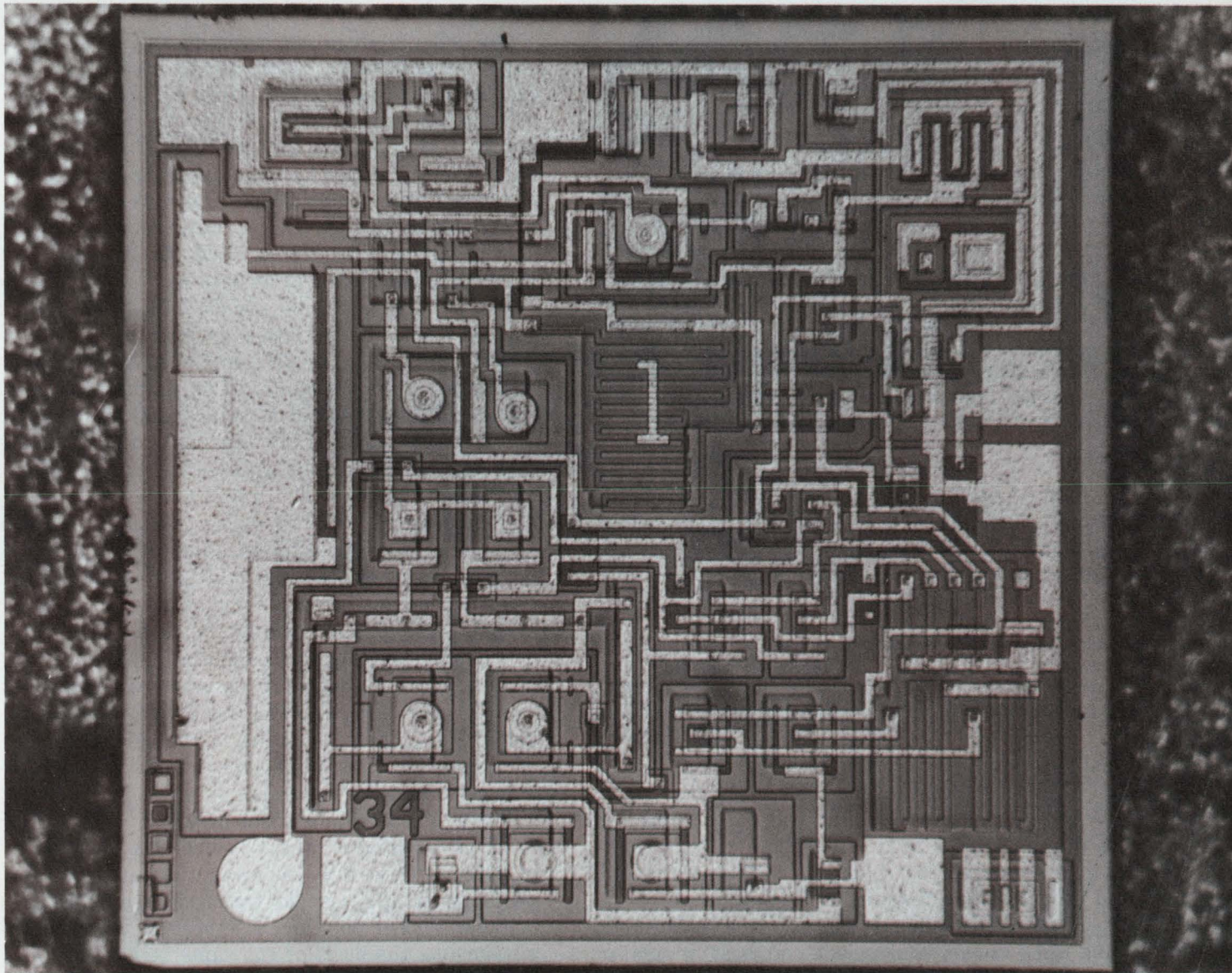
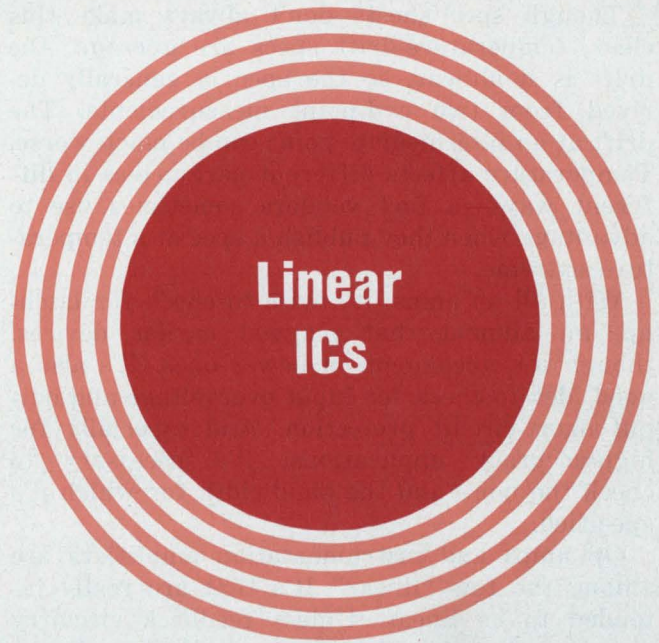

A super-beta op amp with maximum 25 C bias of 15 nA, offsets of 2 nA and 4 mV, and slew rate of 2.5 V/ μ s,

the Texas Instruments SN 72771 requires external frequency compensation. The 72770 does not.

Though spec sheets don't always make this clear, temperature-drift specs are *average*; the drift is nonlinear, so the spec is generally derived from two end-point measurements. The drift at an intermediate point can be much worse. Temperature affects different parameters in different ways—a fact vendors sometimes use to advantage when they publish a spec at a temperature extreme.

With all op amps, it's wise to check for latch-up, an ailment that plagued earlier devices, though it's uncommon in newer ones. It's also a good idea to check for input overvoltage and output short-circuit protection. And especially for high-accuracy applications, it's necessary to check the noise and the bandwidth for which it's specified.

Op amps and instrumentation amplifiers are among the few "linear" ICs that are really intended to be linear. Unless feedback circuitry dictates otherwise, the output should be a linear

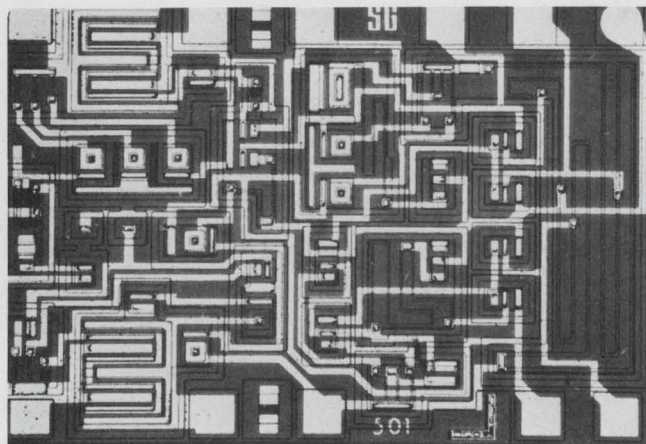

Simultaneous positive and negative 15-V outputs track within 150 mV in Silicon General's SG1501 regulator.

function of the input. Most non-op-amp LICs are definitely not linear. In circuits like comparators and sense amplifiers, most quality criteria are identical to those in op amps.

Oblivious voltage regulators

In other circuits, criteria are different. The most universal of these nonlinear "linear" ICs is the monolithic voltage regulator. Its output, ideally, should vary not at all with changes in input, load or temperature. But it does.

While output current and voltage capabilities are the first specs to consider in a voltage regulator, the degree to which the output stays put and ignores other changes is the measure of quality. It should be an easy matter to run through some spec sheets and select the best regulator for a particular requirement, but it's not.

A user may find that the maximum load cur-

rent in the headline of a spec sheet, often expressed as "up to" or "as much as" x milliamperes, is available only with the minimum load voltage, or only with the minimum input-to-output voltage differential, or only at 25 C, a temperature that may be difficult to maintain under load. He may find that a particular current is available only if he uses an infinite heat sink—a demanding condition.

While textbooks define load regulation in terms of the output-voltage change from no load (0 current) to full load, spec sheets may substitute a small current for the no-load condition. They may define line and load regulation at a fixed ambient temperature, rarely defining ambient. They may define regulation with a fixed chip or junction temperature—a parameter that may be difficult to measure and more difficult to fix.

Thus, if a man finds the load voltage dropping more than it should as he increases load current, the vendor can reasonably argue, "But you changed the junction temperature; the spec says you must keep it constant."

One spec might present ripple and noise separately (ripple being harmonically related to line frequency and most often given at 120 Hz). Another spec might combine the two. Combined specs, if they follow the practice of the power-supply industry, may soon appear as unfamiliar acronyms that derive from terms like "Periodic and Random Deviations," "Continuous and Random Unwanted Deviations," and "Continuous and Random Amplitude Perturbations."

When ripple and noise are combined in a single spec, the noise bandwidth may start at 10 Hz or 100 Hz and end at 10 kHz or 100 kHz. But ruinous noise might not show up on scopes with less than 50-MHz bandwidth. And noise is usually given in rms, though it's the peak-to-peak value that hurts. Dangerous spikes—tall and skinny ones—can vanish in rms specs.

Temperature coefficient, a most important spec, is usually given as an average percent per degree. It's then safe to multiply by the total change from 25 C to get the maximum change in output voltage. But the reverse is not true.

When the spec appears as a total percent change—from, say -55 to +125 C—one cannot divide, say, 1% by 180 degrees, to get a tempco of 0.0055%/°C. For tempco is not linear. The voltage excursion for a 1° change at one temperature may not equal the excursion at another.

Even the same data sheet may give some specs in units of voltage, others in decibels and others in percent (hopefully defining the reference for percent), so it's wise to translate everything to voltage. Where possible, it's best to make comparisons on the basis of the same test conditions.

It's thus a grand tribute to the value and convenience of IC voltage regulators that they are

finding ever wider usage—especially as local, point-of-load regulators. It's easy to find examples of fine performance and, at the same time, to observe some of the problems in comparing specs.

Regulators for close control

The Signetics SE550 can deliver 2 to 40 V, of either polarity, from inputs of 8.5 to 50 V. Over -55 to $+125$ C it has maximum load regulation of $0.6\% V_{out}$. Maximum line regulation over the full temperature range is $0.25 V_{out}$ when the input voltage is restricted to 12 to 40 V.

Typical ripple rejection from 50 Hz to 10 kHz is 75 dB with no bypass capacitor across the reference, 90 dB with a $5\text{-}\mu\text{F}$ bypass. Output noise, from 100 Hz to 10 kHz, is typically $20 \mu\text{V rms}$ with no bypass, $2.5 \mu\text{V rms}$ with $5 \mu\text{F}$.

For the same input range, 8.5 to 50 V, Intersil's 105 gives a slightly narrower output range, 4.5 to 40 V. Load reg for 0 to 12-mA outputs is 0.1% max from -55 to $+125$ C. Line reg at 25 C is $0.06\%/V$ for input-output differentials of 5 V or less, $0.03\%/V$ for greater differentials. Ripple at 120 Hz is $0.01\%/V$ max with a $10\text{-}\mu\text{F}$ reference bypass, and noise is typically 0.002% max from 10 Hz to 10 kHz with a $0.1\text{-}\mu\text{F}$ bypass.

Silicon General claims a first in the SG1501 dual-voltage tracking regulator, which simultaneously delivers $+15$ and -15 V, tracking within 150 mV. The company also has the SG1502, with independent control of outputs from 10 to 28 V. Both deliver 0 to 50 mA. Over -55 to $+125$ C the 1501's load reg is 30 mV max, while the 1502's is $0.3\% V_{out}$.

For line reg the 1501 has 20 mV max over the temperature range for inputs of greater than 17 V, while the 1502 has $0.2\% V_{out}$ for 10 V change in input. Ripple rejection at 120 Hz is 25 dB typical, and output noise is typically $50 \mu\text{V rms}$ from 100 Hz to 10 kHz for both.

Three-lead regulators

Unlike other regulators, National Semiconductor's LM109 provides a fixed 5-V output. And unlike others that have 8 to 14 pins, the National device is in a 3-pin TO-5 for current to 500 mA, or a 3-pin TO-3 for up to 1.5 A. National does not provide adjustable current limiting and remote sensing, which are common in others.

National's specs are referred to junction rather than ambient temperatures. At 25 C, the load reg for the TO-3 packaged LM109K is 100 mV max for inputs of 7 to 25 V. Output noise is typically $40 \mu\text{V}$ from 10 Hz to 100 kHz.

Fairchild is about to introduce a family of three-lead regulators in TO-66 plastic power packages. The family, $\mu\text{A}7800$, will eventually in-

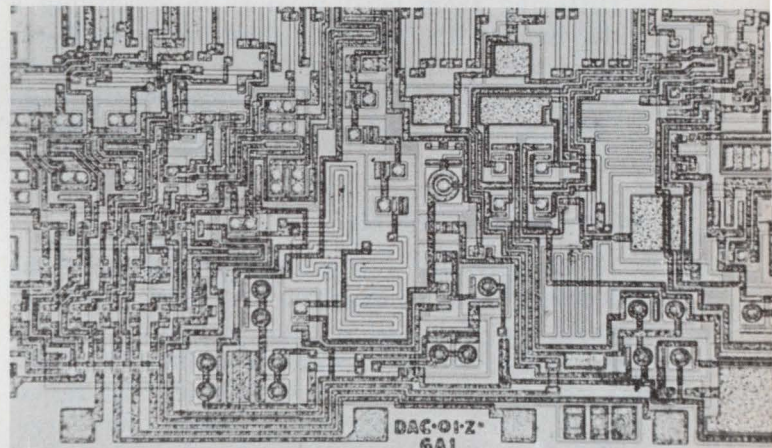
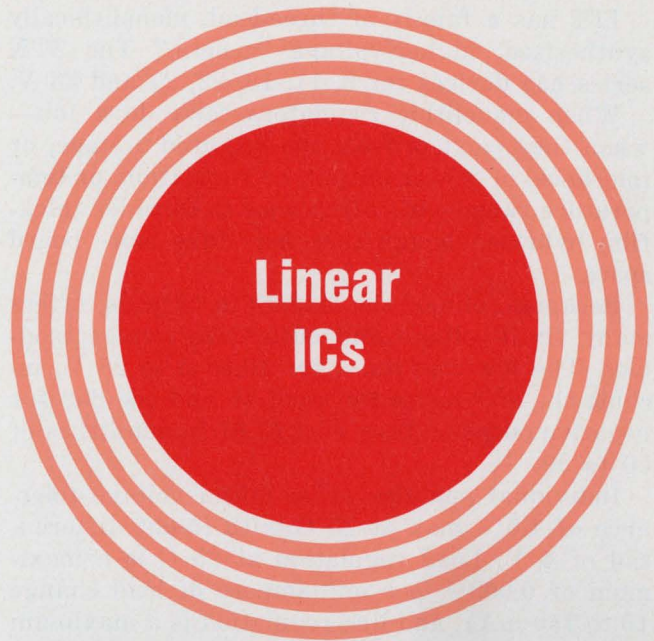

A six-bit DAC, the Precision Monolithics monoDAC-01 is the first to include current sources, current switches, ladder network, reference and amplifier on one chip.

clude any voltage a user wants from 5 to 30 V in 100-mV steps, but it will start with 5, 6, 8, 12, 15, 18 and 24 V.

The maximum output power will be 24 W, and the price at 100-up levels will be \$1.75. Like National's LM109, these devices have internal current limiting, and they're a lot simpler to use than devices that require 8 to 14 precisely positioned holes in a heat sink.

National has another unusual device, the LM-113, which can be classed as a voltage regulator, but in a different sense. It's monolithically synthesized, temperature-compensated, low-voltage reference in a two-lead package.

Functionally it's like a zener with reverse breakdown at 1 mA of 1.220 V and with tolerances of 1, 2 and 5%. For currents of 0.5 to 20 mA, the "zener" voltage changes no more than 15 mV at 25 C ambient. At 1 mA, the change is less than 5 mV for ambients from -55 to $+125$ C.

ITT has a family of three-lead, monolithically synthesized, higher-voltage "zeners." The ZTK series has devices for 9, 11, 18, 22, 27 and 33 V.

When monolithic regulators can't do a job—when they can't provide the required voltage, or tolerance, or power output, or regulation, or temperature range—it's often wise to consider thick-film hybrids, though they may take more board space.

Beckman, one of the leaders in hybrids, offers many fixed-voltage and adjustable-voltage modules. The low-cost lines, for fixed 5 to 28 V, include the 809 series for positive and the 859 for negative outputs. They cost \$7.61 in quantities of 50 to 99.

Individual modules offer initial voltage tolerance of 1.5% max at 25 C with in-out differential of 4 V. Load regulation at 25 C is a maximum of 0.003% per milliamperes of load change (0 to 750 mA), and line regulation is a maximum of 0.03% $E_o/\% E_{in}$.

Differing from most vendors in specifying a wider bandwidth for ripple than for noise, Beckman specifies ripple rejection of at least 34 dB from dc to 100 kHz and output-noise peak voltage of 0.002% (at 3-sigma limits) from 10 Hz to 10 kHz.

Better digital converters

IC manufacturers have extended the use of the adjective "linear" (sometimes "analog") to many circuits that are half digital. So their linear-IC lines include not only nonlinear circuits, like voltage regulators and multipliers, but half-digital circuits, like comparators, sense amplifiers, threshold detectors, and analog-to-digital and digital-to-analog converters.

Use of the adjective "linear" may stem from the fact that most of the problems are on the linear or analog end of the circuit—but not all. It's still necessary to ascertain that digital levels are compatible with peripheral logic circuits and that switching speeds and noise margins are adequate.

The main evaluation criteria, however, are similar to those for op amps. They entail, principally, the important difference between typical and guaranteed for speed and error specs.

DACs and ADCs, in addition, present wide new horizons for confusion. The problems start with the fact that digital codes, however erroneous they may be, inspire confidence. A man who would balk at reading 3.24 on a pointer meter might readily accept 3.24587 on a digital meter as a perfectly truthful representation of reality.

A 10-bit DAC or ADC readily suggests accuracy of one part in 1024, or about 0.1%. And since vendors tend to discuss accuracies to one half of a least-significant bit, a 10-bit DAC is endowed with 0.05% accuracy.

More conservative vendors are careful to point out that a 10-bit device offers 0.1% resolution, rather than accuracy. That's better, but not enough.

A 10-bit DAC should certainly deliver 1024 different output levels. Then, as the input code (if it's straight binary) increases from 0000000000 to 1111111111, the output should increase linearly in steps equal to 1/1024 of the required full-scale output. It may not. Because switches aren't perfect and resistors may not have exact 1-2-4-8 ratios, there can be ascending input-code transitions that result in descending output voltage.

If one resistance is a trifle high and the next a trifle low, the DAC may not be monotonic—the output voltage for input code 1111 may be lower than for 1110.

Further, even if the DAC is monotonic, it may not be linear; its output steps may be of unequal height, so they don't conform to a straight line from zero to full scale. And it often happens that linearity is acceptable at low speeds—when input codes are changed slowly—and miserable at high speeds because of time-constant imbalances.

Still further, since switches don't change state instantly, there can be wildly erratic outputs during transitions. For example, as the input changes from 011 (the code for 3) to 100 (4), the first bit may change faster than the next two. And for a moment the code is 111 instead of 100, so the output corresponds to 7 as it's trying to

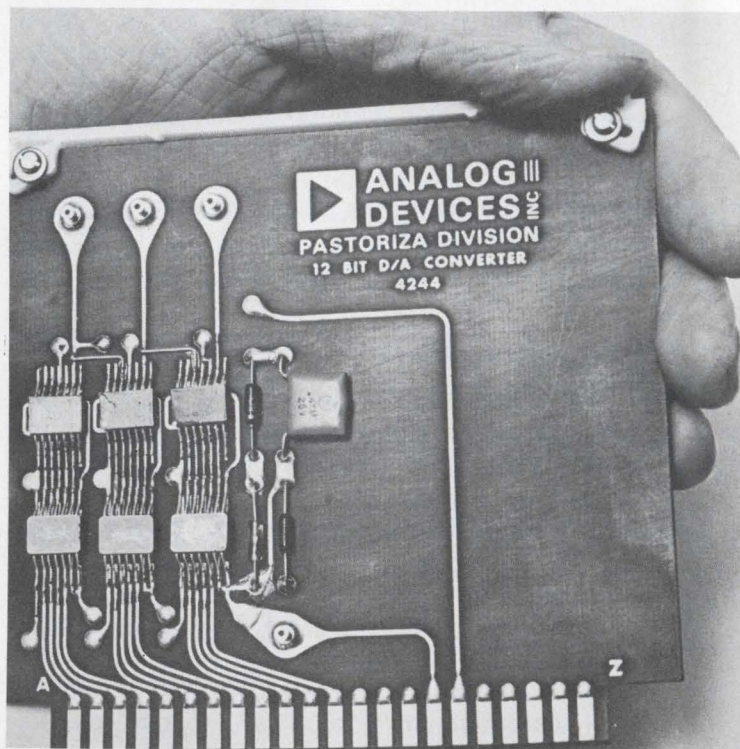

The first "monolithic" 12-bit DAC was originally offered by Analog Devices in three quad-switch and three quad-resistor packages. The company now has a single 12-bit resistor package in the AD550 line.

go from 3 to 4. That transient noise spike is called a glitch, and unfortunately the digital-to-analog world is very much a glitched one.

As the number of bits for DAC or ADC goes higher, all problems become tougher. Component limitations make accuracies of better than 0.01% (13 bits) almost impossible to achieve, especially where considerations must be given to speed, component aging, power-supply sensitivity, noise and temperature.

Shifting the burden

Vendors often transfer some of these problems by offering pieces of a converter, leaving the user with the problem of putting the pieces together and determining the total error due to the combination.

The user finds switches for 12-bit (at 25 C) resolution, adds resistor networks for 12-bit (at 25 C) resolution, then adds a reference supply, whose drift should be commensurately low (12 bits is equivalent to 1 part in 4096, or about 0.025%, or 250 parts per million). Then, if a user requires a voltage output equivalent to the summed currents in the usual DAC, he "merely" adds an op amp with suitable speed and error specs.

Of course, he must also be aware of loading errors at the input of an ADC or output of a DAC. If the input resistance of an ADC is 1000 ohms, the source resistance feeding it must be less than 0.1 ohm to keep loading error under 0.01%.

A user who combines all the parts and gets 12-bit accuracy (relative to the reference) at high speeds over a wide temperature range is very skillful or very lucky. But it's possible. And vendors can help.

In March, 1970, Analog Devices introduced what it hailed as the first 12-bit monolithic DAC, the AD550 line. In this case "monolithic" referred to three quad-switch packages and three thin-film-resistor quads, with switch and resistor packages available at different accuracy levels corresponding to the most- to least-significant four bits. The company now has single 12-bit resistor packages.

The AD550's quad switches, like quads from vendors who introduced them later, actually include a fifth transistor to track temperature changes in the other switches and, with an op amp, continually readjust their base voltages for constant collector current and also to temperature-compensate an external reference.

A line soon to be introduced will have a sixth transistor for temperature tracking in a "quint" switch package that will go with 10-bit resistor networks.

As an extension of the 550 line, Analog has

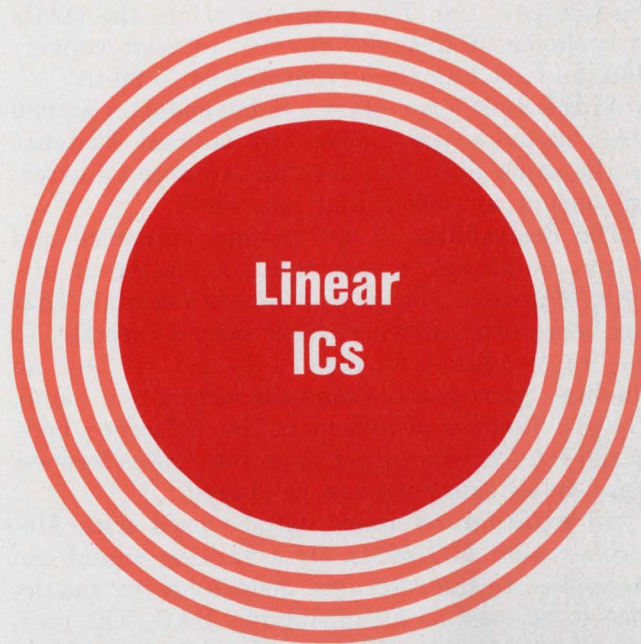

just introduced plastic-DIP versions. In quantities of 100 to 249, 12-bit and 8-bit switch complements cost \$15 and \$8, 12-bit and 8-bit resistor networks cost \$29 and \$16.

At the same time, at higher prices, the company now offers selected quads from the original line for use in DACs with up to 16 bits. In addition the company has AD555 quad-voltage switches. They accept references of either polarity.

Intersil offers quad current switches for 12-bit DACs or ADCs as the ICL8018 (0.01%), 8019 (0.1%) and 8020 (1%). And Burr-Brown has similar quad-switch packages for 12-bit linearity from -55 to +125 C.

For less ambitious accuracy, Fairchild has a single-chip, 10-bit current source, the μ A722, which, with an external resistor array and voltage source, the company forthrightly describes as having accuracy of 8-1/2 bits for 0 to +55 C or 7-1/2 bits for -20 to +85 C.

Beckman's 813 is a 10-bit thick-film ladder designed specifically for use with the μ A722. Beckman also offers 8, 12 and 14-bit ladders, multichip ladder switches and complete multichip ADCs and DACs for resolution to 11 bits.

A smaller manufacturer, Micro Networks, has multichip hybrids with thin-film resistors, monolithic switch chips and op amp chips—all in single DIP-like packages. The company has 6, 8 and 10-bit DACs, with or without op amps, for -55 to +125 C or 0 to 70 C. Complete 12-bit DACs are now in prototype production.

Precision Monolithics, Inc., provides an almost complete DAC, the aimDAC-100, in a single two-chip package that includes reference, switching circuits and thin-film ladder. The unit must be used with an external op amp, whose settling time, PMI points out, must be added to that of

the aimDAC-100. The company offers the DACs in a choice of linearity for 10- to 6-bit conversion, and settling time from 375 ns to 90 ns.

At the 8-bit level, Harris Semiconductor's 1080 DAC includes the ladder and current switches on the same chip. But the unit requires an external output amplifier and reference.

The desirability of an on-chip reference and output amplifier is very much a matter of dispute. Motorola, Harris and others maintain that engineers often use a current output directly, so they're penalized if they're forced to buy an on-chip current-to-voltage-converting op amp. They're further penalized if the reference node in the DAC is committed to an internal reference, since an external one can be shared.

An external reference can be used with Motorola's 6-bit MC1406L. Or a varying signal can be applied to the reference node, allowing the device to be used as a multiplying DAC. The unit, at only \$3.95 at the 100-piece level for 0 to 75 C, is the fastest single-chip DAC, boasting 250-ns maximum settling time to half a least-significant bit.

In contrast, the Precision Monolithics mono-DAC-01 has 3- μ s maximum settling and costs \$9.95 at the 2000-piece level. But this device is the only one with everything—a diffused ladder network, current sources, switches, voltage reference and output amplifier—all on a single chip.

Though the \$9.95 device is for 0 to 70 C, others are available for -55 to +125 C. And most units in the line can deliver full-scale outputs of +10 V, ± 10 V or ± 5 V. The zero level can be trimmed by an external potentiometer.

Enter, the phase-locked loop

There's a new, very important linear IC that's not linear—the phase-locked loop, whose field of application may prove almost as diverse as that of the op amp. Completely without inductors, the PLL is a frequency-selective circuit that can be tuned to lock to an input signal over a range of from less than 1 Hz to 30 MHz and to track small frequency deviations.

Basically it includes a phase comparator, one of whose inputs looks at the input signal while the other sees the output of a voltage-controlled oscillator. The comparator's output goes to a low-pass filter, which feeds a dc amplifier whose demodulated output serves as the error signal to control the VCO and to lock it to the input signal.

Signetics, last year, was first to offer PLLs in monolithic form, and it now has six PLL ICs, all priced at \$6.35 in lots of 100 to 999. Four of the circuits are generalized, lending themselves to such applications as an FM demodulator for radio (10.7 MHz) or TV (4.5 MHz), a tone or telemetry decoder, tracking filter, stabilizer for

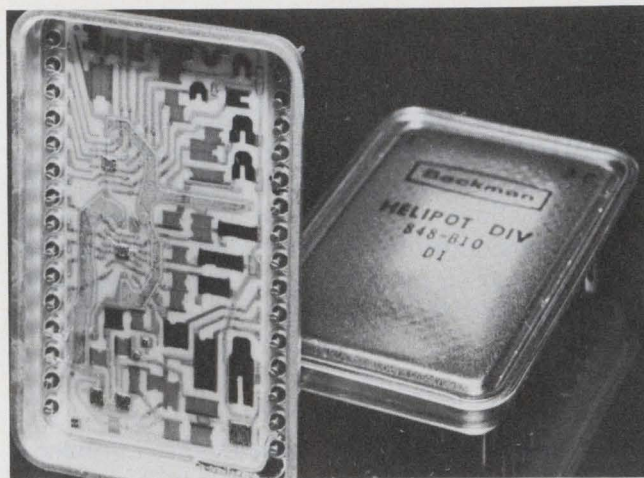

Resolution to 11 bits is available in Beckman's 848 hybrid DAC with thick-film resistors and IC chips.

oscillators or signal generators, data synchronizer, and frequency multiplier or divider.

Two of the circuits are more specialized. The NE566V is a high-stability (100 ppm/ $^{\circ}$ C) function generator that delivers triangle and square waves whose rep rates can be adjusted over a 10-to-1 range up to 1 MHz. The NE567V is a tone decoder for center frequencies that can be adjusted over a 20-to-1 range from 10 MHz to 500 kHz.

While Signetics led the PLL field, others were quick to follow. Motorola, for example, has just introduced the MC1310 stereo-FM multiplex demodulator. Like other PLLs, it eliminates coils, leaves the user with a minimum number of adjustments and conserves printed-circuit real estate. Its introductory price is about \$3 at the 50,000-piece level.

General Electric has a similar device, the GEL 293, which has only one frequency adjustment and a variable stereo-level threshold. It provides 100 mA to drive a stereo lamp and it includes muting circuitry and provision for stereo/monaural switching.

Consumer ICs: Many for few

Products like the Motorola and GE demultiplexers and the Signetics demodulators are typical of a growing number of linear ICs aimed at a small number of customers who can use vast quantities for consumer applications. TV and radio are the obvious massive applications. But more and more ICs will be aimed at cassette, cartridge and open-reel tape recorders, dictating equipment, phonographs, intercoms, electronic organs, home-movie projectors and an array of newer consumer products still on the drawing boards.

RCA has developed many entertainment ICs—dating to 1966, when it introduced the CA3012 i-f amplifier for FM (10.7 MHz) or TV sound

(4.5 MHz). The company boasts the first TV sound i-f, the first automatic frequency control, the first TV sound i-f with dc volume control, the first picture i-f and the first chroma subsystem (on two chips).

This year RCA introduced a complete AM receiver subsystem, the CA3088E. It includes the mixer, two i-f stages, detector and audio preamp. It provides i-f and rf agc and output for a tuning meter.

The company has a companion FM i-f system, the CA3089E, which includes three i-f stages with level detection and limiting, quadrature detector, agc and afc outputs, audio preamp and a squelch drive and control.

At the same time RCA introduced CA3090Q stereo multiplex decoder, which is functionally similar to the Motorola and GE circuits, except that it requires one low-inductance tuning coil.

Motorola's most recent entertainment IC, the XC1390P, is a complete TV vertical-deflection system that includes oscillator, output stage, fly-back section and blanking. The circuit eliminates output transformer and linearity control and provides independent hold and size controls. It's tentatively priced at about \$2.50 in large quantities.

ITT has a string of consumer ICs. The SAJ-110 is a seven-stage frequency divider for electronic organs, and the SAJ-170 is a seven-stage divider for wall-model and table-model quartz-controlled clocks.

The TBA-120 is an FM i-f amplifier and demodulator, and the TAA-790 is a TV jungle (miscellaneous) circuit that includes sync separator, horizontal oscillator, afc, automatic phase control and noise blanking.

For a different mass market, ITT makes the TAA-775G power oscillator for control of automobile turn signals or windshield-power speed. The SAK-110 pulse shaper is used as an automobile revolution counter. A similar circuit, the TP100, is Transitron's version of an auto tachometer.

Sprague is another major factor in consumer ICs. Toward the end of 1967, it introduced the first quadrature FM detector, the ULN 2111, which includes amplifier, limiter and discriminator and requires a tuning coil with only a single winding. Sprague followed with an FM i-f amplifier/discriminator/audio preamp for 10.7 MHz and another for 4.5 MHz.

The company added the ULN 2114 chroma demodulator, the 2127 chroma amplifier with agc and color killer, and the 2144 chroma subcarrier-regeneration system, which includes a phase-locked-loop oscillator, gated burst amplifier, color killer, automatic color-control detector and amplifier, and automatic picture control and amplifier.

Sprague has four stereo demultiplexers. For

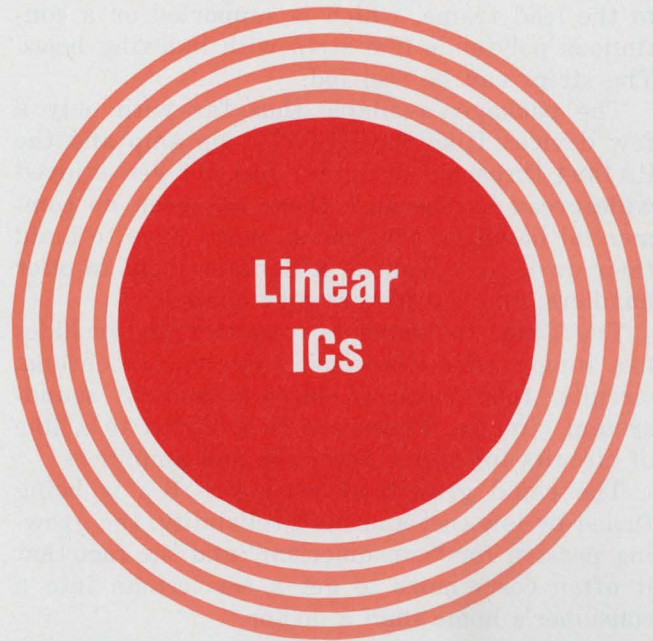

audio systems, it offers the ULN 2130 Class A stereo driver, with 30-dB gain and 20-mA output, and the ULN 2126 dual preamp, with 68-dB gain and 1/2-dB typical channel matching.

General Electric's PA239 dual preamp also offers 68-dB typical voltage gain. Channel match is 0.3 dB typical and 2 dB max. The company also has a series of single-channel audio power amplifiers for 1, 2, 3.5 and 5 W, and a brand new dual power amplifier, the GEL277, for 2 W per channel. Maximum distortion at 1 kHz with full output is 2%. For color TV, GE just introduced the GEL3072 chroma demodulator.

Some of the GE circuits may offer high-volume users an added advantage if they're made available in the company's unique miniMod package. It lends itself admirably to high-speed handling, testing and mounting.

Bump terminations on the IC chips are simultaneously bonded (with GE's Multibond process)

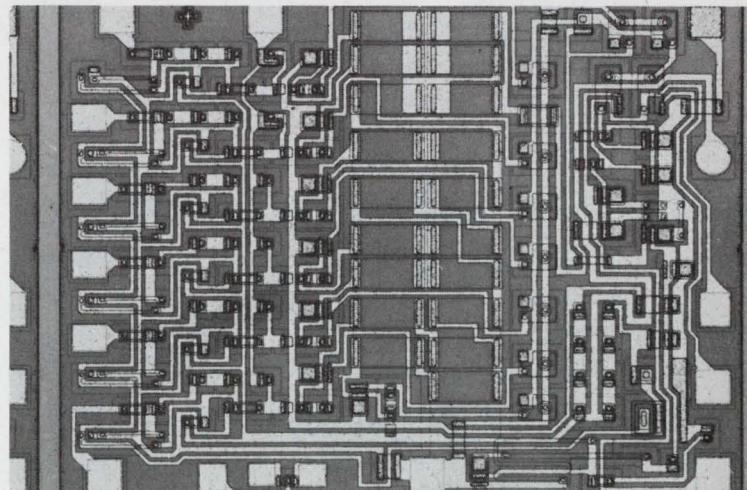

A fast, single-chip DAC, Motorola's 6-bit MC1406 settles to half the least-significant bit in less than 250 ns. The unit does not include a reference, or output, op amp.

to the lead frame, which is supported on a continuous polyimide film strip with indexing holes. The strips can be reel fed.

The package, available thus far with only a few devices (like the GEL1741 op amp and the PA1494 threshold detector) has not yet enjoyed widespread use because there has been no commercial handling equipment; users have to build their own. Now Kulicke & Soffa is about to offer handlers, and the picture may change.

The Texas Instruments consumer line includes five jungle (miscellaneous) circuits, six chroma circuits, four video i-f circuits and 13 sound-system circuits. These are in addition to a line of circuits for stereo receivers and amplifiers.

The rapid growth of consumer ICs is being fueled by low cost and high reliability, the growing passion for "consumerism" and the fact that it often costs more to get a serviceman into a consumer's home than a doctor.

How good is the guarantee?

Nevertheless the engineer buying them must exercise the same care he uses with any other IC. For here, too, vendors may write specs for conditions that don't correspond to those in an engineer's design.

For any IC, an engineer must evaluate the manufacturer's guarantee. Does it mean the vendor actually measures to a spec, or merely replaces the device if it doesn't meet the published spec? If specs are typical, what is the likely spread?

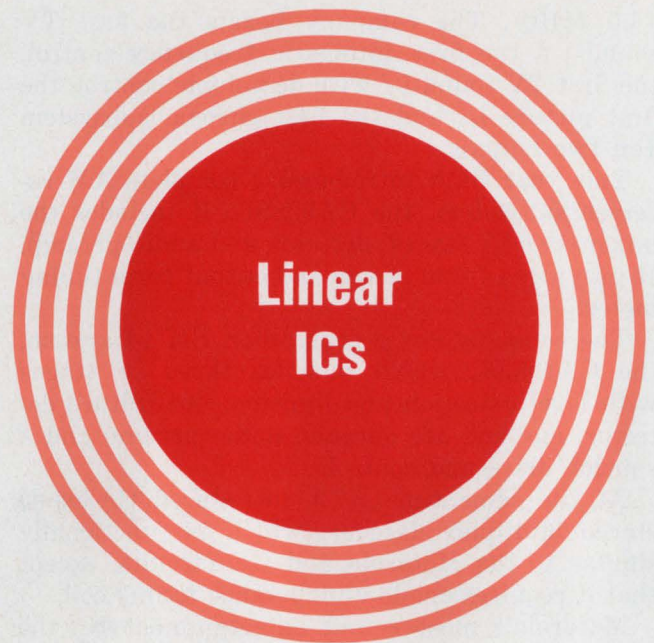

What about delivery? No vendor has an infinite stock of every device. One large order can wipe out an inventory. It's this fact that prompted one industry wit to comment that the classic price curve is 50 cents for 1 to 99, \$3 for 10,000-up.

Because of the often-chaotic condition of the semiconductor industry, specs and prices can vary over a vast range and from day to day. At the extremes, one vendor says: "We make two devices—one with all leads shorted, the other with all leads open. Anything in between is negotiable." ■■

Need more information?

The ICs mentioned in this report have been selected for outstanding or unique qualities, but specifications not included may have overriding significance in specific applications. Readers who would like more information on these or other products may wish to consult the manufacturers. ELECTRONIC DESIGN is grateful to the following for their very special help in furnishing information for this report.

Amperex Electronic Corp., 99 Bear Hill Rd., Cranston, R. I. 02920. (401) 737-3200.
Advanced Micro Devices, Inc., 901 Thompson Place, Sunnyvale, Calif. 94086. (408) 732-2400. (Leonard Brown, Linear IC Marketing Manager).
Analog Devices, Inc., Route 1, Industrial Park, P. O. Box 280, Norwood, Mass. 02062. (617) 329-4700.
Beckman Instruments, Inc., Helipot Div., 2500 Harbor Blvd., Fullerton, Calif. 92634. (714) 871-4848.
Burr-Brown Research Corp., International Airport Industrial Park, Tucson, Ariz. 85706. (602) 294-1431.
DDC, ILC Data Device Corp., 100 Tec St., Hicksville, N.Y. 11801. (516) 433-5330.
Fairchild Semiconductor, 313 Fairchild Drive, Mountain View, Calif. 94040. (415) 962-5011. (August Pfaehler, Linear IC Product Marketing Manager).
General Electric, Electronics Park, Syracuse, N.Y. 13201. (315) 456-3510.
Harris Semiconductor, P.O. Box 883, Melbourne, Fla. 32901. (305) 727-5400.
Intersil Inc., 10900 N. Tantau Ave., Cupertino, Calif. 95014. (408) 257-5450.

ITT Semiconductors, 3301 Electronics Way, West Palm Beach, Fla. 33407. (305) 842-2411.
Kulicke & Soffa Industries, Inc., 135 Commerce Dr., Fort Washington, Pa. 19034. (215) 646-5800.
Micro Networks Corp., 5 Barbara Lane, Worcester, Mass. 01604. (617) 756-4635.
Motorola Semiconductor Products Inc., 5005 E. McDowell, Phoenix, Ariz. 85036. (602) 273-3465. (Steven Thompson, Linear IC Marketing Manager; Karl Huehne, Linear IC Application Manager; William Howard, Standard Linear IC Product Manager).
National Semiconductor Corp., 2900 Semiconductor Dr., Santa Clara, Calif. 95051. (408) 732-5000. (Robert Dobkin, Director Advanced Circuit Development; Joel Scheinberg, Product Marketing Manager for Linear ICs).
Precision Monolithics Inc., 1500 Space Park Drive, Santa Clara, Calif. 95050. (408) 246-9222. (Marvin Rudin, President; David Campbell, Product Manager; George Erdi, Product Manager; Jerome Zis, Product Manager).
RCA Solid State Div., Route 202, Somerville, N. J. 08876. (201) 485-3900.
Signetics Corp., 811 E. Arques Ave., Sunnyvale, Calif. 94086. (408) 739-7700. (Arthur Fury, Manager Linear Product Marketing).
Silicon General Inc., 7382 Bolsa Ave., Westminster, Calif. 92683. (714) 892-5531.
Solitron Devices, Inc., 8808 Balboa Ave., San Diego, Calif. 92123. (714) 278-8780.
Sprague Electric Co., 347 Marshall St., North Adams, Mass. 01247. (413) 664-4411.
Teledyne Philbrick, Allied Drive at Route 128, Dedham, Mass. 02026. (617) 329-1600.
Teledyne Semiconductor, 1300 Terra Bella Ave., Mountain View, Calif. 94040. (415) 968-9241.
Texas Instruments Inc., 13500 North Central Expy., Dallas, Tex. 75222. (214) 238-3741.
Transitron Electronic Corp., 168 Albion St., Wakefield, Mass. 01880. (617) 245-4500.
Zeltex Inc., 1000 Chalamar Rd., Concord, Calif. 94520. (415) 686-6660.

LINEARS FROM RAYTHEON SEMICONDUCTOR.

OP AMPS

702 Wideband Amplifier
709 General Purpose
725 Precision
741 General Purpose
747 Dual 741
748 Uncompensated 741
4709 Dual 709

101 General Purpose
107 Compensated 101
108 Precision*

4558 Dual 741 (Available in mini-DIP)

4531 High Slew Rate
4131 Precision
4132 Micropower

INTERFACE ELEMENTS

710 High Speed Comparator
711 Dual High Speed Comparator
9622 Dual-Line Receiver
7520 Series Core Memory Sense Amplifiers

4431 Dual-Line Receiver
1414 Dual 710 with strobes
1488 Quad Line Driver / EIA Compatible*
1489 Quad Line Receiver / EIA Compatible*

VOLTAGE REGULATORS

723 Precision Positive / Negative
109 +5V Voltage Regulator*

RAYTHEON LINEARS ARE AVAILABLE IN ALL POPULAR PACKAGES:

Plastics — 8-pin mini DIP; 14 and 16-pin DIPs

T Pak — TO-3; 8 and 10-pin TO-5

Ceramic — 14 and 16-pin DIPs; 10 and 14-pin flat packs

When you need a linear IC of any kind, give us a call. We've got what you want. We're stronger than ever in both proprietary and off-the-shelf linear circuits.

And that's not our only strength. Raytheon Semiconductor has changed. Our new technical team is deeply involved in development programs to provide new design tools. New digital analog interfacing that allows active switching and amplifying. Greater integration of external parts in voltage regulators. Super Beta process for precision op amps.

If you haven't been keeping up with us lately you've got a surprise coming. Write for more LIC information and see.

Raytheon Semiconductor, 350 Ellis Street, Mountain View, California 94040. (415) 968-9211.

RAYTHEON

**RIP THIS PAGE OUT
AND TACK IT ON YOUR WALL.
YOU CAN USE IT.**

INFORMATION RETRIEVAL NUMBER 40



*Available fourth quarter 1971.

Need a tone decoder? Just modify a phase-locked loop, and you can use low-cost ICs to eliminate bulky tuned circuits and mechanical filters.

The growing use of push-button-telephone, remote-control and telemetry systems has created a pressing need for better and cheaper tone decoders. The usual decoders—resonant LC circuits, tuning forks, reeds, crystals—give adequate decoding, but all introduce problems of one sort or another: sensitivity to noise, interfering signals and temperature changes; sluggish response; bulkiness.

What's better and what's cheaper than the usual design? Phase-locked loops. Adding a lock detector to a phase-locked loop (PLL) results in a tone decoder that operates well in the presence of noise and interfering signals. And it needn't be sensitive to temperature changes. If IC PLL components are used, the decoders are less bulky and operate over wider frequency ranges than decoders made with resonant LC circuit circuits, tuning forks or crystals.

You might think that a PLL alone can be used as a tone decoder, since its output varies with frequency. But there's a joker in that deck. A review of the PLL's operation reveals that you have to add a phase shifter and another phase detector.

You need more than just a phase-locked loop

A phase-locked loop is basically an electronic servo loop consisting of a phase detector, a low-pass filter and a current-controlled oscillator (Fig. 1). It is capable of locking or 'synchronizing' with an incoming signal and of tracking the signal as its frequency changes.

When the loop is tracking, the phase detector compares the phase of the incoming signal with the controlled oscillator phase. If the phase changes, indicating that the incoming frequency is beginning to change, the phase detector output voltage also changes. The latter is just enough to keep the controlled oscillator frequency the same as the incoming frequency and to preserve the locked condition. Thus the average voltage or

current applied to the controlled oscillator is a function of the frequency of the incoming signal. In fact, the low-pass filter voltage is the demodulated output when the incoming signal is frequency-modulated (provided the controlled oscillator is linear).

The frequency range over which the loop can track a signal, called the lock range, is determined by the maximum swing of the controlled oscillator and the maximum phase-detector output for the input-signal level present.

There is also a range, called the capture range, over which the loop can acquire a signal. It can never be greater than the lock range, and it is determined by the low-pass filter time constant.

The capture range is always symmetrical to the free-running frequency of the controlled oscillator, unless the oscillator runs out of swing capability on one side or the other. Because of this symmetry, the free-running oscillator frequency, f_0 , is termed the center frequency of the loop. When the loop is not locked, its output volt-

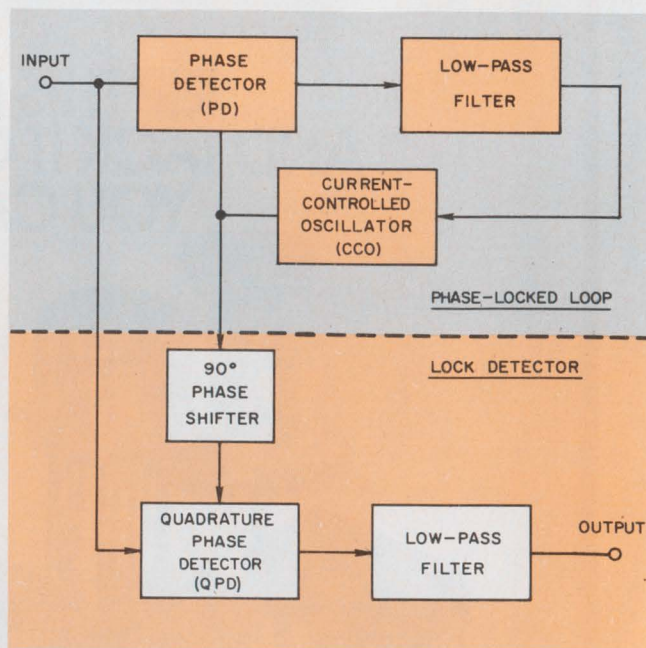

1. Adding a lock detector—consisting of a 90° phase shifter and a quadrature phase detector—to a conventional phase-locked loop produces a tone decoder circuit that operates over a wide frequency range.

James V. Ball, Senior Design Engineer, Communications Systems, Signetics Corp., 811 E. Arques Ave., Sunnyvale, Calif. 94086

Edited by: Steven A. Erenburg, Microelectronics Editor

age is the same as when it is locked to a signal at the center frequency. The phase-locked loop, then, cannot distinguish between the presence or absence of a signal at the center frequency.

A 90° phase shifter and a second phase detector, called the quadrature phase detector, neatly solves the problem and converts the PLL to a tone decoder. Figure 2 shows the filtered outputs of the phase detector and quadrature phase detector for an incoming signal equal to, lower than or and higher than the center frequency. Note that while the average phase-detector output rises both above and below the quiescent (unlocked) level, the average output of the quadrature phase detector is always lower than the quiescent level. And, in fact, the output of the quadrature unit is maximum at the center frequency. Thus it is a good indication of lock when compared with a threshold level somewhat lower than its quiescent level.

Tone decoders can be assembled with discrete components or with IC phase detectors, VCOs or complete phase-locked loops. Even a fully inte-

grated decoder is available as a building block for tone-decoding applications.

Build a Touch-Tone decoder on a card

Many applications arise in which digital data is to be transmitted by tones. Touch-Tone decoding is of great interest, since all sorts of remote control possibilities open up if you can make use of the decoder—the push-button “dial”—of the phone. Here a combination of two frequencies designate each digit; the telephone exchange must sense and separate the two frequencies to decode the dialing information.

A low-cost decoder for all 12 digits (Touch-Tone button characters 0 to 9, the space button and the asterisk button) can be made with seven tone decoders. The schematic for a complete Touch-Tone decoder using SE567 decoders is shown in Fig. 3.

The seven tone decoders, their inputs connected in common to a phone line or acoustical coupler, drive three SE/885 NOR gate packages. Each

Other ways to decode tone information have shortcomings

A common way of decoding tone information is to use a highly stable tuned reed or other mechanically resonant system—such as a tuning fork or piezoelectric crystal—that begins vibrating when the proper tone is present.

Being mechanical, these units are often sensitive to shock and mounting position, and they are also limited as to audio frequencies. The frequency is usually adjusted by the manufacturer, which makes such devices unsuitable as general building blocks. Their high-Q, places great stability demands on the frequency generator, or encoder, so that often a mechanically resonant decoder must be used.

Hand in hand with the high Q goes high noise and outside frequency rejection (so simultaneous tone coding is possible), but there is also slow response because some integration of the input energy is necessary.

Another proved way of decoding frequencies is to use resonant LC circuits. These present considerable difficulty in designing a typical decoding system. In the audio ranges, where much frequency coding is accomplished, the LC networks are quite bulky and usually not adjustable, unless expensive components are used.

Naturally a single-stage network does not give much selectivity, so very careful amplitude control is necessary for good bandwidth control. In a simultaneous tone system, the amplitude control of one tone is hampered by the level of the second tone. In Touch-Tone systems band separation prefilters are often required to attenuate the second tone.

The alternative is to use additional LC stages for greater selectivity, with their attendant expense and bulk. At higher frequencies, from midband audio and up, the costs and size are reduced somewhat. Where precision frequency discrimination is required over a wide temperature range, the designer is still saddled with a formidable problem.

Theoretically anything that can be done with LC networks can also be done with active RC networks. They are becoming more widely used as low-cost, high-quality operational amplifiers become available. Even here there are problems, though. Most active bandpass filters available off the shelf have limitations on both frequency and temperature, and they are expensive.

Techniques that measure the time between successive voltages or the same magnitude can be used for filterless frequency discrimination. Zero-crossing detection is one such method. It is apparent, however, that a clean signal must be available for straight-forward period measurement, unless a rather long integration period is used. In simultaneous tone systems, or systems with noisy channels, extensive prefiltering must be used, with added bulk and cost.

All of these methods, with the exception of reeds or tuning forks, react quite fast to an incoming signal of the proper frequency. This can be a detriment when the input signal is likely to contain spurious frequencies within the detection band, owing to noise, voice or occasional pulses. Thus it may be necessary to add output delay circuitry to prevent false outputs.

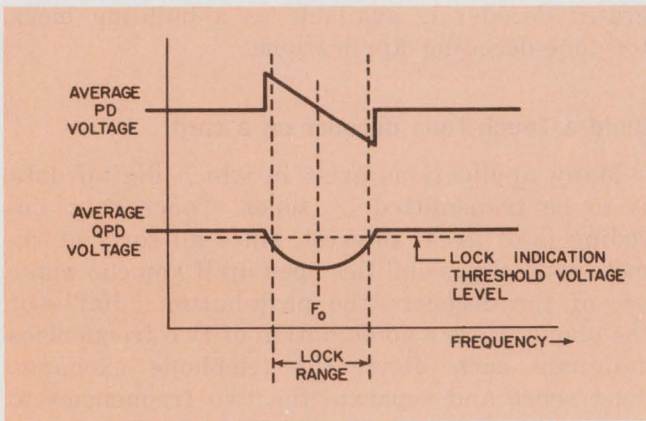

2. The output of the quadrature phase detector (QPD) varies with frequency when the loop is tracking and is a good indication of lock. The loop detector (PD) output doesn't provide this information.

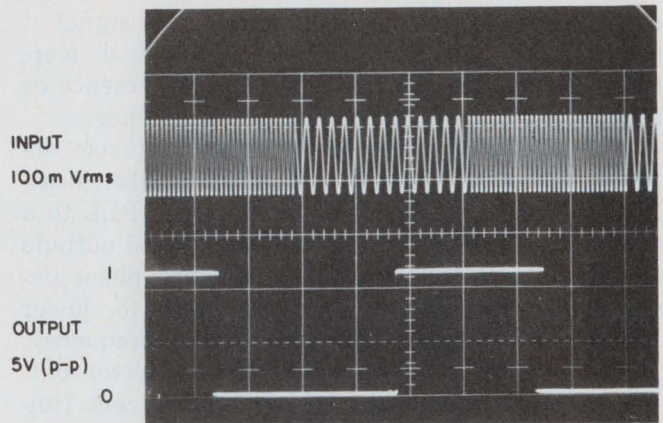

4. Two phase-locked loop tone decoders can be used to detect data transmitted by frequency shift keying methods. The loop can detect low amplitude signals and provide a TTL compatible output.

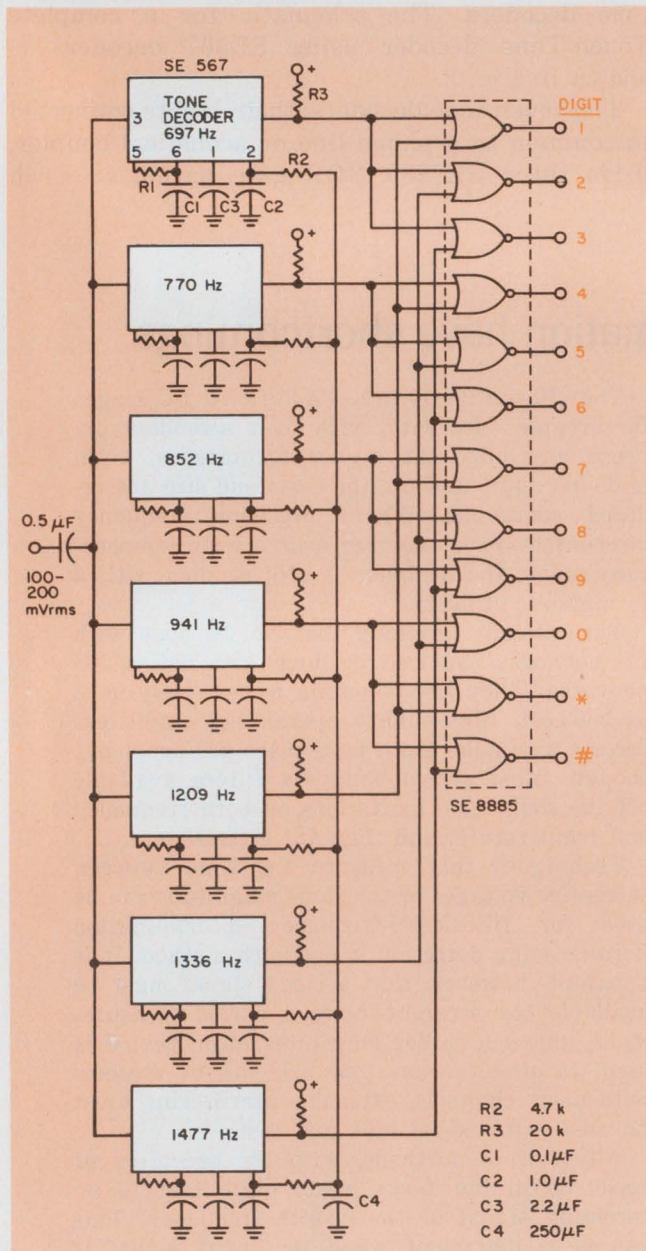

3. This low-cost IC Touch-Tone decoder can be built on a single card and is one-tenth the size of comparable decoders available from the phone company. R_1 and C_1 are used to tune each decoder.

tone decoder is tuned, by means of R_1 and C_1 , to one of the seven tones according to the relationship $f_0 = 1/R_1C_1$. The center frequency stability is, in most cases, entirely dependent on the temperature coefficient of the $R_1 C_1$ products.

Detection bandwidth is selected by R_2 and C_2 . The 4.7K-ohm resistor and 1 μF capacitor produce an 8% bandwidth with a 100-mV rms input, and 5% with 50-mV rms input. Since the bandwidth varies only as the square root of C_2 , a precision capacitor is not needed. Even a $\pm 20\%$ electrolytic will set the bandwidth to within 10% of the desired value. Capacitor C_4 decouples the seven units. The smallest value that C_2 can have is $130/f_0$ (μF), which is the desired value for maximum operating speed.

Choosing C_3 is a simple matter, since its function is simply to extract a dc level for threshold comparison at the output stage. A typical minimum value is about twice C_2 . However, if output pulsing just outside the band or during turn-on is noticed, C_3 should be increased to a larger value. C_3 can be a wide-tolerance, low-cost part. Making it larger than necessary will introduce turn-on and turn-off delay, which can be useful in rejecting spurious in-band signals.

There are many other techniques for transmitting data digitally. The simplest involves simply keying the tone ON and OFF to generate the ONES and ZEROS, respectively.

Another method of digital data transmission is frequency shift keying, in which the one and zero are each represented by a different tone. For low-speed decoding, two IC tone decoders can be used, each responding to one frequency (Fig. 4). If the two frequencies are within 10% of each other, a single tone decoder tuned to the mid-frequency may be used, the data output being taken from the low-pass capacitor C_2 , with the normal pin 8 output serving as an indication that data is being received. The maximum transmission rate in this case is about $f_0/5$ baud. ■■

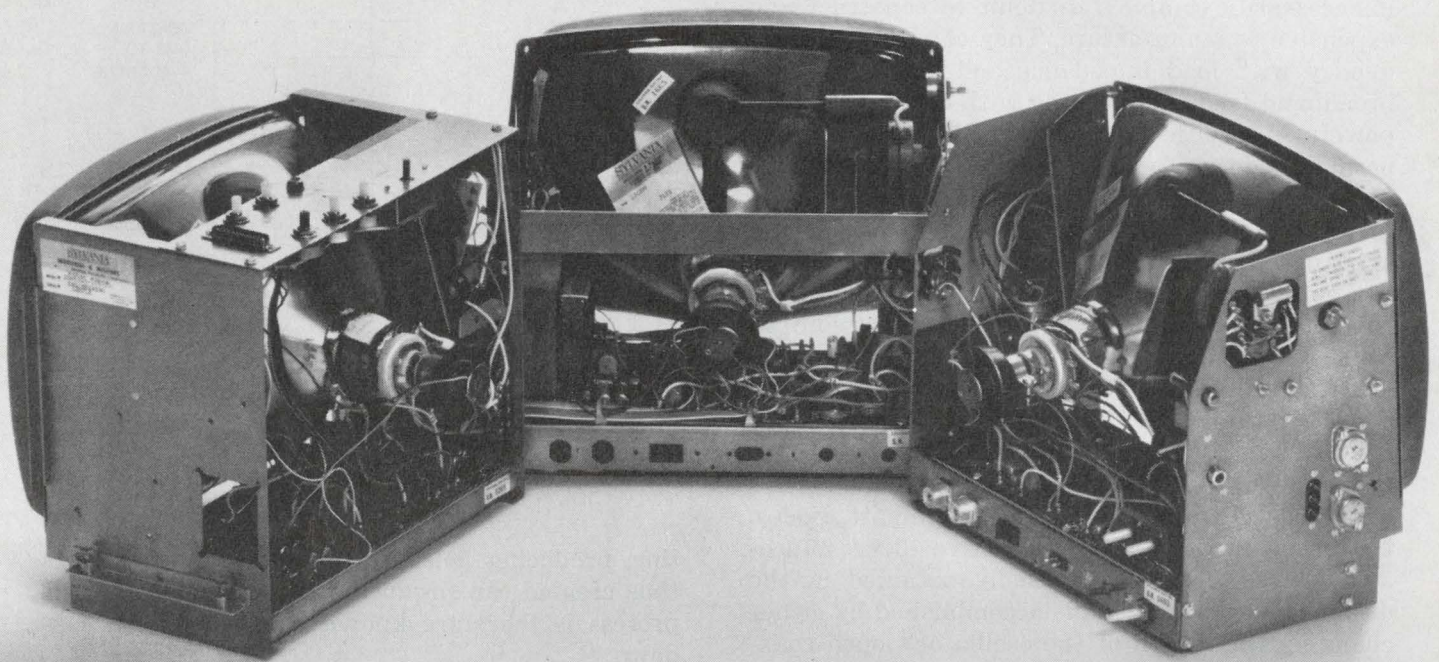

We have only one standard 12" monitor. All three are shown above.

A 12" monitor is standard in everybody's line.
Except in GTE Sylvania's.

The only thing standard about our 12" monitor is
the size of the CRT.

We can't work magic with a 12" hunk of picture
tube, but you'll be amazed at what we can do with
the rest of the unit.

Would you like the controls on the top? Back?
Front? Side?

Do you need more space in the upper right-hand
corner? Or the lower left? Or maybe you need a little
extra space on top.

That's no problem for us because our standard
monitor is designed to be flexible.

If you can find the space for a 12" CRT, we'll find
the space for the electronics.

Three versions of our standard monitor are shown
above.

Yours could be number four.

Sylvania Electronic Components, Seneca Falls,
New York 13148.

GTE SYLVANIA

To use Gunn or Impatt diodes in the same microwave oscillator structure, you must be able to match a broad range of reactive diode impedances. Here's how.

Many modern solid-state microwave power sources built around Gunn and Impatt diodes are unnecessarily complex, difficult to construct and expensive to manufacture. They change their frequency with load impedance and do not provide broadband frequency tuning with constant output power. A sacrifice in Q often must be made to permit diode-to-cavity impedance matching. And, perhaps most importantly, cavities are frequently unable to accept a wide variation in device impedance parameters, because their impedances cannot be altered over a range sufficient to provide the conjugate impedance match that is required for oscillation.

These problems can be overcome by employing dielectric tuning for broadband low-loss tunability, and by only loosely coupling the cavity to both the diode and the output. The design that results can be used with either Gunn or Impatt diodes, because a broad range of reactive diode impedance values can be very easily obtained in the designed oscillator. This is accomplished by either changing the length of the oscillator's open coaxial transmission line or by changing the capacitive fringing impedance at the open end of the oscillator cavity.

First study the properties of the diodes

Since the heart of any diode oscillator is the diode, the logical way to begin the design job is by looking at the parameters and equivalent-circuit representations of the Gunn and Impatt diodes.

The Impatt (for impact avalanche and transit time) diode is best analyzed by considering it as broken into three regions; an avalanche zone, a drift zone and an inactive zone.

The avalanche zone refers to the internal secondary emission at a p-n junction reverse-biased into breakdown. Under high field strengths, charge carriers can acquire enough energy to knock valence electrons into the conduction band,

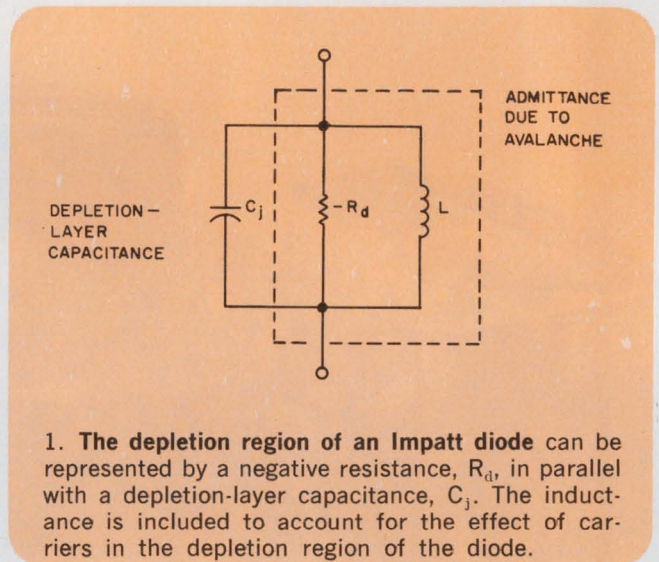

thus producing hole-electron pairs. The carriers thus created can produce other carriers, and the process is therefore known as avalanche breakdown.

The current is ultimately limited by its own space charge, which weakens the field inside the avalanche region of the p-n junction to exactly the value necessary to sustain the avalanche without further growth. The avalanche takes time to build up as the voltage rises and requires time to subside after the voltage passes its maximum. In fact, it can be shown that the avalanche process is inductive in nature, and that, therefore, the phase angle of the current lags behind the angle of the voltage by 90° .

No carriers are formed in the drift zone; however, space-charge and transit-time effects are important here. The time it takes carriers to travel across this region of the diode is long enough so the carriers crossing a field region can reach the opposite side out of phase with the applied voltage. At a given frequency, the total lag is 180° , and the device exhibits a negative resistance.

A depletion layer capacitance current also exists in addition to the current induced by the carriers drifting in the depletion region. The de-

Carl F. Klein, Senior Research Engineer, Johnson Service Co., 507 East Michigan St., Milwaukee 53201.

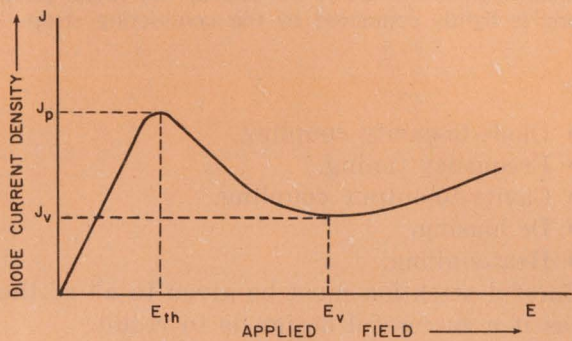

2. Negative resistance is exhibited for values of E-field between E_{th} and E_v in this plot of current density vs applied electric field for a sample of homogenous n-type gallium arsenide. J_p and J_v are the peak and valley current densities, respectively.

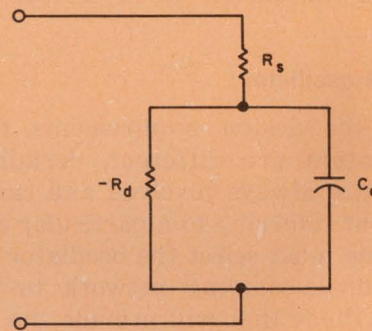

3. The domain capacitance, C_d , of an active gallium arsenide chip is voltage-dependent. In this equivalent circuit model, $-R_d$ is the negative resistance of the diode, and R_s is the ohmic resistance of the material outside of the active area.

pletion capacitance is modified, however, by the presence of carriers in the depletion region. The effect of these carriers can be represented by an inductance in shunt with the depletion-layer capacitance. The diode's depletion region can thus be represented by a shunt capacitance, inductance and resistance (Fig. 1).

Outside the depletion region is the inactive zone. This region acts as a parasitic resistance in series with the shunt depletion region resistance and reactance. All of the interesting phenomena, however, take place in the depletion region. Misawa and others have made detailed calculations that differentiate between Read structures, p-i-n structures and simple p-n junctions. The theories have shown that negative resistance effects are exhibited by any type of avalanche junction, even when the avalanche and drift regions coincide.

Gunn diodes use two-valley semiconductors

The transferred electron or Gunn phenomenon is associated with semiconductors that exhibit a voltage-controlled bulk negative conductance brought about by the unique electronic band structure found in two-valley semiconductors.

When the required electric field is applied to this type of semiconductor chip, the conduction band electrons are transferred to higher energy levels at which the electrons have less mobility. As a result of the loss of high-mobility electrons, the medium exhibits a negative differential resistivity. Negative differential mobility is a property of a few materials such as n-type gallium arsenide (GaAs), indium phosphide (InP) or cadmium telluride (CdTe).

As the applied electric field is increased above the threshold field, E_{th} , (Fig. 2), a high field domain is nucleated at the source contact. This reduces the electric field in the rest of the diode outside the domain and causes the current to drop. Because of the negative differential mobility for $E_{th} < E < E_v$, where E_v is the valley electric field, the domain rapidly builds up, causing a further decrease in bulk current and electric field outside the domain.

Since the device voltage is assumed to remain constant, the buildup continues until the electric field in the domain is above the negative differential mobility range. The high field then drifts across the sample and disappears at the anode contact. As the old domain disappears at the anode, the electric field behind it increases, until

the threshold field is reached and a new domain is formed.

The active region of the Gunn diode can thus be treated as a negative resistance in parallel with a voltage-dependent capacitance' (Fig. 3).

For effective circuit design at high frequencies, a good description of the packaged diode is necessary. The basic diode package is cylindrical, typically 0.08 inch in diameter, with its axis normal to two parallel metal surfaces (Fig. 4).

This configuration can be represented by an equivalent circuit with three components: a package capacitance, C_{pk} , a package inductance, L_{pk} , and a contact capacitance, C_c (Fig. 5). The contact capacitance is very small—on the order of 0.03 pF—and can usually be neglected.

Designing the oscillator

Although the design requirements for individual oscillators are different, certain generalized steps are always involved and can be discussed without referring to a particular design.

Initially one must select the oscillator configuration and diode-coupling network to be used, along with a diode that will provide the required negative resistance for operation at the desired frequency of oscillation. It is then necessary to determine whether the diode's packaging parameters, such as L_{pk} and C_{pk} , can be used to form an economical microwave oscillator circuit with the proper coupling network, or whether they can be compensated for and neglected.

The coupling network and parameters to permit oscillation at the prescribed frequency must then be determined and chosen. Small-signal parameters and equivalent circuits serve as useful design guidelines; however, they cannot be applied rigorously, since the small-signal parameters are changed under large-signal operation.

If the large-signal parameters are not given at the desired frequency of operation, measurements should be made to obtain the exact dynamic impedance.^{2,3} The impedance of a diode can be determined by placing it in a holder and requiring that it see a conjugate match at its oscillating frequency.

Once the diode's impedance is known, the task of designing a solid-state oscillator consists of presenting to the terminals of the diode a circuit impedance that is the conjugate of the device impedance. The positive resistance of the microwave circuit must match itself to the negative resistance of the device. The frequency of oscillation is determined by matching the device's reactance to that of the cavity.

In addition to meeting the basic theoretical requirement of providing a conjugate match, the oscillator designer must also concern himself with the following important considerations:

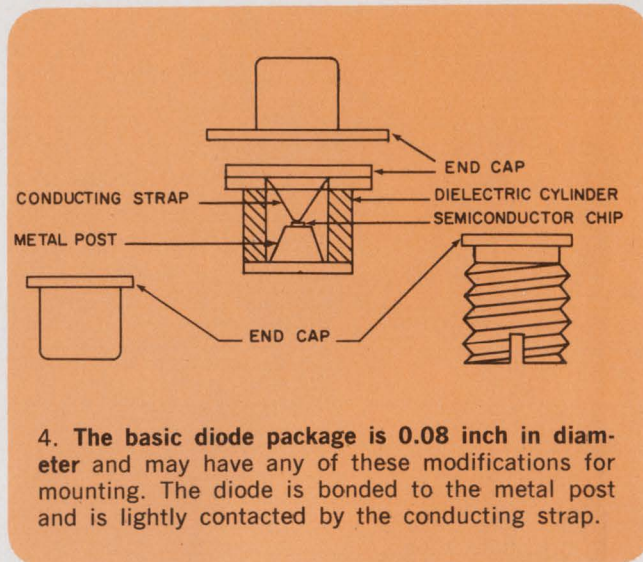

4. The basic diode package is 0.08 inch in diameter and may have any of these modifications for mounting. The diode is bonded to the metal post and is lightly contacted by the conducting strap.

- Diode-to-cavity coupling.
- Frequency tuning.
- Cavity-to-output coupling.
- Dc biasing.
- Heat-sinking.

Careful attention must be given to all of these areas if a successful design is to result.

For low noise, use loose diode coupling

The technique used to couple the diode's impedance to that of a high-Q cavity is the key to obtaining high oscillator Q and low-noise performance. Since solid-state diodes have low impedances, they load the oscillator cavity into which they are inserted, and thus lower its Q. In a well-designed structure, the cavity forms the fundamental resonator for the diode. To reduce the loading effect of the diode on the oscillator's cavity, the diode can be coupled to the cavity at a low-impedance point, and a portion of the circulation current can be bypassed to decrease the coupling. This decoupling can be achieved by building a current-divider network, consisting of series and shunt impedances, around the diode.

A variety of diode-to-cavity coupling techniques are available. The diode may be coupled to the oscillator cavity as an antenna; as a post or part of a post in a waveguide cavity; or as part of an open or shorted transmission line in a coaxial cavity. The extent to which the current division concept can be extended to each of these coupling techniques varies with the circuit approach used. Different types of impedance matching networks can be used in each instance to decouple the oscillator cavity from the diode.

In high-performance design, the diode is loosely coupled to a high-Q cavity. In this way variations in load impedance tend to be isolated from the device.

An oscillator can be tuned by changing either

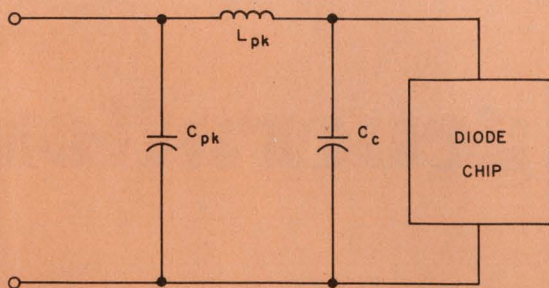

5. The contact capacitance, C_c , is usually very small—on the order of 0.01 pF—and can be neglected in most cases when this equivalent-circuit model of a standard diode package is employed.

the device impedance or the circuit impedance. If the diode is loosely coupled to the cavity via an impedance-matching network, the cavity forms the fundamental resonator, and thus changes in the oscillator frequency are basically dependent upon changes in the circuit impedance.

Frequency tuning is basically limited by the magnitude of the negative resistance the oscillator can supply and the conditions for stable oscillation imposed by the circuit. To obtain broadband low-loss tunability, some form of dielectric tuning can be utilized.

For high isolation, use loose output coupling

Once the diode-to-cavity coupling has been chosen, it is necessary to decide upon an appropriate resonator-to-load coupling technique. Numerous inductive and capacitive techniques are available in both coaxial and waveguide configurations.⁴ Optimum coupling is achieved when the output coupling reaches a value where the combined cavity and load losses are matched to the negative impedance of the solid-state device.

The stability of the oscillator and its variation in power and frequency with variations in load impedance are determined by the degree of coupling between the resonator and the output transmission line. The smaller the degree of coupling, the greater the amount of isolation.

For a waveguide output, an iris is often used to couple the waveguide to the resonator. Impedance matching can be provided by an adjustable screw or post in a section of reduced-height waveguide. The degree of coupling between the cavity and the waveguide can be controlled by varying the size of the coupling iris.

If coaxial coupling is desired, a capacitive probe or an inductive loop can be utilized. The exact location of the probe or loop will determine the degree of coupling that will be obtained.

Provisions for dc biasing should not influence the rf performance of the oscillator. The dc bias potential must be applied to the diode through a network that will prevent rf leakage. The bias circuit must, therefore, present a high rf impedance to the diode. This can be accomplished in several ways.

One approach is to use a shorted quarter-wavelength section of transmission line. The input impedance to a quarter-wavelength section of line is $Z_i = Z_0^2/Z_L$, where Z_0 is the characteristic impedance of the line and Z_L is the load impedance.

A high-impedance line can thus be loaded with a bypass capacitance element so that Z_L approaches zero and Z_i approaches infinity, thereby providing rf isolation.

Rf choking can also be obtained with a fine wire lead and a bypass capacitor. In some cases dc biasing can be accomplished by shunting the rf directly to ground by means of a large bypass capacitor.

Last, but not least—heat-sinking

One of the biggest problems confronting the designer of a solid-state diode oscillator is the removal of heat. The maximum suggested operating temperature of an avalanche diode junction is around 200°C. Thus the heat-flow resistance between junction and package and between package and heat sink are some of the most critical parameters in the oscillator design.

A short path through a good heat conductor is recommended to keep the thermal resistance between the diode and the external cooling medium low. When producing higher-power diodes, manufacturers reduce the thermal resistance from the diode wafer to its package by mounting the chip in an inverted, or flip-chip, configuration. This puts the heat-producing avalanche region as close as possible to the heat sink. ■■

References

1. Mantena, N.R., Wright, M.L., "Circuit Model Simulation of Gunn Effect Devices," *IEEE Transactions on Microwave Theory and Techniques*, Vol. MTT 17, No. 7, July, 1969.
2. DeLoach, B.C., Johnston, R.L. "Avalanche Transit-Time Microwave Oscillators and Amplifiers," *IEEE Transactions on Electron Devices*, Vol. MTT 13, No. 1, January, 1966.
3. Scharfetter, D.L., Gummel, H.K., "Large-Signal Analysis of a Silicon Read Diode Oscillator," *IEEE Transactions on Electron Devices*, Vol. ED 16, No. 1, January, 1969.
4. Westman, H.P., Editor, *Reference Data for Radio Engineers*, Fourth Edition, International Telephone and Telegraph Corp., New York, 1964, p. 641.

This article has treated the general principles of solid-state diode oscillator design. A second article, "Any Microwave Diode will Work," which will appear in the next issue of ELECTRONIC DESIGN, will apply these principles to the design of an X-band oscillator.

Emcor's new generation

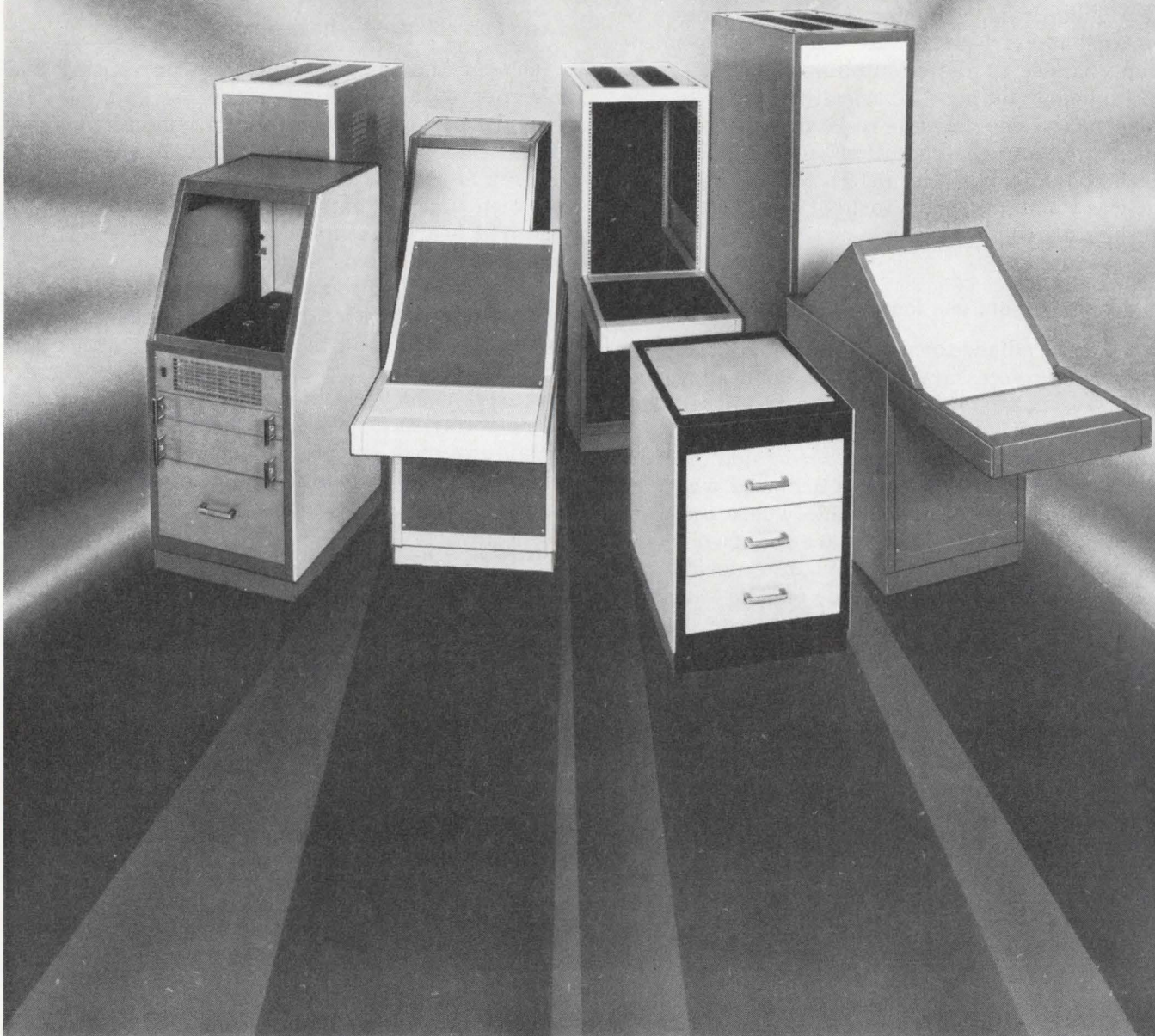

of electronic enclosures...

ESQ.

ESQ. Modular Enclosures combine the Economy of EMCOR I and the Modern Styling of EMCOR II . . . plus all the EMCOR quality you've learned to expect.

ESQ. adds another exciting dimension to the world of electronic enclosures . . . with new colors, new sizes, new hardware and new styling!

ESQ. is available in four basic configurations: vertical, sloped front, low silhouette and steel work/writing top models.

New 30 $\frac{3}{4}$ " deep frames are available in both vertical and sloped front models to house the new, deeper electronic packages.

Hundreds of basic frames, in both 19" and 24" panel widths, and a wide array of accessories offer virtually unlimited combinations to house a whole world of equipment: electrical, electronic, controls, computer, computer peripheral, instrumentation, to name but a few.

EMCOR offers you a choice of three outstanding lines . . . the economical EMCOR I . . . the top of the line EMCOR II . . . and now ESQ, the new series that combines the best of both . . . at a cost that makes it another great EMCOR value.

Write today for a copy of the new ESQ catalog and the name of your nearest EMCOR representative. Ingersoll Products, Division of Borg-Warner Corp., 1000 West 120th Street, Chicago, Illinois 60643.

Ingersoll Products



Design active elliptic filters easily

from tables. All you need is passband ripple, stopband rejection and the required frequencies.

Active elliptic-function filters offer an excellent approximation to an ideal frequency-domain filter response. In the passband-to-stopband transition region, they can be designed to have a steeper rate of descent than Butterworth or Chebyshev types. And now they, too, can be designed easily from tables.

The normalized low-pass frequency response of an active elliptic-function filter is shown in Fig. 1, where R_{dB} is the passband ripple in dB, A_{dB} is the minimum stopband attenuation in dB, and ω_s is the lowest stopband frequency (in radians-per-second) at which A_{dB} occurs.

The circuit schematic of an elliptic-function active filter section is shown in Fig. 2. The number of sections required in a complete filter is $(N-1)/2$, where N defines the order of the filter.

For filter sections of this type in a complete active elliptic filter, the table on pages 78-79 has normalized resistances and capacitances. Section gain and closed-loop op-amp gain, K , are also presented. A 1, 2 and 3-section filter, which corresponds to odd-ordered filters from $N=3$ through $N=7$, respectively, can be designed for passband ripples of 0.01 dB and 0.28 dB.

The ripple value of 0.01 dB was chosen because it represents a practical figure for use in pulse-transmission filters. The larger ripple value should satisfy most general filtering requirements.

The tabulated values are normalized for a cutoff frequency of one radian per second. To denormalize the values, a convenient impedance scaling factor, M , must be selected. Then:

$$R'' = R'M \quad (1)$$

and

$$C'' = \frac{C'}{2\pi f M}, \quad (2)$$

where R' and C' are the tabulated normalized values and R'' and C'' are the new denormalized values for a cutoff of f Hz, which is determined by the design specs. Resistors $R6$ and $R7$ may

both be denormalized arbitrarily, since only the ratio of the two enters into the design.

The over-all filter gain is the product of the individual section gains, which is also tabulated.

As an example of how the table may be used to design a low-pass filter, consider the following specifications: passband ripple of less than 0.5 dB at 1000 Hz and below; stopband rejection of greater than 35 dB at 3000 Hz and above.

Upon inspection of the tables, we see that the filter for $N=3$ and $R_{dB}=0.28$ dB has a listing for $\omega_s=2.9238$ radians-per-second and $A_{dB}=39.48$ dB. When the one radian-per-second cutoff is scaled to 1000 Hz, the response is 39.48 dB down at 2923 Hz, as required.

The schematic is shown in Fig. 3a. Formulas 1 and 2 are used with $M=10$ k and $f=1000$ Hz to give the denormalized filter.

Applicable for high-pass filters, too

High-pass filters may also be designed. For this, the table is used initially in the same way that it is for low-pass filters, provided that ω_s is redefined as the highest stopband frequency at which A_{dB} occurs. Then a low-pass-to-high-pass transformation is performed by replacing each normalized capacitor with a resistor that has a reciprocal value and, similarly, by replacing each normalized resistor (except $R6$ and $R7$) with a capacitor that has a reciprocal value.

As an example of a high-pass filter design, consider the following specifications: passband ripple of less than 0.5 dB at 300 Hz and above; stopband rejection of greater than 35 dB at 100 Hz and below.

The identical low-pass prototype for the low-pass example can again be used. Since $\omega_s = 2.9238$ radians-per-second, scaling the cutoff to 300 Hz will place the 39.48 dB point at $300/2.9238=102.6$ Hz, thus satisfying the requirement. However, before denormalization, a low-pass to high-pass transformation must be performed (Fig. 3b). Using $M=10$ k and $f=300$ Hz results in the final component values (in color). ■■

(continued on pg. 78)

Arthur B. Williams, Senior Project Engineer, Singer Tele-Signal Corp., 250 Crossways Park Dr., Woodbury, L.I., N.Y. 11797.

How is the elliptic-function filter different?

Ideal filter characteristics are generally approximated by elliptic-function, Butterworth or Chebyshev filters. How does the elliptic-function type differ basically from the two others?

The Butterworth filter is extremely flat at very low frequencies. Its transfer function is of the form $1/P(s)$, where $P(s)$ is a polynomial, $s=j\omega$, and the function has roots on a unit circle in the complex plane.

The Chebyshev filter has a steeper transition

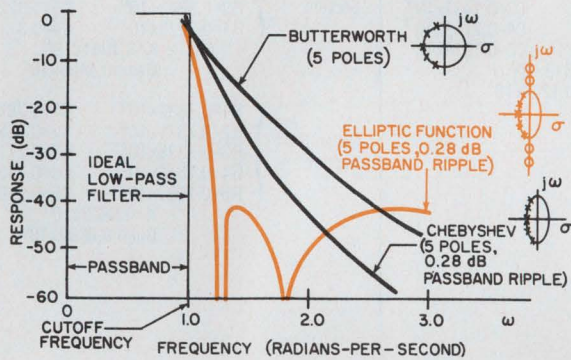

from the passband-to-stopband region, but its stopband rejection is not significantly greater near cutoff, compared with the Butterworth filter. The transfer function is of the same form as the Butterworth, but the roots of the denominator are on an ellipse rather than a circle. Both the Butterworth and the Chebyshev transfer functions are of the all-pole type—they have response zeros only at infinite frequencies.

The elliptic-function transfer function, however, contains zeros as well as poles at finite frequencies. The zeros are so placed that equal ripple passband behavior results, as in the Chebyshev case. The stopband ripple is of the same peak-to-peak amplitude as the passband ripple.

The use of finite transmission zeros results in the steepest rate of descent possible for a fixed degree of circuit complexity and number of filter sections. The elliptic transfer function is of the form $N(s)/P(s)$, where $N(s)$ is a polynomial having roots on the $j\omega$ -axis, thus yielding the transmission zeros. $P(s)$ is a polynomial, similar to the Chebyshev type, resulting in poles on an ellipse.

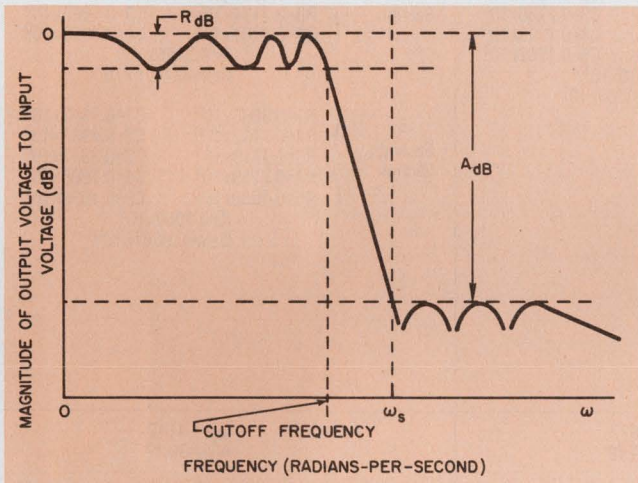

1. The low-pass elliptic-function response curve features the steepest rate of descent from passband to stopband, when compared to Butterworth and Chebyshev filters. Peak-to-peak ripples above and below ω_s are equal.

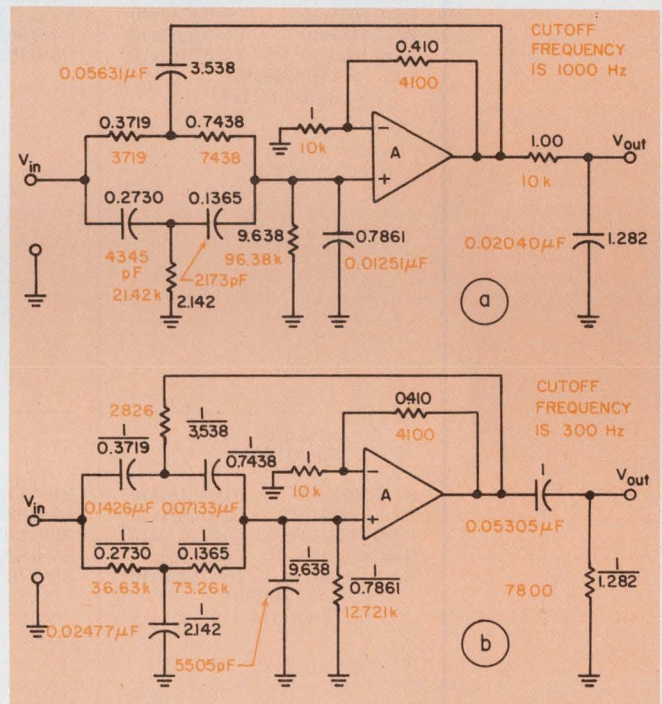

3. An elliptic-function filter design for a low-pass filter (a) or a high-pass filter (b) is obtained directly from the table. Denormalized component values are shown in color. Each filter has a passband ripple of 0.28 dB and a stopband rejection of greater than 35 dB.

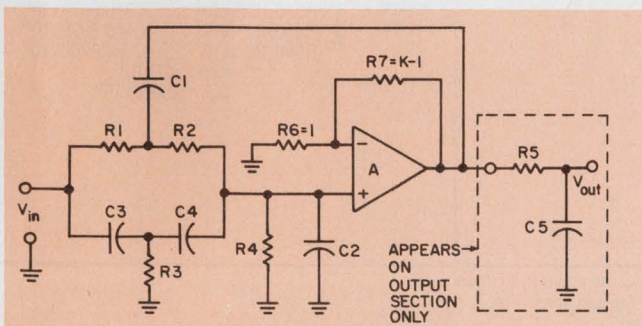

2. A total of $(N-1)/2$ of these sections is required for an N -ordered elliptic-function filter. A 741 or 709 op amp may be used, and resistors and capacitors of 1% tolerance are adequate for normal filtering.

Table. Active elliptic-function filter design data

Filter Order, N ($\frac{N-1}{2}$ Sections)	3 (1 Section)		5 (2 Sections)
	0.01	0.28	0.01
Passband Ripple Factor— R_{dB} (dB)	$\omega_s=7.1853$ $A_{dB}=49.33$ $R1=0.3487 \times 10^0$ $C1=0.2418 \times 10^1$ $R2=0.6974 \times 10^0$ $C2=0.5374 \times 10^0$ $R3=0.5045 \times 10^1$ $C3=0.7428 \times 10^{-1}$ $R4=0.2270 \times 10^2$ $C4=0.3714 \times 10^{-1}$ $R5=0.1000 \times 10^1$ $C5=0.6289 \times 10^0$ $K=0.1148 \times 10^1$ $Gain=0.1098 \times 10^1$	$\omega_s=4.1336$ $A_{dB}=48.91$ $R1=0.3525 \times 10^0$ $C1=0.3730 \times 10^1$ $R2=0.7050 \times 10^0$ $C2=0.8289 \times 10^0$ $R3=0.4084 \times 10^1$ $C3=0.1431 \times 10^0$ $R4=0.1838 \times 10^2$ $C4=0.7155 \times 10^{-1}$ $R5=0.1000 \times 10^1$ $C5=0.1314 \times 10^1$ $K=0.1319 \times 10^1$ $Gain=0.1247 \times 10^1$	$\omega_s=2.000$ $A_{dB}=49.22$ First Section { $R1=0.4452 \times 10^0$ $C1=0.2784 \times 10^1$ $R2=0.8904 \times 10^0$ $C2=0.6186 \times 10^0$ $R3=0.8843 \times 10^0$ $C3=0.6228 \times 10^0$ $R4=0.3979 \times 10^1$ $C4=0.3114 \times 10^0$ $K=0.1941 \times 10^1$ $Gain=0.1453 \times 10^1$ Second Section { $R1=0.3686 \times 10^0$ $C1=0.3851 \times 10^1$ $R2=0.7371 \times 10^0$ $C2=0.8557 \times 10^0$ $R3=0.2325 \times 10^1$ $C3=0.2713 \times 10^0$ $R4=0.1046 \times 10^2$ $C4=0.1357 \times 10^0$ $R5=0.1000 \times 10^1$ $C5=0.1100 \times 10^1$ $K=0.9609 \times 10^0$ $Gain=0.8690 \times 10^0$
	$\omega_s=5.2408$ $A_{dB}=41.00$ $R1=0.3620 \times 10^0$ $C1=0.2340 \times 10^1$ $R2=0.7240 \times 10^0$ $C2=0.5199 \times 10^0$ $R3=0.2805 \times 10^1$ $C3=0.1342 \times 10^0$ $R4=0.1262 \times 10^2$ $C4=0.6710 \times 10^{-1}$ $R5=0.1000 \times 10^1$ $C5=0.6193 \times 10^0$ $K=0.1206 \times 10^1$ $Gain=0.1111 \times 10^1$	$\omega_s=2.9238$ $A_{dB}=39.48$ $R1=0.3719 \times 10^0$ $C1=0.3538 \times 10^1$ $R2=0.7438 \times 10^0$ $C2=0.7861 \times 10^0$ $R3=0.2142 \times 10^1$ $C3=0.2730 \times 10^0$ $R4=0.9638 \times 10^1$ $C4=0.1365 \times 10^0$ $R5=0.1000 \times 10^1$ $C5=0.1282 \times 10^1$ $K=0.1410 \times 10^1$ $Gain=0.1263 \times 10^1$	$\omega_s=1.7013$ $A_{dB}=40.81$ First Section { $R1=0.4847 \times 10^0$ $C1=0.2591 \times 10^1$ $R2=0.9695 \times 10^0$ $C2=0.5757 \times 10^0$ $R3=0.7114 \times 10^0$ $C3=0.7845 \times 10^0$ $R4=0.3201 \times 10^1$ $C4=0.3923 \times 10^0$ $K=0.2145 \times 10^1$ $Gain=0.1475 \times 10^1$ Second Section { $R1=0.3866 \times 10^0$ $C1=0.3583 \times 10^1$ $R2=0.7732 \times 10^0$ $C2=0.7963 \times 10^0$ $R3=0.1613 \times 10^1$ $C3=0.3817 \times 10^0$ $R4=0.7259 \times 10^1$ $C4=0.1908 \times 10^0$ $R5=0.1000 \times 10^1$ $C5=0.1039 \times 10^1$ $K=0.1050 \times 10^1$ $Gain=0.9057 \times 10^0$
	$\omega_s=3.6280$ $A_{dB}=31.14$ $R1=0.3922 \times 10^0$ $C1=0.2183 \times 10^1$ $R2=0.7844 \times 10^0$ $C2=0.4851 \times 10^0$ $R3=0.1480 \times 10^1$ $C3=0.2570 \times 10^0$ $R4=0.6662 \times 10^1$ $C4=0.1285 \times 10^0$ $R5=0.1000 \times 10^1$ $C5=0.5968 \times 10^0$ $K=0.1343 \times 10^1$ $Gain=0.1141 \times 10^1$	$\omega_s=2.0627$ $A_{dB}=29.49$ $R1=0.4119 \times 10^0$ $C1=0.3201 \times 10^1$ $R2=0.8238 \times 10^0$ $C2=0.7113 \times 10^0$ $R3=0.1165 \times 10^1$ $C3=0.5028 \times 10^0$ $R4=0.5243 \times 10^1$ $C4=0.2514 \times 10^0$ $R5=0.1000 \times 10^1$ $C5=0.1212 \times 10^1$ $K=0.1603 \times 10^1$ $Gain=0.1297 \times 10^1$	$\omega_s=1.4142$ $A_{dB}=30.17$ First Section { $R1=0.5443 \times 10^0$ $C1=0.2364 \times 10^1$ $R2=0.1088 \times 10^1$ $C2=0.5253 \times 10^0$ $R3=0.5733 \times 10^0$ $C3=0.9974 \times 10^0$ $R4=0.2580 \times 10^1$ $C4=0.4987 \times 10^0$ $K=0.2471 \times 10^1$ $Gain=0.1513 \times 10^1$ Second Section { $R1=0.4239 \times 10^0$ $C1=0.3133 \times 10^1$ $R2=0.8479 \times 10^0$ $C2=0.6962 \times 10^0$ $R3=0.1039 \times 10^1$ $C3=0.5678 \times 10^0$ $R4=0.4679 \times 10^1$ $C4=0.2839 \times 10^0$ $R5=0.1000 \times 10^1$ $C5=0.9260 \times 10^0$ $K=0.1247 \times 10^1$ $Gain=0.9806 \times 10^0$

Note: 1. Resistance and capacitance values are normalized. 2. ω_s = lowest (highest) stopband frequency in radians per second for low-pass (high-pass) filters. 3. A_{dB} = minimum stopband attenuation in dB. 4. K = closed-loop op-amp gain per section. 5. "Gain" is for a section.

5 (2 Sections)		7 (3 Sections)			
0.28		0.01		0.28	
$\omega_s = 1.5557$ $A_{dB} = 50.10$		$\omega_s = 1.1924$ $A_{dB} = 40.5$		$\omega_s = 1.3902$ $A_{dB} = 70.19$	
First Section	$R1 = 0.4698 \times 10^0$ $C1 = 0.3086 \times 10^1$ $R2 = 0.9396 \times 10^0$ $C2 = 0.6858 \times 10^0$ $R3 = 0.7651 \times 10^0$ $C3 = 0.8422 \times 10^0$ $R4 = 0.3443 \times 10^1$ $C4 = 0.4211 \times 10^0$ $K = 0.2173 \times 10^1$ Gain = 0.1542×10^1	First Section	$R1 = 0.5902 \times 10^0$ $C1 = 0.2396 \times 10^1$ $R2 = 0.1180 \times 10^1$ $C2 = 0.5325 \times 10^0$ $R3 = 0.5107 \times 10^0$ $C3 = 0.1230 \times 10^1$ $R4 = 0.2298 \times 10^1$ $C4 = 0.6153 \times 10^0$ $K = 0.2837 \times 10^1$ Gain = 0.1602×10^1	First Section	$R1 = 0.5048 \times 10^0$ $C1 = 0.2929 \times 10^1$ $R2 = 0.1009 \times 10^1$ $C2 = 0.6509 \times 10^0$ $R3 = 0.6543 \times 10^0$ $C3 = 0.1004 \times 10^1$ $R4 = 0.2944 \times 10^1$ $C4 = 0.5021 \times 10^0$ $K = 0.2435 \times 10^1$ Gain = 0.1608×10^1
Second Section	$R1 = 0.3685 \times 10^0$ $C1 = 0.5142 \times 10^1$ $R2 = 0.7370 \times 10^0$ $C2 = 0.1142 \times 10^1$ $R3 = 0.2330 \times 10^1$ $C3 = 0.3615 \times 10^0$ $R4 = 0.1048 \times 10^2$ $C4 = 0.1807 \times 10^0$ $R5 = 0.1000 \times 10^1$ $C5 = 0.2019 \times 10^1$ $K = 0.1220 \times 10^1$ Gain = 0.1104×10^1	Second Section	$R1 = 0.5156 \times 10^0$ $C1 = 0.2847 \times 10^1$ $R2 = 0.1031 \times 10^1$ $C2 = 0.6326 \times 10^0$ $R3 = 0.6285 \times 10^0$ $C3 = 0.1038 \times 10^1$ $R4 = 0.2828 \times 10^1$ $C4 = 0.5190 \times 10^0$ $K = 0.2153 \times 10^1$ Gain = 0.1392×10^1	Second Section	$R1 = 0.4277 \times 10^0$ $C1 = 0.3949 \times 10^1$ $R2 = 0.8555 \times 10^0$ $C2 = 0.8777 \times 10^0$ $R3 = 0.1006 \times 10^1$ $C3 = 0.7458 \times 10^0$ $R4 = 0.4531 \times 10^1$ $C4 = 0.3729 \times 10^0$ $K = 0.1844 \times 10^1$ Gain = 0.1437×10^1
		Third Section	$R1 = 0.3909 \times 10^0$ $C1 = 0.4187 \times 10^1$ $R2 = 0.7819 \times 10^0$ $C2 = 0.9305 \times 10^0$ $R3 = 0.1508 \times 10^1$ $C3 = 0.4825 \times 10^0$ $R4 = 0.6786 \times 10^1$ $C4 = 0.2412 \times 10^0$ $R5 = 0.1000 \times 10^1$ $C5 = 0.1229 \times 10^1$ $K = 0.1039 \times 10^1$ Gain = 0.8862×10^0	Third Section	$R1 = 0.3493 \times 10^0$ $C1 = 0.7029 \times 10^1$ $R2 = 0.6986 \times 10^0$ $C2 = 0.1562 \times 10^1$ $R3 = 0.4856 \times 10^1$ $C3 = 0.2247 \times 10^0$ $R4 = 0.2185 \times 10^2$ $C4 = 0.1123 \times 10^0$ $R5 = 0.1000 \times 10^1$ $C5 = 0.2762 \times 10^1$ $K = 0.1087 \times 10^1$ Gain = 0.1037×10^1
$\omega_s = 1.3054$ $A_{dB} = 39.17$		$\omega_s = 1.3054$ $A_{dB} = 50.11$		$\omega_s = 1.2521$ $A_{dB} = 60.18$	
First Section	$R1 = 0.5280 \times 10^0$ $C1 = 0.2757 \times 10^1$ $R2 = 0.1056 \times 10^1$ $C2 = 0.6127 \times 10^0$ $R3 = 0.6027 \times 10^0$ $C3 = 0.1073 \times 10^1$ $R4 = 0.2712 \times 10^1$ $C4 = 0.5368 \times 10^0$ $K = 0.2479 \times 10^1$ Gain = 0.1565×10^1	First Section	$R1 = 0.5517 \times 10^0$ $C1 = 0.2532 \times 10^1$ $R2 = 0.1103 \times 10^1$ $C2 = 0.5626 \times 10^0$ $R3 = 0.5614 \times 10^0$ $C3 = 0.1105 \times 10^1$ $R4 = 0.2526 \times 10^1$ $C4 = 0.5529 \times 10^0$ $K = 0.2624 \times 10^1$ Gain = 0.1585×10^1	First Section	$R1 = 0.5449 \times 10^0$ $C1 = 0.2718 \times 10^1$ $R2 = 0.1089 \times 10^1$ $C2 = 0.6040 \times 10^0$ $R3 = 0.5723 \times 10^0$ $C3 = 0.1150 \times 10^1$ $R4 = 0.2575 \times 10^1$ $C4 = 0.5751 \times 10^0$ $K = 0.2643 \times 10^1$ Gain = 0.1617×10^1
Second Section	$R1 = 0.3942 \times 10^0$ $C1 = 0.4572 \times 10^1$ $R2 = 0.7884 \times 10^0$ $C2 = 0.1015 \times 10^1$ $R3 = 0.1439 \times 10^1$ $C3 = 0.5564 \times 10^0$ $R4 = 0.6477 \times 10^1$ $C4 = 0.2782 \times 10^0$ $R5 = 0.1000 \times 10^1$ $C5 = 0.1831 \times 10^1$ $K = 0.1360 \times 10^1$ Gain = 0.1149×10^1	Second Section	$R1 = 0.4751 \times 10^0$ $C1 = 0.3128 \times 10^1$ $R2 = 0.9501 \times 10^0$ $C2 = 0.6950 \times 10^0$ $R3 = 0.7449 \times 10^0$ $C3 = 0.8865 \times 10^0$ $R4 = 0.3352 \times 10^1$ $C4 = 0.4433 \times 10^0$ $K = 0.1913 \times 10^1$ Gain = 0.1342×10^1	Second Section	$R1 = 0.4595 \times 10^0$ $C1 = 0.3608 \times 10^1$ $R2 = 0.9189 \times 10^0$ $C2 = 0.8018 \times 10^0$ $R3 = 0.8095 \times 10^0$ $C3 = 0.9102 \times 10^0$ $R4 = 0.3643 \times 10^1$ $C4 = 0.4551 \times 10^0$ $K = 0.2013 \times 10^1$ Gain = 0.1461×10^1
		Third Section	$R1 = 0.3712 \times 10^0$ $C1 = 0.4706 \times 10^1$ $R2 = 0.7423 \times 10^0$ $C2 = 0.1045 \times 10^1$ $R3 = 0.2181 \times 10^1$ $C3 = 0.3560 \times 10^0$ $R4 = 0.9813 \times 10^1$ $C4 = 0.1780 \times 10^0$ $R5 = 0.1000 \times 10^1$ $C5 = 0.1366 \times 10^1$ $K = 0.9318 \times 10^0$ Gain = 0.8369×10^0	Third Section	$R1 = 0.3575 \times 10^0$ $C1 = 0.6517 \times 10^1$ $R2 = 0.7150 \times 10^0$ $C2 = 0.1448 \times 10^1$ $R3 = 0.3288 \times 10^1$ $C3 = 0.3149 \times 10^0$ $R4 = 0.1480 \times 10^2$ $C4 = 0.1575 \times 10^0$ $R5 = 0.1000 \times 10^1$ $C5 = 0.2571 \times 10^1$ $K = 0.1136 \times 10^1$ Gain = 0.1059×10^1
$\omega_s = 1.1547$ $A_{dB} = 29.53$		$\omega_s = 1.4663$ $A_{dB} = 60.55$		$\omega_s = 1.1547$ $A_{dB} = 50.86$	
First Section	$R1 = 0.5833 \times 10^0$ $C1 = 0.2510 \times 10^1$ $R2 = 0.1166 \times 10^1$ $C2 = 0.5577 \times 10^0$ $R3 = 0.5186 \times 10^0$ $C3 = 0.1254 \times 10^1$ $R4 = 0.2334 \times 10^1$ $C4 = 0.6272 \times 10^0$ $K = 0.2786 \times 10^1$ Gain = 0.1592×10^1	First Section	$R1 = 0.5094 \times 10^0$ $C1 = 0.2713 \times 10^1$ $R2 = 0.1018 \times 10^1$ $C2 = 0.6028 \times 10^0$ $R3 = 0.6430 \times 10^0$ $C3 = 0.9551 \times 10^0$ $R4 = 0.2893 \times 10^1$ $C4 = 0.4776 \times 10^0$ $K = 0.2398 \times 10^1$ Gain = 0.1569×10^1	First Section	$R1 = 0.5825 \times 10^0$ $C1 = 0.2548 \times 10^1$ $R2 = 0.1165 \times 10^1$ $C2 = 0.5661 \times 10^0$ $R3 = 0.5195 \times 10^0$ $C3 = 0.1270 \times 10^1$ $R4 = 0.2338 \times 10^1$ $C4 = 0.6349 \times 10^0$ $K = 0.2843 \times 10^1$ Gain = 0.1627×10^1
Second Section	$R1 = 0.4330 \times 10^0$ $C1 = 0.3913 \times 10^1$ $R2 = 0.8661 \times 10^0$ $C2 = 0.8695 \times 10^0$ $R3 = 0.9651 \times 10^0$ $C3 = 0.7803 \times 10^0$ $R4 = 0.4343 \times 10^1$ $C4 = 0.3902 \times 10^0$ $R5 = 0.1000 \times 10^1$ $C5 = 0.1597 \times 10^1$ $K = 0.1578 \times 10^1$ Gain = 0.1214×10^1	Second Section	$R1 = 0.4387 \times 10^0$ $C1 = 0.3429 \times 10^1$ $R2 = 0.8773 \times 10^0$ $C2 = 0.7620 \times 10^0$ $R3 = 0.9255 \times 10^0$ $C3 = 0.7223 \times 10^0$ $R4 = 0.4165 \times 10^1$ $C4 = 0.3612 \times 10^0$ $K = 0.1711 \times 10^1$ Gain = 0.1300×10^1	Second Section	$R1 = 0.4958 \times 10^0$ $C1 = 0.3274 \times 10^1$ $R2 = 0.9916 \times 10^0$ $C2 = 0.7276 \times 10^0$ $R3 = 0.6781 \times 10^0$ $C3 = 0.1063 \times 10^1$ $R4 = 0.3052 \times 10^1$ $C4 = 0.5320 \times 10^0$ $K = 0.2214 \times 10^1$ Gain = 0.1489×10^1
		Third Section	$R1 = 0.3579 \times 10^0$ $C1 = 0.5155 \times 10^1$ $R2 = 0.7157 \times 10^0$ $C2 = 0.1145 \times 10^1$ $R3 = 0.3242 \times 10^1$ $C3 = 0.2529 \times 10^0$ $R4 = 0.1459 \times 10^2$ $C4 = 0.1265 \times 10^0$ $R5 = 0.1000 \times 10^1$ $C5 = 0.1482 \times 10^1$ $K = 0.8599 \times 10^0$ Gain = 0.8009×10^0	Third Section	$R1 = 0.3696 \times 10^0$ $C1 = 0.5919 \times 10^1$ $R2 = 0.7393 \times 10^0$ $C2 = 0.1315 \times 10^1$ $R3 = 0.2263 \times 10^1$ $C3 = 0.4297 \times 10^0$ $R4 = 0.1018 \times 10^2$ $C4 = 0.2148 \times 10^0$ $R5 = 0.1000 \times 10^1$ $C5 = 0.2352 \times 10^1$ $K = 0.1206 \times 10^1$ Gain = 0.1088×10^1

DATA COMMUNICATIONS

equipment for on-line, real-time processing

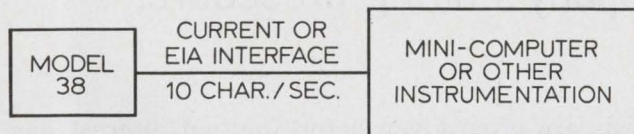

A second interface option is really two options in one. The set is equipped with both a voltage interface that conforms with EIA Standard RS-232-C and a current interface of 20 or 60 ma.

This means you can readily fit the model 38 into just about any switched network, private line or time-sharing system going without special "black box" engineering. Or use it to add maximum input/output capabilities to your mini-computer at a realistic price.

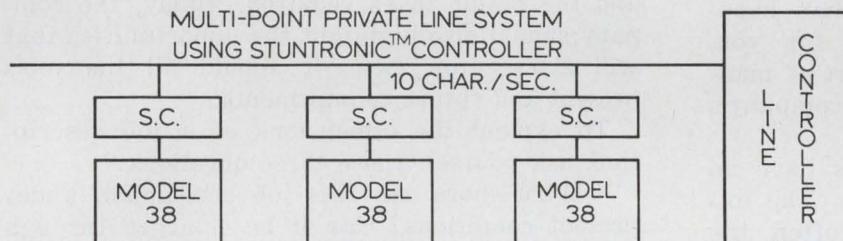

You can even use the model 38 in multi-point "selective calling" systems by adding a Teletype Stuntronic™ station controller.



... automatic send-receive operation up to 2400 words per minute

For systems requiring higher speed capabilities, the model 38 can be used with the Teletype 4210 magnetic tape data terminal. This combination provides on-line speeds up to 240 characters per second. The 4210 uses compact 3" x 3" x 1" magnetic tape cartridges that hold up to 150,000 characters of data. Tape recording, editing, and correction functions are extremely simple.



If you are generating heavy-data loads in a teleprocessing or remote batch processing system, the on-line time saving aspects of this terminal combination are exceptionally dramatic. It is also possible to send or receive data on-line with the model 38 at 100 wpm using the optional built-in modem, if required.



So take a close look at this new wide-platen terminal offering. If you would like more information on the model 38, or any other part of the total line of Teletype data communications equipment, write: Teletype Corporation, 5555 Touhy Ave., Dept. 89-29, Skokie, Illinois 60076.

We would like to be of service.

TELETYPE
machines that make data move

Teletype is a trademark registered in the U. S. Pat. Office

Want to hire that elusive executive?

You'll have to answer his complaints as a job hunter first, which may mean updating your company's hiring procedure.

The increasing complexity of management, some "dead wood" cut during the slump and still "floating" in the market, and the population "dent" in the executive age group have all contributed to making hiring procedures in many companies obsolete.

The abundance of executive talent on the market has resulted in relaxation of hiring procedures in many companies, rather than hard-headed re-evaluation. It's important for you, as an engineer planning to become part of management, to decide which of your company's hiring procedures may be out of date.

Generally speaking, most companies have no appropriate plan for hiring executives. The initial procedures used by firms are often the same as those used in hiring clerical personnel, and no company gains insight into an executive's ability by asking him what subjects he liked best in school.

One of the best starting points for evaluating your company's method of hiring is to consider the viewpoint of the candidates. By talking with a number of them, I turned up the following four ways that companies reportedly discourage key prospects:

1. *Lack of a specific job description.* The description given the employment agency is generally so broad that many who apply would obviously not be interested or qualified. Too often the only way the potential applicant can determine the nature of the position is by interviewing the interviewer.

2. *Lack of realistic qualifications.* The "man of 35 with 50 years of experience" is still incredibly popular.

3. *Lack of organized interviews.* Failure to review the job prospect's background results in an interview that is haphazard and undirected. Also, areas to be explored are often not divided among the interviewers, resulting in annoying repetition and little exploration in depth.

4. *Lack of discriminate testing.* Psychological

tests are often given before mutual interest has been determined. At times these tests are administered routinely and not explained properly.

Job descriptions that do the job

A job description was once considered complete if it included a summary of responsibilities and the major tasks required. Today, the company should also highlight the opportunities that will attract top men; it should fill the job's present and future commitments.

To expand the dimensions of a job description, ask yourself these three questions:

- What more can this job accomplish under present conditions? Can it be enlarged through new talents, new attitudes or new facilities? Also, what company plans or industry trends may cause this job to change?

- How can this job better complement the flow of work? For the good of team management, the need for gearing in with other responsibilities may sometimes take precedence over the responsibility of the job itself.

- How will a new job affect the existing operation? In drawing up the new job, try to minimize prospective conflicts with other departments, and wherever possible add new advantages to the status quo.

What it takes to fill the bill

In today's world of business neither the man nor the job is likely to be static and quantifiable; they cannot be measured and matched perfectly. Although you'll want to start your search with a clear idea of man specifications, you should make a distinction between what is mandatory and what is merely desirable.

Be advised, however, that mandatory requirements are much too often set arbitrarily. Sometimes they grow out of an attempt to avoid the weaknesses of the man you're replacing; sometimes they're an unconscious attempt to find someone just like him. Hiring plans that are designed for the team concept in management should include a list of mandatory requirements

J. Paul Pless, Director of Executive Training, Jewish Home and Hospital for the Aged, New York, N. Y.

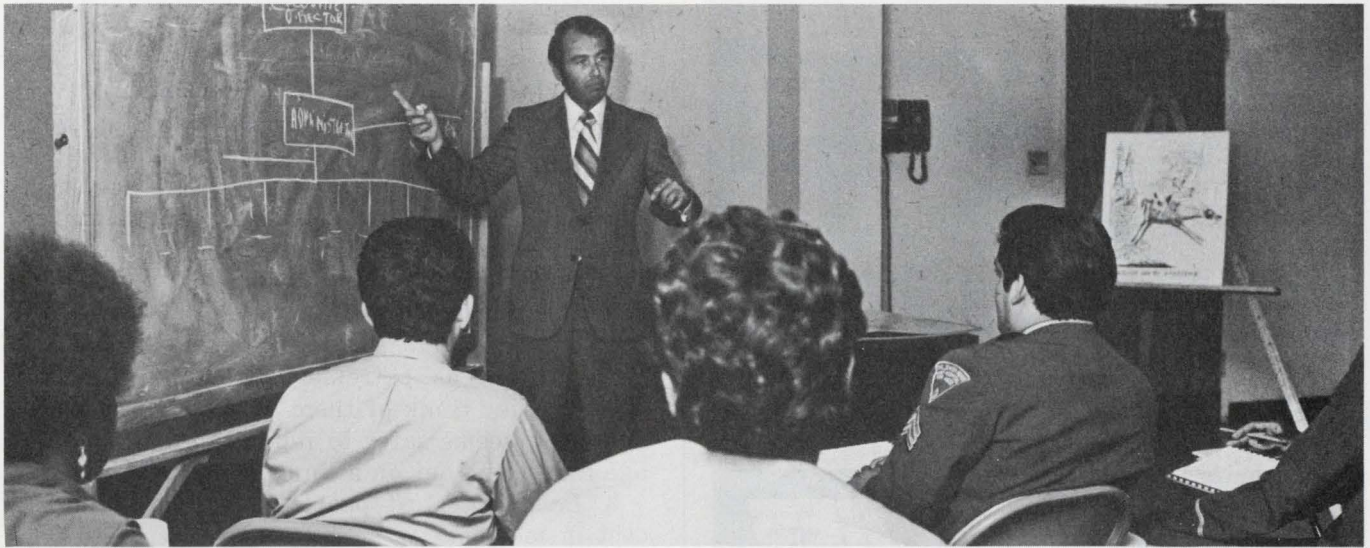

Author/training-director Jeff Pless instructs one of his classes in the art of supervision.

that complement those skills already available on your staff.

Also, where requirements are concerned, a helpful question to ask is: "How long can I allow for the man to grow into his job?" If you consider the amount of time the company can afford before the man on the job must produce, you may find that your demands for the job are stretchable. Making a choice, for instance, between an experienced, but limited, man and a promising, but inexperienced one can best be done with a deadline in mind.

Try to keep such specifications as age, specific industry experience, education and personal characteristics secondary to the over-all requirement—finding a man who can fill the job successfully. Unrealistic requirements, particularly with respect to age and specific trade experience, are still listed as among the most common reasons for failure to find the best executives.

Producing the productive meeting

If your present personnel staff does not have the proper manpower or facilities to tackle the top-level situation effectively, it pays to assign one member of your management group to do the job. The employment form used should focus on business experience and job success, because this is the yardstick that reflects the combination of a man's mental and technical abilities, his personality and general adjustment. What he emphasizes, and how, on the form helps you to evaluate his executive ability.

Open the interview by giving the candidate an over-all picture of your company—its history, products, markets, facilities and organization. Then outline the job in some detail, answering questions as they come up.

Ask the individual: "How does your experience tie in with the job description?" His answer will

show how he analyzes the job and how he organizes his thoughts. Present an actual problem in the man's field and ask him how he would handle it. Problem-solving discussions provide a proved way of evaluating engineers.

Keying the conversation to the applicant's experience and job success, ask for before-and-after figures in connection with a project he says he has directed. Or ask: "What new techniques did you introduce while you were in charge?" And: "How did you overcome resistance?"

Don't overlook the opportunity to present a good image of your company, even to those candidates who seem unsuitable for the job. They will probably end up as executives in other firms, and a good impression now may pay off for your company in the future.

The second meeting is usually the critical one. At your first get-together, you and candidate were both subject to "first-impression optimism." A second meeting gives you a chance to test impressions, size up what the other has to offer and confirm mutual interest.

While you're weighing the candidate, chances are he'll be weighing your company against his present one or against others offering job opportunities. Hence use the follow-up meeting to demonstrate those benefits of the job, the company and the community that your previous talks indicated will appeal most for him. Too often a tour of the factory is standard treatment when the applicant is much more interested in a tour of the community or an opportunity to get better acquainted with prospective co-workers.

Bias obviates objective evaluation

Your first impressions of a candidate may be erroneous. Researchers have found that because of our own personalities, we are likely to see only part of the truth about a man or his performance.

PUSH BUTTON MINIATURES

MSPN SERIES

Lighted snap-action DPDT models handle 6A @ 125 VAC & features separate connections to T-1 $\frac{3}{4}$ lamp. $\frac{1}{2}$ ", $\frac{5}{8}$ ", $\frac{3}{4}$ " round or square buttons; transparent or translucent colors. P.C. side terminals.



ALCOSWITCH® ILLUMINATED

DIV. OF ALCO ELECTRONIC PRODUCTS, INC., LAWRENCE, MASS.

INFORMATION RETRIEVAL NUMBER 91

PUSH BUTTON MINIATURES

Push-ON, Push-OFF

Exceptionally high current. 6A @ 125 VAC. Snap-action with fast make and break contacts. SPDT, DPDT & 4PDT, usable as either Norm. Open or Norm. Closed switch. Silver contacts & terminals.

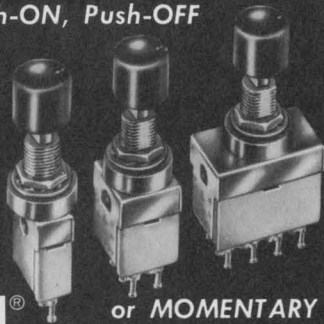

ALCOSWITCH® or MOMENTARY

DIV. OF ALCO ELECTRONIC PRODUCTS, INC., LAWRENCE, MASS.

INFORMATION RETRIEVAL NUMBER 92

ROCKER & PADDLE MINIATURES

New series of economy "snap-in" switches have high 6 amps rating. Features ease of installation in .49 x .59" hole. Choice of SPDT & DPDT in 4 colors, adds distinction to front panel. Molded "silver" terminals & contacts.

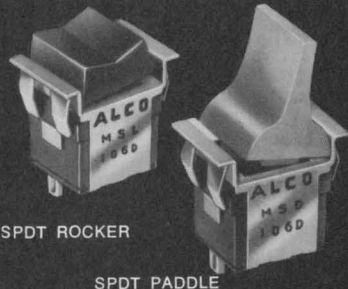

SPDT ROCKER

SPDT PADDLE

ALCOSWITCH®

DIV. OF ALCO ELECTRONIC PRODUCTS, INC., LAWRENCE, MASS.

INFORMATION RETRIEVAL NUMBER 93

ROCKER SWITCH

ILLUMINATED

New brilliance in a miniature rocker featuring front panel lamp replacement. Entire switch simply snaps into .655" x .728" hole. Choice of 3 doublepole switching actions; 4 lens colors & 4 voltages. Replaceable lamp. Rated 6A @ 125 VAC.



MSLN-206
DPDT

SNAP
IN AND
OUT!

ALCOSWITCH® MINIATURE SIZE

DIV. OF ALCO ELECTRONIC PRODUCTS, INC., LAWRENCE, MASS.

INFORMATION RETRIEVAL NUMBER 94

Blind spots that may block an interviewer when he appraises an applicant are:

1. *Halo effect.* A prospect may have a very pleasant personality. Because we like him, we're inclined to overestimate his intelligence. The good verbalizer can often fool you, too. He seems capable of outstanding performance, but his fluency may indicate a handicap. His inefficiency may have forced him to become a "talker" because he is not a "doer."

2. *Central tendency.* Most people hesitate to judge others as extremely poor or extremely good, so they think of them as somewhere in the middle. It seems safer to judge the man as average than to go out on a limb.

3. *Leniency.* Most people try to be kind. Except in moments of actual annoyance, they tend to make the most of good points and overlook the negative aspects.

4. *Familiarity.* Sometimes an executive downrates a man because he knows him too well, while a competing candidate presenting only his best qualities strikes him as being much better.

5. *Personal idiosyncrasy.* A man's personality or his mode of dressing may be displeasing.

Recognizing that biases can enter into the appraisal of a candidate—no matter how many opinions are sought—many companies insist on adding a more objective evaluation into the final decision. Two methods are widely used to obtain more information about prospective employees, but opinions as to the value of these methods are sharply divided.

Psychological tests are used by some companies. Experience has been that in hiring executive personnel, the use of tests is limited because (1) There's difficulty in translating successful executive performance into factors that can be measured by psychological tests; (2) Tests are not always selected, validated, administered and interpreted by trained personnel; and (3) Tests engender a negative reaction in many people, especially at higher job levels.

Many firms today are using an experienced psychologist to conduct an in-depth interview with the two or three candidates who have survived preliminary screening.

There is no guarantee that your final decision will be an easy one—even after employing the most painstaking hiring procedures. In fact, after seeing a parade of candidates, the temptation may be strong to cut loose from the problem by forcing a decision.

Never hire a man in desperation, for expediency or on a "better than nothing" evaluation. Unless you are fully satisfied that your candidate can do the job and hold his own against his counterpart in your competition, look further. A wrong choice now will result in another search later—and under more difficult circumstances. ■■

Save \$15 on our new communications kit and get something special in your system.

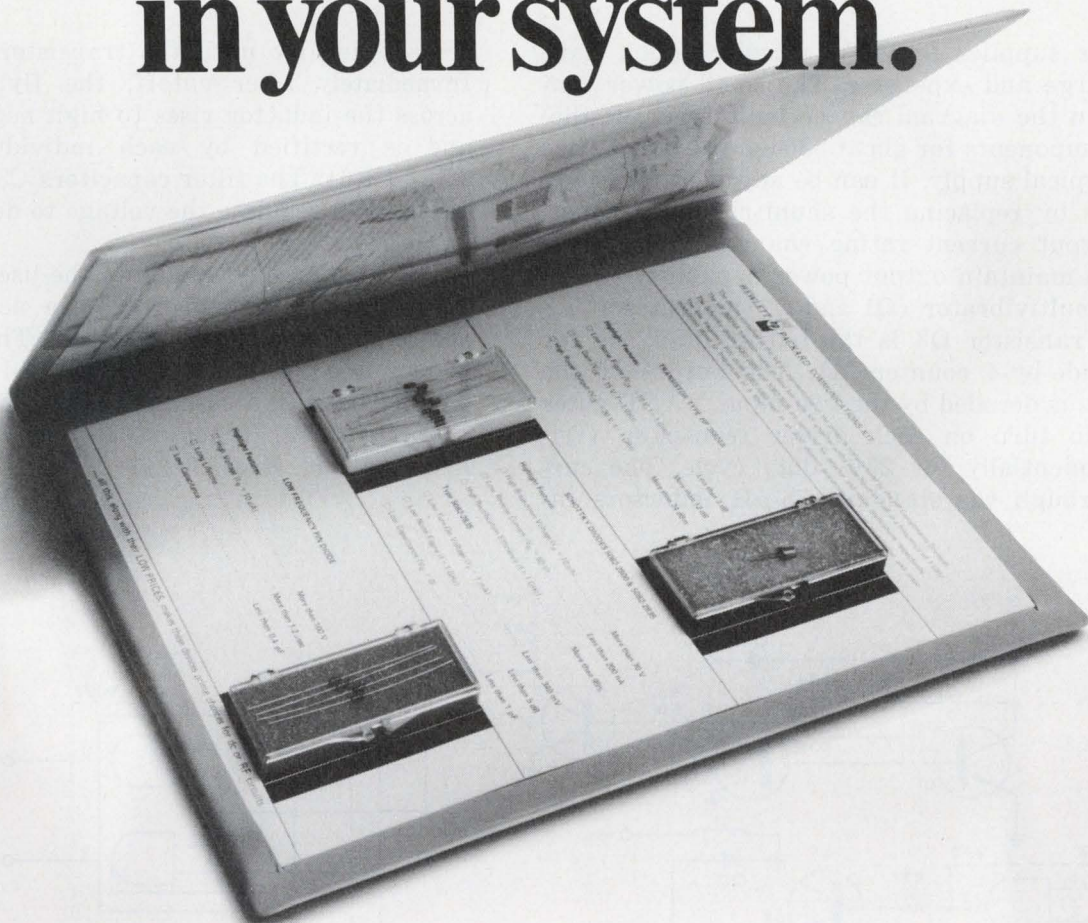

The kit contains 12 Schottky diodes, 4 pin diodes, and one low-noise transistor. As well as application notes and data sheets.

If you bought these components separately, it would cost you more than \$34. But right now you can buy the whole kit and kaboodle for \$19.40. We're sure that once you've tried them, you'll come back for more.

This is the kind of performance that will bring you back. The HP 2800 Schottky diode is ideally suited for high level detector applications with a breakdown voltage of 70 volts. The HP 2835 Schottky diode with a breakdown voltage of 5 volts and a forward voltage drop of .33 volts at one mA makes an ideal VHF/UHF mixer.

The HP 3080 pin diode as an AGC element guarantees low cross-

modulation and intermodulation down to frequencies of 5 MHz. The HP 35824A transistor makes an ideal low noise RF amplifier with a noise figure of 3 dB at 1 GHz.

So if you're looking for ways to improve the performance of your RF amplifiers, mixers, detectors or AGC's, tear out the coupon and a check and send them both in.

You may also want one of our very popular Schottky diode kits. For \$8.40, you get eight each of three different Schottky barrier diodes. Try them and see what a difference they make in your circuits.

Clip this coupon and mail with check, money order or P.O. to: Hewlett-Packard Associates, 620 Page Mill Road, Palo Alto, California 94304. Your local HP sales office can also handle the order.

\$34.00 value for \$19.40!

(offer expires on January 31, 1972)

- Send me one of your communications kits. (HP 5082-0051)
- Here's \$8.40 for a diode kit. (HP 5082-0050)
(California residents add 5% sales tax)

Name _____

Company _____

City/State/Zip _____

- Frequencies less than 10 MHz
 10 to 250 MHz 250 to 500 MHz
 500 to 1000 MHz greater than 1000 MHz

HEWLETT  PACKARD

COMPONENTS

01109

INFORMATION RETRIEVAL NUMBER 44

MOS power converter is small and costs \$30

Power supplies for MOS circuitry don't have to be large and expensive. The small power converter in the diagram can be built from off-the-shelf components for about \$30—a third the price for a typical supply. It can be adjusted for many voltages by replacing the shunt-regulator zener. The output current rating changes correspondingly to maintain output power capability.

The multivibrator (Q1 and Q2) operates at 1.3 MHz. Transistor Q3 is the buffer interface for the divide-by-4 counter M1. The output of the counters is decoded by the two-input NAND gates (M2) to turn on each driver transistor (Q4-Q7) sequentially for 25% duty cycle. The current through the standard 75- μ H inductors in-

creases linearly until the transistor cuts it off. Immediately after cutoff, the flyback voltage across the inductor rises to high negative values and is rectified by each individual rectifier (CR3-CR6). The filter capacitors C3 and C6 and zener CR-9 regulate the voltage to deliver -22 V at 60 mA.

The high frequency allows the use of standard TO-5 transistors, which require no heat sinks, and of standard 75- μ H inductors. The whole unit is mounted on 3 x 2-3/4 x 7/16-inch printed-circuit board in a standard card-rack assembly.

M. Deranian, Honeywell Information Systems, Framingham, Mass. 01701

VOTE FOR 311

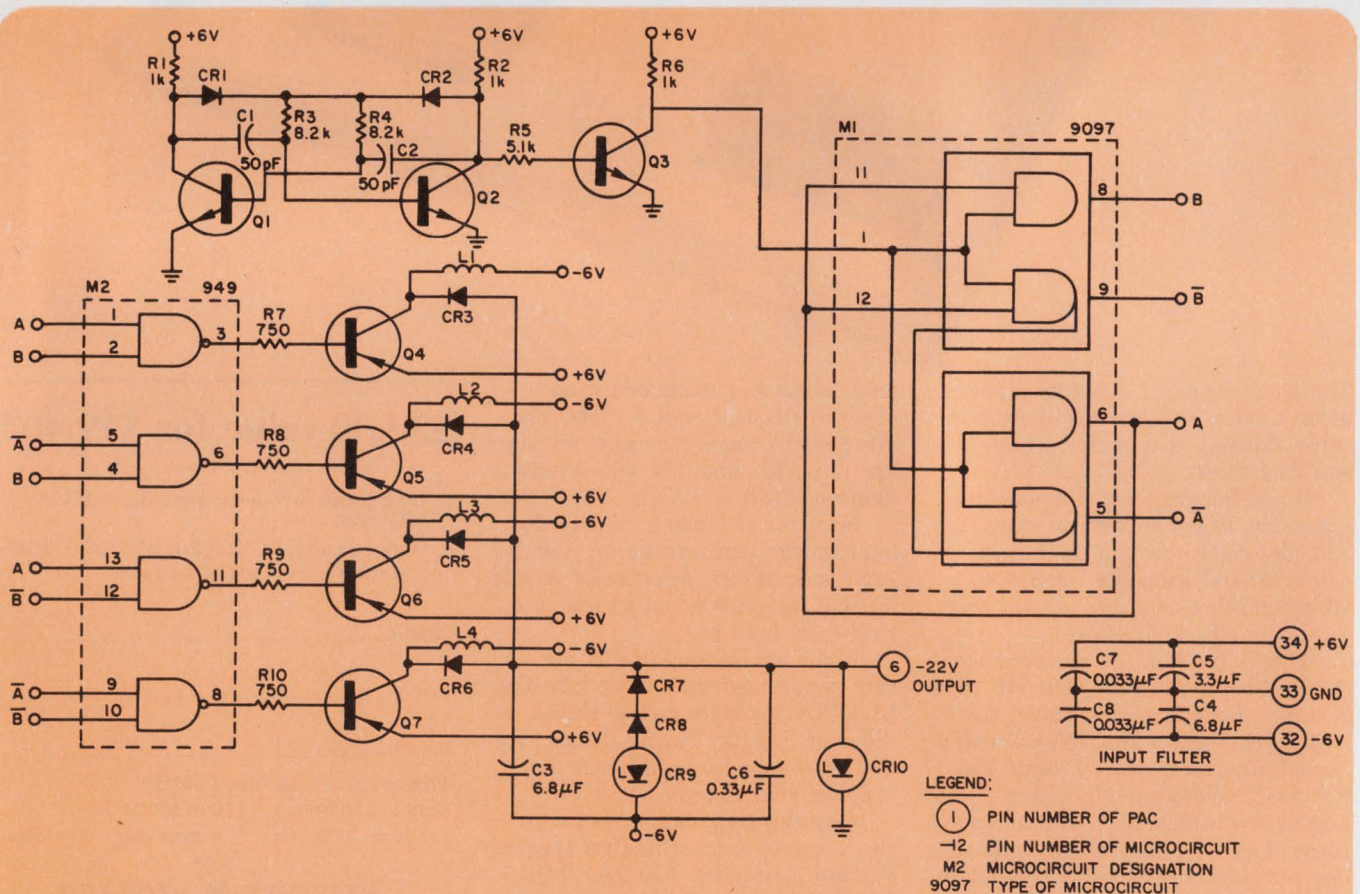

Built from off-the-shelf parts, this power converter for MOS circuitry can be extended to cover posi-

tive voltages by using inverters and npn driver transistors. Bulky coils are eliminated.

Look how we widened a credibility gap.

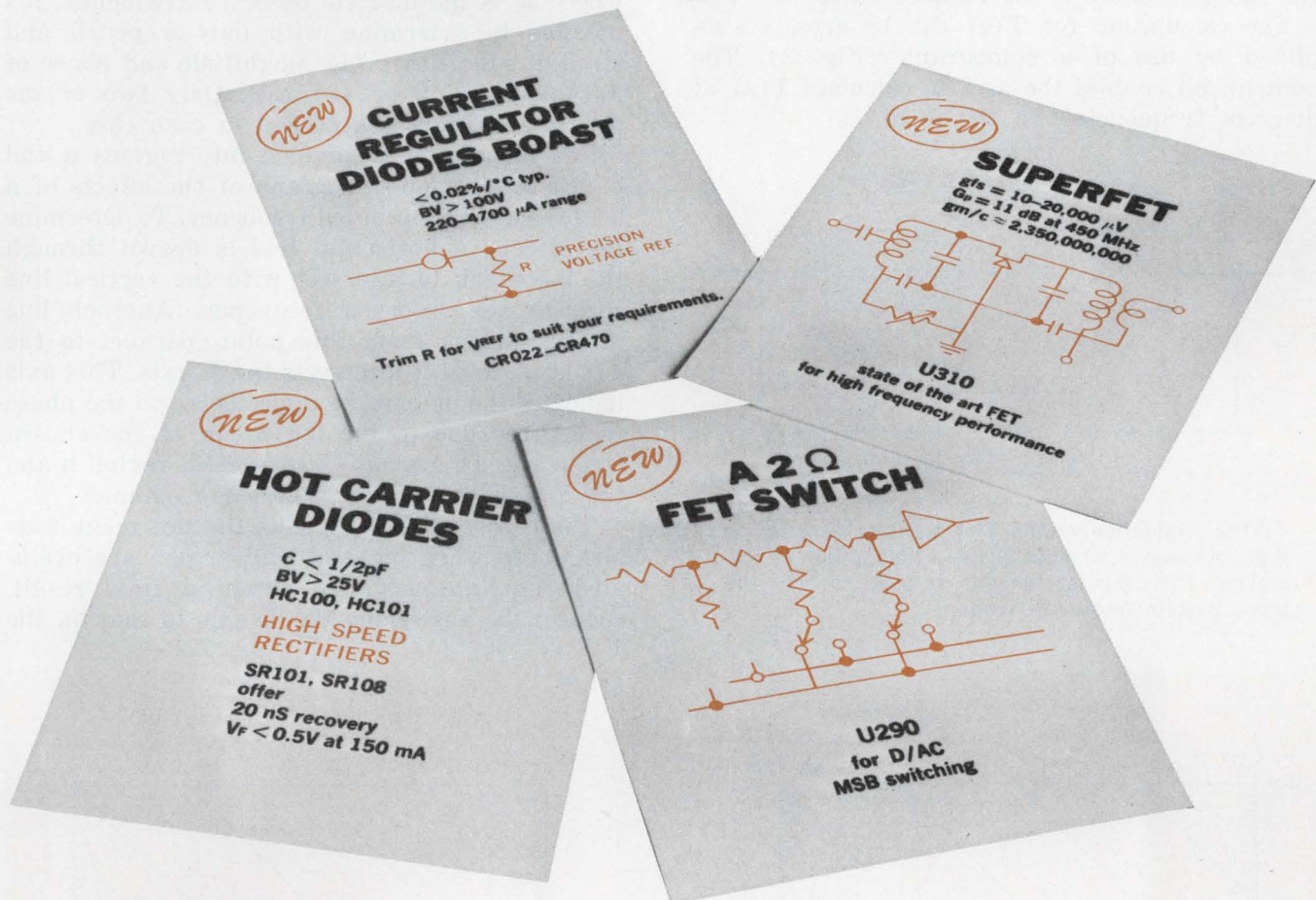

We've done it again — four more times, in fact. We've left our competition blinking in wonder.

Study the four winners above carefully. They have performance characteristics our competition finds hard to believe.

For example, we call U310 "SuperFET" because of its high g_{fs} and g_{fs}/c . Our CR Series Current Regulators have \approx zero temperature coefficient. Our U290 switch has the lowest ON resistance in the industry and the lowest price. Our HC 100/101 Schottky Diodes fea-

ture picosecond switching times and SR108 has $V_f < 0.5 \text{ V}$ at 150 mA.

The point is: we immodestly feel that anybody who can produce these four devices at competitive prices must be leading the field in advanced technology. Best of all, they are only a few samples of our latest talents.

So whether your application calls for something special, or off the shelf, just let us know.

You can believe you'll get the best.



Siliconix incorporated

2201 Laurelwood Road • Santa Clara • Calif. 95054
Phone (408) 246-8000 Ext. 201 • TWX: 910-338-0227

Siliconix distributors. Hamilton/AVNET, Semiconductor Specialists, Cramer Electronics, Liberty Electronics, Elmar Electronics, Western Radio, Norelcom. **Siliconix sales offices.** Bethpage, New York (516) 796-4680 / Norwood, Massachusetts (617) 769-3780 / St. Louis (314) 291-3616 / Minneapolis (612) 920-4483 / Long Beach, California (213) 420-1307 / Santa Clara, California (408) 246-8000 / San Diego, ZE 7-1301 / Denver (303) 744-0404 / Phoenix (602) 947-3183. **Overseas sales offices.** Siliconix Limited, Saunders Way, Sketty, Swansea, Great Britain / Siliconix GmbH, 7024 Bernhausen, Postfach 1340, W. Germany / Siliconix S.A.R.L., 94-Saint-Maur, France, Tel. 283-57-90.

Nomograph speeds design of lag/lead network

In the design of closed-loop systems, it's frequently necessary to alter the system frequency response by inserting some type of lag/lead network into the main path of the system. This is shown in Fig. 1, where $T(s)$ is the added transfer function and s is the Laplace variable.

The calculation for $T(s)$ can be greatly simplified by use of a nomograph (Fig. 2). The nomograph enables the user to calculate $T(s)$ at discrete frequencies. In the form

$$T(s) = \frac{\left(1 + \frac{s}{\omega_{\text{lead}}}\right)}{\left(1 + \frac{s}{\omega_{\text{lag}}}\right)} \Big|_{s = j\omega_0}$$

where ω_0 is the discrete observed frequency, it's possible to determine with only a pencil and straight edge either (1) magnitude and phase of $T(s)$; (2) ω_{lead} , or (3) ω_{lag} . Only two of the three parameters are needed in each case.

The nomograph is divided into regions a and b. The left region is a graph of the effects of a lag break vs the observed frequency. To determine the effects, a horizontal line is drawn through the lag break to intersect with the vertical line through the observed frequency. Another line is then drawn from this point, parallel to the 45° lines, until it intersects the X axis. This axis indicates the magnitude in decibels and the phase in degrees due to the lag break at the chosen frequency. To evaluate lead breaks, region b and the Y axis are used in the same manner.

The center scale, C, yields the net magnitude and phase when lag and lead breaks are evaluated simultaneously. To obtain a final result, connect the answer on the X axis to that on the

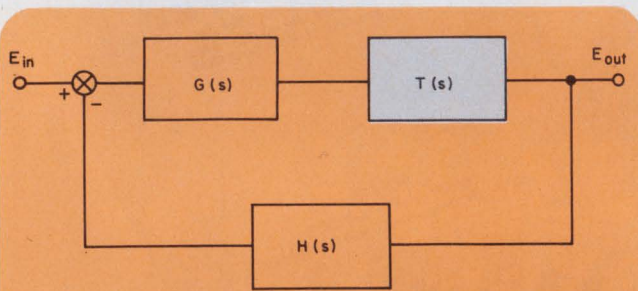

1. The evaluation of the $T(s)$ transfer function is greatly speeded when a lag/lead nomograph is employed. This transfer function is used to alter the basic system frequency response.

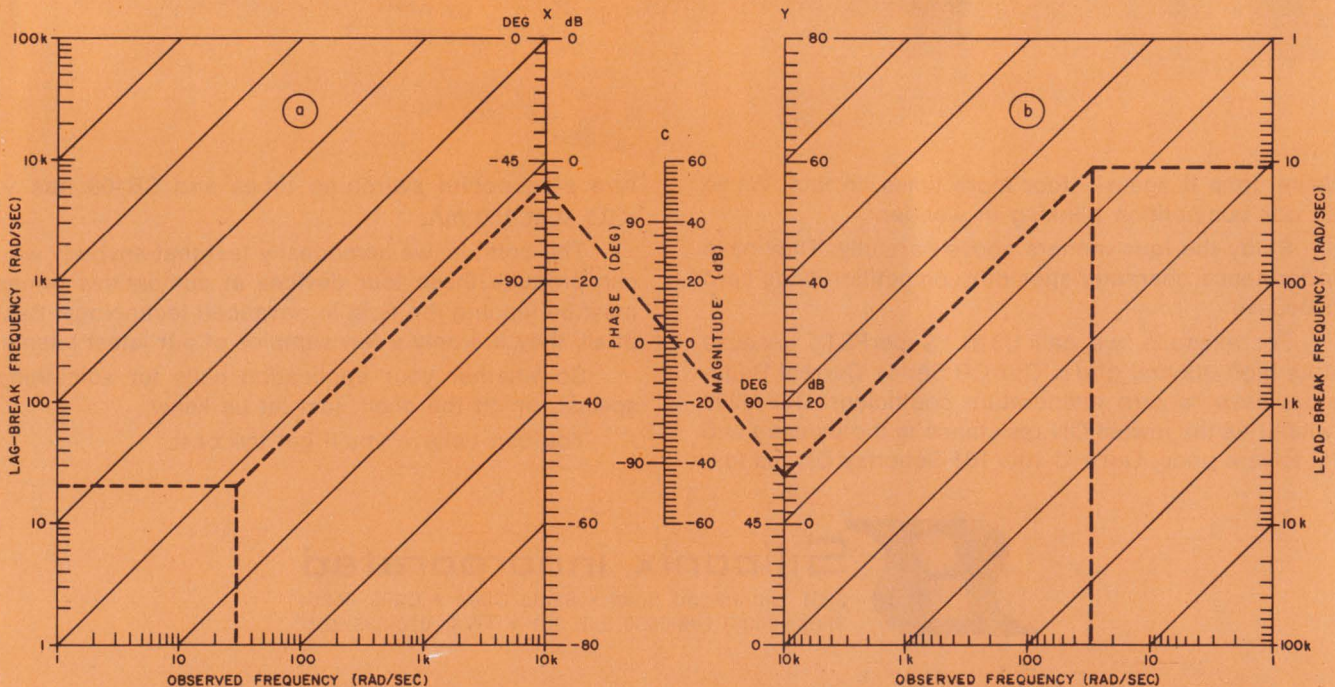

2. A lag/lead nomograph, with regions a and b, aids in the calculation of lag-break effects in region

a and lead-break effects in b. The center scale, C, is used for both lag and lead breaks.



HELIPOT BREAKS THE HALF-BUCK BARRIER.

Here they are: the best buys. Our new Series 72 single-turn $\frac{3}{8}$ " cermet trimmers at an eye-opening 49¢ each in the 1,000 quantity. They're equally well-priced in other quantities, too. One alone costs just 70¢.

But there's also that dependable Helipot quality and performance, plus things you don't get elsewhere. Like our resistance and slider stability . . . change is less than 0.5% in the first 1,000 operation hours, progressively less thereafter. Impressive, when the life expectancy exceeds five years' continuous duty under full-rated power. And the Series 72 sealing — compatible with wave soldering, low-viscosity potting, and board washing even with chlorinated solvents.

Add the wide range of values, ± 100 ppm/ $^{\circ}$ C tempco, and off-the-shelf availability from 17 nationwide stocking points and what have you got? The best reasons in the world for requesting complete specs and data on this breakthrough line of Helipot cermet trimmers. Do it now — it won't cost you a cent.

Beckman®

INSTRUMENTS, INC.
HELIPOT DIVISION
FULLERTON, CALIFORNIA

HELPING SCIENCE AND INDUSTRY IMPROVE THE QUALITY OF LIFE.

INFORMATION RETRIEVAL NUMBER 45

Y axis. The final answer is the point of intersection of scale C.

Here is an example: Assume a system in which a lead break must be positioned in such a way that, when it is combined with a predefined lag positioned at 20 rad/sec, the system has 10° of lead phase at 30 rad/sec. The positioning of this break is determined as follows:

1. Draw the vertical and horizontal lines for the lag break in region a.

2. From the point of intersection, draw the 45° line that will intersect the X axis.

3. From the X axis intersection, draw a straight line through the +10° point on the C scale until it intersects the Y axis.

4. Draw a line from the Y axis intersection parallel to the 45° lines in region b, until the vertical line drawn through the observed frequency is intercepted.

frequency is intercepted.

5. Draw a horizontal line through this point to the lead-break frequency axis for that frequency.

If a lag or lead break at the observed frequency has a phase in the region $-90^\circ > \text{phase angle} > 90^\circ$, the observed frequency is more than a decade past the break frequency, and the magnitude and phase must be treated independently. The magnitude is treated as in the example, but to determine the correct phase, the value of phase on the X or Y axis must be marked off as the asymptotic value $\pm 90^\circ$. This point is then used to determine the effect of lag/lead combinations.

Edwin R. Howard, Computer Applications Engineer, United Aircraft Corp., Norwalk, Conn. 06856.

VOTE FOR 312

Inexpensive circuit extends low-cost unijunction range

Sawtooth oscillator circuits with a wide range of charging resistance and capacitance can be built with a low-cost unijunction transistor. All that's needed to extend the range of the unijunction is a single 24¢ transistor in a simple circuit.

Without the added transistor, a unijunction like the 70¢ D5E43 has valley current, peak-point emitter leakage and an intrinsic standoff ratio that limit its use in a sawtooth oscillator circuit. With the 24¢ transistor, the need for expensive unijunctions, like the \$7.70 2N494, is eliminated in many cases.

In the diagram, transistor Q₁ assists in rapidly discharging C to a point below the valley voltage of the UJT, so that the UJT cannot sustain conduction even for low values of R. The base of Q₁ is driven by the same capacitor, C, through the UJT emitter-to-base 1 path as soon as the UJT triggers. A negative bias supply is required, since the interbase resistance of the UJT would otherwise produce a positive bias at the Q₁ base.

Base 2 of the UJT is returned to a zener-regulated 9 V rather than to the 16-V charging voltage, to lower the peak-point firing voltage and to linearize the sawtooth waveform. This also reduces the effects of leakage, making it possible to use higher values of R.

It's possible to operate the circuit with values of R from 500 Ω to about 3.6 MΩ—and, with reduced C, to frequencies as high as 100 kHz. With

C=1.0 μF, the sawtooth discharge time is 10 μs and quite linear, indicating a constant-current discharge of about 400 mA through the 800-mA-rated 2N5451. In contrast, an unmodified circuit, with a 1.0-μF capacitance and a 20-Ω base-1 resistor, has an approximate fall time of 200 μs with R limited to the range of 2.2 kΩ to 1.2 MΩ.

R. W. Johnson, Consulting Engineer, R. W. Johnson Co., 7511 Clay Ave., Huntington Beach, Calif. 92648.

VOTE FOR 313

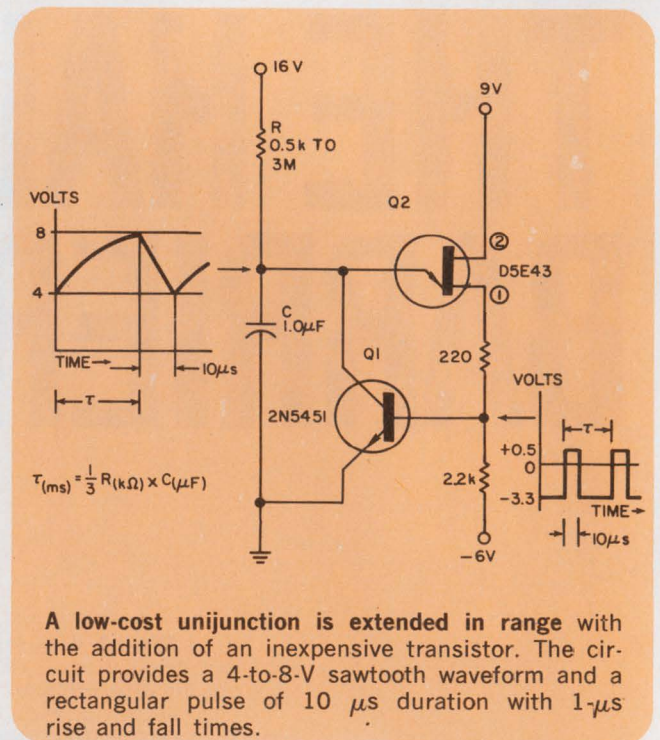

The first desk-top DZM*

Someday you will turn to a CRT terminal on your desk for computer assistance on all your design efforts.

Someday a desk-top copier will give you instant access to texts and catalog information, via display or hard-copy reproduction.

Someday you will not only see and talk to a caller, but exchange documents with him from your desk.

Today, on your desk, you can have the first of these instant-information machines, one you will use regularly to characterize components for your designs, fast, accurately, easily. Why wait?

The new GR 1684 DZM measures resistance, inductance, and capacitance, at the push of a button to 1% accuracy on a 4-place digital readout. No more manual null balancing and interpolating analog results. Yesterday's methods are gone. The 1684 belongs on your design desk today.

And, for the day when your CAD's include computer-evaluated components, the 1684 has a data-output option for direct computer input of component characteristics.

Now consider the DZM's measurement ranges of 2,000,000,000:1, six-terminal connections for stray-free and in-situ accuracy, optional dissipation factor readout, small size, bright styling, and low \$1050 price.

The GR 1684 is the first of the new breed of economical, general-purpose impedance bridges. You should have one.

Demonstrators are now available world-wide. Telephone your nearest GR office or write GR, 300 Baker Avenue, Concord, Mass. 01742. In Europe, write to Postfach124, CH 8034, Zurich, Switzerland.

Prices are net FOB, Concord, Mass.



General Radio

NEW YORK (N.Y.) 212 964-2722 (N.J.) 201 791-8990 • BOSTON 617 646-0550
 CHICAGO 312 992-0800 • WASHINGTON, D.C. 301 881-5333 • LOS ANGELES 714 540-9830
 TORONTO 416 252-3395 • ZÜRICH (01) 55 24 20
 GRASON-STADLER 617 369-3787 • TIME/DATA 415 327-8322



*Digital Impedance Meter

Improve MOS multiplexing with a precision system

The major problems that arise when MOS devices are used in common multiplexing applications involve signal distortion, large common-source capacitance, temperature-dependent transfer functions, interface circuit when the drive is obtained from TTL/DTL levels, leakage current from substrate to source and switching transient noise.

The circuit shown offers a solution to all of these difficulties. The source of the signal switching-transistor is connected to the virtual ground of the first amplifier. The gate-source voltage of the signal switching-transistor does not change significantly with signal excursions, and the channel resistance thus remains fairly constant, reducing harmonic distortion.

Since the common source is connected to a virtual ground, the large capacitance that may be present is not subject to large charging voltages. The capacitance does not load the input signals and the transients produced by switching from one channel to another are much reduced.

The temperature dependence of the transfer function is reduced by an order of magnitude

by the use of an MOS transistor in the feedback path of the amplifier, which is connected for unity gain.

The second amplifier provides gain and a second signal inversion. The use of two amplifiers in this manner allows large signals to be obtained without using a high reverse-bias on the substrate of the MOS transistor, and a large negative voltage to keep the device ON during the negative excursion of the signal.

The problems involved in driving the MOS devices from TTL/DTL levels have been avoided by using M1202/1402 silicon-gate MOS transistors. The narrow threshold voltage range (-1 to -2 V) allows the devices to operate in a simple interface circuit as shown.

The autoregistration feature of the silicon-gate process reduces the gate overlap capacitances in this type of device to 0.3 pF—about five times lower than the overlap capacitances of a conventional $300\text{-}\Omega$ MOS device. The portion of the switching transient due to overlap capacitance is thereby reduced by using silicon gate devices.

J. A. Roberts & J. Driscoll, G.E.C. Semiconductors Ltd., Freebournes Road, Witham, Essex, England.

VOTE FOR 314

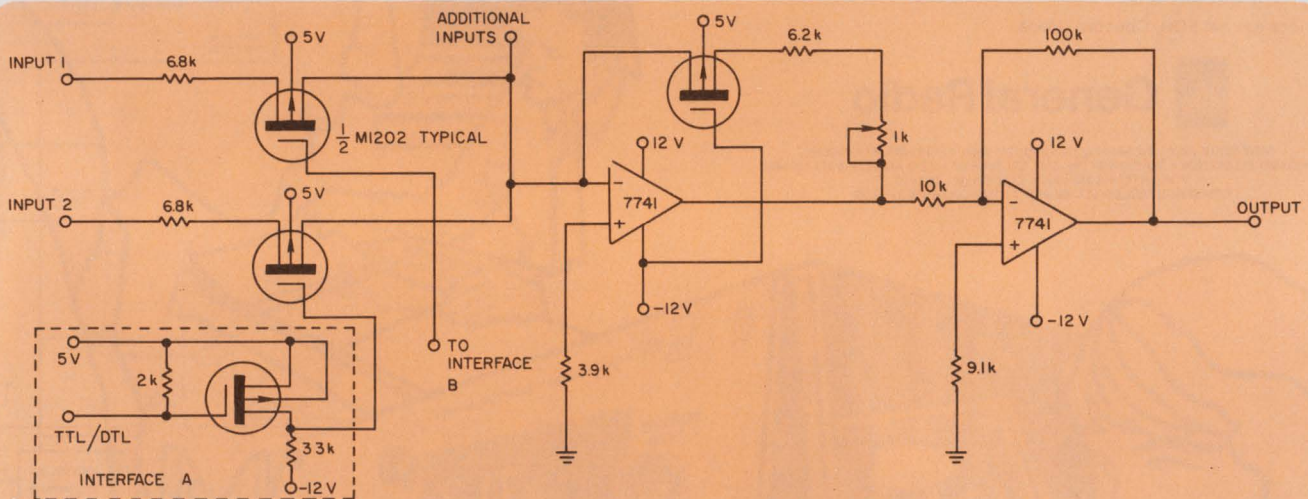

A basic rearrangement of the usual MOS multiplexer results in a precision multiplexing system.

The number of input channels can be readily extended beyond the two shown here.

IFD Winner for June 24, 1971

Mogens Ravn, Digital Systems Applications, Fairchild Semiconductor, 464 Ellis St., Mountain View, Calif. His idea "Simple Clock Generator Has Guaranteed Start-Up" has been voted the Most Valuable of Issue award.

Vote for the Best Idea in this issue.

VOTE! Go through all Idea-for-Design entries, select the best, and circle the appropriate number on the Reader-Service-Card.

SEND US YOUR IDEAS FOR DESIGN. You may win a grand total of \$1050 (cash)! Here's how. Submit your IFD describing a new or important circuit or design technique, the clever use of a new component or test equipment, packaging tips, cost-saving ideas to our Ideas-for-Design editor. You will receive \$20 for each accepted idea, \$30 more if it is voted best-of-issue by our readers. The best-of-issue winners become eligible for the Idea Of the Year award of \$1000.

Are nervous resistors giving your products the jitters?

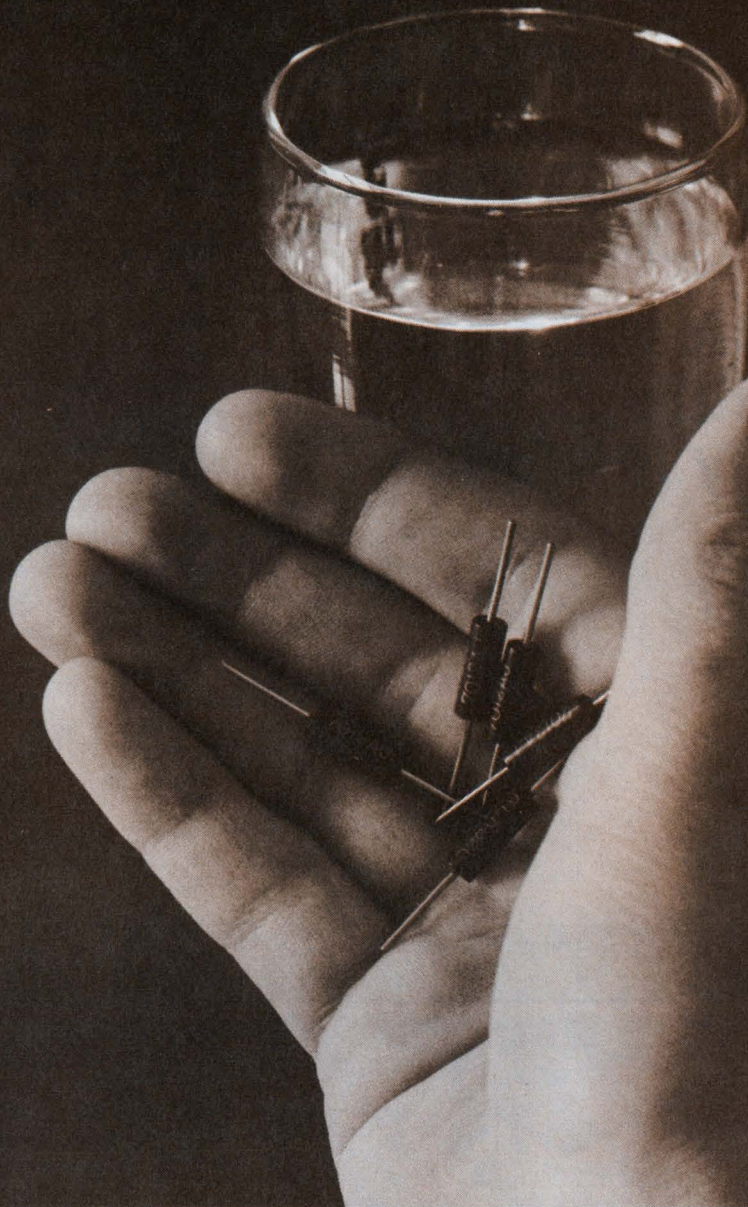

Stabilize with Metal Glaze™

Stability. The magic word in electronic components. And in resistors, the word for stability is Metal Glaze. And the word is out, because millions are already in field use.

Metal Glaze, noted for its mechanical and electrical ruggedness, is also an extremely stable resistive system. Operated at rated power, and in many cases at twice rated power, Metal Glaze resistors go coolly along, resisting change for thousands of hours. They are truly precision resistors, and we have reams

of test printouts to prove our case.

The glass-hard Metal Glaze film is permanently fused to a solid ceramic core. The lead wire terminations are soldered to the core in a patented process. This makes the resistive element and the terminations one continuous component ready for molding in an environmentally protective envelope.

Competitively priced in power ratings from 1/8 watt to 2 watts, Metal Glaze resistors are available to 1% tolerance, and 100 ppm temperature coefficient.

TRW Metal Glaze resistors are available in quantity from your local TRW industrial distributor. Or contact TRW Electronic Components, IRC Boone Division, Boone, North Carolina 28607. Phone (704) 264-8861.

TRW[®]
IRC RESISTORS

INFORMATION RETRIEVAL NUMBER 47

Now, there's a digital voltmeter that offers a combination of capabilities never before available. The new Hewlett-Packard 3403A.

Outstanding features of the 3403A are its eight-decade bandwidth, its six-decade ac voltage range (10 mV to 1000 V full-scale), its ability to measure both simple and complex signals with great accuracy ($\pm 0.2\%$ reading $\pm 0.2\%$ range), and its advanced, solid-state 3-digit display.

With the 3403A, you can measure ac, dc, or ac + dc, with **true-RMS accuracy**—and get your readout in either volts or dB. Its wide voltage range, and **extraordinarily wide fre-**

quency range give it unprecedented versatility. Its **direct readout in dB** makes it a "natural" for all kinds of communications work. And its ability to measure complex signals with crest factors as high as 10:1 makes it especially useful for noise measurement.

The 3403A is available with a wide variety of options and accessories, including dB display, autoranging, isolated or nonisolated digital output, isolated remote control, printer cables, active probes, and a rack adapter frame...making it ideal for systems applications, as well as lab and production work.

The 3403A's price ranges from \$1400 to \$2100, depending on options. An ac-only version, the 3403B, is also available, starting at \$1150. For further information on the versatile new 3403A, contact your local HP field engineer. Or write Hewlett-Packard, Palo Alto, California 94304. In Europe: 1217 Meyrin-Geneva, Switzerland.

091/19

HEWLETT  PACKARD

DIGITAL VOLTMETERS

HP's new 3403A voltmeter puts it all together... at an amazingly low price

- True-RMS accuracy
- AC from 2 Hz to 100 MHz, plus DC
- Digital readout, in volts or dB



new products

Micro-power, state-variable filter decodes tones over two octaves

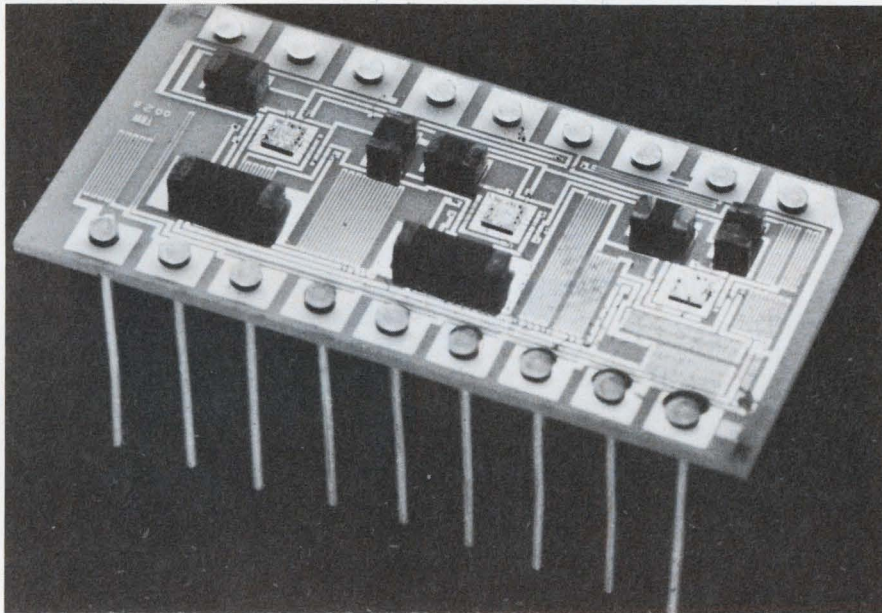

TRW Semiconductor, 14520 Aviation Blvd., Lawndale, Calif. Phone: (213) 679-4561. P&A: \$45 (1 to 99), \$33 (100 to 999); 30 days.

Developed for use in high-speed, multi-tone sequential, tone-decoding systems, a unique new thin-film hybrid active bandpass filter provides over two octaves of bandwidth, microwatts of power dissipation and pin-selectable frequency programming versatility.

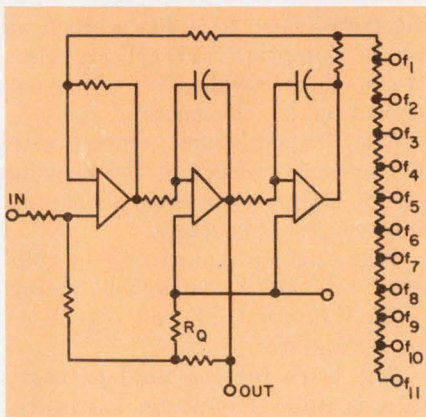

A new multi-tone active filter allows independent frequency and Q adjustments. Its design allows center frequency to be determined by the attenuation in the upper feedback loop

The filter spans a frequency range of 400 Hz to 2 kHz and a Q range from 1 to 150. It features excellent frequency stability of $\pm 0.005\%/^{\circ}\text{C}$.

Frequency range and stability result from the use of cermet resistive elements with a temperature coefficient of only $-50\text{ ppm}/^{\circ}\text{C}$ and sheet resistivities of $500\ \Omega/\text{square}$. Functional resistor trimming by laser allows precision fre-

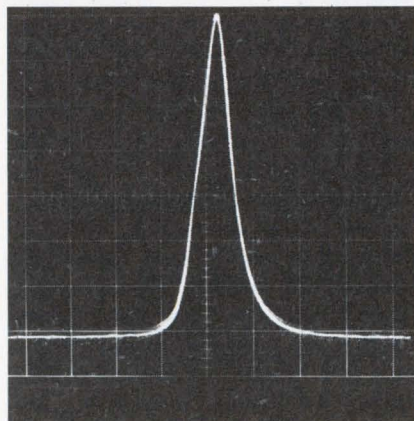

while the lower loop determines Q. The filter's response (right) is shown at a Q of 100. Horizontal scale markings are 25 Hz/cm and vertical scale markings are 0.05 V/cm.

quency adjustment to $\pm 0.1\%$.

An outstanding characteristic of this filter is its ability to operate from a 4-V supply while dissipating only $500\ \mu\text{W}$. This is related to its use of three micro-power wide-band op amps that allow the filter to have a nominal gain of 40 dB with only 1-dB variation, while operating over -30 to $+70^{\circ}\text{C}$.

The new filter can respond to tone bursts of less than 30 ms with a nominal bandwidth of 15 Hz, thanks to a clever switching technique. When the filter's output rises to a certain required level a large-value resistor is switched in series with an internal Q-control resistor. This forces the filter's bandwidth to become very large and its output to decay very rapidly. And since the response time of a two-pole filter is inversely proportional to bandwidth, tone bursts of short duration are handled.

In actual operation, frequency selection is performed by a logic network and an appropriate number of switches. The center frequency is selected by grounding the pin for that particular frequency. Any one of eleven frequencies may be selected. By switching in an external resistor, Q or bandwidth may also be changed.

When a sequence of incoming tones is received by the filter, the logic network is triggered by the first tone and sequences to the second frequency. If that second frequency is identical to the second tone, the filter provides an output, which in turn sequences the logic network again, and so on to give addressable codes.

The filter can be used in the communications field for CTCSS (Continuous Tone Coded Squelch Systems) and selective-calling systems for mobile and portable radios. Other applications include medical electronics, industrial controls and decoding transmitted data over telephone lines.

CIRCLE NO. 250

new 12-BIT ADC

\$99

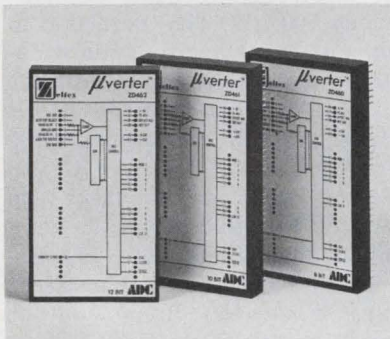

DAC's

8-Bit Binary . . .	\$19
2-Digit BCD . . .	\$19
10-Bit Binary . . .	\$29
3-Digit BCD . . .	\$39
12-Bit Binary . . .	\$49

ADC's

8-Bit Binary . . .	\$49
10-Bit Binary . . .	\$69
12-Bit Binary . . .	\$99

(Single Quantity Prices)

FEATURES:

- Ready to use (need only dc power)
- DAC settling time . . . from 2 μ s
- ADC conversion times . . . from 15 μ s
- ADC quantizing error . . . $\pm 1/2$ LSB
- Absolute accuracy . . . $> \pm 1/2$ LSB
- Linearity . . . from 0.01%
- Tempco . . . 20 ppm/ $^{\circ}$ C
- Operating temp . . . 0 $^{\circ}$ C to 70 $^{\circ}$ C
- Analog ranges . . .
 ± 10 V, ± 5 V, 0V to 10V
- DTL/TTL compatible
- ADC - parallel & NRZ serial output
- All models pin-for-pin compatible

Call, TWX, or write today!

TEL: (415)686-6660

TWX: 910-481-9477

eltex INC.

A SUBSIDIARY OF REDCOR CORP.
1000 Chatham Road · Concord, California 94520

INFORMATION RETRIEVAL NUMBER 131

MODULES & SUBASSEMBLIES

64-gun cathode-ray display increases readout density

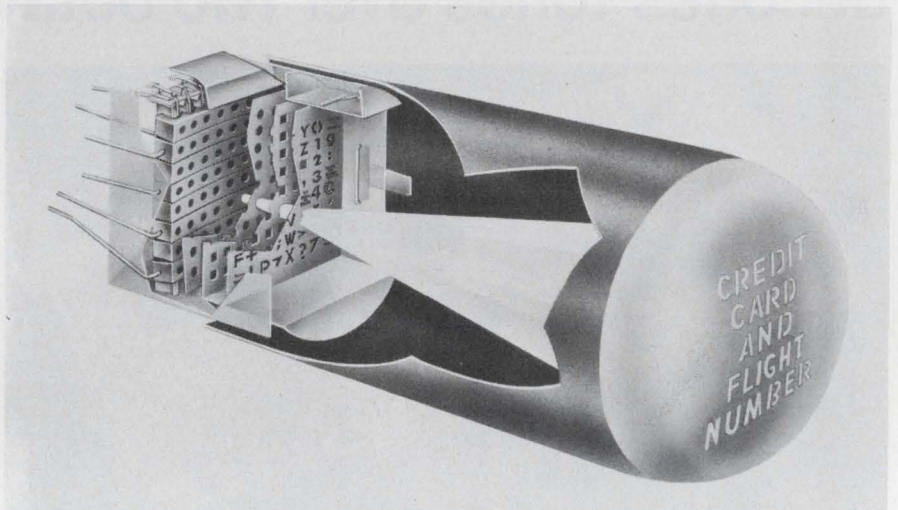

Industrial Electronic Engineers, Inc., 7720 Lemona Ave., Van Nuys, Calif. Phone: (213) 787-0311. Price: see text.

The 6500 series Nimo display employs a 64-gun vacuum tube which can display up to 64 character/symbol combinations on a 0.63-by-0.63-in. display area. Character heights range from 0.125 to 0.562 in.

Fundamentally, the device is a 64-flood-gun, shaped-beam, cathode-ray vacuum tube. The tube does not need external or internal focusing means. It can display the full alphanumeric typewriter keyboard or any 64 messages, symbols, text material, or combinations of these images.

Typical applications would include key-to-tape/disc displays, digital instrumentation, annunciators, message boards, computer prompters, keypunch readouts and optical data scanning systems.

The tube has eight identical horizontal grid-control bars each of which has eight grid apertures mechanically oriented to the center of a phosphor-coated screen. Spaced away from the grid-control bars is a common spherical anode, having 64 anode apertures. The anode is followed by a rectangular mask. There are eight filaments aligned with each grid aperture. One blanking grid is associated with each filament, running parallel

and in very close proximity to it.

The filaments draw 0.8 A at a constant drain at 1.75 V ± 1.5 ac or dc. A row-column or aperture-blanking grid selection is made, selecting one of the desired guns, each of which is independent. Both the blanking and aperture grid for the selected position are then positive with reference to the cathode. The lens aperture is then effectively open and electrons are accelerated in the gun structure passing through the grid aperture hole. The remaining 63 guns are electrically OFF.

A metal character mask (which can be custom designed) with openings etched in the shape of the desired characters intercepts the electron beam. It is maintained at anode potential and collects electrons which collide with areas not etched out of the mask.

The shaped beam collides with the phosphor screen at the viewing end of the glass envelope displaying the selected characters.

Blanking and aperture-grid voltages are MOS compatible, being +2.5 V dc for OFF and -10 V dc for ON states.

The price for the total package, that is, tube, mounting, hardware, driver/decoder and anode power supply will be less than \$100 in OEM quantities. The 1000-piece tube price is below \$40.

CIRCLE NO. 251

DESIGN

IDEAS

FROM
SYLVANIA

Let us mill.

Not all sheet-metal parts should be manufactured by force and violence. It's much more humane to dissolve away the unwanted metal. This process, called photo chemical machining, leaves the parts unstressed, unbent, unbroken, unbeaten. It's extremely accurate. And it may cost less than militant methods such as stamping and machining.

We became expert in photo chemical machining by running one of the largest chemical milling operations ever set up. It's a continuous process that turns out a couple of million color TV aperture masks per year. (Each mask is pierced by half-a-million tiny, round holes.)

If we can make masks, we can make almost anything by photo chemical machining: parts such as IC lead frames, display-tube numbers, grids, heaters, computer-card guides, electric-razor cutter heads. We do everything: artwork, milling, finish plating.

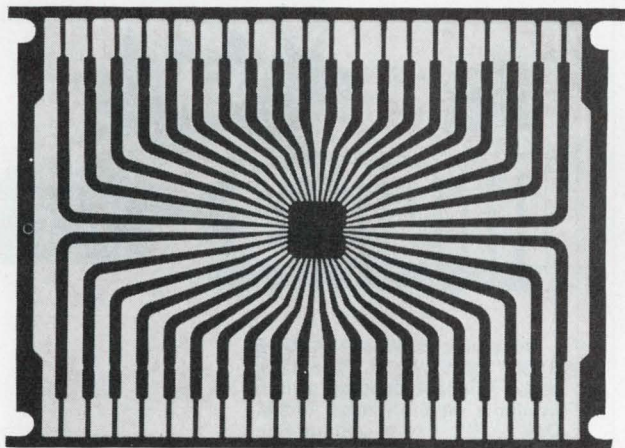

40-lead IC frame. (PCM part)

Naturally, we welcome run-of-the-mill chemical milling work. (It's our bread and butter.) But we're overjoyed when people give us a really tough PCM job. We have a whole crew of metallurgists, chemists and designers, and they can come up with sweet answers where others produced sour notes.

So if you're having any problem with PCM parts, come to us.

Instead of just milling around.

For more about PCM, call Bill Johnson at 717-265-2121. Or write him at GTE Sylvania, Chemical & Metallurgical Division, Towanda, Pa. 18848.

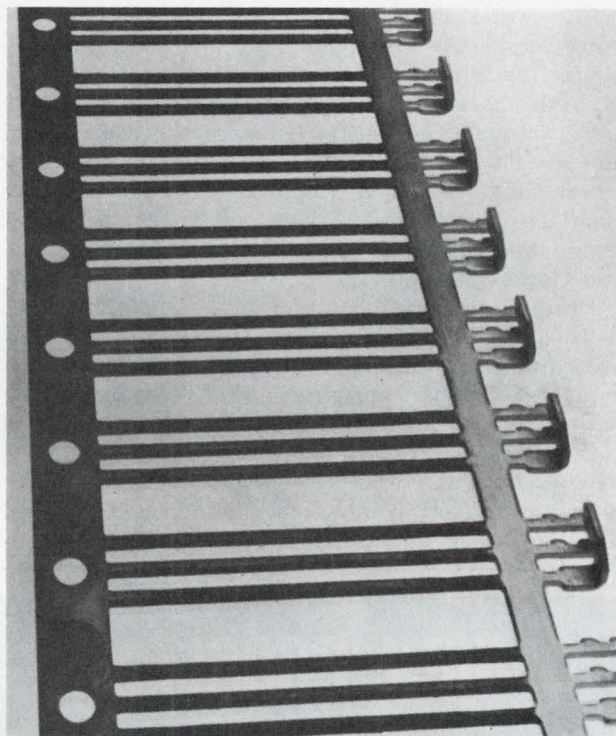

Gold-plated transistor lead frame. (Stamped part)

Stamp out everything.

One of our most creative areas is the stamping of electronic parts.

We can bang them out like a machine gun—about 10 million parts per day. From a wide range of materials. In all sorts of finishes and tempers. To extremely close tolerances.

We've got presses that will blank, cup, draw, pierce, bead, knurl and trim—all in one pass.

We'll take on the most intricate shapes you have, make our own dies for them and knock out beautiful parts by the barrelful.

And we'll do it at a reasonable cost. (After all, stamping is the most economical way to mass-produce metal parts.)

So give us your huddled contacts. Your teeming lamp bases. Your integrated circuit parts. Your cans and headers. Your anything and everything.

And we'll stamp 'em out for you.

Call our stamping people at 717-764-9853. Ask for Hal Martin. Or write to him at: GTE Sylvania, Parts Division, 1128 Roosevelt Ave., York, Pa. 17404.

GTE SYLVANIA

INFORMATION RETRIEVAL NUMBER 132

Large LED numeric display holds 0.77-in. characters

Opcoa, Inc., 330 Talmadge Rd., Edison, N. J. Phone: (201) 287-0355. P&A: \$14.50 (1000 quantities); stock to 30 days.

The largest seven-segment LED numeric display yet announced is a new one from Opcoa with 0.77-in.-high characters. The display is easily readable at 40-ft distances and is designed for applications where distant display reading—such as in production lines, systems, rack-mounted instruments and clocks—is required.

Despite its large character size, it is quite pleasant to view and, according to the manufacturer, avoids the "gappy" appearance that most large character LED displays suffer from. Each of its seven segments contains two red electro-luminescent GaP chips, each of

which illuminates a rectangular bar by reflective techniques. There are two bars to a segment, which emit light in all directions. Because each die's side light is reflected upwards, the light is diffused over a rectangular surface which results in a bar-width-to-character-height ratio pleasing to the eye. An opaque black plastic face enhances the display's contrast by blocking out the display's chip interconnect patterns.

This new display is TTL compatible and requires only 15 to 30 mA per segment to operate. It is rated for a half-life (the time in which initial light output is reduced by 50%) between 100,000 and 1,000,000 hours. Each segment's pair of GaP diodes is connected in series for a typical oper-

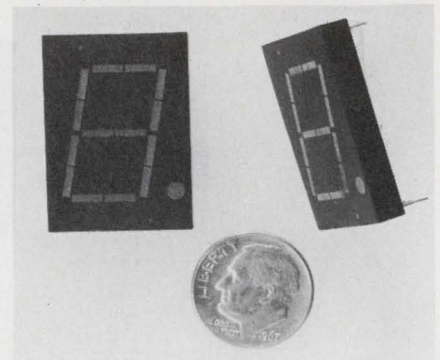

Seven-segment LED display has 0.77-in.-high characters—largest yet.

ating voltage of 4.2 V at 15 mA. A decimal point on the display requires 2.1 V at 15 mA.

Dimming the display may be accomplished by either reducing the operating current or by duty factor variations with a pulsed supply. The display can also be multiplexed.

A practical feature is its slim depth of 0.165 in. (excluding pins) for freedom of assembly. The display's width is 0.8 in. and height is 1.1 in. Pins are spaced on 0.1-in. centers.

CIRCLE NO. 252

DESIGN PROBLEMS? solve them with PIONEER PHOTOCELLS

STANDARD MODELS

Curves for load line design available for each model.

CDS Type No.	1 FC Simulated Daylight 50 V AC Mean* Output	Nominal Resistance 50 FC 2800° K Incand.	Max. Dark Current** or Min. Dark Resistance	Max. Dissip.	Max. Volt Dark
701	1.5 ma		25 ua		500 V
702	3 ma		25 ua	all rated	500 V
703	6 ma		40 ua	¼ watt	350 V
710		1330 ohms	4 meg.	continuous 1 watt	500 V
711		670 ohms	4 meg.	1 minute	500 V
712		330 ohms	2.5 meg.		350 V
901	1.5 ma		25 ua	All	1000 V
902	3 ma		25 ua	rated	1000 V
903	6 ma		40 ua	½ watt	700 V
904	12 ma		200 ua	contin-	500 V
910		1330 ohms	4 meg.	uous	1000 V
911		670 ohms	4 meg.	2 watts	1000 V
912		330 ohms	2.5 meg.	1 minute	700 V
913		165 ohms	0.5 meg.		500 V

*Range of values in any category equal to ±33% of mean.
**Measured at 100 V, 5 seconds after 50 FC light extinguished.



CDS-9
A 1" photocell, especially designed for numerous applications in outside or inside lighting, flame control, and relay applications where the light source is incandescent. Proven by hundreds of thousands of photocell years of service.

CDS-7
Has the same general characteristics as the CDS-9 but a smaller size (½") for use where space is at a minimum.

CDS-5
A very compact unit with a T.O. 5 housing, produced to your specifications. Our engineering department will work with you on any special application of photosensitive layers.

THE **PIONEER**
ELECTRIC & RESEARCH CORPORATION
Subsidiary of **GENCO** Controls, Inc.
743 Circle Ave., Forest Park, Ill. 60130
Telephone: (312) 771-8242

INFORMATION RETRIEVAL NUMBER 51

the NEW mighty-mini

Schrack's NEW MINIATURE STEPPING SWITCH. Type RTM, is the smallest stepping switch available on the market today. Only ¼ the size of comparable steppers, it combines high performance with economy of space and cost.

The RTM is equipped with 2 x 10 or 2 x 12 gold-plated contacts and mates with our socket which meets standard printed circuit spacings. Unique hold-down spring enables mounting in any position.

Write for free catalog today. Schrack also manufactures all types of relays, stepping switches and accessories. Catalogs upon request.

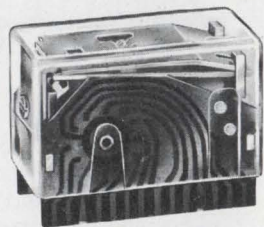

1 41/64"L x
13/16"W x 15/16"H

SCHRACK ELECTRICAL SALES CORP

1140 Broadway, New York, New York 10001
tel: (212) 683-0790

INFORMATION RETRIEVAL NUMBER 52

ELECTRONIC DESIGN 21, October 14, 1971

If you need rugged accuracy
over a wide range
of measurements...

Buy
Triplett's 630-NA

Model 630-NA



\$103

1. 70-range V-O-M with single range switch and DC polarity-reversing switch.
2. Accuracy 1½% DC and 3% AC; mirrored scale.
3. Diode overload-protected suspension movement; temperature compensation.

Its diode overload-protected suspension meter movement; simplified, long-scale, mirrored dial; and 70-range measurement capability to 6,000 V AC and DC, 12 A DC and 100 megohms demonstrate that Triplett's Model 630-NA V-O-M can handle practically any electrical measurement you may need. All these features add up to 1½% DC accuracy (3% AC) and the ruggedness necessary

to make this a take-anywhere tester that's ideal for design, maintenance, quality control and production applications. It's a real value at \$103 so see it right now at your local Triplett distributor. If you'd like 200,000 Ohms per Volt DC and 20,000 Ohms per Volt AC sensitivity rather than the 630-NA's 20,000 and 10,000 Ohms per Volt DC and AC, respectively, and you're willing to use a spe-

cial high-voltage probe for the 3 and 6 KV ranges in order to get that extra sensitivity, ask your distributor for Triplett's Model 630-NS at \$122. For more information, or for a free demonstration, see him or your Triplett sales representative. Triplett Corporation, Bluffton, Ohio 45817.

TRIPLETT

The World's most complete line of V-O-Ms
... choose the one that's just right for you.

Introducing the

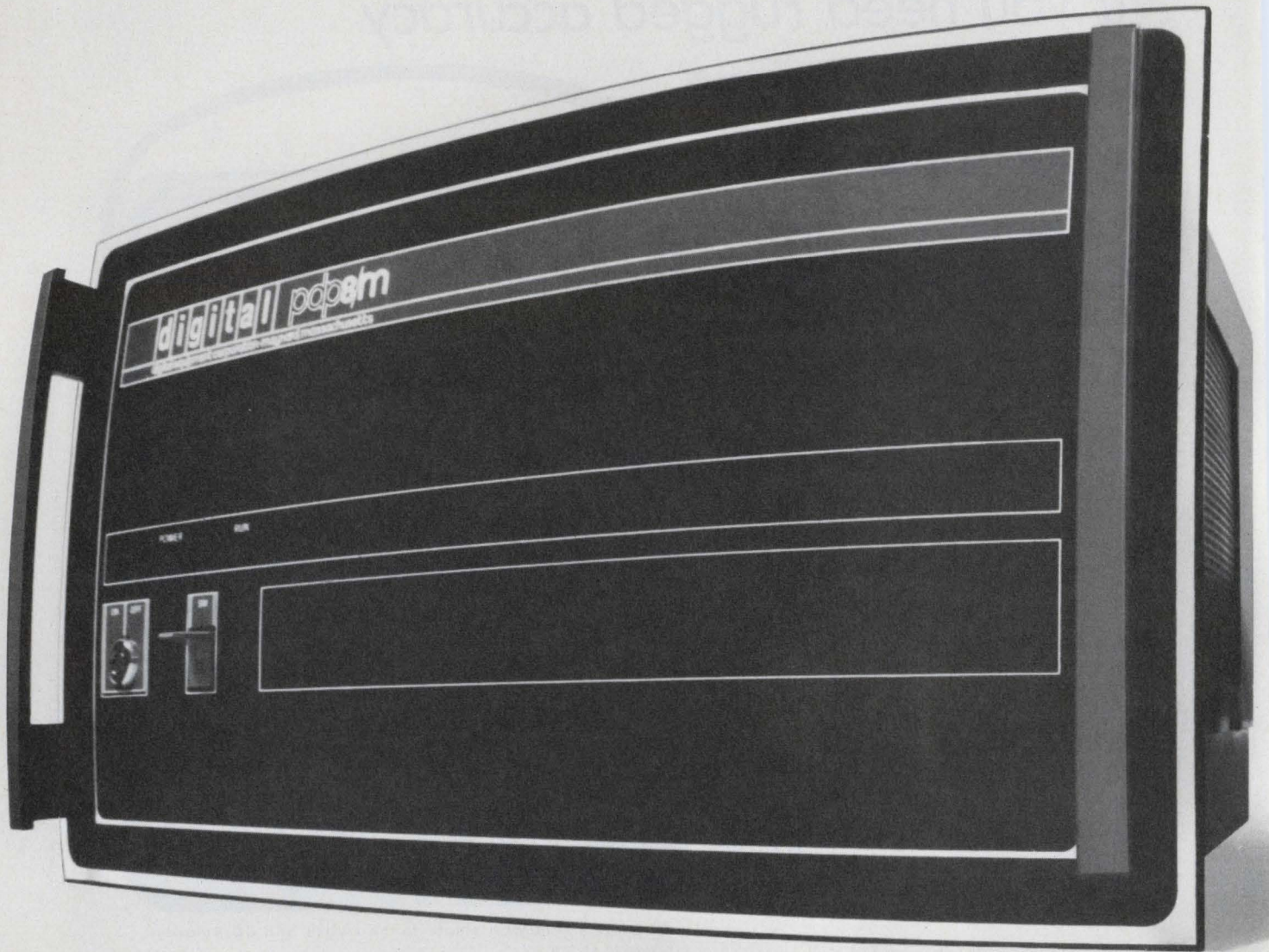

On your left, the 12-bit PDP-8/M. On your right, the 16-bit PDP-11/05. Our brand new additions to the world's most popular families of minicomputers.

Complete computers — at incredibly low prices. Like \$3,069 for the 11/05, and \$2,362 for the 8/M in quantities of 100. Even the dis-

count schedule is new. Very attractive.

In addition, they're compatible with the rest of the family members. Their options. Their peripherals.

They have the features of their bigger brothers. And, a full instruction set. OEM-oriented architecture. Both

the UNIBUS™ architecture of the 11/05 and the OMNIBUS™ architecture of the 8/M permit easy, flexible configuring and interfacing. Real pluses for the OEM.

They're built with the kind of reliability that comes easy after delivering over 11,000 minicomputers.

OEM Yardsticks

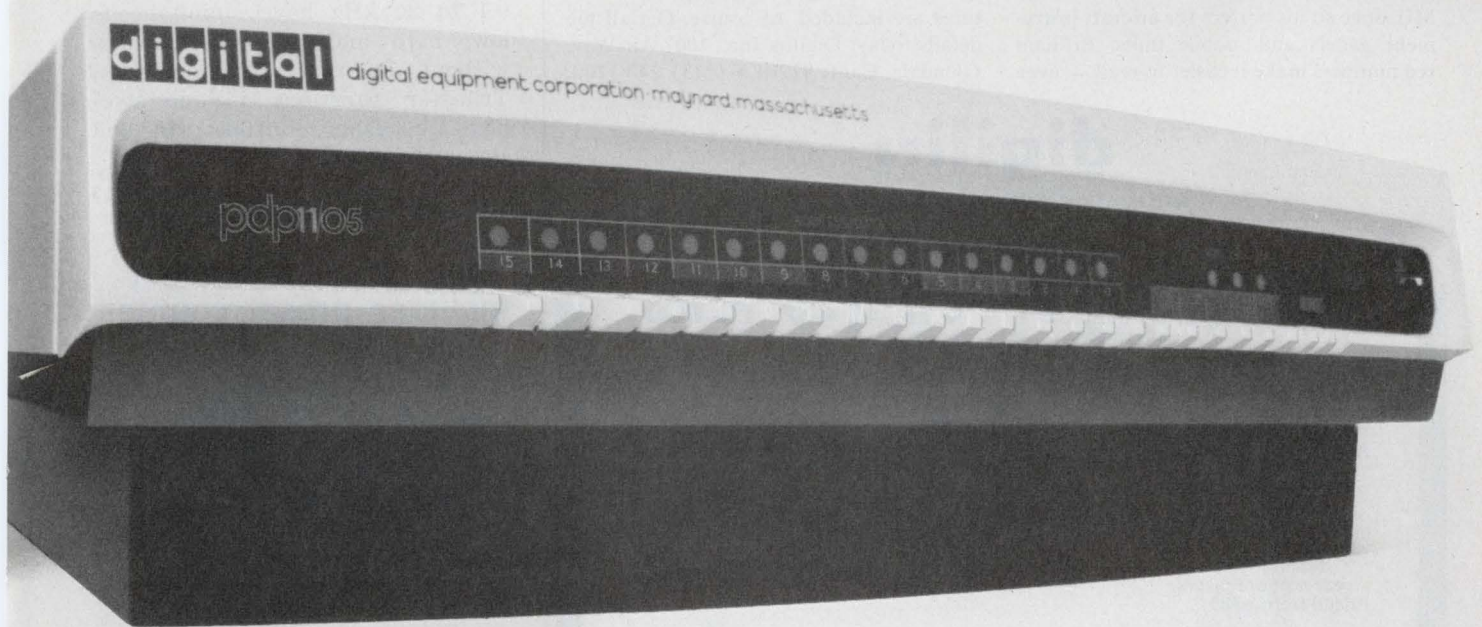

And, they're supported with more field backup than you can get anywhere else. Worldwide.

PDP-11/05. PDP-8/M. Designed for the OEM. Priced for the OEM. Choice for the OEM. From the leader in OEM computer applications.

Now there's a whole new set of standards to measure up to.

Write for more information. Digital Equipment Corporation, Main Street, Maynard, Massachusetts 01754, (617) 897-5111.

digital

No room for a digital panel meter?

Actual size. Cut out and use as a template.

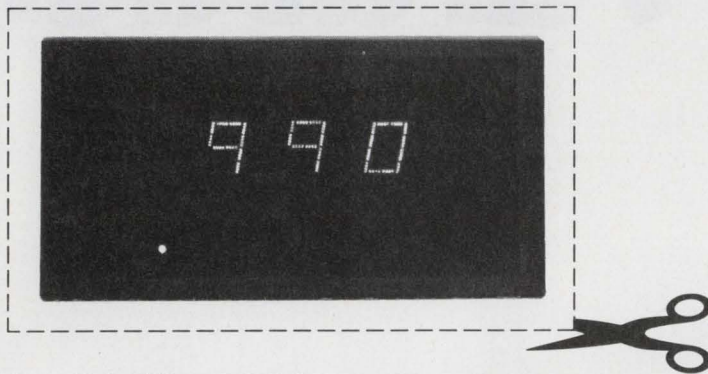

Try the Digilin 3330 on for size

If you've got space for a commemorative stamp, you've got room for our new 3½-digit light-emitting diode meter, the world's smallest digital panel meter. It's all-solid-state — an industry first — and reliability and ruggedness are practically MIL-spec so it's perfect for aircraft instrument panels and mobile units. Brilliant red numbers make it easier to read — even

in direct sunlight. A dream for portable applications because of its small size, light weight and 5 volt power requirement. True floating differential input. Standard TTL-compatible BCD output. Digilin auto-zero and constant high input impedance features are included, of course. Get all the details today. Digilin, Inc., 1007 Air Way, Glendale, Calif. 91201 • (213) 240-1200.

digilin
DIGITAL INSTRUMENTS

INFORMATION RETRIEVAL NUMBER 98

SPELLMAN HIGH VOLTAGE DC POWER SUPPLIES

1 KV to 500 KV

RHR/UHR SERIES: 0.01% regulation. 0.02% RMS ripple. All solid state. Rack mounted. Low cost. 115V AC input. Used for

- CRT displays
- photomultipliers
- linear accelerators
- computer terminals
- dielectric and tube testing
- low power lasers

Priced from \$325

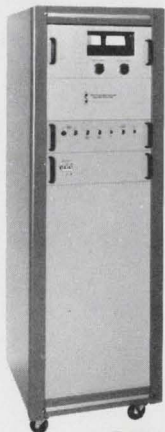
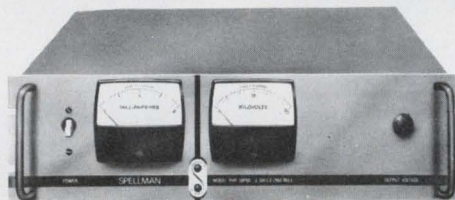

HIGH POWER SERIES REGULATED to 0.002%. HP Series units up to 200 KV feature constant voltage / constant current modes with automatic crossover. 100 μsec transient response. Used for

- gas lasers
- sputtering and radiation equipment
- capacitor chargers
- accelerators
- spectroscopy
- microwave tube sources

MINIATURE: Encapsulated, all solid state, high voltage, miniature DC power supplies. Used for

- CRT displays
- photomultipliers and quantity low cost precision applications. Available in regulated (RM Series) and unregulated (UM Series) models. DC input. Quantities of 100 priced from \$50.



Write or call for detailed technical literature

SPELLMAN
HIGH VOLTAGE
ELECTRONICS CORP.



1930 Adeo Avenue
Bronx, New York 10469
212/671-0300
Our third decade of leadership
in high voltage technology.

INFORMATION RETRIEVAL NUMBER 55

MODULES & SUBASSEMBLIES

Tunable active filters cover 0.1 to 20 kHz

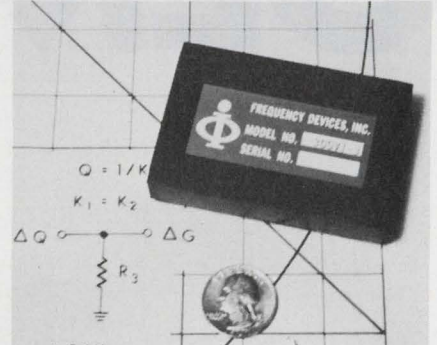

Frequency Devices, Inc., 25 Locust St., Haverhill, Mass. Phone: (617) 372-6930.

Series 300 voltage-tunable active filters are two-pole devices whose cutoff frequencies vary linearly over a 20:1 range by the application of a +0.5 to +10-V control signal. Five models covering 0.1 to 20 kHz have simultaneous low, high and bandpass outputs without external components. Transfer functions include two-pole Chebyshev, Butterworth and Bessel functions.

CIRCLE NO. 253

Shaft position encoder includes preset counter



Disc Instruments, Inc., 2701 S. Halladay St., Santa Ana, Calif. Phone: (714) 549-0343. Price: under \$500.

A new detecting/controlling element for process systems significantly reduces equipment cost and space requirements by integrating a 3 to 6-digit preset counter into a Rotaswitch photoelectric shaft position encoder. Capable of providing highly accurate pulse counts of up to 5000 per revolution, the preset encoder houses thumbwheel switches for programming the control function.

CIRCLE NO. 254

Phototransistors

This listing represents only a portion of the Clairex line of phototransistors.

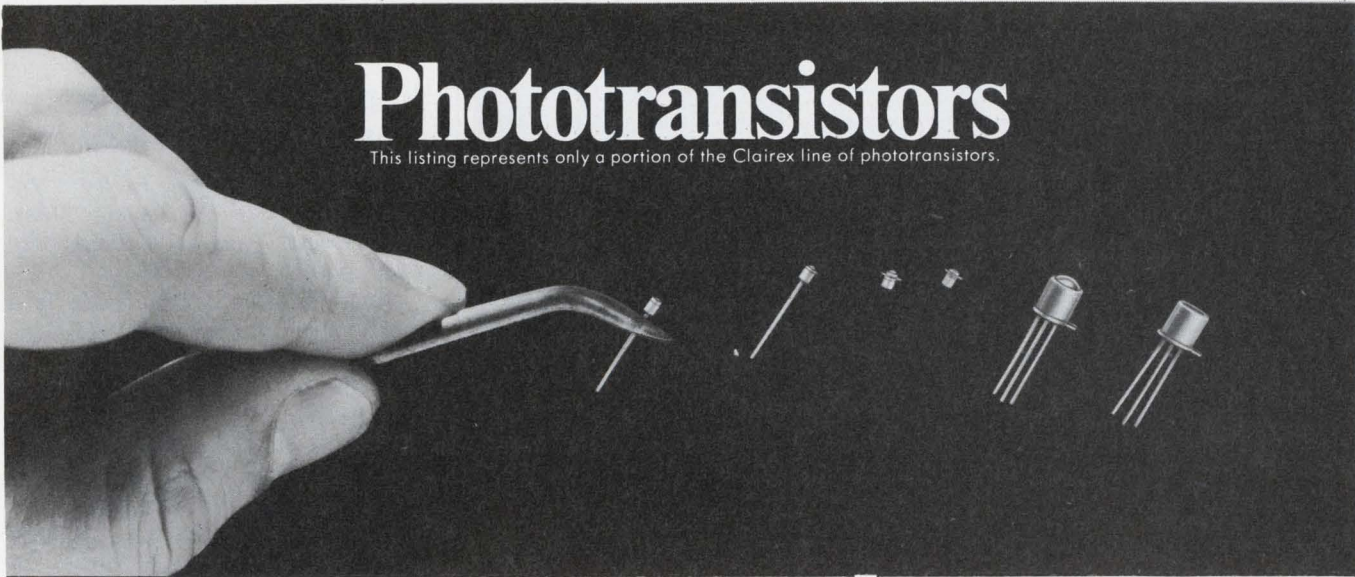

Silicon NPN Planar Epitaxial Phototransistors	Maximum Ratings								Maximum Ratings							
	Maximum Temperatures Storage Temperature -65°C to $+200^{\circ}\text{C}$ Operating Junction Temperature $+150^{\circ}\text{C}$ Maximum Power Dissipation Total Dissipation at 25°C , $P_T=250\text{mW}$ derate $2.0\text{mW}/^{\circ}\text{C}$ Total Dissipation at 100°C , $P_T=100\text{mW}$								Maximum Temperatures Storage Temperature -65°C to $+180^{\circ}\text{C}$ Operating Junction Temperature $+150^{\circ}\text{C}$ Maximum Power Dissipation Total Dissipation at 25°C , $P_T=50\text{mW}$ derate $0.5\text{mW}/^{\circ}\text{C}$ Total Dissipation at 100°C , $P_T=12.5\text{mW}$							
ELECTRICAL CHARACTERISTICS	CLT 2010	CLT 2030	CLT 2130	CLT 2160	CLR 2050	CLR 2060	CLR 2170	CLR 2180	CLT 3020	CLT 3030	CLT 3160	CLT 3170	CLT 4020	CLT 4030	CLT 4160	CLT 4170
Package or Size ("O.D.)	TO-18	TO-18	TO-18	TO-18	TO-18	TO-18	TO-18	TO-18	.060"	.060"	.060"	.060"	.060"	.060"	.060"	.060"
Window or Lens	W	W	L	L	W	W	L	L	W	W	L	L	W	W	L	L
MAX VOLTAGES (Volts)																
V _{CBO}	80	60	80	60	80	80	80	80								
V _{CEO}	50	30	50	30	40	40	40	40	50	40	50	40	50	40	50	40
V _{ECO}	5	5	5	5					5	5	5	5	5	5	5	5
V _{EBO}					10	10	10	10								
MAX CURRENT I _C ma, Note 3.	200	200	200	200	200	200	200	200	200	200	200	200	200	200	200	200
LIGHT CURRENT in ma, Note 1.																
I _L (V _{CE} =5V, H=0.02mW/cm ²)								0.2	0.4							
								0.5	0.8							
I _L (V _{CE} =5V, H=0.2mW/cm ²)								0.6	1.4	2.0	4.0					
								1.8	4.0							
I _L (V _{CE} =5V, H=2.0mW/cm ²)								6.0	14.0							
I _L (V _{CE} =5V, H=5.0mW/cm ²)		0.2	1.0	0.6	4.0								0.1	0.25	0.5	2.0
		0.6	3.0	1.8	12.0								0.4	1.0	2.0	7.0
I _L (V _{CE} =5V, H=20.0mW/cm ²)													1.2	3.0	7.0	
													10	10	10	10
DARK CURRENT																
I _D (I _{CEO} @ 25°C) in na, H=0	max.	25	25	25	25	50	50	50	50							
I _D (I _{CEO} @ 100°C) in μa, H=0	max.	25	25	25	25											
BREAK DOWN VOLTAGES (Volts)																
BV _{CEO} I _C =100 μa	min.	50	30	50	30	40	40	40	40	50	40	50	40	50	40	50
BV _{CBO} I _C =100 μa	min.	80	60	80	60	80	80	80	80							
BV _{EBO} I _E =100 μa	min.					10	10	10	10							
BV _{ECO} I _{EC} =100 μa	min.	5	5	5	5					5	5	5	5	5	5	5
t _r μsec (I _C =0.5ma, R _L =100 Ω) Note 2. (Typical)		3	3	3	3	100	100	100	100	1.5	1.5	1.5	1.5	1.5	1.5	1.5
t _f μsec (V _{CC} =5V)		3	3	3	3	150	150	150	150	1.5	1.5	1.5	1.5	1.5	1.5	1.5
V _{CE} (SAT) I _C =10ma, I _B =0.05ma, H=0						1.0	1.0	1.0	1.0							
V _{CE} (SAT) I _C =10ma, I _B =0.5ma, H=0		0.30	0.30	0.35	0.30											
V _{CE} (SAT) I _C =0.4, H=20mW/cm ²										0.3	0.3	0.3	0.3	0.3	0.3	0.3

Note 1: The light source is a frosted tungsten incandescent lamp at 2854°K. Note 2: The light source is a gallium arsenide LED pulsed with a rise and fall time of $< 0.3 \mu\text{sec}$. Note 3: Pulsed conditions: 300 μsec., 2% duty cycle.

For complete specifications on any or all types of Phototransistors, call or write

CLAIREX ELECTRONICS

A DIVISION OF CLAIREX® CORPORATION • 560 SOUTH THIRD AVE., MOUNT VERNON, N.Y. 10550 • TEL: 914-664-6602

INFORMATION RETRIEVAL NUMBER 56

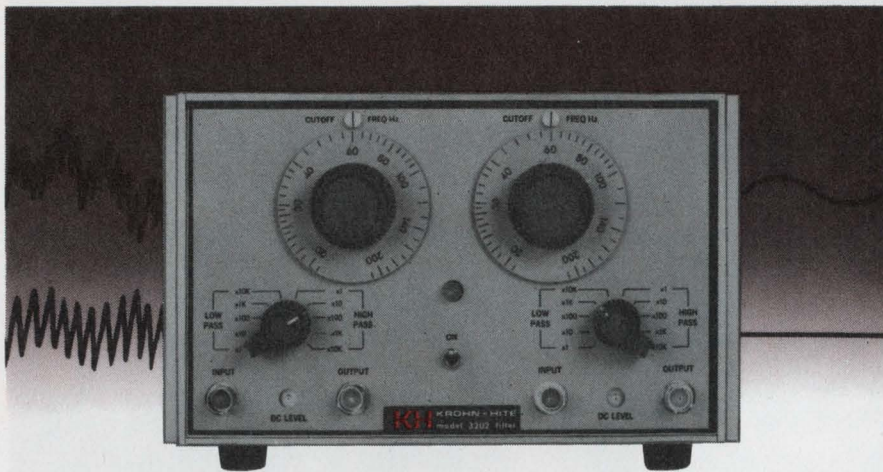

Best way to get rid of unwanted signals

K-H multifunction filter.

Model 3202 all solid state filter with two independent channels gives you continuously adjustable high-pass, low-pass, bandpass or band reject functions over a 20 Hz to 2 MHz frequency range; provides the flexibility essential for complex frequency or time domain measurements.

Check these exclusive features. See for yourself why the Krohn-Hite Model 3202 is such an exceptional value at \$795.

FUNCTIONS: Low-pass — direct coupled with low drift. High-pass — upper 3 db at 10 MHz. Bandpass — continuously variable. Band rejection — variable broad band or sharp null.

TWO RESPONSE CHARACTERISTICS: (1) Fourth-order Butterworth or (2) simple R-C (transient free).

ZERO-db INSERTION LOSS: All-silicon amplifiers provide unity gain passband response. 24 db per octave slopes per channel extend to at least 80 db.

90-db DYNAMIC RANGE: Low hum and noise (100 micro-volts) eliminate costly preamplifiers.

There's more. Write for complete data. Contact your Krohn-Hite Representative for an eye-opening demonstration.

OVERSEAS SALES OFFICES: BELGIUM, C. N. Rood s. a.; DENMARK, SC Metric A/S; FRANCE, Antares; GERMANY, Nucletron Vertriebs-GMBH; HOLLAND, C. N. Rood n. v.; ITALY, Dott. Ing. Mario Vianello; SWEDEN, Teleinstrument; ISRAEL, R.D.T. Elect. Eng. Ltd.; JAPAN, Shoshin Shoji Kaisha, Ltd.;

KH KROHN-HITE CORPORATION

580 Massachusetts Ave., Cambridge, Mass. 02139, U.S.A.
Phone: (617) 491-3211 TWX: 710-320-6583

Oscillators / Filters / AC Power Sources / DC Power Supplies / Amplifiers
INFORMATION RETRIEVAL NUMBER 57

Improved 10-bit d/a slashes price to \$29

Analog Devices, Inc., Route 1 Industrial Park, Norwood, Mass. Phone: (617) 329-4700. P&A: \$29 (100 quantities); stock.

Model DAC-102 10-bit d/a is a pin-for-pin replacement of the higher-cost model DAC-10H. The new converter provides $\pm 1/2$ -LSB linearity and a ± 10 -V, ± 5 -mA output, as did the predecessor model DAC-10H, but also reduces settling time for $\pm 1/2$ -LSB accuracy from 25 to 5μ s. It also slashes temperature drift from 50 to 30 ppm/ $^{\circ}$ C.

CIRCLE NO. 255

Voltage comparator has 1-mV repeatability

California Electronic Mfg. Co., Inc., Box 555, Alamo, Calif. Phone: (415) 932-3911. P&A: \$38; stock.

Designed for industrial control applications, the Voltensor model 550 voltage comparator has a set-point resolution and repeatability of 1 mV, hysteresis of less than 50 mV, operating time of less than 25 μ s and trip-point stability of less than 8 mV/ $^{\circ}$ C. Accepting power from ± 10 to ± 25 V dc, each set-point has an output of 50 mA at approximately 80% of power-supply voltage.

CIRCLE NO. 256

Six numeric readouts use liquid crystals

RCA Solid State Div., Route 202, Somerville, N. J. Phone: (201) 485-3900. Price: \$25 (single-digit models), \$75 (four-digit models).

Six new developmental reflective and transmissive-type numeric liquid-crystal readouts are available. The TA8032 (transmissive) and TA8034 (reflective) are single-digit, 7-segment readouts. The TA8041 and TA8043 (transmissive) and TA8040 and TA8042 (reflective) are 4-digit, 7-segment readouts. All interface with COS/MOS ICs. The TA8040 and TA8041 include decimal points before each digit. The TA8042 and TA8043 have colons between the second and third digits.

CIRCLE NO. 257

You don't need hard solder to get fatigue-free Power Transistor Performance

RCA's exclusive Controlled Solder Process technology gives you—at no extra charge—with no special ordering—right off-the-shelf—freedom from the worry and expense of thermal fatigue failures.

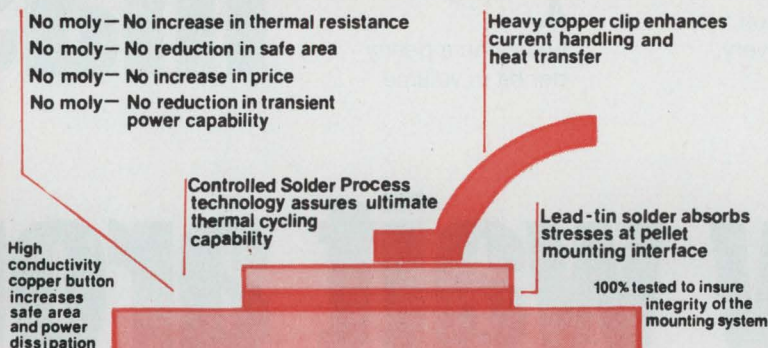

Compare these ratings with your equipment needs:

Types	ΔT_c	Min. TCR (Cycles)	No. of Failures
2N3055	75°C	120,000	Zero
2N3772	75°C	100,000	Zero
2N3773	75°C	100,000	Zero

Our ongoing tests have already surpassed the published ratings on the 2N3055, for example. So far we've exceeded 10,000,000 device cycles at a ΔT_c of 65°C without a failure. This calculates to a failure rate of less than 0.009% per 1000 cycles.

Hard solder and moly expansion matching systems do provide excellent thermal cycling. And RCA first announced such systems some 10 years ago. But moly introduces a host of disadvantages. Check the diagram.

Today, RCA's Controlled Solder Process technology is the most effective method for assuring freedom from thermal fatigue failure in power transistors. No other mounting method—standard lead-tin solder, hard solder, expansion matchers, or any combination of these—can match the total performance of an RCA transistor with Controlled Solder Process technology.

RCA's exclusive Controlled Solder Process technology takes the stress off the pellet set up by the mounting materials, drastically reduces the amount of impurities introduced into the solder, and avoids propagation of the microcracks that cause transistor failure. Don't take RCA's word for it. Test it yourself.

RCA's power transistor capability is backed by thermal cycle ratings. Compare this capability with any and all others.

Consult your local RCA Representative or your RCA Distributor. There's a new brochure on Thermal Cycle Ratings and Controlled Solder Process. 1CE-405. Write for it. RCA, Commercial Engineering, Section 57J14/UTS24, Harrison, N.J. 07029. International: RCA, Sunbury-on-Thames, U.K. or P.O. Box 112, Hong Kong. In Canada: RCA Limited, Ste. Anne de Bellevue, 810 Quebec.

RCA Solid State

INFORMATION RETRIEVAL NUMBER 58

This ROM doesn't need masks.

1.
Millisecond/bit
programming.

2.
Proven reliability.

3.
Volume production,
off-the-shelf delivery.

4.
Less than a penny
per bit in volume.

**Why wait around
and pay more
for
one that does?**

The masked ROM has had it.

The future of the masked memory is being cut short by a 2nd-generation ROM of a different color: Intersil's 256-bit (32 x 8) 50-ns programable IM5600.

It's a fully decoded T²L memory, housed in a 16-pin ceramic or plastic DIP or flatpack.

It comes in full military or commercial ranges, with a choice of open-collector or tri-state outputs.

The difference is that every IM5600 is delivered with logic "zeros" in all 256 locations. When you need a particular ROM, you *yourself* can program—permanently and very simply—the logic "ones" wherever your truth table dictates.

And by every standard, the completed ROM measures up to and beats what's previously been available.

	BIPOLAR MASKED ROM	INTERSIL IM5600 ROM
Price	Down to 1¢ per bit	Below 1¢ per bit
Mask charge	\$500 typical	Zero
Inventory costs	High	Minimum
Availability	In quantity	In quantity
Delivery	5 to 12 weeks	Immediate
Reliability	Excellent	Excellent

The price is right.

In any quantity, the IM5600 costs less than the masked ROM. That's less than a penny a bit in volume.

But you save other ways, too. For instance, you can cut your inventory and service costs because you only have to stock one kind of memory, instead of a different masked ROM for every variation of your truth table.

Get a programmer free.



But here's the biggest bargain. Get a free programmer box with your first order of IM5600s totaling 1,000 pieces or more.

This suitcase-mounted unit automatically tests each ROM, programs it and then verifies the accuracy of the completed memory. All at a rate of better than two ROMs per minute.

Reliability is a quarter-billion bit hours.

And do they last? You bet. A constantly monitored study has logged well over 1,000,000 device hours of high temperature operating and storage life testing without a single failure. Send for full details covered in IM5600 Reliability Report.

By the carload, quick as a wink.

The IM5600 is in volume production right now. Ask for what you need and get it when you need it.

It can be computer-programed at a millisecond a bit, or one girl can program a thousand memories a day using an Intersil Portable Programmer Box. Order them pre-programed from your Intersil distributor and you still get off-the-shelf delivery. Or buy quantities of blank ROMs, mount them on your own PC cards and stock them. When you need it, program a complete card at a time, plug it in and go! And Intersil guarantees 100% programming yield. From Intersil, the one to remember when it comes to memories. 10900 North Tantau Ave., Cupertino, CA 95014.

Get 'em here.

Intersil stocking distributors. Schweber Electronics; Century Electronics; Semiconductor Specialists; DeMambro Electronics; R. V. Weatherford Co.

Intersil area sales offices. Los Angeles (213) 370-5766; Metropolitan New York (201) 567-5585; Minneapolis (612) 925-1844; San Francisco Bay Area (408) 257-5450; Singapore, Telex RS 21607.

Overseas representatives. Clichy, France: Tranchant Electronique. Amsterdam, Holland: Klaasing Electronics. Tokyo, Japan: Internix. Zurich, Switzerland: Laser & Electronic Equipment. London, U.K.: Tranchant Electronique. Munich, West Germany: Spezial Electronics. U.S. sales reps in all major cities.

Intersil



INFORMATION RETRIEVAL NUMBER 59

Now the famous 829 has a "G" for good measure!



Calibrate or Measure
with the

RFL Model 829G

RFL's famous 829, for 15 years the industry calibration standard, now gives way to the new 829G — still the industry calibration standard, but now it's twice as useful. The 829G provides a precision source of AC and DC volts, amps and ohms — plus precision measurements of these parameters from external sources. It offers four-terminal sensing in both source and measurement modes, and high accuracy, resolution and regulation, with 5-digit readout. 5 ranges of AC or DC, 0.1 to 1000V. 6 ranges of current, 100 μ A to 10A. 50, 60, 400, 1000 Hz AC plus EXT. And many other features — all for just \$3,600. Write for complete data today. RFL Industries, Inc., Instrumentation Div., Boonton, New Jersey 07005. Tel: (201) 334-3100 / TWX: 710-987-8352 / CABLE RADAIRCO, N. J.



RFL Industries, Inc.

MODULES & SUBASSEMBLIES

Video amplifier maximizes bandwidth

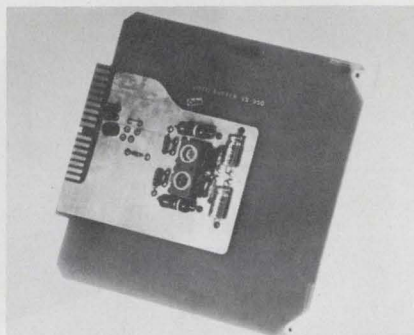

Constantine Engineering Laboratories Co., 1150 E. 8th St., Upland, Calif. Phone: (714) 982-0215.

The VB950 video buffer is a variable-gain, complementary emitter-follower, voltage amplifier designed for CRT display systems where maximum video bandwidth is required. Placed between a generated video signal and amplifier, it provides low output impedance to drive remote amplifiers. It has a 1-k Ω input impedance and internal gain and contrast controls (remote provisions are available).

CIRCLE NO. 258

12-bit d/a converter gets to 0.01% in 750 ns

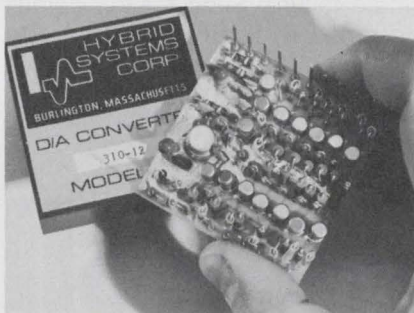

Hybrid Systems Corp., 95 Terrace Hall Ave., Burlington, Mass. Phone: (617) 272-1522. P&A: \$145; stock to 2 wks.

Model 310-12 12-bit d/a converter designed for graphics systems combines high-speed settling and multiplication in a single package. It settles to 0.0125% in just 750 ns and can accept 0 to +6.2 V from external sources. If a sawtooth is applied to its external reference input, the output will also be a sawtooth, but attenuated to a level determined by the digital input word.

CIRCLE NO. 259

Compact LED module has 7-segment display

Monsanto Electronic Special Products, 10131 Bubb Rd., Cupertino, Calif. Phone: (408) 257-2140. P&A: \$12 (1000 quantities); stock.

A new LED display module designated MDA6101 combines in a single low-cost package Monsanto's MAN 1A seven-segment display, the segment current-limiting resistors and Monsanto's MSD047 decoder/driver. The plug-in package offers users a pre-designed and assembled digital display that measures less than 1-in. high and 1-1/2-in. deep and is mounted on 0.4-in. centers.

CIRCLE NO. 260

Computer power supply steps up +5 V to ± 15 V

Burr-Brown Research Corp., International Airport Industrial Park, Tucson, Ariz. Phone: (602) 294-1431. P&A: \$89; stock.

A new low-profile dc-to-dc converter for computer-interface circuits, model 546, provides dual output voltages of ± 15 V dc from a supply of +4.5 to +5.5 V dc. A current output of ± 120 mA is enough to supply 10 to 15 op amps or three a/d converters. Input-output isolation of the 546 is excess of 1000 M Ω .

CIRCLE NO. 261

Fast-setting op amp has 75-V/ μ s slew rate

Teledyne Philbrick, Allied Drive at Route 128, Dedham, Mass. Phone: (617) 329-1600. P&A: \$33.50; stock.

The new 1027 FET op amp settles to within 0.01% of final value in 0.8 μ s with a slew rate of 75 V/ μ s. Its full-output swing is up to 1 MHz and small-signal response up to 10 MHz minimum. Only 0.4-in. high, the 1027 with dual monolithic FET inputs provides low bias currents, high input impedance and large temperature-gradient immunity.

CIRCLE NO. 262

Digital-display units mate counter/decoders



Display General, Inc., 241 Crescent St., Waltham, Mass. Phone: (617) 899-2704. P&A: \$86.12 (10-quantity 3-digit decoder with bezel); stock.

Series 103 digital displays are available in 2 through 10-digit packages for any counter or decoder type or combination of types. Unidirectional decimal base counter modules (up to 15 MHz count) are available with or without quad-latch memory storage. Decode modules are available with or without quad latch memory storage and accept 4-line 8-4-2-1 BCD code.

CIRCLE NO. 263

LED assembly shows 0.625-in. characters

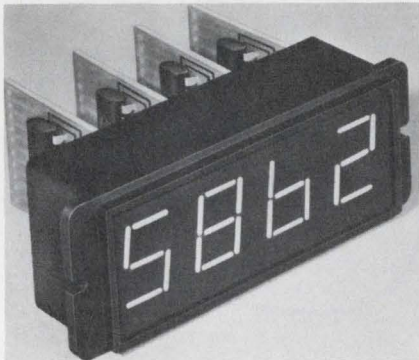

Dialight Corp., 60 Stewart Ave., Brooklyn, N.Y. Phone: (212) 497-7600. Price: \$52.25 for 4-digit assembly (100 quantities).

Character heights of 0.625 in. are obtained with the new 739 LED readout assembly. The display of 1 to 10 characters is made up of GaP diodes arranged in a seven-segment format. Each character is mounted on its own PC board with a decoder/driver that forms the numerals. A decimal point to the right of each character is available as an option.

CIRCLE NO. 264

DISCRIMINATING
ENGINEERS
ARE
AMAZED...

FIRST BY
THEIR HIGH
QUALITY
&
BROAD
APPLICATION

...THEN BY
THE
LOW COST

SWITCHCRAFT *Preh*
INC.

2 TO 7 CONTACT LOW-LEVEL AUDIO CONNECTORS

FITS IN WITH TODAY'S TREND IN MINIATURIZATION

Excellence throughout, low cost, wide variety of types and broad range of standard and optional features call-up practical and economical solutions to many design and cost-control problems in low level connections . . . particularly where miniaturization is a design consideration.

OVER 90 CIRCUIT-TAILORED TYPES

Includes male and female plugs and receptacles from 2 to 7 contacts, in nickel-plated shells, or snap-on plastic shells. 13 different receptacles offer some form of internal switching (SPST, SPDT in addition to mating of contact circuits . . . in some instances eliminating need for external switches! Silver plated pins for low contact resistance. Exclusive "automatic" grounding and fool-proof polarization provisions. Contact friction coupling for minimal mechanical interference noise; locking coupling for reliability where vibration is a factor. Ingenious 8-

position right-angle plug enables you to position cable entry in any of 8 different angles. Etc., etc. Rugged and versatile . . . yet they cost surprisingly little.

APPLICATIONS LIMITED ONLY BY YOUR IMAGINATION!

Virtually unlimited commercial, industrial, consumer and military applications in any type of low level circuitry: audio and test equipment, instruments, computers, cameras, control devices, communications equipment and business machines. Receptacles for flush, extended, P.C. board, screw and rivet type mounting; straight cord, 90° angle; control and switching plugs; many others.

SEND FOR THE NEW COMPREHENSIVE ENGINEERING SPECIFICATION

CATALOG NO. C-503 or see your local Switchcraft Authorized Industrial Distributor . . . he has units for your inspection, and can make immediate delivery at factory prices.

SWITCHCRAFT
INC.

5529 No. Elston Ave., Chicago, Ill. 60630

* Preh is a trademark of Preh Electromechanical Works, Bavaria, Germany

INFORMATION RETRIEVAL NUMBER 61

Segmented readouts have 5/8-in. characters

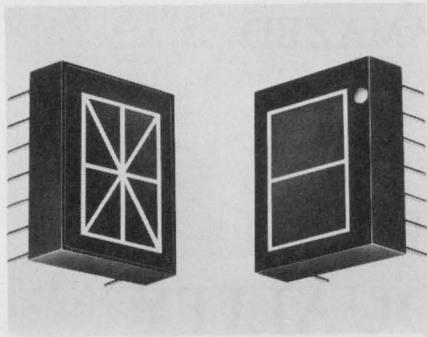

Pinlites, 1275 Bloomfield Ave., Fairfield, N. J. Phone: (201) 226-7724.

The new Dynamic Duo are matching 5/8-in.-character-height, dual-in-line, digital and alphanumeric readouts. Both operate from 5 V providing 7000 ft-lamberts of brightness. The Dip1050 is a 7-segment digital device which can be mounted on a 0.3-in. 14-pin DIP socket. The Dip1050A is a full-16-segment alphanumeric device which can be mounted on 0.6-in. 24-pin DIPs.

CIRCLE NO. 266

LED numeric display uses seven segments

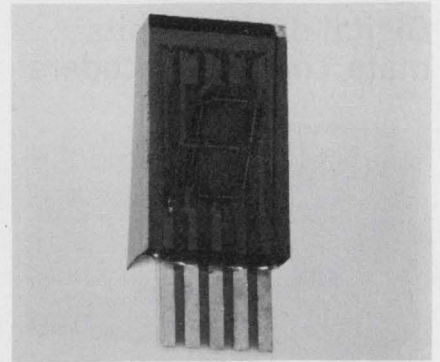

European Electronic Products Corp., 10150 W. Jefferson Blvd., Culver City, Calif. Phone: (213) 838-1912. P&A: \$11 (100 quantities); stock.

A new seven-segment, red, LED, numeric display features compact size of 0.7 by 0.295 in. The EP3 includes high brightness of 500 ft-lamberts and low power consumption at 20 mA of 480 mW. The new display also features single-plane, wide-angle viewing. The EP3 is intended for a variety of industrial and military applications.

CIRCLE NO. 267

Why spend time looking through our catalogs?

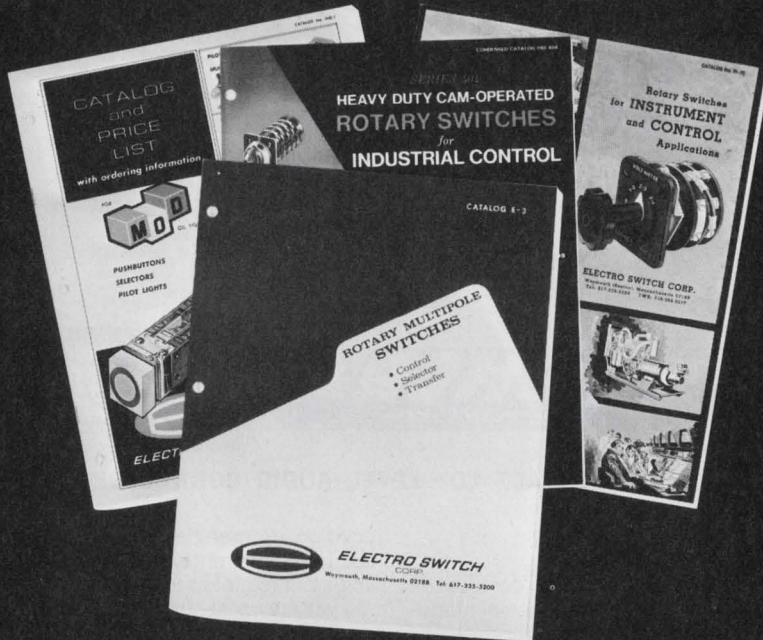

To save time (and money) designing a custom switch!

The overwhelming chances are that you'll find the *exact* power switch you need in one of our catalogs. Here's why: You'll find literally *hundreds* of types *in stock*. Or you can combine your own special configuration from *millions* of components off-the-shelf! Choose from Rotary, Cam, Detent & Snap-action, Pushbutton and other types. Standard specs range from 1/2 up to 200 Amps...from one to 75 poles per switch...plus combinations (tandem, gear train, etc.). And if you don't find your specific need, we'll find it (or build it) for you...usually at *standard* switch prices!

Send for Bulletin C-1 (our "Catalog of available catalogs") or tell us your specific interests for detailed information.



ELECTRO SWITCH
CORP.

Weymouth, Massachusetts 02188

Telephone: 617/335/5200 TWX: 710/388/0377
INFORMATION RETRIEVAL NUMBER 62

HV CRT power supply spans 10 to 20 kV

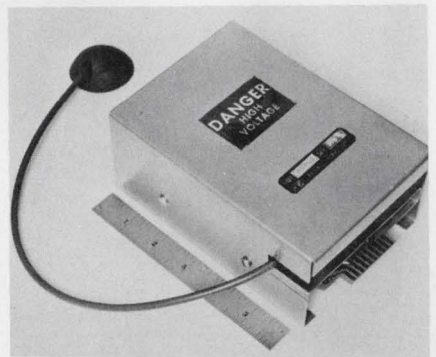

Walden Electronics, 223 Crescent St., Waltham, Mass. Phone: (617) 899-0510. P&A: \$100 to \$120; stock to 3 wks.

Series 700 high-voltage power supply, specifically designed for use in CRT display systems, includes standard output voltages of 10, 12, 15, 18 and 20 kV. It also features line and load regulation of 0.1%, ripple of 0.5% pk-pk and full-load transient response of 0.3% peak, recovering in less than 2 μ s. The supply operates from an input of 24 \pm 3 V dc.

CIRCLE NO. 268

**Now,
a new half-size
relay with
100 million operations
plus
4-amp overload,
hermetically sealed
at the price of
an equivalent reed**



ACTUAL SIZE

Sound good? Not only is the price right... you get more for the price. Like vibration: 10G, 55-2000 Hz, .06 DA, 10-55 Hz. Shock: 50G @ 6 milliseconds, 1/2 sine. Before you buy another low-cost relay or a reed relay, call your nearest General Electric Electronic Component Sales Representative or write General Electric Co., Section 792-47, Schenectady, N. Y. 12345.

GENERAL  ELECTRIC

INFORMATION RETRIEVAL NUMBER 63

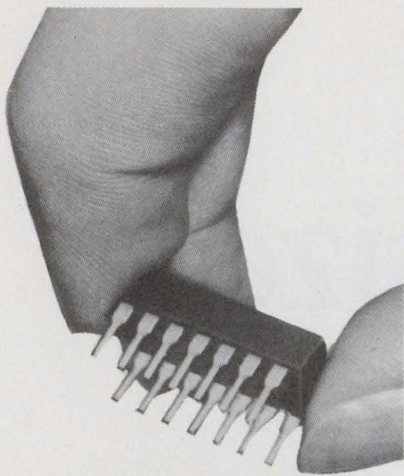

can one **LATCHING RELAY** offer all this?

- High Reliability
(100×10^6 operations)
- Inherent Contact Memory
- Bounce-Free Operation
- Self-Healing Contacts
- Operation in Any Mounting Position
- Miniature Size
- No Latching Current
- Virtually No Noise
- Shock and Vibration Resistance
- For Signals from DC to 120 MHz

Yes... if it's a **LOGCELL[®]** Mercury Film Relay

Both latching and nonlatching Logcell Relays are available. For more information about Logcell Relays, and Logcell Switches, too, write Fifth Dimension Inc., Box 483, Princeton, New Jersey 08540. Or call (609) 924-5990.

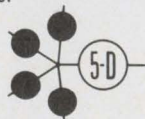

FIFTH DIMENSION INC.

INFORMATION RETRIEVAL NUMBER 64

Custom bipolar IC design lowers cost and turn-around

Interdesign Corp., 165 S. Murphy Ave., Sunnyvale, Calif. Phone: (408) 732-4171. P&A: see text.

A versatile concept known as the Monochip shortens custom bipolar IC design time from the usual four months to as little as two weeks per circuit and costs about 20% as much as previous approaches.

What makes this possible is a simple idea: each chip contains a large number of standardized components which are processed routinely up to the metal-evaporation stage and then put into inventory.

The only non-standard step is to draw up an interconnection mask which connects the components together, just like wiring up a number of discrete components. This mask is then applied to a waiting wafer. The entire process, from circuit diagram to prototypes, takes about 10 working days. And, since

only a single mask has to be cut instead of the normal six or seven, the cost is much lower.

The first Monochip version, called Monochip A, is designed for both digital and linear circuits with an operating voltage up to 20 V. It contains 57 small npn transistors, two high-current (200 mA) npn transistors, 19 lateral pnp transistors, 16 Schottky-barrier diodes and 167 resistors—for a total of 261 components. If the circuit to be integrated is smaller than this, the unused components are ignored.

Although the process used for the A version is optimized as a linear process, the presence of the Schottky diodes provides very short switching times for high-speed digital applications.

The new devices offer great flexibility. Each transistor can be converted into a diode by shorting its collector and base together by using one of the junction diodes. Transistors can also be paralleled for higher-current operation. Any junction can be used as a capacitor, and series or parallel resistor combinations can provide a wide range of values.

A design kit is available which contains a selection of Monochip components for breadboarding, a booklet with their characteristics, design hints and a layout drawing. Since the components are drawn from the Monochip, their performance is identical to those in the finished IC, and all stray effects can be safely simulated. Once the circuit is breadboarded, the engineer interconnects the Monochip components on the drawing according to his circuit diagram and sends it to Interdesign for a mask.

With an initial cost of \$2800, one can obtain a Monochip A, in 100-quantity lots, for \$1.50 to \$10 per circuit, depending on circuit complexity. Each circuit can be obtained in conventional 14 or 16-pin ceramic or plastic DIPs.

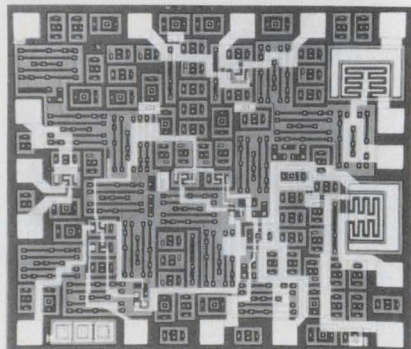
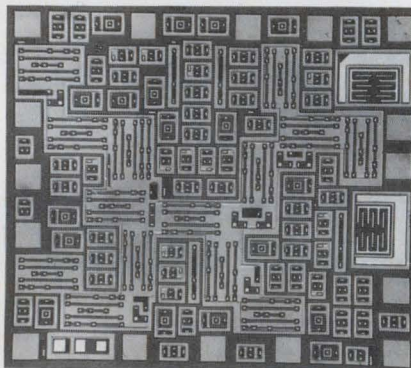

Blank Monochip bipolar IC (top) is custom designed and integrated (bottom) in as little as two weeks and at 20% of conventional costs.

CIRCLE NO. 269

OUR ANGLE: Modular D/S and S/D Converters

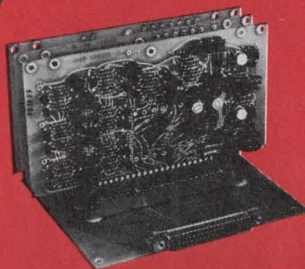

IN

A

Do Low Cost Repairable Circuit Cards Make Sense from Your Angle?

North Atlantic's new 701 D/S and 711 S/D Converters offer unmatched advantages for the digital/analog interface at low-low cost . . . typically \$1000. Open-card construction is easily and economically maintained. Adaptable to systems needs, interchangeable converter cards are compatible with your automatic test, simulation or digital control systems.

Compared to 19" panel designs, these units provide a choice of accuracy, frequency, resolution, and systems customization without the extra bulk and expense of unnecessary power supplies and other panel controls. They are ideal for multi-channel applications where a converter is assigned to a specific function.

These new converters are available to meet a wide range of systems needs. The 701 D/S has selectable accuracies of 9 or 12 bits with resolution of 8 through 14 bits, transformer output isolation and short circuit protection, operation at 60 Hz or 400 Hz with 1VA or 10VA output. The 711 S/D has 0.05° accuracy, 13 bit resolution with input transformer isolation, and continuously tracks 400 Hz synchro data to 1000°/second.

Don't these converters make sense from any angle? Talk it over with your North Atlantic sales engineering representative today.

NORTH ATLANTIC
industries, inc.

200 TERMINAL DRIVE, PLAINVIEW, NEW YORK 11803
cable: noatlantic / twx: 510-221-1879 / phone: (516) 681-8600

INFORMATION RETRIEVAL NUMBER 65

the altogether

Complete 16 channel data acquisition system available in 18 ounce, 34 cubic inch module that interfaces with most popular mini-computers in use today.

- Fast throughput rate up to 100 KHz
- High resolution up to 12 binary bits
- Variety of output formats . . . Binary or BCD
- Two modes — random or sequential

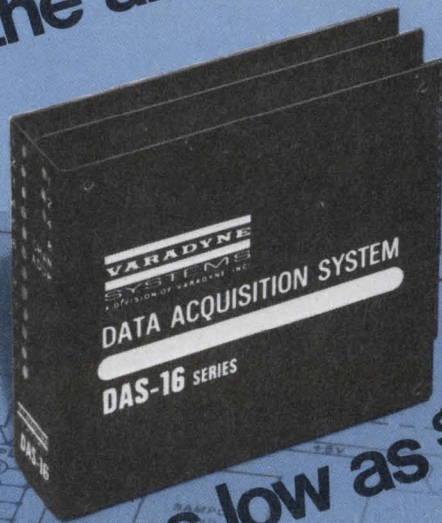

for as low as \$990⁰⁰

VARADYNE SYSTEMS
A DIVISION OF VARADYNE, INC.

1020 TURNPIKE STREET, CANTON, MASSACHUSETTS 02021 / TELEPHONE (617) 828-6395 TWX 710-348-0135

INFORMATION RETRIEVAL NUMBER 66

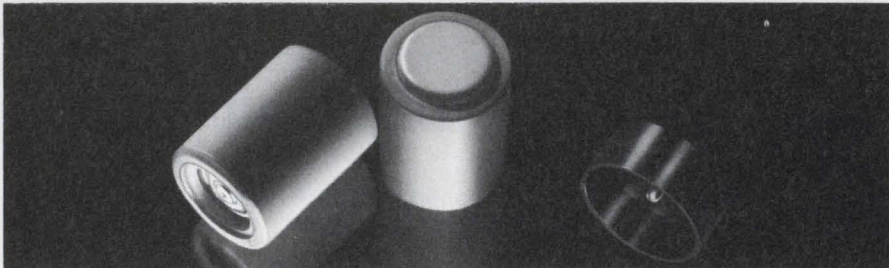

NEW LONG LIFE LITHIUM BATTERY

The G2600-B1 battery (1 and 3/8" long x 1.0" diameter) provides a nominal 3.2 volts over the temperature range of -40°F to +165°F. Hermetic sealing and glass ampule electrolyte storage make possible a shelf life of 10 years or more. In addition, the G2600-B1 is ideal for low drain, long life applications. This battery demonstrates our advanced state-of-the-art capability in solving your battery problems.

The performance tables below tell the G2600-B1 story the best way possible:

For more complete information on this new power source, call or write Marketing Manager, Honeywell Power Sources Center, Route 309, Montgomeryville, Pa. 18936. (215-699-3585)

Current	AVERAGE VOLTAGE			LIFE TO 2.5 VOLTS (HOURS)		
	-40°F	+75°F	+165°F	-40°F	+75°F	+165°F
250 ma		2.2	2.3		0.5°	0.6°
200 ma		2.5	2.6		0.7°	0.8°
110 ma		2.7	2.8		3.5	3.7
50 ma	2.6	3.1	3.2	8	12	12
20 ma	2.7	3.1	3.2	20	27	29
10 ma	3.1	3.1	3.2	55	55	55
1 ma	3.2	3.2	3.2	500	500	400
.5 ma	3.2	3.2	3.2	1100	1000	900
.25 ma	3.2	3.2	3.2	2200	1700	1200

*Cut-off to 2.0 volts

INFORMATION RETRIEVAL NUMBER 67

ICs & SEMICONDUCTORS

512-bit field pROM has extra test bit

Motorola Semiconductor Products, Inc., Box 20912, Phoenix, Ariz. Phone: (602) 273-6900. P&A: \$45 (100 quantities); stock.

The MCM4003AL/4004AL is a 512-bit field-programmable ROM that is tested before programming. Added to its 64 eight-bit words is a ninth bit. A few of the 64 links on the ninth bit are opened at the factory for element, functional and ac testing. Since the ninth bit represents the worst-case propagation delay, this too can be tested. With half of the 64 NiCr links unprogrammed, additional tests can be performed by the user.

CIRCLE NO. 270

Quad line receiver improves noise immunity

Harris Semiconductor, Melbourne, Fla. Phone: (305) 727-5412. P&A: \$4 (100 quantities); stock.

A new quad line receiver with improved noise immunity is designed to interface between single-ended transmission lines and data terminals. The HD-1489A was designed to receive data transmitted by the earlier-announced HD-1488. Both devices meet the requirements of the EIA Standard RS-232C. The HD-1489A provides a hysteresis of 1.15 V compared with a typical 0.25 V in earlier line receivers for improved noise immunity.

CIRCLE NO. 271

Voltage regulators use one-chip circuitry

Sprague Electric Co., 347 Marshall St., N. Adams, Mass. Phone: (413) 664-4411.

New monolithic voltage regulators feature a temperature-compensated reference amplifier, an error amplifier, a power transistor, and current-limiting circuitry, all on one chip. Type UL-2723 regulators may be used for output currents up to 250 mA, with an output voltage adjustable from 2 to 37 V on either positive or negative-supply operation. They are housed in 14-pin dual-in-line plastic packages.

CIRCLE NO. 272

THE CROWD DISAPPEARS AT 20MHz

Now we're alone with the world's first 20 megahertz function generator, which starting at 0.0001 Hz, makes it twice the frequency range of other wide-range function generators. The model 7230 thus opens up new signal generator applications in the testing of MOS devices and IC's where frequencies are well over 10 MHz and will be going higher. It also will find application in pulse generation with its 30V P-P outputs and 10 nanosecond rise/fall times (equivalent slew rate of 2400 V/microsecond). Another new field for the 7230 will be intermediate frequency applications in FM receivers and telemetry. For only \$795 you get a precision source of sine, square, triangle, ramp, pulse and sync waveforms, plus these other features: VCF input control; several choices of DC offset; sync input for locking the generator to an external clock, and 80 db of step attenuation. And if 11 MHz is still all you need, you should check out EXACT's other three fine instruments in this series: the Model 7030, which has the same operating features of the 7230 above but saves you \$200; the Model 7050, same as the 7030 but with the additional capability to trigger and gate (with variable start/stop levels on the triggered and gated waveforms) for \$745; and the Model 7060, which at \$845 adds a second generator (again at 11 MHz) for ramp, pulse and sweep, 1000 seconds to 100 nanoseconds. Call on us to rise above the crowd with your next function generator.



EXACT
electronics, inc.

Box 160
Hillsboro, Oregon 97123

(503) 648-6661
TWX 910-460-8811

a subsidiary of
Vector
Management
Corp.

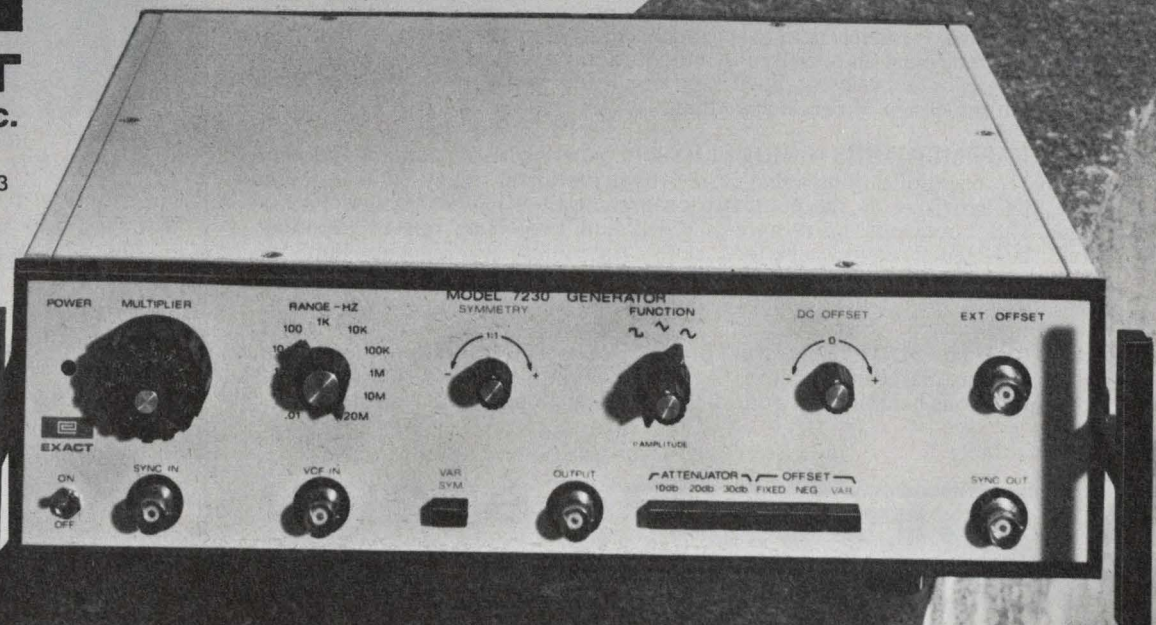

JOIN THE GROWING TEAM at BURR-BROWN in TUCSON

We are looking for individuals for
the following career opportunities:

COMPONENT ENGINEER-Will direct the evaluation of active and passive electronic components to determine their optimum usage in Burr-Brown products. Will investigate and recommend second sources for existing components, solve component related problems in production, and interface with design engineers and outside vendors. Must have a BSEE or equivalent and two years related experience. Applicant must have a working knowledge of linear and digital circuits, plus an intimate knowledge of component specifying, construction, and test methods.

PRODUCT ENGINEER-This individual will be defining and solving any technical problems in the design, production and testing of such products as operational amplifiers, analog multipliers, active filters, sample/hold units, and A/D and D/A converters. This person will interface with production personnel, design engineers, and applications engineers, and be experienced in finding and solving technical product problems. Must have a BSEE or equivalent, a thorough knowledge of manufacturing processes and product support activities.

LINEAR CIRCUIT DESIGNER-This person will develop advanced monolithic integrated circuits in the areas of amplifiers, analog functions, and A/D-D/A conversion. Applicant will have at least a BSEE and two years of linear circuit design and must have demonstrated a competence in linear product development.

PACKAGE DESIGNERS-Will be working in the areas of printed circuit design, thin and thick film layout design, and package design. Must have a BSEE, BSME, or equivalent and five years of drafting, PC design, and package design experience in an electronics atmosphere. Supervisory experience extremely helpful.

DESIGN ENGINEERS-These team-members, through their product design activity, will be integrating marketing inputs, knowledge of production processes and electronic components with their circuit design expertise to provide profitable product design. Product design engineers are needed in the areas of operational amplifiers, instrumentation amplifiers, analog-to-digital and digital-to-analog converters. Successful applicants will have a BSEE and at least 3 years in the design of functional circuits.

SALES/APPLICATIONS ENGINEERS-Will work with customers and representatives on applications using Burr-Brown products. They will help coordinate the activities of the company's representatives in seeking new business. Successful applicants must have a BSEE and two years related experience. Must have good communications skills, the ability to recognize and solve business problems, and an interest in moving into sales oriented management. Positions are open in both domestic and international sales.

CONTACT-Jim M. Williams, Burr-Brown Research Corporation, International Airport Industrial Park, Tucson, Arizona 85706. Telephone (602) 294-1431. All applications held in strict confidence. An equal opportunity employer.



BURR-BROWN
RESEARCH CORPORATION
International Airport Industrial Park • Tucson, Arizona 85706
TEL: 602-294-1431 • TWX: 910-952-1111 • CABLE: BBRCORP

ICs & SEMICONDUCTORS

130-V/ μ s monolithic op amp costs \$15

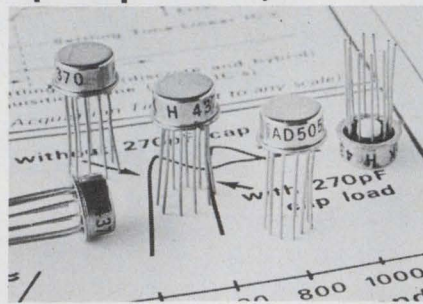

Analog Devices, Inc., Route 1 Industrial Park, Norwood, Mass. Phone: (617) 329-4700. Availability: stock.

The new monolithic AD505 op amp exhibits 130-V/ μ s slewing and settles to 0.1% in 1 μ s following a full-scale input step. Key to the AD505's low price is its monolithic construction and its design that is based directly upon feedforward circuit concepts employed in earlier high-speed discrete-component op amps. Full-power response is to 2 MHz and gain-bandwidth product is 12 MHz.

CIRCLE NO. 273

10-bit d/a converter shrinks cost to \$15.95

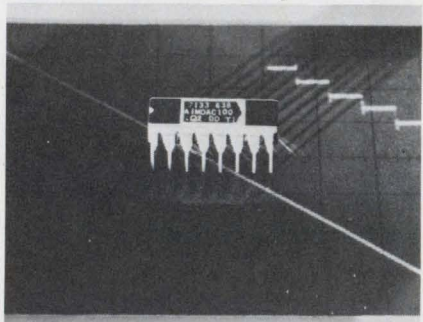

Precision Monolithics, Inc., 1500 Space Park Dr., Santa Clara, Calif. Phone: (408) 246-9222. Price: \$15.95 (2000 quantities).

The low-priced 10-bit aimDAC-100CDT d/a converter is a two-chip hybrid unit packaged in a hermetically sealed 16-pin DIP. It features 375-ns maximum settling time, 0.2% linearity over 0 to +70°C and operates from ± 6 -V to ± 18 -V supplies. Its full-scale temperature coefficient is 120 ppm/ $^{\circ}$ C. The aimDAC 100CDT is DTL/TTL compatible with a choice of +5, +10, ± 2.5 or ± 5 -V outputs.

CIRCLE NO. 274

All Relays Are Not Created Equal!

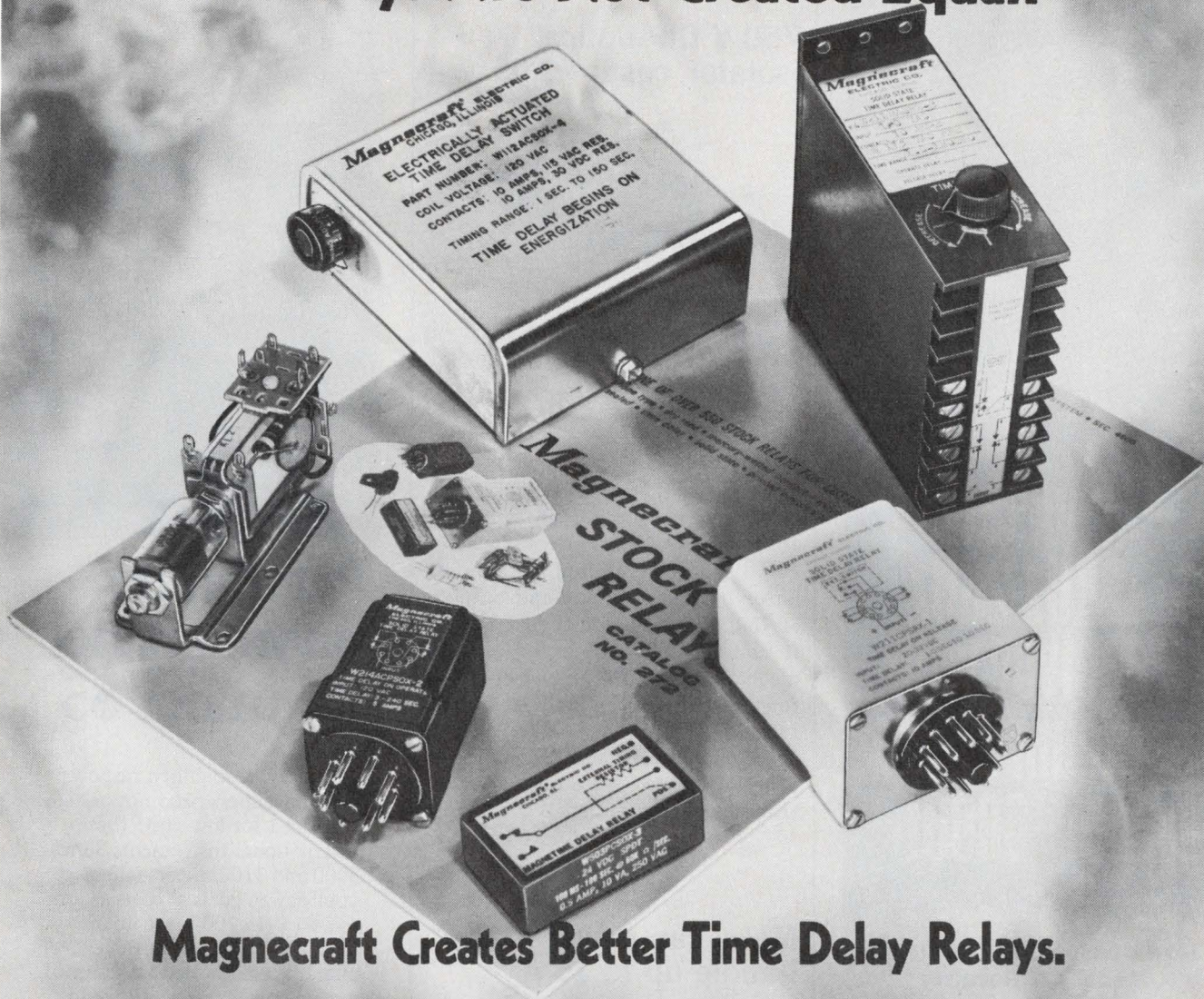

Magnecraft Creates Better Time Delay Relays.

Magnecraft relays are not created equal, because they are created to be better. Created better than its competitors, created better than the most demanding requirements, created better because reliability is important. We are then in the best position to help solve your switching and control needs, not just sell you a relay.

We make time delay relays that are not just good time delay relays, but are actually subsystems, ready to work for you. We offer programmable solid state (hybrid) time delay relays to speed up your process control and general control design work, most inexpensively. We even produce one so small that it occupies less than 2 square inches of space. We have various types of mountings available, printed circuit, plug-in and surface mount. Our electromechanical air-dashpot time delay relays are designed to operate in adverse ambient conditions, such as high temperature, line spikes and where no stand by power is available. When your design calls for a time delay relay, turn to Magnecraft with confidence.

Our 20 years experience has enabled us to do more than just build a good relay. We can help you solve your switching and control problems. Your first step is simple. Send today for Stock Catalog #272, listing over 550 different relays, stocked by Magnecraft and its nationwide network of distributors.

Magnecraft[®] ELECTRIC COMPANY

5575 NORTH LYNCH AVENUE • CHICAGO, ILLINOIS 60630 • 312 • 282-5500 • TWX-910-221-5221

At last!



A portable 2KHz-2GHz receiver with spectrum display under \$6800!

Now commercially available
Model A-2 Receiver

- Rugged, portable design
- 2 KHz — 2 GHz R.F.
- 1-5 uv sens.
- AM-FM-CW
- Spectrum Display Unit
- Signal Meter
- Battery and AC operation
- 17 x 12 x 6 inches — 28 lbs.
- Over 7 years of field use.

Partial sets available for as low as \$1590 with limited frequency coverage.

Write or phone today for specs on Mason A2 Receiver . . .

M
E I F . G .
M A S O N
E N G I N E E R I N G

Fairfield, Conn. 06430 • 203/255-3461
1700 Post Road • Heritage Square
INFORMATION RETRIEVAL NUMBER 70

118

COMPONENTS

750-V DIP optical isolator costs \$2.55

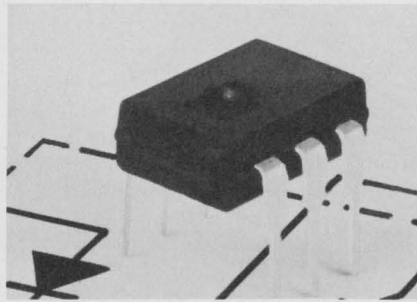

Fairchild Microwave & Optoelectronics, 3500 Deer Creek Rd., Palo Alto, Calif. Phone: (415) 493-3100.

A low-cost optically coupled isolator has a coupling efficiency of 10%, typical isolation resistance of $10^{11} \Omega$ and a minimum voltage isolation (between input and output) of 750 V. Designated the FPLA810, it can be substituted for electro-mechanical relays or pulse transformers. It couples analog signals independent of the signal rate of change and overcomes poor isolation resistance encountered with transformers.

CIRCLE NO. 275

Metal-can power triacs handle up to 15 A

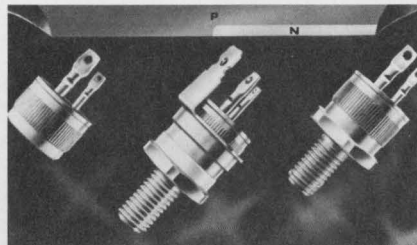

General Electric Co., Electronic Components Div., Syracuse, N. Y. Phone: (315) 456-2357. P&A: \$1.63, \$1.98, \$2.10 (1000 quantities); stock.

A new line of triacs features Power-Glas passivated chips that yield low leakage-current levels (0.1 mA), high commutating dv/dt (4 V/ μ s), stability, improved performance and high reliability. The SC240, SC245 and SC250, are 6, 10 and 15-A triacs, respectively, and are available in 200, 400 and 500-V types in press-fit, stud and isolated-stud packages.

CIRCLE NO. 276

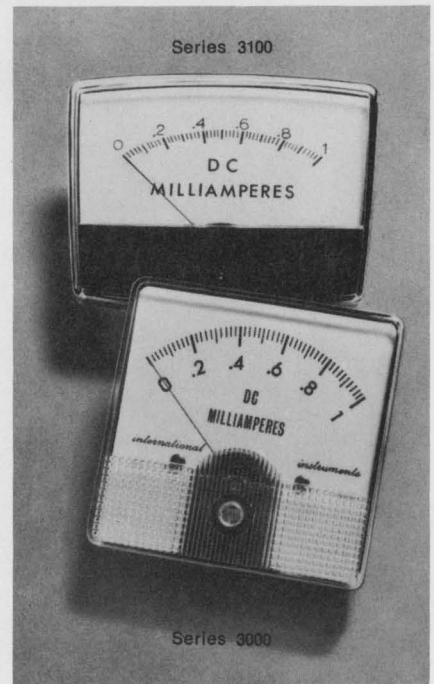

Put quality on your panel for under \$5

Accuracy, readability, response and ruggedness need not be sacrificed for low cost: these International Instruments Series 3000 and 3100 meters will meet your design goals at costs as low as \$4.15 (in 100-piece quantities), for a 1½" square DC millimeter. Jeweled D'Arsonval movements, in ranges down to 50 μ a, provide response time to 2 sec. max. and initial accuracy to $\pm 2\%$ DC ($\pm 3\%$ AC), meet shock and vibration requirements of ANS C39.1. Repeatability is maintained over the life of the meter.

Both Series available in 1½, 2, 2½, 3½ and 4 inch sizes, in 61 standard ranges from 50 DC μ a to 5000 AC volts. Clear acrylic crystals, sweep scales and red bar-type pointers enhance readability and random-size compatibility. Custom dials carrying your trademark and special colored shrouds available at moderate additional cost. For data and quotes, send requirements to:

i INTERNATIONAL
INSTRUMENTS

DIVISION OF SIGMA INSTRUMENTS, INC.
88 MARSH HILL RD., ORANGE, CONN. 06477

INFORMATION RETRIEVAL NUMBER 71
ELECTRONIC DESIGN 21, October 14, 1971

Mylar foil capacitors have 20-V/ μ s rise time

Siemens Corp., 186 Wood Ave. S., Iselin, N. J. Phone: (201) 499-1000.

A line of metallized mylar foil capacitors feature pulse rise times of up to 20 V/ μ s. Type MKH capacitors are suited for use in triggering circuits and other pulse-forming networks with operation at rated rise times. To aid compact circuit designs, these capacitors are available as rectangular plug-in types or in oval shapes with axial leads. Special construction techniques result in low contact resistance between the self-healing polyester foil and leads.

CIRCLE NO. 277

Hybrid regulators handle 5 to 24 V dc

Epitek Electronics Ltd., 19 Grenfell Crescent, Ottawa, Ontario, Canada. Phone: (613) 825-3911.

Series 102 voltage regulators are fixed-voltage hybrid regulators for the range of 5 to 24 V dc. They handle a continuous load current of 2 A and provide 20-mV load regulation and temperature coefficient of 0.01%/°C. Studs for mounting the regulator module on a heat sink are an integral part of the package, permitting power dissipations up to 20 W. The regulators provide an input change of 10 mV/V.

CIRCLE NO. 278

Temperature stabilizer handles TO-5s at 65°C

Jermyn Industries, Vestry Estate, Sevenoaks, Kent, England.

The 4ST2-4 is designed to control the temperature of TO-5 devices at 65°C. This new stabilizer enables inexpensive commercial-grade ICs to be operated in a stable environment below 70°C. It is suitable for those ICs with lead lengths restricted to 0.5 in. Power requirements are 0.6 W at 24 V ac/dc (25°C ambient). The 4ST2-4 incorporates a semiconductor heater for infinitely proportional temperature control.

CIRCLE NO. 279

Our new lab recorder will turn you on...

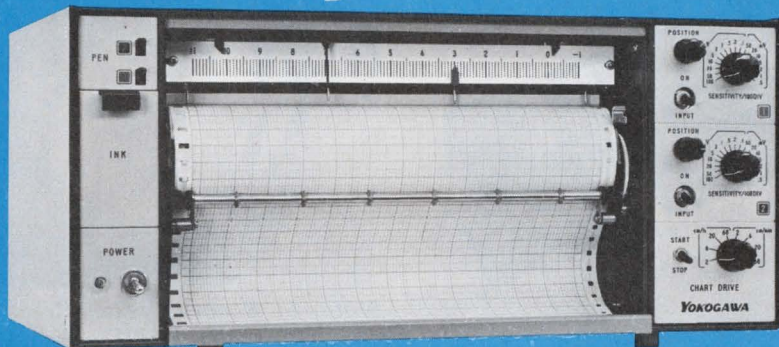

- * 500 μ Volt Full Scale Sensitivity
- * 1 Megohm Constant Input Resistance
- * 180 dB DC Common Mode Noise Rejection
- * 140 dB AC Common Mode Noise Rejection
- * $\pm 0.3\%$ Accuracy Full Scale
- * DC Servo Mechanism Drive
- * Refillable Ink Cartridge
- * FET Chopper Modulation Amplifier
- * Self Folding Strip Chart
- * Single or Multi Range Chart Speeds
- * 1 or 2 Pens
- * Wide Selection of Optional Equipment and Input Converters

Write for our new 10-page Lab Recorder brochure. We're confident you'll be turned on.



Yokogawa Electric

In the USA, contact:

Yewtec Corporation

1995 PALMER AVENUE, LARCHMONT, NEW YORK 10538

Telephone: 914 834-3550

INFORMATION RETRIEVAL NUMBER 72

PLUG ACCESSORIES

FOR HIGH DENSITY PACKAGING PANELS
Greater flexibility in prototyping and packaging

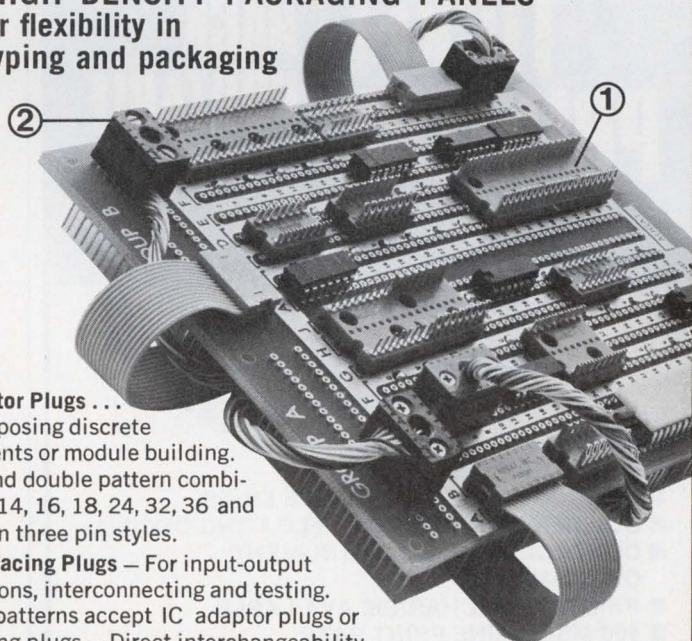

① Adaptor Plugs ...

For interposing discrete components or module building. Single and double pattern combinations, 14, 16, 18, 24, 32, 36 and 40 pins in three pin styles.

② Interfacing Plugs —

For input-output connections, interconnecting and testing. Contact patterns accept IC adaptor plugs or interfacing plugs — Direct interchangeability.

IC PACKAGING PANELS

AUGAT

INC.

TEL: 617-222-2202

31 PERRY AVE., ATTLEBORO, MASS. 02703

Request Catalog 266 and Data Sheet 266J

INFORMATION RETRIEVAL NUMBER 73

Cermet 20-turn trimmer can dissipate 0.75 W

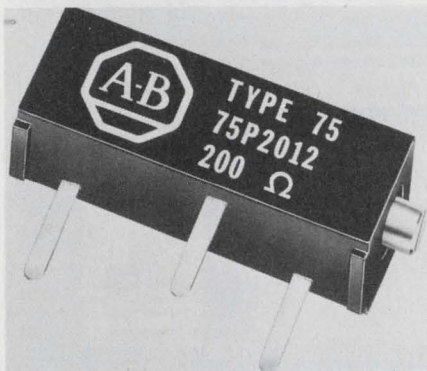

Allen-Bradley Co., Electronics Div., 1201 S. Second St., Milwaukee, Wis. Phone: (414) 771-2600. P&A: \$1.59 (100 quantities); 4 to 6 wks.

A new 3/4-in.-long immersion-sealed cermet 20-turn trimmer is rated at 0.5 W at 85°C or 0.75 watt at 25°C with an operating temperature range of -65 to +125°C. Type 75 has a temperature coefficient of 100 ppm/°C and resistance values from 100 Ω to 1 MΩ.

CIRCLE NO. 280

Dual power driver supplies up to 6 A



Motorola Semiconductor Products, Inc., Box 20912, Phoenix, Ariz. Phone: (602) 273-6900. Price: \$7.95 (100 quantities).

High-current loads can be driven by logic circuitry using the MCH-2890 dual power driver. The MCH-2890 combines a dual two-input TTL AND gate and a pair of Darlington power transistors in a hybrid design to provide up to 6 A at a 10% duty cycle and a 25-ms pulse width. Continuous output current is 1 A. The unit translates logic levels to high power outputs.

CIRCLE NO. 281

Top-hat resistors are 0.0015% stable

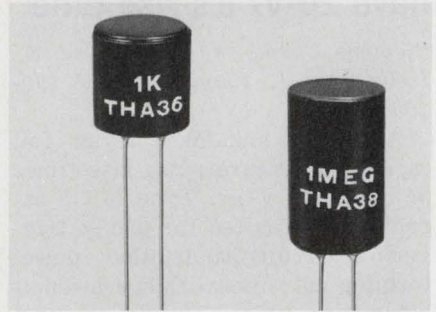

Julie Research Laboratories, Inc., 211 W. 61st St., New York, N. Y. Phone: (212) 245-2727. P&A: \$1.50 to \$7; 5 to 10 days.

Hermetically-sealed resistors of top-hat design offer an absolute accuracy and stability from 0.0015% and ratio accuracy and stability from 0.0005%. Called the THA series, the resistors are available in two sizes: the THA-36 which measures 3/8 in. in diameter by 1/2 in., and the THA-38 which is 3/8 in. by 3/4-in. high. They span values from 1 Ω to 1 MΩ.

CIRCLE NO. 282

DIGITAL TICKET PRINTERS **OEM - RACK - PORTABLE**

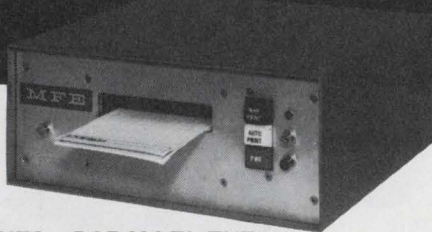

- BCD INPUTS - PARALLEL ENTRY
- TAB CARD SIZE - 3 COPIES
- INDEXING - 20 CONSECUTIVE LINES
- COLUMN SUPPRESSION - FLOATING DECIMAL
- CONTROLLABLE BY INSTRUMENT OR COMPUTER
- PRINTING MECHANISM AVAILABLE
- 400 MSEC/LINE PRINT RATE
- MANY OPTIONS/ CHARACTER WHEELS

VALUE PRICED FROM \$154



340 Fordham Rd., Wilmington, Mass. 01887 (617) 658-5500 TWX 710-347-6938

INFORMATION RETRIEVAL NUMBER 136

THE INTERCHANGEABLE 1.

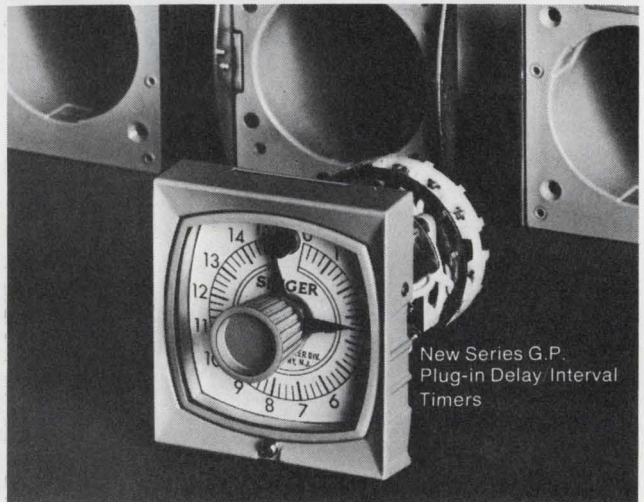

New Series G.P. Plug-in Delay Interval Timers

Completely interchangeable with over 80% of the most widely used Plug-in Delay/Interval Timers

Who ever heard of a line of plug-in delay/interval Timers that is reliable, economical and interchangeable for as little as \$27.90? You just did.

Delivery is stock to 6 weeks, depending upon quantity. Consult us for further information and the G.P. Bulletin 310. Call 201-887-2200.



Industrial Timer Division, U.S. Highway 287, Parsippany, N.J. 07054 201/887-2200

INFORMATION RETRIEVAL NUMBER 137

INFORMATION RETRIEVAL NUMBER 74 ►

Amperex photosensitive devices...

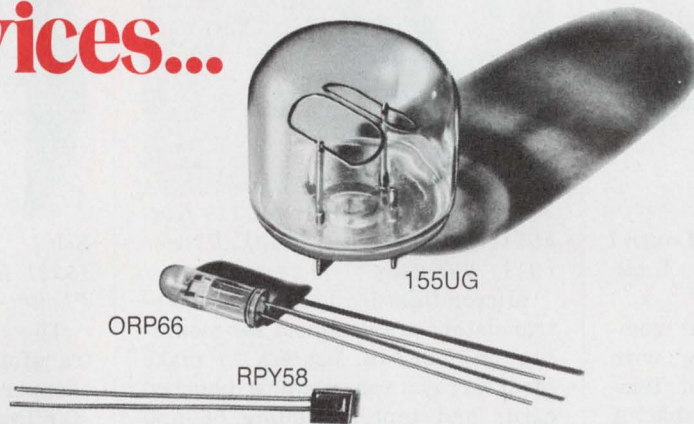

ORP66

155UG

RPY58

another facet of our electro-optics capability.

In addition to the well-known lines of Plumbicon* and vidicon TV camera tubes, X-ray image intensifiers and instrument cathode ray tubes, Amperex' total capability in electro-optics encompasses a broad line of photosensitive devices. Included are high-vacuum and gas-filled photo tubes covering a wide spectral range and a complete line of cadmium sulphide photoconductive cells.

155UG: Typical and popular is the 155UG gas filled photo tube, sensitive to ultra-violet radiation. It has a peak spectral response at 220nm and only 10% response at 206nm and 250nm. It is intended for use as an on-off device in flame-failure and flame-detection circuits.

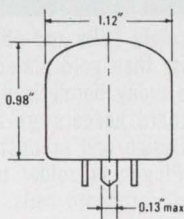

ORP66: The ORP66 cadmium sulphide photoconductive cell offers shock and vibration resistance and high sensitivity in a hermetically sealed envelope. It has wide spectral response, peaking at 630nm. It is intended for on-off as well as variable brightness control applications.

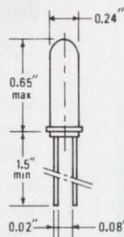

RPY58, RPY71: Examples of very inexpensive cadmium sulphide photoconductive devices are types RPY58 and RPY71, with peak spectral response at 550nm. Sensitivities are linear; 3 orders of magnitude in the RPY58; 4 orders of magnitude in the RPY71. Both of these devices are ideally suited for electronic control applications in toys, cameras, etc.

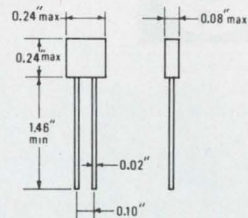

For more information on Amperex photosensitive devices, contact:
Electro-Optical Devices Division, Amperex Electronic Corp., Slatersville, R. I. 02876 Tel.: 401-762-3800



Amperex®

TOMORROW'S THINKING IN TODAY'S PRODUCTS
A NORTH AMERICAN PHILIPS COMPANY

*Reg. T.M. of N.V. Philips' of Holland

Indicating thermostat shows over-temperature

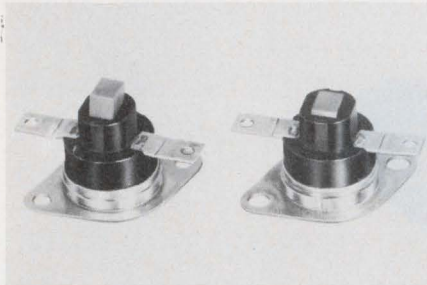

Texas Instruments, Inc., Control Products Div., Attleboro, Mass. Phone: (617) 222-2800.

A Klixon thermostat that combines snap-action switching with positive visual indication of temperature anomalies is available. A colored button extends from the top of the device when the switch contacts first open at a preset temperature. The contacts automatically reset when the temperature returns to normal but the button remains up to show that over-temperature has occurred. The button may be reset.

CIRCLE NO. 283

Tiny phototransistors fit 0.087-in. centers

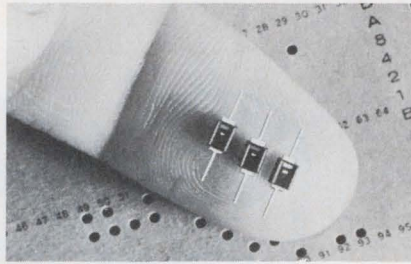

Sensor Technology, Inc., 7118 Gerald Ave., Van Nuys, Calif. Phone: (213) 781-2154.

Microminiature logic-level phototransistors are designed for mounting on 0.087-in. centers to make ideal arrays for reading punched cards and tape, including 96 and 80-column cards. Packaged in plastic housings 0.085-in. wide by 0.105-in. long by 0.045-in. high, STPT-260P Opto-Pak units provide outputs of 2 mA at 1 mW/cm², switch at 6 μs and have peak spectral response of 800 nm typical (60% of output at 655 nm and 960 nm).

CIRCLE NO. 284

Isolated microchopper works up to 1.5 MHz



Solid State Electronics Corp., 15321 Rayen St., Sepulveda, Calif. Phone: (213) 894-2271.

The NS8000A is a complete transformer-isolated solid-state chopper for dc to 1.5 MHz using stabilized silicon ICs in a TO-5 can. Its uses include low-level and high-speed modulation, demodulation, commutation and switching. It has 100 μV of offset voltage, 5 nA of leakage current and 100 Ω of saturated dynamic impedance. In addition, it has a high OFF impedance, fast switching speed and 0.3 μV/°C thermal stability.

CIRCLE NO. 285

our tape heads sell computer tape drives!

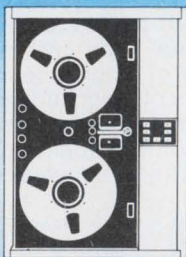

Nortronics' comprehensive line of 7 and 9 channel, IBM-compatible heads for 1/2" tape are specified by leading manufacturers all over the world.

Maybe that's because of extra features such as our terminal connector which provides rapid head plugability. But we also think it's due to Nortronics' unique ability to design the right head and deliver it in prototype or production quantities—anywhere in this world! Write for detailed technical information on Nortronics digital heads today!



world's leader in magnetic heads

NORTRONICS
COMPANY, INC.

8101 Tenth Ave. North • Minneapolis, Minn. 55427 • Tel: 612-545-0401

INFORMATION RETRIEVAL NUMBER 75

Plastic Cheaper Than Gold?

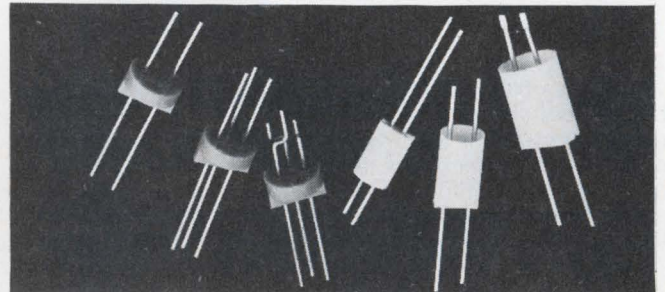

Lots cheaper. That's why you can encapsulate LEDs and photo cells on GE plastic headers for up to 25% less than gold plated, solder sealed cans. Reliable enough to replace many hermetically sealed devices in non-critical applications, standard headers are available off-the-shelf for \$10 per M and lower. Design and production capability for your own special types too. Plug-in or solder to circuit boards. Bipin bases shown on right ideal for photo cells. Headers (left) come with several options on twist, form, and number of lead wires. Write today or call today for more information.

General Electric Company, Lamp Metals and Components Department, 21800 Tungsten Road, Cleveland, Ohio 44117 Telephone: (216) 266-3942

GENERAL ELECTRIC

INFORMATION RETRIEVAL NUMBER 76

ELECTRONIC DESIGN 21, October 14, 1971

Compact design ideas for positioning... timing... control.

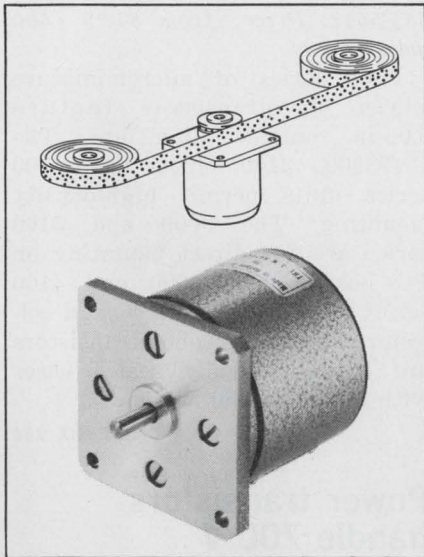

LOW-COST INCREMENTAL DRIVE

These are about the lowest cost logic drive stepper motors available. Pricing starts as low as \$64 per unit including the logic drive. Designed for 5-volt operation they are compact, reliable and have earned an outstanding reputation in computer applications. All in all, there are 13 different models available offering working torque up to 22 oz.-in. and pull-in rates up to 900 steps/sec. In addition to motors we can supply a complete stepper system which includes the motor, electronic logic and variable speed drive. If your design requires low cost but high performance incremental drives find out about these 5-volt permanent magnet logic steppers. Write for literature.

INFORMATION RETRIEVAL NUMBER 77

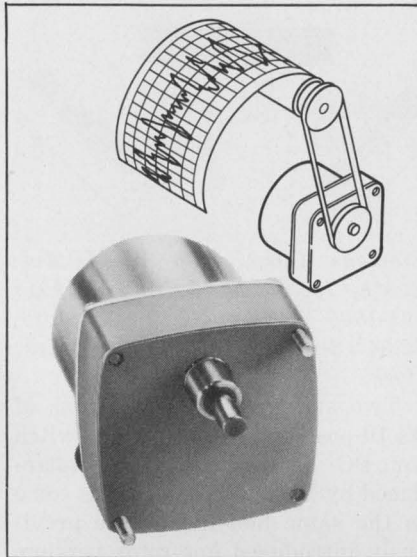

SPACE-SAVING SYNCHRONOUS DRIVE

Motor performance, size, weight and cost are critical in all applications. Our 86000 Series Synchronous Motor has won wide acceptance because it meets all of these requirements.

It has extremely fast start/stop characteristics without resorting to prestarts or clutching. Torque is high — 6 oz.-in. @ 300 RPM at the rotor shaft and up to 200 oz.-in. usable power with gearing. You have the choice of two designs, a reversible motor or a dual speed unidirectional model which employs an integral capstan clutch.

As for size, it is smaller than most similar motors — only $2\frac{3}{8}$ " square and $2\frac{1}{2}$ " deep, including the NEMA configuration gearhead.

Weight is less than 2 lbs. Prices start under \$20 in single quantities. You can select off-the-shelf units from 14 speed/torque combinations for the reversible model. Also, 14 combinations of the dual speed unidirectional motor are available. Rated for 120 VAC 60 Hz operation — input power is only 8 watts nominal. Other operating voltages are available. Write for literature.

INFORMATION RETRIEVAL NUMBER 78

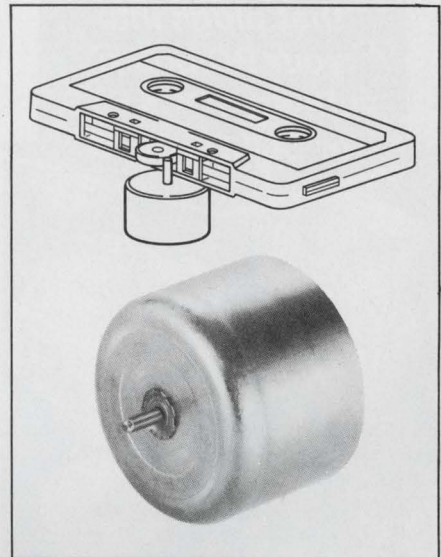

COMPACT DC CASSETTE DRIVE

Many of the world's largest manufacturers of cassette tape recorders use this miniature DC motor. Only 1.34" dia. x 0.93" depth, its performance is exceptional. Working torque is 0.15 oz.-in. @ 2,000 RPM. It operates on 4.5 VDC, and output speed can be electronically controlled.

Exceptionally long brush life makes this motor ideally suited for volume applications in instrumentation and computer peripherals. Especially in magnetic tape drives, tape take-up drives and constant velocity drives.

A companion motor, with higher torque but shorter life, is also available for chart and pen drives in portable recorders, automation instrumentation, and business machines. We will be happy to provide design assistance and circuitry for electronic speed control. Write for literature.

INFORMATION RETRIEVAL NUMBER 79

THE A. W. HAYDON COMPANY



232 North Elm Street, Waterbury, Conn. 06720 Tel. (203) 756-4481 TWX: 710-477-3141
In Europe: Polymotor International - Brussels 1, Belgium

the only printed circuit Relay

that plugs into your PC board without SOCKETS or SOLDERING

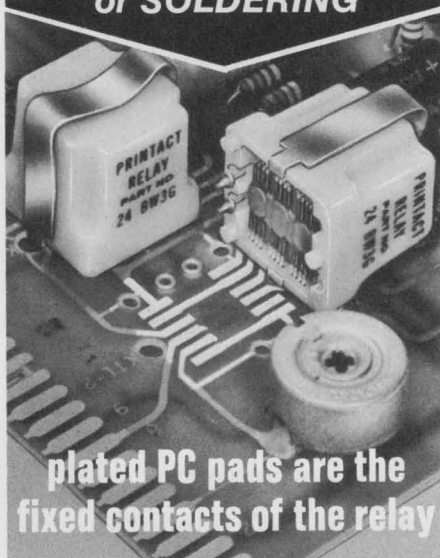

Printact[®] MAGNETIC LATCHING AND NON-LATCHING RELAYS

The only relay designed to make full use of printed circuit technology. Unlike others adapted with terminal pins or sockets for solder mounting, Printact plugs directly into your module. Precious metal plated PC pads mate with shorting bar contacts on the pivoting armature, which is the single moving part. Held by a permanent magnet, it eliminates return springs, pigtailed, electrical and mechanical connections—assuring reliability for millions of cycles.

Inherent Custom Features include: Low Thermal EMF, Low Contact Bounce, Impedance Matching, 45-60 db Isolation, Bifurcated Contacts, and Encapsulated Coil—all at low cost!

Send for Test Sample and PC Board Preparation Aids to simplify design and production of your module.

For action write or call 212—EX 2-4800.

Executone

PRINTACT RELAY DIVISION
P.O. Box 1430ED
LONG ISLAND CITY, N.Y. 11101

INFORMATION RETRIEVAL NUMBER 80

COMPONENTS

Programming switch has multi-rotor styles

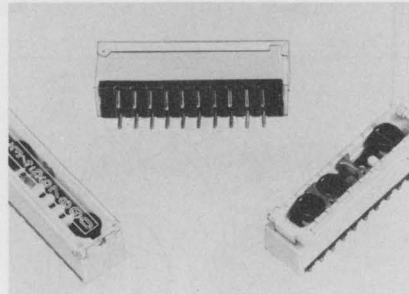

Siemens Corp., 186 Wood Ave. South, Iselin, N. J. Phone: (201) 494-1000. P&A: \$2.40 (2-rotor), \$2.85 (3-rotor), for 250 quantities; stock.

Two and three-rotor versions of its 10-position programming switch for PC boards have been introduced by Siemens. These units come in the same housing as the previously introduced one-rotor version, which covers less than 0.35-in. square. A small screwdriver is all that is required to turn each rotor 180 degrees from one detented position to another.

CIRCLE NO. 286

Modular rocker switches lower their profiles

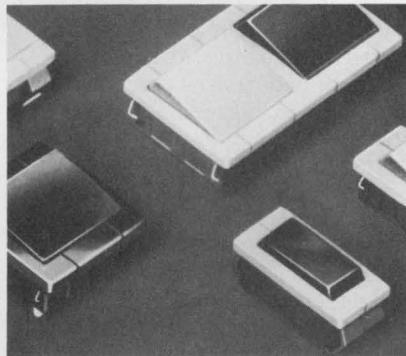

Leecraft Mfg. Co., Inc., 21-16 44th Rd., Long Island City, N. Y. Phone: (212) 392-8800.

Handsomely designed, new low-profile modular single-pole or double-pole rocker switches are suitable for many applications. Two to six modules of these switches can be combined to produce a single, multi-purpose switch. Lighted or unlighted versions are offered in the series 30-000 modular switches which may be ordered with body and rocker in either light grey or black.

CIRCLE NO. 287

Silicon phototransistors have small diameters

Clairex Corp., 560 S. Third Ave., Mount Vernon, N. Y. Phone: (914) 684-5512. Price: from \$1.79 (500 quantities).

Four series of microminiature silicon phototransistors feature 0.06-in. outside diameters. The CLT3000, 3100, 4000 and 4100 series units permit high-density mounting. The 3000 and 3100 series are for direct mounting on PC boards. The 4000 and 4100 series ones have 0.5-in. coaxial collector leads. All phototransistors are in hermetically sealed cases with lensed or flat windows.

CIRCLE NO. 288

Power transistors handle 700 V

Solitron Devices, Inc., 1177 Blue Heron Blvd., Riviera Beach, Fla. Phone: (305) 848-4311. Availability: stock.

A new series of 700-V high-voltage silicon power transistors surpass in reliability the performance of many comparable devices now available in the industry. Identified as the SDT500 series they are packaged in JEDEC TO-3 cases and are of 100% planar construction. Leakage levels are low at elevated temperatures (10 μ A at 150°C at a collector-emitter voltage of 400 V).

CIRCLE NO. 289

Monolithic capacitor arrays come in DIPs

Aerovox Corp., New Bedford, Mass. Phone: (617) 994-9661.

Employing Ceralam multi-layer chip capacitors, new 14 and 16-pin DIP packages are now offered with capacitor arrays. Low-cost prototype quantities for evaluation are supplied with standard chip capacitors mounted in pre-formed packages. For production quantities, the entire capacitor array can be fabricated as a single monolithic structure with multiple connections attached to the lead frame. Chip capacitors are provided in ratings of 25, 50 and 100 V dc from 1 pF through 1 μ F.

CIRCLE NO. 290

The gaussmeter comes to the production line.

If any of the products you make include permanent magnets, you could use a Bell gaussmeter. It's the best quality control check you can use. And in addition to testing, we can even help with production. We have a complete line of magnetizers, sorters, stabilizers, and demagnetizers. Write for our detailed brochure to: 4949 Freeway Drive East, Columbus, Ohio 43229.
E. W. Bell Inc.

A subsidiary of The Arnold Engineering Co.

INFORMATION RETRIEVAL NUMBER 81

UNUSUAL BARGAINS

... MANY U. S. GOV'T SURPLUS

FREE! GIANT CATALOG

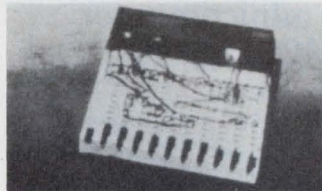

NEW! ELECTRONIC DIGITAL COMPUTER KIT!

Solve problems, play games, predict weather with this actual working model of giant electronic brains. Amazing new fun way to learn all about computer programming . . . logic, decimal, binary systems. Laws of Sets—even do your own programming after completing simplified 116 page instructive booklet. Includes step-by-step assembly diagrams. Circuits easily changed. Readout from illuminated control panel. Req. 2 "D" batt. (not incl.). Best model we've seen—for home, school, industry.
No. 71,434DA (11" x 12 1/2" x 14") \$31.50 Ppd.

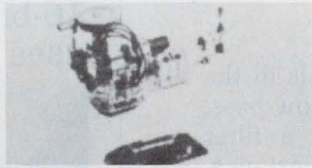

AMAZING NEW WANKEL ENGINE KIT!

Thrill to the fun of building your own see-through motorized model of revolutionary pistonless type engine, rights for which GM recently paid \$50 million! Only engine experts think economically modifiable to meet new pollution standards. Replaces piston, cylinder, crank assemblies with rotating discs (sections removed for firing chambers). Smaller than conventional; fewer parts, greater reliability, same speed w/less horsepower. Feat: flashing plugs, rubber fan belt, stick-shift on-off switch. Req. 2-1.5V batt. (not incl.).
No. 71,424DA (4 1/2" 5" x 9") \$6.75 Ppd



18" FLEXIBLE FIBERSCOPE

Hi-resolution image-transmitter lets you see into remote, inaccessible illuminated areas, through pipes, tubes or any 3/8" opening no matter how intricate. Provides clear, wide sighting, 7X magnifying eyepiece focuses from less than 1/2" from subject to infinity. Ideal for monitoring hazardous processes, surveillance instrument, demonstrate fiber optics. Over 4,000 coherent glass fibers (.002"), 3/8" dia, semi-rigid gooseneck sheathing.
Stock No. 60,857DA \$40.00 Ppd.

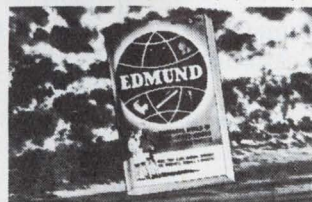

GIANT FREE CATALOG

Completely new 1972 edition—148 pages. Bargains galore! New categories, items, illustrations. 1,000's of buys for industry — Optics, Science, Math. On-the-job helps, quality control aids. Optics for research labs, design engineers experimenters. Instruments for checking, measuring . . . to speed work, improve quality, cut costs. Huge selection of telescopes, microscopes, and other hard-to-get war surplus bargains. Write for Catalog DA.

EDMUND SCIENTIFIC CO. 300 EDSCORP BLDG. BARRINGTON, NEW JERSEY 08007
ORDER BY STOCK NUMBER · OPEN ACCOUNT TO RATED FIRMS · MONEY-BACK GUARANTEE

INFORMATION RETRIEVAL NUMBER 82

ELECTRONIC DESIGN 21, October 14, 1971

If you've forgotten about electroluminescence, unforget!

OVONIC DISPLAYS

has developed

ELECTROLUMINESCENT LAMPS

WITH HALF-LIFE

OF 15,000 HOURS

AND

RED ELECTROLUMINESCENT LAMPS

(Blue and white lamps are under development.)

Color Range	Voltage/Frequency	Brightness	Half-Life
Green-Yellow	115V/400Hz	20 Ft. L.	15,000 Hrs.
Green-Yellow	90V/10KHz	47 Ft. L.	500 Hrs.
Green-Yellow	250V/60Hz	15 Ft. L.	Being Tested
Red	115V/400Hz	4 Ft. L.	Being Tested

For application assistance, Ovonic EL specifications, test samples, pricing or just discussion, call or write Mr. Peter Tarrant, Marketing Manager,



OVONIC DISPLAYS

Division of Energy Conversion Devices, Inc.

333 Park Street
Troy, Michigan 48084
Phone (313) 588-7510

INFORMATION RETRIEVAL NUMBER 83

ITHACO's precision variable electronic band-pass filters are designed for multi-channel applications requiring close phase and amplitude matching between channels in the frequency range of .01Hz to 100KHz

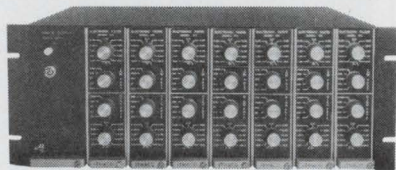

If your problem is analyzing a variety of signals in the presence of noise, then Ithaco's 4100 series of low-pass, high-pass and band-pass filters will provide a filter setting for optimum signal enhancement. For instance, filter cutoff, bandwidth and noise bandwidth are precisely controlled in convenient $\frac{1}{3}$ octave settings. Multi-channel applications are served by three and seven channel racks, with close phase ($\pm 3^\circ$) and amplitude ($\pm .1$ db) tracking between channels. A maximum signal handling capability of 10 volts and a noise floor of less than 50μ volts results in unmatched performance.

The 4100 series is ideal for most acoustic, environmental test, geophysical, EW and general research applications. Ithaco also provides amplifiers, racks, power supplies . . . right on up to custom engineered data acquisition systems.

Write to Ithaco, Inc., 735 W. Clinton Street, Ithaca, New York 14850, for complete price and product information. Or call Don Chandler at 607-272-7640 to discuss your specific application.

ITHACO

735 W. CLINTON STREET, ITHACA, NEW YORK 14850
INFORMATION RETRIEVAL NUMBER 84

DATA PROCESSING

Touch-Tone decoder mates phones to TTL

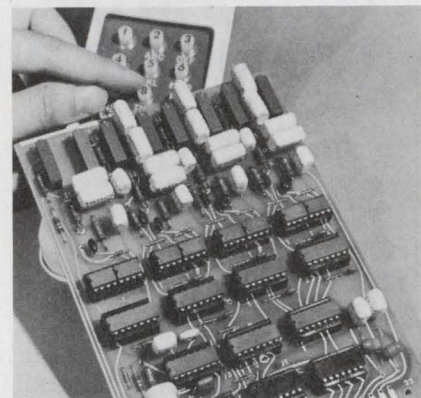

Kenics Systems Corp., 125 Harvard St., Cambridge, Mass. Phone: (617) 868-5100.

To select and actuate remote equipment or interface a computer with telephone equipment, a new TouchTone unit decodes the standard telephone two-tone signal into a 16-mA 5-V TTL output. A companion circuit to the decoder delivers constant-level signals to the decoder. Input signals from 80 mV to 2 V are retransmitted at the optimum strength to source the decoder.

CIRCLE NO. 291

16-bit minicomputer uses MOS/LSI ICs

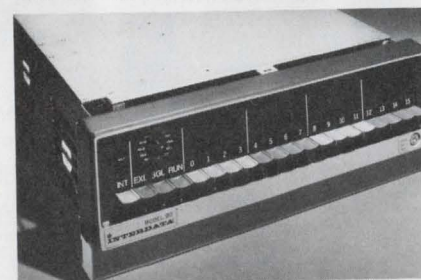

Interdata, 2 Crescent Pl., Oceanport, N. J. Phone: (201) 229-4040. P&A: \$15,000; 2nd quarter, 1972.

The new model 80 is an LSI-based minicomputer with data word lengths of 8, 16 or 32 bits. It utilizes a comprehensive set of 113 instructions, including multiply/divide, floating point and list processing. Word size is 16 bits (17 with parity option). There are sixteen 16-bit hardware general registers, 15 of which may be used for indexing. The model 80 uses 1024-bit MOS devices in 16 kbyte storage units.

CIRCLE NO. 292

Thank you for showing us that engineers still appreciate creative design. Design that isn't measured by how many jazzy junctions and metallurgical miracles you can cram onto a chip of silicon. Design that goes back to the fundamental constraints of circuits, functions and economics.

Three months ago, the engineering team which had labored so long to produce the first major instrument breakthrough in five years agreed that the job was done. So we called in the toughest bunch of critics in the business — the editors of the leading technical magazines in electronics.

We told them, and showed them, what we had done: gone back to fundamentals and developed a *completely new generation of digital multimeters*. We showed them original, patent-applied-for circuits that achieved orders-of-magnitude improved performance, at a *fraction* of the cost of the circuits then in use. Circuits that made it possible to actually cut the selling price of a premium-grade 5½ digit multimeter by 50% or more . . . while significantly reducing the component count, and thereby greatly enhancing reliability.

Then we showed them a vastly improved package . . . easy to use, convenient to calibrate . . . a package that saved half the size and more than half the weight that

burdened earlier premium-grade DMM's. And just for good measure, we showed them a compatible family of 4½ digit designs, at equally startling savings.

They came. They saw. They probed. They challenged. (We must have explained our new TRI-PHASIC™, ISOPOLAR™, and RATIOHMIC™ circuits dozens of times.)

And then came the editorial critiques. Admittedly, we're not in the best position to be objective, but cooler, less involved colleagues tell us that they cannot remember ever having seen such a *consistently enthusiastic* editorial response to a new family of instruments.

But the story doesn't end there. The phone began to ring steadily. Letters poured in. We got firm purchase orders even before our catalog was printed. Our first production run was sold out before we had provided a single field rep with a demo unit. And the response continues to exceed all reasonable expectations.

There isn't sufficient space on this page for complete specs, or competitive comparisons, just enough to show you one of our beautiful new 2000-Series Digital Multimeters. But please write or call. We'd like to show you what the excitement is all about. Data Precision Company, Audubon Road, Wakefield, Massachusetts 01880. Phone (617) 246-1600



Model 2540, 5½ digits. DC volts, AC volts, Resistance, Voltage Ratio. Auto-ranging. Auto-Polarity. Isolated BCD outputs. Remote triggering. Remote ranging. Basic accuracy ±0.001% f.s. ±0.007% rdg ±1 l.s.d. for 6 months. One-piece price: \$1,195.00

 **DATA PRECISION**
...years ahead

The problem eliminator...

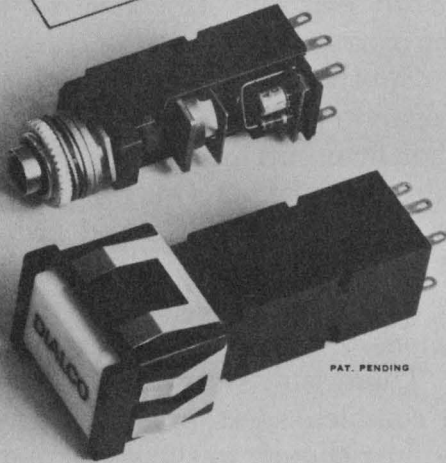
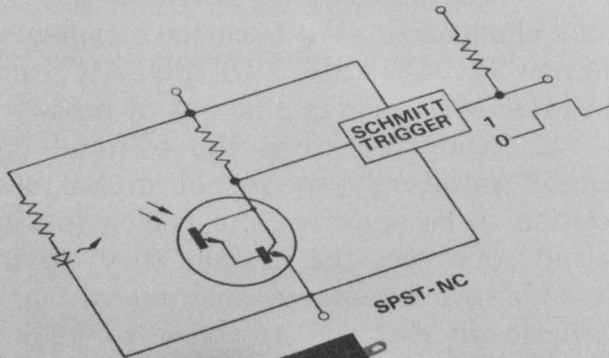

Dialight's new contactless solid state switch

This new illuminated pushbutton switch eliminates contact bounce, contamination, intermittent switching at low levels... all the problems associated with mechanical switches. Because it switches *electronically*. Pressing the button interposes a shutter between an LED light source and a photo-Darlington amplifier. This actuates a built-in Schmitt trigger to provide clean switching with rise and fall times of less than 100 nsec—many times faster than any mechanical or Hall Effect switch. It has many times their life too— 10^7 operations at rated load.

The Dialight Contactless Switch interfaces directly with ICs or discrete circuitry. It's available for panel and snap-in mounting (interchangeable with existing Dialight switch caps and bezel assemblies), and in SPST-NO, SPST-NC and SPDT types. Write for technical and applications bulletin SW6110.

DIALIGHT

DIALIGHT CORPORATION, A NORTH AMERICAN PHILIPS COMPANY
60 STEWART AVENUE, BROOKLYN, N. Y. 11237 • (212) 497-7600

INFORMATION RETRIEVAL NUMBER 86

FREE CATALOG!!

**Hand Tool
and
Magnifier
Catalog
No. 171**

*...tools for
miniature and
sub-miniature
applications*

Tweezersfeaturing Boley and Dumont style Swiss tweezers—available in all alloys.

Pliersfeaturing the famous Lindstrom "Box-Joint" Swedish pliers—perfect for precision work.

Magnifiersfeaturing Bausch and Lomb and Peer monocular and binocular eye loupes—perfect for closeup inspection and assembly.

Cuttersscissors and nippers for special wire cutting problems.

Also featured are miniature screwdrivers, pin vises, knives, etc. Let these money-saving tools go to work for you!

Ask for Catalog No. 171

HAMMEL, RIGLANDER & CO., INC.
435 Hudson Street • New York, N.Y. 10014

INFORMATION RETRIEVAL NUMBER 87

"IT'S GOOD BUSINESS
TO HIRE THE HANDICAPPED."

ISN'T THAT A GREAT IDEA, SNOOPY?



THE PRESIDENT'S COMMITTEE ON EMPLOYMENT
OF THE HANDICAPPED, WASHINGTON, D. C.

Asynchronous modem transmits at 300 bits/s

General DataComm Industries, 537 Newton Ave., Norwalk, Conn. Phone: (203) 847-2445.

The 103F Multimodem data set is a low-speed, asynchronous modem that transmits serial binary data at up to 300 bits/s over private lines. It operates in two-wire full or half-duplex modes on leased voice-grade circuits and is compatible with Western Electric series 103 sets. The 103F has a test feature which permits data loopback on its analog or tone side at the telephone line interface.

CIRCLE NO. 293

Modem sends data and quality voice at once

Phonoplex Corp., Sub. of Instrument Systems Corp., 410 Jericho Tpke., Jericho, N. Y. Phone: (516) 822-4200. Price: approx. \$2000.

The first modem capable of simultaneously transmitting significant quantities of data as well as a quality voice channel over the same single telephone channel has been developed. This new modem, model DVM1300, has a data capacity of 1300 bits in addition to the quality voice channel. It can operate in the full-duplex mode over tie lines and in the half-duplex mode over dial-up networks.

CIRCLE NO. 294

200-track/in. heads record at 2200 bits/in.

Information Magnetics Corp., 5743 Thornwood Dr., Goleta, Calif. Phone: (805) 964-6828.

A new series of narrow-track recording heads is designed for recording and reading data on oxide-coated disc packs. Model 2200-NT flying heads are said to be ideal for use in conjunction with double-density removable disc pack systems writing 200 tracks/in. at 2200 bits/in. They feature core construction of high-permeability ferrites precision-wound with magnet wire coils for compatible electro-magnetic performance.

CIRCLE NO. 295

Three new GE SSL's to put more energy in your work

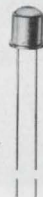

SSL-54

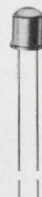

SSL-55B



SSL-55C

We've just come up with three lens-end infrared solid state lamps with more useful energy than before.

SSL-54 has more power in the narrow 20° cone than its sister lamps, SSL-4 and SSL-34. And you still get the same fast rise time.

SSL-55B and SSL-55C, in a 20° cone, generate almost twice the mW per dollar than any other GE SSL. So you can use less expensive detectors than before. Or place them farther away than before.

Typical ratings for the SSL-54, SSL-55B and the SSL-55C are 1.0mW, 4.8mW and 6.0mW, respectively.

They're just right for "mark sense" applications, detection systems, and computer-related uses like BOT and EOT sensing.

1000 lamp prices: SSL-54 — \$1.21, SSL-55B — \$2.26, SSL-55C — \$2.52 ea.

Complete technical information on the new SSL's — previously called light emitting diodes — is free. Just write.

and seven other ways to make your job a little easier.



NEW NEON GLOW LAMP

#3AG-F. New circuit component lamp with tinned leads, and a special silicone Dri-Film® coating that increases leakage resistance to 1,000 megohms minimum. Use with MOSFET, matrix or time delays.



NEW RED NUMERIC DISPLAYS

SSL-140 SSL-190. Red, easy-to-read seven segment solid state readouts with character heights of .140" and .190". Wide segments for each viewing.

All products shown actual size.

© Trademark of General Electric Company.

NEW WEDGE BASE INCANDESCENT LAMPS (low-cost, all-glass construction)

#74



#557



#558



#657



#74. New smaller size wedge base lamp for automotive and aircraft indicator and electronic applications, where space is at a premium. T-1 3/4 bulb size, 14V, 0.1A, .75cp.

#557. First wedge base flasher lamp. For attention-getting warning lights on instrument panel. The

ratings: 14V, .42A, 2.5cp. #558. Lens end wedge base lamp beams light for fiber optics illumination, instrument panels, and warning lights. 14V, .27A.

#657. New 28-volt wedge base lamp for indicator applications. It completes GE's line of 6.3-, 14- and 28-volt ratings.

For General Electric's 2-part SSL manual on theory, characteristics and applications — 106 pages in all — send \$1.00 for each set to: General Electric Company, Miniature Lamp Department, #382, Nela Park, Cleveland, Ohio 44112.

CIRCLE NO. 211 SSL; 212 RED NUMERIC; 213 WEDGE BASE; 214 NEON GLOW

GENERAL  ELECTRIC

Graphic transceiver uses phones directly

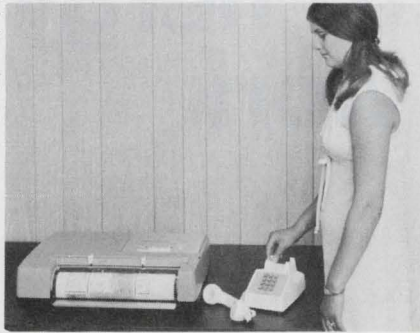

Graphic Sciences, Inc., Corporate Dr., Commerce Park, Danbury, Conn. Phone: (203) 744-3100.

A high-speed graphic transceiver can directly communicate between locations without acoustic coupling by using the telephone company's Data Access Arrangement (DAA). Known as dex181, it is capable of transmitting or receiving an 8-1/2-by-11-in. document in 3 minutes. It uses a single sheet of electro-sensitive paper and has adjustable indices for editing copy and reducing transmission time.

CIRCLE NO. 296

Low-cost CRT terminal mates teletypewriters

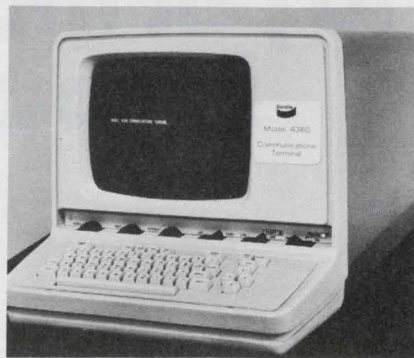

Interactives Terminal Corp., Sub. of Bendix Corp., Southfield, Mich. Phone: (313) 352-6233.

A new low-cost (\$78/month rental) CRT computer terminal compatible with teletypewriters is the 4380 which displays 40 or 80 characters/line in 10 or 12 lines/display. This noiseless terminal is offered with a choice of seven options and four screen sizes. Up to three options can be used simultaneously. The unit transmits up to 4800 baud in parallel or serial modes.

CIRCLE NO. 297

High capacity computer uses a disc system



Hewlett-Packard Co., 1501 Page Mill Rd., Palo Alto, Calif. Phone: (415) 493-1501. P&A: from \$32,950; fall, 1971.

Model 2120A disc-based system combines the model 2100A computer and the 7900A moving-head disc with sophisticated software that includes a capability for extended disc file management. The model 7900A moving-head disc offers five million 8-bit bytes of on-line storage with an average access time of 35 ms.

CIRCLE NO. 298

ON THE MOST WANTED LIST



ALIAS MINI & MAXI

Real names: **TH-Jr. and TH-65**. Smallest and largest members of the "Tenney Gang" of reach-in, temperature-humidity chambers. Easily identified by the Tenney Vapor-Flo® humidity generation system and the fully hermetic, all-welded Hermeticool® refrigeration system.

Known to cover a temperature range of 0°F to 200°F and a humidity range of 20% to 95% RH. Noted for responsive performance. Praised for ease of operation and high reliability.

Can be found serving in evaluation or manufacturing of products sensitive to temperature and humidity environments. For details on Mini, Maxi and all the Gang in-between, call or write today:

Tenney
ENGINEERING, INC.

1090 Springfield Rd., Union, New Jersey 07083 • (201) 686-7870
Western Division: 15721 Texaco St., Paramount, Calif. 90723



INFORMATION RETRIEVAL NUMBER 90

Ultra critical uses?

Model	Resistance Range	Power Rating @ 70°C	*Max. Oper. Volts	Length Inches	Diameter Inches
MOX-2					
MOX-400	1 - 2500 megs	.25W	1,000V	.420 ± .050	.130 ± .010
MOX-750	1 - 5000 megs	.50W	2,000V	.790 ± .050	.130 ± .010
MOX-1125	1 - 10000 megs	1.00W	5,000V	1.175 ± .060	.130 ± .010
MOX-1	10K - 500 megs	2.50W	7,500V	1.062 ± .060	.284 ± .010
MOX-2	20K - 1000 megs	5.00W	15,000V	2.062 ± .060	.284 ± .010
MOX-3	30K - 1500 megs	7.50W	22,500V	3.062 ± .060	.284 ± .010
MOX-4	40K - 2000 megs	10.00W	30,000V	4.062 ± .060	.284 ± .010
MOX-5	50K - 2500 megs	12.50W	37,500V	5.062 ± .060	.284 ± .010

*Applicable above critical resistance. Maximum operating temperature, 220°C. Encapsulation: Si Conformal.

Mastermox Resistors are still the best answer.

10K ohms to 10,000 Megohms Resistance

Mastermox resistors bring new accuracy to ultra-precision applications. Advanced metal oxide glaze construction. More watts per cubic inch means twice the performance in equivalent space. Stable? To new limits! Use Mastermox resistors to obtain new performance highs.

Send for Mastermox brochure.

DMA 536

VICTOREEN INSTRUMENT DIVISION
10101 WOODLAND AVENUE - CLEVELAND, OHIO 44104



INFORMATION RETRIEVAL NUMBER 95

ELECTRONIC DESIGN 21, October 14, 1971

Heath/Schlumberger?

That's right . . . Heath/Schlumberger. A new name in design-quality, factory assembled and calibrated instruments.

The "Heath" part of our name comes from being a division of that well known manufacturer of kits. But we don't make kits. In fact, Heath/Schlumberger is an entirely separate operation.

The "Schlumberger" (pronounced Shlum-bear-zhay) part of our name comes from being a member of that world-wide corporation devoted to measurements of many kinds. Schlumberger is one of the leading European manufacturers of electronic instrumentation.

With that background, you can see why we are producing state-of-the-art, ready-to-use, instrumentation . . . comparable to some of the best in performance . . . but with better performance/price ratios.

So when you are ready to buy electronic instruments, check the growing Heath/Schlumberger line.

We're the group to watch.

To order or receive additional information, write Dept. 520-26.



Heath/Schlumberger
Scientific Instruments
Benton Harbor,
Michigan 49022

- A. SM-104A 80 MHz counter. BCD output. 1 MHz TCXO with 1 ppm/yr. stability. \$500.
- B. EU-205B solid-state strip chart recorder. 23 speeds, 30 in/min. to 0.2 in/hr.; 18 calibrated ranges, 1 mV to 500 V full scale. 0.5 sec. pen response. 0.1% tracking accuracy and linearity. Completely programmable. \$675.
- C. EU-70A solid-state dual trace scope. DC-15 MHz. Complete dual trace capability. Triggered sweep. 18 calibrated time bases. X-Y capability. \$595.
- D. SM-105A 80 MHz counter. Same as SM-104A above but without BCD output and uses a 1 MHz crystal with ± 10 ppm/yr. stability. \$350.
- E. EU-81A function generator. Sine, square and triangle wave output. 0.1 Hz to 1 MHz. Linear dial. External voltage control. \$245.

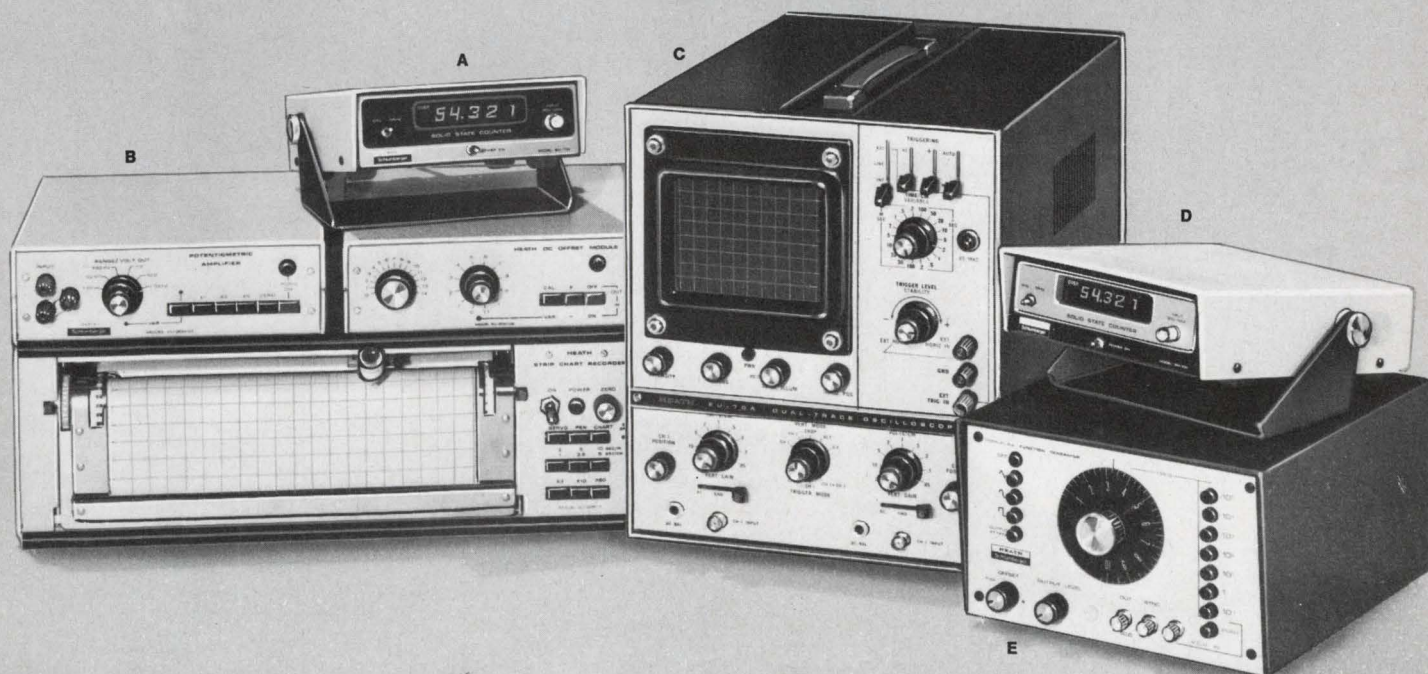

BULOVA Crystal Oscillators with high stability over extended temperature ranges

Now Bulova has available Temperature Compensated and High Stability Crystal Oscillators that are uniquely designed for increased performance capability.

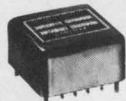

TCXO-30

TEMPERATURE COMPENSATED CRYSTAL OSCILLATOR

Frequency Stability:
 $\pm 5\text{pp} 10^7$ over temperature
range of -55°C to $+85^\circ\text{C}$.

Employs a computer-selected-and-optimized compensation network designed to maintain frequency stability over wide temperature ranges without the need for an oven ($\pm 0.5\text{PPM}$ from -55°C to $+85^\circ\text{C}$). Operating over a frequency range of 3MHz to 5MHz, it consumes only 50MW and is just four-cubic-inches. Aging rate is $1.0\text{pp} 10^8$ per week.



PCOXO-101

HIGH STABILITY CRYSTAL OSCILLATOR

Frequency Stability:
 $\pm 1.0\text{PP} 10^8$ over
temperature range of
 -55°C to $+70^\circ\text{C}$

Within a plug-in package is a high precision crystal and an oscillator circuit with AGC to maintain low constant crystal drive in a stable DC proportional control oven. The result is a crystal oscillator of unusual high frequency stability ($\pm 1.0\text{PP} 10^8$ from -55°C to $+70^\circ\text{C}$), a short term stability of $1\text{PP} 10^{10}$ per second, an aging rate of $1\text{PP} 10^9$ per day and with a frequency output of 1.0 or 5.0 MHz.

If you have a crystal oscillator problem that needs solving, call (212) 335-6000, see EEM section 2300, or write —



BULOVA
FREQUENCY
CONTROL PRODUCTS

Electronics Division of Bulova Watch Co., Inc.
61-20 Woodside Ave., Woodside, N. Y. 11377

INSTRUMENTATION

3-1/2-digit DPM sells for \$99.75



Weston Instruments, Inc., 614
Frelinghuysen Ave., Newark, N. J.
Phone: (201) 243-4700. P&A:
\$99.75; stock.

A new dual-slope 3-1/2-digit DPM meets the low-cost needs of the OEM. The single-polarity model 1291 has a full-scale readout of 1000 and 100% over-range (readout of 1999). Its accuracy is 0.1% of full scale ± 1 digit, minimum full-scale range is 100 mV or $10 \mu\text{A}$ and input impedance is 50 M Ω . Optional features include BCD output and programmable decimal points.

CIRCLE NO. 299

Magnetics tester analyzes cores/coils



Advanced Magnetic Products, Inc.,
1600 Victory Blvd., Glendale, Calif.
Phone: (213) 243-8822. P&A:
\$375; 30 days.

The CT-100-AB magnetic analyzer is capable of detecting bucking coils, open coils, coils shorted to ground and magnetic-circuit sensitivity for a single shorted turn of an iron-core coil assembly. The magnetic analysis is performed at a test frequency of 1 MHz. The test signal detects pure frequency effect losses and complex permeability inherent in the magnetic core material.

CIRCLE NO. 300

Attention Advertisers:

Could you use copies of your ad exactly as it appeared in ELECTRONIC DESIGN? Then order your reprints directly from us; the minimum unit order is 500 copies.

Please specify if you would like the reprint line omitted on your copies and mail your written order to ELECTRONIC DESIGN, Production Dept., 50 Essex Street, Rochelle Park, New Jersey 07662.

500 1,000 Add'l M
8x10 or smaller

1 color, 1 side	\$74.70	82.95	18.15
2 color, 1 side	95.47	108.00	25.28
4 color, 1 side	311.03	342.00	44.33

Spreads

1 color	113.66	126.65	25.98
2 color	191.19	205.98	29.58
4 color	354.17	380.76	53.19

Prices FOB Waseca, Minn.

A mouse has already been saved from leukemia.

Help us save a man.

For years, you've been giving people with leukemia your sympathy. But sympathy can't cure leukemia. Money can. Give us enough of that, and maybe we'll be able to do for a man what has already been done for a mouse.



American Cancer Society

Continuity verifier checks 128 points/s

SCI Electronics, Inc., 8330 Broadway, Houston, Tex. Phone: (713) 641-0211. P&A: \$1500; 30 to 60 days.

A new continuity tester automatically verifies wiring, harnesses, mother boards, and cables. It automatically sequences through 128 points looking at every point in less than one second. Known as the ACV, it checks for overwires, shorts or opens. Up to 128 points at a time are checked and displayed on a screen. The left side of the screen is a "master" or "wire from" area while the right side is a "slave" or "wire to" area.

CIRCLE NO. 301

5-MHz, 20-V pulse generator costs \$300

Data Dynamics, Div. of Electronic Counters, Inc., 240 Humphrey St., Englewood, N. J. Phone: (201) 567-5300.

Low-cost model 5105 pulse generator spans 0.1 Hz to 5 MHz with an output of ± 20 V into a 50- Ω load, or a 400-mA output current pulse. Three simultaneous pulse outputs are available: positive, negative, and a current-sinking +4.5-V output specifically designed for TTL, RTL and DTL ICs. A 100% duty cycle, pulse or square-wave output and pulse widths from 10 ns to 10 s are other features.

CIRCLE NO. 302

4-1/2-digit DVM is full of features

United Systems Corp., 918 Woodley Rd., Dayton, Ohio. Phone: (513) 254-6251. P&A: \$525; stock to 8 wks.

The DigiTec model 266 is a new 4-1/2-digit DVM with many features. The meter has accuracy of 0.02% of reading, a guarded input and isolated BCD and systems functions. Additional features include resolution of 100 μ V and voltage measurement to 1000 V dc. The DigiTec 266 uses LED displays and includes front-panel controls for self-check zeroing and calibration.

CIRCLE NO. 303

Pulse gen. plug-ins provide 125-MHz drive

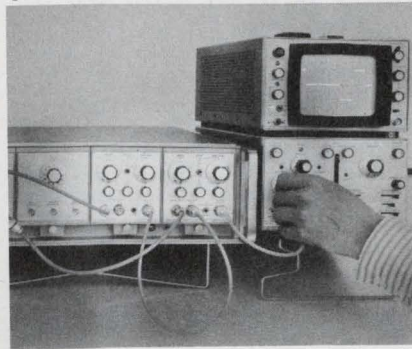

Hewlett-Packard, 1501 Page Mill Rd., Palo Alto, Calif. Phone: (415) 493-1501. P&A: \$950; 8 wks.

A pair of new plug-ins give 125-MHz drive capability to Hewlett-Packard's 1900 series modular pulse generators. One (model 1921A) provides positive-going pulses in response to input triggers while the other (model 1922A) provides negative-going pulses. The 0.5 to 5-V range of pulse amplitudes and ± 5 -V offset range for setting baseline are well suited for TTL and ECL IC logic levels.

CIRCLE NO. 304

Plug-in analyzer covers 1 to 1800 MHz

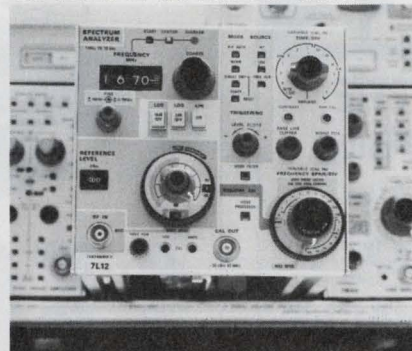

Tektronix, Inc., Box 500, Beaverton, Ore. Phone: (503) 644-0161. P&A: \$4850; 4th quarter, 1971.

The 7L12 is a plug-in swept-front-end spectrum analyzer with absolute amplitude and frequency calibration, 70-dB dynamic range and less than 70 dB of intermodulation distortion. This 1 to 1800-MHz unit has internal spurious signals, except for 0 Hz, that are less than twice the noise. Resolution shape factor is 4:1 at 6 to 60 dB down. The 7L12 plugs into all eight 7000-series scopes.

CIRCLE NO. 305

"0" T.C. Capacitor
"0" T.C. Capacitor
"0" T.C. Capacitor
"0" T.C. Capacitor
"0" T.C. Capacitor
"0" T.C. Capacitor
"0" T.C. Capacitor
"0" T.C. Capacitor

± 10 PPM/ $^{\circ}$ C
 -55° C to $+85^{\circ}$ C
Accurate to $\pm .01\%$

Part of EAI's component capability includes: thick-film amplifiers, filters, analog/digital function modules, hybrid function modules, precision capacitors . . .

EAI precision components

193 Monmouth Parkway
West Long Branch, New Jersey 07764
(201) 229-1100

Point-point wire form improves array bussing

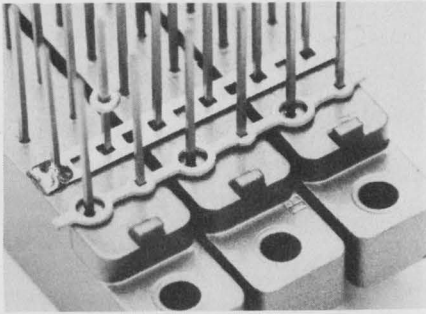

Rogers Corp., Rogers, Conn. Phone: (203) 853-4141.

A point-to-point wire form has been developed for bussing selected in-line pins in connector arrays. Called Strip/Bus, it differs from conventional bussing systems in that installation is completed without spring-action fittings and it lies flush on the connector block, thus exposing the maximum wrappable pin length. It does not interfere with the laying of wires and may be installed without special tools on more than one level.

CIRCLE NO. 306

Wirewrap panel board takes 180 14-lead DIPs

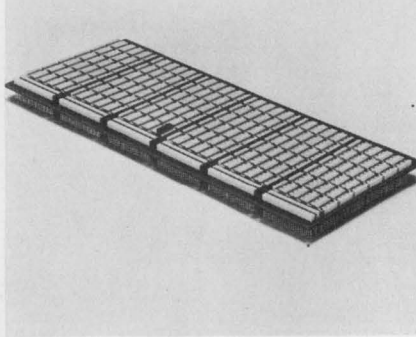

Robinson-Nugent, Inc., 800 E. 8th St., New Albany, Ind. Phone: (812) 945-0211. P&A: \$190 (100 quantities), stock to 4 wks.

Up to 180 14-lead DIP devices may be plugged into a new wire-wrap panel board. A total of 276 I/O positions are located at the head-end of the board. Its double sides provide power and ground connection for each socket position. Maximum copper planes on top and bottom of the board permit good power and ground distribution.

CIRCLE NO. 307

Pin header/plug mates 24-lead DIPs

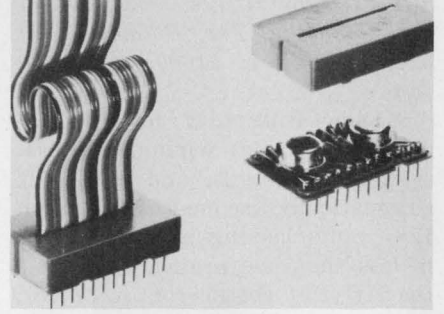

Jermyn Industries, Vestry Estate, Sevenoaks, Kent, England.

The A23-2054 pin header/plug is compatible with most 24-lead 0.6-in.-pitch DIP sockets and provides a convenient plug-in housing for discrete components. The unit is soldered between terminal extensions and protected by a clip-on cover. It may also be used as a free plug, the cover being provided with slots in the top and with one end for cable entry. Overall dimensions are 1.29-in. long by 0.79-in. wide by 0.3-in. high.

CIRCLE NO. 308



FREE

LAFAYETTE 1972 Catalog

Our 51st Year



468 PAGES

Your 1st Guide To Everything in Electronics

- Stereo/Hi-Fi Components • Musical Instruments and Amplifiers • Photography Equipment • Ham and CB Gear
- Public Address Systems • Tools and Test Equipment
- Educational and Optical Equipment • Black and White/Color Televisions • Police and Fire Monitor Receivers
- Books and Parts Plus Thousands of Additional Items

Lafayette Radio Electronics, Dept. 45091
P.O. Box 10, Syosset, L.I., N.Y. 11791

Send me the FREE 1972 LAFAYETTE Catalog 45091

Name

Address

City State

Zip (please include your Zip Code No.)

INFORMATION RETRIEVAL NUMBER 104

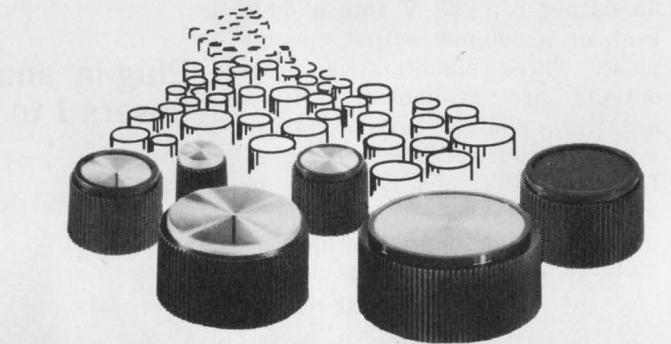

1,500,000

KNOBS TO CHOOSE FROM...

and they're "Warranted for Life"

Kurz-Kasch has over 1½ million low cost, high quality knobs in inventory, ready to ship to you. (You save . . . no tooling cost on stock knobs, specials 4 to 6 weeks delivery.) Your local distributor's stock is available at factory prices. Select instrument and control knobs from 24 families with 367 basic sizes and shapes in general purpose phenolics, melamines and ureas. All Kurz-Kasch knobs are warranted for the life of the product on which they're used. Send now for free 20 page catalog. (Also found in THOMAS REGISTER "THOMCAT."®)



Kurz-Kasch, Inc.
1421 S. Broadway
Dayton, Ohio 45401
513/223-8161

INFORMATION RETRIEVAL NUMBER 105

ELECTRONIC DESIGN 21, October 14, 1971

Our signal corps.

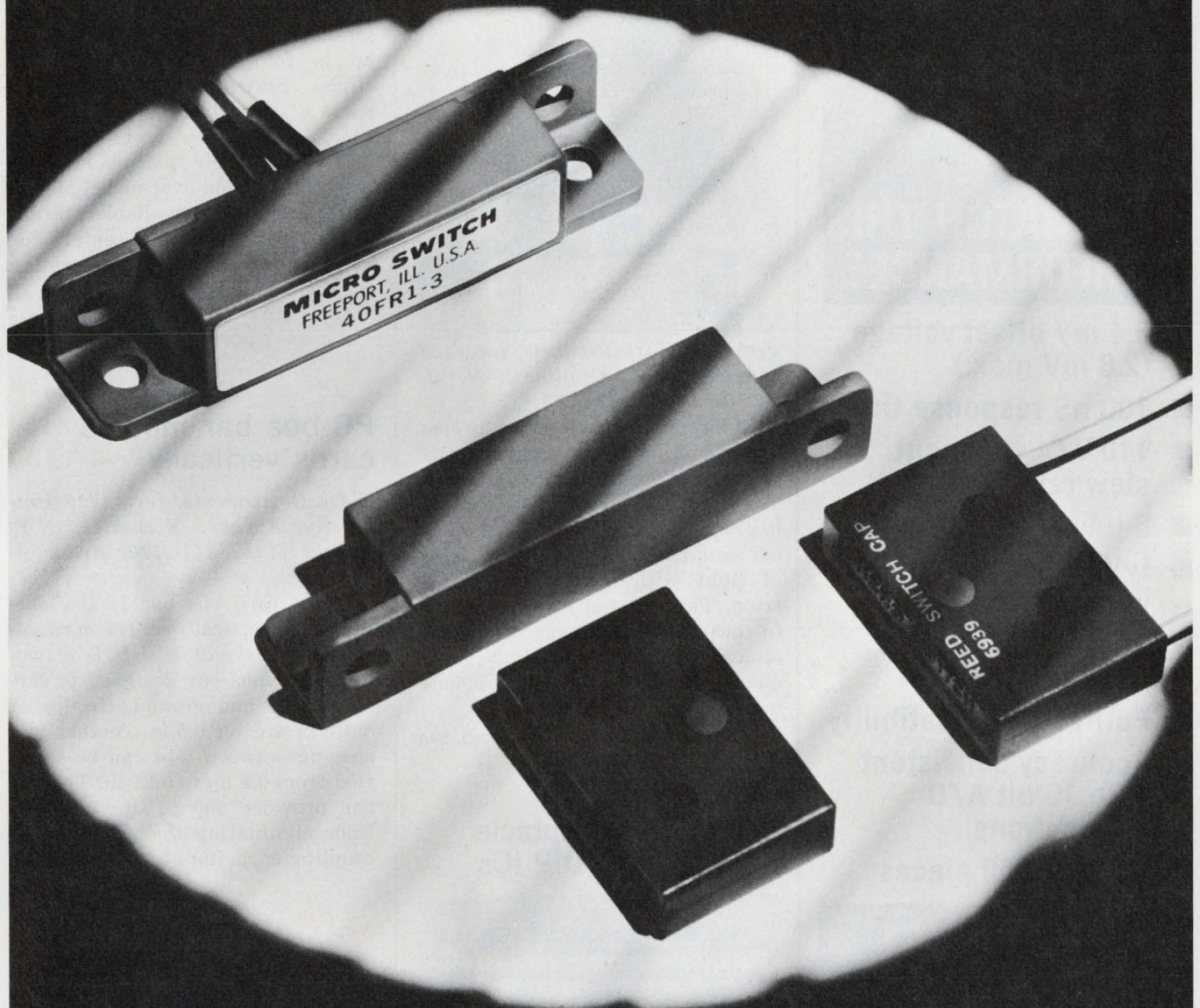

Our FR reed proximity switches indicate what's happening. The instant it happens.

Up to 10,000,000 times at their rated load. Or almost infinitely at reduced loads.

They're magnetically actuated. So nothing mechanical can break down or foul up. And the contact area is hermetically sealed. So nothing outside can get in.

Our 40FR switch (1" sensitivity) is enclosed in a die-cast aluminum housing, while our compact 50FR (0.450" sensitivity) has a thermoset

plastic housing. Both provide protection from shock, vibration and physical abuse.

FR switches can monitor aircraft entry, cargo and landing gear doors. They also may be just what is needed in most any tough ship, missile, tank or artillery application you have. In industry, they can monitor or count on most conveyor systems. For more information, call your

MICRO SWITCH

FREEPORT, ILLINOIS 61032

A DIVISION OF HONEYWELL

MICRO SWITCH Branch Office (in the Yellow Pages under "Switches, Electric"). Or write.

HONEYWELL INTERNATIONAL—Sales and Service offices in all principal cities of the world. Manufacturing in Australia, Canada, Finland, France, Germany, Japan, Mexico, Netherlands, Spain, Taiwan, U.K. and U.S.A.

INFORMATION RETRIEVAL NUMBER 106

HOW MANY PRECISION COMPARATORS

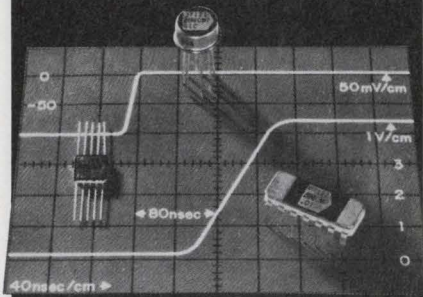

CAN MATCH THIS PERFORMANCE?

- 0.4 mV offset voltage (2.8 mV max.)
- 100 nS response time
- 110 V/ μ sec input slew rate
- 5 nA offset current
- 1 μ V/ $^{\circ}$ C nulled offset voltage drift
- Standard Supplies \pm 5V to \pm 18V
- Full TTL Compatibility
- Accuracy consistent with 15 bit A/D applications
- \$3.15 @ 250 pieces

**ONLY ONE!
THE**

MONO CMP-01CJ

**IMMEDIATE DELIVERY
FROM DISTRIBUTOR STOCK**

REMEMBER — for A/D applications the CMP-01 is an ideal companion to the AIM DAC-100 (10 bit) and mono DAC-01 (6 bit) D/A Converters

MONO **PRECISION
MONOLITHICS**
INCORPORATED

1500 SPACE PARK DRIVE, SANTA CLARA, CALIFORNIA 95050
TEL. (408) 246-9225 • TWX 910-338-0528 • CABLE MONO

A **BOURNS** Affiliate

INFORMATION RETRIEVAL NUMBER 107

PACKAGING & MATERIALS

Coated panels are emi/rfi shielded



Technical Wire Products, Inc., 129 Dermody St., Cranford, N. J. Phone: (201) 272-5500.

ECTC panels are electrically conductive, transparent, coated, emi/rfi shielded optical-display windows. The standard conductive coating has a nominal resistivity of 14 Ω per square and 75% transmission of light within the visible spectrum. This coating may be applied to nearly all ceramic or plastic optical materials including glass, quartz, acrylics and polycarbonate materials.

CIRCLE NO. 340

Cartridge/receptacle hold up to 5 DIP ICs

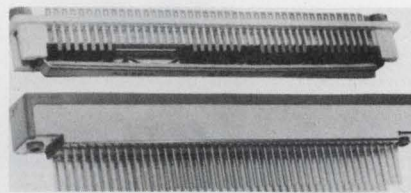

SAE Advanced Packaging, 2165 S. Grand Ave., Santa Ana, Calif. Phone: (714) 540-9256. Price: see text.

A new high-capacitance, low impedance IC packaging concept does away with soldering, PC boards, card files, extractors, extenders and related hardware. Called Dipstik, it's based on a protective cartridge and receptacle that hold up to five DIP ICs providing its own heat sink, emi rfi shielding and 100% test-point capability at about \$1 per position.

CIRCLE NO. 341

IC socket family accepts TO-5/18s

Bunker Ramo Corp., Barnes Div., 24 N. Lansdowne Ave., Lansdowne, Pa. Phone: (215) 622-1525.

A new low-cost series of 12 IC sockets accepts "TO" devices with up to four leads on 0.1-in. pin circles. Series 131-55 sockets are made of glass-filled nylon for continuous operation from -55 to $+125^{\circ}$ C. Their phosphor-bronze contacts are gold-over-nickel plated. Three styles are available: terminals on 0.2 and 0.3-in. centers for TO-5 devices and on 0.2-in. centers for TO-18 devices.

CIRCLE NO. 342

PC bus bar mounts cards vertically

Eldre Components, Inc., 1239 University Avenue, Rochester, N.Y. Phone: (716) 244-2570. Availability: stock.

A PC card bus bar is available to mount vertically on the card adjacent to rows of ICs. It is a two-conductor bus bar designed to carry voltage and ground. Groups of outputs are on 0.5-in. centers and spacing between tabs can be specified from 0.1 up to 0.25-in. The bus bar provides 600 pF/in.² between leads eliminating the need for decoupling capacitors to reduce noise.

CIRCLE NO. 343

Wire-Wrap sockets come in single strips

Robinson-Nugent, Inc., 800 E. 8th St., New Albany, Ind. Phone: (812) 945-0211. Price: \$1.22 (100 quantities).

Sockets for Wire-Wrapping of solder mounts are available singly or assembled on PC boards in any length, with contacts and terminals on 0.1-in. in-line spacings. Modular sockets may be constructed for breadboarding or packaging of any odd-configuration socket requirements of 0.1-in. spacing. The standard socket has 25 contacts with a length of 2.5-in.

CIRCLE NO. 344

16 Plug-in Modules make the

OMNIGRAPHIC®

X-Y RECORDER

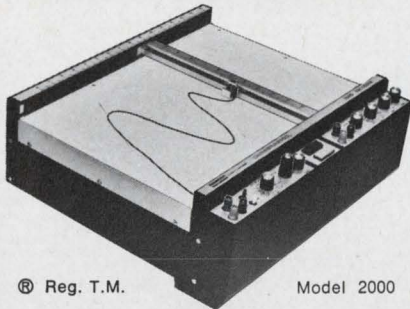

® Reg. T.M.

Model 2000

a terrific value at

\$795 plus modules

Why? Because now there's a module for AC to DC conversions, another for both AC and DC... plus more for every function you may require. What's more, they're all interchangeable. And just look at these features:

- 30 in./sec. speed
- $\pm 0.2\%$ accuracy
- local/remote pen control
- electric pen lift
- high input resistance
- interchangeable amplifiers
- \$795 plus modules

A companion strip chart recorder, model 3000, now is available with a full span automatic integrator for gas chromatography and with modules for point plotting.

Write for brochures today.



**houston
instrument**

DIVISION OF BAUSCH & LOMB

4950 Terminal Avenue, Bellaire, Texas 77401
(713) 667-7403 Cable Hoinco

**houston
instrument** | European Office

Johanneskirchner Strasse 17, 8043 Unterfohring
München, W. Germany (0811) 97-1673

INFORMATION RETRIEVAL NUMBER 108

ELECTRONIC DESIGN 21, October 14, 1971

MICROWAVES & LASERS

Ka-band balanced mixer lowers noise to 5 dB

SpaceKom, Inc., Box 10, Goleta,
Calif. Phone: (805) 967-7114.

A new balanced mixer provides a 1-dB i-f passband from dc to 6 GHz and gives only 5 dB of maximum noise figure (ssb) at Ka and K bands. Model CK-10 has rf input from 28 to 33 GHz and a noise figure of 5 dB for a 60-MHz and 4.8 dB for a 2.5-GHz i-f. Local-oscillator-to-rf isolation is 27 dB minimum. A slightly lower noise figure is obtained with the model CK-9 mixer, which covers 18 to 26 GHz.

CIRCLE NO. 345

Ballasted transistor delivers 10 W at 2 GHz

RCA Solid State Div., Route 202,
Somerville, N. J. Phone: (201)
485-3900. P&A: \$185 (100 quantities); stock.

A new microwave transistor yields 10 W of output power at 2 GHz and features overlay multiple-emitter-site construction and emitter-ballasting resistors. Designated as TA7995, the device also offers very high gain of 7 dB. The use of emitter-ballasting resistors, together with a low-thermal-resistance stripline package makes the TA-7995 a rugged and reliable device.

CIRCLE NO. 346

Microwave p-i-n diodes decrease distortion

Unitrode Corp., 580 Pleasant St.,
Watertown, Mass. Phone: (617)
926-0404. P&A: from 90¢; stock.

New p-i-n diodes feature low insertion loss, fused-in-glass reliability and low-distortion switching and attenuating. They satisfy designers' needs for strict harmonic or intermodulation product requirements in vhf or uhf systems. Characteristics include guaranteed second and third-harmonic levels of 90 dB below fundamental and intermodulation products of 60 dB.

CIRCLE NO. 347

HOW MANY 10 bit D/A CONVERTERS

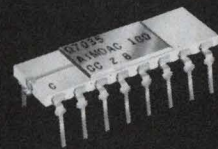

**COST ONLY
\$15.95
and GIVE YOU
ALL THIS?**

- Complete current converter with internal reference and ladder. Just add monoOP-01 for Voltage Converter.
- 375nS settling time for 10 bits, 225nS for 8 bits
- 0.2% linearity over temperature
- 120 PPM/°C Full scale Tempco
- +5V, +10V, $\pm 2.5V$ or $\pm 5V$ output
- $\pm 6V$ to $\pm 18V$ supplies
- 0°C to 70°C guaranteed performance
- DTL/TTL compatible
- \$15.95 @ 2,000 pieces

ONLY ONE! THE AIM DAC-100CDT

REMEMBER: For 6 bit applications choose the single chip monoDAC-01HS with built-in high speed output amplifier. \$9.95 @ 2000 pieces.



1500 SPACE PARK DRIVE, SANTA CLARA, CALIFORNIA 95050
TEL. (408) 246-9225 • TWX 910-338-0528 • CABLE MONO

A BOURNS Affiliate

INFORMATION RETRIEVAL NUMBER 109

137

When you're known for Rolls-Royces,

it's hard to get Volkswagen buyers to think of you.

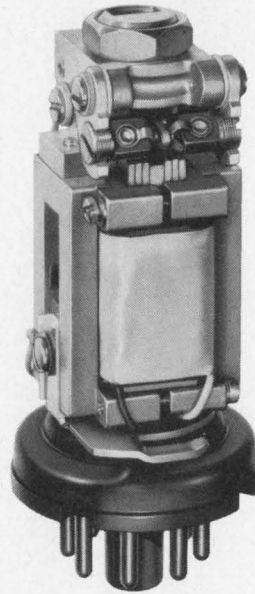

Series 72 Pulse and Telegraph Polar Relay . . . pulse repetition to 400/sec., life in hundreds of millions of operations

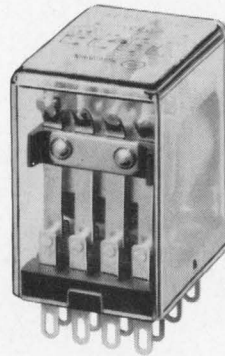

Series 67 General purpose AC & DC, 4PDT, 5A

SIGMA has 2000 good, different general-purpose relays— many for 50¢/pole.

If you think of Sigma as a sensitive, close-differential relay house, you're partly correct. We're also a low-priced, general purpose relay house — as a substantial number of vending machine, alarm system, industrial control, copier and communications equipment manufacturers will attest.

For demanding applications such as computer peripherals, you can have one-cubic-inch 4PDT switching, on AC or DC coil signals, of low-level to 5-amp. loads at least 100,000 times with the Series 67. Fast wiring, mounting and interchangeability results from PC or solder terminals, or in sockets with PC or solder terminals.



Single-, two- or three-pole switching of loads up to 10 amps, for one million operations at 28 VDC or one-half million at 115VAC, is provided by the versatile and quickly-installed Series 68.

For up to 6PDT switching of low-level to 5 amp. loads by voltage adjustment, or 1-amp. loads on sensitive current adjustment, the Series 62 combines long life (up to 50 million operations with bifurcated contacts) with moderate cost.



For positive response to coil signals as low as 50 mw, at a cost of under 75¢/relay in quantity, the Series 65 is well-suited to TV channel selectors, slide projectors, vending machines and similar uses involving SPDT switching of 1-amp. loads.

Up to 3PDT switching of 5- or 10-amp. loads, on AC or DC voltages, is available in the compact and low-cost Series 50; wide application in automated equipment, switching small motors, solenoids and other relays.



We'll be glad to supply detailed technical data on any of the general-purpose relays mentioned, with complete price and delivery information on standards. Better yet, tell us your requirements (load, life, cost, driving signal, operating speed and environment) and let us recommend the relay best suited to the job. We can save you time, disappointment and perhaps some money as well. Sigma Instruments, Inc., 170 Pearl St., Braintree, Massachusetts 02185.

SIGMA INSTRUMENTS INC

Thin-film amplifiers cover 3.7 to 4.2 GHz



Avantek, Inc., 2981 Copper Rd., Santa Clara, Calif. Phone: (408) 739-6170.

A new series of thin-film amplifiers are designed specifically for communication-satellite earth stations over 3.7 to 4.2 GHz. AMT-4210N series amplifiers feature a +13 dBm output power at the 1-dB gain-compression point and an intercept point of +23 dBm. This results in a third-order intermodulation level of more than 66 dB down from two -10-dBm signals at the output.

CIRCLE NO. 348

28-V 50-W transistor gains 12 dB at 400 MHz



Communications Transistor Corp., 301 Industrial Way, San Carlos, Calif. Phone: (415) 591-8921. P&A: \$90; 2 wks.

The XB50-28 is a new 400-MHz 28-V transistor with 50 W of output power, 12 dB gain and an input Q of less than 2. It is a single-chip hermetically sealed unit in a microstrip package which reduces package-associated parasitics. It is guaranteed to withstand infinite VSWR at rated output power and supply voltage.

CIRCLE NO. 349

Tiny sensor uses LEDs/phototransistors

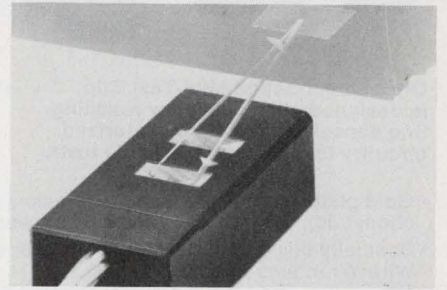

HEI, Inc., Jonathan Industrial Center, Chaska, Minn. Phone: (612) 448-3510. Price: \$14 (100 quantities).

A new end-of-tape/beginning-of-tape sensor module for magnetic-tape drive applications features GaAs LEDs for the light source and photodarlington transistors as the sensors. The EOT-382-XXX senses reflective strips placed at the beginning or end of magnetic tape, and can thus control a reverse or stop function of a tape drive.

CIRCLE NO. 350



INFORMATION RETRIEVAL NUMBER 111

DIGITEC

DVMs & DMMs

Nowhere can you find the selection of value designed Voltmeters and Multimeters as with DigiTec. You could spend much more and not receive the advantages of our outstanding specifications and features. Budget minded engineers have become increasingly aware of DigiTec's accuracy and performance uniquely designed for both bench and system applications.

If your requirements call for an inexpensive VOM which measures 10 ranges of DC volts and resistance, you need a DIGITEC MODEL 261 for only \$279. Capable of measuring AC and DC volts and current and resistance, THE MODEL 262A is a "must" . . . value priced at \$375. Both of these instruments are in a rugged metal case and may be equipped with a battery pack for complete portability.

We have developed a new family of 4½ digit instruments which offer the very finest performance in their class. A few of the many features are: .02% accuracy, LED displays, guarded input and isolated BCD output. THE BASIC DVM is priced at a low \$525 and is available from stock. An AUTO-RANGING DVM is offered at only \$625. THE MODEL 269 is A FULL MULTIMETER, unmatched in value at \$695 (including internal current shunts and isolated BCD . . . no add on prices). A 6 RANGE MILLIVOLTMETER, with 1µVolt resolution, is available at \$795.

Write or call for assistance in selecting the most suitable instrument for your application.

DIGITEC by UNITED SYSTEMS CORPORATION

918 Woodley Road • Dayton, Ohio 45403 • (513) 254-6251
Representatives throughout the world
For complete specifications, request new catalog

the grabber.

Our plunger action Mini-Test Clip is designed specifically for reaching into densely packaged miniaturized circuitry to make rapid, reliable tests.

- Gold plated copper contact hook makes positive connection, and won't damage lead wires.
- Specially designed tip slides down over square Wire-Wrap* pins for solid contact.
- Integrally molded wire assures greater reliability and eliminates time-consuming assembly.
- Molded nylon probe provides complete insulation to point of connection.
- Four models offer widest selection of connecting plugs. Write for complete information and prices.

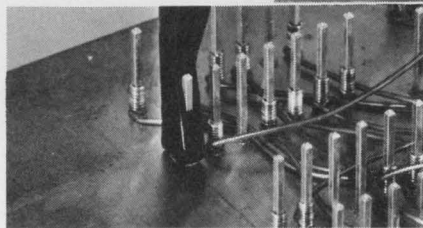
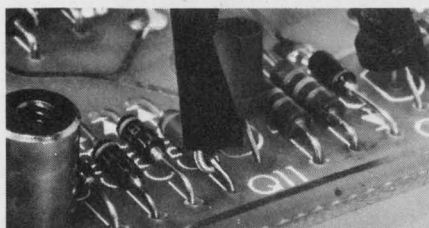
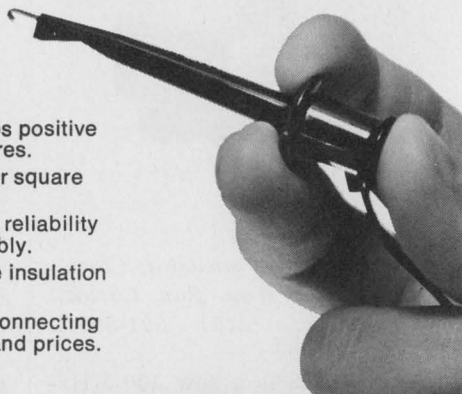

POMONA ELECTRONICS

1500 E. Ninth St., Pomona, Calif. 91766 • Telephone: (714) 623-3463

INFORMATION RETRIEVAL NUMBER 112

Our Long Term Life Insurance Policy.

It protects the life of our fans for 10 years.

We call it, "The Grand Prix Sleeve Bearing."

This patented bearing innovation assures continuous lube circulation, positive retention, and inherent oil cooling for longer, cooler, more efficient operation than conventional designs.

Protect the life of your equipment from the damaging effects of heat by specifying a G.P. equipped Boxer, MiniBoxer, or SuperBoxer fan. There are more than 20 models to choose from.

For information on our full line of reliable airmovers, send for catalog No. ND4r.

It's free, and contains performance data, electrical and mechanical specifications on more than 100 units.

And valuable application information too.

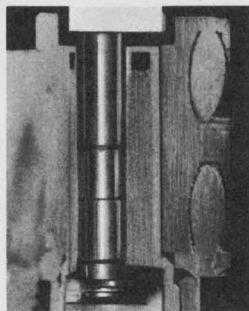

For immediate service, contact us at IMC Magnetics Corp., New Hampshire Division, Route 16B, Rochester, N.H. 03867, tel. 603-332-5300. Or the IMC stocking distributor in your area. There are more than 50 nationwide and overseas.



INFORMATION RETRIEVAL NUMBER 113

evaluation samples

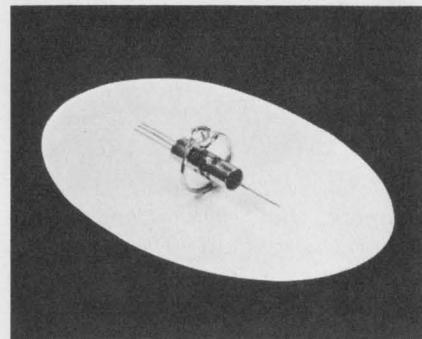

Low-price reed relay

A new low-cost reed relay is being offered for as low as 29¢ (1 million quantities). Other price breaks are: 39¢ for 100,000; 56¢ for 10,000; and 80¢ for 1000 quantities. This new relay features MIL-Q-9858A specifications, a magnetic shield for high-density packing and contact resistance of less than 100 mΩ. Its contacts are rated at 1 A or 250-V switching at 20 W. Coils are available for 1, 3, 5, 6, 10, 12, 15 and 24 V. The relay's size is 0.275-in. in outside diameter by 0.95-in. long. Free samples are available. Electronic Applications Co.

CIRCLE NO. 351

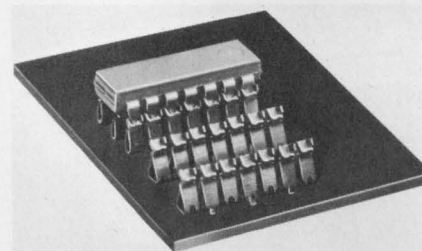

PC connector

A newly designed DIP connector for PC boards is available with a grid-contact arrangement for improved support and assembly flexibility and tolerance. It employs 1938-8 Soldercon terminals which are available in chain form or pre-cut strips to fit specific IC requirements. The terminals hold typical center spacings of 0.1 in. between terminals of DIPs. They extend 0.18 in. above the board. A free connector sample and data are available. Molex Inc.

CIRCLE NO. 352

design aids



Metals draw/die kit

A tool known as the Di-Acro-Draw-Di will produce drawn shapes in metals, economically, and without requiring custom mated male and female dies. The tool is introduced in kit form and consists of three segments, a metal housing, a variety of resilient K-Prene Urethane inserts, and a cavity blank which is machined to the shape of the finished part and mounted on a riser. By changing the combinations of K-Prene spring and pad inserts, the user can adapt quickly to job changes involving different shapes, draw depths, materials and material thicknesses. Di-Acro Div. of Houdaille Industries, Inc.

CIRCLE NO. 353

Bridge-rectifier guide

A pocket guide to silicon bridge rectifiers is available. The guide supplies comparative information on bridge rectifiers manufactured by Motorola, International Rectifier, Varo, Unitor, Solitron, Semtech, Westinghouse, General Instrument and others. Complete electrical ratings plus outline drawings are included on the bridge rectifiers. General Instrument Corp.

CIRCLE NO. 354

Capacitor attachments

A free technical guide on capacitor attachments is available. It is a complete guideline to the proper termination of various conductor metalizations used on chip capacitors. These include gold, platinum-gold, silver, platinum-silver, palladium-silver, palladium-gold and aluminum. Monolithic Dielectrics, Inc.

CIRCLE NO. 355

VACTEC

"PLASTIC" PHOTOCELLS

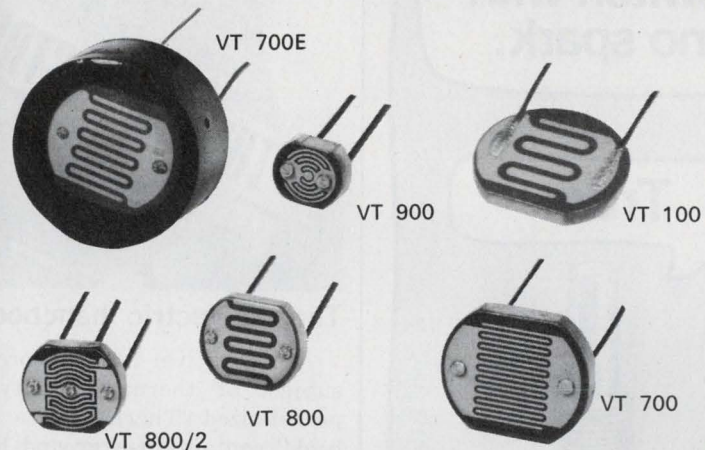

Twice actual size, priced as low as .25 each ($\pm 33\%$ tolerance) in 10,000 quantities.

EVEN LOWER FOR $\pm 50\%$ TOLERANCE

Low Cost Way to Meet Most Photocell Requirements

Here is a complete line made with the same quality characteristics and precise tolerances by the originator of the first **stable** plastic coated cell. Six different thin-film materials of CdS and CdSe deposited on ceramic substrates. A VACTEC development with almost 10 years of production experience. When others said it couldn't be done — we were doing it! NOW improved passivation processes make them better than ever. Why experiment — buy where the experience is. The proof — they have been used in **millions** of cameras all over the world!

The newest addition is the VT 800/2 series, a dual element cell with bifilar type electrode for two-cell controls from a single light source. The expanded line also includes the epoxy encapsulated VT 700E series for protection against humidity and salt spray.

Costing less than $\frac{1}{2}$ of hermetically sealed cells, they have excellent resistance to humidity, eliminating need for hermetic cells in **most** applications. VACTEC "plastic" photocells are conveniently controlled by ambient light or from closely coupled low voltage lamps. Industrial and commercial applications, like controlling relays in line voltage circuits; switching SCR's on or off; phase control and proportional circuits; audio controls; and feedback elements for motor speed controls in consumer appliances.

Series Type	Substitutes for hermetic type
VT 100	TO-8
VT 700 and VT 700E	TO-8
VT 800 and VT 800/2	TO-5
VT 900	TO-18

Write for Bulletin PCD-6 PCD-41, 57, 58, and 59



VACTEC, INC.

2423 Northline Ind. Blvd. • Maryland Heights, Missouri 63043
(314) 872-8300

Specializing in standard Cds, Cdse, and Se cells. Custom engineering for every photocell need. Listed in EBG under "Semi-Conductors" and EEM Sec. 3700.

You're a penny-pinching, up-tight, li'l switch with no spark.

True.

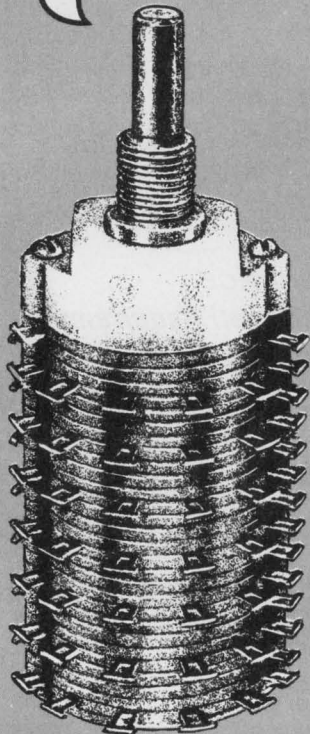

There's no better value than a Stackpole rotary switch. Fast delivery and quality features, but at a price you can afford. Unique design achieves a totally enclosed rotary, without sacrificing complex switching capability. Rigid construction and molded terminals produce a switch so tight it's explosion proof. Samples immediately. Production quantities in 1 to 2 weeks. Including switches with PC mounting. For details, send for Bulletin 73-103.



INFORMATION RETRIEVAL NUMBER 115

application notes

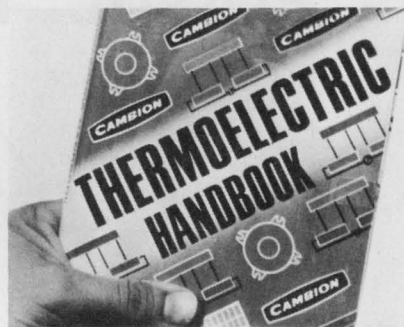

Thermoelectric handbook

A definitive test explores the subject of thermoelectricity. The pocket-sized "Thermoelectric Handbook" contains background history on the theory and development of the Peltier and Seebeck Effects, along with their applications in the fields of electronics, medicine and research. The handbook serves as a valuable guide to a better understanding of how thermoelectric devices function. Cambridge Thermionic Corp.

CIRCLE NO. 356

Monitoring noise pollution

A 24-page booklet gives a capsule analysis of current U.S. Government regulations enacted to protect the hearing of nearly everyone exposed to industrial noise hazards. It describes the techniques and equipment used to measure plant noise and to monitor employee hearing as required by the new statutes. General Radio.

CIRCLE NO. 357

Power semiconductors

A new series of Westinghouse's popular "Tech Tips" includes articles on the selection, application, use and maintenance of discrete power semiconductors and subsystems. The first "Tech Tip," "Thyristor Selection and Calculations for Pulse Applications," describes a new procedure for selecting the correct thyristor for pulse applications using only information given on standard data sheets. Westinghouse Electric Corp., Semiconductor Div.

CIRCLE NO. 358



High-frequency transistors

A primer is available to familiarize the microwave designer with the terminology used in describing the characteristics of high-frequency transistors. The 24-page document also treats the capabilities and limitations of these transistors, while discussing their ac and dc voltage characteristics. Avantek, Inc.

CIRCLE NO. 359

Low-noise FETs

A new application note compares FETs to low-noise bipolar transistors to provide designers with a better understanding of the noise relationships between the devices and their circuits. Included in the note are basic definitions, how to determine noise figures, test procedures, using equivalent noise and current sources, and a comparison of low-noise FET performance to bipolar transistors. Teledyne Semiconductor.

CIRCLE NO. 360

Reducing hum and crosstalk

A pamphlet discusses the problems involved in how to effectively reduce hum, crosstalk and stray pickup in transmission lines. The article details methods used to solve common ground-loop problems. Deerfield Laboratory.

CIRCLE NO. 361

Tape recorder handbook

A practical guide for users of instrumentation tape recorders is available. The 43-page handbook contains an introduction to magnetic-tape systems, what to look for in selecting a glossary of instrumentation terms and a concise explanation of how magnetic tape heads work. Bell & Howell Co.

CIRCLE NO. 362

new literature

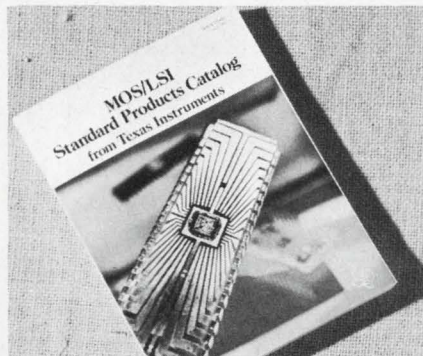

MOS/LSI ICs

A new 314-page MOS/LSI IC catalog contains specifications and schematics on Texas Instruments' MOS line, comprehensive cross-reference guides, details on plastic and ceramic packages and applications data. Texas Instruments.

CIRCLE NO. 363

Ceramic substrates

Polished standard-size 99.5% Al_2O_3 substrates for microwave and thin-film circuit applications are discussed in a data sheet. Acumet Engineering Corp.

CIRCLE NO. 364

FET VOMs

A six-page brochure features four new portable, battery-operated FET volt-ohm-milliammeters and accessories. Triplett Corp.

CIRCLE NO. 365

Laser equipment

A new four-page bulletin describes a series of energy and power measurement equipment for argon, krypton, ruby, neodymium, CO_2 and cw or pulsed lasers. Quantronix Corp.

CIRCLE NO. 366

Instruments

A 20-page catalog describes a new line of spectrum analyzers, sweep generators, programmable attenuators, and lumped-component miniature lowpass and bandpass filters. Texscan Corp.

CIRCLE NO. 367

Allied/Radio Shack catalog

Allied Radio Shack's new 1972 electronic parts and accessories catalog lists thousands of hard-to-find electronic items. The 132-page catalog is a complete buying guide for hobbyists, kit builders, radio hams, citizen's band users, electricians, servicemen, technicians, hi-fi installers, experimenters and anyone interested in any aspect of electronics. Allied Radio Shack, A Tandy Corp. Co.

CIRCLE NO. 368

PC relays

A printed-circuit relays catalog details custom and standard relay features, dimensions, modes of operation, single and double-coil voltages, resistances, times characteristics and ratings at various current loads. Printact Relay Div. of Executone, Inc.

CIRCLE NO. 369

Pilot lights

A new guide to a wide range of pilot lights, switches and voltage testers is available. Industrial Devices, Inc.

CIRCLE NO. 370

Bridge rectifiers

A four-page catalog features 144 standard silicon bridge rectifier assemblies with controlled-avalanche or fast-recovery characteristics. Sarkes Tarzian, Inc.

CIRCLE NO. 371

Wire and rod alloys

Detailed pricing and technical information on 90 different alloys and metals in wire, rod and strip form are included in a revised 54-page handbook. Techalloy Co., Inc.

CIRCLE NO. 372

Thumbwheel switches

A six-page brochure details modular thumbwheel switch product lines. Digitran Co.

CIRCLE NO. 373

For five cents, I'd start something.

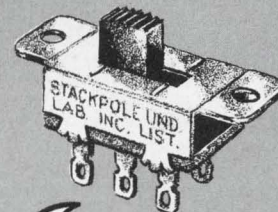
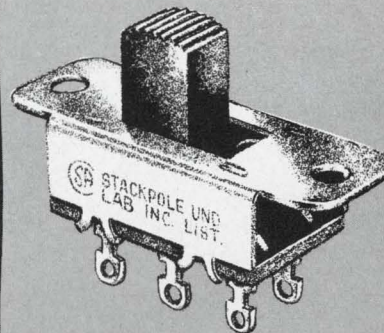

me too.

Turn on with a Stackpole slide switch. Prices start at 5¢ for this field proven standard of the industry. Available in two sizes, Regular and the new 50% smaller Miniature Series. Fully UL and CSA approved. Rated from 1 to 10 amps @ 125 and 250 volts (Miniature Series rated at 3 amps @ 125 V). Over 23 basic types, 7960 variations of slide and rocker switch adaptations. For complete details, send for Bulletin 78/79-100.



INFORMATION RETRIEVAL NUMBER 116

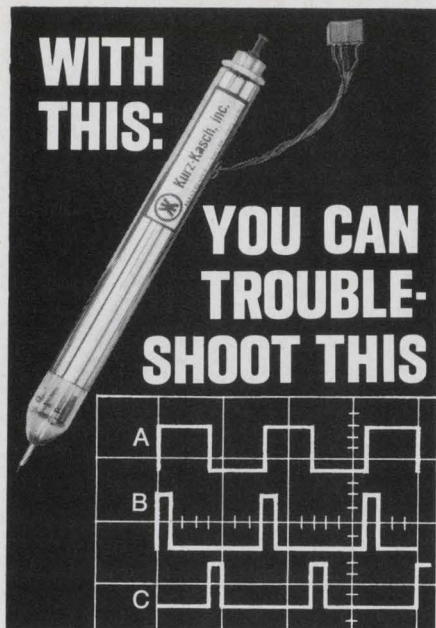

LOOK AT THESE NEW FEATURES ON THE KURZ-KASCH LOGIC PROBES*

Basic Model LP-520 — Provides the color coded (red, white & blue) visual readout system at when probe tip and gate/gates inputs are in coincidence. (see diagram above.) Example: **A.** Gate 1 input **B.** Probe tip input; pulse indicator displays, Moving probe tip to **C.** pulse indicator does not display. Add \$10.00 and suffix G.

ADD THESE FEATURES: G-S-M Gating Feature(-G) — Pulse indicator displays only when probe tip and gate/gates inputs are in coincidence. (see diagram above.) Example: **A.** Gate 1 input **B.** Probe tip input; pulse indicator displays, Moving probe tip to **C.** pulse indicator does not display. Add \$10.00 and suffix G.

Memory & Stretch(-M) — Push-Pull switch for selecting stretch or latch mode. Stretch mode detects high speed pulse and displays blue "P" lamp for 200 mS. Latch mode captures high speed pulse/trains and latches blue "P" display on until reset. Add \$10.00 and suffix M.

5 Nano-Second Capability(-S) — This allows detection of pulses up to 10 x faster than standard probes. Add \$10.00 and suffix S.

Free Trial Offer — Keep abreast of the state of the art. Kurz-Kasch offers a 15 day free trial period. Select the Kurz-Kasch logic probe model above (or any combination of features) that fit your requirements. At the end of 15 days, you may return the probe, or, send us your check. *All the features you ever needed for testing digital logic now available in one economical probe unit; 3 input channels, 5 nano-second pulse width detection, pulse latching.*

Kurz-Kash offers a complete line of digital logic testing instruments. Want to talk about your instrumentation requirements? Call Tom Barth, or Dick Pitner, now, at (513) 223-8161.



Kurz-Kasch, Inc.

1421 S. Broadway, Dayton, Ohio 45401

*Patent #3,525,939 applies, others pending

INFORMATION RETRIEVAL NUMBER 117

NEW LITERATURE

Drafting aids

A new eight-page catalog describes drafting and engineering aids. These include drawing protectors, instrument holders for tilted drawing boards, zero-center scales for measuring both ways from centerlines, and slide rules for locating decimal points without scratch-paper or mental arithmetic. Devonics, Inc.

CIRCLE NO. 374

Instruments/equipment

A 48-page catalog describes a supplier firm's inventory of scopes, pulse and signal generators, voltmeters, Q meters, frequency converters, power supplies and counter/timers. It also includes microwave components, test equipment, production tools and electrical components. Baynton Electronics Corp.

CIRCLE NO. 375

Rack/panel connectors

Two new rectangular rack-and-panel connector families are described in an eight-page catalog. Amphenol Industrial Div. of The Bunker-Ramo Corp.

CIRCLE NO. 376

Sockets

A new 14-page guide describes and illustrates a complete line of DIP, transistor and tube sockets. Over 360 models are shown. Elco Corp.

CIRCLE NO. 377

Thumbwheel switches

A selection of standard and miniature thumbwheel switches is described in a four-page brochure. A. W. Haydon Co.

CIRCLE NO. 378

Cermet resistor networks

A four-page brochure describes new lines of cermet resistor networks. They are used as IC logic circuit terminators, pull-up and pull-down resistor arrays, voltage dividers and other applications that require resistors combining high reliability with small size. Allen-Bradley Co., Electronics Div.

CIRCLE NO. 379

Solid-state relays

A line of computer-compatible solid-state spst ac relays capable of switching 2, 10 and 25 A at 120 and 240 V is described in a new brochure. International Rectifier Corp., Crydom Div.

CIRCLE NO. 380

Gears

A complete selection of precision mechanical components is contained in a compact 446-page catalog. PIC Design, Corp.

CIRCLE NO. 381

DIP heat sinks

A series of low-cost heat sinks designed for use with all standard DIP IC packages from 14 to 42 pins is described in a new bulletin. Astrodyne, Inc.

CIRCLE NO. 382

Power supply products

A 26-page catalog describes electrical and mechanical characteristics of ballasts for high-intensity discharge lamps, incandescent-to-mercury conversion units, line-voltage regulators and stabilizers and computer power supplies. Sola Electric.

CIRCLE NO. 383

Scientific instruments

A new condensed catalog describes products for researchers in the physical and life sciences and for engineers in many disciplines. These include lock-in amplifiers and accessories, electrometers, electrochemical instruments, signal averagers and correlators and biomedical response systems. Princeton Applied Research Corp.

CIRCLE NO. 384

Instruments and systems

A short-form catalog details such instruments and systems as primary phase standards, phase-meters, phase-to-dc converters, voltmeters, probes, accelerometers, vibration monitors and filters and telemetry equipment. Dytronics Co., Inc.

CIRCLE NO. 385

Stepping motors

A new catalog on stepping motors for precise incremental control of rotary or linear motion cites the advantages in power, torque and resolution of three-phase, variable-reluctance motors over conventional permanent-magnet step motors. It points out their suitability for use in computer peripheral equipment and open-loop control techniques. Warner Electric Brake & Clutch Co.

CIRCLE NO. 386

Frequency instruments

A new condensed catalog presents new frequency synthesizers and amplifiers. Included in this eight-page brochure are general information and specification sheets for synthesized signal generators, frequency synthesizers, broadband and tunable amplifiers and amplifier modules. RF Communications, Inc.

CIRCLE NO. 387

Thermocouple meters

A bulletin describes a complete line of thermocouple meters and pyrometers. Omega Engineering, Inc.

CIRCLE NO. 388

Handling equipment

A new 20-page catalog describes a complete line of steel-wire shelving and trucks, accessories, dollies, casters and wire-handling baskets. Metropolitan Wire Goods Corp.

CIRCLE NO. 389

Impulse counters

Long-life electromechanical counters in 3, 4, 6, and 8-digit models are described in a new bulletin. Sodeco.

CIRCLE NO. 390

Pressure sensors

An eight-page catalog gives complete specifications and prices on six new lines of industrial pressure sensors. Standard Controls, Inc.

CIRCLE NO. 391

nickel-cadmium battery
APPLICATION ENGINEERING HANDBOOK

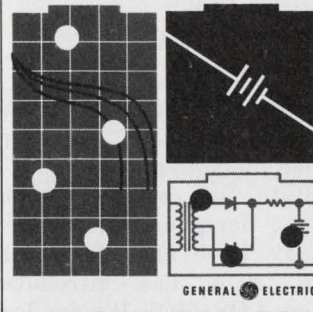

Here's a new, comprehensive manual of interest to all designers—200 pages of application information. To find out how you can order this unique engineering handbook, circle the number below on the reader service card. Or write—General Electric Company, P. O. Box 114, Gainesville, Florida 32601.

GENERAL  ELECTRIC

all you need to know about nickel-cadmium rechargeable batteries

INFORMATION RETRIEVAL NUMBER 118

USING ACTIVE FILTERS OR PASSIVE FILTERS ?

Are size, shape or weight considerations important? Special mechanical configurations offered—Hermetically sealed or encapsulations for pcb installations

Low, high, band pass and reject designs—Butterworth, Chebishev, Bessel or elliptic response characteristics—wide range of source and load impedances

Low frequency actives, stable toroidal LC's, RC twin-T's

**No EXTERNAL components required
Unbiased recommendations on active or passive filter selections for maximum economy**

White

instruments, incorporated

PHONE AREA 512/892-0752 • P.O. Box 698 AUSTIN TEXAS 78767

INFORMATION RETRIEVAL NUMBER 119

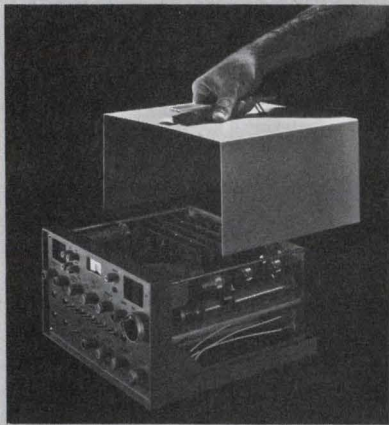

OPTIMA ENCLOSURES Quality Response

Tired of extracting your electronics from a sheet metal jungle? Access and serviceability are important to you.

With this thought in mind we have responded with a Small Case which allows unrestricted access to the top, rear, and both sides of your electronics simply by removing two screws. Remove two more screws and the entire chassis slides out the front of the case for the ultimate in ease of service.

At OPTIMA we manufacture for electronics. We know that access is important and design it into our products.

OPTIMA Small Cases—a quality response to your enclosure needs.

Write or call for a free catalog.

OPTIMA

enclosures

2166 Mountain Industrial Blvd.
Tucker, Georgia, 30084
Telephone 404-939-6340

A division of Scientific-Atlanta, Inc.

INFORMATION RETRIEVAL NUMBER 120

bulletin board

of product news
and development

A full complement of 31 COS/MOS unencapsulated IC chips have been made available by RCA Solid State Div. to provide the equipment designer with a new technology in hybrid design. In addition, RCA has introduced eight new COS/MOS ICs for low-voltage (3 to 15 V) applications.

CIRCLE NO. 392

Raytheon Semiconductor has introduced a complete line of SCRs consisting of planar and diffused types to handle up to 35 A with voltages up to 800 V. They are available in standard TO-18, -39, -48, -64, and -66 configurations.

CIRCLE NO. 393

Datapac of Costa Mesa, Calif., has announced off-the-shelf alterable ROMs for less than 1.5¢/bit.

CIRCLE NO. 394

I. P. Sharp Assoc., Ltd., Ottawa, Ontario, Canada, has come up with a projector system capable of demonstrating a teleprinter terminal's input/output data to groups of up to 40 people. The 2510T projects a large image onto a screen, blackboard or wall, behind the terminal user by using mylar onto which the input/output data is typed by the terminal.

CIRCLE NO. 395

A new add-on core memory from Computer Hardware Consultants & Services, Inc. of Warrington, Pa. allows IBM 360/30 mainframe users to expand their system's memory capacities.

CIRCLE NO. 396

Floating point hardware is now available from Hewlett-Packard as an option to its model 2100 digital computer.

CIRCLE NO. 397

Isomet Corp., Oakland, N.J., is making available high-quality single crystals of lithium formate monohydrate, suitable for efficient second-harmonic generation of laser radiation.

CIRCLE NO. 398

Tektronix has added the model 915 X-Y plotter as an output peripheral to its line of calculators. The plotter prints graphs, plots and charts on 8-1/2-by-11-in. or 11-by-17-in. graph paper within an accuracy of ± 0.02 in. Its cost is \$2650 and it will be available in December, 1971.

CIRCLE NO. 399

Price reductions

Prices on Burroughs Corp.'s C-2500 BCD decoder and counting assemblies with Nixie tube readouts have been reduced by as much as 30%.

CIRCLE NO. 400

Prices of Hewlett-Packard's 1/2-W impatt diodes have been lowered to \$95 each, down from \$150, for quantities of 1 to 9. For quantities of 100 to 249, prices have been lowered to \$47.50 each, down from \$100.

CIRCLE NO. 401

Price reductions up to 40% have been announced by Fairchild Microwave & Optoelectronics for its FND10 and FND10A LED single-digit displays.

CIRCLE NO. 402

Intersil, Inc. has reduced prices on its IM5500 and IM5600 line of bipolar memories. Price reductions range from 3.5% to 33.5%.

CIRCLE NO. 403

Our
new
micropower
op amp
runs
off $\pm 1\text{V}$
with $20\ \mu\text{W}$
power
consumption.

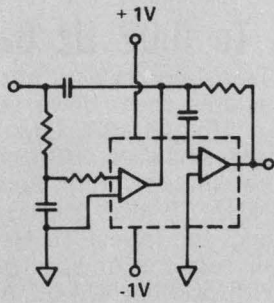

UC4252

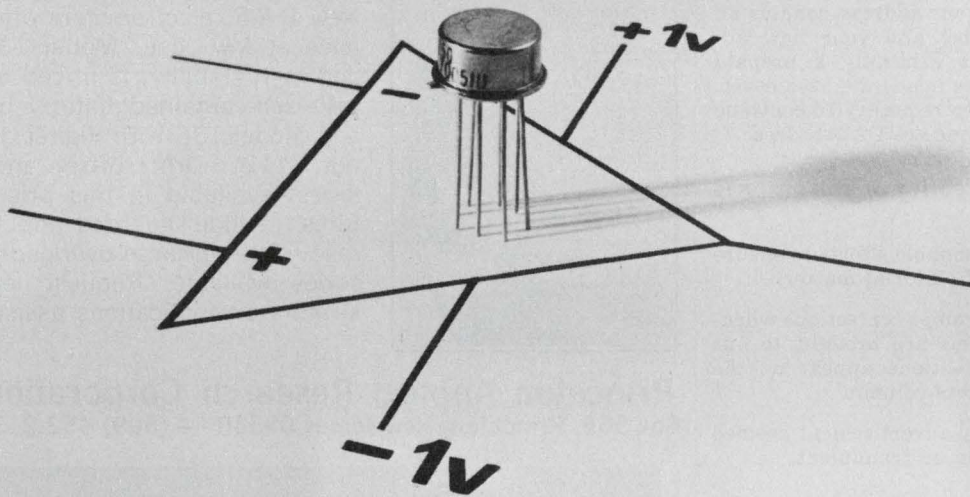
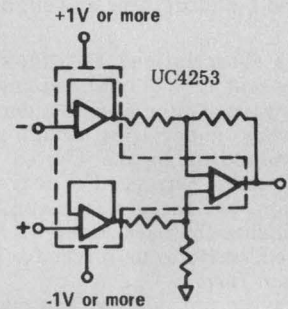

That's all.

Solitron's UC4250 micropower op amp is now available as a dual, (UC4252) and as a triple (UC4253) in all popular packages.

Some people call it "PROGRAMABLE" we call it VERSATILE. The UC4250 series uses so little power that its batteries will last as long as their shelf life. It needs so little voltage that only two single cells are needed. (Although it can handle up to $\pm 18\text{V}$.)

The other specifications aren't so bad either. 3 nanoamps input bias current with temperature

drift of less than 1 picoamp per degree C. The open loop-gain is 100 db gain into a 10K load. And it's available now.

Solitron Devices, Inc., P. O. Box 1416
San Diego, California 92112
Telephone (714) 278-8780.
TWX 910-335-1221



SAN DIEGO, CALIF.
8808 Balboa Ave.
C-MOS, P-MOS Circuits
Diodes, Rectifiers, & Zeners
FET & Dual FET Transistors
High Voltage Assemblies
Linear & Monolithic IC's

TAPPAN, N.Y.
256 Oak Tree Road
Diodes & Rectifiers
Ferrite & Ferrite Devices
High Voltage Assemblies
Power Rectifiers
Thick Film Hybrid Circuits

RIVERA BEACH, FLA.
1177 Blue Heron Blvd.
Hi-Rel Power Hybrids
Hi-Rel Power Transistors
PNP - NPN Ind. Transistors
Si & Ge Power Transistors

JUPITER, FLA.
1440 W. Indiantown Rd.
Microwave IC's
Microwave Semiconductor
Microwave Stripline Components
RF Semiconductor

PORT SOLERNO, FLA.
Cove Road
Microwave Connectors
Plaxial (R) Cable
Precision RF Coaxial
BEN BAROO ISRAEL
AEL Israel, Ltd.
Full line of Solitron devices

KENT, ENGLAND
London Road, Sevenoaks
Full line of Solitron devices
TOKYO 105, JAPAN
No. 5 S-Chrome
Shibahamamatsu-cho
Minato-ku
Full line of Solitron devices

ELECTRONIC DESIGN's function is:

- To aid progress in the electronics manufacturing industry by promoting good design.
- To give the electronic design engineer concepts and ideas that make his job easier and more productive.
- To provide a central source of timely electronics information.
- To promote two-way communication between manufacturer and engineer.

Want a subscription? ELECTRONIC DESIGN is sent free to qualified engineers and engineering managers doing design work, supervising design or setting standards in the United States and Western Europe. For a free subscription, use the postfree application form inside the back cover. If none is included, write to us direct for an application form.

If you do not qualify, you may take out a paid subscription for \$25 a year in the U.S.A., \$35 a year elsewhere. Single copies are \$1.50 each.

If you change your address, send us an old mailing label and your new address; there is generally a prepaid postcard for this inside the back cover. You will have to requalify to continue receiving ELECTRONIC DESIGN free.

The accuracy policy of ELECTRONIC DESIGN is:

- To make reasonable efforts to ensure the accuracy of editorial matter.
- To publish prompt corrections whenever inaccuracies are brought to our attention. Corrections appear at the end of the Letters column.
- To refuse any advertisement deemed to be misleading or fraudulent.

Microfilm copies are available of complete volumes of ELECTRONIC DESIGN at \$19.00 per volume, beginning with Volume 9, 1961. Work is now in process to complete the microfilm edition of Volumes 1-8. Reprints of individual articles may be obtained for \$2.00 each, prepaid (\$.50 for each additional copy of the same article) no matter how long the article. For further details and to place orders, contact the Customer Services Department, University Microfilms, 300 North Zeeb Road, Ann Arbor, Michigan 48106; telephone (313) 761-4700.

Want to contact us? If you have any comments or wish to submit a manuscript or article outline, address your correspondence to:

Editor
ELECTRONIC DESIGN,
50 Essex Street,
Rochelle Park, N.J. 07662

Design Data from

Get Detailed Analysis Of Spectra To 0.02 Hz Bandwidth

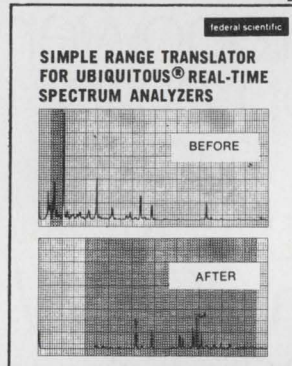

New 30A Range Translator selects narrow bands of frequency, translates them down so they can be analyzed by a Ubiquitous® Low Frequency Real-Time Spectrum Analyzer. (Special version feeds FFT computer inputs, etc.) Selects bands with widths of 20 kHz, 10 kHz, 2 kHz, 1 kHz. Up to 7 ranges supplied, the lowest 10 Hz. Ideal for expansion of small sections of spectrum for detailed analysis. With 500-line UA-6B Analyzer on 10 Hz scale, nominal bandwidth is 0.02 Hz. Customize: you can order even one range. Inexpensive low frequency oscillator can be used; or up to 10 precision oscillator steps can be integral to 30A.

CIRCLE NO. 171

Federal Scientific Corporation
a subsidiary of Elgin National Industries, Inc.
615 West 131st Street, New York, N. Y. 10027

Economical High Performance Electrometers

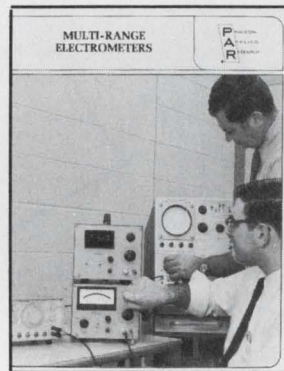

New P.A.R. electrometers offer superior performance at low cost. Model 134, with wide range and high stability, is priced at \$615; Model 135, with self-contained battery power supply, \$675; and Model 136 with digital display and BCD output, \$1125. Drift, offset and noise figures are lowest available in this price range. Other features include guarded input circuits and fast recovery from large overloads. Full line of accessories available. Request new brochure, demonstration or applications assistance.

CIRCLE NO. 172

Princeton Applied Research Corporation
Box 565, Princeton, New Jersey 08540 — (609) 452-2111

FUNDAMENTALS OF INTEGRATED CIRCUITS

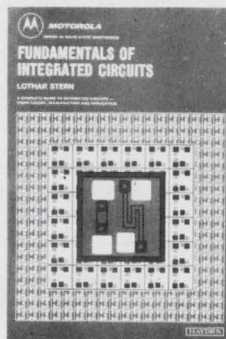

A practical guide to integrated circuits, their theory, manufacture, and applications. This new guide by Lothar Stern offers complete, highly readable coverage of the various techniques of circuit fabrication, and their effect on circuit design and performance. As to marketing considerations, it compares the characteristics of the numerous IC structures devised to date in terms of economics and logistics. A volume in the **Motorola Series in Solid-State Electronics**. 198 pages, 7 x 10, illustrated. \$8.95, clothbound. Circle the reader-service number below for 15-day examination copies.

Hayden Book Company, Inc.
116 West 14th Street
New York, N.Y. 10011

CIRCLE NO. 173

Manufacturers

Advertisements of booklets, brochures, catalogs and data sheets. To order use Reader-ServiceCard (Advertisement)

Terminal Block Selector

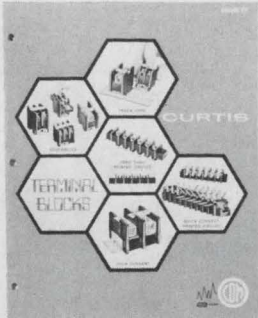

A new 24-page, completely illustrated catalog contains photos, descriptions, ratings, engineering drawings, and prices of the complete line of Curtis terminal blocks. Included are printed circuit, insulated feed-thru, quick disconnect, track type, and high current terminal blocks. Handy selection chart quickly locates the perfect block for your particular requirements. Send today for your free copy.

Curtis Development & Mfg. Co.
3236 North 33rd Street
Milwaukee, Wisconsin 53216

CIRCLE NO. 174

PC Drafting Aids Catalog

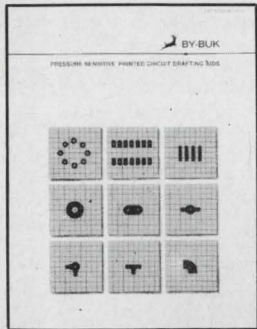

Thousands of time saving, cost saving artwork ideas are found in the By-Buk P-50 catalog of pressure sensitive printed circuit drafting aids. With the most practical artwork patterns for: TO cans, multi-pads, dual-inlines and flat packs featured. Donuts, connector strips, teardrops, ovals, tapes, tees, elbows, etc., by the hundreds are included in the most comprehensive list of sizes. Opaque black, transparent red and transparent blue materials for one and two-sided board designs. For a free copy and samples, write today.

By-Buk Company
Subsidiary of Webtek Corp.
4326 W. Pico Blvd.
Los Angeles, California 90019
(213) 937-3511

CIRCLE NO. 175

Free — New Alvin Template Catalog



A must for every electronic engineer and draftsman! The comprehensive 36 page Alvin catalog clearly illustrates and describes over 400 templates for practically every use. This template catalog is categorized in sections and shows the templates used for each field, ie, electrical and electronic symbol templates, mechanical engineering templates and many others. Alvin's precision made, time-saving templates cover completely the needs of draftsmen and engineers in all categories. Send for free catalog now.

CIRCLE NO. 176

ALVIN & CO., INC.
611 Palisado Avenue
Windsor, Connecticut 06095

Electronic Design

Advertising Sales Staff

Bryce Gray
Sales Manager

Rochelle Park, N.J. 07662

Robert W. Gascoigne
Daniel J. Rowland
50 Essex Street
(201) 843-0550
TWX: 710-990-5071

Philadelphia

Thomas P. Barth
50 Essex Street
Rochelle Park, N. J. 07662
(201) 843-0550

Boston 02154

Joseph F. Palmer
1268 Main Street
Waltham, Mass.
(617) 894-2700

Chicago 60611

Thomas P. Kavooras
Berry Conner, Jr.
200 East Ontario
(312) 337-0588

Cleveland

Thomas P. Kavooras
(Chicago)
(312) 337-0588
(call collect)

Los Angeles 90303

Stanley I. Ehrenclou
Burt Underwood
2930 Imperial Highway
Inglewood, Calif
(213) 757-0183

San Francisco 94022

Jerry D. Latta
95 Main Street
Los Altos, Calif.
(415) 941-3084

London W. 1

For United Kingdom and Holland
Brayton C. Nichols

For Eastern Europe

Peter Kehr

The American Magazine Group

27 Maddox Street

London, W. 1, England

Phone: 499-0180

Cable: Ammagnic, London

Verviers, Belgium

For Continental Europe

Andre Jamar

1, Ru Mallar, 1

(087) 253.83 Telex 41563

Tokyo

Haruki Hirayama

Electronic Media Service

5th Floor, Lila Bldg.,

4-9-8 Roppongi

Minato-ku

Phone: 402-4556

Cable: Electronicmedia, Tokyo



DPMs

Actual Size



**In 2½, 3½ or 4½-digit models.
We've got them all.
Just ask us.**

GRALEX INDUSTRIES

DIV. OF GENERAL MICROWAVE CORP. • 155 MARINE ST., FARMINGDALE, N. Y. • 516-694-3600
INFORMATION RETRIEVAL NUMBER 141

filters BANDPASS & NOTCH

- Seven day delivery
- Low cost
- Computer designed
- PC board mounting
- Excellent frequency stability
- Encapsulated

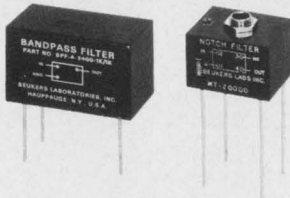

Information from
**BEUKERS
LABORATORIES, INC.**

1324 Motor Parkway
Hauppauge, New York 11787
516-234-2200

INFORMATION RETRIEVAL NUMBER 121

How long must you keep important papers?

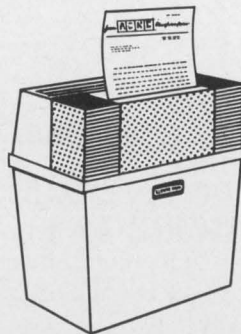

Write for free booklet, ED-10,
**RECORD RETENTION
TIMETABLE**, describing
Retention Periods as allowed
by government authorities,
and how to dispose
of them safely without
loss or worry!

ELECTRIC WASTEBASKET CORP.
145 West 45th St., New York, 10036
Selected dealers all over the United States.

INFORMATION RETRIEVAL NUMBER 122

advertiser's index

Advertiser	Page
AMP, Incorporated	18
Abbott Transistor Laboratories Incorporated	6
Alco Electronic Products, Inc.	84
Alvin & Co., Inc.	149
American Astrionics, Inc.	151
Amperex Electronic Corporation.....	121
Amperite	7
Amphenol Components Group	12
Augat, Inc.	119
Beckman Instruments, Inc., Helipot Division	89
Belden Corporation	25
Bell, Inc., F. W.	125
Beukers Laboratories Inc.	150
Bourns Inc., Trimpot Products Division	33
Bulova Frequency Control Products	132
Burdny Corporation	4, 5
Burr-Brown Research Corporation.....	116
By-Buk Company	149
Cinch-Nuline, A Division of TRW, Inc.	29
Cincinnati Milacron Company	44
Clairex Electronics, A Division of Clairex Corporation	103
Curtis Development & Mfg. Co.....	148
Dale Electronics, Inc.	Cover II
Damon Engineering, Inc.	37
Data Precision Company	127
Dialight Corporation	128
Digilin, Inc.	102
Digital Equipment Corporation	100, 101
Dow Corning Corporation.....	10, 11, 13
Edmund Scientific Company	125
Electric Wastebasket Corp.	150
Electro Switch Corp.	110
Electronic Associates, Inc., Precision Components	133
Exact Electronics, Inc.	115
Executone, Inc., Printact Relay Division	124
Federal Scientific Corporation	148
Fifth Dimension, Inc.	112
GTE Automatic Electric	8, 9
GTE Sylvania, Chemical Metallurgical Parts	97
GTE Sylvania, Electronic Components	69
Garrett Corporation, Aircsearch Division	34
General Electric Company	145
General Electric Company Electronic Components	111
General Electric Company, Lamp Metals & Components Dept.	122
General Electric Company, Miniature Lamp Dept.	129
General Radio Company	91
Gralex Industries	150
Hammel Riglander & Co. Inc.	128
Haydon Company, A. W., The	123
Heath Schlumberger Scientific Instruments	131
Heinemann Electric Company	27
Hewlett-Packard	1, 17, 85, 94
Honeywell Power Sources Center.....	114
Houston Instrument, A Division of Bausch & Lomb	137
IMC Magnetics Corporation	140
Ingersoll Products, Division of Borg Warner Corporation	74, 75
Intersil	106, 107
International Instruments Division of Sigma Instruments, Inc.	118
Ithaco	126

Advertiser	Page
Johnson Company, E. F.	36
Krohn-Hite Corporation	104
Kruse Electronics	104
Kurz-Kasch, Inc.	134, 144
Lafayette Radio Electronics	134
Lambda Electronics Corp.	Cover III
MFE Corporation	120
Magnecraft Electric Company	117
Mason Engineering, F. G.	118
MicroSwitch, A Division of Honeywell	135
Molex, Incorporated	21
Monsanto Company	46
Motorola Component Products Dept.	14
Motorola Semiconductor Products, Inc.	40, 48, 49
National Semiconductor Corporation	50
North Atlantic Industries, Inc.	113
Nortronics Company, Inc.	122
Oak Manufacturing Co.	31
Ovonic Displays	125
Philips Electronic Components and Materials Division.....	2, 16A, 16B, 38
Pioneer Electric & Research Corp.....	98
Pomona Electronics Co., Inc.	140
Precision Monolithics, Incorporated	136, 137
Princeton Applied Research Corp.....	148
RCA Electronic Components	Cover IV
RCA Solid State Division	47, 64A—H, 105
RFL Industries, Inc.	108
Raytheon Company, Semiconductor Operation	65
Rotron, Incorporated	45
Schrack Electrical Sales Corp.....	98
Scientific Atlanta, Inc.	146
Siemens Corporation	2
Sigma Instruments, Inc.	138
Signetics Corporation	16
Siliconix Incorporated	87
Singer, Industrial Timer Division.....	120
Solitron Devices, Inc.	147
Spellman High Voltage Co., Inc.....	102
Sperry Rand Displays Division.....	35
Stackpole Components Company	142, 143
Switchcraft, Inc.	109
TEAC Corporation of America	39
TRW Electronic Components, IRC Division	93
Tecnetics Inc.	152
Teletype Corporation	80, 81
Tenney Engineering, Inc.	130
Triplett Corporation	99
Unimax Switch, Division Maxon Electronics Corporation	15
United Systems Corporation	139
Unitrode Corporation	43
Vactec Inc.	141
Varadyne Systems, A Division of Varadyne, Inc.	114
Victoreen Instrument, Div. of VLN Corp.	130
White Instruments Incorporated	145
Yewtec Corporation	119
Zeltex, Inc.	96

When A/Ds sample at 10-30 MHz--it's front end dynamic response that counts!

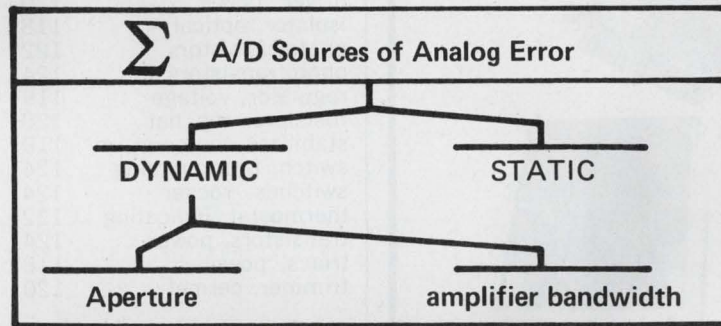

When you select a high speed A/D Converter . . .

- Know your sources of error . . .
- Know under what signal conditions the errors can be devastating . . .
- Don't get caught short with limited dynamic response to fast slewing signals . . .
- Select American Astrionics A/D Converters for fast aperture, wideband track and hold "up front" that won't let you down!**



	AD 1000	AD 3000
Maximum sample rate	10 MHz	30 MHz
Resolution	6, 7, 8 bits	6, 7 bits
Aperture Time	<75 picosec	<50 picosec
Analog Bandwidth	>100 MHz	>100 MHz

Also contact us for:

- MOS-LSI Buffer Memories for high speed storage
(10-30 Megawords/sec input, slowed down for transfer)
- Logarithmic Video Amplifiers
- Integrated High Speed Systems

american astrionics, inc.

Subsidiary of Technicolor, Inc.

855 N. Cahuenga Blvd., Hollywood, Calif. 90038
Phone (213) 462-6111

INFORMATION RETRIEVAL NUMBER 123

MODULAR HIGH VOLTAGE POWER SUPPLIES

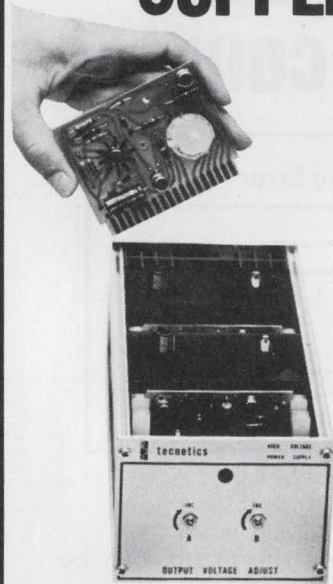

For breadboarding and production systems

Tecnetics introduces the new HV Modular High Voltage power supplies to fill system designers' needs for a greater selection of voltage ranges and outputs.

HV Modular High Voltage power supplies can be used in initial breadboarding and production systems.

HV output modules are available in nine adjustable ranges from -300 VDC to 25,000 VDC with standard or precision regulation. (A precision regulator module improves regulation by a factor of 10 to 1.)

Four standard frames offer up to four output voltages. Custom frame lengths available.

HV Modular High Voltage power supplies are ideally suited to systems, labs and production lines.

HV Modular High Voltage power supplies are priced from \$250.

(See EEM Cat., pp. 880-885 vol.1)

For complete data write:

tecnetics inc.

P.O.Box 910, Boulder Industrial
Park, Boulder, Colorado 80302
(303) 442-3837 TWX 910-940-3246

product index

Information Retrieval Service. New Products, Evaluation Samples (ES), Design Aids (DA), Application Notes (AN), and New Literature (NL) in this issue are listed here with page and Information Retrieval numbers. Reader requests will be promptly processed by computer and mailed to the manufacturer within three days.

Category	Page	IRN	Category	Page	IRN
Components			filter, active	102	253
capacitors, mylar	119	277	op amp, FET	108	262
capacitor arrays, DIP	124	290	power supply, CRT	110	268
chopper, solid-state	122	285	readouts, 5/8-in.	110	266
driver, power	120	281	readouts, liquid-crystal	104	257
isolator, optical	118	275			
phototransistors	122	284	Packaging & Materials		
phototransistors	124	288	bus bar, PC	136	343
regulator, voltage	119	278	header/plug, pin	134	308
resistors, top hat	120	282	packaging system	136	341
stabilizer, temperature	119	279	panel, conductive	136	340
switch, programming	124	286	sockets, single-strip	136	344
switches, rocker	124	287	sockets, TO-5/18	136	342
thermostat, indicating	122	283	wire form	134	306
transistors, power	124	289	Wire Wrap board	134	307
triacs, power	118	276			
trimmer, cermet	120	280			
Data Processing			new literature		
computer system, disc	130	298	Allied/Radio Shack	143	368
decoder, Touch-Tone	126	291	connectors, rack/panel	144	376
minicomputer, 16-bit	126	292	drafting aids	144	374
modem, data	129	293	ICs, MOS/LSI	143	363
modem, data	129	294	instruments	143	367
recording heads	129	295	instruments	144	375
terminal, CRT	130	297	laser equipment	143	366
transceiver, graphic	130	296	pilot lights	143	370
			rectifiers, bridge	143	371
ICs & Semiconductors			relays, PC	143	369
converter, d/a	116	274	sockets	144	377
ICs, custom	112	269	substrates, ceramic	143	364
line receiver, quad	114	271	switches, thumbwheel	143	373
op amp, monolithic	116	273	VOMs, FET	143	365
regulators, voltage	114	272	wire and rod alloys	143	372
ROM, programmable	114	270			
Instrumentation			application notes		
analyzer, magnetic core	132	300	FETs, low-noise	142	360
analyzer, spectrum	133	305	hum and crosstalk	142	361
continuity tester	133	301	noise monitoring	142	357
DPM, 3-1/2-digit	132	299	power semiconductors	142	358
DVM, 4-1/2-digit	133	303	tape recorders	142	362
generator, pulse	133	302	thermoelectricity	142	356
plug-ins, pulse generator	133	304	transistors, microwave	142	359
Microwaves & Lasers			design aids		
amplifiers, thin-film	139	348	bridge rectifier guide	141	354
diodes, p-i-n	137	347	capacitor attachments	141	355
mixer, balanced	137	345	draw/die kit, metal	141	353
sensor, tapé	139	350			
transistor, microwave	139	349	evaluation samples		
transistor, 2-GHz	137	346	connector, PC	140	352
			relay, reed	140	351
Modules & Subassemblies					
amplifier, video buffer	108	258			
comparator, voltage	104	256			
converter, d/a	104	255			
converter, d/a	108	259			
converter, dc-to-dc	108	261			
display, digital	109	263			
display, LED	98	252			
display, numeric	110	267			
display, 64-gun	96	251			
display assembly, LED	109	264			
display module	108	260			
encoder, shaft	102	254			
filter, active	95	250			

Do you face a make or buy decision on power supplies?

USE LAMBDA POWER HYBRID VOLTAGE REGULATORS—AND BUILD YOUR OWN.

(\$16 in quantities of 1000)

ACTUAL SIZE

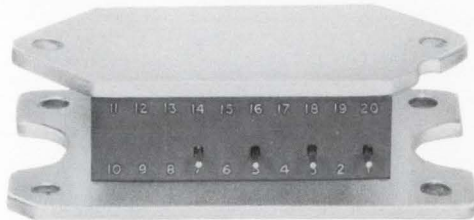

**FROM MELVILLE, N.Y.
1-DAY DELIVERY**

ACTUAL SIZE

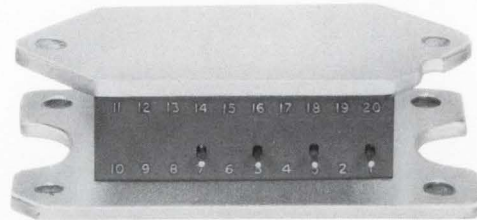

**FROM CHICAGO, ILL.
1-DAY DELIVERY**

ACTUAL SIZE

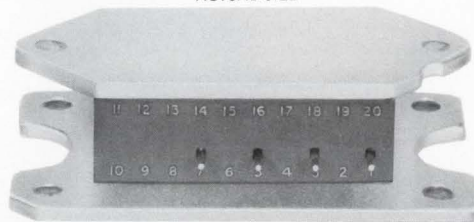

**FROM N. HOLLYWOOD, CAL.
1-DAY DELIVERY**

ACTUAL SIZE

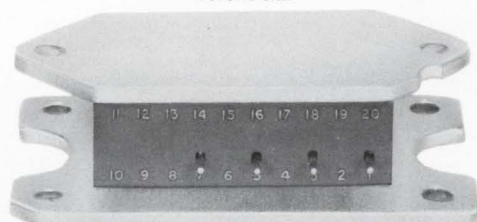

**FROM MONTREAL, QUE.
1-DAY DELIVERY**

The world's first Power Hybrid Voltage Regulator, the biggest advance in power supply design since the silicon power transistor, is now available for 1-day shipment from four Lambda distributing points.

22 models provide up to 28 VDC, up to 5 A output, 85 watts dissipation, 0.2% line or load regulation . . . @ \$16 in quantities of 1000.

If you build your own power supplies, the Power Hybrid Voltage Regulator will save you money at every step from design through production. And now Lambda will save you time as well. Call or write for Brochure L-10.

MELVILLE, NEW YORK 11746, 515 Broad Hollow Road, Tel. 516-694-4200
 ARLINGTON HEIGHTS, (CHICAGO) ILL. 60005, 2420 East Oakton St., Unit Q, Tel. 312-593-2550
 NORTH HOLLYWOOD, CALIF. 91605, 13425 Wyandotte Street, Tel. 213-877-0041
 MONTREAL, QUEBEC, 100C Hymus Blvd., Pointe-Claire, Quebec-730, Tel. 514-697-6520

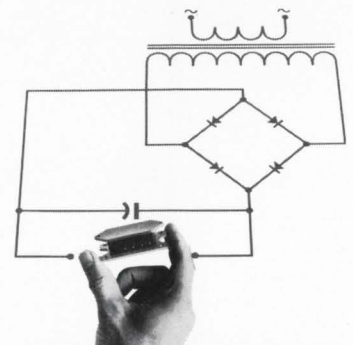

**WHETHER
YOU MAKE
OR BUY...**

**LAMBDA
ELECTRONICS CORP.**

A  Company

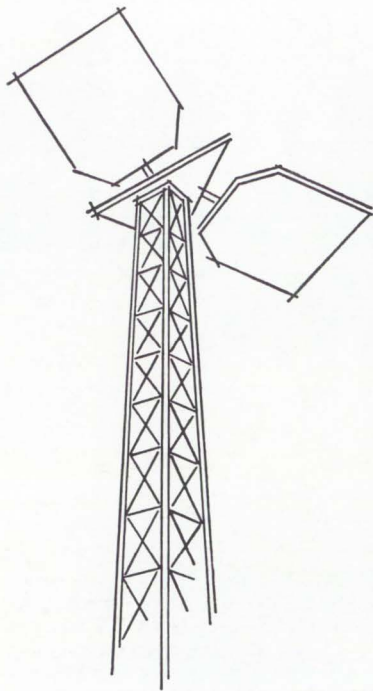

The easy way to communicate

Just look at the charts. The basic facts they present dramatize RCA's single-source capability in total product for your communications needs.

These devices are performance-proved. You get maximum dependability in communications applications.

For more information, see your RCA Representative or call Microwave Marketing: (201) 485-3900; TWX 710 995-4474. International: RCA, 2-4 rue du Lièvre, 1227 Geneva, Switzerland, or Sunbury-on-Thames, U.K., or P.O. Box 112, Hong Kong.

TWT's

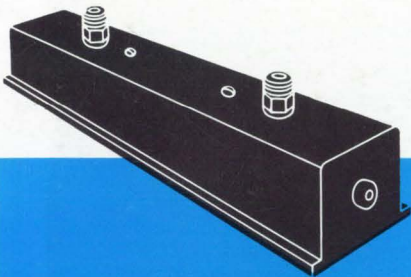

Choose RCA traveling-wave tubes. Select from one of the industry's widest lines, supported by a 20-year background in developing and field-testing state-of-the-art systems.

RCA Type	Power Output (W)	Frequency (GHz)	Application
A1378	20	7.9 - 8.4	Government
A1446	20	9.8 - 10.7	Government
A1447	5	7.9 - 8.4	Government
A1390	20	10.7 - 11.7	Common Carrier
A1443	15	10.7 - 11.7	Common Carrier
A1455	20	12.7 - 12.95	Community Antenna Relay System
A1456	20	10.7 - 13.2	Common Carrier, Community Antenna Relay System
A1460	15	13.0 - 14.0	Government

TEA's

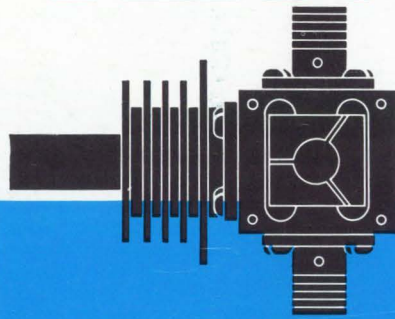

Now you have the transferred-electron amplifier, introduced by RCA to the industry earlier this year. This is the first available octave bandwidth solid-state amplifier for C-band and above.

RCA Type	Power Output (mW)	Frequency (GHz)	Application
S384	250	6.0 - 8.0	Common Carrier
S385	250	8.0 - 10.0	Government, Common Carrier
S386	120	14.0 - 16.0	Community Antenna Relay System

TEO's

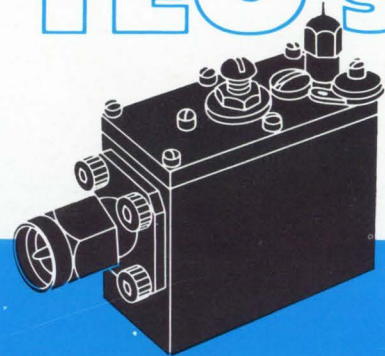

You have accepted the transferred-electron oscillator as another of RCA's major contributions to microwave design. Now you have a choice in standard products and subsystems for pulsed and CW applications from L-through Ku-band.

RCA Type	Power Output (mW)	Frequency (GHz)	Application
S409	100	6.0 - 8.0	Common Carrier
S410	30	8.0 - 10.0	Government, Common Carrier
S411	30	10.0 - 12.0	Common Carrier
S412	10	12.0 - 14.0	Business Radio, Community Antenna Relay System

RCA